

CECW-ED Engineer Manual 1110-2-2201	Department of the Army U.S. Army Corps of Engineers Washington, DC 20314-1000	EM 1110-2-2201 31 May 1994
	Engineering and Design ARCH DAM DESIGN	
	Distribution Restriction Statement Approved for public release; distribution is unlimited.	

DEPARTMENT OF THE ARMY
U.S. Army Corps of Engineers
Washington, DC 20314-1000

EM 1110-2-2201

CECW-EG

Manual
No. 1110-2-2201

31 May 1994

Engineering and Design
ARCH DAM DESIGN

- 1. Purpose.** This manual provides information and guidance on the design, analysis, and construction of concrete arch dams.
- 2. Applicability.** This manual applies to HQUSACE elements, major subordinate commands, districts, laboratories, and field operating activities (FOA) having civil works responsibilities.
- 3. Discussion.** This manual provides general information, design criteria and procedures, static and dynamic analysis procedures, temperature studies, concrete testing requirements, foundation investigation requirements, and instrumentation and construction information for the design of concrete arch dams.

FOR THE COMMANDER:



WILLIAM D. BROWN
Colonel, Corps of Engineers
Chief of Staff

Engineering and Design
ARCH DAM DESIGN

Table of Contents

Subject		Paragraph	Page
CHAPTER 1.	INTRODUCTION		
	Purpose and Scope-----	1-1	1-1
	Applicability-----	1-2	1-1
	References-----	1-3	1-1
	Definitions-----	1-4	1-2
CHAPTER 2.	GENERAL DESIGN CONSIDERATIONS		
	Dam Site-----	2-1	2-1
	Length-Height Ratio-----	2-2	2-1
	Smooth Abutments-----	2-3	2-1
	Angle Between Arch and Abutment-----	2-4	2-1
	Arch Abutments-----	2-5	2-2
	Foundation-----	2-6	2-3
	Foundation Deformation Modulus-----	2-7	2-3
	Effect of Overflow Spillway-----	2-8	2-4
CHAPTER 3.	SPILLWAYS, OUTLET WORKS AND APPURTENANCES, AND RESTITUTION CONCRETE		
	Introduction-----	3-1	3-1
	Spillways-----	3-2	3-1
	Outlet Works-----	3-3	3-8
	Appurtenances-----	3-4	3-13
	Restitution Concrete-----	3-5	3-24
CHAPTER 4.	LOADING COMBINATIONS		
	General-----	4-1	4-1
	Loading Combinations-----	4-2	4-2
	Selection of Load Cases for Various Phases of Design-----	4-3	4-5

<u>Subject</u>		<u>Paragraph</u>	<u>Page</u>
CHAPTER 5.	DESIGN LAYOUT		
	General Design Process-----	5-1	5-1
	Levels of Design-----	5-2	5-1
	Procedure-----	5-3	5-2
	Manual Layout-----	5-4	5-2
	Preliminary Stress Analyses-----	5-5	5-13
	Evaluation of Results-----	5-6	5-14
	Improvement of Design-----	5-7	5-14
	Presentation of Design Layout-----	5-8	5-15
	Computer-assisted Layouts-----	5-9	5-20
CHAPTER 6.	STATIC ANALYSIS		
	Introduction-----	6-1	6-1
	Design Data Required-----	6-2	6-1
	Method of Analysis-----	6-3	6-3
	Structural Modeling-----	6-4	6-5
	Presentation of Results-----	6-5	6-17
	Evaluation of Stress Results-----	6-6	6-18
CHAPTER 7.	EARTHQUAKE RESPONSE ANALYSIS		
	Introduction-----	7-1	7-1
	Geological-Seismological Investigation----	7-2	7-1
	Design Earthquakes-----	7-3	7-3
	Earthquake Ground Motions-----	7-4	7-3
	Finite Element Modeling Factors Affecting Dynamic Response-----	7-5	7-6
	Method of Analysis-----	7-6	7-12
	Evaluation and Presentation of Results----	7-7	7-14
CHAPTER 8.	TEMPERATURE STUDIES		
	Introduction-----	8-1	8-1
	Operational Temperature Studies-----	8-2	8-1
	Construction Temperatures Studies-----	8-3	8-15
CHAPTER 9.	STRUCTURAL PROPERTIES		
	Introduction-----	9-1	9-1
	Material Investigations-----	9-2	9-1
	Mix Designs-----	9-3	9-3
	Testing During Design-----	9-4	9-6
	Properties To Be Assumed Prior To Testing-----	9-5	9-10

<u>Subject</u>		<u>Paragraph</u>	<u>Page</u>
CHAPTER 10.	FOUNDATION INVESTIGATIONS		
	Introduction-----	10-1	10-1
	Site Selection Investigations-----	10-2	10-1
	Geological Investigations of Selected Dam Site-----	10-3	10-2
	Rock Mechanics Investigations-----	10-4	10-11
	Rock Mechanics Analyses-----	10-5	10-18
CHAPTER 11.	CRITERIA		
	Static-----	11-1	11-1
	Dynamic-----	11-2	11-3
CHAPTER 12.	INSTRUMENTATION		
	Introduction-----	12-1	12-1
	General Considerations-----	12-2	12-1
	Monitoring Movement-----	12-3	12-2
	Monitoring Stresses and Strains-----	12-4	12-5
	Seepage Monitoring-----	12-5	12-5
	Pressure Monitoring-----	12-6	12-5
	Temperature Monitoring-----	12-7	12-6
	General Layout Requirements-----	12-8	12-6
	Readout Schedule-----	12-9	12-12
CHAPTER 13.	CONSTRUCTION		
	Introduction-----	13-1	13-1
	Diversion-----	13-2	13-1
	Foundation Excavation-----	13-3	13-5
	Consolidation Grouting and Grout Curtain-----	13-4	13-5
	Concrete Operations-----	13-5	13-10
	Monolith Joints-----	13-6	13-13
	Galleries and Adits-----	13-7	13-23
	Drains-----	13-8	13-27
	Appurtenant Structures-----	13-9	13-28

CHAPTER 1

INTRODUCTION

1-1. Purpose and Scope.

a. This manual provides general information, design criteria and procedures, static and dynamic analysis procedures, temperature studies, concrete testing requirements, foundation investigation requirements, and instrumentation and construction information for the design of concrete arch dams. The guidance provided in this manual is based on state of the art in this field as practiced at the time of publication. This manual will be updated as changes in design and analysis of arch dams are developed. The information on design and analysis presented in this manual is only applicable to arch dams whose horizontal and vertical sections are bounded by one or more circular arcs or a combination of straight lines and circular arcs.

b. This manual is a product of the Arch Dam Task Group which is a component of the Computer-Aided Structural Engineering (CASE) Program of the U.S. Army Corps of Engineers (USACE). Task group members are from the USACE, U.S. Bureau of Reclamation (USBR), and the Federal Energy Regulatory Commission (FERC). Individual members and others contributing to this manual are as follows: Donald R. Dressler (CECW-ED), Jerry L. Foster (CECW-ED), G. Ray Navidi (CEORH-ED), Terry W. West (FERC), William K. Wigner (CESAJ-EN), H. Wayne Jones (CEWES-IM), Byron J. Foster (CESAD-EN), David A. Dollar (USBR), Larry K. Nuss (USBR), Howard L. Boggs (USBR, retired/consultant), Dr. Yusof Ghanaat (QUEST Structures/consultant) and Dr. James W. Erwin (USACE, retired/consultant).

c. Credit is given to Mr. Merlin D. Copen (USBR, retired) who inspired much of the work contained in this manual. Mr. Copen's work as a consultant to the U.S. Army Engineer District, Jacksonville, on the Corps' first double-curved arch dam design, Portugues Arch Dam, gave birth to this manual. Professor Ray W. Clough, Sc. D. (Structures consultant), also a consultant to the Jacksonville District for the design of the Portugues Arch Dam, provided invaluable comments and recommendations in his review and editing of this manual.

1-2. Applicability. This manual is applicable to all HQUSACE elements, major subordinate commands, districts, laboratories, and field operating activities having civil works responsibilities.

1-3. References and Related Material.

a. References. References are listed in Appendix A.

b. Related Material. In conjunction with this manual and as part of the Civil Works Guidance Update Program, a number of design and analysis tools have been developed or enhanced for use by USACE districts. A brief description is as follows:

(1) Arch Dam Stress Analysis System (ADSAS) (U.S. Bureau of Reclamation (USBR) 1975). This is the computerized version of the trial load method of analyzing arch dams developed by the Bureau of Reclamation. ADSAS has been converted from mainframe to PC and a revised, user-friendly manual has been prepared. ADSAS is a powerful design tool which has been used in the design of most modern arch dams in the United States.

(2) Graphics-Based Dam Analysis Program (GDAP) (Ghanaat 1993a). GDAP is a finite element program for static and dynamic analysis of concrete arch dams based on the Arch Dam Analysis Program (ADAP) that was developed by the University of California for the USBR in 1974. The GDAP program is PC-based and has graphics pre- and postprocessing capabilities. The finite element meshes of the dam, foundation rock, and the reservoir are generated automatically from a limited amount of data. Other general-purpose finite element method (FEM) programs can also be used for the analysis of arch dams.

(3) Interactive Graphics Layout of Arch Dams (IGLAD) is an interactive PC-based program for the layout of double-curvature arch dams. The program enables the designer to prepare a layout, perform necessary adjustments, perform stress analyses using ADSAS, and generate postprocessing graphics and data. This program was developed by the USACE.

1-4. Definitions. Terminology used in the design and analysis of arch dams is not universal in meaning. To avoid ambiguity, descriptions are defined and shown pictorially, and these definitions will be used throughout this manual.

a. Arch (Arch Unit). Arch (or arch unit) refers to a portion of the dam bounded by two horizontal planes, 1 foot apart. Arches may have uniform thickness or may be designed so that their thickness increases gradually on both sides of the reference plane (variable thickness arches).

b. Cantilever (Cantilever Unit). Cantilever (or cantilever unit) is a portion of the dam contained between two vertical radial planes, 1 foot apart.

c. Extrados and Intrados. The terminology most commonly used in referring to the upstream and downstream faces of an arch dam is extrados and intrados. Extrados is the upstream face of arches and intrados is the downstream face of the arches. These terms are used only for the horizontal (arch) units; the faces of the cantilever units are referred to as upstream and downstream, as appropriate. See Figure 1-1 for these definitions.

d. Site Shape. The overall shape of the site is classified as a narrow-V, wide-V, narrow-U, or wide-U as shown in Figure 1-2. These terms, while being subjective, present the designer a visualization of a site form from which to conceptually formulate the design. The terms also help the designer to develop knowledge and/or experience with dams at other sites. Common to all arch dam sites is the crest length-to-height ratio, $cl:h$. Assuming for comparison that factors such as central angle and height of dam are equal, the arches of dams designed for wider canyons would be more flexible in relation to cantilever stiffness than those of dams in narrow canyons, and a proportionately larger part of the load would be carried by cantilever action.

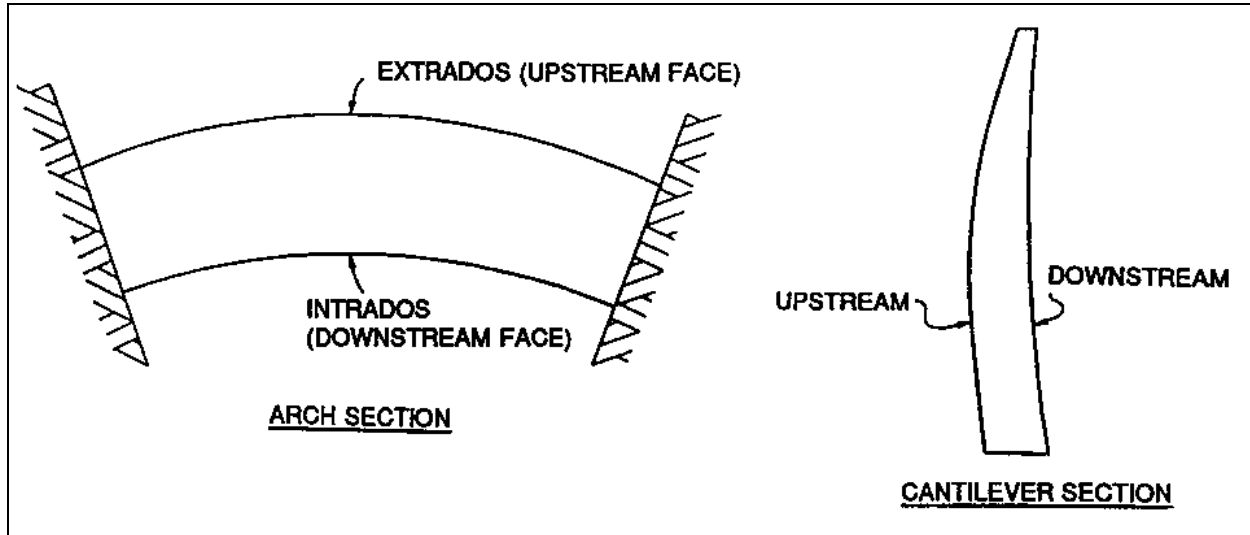

Figure 1-1. Typical arch unit and cantilever unit

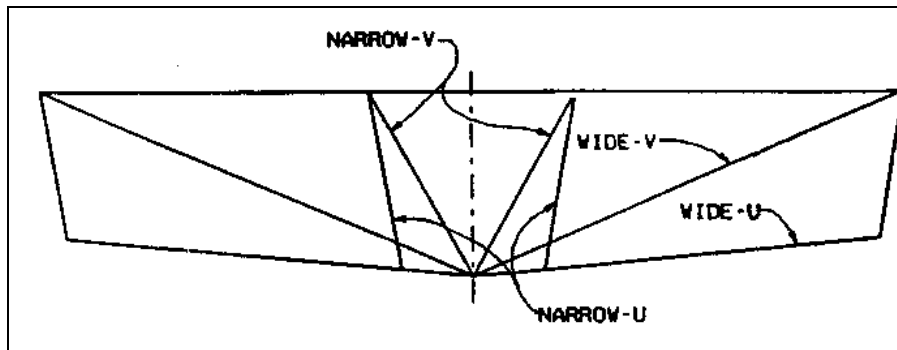

Figure 1-2. Schematic profiles of various dam sites

e. Crest Length-Height Ratio. The crest length-to-height ratios of dams may be used as a basis for comparison of proposed designs with existing conditions and with the relative effects of other controlling factors such as central angle, shape of profile, and type of layout. The length-to-height ratio also gives a rough indication of the economic limit of an arch dam as compared with a dam of gravity design (Figure 1-2). See paragraph 2-1b for general guidelines.

f. Narrow-V. A narrow-V site would have a $cl:h$ of 2:1 or less. Such canyon walls are generally straight, with few undulations, and converge to a narrow streambed. This type of site is preferable for arch dams since the applied load will be transferred to the rock predominantly by arch action. Arches will be generally uniform in thickness, and the cantilevers will be nearly vertical with some slight curvature at the arch crown. Faces most likely will be circular in plan, and the dam will be relatively thin. From the standpoint of avoiding excessive tensile stresses in the arch, a type of layout should be used which will provide as much curvature as possible in the arches. In some sites, it may be necessary to use variable-thickness arches

with a variation in location of circular arc centers to produce greater curvature in the lower arches. Figure 1-4 shows an example of a two-centered variable-thickness arch dam for a nonsymmetrical site.

g. Wide-V. A wide-V site would have a $cl:h$ of 5:1 or more. The upper limit for $cl:h$ for arch dams is about 10:1. Canyon walls will have more pronounced undulations but will be generally straight after excavation, converging to a less pronounced v-notch below the streambed. Most of the live load will be transferred to rock by arch action. Arches will generally be uniform in thickness with some possible increase in thickness near the abutments. The "crown" (central) cantilever will have more curvature and base thickness than that in a narrow-V of the same height. In plan, the crest most likely would be three-centered and would transition to single-center circular arches at the streambed. Arches would be thicker than those in the narrow-V site.

h. Narrow-U. In narrow-U sites, the canyon walls are near vertical in the upper half of the canyon. The streambed width is fairly large, i.e., perhaps one-half the canyon width at the crest. Above $0.25h$, most of the live load will be transferred to rock by arch action. Below $0.25h$, the live load will increasingly be supported by cantilever action toward the lowest point. There the cantilevers have become stubby while the arches are still relatively long. The upper arches will be uniform in thickness but become variable in thickness near the streambed. The crown cantilever will have more curvature than the crown cantilever in a narrow-V site of equal height. Faces will generally be circular in plan. Arches will be thin because of the narrow site. In dams constructed in U-shaped canyons, the lower arches have chord lengths almost as long as those near the top. In such cases, use of a variable-thickness arch layout will normally give a relatively uniform stress distribution. Undercutting on the upstream face may be desirable to eliminate areas of tensile stress at the bases of cantilevers.

i. Wide-U. Wide-U sites are the most difficult for an arch dam design because most of the arches are long compared to the crest length. In the lower $0.25h$, much of the live load is carried by cantilever action because the long flexible arches carry relatively little load. In this area, cantilever thickness tends to increase rapidly to support the increased water pressure. Arch thickness variation in the horizontal direction may range from uniform at the crest to variable at the streambed. The transition will most likely occur at about the upper one-third level. The crown cantilever here should have the most curvature of any type of site.

j. Reference Plane. As shown in Figures 1-3 through 1-5, the reference plane is a vertical radial plane usually based in the streambed. The reference plane contains the crown cantilever and the loci of the central centers as shown in Figure 1-6. It is from this plane that the angle to the arch abutment is measured. Also shown are the axis and axis center. The axis is a vertical surface curved in plan intersecting the crown cantilever at the crest and upstream face. The axis is developed in plan by the axis radius which is the distance between the axis and the axis center located downstream. A method of estimating values for these terms will be described in a later section. The reference plane will theoretically consist of one, two, or three planes of centers. One plane of centers is used to describe arches in a symmetrical site as shown in Figure 1-3. Two planes of centers are used to describe arches in nonsymmetrical sites as shown in Figure 1-4. Three planes

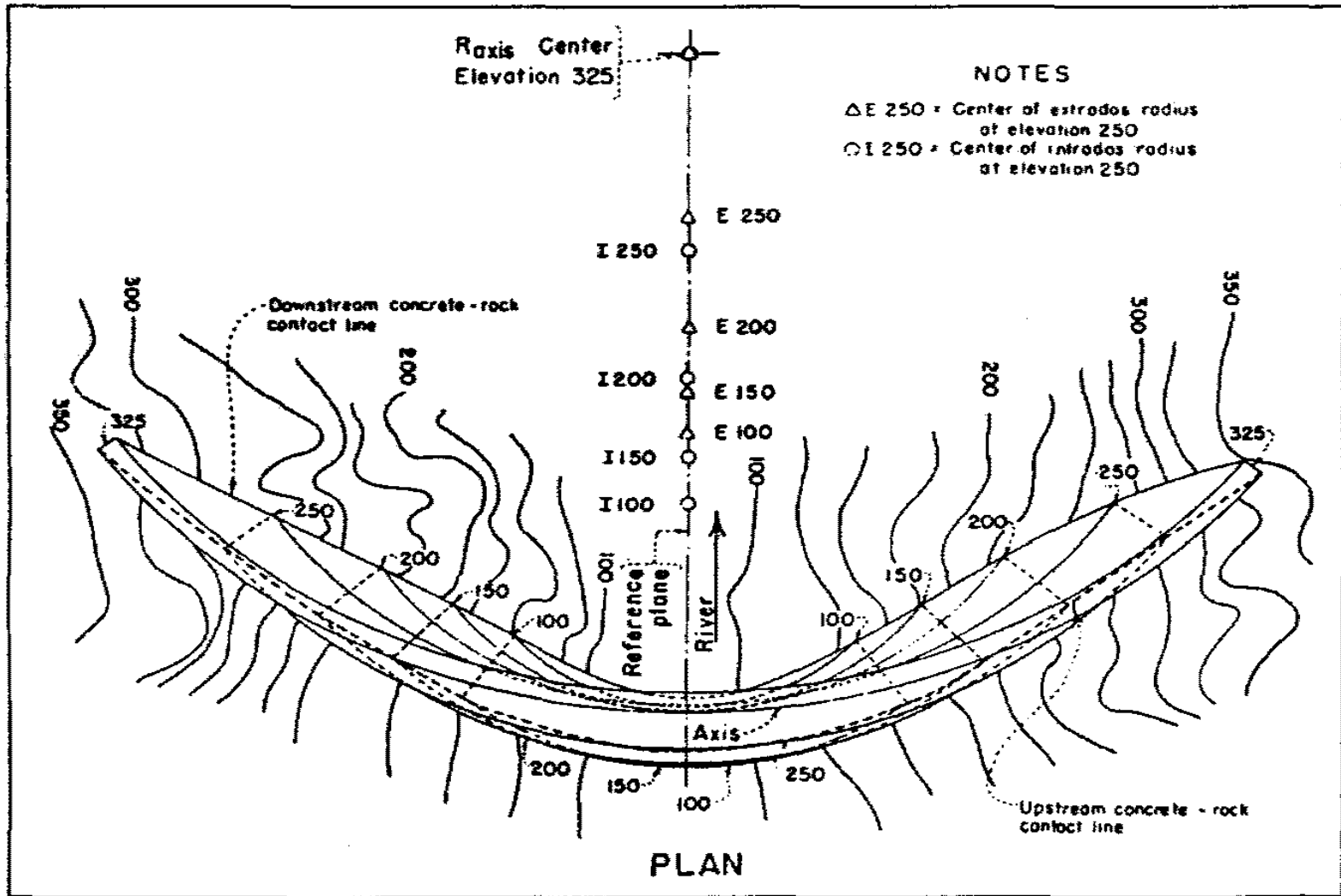

Figure 1-3. Typical single-center variable thickness arch dam in a symmetrical site

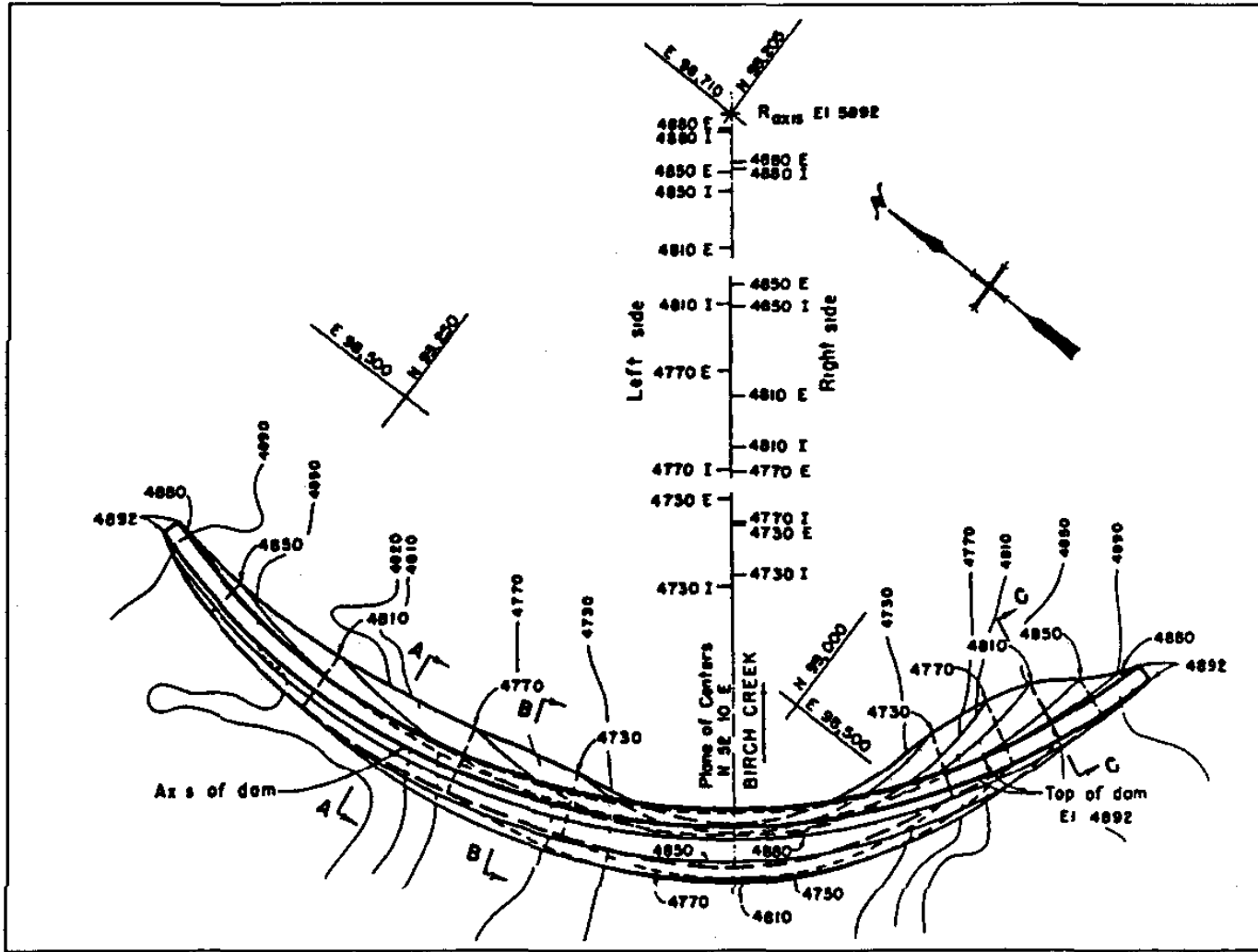
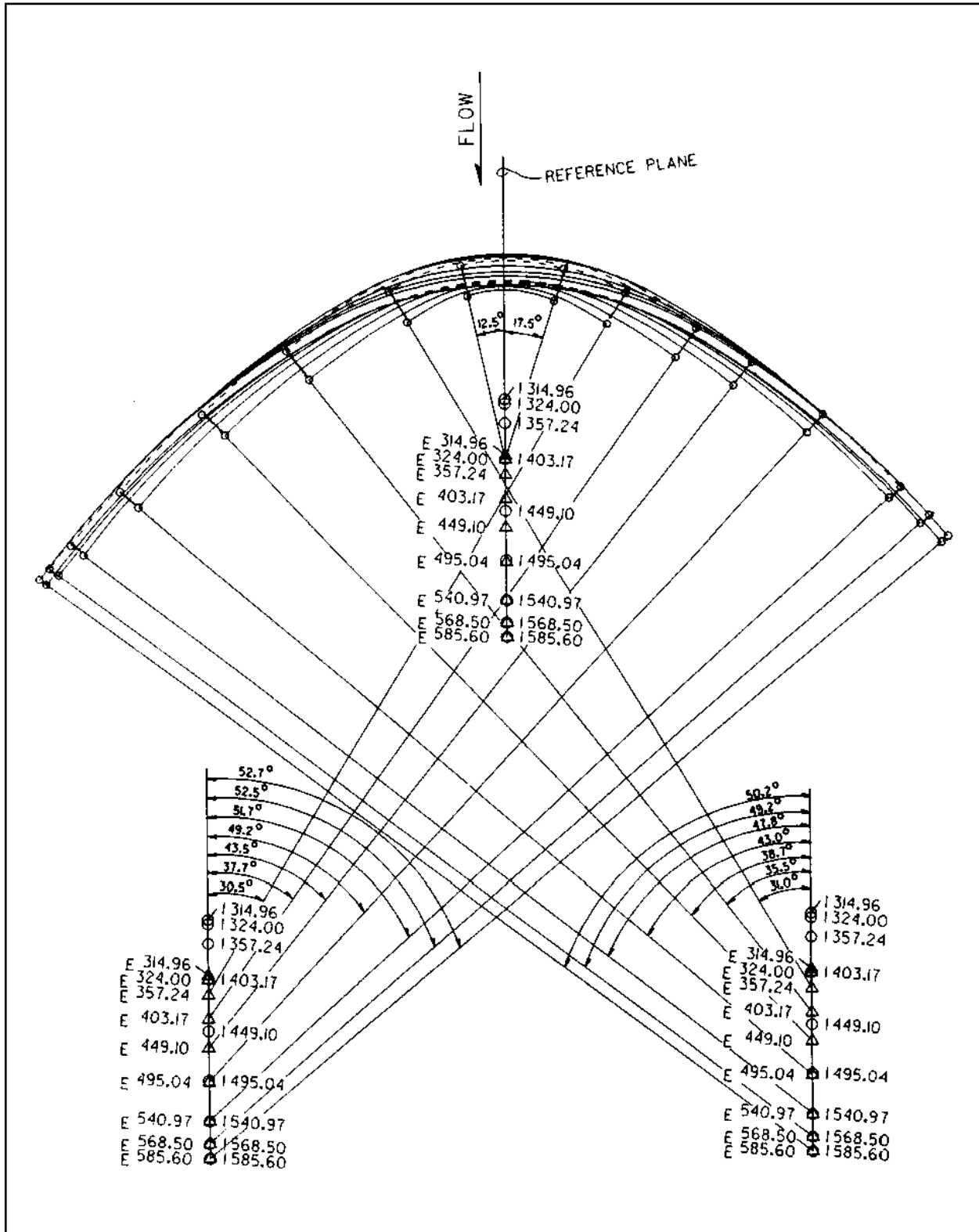

Figure 1-4. Typical two-centered variable-thickness arch dam in a nonsymmetrical site



1-8

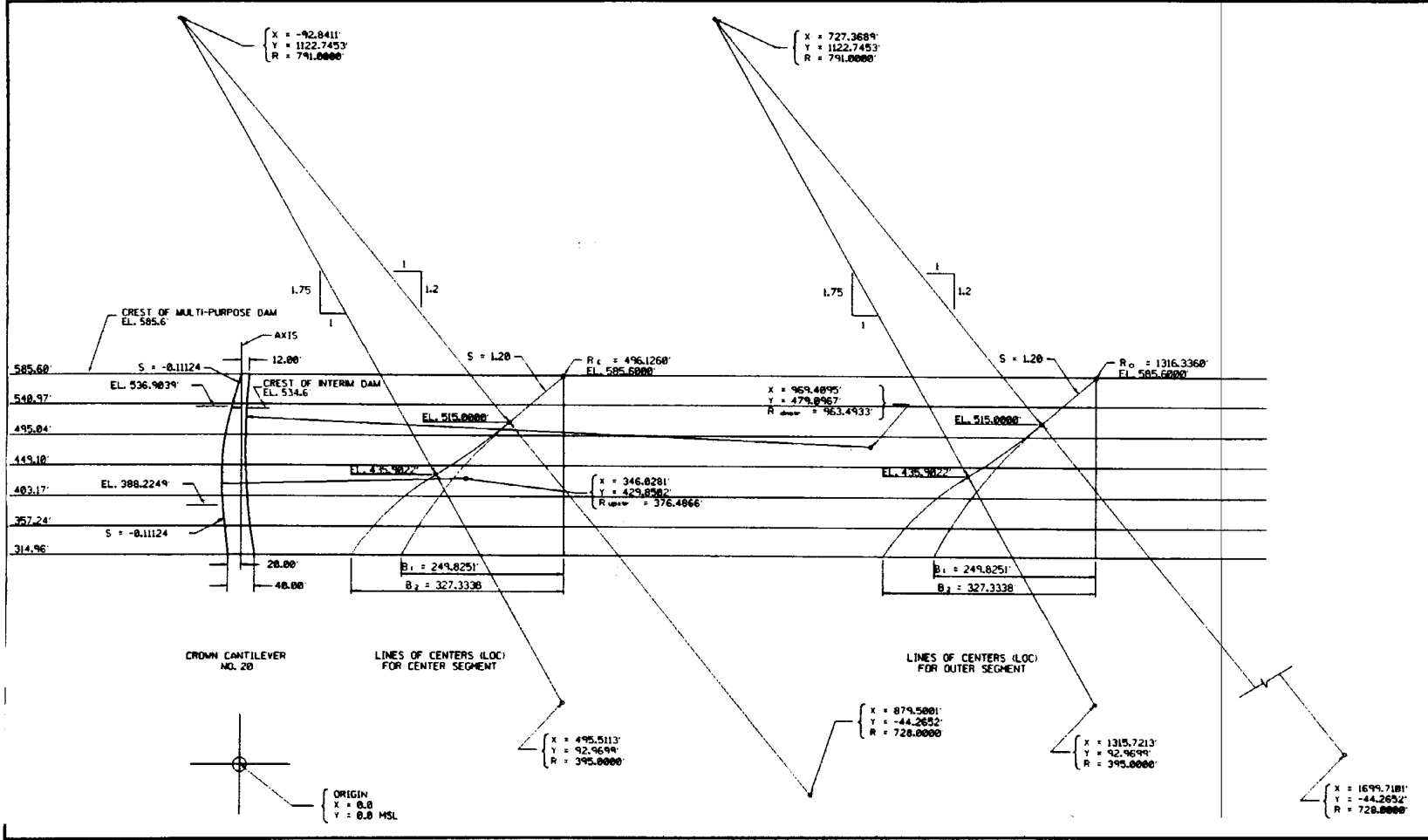

Figure 1-6. Section along reference plane of plane shown in Figure 1-5

of centers are used to describe a three-centered arch dam as shown in Figure 1-5.

k. Crown Cantilever. The crown cantilever is defined as the maximum height vertical cantilever and is usually located in the streambed. It is directed radially toward the axis center. The crown cantilever and the arch crowns are at the same location on symmetrical arch dams. On nonsymmetrical arch dams, the arch crowns will be offset toward the longer side. Maximum radial deflections will occur at the crown cantilever of symmetrical dams but generally between the crown cantilever and arch crowns on nonsymmetrical arch dams.

l. Single Curvature. Single-curvature arch dams are curved in plan only. Vertical sections, or cantilevers, have vertical or straight sloped faces, or may also be curved with the limitation that no concrete overhangs the concrete below. These types of shapes were common prior to 1950.

m. Double Curvature. Double-curvature arch dams means the dam is curved in plan and elevation as shown in Figure 1-7. This type of dam utilizes the concrete weight to greater advantage than single-curvature arch dams. Consequently, less concrete is needed resulting in a thinner, more efficient dam.

n. Overhang. Overhang refers to the concrete on the downstream face where the upper portion overhangs the lower portion. Overhang is most at the crown cantilever, gradually diminishing toward the abutments. The overhanging concrete tends to negate tension on the downstream face in the upper one-quarter caused by reaction of the lightly loaded upper arches.

o. Undercutting. Undercutting refers to the upstream face where the concrete/rock contact undercuts the concrete above it. Undercutting causes the moment from concrete weight to compress the concrete along the heel and tends to negate tension from the reservoir pressure. If an exaggerated undercutting becomes necessary, an imbalance during construction may occur in which case several of the concrete blocks may have to be supported with mass concrete props placed integrally with the blocks. Each prop width is less than the block width to avoid additional arch action. The lowest lift within the prop is painted with a bond breaker to avoid additional cantilever action. Undercutting is most predominant at the base of the crown cantilever. Generally, as the crest length-to-height ratio increases so do the overhang and the undercutting.

p. Symmetrical. In addition to the canyon shapes previously described, the canyon is also described as symmetrical or nonsymmetrical. In general, sites are not absolutely symmetrical but are considered symmetrical if the arch lengths on each side differ by less than about 5 percent between $0.15H$ and $0.85H$. Figure 1-3 shows the plan view of a typical dam in a symmetrical site.

q. Nonsymmetrical. Nonsymmetrical sites result in dams with longer arches on one side of the crown cantilever than the other. Dams for such sites will quite possibly have two reference planes, one for each side but with a common crown cantilever as shown in Figure 1-4. The short side with

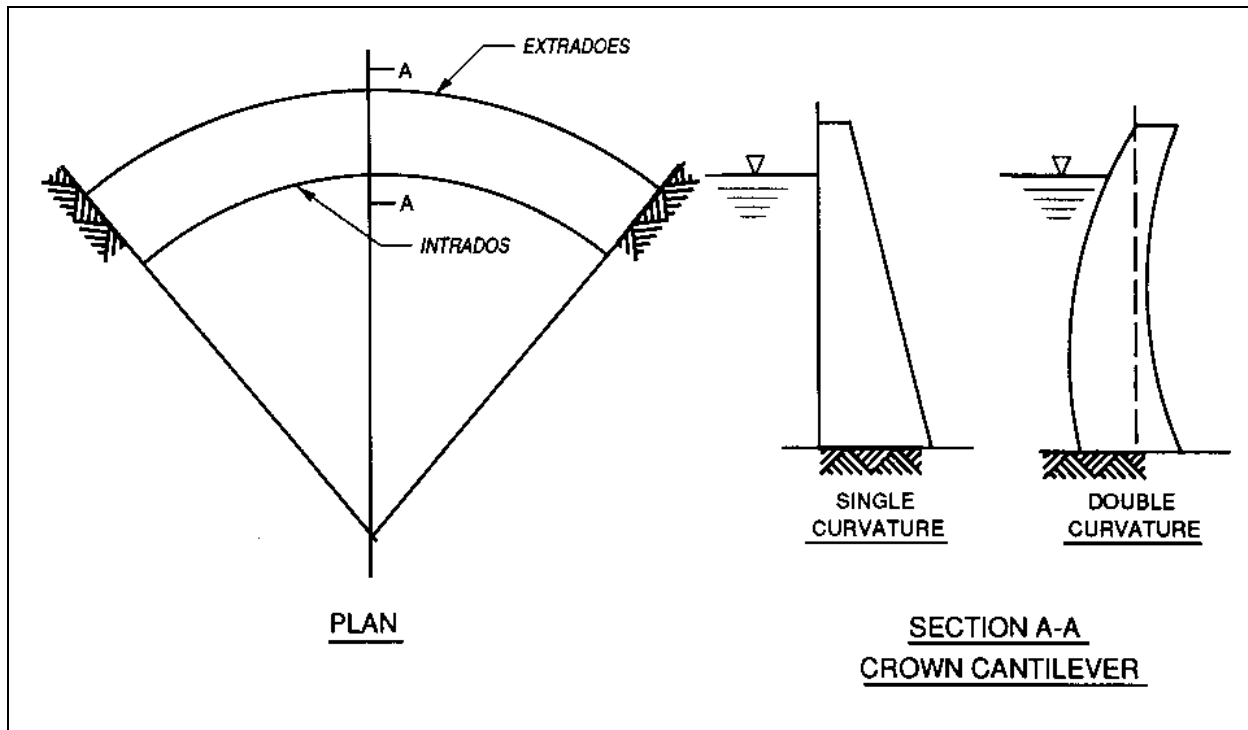

Figure 1-7. Example of single- and double-curvature dams

the steeper-wall canyon will have shorter radii and exhibit more arch action. Whereas the longer side, abutting into the flatter slope, will have less arch action and will be relatively thicker along the abutments. In general, the maximum deflection at each elevation will not occur at the crown cantilever but more toward the midpoint of each arch. A different axis radius for each side will be necessary. To maintain continuity, however, each pair of lines must lie along the reference plane. In some cases the axis radius (R_{axis}) may be different on each side, and the arches may be uniform or variable in thickness. A region of stress concentration is likely to exist in an arch dam having a nonsymmetrical profile. In some cases improvements of a nonsymmetrical layout by one or a combination of the following methods may be warranted: by excavating deeper in appropriate places, by constructing an artificial abutment, or by reorienting and/or relocating the dam.

r. Lines of Centers. A line in space which is the loci of centers for circular arcs is used to describe a face of the dam. For uniform-thickness arches, a single line of centers will describe the extrados and intrados faces. Variable-thickness arches require two lines of centers. Nonsymmetrical sites need one or two lines of centers for each side of the dam. Three-centered arches have three lines of centers as shown in Figure 1-6. It should be noted in Figure 1-6 that the lines of centers for the outer segments are identical and only one pair is shown. Also, in Figure 1-6, arches of variable thickness are used below elevation 515 feet.

s. Constant Center. A constant-center dam has a vertical line at the axis center to describe the center for all arches. All arches are uniform in thickness and the crown cantilever is representative of all vertical sections.

t. Single Center. Single-center constant thickness arches have the same center describing the extrados and the intrados which means all arches are uniform in thickness between abutments. Single-center variable-thickness arches have different centers describing the extrados and the intrados; however, both lie along the reference plane. The lines of centers need not be vertical but must be coplanar with the crown cantilever. This arch shape is applicable to narrow canyon sites such as those with $c_1:h$ less than 3:1.

u. Two Centered. In two-centered arches, both planes are coplanar with the crown cantilever. The left plane contains the extrados and intrados lines of centers required to properly shape the left side of the arches as measured from the crown cantilever to the abutments. The right plane of centers contains the extrados and intrados lines of centers for the right-side arches.

v. Three Centered. With three-centered arches, only the center segment is coplanar with the crown cantilever. The center segment and outer segment are coplanar at an angle of compound curvature as measured from the reference plane. Three-centered arches approximate an ellipse. Figure 1-5 shows a typical three-centered arch. A parabola can be approximated by using straight tangents in the outer segment instead of arcs. Three-centered or elliptical arches can be used advantageously in wide-U or V-shaped canyons. Elliptical arches have the inherent characteristics of conforming more nearly to the line of thrust for wide sites than do circular arches. Consequently, the concrete is stressed more uniformly throughout its thickness. Because of the smaller influences from moments, elliptical arches require little, if any, variable thickness.

CHAPTER 2

GENERAL DESIGN CONSIDERATIONS

2-1. Dam Site. Unlike a concrete gravity dam which carries the entire load by its self weight, an arch dam obtains its stability by both the self weight and, to a great extent, by transmitting the imposed loads by arch action into the valley walls. The geometry of the dam site is, therefore, the most basic consideration in the selection of an arch dam. As a general rule, an arch dam requires a site with abutments of sufficient strength to support the arch thrust. On special occasions artificial abutments - thrust blocks - may be used in the absence of suitable abutment(s); see Chapter 3 for additional discussion on thrust blocks.

2-2. Length-Height Ratio. Traditionally, most of the arch dams in the United States have been constructed in canyon sites with length-height ratios of less than 4 to 1. Although the greatest economic advantage may be realized for a length-height ratio of less than 4 to 1, sites with greater ratios should also be given serious consideration. With the present state of the art in arch dam design automation, it is now possible to obtain "optimum design" for sites which would have been considered difficult in the past. An arch dam must be given first consideration for a site with length-height ratio of 3 or less. For sites having length-height ratios between 3 and 6, an arch dam may still provide the most feasible structure depending on the extent of foundation excavation required to reach suitable material. The effect of factors other than length-height ratio becomes much more predominant in the selection process for dam sites with length-height ratios greater than 6. For these sites a careful study must be performed with consideration given to the diversion requirements, availability of construction material, and spillway and outlet works requirements. The results of these studies may prove the arch dam as a viable choice for wider sites.

2-3. Smooth Abutments. The arch dam profile should be made as smooth as practicable. The overall appearance on each abutment should resemble a smooth geometric curve composed of one or two parabolas or hyperbolas. One point of contraflexure in the profile of each abutment will provide for a smooth force distribution along the rock contact. Each original ground surface may have a very irregular profile before excavation, but the prominent points should be removed together with removing weathering to sound rock. Each abutment surface irregularity of peaks and valleys represents points of force concentration at the peaks and correspondingly less force in the valleys. As can be readily surmised, design difficulties lead to structural inefficiencies, more concrete, and increased costs. Thus, it is generally prudent engineering from the beginning to overexcavate the rock and provide for a smooth profile. At the microscale, the abutment should be made smooth, that is, rock knobs remaining after the macroexcavation should, after consensus with the geologist, be removed. Generally, the excavation lines shown in the specifications have tolerances such as ± 1 foot in 20 feet.

2-4. Angle Between Arch and Abutment. Given a geometrically suitable site, another important consideration of an arch dam is the rock contour lines, or the angle which the arches make with the abutment rock contour lines. The angle α in Figure 2-1 should, as a general rule, be greater than 30 degrees to

avoid high concentration of shear stresses near the rock surface. Inasmuch as this angle is determined only after the results of the stress analysis are available, the angle β may be used as a guideline during the preparation of the layout. The arches should be arranged so that β is larger than 40 degrees in the upper half. Care must be taken in using these guidelines since the arch thrust, H , is only the tangential component of the total force, and the other two components, vertical and radial, and their respective orientations, must also be examined in the more advanced stages of design. Additionally, the elevation of the arch being investigated should be considered, e.g., an arch located at or near the top of the dam may not be carrying appreciable tangential thrust if the continuity of the arch is broken by an overflow spillway. Observing this criterion - the minimum angle - ensures that there is sufficient rock mass downstream to withstand the applied loads. In addition to this requirement, the directions of joint systems in the rock should be given careful consideration in making the layout to ensure stable abutments under all loading conditions.

2-5. Arch Abutments. Full-radial arch abutments (normal to the axis) are advantageous for good bearing against the rock. However, where excessive excavation at the extrados would result from the use of full-radial abutments and the rock has the required strength and stability, the abutments may be reduced to half-radial as shown in Figure 2-2a. Where excessive excavation at the intrados would result from the use of full-radial abutments, greater-than-radial abutments may be used as shown in Figure 2-2b. In such cases, shearing resistance should be carefully investigated. Where full-radial arch abutments cannot be used because excessive excavation would result from the use of

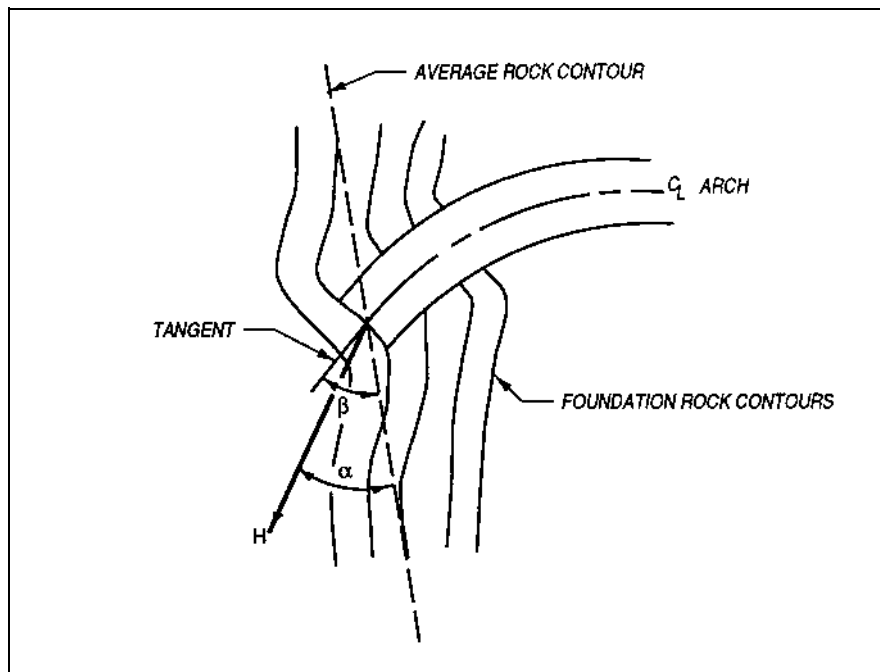

Figure 2-1. Angle between arch thrust and rock contours

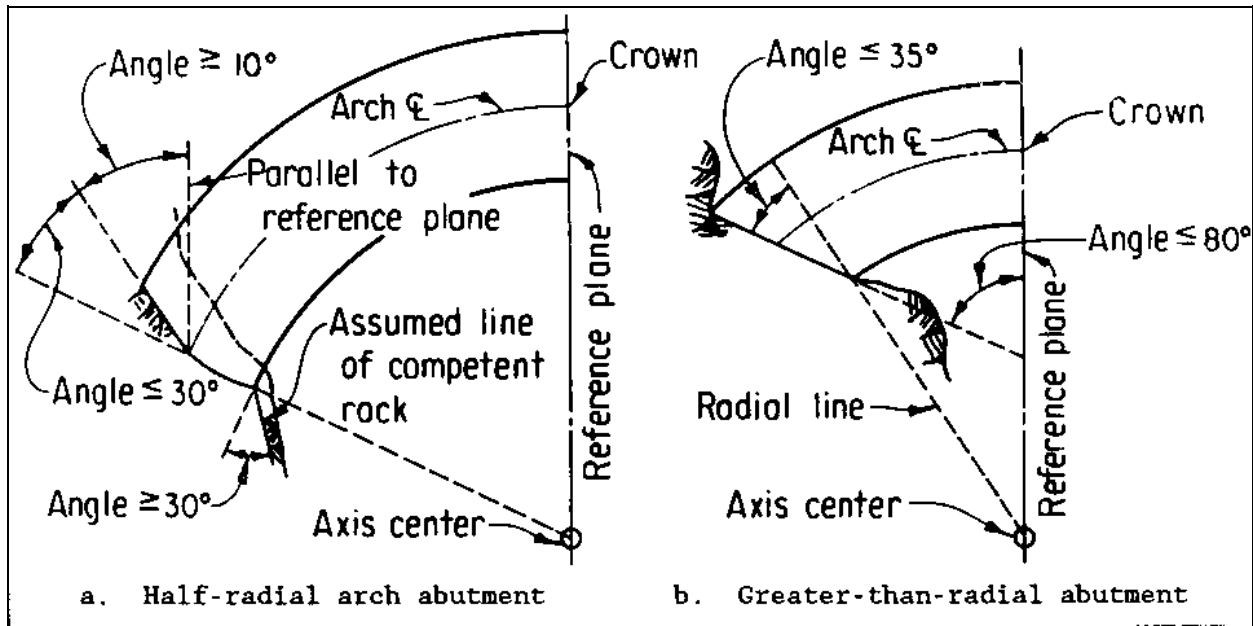

Figure 2-2. Arch abutment types

either of the two shapes mentioned, special studies may be made for determining the possible use of other shapes having a minimum excavation. These special studies would determine to what extent the arch abutment could vary from the full-radial and still fulfill all requirements for stability and stress distribution.

2-6. Foundation. An arch dam requires a competent rock foundation of sufficient strength to withstand the imposed loads from the dam and the reservoir. Inasmuch as the loads are transmitted to the foundation along the entire dam-foundation contact area, the abutment must meet the same minimum foundation requirements as that for the deepest part of the dam, commensurate with the magnitude of resultant forces at a given arch elevation. Because of its small dam-foundation contact area, as compared to other types of dams, an arch dam exerts a larger bearing pressure on the foundation. For the purpose of site selection, a foundation with a compressive strength sufficient to carry the load from a gravity dam would also be satisfactory for an arch dam, recognizing that very seldom are foundations made up of a single type of rock of uniform strength and that this is only an average "effective" value for the entire foundation. Arch dams are capable of spanning weak zones of foundation, and the presence of faults and shears does not appreciably affect the stresses in the dam provided that the thickness of a weak zone is no more than about one times the base thickness of the dam. A description of the treatment of these faults and shear zones is discussed in paragraph 3-5.

2-7. Foundation Deformation Modulus. Deformation behavior of the foundation has a direct effect on the stresses within the dam. Lower values of foundation deformation modulus, i.e., a more yielding foundation, reduce the tension at the base of the dam along the foundation and, conversely, a foundation with high-deformation modulus values results in higher tensile stresses along the base. It is, therefore, important to determine the deformation modulus of the foundation at the earliest stage of design. This information becomes more

critical when there are indications that the deformation modulus for one abutment may be drastically different than for the other abutment. Having this knowledge at early stages of design, the structural designer can shape the dam properly so that excessive stresses are avoided. A foundation should not be considered inadequate solely because of low values of deformation moduli. Foundation grouting may improve the deformation behavior of the rock mass and should be considered in determining the deformation moduli used in the design of the dam. When deformation values smaller than 500,000 pounds per square inch (psi) are present, the question of how much a grouting program can improve the foundation becomes critical, and a thorough stress analysis should be performed using a reasonable range of deformation moduli. The design is acceptable if the dam stresses are within allowable stresses under all assumed conditions.

2-8. Effect of Overflow Spillway. If an overflow type of spillway is used and is located near the center of the dam, no arch action is considered above the crest elevation of the spillway. If a spillway is located near one side of the dam, there may be some arch action above the crest elevation of the spillway. In either case, the upper portion of the dam above the spillway crest must be designed to withstand the effects of the loading imposed above the crest by water pressure, concrete mass, temperature, and earthquake.

CHAPTER 3

SPILLWAYS, OUTLET WORKS AND APPURTENANCES,
AND RESTITUTION CONCRETE

3-1. Introduction. This chapter describes the influence of voids through the arch dam and structural additions outside the theoretical limits of the arch dam. Voids through the dam in the radial direction are spillways, access adits, and outlet works, in the tangential direction are adits, galleries, and tunnels, and in the vertical direction are stairway wells and elevator shafts. Often associated with spillways and outlet works are blockouts or chambers for gate structures. External structures are restitution concrete which includes thrust blocks, pads, pulvino, socle, or other dental type concrete, spillway flip buckets on the downstream face, and corbels on the upstream face.

3-2. Spillways. Numerous types of spillways are associated with arch dams. Each is a function of the project purpose, i.e., storage or detention, or to bypass flood flows or flows that exceed diversion needs. Spillways for concrete dams may be considered attached or detached.

a. Attached Spillways. Attached spillways are through the crest or through the dam. Through-the-crest spillways have a free fall which is controlled or uncontrolled; OG (ogee) types are shaped to optimize the nappe. In general, the usual crest spillway will be constructed as a notch at the crest. The spillway notch can be located either over the streambed or along one or both abutments as shown in Figure 3-1. A spillway opening can also be placed below the crest through the dam. Similar to the notch spillway, this opening can be located either over the streambed, as shown in Figure 3-2, or near one or both abutments. The location through the dam, whether at the crest or below the crest, is always a compromise between hydraulic, geotechnical, and structural considerations. Impact of the jets on the foundation rock may require treatment to avoid eroding the foundation. Spillways through the dam are located sufficiently below the crest so that effective arch action exists above and below the spillway openings.

(1) Spillway at Crest. With this alignment, the spillway crest, piers, and flipbucket are designed to align the flow with the streambed to cause minimal possible bank erosion and/or to require minimal subsequent beneficiation. However, the notch reduces the arch action by the depth of the notch, i.e., the vertical distance between the dam crest and spillway crest which is normally pure arch restraint is nullified and replaced with cantilever action. To accommodate this reduced stiffness, additional concrete must be added below the spillway crest or the entire arch dam must be reshaped, thus complicating the geometry. Not that this is detrimental, but arch dam shapes work more efficiently when kept simple and smooth in both plan and elevation. Moving the spillway notch to either abutment as shown in Figure 3-1 or splitting the spillway crest length and locating half along each abutment will restore most of the arch action to the dam crest. Spillway notches through the crest near abutments interrupt arch action locally, but not significantly, as can be shown in numerous numerical analysis and scale model studies. The effect of abutment spillways is structurally less distressful on arch dams in wide



Figure 3-1. East Canyon Dam with spillway notch near left abutment (USBR)

valleys where the top arch is long compared to the structural height, such as a 5:1 crest length-to-height ratio, or in canyons where the climate fluctuates excessively (± 50 °F) between summer and winter. In this latter case, winter temperature loads generally cause tensile stresses on both faces near the crest abutment, where the dam is thinnest and responds more quickly and dramatically than thicker sections. Thus, locating the spillway notches along the abutments is a natural structural location. The effects of a center notch, in addition to reducing arch action, are to require that concrete above the spillway crest support the reservoir load by cantilever action. Consequently, design of the vertical section must not only account for stresses from dead load and reservoir but meet stability requirements for shear. Temperature load in this portion of the dam is usually omitted from structural analyses. Earthquake loads also can become a problem and must be considered. On certain arch dams where the spillway width is a small proportion of the total crest length, some arch action will occur in the adjacent curved sections that will improve resistance to flood loads. Usually the beginning of this arch action is about the notch depth away from the pier. The more recent arch dams are thin efficient structures that make flood loads above the spillway crest of greater concern.

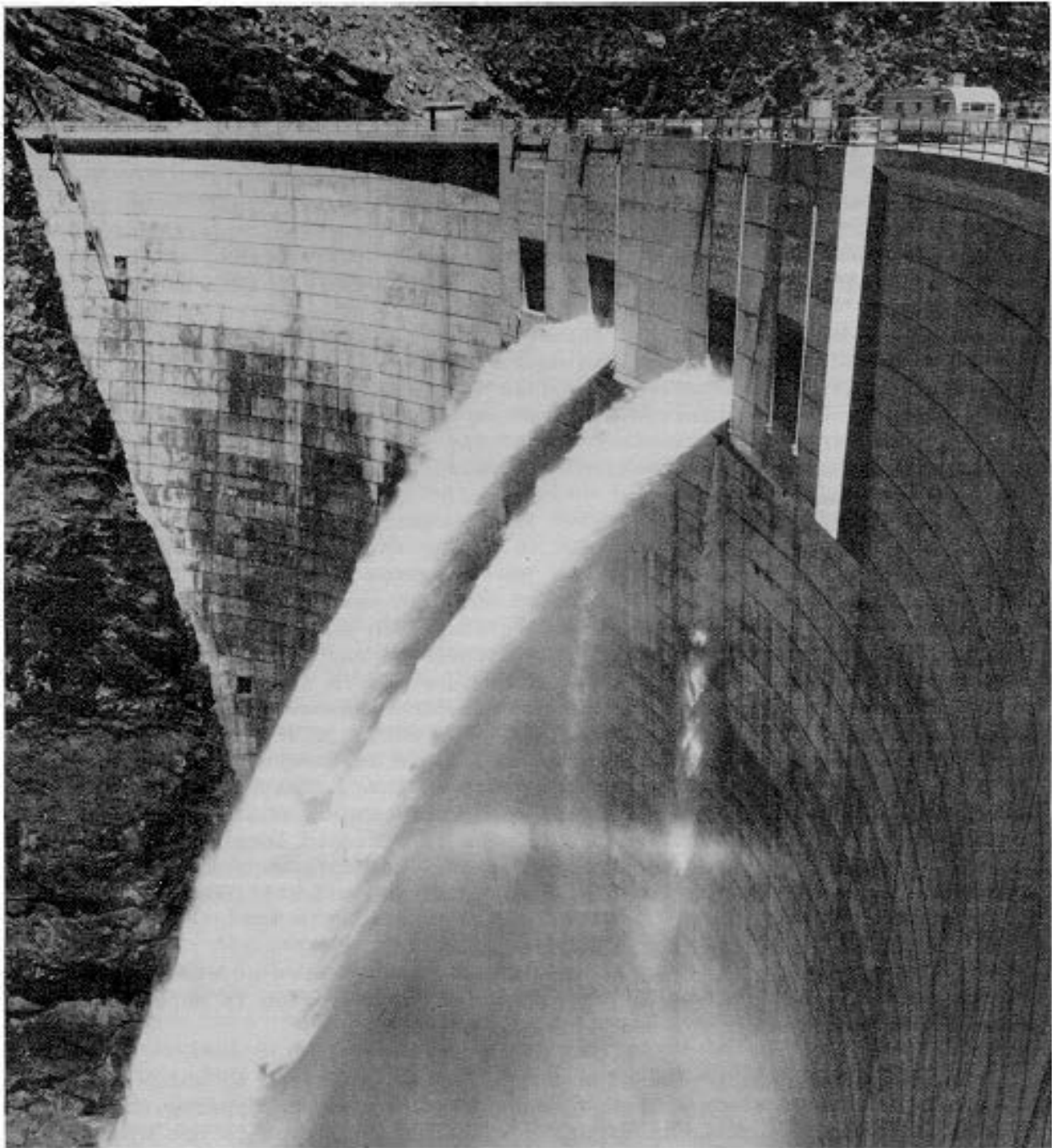

Figure 3-2. Through spillway below crest on Morrow Point Dam (USBR)

(2) Spillways Below Crest (thru Spillways). Spillways are constructed through the arch dam at some optimal distance below the dam crest to reduce the plunge and provide for additional discharge. The spillway may be visualized as multiple orifices, either round or rectangular, and controlled with some type of gates. The set of openings either may be centered over the streambed as shown in Figure 3-2 or split toward either or both abutments. The set is surrounded by mass concrete and locally reinforced to preserve, for the analyses, the assumption of a homogenous and monolithic structure. With this in mind, local reinforcement and/or added mass concrete must be designed so that the dam as a whole is not affected by the existence of the spillway. To minimize disruption of the flow of forces within the dam, the several openings should be aligned with the major principal compressive stresses resulting from the most frequent loading combination. Around the abutment, the major principal stresses on the downstream face are generally normal to the abutment. This alignment would tend to stagger the openings, thus creating design difficulties. In practice, however, all openings are aligned at the same elevation and oriented radially through the dam. If necessary, each orifice may be directed at a predetermined nonradial angle to converge the flows for energy dissipation or to direct the flow to a smaller impact area such as a stilling basin or a reinforced concrete impact pad. Between each orifice, within a set, are normal reinforced concrete piers designed to support the gravity load above the spillway and the water force on the gates.

(3) Flip Bucket. The massive flip bucket, depending on site conditions, may be located near the crest to direct the jet impact near the dam toe or farther down the face to flip the jet away from the toe. In either case, the supporting structure is constructed of solid mass concrete generally with vertical sides. By judiciously limiting its width and height, the supporting structure may be designed not to add stiffness to any of the arches or cantilevers. To assure this result, mastic is inserted in the contraction joints to the theoretical limits of the downstream face defined before the flip bucket was added as shown in Figure 3-3. The mastic disrupts any arch action that might develop. For the same reason, mastic is inserted during construction in the OG corbel overhang on the upstream face. These features protect the smooth flow of stresses and avoid reentrant corners which may precipitate cracking or spalling. Cantilever stiffness is enhanced locally but not enough to cause redistribution of the applied loads. Reinforcement in the supporting structure and accompanying training walls will not add stiffness to the arch dam.

b. Detached Spillways. Detached spillways consist of side channel, chute, tunnel, and morning glory spillways. The selection is dependent upon site conditions.

(1) Side Channel. The side channel spillway is one in which the control weir is placed along the side of and parallel to the upper portion of the discharge channel as shown in Figure 3-4. While this type is not hydraulically efficient nor inexpensive, it is used where a long overflow crest is desired to limit the surcharge head, where the abutments are steep, or where the control must be connected to a narrow channel or tunnel. Consequently, by being entirely upstream from the arch dam, the spillway causes no interference with the dam and only has a limited effect on the foundation. Similarly, along the upstream abutment, any spillway interference is mitigated by the usual low stresses in the foundation caused by the dam loads. Usually,

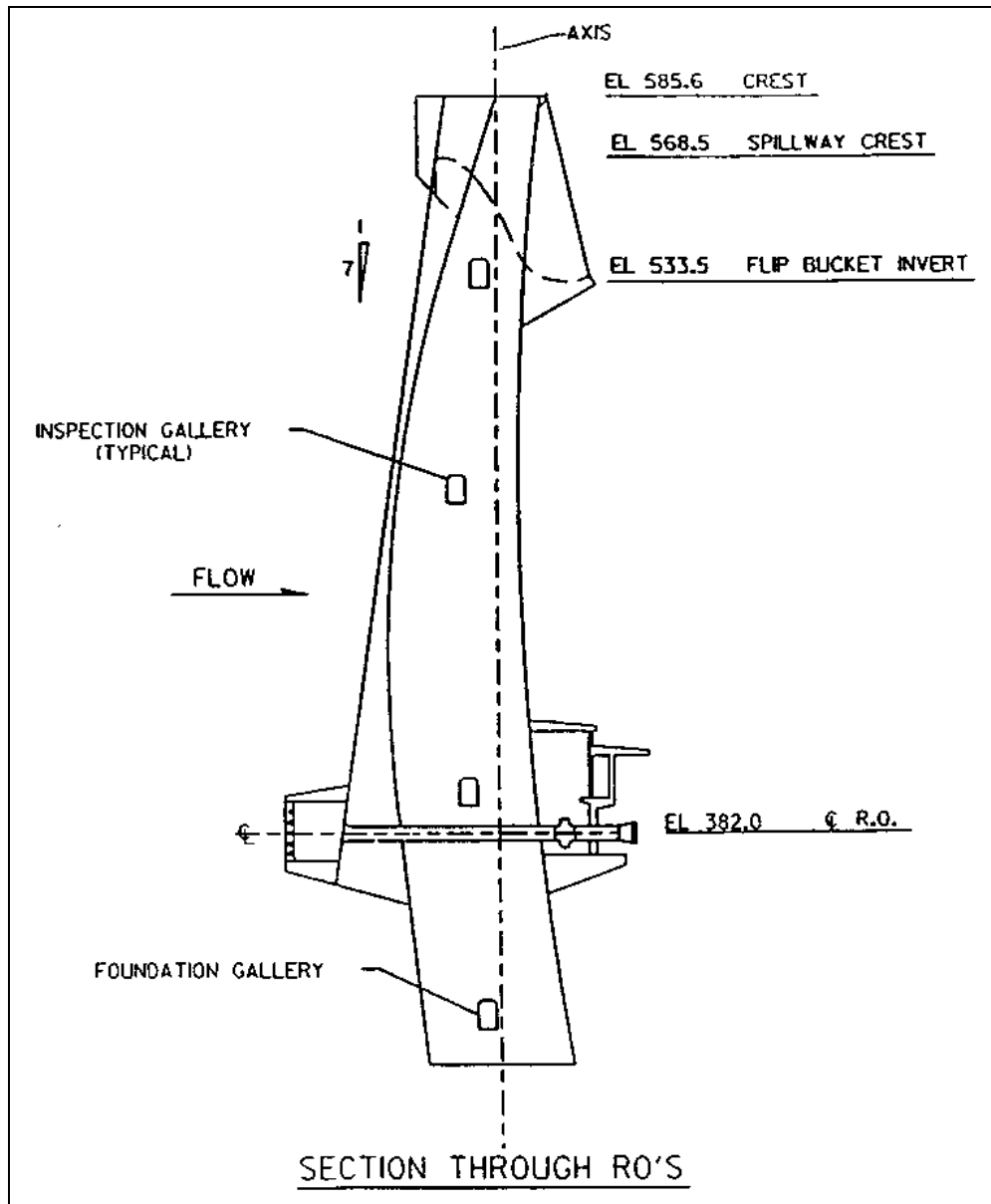

Figure 3-3. Typical section through spillway of a dam

stresses near the crest abutment are much less than the maximum allowable or, quite possibly, are tensile stresses.

(2) Chute Spillway. Chute spillways shown in Figure 3-5 convey discharge from the reservoir to the downstream river level through an open channel placed either along a dam abutment or through a saddle. In either case, the chute is not only removed from the main dam, but the initial slope by being flat isolates the remaining chute from the eventual stressed foundation rock.

(3) Tunnel Spillway. Tunnel spillways convey the discharge around the dam and consist of a vertical or inclined shaft, a large radius elbow, and a

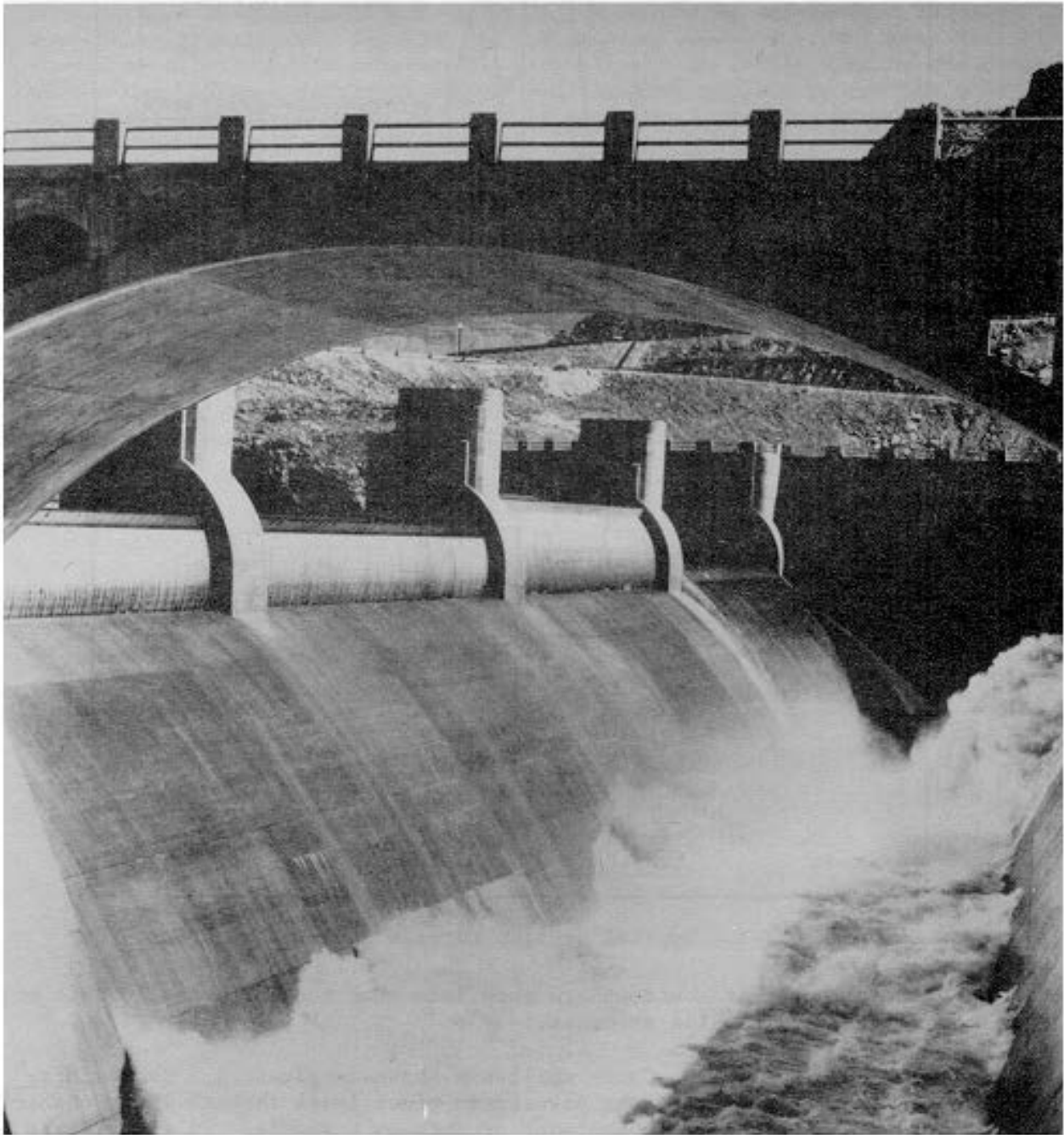

Figure 3-4. Side channel spillway at Hoover Dam (USBR)



Figure 3-5. Chute spillway at Stewart Mountain Dam (USSR)

horizontal tunnel at the downstream end. Tunnel spillways may present advantages for damsites in narrow canyons with steep abutments or at sites where there is danger to open channels from snow or rock slides. The tunnel alignment usually traverses the stressed foundation and consequently should be at least one abutment thickness from the concrete to rock contact. Any need for increased spacing would be based on structural height and applied load combinations. Note that these tunnels are designed to flow up to 75 percent full, in which case in situ and superimposed stresses from the dam may govern the design. The corollary is that the tunnel walls must be strong enough to avoid creating a weakness in the foundation and subsequent stability problems with the dam.

(4) Morning Glory Spillway. A morning glory spillway such as that shown in Figure 3-6 is one in which the water enters over a horizontally positioned lip, which is circular in plan, and then flows to the downstream river channel through a horizontal or near horizontal tunnel. A morning glory spillway usually can be used advantageously at damsites in narrow canyons where the abutments rise steeply or where a diversion tunnel is available for use as the downstream leg. If a vertical drop structure is to be located upstream, it should not interfere structurally with the dam. A sloping tunnel offers the same concerns as previously discussed.

3-3. Outlet Works. Outlet works are a combination of structures and equipment required for the safe operation and control of water released from a reservoir to serve downstream needs. Outlet works are usually classified according to their purpose such as river outlets, which serve to regulate flows to the river and control the reservoir elevation, irrigation or municipal water supply outlets, which control the flow of water into a canal, pipeline, or river to satisfy specified needs, or, power outlets, which provide passage of water to turbines for power generation. In general, outlet works do not structurally impact the design of an arch dam as shown in Figure 3-7. The major difficulty may lie in adapting the outlet works to the arch dam, especially a small double-curvature thin arch dam where the midheight thickness may be 25 feet or less. Taller and/or heavier dams will have a significant differential head between the intake and the valve or gate house, and the conduit may have several bends. All of the features can be designed and constructed but not without some compromise. Outlet works should be located away from the abutments to avoid interference with the smooth flow of stresses into the rock and smooth flow of water into the conduit. A nominal distance of 10 diameters will provide sufficient space for convergence of stresses past the conduit.

a. Intake Structures. Intake structures, in addition to forming the entrance into the outlet works, may accommodate control devices and the necessary auxiliary appurtenances such as trashracks, fish screens, and bypass devices (Figure 3-8). An intake structure usually consists of a submerged structure on the upstream face or an intake tower in the reservoir. Vertical curvature on the upstream face may result in more than usual massive concrete components as shown in Figure 3-9 to provide a straight track for the stop logs or bulkhead gate. A compromise to relieve some of the massiveness is to recess portions of the track into the dam face. This recess which resembles a rectangular notch in plan reduces the stiffness of those arches involved not only at the notch but for some lateral distance, depending on the notch depth.

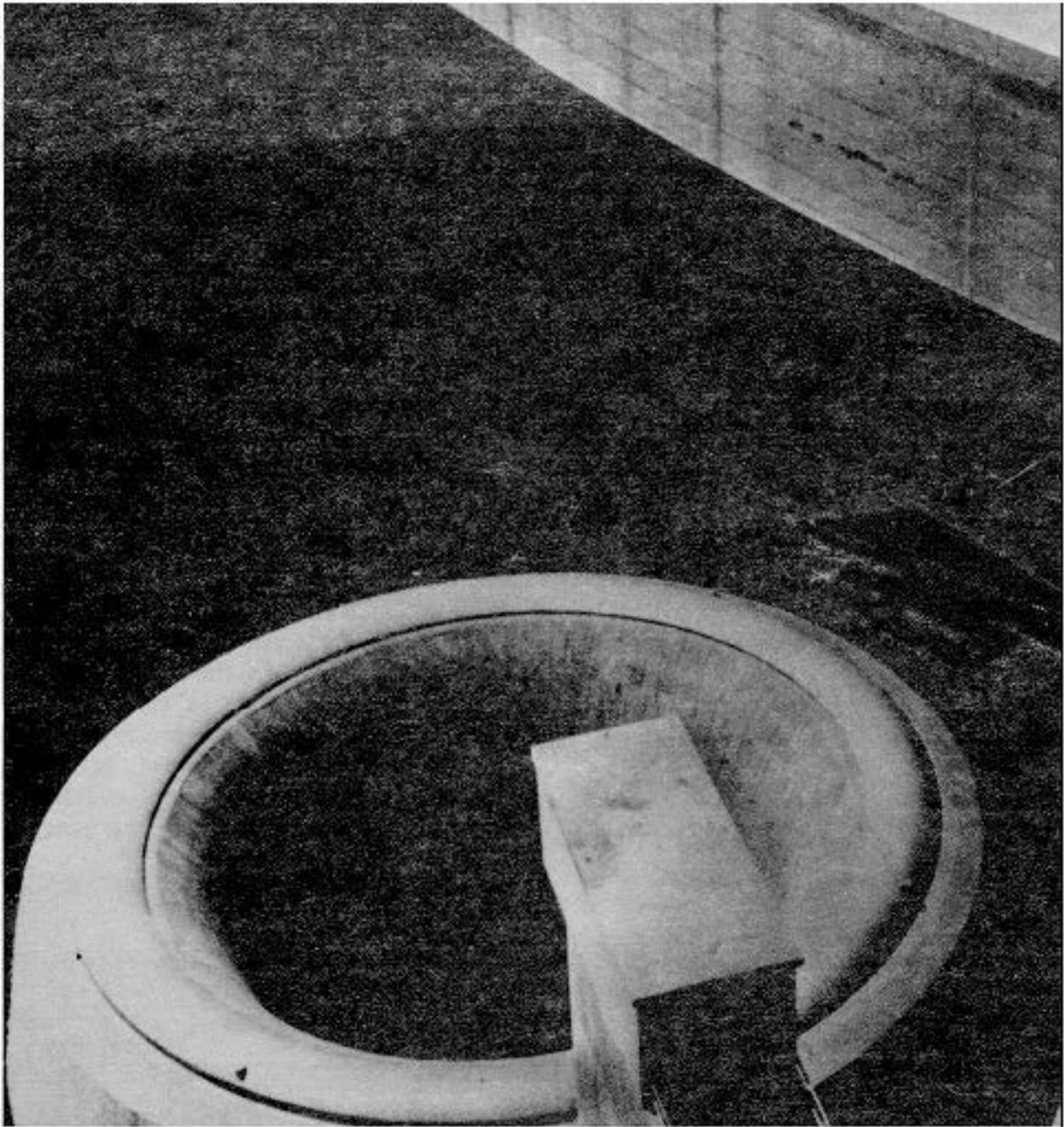
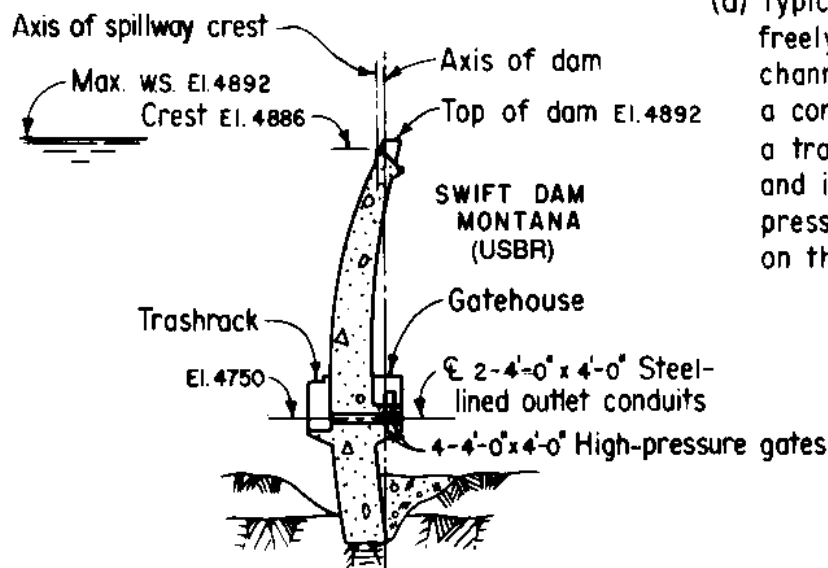
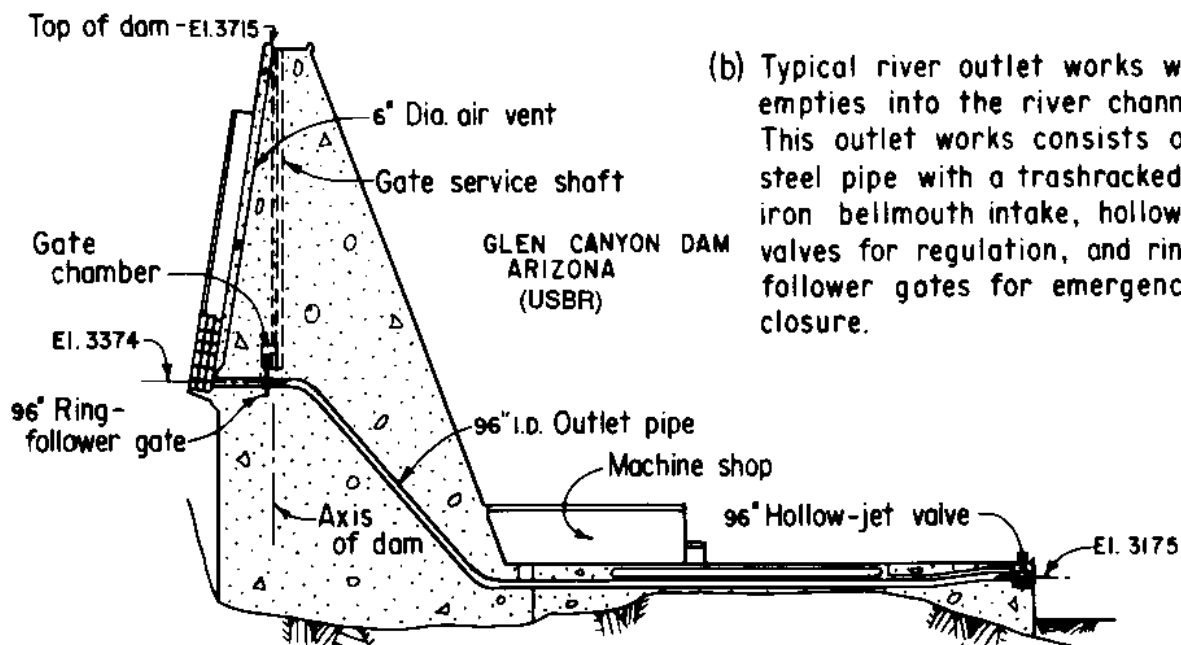

Figure 3-6. Morning glory spillway at Hungry Horse Dam. Note upstream face of dam in upper right (USBR)



SECTION THRU RIVER OUTLETS
(a)

(a) Typical river outlet works which freely discharges into the river channel. This outlet works is a conduit through the dam with a trashrack on the upstream face and is controlled by two high-pressure gates in a gatehouse on the downstream face of the dam



SECTION THRU RIVER OUTLETS
(b)

(b) Typical river outlet works which empties into the river channel. This outlet works consists of steel pipe with a trashracked cast iron bellmouth intake, hollow-jet valves for regulation, and ring-follower gates for emergency closure.

Figure 3-7. Typical river outlet works without a stilling basin

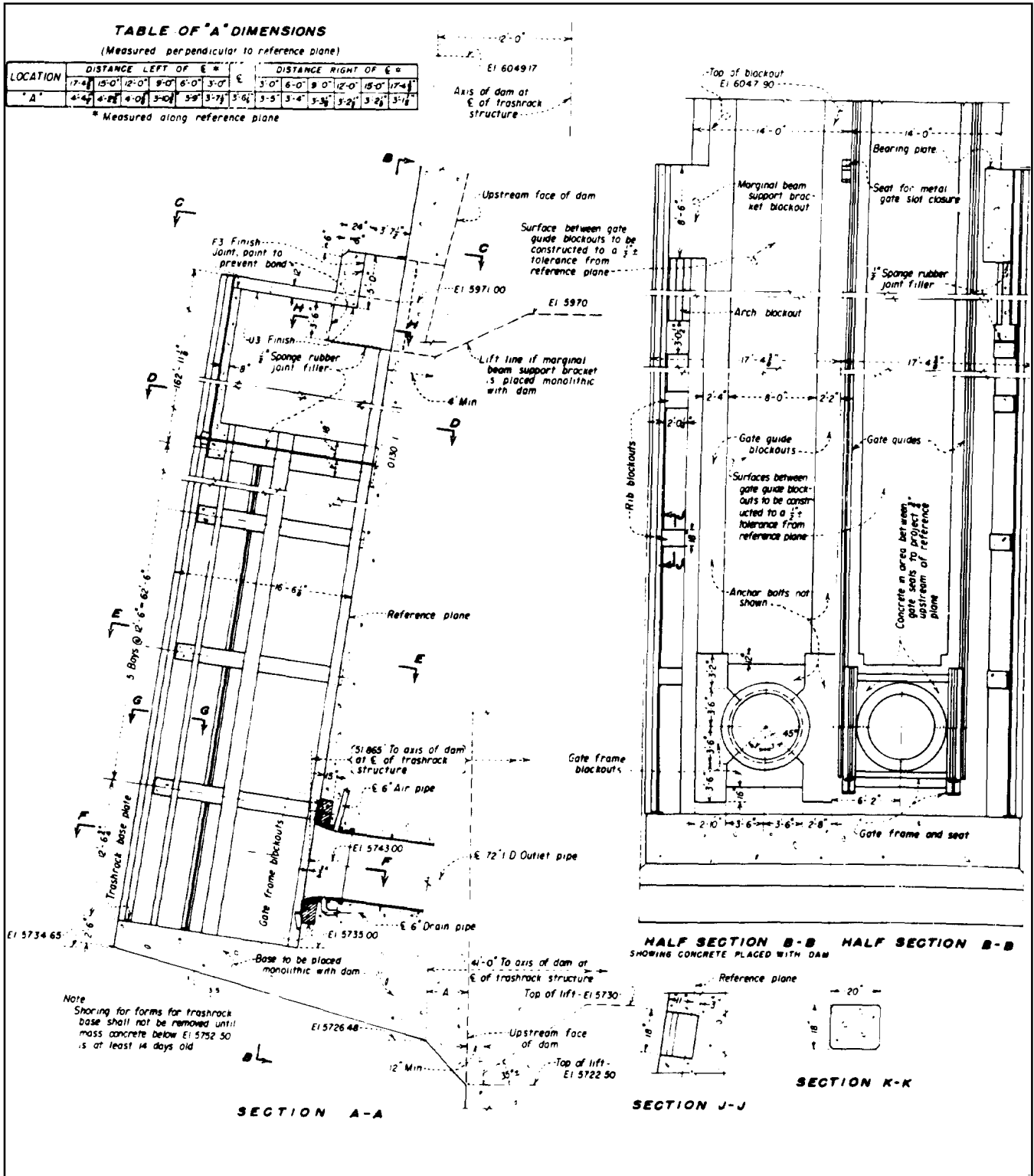

Figure 3-8. Typical river outlets trashrack structure (USBR)

3-12

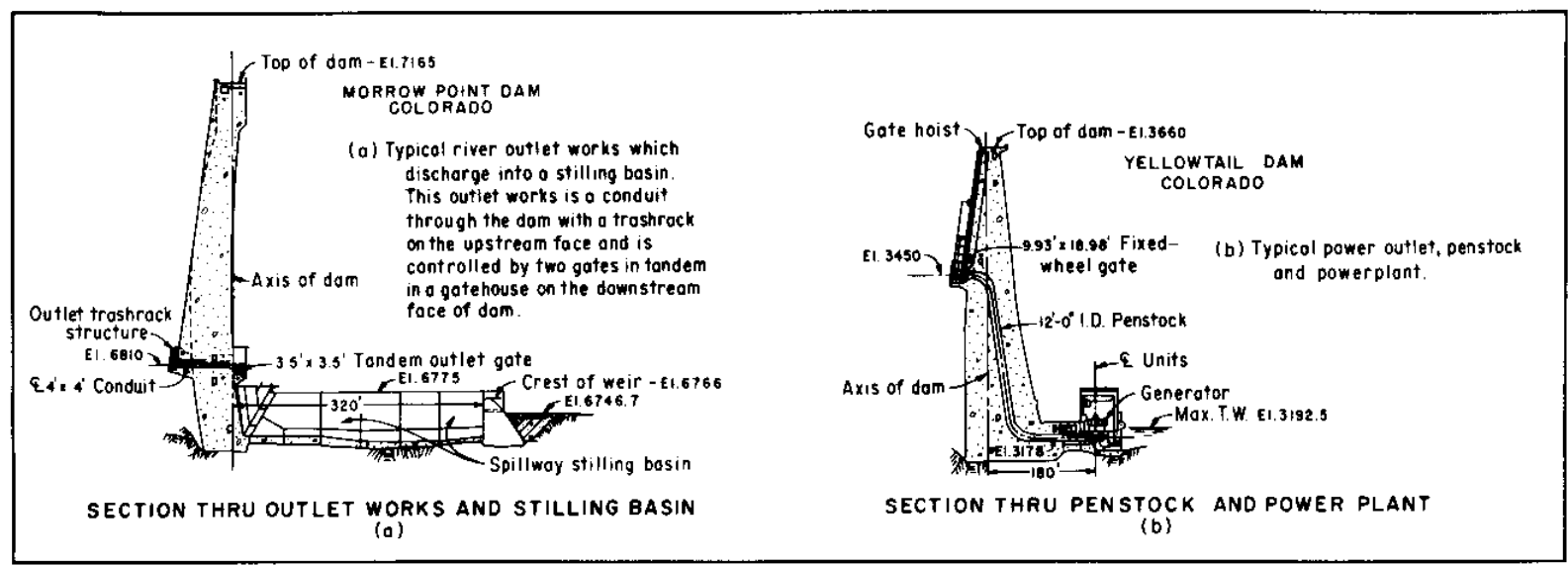

Figure 3-9. Typical river outlet works and power outlet (USBR)

b. Conduit. The outlet works conduit through a concrete dam may be lined or unlined, as in a power outlet, (Figure 3-10) but when the conduit is lined it may be assumed that a portion of the stress is being taken by the liner and not all is being transferred to the surrounding concrete. The temperature differential between the cool water passing through the conduit and the warmer concrete mass will produce tensile stresses in the concrete immediately adjacent to the conduit. In addition, the bursting effect from hydrostatic pressures will cause tensile stresses at the periphery of the conduit. Such tensile stresses and possible propagation of concrete cracking usually extend only a short distance in from the opening of the conduit. It is common practice to reinforce only the concrete adjacent to the opening. The most useful method for determining the stresses in the concrete surrounding the outlet conduit is the finite element method (FEM) of analysis.

c. Control House. The design of a control house depends upon the location and size of the structure, the operating and control equipment required, and the conditions of operation. The loadings and temperature conditions used in the design should be established to meet any situation which may be expected to occur during construction or during operation. In thin dams, the floor for the house is normally a reinforced concrete haunched slab cantilevered from the downstream face and designed to support the valves and houses. Neither the reinforcement nor the concrete should interfere with structural action of the arches and cantilevers. Emergency gates or valves are used only to completely shut off the flow in the outlet for repair, inspection maintenance or emergency closure. Common fixed wheel gates, such as shown in Figure 3-11, are either at the face or in a slot in the dam.

3-4. Appurtenances.

a. Elevator Tower and Shaft. Elevators are placed in concrete dams to provide access between the top of the dam and the gallery system, equipment and control chambers, and the power plant as shown in Figure 3-12. The elevator structure consists of an elevator shaft that is formed within the mass concrete and a tower at the crest of the dam. The shaft should have connecting adits which provide access into the gallery system and into operation and maintenance chambers. These adits should be located to provide access to the various galleries and to all locations at which monitoring and inspection of the dam or maintenance and control of equipment may be required. Stairways and/or emergency adits to the gallery system should be incorporated between elevator stops to provide an emergency exit such as shown in Figure 3-13. The design of reinforcement around a shaft can be accomplished by the use of finite element studies using the appropriate forces or stresses computed when analyzing the arch dam. In addition, stresses within the dam near the shaft due to temperature and other appropriate loads should be analyzed to determine if tension can develop at the shaft and be of such magnitude that reinforcement would be required. To minimize structural damage to the arches, the shaft should be aligned totally within the mass concrete and centered between the faces. However, the necessarily vertical shaft may not fit inside a thin arch dam. In such a case, the shaft could be moved to the abutment or designed to be entirely outside the dam but attached for vertical stability to the downstream face. This solution may not be esthetically pleasing, but it is functional, because if the shaft emerges through the downstream face it forms a rectangular notch that diverts the smooth flow of arch stresses and reduces arch stiffness.

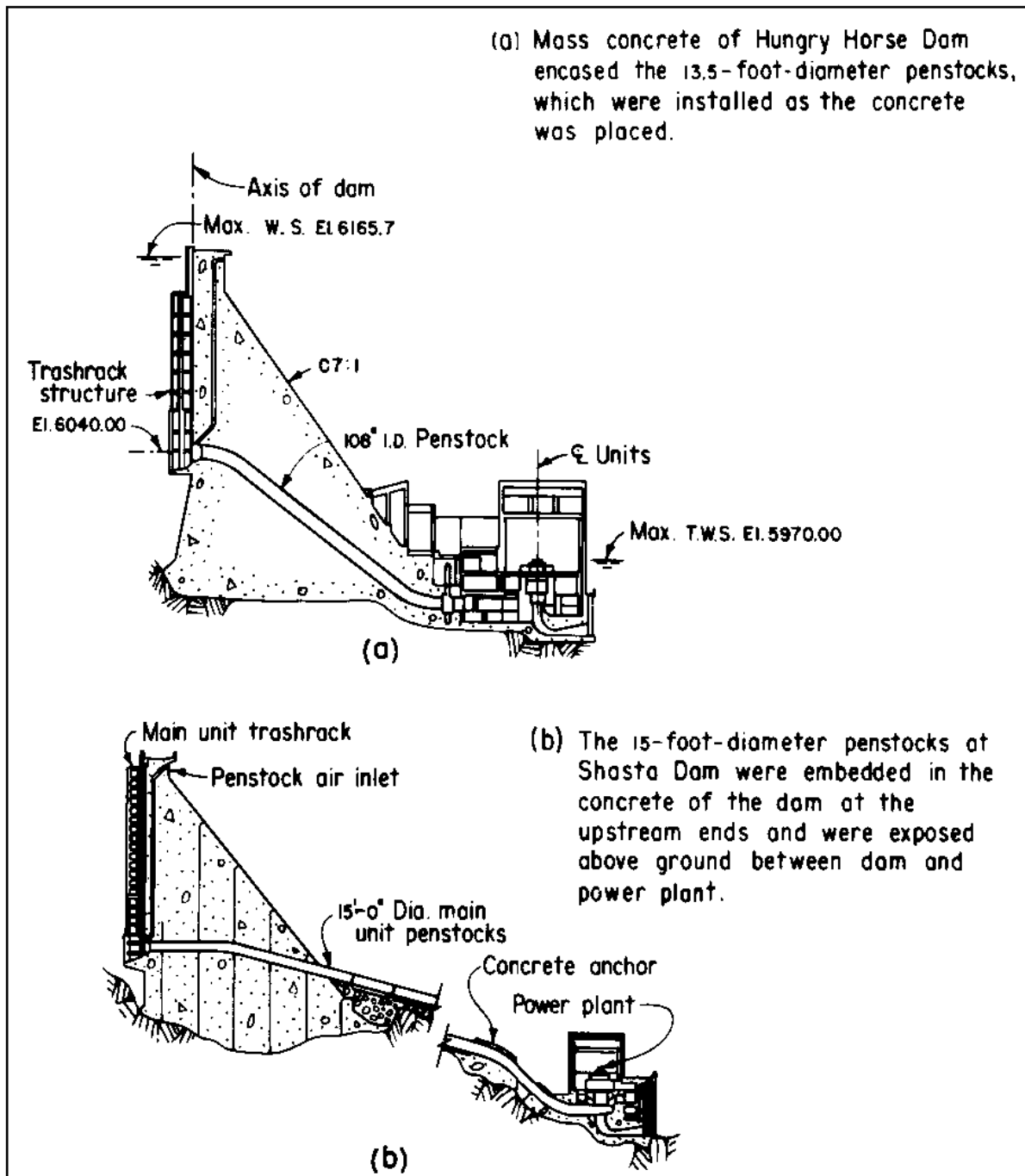

Figure 3-10. Typical penstock installations (USBR)

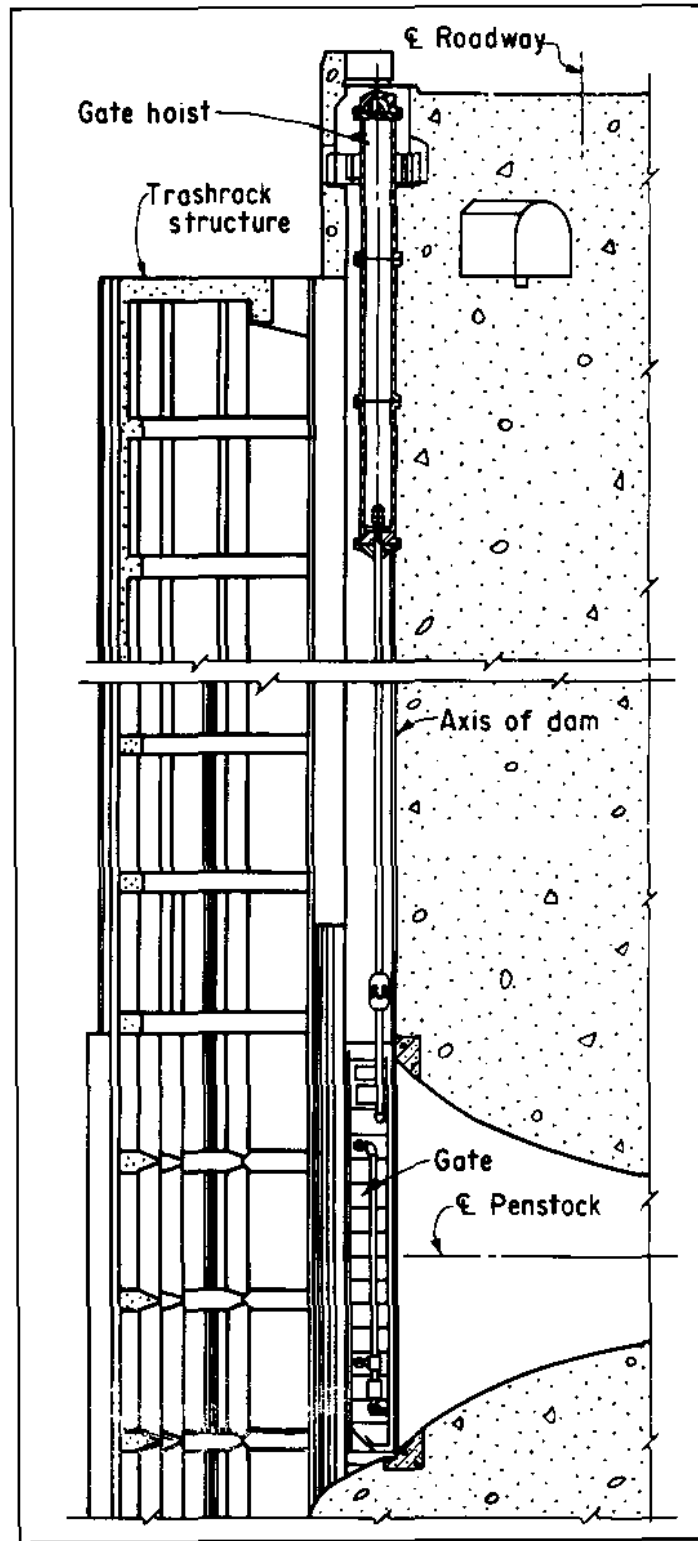

Figure 3-11. Typical fixed wheel gate installation at upstream face of dam (USBR)

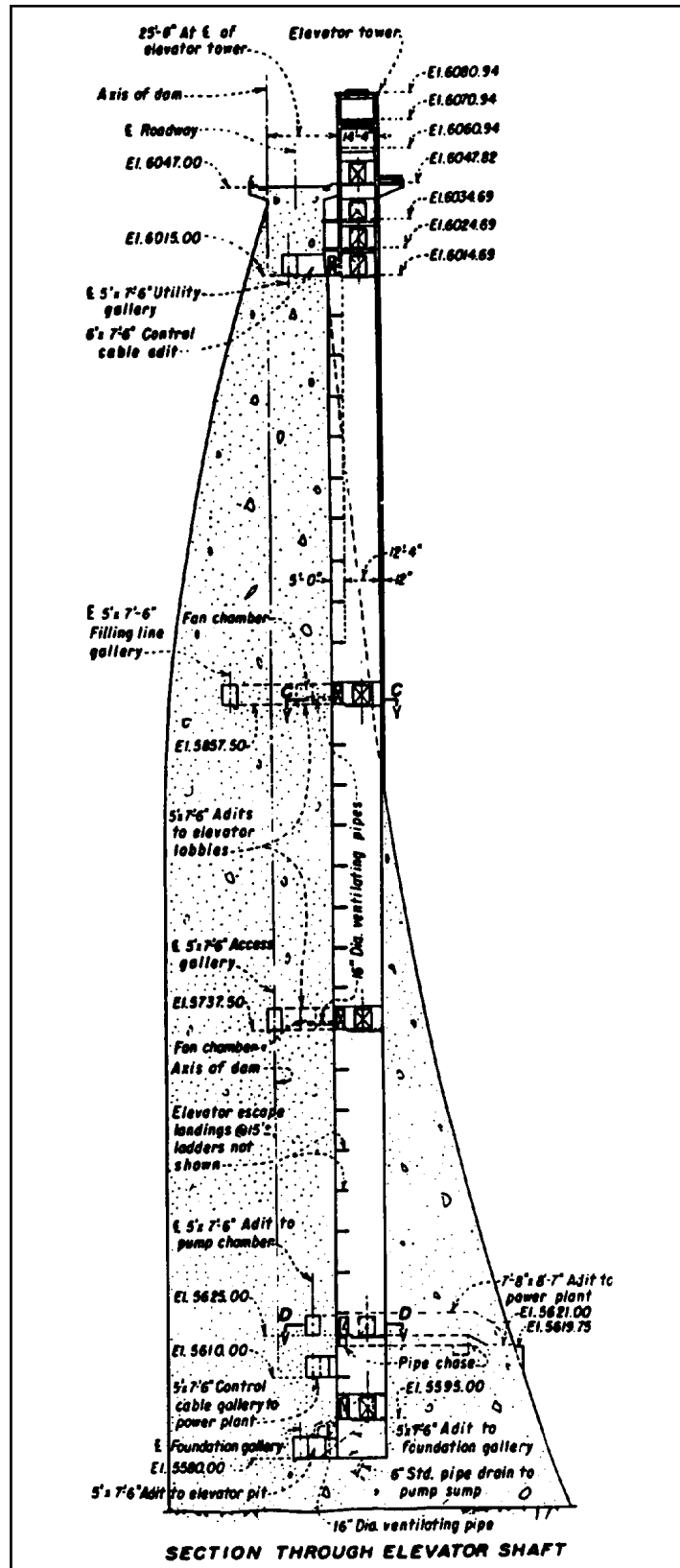

Figure 3-12. Structural and architectural layout of elevator shaft and tower in Flaming Gorge Dam (USBR) (Continued)

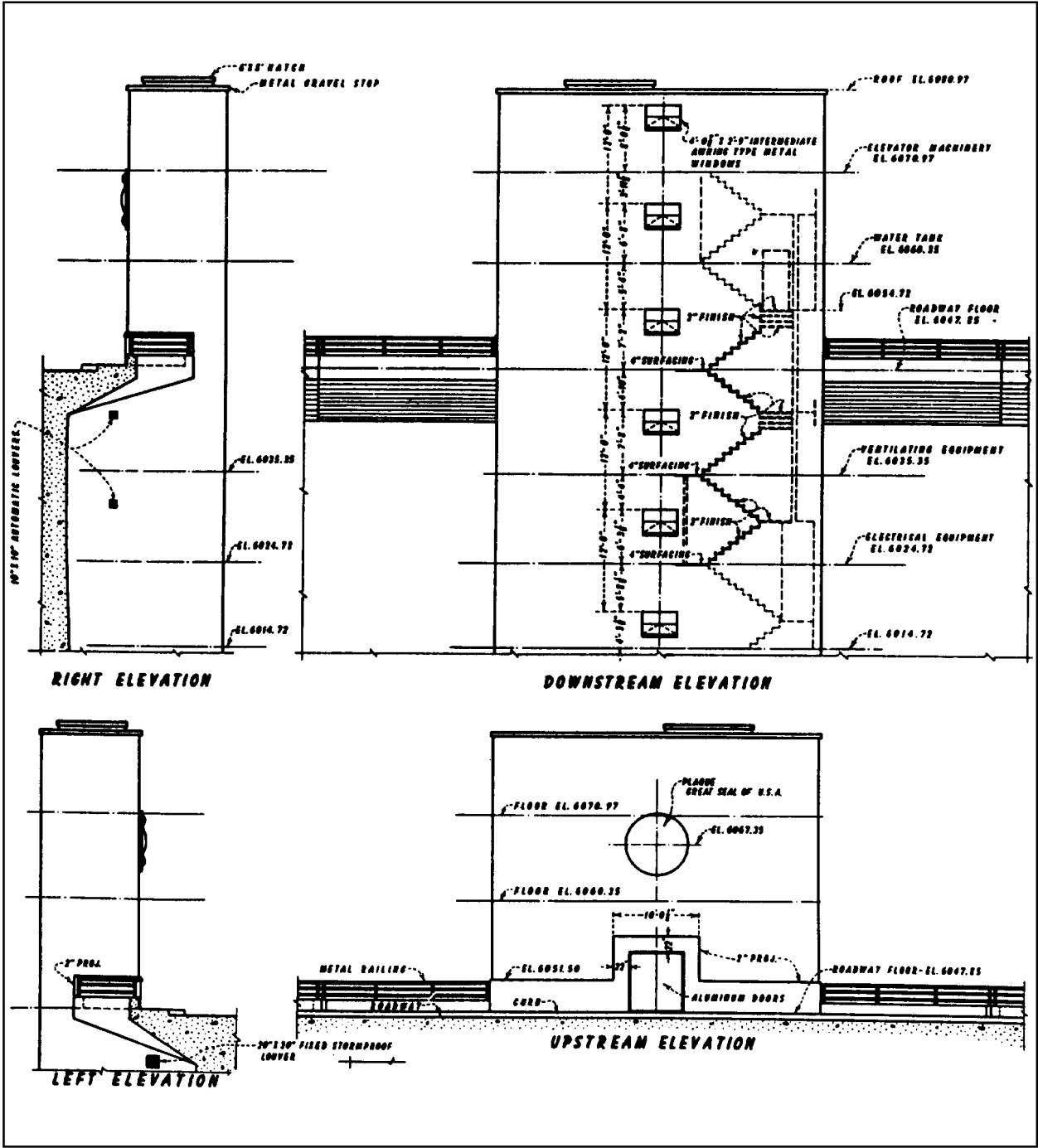

Figure 3-12. (Concluded)

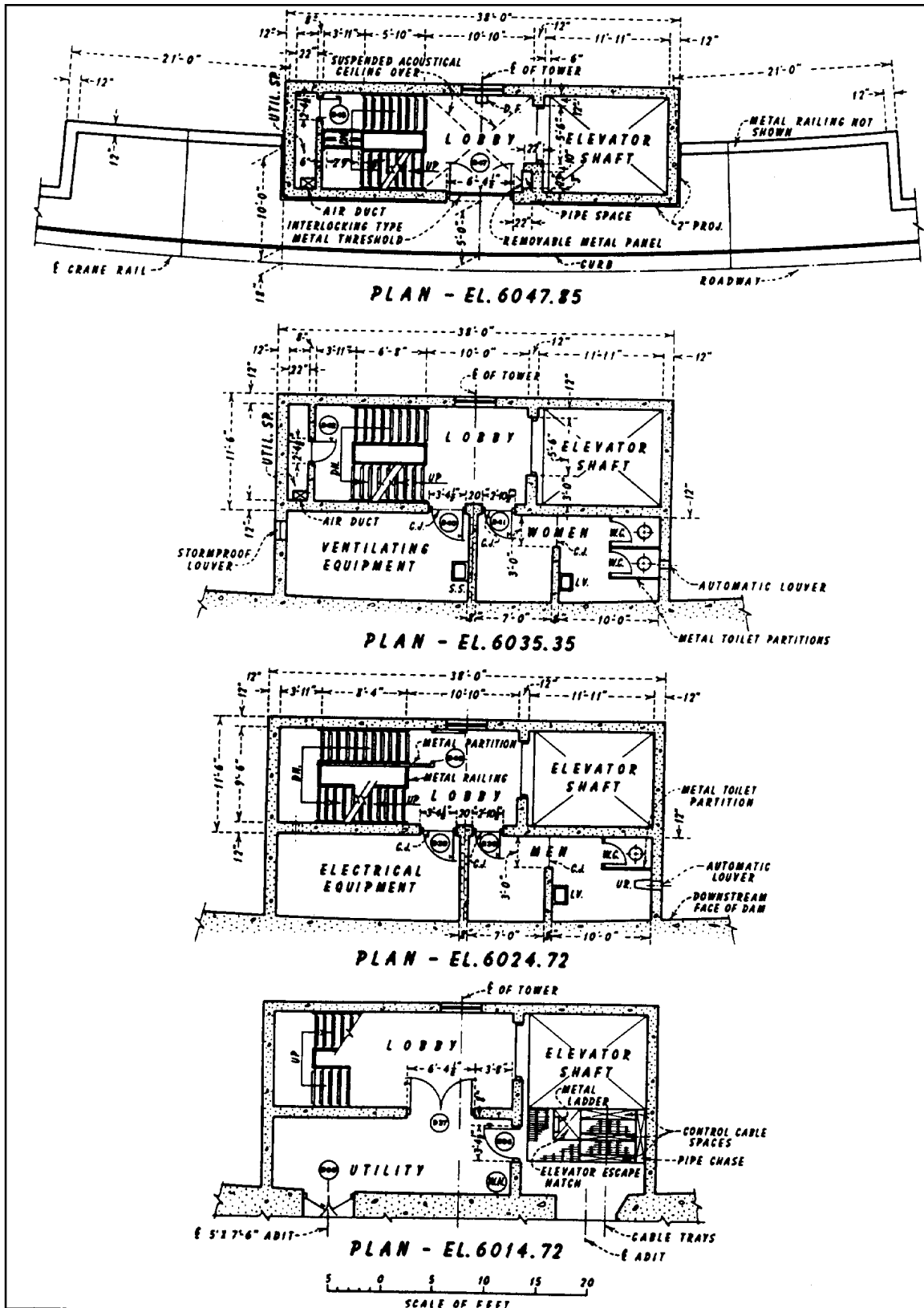

Figure 3-13. Details of layout of elevator shaft and tower in Flaming Gorge Dam (USBR)

b. Bridges. Bridges may be required on the top of the dam to carry a highway over the spillway or to provide roadway access to the top of the dam at some point other than its end. Design criteria for highway bridges usually conform to the standard specifications adopted by the American Association of State Highway Officials and are modified to satisfy local conditions and any particular requirement of the project. Bridges, regardless of how heavy, whether of steel or concrete, or with fixed or pinned connections, are not considered sufficiently strong to transfer arch loads from one mass concrete pier to the other.

c. Top of the Dam. The top of the dam may contain a highway, maintenance road, or walkway such as shown in Figure 3-14. If a roadway is to be built across the dam, the normal top of the dam can be widened with corbels which cantilever the road or walkway out from the upstream or downstream faces of the dam. The width of the roadway on the top of the dam is dependent upon the type and size of roadway, sidewalks, and maintenance and operation space needed to accomplish the tasks required. Parapets or handrails are required both upstream and downstream on the top of the dam and should be designed to meet safety requirements. The minimum height of parapet above the sidewalk should be 3 feet 6 inches. A solid upstream parapet may be used to increase the freeboard if additional height is needed. The design of the reinforcement for the top of the dam involves determining the amount of reinforcement required for the live and dead loads on the roadway cantilevers and any temperature stresses which may develop. Temperature reinforcement required at the top of the dam is dependent upon the configuration and size of the area and the temperature condition which may occur at the site. After the temperature distributions are determined by studies, the temperature stresses that occur can be analyzed by use of the FEM. If a roadway width greater than the theoretical crest thickness of the dam is required, the additional horizontal stiffness of the roadway section may interfere with the arch actions at the top of the dam. To prevent such interference, horizontal contraction joints should be provided in the roadway section with appropriate joint material. The contraction joints should begin at the edge of the roadway and extend to the theoretical limits of the dam face. Live loads such as hoists, cranes, stoplogs, and trucks are not added to the vertical loads when analyzing the arch dam; these loads may weigh less than 10 cubic yards (cu yd) of concrete, an insignificant amount in a concrete dam.

d. Galleries and Adits. A gallery is a formed opening within the dam to provide access into or through the dam. Galleries are either transverse or longitudinal and may be horizontal or on a slope as shown in Figure 3-15. Galleries connecting other galleries or connecting with other features such as power plants, elevators, and pump chambers are called adits. Some of the more common uses or purposes of galleries are to provide a drainageway for water percolating through the upstream face or seeping through the foundation, space for drilling and grouting the foundation, space for headers and equipment used in artificially cooling the concrete blocks and for grouting contraction joints, access to the interior of the structure for observing its behavior, access to and room for mechanical and electrical equipment, access through the dam for control cables and/or power cables, and access routes for visitors, as shown in Figure 3-16. The location and size of a gallery will depend on its intended use or purpose. The size is normally 5 feet wide by 7.5 feet high. In small, thin arch dams, galleries are not used where the radial thickness is less than five times the width. This gives the cantilevers sufficient section

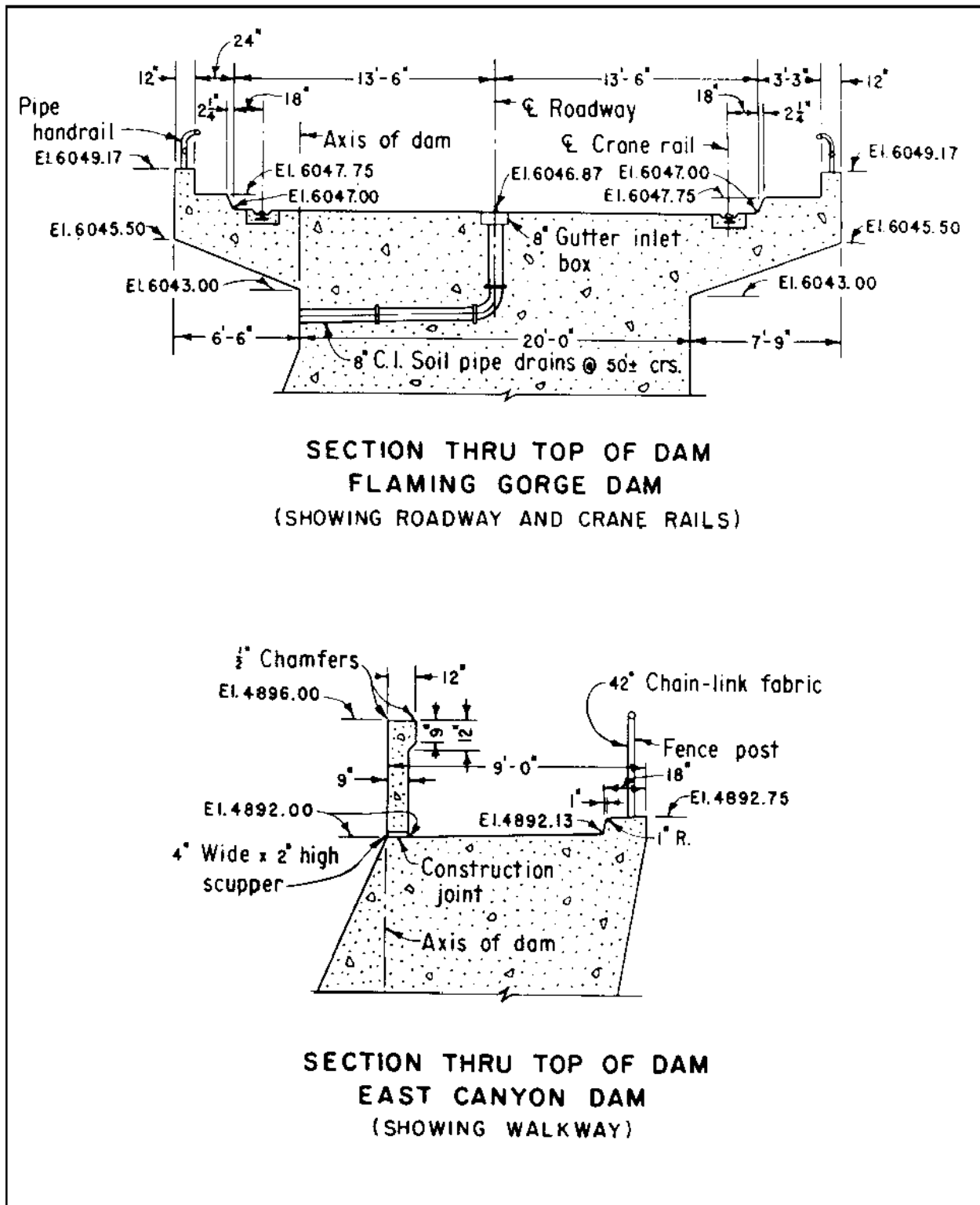

Figure 3-14. Typical sections at top of an arch dam (USBR)

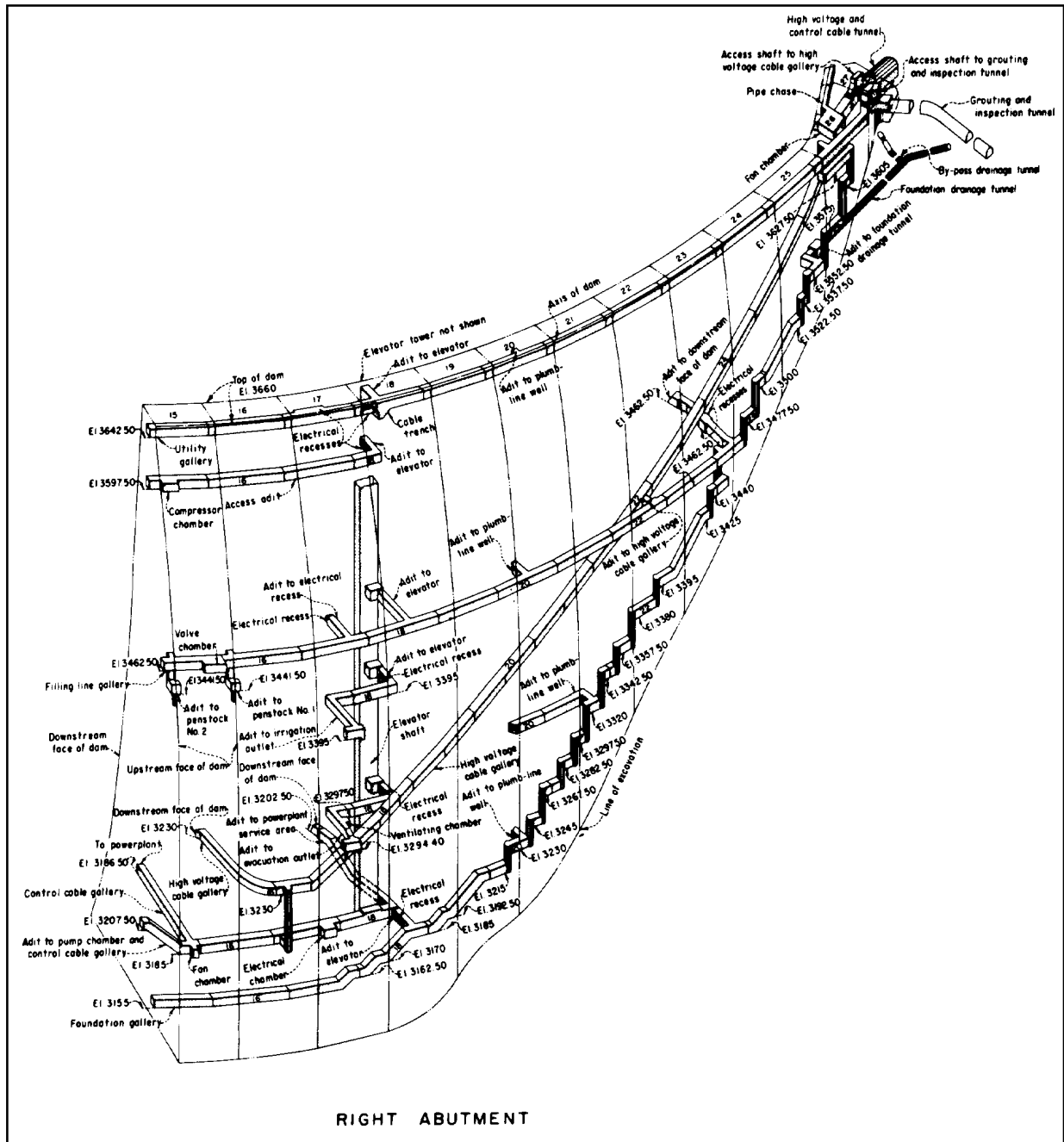

Figure 3-15. Gallery system in right side of Yellowtail Dam (USBR)

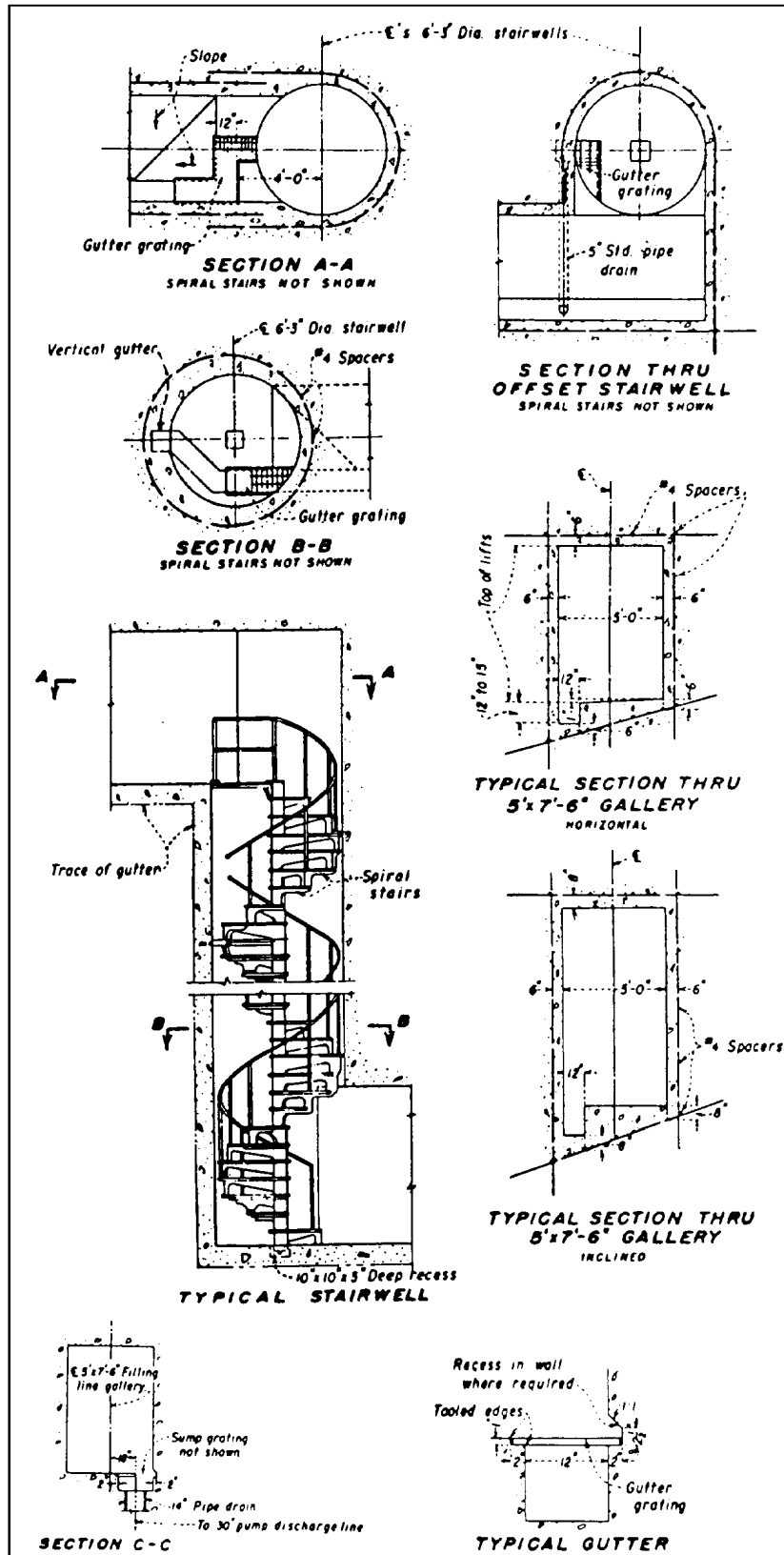

Figure 3-16. (Concluded)

modulus to perform as intended. A distance of two diameters on either side of the gallery provides sufficient thickness to mitigate the high vertical stresses that concentrate along the gallery walls and to develop the necessary section modulus. In thin arch dams, access galleries can be designed smaller than 5 feet wide such as an elliptically shaped gallery 2 feet wide by 8 feet high that contains lighting across the top, a noncorrosive grating for pedestrian traffic, and provides space for drainage.

3-5. Restitution Concrete. Because of topographical and geological features, all damsites are nonsymmetrical and have an irregular profile; however, during the design of an arch dam, a significant saving in keyway excavation may be achieved by building up certain regions of the footprint with mass concrete to form an artificial foundation and provide a smooth perimeter for the dam. At a particular site, restitution concrete may be local "dental" concrete, the more extensive "pad," or "thrust blocks" along the crest. In each case, the longitudinal and transverse shape is different for different design purposes, and, accordingly, restitution concrete may be extensive upstream, downstream, or around the perimeter of the dam. In keeping with the concept of efficiency and economy, each arch dam design should be made as geometrically simple as possible; the optimum is a symmetrical design. With this in mind, restitution concrete can be added to the foundation to smooth the profile and make the site more symmetrical, and/or provide a better distribution of stresses to the foundation. Restitution concrete is added to the rock contact either before or during construction; the concrete mix is the same mass concrete used to construct the dam.

a. Dental Concrete. Dental concrete is used to improve local geological or topographical discontinuities that might adversely affect stability or deformation as shown in Figure 3-17. Discontinuities include joints, seams, faults, and shattered or inferior rock uncovered during exploratory drilling or final excavation that make complete removal impractical. The necessary amount of concrete replacement in these weak geological zones is usually determined from finite element analyses in which geologic properties, geometric limits, and internal and/or external loads are defined. For relatively homogenous rock foundations with only nominal faulting or shearing, the following approximate formulas can be used for determining the depth of dental treatment:

$$d = 0.002bH + 5 \text{ for } H \text{ greater than or equal to } 150 \text{ feet}$$
$$d = 0.3b + 5 \text{ for } H \text{ less than } 150 \text{ feet}$$

where

H = height of dam above general foundation level, in feet
b = width of weak zone, in feet, and
d = depth of excavation of weak zone below surface of adjoining sound rock, in feet

b. Pad. A concrete pad is added to the foundation to smooth the arch dam profile, to make the site more symmetrical, to reduce excavation, and/or to provide a better distribution of stresses on the foundation. To smooth the profile, pad concrete is placed around the arch dam perimeter, made irregular due to topography or geology, such as in box canyons or bridging low-strength rock types. Such treatment is not unique to the United States. The

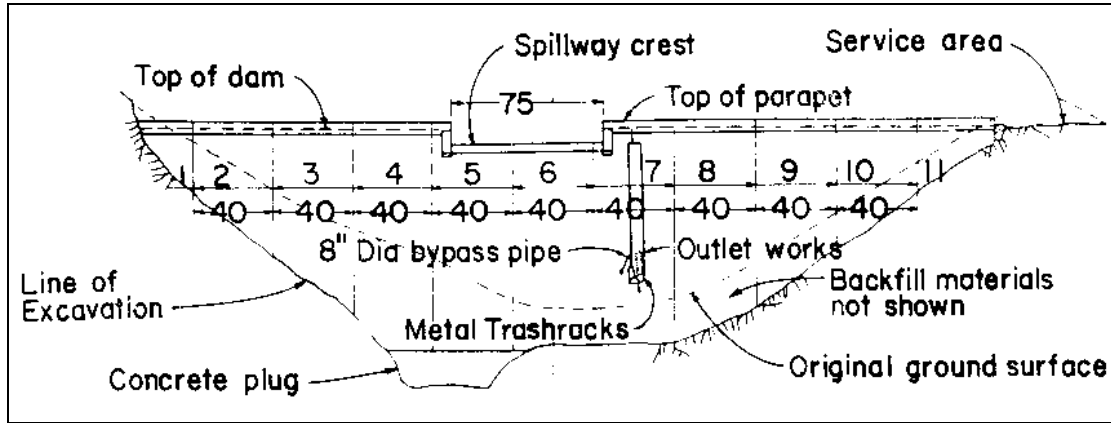

Figure 3-17. Upstream elevation of Wildhorse Dam. Note dental concrete (concrete plug) (USBR)

additional thickness along the abutment is called a socle in Portugal. Arch dams in nonsymmetrical sites can be designed more efficiently by constructing a pad along the abutment of the long side. Reduced excavation is accomplished by filling in a single but prominent depression with a pad rather than excavating the entire abutment to smooth the profile. The pad, because it is analogous to a spread footing, will reduce pressure and deformation, especially on weak rock.

(1) The pad in cross section has the geometric shape of a trapezoid. The top surface of the trapezoid then becomes the profile for the arch dam. To develop a smooth profile for the arch dam, the trapezoidal height will vary along the contact. The size of the footing is a function of the arch abutment thickness. At the contact of the arch and the pad, the pad thickness is greater than the arch thickness by a nominal amount of 5 feet, or greater, as determined from two-dimensional (2-D) finite element studies. The extra concrete thickness, analogous to a berm, is constructed on both faces. This berm provides geometric and structural delineation between the dam and the pad. Below the berm, the pad slopes according to the canyon profile. The slope is described in a vertical radial plane. In a wide valley where gravity action is predominant, a nominal slope of 1:1 is suggested on the downstream side. In narrow canyons, where arch action is the major structural resistance, the slope may be steeper. The upstream face may be sloped or vertical depending on the loading combinations. For example, reservoir drawdown during the summer coupled with high temperatures will cause upstream deflection and corresponding larger compressive stresses along the heel. Thus, to simulate the abutment the upstream face should be sloped upstream. Otherwise, a vertical or near vertical face will suffice. Normally, a constant slope will be sufficient, both upstream and downstream. A pad should be used to fill depressions in the profile that would otherwise cause overexcavation and to smooth the profile or to improve the site symmetry.

(2) The appropriate shape should be evaluated with horizontal and vertical sections at points on the berm. Classical shallow beam structural analyses are not applicable because the pad is not a shallow beam. For completeness, check the shape for stress and stability at several representative locations around the perimeter. Loads to be considered in structural design of the pad include moment, thrust, and shear from the arch dam, as well as the

reservoir pressure. The load on the massive footing for a cantilever should also include its own weight. Two-dimensional FEMs are ideally suited to shape and analyze the various loads and load combinations. Reshaping and reanalysis then can also be easily accomplished.

(3) Construction of the pad may occur before or during construction of the arch dam. For example, if the foundation rock is very hard and/or massive, higher-strength concrete can be placed months before the arch is constructed. In this way, the pad concrete has time to cure and perhaps more closely approximate the actual foundation conditions. Or, as with the socle where a slightly different geometric shape is required at the arch abutment than at the top of the footing, the more efficient method is to construct the footing monolithic with the arch dam, in blocks, and lifts. Special forming details are necessary at the berm; above and below the berm, normal slip forming is sufficient. Artificial cooling and contraction joint grouting is recommended to avoid radial crack propagation into the dam from future shrinkage and settlement. As with the arch dam, no reinforcing steel is necessary in the foundation shaping concrete. Longitudinal contraction joints should be avoided to prevent possible tangential crack propagation into the dam. If, during construction, a significant crack should appear in the foundation or dam concrete and continue to run through successive lifts, a proven remedy is to provide a mat of reinforcing steel on the next lift of the block with the crack but not necessarily across contraction joints.

c. Thrust Blocks. Thrust blocks are another type of restitution concrete. These components are constructed of mass concrete on foundation rock and form an extension of the arch dam crest. They are particularly useful in sites with steep side slopes extending about three-fourths the distance to the top and then rapidly flattening. In such a site, significantly additional water storage can be achieved by thrust blocks without a proportional increase in costs. For small and short extensions beyond the neat line, the cross-sectional shape can simply be a continuation of arch dam geometry as shown on Figure 3-18; thus, for some distance past the neat line, arch action will resist some of the applied load. Beyond that distance, cantilever action resists the water load and must be stable as with a gravity dam. The extension may be a straight tangent or curved as dictated by the topography, as shown in Figure 3-19. If curved, the applied load is distributed horizontally and vertically, in which case the section can be thinner than a straight gravity section. If straight, the tangent section will exhibit some horizontal beam action, but conservatively, none should be assumed unless artificial cooling and contraction joint grouting are utilized. For cases where the thrust block sections are shaped as gravity dams, the analysis approximates the thrust block stiffness by reducing the foundation modulus on those arches connected to the thrust blocks. A reasonable value for the crest abutments is 100 kips per square inch (ksi). The abutment/foundation modulus should be linearly interpolated at elevations between the crest and the first lower arch abutting on rock. The reliability of this assumption should be tested by performing parametric studies with several different assumed rock moduli, comparing arch and cantilever stresses on each face, and noting the stress differences in the lower half of the dam. In general, stress differences should be localized around the thrust blocks.

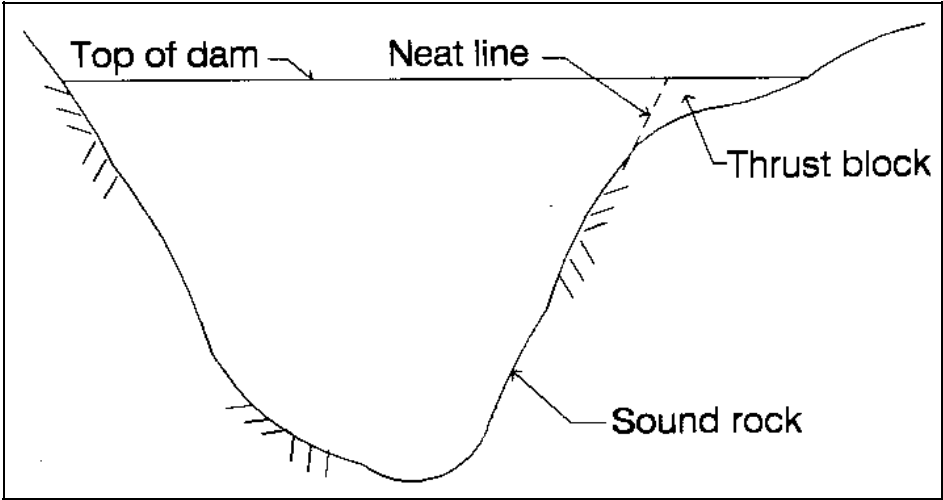

Figure 3-18. Schematic elevation of simple thrust block as a right abutment extension of an arch dam

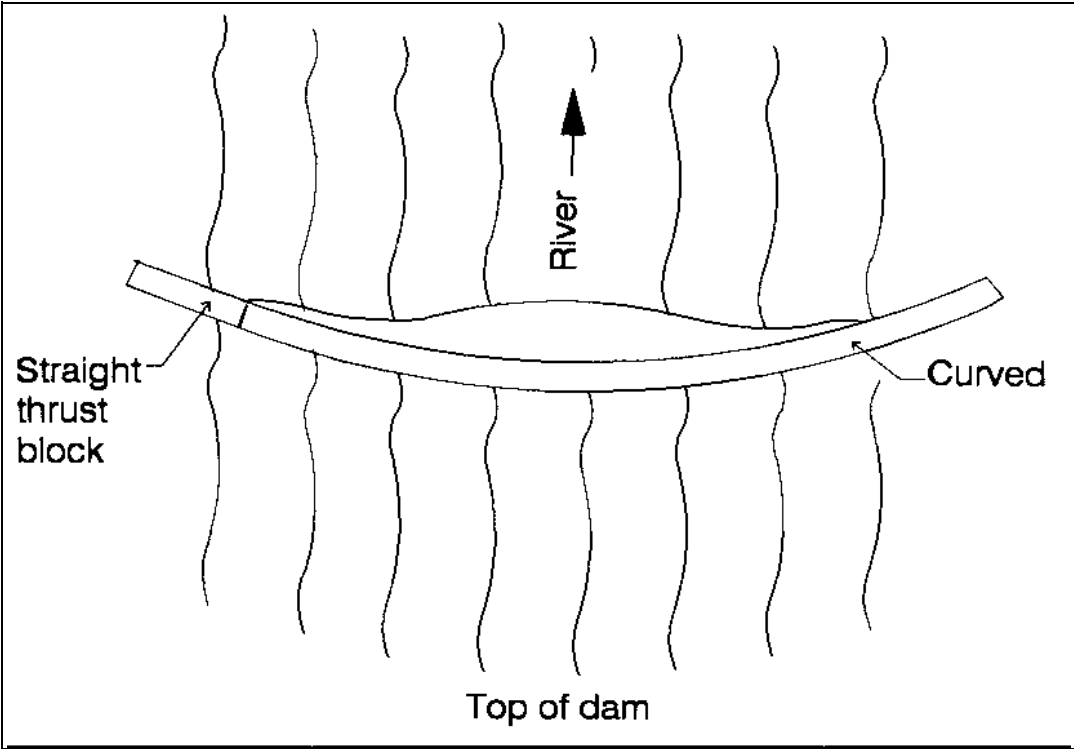

Figure 3-19. Schematic plan of straight and curved thrust blocks and water barrier

CHAPTER 4

LOADING COMBINATIONS

4-1. General. Arch dams are designed for the same loads as other dams with the exception of the temperature load which has a significant influence in arch dam design as compared to gravity dam design. The loads for which an arch dam must be designed are as follows:

a. Dead Load. Dead load is due to the weight of the concrete plus the appurtenant structures. The unit weight of the concrete is based on the laboratory test results of the mix design; however, for preliminary design a unit weight of 150 pounds per cubic foot (pcf) can be used. The weight of the appurtenances is normally negligible compared to the weight of the dam and may be neglected in static design. In the case of a massive, overflow-ogee-weir spillway or massive outlet works, it may be prudent to include these structures in the finite element model used for static and dynamic analyses.

b. Temperature Load. The temperature load results from the differences between the closure (grouting) temperature and concrete temperatures in the dam during its operation. The closure temperature is the concrete temperature at the time of grouting of the contraction joints. This temperature, which in effect is the datum for all the future temperature loading, is determined from the results of the stress analyses of the dam under different loading combinations. Another way to describe the closure temperature may be to consider it as a stress-free temperature (only for dams that are grouted). For example, if an arch dam is grouted at 55 °F, there will not be any stresses due to the temperature loading in the dam as long as the operating temperature of the dam remains at 55 °F. However, once the concrete temperature exceeds 55 °F, the resulting positive temperature loading will cause compressive stresses in the arches which in turn result in deflection into the reservoir. The opposite is true when in the winter the concrete temperature goes below 55 °F. In this case, the arches will experience tension which would cause deflection downstream. The selection of the closure temperature usually involves a compromise between the ideal stress distribution in the dam and practical considerations such as the feasibility of achieving the desired closure temperature. The closure (grouting) temperature is one of the most important construction parameters in arch dams because once the monolith joints are grouted, the structure is assumed to become monolithic and the arch action begins. Following the determination of the closure temperature, the individual blocks should be sized to prevent cracking during construction and to provide satisfactory contraction joint opening for grouting.

(1) The following hypothetical example may help explain the role of the temperature load - and that of the closure temperature - in arch dams. Consider an arch dam to be designed for a site with uniform air and water temperatures of 65 °F, i.e., no seasonal cyclic temperature changes in the air and reservoir. Neglecting the effect of the solar radiation, the operational concrete temperature is then the same as that of the air and reservoir: 65 °F. It is further assumed that there is no fluctuation in the reservoir level, so the dam is subjected to the full reservoir load at all times. Since the hydrostatic load in this example produces large tensile stresses along the heel of the cantilevers, the design objective would be to counteract the

tensile stresses by introducing a large temperature load which would cause the cantilevers to deflect into the reservoir. This objective can be accomplished by choosing the lowest possible closure temperature - say 35 °F - which would result in a 30-°F (65 °F - 35 °F) temperature load.

(2) As seen in the simplified example, the closure temperature is a design parameter which, within certain constraints, can be selected to help achieve desirable stress distribution in arch dams; thus, it has an effect on the geometry, i.e., the vertical and horizontal curvatures of the dam. Figure 4-1 shows the relationship between the closure temperature and the operating concrete temperatures which comprise the temperature loading as used for the Portugues Dam, Ponce, Puerto Rico.

c. Hydrostatic Load. The reservoir load is based on a study of the reservoir operation. Unlike a gravity dam for which higher reservoir levels would result in more critical cases, an arch dam may experience higher tensile stresses (on the downstream face) under low reservoir elevations. Studies of the reservoir operation should include the frequency of occurrence and duration of reservoir stages and the time of the year in which different water stages occur. These data are used in conjunction with the appropriate temperature information as shown in Figure 4-2 (see Chapter 8 for temperature study).

d. Earthquake Load. For arch dams in earthquake zones, two levels of earthquakes should be used. These are the Operational Basis Earthquake (OBE) and the Maximum Design Earthquake (MDE). OBE is defined as a ground motion having a 50 percent chance of exceedance in 100 years. The dam is expected to respond elastically under the OBE (assuming continuous monolithic action along the entire length of the dam). MDE is the maximum level of ground motion for which the arch dam should be analyzed, and it is usually equated to the maximum credible earthquake (MCE). MCE is defined as the largest reasonable possible earthquake that could occur along a recognized fault or within a particular seismic source. If dam failure poses no hazard to life, an MDE lower than MCE level of motion may be specified. Under the MDE, the dam is allowed to respond nonlinearly and incur significant damage, but without a catastrophic failure in terms of loss of life or economics. Close coordination should be maintained with HQUSACE (CECW-ED) during the selection process of earthquake ground motions for arch dams.

e. Miscellaneous Loads. Where applicable, loads due to ice and silt should be included in the design of an arch dam. In the absence of design data, an ice load of 5 kips per linear foot of contact along the axis may be assumed. The silt load should be determined from the results of the sedimentation study for the dam. If these loads are small compared to the other loads, they can be neglected at the discretion of the designer.

4-2. Loading Combinations. Arch dams are designed for two groups of loading combinations. The first group combines all the static loads and the second group takes into account the effects of earthquake. Depending on the probability of occurrence of the cases in each group, they are labeled as Usual, Unusual, and Extreme loading cases. It must be stressed that each dam is a unique structure, and there are many factors to consider when deciding on the loading combinations. Factors such as climatic conditions, purpose of reservoir, spillway usage, operation of reservoir (as designed and anticipated

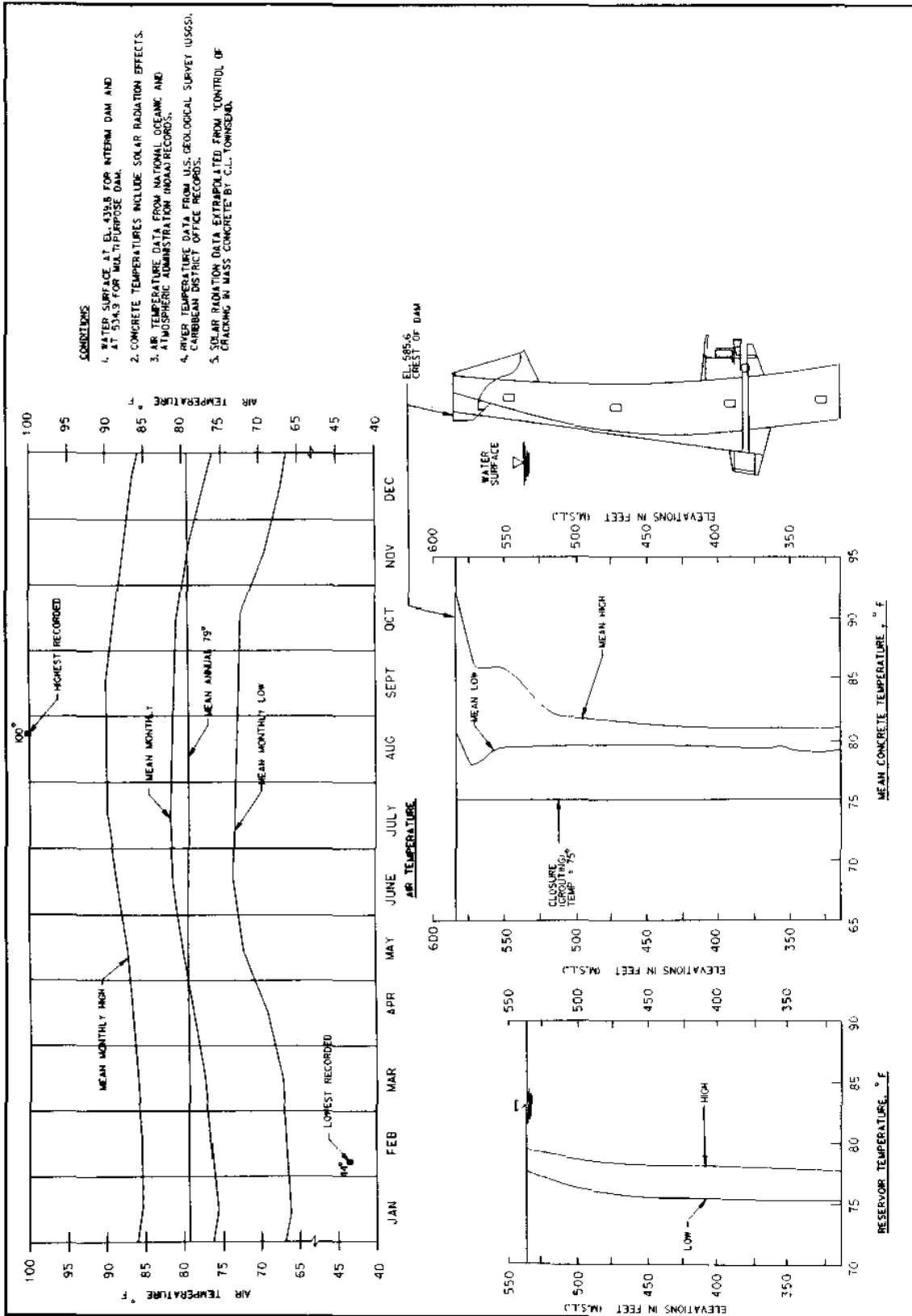

Figure 4-1. Mean concrete temperature

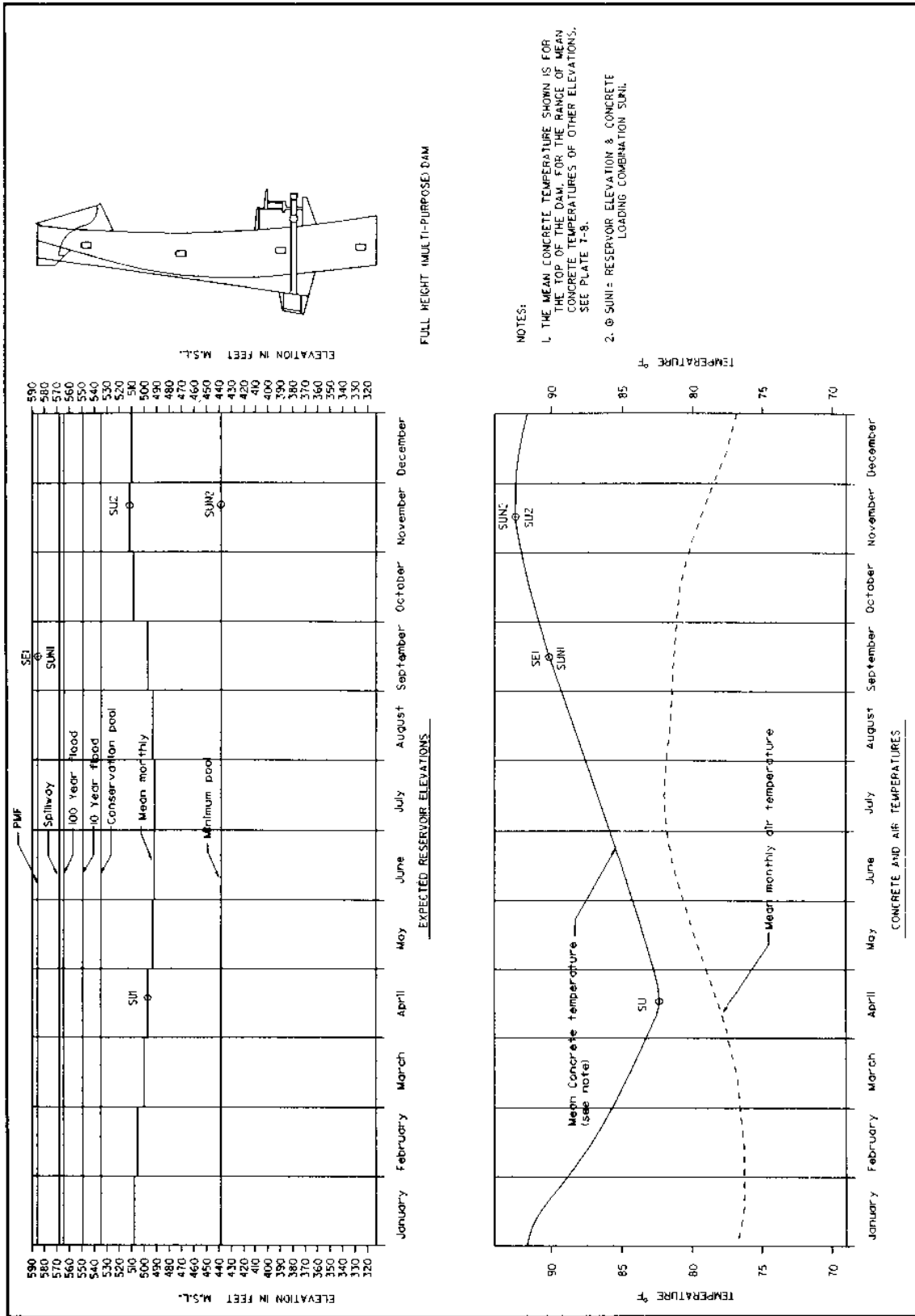

Figure 4-2. Reservoir elevations, mean concrete and air temperatures

actual), and location have direct bearing on the approach taken in determining and combining the loads and the classification of the loading combinations. Figure 4-2 illustrates the selection of the loading combinations for the Portugues Dam, Ponce, Puerto Rico. Tables 4-1 and 4-2 present the static and dynamic loading combinations which must be investigated as a minimum. The allowables and factors of safety are discussed in Chapter 11.

4-3. Selection of Load Cases for Various Phases of Design.

a. Reconnaissance. No detailed design is required during reconnaissance studies. The study in this phase is limited to the volume computation as discussed in Chapter 6 for the purpose of comparative studies with other types of dams. Of course, it is assumed that a suitable site exists for an arch dam based on the geometry of the site and the type of foundation material.

b. Feasibility. Limited design work should be accomplished during this phase of the design. From the results of the basic hydrology study, the preliminary loading combinations should be established and the temperature loading on the dam should be estimated from a study of similar projects. Basic dimensions of the dam should be determined using the procedure discussed in Chapter 6 to the extent necessary to obtain the data required for stress analysis. Only a static design analysis using two opposing loading combinations is required at this time. Based on the results of the stress analysis, a number of trials and adjustments in the geometry may be required to obtain acceptable stress distribution throughout the dam.

c. Preconstruction Engineering and Design (PED). Detailed design and analysis of the dam are to be performed during the PED phase with the results presented in various Feature Design Memoranda (FDM). The load cases must be established at the earliest stages of this phase. The temperature loading needs to be determined from the results of the temperature study which is initiated at beginning of PED, and the final reservoir elevations, their durations, and the time of year in which these reservoir stages are expected must be determined in order to develop the loading combinations as shown in Figure 4-2. The selection of the loads for the loading combinations should be given careful consideration. As an example related to Figure 4-2, it is considered prudent to select the middle of September for the probable maximum flood (PMF), although theoretically the PMF could happen at any time during the 12-month cycle. The rationale is that it is more likely for the PMF to occur in the middle of the wet season - for this particular site - than any other time. The significance of the above example is in the "concrete temperature occurring at that time," in accordance with case SE1, Table 4-1. If the PMF is assumed to happen in April when the mean concrete temperature is at its lowest, there would be a very small temperature on the dam (as shown by the closure temperature and the mean low concrete curve in Figure 4-1) which would result in too much conservatism. The opposite would be true if the PMF is assumed in November.

TABLE 4-1

Static Loading Combinations

Static Usual (SU)

SU1: Minimum usual concrete temperature.
Reservoir elevation occurring at that time. Dead Load.

SU2: Maximum usual concrete temperature.
Reservoir elevation occurring at that time. Dead Load.

SU3: Normal Operating Reservoir Condition.
Concrete temperature occurring at that time. Dead Load.

Static Unusual (SUN)

SUN1: Reservoir at spillway crest elevation.
Concrete temperature at that time. Dead Load.

SUN2: Minimum design reservoir elevation.
Concrete temperature occurring at that time. Dead Load.

SUN3: End of construction condition. Structure completed, empty
reservoir. Temperature Load.

Static Extreme (SE)

SE1: Reservoir at Probable Maximum Flood (PMF) elevation. Concrete
temperature occurring at that time. Dead Load.

TABLE 4-2

Dynamic Loading Combinations¹

Dynamic Unusual (DUN)

DUN1: Operating Basis Earthquake (OBE) plus static load case SU3.

DUN2: OBE plus static load case SUN3.

Dynamic Extreme (DE)

DE1: Maximum Design Earthquake (MDE) plus static load case SU3.

¹ See Chapter 11 for guidelines for treatment of dynamic response of the dam.

CHAPTER 5

DESIGN LAYOUT

5-1. General Design Process. Design of an arch dam involves the layout of a tentative shape for the structure, preliminary static stress analysis of this layout, evaluation of the stress results, and refinement of the arch dam shape. Several iterations through the design process are necessary to produce a satisfactory design which exhibits stress levels within an acceptable range. The final dam layout that evolves from the iterative design process is then statically analyzed by the finite element method. "Static analysis" refers to the analysis performed after a layout has been achieved through the design process. "Preliminary stress analysis" refers to the method of analysis performed during the iterative design process to investigate the state of stress for tentative layouts. The computer program ADSAS (Arch Dam Stress Analysis System) (USBR 1975) is used for the preliminary stress analysis and is discussed in more detail in paragraph 5-5. GDAP (Graphics-based Dam Analysis Program) (Ghanaat 1993a) is a special purpose finite element program, specifically developed for the analysis of arch dams. GDAP is discussed in more detail in Chapter 6. Preliminary stress analyses are relatively quick and inexpensive to run compared to the static analysis which is more detailed, both in its input as well as its output. Although past history has shown that results from both procedures are comparable, an arch dam layout that reaches the static analysis phase may still require refinement, pending evaluation of static analysis results.

5-2. Levels of Design. There are three phases of the life cycle process of a project for which layouts are developed; reconnaissance, feasibility, and PED. The degree of refinement for a layout is determined by the phase for which the design is developed.

a. Reconnaissance Phase. Of the three phases mentioned in paragraph 5-2, the least amount of engineering design effort will be expended in the reconnaissance phase. Examination of existing topographic maps in conjunction with site visits should result in the selection of several potential sites. When selecting sites during the reconnaissance phase, emphasis should be placed on site suitability, i.e., sites with adequate canyon profiles and foundation characteristics.

(1) Reconnaissance level layouts for different sites can be produced quickly from the empirical equations discussed in paragraph 5-4. Empirical equations to determine concrete quantities from these layouts are presented in paragraph 5-6. Alternatively, the structural engineer may elect to base reconnaissance level layouts on previous designs which are similar in height, shape of profile, loading configuration, and for which stresses are satisfactory. However, it should be pointed out that most arch dams which have been constructed to date are single-center. Because the technology exists today which simplifies the layout of more efficient, multicentered arch dams, most dams that will be designed in the future will be of the multicentered variety. Therefore, basing a tentative, reconnaissance level layout on an existing single-center arch dam may result in conservative estimates of concrete quantity.

(2) Topographic maps or quad sheets that cover an adequate reach of river provide sufficient engineering data for this phase. From this region, one or more potential sites are selected. The areas around these sites are enlarged to 1:50 or 1:100 scale drawings. These enlarged topographic sheets and the empirical formulas in paragraphs 5-4 and 5-6 will produce the geometry and concrete volume for a reconnaissance level layout.

b. Feasibility Phase. Designs during the feasibility phase are used in the selection of the final site location and as a basis for establishing the baseline cost estimate. Feasibility designs are made in greater detail than reconnaissance designs since a closer approximation to final design is required.

(1) As a result of the work performed during the reconnaissance phase, the structural engineer should now have available one or more potential sites to evaluate during the feasibility phase. Using the iterative layout process discussed in paragraph 5-4, tentative designs will be plotted, analyzed, evaluated, and refined for each potential site until a proposed layout evolves that provides the best balance between minimal concrete volume and minimum stress level. Load cases to be analyzed during the feasibility phase are discussed in Chapter 4. From the sites evaluated and their respective layouts, the structural engineer will select the most economical design, and this will be carried into the PED phase. A baseline cost estimate will be developed for the final layout.

(2) The iterative layout process requires a certain amount of topographic and subsurface information. However, these data should be obtained with the knowledge that funds for feasibility studies are limited. Aerial topographic surveys of potential sites are required as well as a few core borings to determine an approximation of the depth of overburden. Loading conditions, as discussed in Chapter 4, should be defined.

c. Preconstruction Engineering and Design. Design work during this phase is presented in the FDM which is also used to develop contract plans and specifications. The final design layout produced during the feasibility stage is subjected to further static and dynamic analysis during the PED phase. Any remaining load cases that have not been analyzed during the feasibility phase should be analyzed and evaluated at this time. This may require that any missing data (operating conditions, thermal loads, etc.) be finalized prior to the analysis. If results from all of the preliminary stress analysis load cases indicate the final layout is acceptable, design may proceed to the static FEM analysis. Otherwise, the layout requires refinement.

5-3. Procedure. A single-center, variable-thickness, arch dam is assumed for the purpose of discussion. The procedure for laying out other types of arch dams differs only in the way the arches are defined.

5-4. Manual Layout. Although the term "Layout of an arch dam" implies a single procedure, layout actually consists of an iterative, refining process involving several layouts, each successive one improving on the previous. The first of these layouts require the structural designer to assume some initial parameters which will define the shape of the arch dam. As stated in paragraph 5-2a(2), a 1:50- or 1:100-scale topographic map of a dam site is required before layout begins. If possible, the contours should represent

topography of foundation rock; however, in most instances, only surface topography is available at this stage of design. The structural designer must then assume a reasonable amount of overburden, based on core borings or sound judgement, to produce a topo sheet that reflects the excavated foundation.

a. Axis. The crest elevation required for the dam should be known at this time from hydrologic data and this, in conjunction with the elevation of the streambed (or assumed foundation elevation) at the general location of the dam, determines the dam height, H (feet). The structural designer should select a value for the radius of the dam axis (R_{AXIS}). For the initial layout where the engineer would have no reasonable estimate for the value of R_{AXIS} from a previous layout, the following empirical relationship has been derived by the USBR (Boggs 1977) based on historical data from existing dams:

$$R_{\text{AXIS}} = 0.6 L_1 \quad (5-1)$$

where L_1 represents the straight line distance (in feet) measured (from the topo sheet) between abutments excavated to assumed foundation rock at the crest elevation. At this time, the structural designer should also measure the straight line distance between abutments excavated to assumed foundation rock at an elevation (el)¹ 0.15H above the base (L_2). See example in Figure 5-1. These three variables (H , L_1 , and L_2) are also used to define an initial shape for the crown cantilever (paragraph 5-4c).

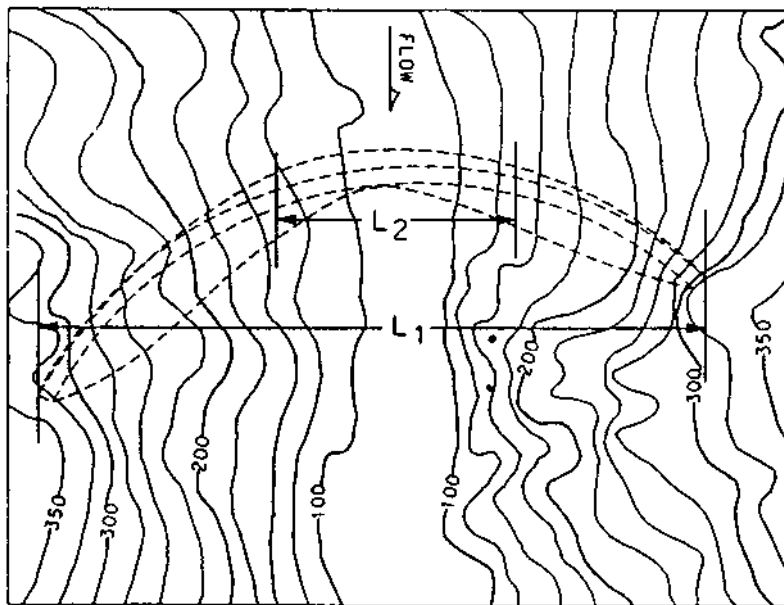

Figure 5-1. Determination of empirical values L_1 and L_2

¹ All elevations (el) cited herein are in feet referred to the National Geodetic Vertical Datum (NGVD).

(1) On a sheet of vellum or transparent paper, an arc is drawn with a radius equal to R_{AXIS} at the same scale as the topo sheet. This arc represents the axis of the dam. The vellum is then overlaid and positioned on the topo sheet so as to produce an optimum position and location for the dam crest; for this position, the angle of incidence to the topo contour at the crest elevation (β in Figure 2-1) should be approximately equal on each side. As shown in Figure 5-2, R_{AXIS} may require lengthening if the arc fails to make contact with the abutments or if the central angle exceeds 120 degrees.

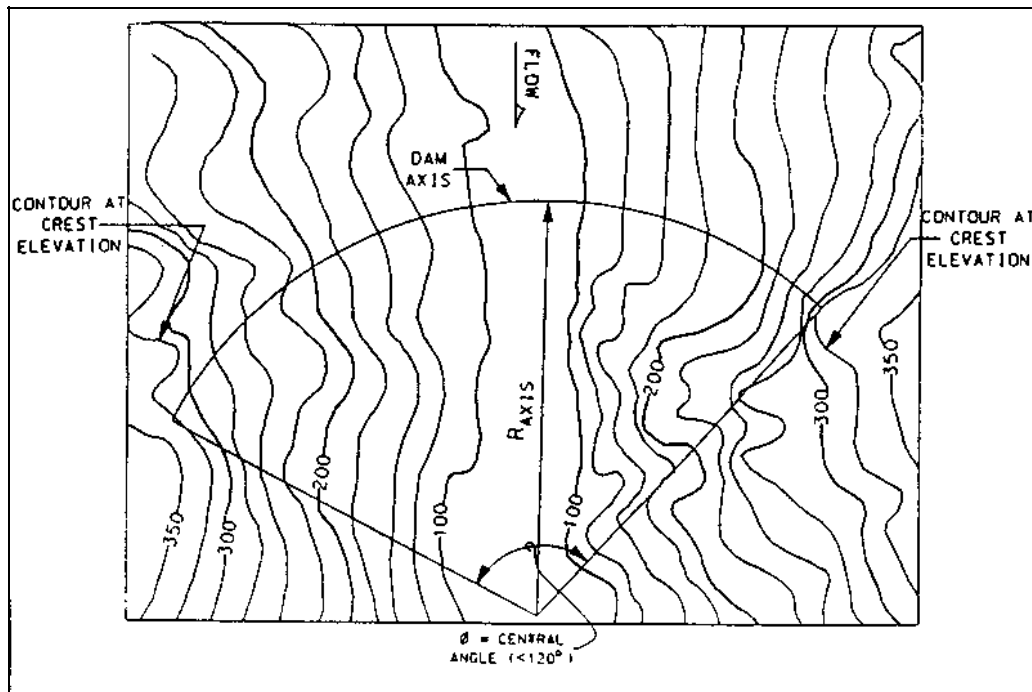

Figure 5-2. Layout of dam axis

(2) The magnitude of the central angle of the top arch is a controlling value which influences the curvature of the entire dam. Objectionable tensile stresses will develop in arches of insufficient curvature; such a condition often occurs in the lower elevations of a dam having a V-shape profile. The largest central angle practicable should be used considering that the foundation rock topography may be inaccurately mapped and that the arch abutments may need to be extended to somewhat deeper excavation than originally planned. Due to limitations imposed by topographic conditions and foundation requirements, for most layouts, the largest practicable central angle for the top arch varies between 100 and 120 degrees.

b. Location of Crown Cantilever and Reference Plane. On the overlay, locate the crown cantilever at the intersection of the dam axis and the lowest point of the site topography (i.e., the riverbed). This corresponds to the point of maximum depth of the dam. A vertical plane passing through this point and the axis center represents the reference plane (or plane of centers). On the overlay plan, this plane is shown as a line connecting the crown cantilever and the axis center. Later, when arcs representing arches at other elevations are drawn, they will be located so that the centers of the arcs will be located on the reference plane. Ideally, the reference plane

should be at the midpoint of the axis. This seldom occurs, however, because most canyons are not symmetrical about their lowest point.

c. Crown Cantilever Geometry. The geometry of the crown cantilever controls the shape of the entire dam and, as a result, the distribution and magnitude of stresses within the body. The empirical equations which follow can be used to define thicknesses of the crown at three locations; the crest, the base, and at el 0.45H above the base:

$$T_C = 0.01(H + 1.2L_1) \quad (5-2)$$

$$T_B = \sqrt[3]{0.0012HL_1L_2\left(\frac{H}{400}\right)^{\frac{H}{400}}} \quad (5-3)$$

$$T_{0.45} = 0.95T_B \quad (5-4)$$

(1) In addition, upstream and downstream projections of the extrados (upstream) and intrados (downstream) faces can also be arrived at empirically. Those relationships are:

$$USP_{CREST} = 0.0 \quad (5-5)$$

$$USP_{BASE} = 0.67T_B \quad (5-6)$$

$$USP_{0.45H} = 0.95T_B \quad (5-7)$$

$$DSP_{CREST} = T_C \quad (5-8)$$

$$DSP_{BASE} = 0.33T_B \quad (5-9)$$

$$DSP_{0.45H} = 0.0 \quad (5-10)$$

(Note: These empirical equations were developed by the USBR and are based on historical data compiled from existing dams. However, the engineer is not restricted to using the parameters derived from the empirical equations; they are presented as an aid for developing initial parameters and only for the first layout. Sound engineering judgement resulting from experience obtained in arch dam layout may also be utilized when defining an initial layout or refining a previous one. Values for subsequent layouts will consist of adjustments, usually by engineering evaluation of stress analysis, of the values used in the previous iterations.)

(2) As shown in Figure 5-3, the upstream and downstream projections at the crest, base, and at el 0.45H above the base can now be plotted in elevation in reference to the dam axis. This plot is referred to as the "plane of centers" view. The next step is to define the upstream and downstream faces of the crown cantilever using a circular arc (or combinations of straight lines and circular arcs) which passes through the upstream and downstream projection points as shown in Figure 5-4. With the faces defined in this

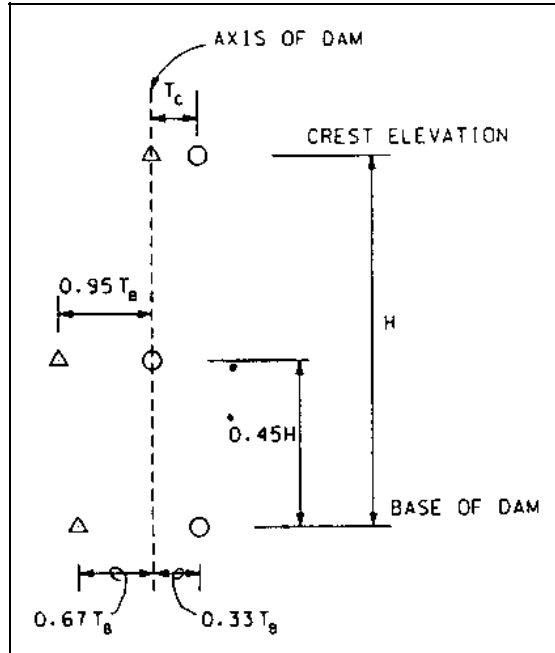

Figure 5-3. Empirically derived projections of the crown cantilever

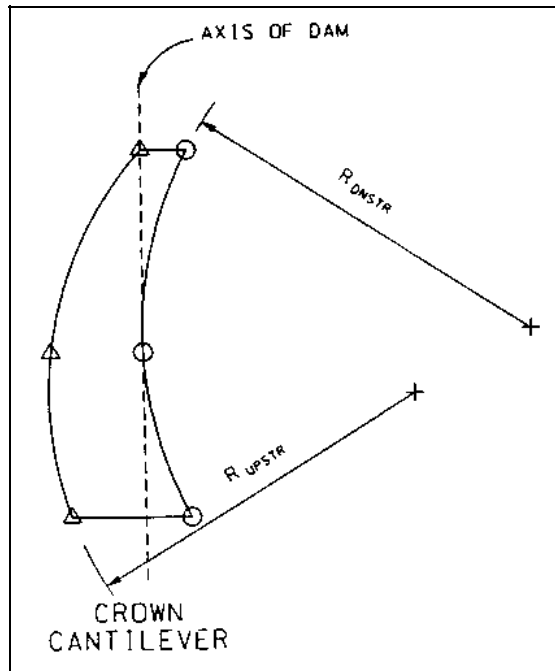

Figure 5-4. Definition of upstream and downstream faces

manner, upstream and downstream projections at any elevation can be obtained. This information will be necessary when laying out the arches.

d. Estimating the Dam Footprint. The axis of the dam on the topographic overlay corresponds to the upstream face of the dam at the crest. An arc representing the downstream face of the crest can be drawn with the center of the arc at the axis center and a radius equal to R_{AXIS} reduced by the thickness at the crest, T_c . On the plan overlay, three points are identified to aid in laying out the contact line between the foundation and the upstream face of the dam. Two of the points are the intersection of the axis of the dam with the foundation contour at the crest elevation at each abutment (points A and B). The third point is the upstream projection of the crown cantilever at the base. This point can be plotted in reference to the axis of the dam based on information taken from the plane of centers view (Figure 5-5). Using a french curve, a smooth curve is placed beginning at the upstream face of the crest on one abutment, passing through the upstream projection of the crown cantilever at the base (point C), and terminating at the upstream face of the crest at the other abutment (points A and B in Figure 5-6).

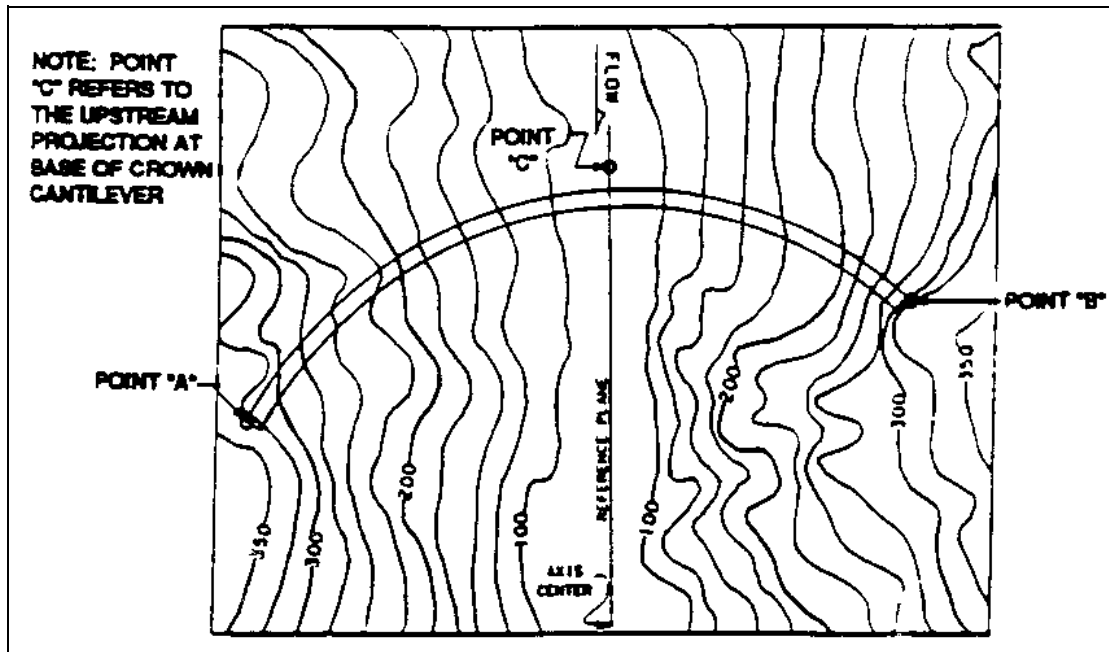

Figure 5-5. Contact points between dam and foundation at crest and crown cantilever

e. Layout of the Arches. Of all that is involved in arch dam layout, this step is possibly the most difficult. For shaping and analysis purposes, between 5 and 10 evenly spaced horizontal arches are drawn. These arches should be spaced not less than 20 feet nor greater than 100 feet apart. The lowest arch should be 0.15H to 0.20H above the base of the crown cantilever.

(1) Beginning at the arch immediately below the crest, determine, from the plane of the centers view, the upstream and downstream projections of the crown cantilever at that specific arch elevation. These projections are then

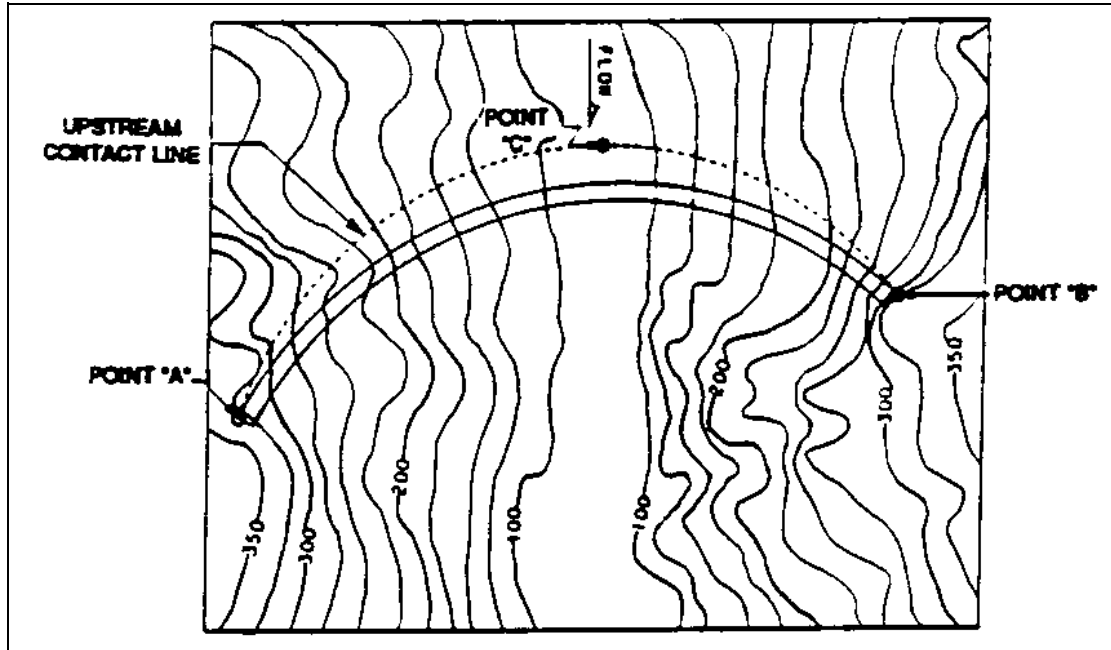

Figure 5-6. Upstream contact line at dam-foundation interface

plotted on the plan view along the reference plane. Using a beam compass, trial arcs representing the upstream face of the dam at that specific arch elevation are tested until one is found which meets the following criteria:

(a) The arc center must lie along the reference plane.

(b) The arc must pass through the upstream projection of the crown cantilever as plotted on the plan view.

(c) Both ends of the arc must terminate on the upstream contact line at a foundation elevation equal to or slightly deeper than the arch elevation.

(2) Locating an arch which satisfies all of these criteria is a trial and error process which may not be possible with a single-center layout. This is generally the case when dealing with unsymmetrical canyons where different lines of centers are required for each abutment (Figure 1-4). Figure 5-7 shows an example of an arch that meets the criteria. Of particular importance is that the ends of the arch must extend into the abutments and not fall short of them. This ensures that a "gap" does not exist between the dam and foundation.

(3) This procedure is repeated to produce the downstream face of the arch. Similar to what was performed for the upstream face, the downstream projection of the crown cantilever is determined from the plane of centers view and plotted on the plan view. The beam compass is then used to locate an arc that meets the three criteria with the exception that the arc must pass through the downstream projection of the crown cantilever with ends that terminate on the radial to the extrados at the abutment (Figure 5-7). If the same arch center is used for the upstream and downstream faces, a uniform thickness arch is produced. If the arch centers do not coincide, the

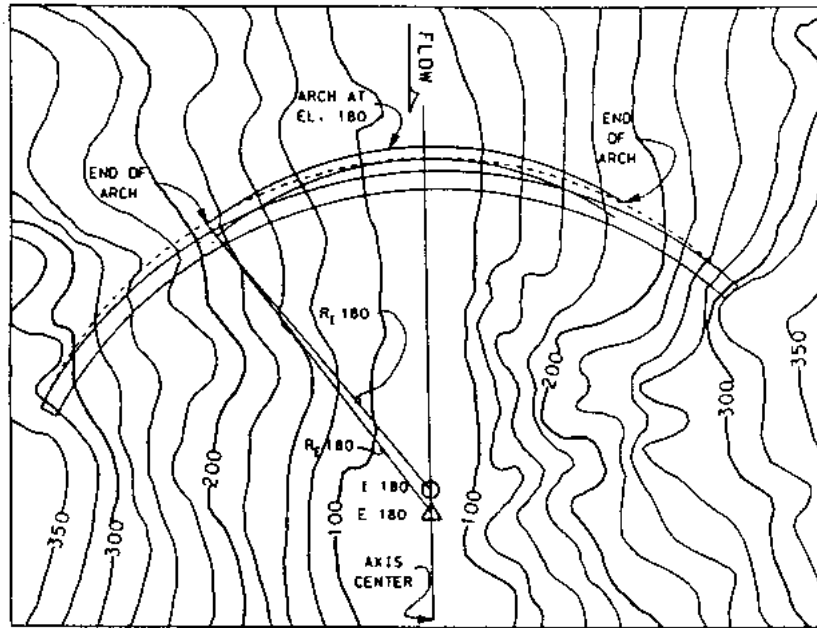

Figure 5-7. Typical layout of an arch section

arch produced will vary in thickness along its length (variable thickness arch).

(4) Once a satisfactory arch has been produced, the locations of the arch centers for the upstream and downstream face are marked along the reference plane on the plan view. Standard practice is to identify the extrados (upstream) face with a triangle (Δ) and the intrados (downstream) face with a circle (O). The corresponding arch elevation should be identified with each. See Figure 1-5 for an example. Although these arch centers appear to lie on a straight line in plan, they all are positioned at their respective arch elevations, and it is highly unlikely that they are on a straight line in three-dimensional (3-D) space.

(5) Arches at the remaining elevations are plotted in similar fashion. Of particular importance to producing an acceptable plan view is to ensure that the footprint, when viewed in plan, is smooth and free flowing with no abrupt changes or reverse curvature. This requirement is usually met by the fact that a footprint is predetermined; however, endpoints of arches may not terminate exactly on the footprint. Revision of the footprint is necessary to ensure that it passes through all actual arch endpoints prior to checking it for smoothness.

f. Reviewing the Layout. Layout of an arch dam includes the preparation of three different drawings. The first is the plan view, which begins with locating a crest and ends with plotting the arches. The second drawing is a section, in elevation, along the reference plane, called the plane-of-centers view. This view has been partially produced when the crown cantilever was created, but it requires expansion to include the lines of centers, as will to be discussed in paragraph 5-4f(1). The third drawing to be produced is a profile (looking downstream) of the axis of the dam and the foundation.

Proper review includes examining all views for "smoothness," because abrupt changes in geometry will result in excessive stress concentrations. The term "smoothness" will be discussed in the following paragraph. Only when the plan view, plane of centers, and profile demonstrate "smoothness" and are in agreement is the layout ready for preliminary stress analysis. It should be pointed out that all three views are dependent on each other; when making adjustments to the geometry, it is impossible to change parameters in any view without impacting the others.

(1) Creating and Reviewing the Plane-of-centers View. In addition to the crown cantilever, the plane of centers also includes the lines of centers for the upstream and downstream face. A section is passed along the reference plane in plan to produce the plane-of-centers view. Each arch center, upstream and downstream, is plotted in elevation in reference to the axis center, as shown in Figure 5-8. The lines of centers are produced by attempting to pass a smooth curve through each set of arch centers (Figure 5-9). These lines of center define the centers for all arches at any elevation. If the curve does not pass through the arch centers located during the arch layout procedure, those arch centers will be repositioned to fall on the appropriate line of centers. Those particular arches will require adjustment on the plan view to reflect the change in position of the arch center. The structural engineer should understand that this adjustment will involve either lengthening or shortening the radius for that particular arch which will impact where the ends of the arch terminate on the abutments. Lines of centers should be smooth flowing without abrupt changes and capable of being emulated using combinations of circular curve and straight line segments, as shown in the example on Figure 5-10. The circular arcs and straight line segments used to define the lines of centers will be input into ADSAS when performing the preliminary stress analysis.

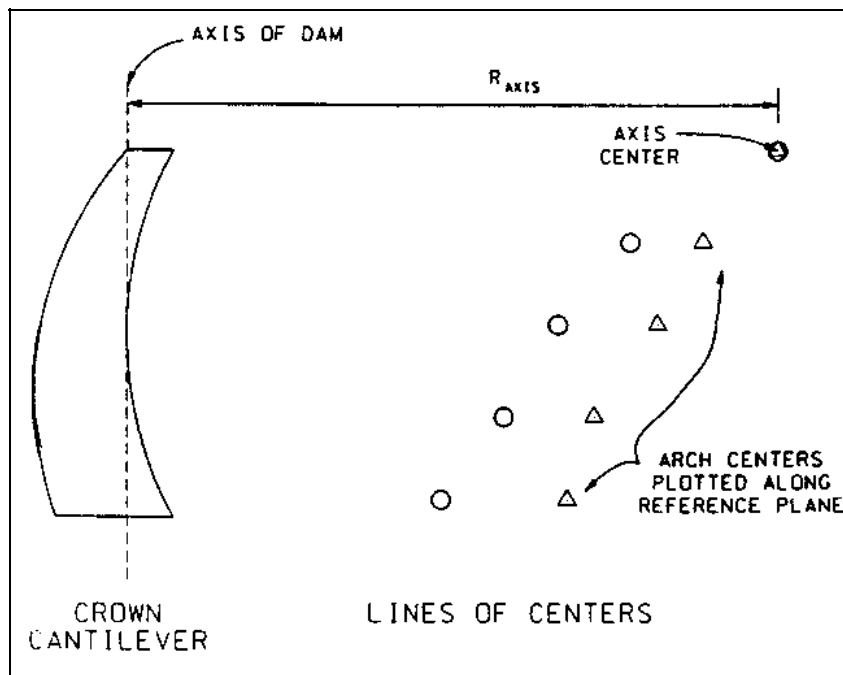

Figure 5-8. Plotting of arch centers along reference

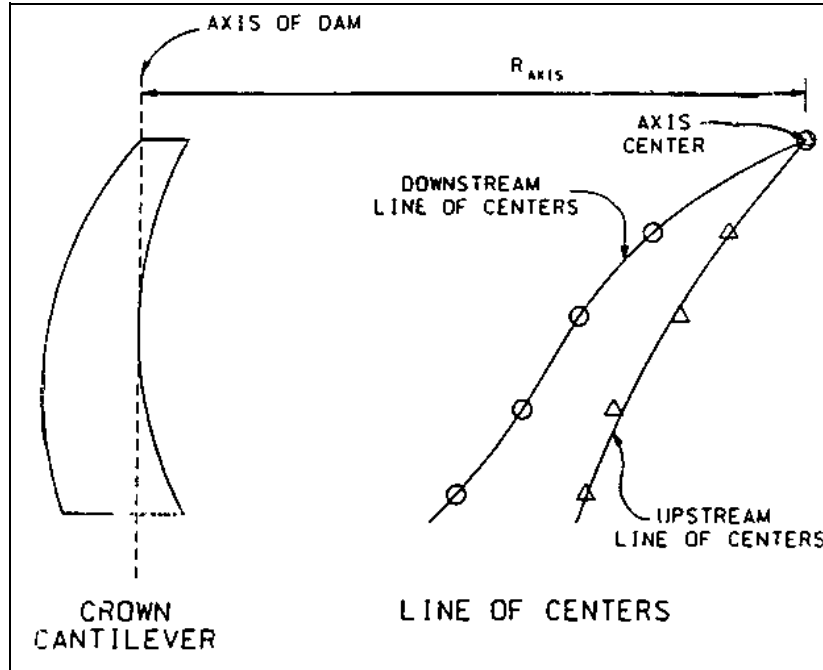

Figure 5-9. Development of the lines of centers

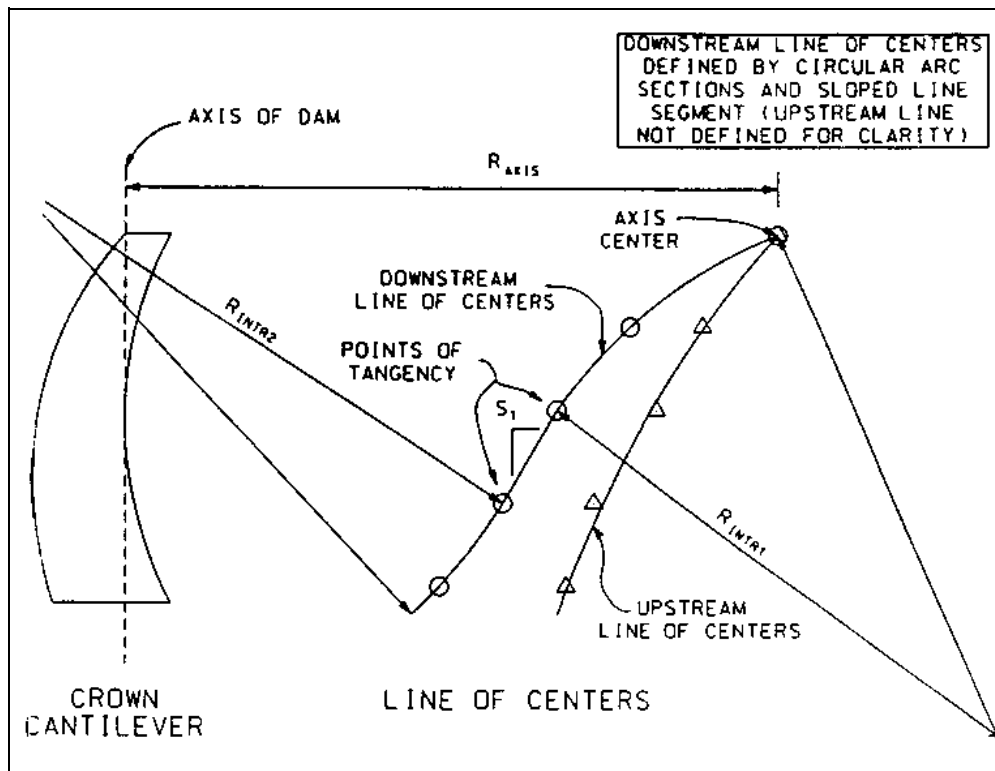

Figure 5-10. Defining the lines of centers

(2) Developing the Profile View. Once a satisfactory plan view and plane-of-centers view has been obtained, the profile view is ready to be created. The profile view is used to examine the amount of excavation that a particular layout has induced. The profile view consists of a developed elevation of the upstream face of the dam (looking downstream) with the foundation topography shown. It should be noted that this is a developed view rather than projection of the upstream face onto a flat plane. This "unwrapping" results in a view in which no distortion of the abutments exists. Figures 5-11 and 5-12 show, respectively, examples of acceptable and unacceptable profiles.

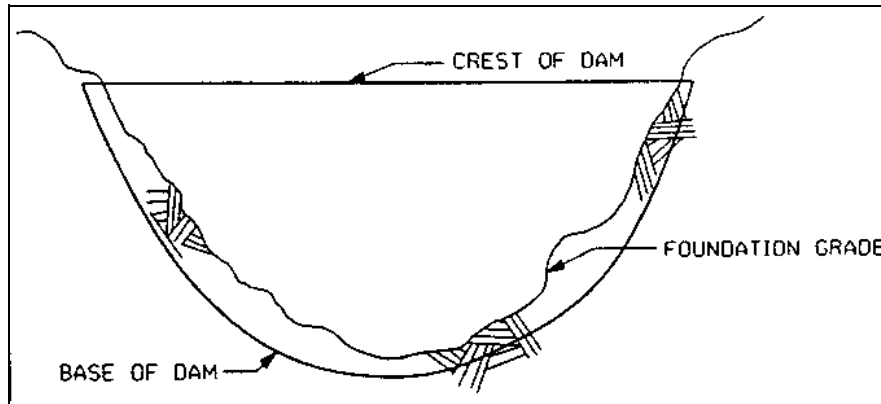

Figure 5-11. Example of an acceptable developed profile view

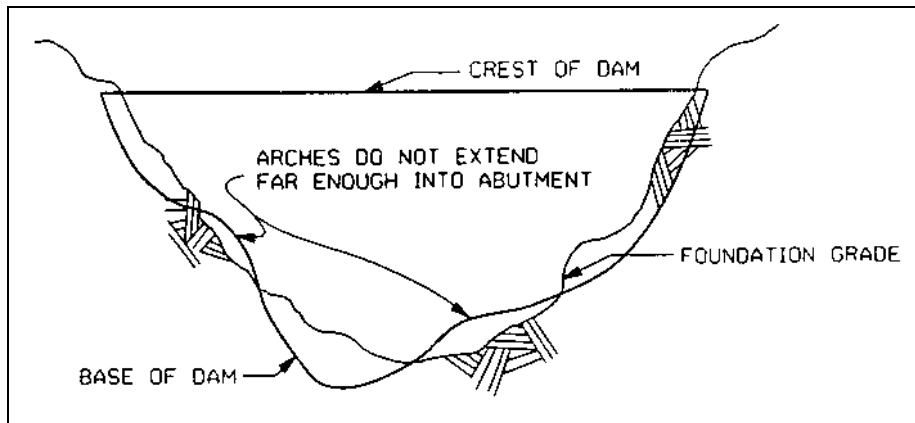

Figure 5-12. Example of an unacceptable developed profile view

(3) Foundation of Dam. In general, the foundation of the dam should be as the lines of centers: smooth and free flowing with no abrupt changes in geometry. The base of the dam must also extend into the foundation; otherwise, an undesirable condition develops in that "gaps" will occur between the base of the dam and the foundation, requiring foundation treatment. Pronounced anomalies should be removed by reshaping the affected arches until a smooth profile is obtained.

5-5. Preliminary Stress Analyses. After a satisfactory layout has been obtained, a preliminary stress analysis is performed to determine the state of stress of the dam under various loading conditions. The computer program ADSAS was developed by the USBR (1975) for this purpose. The Corps of Engineers adapted ADSAS for use on a microcomputer. ADSAS is based on the trial load method of analysis. A discussion on the theory of the trial load method is beyond the scope of this document; however, the USBR (1977) addresses this topic in detail.

a. ADSAS Input. While an exact description of the steps necessary to prepare an input data file for ADSAS is documented in the operations manual (USBR 1975) and an upcoming Corps of Engineers' manual. A brief description is included here. A typical ADSAS input data file contains four groups of information: a geometry definition section, material properties, loading conditions, and output control cards.

(1) Geometry Definition. Critical to the success of obtaining an accurate analysis is the ability to convey to the program the geometry which defines the shape of the arch dam. This geometry consists of:

(a) Crown cantilever geometry. Base elevation, crest elevation, projections of the upstream and downstream faces at the crest and the base, X and Y coordinates, and radii of all circular arcs used in defining the upstream and downstream faces, and slopes of any straight line segments used in defining the upstream and downstream faces.

(b) Lines-of-centers geometry. Axis radius, X and Y coordinates and radii of any circular arcs used in defining all lines of centers, slopes of any straight line segments used in defining all lines of centers, elevations at intersections between segments defining lines of centers, and horizontal distances from axis center to intrados and extrados lines of centers.

(c) Arch geometry. Elevations of all arches, angles to abutments for all arches, and angles of compound curvature.

All data required for the crown cantilever and lines of centers geometry are taken from the planes-of-centers view while data required for the arch geometry should be available from the plan view.

(2) Materials Properties. ADSAS analysis also requires material properties of both the concrete and the foundation rock. These data include modulus of elasticity of the concrete and foundation rock, Poisson's ratio for the concrete and foundation rock, coefficient of thermal expansion of the concrete, and unit weight of concrete.

(3) Loading Conditions. During layout, only static loading conditions are analyzed. Static load cases are discussed in Chapter 4. ADSAS is capable of analyzing hydrostatic, thermal, silt, ice, tailwater loads, and dead weight.

(4) Output Control. ADSAS provides the user with the ability to toggle on or off different portions of the output to control the length of the report while capturing pertinent information.

5-6. Evaluation of Results. Evaluation requires a thorough examination of all the analytical output. Types of information to be reviewed are the crown cantilever description, intrados and extrados lines of centers, geometrical statistics, dead load stresses and stability of blocks during construction, radial and tangential deflections and angular deformations, loading distributions, arch and cantilever stresses, and principal stresses. If any aspect of the design is either incorrect or does not comply with established criteria, modifications must be made to improve the design.

a. Resultant Components. Evaluation of the arch dam may also include examination of the resultants along the abutments. These resultants are separated into three components; radial, tangential, and vertical. The combined radial and tangential resultant should be directed into the abutment rock. In the lower arches, that abutment may tend to parallel the surface contours or daylight into the canyon. Prudent engineering suggests that the resultant be turned into the abutment. The solution may be a combination of increasing stiffness in the upper arches or flexibility in the lower arches. The effect is mitigated by including the vertical component which then directs the total resultant downward into the foundation.

b. Volume of Concrete. One major factor of a layout that requires evaluation is the volume of concrete that is generated. ADSAS computes this volume as part of its output. If a quantity is desired without proceeding through a preliminary stress analysis (as for a reconnaissance layout), that value can be arrived at empirically by the following equation (see paragraph 5-4a for definition of variables):

$$v = 0.000002H^2L_2 \frac{(H + 0.8L_2)}{L_1 - L_2} + 0.0004HL_1[H + L_1] \quad (5-11)$$

The volume of concrete calculated in ADSAS or derived from Equation 5-11 does not reflect mass concrete in thrust blocks, flip buckets, spillways, or other appurtenances.

5-7. Improvement of Design. The best of alternative designs will have stresses distributed as uniformly as possible within allowable limits combined with a minimum of concrete. Where to terminate a design and accept a final layout based on these criteria are difficult in some dams with widely varying loading conditions, such as with a flood control dam which has periods of low and high reservoir elevations. The primary means of effecting changes in the behavior of the dam is by adjusting the shape of the structure. Whenever the overall stress level in the structure is far below the allowable limits, concrete volume can be reduced, thereby utilizing the remaining concrete more efficiently and improving the economy. Following are some examples of how a design can be improved by shaping.

a. Loads and Deflections. Load distribution and deflection patterns should vary smoothly from point to point. Often when an irregular pattern occurs, it is necessary to cause load to be shifted from the vertical cantilever units to the horizontal arches. Such a transfer can be produced by changing the stiffness of the cantilever relative to the arch.

b. Reshaping Arches. If an arch exhibits tensile stress on the downstream face at the crown, one alternative would be to reduce the arch thickness by cutting concrete from the downstream face at the crown while maintaining the same intrados contact at the abutment. Another possibility would be to stiffen the crown area of the arch by increasing the horizontal curvature which increases the rise of the arch.

c. Reshaping Cantilevers. When cantilevers are too severely undercut, they are unstable and tend to overturn upstream during construction. The cantilevers must then be shaped to redistribute the dead weight such that the sections are stable. Severe overhang will cause tension to develop on the upper upstream face, contraction joints in the affected area to close, and prevent satisfactory grouting.

d. Force-stress Relationship. Shaping is the key to producing a complete and balanced arch dam design. The task of the designer is to determine where and to what degree the shape should be adjusted. Figure 5-13 should be used to determine the appropriate changes to be made to the structural shape. If an unsatisfactory stress condition is noticed, the forces causing those stresses and the direction in which they act can be determined by Figure 5-13. For example, the equations of stress indicate which forces combine to produce a particular stress. Knowing the force involved and its algebraic sign, it is possible to determine its direction from the sign convention shown on the figure. With that information the proper adjustment in the shape can be made so that the forces act to produce the desired stresses.

5-8. Presentation of Design Layout. Figures and plates that clearly show the results of the design layout and preliminary stress analyses should be included in the FDM. Plates that illustrate and describe the detailed geometry of the arch dam include:

a. Plan View. Arches, arch centers, angles to the abutments, axis center, dam-foundation contact line, and dam orientation angle are some items that are included in this view of the dam overlaid on the site topography (Figure 1-5).

b. Section along Reference Plane. This plate includes all the information that defines the vertical curvature of the crown cantilever and the line(s) of centers (Figure 1-6).

c. Cantilever Sections. All cantilevers generated during the preliminary stress analysis should be shown. Showing the thickness at the base and at the crest of each cantilever is also recommended as shown in Figure 5-14.

d. Arch Sections. Arch sections generated as a result of the preliminary stress analysis should be plotted. Appropriate thicknesses at the reference plane and at each abutment should be shown for each arch as shown in Figure 5-15.

e. Profile. A profile, developed along the axis of the dam, should be presented, showing locations of cantilevers and the existing foundation grade as shown in Figure 5-16.

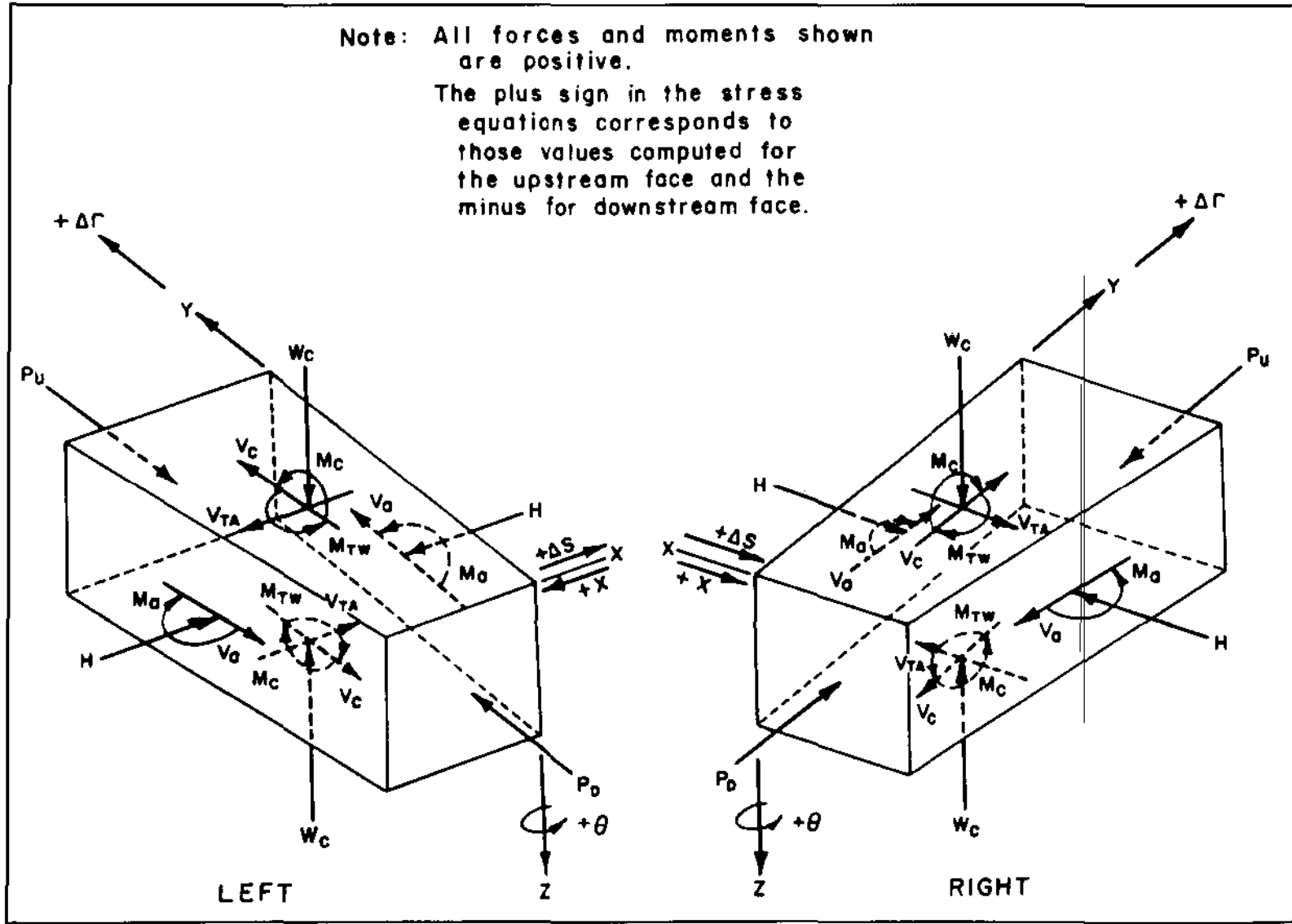

Figure 5-13. Sign convention for arch computations in ADSAS

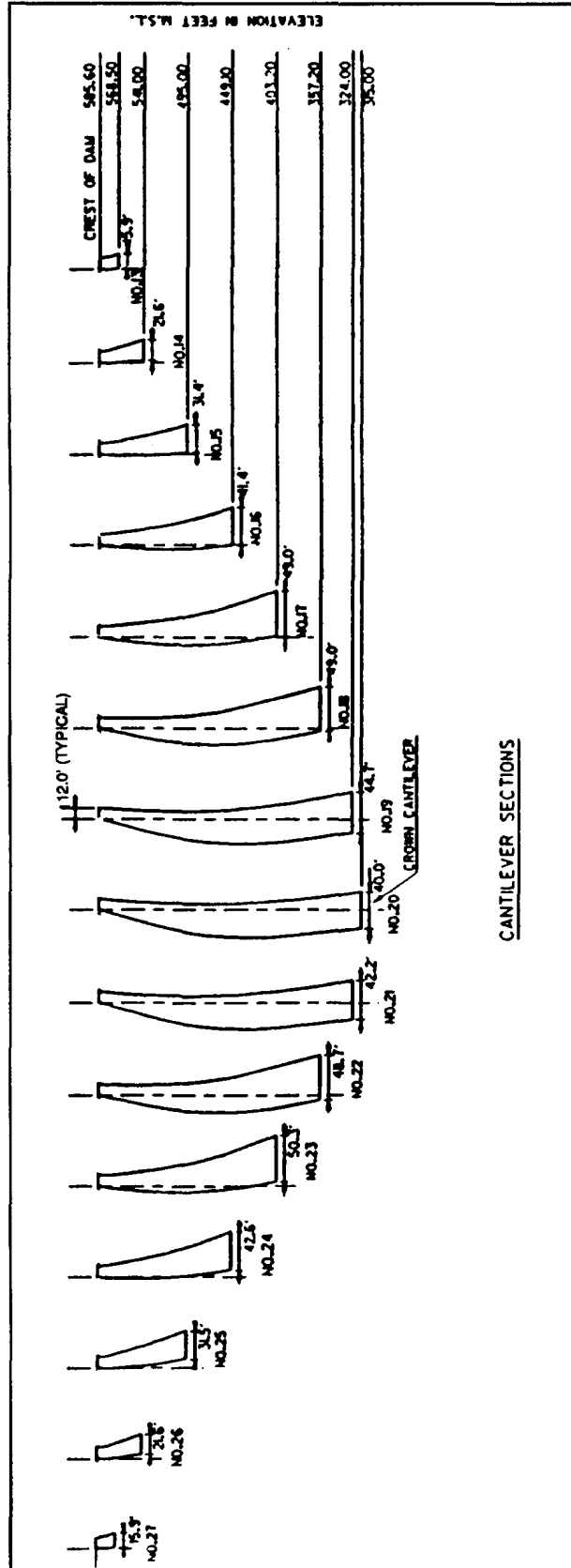

Figure 5-14. Cantilever sections

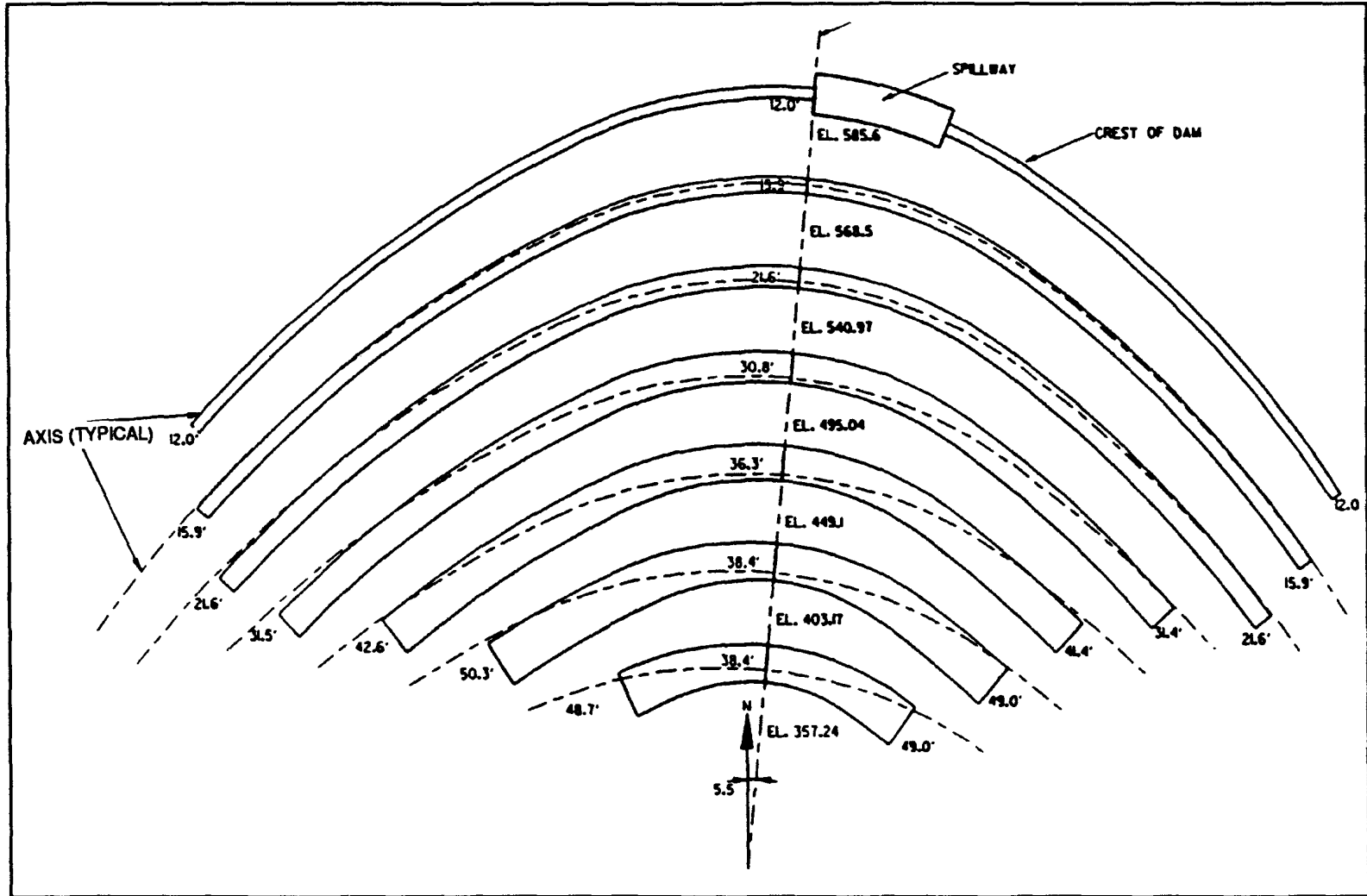

Figure 5-15. Arch sections

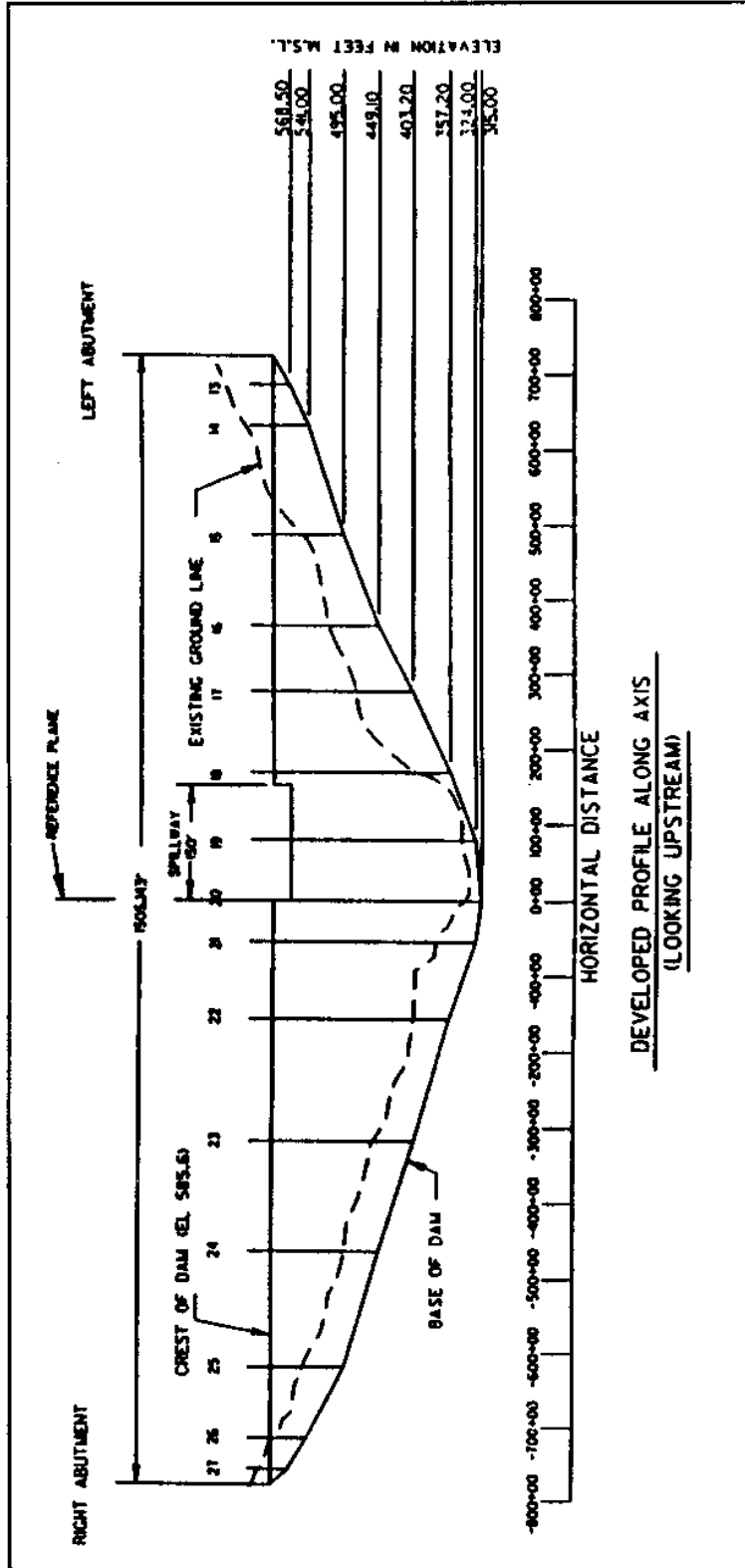

Figure 5-16. Developed profile

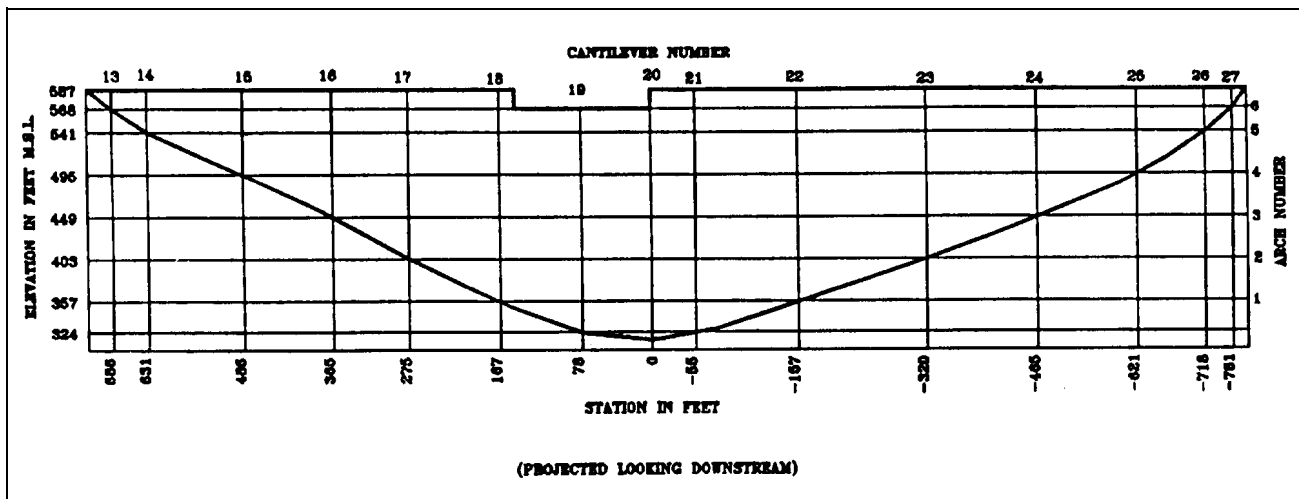

Figure 5-17. ADSAS model

f. ADSAS Model. A plot showing the model of cantilever and arch units generated by ADSAS and the associated cantilever and arch numbering scheme is plotted and shown in the FDM as shown in Figure 5-17.

g. Stress Contours. Contour plots of arch and cantilever stresses on the upstream and downstream faces for all load cases are presented in the FDM as shown in Figure 5-18.

h. Dead Load Stresses. Stresses produced in the ungrouted cantilevers as a result of the construction sequence should be tabulated and presented in the FDM as shown in Figure 5-19.

5-9. Computer-assisted Layouts. The procedures mentioned in this chapter involve manual layout routines using normal drafting equipment. As mentioned, the iterative layout procedure can be quite time consuming. Automated capabilities using desktop computers are currently being developed which enable the structural designer to interactively edit trial layouts while continuously updating plan, plane of centers, and profile views. When an acceptable layout is achieved, the program generates an ADSAS data file which is input into a PC version of ADSAS. In all, developing these tools on a desktop computer allows the structural designer to proceed through the layout process at a faster rate than could be achieved manually, thereby, reducing design time and cost.

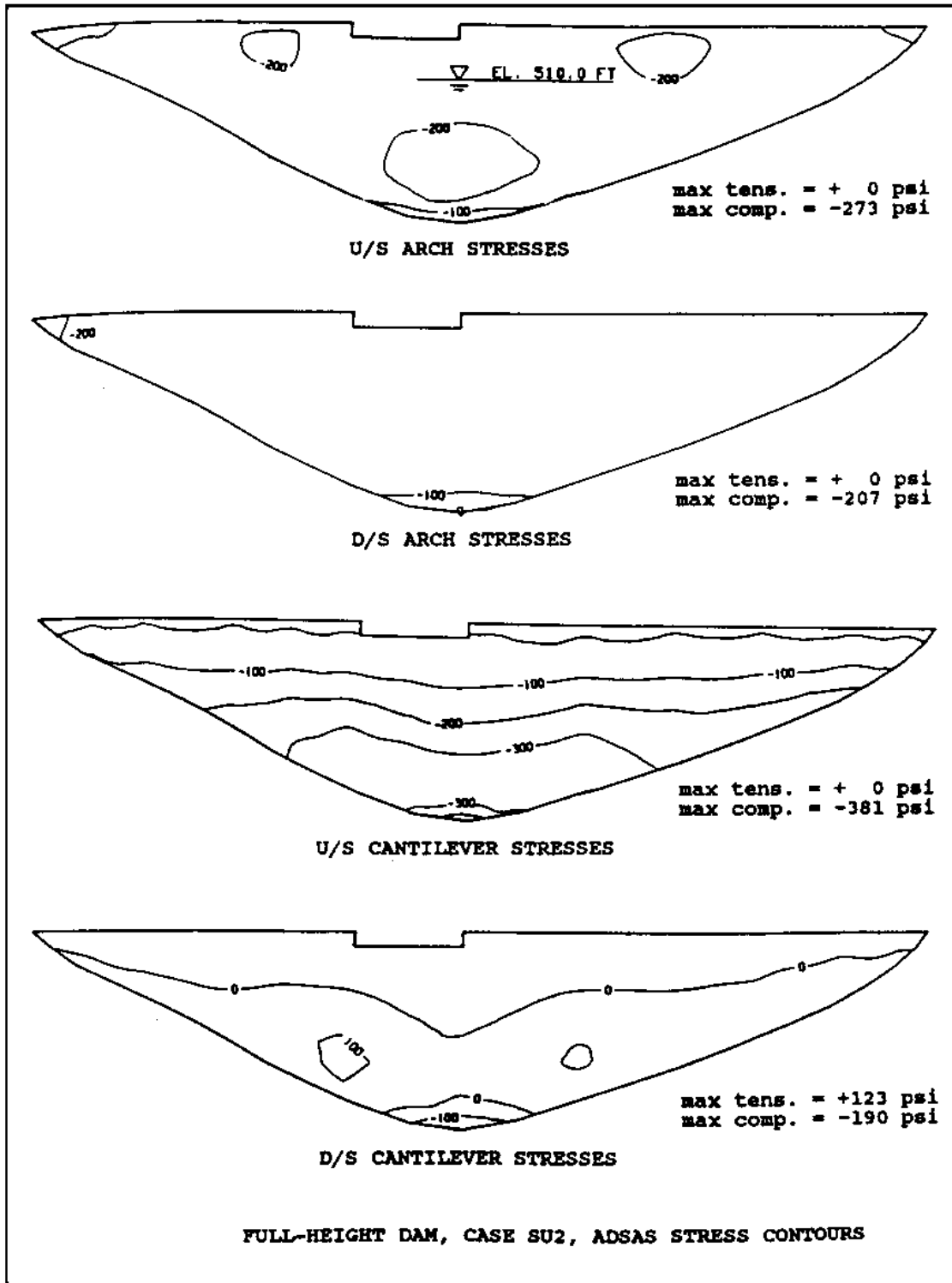

Figure 5-18. ADSAS stress contours

MINIMUM DEAD LOAD STRESSES (IN PSI) BY CANTILEVER				
CANTILEVER NUMBER	STRESS BASED ON CONCRETE PLACED ON	ELEVATION OF MINIMUM STRESS	MINIMUM DOWNSTREAM STRESS	UPSTREAM FACE STRESS
20	495.04	314.96	48	-406.
21	540.97	324.00	66.	-459.
22	587.20	357.24	142.	-483.
23	587.20	403.27	111.	-357.
24	587.20	449.10	80.	-265.
25	587.20	495.04	61.	-197.
26	587.20	540.97	18.	-95.
27	587.20	567.20	-2.	-35.
19	540.97	324.00	103.	-482.
18	587.20	357.24	156.	-496.
17	587.20	403.17	89.	-340.
16	587.20	449.10	37.	-227.
15	587.20	495.04	15.	-152.
14	587.20	540.97	5.	-81.
13	587.20	567.20	-6.	-32.
NOTE: MINUS SIGN INDICATES COMPRESSION				

Figure 5-19. Dead load stresses

CHAPTER 6
STATIC ANALYSIS

6-1. Introduction. This chapter describes static analysis of concrete arch dams using the FEM. The purpose of FEM analysis is to perform more accurate and realistic analysis by eliminating many assumptions made in the traditional methods. The main advantages of FEM are its versatility and its ability for exploring foundation conditions and representing the more realistic interaction of dam and foundation rock. In particular, nonhomogeneous rock properties, weak zones, clay or gouge seams, and discontinuities in the foundation may be considered in the analysis to evaluate their effects on the stress distribution. The cracked sections or open joints in the structure can be modeled; thrust blocks and the spillway openings in the crest are appropriately included in the mathematical models; and the stresses around the galleries and other openings can be investigated.

6-2. Design Data Required. Design data needed for structural analysis of a concrete arch dam are: Poisson's ratio, strength and elastic properties of the concrete, Poisson's ratio and deformation modulus of the foundation rock, unit weight and coefficient of thermal expansion of the concrete, geometric data of the dam layout, geometric data of spillway openings and thrust blocks, operating reservoir and tailwater surfaces, temperature changes within the dam, probable sediment depth in the reservoir, probable ice load, and the uplift pressure. A description of each data type is as follows:

a. Concrete Properties. The material properties of the concrete for use in static analysis are influenced by mix proportions, cement, aggregate, admixtures, and age. These data are not available beforehand and should be estimated based on published data and according to experience in similar design and personal judgment; however, actual measured data should be used in the final analysis as they become available. The concrete data needed for the analysis are:

- (1) Sustained modulus of elasticity
- (2) Poisson's ratio
- (3) Unit weight
- (4) Compressive strength
- (5) Tensile strength
- (6) Coefficient of thermal expansion

The sustained modulus of elasticity is used in the analyses of the static loads to account for the creep effects. In the absence of long-term test data, a sustained modulus of elasticity equal to 60 to 70 percent of the instantaneous modulus may be used. The standard test method for measurement of the concrete properties is given in Chapter 9.

b. Foundation Properties. The foundation data required for structural analysis are Poisson's ratio and the deformation modulus of the rock supporting the arch dam. Deformation modulus is defined as the ratio of applied stress to resulting elastic plus inelastic strains and thus includes the effects of joints, shears, and faults. Deformation modulus is obtained by in situ tests (Structural Properties, Chapter 9) or is estimated from elastic modulus of the rock using a reduction factor (Von Thun and Tarbox 1971 (Oct)). If more than one material type is present in the foundation, an effective deformation modulus should be used instead. For nonhomogeneous foundations, several effective deformation modulus values may be needed to adequately define the foundation characteristics.

c. Geometric Data. The necessary data for constructing a finite element mesh of an arch dam is obtained from drawings containing information defining the geometry of the dam shape. These include the plan view and section along the reference plane, as shown in Figures 1-5 and 1-6. In practice, arch dams are geometrically described as multicentered arches with their centers varied by elevation in addition to the arch opening angles and radii varying for each side with elevation. Elliptical arch shapes may be approximated for the various elevations by three-centered arches including central segments with shorter radii and two outer segments with equal but longer radii. The basic geometric data of a multicentered dam at each elevation for the upstream and downstream faces are as follows:

- (1) Radius of central arcs
- (2) Radius of outer arcs
- (3) Angles to point of compounding curvatures
- (4) Angles to abutments
- (5) Location of centers of central arcs

Preparation of finite element mesh data from these geometric data is very time consuming because most general-purpose finite element programs cannot directly handle these data or the similar ADSAS input data; however, GDAP (Ghanaat 1993a), a specialized arch dam analysis program, can automatically generate coordinates of all nodal points, element data, element distributed loads, and the nodal boundary conditions from such limited geometric data or even directly from ADSAS input data for any arch dam-foundation system. Geometric data for modeling thrust blocks, spillway openings, and other structural features are obtained directly from the associated design drawings.

d. Static Loads. The basic loads contributing to the design or safety analysis of arch dams are gravity, reservoir water, temperature changes, silt, ice, uplift, and earthquake loads. The data needed to specify each individual static load are described in this section. Earthquake loads and their effects are discussed in Chapter 7, and the various load combinations are presented in Chapter 4.

(1) Gravity Loads. Gravity loads due to weight of the material are computed from the unit weight and geometry of the finite elements. The dead weight may be applied either to free-standing cantilevers without arch action

to simulate the construction process or to the monolithic arch structure with all the contraction joints grouted. Although the first assumption usually is more appropriate, a combination of the two is more realistic in situations where the vertical curvature of the cantilevers is so pronounced that it is necessary to limit the height of free-standing cantilevers by grouting the lower part of the dam. In those cases, a gravity load analysis which closely follows the construction sequence is more representative. The weight of the appurtenant structures that are not modeled as part of the finite element model but are supported by the dam, if significant, are input as external concentrated loads and are applied to the supporting nodal points.

(2) Reservoir Water. Most finite element programs such as the GDAP and SAP-IV handle hydrostatic loads as distributed surface loads. The surface loads are then applied to the structure as concentrated nodal loads. Therefore, hydrostatically varying surface pressure can be specified by using a reference fluid surface and a fluid weight density as input.

(3) Temperature. Temperature data needed in structural analysis result from the differences between the closure temperature and concrete temperature expected in the dam during its operation. Temperature changes include high and low temperature conditions and usually vary: by elevation, across the arch, and in the upstream-downstream direction. Temperature distribution in the concrete is determined by temperature studies (Chapter 8) considering the effects of transient air and water temperatures, fluctuation of reservoir level, and the solar radiation. The nonlinear temperature distribution calculated in these studies is approximated by straight line distribution through the dam thickness for the use in structural analysis performed in using shell elements. However, if several solid elements are used through the thickness, a nonlinear temperature distribution can be approximated.

(4) Silt. Arch dams often are subjected to silt pressures due to sedimentary materials deposited in the reservoir. The saturated silt loads are treated as hydrostatically varying pressures acting on the upstream face of the dam and on the valley floor. A silt reference level and the weight density of the equivalent fluid are needed to specify the silt pressures.

(5) Ice. Ice pressure can exert a significant load on dams located at high altitudes and should be considered as a design load when the ice cover is relatively thick. The actual ice pressure is very difficult to estimate because it depends on a number of parameters that are not easily available. In that case, an estimate of ice pressure as given in Chapter 4 may be used.

(6) Uplift. The effects of uplift pressures on stress distribution in thin arch dams are negligible and, thus, may be ignored; however, uplift can have a significant influence on the stability of a thick gravity-arch dam and should be considered in the analysis. For more discussion on the subject, refer to "Theoretical Manual for Analysis of Arch Dams" (Ghanaat 1993b).

6-3. Method of Analysis. The static analysis of an arch dam should be based on the 3-D FEM. The FEM is capable of representing the actual 3-D behavior of an arch dam-foundation system and can handle any arbitrary geometry of the dam and valley shape. Furthermore, the method can account for a variety of loads and is equally applicable to gravity arch sections as well as to slender and doubly curved arch dam structures.

a. The FEM is essentially a procedure by which a continuum such as an arch dam structure is approximated by an assemblage of discrete elements interconnected only at a finite number of nodal points having a finite number of unknowns. Although various formulations of the FEM exist today, only the displacement-based formulation which is the basis for almost all major practical structural analysis programs is described briefly here. The displacement-based FEM is an extension of the displacement method that was used extensively for the analysis of the framed and truss type structures before the FEM was developed (Przemieniecki 1968). Detailed formulations of the FEM are given by Zienkiewicz (1971), Cook (1981), and Bathe and Wilson (1976). Application of the method to the analysis of arch dams is presented in the "Theoretical Manual for Analysis of Arch Dams" (Ghanaat 1993b). Following is an outline of the finite element computer analysis for static loads, as a sequence of analytical steps:

(1) Divide the dam structure and the foundation rock into an appropriate number of discrete subregions (finite elements) connected at joints called nodal points. For a discussion of mesh density, see paragraph 6-4.

(2) Compute the stiffness matrix of each individual element according to the nodal degrees of freedom and the force-displacement relationships defining the element.

(3) Add the stiffness matrices of the individual elements to form the stiffness matrix of the complete structure (direct stiffness method).

(4) Define appropriate boundary conditions and establish equilibrium conditions at the nodal points. The resulting system of equations for the assembled structure may be expressed as:

$$ku = p \quad (6-1)$$

where

k = stiffness matrix
u = displacement vector
p = load vector

(5) Solve the system of equations for the unknown nodal displacements u.

(6) Calculate element stresses from the relationship between the element strains and the nodal displacements assuming an elastic strain-stress relationship.

b. Most general-purpose finite element computer programs follow these above analytical steps for static structural analysis, but their applicability to arch dams may be judged by whether they have the following characteristics:

(1) An efficient graphics-based preprocessor with automatic mesh generation capabilities to facilitate development of mathematical models and to check the accuracy of input data.

(2) Efficient and appropriate finite element types for realistic representation of the various components of the dam structure.

(3) Efficient programming methods and numerical techniques appropriate for the solution of large systems with many degrees of freedom.

(4) Postprocessing capabilities providing graphics for evaluation and presentation of the results.

c. SAP-IV (Bathe, Wilson, and Peterson 1974) and GDAP (Ghanaat 1993a) are two widely used programs for the analysis of arch dams. These programs are briefly described here. SAP-IV is a general-purpose finite element computer program for the static and dynamic analysis of linearly elastic structures and continua. This program has been designed for the analysis of large structural systems. Its element library for dam analysis includes eight-node and variable-number-node, 3-D solid elements. The program can handle various static loads including hydrostatic pressures, temperature, gravity due to weight of the material, and concentrated loads applied at the nodal points. However, the program lacks pre- and postprocessing capabilities. Thus, finite element meshes of the dam and foundation must be constructed manually from the input nodal coordinates and element connectivities. Also, the computed stress results are given in the direction of local or global axes and cannot be interpreted reliably unless they are transformed into dam surface arch and cantilever stresses by the user.

d. GDAP has been specifically designed for the analysis of arch dams. It uses the basic program organization and numerical techniques of SAP-IV but has pre- and postprocessing capabilities in addition to the special shell elements. The thick-shell element of GDAP, which is represented by its mid-surface nodes, uses a special integration scheme that improves bending behavior of the element by reducing erroneous shear energy. The 16-node shell is the other GDAP special dam analysis element; this retains all 16-surface nodes and uses incompatible modes to improve the bending behavior of the element. In addition to the shell elements, eight-node solid elements are also provided for modeling the foundation rock. The preprocessor of GDAP automatically generates finite element meshes for any arbitrary geometry of the dam and the valley shape, and it produces various 3-D and 2-D graphics for examining the accuracy of mathematical models. The postprocessor of GDAP displays nodal displacements and provides contours of the dam face arch and cantilever stresses as well as vector plots of the principal stresses acting in the faces.

e. Other general-purpose FEM programs, such as ABAQUS (Hibbitt, Karlsson, and Sorenson 1988), GTSTRUDL (Georgia Institute of Technology 1983), etc., can also be used in the analysis of arch dams. Special care should be used to assure that they have the characteristics identified in paragraph 6-3b. Also, the stress results from general-purpose FEM programs may be computed in local or global coordinates and, therefore, may need to be translated into surface arch and cantilever stresses by the user prior to postprocessing.

6-4. Structural Modeling. Arch dams are 3-D systems consisting of a concrete arch supported by flexible foundation rock and impounding a reservoir of water. One of the most important requirements in arch dam analysis is to develop accurate models representative of the actual 3-D behavior of the

system. A typical finite element idealization of a concrete arch dam and its foundation rock is shown in Figure 6-1. This section presents general guidelines on structural modeling for linear-elastic static analysis of single arch dams. The guidelines aim to provide a reasonable compromise between the accuracy of the analysis and the computational costs. They are primarily based on the results of numerous case studies and not on any rigorous mathematical derivation. The procedures and guidelines for developing mathematical models of various components of an arch dam are as follows:

a. Dam Model. An appropriate finite element mesh for an arch dam can only be achieved by careful consideration of the dam geometry and the type of analysis for which the dam is modeled. For example, the finite element model of a double-curvature thin-shell structure differs from the model of a thick gravity-arch section. Furthermore, a structural model developed solely for a linear-elastic analysis generally is not appropriate for a nonlinear analysis.

(1) Number of Element Layers. Arch dam types may be divided, according to the geometry of their cross sections, into thin, moderately thin, and thick gravity-arch sections. Table 6-1 identifies each of these types with regard to crest thickness (t_c) and base thickness (t_b), each expressed as a ratio to the height (H). Also shown is the ratio of base-to-crest thickness. Each of these dam types may be subject to further classification based on the geometry of arch sections as described in Chapter 1. The GDAP element library contains several elements for modeling the dam and foundation, as described previously and shown in Figures 6-2, 6-3, and 6-4. The body of a thin arch dam, usually curved both in plan and elevation, is best represented by a combination of special-purpose shell elements available in the GDAP program (Figures 6-2b, 6-4c and d). The general 3-D solid element shown in Figure 6-4b, which may have from 8 to 21 nodes, can also be used, but these are not as accurate as the GDAP shell elements in representing bending moments and shear deformations of thin shell structures. In either case, a single layer of solid elements which use quadratic displacement and geometry interpolation functions in the dam face directions and linear interpolation in the dam thickness direction is sufficient to accurately represent the body of the dam (Figure 6-1). These finite elements are discussed in more detail in the "Theoretical Manual for Analysis of Arch Dams" (Ghanaat 1993b).

(a) Moderately thin arch dams are modeled essentially similar to the thin arch dams, except that 3-D solid elements should be used near the base and the abutment regions where the shell behavior assumption becomes invalid due to excessive thickness of the arch.

(b) Gravity-arch dams should be modeled by two or more layers of solid elements in the thickness direction depending on their section thickness. Any of the solid elements shown in Figures 6-4a, b, or d may be used to model the dam. It is important to note that multilayer element meshes are essential to determine a detailed stress distribution across the thickness and to provide additional element nodes for specifying nonlinear temperature distributions.

(2) Size of the Dam Mesh. There are no established rules for selecting an optimum mesh size for subdividing an arch dam in the surface directions. The best approach, however, is to define and analyze several meshes of different element types and sizes and then select the one that is computationally

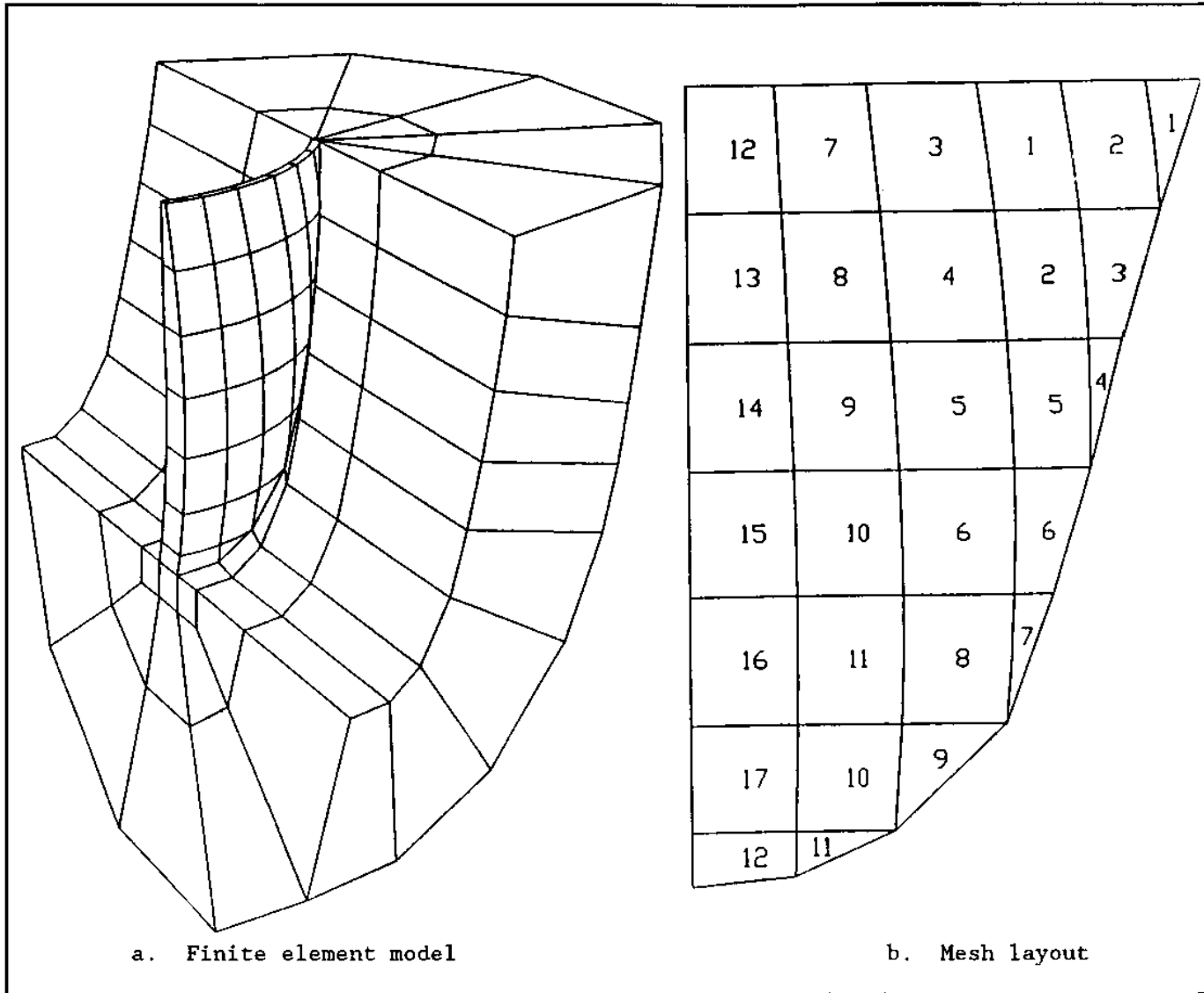

Figure 6-1. Finite element model of Morrow Point Dam and foundation

TABLE 6-1

Arch Dam Types

	<u>t_c/H</u>	<u>t_n/H</u>	<u>t_n/t_c</u>
Thin arch	0.025-0.05	0.09-0.25	2.9-5
Moderately thin	0.025-0.05	0.25-0.4	5-10
Thick gravity-arch	0.05 -0.10	0.5 -1.0	8-15

efficient and provides reasonably accurate results. The main factors to consider in choosing the mesh include the size and geometry of the dam, type of elements to be used, type and location of spillway, foundation profile, as well as dynamic characteristics of the dam, and the number of vibration modes required in the subsequent earthquake analysis. The size of the finite elements should be selected so that the mesh accurately matches the overall geometry, the thickness, and the curvature of the dam structures. As the dam curvature increases, smaller elements are needed to represent the geometry. The element types used to model a dam affect not only the required mesh size but greatly influence the results. For example, idealization of arch dams with flat face elements requires the use of smaller elements and, thus, a larger number of them, and yet such elements can not reproduce the transverse shear deformations through the dam which may not be negligible. On the other hand, the same dam can be modeled with fewer curved thick-shell elements such as those available in GDAP and thus obtain superior bending behavior and also include the transverse shear deformations. Figure 6-2 shows an example of three finite element meshes of Morrow Point Arch Dam with rigid foundation rock. Downstream deflections of the crown cantilever due to hydrostatic loads (Figure 6-5) indicate that normal and fine meshes of shell elements provide essentially identical results, and the coarse mesh of shell elements underestimates the deflections by less than 1 percent at the crest and by less than 10 percent at lower elevations. Similar results were obtained for the stresses but are not shown here. This example indicates that the normal mesh size provides accurate results and can be used in most typical analysis. If desired, however, the coarse mesh may be used in preliminary analyses for reasons of economy. For the thick-shell elements used in this example, various parameters such as the element length along the surface (a), the ratio of the thickness to the length (t/a), and the ratio of the length to the radius of curvature ($\phi = a/R$) for the coarse and normal meshes are given in Table 6-2 as a reference. These data indicate that the GDAP shell elements with an angle of curvature less than 20 degrees and a length equal or less than 150 feet, provide sufficient accuracy for practical analysis of arch dams with simple geometry and size comparable to that of Morrow Point Dam. For other arch dams with irregular foundation profile, or with attached spillway, or when the lower-order solid elements are used, a finer mesh than that shown in Table 6-2 may be required.

b. Foundation Model. An ideal foundation model is one which extends to infinity or includes all actual geological features of the rock and extends to

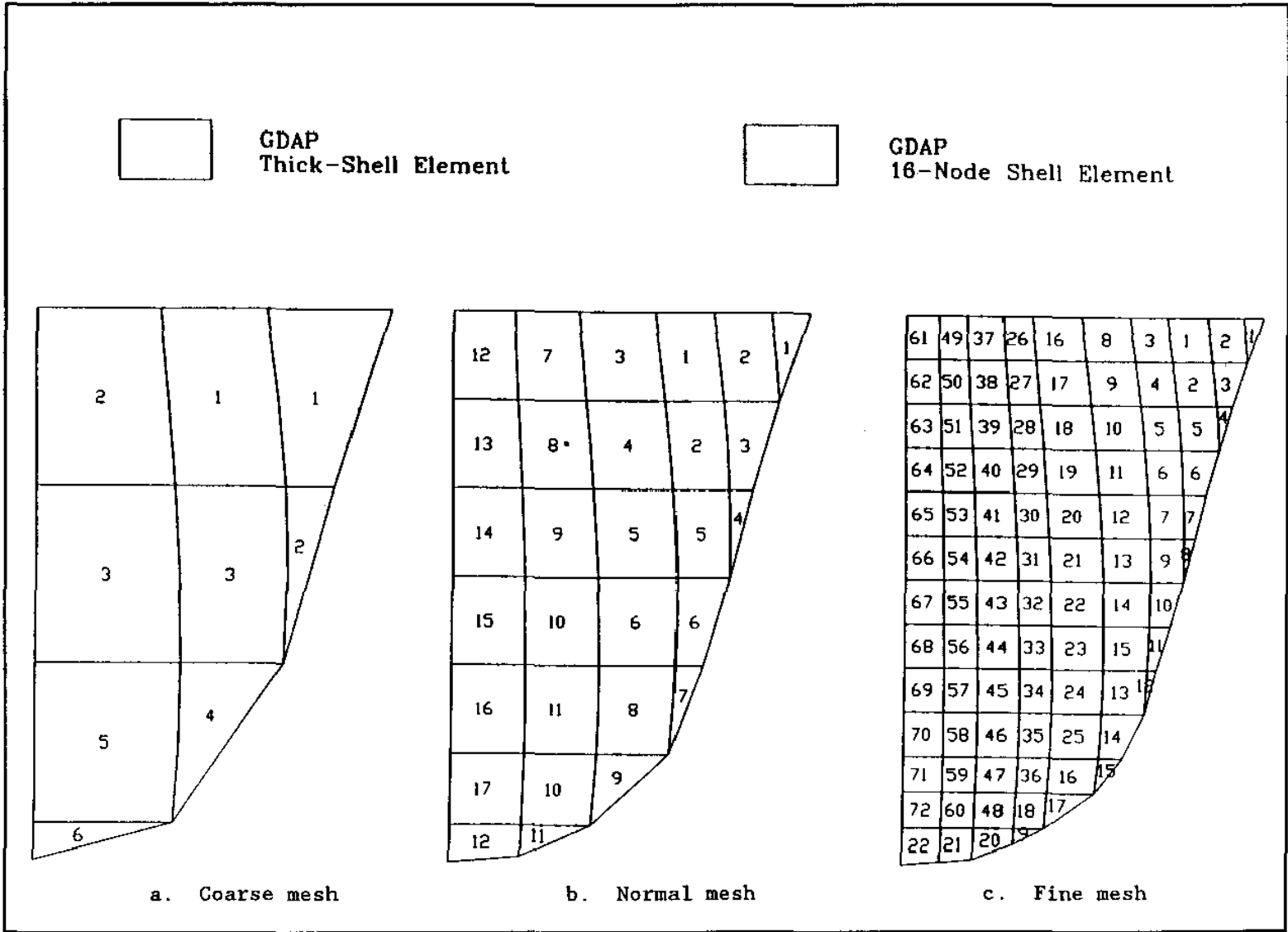

Figure 6-2. Alternative meshes for Morrow Point Dam

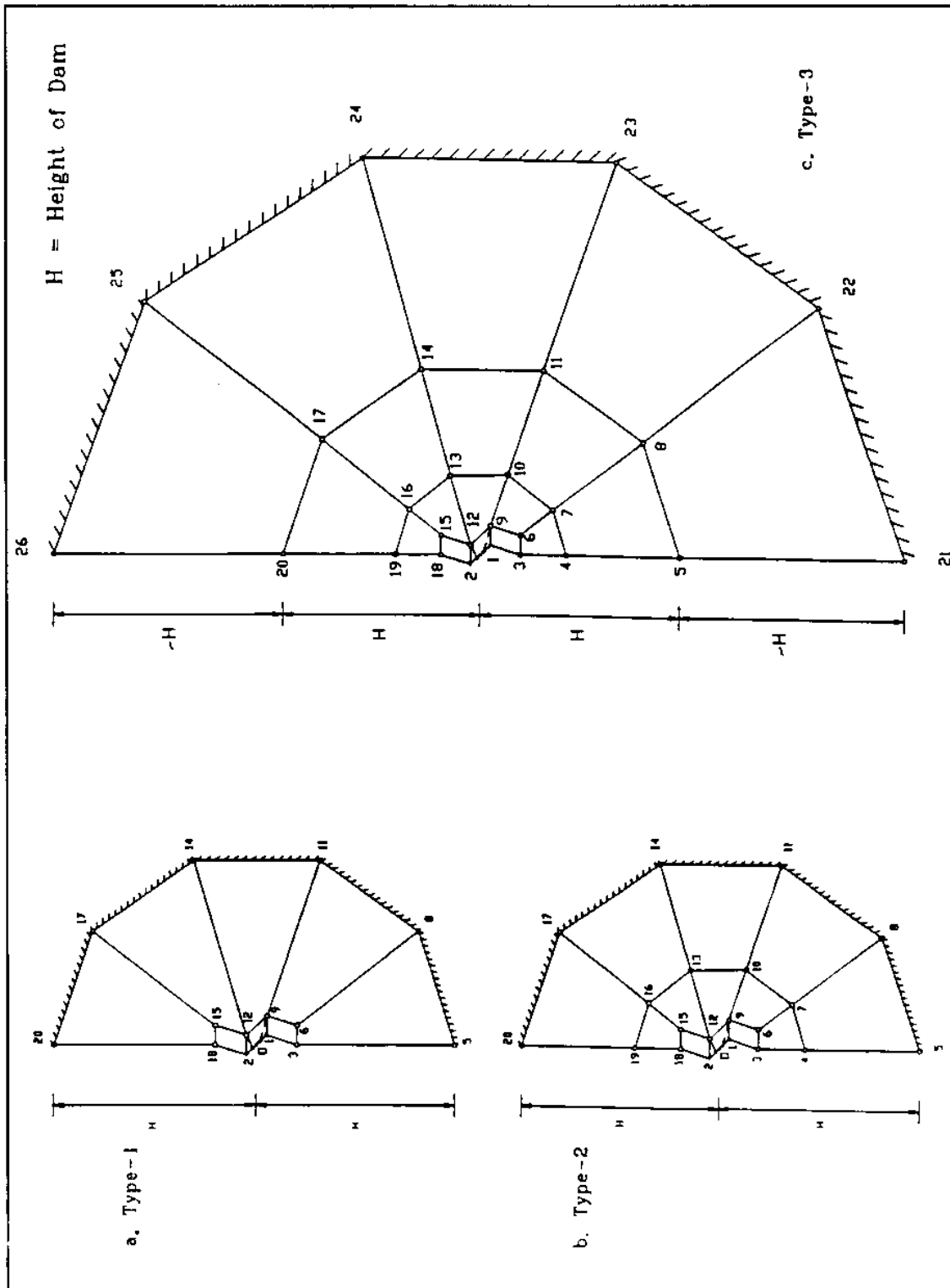

Figure 6-3. GDAP foundation mesh types

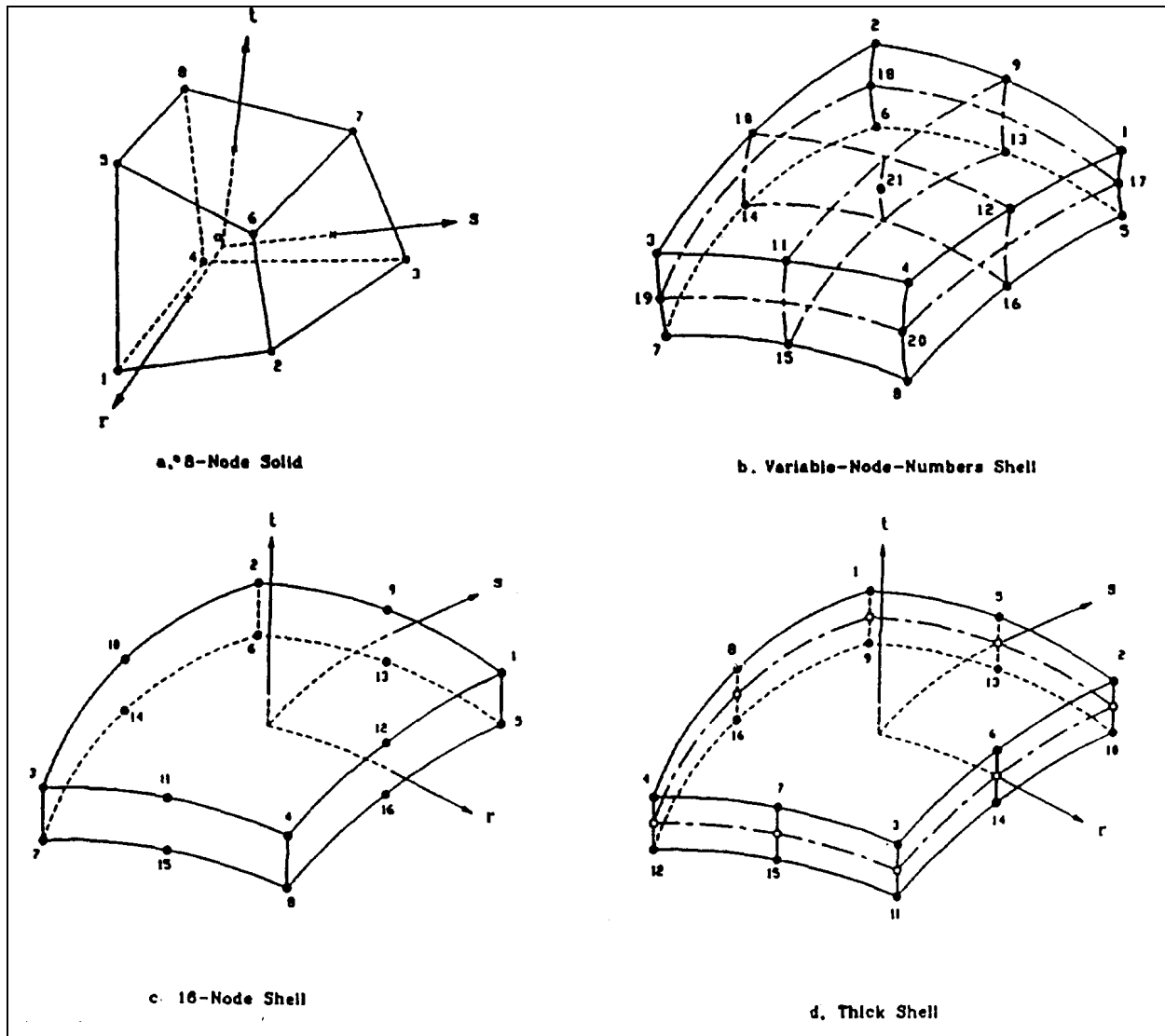

Figure 6-4. Shell and 3-D elements for arch dams

a very large distance where boundary effects on the stresses in the dam become negligible. In practice, however, these idealized models are not possible because analytical techniques to deal with infinite foundation models are not yet sufficiently developed, and very extensive models are computationally prohibitive, even if the necessary geological data were available. Instead, a simplified foundation model is used which extends a sufficiently large distance that boundary effects are insignificant; the effects of the geological formation are partly accounted for by using modulus of deformation rather than the modulus of elasticity of the rock. In general, the geometry of the rock supporting an arch dam is completely different for different dams and cannot be represented by a single rule; however, simplified prismatic foundation models available in the GDAP program (Figure 6-1) provide adequate models that can conveniently be adapted to different conditions. The foundation mesh types available in the GDAP are shown in Figure 6-3. All three meshes are

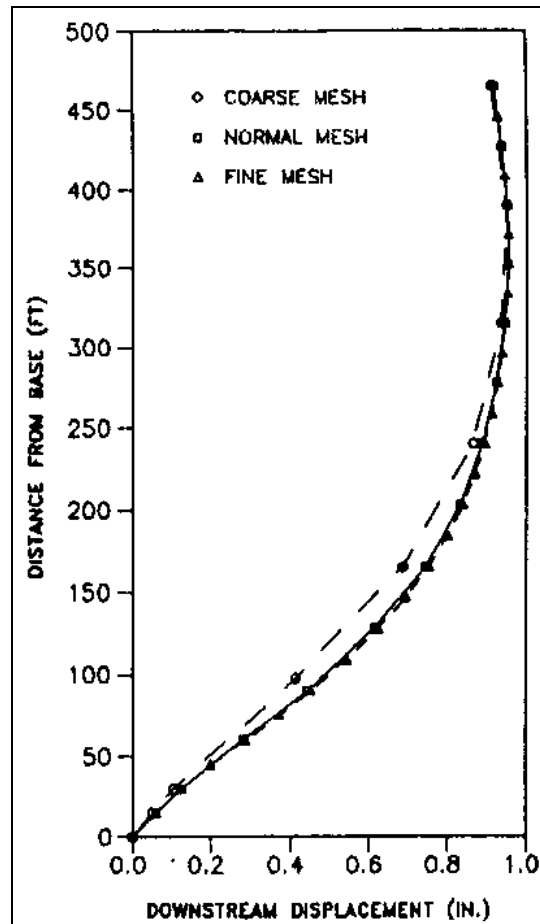

Figure 6-5. Crown section displacements of Morrow Point Dam for alternative meshes

TABLE 6-2

Element Mesh Parameters

<u>Mesh</u>	<u>a</u> <u>ft</u>	<u>t/a</u> <u>crest</u>	<u>t/a</u> <u>base</u>	<u>φ</u>
Coarse	150	0.08	0.34	20
Normal	75	0.15	0.70	10

constructed on semicircular planes cut into the canyon walls and oriented normal to the rock-concrete interface as indicated in Figure 6-1a; they differ only with respect to the extent of the rock and the number of elements in each semicircular plane. Eight-node solid elements with anisotropic material properties (Figure 6-4a) are most commonly used for modeling the foundation rock.

The foundation mesh is arranged so that smaller elements are located adjacent to the dam-foundation contact surface and the elements become larger toward the boundaries of the model. The size of elements used near the interface is controlled by the dam thickness, and the size of the larger elements depends on the extent of foundation mesh and the number of elements to be used in each section.

(1) Effects of Foundation Deformability. The importance of foundation interaction on the displacements and stresses resulting from loading an arch dam has long been recognized. The results of a parametric study of Morrow Point Dam, presented in Figures 6-6 through 6-8, demonstrate qualitatively the relative importance of the foundation modulus on the dam response. Three values of the rock modulus were considered: (a) rigid, (b) the same modulus as the concrete, and (c) one-fifth (1/5) the modulus of concrete. The analyses were made only for hydrostatic loads, and the effect of water load acting on the flexible foundation at the valley floor and on the flanks was also investigated. Figure 6-6 shows the deformation patterns while Figure 6-8 compares the arch and cantilever stresses along the crown cantilever section. Deformations clearly are strongly affected by the rock modulus. The rotation of foundation rock, caused by the reservoir water, results in a slight rotation of the dam section in the upstream direction which is more pronounced for weaker rocks. Stresses also are considerably affected by foundation flexibility as compared with the rigid foundation assumption and are further increased by the weight of the impounded water which causes deformations of the foundation rock at the valley floor and flanks. It is important to realize that actual foundations are seldom uniform and may have extensive weak zones. In such cases different values of rock modulus should be assigned to different zones so that the variability effects may be assessed.

(2) Size of the Foundation-Rock Region. To account for the flexibility effects of the foundation rock, an appropriate volume of the foundation should be included in the dam-foundation model to be analyzed; however, the amount of flexibility that is contributed by the foundation rock in actual field conditions has not been established. Larger foundation meshes can provide greater flexibility; however, if more finite elements are used to subdivide the foundation rock, greater data preparation and computational efforts are required. Moreover, the increased flexibility also can be obtained by using a reduced foundation modulus. Therefore, the foundation idealization models presented in Figure 6-3 may be sufficient to select the minimum mesh extent (i.e., radius of semicircle R_f) which adequately represents the foundation flexibility effects. In static analysis, flexibility of foundation affects displacements and stresses induced in the dam. For practical analysis, the minimum R_f is selected as a distance beyond which increasing R_f has negligible effects on the displacements and stresses in the dam. The static displacements along the crown cantilever of Morrow Point Dam for two concrete to rock modulus ratios and for three foundation mesh types are shown in Figure 6-7. These results and the stress results (not shown here) suggest that foundation mesh type-1 is adequate for most practical analyses and especially for foundations in which the rock modulus is equal to or greater than the concrete modulus. For very flexible foundation rocks, however, mesh type-3 with an R_f equal to two dam heights should be used.

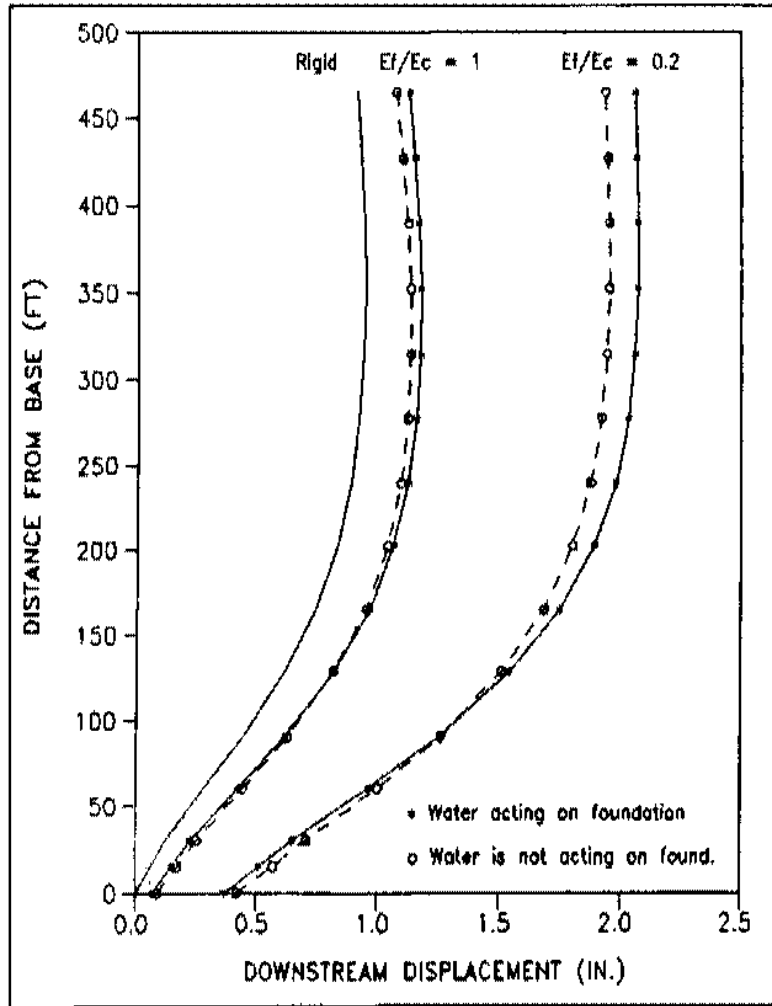

Figure 6-6. Crown section displacements of Morrow Point Dam for different foundation-to-concrete modulus ratios with and without water acting on valley floor

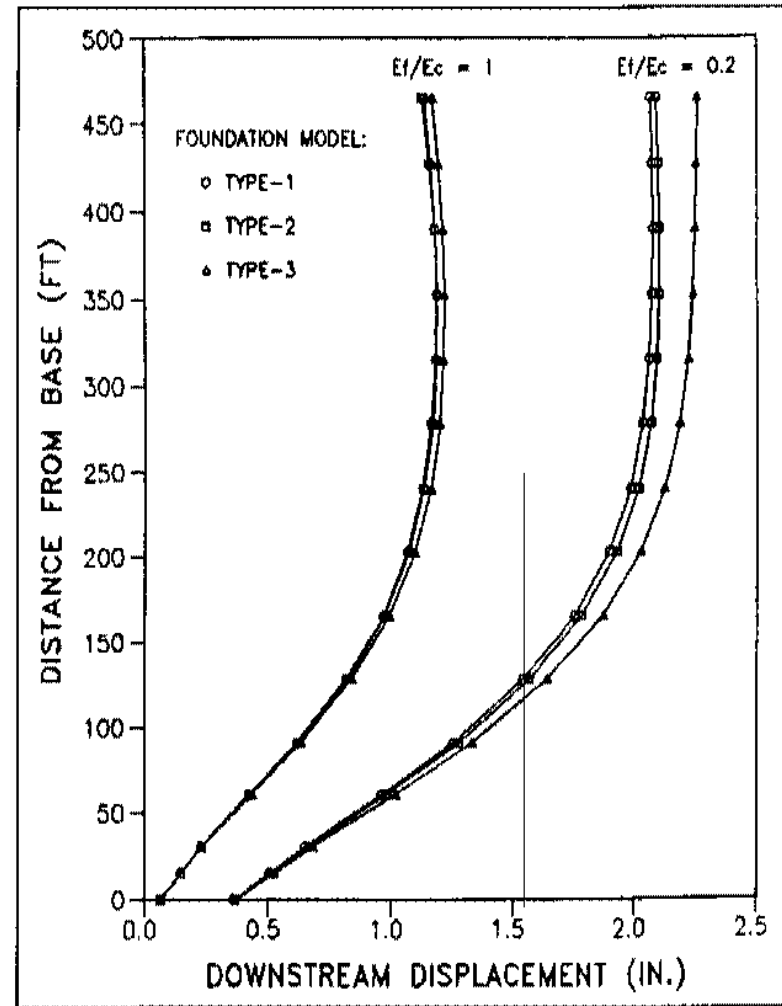

Figure 6-7. Crown section displacements of Morrow Point Dam for two foundation-to-concrete modulus ratios and for three foundation mesh types

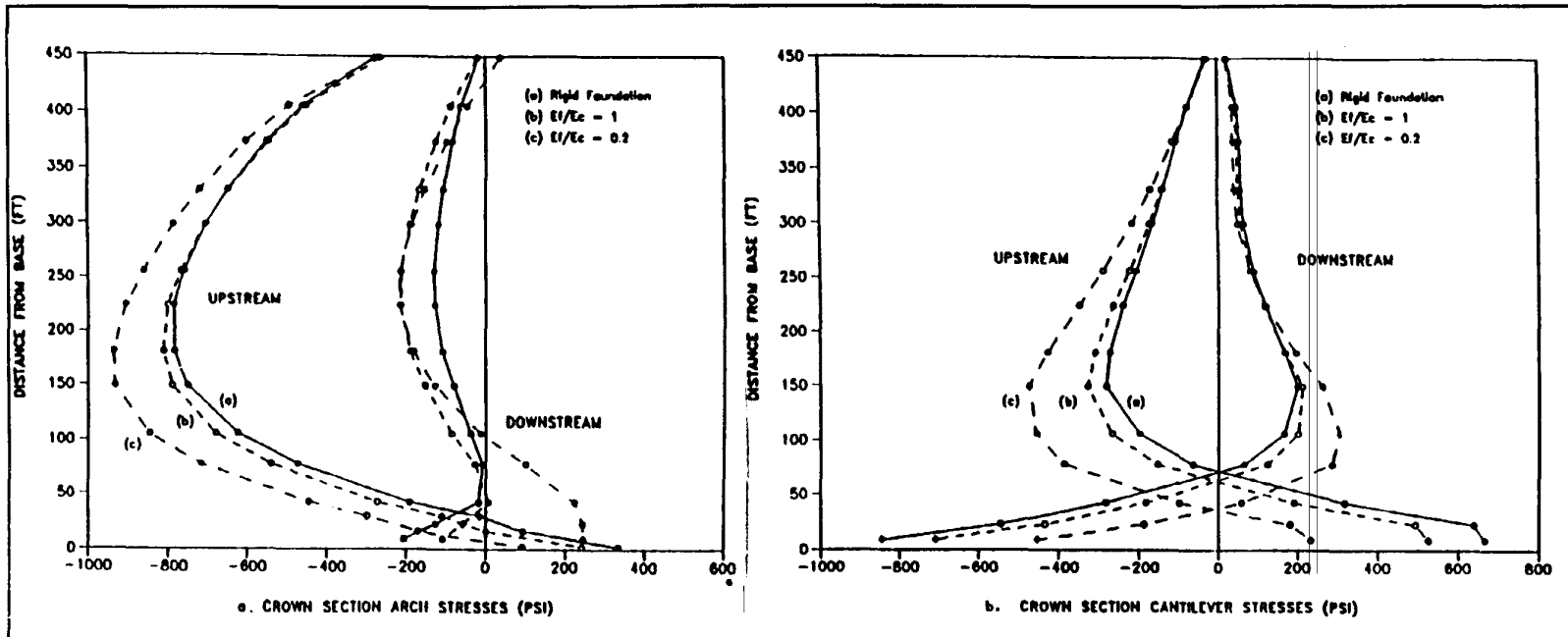

Figure 6-8. Crown section arch and cantilever stresses of Morrow Point Dam for different foundation-to-concrete modulus ratios with (c & d) and without (a & b) water loads acting on valley floor (Continued)

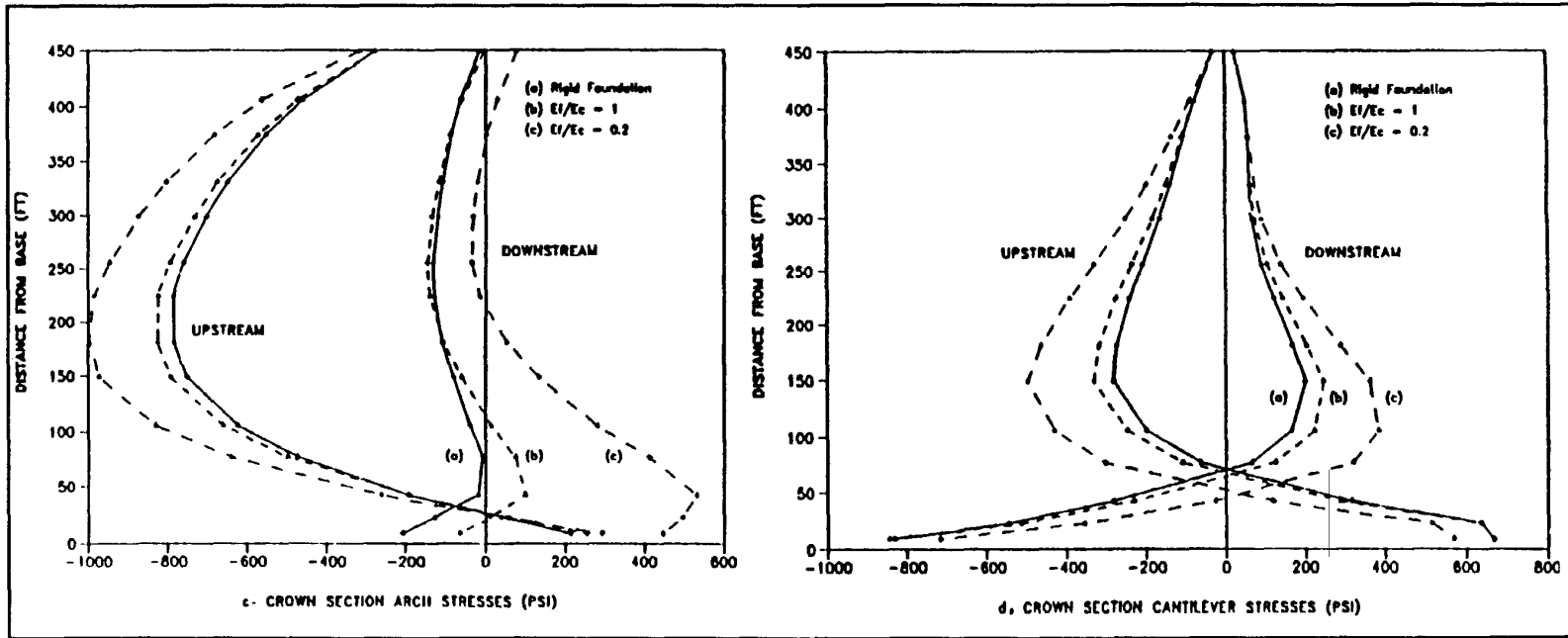

Figure 6-8. (Concluded)

c. Appurtenant Structures. All modern dams include a number of appurtenant structures and devices such as thrust blocks, spillways, galleries, and other openings. The effects of such appurtenances, if significant, should be considered in the analysis by including them in the finite element model of the dam structure.

(1) Thrust Blocks. Thrust blocks are often used as an artificial abutment where the foundation rock does not extend high enough to support the arches. Their main function is to resist the forces transmitted by the upper arches and transfer them to sound foundation rock at their base. They are a critical component of an arch dam design and should be included appropriately as part of the finite element model of the dam-foundation system. Thrust blocks may be adequately modeled using 8-node elements or any variation of 8-to-20 node solid elements shown in Figures 6-4a and 6-4b. Several element layers are usually required to match the arch mesh at the junction and to account for excessive thickness of the thrust block.

(2) Spillways, Galleries, and Other Openings. Arch dams may be designed to accommodate spillways and various other openings such as galleries, sluiceways, and river outlets. Stresses usually tend to concentrate excessively in the area of such openings, and care should be taken to reduce their effects. The large cuts made at the crests of arch dams to provide openings for overflow spillways should be included in the finite element model of the dam structure in order to assess their effects on the stress distribution. If necessary, the design of the dam should be modified to transfer load around the opening in the crest or to proportion the dam thickness to reduce the resulting stress concentrations. Spillways provided by tunnels or side channels that are independent of the arch dam are analyzed and designed separately; thus, they are not included in the finite element model of the dam.

(3) Other Openings Such as the Galleries, Sluiceways, and River Outlets. These openings introduce a local disturbance in the prevalent stress field and, in general, weaken the structure locally; however, the size of these openings usually does not have a significant influence on the overall stiffness of the dam structure, and their effect on the stress distribution may be ignored if adequate reinforcing is provided to carry the forces around the openings. Therefore, such openings need not be considered in the finite element mesh provided that the openings are small and adequately reinforced.

6-5. Presentation of Results. An important aspect of any finite element analysis is that of selecting and presenting essential information from the extensive results produced. It is extremely helpful to have the results presented in graphical form, both for checking and evaluation purposes. The results should contain information for the complete structure to make a judgment regarding the dam safety, as well as to determine whether the boundary locations are suitable or whether there are inconsistencies in the stress distribution.

a. The basic results of a typical static analysis of an arch dam consist of nodal displacements and element stresses computed at various element locations. As a minimum, nodal displacements and surface stresses for the design load combinations specified in Chapter 4 should be presented. Additional displacement and stress results due to the individual load pattern are

also desirable because they provide basic information for interpretation of the indicated dam behavior.

b. Nodal displacements are computed in most computer analyses and are directly available. They are simply presented as deflected shapes across selected arches and cantilevers or for the entire dam structure in the form of 3-D plots. However, consideration should be given to whether the displacements should be indicated in global (x,y) coordinates, or in terms of radial and tangential components for each surface node. The stresses usually are computed with respect to a global coordinate system but they should be transformed to surface arch, cantilever, and principal stress directions to simplify their interpretation. The arch and cantilever stress quantities usually are plotted as stress contours on each dam face, while the principal stresses on each face are presented in the form of vector plots as shown in Figure 6-9. In addition, plots of the arch and cantilever stresses determined across the upper arch section and along the cantilever sections are desirable for further detailed study of the stresses.

6-6. Evaluation of Stress Results.

a. Evaluation of the stress results should start with careful examination of the dam response to assure the validity of the computed results. Nodal displacements and stresses due to the individual loads are the most appropriate data for this purpose. In particular, displacements and stresses across the upper arch and the crown cantilever sections are extremely helpful. Such data are inspected for any unusual distributions and magnitudes that cannot be explained by intuition and which differ significantly from the results for similar arch dams. Once the accuracy of the analytical results has been accepted, the performance of the dam for the postulated loading combinations must be evaluated.

b. This second stage of evaluation involves comparing the maximum calculated stresses with the specified strength of the concrete according to the criteria established in Chapter 11. The analysis should include the effects of all actual static loads that will act on the structure during the operations, in accordance with the "Load Combinations" criteria presented in Chapter 4. The largest compressive and tensile stress for each load combination case should be less than the compressive and tensile strength of the concrete by the factors of safety specified for each design load combination. When design criteria for all postulated loads are met and the factors of safety are in the acceptable range, the design is considered satisfactory, or, in the case of an existing dam, it is considered safe under the static loads. However, if calculated tensile stresses exceed the cracking strength of the concrete or the lift joints or if tensile stresses are indicated across the vertical monolith joints, the possibility of tension cracking and joint opening must be considered and judgement is required to interpret the results.

(1) Under the static loads, a well designed arch dam should develop essentially compressive stresses that are significantly less than the compressive strength of the concrete; however, tensile stresses may be developed under multiple loading combinations, particularly when the temperature drop is large and other conditions are unfavorable. Although unreinforced concrete can tolerate a limited amount of tensile stress, it is important to keep the

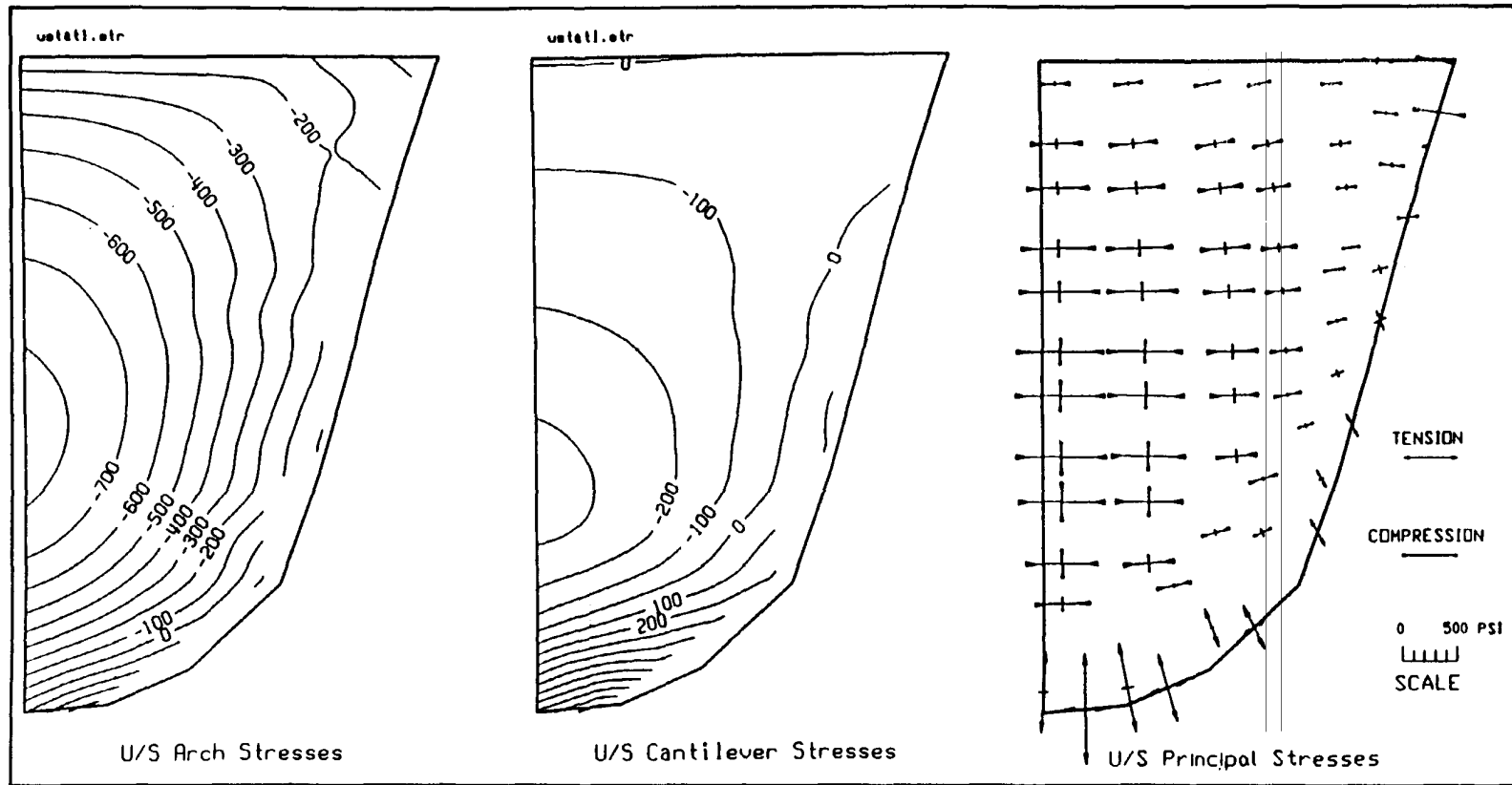

Figure 6-9. Arch and cantilever stress contours and vector plot of principal stresses for upstream face of Morrow Point Dam

tension to a minimum so that the arch has sufficient reserve strength if subjected to additional seismic loads. Vertical (cantilever) tensile stresses can be minimized by vertical arching and overhanging of the crest, but the amount by which this can be done is limited by the stress and stability of individual cantilever blocks during the construction process. When the design limits are reached or, as in the case of many existing dams, when the dam is not designed for severe loading conditions, some cracking could occur at the base and near the abutments. Linear-elastic analyses often indicate large stresses near the geometric discontinuity at the foundation contact. However, it is important to note that the tensile stresses indicated at the base of the arch dams by linear-elastic analyses are partly fictitious because these analyses do not take into account the limited bond between the concrete and foundation rock as well as the joints in the rock that could open when subjected to tensile forces. In this situation, a more realistic estimate of static stresses at the base of the dam may be obtained by a linear-elastic analysis that uses a reduced foundation deformation modulus to decrease the tension in the fractured rock.

(2) Arch dams rely significantly on arch action to transfer horizontal loads to the foundation. Therefore, in general, compressive arch stresses are expected throughout the dam; however, the analyses of monolithic arch dams with empty reservoirs, with low water levels, or with severe low temperatures have indicated that zones of horizontal tensile stresses can develop on the upstream and downstream dam faces. These tensile stresses combined with additional tensile stresses due to temperature drop tend to open the vertical contraction joints which are expected to have little or no tensile strength. It is apparent that joint opening will relieve any indicated arch tensile stresses, and the corresponding loads can be redistributed to cantilever action provided that tensile arch stresses are limited to only a small portion of the dam.

(3) Shear stresses are rarely a problem in an arch dam; nevertheless, they should be checked to make sure that they remain within the allowable limits.

c. In conclusion, the results of a linear elastic analysis are valid only if the cracking or joint openings that occur in the dam are minor and the total stiffness of the structure is not affected significantly. Therefore, it is necessary to evaluate the extent of cracking and to judge whether or not a state of no tension can safely be achieved in the dam and its foundation. If appreciable cracking is indicated, it is desirable to investigate its extent and its effects on actual stresses and deflections by analytical procedures. An approximate investigation based on a simplified nonlinear analysis may be made by eliminating the tension areas by iteration and reanalyzing the arch.

CHAPTER 7

EARTHQUAKE RESPONSE ANALYSIS

7-1. Introduction. A dynamic method of analysis is required to properly assess the safety of existing concrete arch dams and to evaluate proposed designs for new dams that are located in regions with significant seismicity. Dynamic analysis is also performed to determine the adequacy of structural modifications proposed to improve the seismic performance of old dams. The prediction of the actual dynamic response of arch dams to earthquake loadings is a very complicated problem and depends on several factors including intensity and characteristics of the design earthquakes, interaction of the dam with the foundation rock and reservoir water, computer modeling, and the material properties used in the analysis. Detailed descriptions of the recommended dynamic analysis procedures are provided in the "Theoretical Manual for Analysis of Arch Dams" (Ghanaat 1993b). Guidance concerning the seismic studies needed to specify the design earthquake ground motions, methods of analysis, parameters influencing the dam response, and the presentation and evaluation of the analysis results are discussed in this chapter.

7-2. Geological-Seismological Investigation. Estimation of appropriate seismic excitation parameters is an important aspect of the seismic design, analysis, and evaluation of new and existing dams. Concrete arch dams built in seismic regions may be subjected to ground shaking due to an earthquake at the dam site or, more likely, to ground motions induced by distant earthquakes. In addition, large dams may experience earthquakes triggered at the dam site immediately following the reservoir impoundment or during a rapid drawdown. However, such reservoir-induced earthquakes are usually no greater than those to be expected without the reservoir, and they do not augment the seismicity of the region. The estimation of future earthquake ground motions at a dam site requires geological, seismological, geophysical, and geotechnical investigations. The primary purposes of these studies are to establish the tectonic and geologic setting at and in the vicinity of the dam site, to identify active faults and seismic sources, to collect and analyze the historic and instrumental seismic data, and to study the foundation conditions at the dam site that form the basis for estimating the ground motions. However, the lack of necessary data or difficulty in obtaining them, as well as numerous uncertainties associated with the source mechanism and the seismic wave propagation, often complicate the estimation process of ground motions. Therefore, at the present time seismic parameters for dam projects are approximated by empirical relations and through simplified procedures that decouple or neglect the effects of less understood phenomena. The primary factors that must be considered in determination of the seismic parameters for dam projects are discussed in the following paragraphs.

a. Regional Geologic Setting. A study of regional geology is required to understand the overall geologic setting and seismic history of a dam site. The study area, as a minimum, should cover a 100 km radius around the site. But in some cases it may be extended to as far as 300 km in order to include all significant geologic features such as major faults and to account for area-specific attenuation of earthquake ground motion with distance. A typical geologic study consists of:

- (1) Description of the plate tectonic setting of the dam region together with an account of recent movements.
- (2) Regional geologic history and physiographic features.
- (3) Description of geologic formations, rock types, soil deposits.
- (4) Compilation of active faults in the site region and assessment of the capability of faults to generate earthquakes.

(5) Characterization of each capable fault in terms of its maximum expected earthquake, recurrence intervals, total fault length, slip rate, slip history, and displacement per event, etc. Field work such as an exploratory trench or bulldozer cuts may also be required to evaluate the seismic history.

b. Regional Seismicity. The seismic history of a region provides information on the occurrence of past earthquakes that help to identify seismicity patterns and, thus, give an indication of what might be expected in the future. Procedures for estimating the ground motion parameters at a particular site are primarily based on historic and instrumentally recorded earthquakes and other pertinent geologic considerations. It is important, therefore, to carefully examine such information for accuracy, completeness and consistency. When possible, the following investigations may be required:

- (1) Identification of seismic sources significant to the site, usually within about a 200-km radius.
- (2) Development of a catalog of the historical and instrumentally recorded earthquakes for the dam site region. The data, whenever possible, should include locations, magnitudes or epicentral intensity, date and time of occurrence, focal depth, and focal mechanism.
- (3) Illustration of the compiled information by means of appropriate regional and local seismicity maps.
- (4) Analysis of seismicity data to construct recurrence curves of the frequency of earthquakes for the dam region, to examine spatial patterns of epicenters for possible connection with the identified geologic structures, and to evaluate the catalog for completeness and accuracy.
- (5) A review of the likelihood of reservoir induced seismicity (RIS) at the dam site, although this is not expected to influence the design earthquake parameters as previously mentioned.

c. Local Geologic Setting. Local geology should be studied to evaluate some of the site-specific characteristics of the ground motion at the dam site. Such data include rock types, surface structures, local faults, shears and joints, and the orientation and spacing of joint systems. In some cases, there may be geologic evidence of primary or sympathetic fault movement through the dam foundation. In those situations, a detailed geologic mapping, and geophysical and geotechnical exploration should be carried out to assess the potential, amount, and the type of such movements at the dam site.

7-3. Design Earthquakes. The geological and seismological investigations described in the previous paragraph provide the basis for estimating the earthquake ground motions to be used in the design and analysis of arch dams. The level of such earthquake ground motions depend on the seismic activity in the dam site vicinity, source-to-site distance, length of potential fault ruptures, source mechanism, surface geology of the dam site, and so on. Two approaches are available for estimating the ground motion parameters: deterministic and probabilistic. Both approaches require specification of seismic sources, assessing maximum magnitudes for each of the sources, and selecting ground motion attenuation relationships. The probabilistic analysis requires the additional specification of the frequency of earthquake recurrence for each of the sources in order to evaluate the likelihood of exceeding various level of ground motion at the site. The earthquake ground motions for which arch dams should be designed or analyzed include OBEs and MDEs. The ground motions defined for each of these earthquakes are discussed in the following paragraphs.

a. Operating Basis Earthquake (OBE). The OBE is defined as the ground motion with a 50 percent probability of being exceeded in 100 years. In design and safety evaluation of arch dams, an OBE event should be considered as an unusual loading condition as described in Chapter 4. The dam, its appurtenant structures, and equipment should remain fully operational with minor or no damage when subjected to earthquake ground motions not exceeding the OBE.

b. Maximum Design Earthquake (MDE). The MDE is the maximum level of ground motion for which the arch dam should be analyzed. The MDE is usually equated to the MCE which, by definition, is the largest reasonably possible earthquake that could occur along a recognized fault or within a particular seismic source zone. In cases where the dam failure poses no danger to life or would not have severe economic consequences, an MDE less than the MCE may be used for economic reasons. An MDE event should be considered as an extreme loading condition for which significant damage is acceptable, but without a catastrophic failure causing loss of life or severe economic loss.

c. Reservoir-induced Earthquake (RIE). The reservoir-induced earthquake is the maximum level of ground motion that may be triggered at the dam site during filling, rapid drawdown, or immediately following the reservoir impoundment. Statistical analysis of the presumed RIE cases have indicated a relation between the occurrence of RIE and the maximum water depth, reservoir volume, stress regime, and local geology. The likelihood of an RIE is normally considered for dams higher than about 250 feet and reservoirs with capacity larger than about 10^5 acre-feet, but the possibility of an RIE occurring at new smaller dams located in tectonically sensitive areas should not be ruled out. The possibility of RIE's should therefore be considered when designing new high dams, even if the region shows low historical seismicity. The determination of whether the RIE should be considered as a dynamic unusual or a dynamic extreme loading condition (Table 4-2) should be based on the probability of occurrence but recognizing that the RIE is no greater than the expected earthquake if the reservoir had not been built.

7-4. Earthquake Ground Motions. The earthquake ground motions are characterized in terms of peak ground acceleration, velocity, or displacement values,

and seismic response spectra or acceleration time histories. For the evaluation of arch dams, the response spectrum and/or time-history representation of earthquake ground motions should be used. The ground motion parameters for the OBE are determined based on the probabilistic method. For the MCE, however, they are normally estimated by deterministic analysis, but a probabilistic analysis should also be considered so that the likelihood of a given intensity of ground motion during the design life of the dam structure can be determined. The earthquake ground motions required as input for the seismic analysis of arch dams are described in the following subparagraphs.

a. Design Response Spectra. The ground motion used for the seismic analysis of arch dams generally is defined in the form of smooth response spectra and the associated acceleration time histories. In most cases site-specific response spectra are required, except when the seismic hazard is very low; in which case a generic spectral shape such as that provided in most building codes may suffice. When site-specific response spectra are required, the effects of magnitude, distance, and local geological conditions on the amplitude and frequency content of the ground motions should be considered. In general, the shape of the response spectrum for an OBE event is different from that for the MCE, due to differences in the magnitude and the earthquake sources as shown in Figure 7-1. Thus, two separate sets of smooth response spectra may be required, one for the OBE and another for the MCE. The smooth response spectra for each design earthquake should be developed for both horizontal and vertical components of the ground motion. The design spectra are typically developed for 5 percent damping. Estimates for other damping values can be obtained using available relationships (Newmark and Hall 1982). The vertical response spectra can be estimated using the simplified published relationships between the vertical and horizontal spectra which will be described in a future engineer manual. The relationship used should recognize the significant influence of the source-to-site distance and of the particular period range (≤ 0.2 sec) on the vertical response spectra.

b. Acceleration Time Histories. When acceleration time histories of ground motions are used as seismic input for the dynamic analysis of arch dams, they should be established with the design response spectra and should have appropriate strong motion duration and number of peaks. The duration of strong motion is commonly measured by the *bracketed duration*. This is the duration of shaking between the first and last accelerations of the accelerogram exceeding 0.05 g.

(1) Acceleration time histories are either selected from recorded ground motions appropriate to the site, or they are synthetically developed or modified from one or more ground motions. In the first approach, several records are usually required to ensure that the response spectra of all records as a whole do not fall below the smooth design spectra. This procedure has the advantage that the dam is analyzed for natural motions, several dynamic analyses should be performed. In addition, the response spectrum of individual records may have peaks that substantially exceed the design response spectra.

(2) Alternatively, acceleration time histories are developed either by artificially generating an accelerogram or by modifying a recorded accelerogram so that the response spectrum of the resulting accelerogram closely matches the design response spectra. The latter technique is preferred,

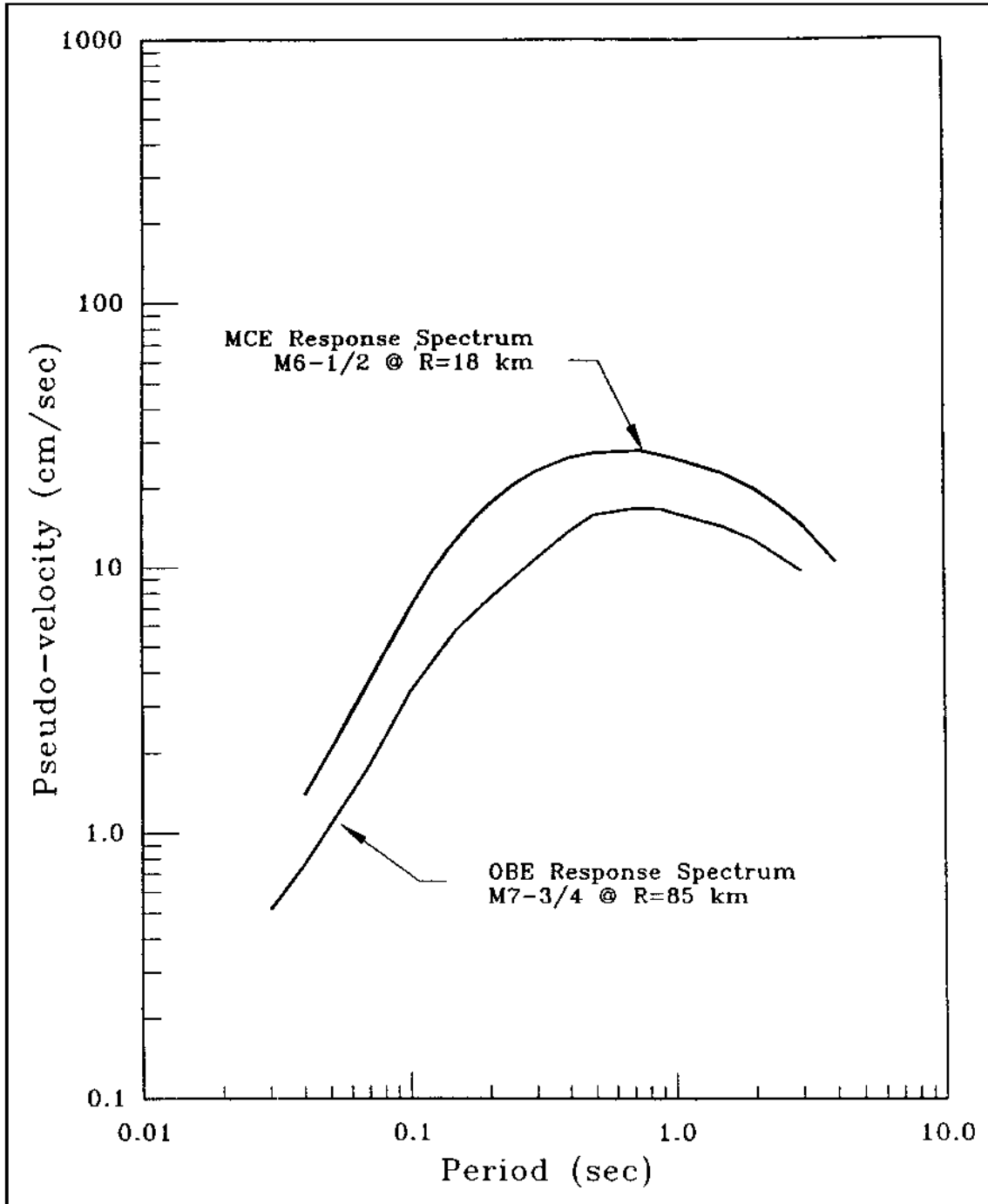

Figure 7-1. Smooth design response-spectrum examples for OBE and MCE events for 5 percent damping

because it starts with a natural accelerogram and thus preserves the duration and phasing of the original record and produces time histories that look natural. An example of this procedure which shows a good match with the smooth design response spectrum is demonstrated in Figure 7-2.

(3) For large thin arch dams with fundamental periods near 0.5 to 1 sec located at close distances to the earthquake source, it is desirable to include a strong intermediate-to-long period pulse (0.5 to 5 sec) to account for the "fling" characteristic of near-source ground motion.

7-5. Finite Element Modeling Factors Affecting Dynamic Response. Dynamic analysis of arch dams for earthquake loading should be based on a 3-D idealization of the dam-water-foundation system which accounts for the significant interaction effects of the foundation rock and the impounded water. To compute the linear response of the dam, the concrete arch and the foundation rock are modeled by standard finite elements, whereas the interaction effects of the impounded water can be represented with any of three different level of refinement. In addition, the dynamic response of arch dams is affected by the damping and by the intensity and spatial variation of the seismic input. These factors and the finite element modeling of various components of an arch dam are discussed in the following sections.

a. Arch Dam. The finite element model of an arch dam for dynamic analysis is essentially identical to that developed for the static analysis. In a linear-elastic analysis, the arch dam is modeled as a monolithic structure with no allowance for the probable contraction joint opening during earthquake excitation. Thin and moderately thin arch dams are adequately modeled by a single layer of shell elements, whereas thick gravity-arch dams should be represented by two or more layers of solid elements through the dam thickness. The size of the mesh should be selected following the general guidelines presented in Chapter 6 for static analysis and shown in Figure 6-1. In addition, the dynamic response of the appurtenant structures attached to the dam may be significant and also should be considered. For example, the power intakes attached to the dam may include free-standing cantilevers that could vibrate during the earthquake shaking. The power intakes in this case should be included as part of the dam model to ensure that the dam stresses induced by the vibration of these components are not excessive.

b. Dam-foundation Rock Interaction. Arch dams are designed to resist the major part of the water pressures and other loads by transmitting them through arch action to the canyon walls. Consequently, the effects of foundation rock on the earthquake response of arch dams are expected to be significant and must be considered in the dynamic analysis. However, a complete solution of the dam foundation interaction effects is very complicated and such procedures have not yet been fully developed. There are two major factors contributing to this complex interaction problem. First is the lack of a 3-D model of the unbounded foundation rock region to account for energy loss due to the radiation of vibration waves. The other and even more important contributing factor is related to the prescription of spatial variation of the seismic input at the dam-foundation interface, resulting from wave propagation of seismic waves through the foundation rock and from scattering by the canyon topography. Faced with these difficulties, an overly simplified model of the foundation rock (Clough 1980) is currently used in practice. This widely used simplified model ignores inertial and damping effects and considers only the

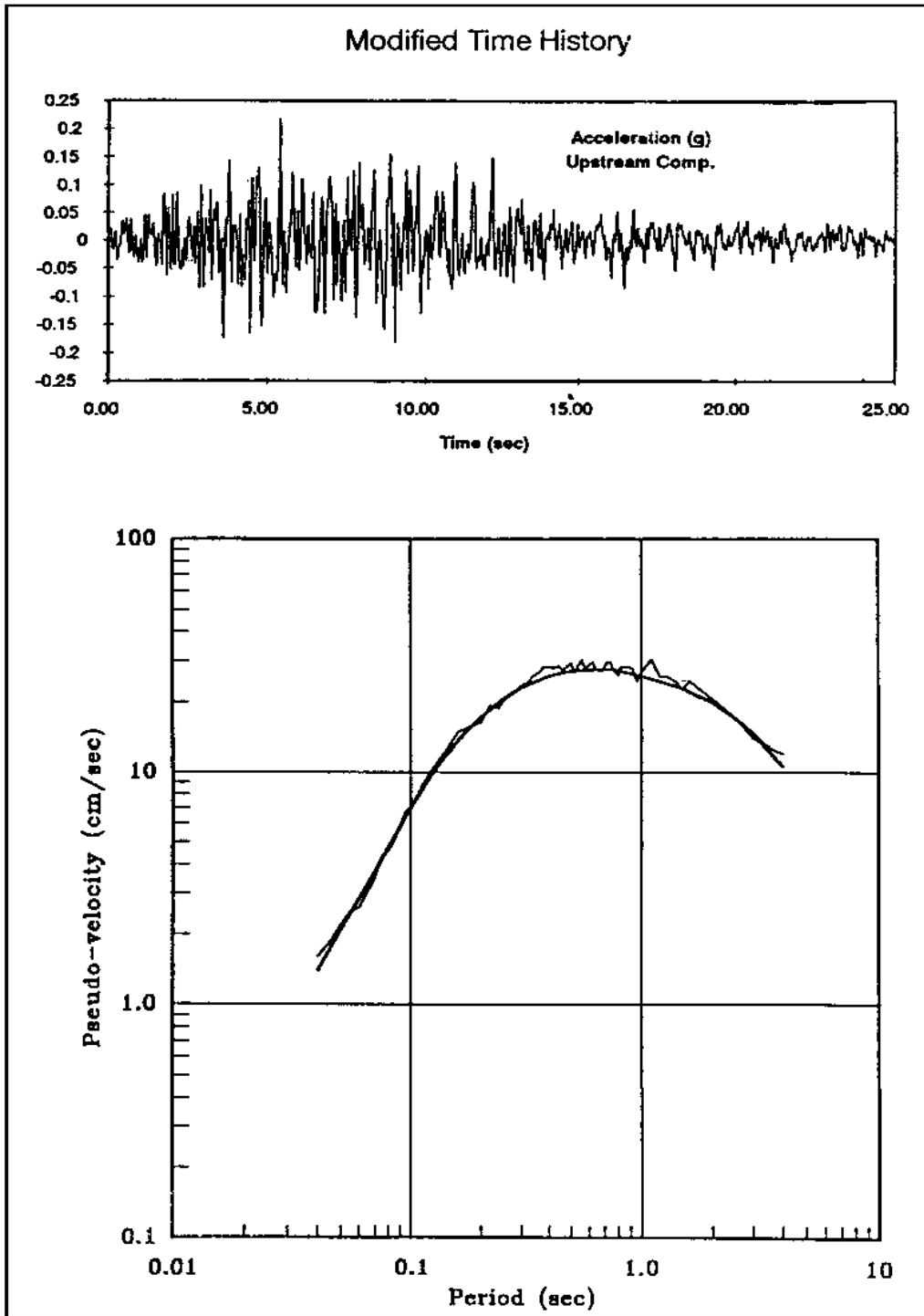

Figure 7-2. Comparison of response spectrum of modified time history and smooth-design response spectrum for 5 percent damping

flexibility of the foundation rock. The foundation model for the dynamic analysis is therefore similar to that described for the static analysis in Chapter 6. As shown in Figures 6-1a and 6-3, an appropriate volume of the foundation rock should be idealized by the finite element discretization of the rock region. Each foundation element is represented by a solid element having eight or more nodes and characterized by its dynamic deformation modulus and Poisson's ratio.

(1) Shape of Foundation Model. Using the finite element procedure, a foundation model can be developed to match the natural topography of the foundation rock region. However, such a refined model is usually not required in practice. Instead, a prismatic model employed in the GDAP program and described in Chapter 6 may be used. This foundation model depicted in Figure 6-1a is constructed on semicircular planes cut into the canyon walls normal to the dam-foundation contact surface; in moving from the base to the dam crest, each semicircle is rotated about a diameter always oriented in the upstream-downstream direction.

(2) Size of Foundation Model. The size of the foundation model considered in GDAP is controlled by the radius (R_f) of the semicircular planes described in the previous paragraph. In the static analysis discussed previously, R_f was selected so that the static displacements and stresses induced in the dam were not changed by further increase of the foundation size. In the dynamic analysis, the natural frequencies and mode shapes of vibration control the dam response to earthquakes. Therefore, the size of a foundation model should be selected so that the static displacements and stresses, as well as the natural frequencies and mode shapes, are accurately computed. The natural frequencies of the dam-foundation system decrease as the size of the flexible foundation rock increases (Clough et al. 1985 and Fok and Chopra 1985), but for the massless foundation, the changes are negligible when the foundation size R_f is greater than one dam height, except for the foundation rocks with very low modulus of elasticity. For most practical purposes, a massless foundation model with R_f equal to one dam height is adequate. However, when the modulus ratio of the rock to concrete is less than one-half, a model with R_f equal to two times dam height should be used.

c. Dam-water Interaction. Interaction between the dam and impounded water is an important factor affecting the dynamic response of arch dams during earthquake ground shaking. In the simplest form, this interaction can be represented by an "added mass" attached to the dam first formulated by Westergaard (1933). A more accurate representation of the added mass is obtained using a finite element formulation which accounts for the complicated geometry of the arch dam and the reservoir (Kuo 1982 (Aug)). Both approaches, however, ignore compressibility of water and the energy loss due to radiation of pressure waves in the upstream direction and due to reflection and refraction at the reservoir bottom. These factors have been included in a recent and more refined formulation (Fok and Chopra 1985 (July)), but computation of the resulting frequency-dependent hydrodynamic pressure terms requires extensive efforts and requires consideration of a range of reservoir-bottom reflection coefficients.

(1) Generalized Westergaard Added Mass. Westergaard (1933) demonstrated that the effects of hydrodynamic pressures acting on the vertical face of a rigid gravity dam could be represented by an added mass attached to the

dam, if the compressibility of water is neglected. A general form of this incompressible added-mass concept has been applied to the analysis of arch dams (Kuo 1982 (Aug)). This generalized formulation, also described by Ghanaat (1993b), is based on the same parabolic pressure distribution in the vertical direction used by Westergaard, but it recognizes the fact that the hydrodynamic pressures acting on the curved surface of an arch dam are due to the total accelerations normal to the dam face. Although the resulting added mass calculated in this manner is often used in the analysis of arch dams, it does not properly consider the hydrodynamic effects. In fact, there is no rational basis for the assumed parabolic pressure distribution used for the arch dams, because limitations imposed in the original Westergaard formulation are violated. The original Westergaard formulation assumed a rigid dam with a vertical upstream face and an infinite reservoir. However, the procedure is very simple and provides a reasonable estimate of the hydrodynamic effects for preliminary or feasibility analysis. The generalized added-mass formulation has been implemented in the GDAP program and is available as an option. The program automatically calculates the added mass for each nodal point on the upstream face of the dam; the resulting added mass of water is then added to the mass of concrete to account for the hydrodynamic forces acting on the dam.

(2) Incompressible Finite Element Added Mass. In more refined analyses of new and existing arch dams, the effects of reservoir-water interaction due to seismic loading is represented by an equivalent added mass of water obtained from the hydrodynamic pressures acting on the face of the dam. The procedure is based on a finite element solution of the pressure wave equation subjected to appropriate boundary conditions (Kuo 1982 (Aug) and Ghanaat (1993b)). The nodal point pressures of the incompressible water elements are the unknowns. The bottom and sides of the reservoir, as well as a vertical plane at the upstream end, are assumed to be rigid. In addition, the hydrodynamic pressures at the water-free surface are set to zero; thus the effects of surface waves are neglected, but these have little effect on the seismic response. In general, a finite element model of the reservoir water can be developed to match the natural canyon topography, but a prismatic reservoir model available in the GDAP program is quite adequate in most practical situations. The GDAP reservoir model is represented by a cylindrical surface generated by translating the dam-water interface nodes in the upstream direction as shown in Figure 7-3a. The resulting water nodes generated in this manner match those on the dam face and are usually arranged in successive planes parallel to the dam axis, with the distance between the planes increasing with distance from the dam. Experience shows that the reservoir water should include at least three layers of elements that extend upstream a distance at least three times the water depth.

(3) Compressible Water with Absorptive Reservoir Bottom. The added-mass representation of hydrodynamic effects ignores both water compressibility effects and the energy absorption mechanism at the reservoir bottom. These factors have been included in a recent formulation of the dam-water interaction mechanism which is fully described by Fok and Chopra (1985 (July)). It introduces frequency-dependent hydrodynamic terms in the equations of motion that can be interpreted as an added mass, an added damping, and an added force. The added damping term arises from the refraction of hydrodynamic pressure waves into the absorptive reservoir bottom and also from the propagation of pressure waves in the upstream direction. The energy loss at the reservoir bottom is approximated by the wave reflection coefficient α , which

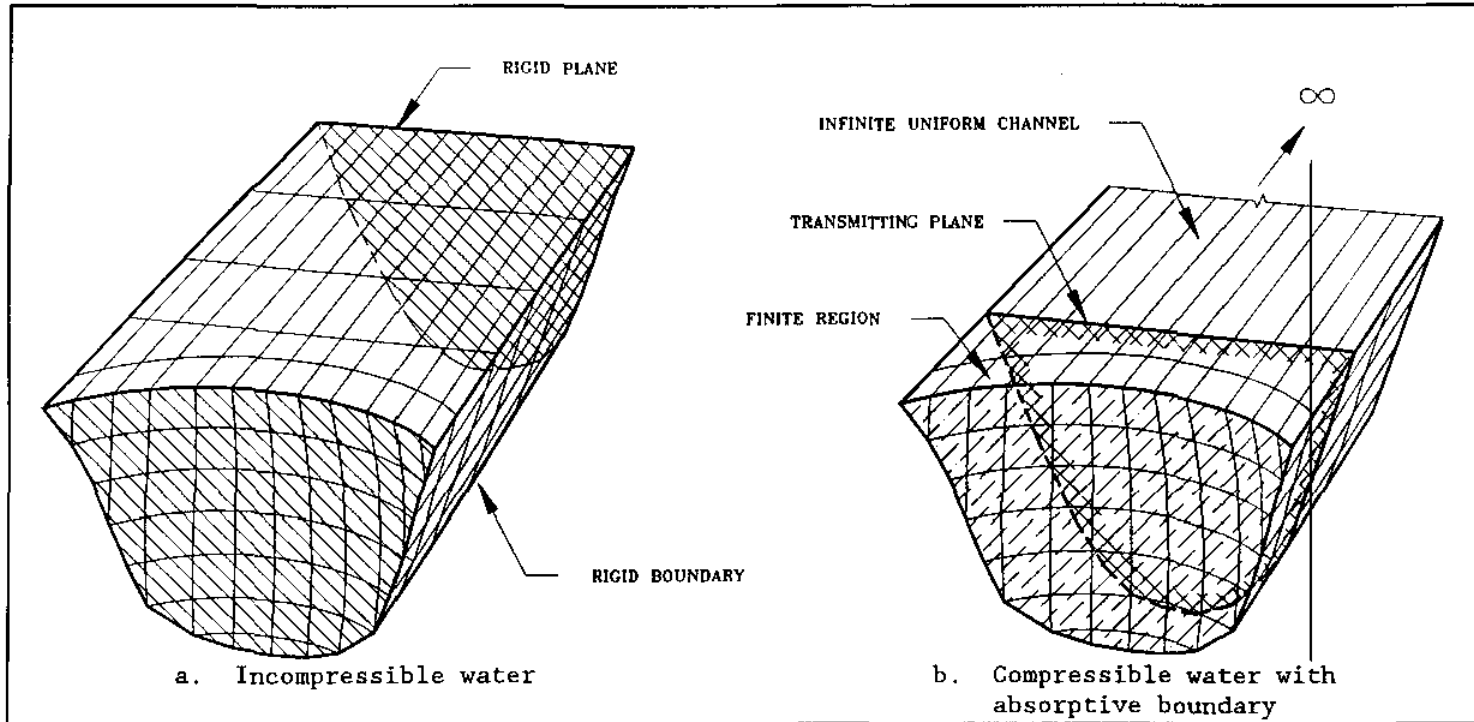

Figure 7-3. Finite element models of fluid domain with and without water compressibility

is defined as the ratio of reflected-to-incident wave amplitude of a pressure wave striking the reservoir bottom. The values of α can be varied from $\alpha = 1.0$, for a rigid, nonabsorptive boundary similar to that used in the GDAP model, to $\alpha = 0.0$, indicating total absorption.

(a) The response analysis of an arch dam including the effects of dam-water interaction, water compressibility, and reservoir-bottom absorption can be performed using the EACD-3D program (Fok, Hall, and Chopra 1986 (July)). The finite element idealizations of the dam and foundation rock employed in this program are essentially equivalent to those employed by the GDAP program; the fluid region near the dam is modeled by liquid finite elements similar to those in GDAP, but, unlike the GDAP, these elements are of compressible water and are connected to a uniform channel extending to infinity to permit pressure waves to radiate away from the dam (Figure 7-3b).

(b) Another major difference of the EACD-3D model is that the reservoir boundary is absorptive and thus dissipation of hydrodynamic pressure waves in the reservoir bottom materials is permitted. However, this method requires considerable computational effort and is too complicated for most practical applications. An even more important consideration is the lack of guidance or measured data for determining an appropriate α factor for use in the analysis. Consequently, such analyses must be repeated for a range of α factors in order to establish a lower and upper bound estimate of the dam response. It is also important to note that the significance of water compressibility depends on the dynamic characteristics of the dam and the impounded water. Similar to gravity dams (Chopra 1968), the effects of water compressibility for an arch dam can be neglected if the ratio of the natural frequency of the reservoir water to the natural frequency of the arch dam-foundation system without water is greater than 2.

d. Damping. Damping has a significant effect on the response of an arch dam to earthquake and other dynamic loads. The energy loss arises from several sources including the concrete arch structure, foundation rock, and the reservoir water. Dissipation of energy in the concrete arch structure is due to internal friction within the concrete material and at construction joints. In the foundation rock this energy loss is facilitated by propagation of elastic waves away from the dam (radiation damping) and by hysteretic losses due to sliding on cracks and fissures within the rock volume. An additional source of damping, as discussed in paragraph 7-5c(3), is associated with the energy loss due to refraction of hydrodynamic pressure waves into the reservoir bottom materials and propagation of pressure waves in the upstream direction.

(1) The current standard earthquake analysis of arch dams is based on a massless foundation rock model and employs incompressible added mass for representing the hydrodynamic effects. In this type of analysis, only the material damping associated with the concrete structure is explicitly considered. The overall damping constant for the entire model in such linear-elastic analyses is normally specified based on the amplitude of the displacements, the opening of the vertical contraction joints, and the amount of cracking that may occur in the concrete arch. Considering that the measured damping values for concrete dams subjected to earthquake loading are scarce and that the effects of contraction joints, lift surfaces, and cracks cannot

be precisely determined, the damping value for a moderate shaking such as an OBE event should be limited to 5 percent.

(2) However, under the MCE earthquake ground motions, damping constants of 7 or 10 percent may be used depending on the level of strains developed in the concrete and the amount of nonlinear joint opening and/or cracking that occurs. In more severe MCE conditions, especially for large dams, additional damping can be incorporated in the analysis by employing a dam-water interaction model which includes water compressibility and permits for the dissipation of energy at the reservoir boundary.

7-6. Method of Analysis. The current earthquake response analysis of arch dams is based on linear-elastic dynamic analysis using the finite element procedures. It is assumed that the concrete dam and the interaction mechanisms with the foundation rock and the impounded water exhibit linear-elastic behavior. Using this method, the arch dam and the foundation rock are treated as 3-D systems idealized by the finite element discretization discussed in previous paragraphs and in Chapter 6. Under the incompressible added-mass assumption for the impounded water, the response analysis is performed using the response-spectrum modal-superposition or the time-history method. For the case of compressible water, however, the response of the dam to dynamic loads must be evaluated using a frequency-domain procedure, in order to deal with the frequency-dependent hydrodynamic terms. These methods of analyses are discussed in the following paragraphs.

a. Response-spectrum Analysis. The response-spectrum method of analysis uses a response-spectrum representation of the seismic input motions to compute the maximum response of an arch dam to earthquake loads. This approximate method provides an efficient procedure for the preliminary analyses of new and existing arch dams. It may also be used for the final analyses, if the calculated maximum stress values are sufficiently less than the allowable stresses of the concrete. Using this procedure, the maximum response of the arch dam is obtained by combining the maximum responses for each mode of vibration computed separately.

(1) A complete description of the method is given in the theoretical manual by Ghanaat (1993b). First, the natural frequencies and mode shapes of undamped free vibration for the combined dam-water-foundation system are evaluated; the free vibration equations of motion are assembled considering the mass of the dam-water system and the stiffness of the combined dam and foundation rock models. The maximum response in each mode of vibration is then obtained from the specified response spectrum for each component of the ground motion, using the modal damping and the natural period of vibration for each particular mode. The same damping constant is used in all modes as represented by the response-spectrum curves. Since each mode reaches its maximum response at a different time, the total maximum response quantities for the dam, such as the nodal displacements and the element stresses, are approximated by combining the modal responses using the square root of the sum of the squares (SRSS) or complete quadratic combination (CQC) procedure. Finally, the resulting total maximum responses evaluated independently for each component of the earthquake ground motion are further combined by the SRSS method for the three earthquake input components, two horizontal and one vertical.

(2) For a linear-elastic response, only a few lower modes of vibration are needed to express the essential dynamic behavior of the dam structure. The appropriate number of vibration modes required in a particular analysis depends on the dynamic characteristics of the dam structure and on the nature of earthquake ground motion. But, in all cases, a sufficient number of modes should be included so that at least 90 percent of the "exact" dynamic response is achieved. Since the "exact" response values are not known, a trial-and-error procedure may be adapted, or it may be demonstrated that the participating effective modal masses are at least 90 percent of the total mass of the structure.

b. Time-history Analysis. Time-history analysis should be performed when the maximum stress values computed by the response-spectrum method are approaching or exceeding the tensile strength of the concrete. In these situations, linear-elastic time-history analyses are performed to estimate the maximum stresses more accurately as well as to account for the time-dependent nature of the dynamic response. Time-history analyses provide not only the maximum stress values, but also the simultaneous, spatial extent and number of excursions beyond any specified stress value. Thus, they can indicate if the calculated stresses beyond the allowable values are isolated incidents or if they occur repeatedly and over a significant area.

(1) The seismic input in time-history analyses is represented by the acceleration time histories of the earthquake ground motion. Three acceleration records corresponding to three components of the specified earthquake are required; they should be applied at the fixed boundaries of the foundation model in the channel, across the channel, and in the vertical directions. The acceleration time histories are established following the procedures described in paragraph 7-4b.

(2) The structural models of the dam, foundation rock, and the impounded water for a time-history analysis are identical to those developed for response-spectrum analysis. However, the solution to the equations of motion is obtained by a step-by-step numerical integration procedure. Two methods of solution are available: direct integration and mode superposition (Ghanaat, technical report in preparation). In the direct method, step-by-step integration is applied to the original equations of motion with no transformation being carried out to uncouple them. Hence, this method requires that the damping matrix to be represented is in explicit form. In practice, this is accomplished using Raleigh damping (Clough and Penzien 1975), which is of the form

$$c = a_0 m + a_1 k$$

where coefficients a_0 and a_1 are obtained from two given damping ratios associated with two frequencies of vibration. The direct integration method is most effective when the response is required for a relatively short duration. Otherwise, the mode superposition method in which the step-by-step integration is applied to the uncoupled equations of motion will be more efficient. In the mode superposition method, first the undamped vibration mode shapes and frequencies are calculated, and the equations of motion are transformed to those coordinates. Then the response history for each mode is evaluated

separately at each time-step, and the calculated modal response histories are combined to obtain the total response of the dam structure. It should be noted that the damping in this case is expressed by the modal damping ratios and need not be specified in explicit form.

7-7. Evaluation and Presentation of Results. The earthquake performance of arch dams is currently evaluated using the numerical results obtained from a linear-dynamic analysis. The results of linear analysis provide a satisfactory estimate of the dynamic response to low- or moderate-intensity OBE earthquake motions for which the resulting deformations of the dam are within the linear-elastic range. In this case, the performance evaluation is based on simple stress checks in which the calculated elastic stresses are compared with the specified strength of the concrete. Under the MCE ground motions, it is possible that the calculated stresses would exceed the allowable values and that significant damage could occur. In such extreme cases, the dam should retain the impounded water without rupture, but the actual level of damage can be estimated only by a nonlinear analysis that takes account of the basic nonlinear behavior mechanisms such as the joint opening, tensile cracking, and the foundation failure. However, a complete nonlinear analysis is not currently possible, and linear analysis continues to be the primary tool for assessing the seismic performance of arch dams subjected to damaging earthquakes. Evaluation of the seismic performance for the MCE is more complicated, it requires some judgement and elaborate interpretations of the results before a reasonable estimate of the expected level of damage can be made or the possibility of collapse can be assessed.

a. Evaluation of Response-spectrum Analysis. The first step in response spectrum analysis is the calculation of vibration mode shapes and frequencies. The mode shapes and frequencies provide insight into the basic dynamic response behavior of an arch dam. They provide some advance indication of the sensitivity of the dynamic response to earthquake ground motions having various frequency contents. Figure 7-4 demonstrates a convenient way for presenting the mode shapes. In this figure the vibration modes are depicted as the plot of deflected shapes along the arch sections at various elevations. After the calculation of mode shapes and frequencies, the maximum dynamic response of the dam structure is computed. These usually include the maximum nodal displacements and element stresses. In particular, the element stresses are the primary response quantity used for the evaluation of earthquake performance of the dam.

(1) Dynamic Response. The basic results of a response-spectrum analysis include the extreme values of the nodal displacements and element stresses due to the earthquake loading. As discussed earlier, these extreme response values are obtained by combining the maximum responses developed in each mode of vibration using the SRSS or CQC combination rule. In addition, they are further combined by the SRSS method to include the effects of all three components of the earthquake ground motion. Thus, the resulting dynamic response values obtained in this manner have no sign and should be interpreted as being either positive or negative. For example the response-spectrum stress values are assumed to be either tension or compression.

(2) Total Response. The evaluation of earthquake performance of an arch dam using the response-spectrum method of analysis involves comparison of the total stresses due to both static and earthquake loads with the expected

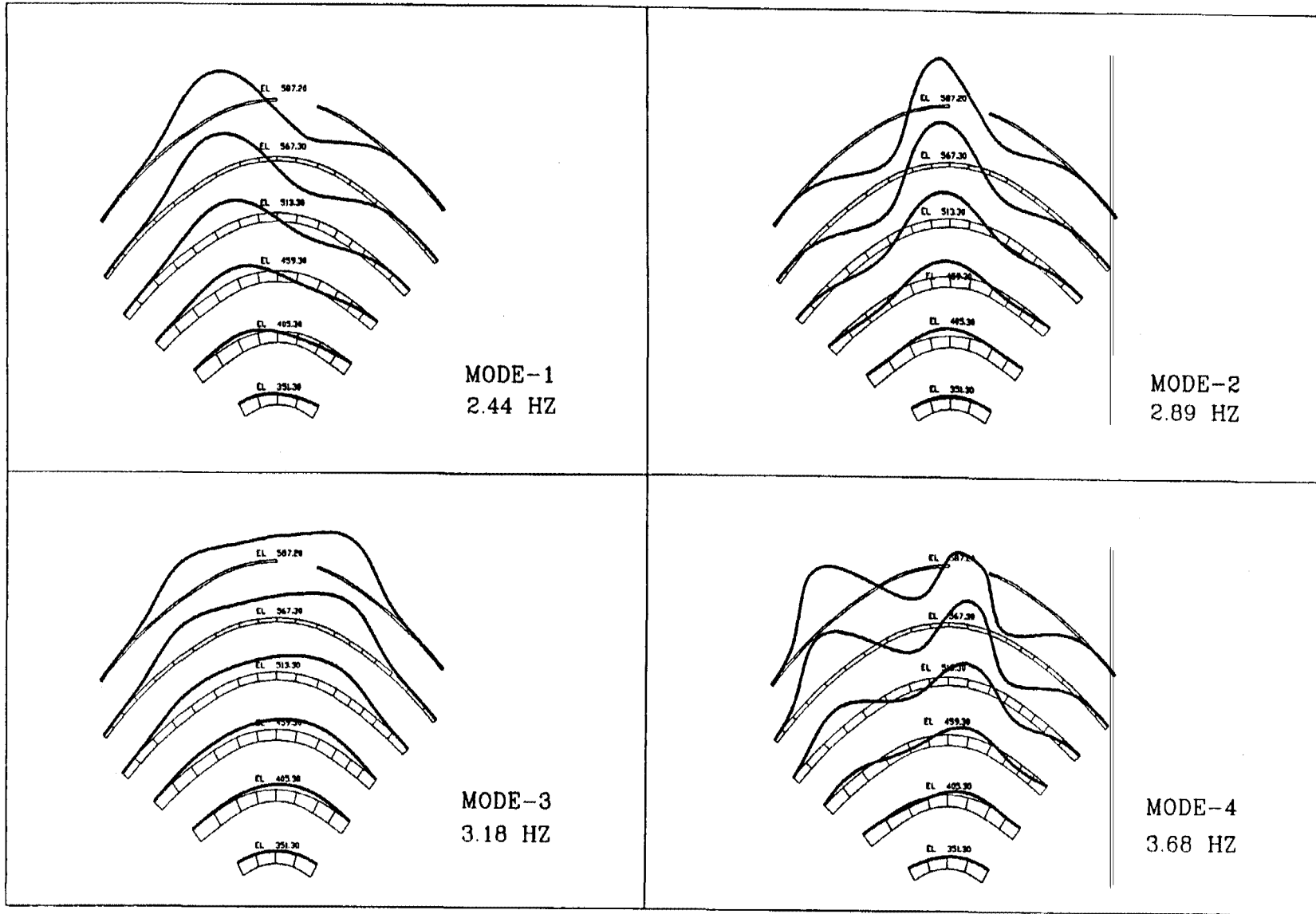

Figure 7-4. Four lowest vibration modes of Portugues Arch Dam

strength of the concrete. To obtain the total stress values, the response-spectrum estimate of the dynamic stresses (σ_d) should be combined with the effects of static loads (σ_{st}). The static stresses in a dam prior to the earthquake are computed using the procedures described in Chapter 6. The static loads to be considered include the self-weight, hydrostatic pressures, and the temperature changes that are expected during the normal operating condition as discussed in Chapter 4. Since response-spectrum stresses have no sign, combination of static and dynamic stresses should consider dynamic stresses to be either positive or negative, leading to the maximum values of total tensile or compressive stresses:

$$\sigma_{\max} = \sigma_{st} \pm \sigma_d$$

(a) This combination of static and dynamic stresses is appropriate if Σ_{st} and Σ_d are oriented similarly. This is true for arch or cantilever stresses at any point on the dam surface, but generally is not true for the principal stresses. In fact, it is not possible to calculate the principal stresses from a response-spectrum analysis, because the maximum arch and cantilever stresses do not occur at the same time; therefore, they cannot be used in the principal stress formulas.

(b) The computed total arch and cantilever stresses for the upstream and downstream faces of the dam should be displayed in the form of stress contours as shown in Figure 7-5. These represent the envelopes of maximum total arch and cantilever stresses on the faces of the dam, but because they are not concurrent they cannot be combined to obtain envelopes of principal stresses, as was mentioned previously.

b. Results of Time-history Analysis. Time-history analysis computes time-dependent dynamic response of the dam model for the entire duration of the earthquake excitation. The results of such analyses provide not only the maximum response values, but also include time-dependent information that must be examined and interpreted systematically. Although evaluation of the dynamic response alone may sometimes be required, the final evaluation should be based on the total response which also includes the effects of static loads.

(1) Mode Shapes and Nodal Displacements. Vibration mode shapes and frequencies are required when the mode-superposition method of time-history analysis is employed. But it is also a good practice to compute them for the direct method. The computed vibration modes may be presented as shown in Figure 7-4 and discussed previously. The magnitude of nodal displacements and deflected shape of an arch dam provide a visual means for the evaluation of earthquake performance. As a minimum, displacement time histories for several critical nodal points should be displayed and evaluated. Figure 7-6 shows an example of such displacement histories for a nodal point on the dam crest.

(2) Envelopes of Maximum and Minimum Arch and Cantilever Stresses. Examination of the stress results for a time-history analysis should start with presentation of the maximum and minimum arch and cantilever stresses. These stresses should be displayed in the form of contour plots for the upstream and downstream faces of the dam. The contour plots of the maximum

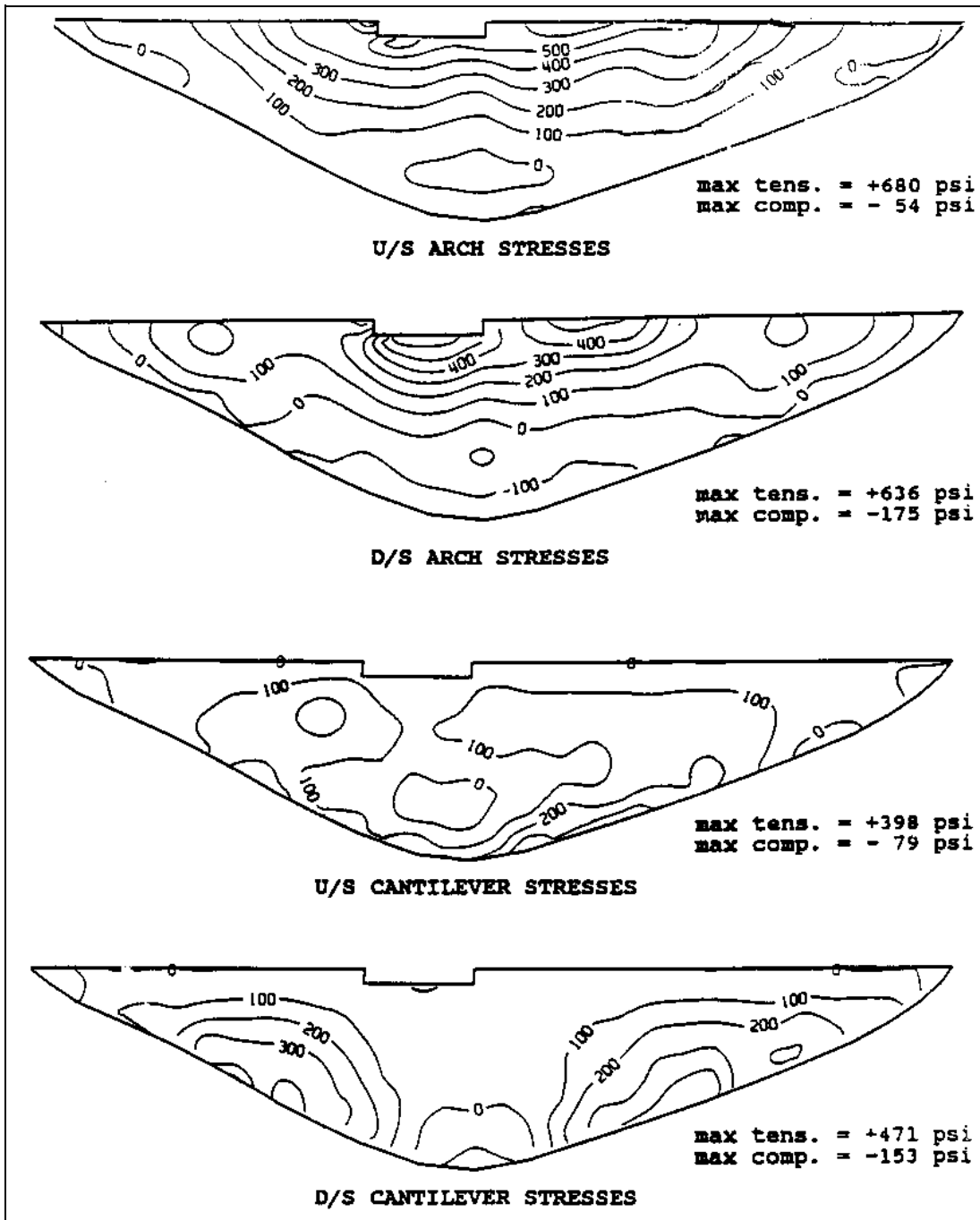

Figure 7-5. Envelope of maximum arch and cantilever stress (in psi)

arch and cantilever stresses represent the largest computed tensile (positive) stresses at all locations in the dam during the earthquake ground shaking (Figure 7-5). Similarly, the contour plots of the minimum stresses represent the largest compressive (negative) arch and cantilever stresses in the dam. The maximum and the minimum stresses at different points are generally reached at different instants of time. Contour plots of the maximum arch and cantilever stresses provide a convenient means for identifying the overstressed

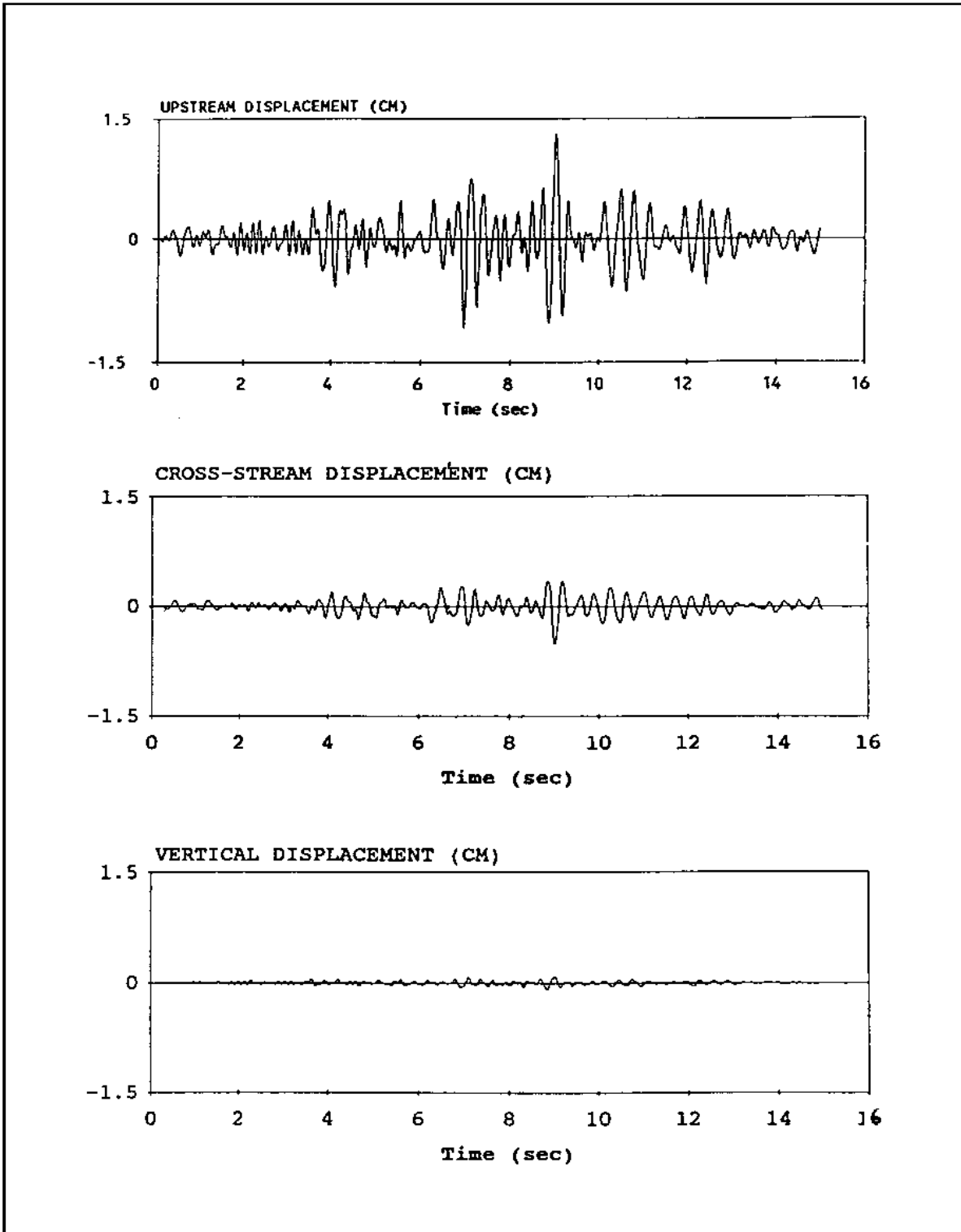

Figure 7-6. Displacement time history of a crest node in upstream, cross-stream, and vertical direction

areas where the maximum stresses approach or exceed tensile strength of the concrete. Based on this information, the extent and severity of tensile stresses are determined, and if necessary, further evaluation which accounts for the time-dependent nature of the dynamic response should be made as described in the following sections. Contour plots of the minimum stresses show the extreme compressive stresses that the dam would experience during the earthquake loading. The compressive stresses should be examined to ensure that they meet the specified safety factors for the dynamic loading (Chapter 11).

(3) Concurrent Stresses. The envelopes of maximum and minimum stresses discussed in paragraph 7-7b(2) demonstrate the largest tensile and compressive stresses that are developed at different instants of time. They serve to identify the overstressed regions and the times at which the critical stresses occur. This information is then used to produce the concurrent (or simultaneous) state of stresses corresponding to the time steps at which the critical stresses in the overstressed regions reach their maxima. The concurrent arch and cantilever stresses in the form of contour plots (Figure 7-7) can be viewed as snap shots of the worst stress conditions.

(4) Envelopes of Maximum and Minimum Principal Stresses. The time histories of principal stresses at any point on the faces of the dam are easily computed from the histories of arch, cantilever, and shear stresses at that point. When the effects of static loads are considered, the static and dynamic arch, cantilever, and shear stresses must be combined for each instant of time prior to the calculation of the total principal stresses for the same times. The resulting time histories of principal stresses are used to obtain the maxima and minima at all points on both faces of the dam which are then presented as vector plots as shown in Figures 7-8 and 7-9.

(5) Time History of Critical Stresses. When the maximum and concurrent stresses show that the computed stresses exceed the allowable value, the time histories of critical stresses should be presented for a more detailed evaluation (Figure 7-10). In this evaluation the time histories for the largest maximum arch and cantilever stresses should be examined to determine the number of cycles that the maximum stresses exceed the allowable value. This would indicate whether the excursion beyond the allowable value is an isolated case or is repeated many times during the ground motion. The total duration that the allowable value (or cracking stress) is exceeded by these excursions should also be estimated to demonstrate whether the maximum stress cycles are merely spikes or they are of longer duration and, thus, more damaging. The number of times that the allowable stress can safely be exceeded has not yet been established. In practice, however, up to five stress cycles have been permitted based on judgement but have not been substantiated by experimental data. The stress histories at each critical location should be examined for two opposite points on the upstream and downstream faces of the dam as in Figure 7-10. For example, a pair of cantilever stress histories can demonstrate if stresses on both faces are tension, or if one is tension and the other is compression. The implication of cantilever stresses being tension on both faces is that the tensile cracking may penetrate through the dam section, whereas in the case of arch stresses, this indicates a complete separation of the contraction joint at the location of maximum tensile stresses.

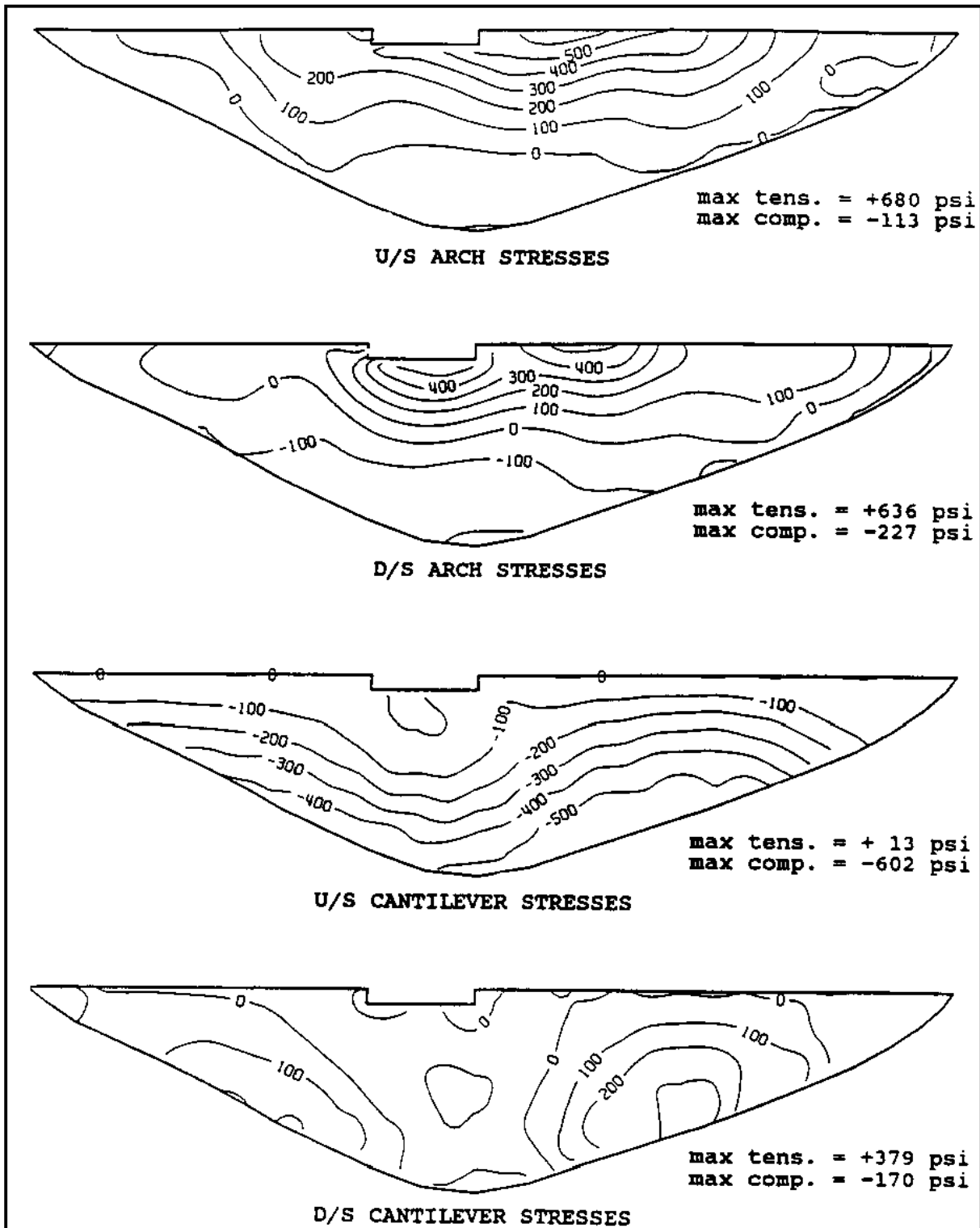

Figure 7-7. Concurrent arch and cantilever stresses (in psi) at time-step corresponding to maximum arch stress

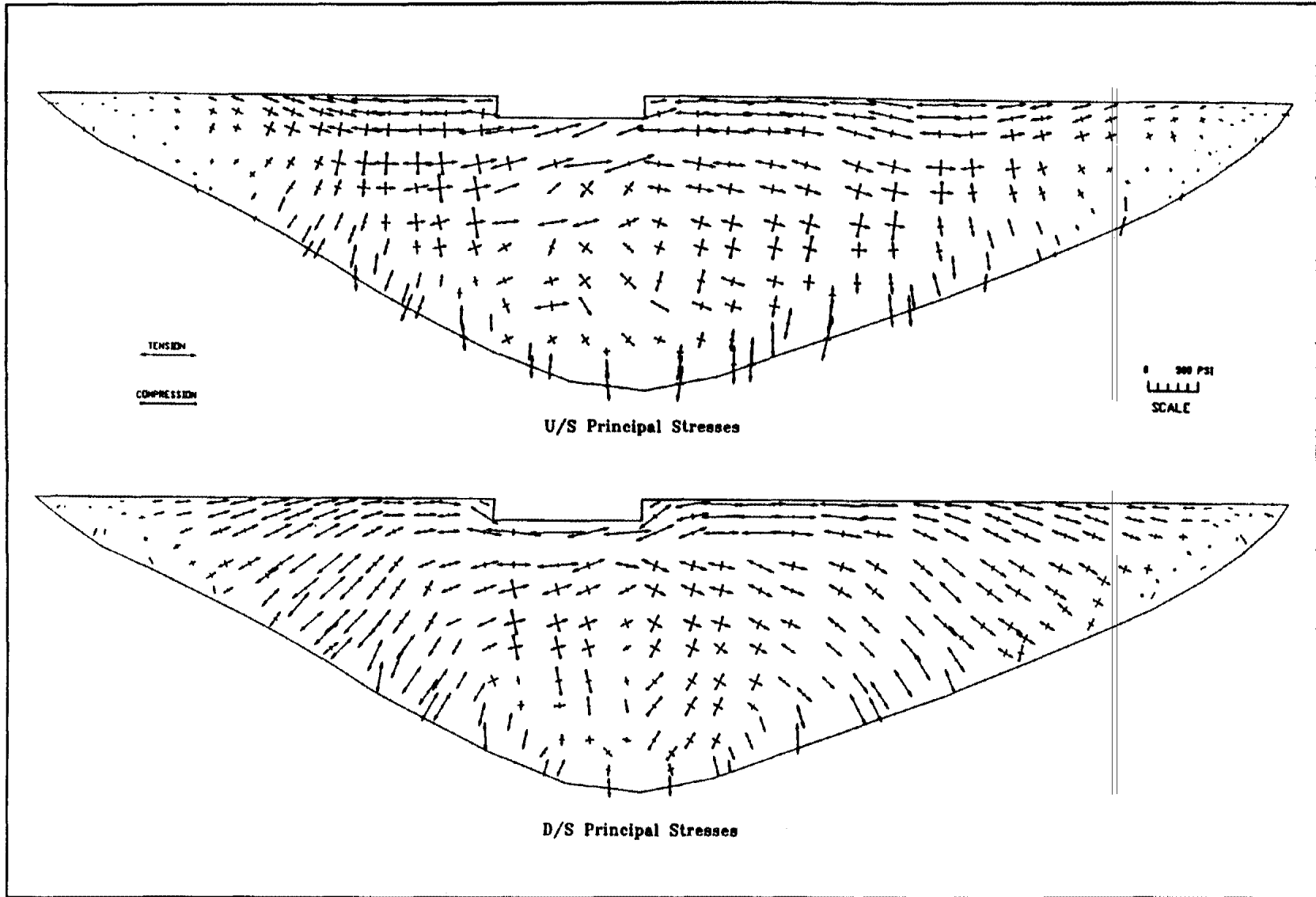

Figure 7-8. Envelope of maximum principal stresses with their corresponding perpendicular pair

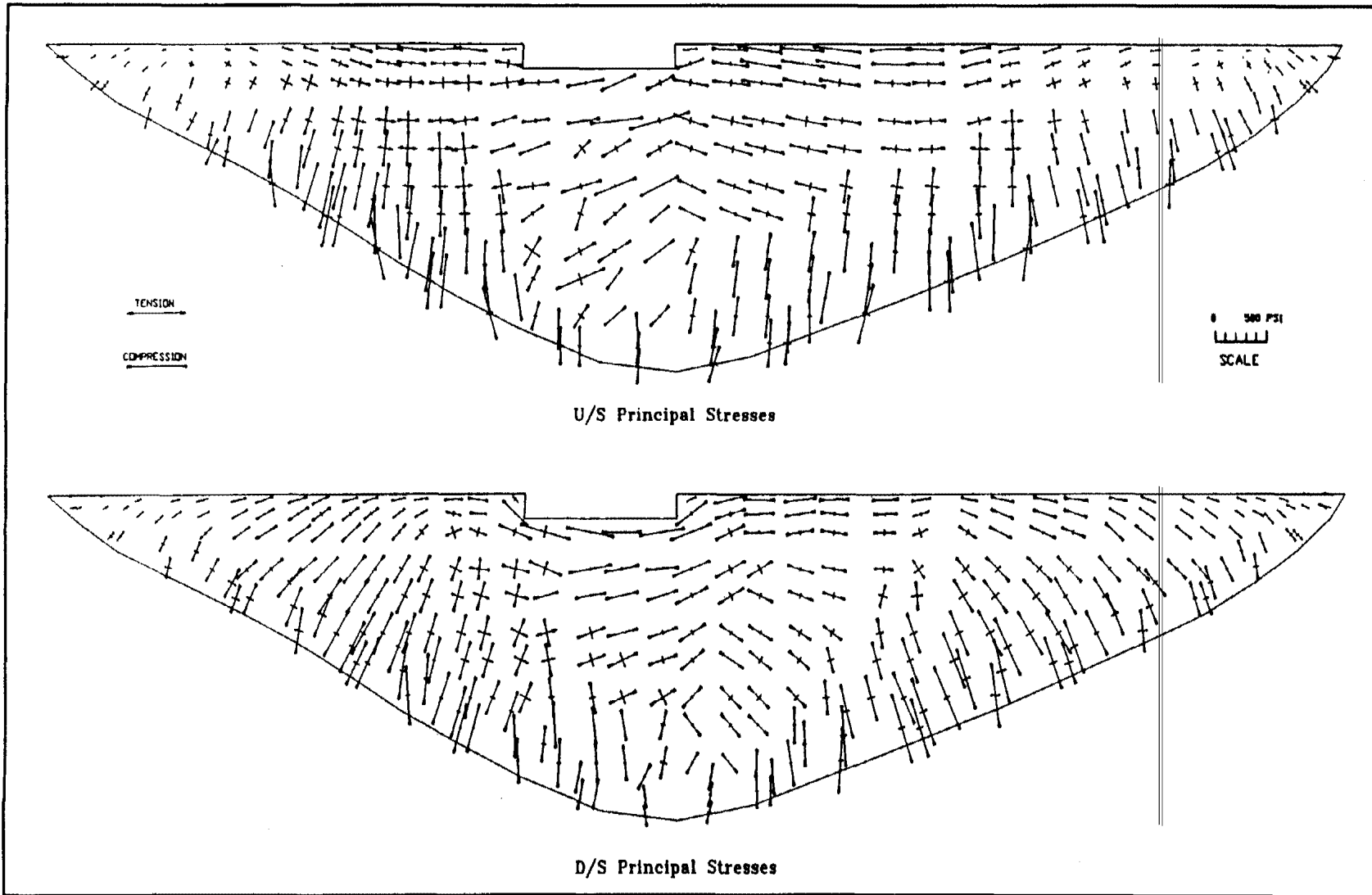

Figure 7-9. Envelope of maximum-minimum principal stresses with their corresponding perpendicular pair

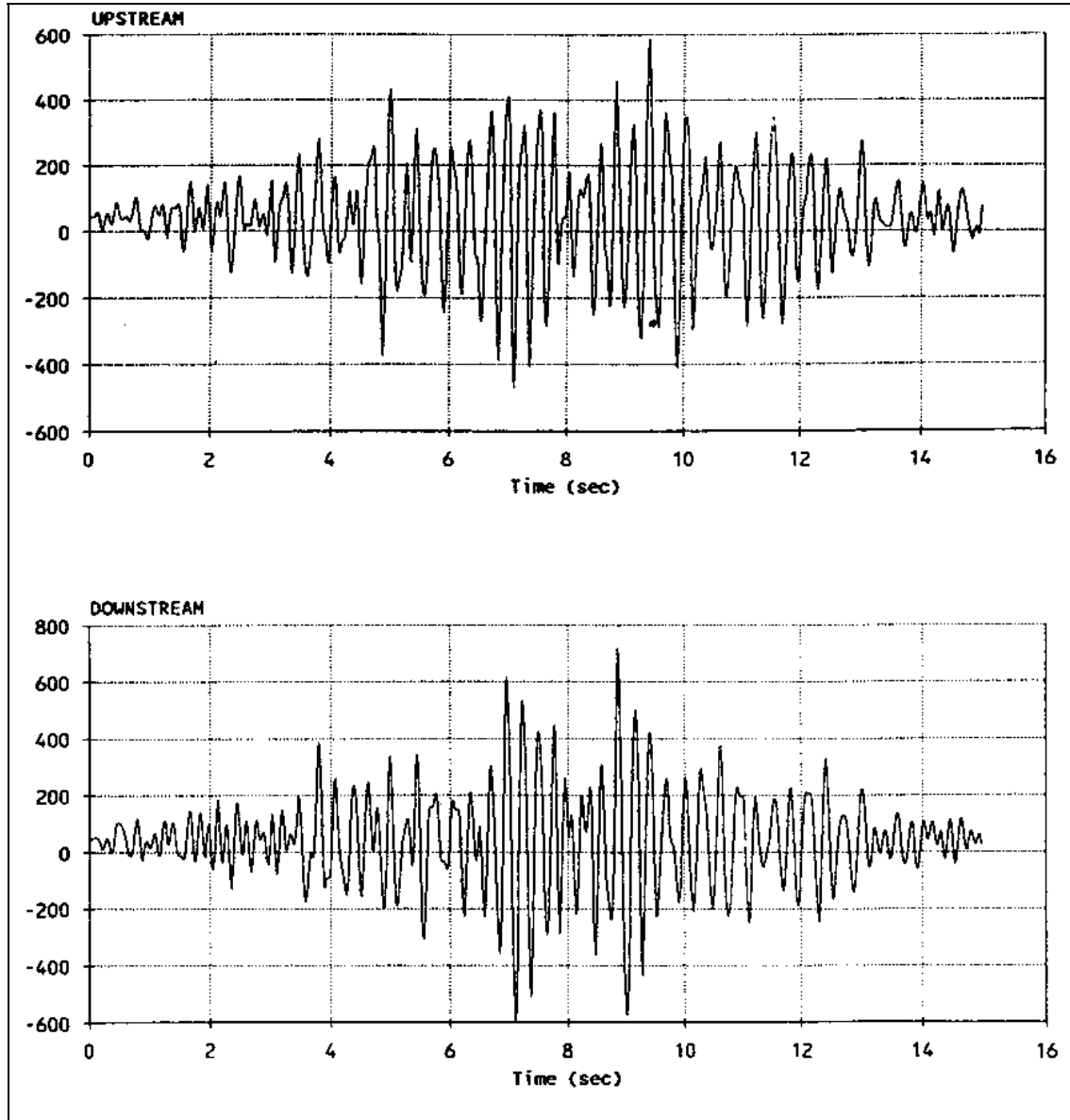

Figure 7-10. Time histories of arch stresses (in psi) at two opposite points on upstream and downstream faces of dam

CHAPTER 8

TEMPERATURE STUDIES

8-1. Introduction. Temperature studies for arch dams fall into two distinct categories. The first category is the operational temperature study which is used to determine the temperature loading in the dam. This study is performed early in the design process. The second category includes the construction temperature studies which are usually performed after an acceptable layout has been obtained. The construction temperature studies are needed to assure that the design closure temperature can be obtained while minimizing the possibility of thermally induced cracking. The details of each of these studies are discussed in this chapter. Guidance is given on when the studies should be started, values that can be assumed prior to completion of the studies, how to perform the studies, and what information is required to do the studies.

8-2. Operational Temperature Studies.

a. General. The operational temperature studies are studies that are performed to determine the temperature distributions that the dam will experience during its expected life time. The shape of the temperature distribution through the thickness of the dam is, for the most part, controlled by the thickness of the structure. Dams with relatively thin sections will tend to experience temperature distributions that approach a straight line from the reservoir temperature on the upstream face to the air temperature on the downstream face as shown in Figure 8-1. Dams with a relatively thick section will experience a somewhat different temperature distribution. The temperatures in the center of a thick section will not respond as quickly to changes as temperatures at the faces. The temperatures in the center of the section will remain at or about the closure temperature,¹ with fluctuations of small amplitude caused by varying environmental conditions. The concrete in close proximity to the faces will respond quickly to the air and water temperature changes. Therefore, temperature distributions will result that are similar to those shown in Figure 8-2.

(1) Before describing how these distributions can be obtained for analysis, a description of how the temperatures are applied in the various analysis tools is appropriate. During the early design stages, when a dam layout is being determined, the trial load method is used. The computerized version of the trial load method which is widely used for the layout of the dam is the program ADSAS. ADSAS allows for temperatures to be applied in two ways. The first represents a uniform change in temperature from the grout temperature. The second is a linear temperature load. This linear load can be used to describe a straight line change in temperature from the upstream to downstream faces. These two methods can be used in combination to apply changes in temperature from the grout temperature as well as temperature

¹ The terms grout temperature and closure temperature are often used interchangeably. They represent the concrete temperature condition at which no temperature stress exists. This is also referred to as the stress-free temperature condition.

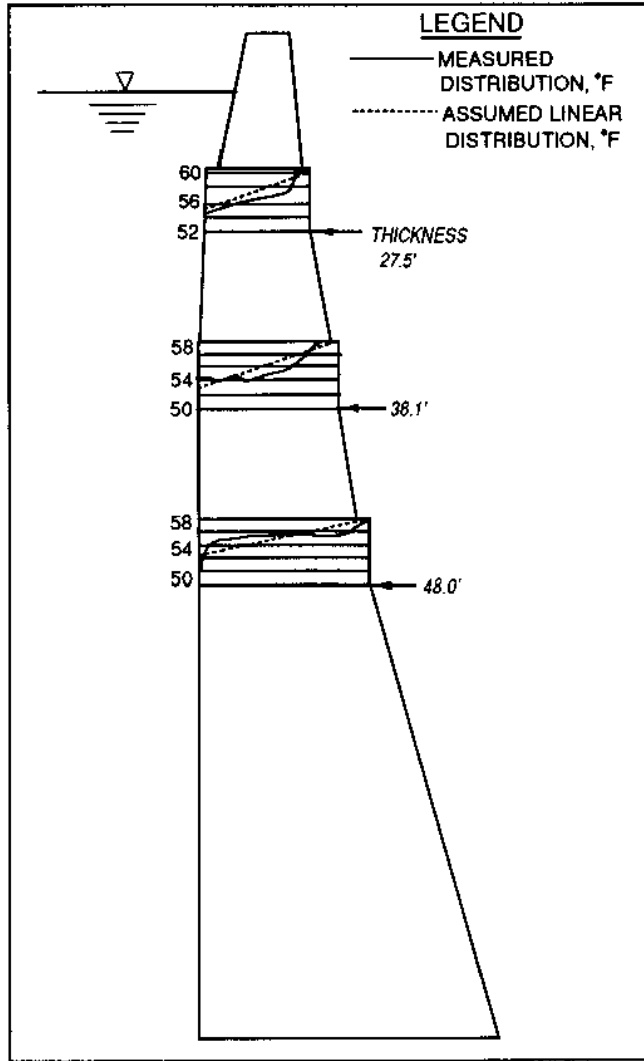

Figure 8-1. Measured temperature distributions in March for a relatively thin dam

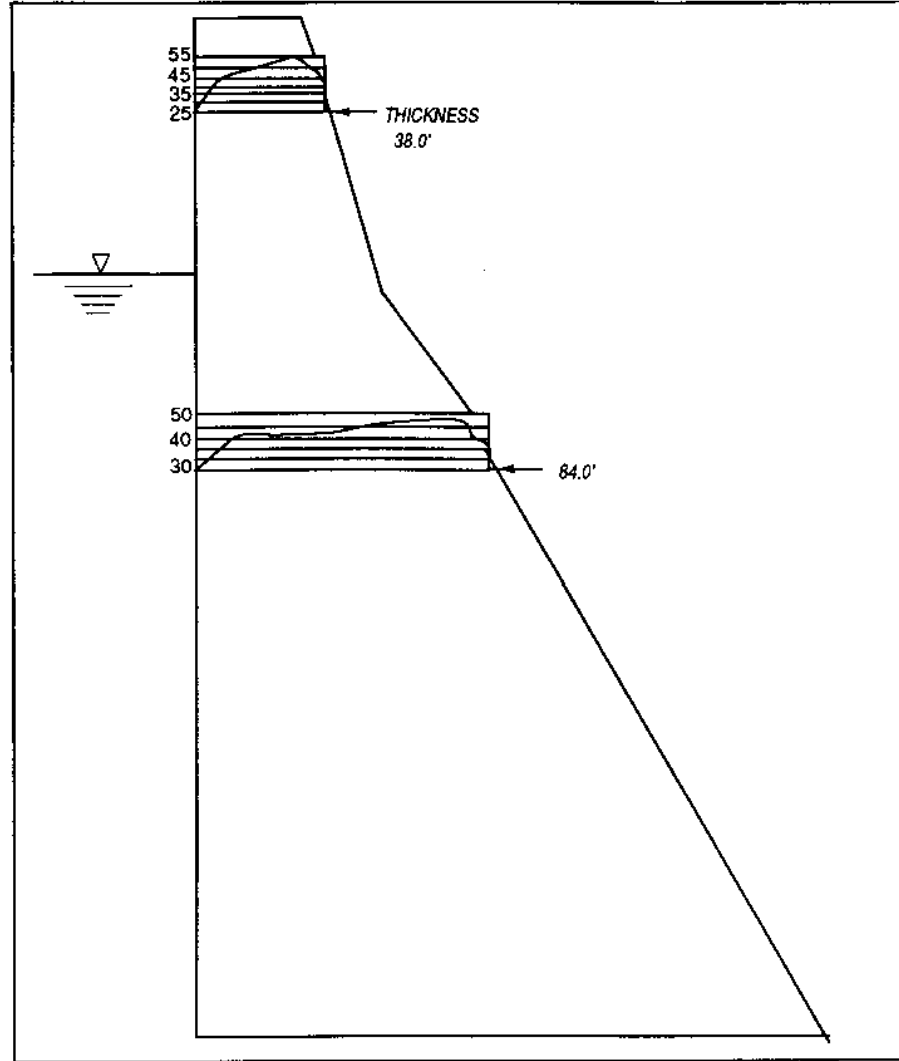

Figure 8-2. Measured temperature distributions in December for a relatively thick dam

differences through the section. The resulting distribution will be a straight line distribution.

(2) During later stages of analysis, usually after the final shape of the dam has been determined, the FEM is used to analyze both the static and dynamic conditions. In most general-purpose finite element programs, temperatures are applied at nodal points. This allows for the application of temperature distributions other than linear if nodes are provided through the thickness of the dam as well as at the faces.

(3) Keeping in mind the method of stress analysis to be used, one can now choose the method of determining the temperature distributions. There are two methods available for determining the distributions. The first method involves determining the range of mean concrete temperatures that a slab of concrete will experience if it is exposed to varying temperatures on its two faces. This method can be performed in a relatively short time frame and is especially applicable when the trial load method is being used and when the dam being analyzed is relatively thin. When the dam being analyzed is a thick structure, the FEM can be used to determine the temperature distributions.

(4) The temperature distributions are controlled by material properties and various site specific conditions, including air temperatures, reservoir water temperatures, solar radiation, and in some instances, foundation temperatures. The remainder of this section will discuss how the site conditions can be estimated for a new site and how these conditions are applied to the various computational techniques to determine temperature distributions to be used in stress analysis of the dam.

b. Reservoir Temperature. The temperature of a dam will be greatly influenced by the temperature of the impounded water. In all reservoirs the temperature of the water varies with depth and with the seasons of the year. It is reasonable to assume that the temperature of the water will have only an annual variation, i.e., to neglect daily variations. The amount of this variation is dependent on the depth of reservoir and on the reservoir operation. The key characteristics of the reservoir operation are inflow-outflow rates and the storage capacity of the reservoir.

(1) When a structure is being designed there is obviously no data available on the resulting reservoir. The best source of this data would be nearby reservoirs. Criteria for judging applicability of these reservoirs to the site in question should include elevation, latitude, air temperatures, river temperatures and reservoir exchange rate.¹ The USBR has compiled this type of information as well as reservoir temperature distributions for various reservoirs and has reported the data in its Engineering Monograph No. 34 (Townsend 1965). Figure 8-3 has been reproduced from that publication.

(2) If data are available on river flows and the temperature of the river water, the principle of heat continuity can be used to obtain estimates heat transfer across the reservoir surface. Determination of this heat transfer requires estimates of evaporation, conduction, absorption, and

¹ The reservoir exchange rate is measured as the ratio of the mean annual river discharge to the reservoir capacity.

LOCATION	RANGE OF MONTHLY MEAN AIR TEMP.	MEAN ANNUAL AIR TEMP.	RANGE OF MONTHLY MEAN RIVER WATER TEMP.	MEAN ANNUAL RIVER DISCHARGE RESERVOIR CAPACITY	PERIOD OF RECORD	REMARKS
Glen Canyon Dam	36°-88°	62°	34°-80°	1:2.5	1964	Res. storage started in March 1963
Hoover Dam	51°-96°	73°	40°-82°	1:2.4	1938-1948	Reservoir filling thru 1937
Hungry Horse Dam	22°-65°	43°	34°-55°	1:1.6	1954-1959	Reservoir filling 1951-1953
Flaming Gorge Dam	24°-72°	48°	32°-68°	1:2.6	1964	Res. storage started in Nov 1962
Shasta Dam	45°-82°	62°	44°-68°	1:2.1	1946-1952	Reservoir filling thru 1945
Grand Coulee Dam	24°-74°	51°	34°-65°	7.9:1	1942-1952	Reservoir filled in June 1942

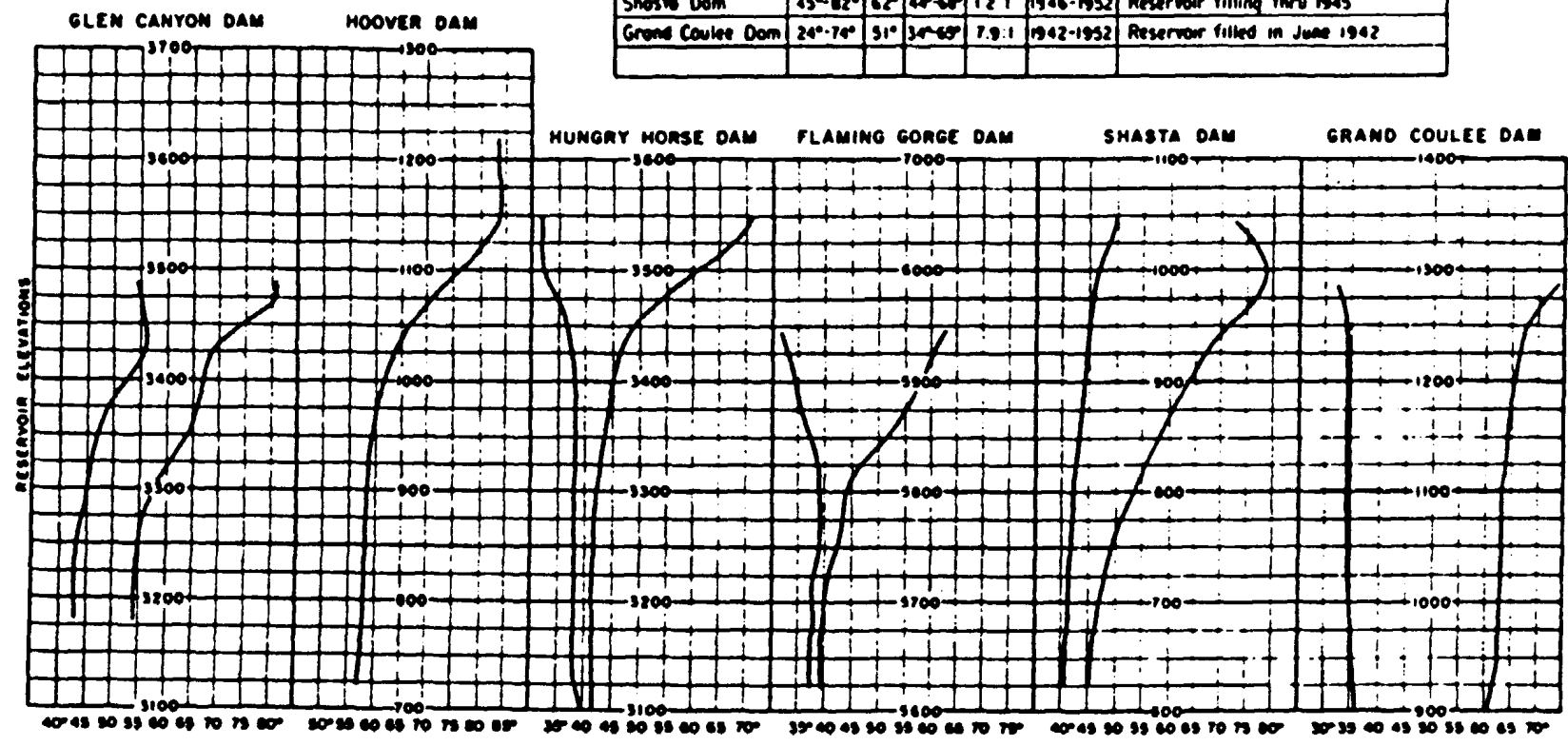

Figure 8-3. Typical reservoir temperature distributions (USBR)

reflection of solar radiation and reradiation, which are based on estimates of cloud cover, air temperatures, wind, and relative humidity. Since so many parameters need to be assumed, this method may be no better than using available reservoir data and adapting it to the new site.

(3) The designer should recognize that the dam's temperatures will be influenced significantly by reservoir temperatures. Therefore, as additional data become available, the assumptions made during design should be reevaluated. Also, it is good practice to provide instrumentation in the completed structure to verify all design assumptions.

c. Air Temperatures. Estimates of the air temperatures at a dam site will usually be made based on the data at nearby weather stations. The U.S. Weather Bureau has published data for many locations in the United States, compiled by state. Adjustments of the data from the nearest recording stations to the dam site can be used to estimate the temperatures at the site. For every 250 feet of elevation increase there is about a 1 °F decrease in temperature. To account for a positive 1.4-degree latitude change, the temperatures can be reduced by 1 °F. As with the reservoir temperatures, it is prudent to begin compiling air temperature data as early in the design process as possible to verify the assumed temperatures.

(1) During the discussion of reservoir temperatures, it was pointed out that daily water temperature fluctuations were not of significant concern; however, daily air temperature fluctuations will have a significant effect on the concrete temperatures. Therefore, estimates of the mean daily and mean annual air cycles are needed. A third temperature cycle is also used to account for the maximum and minimum air temperatures at the site. This cycle has a period of 15 days. During the computation of the concrete temperatures, these cycles are applied as sinusoidal variations. The air cycles are not truly sinusoidal, however, this assumption is an acceptable approximation. The pertinent data from the weather station required for the analyses are:

(a) Mean monthly temperatures (maximum, minimum, and average temperatures)

(b) Mean annual temperature

(c) Highest recorded temperature

(d) Lowest recorded temperature

(2) Paragraph 8-2e describes how these cycles are calculated and applied in the computations for concrete temperatures.

d. Solar Radiation. The effect of solar radiation on the exposed surfaces of a dam is to raise the temperature of the structure. Most concrete arch dams are subjected to their most severe loading in the winter. Therefore, the effect of solar radiation generally is to reduce the design loads. However, for cases where the high or summer temperature condition governs the design, the effect of solar radiation worsens the design loads. Also, in harsh climates where the dam is oriented in an advantageous direction, the effect of solar radiation on the low temperature conditions may be significant enough to reduce the temperature loads to an acceptable level.

(1) The mean concrete temperature requires adjustments due to the effect of solar radiation on the surface of the dam. The downstream face, and the upstream face when not covered by reservoir water, receive an appreciable amount of radiant heat from the sun, and this has the effect of warming the concrete surface above the surrounding air temperature. The amount of this temperature rise has been recorded at the faces of several dams in the western portion of the United States. These data were then correlated with theoretical studies which take into consideration varying slopes, orientation of the exposed faces, and latitudes. Figures 8-4 to 8-7 summarize the results and give values of the temperature increase for various latitudes, slopes, and orientations. It should be noted that the curves give a value for the mean annual increase in temperature and not for any particular hour, day, or month. Examples of how this solar radiation varies throughout the year are given in Figure 8-8.

(2) If a straight gravity dam is being considered, the orientation will be the same for all points on the dam, and only one value for each of the upstream and downstream faces will be required. For an arch dam, values at the quarter points should be obtained as the sun's rays will strike different parts of the dam at varying angles. The temperature rises shown on the graph should be corrected by a terrain factor which is expressed as the ratio of actual exposure to the sun's rays to the theoretical exposure. This is required because the theoretical computations assumed a horizontal plane at the base of the structure, and the effect of the surrounding terrain is to block out certain hours of sunshine. Although this terrain factor will actually vary for different points on the dam, an east-west profile of the area terrain, which passes through the crown cantilever of the dam, will give a single factor which can be used for all points and remain within the limits of accuracy of the method itself.

(3) The curves shown in Figures 8-4 to 8-7 are based on data obtained by the USBR. The data are based on the weather patterns and the latitudes of the western portion of the United States. A USBR memorandum entitled "The Average Temperature Rise of the Surface of a Concrete Dam Due to Solar Radiations," by W. A. Trimble (1954), describes the mathematics and the measured data which were used to determine the curves. Unfortunately, the amount of time required to gather data for such studies is significant. Therefore, if an arch dam is to be built in an area where the available data is not applicable and solar radiation is expected to be important, it is necessary to recognize this early in the design process and begin gathering the necessary data as soon as possible.

e. Procedure. This section will provide a description of the procedures used to determine the concrete temperature loads.

(1) The first method involves the calculation of the range of mean concrete temperatures. This method will result in the mean concrete temperatures that a flat slab will experience if exposed to: a) air on both faces or b) water on both faces. These two temperature calculations are then averaged to determine the range of mean concrete temperatures if the slab is exposed to water on the upstream face and air on the downstream face. A detailed description and example of this calculation is available in the USBR Engineering Monograph No. 34 (Townsend 1965). This process has been automated and is available in the program TEMPER through the Engineering Computer Program

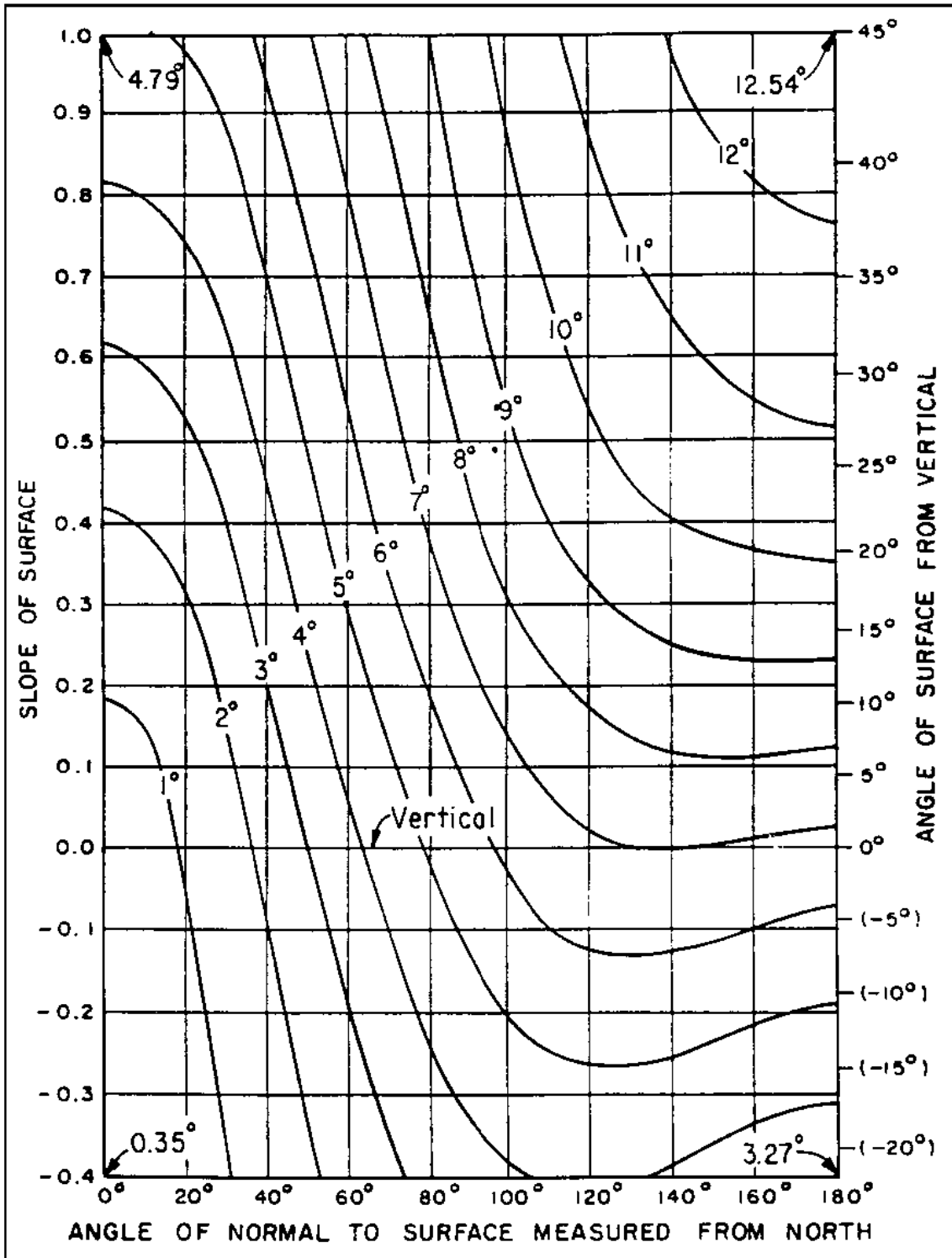

Figure 8-4. Increase in temperature due to solar radiation, latitudes 30° - 35° (USBR)

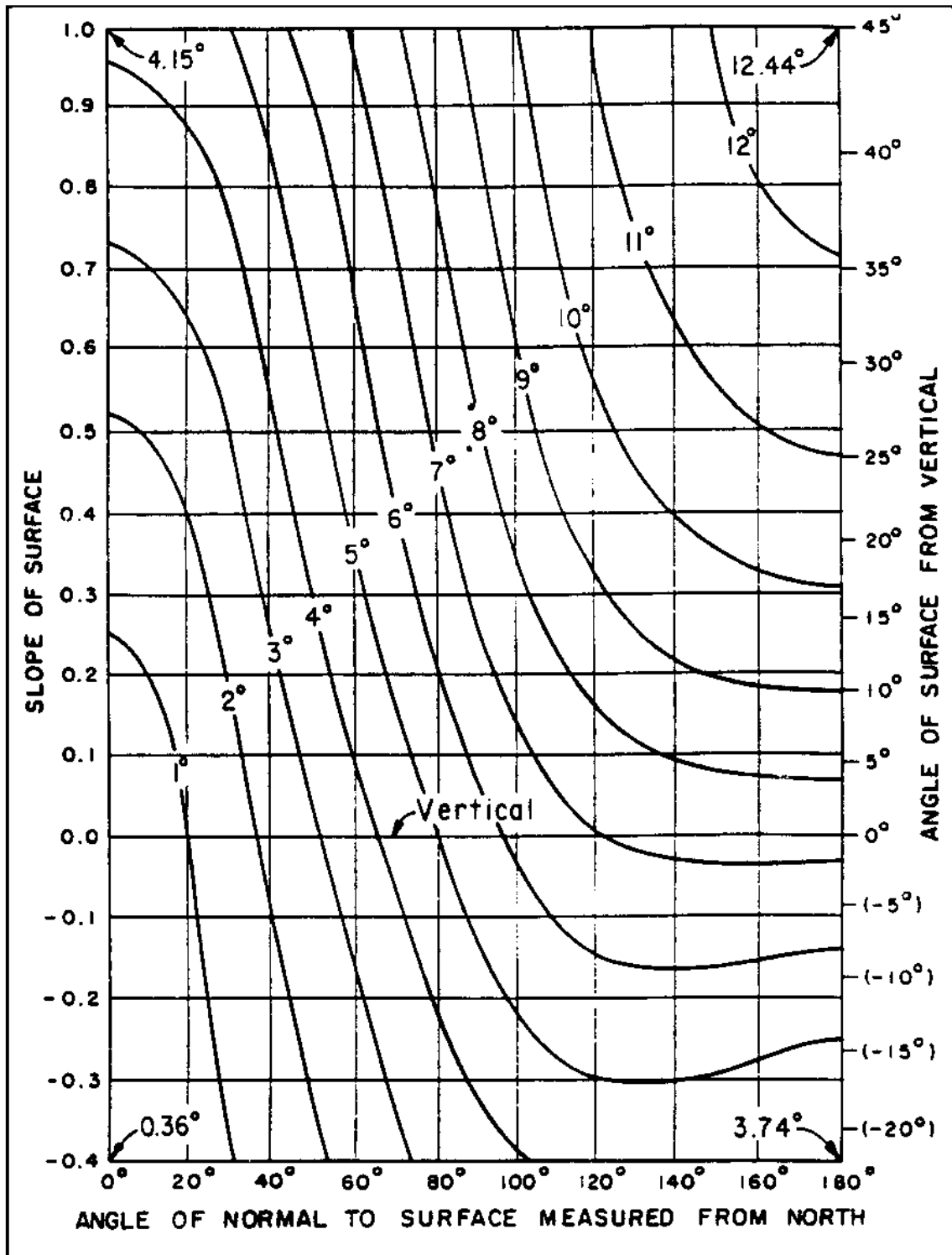

Figure 8-5. Increase in temperature due to solar radiation, latitudes 35° - 40° (USBR)

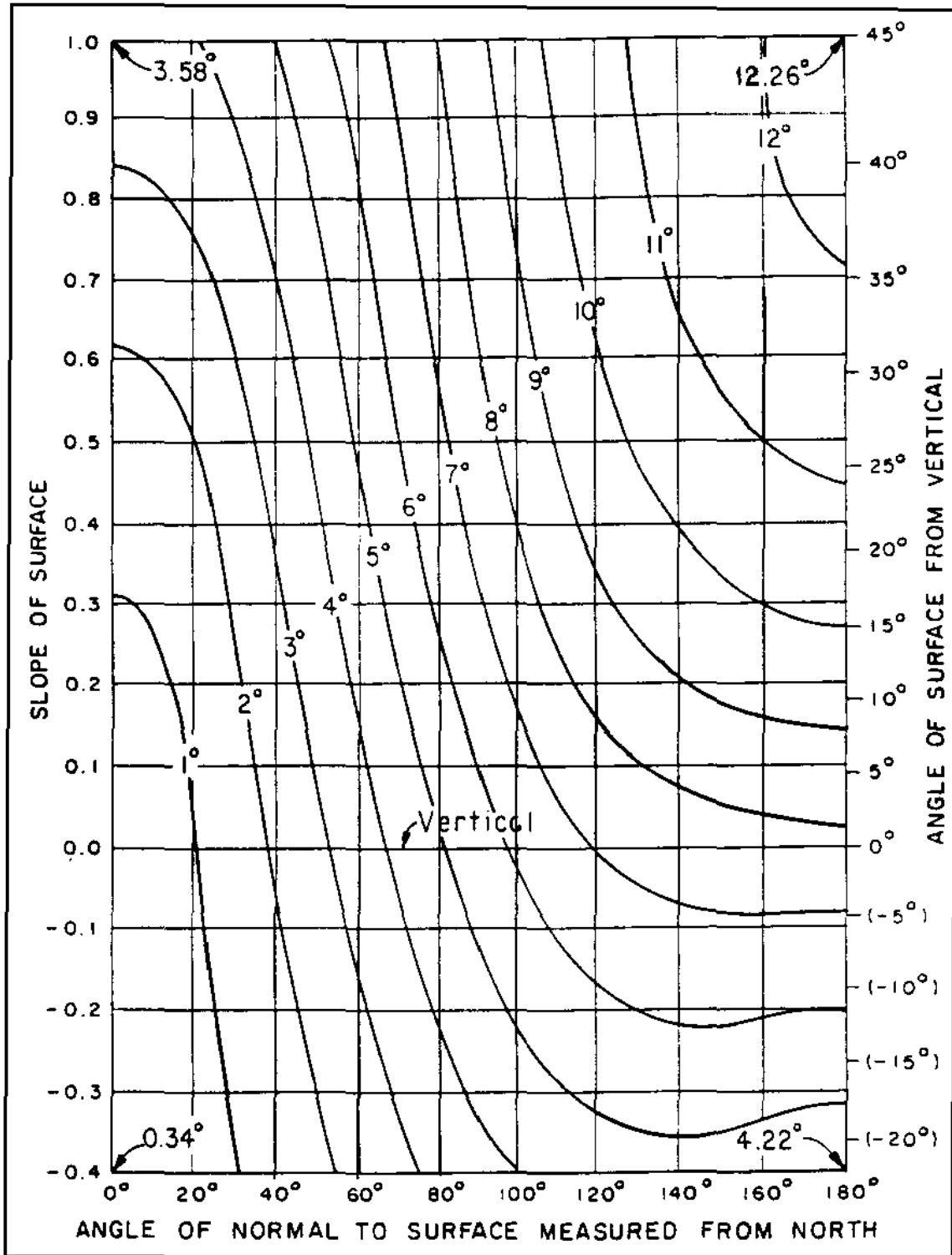

Figure 8-6. Increase in temperature due to solar radiation, latitudes 40° - 45° (USBR)

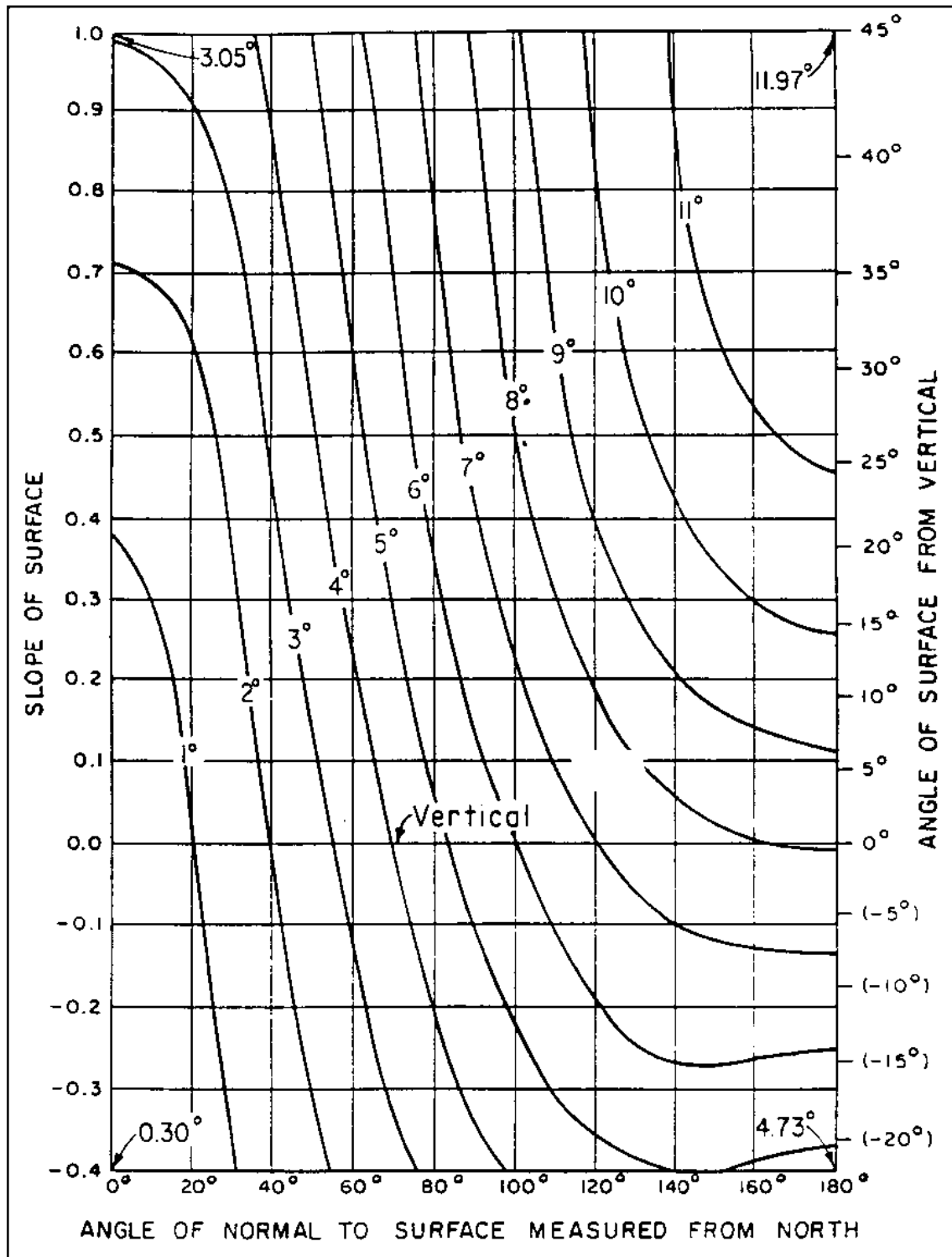

Figure 8-7. Increase in temperature due to solar radiation, latitudes 45° - 50° (USBR)

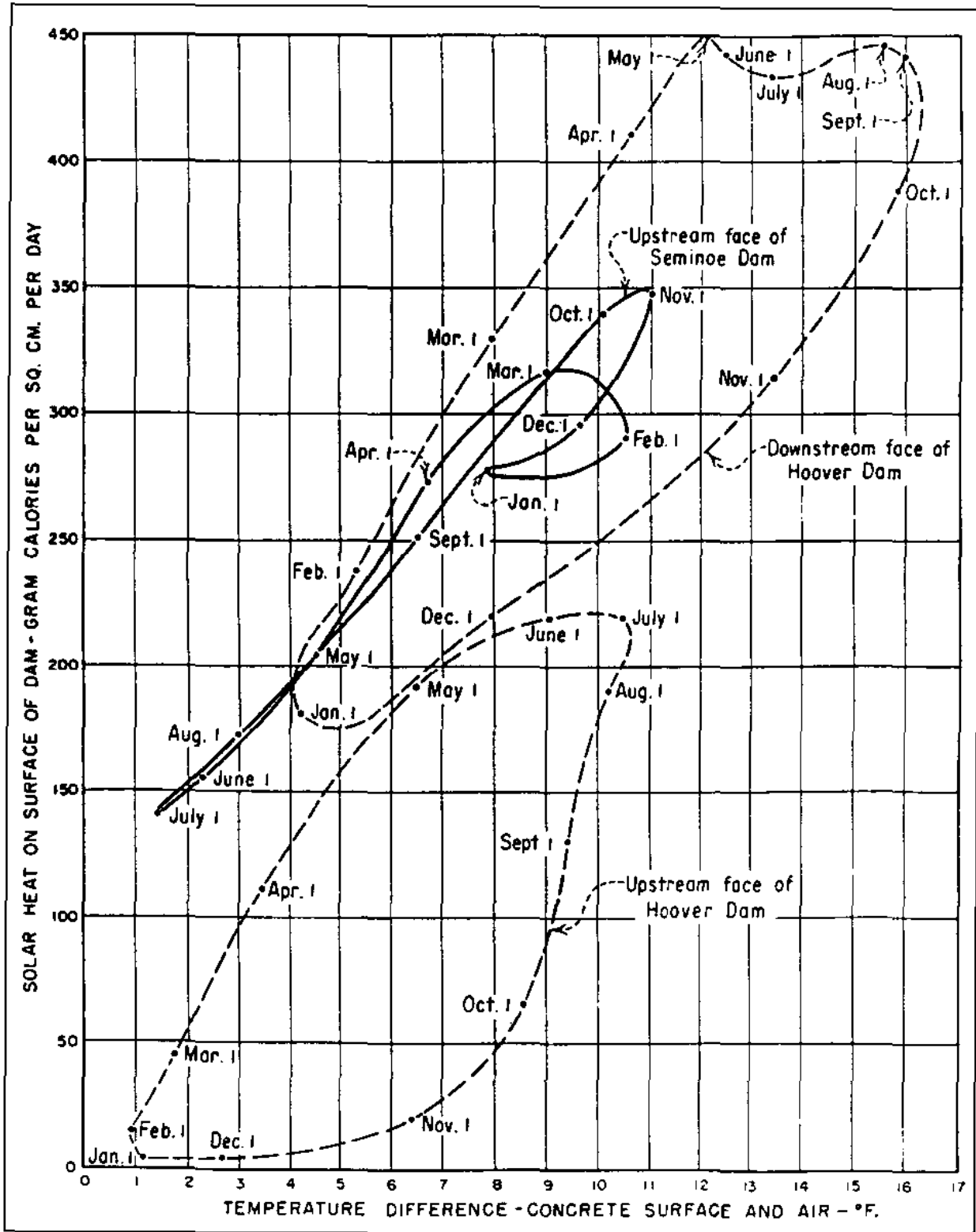

Figure 8-8. Variation of solar radiation during a typical year (USBR)

Library at the U.S. Army Engineer Waterways Experiment Station. Using the computer program will save a great deal of time; however, it would be very instructive to perform the calculation by hand at least once. The steps involved in this process are:

(a) Determine the input temperatures. An explanation of the required data has already been given in paragraphs 8-2b through d.

(b) Determine where in the structure temperatures are desired. These locations should correspond to the "arch" elevations in a trial load analysis and element boundaries or nodal locations in a finite element analysis.

(c) Determine air and water temperature cycles. As previously mentioned, the reservoir temperatures may be assumed to experience only annual temperature cycles. At the elevations of interest, the reservoir cycle would be the average of the maximum water temperature and the minimum water temperature, plus or minus one-half the difference between the maximum and minimum water temperatures. As mentioned before, three air temperature cycles are required. Table 8-1 describes how these cycles are obtained.

(d) Perform the computation. As previously mentioned, the details of the computation are described in the USBR Engineering Monograph No. 34 (Townsend 1965). Only a general description will be presented in this manual. The theory involved is that of heat flow through a flat slab of uniform thickness. The basis of the calculations is a curve of the thickness of the slab versus the ratio: variation of mean temperature of slab to variation of external temperature. To apply the curve, the thickness of the slab is an "effective" thickness related to the actual thickness of the dam, the diffusivity of the concrete, and the air cycle being utilized; yearly, 15-day, or daily cycle. Once the effective thickness is known, the graph is entered and the ratio is read from the ordinate. This is repeated for the three cycles and the ratios are noted. Then, using the cycles for air and then water, the maximum and minimum concrete temperatures for air on both faces and water on both faces are determined. These values are then averaged to determine the range of concrete temperatures for water on the upstream face and air on the downstream face.

(e) Correct for the effects of solar radiation.

(f) Apply results to the stress analysis.

(2) Another method to determine concrete temperatures utilizes finite element techniques. Arch dams are truly 3-D structures from a stress standpoint; however, from a heat-flow standpoint, very little heat will be transmitted in a direction which is normal to vertical planes, i.e., longitudinally through the dam. This allows 2-D heat-flow analyses to be performed. Something to keep in mind is that the results from the heat-flow analyses must be applied to nodes of the 3-D stress model. Therefore, for ease of application, it may be worthwhile to use a 3-D heat-flow model. The benefits of ease of application must be weighed against an increase in computational costs and use of a "coarse" 3-D finite element mesh for the temperature calculations.

TABLE 8-1

Amplitude of Air Temperatures

<u>Period</u>	<u>Extreme Weather Condition</u>		<u>Usual Weather Condition</u>	
	<u>Above</u>	<u>Below</u>	<u>Above</u>	<u>Below</u>
Annual	(1)	(2)	(1)	(2)
15-day	(4)	(5)	(6)	(7)
Daily	(3)	(3)	(3)	(3)

- (1) The difference between the highest mean monthly and the mean annual
- (2) The absolute difference between the lowest mean monthly and the mean annual
- (3) One-half the minimum difference between any mean monthly maximum and the corresponding mean monthly minimum
- (4) The difference between (1+3) and (the highest maximum recorded minus the mean annual)
- (5) The difference between (2+3) and (the lowest minimum recorded difference from the mean)
- (6) The difference between (1+3) and (the difference between the mean annual and the average of the highest maximum recorded and the highest mean monthly maximum)
- (7) The difference between (2+3) and (the difference between the mean annual and the average of the minimum recorded and the lowest mean monthly minimum)

Example, °F

<u>Month</u>	<u>Mean</u>	<u>Mean Max</u>	<u>Mean Min</u>	<u>Difference</u>	<u>High/Low</u>
Jan	47.2	58.8	35.7	23.1	
Feb	51.4	63.5	39.3	24.2	21
Mar	57.1	70.6	43.6	27.0	
Apr	66.0	80.4	51.6	28.8	
May	74.8	89.5	60.0	29.5	
Jun	83.3	98.3	68.4	29.9	
Jul	89.1	102.4	75.6	26.8	116
Aug	86.6	99.7	73.6	26.1	
Sep	81.7	95.3	68.2	27.1	
Oct	70.4	84.1	56.7	27.4	
Nov	57.0	70.0	43.9	26.1	
Dec	49.3	60.4	38.3	22.1	
Annual	67.8	81.1	54.6		

(Continued)

TABLE 8-1. (Concluded)

	Mean annual	67.8		
	Highest mean monthly	89.1		
	Lowest mean monthly	47.2		
	Highest	116.0		
	Lowest	21.0		
	Highest mean max	102.4		
	Lowest mean min	35.7		
	Lowest difference	22.1		
	<hr/>			
	Extreme Weather		Usual Weather	
	Condition		Condition	
<u>Period</u>	<u>Above</u>	<u>Below</u>	<u>Above</u>	<u>Below</u>
Annual	21.3	20.6	21.3	20.6
15-day	15.9	15.2	9.1	7.8
Daily	11.0	11.0	11.0	11.0

(a) A finite element model of either the entire dam or of the crown cantilever should be prepared. The water and air cycles are applied around the boundaries of the model and the mean annual air temperature can be applied to the foundation.¹ In most general-purpose finite element programs, steady state and transient solutions are possible. When performing these analyses, the transient solution is utilized. An initial temperature is required. By assuming the initial temperature to be the mean annual air temperature of the site, the transient solution will "settle" to a temperature distribution through the dam that is cyclic in nature. The key to this analysis is to let the solution run long enough for the cycle to settle down. The length of time necessary will be dependent on the thickness of the dam and the material properties. By plotting the response (temperature) of a node in the middle of the dam, a visual inspection can be made and a decision made as to whether or not the solution was carried out long enough. A cyclic response will begin at the initial temperature and the value about which the cycle is fluctuating will drift to a final stable value with all subsequent cycles fluctuating about this value. Based on these results, a solution time step can be chosen to represent the summer and winter concrete temperatures. Then the temperatures can be applied directly to the nodes of the 3-D stress model, if the same model is used for the temperature calculations. If a different model is used for the temperature calculations, a procedure must be developed to spread the 2-D heat flow results throughout the 3-D stress model.

¹ If the dam site is in an area of geothermal activity, the mean annual air temperature may not be appropriate for the foundation temperature. In these cases, data should be collected from the site and foundation temperatures should be used based on this data.

f. Summary. Paragraph 8-2 has described the data necessary to determine the operational temperature loads, the methods that can be used to estimate the data which may not be available at a new dam site, and the methods available to calculate the concrete temperatures. It is necessary for the engineer to determine that the methods used are consistent with the level of evaluation being performed and the stress analysis technique to be employed. The thickness of the dam and, therefore, the resulting temperature distribution should be kept in mind while choosing the temperature analysis technique. The premise here is that thinner structures respond faster to environmental temperature changes than thicker structures. USBR Engineering Monograph No. 34 (Townsend 1965) is a good reference for both the techniques used and data that have been compiled for dams in the western portion of the United States. The Corps' program TEMPER is available to use in determining the range of mean concrete temperatures. Finally, it is important to begin an instrumentation program early in the design process to verify the assumptions made during the temperature calculations.

8-3. Construction Temperatures Studies.

a. General. Before the final stages of the design process it is necessary to begin considering how the dam will be constructed and what, if any, temperature control measures need to be implemented. Temperature controls are usually needed to minimize the possibility of thermally induced cracking, since cracking will affect the watertightness, durability, appearance, and the internal stress distribution in the dam. The most common temperature control measures include precooling, postcooling, using low heat cements and pozzolans, reducing cement content, reducing the water-cement ratio, placement in smaller construction lifts, and restricting placement to nighttime (during hot weather conditions) or to warm months only (in areas of extreme cold weather conditions). This section will cover precooling methods, postcooling procedures, monolith size restrictions, and time of placing requirements. These items must be properly selected in order that a crack-free dam can be constructed with the desired closure temperature. This section also discusses how these variables influence the construction of the dam and how they can be determined.

b. The Temperature Control Problem. The construction temperature control problem can be understood by looking at what happens to the mass concrete after it is placed.

(1) During the early age of the concrete, as the cement hydrates, heat is generated and causes a rise in temperature in the entire mass. Under normal conditions some heat will be lost at the surface while the heat generated at the core is trapped. As the temperature in the core continues to increase, this concrete begins to expand; at the same time, the surface concrete is cooling and, therefore, contracting. In addition, the surface may also be drying which will cause additional shrinkage. As a result of the differential temperatures and shrinkage between the core and the surface, compression develops in the interior, and tensile stresses develop at the surface. When these tensile stresses exceed the tensile strength capacity, the concrete will crack.

(2) Over a period of time the compressive stresses that are generated in the core tend to be relieved as a result of the creep properties of the

material. As this is happening, the massive core also begins to cool, and it contracts as it cools. This contraction, if restrained by either the foundation, the exterior surfaces, or the previously placed concrete, will cause tensile stresses to develop in the core. As with the previous case, once these tensile stresses exceed the tensile strength capacity of the concrete, the structure will crack.

c. The Ideal Condition. The ideal condition would be simply to eliminate any temperature gradient or temperature drop. This is possible only if the initial placement temperature of the concrete is set low enough so that the temperature rise due to hydration of the cement would just bring the concrete temperature up to its final stable state. For example, if the final stable temperature is determined to be 80 °F and the concrete is expected to have a 30 °F temperature rise, then the initial placement temperature could be set at 50 °F, and the designer could be assured that there would be little chance of thermally induced cracking. This example would result in no volumetric temperature shrinkage. However, it may not always be feasible or economical to place concrete at such a low temperature, especially where the final stable temperature falls below 70 °F. In most cases, it is more economical to set the initial placement temperature slightly above the value that would give the "ideal" condition, thereby accepting a slight temperature drop and a small amount of volumetric temperature shrinkage.

d. Precooling.

(1) Precooling is the lowering of the placement temperature of the concrete and is one of the most effective and positive of the temperature control methods. Precooling can also improve the workability of the concrete as well as reduce the rate of heat generated during the hydration. The initial selection of the placement temperature can be achieved by assuming that a zero-stress condition will exist at the time of the initial peak temperature. A preliminary concrete placement temperature can be selected by using the following expression (American Concrete Institute (ACI) 1980):

$$T_i = T_f + (100 * C) / (e * R) - dt \quad (8-1)$$

where

T_i = placing temperature
 T_f = final stable temperature
C = strain capacity (millionths)
e = coefficient of thermal expansion (millionths/degree of temperature)
R = degree of restraint (percent)
dt = initial temperature rise

In this expression, the final stable temperature is that temperature calculated as described in paragraph 8-2 of this chapter. In the absence of that information, the final stable temperature can be assumed to be equal to the average annual air and water temperatures. By assuming 100 percent restraint (as would occur at the contact between the dam and the foundation), the equation becomes:

$$T_i = T_f + C/e - dt \quad (8-2)$$

As an example, if the average annual air temperature is 45 °F, the slow load strain capacity is 120 millionths, the coefficient of thermal expansion is 5 millionths per °F, and the initial temperature rise is 20 °F, then the maximum placement temperature would be in the order of 49 °F. The material property values for these variables should be obtained from test results and from the other studies discussed in other parts of this chapter. Table 8-2 shows a comparison of the average annual temperature and the specified maximum placement temperature for various arch dams constructed in the United States.

TABLE 8-2

Comparison of Mean Annual and Placement Temperatures (°F)

<u>Dam</u>	<u>Mean Annual</u>	<u>Placement</u>
Swan Lake	45	50
Strontia Springs	52	55
Crystal	37	40-50
Mossyrock	50	60
Morrow Point	39	40-60
Glen Canyon	62	<50

(2) The method or methods of reducing concrete placement temperatures will vary depending upon the degree of cooling required, the ambient conditions, and the contractor's equipment. The typical methods of cooling concrete are listed in Table 8-3 in approximate order of increasing cost (Waddell 1968).

TABLE 8-3

Precooling Methods

<u>Method of Precooling Concrete</u>	<u>Approximate Temperature Reduction (°F)</u>
Sprinkle coarse aggregate (CA) stockpiles	6
Chill mix water	3
Replace 80% of the mix water with ice	12
Vacuum cool CA to 35 or 38 °F	31
Cold-air cool CA to 40 °F	25
Cool CA by inundation to 40 °F	30
Vacuum cool fine aggregate to 34 °F	12
Contact cool cement to 80 °F	3

e. Postcooling. Postcooling is used both to reduce the peak temperature which occurs during the early stage of construction, and to allow for a uniform temperature reduction in the concrete mass to the point where the monolith joints can be grouted. Postcooling is accomplished by circulating water through cooling coils embedded between each lift of concrete. Following proper guidelines, concrete temperatures can safely be reduced to temperatures as low as 38 °F. Figure 8-9 shows a typical temperature history for post-cooled concrete. Descriptions of the cooling periods and of the materials and procedures to be used in the postcooling operation are discussed in the following paragraphs.

(1) Initial Cooling Period. During the initial cooling period (see Figure 8-9) the initial rise in temperature is controlled and a significant amount of heat is withdrawn during the time when the concrete has a low modulus of elasticity. The total reduction in the peak temperature may be small (3 to 5 °F), but it is significant. The initial cooling period will continue to remove a significant amount of heat during the early ages of the concrete when the modulus of elasticity is relatively low. It is preferable, however, not to remove more than 1/2 to 1 °F per day and not to continue the initial cooling for more than 15 to 30 days. Rapid cooling could result in tensions developing in the area of the cooling coils which will exceed the tensile strength of the concrete.

(2) Intermediate and Final Cooling Periods. The intermediate and final cooling periods are used to lower the concrete temperature to the desired grouting temperature. In general, the same rules apply to the intermediate and final cooling periods as to the initial cooling period except that the cooling rate should not exceed 1/2 °F per day. This lower rate is necessary because of the higher modulus of elasticity of the concrete. The need for the intermediate cooling period is dependent upon the need to reduce the vertical temperature gradient which occurs at the upper boundary of the grout lift. If an intermediate cooling period is needed, then the temperature drop occurring in the period is approximately half the total required. Each grout lift goes through this intermediate cooling period before the previous grout lift can go through its final cooling.

(3) Materials. The coils used in the postcooling process should be a thin-wall steel tubing. The diameter of the coils is selected as that which will most economically pass the required flow of water through the known length of coil. A small diameter may reduce the cost of the coil, but would increase the pumping cost. Coils with a 1-inch outside diameter are common for small flows. The water used in the postcooling operation must be free of silt which could clog the system. If cool river water is available year round, it usually will be cheaper than refrigerated water provided the required concrete temperature can be obtained within the desired time. The use of river water will usually require more and longer coils and a greater pumping capacity, but it could eliminate the need for a refrigeration plant.

(4) Layout. Individual coils can range in length from 600 to 1,300 feet. However, it is preferable to limit the length of each coil to 800 feet. Wherever possible, horizontal spacings equal to the vertical lift spacings give the most uniform temperature distribution during cooling. With

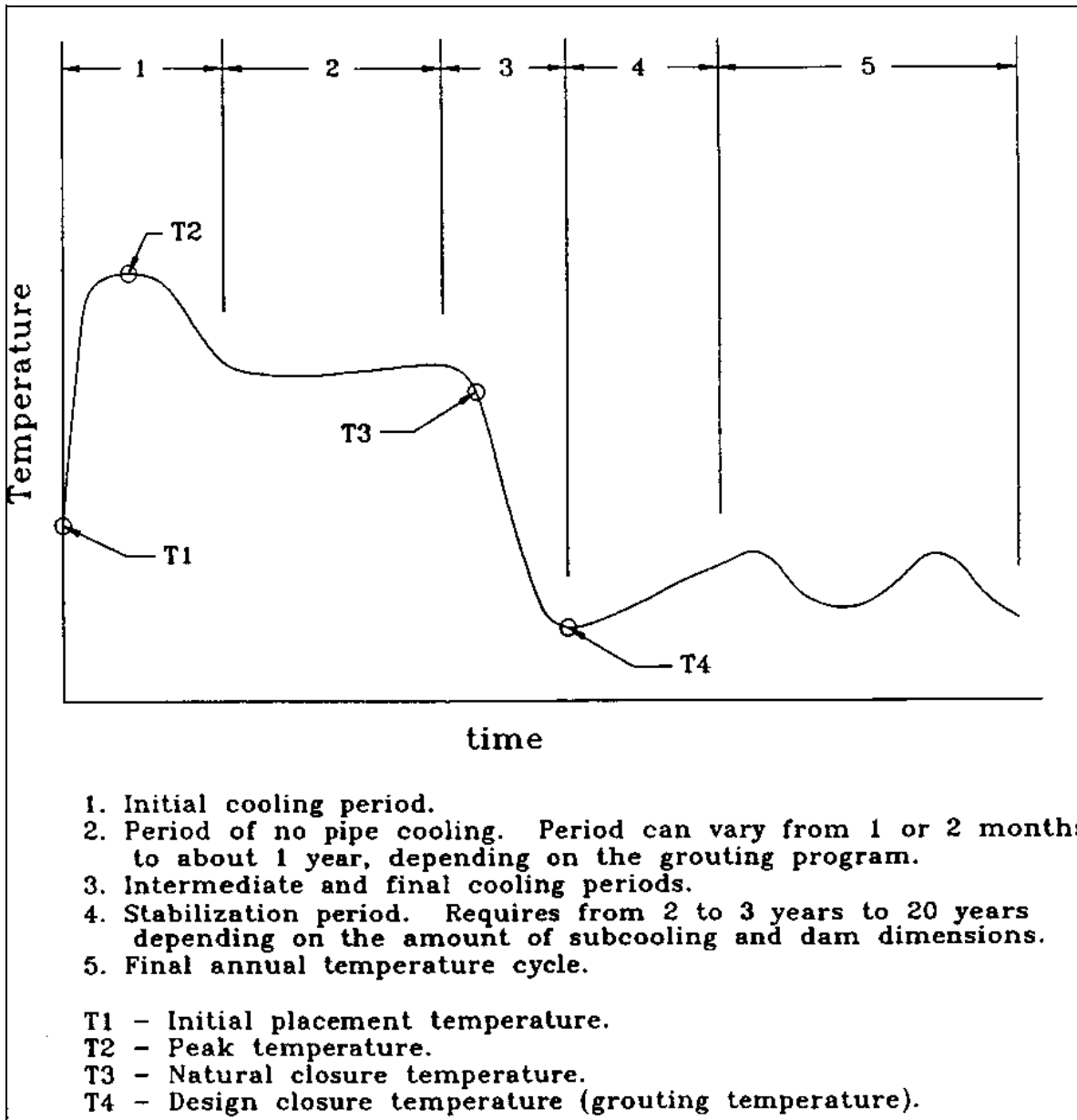

Figure 8-9. Temperature history for artificially cooled concrete where monolith joints are grouted (adapted from Townsend 1965)

lifts in excess of 7.5 feet, this may not be practical. Horizontal spacings from 2 to 6 feet are most common. Coils are often spaced closer together near the foundation to limit the peak temperatures further in areas where the restraint is large.

(5) Procedures. The cooling coils should be fixed in position by the use of tie-down wires which were embedded in the lift surfaces prior to final set. Compression type connections should be used and the coil system should be pressure tested prior to placement of concrete. It should also undergo a pumping test at the design flow to check for friction losses. Each coil

should include a visual flow indicator. Circulation of water through the cooling coils should be in process at the time that concrete placement begins. Since the water flowing through the coil is being warmed by the concrete, reversing the flow daily will give a more uniform reduction in temperature and help to prevent clogging. The cooling operations should be monitored by resistance-type thermometers embedded in the concrete at representative locations. When refrigerated systems are used, the flow seldom exceeds 4 gallons per minute (gpm). These are closed systems where the water is simply recirculated through the refrigeration plant. Systems using river water could have flow rates as high as 15 gpm. In these systems, the water is usually wasted after flowing through the system and new river water is supplied at the intake. Once the final cooling has been completed, the coils should be filled with grout.

f. Closure Temperature Analysis. One of the most important loadings on any arch dam is the temperature loading. The temperature loading is obtained by calculating the difference between the operational concrete temperature (paragraph 8-2) and the design closure temperature (Chapter 4). The design closure temperature is sometimes referred to as the grouting temperature, and is commonly obtained by cooling the concrete to the desired temperature and grouting the joints. However, grouting of the joints may not always be necessary, or possible. In some cases, it may be more desirable to select the placement temperature for the concrete so that the natural closure temperature of the structure corresponds to the design closure temperature. This is the "ideal condition" discussed in paragraph 8-3c. The purpose of the closure temperature analysis is to determine how the design closure temperature can be obtained while minimizing the possibility of cracking the structure.

(1) Before performing a detailed closure temperature analysis, a preliminary (simplified) analysis should be performed. The first step in the closure temperature study is to look at the typical temperature cycle for artificially cooled concrete. Artificially cooled concrete is concrete that incorporates the postcooling procedures discussed in paragraph 8-3e. Figure 8-9 shows a typical temperature cycle for artificially cooled concrete when the joints are to be grouted. The temperatures shown in this figure and those discussed in the next few paragraphs should be considered average temperatures. There are many factors that influence the temperature history including the placement temperature, the types and amounts of cementitious materials, the size of the monoliths, the placement rates, and the exposure conditions. As shown in the figure, there are five phases to the temperature history. Phase 1 begins as the concrete is being placed and continues while the cooling coils are in operation. Phase 2 covers the period between the initial postcooling operations and the intermediate and/or final cooling period. Phase 3 is the phase when the postcooling is restarted and continues until the joints are grouted. Phase 4 is the period after the grouting operation in which the concrete temperatures reach their final stable state. Phase 5 is the continuation of the final annual concrete temperature cycle, or the operating temperature of the structure, which is discussed in paragraph 8-2.

(2) There are four important points along this temperature history line which are determined as part of the closure temperature analysis. Temperature T1 is the placement temperature of the concrete. Temperature T2 is the maximum or peak temperature. Temperature T3 is the natural closure temperature,

or the temperature at which the joints begin to open. Temperature T4 is the design closure temperature, or the temperature of the concrete when the contraction joints are grouted. The preliminary analysis can be made to assure that the dam is constructable by evaluating each of these four temperatures. This is done by starting with temperature T4 and working back up the curve.

(a) Temperature T4 is set by the design analysis and is, therefore, fixed as far as the closure temperature analysis is concerned. For the example discussed in the next few paragraphs, a design closure temperature (T4) of 50 °F is assumed.

(b) Temperature T3 can be calculated by selecting a monolith width, using the coefficient of thermal expansion test results and assuming a required joint opening for grouting. An arch dam with a 50-foot monolith, a 5.0×10^{-6} inch/inch/°F coefficient of thermal expansion, and a joint opening of 3/32 inch would require a temperature drop of:

$$\Delta T = \frac{3/32 \text{ inch}}{50 \text{ feet} \times 12 \text{ inches/foot}} \times \frac{1}{5.0 \times 10^{-6}/\text{°F}} = 31.25 \text{ °F} \quad (8-3)$$

For this type of analysis, temperatures can be rounded off to the nearest whole degree without a significant impact in the conclusions. Therefore, a ΔT of 31 °F is acceptable and T3 becomes 81 °F.

(c) The difference between T3 and T2 will vary according to the thickness of the lift and the placement temperature. This variation is usually small and is sometimes ignored for the preliminary closure temperature analysis. If included in the analysis, the following values can be assumed. For lift heights of 5 feet, a 3 °F difference can be assumed. For 10-foot lifts, a 5 °F temperature difference is more appropriate. Therefore, for a 10-foot lift height the average peak temperature (T2) becomes 86 °F (81 + 5 °F).

(d) The placement temperature (T1) can be calculated based on the anticipated temperature rise caused by the heat of hydration. There are many factors that influence the temperature rise such as the type and fineness of cement, the use of flyash to replace cement, the lift height, the cooling coil layout, the thermal properties of the concrete, the ambient condition, the construction procedures, etc. Because of the variety of factors affecting temperature rise, it is difficult to determine this quantity without specific information about the concrete materials, mix design, and ambient conditions. For the example discussed in this section, we will simply assume that a 25 °F difference exists between T1 and T2, which is somewhat typical when Type II cement and flyash are used in the concrete mix and a 10-foot lift height is selected. This 25 °F temperature rise will yield a placement temperature of 61 °F. Allowing for some error in the analysis and some variation during the construction process, a temperature range of 60 ± 5 °F would be specified for this example.

(3) Using the procedure in the previous paragraphs, the temperatures along the temperature history curve can be estimated. The next step in this preliminary closure temperature analysis is to determine if any of the

temperatures and/or changes in temperatures could result in thermal cracking, or if they represent conditions which are not constructable. Two aspects of the temperature history need to be closely evaluated:

(a) The placement and peak temperatures. To be economical, the placement temperature should be near the mean annual air temperature. If the calculated placement temperature from the preliminary analysis is less than 45 °F or greater than 70 °F, or if placement temperature is 10 °F above the mean annual air temperature, then a more detailed closure temperature analysis should be performed. A detailed analysis should also be performed if the required peak temperature (T₂) is above 105 °F.

(b) The temperature drop from the peak to design closure temperature. The strain created during the final cooling period should not exceed the slow load strain capacity of the concrete as determined from test results (see Chapter 9). The maximum temperature drop can be determined by dividing the slow load strain capacity by the coefficient of thermal expansion. For example, if the slow load strain capacity is 120 millionths and the coefficient of thermal expansion is 5 millionths per °F, the maximum temperature drop will be 24 °F. Based on the values assumed in paragraph 8-3f(2)(c) (required temperature drop of 36 °F), the monolith width would need to be increased, or a more detailed closure temperature analysis would be required. In this case, by increasing the monolith width to 80 feet the required temperature drop would be reduced to 24.5 °F. The combination of the large monolith width and excessive temperature drop would usually require that a detailed closure analysis be performed to more accurately determine the construction parameters and temperature values.

(4) If either of the conditions stated in paragraph 8-3f(3) indicate a problem with obtaining the design closure temperature without jeopardizing the constructability of the dam, then a more detailed closure temperature analysis is required. The details of how to perform a detailed closure temperature analysis are presented in the next paragraphs.

(5) To perform a detailed closure temperature analysis, the following assumptions are required:

(a) The principle of superposition must apply. That is, the strains produced at any increment of time are independent of the effects of any strains produced at any previous increment of time.

(b) When the monolith joints are closed, the concrete is restrained from expanding by the adjacent monoliths and compressive stresses will develop in the monolith joints.

(c) The concrete is not restrained from contraction. In other words, no tensile stresses will develop due to contraction of the concrete. Contraction of the concrete will produce either a relaxation of compressive stresses at the joint, or a joint opening.

(d) Joint opening will occur only after all compressive stresses have been relieved.

(e) Creep is applied only to compressive stresses.

(f) Only the effects of thermal expansion or contraction and added weight are considered.

(6) To perform the closure temperature analysis, the time varying properties of coefficient of linear thermal expansion, rate of creep, modulus of elasticity, and Poisson's ratio will be needed. These material properties will be needed from the time of placement through several months. Chapter 9 furnishes more information on the material testing required.

(7) The first step in the closure temperature analysis is to predict the temperature history of a "typical" lift within the dam. This can be done with a heat-flow finite element program. The details of such a heat-flow analysis are discussed in ETL 1110-2-324. The main difference between the details discussed in the ETL and those discussed in this section is that the information needed for a closure temperature can be simplified such that the entire structure need not be modeled if a "typical" temperature history for each lift can be estimated. This can usually be done with a 2-D model with a limited number of lifts above the base of the dam. Ten lifts will usually be sufficient for most arch dam closure temperature analyses. If the thickness of the dam changes significantly near the crest, then additional heat-flow models may be necessary in that region.

(8) Once the temperature history of a "typical" lift has been estimated, the next step is to calculate the theoretical strain caused by the change in temperature for each increment of time. This theoretical strain is calculated by:

$$\epsilon_t = e_i * \Delta T = e_i * (T_i - T_{i-1}) \quad (8-4)$$

where

ϵ_t = incremental strain due to the change in temperature from time t_{i-1} to t_i
 e_i = coefficient of linear thermal expansion at time t_i
 ΔT = change in temperature
 T_i = temperature at time t_i
 T_{i-1} = temperature at time t_{i-1}

(9) In addition, the theoretical strain due to construction loads can be added by the following equation:

$$\epsilon_{wt} = \frac{\mu_i * \Delta wt}{E_i} = \frac{\mu_i * (wt_i - wt_{i-1})}{E_i} \quad (8-5)$$

where

ϵ_{wt} = incremental strain due to added weight from time t_{i-1} to t_i
 μ_i = Poisson's ratio at time t_i
 Δwt = the incremental change in weight
 E_i = modulus of elasticity at time t_i
 wt_i = weight at time t_i
 wt_{i-1} = weight at time t_{i-1}

(10) The total incremental strain is the sum of the incremental strain due to changes in temperature and added weight, as follows:

$$\epsilon_i = \epsilon_t + \epsilon_{wt} = e_i * (T_i - T_{i-1}) + \frac{\mu_i * (wt_i - wt_{i-1})}{E_i} \quad (8-6)$$

where

ϵ_i = total incremental strain at time t_i

(11) The incremental stress can be calculated by:

$$\sigma_i = \epsilon_i * E_i \quad (8-7)$$

where

σ_i = total incremental stress at time t_i

(12) Once the stress has been determined for each time increment, creep can be applied to the stress to determine how that incremental stress is relaxed over time. The following equation applies to stress relaxation under constant strain:

$$\sigma_{i-n} = \frac{1}{1/E_i + [c_i * \ln(t_n - t_i + 1)]} \text{ per unit strain} \quad (8-8)$$

where

σ_{i-n} = stress at time t_n due to an increment of strain at time t_i
 c_i = rate of creep at time t_i

(13) To estimate the total stress at any time t_n , the following equation can be used:

$$\sigma_n = \sum_{i=1}^n \sigma_{i-n} \quad (8-9)$$

where

σ_n = total stress at time t_n

(14) If the total stress in the monolith joint at the end of time t_n is in compression ($\sigma_n \geq 0$), then the temperature drop necessary to relieve the compressive stress can be determined by:

$$dT_n = T_n - T'_n = \frac{\sigma_n}{e_n * E_n} \quad (8-10)$$

where

T'_n = natural closure temperature of the structure at time t_n
 T_n = concrete temperature at time t_n .

(15) Under normal circumstances, T'_n should not vary significantly after 20 to 30 days after concrete placement and can simply be referred to as T' . In the closure temperature analysis, the steady state value for T' is the critical value for estimating the monolith width. With T' and the design closure temperature, the minimum monolith width required to be able to grout the monolith joints can be determined by:

$$l_{min} = \frac{x}{e_n * (T' - T_g)} \quad (8-11)$$

where

l_{min} = minimum size (width) of monolith that will produce an acceptable joint opening for grouting
 x = joint opening needed to be able to grout the joint
 T_g = temperature at which the joints are to be grouted (the design closure temperature)

g. The UngROUTed Option. If the preliminary and/or detailed closure temperature analysis indicates a problem with obtaining the design closure temperature because the required placement temperatures are higher than acceptable (greater than 70 °F), then the ungrouted option should be considered. The ungrouted option assumes that the "natural" closure temperature is the same as the "design" closure temperature. Figure 8-10 shows the temperature cycle for the ungrouted option. In this option, the concrete is placed at a low enough temperature such that the natural closure temperature falls within a specified value. A detailed closure temperature analysis is required in order to obtain adequate confidence that the dam will achieve the required closure temperature. Design Memorandum No. 21 (US Army Engineer District (USAED), Jacksonville, 1988 (Feb)) provides additional details of the analysis for the ungrouted option.

h. Nonlinear, Incremental Structural Analysis. Once the closure temperature study has been satisfactorily completed, the next step is to perform a nonlinear, incremental structural analysis (NISA) using the construction parameters resulting from the closure temperature study. ETL 1110-2-324 provides guidance for performing a NISA. If the structural configuration or the construction sequence is modified as a result of the NISA, then a reanalysis of the closure temperature may be required.

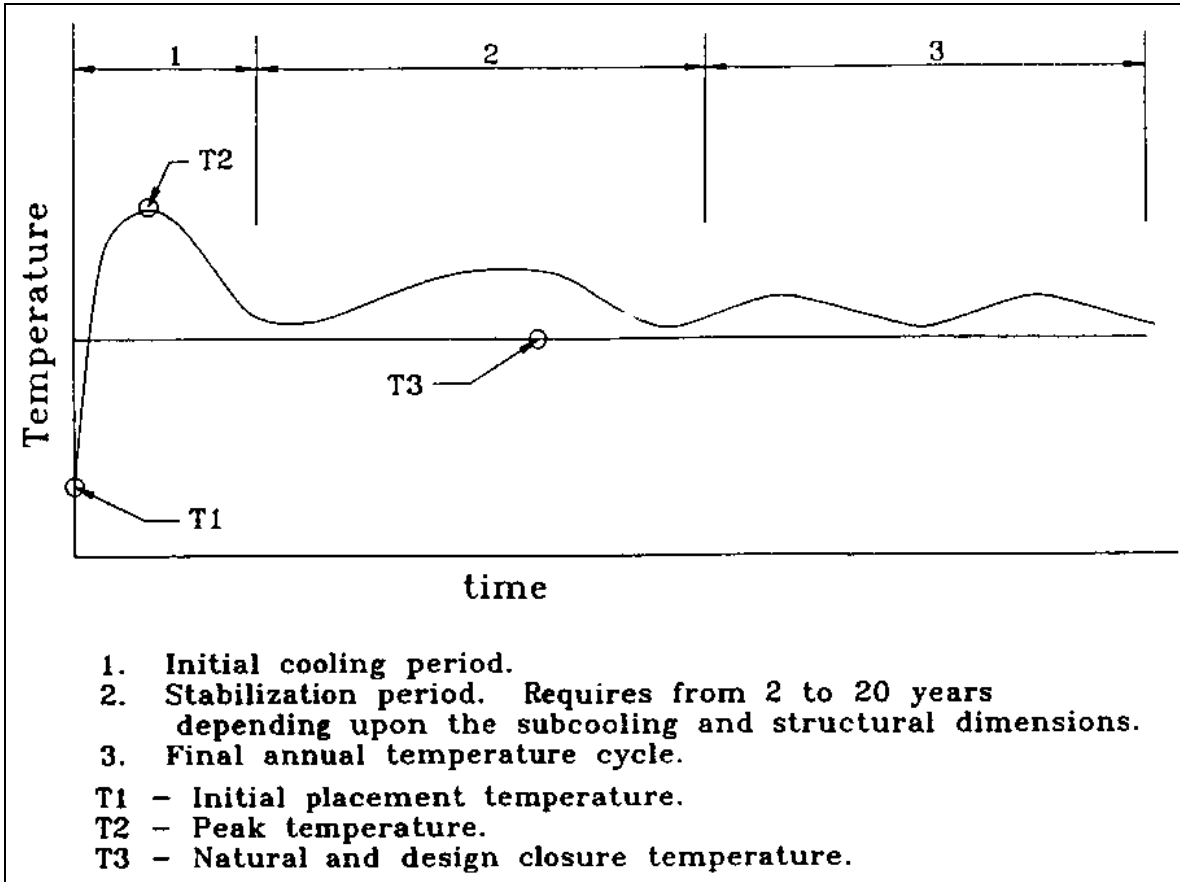

Figure 8-10. Temperature history for artificially cooled concrete where monolith joints are not grouted

CHAPTER 9

STRUCTURAL PROPERTIES

9-1. Introduction. Unlike gravity dams that use the weight of the concrete for stability, arch dams utilize the strength of the concrete to resist the hydrostatic loads. Therefore, the concrete used in arch dams must meet very specific strength requirements. In addition to meeting strength criteria, concrete used in arch dams must meet the usual requirements for durability, permeability, and workability. Like all mass concrete structures, arch dams must keep the heat of hydration to a minimum by reducing the cement content, using low-heat cement, and using pozzolans. This chapter discusses the material investigations and mixture proportioning requirements necessary to assure the concrete used in arch dams will meet each of these special requirements. This chapter also discusses the testing for structural and thermal properties that relates to the design and analysis of arch dams, and it provides recommended values which may be used prior to obtaining test results.

9-2. Material Investigations. General guidance on concrete material investigations can be found in EM 1110-2-2000. The material discussed in the next few paragraphs is intended to supplement EM 1110-2-2000 and to provide specific guidance in the investigations that should be performed for arch dams.

a. Cement. Under normal conditions the cementitious materials used in an arch dam will simply be a Type II portland cement (with heat of hydration limited to 70 cal/gm) in combination with a pozzolan. However, Type II cement may not be available in all project areas. The lack of Type II cement does not imply that massive concrete structures, such as arch dams, are not constructable. It will only be necessary to investigate how the available materials and local conditions can be utilized. For example, the heat of hydration for a Type I cement can be reduced by modifying the cement grinding process to provide a reduced fineness. Most cement manufacturers should be willing to do this since it reduces their cost in grinding the cement. However, there would not necessarily be a cost savings to the Government, since separate silos would be required to store the specially ground cement. In evaluating the cement sources, it is preferable to test each of the available cements at various fineness to determine the heat generation characteristics of each. This information is useful in performing parametric thermal studies.

b. Pozzolans. Pozzolans are siliceous or siliceous and aluminous materials which in themselves possess little or no cementitious value; however, pozzolans will chemically react, in finely divided form and in the presence of moisture, with calcium hydroxide at ordinary temperatures to form compounds possessing cementitious properties. There are three classifications for pozzolans: Class N, Class F, and Class C.

(1) Class N pozzolans are naturally occurring pozzolans that must be mined and ground before they can be used. Many natural pozzolans must also be calcined at high temperatures to activate the clay constituent. As a result, Class N pozzolans are not as economical as Classes F and C, if these other classes are readily available.

(2) Classes F and C are fly ashes which result from burning powdered coal in boiler plants, such as electric generating facilities. The ash is collected to prevent it from entering the atmosphere. Being a byproduct of another industry, fly ash is usually much cheaper than cement. However, some of the savings in material may be offset by the additional material handling and storage costs. Fly ash particles are spherical and are about the same fineness as cement. The spherical shape helps reduce the water requirement in the concrete mix.

(3) It is important that the pozzolan source produce consistent material properties, such as constant fineness and constant carbon content. Otherwise, uniformity of concrete will be affected. Therefore, an acceptable pozzolan source must be capable of supplying the total project needs.

(4) In mass concrete, pozzolans are usually used to replace a portion of the cement, not to increase the cementitious material content. This will reduce the amount of portland cement in the mixture proportions. Not only will this cement reduction lower the heat generated within the mass, but the use of pozzolans will improve workability, long-term strength, and resistance to attack by sulphates and other destructive agents. Pozzolans can also reduce bleeding and permeability and control alkali-aggregate reaction.

(5) However, when pozzolans are used as a cement replacement, the time rate of strength gain will be adversely affected; the more pozzolan replacement, the lower the early strength. As a result, an optimization study should be performed to determine the appropriate amount of pozzolan to be used. The optimization study must consider both the long-term and the early-age strengths. The early-age strength is important because of the need for form stripping, setting of subsequent forms, and lift joint preparation. The practical limits on the percentage of pozzolan that should be used in mass concrete range from 15 to 50 percent. During the planning phases and prior to performing the optimization study, a value of 25 to 35 percent can be assumed.

c. Aggregates. Aggregates used in mass concrete will usually consist of natural sand, gravel, and crushed rock. Natural sands and gravels are the most common and are used whenever they are of satisfactory quality and can be obtained economically in sufficient quantity. Crushed rock is widely used for the larger coarse aggregates and occasionally for smaller aggregates including sand when suitable materials from natural deposits are not economically available. However, production of workable concrete from sharp, angular, crushed fragments usually requires more vibration and cement than that of concrete made with well-rounded sand and gravel.

(1) Suitable aggregate should be composed of clean, uncoated, properly shaped particles of strong, durable materials. When incorporated into concrete, it should satisfactorily resist chemical or physical changes such as cracking, swelling, softening, leaching, or chemical alteration. Aggregates should not contain contaminating substances which might contribute to deteriorating or unsightly appearance of the concrete.

(2) The decision to develop an on-site aggregate quarry versus hauling from an existing commercial quarry should be based on an economic feasibility study of each. The study should determine if the commercial source(s) can produce aggregates of the size and in the quantity needed. If an on-site

quarry is selected, then the testing of the on-site source should include a determination of the effort required to produce the aggregate. This information should be included in the contract documents for the prospective bidders.

d. Water. All readily available water sources at the project site should be investigated during the design phase for suitability for mixing and curing water. The purest available water should be used. When a water source is of questionable quality, it should be tested in accordance with CRD-C 400 and CRD-C 406 (USAEWES 1949). When testing the water in accordance with CRD-C 406, the designer may want to consider including ages greater than the 7 and 28 days required in the CRD specification. This is especially true when dealing with a design age of 180 or 360 days, because the detrimental effects of the water may not become apparent until the later ages. Since there are usually differences between in-place concrete using an on-site water source and lab mix designs using ordinary tap water, the designer may want to consider having the lab perform the mix designs using the anticipated on-site water.

e. Admixtures. Admixtures normally used in arch dam construction include air-entraining, water-reducing, retarding, and water-reducing/retarding admixtures. During cold weather, accelerating admixtures are sometimes used. Since each of these admixtures is readily available throughout the United States, no special investigations are required.

9-3. Mix Designs. The mixture proportions to be used in the main body of the dam should be determined by a laboratory utilizing materials that are representative of those to be used on the project. The design mix should be the most economical one that will produce a concrete with the lowest practical slump that can be efficiently consolidated, the largest maximum size aggregate that will minimize the required cementitious materials, adequate early-age and later-age strength, and adequate long-term durability. In addition, the mix design must be consistent with the design requirements discussed in the other chapters of this manual. A mix design study should be performed to include various mixture proportions that would account for changes in material properties that might reasonably be expected to occur during the construction of the project. For example, if special requirements are needed for the cement (such as a reduced fineness), then a mix with the cement normally available should be developed to account for the possibility that the special cement may not always be obtainable. This would provide valuable information during construction that could avoid prolonged delays.

a. Compressive Strength. The required compressive strength of the concrete is determined during the static and dynamic structural analyses. EM 1110-2-2000 requires that the mixture proportions for the concrete be selected so that the average compressive strength (f_{cr}) exceeds the required compressive strength (f'_c) by a specified amount. The amount that f_{cr} should exceed f'_c depends upon the classification of the concrete (structural or non-structural) and the availability of test records from the concrete production facility. Concrete for an arch dam meets the requirements in EM 1110-2-2000 for both structural concrete and nonstructural (mass) concrete. That is, arch dams rely on the strength of the concrete in lieu of its mass, which would classify it as a structural concrete. However, the concrete is unreinforced mass concrete, which would classify it as a nonstructural concrete. For determining the required compressive strength (f_{cr}) for use in the mix designs, the preferred method would be the method for nonstructural concrete.

Assuming that no test records are available from the concrete plant, this would require the mix design to be based on the following relationship:

$$f_{cr} = f'_c + 600 \text{ psi} \quad (9-1)$$

This equation will be valid during the design phase, but it can change during construction of the dam as test data from the concrete plant becomes available.

b. Water-cement Ratio. Table 9-1 shows the maximum water-cement ratios recommended for concrete used in most arch dams. These water-cement ratios are based on minimum durability requirements. The strength requirements in the preceding paragraph may dictate an even lower value. In thin structures (thicknesses less than approximately 30 feet) it may not be practical to change mixes within the body of the structure, so the lowest water-cement ratio should be used throughout the dam. In thick dams (thicknesses greater than approximately 50 feet), it may be practical to use an interior class of concrete with a water-cement ratio as high as 0.80. However, the concrete in the upstream and downstream faces should each extend into the dam a minimum of 15 to 20 feet before transitioning to the interior mixture. In addition, the interior concrete mix should meet the same strength requirements of the surface mixes.

TABLE 9-1

Maximum Permissible Water-Cement Ratio

Location in Dam	Severe or Moderate Climate	Mild Climate
Upstream face above minimum pool	0.47	0.57
Interior (for thick dams only)	0.80	0.80
Downstream face and upstream face below minimum pool	0.52	0.57

c. Maximum Size Aggregate. EM 1110-2-2000 recommends 6 inches as the nominal maximum size aggregate (MSA) for use in massive sections of dams. However, a 6-inch MSA may not always produce the most economical mixture proportion. Figure 9-1 shows that for a 90-day compressive strength of 5,000 psi, a 3-inch MSA would require less cement per cubic yard than a 6-inch MSA. Therefore, the selection of a MSA should be based on the size that will minimize the cement requirement. Another consideration in the selection of the MSA is the availability of the larger sizes and the cost of handling additional sizes. However, if the various sizes are available, the savings in cement and the savings in temperature control measures needed to control heat generation should offset the cost of handling the additional aggregate sizes.

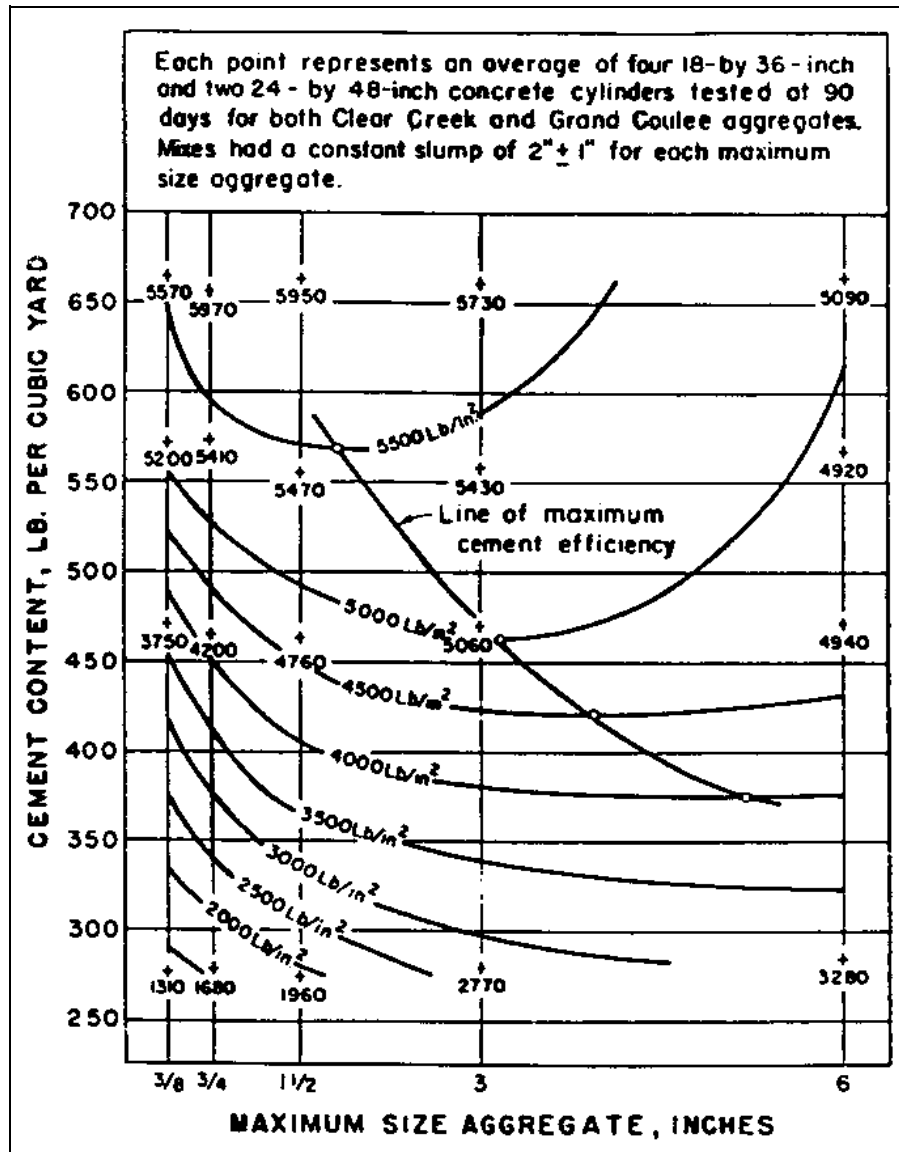

Figure 9-1. Variation of cement content with maximum size aggregate for various compressive strengths. Chart shows that compressive strength varies inversely with maximum size aggregate for minimum cement content (USBR 1981)

d. Design Age. The design age for mass concrete is usually set between 90 days and 1 year. This is done to limit the cement necessary to obtain the desired strength. However, there are early-age strength requirements that must also be considered: form removal, resetting of subsequent forms, lift line preparation, construction loading, and impoundment of reservoir. There are also some difficulties that must be considered when selecting a very long design age. These include: the time required to develop the mixture proportions and perform the necessary property testing and the quality assurance evaluation of the mixture proportions during construction.

(1) During the design phase, selection of a 1-year design strength would normally require a minimum of 2 years to complete the mix design studies and then perform the necessary testing for structural properties. This assumes that all the material investigations discussed earlier in this manual and in EM 1110-2-2000 have been completed and that the laboratory has an adequate supply of representative material to do all required testing. In many cases, there may not be sufficient time to perform these functions in sequence, thus they must be done concurrently with adjustments made at the conclusion of the testing.

(2) During the construction phase of the project, the problems with extended design ages become even more serious. The quality assurance program requires that the contracting officer be responsible for assuring that the strength requirements of the project are met. With a Government-furnished mix design, the Contracting Officer must perform strength testing to assure the adequacy of the mixture proportions and make adjustments in the mix proportions when necessary. The problem with identifying variability of concrete batches with extended design ages of up to 1 year are obvious. As a result, the laboratory should develop a relationship between accelerated tests and standard cured specimens. EM 1110-2-2000 requires that, during construction, two specimens be tested in accordance with the accelerated test procedures, one specimen be tested at an information age, and two specimens be tested at the design age. The single-information-age specimen should coincide with form stripping or form resetting schedules. For mass concrete construction where the design age usually exceeds 90 days, it is recommended that an additional information-age specimen be tested at 28 days.

9-4. Testing During Design. During the design phase of the project, test information is needed to adequately define the expected properties of the concrete. For the purposes of this manual, the type of tests required are divided into two categories: structural properties testing and thermal properties testing. The number of tests and age at which they should be performed will vary depending on the type of analyses to be performed. However, Table 9-2 should be used in developing the overall testing program. If several mixes are to be investigated by the laboratory for possible use, then the primary mix should be tested in accordance with Table 9-2 and sufficient isolated tests performed on the secondary mixes to allow for comparisons to the primary mix results. ACI STP 169B (1978) and Neville (1981) provide additional information following tests and their significance.

a. Structural Properties Testing.

(1) Compressive Strength. Compressive strength testing at various ages will be available from the mix design studies. However, additional companion compressive tests at various ages may be required for correlation to other properties, such as tensile strength, shear strength, modulus of elasticity, Poisson's ratio, and dynamic compressive strength. Most of the compression testing will be in accordance with CRD-C 14 (USAEWES 1949), which is a uniaxial test. However, if the stress analysis is to consider a biaxial stress state, then additional biaxial testing may need to be performed.

TABLE 9-2

Recommended Testing Program

Test	Age of Specimens (days)						
	1	3	7	28	90	180	1 yr.
Compression test	*	*	*	*	*	*	*
Modulus of rupture	*	*	*	*	*	*	*
Splitting tensile test				*			*
Shear test				*			*
Modulus of elasticity	*	*	*	*	*	*	*
Poisson's ratio	*	*	*	*	*	*	*
Dynamic tests							*
Creep	*	*	*	*	*	*	*
Strain capacity		*	*	*			*
Coefficient of thermal expansion	*	*	*	*			*
Specific heat	*	*	*	*			*
Thermal diffusivity	*	*	*	*			*

(2) Tensile Strength. The limiting factor in the design and analysis of arch dams will usually be the tensile strength of the concrete. Currently there are three accepted methods of obtaining the concrete tensile strength: direct tension test; the splitting tension test; and the modulus of rupture test. The direct tension test can give the truest indication of the tensile strength but is highly susceptible to problems in handling, sample preparation, surface cracking due to drying, and testing technique; therefore, it can often give erratic results. The splitting tension test also provides a good indication of the true tensile strength of the concrete and it has the advantage of being the easiest tension test to perform. In addition, the splitting tensile test compensates for any surface cracking and gives consistent and repeatable test results. However, when using the splitting tension test results as a criteria for determining the acceptability of a design, the designer should be aware that these results represent nonlinear performance that is normally being compared to a tensile stress computed from a linear analysis. The modulus of rupture test gives a value that is calculated based on assumed linear elastic behavior of the concrete. It gives consistent results and has the advantage of also being more consistent with the assumption of linear elastic behavior used in the design. A more detailed discussion of the importance of these tests in the evaluation of concrete dams is presented the ACI Journal (Raphael 1984). In testing for tensile strength for arch dam projects, the testing should include a combination of splitting tension tests (CRD-C 77) and modulus of rupture tests (CRD-C 16) (USAEWES 1949).

(3) Shear Strength. The shear strength of concrete results from a combination of internal friction (which varies with the normal compressive stress) and cohesive strength (zero normal load shear strength). Companion series of shear strength tests should be conducted at several different normal stress values covering the range of normal stresses to be expected in the dam. These values should be used to obtain a curve of shear strength versus normal stress. Shear strength is determined in accordance with CRD-C 90 (USAEWES 1949).

(4) Modulus of Elasticity. When load is applied to concrete it will deform. The amount of deformation will depend upon the magnitude of the load, the rate of loading, and the total time of loading. In the analysis of arch dams, three types of deformations must be considered: instantaneous modulus of elasticity; sustained modulus of elasticity; and dynamic modulus of elasticity. Dynamic modulus of elasticity will be discussed in a separate section.

(a) The instantaneous modulus of elasticity is the static modulus of elasticity, as determined by CRD-C 19 (USAEWES 1949). The modulus of elasticity in tension is usually assumed to be equal to that in compression. Therefore, no separate modulus testing in tension is required. Typical values for instantaneous (static) modulus of elasticity will range from 3.5×10^6 psi to 5.5×10^6 psi at 28 days and from 4.3×10^6 psi to 6.8×10^6 psi at 1 year.

(b) The sustained modulus of elasticity includes the effects of creep, and can be obtained directly from creep tests. This is done by dividing the sustained load on the test specimen by the total deformation. The age of the specimen at the time of loading and the total time of loading will affect the result. It is recommended that the age of a specimen at the time of loading be at least 1 year and that the total time under load also be 1 year. The sustained modulus under these conditions will typically be approximately two-thirds that of the instantaneous modulus of elasticity.

(5) Dynamic Properties. Testing for concrete dynamic properties should include compressive strength, modulus of rupture or splitting tensile strength, and modulus of elasticity. The dynamic testing can be performed at any age for information but is only required at the specified design age. The rate of loading used in the testing should reflect the actual rate with which the dam will be stressed from zero to the maximum value. This rate should be available from a preliminary dynamic analysis. If the rate of loading is not available, then several rates should be used covering a range that can be reasonably expected. For example, a range of rates that would cause failure at 20 to 150 milliseconds could be used.

(6) Poisson's Ratio. Poisson's ratio is defined in American Society for Testing and Materials (ASTM) E6 (ASTM 1992) as "the absolute value of the ratio of transverse strain to the corresponding axial strain below the proportional limit of the material." In simplified terms, it is the ratio of lateral strain to axial strain. Poisson's ratio for mass concrete will typically range from 0.15 to 0.20 for static loads, and from 0.24 to 0.25 for dynamic loads.

(7) Creep. Creep is time-dependent deformation due to sustained load. Creep can also be thought of as a relaxation of stress under a constant

strain. In addition to using the creep test to determine the sustained modulus of elasticity (discussed previously), creep is extremely important in the thermal studies. However, unlike the sustained modulus of elasticity, the thermal studies need early age creep information.

(8) Strain Capacity. Analyses that are based on tensile strain capacity rather than tensile strength will require some information on strain capacity. Examples of these types of analyses include the closure temperature and NISA as discussed in Chapter 8. Strain capacity can be measured in accordance with CRD-C 71 (USAEWES 1949) or can be estimated from the results of the modulus of elasticity, modulus of rupture, and specific creep tests (Houghton 1976).

b. Thermal Properties. Understanding the thermal properties of concrete is vital in planning mass concrete construction. The basic properties involved include coefficient of thermal expansion, specific heat, thermal conductivity, and thermal diffusivity.

(1) Coefficient of Thermal Expansion. Coefficient of thermal expansion is the change in linear dimension per unit length divided by the temperature change. The coefficient of thermal expansion is influenced by both the cement paste and the aggregate. Since these materials have dissimilar thermal expansion coefficients, the coefficient for the concrete is highly dependent on the mix proportions, and since aggregate occupies a larger portion of the mix in mass concrete, the thermal expansion coefficient for mass concrete is more influenced by the aggregate. Coefficient of thermal expansion is expressed in terms of inch per inch per degree Fahrenheit (in./in./°F). In many cases, the length units are dropped and the quantities are expressed in terms of the strain value per °F. This abbreviated form is completely acceptable. Typical values for mass concrete range from 3.0 to $7.5 \times 10^{-6}/\text{°F}$. Testing for coefficient of thermal expansion should be in accordance with CRD-C 39 (USAEWES 1949). However, the test should be modified to account for the temperature ranges to which the concrete will be subjected, including the early-age temperatures.

(2) Specific Heat. Specific heat is the heat capacity per unit temperature. It is primarily influenced by moisture content and concrete temperature. Specific heat is typically expressed in terms of Btu/pound-degree Fahrenheit (Btu/lb-°F). Specific heat for mass concrete typically ranges from 0.20 to 0.25 Btu/lb-°F. Testing for specific heat should be in accordance with CRD-C 124 (USAEWES 1949).

(3) Thermal Conductivity. Thermal conductivity is a measure of the ability of the material to conduct heat. It is the rate at which heat is transmitted through a material of unit area and thickness when there is a unit difference in temperature between the two faces. For mass concrete, thermal conductivity is primarily influenced by aggregate type and water content, with aggregate having the larger influence. Within the normal ambient temperatures, conductivity is usually constant. Conductivity is typically expressed in terms of Btu-inch per hour-square foot-degree Fahrenheit (Btu-in./hr-ft²-°F). Thermal conductivity for mass concrete typically ranges from 13 to 24 Btu-in./hr-ft²-°F. It can be determined in accordance with CRD-C 44 (USAEWES 1949) or it can be calculated by the following equation:

$$k = \sigma c \rho$$

(9-2)

where

- k = thermal conductivity
- σ = thermal diffusivity
- c = specific heat
- ρ = density of concrete

(4) Thermal Diffusivity. Thermal diffusivity is a measure of the rate at which temperature changes can take place within the mass. As with thermal conductivity, thermal diffusivity is primarily influenced by aggregate type and water content, with aggregate having the larger influence. Within the normal ambient temperatures, diffusivity is usually constant. Diffusivity is typically expressed in terms of square feet/hour (ft²/hr). For mass concrete, it typically ranges from 0.02 to 0.06 ft²/hr and is measured using CRD-C 37 (USAEWES 1949).

(5) Adiabatic Temperature Rise. The adiabatic temperature rise should be determined for each mix anticipated for use in the project. The adiabatic temperature rise is determined using CRD-C 38 (USAEWES 1949).

9-5. Properties To Be Assumed Prior To Testing. During the early stages of design analysis it is not practical to perform in-depth testing. Therefore, the values shown in Tables 9-3, 9-4, and 9-5 can be used as a guide during the early design stages and as a comparison to assure that the test results fall within reasonable limits.

TABLE 9-3

Static Values (Structural)

Compressive strength (f'_c)	$\geq 4,000$ psi
Tensile strength (f'_t)	10% of f'_c
Shear strength (v)	
Cohesion	10% of f'_c
Coef. of internal friction	1.0 ($\phi = 45^\circ$)
Instantaneous modulus of elasticity (E_i)	4.5×10^6 psi
Sustained modulus of elasticity (E_s)	3.0×10^6 psi
Poisson's ratio (μ_s)	0.20
Unit weight of concrete (ρ_c)	150 pcf
Strain capacity (ϵ_c)	
rapid load	100×10^{-6} in/in
slow load	150×10^{-6} in/in

TABLE 9-4

Dynamic Values (Structural)

Compressive strength (f'_{cd})	130% f'_c
Tensile strength (f'_{td})	130% f'_t
Modulus of elasticity (E_D)	5.5×10^6 psi
Poisson's ratio (μ_d)	0.25

TABLE 9-5

Thermal Values

Coefficient of thermal expansion (e)	5.0×10^{-6} per °F
Specific heat (c)	0.22 Btu/lb-°F
Thermal conductivity (k)	16 Btu-in./hr-ft ² -°F
Thermal diffusivity (σ)	0.04 ft ² /hr

CHAPTER 10

FOUNDATION INVESTIGATIONS

10-1. Introduction. Foundation investigations for arch dams generally must be accomplished in more exacting detail than for other dam types because of the critical relationship of the dam to its foundation and to its abutments. This chapter will describe the procedures which are commonly followed in accomplishing each phase of these investigations including the foundation analysis. It is very important that these investigations employ the latest state-of-the-art techniques in geological and rock mechanics investigations. This work is usually accomplished in relatively discrete increments or phases with each leading to the succeeding one and building upon the previous one. These phases are described as separate sections in the following text and are covered in chronological order as they are normally accomplished. Usually, a considerable amount of geological information and data are available in the form of published literature, maps, remotely sensed imagery, etc. which should be assembled and studied prior to initiation of field investigations. This information is very useful in forming the basis for a very preliminary appraisal of site adequacy and also serves as the basis for initiation of the succeeding phase of the investigation.

10-2. Site Selection Investigations. This phase of foundation investigation is performed for the purpose of locating the safest and most economical site(s) on which to construct the arch dam. It also will serve to verify the suitability of the foundation to accommodate an arch dam. The effort required depends on the level of design as discussed in Chapter 5, paragraph 5-2.

a. It is important to determine the rock types, rock quality, and suitable founding depths for the dam. This information will be required in estimating foundation treatment and excavation depths necessary for the construction of a dam at each of the potential sites being investigated. This information is utilized in the development of cost comparisons between the various sites being evaluated for site selection. Investigational techniques at this stage normally consist of geophysical surveys and limited core borings used together to prepare a subsurface interpretation along the alignment of each site under evaluation. Sufficient data must be obtained to preclude the likelihood of missing major foundation defects which could change the order of comparison of the sites evaluated. The type and spacing of core borings as well as the geophysical surveys must be designed by a competent engineering geologist taking into account the foundation rock types and conditions and anticipated structural configuration of the dam. This must be done in close coordination with the dam designer.

b. A major factor that must be considered in site selection is the topography of the site. Sites are classified as narrow-V, wide-V, narrow-U, or wide-U as discussed in Chapter 1. Another factor to be considered in site selection is the quality of the rock foundation and the depth of excavation required to expose rock suitable for founding the structure. A third factor is the storage capacity of the reservoir provided by each different site investigated. All these factors must be considered in the economic comparison of each site to the others.

10-3. Geological Investigations of Selected Dam Site. Very detailed geological investigations must be performed at the selected dam site location to provide a thorough interpretation and analysis of foundation conditions. These investigations must completely define the rock mass characteristics in each abutment and the valley bottom to include accurate mapping of rock types, statistical analysis of rock mass discontinuities (joints, bedding planes, schistosity, etc.), location of faults and shear zones, and zonation of the subsurface according to rock quality as it is controlled by weathering. In addition to these geologic studies, the potential for earthquake effects must be assessed based on a seismological investigation performed as discussed in Chapter 7.

a. Surface Investigations. This stage of investigation frequently entails additional topographic mapping to a more detailed scale than was needed for the site selection investigations. This is followed by detailed geologic mapping of all surface exposures of rock. Frequently it is necessary to increase these exposures by excavating trenches and pits to reveal the rock surface in areas covered by soil and vegetation. The fracture pattern existing in the rock mass is of particular significance and must be carefully mapped and analyzed. Any evidence of faulting and shearing should be investigated. Linear and abnormal configurations of surface drainage features revealed by remote sensing or on topographic maps may be surface reflections of faults or shear zones and should be investigated if they are located in or near the dam foundation. They may also be of seismological concern if there is evidence that they could be active faults. This concern may require fault trenching and age dating of gouge materials as well as establishing the relationship of the soil cover to last fault displacement to evaluate the potential for future activity on the fault. The surface geologic mapping should provide a sound basis for planning the subsurface investigations, which are the next step.

b. Subsurface Investigations. The subsurface investigation program must be very thoroughly planned in advance to obtain all of the necessary information from each boring. This is a very expensive portion of the design effort and it can become much more expensive if the initial planning overlooks requirements which necessitate reboring or retesting of existing borings to obtain data which should have been obtained initially. EM 1110-1-1804, "Geotechnical Investigations," should be used as a guide when planning the subsurface investigations. The following paragraphs address procedures which must be considered in planning the subsurface investigation program for an arch dam.

(1) Core borings must be obtained in order to provide hard data on foundation conditions. There are numerous decisions which must be made regarding the borings. The boring location plan is perhaps the first. This plan should contemplate a phased approach to the boring program so that future boring locations can be determined based upon data obtained from the earlier phase. The ultimate goal in locating borings is to provide sufficient coverage within the foundation to essentially preclude the possibility of adverse foundation features escaping detection. This can be accomplished by judicious spacing of borings along the dam axis utilizing both vertical and inclined orientations. Refer to Figures 10-1 and 10-2 for examples of an arch dam boring layout. Target depth for borings is another important consideration. Minimum depths should be established during planning with maximum depth left

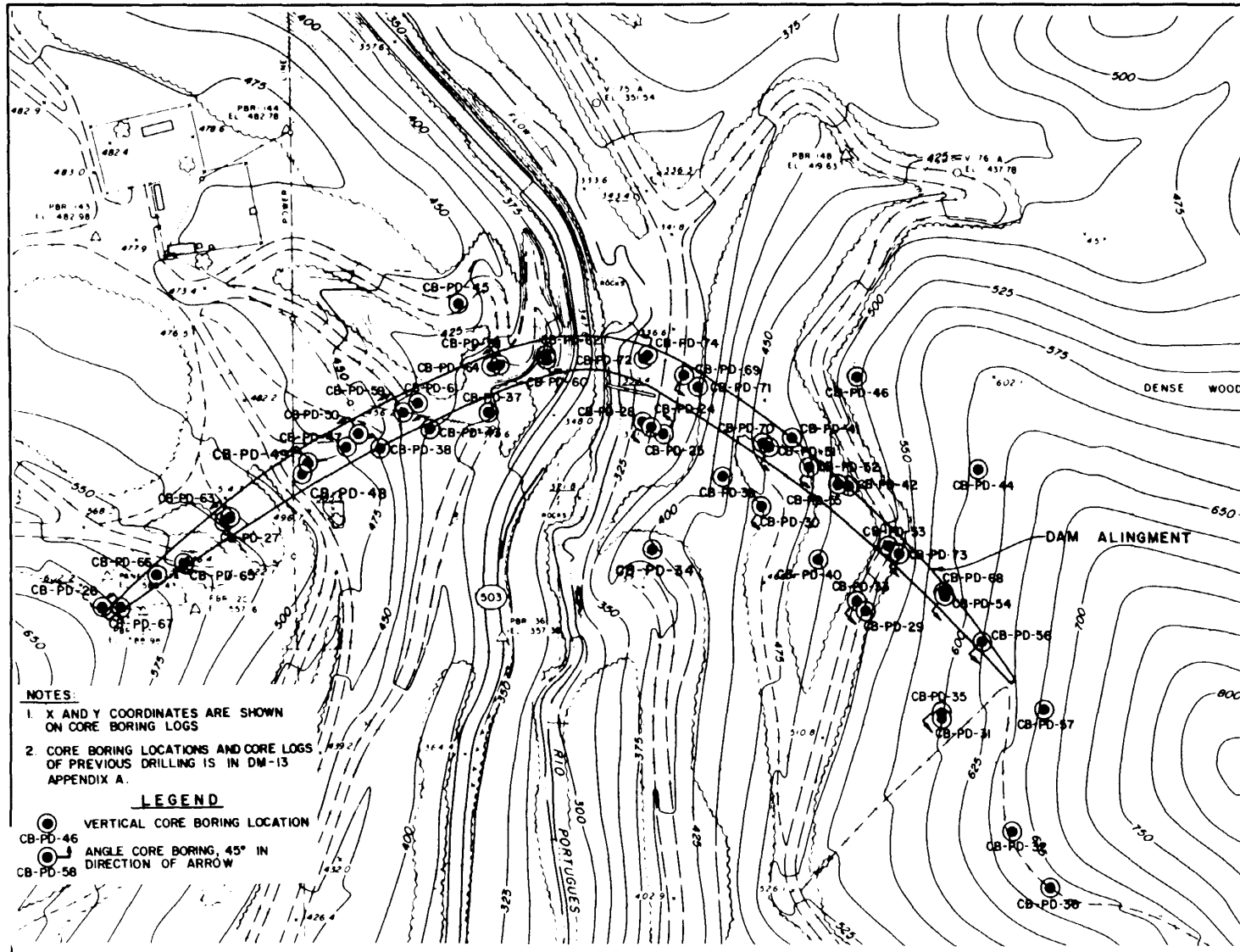

Figure 10-1. Arch dam boring layout plan from Portugues Dam Design Memorandum No. 22 (USAED, Jacksonville, 1988b)

10-4

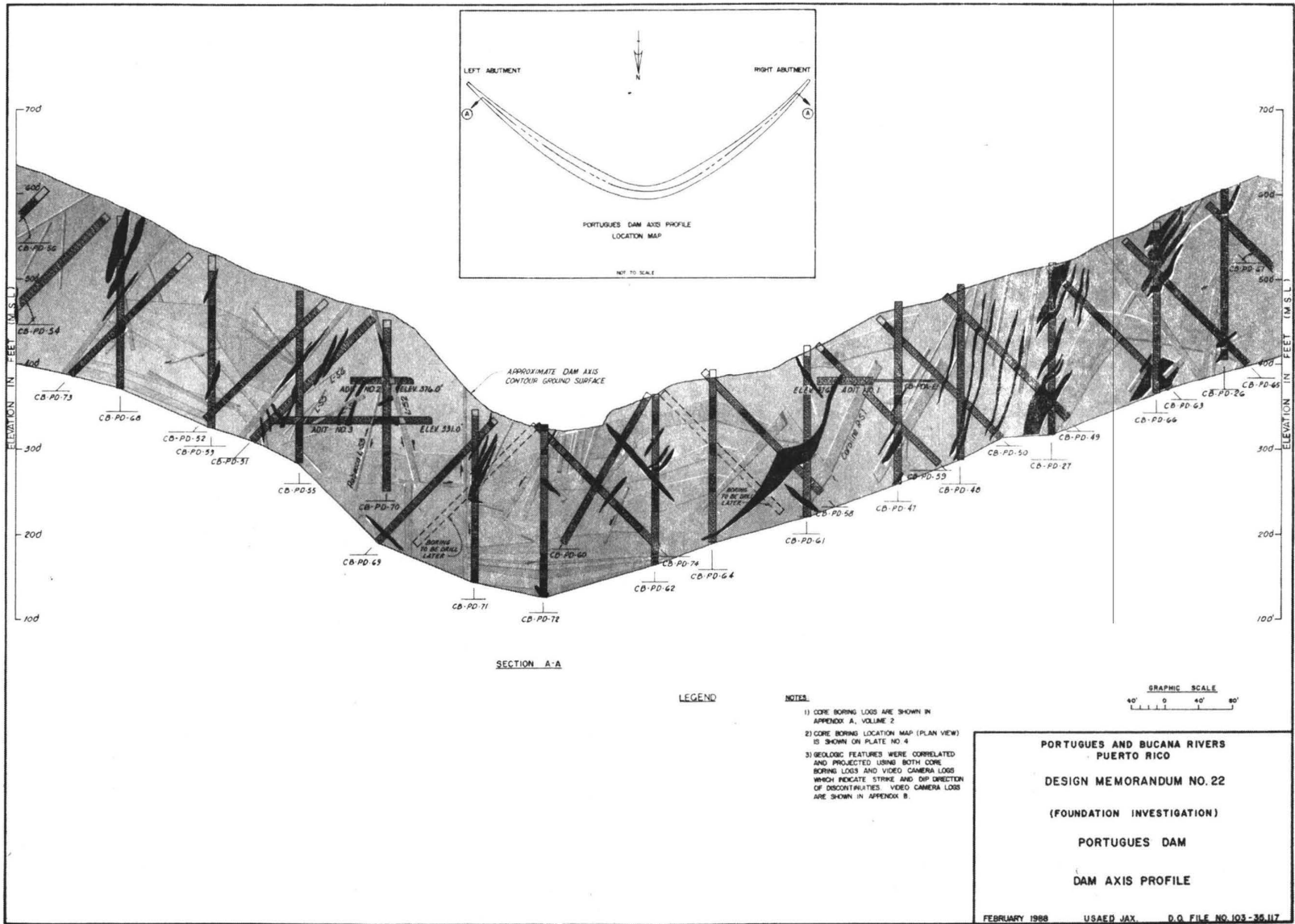

Figure 10-2. Arch dam boring profile from Portugues Dam Design Memorandum No. 22 (USAED, Jacksonville, 1988b)

to the discretion of the geologist supervising the drilling as it is accomplished. Core diameter and type of core barrel are important considerations that affect both the cost of the investigation and the quality of the results. It may well be necessary to experiment with different combinations in order to determine the size and type of barrel that is most effective.

(2) Rock core logging is critical to the subsurface investigation. It is essential that this be performed in considerable detail by a competent geologist, and it is preferable that all rock core logging be done by the same individual, where feasible, for the sake of consistency. The logging should include descriptions of rock type, rock quality including degree of weathering, fractures, faults, shears, rock quality designation (RQD), sufficient data to utilize the selected rock mass rating system, and should be supported with photographs of all of the core taken while still fresh. It is important that the geologist be present during drilling in order to log such occurrences as drill fluid losses, rod drops, changes in drill fluid color, rod chatter, drilling rate, etc. These types of data used in conjunction with the log of the rock core can greatly improve the interpretation of the foundation encountered by a particular boring.

(3) Bore hole logging and testing should be utilized to enhance the amount of information obtained from each hole drilled. Certain techniques work better in some environments than in others; thus, the following techniques listed must be utilized discriminately according to their applicability to the site conditions. Bore hole logging systems include caliper logs, resistivity logs, SP logs, sonic logs, radioactive logs, etc. Bore hole TV cameras also provide important information on foundation conditions such as frequency and orientation of fractures and condition of rock in intervals of lost core. Bore hole pressure meters such as the Goodman Jack may provide valuable information on the rock mass deformation properties. Water pressure testing is important to develop data on the potential seepage characteristics of the dam foundation. All these techniques should be considered when planning the subsurface investigations. It is generally more efficient to perform these investigations at the time the hole is being drilled than to return to the hole at a later date.

(4) Laboratory testing of core samples is necessary to provide design data on foundation conditions. Petrographic analysis is required to correctly identify the rock types involved. It is necessary to obtain shear strength parameters for each different rock type in order to analyze the stability of the foundation. The shear tests are normally run in a direct shear box and are performed on intact samples, sawed samples, and along preexisting fracture planes. This provides upper- and lower-bound parameters as well as parameters existing on natural fractures in the rock. The geologist and design engineer can then use these data to better evaluate and select appropriate shear and friction parameters for use in the foundation stability analysis. Another test performed on core samples is the unconfined compression test with modulus of elasticity determination. This provides an index of rock quality and gives upper-bound values of the deformation modulus of the rock for later comparison and correlation with in situ rock mass deformation tests. Refer to paragraph 10-3c(4) and 10-4a for additional discussion of laboratory testing.

(5) Geophysical surveying techniques can be utilized to improve the geological interpretation of the foundation conditions. These should be used

in conjunction with the surface geological mapping and with the core borings to provide an integrated interpretation of subsurface conditions. Surface resistivity and refraction seismology are techniques which may provide usable data on depth of overburden and rock quality variations with depth as well as stratification. Cross-hole seismic surveys are sometimes successful in detecting large fault zones or shear zones trending between borings. Other geophysical techniques such as ground penetrating radar and electrical spontaneous potential are available, are being further refined and improved, and should be considered for environments where they have a likelihood of success. Seismic techniques are also appropriate for determining the dynamic modulus of deformation of the rock mass. This is discussed further in paragraph 10-4b(2).

(6) Ground water investigations and permeability testing are necessary for several reasons. These investigations provide the basis for design of any dewatering systems required during construction. They also provide the data to evaluate the reservoir's capability to impound water and to design seepage and uplift control required in the foundation beneath the dam and in the abutments. These data also provide the basis for making assumptions of uplift on rock wedges. Ground water levels, or their absence, should be carefully and accurately determined in all borings. Water pressure testing should be accomplished in most foundation and abutment borings to locate potential seepage zones and to provide data to help in designing the foundation grouting program. The literature is extensive concerning procedures for performing and evaluating bore hole pressure tests. Pumping tests are also very important in providing data for evaluation of the foundation seepage characteristics of the foundation. Reference is made to EM 1110-1-1804 for further guidance on both pressure testing and pump testing.

(7) Grout testing is necessary for multiple reasons. First, it is necessary to evaluate the groutability of the foundation. Water pressure testing alone can be very misleading in evaluating groutability because rock with very fine fractures may take significant quantities of water but be impervious to even a very thin cement grout. Grout testing is also required for determining the optimal size grout hole and the most effective means of drilling the hole. In some rock foundations, percussion drills with cuttings removed by air provide the best holes for grout injection, while in others, rotary drills utilizing water for cuttings removal are the most appropriate. A grout test provides the opportunity to experiment with multiple drilling techniques and various hole diameters to determine the most effective ones prior to entering into the main construction contract when changes are normally quite expensive. Another important reason for grout testing is to improve the estimates of quantity of grout take and length of holes likely to be required in the main contract. Perhaps the most important reason to perform a grout test is to provide an evaluation of the probable effectiveness of the grout curtain for consideration during design. Refer to EM 1110-2-3506 for details concerning design of grout tests.

(8) Rim tests and evaluations are important in some reservoir areas where there may be concerns for excessive loss of water through rim leakage or where potentially large landslides may occur which could displace a significant volume of the lake causing over topping of the dam. These evaluations can be accomplished through topographic and geologic mapping of the reservoir rim followed by core boring, water table determination, and pressure testing

in those areas of concern. Remedial measures may be required in areas which are susceptible either to excessive leakage or to significant landslides.

c. Abutment Adits. Adits provide excellent access for in situ observation and mapping of foundation conditions as well as large-scale rock mass testing. Information obtained from adit investigations provides a much higher level of confidence that all significant foundation defects have been detected than if borings and geophysical surveys alone are used. They also greatly improve the confidence level in the mapping and statistical evaluation of the rock mass fracture system. It is advisable to include adits in the subsurface investigation program for arch dam sites with difficult or unusual foundation conditions.

(1) Exploratory adits may be of various sizes and shapes, however, 5 feet wide by 7 feet high is considered to be about the minimum size. A more practical size is 7 feet wide by 8 feet high in that it provides adequate space for the contractor's excavating equipment and for in situ rock mechanics testing. The horseshoe shape is a good configuration for an exploratory adit. It provides essentially vertical side surfaces and a horizontal floor surface which are more easily surveyed and mapped than curved configurations. The adit locations in the abutments should be selected with two factors in mind. First, it is desirable to locate them so that the in situ rock mechanics tests can be performed at or near the location of the maximum stress to be applied to the foundation by the dam. This is normally at about the one-third height of the dam. Another factor to be considered in the location is the geology of the abutments. If there are conditions of concern, such as faults, shear zones, etc., it may be necessary to locate the adits to provide access to these features for in-place inspection and testing. The adits should be oriented to provide maximum intersection of the fracture system and to provide access for in situ testing of the rock mass immediately below the founding level of the dam. It is prudent to construct an adit in each abutment if foundation conditions vary significantly from one abutment to the other. Geological conditions may require more than one adit in an abutment.

(2) Geologic mapping is required for each adit. The preferred procedure to follow is the full periphery method as described in EM 1110-1-1804. The results can be displayed in reports in both plan and isometric views. Refer to Figures 10-3 and 10-4 for examples.

(3) Surveys of joints and other rock mass discontinuities should be accomplished while performing the adit mapping. The adits provide excellent exposures for obtaining data for a statistical analysis of the fracture system in the rock. It is important to perform bias checks to assure that the orientation of the adit is not resulting in over counting of some joint sets in relation to others. For instance, a joint set oriented perpendicular to the axis of the adit will be intersected much more frequently than one oriented parallel, thereby tending to bias the statistical analysis. It is also important to describe the spacing, frequency, extent or degree of separation, openness, roughness, joint filler, and wall rock condition of weathering of each fracture set across the width and height of the adit. This information is needed when determining shear strength parameters for individual fracture sets for use in stability analysis. Stereographic projection coupled with

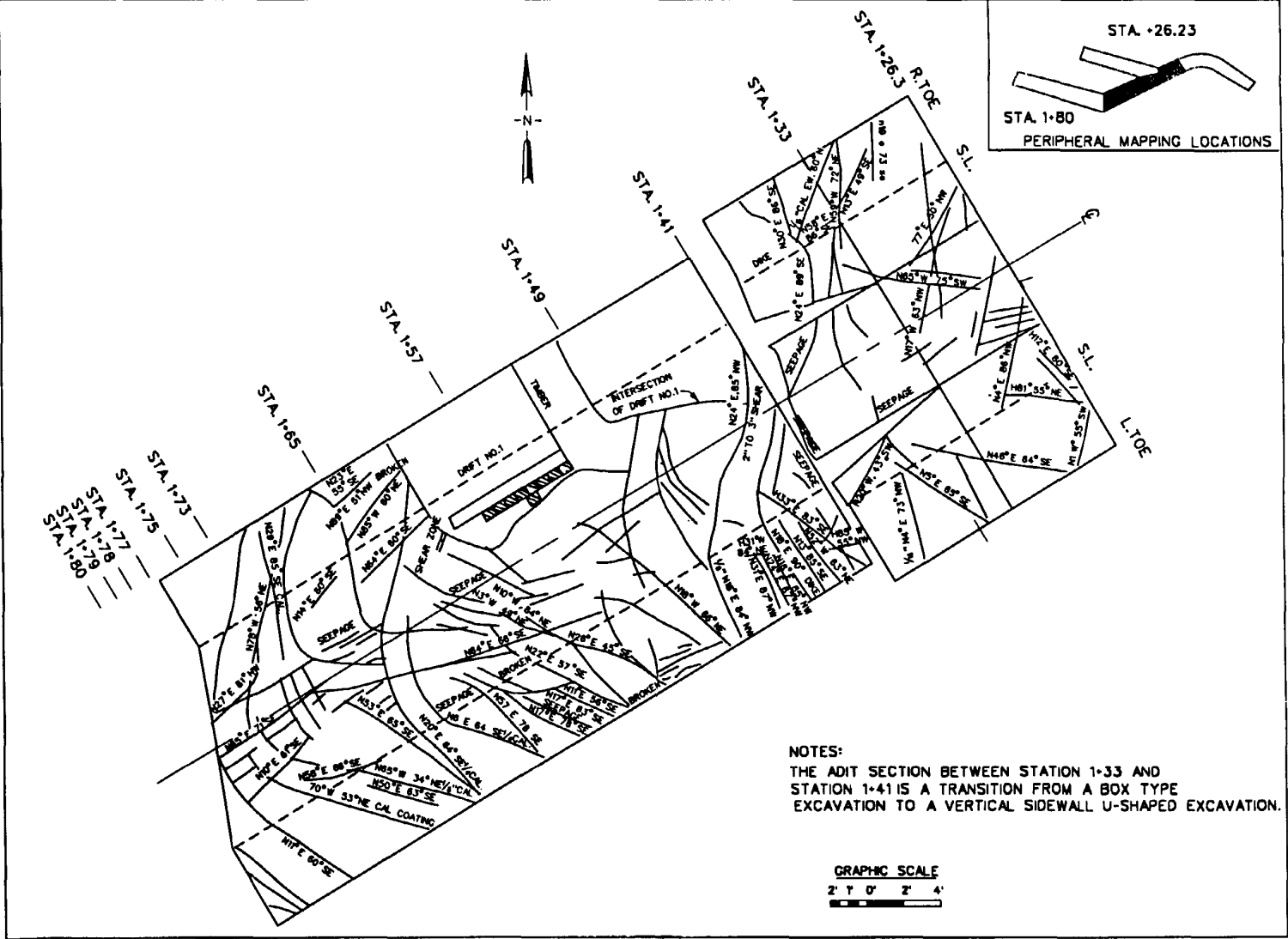

Figure 10-3. Adit periphery mapping plan view from Portugues Dam Design Memorandum No. 22 (USAED, Jacksonville, 1988b)

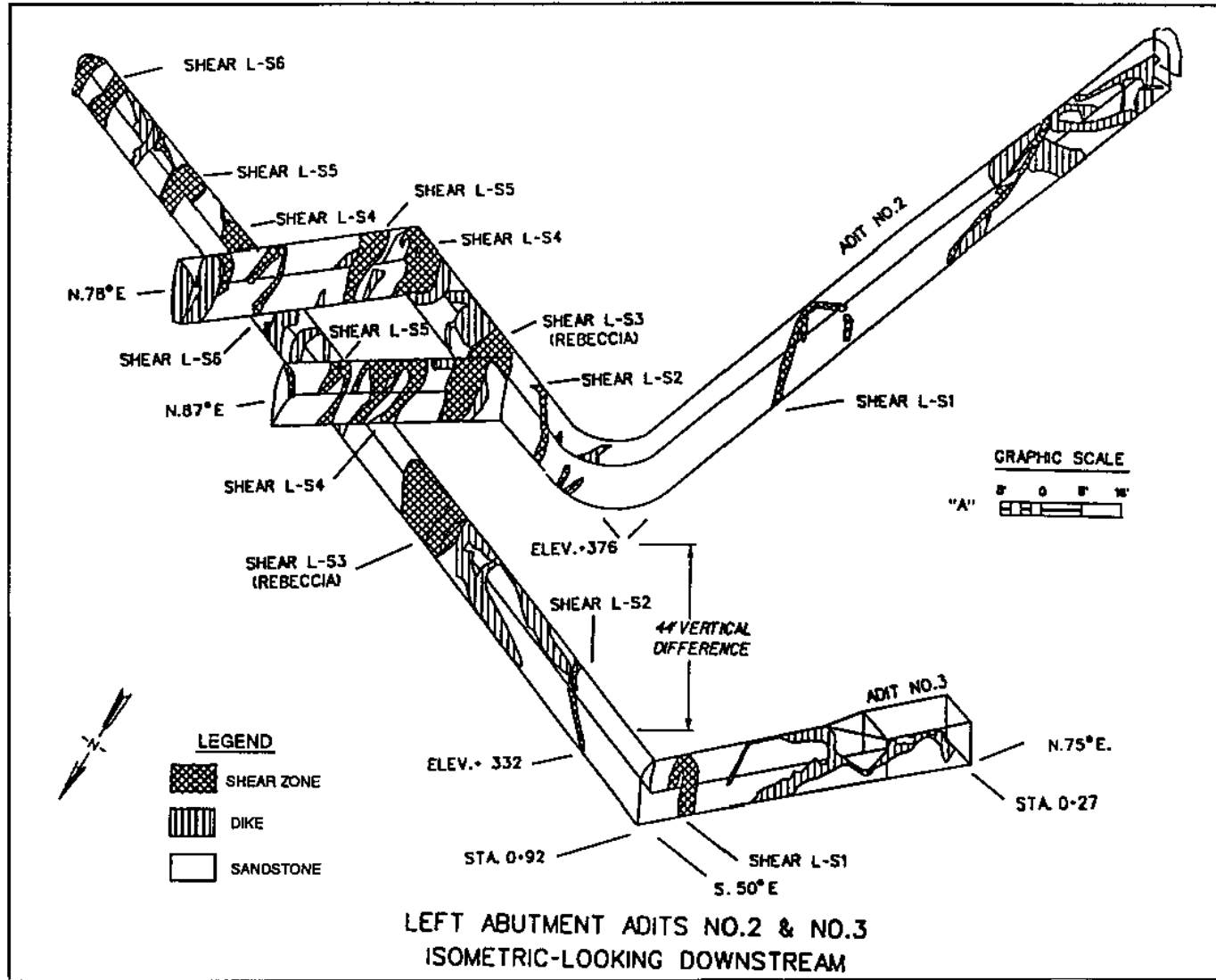

Figure 10-4. Adit periphery mapping isometric view from Portugues Dam Design Memorandum No. 22 (USAED, Jacksonville, 1988b)

statistical analysis is an excellent method for determining the preferred orientation of the joint sets.

(4) Adits provide an opportunity to obtain samples for laboratory testing as well as providing access for in situ testing. Shear zones and faults with their gouge and brecciated intervals may be sampled for laboratory testing. The tests may include mineral identification, shear strength determination, Atterberg limits of soil-like materials, etc. In situ testing may include uniaxial jacking tests to determine the rock mass deformation properties, shear testing of discontinuities, and measurement of in situ rock stress.

d. Test Excavations. Test excavations are valuable aids in a dam site investigation.

(1) Test pits and trenches can provide the field geologist with strategically located exposures of the bedrock for mapping purposes. A bulldozer is usually necessary to prepare access roads to core drill locations. Excavation for abutment access roads can provide very good exposures of the rock surface. These roads can be extended as necessary to provide the field geologist with exposures where they are needed. Normally, it is wise to expose the bedrock for mapping in trenches or road cuts that zig zag across the dam site from valley bottom to the top of dam on each abutment. This additional exposure of the rock will normally significantly improve the geologic interpretation of foundation conditions.

(2) Large diameter calyx borings may in some instances be required where individual foundation features are of such concern that it is necessary for the field geologist to examine them in place. They are very expensive but are less costly than excavating an adit.

(3) The dam foundation in the valley bottom and on the abutments may be excavated by separate contract prior to the main dam contract as a means of fully exposing the foundation for examination by the geologists and the dam designers. At this point in time, changes in the dam's design can still be made without incurring excessive delay costs from the main dam contractor. The foundation should be carefully mapped and the geologic interpretation formalized as a part of the foundation design memorandum. It should also be incorporated into the final foundation report required by ER 1110-1-1801. Final foundation preparation and cleanup, including some additional excavation, should be left for the main dam contract because most rock surfaces will loosen and weather when left exposed to the elements for a significant period of time.

e. Rock Mass Rating System. An important consideration in the geological investigations of an arch dam foundation is to obtain sufficient data to allow the quality of the foundation to be quantitatively compared from one area to another. In order to do this, it is necessary to adopt a rock mass rating system for use throughout the geological investigations. Several such systems have been developed. Bieniawski (1990) provides a survey of the more widely accepted systems. These systems were for the most part developed to provide a means of evaluating rock mass quality for tunneling; however, they can be adapted to provide a meaningful comparison of rock quality in a foundation. The geomechanics classification proposed by Bieniawski (1973) is

particularly useful. This system assigns numerical values to six different rock parameters which can be obtained in the field and from core borings. The rock mass rating (RMR) is calculated as follows:

$$R = A + B + C + D + E - F \quad (10-1)$$

where

- A = Compressive strength of intact rock
- B = Deere's RQD
- C = Spacing of joints
- D = Condition of joints
- E = Ground water conditions
- F = Adjustment for adverse joint orientation

Factor F is very important in assessing rock quality in a tunnel but is not necessarily appropriate in a classification system for assessing the rock mass strength of an arch dam foundation, since it is taken into account in the foundation stability analysis. For this reason it may be advisable to consider altering the system for individual arch dam foundation evaluations. Table 10-1 from Bieniawski (1990) provides the geomechanics classification of jointed rock masses. It is important when logging rock core or when performing geologic mapping to assure that all data necessary for the rock mass rating system are collected.

f. Stereonet Analysis of Rock Fracture System. An analysis must be made of the fracture system in each abutment and the valley section for use in the rock mechanics analysis of foundation and abutment stability. The Schmidt equal area stereonet utilizing the lower hemisphere projection is the conventional system normally used. Individual fractures (joints) are located on the stereonet by plotting the point on the lower hemisphere where a pole constructed normal to the plane of the fracture would pierce the hemisphere. After all fractures being analyzed are plotted on the stereonet, an equal area counting procedure is used to determine the percentage of poles which fall in each area. These are then contoured similar to the contouring procedure for a topographic map. The contoured stereonet can then be readily evaluated to determine the orientation of the primary, secondary, tertiary, etc. joint sets. Refer to Figure 10-5 for an example of an equal area joint polar diagram. For more detailed discussions of stereonet analysis refer to a structural geology text such as Billings (1954).

10-4. Rock Mechanics Investigations. The foundation of an arch dam must function as an integral part of the structure. It is very important that the dam designer fully appreciate and understand the mechanical properties of the foundation. To fully describe the foundation conditions so that they may be quantified for incorporation in the dam design, it is first necessary to accurately and completely define the geologic conditions as described previously, and then define the rock mass mechanical properties. A thorough rock mechanics investigation of the geologic environment of the foundation is necessary to provide the quantification of foundation properties necessary for the dam foundation analysis. It is extremely important that the engineering geologist, geotechnical engineer, and the structural designer work closely and

TABLE 10-1

Geomechanics Classification of Jointed Rock Masses.
(from Bieniawski (1990))

A. CLASSIFICATION PARAMETERS AND THEIR RATINGS

PARAMETER		RANGES OF VALUES							
1	Strength of intact rock material	Point-load strength index	> 10 MPa	4 - 10 MPa	2 - 4 MPa	1 - 2 MPa	For this low range - uniaxial compressive test is preferred		
		Uniaxial compressive strength	> 250 MPa	100 - 250 MPa	50 - 100 MPa	25 - 50 MPa	5-25 MPa	1-5 MPa	< 1 MPa
	Rating	15	12	7	4	2	1	0	
2	Drill core quality RQD		90% - 100%	75% - 90%	50% - 75%	25% - 50%	< 25%		
	Rating		20	17	13	8	3		
3	Spacing of discontinuities		> 2 m	0.6 - 2 m	200 - 600 mm	60 - 200 mm	< 60 mm		
	Rating		20	15	10	8	5		
4	Condition of discontinuities		Very rough surfaces. Not continuous. No separation. Unweathered wall rock.	Slightly rough surfaces. Separation < 1 mm. Slightly weathered walls.	Slightly rough surfaces. Separation < 1 mm. Highly weathered walls.	Slickensided surfaces OR Gouge < 5 mm thick OR Separation 1-5 mm. Continuous.	Soft gouge > 5 mm thick OR Separation > 5 mm. Continuous.		
	Rating		30	25	20	10	0		
5	Ground water	Inflow per 10 m tunnel length	None	< 10 litres/min	10-25 litres/min	25 - 125 litres/min	> 125		
		Ratio $\frac{\text{joint water pressure}}{\text{major principal stress}}$	0	0.0-0.1	0.1-0.2	0.2-0.5	> 0.5		
		General conditions	Completely dry	Damp	Wet	Dripping	Flowing		
	Rating		15	10	7	4	0		

B. RATING ADJUSTMENT FOR JOINT ORIENTATIONS

Strike and dip orientations of joints		Very favourable	Favourable	Fair	Unfavourable	Very unfavourable
Ratings	Tunnels	0	-2	-5	-10	-12
	Foundations	0	-2	-7	-15	-25
	Slopes	0	-5	-25	-50	-60

C. ROCK MASS CLASSES DETERMINED FROM TOTAL RATINGS

Rating	100-81	80-61	60-41	40-21	< 20
Class No	I	II	III	IV	V
Description	Very good rock	Good rock	Fair rock	Poor rock	Very poor rock

D. MEANING OF ROCK MASS CLASSES

Class No	I	II	III	IV	V
Average stand-up time	10 years for 15 m span	6 months for 8 m span	1 week for 5 m span	10 hours for 2.5 m span	30 minutes for 1 m span
Cohesion of the rock mass	> 400 kPa	300 - 400 kPa	200 - 300 kPa	100 - 200 kPa	< 100 kPa
Friction angle of the rock mass	> 45°	35° - 45°	25° - 35°	15° - 25°	< 15°

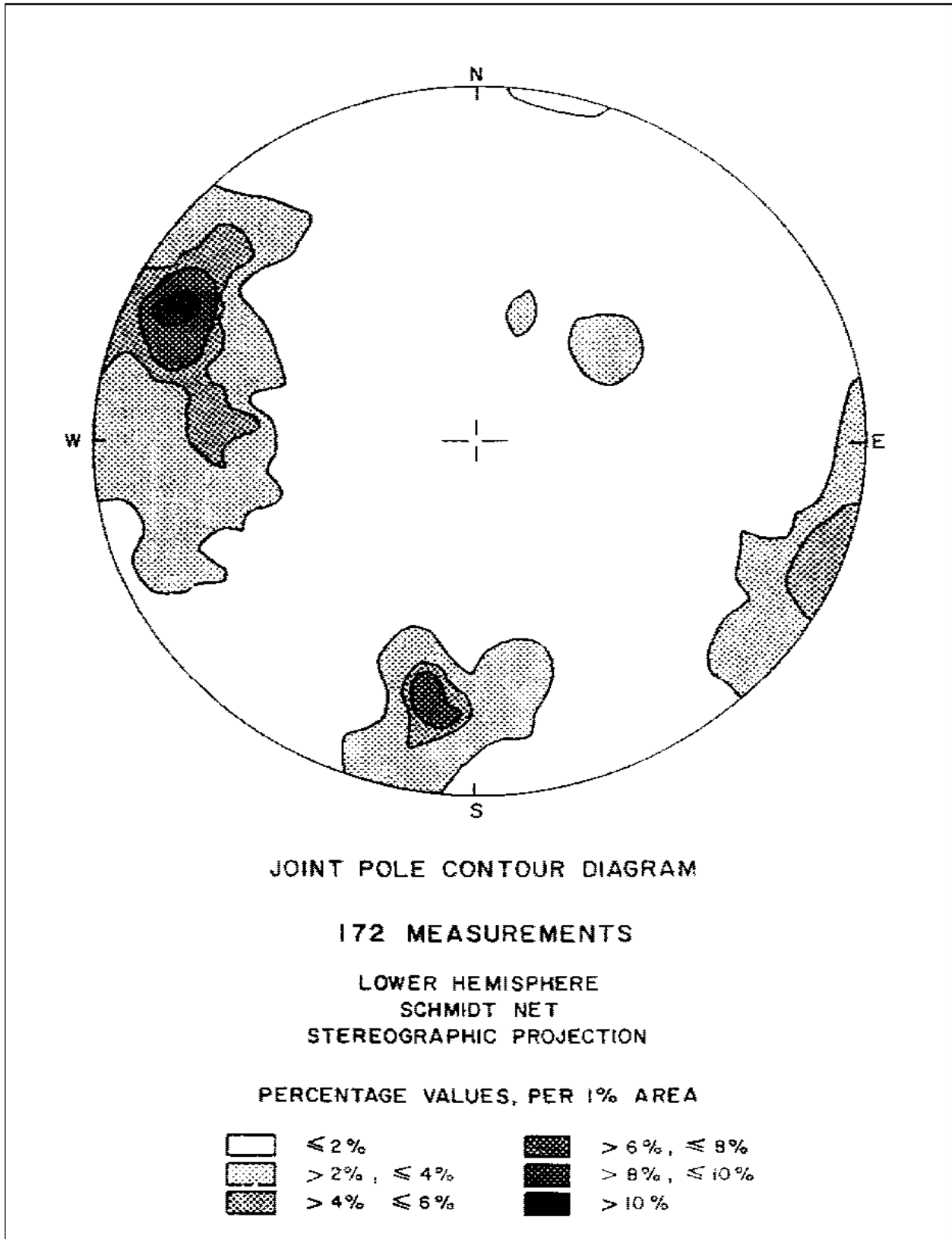

Figure 10-5. Equal area joint pole contour diagram from Portugues Dam Design Memorandum No. 22 (USAED, Jacksonville, 1988b)

cooperatively during the rock mechanics investigation and foundation analysis to assure that the concerns of each are adequately addressed. Each has a unique perspective on the design which can contribute to the success of the rock mechanics investigation and foundation analysis.

a. Laboratory Testing of Samples. Brief discussions of laboratory testing are contained in preceding paragraphs 10-3b(4) and 10-3c(4). Laboratory testing is much less expensive than in situ testing and can provide very good data. The laboratory testing must be evaluated and the design assumptions made by a competent and experienced geotechnical engineer in full coordination with an engineering geologist who fully appreciates the geologic conditions in the foundation which could adversely affect the performance of the dam. The laboratory testing should incorporate unconfined compression tests including determination of modulus of elasticity on a suite of samples from each rock type and each rock quality to be found below the founding level of the dam. These tests will provide an index of rock strength and will provide data on the upper bound deformation modulus of the rock. Direct shear testing should be performed on a suite of samples from each rock type and rock quality to provide data for use in determining shear strength values to be used in foundation analyses. This type of test should be performed under three separate conditions: on intact samples to provide an upper-bound set of data on shear strength parameters, on sawed surfaces to provide a lower-bound or residual strength set of data, and finally, on natural fractures to provide data on the shear friction parameters resisting sliding on these features. In those cases where clay or silt material exists as gouge in fault zones, in shear zones, or as in-filling in open joints, it is advisable to obtain samples of this material and perform shear tests on preferably undisturbed samples or on remolded samples where undisturbed samples are not feasible. Both triaxial and direct shear tests are appropriate for these samples. When interpreted conservatively and with a full appreciation of the geologic conditions, test data obtained as described will usually provide a sound basis for estimating the shear strength parameters for use in the foundation stability analyses.

b. Abutment Adits. Adits are excavated in the abutments for two primary purposes. First, they are constructed to provide access to map geologic conditions and to expose geologic features of structural concern. Of equal importance is the access provided to perform in situ rock mechanics testing of foundation conditions.

(1) In situ deformation testing is performed in the adits as a means of determining the stiffness of the foundation. From these tests the static modulus of deformation of the foundation can be calculated at that particular location. Several different techniques have been developed for performing deformation testing. These include the uniaxial jacking test, the radial jacking test, and the pressure chamber jacking test. The uniaxial jacking test is the one most commonly used primarily because it is less costly and easier to set up while still providing satisfactory results. Figure 10-6 is a diagram of a typical uniaxial jacking test setup. It consists of the following: a load frame which transfers load from one wall of the adit to the other, two flat jacks which apply the loads to the rock surfaces, two multi-position borehole extensometers which measure the deflection or deformation of

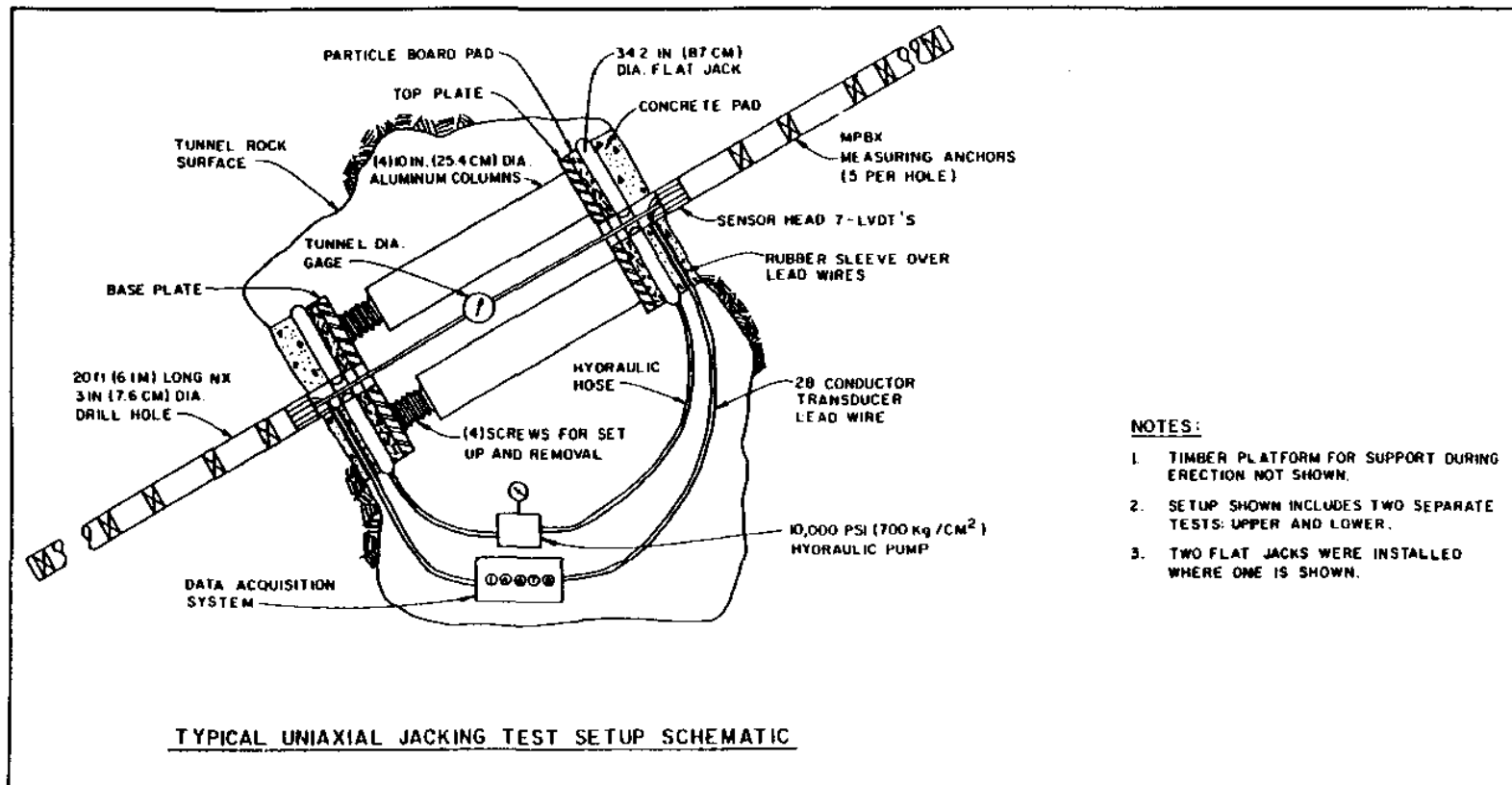

Figure 10-6. Uniaxial jacking test diagram from Portugues Dam Design Memorandum No. 22 (USAED, Jacksonville, 1988b)

the rock mass as it is loaded or unloaded, a tunnel diameter gauge which measures changes in tunnel dimensions as load is applied or released, and a very high-pressure hydraulic jack. The axial orientation of the test is selected to coincide with the resultant of the forces applied to the foundation by the dam. The test as depicted in Figure 10-6 provides a measure of the rock mass deformation on two opposing surfaces of the adit. This in effect provides two rock mass modulus of deformation tests at this location. The test is performed by loading the rock in predetermined increments for a specific period of time. Incremental increases of 200 psi held for periods of 24 hours with complete unload between each pressure increase is commonly used. The unloaded increment of time is also commonly 24 hours. The maximum load applied should exceed the maximum pressure to be applied by the dam. A maximum test pressure of 1,000 psi is commonly used. Deformation measurements should be made at frequent intervals during both loading and unloading cycles. These measurements can provide data for evaluating the creep potential and initial set after loading in the rock mass in addition to the modulus of deformation. The following publication of the American Society for Testing and Materials (ASTM) provide detailed test and analytical procedures for computing the rock mass modulus of deformation D4395-84 (ASTM 1984b). The following equations taken from these references may be used for computing the modulus of deformation:

Flexible loading system

(Surface deflection at center of circularly loaded area)

$$E = \frac{2(1-\mu^2)QR}{W_c} \quad (10-2)$$

(Surface deflection at center of annularly loaded area)

$$E = \frac{2Q(1-\mu^2)(R_2-R_1)}{W_c} \quad (10-3)$$

Rigid loading system

(surface deflection)

$$E = \frac{(1-\mu^2)(P_1)}{2W_a R} \quad (10-4)$$

where

- E = modulus of deformation
- μ = Poisson's ratio
- Q = pressure
- R = radius of loaded area or radius of rigid plate
- W_c = deflection at center of loaded area

R_2 = outside radius of annulus
 R_1 = inside radius of annulus
 W_a = average deflection of the rigid plate
 P = total load on the rigid plate

The ASTM references contain other equations for calculating the modulus of deformation for deflections measured within the rock mass. Refer to the Rock Testing Handbook (USAEWES 1990) for detailed testing standards for the different techniques of in situ, static rock mass modulus of deformation determination.

(2) Procedures are available for determining the elastic properties of rock utilizing seismic techniques. These are described in some detail in ASTM publication STP402 (ASTM 1965a). This technique provides a Poisson's ratio and the dynamic modulus of deformation of the rock mass. Use of the technique for arch dam foundation evaluation must be tempered with considerable practical knowledge and judgement, because the dynamic modulus of deformation so determined is usually significantly higher than the static modulus determined by the uniaxial or radial jacking tests. The open fractures in the rock mass are a major factor in this discrepancy. The rock mass behaves more in the static mode than the dynamic mode under loading from a dam, therefore, the static modulus is more appropriate for analyzing the foundation for an arch dam, except in evaluating dynamic earthquake response.

(3) In situ shear testing can be performed in an adit to test the shearing resistance of an individual feature in the foundation if conditions demand this information. The test, however, is very expensive and provides information only on the feature tested. In many cases it is more practical to perform extensive laboratory tests of shear strength and to use this information along with engineering experience as the basis for arriving at the proper shear strength parameters for use in the foundation stability analyses. In those cases where in situ shear testing is called for, procedures for performing the test can be found in the Rock Testing Handbook (USAEWES 1990).

(4) In those cases where abnormally high in situ stress may exist in the foundation or abutment rock mass, it may be advisable to perform in situ testing to measure the in-place stress regime for consideration during the foundation analysis. Several instruments have been developed for measuring the strain release in an overcored bore hole. These instruments are suitable for determining the in situ stress existing within about 25 feet of a free face or surface from which a boring can be drilled. Flat jacks may be used for measuring stress existing immediately beneath a free face or surface. Bore hole hydraulic fracturing techniques are appropriate for measuring in situ stress at locations remote from a drilling surface. This procedure can measure in-place stress hundreds of feet from the surface. One clue to the existence of a high in situ stress field is the appearance of diskings in rock core samples. This diskings is caused by stress release in the core occurring after it is freed from the restraint of the surrounding rock by the coring action. Numerous publications available in the literature describe the various in situ stress determination techniques. ASTM publication STP402 (ASTM 1965a) and Haimson (1968) describe various instruments and techniques.

(5) Sampling and laboratory testing have been discussed previously in paragraphs 10-3b(3), 10-3c(4), and 10-4a. In addition to samples obtained

from core borings, the adits are also good locations for obtaining samples for laboratory testing. This is particularly true of samples of hard-to-retrieve materials such as fault breccia and fault gouge. These materials must be sampled very carefully to minimize disturbance, and immediately after exposure to retain near natural moisture content. Where possible, planning and preparation for this sampling should be done prior to adit excavation to enhance the likelihood of obtaining usable samples.

10-5. Rock Mechanics Analyses. The dam foundation, and in particular its abutments, must be carefully analyzed to evaluate resistance to shear failure, deformation characteristics, and permeability. The foundation must respond as an integral part of the dam and must be fully considered in the design of the dam. Of particular importance is the analysis of the fracture system within the rock mass, including the joints, faults, shears, bedding, schistosity, and foliation. These features must be considered in relation to each other because intersecting fractures can sometimes form potential failure wedges which are more susceptible to sliding than either fracture alone. Since the elastic properties of the dam and its foundation are significant factors in the performance of the dam, it is necessary to estimate the deformation properties of the foundation and abutments within a reasonable degree of accuracy. The permeability of the foundation and uplift pressures on potential failure wedges must be evaluated and incorporated into the design. The engineering geologist, geotechnical engineer, and structural engineer responsible for the dam design must work in full coordination and cooperation in the performance of these analyses to assure that the concerns and objectives of each discipline are satisfied to the maximum extent possible.

a. Rock Mass Property Determination. Methods of testing the rock mass to define its physical properties have previously been discussed. These discussions are continued here and include the processes necessary to arrive at values to be used in the foundation and abutment analyses.

(1) In order to perform stability analyses of the foundation and the abutments, it is necessary to select appropriate values of the shear strength of each fracture set, shear, fault, or other discontinuity which could form a side of a kinematically capable failure wedge. Laboratory shear tests normally will provide the basic data required for selecting these shear strength values. As stated previously in paragraphs 10-3b(4) and 10-4a, direct shear testing should be performed on a suite of samples from each rock type and rock quality. This test should be performed under three separate conditions to provide upper- and lower-bound rock strength and shear friction as described in paragraph 10-4.

(a) The data provided by this series of tests should provide part of the basis for determining reliable shear friction values resisting movement on discontinuities. There are other factors which must also be considered in arriving at acceptable shear strength values on a discontinuity. Roughness measures such as the angle of the asperities (angle "i" in Figure 10-7) have a significant effect upon the shear strength of a joint because, for movement to take place, the rock mass must either dilate by riding up and over the asperities or it must shear through them. Either mechanism takes considerable additional energy. The condition (degree of weathering) of the wall rock is

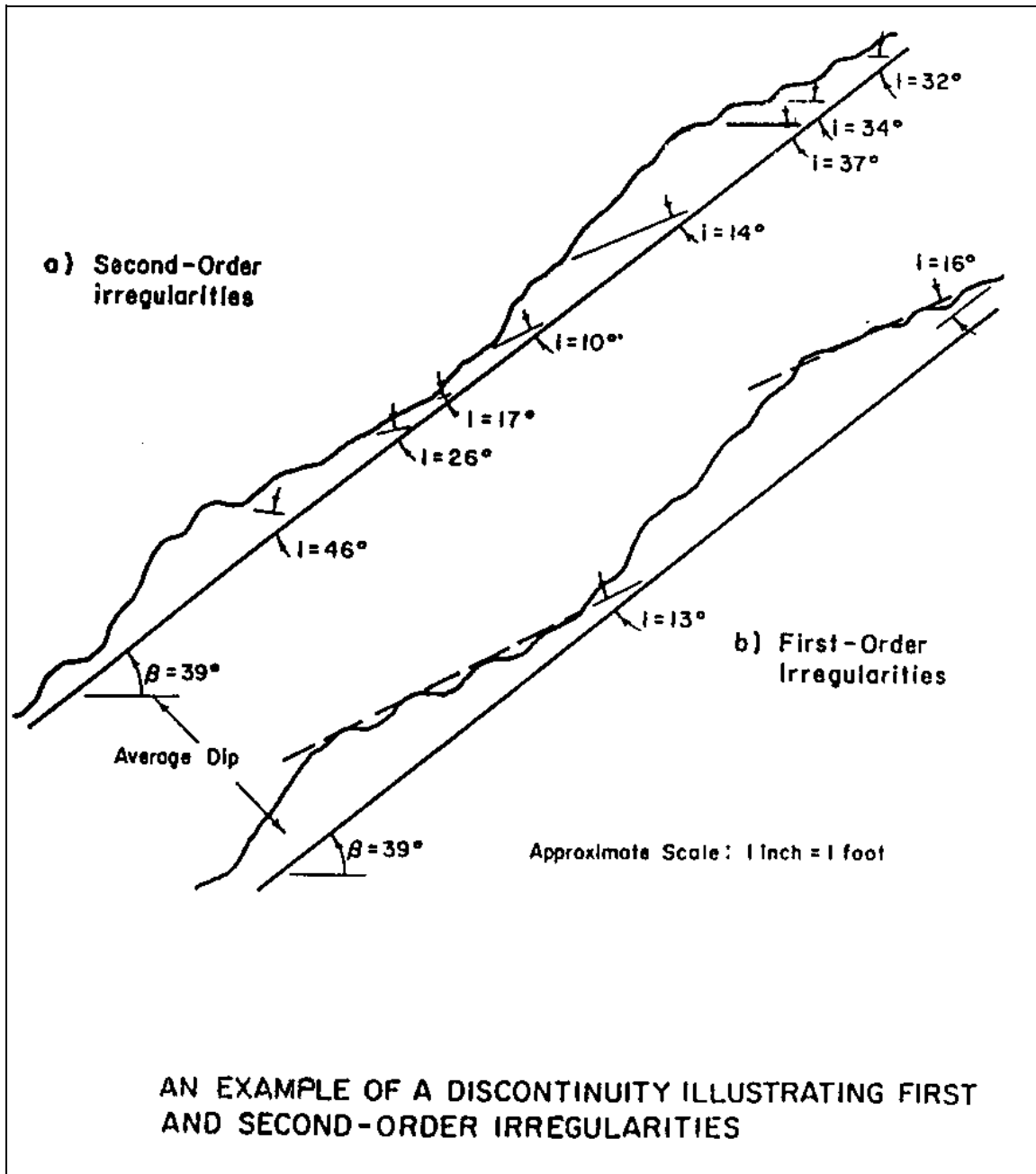

Figure 10-7. Diagram of asperity angle "i" measurement (Hendron, Cording, and Aiyer 1971)

another factor to be considered as is the continuity or extent of the open joints which can significantly affect shear resistance to movement. Fracture filling material, such as clay or silt, can dramatically reduce the shear friction strength of a fracture and must be considered.

(b) A conservative evaluation of shear strength for rock-to-rock contact on a fracture under relatively low normal load is provided by the following equation:

$$S = N \tan(\phi_r + i) \quad (10-5)$$

(after Patton 1966)

where

S = shear strength of fracture
N = normal stress on fracture
 ϕ_r = residual friction angle
i = asperity angle

In this equation, the value of cohesion is omitted under the assumption that failure occurring under a low normal stress would likely result in the wedge overriding the asperities rather than shearing through them. The residual friction angle is derived from the direct shear test on sawed surfaces and should be taken at about the lower one-third point of the range of test values. The asperity angle is developed from actual measurements of the roughness on typical joints in the foundation. It is important to measure the asperity angle in the same direction that movement would likely occur since the degree of roughness varies considerably from one orientation to another. The angles are measured from a string line oriented in the likely direction of movement. (Refer to Figure 10-8 for an example of a field measurement setup.) Rock shear test results obtained from sawed surfaces are more consistent and amenable to interpretation than those obtained from shearing of intact rock or those obtained from shear testing along natural fractures. A more reliable shear strength value is thus developed by adding the angle of the asperities to the residual shear friction angle in this equation. The concept of utilizing the angle of the asperities was developed by Patton (1966) and is explained in the reference by Hoek and Bray (1981).

(c) The selected shear strength values for a particular joint may require modification depending upon the other factors noted previously which affect shear strength such as continuity or extent of the fracture, condition of its wall rock, and in-filling material, if any. If fracture continuity is less than 100 percent, then added strength can be allowed for shear through intact rock. The test data obtained from samples sheared through intact rock provide a basis for assigning shear strength values to the portion of the failure plane which is not part of the natural fracture. If the wall rock is weakened by weathering, the strength must be reduced. The suite of tests performed on weathered rock will provide data on which to base this reduction in shear strength. If soft in-filling material is present, rock-to-rock contact is diminished, and the strength must be reduced as a compensation.

(d) Where gouge material exists along shears or faults or where joint filling is present, it is necessary to obtain samples of this material for testing. This can best be done from an adit because it is often impossible to obtain an adequate quantity for testing from a bore hole. Undisturbed samples are preferred, but often they are not feasible to obtain. Remolded samples

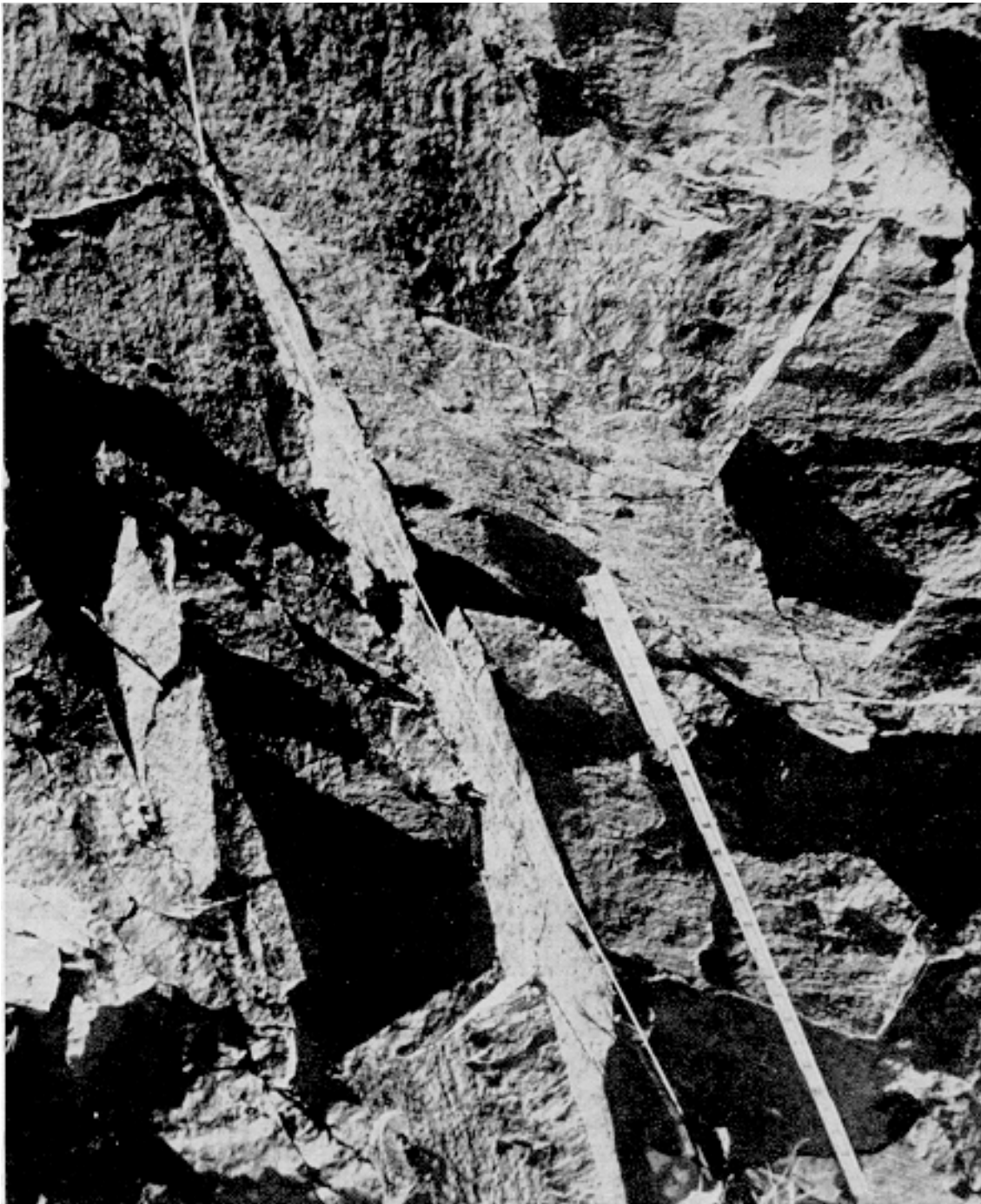

Figure 10-8. Picture of asperity angle "i" measured in the field utilizing a string line for orientation from Portugues Dam Design Memorandum No. 22 (USAED, Jacksonville, 1988b)

tested at in situ density and moisture content will normally provide satisfactory results. The strength properties of the gouge or in-filling material can be tested utilizing conventional soil property tests. The consolidated, undrained triaxial test is appropriate for testing this material. In the stability analysis, an estimate must be made of the percentage of the potential failure surface which could pass through these soil-like materials. The strength of that portion of the potential failure surface must be assessed based on the tests of the gouge or in-filling material.

(2) The deformability or stiffness of an arch dam foundation must be estimated for incorporation in the stress analysis of the dam. The modulus of deformation of the rock mass is a measure of the foundation's deformation characteristics. The modulus can be expected to vary significantly from the valley bottom to the abutments and from one rock quality or rock type to another. The methods of testing and measuring the modulus of deformation have previously been described in paragraph 10-4b(1). It is necessary to translate the test results from a few specific locations to an interpretation of the deformation characteristics of the entire foundation. In order to do this on a quantitative basis, a rock mass rating system is required which permits quantitative evaluation of the rock mass quality over the entire foundation area. There are several rock mass rating systems currently in use world wide. The geomechanics classification system developed by Bieniawski (1990) and described previously in paragraph 10-3e has proven very useful for foundation analysis. A relationship has been suggested by Serafim and Pereira (1983) between the geomechanics classification system RMR and the in situ modulus of deformation of the rock mass. This relationship is expressed in the following equation:

$$E = 10^{\left(\frac{RMR-10}{40}\right)} \quad (10-6)$$

where

E = modulus of deformation measured in gigapascals (GPa)

1 GPa = 145,037.7 psi

This equation was used in the rock mechanics analysis of the Portugues Dam Foundation and was a valid predictive model of the foundation deformation properties of the dam. Once this model is validated for a particular site, it is possible to compare the entire site conditions to the in situ tests of modulus of deformation. This is accomplished by determining the RMR for the segment of rock of concern in each core boring made in the foundation and then comparing these borings with the RMR of the core borings made for installation of the extensometers at the location of the in situ modulus of deformation tests. This comparison used in concert with the relationship noted by Serafim and Pereira (1983) then allows the assignment of modulus of deformation values to each major portion of the foundation. These values can then be applied in the finite element analysis of the dam and its foundation.

(3) The permeability of the foundation and abutments must be determined for several reasons. As stated earlier in paragraph 10-3b(6), these data are

required to evaluate the reservoir's capability to impound water, to provide a basis for design of construction dewatering systems, to provide a basis for design of uplift relief systems, and to serve as the basis for estimating the amount of uplift that must be considered in the stability analysis. The permeability of the foundation can be estimated based primarily on bore hole pressure test data supported by a limited amount of pump test data. Refer to EM 1110-2-1901 and Technical Report S-76-2 (Zeigler 1976) for methods of calculating the permeability from bore hole pressure test data. A pertinent equation from EM 1110-2-1901 is as follows:

$$K_e = \frac{Q \ln (R/r)}{2\pi LH} \quad (10-7)$$

where

K_e = equivalent coefficient of permeability
 r = radius of bore hole in feet
 Q = volume of flow rate in cfs
 H = excess pressure head at center of test in feet
 R = radius of influence in feet (0.5L to 1.0L)
 L = length of test section of bore hole
 π = pi

Refer to TM 5-818-5 for a description of methods of determination of permeability from pump test data.

(4) In cases where abnormal in situ stress conditions are indicated, it may be necessary to perform tests to measure the in situ stress existing in the rock mass, as discussed in paragraph 10-4b(4). These stresses may be significant in the foundation stability analysis. There are several techniques and variations of these techniques available for measuring in situ stress in rock masses. The overcoring procedure is commonly used to measure stresses within a relatively short distance (± 25 feet) from an exposed surface or free face. The hydraulic fracturing procedure is used to measure stresses existing at locations remote from an exposed surface or free face. Refer to the Rock Testing Handbook (USAEWES 1990) for testing standards and recommended methods for performing the overcoring procedure.

(5) The Poisson's ratio of the rock mass must be estimated for some foundation analyses. A satisfactory method of doing this is to obtain the Poisson's ratio at the same time that the modulus of elasticity is determined while measuring the unconfined compression strength of intact rock core samples from each different rock type and quality in the foundation. Mean values obtained from each rock type and quality will provide values that are satisfactory for this purpose.

b. Abutment Stability Analysis. Much of the previous narrative was intended to provide data and information necessary to perform the abutment stability analyses. Abutment stability is critical to the overall stability of an arch dam. The following subparagraph describes the analytical procedures, the first of which is the use of the stereonet for slope stability analysis.

(1) The procedure for performing a statistical representation of the rock mass fracture system utilizing the equal area stereonet has already been described in paragraph 10-3f. This concept has also been adapted for use in the stability analysis of the foundation and abutment. The first step in analyzing the stability of the dam foundation is to locate any fracture, fracture set, or combination of fractures which could form a wedge kinematically capable of failure, either as a result of foundation excavation or under the forces applied to the foundation by the dam. For a wedge to be kinematically capable of failure, the dip of the potential failure plane or the plunge of the intersection of two fracture planes along which sliding could occur must intersect or "daylight" on the rock slope or free face. This must also occur in a location which would accommodate failure under the forces imposed by gravity and/or the dam. This step of the analysis is accomplished by plotting the great circle representation of each fracture or fracture set and the natural or cut slope (free face) on an equatorial equal angle stereonet, as demonstrated in Figure 10-9. If the great circle representation of the free face intersects the great circle of both fracture planes and the plunge of the wedge of rock is a flatter angle than the dip of the free face, then movement of the wedge is kinematically possible without the necessity for crossbed shear through intact rock. The same test can be applied to sliding on a single plane which strikes subparallel to the free face and dips at an angle flatter than the free face. All major fracture sets and unique fractures such as faults and shears must be analyzed for their kinematic capability of movement. Those with the potential for failure must be further analyzed taking into account shearing resistance on the failure planes and driving forces which contribute to the potential for sliding. Since the fractures within an identified joint set normally have a range of orientations, it is not adequate to consider only the average or median orientation. Orientations near the bounds of the range must also be evaluated since they do exist in the rock mass. This first step of determining those wedges which could kinematically fail will eliminate a great many wedges from the need for further analysis. Step-by-step procedures for rock wedge stability analysis utilizing the equal angle stereonet are contained in the references by Hoek and Bray (1981) and by Hendron, Cording, and Aiyer (1971).

(2) After determining those fractures and fracture combinations which are kinematically capable of allowing a wedge of rock to fail, it is then necessary to determine the geometry of a block which would be significant in the foundation of the dam. One conservative assumption that should be made in many cases is that the joint sets identified by the geological investigations are pervasive in the abutment on which they have been identified. By that it is meant that they can be expected to occur anywhere on the abutment. Next, a daylight point of the line of intersection of two fracture systems is chosen and the surface trace of the fractures is drawn. Once all the corners are located, the areas and volumes can be calculated. From this the volume of rock can be determined and converted into the weight of the wedge. The area of the fracture planes can be computed for use in determining the uplift forces acting on the wedge. The size of the wedge must be large enough to be significant to the stability of the dam; i.e., it should be large enough to cause catastrophic failure of the dam. For a wedge to be significant it must be possible for it to exist beneath the dam or immediately adjacent to the dam. Combinations of fractures which result in wedges that are above the top of the dam or outside the foundation of the dam need not be considered unless excavation will in some way make them a hazard to safety. A third fracture or

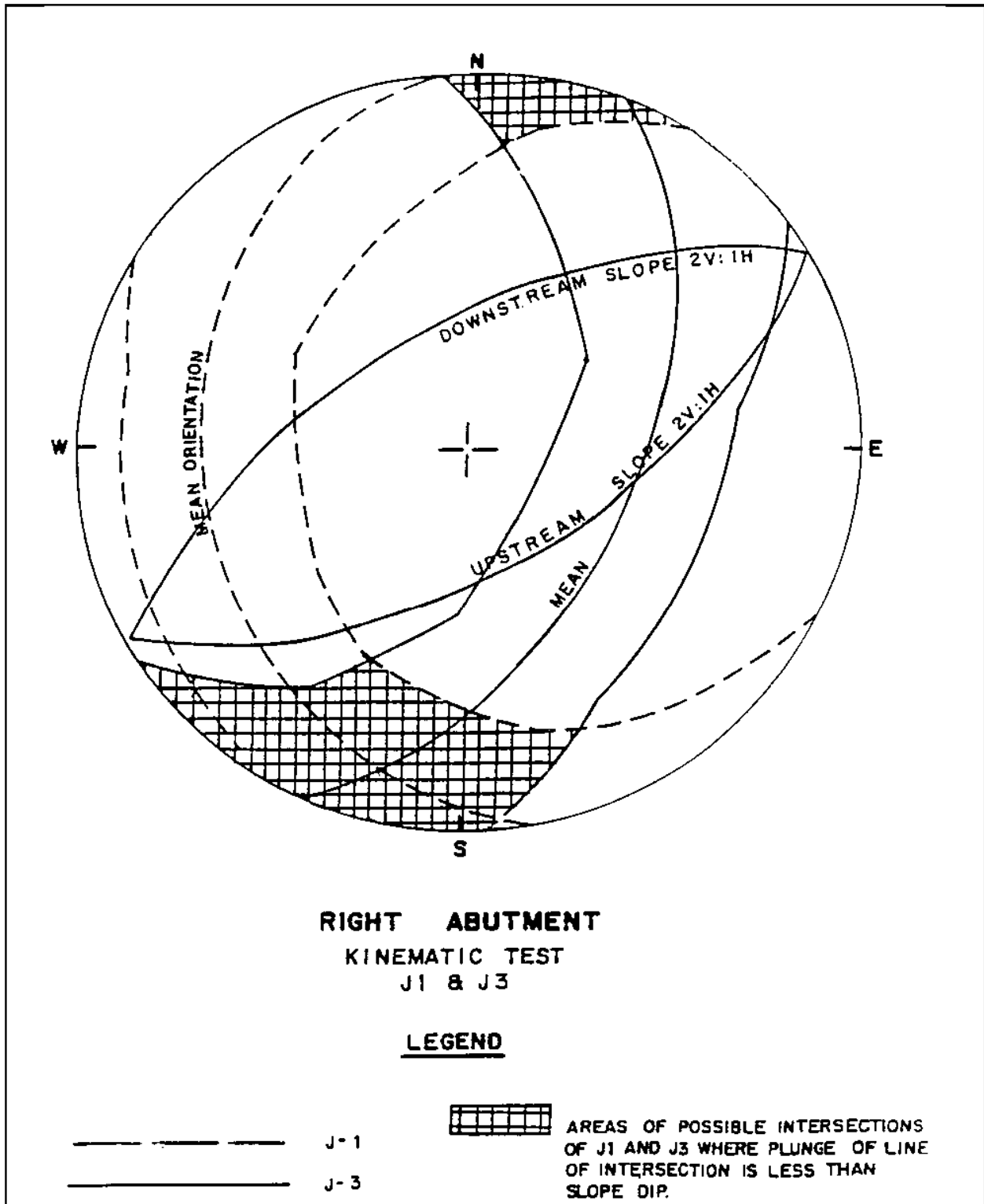

Figure 10-9. An equatorial angle stereonet plot showing two intersecting joint sets and two cut slopes demonstrating kinematic capability for failure from Portugues Dam Design Memorandum No. 24 (USAED, Jacksonville, 1990)

fracture set is required in most wedge geometries to cut the back of the wedge free. If no such fracture exists, it is conservative to assume that a tension fracture does exist in the position where such a feature is needed and no tensile strength exists across this feature. A wedge the size of the entire abutment is considered the most critical and is considered the definitive case for each set of intersecting fractures. Smaller wedges must also be considered but are less likely to result in catastrophic failure of the dam as they become smaller.

(3) Three different static loading combinations must be analyzed. These cases have been described in Chapter 4 as static usual, the static unusual, and the static extreme. In addition, the dynamic loadings from earthquakes must be incorporated for dams in areas where there is earthquake potential. Refer to Chapter 4 for description of each different loading case. The loads which must be included in the analysis of potential rock failure wedges are: weight of the rock wedge; driving force applied by the dam; uplift applied by hydrostatic forces acting against the boundaries of the wedge; and dynamic forces generated by the design earthquake. The weight of the rock wedge is determined by calculating the volume of the wedge times the unit weight of the rock. The forces applied by the dam are obtained from the structural analysis of the dam. The computation of uplift forces is based upon the following assumptions:

(a) Fractures are open over 100 percent of the wedge area and are completely hydraulically connected to the surface.

(b) Head values vary linearly from maximum value at backplane to zero at daylight point.

(c) Back planes or other planes or segments of planes acted on directly by the reservoir receive full hydrostatic force.

Dynamic loads attributed to the design earthquake are based upon the design earthquake studies which develop ground motions for both an OBE and the MCE. These studies provide values for the magnitude, distance, peak acceleration, peak velocity, peak displacement, and duration of the earthquakes.

(4) The following sliding factors of safety (FS) should be used for the different loading cases:

- (a) Static usual loads ----- FS = 2.0
- (b) Static unusual loads ----- FS = 1.3
- (c) Static extreme loads ----- FS = 1.1
- (d) Dynamic unusual loads ----- FS = 1.3
- (e) Dynamic extreme loads ----- FS = 1.1

These FSs are based on a comprehensive field investigation and testing program as described previously in this chapter. In any case where the minimum FS is not attained, HQUSACE (CECW-EG) should be consulted before proceeding with design.

(5) The first step in performing a stability analysis of an abutment is to determine those wedges of significant size which are kinematically capable of moving. This step has already been described in paragraph 10-5b(1). The next step is to determine the FS against sliding of the blocks where movement is kinematically possible. There are three different methods that can be used for performing this analysis. The conventional 2-D procedure can be used for conditions where sliding will occur on a single fracture plane. This is the most simple of the three procedures, however, it is not appropriate for the more complicated wedge type conditions where sliding can occur on two or more planes, on the intersection of two planes, or by lifting off one plane and sliding or rotating on another. The 2-D procedure is described and illustrated in EM 1110-1-2907. For more complicated failure mechanisms one of the following procedures should be employed: graphical slope stability analysis utilizing stereonet or vector analysis, as described in the following paragraphs.

(a) The graphical slope stability analysis is a continuation of the procedure already described for utilizing an equal angle stereonet to determine those wedges where failure is kinematically possible. This step involves plotting on the stereonet those parameters which are involved with the stability of the block. The first of these is the reaction which resists failure. This consists of a plot of the friction cone which exists on each plane involved in the wedge. This establishes the stable zone on the stereonet. The friction cone will plot as a circle on the stereonet. There will be a separate friction cone plotted for each fracture involved in the boundary of the wedge. The next step requires the determination of the resultant of the forces that are driving the wedge. These forces may include the weight of the rock wedge, uplift resulting from hydrostatic pressure acting normal to all the planes which define the wedge boundaries, thrust of the dam, and where earthquake loading is of concern those inertial forces which could be imposed by an earthquake. The resultant of these forces is obtained by the graphical summation of the vectors representing each force. If the resultant of these forces falls within the cone of friction, then the wedge is stable. In other words, if the resultant acts at an angle to the normal of the failure plane which is less than the angle of friction, then failure will not occur. The FS against sliding may be determined by dividing the tangent of the friction angle by the tangent of the angle made by the resultant of forces and the normal. Detailed descriptions of this technique along with examples are contained in the reference by Hendron, Cording, and Aiyer (1971); it is illustrated in Figure 10-10.

(b) The vector analysis procedure requires that all fractures forming the boundary of the wedge be described vectorially relative to the orientation of the abutment face. Vectors must be developed for the strike, dip, normal, and lines of intersection of the boundary fractures. Applied force vectors must be developed for weight of wedge, uplift on all boundary fractures, thrust of the dam, and inertial force resulting from the design earthquake. All these must be combined to form a resultant relative to the abutment face. From this the mode of failure is determined, i.e., sliding on a single plane, sliding on the intersection of two planes, or lifting all planes. By employing the vector analysis procedures described in detail and illustrated in the reference by Hendron, Cording, and Aiyer (1971), the stability of the wedge can be calculated and an FS can be determined. Figure 10-10 also illustrates this procedure.

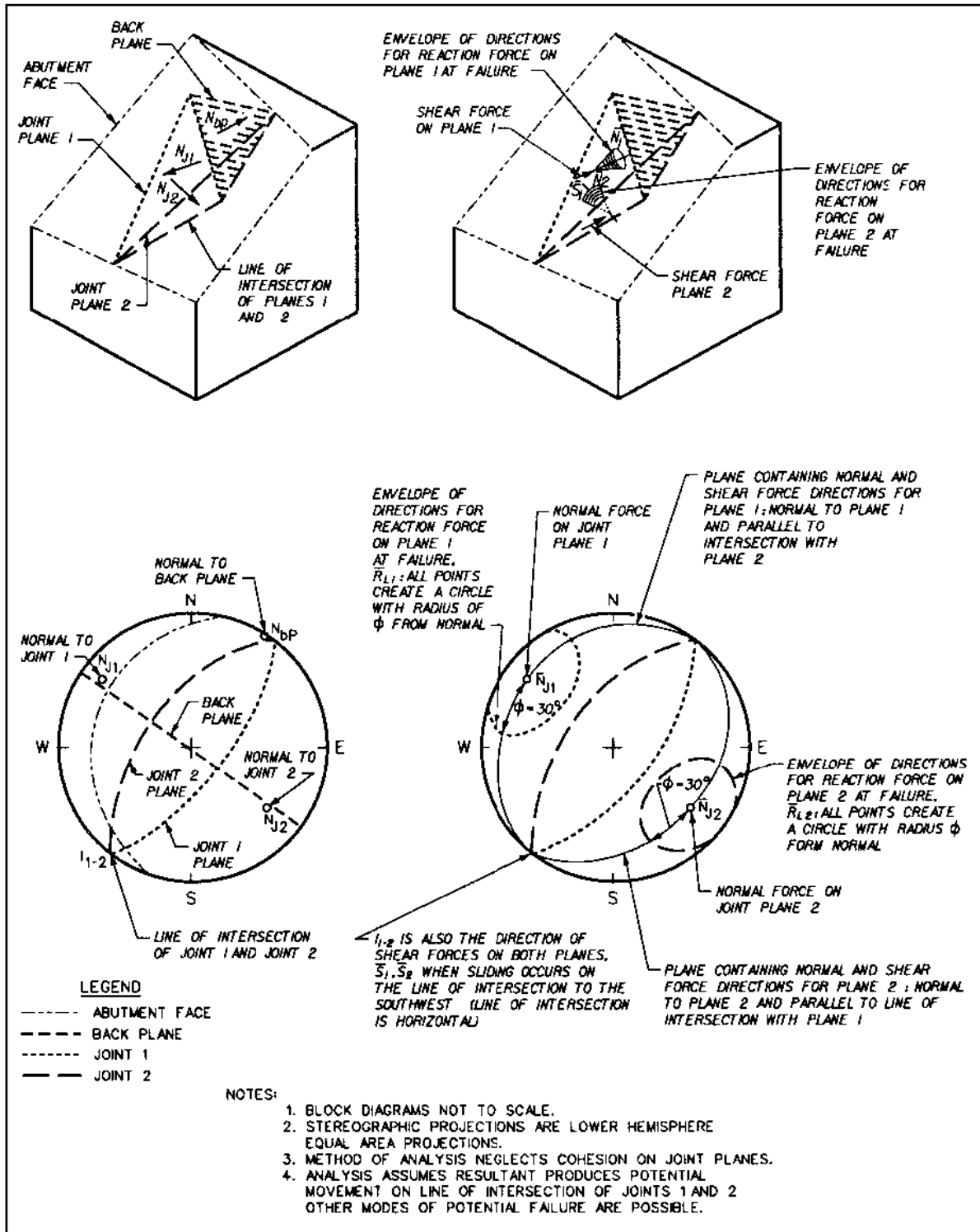

Figure 10-10. Illustration of both the vector and graphical stereonet technique of slope stability analysis from Portugues Dam Design Memorandum No. 24, (USAED, Jacksonville, 1990) (Continued)

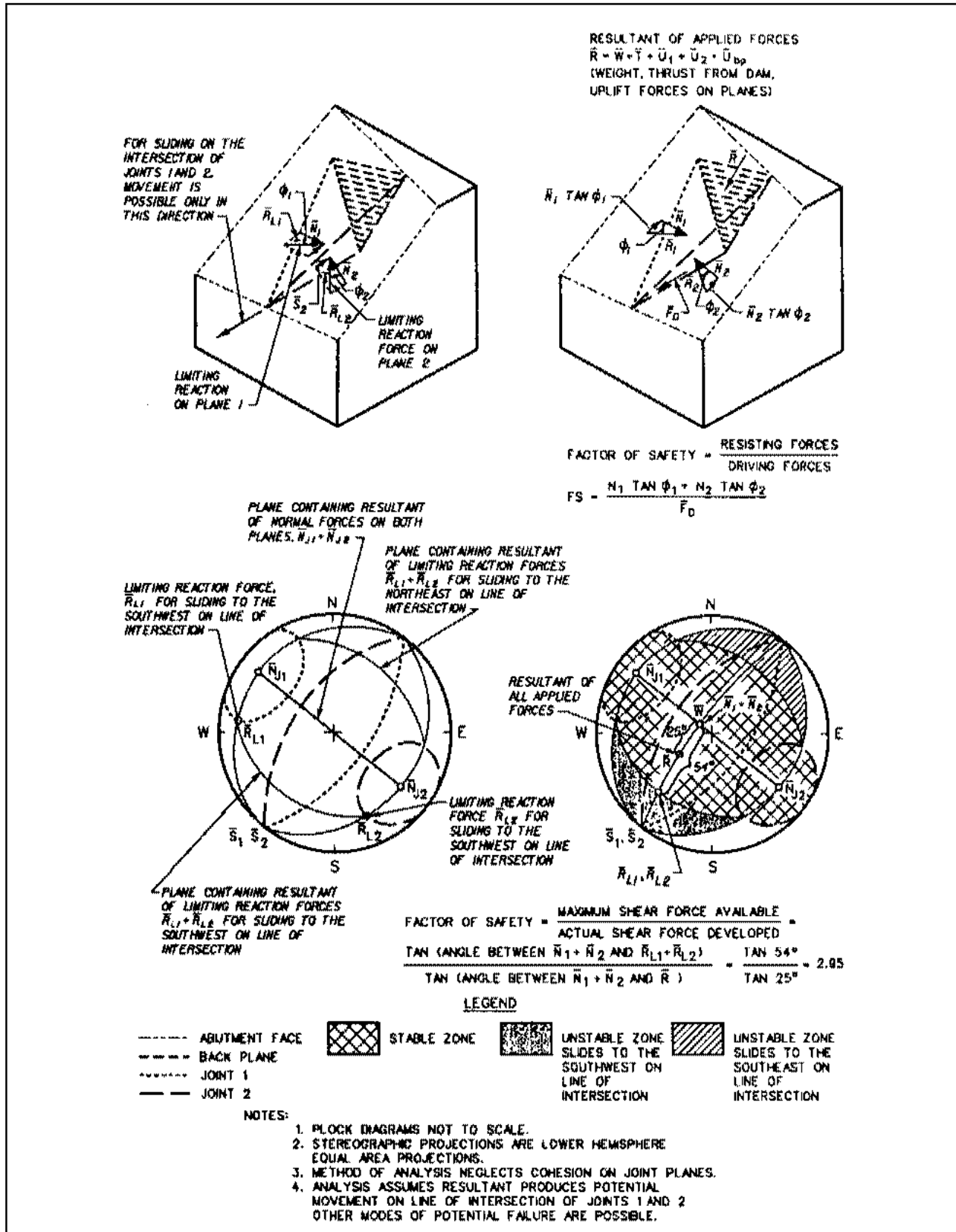

Figure 10-10. (Concluded)

EM 1110-2-2201
31 May 94

(c) The analysis of the stability of the abutments of an arch dam requires very careful application of both engineering geology and rock mechanics investigative and analytical techniques. When these procedures are properly applied and their results accounted for in the design, a high degree of confidence in the stability of the dam foundation is justified.

CHAPTER 11

CRITERIA

11-1. Static.

a. Selection of Loading Combinations. Tables 4-1 and 4-2 presented the static and dynamic loading combinations to be used for designing arch dams. The load cases covered in these tables should be sufficient to cover most arch dams; however, the structural designer should closely examine each load case to ensure that it is applicable to his/her project and that it is properly classified under one of the three categories, i.e., Usual, Unusual, and Extreme. For example, loading combination SUN1 in Table 4-1 may be more appropriate under the Usual loading combinations for a hydropower dam since the reservoir level is more likely to be maintained routinely at or near the spillway crest. The same situation may apply to the load case SUN3 for a flood control dam. Again, this case would be more appropriate as a Usual condition for a single purpose, flood control dam if a dry reservoir is normally to be maintained. The loading combinations should be established at the earliest stages of design and adhered to throughout the development of the final design. Since there are different allowables and FS's for different groups of loading combinations, the selection and classification of load cases greatly influence the geometry of an arch dam and the resulting stresses.

b. Allowables and Factors of Safety - Static Loading. The allowable stresses and FS's for static loading combinations are given in Table 11-1. Arch dams should be designed using a minimum concrete compressive strength, f'_c , of 4,000 psi. In most cases, a single concrete mix with an f'_c of 4,000 psi would be sufficient for the entire dam; however, the final selection of the concrete strength would have to be based on the requirements of the stress analysis. Where the results of the stress analysis indicate the need for higher allowables than what a 4,000 psi concrete produces, it may be possible to use more than one design strength concrete in the dam, i.e., a concrete mix with an f'_c of 4,000 psi for most of the dam and a higher-strength concrete only for the localized areas which require the higher allowables. For large dams, it may be economically advantageous to use higher-strength concrete in areas where stresses exceed the allowables for the 4,000 psi concrete, rather than using a single higher-strength concrete for the entire dam. Tensile strength of the concrete, f'_t , is based on the results of the splitting tensile tests for the mix design being considered for the dam. In the absence of test results and for preliminary design purpose, a value for f'_t equal to 10 percent of the compressive strength may be used. This value is based on extensive testing performed for the Portugues Dam (USAED, Jacksonville, 1988a) and is consistent with work done by Raphael (1984). The sliding FS's shown in Table 11-1 are based on a comprehensive field investigation and testing program as described in Chapter 10.

c. Stability of Cantilevers During Construction. Arch dams are constructed in monoliths in the same manner as a gravity dam. Because of the vertical curvature, the monoliths of an arch dam may be unstable against overturning prior to the grouting of the monolith joints and the raising of the reservoir. The stability of the cantilevers must be checked during early

TABLE 11-1

Static Loading Combinations

Allowables and Factors of Safety

f'_c = Compressive strength \geq 4,000 psi
 f'_t = Tensile strength
 f_c = Allowable compressive stress
 f_t = Allowable tensile stress
 FS_s = Factor of safety against sliding

Static Usual

$f_c = f'_c/4$	$f_t = f'_t$	$FS_s = 2.0$
----------------	--------------	--------------

Static Unusual

$f_c = f'_c/2.5$	$f_t = f'_t$	$FS_s = 1.3$
------------------	--------------	--------------

Static Extreme

$f_c = f'_c/1.5$	$f_t = f'_t$	$FS_s = 1.1$
------------------	--------------	--------------

Construction Condition (before grouting)

Resultant location within base, $f_t = f'_t$

stages of the design layout to assure that each cantilever is stable at different stages of concrete placement. Table 11-1 contains a construction condition load case with $f_t = f'_t$. This allowable is permitted only if the concrete has aged sufficiently - normally a 1-year strength is specified - to gain its design strength. This is generally not a concern since the cantilevers experience this level of tensile stresses after they have been topped off, and at this time the specified strength age has elapsed for the lower lifts where the high tensile stresses are likely to occur. As a general rule, tensile stresses should not be allowed to reach this limit since other loading combinations would more than likely worsen this condition. Cantilever stability may not be a problem if reservoir filling is concurrent with the construction of the dam.

d. Tensile Stresses.

(1) General. Tensile stresses are inherent to most double-curvature arch dams and require further discussion. As seen in Table 11-1, the allowable tensile stress is equal to the tensile strength of concrete which indicates an FS of unity. However, the intent of any design is to minimize or limit tensile stresses to localized areas by reshaping and/or redesigning the dam to the extent possible as discussed in Chapter 6, paragraph 6-6. A dam designed with high tensile stresses - though within the allowable - in too many areas would more than likely exceed the compressive allowables under one or more loading combinations. The allowables in Table 11-1 are established

based on the failure mode of arch dams. When the tensile strength of the concrete is exceeded and cracking occurs, the uncracked portion of the cantilever would tend to carry more compression and the balance of the loads would have to be carried by the arches. If the cracking due to tension becomes widespread, too much of the load will have to be carried by the arches. The uncracked portion of the cantilevers, in turn, can exceed the compressive strength of the concrete and cause crushing failure of the concrete (unless the foundation has failed first). Therefore, since compression is the mode of failure of an arch dam, a more conservative approach is taken in establishing the allowable compressive stresses, as seen Table 11-1.

(2) Design Guidelines. As discussed in the previous paragraph, one of the objectives in arch dam design is minimizing the magnitude and the locations of tension in the dam. Most arch dams exhibit tensile stresses at the downstream face of the cantilevers along the foundation under the low reservoir-high temperature condition and during - or at the end of - construction. Although attempts should be made to improve the stresses as much as possible, this condition should not be regarded as a significant problem as long as the stability of the cantilevers is not in question, as discussed in paragraph 11-1c. Tensile stresses at the downstream face of cantilevers are relieved - to a varying degree - when the reservoir level rises. Even if some cracking has occurred, the additional hydrostatic load and the resulting downstream deflection will cause the cracks to close. Tension at the upstream face of the dam should be given a more careful consideration. The primary reason for the concern is the possibility of a seepage path through the dam if cracks were to develop and extend through the thickness of the dam. It should be stated that cracked cantilevers do not imply a dam failure. Loads previously carried by cantilevers before cracking will be transferred to the arches and other cantilevers. A cracked cantilever analysis should be performed to ensure the compressive stresses of the remaining uncracked section and the other arches and cantilevers remain within the allowable concrete stresses. This type of analysis may be performed using the computer program ADSAS (USBR 1975 and USAEWES, instruction report, in preparation) or, if needed, a more refined FEM analysis. As mentioned earlier, tension is not the mode of failure in an arch dam. The reason for the elaborate treatment of this subject is that reducing tensile stresses to the acceptable level in arch dams is the most difficult step in the layout and design procedure.

11-2. Dynamic.

a. Allowables and FS Safety - Dynamic Loading. Establishing the acceptability of performance of arch dams under dynamic load cases is a complicated process which cannot be summarized in a table as was done in Table 11-1 for the static condition. The allowables given in the following table are only the first step in determining the safety criteria and should not be regarded as absolute limits. Additional discussion on this subject is presented later in this chapter. In Table 11-2, f'_{cd} and f'_{td} are based on the test results for the appropriate rate of loading as indicated by the dynamic analysis. If the laboratory testing is done before the results of the dynamic analysis are available, several rates of loading may be used to develop a curve for future use. A range of failure times between 20 msec and 150 msec should provide sufficient test data to cover most cases. The dynamic tensile strength, f'_{td} , in Table 11-2 is based on the modulus of rupture test for the

TABLE 11-2

Dynamic Loading Combinations

Allowables and Factors of Safety

f'_{cd} = Dynamic compressive strength
 f'_{td} = Dynamic tensile strength
 f_c = Allowable compressive stress
 f_t = Allowable tensile stress
 FS_s = Factor of Safety against sliding

Dynamic Unusual

$$f_c = f'_{cd}/2.5 \qquad f_t = f'_{td} \qquad FS_s = 1.3$$

Dynamic Extreme

$$f_c = f'_{cd}/1.5 \qquad f_t = f'_{td} \qquad FS = 1.1$$

the concrete used in the dam, as modified according to the approach discussed by Raphael (1984). The sliding FS in Table 11-2 are based on a comprehensive field investigation and testing program as described in Chapter 10.

b. Acceptability of Performance. The dynamic load cases to be used in the analysis of arch dams were given in Table 4-2. Under load case DUN1, OBE + Normal Operating Reservoir Condition, the stresses in the dam must remain totally within the elastic range of concrete, assuming the dam behaves as a monolithic structure. For the end of construction condition, load case DUN2, localized inelastic behavior will be allowed; however, no condition leading to the impairment of operation will be permitted. In the case of the MDE loading, i.e., load case DE1, nonlinear, inelastic behavior will be allowed while maintaining the structural integrity of the dam. This means that no conditions leading to the uncontrolled release of water will be permitted. However, in cases where the ground motions due to OBE approach the MDE's ground motions, some inelastic behavior is allowed in localized areas of the dam.

c. Dynamic Response of Arch Dams. The extraordinary strength of arch dams has been recognized for centuries, a fact attested by some of the oldest masonry structures still standing in the Middle East. According to records to date, there has been no structural failure of an arch dam due to an earthquake. However, some of the modern dams, i.e., the ones constructed in the 1900's, will probably show signs of distress if analyzed using state-of-the-art methods of analysis, even though some of these dams have experienced severe earthquakes without suffering any structural damages. Depending on the intensity of the ground motions and other pertinent design parameters, an arch dam would typically exhibit high tensile stresses in the arch (horizontal) direction in the upper part of the dam and in the vertical direction at the base of cantilevers when analyzed using a linear FEM. Considering the fact that in reality the dam is constructed in monoliths which are separated from each other by vertical contraction joints, the indicated horizontal tensile stresses as determined from a linear analysis, will be redistributed since

31 May 94

contraction joints are not capable of transferring tension. The magnitude of the real tensile stresses depend largely on the spacing of monolith joints. It is anticipated that longer monoliths would develop larger horizontal tensile stresses than shorter monoliths.

CHAPTER 12

INSTRUMENTATION

12-1. Introduction. There are several reasons to incorporate instrumentation into any dam. One reason is so that the design and construction engineers can follow the behavior of the dam during its construction. Another reason is to compare the performance of the dam under operating conditions with that predicted by the designers. There is also the need to evaluate the overall condition and safety of the dam on a regular basis. A good instrumentation program can also increase the knowledge of the designer, and that knowledge can be applied to future projects. This chapter will discuss the instrumentation requirements that are needed to accomplish several of these points as they relate to arch dams. EM 1110-2-4300 and the Concrete Dam Instrumentation Manual (USBR 1987) give a more detailed description of the various types of instruments discussed in this chapter, as well as several other types of instruments that may be of interest in a project-specific case. EM 1110-2-4300 also discusses some general requirements in establishing and executing an instrumentation program including the proper method of installation, calibration, and maintenance of the instrumentations as well as the collection and reduction of data.

12-2. General Considerations. In establishing any instrumentation program, it is important to understand the objectives of the program, the need for each type of instrument, the environment in which the instrument will be, the difficulty in gathering the data, and the time and effort in reducing and understanding the data generated. The wrong type of instrument may not measure the desired behavior. And while insufficient instrumentation may ignore important structural behavior, excessive instrumentation may bury the design engineer in a mound of paper that hides a serious condition. It is also important that some consideration be given to the initial and long-term cost of the program and the availability of trained personnel to collect the data. The cost of purchasing and installing the instruments will be up to 3 percent of the general construction cost (Fifteenth Congress on Large Dams 1985). A large instrumentation program will require a long-term commitment by management to maintain the program.

a. Instrument Selection. Instruments and associated equipment should be rugged and capable of long-term operation in an adverse environment. It is preferable to incorporate instruments of similar types (such as electric resistance versus vibrating wire types) in order to reduce the need for several types of readout equipment and training in numerous different types of equipment. The final decision of which type of instruments to use will be site specific. For example, most electric resistance instruments are restricted by the total length of the lead wires, while vibrating wire instruments are not. Therefore, if it is desirable to reduce the number of readout stations, then the length of the lead wires may dictate the use of vibrating wire instruments.

b. Redundancy. Every instrumentation program should include some redundancy, especially with embedded instruments since it is usually not possible to repair damaged embedded instruments. The cost to retrofit replacement instruments will far exceed the cost of providing adequate redundancy.

Redundancy, in this case, is more than only the furnishing of additional instruments to account for those that are defective or are damaged during installation. Redundancy includes providing different instruments which can measure similar behavior with different methods. For example, for measuring movement, a good instrumentation program should have both plumb lines and a good trilateration system. Redundancy of instruments is especially critical in key areas and around special features (Moore and Kebler 1985).

c. Automatic Data Collection and Remote Monitoring. The use of automatic data collection and remote monitoring is becoming more popular in recent years because electronic instruments lend themselves to this type of operation. Automatic data collection and remote monitoring will reduce the labor involved in gathering data and will reduce the time required to process and evaluate the data. However, automatic data collection and remote monitoring should not preclude the design engineer obtaining knowledge of onsite conditions existing when the data was obtained (Jansen 1988). It is important to remember that instruments do not ensure dam safety, they only document performance. Remote monitoring is not a substitute for a thorough inspection program. Regular visits to the dam by experienced design engineers are essential.

d. Readings During Construction. Some of the most valuable information obtained in any instrumentation program is the information gathered prior to and during the construction of the dam and during initial reservoir filling. Because of the importance of gathering good data due to the effects of construction, efforts should be made to obtain readings as early and as frequently as possible during the construction. Special provisions should be made in the contract documents to allow access to the instrument readout points and/or stations at the regular intervals outlined in paragraph 12-9.

e. Fabrication and Installation. As noted in EM 1110-2-4300, fabrication and installation of the instruments should be done by trained Government personnel, not by contractor-furnished unskilled laborers. The initial readout schedule for the various types of instruments described in this chapter is presented in paragraph 12-9.

f. Instrument Types. The basic types of instruments can be described by the items that they measure. The types discussed in this chapter include movement, stresses or strains, seepage, pressure, and temperature. Each of these types is discussed in the next few paragraphs, with recommendations for each. Other types such as seismic, water elevation gauges, etc. are not discussed herein.

12-3. Monitoring Movement. Because of the monolithic behavior of arch dams, displacement is probably the most meaningful parameter that can be readily monitored. Although displacements occur in all directions, the most significant displacements are usually the ones that take place in a horizontal plane. All concrete arch dams should have provisions for measuring these displacements, including relative movements between points within the dam and movement of the dam relative to a remote fixed point. In new construction, plumb lines are still the preferred instrument to monitor the relative horizontal movements within an arch dam. In existing structures, it may be easier to install inclinometers or a series of tiltmeters or electrolevels. All arch dams (new or existing) should include trilateration or triangulation surveys.

a. Plumblines. Plumblines and optical plummets measure bending, tilting, and deflections of concrete structures. Conventional plumblines are suspended from the top of the structure and extend down to the lowest readout gallery. If the curvature of the dam will not permit this type of installation, then a series of conventional plumblines can be installed as shown in Figure 12-1. Inverted plumblines are commonly used in conjunction with conventional plumblines to extend the total length of measurable deflections well into the foundation. The primary disadvantages to conventional plumblines are that they require trained personnel to obtain readings, the metal components are subject to corrosion, and no readings can be obtained until the structure is complete. An optical plummet can be used as a substitute for a conventional plumblineline. The optical plummet is line-of-sight instrumentation that uses bubble levels or mercury reflectors to keep the reading line precisely vertical. Since it is an optical instrument, it is not susceptible to the corrosion problems of the conventional plumblineline. However, as with the conventional plumblineline, the optical plummet requires trained personnel to obtain readings, and no readings can be obtained until the structure is complete. Also, the optical plummet is susceptible to errors caused by refraction of light waves, as well as distortions due to atmospheric conditions.

b. Inclinometer. Inclinometers are used to measure angles from vertical. They can be used both in the concrete mass or extended into the foundation. Extending the inclinometer into the foundation can provide information on a potential sliding plane being investigated. Inclinometers consist of a metal or plastic casing embedded into the concrete, a probe, and a readout unit. The casing is grouted into a core hole, which makes it especially attractive for installation in existing structures. If an aluminum casing is used, the casing should be coated with epoxy to prevent corrosion. The casing has four grooves on the inside walls at 90 degrees from one another. The casing should be installed so that one set of grooves are in the radial direction and one set in the tangential direction. As with the plumblines, inclinometers require trained personnel to obtain readings. More information on inclinometers can be found in the Concrete Dam Instrumentation Manual (USBR 1987).

c. Extensometer. Extensometers are used to measure small (2- to 4-inch) deflections along the length of the instrument. Extensometers can be supplied with several (5 to 10) anchor heads. When inserted into a dam foundation, the heads can be positioned on either side of a zone of interest so that the deflection of that zone under load can be obtained. However, limitation on the amplitude of deflections that an extensometer can measure may require periodically resetting the reading heads. Extensometers can be installed at almost any angle. It is preferable to install some extensometers early in the concrete placement to determine deformations in the foundation during construction.

d. Joint Meter. Joint meters are used to measure the opening of monolith joints. Depending on the meter being used, the maximum opening that can be measured may range from 0.08 to 0.4 inches. Joint meters provide information about when the joints have begun to open and if there is adequate opening for grouting. They also give an indication of the effectiveness of the grouting and show whether any movement occurs in the joint during and after grouting.

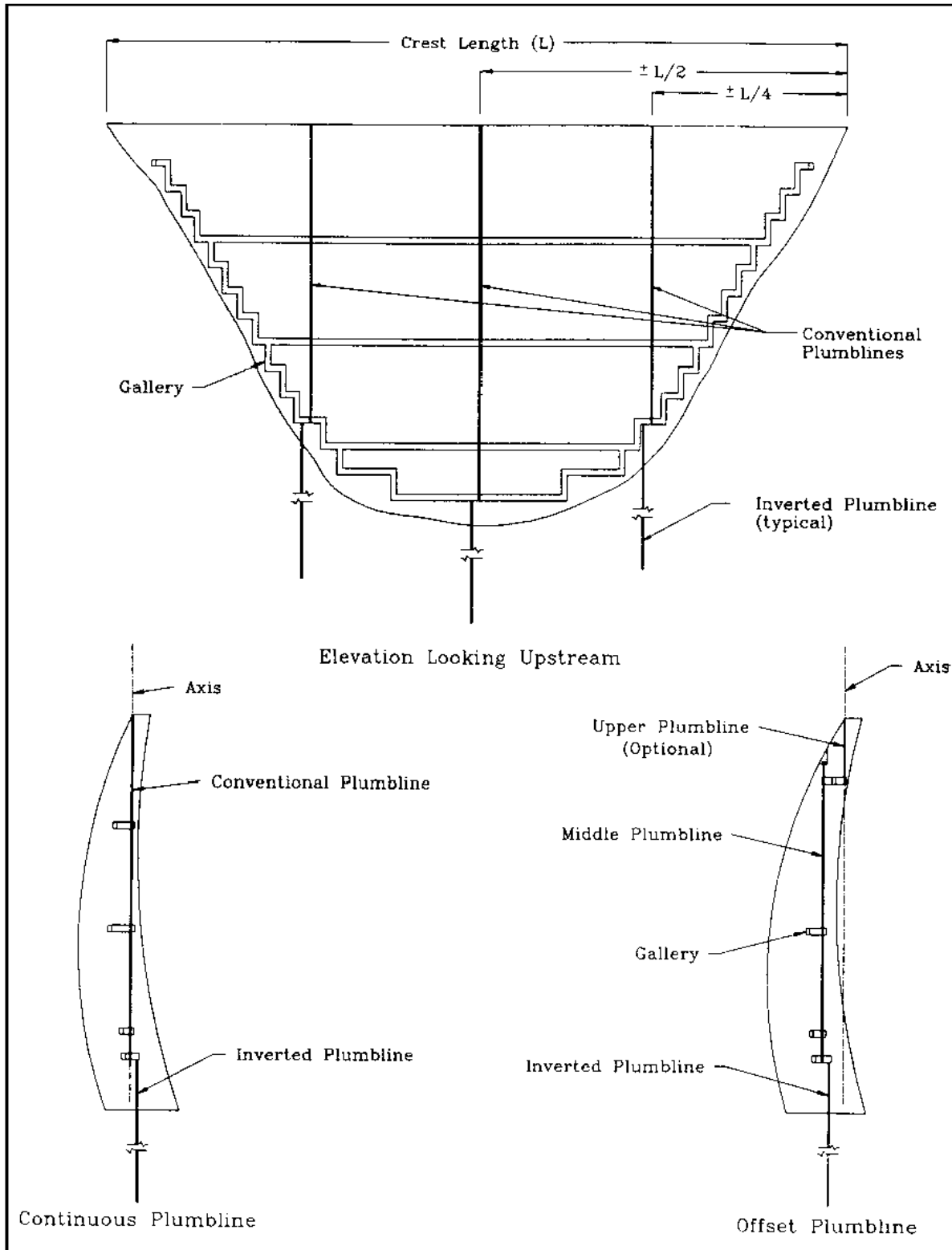

Figure 12-1. Typical layout for plumb lines

e. Trilateration and Triangulation Surveys. These two methods of precise measurements utilize theories and equations of geometry to transform linear and angular measurements into deflections of alignment points. Triangulation is based on a single known side length (baseline) and three measured angles of a triangle to determine lengths of the remaining two sides. Trilateration uses electronic distance measurement (EDM) instruments to measure the lengths of the sides of the triangle and uses these lengths to calculate the angles. The accuracy of each of these methods is very dependent on the skill of the crew and equipment being used. It can also be costly and time consuming to gather and reduce the data. The required accuracy and precision of the two methods is outlined in the Concrete Dam Instrumentation Manual (USBR 1987).

12-4. Monitoring Stresses and Strains.

a. Strain Meters. Strain meters measure strain and temperature. Since they measure strain at one location and in one direction only, it is usually necessary to install strain meters in groups of up to 12 instruments with the help of a "spider" frame (Figure C-3 in EM 1110-2-4300). Since strain meters do not directly measure stress, it is usually necessary to convert strains to stresses. This will require a knowledge of the concrete materials which are changing with time, such as creep, shrinkage, and modulus of elasticity. These material properties, as well as the coefficient of thermal expansion and Poisson's ratio, are usually determined by laboratory testing prior to construction. However, if the mix design is revised due to field conditions, then the testing may need to be repeated to accurately determine stresses from the strain measurements.

b. "No-stress" Strain Meters. These meters are identical to the strain meters discussed in the previous paragraph, except the method of installation isolates the meters within the mass concrete so that the volume changes in the concrete can be measured in the absence of external loading. This arrangement usually consists of one vertical and one horizontal meter.

c. Stress Meters. Stress meters measure compressive stress independently of shrinkage, expansion, creep, or changes in modulus of elasticity. They are used for special applications such as determining vertical stress at the base of a section for comparison and checks of results from strain meters. They are also used in the arches for determining horizontal stress normal to the direction of thrust in the thinner arch elements near the top of the dam.

12-5. Seepage Monitoring. Seepage through a dam or its foundation is visible evidence that the dam is not a perfect water barrier. Continued measurement of this seepage can provide an indication of progressive dissolution or erosion in a dam foundation or abutment. The types of instruments used to monitor seepage include weirs, flowmeters, and calibrated catch containers.

12-6. Pressure Monitoring. Although uplift pressure is not a critical issue in the stress analysis of arch dams, it is extremely important in the foundation stability analysis and should be included as part of the overall instrumentation program. However, measuring water pressures in a rock foundation is always a difficult problem since it can change over short distances because of jointing and fissuration.

a. Open Piezometers. Open piezometers are used to measure the average water level elevations in different zones of materials. Open piezometers include observation wells and slotted-pipe or porous-tube piezometers. Foundation drains can be considered a type of observation well. However, the use of drains or other open piezometers with long influence zones is not recommended for measuring uplift pressures in concrete dams. They are accessible to water over most, if not all, of their length and, as such, they tap water from different layers. The result is often a water level that is an average between the smallest and largest pressure heads crossed with no indications of what it truly represents.

b. Closed Piezometers. Closed piezometers measure pressure over a small influence zone (usually 3 feet). Typical closed piezometers are the electric resistance or vibrating wire piezometers. These piezometers are applicable for measuring pore pressures at the concrete/foundation contact as well as at several zones within the foundation rock.

c. Standpipe with Bourdon-type Gauge. A standpipe with a Bourdon-type gauge is the one of the simplest, and perhaps the cheapest, ways to measure uplift pressures at the dam/foundation contact. There are various ways of installing this uplift pressure system, but the two most common are as shown in Figure 12-2. This type of uplift pressure measuring system is an example of an open-system piezometer discussed in paragraph 12-6a, but with a small influence zone, usually only about 3 feet into the foundation. Closed piezometers can also be added at a few locations as verification of this uplift pressure measurement system. In dams without a foundation gallery, closed piezometers should be used to measure uplift pressures at the dam/foundation contact.

12-7. Temperature Monitoring. Temperature sensing devices are very important in arch dams since volume change caused by temperature fluctuation is a significant contributor to the loading on a arch dam. Thermometers are used to determine the temperature gradients and history of the concrete mass for use in evaluating thermal stresses which contribute to thermal cracking. They are also used to control the cooling process during the grouting operations and are used to determine the mean concrete temperatures due to reservoir and seasonal fluctuation. Thermometers are preferred over thermocouples because they have been more dependable, have greater precision, and are less complicated in their operation. Standpipes filled with water have also been used as a substitute for permanent thermometers. In using a standpipe, a thermometer is lowered into the standpipe to the desired elevation and held there until the reading stabilizes. Standpipes can be an effective way to obtain vertical temperature gradients but are not practical for measuring temperature variation between the upstream and downstream faces of the dam. The addition of several standpipes through the thickness of the dam will add extra complications to the overall construction process. Standpipes also tend to indicate higher temperatures than thermometers (Sixteenth Congress on Large Dams 1986).

12-8. General Layout Requirements. The general instrument layout recommended for arch dams is shown in Figures 12-3 and 12-4. Instruments, other than those needed specifically for construction, should be positioned at points that correspond to those used in the design and analysis. This is done for ease of comparison of the predicted and measured performance of the dam.

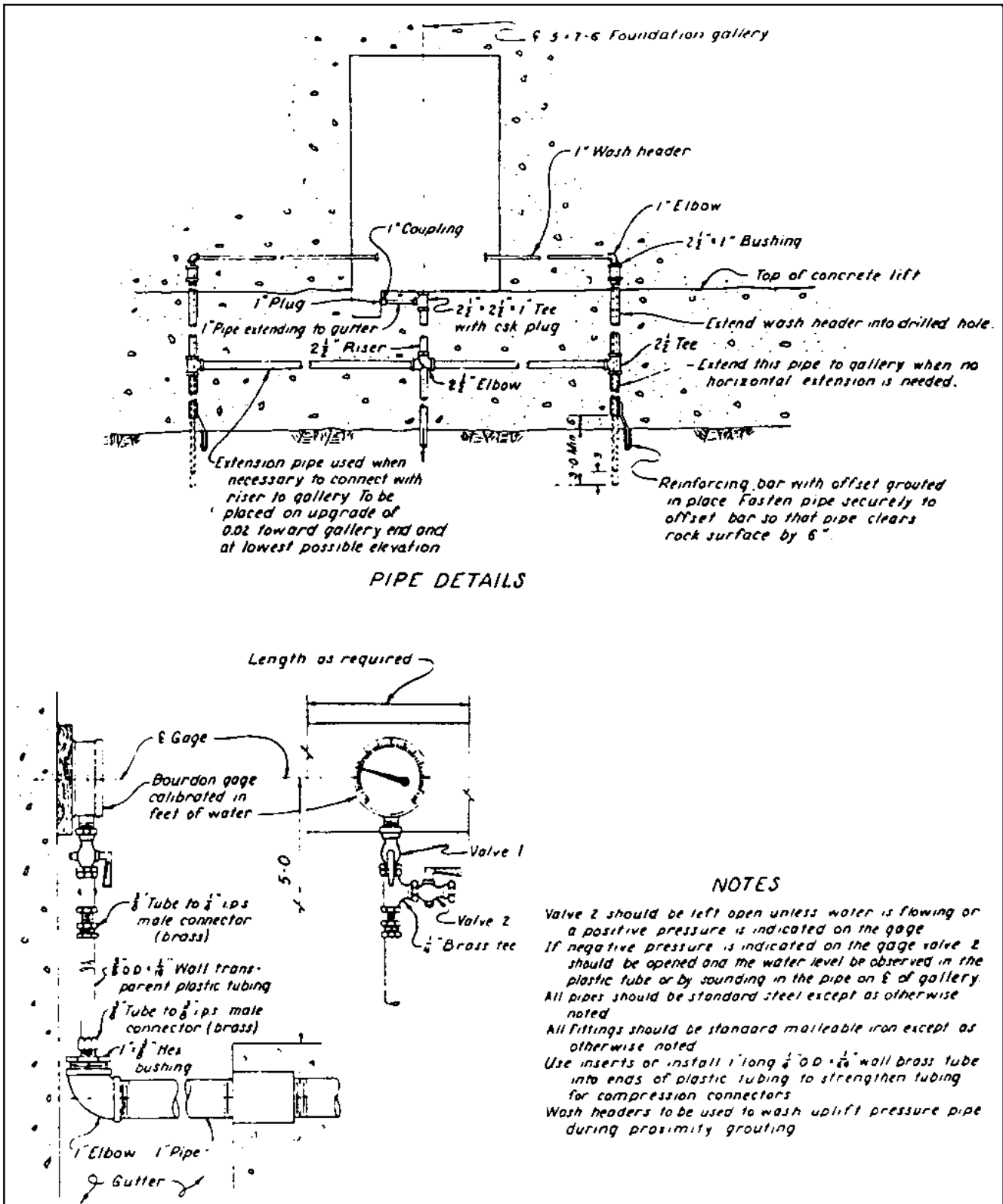

Figure 12-2. Typical Bourdon gauge installation (USBR 1987)

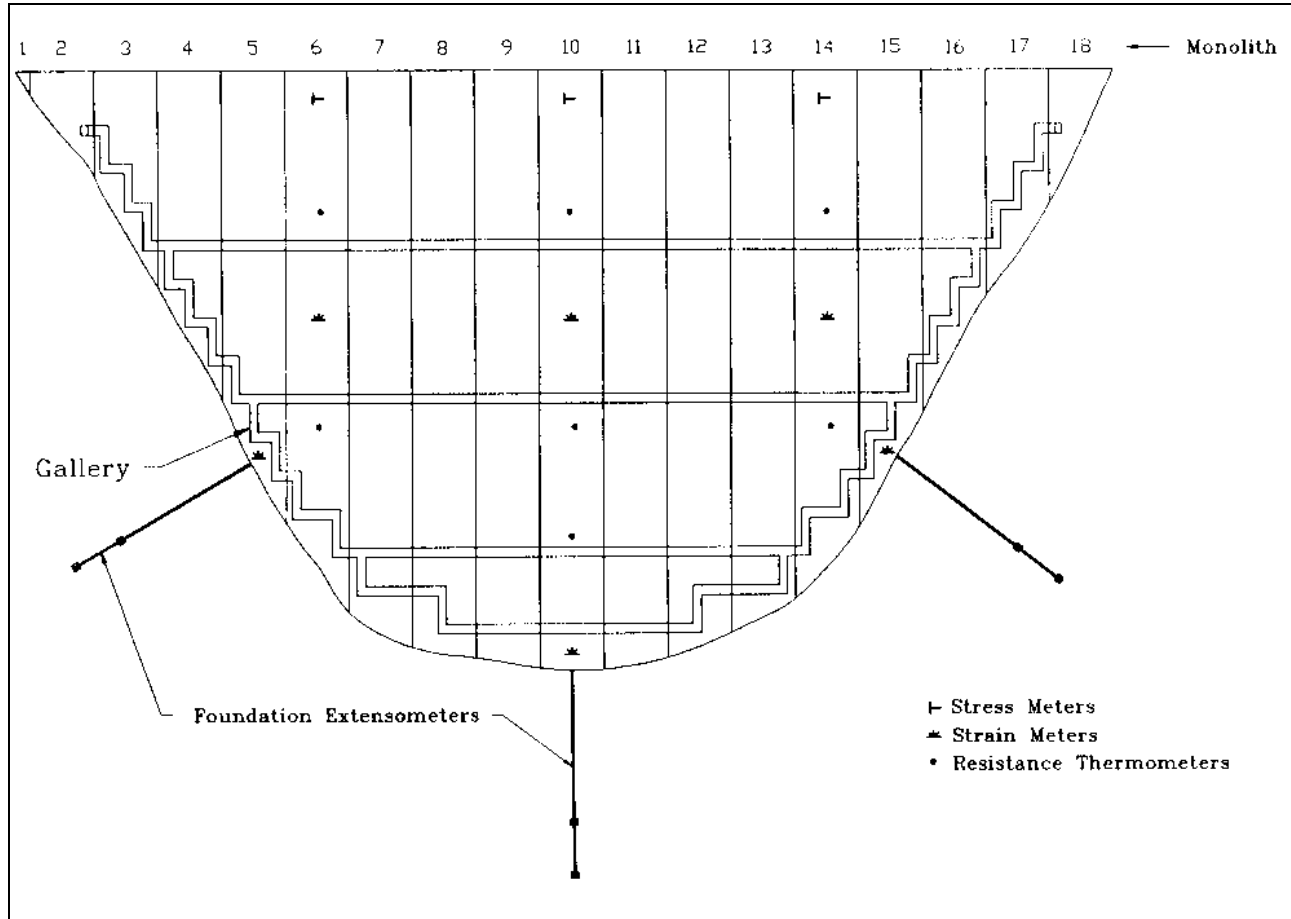

Figure 12-3. Recommended location of embedded instruments in arch dams (elevation looking upstream)

a. Movement Instruments.

(1) Plumblines. A minimum of three plumblines should be installed at locations that correspond to the maximum section of the dam (the crown cantilever) and to the midpoints to each abutment, as shown in Figure 12-1. If the curvature does not permit a continuous plumbline to be installed from the top of the dam, then a shortened plumbline can be installed. If an upper gallery is available, a staggered plumbline can be installed.

(2) Extensometers and Inclinerometers. Extensometers and inclinometers should be installed into the foundation as early in the construction as practical, preferably before concrete placement, to determine deformations in the foundation due to construction activities. The location of the extensometers should correspond to the arch elevations for the other instrumentation groups. The total length of the extensometer should be between 25 and 50 percent of the height of the dam. Additional extensometers or inclinometers should be located wherever there is a change in foundation type or a potential slide plane. If inclinometers are to be used in lieu of plumblines, they should be installed at the general locations discussed in paragraph 12-8a(1).

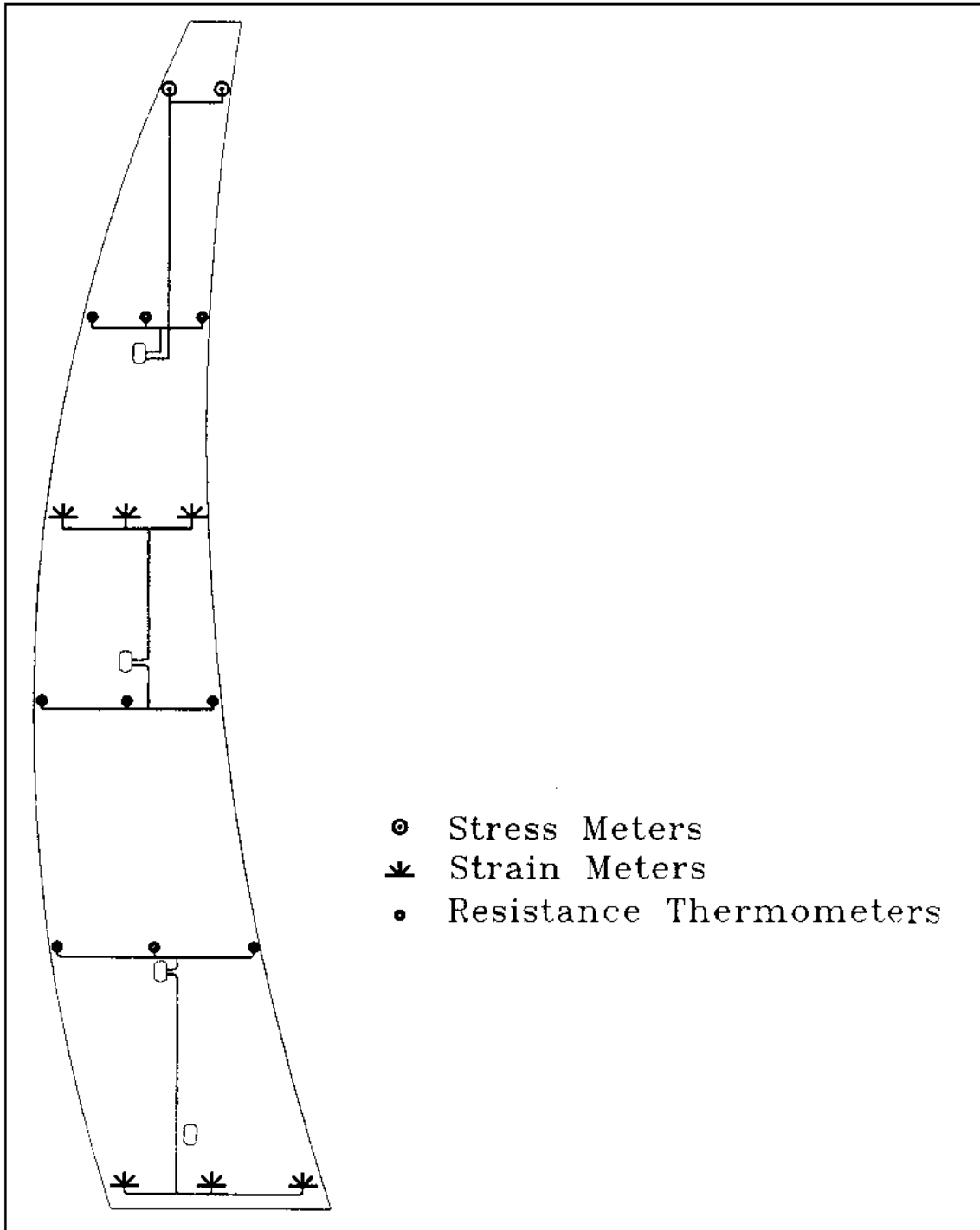

Figure 12-4. Recommended location of embedded instrumentation in arch dam (section at crown cantilever)

(3) Joint meters. One or two joint meters are required in every other monolith joint at the midheight elevation of alternate grout lifts (Figure 12-5).

(4) Triangulation and trilateration targets. Targets should be placed at the crest and at one or more points on the downstream face, as shown in Figure 12-6. The targets should correspond to the location of the plumb lines.

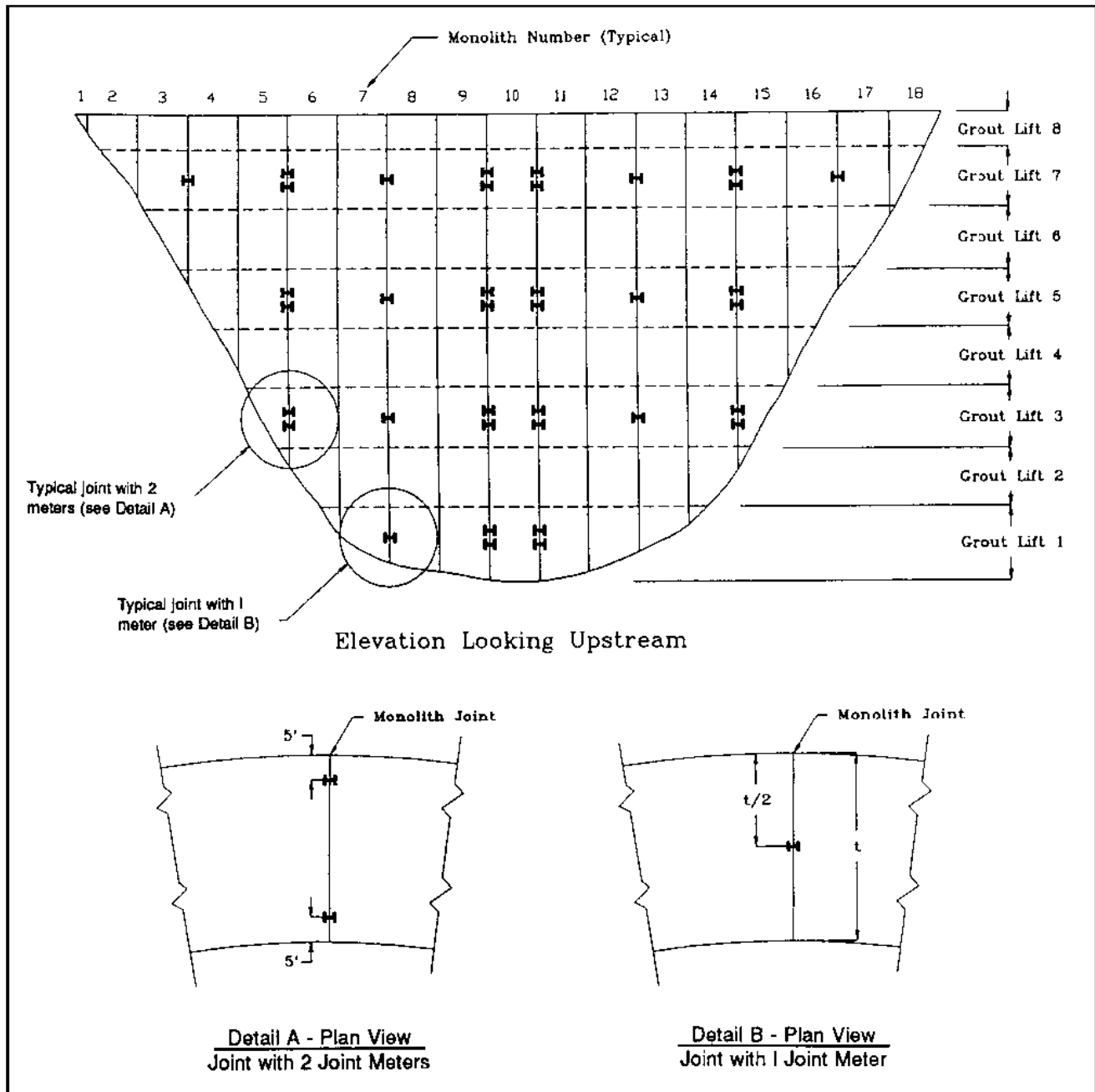

Figure 12-5. Layout for joint meters

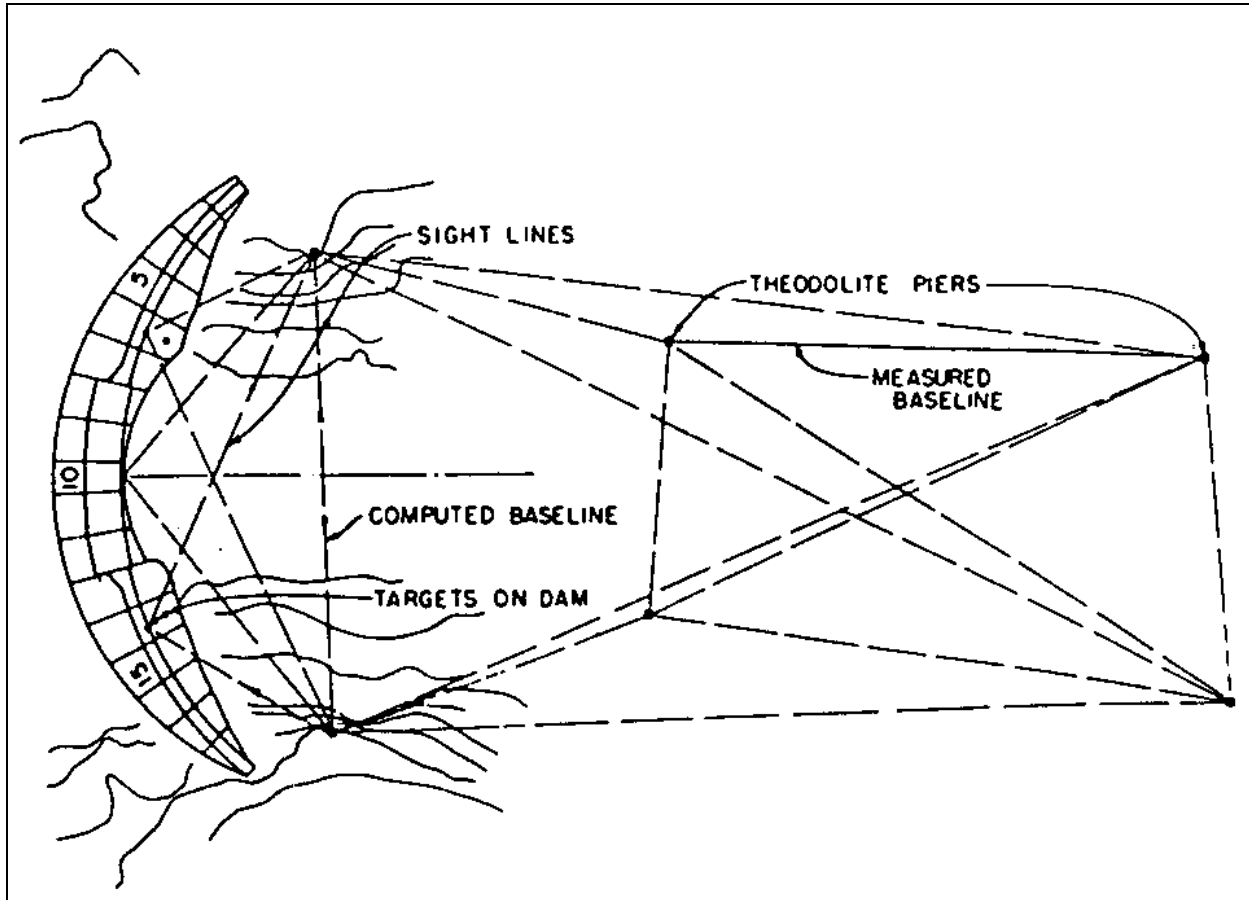

Figure 12-6. Layout for triangular or trilateration network

b. Stress/strain Clusters. Clusters of strain meters, "no-stress" strain meters, and stress meters should be positioned along four or five arch elevations that correspond to arch elevations used in the design and analysis (see Figures 12-3 and 12-4). An additional set of instruments should be positioned at the base of the crown cantilever. At each of the instrumentation points, two clusters of instruments should be placed near the upstream and downstream faces or at three locations between the faces. Where the thickness of the dam permits and where more detailed information is desired about the stress distribution through the dam, five or more instrument groups can be placed between the upstream and downstream faces of the dam.

c. Seepage. Initially, seepage through the joints and through the drains can be measured at two weirs, each located to collect seepage through the drains along each abutment. Measurements of individual drains should also be made on a regular basis. Additional seepage monitoring points can be added after the initial reservoir filling, if the need arises.

d. Pressure. Three uplift pressure groups (standpipe or closed piezometer groups) should be located in a similar manner as the plumb-lines. There should be at least four uplift pressure measuring points through the thickness of the dam in each group with a spacing between points of no more than 30 feet.

e. Temperature. Thermometers should be installed at locations shown in Figure 12-7 to verify the thermal gradient through the structure and to obtain the temperature history of the concrete. This information is used for comparison with the thermal studies discussed in Chapter 8. Thermometers are not typically located near the other instrument clusters when the instruments in these clusters also sense temperature. If the thermometer groups are not located at the center of the grout lifts, then additional thermometers may be required to monitor the temperature of the concrete from the time of placement through the time of joint grouting. These thermometers should be located at the center of each monolith at points that correspond to the midheight of each of the grout lifts and are used to assure that the concrete has reached the required grouting temperatures.

f. Other Instrument Groups. Instruments should also be positioned in various arrays near areas of special interest, such as around galleries or around any other openings through the dam. Conduits running through the dam should include strain meters on the metal conduits and on the reinforcing steel surrounding the conduits.

12-9. Readout Schedule. Each dam will have its own site-specific requirements for instrumentation and readout schedule. Table 12-1 shows some general guidelines that should be used in establishing the general readout schedule for each dam. EM 1110-2-4300 and the Concrete Dam Instrumentation Manual (USBR 1987) also provide general guidance on readout schedules for instruments not covered by this manual. Variations in the guidelines shown in Table 12-1 will occur when special conditions arise at the dam site, such as long periods of unusually high or low water levels, seismic activity, or unexplained behavior of the dam, such as cracking, increased seepage, etc.

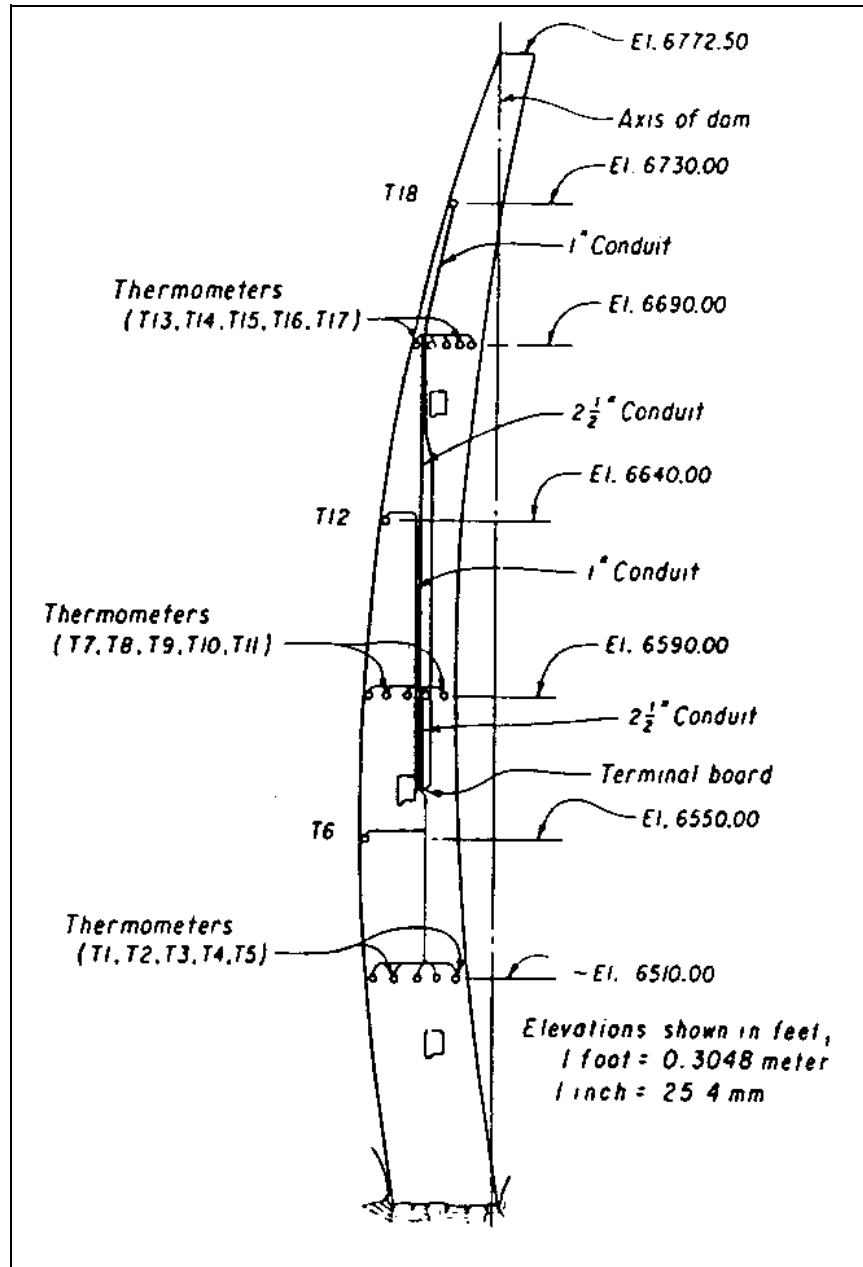

Figure 12-7. Layout for thermometer installation
(USBR 1987)

TABLE 12-1

Recommended Readout Schedule

Type of Instrument	During Construction ¹	During Initial Filling	First 2 years of Operation	Next 5 years of Operation	After 7 years of Operation
Plumblines and optical plummets	N/A	weekly	monthly	quarterly	semi-annually
Inverted Plumblines	weekly	weekly	monthly	quarterly	semi-annually
Inclinometers	weekly	weekly	monthly	quarterly	semi-annually
Extensometers	weekly	weekly	monthly	quarterly	semi-annually
Joint meters	weekly	weekly	biweekly	quarterly	semi-annually
Triangulation	N/A	weekly	monthly	quarterly	semi-annually
Trilateration	N/A	weekly	monthly	quarterly	semi-annually
Strain meters	weekly ²	weekly	monthly	quarterly	semi-annually
"No-Stress" strain meters	weekly ²	weekly	monthly	quarterly	semi-annually
Stress meters	weekly ²	weekly	monthly	quarterly	semi-annually
Weirs, etc.	N/A	weekly	weekly	monthly	quarterly
Open piezometers	monthly	monthly	quarterly	quarterly	semi-annually
Closed piezometers	weekly ³	weekly	monthly	quarterly	semi-annually
Uplift pressure gauges	weekly	weekly	biweekly	monthly	quarterly
Thermometers	weekly ⁴	weekly	monthly	monthly	quarterly

¹ Initial readings for all embedded instruments should be made within 3 hours after embedment.

² After initial readings are obtained, readings are continued every 12 hours for 15 days, daily for the next 12 days, twice weekly for 4 weeks, and weekly thereafter.

³ Daily during curtain grouting.

⁴ After initial readings are obtained, readings are continued every 6 hours for 3 days, every 12 hours for 12 days, daily for the next 12 days, twice weekly for 4 weeks, and weekly thereafter.

CHAPTER 13

CONSTRUCTION

13-1. Introduction. The design and analysis of any dam assumes that the construction will provide a suitable foundation (with minimal damage) and uniform quality of concrete. The design also depends on the construction to satisfy many of the design assumptions, including such items as the design closure temperature. The topics in this chapter will deal with the construction aspects of arch dams as they relate to the preparation of planning, design, and construction documents. Contract administration aspects are beyond the scope of this manual.

13-2. Diversion.

a. General. With arch dams, as with all concrete dams, flooding of the working area is not as serious an event as it is with embankment dams, since flooding should not cause serious damage to the completed portions of the dam and will not cause the works to be abandoned. For this reason, the diversion scheme can be designed for floods of relatively high frequencies corresponding to a 25-, 10-, or 5-year event. In addition, if sluices and low blocks are incorporated into the diversion scheme, the design flood frequency is reduced and more protection against flooding is added as the completed concrete elevation increases.

b. The Diversion Scheme. The diversion scheme will usually be a compromise between the cost of diversion and the amount of risk involved. The proper diversion plan should minimize serious potential flood damage to the construction site while also minimizing expense. The factors that the designer should consider in the study to determine the best diversion scheme include: streamflow characteristics; size and frequency of diversion flood; available regulation by existing upstream dams; available methods of diversion; and environmental concerns. Since streamflow characteristics, existing dams, and environmental concerns are project-specific items, they will not be addressed in this chapter.

(1) Size and Frequency of Diversion Flood. In selecting the flood to be used in any diversion scheme, it is not economically feasible to plan on diverting the largest flood that has ever occurred or may be expected to occur at the site. Consideration should be given to how long the work will be under construction (to determine the number of flood seasons which will be encountered), the cost of possible damage to work completed or still under construction if it is flooded, the delay to completion of the work, and the safety of workers and the downstream inhabitants caused by the diversion works. For concrete dams, the cost of damage to the project would be limited to loss of items such as formwork and stationary equipment. Delays to the construction would be primarily the cleanup of the completed work, possible replacement of damaged equipment, and possible resupply of construction materials (Figure 13-1). It is doubtful that there would be any part of the completed work that would need to be removed and reworked. The risk to workers and downstream residents should also be minimal since the normal loads on the dam are usually much higher than the diversion loads, and overtopping should not cause



Figure 13-1. View from right abutment of partially complete Monticello Dam in California showing water flowing over low blocks (USBR)

serious undermining of the dam. And, as the concrete construction increases in elevation, the size of storm that the project can contain is substantially increased. Based on these considerations, it is not uncommon for the diversion scheme to be designed to initially handle a flood with a frequency corresponding to a 5- or 10-year event.

(2) Protection of the Diversion Works. The diversion scheme should be designed to either allow floating logs, ice and other debris to pass through the diversion works without jamming inside them and reducing their capacity, or prevent these items from entering the diversion works (International Commission on Large Dams 1986). Systems such as trash structures or log booms can be installed upstream of the construction site to provide protection by collecting floating debris.

(3) Other Considerations. If partial filling of the reservoir before completing the construction of the dam is being considered, then the diversion scheme must take into account the partial loss of flood storage. In addition,

partial filling will require that some method (such as gates, valves, etc.) be included in the diversion scheme so that the reservoir level can be controlled.

c. Methods of Diversion. Typical diversion schemes for arch dams include tunnels, flumes or conduits, sluices, low blocks, or a combination of any of these. Each of these will require some sort of cofferdam across the river upstream of the dam to dewater the construction site. A cofferdam may also be required downstream. The determination of which method or methods of diversion should be considered will rest on the site conditions.

(1) Tunnels and Culverts. Tunnels are the most common method of diversion used in very narrow valleys (Figure 13-2). The main advantage to using a diversion tunnel is that it eliminates some of the need for the staged construction required by other diversion methods. They also do not interfere with the foundation excavation or dam construction. The main disadvantage of a tunnel is that it is expensive, especially when a lining is required. As a result, when a tunnel is being evaluated as part of the diversion scheme, an unlined tunnel should be considered whenever water velocities and the rock strengths will allow. At sites where a deep crevice exists at the stream level and restitution concrete is already required to prevent excessive excavation, a culvert may be more economical than a tunnel (Figure 13-3). All tunnels and culverts will require a bulkhead scheme at their intakes to allow for closure and will need to be plugged with concrete once the dam is completed. The concrete plug will need to have a postcooling and grouting system (Figure 13-4).

(2) Channels and Flumes. Channels and flumes are used in conjunction with sluices and low blocks to pass the stream flows during the early construction phases. Channels and flumes should be considered in all but very narrow sites (Figures 13-5 and 13-6). Flumes work well where flows can be carried around the construction area or across low blocks. Channels will require that the construction be staged so that the dam can be constructed along one abutment while the river is being diverted along the base of the other abutment (Figure 13-6). Once the construction reaches sufficient height, the water is diverted through sluices in the completed monoliths (Figure 13-7). A similar situation applies for flumes. However, flumes can be used to pass the river through the construction site over completed portions of the dam. If the flume has adequate clearance, it is possible to perform limited work under the flume.

(3) Sluices and Low Blocks. Sluices and low blocks are used in conjunction with channels and flumes. Sluices and low blocks are used in the intermediate and later stages of construction when channels and flumes are no longer useful. Sluices become very economical if they can be incorporated into the appurtenant structures, such as part of the outlet works or power penstock (Figure 13-7). It is acceptable to design this type of diversion scheme so that the permanent outlet works or temporary low-level outlets handle smaller floods, with larger floods overtopping the low blocks (Figure 13-8). The low blocks are blocks which are purposely lagged behind the other blocks. As with the tunnel option, sluices not incorporated into the appurtenant structures will need to be closed off and concrete backfilled at the end of the construction (Figure 13-9).

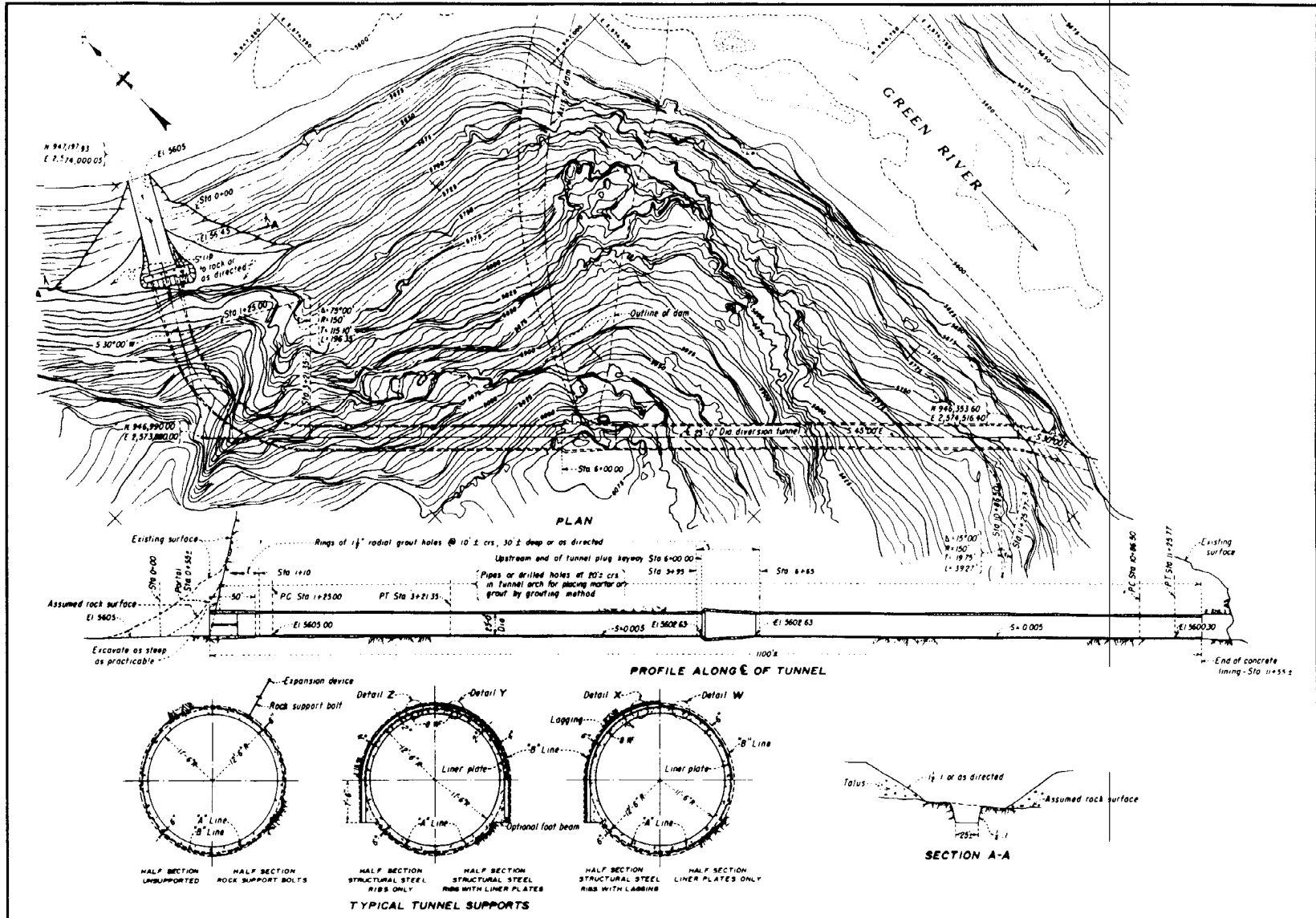

Figure 13-2. Diversion tunnel for Flaming Gorge Dam (USBR)

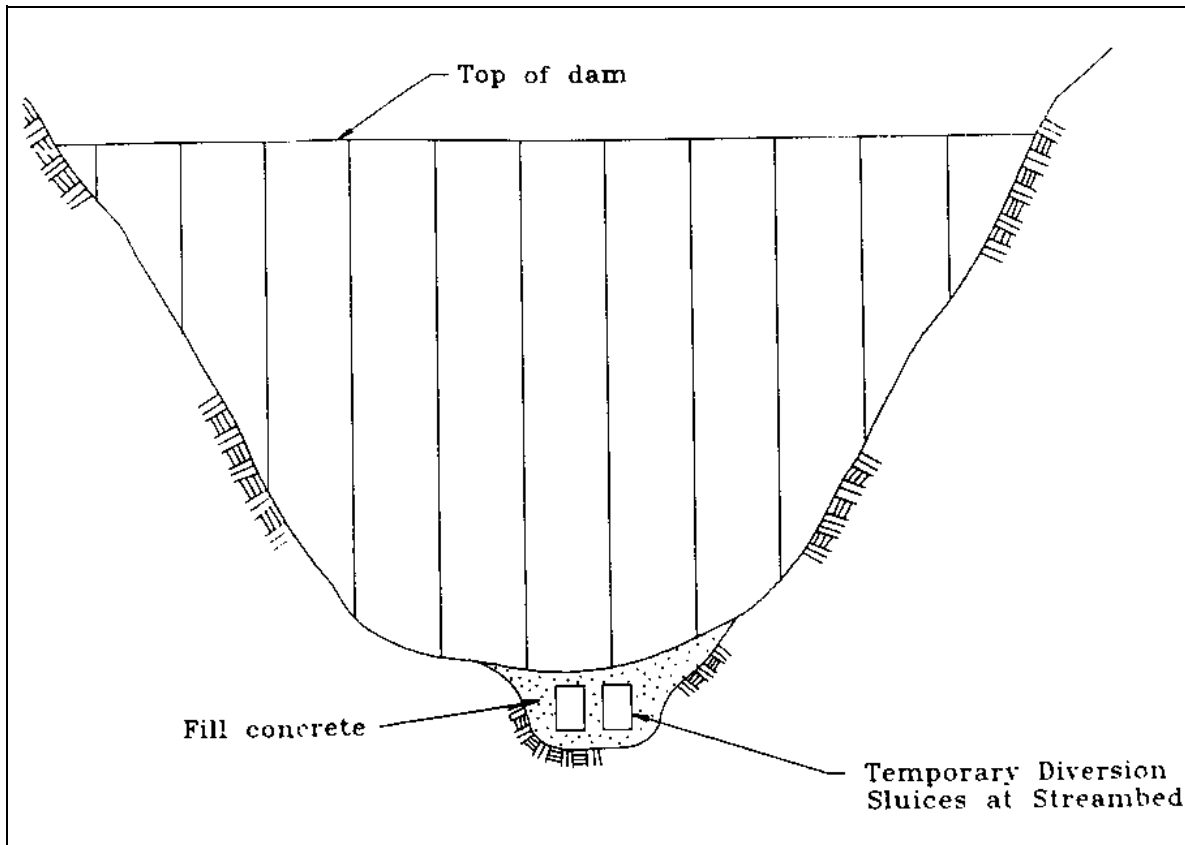

Figure 13-3. Diversion sluices through concrete pad at the base of a dam

13-3. Foundation Excavation. Excavation of the foundation for an arch dam will require that weak areas be removed to provide a firm foundation capable of withstanding the loads applied to it. Sharp breaks and irregularities in the excavation profile should be avoided (U.S. Committee on Large Dams 1988). Excavation should be performed in such manner that a relatively smooth foundation contact is obtained without excessive damage due to blasting. However, it is usually not necessary to over-excavate to produce a symmetrical site. A symmetrical site can be obtained by the use of restitutorial concrete such as dental concrete, pads, thrust blocks, etc. Chapter 3 discusses restitutorial concrete. Foundations that are subject to weathering and that will be left exposed for a period of time prior to concrete placement should be protected by leaving a sacrificial layer of the foundation material in place or by protecting the final foundation grade with shotcrete that would be removed prior to concrete placement.

13-4. Consolidation Grouting and Grout Curtain. The foundation grouting program should be the minimum required to consolidate the foundation and repair any damage done to the foundation during the excavation and to provide for seepage control. The final grouting plan must be adapted to suit field conditions at each site.

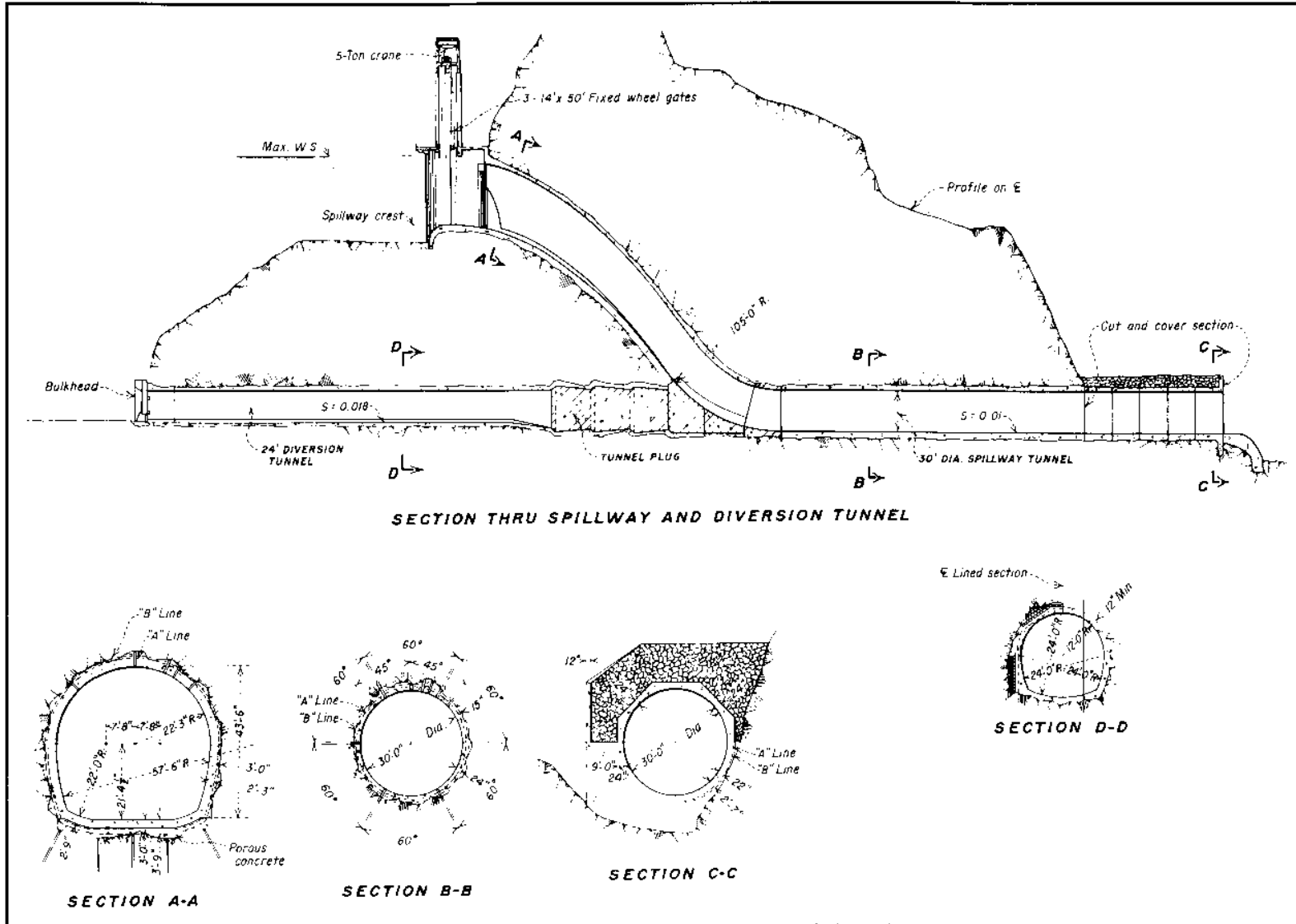

Figure 13-4. Typical diversion tunnel plug (USBR)

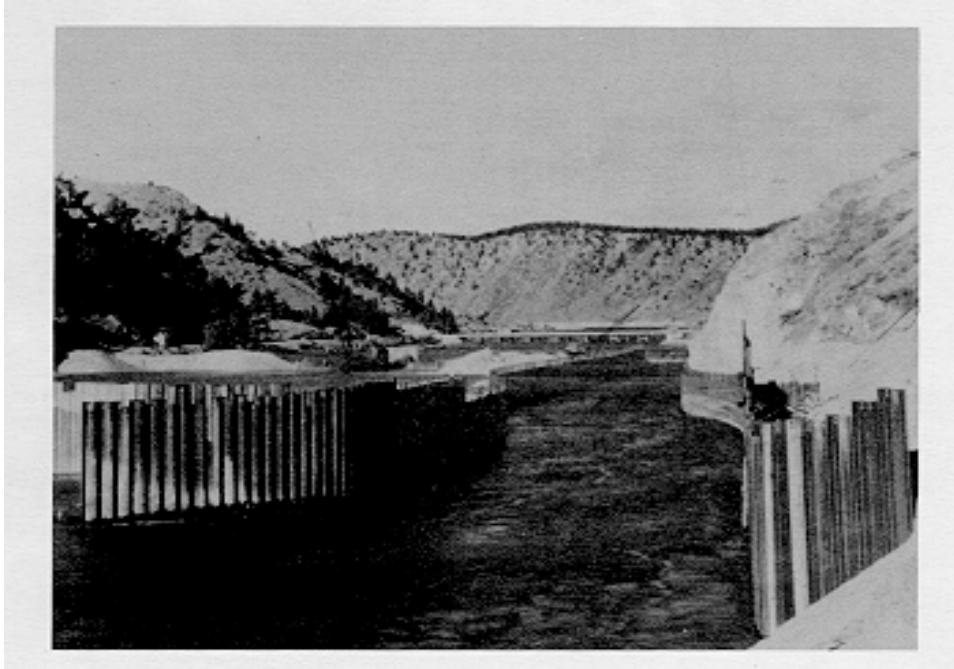

Figure 13-5. Complete diversion flume at Canyon Ferry damsite in use for first stage diversion (USBR)

a. Consolidation Grouting. Consolidation grouting consists of all grouting required to fill voids, fracture zones, and cracks at and slightly below the excavated foundation. Consolidation grouting is performed before any other grouting is done and is usually accomplished from the excavated surface using low pressures. In cases of very steep abutments, the grouting can be performed from the top of concrete placements to prevent "slabbing" of the rock. Holes should be drilled normal to the excavated surface, unless it is desired to intersect known faults, shears, fractures, joints, and cracks. Depths vary from 20 to 50 feet depending on the local conditions. A split-spacing process should be used to assure that all groutable voids, fracture zones, and cracks have been filled.

b. Grout Curtain. The purpose of a grout curtain is to control seepage. It is installed using higher pressures and grouting to a greater depth than the consolidation grouting. The depth of the grout curtain will depend on the foundation characteristics but will typically vary from 30 to 70 percent of the hydrostatic head. To permit the higher pressures, grout curtains are usually installed from the foundation gallery in the dam or from the top of concrete placements. If lower pressures in the upper portion can be used, the grout curtain can also be placed at foundation grade prior to concrete placement and supplemented by a short segment of grouting from the gallery to connect the dam and the previously installed curtain. Grout curtains can also be installed from adits or tunnels that extend into the abutments. The grout curtain should be positioned along the footprint of the dam in a region of zero or minimum tensile stress. It should extend into the foundation so that the base of the grout curtain is located at the vertical projection of the heel of the dam. To assist in the drilling operations, pipes are embedded in

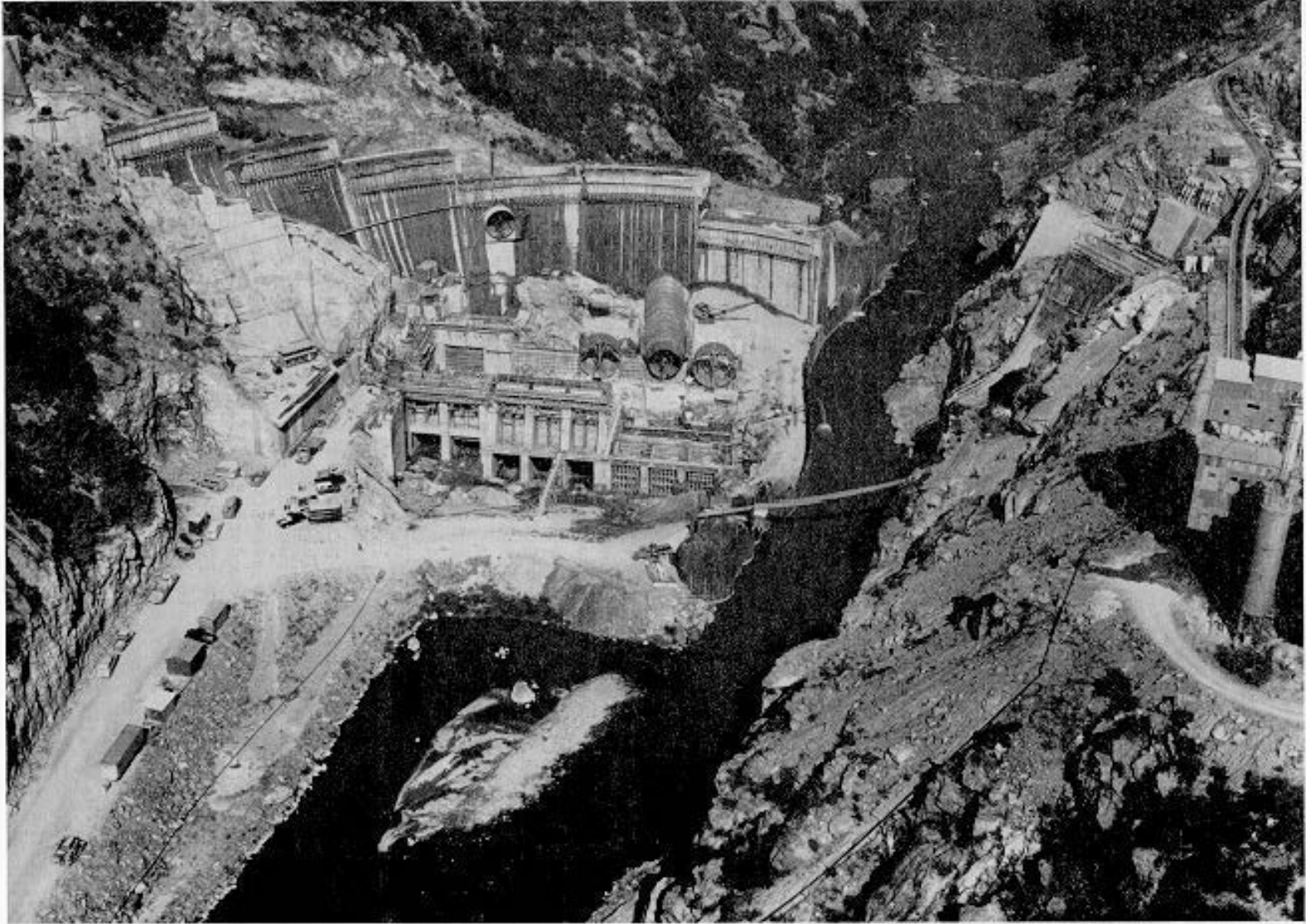

Figure 13-6. Channel used in the Phase I diversion for Smith Mountain Dam (photograph courtesy of Appalachian Power Company)

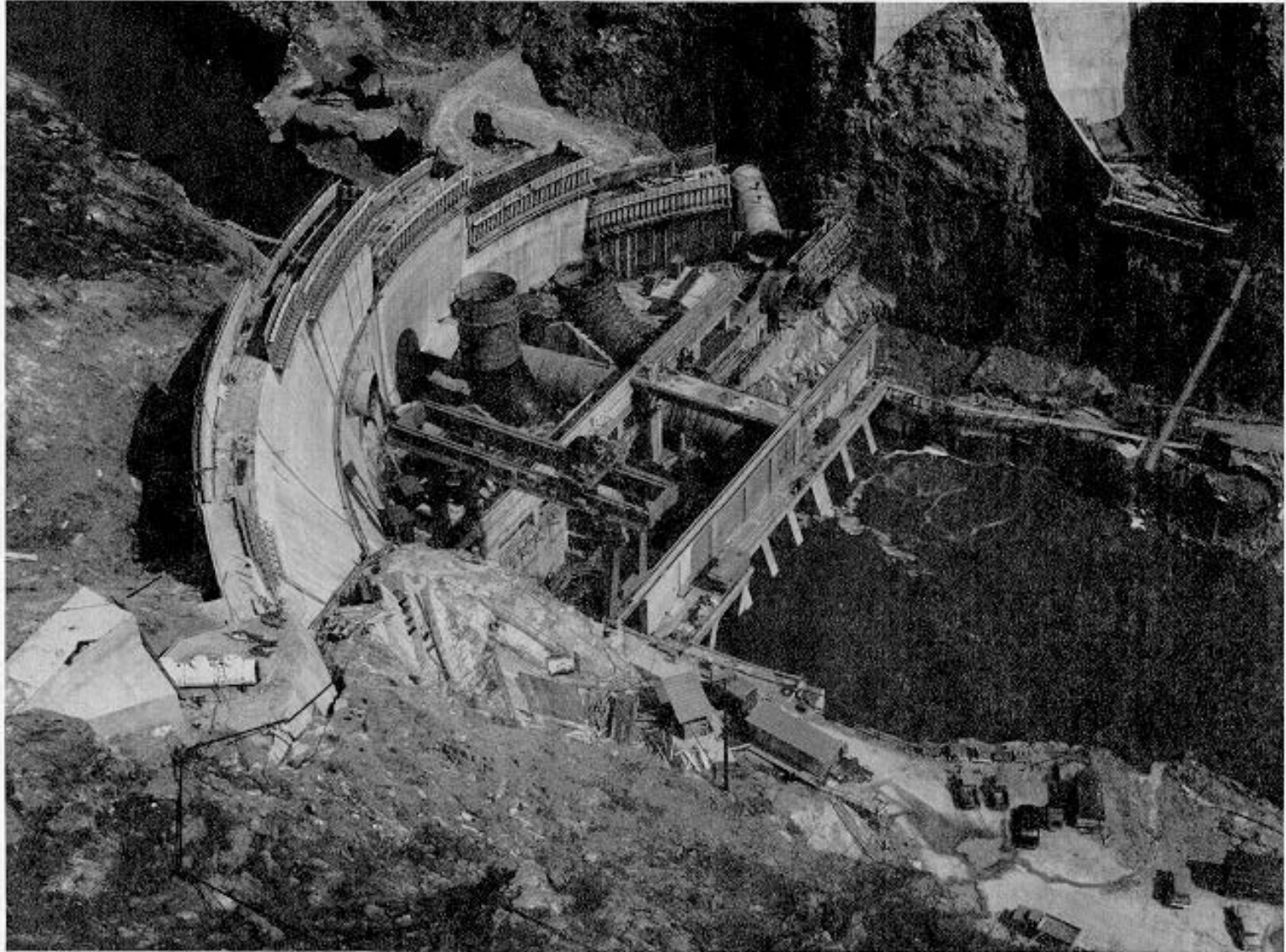

Figure 13-7. Sluice used in the Phase II diversion for Smith Mountain dam (photograph courtesy of Appalachian Power Company)

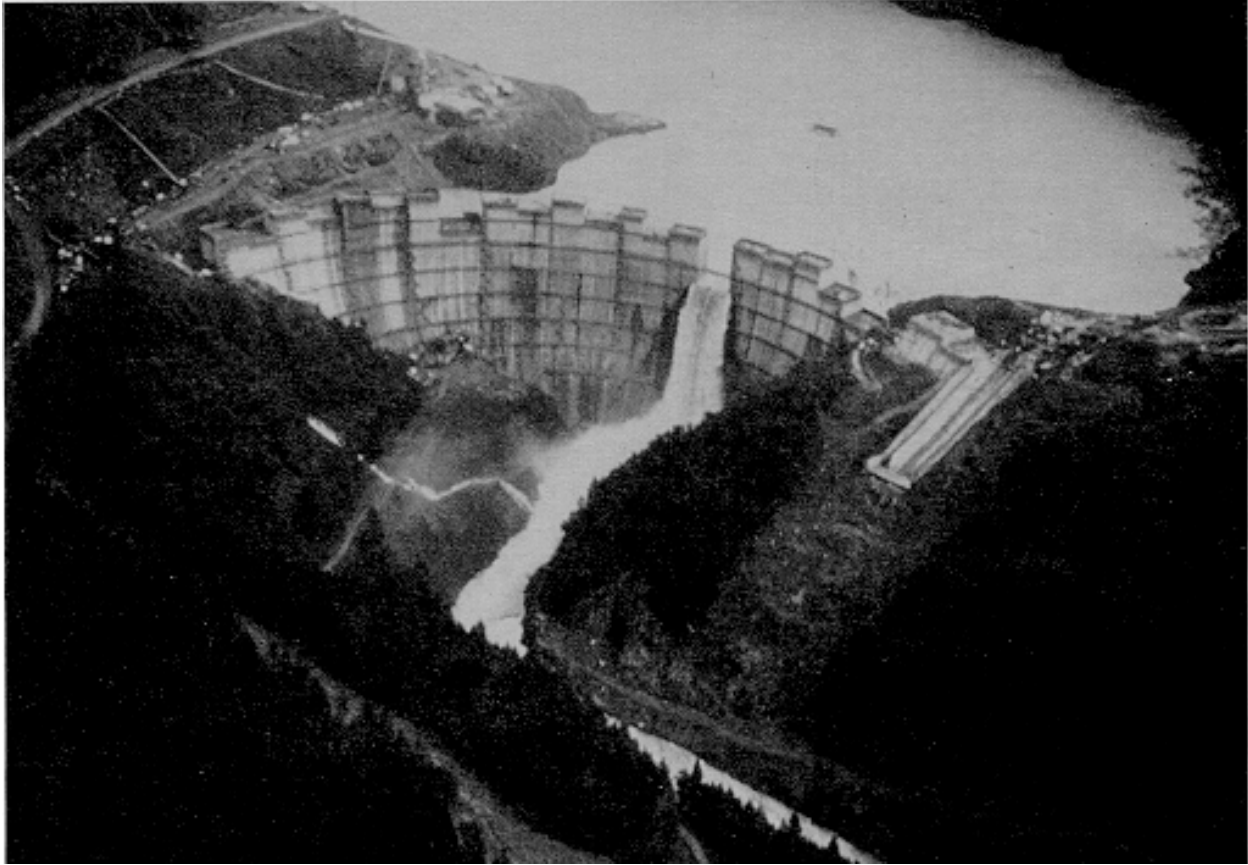

Figure 13-8. Aerial view of partially completed New Bullards Bar Dam in California showing water flowing over the low blocks (photograph courtesy of Yuba County Water Agency)

the concrete. Once the concrete placement has reached an elevation that the grouting pressure will not damage or lift the concrete, the grout holes are drilled through these pipes and into the foundation. Grout curtain operations should be performed before concrete placement starts or after the monolith joints have been grouted to prevent damage to the embedded grout stops and to prevent leakage into the monolith joints.

13-5. Concrete Operations. The concrete operations discussed in this section are the special concrete construction requirements for arch dams which are not covered in other chapters of this and other manuals. The topics of precooling and postcooling concrete are covered in Chapter 8. General concrete properties and mix design considerations are covered in Chapter 9. EM 1110-2-2000 discusses general concrete material investigations and specifications.

a. Formwork. Although modern arch dams are almost always curved in both plan and section, the forms used in constructing these dams are usually comprised of short, plane segments. The length of these segments correspond to the length of form panels, which should not exceed 8 feet. The detailed

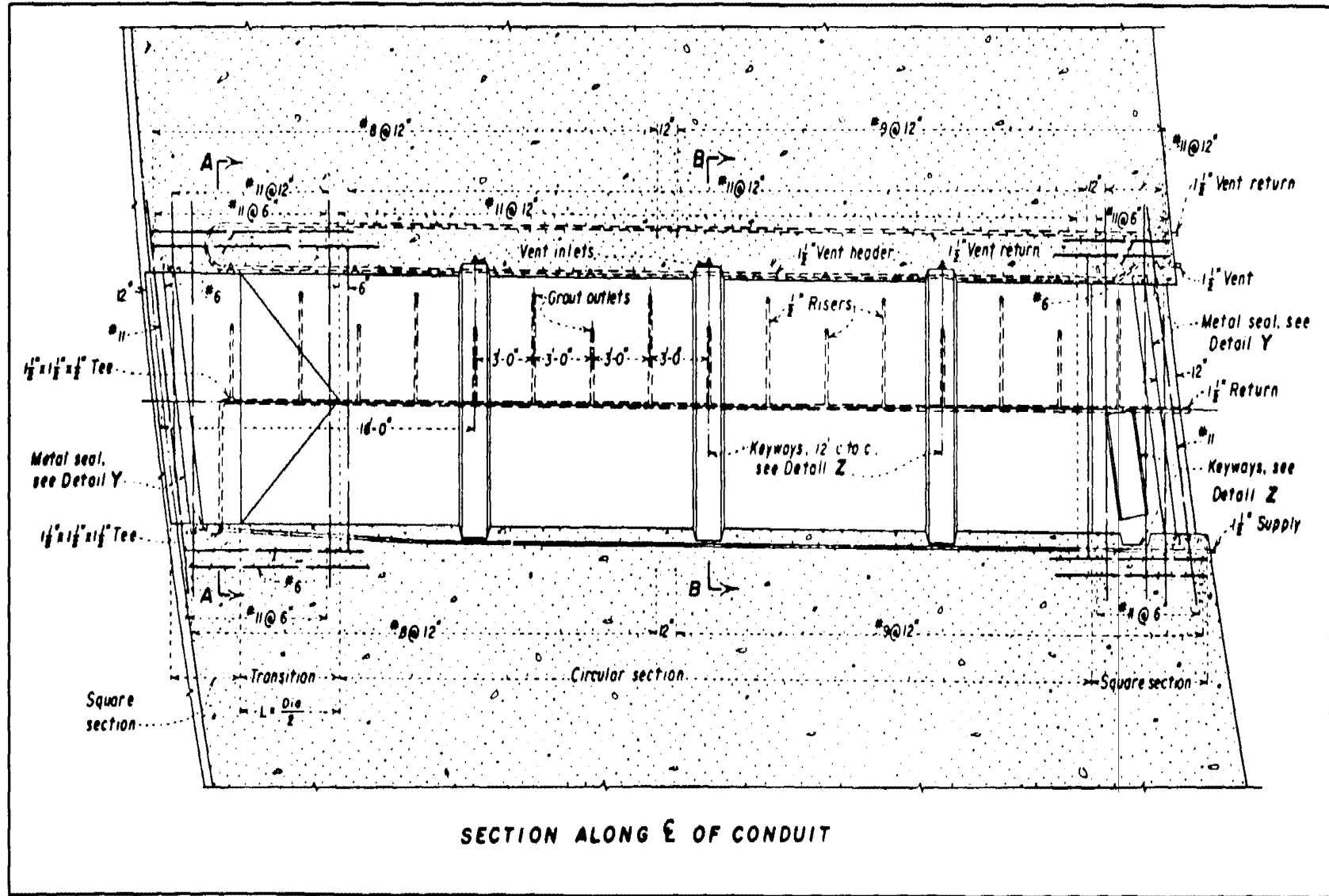

Figure 13-9. Diversion conduit through Morrow Point Dam (USBR) (Continued)

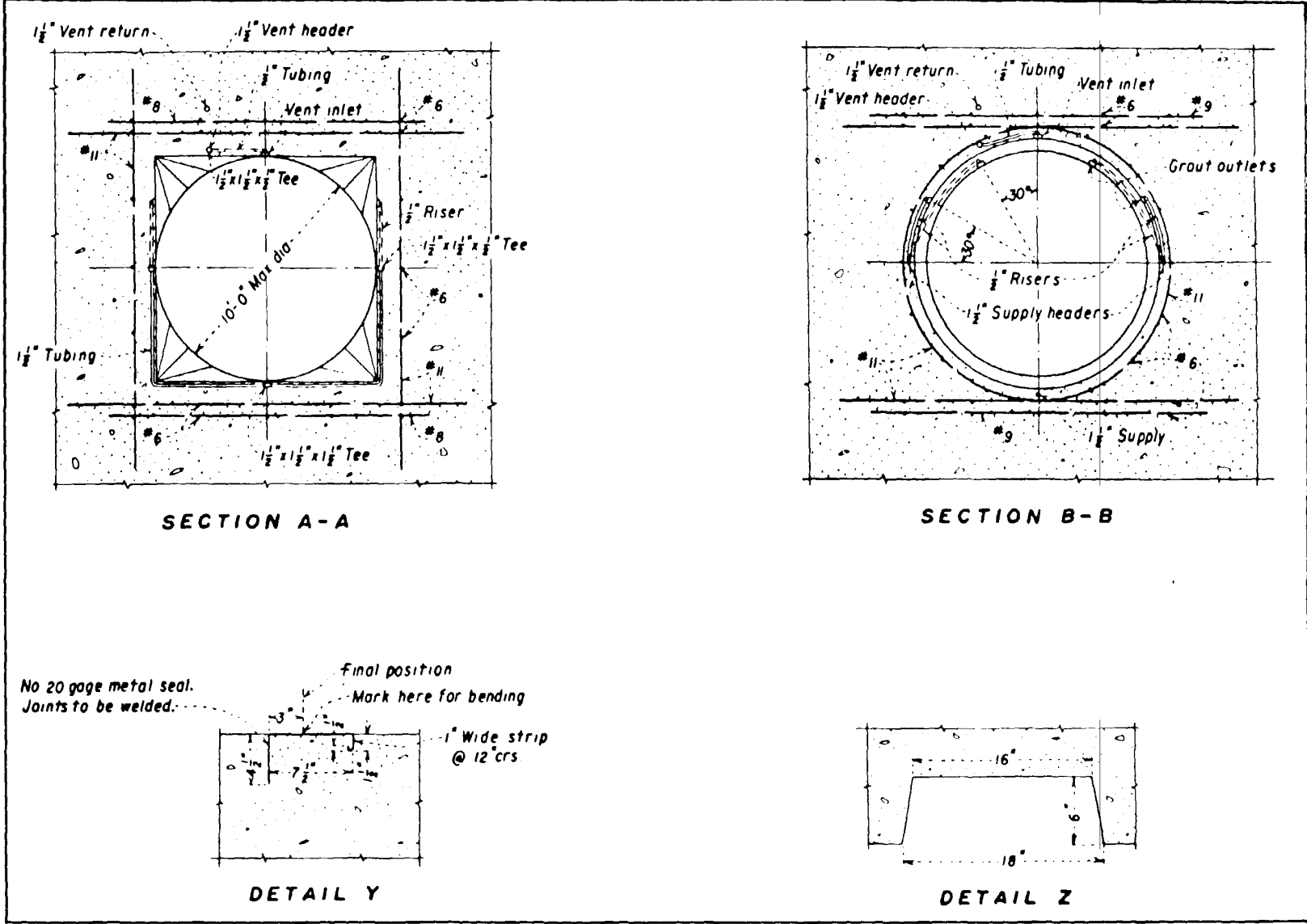

Figure 13-9. (Concluded)

13-12

positioning of the formwork is usually supplied to the contractor as part of the contract documents. The computer program Arch Dam Construction Program (ADCOP) has been developed to generate the information needed to establish the location of the formwork along the upstream and downstream faces of each lift. ADCOP is a PC based computer program which requires arch dam geometry information similar to the ADSAS program and generates data which will control layout of formwork for each monolith in the body of an arch dam. ADCOP generates contraction joints which are spiral in nature.

b. Height Differential. The maximum height differential between adjacent monoliths should be no more than 40 feet and no more than 70 to 100 feet between highest and lowest blocks in the dam. For dams with a pronounced overhang, limits should be placed on the placement of concrete with respect to ungrouted monoliths to avoid undesirable deflection and coincident tensile stresses.

c. Concrete Quality. The current trend in mass concrete construction is to minimize the use of cement by varying the concrete mixes used in different parts of the structure. This is usually done between the upstream and downstream faces and in areas of localized high stresses. For large dams, this practice can be very beneficial. For smaller dams, where the thicknesses are less than 30 feet, it may not be practical to vary the mix from the upstream to downstream faces. The benefits of adjusting the concrete mix for localized areas should be addressed, but the minimum requirements discussed in Chapter 9 should not be relaxed. Also, the effects of the differing cement contents created by these adjustments must be considered in the construction temperature studies discussed in Chapter 8.

d. Joint Cleanup. A good bond between horizontal construction joints is essential if cantilever tensile load transfer is to be achieved and leakage to the downstream face is to be minimized. Bond strength between lift lines can be almost as strong as the in-place concrete if the joints are properly prepared and the freshly placed concrete is well consolidated. Vertical contraction (monolith) joints that are to be grouted should be constructed so that no bond exists between the blocks in order that effective joint opening can be accomplished during the final cooling phase without cracking the mass concrete.

e. Exposed Joint Details. Joints should be chamfered at the exposed faces of the dam to give a desirable appearance and to minimize spalling.

13-6. Monolith Joints.

a. Spacing of Monolith Joints. The width of a monolith is the distance between monolith joints as measured along the axis of the dam. The determination of the monolith width will be part of the results of the closure temperature analysis discussed in Chapter 8. Once set, the monolith joint spacing should be constant throughout the dam if possible. In general, if the joints are to be grouted, monolith widths will be set at a value that allows for sufficient contraction to open the joints for grouting. However, there are limits to monolith widths. In recent construction, monolith widths have been commonly set at approximately 50 feet but with some structures having monoliths ranging from 30 to 80 feet. The USBR (1977) recommends that the ratio of the longer to shorter dimensions of a monolith be between 1 and 2.

Therefore, a dam with a base thickness of 30 feet could have a maximum monolith width of 60 feet. However, the thickness of the base of a dam will vary significantly as the dam progresses from the crown cantilever up the abutment contacts. Near the upper regions of the abutment contacts, the base thickness of the dam will drop to a value close to the thickness of the crest. If a dam has a base thickness of 30 feet at the crown cantilever and a crest thickness of only 10 feet, then the limit on the monolith width at the crown cantilever will be 60 feet while the limit near the ends of the dam would be 20 feet. Since monolith spacing must be uniform throughout the dam, the maximum limit can be set at the higher value determined for the crown cantilever, with the understanding that some cracking could be expected along the abutment contacts near the ends of the dam. In any case, the joint spacing should never exceed 80 feet.

b. Lift Heights. Lift heights are typically set at 5, 7.5, or 10 feet. This height should be uniform as the construction progresses from the base.

c. Water stops and Grout stops. The terms water stop and grout stop describe the same material used for different purposes. A water stop is used to prevent seepage from migrating through a joint, typically from the upstream face of the dam to the downstream face. A grout stop is used to confine the grout within a specified area of a joint. The materials used in water stops and grout stops are covered in EM 1110-2-2102. General layout for the water stops/grout stops for a grouted dam is shown in Figure 13-10. Figure 13-20 also shows a typical layout at the upstream face for ungrouted cases where a joint drain is added. Proper installation and protection of the water stop/grout stop during construction is as important as the shape and material.

d. Shear Keys. Shear keys are installed in monolith joints to provide shearing resistance between monoliths. During construction they also help maintain alignment of the blocks, and they may help individual blocks "bridge" weak zones within the foundation. Vertical shear keys, similar to those shown in Figure 13-11, will also increase the seepage path between the upstream and downstream faces. Other shapes of shear key, such as the dimple, waffle, etc., shown in Figures 13-12 and 13-13, have also been used. The main advantage in these other shaped keys is the use of standard forms and, in the case of the dimple shape, less interference with the grouting operations. However, these other shapes provide additional problems in concrete placement and are not as effective in extending the seepage path as are the vertical keys.

e. Vertical Versus Spiral Joints. Arch dams can be constructed with either vertical or spiral radial contraction joints. Vertical radial joints are created when all monolith joints, at each lift, are constructed on a radial line between the dam axis and the axis center on the line of centers (see Chapter 5 for definition of dam axis and axis center). Therefore, when looking at a plan view of a vertical joint, the joints created at each construction lift will fall on the same radial line. Spiral joints are created when the monolith joints, at each lift, are constructed on a radial line between the dam axis and with the intrados line of centers for that lift elevation. Therefore, when looking at a plan view of a spiral joint, each joint created at each construction lift will be slightly rotated about the dam axis. Spiral radial joints will also provide some keying of the monoliths, while vertical radial joints will not.

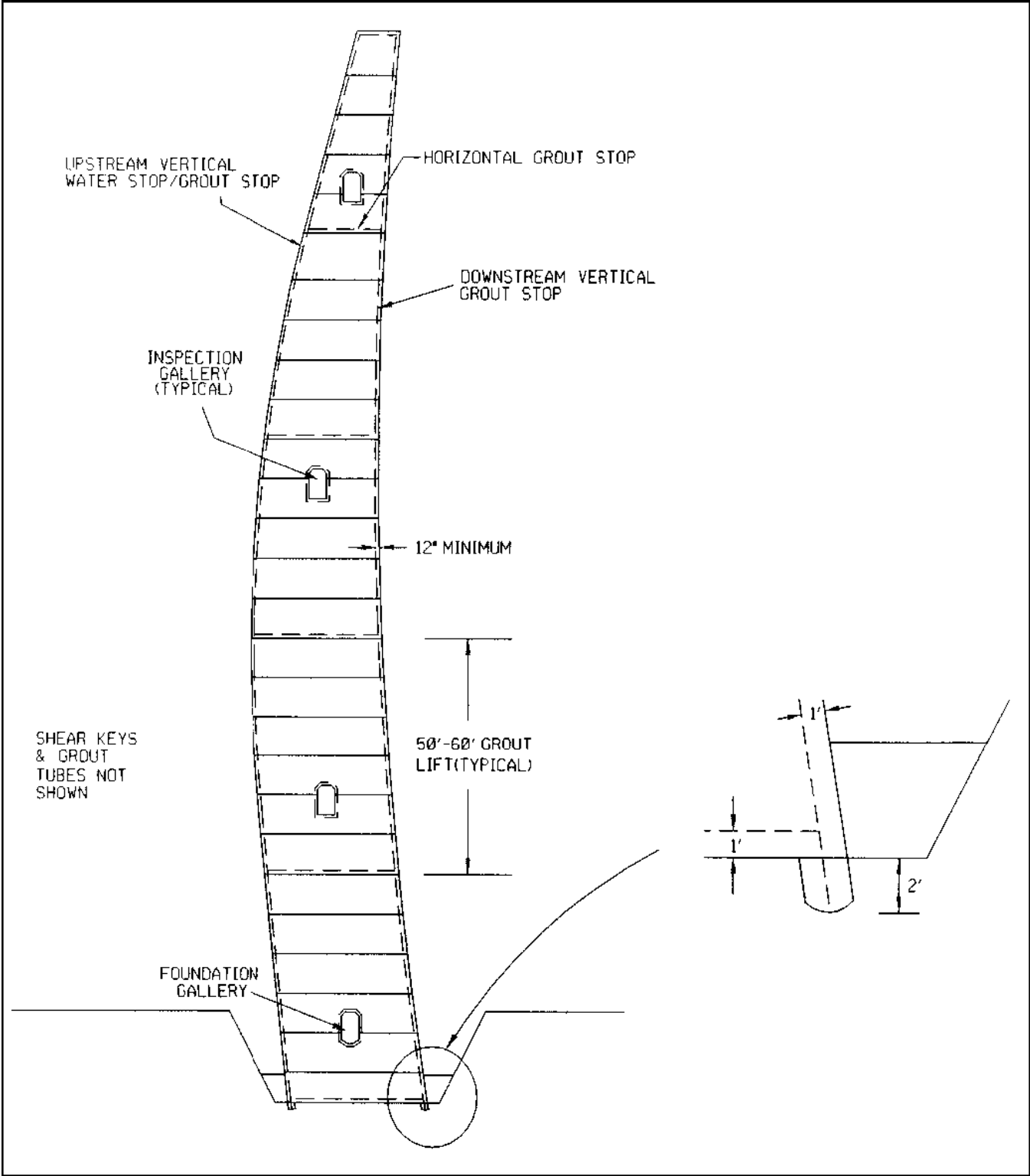

Figure 13-10. Water stop and grout stop details

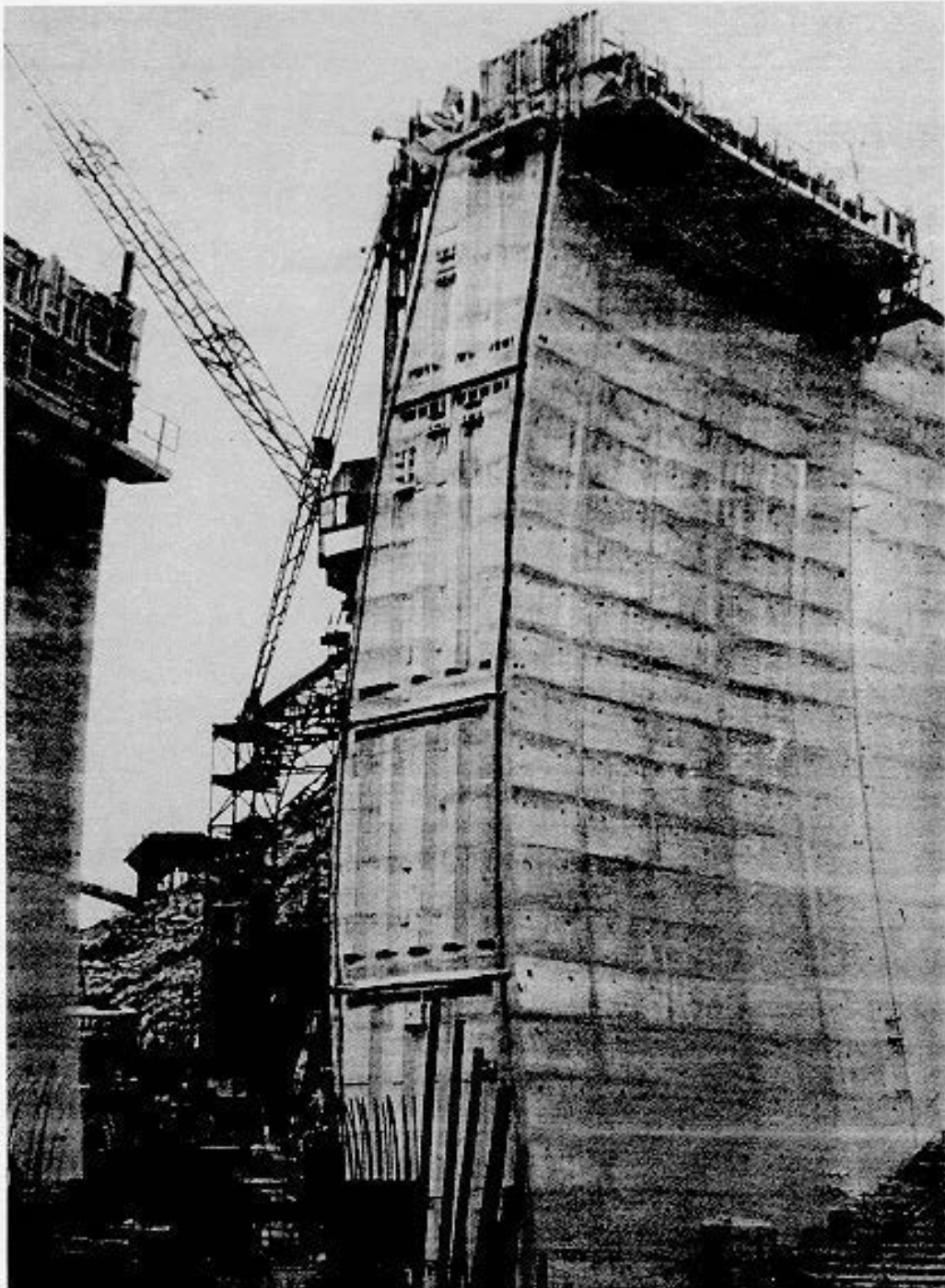

Figure 13-11. Vertical keys at monolith joints of Monar Dam,
Scotland

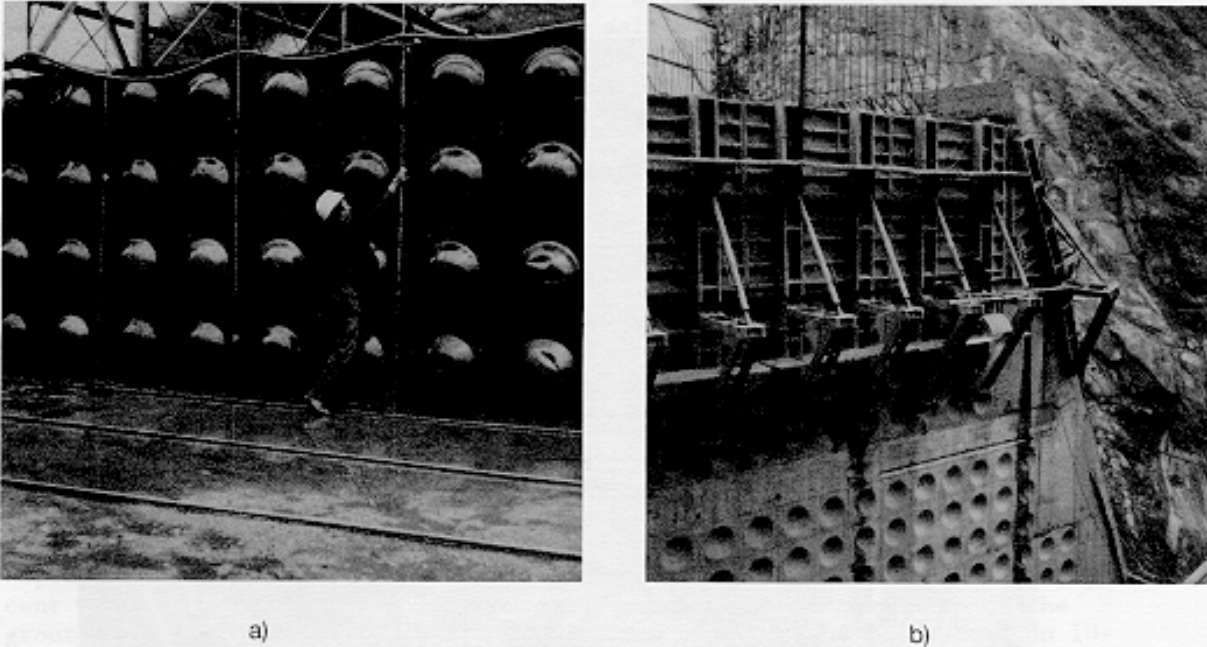

Figure 13-12. Dimple shear keys

f. Monolith Joint Grouting. The purpose of grouting monolith joints is to provide a monolithic structure at a specified "closure temperature." To accomplish this, grout is injected into the joint by a means of embedded pipes similar to those shown in Figures 13-14 and 13-15. To ensure complete grouting of the joint prior to grout set, and to prevent excessive pressure on the seals and the blocks, grout lifts are usually limited to between 50 and 60 feet.

(1) Joint Opening for Grouting. The amount that a joint will open during the final cooling period will depend upon the spacing of the monolith joints, the thermal properties of the concrete, and the temperature drop during the final cooling period. The typical range of joint openings needed for grouting is 1/16 to 3/32 inch. With arch dams, where it is desirable to have a monolithic structure that will transfer compressive loads across the monolith joints, it is better to have an opening that will allow as thick a grout as practical to be placed. A grout mixture with a water-cement ratio of 0.66 (1 to 1 by volume) will usually require an opening on the higher side of the range given (Water Resources Commission 1981). In the initial design process, a required joint opening of 3/32 inch should be assumed.

(2) Layout Details. The supply loop at the base of the grout lift provides a means of delivering the grout to the riser pipes. Grout can be injected into one end of the looped pipe. The vertical risers extend from the supply loop at 6-foot intervals. Each riser contains outlets spaced 10 feet on centers, which are staggered to provide better grout coverage to the joint.

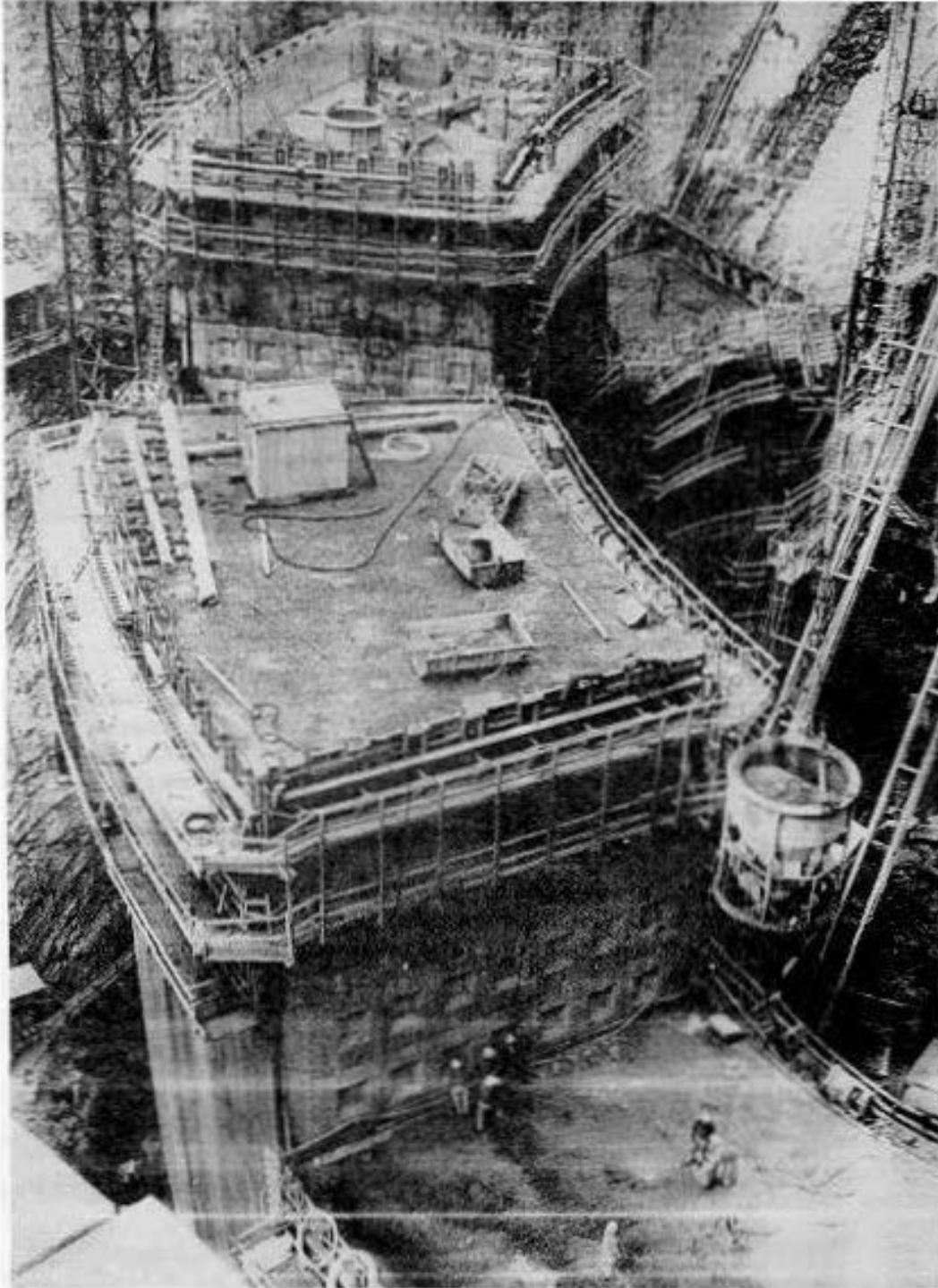

Figure 13-13. Waffle keys at the vertical monolith joints of Gordon Dam, Australia

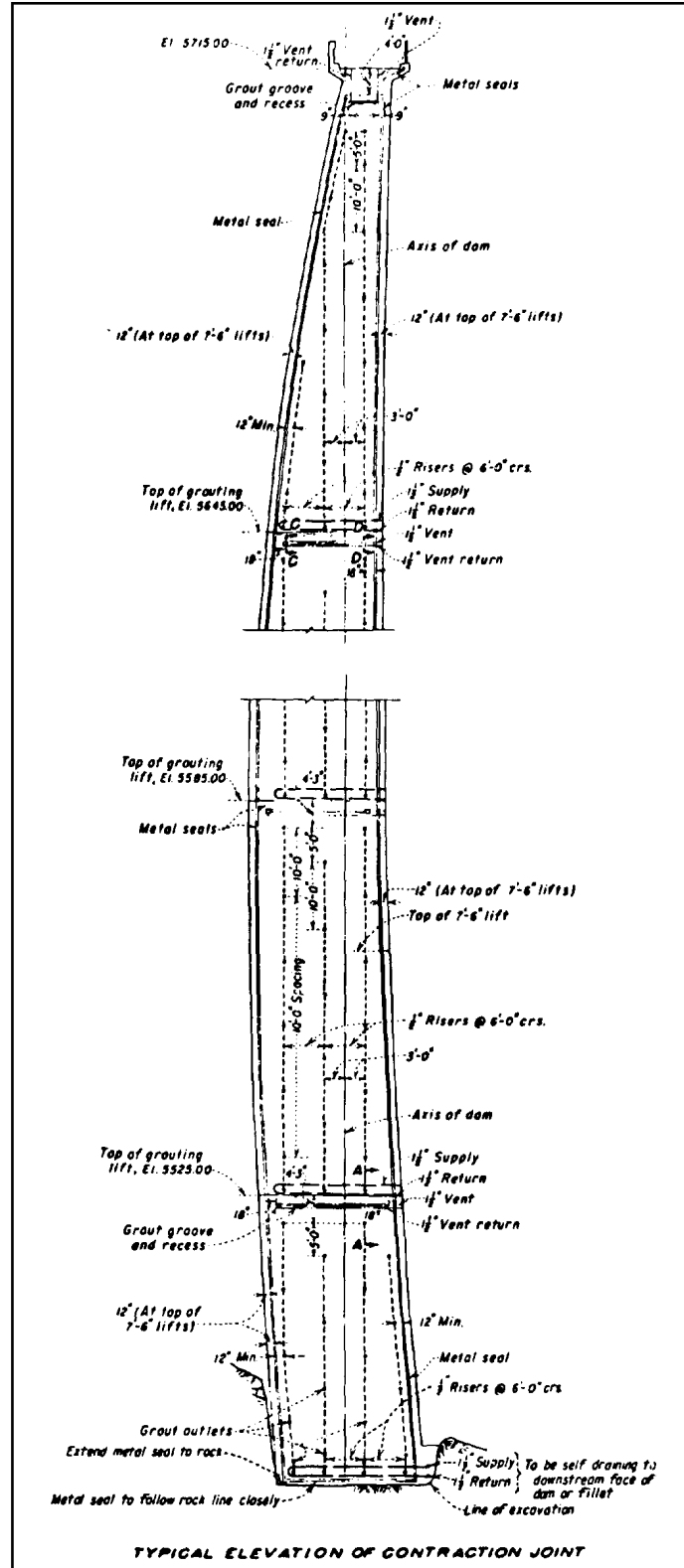

Figure 13-14. Contraction joint and grouting system for East Canyon Dam (USBR) (Continued)

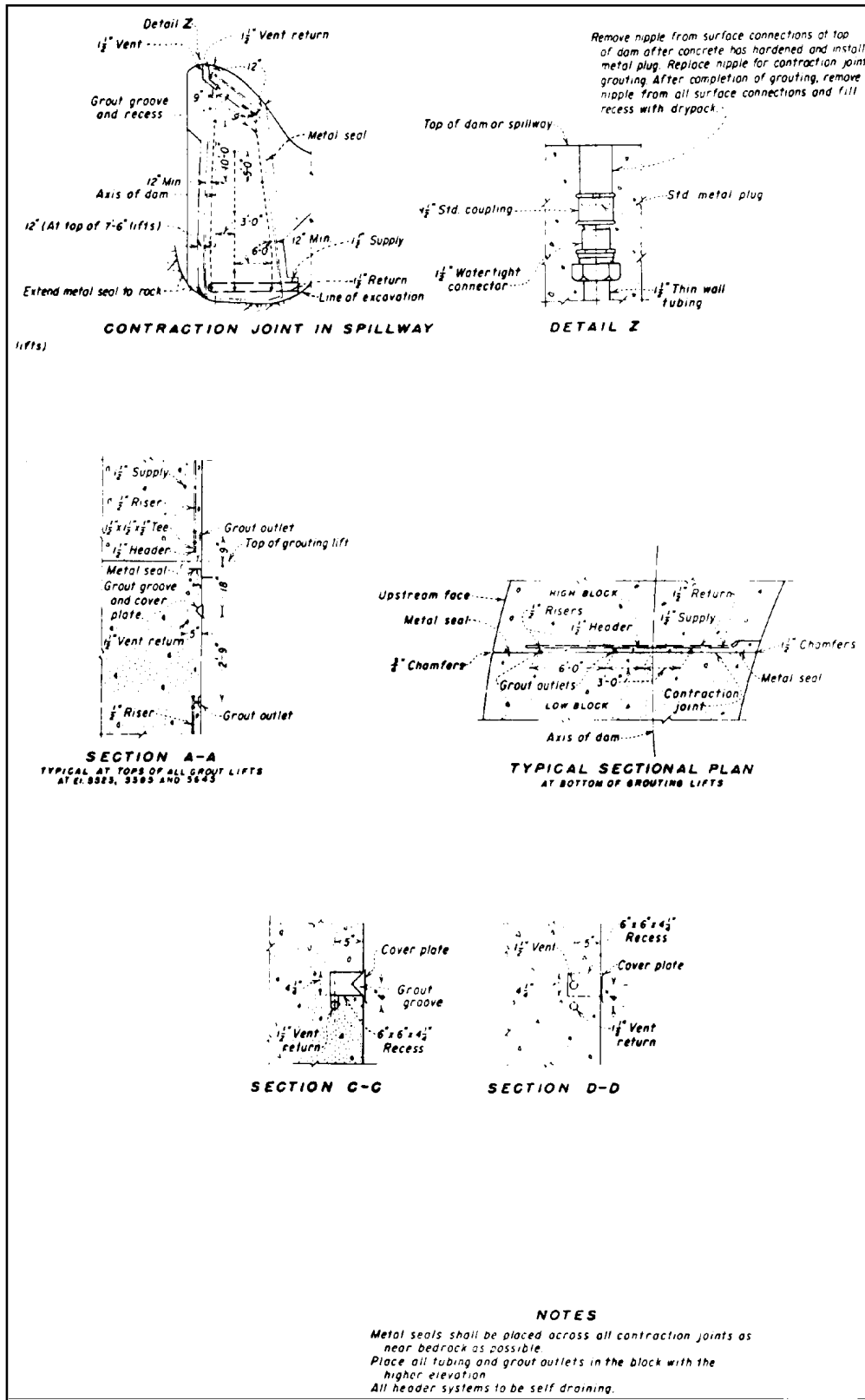

Figure 13-14. (Concluded)

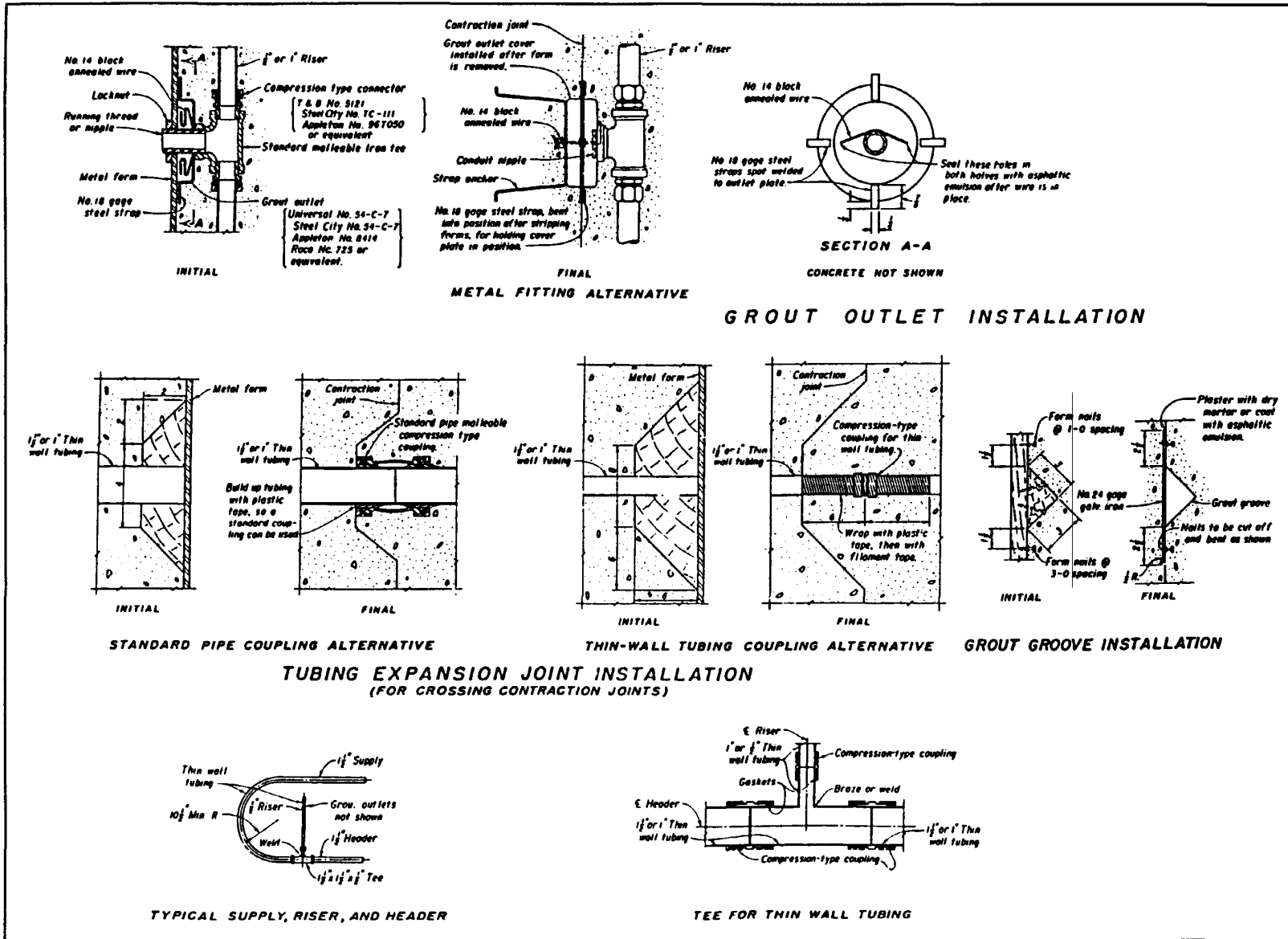

Figure 13-15. Example of grouting system details (USBR) (Continued)

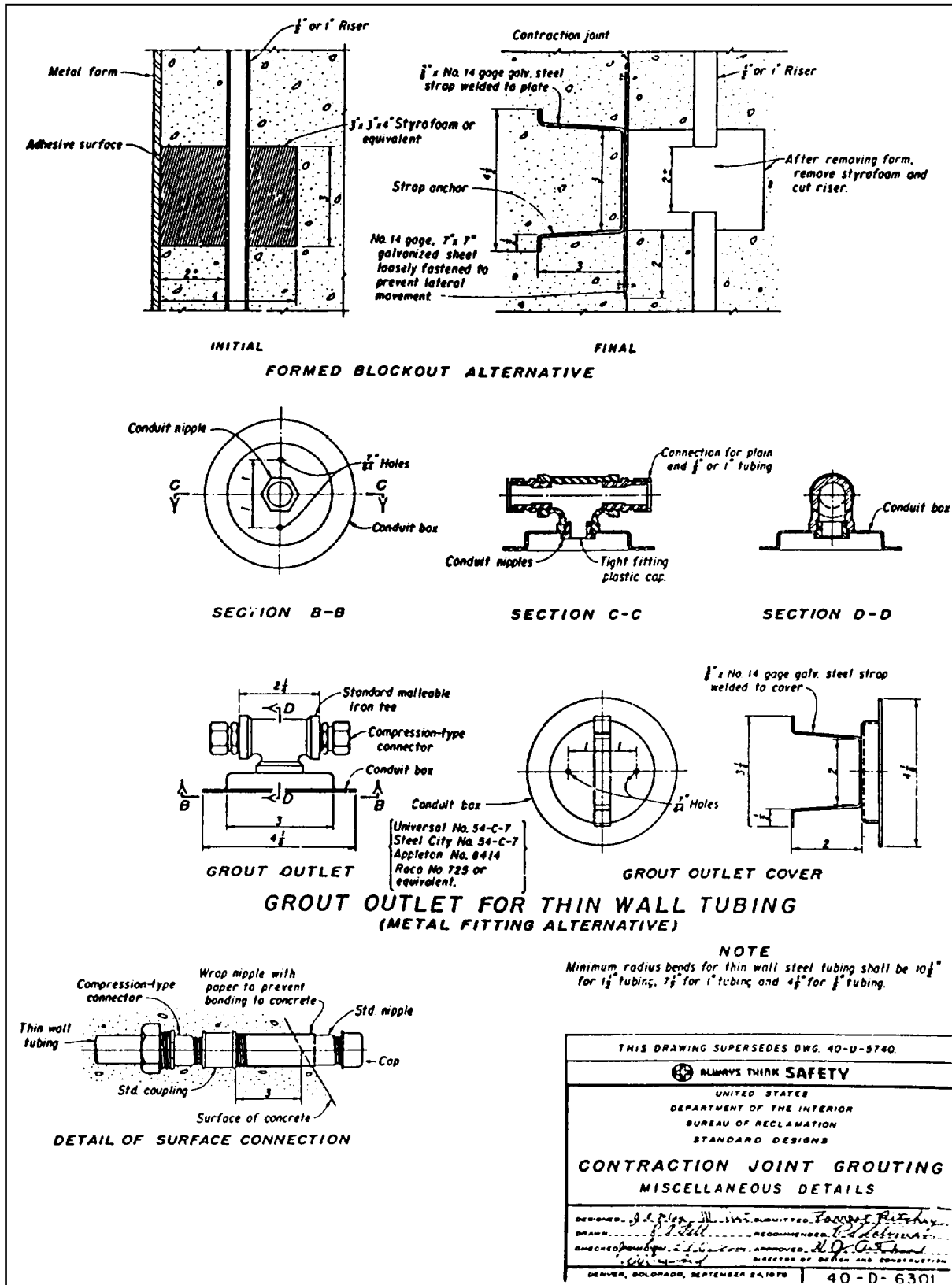

Figure 13-15. (Concluded)

The risers are discontinued near the vent loop (groove) provided at the top of the grout lift. Vent pipes are positioned at each end of the vent groove to permit air, water, and thin grout to escape in either direction. Normally, these systems are terminated at the downstream face. Under some conditions, they can be terminated in galleries. The ends of the pipes have nipples that can be removed after completion of the grouting and the remaining holes filled with dry pack. Typical grout outlet and vent details are shown in Figures 13-14 and 13-15.

(3) Preparation for Grouting. Prior to grouting, the system is tested to assure that obstructions do not exist. The monolith joint is then cleaned with air and water under pressure. The joint is filled with water for a period of 24 hours. The water is drained from the joint to be grouted. Joints of two or more ungrouted joints on either side are filled with water, but not pressurized. Once the grout reaches the top of the grout lift, the lift above is filled with water to protect the upper grout stop. Immediately after a grouting operation is completed, the water is drained from the joints in the lift above. Water in the adjacent ungrouted joints should remain in place for at least 6 hours after the grouting operation is completed.

(4) Grout Mix. The grout should consist of the thickest mix that will enter the joint, fill all of the small voids, and travel to the vent. Grout mixes usually vary from water-cement ratios of 2 to 1 by volume (1.33 by weight) at the start of the grouting operation to thicker mixes (1 to 1 by volume or 0.66 by weight) as the operation progresses. If the joints are sufficiently open to accept a thicker grout, then mixes with ratios of 0.70 to 1 by volume (0.46 by weight) should be used to finish the job.

(5) Grouting Operation. Grout is injected in the supply loop at the bottom of the grout lift so that grout first comes in contact with the riser farthest from the supply portal. This will allow for the most favorable expulsion of air, water, and diluted grout as the grouting operation progresses. Once the grout appears at the return end of the supply loop, the return end is closed and the grout is forced up the risers and into the joint. The grouting must proceed at a rate fast enough that the grout will not set before the entire joint is filled with a thick grout. However, the rate of grouting must also be slow enough to allow the grout to settle into the joint. When thick grout reaches one end of the vent loop at the top of the grout lift, grouting operations are stopped for a short time (5 to 10 minutes) to allow the grout to settle in the joint. After three to five repetitions of a showing of thick grout, the valves are closed and the supply pressure increased to the allowable limit (usually 30 to 50 psi) to force grout into all small openings of the joint and to force the excess water into the pores of the concrete, leaving a grout film of lower water-cement ratio and higher density in the joint. The limiting pressure is set at a value that will avoid excessive deflection in the block and joint opening in the grouted portions below the joint. The system is sealed off when no more grout can be forced into the joint as the pressure is maintained.

13-7. Galleries and Adits.

a. General. Adits are near horizontal passageways that extend from the surface into the dam or foundation. Galleries are the internal passageways within the dam and foundation and can be horizontal, vertical, or sloped.

Chambers or vaults are created when galleries are enlarged to accommodate equipment. Galleries serve a variety of purposes. During construction, they can provide access to manifolds for the concrete postcooling and grouting operations. The foundation gallery also provides a work space for the installation of the grout and drainage curtains. During operation, galleries provide access for inspection and for collection of instrumentation data. They also provide a means to collect the drainage from the face and gutter drains and from the foundation drains. Galleries can also provide access to embedded equipment such as gates or valves. However, with all the benefits of galleries, there are also many problems. Galleries interfere with the construction operations and, therefore, increase the cost of construction. They provide areas of potential stress concentrations, and they may interfere with the proper performance of the dam. Therefore, galleries, as well as other openings in the dam, should be minimized as much as possible.

b. Location and Size. Typical galleries are 5 feet wide by 7.5 feet high. Figure 13-16 shows the most typical shapes of galleries currently being used. Foundation galleries are somewhat larger to allow for the drilling and grouting operations required for the grout and drainage curtains. Foundation galleries can be as large as 6 feet wide by 8.5 feet high. Personnel access galleries, which provide access only between various features within the dam, can be as small as 3 feet wide by 7 feet high. Spiral stairs should be 6 feet 3 inches in diameter to accommodate commercially available metal stairs.

c. Limitations of Dam Thickness. Galleries should not be put in areas where the thickness of the dam is less than five times the width of the gallery.

d. Reinforcement Requirements. Reinforcement around galleries is not recommended unless the gallery itself will produce localized high tensile stresses or if it is positioned in an area where the surrounding concrete is already in tension due to the other external loads being applied to it. Even under these conditions, reinforcement is only required if the cracking produced by these tensions is expected to propagate to the reservoir. Reinforcement will also be required in the larger chambers formed to accommodate equipment.

e. Layout Details (Figure 13-17). Gallery and adit floors should be set at the top of a placement lift for ease of construction. Galleries should be at a slope comfortable for walking. Ramps can be used for slopes up to 10 degrees without special precautions and up to 15 degrees if nonslip surfaces are provided. Stairs can be used for slopes up to 40 degrees. Spiral stairs or vertical ladders can be used in areas where slopes exceed these limits. Landings should be provided approximately every 12 vertical feet when spiral stairs or ladders are used. Landings should also be provided in stairways if at all possible. Handrails should be provided in all galleries where the slope is greater than 10 degrees. There should be a minimum of 5 feet between the floor of the foundation gallery and the rock interface. There should also be a minimum 5-foot spacing between a gallery or adit and the monolith joints and external faces. The preferable location of the galleries is near the center of the monolith to minimize its impact on the section modulus of the cantilever. As a minimum, galleries should be located away from the upstream face at a distance that corresponds to 5 percent of the hydrostatic head.

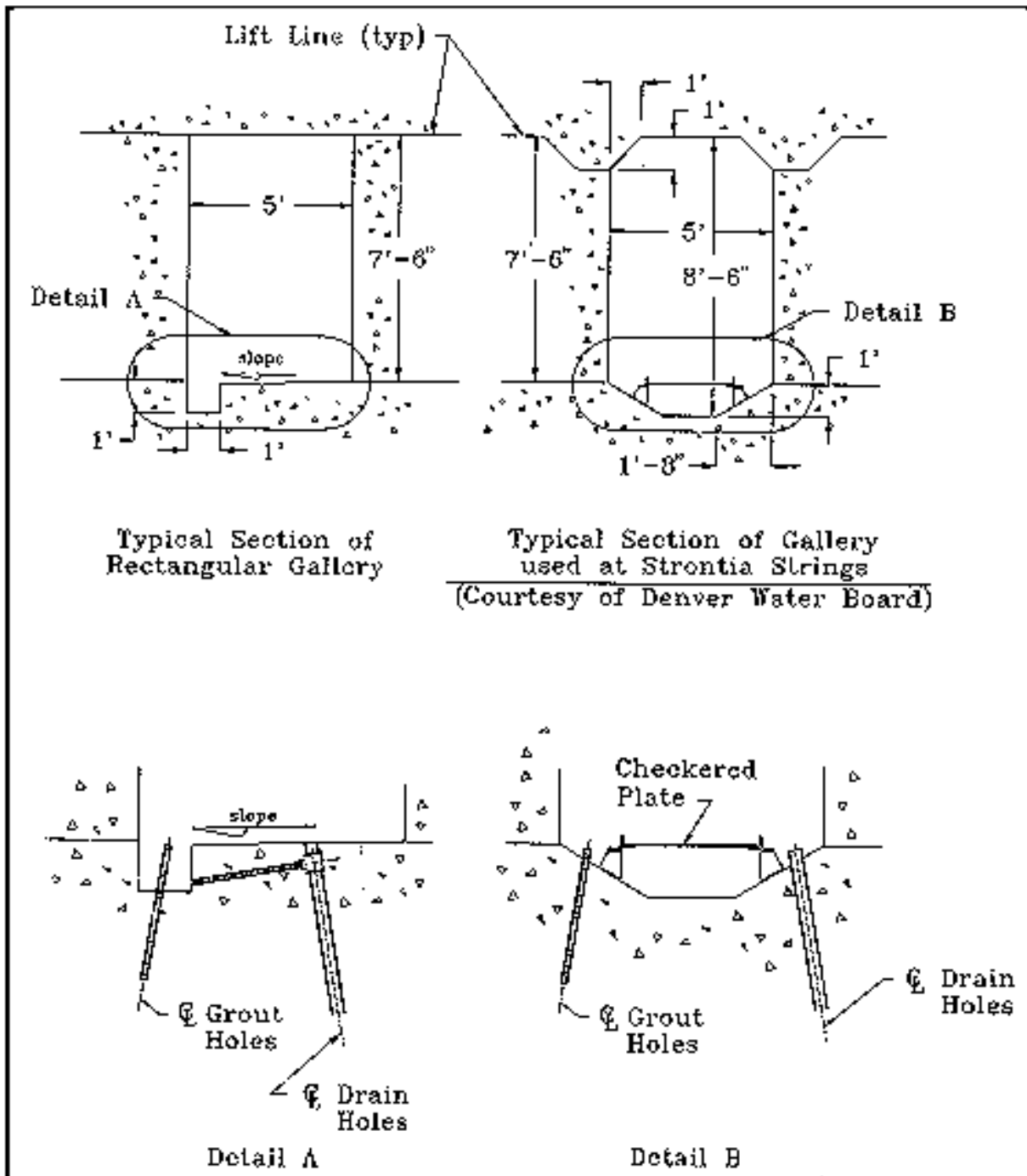

Figure 13-16. Typical gallery details

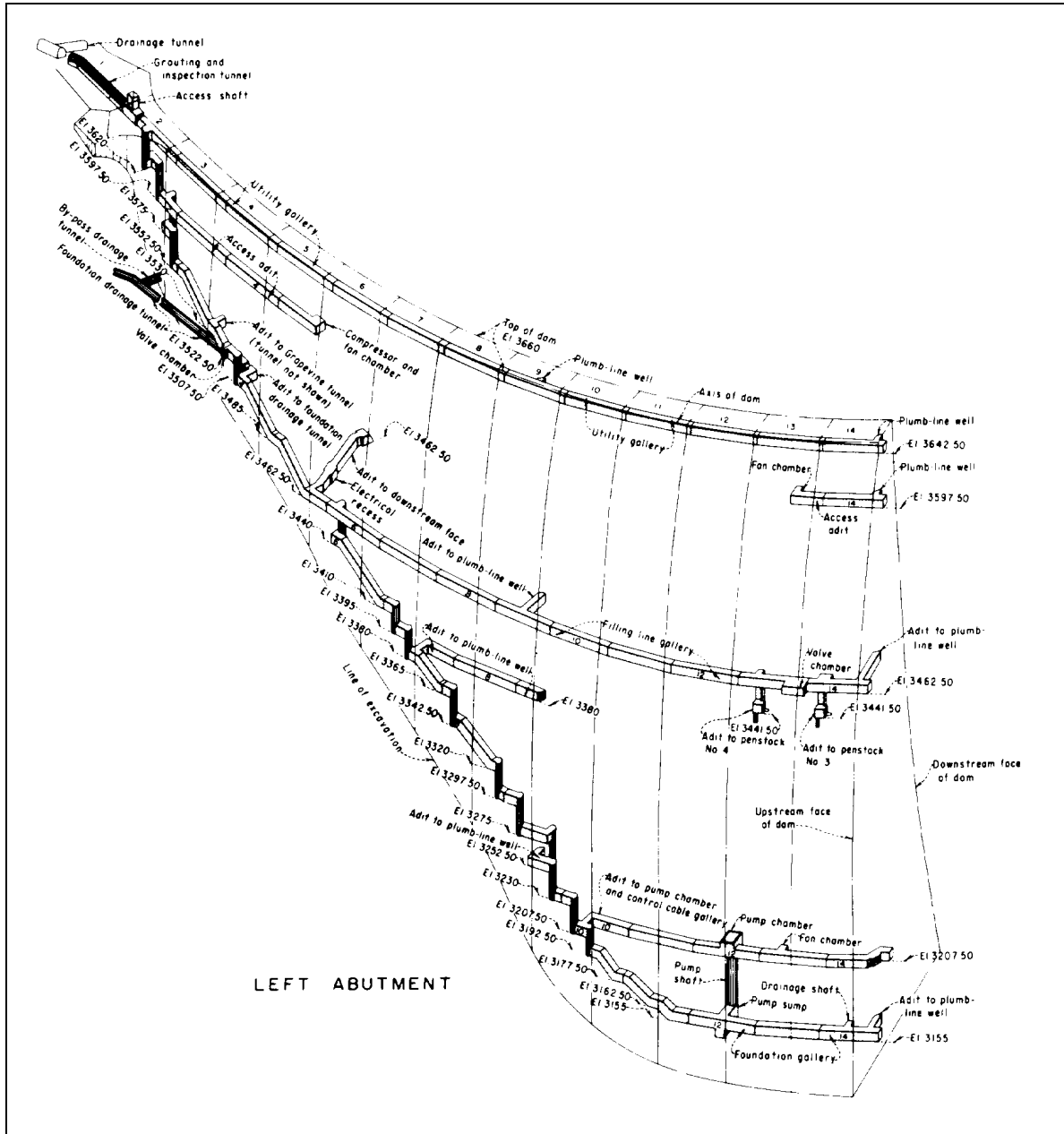

Figure 13-17. Left abutment gallery system for Yellowtail Dam (USBR)

f. Utilities. Water and air lines should be embedded in the concrete to help in future maintenance operations. Lighting and ventilation should also be provided for the convenience and safety of personnel working in the galleries. Telephones should be located in gate rooms or chambers within the dam, as well as scattered locations throughout the galleries, for use in emergencies and for convenience of operation and maintenance personnel.

13-8. Drains. Drains fall into two categories: foundation drains and embedded drains. Embedded drains include face drains, gutter drains, and joint drains. All arch dams should include provisions for foundation drains and for face and gutter drains. Joint drains are not recommended if the monolith joints are to be grouted because they can interfere with the grouting process. Providing water/grout stops on each side of the drain help alleviate that problem, but the addition of the drain and the grout stop reduces the available contact area between the grout and mass concrete and thereby reduces the area for load transfer between adjacent monoliths.

a. Foundation drains. Foundation drains provide a way to intercept the seepage that passes through and around the grout curtain and thereby prevents excessive hydrostatic pressures from building up within the foundation and at the dam/foundation contact. The depth of the foundation drains will vary depending on the foundation conditions but typically ranges from 20 to 40 percent of the reservoir depth and from 35 to 75 percent of the depth of the grout curtain. Holes are usually 3 inches in diameter and are spaced on 10-foot centers. Holes should not be drilled until after all foundation grouting in the area has been completed. Foundation drains are typically drilled from the foundation gallery, but if no foundation gallery is provided, they can be drilled from the downstream face. Foundation drains can also be installed in adits or tunnels that extend into the abutments.

b. Face Drains. Face drains are installed to intercept seepage along the lift lines or through the concrete. They help minimize hydrostatic pressure within dam as well as staining on the downstream face. Face drains extend from the crest of the dam to the foundation gallery. If there is no foundation gallery, then the drains are extended to the downstream face and connected to a drain pipe in the downstream fillet. They should be 5 or 6 inches in diameter and located 5 to 10 feet from upstream face. If the crest of the dam is thin, the diameter of the drains can be reduced and/or the distance from the upstream face can be reduced as they approach the crest. Face drains should be evenly spaced along the face at approximately 10 feet on centers (Figure 13-18).

c. Gutter Drains. Gutter drains are drains that connect the gutters of the individual galleries to provide a means of transporting seepage collected in the upper galleries to the foundation gallery and eventually to the downstream face or to a sump. These drains are 8-inch-diameter pipes and extend from the drainage gutter in one gallery to the wall or drainage gutter in the next lower gallery. These drains are located in approximately every fourth monolith (Figure 13-19).

d. Joint Drains. As noted earlier, joint drains are not normally installed in arch dams because of the joint grouting operations. However, if the monolith joints are not to be grouted, or if drains are required in grouted joints and can effectively be installed, then a 5- or 6-inch drain

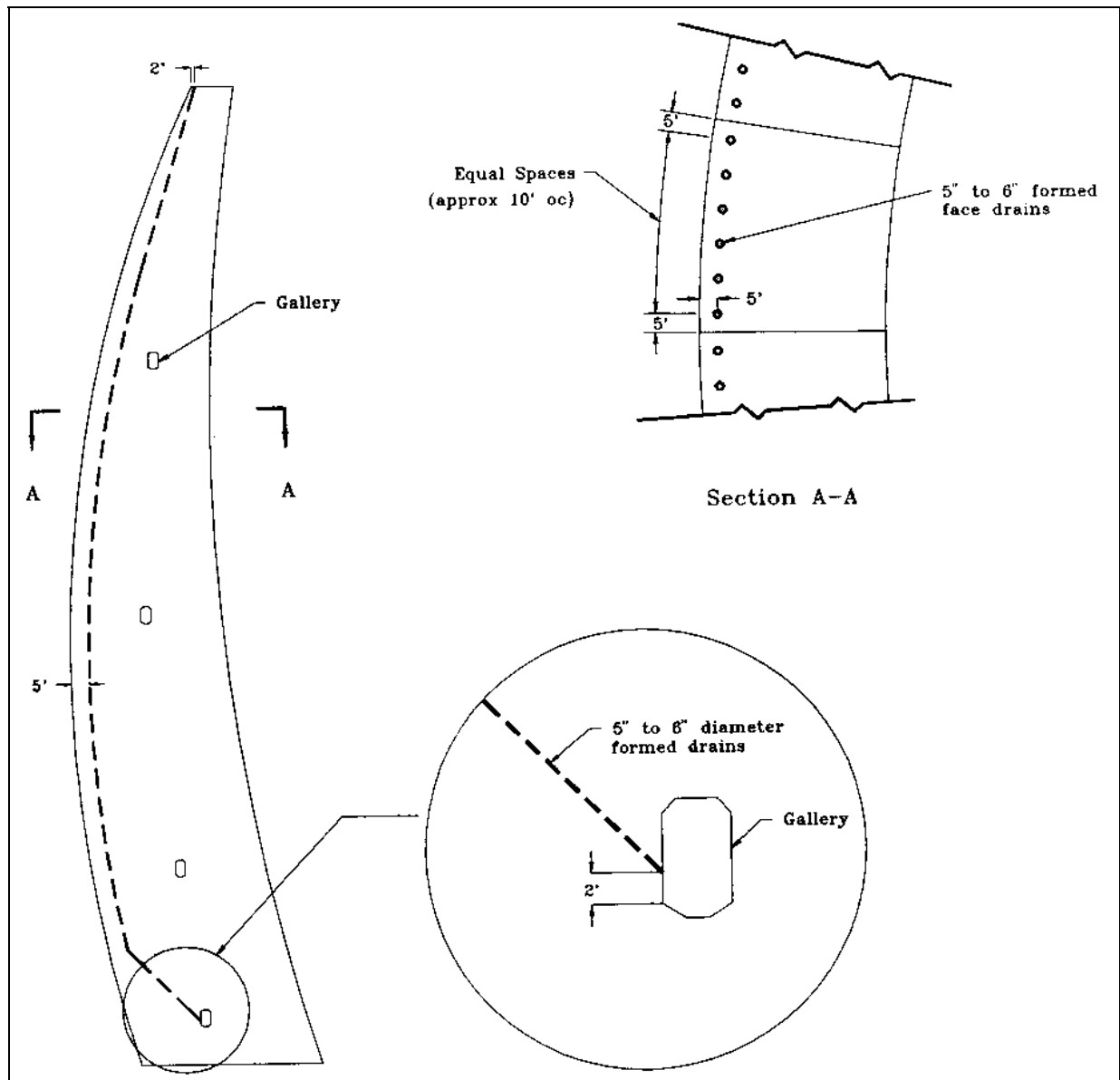

Figure 13-18. Details of face drains

similar to the face drains should be used. The drain should extend from the crest of the dam to the foundation and should be connected to the foundation gallery (Figure 13-20).

13-9. Appurtenant Structures. The appurtenant structures should be kept as simple as possible to minimize interference with the mass concrete construction. Outlet works should be limited to as few monoliths as possible. Conduits should be aligned horizontally through the dam and should be restricted to a single construction lift. Vertical sections of the conduits can be placed outside the main body of the dam.

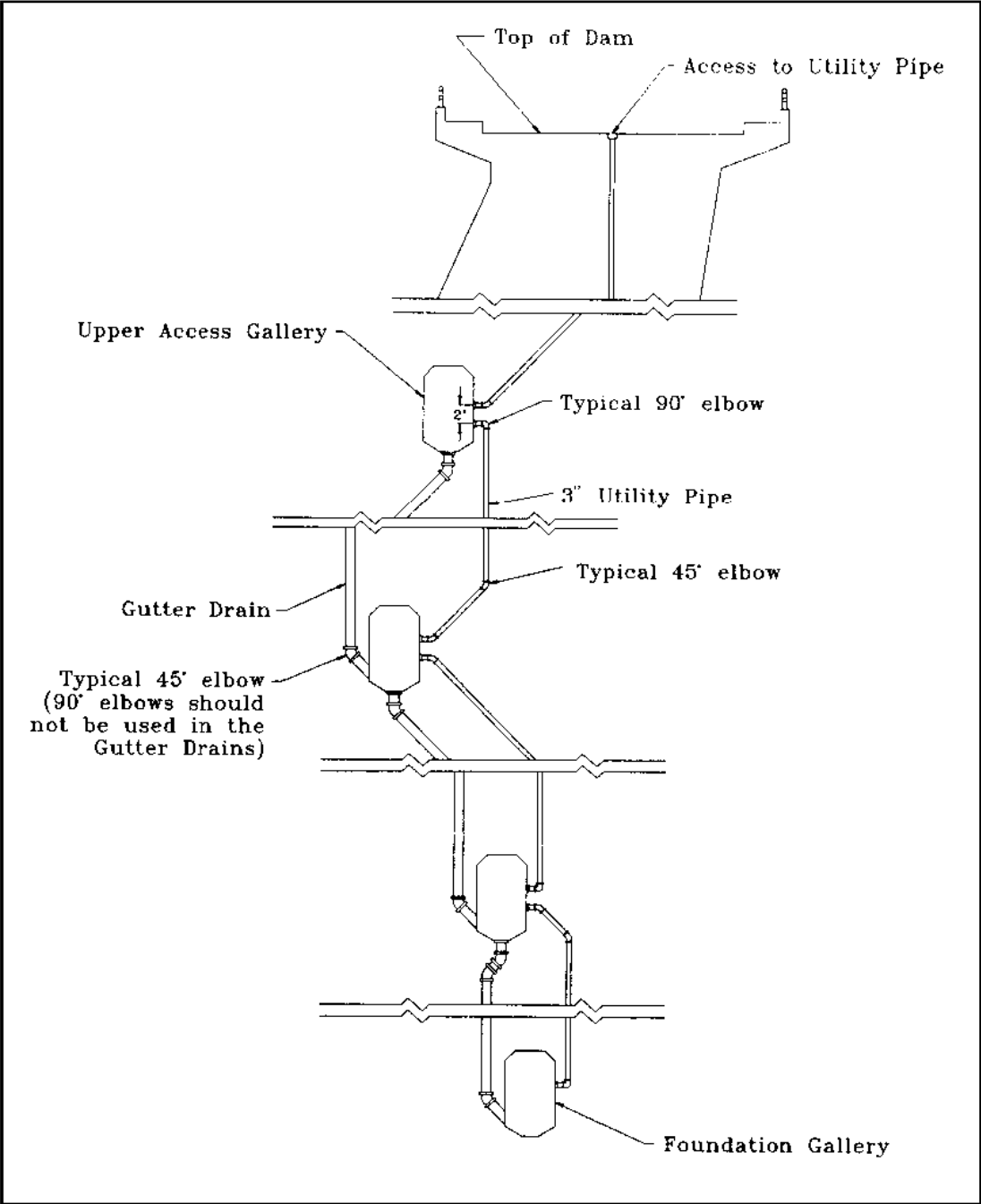

Figure 13-19. Details of gutter drains and utility piping

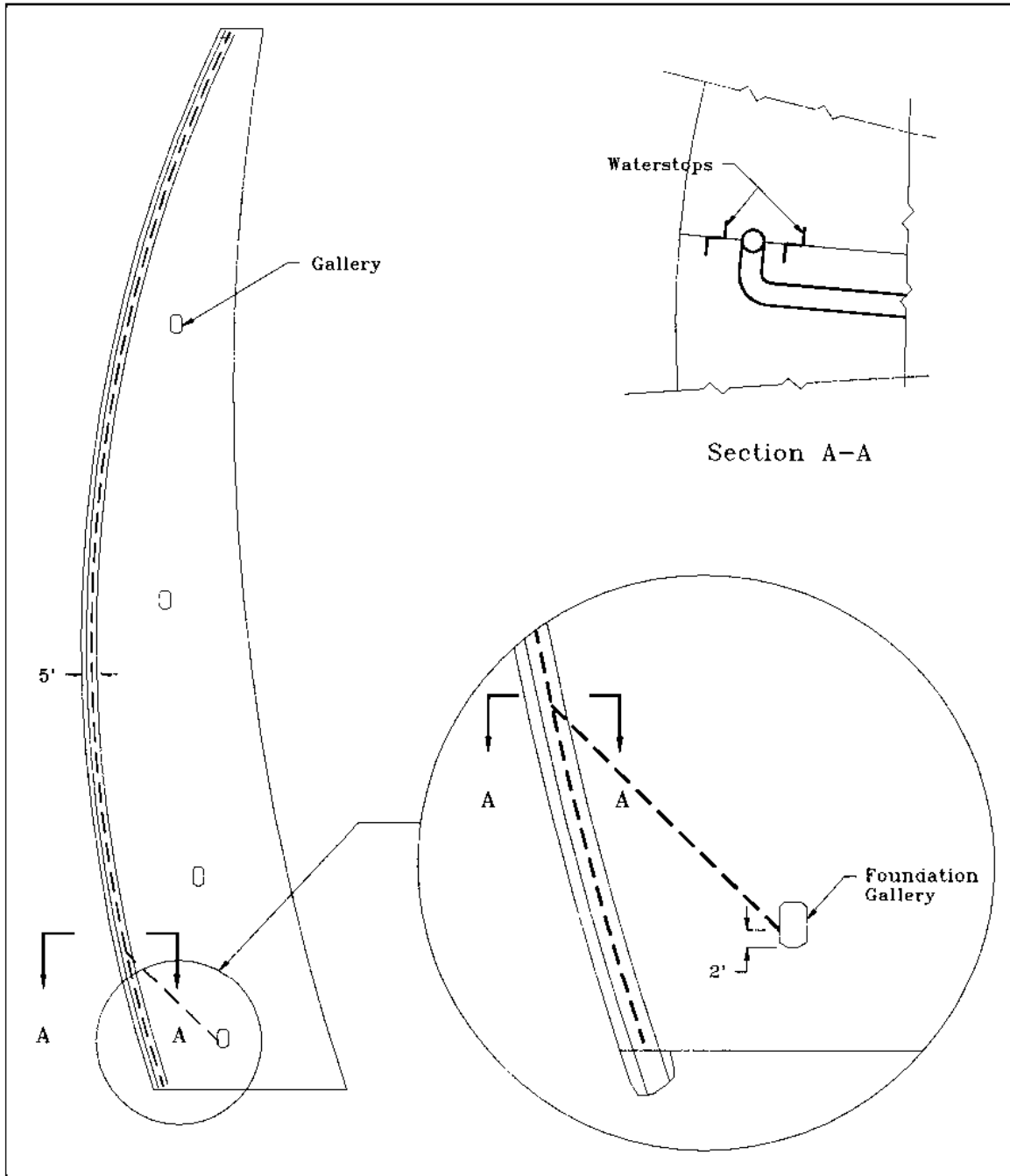

Figure 13-20. Details of joint drains

APPENDIX A

REFERENCES

A-1. Government Publications.

TM 5-818-5, Dewatering and Groundwater Control.

ER 1110-1-1801, Construction Foundation Reports.

EM 1110-1-1804, Geotechnical Investigations.

EM 1110-1-2907, Rock Reinforcement.

EM 1110-2-1901, Seepage Analysis and Control for Dams.

EM 1110-2-2000, Standard Practice for Concrete.

EM 1110-2-2102, Waterstops and Other Joint Materials.

EM 1110-2-3506, Grouting Technology.

EM 1110-2-4300, Instrumentation for Concrete Structures.

ETL 1110-2-324, Special Design Provisions for Massive Concrete Structures.

CRD-C 14. "Standard Test Method for Compressive Strength of Cylindrical Concrete Cylinders."

CRD-C 16. "Standard Test Method for Flexural Strength of Concrete (Using Simple Beam with Third-Point Loading)."

CRD-C 19. "Standard Method of Test for Static Modulus of Elasticity and Poisson's Ratio of Concrete in Compression."

CRD-C 37. "Method of Test for Thermal Diffusivity of Mass Concrete."

CRD-C 38. "Method of Test for Temperature Rise in Concrete."

CRD-C 39. "Method of Test for Coefficient of Linear Thermal Expansion of Concrete."

CRD-C 44. "Method for Calculation of Thermal Conductivity of Concrete."

CRD-C 54. "Standard Test Method for Creep of Concrete in Compression."

CRD-C 71. "Standard Test Method for Ultimate Strain Capacity of Concrete."

CRD-C 77. "Standard Method of Test for Splitting Tensile Strength of Cylindrical Concrete Specimens."

EM 1110-2-2201
31 May 94

CRD-C 90. "Method of Test for Transverse Shear Strength Confined, Single Plane or Double Plane."

CRD-C 124. "Methods of Test for Specific Heat of Aggregates, Concrete, and other Materials (Method of Mixtures)."

CRD-C 400. "Requirements for Water for Use in Mixing or Curing Concrete."

CRD-C 406. "Test Method for Compressive Strength of Mortar for Use in Evaluating Water for Mixing Concrete."

Bieniawski, Z. T. 1990 (Jan). "Tunnel Design by Rock Mass Classifications," Technical Report GL-79-19, U.S. Army Engineer Waterways Experiment Station, Vicksburg, MS.

Boggs, Howard L. 1977 (Jan). "Guide for Preliminary Design of Arch Dams," Engineering Monograph No. 36, U.S. Department of the Interior, U.S. Bureau of Reclamation, Denver, CO.

Ghanaat, Y. 1993a (Aug). "GDAP - Graphics-based Dam Analysis Program," Instruction Report ITL-93-3, U.S. Army Engineer Waterways Experiment Station, Vicksburg, MS.

Ghanaat, Y. 1993b (Jul). "Theoretical Manual For Analysis of Arch Dams," Instruction Report ITL-93-1, U.S. Army Engineer Waterways Experiment Station, Vicksburg, MS.

Hendron, A. J., Cording, E. J., and Aiyer, A. K. 1971 (July). "Analytical and Graphical Methods for the Analysis of Slopes in Rock Masses," NCG Technical Report No. 36, U.S. Army Engineer Waterways Experiment Station, Vicksburg, MS.

Trimble, W. A. 1954 (Aug). "The Average Temperature Rise of the Surface of a Concrete Dam Due to Solar Radiations," U.S. Department of the Interior, U.S. Bureau of Reclamation, Denver, CO.

Townsend. 1965. "Control of Cracking in Mass Concrete Structures," Engineering Monograph No. 34, U.S. Department of the Interior, U.S. Bureau of Reclamation, Denver, CO.

U.S. Army Engineer District, Jacksonville. 1988a (Feb). "Structural Properties and Special Studies," Design Memorandum No. 21, Portugues Dam, Jacksonville, FL.

U.S. Army Engineer District, Jacksonville. 1988b (Feb). "Portugues Dam Foundation Investigation," Design Memorandum No. 22 (unpublished document), Jacksonville, FL.

U.S. Army Engineer District, Jacksonville. 1990 (Mar). "Portugues and Bucana Rivers, Puerto Rico, Design Memorandum, No. 24 (FDM), Appendix "A", Foundation Excavation Investigation, Portugues Dam (unpublished document), Jacksonville, FL.

U.S. Army Engineer Waterways Experiment Station. 1949. Handbook for Concrete and Cement (with quarterly supplements), all CRD-C designations, Vicksburg, MS.

U.S. Army Engineer Waterways Experiment Station. 1990 (Mar). Rock Testing Handbook, Vicksburg, MS.

U.S. Bureau of Reclamation. 1975. "ADSAS - Arch Dam Stress Analysis System," U.S. Department of the Interior, Denver, CO.

U.S. Bureau of Reclamation. 1977. "Design of Arch Dams," Design Manual for Concrete Arch Dams, U.S. Department of the Interior, Denver, CO.

U.S. Bureau of Reclamation. 1981. Concrete Manual, 8th ed, Washington, DC.

U.S. Bureau of Reclamation. 1987. Concrete Dam Instrumentation Manual, U.S. Department of the Interior, Denver, CO.

U.S. Committee on Large Dams. 1988. "Development of Dam Engineering in the United States," Pergamon Books, New York.

Zeigler, Timothy W. 1976 (Jan). "Determination of Rock Mass Permeability," Technical Report S-76-2, U.S. Army Engineer Waterways Experiment Station, Vicksburg, MS.

A-2. Non-Government Publications.

American Concrete Institute. 1970. "Mass Concrete for Dams and other Structures," ACI 207.1R-70, Detroit, MI.

American Concrete Institute. 1978. "Significance of Tests and Properties of Concrete and Concrete-Making Materials," ACI STP 169B, Detroit, MI.

American Concrete Institute. 1980. "Cooling and Insulating Systems for Mass Concrete," ACI 207.4R-80, Detroit, MI.

American Society of Testing Materials. 1965a. "Testing Techniques for Rock Mechanics," ASTM-STP402, Philadelphia, PA.

American Society of Testing Materials. 1965b. "Instruments and Apparatus for Soil and Rock Mechanics," ASTM-STP392, Philadelphia, PA.

American Society of Testing Materials. 1984a. "Standard Test Method for Determining the In Situ Modulus of Deformation of Rock Mass Using the Rigid Plate Loading Method," ASTM-D4394-84, Annual Book of ASTM Standards, Vol 04.08, Philadelphia, PA.

American Society of Testing Materials. 1984b. "Standard Test Method for Determining the In Situ Modulus of Deformation of Rock Mass Using the Flexible Plate Loading Method," ASTM-D4395-84, Annual Book of ASTM Standards, Vol 04.08, Philadelphia, PA.

EM 1110-2-2201
31 May 94

American Society for Testing and Materials. 1992. "Standard Terminology Relating to Methods of Mechanical Testing," ASTM E6-89, Philadelphia, PA.

Bathe, K. J., and Wilson, E. L. 1976. Numerical Methods in Finite Element Analysis, Prentice-Hall, Englewood Cliffs, NJ.

Bathe, K. J., Wilson, E. L., and Peterson, F. E. 1974 (Apr). "SAP IV - A Structural Analysis Program for Static and Dynamic Response of Linear Systems," Report No. EERC/UCG 73-11, Earthquake Engineering Research Center, University of California, Berkeley.

Bieniawski, Z. T. 1973. "Engineering Classification of Jointed Rock Mass," Civil Engineering in South Africa, Marshalltown, South African Institution of Civil Engineers, Vol 15, No. 12, pp 335-344.

Billings, Marland P. 1954. "Structural Geology," Prentice-Hall, Englewood Cliffs, N.J., pp 106-115 and 482-488.

Chopra, A. K. 1968. "Earthquake Behavior of Reservoir-Dam Systems," Journal of Engineering Mechanics Division, American Society of Civil Engineers, Vol 94, pp 1475-1500.

Clough, R. W. 1980. "Nonlinear Mechanisms in the Seismic Response of Arch Dams," International Conference on Earthquake Engineering, Skopje, Yugoslavia.

Clough, R. W., Chang, K. T., Chen, H. Q., and Ghanaat, Y. 1985 (Oct). "Dynamic Interaction Effects in Arch Dams," Report No. UCB/EERC-85/11, University of California Earthquake Engineering Research Center, Berkeley, CA.

Clough, R. W., and Penzien, J. 1975. "Dynamics of Structures," McGraw-Hill, New York.

Cook, R. D. 1981. Concepts and Applications of Finite Element Analysis, John Wiley and Sons, New York.

Fifteenth Congress on Large Dams. 1985. "General Report," Georges Post, Q.56, Lausanne, Switzerland, pp 1623-1723.

Fok, K. L., and Chopra, A. K. 1985 (July). "Earthquake Analysis and Response of Concrete Arch Dams," Report No. UCB/EERC-85/07, University of California Earthquake Engineering Research Center, Berkeley, CA.

Fok, K. L., Hall, J. F., and Chopra, A. K. 1986 (July). "EACD-3D: A Computer Program for Three-Dimensional Earthquake Analysis of Concrete Dams," Report No. UCB/EERC-86-09, University of California Earthquake Engineering Research Center, Berkeley, CA.

Georgia Institute of Technology. 1983 (Apr). "GTSTRUDL User's Manual" (in 3 Vol), GTICES Systems Laboratory, School of Civil Engineering, Atlanta, GA.

Haimson, Bezalel. 1968. "Hydraulic Fracturing in Porous and Nonporous Rock and Its Potential for Determining In Situ Stresses at Great Depth," Ph.D. diss., University of Minnesota.

Hibbitt, Karlsson, and Sorenson, Inc. 1988. "ABAQUS - Structural and Heat Transfer Finite Element Code," User's Manual, Providence, RI.

Hoek, E., and Bray, J. W. 1981. "Rock Slope Engineering," Rev. 3rd ed., Institution of Mining and Metallurgy, London.

Houghton, D. L. 1976 (Dec). "Determining Tensile Strain Through Capacity of Mass Concrete," ACI Journal, pp 691-700.

International Commission on Large Dams (ICOLD). 1986. "River Control During Dam Construction," Bulletin 48a.

Jansen, Robert B. 1988. Advanced Dam Engineering for Design, Construction and Stabilization, Van Nostrand Reinhold, New York.

Kuo, J. S. H. 1982 (Aug). "Fluid-Structure Interactions: Added-mass Computations for Incompressible Fluid," Report No. UCB/EERC-82/09, University of California Earthquake Engineering Research Center, Berkeley, CA.

Moore, Bruce H., and Kebler, Brian K. 1985. "Multiple Integrated Instrumentation Program, Locks & Dam No. 26, Mississippi River," Fifteenth Congress on Large Dams, Q.56, R.30, Lausanne, Switzerland, pp 621-642.

Neville, A. M. 1981. Properties of Concrete, Pitman Publishing, Marshfield, MA.

Newmark, N. M., and Hall, W. J. 1982. "Earthquake Spectra and Design: Engineering Monographs on Earthquake Criteria, Structural Design, and Strong Motion Records," Earthquake Engineering Research Institute Monograph, Berkeley, CA.

Patton, F. D. 1966. "Multiple Modes of Shear Failure in Rock," Proceedings of First Congress of International Society of Rock Mechanics, Lisbon, Portugal.

Przemieniecki, J. S. 1968. Theory of Matrix Structural Analysis, McGraw-Hill, New York.

Raphael, Jerome M. 1984 (Mar-Apr). "The Tensile Strength of Concrete," ACI Journal, Proceedings Vol 81, pp 158-165.

Serafim, J. L., and Pereira, J. P. 1983. "Considerations of the Geomechanics Classification of Bieniawski," Proceedings of International Symposium on Engineering Geology in Underground Construction, Laboratorio Nacional Engenharia Civil, Lisbon, Portugal.

Sixteenth Congress on Large Dams. 1986. "Concrete Cooling at El Cajon Dam, Honduras," Q.62, San Francisco, CA, pp 231-246.

Von Thun, J. L., and Tarbox, G. S. 1971 (Oct). "Deformation Modulus Determined by Joint-Shear Index and Shear Catalog," Proceedings of the International Symposium on Rock Mechanics, Nancy, France.

EM 1110-2-2201
31 May 94

Waddell, Joseph J. 1968. Concrete Construction Handbook, McGraw-Hill, New York.

Water Resources Commission, N.S.W. 1981. Grouting Manual, 4th ed., North Sydney, Australia.

Westergaard, H. M. 1933. "Water Pressures on Dams During Earthquakes," Transactions, American Society of Civil Engineers, Vol 98, New York.

Zienkiewicz, O. C. 1971. The Finite Element Method in Engineering Science, McGraw-Hill, New York.