



**US Army Corps  
of Engineers®**

# **ELEVATIONS FOR DESIGN OF HURRICANE PROTECTION LEVEES AND STRUCTURES**

**Lake Pontchartrain and Vicinity, Louisiana Project  
West Bank and Vicinity, Louisiana Project  
New Orleans to Venice, Louisiana Project**

**REPORT  
Version 2.0**

**Prepared by:  
U.S. Army Corps of Engineers  
New Orleans District  
December 2014**

*This page is intentionally left blank.*

# TABLE OF CONTENTS

Foreword.....	1
Executive Summary.....	3
1.0 – Introduction.....	9
1.1 – Background.....	9
1.2 – Description of Project Area.....	10
1.3 – Design Intent.....	10
1.4 – Report Organization.....	17
2.0 – Hydraulic Design Approach.....	19
2.1 – General.....	19
2.2 – Modeling Process.....	19
2.3 – Design Conditions.....	31
2.4 – Design Elevations and Loads.....	35
2.5 – Step-Wise Design Approach.....	37
2.6 – Example 1: Jefferson Parish Lakefront.....	51
2.7 – Example 2: MRGO.....	55
2.8 – Extensions for Coincident Mississippi River Levees.....	60
3.0 – Lake Pontchartrain and Vicinity.....	71
3.1 – General.....	71
3.2 – St. Charles Parish.....	73
3.3 – Jefferson Parish Lakefront.....	87
3.4 – Orleans Parish – Metro Lakefront.....	103
3.5 – Orleans Parish – Lakefront East.....	125
3.6 – South Point to MRGO/GIWW Closure.....	141
3.7 – IHNC/GIWW Basin.....	162
3.8 – Closures at GIWW/MRGO and Seabrook.....	172
3.9 – St. Bernard Parish.....	180
4.0 – West Bank and Vicinity.....	198
4.1 – General.....	198
4.2 – Lake Cataouatche Reach.....	199
4.3 – Westwego to Harvey Canal Reach.....	211
4.4 – East of Harvey Canal Reach.....	225
4.5 – West Closure Complex.....	245
5.0 – Mississippi River Coincident with LPV and WBV.....	254
5.1 – General.....	254
5.2 – Plaquemines Parish West Bank (RM 70W to RM 81W).....	259
5.3 – Orleans Parish West Bank (RM 82W to 95W).....	267
5.4 – Jefferson Parish West Bank (RM 96W to RM 114W).....	275

5.5 – St. Charles Parish West Bank (RM 115W to RM 118W).....	287
5.6 – Plaquemines/St. Bernard East Bank (RM 82E to RM 91E).....	291
5.7 – Orleans Parish East Bank (RM 92E to RM 103E).....	298
5.8 – Jefferson Parish East Bank (RM 104E to RM 114E).....	304
5.9 – St. Charles Parish East Bank (RM 115E to RM 127E).....	311
6.0 – New Orleans to Venice.....	318
6.1 – General.....	318
6.2 – West Bank – Non-Federal Levee System.....	324
6.3 – West Bank – Federal Levee System.....	344
6.4 – East Bank – Federal Levee System.....	354
6.5 – Mississippi River West Bank (RM 10 – RM 70).....	360
6.6 – Mississippi River East Bank (RM 44 – RM 59).....	403
6.7 – Transition Zones at RM 44.....	416
6.8 – New Orleans to Venice Epoch Adjustments by Hydraulic Reach.....	418
7.0 – Conclusions.....	422

## LIST OF FIGURES

Figure 1-1 – LPV, WBV, and NOV Projects.....	10
Figure 1-2 – Subsidence Rates of Southern Louisiana.....	14
Figure 2-1 – JPM-OS Components and Their Interactions.....	20
Figure 2-2 – STWAVE Output Point Locations.....	23
Figure 2-3 – STWAVE Model with Friction.....	23
Figure 2-4 – STWAVE Model without Friction.....	24
Figure 2-5 – Numerical Results at Lake Pontchartrain (upper panel) and MRGO (lower panel) from ADCIRC and STWAVE.....	27
Figure 2-6 – Frequency Curves of the Wave Height and Wave Period at Lake Pontchartrain (point 230) Based on the STWAVE Results and the JPM-OS Method.....	28
Figure 2-7 – Definition Sketch of Wave Force Calculations (Coastal Engineering Manual, 2001)....	31
Figure 2-8 – Estimated Relative Sea Level Rise During 100 Year (Subsidence + Eustatic Sea Level Rise).....	32
Figure 2-9 – Time Histories of Surge Elevation and Wave Characteristics during Storm 27 at Lake Pontchartrain (upper panel) and at Lake Borgne (lower panel).....	39
Figure 2-10 – Definitions for Overtopping for Levee and Floodwall.....	44
Figure 2-11 – The 50% and 90% Confidence Limit Value and Number of Simulations.....	47
Figure 2-12– Result of Monte Carlo Analysis for Jefferson Lakefront Levee (existing conditions)...	48
Figure 2-13 – Jefferson Parish Lakefront (Points 217 – 219 and 228 – 237).....	51
Figure 2-14 – Cross-section Jefferson Lakefront Levee.....	53
Figure 2-15 – Overtopping Rate as a Function of the Probability of Exceedence for the Jefferson Lakefront Levee (Existing Conditions), 1% Event.....	54
Figure 2-16 – MRGO Levee with Output Points from ADCIRC and STWAVE.....	55
Figure 2-17 – Proposed Cross-Section at the Southern Portion of the MRGO Levee.....	58
Figure 2-18 – Overtopping Rate as a Function of the Probability of Exceedence for the MRGO Levee (existing conditions) for the 1% Event.....	59
Figure 2-19 – Stage-Flow Relationships at Six USACE Stations Along the Mississippi River.....	62
Figure 2-20 – Surge Maxima Relationship Between the 167,000 cfs and the 400,000 cfs Runs at Various Points Along the Mississippi River.....	63
Figure 2-21 – Correlation Between the 17 Storms from the Original 152 Storm Suite (SL15v3 grid) and New 17 Storm Results (SL15v7 grid) for 167,000 cfs (upper panel) and 400,000 cfs (lower panel).....	64
Figure 2-22 – Comparison Between Historical Observations and (Interpolated) ADCIRC Storm Surge.....	66
Figure 3-1 – Typical Levee Design Cross-Sections St. Charles Parish Levee West (SC02-A).....	82
Figure 3-2 – Typical Levee Design Cross-Sections St. Charles Parish Levee East (SC02-B).....	83
Figure 3-3 – Typical Levee Design Cross-Sections Airport Runway Levee (SC14).....	84
Figure 3-4 – not used .....	
Figure 3-5 – Situation for Pump Station #1 (JL02).....	91
Figure 3-6 – Typical Levee Design Cross-Sections Lakefront Levee (JL10).....	99
Figure 3-7 – Typical Levee Design Cross-Sections US Coast Guard Station Levee (JL10).....	100
Figure 3-8 – Typical Levee Design Cross-Sections New Orleans – Metro Lakefront Levee (NO01)..	117
Figure 3-9 – Typical Levee Design Cross-Sections Topaz Street Levee (NO06-LT).....	118
Figure 3-10 – Typical Levee Design Cross-Sections Topaz Street Levee/Floodwall Combination (NO10LI).....	119

Figure 3-11 – Typical Levee Design Cross-Sections Topaz Street Levee/Floodwall Combination (NO10-LL).....	120
Figure 3-12 Typical Levee Design Cross-Sections New Orleans – Metro Lakefront Levee (NO15-L).....	121
Figure 3-13 – Typical Levee Design Cross-Sections Citrus Lakefront Levee (NE01).....	135
Figure 3-14 – Typical Levee Design Cross-Sections New Orleans East Lakefront Levee (NE02).....	136
Figure 3-15 – Typical Levee Design Cross-Sections New Orleans Lakefront Airport – East Levee (NE03-LI).....	137
Figure 3-16 – Typical Levee Design Cross-Sections South Point Transition Levee (NE31).....	138
Figure 3-17 – Typical Levee Design Cross-Sections South Point to Hwy 90 Levee (NE10-A).....	151
Figure 3-18 – Typical Levee Design Cross-Sections South Point to Hwy 90 Levee (NE10-B).....	152
Figure 3-19 – Typical Levee Design Cross-Sections South Point to Hwy 90 Levee (NE10-C).....	153
Figure 3-20 – Typical Levee Design Cross-Sections Hwy90 to CSX Railroad Levee (NE11-A).....	154
Figure 3-21 – Typical Levee Design Cross-Sections CSX Railroad to GIWW Levee (NE11-B).....	155
Figure 3-22 – Typical Levee Design Cross-Sections New Orleans East Back Levee (NE12-A).....	156
Figure 3-23 – Typical Levee Design Cross-Sections New Orleans East Back Levee (NE12-B-L).....	157
Figure 3-24 – Typical Levee Design Cross-Sections New Orleans East Back Levee (NE17).....	158
Figure 3-25 – Typical Levee Design Cross-Sections New Orleans East Back Levee (NE32).....	159
Figure 3-26 – Typical Levee Design Cross-Section IHNC/GIWW Levee.....	171
Figure 3-27 – Typical Levee Design Cross-Section MRGO Levee/Floodwall Combination (SB11)..	188
Figure 3-28 – Typical Levee Design Cross-Section MRGO Levee/Floodwall Combination (SB12)..	189
Figure 3-29 – Typical Levee Design Cross-Section MRGO Levee/Floodwall Combination (SB13)..	190
Figure 3-30 – Typical Levee Design Cross-Section MRGO Levee/Floodwall Combination (SB15)..	191
Figure 3-31 – Typical Levee Design Cross-Section Caernarvon to Verret Levee/Floodwall Combination (SB16).....	192
Figure 3-32 – Typical Levee Design Cross-Section Caernarvon to Verret Levee/Floodwall Combination (SB17).....	193
Figure 3-33 – Typical Levee Design Cross-Section Transition Reach Levee/Floodwall Combination (SB21-TR) Future Condition.....	194
Figure 3-34 – Typical Levee Cross-Section Transition Reach Levee/Floodwall Combination (SB161-LT).....	195
Figure 4-1 – Typical Levee Design Cross-Sections US90 to Bayou Segnette State Park Levee (WB01).....	207
Figure 4-2 – Typical Levee Design Cross-Sections Mississippi River to US90 Levee (WB31-L-EW).....	208
Figure 4-3 – Typical Levee Design Cross-Sections Mississippi River to US90 Levee (WB31-L-NS).....	209
Figure 4-4 – Typical Levee Design Cross-Sections Westwego to Harvey Levees (WB08-B, WB41 and WB42-L).....	221
Figure 4-5 – Typical Levee Design Cross-Sections Westwego to Harvey Levees WB43-A.....	222
Figure 4-6 – Typical Levee Design Cross-Sections Westwego to Harvey Levees WB43-D-L.....	223
Figure 4-7 – Typical Levee Design Cross-Sections Harvey Canal Levees (WB14-L).....	238
Figure 4-8 – Typical Levee Design Cross-Sections Transition Point Hero Canal to Oakville (WB19), Hero Canal Area West and East of Pump Station (WB19-A1 and WB19-A2).....	239
Figure 4-9 – Typical Levee Design Cross-Sections Algiers Canal Levees (WB30-L1 and WB30-L2).....	240
Figure 4-10 – Typical Levee Design Cross-Section WCC Intake Levee (WB90-L1).....	251
Figure 4-11 – Typical Levee Design Cross-Sections WCC Discharge Levee (WB90-L2).....	252
Figure 5-1 – MRL-HSDRRS Levees and Floodwalls.....	255
Figure 5-2 – Schematic of the Lower Mississippi River with the Dominant Hydraulic Forces.....	256

Figure 5-3 – Water Level Variation Along the Mississippi River (Source <a href="http://www.rivergages.com">www.rivergages.com</a> ).....	257
Figure 5-4 – Water level Variation at Carrollton in August – September 2005 (upper panel) and 2008 (lower panel) (Source: <a href="http://www.rivergages.com">www.rivergages.com</a> ).....	258
Figure 5-5 – Plaquemines Parish West Bank (RM 70W – RM 81W) – Levee and Floodwall Sections.....	259
Figure 5-6 – Typical Levee Design Cross-Section (RM 70W – RM 80W) – Plaquemines Parish West Bank.....	264
Figure 5-7 – Orleans Parish West Bank (RM 70W – RM 81W) – Levees and Floodwall Sections....	267
Figure 5-8 – Typical Levee Design Cross-Section (RM 82W – RM 95W) – Orleans Parish West Bank.....	272
Figure 5-9 – Jefferson Parish West Bank (RM 96W – RM 114W) – Levee and Floodwall Sections..	275
Figure 5-10 – Jefferson Parish West Bank (RM 96W – RM 114W) – Levee and Floodwall Sections.....	276
Figure 5-11 – Typical Levee Design Cross-Section for Wave Force (RM 96W – RM 114W) – Jefferson Parish West Bank.....	283
Figure 5-12 – St. Charles Parish West Bank (RM 115W – RM118W) – Levee and Floodwall Sections.....	287
Figure 5-13 – Typical Levee Design Cross-Section (RM 115W – RM 118W) – St. Charles Parish West Bank.....	289
Figure 5-14 – Plaquemines Parish/St. Bernard Parish East Bank (RM 82E – RM 91E) – Levee and Floodwall Sections.....	291
Figure 5-15 – Typical Levee Design Cross-Section (RM 82E – RM 91E) – Plaquemines/St. Bernard Parish East Bank.....	295
Figure 5-16 – Orleans Parish East Bank (RM 92E – RM 103E) – Levee and Floodwall Sections.....	298
Figure 5-17 – Typical Levee Design Cross-Section (RM 92E – RM103E) – Orleans Parish East Bank.....	302
Figure 5-18 – Jefferson Parish East Bank (RM 104E – RM 114E) – Levee and Floodwall Sections..	304
Figure 5-19 – Typical Levee Design Cross-Section (RM 104E – RM 114E) – Jefferson Parish East Bank.....	308
Figure 5-20 – St. Charles Parish East Bank (RM 115E – RM 127E) – Levee and Floodwall Sections.....	311
Figure 5-21 – Typical Levee Design Cross-Section (RM 115E – RM 127E) – St. Charles East Bank.....	316
Figure 6-1 – New Orleans to Venice Project, Including the Non-Federal Levee Incorporation into NOV.....	319
Figure 6-2 – Hydraulic Reaches Mississippi River at East Bank and West Bank River Mile 63-70..	360
Figure 6-3 – Hydraulic Reaches Mississippi River at East Bank and West Bank River Mile 53-63..	361
Figure 6-4 – New Orleans to Venice Hydraulic Reaches Mississippi River at East Bank and West...	362
Figure 6-5 – New Orleans to Venice Hydraulic Reaches Mississippi River at West Bank River Mile 30-44.....	363
Figure 6-6 – New Orleans to Venice Hydraulic Reaches Mississippi River at West Bank River Mil 11-33.....	364
Figure 6-7 – New Orleans to Venice Mississippi River West Bank – Project Design Elevations and Surge Levels.....	379
Figure 6-8 – New Orleans to Venice Hydraulic Reaches Mississippi River at East Bank and West Bank River Mile 53-63.....	403
Figure 6-9 – New Orleans to Venice Hydraulic Reaches Mississippi River at East Bank and West Bank River Mile 45-53.....	404
Figure 6-10 – Project Design Elevations and Surge Levels Mississippi River at West Bank.....	409
Figure 6-11 – Transition Zones at East Bank and West Bank Around River Mile 44.....	416

Figure 6-12 – Detail Transition Zone East Bank.....	417
Figure 6-13 – Detail Transition Zone West Bank.....	417



## LIST OF TABLES

Table 2-1 – Future Conditions for Surge Level and Wave Characteristics.....	34
Table 2-2 – Input for Monte Carol Analysis.....	46
Table 2-3 – Surge Elevations at Jefferson Parish Lakefront (2007 conditions).....	52
Table 2-4 – Wave Characteristics at Jefferson Parish Lakefront.....	52
Table 2-5 – Surge Levels at MRGO Levee for the 2010 Conditions.....	56
Table 2-6 – Wave Characteristics at MRGO Levee.....	57
Table 2-7 – Storms Selected for the Historical Hurricanes.....	65
Table 2-8 – Probability Density of Hurricanes in Various Months Based on Hurricanes in the New Orleans Area in the Period 1941 – 2005.....	67
Table 2-9 – Cumulative Probability Density Distribution of the Lower Mississippi River Discharge (in 1,000 cfs) for the Various Months in the Hurricane Season Based on the Period 1976 – 2002....	68
Table 3-1 – St. Charles Parish Hydraulic Reaches – 1% Hydraulic Boundary Conditions.....	75
Table 3-2 – St. Charles Parish Hydraulic Reaches – 1% Design Information.....	80
Table 3-3 – St. Charles Parish Hydraulic Reaches – Resiliency.....	85
Table 3-4 – Jefferson Parish Lakefront Hydraulic Reaches – 1% Hydraulic Boundary Conditions...	89
Table 3-5 – Jefferson Parish Lakefront Hydraulic Reaches – 1% Design Information.....	96
Table 3-6 – Jefferson Parish Lakefront Hydraulic Reaches – Resiliency.....	101
Table 3-7 – Orleans Parish – Metro Lakefront Hydraulic Reaches – 1% Hydraulic Boundary Conditions.....	105
Table 3-8 – Orleans Parish – Metro Lakefront Hydraulic Reaches – 1% Design Information.....	113
Table 3-9 – Orleans Parish Metro Lakefront – Resiliency.....	122
Table 3-10 – Orleans Parish – Lakefront East Hydraulic Reaches – 1% Hydraulic Boundary Condition.....	127
Table 3-11 – Orleans Parish – Lakefront East Hydraulic Reaches – 1% Design Information.....	133
Table 3-12 – Orleans Parish – Lakefront East Hydraulic Reaches – Resiliency.....	139
Table 3-13 – Orleans Parish – South Point to MRGO/GIWW Closure – 1% Hydraulic Boundary Condition.....	143
Table 3-14 – Orleans Parish – South Point to MRGO/GIWW Closure – 1% Design Information.....	149
Table 3-15 – Orleans Parish – South Point to MRGO/GIWW Closure – Resiliency.....	160
Table 3-16 – IHNC/GIWW Basin Hydraulic Reaches – 1% Hydraulic Boundary Conditions.....	164
Table 3-17 – IHNC/GIWW Basin Hydraulic Reaches – 1% Design Information.....	169
Table 3-18 – Closures at GIWW/MRGO and Seabrook Hydraulic Reaches – 1% Hydraulic Boundary Conditions.....	174
Table 3-19 – Closures at GIWW/MRGO and Seabrook Hydraulic Reaches – 1% Design Information .....	176
Table 3-20 – Closures at GIWW/MRGO and Seabrook Hydraulic Reaches – Resiliency.....	179
Table 3-21 – St. Bernard Parish Hydraulic Reaches – 1% Hydraulic Boundary Conditions.....	182
Table 3-22 – St. Bernard Parish Hydraulic Reaches – 1% Design Information .....	186
Table 3-23 – St. Bernard Parish Hydraulic Reaches – Resiliency.....	197
Table 4-1 – Lake Cataouatche Hydraulic Reaches – 1% Hydraulic Boundary Conditions.....	204
Table 4-2 – Lake Cataouatche Hydraulic Reaches – 1% Design Information.....	208
Table 4-3 – Lake Cataouatche Hydraulic Reaches – Resiliency.....	213
Table 4-4 – Westwego to Harvey Canal Hydraulic Reaches – 1% Hydraulic Boundary Conditions...	215
Table 4-5 – Westwego to Harvey Canal Hydraulic Reaches – 1% Design Information .....	221
Table 4-6 – Westwego to Harvey Canal Hydraulic Reaches – Resiliency.....	227

Table 4-7 – East of Harvey Canal Hydraulic Reaches – 1% Hydraulic Boundary Conditions.....	227
Table 4-8 – East of Harvey Canal Hydraulic Reaches – 1% Design Information.....	235
Table 4-9 – East of Harvey Canal Hydraulic Reaches – Resiliency.....	241
Table 4-10 – West Closure Complex Hydraulic Reaches – 1% Hydraulic Boundary Conditions.....	247
Table 4-11 – West Closure Complex Hydraulic Reaches – 1% Design Information.....	250
Table 4-12 – West Closure Complex Hydraulic Reaches – Resiliency.....	253
Table 5-1 – Plaquemines Parish West Bank (RM 70W – RM 81W) – 1% Hydraulic Boundary Conditions.....	260
Table 5-2 – Plaquemines Parish West Bank (RM 70W – RM 81W) – 1% Design Information .....	262
Table 5-3 – Plaquemines Parish West Bank (RM 70W – RM 81W) – Resiliency Analysis.....	265
Table 5-4 – Orleans Parish West Bank (RM 82W – RM 95W) – 1% Hydraulic Boundary Condition.....	268
Table 5-5 – Orleans Parish West Bank (RM 82W – RM 95W) – 1% Design Information.....	270
Table 5-6 – Orleans Parish West Bank (RM 82W – RM 95W) – Resiliency Analysis.....	273
Table 5-7 – Jefferson Parish West Bank (RM 96W – RM 114W) – 1% Hydraulic Boundary Conditions.....	277
Table 5-8 – Jefferson Parish West Bank (RM 96W – RM 114W) – 1% Design Information.....	280
Table 5-9 – Jefferson Parish West Bank (RM 96W – RM 114W) – Resiliency Analysis.....	283
Table 5-10 – St. Charles Parish West Bank (RM 115W – RM 118W) – 1% Hydraulic Boundary Conditions.....	288
Table 5-11 – St. Charles Parish West Bank (RM 115W – RM 118W) – 1% Design Information.....	289
Table 5-12 – St. Charles Parish West Bank (RM 115W – RM 118W) – Resiliency Analysis.....	290
Table 5-13 – Plaquemines/St. Bernard Parish East Bank (RM 82E – RM 91E) – 1% Hydraulic .....	292
Table 5-14 – Plaquemines/St. Bernard Parish East Bank (RM 82E – RM 91E) – 1% Design Information.....	294
Table 5-15 – Plaquemin302es/St. Bernard Parish East Bank (RM 82E – RM 91E) – Resiliency Analysis.....	296
Table 5-16 – Orleans Parish East Bank (RM 92E – RM 103E) – 1% Hydraulic Boundary Conditions.....	299
Table 5-17 – Orleans Parish East Bank (RM 92E – RM 103E) – 1% Design Information.....	300
Table 5-18 – Orleans Parish East Bank (RM 92E – RM 103E) – Resiliency Analysis.....	302
Table 5-19 – Jefferson Parish East Bank (RM 104E – RM 114E) – 1% Hydraulic Boundary Conditions.....	305
Table 5-20 – Jefferson Parish East Bank (RM 104E – RM 114E) – 1% Design Information.....	307
Table 5-21 – Jefferson Parish East Bank (RM 104E – RM 114E) – Resiliency Analysis.....	309
Table 5-22 – St. Charles Parish East Bank (RM 115E – RM 127E) – 1% Hydraulic Boundary Conditions.....	312
Table 5-23 – St. Charles Parish East Bank (RM 115E – RM 127E) – 1% Design Information.....	314
Table 5-24 – St. Charles Parish East Bank (RM 115E – RM 127E) – Resiliency Analysis.....	316
Table 6-1 – Ground Elevations.....	323
Table 6-2 – New Orleans to Venice West Bank – Non –Federal System – 1% Hydraulic Boundary Conditions.....	324
Table 6-3 – New Orleans to Venice West Bank – Non –Federal System – 2% Hydraulic Boundary Conditions.....	327
Table 6-4 – New Orleans to Venice West Bank – Non –Federal System – 4% Hydraulic Boundary Conditions.....	330

Table 6-5 – New Orleans to Venice West Bank – Non –Federal System – 1% Project Design Information.....	332
Table 6-6 – New Orleans to Venice West Bank – Non –Federal System – 2% Project Design Information.....	335
Table 6-7 – New Orleans to Venice West Bank – Non –Federal System – 4% Project Design Information.....	338
Table 6-8 – New Orleans to Venice West Bank – Non-Federal System – Resiliency Analysis.....	341
Table 6-9 – New Orleans to Venice West Bank – Federal System – 1% Hydraulic Boundary Conditions.....	344
Table 6-10 – New Orleans to Venice West Bank – Federal System – 2% Hydraulic Boundary Conditions.....	346
Table 6-11 – New Orleans to Venice West Bank – Federal System – 1% Design Information.....	348
Table 6-12 – New Orleans to Venice West Bank – Federal System – 2% Design Information.....	350
Table 6-13 – New Orleans to Venice West Bank – Federal System – Resiliency Analysis.....	352
Table 6-14 – New Orleans to Venice East Bank – Federal System – 1% Hydraulic Boundary Condition.....	354
Table 6-15 – New Orleans to Venice East Bank – Federal System – 2% Hydraulic Boundary Condition.....	356
Table 6-16 – New Orleans to Venice East Bank – Federal System – 1% Design Information.....	357
Table 6-17 – New Orleans to Venice East Bank – Federal System – 2% Design Information.....	358
Table 6-18 – New Orleans to Venice East Bank – Federal System – Resiliency Analysis.....	359
Table 6-19 – New Orleans to Venice Mississippi River West Bank – 1% Hydraulic Boundary Conditions – Existing & Future Conditions.....	365
Table 6-20 – New Orleans to Venice Mississippi River West Bank – 2% Hydraulic Boundary Conditions – Existing & Future Conditions.....	372
Table 6-21 – New Orleans to Venice Mississippi River West Bank – 1% Levee Design Information – Existing and Future Conditions.....	380
Table 6-22 – New Orleans to Venice Mississippi River West Bank – 2% Levee Design Information – Existing and Future Conditions.....	387
Table 6-23 – New Orleans to Venice Mississippi River West Bank – 1% Levee/Floodwalls Design Information – Future Conditions.....	393
Table 6-24 – New Orleans to Venice Mississippi River West Bank – 2% Levee/Floodwalls Design Information – Future Conditions.....	394
Table 6-25 – New Orleans to Venice Mississippi River West Bank – Resiliency Analysis Levees Existing and Future Conditions.....	395
Table 6-26 – New Orleans to Venice Mississippi River West Bank – Resiliency Analysis Levee/Floodwall Future Conditions.....	402
Table 6-27 – New Orleans to Venice Mississippi River East Bank RM 44-59 – 1% Hydraulic Boundary Conditions – Existing Conditions.....	405
Table 6-28 – New Orleans to Venice Mississippi River East Bank RM 44-59 – 2% Hydraulic Boundary Conditions – Existing Conditions.....	407
Table 6-29 – New Orleans to Venice Mississippi River East Bank RM 44-59 – 1% Design Information – Existing Conditions.....	410
Table 6-30 – New Orleans to Venice Mississippi River East Bank RM 44-59 – 2% Design Information – Existing Conditions.....	412
Table 6-31 – New Orleans to Venice Mississippi River East Bank RM 44-59 – Resiliency Analysis 1% Design Elevations Existing Conditions.....	414
Table 6-32 – New Orleans to Venice Epoch Adjustments by Hydraulic Reach.....	418

## **PLATES**

- Plate 1 - LPV, WBV and MRL Project Alignments
- Plate 2 - LPV St. Charles Parish East Bank
- Plate 3 - LPV Jefferson Parish Lakefront
- Plate 4 - LPV Orleans Parish Metro Lakefront
- Plate 5 - LPV Orleans Parish Lakefront East
- Plate 6 - LPV Orleans Parish – South Point to MRGO/GIWW Closure
- Plate 7 - LPV IHNC and GIWW Basin
- Plate 8 - LPV St. Bernard Parish
- Plate 9 - WBV Lake Cataouatche Reach
- Plate 9A - WBV Bayou Segnette
- Plate 10 - WBV Westwego to Harvey Canal Reach
- Plate 11 - WBV East of Harvey Canal Reach
- Plate 12 - WBV Algiers Canal Reach
- Plate 13 - WBV West Closure Complex
- Plate 14A - WBV-MRL Co-Located Engineered Alternative Measures
- Plate 14B - WBV-MRL Co-Located Resilient Features
- Plate 15 - NOV Project Alignments
- Plate 16 – NFL West Bank Backlevee – Oakville to St. Jude (1 of 2)
- Plate 17 – NFL West Bank Backlevee – Oakville to St. Jude (2 of 2)
- Plate 18 – NOV West Bank Backlevee – St. Jude to Venice (1 of 2)
- Plate 19 – NOV West Bank Backlevee – St. Jude to Venice (2 of 2)
- Plate 20 – NOV East Bank Backlevee – Phoenix to Bohemia

## APPENDICES

- Appendix A - Maps of 1% SURGE Levels, Wave Heights, and Wave Periods
- Appendix B - Sample Design Calculations
- Appendix C - Boussinesq Modeling (Author: P. Lynett, Texas A&M)
- Appendix D - Comparison Between Empirical and Boussinesq Approach
- Appendix E - Goda Formula Input Data
- Appendix F - Overtopping Criterion (Author: S. A. Hughes, ERDC)
- Appendix G - Surge and Wave Modeling For River and Sea Level Rise Sensitivity (Version 2 July 2010, Authors: T. Wamsley, M. Cialone, D. Resio, ERDC)
- Appendix H - Joint Probability Method with Optimal sampling (JPM-OS) Including River Discharge Variation (Author: D. Resio, ERDC)
- Appendix I - Wave Assessment Mississippi River (Version 26 May 2010, Authors: M.V. Ledden, M. Agnew, M. Kluyver)
- Appendix J - Numerical Modeling Study of Western Closure Complex Project (Letter Report Version 4, Authors: ERDC)
- Appendix K - SWAN Modeling Lower Plaquemines Parish (Version 20 Jul 2010)
- Appendix L - Future Conditions (Authors: J. Smith, ERDC and J. Atkinson, Ayres Associates)
- Appendix M - CEMVN-ED-H Memorandum for Record, Subject: West Bank and Vicinity – Algiers Canal Design Levee Grade (13 Jan 2014)
- Appendix N - Wind Speed for 100-Year and 500-Year Event
- Appendix O - Sea Level Rise - Impact Assessment of New Relative Sea Level Change Engineer Circular for Flood Risk Reduction Projects in the New Orleans Area (17 Feb 2011, Authors: S. Ayres, M.V. Ledden, M. Agnew)
- Appendix P - The I-10 & I-310 Floodwall Overtopping Analysis (10 Apr 2009)
- Appendix Q - Investigation of ADCIRC Surge Results in St. Charles Parish (16 May 2008, Authors: H. Roberts, Arcadis; J. Atkinson, Ayres Associates; J. Westerink and H. Westerink. University of Notre Dame)
- Appendix R - Sensitivity Analysis on Storm Modeling Results for Lake Pontchartrain and Vicinity (LPV), West bank and Vicinity (WBV) and New Orleans to Venice (NOV)/Non- Federal Levee (NFL) Incorporation into NOV Hurricane Storm Damage and Risk Reduction (HSDRRS) Projects
- Appendix S - LPV-149 HSDRRS Floodwall tie-in at the MRL
- Appendix T - Overtopping Design Criteria Tables

## LIST OF ACRONYMS AND TERMINOLOGY

<b>ABFE</b>	Advisory Base Flood Elevation
<b>ACES</b>	Automated Coastal Engineering System
<b>ADCIRC</b>	Advanced Circulation Model
<b>A-E</b>	Architect-Engine Consultant or Contractors
<b>AMID</b>	Almonaster-Michoud Industrial District (Pump Station)
<b>ASCE</b>	American Society of Civil Engineers
<b>BW</b>	Breakwater
<b>BN&amp;SF</b>	Burlington North & Santa Fe Railroad
<b>CEM</b>	Coastal Engineering Manual
<b>CENT</b>	Coastal Engineering Technical Note
<b>cfs</b>	Cubic Feet per Second listed as cft/s <sup>2</sup> on page 256
<b>cfs/ft</b>	Cubic Feet per Second per Foot
<b>CHL</b>	Coastal and Hydraulics Laboratory (USACE)
<b>COULWAVE</b>	Cornell University Long and Intermediate Wave Modeling Package
<b>CSX</b>	Chessie System Railroad
<b>DFIRM</b>	Digital Flood Insurance Rate Map
<b>EC</b>	Engineering Circular
<b>EM</b>	Engineering Manual
<b>ER</b>	Engineer Regulation (USACE)
<b>ERDC</b>	Engineering Research and Development Center (USACE)
<b>ETL</b>	Engineering Technical Letter
<b>FEMA</b>	Federal Emergency Management Authority
<b>ft</b>	Foot or Feet
<b>ft-lb/ft</b>	Foot-pound per Foot
<b>FUNWAVE</b>	Full Nonlinear Boussinesq Wave Model
<b>FW</b>	Floodwall
<b>G</b>	Gate
<b>GIWW</b>	Gulf Intracoastal Waterway
<b>Hs</b>	Significant Wave Height
<b>HSDRRS</b>	Hurricane and Storm Damage Risk Reduction System
<b>HURDAT</b>	Hurricane Database – NOAA
<b>H/T</b>	Height per Time
<b>Hwy</b>	Highway
<b>I</b>	Interstate
<b>ICRR</b>	Illinois Central Railroad (Canadian National Railroad)
<b>IEPR</b>	Independent External Peer Review
<b>IHNC</b>	Inner Harbor Navigation Canal (Industrial Canal)

<b>IPET</b>	Interagency Performance Evaluation Team
<b>JPM-OS</b>	Joint Probability Method - Optimal Sampling
<b>kip/ft</b>	Kilopound per Foot
<b>L</b>	Levee
<b>L<sub>0</sub></b>	Deep Water Wavelength
<b>LA</b>	Louisiana
<b>LACPR</b>	Louisiana Coastal Protection and Restoration Study
<b>lb/ft</b>	Pound per Foot
<b>LCA</b>	Louisiana Coastal Area Plan
<b>LI</b>	Levee/I-wall Combination
<b>LIDAR</b>	Light Detection and Ranging
<b>MATLAB</b>	Numerical Modeling Program by The MathWorks
<b>mbar</b>	Millibars
<b>MCS</b>	Monte Carlo Simulation
<b>mph</b>	Miles per Hour
<b>MRGO</b>	Mississippi River Gulf Outlet
<b>MVN</b>	Mississippi Valley Division (USACE New Orleans)
<b>NAVD88</b>	North American Vertical Datum of 1988 2004.65
<b>NCC</b>	Notice of Construction Completion
<b>NFIP</b>	National Flood Insurance Program
<b>nm</b>	Nautical Mile
<b>NOAA</b>	National Oceanic and Atmospheric Administration
<b>NS</b>	Norfolk Southern Railroad
<b>ORPT</b>	One Percent Review Team
<b>%</b>	Percent
<b>PS</b>	Pump Station
<b>PBL</b>	Planetary Boundary Layer Model
<b>PC-Overslag</b>	Dutch Wave Run-up and Overtopping Software
<b>PgDT</b>	Program Delivery Team
<b>PS</b>	Pump Station
<b>REF/DIF</b>	Refraction/Diffraction Model
<b>RM</b>	River Mile
<b>RR</b>	Railroad
<b>RSLR</b>	Relative Sea Level Rise
<b>s</b>	Second (as referred to in measurements or equations)
<b>SHORECIRC</b>	A Quasi 3-D Nearshore Model
<b>SLFPA</b>	South Louisiana Flood Protection Area
<b>SLOSH</b>	Sea, Lake, and Overland Surges from Hurricanes

<b>SLR</b>	Sea Level Rise
<b>SMS</b>	Surface Water Modeling System
<b>SPH</b>	Standard Project Hurricane
<b>SPM</b>	Shore Protection Manual
<b>STAT</b>	Statue
<b>std</b>	Standard Deviation
<b>STWAVE</b>	Steady State Spectral Wave Model
<b>SWAN</b>	Simulating Wave Nearshore Model
<b>S&amp;WB</b>	Sewage & Water Board (New Orleans)
<b>TAW</b>	Technical Advisory Committee on Flood Defense (The Netherlands)
<b> Tp</b>	Peak Wave Period
<b>US</b>	United States
<b>USACE</b>	United States Army Corp of Engineers
<b>WAM</b>	Global Ocean Wave Prediction Model
<b>WBV</b>	West Bank and Vicinity
<b>WCC</b>	Western Closure Complex
<b>WISWAVE</b>	Wave Information Study Wave Model





## FOREWORD

This report supersedes the October 2007 report *Elevations for Design of Hurricane Protection Levees and Structures Report*, commonly referred to as the October 2007 Design Elevation Report (DER). Since completion of the October 2007 DER, the methodologies described in **Chapter 2** of the original report were incorporated into a design guideline document, Hurricane and Storm Damage Reduction System Design Guidelines, Interim, with revisions through June 2012. These guidelines have been reviewed by an Independent External Peer Review (IEPR) Panel. The IEPR of the design guidelines, completed in June 2010, resulted in the need to revise the text of Chapter 2 to add clarification and make grammatical corrections. Two additional IEPRs were also completed. The first IEPR, completed in December 2010, was a review of the original October 2007 DER. The second IEPR, completed in September 2012, was a review of a revised version (2011) of the DER and its supporting Addendum. The 2011 revised version of the DER and its supporting Addendum were not completed as final revised versions of the report, and are not considered official versions of the DER. All associated edits and information included in the 2011 revised version of the DER and its supporting Addendum were incorporated into this report (DER Version 2.0). Additionally, all comments from the two additional IEPRs were successfully closed and concurred upon by the Corps and the IEPR panel. Any agreed-to changes have been incorporated into this report (DER Version 2.0). There are only two official and final versions of the DER: October 2007 (original) and December 2014 (Version 2.0). All other versions (and Addendums) were works-in-progress which were not finalized until the DER Version 2.0 (this document) was completed.

The October 2007 DER included the initial hydraulic design elevations for the Lake Pontchartrain and Vicinity (LPV) and West Bank and Vicinity (WBV) Projects in Chapters 3 and 4, respectively. These chapters have been updated to include the final hydraulic design elevations. The process for defining the final hydraulic design elevation is as follows: All alternatives (where available) for their corresponding hydraulic reach were reviewed along with the 95 or 100% structure or levee plans and specifications (P&S). The alternative that corresponded to the 95 or 100% P&S was considered the final hydraulic design. The data from the final hydraulic design was used to update data for the hydraulic boundary conditions, hydraulic design elevation, and wave loads.

Two new chapters have been added which were not included in the October 2007 DER. The chapters document the hurricane design elevations for the Mississippi River Levees (MRL) in the New Orleans area bordering LPV and WBV, to include the final design elevations for the WBV-MRL Co-located Levees and design elevations for MRL coincident levees (Chapter 5) and the initial design elevations for the New Orleans to Venice Project (Chapter 6). Chapter 7 includes Conclusions.

**Plates 2-14B** were updated with the LPV, WBV and WBV-MRL final design elevations for existing (2007) and future (2057) for levees. Hard structures; which included levee/floodwall combinations, pumping stations, floodwalls and gates, were updated for future (2057) conditions. Similarly, **Plates 15-20** were created with the initial design elevations for NOV and Non-Federal Levee (NFL) Incorporation into NOV. The NOV/NFL initial design elevations include existing (2013) and future (2063) for levees. Hard structures for NOV/NFL; which include levee/floodwall combinations, pump stations, floodwalls and gates, include future (2063) conditions. The plates show the hydraulic design reaches. The construction design reaches were not included since they are subject to change over time and are not yet final.

*This page is intentionally left blank.*

## EXECUTIVE SUMMARY

This report, *Elevations for Design of Hurricane Protection Levees and Structures Report, Version 2.0*, provides a detailed documentation of the coastal and hydraulic engineering analysis performed to determine the project design elevations for three projects within the Greater New Orleans Hurricane and Storm Damage Risk Reduction System (GNO HSDRRS); Lake Pontchartrain and Vicinity, West Bank and Vicinity, and New Orleans to Venice Projects, including the portions of the Mississippi River levees coincident with these projects. The 3<sup>rd</sup> Supplemental (PL 109-148), 4<sup>th</sup> Supplemental (PL 109-234), 5<sup>th</sup> Supplemental (PL 110-28), 6<sup>th</sup> Supplemental (PL 110-252), and 7<sup>th</sup> Supplemental (PL 110-329) appropriations authorized the Secretary of the Army to:

- Repair and restore these projects;
- Accelerate the completion of unconstructed portions;
- Armor critical elements; and
- In the case of the existing Lake Pontchartrain and Vicinity and the existing West Bank and Vicinity Projects, raise levee heights where necessary and otherwise enhance the existing Lake Pontchartrain and Vicinity Project and the existing West Bank and Vicinity Project to provide the levels of risk reduction necessary to achieve the certification required for participation in the National Flood Insurance Program under the base flood elevations current at the time of this construction.

The report presents design elevations for the three projects within the GNO HSDRRS. For Lake Pontchartrain and Vicinity and West Bank and Vicinity portions of the GNO HSDRRS, the 1% project design elevation is presented; these elevations are sufficient to provide risk reduction from a hurricane event that would produce a 1 percent (%) annual exceedence surge elevation and associated waves. The LPV and WBV HSDRRS meet the hydraulic requirements for levee certification, as documented in Engineering Circular 1110-2-6067, USACE Process for the National Flood Insurance Program (NFIP) Levee System Evaluation, August 2010.

For the New Orleans to Venice portion of the GNO HSDRRS, two (or three in the case of the Non-Federal Levee (NFL) Incorporation into NOV) design elevations are presented, the 1% project design elevation and the 2% project design elevation. The 4% project design elevation is also presented for portions of the NFL HSDRRS. The 2% project design elevations are sufficient to provide risk reduction from a hurricane event that would produce a 2% annual exceedence surge elevation and associated waves. The 4% project design elevations are sufficient to provide risk reduction from a hurricane event that would produce a 4% annual exceedence surge elevation and associated waves.

The design elevations and levee slopes presented in this report for the Lake Pontchartrain and Vicinity and West Bank and Vicinity Projects are the final values, unless design is still ongoing.

The NOV/NFL elevations presented in this update of the report should be considered initial elevations. Elevations are appropriate for design of some of the levee/floodwall reaches which will not be impacted by subsequent studies which might further modify the system ‘footprint’

enough to require reanalysis of the levee grades for that specific reach. More thorough engineering investigations will follow to determine final construction elevations on many reaches of the NOV/NFL HSDRRS. Additional studies may be performed to evaluate alternatives. The designers may evaluate new alignments, change a levee to a floodwall, change levee cross-sections, add breakwaters, incorporate armoring, and other measures that can change the parameters used to calculate the design elevations.

Hydraulic design and analysis associated with these investigations will be documented in engineering analysis reports and also in updates to this report. All hydraulic analyses associated with the GNO HSDRRS can be found in one comprehensive document.

To assure continuity of design methodology and provide close quality management, final design elevations utilized throughout the New Orleans area will be reviewed by the New Orleans District Engineering Division Chief of Hydraulics and Hydrologic Branch.

## **NEW PROCESSES AND PROCEDURES**

For the coastal and hydraulic engineering analyses, new processes and procedures were formulated. A team consisting of members from the Corps of Engineers (USACE), Federal Emergency Management Agency (FEMA), National Oceanographic and Atmospheric Administration (NOAA), private sector, and academia developed a new process for estimating hurricane inundation probabilities, the Joint Probability Method with Optimal Sampling (JPM-OS). These results are being applied to USACE work including the HSDRRS, Interagency Performance Evaluation Team (IPET) risk analysis, Louisiana Coastal Restoration and Restoration Project, and FEMA Base Flood Elevations for production of Digital Flood Insurance Rate Maps (DFIRM) for coastal Louisiana (LA) and Texas. The USACE and FEMA work use the same model grids, the same model software, the same model input, such as wind fields, and the same method for estimating hurricane inundation probabilities. Additional information can be found in **Chapter 2**. A more detailed description of the process and the modeling can be found in the White Paper, “Estimating Hurricane Inundation Probabilities” and documents prepared for FEMA for the coastal base flood elevation work.

A team of USACE, academia, and Dutch experts developed a step-wise approach to determining design elevations based on a probabilistic analysis of wave overtopping rates. This analysis incorporates the uncertainties associated with the coastal parameters used to compute overtopping rates. A similar methodology has been developed using the Goda formulas to compute the wave forces with different confidence levels. The step wise approach is described in detail in **Chapter 2**. The step wise approach has been incorporated into design guidelines prepared by the New Orleans District.

Criteria for wave overtopping thresholds were established in consultation with the American Society of Civil Engineer (ASCE) External Review Panel. USACE Engineering Research and Development Center (ERDC) evaluated overtopping criteria and prepared a paper, Evaluation of Permissible Wave Overtopping Criteria for Earthen Levees without Erosion Protection, found in **Appendix F**.

An extensive USACE/FEMA internal review and an ASCE external review were conducted during the period March through August 2007. Consultation with ASCE external review members and USACE experts began much earlier in the design process. Comments have been incorporated into this report. The review documents can be found in USACE/FEMA South East Louisiana Joint Surge Study Independent Technical Review (Draft Report 15 August 2007) and ASCE One Percent Review Team (OPRT), Report Number 1 (31 May 2007) and Report Number 2 (30 July 2007).

Design guidelines have been developed and are presented in the design guideline document, Hurricane and Storm Damage Reduction System Design Guidelines, Interim, with revisions thru June 2012. These guidelines have been reviewed by an Independent External Peer Review (IEPR). The IEPR of the design guidelines, completed in June 2010, resulted in the need to revise the text of Chapter 2 to add clarification and make grammatical corrections.

Two Independent External Peer Reviews were conducted for various versions of the DER, to include a draft version. The first IEPR, completed in December 2010, was a review of the original October 2007 DER. The second IEPR, completed in September 2012, was a review of a revised version (2011) of the DER and its supporting Addendum. The 2011 revised version of the DER and its supporting Addendum were not completed as final revised versions of the report. All associated edits and information included in the 2011 revised version of the DER and its supporting Addendum were incorporated into this report (DER Version 2.0). Additionally, all comments from the two additional IEPRs were successfully closed and concurred upon by the Corps and the IEPR panel. Any agreed-to changes have been incorporated into this report (DER Version 2.0). There are only two official and final versions of the DER: October 2007 (original) and December 2014 (Version 2.0). All other versions (and Addendums) were works-in-progress which were not finalized until the DER Version 2.0 (this document) was completed.

## **IPET FINDINGS AND APPLICATION TO THE DESIGN ELEVATIONS**

As documented in the IPET report, Performance Evaluation of the New Orleans and Southeast Louisiana Hurricane Protection System, Draft Final Report of the Interagency Performance Evaluation Task Force, Volume 1, Executive Summary and Overview, there were three overarching findings and recommendations:

1. The hurricane protection system in New Orleans did not perform as a system. IPET findings indicated it was important that all components have a common capability based on the character of the hazard they face.
2. Redundancy should be a component of the system.
3. Consideration should be given to the performance of the system if the design event or system requirements are exceeded.

A systems approach was used in the coastal and hydraulic engineering analyses. Surge and wave models were inclusive of the protection system area. Analyses included the evaluation of the effects of subsidence and sea level rise on surge elevations and waves. Construction of the hurricane protection system to the design elevations and cross-sections in this report ensures that the components have a common capability based on the hazard.

Redundancy has been included in the system. The existing levee/floodwall system in the Inner Harbor Navigation Canal/GIWW (IHNC/GIWW) and along the outfall canals will provide a useful measure of redundancy to the flood risk reduction system behind the primary line of protection such as the MRGO/GIWW gates, Seabrook gate, and the permanent outfall closures and pumps. Sector gate alternatives for the Harvey and Algiers Canal will also have some levee/floodwalls along the interior drainage outlets that can provide a measure of redundancy.

Consideration has been given in the analyses to resiliency, the performance of the system if the design event or system requirements are exceeded. The USACE must be in a position to ensure that the system is resilient to severe hurricanes both now and into the future. Resiliency research facilitates the USACE to build better levees. Incorporation of resiliency into levee design will build trust in the community.

## **SEA LEVEL CHANGE**

The Louisiana Coastal Protection & Restoration (LACPR) Final Report came out with new rates of relative sea level rise in 2009. This report came after the HSDRRS modeling and hydraulic design were completed, plans and specifications were completed, and construction was underway. The sea level rise rates were developed by ERDC based on the Intergovernmental Panel on Climate Change Fourth Assessment Report, published in 2007. The relative sea level rise mid range values for Pontchartrain area was 1.3 ft/50 years; the high range value for Pontchartrain area was 2.6 ft/50 years. The values were added to the statistical surface for existing condition, no modeling performed, no levee design performed. For example, a levee of design height of 14 ft in 2010 would be 15.3 ft in 2060 for the mid range value and 16.6 ft in 2060 for the high range value.

Compare and contrast this with the methodology performed for HSDRRS using the rate of 1 ft in 50 years. 1 ft natural subsidence was placed in the ADCIRC model, and a subset of the 152 total storms was modeled. Water level change values were developed from the model results. The water level change values were added to the 1% chance annual exceedence surge level. Adjustments were made to wave characteristics. The height of the levee was determined using HSDRRS design guidelines.

To show the difference in design elevations with the two methods, the LACPR levee elevation for St Bernard levees for future conditions using the mid range value would be 28.1 to 30.6 ft. Using the HSDRRS methodology, the future condition elevations are 29.0 to 31.5 ft, about 1 ft higher.

A USACE Circular was published in June 2009 prescribing the use of gage data to determine the relative sea level change, a different process than what was followed for HSDRRS. As a result of the circular, an assessment, found in **Appendix O**, was prepared to put the design elevations in context with the three different rates of sea level change prescribed in Engineering Circular (EC) 1165-2-211. The assessment included a description of how the HSDRRS can be modified in the event the actual change in the design surge levels is greater than the predicted change.

## **ADDITIONAL MODELING**

Additional ADCIRC modeling was conducted for St. Charles Parish. The purpose of the additional modeling was to resolve differences in the model results for this region compared to available gauge data for Hurricane Katrina. The new modeling included adding resolution to the mesh, new bathymetry data, updating manning's n, and running the model. The results of the modeling yield lower surge elevations for this reach; however, there were no changes to the significant wave height or peak period. The study and findings are presented in **Appendix Q**.

Additional ADCIRC and wave modeling was conducted for the Mississippi River coincident levees. Extension and application of the JPM-OS to compute the 1% surge levels along the Mississippi River were completed by ERDC. ERDC provided a new code of the JPM-OS that computes the surge level probability depending on the discharge variation in the hurricane season. These details can be found in **Appendix H**. STWAVE model results are not available for the Mississippi River because of lack of resolution in the STWAVE models for the Mississippi River area. An empirical approach has been selected to determine the appropriate design waves for the Mississippi River. The new analysis utilizes the Bretschneider Equation, and accounts for the varying wind direction, wind speed, and fetch of each of the 152 synthetic storms. The full details of the wave assessment can be found in **Appendix I**.

A SWAN (Simulating Waves Nearshore) model was developed to assess the wave climate along the Mississippi River levees below RM 44 to further lend confidence to the methodology used for the NOV-MRL co-located levees. The results of this modeling effort are discussed in **Appendix K**.

A sensitivity analysis on storm surge modeling results was performed using a subset of 18 storms in ADCIRC, to determine the potential impact of the vertical datum update from NAVD88 2004.65 to NAVD88 2009.55 to the published design elevations for LPV, WBV and NOV/NFL Projects. The details can be found in **Appendix R**.



*This page is intentionally left blank.*

## **1.0 INTRODUCTION**

### **1.1 BACKGROUND**

The purpose of this report is to document the analysis performed by the U. S. Army Corps of Engineers (USACE) Mississippi Valley Division New Orleans District (MVN) to determine GNO HSDRRS design elevations. The GNO HSDRRS design elevations developed for Lake Pontchartrain and Vicinity (LPV) and West Bank and Vicinity (WBV) Projects, including the portions of the Mississippi River levees that are coincident with these two projects, are sufficient to provide risk reduction from a hurricane event that would produce a 1% annual chance exceedence surge elevation and associated waves. This surge elevation has a 1% chance of being equaled or exceeded during any year. The GNO HSDRRS design elevations developed for the New Orleans to Venice (NOV) Project and Non-Federal Levee (NFL) Incorporation into NOV, are sufficient to provide risk reduction from a hurricane event that would produce a 2% annual chance exceedence surge elevation and associated waves. Also documented in this report are design elevations for the NOV/NFL Project that are sufficient to provide risk reduction from a hurricane event that would produce a 1% (and additionally 4% for NFL) annual chance exceedence surge elevation and associated waves.

In September 2006, a preliminary analysis was performed by the New Orleans District to provide initial design elevations for ongoing design and evaluation of the LPV and WBV portions of the HSDRRS. This work was in advance of the completion of modeling and analysis performed jointly by the USACE/Federal Emergency Management Agency (FEMA) modeling team. The modeling work has advanced to sufficient completion for use in design. This report provides design elevations based on this advanced modeling effort.

This report presents the hydraulic design elevations for conceptual design of levees, floodwalls, breakwaters, seawalls and structures for LPV, WBV and NOV portions of the GNO HSDRRS. This chapter provides background (Section 1.1) and provides a description of the area (Section 1.2). Next, it discusses the intent of the design for the GNO HSDRRS (Section 1.3). This chapter closes with an outline of the report (Section 1.4).

An extensive USACE/FEMA internal review and an American Society of Civil Engineers (ASCE) external review was conducted during the period March through August 2007. Comments have been incorporated into this report. The review documents can be found in USACE/FEMA South East Louisiana Joint Surge Study Independent Technical Review (Draft Report 15 August 2007) and ASCE One Percent Review Team (OPRT), Report Number 1 (31 May 2007) and Report Number 2 (30 July 2007).

Two IEPRs were conducted on the October 2007 DER and a draft revision. The purpose of the IEPR is to provide independent assessment of the economic, engineering, and environmental analysis of the project study. The panel found the engineering methods, models, and analyses used in the GNO HSDRRS DERs to be adequate and acceptable. Consideration for comments provided to USACE as a result of the final IEPR report has been incorporated into this version of the GNO HSDRRS DER.

## 1.2 DESCRIPTION OF PROJECT AREA

The LPV, WBV, and NOV Projects are shown in **Figure 1-1**. The LPV Project is designed to provide hurricane risk reduction for residents between Lake Pontchartrain and the Mississippi River levee. The WBV Project is designed to provide hurricane risk reduction for the urban area from Lake Cataouatche to Oakville, LA, along the west bank of the Mississippi. The NOV Project is designed to provide hurricane risk reduction for portions of Plaquemines Parish adjacent to the Mississippi River levees. The Non-Federal levees in Plaquemines Parish on the west side of the Mississippi River will be incorporated into the existing NOV Project. The majority of the communities within the parishes of Orleans, Jefferson, St. Bernard, St. Charles, and Plaquemines lie within these project areas.

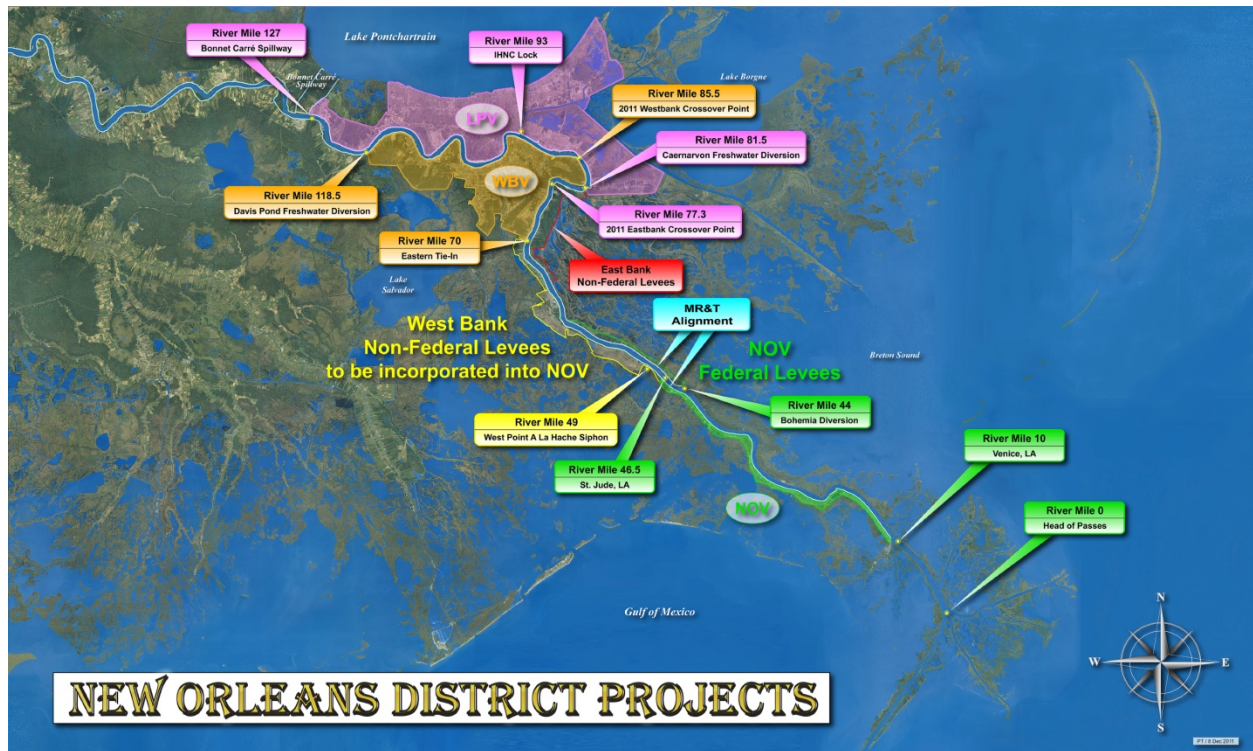


Figure 1-1 – LPV, WBV, and NOV Projects

## 1.3 DESIGN INTENT

The design intent for the GNO HSDRRS has several major components:

- Levee/Structure Design Elevation
- Risk Based Analysis
- Levee/Structure Survivability
- Interior Structures/Pump Stations
- Subsidence
- Future Conditions
- Time Frame
- Monitoring and Maintenance

## **Levee/Structure Design Elevation**

The HSDRRS design elevations for LPV and WBV are sufficient to provide risk reduction from a hurricane event that would produce a 1% annual chance exceedence surge elevation and associated waves. The design elevations presented in this report are determined using the 1% annual chance exceedence surge elevation, 1% annual chance exceedence wave height, and 1% annual chance exceedence peak wave period, and assume simultaneous occurrence of maxima of surge level and wave characteristics. These assumptions are conservative and are in line with a resilient design approach (see Interagency Performance Evaluation Team (IPET), 2007).

The HSDRRS design elevations for NOV are sufficient to provide risk reduction from a hurricane event that would produce a 2% annual chance exceedence surge elevation and associated waves. The design elevations presented in this report are determined using the 2% annual chance exceedence surge elevation, 2% annual chance exceedence wave height, and 2% annual chance exceedence peak wave period, and assume simultaneous occurrence of maxima of surge level and wave characteristics. In addition, design elevations to provide risk reduction from a hurricane event that would produce a 1% annual chance exceedence surge elevation and associated waves are included in this document. Additionally, the HSDRRS design elevations for NFL are presented for a 4% annual chance exceedence surge elevation and associated waves are included in this document.

Design criteria for the levee and structure elevations also consider wave overtopping limits. Guidelines for establishing the overtopping rate threshold (i.e., the threshold associated with the onset of levee erosion and damage) for different types of embankments can be found in Engineering Manual (EM) 1110-2-1100 (Part VI), Table VI-5-6. These threshold values are consistent with those that are adopted by the Technical Advisory Committee on Flood Defence in the Netherlands (Technische Adviescommissie voor de Waterkeringen) (TAW, 1989 and TAW, 2002). After consultation with the ASCE External Review Panel, the following wave overtopping rates have been established for the New Orleans District hurricane protection systems:

- For the design surge elevation, wave height and wave period, the maximum allowable average wave overtopping of 0.1 cubic feet per second per foot (cfs/ft) at 90% level of assurance and 0.01 cfs/ft at 50% level of assurance for grass-covered levees;
- For the design surge elevation, wave height and wave period, the maximum allowable average wave overtopping of 0.1 cfs/ft at 90% level of assurance and 0.03 cfs/ft at 50% level of assurance for floodwalls with appropriate protection on the back side.

## **Risk Based Analysis**

In the mid-1990s, USACE adopted a risk analysis approach for flood damage reduction project development. That policy, Engineering Regulation (ER) 1105-2-101, Risk Analysis for Flood Damage Reduction Studies, was updated in January 2006. Risk analysis explicitly, and analytically, incorporates consideration of uncertainty of parameters and functions used in the analysis to determine the undesirable consequences. Uncertainty is defined herein as a measure of the imprecision of knowledge of variables and functions. Uncertainty may be represented by a specific probability distribution with associated parameters, or sometimes expressed simply as standard deviation (std).

Present guidance supplements freeboard by providing upper and lower bounds of required levee performance based on specified levels of assurance of protecting against the design flood. Levee and floodwall performance here is defined as providing assurance. As stated above, the design criteria are that the wave overtopping rate does not exceed 0.1 cfs/ft with 90% assurance. Furthermore, it does not exceed 0.01 cfs/ft with 50% assurance for grass-covered levees and 0.03 cfs/ft for floodwalls with appropriate protection on the back side. A probabilistic approach is used in calculating wave overtopping that incorporates uncertainty in the surge elevation and wave characteristics.

With completion of the LPV and WBV HSDRRS construction, USACE has complied with the requirements for National Flood Insurance Program Levee System Evaluation, as set forth in Engineer Circular (EC) 1110-2-6067, dated August 2010. The EC is consistent with and founded on the principles of 44 Code of Federal Regulations (CFR) 65.10 while updating methods and references to current USACE practices and criteria. The first USACE national guidance related to levee system evaluation was issued in April 1997. This policy, coordinated with and accepted by FEMA, required the use of risk analysis (statistically based levee height) for levee system evaluations performed by USACE. Since then, all supplemental USACE guidance for levee system evaluation has been coordinated with FEMA. FEMA was a partner on the Project Delivery Team and the Review Team process for this EC. The EC requires that a Levee System Evaluation Report be prepared. The Levee System Evaluation Report included all of the documentation as to the evaluation of the levee system. The Levee System Evaluation Report has explicit identification and explanation of the hydraulic requirements for accreditation of the HSDRRS and clearly indicate how the completed LPV and WBV HSDRRS complies with accreditation requirements. Any additional computations associated with the levee system evaluation are included in the Levee System Evaluation Report.

### **Levee Survivability – Resilience**

IPET identified resilience as one of the “Overarching Lessons Learned” from Hurricane Katrina. Engineers are working to develop guidance to define resiliency and the level of resilience needed for levees and structures. Resiliency is herein briefly defined as the ability of the levee or structure to provide protection during events greater than the design event without total failure.

The minimum criteria for resilience must be that levees and structures do not catastrophically breach when design criteria are exceeded. Resilience also includes designing for possible changes in conditions, with the flexibility to adapt to future design conditions. Guidance being considered for LPV and WBV includes ensuring that the height of all barriers is sufficient to prevent free flow at the 0.2% annual chance exceedence event. The 0.2% annual chance exceedence event was selected because it represents the approximate recurrence of Hurricane Katrina. Surge elevations for the 0.2% annual chance exceedence event are included in the report.

### **Structures / Pump Stations**

Pump stations throughout the New Orleans area have been constructed and are operated and maintained by local government agencies. Prior to construction, there were no existing Federal

pump stations in the GNO HSDRRS. Prior and present hurricane protection projects do not rely significantly on the ability to pump out water from rainfall and overtopping of levees and walls.

In urban and urbanizing areas, provision of a basic drainage system to collect and convey local runoff from rainfall is usually considered a non-Federal responsibility. Within the New Orleans area, however, there is a Federal project to improve interior drainage, the Southeast Louisiana Urban Flood Control Project.

Recognizing the damage that may result from a weakened or inoperable storm drainage system, the New Orleans District is working on several authorized features to reduce the consequences of interior flooding. They include:

- Completion of the Southeast Louisiana Urban Flood Control Project, a federal project to improve interior drainage in New Orleans and surrounding communities.
- Design and construction of positive shut-off gates at pump stations to block backflow.
- Providing fronting protection at pump stations to improve resilience and survivability of pump stations through storm surge events.
- Storm proofing selected pump stations to improve discharge capabilities during storm events.

### **Subsidence and Sea Level Rise**

Planning for anticipated subsidence, both short-term and long-term, is included in the design of the HSDRRS. During the design of individual reaches, geologists and geotechnical engineers will examine site-specific soil conditions and estimate long-term settlement and subsidence in the barriers. For levees over soft foundations, engineers typically recommend construction in several lifts. This allows the foundation soils to consolidate and gain in shear strength. When future lifts are constructed to higher elevations, the footprint of the levee system does not need to increase. Final construction lifts are typically constructed with a foot or more of added height in anticipation of long-term settlement. This added height assures that the levee crown elevation will be at or above the design elevation.

Sea level rise and subsidence have an effect on hurricane surge elevations and wave characteristics. Both have been included in the ongoing hurricane modeling and calculation of levee and floodwall design elevations.

Natural subsidence rates were determined from work performed from the Louisiana Coastal Area, Louisiana, Ecosystem Restoration Study report (2004). The natural subsidence rate consists of relative subsidence and sea level rise.

Relative subsidence rates were derived using the database of long-term rates maintained by USACE MVN. Rates ranged from 0.5 ft per century to 1.0 ft per century for LPV and WBV protection areas (**Figure 1-2**).

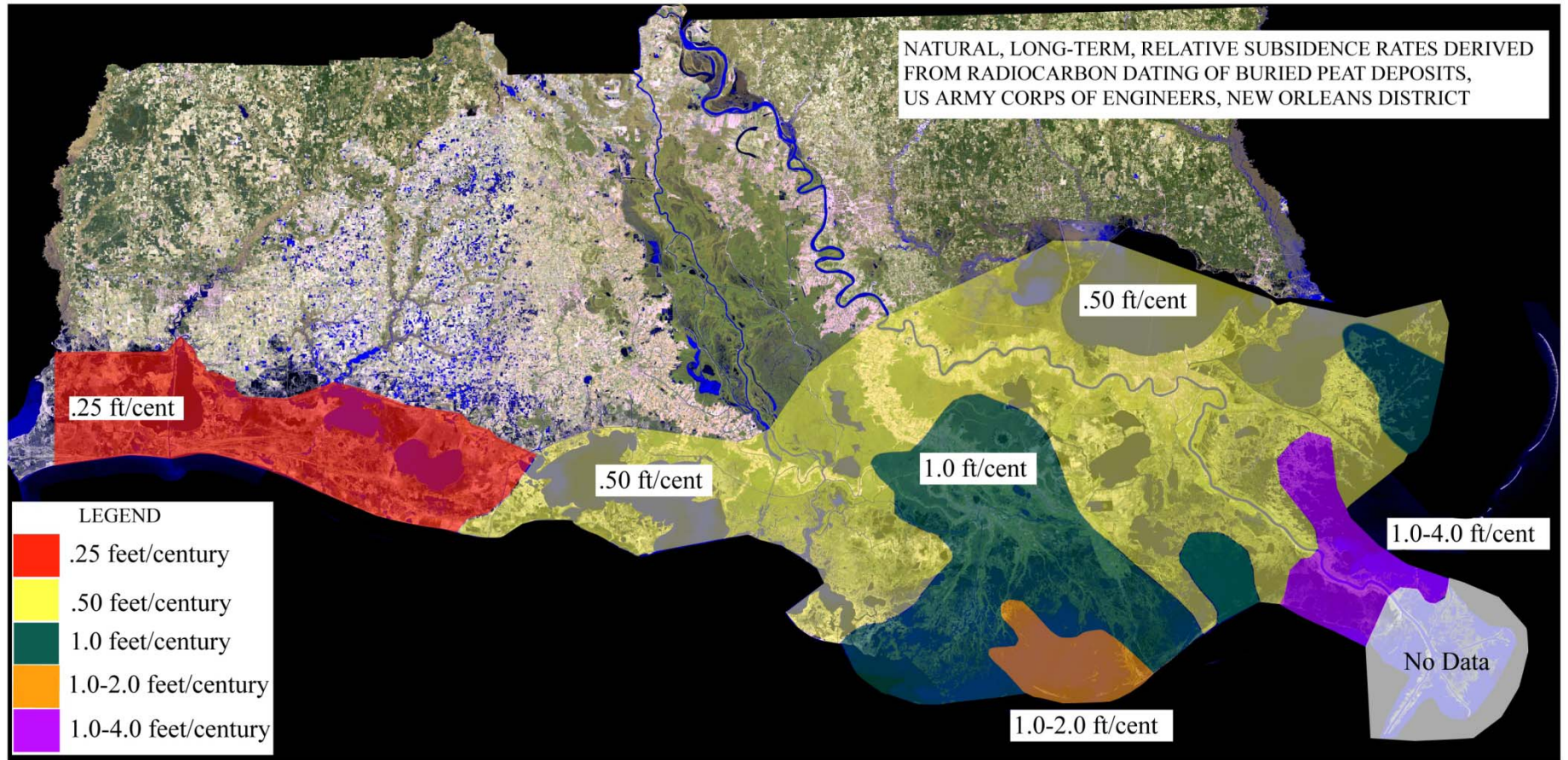


Figure 1-2 – Subsidence Rates of Southern Louisiana

The subsidence rates were determined as follows:

Radiocarbon dating of buried peat horizons representing previous marsh surfaces at mean sea level is another commonly used technique for estimating long-term relative sea level rise rates throughout coastal Louisiana. The depth of the sample divided by its approximate age yields an estimate of the relative sea level rise rate. This technique allows estimates of relative sea level rise over the past several thousand years. However, because these rates represent long-term averages they may not reflect changes in the rates due to short term changes in the processes, such as recent sea level rise. Previous investigations of stratigraphic relative sea level rise using this technique include those of Coleman and Smith (1964), Gagliano and van Beek (1970), Gerdes (1982), Penland et al. (1988), Roberts (1985) and Kulp (2000). Rates derived using this technique vary widely depending on location, sediment age, sediment thickness, and depositional environment. In general, relative sea level rise rates are greatest where Holocene sediments are thickest. Younger sediments also have high relative rates due to the rapid dewatering which occurs after deposition. Presently, the highest rates are located at the mouth of the Mississippi River and along the axis of the infilled ancestral Mississippi River valley which runs from near Houma to Grand Isle (May 1984). Artificial drainage and subsurface fluid withdrawal can greatly increase the relative sea level rise rate experienced throughout the deltaic plain.

The predicted sea level rise (or eustatic sea level rise), 1.3 ft per century, was taken from the Intergovernmental Panel on Climate Change Third Assessment Report, published in 2001. (Note - Fourth Assessment Report had not been published at the time of analysis; it was published later in 2007).

Adding the two values together, natural subsidence rates in the LPV and WBV hurricane protection areas ranged from 1.8 ft per century to 2.3 ft per century.

The Engineering Research and Development Center used the ADCIRC and STWAVE models to evaluate the effect of natural subsidence on surge elevations and waves to determine how surge and waves will change in the future, 50 years from now (the year 2057).

Natural subsidence was modeled as apparent sea level rise. Five storms were selected from simulations representing today's conditions (2007). Each of the five storms were run with a 1 ft, 2 ft, and 3 ft increase in water level. No other changes to input were made (same offshore waves, same friction, same model parameters, etc.).

Model results showed that effects of apparent sea level rise are not uniform across the hurricane protection area - the effects depend on water depth and topography of area.

From the model results, the following effects were determined:

Lake Pontchartrain, New Orleans, and St Bernard, change in surge elevation = +1.5 ft, change in wave height = +0.75 ft, change in wave period = +0.4 seconds. Caernarvon and West Bank, change in surge elevation = +2.0 ft, change in wave height = +1.0 ft, and change in wave period = +0.5 seconds



The changes were added to the existing conditions (2007) surge level and wave characteristics. The resulting future conditions (2057) were used to calculate design elevations.

### **Future Conditions**

Design elevations have been calculated for both existing conditions and future conditions (year 2057). Existing conditions represent conditions that will exist with the completion of the HSDRRS. Future conditions include changes in surge elevation and wave characteristics due to subsidence and sea level rise. Historical subsidence, projections of sea level rise, and previous studies have been used to estimate future changes in surge elevation. As noted in this report, the effect of increasing sea level rise on surge levels has been further investigated and resulted in the 1.5 - 2.8 ft increase in surge level, applied as future conditions. Moreover, the wave characteristics have also been corrected for the increasing water depth.

The New Orleans District recommends regular reassessment of design parameters in order to assure the effectiveness of the system in future years. Changes in sea level and land loss are some of the factors that need to be periodically revisited. As the inventory of storms increases, periodic assessment using the Joint Probability Method with Optimal Sampling (JPM-OS) should also be undertaken. The system should also undergo a reassessment after major events or significant changes in design and analysis methodologies. The need for a post-authorization change should be addressed after each reassessment. Such reviews should be conducted no less than once every 10 years.

### **Time Frame**

The goal of the New Orleans District, to deliver a complete system of hurricane and storm damage reduction barriers to provide a 1% annual exceedence event level of risk reduction to the greater New Orleans area within the LPV and WBV Projects, has been completed. The U. S. Department of Homeland Security's Federal Emergency Management Agency (FEMA) letter, dated February 20, 2014, recognizes receipt of documentation and data "...and, based on receipt of this information; the minimum certification requirements outlined in Title 44 of the Code of Federal Regulations, Section 65.10 have been met." "Therefore," the FEMA letter continues, "this levee certification has been accepted and the levee system will be shown on the new Flood Insurance Rate Maps (FIRM) as providing protection from the base flood."

Ongoing design and construction work in the NOV Project area, to include NFL incorporation into NOV, is scheduled for completion in the 2016-2017 timeframe.

### **Monitoring and Maintenance**

At a minimum, levees are inspected and maintained according to FEMA regulations contained in 44 CFR 65.10(d), Maintenance Plans and Criteria. This federal regulation requires formal and regular documentation attesting to the "stability, height and overall integrity of the levee and its associated structures and systems."

Once initial construction is completed, the responsibility to operate, maintain, repair, replace and rehabilitate barriers is turned over to the local sponsor in most cases. Periodic inspections and

annual reviews submitted to the USACE will assure proper performance. To ensure requirements are well understood, an operations, maintenance, repair, replacement, and rehabilitation manual will be developed for each project and serve as the basis for future monitoring, inspection and reporting.

#### **1.4 REPORT ORGANIZATION**

A description of the design approach to determine the design elevations is discussed in **Chapter 2**. The design approach includes the use of surge elevations and wave characteristics that have been derived using the recently developed probabilistic method, JPM-OS method. Furthermore, two design scenarios are defined in this chapter: existing conditions and future conditions. Both scenarios are applied during the design process. **Chapter 3** presents the resulting final design elevations for LPV project area. Chapter 4 presents the final design elevations for the WBV project area. **Chapter 5** presents the work that was performed for the Mississippi River levees that are coincident with the LPV and WBV HSDRRS. **Chapter 6** presents the initial design elevations for the New Orleans to Venice project area. **Chapter 7** briefly presents conclusions. For the convenience of the reader, generic procedures and methods are reported in the appendices.

*This page is intentionally left blank.*

## **2.0 HYDRAULIC DESIGN APPROACH**

### **2.1 GENERAL**

This chapter presents the hydraulic design approach for the levee design elevations, structure design elevations, and cross-sections of the LPV and WBV HSDRRS and the Mississippi River work coincident with the HSDRRS. The hydraulic design approach was originally developed for LPV and WBV. Modifications to the original design approach were necessary to apply this approach to the coincident Mississippi River work within LPV and WBV, and the NOV Project. Variation in river discharge and also the wave modeling in the Mississippi River amongst others were not included in the original approach. This chapter will first focus on the approach followed in the design for LPV and WBV and then discuss the adaptations to make this approach applicable to the coincident Mississippi River work within LPV and WBV, and the NOV Project.

The outline of this chapter is as follows. **Section 2.2, 2.3** and **2.4** provide an overview of the modeling, frequency analysis, and methods used in the determination of the design elevations for the HSDRRS. **Section 2.5** presents the step-wise methodology for the determination of the design elevations. **Section 2.6** and **2.7** contain two examples (Jefferson Lakefront and MRGO levee) of this design approach. **Section 2.8** discusses the approach for the coincident Mississippi River work within LPV and WBV. This section discusses the extensions and changes from the original approach discussed for the HSDRRS.

### **2.2 MODELING PROCESS**

#### **JPM-OS PROCESS**

In 2006 and 2007, a team consisting of members of USACE, FEMA, National Oceanographic and Atmospheric Administration (NOAA), the private sector, and academia developed a new process for estimating hurricane inundation probabilities, the JPM-OS (Resio, 2007). This work was initiated for the Louisiana Coastal Protection and Restoration Study (LACPR), but now is being applied to USACE work including the HSDRRS, IPET risk analysis, and FEMA Base Flood Elevations for production of Digital Flood Insurance Rate Maps (DFIRM) for coastal Louisiana and Texas. The Corps and FEMA's work use the same model grids, the same model software, the same model input, such as wind fields, and the same method for estimating hurricane inundation probabilities. The JPM-OS process is shown in **Figure 2-1**. A more detailed description of the process and the modeling can be found in the White Paper, "Estimating Hurricane Inundation Probabilities" and documents prepared for FEMA for the coastal base flood elevation work.

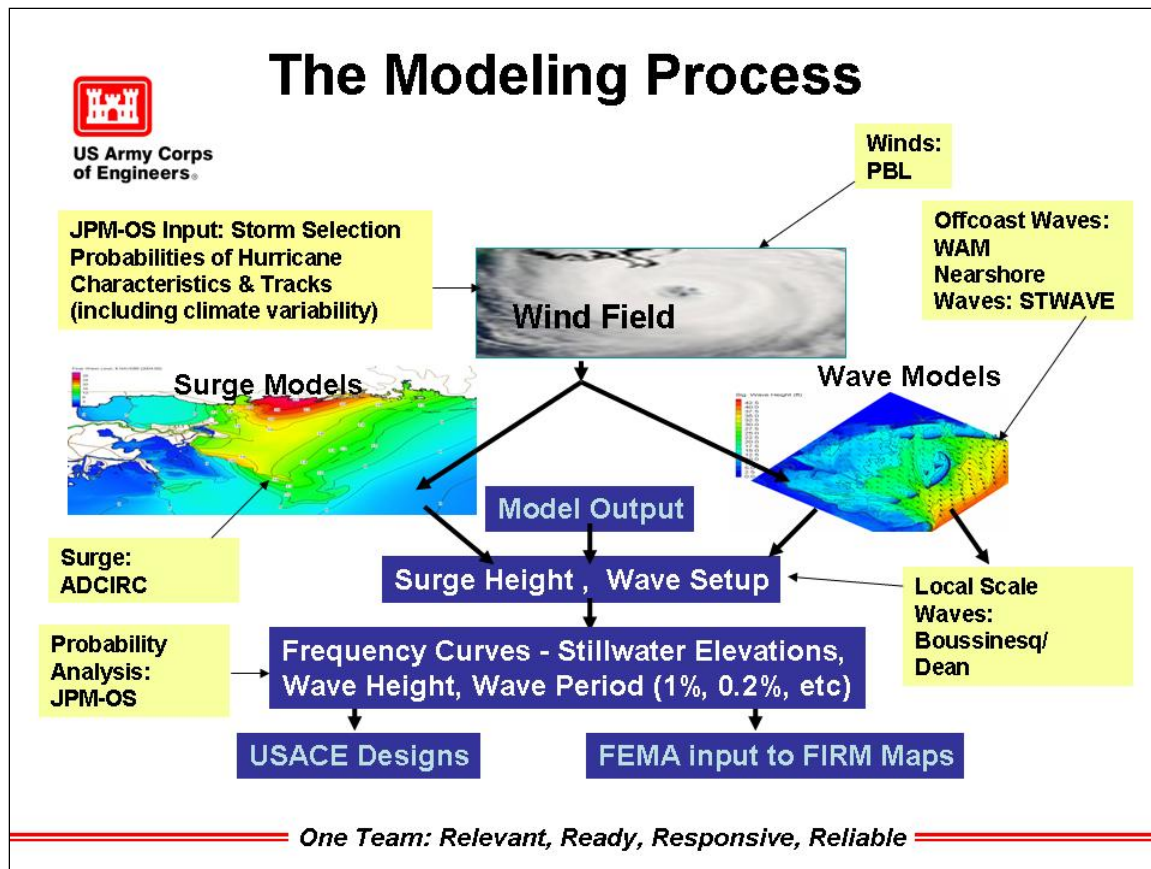


Figure 2-1 – JPM-OS Components and Their Interactions

The following models were used in the JPM-OS process:

**PBL – Planetary Boundary Layer Model.** A marine planetary boundary layer model linking marine wind profiles to large scale pressure gradients and thermal properties was developed by Oceanweather, Inc. Oceanweather, Inc is an internationally known company serving the international shipping, offshore industry and coastal engineering communities.

**ADCIRC – Advanced Circulation Model.** The ADCIRC model was used for the surge modeling. ADCIRC was developed by the ADCIRC Development Group which includes representatives from the University of North Carolina; the University of Oklahoma; the University of Notre Dame; and the University of Texas. The New Orleans District is a development partner with the ADCIRC Development Group. The ADCIRC Model is a state-of-the-art model that solves the generalized wave-continuity equation on linear triangular elements. For the coastal Louisiana modeling, the finite element grid contains approximately 2.1 million horizontal nodes and 4.2 million elements.

**WAM – Wave Prediction Model.** The global ocean Wave Prediction Model, WAM, is a third generation wave model developed by the USACE Engineering Research and Development Center (ERDC) Coastal and Hydraulics Laboratory (CHL). WAM was used for offshore waves and boundary conditions for the nearshore wave modeling. WAM predicts directional spectra. WAM also predicts wave properties such as: significant wave height; mean wave direction and frequency; swell wave height and mean direction; and wind stress fields corrected by including the wave-induced stress and the drag coefficient at each grid point during chosen output times.

**STWAVE – Steady State Spectral Wave Model.** STWAVE is a nearshore wave model developed by CHL. For the JPM-OS effort, STWAVE was used to generate the nearshore wave heights and wave periods using boundary conditions from the WAM modeling. The WAM-to-STWAVE procedure was applied for each storm. For the analyses completed to date, the STWAVE model did not include frictional effects because of scientific uncertainty which implies erring on the conservative side. For more information about the background of this choice, the reader is referred to *Flood Insurance Study: Southeastern Parishes, Louisiana Offshore Water Levels and Waves* USACE (2008).

**SWAN – Simulating Waves Nearshore.** SWAN is a shallow water wave model that is an extension of deep water third-generation wave models. It incorporates the state-of-the-art formulations for the deep water processes of wave generation, dissipation, and the quadruplet wave-wave interactions from the WAM model (Komen et al., 1994). In shallow water, these processes have been supplemented with state-of-the-art formulations for dissipation due to bottom friction, triad wave-wave interactions, and depth induced breaking. SWAN is fully spectral (in all directions and frequencies) and computes the evolution of wind waves in coastal regions with shallow water and ambient current.

USACE has used SWAN to determine design wave conditions for many components of the new Hurricane and Storm Damage Risk Reduction System of greater New Orleans.

**PC-OVERSLAG – Dutch Wave Run-up and Overtopping Model.** This program computes the overtopping rate for complicated cross-sections with a wave berm. The program is based on the overtopping guidelines from the TAW guideline in the Netherlands.

**COULWAVE – Boussinesq Wave Model.** This model (Cornell University Long and Intermediate Wave model) was developed by Patrick Lynett (Texas A&M) and Phil Liu (Cornell) at Cornell during the late 1990s. The target applications of the model are nearshore wind wave prediction, landslide-generated waves, and tsunamis, with a particular focus on capturing the movement along the shoreline (i.e. run-up and inundation). COULWAVE has the capability of solving of number of wave propagation models; however the applications for this project use the Boussinesq-type equations.

The JPM-OS modeling process (**Figure 2-1**) is as follows. The PBL model was used to generate the wind fields required in the JPM-OS process. For each storm, the PBL model was used to construct 15-minute snapshots of wind and pressure fields for driving the surge and wave models. ADCIRC, WAM, and STWAVE model runs were performed on high speed computers at ERDC in Vicksburg, MS, the Lonestar computer at the University of Texas, and similar

computers. With all major rivers already “spun up,” the surge model ADCIRC was initiated assuming zero tide because the tide is not very energetic in this region (0.5 to 2.0 ft tidal range) and plays a minor role in the total surge during hurricanes in Southeastern Louisiana.

The spectral deep water wave model WAM was run, in parallel with the initial ADCIRC run, to establish the directional wave spectra that serve as the boundary conditions for the near-coast wave model, STWAVE. The STWAVE model was used to produce the wave fields and estimated radiation stress fields. These stress fields, added to the PBL estimated wind stresses, were used in the ADCIRC model for the time period during which the radiation stress makes a significant contribution to the water levels.

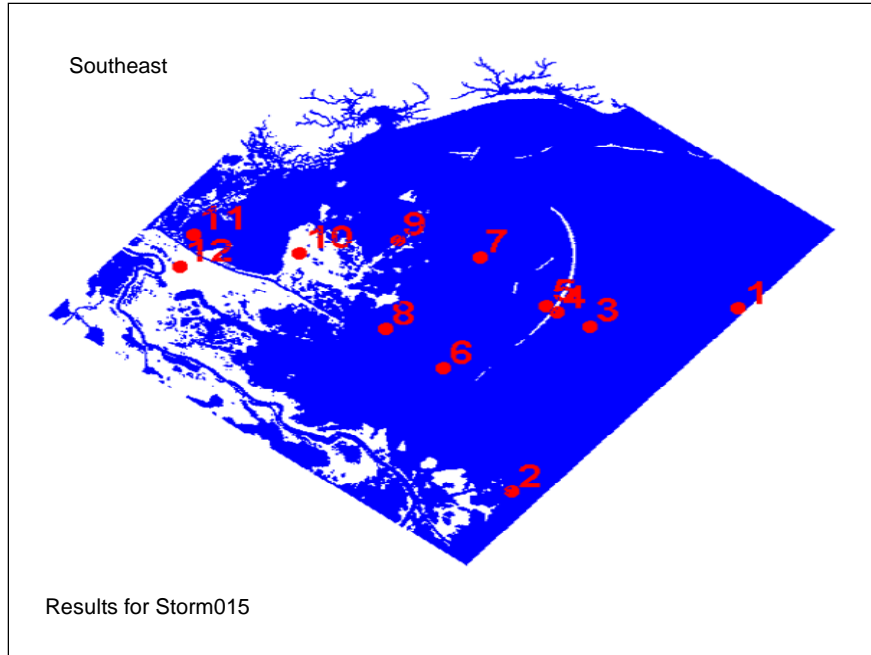
Two conditions of the LPV and WBV portions of the HSDRRS were modeled with ADCIRC/STWAVE for design purposes; 2007 condition and 2010 condition. The **2007 condition** considered the interim gates and closures at the three outfall canals, and levees and floodwalls constructed to pre-Katrina authorized elevations. The **2010 condition** considered the permanent gates and closures at the three outfall canals, a barrier gate on the Gulf Intracoastal Waterway (GIWW)/MRGO, and levees and floodwalls constructed to elevations at or greater than the preliminary 1% design elevations. For the 2010 runs, no barrier gate was present at Seabrook.

For most Joint Probability Methods, several thousand events are evaluated. With the JPM-OS method, optimal sampling allows for a smaller number of events to be used. Based on optimized sampling, 152 hurricane events were modeled for the 2007 condition, and 56 hurricane events were modeled for the 2010 condition. For the 2010 condition, outputs from the 56 storms were used with outputs of 96 storms from the 2007 condition to create a dataset of 152 storms required for the frequency analysis. A relationship was determined from the two sets of conditions and applied to achieve a consistent dataset.

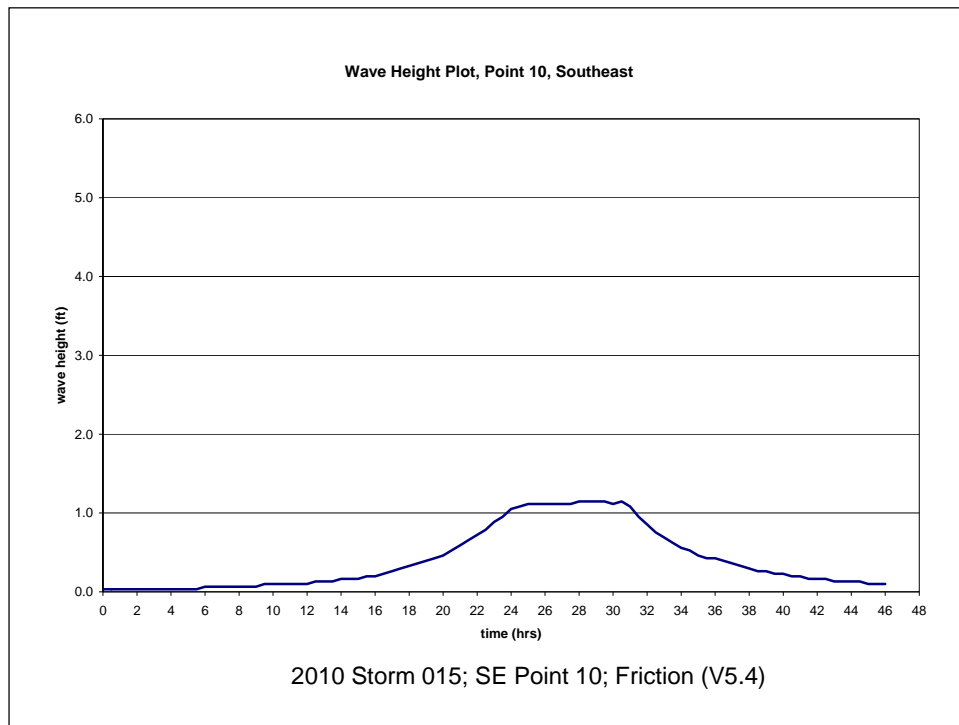
The 2007 results from ADCIRC and STWAVE were used for Lake Pontchartrain Lakefront area and the West Bank. These areas are not affected by the barrier gate at MRGO/GIWW. The 2010 model results used for the analysis of the MRGO/GIWW gate were applied to the levee/floodwall sections starting from South Point to GIWW, the GIWW sections outside the gate and the St. Bernard levee sections. In addition to that, the levee/floodwall sections of the GIWW and Inner Harbor Navigation Canal (IHNC) inside the gate with no Seabrook Gate were also designed with the ADCIRC results.

A special remark is made regarding the STWAVE results. As stated above, the STWAVE results in this design analysis do not consider friction. Sensitivity runs with the STWAVE model show that a run with and without friction can result in differences in wave heights of 3.0 ft or more for the same storm.

**Figure 2-2, Figure 2-3, and Figure 2-4** illustrate the differences in model output with and without friction. **Figure 2-2** shows the location of several output points in the SWTAVE models. **Figure 2-3 and Figure 2-4** show the wave heights for Storm 15 at point 10 from STWAVE with friction and STWAVE without friction.

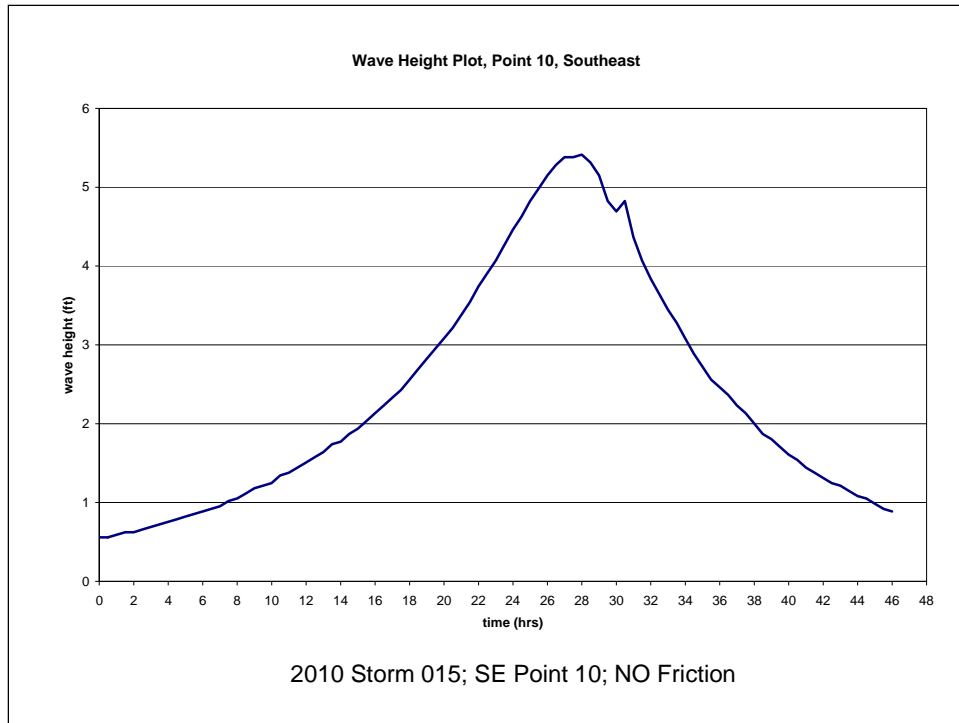


**Figure 2-2 – STWAVE Output Point Locations**



**Figure 2-3 – STWAVE Model with Friction**





**Figure 2-4 – STWAVE Model without Friction**

ERDC has run the Katrina wind fields in the Lake Pontchartrain STWAVE model with friction, to determine the effect of friction on wave climate in the lake and in the marshes of St. Charles Parish. The results show only small changes in the waves in Lake Pontchartrain and differences on the order of 1.0 to 2.0 ft in the marshes of St. Charles Parish. Furthermore, preliminary results from the LACPR work indicate that the magnitude of the difference in design elevations as a result of the lower wave height can be as much as 4.0 to 6.0 ft when extensive marsh vegetation exists in front of the levee system (e.g. Caernarvon to Verret levee).

As Don Resio of ERDC indicated, how the landscape interacts with the waves is an area where research is needed. He said that until there is good wave data in for coastal Louisiana, models that use friction will overestimate the effects of vegetation on wetlands. Another aspect is that it is unknown as to what the wetlands will be in the future. At present, there is no authorization to maintain coastal features. Further, use of science where there is no agreement among the experts and there is so much scientific uncertainty does not make sense for detailed designs.

Based on these considerations, the wave results without friction have been applied in this design study. Use of the STWAVE results without friction for the HSDRRS design elevations results in a conservative design. Evaluation of waves can become part of a continued evaluation.

### **Frequency Analysis**

The output from the ADCIRC and STWAVE models used in the frequency analysis are the maximum surge elevation and maximum wave characteristics (significant wave height, peak

period, and wave direction) in front of the levee or floodwall. The distance at which output is extracted from these models depends on the grid resolution of both the surge and the wave model. The grid resolution for the 2007 and 2010 conditions prescribes the use of the wave results a distance of 600 ft from the protection levee or structure. The 600 ft distance is grid dependent. Evaluation of the grid resolution for future STWAVE models will need to be made to determine this distance.

Because the foreshore is generally very shallow (same order as the wave height), wave breaking plays an important role in the 600 ft distance. Hence, it is not likely that the wave height at 600 ft in front of the levee or structure will be equal to the wave height at the toe of the levee or structure, but will be higher. This will be further discussed in another section. Also, this foreshore area is normally vegetated or has foreshore protection. Hence, erosion during storms of this area, which could alter the wave characteristics, is not expected.

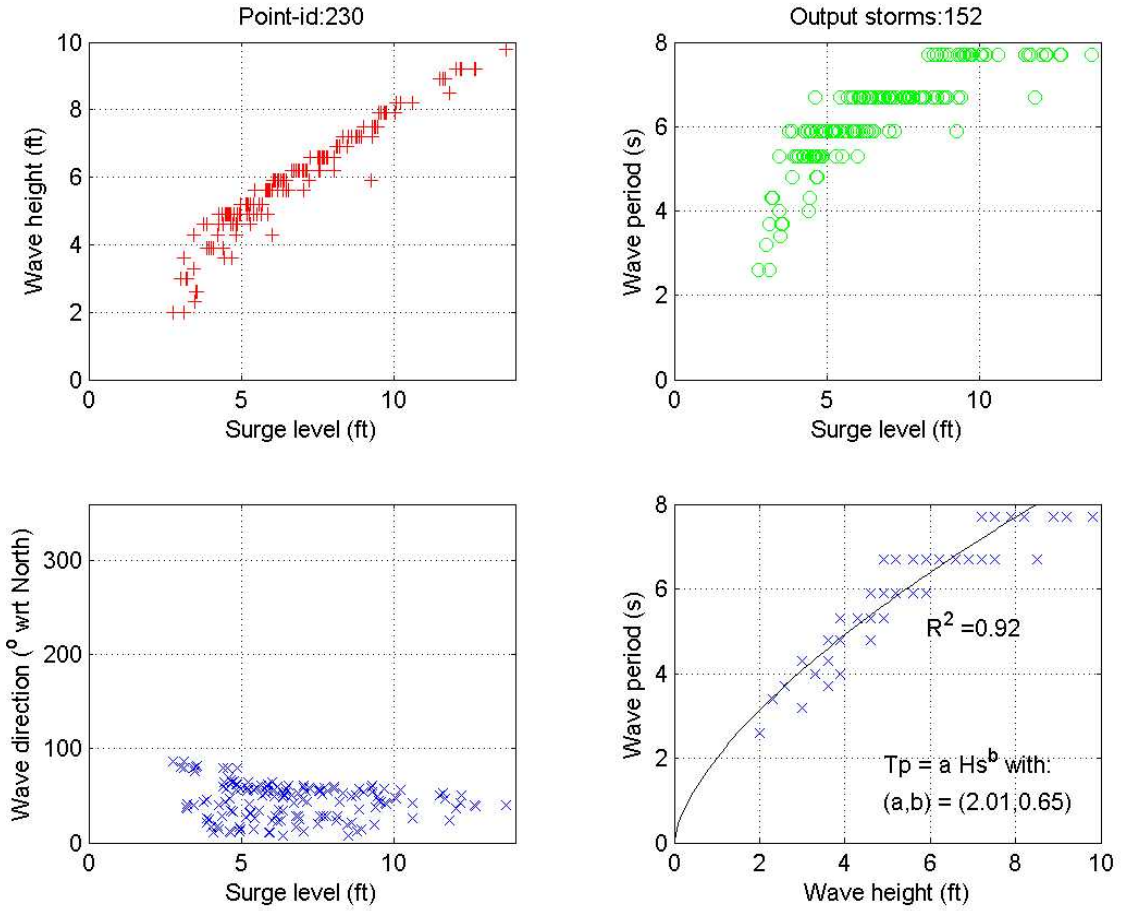
An example of the model output at two locations within the hurricane protection system is shown in **Figure 2-5**. The wave characteristics along Lake Pontchartrain are typically wind-generated and depth-limited waves. There is a high correlation between the wave height and the wave period and between the surge level and wave height for this area ( $R^2 = 0.92$ ). In contrast, the results at the MRGO are much more scattered. The relationship between the surge level and the wave height is less evident, and the wave period strongly varies as a function of the wave height ( $R^2 = 0.42$ ). Long wave periods are observed for a few storm conditions. The computed long wave periods are probably related to swell waves from the ocean, see (IPET, 2007).

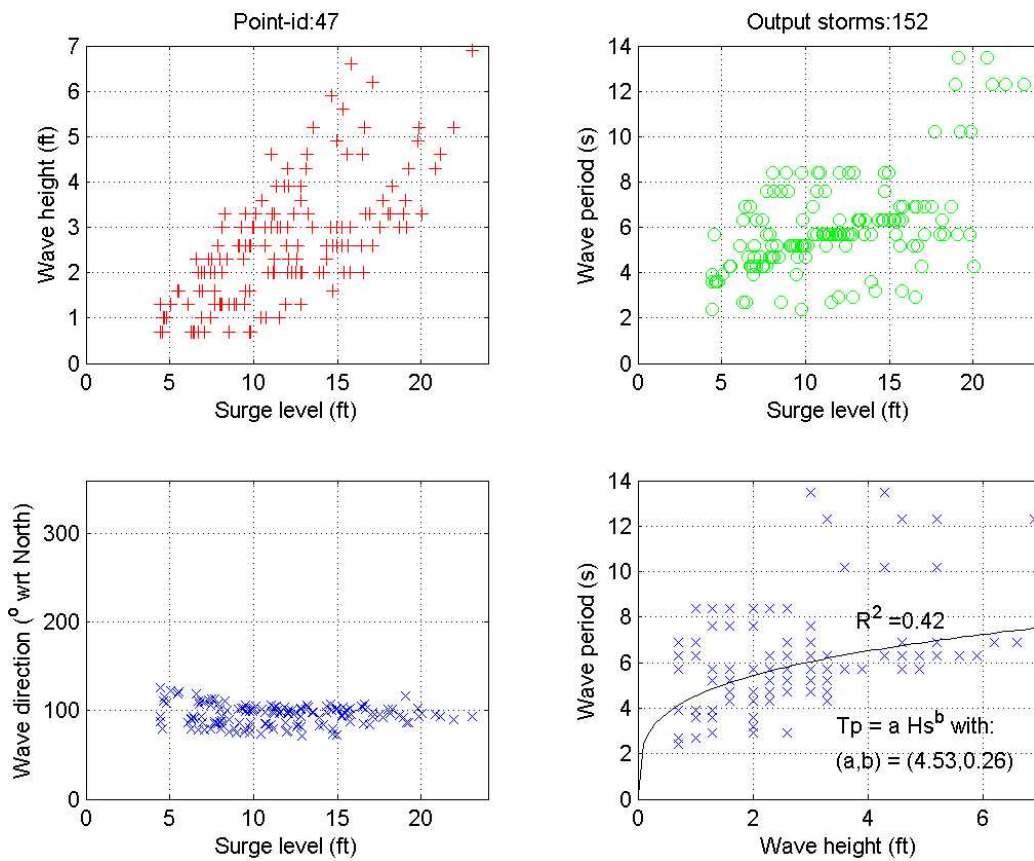
A Joint Probability Method has been applied to derive the surge elevation, wave height, and wave period frequency curves at specific points along the hurricane protection system using output from ADCIRC and STWAVE. This probabilistic model takes into account the joint probability of forward speed, size, central pressure, angle of approach, and geographic distribution of the hurricanes. For more information about this Joint Probability Method, see Resio (2007).

Surge frequency curves have been estimated from the ADCIRC output of the 152 storms for 2007 and 2010 conditions. There may be instances where there is no output from the 152 storms. For instance, a point near the levee system could be dry during the entire storm because of relative high ground and/or offshore winds during that particular storm. In this case, estimates are to be made of the surge elevation for the missing output so that the frequency analysis continued to be based on 152 values. The resulting 1% surge levels are considered to be “best estimate” values. In addition to the best estimates, the probabilistic model also provides an error estimate of the 1% surge levels. Errors are generally in the order of 1.0 to 2.0 ft for the 1% surge levels.

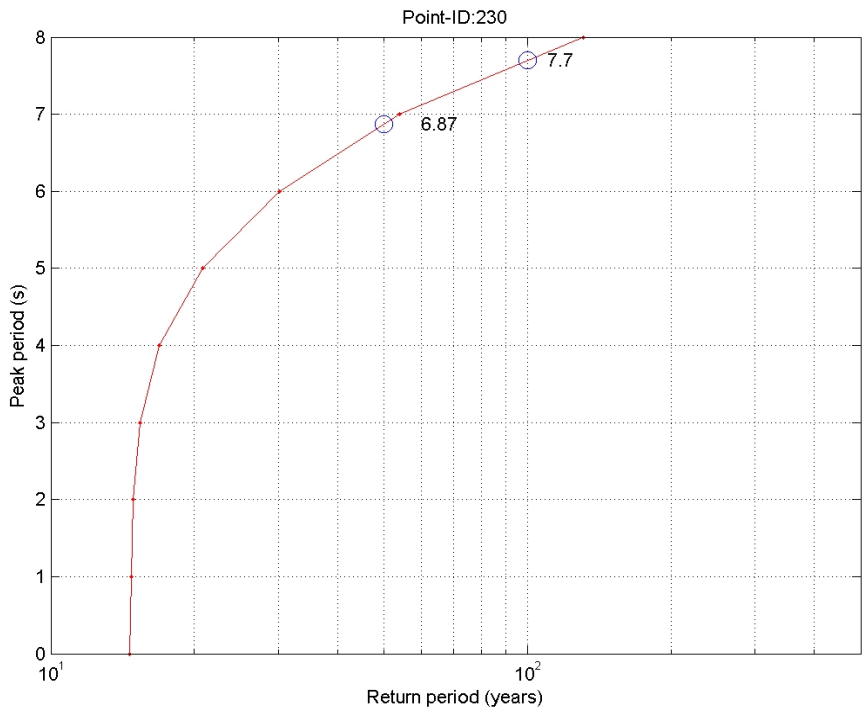
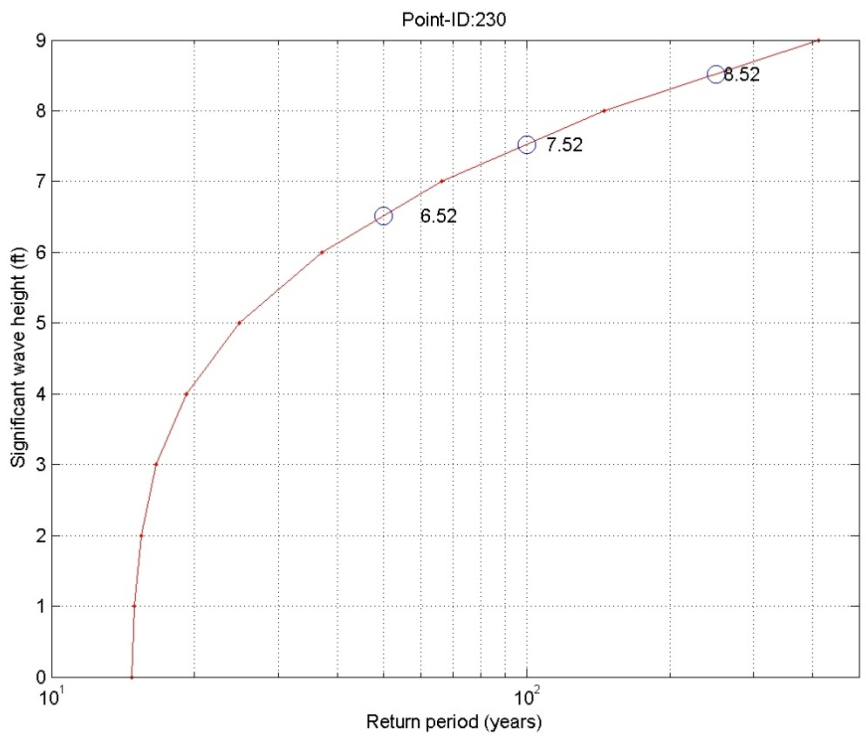
The Joint Probability Method (Resio, 2007) for the surge levels is also used to develop frequency curves for wave height and wave period. Examples of frequency curves can be found in **Figure 2-6**. The errors in the 1% wave height and wave period have been based on expert judgment (Smith, 2006, pers. comm.). The standard deviations of the 1% wave height and wave period are assumed to be 10% and 20% of the best estimate value, respectively. These values are

considered to be typical for errors between wave measurements and modeling outputs for nearshore wave modeling applications.





**Figure 2-5 – Numerical Results at Lake Pontchartrain (upper panel) and MRGO (lower panel) from ADCIRC and STWAVE**



**Figure 2-6 – Frequency Curves of the Wave Height and Wave Period at Lake Pontchartrain (point 230) Based on the STWAVE Results and the JPM-OS Method**

From the JPM-OS frequency analysis, 1% surge elevations, 1% wave heights, 1% peak wave periods, and wave direction for existing conditions are applied in the wave run-up and overtopping calculations. **Appendix A** shows the 1% values for the surge levels and wave characteristics that have been used in this design report. These values do not consider any future changes due to factors such as subsidence and sea level rise. An additional analysis is performed representing conditions that may occur 50 years in the future and is discussed in a different section. This future condition (year 2057) does consider changes in the surge levels and wave characteristics due to subsidence and sea level rise.

## Wave Overtopping

Several methods are presently available for computing the wave overtopping rates. These methods can be divided into empirical methods (e.g. Van der Meer and Jansen, 1995 and Franco, 1999) and process-based methods (e.g. Lynett, 2002, 2004). Both methods are described here briefly:

- **Empirical methods:** Several empirical relationships are derived between the offshore hydraulic conditions (wave height, period, and water level), the levee geometry (levee height, slope) and the wave run-up and overtopping rate. These formulations are generally fitted against extensive sets of laboratory data. For levees, there are well-known relationships formulated by Van der Meer and Jansen (1995) for wave run-up and overtopping. These relationships include the effect of berms, roughness, and wave incidence. These formulations have been incorporated in a software program (PC-Overslag) which is available on the internet at no cost (TAW, 2002)<sup>1</sup>. A second set of formulas developed by Franco & Franco (1999) were used to compute wave overtopping at a vertical wall. The equations were placed in an Excel spreadsheet. Samples of the PC-Overslag output and the Franco & Franco spreadsheet are contained in **Appendix B**.
- **Process-based methods:** In a process-based approach, the run-up and overtopping rates are computed using the fundamental balance equations for mass and momentum of fluid motion. A Boussinesq model is presently the most appropriate model to compute these parameters within a reasonable time frame. The Boussinesq COULWAVE model from Texas AM was used for this report (e.g. Lynett, 2002, 2004). An extensive description of this model and the validation tests has been included in **Appendix C** of this report.

Both methods have their advantages and disadvantages. The empirical methods are based on fitted curves through laboratory data, and their use is fairly straightforward. However, the disadvantage of the empirical methods is that these formulations cannot cope with very complex geometries. The basis of Boussinesq models is the governing equations of mass and momentum. These models are able to handle more complex geometries. A drawback of these models is that they are still in an early stage of development, and the application is time-consuming. In addition, the Boussinesq model does not compute run-up and overtopping at vertical walls.

---

<sup>1</sup> The reader is referred to the website: <http://www.waterkeren.nl/download/pcoverslag.htm>

The empirical approach is mostly used in this design report. Full Boussinesq results were not available in sufficient time to be used in the design process. As a design tool, the Boussinesq model lacks the capability to execute in a production mode. Compound levee cross-sections could not be modified iteratively in a straightforward and timely process. Several Boussinesq runs were made and have been compared with the empirical approach (**Appendix D**). Both approaches give overtopping rates within a factor of 2 to 3 of each other if overtopping rates of 0.01 – 0.1 cfs/ft are considered. In terms of levee/flood wall heights, the differences in design elevations will be small (< 1.0 ft).

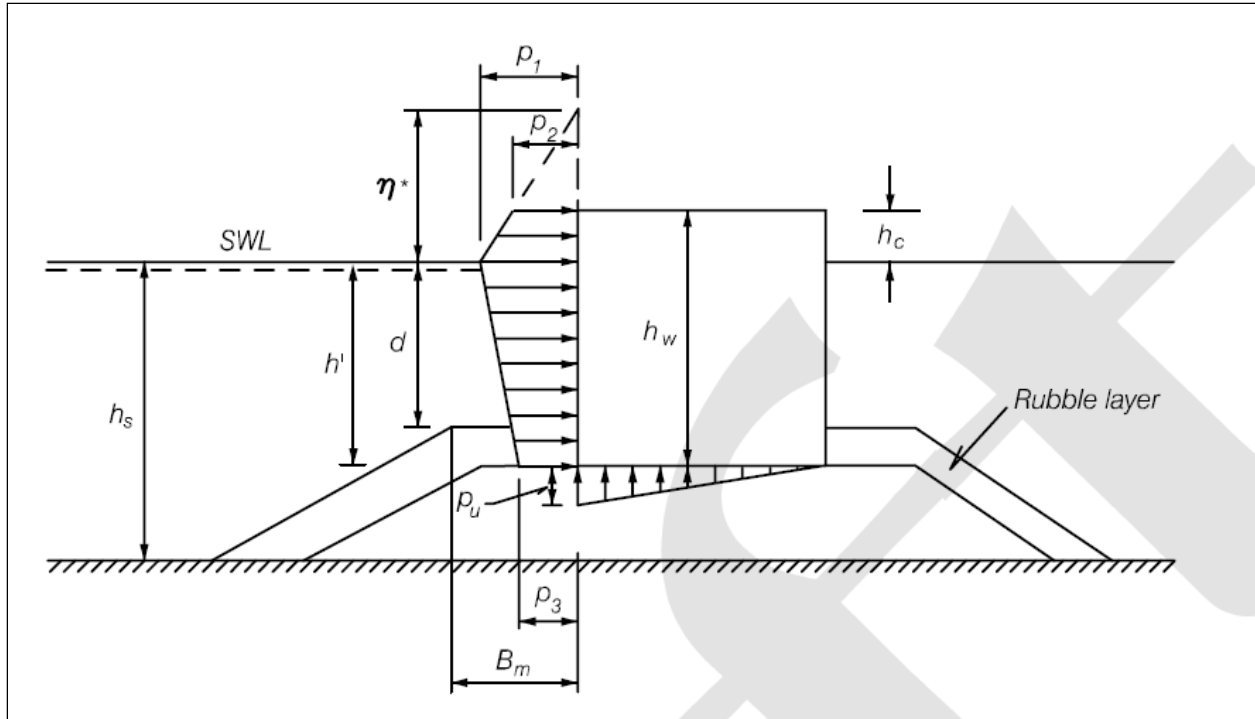
## **Wave Forces**

For floodwalls, pump station fronting protection, tie-in walls, and other vertical “hard” structures, the Goda formulation for computing wave forces is used (EM 1110-2-1100 (Part VI) Chapter 5, 1 June 2006). A definition sketch is shown in **Figure 2-7**. Hydraulic inputs for these computations are the incoming wave height, wave period, and the surge level. Moreover, the geometrical parameters of the structure (bottom elevation, top of wall, etc.) are inputs for this computation. The resulting wave forces from the Goda method include both the hydrostatic and the dynamic pressure of the waves. The Goda method provides wave forces due to both non-breaking and breaking waves. Notice that the hydrostatic pressure due to the surge level has to be accounted for, as well.

The following definitions apply to **Figure 2-7**:

- $p_1..p_3$  are pressures at different levels ( $p_1$  at surge level,  $p_2$  at top of wall,  $p_3$  at bottom),
- $h$  and  $d$  are depths,
- $B$  is the width of the berm,
- $\eta$  is the difference between surge level and the point at which the wave pressures are assumed to be zero.

For more information, the reader is referred to EM 1110-2-1100 (Part VI) Chapter 5, 1 June 2006. **Appendix E** shows calculations of wave loadings on vertical walls using the Goda Formula.



**Figure 2-7 – Definition Sketch of Wave Force Calculations (Coastal Engineering Manual, 2001)**

For submerged structures such as submerged breakwaters, ERDC has developed equations from measurements on a vertical wall in a straight flume physical model (Hughes, 2007). There is the possibility of reflected waves in a confined basin, since the flumes tests did not consider wave amplification due to waves reflected from other vertical surfaces. Although reflection would be possible under some conditions, the possibility of wave reflection was unlikely during a hurricane event when the seas were extremely disturbed. The reflected waves would need to be considered if forces during normal conditions are required.

### **2.3 DESIGN CONDITIONS**

Two design conditions are considered in this report, existing conditions and future conditions, and are discussed below.

#### **Existing Conditions**

Design elevations for this scenario are considered to reflect conditions that are likely to exist in the year 2007 or year 2010 (2013 for NOV). It is assumed that all levee and floodwall repairs have been made, and the interim or permanent closures and pumping stations at 17<sup>th</sup> Street, Orleans Avenue and London Avenue Outfall Canals, the barrier and gates in the MRGO/GIWW (IHNC Surge Barrier), and the WCC are in place.

For most of the HSDRRS analysis, the existing surge elevations are based on the ADCIRC results of the 152 storm conditions for the 2007 case in conjunction with the JPM-OS method.



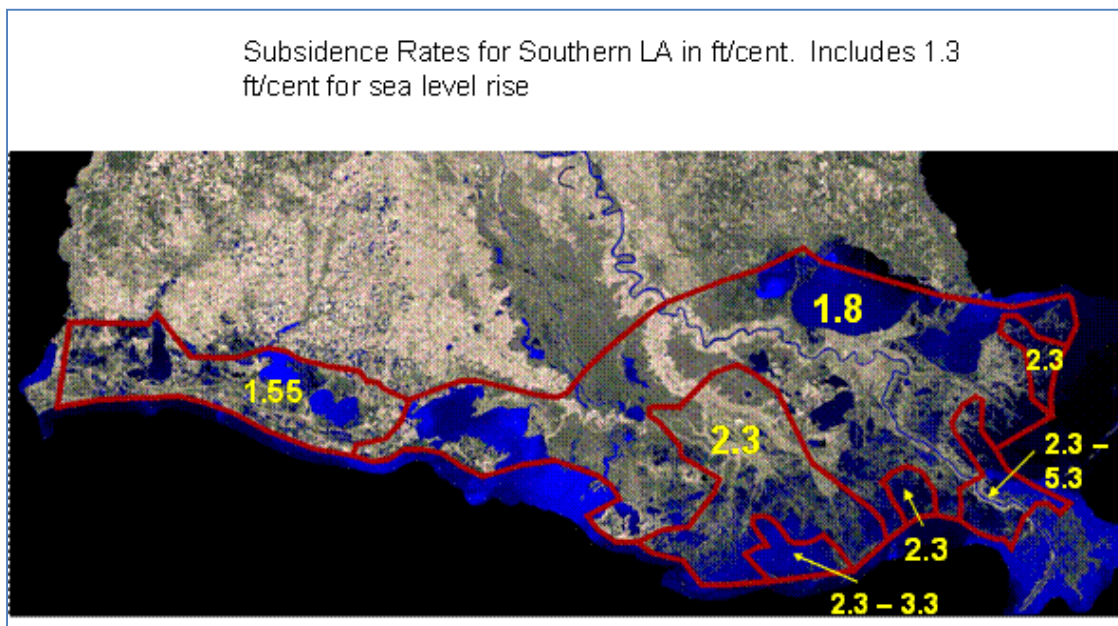
The existing wave conditions are derived based on the STWAVE results, and are derived in a similar way. Model results from the 2010 condition were used for the analysis of the area that is affected by the MRGO/GIWW gate (IHNC Surge Barrier). The 2010 results have also been applied to the back levees of the NOV Project.

For the coincident work of the Mississippi River Levees and HSDRRS, the existing surge elevations have been based on a modified probabilistic analysis which included the variation of river discharge, as described in Section 2.8.

### Future Conditions

Design elevations for this scenario are considered to reflect conditions that are likely to exist in the year 2057 (2063 for NOV). Changes in surge elevations will occur in the future due to subsidence and sea level rise. Historical subsidence, projections of sea level rise, and previous studies were used to estimate future changes in surge elevations. Natural subsidence rates, including sea level rise, have been mapped for the LCA effort (USACE, 2004). **Figure 2-8** shows the combined natural subsidence/eustatic sea level rise for the hurricane protection project area. The values presented in **Figure 2-8** are geologic rates and do not consider any factors such as pumped drainage, which can influence regional subsidence.

The figure shows that the relative sea level rise is 1.8 ft for the Lake Pontchartrain/Lake Borgne area over 100 years (which is equivalent to 0.9 ft over 50 years). This area covers the region in which the HSDRRS is located. The 0.9 ft over 50 years has been rounded off to 1.0 ft of relative sea level rise for the HSDRRS over 50 years. This relative sea level rise of 1.0 ft per 50 years has been used as a basis to establish future surge and wave conditions in the design analysis of the HSDRRS.



**Figure 2-8 – Estimated Relative Sea Level Rise During 100 Year (Subsidence + Eustatic Sea Level Rise)**

Apart from sea level rise and subsidence, another factor that might influence the hydraulic boundary conditions are changes in the storm climate (frequency and intensity of future storms). At this moment, there is no consensus in the scientific community about these effects. Nor is there clear guidance as to how incorporate changes in storm climate as a result of climate change into the hydraulic boundary conditions. Hence, these factors have not been considered in the methodology to derive the future hydraulic boundary conditions. As indicated previously, a re-evaluation of the hydraulic boundary conditions would be performed every 10 years, including assumptions regarding the effects of climate change on the storm climate.

In the following, the future conditions of the various systems (LPV and WBV, Mississippi River Coincident, and NOV) are discussed.

### **LPV and WBV – Future Conditions**

**Figure 2-8** shows that the relative sea level rise is 1.8 ft for the Lake Pontchartrain/Lake Borgne area over 100 years (which is equivalent to 0.9 ft over 50 years). This area covers the region in which the LPV and WBV is located. The 0.9 ft over 50 years has been rounded off to 1.0 ft of relative sea level rise over 50 years. This relative sea level rise of 1.0 ft per 50 years has been used as a basis to establish future surge and wave conditions in the design analysis.

Several ADCIRC and STWAVE model runs were performed to investigate the effect of the increasing sea level rise on surge levels and wave characteristics (**Appendix L**). These results show that:

1. The surge levels increase more than proportional to increasing sea level rise (factor 1.5 to 2.0 ft). A factor 1.5 ft implies that 1.0 ft sea level rise results in 1.5 ft increase of the surge level etc.
2. The wave heights increase due to sea level rise. The relative effect on the wave heights is about 0.3 to 0.6 ft, which means that 1.0 ft surge level results in 0.3 to 0.6 ft increment of wave height.
3. The effects are not uniform in the entire area but depend on the local water depth, and geometry of the area of interest.

Based on the results in **Appendix L**, the future conditions are summarized below (**Table 2-1**):

**Table 2-1 – Future Conditions for Surge Level and Wave Characteristics**

Future Conditions	Surge Level $h_{\text{surge}}$		Significant Wave Height $H_s$		Peak Period $T_p$
	$\Delta h_{\text{surge}} / \Delta h_{\text{sealevel}}$ (-)	$\Delta h_{\text{surge}}$ (ft)	$\Delta H / \Delta h_{\text{surge}}$ (-)	$\Delta H$ (ft)	$\Delta T_p$ (s)
Lake Pontchartrain, New Orleans East, IHNC and GIWW, St. Bernard	1.5	+1.5 ft	0.5	+0.75 ft	Increase by assuming unchanged wave steepness ( $H/T^2$ )
Caernarvon, West Bank	2.0	+2 ft	0.5	+1 ft	Increase by unchanged wave steepness ( $H/T^2$ )

Because the future condition surge elevations are derived from the surge elevations for existing conditions, uncertainty in the data and methodologies has been included. No additional value was added to address uncertainty in the increment representing subsidence, land loss, and sea level rise. The future condition surge elevation was used in wave computations, wave loads on walls and other “hard” structures, and to determine design elevations.

Apart from sea level rise and subsidence, another factor that might influence the hydraulic boundary conditions are changes in the storm climate (frequency and intensity of future storms). At this moment, there is no consensus in the scientific community about these effects. Nor is there clear guidance as to how incorporate changes in storm climate as a result of climate change into the hydraulic boundary conditions. Hence, these factors have not been considered in the methodology to derive the future hydraulic boundary conditions. As indicated previously, a re-evaluation of the hydraulic boundary conditions would be performed every 10 years, including assumptions regarding the effects of climate change on the storm climate.

**Coincident Mississippi River Work – Future Conditions**

For the Mississippi River, the 1.0 ft sea level rise scenario was also adopted to define the future hydraulic conditions 50 years from now. The future condition 1% surge levels and standard deviations for the Mississippi River were derived as follows:

1. 17 storms were run with ADCIRC for Mississippi River discharge of 167,000 cfs and 400,000 cfs with a 2.0 ft increment in the sea level,
2. Peak surge levels were generated for all 152 storms by fitting a trend line between the existing and future storm results of the 17 storms,
3. Joint probability analysis was carried out using these data to define the 1% surge level for a 2.0 ft sea level rise scenario,
4. The increment in 1% surge for a 2.0 ft sea level rise scenario was determined by comparing against the existing 1% surge levels,

5. 50% of the increment in 1% surge found in the previous step was added to the 1% existing surge level to define the future surge level for the 1.0 ft sea level rise scenario.

The future waves were determined as follows. All 152 storms were again analyzed using the empirical method which has been applied for existing conditions. To account for the future conditions, the hydrographs for each RM in this analysis have been modified to reflect the increase in water levels due to sea level rise. The hydrographs applied in this analysis originated from the 400,000 cfs runs. The resulting 152 peak wave heights and wave periods have been fitted linearly to the existing 152 peak wave heights and periods to obtain a trend line. The future 1% wave height and 1% wave period have been computed for each RM using the trend line.

### **NOV Project – Future Conditions**

For the back levees in the NOV system, the analysis used to develop future condition surge levels for LPV and WBV were applied. This analysis is documented earlier in this section. The surge adjustment factor used for the East Bank back levees was 1.5 ft; the surge adjustment factor used for the West Bank back levees was 2.0 ft. For the Mississippi River Levees within the NOV project area, the future surge elevations were developed using the methodology employed for the coincident Mississippi River work within LPV and WBV.

## **2.4 DESIGN ELEVATIONS AND LOADS**

In the design analysis, two types of flood protection are considered; levee type structures (levees and rock breakwaters) and hard structures (floodwalls and other structures like pumping stations).

### **Levees**

The design elevations are computed for both the present and the future conditions. The design elevations presented in this report only consider (relative) sea level rise for future conditions, but do not consider settlement or other structural adjustments. The design elevation recommended for levee construction at this time is the existing elevation. The levees are expected to be adapted several times during its lifetime due to settlement, and changes in the hydraulic conditions should be taken into account as well.

### **Floodwalls and Other Structures**

The recommended design elevation for floodwalls and other “hard” structures is the future conditions elevation. The recommended design elevation for floodwalls and other “hard” structures should be no less than the future condition design elevation of adjacent levees. Floodwalls and other “hard” structures will require extensive reconstruction in the future; incorporating future changes into the design of these structures now is a prudent design consideration.

Note that the hydraulic design analysis does not include adjustments for local settlement. In other words, the design elevations of the floodwalls and levees from the hydraulic analysis are the elevations after adjustments for local settlement. Prior to finalizing the elevations, a local settlement analysis needs to be carried out to define the actual construction elevations to make sure that the hydraulic design elevation is achieved after the adjustment for local settlement.

The design elevations of floodwalls may include structural superiority. Structural superiority is incorporated in the design elevation for those structures that would be very difficult to rebuild, if damaged, due to disruption in services. Examples where structural superiority are applied are major highway and railroad gates that require detours, pumping station fronting protection that requires reductions to pumping capacity, and sector gated structures. These structures are to be constructed to the 2057 levels plus some additional height as determined by Structures Branch for structural superiority. Floodwalls that may be reconstructed in areas with little or no disruption of services are to be constructed to the 2057 level.

The wave forces have been computed for the floodwalls and submerged breakwaters. These forces are evaluated for future conditions (2057). Wave forces are evaluated for two confidence levels (50% and 90%) to present the uncertainty in these numbers. The Corps has made the decision to use the wave forces with the 90% confidence levels in the structural design.

To account for changes due to subsidence and sea level rise over a 50 year period, the surge elevations are adjusted by 1.5 to 2.0 ft. The wave characteristics are adjusted based on half the increase in surge elevations (i.e. 0.75 ft and 1.0 ft). The effect on the wave period is determined by assuming that the wave steepness ( $H/T^2$ ) remains constant.

## 2.5 STEP-WISE DESIGN APPROACH

This section describes the step-wise approach used for determining initial and final design elevations of the levees and structures. The step-wise approach is intended to be used for each section that is more or less uniform in terms of hydraulic boundary conditions (water levels, and wave characteristics) and geometry (levee, floodwall, and structure). The HSDRRS reaches were divided into reaches with similar hydraulic boundary conditions, based on the JPM-OS frequency results for the water levels and wave characteristics.

Before giving an overview of the step-wise approach, several choices and assumptions in the design approach are discussed in detail. These items are:

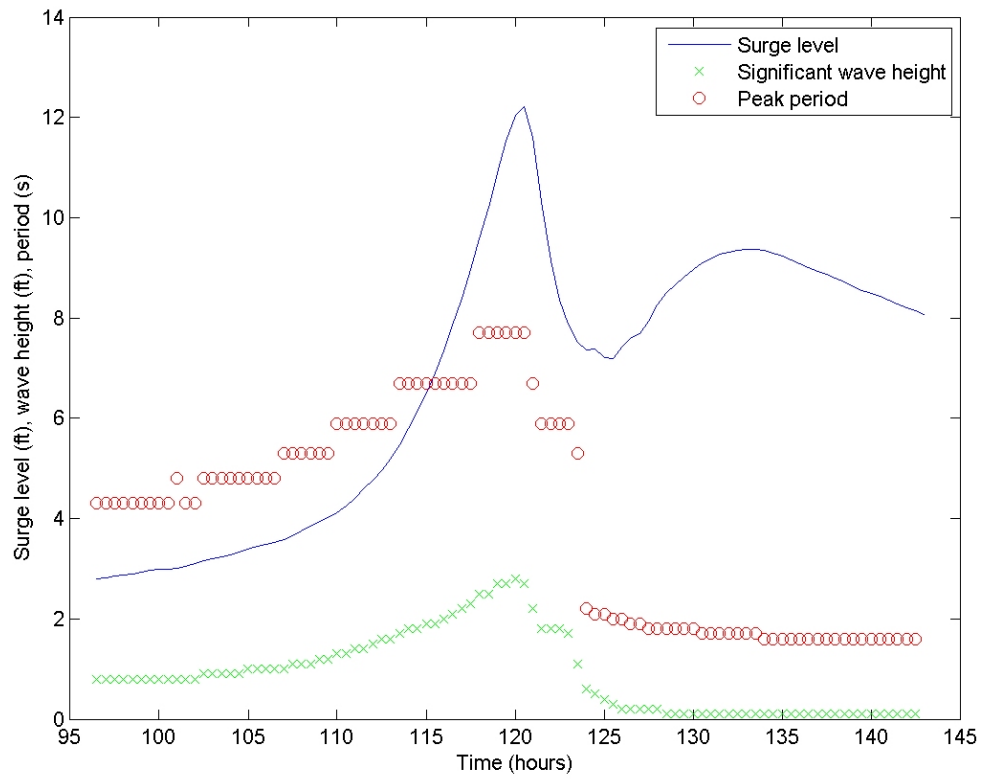
- Use of 1% values for surge elevations and waves
- Simultaneous occurrence of maxima
- Breaker parameter
- Overtopping criteria
- Dealing with uncertainties

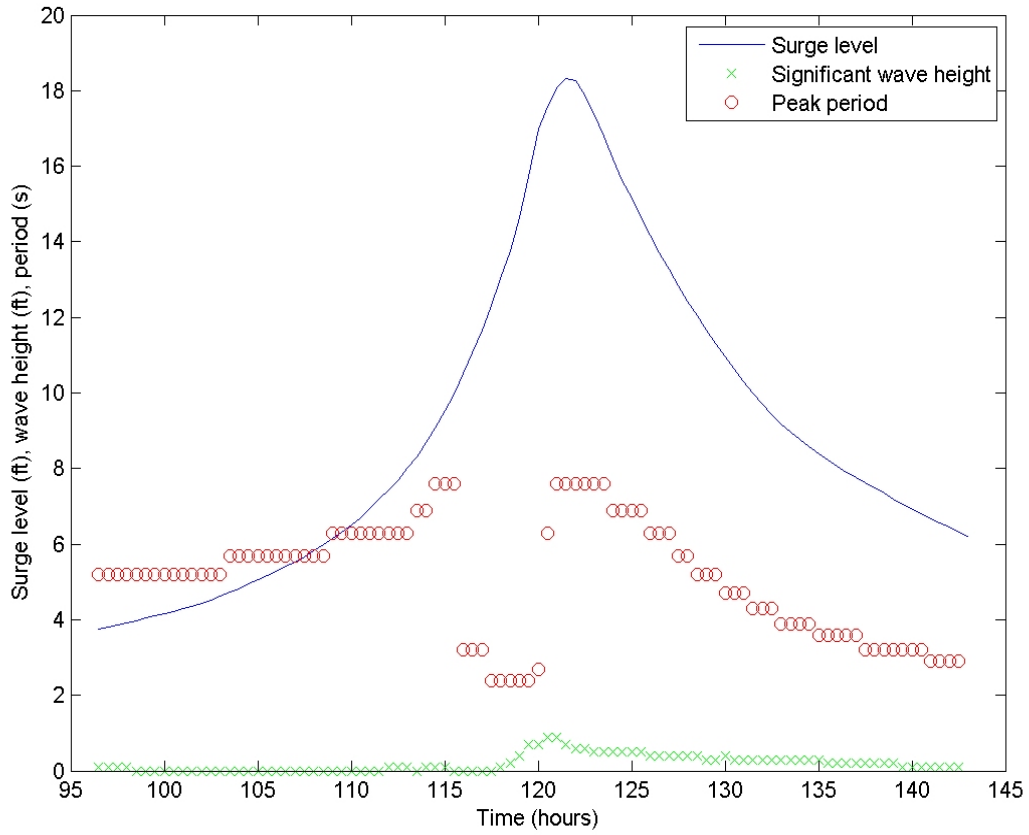
### Use of 1% Values for Surge Elevations and Waves

The step-wise design approach below is probabilistic in the sense that it makes use of the derived 1% surge elevations and 1% wave characteristics based on the JPM-OS method (Resio, 2007). The procedure also includes an uncertainty analysis that accounts for uncertainties in the hydraulic parameters and the overtopping coefficients. However, the approach is not fully probabilistic because the correlation between the water elevation and the wave characteristics is not taken into account. This assumption is an important restriction of this approach. Because of this assumption, the presented approach is conservative. The impact of this assumption may vary from location to location.

### Simultaneous Occurrence of Maxima

Another assumption in the design approach is that the maximum water elevation and the maximum wave height occur simultaneously. **Figure 2-9** shows time series of surge elevation and wave characteristics at two locations: Lake Pontchartrain and Lake Borgne. The plots, from ADCIRC and STWAVE model computations, show that the time lag between the peak of the surge elevation and the wave characteristics at both sites is small ( $< 1$  hour). It should be noted that there are cases in which the time lag between surge and waves is a bit larger (1 to 2 hours). Although this assumption might be conservative for some locations, we feel that assuming a coincidence of maximum surge and maximum waves is reasonable for most of the levee and floodwall sections in our design approach.





**Figure 2-9 – Time Histories of Surge Elevation and Wave Characteristics during Storm 27 at Lake Pontchartrain (upper panel) and at Lake Borgne (lower panel)**



## **Breaker Parameter**

In the design approach, overtopping rates are computed using empirical formulations. One input is the wave height at the toe of the structure. This value must be estimated from the wave results from the STWAVE modeling. During the STWAVE modeling output locations were selected at 600 ft before the protection levee or structure. This distance was chosen because the wave modeling does not have enough resolution close to the structures, and the wave model results become inaccurate.

Because the foreshore is generally very shallow (same order as the wave height), wave breaking plays an important role in that 600 ft. Hence, it is not likely that the wave height at 600 ft in front of the levee or structure will be equal to the wave height at the toe of the levee or structure, but will be higher. To account for breaking in front of the levee or structure, the wave height from STWAVE is reduced using a factor called the breaker parameter. The breaker parameter is defined herein as the ratio between the significant wave height and the water depth. In the literature, the breaker parameter is often a constant or it is expressed as a function of bottom slope or incident wave.

The upper limit for the breaker parameter is 0.78 based on theoretical considerations: refer to the Coastal Engineering Manual (CEM, 2001). This number holds for a solitary wave traveling over a horizontal bottom. In the saturated breaking zone for irregular waves, breaker parameter values range between 0.5 – 0.7. This range is generally applicable for coastal features with mild sloping beds, such as beaches. For relatively long, shallow, flat foreshores, the breaker parameter is around 0.4 (Van der Meer, 1979; TAW, 1989). This value is confirmed by laboratory experiments (Resio, 2006, pers. comm.) and Boussinesq runs (Lynett, 2006 pers. comm.) for similar situations.

Because of the long shallow foreshores in front the levees and structures within the project area, ERDC recommends a value of 0.4 for the entire HSDRRS protection area. This number has been applied to translate the significant wave heights based on STWAVE model results 600 ft from the levee to the significant wave height at the toe of the levee or structure using the local water depth at the toe. The peak period from STWAVE has been used without modification.

## **Overtopping Criteria**

ERDC carried out a literature survey to underpin the value for the overtopping criterion for levees that must be used in this design approach (Hughes, 2007; and **Appendix F**). The survey shows that various numbers have been proposed. Experimental validation of these numbers is very limited. Typical values according to the Dutch guidelines are (TAW, 2002):

- 0.001 cfs/ft for sandy soil with a poor grass cover
- 0.01 cfs/ft for clayey soil with a reasonably good grass cover
- 0.1 cfs/ft for a clay covering and a grass cover according to the requirements for the outer slope or for an armored inner slope

The literature review suggests that a 0.1 cfs/ft is an appropriate range for maximum allowable overtopping rates based on Dutch and Japanese research.

However, it is difficult to assess the adequacy of applying criteria for the New Orleans area without a good understanding of the overall quality of the levees following many different periods of construction and the effects of stresses of past hurricanes. The actual field evidence supporting these criteria is limited. After consultation with the ASCE External Review Panel, the following wave overtopping rates have been established for the New Orleans District hurricane protection system:

- For the surge elevation, wave height, and wave period determined for the authorized level of risk reduction, the maximum allowable average wave overtopping of 0.1 cfs/ft at 90% level of assurance and 0.01 cfs/ft at 50% level of assurance for grass-covered levees
- For the surge elevation, wave height, and wave period determined for the authorized level of risk reduction, the maximum allowable average wave overtopping of 0.1 cfs/ft at 90% level of assurance and 0.03 cfs/ft at 50% level of assurance for wall type structures with appropriate protection on the back side.

It should be noted that Congress has not provided the USACE authority to design for the 0.2% level of risk reduction.

Note that the average overtopping rate is an average over many wave periods. Because the wave field is random in nature, the individual wave overtopping of one specific wave can be higher or lower. The TAW manual gives a method to compute the individual maximum overtopping volume. To give a rough idea, an average overtopping rate of 0.01 cfs/ft ( $\approx 1$  l/s/m) can be accompanied with an individual overtopping volume of 1 – 10 cft/ft ( $\approx 100$  – 1000 l/m) (TAW, 2002).

### **Dealing with Uncertainties**

The hydraulic and geometrical parameters in the design approach are uncertain. For instance, there are errors in the computed surge elevation near the levees/floodwalls by the PBL / ADCIRC / STWAVE models. The same holds for the possible errors in the wave results near the toe of the levee/floodwall from PBL/WAM/STWAVE. Also, the coefficients of the empirical overtopping equations are calibrated against laboratory and field experiments and are inherently uncertain.

It is believed that the uncertainty in these parameters should be taken into account in the design process to come up with a robust design. This section describes the method used that accounts for uncertainties in water elevations and waves, and computes the overtopping rate with state-of-the-art formulations. The objective of this method is to include the uncertainties check if the overtopping criteria are still met with a certain percentage of assurance.

A common way of dealing with uncertainties is the application of a Monte Carlo analysis. This procedure is also adopted herein. In the Monte Carlo analysis the overtopping algorithm is repeated to compute the overtopping rate many times. Based on these outputs, a statistical distribution can be derived from the resulting overtopping rates. The parameters that are included

in the Monte Carlo analysis are the 1% surge elevation, wave height and wave period. Uncertainties in the geometric parameters are not included; it is assumed that the proposed heights and slopes in this design document are minimum values that will be constructed.

To determine the overtopping rate in the Monte Carlo analysis, the probabilistic overtopping formulations from Van der Meer are applied for levees (see text box below) and the Franco & Franco formulation for floodwalls. The analysis is not specific to these formulations, Boussinesq results could also be incorporated in the method. Besides the geometric parameters (levee height and slope), hydraulic input parameters for determination of the overtopping rate in Equations 1 and 2 are the water elevation ( $\zeta$ ), the significant wave height ( $H_s$ ) and the peak wave period ( $T_p$ ).

## Van der Meer overtopping formulations

The overtopping formulation from Van der Meer reads (TAW, 2002):

$$\frac{q}{\sqrt{gH_{m0}^3}} = \frac{0.067}{\sqrt{\tan \alpha}} \gamma_b \xi_0 \exp\left(-4.75 \frac{R_c}{H_{m0}} \frac{1}{\xi_0 \gamma_b \gamma_f \gamma_\beta \gamma_v}\right)$$

with maximum: 
$$\frac{q}{\sqrt{gH_{m0}^3}} = 0.2 \exp\left(-2.6 \frac{R_c}{H_{m0}} \frac{1}{\gamma_f \gamma_\beta}\right) \quad (1)$$

With:

q : average overtopping rate [cfs/ft]

g : gravitational acceleration [ft/s<sup>2</sup>]

H<sub>m0</sub> : wave height at toe of the structure [ft]

ξ<sub>0</sub>: surf similarity parameter [-]

α : slope [-]

R<sub>c</sub> : freeboard [ft]

γ : coefficient for presence of berm (b), friction (f), wave incidence (β), vertical wall (v)

The surf similarity parameter ξ<sub>0</sub> is defined herein as ξ<sub>0</sub> = tan α / √s<sub>0</sub> with α the angle of slope and s<sub>0</sub> the wave steepness. The wave steepness follows from s<sub>0</sub> = 2 π H<sub>m0</sub> / (g T<sup>2</sup> m<sub>-1,0</sub>). The coefficients -4.75 and -2.6 in Equation 1 are the mean values. The standard deviations of these coefficients are equal to 0.5 and 0.35, respectively and these errors are normally distributed (TAW, 2002). The reader is referred to TAW (2002) for definitions of the various coefficients for presence of berm, friction, wave incidence, vertical wall.

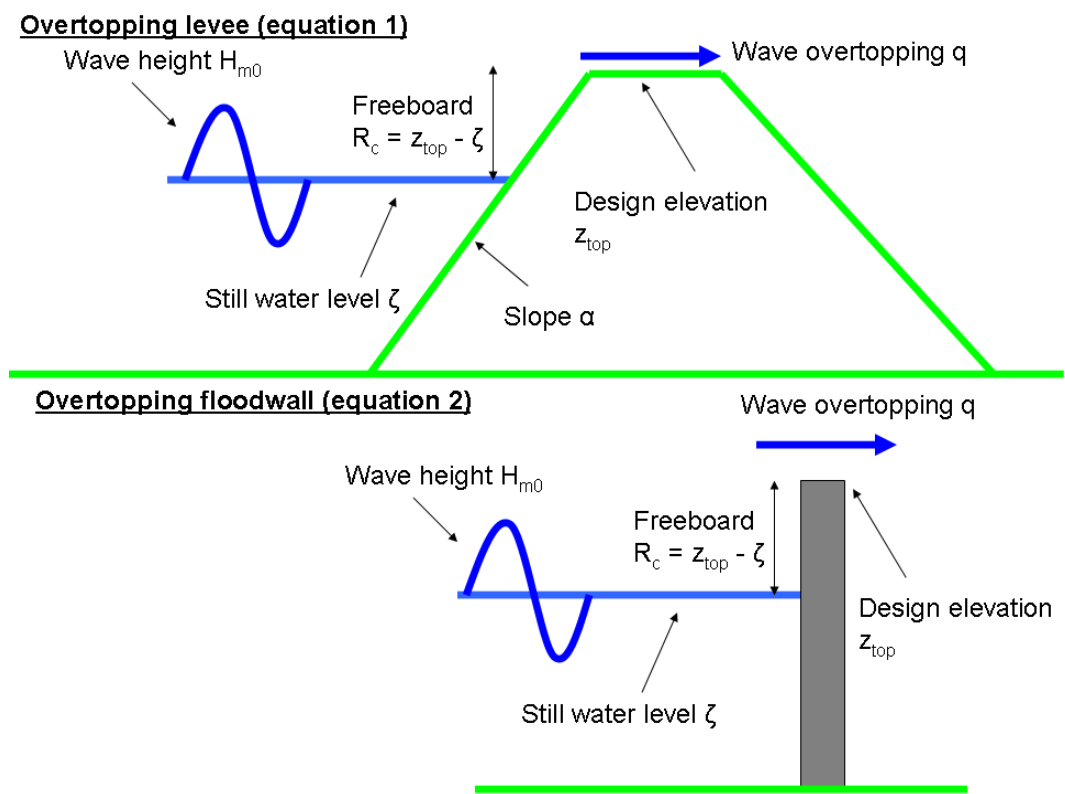
Equation 1 is valid for ξ<sub>0</sub> < 5 and slopes steeper than 1:8. For values of ξ<sub>0</sub> > 7 the following equation is proposed for the overtopping rate:

$$\frac{q}{\sqrt{gH_{m0}^3}} = 10^{-0.92} \exp\left(-\frac{R_c}{\gamma_f \gamma_\beta H_{m0} (0.33 + 0.022 \xi_0)}\right) \quad (2)$$

The overtopping rates for the range 5 < ξ<sub>0</sub> < 7 are obtained by linear interpolation of Equation 1 and 2 using the logarithmic value of the overtopping rates. For slopes between 1:8 and 1:15, the solution should be found by iteration. If the slope is less than 1:15, it should be considered as a berm or a foreshore depending on the length of the section compared to the deep water wavelength. The coefficient -0.92 is the mean value. The standard deviation of this coefficient is equal to 0.24 and the error is normally distributed (TAW, 2002).

**Figure 2-10** graphically shows the overtopping for a levee and floodwall situation including the most relevant parameters.

In the design process, we use the best estimate 1% values for these parameters from the JPM-OS method (Resio, 2007); uncertainty in these values exists. Resio (2007) has provided a method to derive the standard deviation in the 1% surge elevation. Standard deviation values of 10% of the average significant wave height and 20% of the peak period were used (Smith, 2006, pers. comm.). In absence of data, all uncertainties are assumed to be normally distributed. If additional data would show another distribution, that distribution has to be included in the methodology.



**Figure 2-10 – Definitions for Overtopping for Levee and Floodwall**

The Monte Carlo Analysis is executed as follows:

1. Draw a random number between 0 and 1 to set the exceedence probability ( $p$ ).
2. Compute the water elevation from a normal distribution using the mean 1% surge elevation and standard deviation as parameters and with an exceedence probability ( $p$ ).
3. Draw a random number between 0 and 1 to set the exceedence probability ( $p$ ).
4. Compute the wave height and wave period from a normal distribution using the mean 1% wave height/wave period and the associated standard deviation and with an exceedence probability ( $p$ ).
5. Repeat step 3 and 4 for the three overtopping coefficients independently.
6. Compute the overtopping rate for these hydraulic parameters and overtopping coefficients determined in step 2, 4 and 5 using the Van der Meer overtopping formulations for levees or the Franco & Franco equation for floodwalls (see Equations 1 and 2 in the textbox).
7. Repeat the Step 1 through 5 a large number of times. ( $N$ )
8. Compute the 50% and 90% confidence limit of the overtopping rate. (i.e.  $q_{50}$  and  $q_{90}$ )

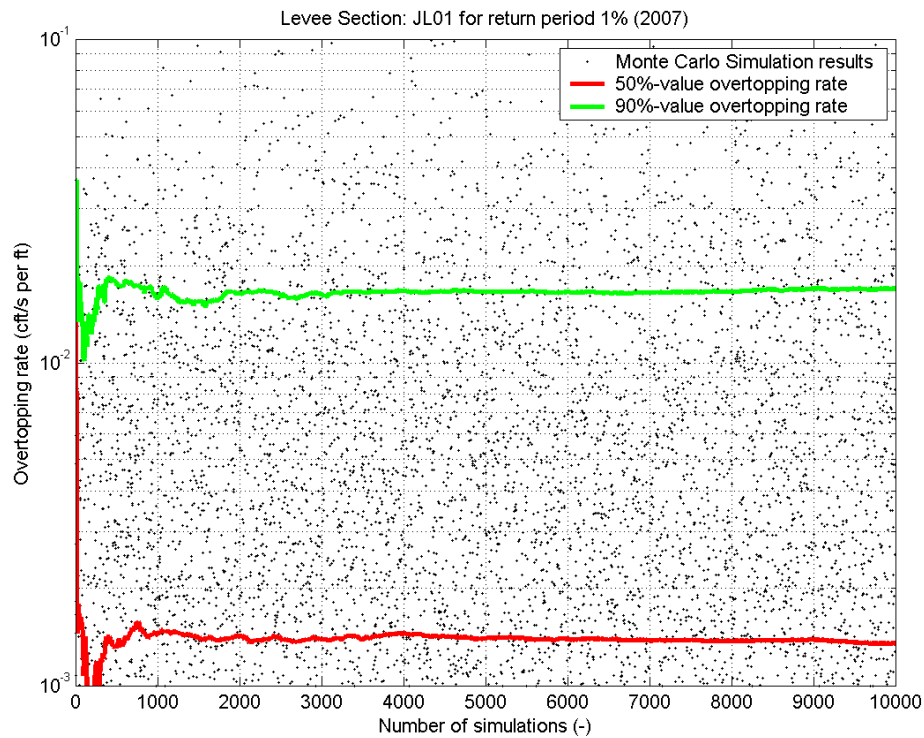
The procedure is implemented in the numerical software package MATLAB because it is a computationally intensive procedure. MATLAB is a high-level technical computing language and interactive environment for algorithm development, data visualization, data analysis, and numeric computation. You can use MATLAB in a wide range of applications, including signal and image processing, communications, control design, test and measurement, financial modeling and analysis, and computational biology. Add-on toolboxes (collections of special-purpose MATLAB functions, available separately) extend the MATLAB environment to solve particular classes of problems in these application areas (see also [www.mathworks.com](http://www.mathworks.com)).

The Jefferson Lakefront levee section along Lake Pontchartrain has been taken as an example herein to show one result of this uncertainty analysis. **Table 2-2** shows the typical input needed for the Monte Carlo Analysis. It shows the input parameters for the coefficients of the overtopping formulation, the 1% hydraulic design characteristics, and the levee characteristics. The levee characteristics are listed such as the design height and the slope. Note that the levee height of 16.5 ft and 1 Vertical: 4 Horizontal (herein slope will be shown as a ratio 1:4 etc.) is just an example for this specific site. The height and the slope are the two design variables to meet the overtopping criteria and will vary significantly throughout the entire system depending on the hydraulic loading conditions (surge and waves).

Several test runs show that  $N$  should be much larger than 1,000 to reach statistically stationary results for the 50% and 90% confidence limit value of the overtopping rate. For this particular case, 2,000 runs may have been sufficient for stationary results. **Figure 2-11** shows the confidence limit values as a function of the number of simulations during the Monte Carlo Analysis. The dots represent the actual results from the Monte Carlo simulation, whereas the red and green lines represent the moving value over the number of simulations. The exact number of simulations depends on the magnitude of the uncertainties in the various parameters. Therefore,  $N = 10,000$  is recommended to make sure that statistically stationary results are always achieved.

**Table 2-2– Input for Monte Carlo Analysis**

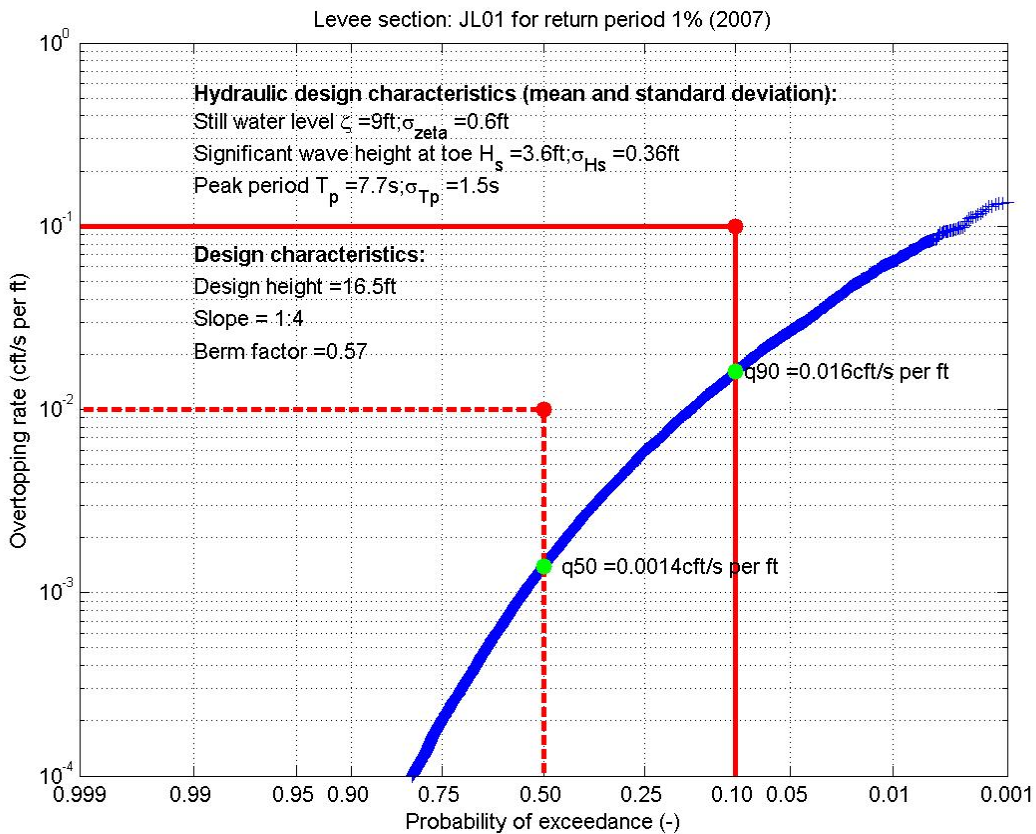
<b>Parameter</b>	<b>Mean</b>	<b>STD</b>	<b>Unit</b>	<b>Remarks</b>
Coefficient Overtopping Formula in Equation 1	-4.75	0.5	-	Values for the mean and standard deviation follow from TAW Manual (TAW, 2002)
Coefficient Overtopping Formula in Equation 1	-2.6	0.35	-	See Above
Coefficient Overtopping Formula in Equation 2	-0.92	0.24	-	See Above
1% Water Elevation	9.0	0.6	ft	Values follow from JPM-OS analysis (Resio, 2007)
1% Wave Height	3.6	0.4	ft	Mean value from JPM-OS analysis, standard deviation 10% of mean value based on expert judgment
1% Wave Period	7.7	1.54	s	Mean value from JPM-OS analysis, standard deviation 20% of mean value based on expert judgment
Levee height	16.5	-	ft	-
Slope	1:4	-	-	-
Berm Factor	0.6	-	-	-
Number of Runs	10,000	-	-	-



**Figure 2-11 – The 50% and 90% Confidence Limit Value and Number of Simulations**

**Figure 2-12** shows the result of the Monte Carlo analysis; overtopping rate is shown as a function of the exceedence probability. The red lines indicate the 50% and 90% confidence limit value of the overtopping rate for levees. The 50%- and 90%-value of the actual overtopping rate for this specific levee section are also depicted in the plot. The result shows that the 90%-value for overtopping is below 0.1 cfs/ft and the 50%-value is below 0.01 cfs/ft, and this section meets the design criteria.





**Figure 2-12– Result of Monte Carlo Analysis for Jefferson Lakefront Levee (existing conditions)**

The computation of the overtopping rate in the present MATLAB routine is limited in the sense that it can only take into account an average slope for the entire cross-section. If a wave berm exists, this effect is included in a berm factor. The following procedure was carried out to determine this berm factor. First, the overtopping rate is computed with PC-Overslag with the best estimates of surge level and waves. Next, the berm factor is calibrated with the Van der Meer overtopping formulations to get exactly same result from PC-Overslag. Then, the berm factor is checked to see if it is in between the recommended range of 0.6 – 1.0 (which was almost always the case, sometimes a lower berm factor was found, but the 0.6 was used as lower limit). Finally, the calibrated berm factor is applied in the uncertainty analysis (and keep this factor constant) throughout the Monte Carlo analysis in MATLAB.

Notice that the uncertainty analysis described above is also implemented to compute the wave forces with different confidence levels. It makes use of exactly the same procedure, but computes the wave forces based on the Goda formulation. A Monte Carlo Simulation was performed with the water level, wave height, and wave period, and the associated uncertainty, to compute the 50% and 90% assurance wave forces. Dependency between the errors in the wave height and wave period was maintained, whereas the error in the surge level and the wave characteristics was treated independently.

## **Step-Wise Approach**

The proposed step-wise approach for hydraulic design is summarized as follows:

### **Step 1: Water Elevation**

- 1.1 Examine the 1% surge elevation from the surge frequency plots at all output points along the reach under consideration. The 1% surge elevations are the results based on the 152 storm combinations and using the probabilistic tool (JPM-OS method).
- 1.2 Determine the maximum 1% surge elevation for a design reach and use this number for the entire reach. The maximum is chosen to meet the design criterion at the most critical point in the section.

### **Step 2: Wave Characteristics**

- 2.1 Examine the 1% significant wave height and 1% peak period from the frequency plots at all output points along the reach. The 1% wave heights and peak periods are the results based on the 152 storm combinations and using the probabilistic tool based on the JPM-OS method.
- 2.2 Determine the maximum 1% significant wave height and peak period for the reach and use these numbers for the entire reach. The maximum wave height and wave period are chosen to meet the design criterion at the most critical point in the section under consideration.
- 2.3 Determine if the foreshore in front of the structure is shallow. The foreshore is shallow if the ratio between the significant wave height ( $H_s$ ) and the water depth ( $h$ ) is small ( $H_s/h > 1/3$ ) and if the foreshore length ( $L$ ) is longer than one deep water wavelength  $L_0$  (thus:  $L > L_0$  with  $L_0 = gT_p^2/(2\pi)$ ). If so, the wave height at the toe of the structure should be reduced according to  $H_{smax} = 0.4 h$ . This reduction should only be applied if an empirical method is applied for determining the overtopping rate (e.g. PC-Overslag). The breaking effect is automatically included in the Boussinesq runs.

### **Step 3: Overtopping Rate**

- 3.1 Apply PC-Overslag with Van der Meer formulations (CEM, 2001) to determine the overtopping rates. If a wall is present, the empirical formulation of Franco & Franco (1999) will be applied. For specific complicated cross-sections, the Boussinesq lookup tables may be applied as well to compute the overtopping rate.
- 3.2 Determine the overtopping rate based on the 1% surge elevation, the significant wave height and the peak period for each reach. Use the reduced wave height in case of a shallow foreshore in the empirical approach only (e.g. PC-Overslag).

### **Step 4: Dealing with Uncertainties**

- 4.1 Apply a Monte Carlo Simulation to compute the chance of exceedence of the overtopping rate given the design elevation and slope from Step 3. This method takes into account the uncertainties in the 1% water elevation, the 1% wave height and the 1% peak wave period.

4.2 Check if the overtopping rate will not exceed the design thresholds for overtopping. If yes, the design process is finished from a hydraulic point of view. If not, adapt the levee or floodwall height or slope in such a way that this criterion is reached by repeating Steps 3 and 4.

**Step 5: Resiliency**

5.1 For the design analysis, the final 1% design elevation is checked against the 0.2% surge elevation (50% confidence level). If the design elevation is lower, the elevation is raised to prevent free flow over the HSDRRS from a resiliency point of view. This step is not followed for the 2% design elevations for New Orleans to Venice Project.

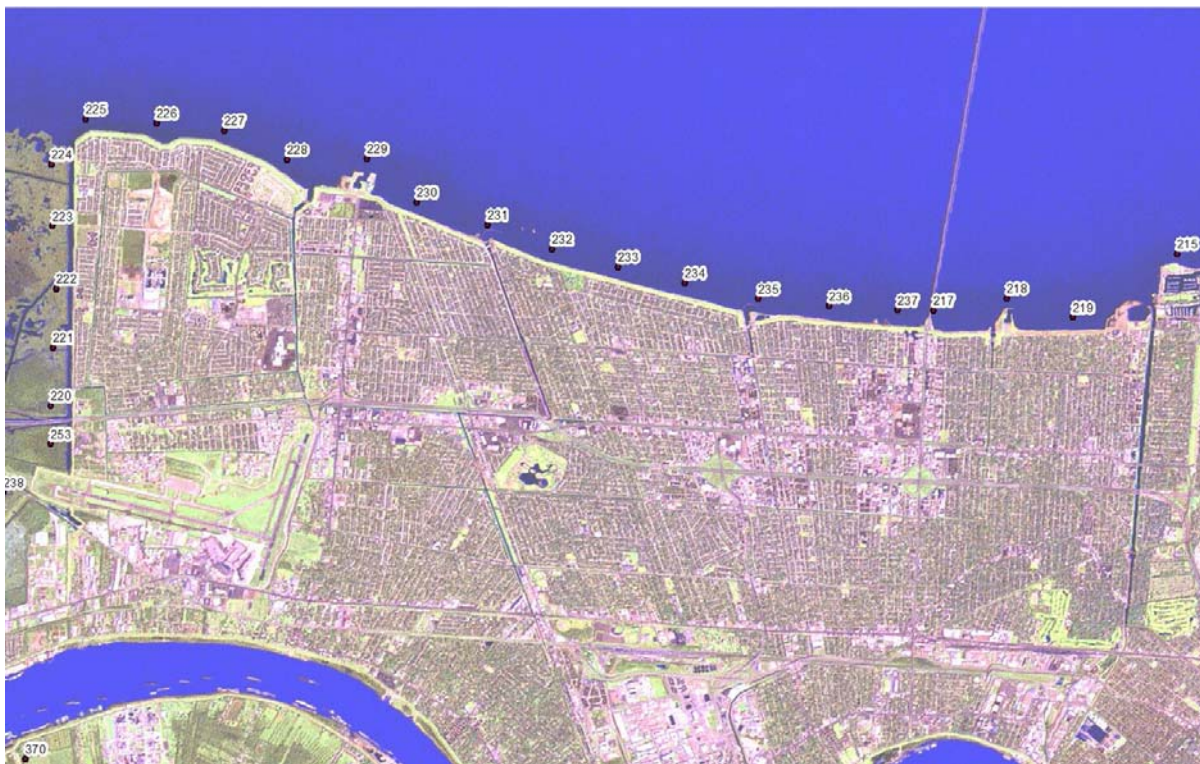
## 2.6 EXAMPLE 1: JEFFERSON PARISH LAKEFRONT

The following is an example of the application of the step-wise design approach for a levee location along the Jefferson Parish Lakefront (**Figure 2-13**). The preliminary design numbers used in September 2005 were as follows:

- Water elevation 12 ft (10 ft including 2 ft uncertainty)
- Significant wave height 7.9 ft
- Peak period 7.2 s

The proposed preliminary levee had an elevation of 16 ft and an average slope of 1:7. The resulting overtopping rate was about 0.1 cfs/ft.

The step-wise design approach is applied below using the ADCIRC and STWAVE results from the 2007 grid. The output locations along this reach are shown in **Figure 2-13**. The output points 228 through 237 and 217 through 219 belong to this reach.



**Figure 2-13 – Jefferson Parish Lakefront (Points 217 – 219 and 228 – 237)**

### **Step 1: 1% Surge Elevation**

The 1% surge elevation along Jefferson Parish Lakefront is between 9.3 and 9.6 ft (**Table 2-3**). These numbers include the local wave setup just in front of the levee. The maximum 1% surge

elevation is 9.0 ft at points 228 and 230; we have selected output point 230 here. The standard deviation at this point is 0.6 ft.

**Table 2-3 – Surge Elevations at Jefferson Parish Lakefront (2007 conditions)**

Pointid	2% event		1% event		0.2% event	
	mean	std	mean	std	mean	std
225	8	0.4	9.3	0.7	11.6	1.1
226	7.9	0.4	9.2	0.6	11.4	1.1
227	7.8	0.4	9.1	0.6	11.3	1.1
228	7.8	0.4	9	0.7	11.3	1.1
229	7.7	0.4	8.9	0.6	11.1	1.1
230	7.7	0.4	9	0.6	11.2	1.1
231	7.7	0.4	9	0.6	11.2	1.1
232	7.7	0.4	9	0.6	11.2	1.1
233	7.7	0.4	9	0.6	11.2	1.1
234	7.6	0.4	8.9	0.7	11.2	1.1
235	7.6	0.4	8.9	0.7	11.2	1.1
236	7.6	0.4	8.9	0.7	11.2	1.1
237	7.6	0.4	8.9	0.7	11.2	1.1
217	7.6	0.4	8.8	0.7	11.2	1.2
218	7.5	0.4	8.8	0.7	11.2	1.2
219	7.5	0.5	8.8	0.7	11.4	1.3

**Step 2: Wave Characteristics**

The significant wave height and wave period are listed in **Table 2-4**. The maximum 1% significant wave height is 7.5 ft and the maximum peak period is 7.7 seconds (s). The wave characteristics in **Table 2-4** are at 600 ft from the levee. The bottom elevation 600 ft from the shoreline is approximately 0.0 ft.

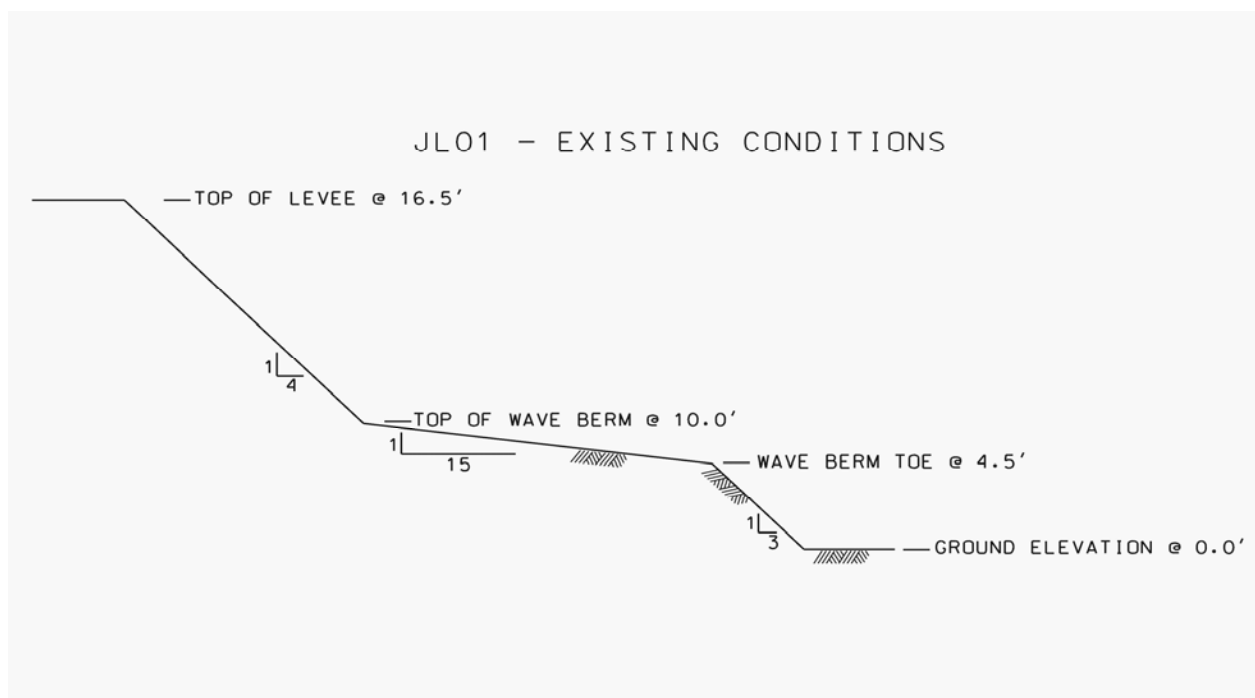
**Table 2-4 – Wave Characteristics at Jefferson Parish Lakefront**

Pointid	2% event		1% event		0.2% event	
	Hs (ft)	Tp (s)	Hs (ft)	Tp (s)	Hs (ft)	Tp (s)
225	6.3	7.0	7.4	7.8	9.1	9.0
226	6.7	7.0	7.8	7.8	9.5	9.0
227	6.6	6.9	7.7	7.7	9.4	9.0
228	6.4	7.0	7.4	7.7	9.0	9.0
229	7.2	6.7	8.4	7.5	10.2	8.8
230	6.5	6.9	7.5	7.7	9.2	9.0
231	6.5	6.8	7.6	7.7	9.2	9.0
232	6.2	6.8	7.2	7.6	8.9	9.0
233	6.0	6.9	7.0	7.7	8.7	9.1
234	6.2	6.7	7.2	7.6	8.9	9.0
235	6.3	6.7	7.4	7.5	9.1	8.9
236	5.8	6.7	6.8	7.6	8.5	9.0
237	6.0	6.6	7.1	7.5	8.8	8.8
217	6.3	8.7	1.6	3.3	2.6	4.9
218	6.4	8.6	1.6	3.4	2.6	4.6
219	5.9	8.6	1.7	3.2	2.7	4.2

The 1% surge elevation (h) is 9.0 ft, so the 1% wave height (H) is about 80% of the water depth. This implies that the foreshore can be considered as shallow ( $H/h \approx 1$ ) and breaking will take place towards the toe of the structure. The length of the foreshore is approximately 400 ft, whereas the deep water wavelength is about 300 ft. Because the shallow foreshore is longer than one deep water wavelength, the maximum significant wave height is assumed to be  $H_{smax} = 0.4 h$  ( $\approx 3.6$  ft). To summarize: design wave characteristics are  $H_s = 3.6$  ft and  $T_p = 7.7$  s.

### **Step 3: Overtopping Rate**

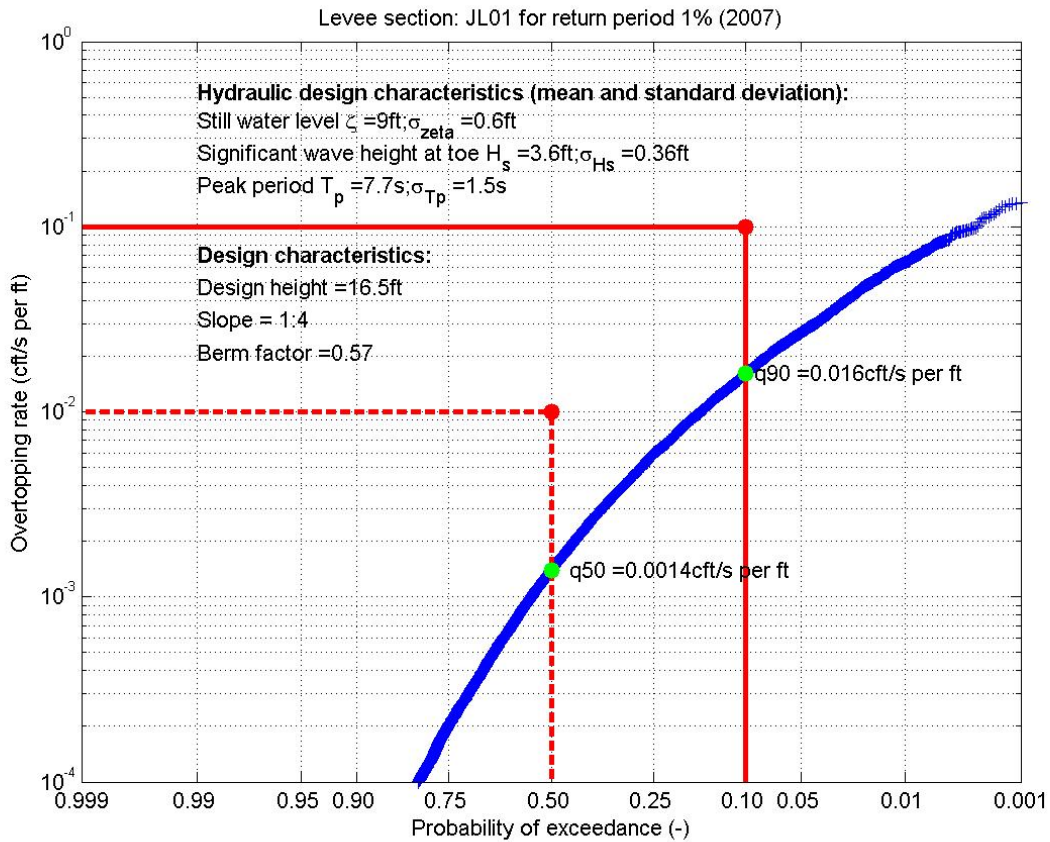
The original cross-sectional profile of the Jefferson Lakefront Levee for existing conditions is shown in **Figure 2-14**. The software program PC-Overslag was used to determine the overtopping rate. The average overtopping rate is 0.002 cfs/ft at this cross-section. Notice that the overtopping criterion is well below the design criterion for the average overtopping rate (0.01 cfs/ft). Because this is an existing levee, the levee slope or height are not adapted.



**Figure 2-14 – Cross-section Jefferson Lakefront Levee**

### **Step 4: Dealing with Uncertainties**

The result of the uncertainty method is shown in **Figure 2-15**. It shows the frequency curve of the overtopping rate (levee height 16.5 ft including a berm) using the mean / standard deviations of the 1% water elevation (9.0 ft / 0.6 ft), the wave height at the toe (3.6 ft / 0.4 ft) and the peak period (7.7 s / 1.5 s). The overtopping rate is 0.02 cfs/ft at a 90% confidence limit and is 0.001 cfs/ft at a 50% confidence limit. These values meet the design criteria for levees.



**Figure 2-15 – Overtopping Rate as a Function of the Probability of Exceedance for the Jefferson Lakefront Levee (Existing Conditions), 1% Event**

**Step 5: Resilience for Events above Design Level**

The effect of resilience is investigated using the 0.2% value for the surge elevation. The surge level is 11.2 ft

## 2.7 EXAMPLE 2: MRGO

The following is an example of the application of the step-wise design approach for a location along the MRGO levee (**Figure 2-16**). The preliminary design numbers used in September 2005 were (segment 1):

- Water level 17 ft (14.5 ft including 2.5 ft uncertainty)
- Significant wave height 11.0 ft
- Peak period 12.0 s

The proposed preliminary levee height had a crest elevation of 24 ft with a composite slope of 1:12, and a computed overtopping rate of 0.1 cfs/ft.

The step-wise design approach is applied below using the ADCIRC and STWAVE results from the 2010 grid. The 2010 conditions have been chosen because this area is affected by the gates at MRGO/GIWW. The output locations along this reach are shown in **Figure 2.16**. The output points 35 - 54 and 21 - 22 belong to this reach.



**Figure 2-16 – MRGO Levee with Output Points from ADCIRC and STWAVE**



### **Step 1: 1% Surge Elevation**

The 1% surge elevation along MRGO levee is between 14.9 and 18.4 ft (**Table 2-5**). The variation in the surge level is quite large ( $> 3.0$  ft), indicating that this reach should be subdivided for the final design. This example is only meant to show the step-wise approach. Point 33 was used for the most southern section of this levee. The maximum 1% surge level is 15.6 ft at Point 33; the maximum standard deviation is 1.2 ft.

**Table 2-5 – Surge Levels at MRGO Levee for the 2010 Conditions**

Pointid	2% event		1% event		0.2% event	
	mean	std	mean	std	mean	std
33	13.5	0.8	15.6	1.2	19.9	2.1
34	12.9	0.6	14.8	0.9	18.1	1.6
35	12.4	0.8	14.9	1.3	19.4	2.2
36	12.4	0.6	14.3	1.0	17.7	1.7
37	12.5	0.6	14.5	1.0	17.9	1.7
38	12.7	0.9	15.2	1.3	19.8	2.3
39	11.7	0.9	14.7	1.3	19.4	2.3
40	12.0	0.8	14.9	1.2	19.3	2.2
41	11.3	0.8	14.6	1.3	19.1	2.2
42	13.4	0.8	16.1	1.3	20.6	2.2
43	13.2	0.8	15.8	1.2	20.0	2.1
44	13.4	0.7	15.8	1.0	19.5	1.8
45	13.7	0.7	15.9	1.0	19.6	1.8
46	13.9	0.7	16.1	1.1	19.9	1.9
47	14.1	0.7	16.4	1.1	20.2	1.9
48	14.3	0.7	16.7	1.1	20.5	1.9
49	14.5	0.7	17.0	1.1	20.8	1.9
50	14.7	0.7	17.3	1.1	21.1	1.9
51	14.9	0.7	17.6	1.1	21.4	1.9
52	15.1	0.7	17.9	1.1	21.7	1.9
53	15.3	0.7	18.2	1.1	22.0	1.9
54	15.5	0.7	18.4	1.0	22.1	1.8

### **Step 2: Wave Characteristics**

The significant wave height and wave peak period are listed in **Table 2-6**. In the southern section, the maximum 1% significant wave height for Point 33 is 5.4 ft and the peak period is 8.9 s. The bottom elevation 600 ft from the shoreline is approximately 0.0 ft. The 1% surge elevation is 15.6 ft, so the 1% wave height is about 35% of the water depth. This implies that the foreshore can be considered as shallow ( $H/h < 1/3$ ) and breaking will be very limited towards the toe of the levee. Therefore, the 1% wave height will not be affected by the foreshore. To summarize: design wave characteristics are  $H_s = 5.4$  ft and  $T_p = 8.9$  s for this specific location under existing conditions.

**Table 2-6 – Wave Characteristics at MRGO Levee**

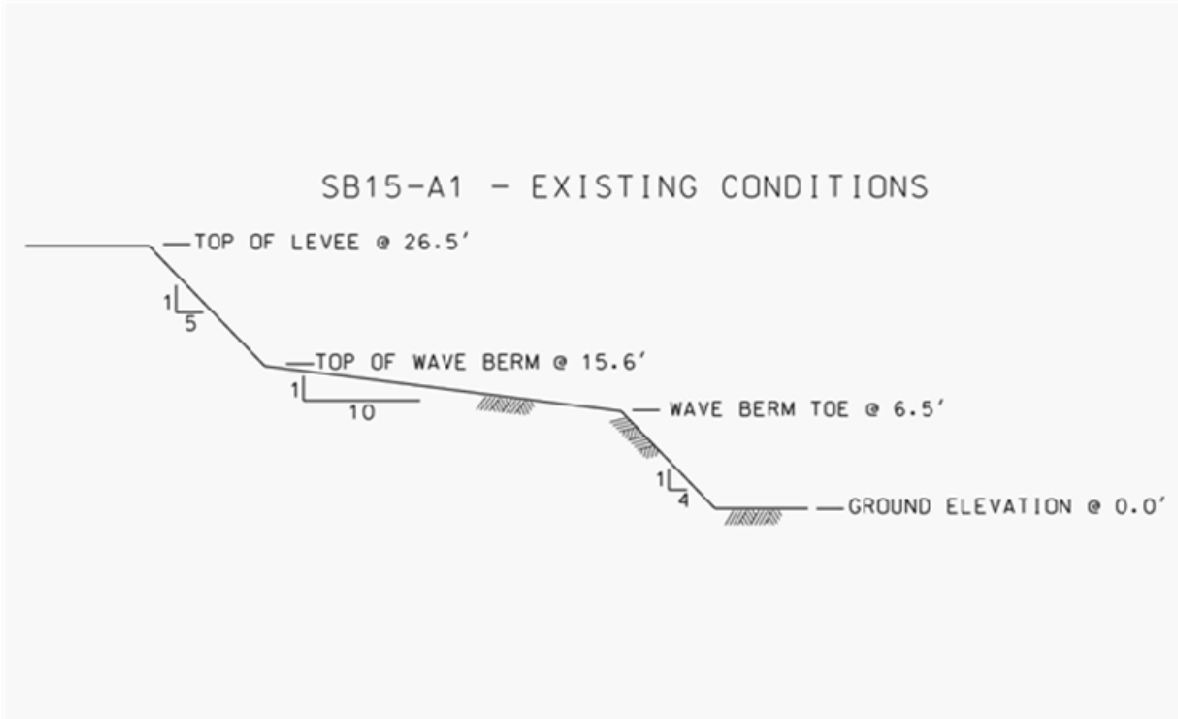
Pointid	2% event		1% event		0.2% event	
	Hs (ft)	Tp (s)	Hs (ft)	Tp (s)	Hs (ft)	Tp (s)
33	3.7	7.5	5.4	8.9	9.9	14.4
34	4.2	7.6	5.4	8.5	7.5	9.9
35	2.2	6.5	4.3	8.7	9.0	16.9
36	2.7	6.4	3.4	7.4	4.7	8.9
37	2.0	5.7	2.8	6.8	4.1	8.5
38	1.1	4.7	2.7	6.7	6.8	14.2
39	0.2	2.8	2.5	5.7	6.0	10.1
40	0.2	3.3	2.3	5.7	5.3	8.7
41	0.6	2.1	3.4	5.6	6.2	8.3
42	3.2	4.4	5.3	6.3	10.0	14.3
43	3.3	4.1	5.3	5.8	8.7	9.7
44	3.2	4.7	4.8	6.1	7.5	7.8
45	5.9	5.2	7.1	5.9	9.0	6.9
46	5.4	5.2	6.5	5.9	8.4	6.9
47	5.6	5.2	6.9	5.9	8.9	6.9
48	5.8	5.2	7.1	5.9	9.1	6.9
49	6.0	5.3	7.3	5.9	9.3	7.0
50	6.0	5.1	7.3	5.8	9.4	6.9
51	5.6	5.2	6.9	5.8	9.0	6.8
52	5.8	5.3	7.1	5.9	9.3	6.9
53	5.3	5.1	6.7	5.8	8.7	6.8
54	5.3	5.0	6.4	5.7	8.3	6.8

**Step 3: Overtopping Rate**

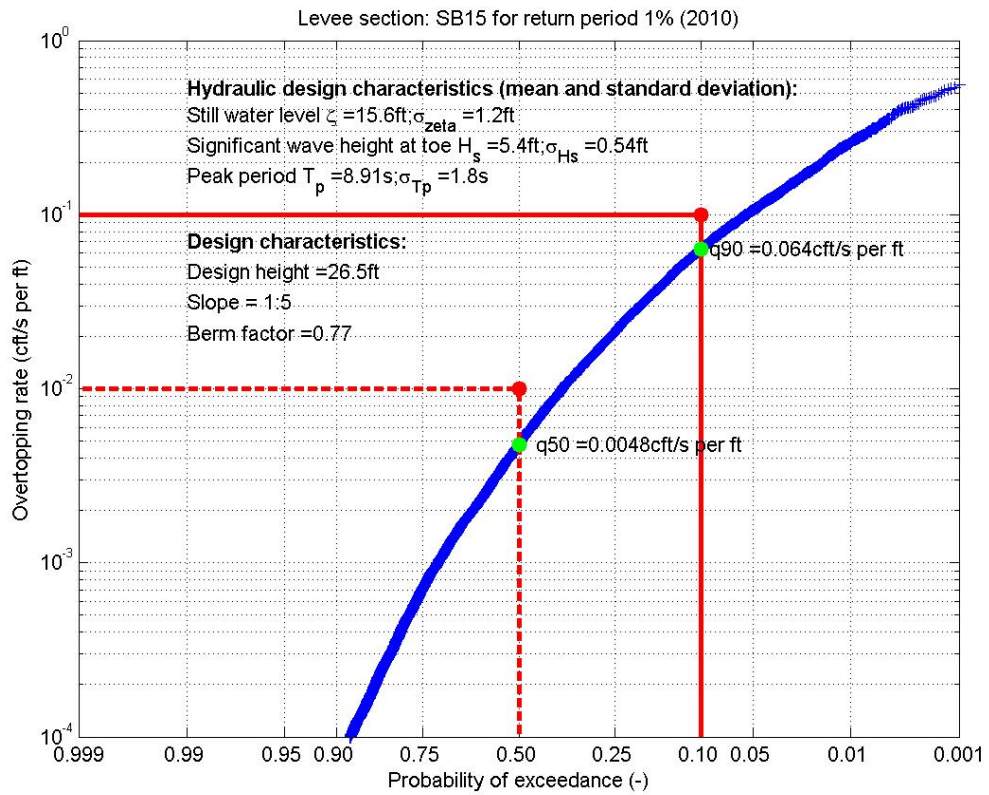
The proposed cross-sectional profile is given in **Figure 2-17**. PC-Overslag was used to determine the mean overtopping rate first. The mean overtopping rate is 0.006 cfs/ft for this cross-section.

**Step 4: Dealing with Uncertainties**

The result of the uncertainty analysis is shown in **Figure 2-18**. It shows the frequency curve of the overtopping rate given the mean values and standard deviations of the 1% water level (15.6 ft / 1.2 ft), the wave height (5.4 ft / 0.5 ft) and the peak period (8.9 s / 1.8 s). The overtopping rate at the upper 90% confidence limit is 0.06 cfs/ft, and the 50% confidence overtopping rate equals 0.005 cfs/ft. Both overtopping rates show that this cross-section fulfills the design criteria.



**Figure 2-17 – Proposed Cross-Section at the Southern Portion of the MRGO Levee**



**Figure 2-18 – Overtopping Rate as a Function of the Probability of Exceedance for the MRGO Levee (existing conditions) for the 1% Event**

**Step 5: Resilience for Events above Design Level**

The effect of resilience is investigated using the 0.2% surge level. The surge level is 19.9 ft

## **2.8 EXTENSIONS FOR COINCIDENT MISSISSIPPI RIVER LEVEES**

This section summarizes the extensions necessary to apply the original HSDRRS design approach to the coincident Mississippi River work. The original HSDRRS design approach has been discussed in the previous sections. Three major extensions were necessary:

- 1) The ADCIRC grid needed to be updated and calibrated for the Mississippi River.
- 2) The JPM-OS method needed to be extended to handle variable river discharge.
- 3) The wave modeling needed to be extended because the original approach with STWAVE did not include the Mississippi River.

### **Improvements to the Original ADCIRC Grid**

This section summarizes the ADCIRC modeling performed in the framework of the Mississippi River levees. Two sets of model runs were performed; the first in 2008 (Bioengineering/ARCADIS, 2008), the second in 2010 by ERDC (**Appendix G**). Prior to these model runs, the following steps were executed to make ADCIRC suitable for the Mississippi River Levee Assessment in 2008 (Bioengineering/ARCADIS, 2008):

- 1) Improvement of the existing model grid SL15v3 into SL15v7
- 2) Validation of the river stages for different discharges
- 3) Simulations for different combinations of storms and river discharges

These items are discussed consecutively below.

#### **Step 1: Improvements of Existing Model Grid**

The SL15v3 grid was originally calibrated for low flows as observed during Hurricane Katrina. Comparisons of modeling results with observed stage-discharge relationships showed that several modifications were required to represent the stages during higher river discharges. First, the model resolution was increased in the area south of Pointe A La Hache to capture the high river flows using hydrographic surveys from 2004. Subsequently, the roughness coefficients were again assigned to the modeling grid using the bathymetry and grid resolution. Similar roughness classifications were applied as in the original model grid. Finally, the method to correct the marine winds due to the presence of land roughness was adjusted.

For initial modeling performed in 2008, the elevations of the NOV levees and structures were set at heights from the original design documents. For the subsequent modeling performed in 2010, the elevations of the NOV levees and structures were set at preliminarily defined heights that resulted in a proximate 2% level of risk reduction, based on results from the 2010 condition modeling performed for the HSDRRS. The West Closure Complex (WCC) and the Caernarvon floodgate were also added to the grid.

## **Step 2: Validation Against Measurements**

The new model grid was validated in three ways. First, the model was run for different steady flow discharges, and the predicted stages were compared with measured stages at six different locations along the Lower Mississippi. **Figure 2-19** shows measured data as scatter points with associated best-fit curves. The predicted data are shown as connected blue dots. The river stages are predicted very well for discharges up to 900,000 cubic feet per second (cfs) (25,000 cubic meters per second [ $\text{m}^3/\text{s}$ ]). Note that the relevant discharge regime for the hurricane season is 100,000 – 600,000 cfs (3,000 – 16,000  $\text{m}^3/\text{s}$ ). Second, the measured discharges at various points along the river were compared with the model predictions. With the exception of Grand Pass and Pass a Loutre, the comparisons are good. Finally, high water marks (HWM) from USACE and URS in the entire New Orleans area (mainly outside the Mississippi River) during Hurricane Katrina were compared with the ADCIRC model predictions. The average error between the ADCIRC results and the HWM is 1.2 ft - 1.5 ft for both sets. This is equivalent to the old grid indicating that the model performance outside the river has not changed due to these adaptations.

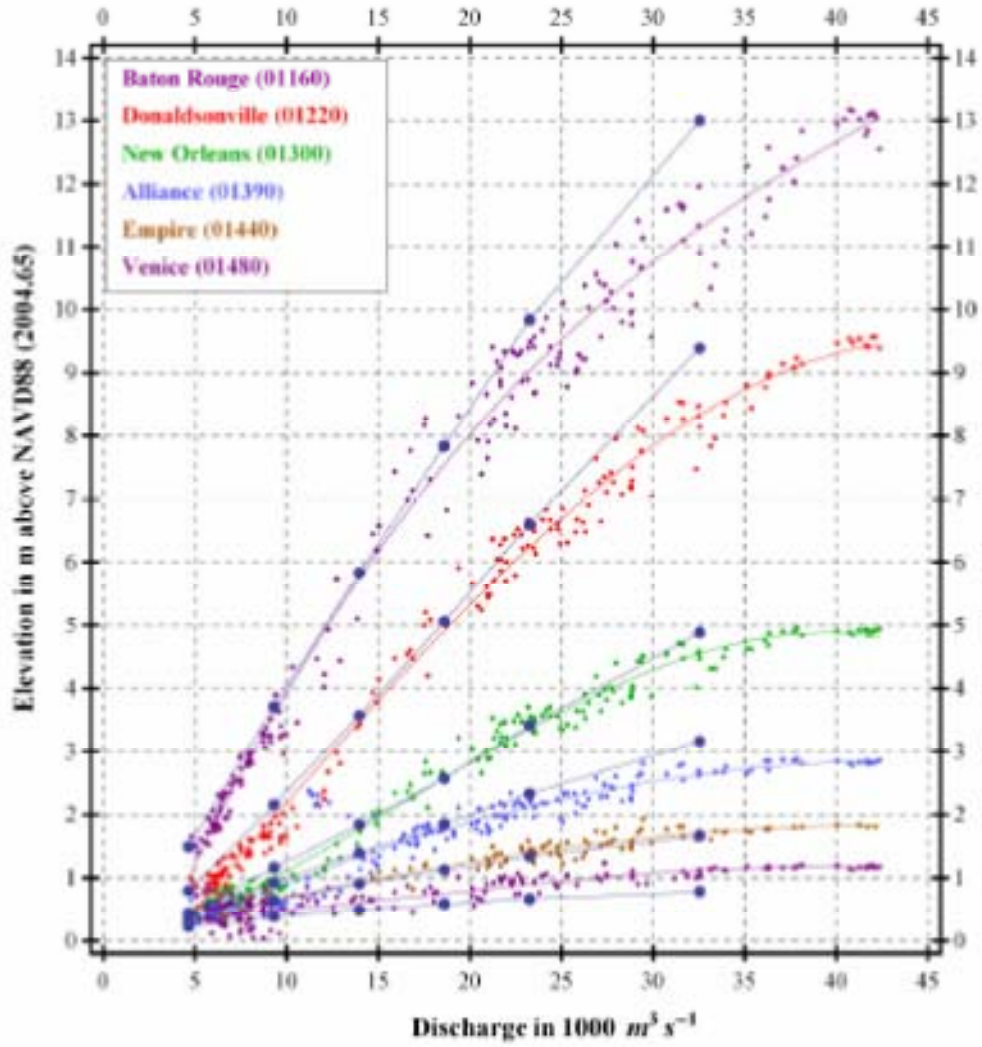
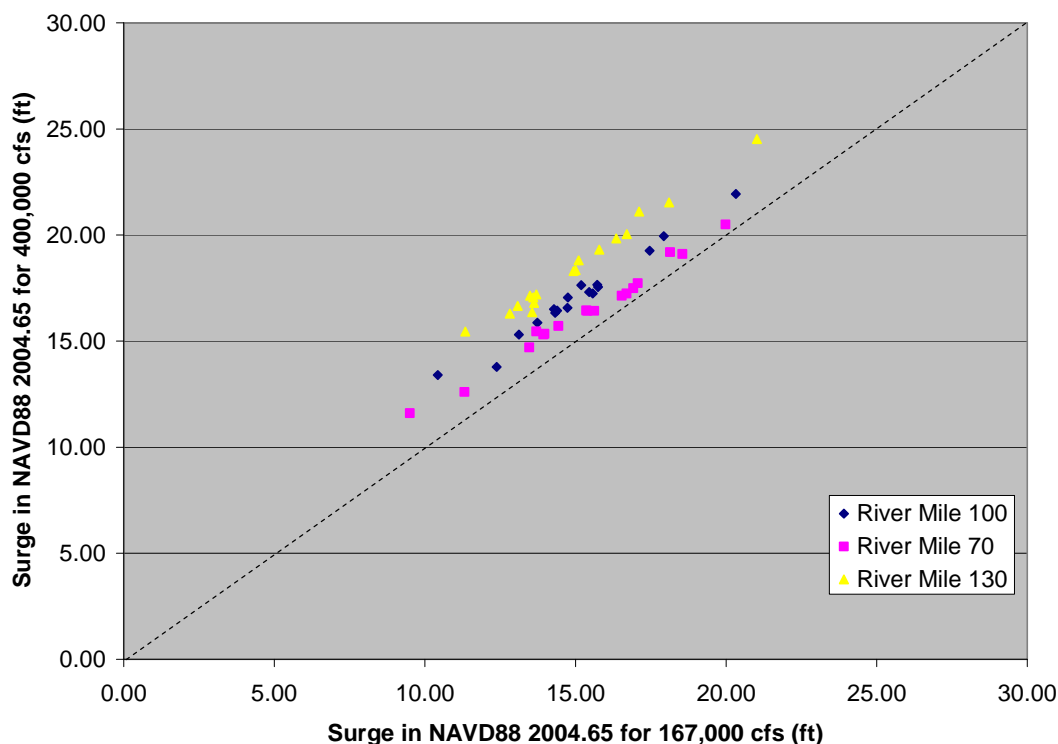


Figure 2-19 – Stage-Flow Relationships at Six USACE Stations Along the Mississippi River

### **Step 3: Simulations for Different Storms and River Discharges**

Seventeen storms were selected out of the 152 storm suite to simulate the hurricane stages in the Mississippi River with different discharge conditions. The storm-ids are 14, 15, 17, 18, 23, 24, 26, 27, 32, 35, 52, 53, 56, 57, 69, 73, and 77. These storms were selected to cover the range of storms needed to adequately define surge frequency curves in the river, as well as the Oakville area on the west bank and the Caernarvon area on the east bank.

Simulations were carried out with two different constant discharges in the Lower Mississippi in 2010 (**Appendix G**): 167,000 cfs and 400,000 cfs. These two discharges are considered to be representative for the lower end and the higher end of the discharge distribution in the hurricane season. The discharge distribution between the Lower Mississippi and the Atchafalaya is kept constant (70% / 30%). **Figure 2-20** shows the maximum surge levels for these storms at three different points along the Mississippi River.

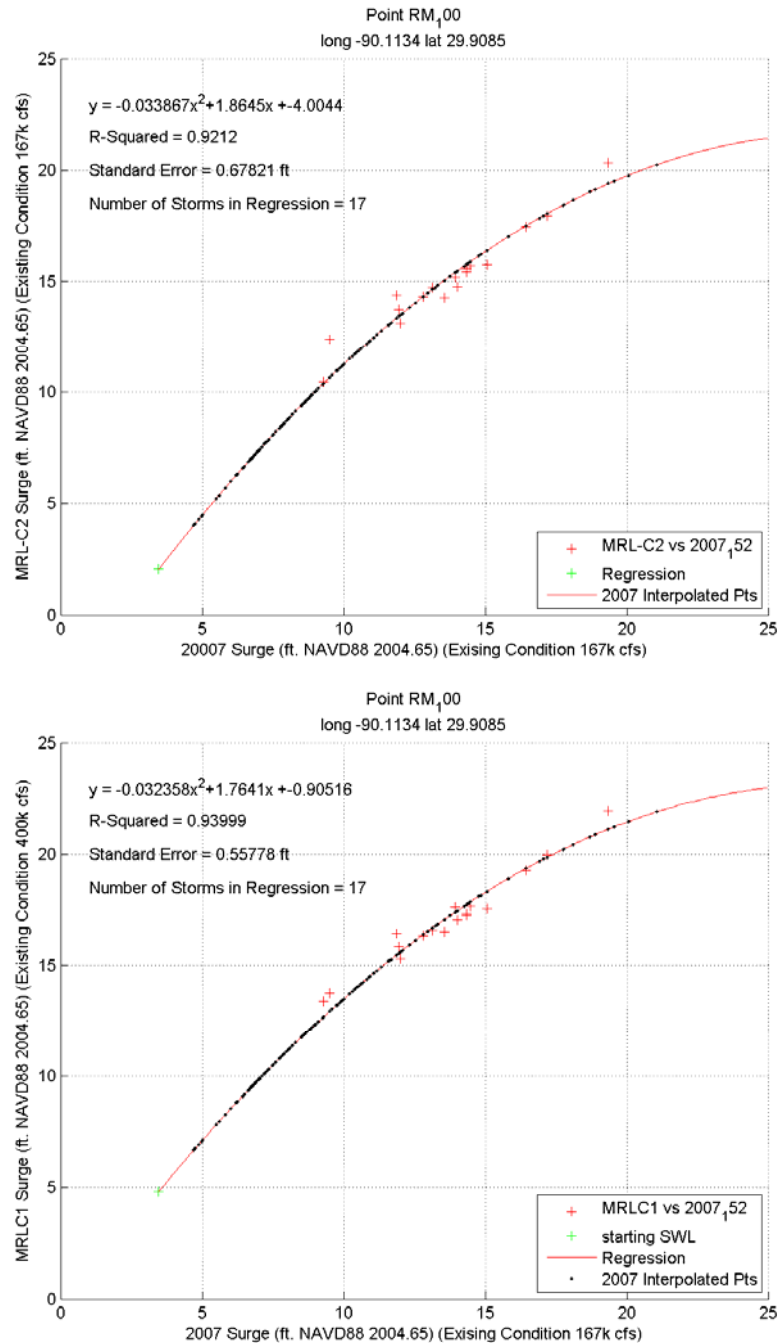


**Figure 2-20 – Surge Maxima Relationship Between the 167,000 cfs and the 400,000 cfs Runs at Various Points Along the Mississippi River**

For the statistical analysis, the peak surge for the entire suite of 152 storms is necessary. Since only 17 storm results are available from the ADCIRC runs, the remaining 135 peak surge levels have been produced using a correlation analysis. A correlation has been carried out at each river mile (RM) between the 17 storm results from the original 2007 storm set (SL15v3 grid) and the new 17 storm runs (SL15v7 grid) applying a second-order polynomial. As can be observed in **Figure 2-21** below for the Carrollton location, the correlation is high ( $R^2 > 0.9$ ) for both the



167,000 cfs and 400,000 cfs Mississippi River discharge. This high correlation is obtained throughout the entire Mississippi River. Using the second-order equation, a full storm suite of 152 peak results has been created at all river mile points for both discharge levels.



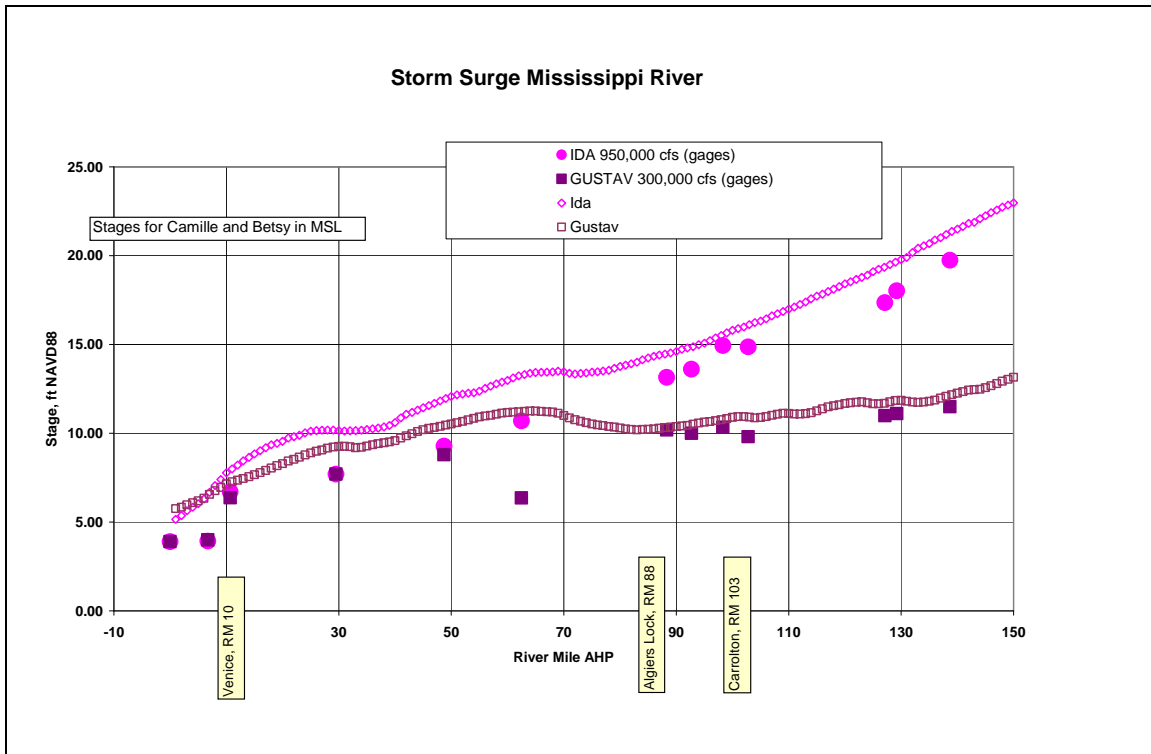
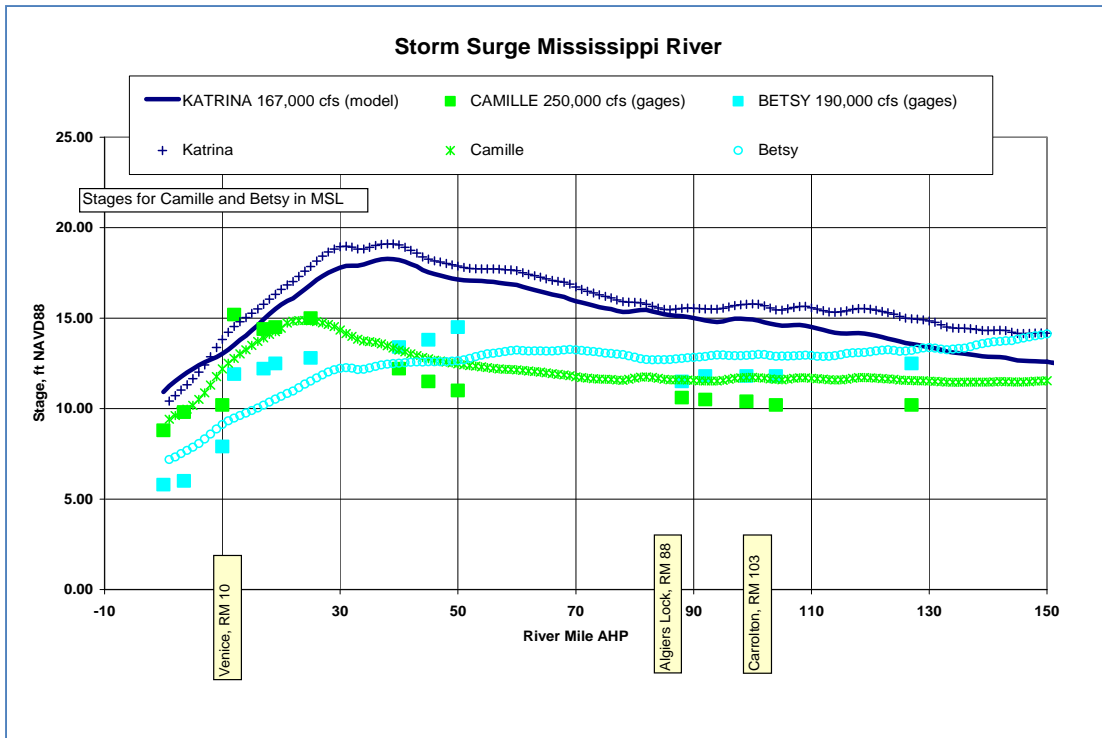
**Figure 2-21 – Correlation Between the 17 Storms from the Original 152 Storm Suite (SL15v3 grid) and New 17 Storm Results (SL15v7 grid) for 167,000 cfs (upper panel) and 400,000 cfs (lower panel)**

To further gain confidence in the ADCIRC modeling results for hurricane surge in the Mississippi River, surge level observations along the Mississippi River were compared with the ADCIRC surge level results. First, the hurricane characteristics of the historical storms and the Mississippi River discharge were derived from various sources and are summarized in **Table 2-7**. Note that some of these parameters have been estimated since no detailed data was available. Next, storms were selected from the 152 storm suite with tracks and storm characteristics (pressure and radius to maximum wind) close to the historical storm. The storm results have been interpolated (or extrapolated if necessary) linearly for central pressure, radius to max winds and river discharge using the 167,000 cfs and 400,000 cfs results.

**Table 2-7 Storms Selected for the Historical Hurricanes**

	<b>Central Pressure millibars (mbar)</b>	<b>Radius to Max Winds nautical miles (nm)</b>	<b>Mississippi River Discharge (cfs)</b>	<b>Storms Selected</b>
Katrina	902	18	167,000	23,26,27,32,35,36
Camille	905	14	250,000	31,32,35,40,41,44
Gustav	972	18	300,000	50,53
Ida	985	18	950,000	121,122
Betsy	941	18	190,000	50,51,52,53

**Figure 2-22** shows the comparison between surge level observations and (interpolated) ADCIRC surge levels along the Mississippi River. In general, the surge level patterns in the Mississippi River from the ADCIRC storm results match pretty well. There are differences due deviations in track, different bathymetry and levee geometry for the older storms. Nevertheless, the various distinct trends in surge in the Mississippi River (e.g. the downstream peak for Hurricanes Camille and Katrina versus the more gradual trends for Hurricanes Gustav and Betsy) are also present in the ADCIRC results.



**Figure 2-22 – Comparison Between Historical Observations and (Interpolated) ADCIRC Storm Surge**

## Extension and Application JPM-OS Method

This section summarizes the work at ERDC with regards to the extension and application of the JPM-OS to compute the 1% surge levels along the Mississippi River (**Appendix H** Section H.1). ERDC provided a new code of the JPM-OS that computes the surge level probability depending on the discharge variation in the hurricane season. Hurricane season begins on June 1 and runs through November 30 each year. In this approach, two important assumptions are made:

1. Hurricane strength is uncorrelated with the river discharge.
2. Hurricane activity and river discharge are independent phenomena.

Both assumptions have been validated which is shown **Appendix H** Section H.2 and **Appendix H** Section H.3, respectively.

Three probability density functions need to be known to compute the probability of the surge level if the river discharge can vary:

- 1) The probability density of the surge level given a certain discharge  $p(\eta|Q)$
- 2) The hurricane probability density for each hurricane month  $p(m)$
- 3) The discharge probability density for each hurricane month  $p_m(Q)$

The density function  $p(\eta|Q)$  can be derived from the ADCIRC runs with different combinations of discharge and storm characteristics. The hurricane probability density function  $p(m)$  was estimated based on historical data of hurricanes in the Gulf of Mexico. From the 22 hurricanes in the 1941 through 2005, 14 storms were within the geographic window for the New Orleans area. Based on these 14 storms the probability density function  $p(m)$  of hurricanes in the various months was derived. **Table 2-8** shows the probability density function.

**Table 2-8 Probability Density of Hurricanes in Various Months Based on Hurricanes in the New Orleans Area in the Period 1941- 2005**

	June	July	August	September	October	Total
Number of Hurricanes	1	1	4	6	2	14
$p(m)$	1/14	1/14	4/14	6/14	2/14	1

The discharge probability function  $p_m(Q)$  was based on data of the discharge of the Lower Mississippi River. **Table 2-9** shows the probability density distribution of the river discharge for various months in the period 1976 through 2002. This period of record was chosen because of the human-induced changes in the river discharge distribution in the early 1970s.

**Table 2-9 – Cumulative Probability Density Distribution of the Lower Mississippi River Discharge (in 1,000 cfs) for the Various Months in the Hurricane Season Based on the Period 1976 – 2002**

Cumulative Probability Density											
Month	0.0	0.1	0.2	0.3	0.4	0.5	0.6	0.7	0.8	0.9	1.0
June	119	329	404	476	555	639	698	761	866	1066	1584
July	103	294	334	364	392	415	457	518	579	684	966
August	91	194	222	243	288	294	320	341	385	462	833
September	63	147	182	201	217	231	252	273	301	357	730
October	51	154	175	194	219	243	273	320	362	453	831

The surge level statistics were then computed using the 152 (interpolated) peak surge levels with the 167,000 cfs and 400,000 cfs Mississippi River discharge.

### Wave Assessment Mississippi River

This section summarizes the wave assessment for the Mississippi River levees that are coincident with the HSDRRS. The full details of this approach can be found in **Appendix I**. STWAVE model results are not available for the Mississippi River because of lack of resolution in the STWAVE models for the Mississippi River area. An empirical approach has been selected to determine the appropriate design waves for the Mississippi River. The new analysis utilizes the Bretschneider Equation, and accounts for the varying wind direction, wind speed, and fetch of each of the 152 synthetic storms.

The methodology for determination of the design waves for the Mississippi River levee system consists of two steps:

**Step 1:** Determine the wave characteristics at the peak surge level for all 152 storms using an empirical approach based on fetch, wind speed and local water depth. The batture elevation is compared to the surge elevation to determine if wave breaking could occur. If wave breaking is likely to occur, the wave heights are reduced; the wave period, however, is not modified. This is consistent with the general procedure for the HSDRRS, in which wave breaking near the levee due to shallow water depths is accounted for.

**Step 2:** Calculate the 1% wave height and peak wave period using the 152 storm wave heights and wave periods from the previous step, taking into consideration the storm probabilities;

Important differences compared with the HSDRSS methodology previously presented are the following:

- **Coincidence of Surge and Waves:** The design assumption for the HSDRSS is that peak waves and peak surge always (perfectly) coincide. Although realistic for areas like Lake

Pontchartrain, this assumption is much less realistic for the river. The strong variation in the levee/structure orientation and fetch lengths for different wind directions makes inclusion of the timing of surge and waves necessary to obtain realistic estimates of the wave characteristics. The timing of surge and waves in the Mississippi River is taken fully into account by analyzing the full suite of 152 storms and computing the wave heights at each location throughout the entire storm and selecting the wave heights at peak surge for further processing.

- **Wave Angle:** Another design assumption for the HSDRSS is that the waves approach the levees and structures at an angle perpendicular to the levee/structure. For the Mississippi River levee system, the wave angle with respect to the levee and structure orientation has been included in this wave assessment. The strong variation in levee and structure orientation and also fetch lengths for different wind directions make inclusion of the wave angle necessary to obtain realistic estimates of the wave characteristics.
- **Statistics:** The statistical procedure to derive the 1% waves is different from the standard procedure used for the HSDRRS. The JPM-OS program could not be applied herein, since this program implicitly assumes the dependent variable (i.e. wave characteristics) to be a function of the independent variables (i.e. hurricane characteristics such as pressure, radius). That is not the case for the waves along most of the Mississippi River levee system, and the resulting 1% waves appear to be not realistic, given the individual storm results. The approach followed herein is to use the probabilities of the first 81 storms out of the entire 152 storm suite; these storm probabilities were created originally for the IPET risk model. The 1% wave height and 1% wave period have been estimated fitting an extreme value distribution (Weibull) through the computed wave heights and wave periods, respectively.

There is very limited wave data available for the Mississippi River to validate the computed wave results for the individual storms. Two sources of information have been used to perform a qualitative assessment of the computed waves; a video from the waves at the Mississippi River in the Kenner Bend and observations made by Mr. Bob Turner of South Louisiana Flood Protection East (SLFPA-East) along the Mississippi River levee near Chalmette Battlefield just after Hurricane Katrina. The two comparisons show that the computed wave characteristics are qualitatively in line with the observations. It is therefore concluded that the methodology provides a good basis for the determination of the 1% design wave statistics and levee design elevations.

*This page is intentionally left blank*

## 3.0 LAKE PONTCHARTRAIN AND VICINITY

### 3.1 GENERAL

The Lake Pontchartrain and Vicinity (LPV) region of the HSDRRS extends upstream from the Bonnet Carré Spillway East Guide Levee (St. Charles Parish) to the downstream point of Caernarvon floodwall (St. Bernard Parish). This study traverses the Parishes of St. Charles, Jefferson, Orleans, and St. Bernard (**Plate 1**). The water bodies affected by the LPV project are the east bank of the Mississippi River, Lake Pontchartrain's southern shoreline, Inner Harbor Navigation Canal (IHNC), Gulf Intracoastal Waterway (GIWW), Mississippi River Gulf Outlet (MRGO), and Lake Borgne.

The design elevations in the Lake Pontchartrain region are dominated by surge levels caused by wind setup at the lake and surge intrusion from the Gulf of Mexico. The waves near the levees at the Lakefront of Lake Pontchartrain are locally generated wind waves with the 1% chance annual exceedence surge elevations of 10 ft along the entire Lakefront area. The 1% chance annual exceedence wave characteristics in front of the levees are significant with wave heights of 7 to 8 ft and peak periods of 7 to 8 seconds(s). For St. Charles Parish, the modeled wave height and wave period results are lower than other project areas along Lake Pontchartrain due to the marsh areas in St. Charles Parish. However, surge elevations are similar to the Lakefront area.

Special consideration has been given to the I-10 & I-310 floodwall overtopping analysis. Residents of St. Charles and Jefferson Parish rely heavily upon the ability of the St. Charles Parish levee and West Return Wall system for protection against rising waters of Lake Pontchartrain during hurricane events. The levee system runs beneath a series of ramps and loops for both I-10 and I-310. The floodwall clearance has become an issue because overhead structures limit the amount of increase in construction height. Subsequently, overtopping analysis was performed at each location to quantify overtopping volumes and magnitude resulting from floodwall height limitations. The overtopping criteria used for the design of these specific locations differ from that of the rest of the HSDRRS. The I-10 & I-310 Floodwall Overtopping Analysis (April, 2009) describes these differences and can be found in **Appendix P**. The analysis and criteria have completed review by IEPR.

The hydraulic conditions along the eastern side of Orleans and St. Bernard Parish are quite different from the Lake Pontchartrain conditions. The 1% chance annual exceedence surge elevations are 15 to 17 ft and the wave climates are different. The 1% wave height in the parishes is generally lower than Lake Pontchartrain by 4 to 6 ft due to relatively shallow areas. However, the wave periods are generally larger 8 to 10 s, with wave periods >12 s for events above the design event (<1%). According to the hind cast model of Hurricane Katrina, long swell waves from the Gulf of Mexico can have a devastating effect (IPET, 2007).

**Appendix S** is an overtopping analysis of the LPV-149 Floodwall Tie-In to the existing Mississippi River Levee. This appendix documents the overtopping analysis completed which showed that the tie-in, as originally constructed, did not meet the HSDRRS wave overtopping



criteria for 1% existing conditions. The tie-in was reconstructed (LPV-149A) to meet the HSDRRS wave overtopping criteria for 1% existing conditions.

The chapter is divided into eight sections:

- **Section 3.2** – St. Charles Parish (**Plate 2**)
- **Section 3.3** – Jefferson Parish Lakefront (**Plate 3**)
- **Section 3.4** – Orleans Parish – Metro Lakefront (**Plate 4**)
- **Section 3.5** – Orleans Parish – Lakefront East (**Plate 5**)
- **Section 3.6** – South Point to MRGO/GIWW closure (**Plate 6**)
- **Section 3.7** – IHNC/GIWW Basin (**Plate 7**)
- **Section 3.8** – Closures at GIWW/MRGO and Seabrook
- **Section 3.9** – St. Bernard Parish (**Plate 8**)

The individual subsections present the 1% chance annual exceedence hydraulic boundary conditions, 1% chance annual exceedence design elevations, and the resiliency analysis for the 0.2% chance annual exceedence storm event. Unless otherwise noted, elevations presented in this report are in feet/foot North American Vertical Datum of 1988 - 2004.65 (NAVD88).

The minimum criteria for resiliency must be that levees and structures do not catastrophically breach when design criteria are exceeded. Resilience also includes designing for possible changes in conditions, with the flexibility to adapt to future design conditions. For the design analysis, the final 1% design elevation is checked against the 0.2% surge elevation (50% confidence level). If the design elevation is lower, the elevation is raised to prevent free flow over the HSDRRS from a resiliency point of view. Additional armoring may be required to meet the desired final level of resiliency; this is addressed in HSDRRS Levee Armoring EAR, June 2014.

The information included in the tables in this chapter are also summarized in **Appendix T**, Overtopping Design Criteria Tables.

## 3.2 ST. CHARLES PARISH

Each alternative for hydraulic reaches along the St. Charles Parish reach was reviewed during this update process. The alternatives for each corresponding hydraulic reach (where available) were reviewed along with the 95 or 100% structure or levee design plans. The alternative that best corresponded to the 95 or 100% structural design plans was considered the final hydraulic design. The data from the final hydraulic design was used to update data for the hydraulic boundary conditions, design elevations, and wave loads within this report.

The hydraulic reach identification has been updated from the October 2007 DER to match the current design conditions in their corresponding area.

### 3.2.1 General

The St. Charles Parish reach consists of two large levee sections; St. Charles Parish Levee East and West of I-310, two large levee/floodwall combination sections at the St. Charles Western Return Wall, and several stretches of floodwalls and structures in between. The reach runs from the Bonnet Carré Spillway to the Jefferson/St. Charles Parish boundary at the New Orleans Airport East–West runway terminus (**Plate 2**). The total length is approximately 10.7 miles.

St. Charles Parish has several drainage structures to allow intercepted drainage to flow north into the adjacent bayous and drainage canals and ultimately into Lake Pontchartrain. St. Charles Parish hydraulic reach number two is identified as (**SC02**) and subsequent numbers for the remaining hydraulic reaches.

**Plate 2** shows the hydraulic boundaries for St. Charles Parish reach. The numbers indicate the hydraulic design elevations for several structures along the reach. The elevations displayed for levees will have both existing conditions (2007) and future conditions (2057), unless otherwise stated. The elevations displayed for hard structures (floodwalls, floodwall/levee combinations, pump stations, etc.) will have future (2057) conditions only. All hard structures are designed and built for future conditions (2057) only. If structural superiority is included with a specific hard structure the hydraulic design elevation will have an additional number, color coded green. The hydraulic reaches in **Plate 2** are different colors only to show the boundary limits of each reach. The colors do not represent a specific type of structure.

This figure also shows the construction reaches as they correspond to the hydraulic reach. The construction boundary is off-set from the hydraulic boundary and labelled opposite the hydraulic reach label.

### 3.2.2 Hydraulic Boundary Conditions

The hydraulic design characteristics for the hydraulic reaches along the St. Charles Parish reach are listed in **Table 3-1**. The existing hydraulic conditions are based on the JPM-OS method using the results from ADCIRC and STWAVE model runs. To account for changes due to subsidence and sea level rise over a 50 year period, the surge elevations were adjusted by adding

1.5 ft and the wave heights were adjusted by adding 0.75 ft for future conditions. The wave period is computed using the assumption that the wave steepness remains constant.

**Table 3-1 St. Charles Parish Hydraulic Reaches – 1% Hydraulic Boundary Conditions**

St. Charles Parish Reaches 1% Hydraulic Boundary Conditions									
Hydraulic Reach	Name	Type	Condition	Surge Level (ft)		Significant Wave Height (ft)		Peak Period (s)	
				Mean	Std	Mean	Std	Mean	Std
SC01-A1	St. Charles Western Return Wall 17.5 ft	Structure/Wall	Future	10.9	0.7	4.4	0.3	7.2	1.3
SC01-A2	St. Charles Western Return Wall 17.0 ft	Structure/Wall	Future	11.6	0.8	3.9	0.3	4.9	0.9
SC02-A	St. Charles Parish Levee West of I-310	Levee	Existing	11.0	0.8	2.3	0.2	4.2	0.8
SC02-A	St. Charles Parish Levee West of I-310	Levee	Future	12.5	0.8	3.1	0.2	4.8	0.8
SC02-B	St. Charles Parish Levee East of I-310	Levee	Existing	10.5	0.8	1.6	0.2	3.2	0.6
SC02-B	St. Charles Parish Levee East of I-310	Levee	Future	12.0	0.8	2.4	0.2	3.9	0.6
SC04	St. Rose Canal Drainage Structure T-Wall	Structure/Wall	Future	11.9	0.9	2.7	0.2	4.5	0.8
SC04-G	St. Rose Canal Drainage Gate	Structure/Wall	Future	11.9	0.9	2.7	0.2	4.5	0.8
SC05-FW	Good Hope Floodwall	Structure/Wall	Future	12.5	0.8	3.1	0.2	4.7	0.8
SC05-G	Good Hope Gate	Structure/Wall	Future	12.5	0.8	3.1	0.2	4.7	0.8
SC06	Gulf South Pipeline T-wall	Structure/Wall	Future	12.5	0.8	3.1	0.2	4.8	0.8
SC07	Cross Bayou Canal T-wall	Structure/Wall	Future	12.5	0.8	3.1	0.2	4.7	0.8
SC08-FW1	Bayou Trepagnier Complex Fronting Protection T-walls	Structure/Wall	Future	12.5	0.8	2.7	0.2	4.0	0.7

St. Charles Parish Reaches 1% Hydraulic Boundary Conditions									
Hydraulic Reach	Name	Type	Condition	Surge Level (ft)		Significant Wave Height (ft)		Peak Period (s)	
				Mean	Std	Mean	Std	Mean	Std
SC08-FW2	Bayou Trepagnier Complex T-walls	Structure/Wall	Future	12.5	0.8	2.7	0.2	4.0	0.7
SC09	Almedia Drainage Structure	Structure/Wall	Future	12.0	0.8	2.4	0.2	3.9	0.6
SC09-G	Almedia Drainage Gate	Structure/Wall	Future	12.0	0.8	2.4	0.2	3.9	0.6
SC10	Walker Drainage Structure	Structure/Wall	Future	11.9	0.8	2.5	0.2	3.8	0.6
SC10-G	Walker Drainage Gate	Structure/Wall	Future	11.9	0.8	2.5	0.2	3.8	0.6
SC11	Bonnet Carre Tie-in Floodwall	Structure/Wall	Future	12.5	0.8	2.7	0.2	4.0	0.7
SC12-FW1	I-310 Floodwall	Structure/Wall	Future	12.0	0.9	2.3	0.2	3.9	0.6
SC12-FW2	I-310 Floodwall	Structure/Wall	Future	12.0	0.9	2.3	0.2	3.9	0.6
SC13-FW	ICRR (Canadian National Railroad) Gate Monolith	Structure/Wall	Future	11.8	0.8	2.4	0.2	4.0	0.7
SC13-G	ICRR (Canadian National Railroad) Gate	Structure/Wall	Future	11.8	0.8	2.4	0.2	4.0	0.7
SC14	Airport Runway Levee	Levee	Existing	10.3	0.8	1.9	0.2	3.8	0.8
SC14	Airport Runway Levee	Levee	Future	11.8	0.8	2.7	0.2	4.5	0.8
SC15-FW	Shell Pipeline to Good Hope Floodwall	Structure/Wall	Future	12.5	0.8	3.1	0.2	4.7	0.8
SC30	Western Return Wall South Transition Connects to SC01-A)	Structure/Wall	Future	11.8	0.8	2.9	0.2	5.0	0.9

**St. Charles Western Return Wall Levee/Floodwall Combination (SC01-A1 and SC01-A2):** The levee/floodwall combination runs in a north-south direction along the St. Charles/Jefferson Parish boundary from Lake Pontchartrain to I-10. The hydraulic reach is 2.77 miles long. The design surge level, significant wave height, and peak period for the levee/I-walls are 10.9 ft, 4.4 ft, and 7.2 s for SC01-A1 and 11.6 ft, 3.9 ft, and 4.9 s for SC01-A2, respectively (Table 3-1).

**St. Charles Parish Levee West of I-310 (SC02-A):** The levee runs in an east-west direction from the I-310 Floodwall (SC12) to the Bayou Trepagnier Pump Station (SC08-FW1 and SC08-FW2). The hydraulic reach is 6.28 miles long and is transected by the 509 ft St. Rose Canal Drainage Structure (SC04), the 465 ft Good Hope Floodwall and Gate (SC05-F and SC05-G), the 227 ft Gulf Pipeline T-wall (SC06), the 441 ft Cross Bayou Canal T-wall (SC07), and the 167 ft Walker Drainage Structure (SC10). An elevation of 0 ft was assumed for the toe of the levee. The levee's design surge level, significant wave height, and peak period for existing conditions are 11 ft, 2.3 ft, and 4.2 s, respectively. The levee's design surge level, significant wave height, and peak period for future conditions are 12.5 ft, 3.1 ft, and 4.8 s, respectively (Table 3-1).

**St. Charles Parish Levee East of I-310 (SC02-B):** The levee runs in a northeast-southwest direction from the Illinois Central Railroad – Canadian National Railroad (ICRR) Floodgate (SC13-FW and SC13-G) to the I-310 Floodwall (SC12). The hydraulic reach is 2.27 miles long and is transected by the 162 ft Almedia Drainage Structure (SC09) and the 168 ft Walker Drainage Structure (SC10). An elevation of 0 ft was assumed for the toe of the levee. The levee's design surge level, significant wave height, and peak period for existing conditions are 10.5 ft, 1.6 ft, and 3.2 s, respectively. The levee's design surge level, significant wave height, and peak period for future conditions are 12 ft, 2.4 ft, and 3.9 s, respectively (Table 3-1).

**St. Rose Canal Drainage Structure and Gate (SC04 and SC04-G):** The structure runs in an east-west direction and is located within St. Charles Parish Levee West of I-310 (SC02-A). The reach is 509 ft long. The structure's design surge level, significant wave height, and peak period for future conditions are 11.9 ft, 2.7 ft, and 4.5 s, respectively (Table 3-1).

**Good Hope Floodwall and Gate (SC05-FW and SC05-G):** The structure runs in an east-west direction and is located within St. Charles Parish Levee West of I-310 (SC02-A). The reach is 465 ft long. The structure's design surge level, significant wave height, and peak period for future conditions are 12.5 ft, 3.1 ft, and 4.7 s, respectively (Table 3-1).

**Gulf South Pipeline T-wall (SC06):** The floodwall runs in an east-west direction and is located within St. Charles Parish Levee West of I-310 (SC02-A). The reach is 228 ft long. The floodwall's design surge level, significant wave height, and peak period for future conditions are 12.5 ft, 3.1 ft, and 4.8 s, respectively (Table 3-1).

**Cross Bayou Canal T-wall (SC07):** The floodwall runs in an east-west direction and is located within St. Charles Parish Levee West of I-310 (SC02-A). The reach is 442 ft long. The floodwall's design surge level, significant wave height, and peak period for future conditions are 12.5 ft, 3.1 ft, and 4.7 s, respectively (Table 3-1).

**Bayou Trepagnier Pump Station (SC08-FW1 and SC08-FW2):** The structure runs in a northwest-southeast direction and is between Bonnet Carré Tie-in Floodwall (SC11) and St. Charles Parish Levee West of I-310 (SC02-A). The reach is 426 ft long. The structure's design surge level, significant wave height, and peak period for future conditions are 12.5 ft, 2.7 ft, and 4.0 s, respectively (Table 3-1).

**Almedia Drainage Structure and Gate (SC09 and SC09-G):** The structure runs in an east-west direction and is located within St. Charles Parish Levee East of I-310 (SC02-B). The reach is 162 ft long. The structure's design surge level, significant wave height, and peak period for future conditions are 12 ft, 2.4 ft, and 3.9 s, respectively (Table 3-1).

**Walker Drainage Structure and Gate (SC10 and SC10-G):** The structure runs in a northeast-southwest direction and is located within St. Charles Parish Levee East of I-310 (SC02-B). The reach is 168 ft long. The structure's design surge level, significant wave height, and peak period for future conditions are 11.9 ft, 2.5 ft, and 3.8 s, respectively (Table 3-1).

**Bonnet Carré Tie-in Floodwall (SC11):** The floodwall runs in a northwest-southeast direction and ties the Bayou Trepagnier Pump Station (SC08-FW1 and SC08-FW2) floodwalls into the Bonnet Carré Levee. The reach is 107 ft long. The floodwall's design surge level, significant wave height, and peak period for future conditions are 12.5 ft, 2.7 ft, and 4.0 s, respectively (Table 3-1).

The Bonnet Carré lower guide levee from St. Charles HSDRRS intersects Bayou Trepagnier to the Mississippi River, and forms part of the perimeter system for the St. Charles Parish reach.

**I-310 Floodwalls (SC12-FW1 and SC12-FW2):** Both floodwalls run in an east-west direction and are located between St. Charles Parish Levee West of I-310 (SC02-A) and St. Charles Parish Levee East of I-310 (SC02-B). SC12-FW2 runs underneath the I-310 roadway. The reach is 1,628 ft long. The floodwall's design surge level, significant wave height, and peak period for future conditions are 12 ft, 2.3 ft, and 3.9 s, respectively (Table 3-1).

**ICRR Floodgate (SC13-FW and SC13-G):** The structure runs in a northeast-southwest direction perpendicular to the railroad tracks to St. Charles Parish East (SC02-B). The hydraulic reach is 507 ft long. The structure's design surge level, significant wave height, and peak period for future conditions are 11.8 ft, 2.4 ft, and 4.0 s, respectively (Table 3-1).

**Airport Runway Levee (SC14):** The levee runs in an east-west direction parallel to the airport runway then turns to the south, again running parallel to the airport runway and ties into the ICRR Floodgate (SC13). The hydraulic reach is 1,581 ft long. The levee's design surge level, significant wave height, and peak period are 10.3 ft, 1.9 ft, and 3.8 s, respectively. The levee's design surge level, significant wave height, and peak period for future conditions are 11.8 ft, 2.7 ft, and 4.5 s, respectively (Table 3-1).

**Shell Pipeline to Good Hope Levee (SC15-FW):** The floodwall runs in an east-west direction and is located within St. Charles Parish Levee West of I-310 (SC02-A). The hydraulic reach is

158 ft long. The levee's design surge level, significant wave height, and peak period for future conditions are 12.5 ft, 3.1 ft, and 4.7 s, respectively (**Table 3-1**).

**Western Return Wall South (SC30):** The floodwall runs in a north-south direction along the St. Charles/Jefferson Parish boundary from I-10 to West 24<sup>th</sup> Street where the alignment runs northeast-southwest to the Airport Runway Levee (**SC14**). The hydraulic reach is 0.67 mile long. The floodwall's design surge level, significant wave height, and peak period for future conditions are 11.8 ft, 2.9 ft, and 5.0 s, respectively (**Table 3-1**).

### **3.2.3. Project Design Elevations**

The design characteristics for the sections in St. Charles Parish are listed in **Table 3-2**. Reaches **SC01-A1, SC01-A2 and SC15-FW** are floodwalls; hydraulic reaches **SC02-A, SC02-B,** and **SC14** are levees; the remaining hydraulic reaches are floodwalls or structures. Note that structures are only evaluated for future conditions because they are hard structures. **SC08-FW1** and **SC11** include 2.0 ft of structural superiority.



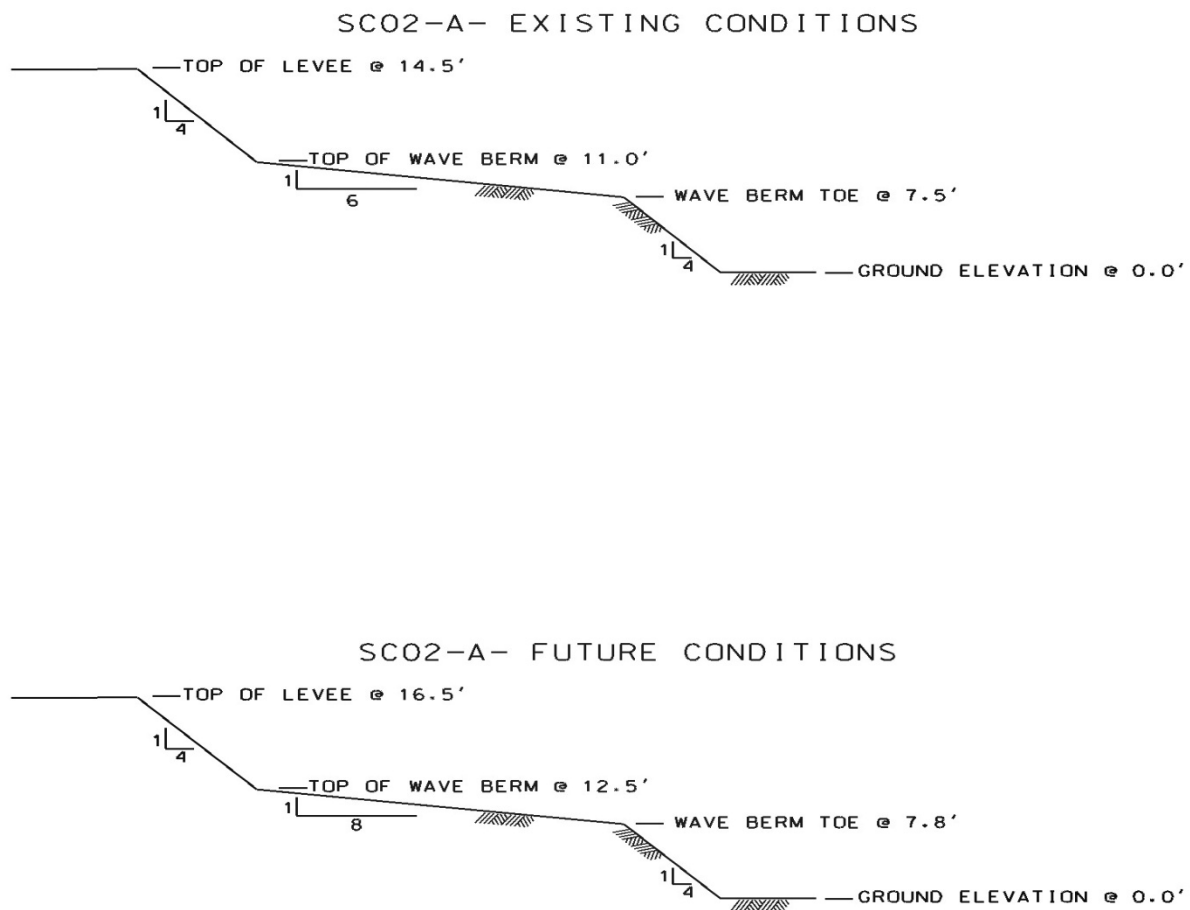
**Table 3-2 St. Charles Parish Hydraulic Reaches – 1% Design Information**

St. Charles Parish Reaches 1% Hydraulic Design Elevations							
Hydraulic Reach	Name	Type	Condition	Depth at Toe (ft)	Elevation (ft)	Overtopping Rate	
						q50 (cfs/ft)	q90 (cfs/ft)
SC01-A1	St. Charles Western Return Wall 17.5 ft	Structure/Wall	Future	10.9	17.5	0.013	0.047
SC01-A2	St. Charles Western Return Wall 17.0 ft	Structure/Wall	Future	11.6	17.0	0.022	0.078
SC02-A	St. Charles Parish Levee West of I-310	Levee	Existing	11.0	14.5	0.007	0.082
SC02-A	St. Charles Parish Levee West of I-310	Levee	Future	12.5	16.5	0.006	0.065
SC02-B	St. Charles Parish Levee East of I-310	Levee	Existing	10.5	14.0	0.004	0.041
SC02-B	St. Charles Parish Levee East of I-310	Levee	Future	12.0	15.5	0.004	0.048
SC04	St. Rose Canal Drainage Structure T-Wall	Structure/Wall	Future	11.9	16.5	0.010	0.065
SC04-G	St. Rose Canal Drainage Gate	Structure/Wall	Future	11.9	16.5	0.010	0.065
SC05-FW	Good Hope Floodwall	Structure/Wall	Future	12.5	17.0	0.020	0.078
SC05-G	Good Hope Gate	Structure/Wall	Future	12.5	17.0	0.020	0.078
SC06	Gulf South Pipeline T-wall	Structure/Wall	Future	12.5	17.0	0.020	0.077
SC07	Cross Bayou Canal T-wall	Structure/Wall	Future	12.5	17.0	0.019	0.078
SC08-FW1	Bayou Trepagnier Complex Fronting Protection T-walls	Structure/Wall	Future	12.5	18.5 <sup>SS</sup>	0.001	0.004

St. Charles Parish Reaches 1% Hydraulic Design Elevations							
Hydraulic Reach	Name	Type	Condition	Depth at Toe (ft)	Elevation (ft)	Overtopping Rate	
						q50 (cfs/ft)	q90 (cfs/ft)
SC08-FW2	Bayou Trepagnier Complex T-walls	Structure/Wall	Future	12.5	16.5	0.001	0.004
SC09	Almedia Drainage Structure	Structure/Wall	Future	12.0	15.5	0.012	0.066
SC09-G	Almedia Drainage Gate	Structure/Wall	Future	12.0	15.5	0.012	0.066
SC10	Walker Drainage Structure	Structure/Wall	Future	11.9	15.5	0.015	0.071
SC10-G	Walker Drainage Gate	Structure/Wall	Future	11.9	15.5	0.015	0.071
SC11	Bonnet Carre Tie-in Floodwall	Structure/Wall	Future	12.5	18.5 <sup>SS</sup>	0.001	0.004
SC12-FW1	I-310 Floodwall Under Ramps	Structure/Wall	Future	12.0	13.5	0.009	0.054
SC12-FW2	I-310 Floodwall	Structure/Wall	Future	12.0	15.5	0.009	0.054
SC13-FW	ICRR (Canadian National Railroad) Gate Monolith	Structure/Wall	Future	11.8	15.5	0.009	0.050
SC13-G	ICRR (Canadian National Railroad) Gate	Structure/Wall	Future	11.8	15.5	0.009	0.050
SC14	Airport Runway Levee	Levee	Existing	5.7	14.0	0.004	0.050
SC14	Airport Runway Levee	Levee	Future	7.2	15.5	0.004	0.051
SC15	Shell Pipeline to Good Hope Floodwall	Structure/Wall	Future	12.5	17.0	0.012	0.051
SC30	Western Return Wall South Transition (Connects to SC01-A)	Structure/Wall	Future	11.8	16.0	0.011	0.049

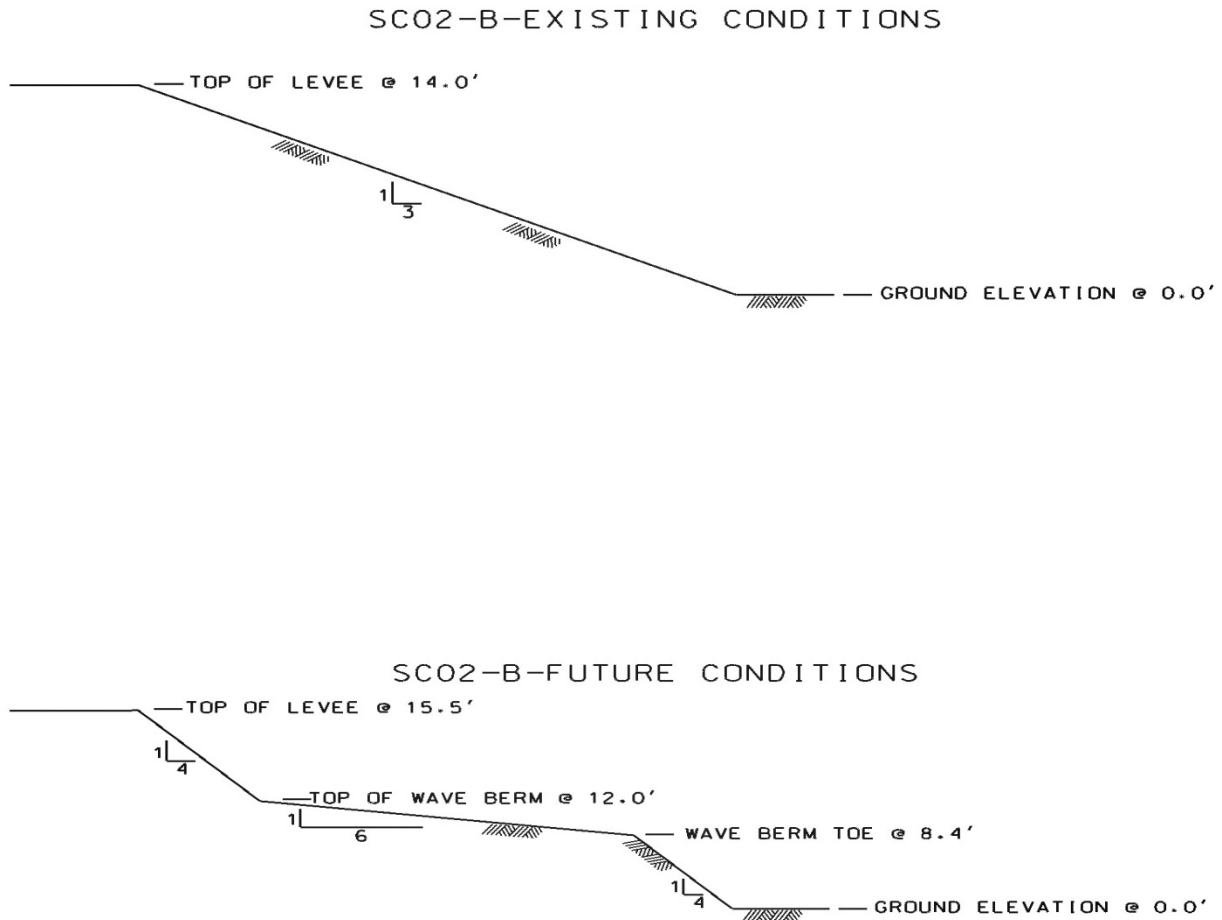
### 3.2.4 Typical Cross-Sections

The typical levee design cross-section for the 1% design (existing and future conditions) of St. Charles Levee West (SC02-A) is shown in **Figure 3-1**. The SC02-A levee section is a bit more exposed with a higher surge level and also higher waves. Therefore, the design elevation is higher and has a wave berm in order to meet the design criteria. The flat slope and the levee elevation were allowed to vary to meet the design criterion. The 1% hydraulic design elevation for existing conditions is 14.5 ft and 16.5 ft for future conditions.



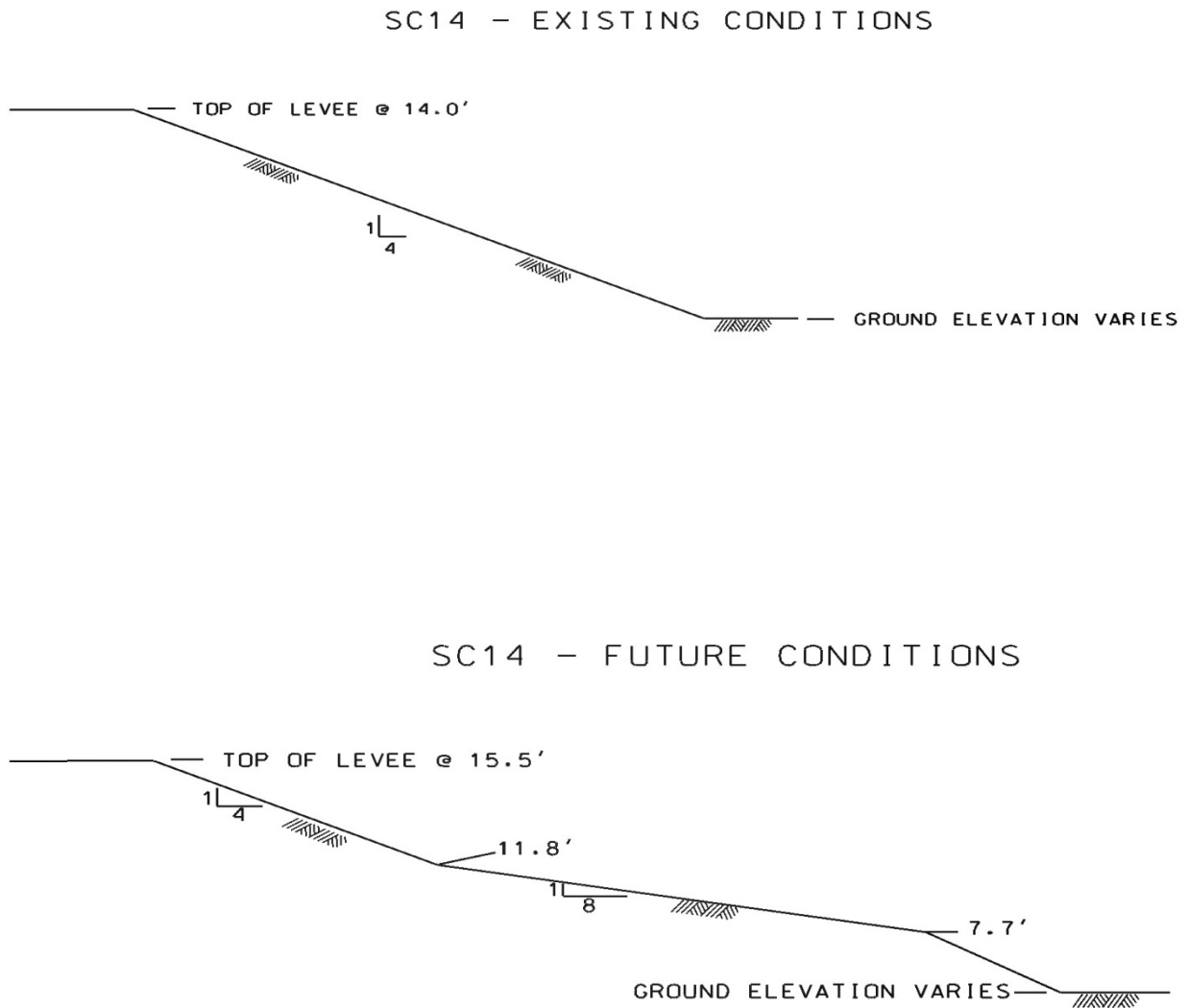
**Figure 3-1 Typical Levee Design Cross-sections St. Charles Parish Levee West (SC02-A)**

The typical levee design cross-section for the 1% design, existing and future conditions, of St. Charles Levee East (SC02-B) is shown in **Figure 3-2**. The SC02-B levee section has a 14 ft elevation (existing conditions) with a 1:3 slope. The 1% hydraulic design elevation is 14 ft for existing conditions and 15.5 ft for future conditions. For future conditions the elevation must be raised to 15.5 ft and a wave berm has been included to meet the design criteria.



**Figure 3-2 Typical Levee Design Cross-sections St. Charles Parish Levee East (SC02-B)**

The typical levee design cross-section for the 1% design, existing and future conditions of the Airport Runway Levee (SC14) is shown in **Figure 3-3**. The 1% hydraulic design elevation for existing conditions must be 14 ft and 15.5 ft with a wave berm for future conditions.



**Figure 3-3 Typical Levee Design Cross-sections Airport Runway Levee (SC14)**

### 3.2.5 Resiliency

The hydraulic designs for the levees and structures within St. Charles Parish were examined for resiliency by computing the 0.2% surge level (50% confidence). The results are presented in **Table 3-3**. For all sections, the 0.2% surge level remains below the top of the flood defense.

**Table 3-3 St. Charles Parish Hydraulic Reaches – Resiliency**

<b>St. Charles Parish Reaches Resiliency Analysis (0.2% Event)</b>					
<b>Hydraulic Reach</b>	<b>Name</b>	<b>Type</b>	<b>Condition</b>	<b>Design Elevation (ft)</b>	<b>0.2% Event</b>
					<b>Surge Level (ft)</b>
<b>SC01-A1</b>	St. Charles Western Return Wall 17.5ft	Structure/Wall	Future	17.5	13.4
<b>SC01-A2</b>	St. Charles Western Return Wall 17.0ft	Structure/Wall	Future	17.0	14.5
<b>SC02-A</b>	St. Charles Parish Levee West of I-310	Levee	Existing	14.5	13.8
<b>SC02-A</b>	St. Charles Parish Levee West of I-310	Levee	Future	16.5	15.3
<b>SC02-B</b>	St. Charles Parish Levee East of I-310	Levee	Existing	14.0	13.5
<b>SC02-B</b>	St. Charles Parish Levee East of I-310	Levee	Future	15.5	15.0
<b>SC04</b>	St. Rose Canal Drainage Structure T-Wall	Structure/Wall	Future	16.5	15.2
<b>SC04-G</b>	St. Rose Canal Drainage Gate	Structure/Wall	Future	16.5	15.2
<b>SC05-FW</b>	Good Hope Floodwall	Structure/Wall	Future	17.0	15.4
<b>SC05-G</b>	Good Hope Gate	Structure/Wall	Future	17.0	15.4
<b>SC06</b>	Gulf South Pipeline T-wall	Structure/Wall	Future	17.0	15.5
<b>SC07</b>	Cross Bayou Canal T-wall	Structure/Wall	Future	17.0	15.4
<b>SC08-FW1</b>	Bayou Trepagnier Complex Fronting Protection T-walls	Structure/Wall	Future	18.5 <sup>ss</sup>	15.3
<b>SC08-FW2</b>	Bayou Trepagnier Complex T-walls	Structure/Wall	Future	16.5	15.3
<b>SC09</b>	Almedia Drainage Structure	Structure/Wall	Future	15.5	15.0
<b>SC09-G</b>	Almedia Drainage Gate	Structure/Wall	Future	15.5	15.0
<b>SC10</b>	Walker Drainage Structure	Structure/Wall	Future	15.5	14.9

St. Charles Parish Reaches Resiliency Analysis (0.2% Event)					
Hydraulic Reach	Name	Type	Condition	Design Elevati on (ft)	0.2% Event
					Surge Level (ft)
SC10-G	Walker Drainage Gate	Structure/Wall	Future	15.5	14.9
SC11	Bonnet Carre Tie-in Floodwall	Structure/Wall	Future	18.5 <sup>ss</sup>	15.3
SC12-FW1	I-310 Floodwall Under Ramps	Structure/Wall	Future	13.5	15.1
SC12-FW2	I-310 Floodwall	Structure/Wall	Future	15.5	15.1
SC13-FW	ICRR (Canadian National Railroad) Gate Monolith	Structure/Wall	Future	15.5	14.8
SC13-G	ICRR (Canadian National Railroad) Gate	Structure/Wall	Future	15.5	14.8
SC14	Airport Runway Levee	Levee	Existing	14.0	13.3
SC14	Airport Runway Levee	Levee	Future	15.5	14.8
SC15-FW	Shell Pipeline to Good Hope Floodwall	Structure/Wall	Future	17.0	15.4
SC30	Western Return Wall South Transition (Connects to SC01-A)	Structure/Wall	Future	16.0	14.7

### 3.3 JEFFERSON PARISH LAKEFRONT

Each alternative for hydraulic reaches within the Jefferson Parish Lakefront reach was reviewed during this update process. The alternatives for each corresponding hydraulic reach (where available) were reviewed along with the 95 or 100% structure or levee design plans. The alternative that best corresponded to the 95 or 100% structural design plans was considered the final hydraulic design. The data from the final hydraulic design was used to update data for the hydraulic boundary conditions, design elevations, and wave loads within this report.

The hydraulic reach identification has been updated from the October 2007 DER to match the current design conditions in their corresponding area.

#### 3.3.1 General

The Jefferson Parish Lakefront reach of the LPV is located along the southern shore of Lake Pontchartrain (**Plate 3**). The HSDRRS runs in an east-west direction from the St. Charles/Jefferson Parish boundary at the return levee to the Jefferson/Orleans Parish boundary at the 17<sup>th</sup> Street Canal and consists of one large levee with several stretches of floodwalls, floodgates, and pump stations. The total length is approximately 10.4 miles. Jefferson Parish hydraulic reach number one is identified as (**JL01**) and subsequent numbers for the remaining hydraulic reaches.

**Plate 3** shows the hydraulic boundaries for the Jefferson Parish reach. The numbers indicate the hydraulic design elevations for several structures along the reach. The elevations displayed for levees will have both existing conditions (2007) and future conditions (2057), unless otherwise stated. The elevations displayed for hard structures (floodwalls, floodwall/levee combinations, pump stations, etc.) will have future (2057) conditions only. All hard structures are designed and built for future conditions (2057) only. If structural superiority is included with a specific hard structure, the hydraulic design elevation will have an additional number, color coded green. The hydraulic reaches in **Plate 3** are different colors only to show the boundary limits of each reach. The colors do not represent a specific type of structure.

This figure also shows the construction reaches as they correspond to the hydraulic reach. The construction boundary is off-set from the hydraulic boundary and labelled opposite the hydraulic reach label.

#### 3.3.2 Hydraulic Boundary Conditions

The hydraulic design characteristics for the sections in Jefferson Parish Lakefront are listed in **Table 3-4**. The existing hydraulic conditions are based on the JPM-OS method using the results from ADCIRC and STWAVE model runs. To account for changes due to subsidence and sea level rise over a 50 year period, the surge elevations were adjusted by adding 1.5 ft and the wave heights were adjusted by adding 0.75 ft, for future conditions. The wave period is computed using the assumption that the wave steepness remains constant.



The offshore 1% hydraulic wave heights have been changed due to the presence of breakwaters in front of the pump stations (**JL02–JL05**) and to the shallow foreshore (**JL01, JL06–JL09**). This will be explained further in the following sections.

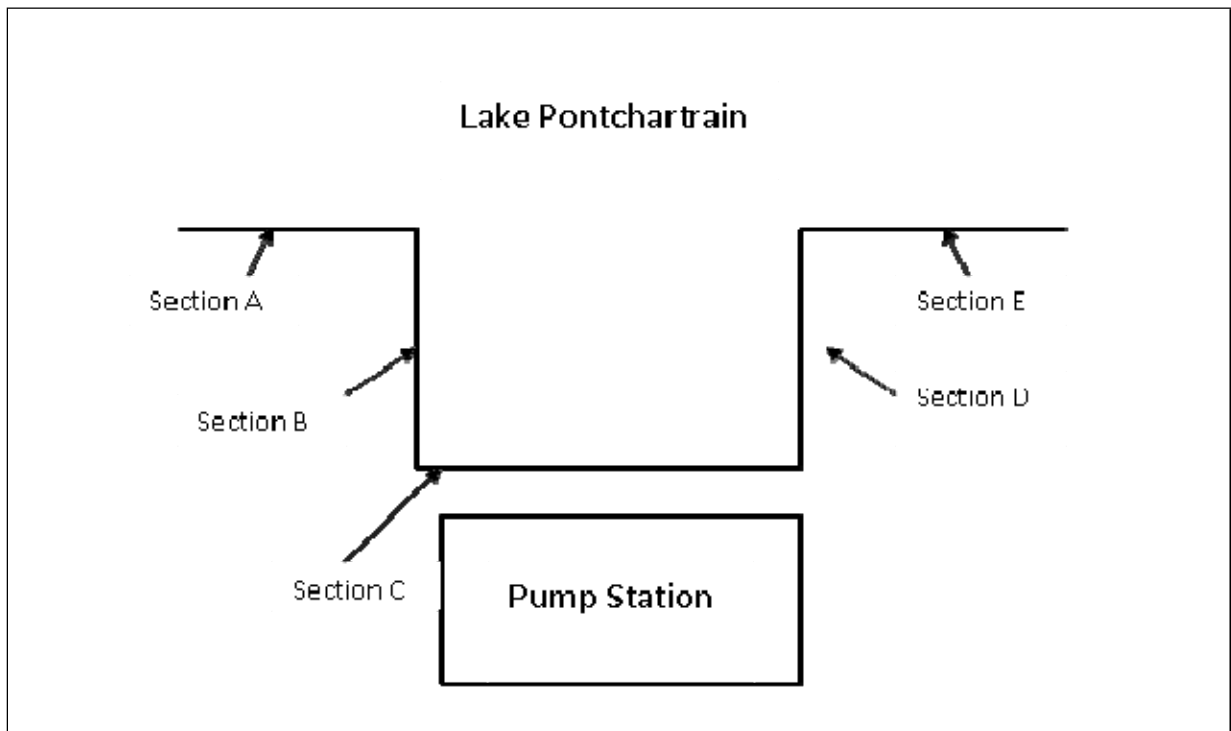
**Table 3-4 Jefferson Parish Lakefront Hydraulic Reaches – 1% Hydraulic Boundary Conditions**

<b>Jefferson Parish Reaches 1% Hydraulic Boundary Conditions</b>									
<b>Hydraulic Reach</b>	<b>Name</b>	<b>Type</b>	<b>Condition</b>	<b>Surge Level (ft)</b>		<b>Significant Wave Height (ft)</b>		<b>Peak Period (s)</b>	
				<b>Mean</b>	<b>Std</b>	<b>Mean</b>	<b>Std</b>	<b>Mean</b>	<b>Std</b>
<b>JL01</b>	Lakefront Levee	Levee	Existing	9.0	0.6	4.1	0.4	7.7	1.5
<b>JL01</b>	Lakefront Levee	Levee	Future	10.5	0.6	4.7	0.4	8.3	1.5
<b>JL02bw</b>	Bonnabel Pump Station #1 Breakwater at 14 ft	Structure/Wall	Future	10.3	0.7	7.1	0.3	8.1	1.6
<b>JL02</b>	Bonnabel Pump Station #1 Fronting Protection	Structure/Wall	Future	10.3	0.7	2.5	0.3	8.1	1.6
<b>JL03bw</b>	Suburban Pump Station #2 Breakwater at 13.2ft	Structure/Wall	Future	10.4	0.7	7.0	0.3	8.1	1.6
<b>JL03</b>	Suburban Pump Station #2 Fronting Protection	Structure/Wall	Future	10.4	0.7	2.8	0.3	8.1	1.6
<b>JL04bw</b>	Elmwood Pump Station #3 Breakwater at 10 ft	Structure/Wall	Future	10.5	0.6	7.6	0.4	8.1	1.6
<b>JL04</b>	Elmwood Pump Station #3 Fronting Protection	Structure/Wall	Future	10.5	0.6	4.2	0.4	8.1	1.6
<b>JL05bw</b>	Duncan Pump Station #4 Breakwater at 14 ft	Structure/Wall	Future	10.5	0.7	7.1	0.3	8.1	1.6
<b>JL05</b>	Duncan Pump Station #4 Fronting Protection	Structure/Wall	Future	10.5	0.7	2.5	0.3	8.1	1.6
<b>JL06</b>	Causeway Northbound & Southbound T-wall	Structure/Wall	Future	10.3	0.7	1.3	0.6	7.8	1.5
<b>JL07</b>	Williams Blvd. Floodgate	Structure/Wall	Future	10.4	0.6	2.8	0.2	8.5	1.5

**Jefferson Parish Reaches  
1% Hydraulic Boundary Conditions**

Hydraulic Reach	Name	Type	Condition	Surge Level (ft)		Significant Wave Height (ft)		Peak Period (s)	
				Mean	Std	Mean	Std	Mean	Std
<b>JL08</b>	Bonnabel Boat Launch Floodgate	Structure/Wall	Future	10.3	0.7	2.7	0.2	8.3	1.5
<b>JL09</b>	Return Wall	Structure/Wall	Future	10.3	0.7	4.9	0.4	8.3	1.6
<b>JL10</b>	US Coast Guard Station Levee	Levee	Existing	8.7	0.7	2.3	0.2	7.2	1.4
<b>JL10</b>	US Coast Guard Station Levee	Levee	Future	10.2	0.7	2.9	0.2	8.1	1.4

There are four pump stations along the Jefferson Parish Lakefront Levee. The typical configuration is shown in **Figure 3-5**. Pump Stations #1 and #4 (**JL02** and **JL05**) are not presently protected from waves with breakwaters; however, breakwaters have been added to the final design. Pump Stations #2 and #3 (**JL03** and **JL04**) have breakwaters that transform and reduce the waves. The fronting protection connects with the tie-in walls to form a continuous wall of protection. The entire wall structure currently has an overall length of 1,052 ft for **JL02** and 704 ft for **JL04**. In the design analysis, the wall elevation was extended to prevent overtopping. As seen in **Figure 3-5**, the tie-in wall sections labeled A, C, and E are subjected to more direct wave attack from Lake Pontchartrain than the other walls. Assuming that Section C is the most vulnerable section, the wave conditions were computed for that Section and the final design grade obtained for that analysis was then applied to the other sections.



**Figure 3-5 Situation for Pump Station #1 (JL02)**

**Lakefront Levee (JL01):** The levee runs in an east-west direction from the St. Charles/Jefferson Parish boundary just after the Return Wall (re-curved wall) (**JL09**) to the Jefferson/Orleans Parish boundary near the 17<sup>th</sup> Street Canal. The reach is 8.7 miles long and is transected by several structures:

- a 1,052 ft structure at Pump Station #1 (Bonnabel) (**JL02**);
- a 1,368 ft structure at Pump Station #2 (Suburban) (**JL03**);
- a 704 ft structure at Pump Station #3 (Elmwood) (**JL04**);
- a 2,206 ft structure at Pump Station #4 (Duncan) (**JL05**);
- a 535 ft structure at Causeway Floodwall (**JL06**);

- a 189 ft structure at Williams Boulevard Floodgate (**JL07**);
- a 209 ft structure at Williams Boulevard Floodgate (**JL08**); and
- a 1,052 ft levee at the US Coast Guard Station Levee (**JL10**).

Because of the shallowness of the foreshore, the 1% wave height has been reduced for the levee section (**JL01**). The wave height was established at 40% of the design water depth. New bathymetric soundings indicate a deeper offshore bathymetry than what was assumed in the initial design of the Jefferson Lakefront levee. The original assumption was a foreshore elevation of -0.4 feet with a 3.6 feet design wave. The new surveys show foreshore elevations to be between -2.0 feet and -5.0 feet. The levee's design surge level, significant wave height, and peak period for existing conditions are 9.0 ft, 4.1 ft, and 7.7 s, respectively, and the design surge level, significant wave height, and peak period for future conditions are 10.5 ft, 4.7 ft, and 8.3 s, respectively (**Table 3-4**). With modified foreshore  $H_s = 4.2$  and 4.8 ft, respectively, and no change to wave period.

**Pump Station #1 also known as Bonnabel (JL02):** The floodwall for the pump station runs in an east-west direction along Lake Pontchartrain and is located within the Jefferson Lakefront Levee (**JL01**) reach. The pump station reach is 1,052 ft long. An impermeable breakwater is present as fronting protection with a design elevation of 14 ft. The breakwaters are vertical walls placed in front of the pump stations at an average bottom surface elevation of -5.0 ft with riprap protection 2.0 ft above the toe. The incoming wave height and peak period are almost the same for all pump stations. Herein, we have used  $H_s = 7.1$  ft and  $T_p = 8.1$  s for the incoming future wave characteristics at all pump stations. Transmitted wave heights were computed using Goda's Wave Transmission Formula and the resulting transmitted wave height is listed in (**Table 3-4**). It was assumed that the wave period would not be affected. The floodwall's design surge level, significant wave height, and peak period for future conditions are 10.3 ft, 2.5 ft, and 8.1 s, respectively (**Table 3-4**).

**Pump Station #2 also known as Suburban (JL03):** The floodwall providing protection for the pump station runs in an east-west direction along Lake Pontchartrain and is located within the Jefferson Lakefront Levee (**JL01**) reach. The pump station reach is 1,368 ft long. An impermeable breakwater is present as fronting protection with a design elevation of 13.2 ft. The breakwaters are vertical walls placed in front of the pump stations at an average bottom surface elevation of -5.0 ft with riprap protection 2.0 ft above the toe. The incoming wave height and peak period are almost the same for all pump stations. Herein, we have used  $H_s = 7.0$  ft and  $T_p = 8.1$  s for the incoming future wave characteristics at all pump stations. Transmitted wave heights were computed using Goda's Wave Transmission Formula and the resulting transmitted wave height is listed in (**Table 3-4**). It was assumed that the wave period would not be affected. The floodwall's design surge level, significant wave height, and peak period for future conditions are 10.4 ft, 2.8 ft, and 8.1 s, respectively (**Table 3-4**).

**Pump Station #3 also known as Elmwood (JL04):** The floodwall providing protection for the pump station runs in an east-west direction along Lake Pontchartrain and is located within the Jefferson Lakefront Levee (**JL01**) reach. The pump station reach is 704 ft long. An impermeable breakwater is present as fronting protection with a design elevation of 10 ft. The breakwaters are vertical walls placed in front of the pump stations at an average bottom surface elevation of -5.0

ft with riprap protection 2.0 ft above the toe. The incoming wave height and peak period are almost the same for all pump stations. Herein, we have used  $H_s = 7.6$  ft and  $T_p = 8.1$  s for the incoming future wave characteristics at all pump stations. Transmitted wave heights were computed using Goda's Wave Transmission Formula and the resulting transmitted wave height is listed in **Table 3-4**. It was assumed that the wave period would not be affected. The floodwall's design surge level, significant wave height, and peak period for future conditions are 10.5 ft, 4.2 ft, and 8.1 s, respectively (**Table 3-4**).

**Pump Station #4 also known as Duncan (JL05):** The floodwall providing protection for the pump station runs in an east-west direction along Lake Pontchartrain and is located within the Jefferson Lakefront Levee (**JL01**) reach. The pump station reach is 2,206 ft long. An impermeable breakwater is present as fronting protection with a design elevation of 14 ft. The breakwaters are vertical walls placed in front of the pump stations at an average bottom surface elevation of -5.0 ft with riprap protection 2.0 ft above the toe. The incoming wave height and peak period are almost the same for all pump stations. Herein, we have used  $H_s = 7.1$  ft and  $T_p = 8.1$  s for the incoming future wave characteristics at all pump stations. Transmitted wave heights were computed using Goda's Wave Transmission Formula and the resulting transmitted wave height is listed in (**Table 3-4**). It was assumed that the wave period would not be affected. The floodwall's design surge level, significant wave height, and peak period for future conditions are 10.5 ft, 2.5 ft, and 8.1 s, respectively (**Table 3-4**).

**Causeway Southbound and Northbound Floodwalls (JL06):** The floodwall runs in an east-west direction along Lake Pontchartrain and is located within the Jefferson Lakefront Levee (**JL01**). The floodwalls are adjacent to JL01 off at Causeway Blvd and are 535 ft long.

**JL06** was originally designed as a crib wall, but after further consideration, **JL06** was reconfigured as a T-wall in line with the existing levee alignment for the Phase 2 design. Because of the shallowness of the foreshore, the 1% wave height has been reduced for the floodwalls (**JL06**). An average elevation of the existing ground in front of the floodwalls, over a distance of approximately one wavelength, was used to adjust the wave height. The wave height was established as 40% of the design water depth. The floodwall will be built in line with the existing levee alignment. An average elevation of 7.0 ft was assumed for the foreshore elevation. The following is a brief description of the land features. The floodwall's design surge level, depth-limited significant wave height, and peak period for future conditions are 10.3 ft, 1.3 ft, and 7.8 s, respectively (**Table 3-4**).

**Williams Boulevard Floodgate (JL07):** The floodgate runs in an east-west direction along Lake Pontchartrain and is located within the Jefferson Lakefront Levee (**JL01**). The floodgate is 189 ft long. Because of the shallowness of the foreshore, the 1% wave height has been reduced for floodgate (**JL07**). An average elevation of the existing ground in front of the floodwalls, over a distance of approximately one wavelength, was used to adjust the wave height. The wave height was established as 40% of the design water depth. Land in front of the floodwall varies from as high as an elevation of 8.5 ft to as low as 2.5 ft over a distance of about 330 ft. An average elevation of 3.5 ft was assumed. The following is a brief description of the land features. The floodgate's design surge level, significant wave height, and peak period for future conditions are 10.4 ft, 2.8 ft, and 8.5 s, respectively (**Table 3-4**).

**Bonnabel Boat Launch Floodgate (JL08):** The floodgate runs in an east-west direction along Lake Pontchartrain and is located within the Jefferson Lakefront Levee (JL01). The floodgate is 209 ft long. Because of the shallowness of the foreshore, the 1% wave height has been reduced for the floodgate (JL08). An average elevation of the existing ground in front of the floodwalls, over a distance of approximately one wavelength, was used to adjust the wave height. The wave height was established as 40% of the design water depth. Land in front of the floodwall varies from as high as an elevation of 8.0 ft to as low as 2.5 ft over a distance of about 525 ft. An average elevation of 3.5 ft was assumed. The following is a brief description of the land features. The floodgate's design surge level, significant wave height, and peak period for future conditions are 10.3 ft, 2.7 ft, and 8.3 s, respectively (Table 3-4).

**Return Wall (re-curved wall) (JL09):** The floodwall runs in an east-west direction along Lake Pontchartrain from SC01-A levee/floodwall combination and curves along the shore line and ties-in with JL01 levee near Shenandoah Street. The floodwall is 993 ft long. Because of the shallowness of the foreshore, the 1% wave height has been reduced for floodwall (JL09). An average elevation of the existing ground in front of the floodwalls, over a distance of approximately one wavelength, was used to adjust the wave height. The wave height was established as 40% of the design water depth. The foreshore in front of the return floodwall varies. An elevation of -2.0 ft was assumed for this section. The following is a brief description of the land features. The floodwall's design surge level, significant wave height, and peak period for future conditions are 10.3 ft, 4.9 ft, and 8.3 s, respectively (Table 3-4).

**US Coast Guard Station Levee (JL10):** The levee runs in an east-west direction from the Jefferson Lakefront Levee (JL01) just near Huron Street to the Jefferson/Orleans Parish boundary near the 17<sup>th</sup> Street Canal. The levee is 1,573 ft long.

The available footprint for the levee adjacent to the Coast Guard Station and its parking lot is not sufficient for a wave berm. However, the ground between the levee and the water's edge has been raised to an elevation of 3.0 to 6.0 ft and the distance is greater than 250 ft from the toe of the levee to the water's edge at the Coast Guard Station and westward and is greater than 150 ft eastward of the Station. There is an outer breakwater that has an elevation of 2.0 to 5.0 ft. With these features the wave that is acting upon the levee will be assumed depth limited. An average ground elevation of 3.0 ft was conservatively assumed for the wave overtopping analysis. The design criteria (surge, initial wave height, and wave period) is from data point 215, the same as used for the New Orleans Marina (NO06), which is directly across the 17<sup>th</sup> Street Canal from this area. The wave height was reduced by 40% of the average water depth between the bulkhead and the toe of the levee. It was also assume that there was a smooth flat grass slope for the levee. The levee's design surge level, depth-limited wave height, and peak period for existing conditions are 8.7 ft, 2.3 ft, and 7.2 s, respectively and the design surge level, depth-limited wave height, and peak period for future conditions are 10.2 ft, 2.9 ft, and 8.1 s, respectively (Table 3-4).

### 3.3.3 Project Design Elevations

The design characteristics for the hydraulic reaches in Jefferson Parish Lakefront are listed in Table 3-5. Hydraulic reaches JL01 and JL10 are levees, while the remaining hydraulic reaches are structures. Note that structures are only evaluated for future conditions, because these are

hard structures. Pump Station #4 also known as Duncan (**JL05**) does not include structural superiority. **JL05** was designed to a elevation which matches the surrounding T-walls. Pump Station #1 also known as Bonnabel (**JL02**), Pump Station #2 also known as Suburban (**JL03**), Pump Station #3 also known as Elmwood (**JL04**), Causeway Southbound and Northbound Floodwalls (**JL06**), Williams Boulevard Floodgate (**JL07**), and Bonnabel Boat Launch Floodgate (**JL08**) included 2.0 ft of structural superiority.



**Table 3-5 Jefferson Parish Lakefront Hydraulic Reaches – 1% Design Information**

<b>Jefferson Parish Reaches 1% Hydraulic Design Elevations</b>							
<b>Hydraulic Reach</b>	<b>Name</b>	<b>Type</b>	<b>Condition</b>	<b>Depth at Toe (ft)</b>	<b>Elevation (ft)</b>	<b>Overtopping Rate</b>	
						<b>q50 (cfs/ft)</b>	<b>q90 (cfs/ft)</b>
<b>JL01</b>	Lakefront Levee	Levee	Existing	10.3	15.5	0.001	0.016
<b>JL01</b>	Lakefront Levee	Levee	Future	11.8	17.5	0.002	0.024
<b>JL02bw</b>	Bonnabel Pump Station #1 Breakwater at 14 ft	Structure/Wall	Future	17.8	14.0	*	*
<b>JL02</b>	Bonnabel Pump Station #1 Fronting Protection	Structure/Wall	Future	*	16.0 <sup>ss</sup>	0.001	0.003
<b>JL03bw</b>	Suburban Pump Station #2 Breakwater at 13.2 ft	Structure/Wall	Future	17.5	13.2	*	*
<b>JL03</b>	Suburban Pump Station #2 Fronting Protection	Structure/Wall	Future	*	16.0 <sup>ss</sup>	0.002	0.009
<b>JL04bw</b>	Elmwood Pump Station #3 Breakwater at 10 ft	Structure/Wall	Future	19.0	10.0	*	*
<b>JL04</b>	Elmwood Pump Station #3 Fronting Protection	Structure/Wall	Future	*	18.5 <sup>ss</sup>	0.004	0.016
<b>JL05bw</b>	Duncam Pump Station #4 Breakwater at 14 ft	Structure/Wall	Future	17.8	14.0	*	*
<b>JL05</b>	Duncam Pump Station #4 Fronting Protection	Structure/Wall	Future	*	16.0 <sup>ss</sup>	0.001	0.004
<b>JL06</b>	Causeway Northbound & Southbound T-wall	Structure/Wall	Future	3.3	15.0 <sup>ss</sup>	0.001	0.002
<b>JL07</b>	Williams Blvd Floodgate	Structure/Wall	Future	6.9	16.5 <sup>ss</sup>	0.000	0.003
<b>JL08</b>	Bonnabel Boat Launch Floodgate	Structure/Wall	Future	6.8	16.5 <sup>ss</sup>	0.000	0.003

Jefferson Parish Reaches 1% Hydraulic Design Elevations							
Hydraulic Reach	Name	Type	Condition	Depth at Toe (ft)	Elevation (ft)	Overtopping Rate	
						q50 (cfs/ft)	q90 (cfs/ft)
JL09	Return Wall	Structure/Wall	Future	12.3	17.5	0.028	0.086
JL10	US Coast Guard Station Levee	Levee	Existing	5.7	13.5	0.01	0.062
JL10	US Coast Guard Station Levee	Levee	Future	7.2	17.0	0.0081	0.042

\* No Data

<sup>ss</sup> includes 2 ft of structural superiority

### 3.3.4 Typical Cross-Sections

The typical levee design cross-section for the 1% design, existing and future conditions of the Lakefront Levee (**JL01**), is shown in **Figure 3-6**. The wave berm with a 1:15 slope is an important element to reduce the wave overtopping. In addition, new survey data and recalculations indicate that the initial levee design does not meet the overtopping criteria without additional wave run-up attenuation. Additional modifications to the foreshore need to be implemented in order to meet the HSDRRS wave overtopping criteria. The foreshore protection required to meet overtopping criteria is indicated in the figure.

The 1% hydraulic design elevation for existing conditions must be 15.5 ft and future conditions must be 17.5 ft.

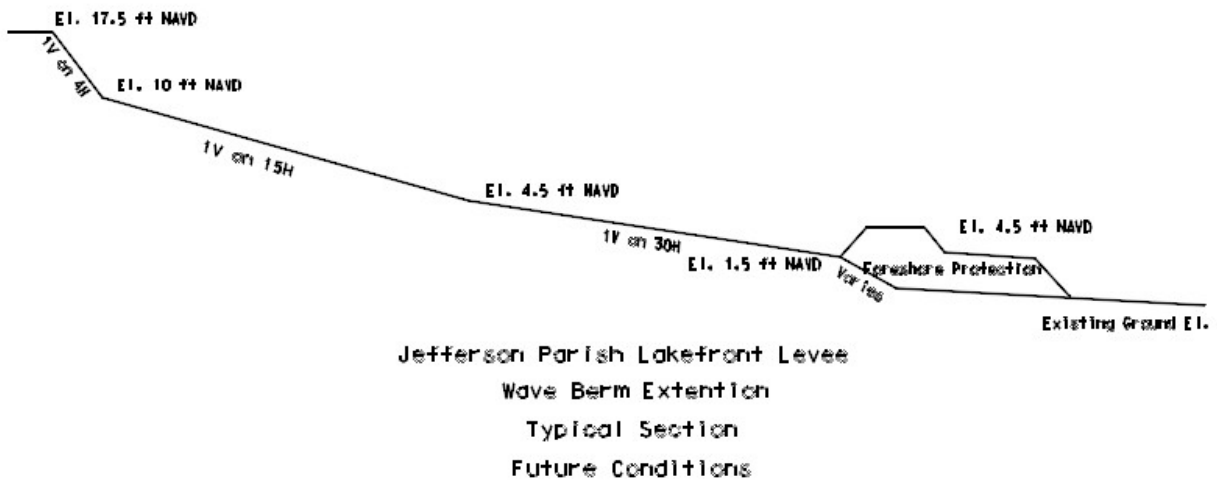
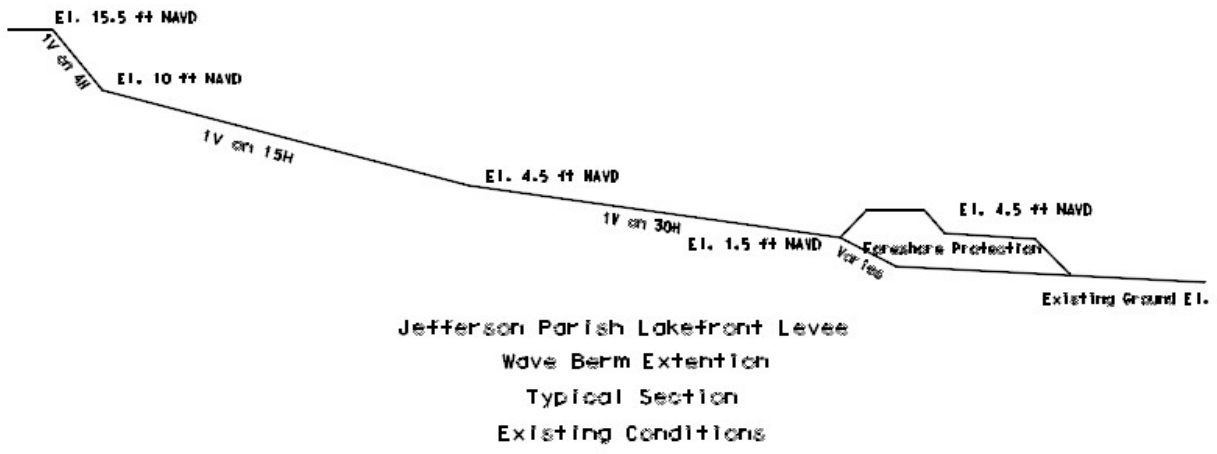
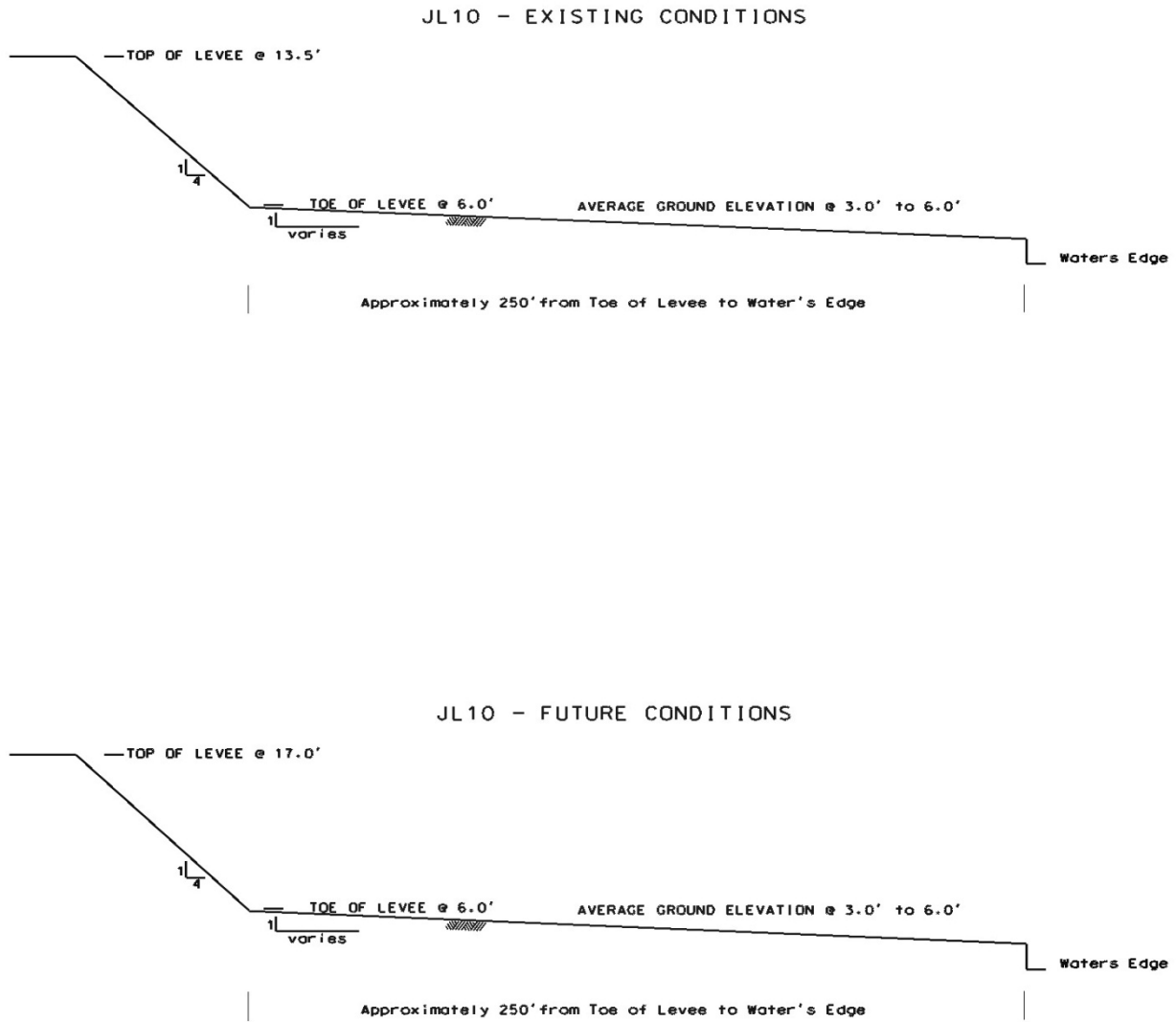


Figure 3-6 Typical Levee Design Cross-sections Lakefront Levee (JL01)

The typical levee design cross-section for the 1% design existing and future conditions of the US Coast Guard Station Levee (JL10) is shown in **Figure 3-7**. The 1% hydraulic design elevation for existing conditions must be 13.5 ft and future conditions must be 17 ft.



**Figure 3-7 Typical Levee Design Cross-sections US Coast Guard Station Levee (JL10)**

The hydraulic design elevation of the pump stations equals 16 ft (**JL02** and **JL05**) with a 14 ft breakwater and 16.0 (**JL03**) with a 13.2 ft breakwater in front of these stations. The design elevation for pump station (**JL04**) is 18.5 ft with a 10 ft breakwater. The design elevation of these pump stations includes 2.0 ft of structural superiority. The elevations of the tie-in walls near the pump stations were selected to be the same as the fronting protection elevations at each pump station. At all pump stations, the floodwall tie-ins are situated on top of earthen berms up to 8.0 ft with 1:3 slopes. The top of wall elevation is equivalent to the design elevation of that specific pump station.

The hydraulic design elevation at the Causeway Southbound and Northbound T-walls (**JL06**) needs to be 15 ft to meet the design criteria for overtopping. Notice that the incoming waves are relatively high compared with the other sections because of the deep foreshore resulting in a high elevation. The design elevations of the floodgates at Williams Boulevard Floodgate (**JL07**) and Bonnabel Boulevard Floodgate (**JL08**) are 16.5 ft. These floodgates include structural superiority of 2.0 ft.

Initially, the typical cross-section existing in the field, in August 2006, was used for Hydraulic Reach Return Wall (re-curved) (**JL09**). This Return Wall cross-section represented a 1,160 ft reach at the far western end of the Jefferson Parish Lakefront Levee. Current levee crest elevation varies from about 15 to 16 ft. Based on the analysis the current elevation will not be enough to meet the criteria of the overtopping rate. Therefore, it is proposed to replace the re-curved wall with a floodwall with a design elevation of 17.5 ft. and the length is 933 ft.

### 3.3.5 Resiliency

The hydraulic designs for the levees and structures within Jefferson Parish were examined for resiliency by computing the 0.2% surge level (50% confidence). The results are presented in **Table 3-6**. For all sections, the 0.2% surge level remains below the top of the flood defense.

**Table 3-6 Jefferson Parish Lakefront Hydraulic Reaches - Resiliency**

Jefferson Parish Reaches Resiliency Analysis (0.2% Event)					
Hydraulic Reach	Name	Type	Condition	Elevation (ft)	0.2% Event
					Surge Level (ft)
<b>JL01</b>	Lakefront Levee	Levee	Existing	15.5	11.2
<b>JL01</b>	Lakefront Levee	Levee	Future	17.5	12.7
<b>JL02bw</b>	Bonnabel Pump Station #1 Breakwater at 14 ft	Structure/Wall	Future	14.0	12.7

Jefferson Parish Reaches Resiliency Analysis (0.2% Event)					
Hydraulic Reach	Name	Type	Condition	Elevation (ft)	0.2% Event
					Surge Level (ft)
JL02	Bonnabel Pump Station #1 Fronting Protection	Structure/Wall	Future	16.0 <sup>ss</sup>	12.7
JL03bw	Suburban Pump Station #2 Breakwater at 13.2 ft	Structure/Wall	Future	13.2	12.7
JL03	Suburban Pump Station #2 Fronting Protection	Structure/Wall	Future	16.0 <sup>ss</sup>	12.7
JL04bw	Elmwood Pump Station #3 Breakwater at 10 ft	Structure/Wall	Future	10.0	12.7
JL04	Elmwood Pump Station #3 Fronting Protection	Structure/Wall	Future	18.5 <sup>ss</sup>	12.7
JL05bw	Duncam Pump Station #4 Breakwater at 14 ft	Structure/Wall	Future	14.0	12.8
JL05	Duncam Pump Station #4 Fronting Protection	Structure/Wall	Future	16.0 <sup>ss</sup>	12.8
JL06	Causeway Northbound & Southbound T-wall	Structure/Wall	Future	15.0 <sup>ss</sup>	12.7
JL07	Williams Blvd. Floodgate	Structure/Wall	Future	16.5 <sup>ss</sup>	12.6
JL08	Bonnabel Boat Launch Floodgate	Structure/Wall	Future	16.5 <sup>ss</sup>	12.7
JL09	Return Wall	Structure/Wall	Future	17.5	13.1
JL10	US Coast Guard Station Levee	Levee	Existing	13.5	11.3
JL10	US Coast Guard Station Levee	Levee	Future	17.0	12.8

### 3.4 ORLEANS PARISH – METRO LAKEFRONT

Each alternative for hydraulic reaches along the Orleans Parish – Metro Lakefront reach was reviewed during this update process. The alternatives for each corresponding hydraulic reach (where available) were reviewed along with the 95 or 100% structure or levee design plans. The alternative that best corresponded to the 95 or 100% structural design plans was considered the final hydraulic design. The data from the final hydraulic design was used to update data for the hydraulic boundary conditions, design elevations, and wave loads within this report.

The hydraulic reach identification has been updated from the October 2007 DER to match the current design conditions in their corresponding area.

#### 3.4.1 General

The Orleans Parish – Metro Lakefront reach consists of one large levee with several sections of floodwalls. The levee runs in an east-west direction from the Jefferson/Orleans Parish boundary to the IHNC along the southern shores of Lake Pontchartrain (**Plate 4**) encompassing a total length of approximately 4 miles. The levee has intermittent floodwalls at the outfall canals of Topaz Street, London Avenue, Orleans Avenue, 17<sup>th</sup> Street, Lakeside Drive, and Leroy Johnson Drive; and floodgates at Bayou St. John and Marconi Drive. Orleans Parish is further discussed in the New Orleans Lakefront East reach to South Point section and the South Point to GIWW section, and the reaches along GIWW and IHNC in the Orleans Parish. Orleans Parish – Metro Lakefront levee hydraulic reach number one is identified as (**NO01**) and subsequent numbers for the remaining hydraulic reaches.

**Plate 4** shows the hydraulic boundaries for the Orleans Parish – Metro Lakefront. The numbers indicate the hydraulic design elevations for several structures along the reach. The elevations displayed for levees will have both existing conditions (2007) and future conditions (2057). All hard structures are designed and built for future conditions (2057) only. If structural superiority is included with a specific hard structure the hydraulic design elevation will have an additional number, color coded green. The hydraulic reaches in **Plate 4** are different colors only to show the boundary limits of each reach. The colors do not represent a specific type of structure.

This figure also show the construction reaches as they correspond to the hydraulic reach. The construction boundary is off-set from the hydraulic boundary and labelled opposite the hydraulic reach label.

#### 3.4.2 Hydraulic Boundary Conditions

The hydraulic design characteristics for the reaches in Orleans Parish Metro – Lakefront are listed in (**Table 3-7**). The existing hydraulic conditions are based on the JPM-OS method using the results from ADCIRC and STWAVE model runs. To account for changes due to subsidence and sea level rise over a 50 year period, the surge elevations were adjusted by adding 1.5 ft and the wave heights were adjusted by adding 0.75 ft, for future conditions. The wave period is computed using the assumption that the wave steepness remains constant. The hydraulic boundary conditions for the Orleans Metro – Lakefront have been based on numerical



computations using the 2007 grid without the Seabrook Gate. It is assumed that the gate has no affect on the hydraulic boundary conditions in this area because the channel is a constricted opening on a long straight length of levee.

The offshore 1% hydraulic wave characteristics have been changed due to the presence of shallow foreshore and/or sheltered conditions. This will be explained further below.

The Orleans Parish Lakefront Metro consists of two levee segments, the New Orleans Lakefront Levee (NO01) and Topaz Street Levee (**NO10**). Segment NO01 runs from the 17<sup>th</sup> Street Canal at the Orleans - Jefferson Parish Line to the IHNC. Segment NO10 runs in a north-south direction and extends south from Lake Pontchartrain along Lakeshore Drive in the vicinity of Topaz Drive. Segment NO10 is located immediately east of the New Orleans Marina. At both sections, the wave height has been reduced because of the shallow foreshore.

**Table 3-7 Orleans Parish – Metro Lakefront Hydraulic Reaches – 1% Hydraulic Boundary Conditions**

<b>Orleans Parish Metro Lakefront Reaches 1% Hydraulic Boundary Conditions</b>									
<b>Hydraulic Reach</b>	<b>Name</b>	<b>Type</b>	<b>Condition</b>	<b>Surge Level (ft)</b>		<b>Significant Wave Height (ft)</b>		<b>Peak Period (s)</b>	
				<b>Mean</b>	<b>Std</b>	<b>Mean</b>	<b>Std</b>	<b>Mean</b>	<b>Std</b>
<b>NO01</b>	New Orleans Lakefront Levee	Levee	Existing	8.7	0.7	5.1	0.5	7.2	1.4
<b>NO01</b>	New Orleans Lakefront Levee	Levee	Future	10.2	0.7	5.7	0.5	7.6	1.4
<b>NO06-FW</b>	New Orleans Marina Floodwall	Structure/Wall	Future	10.2	0.7	3.3	0.3	8.0	1.6
<b>NO06-LT</b>	New Orleans Marina Levee/Floodwall Combination at Coconut Beach	Structure/Wall	Future	10.2	0.7	3.3	0.3	8.0	1.6
<b>NO07-A</b>	Bayou St. John Lakefront Floodwall	Structure/Wall	Future	10.1	0.8	4.4	0.4	7.4	1.5
<b>NO07-B</b>	Bayou St. John Bayou Floodwall	Structure/Wall	Future	10.1	0.8	3.0	0.3	4.0	0.8
<b>NO07-BL</b>	Bayou St. John Landward of Lakeshore Dr	Levee	Existing	8.6	0.8	3.0*	0.3	4.0*	0.8
<b>NO07-BL</b>	Bayou St. John Landward of Lakeshore Dr	Levee	Future	10.1	0.8	3.0*	0.3	4.0*	0.8
<b>NO07-C</b>	Bayou St. John Sector Gate	Structure/Wall	Future	10.1	0.8	3.0	0.3	4.0	0.8
<b>NO08</b>	Pontchartrain Beach	Structure/Wall	Future	10.1	0.8	3.6	0.3	7.3	1.3
<b>NO09</b>	American Standard Floodwall	Structure/Wall	Future	10.1	0.8	4.4	0.6	7.1	1.4

Orleans Parish Metro Lakefront Reaches 1% Hydraulic Boundary Conditions									
Hydraulic Reach	Name	Type	Condition	Surge Level (ft)		Significant Wave Height (ft)		Peak Period (s)	
				Mean	Std	Mean	Std	Mean	Std
NO10-LI	Topaz Street Levee/Floodwall Combination	Structure/Wall	Future	10.2	0.7	2.9	0.3	8.1	1.7
NO10-LL	Topaz Street Levee/Floodwall Combination	Structure/Wall	Future	10.2	0.7	2.9	0.3	8.1	1.7
NO11	London Avenue Outfall Canal Closures	Structure/Wall	Future	10.1	0.8	2.2	0.2	3.4	0.7
NO12	Orleans Avenue Outfall Canal Closure	Structure/Wall	Future	10.2	0.8	3.3	0.3	5.9	1.2
NO13	17th Street Outfall Canal Closure	Structure/Wall	Future	10.2	0.7	7.2	0.7	6.9	1.4
NO14-G1	Floodgate near Seabrook	Structure/Wall	Future	10.1	0.8	2.5	0.2	7.9	1.4
NO14-G2	Ramp at Leroy Johnson Drive	Levee	Existing	8.6	0.8	1.9	0.2	6.9	1.4
NO14-G2	Ramp at Leroy Johnson Drive	Levee	Future	10.1	0.8	2.5	0.2	7.9	1.4
NO14-G3	Floodgate at Marconi Drive	Structure/Wall	Future	10.2	0.8	2.5	0.2	7.9	1.4
NO14-G4	Floodgate at Lakeshore Drive just North of Lake Marina Avenue	Structure/Wall	Future	10.2	0.8	2.5	0.2	7.9	1.4

Orleans Parish Metro Lakefront Reaches 1% Hydraulic Boundary Conditions									
Hydraulic Reach	Name	Type	Condition	Surge Level (ft)		Significant Wave Height (ft)		Peak Period (s)	
				Mean	Std	Mean	Std	Mean	Std
NO14-L1A	West Roadway Gate	Structure/Wall	Future	10.2	0.8	2.5	0.2	7.9	1.4
NO14-L1	West Marina Gate	Structure/Wall	Future	10.2	0.8	2.5	0.2	7.9	1.4
NO14-L2	East Marina Gate	Structure/Wall	Future	10.2	0.8	2.5	0.2	7.9	1.4
NO14-L4A	Pontchartrain Blvd Gate	Structure/Wall	Future	10.2	0.8	2.5	0.2	7.9	1.4
NO15-G2	NO15 Lakeshore Drive Floodgate West of London Avenue Outfall Canal	Closure	Future	10.1	0.8	1.6	0.1	8.7	1.4
NO15-G3	Ramp at Lakeshore Drive West of Elysian Field Avenue	Levee	Existing	8.7	0.8	1.9	0.2	7.2	1.4
NO15-G3	Ramp at Lakeshore Drive West of Elysian Field Avenue	Levee	Future	10.2	0.8	2.5	0.2	7.9	1.4
NO15-G4	Ramp at Lakeshore Drive East of Elysian Field Avenue	Levee	Existing	8.6	0.8	1.0	0.1	6.9	1.4
NO15-G4	Ramp at Lakeshore Drive East of Elysian Field Avenue	Levee	Future	10.1	0.8	1.6	0.1	8.7	1.4

Orleans Parish Metro Lakefront Reaches 1% Hydraulic Boundary Conditions									
Hydraulic Reach	Name	Type	Condition	Surge Level (ft)		Significant Wave Height (ft)		Peak Period (s)	
				Mean	Std	Mean	Std	Mean	Std
NO15-G5	Ramp at Franklin Avenue	Levee	Existing	8.6	0.8	1.0	0.1	6.9	1.4
NO15-G5	Ramp at Franklin Avenue	Levee	Future	10.1	0.8	1.6	0.1	8.7	1.4
NO15-L9A	West Floodgate at Pontchartrain Beach	Structure/Wall	Future	10.1	0.8	1.6	0.1	8.7	1.4
NO15-L9B	Center Floodgate at Pontchartrain Beach	Structure/Wall	Future	10.1	0.8	1.6	0.1	8.7	1.4
NO15-L9C	East Floodgate at Pontchartrain Beach	Structure/Wall	Future	10.1	0.8	1.6	0.1	8.7	1.4
NO15-L	Canal Boulevard Ramp Levee	Levee	Existing	8.7	0.7	2.5	0.5	7.2	1.4
NO15-L	Canal Boulevard Ramp Levee	Levee	Future	10.2	0.7	3.1	0.5	7.6	1.4
NO16	Lakeshore Drive Near Rail Street Floodgate	Structure/Wall	Future	10.1	0.8	5.6	0.5	7.3	1.4
NO17	Leroy Johnson Drive	Structure/Wall	Future	10.1	0.8	4.0	0.3	7.0	1.3
NO20-FW1	Floodwall Under Leon C. Simon Drive Near Seabrook (West)	Structure/Wall	Future	10.1	0.8	4.6	0.4	7.0	1.3
NO20-FW2	I-wall Tie-in to Seabrook Gate (West)	Structure/Wall	Future	10.1	0.8	4.6	0.4	7.0	1.3
NO20-G1	Boat Launch Gate Near Seabrook (West)	Structure/Wall	Future	10.1	0.8	4.6	0.4	7.0	1.3
NO20-G2	Norfolk Southern Railroad Gate Near Seabrook (West)	Structure/Wall	Future	10.1	0.8	4.6	0.4	7.0	1.3

**New Orleans Lakefront Levee (NO01):** The levee runs in an east-west direction and is located between the Jefferson/Orleans Parish boundary at the 17<sup>th</sup> Street Canal and the IHNC. The hydraulic reach is 4.1 miles long and is transected by:

- the 2,179 floodwall and the 2,292 ft levee/floodwall combination at the New Orleans Marina (**NO06-FW** and **NO06-LT**);
- the 643 ft, 1,581 ft and 0.58 mile structures at Bayou St. John Floodwalls (**NO07-A**, **NO07-B**, and **NO07-C**);
- the 0.58 mile Pontchartrain Beach Floodwall (**NO08**);
- the 829 ft American Standard Floodwall (**NO09**);
- the 189 and 665 ft structures at Topaz Street (**NO10-LI** and **NO10-LL**);
- the 0.89 mile outfall canals at London Avenue (**NO11**), 0.60 mile Orleans Avenue (**NO12**), and the 352 ft 17<sup>th</sup> Street Canal (**NO13**);
- the Marconi Drive Floodgate (**NO14**);
- the 83, 81, 75, 98 ft floodgates (**NO15-G2** through **NO15-G5**);
- the 164 ft levee at Canal Boulevard (**NO15-L**);
- the 166 ft Lakeshore Drive near Rail Street Floodgate (**NO16**); and
- the 682 ft Leroy Johnson Drive Floodwall (**NO17**).

The wave height has been reduced due to the shallow foreshore. An average elevation of -4.0 ft was assumed for the foreshore elevation in front of the sea wall. The wave height at the toe of the sea wall is assumed to be 40% of the local water depth. The stretch between the seawall and the actual levee varies between 85 and 1,000 ft, and the elevation varies from 3.0 to 5.0 ft. The shortest distance is taken as a reference point in the hydraulic design. Because the distance of 85 ft is much less than one wavelength ( $\approx 300$  ft), no further reduction of the wave height is included and the stretch between the seawall and the actual levee acts as a wave berm in the hydraulic design computations.

Besides the three levee sections, there are various floodwalls, closure structures, and floodgates along the New Orleans Lakefront. Floodwalls and closure structures were looked at individually for this effort. An average elevation of the existing ground in front of the structure, over a distance of approximately one wavelength, was used to adjust the wave height. Wave height was established as 40% of the design water depth. The levee's design surge level, significant wave height, and peak period for existing conditions are 8.7 ft, 5.1 ft, and 7.2 s, respectively. The levee's design surge level, significant wave height, and peak period for future conditions are 10.2 ft, 5.7 ft, and 7.6 s, respectively (**Table 3-7**).

**New Orleans Marina –Floodwall and Levee/Floodwall Combinations (NO06-FW and NO06-LT):** These structures run in an east-west direction along Lake Pontchartrain and are located in the Lakefront Levee (**NO01**). The reaches are 2,179 and 2,292 ft long and run parallel to Lake Marina Avenue. The land elevation is approximately 3 ft but varies along the reach. The land elevation used for design one wavelength from the toe of the levee is 0.40 ft. Both structure's design surge level, significant wave height, and peak period for future conditions are 10.2 ft, 3.3 ft, and 8.0 s, respectively (**Table 3-7**).

**Bayou St. John Floodwalls (NO07-A, NO07-B, and NO07-C):** The floodwalls are set back from the lake and are fronted by Lakeshore Drive. **NO07-A** is 643 ft long; **NO07-B** is 1,518 ft long and **NO07-C** is 0.58 mile long. It was assumed that waves would be reduced to a random nature with a 3.0 ft wave height and a 4.0 s period. Future waves were adjusted based on an increase in water depth. The floodwall's design surge level, significant wave height, and peak period, future conditions, for **NO07-A** are 10.1 ft, 4.4 ft, and 7.4 s, respectively (**Table 3-7**). The floodwall's design surge level, significant wave height, and peak period, future conditions, for **NO07-B** and **NO07-C** are 10.1 ft, 3.0 ft, and 4.0 s, respectively (**Table 3-7**).

**Pontchartrain Beach Floodwall (NO08):** The floodwall runs in an east-west direction along Lake Pontchartrain and is located in the Lakefront Levee (**NO01**). The reach is 0.58 mile long. Land in front of the floodwall varies from as high as an elevation of 5.0 ft to as low as 2.0 ft over a distance of about 180 ft. More lakeward, the elevation is lower (0 to 2.0 ft). We have applied an average elevation of 1.0 ft in the design computation at a distance of one wavelength ( $\approx 300$  ft) from the floodwall. The floodwall's design surge level, significant wave height, and peak period for future conditions are 10.1 ft, 3.6 ft, and 7.3 s, respectively (**Table 3-7**).

**American Standard Floodwall (NO09):** The floodwall runs in an east-west direction along Lake Pontchartrain and is located in the Lakefront Levee (**NO01**). The reach is 829 ft long. Land in front of the floodwall was originally at 6.0 ft. The land has significantly subsided since construction. The floodwall is about 100 ft from the lakeshore. The slope of the lake is mild (1:100 to 1:1,000). Herein, we assume a 1:100 slope and have applied an elevation of -4.0 ft at a distance of one wavelength ( $\approx 300$  ft) from the floodwall. However, the seawall and the land just in front of the floodwall will partly break the waves. For this reason, we have applied an average elevation of -1.0 ft for the area in front of the floodwall to account for this effect. The floodwall's design surge level, significant wave height, and peak period for future conditions are 10.1 ft, 4.4 ft, and 7.1 s, respectively (**Table 3-7**).

**Topaz Street Levee/Floodwall Combinations (NO10-LI and NO10-LL):** These levee/I-wall and levee/L-wall combinations run in north to south direction along Lake Pontchartrain and are located in the Lakefront Levee (**NE01**). **NO10-LI** is 189 ft long and **NO10-LL** is 665 ft long. Land elevations in this area are at an elevation of 3.0 ft. The wave height at the toe of the levee is assumed to be 40% of the local water depth. Both structures design surge level, significant wave height, and peak period for future conditions are 10.2 ft, 2.9 ft, and 8.1 s, respectively (**Table 3-7**).

**London Avenue Outfall Canal Closure Structures (NO11):** At the mouth of the outfall canal a temporary closure structure is in place until the permanent pump station is built to help shelter the canal from the lake. The reach is 0.89 mile long. A 2.2 ft wave height with a 3.4 s wave period was used for the **NO11**. The proposed pump station is located inside the outfall canals where the temporary pump station is located. The structure's design surge level, significant wave height, and peak period for future conditions are 10.1 ft, 2.2 ft, and 3.4 s, respectively (**Table 3-7**).

**Orleans Avenue Outfall Canal Closure Structures (NO12):** At the mouth of the outfall canal a temporary closure structure is in place until the permanent pump station is built to help shelter

the canal from the lake. The reach is 0.60 mile long. A 3.3 ft wave height with a 5.9 s wave period was used for the **NO12**. The proposed pump station is located inside the outfall canals where the temporary pump station is located. The structure's design surge level, significant wave height, and peak period for future conditions are 10.2 ft, 3.3 ft, and 5.9 s, respectively (**Table 3-7**).

**17<sup>th</sup> Street Outfall Canal Closure Structures (NO13):** At the mouth of the outfall canal a temporary closure structure is in place until the permanent pump station is built to help shelter the canal from the lake. The reach is 184 ft long. A 7.2 ft wave height with a 6.9 s wave period was used for the **NO13**. The proposed pump station is located inside the outfall canals where the temporary pump station is located. The structure's design surge level, significant wave height, and peak period for future conditions are 10.2 ft, 7.2 ft, and 6.9 s, respectively (**Table 3-7**).

**New Orleans Metro 14 Floodgates (NO14-G1 through NO14-G4):** The floodgate runs parallel to Lakeshore Drive, in an east-west direction along Lake Pontchartrain. The gates range from 35 to 195 ft in length. The average ground elevation one wavelength from the toe of this floodgate is estimated to be 4.0 ft. The floodgate's design surge level, significant wave height, and peak period for future conditions are 10.1 and 10.2 ft, 2.5 ft, and 7.9 s, respectively (**Table 3-7**).

**New Orleans Metro 15 Floodgates (NO15-G2 through NO15-G5):** The floodgate runs parallel to Lakeshore Drive, in an east-west direction along Lake Pontchartrain. The gates range from 75 to 98 ft in length. The average ground elevation one wavelength from the toe of these floodgates is estimated to be 4.5 ft. The wave height at the toe of the floodgates is assumed to be 40% of the local water depth. The design surge level, significant wave height, and peak period for future conditions are 10.1 ft, 1.6 ft, and 8.7 s, respectively (**Table 3-7**).

**Canal Boulevard Ramp Levee (NO15-L):** The levee is perpendicular to Canal Boulevard and runs parallel to Lakeshore Drive, in an east-west direction along Lake Pontchartrain. The levee is 164 ft long. The average ground elevation one wavelength from the toe of this levee is estimated to be 4.5 ft. The wave height at the toe of the levee is assumed to be 40% of the local water depth. The levee's design surge level, significant wave height, and peak period for existing conditions are 8.7 ft, 2.5 ft, and 7.2 s, respectively. The levee's design surge level, significant wave height, and peak period for future conditions are 10.2 ft, 3.1 ft, and 7.6 s, respectively (**Table 3-7**).

**Lakeshore Drive near Rail Street Floodgate (NO16):** The floodgate at Lakeshore Drive near Rail Street is located at the top of the existing ramp where Lakeshore Drive crosses the existing Lakefront levee. The reach is 166 ft long. The base of the floodgate is at approximately 14.5 ft and is close to the lakeshore ( $\approx 100$  ft). An average elevation of -4.0 ft was used at a distance of one wavelength ( $\approx 300$  ft) from the floodgate. However, the seawall and the land just in front of the floodwall will partly break the waves. For this reason, we have applied an average elevation of -1.0 ft for the area in front of the floodwall to account for this effect. The floodgate's design surge level, significant wave height, and peak period for future conditions are 10.1 ft, 5.6 ft, and 7.3 s, respectively (**Table 3-7**).



**Leroy Johnson Drive Floodwall (NO17):** The floodwall at Lakeshore Drive near the Hickey Bridge is located lakeward next to the Hickey Bridge near the IHNC. The reach is 682 ft long. The base of the floodwall is at approximately 7.5 ft. An average elevation of 0 ft was used at a distance of one wavelength ( $\approx 300$  ft) from the floodwall. The floodwall's design surge level, significant wave height, and peak period for future conditions are 10.1 ft, 4.0 ft, and 7.0 s, respectively (**Table 3-7**).

### **Seabrook Closure Complex Reaches**

**Norfolk Southern Railroad Gates and Floodwalls near Seabrook West (NO20-FW1, NO20-FW2, NO20-G1, and NO20-G2):** The structures run in a north-south direction from Leroy Johnson Drive (**NO17**) to the Seabrook Floodwall (**SBRK-FW1**). The reaches total length is 415 ft long. The design surge level, significant wave height, and peak period, future conditions, for all structures in the at Seabrook are 10.1 ft, 4.6 ft, and 7.0 s, respectively (**Table 3-7**).

### **3.4.3 Project Design Elevations**

The design characteristics for the hydraulic reaches in Orleans Parish –Metro Lakefront are listed in **Table 3-8**. Hydraulic reaches **NO01** and **NO15-L** are levees; **NO06-LT**, **NO10-LI**, and **NO10-LL** are levee/floodwall combinations; the remaining reaches are floodwalls or gates. Note that these structures are only evaluated for future conditions, because these are hard structures. Lakeshore Drive near Rail Street Floodgate - Floodwall (**NO16**) design grade elevation includes 2.0 ft structural superiority.

**Table 3-8 Orleans Parish –Metro Lakefront Hydraulic Reaches – 1% Design Information**

<b>Orleans Parish Metro Lakefront Reaches 1% Hydraulic Design Elevations</b>							
<b>Hydraulic Reach</b>	<b>Name</b>	<b>Type</b>	<b>Condition</b>	<b>Depth at Toe (ft)</b>	<b>Elevation (ft)</b>	<b>Overtopping Rate</b>	
						<b>q50 (cfs/ft)</b>	<b>q90 (cfs/ft)</b>
<b>NO01</b>	New Orleans Lakefront Levee	Levee	Existing	12.8	16.0	0.007	0.063
<b>NO01</b>	New Orleans Lakefront Levee	Levee	Future	14.3	19.0	0.008	0.067
<b>NO06-FW</b>	New Orleans Marina Floodwall	Structure/Wall	Future	8.3	16.0	0.003	0.020
<b>NO06-LT</b>	New Orleans Marina Levee/Floodwall Combination at Coconut Beach	Structure/Wall	Future	8.3	16.0	0.003	0.020
<b>NO07-A</b>	Bayou St. John Lakefront Floodwall	Structure/Wall	Future	11.0	16.0	0.026	0.093
<b>NO07-B</b>	Bayou St. John Bayou Floodwall	Structure/Wall	Future	7.5	16.0	0.002	0.011
<b>NO07-B</b>	Bayou St. John Landward of Lakeshore Dr	Levee	Existing	8.6	15.0	0.007	0.084
<b>NO07-B</b>	Bayou St. John Landward of Lakeshore Dr	Levee	Future	10.1	16.5	0.008	0.058
<b>NO07-C</b>	Bayou St. John Sector Gate	Structure/Wall	Future	7.5	16.0	0.002	0.011
<b>NO08</b>	Pontchartrain Beach	Structure/Wall	Future	9.0	16.0	0.007	0.033
<b>NO09</b>	American Standard Floodwall	Structure/Wall	Future	11.0	16.5	0.028	0.096
<b>NO10-LI</b>	Topaz Street Levee/Floodwall Combination	Structure/Wall	Future	7.3	18.0	0.003	0.020

Orleans Parish Metro Lakefront Reaches 1% Hydraulic Design Elevations							
Hydraulic Reach	Name	Type	Condition	Depth at Toe (ft)	Elevation (ft)	Overtopping Rate	
						q50 (cfs/ft)	q90 (cfs/ft)
NO10-LL	Topaz Street Levee/Floodwall Combination	Structure/Wall	Future	7.3	16.0	0.003	0.020
NO11	London Avenue Outfall Canal Closures	Structure/Wall	Future	7.5	18.0	0.000	0.007
NO12	Orleans Avenue Outfall Canal Closure	Structure/Wall	Future	7.5	18.0	0.001	0.003
NO13	17th Street Outfall Canal Closure	Structure/Wall	Future	11.3	18.0	0.004	0.020
NO14-G1	Floodgate at Leroy Johnson Drive within NO17	Structure/Wall	Future	6.3	16.0	0.000	0.002
NO14-G2	Ramp at Leroy Johnson Drive within NO01	Levee	Existing	4.8	16.0	0.000	0.002
NO14-G2	Ramp at Leroy Johnson Drive within NO01	Levee	Future	6.3	19.0	0.000	0.002
NO14-G3	Floodgate at Marconi Drive	Structure/Wall	Future	-	16.0	0.000	0.001
NO14-G4	Floodgate at Lakeshore Drive just North of Lake Marina Avenue	Structure/Wall	Future	6.3	16.0	0.000	0.002
NO14-L1A	West Roadway Gate	Structure/Wall	Future	7.3	16.0	0.000	0.002
NO14-L1	West Marina Gate	Structure/Wall	Future	8.3	16.0	0.000	0.002
NO14-L2	East Marina Gate	Structure/Wall	Future	8.3	16.0	0.000	0.002
NO14-L4A	Pontchartrain Blvd Gate	Structure/Wall	Future	8.3	16.0	0.000	0.002

Orleans Parish Metro Lakefront Reaches 1% Hydraulic Design Elevations							
Hydraulic Reach	Name	Type	Condition	Depth at Toe (ft)	Elevation (ft)	Overtopping Rate	
						q50 (cfs/ft)	q90 (cfs/ft)
NO15-G2	NO15 Lakeshore Drive Floodgate West of London Avenue Outfall Canal	Closure	Future	4.0	18.5	0.000	0.001
NO15-G3	Ramp at Lakeshore Drive West of Elysian Field Ave	Levee	Existing	4.8	16.0	0.000	0.002
NO15-G3	Ramp at Lakeshore Drive West of Elysian Field Avenue	Levee	Future	6.3	19.0	0.000	0.002
NO15-G4	Ramp at Lakeshore Drive East of Elysian Field Avenue	Levee	Existing	2.5	16.0	0.000	0.001
NO15-G4	Ramp at Lakeshore Drive East of Elysian Field Avenue	Levee	Future	4.0	19.0	0.000	0.001
NO15-G5	Ramp at Franklin Avenue	Levee	Existing	2.5	16.0	0.000	0.001
NO15-G5	Ramp at Franklin Avenue	Levee	Future	4.0	19.0	0.000	0.001
NO15-L9A	West Floodgate at Pontchartrain Beach	Structure/Wall	Future	4.0	16.0	0.000	0.001
NO15-L9B	Center Floodgate at Pontchartrain Beach	Structure/Wall	Future	4.0	16.0	0.000	0.001
NO15-L9C	East Floodgate at Pontchartrain Beach	Structure/Wall	Future	4.0	16.0	0.000	0.001
NO15-L	Canal Boulevard Ramp Levee	Levee	Existing	12.8	16.0	0.006	0.060
NO15-L	Canal Boulevard Ramp Levee	Levee	Future	14.3	19.0	0.008	0.066
NO16	Lakeshore Drive Near Rail Street Floodgate	Structure/Wall	Future	14.0	18.0 <sup>SS</sup>	0.002	0.030
NO17	Leroy Johnson Drive	Structure/Wall	Future	10.0	16.5	0.009	0.038

Orleans Parish Metro Lakefront Reaches 1% Hydraulic Design Elevations							
Hydraulic Reach	Name	Type	Condition	Depth at Toe (ft)	Elevation (ft)	Overtopping Rate	
						q50 (cfs/ft)	q90 (cfs/ft)
NO20-FW1	Floodwall Under Leon C. Simon Drive Near Seabrook (West)	Structure/Wall	Future	11.6	16.5	0.024	0.08
NO20-FW2	I-wall Tie-in to Seabrook Gate (West)	Structure/Wall	Future	11.6	17.0	0.016	0.06
NO20-G1	Boat Launch Gate Near Seabrook (West)	Structure/Wall	Future	11.6	16.5	0.024	0.08
NO20-G2	Norfolk Southern Railroad Gate Near Seabrook (West)	Structure/Wall	Future	11.6	16.5	0.024	0.08

### 3.4.4 Typical Cross-Sections

The typical levee design cross-section for the 1% design, existing and future conditions of the New Orleans Lakefront Levee (NO01) are shown in **Figure 3-8**. This levee reach is setback from the lakefront seawall from 85 to about 1,000 ft. The land elevation in this setback area used for design was 4.0 ft. The land has subsided several feet since the original design and the current levee crest elevation is approximately 17 ft. The 1% design elevation existing condition is 16 ft and 19 ft for future conditions. The design grade elevation is 16 ft.

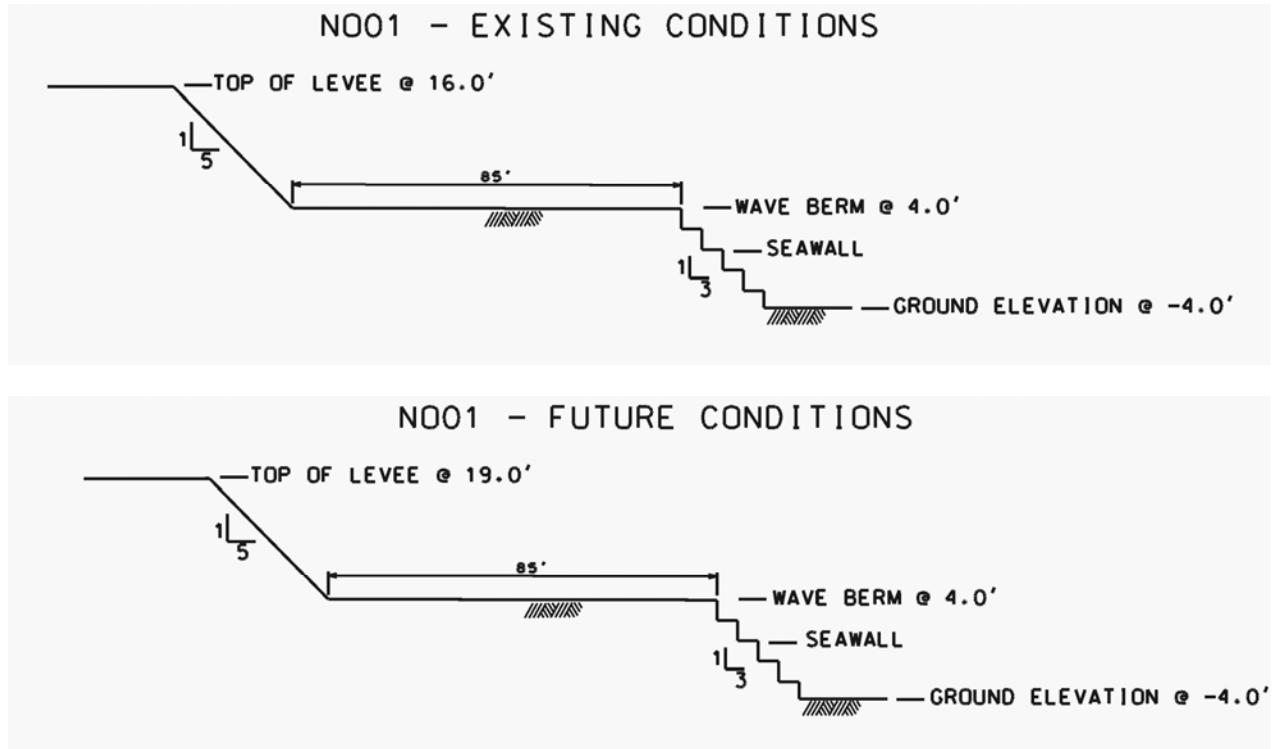
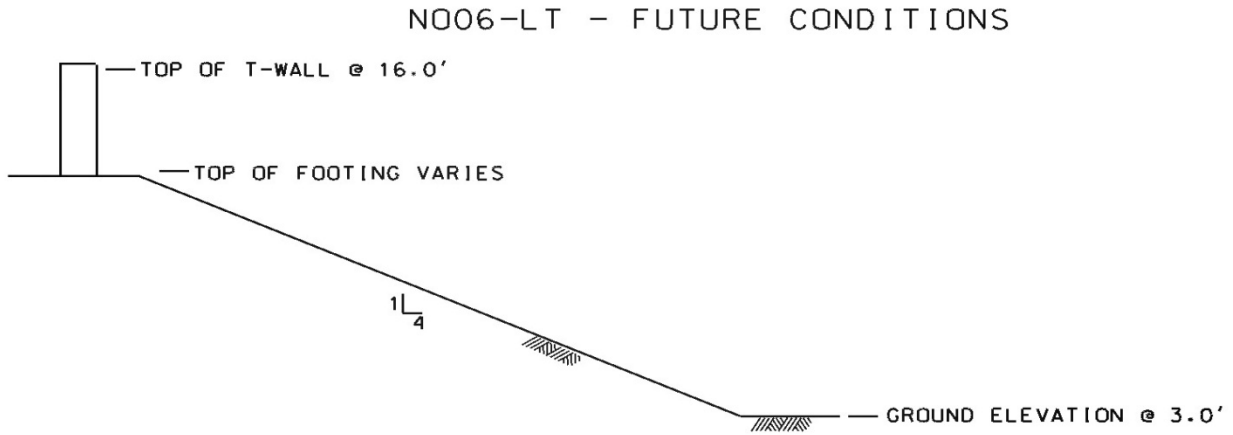


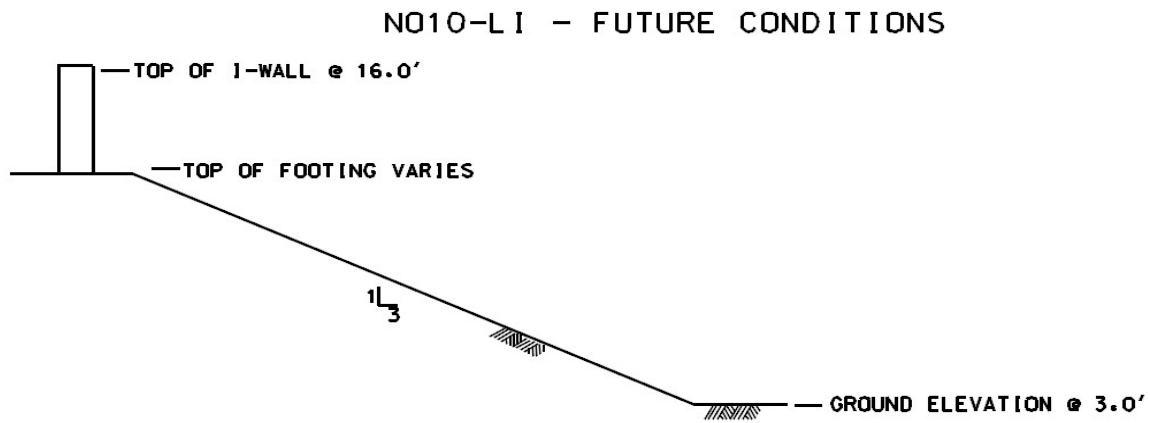
Figure 3-8 Typical Levee Design Cross-sections New Orleans – Metro Lakefront Levee (NO01)

The typical levee design cross-section for the 1% design future conditions of the New Orleans Marina Levee/Floodwall Combination at Coconut Beach (NO06-LT) is shown in **Figure 3-9**. The 1% design elevation future condition is 16 ft, as well as the design grade elevation.



**Figure 3-9 Typical Levee Design Cross-section Topaz Street Levee (NO06-LT)**

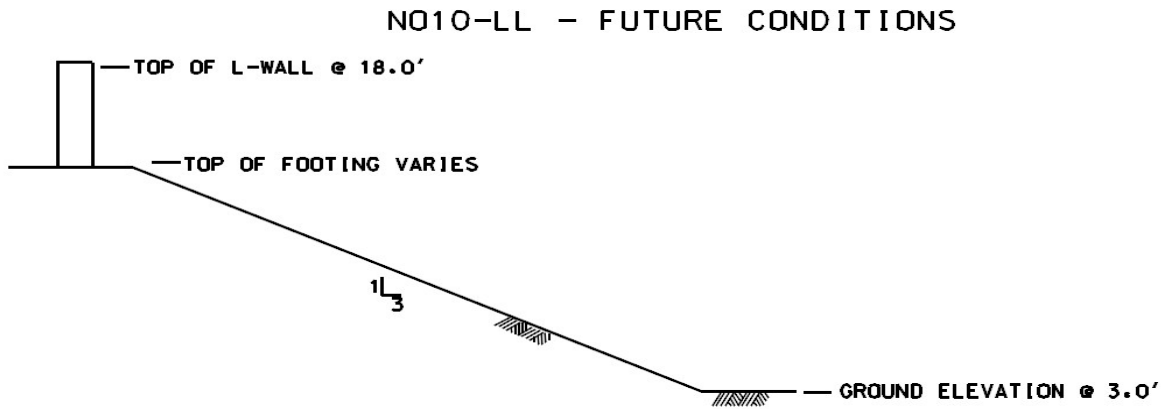
The typical levee design cross-section for the 1% design existing and future conditions of the Topaz Street Levee/Floodwall Combination, specifically levee/I-wall, **(NO10-LI)** is shown in **Figure 3-10**. Land elevations in this area are at an elevation of 3.0 ft. The existing levee slope of 1:3 was also used for the proposed levee in this reach due to the limited space for expanding the levee footprint. The 1% design elevation for future condition is 18 ft.



**Figure 3-10 Typical Levee Design Cross-sections Topaz Street Levee/Floodwall Combination (NO10-LI)**

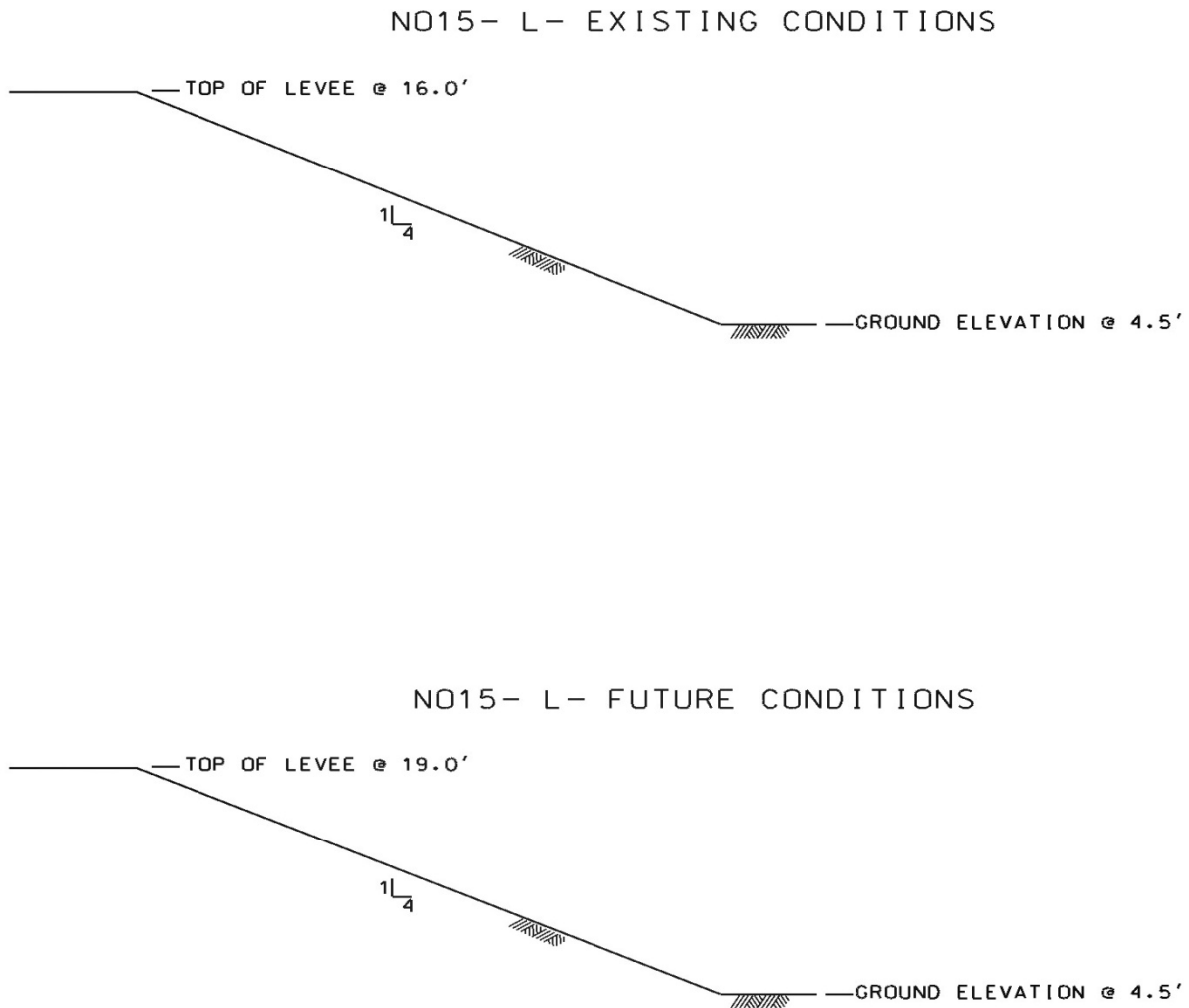


The typical levee design cross-section for the 1% design existing and future conditions of the Topaz Street Levee/Floodwall Combination, specifically levee/L-wall, **(NO10-LL)** is shown in **Figure 3-11**. Land elevations in this area are at an elevation of 3.0 ft. The existing levee slope of 1:3 was also used for the proposed levee in this reach due to the limited space for expanding the levee footprint. The 1% design future condition is 16 ft.



**Figure 3-11 Typical Levee Design Cross-sections Topaz Street Levee/Floodwall Combination (NO10-LL)**

The typical levee design cross-section for the 1% design, existing and future conditions of the Canal Boulevard Ramp Levee (NO15-L) is shown in **Figure 3-12**. Land elevations in the area are at 4.5 ft. The existing slope of 1:4 was used for the proposed levee in the reach due to the limited spaced of expanding the levee footprint. The 1% design elevation existing condition is 16 ft and 19 ft for future conditions.



**Figure 3-12 Typical Levee Design Cross-sections New Orleans – Metro Lakefront Levee (NO15-L)**

The various floodwalls and gates in the Orleans Parish Lakefront Metro area have hydraulic design elevations ranging from 16.0, 16.5, 18.0 and 18.5 ft for future conditions.

### 3.4.5 Resiliency

The hydraulic designs for the levees and structures within Orleans Parish – Metro Lakefront were examined for resiliency by computing the 0.2% surge level (50% confidence). The results are presented in **Table 3-9**. For all sections, the 0.2% surge level remains below the top of the flood defense.

Resiliency was calculated for **NO20-FW1**, **NO20-FW2**, **NO20-G1**, and **NO20-G2**. The surge level was calculated at 12.8 ft for all **NO20** structures.

**Table 3-9 Orleans Parish Metro Lakefront – Resiliency**

Orleans Parish Metro Lakefront Reaches Resiliency Analysis (0.2% Event)					
Hydraulic Reach	Name	Type	Condition	Elevation (ft)	0.2% Event
					Surge Level (ft)
<b>NO01</b>	New Orleans Lakefront Levee	Levee	Existing	16.0	11.3
<b>NO01</b>	New Orleans Lakefront Levee	Levee	Future	19.0	12.8
<b>NO06-FW</b>	New Orleans Marina Floodwall	Structure/Wall	Future	16.0	12.8
<b>NO06-LT</b>	New Orleans Marina Levee/Floodwall Combination at Coconut Beach	Structure/Wall	Future	16.0	12.8
<b>NO07-A</b>	Bayou St. John Lakefront Floodwall	Structure/Wall	Future	16.0	13.1
<b>NO07-B</b>	Bayou St. John Bayou Floodwall	Structure/Wall	Future	16.0	13.1
<b>NO07-C</b>	Bayou St. John Sector Gate	Structure/Wall	Future	16.0	13.1
<b>NO08</b>	Pontchartrain Beach	Structure/Wall	Future	16.0	12.9
<b>NO09</b>	American Standard Floodwall	Structure/Wall	Future	16.5	12.8
<b>NO10-LI</b>	Topaz Street Levee/Floodwall Combination	Structure/Wall	Future	18.0	12.8
<b>NO10-LL</b>	Topaz Street Levee/Floodwall Combination	Structure/Wall	Future	16.0	12.8

Orleans Parish Metro Lakefront Reaches Resiliency Analysis (0.2% Event)					
Hydraulic Reach	Name	Type	Condition	Elevation (ft)	0.2% Event
					Surge Level (ft)
NO11	London Avenue Outfall Canal Closures	Structure/Wall	Future	18.0	12.9
NO12	Orleans Avenue Outfall Canal Closure	Structure/Wall	Future	18.0	13.1
NO13	17th St. Outfall Canal Closure	Structure/Wall	Future	18.0	12.8
NO14-G1	Floodgate at Leroy Johnson Drive within NO17	Structure/Wall	Future	16.0	13.1
NO14-G2	Ramp at Leroy Johnson Drive within NO01	Levee	Existing	16.0	11.6
NO14-G2	Ramp at Leroy Johnson Drive within NO01	Levee	Future	19.0	13.1
NO14-G3	Floodgate at Marconi Drive	Structure/Wall	Future	16.0	13.1
NO14-G4	Floodgate at Lakeshore Drive just North of Lake Marina Avenue	Structure/Wall	Future	16.0	13.1
NO14-L1A	West Roadway Gate	Structure/Wall	Future	16.0	13.1
NO14-L1	West Marina Gate	Structure/Wall	Future	16.0	13.1
NO14-L2	East Marina Gate	Structure/Wall	Future	16.0	13.1
NO14-L4A	Pontchartrain Blvd Gate	Structure/Wall	Future	16.0	13.1
NO15-G2	NO15 Lakeshore Drive Floodgate West of London Avenue Outfall Canal	Structure/Wall	Future	18.5	12.9
NO15-G3	Ramp at Lakeshore Drive West of Elysian Field Avenue	Levee	Existing	16.0	11.8

Orleans Parish Metro Lakefront Reaches Resiliency Analysis (0.2% Event)					
Hydraulic Reach	Name	Type	Condition	Elevation (ft)	0.2% Event
					Surge Level (ft)
NO15-G3	Ramp at Lakeshore Drive West of Elysian Field Avenue	Levee	Future	19.0	13.1
NO15-G4	Ramp at Lakeshore Drive East of Elysian Field Avenue	Levee	Existing	16.0	11.4
NO15-G4	Ramp at Lakeshore Drive East of Elysian Field Avenue	Levee	Future	19.0	12.9
NO15-G5	Ramp at Franklin Avenue	Levee	Existing	16.0	11.4
NO15-G5	Ramp at Franklin Avenue	Levee	Future	19.0	12.9
NO15-L9A	West Floodgate at Pontchartrain Beach	Structure/Wall	Future	16.0	12.9
NO15-L9B	Center Floodgate at Pontchartrain Beach	Structure/Wall	Future	16.0	12.9
NO15-L9C	East Floodgate at Pontchartrain Beach	Structure/Wall	Future	16.0	12.9
NO15-L	Canal Boulevard Ramp Levee	Levee	Existing	16.0	11.3
NO15-L	Canal Boulevard Ramp Levee	Levee	Future	19.0	12.8
NO16	Lakeshore Drive Near Rail St. Floodgate	Structure/Wall	Future	18.0 <sup>ss</sup>	13.1
NO17	Leroy Johnson Drive	Structure/Wall	Future	16.5	12.8
NO20-FW1	Floodwall Under Leon C. Simon Drive Near Seabrook (West)	Structure/Wall	Future	16.5	12.8
NO20-FW2	I-wall Tie-in to Seabrook Gate (West)	Structure/Wall	Future	17.0	12.8
NO20-G1	Boat Launch Gate Near Seabrook (West)	Structure/Wall	Future	16.5	12.8
NO20-G2	Norfolk Southern Railroad Gate Near Seabrook (West)	Structure/Wall	Future	16.5	12.8

### 3.5 ORLEANS PARISH – LAKEFRONT EAST

Each alternative for hydraulic reaches along Orleans Parish – Lakefront East was reviewed during this update process. The alternatives for each corresponding hydraulic reach (where available) were reviewed along with the 95 or 100% structure or levee design plans. The alternative that best corresponded to the 95 or 100% structural design plans was considered the final hydraulic design. The data from the final hydraulic design was used to update data for the hydraulic boundary conditions, design elevations, and wave loads within this report.

The hydraulic reach identification has been updated from the October 2007 DER to match the current design conditions in their corresponding area.

#### 3.5.1 General

The Orleans Parish - Lakefront East reach consists of the levees along the southeastern shore of Lake Pontchartrain in an east-west direction from the IHNC to South Point (**Plate 5**). The Orleans Parish - Lakefront East hydraulic reaches discussed within this section are within the flood control structures of MRGO and GIWW at the IHNC Surge Barrier.

The reach consists of two large levee sections, the Citrus Lakefront Levee and the Orleans East Lakefront Levee, with several small stretches of floodwalls and structures in between. The levee spans 13.5 miles from the IHNC to South Point. Along the stretch a railroad, breakwater, and foreshore protection exist to reduce the overtopping rates. Orleans Parish – Lakefront East levee station number one is identified as (**NE01**), and subsequent numbers. South Point Transition Reach (**NE31**) will be discussed in this section.

**Plate 5** shows the hydraulic boundaries for the New Orleans Lakefront East. The numbers indicate the hydraulic design elevations for several structures along the reach. The elevations displayed for levees will have both existing conditions (2007) and future conditions (2057). The elevations displayed for hard structures (floodwalls, floodwall/levee combinations, pump stations, etc.) will have future (2057) conditions only. All hard structures are designed and built for future conditions (2057) only. If structural superiority is included with a specific hard structure the hydraulic design elevation will have an additional number, color coded green. The hydraulic reaches in **Plate 5** are different colors only to show the boundary limits of each reach. The colors do not represent a specific type of structure.

This figure also show the construction reaches as they correspond to the hydraulic reach. The construction boundary is off-set from the hydraulic boundary and labelled opposite the hydraulic reach label.

#### 3.5.2 Hydraulic Boundary Conditions

The hydraulic design characteristics for the reaches in Orleans Parish – Metro Lakefront are listed in **Table 3-10**. The existing hydraulic conditions are based on the JPM-OS method using the results from ADCIRC and STWAVE model runs. To account for changes due to subsidence and sea level rise over a 50 year period, the surge elevations were adjusted by adding 1.5 ft and

the wave heights were adjusted by adding 0.75 ft, for future conditions. The wave period is computed using the assumption that the wave steepness remains constant. The hydraulic boundary conditions for the Orleans Metro – Lakefront have been based on numerical computations using the 2007 grid without the Seabrook Gate. It is assumed that the gate has no affect on the hydraulic boundary conditions in this area because the channel is a constricted opening on a long straight length of levee.

The onshore 1% hydraulic wave characteristics have been changed due to the presence of shallow foreshore and/or sheltered conditions. This will be explained further below.

**Table 3-10 Orleans Parish – Lakefront East Hydraulic Reaches – 1% Hydraulic Boundary Conditions**

<b>Orleans Parish - Lakefront East Reaches 1% Hydraulic Boundary Conditions</b>									
<b>Hydraulic Reach</b>	<b>Name</b>	<b>Type</b>	<b>Condition</b>	<b>Surge Level (ft)</b>		<b>Significant Wave Height (ft)</b>		<b>Peak Period (s)</b>	
				<b>Mean</b>	<b>Std</b>	<b>Mean</b>	<b>Std</b>	<b>Mean</b>	<b>Std</b>
<b>NE01</b>	Citrus Lakefront Levee/I-wall	Structure/Wall	Existing	8.6	0.7	2.0	0.5	6.7	1.3
<b>NE01</b>	Citrus Lakefront Levee/I-wall	Structure/Wall	Future	10.1	0.7	1.6	0.3	7.1	1.4
<b>NE01-BW</b>	Citrus Lakefront Breakwater	Structure/Wall	Existing	8.6	0.7	4.6	0.5	6.7	1.3
<b>NE01-BW</b>	Citrus Lakefront Breakwater	Structure/Wall	Future	10.1	0.7	5.2	0.3	7.1	1.4
<b>NE02</b>	New Orleans East Lakefront Levee	Levee	Existing	8.9	0.7	4.0	0.4	6.6	1.3
<b>NE02</b>	New Orleans East Lakefront Levee	Levee	Future	10.4	0.7	4.6	0.4	7.1	1.3
<b>NE03-FW</b>	New Orleans Lakefront Airport East T-wall	Structure/Wall	Future	9.9	0.7	3.2	0.3	7.4	1.3
<b>NE03-LI</b>	New Orleans Lakefront Airport East Levee/Floodwall Combination	Structure/Wall	Future	9.9	0.7	2.4	0.2	7.4	1.3
<b>NE04-FW</b>	New Orleans Lakefront Airport West Floodwall	Structure/Wall	Future	10.0	0.7	3.2	0.3	7.5	1.4
<b>NE04-G</b>	Downman Road Gate	Structure/Wall	Future	10.0	0.7	3.2	0.3	7.5	1.4
<b>NE05</b>	Lincoln Beach Floodwall	Structure/Wall	Future	10.1	0.7	2.4	0.2	7.6	1.3
<b>NE06</b>	Collins Pipeline Crossing Floodwall	Structure/Wall	Future	10.4	0.7	3.8	0.3	7.1	1.3
<b>NE07</b>	Citrus Pump Station (OP #10)	Structure/Wall	Future	10.0	0.7	1.6	0.5	7.1	1.3



Orleans Parish - Lakefront East Reaches 1% Hydraulic Boundary Conditions									
Hydraulic Reach	Name	Type	Condition	Surge Level (ft)		Significant Wave Height (ft)		Peak Period (s)	
				Mean	Std	Mean	Std	Mean	Std
NE08	Jahncke Pump Station (OP #14)	Structure/Wall	Future	10.0	0.7	1.6	0.5	7.1	1.3
NE09	St Charles Pump Station (OP #16)	Structure/Wall	Future	9.9	0.7	4.0	0.3	7.3	1.3
NE30-FW	Transition Reach from NE01-NE02 T-walls	Structure/Wall	Future	10.1	0.7	4.8	0.4	7.1	1.3
NE31	South Point Transition Reach from NE02 to NE17 at I-10	Levee	Existing	9.0	0.7	3.6	0.4	5.8	1.2
NE31	South Point Transition Reach from NE02 to NE17 at I-10	Levee	Future	10.5	0.7	4.2	0.4	6.3	1.2

**Citrus Lakefront Levee/I-wall and Breakwater (NE01 and NE01-BW):** The levee/I-wall combination runs in an east-west direction along Lake Pontchartrain and is located between New Orleans Lakefront Airport east floodwall (**NE03**) and the transition reach (**NE30**). The reach starts approximately 770 feet east of Edward Street and ends at Paris Road. This reach is 4.0 miles long and is transected by; a 1,480 ft floodwall at Lincoln Beach (**NE05**); a 174 ft floodwall for Citrus (OP #10) Pump Station (**NE07**); and a 125 ft floodwall Jahncke (OP #14) Pump Station (**NE08**).

The current breakwater is the first line of protection for the Citrus Lakefront Levee (**NE01**) from within Lake Pontchartrain. The breakwater has a current elevation of 9.0 ft and an approximate width of 65 ft. The existing conditions design for the Citrus Lakefront Levee in this report was based on the assumption that the breakwater would be maintained at the current elevation (9.5 ft).

The railroad between the breakwater and the Citrus Lakefront Levee (**NE01**) acts as a wave berm. The current elevation of the railroad varies from 6.0 to 7.5 ft and its width is 40 ft. These dimensions have been applied in the hydraulic computation for this reach. The hydraulic design in this report assumed that the railroad dimensions are maintained at least an elevation of 6.0 ft and a width of 30 to 40 ft.

The offshore wave heights of 6.0 to 7.0 ft cannot be supported in the depths at the toe of the breakwater structure. So the design wave heights at the toe were reduced, using a maximum wave height of 40% of the design water depth as the depth-limiting criterion. The waves would be further reduced by the breakwater. The current breakwater, with an approximate elevation of 9.0 ft, provides substantial wave reduction for existing conditions. A 13.5 ft breakwater is required for future conditions.

Transmitted wave heights through the breakwater were computed using wave transmission for how crested structures developed by Van der Meer and Pilarczyk. The 1% significant wave height behind the breakwater for existing conditions turns out to be around 2.0 ft, whereas the wave height for future conditions is about 2.5 ft. The incoming wave period of about 7 s has not been changed due to the presence of the breakwater.

This report shows the existing and future conditions for Citrus Lakefront Levee/I-wall combination (**NE01**). For existing conditions the probabilistic loads are higher than the deterministic loads but the opposite is true for the future conditions. This design (14.5 ft levee/I-wall combination with a 9.0 ft breakwater) only applies to existing conditions for a few years into the future. To meet the future wave overtopping criteria, the breakwater will have to be raised within ten years. The future probabilistic wave loads were used in the design of the I-wall. The levee/I-wall combinations design surge level, significant wave height, and peak period for existing conditions are 8.6 ft, 2.0 ft, and 6.7 s, respectively. The levee/I-wall combinations design surge level, significant wave height, and peak period for future conditions are 10.1 ft, 1.6 ft, and 7.1 s, respectively (**Table 3-10**).

**New Orleans East Lakefront Levee (NE02):** The levee runs in a northeast-southwest direction and is located between the transition reach (NE30) and South Point transition levee (NE31). The reach starts approximately 400 ft east of Paris Road and ends at NE31. The reach is 6.0 miles long and is transected by a 470 ft floodwall at Collins Pipeline Crossing (NE06).

The railroad between the foreshore protection and the New Orleans East Lakefront levee acts as a wave berm and will further reduce the wave height. The dimensions have been applied in the hydraulic computation for this reach. The hydraulic design in this report assumes that the railroad dimensions are maintained at least at an elevation of 6.0 ft and a width of 40 ft.

The offshore wave heights of 6.0 to 7.0 ft cannot be supported in the depths at the toe of the foreshore protection structure. So the design wave heights at the toe were reduced, using a maximum wave height of 40% of the design water depth as the depth-limiting criteria.

The designs for the New Orleans East Lakefront levee in this report were based on the assumption that the foreshore protection would be maintained at the existing elevation (6 ft). The levees design surge level, significant wave height, and peak period for existing conditions are 8.9 ft, 4.0 ft, and 6.6 s, respectively. The levee's design surge level, significant wave height, and peak period for future conditions are 10.4 ft, 4.6 ft, and 7.1 s, respectively (Table 3-10).

**New Orleans Lakefront Airport Reach – East Floodwall and Levee/I-wall (NE03-FW and NE03-LI):** The floodwalls and levee/floodwall combination are in the eastern reach of the New Orleans Airport reach. The structures are located between New Orleans Lakefront Airport Reach - West (NE04-FW) and the Citrus Lakefront Levee (NE01). The structure starts near West Laverne Street and runs in an east-west direction along Hayne Boulevard and parallel to the Norfolk Southern Railroad and ties in with NE01 east of Edwards Street. This reach is 1.3 miles long and is transected by the St. Charles Pump Station (NE09).

Beginning at the lake, land elevation is 4.0 ft. The elevation ascends for some distance to elevation 4.5 ft, descends again, and then rises at the floodwall berm to elevation 4.0 ft for a minimum distance of 400 ft. However, this only holds for waves coming perpendicular to the shoreline. In the case of waves coming from the northwest or the northeast, the sheltering effect of the Lakefront Airport is probably less due to shorter distance to the lake. The Norfolk Southern Railroad runs parallel to the levee with an elevation of approximately 6.4 ft. To be conservative, we have assumed a land elevation of 0 ft at one wavelength from the floodwall.

The foreshore ranges from elevations of 3.0 to 9.0 ft based on LIDAR data. The distance from the toe of the levee to the bulkhead of the Lakefront Airport ranges from 500 ft to over 1,000 ft. From this information, the conservative elevation of the foreshore was assumed to be 4.0 ft in the hydraulic design of this reach. The floodwall's design surge level, significant wave height, and peak period for future conditions are 9.9 ft, 3.2 ft, and 7.4 s, respectively. The levee/floodwall combination's design surge level, significant wave height, and peak period for future conditions are 9.9 ft, 2.4 ft, and 7.4 s, respectively (Table 3-10).

**New Orleans Lakefront Airport Floodwalls – West Floodwall and Downman Road Gate (NE04-FW and NE04-G)** The floodwalls and gate are in the western reach of the New Orleans

Airport reach. The structures are located between the Seabrook floodwall (**SBRK-FW2**) and New Orleans Lakefront Airport Reach - East (**NE03**). The structures start near the flood control structures for the IHNC at Jourdan Road and run in an east-west direction along Hayne Boulevard and parallel to the Norfolk Southern Railroad then ties in with **NE03** near Alabama Street. This reach is 1,900 ft long and is transected by an 87 ft gate at Downman Road.

Beginning at the lake, land elevation is 4.0 ft. The elevation ascends for some distance to elevation 4.5 ft, descends again then rises at the floodwall berm to elevation 4.0 ft for a minimum distance of 400 ft. However, this only holds for waves coming perpendicular to the shoreline. In the case of waves coming from the northwest or the northeast, the sheltering effect of the Lakefront Airport is probably less because of the shorter distance to the lake. To be conservative, we have assumed a land elevation of 0 ft at one wavelength from the floodwall. The floodwall's design surge level, significant wave height, and peak period for future conditions are 10 ft, 3.2 ft, and 7.5 s, respectively. The gate's design surge level, significant wave height, and peak period for future conditions are 10 ft, 3.2 ft, and 7.5 s, respectively (**Table 3-10**).

**Lincoln Beach Floodwall (NE05):** The floodwall runs in an east-west direction along Lake Pontchartrain and is located within the Citrus Lakefront Levee (**NE01**). The floodwall starts near Vincent Road where it ties-in with **NE01**, runs parallel to Hayne Road and the Norfolk Southern Railroad, and after 1,480 ft again ties-in with **NE01**.

Land in front of the floodwall gradually slopes upward from the lake to an elevation of 4.4 ft over a distance of about 500 ft. An average elevation of 4.0 ft was assumed at the toe of the floodwall. The floodwall's design surge level, depth-limited wave height, and peak period for future conditions are 10.1 ft, 2.4 ft, and 7.6 s, respectively (**Table 3-10**).

**Collins Pipeline Crossing Floodwall (NE06):** The floodwall runs in an east-west direction along Lake Pontchartrain and is located within the Citrus Lakefront Levee (**NE01**). The reach is 430 ft long and runs parallel to the Norfolk Southern Railroad. An average elevation of 1.0 ft was assumed in front of this floodwall. The floodwall's design surge level, significant wave height, and peak period for future conditions are 10.4 ft, 3.8 ft, and 7.1 s, respectively (**Table 3-10**). The design section is the same as **NE01**.

**Citrus Pump Station also known as OP #10 (NE07):** The floodwall runs in an east-west direction along Lake Pontchartrain and is located within the Citrus Lakefront Levee (**NE01**) reach. The reach is 170 ft long and runs parallel to the Norfolk Southern Railroad. An average elevation of 0 ft was assumed in front of the pump stations. The floodwall's design surge level, significant wave height, and peak period for future conditions are 10.0 ft, 1.6 ft, and 7.1 s, respectively (**Table 3-10**).

**Jahncke Pump Station also known as OP #14 (NE08):** The floodwall runs in an east-west direction along Lake Pontchartrain and is located within the Citrus Lakefront Levee (**NE01**) reach. The reach is 125 ft long and runs parallel to Hayne Road and the Norfolk Southern Railroad. An average elevation of 0 ft was assumed in front of the pump stations. The floodwall's design surge level, significant wave height, and peak period for future conditions are 10.0 ft, 1.6 ft, and 7.1 s, respectively. (**Table 3-10**).

**St. Charles Pump Station also known as OP #16 (NE09):** The floodwall runs in an east-west direction along Lake Pontchartrain and is located within the Citrus Lakefront Levee (NE01) reach. The reach is 30 ft long and runs parallel to Hayne Road and the Norfolk Southern Railroad at Danube Road. An average elevation of 0 ft was assumed in front of the pump stations. The floodwall's design surge level, significant wave height, and peak period for future conditions are 9.9 ft, 4.0 ft, and 7.3 s, respectively (Table 3-10). The design section is the same as NE03. The discharge outlet is at the toe of the levee/I-wall combination in the lee at the marina.

**Transition Reach NE01 - NE02 Floodwall (NE30-FW):** The transition reach runs in an east-west direction along Lake Pontchartrain. The reach is located between the Citrus Lakefront Levee (NE01) and the New Orleans Lakefront Levee (NE02). The reach starts near the breakwater of NE01, so as to provide an effective transition between NE01 and NE02, and ends near Paris Road. The reach continues 400 ft east of Paris Road as a levee. This reach is 840 ft long.

The railroad between the breakwater and the Citrus Lakefront floodwall acts as a wave berm. The current elevation of the railroad is 6.0 ft and its length is 40 ft. These dimensions have been applied in the hydraulic design. Hence, maintaining the railroad at an elevation of 6.0 ft is a prerequisite for the presented hydraulic designs in this report and was used in the hydraulic computation of the overtopping rate for this levee section.

The hydraulic design in this report assumes that the railroad dimensions are maintained at least an elevation of 6.0 ft and a width of 40 ft and the breakwater in front of the railroad at 7.5 ft. The floodwall's design surge level, significant wave height, and peak period for future conditions are 10.1 ft, 4.8 ft, and 7.1 s, respectively (Table 3-10).

**South Point Transition Reach (NE31):** The transition reach is a levee, runs from South Point, in a northwest-southwest direction to I-10. This reach is located between the New Orleans Lakefront Levee (NE02) and the I-10 Levee (NE17). An average elevation of 0 ft in front of the levee is assumed for this design. The levee's design surge level, significant wave height, and peak period for existing conditions are 9.0 ft, 3.6 ft, and 5.8 s, respectively. The levee's design surge level, significant wave height, and peak period for future conditions are 10.5 ft, 4.2 ft, and 6.3 s, respectively (Table 3-10). NE31 is a transition reach from NE02 to NE10-A.

### 3.5.3 Project Design Elevations

The design characteristics for the hydraulic reaches in Orleans Parish – Lakefront East are listed in (Table 3-11). Hydraulic reach NE01 is a levee/I-wall combination; hydraulic reaches NE02, NE30, and NE31 are levees; and the remaining hydraulic reaches are floodwalls or structures. Note that structures (including levee/floodwall combinations) are only evaluated for future conditions because they are hard structures. Collins Pipeline Crossing Floodwall (NE06) design grade elevation includes 2.0 ft of structural superiority.

**Table 3-11 Orleans Parish – Lakefront East Hydraulic Reaches – 1% Design Information**

Orleans Parish - Lakefront East Reaches 1% Hydraulic Design Elevations							
Hydraulic Reach	Name	Type	Condition	Depth at Toe (ft)	Elevation (ft)	Overtopping Rate	
						q50 (cfs/ft)	q90 (cfs/ft)
NE01	Citrus Lakefront Levee/I-wall	Structure/Wall	Existing	*	14.5	0.001	0.009
NE01	Citrus Lakefront Levee/I-wall	Structure/Wall	Future	*	14.5	0.001	0.01
NE01-BW	Citrus Lakefront Breakwater	Structure/Wall	Existing	11.6	9.0	N/A	N/A
NE01-BW	Citrus Lakefront Breakwater	Structure/Wall	Future	13.1	13.5	N/A	N/A
NE02	New Orleans East Lakefront Levee	Levee	Existing	10.0	16.5	0.007	0.056
NE02	New Orleans East Lakefront Levee	Levee	Future	11.5	20.5	0.001	0.053
NE03-FW	New Orleans Lakefront Airport East T-walls	Structure/Wall	Future	8.0	15.5	0.003	0.015
NE03-LI	New Orleans Lakefront Airport East Levee/Floodwall Combination	Structure/Wall	Future	6.0	15.5	0.006	0.035
NE04-FW	New Orleans Lakefront Airport West Floodwall	Structure/Wall	Future	8.0	15.5	0.004	0.019
NE04-G	Downman Road Gate	Structure/Wall	Future	8.0	15.5	0.004	0.019
NE05	Lincoln Beach Floodwall	Structure/Wall	Future	6.0	15.5	0.000	0.003
NE06	Collins Pipeline Crossing Floodwall	Structure/Wall	Future	9.5	17.5 <sup>ss</sup>	0.003	0.012

Orleans Parish - Lakefront East Reaches 1% Hydraulic Design Elevations							
Hydraulic Reach	Name	Type	Condition	Depth at Toe (ft)	Elevation (ft)	Overtopping Rate	
						q50 (cfs/ft)	q90 (cfs/ft)
NE07	Citrus Pump Station (OP #10)	Structure/Wall	Future	11.5	14.5	0.020	0.069
NE08	Jahncke Pump Station (OP #14)	Structure/Wall	Future	11.5	14.5	0.020	0.069
NE09	St Charles Pump Station (OP #16)	Structure/Wall	Future	10.0	15.5	0.017	0.060
NE30-FW	Transition Reach from NE01-NE02 T-walls	Structure/Wall	Future	12.0	14.5-17.5	0.010	0.087
NE31	South Point Transition Reach from NE02 to NE17 at I-10	Levee	Existing	9.0	16.5	0.009	0.058
NE31	South Point Transition Reach from NE02 to NE17 at I-10	Levee	Future	10.5	18.0	0.007	0.053

\*Toe of I-wall is the Top of Levee

### 3.5.4 Typical Cross-Sections

The typical levee design cross-sections for the 1% design, existing conditions and future conditions, of Citrus Lakefront levee/I-wall combination (**NE01**) are shown in **Figure 3-13**. The 1% design elevation for existing conditions must be 14.5 ft. The current breakwater elevation at 9.0 ft and the railroad (40 ft wide, elevation 6.0 ft) are important elements that reduce the wave heights in front of the actual levee. Therefore, the levee elevation can be relatively low in order to meet the design criteria. The railroad and breakwater protection are part of the flood defense and these must be maintained at elevations. The hydraulic design grade elevation is 14.5ft.

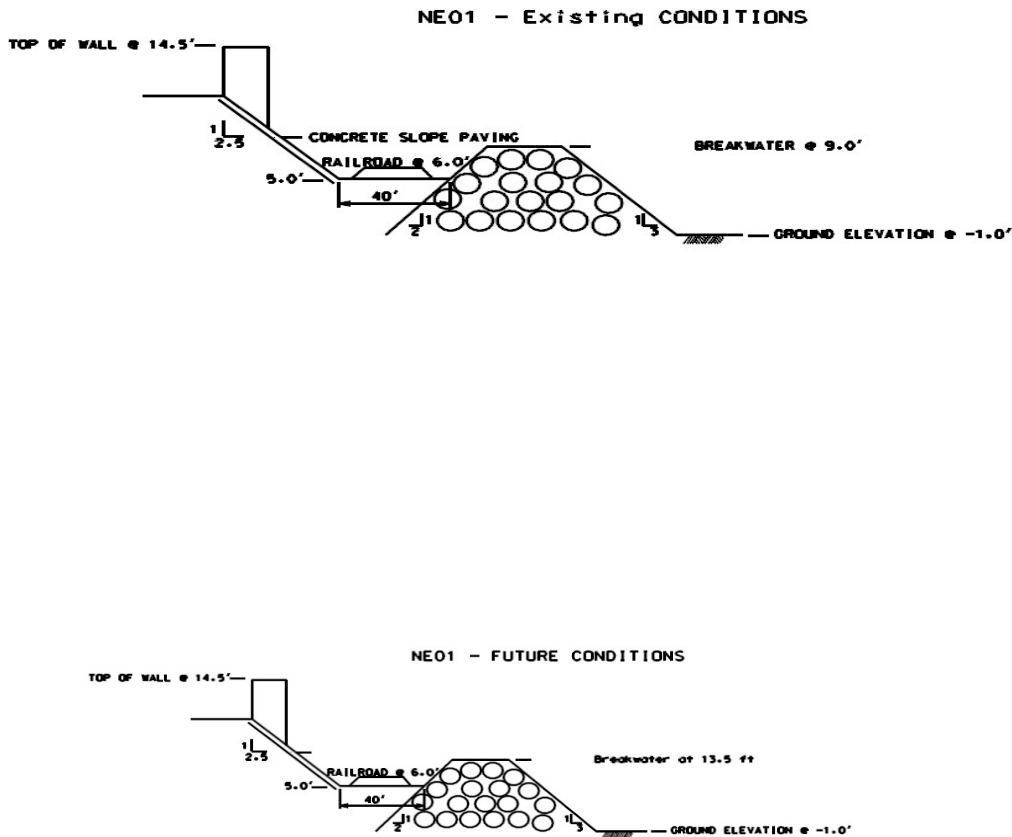
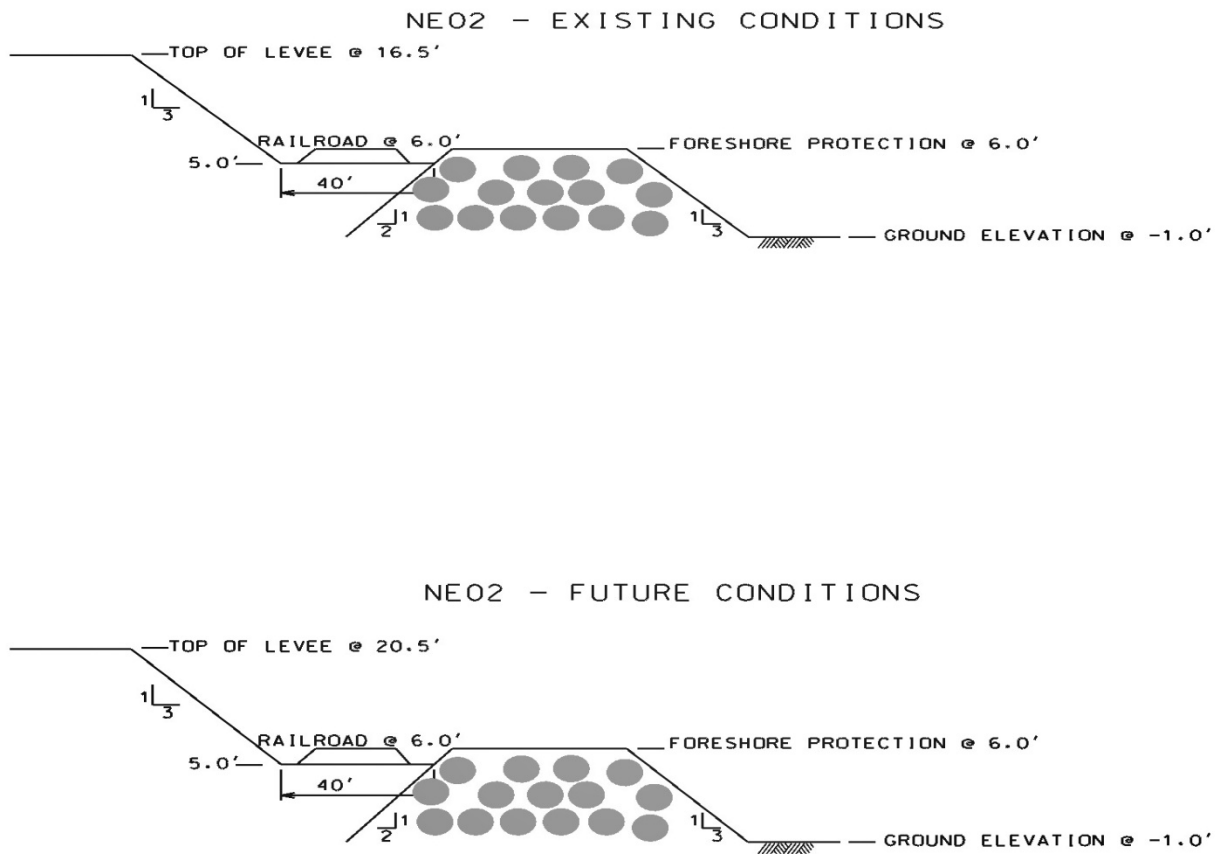


Figure 3-13 Typical Levee Design Cross-section Citrus Lakefront Levee (NE01)



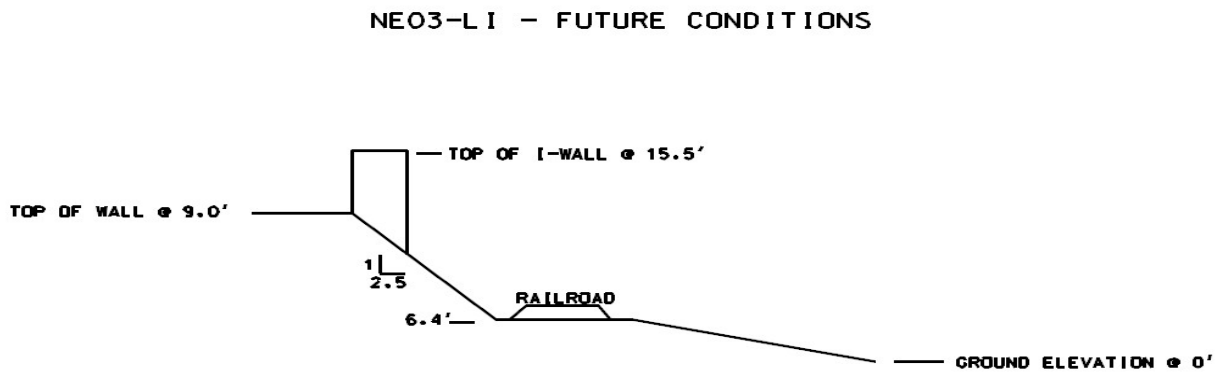
The typical levee design cross-section for the 1% design, existing and future conditions, of New Orleans East Lakefront Levee (NE02) is shown in Figure 3-14. The 1% design elevation for existing conditions must be 16.5 ft and 20.5 ft for future conditions. Notice that these elevations are higher than the Citrus Lakefront Levee. This is partly because the surge levels are a bit higher towards the east. Furthermore, the fronting protection is much lower here (foreshore 6.0 ft instead of breakwater 9.0 ft) and results in less wave reduction. The railroad and foreshore protection are part of the flood defense and must be maintained at these elevations.



**Figure 3-14 Typical Levee Design Cross-sections New Orleans East Lakefront Levee (NE02)**

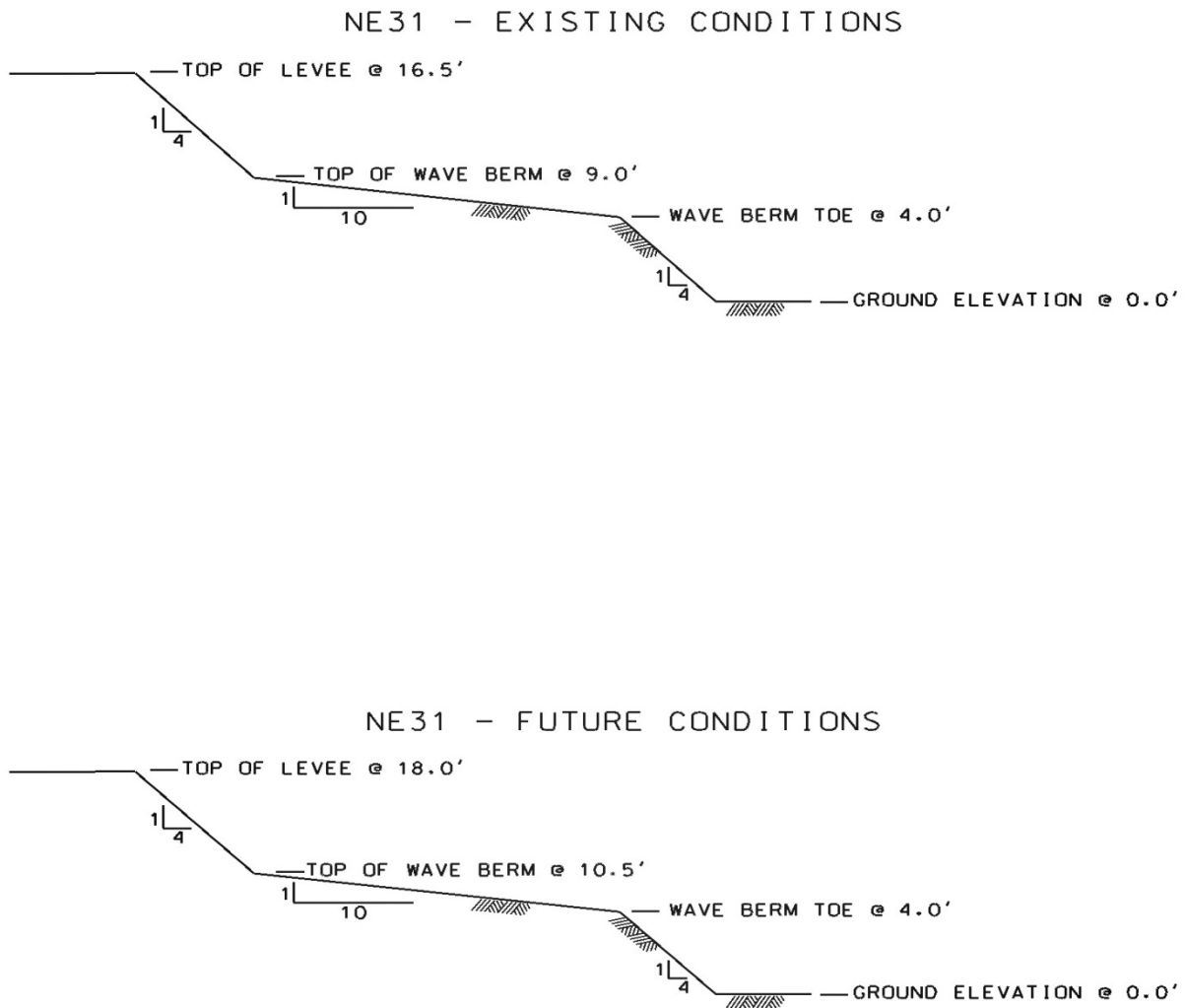
The typical levee design cross-section for the 1% design future condition grade conditions of New Orleans Lakefront Airport - East Levee/floodwall combination (NE03-LI) is show in

**Figure 3-15.** The foreshore elevations range from 3.0 ft to 9.0 ft based on Lidar data. The distance from the toe of the levee to the bulkhead of the Lakefront Airport ranges from 500 ft to over 1000 ft. From this information the conservative elevation of the foreshore was assumed to be 4.0 ft. The 1% design elevation for future conditions must be 15.5 ft.



**Figure 3-15 Typical Levee Design Cross-section New Orleans Lakefront Airport – East Levee (NE03-L1)**

The typical levee design cross-section for the 1% design, existing and future conditions, of the South Point Transition Reach (NE31) is shown in **Figure 3-16**. The 1% design elevation for existing conditions must be 16.5 ft and 18 ft for future conditions.



**Figure 3-16 Typical Levee Design Cross-sections South Point Transition Levee (NE31)**

The various floodwalls and gates in the Orleans Parish Lakefront East area have design elevations ranging from 15.5 to 17.5 ft for future conditions.

### 3.5.5 Resiliency

The hydraulic designs for the levees and structures within Orleans Parish – Lakefront East were examined for resiliency by computing the 0.2% surge level (50% confidence). The results are presented in **Table 3-12**. For all sections, the 0.2% surge level remains below the top of the flood defense.

**Table 3-12 Orleans Parish – Lakefront East Hydraulic Reaches – Resiliency**

Orleans Parish - Lakefront East Reaches Resiliency Analysis (0.2% Event)					
Hydraulic Reach	Name	Type	Condition	Elevation (ft)	0.2% Event
					Surge Level (ft)
NE01	Citrus Lakefront Levee/I-wall	Structure/Wall	Existing	14.5	11.0
NE01	Citrus Lakefront Levee/I-wall	Structure/Wall	Future	14.5	12.5
NE01-BW	Citrus Lakefront Levee/I-wall	Structure/Wall	Existing	9.0	11.0
NE01-BW	Citrus Lakefront Levee/I-wall	Structure/Wall	Future	13.5	12.5
NE02	New Orleans East Lakefront Levee	Levee	Existing	16.5	11.5
NE02	New Orleans East Lakefront Levee	Levee	Future	20.5	13.0
NE03-FW	New Orleans Lakefront Airport East T-wall	Structure/Wall	Future	15.5	12.3
NE03-LI	New Orleans Lakefront Airport East Levee/Floodwall Combination	Structure/Wall	Future	15.5	12.3
NE04-FW	New Orleans Lakefront Airport West Floodwall	Structure/Wall	Future	15.5	12.6
NE04-G	Downman Road Gate	Structure/Wall	Future	15.5	12.6
NE05	Lincoln Beach Floodwall	Structure/Wall	Future	15.5	12.5
NE06	Collins Pipeline Crossing Floodwall	Structure/Wall	Future	17.5 <sup>SS</sup>	13.0
NE07	Citrus Pump Station (OP #10)	Structure/Wall	Future	14.5	12.4
NE08	Jahncke Pump Station (OP #14)	Structure/Wall	Future	14.5	12.4

Orleans Parish - Lakefront East Reaches Resiliency Analysis (0.2% Event)					
Hydraulic Reach	Name	Type	Condition	Elevation (ft)	0.2% Event
					Surge Level (ft)
NE09	St. Charles Pump Station (OP #16)	Structure/Wall	Future	15.5	12.3
NE30-FW	Transition Reach from NE01-NE02 T-walls	Structure/Wall	Future	14.5-17.5	13.0
NE31	South Point Transition Reach from NE02 to NE17 at I-10	Levee	Existing	16.5	11.7
NE31	South Point Transition Reach from NE02 to NE17 at I-10	Levee	Future	18.0	13.2

### 3.6 ORLEANS PARISH – SOUTH POINT TO MRGO/GIWW CLOSURE

Each alternative for hydraulic reaches within Orleans Parish – GIWW & MRGO Reaches – Outside the IHNC Surge Barrier was reviewed during this update process. The alternatives for each corresponding hydraulic reach (where available) were reviewed along with the 95 or 100% structure or levee design plans. The alternative that best corresponded to the 95 or 100% structural design plans was considered the final hydraulic design. The data from the final hydraulic design was used to update data for the hydraulic boundary conditions, design elevations, and wave loads within this report.

The hydraulic reach identification has been updated from the October 2007 DER to match the current design conditions in their corresponding area.

#### 3.6.1 General

The Orleans Parish – South Point to MRGO/GIWW Closure runs from South Point through the Bayou Sauvage National Wildlife Refuge, in a north-south direction, then along the GIWW ending at the IHNC Surge Barrier, in an east-west direction (**Plate 6**). The reaches discussed within this section are outside the flood control structures of MRGO and GIWW at the IHNC Surge Barrier.

This reach consists of several large levee segments from South Point to Michoud Canal along the GIWW, with two small stretches of floodwall, floodgates, and a pump station in between. This levee spans 12 miles from South Point to the IHNC Surge Barrier. The South Point to GIWW levee is included in this section of the report because the surge levels along this levee are affected by the structures on the MRGO/GIWW. Orleans Parish – GIWW & MRGO Reaches – Outside the IHNC Surge Barrier levee hydraulic reach number 32 is identified as (**NE32**) and subsequent numbers for the remaining hydraulic reaches. Notice that the South Point Transition Reach (**NE31**) was discussed in another section and will not be discussed in this section.

This alignment, levees and floodwalls along all of the IHNC, and that portion of the GIWW/MRGO from the IHNC to the southern side of the Bayou Bienvenue Floodgate, and the southeastern edge of the Michoud Canal, will be isolated from hurricane surges emanating from Lake Borgne by the IHNC Surge Barrier. The IHNC Surge Barrier consists of one navigable floodgate at the GIWW, connected by a 2.5 mile floodwall through the MRGO. The IHNC Surge Barrier will be discussed in more detail in another section.

**Plate 6** shows the hydraulic boundaries for the Orleans Parish reach. The numbers indicate the hydraulic design elevations for several structures along the reach. The elevations displayed for levees will have both existing conditions (2007) and future conditions (2057), unless otherwise stated. The elevations displayed for hard structures (floodwalls, floodwall/levee combinations, pump stations, etc.) will have future (2057) conditions only. All hard structures are designed and built for future conditions (2057) only. If structural superiority is included with a specific hard structure the hydraulic design elevation will have an additional number, color coded green. The hydraulic reaches in **Plate 6** are different colors only to show the boundary limits of each reach. The colors do not represent a specific type of structure.

This figure also show the construction reaches as they correspond to the hydraulic reach. The construction boundary is off-set from the hydraulic boundary and labelled opposite the hydraulic reach label.

### **3.6.2 Hydraulic Boundary Conditions**

The hydraulic design characteristics for the reaches in Orleans Parish – MRGO & GIWW – Outside the IHNC Surge Barrier are listed in **Table 3-13**. The existing hydraulic conditions are based on the JPM-OS method using the results from ADCIRC and STWAVE model runs. To account for changes due to subsidence and sea level rise over a 50-year period, the surge elevations were adjusted by adding 1.5 ft and the wave heights were adjusted by adding 0.75 ft, for future conditions. The wave period is computed using the assumption that the wave steepness remains constant. The hydraulic boundary conditions have been based on numerical computations with the structures at MRGO and GIWW in place (2010 grid). The effect on the 1% surge levels is about 0.5 ft along the South Point to GIWW levee. Near the gates, this effect increases to about 1.0 ft. The effect on the wave characteristics is limited. Because of the higher surge levels, the wave height and period also increase in the surrounding of the gates.

**Table 3-13 Orleans Parish – South Point to MRGO/GIWW Closure – 1% Hydraulic Boundary Conditions**

<b>Orleans Parish - South Point to MRGO/GIWW Closure Reaches 1% Hydraulic Boundary Conditions</b>									
<b>Hydraulic Reach</b>	<b>Name</b>	<b>Type</b>	<b>Condition</b>	<b>Surge Level (ft)</b>		<b>Significant Wave Height (ft)</b>		<b>Peak Period (s)</b>	
				<b>Mean</b>	<b>Std</b>	<b>Mean</b>	<b>Std</b>	<b>Mean</b>	<b>Std</b>
<b>NE10-A</b>	South Point to Hwy 90 Levee NE17 at I-10 to NE13 at Hwy 11 Levee	Levee	Existing	9.5	0.8	3.6	0.4	5.8	1.2
<b>NE10-A</b>	South Point to Hwy 90 Levee NE17 at I-10 to NE13 at Hwy 11 Levee	Levee	Future	11.0	0.8	4.2	0.4	6.3	1.2
<b>NE10-B</b>	South Point to Hwy 90 NE13 at Hwy 11 - 0.9 Mile South to NE10-C Levee	Levee	Existing	9.7	0.9	3.9	0.4	5.8	1.2
<b>NE10-B</b>	South Point to Hwy 90 NE13 at Hwy 11 - 0.9 Mile South to NE10-C Levee	Levee	Future	11.2	0.9	4.5	0.4	6.2	1.2
<b>NE10-C</b>	South Point to Hwy 90 NE10-B South - 2.4 Miles to NE14 at Hwy 90	Levee	Existing	10.6	0.8	4.2	0.4	5.7	1.1
<b>NE10-C</b>	South Point to Hwy 90 NE10-B South - 2.4 Miles to NE14 at Hwy 90	Levee	Future	12.1	0.8	4.8	0.4	6.1	1.1
<b>NE11-A</b>	Hwy 90 to CSX RR Levee	Levee	Existing	14.3	0.9	5.5	0.6	6.1	1.2



**Orleans Parish - South Point to MRGO/GIWW Closure Reaches  
1% Hydraulic Boundary Conditions**

Hydraulic Reach	Name	Type	Condition	Surge Level (ft)		Significant Wave Height (ft)		Peak Period (s)	
				Mean	Std	Mean	Std	Mean	Std
NE11-A	Hwy 90 to CSX RR Levee	Levee	Future	15.8	0.9	6.1	0.6	6.4	1.2
NE11-B	CSX RR to GIWW Levee	Levee	Existing	16.2	1.0	6.4	0.6	6.8	1.4
NE11-B	CSX RR to GIWW Levee	Levee	Future	17.7	1.0	7.0	0.6	7.1	1.4
NE12-A	New Orleans East Back Levee From Pump Station 15 East Along GIWW	Levee	Existing	17.4	1.0	7.0	0.7	6.8	1.4
NE12-A	New Orleans East Back Levee From Pump Station 15 East Along GIWW	Levee	Future	18.9	1.0	7.6	0.7	7.1	1.4
NE12-B-L	New Orleans East Back Levee From Gate to Pump Station 15	Levee	Existing	18.4	1.0	7.4	0.7	6.8	1.4
NE12-B-L	New Orleans East Back Levee From Gate to Pump Station 15	Levee	Future	19.9	1.0	8.0	0.7	7.1	1.4
NE12-B-FW	Tie-ins Between NE12-B and IHNC T-walls	Structure/Wall	Future	19.9	1.0	8.0	0.7	7.1	1.4
NE13	Hwy 11 Floodgate	Structure/Wall	Future	11.0	0.8	4.4	0.4	6.2	1.2

**Orleans Parish - South Point to MRGO/GIWW Closure Reaches  
1% Hydraulic Boundary Conditions**

Hydraulic Reach	Name	Type	Condition	Surge Level (ft)		Significant Wave Height (ft)		Peak Period (s)	
				Mean	Std	Mean	Std	Mean	Std
NE14	Hwy 90 Floodgate	Structure/Wall	Future	12.5	0.9	5.0	0.4	6.1	1.1
NE15-G	CSX RR Floodgate	Structure/Wall	Future	17.3	1.0	6.8	0.6	7.1	1.4
NE15-FW	CSX RR Floodwall	Structure/Wall	Future	17.3	1.0	6.8	0.6	7.1	1.4
NE16	New Orleans East Pump Station 15 T-walls	Structure/Wall	Future	18.9	1.0	7.6	0.7	7.1	1.4
NE17	I-10 Levee Ramp Flank	Levee	Existing	9.5	0.8	3.2	0.3	5.3	1.1
NE17	I-10 Levee Ramp Flank	Levee	Future	11.0	0.8	4.0	0.3	5.9	1.1
NE32	Transition Levee Between NE11-B & NE12-A	Levee	Existing	16.2	1.0	6.5	0.7	6.8	1.4
NE32	Transition Levee Between NE11-B & NE12-A	Levee	Future	17.7	1.0	7.1	0.7	7.1	1.4

**South Point to GIWW Levee (NE10-A):** The levee runs in a northwest-southeast direction from the I-10 Levee (NE17) to the Hwy 11 Floodgate (NE13). The reach is 0.72 mile long. The ground elevation in front of the levee is assumed to be 0.35 ft. The levee's design surge level, significant wave height, and peak period for existing conditions are 9.5 ft, 3.6 ft, and 5.8 s, respectively. The levee's design surge level, significant wave height, and peak period for future conditions are 11 ft, 4.2 ft, and 6.3 s, respectively (Table 3-13).

**South Point to GIWW Levee (NE10-B):** The levee runs in a north-south direction from the Hwy 90 Floodgate (NE13) to the South Point to GIWW Levee (NE10-C). The reach is 0.97 mile long. The ground elevation in front of the levee is assumed to be 0 ft. The levee's design surge level, significant wave height, and peak period for existing conditions are 9.7 ft, 3.9 ft, and 5.8 s, respectively. The levee's design surge level, significant wave height, and peak period for future conditions are 11.2 ft, 4.5 ft, and 6.2 s, respectively (Table 3-13).

**South Point to GIWW Levee (NE10-C):** The levee runs in a north-south direction from the South Point to GIWW Levee (NE10-B) to the Hwy 90 Floodgate (NE14). The reach is 2.4 miles long. The ground elevation in front of the levee is assumed to be 0 ft. The levee's design surge level, significant wave height, and peak period for existing conditions are 10.6 ft, 4.2 ft, and 5.7 s, respectively. The levee's design surge level, significant wave height, and peak period for future conditions are 12.1 ft, 4.8 ft, and 6.1 s, respectively (Table 3-13).

**Hwy 90 to CSX Railroad Levee (NE11-A):** The levee runs in a north-south direction from the Hwy 90 Floodgate (NE14) to the CSX Railroad Floodgate and Floodwall (NE15-G and NE15-FW). The reach is 2.2 miles long. The ground elevation in front of the levee is assumed to be 0.35 ft. The levee's design surge level, significant wave height, and peak period for existing conditions are 14.3 ft, 5.5 ft, and 6.1 s, respectively. The levee's design surge level, significant wave height, and peak period for future conditions are 15.8 ft, 6.1 ft, and 6.4 s, respectively (Table 3-13).

**CSX Railroad to GIWW Levee (NE11-B):** The levee runs in a north-south direction from the CSX Railroad Floodgate and Floodwall (NE15-G and NE15-FW) to the Transition Levee (NE32). The reach is 0.7 miles long. The ground elevation in front of the levee is assumed to be 0 ft. The levees design surge level, significant wave height, and peak period for existing conditions are 16.2 ft, 6.4 ft, and 6.8 s, respectively. The levee's design surge level, significant wave height, and peak period for future conditions are 17.7 ft, 7.0 ft, and 7.1 s, respectively (Table 3-13).

**New Orleans East Back Levee from Pump Station 15 East Along GIWW (NE12-A):** The levee runs from the Transition Levee (NE32) in an east-west direction along the GIWW to the New Orleans East Pump Station 15 (NE16). The reach is 2.3 miles long. The ground elevation in front of the levee is assumed to be 0 ft. The levees design surge level, significant wave height, and peak period for existing conditions are 17.4 ft, 7.0 ft, and 6.8 s, respectively. The levee's design surge level, significant wave height, and peak period for future conditions are 18.9 ft, 7.6 ft, and 7.1 s, respectively (Table 3-13).

**New Orleans East Back Levee and Floodwall (NE12-B-L and NE12-B-FW):** The levee runs from the New Orleans East Pump Station 15 (NE16) in an east-west direction along the GIWW to Michoud Canal and the GIWW Closure Gate (**Gate-A1**) of the IHNC Surge Barrier. The reach is 2.15 miles long. The ground elevation in front of the levee is assumed to be 0 ft. The levees design surge level, significant wave height, and peak period for existing conditions are 18.4 ft, 7.4 ft, and 6.8 s, respectively. The levee's design surge level, significant wave height, and peak period for future conditions are 19.9 ft, 8.0 ft, and 7.1 s, respectively (**Table 3-13**). The floodwall's design surge level, significant wave height, and peak period for future conditions are 19.9 ft, 8.0 ft, and 7.1 s, respectively (**Table 3-13**).

**Hwy 11 Floodgate (NE13):** The floodgate lies between South Point to GIWW Levees NE10-A and NE10-B and transects Hwy 11. The flood control structure is 290 ft long. The ground elevation in front of the floodgate/structure is assumed to be 0 ft one wavelength from the structure ( $\approx 300$  ft). The gate's design surge level, significant wave height, and peak period for future conditions are 11 ft, 4.4 ft, and 6.2 s, respectively (**Table 3-13**).

**Hwy 90 Floodgate (NE14):** The floodgate lies between South Point to GIWW Levee (NE10-C) and Hwy 90 to CSX Railroad Levee (NE11-A) and transects Hwy 90. The flood control structure is 305 ft long. The ground elevation in front of the floodgate/structure is assumed to be 0 ft one wavelength from the structure ( $\approx 300$  ft). The gate's design surge level, significant wave height, and peak period for future conditions are 12.5 ft, 5.0 ft, and 6.1 s, respectively (**Table 3-13**).

**CSX Railroad Floodgate and Floodwall (NE15-G and NE-15-FW):** The flood control structures lie between Hwy 90 to CSX Railroad Levee (NE11-A) and Hwy 90 to CSX Railroad Levee (NE11-B) and transects CSX Railroad. The flood control structures are 150 ft long. The ground elevation in front of the floodgate/structure is assumed to be 0.4 ft one wavelength from the structure ( $\approx 300$  ft). The gate and floodwall's design surge level, significant wave height, and peak period for future conditions are 17.3 ft, 6.8 ft, and 7.1 s, respectively (**Table 3-13**).

**New Orleans East Pump Station 15 T-wall (also known as OP #15) (NE16):** The T-wall lies between the New Orleans East Back Levee from Pump Station 15 along GIWW (NE12-A) to New Orleans East Back Levee and Floodwall (NE12-B-L and NE12-B-FW). The T-walls are 670 ft long. The ground elevation in front of the floodgate/structure is assumed to be 0 ft one wavelength from the structure ( $\approx 300$  ft). The gate's design surge level, significant wave height, and peak period for future conditions are 18.9 ft, 7.6 ft, and 7.1 s, respectively (**Table 3-13**).

**I-10 Levee (NE17):** The levee runs from the South Point Transition Reach (NE31) in a north-south direction across I-10 to South Point to GIWW Levee (NE10-A). The reach is 510 ft long. The ground elevation in front of the levee is assumed to be 0 ft. The levee's design surge level, significant wave height, and peak period for existing conditions are 9.5 ft, 3.2 ft, and 5.3 s, respectively (**Table 3-13**). The levee's design surge level, significant wave height, and peak period for future conditions are 11.0 ft, 4.0 ft, and 5.9 s, respectively (**Table 3-13**).

**Transition Levee between NE11-B and NE12-A (NE32):** A transition levee has been included in between the CSX Railroad to GIWW levee (NE11-B) and the New Orleans East Back Levee (NE12-B-L). The reach is 1,000 ft long. The ground elevation in front of the levee is assumed to

be 0 ft. The levee's design surge level, significant wave height, and peak period for existing conditions are 16.2 ft, 6.5 ft, and 6.8 s, respectively (**Table 3-13**). The floodwall's design surge level, significant wave height, and peak period for future conditions are 17.7 ft, 7.1 ft, and 7.1 s, respectively (**Table 3-13**).

### **3.6.3 Project Design Elevations**

The design characteristics for the hydraulic reaches between in Orleans Parish – GIWW & MRGO Reaches – Outside the IHNC Surge barrier are listed in (**Table 3-14**). Hydraulic reaches **NE10-A**, **NE10-B**, **NE10-C**, **NE11-A**, **NE11-B**, **NE12-A**, **NE12-B-L**, **NE-17**, and **NE-32** are levees; and the remaining hydraulic reaches are floodwalls, floodgates or structures. The levees are designed for both existing and future conditions. Note that structures are only evaluated for future conditions because they are hard structures.

**Table 3-14 Orleans Parish – South Point to MRGO/GIWW Closure – 1% Design Information**

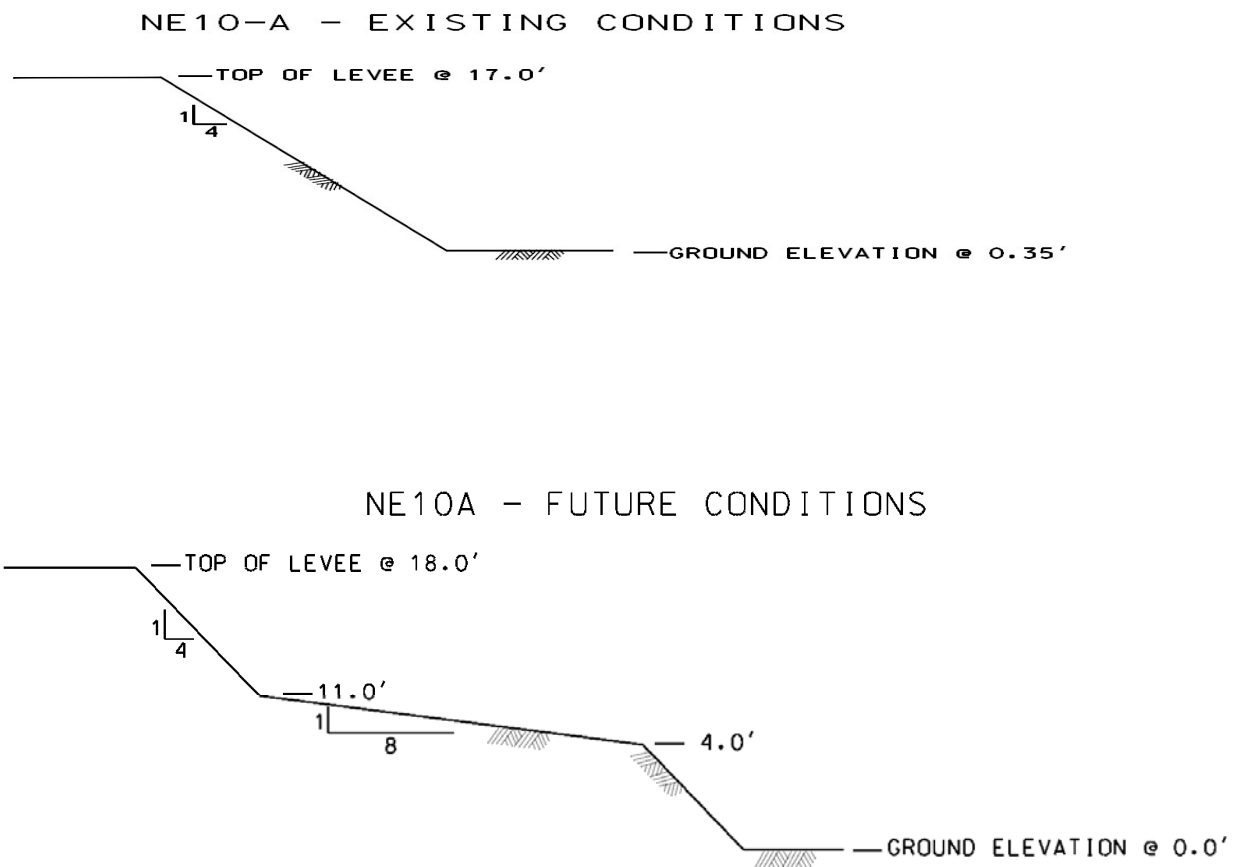
<b>Orleans Parish - GIWW &amp; MRGO Reaches - Outside the IHNC Surge Barrier Reaches 1% Hydraulic Design Elevations</b>							
<b>Hydraulic Reach</b>	<b>Name</b>	<b>Type</b>	<b>Condition</b>	<b>Depth at Toe (ft)</b>	<b>Elevation (ft)</b>	<b>Overtopping Rate</b>	
						<b>q50 (cfs/ft)</b>	<b>q90 (cfs/ft)</b>
<b>NE10-A</b>	South Point to Hwy 90 Levee NE17 at I-10 to NE13 at Hwy 11 Levee	Levee	Existing	9.0	17.0	0.009	0.062
<b>NE10-A</b>	South Point to Hwy 90 Levee NE17 at I-10 to NE13 at Hwy 11 Levee	Levee	Future	10.5	18.0	0.005	0.045
<b>NE10-B</b>	South Point to Hwy 90 NE13 at Hwy 11 - 0.9 Mile South to NE10-C Levee	Levee	Existing	9.8	17.0	0.005	0.049
<b>NE10-B</b>	South Point to Hwy 90 NE13 at Hwy 11 - 0.9 Mile South to NE10-C Levee	Levee	Future	11.3	18.0	0.007	0.070
<b>NE10-C</b>	South Point to Hwy 90 NE10-B South 2.4 Miles to NE14 at Hwy 90	Levee	Existing	10.6	17.0	0.003	0.035
<b>NE10-C</b>	South Point to Hwy 90 NE10-B South 2.4 Miles to NE14 at Hwy 90	Levee	Future	12.0	19.0	0.010	0.080
<b>NE11-A</b>	Hwy 90 to CSX RR Levee	Levee	Existing	13.8	22.0	0.007	0.072
<b>NE11-A</b>	Hwy 90 to CSX RR Levee	Levee	Future	15.3	23.5	0.008	0.075
<b>NE11-B</b>	CSX RR to GIWW Levee	Levee	Existing	16.0	24.0	0.010	0.100
<b>NE11-B</b>	CSX RR to GIWW Levee	Levee	Future	17.5	27.5	0.005	0.050

**Orleans Parish - GIWW & MRGO Reaches - Outside the IHNC Surge Barrier Reaches  
1% Hydraulic Design Elevations**

Hydraulic Reach	Name	Type	Condition	Depth at Toe (ft)	Elevation (ft)	Overtopping Rate	
						q50 (cfs/ft)	q90 (cfs/ft)
NE12-A	New Orleans East Back Levee from Pump Station 15 East Along GIWW	Levee	Existing	17.5	27.0	0.008	0.083
NE12-A	New Orleans East Back Levee From Pump Station 15 East Along GIWW	Levee	Future	19.0	29.5	0.009	0.082
NE12-B-L	New Orleans East Back Levee From Gate to Pump Station 15	Levee	Existing	18.5	27.5	0.008	0.084
NE12-B-L	New Orleans East Back Levee From Gate to Pump Station 15	Levee	Future	20.0	30.0	0.008	0.080
NE12-B-FW	Tie-ins Between NE12-B and IHNC T-walls	Structure/Wall	Future	20.0	32.0	0.001	0.017
NE13	Hwy 11 Floodgate	Structure/Wall	Future	11.0	18.0	0.010	0.039
NE14	Hwy 90 Floodgate	Structure/Wall	Future	12.5	22.0	0.004	0.017
NE15-G	CSX RR Floodgate	Structure/Wall	Future	17.0	27.5	0.026	0.087
NE15-FW	CSX RR Floodwall	Structure/Wall	Future	17.0	27.5	0.026	0.087
NE16	New Orleans East Pump Station 15 T-walls	Structure/Wall	Future	19.0	30.5	0.028	0.088
NE17	I-10 Levee Ramp Flank	Levee	Existing	8.5	16.5	0.001	0.017
NE17	I-10 Levee Ramp Flank	Levee	Future	10.0	18.0	0.007	0.061
NE32	Transition Levee Between NE11-B & NE12-A	Levee	Existing	16.3	27.0	0.003	0.031
NE32	Transition Levee Between NE11-B & NE12-A	Levee	Future	17.8	29.5	0.003	0.033

### 3.6.4 Typical Cross-Sections

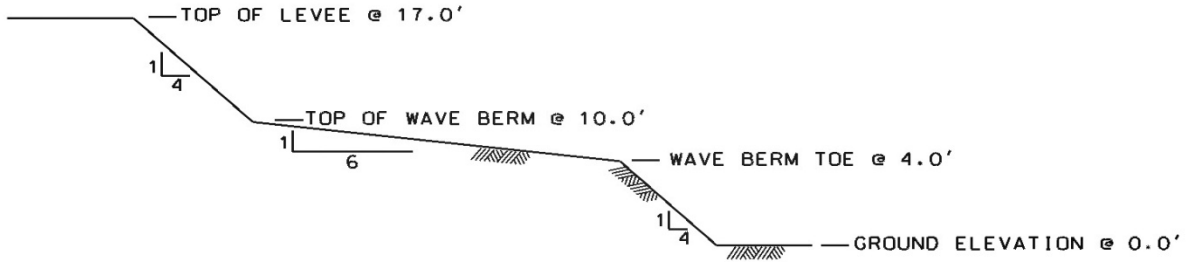
The typical levee design cross-section for the 1% design, existing and future condition, of the I-10 to Hwy 90 levees (NE10-A, NE10-B, and NE10-C) are shown in **Figure 3-17**, **Figure 3-18**, and **Figure 3-19**. The 1% design elevations for existing conditions are 17 ft for all three levees. The future condition elevations are 18 ft for NE10-A and NE10-B, and 19 ft for NE10-C. The design grade elevations for levees NE10-A, NE10-B, and NE10-C are 19 ft. The design grade elevation of 19 ft is the hydraulic design elevation plus 2.0 ft of over-build.



**Figure 3-17 Typical Levee Design Cross-sections South Point to Hwy 90 Levee (NE10-A)**



NE10-B - EXISTING CONDITIONS



NE10-B - FUTURE CONDITIONS

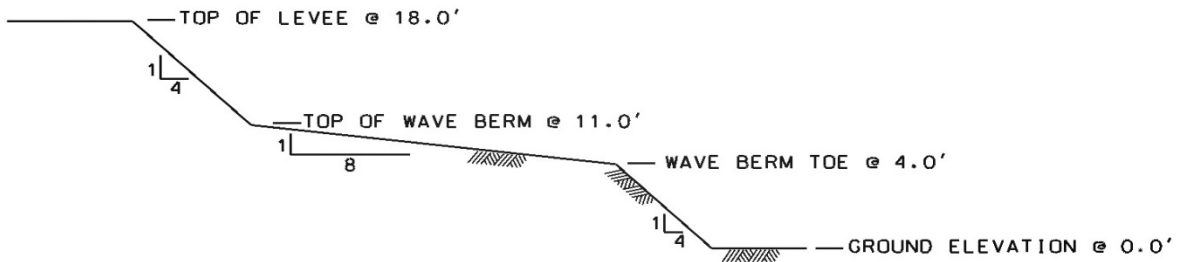
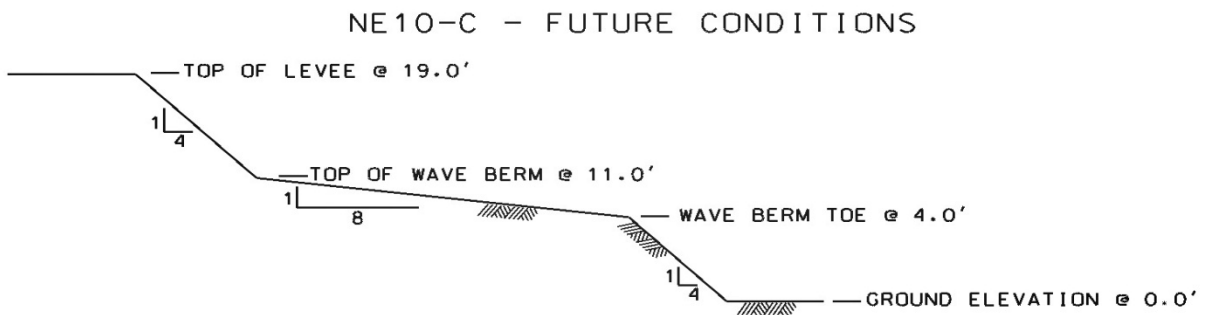
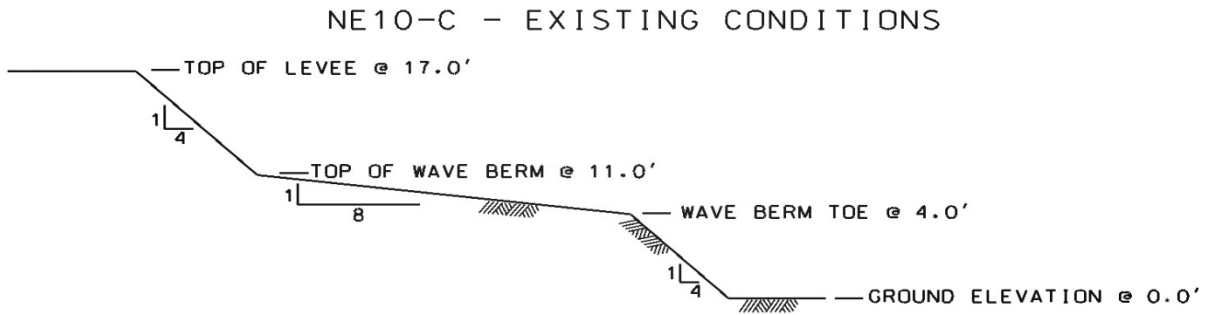
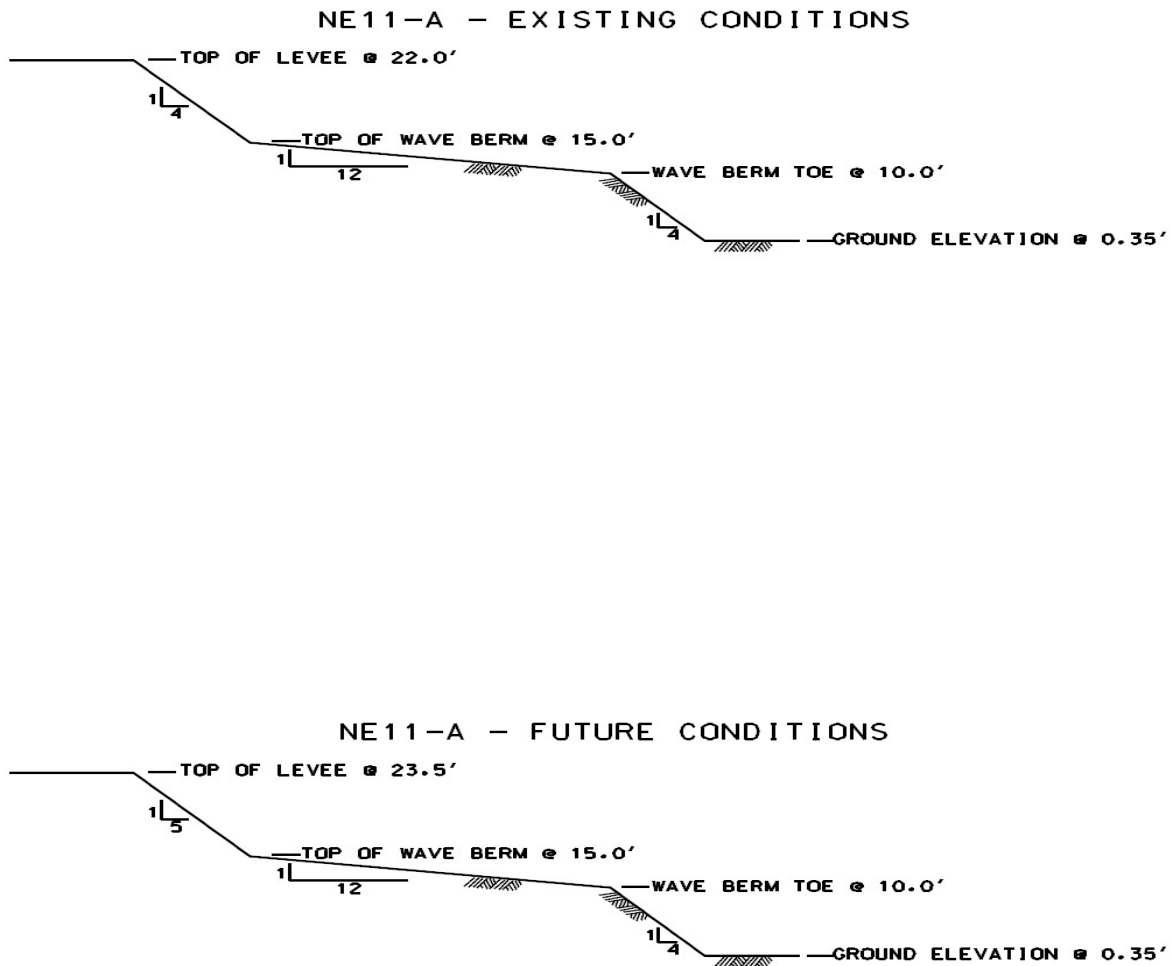


Figure 3-18 Typical Levee Design Cross-sections South Point to Hwy 90 Levee (NE10-B)



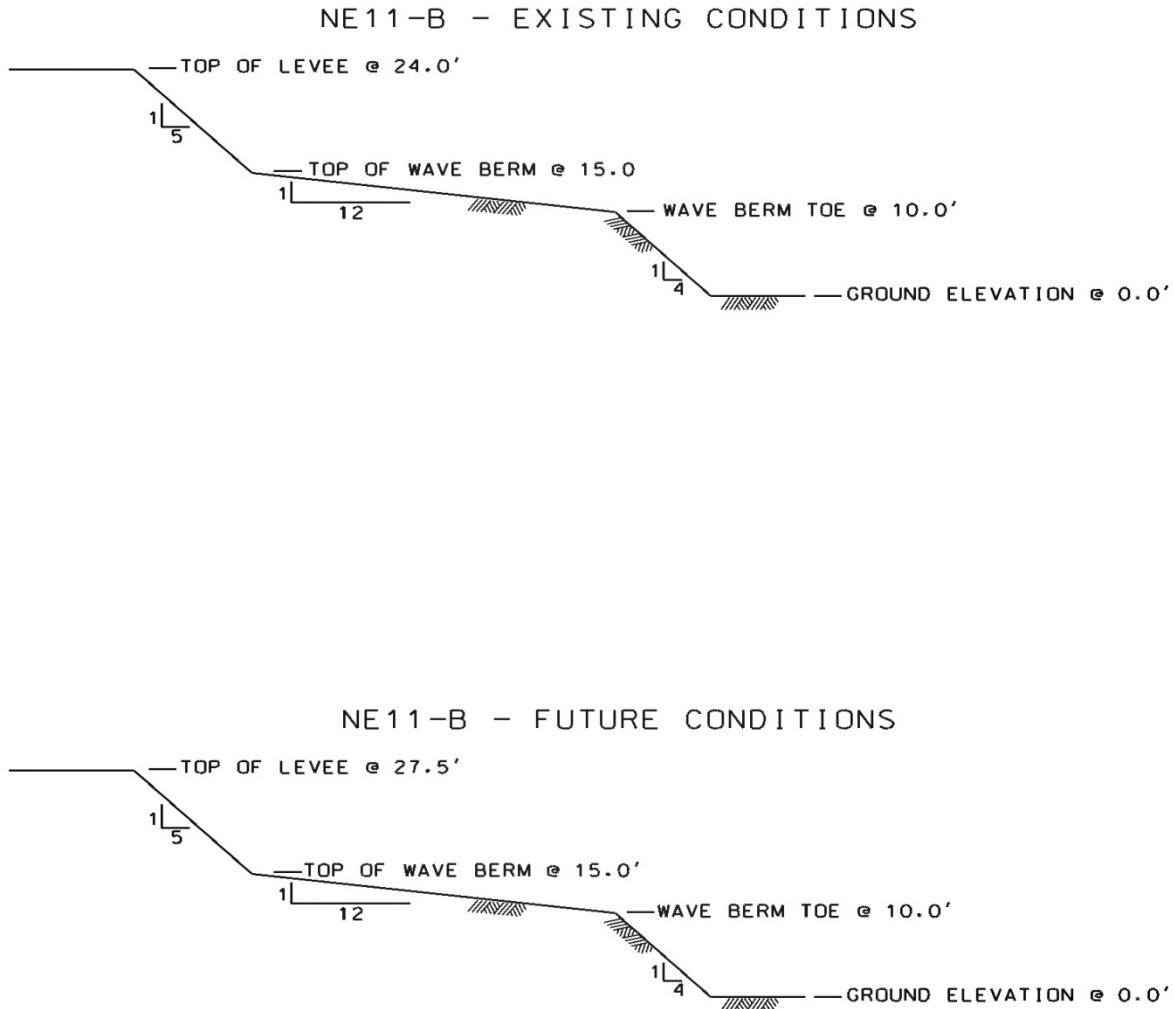
**Figure 3-19 Typical Levee Design Cross-sections South Point to Hwy 90 Levee (NE10-C)**

The typical levee design cross-section for the 1% design, existing and future conditions, of the Hwy 90 to CSX Railroad Levee (NE11-A) is shown in **Figure 3-20**. The 1% design elevations for existing conditions are 22 ft and 23.5 ft for future conditions. The design grade elevation is 25 ft levees, which is the hydraulic design elevation plus 3.0 ft of over-build.



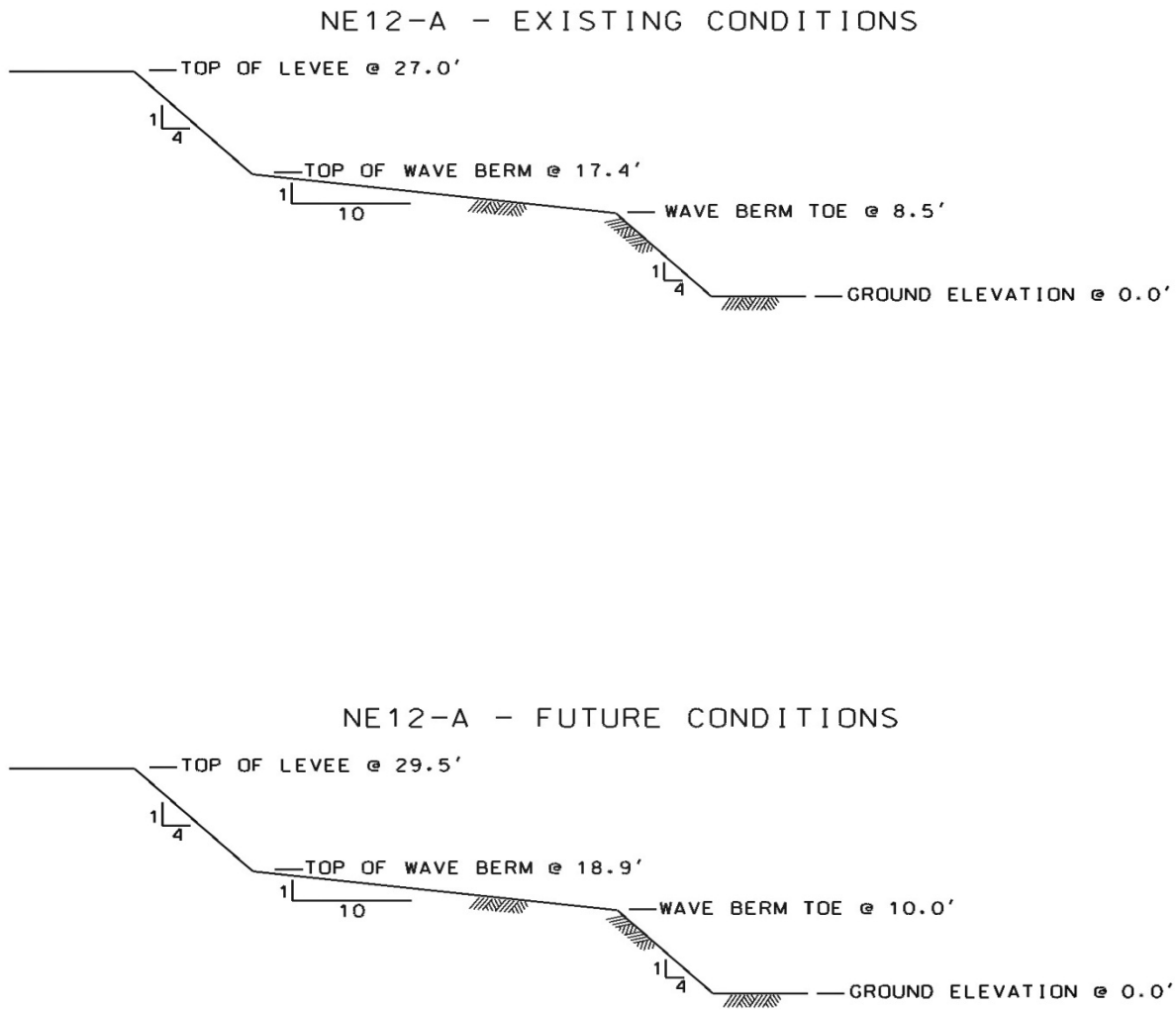
**Figure 3-20 Typical Levee Design Cross-sections Hwy 90 to CSX Railroad Levee (NE11-A)**

The typical levee design cross-section for the 1% design, existing and future conditions, of the Hwy 90 to CSX Railroad to GIWW Levee (NE11-B) is shown in **Figure 3-21**. The 1% design elevations for existing conditions are 24 ft and 27.5 ft for future conditions. The design grade elevation is 25 ft levees, which is the hydraulic design elevation plus 1.0 ft of over-build.



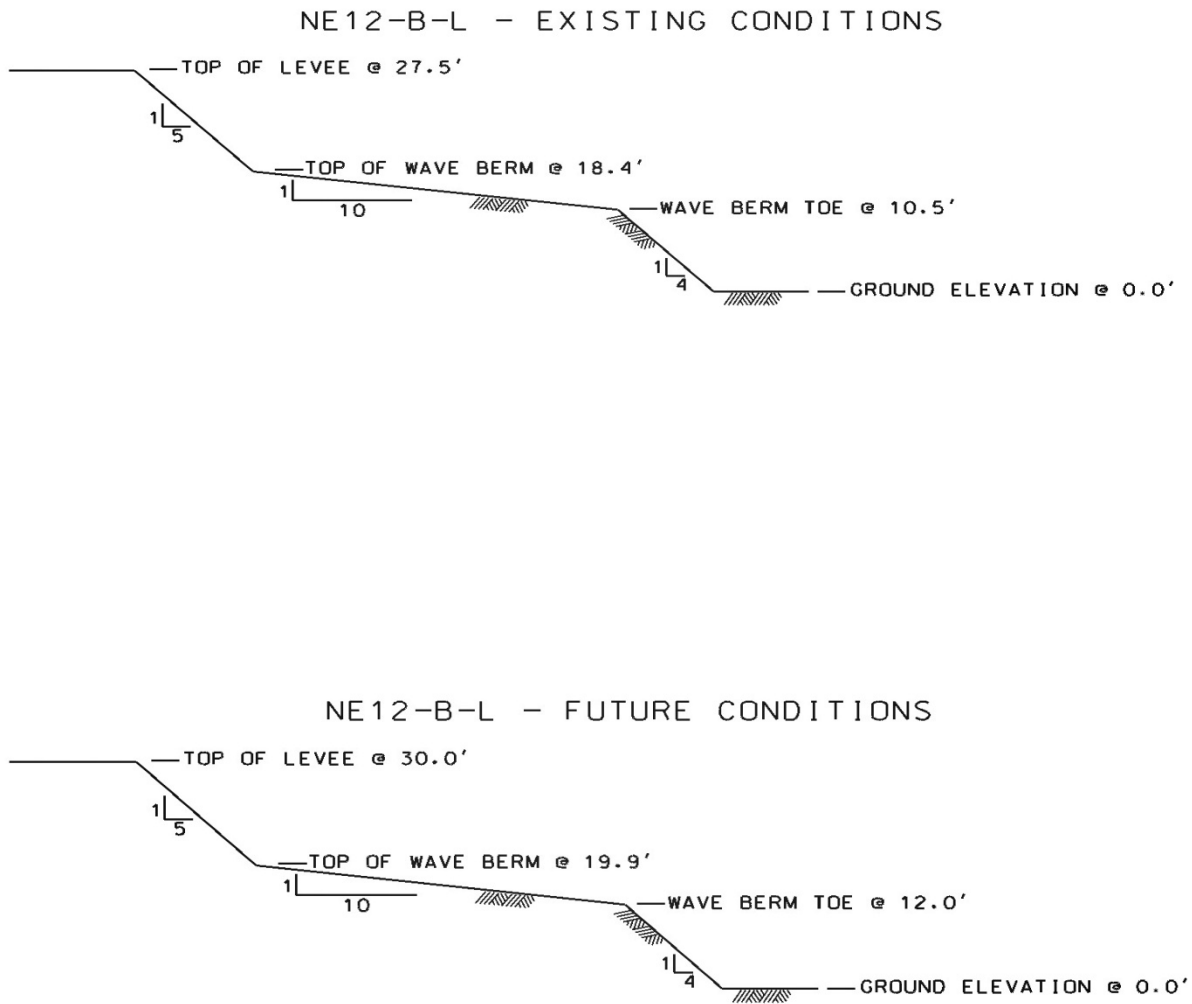
**Figure 3-21 Typical Levee Design Cross-sections CSX Railroad to GIWW Levee (NE11-B)**

The typical levee design cross-section for the 1% design, existing and future conditions, of the New Orleans East Back Levee along the GIWW Levee (NE12-A) is shown in **Figure 3-22**. The 1% design elevations for existing conditions are 27 ft and 29.5 ft for future conditions. The design grade elevation is 28 ft levees, which is the hydraulic design elevation plus 1.0 ft of over-build.



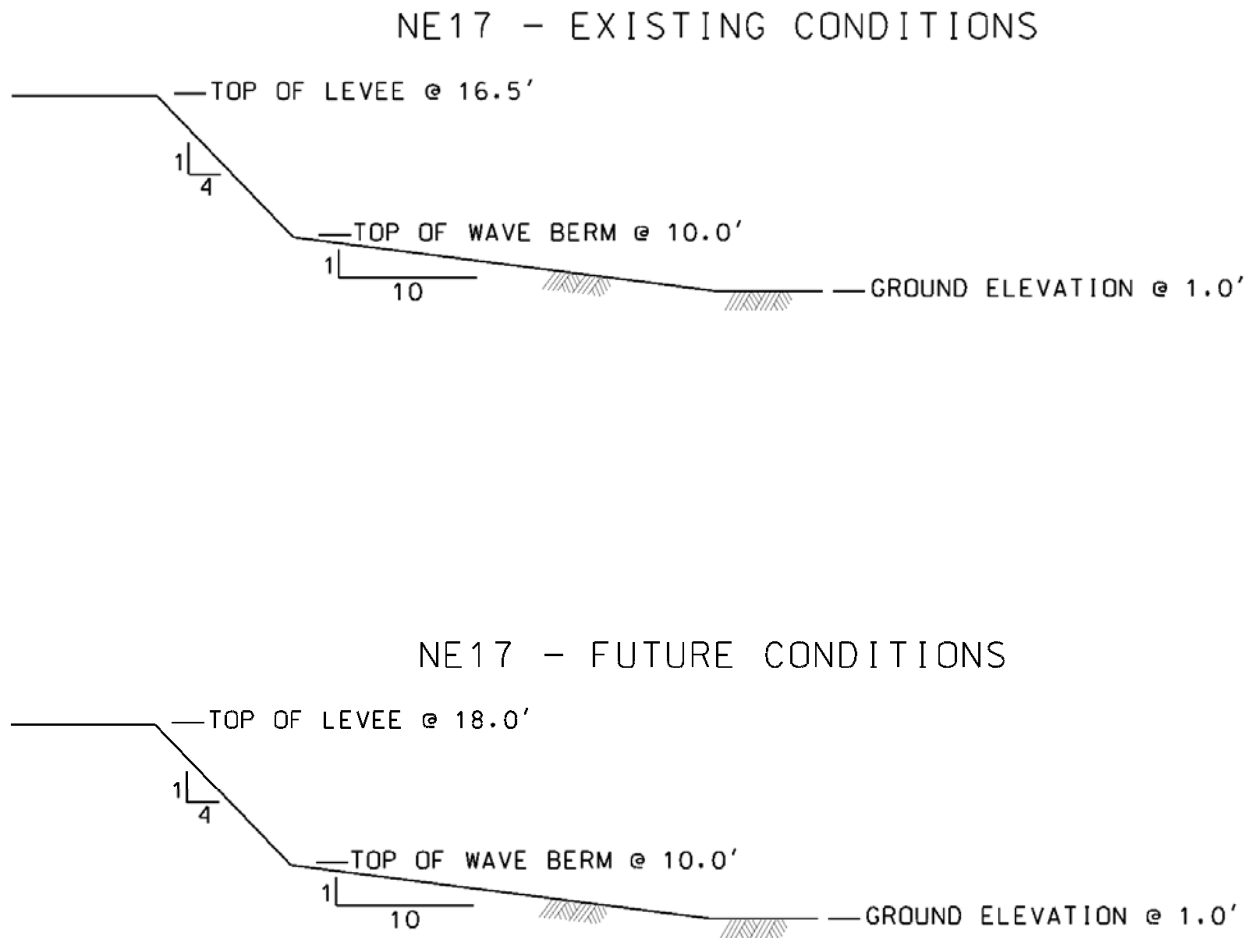
**Figure 3-22 Typical Levee Design Cross-sections New Orleans East Back Levee (NE12-A)**

The typical levee design cross-section for the 1% design, existing and future conditions, of the New Orleans East Back Levee from the GIWW to Pump Station #15 (NE12-B-L) is shown in **Figure 3-23**. The 1% design elevations for existing conditions are 27.5 ft and 30 ft for future conditions. The design grade elevation is 28.5 ft levees, which is the hydraulic design elevation plus 1.0 ft of over-build.



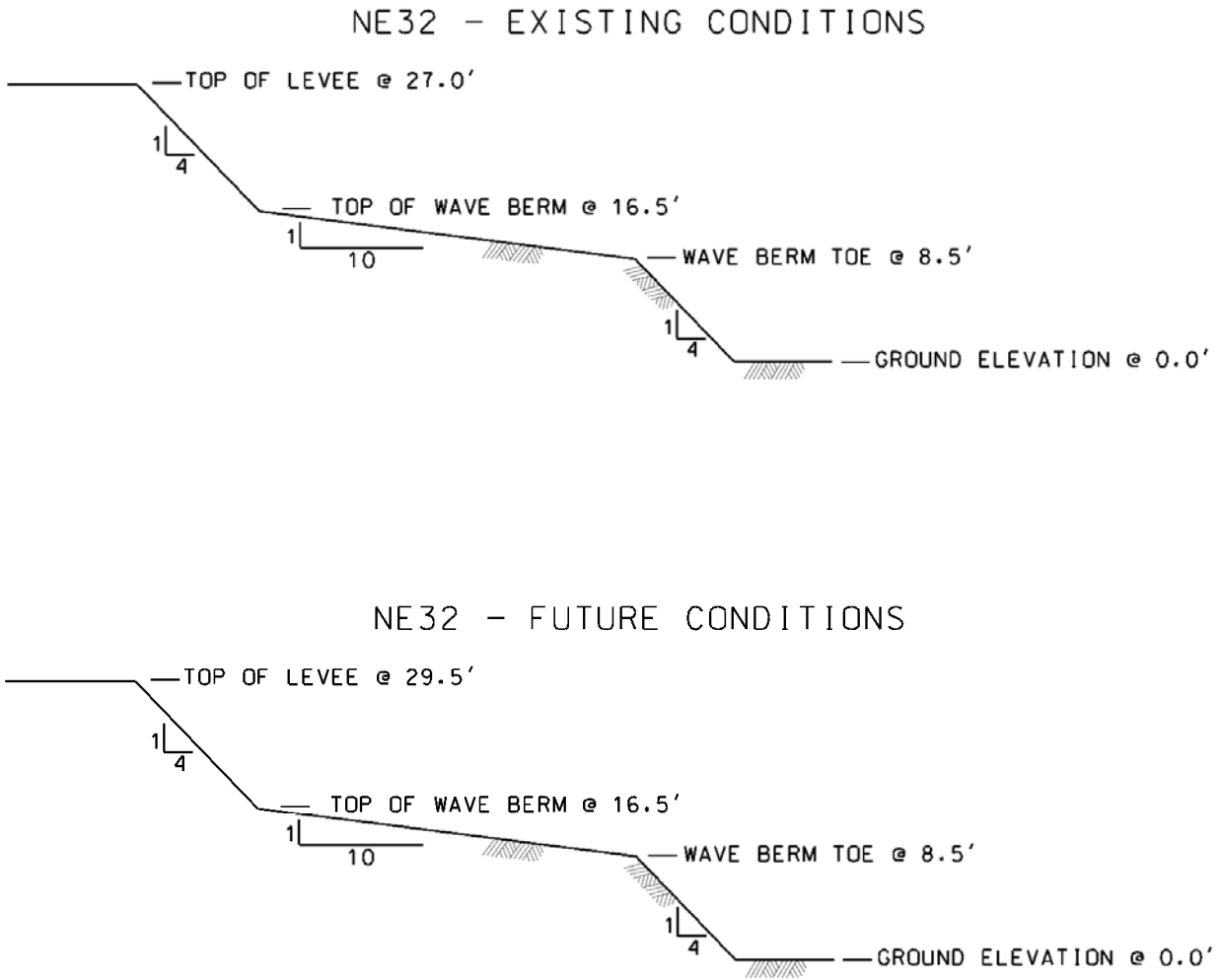
**Figure 3-23 Typical Levee Design Cross-sections New Orleans East Back Levee (NE12-B-L)**

The typical levee design cross-section for the 1% design, existing and future conditions, of the I-10 Levee (NE17) is shown in **Figure 3-24**. The 1% design elevations for existing conditions are 16.5 ft and 18 ft for future conditions.



**Figure 3-24 Typical Levee Design Cross-sections New Orleans East Back Levee (NE17)**

The typical levee design cross-section for the 1% design, existing and future conditions, of the Transition Levee between NE11-B and NE12-A (NE32) is shown in **Figure 3-25**. The 1% design elevations for existing conditions are 27 ft and 29.5 ft for future conditions.



**Figure 3-25 Typical Levee Design Cross-sections New Orleans East Back Levee (NE32)**



### 3.6.5 Resiliency

The hydraulic designs for the levees and structures within MRGO & GIWW – Outside the IHNC Surge Barrier were examined for resiliency by computing the 0.2% surge level (50% confidence). The results are presented in **Table 3-15**. For all sections, the 0.2% surge level remains below the top of the flood defense.

**Table 3-15 Orleans Parish – South Point to MRGO/GIWW Closure – Resiliency**

Orleans Parish – GIWW & MRGO Reaches – Outside the IHNC Surge Reduction Barrier Resiliency Analysis (0.2% Event)					
Hydraulic Reach	Name	Type	Condition	Elevation (ft)	0.2% Event
					Surge Level (ft)
NE10-A	South Point to Hwy 90 Levee NE17 at I-10 to NE13 at Hwy 11 Levee	Levee	Existing	17.0	12.5
NE10-A	South Point to Hwy 90 Levee NE17 at I-10 to NE13 at Hwy 11 Levee	Levee	Future	18.0	14.0
NE10-B	South Point to Hwy 90 NE13 at Hwy 11 – 0.9 Mile South to NE10-C Levee	Levee	Existing	17.0	12.8
NE10-B	South Point to Hwy 90 NE13 at Hwy 11 – 0.9 Mile South to NE10-C Levee	Levee	Future	18.0	14.3
NE10-C	South Point to Hwy 90 NE10-B South – 2.4 Miles to NE14 at Hwy 90	Levee	Existing	17.0	13.5
NE10-C	South Point to Hwy 90 NE10-B South – 2.4 Miles to NE14 at Hwy 90	Levee	Future	19.0	15.0
NE11-A	Hwy 90 to CSX RR Levee	Levee	Existing	22.0	17.5
NE11-A	Hwy 90 to CSX RR Levee	Levee	Future	23.5	19.0
NE11-B	CSX RR to GIWW Levee	Levee	Existing	24.0	19.7
NE11-B	CSX RR to GIWW Levee	Levee	Future	27.5	21.2
NE12-A	New Orleans East Back Levee From Pump Station 15 East Along GIWW	Levee	Existing	27.0	20.9

<b>Orleans Parish – GIWW &amp; MRGO Reaches – Outside the IHNC Surge Reduction Barrier Resiliency Analysis (0.2% Event)</b>					
<b>Hydraulic Reach</b>	<b>Name</b>	<b>Type</b>	<b>Condition</b>	<b>Elevation (ft)</b>	<b>0.2% Event</b>
					<b>Surge Level (ft)</b>
<b>NE12-A</b>	New Orleans East Back Levee From Pump Station 15 East Along GIWW	Levee	Future	29.5	22.4
<b>NE12-B-L</b>	New Orleans East Back Levee From Gate to Pump Station 15	Levee	Existing	27.5	22.1
<b>NE12-B-L</b>	New Orleans East Back Levee From Gate to Pump Station 15	Levee	Future	30.0	23.6
<b>NE12-B-FW</b>	Tie-ins Between NE12-B and IHNC T-walls	T-wall	Future	32.0	23.6
<b>NE13</b>	Hwy 11 Floodgate	Structure/Wall	Future	18.0	14.4
<b>NE14</b>	Hwy 90 Floodgate	Structure/Wall	Future	22.0	15.7
<b>NE15-G</b>	CSX RR Floodgate	Structure/Wall	Future	27.5	20.7
<b>NE15-FW</b>	CSX RR Floodwall	Structure/Wall	Future	27.5	20.7
<b>NE16</b>	New Orleans East Pump Station 15 T-walls	Structure/Wall	Future	30.5	22.4
<b>NE17</b>	I-10 Levee	Levee	Existing	16.5	12.5
<b>NE17</b>	I-10 Levee	Levee	Future	18.0	14.0
<b>NE32</b>	Transition Levee Between NE11-B & NE12-A	Levee	Existing	27.0	19.7
<b>NE32</b>	Transition Levee Between NE11-B & NE12-A	Levee	Future	29.5	21.2

## 3.7 IHNC/GIWW BASIN

### 3.7.1 General

The IHNC/GIWW Basin portion of the LPV is located within the closed structures of the IHNC Surge Barrier and the Seabrook Closure Complex. The IHNC Surge Barrier includes navigable floodgates at GIWW and Bayou Bienvenue; and a 2.0 mile braced floodwall that connects the floodgates in Lake Borgne and a closure structure at MRGO. The Seabrook Closure Complex is located in Lake Pontchartrain at the IHNC inlet. Both closures seal off the entire canal system from the influence of surges from Lake Borgne and Lake Pontchartrain making the IHNC/GIWW a closed (secondary) basin (**Plate 7**).

The HSDRRS along the IHNC consists of three large floodwalls: the IHNC South of I-10; IHNC North of I-10; and IHNC Lock to Pump Station #5; one large levee, the IHNC Levee South of I-10; with several small stretches of floodwalls, pump stations, and a small levees in between.

The HSDRRS along the GIWW consists of one large floodwall at Michoud Canal and Michoud Slip; three large levees – Levee Reach **GI02** to IHNC, Paris Road to Levee Reach **GI02**, Michoud Canal to Michoud Slip – several pump stations, and a floodgate in between (**Plate 7**). The hydraulic reaches identified within the basin are Gulf Intracoastal hydraulic reach number one (**GI01**) and Inner Harbor hydraulic reach number one (**IH01**). **NO20** is included in this section.

**Plate 7** shows the hydraulic boundaries for the IHNC/GIWW Basin. The numbers indicate the hydraulic design elevations for several structures along the reach. The elevations displayed for levees will have both existing conditions (2007) and future conditions (2057), unless otherwise stated. The elevations displayed for hard structures (floodwalls, floodwall/levee combinations, pump stations, etc.) will have future (2057) conditions only. All hard structures are designed and built for future conditions (2057) only. If structural superiority is included with a specific hard structure the hydraulic design elevation will have an additional number, color coded green. The hydraulic reaches in **Plate 7** are different colors only to show the boundary limits of each reach. The colors do not represent a specific type of structure.

This figure also show the construction reaches as they correspond to the hydraulic reach. The construction boundary is off-set from the hydraulic boundary and labelled opposite the hydraulic reach label.

### 3.7.2 Hydraulic Boundary Conditions

The hydraulic design characteristics for the reaches along IHNC and GIWW are listed in **Table 3-16**. The surge level is purely governed by the closure strategy of the two barriers and the drainage into the canals. Herein, it was assumed a 50% (2,831 cfs) pumping capacity for the six stations pumping into the canals. It is assumed the gates would be closed at a surge elevation of 3.0 ft and remained closed for 10 hours. Based on LIDAR data, storage-elevation curves for the areas behind the closed gates at the Seabrook Closure Structure and the IHNC Surge Barrier were computed. This area included the IHNC, MRGO, and Bayou Bienvenue gates. Next, a 100-year rainfall event was imposed into the interior areas which are pumped into the IHNC and the GIWW. The storage needed for this drainage volume appears to be around 3.0 ft. The maximum

surge level was therefore set at 7.9 ft. Because the water level in IHNC/GIWW Basin is fully controlled in this case, the 1% surge level is kept the same for existing and future conditions.

The wave characteristics at IHNC and GIWW have been estimated using an empirical method from Brettschneider (Shores Protection Manual, 1984). This method gives estimates for the fully-developed wave height and the wave period for a given fetch, wind speed, and water depth. The fetch and wind speed are the dominant parameters in this case, because the water depth is quite substantial in the GIWW and IHNC. Because of the difference in dimensions (width and length), the fetch at the IHNC and GIWW differs significantly. Therefore, a distinction has been made between the wave characteristics at the hydraulic reaches along the GIWW and IHNC.

Along the GIWW, the fetch has been estimated at 0.5 mile, which is approximately the width of the GIWW. Wave generation perpendicular to the floodwalls and levees has been assumed to be the most severe condition of overtopping. The applied 1% wind speed is 77 mph as described in **Appendix N**. Under these conditions, the resulting significant wave height of 3.0 ft and the peak period of 3.5 s according to Brettschneider's formulations. These wave characteristics have been applied uniformly for all levee and floodwall reaches along the GIWW and for the hydraulic reaches **IH01-W** and **IH03** along the IHNC. These reaches along the IHNC are exposed to waves that are generated at the intersection of the GIWW and IHNC.

Along the IHNC the width of the canal is much smaller north from I-10 and south of Pump Station #5. Hence, a fetch of 0.25 mile has been applied in combination with a wind speed of 77 mph during design conditions. The resulting significant wave height is 2.3 ft and the peak period is 3.1 s. These characteristics have been applied uniformly for all levee and floodwall reaches along IHNC (except **IH01-W** and **IH03** as discussed above).

The wave characteristics for future conditions are taken similar to those for existing conditions. The waves are determined by the fetch and the wind speed (not by the water depth) in these small canals. Thus, only the 1% surge level has been changed to evaluate future conditions.

The wave characteristics have been based on empirical relationships because the STWAVE model does not have enough resolution to solve the waves properly in these narrow canals.

**Table 3-16 IHNC/GIWW Basin Hydraulic Reaches – 1% Hydraulic Boundary Conditions**

<b>IHNC/GIWW Basin Reaches 1% Hydraulic Boundary Conditions</b>									
<b>Hydraulic Reach</b>	<b>Name</b>	<b>Type</b>	<b>Condition</b>	<b>Surge Level (ft)</b>		<b>Significant Wave Height (ft)</b>		<b>Peak Period (s)</b>	
				<b>Mean</b>	<b>Std</b>	<b>Mean</b>	<b>Std</b>	<b>Mean</b>	<b>Std</b>
<b>GI01</b>	Levee Reach GI02 to IHNC	Levee	Existing	6.3	0.8	2.3	0.2	2.8	0.6
<b>GI01</b>	Levee Reach GI02 to IHNC	Levee	Future	6.6	0.8	2.3	0.2	2.8	0.6
<b>GI02</b>	Paris Road to Levee Reach GI02	Levee	Existing	6.3	0.8	2.3	0.2	2.8	0.6
<b>GI02</b>	Paris Road to Levee Reach GI02	Levee	Future	6.6	0.8	2.3	0.2	2.8	0.6
<b>GI03</b>	Michoud Canal to Michoud Slip	Levee	Existing	6.3	0.8	3.0	0.3	3.5	0.7
<b>GI03</b>	Michoud Canal to Michoud Slip	Levee	Future	6.6	0.8	3.0	0.3	3.5	0.7
<b>GI03-W</b>	Floodwall Under Paris Road Bridge	Structure/Wall	Future	6.6	0.8	3.0	0.3	3.5	0.7
<b>GI04</b>	Michoud Canal and Slip	Structure/Wall	Future	6.6	0.8	3.0	0.3	3.5	0.7
<b>GI05</b>	Amid Pump Station (Pump Station #20)	Structure/Wall	Future	6.6	0.8	2.3	0.2	2.8	0.6
<b>GI06</b>	Elaine Pump Station	Structure/Wall	Future	6.6	0.8	2.3	0.2	2.8	0.6
<b>GI07</b>	Grant Pump Station	Structure/Wall	Future	6.6	0.8	2.3	0.2	2.8	0.6

IHNC/GIWW Basin Reaches 1% Hydraulic Boundary Conditions									
Hydraulic Reach	Name	Type	Condition	Surge Level (ft)		Significant Wave Height (ft)		Peak Period (s)	
				Mean	Std	Mean	Std	Mean	Std
GI08	Bienvenue Floodgate	Structure/Wall	Future	6.6	0.8	3.0	0.3	3.5	0.7
IH01-WN	IHNC South of I-10 N of Florida Avenue	Structure/Wall	Future	6.6	0.8	2.3	0.2	2.8	0.6
IH01-WS	IHNC South of I-10 S of Florida Avenue	Structure/Wall	Future	6.6	0.8	1.7	0.2	2.3	0.5
IH02-W	IHNC North of I-10	Structure/Wall	Future	6.6	0.8	1.7	0.2	2.3	0.5
IH03	IHNC Levee South From I-10	Levee	Existing	6.3	0.8	2.3	0.2	2.8	0.6
IH03	IHNC Levee South From I-10	Levee	Future	6.6	0.8	2.3	0.2	2.8	0.6
IH04-W	IHNC Lock to Pump Station (Pump Station #5)	Structure/Wall	Future	6.6	0.8	1.7	0.2	2.3	0.5
IH05-W	Dwyer Pump Station	Structure/Wall	Future	6.6	0.8	1.7	0.2	2.3	0.5
IH10	Orleans Pump Station #5 to Pump Station #19	Structure/Wall	Future	6.6	0.8	1.7	0.2	2.3	0.5

## **GIWW Hydraulic Reaches**

The computed existing and future design surge level, significant wave height, and peak period for all structures in the GIWW are 6.3 and 6.6 ft, 3.0 ft, and 3.5 s, respectively (**Table 3-16**). The design surge level for each hydraulic reach was updated from 7.9 to 6.3 and 6.6 ft in accordance with the *IHNC System Analysis Report, May 20, 2013*, completed by the USACE MVN District.

**Levee Reach GI02 to IHNC (GI01):** The levee runs in an east-west direction along the GIWW from the **GI02** to IHNC. The hydraulic reach is 4.7 miles long and is transected by the 51 ft Amid Pump Station (OP #20) (**GI05**) and the 133 ft Elaine Pump Station (**GI06**). The bed elevation in front of the **GI01** was set at 0 ft. The existing mean surge level, significant wave height, and peak periods are 6.3 ft, 2.3 ft, and 2.8 s, respectively. The future mean surge level, significant wave height, and peak periods are 6.6 ft, 2.3 ft, and 2.8 s, respectively (**Table 3-16**).

**Levee Reach Paris Road to GI01 (GI02):** The levee runs in an east-west direction along the GIWW from the Floodwall under Paris Road Bridge (**GI03**) to the Levee Reach GI02 to IHNC (**GI01**). The hydraulic reach is 4.4 miles long and is transected by the 23 ft Grant Pump Station (**GI07**). The bed elevation in front of the **GI02** was set at 0 ft. The existing mean surge level, significant wave height, and peak periods are 6.3 ft, 2.3 ft, and 2.8 s, respectively. The future mean surge level, significant wave height, and peak periods are 6.6 ft, 2.3 ft, and 2.8 s, respectively (**Table 3-16**).

**Michoud Canal to Michoud Slip Levee (GI03):** The levee runs in an east-west direction along both banks of the GIWW. The east bank portion ties into the floodwalls which are a part of Michoud Canal and Michoud Slip Floodwall (**GI04**). The west bank portion ties into Paris Road Bridge Floodwall (**GI03-W**), is transected by the 829 ft Bienvenue Floodgate (**GI08**), and ties into the MRGO Closure Structure (**MRGO-FW**). The hydraulic reach is 3.3 miles long. The existing mean surge level, significant wave height, and peak periods are 6.3 ft, 3.0 ft, and 3.5 s, respectively. The future mean surge level, significant wave height, and peak periods are 6.6 ft, 3.0 ft, and 3.5 s, respectively (**Table 3-16**).

**Paris Road Bridge Floodwall (GI03-W):** The floodwall runs in an east-west direction and runs under the Paris Road Bridge. This reach ties Levee Reach Paris Road to GI01 (**GI02**) and the Michoud Canal to Michoud Slip Levee (**GI03**). The reach is 1,004 ft long. The elevation was set at 1.0 ft. The future mean surge level, significant wave height, and peak periods are 6.6 ft, 3.0 ft, and 3.5 s, respectively (**Table 3-16**).

**Michoud Canal and Michoud Slip Floodwalls (GI04):** The Michoud Slip floodwall follows current levee alignment from the Levee Reach Paris Road to GI01 (**GI02**) and to the Michoud Canal to Michoud Slip Levee (**GI03**). The Michoud Canal Floodwall follows the current levee alignment from Michoud Canal to Michoud Slip Levee (**GI03**) to the Tie-ins between NE12-B and the IHNC T-walls (**NE12-B-FW**). The slip reach is 1.0 mile long and the canal reach is 3.8 miles long. The elevation is assumed to be 1.0 ft. The future mean surge level, significant wave height, and peak periods are 6.6 ft, 3.0 ft, and 3.5 s, respectively.

**Amid Pump Station also known as OP #20 (GI05):** The structure is located within the **GI01** levee and is 51 ft long. The elevation is assumed to be 1.0 ft. The future mean surge level, significant wave height, and peak periods are 6.6 ft, 2.3 ft, and 2.8 s, respectively (**Table 3-16**).

**Elaine Pump Station (GI06):** The structure is located within the Levee Reach **GI02** to **IHNC (GI01)** and is 133 ft long. The elevation is assumed to be 1.0 ft. The future mean surge level, significant wave height, and peak periods are 6.6 ft, 2.3 ft, and 2.8 s, respectively (**Table 3-16**).

**Grant Pump Station (GI07):** The structure is located within the Levee Reach **GI02** to **IHNC (GI01)** and is 23 ft long. The elevation is assumed to be 1.0 ft. The future mean surge level, significant wave height, and peak periods are 6.6 ft, 2.3 ft, and 2.8 s, respectively (**Table 3-16**).

**Bienvenue Floodgate (GI08):** The structure is located within the Levee Reach **GI02** to **IHNC (GI01)** and is 829 ft long. The Bienvenue Floodgate has an elevation of -14 ft. The future mean surge level, significant wave height, and peak periods are 6.6 ft, 3.0 ft, and 3.5 s, respectively (**Table 3-16**).

### **IHNC Hydraulic Reaches**

**IHNC South of I-10 Floodwall (IH01-WN):** The floodwall runs in a north-south direction south of I-10 to north of Florida Avenue. The reach is 3.6 miles long. The elevation is assumed to be 1.0 ft. The future mean surge level, significant wave height, and peak periods are 6.6 ft, 2.3 ft, and 2.8 s, respectively (**Table 3-16**).

**IHNC South of I-10 Floodwall (IH01-WS):** The floodwall runs in a north-south direction south of Florida Avenue to **IHNC Lock**. The reach is 3.6 miles long. The elevation is assumed to be 1.0 ft. The future mean surge level, significant wave height, and peak periods are 6.6 ft, 1.7 ft, and 2.3 s, respectively (**Table 3-16**).

**IHNC North of I-10 Floodwall (IH02-W):** The floodwall runs in a north-south direction parallel to the existing alignment and I-10 to the Seabrook floodwall (**SBRK-FW2**). The reach is 2.0 miles long. The elevation is assumed to be 1.0 ft. The future mean surge level, significant wave height, and peak periods are 6.6 ft, 1.7 ft, and 2.3 s, respectively (**Table 3-16**).

**IHNC Levee South from I-10 (IH03):** The levee has two segments: The first segment is on the east bank of the **GIWW** and ties into **IHNC North of I-10 Floodwall (IH02-W)** and the Levee Reach **GI02** to **IHNC (GI01)**. This segment's length is 0.78 mile. The second segment is on the west bank of the **GIWW** and ties into **Orleans Pump Station (#5)** and **Pump Station #19 (IH10)** Levee Reach **GI02** to **IHNC (GI01)**. This segment is 1.13 miles long. The hydraulic reach is 1.9 miles long. The bed elevation in front of the **IH03** was set at 0 ft. The existing mean surge level, significant wave height, and peak periods are 6.3 ft, 2.3 ft, and 2.8 s, respectively. The future mean surge level, significant wave height, and peak periods are 6.6 ft, 2.3 ft, and 2.8 s, respectively (**Table 3-16**).

**IHNC Lock to Pump Station #5 Floodwall (IH04-W):** The floodwall runs in a north-south direction, within the same alignment of the existing floodwall, from the St. Claude Ave. (just south of the **IHNC Lock**) to **Orleans Pump Station #5** and **Pump Station #19 (IH10)**. The reach



is 1.3 miles long. The elevation is assumed to be 1.0 ft. The future mean surge level, significant wave height, and peak periods are 6.6 ft, 1.7 ft, and 2.3 s, respectively (**Table 3-16**).

**Dwyer Pump Station (IH05-W):** The structure is located within the IH02-W hydraulic reach. The reach is 200 ft long. The elevation is assumed to be 1.0 ft. The future mean surge level, significant wave height, and peak periods are 6.6 ft, 1.7 ft, and 2.3 s, respectively (**Table 3-16**).

**Orleans Pump Station (#5) and Pump Station #19 (IH10):** Orleans Pump Station #5 lies on the west bank of the IHNC. The floodwall associated with this pump station runs from IHNC Lock to Pump Station #5 Floodwall (**IH04-W**) to IHNC Levee South from I-10 (**IH03**). This floodwall is 1,052 ft long. Pump Station #19 lies on the east bank of the IHNC. The floodwall associated with this pump station lies in the IHNC South of I-10 Floodwall (**IH01-W**). This floodwall is 362 ft long. The elevation is assumed to be 1.0 ft. The future mean surge level, significant wave height, and peak periods are 6.6 ft, 1.7 ft, and 2.3 s, respectively (**Table 3-16**).

### 3.7.3 Project Design Elevations

The design characteristics for the hydraulic reaches in IHNC and GIWW are listed in (**Table 3-17**). Hydraulic reaches **GI01**, **GI02**, **GI03**, and **IH03** are levees. The remaining reaches are floodwalls, floodgates, or pump stations. The levee reaches are designed for both existing and future conditions. Note that the structures are only evaluated for future conditions, because these are hard structures. Pump Station #5 and Pump Station #19 (**IH10**), and Bienvenue Floodgate (**GI08**) design grade elevations include 2.0 ft of structural superiority.

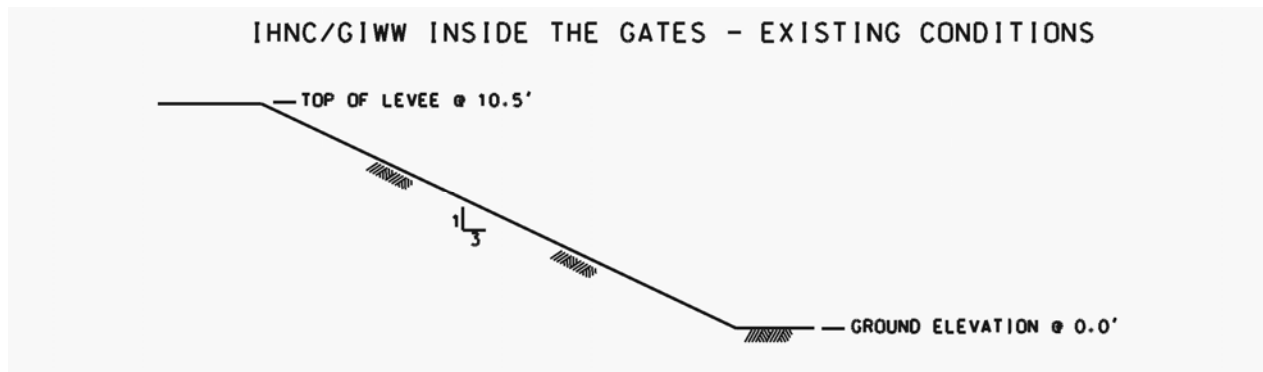
**Table 3-17 IHNC/GIWW Basin Hydraulic Reaches– 1% Design Information**

IHNC/GIWW Basin Reaches 1% Design elevations							
Hydraulic Reach	Name	Type	Condition	Depth at Toe (ft)	Elevation (ft)	Overtopping Rate	
						q50 (cfs/ft)	q90 (cfs/ft)
<b>GI01</b>	Levee Reach GI02 to IHNC	Levee	Existing	6.3	11.5	0.01	0.07
<b>GI01</b>	Levee Reach GI02 to IHNC	Levee	Future	6.6	11.5	0.01	0.07
<b>GI02</b>	Paris Road to Levee Reach GI02	Levee	Existing	6.3	11.5	0.01	0.07
<b>GI02</b>	Paris Road to Levee Reach GI02	Levee	Future	6.6	11.5	0.01	0.07
<b>GI03</b>	Michoud Canal to Michoud Slip	Levee	Existing	6.3	13.5	0.01	0.05
<b>GI03</b>	Michoud Canal to Michoud Slip	Levee	Future	6.6	13.5	0.01	0.05
<b>GI03-W</b>	Floodwall Under Paris Road Bridge	Structure/Wall	Future	6.6	11.5	0.03	0.09
<b>GI04</b>	Michoud Canal and Slip	Structure/Wall	Future	6.6	11.5	0.03	0.09
<b>GI05</b>	Amid Pump Station (Pump Station #20)	Structure/Wall	Future	6.6	10.5	0.01	0.10
<b>GI06</b>	Elaine Pump Station	Structure/Wall	Future	6.6	10.5	0.01	0.10
<b>GI07</b>	Grant Pump Station	Structure/Wall	Future	6.6	10.5	0.01	0.10
<b>GI08</b>	Bienvenue Floodgate	Structure/Wall	Future	20.0	13.5 <sup>SS</sup>	0.03	0.09

IHNC/GIWW Basin Reaches 1% Design elevations							
Hydraulic Reach	Name	Type	Condition	Depth at Toe (ft)	Elevation (ft)	Overtopping Rate	
						q50 (cfs/ft)	q90 (cfs/ft)
IH01-WN	IHNC South of I-10 N of Florida Avenue	Structure/Wall	Future	6.6	10.5	0.01	0.10
IH01-WS	IHNC South of I-10 S of Florida Avenue	Structure/Wall	Future	6.6	10.0	0.01	0.06
IH02-W	IHNC North of I-10	Structure/Wall	Future	6.6	10.0	0.01	0.06
IH03	IHNC Levee South From I-10	Levee	Existing	6.3	11.5	0.01	0.05
IH03	IHNC Levee South From I-10	Levee	Future	6.6	11.5	0.01	0.05
IH04-W	IHNC Lock to Pump Station (Pump Station #5)	Structure/Wall	Future	6.6	10.0	0.01	0.06
IH05-W	Dwyer Pump Station	Structure/Wall	Future	6.6	10.0	0.01	0.06
IH10	Orleans Pump Station #5 to Pump Station #19	Structure/Wall	Future	5.0	12.0 <sup>ss</sup>	0.01	0.06

### 3.7.4 Typical Cross-Sections

The typical levee design cross-section for the 1% design existing conditions of the IHNC/GIWW levee sections is shown in **Figure 3-26**. Notice that the existing and future conditions are equivalent because the surge level should not change because it is fully controlled by the gates. The wave characteristics do not change for future conditions because they are dominated by the fetch (and not depth-limited).



**Figure 3-26 Typical Levee Design Cross-section IHNC/GIWW Levees**

### 3.7.5 Resiliency

For this special case with two closures the designs for the levees and structures along IHNC and GIWW were evaluated against resiliency. The hydraulic characteristics inside the canal systems are dependent on: 1) rainfall and interior drainage, 2) overtopping over the closure gates, 3) pumping capacity and 4) gate closure stage. Wind setup for the 500-year event was estimated to be 0.8 ft. The surge level within the two barriers was calculated at 7.5 ft for existing and 8.9 ft for future conditions for the 500-year rainfall event. The use of the 90% confidence interval water levels as boundary conditions for the calculations, increases the 500-year flood exceedence stages approximately 0.1 ft.

## 3.8 CLOSURES AT GIWW/MRGO AND SEABROOK

### 3.8.1 General

#### IHNC Surge Barrier

The IHNC Surge Barrier project site is located at the western edge of the Golden Triangle marshlands approximately 10 miles east of downtown New Orleans, near the confluence of the GIWW and MRGO, and between Lake Borgne and Lake Pontchartrain. The region is covered by interconnected estuaries, bays, marshes, rivers and channels, while the major relief is defined by features such as river banks and an extensive system of levees and raised roads. The low-lying topography, extensive water bodies, and the intricate system of raised features make the region susceptible to flooding from hurricane storm surge. Hurricane surges can propagate rapidly across the floodplain, come from many directions, and experience dramatic localized amplification due to the topography and raised features (IPET, 2007).

The hydraulic reach identification has been updated from the October 2007 DER to match the current design conditions in their corresponding area.

The IHNC Surge Barrier consists of; two closure gates at GIWW and Bayou Bienvenue, a large braced floodwall, a closure floodwall crossing MRGO, and tie-in structures (**Plate 7**). The braced floodwall spans 2.0 miles from the GIWW to MRGO.

MRGO has become de-authorized, meaning no maintenance dredging is expected to be performed once the MRGO Closure Floodwall is in place. As a result sediment is expected to accumulate and can result in the Golden Triangle marsh returning to its historic pre-dredging condition over a period of time, as presented in *Integrated Final Report to Congress and Legislative Environmental Impact Statement for the MRGO Deep Draft De-authorization Study* (USACE, 2007). Maintenance dredging did not resume in MRGO after Hurricane Katrina.

**Plate 7** shows the hydraulic boundaries for the IHNC Surge Barrier and Seabrook Closure Complex. The numbers indicate the hydraulic design elevations for several structures along the reach. The elevations displayed for levees will have both existing conditions (2007) and future conditions (2057). The elevations displayed for hard structures (floodwalls, floodwall/levee combinations, pump stations, etc.) will have future (2057) conditions only. All hard structures are designed and built for future conditions (2057) only. If structural superiority is included with a specific hard structure the hydraulic design elevation will have an additional number, color coded green. The hydraulic reaches in **Plate 7** are different colors only to show the boundary limits of each reach. The colors do not represent a specific type of structure.

This figure also shows the construction reaches as they correspond to the hydraulic reach. The construction boundary is off-set from the hydraulic boundary and labelled opposite the hydraulic reach label.

### **Seabrook Sector Gate Complex**

The Seabrook Closure Complex consists of one navigable floodgate, two tie-in floodwalls, and swing gates at any road crossings. The proposed Sector Gate Complex is composed of a 95 ft wide sector gate for navigation with vertical lift gates 50 ft wide, placed on either side of the sector gate. The sector gate invert elevation will be -18 ft and the vertical lift gates invert elevations shall be -18 ft. The top of the proposed Sector Gate Complex will be 16 ft and the top of the tie-in features will be 16 ft. A 20 ft swing gate will be incorporated into the floodwall where the closure complex crosses roadways.

#### **3.8.2 Hydraulic Boundary Conditions**

The hydraulic design characteristics for the gates and floodwalls at the IHNC Surge Barrier and Seabrook closures are listed in **Table 3-18**. The existing hydraulic conditions are based on the JPM-OS method using the results from 2010 ADCIRC and STWAVE model runs. To account for changes due to subsidence and sea level rise over a 50-year period, the surge elevations were adjusted by adding 1.5 ft and the wave heights were adjusted by adding 0.75 ft, for future conditions. The wave period is computed using the assumption that the wave steepness remains constant.

**Table 3-18 Closures at GIWW/MRGO and Seabrook Hydraulic Reaches – 1% Hydraulic Boundary Conditions**

<b>Closures at GIWW/MRGO and Seabrook Reaches 1% Hydraulic Boundary Conditions</b>									
<b>Hydraulic Reach</b>	<b>Name</b>	<b>Type</b>	<b>Condition</b>	<b>Surge Level (ft)</b>		<b>Significant Wave Height (ft)</b>		<b>Peak Period (s)</b>	
				<b>Mean</b>	<b>Std</b>	<b>Mean</b>	<b>Std</b>	<b>Mean</b>	<b>Std</b>
<b>GIWW/MRGO</b>									
<b>MRGO-CS</b>	MRGO Closure Floodwall Crenel	Structure/Wall	Future	20.3	1.0	7.8	0.8	8.1	1.6
<b>GIWW-FW</b>	GIWW Tie-in T-walls to Levee	Structure/Wall	Future	20.3	1.0	7.8	0.8	8.1	1.6
<b>BVN-FW</b>	Bayou Bienvenue Braced Floodwall was Levee-A1 Crenel	Structure/Wall	Future	20.3	1.0	7.8	0.8	8.1	1.6
<b>MRGO-FW</b>	Tie-in T-walls and at MRGO Levee	Structure/Wall	Future	20.3	1.0	7.8	0.8	8.1	1.6
<b>GIWW-G</b>	Navigable Floodgate at GIWW	Structure/Wall	Future	20.3	1.0	7.8	0.8	8.1	1.6
<b>GIWW-B</b>	GIWW Concrete Swing Barge	Structure/Wall	Future	20.3	1.0	7.8	0.8	8.1	1.6
<b>BVN-G</b>	Navigable Floodgate at Bayou Bienvenue	Structure/Wall	Future	20.3	1.0	7.8	0.8	8.1	1.6
<b>GIWW-M</b>	GIWW Monoliths	Structure/Wall	Future	20.3	1.0	7.8	0.8	8.1	1.6
<b>Seabrook</b>									
<b>SBRK-G</b>	Closure Gate at Seabrook	Structure/Wall	Future	10.8	0.8	6.0	0.5	6.1	1.1
<b>SBRK-FW</b>	Seabrook Closure Complex East and West Tie-in Walls	Structure/Wall	Future	10.8	0.8	3.2	0.3	6.4	1.2

### **IHNC Surge Barrier Complex**

**MRGO Closure Structure Crenel (MRGO-CS):** The closure structure is a floodwall that crosses MRGO and ties into the MRGO levees Michoud Canal to Michoud Slip Levee (**GI03**) on the west bank and the Braced Floodwall (**Gate-A1-FW2**). The closure structure is 783 ft long.

**Tie-in walls at GIWW and MRGO Closure Structures (GIWW-FW and MRGO-FW):** The floodwalls tie the GIWW gate and the MRGO closure structures into their respective levees and the Bayou Bienvenue Braced Floodwall (**BVN-FW**). **GIWW-FW** is 611 ft long and **MRGO-FW** is 498 ft long. The ground elevation in front of the gates is assumed to be -20 ft and in front of the levee 0 ft. Notice that the 1% wave heights are depth-limited for levee section only.

**Bayou Bienvenue Braced Floodwall Merlon and Crenel (BVN-FW):** The braced floodwall crosses Bayou Bienvenue. The floodwall is 1.3 miles long and is transected by the 218 ft Bayou Bienvenue Closure Gates (**BVN-G**). The ground elevation in front of the floodwall is assumed to be -20 ft and in front of the levee 0 ft. Notice that the 1% wave heights are depth-limited for levee section only.

**GIWW Floodgate, Swing Barge, and Monolith (GIWW-G and GIWW-B):** The floodgate and swing barge cross GIWW and tie into the **Tie-in walls at GIWW (GIWW-FW)** and the Bayou Bienvenue Braced Floodwall Merlon and Crenel (**BVN-FW**). The monolith is adjacent to the GIWW Gates. The structures combined length is 581 ft. The ground elevation in front of the gates is assumed to be -20 ft and in front of the levee 0 ft. Notice that the 1% wave heights are depth-limited for levee section only.

**Navigable Floodgate at Bayou Bienvenue (BVN-G):** The floodgate traverses Bayou Bienvenue Canal and is 218 ft long. The ground elevation in front of the gates is assumed to be -20 ft and in front of the levee 0 ft. Notice that the 1% wave heights are depth-limited for levee section only.

### **Seabrook Sector Gate Complex**

**Closure Gate at Seabrook and Seabrook Floodwalls (SBRK-G and SBRK-FW):** The area in front of the Seabrook is relatively shallow although the narrow navigation channel is deep. The closure gate's design surge level, significant wave height, and peak period for future conditions are 10.8 ft, 6.0 ft, and 6.1 s, respectively. The closure complex tie in wall's design surge level, significant wave height, and peak period for future conditions are 10.8, 3.2, and 6.4 respectively. (**Table 3-18**).

#### **3.8.3 Project Design Elevations**

The design characteristics of the gates and the floodwalls of the IHNC Surge Barrier Complex and the Seabrook Closure Complex are summarized in (**Table 3-19**). The structures are only evaluated for future conditions because they are hard structures.



**Table 3-19 Closures at GIWW/MRGO and Seabrook – 1% Design Information**

Closures at GIWW/MRGO and Seabrook Reaches 1% Hydraulic Design Elevations							
Hydraulic Reach	Name	Type	Condition	Depth at Toe (ft)	Elevation (ft)	Overtopping Rate	
						q50 (cfs/ft)	q90 (cfs/ft)
<b>GIWW/MRGO</b>							
<b>MRGO-CS</b>	MRGO Closure Floodwall Crenel/Merlon (South Barrier Wall)	Structure/Wall	Future	41.3	25.0/26.0	See note below	See note below
<b>GIWW-FW</b>	GIWW Tie-in T-walls to Levee (North T-wall)	Structure/Wall	Future	17.3-20.3	26.0	See note below	See note below
<b>BVN-FW</b>	Bayou Bienvenue Floodwall Crenel/Merlon (South Barrier Wall)	Structure/Wall	Future	35.3	25.0/26.0	See note below	See note below
<b>MRGO-FW</b>	Tie-in T-walls and at MRGO Levee (South T-wall)	Structure/Wall	Future	16.3-20.3	26.0	See note below	See note below
<b>Lake Borgne FW</b>	Lake Borgne Floodwall Crenel/Merlon (North Barrier Wall)	Structure/Wall	Future	41.3	25.0/26.0	See note below	See note below
<b>GIWW-G</b>	Navigable Floodgate at GIWW	Structure/Wall	Future	37.8	26.0	See note below	See note below
<b>GIWW-B</b>	GIWW Concrete Swing Barge	Structure/Wall	Future	37.8	26.0	See note below	See note below
<b>BVN-G</b>	Navigable Floodgate at Bayou Bienvenue	Structure/Wall	Future	28.3	26.0	See note below	See note below
<b>GIWW-M</b>	GIWW Monoliths	Structure/Wall	Future	50.3	26.0	See note below	See note below
<b>Seabrook</b>							
<b>SBRK-G</b>	Closure Gate at Seabrook	Structure/Wall	Future	15.0	16.0	0.208	0.411
<b>SBRK-FW</b>	Seabrook Closure Complex East and West Tie-in Walls	Structure/Wall	Future	8.0	16.0	0.004	0.015

**Note: Wave Overtopping for the MRGO Surge Barrier is explained in detail in the report “Hydraulic Storm Surge & Wave Design, Inner Harbor Navigation Canal Hurricane Protection Project”, AECOM, Inc., prepared for INCA/Gerwick JV, August 2009 and further modified in the IHNC System Analysis Report 2012.**

### **IHNC Surge Barrier Complex**

The estimated overtopping rates for the modeled levee and floodwall sections analyzed seven barrier alternatives. These barrier alternatives varied in regards to the elevation of the barrier only. For each barrier configuration, the five storms of the 152 RISK-fan set (15, 18, 87, 145, and 500) have been evaluated. For the overtopping analysis, the L274 outpoint point set was applied. From this data set, a subset of points was selected to compute the overtopping over the various levee sections along the three areas under consideration (Arnold and van Ledden, 2008).

Review of the ADCIRC and STWAVE surge and wave results near the levees and floodwalls indicated the following:

- The surge level results of the various storms and barrier alternatives provide a natural progression versus time;
- The differences in the surge level results between the various barriers alternatives are small; and
- The wave characteristics, particularly for those areas west of the proposed barrier alignments where there is inadequate grid coverage and grid resolution, show more variation versus time and are sometimes difficult to explain.

### **Seabrook Sector Gate Complex**

The Seabrook Sector Gate invert elevation will be -18 ft and the vertical lift gates invert elevations will be -18 ft. The top of the Sector Gate Complex will be 16 ft and the top of the tie-in features will be 16 ft.

#### **3.8.4 Typical Sections**

This section is blank.

#### **3.8.5 Resiliency**

The hydraulic designs for the structures along GIWW/MRGO and Seabrook Hydraulic Reaches were examined for resiliency by computing the 0.2% surge level (50% confidence). The results are presented in **Table 3-20**. For all sections, the 0.2% surge level remains below the top of the flood defense.

**Table 3-20 Closures at GIWW/MRGO and Seabrook Hydraulic Reaches – Resiliency**

<b>Closures at GIWW/MRGO and Seabrook Reaches Resiliency Analysis (0.2% Event)</b>					
<b>Hydraulic Reach</b>	<b>Name</b>	<b>Type</b>	<b>Condition</b>	<b>Design Elevation (ft)</b>	<b>0.2% Event Surge Level (ft) (ft)</b>
<b>GIWW/MRGO</b>					
<b>MRGO-CS</b>	MRGO Closure Floodwall Crenel/Merlon (South Barrier Wall)	Structure/Wall	Future	25.0/26.0	24.0
<b>GIWW-FW</b>	GIWW Tie-in T-walls to Levee (North T-wall)	Structure/Wall	Future	26.0	24.0
<b>BVN-FW</b>	Bayou Bienvenue Floodwall Crenel/Merlon (South Barrier Wall)	Structure/Wall	Future	25.0/26.0	24.0
<b>MRGO-FW</b>	Tie-in T-walls and at MRGO Levee (South T-wall)	Structure/Wall	Future	26.0	24.0
<b>Lake Borgne FW</b>	Lake Borgne Floodwall Crenel/Merlon (North Barrier Wall)	Structure/Wall	Future	25.0/26.0	
<b>GIWW-G</b>	Navigable Floodgate at GIWW	Structure/Wall	Future	26.0	24.0
<b>GIWW-B</b>	GIWW Concrete Swing Barge	Structure/Wall	Future	26.0	24.0
<b>BVN-G</b>	Navigable Floodgate at Bayou Bienvenue	Structure/Wall	Future	26.0	24.0
<b>GIWW-M</b>	GIWW Monoliths	Structure/Wall	Future	26.0	24.0
<b>Seabrook</b>					
<b>SBRK-G</b>	Closure Gate at Seabrook	Structure/Wall	Future	16.0	13.9
<b>SBRK-FW</b>	Seabrook Closure Complex East and West Tie-in Walls	Structure/Wall	Future	16.0	13.9

### 3.9 ST. BERNARD PARISH

Each alternative for hydraulic reaches within St. Bernard Parish was reviewed during this update process. The alternatives for each corresponding hydraulic reach (where available) were reviewed along with the 95 or 100% structure or levee design plans. The alternative that best corresponded to the 95 or 100% structural design plans was considered the final hydraulic design. The data from the final hydraulic design was used to update data for the hydraulic boundary conditions, design elevations, and wave loads within this report.

The hydraulic reach identification has been updated from the October 2007 DER to match the current design conditions in their corresponding area.

#### 3.9.1 General

The St. Bernard Parish (also referred to as Chalmette Loop and Chalmette Extension) portion of the LPV consists of several large levee/floodwall combinations. The HSDRRS follows the alignment of the current levee system, from the IHNC Surge Barrier, following the MRGO and then the Caernarvon to Verret levee to the Mississippi River (**Plate 8**). The levee/floodwall length is approximately 22.5 miles.

The HSDRRS consists of two large levee/floodwall reaches; the MRGO\_levee/floodwall combination (also known as the Chalmette Loop) and the Caernarvon to Verret levee/floodwall combination, with several stretches of floodwalls and structures in between. The Chalmette Loop and Chalmette Extension are part of the HSDRRS which, in combination with the Mississippi River levees, completely isolate and protect St. Bernard Parish and that portion of Orleans Parish east of the IHNC from storm surge flooding. Analyses of levees along the IHNC and GIWW, which form part of that line of protection, are covered in a previous section of this report. St. Bernard Parish levee hydraulic reach number eleven is identified as (**SB11**) and subsequent numbers for the remaining hydraulic reaches.

**Plate 8** shows the hydraulic boundaries for the St. Bernard Area. The numbers indicate the hydraulic design elevations for several structures along the reach. The elevations displayed for levees will have both existing conditions (2007) and future conditions (2057). The elevations displayed for hard structures (floodwalls, floodwall/levee combinations, pump stations, etc.) will have future (2057) conditions only. All hard structures are designed and built for future conditions (2057) only. If structural superiority is included with a specific hard structure the hydraulic design elevation will have an additional number, color coded green. The hydraulic reaches in **Plate 8** are different colors only to show the boundary limits of each reach. The colors do not represent a specific type of structure.

This figure also show the construction reaches as they correspond to the hydraulic reach. The construction boundary is off-set from the hydraulic boundary and labelled opposite the hydraulic reach label.

#### 3.9.2 Hydraulic Boundary Conditions

The hydraulic design characteristics for the reaches in St. Bernard Parish are listed in **Table 3-21**. The existing hydraulic conditions are based on the JPM-OS method using the results from

ADCIRC and STWAVE model runs. To account for changes due to subsidence and sea level rise over a 50-year period, the surge elevations were adjusted by adding 1.5 ft and the wave heights were adjusted by adding 0.75 ft, for future conditions. The wave period is computed using the assumption that the wave steepness remains constant.

Notice that the hydraulic boundary conditions have been based on numerical computations using the 2010 grid with the gates at MRGO and GIWW in place. The effect on the 1% surge levels near the gates is about 1.0 ft. Because of the higher surge levels, the wave height and period also increase in the surrounding of the gates. For all sections, the bed elevation in front of the levee/floodwall has been assumed to be 0 ft.

**Table 3-21 St. Bernard Parish Hydraulic Reaches – 1% Hydraulic Boundary Conditions**

<b>St. Bernard Parish Reaches 1% Hydraulic Boundary Conditions</b>									
<b>Hydraulic Reach</b>	<b>Name</b>	<b>Type</b>	<b>Condition</b>	<b>Surge Level (ft)</b>		<b>Significant Wave Height (ft)</b>		<b>Peak Period (s)</b>	
				<b>Mean</b>	<b>Std</b>	<b>Mean</b>	<b>Std</b>	<b>Mean</b>	<b>Std</b>
<b>SB11</b>	MRGO Levee - IHNC Surge Barrier Tie-in 1.7 Miles to SB12	Structure/Wall	Future	19.9	1.0	8.0	0.7	7.1	1.4
<b>SB12</b>	MRGO Levee - SB11 0.9 Miles to SB13	Structure/Wall	Future	18.8	1.1	7.5	0.7	7.1	1.4
<b>SB13</b>	MRGO Levee -Bayou Bienvenue to Bayou Dupre	Structure/Wall	Future	17.9	1.1	7.2	0.7	7.1	1.4
<b>SB15</b>	MRGO Levee - Bayou Dupre to Hwy 46	Structure/Wall	Future	17.1	1.2	6.8	0.6	7.2	1.4
<b>SB16</b>	Caernarvon to Verret	Structure/Wall	Future	18.8	1.0	6.0	0.5	7.0	1.3
<b>SB17</b>	Caernarvon to Verret	Structure/Wall	Future	19.4	1.2	6.0	0.5	7.0	1.3
<b>SB19-G</b>	Bayou Dupre Control Structure	Structure/Wall	Future	17.3	1.0	7.5	0.6	8.3	1.6
<b>SB19-FW</b>	Bayou Dupre T-wall Tie-ins	Structure/Wall	Future	17.3	1.0	7.5	0.6	8.3	1.6
<b>SB20</b>	St. Mary Pump Station (Pump Station #8)	Structure/Wall	Future	18.5	1.0	6.0	0.5	7.0	1.3
<b>SB21-TR</b>	Transition Reach	Structure/Wall	Future	19.5	1.2	4.3	0.4	7.2	1.3
<b>SB21-FW</b>	Caernarvon Canal Floodwall (East of Canal)	Structure/Wall	Future	19.5	1.2	4.3	0.4	7.2	1.3
<b>SB21-G1</b>	Caernarvon Canal Sector Gate	Structure/Wall	Future	19.5	1.2	4.3	0.4	7.2	1.3
<b>SB21-G2</b>	Caernarvon Canal Hwy 39 Gate and Railroad Gate	Structure/Wall	Future	19.5	1.2	4.3	0.4	7.2	1.3

St. Bernard Parish Reaches 1% Hydraulic Boundary Conditions									
Hydraulic Reach	Name	Type	Condition	Surge Level (ft)		Significant Wave Height (ft)		Peak Period (s)	
				Mean	Std	Mean	Std	Mean	Std
SB161-LT	Bayou Road to Hwy 46 Levee/Floodwall Combo	Structure/Wall	Future	17.9	1.0	6.4	0.6	7.2	1.4
SB161-G1	Caernarvon to Verret Hwy 46 Floodgate	Structure/Wall	Future	17.9	1.0	6.4	0.6	7.2	1.4
SB161-G2	Caernarvon to Verret Bayou Road Floodgate	Structure/Wall	Future	17.9	1.0	6.4	0.6	7.2	1.4



**MRGO Levee/Floodwall Combination IHNC Surge Barrier Tie-in 1.7 Miles to SB12 (SB11):** The levee/floodwall combination runs in a northwest-southeast direction along MRGO, starting at the IHNC Surge Barrier. The MRGO Levee/floodwall combination is 1.7 miles long and ties-in with MRGO Levee/floodwall Combination (SB12). The levee/floodwall combination's design surge level, significant wave height, and peak period for future conditions are 19.9 ft, 8.0 ft, and 7.1 s, respectively (Table 3-21).

**MRGO Levee/Floodwall Combination SB11 0.9 Mile to SB13 (SB12):** The levee/floodwall combination runs in a northwest-southeast direction along MRGO, starting at the tie-in with SB11. The MRGO Levee/floodwall combination is 0.95 miles long and ties-in with MRGO Levee/floodwall Combination (SB13). The levee/floodwall combination's design surge level, significant wave height, and peak period for future conditions are 18.8 ft, 7.5 ft, and 7.1 s, respectively (Table 3-21).

**MRGO Levee/Floodwall Combination Bayou Bienvenue to Bayou Dupre (SB13):** The levee/floodwall combination runs in a northwest-southeast direction along MRGO, starting at the tie-in with SB12. The MRGO Levee/floodwall combination is 5.3 miles long and ties-in with MRGO Levee/floodwall Combination (SB15). SB13 is transected by the 690 ft Bayou Dupre Control Structure (SB19). The levee/floodwall combination's design surge level, significant wave height, and peak period for future conditions are 17.9 ft, 7.2 ft, and 7.1 s, respectively (Table 3-21).

**MRGO Levee/Floodwall Combination Bayou Dupre to Hwy 46 (SB15):** The levee/floodwall combination runs in a northwest-southeast direction along MRGO, starting at the tie-in with SB19. The levee/floodwall combination follows the current levee's alignment for 3.4 miles then turns in north-south direction 1.2 miles until it ties-in with the Caernarvon levee (SB16). The levee/floodwall combination is a total of 4.6 miles long. The levee/floodwall combination's design surge level, significant wave height, and peak period for future conditions are 17.1 ft, 6.8 ft, and 7.2 s, respectively (Table 3-21).

**Caernarvon Levee/Floodwall Combination (SB16):** The levee/floodwall combination runs in a north-south direction following the current levee's alignment for 2.3 miles, then turns east-west following the current levee alignment for 2.9 miles and ties-in with the Caernarvon levee/floodwall combination (SB17). The levee/floodwall combination is a total of 5.0 miles long and is transected by a 241 ft floodwall at St. Mary's #8 Pump Station (SB20). The levee/floodwall combination's design surge level, significant wave height, and peak period for future conditions are 18.8 ft, 6.0 ft, and 7.0 s, respectively (Table 3-21).

**Caernarvon Levee/Floodwall Combination (SB17):** The levee/floodwall combination runs in an east-west direction following the current levees alignment for 3.6 miles, then turns north-south following the current levee alignment for 0.5 miles and ties-in with the existing Caernarvon levee. The levee/floodwall combination is a total of 4.1 miles long. The levee/floodwall combination's design surge level, significant wave height, and peak period for future conditions are 19.4 ft, 6.0 ft, and 7.0 s, respectively (Table 3-21).

**Bayou Dupre Control Structure (SB19-G and SB19-FW):** The structure runs in a northwest-southeast direction along MRGO following the current levee's alignment and is located within

the MRGO Levee/floodwall combination (**SB13**). The structure is 946 ft long. The control structure's design surge level, significant wave height, and peak period for future conditions are 17.3 ft, 7.5 ft, and 8.3 s, respectively (**Table 3-21**).

**St. Mary's Pump Station #8 (SB20):** The structure runs in an east-west direction following the current levees alignment (**SB16**). The structure is 241 ft long. The structure's design surge level, significant wave height, and peak period for future conditions are 18.5 ft, 6.0 ft, and 7.0 s, respectively (**Table 3-21**).

**Caernarvon Structures (SB21-TR, SB21-FW, SB21-G1, and SB21-G2):** The Transition levee/floodwall combination (**SB21-TR**) runs in a north-south direction, 1,380 ft, from **SB17**, then turns east-west as it crosses the Caernarvon Canal, then turns in a north-south direction and crosses Hwy 39 and ties in with the Mississippi River Levee after 1,900 ft. The floodwalls (**SB21-FW**) are 0.5 miles long and are transected by a 145 ft floodgate at Caernarvon Canal Sector Floodgate (**SB21-G1**) a 97 ft Hwy 39 and a 97 ft railroad Floodgate (**SB21-G2**). The Caernarvon Structures design surge level, significant wave height, and peak period for future conditions are 19.5 ft, 4.3 ft, and 7.2 s, respectively (**Table 3-21**).

**Caernarvon to Verret Road Structures (SB161-LT, SB161-G1, and SB161-G2):** The **SB16** hydraulic reach as identified in the October 2007 DER, has been divided into **SB161-LT**, **SB161-G1**, and **SB161-G2**, and is designed for the Hwy 46 complex area. ADCIRC and STWAVE model output (Point 55) for the 2010 conditions form the basis for the analysis, with the IHNC Surge Barrier in place. The values were adjusted to reflect the future conditions (2057) (**Table 3-21**). Bayou Road to Hwy 46 (**SB161-LT**) is a levee/floodwall combination. The Caernarvon to Verret Road structure's design surge level, significant wave height, and peak period for future conditions are 17.9 ft, 6.4 ft, and 7.2 s, respectively (**Table 3-21**).

### 3.9.3 Project Design Elevations

The design characteristics for the hydraulic reaches in St. Bernard Parish (Chalmette Loop and Chalmette Extension) are listed in (**Table 3-22**). Hydraulic reaches **SB11**, **SB12**, **SB13**, **SB15**, **SB16**, **SB17**, **SB21-TR**, and **SB161-LT** are levee/floodwall combinations. The remaining reaches are floodwalls or floodgates. Note that the structures (including floodwalls, floodgates, and levee/floodwall combinations) are only evaluated for future conditions, because these are hard structures. The Bayou Dupre Control Structure (**SB19-G**) includes 2.0 ft of structural superiority.

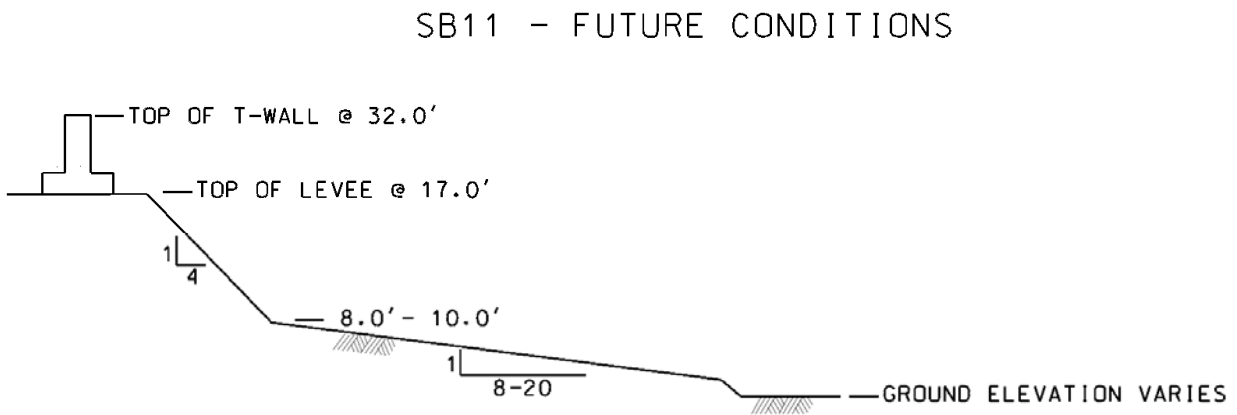
**Table 3-22 St. Bernard Parish Hydraulic Reaches – 1% Design Information**

St. Bernard Parish Reaches 1% Hydraulic Design Elevations							
Hydraulic Reach	Name	Type	Condition	Depth at Toe (ft)	Elevations (ft)	Overtopping Rate	
						q50 (cfs/ft)	q90 (cfs/ft)
SB11	MRGO Levee - IHNC Surge Barrier Tie-in 1.7 Miles to SB12	Structure/Wall	Future	19.9	32.0	0.0010	0.0170
SB12	MRGO Levee - SB11 0.9 Miles to SB13	Structure/Wall	Future	18.8	30.0	0.0004	0.0100
SB13	MRGO Levee -Bayou Bienvenue to Bayou Dupre	Structure/Wall	Future	17.9	29.0	0.0001	0.0030
SB15	MRGO Levee - Bayou Dupre to Hwy 46	Structure/Wall	Future	17.1	28.0	0.0001	0.0014
SB16	Caernarvon to Verret	Structure/Wall	Future	18.8	32.0	0.0062	0.0600
SB17	Caernarvon to Verret	Structure/Wall	Future	17.3	32.0	0.0094	0.0900
SB19-G	Bayou Dupre Control Structure	Structure/Wall	Future	29.8	31.0 <sup>ss</sup>	0.0010	0.0040
SB19-FW	Bayou Dupre T-wall Tie-ins	Structure/Wall	Future	18.5	29.0	0.0210	0.0700
SB20	St. Mary Pump Station (Pump Station #8)	Structure/Wall	Future	19.5	32.0	0.0020	0.0090
SB21-TR	Transition Reach	Structure/Wall	Future	19.5	26.0 - 32.0	0.0100	0.0640
SB21-FW	Caernarvon Canal Floodwall (East of Canal)	Structure/Wall	Future	19.5	26.0	0.0160	0.0770
SB21-G1	Caernarvon Canal Sector Gate	Structure/Wall	Future	19.5	26.0	0.0160	0.0770
SB21-G2	Caernarvon Canal Hwy 39 Gate and Railroad Gate	Structure/Wall	Future	17.9	26.0	0.0160	0.0770

St. Bernard Parish Reaches 1% Hydraulic Design Elevations							
Hydraulic Reach	Name	Type	Condition	Depth at Toe (ft)	Elevations (ft)	Overtopping Rate	
						q50 (cfs/ft)	q90 (cfs/ft)
SB161-LT	Bayou Road to Hwy 46 Levee/Floodwall Combo	Structure/Wall	Future	17.9	30.0	0.0002	0.0050
SB161-G1	Caernarvon to Verret Hwy 46 Floodgate	Structure/Wall	Future	17.9	30.0	0.0052	0.0220
SB161-G2	Caernarvon to Verret Bayou Road Floodgate	Structure/Wall	Future	17.9	30.0	0.0052	0.0220

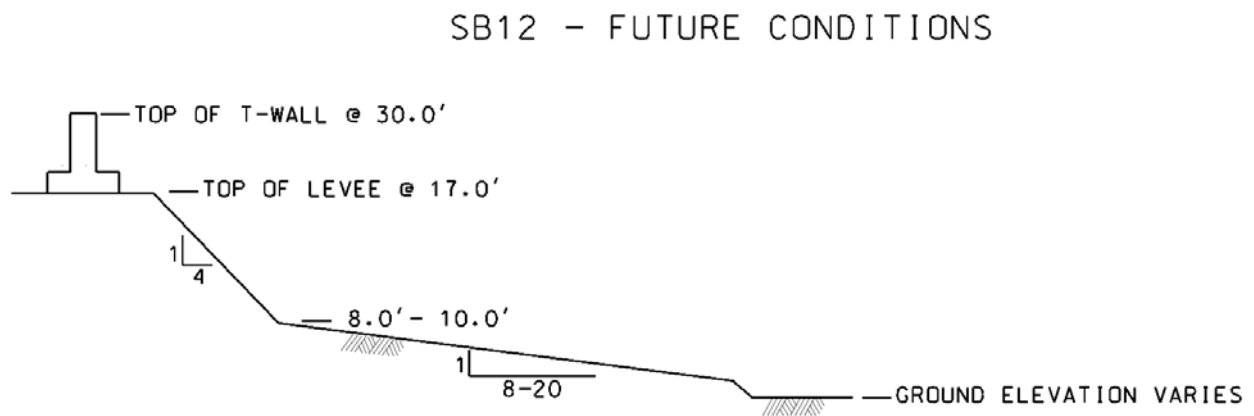
### 3.9.4 Typical Cross-Sections

The typical levee design cross-section for the 1% hydraulic design future conditions of MRGO Levee/floodwall Combination (**SB11**) is shown in **Figure 3-27**. **SB11** was originally designed as an earthen levee with an elevation at 19 ft. The upgrade requires the degradation of the existing levee by 1.5 ft to an elevation of 17.0 ft. The degradation is necessary to widen the top of the levee so the base of the T-wall can be constructed. The 1% hydraulic design elevation for future conditions must be 32 ft. The construction design grade elevation is 32 ft.



**Figure 3-27 Typical Levee Design Cross-section MRGO Levee/Floodwall Combination (SB11)**

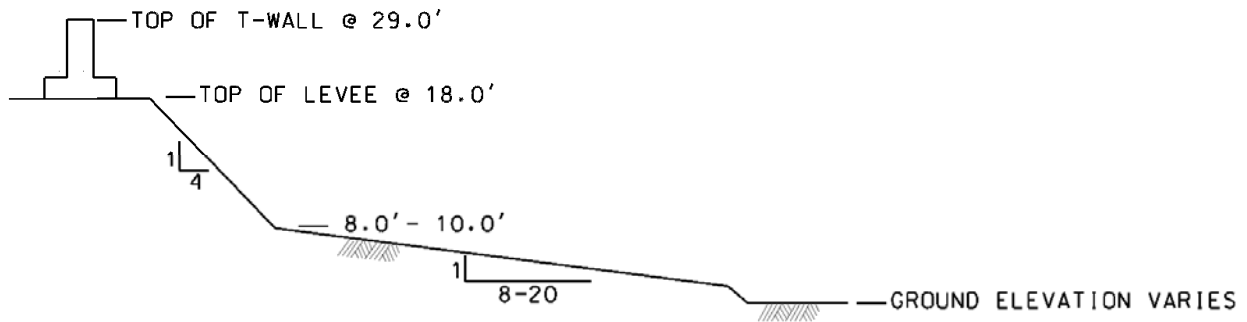
The typical levee design cross-section for the 1% design future conditions of MRGO Levee/Floodwall Combination (SB12) is shown in **Figure 3-28**. SB12 was originally designed as an earthen levee with an elevation at 19 ft. The upgrade requires the degradation of the existing levee by 1.5 ft to an elevation of 17.0 ft. The degradation is necessary to widen the top of the levee so the base of the T-wall can be constructed. The 1% hydraulic design elevation for future conditions must be 30 ft. The construction design grade elevation is 30 ft.



**Figure 3-28 Typical Levee Design Cross-section MRGO Levee/Floodwall Combination (SB12)**

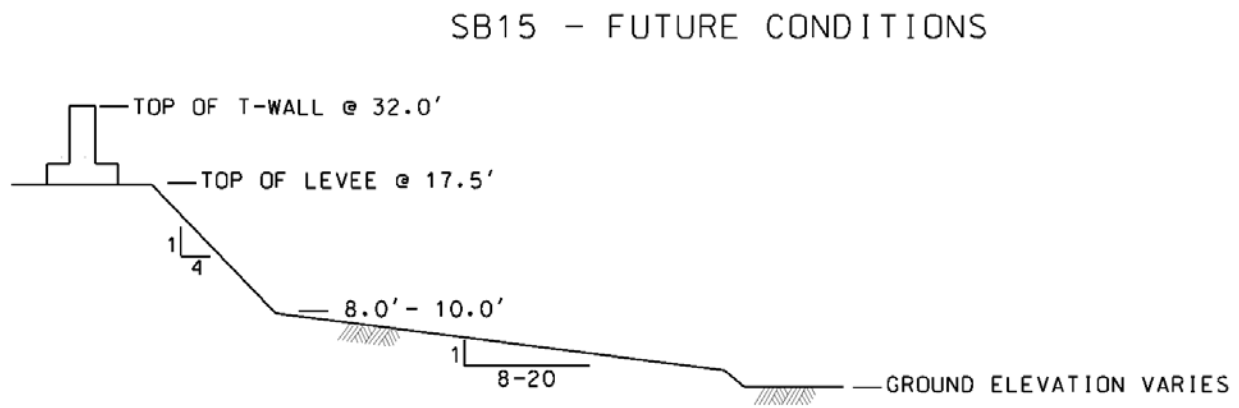
The typical levee design cross-section for the 1% design future conditions of MRGO Levee/Floodwall Combination (SB13) is shown in **Figure 3-29**. SB13 was originally designed as an earthen levee with an elevation at 19 ft. The upgrade requires the degradation of the existing levee by 1.5 ft to an elevation of 18.0 ft. The degradation is necessary to widen the top of the levee so the base of the T-wall can be constructed. The 1% hydraulic design elevation for future conditions must be 29 ft. The construction design grade elevation is 29 ft.

### SB13 - FUTURE CONDITIONS



**Figure 3-29 Typical Levee Design Cross-section MRGO Levee/Floodwall Combination (SB13)**

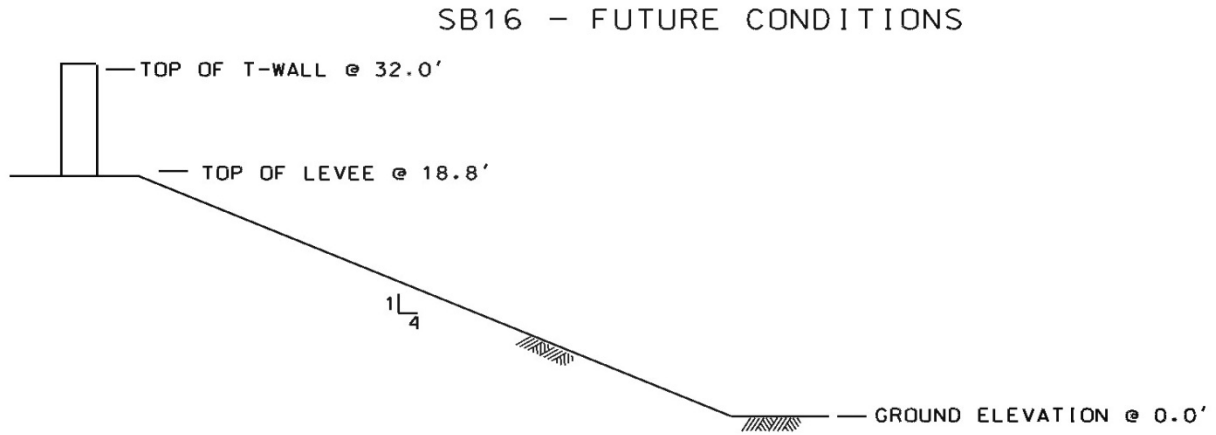
The typical levee design cross-section for the 1% design future conditions of MRGO Levee/Floodwall Combination (SB15) is shown in **Figure 3-30**. SB15 was originally designed as an earthen levee with an elevation at 19 ft. The upgrade requires the degradation of the existing levee by 2.0 ft to an elevation of 17 ft. The degradation is necessary to widen the top of the levee so the base of the T-wall can be constructed. The 1% hydraulic design elevation for future conditions must be 28 ft. The construction design grade elevation is 28 ft.



**Figure 3-30 Typical Levee Design Cross-section MRGO Levee/Floodwall Combination (SB15)**



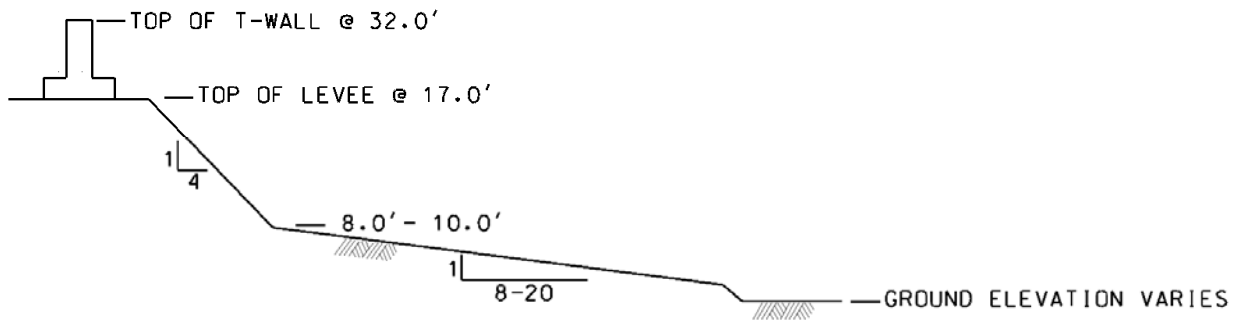
The typical levee cross-section for the 1% design future conditions of Caernarvon to Verret Levee/Floodwall Combination (SB16) is shown in **Figure3-31**. The 1% hydraulic design elevation for future conditions must be 32 ft. The construction design grade elevation is 32 ft.



**Figure 3-31 Typical Levee Design Cross-section Caernarvon to Verret Levee/Floodwall Combination (SB16)**

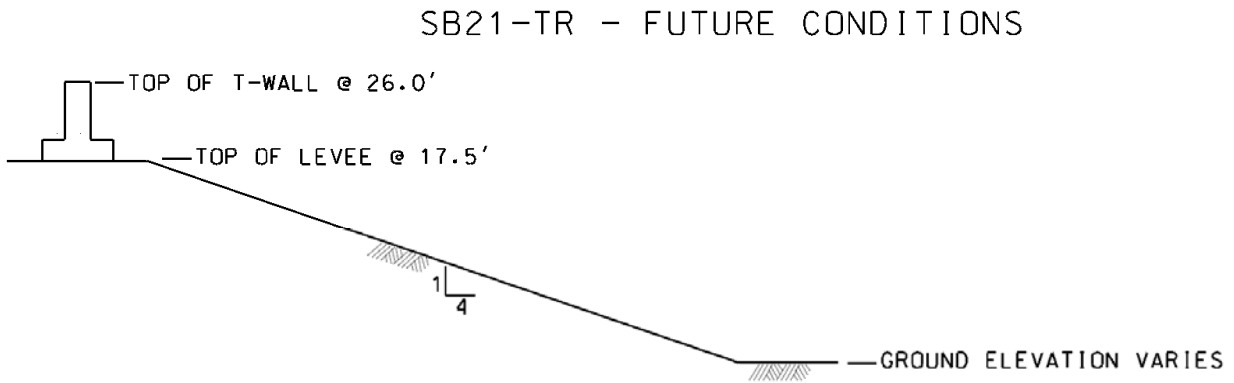
The typical levee design cross-section for the 1% design future conditions of Caernarvon to Verret Levee/Floodwall Combination (SB17) is shown in **Figure 3-32**. The 1% hydraulic design elevation for future conditions must be 32 ft. The construction design grade elevation is 32 ft.

### SB17 - FUTURE CONDITIONS



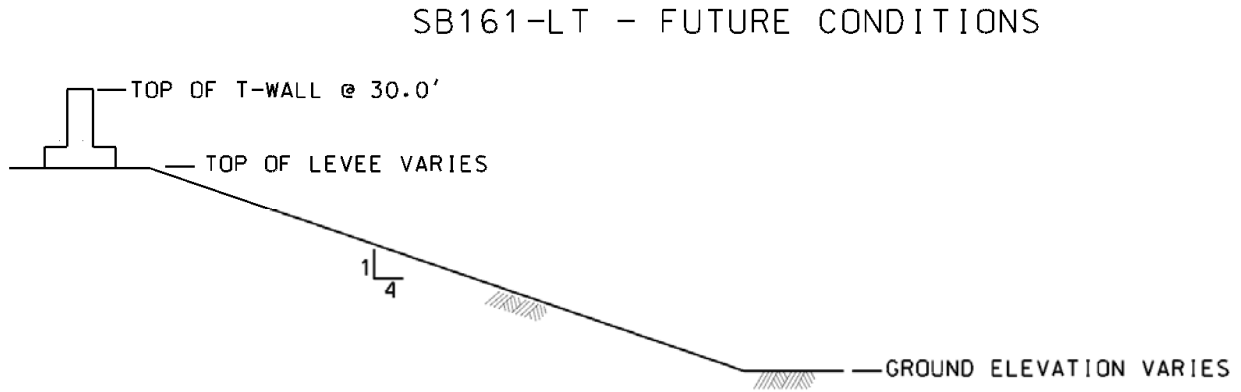
**Figure 3-32 Typical Levee Design Cross-section Caernarvon to Verret Levee/Floodwall Combination (SB17)**

The typical levee design cross-section for the 1% design future of Transition Reach (**SB21-TR**) is shown in **Figure 3-33**. The 1% hydraulic design elevation for future conditions must be 26.0 ft. The construction design grade elevation is 26.0 ft.



**Figure 3-33 Typical Levee Design Cross-section Transition Reach Levee/Floodwall Combination (SB21-TR) Future Conditions**

The typical levee design cross-section for the 1% design future conditions of Bayou Road and State Hwy 23 (SB161-LT) is shown in **Figure 3-34**. The 1% hydraulic design elevation for future conditions must be 30 ft. The design grade elevation is 30 ft.



**Figure 3-34 Typical Levee Design Cross-section Transition Reach Levee/Floodwall Combination (SB161-LT)**

### **3.9.5 Resiliency**

The hydraulic designs for the levees and structures within St. Bernard Parish were examined for resiliency by computing the 0.2% surge level (50% confidence). The results are presented in **Table 3-23**. For all sections, the 0.2% surge level remains below the top of the flood defense.

**Table 3-23 St. Bernard Parish Hydraulic Reaches – Resiliency**

St. Bernard Parish Reaches Resiliency Analysis (0.2% Event)					
Hydraulic Reach	Name	Type	Condition	Elevation (ft)	0.2% Event
					Surge Level (ft)
<b>SB11</b>	MRGO Levee - IHNC Surge Barrier Tie-in 1.7 Miles to SB12	Structure/Wall	Future	32.0	23.6
<b>SB12</b>	MRGO Levee - SB11 0.9 Miles to SB13	Structure/Wall	Future	30.0	22.6
<b>SB13</b>	MRGO Levee -Bayou Bienvenue to Bayou Dupre	Structure/Wall	Future	29.0	21.7
<b>SB15</b>	MRGO Levee - Bayou Dupre to Hwy 46	Structure/Wall	Future	28.0	21.4
<b>SB16</b>	Caernarvon to Verret	Structure/Wall	Future	32.0	22.4
<b>SB17</b>	Caernarvon to Verret	Structure/Wall	Future	32.0	23.5
<b>SB19-G</b>	Bayou Dupre Control Structure	Structure/Wall	Future	31.0 <sup>ss</sup>	21.0
<b>SB19-FW</b>	Bayou Dupre T-wall Tie-ins	Structure/Wall	Future	29.0	21.0
<b>SB20</b>	St. Mary Pump Station (Pump Station #8)	Structure/Wall	Future	32.0	21.8
<b>SB21-TR</b>	Transition Reach	Structure/Wall	Future	26.0–32.0	23.6
<b>SB21-FW</b>	Caernarvon Canal Floodwall (East of Canal)	Structure/Wall	Future	26.0	23.6
<b>SB21-G1</b>	Caernarvon Canal Sector Gate	Structure/Wall	Future	26.0	23.6
<b>SB21-G2</b>	Caernarvon Canal Hwy 39 Gate and Railroad Gate	Structure/Wall	Future	26.0	23.6
<b>SB161-LT</b>	Bayou Road to Hwy 46 Levee/Floodwall Combo	Structure/Wall	Future	30.0	21.4
<b>SB161-G1</b>	Caernarvon to Verret Hwy 46 Floodgate	Structure/Wall	Future	30.0	21.4
<b>SB161-G2</b>	Caernarvon to Verret Bayou Road Floodgate	Structure/Wall	Future	30.0	21.4

## 4.0 WEST BANK AND VICINITY

### 4.1 GENERAL

The West Bank and Vicinity region of the HSDRRS extends from the Davis Pond Freshwater Diversion, near Kenner, LA (St. Charles Parish) to the downstream point at Oakville, LA (Plaquemine Parish). This study traverses the Parishes of St. Charles, Jefferson, and Plaquemines (**Plate 1**). The water bodies affected by the West Bank and Vicinity Project are the west bank of the Mississippi River and Lake Cataouatche.

The design elevations in the West Bank area are dominated by surge levels caused by wind setup at the lake and surge intrusion from the Gulf of Mexico. The 1% surge elevations range from 6.5 ft in Lake Cataouatche to 7.3 ft in the East Harvey area. The wave action is generally low, especially in the narrow canals. The 1% wave characteristics just in front of the levee range from, a significant wave height, 2.0 to 3.0 ft and peak periods of 3.0 to 4.0 s. Notice that the wave characteristics in this area appear to be relatively low compared with what one may expect during these wind speeds. The modelled wave height and wave results appear lower than expected due to the marsh areas in the south. It should be noted that the number of representative output points from ADCIRC at the West Bank was relatively low. However, the 1% surge levels at the West Bank appear to be realistic compared with earlier findings and are therefore applied herein.

**Chapter 4.0** discusses the levee and floodwall elevations for the existing and future conditions in the West Bank and Vicinity. This section is divided into four sections:

- **Section 4.2** – Lake Cataouatche Reach (**Plates 9 and 9A**)
- **Section 4.3** – Westwego to Harvey Canal Reach (**Plate 10**)
- **Section 4.4** – East of Harvey Canal Reach (**Plates 11 and 12**)
- **Section 4.5** – WCC (**Plate 13**)

The individual subsections present the 1% chance annual exceedence hydraulic boundary conditions, 1% chance annual exceedence design elevations, and the resiliency analysis for the 0.2% chance annual exceedence storm event. Unless otherwise noted, elevations presented in this report are in feet/foot North American Vertical Datum of 1988 - 2004.65 (NAVD88).

The minimum criteria for resiliency must be that levees and structures do not catastrophically breach when design criteria are exceeded. Resilience also includes designing for possible changes in conditions, with the flexibility to adapt to future design conditions. For the design analysis, the final 1% design elevation is checked against the 0.2% surge elevation (50% confidence level). If the design elevation is lower, the elevation is raised to prevent free flow over the HSDRRS from a resiliency point of view. Additional armoring may be required to meet the desired final level of resiliency; this armoring is addressed in HSDRRS Levee Armoring EAR, June 2014.

The information included in the tables in this chapter are also summarized in **Appendix T**, Overtopping Design Criteria Tables.

## 4.2 LAKE CATAOUCHE REACH

Each alternative for hydraulic reaches within Lake Cataouatche Reach was reviewed during this update process. The alternatives for each corresponding hydraulic reach (where available) were reviewed along with the 95 or 100% structure or levee design plans. The alternative that best corresponded to the 95 or 100% structural design plans was considered the final hydraulic design. The data from the final hydraulic design was used to update data for the hydraulic boundary conditions, design elevations, and wave loads within this report.

The hydraulic reach identification has been updated from the October 2007 DER to match the current design conditions in their corresponding area.

### 4.2.1 General

The Lake Cataouatche Reach is located along the west bank of the Mississippi River at the Davis Pond Freshwater Diversion Structure, near Kenner, LA (St. Charles Parish) (**Plate 9**). The HSDRRS runs in a north-south direction following the Davis Freshwater Diversion Canal to US90. After crossing US90 the structures run east-west following the Outer Cataouatche Canal to the Bayou Segnette State Park. The levee length is approximately 14.3 miles long. The reach consists of two large levee reaches, the Mississippi River to US90 Levees and the US90 to Bayou Segnette State Park Levee, with several stretches of floodgates, floodwalls, and pump stations in between. The West Bank hydraulic reach number one is identified as (**WB01**) and subsequent numbers for the remaining hydraulic reaches.

Storm surges are reduced by US90, as documented in the *Westwego to Harvey Canal, Louisiana Hurricane Protection Project, Lake Cataouatche Area, Post Authorization Change Report*, dated December 1996, resulting in lower surge elevations for reach **WB31** than those for **WB01** and **WB43**.

**Plate 9** shows the hydraulic boundaries for the Lake Cataouatche Reach. The numbers indicate the hydraulic design elevations for several structures along the reach. The elevations displayed for levees will have both existing conditions (2007) and future conditions (2057). The elevations displayed for hard structures (floodwalls, floodwall/levee combinations, pump stations, etc.) will have future (2057) conditions only. All hard structures are designed and built for future conditions (2057) only. The hydraulic reach identification has been updated from the October 2007 DER to match the current design conditions in their corresponding area.

If structural superiority is included with a specific hard structure the hydraulic design elevation will have an additional number, color coded green. The hydraulic reaches in **Plate 9 and 9A** are different colors only to show the boundary limits of each reach. The colors do not represent a specific type of structure.

This figure also show the construction reaches as they correspond to the hydraulic reach. The construction boundary is off-set from the hydraulic boundary and labelled opposite the hydraulic reach label.



There were previously no constructed hurricane protection levees or floodwalls in reach **WB31**, from the Mississippi River to US90. The eastbank Davis Pond Guide Levee existed on the right of way of the (WB31) HSDRRS levee. There were three different flood protection alternatives evaluated that fall within, or partially within, this reach. The alternatives followed different alignments, but all three would extend from near Kenner to the northern end of the existing Lake Cataouatche levees at US90. The **WB31** final alignment ties in with the Mississippi River levee near Kenner, LA at the Davis Pond Freshwater Diversion Structure and follows the canal to north of US90. It then follows north of US90 until it turns to cross US90 and tie into the US90 to Bayou Segnette State Park Levee (**WB01**) where the hydraulic parameters begin to change.

The existing levee reach, **WB01**, extends from US90 to Bayou Segnette State Park. It trends to the southeast from US90, then due east, and then bends northward (**Plate 9**). The pump station outlet consists of pipes over the existing levee. Future plans are to abandon this station and reroute drainage. The pump stations (Lake Cataouatche Pump Station #1 and #2) will require a vertical wall at the outlet (**WB02**).

After the northward bend in reach **WB01**, the system changes into a floodwall (**Plate 9**) and becomes Bayou Segnette State Park Floodwall (**WB43**). **WB43** extends from Bayou Segnette State Park to the Bayou Segnette Pump Stations #1 and #2 (**WB05**), and consists of an existing floodwall. **Plate 9A** provides a more detailed map of the Bayou Segnette area.

#### **4.2.2 Hydraulic Boundary Conditions**

The hydraulic design characteristics for the Lake Cataouatche Reach are listed in **Table 4-1**. The existing conditions are based on the JPM-OS method using the results from ADCIRC and STWAVE model runs. Output points with the highest values for the reaches were selected, but the variation in the hydraulic conditions is small. To account for changes due to subsidence and sea level rise over a 50 year period, the surge elevations were adjusted by adding 2.0 ft and the wave heights were adjusted by adding 1.0 ft, for future conditions. The wave period is increased in such a way that the wave steepness remains constant.

An average bottom elevation of 0 to 1.0 ft was assumed for ground elevations in front of the levees to determine if the wave heights would be depth limited. A wave height of 40% of the design water depth was used as the depth-limiting criteria. The design wave heights for this reach were all less than 40% of the design water depth, therefore they were not reduced.

**Table 4-1 Lake Cataouatche Hydraulic Reaches – 1% Hydraulic Boundary Conditions**

<b>West Bank Reaches (Lake Cataouatche Reach) 1% Hydraulic Boundary Conditions</b>									
<b>Hydraulic Reach</b>	<b>Name</b>	<b>Type</b>	<b>Condition</b>	<b>Surge Level (ft)</b>		<b>Significant Wave Height (ft)</b>		<b>Peak Period (s)</b>	
				<b>Mean</b>	<b>Std</b>	<b>Mean</b>	<b>Std</b>	<b>Mean</b>	<b>Std</b>
<b>WB01</b>	US 90 to the Bayou Segnette State Park	Levee	Existing	6.5	0.7	2.1	0.2	5.5	1.1
<b>WB01</b>	US 90 to the Bayou Segnette State Park	Levee	Future	8.5	0.7	3.1	0.2	6.7	1.1
<b>WB02</b>	Lake Cataouatche Pump Station #1and #2	Structure/Wall	Future	8.5	0.7	3.1	0.2	6.7	1.1
<b>WB05</b>	Bayou Segnette Pump Station #1and #2	Structure/Wall	Future	8.5	0.7	2.4	0.1	5.6	0.9
<b>WB31-FW1</b>	Western Tie-in Monoliths at US90	Structure/Wall	Future	8.5	0.7	3.1	0.2	6.7	1.1
<b>WB31-FW2</b>	Railroad T-walls Union Pacific and BN&SF Railroads	Structure/Wall	Future	8.5	0.7	2.6	0.2	6.9	1.1
<b>WB31-FW3</b>	Bayou Verret Navigable Floodgates T-wall Section 1	Structure/Wall	Future	8.5	0.7	3.1	0.2	6.7	1.1
<b>WB31-FW4</b>	Bayou Verret Navigable Floodgates T-wall Section 2	Structure/Wall	Future	8.5	0.7	3.1	0.2	6.7	1.1
<b>WB31-G1</b>	BN&SF Railroad Swing Gate	Structure/Wall	Future	8.5	0.7	2.6	0.3	6.3	0.7
<b>WB31-G2</b>	Union Pacific Railroad Swing Gate	Structure/Wall	Future	8.5	0.7	2.6	0.3	6.3	0.7
<b>WB31-G3</b>	Bayou Verret Navigable Floodgate	Structure/Wall	Future	8.5	0.7	3.1	0.2	6.7	1.1
<b>WB31-L East-West</b>	Mississippi River to US 90 Levees	Levee	Existing	6.5	0.7	1.6	0.2	5.4	1.1

<b>West Bank Reaches (Lake Cataouatche Reach) 1% Hydraulic Boundary Conditions</b>									
<b>Hydraulic Reach</b>	<b>Name</b>	<b>Type</b>	<b>Condition</b>	<b>Surge Level (ft)</b>		<b>Significant Wave Height (ft)</b>		<b>Peak Period (s)</b>	
				<b>Mean</b>	<b>Std</b>	<b>Mean</b>	<b>Std</b>	<b>Mean</b>	<b>Std</b>
<b>WB31-L East-West</b>	Mississippi River to US 90 Levees	Levee	Future	8.5	0.7	2.6	0.2	6.9	1.1
<b>WB31-L North-South</b>	Mississippi River to US 90 Levees	Levee	Existing	6.5	0.7	1.5	0.2	2.5	0.5
<b>WB31-L North-South</b>	Mississippi River to US 90 Levees	Levee	Future	8.5	0.7	2.5	0.2	3.2	0.5
<b>WB43</b>	Bayou Segnette State Park Floodwall	Structure/Wall	Future	8.5	0.7	2.4	0.1	5.6	0.9

**US90 to Bayou State Park Levee (WB01):** The levee runs east-west from US90 then trends to the southeast following the Outer Cataouatche Canal, and then turns northward (**Plate 9**). The reach is 10.4 miles long and is transected by a 922 ft structure at Lake Cataouatche Pump Stations #1 and #1 (**WB02**). The levee's design surge level, depth-limited wave height, and peak period for existing conditions are 6.5 ft, 2.1 ft, and 5.5 s, respectively and the future design surge level, depth-limited wave height, and peak period are 8.5 ft, 3.1 ft, and 6.7 s, respectively (**Table 4-1**).

**Lake Cataouatche Pump Station #1 and #2 (WB02):** The floodwall for the pump station runs in an east-west direction within the US90 to Bayou State Park Levee (**WB01**) reach. The reach is 922 ft long. The floodwall's design surge level, depth-limited wave height, and peak period for future conditions are 8.5 ft, 3.1 ft, and 6.7 s, respectively (**Table 4-1**).

**Bayou Segnette Pump Station #1 and #2 (WB05):** The floodwall for the pump station runs in a north-south direction within the US90 to Bayou State Park Levee (**WB01**) reach. The reach is 366 ft long. The floodwall's design surge level, depth-limited wave height, and peak period for future conditions are 8.5 ft, 2.4 ft, and 5.6 s, respectively (**Table 4-1**).

**US90 to Bayou State Park Levee (WB31-L):** The levee runs north-south from the Mississippi River to US90 (**Plate 9**). The reach is 1.3 miles long and is transected by; a 50 ft BN&SF Railroad swing gate (**WB31-G1**); a 289 ft Union Pacific Railroad swing gate (**WB31-G2**); a 1,199 ft Western Tie-in Monolith at US90 (**WB31-FW1**); and a 197 ft floodwall at both Union Pacific and BN&SF railroad (**WB31-FW2**). The levee's design surge level, depth-limited wave height, and peak period for existing conditions are 6.5 ft, 1.6 ft, and 5.4 s, respectively and the future design surge level, depth-limited wave height and peak period are 8.5 ft, 2.6 ft, and 6.9 s, respectively (**Table 4-1**).

**Western Tie-in Monolith at US90 (WB31-FW1):** The floodwall's design surge level, depth-limited wave height, and peak period for future conditions are 8.5 ft, 3.1ft, and 6.7 s, respectively (**Table 4-1**).

**BN&SF Railroad Floodgate and Structure (WB31-G1 and WB31-FW2):** The structure follows the existing levee alignment in a north-south direction. The structure consists of a floodgate and supporting floodwalls surrounding the railroad. The floodgate is 50 ft long and the floodwall is 42 ft long. The gate's design surge level, depth-limited wave height, and peak period for future conditions are 8.5 ft, 2.6 ft, and 6.3 s, respectively (**Table 4-1**). The floodwall's design surge level, depth-limited wave height, and peak period for future conditions are 8.5 ft, 3.1ft, and 6.7 s, respectively (**Table 4-1**).

**Union Pacific Railroad Floodgate and Structure (WB31-G2 and WB31-FW2):** The structure follows the existing levee alignment in a north-south direction. The structure consists of a floodgate and supporting floodwalls. The floodgate is 65 ft long and the floodwall is 70 ft long. The gate's design surge level, depth-limited wave height, and peak period for future conditions are 8.5 ft, 2.6 ft, and 6.3 s, respectively (**Table 4-1**). The floodwall's design surge level, depth-

limited wave height, and peak period for future conditions are 8.5 ft, 2.6 ft, and 6.9 s, respectively (**Table 4-1**).

**Bayou Verret Navigational Floodgate and Structure (WB31-G3, WB31-FW3, and WB31-FW4):** The structure traverses the Bayou Verret Canal in an east-west direction, just south of the Outer Cataouatche Canal. The structure consists of a navigable floodgate and supporting floodwalls. The floodgate is 189 ft long and the floodwalls are 120 and 160 ft long. The structure's design surge level, depth-limited wave height, and peak period for future conditions are 8.5 ft, 3.1 ft, and 6.7 s, respectively (**Table 4-1**).

### 4.2.3 Project Design Elevations

The design characteristics for the hydraulic reaches in the Lake Cataouatche Reach are listed in **Table 4-2**. Hydraulic reaches (**WB01**) and (**WB31-L**) are levees and the remaining reaches are floodwalls, floodgates, or pump stations. Note that these structures are only evaluated for future conditions, because these are hard structures. Lake Cataouatche Pump Stations #1 and #2 (**WB02**), Bayou Segnette Pump Stations #1 and #2 (**WB05**), BN&SF Railroad Floodgate (**WB31-G1**), Union Pacific Railroad Floodgate (**WB31-G2**) and Bayou Verret Navigable Floodgate (**WB31-G3**) design grade elevation includes 2.0 ft of structural superiority.

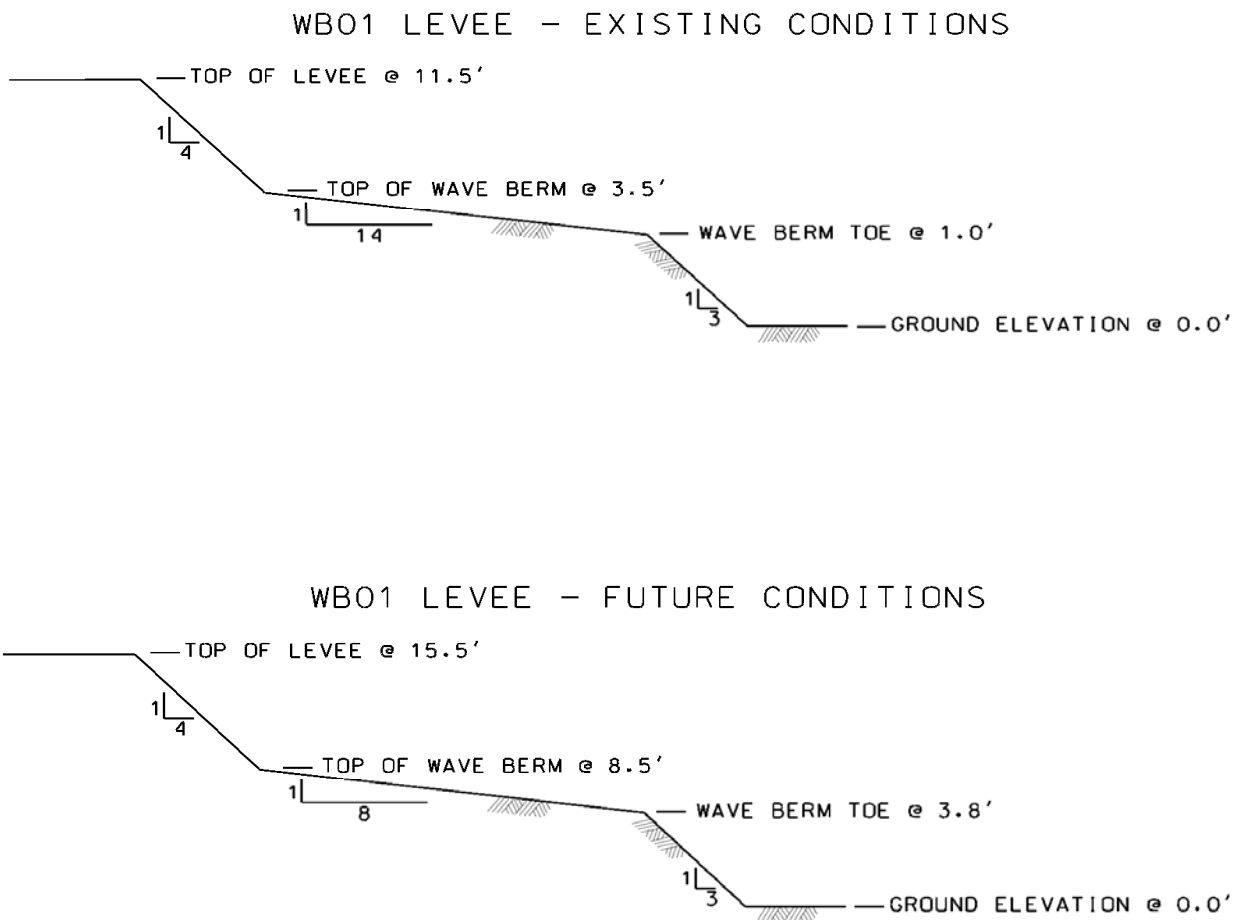
**Table 4-2 Lake Cataouatche Hydraulic Reaches – 1% Design Information**

West Bank Reaches (Lake Cataouatche Reach) 1% Hydraulic Design Elevations							
Hydraulic Reach	Name	Type	Condition	Depth at Toe (ft)	Elevation (ft)	Overtopping Rate	
						q50 (cfs/ft)	q90 (cfs/ft)
WB01	US 90 to the Bayou Segnette State Park	Levee	Existing	6.5	11.5	0.004	0.029
WB01	US 90 to the Bayou Segnette State Park	Levee	Future	8.5	15.5	0.01	0.05
WB02	Lake Cataouatche Pump Station #1 and #2	Structure/Wall	Future	8.5	15.5 <sup>ss</sup>	0.001	0.003
WB05	Bayou Segnette Pump Station #1 and #2	Structure/Wall	Future	8.5	16.0 <sup>ss</sup>	0.000	0.000
WB31-FW1	Western Tie-in Monoliths at US90	Structure/Wall	Future	8.5	15.5	0.0006	0.0031
WB31-FW2	Railroad T-walls Union Pacific and BN&SF Railroads	Structure/Wall	Future	7.5	13.0	0.004	0.02
WB31-FW3	Bayou Verret Navigable Floodgates T-wall Section 1	Structure/Wall	Future	8.5	15.5	0.000	0.0004
WB31-FW4	Bayou Verret Navigable Floodgates T-wall Section 2	Structure/Wall	Future	8.5	15.5	0.000	0.0004
WB31-G1	BN&SF Railroad Swing Gate	Structure/Wall	Future	7.5	15.0 <sup>ss</sup>	0.0002	0.001
WB31-G2	Union Pacific Railroad Swing Gate	Structure/Wall	Future	7.5	15.0 <sup>ss</sup>	0.0002	0.001
WB31-G3	Bayou Verret Navigable Floodgate	Structure/Wall	Future	8.5	16.0 <sup>ss</sup>	0.001	0.002
WB31-L East-West	Mississippi River to US 90 Levees	Levee	Existing	5.5	9.0	0.008	0.092
WB31-L East-West	Mississippi River to US 90 Levees	Levee	Future	7.5	13.0	0.008	0.057

West Bank Reaches (Lake Cataouatche Reach) 1% Hydraulic Design Elevations							
Hydraulic Reach	Name	Type	Condition	Depth at Toe (ft)	Elevation (ft)	Overtopping Rate	
						q50 (cfs/ft)	q90 (cfs/ft)
WB31-L North-South	Mississippi River to US 90 Levees	Levee	Existing	5.5	9.0	0.008	0.092
WB31-L North-South	Mississippi River to US 90 Levees	Levee	Future	7.5	13.0	0.008	0.057
WB43	Bayou Segnette State Park Floodwall	Structure/Wall	Future	8.5	14.0	0.000	0.002

#### 4.2.4 Typical Cross-Sections

The typical levee design cross-section for the 1% design existing and future conditions of the US90 to Bayou Segnette State Park Levee (**WB01**) is show in **Figure 4-1**. The 1% design elevation for existing conditions must be 11.5 ft and 15.5 ft for the future conditions. A wave berm was included to reduce the wave overtopping. The wave berm and the crest must be elevated to meet the design criteria for future conditions.

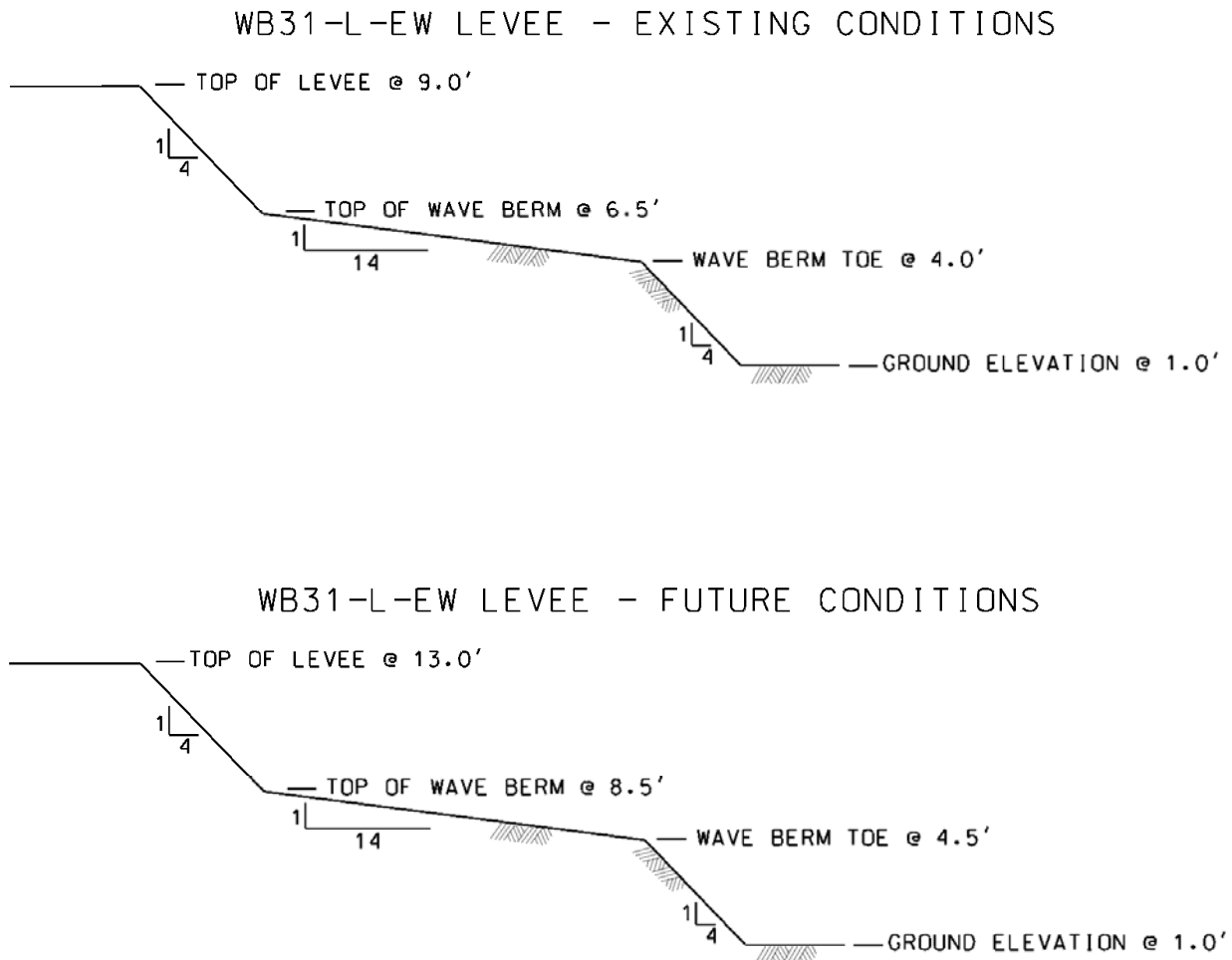


**Figure 4-1 Typical Levee Design Cross-sections US90 to Bayou Segnette State Park Levee (WB01)**

The typical levee design cross-section for the 1% design existing and future conditions of the Mississippi River to US90 Levee (**WB31-L-EW**) is show in **Figure 4-2**. The 1% design



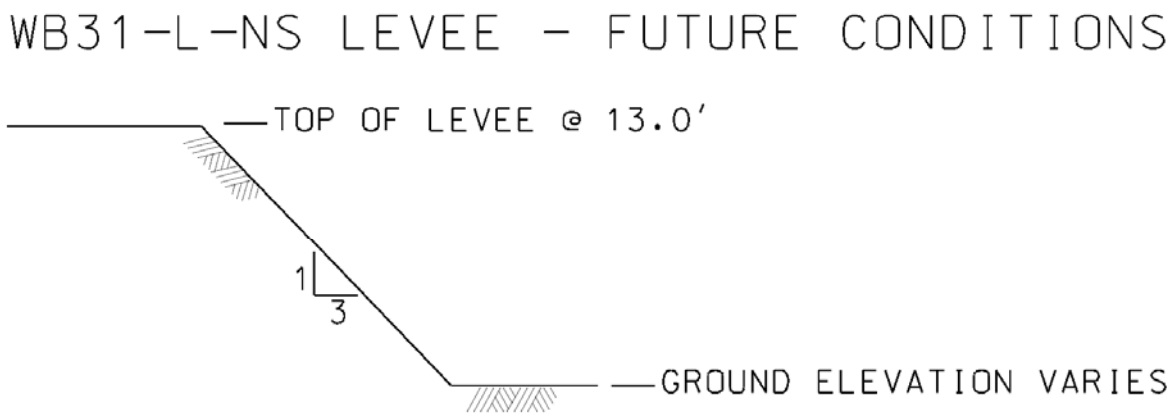
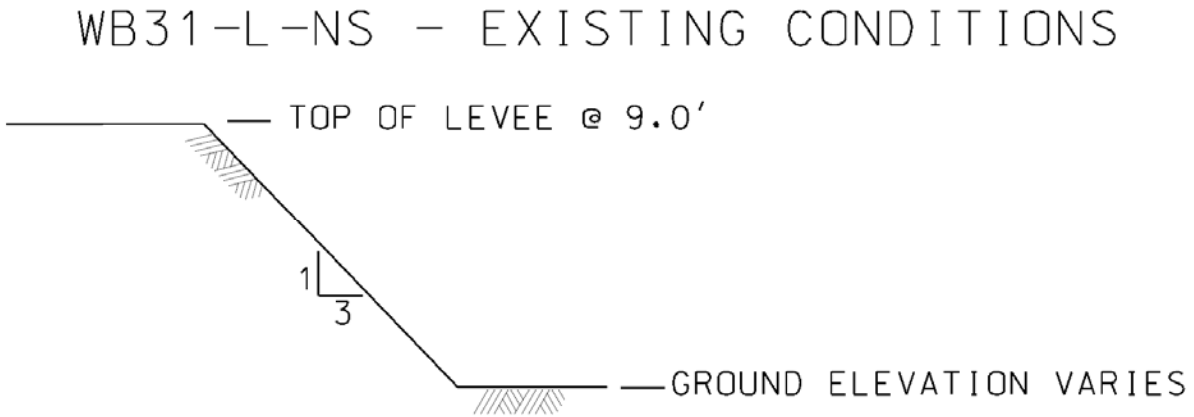
elevation for existing conditions must be 9.0 ft and 13 ft for the future conditions. The design for levees in the Lake Cataouatche area has steep slopes near the crest. A wave berm was included to reduce the wave overtopping. The wave berm and the crest must be elevated to meet the design criteria for future conditions. The construction design grade elevation is 11.5 ft, which is the hydraulic design elevation plus 2.5 ft of over-build.



**Figure 4-2 Typical Levee Design Cross-sections Mississippi River to US90 Levee (WB31-L-EW)**

The typical levee design cross-section for the 1% design existing and future conditions of the Mississippi River to US90 Levee (WB31-L-NS) is show in **Figure 4-3**. The 1% design elevation for existing conditions must be 9.0 ft and 13 ft for the future conditions. The design for levees in the Lake Cataouatche area has steep slopes near the crest. A wave berm was included to reduce

the wave overtopping. The wave berm and the crest must be elevated to meet the design criteria for future conditions. The construction design grade elevation is 11.5 ft, which is the hydraulic design elevation plus 2.5 ft of over-build.



**Figure 4-3 Typical Levee Design Cross-sections Mississippi River to US90 Levee (WB31-L-NS)**

#### **4.2.5 Resiliency**

The hydraulic designs for the levees and structures along the Lake Cataouatche reach were examined for resiliency by computing the 0.2% surge level (50% confidence). The results are presented in **Table 4-3**. For all sections, the 0.2% surge level remains below the top of the flood defense.

**Table 4-3 Lake Cataouatche Hydraulic Reaches – Resiliency**

<b>West Bank Reaches (Lake Cataouatche Reach) Resiliency Analysis (0.2% Event)</b>					
<b>Hydraulic Reach</b>	<b>Name</b>	<b>Type</b>	<b>Condition</b>	<b>Elevation (ft)</b>	<b>0.2% Event</b>
					<b>Surge Level (ft)</b>
<b>WB01</b>	US 90 to the Bayou Segnette State Park	Levee	Existing	11.5	9.0
<b>WB01</b>	US 90 to the Bayou Segnette State Park	Levee	Future	15.5	11.0
<b>WB02</b>	Lake Cataouatche Pump Station #1 and #2	Structure/Wall	Future	15.5 <sup>ss</sup>	11.0
<b>WB05</b>	Bayou Segnette Pump Station #1 and #2	Structure/Wall	Future	16.0 <sup>ss</sup>	11.1
<b>WB31-FW1</b>	Western Tie-in Monoliths at US90	Structure/Wall	Future	15.5	11.0
<b>WB31-FW2</b>	Railroad T-walls Union Pacific and BN&SF Railroads	Structure/Wall	Future	13.0	10.9
<b>WB31-FW3</b>	Bayou Verret Navigable Floodgates T-wall Section 1	Structure/Wall	Future	15.5	11.0
<b>WB31-FW4</b>	Bayou Verret Navigable Floodgates T-wall Section 2	Structure/Wall	Future	15.5	11.0
<b>WB31-G1</b>	BN&SF Railroad Swing Gate	Structure/Wall	Future	15.0 <sup>ss</sup>	10.9
<b>WB31-G2</b>	Union Pacific Railroad Swing Gate	Structure/Wall	Future	15.0 <sup>ss</sup>	10.9
<b>WB31-G3</b>	Bayou Verret Navigable Floodgate	Structure/Wall	Future	16.0 <sup>ss</sup>	11.0
<b>WB31-L East-West</b>	Mississippi River to US 90 Levees	Levee	Existing	9.0	8.9
<b>WB31-L East-West</b>	Mississippi River to US 90 Levees	Levee	Future	13.0	10.9
<b>WB31-L North-South</b>	Mississippi River to US 90 Levees	Levee	Existing	9.0	8.9
<b>WB31-L North-South</b>	Mississippi River to US 90 Levees	Levee	Future	13.0	10.9
<b>WB43</b>	Bayou Segnette State Park Floodwall	Structure/Wall	Future	14.0	11.1

### 4.3 WESTWEGO TO HARVEY CANAL REACH

Each alternative for hydraulic reaches within Westwego to Harvey Canal Reach was reviewed during this update process. The alternatives for each corresponding hydraulic reach (where available) were reviewed along with the 95 or 100% structure or levee design plans. The alternative that best corresponded to the 95 or 100% structural design plans was considered the final hydraulic design. The data from the final hydraulic design was used to update data for the hydraulic boundary conditions, design elevations, and wave loads within this report.

The hydraulic reach identification has been updated from the October 2007 DER to match the current design conditions in their corresponding area.

#### 4.3.1 General

The Westwego to Harvey Canal Reach portion of the WBV is located along the west bank of the Mississippi River in Bayou Segnette State Park from the Segnette Park Pump Stations #1 and #2 (Jefferson Parish) to the Robinson Point Structures at Harvey Canal (Jefferson Parish) (**Plate 10**). The levee follows the current levee alignment and is approximately 19 miles long. The reach consists of three large levee reaches, the New Westwego Pump Station to Orleans Village Levee, the Hwy 3134 to Old Estelle Pump Stations Levee, and the Orleans Village to Ames Pump Station Levee, with several stretches of floodgates, floodwalls, and pump stations in between. The West Bank hydraulic reach number seven is identified as (**WB07**) and subsequent numbers for the remaining hydraulic reaches.

**Plate 10** shows the hydraulic boundaries for the Westwego to Harvey Canal Reach. The numbers indicate the hydraulic design elevations for several structures along the reach. The elevations displayed for levees will have both existing conditions (2007) and future conditions (2057). The elevations displayed for hard structures (floodwalls, floodwall/levee combinations, pump stations, etc.) will have future (2057) conditions only. All hard structures are designed and built for future conditions (2057) only. If structural superiority is included with a specific hard structure the hydraulic design elevation will have an additional number, color coded green. The hydraulic reaches in **Plate 10** are different colors only to show the boundary limits of each reach. The colors do not represent a specific type of structure.

This figure also show the construction reaches as they correspond to the hydraulic reach. The construction boundary is off-set from the hydraulic boundary and labelled opposite the hydraulic reach label.

#### 4.3.2 Hydraulic Boundary Conditions

The hydraulic design characteristics of the reaches in the Westwego to Harvey Canal Reach are listed in **Table 4-4**. The variation in hydraulic conditions was small throughout the reach. To account for changes due to subsidence and sea level rise over a 50 year period, the surge elevations were adjusted by adding 2.0 ft and the wave heights were adjusted by adding 1.0 ft, for future conditions. The wave period is increased in such a way that the wave steepness remains constant.

**Table 4-4 Westwego to Harvey Canal Hydraulic Reaches – 1% Hydraulic Boundary Conditions**

<b>West Bank Reaches (Westwego to Harvey Canal Reach) 1% Hydraulic Boundary Conditions</b>									
<b>Hydraulic Reach</b>	<b>Name</b>	<b>Type</b>	<b>Condition</b>	<b>Surge Level (ft)</b>		<b>Significant Wave Height (ft)</b>		<b>Peak Period (s)</b>	
				<b>Mean</b>	<b>Std</b>	<b>Mean</b>	<b>Std</b>	<b>Mean</b>	<b>Std</b>
<b>WB07</b>	New Westwego Pump Station #2	Structure/Wall	Future	8.5	0.7	2.4	0.1	5.6	0.9
<b>WB08-B</b>	New Westwego Pump Station #2 to Orleans Village Levee	Levee	Existing	6.5	0.7	1.4	0.1	4.3	0.9
<b>WB08-B</b>	New Westwego Pump Station #2 to Orleans Village Levee	Levee	Future	8.5	0.7	2.4	0.1	5.6	0.9
<b>WB10-FW1</b>	Westminster Pump Station Floodwalls	Structure/Wall	Future	8.5	0.7	2.4	0.1	5.6	0.9
<b>WB10-FW2</b>	Westminster Pump Station Tie-in Walls	Structure/Wall	Future	8.5	0.7	2.4	0.1	5.6	0.9
<b>WB11</b>	Ames to Mt. Kennedy Floodwall	Structure/Wall	Future	9.3	0.9	2.3	0.1	4.9	0.7
<b>WB11-P1</b>	Ames Pump Station	Structure/Wall	Future	9.3	0.9	2.3	0.1	4.9	0.7
<b>WB11-P2</b>	Mt. Kennedy Pump Station	Structure/Wall	Future	9.3	0.9	2.3	0.1	4.9	0.7
<b>WB12</b>	Estelle Pump Station #1 (Old Estelle)	Structure/Wall	Future	9.3	0.9	2.3	0.1	4.9	0.7
<b>WB32</b>	Highway 45 to Highway 3134 Floodwall	Structure/Wall	Future	9.3	0.9	2.3	0.1	4.9	0.7
<b>WB41</b>	Highway 3134 to Old Estelle Pump Stations Levee	Levee	Existing	7.3	0.9	1.3	0.1	3.7	0.7
<b>WB41</b>	Highway 3134 to Old Estelle Pump Stations Levee	Levee	Future	9.3	0.9	2.3	0.1	4.9	0.7

West Bank Reaches (Westwego to Harvey Canal Reach) 1% Hydraulic Boundary Conditions									
Hydraulic Reach	Name	Type	Condition	Surge Level (ft)		Significant Wave Height (ft)		Peak Period (s)	
				Mean	Std	Mean	Std	Mean	Std
WB42-FW1	Gulf South 1 Utility Crossing	Structure/Wall	Future	9.3	0.9	2.3	0.1	4.9	0.7
WB42-FW2	Gulf South 2 Utility Crossing	Structure/Wall	Future	9.3	0.9	2.3	0.1	4.9	0.7
WB42-FW3	Chevron Pipeline Crossing	Structure/Wall	Future	9.3	0.9	2.3	0.1	4.9	0.7
WB42-FW4	Enterprise Pipeline Crossing	Structure/Wall	Future	9.3	0.9	2.3	0.1	4.9	0.7
WB42-L	Orleans Village to Highway 45 Levee	Levee	Existing	7.3	0.9	1.3	0.1	3.7	0.7
WB42-L	Orleans Village to Highway 45 Levee	Levee	Future	9.3	0.9	2.3	0.1	4.9	0.7
WB43-A	Segnette Pump Station to Company Canal Levee	Levee	**	3.0	0.5	1.4	0.1	2.5	0.5
WB43-B	Company Canal & Westwego Floodwall	Structure/Wall	**	3.0	0.5	1.4	0.1	2.5	0.5
WB43-C	Old Westwego Pump Station	Structure/Wall	**	3.0	0.5	1.4	0.1	2.5	0.5
WB43-D-CPLX	Bayou Segnette Complex	Structure/Wall	Future	8.5	0.7	2.4	0.1	5.6	0.9
WB43-D-FW	Bayou Segnette Complex Floodwall	Structure/Wall	Future	8.5	0.7	2.4	0.1	5.6	0.9
WB43-D-L	Bayou Segnette Complex Levee	Levee	Existing	6.5	0.7	1.4	0.1	4.3	0.9
WB43-D-L	Bayou Segnette Complex Levee	Levee	Future	8.5	0.7	2.4	0.1	5.6	0.9
WB44-FW1	Old Estelle Pump Station to Robinson Point	Structure/Wall	Future	9.3	0.9	2.3	0.1	4.9	0.7

West Bank Reaches (Westwego to Harvey Canal Reach) 1% Hydraulic Boundary Conditions									
Hydraulic Reach	Name	Type	Condition	Surge Level (ft)		Significant Wave Height (ft)		Peak Period (s)	
				Mean	Std	Mean	Std	Mean	Std
WB44-FW2	Inlet Floodwall	Structure/Wall	*	5.3	0.4	1.5	0.2	2.5	0.5

\*\*The existing and future conditions are the same because the surge levels will be controlled by the actions taken at the Bayou Segnette Complex during storm events.

\*The existing and future conditions are the same because the surge levels will be controlled by the actions taken at the WCC during storm events.

**New Westwego Pump Station Pump Station #2 (WB07):** The structure runs in a northwest-southeast direction and lies between the Bayou Segnette State Park Floodwall (WB43) and the New Westwego Pump Station #2 to Orleans Village Levee (WB08-A). The structure is 535 ft long. The structure's design surge level, wave height, and peak period for future conditions are 8.5 ft, 2.4 ft, and 5.6 s, respectively (Table 4-4).

**Segnette Pump Station to Company Canal Levee (WB08-B):** The levee follows the current levee alignment from the New Westwego Pump Station Pump Station #2 (WB07) to the Orleans Village to Ames Pump Station Levee (WB42-L). The levee is 3.5 miles long and is transected by the 495 ft Westminster Pump Station Tie-in Walls (WB10-FW1 and WB10-FW2) and a 325 ft crossing for 20 inch Gulf South Pipeline. The Gulf South Pipeline includes 11 ft T-walls with scour protection and 1:3 cut slopes. The crossing lies 300 ft west of and parallel to Borrow Canal. The levee's design surge level, depth-limited wave height, and peak period for existing conditions are 6.5 ft, 1.4 ft, and 4.3 s, respectively. The levee's design surge level, wave height, and peak period for future conditions are 8.5 ft, 2.4 ft, and 5.6 s, respectively (Table 4-4).

**Westminster Pump Station Floodwalls and Tie-in Walls (WB10-FW1 and WB10-FW2):** The structure follows the current levee alignment and is located within Segnette Pump Station to Company Canal Levee (WB08-B) reach. The reach is 800 ft long with more than 350 ft of tie-in floodwalls. The structure's design surge level, wave height, and peak period for future conditions are 8.5 ft, 2.4 ft, and 5.6 s, respectively (Table 4-4).

**Ames to Mt. Kennedy Floodwall (WB11):** The floodwall follows the current levee alignment and is located within the Orleans Village to Ames Pump Station Levee (WB42). The floodwall is 524 ft long and lies between the Ames and Mt. Kennedy Pump Stations. The floodwall's design surge level, wave height, and peak period for future conditions are 9.3 ft, 2.3 ft, and 4.9 s, respectively (Table 4-4).

**Ames Pump Station (WB11-P1):** The structure follows the current levee alignment and is located within the Orleans Village to Ames Pump Station Levee (WB42). The structure is 382 ft long. The structure's design surge level, wave height, and peak period for future conditions are 9.3 ft, 2.3 ft, and 4.9 s, respectively (Table 4-4).

**Mt. Kennedy Pump Station (WB11-P2):** The structure follows the current levee alignment and is located within the Orleans Village to Ames Pump Station Levee (WB42). The structure is 345 ft long. The structure's design surge level, wave height, and peak period for future conditions are 9.3 ft, 2.3 ft, and 4.9 s, respectively (Table 4-4).

**Estelle Pump Station also know as Old Estelle Pump Station (WB12):** The structure follows the current levee alignment and is located within the Hwy 45 to Hwy 3134 Floodwall (WB32). The structure is 752 ft long. The structure's design surge level, wave height, and peak period for future conditions are 9.3 ft, 2.3 ft, and 4.9 s, respectively (Table 4-4).

**Hwy 45 to Hwy 3134 Floodwall (WB32):** The floodwall follows the current levee alignment and is located Orleans Village to Ames Pump Station Levee (WB42) and Hwy 3134 to Old



Estelle Pump Stations (**WB41**). The floodwall is 1.3 miles long. The floodwall's design surge level, wave height, and peak period for future conditions are 9.3 ft, 2.3 ft, and 4.9 s, respectively (**Table 4-4**).

**Hwy 3134 to Old Estelle Pump Stations Levee (WB41):** The levee follows the current levee alignment from the Hwy 45 to Hwy 3134 Floodwall (**WB32**) to Estelle Pump Station (**WB12**). The levee is 2.9 miles long. The levee's design surge level, depth-limited wave height, and peak period for existing conditions are 7.3 ft, 1.3 ft, and 3.7 s, respectively. The levee's design surge level, wave height, and peak period for future conditions are 9.3 ft, 2.3 ft, and 4.9 s, respectively (**Table 4-4**).

**Pipeline Crossings – Floodwall (WB42-FW1-FW4):** The floodwalls follow the current levee alignment and are located within the Orleans Village to Hwy 45 Levee (**WB42-L**). The floodwall's design surge level, wave height, and peak period for future conditions are 9.3 ft, 2.3 ft, and 4.9 s, respectively (**Table 4-4**).

**Orleans Village to Hwy 45 Levee (WB42-L):** The levee follows the current levee alignment from Segnette Pump Station to Company Canal Levee (**WB08-B**) to the Hwy 45 to Hwy 3134 Floodwall (**WB32**). The levee is 5.7 miles long and is transected by Ames to Mt. Kennedy Floodwall (**WB11**), Ames and Mt. Kennedy Pump Stations (**WB11-P1** and **WB11-P2**). The levee's design surge level, wave height, and peak period for existing conditions are 7.3 ft, 1.3 ft, and 3.7 s, respectively. The levee's design surge level, depth-limited wave height, and peak period for future conditions are 9.3 ft, 2.3 ft, and 4.9 s, respectively (**Table 4-4**).

**Segnette Pump Station to Company Canal Levee (WB43-A):** The levee follows the current levee alignment from the Bayou Segnette Complex Floodwalls (**WB43-D-FW**) to the Company Canal and Westwego Floodwall (**WB43-B**). The levee is 657 ft long. The levee's computed existing and future design surge level, wave height, and peak period are 3.0 ft, 1.4 ft, and 2.5 s, respectively (**Table 4-4**).

**Company Canal and Westwego Floodwall (WB43-B):** The floodwall alignment runs from Segnette Pump Station to Company Canal Floodwall (**WB43-A**) and around the northern end of Company Canal, then ties-in with Old Westwego Pump Station (**WB43-C**). The floodwall is 0.70 mile long. The floodwall's computed existing and future design surge level, wave height, and peak period are 3.0 ft, 1.4 ft, and 2.5 s, respectively (**Table 4-4**).

**Old Westwego Pump Station (WB43-C):** The structure follows the current levee alignment and is located within Company Canal and Westwego Floodwall (**WB43-B**). The structure is 136 ft long. The structure's computed existing and future design surge level, wave height, and peak period are 3.0 ft, 1.4 ft, and 2.5 s, respectively (**Table 4-4**).

**Bayou Segnette Complex (WB43-D-CPLX):** The complex consists of floodwalls, levees and a navigable floodgate, which traverses the Bayou Segnette Canal just below Company Canal. The complex structures tie into the Bayou Segnette Complex Floodwalls (**WB43-D-FW**) and the Bayou Segnette State Park Floodwall (**WB43**). **WB43** was discussed in a previous section. The

structure is 286 ft long. The structure's design surge level, wave height, and peak period for future conditions are 8.5 ft, 2.4 ft, and 5.6 s, respectively (**Table 4-4**).

**Bayou Segnette Complex Floodwalls (WB43-D-FW):** The floodwalls within the Bayou Segnette Complex traverse the Bayou Segnette Canal just below Company Canal. The floodwalls tie into the Company Canal Levee (**WB43-A**) and the Bayou Segnette State Park Floodwall (**WB43**). **WB43** was discussed in a previous section. The structure is 373 ft long. The structure's design surge level, wave height, and peak period for future conditions are 8.5 ft, 2.4 ft, and 5.6 s, respectively (**Table 4-4**).

**Bayou Segnette Complex Levees (WB43-D-L):** The levees within the Bayou Segnette Complex traverse the Bayou Segnette Canal just below Company Canal. The floodwalls tie into the Company Canal Levee (**WB43-A**) and the Bayou Segnette State Park Floodwall (**WB43**). **WB43** was discussed in a previous section. The structure is 900 ft long. The structure's existing and future design surge level, wave height, and peak period are 6.5 ft, 1.4 ft, and 4.3 s and 8.5 ft, 2.4 ft, and 5.6 s, respectively (**Table 4-4**).

**Old Estelle Pump Station to Robinson Point Floodwall and Inlet Floodwall (WB44-FW1 and WB44-FW2):** The floodwall runs follows the current levee alignment in an east-west direction from Estelle Pump Station #1 (**WB12**) to Estelle Pump Station #2 to Lapalco Sector Gate West Levee (**WB14-L**). **WB12-L** will be discussed further in another section. The structure is 0.8 mile long. **WB44-FW1**'s design surge level, wave height, and peak period for future conditions are 9.3 ft, 2.3 ft, and 4.9 s, respectively (**Table 4-4**). **WB44-FW2**'s computed existing and future design surge level, depth-limited wave height, and peak period are 5.3 ft, 1.5 ft, and 2.5 s, respectively (**Table 4-4**).

### 4.3.3 Project Design Elevations

The design characteristics for the hydraulic reaches in the Westwego to Harvey Reach are listed in **Table 4-5**. Hydraulic reach **WB08-A**, **WB08-B**, **WB41**, and **WB42-L** are levees and the remaining hydraulic reaches are floodwalls or pump stations. Note that structures (including levee/floodwall combinations) are only evaluated for future conditions because they are hard structures. New Westwego Pump Station (**WB07**), Westminster Pump Station (**WB10-FW1**), Ames Pump Station (**WB11-P1**), Mt Kennedy Pump Station (**WB11-P2**), Estelle Pump Station #1 (**WB12**), and Pipeline Crossings – Floodwalls (**WB42-FW2**, **WB42-FW3** and **WB42-FW4**) design grade elevation includes 2.0 ft of structural superiority.

**Table 4-5 Westwego to Harvey Canal Hydraulic Reaches – 1% Design Information**

West Bank Reaches (Westwego to Harvey Canal Reach) 1% Hydraulic Design Elevations							
Hydraulic Reach	Name	Type	Condition	Depth at Toe (ft)	Elevation (ft)	Overtopping Rate	
						q50 (cfs/ft)	q90 (cfs/ft)
<b>WB07</b>	New Westwego Pump Station #2	Structure/Wall	Future	8.5	16.0 <sup>SS</sup>	0.000	0.000
<b>WB08-B</b>	New Westwego Pump Station #2 to Orleans Village Levee	Levee	Existing	5.5	10.5	0.001	0.010
<b>WB08-B</b>	New Westwego Pump Station #2 to Orleans Village Levee	Levee	Future	7.5	14.0	0.008	0.036
<b>WB10-FW1</b>	Westminster Pump Station Floodwalls	Structure/Wall	Future	8.5	16.0 <sup>SS</sup>	0.000	0.000
<b>WB10-FW2</b>	Westminster Pump Station Tie-in Walls	Structure/Wall	Future	8.5	14.0	0.008	0.035
<b>WB11</b>	Ames to Mt. Kennedy Floodwall	Structure/Wall	Future	9.3	14.0	0.001	0.008
<b>WB11-P1</b>	Ames Pump Station	Structure/Wall	Future	9.3	16.0 <sup>SS</sup>	0.000	0.000
<b>WB11-P2</b>	Mt. Kennedy Pump Station	Structure/Wall	Future	9.3	16.0 <sup>SS</sup>	0.000	0.000
<b>WB12</b>	Estelle Pump Station #1 (Old Estelle)	Structure/Wall	Future	9.3	16.0 <sup>SS</sup>	0.000	0.000
<b>WB32</b>	Hwy 45 to Hwy 3134 Floodwall	Structure/Wall	Future	9.3	14.0	0.001	0.008
<b>WB41</b>	Hwy 3134 to Old Estelle Pump Stations Levee	Levee	Existing	7.3	10.5	0.003	0.034
<b>WB41</b>	Hwy 3134 to Old Estelle Pump Stations Levee	Levee	Future	9.3	14.0	0.010	0.061

West Bank Reaches (Westwego to Harvey Canal Reach) 1% Hydraulic Design Elevations							
Hydraulic Reach	Name	Type	Condition	Depth at Toe (ft)	Elevation (ft)	Overtopping Rate	
						q50 (cfs/ft)	q90 (cfs/ft)
WB42-FW1	Gulf South 1 Utility Crossing	Structure/Wall	Future	9.3	16.0 <sup>SS</sup>	0.000	0.000
WB42-FW2	Gulf South 2 Utility Crossing	Structure/Wall	Future	9.3	16.0 <sup>SS</sup>	0.000	0.000
WB42-FW3	Chevron Pipeline Crossing	Structure/Wall	Future	9.3	16.0 <sup>SS</sup>	0.000	0.000
WB42-FW4	Enterprise Pipeline Crossing	Structure/Wall	Future	9.3	16.0 <sup>SS</sup>	0.000	0.000
WB42-L	Orleans Village to Hwy 45 Levee	Levee	Existing	7.3	10.5	0.003	0.035
WB42-L	Orleans Village to Hwy 45 Levee	Levee	Future	9.3	14.0	0.010	0.063
WB43-A	Segnette Pump Station to Company Canal Floodwall	Levee	**	5.0	5.0	0.004	0.049
WB43-B	Company Canal & Westwego Floodwall	Structure/Wall	**	4.4	4.0	0.017	0.091
WB43-C	Old Westwego Pump Station	Structure/Wall	**	5.0	5.0	0.007	0.040
WB43-D-CPLX	Bayou Segnette Complex	Structure/Wall	Future	8.5	16.0	0.000	0.000
WB43-D-FW	Bayou Segnette Complex Floodwall	Structure/Wall	Future	8.5	16.0	0.000	0.000
WB43-D-L	Bayou Segnette Complex Levee	Levee	Existing	5.5	10.5	0.001	0.010
WB43-D-L	Bayou Segnette Complex Levee	Levee	Future	7.5	14.0	0.008	0.036
WB44-FW1	Old Estelle Pump Station to Robinson Point	Structure/Wall	Future	9.3	14.0	0.001	0.008

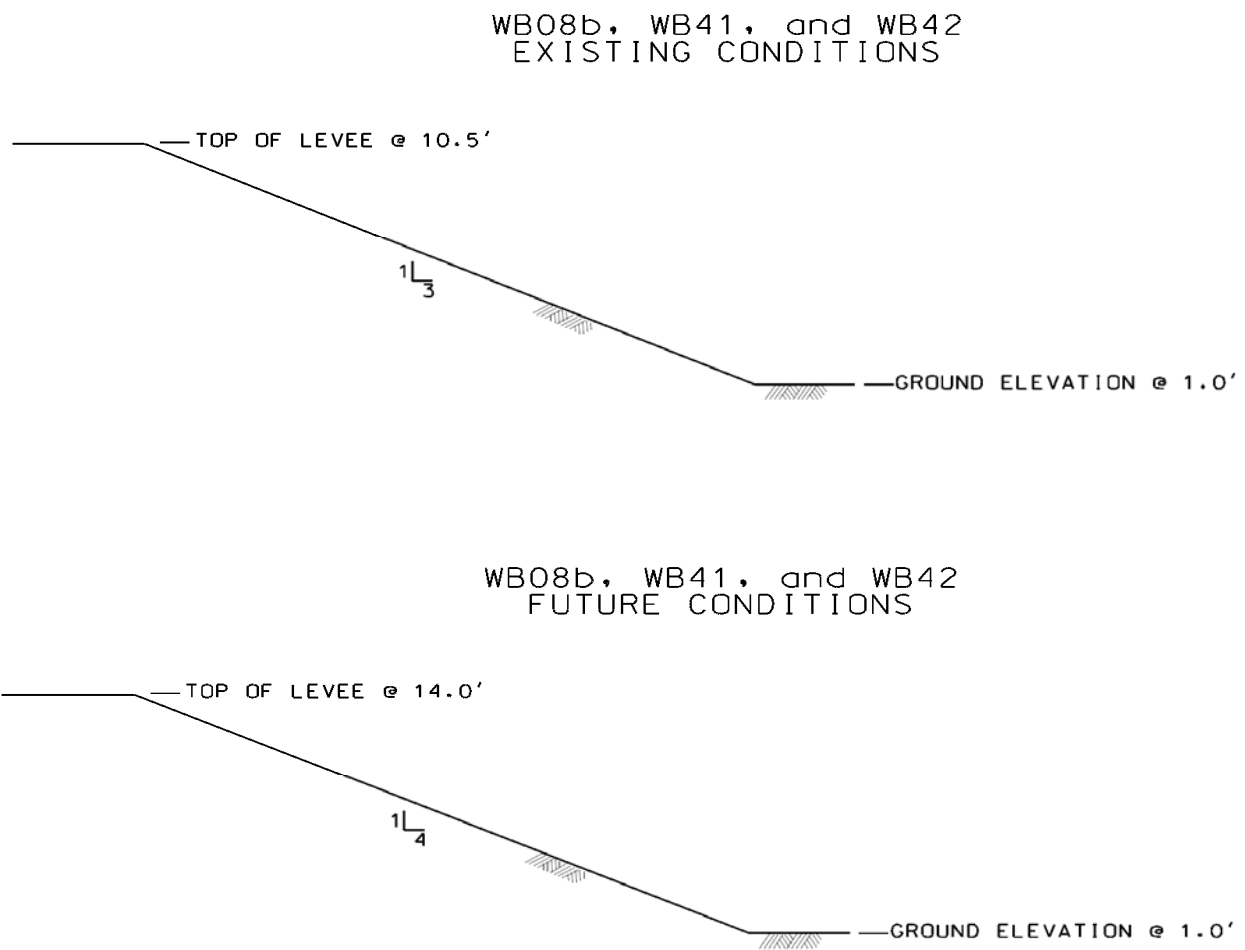
West Bank Reaches (Westwego to Harvey Canal Reach) 1% Hydraulic Design Elevations							
Hydraulic Reach	Name	Type	Condition	Depth at Toe (ft)	Elevation (ft)	Overtopping Rate	
						q50 (cfs/ft)	q90 (cfs/ft)
WB44-FW2	Inlet Floodwall	Structure/Wall	*	5.3	8.5	0.001	0.004

\*\*The existing and future conditions are the same because the surge levels will be controlled by the actions taken at the Bayou Segnette Complex during storm events.

\*The existing and future conditions are the same because the surge levels will be controlled by the actions taken at the WCC during storm events.

#### 4.3.4 Typical Cross-Sections

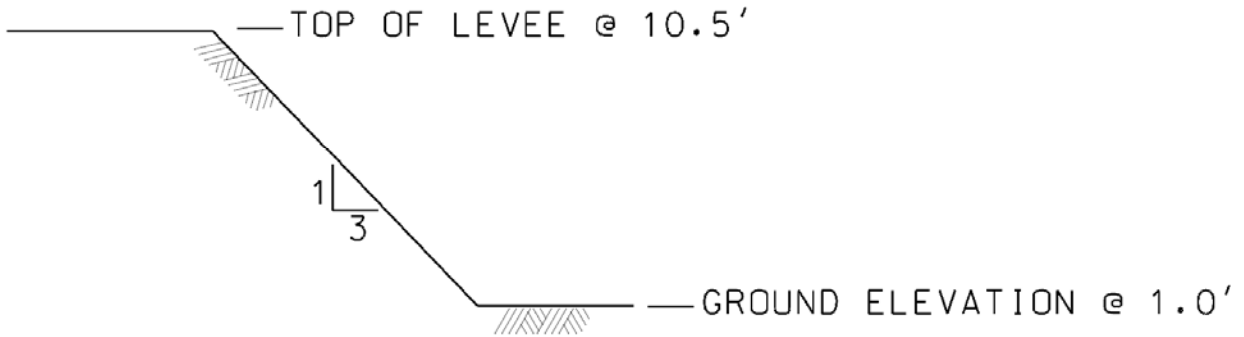
The typical levee design cross-sections for 1% design existing and future conditions of the Segnette Pump Station to Company Canal Levee (**WB08-B**), Hwy 3134 to Old Estelle Pump Stations Levee (**WB41**), and Orleans Village to Hwy 45 Levee (**WB42-L**) are shown in (**Figure 4-4**). All the levees are simple levees with straight slopes and no wave berms. The 1% design elevation for existing conditions must be 10.5 ft and 14 ft for future conditions for each levee. The construction design grade elevation for **WB08-A and WB08-B** is 10.5 ft, meets the hydraulic design elevation. The construction design grade elevation for **WB41 and WB42-L** is 14 ft, which is the hydraulic design elevation plus 3.5 ft of over-build.



**Figure 4-4 Typical Levee Design Cross-sections Westwego to Harvey Levees (WB08-B, WB41, and WB42-L)**

The typical levee design cross-sections for 1% design existing and future conditions of the Westwego to Harvey Levees WB43-A are shown in (Figure 4-5). All the levees are simple levees with straight slopes and no wave berms. The 1% design elevation for existing conditions must be 10.5 ft and 14.0 ft for future conditions for each levee.

### WB43A - EXISTING CONDITIONS



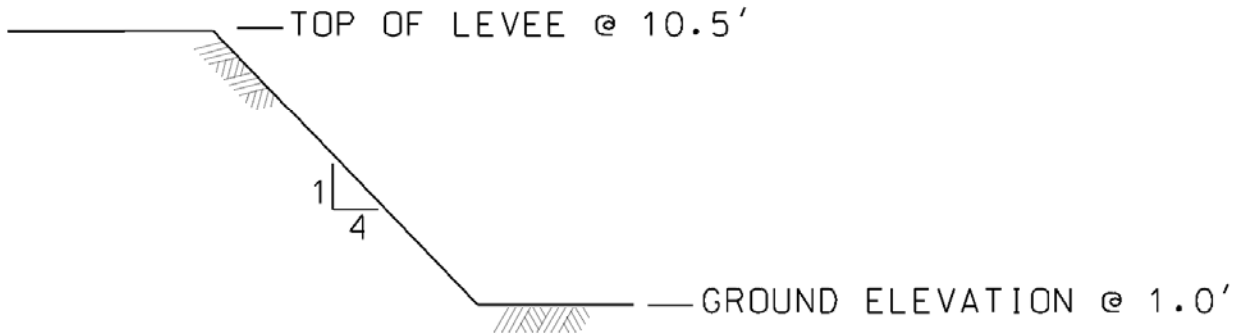
### WB43A - FUTURE CONDITIONS



**Figure 4-5 Typical Levee Design Cross-sections Westwego to Harvey Levees WB43-A**

The typical levee design cross-sections for 1% design existing and future conditions of the Westwego to Harvey Levees WB 43-D-L are shown in **(Figure 4-6)**. All the levees are simple levees with straight slopes and no wave berms. The 1% design elevation for existing conditions must be 10.5 ft and 14 ft for future conditions for each levee.

### WB43-D-L EXISTING CONDITIONS



### WB43-D-L - FUTURE CONDITIONS



**Figure 4-6 Typical Levee Design Cross-sections Westwego to Harvey Levees WB 43-D-L**



### 4.3.5 Resiliency

The hydraulic designs for the levees and structures along the Westwego to Harvey Canal reach were examined for resiliency by computing the 0.2% surge level (50% confidence). The results are presented in **Table 4-6**. For all sections, the 0.2% surge level remains below the top of the flood defense.

**Table 4-6 Westwego to Harvey Canal Hydraulic Reaches - Resiliency**

<b>West Bank Reaches (Westwego to Harvey Canal Reach) Resiliency Analysis (0.2% Event)</b>					
<b>Hydraulic Reach</b>	<b>Name</b>	<b>Type</b>	<b>Condition</b>	<b>Elevation (ft)</b>	<b>0.2% Event</b>
					<b>Surge Level (ft)</b>
<b>WB07</b>	New Westwego Pump Station #2	Structure/Wall	Future	16.0 <sup>ss</sup>	11.1
<b>WB08-B</b>	New Westwego Pump Station #2 to Orleans Village Levee	Levee	Existing	10.5	9.1
<b>WB08-B</b>	New Westwego Pump Station #2 to Orleans Village Levee	Levee	Future	14.0	11.1
<b>WB10-FW1</b>	Westminster Pump Station Floodwalls	Structure/Wall	Future	16.0 <sup>ss</sup>	11.1
<b>WB10-FW2</b>	Westminster Pump Station Tie-in Walls	Structure/Wall	Future	14.0	11.1
<b>WB11</b>	Ames to Mt. Kennedy Floodwall	Structure/Wall	Future	14.0	12.4
<b>WB11-P1</b>	Ames Pump Station	Structure/Wall	Future	16.0 <sup>ss</sup>	12.4
<b>WB11-P2</b>	Kennedy Pump Station	Structure/Wall	Future	16.0 <sup>ss</sup>	12.4
<b>WB12</b>	Estelle Pump Station #1 (Old Estelle)	Structure/Wall	Future	16.0 <sup>ss</sup>	12.4
<b>WB32</b>	Hwy 45 to Hwy 3134 Floodwall	Structure/Wall	Future	14.0	12.4
<b>WB41</b>	Hwy 3134 to Old Estelle Pump Stations Levee	Levee	Existing	10.5	10.4
<b>WB41</b>	Hwy 3134 to Old Estelle Pump Stations Levee	Levee	Future	14.0	12.4
<b>WB42-FW1</b>	Gulf South 1 Utility Crossing	Structure/Wall	Future	16.0 <sup>ss</sup>	12.4
<b>WB42-FW2</b>	Gulf South 2 Utility Crossing	Structure/Wall	Future	16.0 <sup>ss</sup>	12.4

<b>West Bank Reaches (Westwego to Harvey Canal Reach) Resiliency Analysis (0.2% Event)</b>					
<b>Hydraulic Reach</b>	<b>Name</b>	<b>Type</b>	<b>Condition</b>	<b>Elevation (ft)</b>	<b>0.2% Event</b>
					<b>Surge Level (ft)</b>
<b>WB42-FW3</b>	Chevron Pipeline Crossing	Structure/Wall	Future	16.0 <sup>SS</sup>	12.4
<b>WB42-FW4</b>	Enterprise Pipeline Crossing	Structure/Wall	Future	16.0 <sup>SS</sup>	12.4
<b>WB42-L</b>	Orleans Village to Hwy 45 Levee	Levee	Existing	10.5	10.4
<b>WB42-L</b>	Orleans Village to Hwy 45 Levee	Levee	Future	14.0	12.4
<b>WB43-A</b>	Segnette Pump Station to Company Canal Levee	Levee	**	5.0	**
<b>WB43-B</b>	Company Canal & Westwego Floodwall	Structure/Wall	**	4.0	**
<b>WB43-C</b>	Old Westwego Pump Station	Structure/Wall	**	5.0	**
<b>WB43-D-CPLX</b>	Bayou Segnette Complex	Structure/Wall	Future	16.0	11.1
<b>WB43-D-FW</b>	Bayou Segnette Complex Floodwall	Structure/Wall	Future	16.0	11.1
<b>WB43-D-L</b>	Bayou Segnette Complex	Structure/Wall	Existing	10.5	9.1
<b>WB43-D-L</b>	Bayou Segnette Complex	Structure/Wall	Future	14.0	11.1
<b>WB44-FW1</b>	Old Estelle Pump Station to Robinson Point	Structure/Wall	Future	14.0	12.4
<b>WB44-FW2</b>	Inlet Floodwall	Structure/Wall	*	8.5	*

\*\*The existing and future conditions are the same because the surge levels will be controlled by the actions taken at the Bayou Segnette Complex during storm events.

\*The existing and future conditions are the same because the surge levels will be controlled by the actions taken at the WCC during storm events.

#### **4.4 EAST OF HARVEY CANAL REACH**

Each alternative for hydraulic reaches within the East Harvey Canal Reach was reviewed during this update process. The alternatives for each corresponding hydraulic reach (where available)

were reviewed along with the 95 or 100% structure or levee design plans. The alternative that best corresponded to the 95 or 100% structural design plans was considered the final hydraulic design. The data from the final hydraulic design was used to update data for the hydraulic boundary conditions, design elevations, and wave loads within this report.

The hydraulic reach identification has been updated from the October 2007 DER to match the current design conditions in their corresponding area.

#### **4.4.1 General**

The East of Harvey Canal Reach portion of the WBV is located along the west bank of the Mississippi River and includes Harvey, Algiers, and Hero Canals (**Plates 11 and 12**). The reach extends from the levee between Robinson Point on Harvey Canal (Jefferson Parish) and to the terminus of Hero Canal near the Mississippi River (Plaquemines Parish). This reach has several pump stations, levees, and floodwalls. The West Bank hydraulic reach number 14 is identified as (**WB14**) and subsequent numbers for the remaining hydraulic reaches.

**Plates 11 and 12** show the hydraulic boundaries for the East of Harvey Canal Reach to include the Algiers Canal. The numbers indicate the hydraulic design elevations for several structures along the reach. The elevations displayed for levees will have both existing conditions (2007) and future conditions (2057). The elevations displayed for hard structures (floodwalls, floodwall/levee combinations, pump stations, etc.) will have future (2057) conditions only. All hard structures are designed and built for future conditions (2057) only. If structural superiority is included with a specific hard structure the hydraulic design elevation will have an additional number, color coded green. The hydraulic reaches in **Plates 11 and 12** are different colors only to show the boundary limits of each reach. The colors do not represent a specific type of structure.

This figure also shows the construction reaches as they correspond to the hydraulic reach. The construction boundary is off-set from the hydraulic boundary and labelled opposite the hydraulic reach label.

#### **4.4.2 Hydraulic Boundary Conditions**

The hydraulic design characteristics of the reaches east of Harvey Canal are listed in **Table 4-7**. To account for changes due to subsidence and sea level rise over a 50 year period, the surge elevations were adjusted by adding 2.0 ft and the wave heights were adjusted by adding 1.0 ft, for future conditions. The variation in hydraulic conditions was same throughout the reach. The wave period is increased in such a way that the wave steepness remains constant.

**Table 4-7 East of Harvey Canal Hydraulic Reaches – 1% Hydraulic Boundary Conditions**

<b>West Bank Reaches (East of Harvey Canal Reach) 1% Hydraulic Boundary Conditions</b>									
<b>Hydraulic Reach</b>	<b>Name</b>	<b>Type</b>	<b>Condition</b>	<b>Surge Level (ft)</b>		<b>Significant Wave Height (ft)</b>		<b>Peak Period (s)</b>	
				<b>Mean</b>	<b>Std</b>	<b>Mean</b>	<b>Std</b>	<b>Mean</b>	<b>Std</b>
<b>WB14-FW1</b>	Robinson Point to Estelle Pump Station #2 West Floodwall	Structure/Wall	*	5.3	0.4	1.5	0.2	2.5	0.5
<b>WB14-FW2</b>	Hero Pump Station to Algiers Canal Floodwall	Structure/Wall	*	5.3	0.4	1.5	0.2	2.5	0.5
<b>WB14-L</b>	Estelle Pump Station #2 to Lapalco Sector Gate West Levee	Levee	*	5.3	0.4	1.5	0.2	2.5	0.5
<b>WB15-FW1</b>	New Estelle Pump Station and Fronting Protection	Structure/Wall	*	5.3	0.4	1.5	0.2	2.5	0.5
<b>WB15-FW2</b>	New Estelle Pump Station Tie-In Walls	Structure/Wall	*	5.3	0.4	1.5	0.2	2.5	0.5
<b>WB16-P</b>	Cousins Pump Station #1, #2, and #3 (on Harvey Canal) Fronting Protection	Structure/Wall	*	5.3	0.4	1.5	0.2	2.5	0.5
<b>WB16-FW</b>	Cousins Pump Station #1, #2, and #3 (on Harvey Canal) Floodwall	Structure/Wall	*	5.3	0.4	1.5	0.2	2.5	0.5
<b>WB19</b>	Transition Point to Hero Canal to Oakville	Levee	Existing	7.3	0.9	1.3	0.1	3.7	0.7
<b>WB19</b>	Transition Point to Hero Canal to Oakville	Levee	Future	9.3	0.9	2.3	0.1	4.9	0.7
<b>WB19-A1</b>	Hero Canal Area West of Pump Station	Levee	Existing	7.3	0.9	1.3	0.1	3.7	0.7
<b>WB19-A1</b>	Hero Canal Area West of Pump Station	Levee	Future	9.3	0.9	2.3	0.1	4.9	0.7
<b>WB19-A2</b>	Hero Canal Area East of Pump Station	Levee	Existing	7.3	0.9	1.3	0.1	3.7	0.7

West Bank Reaches (East of Harvey Canal Reach) 1% Hydraulic Boundary Conditions									
Hydraulic Reach	Name	Type	Condition	Surge Level (ft)		Significant Wave Height (ft)		Peak Period (s)	
				Mean	Std	Mean	Std	Mean	Std
<b>WB19-A2</b>	Hero Canal Area East of Pump Station	Levee	Future	9.3	0.9	2.3	0.1	4.9	0.7
<b>WB19-A-P</b>	Fronting Protection for Pump Station at Sector Gate	Structure/Wall	Future	9.3	0.9	2.3	0.1	4.9	0.7
<b>WB19-AW-FW</b>	Eastern Tie-in Floodwalls	Structure/Wall	Future	9.3	0.9	2.3	0.1	4.9	0.7
<b>WB19-AW-G1</b>	Hwy 23 Northbound & Southbound T-walls	Structure/Wall	Future	9.3	0.9	2.3	0.1	4.9	0.7
<b>WB19-AW-G2</b>	Eastern Tie-in Railroad Gate & Hwy Gate	Structure/Wall	Future	9.3	0.9	2.3	0.1	4.9	0.7
<b>WB19-FW</b>	Hero Canal Bulkhead Closure Structure Floodwalls	Structure/Wall	Future	9.3	0.9	2.3	0.1	4.9	0.7
<b>WB19-G</b>	Hero Canal Bulkhead Closure Structure	Structure/Wall	Future	9.3	0.9	2.3	0.1	4.9	0.7
<b>WB19-P</b>	Oakville Pump Station Fronting Protection	Pump Station	Future	9.3	0.9	2.3	0.1	4.9	0.7
<b>WB23-P1</b>	Belle Chase Pump Station #1	Structure/Wall	*	5.3	0.4	1.5	0.2	2.5	0.5
<b>WB23-P2</b>	Belle Chase Pump Station #2	Structure/Wall	*	5.3	0.4	1.5	0.2	2.5	0.5
<b>WB23-P3</b>	Whitney Barataria Pump Station	Structure/Wall	*	5.3	0.4	1.5	0.2	2.5	0.5
<b>WB24</b>	Planters Pump Station	Structure/Wall	*	5.3	0.4	1.5	0.2	2.5	0.5
<b>WB27</b>	Hero Pump Station (on Harvey Canal)	Structure/Wall	*	5.3	0.4	1.5	0.2	2.5	0.5
<b>WB30-FW1</b>	Algiers Canal West Floodwall near Belle Chase	Structure/Wall	*	5.3	0.4	1.5	0.2	2.5	0.5

West Bank Reaches (East of Harvey Canal Reach) 1% Hydraulic Boundary Conditions									
Hydraulic Reach	Name	Type	Condition	Surge Level (ft)		Significant Wave Height (ft)		Peak Period (s)	
				Mean	Std	Mean	Std	Mean	Std
WB30-FW2	Algiers Canal East Floodwall near Belle Chase	Structure/Wall	*	5.3	0.4	1.5	0.2	2.5	0.5
WB30-G1	Algiers Canal West Bank Floodgates	Structure/Wall	*	5.3	0.4	1.5	0.2	2.5	0.5
WB30-G2	Algiers Canal West Swing Gate near Belle Chase	Structure/Wall	*	5.3	0.4	1.5	0.2	2.5	0.5
WB30-G3	Algiers Canal West Gate at Belle Chase Tunnel	Structure/Wall	*	5.3	0.4	1.5	0.2	2.5	0.5
WB30-G4	Algiers Canal Railroad Gate West near Belle Chase	Structure/Wall	*	5.3	0.4	1.5	0.2	2.5	0.5
WB30-G5	Algiers Canal East Gate at Tunnel Road near Belle Chase	Structure/Wall	*	5.3	0.4	1.5	0.2	2.5	0.5
WB30-G6	Algiers Canal East Gate at Belle Chase Tunnel	Structure/Wall	*	5.3	0.4	1.5	0.2	2.5	0.5
WB30-G7	Algiers Canal East Gate near Belle Chase	Structure/Wall	*	5.3	0.4	1.5	0.2	2.5	0.5
WB30-G8	Algiers Canal Railroad Gate (east) near Belle Chase	Structure/Wall	*	5.3	0.4	1.5	0.2	2.5	0.5
WB30-L1	Algiers Canal West Bank Levee	Levee	*	5.3	0.4	1.5	0.2	2.5	0.5
WB30-L2	Algiers Canal East Bank Levee	Levee	*	5.3	0.4	1.5	0.2	2.5	0.5
WB30-W-P1	New Orleans S&WB Pump Stations #11 (also known as OP #11)	Structure/Wall	*	5.3	0.4	1.5	0.2	2.5	0.5
WB30-W-P2	New Orleans S&WB Pump Stations #13	Structure/Wall	*	5.3	0.4	1.5	0.2	2.5	0.5
WB40	Harvey Canal Floodwall	Structure/Wall	*	5.3	0.4	1.5	0.2	2.5	0.5

West Bank Reaches (East of Harvey Canal Reach) 1% Hydraulic Boundary Conditions									
Hydraulic Reach	Name	Type	Condition	Surge Level (ft)		Significant Wave Height (ft)		Peak Period (s)	
				Mean	Std	Mean	Std	Mean	Std
WB40-L	Sector Gate at Lapalco Overpass on Harvey Canal	Structure/Wall	*	5.3	0.4	1.5	0.2	2.5	0.5

\*The existing and future conditions are the same because the surge levels will be controlled by the actions taken at the WCC during storm events.

The bottom elevation near the levees and floodwalls is generally around 0 ft or less. Because the wave heights are small in these canals, the exact bottom elevation is not needed because the waves are not depth-limited. The hydraulic design wave heights were not reduced for any of the reaches within this reach, based on this criteria.

### **Harvey Canal**

There are several pump stations that output into Harvey Canal. The impact of increased water volumes into these constricted areas on the surge elevations were accounted for in the design elevations of the system. An existing HEC-RAS model for an ongoing study, *Donaldsonville to the Gulf Feasibility Study*, was modified to include the pumping stations and the Harvey and Algiers Canals. The HEC-RAS model was run with a 100-year rainfall in the interior areas which are pumped into the Harvey and Algiers Canals. The 100-year surge elevation was used as a downstream boundary. Based on the HEC-RAS results, the surge elevations for the output points used for the design of the structures within Harvey Canal were increased by 0.5 ft to account for the pumping into the canal, for both existing and future condition designs.

**Estelle Pump Station #2 to Lapalco Sector Gate West Levee (WB14-L):** The levee runs in a north-south direction from Old Estelle to Robinson Point Floodwall (**WB44**) to Cousins Pump Stations #1, #2, and #3 (**WB16**) on the east bank. This hydraulic reach is 1.6 miles long and is transected by the 0.52 mile long Robinson Point to Estelle Pump Station #2 West Floodwall (**WB14-FW1**) and the 650 ft long New Estelle Pump Station Structure (**WB15-FW1** and **WB14-FW2**).

The portion of **WB14-L** on the west bank of Harvey Canal runs in a north-south direction from Algiers Canal West Bank Levee (**WB30-L**) to Hero Pump Station (**WB27**). This hydraulic reach is 1.0 mile long. The levee's design surge level, significant wave height, and peak period for existing conditions are 5.3 ft, 1.5 ft, and 2.5 s, respectively. The levee's computed existing and future design surge level, significant wave height, and peak period are 5.3 ft, 1.5 ft, and 2.5 s, respectively (**Table 4-7**).

**Robinson Point to Estelle Pump Station #2 West Floodwall (WB14-FW1):** The floodwall runs in a north-south and is 3,620 ft north of Estelle Pump Station #2 (**WB15-FW1**). The hydraulic reach is 2,176 ft long. An average bottom elevation of -6.0 ft was assumed for the canal in front of the walls. The floodwall's design surge level, significant wave height, and peak period for future conditions are 5.3 ft, 1.5 ft, and 2.5 s, respectively (**Table 4-7**).

**Hero Pump Station to Algiers Canal Floodwall (WB14-FW2):** The structures runs in a north-south direction and is 2,390 ft north of Robinson Point to Estelle Pump Station #2 West Floodwall (**WB14-FW1**). The hydraulic reach is 1.0 mile long. An average bottom elevation of -6.0 ft was assumed for the canal in front of the walls. The hydraulic reach is 98 ft long. The structure's design surge level, significant wave height, and peak period for future conditions are 5.3 ft, 1.5 ft, and 2.5 s, respectively (**Table 4-7**).



**New Estelle Pump Station Fronting Protection and Tie-in Walls (WB15-FW1 & WB15-FW2):** The structure and is located within the Estelle Pump Station #2 to Lapalco Sector Gate West Levee (WB14-L). The structures are 650 ft long. An average bottom elevation of -6.0 ft was assumed for the canal in front of the walls. The hydraulic reach is 0.52 mile long. The structure's design surge level, significant wave height, and peak period for future conditions are 5.3 ft, 1.5 ft, and 2.5 s, respectively (Table 4-7).

**Cousins Pump Stations #1, #2, and #3 Fronting Protection and Floodwalls (WB16-P and WB16-FW):** The structures are located off of Lapalco Boulevard near Destrehan Avenue. The hydraulic reach is 1,500 ft long. An average bottom elevation of -6.0 ft was assumed for the canal in front of the walls. The structure's design surge level, significant wave height, and peak period for future conditions are 5.3 ft, 1.5 ft, and 2.5 s, respectively (Table 4-7).

**Hero Pump Station (WB27):** The structures in on the east bank of Harvey Canal and runs in a north-south direction from Estelle Pump Station #2 to Lapalco Sector Gate West Levee (WB14-L) to Sector Gate at Lapalco Overpass on Harvey Canal (WB40-L). The hydraulic reach is 710 ft long. An average bottom elevation of -6.0 ft was assumed for the canal in front of the walls. The structure's design surge level, significant wave height, and peak period for future conditions are 5.3 ft, 1.5 ft, and 2.5 s, respectively (Table 4-7).

**Harvey Canal Floodwall (WB40):** The floodwall runs in a north-south direction from Hero Pump Station #2 (WB40) to the Sector Gate at Lapalco Overpass on Harvey Canal (WB40-L) on the east bank of Harvey Canal. This hydraulic reach is 2.9 miles long. The floodwall's design surge level, significant wave height, and peak period for future conditions are 5.3 ft, 1.5 ft, and 2.5 s, respectively (Table 4-7).

**Sector Gate at Lapalco Overpass on Harvey Canal (WB40-L):** The gate runs in an east-west direction from Harvey Canal Floodwall (WB40) to Cousins Pump Station #1, #2, and #3 (WB16). This hydraulic reach is 1,556 ft long. The gate's design surge level, significant wave height, and peak period for future conditions are 5.3 ft, 1.5 ft, and 2.5 s, respectively (Table 4-7).

### Algiers Canal

The pump stations output into Algiers Canal and the impact of increased water volumes into these constricted areas on the surge elevations in the canals were accounted for in the design elevations of the protection system. With a future design surge elevation of 9.3 ft and current pump efficiencies, stages in Algiers Canal increase by 0.5 ft. If the efficiencies increase such that the pumps can operate at full capacity, stages in the canal increase by 0.7 ft. The surge elevations for the output points used for the design of the structures within Algiers Canal were increased by 0.5 ft to account for the pumping into the canal, for both existing and future condition designs.

**Belle Chasse Pump Stations #1 and #2 and Whitney Barataria Pump Stations (WB23-P1, WB23-P2, and WB23-P3):** The pump stations are within the Algiers Canal Levees (WB30). The pump stations lengths within the levee reach are 279 ft for WB23-P1; 464 ft for WB23-P2; and 1,320 ft for WB23-P3. The pump station's design surge level, significant wave height, and peak period for future conditions are 5.3 ft, 1.5 ft, and 2.5 s, respectively (Table 4-7).

**Planters Pump Station (WB24):** The pump station is within the west bank of Algiers Canal Levee (WB30). The pump stations length within the levee reach are 420 ft. The pump station's design surge level, significant wave height, and peak period for future conditions are 5.3 ft, 1.5 ft, and 2.5 s, respectively (Table 4-7).

**Algiers Canal East and West Bank Levees (WB30-L1 and WB30-L2):** The levees run in a north-south direction on both banks of Algiers Canal from confluence of Hero, Algiers, and Harvey Canals to Algiers Lock. This hydraulic reach is 2.9 miles long and is transected by Belle Chasse Pump Stations #1 and #2, and Whitney Barataria Pump Station (WB23-P1, WB23-P2, and WB23-P3), and Planter Pump Station (WB24); The levee's design surge level, significant wave height, and peak period for existing conditions are 5.3 ft, 1.5 ft, and 2.5 s, respectively. The levee's design surge level, significant wave height, and peak period for future conditions are 5.3 ft, 1.5 ft, and 2.5 s, respectively (Table 4-7).

**New Orleans Sewage & Water Board (S&WB) #13 and OP # 11 Pump Stations (WB30-W-P1 and WB30-W-P2):** The pump stations are within the Algiers Canal Levees (WB30-L). The pump stations lengths within the levee reach are 279 ft for WB30-W-P1 and 464 ft for WB30-W-P2. The pump station's design surge level, significant wave height, and peak period for future conditions are 5.3 ft, 1.5 ft, and 2.5 s, respectively (Table 4-7).

### **Hero Canal**

**Transition Point to Hero Canal to Oakville (WB19):** The levee runs in an east-west direction along Hero Canal from Algiers Canal Levees (WB30-L) to the Oakville Landfill. The hydraulic reach is 3.2 miles long. The levee's design surge level, significant wave height, and peak period for existing conditions are 7.3 ft, 1.3 ft, and 3.7 s, respectively. The levee's design surge level, significant wave height, and peak period for future conditions are 9.3 ft, 2.3 ft, and 4.9 s, respectively (Table 4-7).

**Hero Canal Area Levees (WB19-A1 and WB19-A2):** WB19-A1 lies between the Hero Canal Bulkhead Closure Structure Floodwall (WB19-FW) and Fronting Protection for Hero Canal Bulkhead Closure Structure Pump Station (WB19-A-P). WB19-A2 lies between the Fronting Protection for Hero Canal Bulkhead Closure Structure Pump Station (WB19-A-P) and the Eastern Tie-in Floodwall (WB19-AW-FW). The reaches are 2,690 and 1,537 ft long, respectively. The levee's design surge level, significant wave height, and peak period for existing conditions are 7.3 ft, 1.3 ft, and 3.7 s, respectively. The levee's design surge level, significant wave height, and peak period for future conditions are 9.3 ft, 2.3 ft, and 4.9 s, respectively (Table 4-7).

**Hero Canal Bulkhead Closure Structure (WB19-G):** The gate runs in a north-south direction and crosses Hero Canal. The gate is 100 ft long. The gate's design surge level, significant wave height, and peak period for future conditions are 9.3 ft, 2.3 ft, and 4.9 s, respectively (Table 4-7).

**Fronting Protection for Hero Canal Bulkhead Closure Structure Pump Station (WB19-A-P):** The structure runs in a north-south direction and is located next to the Hero Canal Bulkhead Closure Structure (WB19-A1 and WB19-A2). The structure's design surge level, significant

wave height, and peak period for future conditions are 9.3 ft, 2.3 ft, and 4.9 s, respectively (**Table 4-7**).

**Hero Canal Area Structures (WB19-AW-FW, WB19-AW-G1, and WB19-AW-G2):** The structures include; the Eastern Tie-in Floodwall (**WB19-AW-FW**); the floodgates that the railroad and Hwy 23. The hydraulic reach is 3.2 miles long. The structure's design surge level, significant wave height, and peak period for future conditions are 9.3 ft, 2.3 ft, and 4.9 s, respectively (**Table 4-7**).

**Oakville Pump Station Fronting Protection (WB19-P):** The structure ties into the Hero Canal Bulkhead Closure Structure Floodwall (**WB19-FW**) on the north bank of Hero Canal. The structure is 30 ft long. The structure's design surge level, significant wave height, and peak period for future conditions are 9.3 ft, 2.3 ft, and 4.9 s, respectively (**Table 4-7**).

#### **4.4.3 Project Design Elevations**

The design characteristics for the reaches in the East of Harvey Canal area are listed in (**Table 4-8**). Hydraulic reaches **WB14-L, WB19, WB19-AW, WB30-L1, and WB30-L2** are levees, while the remaining hydraulic reaches are structures. Note that structures are only evaluated for future conditions because they are hard structures. Cousins Pump Stations #1, #2 and #3 Fronting Protection (**WB16-P**), New Estelle Pump Station Fronting Protection (**WB15-FW1**), and Tie In Walls (**WB15-FW2**), Belle Chasse Pump Stations #1 and #2 (**WB23-P1, WB23-P2**), Whitney Barataria Pump Station (**WB23-P3**), Planters Pump Station (**WB24**), New Orleans Sewage & Water Board (S&WB) #13 and OP # 11 Pump Stations (**WB30-W-P1 and WB30-W-P2**) and Hero Pump Station (**WB27**) design grade elevation includes 1.0 ft of structural superiority. Fronting Protection for Hero Canal Bulkhead Closure Structure Pump Station (**WB19-A-P**), Hero Canal Bulkhead Closure Structure (**WB19-G**) and Hero Canal Bulkhead Closure Structure Floodwall (**WB19-FW**) design grade elevation includes 2.0 ft of structural superiority.

**Appendix M** includes a Memorandum for Record (MFR), dated January 13, 2014, outlining the documentation behind the decision to allow a +8.2 El. NAVD88 2004.65 to be used as the minimum levee and floodwall elevation on the entire length of the Algiers Canal (and Harvey Canal). The required design grade for Algiers Canal is +8.5' El (present and future), as outlined in this updated report and the documentation/data submitted to support the February 20, 2014 FEMA letter which accepted the levee certification. As such, any reference to design grade in O&M manuals and Notice of Construction Completion (NCC) survey memos should be +8.5' El. The required design grade for Algiers Canal (and Harvey Canal) are as presented in **Table 4-8** and MVN will strive to achieve +8.5' El. where possible within geotechnical capabilities; however, there is an H&H Branch analysis that shows that +8.2' El. is acceptable to meet HSDRRS overtopping criteria, documented in **Appendix M**.

**Table 4-8 East of Harvey Canal Hydraulic Reaches – 1% Design Information**

West Bank Reaches (East of Harvey Canal Reach) 1% Hydraulic Design Elevations							
Hydraulic Reach	Name	Type	Condition	Depth at Toe (ft)	Elevation (ft)	Overtopping Rate	
						q50 (cfs/ft)	q90 (cfs/ft)
<b>WB14-FW1</b>	Robinson Point to Estelle Pump Station #2 West Floodwall	Structure/Wall	*	5.3	8.5	0.0004	0.002
<b>WB14-FW2</b>	Hero Pump Station to Algiers Canal Floodwall	Structure/Wall	*	5.3	8.5	0.0004	0.002
<b>WB14-L</b>	Estelle Pump Station #2 to Lapalco Sector Gate West Levee	Levee	*	5.3	8.5	0.0001	0.002
<b>WB15-FW1</b>	New Estelle Pump Station and Fronting Protection	Structure/Wall	*	5.3	9.5 <sup>ss</sup>	0.000	0.0003
<b>WB15-FW2</b>	New Estelle Pump Station Tie-In Walls	Structure/Wall	*	5.3	9.5 <sup>ss</sup>	0.000	0.0003
<b>WB16-P</b>	Cousins Pump Station #1, #2, and #3 (on Harvey Canal) Fronting Protection	Structure/Wall	*	5.3	9.5 <sup>ss</sup>	0.000	0.0003
<b>WB16-FW</b>	Cousins Pump Station #1, #2, and #3 (on Harvey Canal) Floodwall	Structure/Wall	*	5.3	8.5	0.0004	0.002
<b>WB19</b>	Transition Point to Hero Canal to Oakville	Levee	Existing	7.3	10.5	0.001	0.025
<b>WB19</b>	Transition Point to Hero Canal to Oakville	Levee	Future	9.3	14.0	0.010	0.063
<b>WB19-A1</b>	Hero Canal Area West of Pump Station	Levee	Existing	7.3	10.5	0.001	0.025
<b>WB19-A1</b>	Hero Canal Area West of Pump Station	Levee	Future	9.3	14.0	0.010	0.063
<b>WB19-A2</b>	Hero Canal Area East of Pump Station	Levee	Existing	7.3	10.5	0.001	0.025
<b>WB19-A2</b>	Hero Canal Area East of Pump Station	Levee	Future	9.3	14.0	0.010	0.063

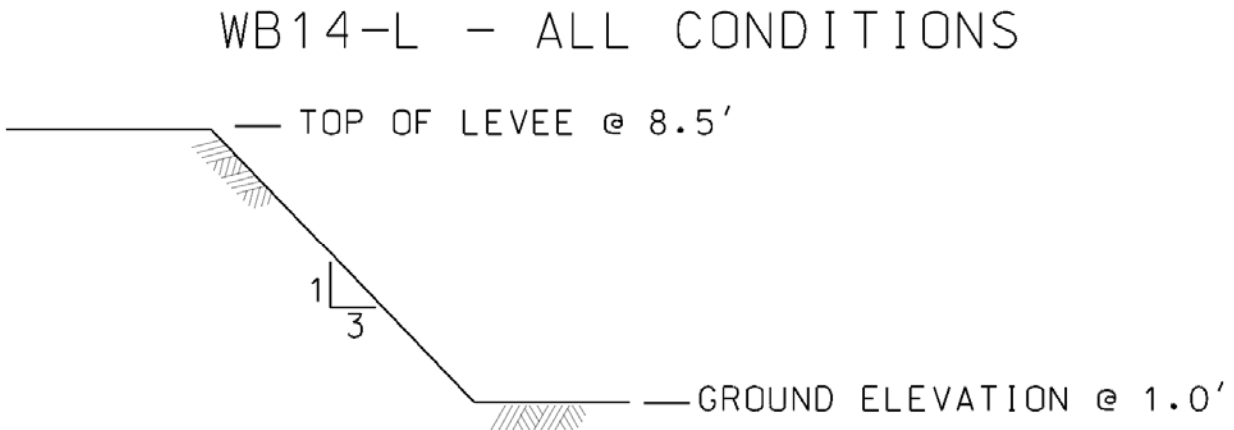
West Bank Reaches (East of Harvey Canal Reach) 1% Hydraulic Design Elevations							
Hydraulic Reach	Name	Type	Condition	Depth at Toe (ft)	Elevation (ft)	Overtopping Rate	
						q50 (cfs/ft)	q90 (cfs/ft)
WB19-A-P	Fronting Protection for Pump Station near Sector Gate	Structure/Wall	Future	9.3	16.0 <sup>SS</sup>	0.001	0.008
WB19-AW-FW	Eastern Tie-in Floodwalls	Structure/Wall	Future	9.3	14.0	0.001	0.008
WB19-AW-G1	Hwy 23 Northbound & Southbound T-walls	Structure/Wall	Future	9.3	14.0	0.001	0.008
WB19-AW-G2	Eastern Tie-in Railroad Gate	Structure/Wall	Future	9.3	14.0	0.001	0.008
WB19-FW	Hero Canal Bulkhead Closure Structure Floodwalls	Structure/Wall	Future	9.3	16.0 <sup>SS</sup>	0.0002	0.0018
WB19-G	Hero Canal Bulkhead Closure Structure	Structure/Wall	Future	9.3	16.0 <sup>SS</sup>	0.0002	0.0018
WB19-P	Oakville Pump Station Fronting Protection	Pump Station	Future	9.3	15.5	0.000	0.001
WB23-P1	Belle Chase Pump Station #1 Fronting Protection	Structure/Wall	*	5.3	9.5 <sup>SS</sup>	0.0000	0.0003
WB23-P2	Belle Chase Pump Station #2 Fronting Protection	Structure/Wall	*	5.3	9.5 <sup>SS</sup>	0.0000	0.0003
WB23-P3	Whitney Barataria Pump Station Fronting Protection	Structure/Wall	*	5.3	9.5 <sup>SS</sup>	0.0000	0.0003
WB24	Planters Pump Station Fronting Protection	Structure/Wall	*	5.3	9.5 <sup>SS</sup>	0.0000	0.0003
WB27	Hero Pump Station (on Harvey Canal) Fronting Protection	Structure/Wall	*	5.3	9.5 <sup>SS</sup>	0.0000	0.000
WB30-FW1	Algiers Canal West Floodwall near Belle Chase	Structure/Wall	*	5.3	8.5	0.0004	0.002
WB30-FW2	Algiers Canal East Floodwall near Belle Chase	Structure/Wall	*	5.3	8.5	0.0004	0.002

West Bank Reaches (East of Harvey Canal Reach) 1% Hydraulic Design Elevations							
Hydraulic Reach	Name	Type	Condition	Depth at Toe (ft)	Elevation (ft)	Overtopping Rate	
						q50 (cfs/ft)	q90 (cfs/ft)
<b>WB30-G1</b>	Algiers Canal West Bank Floodgates	Structure/Wall	*	5.3	8.5	0.0004	0.002
<b>WB30-G2</b>	Algiers Canal West Swing Gate near Belle Chase	Structure/Wall	*	5.3	8.5	0.0004	0.002
<b>WB30-G3</b>	Algiers Canal West Gate at Belle Chase Tunnel	Structure/Wall	*	5.3	8.5	0.0004	0.002
<b>WB30-G4</b>	Algiers Canal Rail Road Gate near Belle Chase	Structure/Wall	*	5.3	8.5	0.0004	0.002
<b>WB30-G5</b>	Algiers Canal East Gate at Tunnel Rd near Belle Chase	Structure/Wall	*	5.3	8.5	0.0004	0.002
<b>WB30-G6</b>	Algiers Canal East Gate at Belle Chase Tunnel	Structure/Wall	*	5.3	8.5	0.0004	0.002
<b>WB30-G7</b>	Algiers Canal East Gate near Belle Chase	Structure/Wall	*	5.3	8.5	0.0004	0.002
<b>WB30-G8</b>	Algiers Canal Rail Road Gate (east) near Belle Chase	Structure/Wall	*	5.3	8.5	0.0004	0.002
<b>WB30-L1</b>	Algiers Canal West Bank Levee	Levee	*	5.3	8.5	0.0001	0.002
<b>WB30-L2</b>	Algiers Canal East Bank Levee	Levee	*	5.3	8.5	0.0001	0.002
<b>WB30-W-P1</b>	New Orleans S&WB Pump Stations #11 (also known as OP #11)	Structure/Wall	*	5.3	9.5 <sup>SS</sup>	0.0000	0.0003
<b>WB30-W-P2</b>	New Orleans S&WB Pump Station #13	Structure/Wall	*	5.3	9.5 <sup>SS</sup>	0.0000	0.0003
<b>WB40</b>	Harvey Canal Floodwall	Structure/Wall	*	5.3	8.5	0.0004	0.002
<b>WB40-L</b>	Sector Gate at Lapalco Overpass on Harvey Canal	Structure/Wall	*	5.3	8.5	0.0004	0.002

\*The existing and future conditions are the same because the surge levels will be controlled by the actions taken at the WCC during storm events.

#### 4.4.4 Typical Cross-Sections

The typical levee design cross-section for the 1% design existing and future conditions of Estelle Pump Station #2 to Lapalco Sector Gate West Levee (**WB14-L**) are shown in **Figure 4-7**. The 1% hydraulic design elevation for existing conditions must be 8.5 ft and 8.5 for future conditions. The construction design grade elevation for **WB14-L** is 12 ft, which are the hydraulic design elevation plus 3.5 ft of over-build.



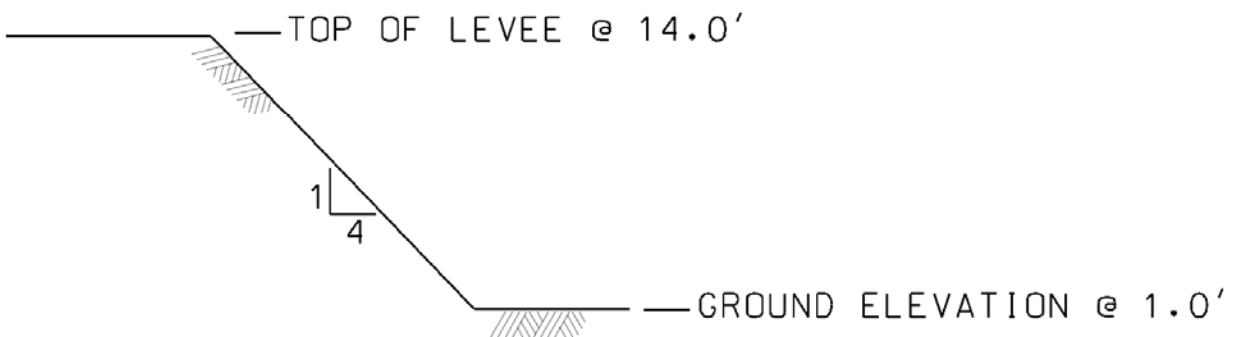
**Figure 4-7 Typical Levee Design Cross-sections Harvey Canal Levees (WB14-L)**

The typical levee design cross-sections for the 1% design existing and future conditions of Transition Point to Hero Canal to Oakville (**WB19**), Hero Canal Area West of Pump Station (**WB19-A1**), and Hero Canal Area East of Pump Station (**WB19-A2**) are shown in **Figure 4-8**. The 1% hydraulic design elevations for existing conditions must be 10.5 ft and 14 for future conditions. The construction design grade elevations are 12.5, 15, 14.5 ft, which is the hydraulic design elevation plus 2.0, 4.5, and 4.0 of over-build.

WB19, WB19-A1 and WB19-A2  
EXISTING CONDITIONS



WB19, WB19-A1 and WB19-A2  
FUTURE CONDITIONS



**Figure 4-8 Typical Levee Design Cross-sections Transition Point Hero Canal to Oakville (WB19), Hero Canal Area West and East of Pump Station (WB19-A1 and WB19-A2)**



The typical levee design cross-sections for the 1% design existing and future conditions of Algiers Canal East and West Bank (**WB30-L1**) and Algiers Canal East Bank Levee (**WB30-L2**) is shown in **Figure 4-9**. The 1% hydraulic design elevation for both levees for existing conditions must be 8.5 ft and 8.5 for future conditions. The construction design grade elevation for (**WB30-L1**) is 9.2 ft, which are the hydraulic design elevation plus 0.7 ft of over-build. The design grade elevation for (**WB30-L2**) is 9.1 ft, which are the hydraulic design elevation plus 0.6 ft of over-build.

## WB30-L1 and WB30-L2 ALL CONDITIONS



**Figure 4-9 Typical Levee Design Cross-sections Algiers Canal Levees (WB30-L1 and WB30-L2)**

#### 4.4.5 Resiliency

The hydraulic designs for the levees and structures along the East of Harvey Canal reach were examined for resiliency by computing the 0.2% surge level (50% confidence). The results are presented in **Table 4-9**. For all sections, the 0.2% surge level remains below the top of the flood defense.

**Table 4-9 East of Harvey Canal Hydraulic Reaches –Resiliency**

<b>West Bank Reaches (East of Harvey Canal Reach) Resiliency Analysis (0.2% Event)</b>					
<b>Hydraulic Reach</b>	<b>Name</b>	<b>Type</b>	<b>Condition</b>	<b>Elevation (ft)</b>	<b>0.2% Event Surge Level (ft)</b>
<b>WB14-FW1</b>	Robinson Point to Estelle Pump Station #2 West Floodwall	Structure/Wall	*	8.5	n/a
<b>WB14-FW2</b>	Hero Pump Station to Algiers Canal Floodwall	Structure/Wall	*	8.5	n/a
<b>WB14-L</b>	Estelle Pump Station #2 to Lapalco Sector Gate West Levee	Levee	*	8.5	n/a
<b>WB15-FW1</b>	New Estelle Pump Station and Fronting Protection	Structure/Wall	*	9.5 <sup>ss</sup>	n/a
<b>WB15-FW2</b>	New Estelle Pump Station Tie-In Walls	Structure/Wall	*	9.5 <sup>ss</sup>	n/a
<b>WB16-P</b>	Cousins Pump Station #1, #2, and #3 (on Harvey Canal) Fronting Protection	Structure/Wall	*	9.5 <sup>ss</sup>	n/a
<b>WB16-FW</b>	Cousins Pump Station #1, #2, and #3 (on Harvey Canal) Floodwall	Structure/Wall	*	8.5	n/a
<b>WB19</b>	Transition Point to Hero Canal to Oakville	Levee	Existing	10.5	10.4

<b>West Bank Reaches (East of Harvey Canal Reach) Resiliency Analysis (0.2% Event)</b>					
<b>Hydraulic Reach</b>	<b>Name</b>	<b>Type</b>	<b>Condition</b>	<b>Elevation (ft)</b>	<b>0.2% Event</b>
					<b>Surge Level (ft)</b>
<b>WB19</b>	Transition Point to Hero Canal to Oakville	Levee	Future	14.0	12.4
<b>WB19-A1</b>	Hero Canal Area West of Pump Station	Levee	Existing	10.5	10.4
<b>WB19-A1</b>	Hero Canal Area West of Pump Station	Levee	Future	14.0	12.4
<b>WB19-A2</b>	Hero Canal Area East of Pump Station	Levee	Existing	10.5	10.4
<b>WB19-A2</b>	Hero Canal Area East of Pump Station	Levee	Future	14.0	12.4
<b>WB19-A-P</b>	Fronting Protection for Pump Station near Sector Gate	Structure/Wall	Future	16.0 <sup>SS</sup>	12.4
<b>WB19-AW-FW</b>	Eastern Tie-in Floodwalls	Structure/Wall	Future	14.0	12.4
<b>WB19-AW-G1</b>	Hwy 23 Northbound & Southbound T-walls	Structure/Wall	Future	14.0	12.4
<b>WB19-AW-G2</b>	Eastern Tie-in Railroad Gate	Structure/Wall	Future	14.0	12.4
<b>WB19-FW</b>	Hero Canal Bulkhead Closure Structure Floodwalls	Structure/Wall	Future	16.0 <sup>SS</sup>	12.4
<b>WB19-G</b>	Hero Canal Bulkhead Closure Structure	Structure/Wall	Future	16.0 <sup>SS</sup>	12.4
<b>WB19-P</b>	Oakville Pump Station Fronting Protection	Structure/Wall	Future	15.5	12.4
<b>WB23-P1</b>	Belle Chase Pump Station #1 Fronting Protection	Structure/Wall	*	9.5 <sup>SS</sup>	n/a

<b>West Bank Reaches (East of Harvey Canal Reach) Resiliency Analysis (0.2% Event)</b>					
<b>Hydraulic Reach</b>	<b>Name</b>	<b>Type</b>	<b>Condition</b>	<b>Elevation (ft)</b>	<b>0.2% Event</b>
					<b>Surge Level (ft)</b>
<b>WB23-P2</b>	Belle Chase Pump Station #2 Fronting Protection	Structure/Wall	*	9.5 <sup>SS</sup>	n/a
<b>WB23-P3</b>	Whitney Barataria Pump Station Fronting Protection	Structure/Wall	*	9.5 <sup>SS</sup>	n/a
<b>WB24</b>	Planters Pump Station Fronting Protection	Structure/Wall	*	9.5 <sup>SS</sup>	n/a
<b>WB27</b>	Hero Pump Station (on Harvey Canal) Fronting Protection	Structure/Wall	*	9.5 <sup>SS</sup>	n/a
<b>WB30-FW1</b>	Algiers Canal West Floodwall near Belle Chase	Structure/Wall	*	8.5	n/a
<b>WB30-FW2</b>	Algiers Canal East Floodwall near Belle Chase	Structure/Wall	*	8.5	n/a
<b>WB30-G1</b>	Algiers Canal West Bank Floodgates	Structure/Wall	*	8.5	n/a
<b>WB30-G2</b>	Algiers Canal West Swing Gate near Belle Chase	Structure/Wall	*	8.5	n/a
<b>WB30-G3</b>	Algiers Canal West Gate at Belle Chase Tunnel	Structure/Wall	*	8.5	n/a
<b>WB30-G4</b>	Algiers Canal Rail Road Gate near Belle Chase	Structure/Wall	*	8.5	n/a
<b>WB30-G5</b>	Algiers Canal East Gate at Tunnel Rd near Belle Chase	Structure/Wall	*	8.5	n/a
<b>WB30-G6</b>	Algiers Canal East Gate at Belle Chase Tunnel	Structure/Wall	*	8.5	n/a
<b>WB30-G7</b>	Algiers Canal East Gate near Belle Chase	Structure/Wall	*	8.5	n/a
<b>WB30-G8</b>	Algiers Canal Rail Road Gate (east) near Belle Chase	Structure/Wall	*	8.5	n/a
<b>WB30-L1</b>	Algiers Canal West Bank Levee	Levee	*	8.5	n/a
<b>WB30-L2</b>	Algiers Canal East Bank Levee	Levee	*	8.5	n/a

West Bank Reaches (East of Harvey Canal Reach) Resiliency Analysis (0.2% Event)					
Hydraulic Reach	Name	Type	Condition	Elevation (ft)	0.2% Event
					Surge Level (ft)
WB30-W-P1	New Orleans S&WB Pump Stations #11 (also known as OP #11)	Structure/Wall	*	9.5 <sup>SS</sup>	n/a
WB30-W-P2	New Orleans S&WB Pump Stations #13	Structure/Wall	*	9.5 <sup>SS</sup>	n/a
WB40	Harvey Canal Floodwall	Structure/Wall	*	8.5	n/a
WB40-L	Sector Gate at Lapalco Overpass on Harvey Canal	Structure/Wall	*	8.5	n/a

\*The existing and future conditions are the same because the surge levels will be controlled by the actions taken at the WCC during storm events.

## 4.5 WEST CLOSURE COMPLEX

Each alternative for hydraulic reaches within the West Closure Complex (WCC) was reviewed during this update process. The alternatives for each corresponding hydraulic reach (where available) were reviewed along with the 95 or 100% structure or levee design plans. The alternative that best corresponded to the 95 or 100% structural design plans was considered the final hydraulic design. The data from the final hydraulic design was used to update data for the hydraulic boundary conditions, design elevations, and wave loads within this report.

The hydraulic reach identification has been updated from the October 2007 DER to match the current design conditions in their corresponding area.

### 4.5.1 Project Location

The WCC is located on the west bank of the Mississippi River in Jefferson and Plaquemines Parishes and is part of the WBV (**Plate 13**). The 225 ft gate structure is primarily located in Plaquemines Parish in the vicinity of the City of Belle Chasse, approximately 3,000 ft south of the confluence of the Algiers and Harvey Canals along the west bank of the GIWW. The complex may reduce the risk of flooding for 245,000 people in the New Orleans area.

The WCC will consist of five sluice gates, a safe house, two navigable sector gates, a 19,300 cfs drainage pump station, a concrete T-wall and flow control structure in an environmentally sensitive location, an earthen levee, and foreshore protection. MRGO will be closed with a large T-wall.

The proposed 404c Floodwall is located on the west bank of Hero Canal adjacent to the Bayou aux Carpes 404c Wetland. The wetland is a nationally significant wetland specifically designated by the Environmental Protection Agency to restrict the discharge of dredged or fill material into the Bayou aux Carpes area as of 16 October 1985. This wetland is one of only 12 sites in the United States with a designation that prohibits the issuing of 404d Permits throughout the country. The proposed 404c Floodwall will be a 4,200 ft long T-wall.

**Plate 13** shows the hydraulic boundaries for the WCC. The numbers indicate the hydraulic design elevations for several structures along the reach. The elevations displayed for levees will have both existing conditions (2007) and future conditions (2057), unless otherwise stated. The elevations displayed for hard structures (floodwalls, floodwall/levee combinations, pump stations, etc.) will have future (2057) conditions only. All hard structures are designed and built for future conditions (2057) only. If structural superiority is included with a specific hard structure the hydraulic design elevation will have an additional number, color coded green. The hydraulic reaches in **Plate 13** are different colors only to show the boundary limits of each reach. The colors do not represent a specific type of structure.

This figure also shows the construction reaches as they correspond to the hydraulic reach. The construction boundary is off-set from the hydraulic boundary and labelled opposite the hydraulic reach label.

#### 4.5.2 Hydraulic Boundary Conditions

The hydraulic design characteristics for the reaches in the Western Closure Complex are listed in **Table 4-10**. To account for changes due to subsidence and sea level rise over a 50 year period, the surge elevations were adjusted by adding 2.0 ft and the wave heights were adjusted by adding 1.0 ft for future conditions. The wave period is computed using the assumption that the wave steepness remains constant.

**Table 4-10 West Closure Complex Hydraulic Reaches – 1% Hydraulic Boundary Conditions**

West Bank Reaches (Western Closure Complex) 1% Hydraulic Boundary Conditions									
Hydraulic Reach	Name	Type	Condition	Surge Level (ft)		Significant Wave Height (ft)		Peak Period (s)	
				Mean	Std	Mean	Std	Mean	Std
<b>WB90-CS</b>	Control Structure at Estelle & Harvey Canals	Structure/Wall	Future	9.3	0.9	2.3	0.1	4.9	0.7
<b>WB90-FW1</b>	WCC 404c Floodwall	Structure/Wall	Future	9.3	0.9	2.3	0.1	4.9	0.7
<b>WB90-FW2</b>	Closure Wall Between 404c Floodwall & WCC Sector Gate	Structure/Wall	Future	9.8	0.9	2.3	0.1	4.9	0.7
<b>WB90-FW3</b>	WCC Discharge T-Wall (East)	Structure/Wall	Future	9.8	0.9	2.3	0.1	4.9	0.7
<b>WB90-G1</b>	WCC Sector Gate	Structure/Wall	Future	9.8	0.9	2.3	0.1	4.9	0.7
<b>WB90 -G2</b>	WCC Sluice Gate	Structure/Wall	Future	9.8	0.9	2.3	0.1	4.9	0.7
<b>WB90-L1</b>	WCC Intake Levee	Levee	*	5.3	0.4	1.5	0.2	2.5	0.5
<b>WB90-L2</b>	WCC Discharge Levee	Levee	Existing	7.8	0.9	1.3	0.1	3.7	0.7
<b>WB90-L2</b>	WCC Discharge Levee	Levee	Future	9.8	0.9	2.3	0.1	4.9	0.7
<b>WB90-P</b>	WCC Pump Station	Structure/Wall	Future	9.8	0.9	2.3	0.1	4.9	0.7

\*The existing and future conditions are the same because the surge levels will be controlled by the actions taken at the WCC during storm events.



**Control Structure at Estelle and Harvey Canals (WB90-CS):** The control structure is located at the confluence of Estelle and Harvey Canals and runs in a north-south direction at Estelle Canal. The hydraulic reach is 220 ft long. The structure's design surge level, significant wave height, and peak period for future conditions are 9.3 ft, 2.3 ft, and 4.9 s, respectively (**Table 4-10**).

**WCC 404c Floodwall (WB90-FW1):** The floodwall (T-wall) runs in a north-south direction from the Control Structure at Estelle and Harvey Canal (**WB90-CS**) to the Closure Wall adjacent to the WCC Sector Gate (**WB90-FW2**). The floodwall runs parallel to Hero Canal and the Bayou aux Carpes 404C Wetlands. The floodwall is 4,200 ft long. The floodwall's design surge level, significant wave height, and peak period for future conditions are 9.3 ft, 2.3 ft, and 4.9 s, respectively (**Table 4-10**).

**Closure Wall Between the 404c Floodwall and the WCC Sector Gate (WB90-FW2):** The closure wall runs in an east-west direction from the 404c Floodwall (**WB90-FW1**) to the WCC Sector Gate (**WB90-G1**). The floodwall is 320 ft long. The floodwall's design surge level, significant wave height, and peak period for future conditions are 9.8 ft, 2.3 ft, and 4.9 s, respectively (**Table 4-10**).

**WCC Discharge T-wall East (WB90-FW3):** The discharge wall runs in an east-west direction from the WCC Sector Gate (**WB90-G1**) to the WCC Discharge Levee (**WC90-L2**). The floodwall is 427 ft long. The wall's design surge level, significant wave height, and peak period for future conditions are 9.8 ft, 2.3 ft, and 4.9 s, respectively (**Table 4-10**).

**WCC Sector Gate (WB90-G1):** The gate traverses Hero Canal in an east-west direction, just south of the confluence of Algiers and Harvey Canals. The gate is 515 ft long. The gate's design surge level, significant wave height, and peak period for future conditions are 9.8 ft, 2.3 ft, and 4.9 s, respectively (**Table 4-10**).

**WCC Sluice Gate (WB90-G2):** The gate lies between the WCC Pump Station (**WB90-P**) and WCC Discharge T-wall East (**WB90-FW3**). The gate is 100 ft long. The gate's design surge level, significant wave height, and peak period for future conditions are 9.8 ft, 2.3 ft, and 4.9 s, respectively (**Table 4-10**).

**WCC Intake Levee (WB90-L1):** The levee runs in a north-south direction on from Algiers Canal East Bank Levee (**WB30-L2**) to the WCC Discharge T-wall East (**WB90-FW3**). The levee is 2,041 ft long. The levee's design surge level, significant wave height, and peak period for existing conditions are 5.3 ft, 1.5 ft, and 2.5 s, respectively. The levee's design surge level, significant wave height, and peak period for future conditions are 5.3 ft, 1.5 ft, and 2.5 s, respectively (**Table 4-10**).

**WCC Discharge Levee (WB90-L2):** The levee runs in a north-south direction on from the WCC Discharge T-wall East (**WB90-FW3**) to the Transition Point to Hero Canal to Oakville Levee (**WB19**). The levee is 0.80 mile long. The levee's design surge level, significant wave height, and peak period for existing conditions are 7.8 ft, 1.3 ft, and 3.7 s, respectively. The

levee's design surge level, significant wave height, and peak period for future conditions are 9.8 ft, 2.3 ft, and 4.9 s, respectively (**Table 4-10**).

**WCC Pump Station (WB90-P):** The structure lies between the Sector Gate (**WB90-G1**) and the WCC Sluice Gate (**WB90-G2**). The structure is more than 480 ft long. The structure's design surge level, significant wave height, and peak period for future conditions are 9.8 ft, 2.3 ft, and 4.9 s, respectively (**Table 4-10**).

#### **4.5.3 Project Design Elevations**

The design characteristics for the reaches in the WCC are listed in (**Table 4-11**). Hydraulic reaches WB90-L1 and WB90-L2 are levees, while the remaining structures are gates and floodwalls. Note that structures are only evaluated for future conditions because they are hard structures. All structures within the WCC design grade elevations include 2.0 ft of structural superiority.

**Table 4-11 West Closure Complex Hydraulic Reaches – 1% Design Information**

West Bank Reaches (West Closure Complex) 1% Hydraulic Design elevations							
Hydraulic Reach	Name	Type	Condition	Depth at Toe (ft)	Overtopping Rate		
					Elevation (ft)	q50 (cfs/ft)	q90 (cfs/ft)
<b>WB90-CS</b>	Control Structure at Estelle & Harvey Canals	Structure/Wall	Future	9.3	16.0 <sup>SS</sup>	0.000	0.0004
<b>WB90-FW1</b>	404c Floodwall	Structure/Wall	Future	9.3	16.0 <sup>SS</sup>	0.000	0.0004
<b>WB90-FW2</b>	Closure Wall Between 404c Floodwall & WCC Sector Gate	Structure/Wall	Future	9.8	16.0 <sup>SS</sup>	0.0001	0.001
<b>WB90-FW3</b>	WCC Discharge T-Wall (East)	Structure/Wall	Future	9.8	16.0 <sup>SS</sup>	0.0001	0.001
<b>WB90-G1</b>	WCC Sector Gate	Structure/Wall	Future	9.8	16.0 <sup>SS</sup>	0.0001	0.001
<b>WB90 -G2</b>	WCC Sluice Gate	Structure/Wall	Future	9.8	16.0 <sup>SS</sup>	0.0001	0.001
<b>WB90-L1</b>	WCC Intake Levee	Levee	*	5.3	8.5	0.001	0.013
<b>WB90-L2</b>	WCC Discharge Levee	Levee	Existing	7.8	11.0	0.003	0.035
<b>WB90-L2</b>	WCC Discharge Levee	Levee	Future	9.8	15.5	0.006	0.032
<b>WB90-P</b>	WCC Pump Station	Structure/Wall	Future	9.8	16.0 <sup>SS</sup>	0.0001	0.001

\*The existing and future conditions are the same because the surge levels will be controlled by the actions taken at the WCC during storm events.

#### 4.5.4 Typical Cross-Sections

The typical levee design cross-section for the 1% design existing and future conditions of the WCC Intake Levee (**WB90-L1**) are shown in **Figure 4-10**. The 1% design elevation for existing conditions must be 8.5 ft for existing and 8.5 ft for future conditions. The construction design grade elevation for WB90-L1 is 8.5 ft.



**Figure 4-10 Typical Levee Design Cross-section WCC Intake Levee (WB90-L1)**

The typical levee design cross-section for the 1% design existing and future conditions of the WCC Discharge Levee (**WB90-L2**) are shown in **Figure 4-11**. The 1% design elevation for existing conditions must be 11 ft for existing and 15.5 ft for future conditions. The construction design grade elevation for **WB90-L1** is 15 ft.

### WB90-L2 EXISTING CONDITIONS



### WB90-L2 FUTURE CONDITIONS



**Figure 4-11 Typical Levee Design Cross-sections WCC Discharge Levee (WB90-L2)**

#### 4.5.5 Resiliency

The hydraulic designs for the levees and structures within along the WCC reach were examined for resiliency by computing the 0.2% surge level (50% confidence). The results are presented in **Table 4-12**. For all sections, the 0.2% surge level remains below the top of the flood defense.

**Table 4-12 West Closure Complex Hydraulic Reaches – Resiliency**

<b>West Bank Reaches (West Closure Complex) Resiliency Analysis (0.2% Event)</b>					
<b>Hydraulic Reach</b>	<b>Name</b>	<b>Type</b>	<b>Condition</b>	<b>Elevation (ft)</b>	<b>0.2% Event</b>
					<b>Surge Level (ft)</b>
<b>WB90-CS</b>	Control Structure at Estelle & Harvey Canals	Structure/Wall	Future	16.0 <sup>SS</sup>	12.4
<b>WB90-FW1</b>	WCC 404c Floodwall	Structure/Wall	Future	16.0 <sup>SS</sup>	12.4
<b>WB90-FW2</b>	Closure Wall Between 404c Floodwall & WCC Sector Gate	Structure/Wall	Future	16.0 <sup>SS</sup>	12.9
<b>WB90-FW3</b>	WCC Discharge T-Wall (East)	Structure/Wall	Future	16.0 <sup>SS</sup>	12.9
<b>WB90-G1</b>	WCC Sector Gate	Structure/Wall	Future	16.0 <sup>SS</sup>	12.9
<b>WB90 -G2</b>	WCC Sluice Gate	Structure/Wall	Future	16.0 <sup>SS</sup>	12.9
<b>WB90-L1</b>	WCC Intake Levee	Levee	**	8.5	*
<b>WB90-L2</b>	WCC Discharge Levee	Levee	Existing	11.0	10.9
<b>WB90-L2</b>	WCC Discharge Levee	Levee	Future	15.5	12.9
<b>WB90-P</b>	WCC Pump Station	Structure/Wall	Future	16.0 <sup>SS</sup>	12.9

\*\*The existing and future conditions are the same because the surge levels will be controlled by the actions taken at the WCC during storm events.

\* No data available

## 5.0 MISSISSIPPI RIVER COINCIDENT WITH LPV AND WBV

### 5.1 GENERAL

The Mississippi River Levee (MRL) system is an integral part of the LPV and WBV Projects. For reaches of the river the HSDRRS and the MRL coincide, meaning they provide risk reduction from both riverine flooding and hurricane surge flooding.

The boundaries of the LPV and WBV coincident MRL system under consideration in this report are as follows:

- RM 70 – RM 118 on the west bank: RM 70 and RM 118 are the points where the WBV Project ties into the west bank of the MRL; at the Eastern-Tie In and the Davis Pond Freshwater Diversion, respectively.
- RM 82 – RM 127 on the east bank: RM 82 and RM 127 are the points where the LPV Project ties into the east bank of the MRL; at the Caernarvon Freshwater Diversion and the Bonnet Carre Spillway, respectively.

The river levees have been further subdivided into several logical reaches based on approximate Parish boundaries. Each reach has also been sub-divided to smaller segments at every RM.

- **Section 5.2** – Plaquemines Parish West Bank (RM 70W to RM 81W) (**Plates 14A and 14B**)
- **Section 5.3** – Orleans Parish West Bank (RM 82W to 95W) (**Plates 14A and 14B**)
- **Section 5.4** – Jefferson Parish West Bank (RM 96W to RM 114W)
- **Section 5.5** – St. Charles Parish West Bank (RM 115W to RM 118W)
- **Section 5.6** – Plaquemines/St. Bernard East Bank (RM 82E to RM 91E)
- **Section 5.7** – Orleans Parish East Bank (RM 92E to RM 103E)
- **Section 5.8** – Jefferson Parish East Bank (RM 104E to RM 114E)
- **Section 5.9** – St. Charles Parish East Bank (RM 115E to RM 127E)

Some reaches of the river levee are co-located, meaning that the required levee grade to reduce risk from the storm surge, that has a one percent chance of being equaled or exceeded in any given year, is higher than the levee grade (the MRL authorized elevations) required to reduce risk from a riverine event. For conditions in 2011, there are approximately 15.5 miles of co-located levees, located within the WBV Belle Chasse polder from RM 70 – RM 85.5. In future years the river mile at which 1% risk reduction elevations govern over MRL authorized elevations moves upriver. It is anticipated that by 2057 the LPV and WBV co-located levees will extend from River Mile 70 to 95.5 for the west bank and River Mile 81.5 to 91 for the east bank.

After completing detailed storm surge modeling and overtopping analyses, it was determined that there was no co-located LPV Mississippi River levee work needed at this time. On the WBV side, approximately 15.5 miles of co-located work is required, from RM 70 – RM 85.5 (Orleans and Plaquemines Parishes in the Belle Chasse polder from English Turn to Oakville). **Plate 14A** shows the WBV-MRL Engineered Alternative Measures (EAMs) features, which have completed construction. The EAMs consist of the construction of clay levees with a 1 vertical on 3 horizontal flood-side and protected-side slope in the upper two contract reaches (WBV-MRL 6.1 and 7.1) and clay levees with protected-side and flood-side slopes steeper than a 1 vertical on 3 horizontal in the lower contract reaches (WBV-MRL 1.1, 3.1 and 4.1). Initially, the

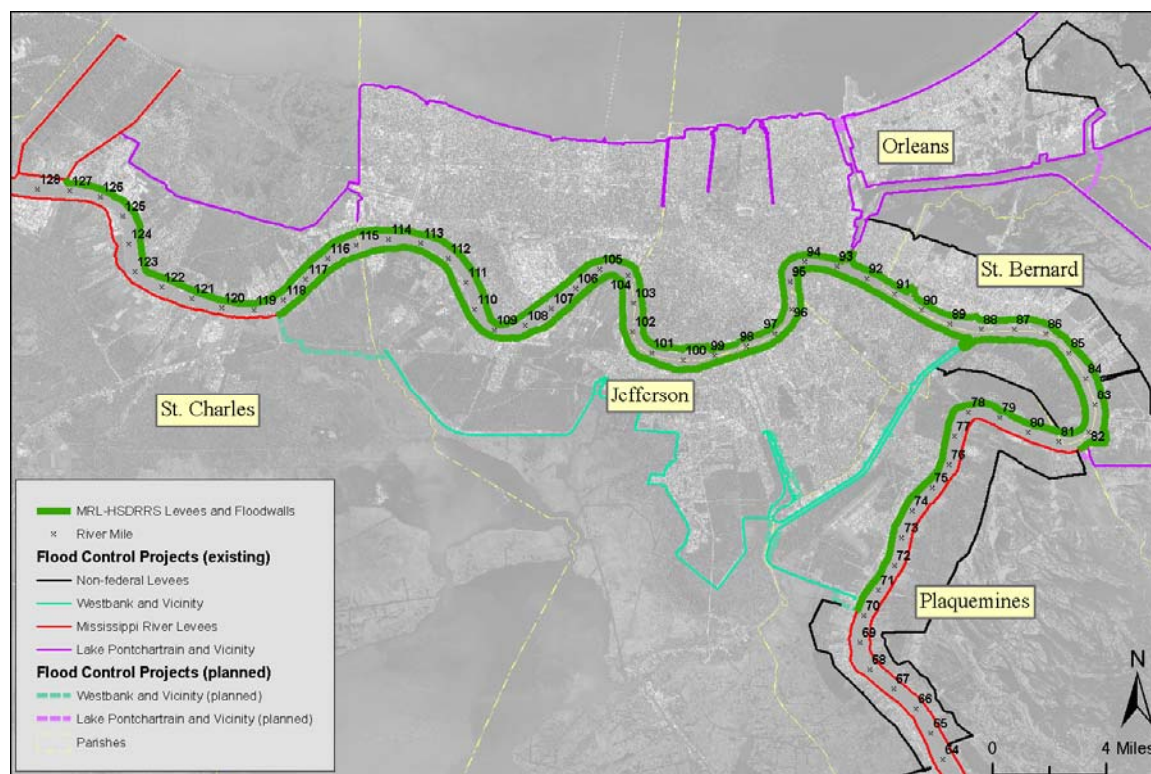
lower three contract reaches (WBV-MRL 1.1, 3.1 and 4.1), from River Mile 70-78, were to be constructed of a stabilized soil. A demonstration section using stabilized soil to raise and cap portions of MRL levees in Belle Chasse near F. Edward Hebert Ave. and Main St. in Plaquemines Parish was completed in February 2011. Due to concerns from the Coastal Protection and Restoration Authority (CPRA), Southeast Louisiana Flood Protection Authority – West (SLFPA-W) and Plaquemines Parish Government (PPG) regarding operation and maintenance issues on the stabilized soil reaches, the decision was made to construct the Engineered Alternative Measures (EAMs) of clay only.

Construction of WBV-MRL EAMs met the requirements for accreditation of the 100-year risk reduction system; however, construction of Resilient Features is required to improve the resiliency and longevity of the system. **Plate 14B** shows the WBV-MRL Co-Located Resilient Features.

### Area Description

The Mississippi River levees under consideration are shown in **Figure 5-1**.

All elevations described herein are in North American Vertical Datum 1988 (2004.65).

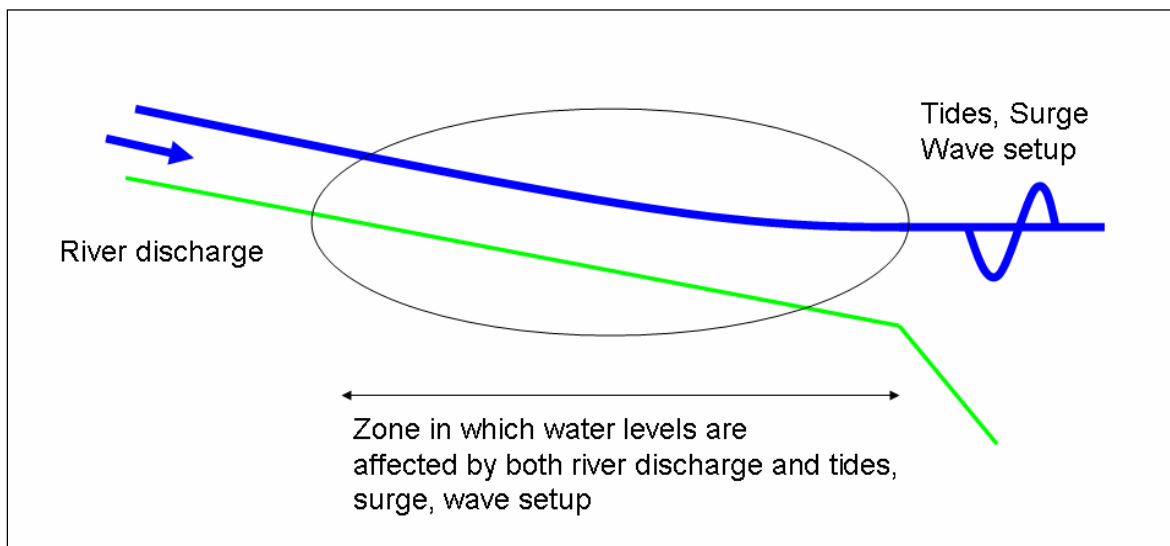


**Figure 5-1 MRL-HSDRRS Levees and Floodwalls**

The major factor for the levee and floodwall design elevations for the coincident MRL-HSDRRS sections is the water or surge level elevation. Waves play a secondary role in the determination of the levee elevations. Waves within the river are locally generated over relatively short fetches due to the levee embankments at both sides of the river; therefore, the waves are small (1.0 – 3.0 ft). It is well known from river theory that the water level near a river mouth is a complex result of the upstream fresh water inflow and the downstream water level fluctuations



(Figure 5-2). The upstream river discharge can be high or low generally depending on the season. The downstream water level can vary due to tides and wind-wave setup due to storm influence. The size of the zone in which this interaction manifests itself depends on the strength of these forces and the river characteristics (water depth, slope, and roughness).

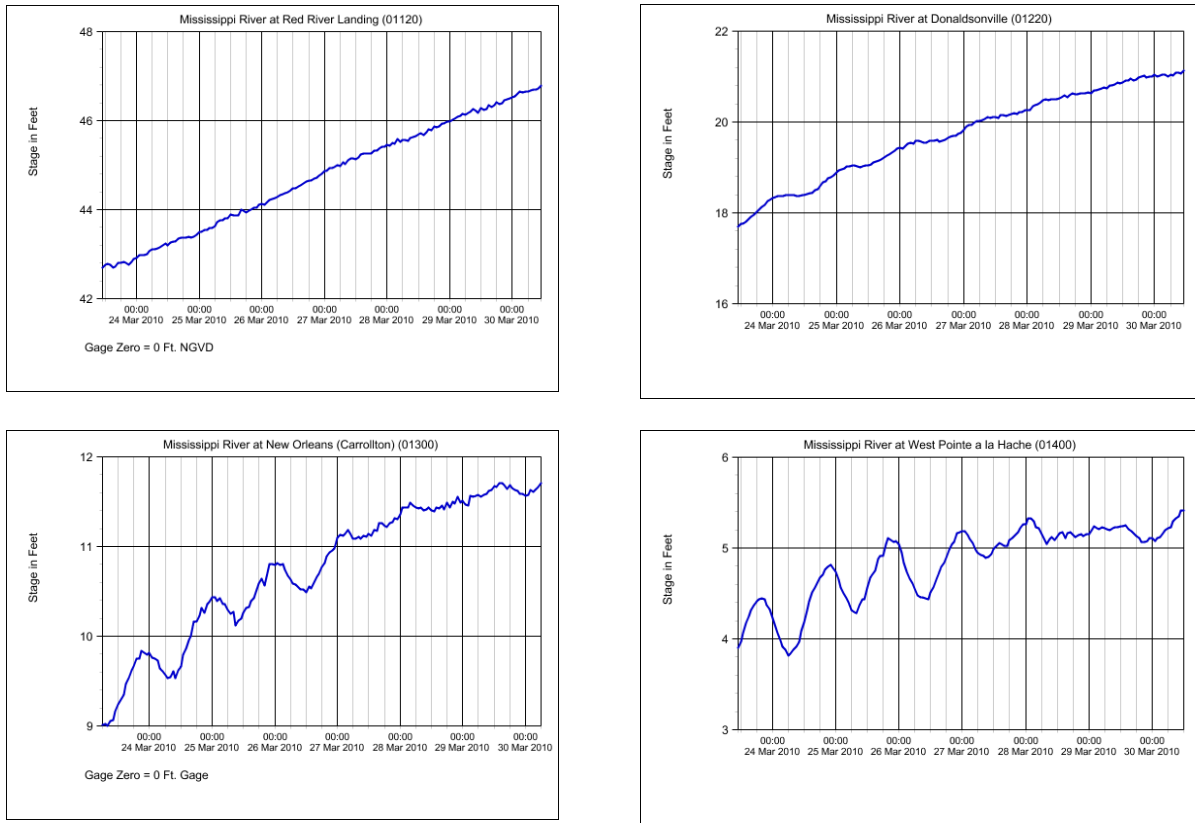


**Figure 5-2 Schematic of the Lower Mississippi River with the Dominant Hydraulic Forces**

### Water Level Observations

To illustrate the water level variation in the Mississippi River, the water level is shown at different stations along the Lower Mississippi River (**Figure 5-3**) for a 1 week period (March 23 – March 30, 2010). From this graph, it can be observed that water levels at Pointe-a-la-Hache and Carrollton fluctuate clearly on a day-to-day basis as a result of the tide in the Gulf of Mexico. At Donaldsonville, LA, there is still a very small modulation visible of the water level and this effect is vanished at Red River Landing. Note also that the tidal influence diminishes over time. This is partly because the influence of the river discharge becomes stronger and dampens the protrusion of the tide into the river, but also has to do with the spring-neap cycle in the tide itself.

**Figure 5-3** also shows the water level gradually increases during this week because of the increasing river discharge upstream. This is very pronounced at Red River Landing with a 4.0 ft water level rise in one week. This water level rise is also visible at the other stations but with a diminishing magnitude in downstream direction. The water level rise at Pointe-a-la-Hache is about 1.0 ft in the same week.



**Figure 5-3 Water Level Variation Along the Mississippi River (Source: [www.rivergages.com](http://www.rivergages.com))**

During hurricanes the interaction between the influence of the river and the sea on the water levels in the New Orleans area is also clearly observed. To show this, the water level variations during August 15 – September 30 are shown at Carrollton in 2005 and 2008 based on gage data in **Figure 5-4**. Note that some data is missing. The water level spikes in these two seasons are clearly correlated to the hurricanes Katrina and Rita (2005) and Gustav and Ike (2008) in these periods. These aspects show that it is necessary to include river discharge as a variable in the joint-probability analysis for determination of the water level statistics for the co-located HSDRSS work in the Mississippi River.

The information included in the tables in this chapter are also summarized in **Appendix T**, Overtopping Design Criteria Tables.

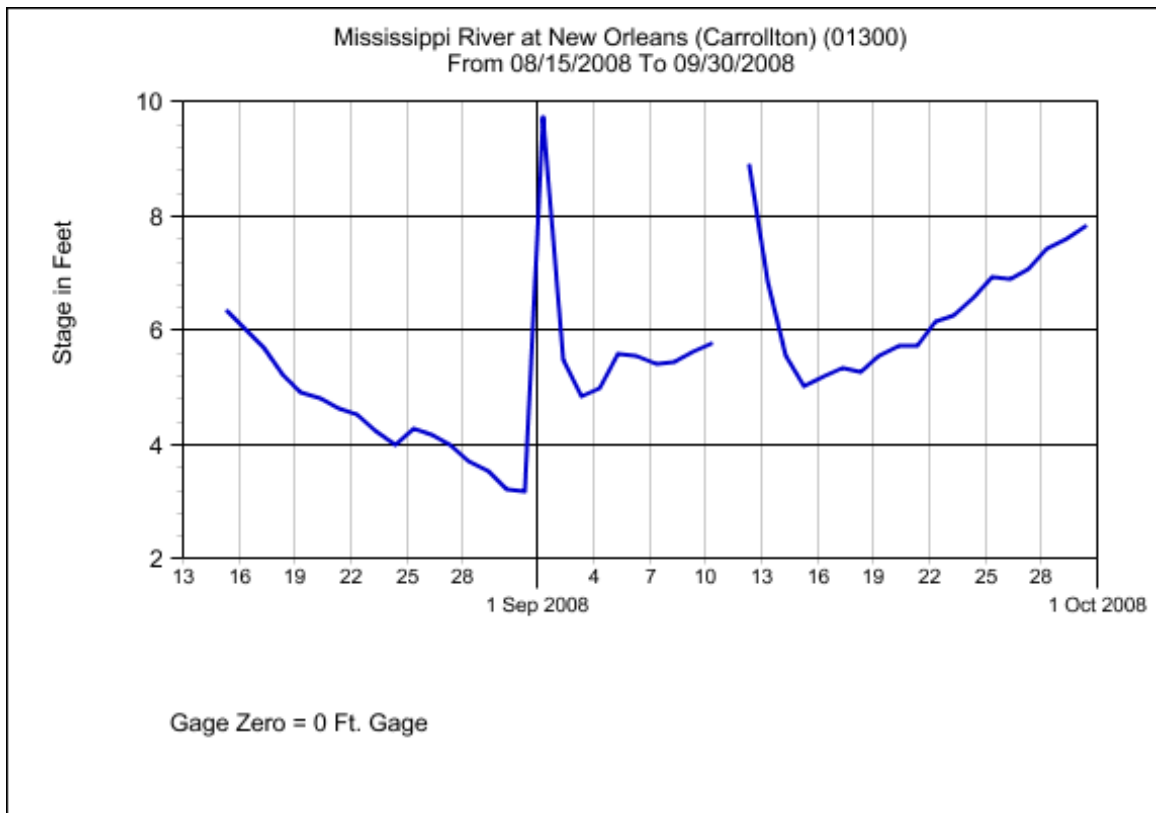
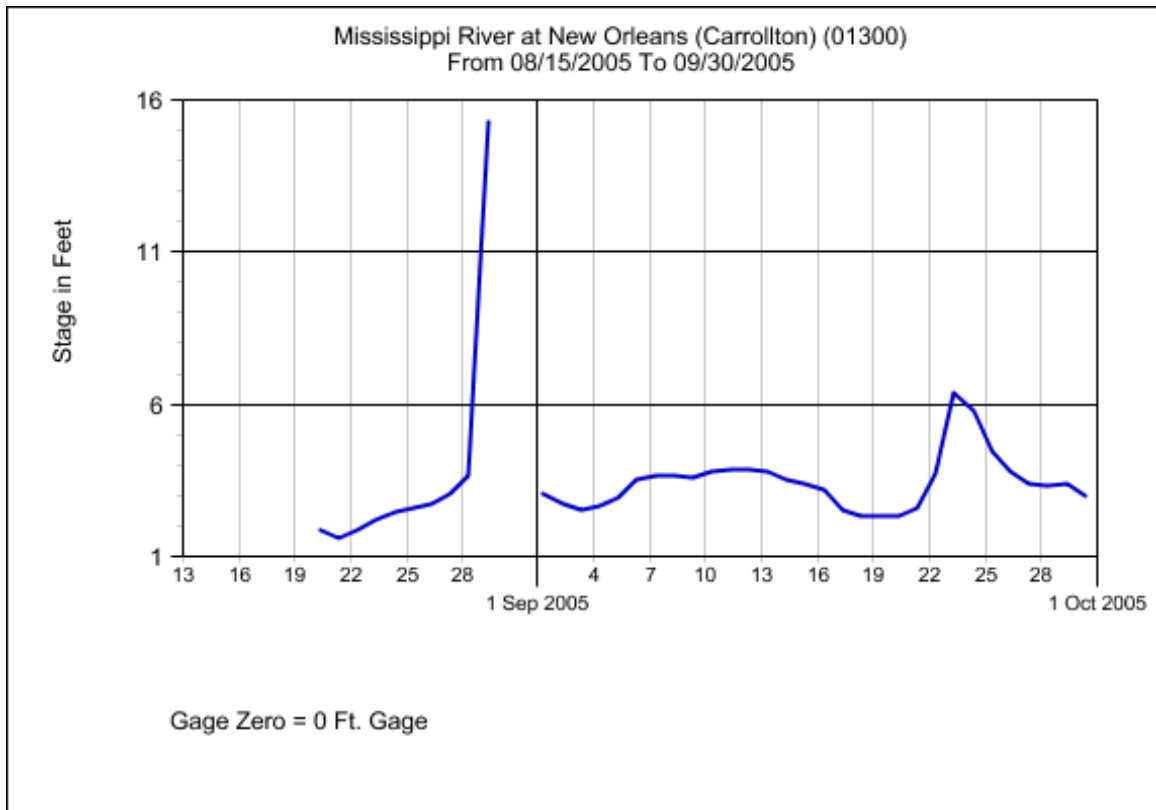


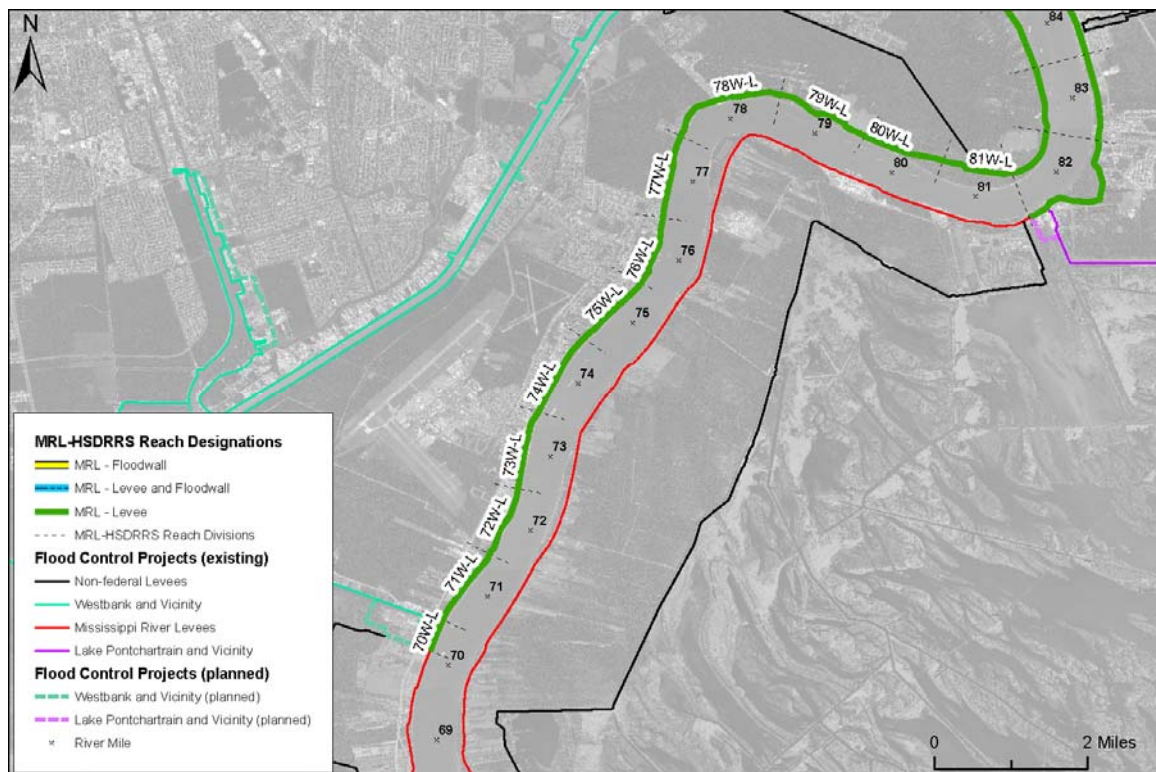
Figure 5-4 Water Level Variation at Carrollton in August - September 2005 (upper panel) and 2008 (lower panel) (Source: [www.rivergages.com](http://www.rivergages.com)).

## 5.2 PLAQUEMINES PARISH WEST BANK (RM 70W TO RM 81W)

### 5.2.1 General

The Plaquemines Parish West Bank MRL-HSDRRS levee reach is from RM 70 to 81. This section is currently existing levee (EAM features previously discussed, as shown on **Plate 14A**). There are reaches of levee and floodwall currently under construction as part of the WBV-MRL Resilient Features (**Plate 14B**). The reach has been split into 13 segments. Each segment is divided at ½ mile upstream and ½ mile downstream from each RM point. It should be noted that a segment 81W-L lies in Orleans and Plaquemines Parish. The “LF” in the segment name stands for “Levee with Floodwall”. **Figure 5-5** shows the location of the Plaquemines Parish West Bank MRL-HSDRRS levee reach.

All elevations described herein are in North American Vertical Datum 1988 (2004.65).



**Figure 5-5** Plaquemines Parish West Bank (RM 70W-RM 81W)– Levee and Floodwall Sections

### 5.2.2 Hydraulic Boundary Conditions

**Table 5-1** summarizes the 1% hydraulic boundary conditions applied for the Plaquemines Parish West Bank MRL-HSDRRS Levees. The 1% surge levels and standard deviations have been derived with the modified probabilistic method JPM-OS. Wave information from the wave model, STWAVE, is not available for the Mississippi River. The wave characteristics used

herein are based on an empirical approach. For a detailed description of the establishment of the surge and wave characteristics, refer to **Chapter 2**.

**Table 5-1 Plaquemines Parish West Bank (RM 70W-RM 81W) – 1% Hydraulic Boundary Conditions**

Plaquemines Parish West Bank (RM 70W to RM 81W)									
1% Hydraulic Boundary Conditions									
Segment	Name	Type	Condition	Surge Level (ft)		Significant Wave Height (ft)		Peak Period (s)	
				Mean	Std	Mean	Std	Mean	Std
70W-L	Plaquemines WB	Levee	Existing	15.4	1.0	2.5	0.3	4.0	0.8
70W-LF	Plaquemines WB	Structure/Wall	Future	17.8	0.8	3.0	0.3	4.0	0.8
70W-L	Plaquemines WB	Levee	Future	17.8	0.8	3.0	0.3	4.0	0.8
71W-L	Plaquemines WB	Levee	Existing	15.4	1.0	2.5	0.3	4.0	0.8
71W-LF	Plaquemines WB	Structure/Wall	Future	17.8	0.8	3.0	0.3	4.0	0.8
71W-L	Plaquemines WB	Levee	Future	17.8	0.8	3.0	0.3	4.0	0.8
72W-L	Plaquemines WB	Levee	Existing	15.3	1.0	2.5	0.3	4.0	0.8
72W-LF	Plaquemines WB	Structure/Wall	Future	17.8	0.8	3.0	0.3	4.0	0.8
72W-L	Plaquemines WB	Levee	Future	17.8	0.8	3.0	0.3	4.0	0.8
73W-L	Plaquemines WB	Levee	Existing	15.3	1.0	2.5	0.3	4.0	0.8
73W-LF	Plaquemines WB	Structure/Wall	Future	17.9	0.8	3.0	0.3	4.0	0.8
73W-L	Plaquemines WB	Levee	Future	17.9	0.8	3.0	0.3	4.0	0.8
74W-L	Plaquemines WB	Levee	Existing	15.2	1.0	2.5	0.3	4.0	0.8
74W-LF	Plaquemines WB	Structure/Wall	Future	17.9	0.8	3.0	0.3	4.0	0.8
74W-L	Plaquemines WB	Levee	Future	17.9	0.8	3.0	0.3	4.0	0.8
75W-L	Plaquemines WB	Levee	Existing	15.2	1.0	2.5	0.3	4.0	0.8
75W-LF	Plaquemines WB	Structure/Wall	Future	17.8	0.8	3.0	0.3	4.0	0.8

Plaquemines Parish West Bank (RM 70W to RM 81W)									
1% Hydraulic Boundary Conditions									
Segment	Name	Type	Condition	Surge Level (ft)		Significant Wave Height (ft)		Peak Period (s)	
				Mean	Std	Mean	Std	Mean	Std
75W-L	Plaquemines WB	Levee	Future	17.8	0.8	3.0	0.3	4.0	0.8
76W-L	Plaquemines WB	Levee	Existing	15.1	1.0	2.5	0.3	4.0	0.8
76W-LF	Plaquemines WB	Structure/Wall	Future	17.8	0.8	3.0	0.3	4.0	0.8
76W-L	Plaquemines WB	Levee	Future	17.8	0.8	3.0	0.3	4.0	0.8
77W-L	Plaquemines WB	Levee	Existing	15.1	1.1	2.5	0.3	4.0	0.8
77W-LF	Plaquemines WB	Structure/Wall	Future	17.8	0.8	3.0	0.3	4.0	0.8
77W-L	Plaquemines WB	Levee	Future	17.8	0.8	3.0	0.3	4.0	0.8
78W-L	Plaquemines WB	Levee	Existing	15.1	1.1	2.5	0.3	4.0	0.8
78W-L	Plaquemines WB	Levee	Future	17.8	0.8	3.0	0.3	4.0	0.8
79W-L	Plaquemines WB	Levee	Existing	15.0	1.1	2.5	0.3	4.0	0.8
79W-L	Plaquemines WB	Levee	Future	17.8	0.8	3.0	0.3	4.0	0.8
80W-L	Plaquemines WB	Levee	Existing	15.0	1.1	1.5	0.2	2.5	0.5
80W-L	Plaquemines WB	Levee	Future	17.8	0.8	2.0	0.2	3.0	0.6
81W-L	Plaquemines WB	Levee	Existing	15.0	1.0	1.5	0.2	2.5	0.5
81W-L	Plaquemines WB	Levee	Future	17.8	0.8	2.0	0.2	3.0	0.6

### 5.2.3 Hydraulic Design Elevations for Levees, Floodwalls, and Structures

The design characteristics of the Plaquemines Parish West Bank MRL-HSDRRS Levees are summarized in **Table 5-2**. The levee sections are designed for both existing and future conditions. Note that the floodwalls and locks are only evaluated for future conditions, because these are hard structures. **Figure 5-6** shows a typical levee design cross-section for the Plaquemines Parish West Bank reach.

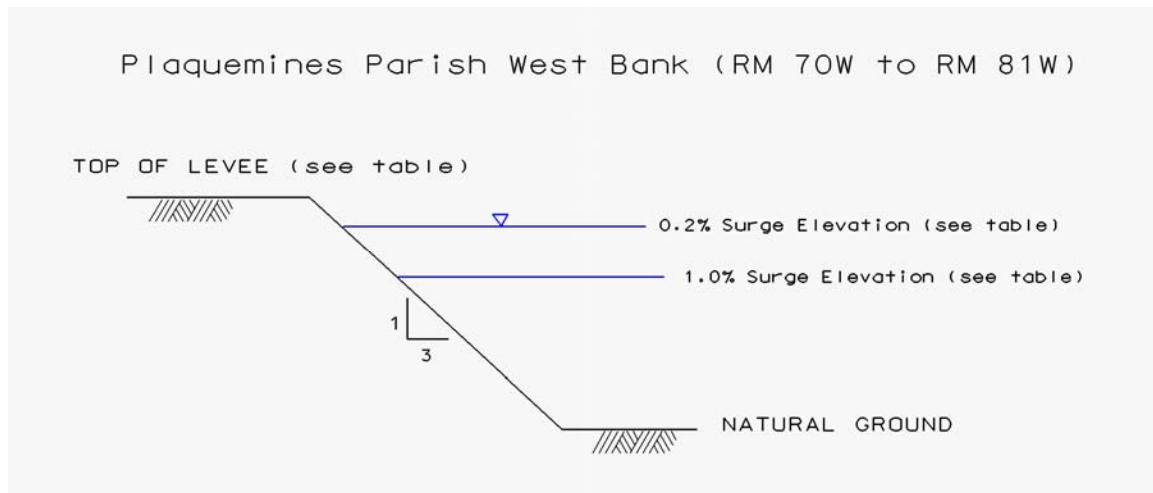
**Table 5-2 Plaquemines Parish West Bank (RM 70W-RM 81W) – 1% Design Information**

Plaquemines Parish West Bank (RM 70W to RM 81W)							
1% Design Elevations							
Segment	Name	Type	Condition	Depth at Toe (ft)	Elevation (ft)	Overtopping Rate	
						q50 (cfs/s per ft)	q90 (cfs/s per ft)
70W-L	Plaquemines WB	Levee	Existing	10.0	21.0	0.007	0.055
70W-LF	Plaquemines WB	Structure/ Wall	Future	12.4	24.5	0.006	0.044
70W-L	Plaquemines WB	Levee	Future	12.4	24.5	0.006	0.044
71W-L	Plaquemines WB	Levee	Existing	9.2	21.0	0.007	0.053
71W-LF	Plaquemines WB	Structure/ Wall	Future	11.7	24.5	0.006	0.048
71W-L	Plaquemines WB	Levee	Future	11.7	24.5	0.006	0.048
72W-L	Plaquemines WB	Levee	Existing	7.9	21.0	0.006	0.052
72W-LF	Plaquemines WB	Structure/ Wall	Future	10.4	24.5	0.006	0.047
72W-L	Plaquemines WB	Levee	Future	10.4	24.5	0.006	0.047
73W-L	Plaquemines WB	Levee	Existing	7.2	21.0	0.006	0.052
73W-LF	Plaquemines WB	Structure/ Wall	Future	9.8	24.5	0.006	0.049
73W-L	Plaquemines WB	Levee	Future	9.8	24.5	0.006	0.049
74W-L	Plaquemines WB	Levee	Existing	8.5	20.5	0.006	0.048
74W-LF	Plaquemines WB	Structure/ Wall	Future	11.1	24.5	0.007	0.049
74W-L	Plaquemines WB	Levee	Future	11.1	24.5	0.007	0.049
75W-L	Plaquemines WB	Levee	Existing	8.9	20.5	0.010	0.074
75W-LF	Plaquemines WB	Structure/ Wall	Future	11.6	24.5	0.006	0.048

75W-L	Plaquemines WB	Levee	Future	11.6	24.5	0.006	0.048
76W-L	Plaquemines WB	Levee	Existing	6.5	20.5	0.009	0.074
76W-LF	Plaquemines WB	Structure/ Wall	Future	9.2	24.5	0.006	0.048
76W-L	Plaquemines WB	Levee	Future	9.2	24.5	0.006	0.048
77W-L	Plaquemines WB	Levee	Existing	7.3	20.5	0.009	0.075
77W-LF	Plaquemines WB	Structure/ Wall	Future	10.0	24.5	0.007	0.047
77W-L	Plaquemines WB	Levee	Future	10.0	24.5	0.007	0.047
78W-L	Plaquemines WB	Levee	Existing	6.6	20.5	0.009	0.072
78W-L	Plaquemines WB	Levee	Future	9.4	24.5	0.006	0.048
79W-L	Plaquemines WB	Levee	Existing	6.4	20.5	0.008	0.068
79W-L	Plaquemines WB	Levee	Future	9.2	24.5	0.006	0.047
80W-L	Plaquemines WB	Levee	Existing	6.4	20.0	0.000	0.001
80W-L	Plaquemines WB	Levee	Future	9.2	24.0	0.000	0.002
81W-L	Plaquemines WB	Levee	Existing	5.7	20.0	0.000	0.001
81W-L	Plaquemines WB	Levee	Future	8.5	24.0	0.000	0.002



## 5.2.4 Typical Sections



**Figure 5-6 Typical Levee Design Cross-section (RM 70W-RM 80W) – Plaquemines Parish West Bank**

## 5.2.5 Resiliency Analysis

The designs for the levees and structures were examined for resiliency by computing the overtopping rate for the 0.2% event for each design (**Table 5-3**).

**Table 5-3 Plaquemines Parish West Bank (RM 70W-RM 81W) – Resiliency Analysis**

Plaquemines Parish West Bank (RM 70W to RM 81W)						
Resiliency Analysis (0.2% Event)						
Segment	Name	Type	Condition	1% Design Elevation (ft)	Best Estimates During 0.2% Event	
					Surge Level (ft)	Overtopping Rate (cfs/s per ft)
70W-L	Plaquemines WB	Levee	Existing	21.0	18.2	1.171
70W-LF	Plaquemines WB	Structure/Wall	Future	24.5	20.7	1.078
70W-L	Plaquemines WB	Levee	Future	24.5	20.7	1.078
71W-L	Plaquemines WB	Levee	Existing	21.0	18.1	1.115
71W-LF	Plaquemines WB	Structure/Wall	Future	24.5	20.8	1.122
71W-L	Plaquemines WB	Levee	Future	24.5	20.8	1.122
72W-L	Plaquemines WB	Levee	Existing	21.0	18.1	1.098
72W-LF	Plaquemines WB	Structure/Wall	Future	24.5	20.8	1.131
72W-L	Plaquemines WB	Levee	Future	24.5	20.8	1.131
73W-L	Plaquemines WB	Levee	Existing	21.0	18.1	1.107
73W-LF	Plaquemines WB	Structure/Wall	Future	24.5	20.8	1.148
73W-L	Plaquemines WB	Levee	Future	24.5	20.8	1.148
74W-L	Plaquemines WB	Levee	Existing	20.5	18.1	1.544
74W-LF	Plaquemines WB	Structure/Wall	Future	24.5	20.8	1.166

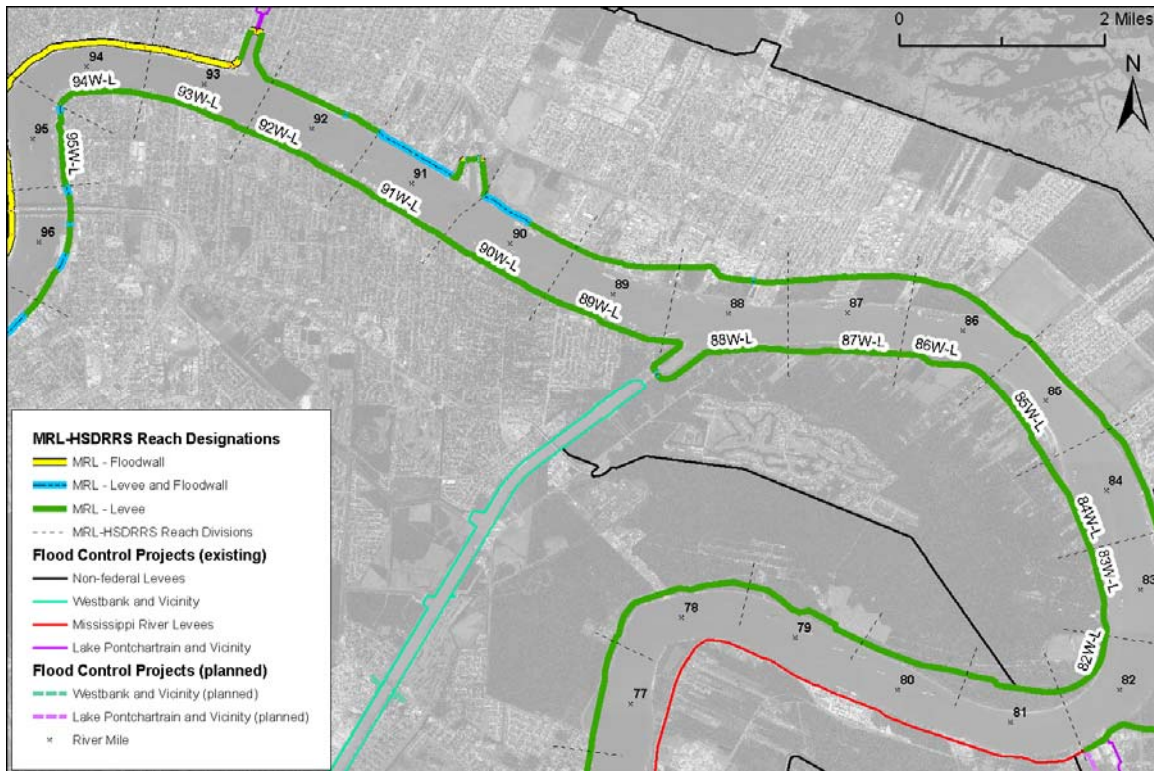
74W-L	Plaquemines WB	Levee	Future	24.5	20.8	1.166
75W-L	Plaquemines WB	Levee	Existing	20.5	18.1	1.488
75W-LF	Plaquemines WB	Structure/ Wall	Future	24.5	20.9	1.184
75W-L	Plaquemines WB	Levee	Future	24.5	20.9	1.184
76W-L	Plaquemines WB	Levee	Existing	20.5	18.0	1.481
76W-LF	Plaquemines WB	Structure/ Wall	Future	24.5	20.9	1.174
76W-L	Plaquemines WB	Levee	Future	24.5	20.9	1.174
77W-L	Plaquemines WB	Levee	Existing	20.5	18.0	1.439
77W-LF	Plaquemines WB	Structure/ Wall	Future	24.5	20.9	1.185
77W-L	Plaquemines WB	Levee	Future	24.5	20.9	1.185
78W-L	Plaquemines WB	Levee	Existing	20.5	18.0	1.429
78W-L	Plaquemines WB	Levee	Future	24.5	20.9	1.191
79W-L	Plaquemines WB	Levee	Existing	20.5	18.0	0.079
79W-L	Plaquemines WB	Levee	Future	24.5	20.9	0.041
80W-L	Plaquemines WB	Levee	Existing	20.0	17.9	0.158
80W-L	Plaquemines WB	Levee	Future	24.0	20.8	0.075
81W-L	Plaquemines WB	Levee	Existing	20.0	17.9	1.201
81W-L	Plaquemines WB	Levee	Future	24.0	20.8	0.795

## 5.3 ORLEANS PARISH WEST BANK (RM 82W TO 95W)

### 5.3.1 General

The Orleans Parish West Bank MRL-HSDRRS levee reach is from RM 82 to 95. The lower portion of this section is currently existing levee (EAM features previously discussed, as shown on **Plate 14A**). This section has two existing hard structures segments: 88W-LF and 95W-LF. The “LF” in the segment name stands for “Levee with Floodwall”. The levee with floodwall is located adjacent to the Algiers lock. The reach has been split into 14 segments. Each segment is divided at ½ mile upstream and ½ mile downstream from each RM point. **Figure 5-7** shows the location of the Orleans Parish West Bank MRL-HSDRRS levee reach.

All elevations described herein are in North American Vertical Datum 1988 (2004.65).



**Figure 5-7 Orleans Parish West Bank (RM 70W-RM 81W) – Levee and Floodwall Sections**

### 5.3.2 Hydraulic Boundary Conditions

**Table 5-4** summarizes the 1% hydraulic boundary conditions applied for the Orleans Parish West Bank MRL-HSDRRS Levees. The 1% surge levels and standard deviations have been derived with the modified probabilistic method JPM-OS. Wave information from the wave model, STWAVE, is not available for the Mississippi River. The wave characteristics used herein are based on an empirical approach. For a detailed description of the establishment of the surge and wave characteristics, referred to **Chapter 2**.

**Table 5-4 Orleans Parish West Bank (RM 82W-RM 95W) – 1% Hydraulic Boundary Conditions**

Orleans Parish West Bank (RM 82W to RM 95W)									
1% Hydraulic Boundary Conditions									
Segment	Name	Type	Condition	Surge Level (ft)		Significant Wave Height (ft)		Peak Period (s)	
				Mean	Std	Mean	Std	Mean	Std
82W-L	Orleans WB	Levee	Existing	15.0	1.0	2.3	0.2	3.8	0.8
82W-L	Orleans WB	Levee	Future	17.8	0.8	2.8	0.3	4.0	0.8
83W-L	Orleans WB	Levee	Existing	15.0	1.0	2.3	0.2	3.8	0.8
83W-L	Orleans WB	Levee	Future	17.7	0.8	2.8	0.3	4.0	0.8
84W-L	Orleans WB	Levee	Existing	15.0	1.0	2.3	0.2	3.8	0.8
84W-L	Orleans WB	Levee	Future	17.7	0.8	2.8	0.3	4.0	0.8
85W-L	Orleans WB	Levee	Existing	15.0	1.0	2.3	0.2	3.8	0.8
85W-L	Orleans WB	Levee	Future	17.7	0.8	2.8	0.3	4.0	0.8
86W-L	Orleans WB	Levee	Existing	15.0	1.0	2.3	0.2	3.8	0.8
86W-L	Orleans WB	Levee	Future	17.8	0.8	2.8	0.3	4.0	0.8
87W-L	Orleans WB	Levee	Existing	15.0	1.0	2.3	0.2	3.8	0.8
87W-L	Orleans WB	Levee	Future	17.8	0.8	2.8	0.3	4.0	0.8
88W-L	Orleans WB	Levee	Existing	15.1	1.0	2.3	0.2	3.8	0.8
88W-LF	Orleans WB	Structure/Wall	Future	17.8	0.8	2.8	0.3	4.0	0.8
88W-L	Orleans WB	Levee	Future	17.8	0.8	2.8	0.3	4.0	0.8
89W-L	Orleans WB	Levee	Existing	15.1	1.0	2.3	0.2	3.8	0.8
89W-L	Orleans WB	Levee	Future	17.9	0.8	2.8	0.3	4.0	0.8
90W-L	Orleans WB	Levee	Existing	15.1	1.0	2.3	0.2	3.8	0.8
90W-L	Orleans WB	Levee	Future	17.9	0.9	2.8	0.3	4.0	0.8
91W-L	Orleans WB	Levee	Existing	15.1	1.0	2.3	0.2	3.8	0.8

91W-L	Orleans WB	Levee	Future	17.9	0.9	2.8	0.3	4.0	0.8
92W-L	Orleans WB	Levee	Existing	15.2	1.1	2.3	0.2	3.8	0.8
92W-L	Orleans WB	Levee	Future	17.9	0.9	2.8	0.3	4.0	0.8
93W-L	Orleans WB	Levee	Existing	15.2	1.1	2.3	0.2	3.8	0.8
93W-L	Orleans WB	Levee	Future	17.9	0.9	2.8	0.3	4.0	0.8
94W-L	Orleans WB	Levee	Existing	15.2	1.1	2.3	0.2	3.8	0.8
94W-L	Orleans WB	Levee	Future	18.0	0.9	2.8	0.3	4.0	0.8
95W-L	Orleans WB	Levee	Existing	15.3	1.1	2.3	0.2	3.8	0.8
95W-LF	Orleans WB	Structure/Wall	Future	18.0	0.9	2.8	0.3	4.0	0.8
95W-L	Orleans WB	Levee	Future	18.0	0.9	2.8	0.3	4.0	0.8

### 5.3.3 Hydraulic Design Elevations for Levees, Floodwalls, and Structures

The design characteristics of the Orleans Parish West Bank MRL-HSDRRS Levees are summarized in **Table 5-5**. The levee sections are designed for both existing and future conditions. Note that the floodwalls and locks are only evaluated for future conditions, because these are hard structures. **Figure 5-8** shows a typical levee design cross-section for the Orleans Parish West Bank reach.

**Table 5-5 Orleans Parish West Bank (RM 82W-RM 95W) – 1% Design Information**

<b>Orleans Parish West Bank (RM 82W to 95W)</b>							
<b>1% Design Elevations</b>							
Segment	Name	Type	Condition	Depth at toe (ft)	Elevation (ft)	Overtopping Rate	
						q50 (cfs/s per ft)	q90 (cfs/s per ft)
82W-L	Orleans WB	Levee	Existing	5.5	20.0	0.006	0.055
82W-L	Orleans WB	Levee	Future	8.3	24.0	0.006	0.044
83W-L	Orleans WB	Levee	Existing	6.1	20.0	0.006	0.054
83W-L	Orleans WB	Levee	Future	8.9	24.0	0.006	0.042
84W-L	Orleans WB	Levee	Existing	7.7	20.0	0.006	0.055
84W-L	Orleans WB	Levee	Future	10.5	24.0	0.006	0.042
85W-L	Orleans WB	Levee	Existing	6.1	20.0	0.006	0.053
85W-L	Orleans WB	Levee	Future	8.9	24.0	0.006	0.043
86W-L	Orleans WB	Levee	Existing	5.9	20.0	0.006	0.057
86W-L	Orleans WB	Levee	Future	8.6	24.0	0.006	0.045
87W-L	Orleans WB	Levee	Existing	6.5	20.0	0.006	0.056
87W-L	Orleans WB	Levee	Future	9.3	24.0	0.006	0.046
88W-L	Orleans WB	Levee	Existing	7.4	20.0	0.007	0.061
88W-LF	Orleans WB	Structure/Wall	Future	10.2	24.0	0.001	0.004
88W-L	Orleans WB	Levee	Future	10.2	24.0	0.007	0.049
89W-L	Orleans WB	Levee	Existing	6.0	20.0	0.007	0.063
89W-L	Orleans WB	Levee	Future	8.8	24.0	0.006	0.048
90W-L	Orleans WB	Levee	Existing	6.2	20.0	0.007	0.063
90W-L	Orleans WB	Levee	Future	9.0	24.0	0.007	0.051

**Orleans Parish West Bank (RM 82W to 95W)**

**1% Design Elevations**

Segment	Name	Type	Condition	Depth at toe (ft)	Elevation (ft)	Overtopping Rate	
						q50 (cfs/s per ft)	q90 (cfs/s per ft)
91W-L	Orleans WB	Levee	Existing	5.7	20.0	0.007	0.063
91W-L	Orleans WB	Levee	Future	8.5	24.0	0.007	0.052
92W-L	Orleans WB	Levee	Existing	6.1	20.0	0.007	0.068
92W-L	Orleans WB	Levee	Future	8.8	24.0	0.007	0.053
93W-L	Orleans WB	Levee	Existing	5.0	20.0	0.007	0.071
93W-L	Orleans WB	Levee	Future	7.7	24.0	0.007	0.054
94W-L	Orleans WB	Levee	Existing	4.8	20.0	0.008	0.075
94W-L	Orleans WB	Levee	Future	7.5	24.0	0.008	0.055
95W-L	Orleans WB	Levee	Existing	3.4	20.0	0.009	0.076
95W-LF	Orleans WB	Structure/Wall	Future	6.1	24.0	0.001	0.006
95W-L	Orleans WB	Levee	Future	6.1	24.0	0.008	0.058



### 5.3.4 Typical Sections

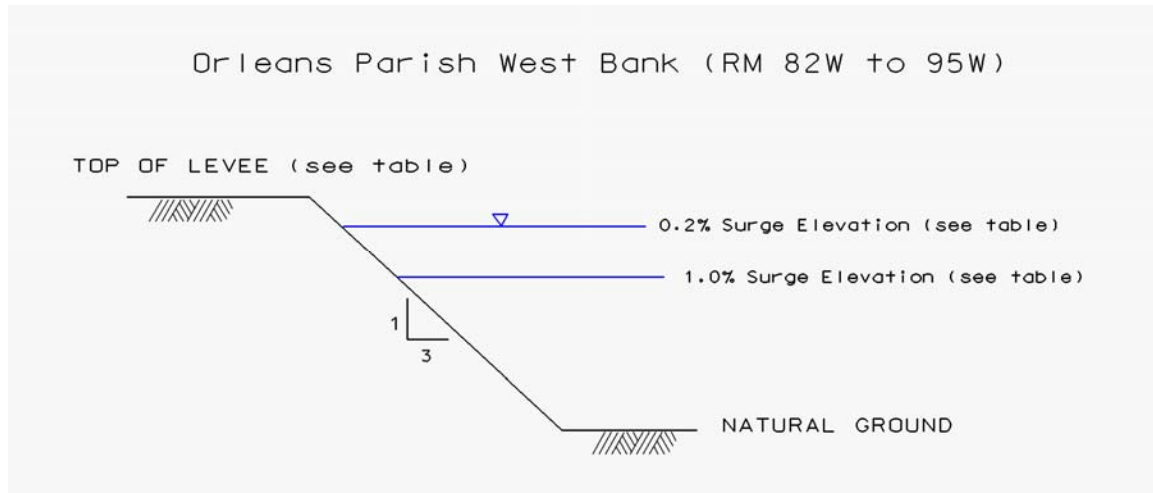


Figure 5-8 Typical Levee Design Cross-section (RM 82W- RM 95W) – Orleans Parish West Bank

### 5.3.5 Resiliency Analysis

The designs for the levees and structures were examined for resiliency by computing the 0.2% surge level (50% confidence). The results are presented in **Table 5-6**.

**Table 5-6 Orleans Parish West Bank (RM 82W–RM 95W) – Resiliency Analysis**

Orleans Parish West Bank (RM 82W to 95W)						
Resiliency Analysis (0.2% Event)						
Segment	Name	Type	Condition	1% Design Elevation (ft)	Best Estimates During 0.2% Event	
					Surge Level (ft)	Overtopping Rate (cfs/s per ft)
82W-L	Orleans WB	Levee	Existing	20.0	17.9	1.210
82W-L	Orleans WB	Levee	Future	24.0	20.8	0.770
83W-L	Orleans WB	Levee	Existing	20.0	17.9	1.162
83W-L	Orleans WB	Levee	Future	24.0	20.7	0.769
84W-L	Orleans WB	Levee	Existing	20.0	17.9	1.148
84W-L	Orleans WB	Levee	Future	24.0	20.8	0.772
85W-L	Orleans WB	Levee	Existing	20.0	17.9	1.156
85W-L	Orleans WB	Levee	Future	24.0	20.8	0.788
86W-L	Orleans WB	Levee	Existing	20.0	17.9	1.182
86W-L	Orleans WB	Levee	Future	24.0	20.8	0.808
87W-L	Orleans WB	Levee	Existing	20.0	18.0	1.239
87W-L	Orleans WB	Levee	Future	24.0	20.9	0.861
88W-L	Orleans WB	Levee	Existing	20.0	18.0	1.278
88W-LF	Orleans WB	Structure/Wall	Future	24.0	20.9	0.306
88W-L	Orleans WB	Levee	Future	24.0	20.9	0.917
89W-L	Orleans WB	Levee	Existing	20.0	18.1	1.302

**Orleans Parish West Bank (RM 82W to 95W)**

**Resiliency Analysis (0.2% Event)**

Segment	Name	Type	Condition	1% Design Elevation (ft)	Best Estimates During 0.2% Event	
					Surge Level (ft)	Overtopping Rate (cfs/s per ft)
89W-L	Orleans WB	Levee	Future	24.0	21.0	0.922
90W-L	Orleans WB	Levee	Existing	20.0	18.1	1.410
90W-L	Orleans WB	Levee	Future	24.0	21.1	0.996
91W-L	Orleans WB	Levee	Existing	20.0	18.1	1.380
91W-L	Orleans WB	Levee	Future	24.0	21.1	1.015
92W-L	Orleans WB	Levee	Existing	20.0	18.2	1.454
92W-L	Orleans WB	Levee	Future	24.0	21.2	1.064
93W-L	Orleans WB	Levee	Existing	20.0	18.2	1.535
93W-L	Orleans WB	Levee	Future	24.0	21.3	1.098
94W-L	Orleans WB	Levee	Existing	20.0	18.3	1.580
94W-L	Orleans WB	Levee	Future	24.0	21.3	1.178
95W-L	Orleans WB	Levee	Existing	20.0	18.4	0.082
95W-LF	Orleans WB	Structure/Wall	Future	24.0	21.4	0.012
95W-L	Orleans WB	Levee	Future	24.0	21.4	0.037

## 5.4 JEFFERSON PARISH WEST BANK (RM 96W TO RM 114W)

### 5.4.1 General

The Jefferson Parish West Bank MRL-HSDRRS levee reach is from RM 96 to 114. The reach has been split into 19 segments. Each segment is divided at ½ mile upstream and ½ mile downstream from each RM point. This section has hard structures at the following RM segments; 96, 97, 98, 99, 102, 106, 107, 108, and 110. **Figure 5-9** and **Figure 5-10** show the location of the Jefferson Parish West Bank MRL-HSDRRS levee reach.

All elevations described herein are in North American Vertical Datum 1988 (2004.65).

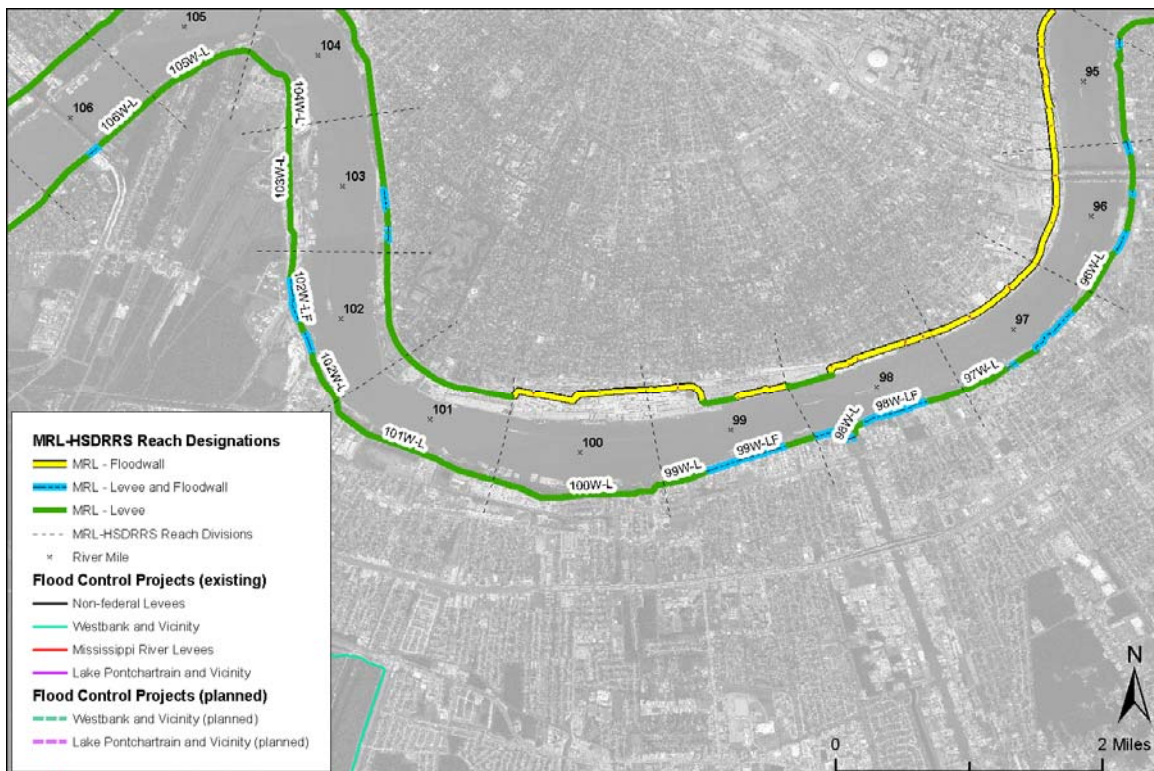


Figure 5-9 Jefferson Parish West Bank (RM 96W-RM 114W) – Levee and Floodwall Sections

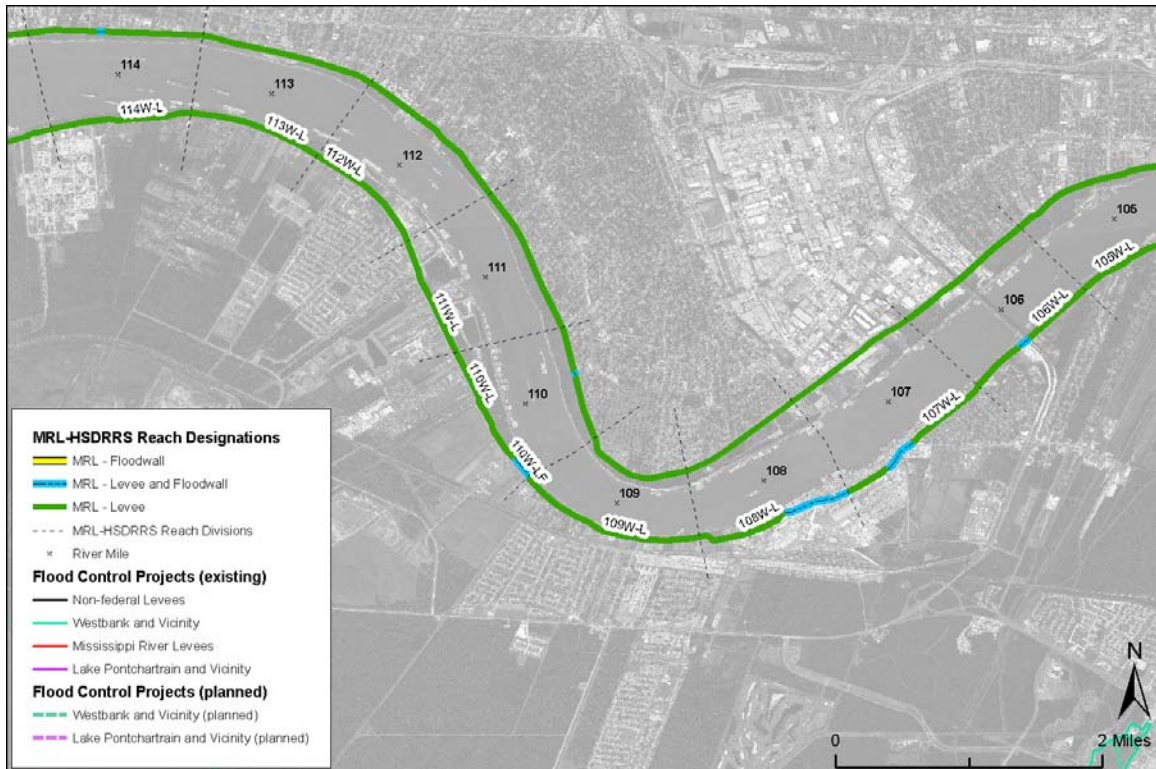


Figure 5-10 Jefferson Parish West Bank (RM 96W-RM 114W) – Levee and Floodwall Sections

## 5.4.2 Hydraulic Boundary Conditions

**Table 5-7** summarizes the 1% hydraulic boundary conditions applied for the Jefferson Parish West Bank MRL-HSDRRS Levees. The 1% surge levels and standard deviations have been derived with the modified probabilistic method JPM-OS. Wave information from the wave model, STWAVE, is not available for the Mississippi River. The wave characteristics used herein are based on an empirical approach. For a detailed description of the establishment of the surge and wave characteristics, refer to **Chapter 2**.

**Table 5-7 Jefferson Parish West Bank (RM 96W-RM 114W) –1% Hydraulic Boundary Conditions**

Jefferson Parish West Bank (RM 96W to RM 114W)									
1% Hydraulic Boundary Conditions									
Segment	Name	Type	Condition	Surge Level (ft)		Significant Wave Height (ft)		Peak Period (s)	
				Mean	Std	Mean	Std	Mean	Std
96W-L	Jefferson WB	Levee	Existing	15.3	1.1	1.5	0.2	2.5	0.5
96W-LF	Jefferson WB	Structure/Wall	Future	18.0	0.9	1.5	0.2	2.5	0.5
96W-L	Jefferson WB	Levee	Future	18.0	0.9	1.5	0.2	2.5	0.5
97W-L	Jefferson WB	Levee	Existing	15.3	1.0	1.5	0.2	2.5	0.5
97W-LF	Jefferson WB	Structure/Wall	Future	18.1	0.9	1.5	0.2	2.5	0.5
97W-L	Jefferson WB	Levee	Future	18.1	0.9	1.5	0.2	2.5	0.5
98W-L	Jefferson WB	Levee	Existing	15.4	1.0	1.5	0.2	2.5	0.5
98W-LF	Jefferson WB	Structure/Wall	Future	18.1	0.9	1.5	0.2	2.5	0.5
98W-L	Jefferson WB	Levee	Future	18.1	0.9	1.5	0.2	2.5	0.5
99W-L	Jefferson WB	Levee	Existing	15.4	1.1	1.5	0.2	2.5	0.5
99W-LF	Jefferson WB	Structure/Wall	Future	18.1	0.9	1.5	0.2	2.5	0.5
99W-L	Jefferson WB	Levee	Future	18.1	0.9	1.5	0.2	2.5	0.5
100W-L	Jefferson WB	Levee	Existing	15.5	1.1	1.5	0.2	3.5	0.7
100W-L	Jefferson WB	Levee	Future	18.2	0.9	2.0	0.2	3.5	0.7

**Jefferson Parish West Bank (RM 96W to RM 114W)**

**1% Hydraulic Boundary Conditions**

Segment	Name	Type	Condition	Surge Level (ft)		Significant Wave Height (ft)		Peak Period (s)	
				Mean	Std	Mean	Std	Mean	Std
101W-L	Jefferson WB	Levee	Existing	15.5	1.1	1.5	0.2	3.5	0.7
101W-L	Jefferson WB	Levee	Future	18.2	1.0	2.0	0.2	3.5	0.7
102W-L	Jefferson WB	Levee	Existing	15.5	1.1	1.5	0.2	3.5	0.7
102W-LF	Jefferson WB	Structure/Wall	Future	18.2	1.0	2.0	0.2	3.5	0.7
102W-L	Jefferson WB	Levee	Future	18.2	1.0	2.0	0.2	3.5	0.7
103W-L	Jefferson WB	Levee	Existing	15.5	1.1	1.5	0.2	3.5	0.7
103W-L	Jefferson WB	Levee	Future	18.2	1.0	2.0	0.2	3.5	0.7
104W-L	Jefferson WB	Levee	Existing	15.5	1.1	1.5	0.2	3.5	0.7
104W-L	Jefferson WB	Levee	Future	18.2	1.0	2.0	0.2	3.5	0.7
105W-L	Jefferson WB	Levee	Existing	15.5	1.1	1.5	0.2	3.5	0.7
105W-L	Jefferson WB	Levee	Future	18.2	1.0	2.0	0.2	3.5	0.7
106W-L	Jefferson WB	Levee	Existing	15.6	1.1	1.5	0.2	3.5	0.7
106W-LF	Jefferson WB	Structure/Wall	Future	18.3	1.0	2.0	0.2	3.5	0.7
106W-L	Jefferson WB	Levee	Future	18.3	1.0	2.0	0.2	3.5	0.7
107W-L	Jefferson WB	Levee	Existing	15.6	1.1	1.5	0.2	2.5	0.5
107W-LF	Jefferson WB	Structure/Wall	Future	18.3	1.0	1.5	0.2	2.5	0.5
107W-L	Jefferson WB	Levee	Future	18.3	1.0	1.5	0.2	2.5	0.5
108W-L	Jefferson WB	Levee	Existing	15.7	1.1	1.5	0.2	2.5	0.5
108W-LF	Jefferson WB	Structure/Wall	Future	18.3	1.0	1.5	0.2	2.5	0.5
108W-L	Jefferson WB	Levee	Future	18.3	1.0	1.5	0.2	2.5	0.5

**Jefferson Parish West Bank (RM 96W to RM 114W)**

**1% Hydraulic Boundary Conditions**

Segment	Name	Type	Condition	Surge Level (ft)		Significant Wave Height (ft)		Peak Period (s)	
				Mean	Std	Mean	Std	Mean	Std
109W-L	Jefferson WB	Levee	Existing	15.7	1.1	2.0	0.2	3.5	0.7
109W-L	Jefferson WB	Levee	Future	18.4	1.1	2.5	0.3	4.0	0.8
110W-L	Jefferson WB	Levee	Existing	15.7	1.1	2.0	0.2	3.5	0.7
110W-LF	Jefferson WB	Structure/Wall	Future	18.4	1.1	2.5	0.3	4.0	0.8
110W-L	Jefferson WB	Levee	Future	18.4	1.1	2.5	0.3	4.0	0.8
111W-L	Jefferson WB	Levee	Existing	15.7	1.1	2.0	0.2	3.5	0.7
111W-L	Jefferson WB	Levee	Future	18.4	1.1	2.5	0.3	4.0	0.8
112W-L	Jefferson WB	Levee	Existing	15.7	1.1	2.0	0.2	3.5	0.7
112W-L	Jefferson WB	Levee	Future	18.5	1.1	2.5	0.3	4.0	0.8
113W-L	Jefferson WB	Levee	Existing	15.8	1.1	2.0	0.2	3.5	0.7
113W-L	Jefferson WB	Levee	Future	18.5	1.1	2.5	0.3	4.0	0.8
114W-L	Jefferson WB	Levee	Existing	15.8	1.2	2.0	0.2	3.5	0.7
114W-L	Jefferson WB	Levee	Future	18.5	1.1	2.5	0.3	4.0	0.8



### 5.4.3 Hydraulic Design Elevations for Levees, Floodwalls, and Structures

The design characteristics of the Jefferson Parish West Bank MRL-HSDRRS Levees are summarized in **Table 5-8**. The levee sections are designed for both existing and future conditions. Note that the floodwalls and locks are only evaluated for future conditions, because these are hard structures. **Figure 5-11** shows a typical levee design cross-section for the Jefferson Parish West Bank reach.

**Table 5-8 Jefferson Parish West Bank (RM 96W-RM 114W) – 1% Design Information**

Jefferson Parish West Bank (RM 96W to RM 114W)							
1% Design Elevations							
Segment	Name	Type	Condition	Depth at Toe (ft)	Elevation (ft)	Overtopping Rate	
						q50 (cfs/s per ft)	q90 (cfs/s per ft)
96W-L	Jefferson WB	Levee	Existing	3.9	19.0	0.000	0.016
96W-LF	Jefferson WB	Structure/Wall	Future	6.6	22.5	0.000	0.000
96W-L	Jefferson WB	Levee	Future	6.6	22.5	0.000	0.003
97W-L	Jefferson WB	Levee	Existing	7.1	19.0	0.000	0.017
97W-LF	Jefferson WB	Structure/Wall	Future	9.8	22.5	0.000	0.000
97W-L	Jefferson WB	Levee	Future	9.8	22.5	0.000	0.003
98W-L	Jefferson WB	Levee	Existing	5.8	19.0	0.001	0.018
98W-LF	Jefferson WB	Structure/Wall	Future	8.5	22.5	0.000	0.001
98W-L	Jefferson WB	Levee	Future	8.5	22.5	0.000	0.003
99W-L	Jefferson WB	Levee	Existing	6.0	19.0	0.000	0.019
99W-LF	Jefferson WB	Structure/Wall	Future	8.7	22.5	0.000	0.001
99W-L	Jefferson WB	Levee	Future	8.7	22.5	0.000	0.004
100W-L	Jefferson WB	Levee	Existing	4.3	19.0	0.004	0.051
100W-L	Jefferson WB	Levee	Future	6.9	22.5	0.006	0.055
101W-L	Jefferson WB	Levee	Existing	3.8	19.0	0.004	0.057

**Jefferson Parish West Bank (RM 96W to RM 114W)**

**1% Design Elevations**

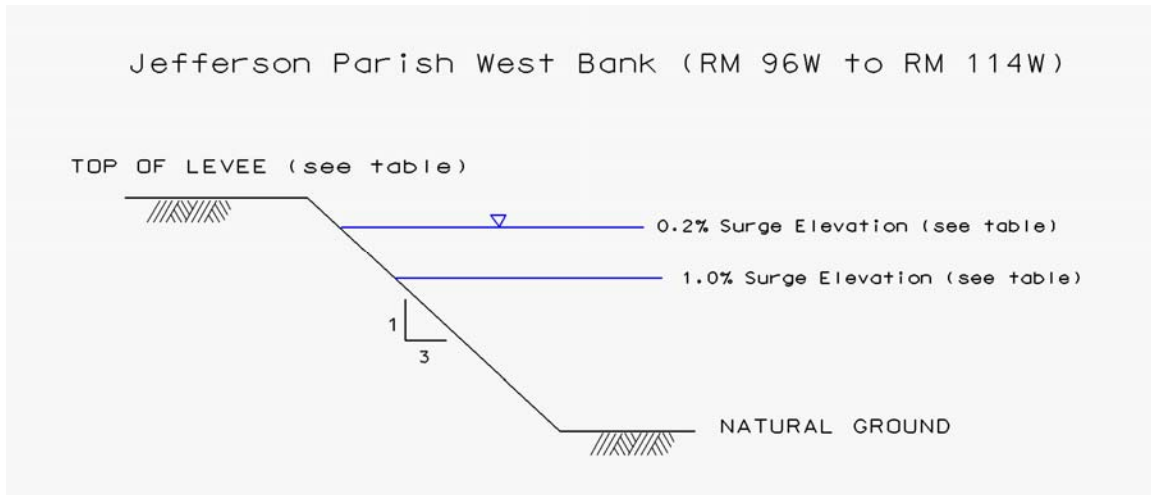
Segment	Name	Type	Condition	Depth at Toe (ft)	Elevation (ft)	Overtopping Rate	
						q50 (cfs/s per ft)	q90 (cfs/s per ft)
101W-L	Jefferson WB	Levee	Future	6.5	22.5	0.006	0.055
102W-L	Jefferson WB	Levee	Existing	0.9	19.0	0.004	0.054
102W-LF	Jefferson WB	Structure/Wall	Future	3.6	22.5	0.001	0.006
102W-L	Jefferson WB	Levee	Future	3.6	22.5	0.006	0.056
103W-L	Jefferson WB	Levee	Existing	4.1	19.0	0.004	0.057
103W-L	Jefferson WB	Levee	Future	6.8	22.5	0.006	0.058
104W-L	Jefferson WB	Levee	Existing	4.8	19.0	0.003	0.055
104W-L	Jefferson WB	Levee	Future	7.5	22.5	0.005	0.056
105W-L	Jefferson WB	Levee	Existing	2.5	19.0	0.004	0.060
105W-L	Jefferson WB	Levee	Future	5.2	22.5	0.006	0.062
106W-L	Jefferson WB	Levee	Existing	5.0	19.0	0.004	0.064
106W-LF	Jefferson WB	Structure/Wall	Future	7.7	22.5	0.001	0.008
106W-L	Jefferson WB	Levee	Future	7.7	22.5	0.007	0.070
107W-L	Jefferson WB	Levee	Existing	-0.1	19.0	0.001	0.030
107W-LF	Jefferson WB	Structure/Wall	Future	2.6	22.5	0.000	0.001
107W-L	Jefferson WB	Levee	Future	2.6	22.5	0.000	0.006
108W-L	Jefferson WB	Levee	Existing	0.0	19.0	0.001	0.032
108W-LF	Jefferson WB	Structure/Wall	Future	2.6	22.5	0.000	0.001
108W-L	Jefferson WB	Levee	Future	2.6	22.5	0.000	0.006
109W-L	Jefferson WB	Levee	Existing	5.2	20.0	0.006	0.068

**Jefferson Parish West Bank (RM 96W to RM 114W)**

**1% Design Elevations**

Segment	Name	Type	Condition	Depth at Toe (ft)	Elevation (ft)	Overtopping Rate	
						q50 (cfs/s per ft)	q90 (cfs/s per ft)
109W-L	Jefferson WB	Levee	Future	7.9	24.0	0.007	0.059
110W-L	Jefferson WB	Levee	Existing	6.1	20.0	0.006	0.068
110W-LF	Jefferson WB	Structure/Wall	Future	8.8	24.0	0.000	0.004
110W-L	Jefferson WB	Levee	Future	8.8	24.0	0.007	0.060
111W-L	Jefferson WB	Levee	Existing	2.8	20.0	0.006	0.070
111W-L	Jefferson WB	Levee	Future	5.5	24.0	0.007	0.061
112W-L	Jefferson WB	Levee	Existing	1.2	20.0	0.007	0.076
112W-L	Jefferson WB	Levee	Future	3.9	24.0	0.007	0.069
113W-L	Jefferson WB	Levee	Existing	4.3	20.0	0.007	0.081
113W-L	Jefferson WB	Levee	Future	7.0	24.0	0.008	0.070
114W-L	Jefferson WB	Levee	Existing	5.3	20.0	0.007	0.084
114W-L	Jefferson WB	Levee	Future	8.1	24.0	0.008	0.072

### 5.4.4 Typical Section



**Figure 5-11 Typical Levee Design Cross-section for Wave Force (RM 96W-RM 114W) – Jefferson Parish West Bank**

### 5.4.5 Resiliency Analysis

The designs for the levees and structures were examined for resiliency by computing the 0.2% surge level (50% confidence). The results are presented in **Table 5-9**.

**Table 5-9 Jefferson Parish West Bank (RM 96W-RM 114W) – Resiliency Analysis**

Jefferson Parish West Bank (RM 96W to RM 114W)						
Resiliency Analysis (0.2% Event)						
Segment	Name	Type	Condition	1% Design Elevation (ft)	Best Estimates During 0.2% Event	
					Surge Level (ft)	Overtopping Rate (cfs/s per ft)
96W-L	Jefferson WB	Levee	Existing	19.0	18.4	0.618
96W-LF	Jefferson WB	Structure/Wall	Future	22.5	21.4	0.183
96W-L	Jefferson WB	Levee	Future	22.5	21.4	0.462
97W-L	Jefferson WB	Levee	Existing	19.0	18.5	0.716
97W-LF	Jefferson WB	Structure/Wall	Future	22.5	21.5	0.217

**Jefferson Parish West Bank (RM 96W to RM 114W)**

**Resiliency Analysis (0.2% Event)**

Segment	Name	Type	Condition	1% Design Elevation (ft)	Best Estimates During 0.2% Event	
					Surge Level (ft)	Overtopping Rate (cfs/s per ft)
97W-L	Jefferson WB	Levee	Future	22.5	21.5	0.515
98W-L	Jefferson WB	Levee	Existing	19.0	18.5	0.829
98W-LF	Jefferson WB	Structure/Wall	Future	22.5	21.5	0.222
98W-L	Jefferson WB	Levee	Future	22.5	21.5	0.598
99W-L	Jefferson WB	Levee	Existing	19.0	18.6	2.352
99W-LF	Jefferson WB	Structure/Wall	Future	22.5	21.6	1.133
99W-L	Jefferson WB	Levee	Future	22.5	21.6	2.185
100W-L	Jefferson WB	Levee	Existing	19.0	18.7	2.484
100W-L	Jefferson WB	Levee	Future	22.5	21.7	2.284
101W-L	Jefferson WB	Levee	Existing	19.0	18.7	2.588
101W-L	Jefferson WB	Levee	Future	22.5	21.8	2.364
102W-L	Jefferson WB	Levee	Existing	19.0	18.8	2.608
102W-LF	Jefferson WB	Structure/Wall	Future	22.5	21.8	1.304
102W-L	Jefferson WB	Levee	Future	22.5	21.8	2.441
103W-L	Jefferson WB	Levee	Existing	19.0	18.8	2.625
103W-L	Jefferson WB	Levee	Future	22.5	21.9	2.460
104W-L	Jefferson WB	Levee	Existing	19.0	18.8	2.676
104W-L	Jefferson WB	Levee	Future	22.5	21.9	2.496
105W-L	Jefferson WB	Levee	Existing	19.0	18.9	2.720
105W-L	Jefferson WB	Levee	Future	22.5	22.0	2.596

**Jefferson Parish West Bank (RM 96W to RM 114W)**

**Resiliency Analysis (0.2% Event)**

Segment	Name	Type	Condition	1% Design Elevation (ft)	Best Estimates During 0.2% Event	
					Surge Level (ft)	Overtopping Rate (cfs/s per ft)
106W-L	Jefferson WB	Levee	Existing	19.0	19.0	1.320
106W-LF	Jefferson WB	Structure/Wall	Future	22.5	22.1	0.649
106W-L	Jefferson WB	Levee	Future	22.5	22.1	1.123
107W-L	Jefferson WB	Levee	Existing	19.0	19.0	1.419
107W-LF	Jefferson WB	Structure/Wall	Future	22.5	22.2	0.763
107W-L	Jefferson WB	Levee	Future	22.5	22.2	1.277
108W-L	Jefferson WB	Levee	Existing	19.0	19.1	3.160
108W-LF	Jefferson WB	Structure/Wall	Future	22.5	22.3	1.469
108W-L	Jefferson WB	Levee	Future	22.5	22.3	2.567
109W-L	Jefferson WB	Levee	Existing	20.0	19.2	1.823
109W-L	Jefferson WB	Levee	Future	24.0	22.3	1.017
110W-L	Jefferson WB	Levee	Existing	20.0	19.2	1.915
110W-LF	Jefferson WB	Structure/Wall	Future	24.0	22.4	0.359
110W-L	Jefferson WB	Levee	Future	24.0	22.4	1.070
111W-L	Jefferson WB	Levee	Existing	20.0	19.3	1.923
111W-L	Jefferson WB	Levee	Future	24.0	22.5	1.122
112W-L	Jefferson WB	Levee	Existing	20.0	19.3	2.035
112W-L	Jefferson WB	Levee	Future	24.0	22.6	1.212
113W-L	Jefferson WB	Levee	Existing	20.0	19.4	2.102
113W-L	Jefferson WB	Levee	Future	24.0	22.7	1.258

**Jefferson Parish West Bank (RM 96W to RM 114W)**

**Resiliency Analysis (0.2% Event)**

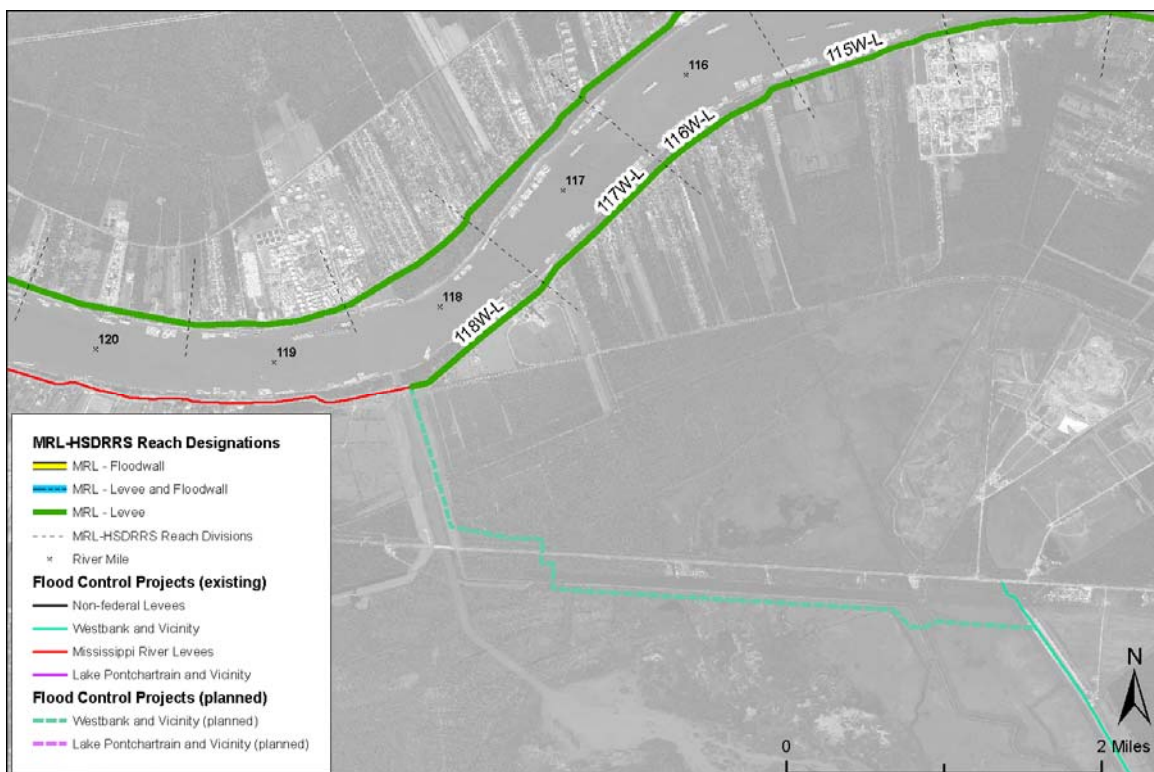
Segment	Name	Type	Condition	1% Design Elevation (ft)	Best Estimates During 0.2% Event	
					Surge Level (ft)	Overtopping Rate (cfs/s per ft)
114W-L	Jefferson WB	Levee	Existing	20.0	19.5	2.200
114W-L	Jefferson WB	Levee	Future	24.0	22.8	1.387

## 5.5 ST. CHARLES PARISH WEST BANK (RM 115W TO RM 118W)

### 5.5.1 General

The St. Charles Parish West Bank MRL-HSDRRS levee reach is from RM 115 to 118. This section has no floodwalls or other hard structures. The reach has been split into four segments. Each segment is divided at ½ mile upstream and ½ mile downstream from each RM point. It should be noted that a segment 118W-L ends at the WBV Project tie-in. **Figure 5-12** shows the location of the St. Charles Parish West Bank MRL-HSDRRS levee reach.

All elevations described herein are in North American Vertical Datum 1988 (2004.65).



**Figure 5-12 St. Charles Parish West Bank (RM 115W-RM 118W) – Levee and Floodwall Sections**

### 5.5.2 Hydraulic Boundary Conditions

**Table 5-10** summarizes the 1% hydraulic boundary conditions applied for the St. Charles Parish West Bank MRL-HSDRRS Levees. The 1% surge levels and standard deviations have been derived with the modified probabilistic method JPM-OS. Wave information from the wave model, STWAVE, is not available for the Mississippi River. The wave characteristics used herein are based on an empirical approach. For a detailed description of the establishment of the surge and wave characteristics, referred to **Chapter 2**.



**Table 5-10 St. Charles Parish West Bank (RM 115W-RM 118W) – 1% Hydraulic Boundary Conditions**

St. Charles Parish West Bank (RM 115W to RM 118W)									
1% Hydraulic Boundary Conditions									
Segment	Name	Type	Condition	Surge Level (ft)		Significant Wave Height (ft)		Peak Period (s)	
				Mean	Std	Mean	Std	Mean	Std
115W-L	St. Charles WB	Levee	Existing	15.9	1.2	2.0	0.2	3.5	0.7
115W-L	St. Charles WB	Levee	Future	18.6	1.2	2.5	0.3	4.0	0.8
116W-L	St. Charles WB	Levee	Existing	15.9	1.2	1.5	0.2	2.5	0.5
116W-L	St. Charles WB	Levee	Future	18.7	1.2	1.5	0.2	2.5	0.5
117W-L	St. Charles WB	Levee	Existing	16.0	1.2	1.5	0.2	2.5	0.5
117W-L	St. Charles WB	Levee	Future	18.7	1.2	1.5	0.2	2.5	0.5
118W-L	St. Charles WB	Levee	Existing	16.0	1.2	1.5	0.2	2.5	0.5
118W-L	St. Charles WB	Levee	Future	18.8	1.2	1.5	0.2	2.5	0.5

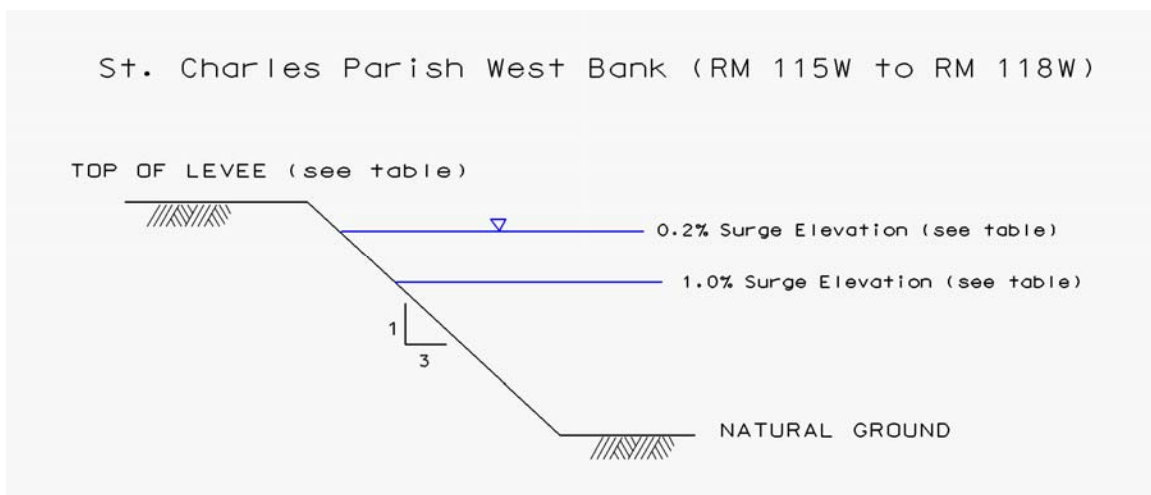
### 5.5.3 Hydraulic Design Elevations for Levees, Floodwalls, and Structures

The design characteristics of the St. Charles Parish West Bank MRL-HSDRRS Levees are summarized in **Table 5-11**. The levee sections are designed for both existing and future conditions. Note that the floodwalls and locks are only evaluated for future conditions, because these are hard structures. **Figure 5-13** shows a typical levee design cross-section for the St. Charles Parish west bank reach.

**Table 5-11 St. Charles Parish West Bank (RM 115W-RM 118W) – 1% Design Information**

St. Charles Parish West Bank (RM 115W to RM 118W)							
1% Design Elevations							
Segment	Name	Type	Condition	Depth at Toe (ft)	Elevation (ft)	Overtopping Rate	
						q50 (cfs/s per ft)	q90 (cfs/s per ft)
115W-L	St. Charles WB	Levee	Existing	4.9	20.0	0.007	0.097
115W-L	St. Charles WB	Levee	Future	7.7	24.0	0.009	0.078
116W-L	St. Charles WB	Levee	Existing	3.7	20.0	0.000	0.010
116W-L	St. Charles WB	Levee	Future	6.5	24.0	0.000	0.001
117W-L	St. Charles WB	Levee	Existing	3.4	20.0	0.000	0.010
117W-L	St. Charles WB	Levee	Future	6.1	24.0	0.000	0.001
118W-L	St. Charles WB	Levee	Existing	3.4	20.0	0.000	0.011
118W-L	St. Charles WB	Levee	Future	6.1	24.0	0.000	0.001

**5.5.4 Typical Sections**



**Figure 5-13 Typical Levee Design Cross-section (RM 115W-RM 118W) – St. Charles Parish West Bank**

### 5.5.5 Resiliency Analysis

The designs for the levees and structures were examined for resiliency by computing the 0.2% surge level (50% confidence). The results are presented in **Table 5-12**.

**Table 5-12 St. Charles Parish West Bank (RM 115W-RM 118W) – Resiliency Analysis**

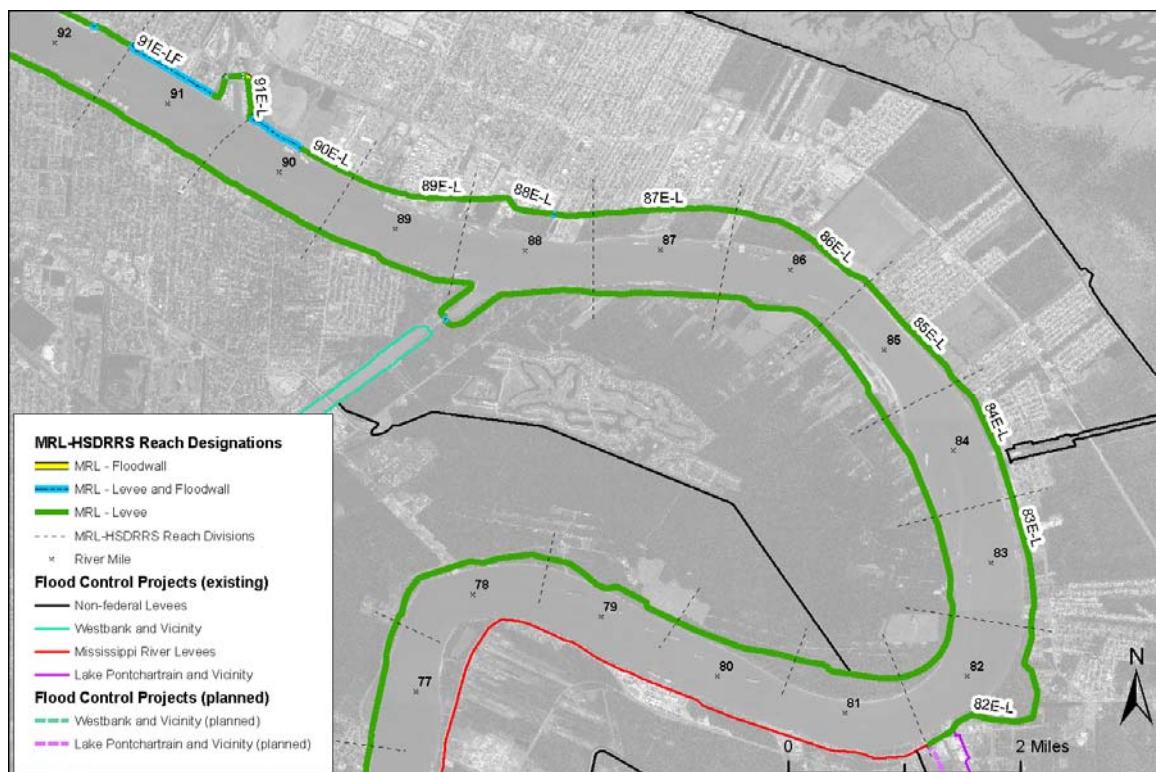
St. Charles Parish West Bank (RM 115W to RM 118W)						
Resiliency Analysis (0.2% Event)						
Segment	Name	Type	Condition	1% Design Elevation (ft)	Best Estimates During 0.2% Event	
					Surge Level (ft)	Overtopping Rate (cfs/s per ft)
115W-L	St. Charles WB	Levee	Existing	20.0	19.6	0.864
115W-L	St. Charles WB	Levee	Future	24.0	22.9	0.460
116W-L	St. Charles WB	Levee	Existing	20.0	19.7	1.002
116W-L	St. Charles WB	Levee	Future	24.0	23.0	0.578
117W-L	St. Charles WB	Levee	Existing	20.0	19.7	1.107
117W-L	St. Charles WB	Levee	Future	24.0	23.1	0.649
118W-L	St. Charles WB	Levee	Existing	20.0	19.8	1.126
118W-L	St. Charles WB	Levee	Future	24.0	23.2	0.704

## 5.6 PLAQUEMINES/ST. BERNARD EAST BANK (RM 82E TO RM 91E)

### 5.6.1 General

The Plaquemines/St. Bernard Parish East Bank MRL-HSDRRS levee reach is from RM 82 to 91. The reach has been split into 10 segments. Each segment is divided at ½ mile upstream and ½ mile downstream from each RM point. This section has hard structures at the following RM segments; 88, 90, and 91. **Figure 5-14** shows the location of the Plaquemines/St. Bernard Parish East Bank MRL-HSDRRS levee reach.

All elevations described herein are in North American Vertical Datum 1988 (2004.65).



**Figure 5-14** Plaquemines/St. Bernard Parish East Bank (RM 82E- RM 91E) – Levee and Floodwall Sections

### 5.6.2 Hydraulic Boundary Conditions

**Table 5-13** summarizes the 1% hydraulic boundary conditions applied for the Plaquemines/St. Bernard Parish East Bank MRL-HSDRRS Levees. The 1% surge levels and standard deviations have been derived with the modified probabilistic method JPM-OS. Wave information from the wave model, STWAVE, is not available for the Mississippi River. The wave characteristics used herein are based on an empirical approach. For a detailed description of the establishment of the surge and wave characteristics, referred to **Chapter 2**.

**Table 5-13 Plaquemines/St. Bernard Parish East Bank (RM 82E- RM 91E) – 1% Hydraulic Boundary Conditions**

Plaquemines/St. Bernard Parish East Bank (RM 82E to RM 91E)									
1% Hydraulic Boundary Conditions									
Segment	Name	Type	Condition	Surge Level		Significant Wave Height		Peak Period	
				(ft)		(ft)		(s)	
				Mean	Std	Mean	Std	Mean	Std
82E-L	St. Bernard EB	Levee	Existing	15.0	1.0	1.5	0.2	2.5	0.5
82E-L	St. Bernard EB	Levee	Future	17.8	0.8	1.5	0.2	2.5	0.5
83E-L	St. Bernard EB	Levee	Existing	15.0	1.0	1.5	0.2	2.5	0.5
83E-L	St. Bernard EB	Levee	Future	17.7	0.8	1.5	0.2	2.5	0.5
84E-L	St. Bernard EB	Levee	Existing	15.0	1.0	1.5	0.2	2.5	0.5
84E-L	St. Bernard EB	Levee	Future	17.7	0.8	1.5	0.2	2.5	0.5
85E-L	St. Bernard EB	Levee	Existing	15.0	1.0	1.5	0.2	2.5	0.5
85E-L	St. Bernard EB	Levee	Future	17.7	0.8	1.5	0.2	2.5	0.5
86E-L	St. Bernard EB	Levee	Existing	15.0	1.0	1.5	0.2	2.5	0.5
86E-L	St. Bernard EB	Levee	Future	17.8	0.8	1.5	0.2	2.5	0.5
87E-L	St. Bernard EB	Levee	Existing	15.0	1.0	1.5	0.2	2.5	0.5
87E-L	St. Bernard EB	Levee	Future	17.8	0.8	1.5	0.2	2.5	0.5
88E-L	St. Bernard EB	Levee	Existing	15.1	1.0	1.5	0.2	2.5	0.5
88E-LF	St. Bernard EB	Structure/Wall	Future	17.8	0.8	1.5	0.2	2.5	0.5
88E-L	St. Bernard EB	Levee	Future	17.8	0.8	1.5	0.2	2.5	0.5
89E-L	St. Bernard EB	Levee	Existing	15.1	1.0	1.5	0.2	2.5	0.5
89E-L	St. Bernard EB	Levee	Future	17.9	0.8	1.5	0.2	2.5	0.5
90E-L	St. Bernard EB	Levee	Existing	15.1	1.0	1.5	0.2	2.5	0.5

**Plaquemines/St. Bernard Parish East Bank (RM 82E to RM 91E)**

**1% Hydraulic Boundary Conditions**

Segment	Name	Type	Condition	Surge Level (ft)		Significant Wave Height (ft)		Peak Period (s)	
				Mean	Std	Mean	Std	Mean	Std
				90E-LF	St. Bernard EB	Structure/Wall	Future	17.9	0.9
90E-L	St. Bernard EB	Levee	Future	17.9	0.9	1.5	0.2	2.5	0.5
91E-L	St. Bernard EB	Levee	Existing	15.1	1.0	1.5	0.2	2.5	0.5
91E-LF	St. Bernard EB	Structure/Wall	Future	17.9	0.9	1.5	0.2	2.5	0.5
91E-L	St. Bernard EB	Levee	Future	17.9	0.9	1.5	0.2	2.5	0.5
91E-F	St. Bernard EB	Structure/Wall	Future	17.9	0.9	1.5	0.2	2.5	0.5

### 5.6.3 Hydraulic Design Elevations for Levees, Floodwalls, and Structures

The design characteristics of the Plaquemines/St. Bernard Parish East Bank MRL-HSDRRS Levees are summarized in **Table 5-14**. The levee sections are designed for both existing and future conditions. Note that the floodwalls and locks are only evaluated for future conditions, because these are hard structures. **Figure 5-15** shows a typical levee design cross-section for the St. Bernard Parish East Bank levee reach.

**Table 5-14 Plaquemines/St. Bernard Parish East Bank (RM 82E- RM 91E) – 1% Design Information**

Plaquemines/St. Bernard Parish East Bank (RM 82E to RM 91E)							
1% Design Elevations							
Segment	Name	Type	Condition	Depth at Toe (ft)	Elevation (ft)	Overtopping Rate	
						q50 (cfs/s per ft)	q90 (cfs/s per ft)
82E-L	St. Bernard EB	Levee	Existing	7.5	18.5	0.001	0.020
82E-L	St. Bernard EB	Levee	Future	10.3	21.0	0.001	0.022
83E-L	St. Bernard EB	Levee	Existing	6.4	18.5	0.001	0.020
83E-L	St. Bernard EB	Levee	Future	9.2	21.0	0.001	0.022
84E-L	St. Bernard EB	Levee	Existing	6.1	18.5	0.001	0.020
84E-L	St. Bernard EB	Levee	Future	8.9	21.0	0.001	0.023
85E-L	St. Bernard EB	Levee	Existing	6.8	18.5	0.001	0.021
85E-L	St. Bernard EB	Levee	Future	9.6	21.0	0.001	0.020
86E-L	St. Bernard EB	Levee	Existing	8.2	18.5	0.001	0.020
86E-L	St. Bernard EB	Levee	Future	11.0	21.0	0.001	0.024
87E-L	St. Bernard EB	Levee	Existing	7.8	18.5	0.001	0.022
87E-L	St. Bernard EB	Levee	Future	10.6	21.0	0.001	0.026
88E-L	St. Bernard EB	Levee	Existing	4.0	18.5	0.001	0.024
88E-LF	St. Bernard EB	Structure/Wall	Future	6.7	21.5	0.000	0.002
88E-L	St. Bernard EB	Levee	Future	6.7	21.5	0.000	0.011

Plaquemines/St. Bernard Parish East Bank (RM 82E to RM 91E)							
1% Design Elevations							
Segment	Name	Type	Condition	Depth at Toe (ft)	Elevation (ft)	Overtopping Rate	
						q50 (cfs/s per ft)	q90 (cfs/s per ft)
89E-L	St. Bernard EB	Levee	Existing	4.3	18.5	0.001	0.027
89E-L	St. Bernard EB	Levee	Future	7.0	21.5	0.000	0.011
90E-L	St. Bernard EB	Levee	Existing	7.0	19.0	0.000	0.011
90E-LF	St. Bernard EB	Structure/Wall	Future	9.7	21.5	0.000	0.003
90E-L	St. Bernard EB	Levee	Future	9.7	21.5	0.000	0.012
91E-L	St. Bernard EB	Levee	Existing	1.4	19.0	0.000	0.011
91E-LF	St. Bernard EB	Structure/Wall	Future	4.1	21.5	0.000	0.003
91E-L	St. Bernard EB	Levee	Future	4.1	21.5	0.000	0.013
91E-F	St. Bernard EB	Structure/Wall	Future	4.1	21.5	0.000	0.003

### 5.6.4 Typical Sections

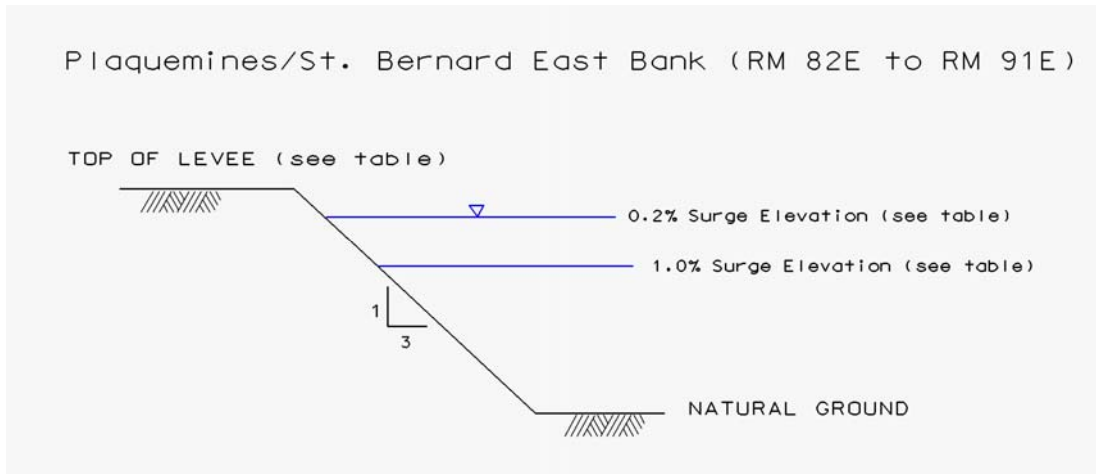


Figure 5-15 Typical Levee Design Cross-section (RM 82E- RM 91E) – Plaquemines/St. Bernard Parish East Bank



### 5.6.5 Resiliency Analysis

The designs for the levees and structures were examined for resiliency by computing the 0.2% surge level (50% confidence). The results are presented in **Table 5-15**.

**Table 5-15 Plaquemines/St. Bernard Parish East Bank (RM 82E- RM 91E) – Resiliency Analysis**

Plaquemines/St. Bernard Parish East Bank (RM 82E to RM 91E)						
Resiliency Analysis (0.2% Event)						
Segment	Name	Type	Condition	1% Design Elevation (ft)	Best Estimates During 0.2% Event	
					Surge Level (ft)	Overtopping Rate (cfs/s per ft)
82E-L	St. Bernard EB	Levee	Existing	18.5	17.9	1.130
82E-L	St. Bernard EB	Levee	Future	21.0	20.8	2.313
83E-L	St. Bernard EB	Levee	Existing	18.5	17.9	1.123
83E-L	St. Bernard EB	Levee	Future	21.0	20.7	2.246
84E-L	St. Bernard EB	Levee	Existing	18.5	17.9	1.107
84E-L	St. Bernard EB	Levee	Future	21.0	20.8	2.310
85E-L	St. Bernard EB	Levee	Existing	18.5	17.9	1.112
85E-L	St. Bernard EB	Levee	Future	21.0	20.8	2.290
86E-L	St. Bernard EB	Levee	Existing	18.5	17.9	1.132
86E-L	St. Bernard EB	Levee	Future	21.0	20.8	2.365
87E-L	St. Bernard EB	Levee	Existing	18.5	18.0	1.218
87E-L	St. Bernard EB	Levee	Future	21.0	20.9	2.475
88E-L	St. Bernard EB	Levee	Existing	18.5	18.0	1.227
88E-LF	St. Bernard EB	Structure/Wall	Future	21.5	20.9	1.103
88E-L	St. Bernard EB	Levee	Future	21.5	20.9	1.879
89E-L	St. Bernard EB	Levee	Existing	18.5	18.1	1.293

**Plaquemines/St. Bernard Parish East Bank (RM 82E to RM 91E)**

**Resiliency Analysis (0.2% Event)**

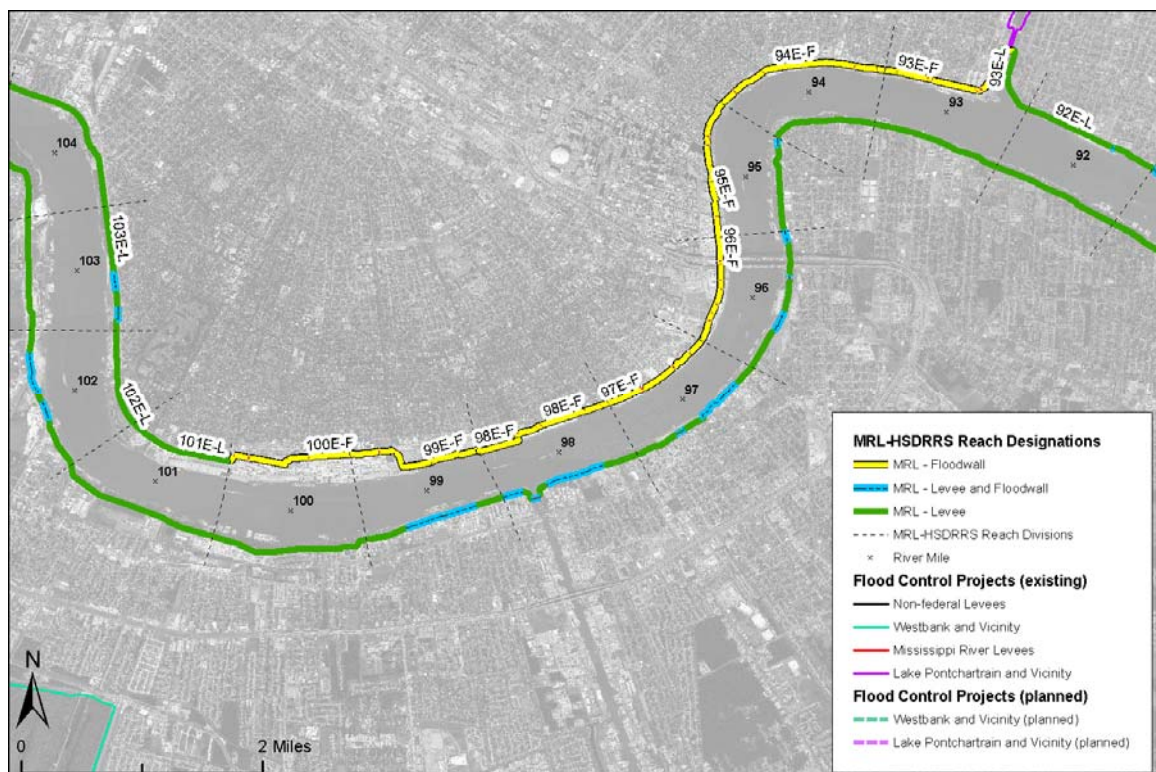
Segment	Name	Type	Condition	1% Design Elevation (ft)	Best Estimates During 0.2% Event	
					Surge Level (ft)	Overtopping Rate (cfs/s per ft)
89E-L	St. Bernard EB	Levee	Future	21.5	21.0	1.959
90E-L	St. Bernard EB	Levee	Existing	19.0	18.1	0.822
90E-LF	St. Bernard EB	Structure/Wall	Future	21.5	21.1	1.260
90E-L	St. Bernard EB	Levee	Future	21.5	21.1	2.013
91E-L	St. Bernard EB	Levee	Existing	19.0	18.1	0.901
91E-LF	St. Bernard EB	Structure/Wall	Future	21.5	21.1	1.279
91E-L	St. Bernard EB	Levee	Future	21.5	21.1	2.132
91E-F	St. Bernard EB	Structure/Wall	Future	21.5	21.1	1.318

## 5.7 ORLEANS PARISH EAST BANK (RM 92E TO RM103E)

### 5.7.1 General

The Orleans Parish East Bank MRL-HSDRRS levee reach exists from RM 92 to 103 (**Figure 5-16**). The reach has been split into 12 segments. Each segment is divided at ½ mile upstream and ½ mile downstream from each RM point. This section has hard structures at the following RM segments: 93, 94, 95, 96, 97, 98, 99, 100, and 103. **Figure 5-16** shows the location of the Orleans Parish East Bank MRL-HSDRRS levee reach.

All elevations described herein are in North American Vertical Datum 1988 (2004.65).



**Figure 5-16 Orleans Parish East Bank (RM 92E-RM 103E) – Levee and Floodwall Sections**

### 5.7.2 Hydraulic Boundary Conditions

**Table 5-16** summarizes the 1% hydraulic boundary conditions applied for the Orleans Parish East Bank MRL-HSDRRS Levees. The 1% surge levels and standard deviations have been derived with the modified probabilistic method JPM-OS. Wave information from the wave model, STWAVE, is not available for the Mississippi River. The wave characteristics used herein are based on an empirical approach. For a detailed description of the establishment of the surge and wave characteristics, refer to **Chapter 2**.

**Table 5-16 Orleans Parish East Bank (RM 92E-RM 103E) – 1% Hydraulic Boundary Conditions**

Orleans Parish East Bank (RM 92E to RM103E)									
1% Hydraulic Boundary Conditions									
Segment	Name	Type	Condition	Surge Level		Significant Wave Height		Peak Period	
				(ft)		(ft)		(s)	
				Mean	Std	Mean	Std	Mean	Std
92E-L	Orleans EB	Levee	Existing	15.2	1.1	1.5	0.2	2.5	0.5
92E-LF	Orleans EB	Structure/Wall	Future	17.9	0.9	1.5	0.2	2.5	0.5
92E-L	Orleans EB	Levee	Future	17.9	0.9	1.5	0.2	2.5	0.5
93E-L	Orleans EB	Levee	Existing	15.2	1.1	1.5	0.2	2.5	0.5
93E-L	Orleans EB	Levee	Future	17.9	0.9	1.5	0.2	2.5	0.5
93E-F	Orleans EB	Structure/Wall	Future	17.9	0.9	1.5	0.2	2.5	0.5
94E-F	Orleans EB	Structure/Wall	Future	18.0	0.9	1.5	0.2	2.5	0.5
95E-F	Orleans EB	Structure/Wall	Future	18.0	0.9	1.5	0.2	2.5	0.5
96E-F	Orleans EB	Structure/Wall	Future	18.0	0.9	1.5	0.2	2.5	0.5
97E-F	Orleans EB	Structure/Wall	Future	18.1	0.9	1.5	0.2	2.5	0.5
98E-F	Orleans EB	Structure/Wall	Future	18.1	0.9	1.5	0.2	2.5	0.5
99E-F	Orleans EB	Structure/Wall	Future	18.1	0.9	1.5	0.2	2.5	0.5
100E-F	Orleans EB	Structure/Wall	Future	18.2	0.9	1.5	0.2	2.5	0.5
101E-L	Orleans EB	Levee	Existing	15.5	1.1	1.5	0.2	2.5	0.5
101E-L	Orleans EB	Levee	Future	18.2	1.0	1.5	0.2	2.5	0.5
102E-L	Orleans EB	Levee	Existing	15.5	1.1	1.5	0.2	2.5	0.5
102E-L	Orleans EB	Levee	Future	18.2	1.0	1.5	0.2	2.5	0.5
103E-L	Orleans EB	Levee	Existing	15.5	1.1	1.5	0.2	2.5	0.5
103E-LF	Orleans EB	Structure/Wall	Future	18.2	1.0	1.5	0.2	2.5	0.5
103E-L	Orleans EB	Levee	Future	18.2	1.0	1.5	0.2	2.5	0.5

### 5.7.3 Hydraulic Design Elevations for Levees, Floodwalls, and Structures

The design characteristics of the Orleans Parish East Bank MRL-HSDRRS Levees are summarized in **Table 5-17**. The levee sections are designed for both existing and future conditions. Note that the floodwalls and locks are only evaluated for future conditions, because these are hard structures. **Figure 5-17** shows a typical levee design cross-section for the Orleans Parish East Bank levee reach.

**Table 5-17 Orleans Parish East Bank (RM 92E-RM 103E) – 1% Design Information**

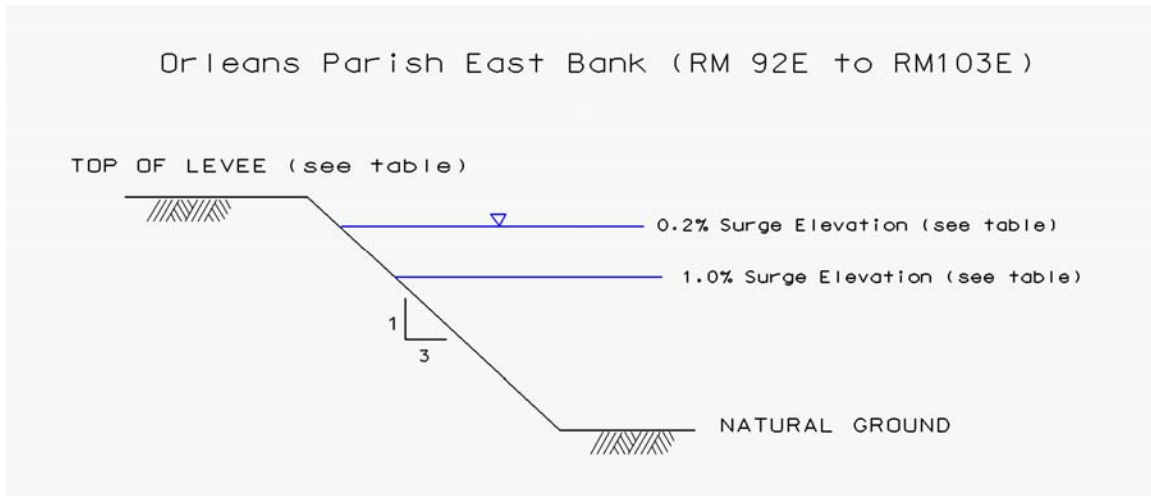
Orleans Parish East Bank (RM 92E to RM103E)							
1% Design Elevations							
Segment	Name	Type	Condition	Depth at Toe (ft)	Elevation (ft)	Overtopping Rate	
						q50 (cfs/s per ft)	q90 (cfs/s per ft)
92E-L	Orleans EB	Levee	Existing	8.0	19.0	0.000	0.012
92E-LF	Orleans EB	Structure/Wall	Future	10.7	21.5	0.000	0.003
92E-L	Orleans EB	Levee	Future	10.7	21.5	0.000	0.013
93E-L	Orleans EB	Levee	Existing	0.6	19.0	0.000	0.012
93E-L	Orleans EB	Levee	Future	3.3	21.5	0.001	0.014
93E-F	Orleans EB	Structure/Wall	Future	3.3	21.5	0.000	0.003
94E-F	Orleans EB	Structure/Wall	Future	2.8	21.5	0.000	0.004
95E-F	Orleans EB	Structure/Wall	Future	2.2	21.5	0.000	0.004
96E-F	Orleans EB	Structure/Wall	Future	2.0	21.5	0.000	0.004
97E-F	Orleans EB	Structure/Wall	Future	4.1	21.5	0.000	0.005
98E-F	Orleans EB	Structure/Wall	Future	4.1	21.5	0.000	0.002
99E-F	Orleans EB	Structure/Wall	Future	6.1	22.0	0.000	0.002
100E-F	Orleans EB	Structure/Wall	Future	1.2	22.0	0.000	0.002
101E-L	Orleans EB	Levee	Existing	-1.5	19.0	0.001	0.023
101E-L	Orleans EB	Levee	Future	1.2	22.0	0.000	0.011
102E-L	Orleans EB	Levee	Existing	-1.9	19.0	0.001	0.023

**Orleans Parish East Bank (RM 92E to RM103E)**

**1% Design Elevations**

Segment	Name	Type	Condition	Depth at Toe (ft)	Elevation (ft)	Overtopping Rate	
						q50 (cfs/s per ft)	q90 (cfs/s per ft)
102E-L	Orleans EB	Levee	Future	0.8	22.0	0.000	0.011
103E-L	Orleans EB	Levee	Existing	3.3	19.0	0.001	0.025
103E-LF	Orleans EB	Structure/Wall	Future	6.0	22.0	0.000	0.002
103E-L	Orleans EB	Levee	Future	6.0	22.0	0.000	0.011

### 5.7.4 Typical Sections



**Figure 5-17 Typical Levee Design Cross-section (RM 92E-RM 103E) – Orleans Parish East Bank**

### 5.7.5 Resiliency Analysis

The designs for the levees and were examined for resiliency by computing the 0.2% surge level (50% confidence). The results are presented in **Table 5-18**.

**Table 5-18 Orleans Parish East Bank (RM 92E-RM 103E) – Resiliency Analysis**

Orleans Parish East Bank (RM 92E to RM103E)						
Resiliency Analysis (0.2% Event)						
Segment	Name	Type	Condition	1% Design Elevation (ft)	Best Estimates During 0.2% Event	
					Surge Level (ft)	Overtopping Rate (cfs/s per ft)
92E-L	Orleans EB	Levee	Existing	19.0	18.2	0.976
92E-LF	Orleans EB	Structure/Wall	Future	21.5	21.2	1.367
92E-L	Orleans EB	Levee	Future	21.5	21.2	2.170
93E-L	Orleans EB	Levee	Existing	19.0	18.2	1.013
93E-L	Orleans EB	Levee	Future	21.5	21.3	2.297

**Orleans Parish East Bank (RM 92E to RM103E)**

**Resiliency Analysis (0.2% Event)**

Segment	Name	Type	Condition	1% Design Elevation (ft)	Best Estimates During 0.2% Event	
					Surge Level (ft)	Overtopping Rate (cfs/s per ft)
93E-F	Orleans EB	Structure/Wall	Future	21.5	21.3	1.470
94E-F	Orleans EB	Structure/Wall	Future	21.5	21.3	1.462
95E-F	Orleans EB	Structure/Wall	Future	21.5	21.4	1.575
96E-F	Orleans EB	Structure/Wall	Future	21.5	21.4	1.591
97E-F	Orleans EB	Structure/Wall	Future	21.5	21.5	1.706
98E-F	Orleans EB	Structure/Wall	Future	21.5	21.5	1.654
99E-F	Orleans EB	Structure/Wall	Future	22.0	21.6	1.271
100E-F	Orleans EB	Structure/Wall	Future	22.0	21.7	1.344
101E-L	Orleans EB	Levee	Existing	19.0	18.7	1.496
101E-L	Orleans EB	Levee	Future	22.0	21.8	2.390
102E-L	Orleans EB	Levee	Existing	19.0	18.8	1.558
102E-L	Orleans EB	Levee	Future	22.0	21.8	2.317
103E-L	Orleans EB	Levee	Existing	19.0	18.8	1.584
103E-LF	Orleans EB	Structure/Wall	Future	22.0	21.9	1.598
103E-L	Orleans EB	Levee	Future	22.0	21.9	2.408



## 5.8 JEFFERSON PARISH EAST BANK (RM 104E TO RM 114E)

### 5.8.1 General

The Jefferson Parish East Bank MRL-HSDRRS levee reach is from RM 104 to 114. The reach has been split into 11 segments. Each segment is divided at ½ mile upstream and ½ mile downstream from each RM point. This section has hard structures at the following RM segments; 110 and 114. **Figure 5-18** shows the location of the Jefferson Parish East Bank MRL-HSDRRS levee reach.

All elevations described herein are in North American Vertical Datum 1988 (2004.65).

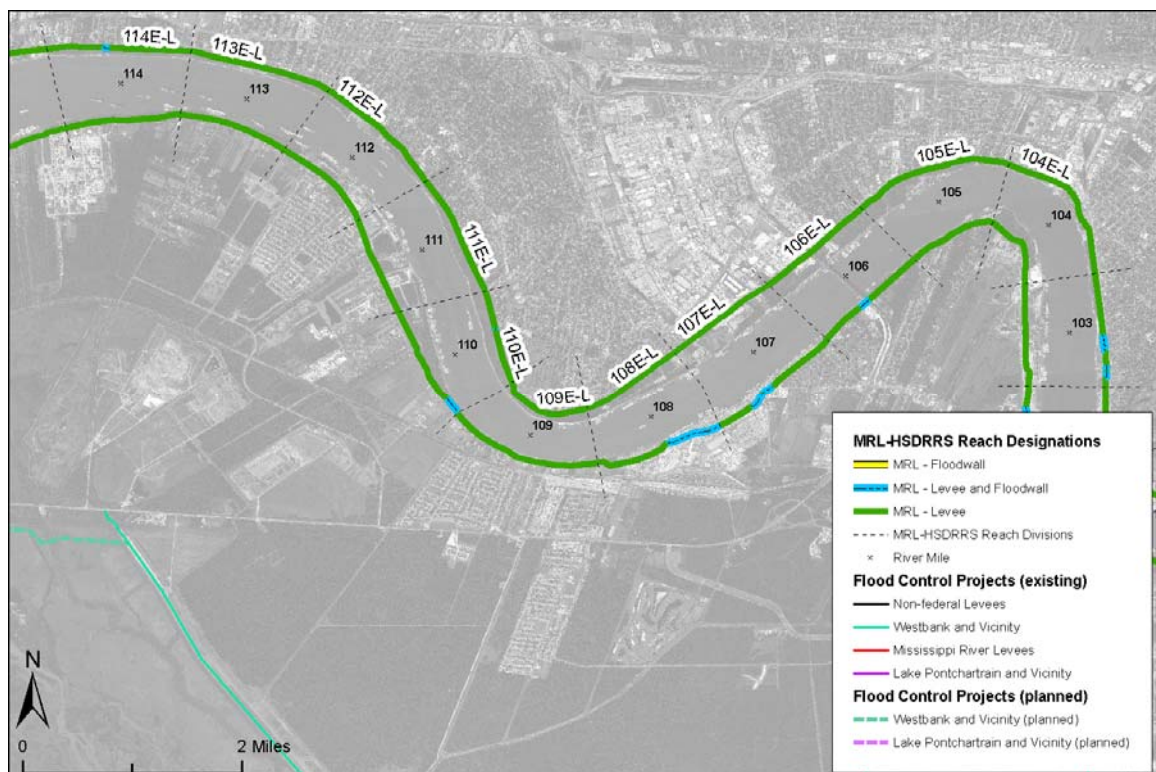


Figure 5-18 Jefferson Parish East Bank (RM 104E-RM 114E) – Levee and Floodwall Sections

### 5.8.2 Hydraulic Boundary Conditions

**Table 5-19** summarizes the 1% hydraulic boundary conditions applied for the Jefferson Parish East Bank MRL-HSDRRS Levees. The 1% surge levels and standard deviations have been derived with the modified probabilistic method JPM-OS. There is no wave information from the wave model STWAVE available for the Mississippi River. The wave characteristics used herein are based on an empirical approach. For a detailed description of the establishment of the surge and wave characteristics, refer to **Chapter 2**.

**Table 5-19 Jefferson Parish East Bank (RM 104E-RM 114E) – 1% Hydraulic Boundary Conditions**

Jefferson Parish East Bank (RM 104E to RM 114E)									
1% Hydraulic Boundary Conditions									
Segment	Name	Type	Condition	Surge Level (ft)		Significant Wave Height (ft)		Peak Period (s)	
				Mean	Std	Mean	Std	Mean	Std
104E-L	Jefferson EB	Levee	Existing	15.5	1.1	1.5	0.2	2.5	0.5
104E-L	Jefferson EB	Levee	Future	18.2	1.0	1.5	0.2	2.5	0.5
105E-L	Jefferson EB	Levee	Existing	15.5	1.1	1.5	0.2	2.5	0.5
105E-L	Jefferson EB	Levee	Future	18.2	1.0	1.5	0.2	2.5	0.5
106E-L	Jefferson EB	Levee	Existing	15.6	1.1	1.5	0.2	2.5	0.5
106E-L	Jefferson EB	Levee	Future	18.3	1.0	1.5	0.2	2.5	0.5
107E-L	Jefferson EB	Levee	Existing	15.6	1.1	1.5	0.2	2.5	0.5
107E-L	Jefferson EB	Levee	Future	18.3	1.0	1.5	0.2	2.5	0.5
108E-L	Jefferson EB	Levee	Existing	15.7	1.1	1.5	0.2	2.5	0.5
108E-L	Jefferson EB	Levee	Future	18.3	1.0	1.5	0.2	2.5	0.5
109E-L	Jefferson EB	Levee	Existing	15.7	1.1	1.5	0.2	2.5	0.5
109E-L	Jefferson EB	Levee	Future	18.4	1.1	1.5	0.2	2.5	0.5
110E-L	Jefferson EB	Levee	Existing	15.7	1.1	1.5	0.2	2.5	0.5
110E-LF	Jefferson EB	Structure/Wall	Future	18.4	1.1	1.5	0.2	2.5	0.5
110E-L	Jefferson EB	Levee	Future	18.4	1.1	1.5	0.2	2.5	0.5
111E-L	Jefferson EB	Levee	Existing	15.7	1.1	1.5	0.2	2.5	0.5
111E-L	Jefferson EB	Levee	Future	18.4	1.1	1.5	0.2	2.5	0.5

Jefferson Parish East Bank (RM 104E to RM 114E)									
1% Hydraulic Boundary Conditions									
Segment	Name	Type	Condition	Surge Level (ft)		Significant Wave Height (ft)		Peak Period (s)	
				Mean	Std	Mean	Std	Mean	Std
112E-L	Jefferson EB	Levee	Existing	15.7	1.1	1.5	0.2	2.5	0.5
112E-L	Jefferson EB	Levee	Future	18.5	1.1	1.5	0.2	2.5	0.5
113E-L	Jefferson EB	Levee	Existing	15.8	1.1	1.5	0.2	2.5	0.5
113E-L	Jefferson EB	Levee	Future	18.5	1.1	1.5	0.2	2.5	0.5
114E-L	Jefferson EB	Levee	Existing	15.8	1.2	1.5	0.2	2.5	0.5
114E-L	Jefferson EB	Levee	Future	18.5	1.1	1.5	0.2	2.5	0.5
114E-LF	Jefferson EB	Structure/Wall	Future	18.5	1.1	1.5	0.2	2.5	0.5

### 5.8.3 Hydraulic Design Elevation for Levees, Floodwalls, and Structures

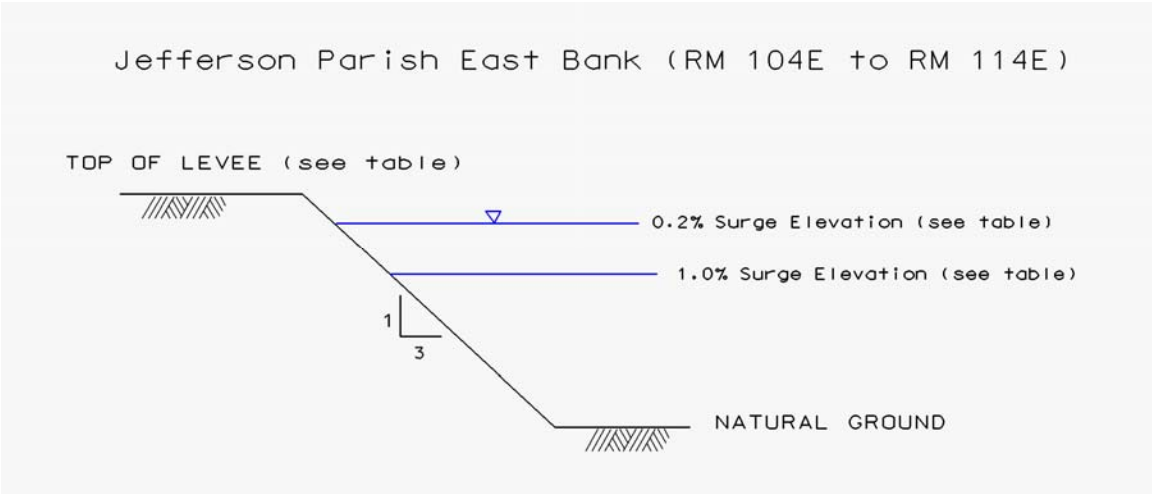
The design characteristics of the Jefferson Parish East Bank MRL-HSDRRS Levees are summarized in **Table 5-20**. The levee sections are designed for both existing and future conditions. Note that the floodwalls and locks are only evaluated for future conditions, because these are hard structures. **Figure 5-19** shows a typical levee design cross-section for the Jefferson Parish East Bank reach.

**Table 5-20 Jefferson Parish East Bank (RM 104E-RM 114E) – 1% Design Information**

Jefferson Parish East Bank (RM 104E to RM 114E)							
1% Design Elevations							
Segment	Name	Type	Condition	Depth at Toe (ft)	Elevation (ft)	Overtopping Rate	
						q50 (cfs/s per ft)	q90 (cfs/s per ft)
104E-L	Jefferson EB	Levee	Existing	2.6	19.0	0.001	0.023
104E-L	Jefferson EB	Levee	Future	5.3	22.0	0.000	0.010
105E-L	Jefferson EB	Levee	Existing	3.5	19.0	0.001	0.025
105E-L	Jefferson EB	Levee	Future	6.2	22.5	0.000	0.005
106E-L	Jefferson EB	Levee	Existing	2.1	19.0	0.001	0.028
106E-L	Jefferson EB	Levee	Future	4.7	22.5	0.000	0.005
107E-L	Jefferson EB	Levee	Existing	-4.3	19.0	0.001	0.032
107E-L	Jefferson EB	Levee	Future	-1.6	22.5	0.000	0.006
108E-L	Jefferson EB	Levee	Existing	1.2	19.0	0.001	0.034
108E-L	Jefferson EB	Levee	Future	3.9	22.5	0.000	0.006
109E-L	Jefferson EB	Levee	Existing	4.3	20.0	0.000	0.006
109E-L	Jefferson EB	Levee	Future	7.0	24.0	0.000	0.000
110E-L	Jefferson EB	Levee	Existing	4.4	20.0	0.000	0.006
110E-LF	Jefferson EB	Structure/Wall	Future	7.1	24.0	0.000	0.000
110E-L	Jefferson EB	Levee	Future	7.1	24.0	0.000	0.000
111E-L	Jefferson EB	Levee	Existing	3.5	20.0	0.000	0.006
111E-L	Jefferson EB	Levee	Future	6.2	24.0	0.000	0.000
112E-L	Jefferson EB	Levee	Existing	1.9	20.0	0.000	0.006
112E-L	Jefferson EB	Levee	Future	4.6	24.0	0.000	0.001
113E-L	Jefferson EB	Levee	Existing	3.7	20.0	0.000	0.007

Jefferson Parish East Bank (RM 104E to RM 114E)							
1% Design Elevations							
Segment	Name	Type	Condition	Depth at Toe (ft)	Elevation (ft)	Overtopping Rate	
						q50 (cfs/s per ft)	q90 (cfs/s per ft)
113E-L	Jefferson EB	Levee	Future	6.4	24.0	0.000	0.001
114E-L	Jefferson EB	Levee	Existing	2.9	20.0	0.000	0.007
114E-L	Jefferson EB	Levee	Future	5.6	24.0	0.000	0.001
114E-LF	Jefferson EB	Structure/Wall	Future	5.6	24.0	0.000	0.000

**5.8.4 Typical Sections**



**Figure 5-19 Typical Levee Design Cross-section (RM 104E-RM 114E) – Jefferson Parish East Bank**

### 5.8.5 Resiliency Analysis

The designs for the levees and structures were examined for resiliency by computing the 0.2% surge level (50% confidence). The results are presented in **Table 5-21**.

**Table 5-21 Jefferson Parish East Bank (RM 104E-RM 114E) – Resiliency Analysis**

Jefferson Parish East Bank (RM 104E to RM 114E)						
Resiliency Analysis (0.2% Event)						
Segment	Name	Type	Condition	1% Design Elevation (ft)	Best Estimates During 0.2% Event	
					Surge Level (ft)	Overtopping Rate (cfs/s per ft)
104E-L	Jefferson EB	Levee	Existing	19.0	18.8	1.630
104E-L	Jefferson EB	Levee	Future	22.0	21.9	2.503
105E-L	Jefferson EB	Levee	Existing	19.0	18.9	1.719
105E-L	Jefferson EB	Levee	Future	22.5	22.0	1.859
106E-L	Jefferson EB	Levee	Existing	19.0	19.0	1.821
106E-L	Jefferson EB	Levee	Future	22.5	22.1	2.002
107E-L	Jefferson EB	Levee	Existing	19.0	19.0	1.936
107E-L	Jefferson EB	Levee	Future	22.5	22.2	2.116
108E-L	Jefferson EB	Levee	Existing	19.0	19.1	2.093
108E-L	Jefferson EB	Levee	Future	22.5	22.3	2.249
109E-L	Jefferson EB	Levee	Existing	20.0	19.2	0.978
109E-L	Jefferson EB	Levee	Future	24.0	22.3	0.776
110E-L	Jefferson EB	Levee	Existing	20.0	19.2	1.015
110E-LF	Jefferson EB	Structure/Wall	Future	24.0	22.4	0.353
110E-L	Jefferson EB	Levee	Future	24.0	22.4	0.792
111E-L	Jefferson EB	Levee	Existing	20.0	19.3	1.061

**Jefferson Parish East Bank (RM 104E to RM 114E)**

**Resiliency Analysis (0.2% Event)**

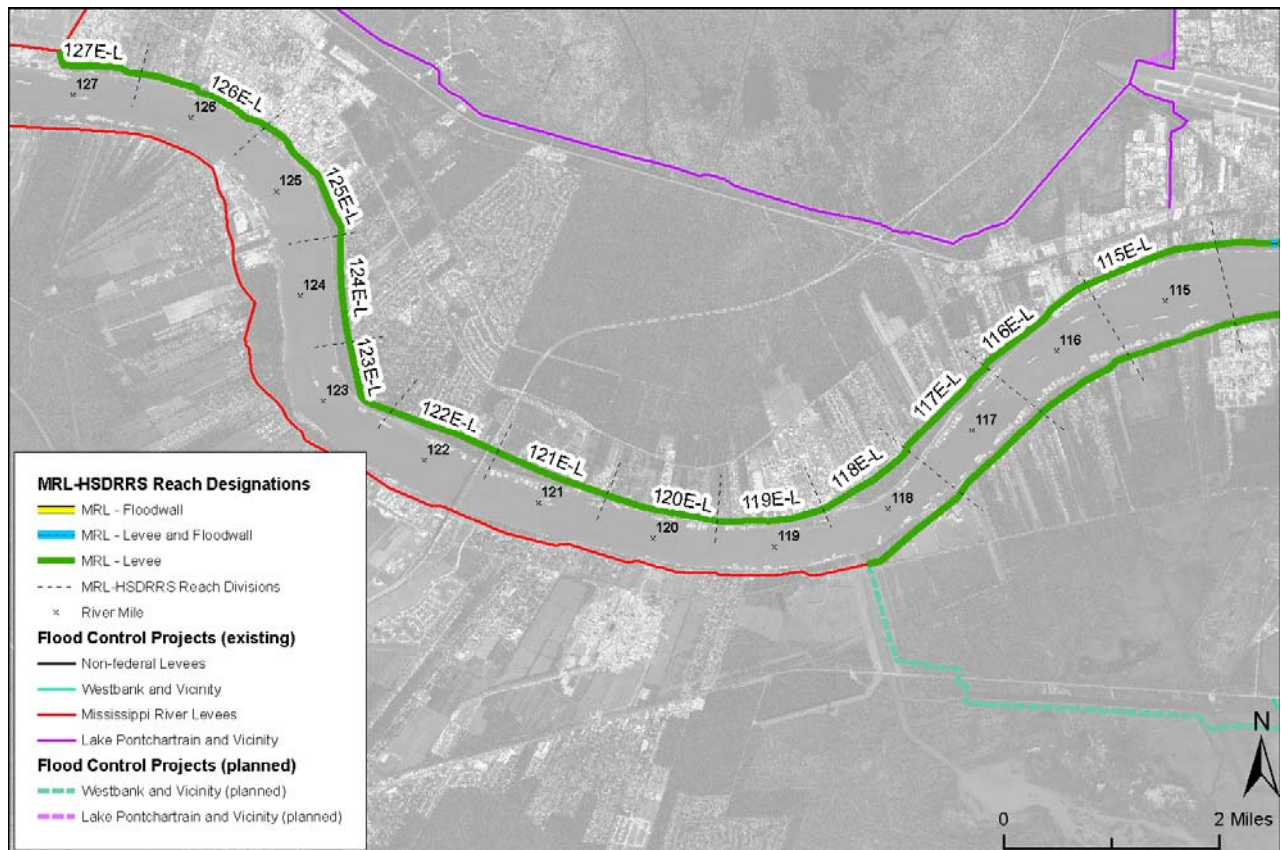
Segment	Name	Type	Condition	1% Design Elevation (ft)	Best Estimates During 0.2% Event	
					Surge Level (ft)	Overtopping Rate (cfs/s per ft)
111E-L	Jefferson EB	Levee	Future	24.0	22.5	0.898
112E-L	Jefferson EB	Levee	Existing	20.0	19.3	1.077
112E-L	Jefferson EB	Levee	Future	24.0	22.6	1.012
113E-L	Jefferson EB	Levee	Existing	20.0	19.4	1.136
113E-L	Jefferson EB	Levee	Future	24.0	22.7	1.059
114E-L	Jefferson EB	Levee	Existing	20.0	19.5	1.238
114E-L	Jefferson EB	Levee	Future	24.0	22.8	1.159
114E-LF	Jefferson EB	Structure/Wall	Future	24.0	22.8	0.576

## 5.9 ST. CHARLES PARISH EAST BANK (RM 115E TO RM 127E)

### 5.9.1 General

The St. Charles Parish East Bank MRL-HSDRRS levee reach is from RM 115 to 127. The reach has been split into 13 segments. Each segment is divided at ½ mile upstream and ½ mile downstream from each RM point. This section has no hard structures. **Figure 5-20** shows the location of the Jefferson Parish East Bank MRL-HSDRRS levee reach.

All elevations described herein are in North American Vertical Datum 1988 (2004.65).



**Figure 5-20 St. Charles Parish East Bank (RM 115E-RM 127E) – Levee and Floodwall Sections**



## 5.9.2 Hydraulic Boundary Conditions

**Table 5-22** summarizes the 1% hydraulic boundary conditions applied for the St. Charles Parish East Bank MRL-HSDRRS Levees. The 1% surge levels and standard deviations have been derived with the modified probabilistic method JPM-OS. Wave information from the wave model, STWAVE, is not available for the Mississippi River. The wave characteristics used herein are based on an empirical approach. For a detailed description of the establishment of the surge and wave characteristics, refer to **Chapter 2**.

**Table 5-22 St. Charles Parish East Bank (RM 115E-RM 127E) – 1% Hydraulic Boundary Conditions**

St. Charles Parish East Bank (RM 115E to RM 127E)									
1% Hydraulic Boundary Conditions									
Segment	Name	Type	Condition	Surge Level (ft)		Significant Wave Height (ft)		Peak Period (s)	
				Mean	Std	Mean	Std	Mean	Std
115E-L	St. Charles EB	Levee	Existing	15.9	1.2	1.5	0.2	2.5	0.5
115E-L	St. Charles EB	Levee	Future	18.6	1.2	1.5	0.2	2.5	0.5
116E-L	St. Charles EB	Levee	Existing	15.9	1.2	1.5	0.2	2.5	0.5
116E-L	St. Charles EB	Levee	Future	18.7	1.2	1.5	0.2	2.5	0.5
117E-L	St. Charles EB	Levee	Existing	16.0	1.2	1.5	0.2	2.5	0.5
117E-L	St. Charles EB	Levee	Future	18.7	1.2	1.5	0.2	2.5	0.5
118E-L	St. Charles EB	Levee	Existing	16.0	1.2	1.5	0.2	2.5	0.5
118E-L	St. Charles EB	Levee	Future	18.8	1.2	1.5	0.2	2.5	0.5
119E-L	St. Charles EB	Levee	Existing	16.0	1.2	1.5	0.2	2.5	0.5
119E-L	St. Charles EB	Levee	Future	18.8	1.2	1.5	0.2	2.5	0.5
120E-L	St. Charles EB	Levee	Existing	16.1	1.2	1.5	0.2	2.5	0.5
120E-L	St. Charles EB	Levee	Future	18.8	1.2	1.5	0.2	2.5	0.5
121E-L	St. Charles EB	Levee	Existing	16.1	1.2	1.5	0.2	2.5	0.5

**St. Charles Parish East Bank (RM 115E to RM 127E)**

**1% Hydraulic Boundary Conditions**

Segment	Name	Type	Condition	Surge Level (ft)		Significant Wave Height (ft)		Peak Period (s)	
				Mean	Std	Mean	Std	Mean	Std
				121E-L	St. Charles EB	Levee	Future	18.9	1.2
122E-L	St. Charles EB	Levee	Existing	16.1	1.2	1.5	0.2	2.5	0.5
122E-L	St. Charles EB	Levee	Future	18.9	1.2	1.5	0.2	2.5	0.5
123E-L	St. Charles EB	Levee	Existing	16.1	1.2	1.5	0.2	2.5	0.5
123E-L	St. Charles EB	Levee	Future	19.0	1.2	1.5	0.2	2.5	0.5
124E-L	St. Charles EB	Levee	Existing	16.1	1.2	1.5	0.2	2.5	0.5
124E-L	St. Charles EB	Levee	Future	19.0	1.3	1.5	0.2	2.5	0.5
125E-L	St. Charles EB	Levee	Existing	16.1	1.2	1.5	0.2	2.5	0.5
125E-L	St. Charles EB	Levee	Future	18.9	1.3	1.5	0.2	2.5	0.5
126E-L	St. Charles EB	Levee	Existing	16.1	1.2	1.5	0.2	2.5	0.5
126E-L	St. Charles EB	Levee	Future	19.0	1.3	1.5	0.2	2.5	0.5
127E-L	St. Charles EB	Levee	Existing	16.1	1.2	1.5	0.2	2.5	0.5
127E-L	St. Charles EB	Levee	Future	19.0	1.3	1.5	0.2	2.5	0.5

### 5.9.3 Hydraulic Design Elevations for Levees, Floodwalls, and Structures

The design characteristics of the St. Charles Parish East Bank MRL-HSDRRS Levees are summarized in **Table 5-23**. The levee sections are designed for both existing and future conditions. Note that the floodwalls and locks are only evaluated for future conditions, because these are hard structures. **Figure 5-21** shows a typical levee design cross-section for the St. Charles Parish East Bank reach.

**Table 5-23 St. Charles Parish East Bank (RM 115E-RM 127E) – 1% Design Information**

St. Charles Parish East Bank (RM 115E to RM 127E)							
1% Design Elevations							
Segment	Name	Type	Condition	Depth at Toe (ft)	Elevation (ft)	Overtopping Rate	
						q50 (cfs/ft)	q90 (cfs/ft)
115E-L	St. Charles EB	Levee	Existing	0.2	20.0	0.000	0.008
115E-L	St. Charles EB	Levee	Future	2.9	24.0	0.000	0.001
116E-L	St. Charles EB	Levee	Existing	0.6	20.0	0.000	0.010
116E-L	St. Charles EB	Levee	Future	3.4	24.0	0.000	0.001
117E-L	St. Charles EB	Levee	Existing	4.9	20.0	0.000	0.010
117E-L	St. Charles EB	Levee	Future	7.7	24.0	0.000	0.001
118E-L	St. Charles EB	Levee	Existing	3.3	20.0	0.000	0.011
118E-L	St. Charles EB	Levee	Future	6.1	24.0	0.000	0.001
119E-L	St. Charles EB	Levee	Existing	2.6	20.0	0.000	0.012
119E-L	St. Charles EB	Levee	Future	5.4	24.0	0.000	0.001
120E-L	St. Charles EB	Levee	Existing	2.9	20.0	0.000	0.013
120E-L	St. Charles EB	Levee	Future	5.7	24.0	0.000	0.001
121E-L	St. Charles EB	Levee	Existing	4.1	20.0	0.000	0.014
121E-L	St. Charles EB	Levee	Future	6.9	24.0	0.000	0.002
122E-L	St. Charles EB	Levee	Existing	2.9	20.0	0.000	0.015

**St. Charles Parish East Bank (RM 115E to RM 127E)**

**1% Design Elevations**

Segment	Name	Type	Condition	Depth at Toe (ft)	Elevat ion (ft)	Overtopping Rate	
						q50 (cfs/ft)	q90 (cfs/ft)
122E-L	St. Charles EB	Levee	Future	5.7	24.0	0.000	0.002
123E-L	St. Charles EB	Levee	Existing	3.1	20.0	0.000	0.015
123E-L	St. Charles EB	Levee	Future	5.9	24.0	0.000	0.002
124E-L	St. Charles EB	Levee	Existing	1.4	20.0	0.000	0.016
124E-L	St. Charles EB	Levee	Future	4.2	24.0	0.000	0.002
125E-L	St. Charles EB	Levee	Existing	1.1	20.0	0.000	0.016
125E-L	St. Charles EB	Levee	Future	3.9	24.0	0.000	0.002
126E-L	St. Charles EB	Levee	Existing	3.4	20.0	0.000	0.017
126E-L	St. Charles EB	Levee	Future	6.2	24.0	0.000	0.002
127E-L	St. Charles EB	Levee	Existing	5.1	20.0	0.000	0.016
127E-L	St. Charles EB	Levee	Future	7.9	24.0	0.000	0.002

### 5.9.4 Typical Sections

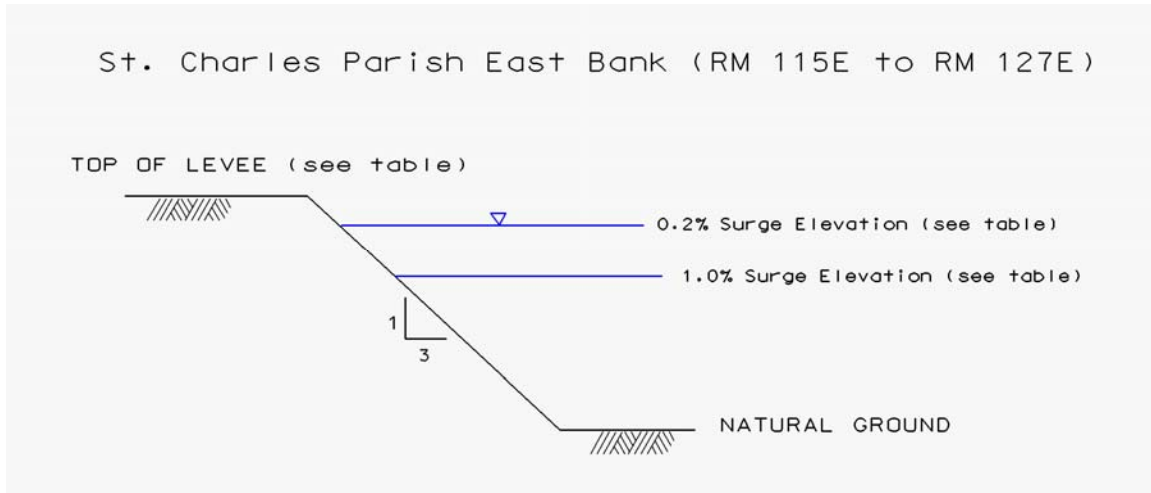


Figure 5-21 Typical Levee Design Cross-section (RM 115E-RM 127E) – St. Charles East Bank

### 5.9.5 Resiliency Analysis

The designs for the levees and structures were examined for resiliency by computing the 0.2% surge level (50% confidence). The results are presented in **Table 5-24**.

Table 5-24 St. Charles Parish East Bank (RM 115E-RM 127E) – Resiliency Analysis

St. Charles Parish East Bank (RM 115E to RM 127E)						
Resiliency Analysis (0.2% Event)						
Segment	Name	Type	Condition	1% Design Elevation (ft)	Best Estimates During 0.2% Event	
					Surge Level (ft)	Overtopping Rate (cfs/s per ft)
115E-L	St. Charles EB	Levee	Existing	20.0	19.6	1.315
115E-L	St. Charles EB	Levee	Future	24.0	22.9	1.205
116E-L	St. Charles EB	Levee	Existing	20.0	19.7	1.375
116E-L	St. Charles EB	Levee	Future	24.0	23.0	1.388
117E-L	St. Charles EB	Levee	Existing	20.0	19.7	1.522
117E-L	St. Charles EB	Levee	Future	24.0	23.1	1.439

**St. Charles Parish East Bank (RM 115E to RM 127E)**

**Resiliency Analysis (0.2% Event)**

Segment	Name	Type	Condition	1% Design Elevation (ft)	Best Estimates During 0.2% Event	
					Surge Level (ft)	Overtopping Rate (cfs/s per ft)
118E-L	St. Charles EB	Levee	Existing	20.0	19.8	1.603
118E-L	St. Charles EB	Levee	Future	24.0	23.2	1.498
119E-L	St. Charles EB	Levee	Existing	20.0	19.9	1.656
119E-L	St. Charles EB	Levee	Future	24.0	23.3	1.594
120E-L	St. Charles EB	Levee	Existing	20.0	19.9	1.805
120E-L	St. Charles EB	Levee	Future	24.0	23.4	1.795
121E-L	St. Charles EB	Levee	Existing	20.0	20.0	1.770
121E-L	St. Charles EB	Levee	Future	24.0	23.4	1.826
122E-L	St. Charles EB	Levee	Existing	20.0	20.0	1.946
122E-L	St. Charles EB	Levee	Future	24.0	23.5	1.899
123E-L	St. Charles EB	Levee	Existing	20.0	20.0	1.955
123E-L	St. Charles EB	Levee	Future	24.0	23.6	1.987
124E-L	St. Charles EB	Levee	Existing	20.0	20.1	1.942
124E-L	St. Charles EB	Levee	Future	24.0	23.6	2.025
125E-L	St. Charles EB	Levee	Existing	20.0	20.1	1.901
125E-L	St. Charles EB	Levee	Future	24.0	23.6	2.134
126E-L	St. Charles EB	Levee	Existing	20.0	20.1	2.153
126E-L	St. Charles EB	Levee	Future	24.0	23.7	2.241
127E-L	St. Charles EB	Levee	Existing	20.0	20.2	2.125
127E-L	St. Charles EB	Levee	Future	24.0	23.8	2.249

## 6.0 NEW ORLEANS TO VENICE

### 6.1 GENERAL

The NOV Project was authorized in the Flood Control Act of 1962 (PL 87-874), which authorized hurricane protection on the Mississippi River Delta at and below New Orleans, LA, for hurricane and storm damage risk reduction. The 3<sup>rd</sup> Supplemental (PL 110-252), 6<sup>th</sup> Supplemental (PL 110-252), and 7<sup>th</sup> Supplemental (PL 110-329) authorized the Secretary of the Army to repair and restore the original NOV Project to provide the level of risk reduction for which it was designed; to accelerate completion of unconstructed portions of the NOV Project; and to armor critical elements of the NOV Project. The 4<sup>th</sup> Supplemental (PL 109-234) and the 6<sup>th</sup> Supplemental (PL110-252) provided the Secretary of the Army funds to incorporate certain non-Federal levees into the NOV Project.

The NOV Project general outline is shown in **Figure 6-1** (noting preliminary contract reaches). The project consists of levees and floodwalls along the Mississippi River and back levees and floodwalls on both the East Bank and West Bank of the river. Together, this system provides risk reduction against hurricane surge and waves for the reaches along the river. The total length of levees and floodwalls is about 120 miles.

The NOV Project is divided into two parts:

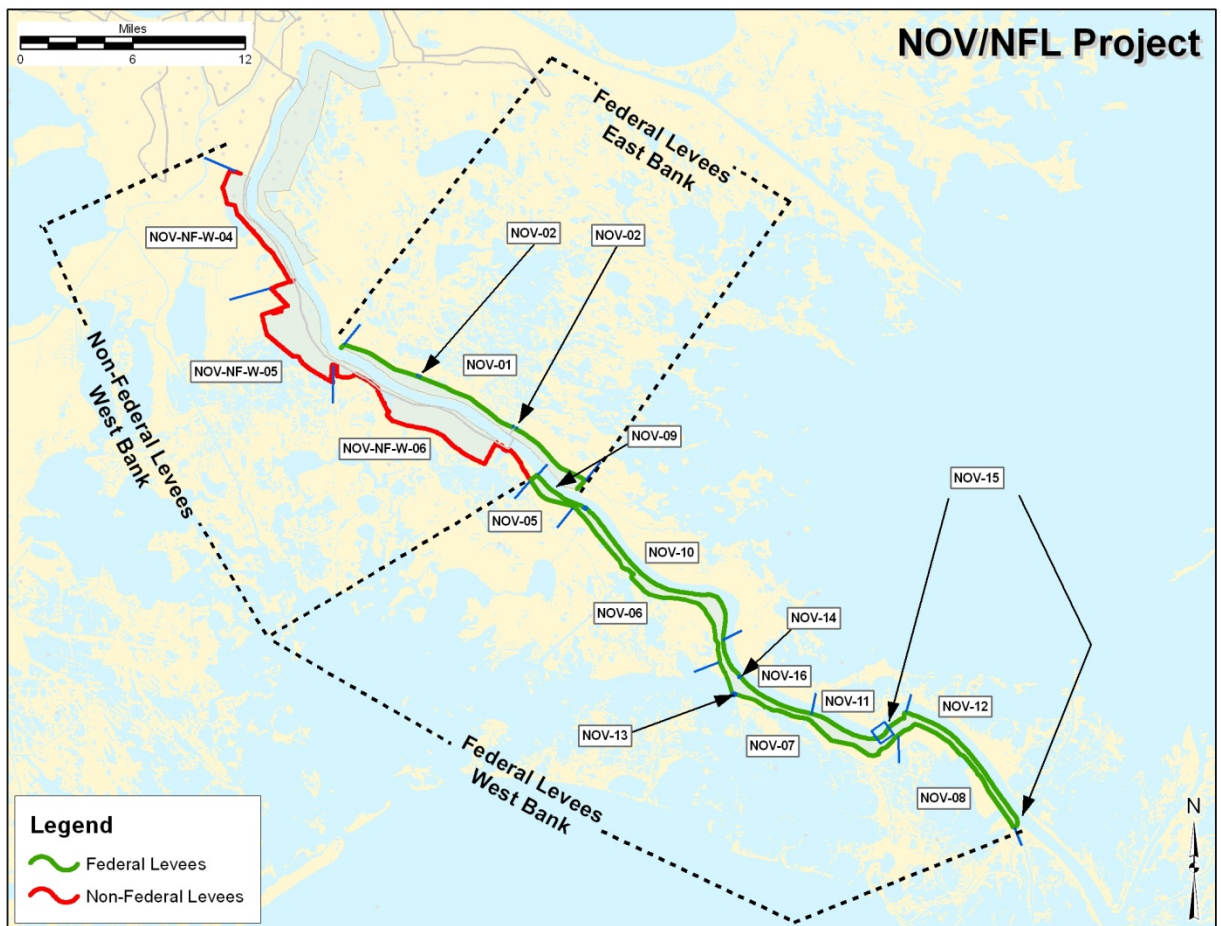
1. Non-Federal Levees to be Incorporated into the Federal Project – this portion of the NOV Project will incorporate certain existing Non-Federal Levees into the NOV Project. The existing levees on the west bank of the Mississippi River and extend from the Oakville, LA area to St. Jude, LA. Reaches in this portion are identified with the prefix NOV-NF in this document.
2. Federal Levees – this portion of the NOV Project consists of the back levee on the West Bank from St. Jude to Venice (Reach A and B), the Mississippi River levees downstream of RM 44 on the West Bank, and the East Bank back levee (Reach C) from Phoenix, LA to Bohemia, LA. The Federal levees are identified with the prefix NOV in this document.

The design elevations for the New Orleans to Venice Project (and Non-Federal Levee Incorporation into the NOV Project) are the initial values determined from hydraulic analyses and form the baseline for detailed design. As was done for the Lake Pontchartrain and Vicinity and West Bank and Vicinity Projects, the designers will work with hydraulic engineers in an iterative process to prepare plans and specifications.

The NOV/NFL design elevations and slopes presented in this report are based on a given alignment and the topographic and bathymetric conditions at the site. Detailed surveys were used where available, but use of LIDAR and historic data were also utilized. During the design process, detailed survey data will be taken, and there will be the opportunity to re-verify the values presented in this report.

Soil borings will also be taken during the design process and stability calculations performed. Changes in the topographic conditions at a levee or structure may occur, necessitating the need to re-verify the values presented in this report.

The designers may look at alternatives such as new alignments and changing a levee to a floodwall and these alternatives can include measures to reduce wave overtopping. If wave overtopping is reduced, design elevations may be reduced, or levee slopes may be steepened. Typical levee slopes are grass covered and are therefore considered to be “smooth”. The placement of riprap on the slope roughens the surface and thereby reduces overtopping. Breakwaters can be used at levees, floodwalls and floodgates to alter the waves before they can break on the structure. Vegetation also alters the wave characteristics. Adding roughness by planting trees appears to have merit in reducing wave overtopping.



**Figure 6-1 New Orleans to Venice Project, including the Non-Federal Levee Incorporation into NOV**

Current structures located along the Non-Federal and Federal portions of the protection system include but are not limited to: Lower Ollie New Pump Station, Lower Ollie Old Pump Station,



Upper Ollie Pump Station, Wilkinson Canal Pump Station, Point Celeste Pump Station, Pointe a la Hache West Pump Station, Diamond Pump Station, Hayes Pump Station, Gainard Wood Pump Station, Empire Floodgate, Sunrise Pump Stations 1 and 2, Grand Liard Pump Station and floodwall, Duvic Pump Station, Point Michel Floodwall, Empire Lock, Gainard Woods Pump Station, Hayes Canal Pump Station, and other floodwalls.

There are currently gaps and low areas in the existing Non-Federal back levee system; one gap is south of Myrtle Grove (near Myrtle Grove Marina Estates) and the second gap is north of St. Jude where there is approximately 2 miles with no back levees. These gaps and low areas present flooding problems during minor tropical events (such as Tropical Storm Lee in 2011 where Hwy 23 was flooded near Myrtle Grove) and major flooding problems during hurricane events (such as Hurricane Isaac in 2012 where a majority of the protected area from LaReussite to St. Jude flooded, including Hwy 23).

In the original authorization, the hurricane protection was co-located with the MRL, Mississippi River, and Tributaries Project along the West Bank of the Mississippi River from RM 10 to RM 44. Upstream of Mile 44, the required MRL design grade was determined to be higher than the required design grade for the NOV Project. Recent modeling indicates that the hurricane surge protrudes further upstream. The MRL system from RM 44 – 70 on the West Bank and the MRL system from RM 44 – 59 on the East Bank is considered herein.

The MRL on the East Bank between RM 59 and 81 are not considered in this report. It does play a role in the overarching flood risk reduction analysis of the area. For instance, all model computations assume that this river levee does not fail during a hurricane. Also, scour or failure of this river levee during a hurricane may cause problems ensuring river flood protection in the river high water season if repairs cannot be made in time.

This chapter provides a detailed documentation of the analysis performed to determine design elevations for the NOV Project for three levels of risk reduction: 1%, 2% and 4% (NFL reaches). The elevations presented are considered initial elevations. The outline of this chapter is as follows:

- **Section 6.2** – West Bank – Non-Federal Levee System (**Plate 16 and 17**)
- **Section 6.3** – West Bank – Federal Levee System (**Plate 18 and 19**)
- **Section 6.4** – East Bank – Federal Levee System (**Plate 20**)
- **Section 6.5** – Mississippi River West Bank (RM 10 – RM 70)
- **Section 6.6** – Mississippi River East Bank (RM 44 – RM 59)
- **Section 6.7** – Transition Zones at RM 44
- **Section 6.8** – New Orleans to Venice Epoch Adjustments by Hydraulic Reach

More thorough engineering investigations will follow to determine the final construction elevations. Additional studies may be performed to evaluate alternatives. The designers may evaluate new alignments, change a levee to a floodwall, change levee cross-sections, add features such as breakwaters, incorporate armoring, and other measures that can change the parameters used to calculate the design elevations. Hydraulic design and analysis associated with upcoming investigations will be documented in subsequent updates to this document.

This section summarizes the process applied to the NOV Project. Note, the NOV Project comprises of both Mississippi River levees and back levees. With respect to the Mississippi River portion of the NOV Project the design process used for the river levee system was employed. Additional analysis was necessary for the back levees at both East Bank and West Bank and is discussed in the following sections.

### **Impact of West Closure Complex**

The 2007 and 2010 conditions of the HSDRRS were modeled with ADCIRC/STWAVE and used for design purposes for the LPV and WBV Projects within the HSDRRS. For the back levees in the NOV system, the 2010 condition ADCIRC results were applied. Note that the 2010 condition runs were made with a low Mississippi River discharge, but the river discharge does not influence the surge levels at these sections. The 2010 condition runs also did not include the WCC.

In 2009, additional runs were performed to determine if there is an effect of the WCC on the surge levels at the West Bank. These runs utilized a small subset of the 152 storms, and the 2010 condition ADCIRC grid modified to include the WCC. The results are contained in the ERDC document “Numerical Modeling Study of the Western Closure Complex Project,” which is **Appendix J** to this document. From these results, it was concluded that there is a small increase in surge south of the WCC for approximately 8 miles of the non-Federal back levee. However, the magnitude of this effect on surge frequency could not be determined from these model runs.

As discussed in **Chapter 2**, in 2010, additional modeling was performed that considered the presence of the WCC using a larger subset of the 152 storms. The model results were used in JPM-OS to develop frequency curves for points along the NOV back levees in the vicinity of Oakville. These frequency curves were compared to curves developed using the 2010 condition results; no increase in 1% surge elevations were found. Therefore, it was concluded that the frequency curves developed using the 2010 condition modeling results were reasonable and appropriate for design for the NOV Project.

### **Wave Assessment**

The statistical wave information from the 2007 and 2010 STWAVE model results was evaluated at the various back levee design sections of the NOV system. The resulting waves from the half-plane modeling approach of STWAVE for the southeast and south grid appeared to be very low (1% significant wave height 1.0 – 2.0 ft). This partly has to do with the fact that the local wave growth component in these runs is not fully accounted for because of the limitations of the half-plane model.

Based on these considerations, it was decided to not use the STWAVE results; instead an empirical approach was used to determine the design waves. For the back levees of the NOV system (all non-federal sections at the West Bank, NOV-05, NOV-06, NOV-07, NOV-08, and NOV-01, the Mississippi River Levee (MRL) portion and NF-02) and the Mississippi River levees below RM 44 (NOV-09, NOV-10, NOV-11, NOV-12, and NOV-16), the following assumptions were applied to determine the design waves:

- **Significant Wave Height:** The significant wave height for design was set at 35% of the water depth. This number appears to be reasonable using the empirical formulations of Bretschneider equation and applying 1% conditions for the area of interest (i.e. 15 ft water depth, 77 miles per hour (mph) wind speed, fetch 50 miles). Note the number is not sensitive for the exact fetch length. The choice for 35% is further confirmed by an analysis of full-plane STWAVE results for the Lake Borgne area developed for the MRGO/GIWW gate, which was recently renamed the IHNC Surge Barrier. The wave height/water depth ratio for a large set of points was analyzed, and a ratio of 25-50% calculated.
- **Wave Period:** A (local) wave steepness of 4% has been adopted to calculate the wave period. The wave steepness is herein defined by the local significant wave height and local wavelength using the peak period. This wave steepness is realistic for local wind-generated waves in open water.

A SWAN (Simulating Waves Nearshore) model was developed to assess the wave climate along the Mississippi River levees below RM 44 to further lend confidence to the methodology used. The results of this modeling effort are discussed in **Appendix K**. In conclusion, the SWAN results show similar wave characteristics as the empirical method. Therefore, the empirical method has been applied herein.

For the back levees and structures, the design waves are calculated as follows using the empirical method. The local ground elevation near the hydraulic reach under consideration was determined based on topographic LIDAR (Light Detection And Ranging) data in Louisiana (Louisiana State University [LSU], 2004), as shown in **Table 6-1**. The design surge level and the ground elevation were used to calculate the local water depth. The significant wave height was set at 35% of this local water depth. Based on the local water depth, the wave period (and thus wave period) was determined using linear wave theory assuming a local wave steepness of 4%.

The information included in the tables in this chapter are also summarized in **Appendix T**, Overtopping Design Criteria Tables.

**Table 6-1 Ground Elevations**

<b>New Orleans to Venice, Ground Elevations at Toe of Structure (ft)</b>	
<b>Segment</b>	<b>Ground Elevation at Toe of Structure (ft)</b>
NOV-NF-W-04a	2.0
NOV-NF-W-04b	2.0
NOV-NF-W-05a	2.0
NOV-NF-W-05b	2.0
NOV-NF-W-05c	1.0
NOV-NF-W-05d	1.0
NOV-NF-W-06a	1.0
NOV-NF-W-06b	1.0
NOV-05	1.0
NOV-06	1.0
NOV-07	0.5
NOV-08	0.5
NOV-09	0.0
NOV-10	0.0
NOV-16	0.0
NOV-11	0.0
NOV-12	0.0
NOV-01a	2.5
NOV-01b	2.5

Considering the very limited information about the waves in the area of interest and the assumptions made above, full-plane runs and additional field measurements would better define the wave characteristics for the NOV system.

## 6.2 WEST BANK – NON-FEDERAL LEVEE SYSTEM

### 6.2.1 General

The West Bank – Non-Federal Levee system consists of approximately 34 miles of back levee from Oakville, LA to St. Jude, LA on the West Bank. Various pump stations are part of this levee system such as Lower Ollie Old and New Pump Station, Wilkinson Pump Station, Pointe Celeste Pump Station and Pointe a la Hache Pump Station. **Plate 15** shows the NFL to be Incorporated into the NOV Project.

All elevations described herein are in North American Vertical Datum 1988 (2004.65).

### 6.2.2 Hydraulic Boundary Conditions

The 1%, 2% and 4% hydraulic boundary conditions for the Non-Federal Levee system at the West Bank are listed in **Table 6-2**, **Table 6-3**, and **Table 6-4**, respectively. Refer to **Chapter 2** for the methodology to derive these boundary conditions for existing and future conditions.

**Table 6-2 New Orleans to Venice West Bank – Non-Federal System – 1% Hydraulic Boundary Conditions**

New Orleans to Venice									
1% Hydraulic Boundary Conditions									
West Bank – Non-Federal Levee System									
Hydraulic Reach	Name	Type	Condition	Surge Level		Significant Wave Height		Peak Period	
				(ft)		(ft)		(s)	
				Mean	Std	Mean	Std	Mean	Std
NOV-NF-W-04a	Non-Fed Oakville to LaReusitte (a)	Levee	Existing	7.3	0.9	1.3	0.1	3.7	0.7
NOV-NF-W-04a	Non-Fed Oakville to LaReusitte (a)	Levee	Future	9.3	0.9	2.3	0.1	4.9	0.7
NOV-NF-W-04b	Non-Fed Oakville to LaReusitte (b)	Levee	Existing	8.0	1.2	2.1	0.2	4.1	0.8
NOV-NF-W-04b	Non-Fed Oakville to LaReusitte (b)	Levee	Future	10.0	1.2	3.1	0.2	5.0	0.8

**New Orleans to Venice**

**1% Hydraulic Boundary Conditions**

**West Bank – Non-Federal Levee System**

Hydraulic Reach	Name	Type	Condition	Surge Level		Significant Wave Height		Peak Period	
				(ft)		(ft)		(s)	
				Mean	Std	Mean	Std	Mean	Std
NOV-NF-W-04b	Lower Ollie New PS	Structure	Future	10.0	1.2	3.1	0.2	5.0	0.8
NOV-NF-W-04b	Lower Ollie Old PS	Structure	Future	10.0	1.2	3.1	0.2	5.0	0.8
NOV-NF-W-04b	Upper Ollie PS	Structure	Future	10.0	1.2	3.1	0.2	5.0	0.8
NOV-NF-W-05a	Non-Fed LaReusitte to Myrtle Grove (a)	Levee	Existing	8.2	1.2	2.2	0.2	4.1	0.8
NOV-NF-W-05a	Non-Fed LaReusitte to Myrtle Grove (a)	Levee	Future	10.2	1.2	3.2	0.2	5.0	0.8
NOV-NF-W-05b	Non-Fed LaReusitte to Myrtle Grove (b)	Levee	Existing	9.0	1.1	2.9	0.3	4.8	1.0
NOV-NF-W-05b	Non-Fed LaReusitte to Myrtle Grove (b)	Levee	Future	11.0	1.1	3.5	0.2	5.2	0.9
NOV-NF-W-05c	Non-Fed LaReusitte to Myrtle Grove (c)	Levee	Existing	9.2	1.1	2.9	0.3	4.8	1.0
NOV-NF-W-05c	Non-Fed LaReusitte to Myrtle Grove (c)	Levee	Future	11.2	1.1	3.9	0.3	5.5	1.0

**New Orleans to Venice**

**1% Hydraulic Boundary Conditions**

**West Bank – Non-Federal Levee System**

Hydraulic Reach	Name	Type	Condition	Surge Level		Significant Wave Height		Peak Period	
				(ft)		(ft)		(s)	
				Mean	Std	Mean	Std	Mean	Std
NOV-NF-W-05d	Non-Fed LaReusitte to Myrtle Grove (d)	Levee	Existing	9.5	1.2	3.1	0.3	4.9	1.0
NOV-NF-W-05d	Non-Fed LaReusitte to Myrtle Grove (d)	Levee	Future	11.5	1.2	4.0	0.3	5.6	1.0
NOV-NF-W-05d	Wilkinson Canal PS	Structure	Future	11.5	1.2	4.0	0.3	5.6	1.0
NOV-NF-W-06a	Non-Fed Myrtle Grove to St Jude (a)	Levee	Existing	9.8	1.2	3.1	0.3	4.9	1.0
NOV-NF-W-06a	Non-Fed Myrtle Grove to St Jude (a)	Levee	Future	11.8	1.2	4.1	0.3	5.6	1.0
NOV-NF-W-06b	Non-Fed Myrtle Grove to St Jude (b)	Levee	Existing	10.4	1.2	3.3	0.3	5.1	1.0
NOV-NF-W-06b	Non-Fed Myrtle Grove to St Jude (b)	Levee	Future	12.4	1.2	4.3	0.3	5.8	1.0
NOV-NF-W-06b	Point Celeste PS	Structure	Future	12.4	1.2	4.3	0.3	5.8	1.0
NOV-NF-W-06b	Pointe a la Hache-West PS	Structure	Future	12.4	1.2	4.3	0.3	5.8	1.0

**Table 6-3 New Orleans to Venice West Bank – Non-Federal System – 2% Hydraulic Boundary Conditions**

<p align="center"><b>New Orleans to Venice</b></p> <p align="center"><b>2% Hydraulic Boundary Conditions</b></p> <p align="center"><b>West Bank – Non-Federal Levee System</b></p>									
Hydraulic Reach	Name	Type	Condition	Surge Level		Significant Wave Height		Peak Period	
				(ft)		(ft)		(s)	
				Mean	Std	Mean	Std	Mean	Std
NOV-NF-W-04a	Non-Fed Oakville to LaReusitte (a)	Levee	Existing	5.5	0.6	1.2	0.1	3.1	0.6
NOV-NF-W-04a	Non-Fed Oakville to LaReusitte (a)	Levee	Future	7.5	0.6	2.2	0.1	4.2	0.6
NOV-NF-W-04b	Non-Fed Oakville to LaReusitte (b)	Levee	Existing	6.0	0.8	1.6	0.2	3.5	0.7
NOV-NF-W-04b	Non-Fed Oakville to LaReusitte (b)	Levee	Future	8.0	0.8	2.6	0.2	4.5	0.7
NOV-NF-W-04b	Lower Ollie New PS	Structure	Future	8.0	0.8	2.6	0.2	4.5	0.7
NOV-NF-W-04b	Lower Ollie Old PS	Structure	Future	8.0	0.8	2.6	0.2	4.5	0.7
NOV-NF-W-04b	Upper Ollie PS	Structure	Future	8.0	0.8	2.6	0.2	4.5	0.7
NOV-NF-W-05a	Non-Fed LaReusitte to Myrtle Grove (a)	Levee	Existing	6.2	0.8	1.5	0.1	3.4	0.7
NOV-NF-W-05a	Non-Fed LaReusitte to Myrtle Grove (a)	Levee	Future	8.2	0.8	2.5	0.1	4.4	0.7



New Orleans to Venice									
2% Hydraulic Boundary Conditions									
West Bank – Non-Federal Levee System									
Hydraulic Reach	Name	Type	Condition	Surge Level		Significant Wave Height		Peak Period	
				(ft)		(ft)		(s)	
				Mean	Std	Mean	Std	Mean	Std
NOV-NF-W-05b	Non-Fed LaReusitte to Myrtle Grove (b)	Levee	Existing	6.9	0.7	1.7	0.2	3.7	0.7
NOV-NF-W-05b	Non-Fed LaReusitte to Myrtle Grove (b)	Levee	Future	8.9	0.7	2.7	0.2	4.6	0.7
NOV-NF-W-05c	Non-Fed LaReusitte to Myrtle Grove (c)	Levee	Existing	7.0	0.7	2.1	0.2	4.1	0.8
NOV-NF-W-05c	Non-Fed LaReusitte to Myrtle Grove (c)	Levee	Future	9.0	0.7	3.1	0.2	5.0	0.8
NOV-NF-W-05d	Non-Fed LaReusitte to Myrtle Grove (d)	Levee	Existing	7.4	0.8	2.2	0.2	4.2	0.8
NOV-NF-W-05d	Non-Fed LaReusitte to Myrtle Grove (d)	Levee	Future	9.4	0.8	3.2	0.2	5.1	0.8
NOV-NF-W-05d	Wilkinson Canal PS	Structure	Future	9.4	0.8	3.2	0.2	5.1	0.8
NOV-NF-W-06a	Non-Fed Myrtle Grove to St Jude (a)	Levee	Existing	7.6	0.8	2.3	0.2	4.3	0.9

New Orleans to Venice									
2% Hydraulic Boundary Conditions									
West Bank – Non-Federal Levee System									
Hydraulic Reach	Name	Type	Condition	Surge Level		Significant Wave Height		Peak Period	
				(ft)		(ft)		(s)	
				Mean	Std	Mean	Std	Mean	Std
NOV-NF-W-06a	Non-Fed Myrtle Grove to St Jude (a)	Levee	Future	9.6	0.8	3.3	0.2	5.1	0.9
NOV-NF-W-06b	Non-Fed Myrtle Grove to St Jude (b)	Levee	Existing	8.2	0.8	2.5	0.3	4.5	0.9
NOV-NF-W-06b	Non-Fed Myrtle Grove to St Jude (b)	Levee	Future	10.2	0.8	3.5	0.3	5.3	0.9
NOV-NF-W-06b	Point Celeste PS	Structure	Future	10.2	0.8	3.5	0.3	5.3	0.9
NOV-NF-W-06b	Pointe a la Hache-West PS	Structure	Future	10.2	0.8	3.5	0.3	5.3	0.9

**Table 6-4 New Orleans to Venice West Bank – Non-Federal System – 4% Hydraulic Boundary Conditions**

New Orleans to Venice									
4% Hydraulic Boundary Conditions									
West Bank – Non-Federal Levee System									
Hydraulic Reach	Name	Type	Condition	Surge Level		Significant Wave Height		Peak Period	
				(ft)		(ft)		(s)	
				Mean	Std	Mean	Std	Mean	Std
NOV-NF-W-04a	Non-Fed Oakville to LaReusitte (a)	Levee	Existing	5.0	0.6	1.1	0.1	2.9	0.6
NOV-NF-W-04a	Non-Fed Oakville to LaReusitte (a)	Levee	Future	7.0	0.6	2.1	0.2	4.1	0.8
NOV-NF-W-04b	Non-Fed Oakville to LaReusitte (b)	Levee	Existing	5.4	0.8	1.3	0.1	3.1	0.6
NOV-NF-W-04b	Non-Fed Oakville to LaReusitte (b)	Levee	Future	7.4	0.8	2.3	0.2	4.2	0.8
NOV-NF-W-05a	Non-Fed LaReusitte to Myrtle Grove (a)	Levee	Existing	5.4	0.8	1.2	0.1	3.0	0.6
NOV-NF-W-05a	Non-Fed LaReusitte to Myrtle Grove (a)	Levee	Future	7.4	0.8	2.2	0.2	4.1	0.8
NOV-NF-W-05b	Non-Fed LaReusitte to Myrtle Grove (b)	Levee	Existing	6.1	0.7	1.5	0.2	3.4	0.7
NOV-NF-W-05b	Non-Fed LaReusitte to Myrtle Grove (b)	Levee	Future	8.1	0.7	2.5	0.3	4.4	0.9

**New Orleans to Venice**

**4% Hydraulic Boundary Conditions**

**West Bank – Non-Federal Levee System**

Hydraulic Reach	Name	Type	Condition	Surge Level		Significant Wave Height		Peak Period	
				(ft)		(ft)		(s)	
				Mean	Std	Mean	Std	Mean	Std
NOV-NF-W-05c	Non-Fed LaReusitte to Myrtle Grove (c)	Levee	Existing	6.3	0.7	1.9	0.2	3.8	0.8
NOV-NF-W-05c	Non-Fed LaReusitte to Myrtle Grove (c)	Levee	Future	8.3	0.7	2.9	0.3	4.8	1.0
NOV-NF-W-05d	Non-Fed LaReusitte to Myrtle Grove (d)	Levee	Existing	6.4	0.8	1.9	0.2	3.9	0.8
NOV-NF-W-05d	Non-Fed LaReusitte to Myrtle Grove (d)	Levee	Future	8.4	0.8	2.9	0.3	4.8	1.0
NOV-NF-W-06a	Non-Fed Myrtle Grove to St Jude (a)	Levee	Existing	6.5	0.8	1.9	0.2	3.9	0.8
NOV-NF-W-06a	Non-Fed Myrtle Grove to St Jude (a)	Levee	Future	8.5	0.8	2.9	0.3	4.8	1.0
NOV-NF-W-06b	Non-Fed Myrtle Grove to St Jude (b)	Levee	Existing	6.8	0.8	2.1	0.2	4.0	0.8
NOV-NF-W-06b	Non-Fed Myrtle Grove to St Jude (b)	Levee	Future	8.8	0.8	3.1	0.3	4.9	1.0

### 6.2.3 Project Design Elevations

The design characteristics of the non-federal levee system at the West Bank are listed in **Table 6-5**, **Table 6-6** and **Table 6-7** for 1%, 2% and 4% hurricane risk reduction, respectively. Levees are evaluated for both existing and future conditions. Hydraulic structures are only evaluated for future conditions.

**Table 6-5 New Orleans to Venice West Bank – Non-Federal System – 1% Project Design Information**

New Orleans to Venice							
1% Project Design Elevations							
West Bank – Non-Federal Levee System							
Hydraulic Reach	Name	Type	Condition	Toe Elevation (ft)	Elevation (ft)	Overtopping Rate	
						q50 (cfs/ft)	q90 (cfs/ft)
NOV-NF-W-04a	Non-Fed Oakville to LaReusitte (a)	Levee	Existing	2.0	10.5	0.001	0.023
NOV-NF-W-04a	Non-Fed Oakville to LaReusitte (a)	Levee	Future	2.0	14.0	0.003	0.028
NOV-NF-W-04b	Non-Fed Oakville to LaReusitte (b)	Levee	Existing	2.0	12.5	0.003	0.056
NOV-NF-W-04b	Non-Fed Oakville to LaReusitte (b)	Levee	Future	2.0	16.5	0.007	0.059
NOV-NF-W-04b	Lower Ollie New PS	Structure	Future	2.0	17.0	0.007	0.053
NOV-NF-W-04b	Lower Ollie Old PS	Structure	Future	2.0	17.0	0.007	0.049
NOV-NF-W-04b	Upper Ollie PS	Structure	Future	2.0	17.0	0.008	0.053

**New Orleans to Venice**  
**1% Project Design Elevations**

**West Bank – Non-Federal Levee System**

Hydraulic Reach	Name	Type	Condition	Toe Elevation (ft)	Elevation (ft)	Overtopping Rate	
						q50 (cfs/ft)	q90 (cfs/ft)
NOV-NF-W-05a	Non-Fed LaReusitte to Myrtle Grove (a)	Levee	Existing	2.0	12.5	0.005	0.082
NOV-NF-W-05a	Non-Fed LaReusitte to Myrtle Grove (a)	Levee	Future	2.0	16.5	0.009	0.078
NOV-NF-W-05b	Non-Fed LaReusitte to Myrtle Grove (b)	Levee	Existing	2.0	14.0	0.006	0.064
NOV-NF-W-05b	Non-Fed LaReusitte to Myrtle Grove (b)	Levee	Future	2.0	18.0	0.009	0.070
NOV-NF-W-05c	Non-Fed LaReusitte to Myrtle Grove (c)	Levee	Existing	1.0	15.0	0.007	0.082
NOV-NF-W-05c	Non-Fed LaReusitte to Myrtle Grove (c)	Levee	Future	1.0	19.0	0.010	0.079
NOV-NF-W-05d	Non-Fed LaReusitte to Myrtle Grove (d)	Levee	Existing	1.0	15.5	0.008	0.088
NOV-NF-W-05d	Non-Fed LaReusitte to Myrtle Grove (d)	Levee	Future	1.0	20.0	0.007	0.061

**New Orleans to Venice**

**1% Project Design Elevations**

**West Bank – Non-Federal Levee System**

<b>Hydraulic Reach</b>	<b>Name</b>	<b>Type</b>	<b>Condition</b>	<b>Toe Elevation (ft)</b>	<b>Elevation (ft)</b>	<b>Overtopping Rate</b>	
						<b>q50 (cfs/ft)</b>	<b>q90 (cfs/ft)</b>
NOV-NF-W-05d	Wilkinson Canal PS	Structure	Future	1.0	19.5	0.017	0.079
NOV-NF-W-06a	Non-Fed Myrtle Grove to St Jude (a)	Levee	Existing	1.0	16.0	0.007	0.080
NOV-NF-W-06a	Non-Fed Myrtle Grove to St Jude (a)	Levee	Future	1.0	20.5	0.008	0.064
NOV-NF-W-06b	Non-Fed Myrtle Grove to St Jude (b)	Levee	Existing	1.0	17.0	0.009	0.089
NOV-NF-W-06b	Non-Fed Myrtle Grove to St Jude (b)	Levee	Future	1.0	20.5	0.008	0.065
NOV-NF-W-06b	Point Celeste PS	Structure	Future	1.0	21.0	0.016	0.072
NOV-NF-W-06b	Pointe a la Hache-West PS	Structure	Future	1.0	21.0	0.017	0.071

**Table 6-6 New Orleans to Venice West Bank – Non-Federal System – 2% Project Design Information**

New Orleans to Venice							
2% Project Design Elevations							
West Bank – Non-Federal Levee System							
Hydraulic Reach	Name	Type	Condition	Toe Elevation (ft)	Elevation (ft)	Overtopping Rate	
						q50 (cfs/ft)	q90 (cfs/ft)
NOV-NF-W-04a	Non-Fed Oakville to LaReusitte (a)	Levee	Existing	2.0	7.5	0.006	0.073
NOV-NF-W-04a	Non-Fed Oakville to LaReusitte (a)	Levee	Future	2.0	11.5	0.009	0.048
NOV-NF-W-04b	Non-Fed Oakville to LaReusitte (b)	Levee	Existing	2.0	9.0	0.004	0.062
NOV-NF-W-04b	Non-Fed Oakville to LaReusitte (b)	Levee	Future	2.0	13.0	0.008	0.055
NOV-NF-W-04b	Lower Ollie New PS	Structure	Future	2.0	13.5	0.015	0.074
NOV-NF-W-04b	Lower Ollie Old PS	Structure	Future	2.0	13.5	0.015	0.073
NOV-NF-W-04b	Upper Ollie PS	Structure	Future	2.0	13.5	0.015	0.077
NOV-NF-W-05a	Non-Fed LaReusitte to Myrtle Grove (a)	Levee	Existing	2.0	9.0	0.004	0.056



**New Orleans to Venice**  
**2% Project Design Elevations**

**West Bank – Non-Federal Levee System**

Hydraulic Reach	Name	Type	Condition	Toe Elevation (ft)	Elevation (ft)	Overtopping Rate	
						q50 (cfs/ft)	q90 (cfs/ft)
NOV-NF-W-05a	Non-Fed LaReusitte to Myrtle Grove (a)	Levee	Future	2.0	13.0	0.007	0.048
NOV-NF-W-05b	Non-Fed LaReusitte to Myrtle Grove (b)	Levee	Existing	2.0	10.0	0.007	0.068
NOV-NF-W-05b	Non-Fed LaReusitte to Myrtle Grove (b)	Levee	Future	2.0	14.0	0.009	0.058
NOV-NF-W-05c	Non-Fed LaReusitte to Myrtle Grove (c)	Levee	Existing	1.0	11.0	0.007	0.058
NOV-NF-W-05c	Non-Fed LaReusitte to Myrtle Grove (c)	Levee	Future	1.0	15.5	0.006	0.037
NOV-NF-W-05d	Non-Fed LaReusitte to Myrtle Grove (d)	Levee	Existing	1.0	11.5	0.008	0.072
NOV-NF-W-05d	Non-Fed LaReusitte to Myrtle Grove (d)	Levee	Future	1.0	16.0	0.008	0.045
NOV-NF-W-05d	Wilkinson Canal PS	Structure	Future	1.0	15.5	0.027	0.097

**New Orleans to Venice**  
**2% Project Design Elevations**

**West Bank – Non-Federal Levee System**

Hydraulic Reach	Name	Type	Condition	Toe Elevation (ft)	Elevation (ft)	Overtopping Rate	
						q50 (cfs/ft)	q90 (cfs/ft)
NOV-NF-W-06a	Non-Fed Myrtle Grove to St Jude (a)	Levee	Existing	1.0	12.0	0.007	0.065
NOV-NF-W-06a	Non-Fed Myrtle Grove to St Jude (a)	Levee	Future	1.0	16.5	0.007	0.044
NOV-NF-W-06b	Non-Fed Myrtle Grove to St Jude (b)	Levee	Existing	1.0	13.0	0.008	0.074
NOV-NF-W-06b	Non-Fed Myrtle Grove to St Jude (b)	Levee	Future	1.0	17.5	0.008	0.053
NOV-NF-W-06b	Point Celeste PS	Structure	Future	1.0	17.0	0.021	0.079
NOV-NF-W-06b	Pointe a la Hache-West PS	Structure	Future	1.0	17.0	0.021	0.079

**Table 6-7 New Orleans to Venice West Bank – Non-Federal System – 4% Project Design Information**

New Orleans to Venice									
4% Project Design Elevations									
West Bank – Non-Federal Levee System									
Hydraulic Reach	Name	Type	Condition	Toe Elevation (ft)	Slope	Berm (yes/ no)	Elevation (ft)	Overtopping Rate	
								q50 (cfs/ft)	q90 (cfs/ft)
NOV-NF-W-04a	Non-Fed Oakville to LaReusitte (a)	Levee	Existing	2.0	1:4	No	7.0	0.003	0.046
NOV-NF-W-04a	Non-Fed Oakville to LaReusitte (a)	Levee	Future	2.0	1:4	No	11.0	0.007	0.053
NOV-NF-W-04b	Non-Fed Oakville to LaReusitte (b)	Levee	Existing	2.0	1:4	No	8.0	0.002	0.042
NOV-NF-W-04b	Non-Fed Oakville to LaReusitte (b)	Levee	Future	2.0	1:4	No	11.5	0.009	0.087
NOV-NF-W-05a	Non-Fed LaReusitte to Myrtle Grove (a)	Levee	Existing	2.0	1:4	No	8.0	0.001	0.025
NOV-NF-W-05a	Non-Fed LaReusitte to Myrtle Grove (a)	Levee	Future	2.0	1:4	No	11.5	0.007	0.066

**New Orleans to Venice**  
**4% Project Design Elevations**

**West Bank – Non-Federal Levee System**

Hydraulic Reach	Name	Type	Condition	Toe Elevation (ft)	Slope	Berm (yes/ no)	Elevation (ft)	Overtopping Rate	
								q50 (cfs/ft)	q90 (cfs/ft)
NOV-NF-W-05b	Non-Fed LaReusitte to Myrtle Grove (b)	Levee	Existing	2.0	1:4	No	9.0	0.003	0.043
NOV-NF-W-05b	Non-Fed LaReusitte to Myrtle Grove (b)	Levee	Future	2.0	1:4	No	13.0	0.006	0.055
NOV-NF-W-05c	Non-Fed LaReusitte to Myrtle Grove (c)	Levee	Existing	1.0	1:4	No	9.5	0.009	0.091
NOV-NF-W-05c	Non-Fed LaReusitte to Myrtle Grove (c)	Levee	Future	1.0	1:4	No	14.0	0.008	0.063
NOV-NF-W-05d	Non-Fed LaReusitte to Myrtle Grove (d)	Levee	Existing	1.0	1:4	No	10.0	0.006	0.062
NOV-NF-W-05d	Non-Fed LaReusitte to Myrtle Grove (d)	Levee	Future	1.0	1:4	No	14.0	0.009	0.075
NOV-NF-W-06a	Non-Fed Myrtle Grove to St Jude (a)	Levee	Existing	1.0	1:4	No	10.0	0.007	0.070
NOV-NF-W-06a	Non-Fed Myrtle Grove to St Jude (a)	Levee	Future	1.0	1:4	No	14.5	0.006	0.052

**New Orleans to Venice**

**4% Project Design Elevations**

**West Bank – Non-Federal Levee System**

<b>Hydraulic Reach</b>	<b>Name</b>	<b>Type</b>	<b>Condition</b>	<b>Toe Elevation (ft)</b>	<b>Slope</b>	<b>Berm (yes/ no)</b>	<b>Elevation (ft)</b>	<b>Overtopping Rate</b>	
								<b>q50 (cfs/ft)</b>	<b>q90 (cfs/ft)</b>
NOV-NF-W-06b	Non-Fed Myrtle Grove to St Jude (b)	Levee	Existing	1.0	1:4	No	11.0	0.004	0.045
NOV-NF-W-06b	Non-Fed Myrtle Grove to St Jude (b)	Levee	Future	1.0	1:4	No	15.0	0.007	0.062

## 6.2.4 Resiliency Analysis

The **1% designs only** for the non-federal system on the West Bank were examined for resiliency by computing the 0.2% surge level (50% confidence) for each design. The results are presented in **Table 6-8**. For all sections, the 0.2% surge elevation remains below the top of the 1% flood defense elevations. Armoring requirements for resiliency will be addressed in a future analysis.

**Table 6-8 New Orleans to Venice West Bank – Non-Federal System – Resiliency Analysis**

New Orleans to Venice					
Mississippi River Levee and Back Levees					
Resiliency Analysis for 1% Design Elevations (0.2% Event)					
West Bank – Non-Federal Levee System					
Hydraulic Reach	Name	Type	Condition	Elevation (ft)	Best Estimates During 0.2% Event
					Surge Level (ft)
NOV-NF-W-04(a)	Non-Fed Oakville to LaReusitte (a)	Levee	Existing	10.5	10.4
NOV-NF-W-04(a)	Non-Fed Oakville to LaReusitte (a)	Levee	Future	14.0	12.4
NOV-NF-W-04(b)	Non-Fed Oakville to LaReusitte (b)	Levee	Existing	12.5	12.1
NOV-NF-W-04(b)	Non-Fed Oakville to LaReusitte (b)	Levee	Future	16.5	14.1
NOV-NF-W-04b	Lower Ollie New PS	Structure/Wall	Future	17.0	14.1
NOV-NF-W-04b	Lower Ollie Old PS	Structure/Wall	Future	17.0	14.1
NOV-NF-W-04b	Upper Ollie PS	Structure/Wall	Future	17.0	14.1
NOV-NF-W-05a	Non-Fed LaReusitte to Myrtle Grove (a)	Levee	Existing	12.5	12.4
NOV-NF-W-05a	Non-Fed LaReusitte to Myrtle Grove (a)	Levee	Future	16.5	14.4

<p style="text-align: center;"><b>New Orleans to Venice</b></p> <p style="text-align: center;"><b>Mississippi River Levee and Back Levees</b></p> <p style="text-align: center;"><b>Resiliency Analysis for 1% Design Elevations (0.2% Event)</b></p> <p style="text-align: center;"><b>West Bank – Non-Federal Levee System</b></p>					
<b>Hydraulic Reach</b>	<b>Name</b>	<b>Type</b>	<b>Condition</b>	<b>Elevation (ft)</b>	<b>Best Estimates During 0.2% Event</b>
					<b>Surge Level (ft)</b>
NOV-NF-W-05b	Non-Fed LaReusitte to Myrtle Grove (b)	Levee	Existing	14.0	13.0
NOV-NF-W-05b	Non-Fed LaReusitte to Myrtle Grove (b)	Levee	Future	18.0	15.0
NOV-NF-W-05c	Non-Fed LaReusitte to Myrtle Grove ©	Levee	Existing	15.0	13.2
NOV-NF-W-05c	Non-Fed LaReusitte to Myrtle Grove ©	Levee	Future	19.0	15.2
NOV-NF-W-05d	Non-Fed LaReusitte to Myrtle Grove (d)	Levee	Existing	15.5	13.8
NOV-NF-W-05d	Non-Fed LaReusitte to Myrtle Grove (d)	Levee	Future	20.0	15.8
NOV-NF-W-05d	Wilkinson Canal PS	Structure/Wall	Future	19.5	15.8
NOV-NF-W-06a	Non-Fed Myrtle Grove to St. Jude (a)	Levee	Existing	16.0	14.2
NOV-NF-W-06a	Non-Fed Myrtle Grove to St. Jude (a)	Levee	Future	20.5	16.2

**New Orleans to Venice**

**Mississippi River Levee and Back Levees**

**Resiliency Analysis for 1% Design Elevations (0.2% Event)**

**West Bank – Non-Federal Levee System**

<b>Hydraulic Reach</b>	<b>Name</b>	<b>Type</b>	<b>Condition</b>	<b>Elevation (ft)</b>	<b>Best Estimates During 0.2% Event</b>
					<b>Surge Level (ft)</b>
NOV-NF-W-06b	Non-Fed Myrtle Grove to St. Jude (b)	Levee	Existing	17.0	14.5
NOV-NF-W-06b	Non-Fed Myrtle Grove to St. Jude (b)	Levee	Future	20.5	16.5
NOV-NF-W-06b	Point Celeste PS	Structure/Wall	Future	21.0	16.5
NOV-NF-W-06b	Pointe a La Hache-West PS	Structure/Wall	Future	21.0	16.5



## 6.3 WEST BANK – FEDERAL LEVEE SYSTEM

### 6.3.1 General

The West Bank – Federal Levee system consists of levees from St Jude to Venice. In the original design from the 1960s, this part of the system was split into two reaches: Reach A from St Jude to Empire and Reach B from Port Sulphur to Venice. Various pump stations are part of this levee system: Hayes, Gainard Wood, Sunrise #1 and #2, and Duvic Pump Stations. **Plate 16** shows the New Orleans to Venice Project, from St. Jude to Venice on the West Bank.

All elevations described herein are in North American Vertical Datum 1988 (2004.65).

### 6.3.2 Hydraulic Boundary Conditions

The 1% and 2% hydraulic boundary conditions for the federal levee system at the West Bank are listed in **Table 6-9** and **Table 6-10**, respectively. Refer to **Chapter 2** for the methodology to derive these boundary conditions for existing and future conditions.

**Table 6-9 New Orleans to Venice West Bank – Federal System – 1% Hydraulic Boundary Conditions**

New Orleans to Venice									
1% Hydraulic Boundary Conditions									
West Bank – Federal Levee System									
Hydraulic Reach	Name	Type	Condition	Surge Level		Significant Wave Height		Peak Period	
				(ft)		(ft)		(s)	
				Mean	Std	Mean	Std	Mean	Std
NOV-05	Upper Reach A – St Jude to City Price	Levee	Existing	11.5	1.0	3.7	0.4	5.4	1.1
NOV-05	Upper Reach A – St Jude to City Price	Levee	Future	13.5	1.0	4.7	0.4	6.1	1.1
NOV-05	Diamond PS	Structure	Future	13.5	1.0	4.7	0.4	6.1	1.1
NOV-06	Reach A – City Price to Empire	Levee	Existing	11.6	1.0	3.7	0.4	5.4	1.1
NOV-06	Reach A – City Price to Empire	Levee	Future	13.6	1.0	4.7	0.4	6.1	1.1
NOV-06	Hayes PS	Structure	Future	13.6	1.0	4.7	0.4	6.1	1.1

New Orleans to Venice									
1% Hydraulic Boundary Conditions									
West Bank – Federal Levee System									
Hydraulic Reach	Name	Type	Condition	Surge Level		Significant Wave Height		Peak Period	
				(ft)		(ft)		(s)	
				Mean	Std	Mean	Std	Mean	Std
NOV-06	Gainard Wood PS	Structure	Future	13.6	1.0	4.7	0.4	6.1	1.1
NOV-07	Reach B-1 Port Sulphur to Ft Jackson	Levee	Existing	11.7	1.1	3.9	0.4	5.6	1.1
NOV-07	Reach B-1 Port Sulphur to Ft Jackson	Levee	Future	13.7	1.1	4.9	0.4	6.2	1.1
NOV-07	Empire Floodgate (NOV-13)	Structure	Future	13.7	1.1	4.9	0.4	6.2	1.1
NOV-07	Sunrise #1 PS	Structure	Future	13.7	1.1	4.9	0.4	6.2	1.1
NOV-07	Sunrise #2 PS	Structure	Future	13.7	1.1	4.9	0.4	6.2	1.1
NOV-07	Grand Liard PS	Structure	Future	13.7	1.1	4.9	0.4	6.2	1.1
NOV-07	Floodwall Grand Liard PS (Part of NOV-15)	Structure	Future	13.7	1.1	4.9	0.4	6.2	1.1
NOV-08	Reach B-2 Ft Jackson to Venice	Levee	Existing	12.0	1.4	4.0	0.4	5.6	1.1
NOV-08	Reach B-2 Ft Jackson to Venice	Levee	Future	14.0	1.4	5.0	0.4	6.3	1.1
NOV-08	Duvic PS	Structure	Future	14.0	1.4	5.0	0.4	6.3	1.1
NOV-08	Floodwall Duvic PS (part of NOV-15)	Structure	Future	14.0	1.4	5.0	0.4	6.3	1.1

**Table 6-10 New Orleans to Venice West Bank – Federal System – 2% Hydraulic Boundary Conditions**

New Orleans to Venice									
2% Hydraulic Boundary Conditions									
West Bank – Federal Levee System									
Hydraulic Reach	Name	Type	Condition	Surge Level		Significant Wave Height		Peak Period	
				(ft)		(ft)		(s)	
				Mean	Std	Mean	Std	Mean	Std
NOV-05	Upper Reach A – St Jude to City Price	Levee	Existing	9.1	0.7	2.8	0.3	4.7	0.9
NOV-05	Upper Reach A – St Jude to City Price	Levee	Future	11.1	0.7	3.8	0.3	5.5	0.9
NOV-05	Diamond PS	Structure	Future	11.1	0.7	3.8	0.3	5.5	0.9
NOV-06	Reach A – City Price to Empire	Levee	Existing	9.2	0.6	2.9	0.3	4.8	1.0
NOV-06	Reach A – City Price to Empire	Levee	Future	11.2	0.6	3.9	0.3	5.5	1.0
NOV-06	Hayes PS	Structure	Future	11.2	0.6	3.9	0.3	5.5	1.0
NOV-06	Gainard Wood PS	Structure	Future	11.2	0.6	3.9	0.3	5.5	1.0
NOV-07	Reach B-1 Port Sulphur to Ft Jackson	Levee	Existing	9.2	0.7	3.0	0.3	4.9	1.0
NOV-07	Reach B-1 Port Sulphur to Ft Jackson	Levee	Future	11.2	0.6	3.9	0.3	5.5	1.0
NOV-07	Empire Floodgate (NOV-13)	Structure	Future	11.2	0.6	3.9	0.3	5.5	1.0
NOV-07	Sunrise #1 PS	Structure	Future	11.2	0.6	3.9	0.3	5.5	1.0

New Orleans to Venice									
2% Hydraulic Boundary Conditions									
West Bank – Federal Levee System									
Hydraulic Reach	Name	Type	Condition	Surge Level		Significant Wave Height		Peak Period	
				(ft)		(ft)		(s)	
				Mean	Std	Mean	Std	Mean	Std
NOV-07	Sunrise #2 PS	Structure	Future	11.2	0.6	3.9	0.3	5.5	1.0
NOV-07	Grand Liard PS	Structure	Future	11.2	0.6	3.9	0.3	5.5	1.0
NOV-07	Floodwall Grand Liard PS (Part of NOV-15)	Floodwall	Future	11.2	0.6	3.9	0.3	5.5	1.0
NOV-08	Reach B-2 Ft Jackson to Venice	Levee	Existing	9.3	0.9	3.1	0.3	4.9	1.0
NOV-08	Reach B-2 Ft Jackson to Venice	Levee	Future	11.3	0.9	4.1	0.3	5.7	1.0
NOV-08	Duvic PS	Structure	Future	11.3	0.9	4.1	0.3	5.7	1.0
NOV-08	Floodwall Duvic PS (part of NOV-15)	Floodwall	Future	11.3	0.9	4.1	0.3	5.7	1.0

### 6.3.3 Project Design Elevations

The design characteristics of the Federal levee system at the West Bank are listed in **Table 6-11** and **Table 6-12** for 1% and 2% risk reduction, respectively. Levees are evaluated for both existing and future conditions; hydraulic structures are only evaluated for future conditions.

**Table 6-11 New Orleans to Venice West Bank – Federal System – 1% Design Information**

New Orleans to Venice							
1% Project Design Elevations							
West Bank – Federal Levee System							
Hydraulic Reach	Name	Type	Condition	Toe Elevation (ft)	Elevation (ft)	Overtopping Rate	
						q50 (cfs/ft)	q90 (cfs/ft)
NOV-05	Upper Reach A – St Jude to City Price	Levee	Existing	1.0	17.0	0.004	0.071
NOV-05	Upper Reach A – St Jude to City Price	Levee	Future	1.0	20.0	0.006	0.079
NOV-05	Diamond PS	Structure	Future	1.0	22.5	0.022	0.077
NOV-06	Reach A – City Price to Empire	Levee	Existing	1.0	17.0	0.006	0.082
NOV-06	Reach A – City Price to Empire	Levee	Future	1.0	20.5	0.008	0.083
NOV-06	Hayes PS	Structure	Future	1.0	22.5	0.024	0.085
NOV-06	Gainard Wood PS	Structure	Future	1.0	22.5	0.024	0.085
NOV-07	Reach B-1 Port Sulphur to Ft Jackson	Levee	Existing	0.5	17.5	0.006	0.085
NOV-07	Reach B-1 Port Sulphur to Ft Jackson	Levee	Future	0.5	21.0	0.007	0.076

**New Orleans to Venice**

**1% Project Design Elevations**

**West Bank – Federal Levee System**

Hydraulic Reach	Name	Type	Condition	Toe Elevation (ft)	Elevation (ft)	Overtopping Rate	
						q50 (cfs/ft)	q90 (cfs/ft)
NOV-07	Empire Floodgate (NOV-13)	Structure	Future	1.0	23.0	0.023	0.083
NOV-07	Sunrise #1 PS	Structure	Future	1.0	23.0	0.022	0.085
NOV-07	Sunrise #2 PS	Structure	Future	1.0	23.0	0.022	0.087
NOV-07	Grand Liard PS	Structure	Future	1.0	23.0	0.023	0.085
NOV-07	Floodwall Grand Liard PS (Part of NOV-15)	Floodwall	Future	1.0	21.0	0.022	0.085
NOV-08	Reach B-2 Ft Jackson to Venice	Levee	Existing	0.5	18.0	0.005	0.096
NOV-08	Reach B-2 Ft Jackson to Venice	Levee	Future	0.5	21.5	0.008	0.094
NOV-08	Duvic PS	Structure	Future	0.5	24.0	0.015	0.074
NOV-08	Floodwall Duvic PS (part of NOV-15)	Floodwall	Future	0.5	22.0	0.015	0.074

**Table 6-12 New Orleans to Venice West Bank – Federal System – 2% Design Information**

New Orleans to Venice							
2% Project Design Elevations							
West Bank – Federal Levee System							
Hydraulic Reach	Name	Type	Condition	Toe Elevation (ft)	Elevation (ft)	Overtopping Rate	
						q50 (cfs/ft)	q90 (cfs/ft)
NOV-05	Upper Reach A – St Jude to City Price	Levee	Existing	1.0	13.0	0.005	0.058
NOV-05	Upper Reach A – St Jude to City Price	Levee	Future	1.0	16.5	0.006	0.056
NOV-05	Diamond PS	Structure	Future	1.0	18.5	0.020	0.065
NOV-06	Reach A – City Price to Empire	Levee	Existing	1.0	13.0	0.009	0.085
NOV-06	Reach A – City Price to Empire	Levee	Future	1.0	16.5	0.010	0.075
NOV-06	Hayes PS	Structure	Future	1.0	18.5	0.026	0.074
NOV-06	Gainard Wood PS	Structure	Future	1.0	18.5	0.026	0.073
NOV-07	Reach B-1 Port Sulphur to Ft Jackson	Levee	Existing	0.5	13.5	0.005	0.065

New Orleans to Venice							
2% Project Design Elevations							
West Bank – Federal Levee System							
Hydraulic Reach	Name	Type	Condition	Toe Elevation (ft)	Elevation (ft)	Overtopping Rate	
						q50 (cfs/ft)	q90 (cfs/ft)
NOV-07	Reach B-1 Port Sulphur to Ft Jackson	Levee	Future	0.5	17.0	0.008	0.062
NOV-07	Empire Floodgate (NOV-13)	Structure	Future	0.5	19.0	0.019	0.059
NOV-07	Sunrise #1 PS	Structure	Future	0.5	19.0	0.019	0.060
NOV-07	Sunrise #2 PS	Structure	Future	0.5	19.0	0.019	0.061
NOV-07	Grand Liard PS	Structure	Future	0.5	19.0	0.019	0.060
NOV-07	Floodwall Grand Liard PS (Part of NOV-15)	Floodwall	Future	0.5	17.0	0.019	0.060
NOV-08	Reach B-2 Ft Jackson to Venice	Levee	Existing	0.5	13.5	0.007	0.068
NOV-08	Reach B-2 Ft Jackson to Venice	Levee	Future	0.5	17.0	0.010	0.082
NOV-08	Duvic PS	Structure	Future	0.5	19.0	0.025	0.088



New Orleans to Venice							
2% Project Design Elevations							
West Bank – Federal Levee System							
Hydraulic Reach	Name	Type	Condition	Toe Elevation (ft)	Elevation (ft)	Overtopping Rate	
						q50 (cfs/ft)	q90 (cfs/ft)
NOV-08	Floodwall Duvic PS (part of NOV-15)	Floodwall	Future	0.5	17.0	0.025	0.089

### 6.3.4 Resiliency Analysis

The **1% designs only** for the Federal system on the West Bank were examined for resiliency by computing the 0.2% surge level (50% confidence) for each design. The results of this resiliency analysis are presented in **Table 6-13**. For all sections, the 0.2% surge elevation remains below the top of the 1% flood defense elevations. Armoring requirements for resiliency will be addressed in a future analysis.

**Table 6-13 New Orleans to Venice West Bank – Federal System – Resiliency Analysis**

New Orleans to Venice					
Mississippi River Levee and Back Levees					
Resiliency Analysis (0.2% Event)					
West Bank – Federal Levee System					
Hydraulic Reach	Name	Type	Condition	Elevation (ft)	Best Estimates During 0.2% Event
					Surge Level (ft)
NOV-05	Diamond PS	Structure/Wall	Future	22.5	17.1
NOV-06	Hayes PS	Structure/Wall	Future	22.5	17.1
NOV-06	Gainard Wood PS	Structure/Wall	Future	22.5	17.1
NOV-07	Empire Floodgate (NOV-13)	Structure/Wall	Future	23.0	17.7

**New Orleans to Venice**  
**Mississippi River Levee and Back Levees**  
**Resiliency Analysis (0.2% Event)**  
**West Bank – Federal Levee System**

<b>Hydraulic Reach</b>	<b>Name</b>	<b>Type</b>	<b>Condition</b>	<b>Elevation (ft)</b>	<b>Best Estimates During 0.2% Event</b>
					<b>Surge Level (ft)</b>
NOV-07	Sunrise #1 PS	Structure/Wall	Future	23.0	17.7
NOV-07	Sunrise #2 PS	Structure/Wall	Future	23.0	17.7
NOV-07	Grand Liard PS	Structure/Wall	Future	23.0	17.7
NOV-07	Floodwall Grand Liard PS (part of NOV-15)	Structure/Wall	Future	23.0	17.7
NOV-08	Duvic PS	Structure/Wall	Future	24.0	18.9
NOV-08	Floodwall Duvic PS (part of NOV-15)	Structure/Wall	Future	24.0	18.9
NOV-05	Upper Reach A – St. Jude to City Price	Levee	Existing	17.0	15.1
NOV-05	Upper Reach A – St. Jude to City Price	Levee	Future	20.0	17.1
NOV-06	Reach A – City Price to Empire	Levee	Existing	17.0	15.1
NOV-06	Reach A – City Price to Empire	Levee	Future	20.5	17.1
NOV-07	Reach B-1 Port Sulphur to Ft. Jackson	Levee	Existing	17.5	15.7
NOV-07	Reach B-1 Port Sulphur to Ft. Jackson	Levee	Future	21.0	17.7
NOV-08	Reach B-2 Ft. Jackson to Venice	Levee	Existing	18.0	16.9
NOV-08	Reach B-2 Ft. Jackson to Venice	Levee	Future	21.5	18.9

## 6.4 EAST BANK – FEDERAL LEVEE SYSTEM

### 6.4.1 General

The East Bank – Federal Levee system consists of levees from Phoenix to Bohemia at the East Bank of the Mississippi River between RM 44 and 59. In the original design from the 1960s, this part of the hurricane protection system was known as Reach C. Two pump stations are part of this levee system: Bellevue and Pointe-a-la-Hache East Pump Station. **Plate 17** shows the New Orleans to Venice Project, from Phoenix to Bohemia on the West Bank.

All elevations described herein are in North American Vertical Datum 1988 (2004.65).

### 6.4.2 Hydraulic Boundary Conditions

The 1% and 2% hydraulic boundary conditions for the federal levee system at the East Bank are listed in **Table 6-14** and **Table 6-15**, respectively. Refer to **Chapter 2** for the methodology to derive these boundary conditions for existing and future conditions.

**Table 6-14 New Orleans to Venice East Bank – Federal System – 1% Hydraulic Boundary Conditions**

New Orleans to Venice									
1% Hydraulic Boundary Conditions									
East Bank – Federal Levee System									
Hydraulic Reach	Name	Type	Condition	Surge Level		Significant Wave Height		Peak Period	
				(ft)		(ft)		(s)	
				Mean	Std	Mean	Std	Mean	Std
NOV-01a	Reach C – East Bank levee Phoenix to Bohemia (a)	Levee	Existing	16.9	0.9	5.0	0.5	6.3	1.3
NOV-01a	Reach C – East Bank levee Phoenix to Bohemia (a)	Levee	Future	18.4	0.9	5.8	0.5	6.8	1.3
NOV-01a	Bellevue PS	Structure	Future	18.4	0.9	5.8	0.5	6.8	1.3
NOV-01b	Reach C – East Bank levee Phoenix to Bohemia (b)	Levee	Existing	16.3	1.0	4.8	0.5	6.2	1.2

**New Orleans to Venice**

**1% Hydraulic Boundary Conditions**

**East Bank – Federal Levee System**

Hydraulic Reach	Name	Type	Condition	Surge Level		Significant Wave Height		Peak Period	
				(ft)		(ft)		(s)	
				Mean	Std	Mean	Std	Mean	Std
NOV-01b	Reach C – East Bank levee Phoenix to Bohemia (b)	Levee	Future	17.8	1.0	5.6	0.5	6.7	1.2
NOV-01b	Pointe a la Hache-East (NOV-15) PS	Structure	Future	17.8	1.0	5.6	0.5	6.7	1.2

**Table 6-15 New Orleans to Venice East Bank – Federal System – 2% Hydraulic Boundary Conditions**

New Orleans to Venice									
2% Hydraulic Boundary Conditions									
East Bank – Federal Levee System									
Hydraulic Reach	Name	Type	Condition	Surge Level		Significant Wave Height		Peak Period	
				(ft)		(ft)		(s)	
				Mean	Std	Mean	Std	Mean	Std
NOV-01a	Reach C – East Bank levee Phoenix to Bohemia (a)	Levee	Existing	14.6	0.6	4.3	0.4	5.6	1.2
NOV-01a	Reach C – East Bank levee Phoenix to Bohemia (a)	Levee	Future	16.1	0.6	5.0	0.4	6.3	1.2
NOV-01a	Bellevue PS	Structure	Future	16.1	0.6	5.0	0.4	6.3	1.2
NOV-01b	Reach C – East Bank levee Phoenix to Bohemia (b)	Levee	Existing	13.9	0.7	4.0	0.4	5.6	1.1
NOV-01b	Reach C – East Bank levee Phoenix to Bohemia (b)	Levee	Future	15.4	0.7	4.7	0.4	6.1	1.1
NOV-01b	Pointe a la Hache-East (NOV-15) PS	Structure	Future	15.4	0.7	4.7	0.4	6.1	1.1

### 6.4.3 Project Design Elevations

The 1% and 2% design characteristics of the Federal levee system at the East Bank are listed in **Table 6-16** and **Table 6-17**, respectively. Levees are evaluated for both existing and future conditions; hydraulic structures are only evaluated for future conditions. The structural design and construction for NOV-01a (Bellevue Pump Station) and NOV-01b (Pointe a la Hache-East Pump Station) includes an additional 2.0 ft for structural superiority.

**Table 6-16 New Orleans to Venice East Bank – Federal System – 1% Design Information**

New Orleans to Venice							
1% Design Elevations							
East Bank – Federal Levee System							
Hydraulic Reach	Name	Type	Condition	Toe Elevation (ft)	Elevation (ft)	Overtopping Rate	
						q50 (cfs/ft)	q90 (cfs/ft)
NOV-01a	Reach C – East Bank levee Phoenix to Bohemia (a)	Levee	Existing	2.5	24.5	0.007	0.086
NOV-01a	Reach C – East Bank levee Phoenix to Bohemia (a)	Levee	Future	2.5	27.5ss	0.007	0.078
NOV-01a	Bellevue PS	Structure	Future	2.5	28.5	0.023	0.077
NOV-01b	Reach C – East Bank levee Phoenix to Bohemia (b)	Levee	Existing	2.5	23.5	0.008	0.089
NOV-01b	Reach C – East Bank levee Phoenix to Bohemia (b)	Levee	Future	2.5	26.5	0.008	0.078
NOV-01b	Pointe a la Hache-East (NOV-15) PS	Structure	Future	2.5	29.5ss	0.023	0.072

**Table 6-17 New Orleans to Venice East Bank – Federal System – 2% Design Information**

New Orleans to Venice							
2% Design Elevations							
East Bank – Federal Levee System							
Hydraulic Reach	Name	Type	Condition	Toe Elevation (ft)	Elevation (ft)	Overtopping Rate	
						q50 (cfs/ft)	q90 (cfs/ft)
NOV-01a	Reach C – East Bank levee Phoenix to Bohemia (a)	Levee	Existing	2.5	20.5	0.010	0.093
NOV-01a	Reach C – East Bank levee Phoenix to Bohemia (a)	Levee	Future	2.5	23.5	0.009	0.076
NOV-01a	Bellevue PS	Structure	Future	2.5	24.0	0.030	0.087
NOV-01b	Reach C – East Bank levee Phoenix to Bohemia (b)	Levee	Existing	2.5	19.5	0.008	0.085
NOV-01b	Reach C – East Bank levee Phoenix to Bohemia (b)	Levee	Future	2.5	22.5	0.007	0.064
NOV-01b	Pointe a la Hache-East (NOV-15) PS	Structure	Future	2.5	25.5	0.025	0.069

#### 6.4.4 Resiliency Analysis

The **1% designs only** for the Federal system on the East Bank were examined for resiliency by computing the 0.2% surge level (50% confidence) for each design. The results of this resiliency analysis are presented in **Table 6-18**. For all sections, the 0.2% surge elevation remains below the top of the 1% flood defense elevations. Armoring requirements for resiliency will be addressed in a future analysis.

**Table 6-18 New Orleans to Venice East Bank – Federal System – Resiliency Analysis**

<b>New Orleans to Venice</b> <b>Mississippi River Levee and Back Levees</b> <b>Resiliency Analysis (0.2% Event)</b> <b>East Bank – Federal Levee System</b>					
<b>Hydraulic Reach</b>	<b>Name</b>	<b>Type</b>	<b>Condition</b>	<b>Elevation (ft)</b>	<b>Best Estimates During 0.2% Event</b>
					<b>Surge Level (ft)</b>
NOV-01a	Reach C – East Bank Back Levee Phoenix to Bohemia (a)	Levee	Existing	24.5	20.0
NOV-01a	Reach C – East Bank Back Levee Phoenix to Bohemia (a)	Levee	Future	27.5	21.5
NOV-01a	Bellevue PS	Structure/Wall	Future	28.5	21.5
NOV-01b	Reach C – East Bank Back Levee Phoenix to Bohemia (b)	Levee	Existing	23.5	20.0
NOV-01b	Reach C – East Bank Back Levee Phoenix to Bohemia (b)	Levee	Future	26.5	21.5
NOV-01b	Pointe a La Hache-East (NOV-15) PS	Structure/Wall	Future	29.5	21.5

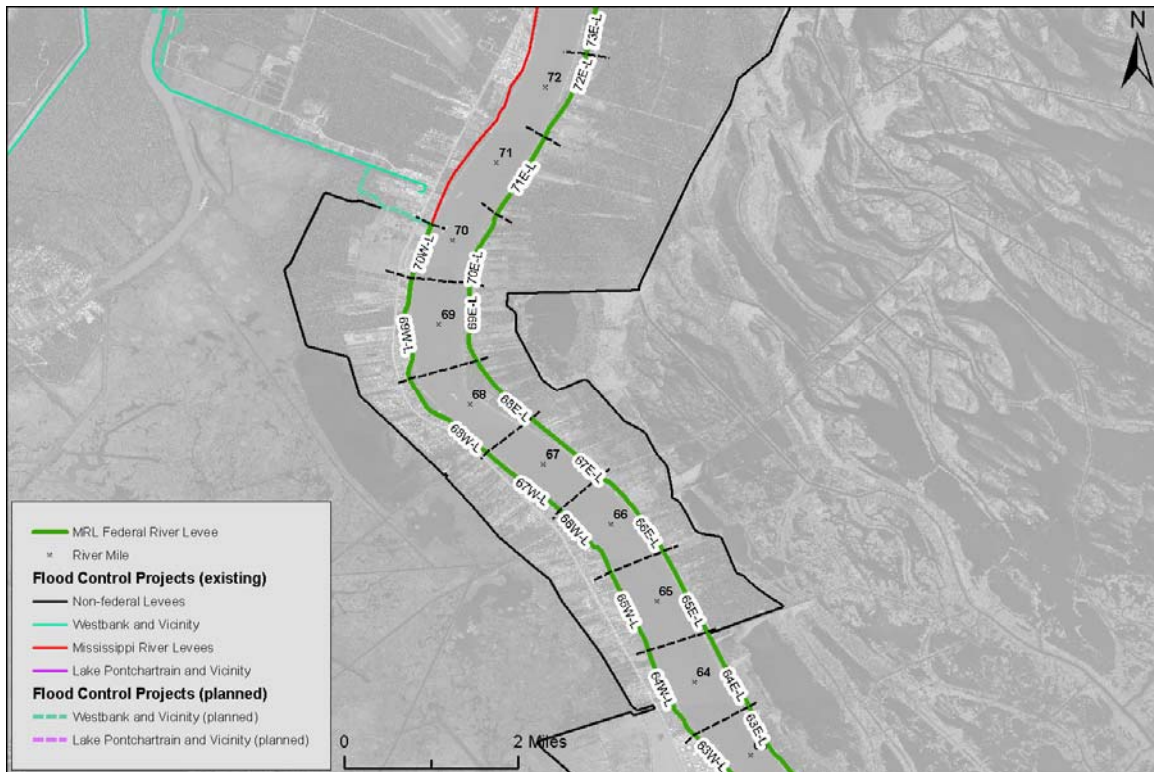


## 6.5 MISSISSIPPI RIVER WEST BANK (RM 10 – RM 70)

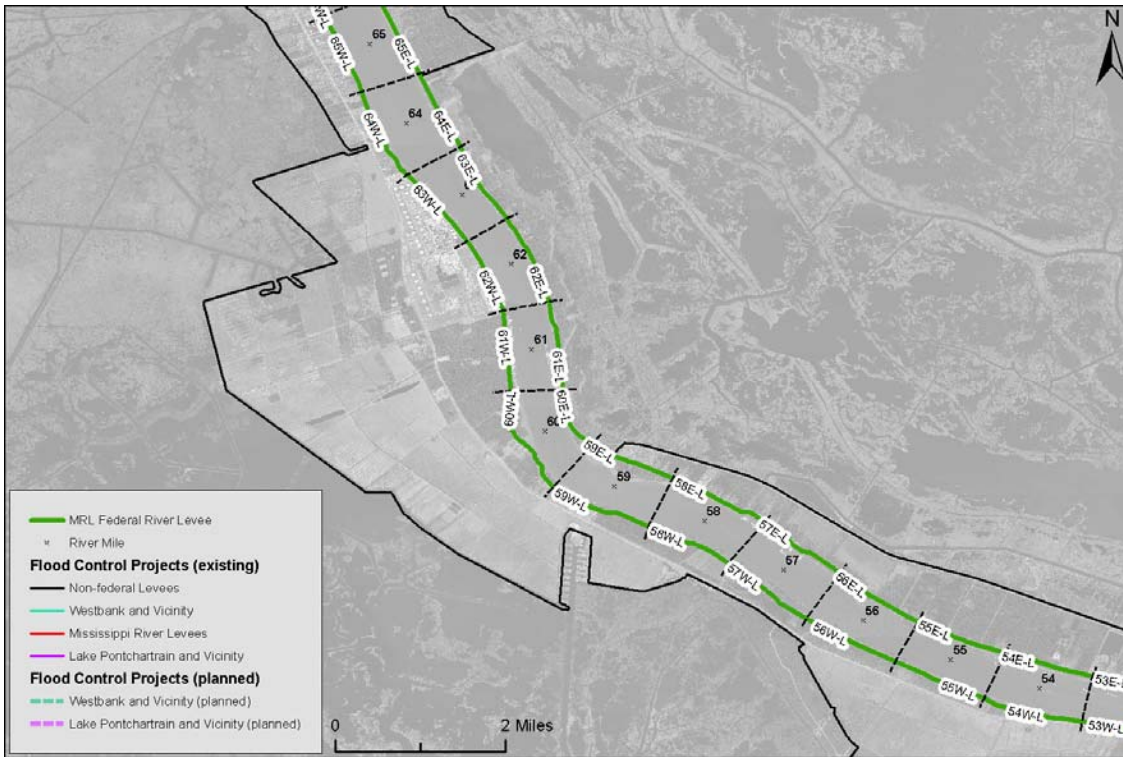
### 6.5.1 General

The Mississippi River levee system at the West Bank under consideration in this section stretches from Venice at RM 10 to Oakville near RM 70. **Figure 6-2** through **Figure 6-5** shows for each river the hydraulic reach along the Mississippi River between these locations.

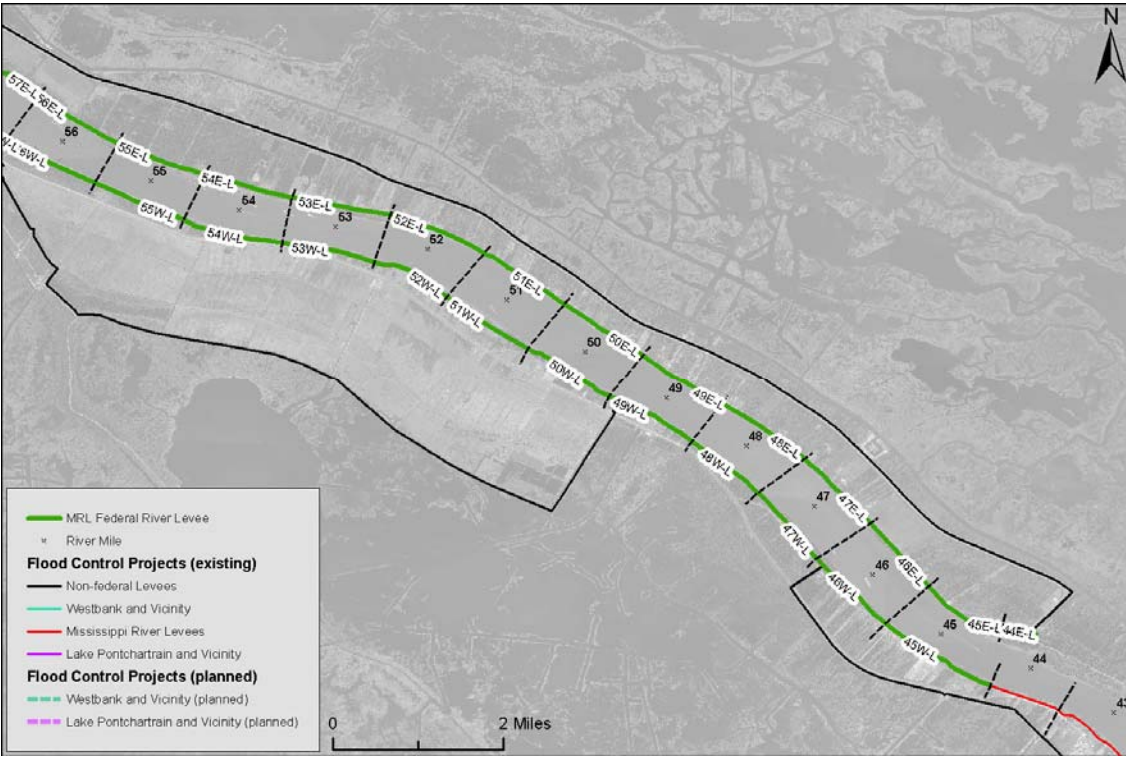
All elevations described herein are in North American Vertical Datum 1988 (2004.65).



**Figure 6-2 Hydraulic Reaches Mississippi River at East Bank and West Bank River Mile 63 - 70**



**Figure 6-3 Hydraulic Reaches Mississippi River at East Bank and West Bank River Mile 53**  
 - 63



**Figure 6-4 New Orleans to Venice Hydraulic Reaches Mississippi River at East Bank and West**

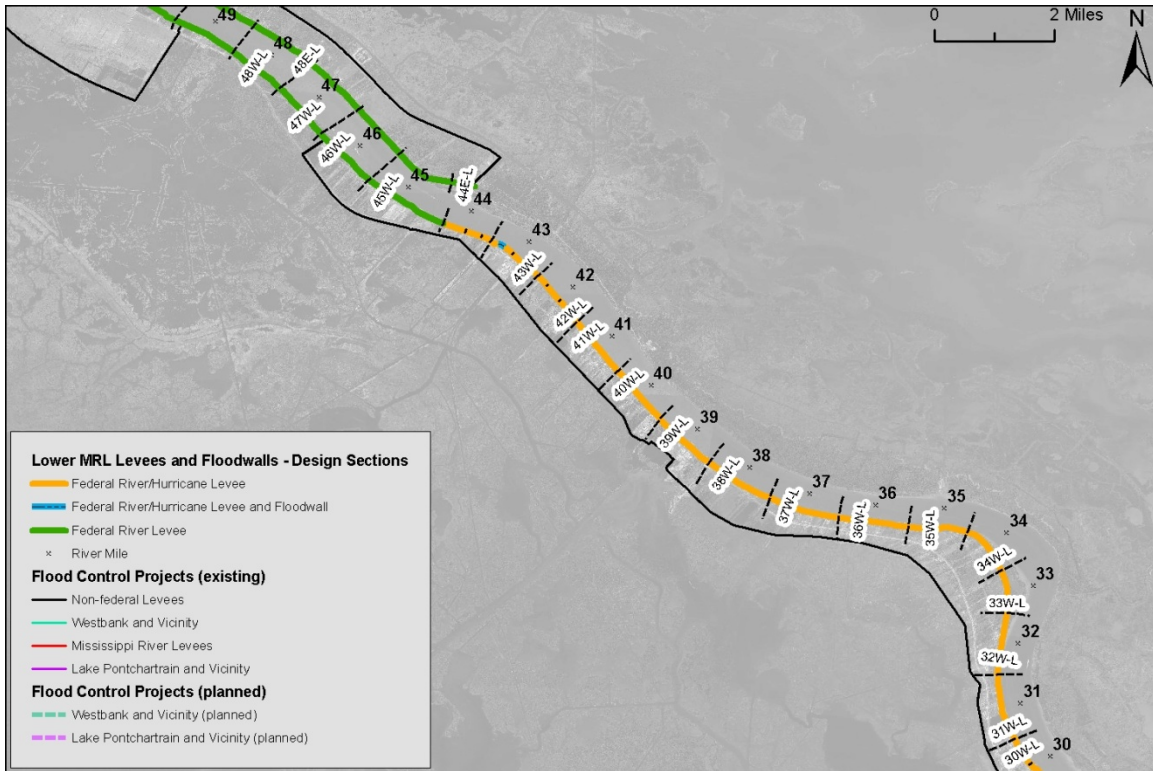


Figure 6-5 New Orleans to Venice Hydraulic Reaches Mississippi River at West Bank River Mile 30 - 44

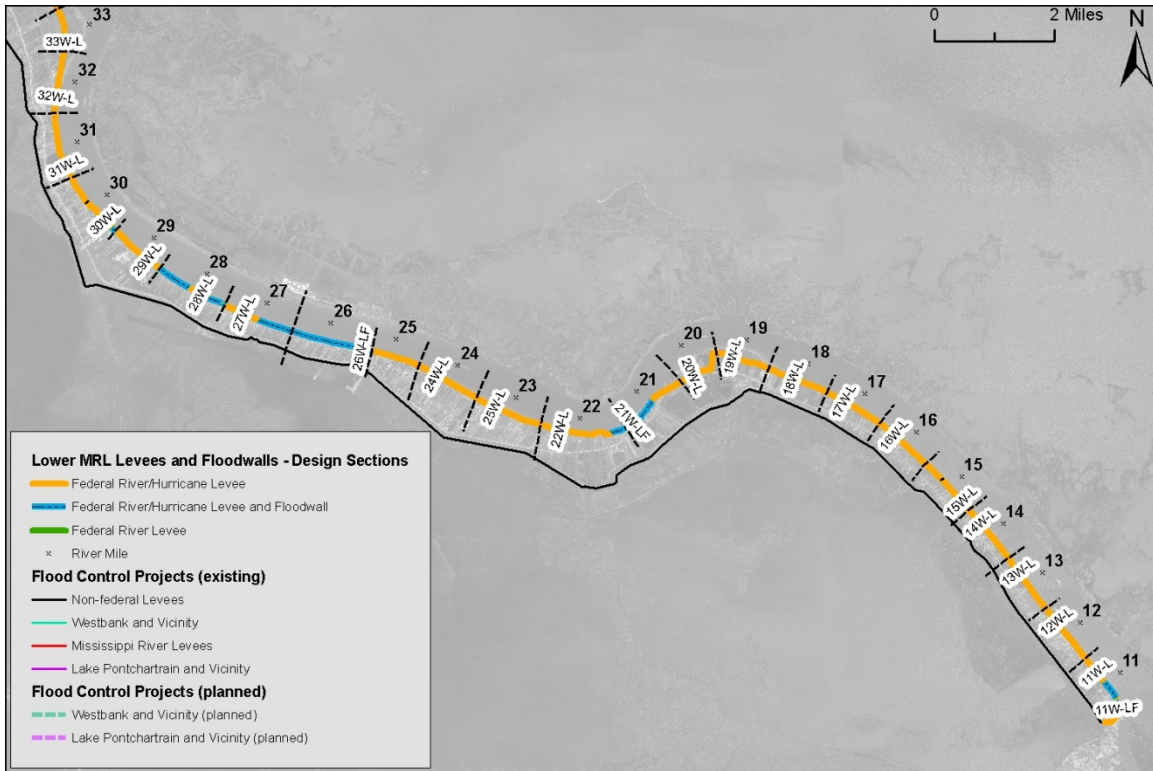


Figure 6-6 New Orleans to Venice Hydraulic Reaches Mississippi River at West Bank River Mile 11 - 33

## 6.5.2 Hydraulic Boundary Conditions

The 1% and 2% hydraulic boundary conditions for the levee system at the West Bank of the Mississippi River between RM 10 and 70 are listed in **Table 6-19** to **Table 6-20**. Refer to **Chapter 2** for the methodology to derive these boundary conditions for existing and future conditions for the 1% and 2% conditions.

**Table 6-19 New Orleans to Venice Mississippi River West Bank – 1% Hydraulic Boundary Conditions – Existing & Future Conditions**

New Orleans to Venice									
1% Hydraulic Boundary Conditions – Existing & Future Conditions									
Mississippi River – West Bank									
Hydraulic Reach	River Mile	Type	Condition	Surge Level		Significant Wave Height		Peak Period	
				(ft)		(ft)		(s)	
				Mean	Std	Mean	Std	Mean	Std
11W-L	11	Levee	Existing	12.4	0.8	5.5	0.6	5.2	1.0
11W-L	11	Levee	Future	13.3	0.8	6.3	0.6	5.5	1.1
12W-L	12	Levee	Existing	12.7	0.9	5.5	0.6	5.2	1.0
12W-L	12	Levee	Future	13.6	0.9	6.3	0.6	5.5	1.1
13W-L	13	Levee	Existing	12.9	0.9	5.5	0.6	5.2	1.0
13W-L	13	Levee	Future	13.8	0.9	6.3	0.6	5.5	1.1
14W-L	14	Levee	Existing	13.1	0.9	6.0	0.6	5.5	1.1
14W-L	14	Levee	Future	14.1	0.9	6.8	0.7	5.8	1.2
15W-L	15	Levee	Existing	13.4	0.9	6.0	0.6	5.5	1.1
15W-L	15	Levee	Future	14.3	0.9	6.8	0.7	5.8	1.2
16W-L	16	Levee	Existing	13.6	0.9	6.0	0.6	5.5	1.1
16W-L	16	Levee	Future	14.5	0.9	6.8	0.7	5.8	1.2
17W-L	17	Levee	Existing	13.9	0.9	6.0	0.6	5.5	1.1
17W-L	17	Levee	Future	14.7	0.9	6.8	0.7	5.8	1.2

**New Orleans to Venice**

**1% Hydraulic Boundary Conditions – Existing & Future Conditions**

**Mississippi River – West Bank**

Hydraulic Reach	River Mile	Type	Condition	Surge Level		Significant Wave Height		Peak Period	
				(ft)		(ft)		(s)	
				Mean	Std	Mean	Std	Mean	Std
18W-L	18	Levee	Existing	14.1	0.9	6.0	0.6	5.5	1.1
18W-L	18	Levee	Future	15.0	0.9	6.8	0.7	5.8	1.2
19W-L	19	Levee	Existing	14.3	1.0	6.0	0.6	5.5	1.1
19W-L	19	Levee	Future	15.1	1.0	6.8	0.7	5.8	1.2
20W-L	20	Levee	Existing	14.5	1.0	6.0	0.6	5.5	1.1
20W-L	20	Levee	Future	15.3	1.0	6.8	0.7	5.8	1.2
21W-L	21	Levee	Existing	14.7	1.0	6.0	0.6	5.5	1.1
21W-L	21	Levee	Future	15.6	1.0	6.8	0.7	5.8	1.2
22W-L	22	Levee	Existing	14.8	1.1	6.0	0.6	5.5	1.1
22W-L	22	Levee	Future	15.7	1.1	6.8	0.7	5.8	1.2
23W-L	23	Levee	Existing	14.9	1.1	6.0	0.6	5.5	1.1
23W-L	23	Levee	Future	15.8	1.1	6.8	0.7	5.8	1.2
24W-L	24	Levee	Existing	15.0	1.1	6.0	0.6	5.5	1.1
24W-L	24	Levee	Future	16.0	1.1	6.8	0.7	5.8	1.2
25W-L	25	Levee	Existing	15.1	1.1	6.0	0.6	5.5	1.1
25W-L	25	Levee	Future	16.1	1.1	6.8	0.7	5.8	1.2
26W-L	26	Levee	Existing	15.3	1.1	6.5	0.7	5.7	1.1
26W-L	26	Levee	Future	16.2	1.1	7.3	0.7	6.0	1.2
27W-L	27	Levee	Existing	15.4	1.1	6.5	0.7	5.7	1.1

**New Orleans to Venice**

**1% Hydraulic Boundary Conditions – Existing & Future Conditions**

**Mississippi River – West Bank**

Hydraulic Reach	River Mile	Type	Condition	Surge Level		Significant Wave Height		Peak Period	
				(ft)		(ft)		(s)	
				Mean	Std	Mean	Std	Mean	Std
27W-L	27	Levee	Future	16.3	1.1	7.3	0.7	6.0	1.2
28W-L	28	Levee	Existing	15.5	1.1	6.5	0.7	5.7	1.1
28W-L	28	Levee	Future	16.5	1.1	7.3	0.7	6.0	1.2
29W-L	29	Levee	Existing	15.6	1.1	6.5	0.7	5.7	1.1
29W-L	29	Levee	Future	16.6	1.1	7.3	0.7	6.0	1.2
30W-L	30	Levee	Existing	15.6	1.1	6.5	0.7	5.7	1.1
30W-L	30	Levee	Future	16.6	1.1	7.3	0.7	6.0	1.2
31W-L	31	Levee	Existing	15.6	1.1	6.5	0.7	5.7	1.1
31W-L	31	Levee	Future	16.6	1.1	7.3	0.7	6.0	1.2
32W-L	32	Levee	Existing	15.5	1.1	6.5	0.7	5.7	1.1
32W-L	32	Levee	Future	16.5	1.1	7.3	0.7	6.0	1.2
33W-L	33	Levee	Existing	15.4	1.0	6.0	0.6	5.5	1.1
33W-L	33	Levee	Future	16.5	1.0	6.8	0.7	5.8	1.2
34W-L	34	Levee	Existing	15.5	1.0	6.0	0.6	5.5	1.1
34W-L	34	Levee	Future	16.5	1.0	6.8	0.7	5.8	1.2
35W-L	35	Levee	Existing	15.5	1.0	6.0	0.6	5.5	1.1
35W-L	35	Levee	Future	16.6	1.0	6.8	0.7	5.8	1.2
36W-L	36	Levee	Existing	15.6	1.1	6.0	0.6	5.5	1.1
36W-L	36	Levee	Future	16.7	1.0	6.8	0.7	5.8	1.2



**New Orleans to Venice**

**1% Hydraulic Boundary Conditions – Existing & Future Conditions**

**Mississippi River – West Bank**

Hydraulic Reach	River Mile	Type	Condition	Surge Level		Significant Wave Height		Peak Period	
				(ft)		(ft)		(s)	
				Mean	Std	Mean	Std	Mean	Std
37W-L	37	Levee	Existing	15.7	1.1	6.0	0.6	5.5	1.1
37W-L	37	Levee	Future	16.7	1.1	6.8	0.7	5.8	1.2
38W-L	38	Levee	Existing	15.7	1.1	6.0	0.6	5.5	1.1
38W-L	38	Levee	Future	16.8	1.1	6.8	0.7	5.8	1.2
39W-L	39	Levee	Existing	15.7	1.1	6.0	0.6	5.5	1.1
39W-L	39	Levee	Future	16.9	1.1	6.8	0.7	5.8	1.2
40W-L	40	Levee	Existing	15.7	1.1	6.0	0.6	5.5	1.1
40W-L	40	Levee	Future	16.9	1.1	6.8	0.7	5.8	1.2
41W-L	41	Levee	Existing	15.7	1.1	5.5	0.6	5.2	1.0
41W-L	41	Levee	Future	16.9	1.1	6.3	0.6	5.5	1.1
42W-L	42	Levee	Existing	15.7	1.1	5.5	0.6	5.2	1.0
42W-L	42	Levee	Future	16.9	1.1	6.3	0.6	5.5	1.1
43W-L	43	Levee	Existing	15.6	1.0	5.0	0.5	5.0	1.0
43W-L	43	Levee	Future	16.9	1.1	5.8	0.6	5.4	1.1
44W-L	44	Levee	Existing	15.6	1.1	5.0	0.5	5.0	1.0
44W-L	44	Levee	Future	16.9	1.1	5.8	0.6	5.4	1.1
45W-L	45	Levee	Existing	15.5	1.0	3.5	0.4	4.5	0.9
45W-L	45	Levee	Future	16.9	1.0	3.8	0.4	4.5	0.9
46W-L	46	Levee	Existing	15.5	1.0	3.5	0.4	4.5	0.9

**New Orleans to Venice**

**1% Hydraulic Boundary Conditions – Existing & Future Conditions**

**Mississippi River – West Bank**

Hydraulic Reach	River Mile	Type	Condition	Surge Level		Significant Wave Height		Peak Period	
				(ft)		(ft)		(s)	
				Mean	Std	Mean	Std	Mean	Std
46W-L	46	Levee	Future	16.9	1.0	3.8	0.4	4.5	0.9
47W-L	47	Levee	Existing	15.5	1.0	3.5	0.4	4.5	0.9
47W-L	47	Levee	Future	16.9	1.0	3.8	0.4	4.5	0.9
48W-L	48	Levee	Existing	15.5	1.0	3.5	0.4	4.5	0.9
48W-L	48	Levee	Future	16.9	1.0	3.8	0.4	4.5	0.9
49W-L	49	Levee	Existing	15.5	1.0	3.5	0.4	4.5	0.9
49W-L	49	Levee	Future	17.0	1.0	3.8	0.4	4.5	0.9
50W-L	50	Levee	Existing	15.5	1.0	3.5	0.4	4.5	0.9
50W-L	50	Levee	Future	17.0	1.0	3.8	0.4	4.5	0.9
51W-L	51	Levee	Existing	15.5	1.0	3.5	0.4	4.5	0.9
51W-L	51	Levee	Future	17.0	1.0	3.8	0.4	4.5	0.9
52W-L	52	Levee	Existing	15.5	1.0	3.5	0.4	4.5	0.9
52W-L	52	Levee	Future	17.1	0.9	3.8	0.4	4.5	0.9
53W-L	53	Levee	Existing	15.5	0.9	3.5	0.4	4.5	0.9
53W-L	53	Levee	Future	17.1	0.9	3.8	0.4	4.5	0.9
54W-L	54	Levee	Existing	15.6	1.0	3.5	0.4	4.5	0.9
54W-L	54	Levee	Future	17.2	0.9	3.8	0.4	4.5	0.9
55W-L	55	Levee	Existing	15.6	0.9	3.5	0.4	4.5	0.9
55W-L	55	Levee	Future	17.3	0.9	3.8	0.4	4.5	0.9

**New Orleans to Venice**

**1% Hydraulic Boundary Conditions – Existing & Future Conditions**

**Mississippi River – West Bank**

Hydraulic Reach	River Mile	Type	Condition	Surge Level		Significant Wave Height		Peak Period	
				(ft)		(ft)		(s)	
				Mean	Std	Mean	Std	Mean	Std
56W-L	56	Levee	Existing	15.7	1.0	3.5	0.4	4.5	0.9
56W-L	56	Levee	Future	17.4	1.0	3.8	0.4	4.5	0.9
57W-L	57	Levee	Existing	15.7	1.0	3.5	0.4	4.5	0.9
57W-L	57	Levee	Future	17.4	1.0	3.8	0.4	4.5	0.9
58W-L	58	Levee	Existing	15.7	0.9	3.5	0.4	4.5	0.9
58W-L	58	Levee	Future	17.4	0.9	3.8	0.4	4.5	0.9
59W-L	59	Levee	Existing	15.7	0.9	3.0	0.3	4.0	0.8
59W-L	59	Levee	Future	17.5	0.9	3.3	0.3	4.0	0.8
60W-L	60	Levee	Existing	15.7	0.9	3.0	0.3	4.0	0.8
60W-L	60	Levee	Future	17.5	0.9	3.3	0.3	4.0	0.8
61W-L	61	Levee	Existing	15.7	0.9	3.0	0.3	4.0	0.8
61W-L	61	Levee	Future	17.5	0.9	3.3	0.3	4.0	0.8
62W-L	62	Levee	Existing	15.6	0.9	3.0	0.3	4.0	0.8
62W-L	62	Levee	Future	17.5	0.9	3.3	0.3	4.0	0.8
63W-L	63	Levee	Existing	15.6	0.9	3.0	0.3	4.0	0.8
63W-L	63	Levee	Future	17.5	0.9	3.3	0.3	4.0	0.8
64W-L	64	Levee	Existing	15.6	0.9	3.0	0.3	4.0	0.8
64W-L	64	Levee	Future	17.6	0.9	3.3	0.3	4.0	0.8
65W-L	65	Levee	Existing	15.5	0.9	3.0	0.3	4.0	0.8

**New Orleans to Venice**

**1% Hydraulic Boundary Conditions – Existing & Future Conditions**

**Mississippi River – West Bank**

Hydraulic Reach	River Mile	Type	Condition	Surge Level		Significant Wave Height		Peak Period	
				(ft)		(ft)		(s)	
				Mean	Std	Mean	Std	Mean	Std
65W-L	65	Levee	Future	17.6	0.9	3.3	0.3	4.0	0.8
66W-L	66	Levee	Existing	15.5	0.9	3.0	0.3	4.0	0.8
66W-L	66	Levee	Future	17.6	0.9	3.3	0.3	4.0	0.8
67W-L	67	Levee	Existing	15.5	0.9	3.0	0.3	4.0	0.8
67W-L	67	Levee	Future	17.7	0.9	3.3	0.3	4.0	0.8
68W-L	68	Levee	Existing	15.5	0.9	3.0	0.3	4.0	0.8
68W-L	68	Levee	Future	17.8	0.9	3.3	0.3	4.0	0.8
69W-L	69	Levee	Existing	15.5	0.9	3.0	0.3	4.0	0.8
69W-L	69	Levee	Future	17.8	0.9	3.3	0.3	4.0	0.8
70W-L	70	Levee	Existing	15.4	0.9	3.0	0.3	4.0	0.8
70W-L	70	Levee	Future	17.8	1.0	3.3	0.3	4.0	0.8

**Table 6-20 New Orleans to Venice Mississippi River West Bank – 2% Hydraulic Boundary Conditions – Existing & Future Conditions**

New Orleans to Venice									
2% Hydraulic Boundary Conditions – Existing & Future Conditions									
Mississippi River – West Bank									
Hydraulic Reach	River Mile	Type	Condition	Surge Level		Significant Wave Height		Peak Period	
				(ft)		(ft)		(s)	
				Mean	Std	Mean	Std	Mean	Std
11W-L	11	Levee	Existing	9.7	0.8	4.8	0.5	4.9	1.0
11W-L	11	Levee	Future	10.5	0.8	5.5	0.6	5.3	1.1
12W-L	12	Levee	Existing	9.9	0.8	4.8	0.5	4.9	1.0
12W-L	12	Levee	Future	10.7	0.8	5.5	0.6	5.3	1.1
13W-L	13	Levee	Existing	10.1	0.8	4.8	0.5	4.9	1.0
13W-L	13	Levee	Future	11.0	0.8	5.5	0.6	5.3	1.1
14W-L	14	Levee	Existing	10.3	0.8	4.8	0.5	4.9	1.0
14W-L	14	Levee	Future	11.2	0.8	5.5	0.6	5.3	1.1
15W-L	15	Levee	Existing	10.5	0.8	4.8	0.5	4.9	1.0
15W-L	15	Levee	Future	11.4	0.8	5.5	0.6	5.3	1.1
16W-L	16	Levee	Existing	10.7	0.8	5.0	0.5	5.0	1.0
16W-L	16	Levee	Future	11.5	0.8	5.8	0.6	5.4	1.1
17W-L	17	Levee	Existing	10.9	0.8	5.0	0.5	5.0	1.0
17W-L	17	Levee	Future	11.7	0.8	5.8	0.6	5.4	1.1
18W-L	18	Levee	Existing	11.1	0.8	5.0	0.5	5.0	1.0
18W-L	18	Levee	Future	11.9	0.8	5.8	0.6	5.4	1.1
19W-L	19	Levee	Existing	11.2	0.9	5.0	0.5	5.0	1.0
19W-L	19	Levee	Future	12.0	0.9	5.8	0.6	5.4	1.1

**New Orleans to Venice**

**2% Hydraulic Boundary Conditions – Existing & Future Conditions**

**Mississippi River – West Bank**

Hydraulic Reach	River Mile	Type	Condition	Surge Level		Significant Wave Height		Peak Period	
				(ft)		(ft)		(s)	
				Mean	Std	Mean	Std	Mean	Std
20W-L	20	Levee	Existing	11.4	0.9	5.0	0.5	5.0	1.0
20W-L	20	Levee	Future	12.2	0.9	5.8	0.6	5.4	1.1
21W-L	21	Levee	Existing	11.5	0.9	5.0	0.5	5.0	1.0
21W-L	21	Levee	Future	12.4	0.9	5.8	0.6	5.4	1.1
22W-L	22	Levee	Existing	11.6	1.0	5.0	0.5	5.0	1.0
22W-L	22	Levee	Future	12.5	1.0	5.8	0.6	5.4	1.1
23W-L	23	Levee	Existing	11.7	1.0	5.0	0.5	5.0	1.0
23W-L	23	Levee	Future	12.6	1.0	5.8	0.6	5.4	1.1
24W-L	24	Levee	Existing	11.8	1.0	5.0	0.5	5.0	1.0
24W-L	24	Levee	Future	12.7	1.0	5.8	0.6	5.4	1.1
25W-L	25	Levee	Existing	11.9	1.0	5.0	0.5	5.0	1.0
25W-L	25	Levee	Future	12.8	1.0	5.8	0.6	5.4	1.1
26W-L	26	Levee	Existing	12.0	1.0	5.5	0.6	5.2	1.0
26W-L	26	Levee	Future	12.9	1.0	6.3	0.6	5.5	1.1
27W-L	27	Levee	Existing	12.1	1.0	5.5	0.6	5.2	1.0
27W-L	27	Levee	Future	13.0	1.0	6.3	0.6	5.5	1.1
28W-L	28	Levee	Existing	12.1	1.0	5.5	0.6	5.2	1.0
28W-L	28	Levee	Future	13.0	1.0	6.3	0.6	5.5	1.1
29W-L	29	Levee	Existing	12.1	1.0	5.5	0.6	5.2	1.0

**New Orleans to Venice**

**2% Hydraulic Boundary Conditions – Existing & Future Conditions**

**Mississippi River – West Bank**

Hydraulic Reach	River Mile	Type	Condition	Surge Level		Significant Wave Height		Peak Period	
				(ft)		(ft)		(s)	
				Mean	Std	Mean	Std	Mean	Std
29W-L	29	Levee	Future	13.1	1.0	6.3	0.6	5.5	1.1
30W-L	30	Levee	Existing	12.1	1.0	5.5	0.6	5.2	1.0
30W-L	30	Levee	Future	13.1	1.0	6.3	0.6	5.5	1.1
31W-L	31	Levee	Existing	12.1	1.0	5.5	0.6	5.2	1.0
31W-L	31	Levee	Future	13.1	1.0	6.3	0.6	5.5	1.1
32W-L	32	Levee	Existing	12.0	1.0	5.5	0.6	5.2	1.0
32W-L	32	Levee	Future	13.0	1.0	6.3	0.6	5.5	1.1
33W-L	33	Levee	Existing	11.9	1.0	5.5	0.6	5.2	1.0
33W-L	33	Levee	Future	12.9	1.0	6.3	0.6	5.5	1.1
34W-L	34	Levee	Existing	11.9	0.9	5.0	0.5	5.0	1.0
34W-L	34	Levee	Future	12.9	0.9	5.8	0.6	5.4	1.1
35W-L	35	Levee	Existing	12.0	1.0	5.0	0.5	5.0	1.0
35W-L	35	Levee	Future	13.0	0.9	5.8	0.6	5.4	1.1
36W-L	36	Levee	Existing	12.0	1.0	5.0	0.5	5.0	1.0
36W-L	36	Levee	Future	13.0	1.0	5.8	0.6	5.4	1.1
37W-L	37	Levee	Existing	12.0	1.0	5.0	0.5	5.0	1.0
37W-L	37	Levee	Future	13.1	1.0	5.8	0.6	5.4	1.1
38W-L	38	Levee	Existing	12.1	1.0	5.0	0.5	5.0	1.0
38W-L	38	Levee	Future	13.2	1.0	5.8	0.6	5.4	1.1

**New Orleans to Venice**

**2% Hydraulic Boundary Conditions – Existing & Future Conditions**

**Mississippi River – West Bank**

Hydraulic Reach	River Mile	Type	Condition	Surge Level		Significant Wave Height		Peak Period	
				(ft)		(ft)		(s)	
				Mean	Std	Mean	Std	Mean	Std
39W-L	39	Levee	Existing	12.1	1.0	5.0	0.5	5.0	1.0
39W-L	39	Levee	Future	13.2	1.0	5.8	0.6	5.4	1.1
40W-L	40	Levee	Existing	12.1	1.0	5.0	0.5	5.0	1.0
40W-L	40	Levee	Future	13.3	1.0	5.8	0.6	5.4	1.1
41W-L	41	Levee	Existing	12.2	1.0	4.5	0.5	4.7	0.9
41W-L	41	Levee	Future	13.4	1.0	5.3	0.5	5.1	1.0
42W-L	42	Levee	Existing	12.2	1.0	4.5	0.5	4.7	0.9
42W-L	42	Levee	Future	13.4	1.0	5.3	0.5	5.1	1.0
43W-L	43	Levee	Existing	12.2	1.0	4.0	0.4	4.5	0.9
43W-L	43	Levee	Future	13.5	1.0	4.8	0.5	4.9	1.0
44W-L	44	Levee	Existing	12.3	1.0	4.0	0.4	4.5	0.9
44W-L	44	Levee	Future	13.6	1.0	4.8	0.5	4.9	1.0
45W-L	45	Levee	Existing	12.3	1.0	2.8	0.3	4.3	0.9
45W-L	45	Levee	Future	13.6	1.0	3.0	0.3	4.3	0.9
46W-L	46	Levee	Existing	12.3	1.0	2.8	0.3	4.3	0.9
46W-L	46	Levee	Future	13.7	1.0	3.0	0.3	4.3	0.9
47W-L	47	Levee	Existing	12.3	1.0	2.8	0.3	4.3	0.9
47W-L	47	Levee	Future	13.7	1.0	3.0	0.3	4.3	0.9
48W-L	48	Levee	Existing	12.3	0.9	2.8	0.3	4.3	0.9



**New Orleans to Venice**

**2% Hydraulic Boundary Conditions – Existing & Future Conditions**

**Mississippi River – West Bank**

Hydraulic Reach	River Mile	Type	Condition	Surge Level		Significant Wave Height		Peak Period	
				(ft)		(ft)		(s)	
				Mean	Std	Mean	Std	Mean	Std
48W-L	48	Levee	Future	13.8	1.0	3.0	0.3	4.3	0.9
49W-L	49	Levee	Existing	12.4	0.9	2.8	0.3	4.3	0.9
49W-L	49	Levee	Future	13.9	0.9	3.0	0.3	4.3	0.9
50W-L	50	Levee	Existing	12.4	0.9	2.8	0.3	4.3	0.9
50W-L	50	Levee	Future	13.9	0.9	3.0	0.3	4.3	0.9
51W-L	51	Levee	Existing	12.5	0.9	2.8	0.3	4.3	0.9
51W-L	51	Levee	Future	14.0	0.9	3.0	0.3	4.3	0.9
52W-L	52	Levee	Existing	12.5	0.9	2.8	0.3	4.3	0.9
52W-L	52	Levee	Future	14.1	0.9	3.0	0.3	4.3	0.9
53W-L	53	Levee	Existing	12.6	0.9	2.8	0.3	4.3	0.9
53W-L	53	Levee	Future	14.2	0.9	3.0	0.3	4.3	0.9
54W-L	54	Levee	Existing	12.7	0.9	2.8	0.3	4.3	0.9
54W-L	54	Levee	Future	14.3	0.9	3.0	0.3	4.3	0.9
55W-L	55	Levee	Existing	12.7	0.9	2.8	0.3	4.3	0.9
55W-L	55	Levee	Future	14.3	0.9	3.0	0.3	4.3	0.9
56W-L	56	Levee	Existing	12.7	0.9	2.8	0.3	4.3	0.9
56W-L	56	Levee	Future	14.4	0.9	3.0	0.3	4.3	0.9
57W-L	57	Levee	Existing	12.7	0.9	2.8	0.3	4.3	0.9
57W-L	57	Levee	Future	14.4	0.9	3.0	0.3	4.3	0.9

**New Orleans to Venice**

**2% Hydraulic Boundary Conditions – Existing & Future Conditions**

**Mississippi River – West Bank**

Hydraulic Reach	River Mile	Type	Condition	Surge Level		Significant Wave Height		Peak Period	
				(ft)		(ft)		(s)	
				Mean	Std	Mean	Std	Mean	Std
58W-L	58	Levee	Existing	12.8	0.9	2.8	0.3	4.3	0.9
58W-L	58	Levee	Future	14.5	0.9	3.0	0.3	4.3	0.9
59W-L	59	Levee	Existing	12.8	0.9	2.3	0.2	3.8	0.8
59W-L	59	Levee	Future	14.5	0.9	2.5	0.3	3.8	0.8
60W-L	60	Levee	Existing	12.8	0.8	2.3	0.2	3.8	0.8
60W-L	60	Levee	Future	14.5	0.8	2.5	0.3	3.8	0.8
61W-L	61	Levee	Existing	12.7	0.8	2.3	0.2	3.8	0.8
61W-L	61	Levee	Future	14.5	0.8	2.5	0.3	3.8	0.8
62W-L	62	Levee	Existing	12.7	0.8	2.3	0.2	3.8	0.8
62W-L	62	Levee	Future	14.5	0.8	2.5	0.3	3.8	0.8
63W-L	63	Levee	Existing	12.7	0.8	2.3	0.2	3.8	0.8
63W-L	63	Levee	Future	14.5	0.8	2.5	0.3	3.8	0.8
64W-L	64	Levee	Existing	12.7	0.8	2.3	0.2	3.8	0.8
64W-L	64	Levee	Future	14.6	0.8	2.5	0.3	3.8	0.8
65W-L	65	Levee	Existing	12.7	0.8	2.3	0.2	3.8	0.8
65W-L	65	Levee	Future	14.6	0.8	2.5	0.3	3.8	0.8
66W-L	66	Levee	Existing	12.6	0.8	2.3	0.2	3.8	0.8
66W-L	66	Levee	Future	14.6	0.8	2.5	0.3	3.8	0.8
67W-L	67	Levee	Existing	12.7	0.8	2.3	0.2	3.8	0.8

**New Orleans to Venice**

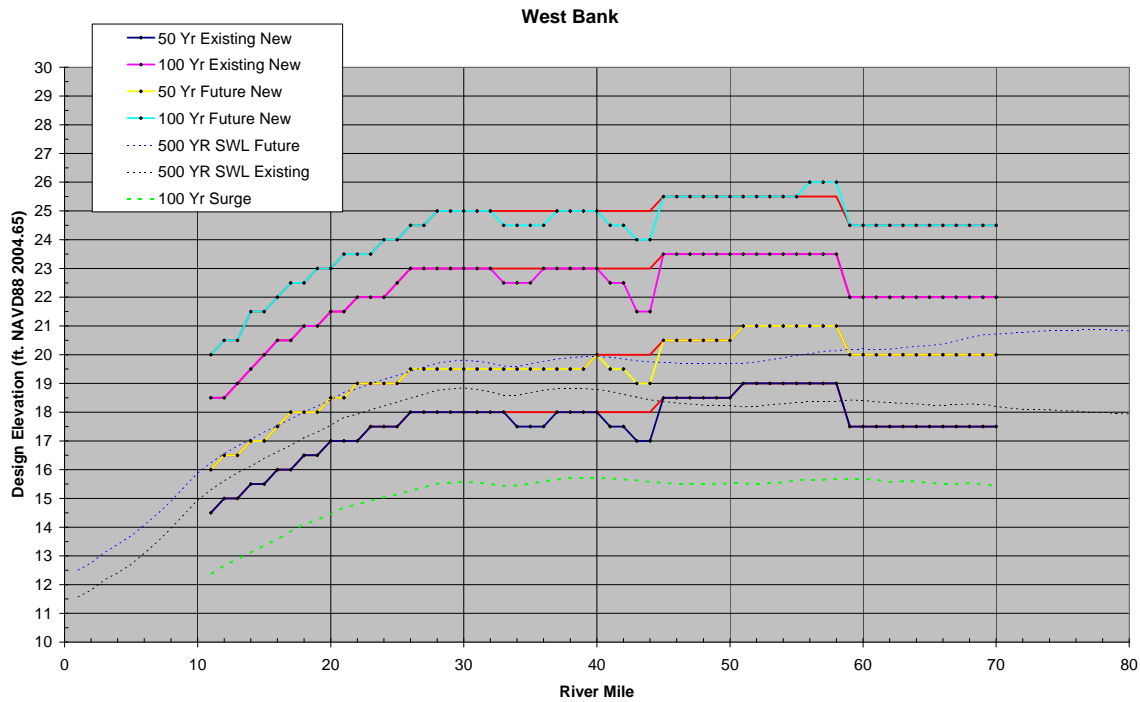
**2% Hydraulic Boundary Conditions – Existing & Future Conditions**

**Mississippi River – West Bank**

Hydraulic Reach	River Mile	Type	Condition	Surge Level		Significant Wave Height		Peak Period	
				(ft)		(ft)		(s)	
				Mean	Std	Mean	Std	Mean	Std
67W-L	67	Levee	Future	14.7	0.8	2.5	0.3	3.8	0.8
68W-L	68	Levee	Existing	12.7	0.8	2.3	0.2	3.8	0.8
68W-L	68	Levee	Future	14.7	0.8	2.5	0.3	3.8	0.8
69W-L	69	Levee	Existing	12.6	0.8	2.3	0.2	3.8	0.8
69W-L	69	Levee	Future	14.7	0.9	2.5	0.3	3.8	0.8
70W-L	70	Levee	Existing	12.5	0.9	2.3	0.2	3.8	0.8
70W-L	70	Levee	Future	14.7	0.9	2.5	0.3	3.8	0.8

### 6.5.3 Project Design Elevations

The 1% and 2% design characteristics of the Mississippi River at the West Bank are listed in **Tables 6-21** through **Table 6-22**. Levees are evaluated for both existing and future conditions; hydraulic structures are only evaluated for future conditions. **Figure 6-7** presents the project design elevations for the levees.



**Figure 6-7 New Orleans to Venice Mississippi River West Bank – Project Design Elevations and Surge Levels**

**Table 6-21 New Orleans to Venice Mississippi River West Bank – 1% Levee Design Information – Existing & Future Conditions**

New Orleans to Venice							
1% Levee Project Design Elevations – Existing & Future Conditions							
Mississippi River – West Bank							
Hydraulic Reach	River Mile	Type	Condition	Toe Elevation (ft)	Elevation (ft)	Overtopping Rate	
						q50 (cfs/ft)	q90 (cfs/ft)
11W-L	11	Levee	Existing	0.0	18.5	0.006	0.063
11W-L	11	Levee	Future	0.0	20.0	0.007	0.068
12W-L	12	Levee	Existing	0.0	18.5	0.01	0.093
12W-L	12	Levee	Future	0.0	20.5	0.007	0.064
13W-L	13	Levee	Existing	0.0	19.0	0.007	0.078
13W-L	13	Levee	Future	0.0	20.5	0.009	0.084
14W-L	14	Levee	Existing	0.0	19.5	0.01	0.093
14W-L	14	Levee	Future	0.0	21.5	0.007	0.068
15W-L	15	Levee	Existing	0.0	20.0	0.008	0.079
15W-L	15	Levee	Future	0.0	21.5	0.009	0.084
16W-L	16	Levee	Existing	0.0	20.5	0.006	0.066
16W-L	16	Levee	Future	0.0	22.0	0.008	0.072
17W-L	17	Levee	Existing	0.0	20.5	0.009	0.089
17W-L	17	Levee	Future	0.0	22.5	0.006	0.065
18W-L	18	Levee	Existing	0.0	21.0	0.008	0.075
18W-L	18	Levee	Future	0.0	22.5	0.009	0.081
19W-L	19	Levee	Existing	0.0	21.0	0.009	0.093

**New Orleans to Venice**

**1% Levee Project Design Elevations – Existing & Future Conditions**

**Mississippi River – West Bank**

Hydraulic Reach	River Mile	Type	Condition	Toe Elevation (ft)	Elevation (ft)	Overtopping Rate	
						q50 (cfs/ft)	q90 (cfs/ft)
19W-L	19	Levee	Future	0.0	23.0	0.006	0.068
20W-L	20	Levee	Existing	0.0	21.5	0.007	0.076
20W-L	20	Levee	Future	0.0	23.0	0.008	0.08
21W-L	21	Levee	Existing	0.0	21.5	0.009	0.099
21W-L	21	Levee	Future	0.0	23.5	0.006	0.073
22W-L	22	Levee	Existing	0.0	22.0	0.006	0.072
22W-L	22	Levee	Future	0.0	23.5	0.007	0.078
23W-L	23	Levee	Existing	0.0	22.0	0.007	0.087
23W-L	23	Levee	Future	0.0	23.5	0.009	0.098
24W-L	24	Levee	Existing	0.0	22.0	0.008	0.098
24W-L	24	Levee	Future	0.0	24.0	0.007	0.079
25W-L	25	Levee	Existing	0.0	22.5	0.006	0.073
25W-L	25	Levee	Future	0.0	24.0	0.008	0.088
26W-L	26	Levee	Existing	0.0	23.0	0.006	0.077
26W-L	26	Levee	Future	0.0	24.5	0.008	0.089
27W-L	27	Levee	Existing	0.0	23.0	0.007	0.08
27W-L	27	Levee	Future	0.0	24.5	0.009	0.092
28W-L	28	Levee	Existing	0.0	23.0	0.009	0.091
28W-L	28	Levee	Future	0.0	25.0	0.007	0.075

**New Orleans to Venice**

**1% Levee Project Design Elevations – Existing & Future Conditions**

**Mississippi River – West Bank**

Hydraulic Reach	River Mile	Type	Condition	Toe Elevation (ft)	Elevation (ft)	Overtopping Rate	
						q50 (cfs/ft)	q90 (cfs/ft)
29W-L	29	Levee	Existing	0.0	23.0	0.009	0.099
29W-L	29	Levee	Future	0.0	25.0	0.008	0.082
30W-L	30	Levee	Existing	0.0	23.0	0.009	0.097
30W-L	30	Levee	Future	0.0	25.0	0.008	0.082
31W-L	31	Levee	Existing	0.0	23.0	0.009	0.098
31W-L	31	Levee	Future	0.0	25.0	0.008	0.085
32W-L	32	Levee	Existing	0.0	23.0	0.009	0.091
32W-L	32	Levee	Future	0.0	25.0	0.008	0.08
33W-L	33	Levee	Existing	0.0	23.0	0.005	0.063
33W-L	33	Levee	Future	0.0	25.0	0.005	0.057
34W-L	34	Levee	Existing	0.0	23.0	0.005	0.061
34W-L	34	Levee	Future	0.0	25.0	0.005	0.057
35W-L	35	Levee	Existing	0.0	23.0	0.005	0.069
35W-L	35	Levee	Future	0.0	25.0	0.005	0.063
36W-L	36	Levee	Existing	0.0	23.0	0.006	0.074
36W-L	36	Levee	Future	0.0	25.0	0.006	0.068
37W-L	37	Levee	Existing	0.0	23.0	0.006	0.076
37W-L	37	Levee	Future	0.0	25.0	0.006	0.073
38W-L	38	Levee	Existing	0.0	23.0	0.007	0.077

**New Orleans to Venice**

**1% Levee Project Design Elevations – Existing & Future Conditions**

**Mississippi River – West Bank**

Hydraulic Reach	River Mile	Type	Condition	Toe Elevation (ft)	Elevation (ft)	Overtopping Rate	
						q50 (cfs/ft)	q90 (cfs/ft)
38W-L	38	Levee	Future	0.0	25.0	0.007	0.073
39W-L	39	Levee	Existing	0.0	23.0	0.007	0.083
39W-L	39	Levee	Future	0.0	25.0	0.007	0.084
40W-L	40	Levee	Existing	0.0	23.0	0.006	0.084
40W-L	40	Levee	Future	0.0	25.0	0.007	0.085
41W-L	41	Levee	Existing	0.0	23.0	0.003	0.046
41W-L	41	Levee	Future	0.0	25.0	0.004	0.053
42W-L	42	Levee	Existing	0.0	23.0	0.003	0.044
42W-L	42	Levee	Future	0.0	25.0	0.004	0.052
43W-L	43	Levee	Existing	0.0	23.0	0.001	0.024
43W-L	43	Levee	Future	0.0	25.0	0.002	0.037
44W-L	44	Levee	Existing	0.0	23.0	0.001	0.022
44W-L	44	Levee	Future	0.0	25.0	0.002	0.036
45W-L	45	Levee	Existing	0.0	23.5	0.008	0.06
45W-L	45	Levee	Future	0.0	25.5	0.007	0.056
46W-L	46	Levee	Existing	0.0	23.5	0.008	0.06
46W-L	46	Levee	Future	0.0	25.5	0.007	0.056
47W-L	47	Levee	Existing	0.0	23.5	0.008	0.06
47W-L	47	Levee	Future	0.0	25.5	0.007	0.058



**New Orleans to Venice**

**1% Levee Project Design Elevations – Existing & Future Conditions**

**Mississippi River – West Bank**

Hydraulic Reach	River Mile	Type	Condition	Toe Elevation (ft)	Elevation (ft)	Overtopping Rate	
						q50 (cfs/ft)	q90 (cfs/ft)
48W-L	48	Levee	Existing	0.0	23.5	0.008	0.061
48W-L	48	Levee	Future	0.0	25.5	0.007	0.058
49W-L	49	Levee	Existing	0.0	23.5	0.008	0.059
49W-L	49	Levee	Future	0.0	25.5	0.008	0.058
50W-L	50	Levee	Existing	0.0	23.5	0.008	0.06
50W-L	50	Levee	Future	0.0	25.5	0.008	0.06
51W-L	51	Levee	Existing	0.0	23.5	0.008	0.058
51W-L	51	Levee	Future	0.0	25.5	0.008	0.06
52W-L	52	Levee	Existing	0.0	23.5	0.008	0.058
52W-L	52	Levee	Future	0.0	25.5	0.009	0.062
53W-L	53	Levee	Existing	0.0	23.5	0.008	0.061
53W-L	53	Levee	Future	0.0	25.5	0.009	0.066
54W-L	54	Levee	Existing	0.0	23.5	0.008	0.058
54W-L	54	Levee	Future	0.0	25.5	0.009	0.065
55W-L	55	Levee	Existing	0.0	23.5	0.009	0.06
55W-L	55	Levee	Future	0.0	25.5	0.01	0.068
56W-L	56	Levee	Existing	0.0	23.5	0.01	0.063
56W-L	56	Levee	Future	0.0	25.5	0.01	0.075
57W-L	57	Levee	Existing	0.0	23.5	0.009	0.062

**New Orleans to Venice**

**1% Levee Project Design Elevations – Existing & Future Conditions**

**Mississippi River – West Bank**

Hydraulic Reach	River Mile	Type	Condition	Toe Elevation (ft)	Elevation (ft)	Overtopping Rate	
						q50 (cfs/ft)	q90 (cfs/ft)
57W-L	57	Levee	Future	0.0	25.5	0.01	0.078
58W-L	58	Levee	Existing	0.0	23.5	0.009	0.063
58W-L	58	Levee	Future	0.0	25.5	0.01	0.076
59W-L	59	Levee	Existing	0.0	22.0	0.009	0.067
59W-L	59	Levee	Future	0.0	24.5	0.007	0.055
60W-L	60	Levee	Existing	0.0	22.0	0.009	0.068
60W-L	60	Levee	Future	0.0	24.5	0.007	0.057
61W-L	61	Levee	Existing	0.0	22.0	0.009	0.064
61W-L	61	Levee	Future	0.0	24.5	0.007	0.054
62W-L	62	Levee	Existing	0.0	22.0	0.008	0.063
62W-L	62	Levee	Future	0.0	24.5	0.007	0.056
63W-L	63	Levee	Existing	0.0	22.0	0.009	0.062
63W-L	63	Levee	Future	0.0	24.5	0.007	0.058
64W-L	64	Levee	Existing	0.0	22.0	0.008	0.061
64W-L	64	Levee	Future	0.0	24.5	0.007	0.058
65W-L	65	Levee	Existing	0.0	22.0	0.008	0.059
65W-L	65	Levee	Future	0.0	24.5	0.007	0.059
66W-L	66	Levee	Existing	0.0	22.0	0.008	0.056
66W-L	66	Levee	Future	0.0	24.5	0.008	0.06

**New Orleans to Venice**

**1% Levee Project Design Elevations – Existing & Future Conditions**

**Mississippi River – West Bank**

Hydraulic Reach	River Mile	Type	Condition	Toe Elevation (ft)	Elevation (ft)	Overtopping Rate	
						q50 (cfs/ft)	q90 (cfs/ft)
67W-L	67	Levee	Existing	0.0	22.0	0.007	0.058
67W-L	67	Levee	Future	0.0	24.5	0.008	0.066
68W-L	68	Levee	Existing	0.0	22.0	0.007	0.06
68W-L	68	Levee	Future	0.0	24.5	0.009	0.072
69W-L	69	Levee	Existing	0.0	22.0	0.007	0.059
69W-L	69	Levee	Future	0.0	24.5	0.009	0.075
70W-L	70	Levee	Existing	0.0	22.0	0.007	0.056
70W-L	70	Levee	Future	0.0	24.5	0.01	0.076

**Table 6-22 New Orleans to Venice Mississippi River West Bank – 2% Levee Design Information – Existing & Future Conditions**

New Orleans to Venice							
2% Levee Project Design Elevations – Existing & Future Conditions							
Mississippi River – West Bank							
Hydraulic Reach	River Mile	Type	Condition	Toe Elevation (ft)	Elevation (ft)	Overtopping Rate	
						q50 (cfs/ft)	q90 (cfs/ft)
11W-L	11	Levee	Existing	0.0	14.5	0.006	0.066
11W-L	11	Levee	Future	0.0	16.0	0.008	0.072
12W-L	12	Levee	Existing	0.0	15.0	0.005	0.056
12W-L	12	Levee	Future	0.0	16.5	0.006	0.062
13W-L	13	Levee	Existing	0.0	15.0	0.007	0.079
13W-L	13	Levee	Future	0.0	16.5	0.009	0.083
14W-L	14	Levee	Existing	0.0	15.5	0.005	0.06
14W-L	14	Levee	Future	0.0	17.0	0.007	0.068
15W-L	15	Levee	Existing	0.0	15.5	0.007	0.08
15W-L	15	Levee	Future	0.0	17.0	0.009	0.086
16W-L	16	Levee	Existing	0.0	16.0	0.006	0.067
16W-L	16	Levee	Future	0.0	17.5	0.008	0.073
17W-L	17	Levee	Existing	0.0	16.0	0.008	0.088
17W-L	17	Levee	Future	0.0	18.0	0.006	0.059
18W-L	18	Levee	Existing	0.0	16.5	0.007	0.07
18W-L	18	Levee	Future	0.0	18.0	0.008	0.075
19W-L	19	Levee	Existing	0.0	16.5	0.008	0.085
19W-L	19	Levee	Future	0.0	18.0	0.009	0.09

**New Orleans to Venice**

**2% Levee Project Design Elevations – Existing & Future Conditions**

**Mississippi River – West Bank**

Hydraulic Reach	River Mile	Type	Condition	Toe Elevation (ft)	Elevation (ft)	Overtopping Rate	
						q50 (cfs/ft)	q90 (cfs/ft)
20W-L	20	Levee	Existing	0.0	17.0	0.005	0.064
20W-L	20	Levee	Future	0.0	18.5	0.007	0.069
21W-L	21	Levee	Existing	0.0	17.0	0.007	0.083
21W-L	21	Levee	Future	0.0	18.5	0.008	0.089
22W-L	22	Levee	Existing	0.0	17.0	0.008	0.092
22W-L	22	Levee	Future	0.0	19.0	0.006	0.063
23W-L	23	Levee	Existing	0.0	17.5	0.005	0.068
23W-L	23	Levee	Future	0.0	19.0	0.007	0.076
24W-L	24	Levee	Existing	0.0	17.5	0.006	0.079
24W-L	24	Levee	Future	0.0	19.0	0.008	0.09
25W-L	25	Levee	Existing	0.0	17.5	0.007	0.087
25W-L	25	Levee	Future	0.0	19.0	0.009	0.1
26W-L	26	Levee	Existing	0.0	18.0	0.006	0.077
26W-L	26	Levee	Future	0.0	19.5	0.007	0.082
27W-L	27	Levee	Existing	0.0	18.0	0.007	0.08
27W-L	27	Levee	Future	0.0	19.5	0.008	0.084
28W-L	28	Levee	Existing	0.0	18.0	0.008	0.085
28W-L	28	Levee	Future	0.0	19.5	0.009	0.091
29W-L	29	Levee	Existing	0.0	18.0	0.007	0.089
29W-L	29	Levee	Future	0.0	19.5	0.009	0.096

**New Orleans to Venice**

**2% Levee Project Design Elevations – Existing & Future Conditions**

**Mississippi River – West Bank**

Hydraulic Reach	River Mile	Type	Condition	Toe Elevation (ft)	Elevation (ft)	Overtopping Rate	
						q50 (cfs/ft)	q90 (cfs/ft)
30W-L	30	Levee	Existing	0.0	18.0	0.007	0.084
30W-L	30	Levee	Future	0.0	19.5	0.009	0.097
31W-L	31	Levee	Existing	0.0	18.0	0.007	0.084
31W-L	31	Levee	Future	0.0	19.5	0.009	0.093
32W-L	32	Levee	Existing	0.0	18.0	0.006	0.074
32W-L	32	Levee	Future	0.0	19.5	0.008	0.087
33W-L	33	Levee	Existing	0.0	18.0	0.006	0.066
33W-L	33	Levee	Future	0.0	19.5	0.007	0.075
34W-L	34	Levee	Existing	0.0	18.0	0.003	0.048
34W-L	34	Levee	Future	0.0	19.5	0.006	0.07
35W-L	35	Levee	Existing	0.0	18.0	0.004	0.056
35W-L	35	Levee	Future	0.0	19.5	0.007	0.074
36W-L	36	Levee	Existing	0.0	18.0	0.004	0.058
36W-L	36	Levee	Future	0.0	19.5	0.007	0.077
37W-L	37	Levee	Existing	0.0	18.0	0.004	0.058
37W-L	37	Levee	Future	0.0	19.5	0.008	0.082
38W-L	38	Levee	Existing	0.0	18.0	0.005	0.06
38W-L	38	Levee	Future	0.0	19.5	0.009	0.095
39W-L	39	Levee	Existing	0.0	18.0	0.005	0.068
39W-L	39	Levee	Future	0.0	19.5	0.009	0.1

**New Orleans to Venice**

**2% Levee Project Design Elevations – Existing & Future Conditions**

**Mississippi River – West Bank**

Hydraulic Reach	River Mile	Type	Condition	Toe Elevation (ft)	Elevation (ft)	Overtopping Rate	
						q50 (cfs/ft)	q90 (cfs/ft)
40W-L	40	Levee	Existing	0.0	18.0	0.005	0.072
40W-L	40	Levee	Future	0.0	20.0	0.006	0.072
41W-L	41	Levee	Existing	0.0	18.0	0.003	0.042
41W-L	41	Levee	Future	0.0	20.0	0.003	0.048
42W-L	42	Levee	Existing	0.0	18.0	0.003	0.043
42W-L	42	Levee	Future	0.0	20.0	0.004	0.051
43W-L	43	Levee	Existing	0.0	18.0	0.001	0.023
43W-L	43	Levee	Future	0.0	20.0	0.002	0.033
44W-L	44	Levee	Existing	0.0	18.0	0.001	0.023
44W-L	44	Levee	Future	0.0	20.0	0.002	0.036
45W-L	45	Levee	Existing	0.0	18.5	0.008	0.054
45W-L	45	Levee	Future	0.0	20.5	0.007	0.051
46W-L	46	Levee	Existing	0.0	18.5	0.008	0.056
46W-L	46	Levee	Future	0.0	20.5	0.007	0.055
47W-L	47	Levee	Existing	0.0	18.5	0.008	0.055
47W-L	47	Levee	Future	0.0	20.5	0.008	0.054
48W-L	48	Levee	Existing	0.0	18.5	0.008	0.06
48W-L	48	Levee	Future	0.0	20.5	0.008	0.057
49W-L	49	Levee	Existing	0.0	18.5	0.01	0.062
49W-L	49	Levee	Future	0.0	20.5	0.008	0.059

**New Orleans to Venice**

**2% Levee Project Design Elevations – Existing & Future Conditions**

**Mississippi River – West Bank**

Hydraulic Reach	River Mile	Type	Condition	Toe Elevation (ft)	Elevation (ft)	Overtopping Rate	
						q50 (cfs/ft)	q90 (cfs/ft)
50W-L	50	Levee	Existing	0.0	18.5	0.01	0.063
50W-L	50	Levee	Future	0.0	20.5	0.009	0.063
51W-L	51	Levee	Existing	0.0	19.0	0.006	0.042
51W-L	51	Levee	Future	0.0	21.0	0.006	0.046
52W-L	52	Levee	Existing	0.0	19.0	0.006	0.042
52W-L	52	Levee	Future	0.0	21.0	0.006	0.045
53W-L	53	Levee	Existing	0.0	19.0	0.007	0.047
53W-L	53	Levee	Future	0.0	21.0	0.007	0.049
54W-L	54	Levee	Existing	0.0	19.0	0.007	0.046
54W-L	54	Levee	Future	0.0	21.0	0.008	0.053
55W-L	55	Levee	Existing	0.0	19.0	0.007	0.047
55W-L	55	Levee	Future	0.0	21.0	0.009	0.055
56W-L	56	Levee	Existing	0.0	19.0	0.008	0.051
56W-L	56	Levee	Future	0.0	21.0	0.009	0.06
57W-L	57	Levee	Existing	0.0	19.0	0.008	0.05
57W-L	57	Levee	Future	0.0	21.0	0.009	0.062
58W-L	58	Levee	Existing	0.0	19.0	0.008	0.051
58W-L	58	Levee	Future	0.0	21.0	0.01	0.065
59W-L	59	Levee	Existing	0.0	17.5	0.009	0.063
59W-L	59	Levee	Future	0.0	20.0	0.006	0.047



**New Orleans to Venice**

**2% Levee Project Design Elevations – Existing & Future Conditions**

**Mississippi River – West Bank**

Hydraulic Reach	River Mile	Type	Condition	Toe Elevation (ft)	Elevation (ft)	Overtopping Rate	
						q50 (cfs/ft)	q90 (cfs/ft)
60W-L	60	Levee	Existing	0.0	17.5	0.009	0.064
60W-L	60	Levee	Future	0.0	20.0	0.006	0.048
61W-L	61	Levee	Existing	0.0	17.5	0.008	0.057
61W-L	61	Levee	Future	0.0	20.0	0.006	0.046
62W-L	62	Levee	Existing	0.0	17.5	0.008	0.059
62W-L	62	Levee	Future	0.0	20.0	0.006	0.045
63W-L	63	Levee	Existing	0.0	17.5	0.008	0.054
63W-L	63	Levee	Future	0.0	20.0	0.006	0.045
64W-L	64	Levee	Existing	0.0	17.5	0.008	0.053
64W-L	64	Levee	Future	0.0	20.0	0.007	0.046
65W-L	65	Levee	Existing	0.0	17.5	0.008	0.054
65W-L	65	Levee	Future	0.0	20.0	0.007	0.05
66W-L	66	Levee	Existing	0.0	17.5	0.007	0.05
66W-L	66	Levee	Future	0.0	20.0	0.006	0.05
67W-L	67	Levee	Existing	0.0	17.5	0.007	0.054
67W-L	67	Levee	Future	0.0	20.0	0.007	0.054
68W-L	68	Levee	Existing	0.0	17.5	0.007	0.055
68W-L	68	Levee	Future	0.0	20.0	0.008	0.058
69W-L	69	Levee	Existing	0.0	17.5	0.006	0.05
69W-L	69	Levee	Future	0.0	20.0	0.007	0.06

New Orleans to Venice							
2% Levee Project Design Elevations – Existing & Future Conditions							
Mississippi River – West Bank							
Hydraulic Reach	River Mile	Type	Condition	Toe Elevation (ft)	Elevation (ft)	Overtopping Rate	
						q50 (cfs/ft)	q90 (cfs/ft)
70W-L	70	Levee	Existing	0.0	17.5	0.006	0.049
70W-L	70	Levee	Future	0.0	20.0	0.008	0.06

**Table 6-23 New Orleans to Venice Mississippi River West Bank – 1% Levee/Floodwalls Design Information – Future Conditions**

New Orleans to Venice							
1% Levee/Floodwall Project Design Elevations – Future Conditions							
Mississippi River – West Bank							
Hydraulic Reach	River Mile	Type	Condition	Toe Elevation (ft)	Elevation (ft)	Overtopping Rate	
						q50 (cfs/ft)	q90 (cfs/ft)
11W-LF	11	Combo	Future	0.0	20.0	0.007	0.068
21W-LF	21	Combo	Future	0.0	23.5	0.006	0.073
22W-LF	22	Combo	Future	0.0	23.5	0.007	0.078
26W-LF	26	Combo	Future	0.0	24.5	0.008	0.089
27W-LF	27	Combo	Future	0.0	24.5	0.009	0.092
28W-LF	28	Combo	Future	0.0	25.0	0.007	0.075
30W-LF	30	Combo	Future	0.0	25.0	0.008	0.082
43W-LF	43	Combo	Future	0.0	25.0	0.002	0.037

**Table 6-24 New Orleans to Venice Mississippi River West Bank – 2% Levee/Floodwall Design Information – Future Conditions**

New Orleans to Venice							
2% Levee/Floodwall Project Design Elevations – Future Conditions							
Mississippi River – West Bank							
Hydraulic Reach	River Mile	Type	Condition	Toe Elevation (ft)	Elevation (ft)	Overtopping Rate	
						q50 (cfs/ft)	q90 (cfs/ft)
11W-LF	11	Combo	Future	0.0	16.0	0.008	0.072
21W-LF	21	Combo	Future	0.0	18.5	0.008	0.089
22W-LF	22	Combo	Future	0.0	19.0	0.006	0.063
26W-LF	26	Combo	Future	0.0	19.5	0.007	0.082
27W-LF	27	Combo	Future	0.0	19.5	0.008	0.084
28W-LF	28	Combo	Future	0.0	19.5	0.009	0.091
30W-LF	30	Combo	Future	0.0	19.5	0.009	0.097
43W-LF	43	Combo	Future	0.0	20.0	0.002	0.033

#### 6.5.4 Resiliency Analysis

The 1% designs only for the West Bank of the Mississippi River were examined for resiliency by computing the 0.2% surge level (50% confidence) for each design. The results of this resiliency analysis are presented in **Table 6-25** and **Table 6-26**. For all sections, the 0.2% surge elevation remains below the top of the 1% flood defense elevations. Armoring requirements for resiliency will be addressed in a future analysis.

**Table 6-25 New Orleans to Venice Mississippi River West Bank – Resiliency Analysis Levees Existing & Future Conditions**

<b>New Orleans to Venice</b>					
<b>Mississippi River West Bank – Existing &amp; Future Conditions</b>					
<b>Resiliency Analysis (0.2% Event)</b>					
<b>Hydraulic Reach</b>	<b>River Mile</b>	<b>Type</b>	<b>Condition</b>	<b>Elevation (ft)</b>	<b>Best Estimates During 0.2% Event</b>
					<b>Surge Level (ft)</b>
11W-L	11	Levee	Existing	18.5	15.3
11W-L	11	Levee	Future	20.0	16.2
12W-L	12	Levee	Existing	18.5	15.6
12W-L	12	Levee	Future	20.5	16.6
13W-L	13	Levee	Existing	19.0	15.9
13W-L	13	Levee	Future	20.5	16.8
14W-L	14	Levee	Existing	19.5	16.1
14W-L	14	Levee	Future	21.5	17.1
15W-L	15	Levee	Existing	20.0	16.4
15W-L	15	Levee	Future	21.5	17.3
16W-L	16	Levee	Existing	20.5	16.6
16W-L	16	Levee	Future	22.0	17.5
17W-L	17	Levee	Existing	20.5	16.9
17W-L	17	Levee	Future	22.5	17.8
18W-L	18	Levee	Existing	21.0	17.1
18W-L	18	Levee	Future	22.5	18.0
19W-L	19	Levee	Existing	21.0	17.3
19W-L	19	Levee	Future	23.0	18.2

**New Orleans to Venice**

**Mississippi River West Bank – Existing & Future Conditions**

**Resiliency Analysis (0.2% Event)**

<b>Hydraulic Reach</b>	<b>River Mile</b>	<b>Type</b>	<b>Condition</b>	<b>Elevation (ft)</b>	<b>Best Estimates During 0.2% Event</b>
					<b>Surge Level (ft)</b>
20W-L	20	Levee	Existing	21.5	17.5
20W-L	20	Levee	Future	23.0	18.4
21W-L	21	Levee	Existing	21.5	17.8
21W-L	21	Levee	Future	23.5	18.7
22W-L	22	Levee	Existing	22.0	17.9
22W-L	22	Levee	Future	23.5	18.8
23W-L	23	Levee	Existing	22.0	18.1
23W-L	23	Levee	Future	23.5	19.0
24W-L	24	Levee	Existing	22.0	18.2
24W-L	24	Levee	Future	24.0	19.2
25W-L	25	Levee	Existing	22.5	18.4
25W-L	25	Levee	Future	24.0	19.3
26W-L	26	Levee	Existing	23.0	18.5
26W-L	26	Levee	Future	24.5	19.4
27W-L	27	Levee	Existing	23.0	18.6
27W-L	27	Levee	Future	24.5	19.6
28W-L	28	Levee	Existing	23.0	18.8
28W-L	28	Levee	Future	25.0	19.7
29W-L	29	Levee	Existing	23.0	18.8

**New Orleans to Venice**

**Mississippi River West Bank – Existing & Future Conditions**

**Resiliency Analysis (0.2% Event)**

<b>Hydraulic Reach</b>	<b>River Mile</b>	<b>Type</b>	<b>Condition</b>	<b>Elevation (ft)</b>	<b>Best Estimates During 0.2% Event</b>
					<b>Surge Level (ft)</b>
29W-L	29	Levee	Future	25.0	19.8
30W-L	30	Levee	Existing	23.0	18.8
30W-L	30	Levee	Future	25.0	19.8
31W-L	31	Levee	Existing	23.0	18.8
31W-L	31	Levee	Future	25.0	19.8
32W-L	32	Levee	Existing	23.0	18.7
32W-L	32	Levee	Future	25.0	19.7
33W-L	33	Levee	Existing	23.0	18.6
33W-L	33	Levee	Future	25.0	19.6
34W-L	34	Levee	Existing	23.0	18.6
34W-L	34	Levee	Future	25.0	19.6
35W-L	35	Levee	Existing	23.0	18.7
35W-L	35	Levee	Future	25.0	19.7
36W-L	36	Levee	Existing	23.0	18.8
36W-L	36	Levee	Future	25.0	19.8
37W-L	37	Levee	Existing	23.0	18.8
37W-L	37	Levee	Future	25.0	19.9
38W-L	38	Levee	Existing	23.0	18.8
38W-L	38	Levee	Future	25.0	19.9

**New Orleans to Venice**

**Mississippi River West Bank – Existing & Future Conditions**

**Resiliency Analysis (0.2% Event)**

<b>Hydraulic Reach</b>	<b>River Mile</b>	<b>Type</b>	<b>Condition</b>	<b>Elevation (ft)</b>	<b>Best Estimates During 0.2% Event</b>
					<b>Surge Level (ft)</b>
39W-L	39	Levee	Existing	23.0	18.8
39W-L	39	Levee	Future	25.0	19.9
40W-L	40	Levee	Existing	23.0	18.8
40W-L	40	Levee	Future	25.0	19.9
41W-L	41	Levee	Existing	23.0	18.7
41W-L	41	Levee	Future	25.0	19.9
42W-L	42	Levee	Existing	23.0	18.6
42W-L	42	Levee	Future	25.0	19.9
43W-L	43	Levee	Existing	23.0	18.5
43W-L	43	Levee	Future	25.0	19.8
44W-L	44	Levee	Existing	23.0	18.4
44W-L	44	Levee	Future	25.0	19.8
45W-L	45	Levee	Existing	23.5	18.4
45W-L	45	Levee	Future	25.5	19.7
46W-L	46	Levee	Existing	23.5	18.3
46W-L	46	Levee	Future	25.5	19.7
47W-L	47	Levee	Existing	23.5	18.3
47W-L	47	Levee	Future	25.5	19.7
48W-L	48	Levee	Existing	23.5	18.3

**New Orleans to Venice**

**Mississippi River West Bank – Existing & Future Conditions**

**Resiliency Analysis (0.2% Event)**

<b>Hydraulic Reach</b>	<b>River Mile</b>	<b>Type</b>	<b>Condition</b>	<b>Elevation (ft)</b>	<b>Best Estimates During 0.2% Event</b>
					<b>Surge Level (ft)</b>
48W-L	48	Levee	Future	25.5	19.7
49W-L	49	Levee	Existing	23.5	18.2
49W-L	49	Levee	Future	25.5	19.7
50W-L	50	Levee	Existing	23.5	18.2
50W-L	50	Levee	Future	25.5	19.7
51W-L	51	Levee	Existing	23.5	18.2
51W-L	51	Levee	Future	25.5	19.7
52W-L	52	Levee	Existing	23.5	18.2
52W-L	52	Levee	Future	25.5	19.7
53W-L	53	Levee	Existing	23.5	18.3
53W-L	53	Levee	Future	25.5	19.8
54W-L	54	Levee	Existing	23.5	18.3
54W-L	54	Levee	Future	25.5	19.9
55W-L	55	Levee	Existing	23.5	18.3
55W-L	55	Levee	Future	25.5	20.0
56W-L	56	Levee	Existing	23.5	18.4
56W-L	56	Levee	Future	25.5	20.0
57W-L	57	Levee	Existing	23.5	18.4
57W-L	57	Levee	Future	25.5	20.1



**New Orleans to Venice**

**Mississippi River West Bank – Existing & Future Conditions**

**Resiliency Analysis (0.2% Event)**

<b>Hydraulic Reach</b>	<b>River Mile</b>	<b>Type</b>	<b>Condition</b>	<b>Elevation (ft)</b>	<b>Best Estimates During 0.2% Event</b>
					<b>Surge Level (ft)</b>
58W-L	58	Levee	Existing	23.5	18.4
58W-L	58	Levee	Future	25.5	20.1
59W-L	59	Levee	Existing	22.0	18.4
59W-L	59	Levee	Future	24.5	20.2
60W-L	60	Levee	Existing	22.0	18.4
60W-L	60	Levee	Future	24.5	20.2
61W-L	61	Levee	Existing	22.0	18.4
61W-L	61	Levee	Future	24.5	20.2
62W-L	62	Levee	Existing	22.0	18.3
62W-L	62	Levee	Future	24.5	20.2
63W-L	63	Levee	Existing	22.0	18.3
63W-L	63	Levee	Future	24.5	20.3
64W-L	64	Levee	Existing	22.0	18.3
64W-L	64	Levee	Future	24.5	20.3
65W-L	65	Levee	Existing	22.0	18.3
65W-L	65	Levee	Future	24.5	20.3
66W-L	66	Levee	Existing	22.0	18.2
66W-L	66	Levee	Future	24.5	20.4
67W-L	67	Levee	Existing	22.0	18.3

**New Orleans to Venice**

**Mississippi River West Bank – Existing & Future Conditions**

**Resiliency Analysis (0.2% Event)**

<b>Hydraulic Reach</b>	<b>River Mile</b>	<b>Type</b>	<b>Condition</b>	<b>Elevation (ft)</b>	<b>Best Estimates During 0.2% Event</b>
					<b>Surge Level (ft)</b>
67W-L	67	Levee	Future	24.5	20.5
68W-L	68	Levee	Existing	22.0	18.3
68W-L	68	Levee	Future	24.5	20.6
69W-L	69	Levee	Existing	22.0	18.3
69W-L	69	Levee	Future	24.5	20.7
70W-L	70	Levee	Existing	22.0	18.2
70W-L	70	Levee	Future	24.5	20.7

**Table 6-26 New Orleans to Venice Mississippi River West Bank – Resiliency Analysis Levee/Floodwall Future Conditions**

New Orleans to Venice						
Mississippi River West Bank – Future Conditions						
Resiliency Analysis Levee/Floodwall Combinations (0.2% Event)						
Hydraulic Reach	River Mile	Type	Condition	Elevation (ft)	Best Estimates During 0.2% Event	
					Surge Level (ft)	Overtopping Rate (cfs/ft)
11W-LF	11	Combo	Future	20.0	16.2	0.466
21W-LF	21	Combo	Future	23.5	18.7	0.361
22W-LF	22	Combo	Future	23.5	18.8	0.407
26W-LF	26	Combo	Future	24.5	19.4	0.369
27W-LF	27	Combo	Future	24.5	19.6	0.409
28W-LF	28	Combo	Future	25.0	19.7	0.364
30W-LF	30	Combo	Future	25.0	19.8	0.381
43W-LF	43	Combo	Future	25.0	19.8	0.197

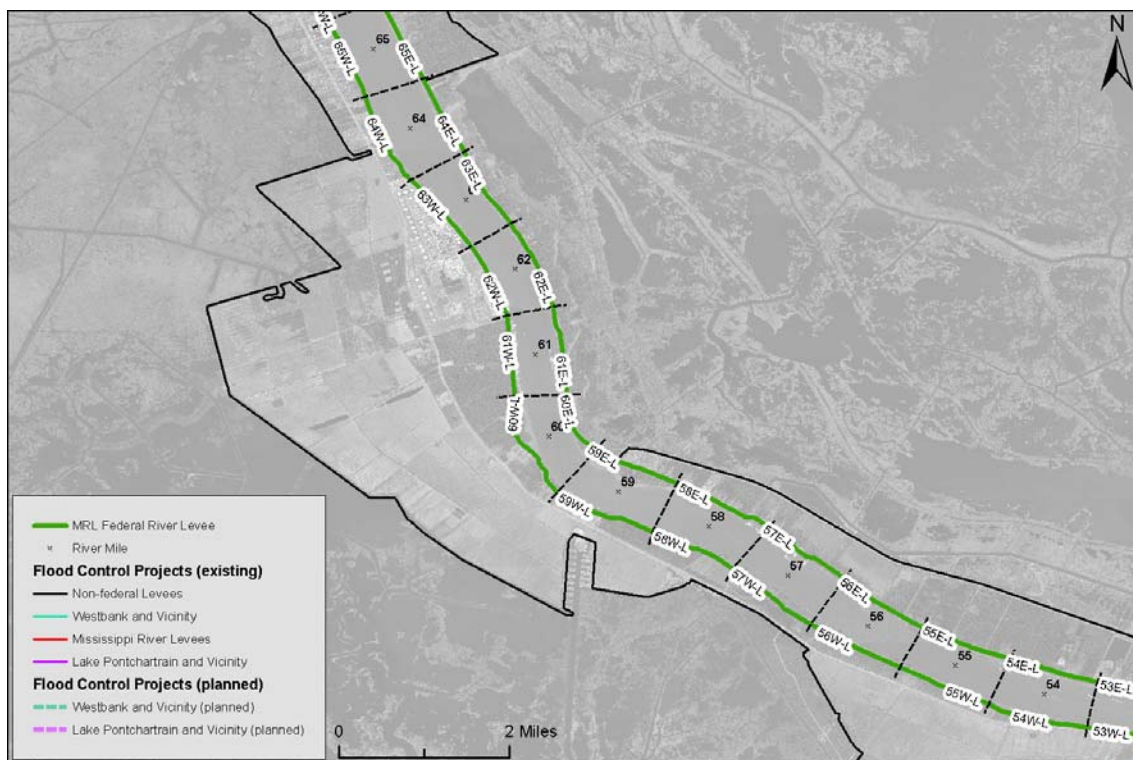
## 6.6 MISSISSIPPI RIVER EAST BANK (RM 44 – RM 59)

### 6.6.1 General

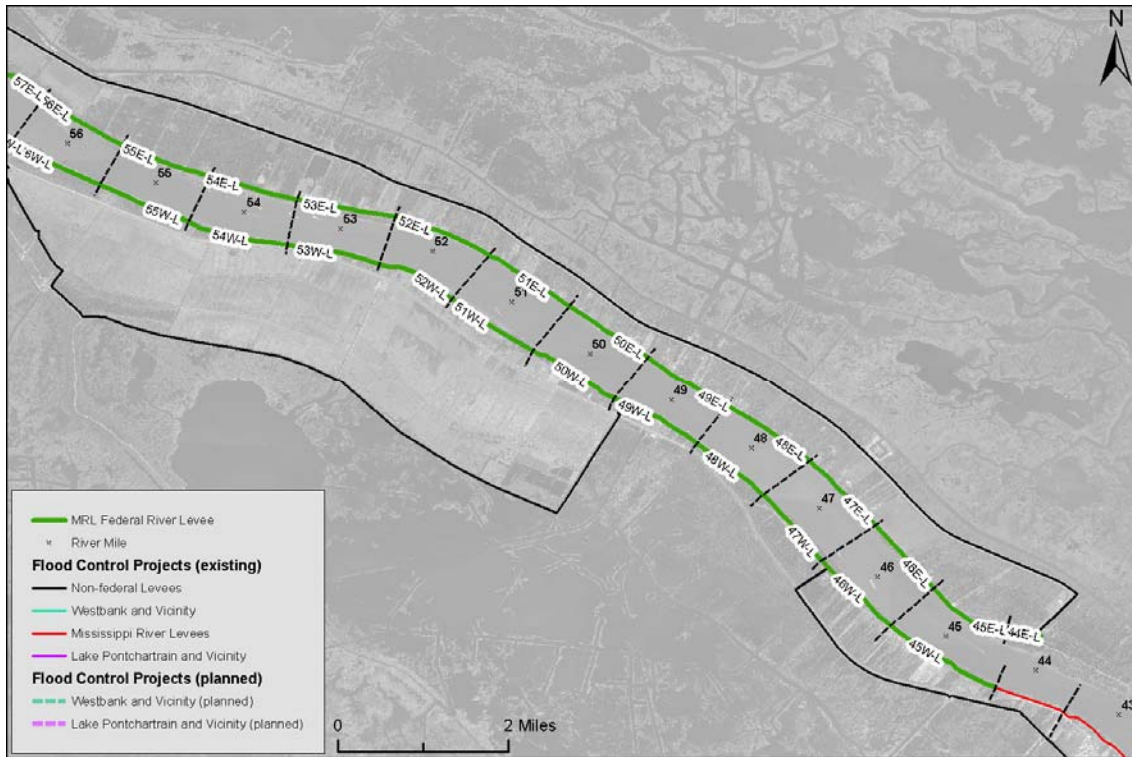
The Mississippi River levee system at the East Bank under consideration in this section stretches from Venice at RM 44 to Oakville near RM 59. **Figure 6-8** and **Figure 6-9** shows the sections along the Mississippi River between these locations.

Note that the Mississippi River Levee system on the East Bank between RM 59 and 81 is not considered in this report. It does, however, play a role in the overarching flood risk reduction analysis of the area. For instance, all model computations assume that this river levee does not fail during a hurricane. Also, scour or failure of this river levee during a hurricane may cause problems ensuring river flood protection in the river high water season if repairs cannot be made in time.

All elevations described herein are in North American Vertical Datum 1988 (2004.65).



**Figure 6-8 New Orleans to Venice Hydraulic Reaches Mississippi River at East Bank and West Bank River Mile 53 - 63**



**Figure 6-9 New Orleans to Venice Hydraulic Reaches Mississippi River at East Bank and West Bank River Mile 45 - 53**

### 6.6.2 Hydraulic Boundary Conditions

The 1% and 2% hydraulic boundary conditions for the levee system at the East Bank of the Mississippi River between RM 44 and 59 are listed in **Table 6-27** and **Table 6-28**. Refer to **Chapter 2** for the methodology to derive these boundary conditions for existing and future conditions.

**Table 6-27 New Orleans to Venice Mississippi River East Bank RM 44-59 – 1% Hydraulic Boundary Conditions– Existing Conditions**

New Orleans to Venice									
1% Hydraulic Boundary Conditions – Existing & Future Conditions									
Mississippi River East Bank RM 44-59									
Hydraulic Reach	River Mile	Type	Condition	Surge Level (ft)		Significant Wave Height (ft)		Peak Period (s)	
				Mean	Std	Mean	Std	Mean	Std
44E-L	44	Levee	Existing	15.6	1.1	1.5	0.2	2.5	0.5
44E-L	44	Levee	Future	16.9	1.1	1.5	0.2	2.5	0.5
45E-L	45	Levee	Existing	15.5	1.0	1.5	0.2	2.5	0.5
45E-L	45	Levee	Future	16.9	1.0	1.5	0.2	2.5	0.5
46E-L	46	Levee	Existing	15.5	1.0	1.5	0.2	2.5	0.5
46E-L	46	Levee	Future	16.9	1.0	1.5	0.2	2.5	0.5
47E-L	47	Levee	Existing	15.5	1.0	1.5	0.2	2.5	0.5
47E-L	47	Levee	Future	16.9	1.0	1.5	0.2	2.5	0.5
48E-L	48	Levee	Existing	15.5	1.0	1.5	0.2	2.5	0.5
48E-L	48	Levee	Future	16.9	1.0	1.5	0.2	2.5	0.5
49E-L	49	Levee	Existing	15.5	1.0	1.5	0.2	2.5	0.5
49E-L	49	Levee	Future	17.0	1.0	1.5	0.2	2.5	0.5
50E-L	50	Levee	Existing	15.5	1.0	1.5	0.2	2.5	0.5
50E-L	50	Levee	Future	17.0	1.0	1.5	0.2	2.5	0.5
51E-L	51	Levee	Existing	15.5	1.0	1.5	0.2	2.5	0.5
51E-L	51	Levee	Future	17.0	1.0	1.5	0.2	2.5	0.5
52E-L	52	Levee	Existing	15.5	1.0	1.5	0.2	2.5	0.5
52E-L	52	Levee	Future	17.1	0.9	1.5	0.2	2.5	0.5
53E-L	53	Levee	Existing	15.5	0.9	1.5	0.2	2.5	0.5

**New Orleans to Venice**

**1% Hydraulic Boundary Conditions – Existing & Future Conditions**

**Mississippi River East Bank RM 44-59**

Hydraulic Reach	River Mile	Type	Condition	Surge Level (ft)		Significant Wave Height (ft)		Peak Period (s)	
				Mean	Std	Mean	Std	Mean	Std
53E-L	53	Levee	Future	17.1	0.9	1.5	0.2	2.5	0.5
54E-L	54	Levee	Existing	15.6	1.0	1.5	0.2	2.5	0.5
54E-L	54	Levee	Future	17.2	0.9	1.5	0.2	2.5	0.5
55E-L	55	Levee	Existing	15.6	0.9	1.5	0.2	2.5	0.5
55E-L	55	Levee	Future	17.3	0.9	1.5	0.2	2.5	0.5
56E-L	56	Levee	Existing	15.7	1.0	1.5	0.2	2.5	0.5
56E-L	56	Levee	Future	17.4	1.0	1.5	0.2	2.5	0.5
57E-L	57	Levee	Existing	15.7	1.0	1.5	0.2	2.5	0.5
57E-L	57	Levee	Future	17.4	1.0	1.5	0.2	2.5	0.5
58E-L	58	Levee	Existing	15.7	0.9	1.5	0.2	2.5	0.5
58E-L	58	Levee	Future	17.4	0.9	1.5	0.2	2.5	0.5
59E-L	59	Levee	Existing	15.7	0.9	1.5	0.2	2.5	0.5
59E-L	59	Levee	Future	17.5	0.9	1.5	0.2	2.5	0.5

**Table 6-28 New Orleans to Venice Mississippi River East Bank RM 44-59 – 2% Hydraulic Boundary Conditions – Existing Conditions**

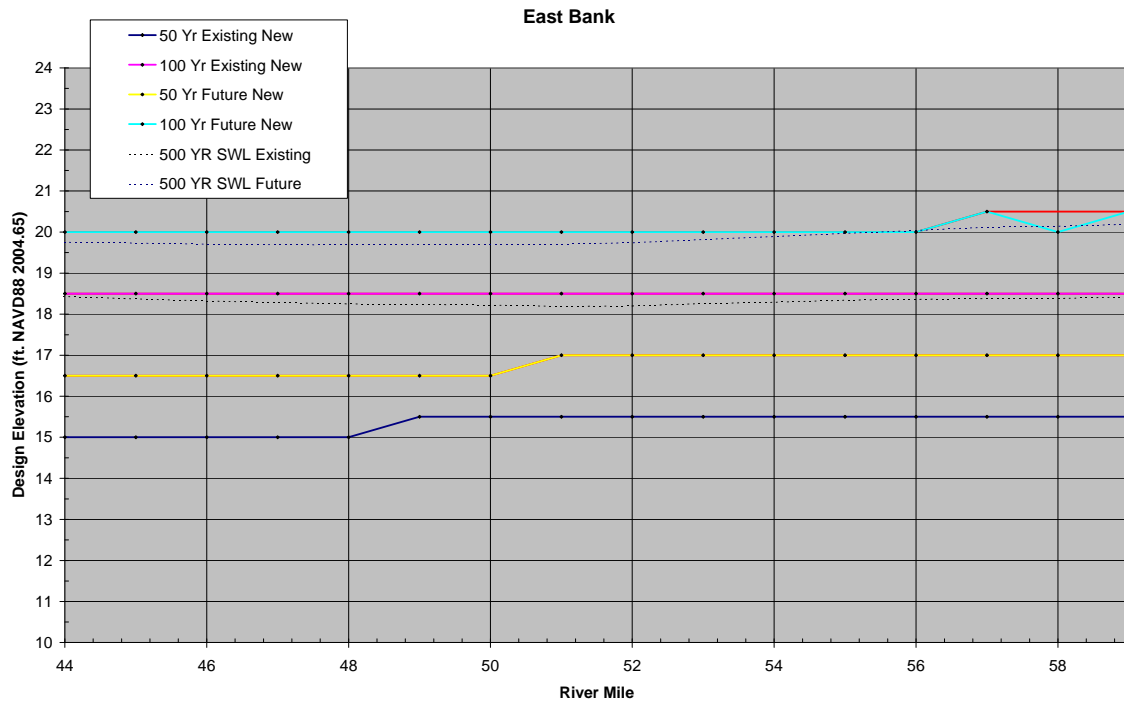
<p align="center"><b>New Orleans to Venice</b></p> <p align="center"><b>2% Hydraulic Boundary Conditions – Existing &amp; Future Conditions</b></p> <p align="center"><b>Mississippi River East Bank RM 44-59</b></p>									
Hydraulic Reach	River Mile	Type	Condition	Surge Level (ft)		Significant Wave Height (ft)		Peak Period (s)	
				Mean	Std	Mean	Std	Mean	Std
44E-L	44	Levee	Existing	12.3	1.0	1.5	0.2	2.5	0.5
44E-L	44	Levee	Future	13.6	1.0	1.5	0.2	2.5	0.5
45E-L	45	Levee	Existing	12.3	1.0	1.5	0.2	2.5	0.5
45E-L	45	Levee	Future	13.6	1.0	1.5	0.2	2.5	0.5
46E-L	46	Levee	Existing	12.3	1.0	1.5	0.2	2.5	0.5
46E-L	46	Levee	Future	13.7	1.0	1.5	0.2	2.5	0.5
47E-L	47	Levee	Existing	12.3	1.0	1.5	0.2	2.5	0.5
47E-L	47	Levee	Future	13.7	1.0	1.5	0.2	2.5	0.5
48E-L	48	Levee	Existing	12.3	0.9	1.5	0.2	2.5	0.5
48E-L	48	Levee	Future	13.8	1.0	1.5	0.2	2.5	0.5
49E-L	49	Levee	Existing	12.4	0.9	1.5	0.2	2.5	0.5
49E-L	49	Levee	Future	13.9	0.9	1.5	0.2	2.5	0.5
50E-L	50	Levee	Existing	12.4	0.9	1.5	0.2	2.5	0.5
50E-L	50	Levee	Future	13.9	0.9	1.5	0.2	2.5	0.5
51E-L	51	Levee	Existing	12.5	0.9	1.5	0.2	2.5	0.5
51E-L	51	Levee	Future	14.0	0.9	1.5	0.2	2.5	0.5
52E-L	52	Levee	Existing	12.5	0.9	1.5	0.2	2.5	0.5
52E-L	52	Levee	Future	14.1	0.9	1.5	0.2	2.5	0.5
53E-L	53	Levee	Existing	12.6	0.9	1.5	0.2	2.5	0.5



New Orleans to Venice									
2% Hydraulic Boundary Conditions – Existing & Future Conditions									
Mississippi River East Bank RM 44-59									
Hydraulic Reach	River Mile	Type	Condition	Surge Level (ft)		Significant Wave Height (ft)		Peak Period (s)	
				Mean	Std	Mean	Std	Mean	Std
53E-L	53	Levee	Future	14.2	0.9	1.5	0.2	2.5	0.5
54E-L	54	Levee	Existing	12.7	0.9	1.5	0.2	2.5	0.5
54E-L	54	Levee	Future	14.3	0.9	1.5	0.2	2.5	0.5
55E-L	55	Levee	Existing	12.7	0.9	1.5	0.2	2.5	0.5
55E-L	55	Levee	Future	14.3	0.9	1.5	0.2	2.5	0.5
56E-L	56	Levee	Existing	12.7	0.9	1.5	0.2	2.5	0.5
56E-L	56	Levee	Future	14.4	0.9	1.5	0.2	2.5	0.5
57E-L	57	Levee	Existing	12.7	0.9	1.5	0.2	2.5	0.5
57E-L	57	Levee	Future	14.4	0.9	1.5	0.2	2.5	0.5
58E-L	58	Levee	Existing	12.8	0.9	1.5	0.2	2.5	0.5
58E-L	58	Levee	Future	14.5	0.9	1.5	0.2	2.5	0.5
59E-L	59	Levee	Existing	12.8	0.9	1.5	0.2	2.5	0.5
59E-L	59	Levee	Future	14.5	0.9	1.5	0.2	2.5	0.5

### 6.6.3 Project Design Elevations

The 1% and 2% design characteristics of the Mississippi River at the East Bank are listed in **Table 6-29** and **Table 6-30**. Levees are evaluated for both existing and future conditions; hydraulic structures are only evaluated for future conditions. **Figure 6-10** also presents the project design heights for the levees.



**Figure 6-10 Project Design Elevations and Surge Levels Mississippi River at West Bank.**

**Table 6-29 New Orleans to Venice Mississippi River East Bank RM 44-59 – 1% Design Information– Existing Conditions**

<b>New Orleans to Venice</b>							
<b>1% Project Design Elevations – Existing &amp; Future Conditions</b>							
<b>Mississippi River East Bank RM 44-59</b>							
<b>Hydraulic Reach</b>	<b>River Mile</b>	<b>Type</b>	<b>Condition</b>	<b>Toe Elevation (ft)</b>	<b>Elevation (ft)</b>	<b>Overtopping Rate</b>	
						<b>q50 (cfs/ft)</b>	<b>q90 (cfs/ft)</b>
44E-L	44	Levee	Existing	0.0	18.5	0.002	0.075
44E-L	44	Levee	Future	0.0	20.0	0.001	0.052
45E-L	45	Levee	Existing	0.0	18.5	0.002	0.064
45E-L	45	Levee	Future	0.0	20.0	0.002	0.046
46E-L	46	Levee	Existing	0.0	18.5	0.002	0.058
46E-L	46	Levee	Future	0.0	20.0	0.002	0.046
47E-L	47	Levee	Existing	0.0	18.5	0.002	0.057
47E-L	47	Levee	Future	0.0	20.0	0.002	0.047
48E-L	48	Levee	Existing	0.0	18.5	0.002	0.052
48E-L	48	Levee	Future	0.0	20.0	0.002	0.044
49E-L	49	Levee	Existing	0.0	18.5	0.002	0.051
49E-L	49	Levee	Future	0.0	20.0	0.002	0.046
50E-L	50	Levee	Existing	0.0	18.5	0.002	0.054
50E-L	50	Levee	Future	0.0	20.0	0.002	0.05
51E-L	51	Levee	Existing	0.0	18.5	0.002	0.052
51E-L	51	Levee	Future	0.0	20.0	0.002	0.053
52E-L	52	Levee	Existing	0.0	18.5	0.002	0.047
52E-L	52	Levee	Future	0.0	20.0	0.002	0.052
53E-L	53	Levee	Existing	0.0	18.5	0.002	0.052

**New Orleans to Venice**

**1% Project Design Elevations – Existing & Future Conditions**

**Mississippi River East Bank RM 44-59**

Hydraulic Reach	River Mile	Type	Condition	Toe Elevation (ft)	Elevation (ft)	Overtopping Rate	
						q50 (cfs/ft)	q90 (cfs/ft)
53E-L	53	Levee	Future	0.0	20.0	0.003	0.062
54E-L	54	Levee	Existing	0.0	18.5	0.002	0.056
54E-L	54	Levee	Future	0.0	20.0	0.003	0.072
55E-L	55	Levee	Existing	0.0	18.5	0.003	0.062
55E-L	55	Levee	Future	0.0	20.0	0.004	0.083
56E-L	56	Levee	Existing	0.0	18.5	0.003	0.067
56E-L	56	Levee	Future	0.0	20.0	0.005	0.098
57E-L	57	Levee	Existing	0.0	18.5	0.003	0.065
57E-L	57	Levee	Future	0.0	20.5	0.002	0.04
58E-L	58	Levee	Existing	0.0	18.5	0.003	0.068
58E-L	58	Levee	Future	0.0	20.5	0.002	0.041
59E-L	59	Levee	Existing	0.0	18.5	0.003	0.065
59E-L	59	Levee	Future	0.0	20.5	0.002	0.043

**Table 6-30 New Orleans to Venice Mississippi River East Bank RM 44-59 – 2% Design Information– Existing Conditions**

New Orleans to Venice							
2% Project Design Elevations – Existing & Future Conditions							
Mississippi River East Bank RM 44-59							
Hydraulic Reach	River Mile	Type	Condition	Toe Elevation (ft)	Elevation (ft)	Overtopping Rate	
						q50 (cfs/ft)	q90 (cfs/ft)
44E-L	44	Levee	Existing	0.0	15.0	0.003	0.088
44E-L	44	Levee	Future	0.0	16.5	0.002	0.056
45E-L	45	Levee	Existing	0.0	15.0	0.004	0.082
45E-L	45	Levee	Future	0.0	16.5	0.002	0.062
46E-L	46	Levee	Existing	0.0	15.0	0.004	0.083
46E-L	46	Levee	Future	0.0	16.5	0.003	0.066
47E-L	47	Levee	Existing	0.0	15.0	0.004	0.081
47E-L	47	Levee	Future	0.0	16.5	0.003	0.065
48E-L	48	Levee	Existing	0.0	15.0	0.004	0.088
48E-L	48	Levee	Future	0.0	16.5	0.003	0.08
49E-L	49	Levee	Existing	0.0	15.5	0.002	0.036
49E-L	49	Levee	Future	0.0	16.5	0.004	0.09
50E-L	50	Levee	Existing	0.0	15.5	0.002	0.04
50E-L	50	Levee	Future	0.0	16.5	0.005	0.097
51E-L	51	Levee	Existing	0.0	15.5	0.002	0.043
51E-L	51	Levee	Future	0.0	17.0	0.002	0.045
52E-L	52	Levee	Existing	0.0	15.5	0.002	0.042
52E-L	52	Levee	Future	0.0	17.0	0.002	0.049
53E-L	53	Levee	Existing	0.0	15.5	0.003	0.05

New Orleans to Venice							
2% Project Design Elevations – Existing & Future Conditions							
Mississippi River East Bank RM 44-59							
Hydraulic Reach	River Mile	Type	Condition	Toe Elevation (ft)	Elevation (ft)	Overtopping Rate	
						q50 (cfs/ft)	q90 (cfs/ft)
53E-L	53	Levee	Future	0.0	17.0	0.003	0.058
54E-L	54	Levee	Existing	0.0	15.5	0.003	0.058
54E-L	54	Levee	Future	0.0	17.0	0.004	0.067
55E-L	55	Levee	Existing	0.0	15.5	0.003	0.062
55E-L	55	Levee	Future	0.0	17.0	0.004	0.075
56E-L	56	Levee	Existing	0.0	15.5	0.004	0.068
56E-L	56	Levee	Future	0.0	17.0	0.005	0.093
57E-L	57	Levee	Existing	0.0	15.5	0.003	0.067
57E-L	57	Levee	Future	0.0	17.0	0.005	0.094
58E-L	58	Levee	Existing	0.0	15.5	0.004	0.066
58E-L	58	Levee	Future	0.0	17.0	0.006	0.087
59E-L	59	Levee	Existing	0.0	15.5	0.004	0.068
59E-L	59	Levee	Future	0.0	17.0	0.006	0.098

#### 6.6.4 Resiliency

The **1% designs only** for the East Bank of the Mississippi River were examined for resiliency by computing the 0.2% surge level (50% confidence) for each design. The results of this resiliency analysis are presented in **Table 6-31**. For all sections, the 0.2% surge elevation remains below the top of the 1% flood defense elevations. Armoring requirements for resiliency will be addressed in a future analysis.

**Table 6-31 New Orleans to Venice Mississippi River East Bank RM 44-59 – Resiliency Analysis 1% Design Elevations Existing Conditions**

<b>New Orleans to Venice</b>					
<b>Mississippi River East Bank – Existing &amp; Future conditions</b>					
<b>Resiliency Analysis (0.2% Event)</b>					
<b>Hydraulic Reach</b>	<b>River Mile</b>	<b>Type</b>	<b>Condition</b>	<b>Elevation (ft)</b>	<b>Best Estimates During 0.2% Event</b>
					<b>Surge Level (ft)</b>
44E-L	44	Levee	Existing	18.5	18.4
44E-L	44	Levee	Future	20	19.8
45E-L	45	Levee	Existing	18.5	18.4
45E-L	45	Levee	Future	20	19.7
46E-L	46	Levee	Existing	18.5	18.3
46E-L	46	Levee	Future	20	19.7
47E-L	47	Levee	Existing	18.5	18.3
47E-L	47	Levee	Future	20	19.7
48E-L	48	Levee	Existing	18.5	18.3
48E-L	48	Levee	Future	20	19.7
49E-L	49	Levee	Existing	18.5	18.2
49E-L	49	Levee	Future	20	19.7
50E-L	50	Levee	Existing	18.5	18.2
50E-L	50	Levee	Future	20	19.7
51E-L	51	Levee	Existing	18.5	18.2
51E-L	51	Levee	Future	20	19.7
52E-L	52	Levee	Existing	18.5	18.2
52E-L	52	Levee	Future	20	19.7
53E-L	53	Levee	Existing	18.5	18.3

**New Orleans to Venice**

**Mississippi River East Bank – Existing & Future conditions**

**Resiliency Analysis (0.2% Event)**

<b>Hydraulic Reach</b>	<b>River Mile</b>	<b>Type</b>	<b>Condition</b>	<b>Elevation (ft)</b>	<b>Best Estimates During 0.2% Event</b>
					<b>Surge Level (ft)</b>
53E-L	53	Levee	Future	20	19.8
54E-L	54	Levee	Existing	18.5	18.3
54E-L	54	Levee	Future	20	19.9
55E-L	55	Levee	Existing	18.5	18.3
55E-L	55	Levee	Future	20	20.0
56E-L	56	Levee	Existing	18.5	18.4
56E-L	56	Levee	Future	20	20.0
57E-L	57	Levee	Existing	18.5	18.4
57E-L	57	Levee	Future	20.5	20.1
58E-L	58	Levee	Existing	18.5	18.4
58E-L	58	Levee	Future	20.5	20.1
59E-L	59	Levee	Existing	18.5	18.4
59E-L	59	Levee	Future	20.5	20.2



## 6.7 TRANSITION ZONE AT RM 44

A transition zone was developed for the reach of the Mississippi River immediately upstream of RM 44, to transition between the two wave climates. The extent of the transition zone was determined using the SWAN modeling results. **Figure 6-11** shows the reaches in the transition zone. The cross-sectional views of the transition zones for each bank of the river are shown in **Figure 6-12** and **Figure 6-13**.

### Location of transitions

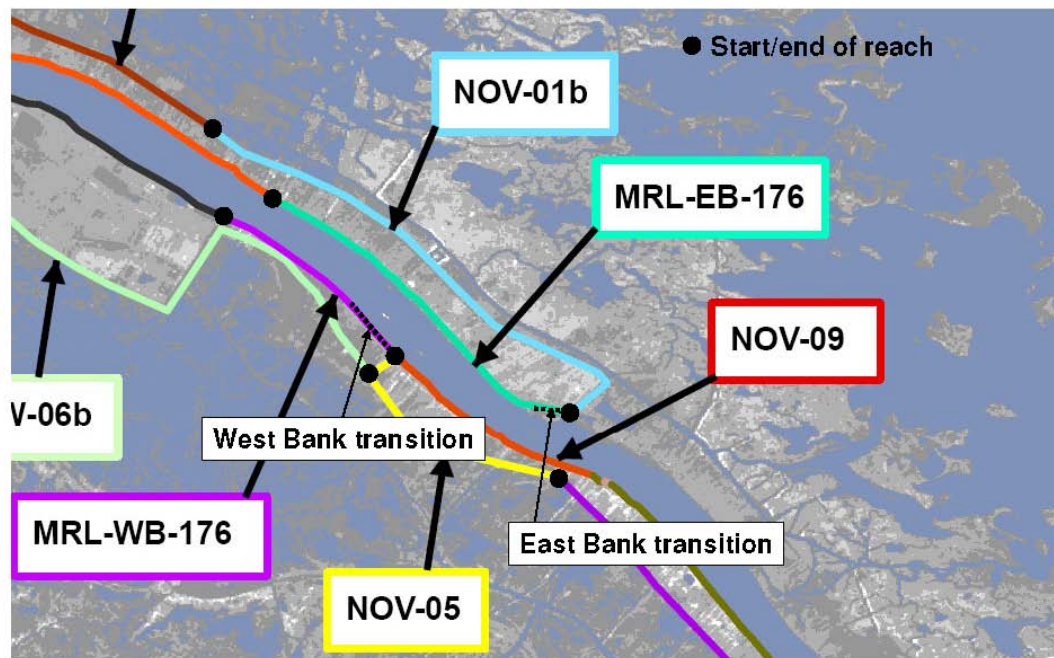
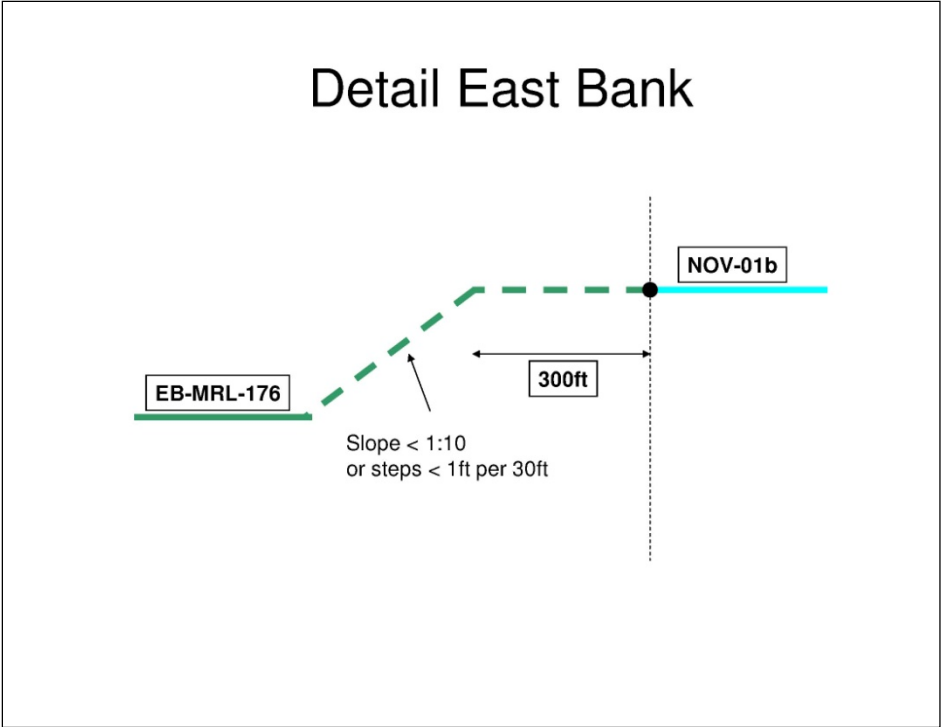
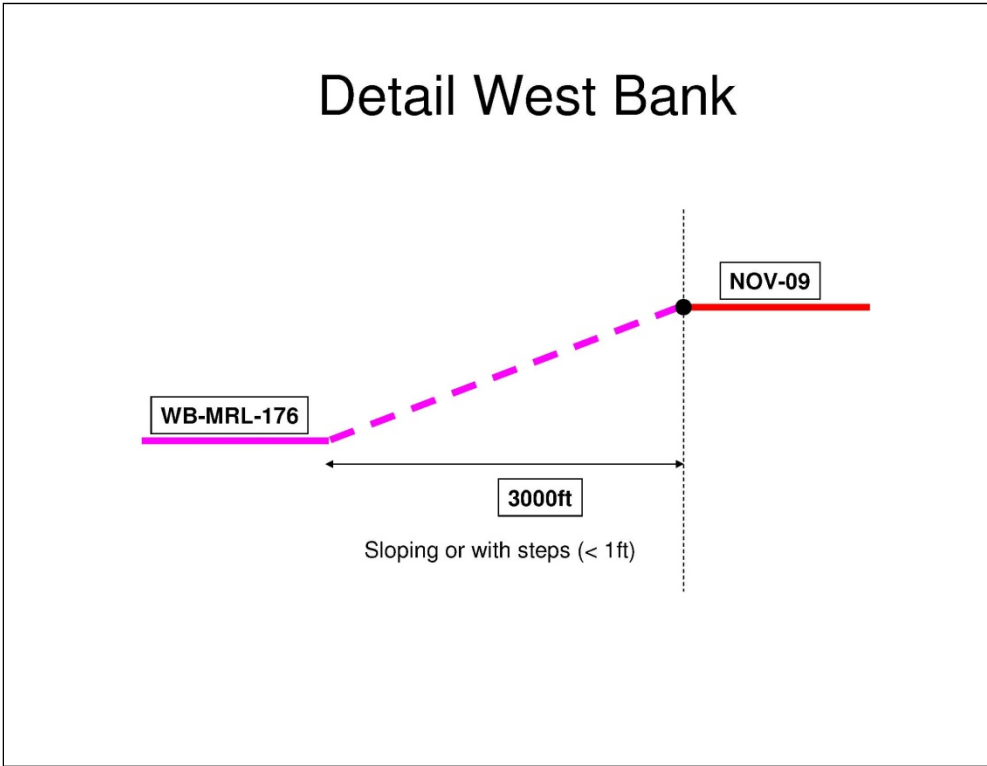


Figure 6-11 Transition Zones at East Bank and West Bank Around River Mile 44



**Figure 6-12 Detail Transition Zone East Bank**



**Figure 6-13 Detail Transition Zone West Bank**

## 6.8 NEW ORLEANS TO VENICE EPOCH ADJUSTMENTS BY HYDRAULIC REACH

The sensitivity analysis on storm surge modeling results related to the vertical datum update from NAVD88 2004.65 to NAVD88 2009.55 (**Appendix R**) recommended that the published design elevations for NOV/NFL remain in NAVD 2004.65 since the analysis was not a comprehensive update considering all changed parameters. It further recommended that a table be added to this update to the DER to publish the required conversion of design elevations from NAVD88 2004.65 to NAVD88 2009.55. Per the May 15, 2014 Memorandum from CEMVN-ED-S, the project datum for the NOV and NFL levees was changed to NAVD88 2009.55, effective immediately. **Table 6-32** shows the required adjustments, by hydraulic reach, between NAVD88 2004.65 and NAVD88 2009.55.

**Table 6-32 New Orleans to Venice Epoch Adjustments by Hydraulic Reach**

New Orleans to Venice 2% Project Design Elevations West Bank – Non-Federal Levee System						
Hydraulic Reach	Name	Type	Condition	Design Elevation (ft)		Notes regarding epoch change value
				NAVD88	Adjustment to NAVD88	
				2004.65	2009.55	
NOV-NF-W-04a	Non-Fed Oakville to LaReusitte (a)	Levee	Existing	7.5	+0.08	NF04-50
NOV-NF-W-04a	Non-Fed Oakville to LaReusitte (a)	Levee	Future	11.5	+0.08	NF04-50
NOV-NF-W-04b	Non-Fed Oakville to LaReusitte (b)	Levee	Existing	9.0	+0.08	NF04-50
NOV-NF-W-04b	Non-Fed Oakville to LaReusitte (b)	Levee	Future	13.0	+0.08	NF04-50

**Table 6-32 New Orleans to Venice Epoch Adjustments by Hydraulic Reach (cont'd)**

New Orleans to Venice 4% Project Design Elevations West Bank – Non-Federal Levee System						
Hydraulic Reach	Name	Type	Condition	Design Elevation (ft)		Notes regarding epoch change value
				NAVD88	Adjustment to NAVD88	
				2004.65	2009.55	
NOV-NF-W-04b	Non-Fed Oakville to LaReusitte (b)	Levee	Existing	8.0	+0.08	NF04-50
NOV-NF-W-04b	Non-Fed Oakville to LaReusitte (b)	Levee	Future	11.5	+0.08	NF04-50
NOV-NF-W-05a	Non-Fed LaReusitte to Myrtle Grove (a)	Levee	Existing	8.0	+0.06	N 366
NOV-NF-W-05a	Non-Fed LaReusitte to Myrtle Grove (a)	Levee	Future	11.5	+0.06	N 366
NOV-NF-W-05b	Non-Fed LaReusitte to Myrtle Grove (b)	Levee	Existing	9.0	+0.06	N 366
NOV-NF-W-05b	Non-Fed LaReusitte to Myrtle Grove (b)	Levee	Future	13.0	+0.06	N 366
NOV-NF-W-05c	Non-Fed LaReusitte to Myrtle Grove (c)	Levee	Existing	9.5	+0.06	N 366
NOV-NF-W-05c	Non-Fed LaReusitte to Myrtle Grove (c)	Levee	Future	14.0	+0.06	N 366
NOV-NF-W-05d	Non-Fed LaReusitte to Myrtle Grove (d)	Levee	Existing	10.0	+0.06	N 366
NOV-NF-W-05d	Non-Fed LaReusitte to Myrtle Grove (d)	Levee	Future	14.0	+0.06	N 366
NOV-NF-W-06a	Non-Fed Myrtle Grove to St Jude (a)	Levee	Existing	10.0	+0.07	R 366
NOV-NF-W-06a	Non-Fed Myrtle Grove to St Jude (a)	Levee	Future	14.5	+0.07	R 366
NOV-NF-W-06b	Non-Fed Myrtle Grove to St Jude (b)	Levee	Existing	11.0	0 / -0.15 / -0.32	interpolation / 13-143C-2 / C 195
NOV-NF-W-06b	Non-Fed Myrtle Grove to St Jude (b)	Levee	Future	15.0	0 / -0.15 / -0.32	interpolation / 13-143C-2 / C 195

**Table 6-32 New Orleans to Venice Epoch Adjustments by Hydraulic Reach (cont'd)**

New Orleans to Venice 2% Project Design Elevations West Bank – Federal Levee System						
Hydraulic Reach	Name	Type	Condition	Design Elevation (ft)		Notes regarding epoch change value
				NAVD88	Adjustment to NAVD88	
				2004.65	2009.55	
NOV-05	Upper Reach A – St Jude to City Price	Levee	Existing	13.0	-0.32	C 195
NOV-05	Upper Reach A – St Jude to City Price	Levee	Future	16.5	-0.32	C 195
NOV-05	Diamond PS	Structure	Future	18.5	-0.32	C 195
NOV-06	Reach A – City Price to Empire	Levee	Existing	13.0	-0.39	MILAN 2
NOV-06	Reach A – City Price to Empire	Levee	Future	16.5	-0.39	MILAN 2
NOV-06	Hayes PS	Structure	Future	18.5	-0.39	MILAN 2
NOV-06	Gainard Wood PS	Structure	Future	18.5	-0.39	MILAN 2
NOV-07	Reach B-1 Port Sulphur to Ft Jackson	Levee	Existing	13.5	-0.6 / -0.7 / -0.8	Based on data comparison (LiDAR 2013 & LiDAR 2014)
NOV-07	Reach B-1 Port Sulphur to Ft Jackson	Levee	Future	17.0	-0.6 / -0.7 / -0.8	Based on data comparison (LiDAR 2013 & LiDAR 2014)
NOV-07	Empire Floodgate (NOV-13)	Structure	Future	19.0	-0.6	Based on data comparison (LiDAR 2013 & LiDAR 2014)
NOV-07	Sunrise #1 PS	Structure	Future	19.0	-0.7	Based on data comparison (LiDAR 2013 & LiDAR 2014)
NOV-07	Sunrise #2 PS	Structure	Future	19.0	-0.7	Based on data comparison (LiDAR 2013 & LiDAR 2014)
NOV-07	Grand Liard PS	Structure	Future	19.0	-0.8	Based on data comparison (LiDAR 2013 & LiDAR 2014)
NOV-07	Floodwall Grand Liard PS (Part of NOV-15)	Floodwall	Future	17.0	-0.8	Based on data comparison (LiDAR 2013 & LiDAR 2014)
NOV-08	Reach B-2 Ft Jackson to Venice	Levee	Existing	13.5	-0.79 / -0.89 / -1.29	H 370 / J 370 / 876 0849 A TIDAL
NOV-08	Reach B-2 Ft Jackson to Venice	Levee	Future	17.0	-0.79 / -0.89 / -1.29	H 370 / J 370 / 876 0849 A TIDAL
NOV-08	Duvic PS	Structure	Future	19.0	-0.89	J 370
NOV-08	Floodwall Duvic PS (part of NOV-15)	Floodwall	Future	17.0	-0.89	J 370

**Table 6-32 New Orleans to Venice Epoch Adjustments by Hydraulic Reach (cont'd)**

New Orleans to Venice 2% Design Elevations East Bank – Federal Levee System						
Hydraulic Reach	Name	Type	Condition	Design Elevation (ft)		Notes regarding epoch change value
				NAVD88	Adjustment to NAVD88	
				2004.65	2009.55	
NOV-01a	Reach C – East Bank levee Phoenix to Bohemia (a)	Levee	Existing	20.5	+0.16	A 152
NOV-01a	Reach C – East Bank levee Phoenix to Bohemia (a)	Levee	Future	23.5	+0.16	A 152
NOV-01a	Bellevue PS	Structure	Future	24.0	+0.16	A 152
NOV-01b	Reach C – East Bank levee Phoenix to Bohemia (b)	Levee	Existing	19.5	-0.22	La Hache
NOV-01b	Reach C – East Bank levee Phoenix to Bohemia (b)	Levee	Future	22.5	-0.22	La Hache
NOV-01b	Pointe a la Hache-East (NOV- 15) PS	Structure	Future	25.5	-0.22	La Hache

New Orleans to Venice 2% Project Design Elevations Mississippi River West Bank – Federal Levee System						
Hydraulic Reach	Name	Type	Condition	Design Elevation (ft)		Notes regarding epoch change value
				NAVD88	Adjustment to NAVD88	
				2004.65	2009.55	
NOV-09	River Miles 46-44	Levee	Existing	18.5	-0.32	C 195
NOV-09	River Miles 46-44	Levee	Future	20.5	-0.32	C 195
NOV-10	River Miles 43-32	Levee	Existing	18.0	-0.39	MILAN 2
NOV-10	River Miles 43-32	Levee	Future	20.0	-0.39	MILAN 2
NOV-16	River Miles 31-26	Levee	Existing	18.0	-0.64	EMPIRE AZ MK 2
NOV-16	River Miles 31-26	Levee	Future	19.5	-0.64	EMPIRE AZ MK 2
NOV-11	River Miles 25-20	Levee	Existing	17.5	-0.79	H 370
NOV-11	River Miles 25-20	Levee	Future	19.0	-0.79	H 370
NOV-12	River Miles 19-11	Levee	Existing	16.5	-0.89 / -1.29	J 370 / 876 0849 A TIDAL
NOV-12	River Miles 19-11	Levee	Future	18.0	-0.89 / -1.29	J 370 / 876 0849 A TIDAL

## 7.0 CONCLUSIONS

The design elevations and levee slopes presented in this report for the New Orleans to Venice Project (and Non-Federal Levee Incorporation into the NOV Project) are the initial values determined from hydraulic analyses and form the baseline for detailed design. As was done for the Lake Pontchartrain and Vicinity and West Bank and Vicinity Projects, the designers will work with hydraulic engineers in an iterative process to prepare plans and specifications. To assure continuity of design methodology and provide close quality management, final design elevations utilized will be reviewed, approved and documented by the New Orleans District Engineering Division Chief of H&H Branch.

The design elevations and levee slopes presented in this report for the Lake Pontchartrain and Vicinity and West Bank and Vicinity Projects are the final values, unless design is still ongoing.

This report documents the process followed by the New Orleans District hydraulic engineers to determine these protection system design elevations. Design guidance has been prepared that incorporates the procedures described in this report. Continued evaluation of the tools, processes, and procedures used in the development of the design elevations and slopes is an important goal. With continued research, design guidance can be revised. The design guidance will be updated routinely.

The Conclusion and Recommendation chapter of the 2007 DER includes a discussion of areas that have been identified for further investigation. This discussion was not updated for inclusion in Version 2.0 of the DER.

Page intentionally left blank



## REFERENCES

1. ASCE One Percent Review Team (OPRT), Report Number 1 (31 May 2007).
2. ASCE One Percent Review Team (OPRT), Report Number 2 (30 July 2007).
3. IPET, Performance Evaluation of the New Orleans and Southeast Louisiana Hurricane Protection System, L.E. Link (editor), 2007.
4. Lynett, P. and Liu, P. L.-F., “A Two-Layer Approach to Water Wave Modeling”, Proc. Royal Society of London A. v. 460, p. 2637-2669, 2004.
5. Lynett, P., Wu, T.-R., and Liu, P. L.-F., 2002. “Modeling Wave Run-up with Depth-Integrated Equations,” *Coastal Engineering*, v. 46(2), p. 89-107.
6. Lynett, P. Personal Communication, 2007.
7. K.W. Pilarczyk, *Dikes and revetments*, 1998.
8. Resio, D.T., White Paper, Estimating Hurricane Inundation Probabilities. U.S. Army Corps of Engineers, ERDC-CHL, 2007.
9. Resio, D. T., Personal Communication, 2007.
10. Smith, J., Personal Communication, 2007.
11. TAW, Wave runup and overtopping at Dikes, Technical Report, Delft, 2002.
12. U.S. Army Corps of Engineers, Coastal Engineering Manual. Engineer Manual 1110-2-1100, U.S. Army Corps of Engineers, Washington, D.C., 2001 (in 6 volumes).
13. USACE/FEMA South East Louisiana Joint Surge Study Independent Technical Review (Draft report 15 August 2007).
14. U.S. Army Corps of Engineers, Risk Analysis for Flood Damage Reduction Studies, Engineering Regulation 1105-2-101, Washington, D. C, 2006.
15. U.S. Army Corps of Engineers, Policy Letter, Guidance on Levee Certification for the National Flood Insurance Program, 10 April 1997.
16. U.S. Army Corps of Engineers, Policy Letter, Guidance on Levee Certification for the National Flood Insurance Program – FEMA Map Modernization Program Issues, 23 June 2006.
17. U.S. Army Corps of Engineers, Shore Protection Manual, 1984.
18. U.S. 44 CFR 65.10(d) Federal Emergency Management Agency (Title 44 - Emergency Management and Assistance Chapter I - Federal Emergency Management Agency, Department of Homeland Security Subchapter B - Insurance and Hazard Mitigation Part 65 - Identification and Mapping of Special Hazard Areas 65.10 Mapping of areas protected by levee systems.
19. U.S. Army Corps of Engineers, Integrated Final report to Congress and Legislative Environmental Impact Statement for the MRGO Deep Draft De-authorization Study, 2007
20. Louisiana Coastal Area, Louisiana, Ecosystem Restoration Study report, 2004.

Page intentionally left blank