

Joint Officer Handbook (JOH)

Staffing and Action Guide



Joint Staff, J-7 JETD
3rd Edition
August 2012

This document is a training aid provided by the Joint Staff J-7 JETD as part of the Joint Staff Officer Project; the information included is from the combatant commands, joint publications, official websites of the Services, other cited government and public sources, and from individual research.

PREFACE

Today's joint environment is fast paced and demanding. To work effectively and meet the diverse demands facing our combatant commands, joint staff officers need to be able to quickly find, access, and apply information in the conduct of daily duties.

The Joint Officer Handbook (JOH) reflects input from serving action officers and senior leaders with the most current joint information available for managing staff activities. Included, as identified by senior leaders across the combatant commands, are competencies and behaviors of highly effective and successful joint staff officers, these provide a roadmap for career self-development.

For those new to the joint environment and staff assignments, the JOH provides guidance, tips and useful general information. It is designed to be practical, portable, and quickly accessible, as new joint officers learn about their command.

The JOH is derived from many sources and there is no monopoly on its content. This manual is for joint officers; we welcome input and recommendations for keeping it relevant. The POC for the JOH is the Joint Training Division, JS DDJ7, at DSN 668-5507 or commercial (757) 203-5507.

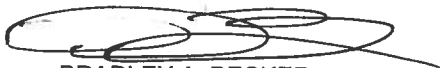

BRADLEY A. BECKER
Brigadier General, U.S. Army
Joint Training

(Intentionally Blank)

Table of Contents

Introduction.....	1
Section 1. Business and Professional Skills.....	5
1.1 Job Knowledge: Roles and Responsibilities of a Joint Staff Officer	5
1.1.1 The Model Staff Officer	5
1.1.2 The Joint Staffing Process (JSAP)	12
1.1.3 Combatant Command Internal Taskings.....	14
1.2 Developing Work Products	14
1.3 Time Management Requirements	18
1.3.1 Tools.....	18
1.3.2 Managing Daily Tasks	19
1.4 Analytical and Critical Thinking Skills	20
1.4.1 Problem Solving	20
1.4.2 Joint Staff Officer Critical Thinking Requirements.....	21
1.4.3 The Ideal Critical Thinker	22
1.5 Communicating Effectively at Executive Levels and Across a Diverse Workforce	27
1.5.1 Working with People.....	28
1.5.2 Effective Writing Skills	28
1.5.3 Effective Briefing Skills	31
1.5.4 Practicing Good E-mail Etiquette	32
1.5.5 Facilitating Effective Meetings.....	34
1.5.6 Working with the Public Affairs Office	36
1.6 Understanding the Combatant Command Workforce and Partner Relationships	43
1.6.1 United States Agency Partners	43
1.6.2 Interagency Partners	48
1.6.3 The National Guard and Reserves.....	56
1.6.4 Multinational Partners.....	61
1.6.5 DOD Government Civil Servants - General Schedule (GS)	63
1.6.6 Working with Government Contractors	64
1.6.7 Working with the other Services.....	67

1.7	Maximizing Technology Software and Hardware Capabilities in the Combatant Commands.....	70
Section 2. Interpersonal Skills Requirements.....		79
2.1	Building Constructive Work Relationships in a Joint Environment.....	79
2.2	Teambuilding	81
2.2.1	Principles of Teamwork	81
2.2.2	Commander's Decision Cycle	87
2.3	Coordinating with other Directorates	89
Section 3. Joint Military Knowledge.....		93
3.1	Foundational Joint Knowledge	93
3.1.1	Organization for National Security.....	93
3.1.2	The National Intelligence Community	103
3.1.3	Department of Defense Organization.....	107
3.1.4	The Joint Staff	111
3.1.5	A Traditional Combatant Command Joint Staff Organization	126
3.1.6	Planning, Programming, Budgeting and Execution System (PPBES)	128
3.1.7	Types of Appropriations	130
3.1.8	Joint Strategic Planning System (JSPS)	132
3.2	Joint Publication System	138
3.3	Joint Logistics	141
3.4	Understanding the Organizations and Missions of the Combatant Commands.....	146
3.5	The Unified Combatant Commands	151
3.5.1	United States Africa Command (USAFRICOM).....	153
3.5.2	United States Central Command (USCENTCOM).....	158
3.5.3	United States European Command (USEUCOM).....	165
3.5.4	United States Northern Command (USNORTHCOM)	170
3.5.5	United States Pacific Command (USPACOM)	177
3.5.6	United States Southern Command (USSOUTHCOM)	186
3.5.7	United States Special Operations Command (USSOCOM).....	193
3.5.8	United States Strategic Command (USSTRATCOM)	212

3.5.9	United States Transportation Command (USTRANSCOM).....	221
3.6	Authorities and Legal Requirements Affecting the Combatant Commands	229
3.6.1	Code of Law of the United States.....	230
3.6.2	Foreign Disclosure and Classification of Information ..	230
3.7	Knowledge, Organization, Capabilities and Business Practices of the Services	234
3.7.1	The Department of the Army	234
3.7.2	The Department of the Navy	238
3.7.3	The Marine Corps.....	245
3.7.4	The Department of the Air Force.....	248
3.7.5	The Coast Guard.....	250
3.8	Effective Participation in Exercise Preparation and Planning ..	253
3.8.1	Joint Training Overview.....	253
3.8.2	Joint Training System (JTS) Overview	258
	Section 4. Critical Mission Areas for the 21st Century	265
4.1	Civil Support	265
4.2	Foreign Humanitarian Assistance	270
	Section 5. Lifelong Learning	275
5.1	Joint Officer Development	275
5.2	What is lifelong learning?	276
	Section 6. Useful Support Information and References	283
6.1	Commander's Critical Information Requirements Process	283
6.2	Acronyms and Abbreviations.....	286
6.3	Glossary of Terms	303
6.4	Comparative Ranks: Services and Government Civilians.....	352
6.5	Index	361

List of Figures

Figure 1:	Joint Staff Action Package Workflow	13
Figure 2:	Critical Thinkers Elements of Reasoning and Intellectual Standards.....	24
Figure 3:	National Guard Bureau Relationships	56
Figure 4:	Example B2C2WG.....	85
Figure 5:	Commander's Decision Cycle.....	88
Figure 6:	Organization for National Security	103
Figure 7:	The Department of Defense Organization Structure	108
Figure 8:	Office of the CJCS	110
Figure 9:	VCJCS Special Staff.....	111
Figure 10:	Joint Staff Organization	114
Figure 11:	J-1 Manpower and Personnel.....	117
Figure 12:	J-2 Intelligence.....	118
Figure 13:	J-3 Operations	119
Figure 14:	J-4 Logistics	120
Figure 15:	J-5 Strategic Plans and Policy	121
Figure 16:	J-7 Joint Force Development.....	123
Figure 17:	J-8 Force Structure, Resources, and Assessment	124
Figure 18:	Organizations Reporting to the Chairman of the Joint Chiefs of Staff	125
Figure 19:	A Traditional Combatant Command Joint Staff Organization.....	126
Figure 20:	PPBES—Acquisition System.....	129
Figure 21:	Typical PPBES Annual Cycle	129
Figure 22:	Joint Strategic Planning System Roles.....	133
Figure 23:	Joint Strategic Planning System	136
Figure 24:	Joint Publication Hierarchy	138
Figure 25:	Joint Core Logistics Capabilities.....	142
Figure 26:	Combatant Command Reporting Organization	146
Figure 27:	Geographic Combatant Commanders' AORs	147
Figure 28:	Chain of Command and Control	149
Figure 29:	Combatant Command Information.....	151
Figure 30:	Combatant Commands and CCSAs.....	153

Figure 31: USAFRICOM HQ Organization	156
Figure 32: USCENTCOM Command Relationships	160
Figure 33: USCENTCOM HQ Organization	162
Figure 34: USEUCOM Command Relationships	166
Figure 35: NORAD and USNORTHCOM Organizations	172
Figure 36: NORAD and USNORTHCOM Command Relationships	173
Figure 37: USNORTHCOM Headquarters Organizations	173
Figure 38: USPACOM Command Structure	179
Figure 39: USSOUTHCOM Command Relationships	188
Figure 40: USSOUTHCOM Internal Organization	191
Figure 41: USSOCOM Headquarters	194
Figure 42: USSOCOM Missions and Collateral Activities.....	195
Figure 43: USSOCOM Command Relationships	198
Figure 44: USSOCOM Component Organizations	199
Figure 45: USSTRATCOM UCP 2011 Responsibilities.....	213
Figure 46: USTRANSCOM Command Relationships	222
Figure 47: USTRANSCOM Internal Organization.....	225
Figure 48: The Joint Training System	258
Figure 49: Joint Event Life Cycle	262
Figure 50: Knowles' Lifelong Learning Competencies.....	280
Figure 51: Commander's Critical Information Requirements Process	284

(Intentionally Blank)

Introduction

Welcome to the joint staff officer community! This training handbook is aimed at helping you, the incoming joint staff officer, learn the basics of joint staff work, and quickly and effectively assimilate into your new environment. Each of the combatant commands recognizes that without proper training the learning curve for incoming joint staff officers is extremely long.

This handbook—the Joint Officer Handbook (JOH)—has been designed to accomplish three important objectives:

- Reduce the learning curve of staff officers before and immediately upon arrival.
- Help staff officers develop a baseline of knowledge of each core competency deemed essential to staff officer job requirements.
- Provide a reference guide for use during the joint assignment.

As you use this handbook you will see the terms Joint Staff Officer (JSO), Action Officer (AO), and Staff Officer (SO) used interchangeably. All JSOs are not action officers, but all joint military AOs are JSOs; some government civilians, interagency representatives, and multinationals also serve in action officer roles throughout the combatant commands. The term staff officer is used as an informal term for both joint staff officers and joint action officers. The primary focus of this handbook is toward the action officer responsibilities for managing actionable taskers and all the associated related activities.

In March 2006, the Joint Staff and the combatant commands undertook an initiative to identify the requisite competencies for staff officer positions and to devise practical solutions to decrease the time between their arrival and when they are able to effectively perform their duties. This initiative commenced with a thorough study of numerous staff officers and leaders from all combatant commands. As a result of the findings and the recommendations of experts in joint training, fifteen core competencies have been identified as crucial to the success of joint staff officers. The Joint Officer Handbook focuses on both the joint content knowledge and the business and professional skills a joint staff officer needs to succeed. The joint competencies identified here are those applicable to and required of joint staff officers worldwide. For

AOs to be successful, according to senior leaders, effective business and professional skills are equally, if not more important than military operational knowledge.

Combatant commanders require that joint staff officers be proficient in the following core competencies:

- **Competency #1:** *Understand the role(s) of a joint staff officer and perform work requirements consistently at a high level of proficiency;*
- **Competency #2:** *Understand the organization and missions of the combatant commands;*
- **Competency #3:** *Exhibit joint and command-level mindset and knowledge and apply them to all work products and services;*
- **Competency #4:** *Be highly knowledgeable of his/her Service organization, capabilities, and business practices;*
- **Competency #5:** *Be knowledgeable of authorities and legal requirements affecting the combatant commands;*
- **Competency #6:** *Be knowledgeable of U.S. Government Agencies (State Department, Department of Justice, Department of Homeland Security, Department of the Treasury, etc.) and cognizant of their relationships with the combatant commands;*
- **Competency #7:** *Write, read, and conduct research at an advanced level appropriate for work in an executive environment;*
- **Competency #8:** *Use well-developed strategic and higher order critical thinking skills for task assignments and problem solving;*
- **Competency #9:** *Exhibit excellent time management skills;*
- **Competency #10:** *Communicate effectively at executive levels and across a diverse workforce;*
- **Competency #11:** *Build constructive work relationships;*
- **Competency #12:** *Effectively manage and lead in a diverse work environment (civilians, contractors, Guard and Reserve, Service Components personnel, interagency and multinational personnel);*
- **Competency #13:** *Maximize technology software and hardware capabilities;*
- **Competency #14:** *Effectively participate in exercise preparation/planning; and*
- **Competency # 15:** *Practice lifelong learning behaviors.*

The JOH is divided into six general categories that provide supporting information for the fifteen competencies:

1. General Business and Professional Skills
2. Interpersonal Skills
3. Military Knowledge: Joint- and Service-Specific
4. Critical Mission Areas for the 21st Century
5. Lifelong Learning Skills and Behaviors
6. References and Supporting Information

Throughout the process of developing this program, senior leaders have consistently pointed out that both the quality and proficiency of lifelong learning skills have a significant effect on the success of a staff officer's ability to manage tasks in a combatant command; if the lifelong learning skills are well developed, the incoming staff officer can focus on learning the combatant command-specific information and the joint knowledge needed to manage daily tasks. Additionally, senior leaders say that staff officers need to fully understand and accept the requirements of the job. One of the first steps to success is for joint staff officers to fully understand what is expected of them, and to then learn and apply the correct skills and knowledge to meet or exceed expectations.

The JOH is provided to help facilitate your transition into the joint world. Although this 3rd edition is being provided only in an electronic version, it can also be printed and put in a small binder to fit into a briefcase, lay out on a desktop, or be carried in a large pocket. You are encouraged to download your own copy and add to the content—new chapters, samples, charts, maps, point of contact information, etc.—to keep it current for your needs, tailored to your job, and readily passed on to your successor.

The Joint Training Facilitator Specialist (JTFS) in your command's training directorate will be the primary local point of contact for collecting information for the annual update and distribution of the JOH. You are encouraged to provide feedback, suggestions, updates and new content for future editions through your JTFS or by calling the Joint Staff J-7.

(Intentionally Blank)

Section 1. Business and Professional Skills

It is important for joint staff officers to understand the job—the role and the requirements—and to perform work requirements consistently at a high level of proficiency. In most cases, joint staff officers are not subject matter experts; rather, they are information integrators. They must be able to effectively find and condense masses of information into manageable packages for review by and decisions from senior leaders.

1.1 Job Knowledge: Roles and Responsibilities of a Joint Staff Officer

1.1.1 The Model Staff Officer

Identifying competencies that both leadership and staff officers themselves see as important for meeting strategic goals helps define a job profile. Both senior leaders and staff officers identified the following requirements:

Staff officers must first develop a solid understanding of the role and work requirements of a joint staff officer before they can become proficient at it.

They need to think in terms of broader objectives, without always focusing on their own functional areas. They need to develop and foster strong interpersonal relationships with other combatant command counterparts. They need a solid understanding of what questions a staff officer needs to ask, and then be capable of responding to taskers rapidly with an all-encompassing approach. They need to understand that their function is to identify a problem, analyze it, identify Courses of Action (COAs) and make recommendations suitable for the General Officer/Flag Officer (GO/FO) level. One of the foundational skills needed is a good knowledge of the staffing process and the ability to construct a staffing package for submission to the chain of command. Joint staff officers need to focus on the quality of the package as well as the technical content rather than resorting to quantity of information included.

Staff officers must find and use accurate joint knowledge for working at the combatant command level.

They need broad knowledge of joint doctrine; processes and procedures; an understanding of the U.S. Interagency (IA) and Non-Governmental

Organization (NGO) processes; and a better understanding of all phases of military planning, mission analysis, and operations from a strategic perspective. Knowledge of national-level guidance and how it relates to their job is essential. Since most staff officers at this level participate in some way in building budgets and submissions for funding, knowledge of the Planning, Programming, Budgeting and Execution System (PPBES) is important.

Staff officers need a general understanding of the Service components—missions and roles, how things are accomplished, Service component perspectives and procedures—and a thorough understanding of the Joint Staff. Command relationships with other U.S. government agencies are both dynamic and complex; as such AOs should develop a good working knowledge of the missions, cultures, and products and services of those agencies represented within their respective combatant command. For those officers serving in the geographic combatant commands, an understanding of regional issues, host nation concerns, economic impacts, and multi-national/cultural assessments is important, as well as Area of Responsibility (AOR) experience and cultural understanding.

Joint staff officers should also understand the linkages between operational art and strategy, and align staff work with senior leaders' guidance and perspectives.

Staff officers are required to use well-developed and varied interpersonal communication and collaboration skills. Improved knowledge management and information sharing is essential for continuity of operations. Effective interpersonal communication skills are essential when working in a combatant command, especially when the combatant command is serving in a supporting role. Collaborative teamwork across directorates is key; it requires that staff officers get away from desks and e-mails to meet face-to-face with their counterparts in order to build networks with other directorates and other command partners, and generate more frequent cross-talk. Keeping fingers on the pulse of the command helps provide horizontal integration/synchronization, which is key for coordinating taskers. A willingness to share information and seek different perspectives from AOs within other divisions/directorates helps develop the best joint solutions to combatant command challenges.

Staff officers require a good understanding of the ramifications of working in a diverse workforce. Staff officers must be cognizant of the various organizational cultures when managing and leading a

diverse workforce that includes active duty, reserve, civilian, contract, interagency, and multinational personnel. They need a solid knowledge of the civilian personnel system and the contractor regulations and their impact on accomplishing the mission.

Joint Staff Officers—particularly those assigned to the combatant commands—require a well-rounded understanding of geo-politics and geo-strategic issues within the commander’s area of responsibility. Military actions are only one pillar of options within the political process. Staff officers should be aware of how their actions fit within the larger scheme of influences within an AOR and within the U.S. government’s strategy. Also, few if any military actions will be unilateral in the 21st Century, and joint officers should understand the relationship with other actors, such as NATO, the United Nations, and combatant commands that border their own AOR.

Staff officers need business skills to adequately address task requirements. Working in a joint environment requires advanced writing and speaking/presentation skills, exceptional organizational and prioritization skills, the ability to quickly and properly classify documents, and high proficiency in software and collaborative technologies. Products for consumption in the joint world need to be strategically focused.

Because of the quantity and complexity of issues, staff officers have to pay attention to a myriad of details; they must avoid incomplete staffing, overlooked issues and lack of coordination with directorates/offices. Working in a combatant command requires confidence in making decisions, taking a more questioning position to ascertain the most appropriate decision recommendation, and the willingness to not readily accept the first answer from someone—analysis and logical thinking are critical to successful completion of task assignments.

Personal Attributes, Abilities, and Attitudes of the Model Staff Officer. Skills and knowledge alone are not enough. It is important to identify the attributes, abilities, and attitudes which make people successful; how skills and knowledge are applied may at times be more critical to success than the proficiency of skills and the degree of subject knowledge. The list below describes the attributes, abilities, and attitudes senior leaders describe as characteristic of highly effective and proficient joint staff officers:

- ***Maintains objectivity and sees the big picture.***

- ***Is adaptable to any situation***—open minded, flexible, resilient, and very adaptable to change.
- ***Is dynamic, with an outgoing personality***—has a great sense of humor and uses it effectively; not so serious with self; has an infectious positive attitude; is able to get along with everyone; knows when and how to have fun without compromising character.
- ***Is professionally focused and career-minded.***
- ***Is self-assured/self-confident.***
- ***Exhibits a high degree of character***—trustworthy, ethical, truthful, and reliable; is loyal, dependable, and morally sound; exhibits honor and moral courage.
- ***Is intelligent, bright, articulate, and mentally agile.***
- ***Is conscientious/detailed/patient.***
- ***Is candid/forthright.***
- ***Uses common sense.***
- ***Is even tempered/level-headed***—not easily angered or flustered; calm under pressure; separates passion from emotion.
- ***Is selfless, modest; checks ego at the door—“doesn’t care who gets the credit” attitude.***
- ***Is sincere, thoughtful, and polite; treats people with respect; has a caring attitude.*** Shows maturity and perspective leading to empathy of the other side.
- ***Maintains balance in life***—work, mission, family, and friends; has spiritual, physical, emotional, and social support to withstand a demanding lifestyle.
- ***Outstanding physical and mental stamina; is energetic.***

Some attributes, abilities and attitudes may be difficult or impossible to teach (for example, common sense), but it is important to cite them in order to provide a full picture of the elements of success. Most of these can be taught, fostered, encouraged, and rewarded and are similar to those characteristics encouraged by the Services.

The best staff officers can anticipate leaders’ requirements and they understand the mission from the boss’ perspective. They keep well-informed by reading professional journals, keep tabs on the Commander’s Critical Information Requirements (CCIRs), keep abreast of breaking news relating to the joint community (e.g., reading the Early Bird, a Department of Defense (DOD) publication: <http://ebird.osd.mil/>), develop a working knowledge of joint publications, and use combatant-command specific knowledge management tools.

According to the Joint Transition Course, taught at the Joint Forces Staff College, “the size, roles, and complexity of a combatant command require a large staff to support the commander with the thousands of required details and decisions for daily operations.” It is the staff’s job to provide information, advice, and recommended courses of action for a broad variety of topics so that the command team can make decisions. To accomplish this, staff officers must:

- **Learn the commander’s policies** and work within them;
- **Keep the commander informed** of pertinent information;
- **Develop** basic decisions into **adequate plans**;
- **Anticipate future needs** and **draft tentative plans** to meet them;
- **Translate plans into orders**, and transmit them to subordinate commands;
- **Ensure compliance** with these orders through constructive inspection and observation; and
- **Supplement the commander’s efforts to ensure unity of effort** throughout the command.

The Joint Staff and senior leaders within the combatant commands rely on staff officers for military advice. They expect AOs to speak up and give advice based upon their knowledge and experience and to know where to go within their respective Service components and/or command organizations for required information.

For each task, a staff AO is responsible for:

- Developing, coordinating, and completing the required analysis,
- Formulating recommended courses of action,
- Presenting the courses of action for guidance and decisions by leadership,
- Preparing correspondence for implementing the decision.

Responsibility for a task ends only when the correspondence has been distributed or when leadership decides that no further action is required.

The 2008 Joint Staff Officer Study identified that effective staff officers practice certain behaviors on a daily basis. A good staff officer anticipates requirements well in advance. In order to do this, a staff officer needs to be knowledgeable of the combatant command’s missions, roles, and responsibilities and have a thorough understanding of his or her directorate’s role in achieving them. Also, a

good staff officer learns **how and when** to keep his or her supervisor informed. A staff officer learns how to do this in three ways: (1) directly asking the supervisor the preferred methods for keeping him or her informed; (2) asking experienced peers and colleagues; and (3) by observing the activities of leadership and other staff officers. Effective staff officers have the ability to pick up on the boss' comment and run with it without formal tasking.

For managing tasks effectively and efficiently on a daily basis, staff officers seek to:

- First, understand what senior leaders need at a ***strategic level*** for tasks, and then use the appropriate format, method, or approach to deliver the final products.
- **Understand the need-to-know**—who should and should not be included for a tasker to be finalized.
- **Understand the commander's intent** and the mission from his or her focus.
- Answer the requirement **before** it ends up in the in-box.
- Remain dedicated and focused on **mission accomplishment**.
- Maintain **situational awareness**.
- Present concise, succinct information and provide solid recommendations to decision makers (**Issue + courses of action + recommendations**).

Outstanding AOs distinguish themselves because they are able to express thoughts clearly (orally and in writing); cultivate a network of contacts, experts, and advisers; have developed mastery of their computer tools; understand the action process; and are extremely knowledgeable of the organization and how to move information through it.

Senior officers depend on staff officers to keep them informed, and to form well-reasoned and defensible positions and recommendations. Successful staff officers report that anticipating requirements and final objectives helps avoid surprises. They clearly define what is needed, ask for input from others in a timely manner, and have a clear understanding of the end results. They must also take the lead on an issue, thoroughly research proposed courses of actions, and provide multiple solutions/recommendations to senior leadership.

In some cases, staff officers inherit complex and on-going tasks from their predecessors and sometimes a task received or inherited cannot be successfully closed during a current tour. In these cases, accurate

documentation and the development of readily-accessible archives are essential.

Often a staff officer is the lead on an action for which he or she is junior in rank to the people needed to provide action or input. Rank should not be an issue when working through a task. In these cases being the lead means you, individually, are responsible for the successful processing of that particular task. Successful staff officers take personal ownership of a task from initial assignment completely through to conclusion.

Staff officers are constantly working under competing priorities, and there is rarely time to get everything completed as fast as others want. Staff officers have to be cautious to not overextend promises to complete everything in requested time frames. They must make choices about what is most important or critical for the command mission and then use time and efforts where they will have the most impact. It is imperative that the staff officer keeps his or her supervisor informed of these scheduling conflicts and resolves them to the satisfaction of the chain of command.

Objectivity is key for a staff officer in seeking solutions to problems—the obvious solution may not be the correct solution. As the Joint Forces Staff College (JFSC) Pub1, *The Joint Staff Officer's Guide 2000*, points out, “gut feeling,” though not a formally recognized methodology for problem-solving, can be a valuable asset in staff work. Analytical methods and automated systems are tools that help to present data related to the problem, but people must make the final decisions. Unquantifiable factors must be considered including law, morals, ethics, aesthetics, politics, culture, and history that can have a significant impact on courses of action, and may play an important role in the final decision.

The staffing process is based on communication, coordination, and collaboration. Sometimes “No” is an interim response, so if you are unable to meet a suspense date, request an extension. Staff officers can create channels for open communication by:

- Asking for a back brief on meetings not attended;
- Keeping your supervisor informed continually—actions move too fast to wait until it is convenient;
- Knowing when issues need to be worked out face-to-face and following through;
- Following up with your peer AOs and other points of contact;

- Keeping notes in the action folder on issues affecting each tasking package.

Some common mistakes to avoid include the following:

- ***Presenting an opinion as policy***—An AO is a part of a staff and a staff operates as a team;
- ***Mixing classified and unclassified documents***—Pay close attention to the guidelines for handling classified documents;
- ***Forgetting that email and internet use are not private;***
- ***Failing to thoroughly staff an action;***
- ***Failing to complete an action by the suspense date or when necessary, obtaining an extension to the suspense date.***

Senior leaders identified the following time management behaviors and activities the exceptional staff officer consistently demonstrates:

- Understands time and uses it effectively;
- Understands the timing requirements of staff work and coordination;
- Successfully manages multiple tasks;
- Gets the job done on time, completed accurately;
- Exhibits flexibility in selecting approaches, is not rigid or didactic;
- Adjusts personal experiences to other paradigms;
- Manages ever-changing requirements;
- Thinks and adapts quickly to unforeseen requirements, tasks, and research outside area of expertise;
- Is detail-oriented, and follows through to completion of task;
- Maintains the flexibility to change course if the situation requires;
- Prioritizes tasks to meet work requirements;
- Archives important information for ready access;
- Uses tools and technologies well for managing work activities.

1.1.2 The Joint Staffing Process (JSAP)

A prime responsibility of AOs is to work action packages using a tasking management system—either the Joint Staff Action Processing (JSAP) system in the Pentagon or the command-selected tasking management tool within each CCMD. AOs develop executive summaries, letters, memoranda, and other documents in response to taskings from the Joint Staff and/or CCMD leadership and they then

coordinate actions among directorates, Services, combatant commands, and government organizations. Figure 1 shows the flow of a tasker once a staff officer receives it.

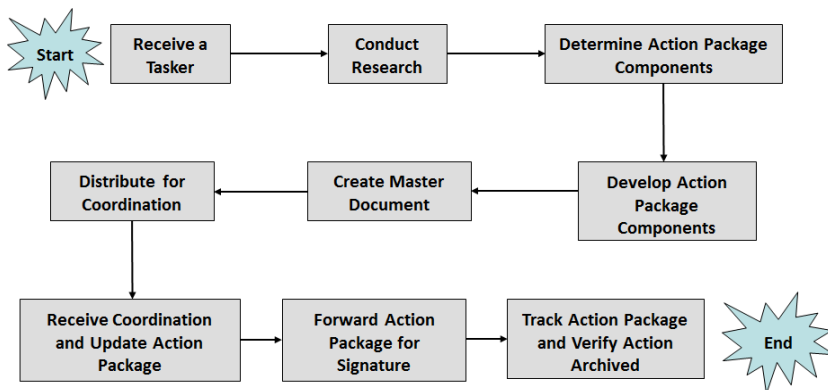

Figure 1: Joint Staff Action Package Workflow

Actions require one or more directorate’s position or response to issues or questions originating with the SECDEF, the general public or other government, military or civilian organizations.

Action Packages are electronic folders containing documents pertinent to the action. A package typically consists of the documents that initiated the action and the documents that respond to the action. There are four basic types of action packages:

- **SJS (Secretary Joint Staff)** packages are actions requiring a response from the Joint Staff Top 5 (CJCS, VCJCS, ACJCS, DJS, or VDJS.) or the designated top leaders within each combatant command. For the Joint Staff the Assignment and Control Branch is responsible for creating electronic action folders and assigning these actions to the appropriate J directorate for response. SJS packages will always include: (1) a tasker; (2) an electronic .pdf or .tif file containing information to include the subject of the action, suspense date, and any original letters, memoranda, or messages addressed to the target command leaders.
- **J Directorate (Joint Directorate)** packages are initiated within a directorate. Directorate Executive Officers (XOs) (also called MilSecs) are responsible for creating electronic action folders for these actions at the request of Action Officers or Division Chiefs.

- **CPC (Chairman’s Public Correspondence)** packages are actions that require a CJCS response to a letter or inquiry from the general public. The CPC Branch typically responds to these actions, although input from Action Officers may sometimes be necessary. Within your combatant command check with your SJS to determine what group is responsible for the CCDR’s public correspondence.
- **FOIA (Freedom of Information Act)** packages are responses to requests made by the public for documents produced by a federal agency. For the Joint Staff, these requests are usually addressed to OSD who then assigns cases with Joint Staff equity to the FOIA Branch of the Information Management Division (IMD). IMD and Joint Staff Directorates review the documents making release/redaction recommendations in accordance with the FOIA, Executive Order 12958, as amended, and the Privacy Act, as applicable. Once completed, the packages are returned to OSD for other agency concurrences or released to the requestors. Within your combatant command check with the SJS to determine how to handle FOIA packages.

1.1.3 Combatant Command Internal Taskings

The majority of the taskers an AO works will be internal combatant command actions. Each combatant command has a Secretary Joint Staff (SJS) in charge of the staffing process who determines command-specific tasking processes and requirements. All of the combatant commands provide some initial training on the command-specific tasking management tool, internal staffing processes, required formats and templates—all of which differ from those of the Joint Staff. Additionally, most combatant commands have some form of an Action Officers Guide which provides command-specified instructions and formats and is stored on a local directory.

1.2 Developing Work Products

The majority of your time will be spent providing information in written form—predominantly staff action papers and related briefings. Combatant commands usually have AO tool kits on line with forms and templates. Check with your directorate to identify format requirements for each type of product. Compiling a sample book of accepted formats within your command will be time-saving. However, formats change over time, so ensure the format you are using is the most up-to-date.

Although there are a broad variety of products AOs may be required to create some of the most typical staff action products, such as: information papers, discussion or position papers, coordination papers, decision papers, staff studies, letters, messages, and estimates. A brief description of each follows.

Information Papers: used to pass information up the chain of command, to pass information between staff offices when no reply is expected, and to issue directives to directors and chiefs of special staff offices. The three most common types are:

- **Fact Sheet:** a one-page document for a rapid update on a specific topic with which the user is familiar; used to update the combatant commander returning from trips, furnish material for a Congressional hearing, submit material for briefing books for a trip, or answer a query.
- **Memorandum for the Record:** a one-page document used to record an event or action taken which would otherwise not be recorded, such as meeting minutes, a telephone conversation, or a one-time information source.
- **Memorandum:** normally one-page; enclosures (e.g., itineraries, schedules) may be attached; usually are informal notes to individual staff members as part of routine business.

Discussion or Position Papers: short outline guides for discussions during consultations, meetings, and command visits; often substantiate the command position, opposition to other command views, questions, or any other material potentially useful in discussions. Typically the Joint Staff recognizes three types of discussion or position papers in their internal processes:

- **Position Paper:** summarizes an issue (including its status, any recommendations), in simple, narrative style using direct, active voice; no more than two pages long; the knowledge level of the intended user should determine the level of detail provided;
- **Talking Paper:** is prepared in “bullet” format, primarily as a guide for discussions for an audience familiar with the subject;
- **Information Paper:** conveys information in preparation for a meeting or briefing; facts are to be presented in clear, concise wording using “tick” and “bullet” format.

The combatant commands use four general categories of discussion or position papers:

- **Point Papers:** often used as guides in discussions outside the command; should not exceed two pages, with a preferred

abbreviated sentence structure, often compiled into books for use during trips, command visits, discussion with visitors, and conferences;

- **Position Papers:** present the command position on unresolved issues, with necessary background information to justify that position and to refute contrary views; may include a talking paper as an enclosure to assist the user if a discussion is anticipated;
- **Discussion Papers:** often prepared for subjects for which discussion could be initiated to obtain views or decisions, extend a recommendation, emphasize a command position, or other appropriate reasons; a good discussion summary advises the commander about the discussion objectives, subjects to avoid, and the recommended position to take;
- **Background Papers:** provide chronological background data, current status, and actions to be accomplished for a particular problem or subject; often used as backup and background material for members of the command group and staff at meetings and conferences, and during visits; if practical, should be limited to one page using a condensed outline style, rather than complete sentences and paragraphs to achieve brevity and clarity; enclosures or tabs may be included to provide additional information.

Coordination Papers: used to coordinate routine actions within the staff:

- **Summary Sheets:** means of communicating with the various elements of a staff. The Joint Staff uses Form 136, Joint Staff Action Processing Form, a specialized summary sheet indicating the level of staff and Service coordination that has taken place for the accompanying action paper. Each of the combatant commands uses its own summary sheet; check with your SJS.
- **Staff Summary Routing Sheets:** standard multipurpose forms that serve as referral slips, memoranda, summaries of action, and permanent records of the internal coordination on an action. Action papers are often forwarded under such sheets, as are copies of routine correspondence submitted for information.

Summary and Staff Summary Routing Sheets are usually processed electronically; although some taskers may be assigned person to person, staff officers establish an electronic trail such as emails, appendices and attachments.

Decision Papers: used to present staff recommendations for decision and/or formal approval:

- **Summary Sheets:** (generic) must clearly state the problem or action requiring decision, the limitations affecting the solution, logical courses of action that could be followed, effects of the various courses of action, and the recommended action to be taken; must include the substantive points necessary to reach a logical decision without excessive recourse to enclosures or the study they summarize.
- **Action Summaries:** memoranda, preferably no more than one, single-spaced page that accompany correspondence or messages to be signed or released; contain the problem, facts, discussion, and conclusions. A recommendation drawn from the attached correspondence or message is clearly stated as the last element.

The Staff Study: a formal paper following a prescribed format, primarily used for administrative and managerial problems where operational considerations are not immediately involved; lists conclusions and recommendations on a specific, clearly stated problem; follows a general problem solving process; develops an analysis of a problem, leading to recommendations for its solution.

Letters: often the recommended action; is attached to a decision paper for approval, signature, and dispatch.

Messages: some actions may recommend dispatching a message, which may be transmitted electronically, or by mail or courier, depending on requirements for speed of delivery and security. Precedence categories indicate the relative order in which a message is processed in the telecommunications system and the speed with which it must be handled during internal headquarters processing. MIL-STD-6040, Department Of Defense Interface Standard: United States Message Text Formatting Program, provides the details and process for sending messages.

Estimates: when there are no clear or feasible solutions to an identified issue, the commander needs the best available estimate of how to proceed—and often must have it in a short time. For these situations the estimate of the situation, the operational counterpart to the staff study may be called for. It has two distinct categories: the Commander's Estimate (of the Situation) and the Staff Estimate. Joint Publication 3-0, Joint Operations, Appendix B; Field Manual (FM) 101-5, Staff Organization and Operations; and JFSC Pub 1, The Joint Staff

Officer's Guide, Chapters 4 and 5 provide specific details for preparing estimates. (Ref: JFSC Pub 1)

1.3 Time Management Requirements

Staff officers sometimes have a difficult time understanding there is no administrative support for their job—you are responsible for every aspect of managing each tasker assigned and for providing accurate and timely input to other personnel for the taskers being managed. One of the most significant aspects of staff work is the constant demands on a staff officer's time. Work time will be devoted to research and writing, preparing and presenting briefings, attending or facilitating meetings, and coordination of taskers. Although you may have little control over the pulls on your time, excellent organizational skills, self-management, and expert use of technical tools will help your productivity. Because the types and pace of work and the level of response required may be different from your prior experience, the following tips may be helpful.

1.3.1 Tools

Microsoft® is the standard suite of tools used for staff work—particularly Outlook, PowerPoint, Word, and Excel. The better you can use these tools, the more efficient you will be. Even if you think you already have good skills, the more mastery you have, the better your time management/productivity will be. Check with your post/base Microsoft® training group to take a Microsoft® proficiency test. Taking a refresher or update course either prior to or immediately upon arrival will help make your transition easier.

Other joint-specific technology systems may be required in your job—some you may use often and others infrequently. Check with your supervisor early in your assignment to identify what systems you will be required to use on a regular basis and see if training is available, if you must learn from your peers, or if you must learn by yourself. Become familiar with video-teleconferencing and any Personal Computer (PC)-based communication tools, shareware, and combatant command directories where information is stored. Make a special effort to learn your tasking management system early in your assignment. Try to improve your skills on the systems or get formal training before it becomes task-critical.

1.3.2 Managing Daily Tasks

The pace of daily work is rapid and the volume of tasks to manage is significant. Developing your time management skills will help you significantly in the execution of assignments. The following are some tips for you to consider:

- **Know your most productive time of the day.** Are you a morning or an afternoon person? When possible, approach your most complex and most mundane tasks during your peak period when your focus is best.
- **Prioritize your tasks.** One way is to use the ABC approach to prioritize each task: “A” for As Soon As Possible (ASAP)—highest priority, must do now; “B” for burning, but not yet critical; “C” for can do later. Your priorities may change several times during the day—just recode work and follow through. Often, senders will label every task as critical; you must use a triage approach to determine those which are the **most** critical—Are they time sensitive? Mission critical? Leadership sensitive?
- **Develop a well-organized approach to managing tasks using Microsoft® Outlook.** Take time to file electronic documents and e-mails to appropriate folders as you complete a stage for each task.
- **Keep e-mails as brief as possible and copy only those who need to be included.** This should reduce the number of e-mails you receive in return. File only those e-mails needed for legal or tracking purposes in related folders.
- **Use the phone to reduce the number of e-mails for yourself and others.**
- **Delete extraneous versions of documents.**
- **Create two reading folders**—one for electronic journals, articles, research; and one which is portable for paper—journals, print-outs, articles, etc. Try to set aside an hour or two during each week for your professional reading.
- **Find your best ways to manage stress and practice them.** For some, physical training helps thinking processes and reduces stress. For others finding a quiet place to relax even for 10 minutes is helpful. Reasonable breaks can help you be more productive and reduce errors.
- **Using a timer** (e.g., your watch alarm) **helps focus, pacing, and development of task standards.** For example, spend the first 15 minutes of the day setting a priority list, an hour working on your most critical task, then the next hour for e-mails, etc. Develop a routine that best helps manage workflow.

- **Beware of the perfectionist syndrome;** sometimes the 80% solution is sufficient.
- **Set a time and the criteria for decision-making** for taskers, and then follow through.
- **Treat your work as a project.** If you have access to Microsoft® Project or other project management tools, they can be helpful in tracking multiple elements of a job. Although these tools require training and constant updating, they can be very helpful in the organization, prioritization and tracking of taskers.

Other staff officers have recommended two widely-used books for your personal library, Dr. Ken Blanchard's One Minute Manager, and Stephen Covey's 7 Habits of Highly Effective People.

1.4 Analytical and Critical Thinking Skills

Joint staff officers need to be adept at analyzing situations and applying appropriate problem-solving skills in order to provide organized, coordinated, and well thought-out inputs to questions and taskings. Staff officers who understand the combatant command's strategic mission logically place task assignments in context and identify courses of action that will more effectively meet the goal to provide sound solutions. Staff officers need to be able to accurately analyze their workloads to determine priorities by importance; to frame each problem in context; and to answer the "who, what, when, where and why" questions.

1.4.1 Problem Solving

The traditional six-step problem solving process is used in all types of professional organizations:

1. Identify and clarify the problem to be addressed;
2. Analyze the problem and its causes;
3. Identify and assess ramifications of potential solutions;
4. Select and plan the solution;
5. Implement the solution;
6. Evaluate: Was the Problem Solved?

Many problem-solving techniques exist—far too many to list here. Some of the most widely used include:

- **Brainstorming:** a group technique designed to generate a large number of ideas for solving a problem or addressing an issue.

- **Systems Thinking:** an approach that looks holistically at a problem. How does this one problem impact the entire organization? What are the ramifications of each proposed solution on the organization?
- **Cause and Effect Diagrams:** combines brainstorming with a concept map (Fishbone and Ishikawa charts). The four major steps include (1) writing a detailed description of the issue to be addressed, to include how often it occurs, where it occurs, and the people involved; (2) identifying the major factors contributing to the problem (can be technical systems, suppliers, individuals, external factors, etc.) and charting them on a concept map to identify causes; (3) identifying causes—for each factor identified in step 2 identify possible causes and expand the concept map; (4) analyzing the concept diagram, discussion and determination of further actions which might require on-site visits, surveys, discussion groups, further research.
- **Mind Mapping:** used to represent items (ideas, tasks, problems) linked to and arranged radially around a key word or idea to help participants avoid hierarchical problem solving approaches and instead, think conceptually and relationally; sometimes called radial or tree structures.
- **Affinity Diagrams:** ideas collected randomly from group members without any censoring then organized into related categories; can be used to:
 - Organize large amounts of information into common themes;
 - Identify new connectivity between ideas and information;
 - Brainstorm root causes and solutions to a particular problem.

1.4.2 Joint Staff Officer Critical Thinking Requirements

As a joint staff officer, you will constantly be required to apply critical thinking skills to your daily work. Senior leaders point out that for working in the combatant command environment staff officers need to be able to:

- Question and not be intimidated by authority;
- Get outside comfort zone, push boundaries;
- Provide data and reasoning behind position taken;
- Think consistently at a strategic level, understand the strategic landscape, and develop work products with a strategic perspective;

- Use available resources to maximum extent;
- Work through obstacles—do not let them halt your efforts;
- Develop an appreciation for second- and third-order effects;
- Think creatively, clearly;
- Know when he/she has the right information;
- Exhibit willingness to challenge the status quo as needed;
- Be proactive in anticipating requirements and questions;
- Think in parallel;
- Generate new ideas and think “outside of the box;”
- Actively listen to all advice before making decisions, then use a “fire and forget” mode.

Experts say that critical thinking skills can be learned and that there is a significant correlation between critical thinking ability and reading comprehension. Critical thinking is the process of making thoughtful judgments to respond to situations, answer questions, solve problems, and address issues. Critical thinking is based on experience, research, observations, and input from others; it is the process of making decisions for what to believe or do in a given situation or to solve problems, answer questions, and address issues.

1.4.3 The Ideal Critical Thinker

The following information concerning critical thinking skills is taken from the Air War College Gateway, Critical Thinking Section, <http://www.au.af.mil/au/awc/awcgate/awc-thkg.htm>, and is a summarization of an article from the Lance Armstrong Foundation, Livestrong.com, at <http://www.livestrong.com/article/14710-overview-of-critical-thinking/>.

In general, the ideal critical thinker is characterized by how he or she lives and approaches life—there has to be a willingness to see ambiguities, multiple potential solutions to a problem, recognition that few answers are black and white, and an interest in exploring the possibilities. Shared characteristics of good critical thinkers include:

- Inquisitiveness about a wide range of issues;
- Concern to become and stay well-informed;
- Alertness to opportunities to use critical thinking;
- Self-confidence in one's abilities to reason;
- Open-mindedness about divergent world views;
- Flexibility in considering alternatives and opinions;
- Understanding the opinions of other people;
- Fair-mindedness in appraising and reasoning;

- Honesty in facing one's own biases, prejudices, stereotypes, egocentric, and sociocentric tendencies;
- Prudence in suspending, making, altering judgments;
- Willingness to reconsider and revise views;
- Clarity in stating a question or concern;
- Orderliness in working with complexity;
- Diligence in seeking relevant information;
- Reasonableness in selecting and applying criteria;
- Care in focusing attention on the concern at hand;
- Persistence through difficulties;
- Precision to the degree permitted by subject and circumstances.

Colonel W. Michael Guillot, in his article, "Critical Thinking for the Military Professional," [Air & Space Power Journal - Chronicles Online Journal](#), (17 Jun 04) provides the Paul model (as depicted in Figure 2) as a reference for how critical thinkers use their thinking capabilities for real world issues. Critical thinkers that apply these elements and follow these standards are able to make "reasoned judgments." The Paul model offers practical guidelines for joint staff officers, who must constantly use their critical skills to determine priorities, collect and validate information, and make sound recommendations to senior leadership for courses of action on a number of military issues.

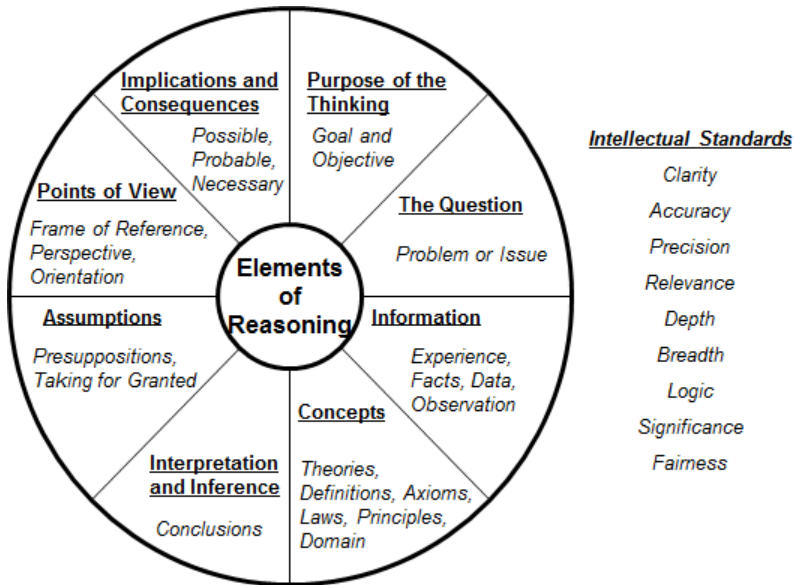

Figure 2: Critical Thinkers Elements of Reasoning and Intellectual Standards

Purpose of the Thinking: The critical thinker looks deeper for the essential motive or purpose in each situation attempting to eliminate false purposes. However, deliberate false purposes are used during war, often as part of an information operations campaign. The key is being able to differentiate between self-deception tendency (false purposes) and planned deception operations.

The Question: As questioning is the most important element of critical thinking, a critical thinker must first accurately define the problem or question to be addressed. Three types of questions are typically used: questions of fact, questions of preference, and questions of judgment. As Colonel Guillot points out, for strategic leaders, questions of judgment (which require reasoning skills) present the greatest challenge. A sample question of judgment with respect to the military would be: What is the best way to fight terrorism?

Information: A critical thinker must take a systems approach in determining how information is linked. When there is an overabundance of information, a critical thinker must determine what information is most vital and then must make a judgment as to the

quality of information selected. Paul identifies three ways the mind gathers information:

- **Inert information:** useless—mind clutter;
- **Activated ignorance:** dangerous—using false information as truth;
- **Activated knowledge:** powerful—truthful information that leads to greater understanding and wise decision-making.

Guillot points out that during wartime, history has shown strategic leaders often feel as though there is a lack of actionable information, which can “lead to strategic indecision.” He also cites military strategist John Boyd who believed effective organizations make decisions with information available at the moment, and they avoid getting bogged down in information overload.

Concepts: The most powerful element of critical thinking is conceptual thinking, which takes an idea or object and makes it comprehensible—the foundation of “out-of-the-box thinking.” Non-critical thinkers, however, stay bogged down in their current concepts and are unable to change their approaches to problem solving. At the strategic level, the inability to think in new and different conceptual ways can be “strategic surprise or strategic disaster.” Guillot uses September 11, 2001 as an example to show how the concept of ‘a missile’ or ‘bomb’ changed and how that altered concept changed our approaches for defense.

Interpretation and Inference: Conscious thought processes that draw a conclusion—good or bad, true or false, logical or illogical—from interpretation of assumptions. Critical thinkers are very careful to first evaluate and interpret available information and to then determine the validity of the assumptions, thus avoiding the dangerous situation of “jumping to conclusions”.

Assumptions: An assumption can be either a subconscious belief or an explicit conscious statement of belief. Value-based assumptions are constructed on how an individual believes the world should function, whereas descriptive assumptions are focused on how the world actually is. Guillot points out that relying on faulty, subconscious assumptions leads to inaccurate conclusions and cites the 2001 anthrax scare as a faulty assumption—one where people assumed that terrorism in the U.S. was carried out by Arabs or Muslims.

Points of View: Critical thinkers look at situations from several perspectives as well as from different domains (specialized areas) of thinking. For instance, critical thinkers may look at terrorism from a

security domain, from a political domain, a legal domain, or a combination of the three. Guillot identifies critical thinking organizations as those which are not opposed to divergent thinking, but instead invite different perspectives and operate without letting a single point of view distort or exclusively dominate the thought processes. Examining issues from different points of view supports a critical thinker working in a strategic environment to better understand the environment and clarify inconsistencies and ambiguities.

Implications and consequences: Implications are what is expected to happen before a decision, whereas consequences are what actually happen after the decision—the possible, probable, and inevitable. When thinking about implications, first consider all the reasonable possibilities—best-to-worst case scenarios. Guillot says:

“At this point one has developed the total expected implication set. It follows that if this set is comprehensive, it will include the consequences of an action. Next the critical thinker should consider which implications are most probable in a scenario. Finally, identify any implications that are inevitable given the situation. This kind of futures analysis is more than simple guessing. It forces one’s thinking to focus on ends. From here the critical thinker can easily compare **possible implications** and **probable implications** with **expectations** of what will solve the problem or address the issue at hand. The critical thinkers expectations become the fourth part of implications: what is a ‘required’ implication given the current problem or scenario.”

Critical thinkers, according to Guillot, apply the **standards of clarity, accuracy, precision, relevance, breadth, depth, logic, significance, and fairness** to each of the elements of reasoning as listed in figure 2 to establish a more reasoned, valid pattern of thinking:

- **Clarity**—the gateway standard, which makes comprehension possible. The critical thinker clearly understands each element (Figure 2) before moving toward identifying usable solutions. The best approach for applying the standards to an individual element is to ask a question related to the standard (see examples that follow).
- **Accuracy**—is this element accurate and truthful? How and where do I verify this information?
- **Precision**—this standard is used to help refine information. Is this precise enough for decision-making? Could this information be more exact?

- **Relevance**—helps focus thinking on the parts of a scenario relative to the question or decision at hand. How is this relevant? What is its priority?
- **Breadth and Depth**—the two standards most closely related; together are complimentary. Is this informational element too narrow or too shallow? Is there breadth in the point of view, concepts, and implications? Is there sufficient depth in information, concepts, assumptions, and questions? Do I have a broad enough view with sufficient detail on the second and third order effects?
- **Logic**—requires reflection and reconsideration—a skeptical look—of any conditional statement or information. Does this make sense? Does this opinion track with the available proof?
- **Significance**—seeks to highlight what applies to a situation as well as what is most important and to help prioritize information, point of view, concepts, and implications, basically, the first step toward planning.
- **Fairness**—based on personal bias, personal motives, and ethical decision-making; seeks to prevent egocentric thinking and self-deception. As to the fairness of a decision, a critical thinker asks, “Have my selfish interests distorted my thinking? Is the proposed decision fair to all concerned?”

For more details and examples, go to the Air War College website to read Colonel Guillot’s full article with more details and specific military examples: <http://www.airpower.au.af.mil/airchronicles/cc/guillot.html>.

1.5 Communicating Effectively at Executive Levels and Across a Diverse Workforce

Staff officers must continuously interact with other people to complete tasks; sometimes they are the one asking others for information and at other times are the suppliers of information to peer directorates, the Joint Staff, and other combatant commands. Practicing collaborative and effective communication, both oral and written, will facilitate all aspects of an AO’s daily work life. While there will be some staff members who do not follow the rules of collaboration, it is important to remember that an effective staff officer uses a highly collaborative approach and practices exceptional interpersonal skills when working with others, even when faced with difficult tasks or difficult people.

1.5.1 Working with People

First, effective joint staff officers are neither Service-biased nor military-biased; they are able to work effectively with people, regardless of affiliation. Often a staff officer is the only military person represented in a group or team. At times the joint staff officer must lead or participate in actions when the military is not the lead or authority for a particular issue. Staff officers will have to interact, brief, and communicate with personnel from other government agencies, with allies and other multinational partners, with the other Services, with the Guard and Reserves and with contractors. Staff officers must learn to work above, below, and without rank and be able to network across higher level staffs.

To communicate effectively across such a diverse workforce, joint staff officers need to be diplomatic, supportive, well-spoken, and open in communications. They must be willing to get out of the chair and talk face-to-face rather than always relying on email and the phone; they do not use e-mail as an avoidance tool. Good staff officers use focused listening skills, and build strong networks of peers and subject matter experts. They work effectively and are able to facilitate working groups and cross-directorate meetings to solicit inputs, problem solve, determine action items, and get commitments/dates and follow-up.

1.5.2 Effective Writing Skills

Effective staff officers know how to write coherently, succinctly, and strategically for an executive level audience. For each task assigned, staff officers should clearly understand for whom they are writing and exactly what type of document and information they are providing.

Staff officers are required to condense large amounts of information and then provide written documents that present clear, concise thoughts on issues. Part of the challenge is deciding the appropriate level of detail for the senior leadership; experienced colleagues can usually provide assistance.

Staff officers are required to provide written courses of action (COAs) and key recommendations to senior leaders, as well as provide the data and reasoning behind proposed actions. This requires solid logic and reasoning skills—for analyzing the problem and selecting the solution—and clarity in all written text—reducing complex or technical jargon to easily understood language.

Senior leaders also want to see attention paid to the quality of products—for example, original content rather than cut-and-paste; and end products that require little-to-no edits. Use built-in spelling and grammar checking software features and also allow time to proofread and edit highly visible or widely circulated reports for usage and style.

Keep the following precepts in mind as you begin to write:

- **Know your reading audience.** Are you writing for decision makers? For subject matter or technical experts? Profiling the reading audience first will help determine the level and types of details that should be included.
- **Have a clear understanding of the purpose for writing.** Is it to inform? To report an incident or results from a meeting? Is it to provide background information? To lead to a decision? Understanding the end objective will help you in selecting the appropriate types and amounts of supporting information.
- **Collect, read, and validate your references.** This will help you identify the supportive elements you need to include in your written end product. The first step is to find relevant, valid information—check your sources carefully! Use official sources—those designated by DOD, the Joint Staff, and the Services, subject matter experts, and factual data from vetted sources. When needing a definition, for example, Webster’s Dictionary—a juried source—is preferable to Wikipedia, a non-peer-reviewed source.
- **Create an outline before you start writing.** Draft your objective statement, and list the supporting elements that will substantiate the writing purpose. Draft a concluding statement. List any attachments or appendices you will need to include. List your references.
- **Use appropriate formats and styles for specific products.** Each combatant command has specific templates and formats for the broad variety of written products required. Check with peers and colleagues to locate where and how these are archived; most offices keep hard copy samples as well as having templates stored on command directorates.
- **Be conscious of the use of acronyms and abbreviations.** If possible use sparingly—but when needed, provide the source words. Your reading audience will consist of individuals from many different organizations, so do not assume that acronyms and abbreviations are “common knowledge.” Between Services, the same acronym or abbreviation can have different meanings.

The military follows the **BLUF** approach—bottom line up front. The Department of Army Pamphlet 600-67, *Effective Writing for Army Leaders*, offers some general guidelines as follows that can serve as practical tips:

General Style Rules:

- Put the reason for writing, the recommendation, or the conclusion of your research in the first or second sentence.
- Write in active voice.
- Use short sentences, generally 15 words or less.
- Paragraphs should be no more than 1 inch deep.
- Use correct spelling, grammar, and punctuation; use Word's spell check and grammar check, remembering that it will not catch errors such as using "*there*" for "*their*."
- Use, "I," "you," and "we" as subjects of sentences.

In addition to the six style items above, when **revising** your work, check for the following:

- Delete or rewrite any sentence that does not logically connect to the one before it and the one after it.
- Minimize the use of prepositional phrases.
- Minimize the use of the verb "to be" and its other forms; these verbs turn other verbs into nouns.

In his essay, *Politics and the English Language*, George Orwell offered rules for writing which are still considered applicable today:

- Never use a metaphor, simile, or other figure of speech which you are used to seeing in print.
- Never use a long word where a short one will do.
- If it is possible to cut a word out, always cut it out.
- Never use the passive when you can use the active.
- Never use a foreign phrase, a scientific word, or a jargon word if you can think of an everyday English equivalent.

Useful Resources:

- **The Tongue and Quill**, Air Force Handbook 33-337 (<http://www.e-publishing.af.mil/shared/media/epubs/afh33-337.pdf>)
- Strunk and White's, **The Elements of Style**
- **Effective Writing for Army Leaders**, Department of Army Pamphlet 600-67

- Robert Shenk's **The Naval Institute Guide to Naval Writing**, 3d Ed.

References:

- Army Pamphlet 600-67, *Effective Writing for Army Leaders*,
- *The Naval Institute Guide to Naval Writing* by Robert Shenk (Naval Institute Press),
- Air Force Handbook 33-337, *The Tongue and Quill*,
- *Revising Business Prose* by Richard Lanham (Scribner's),
- Joint Forces Staff College Pub-1, *The Joint Staff Officer's Guide*.

1.5.3 Effective Briefing Skills

One of the most important and time-consuming aspects of a staff officer's job is creating, presenting, or contributing to briefings. Although you may have prior experience, you will probably be required to develop more sophisticated briefings and to deliver them to very senior levels of military, interagency, and multinational personnel.

The expectation from senior leaders is that you will concisely state the problem, identify optional solutions, recommend courses of action and make your presentation in a direct manner. Generally, the process for preparing a briefing includes:

- Succinctly state the topic or problem to be solved before beginning the research, understand the end objective, and choose the appropriate style of briefing format (as listed below);
- Research the issue—this may be done through use of reference materials, review of prior staff officer work products, subject matter input, or all of the above;
- Plan an approach;
- Prepare a draft; make sure you know or can provide information about all content (to include acronyms);
- Review and revise your work for succinctness;
- Use PowerPoint drill down capabilities as needed for access to background information if questions concerning your references or options arise;
- Proofread and make corrections;
- Practice your briefing;
- Make sure the meeting room is scheduled ahead of time and that you know how to operate the equipment.

There are four basic types of military briefings which the briefer must understand to facilitate a rapid, coordinated response:

- **Information briefing:** The purpose is to present facts to the audience for their comprehension—either to keep them abreast of a current situation or to supply specific requested information; does not require a decision;
- **Decision briefing:** Includes basic elements of the information briefing, but is usually more comprehensive in scope and is presented specifically to determine an answer to a question or a decision about possible courses of action to be taken;
- **Staff briefing:** Most widely-used type of military briefing, designed for a quick, verbal exchange of information among a specified group of people; purpose is to keep a commander and staff mutually informed of the current situation; the expected outcome is a coordination of effort;
- **Mission briefing:** The purpose can be a combination of any or all of the following: impart last-minute information, give specific instructions, or instill an appreciation of the overall mission; it is designed especially to review important details for combat operations; is also used to brief training missions that simulate combat conditions; the expected objective is to achieve thorough and current understanding of operational conditions possibly affecting the successful execution of the mission.

1.5.4 Practicing Good E-mail Etiquette

E-mail consumes a large portion of the work day, and good e-mail etiquette goes a long way to making your work day more manageable. The following tips are from Microsoft® Office's on-line site, from email netiquette's website, and from Career Planning's website:

- **Follow standard writing protocol.** E-mails are official messages representing you, your department, and your command. Do not use informal language, emoticons, or informal e-mail or text message abbreviations. Use standard spelling, grammar, and punctuation rules.
- **Keep messages brief and to the point.** Limit each message to one subject; create separate e-mails when more than one subject is to be addressed.
- **Use capitalization appropriately.** Using all lower case letters is considered mumbling and using all upper case letters is considered shouting. Asterisks or bold lettering are effective

for emphasis. Color and graphics embedded in e-mails often do not transfer due to differences in e-mail programs.

- **Use the Blind Carbon Copy (Bcc) and Courtesy Copy (Cc) appropriately.** Do not use Bcc to keep others from knowing who else you copied on an e-mail, but rather when sending to a large distribution list to keep others from having to see a large list of names. Overuse of the Cc clutters the inbox; copy only those directly involved with the e-mail topic. Others may never realize the courtesy you have extended, but this thoughtful and intentional act reduces the number of e-mails in your in-box, as well.
- **Do not use e-mail as an excuse to avoid personal contact.** Face-to-face and voice to voice communications have value. Do not use e-mail when dealing with a problem with someone. Do not use e-mail to avoid an uncomfortable situation or to cover up a mistake.
- **Remember that e-mail is not private.** E-mail belongs to your organization, in this case the federal government, and can be retrieved, examined and used in a court of law. Anything you put in an e-mail can become public knowledge. Because e-mails can inadvertently be sent to the wrong person or can be forwarded, keep the contents professional to avoid potential embarrassment. Treat e-mails as if they are memos.
- **Be sparing with group e-mail.** Send group e-mail only when useful to every recipient listed. Use the “reply to all” button only when compiling results requiring collective input and only if you have something to add.
- **Use the subject field to indicate content and purpose.** Use commonly-known terms or standard abbreviations to indicate required actions. Be cautious in using acronyms—particularly to non-military personnel. If the e-mail is lengthy, place the word “Long” in the subject field, so the recipient will know the message requires more time than normal
- **Do not send chain letters, virus warnings, or junk mail.** Within your command, the responsible directorate will send notifications for virus warnings. You should notify anyone sending you junk mail or a constant stream of jokes that you want to be removed from the list. Direct personal e-mail to your home account.
- **Remember that your tone cannot be heard in an e-mail.** Be cautious using humor or sarcasm—they can be easily misinterpreted. The nuances of verbal communication (facial

expression, gestures, and tone of voice) are not easily conveyed in e-mails.

- **Use a signature block that includes contact information.** Include your name, title or rank, directorate, postal and e-mail addresses, and phone numbers in your signature block.
- **Summarize long e-mail discussions** rather than including the entire string of messages.

References:

- 12 tips for better e-mail etiquette (<http://office.microsoft.com/en-us/outlook-help/12-tips-for-better-e-mail-etiquette-HA001205410.aspx?CTT=5&origin=HA001201154>)
- About.com, Email Etiquette (www.careerplanning.about.com/od/communication/a/email_etiquette.htm)
- About.com, Email Etiquette: 26 Rules to Follow (http://email.about.com/od/emailnetiquette/tp/core_netiquette.htm)

1.5.5 Facilitating Effective Meetings

Attending and leading meetings is a major part of the staff officer's work life. The following tips are offered as a reminder for those with prior experience and as a general guide for those with minimal experience setting up and managing meetings.

Prior Planning

- The first important question to ask: ***Is a meeting really necessary?*** If you can achieve your objective without a meeting, everyone will appreciate one less meeting to attend.
- Once decided that a meeting is needed, **determine a clear purpose for having a meeting....articulate a clear end objective**—state specifically what you want to accomplish. Is this an exploratory meeting? A brainstorming meeting? A decision-meeting?
- **Determine who needs to attend and why.** Prioritize attendees—who do you absolutely need; if they cannot attend, can you meet with them in advance to get their input, or can they send a representative?
- **Decide the type of meeting.** Computer-based? Video-Teleconferencing (VTC)? Small group? Large Group?
- **Schedule a meeting place.** Ensure it will have the proper equipment (presentation technologies, white boards, landline

for teleconferences, etc.) and that it is large enough for the group. Check within your directorate for procedural guidelines; often a room has to be scheduled far in advance of the actual meeting.

- **Develop an agenda** as far in advance as possible, and **send it to participants**. Include date, time, place, and purpose, your name, phone number, and e-mail; if attendees are coming from another location or from out of town include directions and a map. Ask for confirmation of attendance; if it is a critical decision meeting, ask for notice of inability to attend—even at the last minute.

The Meeting

- The day before **AND** the day of, reconfirm the room reservation; it is not unusual to get bumped by a higher-priority meeting, especially for VTC facilities. Meeting spaces are usually in high demand; if possible have an emergency backup plan (the snack bar? the cafeteria? a classroom? someone's office not in use?)
- Start on time, and briefly make any administrative announcements.
- Quickly introduce attendees—don't forget those dialing in by phone.
- State end objectives, review the agenda, and lay out procedures; for example, will discussion take place during a briefing or upon conclusion?
- Assign a time keeper to cue you at certain intervals, and if needed assign someone to take notes.
- Keep the meeting focused on the agenda items. If topics arise related to but not specific to the topic, create a "parking lot" (on the white board or by the note taker) of discussion points to return to if there is time—it is easy to get sidetracked, so the "parking lot" approach helps maintain focus.
- Control interruptions; keep group on topic; encourage inclusiveness and openness—and protect those who speak up from attack by another group member.
- For long meetings, give breaks, and start meeting immediately at the end of the break time.
- Take a few minutes before the end of the meeting to review with attendees: Was the objective met? Is follow-on necessary—another meeting? Individual responses?
- Thank attendees for attendance; collect notes from note taker.

After the Meeting

As soon as possible compose an after-meeting report for your files, and if warranted, e-mail a copy to attendees.

1.5.6 Working with the Public Affairs Office

We live and operate in a 24/7/365 global information environment, which means that the question is not “**Will** you be interviewed by a news reporter?” but “**When...?**” Understanding how to work with the Public Affairs office will be critical as you work with information operations and the strategic communication message of your command.

Department of Defense Directive 5122.05 identifies one of the roles and responsibilities of the Assistant Secretary of Defense for Public Affairs (ASD(PA)) as the principal spokesperson for the Department of Defense to:

Ensure a free flow of news and information to the news media, the general public, the internal audiences of the Department of Defense, and the other applicable forums, limited only by the security restraints in DoDD 5200.1 and any other applicable statutory mandates or exemptions.

Your combatant command will have additional guidance on interacting with the media and on being the subject of an interview. Your Public Affairs Office will:

- Advise if the proposed interview is authorized and/or appropriate;
- Determine if the media outlet is credible;
- Research potential interview issues, including questions likely to be asked;
- Assist your preparation for the interview (possible questions/answers, rehearsals);
- Make all arrangements (ground rules, time, location, etc.);
- Monitor the interview, to provide an in-house record and follow up on items to be provided later.

The following are quick tips to familiarize you with the process:

The Media Interview

Engaging the media has never been more important. Few members of Congress, the media or the general public have served in the military or

had exposure to military life. Thus, they lack a context in which to understand the events and challenges of today's military.

Joint officers must be prepared to engage the media and to persuasively tell the military's story. The media has a job to tell stories, and we have a story to tell. Ensuring we support the commander's strategic communications objectives, building a positive relationship with the media, and maintaining public support for the military are all dependent upon your successful handling of the media interview. Public affairs professionals concentrate on these goals even on "slow news days" and the relationships they forge with their media counterparts are essential to dealing with the media during crises. Use the resources and talents of your Public Affairs Office!

Interview Preparation:

Before any media opportunity, questions you should ask yourself include:

- Am I the correct person to address the issue?
- What is the format of the interview? (Live or edited?)
- What's the reporter's affiliation? (Reputable news agency?)
- Who else has the reporter spoken with or will speak with?
- What is the reporter's background (Knowledgeable on military issues?)

One of the most important elements of preparation is developing responses (answers to questions plus strong command messages) for the most likely questions (positive and negative). Try to put yourself in the reporter's shoes and think about the questions you would ask if conducting the interview. The messages you develop should be short, memorable, and resonate with the audience. Television reporters are usually looking for 12-15 second sound bites. Ensure that your responses are simple and free of military jargon. Ask yourself, "What do I want the headline to be?" Work that information into your messages.

Develop a "Grand Slam" answer. Almost every reporter will ask one last question, "Do you have anything to add?" This is your opportunity to leave them with a concise sound bite about your subject or organization. The odds of this statement being used are higher because it's the last bit of information you leave with the reporter.

Examples of Command Messages

- *Environment*—"We are committed to being good stewards of the environment. We live here too."

- *Accident*—“We’re just beginning our investigation. Our goal is to find out what happened and prevent similar accidents in the future.”
- *Readiness*—“Our training ensures we are ready to fight anywhere, anytime.”
- *Injury*—“We’re providing the Service Member with the best medical care available. We’re confident he’ll have a complete and speedy recovery.”

Types of Interviews

Ambush

This occurs when a reporter shows up unexpectedly and surprises an unsuspecting interview subject off guard. The atmosphere during these interviews can be tense, but there are ways to overcome the surprise and make the situation come out to your advantage. Remember, you ALWAYS have the right to decline the interview or to reschedule it—this may be the command’s guidance on unexpected interview requests. Rescheduling gives you the opportunity to more fully prepare yourself.

Studio

You will be asked to travel to a television studio and sit down with the host for a discussion on a particular issue. The interview is generally informal and upbeat—an excellent opportunity to highlight your command messages. In this setting, the formats could be a morning show, an edited interview, or a remote feed.

Stand-Up

These are the most common of all interviews. The interview will take place at a mutually agreed upon location to talk about a particular issue. During an accident, you can expect to conduct this type of interview near the incident scene. Depending on the reason for the stand-up, the interview can range anywhere from informal to hostile. In this setting, the formats could be an edited or a live interview.

Press Conference

With few exceptions, these are held in response to a major accident or incident. Requires a location capable of hosting several media at once, and usually begins with a commander, public affairs officer, or the subject matter expert’s opening statement. Following the statement, the floor is open to questions from the media. While they can be hostile or confrontational, they do not have to be. Extensive preparation is required.

Do's and Don'ts

- DO take every opportunity to tell the military's story.
- DO prepare for the interview—anticipate questions and develop responses.
- DO communicate clearly and honestly.
- DO avoid distracting and negative non-verbals—stay calm.
- DO stick to your command messages.
- DON'T speculate.
- DON'T argue.
- DON'T lie.

During the Interview

Using the following techniques will help you more successfully manage interviews:

- **Bridge**—A technique to steer the conversation back to your command message.
- **Nonverbals**—Relax! Remember, you are the expert. DON'T rush responses, avoid distracting body movements, and don't slouch. DO maintain eye contact with the reporter, and show appropriate interest and concern for the issue.
- **Tell the truth—ALWAYS**—The truth may hurt, but lies are deadly; you will probably get caught, and reporters do not forget sources that have “burned” them. Give a direct answer when asked a direct question, even if the answer is, “No, I don't know,” or “I'm sorry, I can't answer that question.” Avoid speculation. You will come across as an honest, forthright person.
- **Get your message across**—Come to an interview prepared with your messages and find opportunities to get them across without ignoring the reporter's questions. Take the initiative. You are the expert. You know what is important to tell the public, so tell them.
- **Be informative, not conversational**—New interviews are exchanges of information. You are the source of information; the reporter represents the public. Don't feel obligated to maintain the social rules of conduct that guide conversations. Beware of the reporter who remains silent, encouraging you to ramble or dilute your original message. It's human nature to want to fill those lulls with conversation. Don't!
- **Be brief**—Reporters generally do not want lengthy, drawn-out explanations. They are looking for quotable quotes—a punchy line that will fill three lines of newsprint or 20 seconds of air time. Use your 20 seconds to get your message across—

there's much more likelihood it will be used. Knowing what you want to say in advance will go a long way in simplifying your answers.

- **Do not go off the record**—*There is no such thing as off the record.* If you do not want something to appear in the media, do not say it.
- **Know your role**—When conducting an interview, understand your role. If you are serving as a spokesperson, remember: reporters will not distinguish between personal opinion and the military's official position—and neither will the public. Answer questions appropriately. If you do not know the answer, tell reporters you will find out; don't speculate.
- **Stay in your lane**—Avoid speaking about subjects with which you are not familiar or are not the appropriate speaking authority.
- **Do not use jargon**—Avoid using terms or acronyms that can't be quoted without explanation. Do not say, "We're pleased the ORI was such a success." Do say, "We're pleased we did so well in our readiness inspection."
- **Say what you mean**—Avoid bureaucratic language. Do not say, "It's clear that much additional work will be required before we have a complete understanding of the issue." Do say, "We're working on it."
- **Correct the record**—If a reporter asks a question based on a false premise, make sure you correct that assumption; be careful, though, not to repeat the reporter's negative words.
- **Remain professional**—Interview situations usually don't become confrontational. However, if it does, keep yourself calm and professional. When you argue with a reporter, you lose (even if you are correct!) and you lose publicly.
- **Do not lose your temper**—Sometimes reporters are intentionally rude to elicit a charged response. Don't fall into the trap. Respond politely, in control at all times. Do not get into arguments—your angry comments may be reported without any mention of the provocation.
- **Be friendly**—It's an interview, not an interrogation. Establish rapport with the reporter.
- **Never use "No Comment"**—No comment IS a comment, and a negative one. Don't say "No comment," or, "I can neither confirm nor deny." The public views this as, "I know but I won't say." Instead, tell the reporter you are unable to answer the question and, if possible, why.

- **Do not answer when you shouldn't**—If you know the answer to a question, but can't say, do not hesitate to refer the reporter to the Public Affairs Office. Again, do not answer questions if you aren't the appropriate spokesperson. If a reporter presses, repeat your answer. Do not waiver, and do not go off the record.
- **Do not guess**—If you do not know the answer to a question, say so. Be sure you offer to either find the answer or find someone else who knows.
- **It's OK to make a mistake**—The tape is rolling, and you realize you've made a mistake. More likely, you suddenly find you have no idea what you were saying. Stop. Say, "I'm sorry I haven't answered your question very well. Let me back up." The reporter usually will prefer your new, crisp response.
- **Talk from the public's point of view**—Remember you are talking through the reporter to the public. How does what you are talking about affect individuals in the community? Answer questions in terms readers and viewers can relate to.
- **Cite facts**—Reporters love facts and figures that will lend credibility to their stories or make certain points. But do not use superlatives to exaggerate facts that will make things sound bigger and better than they are.
- **Be prepared to repeat yourself**—Reporters may repeat their questions because your answer was too long, too complex, or they did not understand you, or they may be simply trying to get a more pithy response. Welcome the question as another opportunity to state your message, perhaps more clearly.
- **Be confident**—You're the expert. You have a message to deliver. Recognize that your expertise or position may be somewhat intimidating for reporters. Put them at ease.
- **Don't be defensive**—Make positive statements instead of denying or refuting comments from others. State your message; let others speak for themselves.
- **Never ask a reporter to preview the story**—Reporters generally never let sources review stories, though they often check back concerning complicated details. It is their job to gather the facts and tell the story accurately—to suggest they can't do so without your input insults their professionalism. It's better to listen carefully during an interview to be aware of when a reporter may not understand something. The likelihood of your being misquoted is reduced substantially if you speak briefly and clearly.

- **Act as a liaison**—Interact between the news organization and your own; provide follow-up video copies, news clippings, etc., of the resulting story to the Public Affairs Office.
- **Provide after-action review and feedback**—Did we get our message out and, if so, how effectively?

Engaging the media and telling the military's story bolsters our reputation with the general public and helps them understand the military's value to the country. Understanding essential media tactics and techniques will help everyone accomplish a successful interview.

Lastly, it is crucial to remember that in an interview, you have 10 seconds to tell your story. You can say about 35 words in 10 seconds. This is the era of sound bites, and according to one study the average network television news sound bite was 6.5 seconds—21 words. Maximizing your “opportunity” in a radio, television, or print interview is critical when you need to get your message out.

Additional Information

- Joint Publication 3-61, Public Affairs
- Meeting the Media. A pocket guide to assist Airmen in communicating with the news media. U.S. Air Force Public Affairs Center of Excellence
- Aukofer and Lawrence, America's Team; The Odd Couple—A Report on the Relationship Between the Media and the Military. Nashville TN: The Freedom Forum First Amendment Center
- Borg, “Communicating With Intent: DOD and Strategic Communication”—
http://www.carlisle.army.mil/DIME/documents/strat_comm_borg.pdf

References:

- DODD 5122.05:
<http://www.dtic.mil/whs/directives/corres/pdf/512205p.pdf>
- Adapted from Headquarters, Air Combat Command Media Training: Introduction and Live Practice and Meeting the Media. A pocket guide to assist Airmen in communicating with the news media. U.S. Air Force Public Affairs Center of Excellence (2008)

1.6 Understanding the Combatant Command Workforce and Partner Relationships

Perhaps for the first time in your career you will be working in a joint environment, which includes representatives from all the Services, the Guard and Reserve, government civilians, U.S. Agencies, and multinational partner organizations. Having a basic understanding of the different organizational missions and cultures can help you begin to establish good working partnerships with the representatives serving in your command.

1.6.1 United States Agency Partners

Department of Defense Combat Support Agencies (CSA)

A Combat Support Agency is a Department of Defense agency, so designated by Congress or the Secretary of Defense (SecDef) that supports military combat operations.¹

CSAs designated under section 193 of Title 10 United States Code fulfill combat support or combat service support functions for joint operating forces across the range of military operations, and in support of combatant commanders executing military operations. CSAs perform support functions or provide supporting operational capabilities, consistent with their establishing directives and pertinent DOD planning guidance.

The combat support mission of a CSA is that portion of its mission involving support for operating forces engaged in planning for, or conducting, military operations. This includes support during conflict or in the conduct of other military activities related to countering threats to U.S. national security. This mission is focused on providing support to echelons at the combatant command level and below and may not encompass the full scope of the CSA's mission.

A CSA shall provide, and plan for, the optimum support capabilities attainable within existing and programmed resources to the operational commanders, within the parameters of the CSA's statutory responsibilities and its chartering DOD Directive. CSAs shall interpret government and departmental regulations to facilitate the execution of their combat support or combat service support mission. For these

¹ Joint Publication 1-02, Department of Defense Dictionary of Military and Associated Terms, As amended through 15 May 2011

purposes, CSAs shall participate fully in the Joint Strategic Planning System (JSPS) and the Joint Operation Planning and Execution System (JOPES) to define current joint warfighting capability needs and shall utilize the Joint Capabilities Integration and Development System (JCIDS) to define and validate future joint warfighting capability needs.²

The current CSAs are:

- Defense Contract Management Agency (DCMA)
- Defense Information Systems Agency (DISA)
- Defense Intelligence Agency (DIA)
- Defense Logistics Agency (DLA)
- Defense Threat Reduction Agency (DTRA)
- National Geospatial-Intelligence Agency (NGA)
- National Security Agency/Central Security Service (NSA/CSS)

CSA Overview

Defense Contract Management Agency (DCMA)

DCMA is the DOD component that works directly with Defense suppliers to help ensure that DOD, federal, and allied government supplies and services are delivered on time, at projected cost, and meet all performance requirements. DCMA directly contributes to the military readiness of the United States and its allies, and helps preserve the nation's freedom.

The DCMA mission is to provide Contract Administration Services to the Department of Defense Acquisition Enterprise and its partners to ensure delivery of quality products and services to the warfighter, on time and on cost.

DCMA professionals serve as "information brokers" and in-plant representatives for military, federal, and allied government buying agencies—both during the initial stages of the acquisition cycle and throughout the life of the resulting contracts.³

Defense Information Systems Agency (DISA)

DISA provides real-time Information Technology (IT) and communications support to the president, vice president, Secretary of Defense, the Military Services, and the combatant commands.

² DODD 3000.06, Combat Support Agencies

³ Defense Contract Management Agency web site <http://www.dcmsa.mil/>

The goal of DISA is to ensure that warfighters can plug into the network and access and share the information they need, anytime, anywhere. DISA is dedicated to delivering the power of information as quickly as possible. A warfighter's ability to leverage the right information at the right time is the difference between mission success and mission failure.⁴

Defense Intelligence Agency (DIA)

The DIA mission is to provide timely, objective, and cogent military intelligence to warfighters, defense planners, and defense and national security policymakers.

DIA consists of more than 16,500 military and civilian employees worldwide and is a major producer and manager of foreign military intelligence. The Director of DIA is a three-star military officer who serves as the principal adviser to the SecDef and to the Chairman of the Joint Chiefs of Staff on matters of military intelligence. The Director also chairs the Military Intelligence Board, which coordinates activities of the defense intelligence community.

DIA possesses a diverse workforce skilled in the areas of military history and doctrine, economics, physics, chemistry, world history, political science, bio-sciences, and computer sciences to name a few.

DIA satisfies the military and military-related intelligence requirements of the secretary and deputy SecDef, the Chairman of the Joint Chiefs of Staff, and the Director of National Intelligence, and provides the military intelligence contribution to national foreign intelligence and counterintelligence. DIA plans, manages, and executes intelligence operations during peacetime, crisis, and war. DIA serves as the DOD lead for coordinating intelligence support to meet combatant command requirements; leads efforts to align analysis, collection, and Intelligence, Surveillance, and Reconnaissance (ISR) activities with all operations; and links and synchronizes military, defense, and national intelligence capabilities.⁵

Defense Logistics Agency (DLA)

The DLA provides supply support and technical and logistics services to the Army, Air Force, Navy and Marine Corps and several federal agencies. Headquartered at Fort Belvoir, Va., the agency is the one source for nearly every consumable item, whether for combat

⁴ Defense Information Systems Agency web site <http://www.disa.mil/>

⁵ Defense Intelligence Agency web site <http://www.dia.mil/>

readiness, emergency preparedness, or day-to-day operations inside DOD.

DLA is the largest DOD CSA with 23,000 employees. It supplies the nation's military services and several civilian agencies with the critical resources needed to accomplish their worldwide missions. DLA provides wide-ranging logistical support for peacetime and wartime operations, as well as emergency preparedness and humanitarian missions. DLA supplies almost every consumable item America's military services need to operate, from meals to jet fuel. In short, if America's forces can eat it, wear it, drive it, or burn it, chances are that DLA helps provide it. DLA also helps dispose of materiel and equipment that is no longer needed.⁶

Defense Threat Reduction Agency (DTRA)

The DTRA mission is to safeguard America and its allies from weapons of mass destruction (chemical, biological, radiological, and nuclear) and high yield explosives by providing capabilities to reduce, eliminate and counter the threat, and mitigate its effects.

DTRA is the U.S. Department of Defense's official Combat Support Agency for countering Weapons of Mass Destruction (WMD). Its people are Subject Matter Experts on WMD, and the agency addresses the entire spectrum of chemical, biological, radiological, nuclear and high yield explosive threats. DTRA's programs include basic science research and development, operational support to U.S. warfighters on the front line, and an in-house WMD think tank that aims to anticipate and mitigate future threats long before they have a chance to harm the United States and our allies. United States Strategic Command (USSTRATCOM) Center for Combating Weapons of Mass Destruction (SCC-WMD), the U.S. Strategic Command Center for Combating Weapons of Mass Destruction, synchronizes Combating Weapons of Mass Destruction efforts across the military's geographic commands and leverages the people, programs and interagency relationships of DTRA at a strategic level. DTRA works with the military services, other elements of the United States government, and countries across the planet on counterproliferation, nonproliferation and WMD reduction issues with one goal in mind: Making the World Safer.

Since DTRA stood up in October 1998 and SCC-WMD in August 2005, the Department of Defense and other federal agencies have

⁶ Defense Logistics Agency web site <http://www.dla.mil/Pages/default.aspx>

increasingly looked to both for support and advice. Both organizations' responsibilities span the full range of activities necessary to combat and respond to WMD proliferation and use. At home and abroad, DTRA and SCC-WMD deliver mission success against a very real and growing threat.⁷

National Geospatial-Intelligence Agency (NGA)

The mission of NGA is to provide timely, relevant, and accurate geospatial intelligence in support of National Security.

The NGA is one of sixteen agencies operating under the Office of the Director of National Intelligence. NGA serves as the functional manager for the National System for Geospatial Intelligence. As such, NGA is responsible to both the Director of National Intelligence and the SecDef.

Geospatial Intelligence (GEOINT) consists of imagery, imagery intelligence, and geospatial information. NGA pursues exploitation and analysis of imagery and geospatial information to describe, assess, and visually depict physical features and geographically referenced activities on the Earth. NGA provides analytical support to its mission partners at the combatant commands, Services, other agencies, as well as international partners through embedded NGA Support Teams.⁸

National Security Agency/Central Security Service (NSA/CSS)

The NSA/CSS core missions are to protect U.S. national security systems and to produce foreign signals intelligence information. NSA/CSS is charged by Executive Order 12333 to:

- Collect (including through clandestine means), process, analyze, produce, and disseminate signals intelligence information and data for foreign intelligence and counterintelligence purposes to support national and departmental missions;
- Act as the National Manager for National Security Systems as established in law and policy, and in this capacity be responsible to the SecDef and to the Director, National Intelligence;
- Prescribe security regulations covering operating practices, including the transmission, handling, and distribution of signals intelligence and communications security material within and

⁷ Defense Threat Reduction Agency web site <http://www.dtra.mil/Home.aspx>

⁸ National Geospatial-Intelligence Agency web site <https://www1.nga.mil/Pages/Default.aspx>

among the elements under control of the Director of the National Security Agency, and exercise the necessary supervisory control to ensure compliance with the regulations.⁹

1.6.2 Interagency Partners

The Department of Defense defines the term **interagency** as United States Government agencies and departments, including the Department of Defense.¹⁰ Whereas **interagency coordination**, within the context of Department of Defense involvement, is the coordination that occurs between elements of Department of Defense and engaged U.S. Government agencies for the purpose of achieving an objective.¹¹

Federal Executive Branch – Executive Departments

The following executive departments are the components of the Federal Executive Branch:

- Department of Agriculture (USDA)
- Department of Commerce (DOC)
- Department of Defense (DOD)
- Department of Education (ED)
- Department of Energy (DOE)
- Department of Health and Human Services (HHS)
- Department of Homeland Security (DHS)
- Department of Housing and Urban Development (HUD)
- Department of Justice (DOJ)
- Department of Labor (DOL)
- Department of State (DOS)
- Department of the Interior (DOI)
- Department of the Treasury (Treasury)
- Department of Transportation (DOT)
- Department of Veterans Affairs (VA)

The following executive departments are the ones most commonly worked with in a combatant command; missions and type of command (geographical or functional) may determine which agencies send representatives to work on site:

⁹ National Security Agency/Central Security Service web site <http://www.nsa.gov/>

¹⁰ Joint Publication 1-02, Department of Defense Dictionary of Military and Associated Terms, As amended through 15 May 2011

¹¹ Ibid

Department of Commerce (DOC) <http://www.commerce.gov/>

The historic mission of the Department of Commerce is "to foster, promote, and develop the foreign and domestic commerce" of the United States. This has evolved, as a result of legislative and administrative additions, to encompass broadly the responsibility to foster, serve, and promote the Nation's economic development and technological advancement. The Department fulfills this mission by:

- Participating with other Government agencies in the creation of national policy, through the president's Cabinet and its subdivisions;
- Promoting and assisting international trade;
- Strengthening the international economic position of the United States;
- Promoting progressive domestic business policies and growth;
- Improving comprehension and uses of the physical environment and its oceanic life;
- Ensuring effective use and growth of the Nation's scientific and technical resources;
- Acquiring, analyzing, and disseminating information regarding the Nation and the economy to help achieve increased social and economic benefit;
- Assisting states, communities, and individuals with economic progress.

The specific functions and programs of the Department that make up the broad activities listed above are authorized by the Department's organic statute (Act of February 14, 1903, 32 Stat. 825) or by other legislation. They also include responsibilities transferred from other Government agencies by Presidential Reorganization Plans, and responsibilities assigned to the Secretary of Commerce or the Department by Executive Order or other actions of the president.

Department of Defense (DOD) <http://www.defense.gov/> and <http://www.defenselink.mil/>

The DOD is responsible for providing the military forces needed to deter war and protect the security of the United States. The major elements of these forces are the Army, Navy, Air Force, and Marine Corps. Under the president, who is also Commander-in-Chief, the SecDef exercises authority, direction, and control over the Department, which includes the Office of the SecDef, the Chairman of the Joint Chiefs of Staff, three Military Departments, nine Unified Combatant Commands, the DOD Inspector General, fifteen Defense Agencies, and seven DOD Field Activities.

The SecDef is the principal defense policy adviser to the president and is responsible for the formulation of general defense policy and policy related to all matters of direct and primary concern to the DOD, and for the execution of approved policy. Under the direction of the president, the Secretary exercises authority, direction, and control over the Department of Defense.¹²

Department of Energy (DOE) <http://www.energy.gov/>

The Department of Energy's overarching mission is to advance the national, economic, and energy security of the United States; to promote scientific and technological innovation in support of that mission; and to ensure the environmental cleanup of the national nuclear weapons complex. The Department's strategic goals to achieve the mission are designed to deliver results along five strategic themes:

- Energy Security: Promoting America's energy security through reliable, clean, and affordable energy;
- Nuclear Security: Ensuring America's nuclear security;
- Scientific Discovery and Innovation: Strengthening U.S. scientific discovery, economic competitiveness, and improving quality of life through innovations in science and technology;
- Environmental Responsibility: Protecting the environment by providing a responsible resolution to the environmental legacy of nuclear weapons production;
- Management Excellence;
- Enable the mission through sound management.¹³

Department of Homeland Security (DHS)

<http://www.dhs.gov/index.shtml>

The Department of Homeland Security leverages resources within federal, state, and local governments, coordinating the transition of multiple agencies and programs into a single, integrated agency focused on protecting the American people and their homeland. More than 87,000 different governmental jurisdictions at the federal, state, and local level have homeland security responsibilities. The comprehensive national strategy seeks to develop a complementary system connecting all levels of government without duplicating effort. Homeland Security is truly a "national mission."

¹² DODD 5100.01, Functions of the Department of Defense and Its Major Components, (<http://www.dtic.mil/whs/directives/corres/pdf/510001p.pdf>)

¹³ Department of Energy web site <http://www.energy.gov/about/index.htm>

The Office of the Secretary of Homeland Security oversees activities with other federal, state, local, and private entities as part of a collaborative effort to strengthen our borders, provide for intelligence analysis and infrastructure protection, improve the use of science and technology to counter WMDs, and to create a comprehensive response and recovery system.¹⁴

The United States Coast Guard is a military, multi-mission, maritime service within the Department of Homeland Security and one of the nation's five armed services. Its core roles are to protect the public, the environment, and U.S. economic and security interests in any maritime region in which those interests may be at risk, including international waters and America's coasts, ports, and inland waterways.¹⁵

Department of Justice (DOJ) <http://www.usdoj.gov/>

The mission of the Department of Justice is to enforce the law and defend the interests of the United States according to the law; to ensure public safety against threats foreign and domestic; to provide federal leadership in preventing and controlling crime; to seek just punishment for those guilty of unlawful behavior; and to ensure fair and impartial administration of justice for all Americans.

The Judiciary Act of 1789 created the Office of the Attorney General which evolved over the years into the head of the Department of Justice and chief law enforcement officer of the Federal Government. The Attorney General represents the United States in legal matters generally and gives advice and opinions to the president and to the heads of the executive departments of the Government when so requested. In matters of exceptional gravity or importance the Attorney General appears in person before the Supreme Court. Since the 1870 Act that established the Department of Justice as an executive department of the government of the United States, the Attorney General has guided the world's largest law office and the central agency for enforcement of federal laws.

The Attorney General presides over the Department which includes a broad array of divisions and agencies that include the Bureau of Alcohol, Tobacco, Firearms and Explosives; National Drug Intelligence Center; Drug Enforcement Administration (DEA); National Security Division; and Federal Bureau of Investigation (FBI).¹⁶

¹⁴ Department of Homeland Security web site <http://www.dhs.gov/xabout/structure/>

¹⁵ United States Coast Guard web site <http://www.uscg.mil/top/missions/>

¹⁶ Department of Justice web site <http://www.usdoj.gov/>

Department of State (DOS) <http://www.state.gov/>

The Executive Branch and the US Congress have constitutional responsibilities for US foreign policy. Within the Executive Branch, the Department of State is the lead US foreign affairs agency, and its head, the Secretary of State, is the President's principal foreign policy adviser, although other officials or individuals may also have significant influence on foreign policy decisions. The Department advances US objectives and interests in the world through its primary role in developing and implementing the President's foreign policy. The Department also has primary responsibility for communication with, services to, and support of American citizens living overseas. The Department supports the foreign affairs activities of other US Government entities including the US Department of Commerce, the US Department of Agriculture, and the US Agency for International Development (USAID) – which reports to the Secretary of State. It also provides an array of important services to foreigners seeking to visit, study or work in, or immigrate to the US.

The Department of State is the lead US agency in certain international actions, including determining citizenship of US passport applicants, determining initial admissibility of foreign citizens to the United States (although Department of Homeland Security makes the final determination at ports of entry), managing American citizen evacuations, and implementing foreign consequence management operations. The Department of State also works closely with USAID in planning and executing international disaster assistance responses. All foreign affairs activities -- US representation abroad, foreign assistance programs, countering international crime, foreign military training programs, the services the Department provides, and more -- are paid for by the foreign affairs budget, which represents little more than 1% of the total federal budget. The purposes of the Department of State include:

- Protecting and assisting US citizens living or traveling abroad;
- Assisting US businesses in the international marketplace;
- Coordinating and providing support for international activities of other US agencies (local, state, or federal government), official visits overseas and at home, and other diplomatic efforts;
- Keeping the public informed about US foreign policy and relations with other countries and providing feedback from the public to administration officials;
- Providing automobile registration in the United States for foreign non-diplomatic staff vehicles and the vehicles of diplomats of foreign countries having diplomatic immunity in the United States.

The Department of State conducts these activities with a civilian workforce composed of Civil Service and Foreign Service. Foreign Service Officers are duly commissioned officers, appointed by the President with advice and consent of the Senate. United States Foreign Service employees, including Foreign Service Officers and Foreign Service Specialists, are assigned to diplomatic, consular and multilateral missions abroad to represent America; analyze and support on political, economic, and social trends; provide outreach and information about American culture and US policy in host countries; adjudicate visas; manage property, human resources, and US Government assets in foreign countries; and respond to the needs of American citizens abroad. The US maintains diplomatic relations with over 190 countries and maintains relations with many international organizations, adding up to a total of more than 250 posts around the world. In the United States, about 5,000 professional, technical, and administrative employees work at compiling and analyzing reports from overseas, providing logistical support to posts, communicating with the American public, formulating and overseeing the budget, issuing passports and travel warnings, and more.

In carrying out these responsibilities the Department of State works in close coordination with other federal agencies, including the Department of Defense, the Department of the Treasury, and the Department of Commerce. As required by the principle of checks and balances, the Department also consults with Congress about foreign policy initiatives and policies. The increasing importance of interagency collaboration dictates close cooperation and communication between the Department of State and Defense, in particular. The presence of Foreign Service Officers in combatant commands helps facilitate two-way communication, improving the military's reach into US Embassies and missions in the Area of Responsibility as well as ensuring that foreign policy and State Department equities are reflected in military planning and activities.

Department of the Treasury (Treasury) <http://www.ustreas.gov/>

The Department of the Treasury's mission is to serve the American people and strengthen national security by managing the U.S. Government's finances effectively, promoting economic growth and stability, and ensuring the safety, soundness, and security of the U.S. and international financial systems.

The mission highlights Treasury's role as the steward of U.S. economic and financial systems, and as an influential participant in the global economy.

The Treasury Department is the executive agency responsible for promoting economic prosperity and ensuring the financial security of the United States. The Department is responsible for a wide range of activities such as advising the president on economic and financial issues, encouraging sustainable economic growth, and fostering improved governance in financial institutions. The Department of the Treasury operates and maintains systems that are critical to the nation's financial infrastructure, such as the production of coin and currency, the disbursement of payments to the American public, revenue collection, and the borrowing of funds necessary to run the federal government. The Department works with other federal agencies, foreign governments, and international financial institutions to encourage global economic growth, raise standards of living, and to the extent possible, predict and prevent economic and financial crises.

The Treasury Department also performs a critical and far-reaching role in enhancing national security by implementing economic sanctions against foreign threats to the U.S., identifying and targeting the financial support networks of national security threats, and improving the safeguards of our financial systems.¹⁷

Department of Transportation (DOT)

<http://www.dot.gov/new/index.htm>

The mission of the DOT is to serve the United States by ensuring a fast, safe, efficient, accessible, and convenient transportation system that meets our vital national interests and enhances the quality of life of the American people, today and into the future.

The Secretary of Transportation is the principal adviser to the president in all matters relating to federal transportation programs. The Secretary is assisted by the Deputy Secretary in this role. The Office of the Secretary (OST) oversees the formulation of national transportation policy and promotes intermodal transportation. Other responsibilities range from negotiation and implementation of international transportation agreements, assuring the fitness of U.S. airlines, enforcing airline consumer protection regulations, issuance of regulations to prevent alcohol and illegal drug misuse in transportation systems, and preparing transportation legislation.

Key agencies within DOT include the Federal Aviation Administration (FAA), Surface Transportation Board (STB), Federal Transit

¹⁷ Department of the Treasury web site <http://www.ustreas.gov/>

Administration (FTA), Maritime Administration (MARAD), and the National Highway Traffic Safety Administration (NHTSA).¹⁸

Independent Government Agencies and Government Corporations

Independent establishments are created by Congress to address concerns that go beyond the scope of ordinary legislation. An independent government agency is an agency of the United States government created by an act of Congress and is independent of the executive departments. A wholly owned government corporation is a corporate entity established by Congress in which the government holds all equity. Fourteen wholly owned government corporations are listed in the Government Corporation Control Act of 1945. The Act does not serve as a general incorporation law; each of these corporations has their own enabling legislation that stipulates its powers.¹⁹ These agencies are responsible for keeping the government and economy running smoothly. The following are some of the more commonly known independent government agencies and government corporations:

- Central Intelligence Agency (CIA)
- Environmental Protection Agency (EPA)
- Federal Communication Commission (FCC)
- Federal Trade Commission (FTC)
- General Services Administration (GSA)
- National Aeronautics and Space Administration (NASA)
- National Science Foundation (NSF)
- National Transportation Safety Board (NTSB)
- Office of the National Counterintelligence Executive (ONCIX)
- Selective Service System (SSS)
- U.S. Trade and Development Agency (USTDA)
- United States Agency for International Development (USAID)
- United States International Trade Commission (USITC)

References:

- DODD 3000.06, Combat Support Agencies
- DODD 5100.01, Functions of the Department of Defense and Its Major Components
- DODD 5105.19, Defense Information Systems Agency (DISA)

¹⁸ Department of Transportation web site <http://www.dot.gov/>

¹⁹ U.S. Code Online via GPO Access (<http://www.gpoaccess.gov/uscode/>). GPO comment: Laws in effect as of January 6, 1999. Document not affected by Public Laws enacted between January 6, 1999 and February 11, 2000.]

- DODD 5105.21, Defense Intelligence Agency (DIA)
- DODD 5105.22, Defense Logistics Agency (DLA)
- DODD 5105.62, Defense Threat Reduction Agency (DTRA)
- DODD 5105.64, Defense Contract Management Agency (DCMA)

1.6.3 The National Guard and Reserves

National Guard (NG)

The NG is the organized militia reserved to the states by the Constitution of the United States under Article 1, Section 8. In 1903, Congress officially designated the organized militia as the NG and established procedures for training and equipping the Guard to active duty military standards. The NG has two branches, the Army National Guard and the Air National Guard. Figure 3 describes the National Guard Bureau (NGB) relationships.

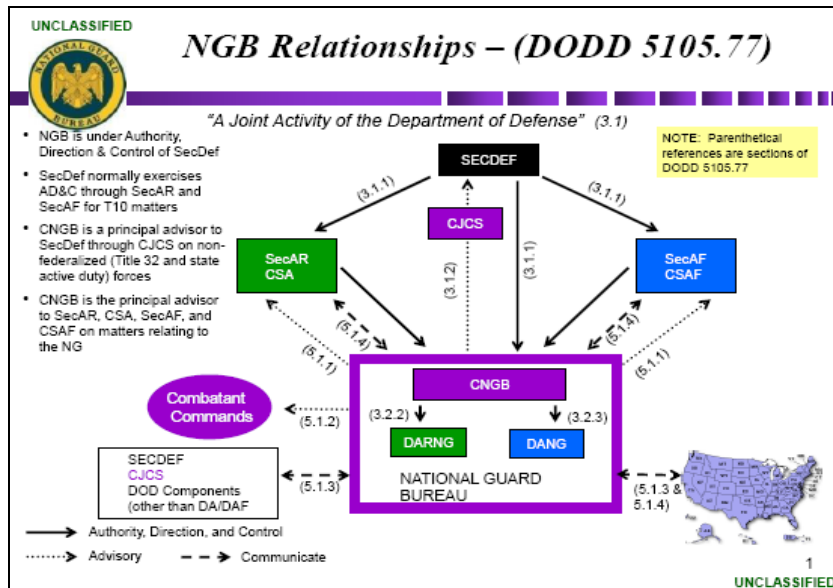

Figure 3: National Guard Bureau Relationships

The NG has a unique dual mission that consists of both Federal and State roles: in peacetime, the governor of each respective state or territory commands the NG; when ordered to active duty for mobilization or called into federal service for emergencies, units of the Guard are under the control of the appropriate service secretary. The

NGB is the channel of communications between the Department of the Army and Department of the Air Force, and the States on all matters pertaining to the NG, the Army National Guard of the United States, and the Air National Guard of the United States.

The NGB is the focal point at the strategic level for NG matters that are not under the authority and direction of the Secretaries of the Army and Air Force, including joint, interagency, and intergovernmental matters where NGB acts through other DOD officials as specified herein.

The Army National Guard (ARNG)

During peacetime, each state NG answers to the leadership in the 50 states, three territories and the District of Columbia. The state, territory, or district leadership is the Commander in Chief for each Guard. Their Adjutants General are answerable to them for the training and readiness of the units. At the state level, the governors reserve the ability, under the Constitution of the United States, to call up members of the NG in time of domestic emergencies or need. The ARNG's state mission is perhaps the most visible and well known. Nearly everyone has seen or heard of Guard units responding to battle fires or to help communities deal with floods, tornadoes, hurricanes, snowstorms, or other emergencies. In times of civil unrest, the citizens of a state can rest assured that the Guard will be ready to respond, if needed.

During national emergencies, however, the president reserves the right to mobilize the NG, putting them in federal duty status. While federalized, the units answer to the combatant commander of the theatre in which they are operating and, ultimately, to the president. Even when not federalized, the ARNG has a federal obligation (or mission.) That mission is to maintain properly trained and equipped units, available for prompt mobilization for war, national emergency, or as otherwise needed. The ARNG is a partner with the Active Army and the Army Reserves in fulfilling the country's military needs.

The Air National Guard (ANG)

The ANG's federal mission is to maintain well-trained, well-equipped units available for prompt mobilization during war and provide assistance during national emergencies (such as natural disasters or civil disturbances). During peacetime, the combat-ready units and support units are assigned to most Air Force major commands to carry out missions compatible with training, mobilization readiness, humanitarian, and contingency operations such as Operation Enduring Freedom in Afghanistan. ANG units may be activated in a number of ways as prescribed by public law. Most of the laws may be found in

Title 10 of the U.S. Code. The ANG provides almost half of the Air Force's tactical airlift support, combat communications functions, aeromedical evacuations and aerial refueling. In addition, the ANG has total responsibility for air defense of the entire United States.

When ANG units are not mobilized or under federal control, they report to the governor of their respective states, territories (Puerto Rico, Guam, Virgin Islands), or the commanding general of the District of Columbia National Guard. Under state law, the ANG provides protection of life, property and preserves peace, order, and public safety. These missions are accomplished through emergency relief support during natural disasters such as floods, earthquakes, and forest fires; search and rescue operations; support to civil defense authorities; maintenance of vital public services and counterdrug operations.

Reference: DOD Directive 5105.77

Reserves

The Reserve Components of the United States Department of Defense and United States Department of Homeland Security (in the case of the United States Coast Guard) are military organizations with members who augment the active duty military when necessary. Although Reservists are entitled by contract/law to 39 days of service, many provide much more support, especially in a current global situation that requires protracted engagements.

The purpose of each Reserve Component is to provide trained units and qualified personnel available for active duty in the armed forces, in time of war or national emergency, or whenever national security may require, to fill the needs of the armed forces whenever more units and personnel are needed than are in the active components. In addition to providing complementary support, Reservists can provide unique capabilities that sometimes are not found in the active component.

The basic policy is that whenever Congress or the president determines that more units and organizations are needed, the Reserves are ordered to active duty and retained as long as needed. Reserves partner with the active components and the National Guard to provide an integrated Total Force that executes military strategy.

The Reserve Component of the Armed Forces includes:

- The Army National Guard (ARNG)
- The Army Reserve (USAR)
- The Navy Reserve (NAVRESFOR)

- The Marine Forces Reserve (MARFORRES)
- The Air National Guard of the United States (USANG)
- The Air Force Reserve (AFRC)
- The Coast Guard Reserve (USCGR)

Reserve Component (RC) Utilization Guidelines:

- Definitions of RC duty statuses can be found in DODI1215.06.
- SecDef goal of one year of Active Duty (AD) for every five years of service.
- Generally, before looking to outside agencies, first source all approved non by-name specific requests with assigned RC members.
- In accordance with DOD Directive 1235.10, Activation, Mobilization, and Demobilization of the Ready Reserve, due consideration shall be given to alternate sourcing solutions (i.e., AD, DOD civilian personnel, etc.) prior to using RC members.
- The Services typically require 30-45 days lead-time to process routine requests for long-term support. (Note: Per Assistant Secretary of Defense Memorandum, 20 August 2008, Reserve Component Alert/Mobilization Decision Process Implementation, the DOD notification goal for routine Mobilization requests is 180 days.)
- RC personnel should primarily be used to backfill forward-deployed AD forces and to support surge operations. RC members should not be used to fill gapped AD billets. Gapped examples include: AD member moved to another position because of training or skill-set; AD member's Permanent Change of Station (PCS) delayed; or AD member on terminal leave.
- RC personnel may be used to support special projects that have a defined end state (i.e., project completion date or condition). This is intended for projects with duration of less than three years. See Active Duty for Operational Support (ADOS)/Active Duty for Special Work (ADSW)/Military Personnel Appropriation (MPA) criteria below.
- If the request is because of a new mission assignment, then manpower funding or internal realignment should be forthcoming. In this case, steps toward a permanent manpower solution with an estimated completion date must be provided in the requirement justification. Services may require compliance with certain milestones to continue funding.
- RC personnel may not be used to fill positions eliminated by

the 2005 Base Realignment and Closure (BRAC) cycle.

- All requests are subject to Service approval.
- Unlike AD members, RC members must perform the duties for which they were originally requested. They may not be moved from one position to another without notifying the paying Service or Agency. Exceptions may be made if the following circumstances arise prior to the completion of an individual's orders:
 - The requirement has been satisfied or assigned mission is complete.
 - The duties assigned to the individual have changed significantly or are no longer linked to the original requirement.

(Note: If deemed necessary by the review, the member will coordinate with his/her chain of command to begin the Release from Active Duty (REFAD) process.)

- **Surge/Contingency Operations Criteria.** The requirement must clearly support a current contingency (i.e. Operation New Dawn/Operation Enduring Freedom) in order to invoke the Mobilization or Operational Support Authority defined in Title 10, U.S. Code (USC). The requirement should have a direct and quantifiable impact on contingency operations. Justification should address the following questions: (Note: Justification must focus on the requirement—not the person requested.)
 - What metrics will be used to measure the impact of this requirement?
 - What specific skill-set is needed to meet this requirement and why must it be a military member (or specific service or Military Occupational Specialty (MOS)/Air Force Specialty Code (AFSC)/Rate/etc.)?
 - What would be the impact on the mission if this requirement were not sourced?
 - What would be the additional cost/risk if sourced elsewhere?
- **ADOS, ADSW/MPA Criteria.**
 - Intended specifically for short term requirements, not as a permanent solution. Should be used to help fill a temporary requirement or to provide backfill until a permanent manpower sourcing solution is established. This type of duty status is ideal for projects or manpower shortfalls due to new missions with a defined end date or

condition. Requirement should not last more than three years. Requestor should include milestones in the justification and be prepared to provide progress updates at defined milestones.

References:

- U.S. Code; <http://www.arng.army.mil/>;
<http://www.ang.af.mil/main/welcome.asp>;

For more information check these websites:

- Navy Reserve (<http://www.navyreserve.navy.mil>)
- Marine Forces Reserve (<http://www.marines.mil/unit/marforres/pages/default.aspx#mainContent>)
- Army Reserve <http://www.goarmy.com/reserve.html>)
- Air National Guard (<http://www.ang.af.mil>)
- Air Force Reserve (<http://www.afrc.af.mil>)
- Army National Guard (<http://www.arng.army.mil>)

1.6.4 Multinational Partners

Multinational operations are usually undertaken within the structure of a coalition or alliance. An **alliance** is a relationship that results from a formal agreement (e.g., treaty) between two or more nations for broad, long-term objectives that further the common interests of the members. A **coalition** is an *ad hoc* arrangement between two or more nations for common action. Coalitions are formed by different nations with different objectives, usually for a single occasion or for longer cooperation in a narrow sector of common interest.

Nations form partnerships in both regional and worldwide patterns as they seek opportunities to promote their mutual national interests, ensure mutual security against real and perceived threats, conduct foreign humanitarian assistance operations, and engage in peace operations. Cultural, diplomatic, religious, psychological, economic, technological, and informational factors all influence and impact multinational operations and participation.

Guidelines for working with Multinational Partners:

- **Respect.** Partners must be included in the planning process and their opinions must be sought in mission assignment. Understanding, consideration, and acceptance of partner ideas are essential to effective communication, as are respect for

each partner's culture, religion, customs, history, and values.

- **Rapport.** U.S. commanders and staffs should establish rapport with their counterparts from partner countries, as well as the Multinational Force Commander (MNFC).
- **Knowledge of Partners.** Much time and effort must be expended in learning about the enemy; a similar effort is required to understand the doctrine, capabilities, strategic goals, culture, religion, customs, history, and values of each partner. This effort will ensure the effective integration of Multinational Forces (MNF) partners into the operation and enhance the synergistic effect of the coalition forces.
- **Patience.** Effective partnerships take time and attention to develop. Diligent pursuit of a trusting, mutually beneficial relationship with multinational partners requires untiring, evenhanded patience. This is easier to accomplish within alliances but is equally necessary regarding prospective coalition partners.

(Note: See JP 3-16 *Multinational Operations* for additional details.)

Action Officer (AO) Considerations:

- **Determine existing relationships with countries in your AOR**—Check with J5 country desks (if applicable).
- **Foreign Clearance Guide (FCG)** (<https://www.fcg.pentagon.mil/>)—Website provides information on various countries.
- **Work with Foreign Disclosure Office (FDO)**—Knows level of clearance for each country.
- **Foreign Visit System (FVS)**—If hosting foreign visitors, ensure visitors submit request in FVS. This is normally done through the embassy.
- **Understand related money issues**—AOs need to be aware of the legal issues that can surround foreign visitors regarding gifts and acceptance of meals. It is important to understand who will pay for what during the visit. It is critical that both the partners and the host/command know this up front so there are no surprises or embarrassments.
- **Planning/Coordination considerations**—Take into consideration:
 - Time Zones,
 - Cultural/Religious differences

- Language barriers²⁰
- Communication procedures (country codes, etc.)
- Food aversions, holidays, etc.

1.6.5 DOD Government Civil Servants - General Schedule (GS)

The number of government civilians working at military commands has risen dramatically due to the high numbers of military deployed and the drawdown of military end strengths. Military positions have converted over to civilian and government contractors are replacing military police, firefighters and trainers to fill the void left from military shortfalls. This growing category of civilian workers serving at the joint commands underscores the need for military personnel to understand their roles and responsibilities as civilian supervisors. It is important for the military supervisor to understand the background of the civilians assigned in the workspace. They could be retired military, active in the Reserves or Guard and because of their length of service, possess skills valuable to the military. Civilians should therefore be looked upon as members of the U.S. Government (USG) interagency team with knowledge, skills and abilities that will prove important toward mission accomplishment.

GS Civilian Position Guidelines: GS positions are governed by a job description or Position Description (PD) and may be further defined by a performance plan with specific job objectives. The PD will outline authorities and responsibilities of the job and is imperative to review if you are responsible to supervise and evaluate civilians. Similarly the performance plan and associated objectives should be reviewed and revised to meet your mission requirements.

A properly constructed performance plan with supporting objectives coupled with timely supervisory direction will enhance the quality of performance in your workplace.

GS pay classification: The GS pay scale is scaled by the 15-grade/10 step system. GS employees are rated for a position based on education, experience, and relevant Knowledge, Skills, and Abilities (KSAs) and are generally hired into a pay grade at the first step (GS-

²⁰ For example, English-as-a-Second Language (ESL) speakers and writers may use words in an unusual way. Native speakers/writers may quickly misinterpret the intent of the message. Alternatively, native speakers may use idioms that are not familiar to ESL speakers. Be very patient when communicating with ESL colleagues and clarify any unusual word choices.

12, step 1). Each additional step is earned after serving a prescribed period of service (at one, two or three year intervals) in at least a satisfactory manner.

Civilian Supervisor Responsibilities: Military personnel on a joint staff may be responsible to supervise and evaluate civilians. As a Military supervisor you have the responsibility to rate your civilian employees yearly and conduct one formal mid-term review. A supervisor should monitor and document civilian performance regularly, provide feedback and guidance and adjust the objectives and goals as necessary to achieve an efficient workforce.

It is important to determine whether your civilian employees are represented by a labor organization, if your employees are in the bargaining unit it is advised that you review the local collective bargaining agreement contract. The contract will outline civilian duty day procedures, such as alternate work schedule, required steps for discipline counseling, employee reviews, appraisals, grievances, employee rights, management rights, and union bargaining obligations. Insure you know what management has agreed to in the contract in order to avoid supervisory mistakes. A simple managerial request for an employee to change office space or locations will typically require union notification.

The success of your supervision will depend on the accuracy and comprehensiveness of your employee performance plans, the guidance and feedback you provide on an interim basis, your knowledge of the rights of management and union obligations and in the end your ability to motivate and communicate effectively with your employees.

1.6.6 Working with Government Contractors

Contractors comprise a large portion of the DOD workforce. Military staff officers who supervise contractors should understand the principle contract currently in force that governs the Statement of Work (SOW) for contractors in their workforce.

Contractors are supplied from several different private companies who were awarded contracts to provide services and qualified personnel to meet Federal Government requirements. The detailed version of these job requirements, responsibilities and deliverables are listed in a Performance Work Statement (PWS). A purchase order is negotiated and represents what the government pays the Contractor to supply

qualified individuals to fulfill contract obligations. A contractor's pay is determined by fees, rates, and salary requirements negotiated between the employee and contracting company at the time of hire. Contractor salaries are not a part of the public record, in contrast to GS Federal pay schedules.

Statement of Work (SOW): Each contractor will have a published PWS or SOW for the specific job, product, or services purchased by the government. The PWS will outline the overall objective, products, services, specific tasks, reporting requirements and general information of contractor duty day, travel requirements and sources of funding. Each contractor normally has an assigned Program Manager (PM) who is responsible for the performance of the work and the daily management of the contract. The PM has full authority to act on all contractual matters relating to daily operation of the contract to include personnel management and will assist the military supervisor as requested.

Working Relationships: Military staff officers who supervise contractors should request and study the PWS, Specific Tasks Section to understand the job responsibilities or deliverables agreed upon between the government and contractor. As a supervisor you have the right to further define these tasks to support your military mission. Insure the PM has provided you the contractor's performance plan and appraisal procedures. You should meet once during the performance cycle to review progress on performance objectives, provide employer feedback and counseling as required. The PM should be consulted for contractual interpretations and to resolve military/contractor differences.

Contractor Evaluation: Contractors normally conduct a self-assessment of their performance compared to stated objectives. Contractors should coordinate their assessment with the military customer. The military customer may exercise the right to comment on contractor performance and if performance is substandard require the PM to insure military objectives are met. Contractors may be eligible for performance bonuses determined by the private contractor in contrast to the GS performance award process. The military customer may convey their recommendations for contractor bonus compensation directly to the PM.

Contractor Do's and Don'ts

The following list was provided by the USNORTHCOM Civilian Personnel Office (CPO) and is a good general list to follow. You

should contact your respective CPO to see if they have command-specific guidelines.

Do:

- Remember contractors are not Government employees
- Contractors must identify themselves as contractors during meetings, telephone conversations, correspondence & e-mails
- Treat contractors as valuable members of the Command team
- Understand their duties & responsibilities are defined via a performance work statement/task order
- Avoid conflicts of interest/unprofessional relationships
- Ask questions & seek advice
- Know who the COR is for the contract(s) that you may supervise

Don't:

- Get involved in the recruiting, selecting/hiring or firing of contractor personnel
- Direct, schedule or critique contractors
- Supervise contractors—avoid the appearance of an employer/employee relationship (i.e. personal services)
- Rate individual contractor personnel performance
- Use Govt & contractor personnel interchangeably
- Utilize contractors to develop Govt requirements or participate in the acquisition process (Performance Work Statements, Independent Govt Cost Estimates, technical evaluations)
- Disclose source selection information to contractor personnel
- Solicit or accept gifts from contractor personnel
- Authorize work outside the scope of the contract (Only warranted Contracting Officers are authorized to obligate the Government)
- Provide official recognition (i.e. awards/letters of appreciation)
- Authorize participation in “morale building” events, time-off or administrative leave

Conclusion: The joint staff officer (JSO) will encounter GS federal civilians and private contractors, all working to support the mission of the Commander. It is important that JSOs recognize that military personnel, DOD civilians, and government contractors are all on the same team. Consult your Civilian Personnel Office, normally the J1 Directorate for GS and military personnel management assistance.

References:

- Office of Personnel Management (OPM) website, <http://www.opm.gov/>
- Performance Work Statement (PWS) J7-08-0005 (Joint Training Specialist Program)

1.6.7 Working with the other Services

An assignment to a combatant command or the Joint Staff will often represent a staff officer's first true experience working with personnel from the other U.S. Military Services and possibly military personnel from North Atlantic Treaty Organization (NATO), allied, or coalition partner nations. Staff officers should recognize that each Service has evolved its own unique culture and way of doing business based on Service history, traditions and operating environment. Historically, the Services have maintained enough of their own infrastructures to execute most missions independently and self-sufficiently. Waning defense budgets, increasing hardware unit costs, advances in communications technology, and the events of the latter half of the 20th century have created a new operating environment, one which demands the joint employment of U.S. military power.

The requirement for joint employment of the U.S. Armed Forces has transformed the training, exercise, and operational environment. At earlier points in their careers military personnel are now receiving joint education and exposure to the other Services.

Some examples of inter-Service joint operations and training include:

- Navy, Marine Corps, and Coast Guard officers aspiring to become Naval Aviators and Naval Flight Officers have jointly trained since the beginning of Naval Aviation with flight instructors from those very same Services. Until recently, Army and Air Force helicopter pilots trained together for several decades.
- Marine Corps armor officers have trained and instructed at the U.S. Army Armor Center and School for years, while Navy personnel from the amphibious community have always been thoroughly invested and integrated with the Marine Corps.
- In a more contemporary context, the Army and Air Force have worked jointly in the tactical airlift of both paratroopers and non-airborne personnel.
- Other officers may gain experience as exchange officers to other U.S. or NATO/Allied Military Services, such as those

selected for opportunities like the Personnel Exchange Program (PEP).

- A select number of personnel from all Services may attend the postgraduate educational institutions or the intermediate or senior service colleges of another Service, while others will serve on the staffs of Joint Task Forces (JTFs).

While these interactions will help staff officers to understand that fundamental differences exist between the Services, operating in the joint environment with the multitude of Services and other partners can present a whole new set of challenges. The joint environment requires staff officers to overcome any Service-centric parochialisms and biases that they may carry. Staff officers should respect the synergy these differences can create and should be mindful of the impact they have on how joint personnel interact, operate, communicate, make decisions, and approach tasks.

A number of factors help influence the thought processes of individual officers in any joint command. Some of the more notable differences between the Services include:

- A *centralized* versus *decentralized* approach. Officers with backgrounds in land-based forces (i.e., Army and Air Force) will typically gravitate toward a “centralized control” mindset endemic of a higher headquarters model. Conversely, officers from the sea-based forces (i.e., Navy, Marine Corps, and Coast Guard) may lean more toward a “decentralized” mindset as a carry-over from a history of ships operating independently at sea with limited communication to home. The way these mindsets apply will vary between combatant commands, often as a function of the operating environment and geographic area of responsibility. All newly-arriving officers should recognize that neither a centralized or decentralized approach has primacy and will often vary depending on the approach of the commander for that combatant command at that particular point in time.
- Size and capacity versus speed and flexibility. The Army, the oldest Service, is steeped in traditions; it has an extremely manpower/soldier-centric operating environment. Its sheer size lends itself to an extensive logistical/support establishment. Conversely, you may observe that the Marine Corps, while also steeped in tradition and focused on the individual Marine, prides itself on its quick responsiveness and its minimal non-combatant infrastructure. Both of these dynamics demand strong leadership skills necessary for

leading what may be large numbers of junior enlisted personnel into direct combat.

- Hardware-Centric versus Base-Centric. The Navy and the Air Force are extremely hardware-centric, i.e., ships and aircraft for the former, and aircraft and (to a lesser extent) missiles and spacecraft for the latter. The Navy tends to be ship-centric, often at the expense of their shore bases, while the Air Force is very base-centric, with an infrastructure and support network that are often the envy of the other Services.
- General versus Specialized Enlisted forces. Navy and Air Force officers, accustomed to working with enlisted personnel who are specialized technicians, may approach joint staff work from a more technical or managerial perspective than that of their ground officer counterparts.
- Static versus Dynamic Mission Sets. Coast Guard officers will tend to reflect many of the predilections of their Navy counterparts, albeit from the perspective of a Service that has had to historically operate with under-resourced assets, aged ships and aircraft, and a mission set emphasis which vacillates between combat, law enforcement, and maritime safety. Although present in Joint Task Forces for the past two decades, Coast Guard officers in combatant commands are a fairly recent innovation, but will likely remain a permanent fixture for the foreseeable future.
- Prior Experience Working with Senior Officers versus Little or None. Differences and disparities between the Services in career paths leading up to a joint assignment may surprise new staff officers in joint assignments. For example, Army and Air Force officers will likely come to a joint assignment with prior junior officer experience as an administrative “exec” to a senior officer at the O-5 and above level. In contrast, Navy, Marine Corps and Coast Guard officers will have had no such experience unless selected for one of the highly competitive Flag Aide or Aide-de-Camp billets to an O-7 or above who rates such an aide.

Success in the joint environment will ultimately depend on the ability to work with other Services. Some tips that can enhance the joint experience include:

1. Suppress your Service pride and check your ego at the door. This will help you to operate more successfully within the joint environment. Although pride in your Service is important and expected, especially in military organizations where esprit de

- corps is so critical, you should not discount or exclude the capabilities or value-added from other Services.
2. Foster a joint culture that is not mutually exclusive of any one Service culture, but instead advocates all Service cultures and leverages the best aspects of each. Realize that a joint environment is different from your Service environment and avoid using generalizations to characterize the combatant command or its personnel. Do not use terms like “Army” instead of “Joint” or “soldier” instead of “Service member”. Additionally, use of terms like battalion or company tend to favor one Service and should be avoided if possible.
 3. Strive to become familiar with the individual Service operating environments of your counterparts and to enlighten them on your Service environment.
 4. Learn about the diverse opportunities and experiences that your counterparts have had—particularly at the company grade and junior field grade officer level in each of the Services.
 5. Maintain an open mind and be open to applying what might be considered as previously “unconventional” approaches, within your individual Service.
 6. View your joint assignment as an opportunity to understand how the other Services work and to better understand what determines the methodologies their officers employ. Identify ways to create synergy between the Services, seek and leverage the diverse expertise available to you, and advocate and employ a team approach.
 7. Finally, remember that we in the joint environment must all work together to ensure that our mission and national defense requirements are fulfilled. Your experiences here at your joint assignment can play an important role when you return to your home Service and are tapped to integrate your operations with other Services, especially in commander or commanding officer positions, as part of a larger joint force.

1.7 Maximizing Technology Software and Hardware Capabilities in the Combatant Commands

Effective staff officers must use the technology systems available to them to efficiently manage time and daily activities—these tools are force multipliers. Staff officers are expected to embrace technology support tools and to maximize the capabilities to increase proficiency and quality in their daily work.

Senior leaders expect good staff officers to have well-developed technology skills. Following is a list of desired skills to help determine the areas where you may need new or refresher training:

- Uses computer system to manage tasks well—files information so that it is easily accessible;
- Follows network security and information assurance protocols;
- Utilizes collaborative work tools to speed the process;
- Able to effectively navigate the world wide web and portals;
- Knows how to effectively use the web for research;
- Able to use the systems of 'record' throughout the specific command and the joint world to full capabilities;
- Uses the Microsoft[®] Office Suite at a high proficiency level:
 - Able to use PowerPoint to effectively build and present four-star level briefings; able to embed and create drill downs;
 - Able to use Outlook effectively to manage high volume of e-mails, files, and communications related to staffing packages;
 - Has advanced skills in Word for constructing and revising documents in multiple formats;
 - Able to use Excel spreadsheets at the level required for the job (some jobs require more detailed use such as the ability to create pivot tables);
 - If needed for the job, is able to use Microsoft[®] Project effectively.
- Has high proficiency for usage of messaging system (particularly important for host nation notification);
- Uses command-sponsored tasking management system effectively (JSAP at the Joint Staff level, and the command specific system in the CCMDs);
- Is not afraid to try new technologies; is willing and able to use/learn other tools needed for the job (e.g., JOPES);
- Has a basic understanding of and uses joint systems and tools [e.g., JOPES, JCIDS, Joint Training Information Management System (JTIMS), and Integrated Priority List (IPL)].

Each combatant command uses numerous technology-based systems to make information available and to move information around (over 300 technology systems are in use at the nine combatant commands). As an AO, a major portion of your job is to find valid information to support the tasks you are assigned. Listed below are some examples of the types of technology support tools available across the combatant commands. During orientation you will probably be introduced to the

tools available or required in your organization; if not, you should ask your experienced colleagues about the available tools. Remember to talk with a broad variety of people as the technology skills and subject matter interest may dictate the tools and how much they are used. Some tools will require initial training which may take place in a classroom or may be on-the-job, learning-by-doing, or tutoring; for others, you may already have some user experience but may need a higher level of proficiency.

- **Combatant Command Directories:** designated directories accessible through your desktop with command specific information.
- **Commander's Knowledge Wall (CKW):** a Microsoft® SharePoint portal established on the Secret Internet Protocol Router Network (SIPRNet). In U.S. Southern Command (USSOUTHCOM), for example, the CKW consists of ten pages (or tabs):
 - **Home Page:** Lays out Objectives, Vision, Mission, and Focus Areas.
 - **Staff Summary:** Each J-Code provides the commander with information on current key issues.
 - **MILGRP Summary:** Each MILGRP provides the commander with information on key issues or significant events relating to the respective country.
 - **IA Summary:** The Interagency Weekly Summary is posted here.
 - **MILGRP RFA:** *Military Groups (MILGRPS) post Requests for Assistance and the status of those requests. Data is removed when assistance is completed.*
 - **COMP SITREP:** Component Commanders provide a daily Situation Report (SITREP), which includes the Component Commander's Evaluation/Assessment Report.
 - **SIG Event:** *All significant events are posted weekly.*
 - **CDR Travel:** *A page that includes the Commander's (CDR's) upcoming travel.*
 - **Engagement Calendar:** Events occurring at the command or requiring command leadership participation.
 - **Senior Leader Travel:** A prioritized list of senior leader travel.

The objectives of the CKW include:

- Enhance the commander's productivity, connectivity, synchronization, and response time in decision-making.
- Enable migration and consolidation of information-sharing tools into a single environment.

- Facilitate horizontal and vertical information sharing, knowledge management, and overall understanding of the commander's directed action.

Synchronous web-based meeting and briefing tools: although many are available, one example is the Defense Connect Online (DCO, or Button 2) capability in use DOD-wide and is available to members of the Interagency. DCO is Adobe Connect software that provides a web-based meeting platform with many powerful options. DCO provides virtual meeting rooms for collaboration in real-time. DCO is available on Non-secure Internet Protocol Router Network (NIPRNet) and SIPRNet (initial account creation is on NIPR at <https://www.dco.dod.mil/>).

Portals: web-based entry points that create access into multiple web-enabled sources of information. Portals allow users to access information from a broad spectrum in a unified format. One example is the Army Training Requirements and Resources System (ATRRS), which compiles student, school, and course information from a variety of sources and presents it in common location and format. Another example is Google that, when conducting a search, searches multiple sites to find the most common results. Portals are powerful tools that multiply information management capabilities.

Knowledge Management Tools: tools that help create, capture, find, organize, analyze, share, and maintain organizational knowledge and expertise. As an example USSOUTHCOM's CKW is a SharePoint portal established on the SIPRNet:

- **Wiki:** a page or collection of web pages designed to enable anyone who accesses it to contribute or modify content using a simplified markup language. Wikis are often used to create collaborative websites and to power community websites. *Wikipedia* is a well-known online information source (an electronic dictionary and encyclopedia where the content is provided by anyone who wants to submit definitions of terms and source information).
- **Blog:** (a contraction of the term "web log") a website, usually maintained by an individual with regular entries of commentary, descriptions of events, or other material such as graphics or video. Entries are commonly displayed in reverse-chronological order. A typical blog combines text, images, and links to other blogs, web pages, and other media related to its topic. The ability for readers to leave comments in an interactive format is an important part of many blogs.

Leadership at USSTRATCOM, for example, established a blog as a way for the commander to interface with all levels of personnel.

- **Content Management Tools**

- **Document Repository (Any Time):** a shared repository for documents and other work products. The ability to store and retrieve information and knowledge from any place at any time is core to team work today. A repository can be as simple as a shared drive online or a memory stick of folders and files that you pass around. Or it can be as comprehensive as a tailored team room (see below).
- **Discussion Threads (Any Time):** in use for 40 years, the original any-time group collaboration tool of the Internet. They allow focused conversations over an extended period of time among, essentially, unlimited numbers of people. On a large-scale, this technology supports professional fora and communities of practice. On a small-scale, teams can develop, discuss, and track a range of topics—from big ideas to bug fixes.
- **Leader-Team Room (Any Time):** online team room which provides a common home for people who function as a unit. It serves as a flexible repository and may have discussion capabilities. In general, such rooms have a menu of optional functions such as calendars and lists. Tailored leader-team rooms are configured to support elements common to all leader-teams. Since they are relatively permanent places, such rooms accumulate knowledge and dynamically reflect a team's personality. U.S. European Command (USEUCOM) uses the Leader Team Room to support their Teams of Leaders Practice.
- **Push-Pull-Prod:** capabilities of a good knowledge management system. A good team room technology allows a team or teams to employ all three approaches to communication. For *push*, you can set alerts for changes in content areas and discussions, or announcements made on the home page. For *pull*, the team room is a repository of all the team's shared information about itself, its work, and often the work itself (if it is an information product). *Prod* technology is currently in its infancy for leader-teams, but prodding comprises much of what team meetings and messaging are all about. Here, good virtual collaboration behaviors are the prod (for more information, see U.S. European Command's (USEUCOM's) *ToL Handbook Coordinating Draft v.1.2.*)

- **Examples of other systems—DOD and Joint**
 - **SIPRNet:** the Secure Internet Protocol Router is DOD's largest interoperable command and control data network, supporting the Global Command and Control System (GCCS), the Defense Message System (DMS), collaborative planning and numerous other classified warfighter applications.
 - **NIPRNet:** Non-Secure Internet Protocol Router Network—a global long-haul IP based network to support unclassified IP data communications services for combat support applications to the DOD, Joint Chiefs of Staff (JCS), Military Departments (MILDEPs), and Combatant Commands (CCMD). NIPRNet provide seamless interoperability IP services to customers and is a common tool across all Services; is one of many systems required to perform daily tasks. All taskers, however, are sent on the SIPRNet, even though not all are classified, which often creates extra work, and limits assignment of tasks.
 - **Defense Military Message System (DMS):** a secure e-mail system to ensure safety for critical operations. DMS was developed for the United States DOD to replace the Automated Digital Network (AUTODIN), the previous official DOD e-mail system as well as 45 separate e-mail systems that functioned within the DOD. Local users of DMS may log onto the system through a user-interface, such as Telos Automated Message Handling System (referred to as Telos or AMHA).
 - **JOPES:** Joint Operation Planning and Execution System—the Chairman of the Joint Chiefs of Staff's joint planning system. It covers the planning spectrum from the president and SecDef through the Chairman, to the combatant commanders and the joint task force commanders. JOPES governs all aspects of conventional joint military operations planning and execution. It is the tool used by **all** echelons of planners and operators to speak a commonly understood language. JOPES furnishes joint commanders and war planners at all levels the standardized policies, procedures, and formats to produce and execute a variety of required tasks.²¹

²¹ The other use of the acronym JOPES is for the online tool used to build TPFDDs (time-phased force and deployment data).

- **DRRS:** Defense Readiness Reporting System—is a mission-focused, capabilities-based, common framework that provides the combatant commanders, Military Services, JCS, and other key DOD users a data-driven environment and the tools for evaluating, in near real-time, the readiness and capability of U.S. Armed Forces to carry out assigned and potential tasks.
- **JTS:** Joint Training System—a four-phase iterative process used in the identification of capability requirements, the planning, execution, and evaluation of required training, as well as the assessment of training readiness.
- **JTIMS:** Joint Training Information Management System—a web-based system providing automated support to the JTS. The system is used by the Joint Staff and major commands to manage all large-scale, military training and operational events. The JTS provides a multi-phase methodology for aligning training strategy with assigned missions while optimizing application of scarce resources. JTIMS supports the task-based, closed-loop features of the JTS by facilitating the development of an integrated, task-based thread to guide all four JTS phases. Training requirements, plans, events, and assessments are all linked to mission and mission essential tasks.
- **JLLP:** Joint Lessons Learned Program—composed of lessons learned and operational organizations distributed across the Services, combatant commands, CSAs, NGB, U.S. Government, Interagency and Coalition community. The JLLP process produces validated information that enables actionable Doctrine, Organization, Training Materiel, Leadership and Education, Personnel, and Facilities (DOTMLPF) changes to improve joint capabilities. The JLLP is a crucial element in enabling complex adaptive responses to changes in the military environment and exists to capture and process operational observations that improve readiness, capabilities, and combat performance.
- **JLLIS:** Joint Lessons Learned Information System—web-based system providing automated solution supporting implementation of the Chairman’s Joint Lessons Learned Program. JLLIS facilitates the development of key products to support discovery, validation, issue resolution processes, evaluation, and dissemination. JLLIS is used by a global community of users to include DOD, CSAs,

Services, U.S. Government Interagency, and our Coalition partners.

- ***JKO***: Joint Knowledge Online—a web-based training and Learning Management System (LMS) used in several combatant commands to deliver relevant, operationally focused joint training and knowledge services and products. This system can also be used to manage and track command-wide training requirements and manage training related information. Note: Combatant commands use other LMS's: check with your training staff to learn which system is used in your command.
- ***JCIDS***: Joint Capabilities Integration and Development System—one of three decision support systems that together form the joint acquisition process. JCIDS represents the identification of needed capabilities upon which acquisition programs are built. JCIDS replaced what previously was called the Requirements Generation System (RGS).
- ***Tasking Management Systems***: each combatant command has a tasking management system used to manage assignments. You will receive training on the specific system used within your command.

(Intentionally Blank)

Section 2. Interpersonal Skills Requirements

2.1 *Building Constructive Work Relationships in a Joint Environment*

The diversity of the workforce and the fast-pace in a combatant command requires the development of constructive work relationships and good collaborative skills. Because most staff officers come to a combatant command from operational assignments where traditional command structures and protocols formed the basis of communication and task management, it may be difficult to accept the fact that the work environment won't tolerate an "I'm in command" attitude. The following tips from senior leaders and successful staff officers are behaviors to incorporate in your daily work:

- Become knowledgeable of roles and responsibilities as well as organizational cultures of work partners—other Services, interagency and multinational partners, Guard and Reserve personnel, government civilians and contractors.
- You must learn to work effectively across the other directorates—even when they may be “stove-piped;” share information willingly and be cooperative with peers. Find collaborative ways to get accurate information in a timely manner—work to build consensus. View personnel within a command as allies and friends, not as the enemy.
- In a diverse work environment a collaborative and persuasive approach is more effective than giving commands and orders. Identify who else has input for a task and include them early in the process; build coalitions.
- Even though you may develop a passion for a topic, keep emotions in check; tasks often require group ownership. Remember, you may be the facilitator and owner of the task, but the problem and solution are owned by the organization—it is a team endeavor.
- Build trust through open communication; use compromise and cooperation as the main approach to business; build consensus through collaborative practices.
- Identify and cultivate reliable sources of information internally and externally across the joint world. Build strong networks and points of contacts and be a reliable source of information yourself.

- Find strengths in people instead of weaknesses; work well with others and try to bring out the best in people.
- Ensure that the meetings you facilitate lead to collaboration not divisiveness.
- Be respectful of others' workloads.
- Share information willingly, even if others do not—set the example.
- Develop effective negotiating skills to reach consensus or agreement; understand the need for compromise and cooperation as the main approach to business. As needed, be able to facilitate conflict resolution for personal projects and sometimes the intermediary for others.
- Use active listening skills; listen to subordinates and peers, as well as senior leaders.
- Be empathetic—try to understand issues from the point of view of others.
- Be a team player—work cooperatively with partners, allies, other Service members, interagency partners, and other members of team—they bring a lot of experience and different ways of accomplishing tasks. Do not fall into becoming Service—or organization-biased—work with people, regardless of their affiliation.
- Develop and use interpersonal skills that allow others to feel well utilized—not used.
- Practice a collaborative work style—be inclusive, ask instead of command.
- Build partnerships with other people in the command.
- If you tell someone you will do something, do it.
- Make an effort to learn about the organizational cultures of personnel from non-military organizations.
- Work to build consensus in staff actions.
- Keep the mission at the front of all tasks and remember that you can do little by yourself—you need the help of others, and they need you.

If you have the opportunity, you may want to take a course in negotiation skills. Several staff officers who were recognized by their combatant commands as model staff officers said they had taken business courses—not military courses—on how to negotiate; each indicated that the courses had helped them significantly in their required staffing efforts. One officer found an advertisement in an airline magazine while on travel, took the course, and claimed it was one of the most significant courses he had ever taken.

2.2 Teambuilding

2.2.1 Principles of Teamwork

Effective joint operations require close coordination, synchronization, and information sharing across the staff directorates. As a result, staff officers serving in the joint arena will often be required to serve on a variety of teams during their assignments. Senior leaders and experienced staff officers have frequently stressed the importance of the ability of joint staff officers to function effectively within the team environment. This section is intended to provide a better understanding of teamwork, some challenges that members of teams can face, and provide some strategies for working effectively in this context.

What is a team?

A team is defined as “a group whose members have complementary skills, are committed to a common purpose, or set of performance goals for which they hold themselves mutually accountable.”²² Many studies have shown that teamwork improves mission performance, increases productivity, and reduces staff conflict. Teamwork eliminates unnecessary layers of management, thereby decreasing the time needed to make recommendations, deliver products, and make decisions. If a staff officer does not know how to operate in this environment, the team can suffer and become ineffective. Staff officers possessing strong interpersonal skills, exercising effective communication, and maintaining a mission focus are more likely to be effective in their job.

Challenges of Teamwork

Anyone that has ever been on a team knows that getting a team to the point of effective performance can be (and often is) hard work. There are numerous team-specific aspects, organizational realities, personal leadership styles and interpersonal skills that can affect the success of a team. Some common challenges that staff officers serving on a team may encounter include:

- Each team will fall under the principal oversight of a staff directorate and the team leader is usually the representative from the organization with the responsibility to meet the objectives of their superior(s).

²² Greenberg, Jerald, “Managing Behavior in Organizations,” 3rd Edition, Upper Saddle River, NJ, Prentice Hall.

- Team members will often represent different stakeholder interests—sometimes conflicting—and all must be considered and addressed.
- Team members may not have been delegated the proper authority to speak on behalf of their organization, may not know enough to adequately represent their interests or may not have been given permission to participate fully.
- Teams require a great deal of planning, organization and follow through on the part of all members.
- Team members do not always know all of the inner workings of their own office, let alone their Directorate.
- Teams must go through a learning process to become effective and that can take time. It is not uncommon for teams to be temporarily less productive than before the team's establishment.
- Interpersonal skills of individual team members can have a large impact on the effectiveness of the team as a whole. Specifically, leadership skills, communication and persuasion skills, attitudes toward diversity, self-awareness, willingness to engage in information sharing, conflict management, willingness to accept responsibility and cooperate with others are all essential to team performance.

Tips for Team Success

Although teamwork has many challenges, there are many skills and effective strategies that staff officers can use to increase their chance for success. Staff officers should approach teamwork by remembering that the team will perform at its best when all members:

- Are focused on a common goal;
- Embrace the mission that has been established;
- Understand how their role on the team fits into the bigger picture;
- Are engaged in forming policies, establishing procedures, and making decisions at their level; and
- Are willing to fully participate and voice their concerns in a constructive way.

Each combatant command team can benefit by practicing the following principles:

- Senior leaders must understand and support the team's objectives and provide appropriate guidance, training and authority to the team.

- Teams must communicate effectively with senior leadership and seek out the guidance and support that they need to succeed in their mission.
- Although there is a team leader for most teams, it is important that these bodies function as one unit and that the team be self-governed. Team leaders should view themselves as coaches that strive to create win-win situations.
- Teams should keep good records and provide training and important background information to new members.
- Current challenges, tight deadlines, and all priorities must be effectively communicated to the team.
- Teams need to cooperate, coordinate, and deconflict not only within their own members, but also with other teams in the organization. It may sometimes be necessary for teams to engage on certain issues with other cross-functional teams that have a stake in a project, product, or deliverable.
- Staff officers should engage in continuous interpersonal skill development and life-long learning practices that affect their ability to operate within the team.

The Nature of Combatant Command Teams

Most combatant commands are organized by function, which can lead to stovepipes and inefficiencies within the organization. For this reason, combatant commanders are advised to establish work teams to manage important combatant command responsibilities. These teams serve a variety of functions and operate at many levels of the combatant command to manage specific processes and accomplish tasks in support of mission accomplishment. For example, General Officer/Flag Officer (GO/FO) level senior leadership may organize several groups to comprise what is often referred to as a Board or Bureau. Cells, Centers, and Councils are also groups formed within the combatant command at the O-6 level. Similarly, working groups may be formed at the Action Officer (AO) level to serve as a liaison or adviser to more senior level leadership. Finally, some combatant commands may form teams at any level to deal with certain issues on a more informal basis. These bodies are referred to as Boards, Bureaus, Cells, Centers and Working Groups (B2C2WG). Because each body fills a crucial role, it is important that joint staff officers understand the principles of teamwork and how to succeed in a team environment.

The purpose of the establishment of B2C2WG entities is multi-faceted. Specifically, each combatant command team serves to:

- Provide a venue for all stakeholders to interface on issues of

mutual interest and ensure appropriate representation for important decisions;

- Establish a battle rhythm to achieve integration of staff that all have unique contributions to the Headquarters;
- Create a body that can make suggestions and recommendations on issues affecting a variety of functions within the combatant command;
- Assist with the establishment and maintenance of staff policies and procedures;
- Develop and propose solutions to problems affecting the team interests.

Some examples of the existing B2C2WGs at the combatant commands may include:

- Joint Plans and Operations Board (JPOB)
- Joint Facilities Utilization Board (JFUB)
- Joint Civil-Military Engineer Board (JCMEB)
- Joint Plans and Operations Council (JPOC)
- Explosive Hazards Coordination Cell (EHCC)
- Humanitarian Assistance Coordination Center (HACC)
- Force Protection Working Group (FPWG)
- Joint Interagency Coordination Group (JIACG)
- Information Operations Working Group (IOWG)
- Intelligence Working Group (IWG)
- Joint Targeting Working Group (JTWG)
- Joint Steering Group (JSG)
- Joint Planning Group (JPG)
- Military Command, Control, and Information Systems Working Group (MCCISWG)
- Rules of Engagement Working Group (ROEWG)

Boards, bureaus, cells, centers, elements, Working Groups (WGs), groups, offices, and planning teams facilitate planning by the staff, decision-making by the commander, and execution by the Headquarters (HQ). Although cross-functional in their membership, most boards, bureaus, cells, centers, elements, WGs, groups, offices, and planning teams fall under the principal oversight of the staff directorates. This arrangement strengthens the staff effort in ways that benefit the organization and its commander in mission execution.

Figure 4 provides an example of the structure of the B2C2WG concept.

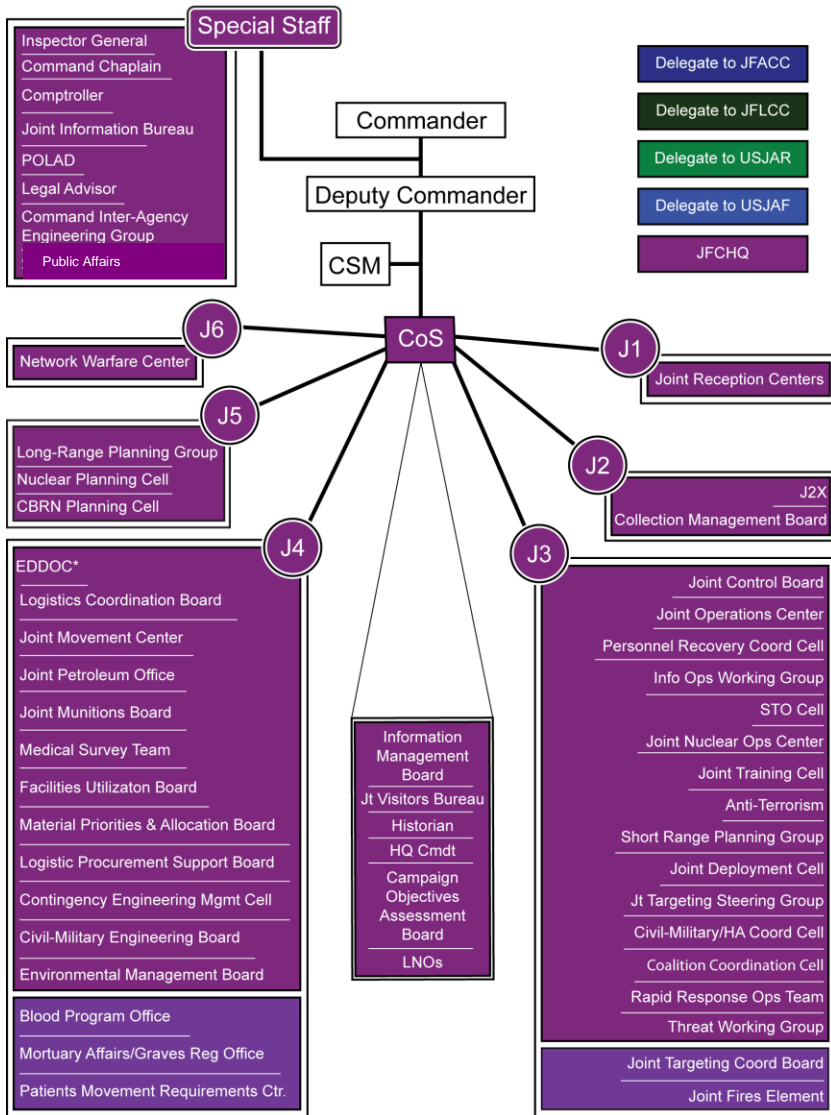

Figure 4: Example B2C2WG

Note: Each combatant command will establish different teams to achieve their missions and this diagram is intended to provide only a framework of the doctrinal perspective on B2C2WGs. Staff officers should check with their office to find out which teams exist at their combatant command.

It is important to note that B2C2WGs will have a hierarchy within their combatant command and operate at many different levels of the command. At the lowest level, working groups are responsible for making plans, doing studies, making estimates, and leading projects. Councils lay in the middle of the hierarchy and are considered the gatekeepers and are responsible for recommending priorities, synchronizing and organizing activities. Finally, at the top of the hierarchy, the Board is responsible for making decisions about command and operational priorities and integrating and synchronizing them. It is also important to note that in a typical team hierarchy, there are usually higher numbers of working groups and teams, fewer Councils and an even smaller number of Boards.

Tips for Success in a B2C2WG

B2C2WGs must have clearly defined goals and specified authorities to be successful. These teams will usually have a charter that articulates these areas as well as specifies the chairperson, mandatory and optional members. Other factors that may help to maximize combatant command team effectiveness include:

- Determine the optimum size of the committee and identify the Chairperson.
- Meetings should only be held when there is a demonstrated need to have the entire team together.
- Meetings should be scheduled and held on a regular date and at a predetermined start and end time. They should start and end on time, and cancellations/reschedulings should be minimized.
- The purpose of the meeting must be clearly stated up front and an agenda must be preplanned. Each meeting should have clearly defined goals and deliverables and ensure the time is well-spent and focused on the issues at hand.
- The agenda and all supporting material for the meeting should be distributed before the meeting.
- During the meeting, the Chairperson should ensure that the environment is conducive to team success. Some ways the leader can accomplish this include:
 - Come to the meeting prepared.
 - Plan ahead and be organized.
 - Communicate often to team members.
 - Show respect for team members and their ideas.
 - Be fair to all team members.
 - Be predictable and consistent, and always demonstrate competence.

- A secretary should be appointed to manage minutes, maintain appropriate invitee lists, and organize meetings
Meeting minutes should include:
 - The date, the start and end time, and location of the meeting;
 - Names of the attendees and those who were absent;
 - Summary of the content of the meeting, discussions held and decisions reached;
 - Details of the next meeting date, time, and location.
- Open communication during the meeting should be encouraged and all ideas heard.
- Conflicts should be managed, resolved, and minimized.
- An environment of mutual respect and trust among team members should be fostered and encouraged.
- Teams should avoid “group think” where seeking agreement becomes so dominant in groups that it overrides the realistic appraisal of alternative problem solutions.

Group maturity and effectiveness is the desired end state for all work teams. This will be achieved when the members work toward a common goal, have open communication, function effectively as a team, and have the equipment, tools and skills necessary to accomplish their objectives.

References:

- Alessandra, T., Hunsaker, P., “Communicating at Work,” New York, Simon and Schuster.
- Certo, Samuel C., “Modern Management,” 9th Edition, Upper Saddle River, NJ, Prentice Hall.
- Greenberg, Jerald, “Managing Behavior in Organizations,” 3rd Edition, Upper Saddle River, NJ, Prentice Hall.
- Joint Publication (JP 3-0) *Joint Operations*, Section 33, JTF HQ.
- Stewart, G., Manz, C., Sims, H. “Team Work and Group Dynamics,” John Wiley and Sons, NJ.

2.2.2 Commander’s Decision Cycle

Ultimately, the combatant command B2C2WGs support the Commander’s Decision Cycle. The decision cycle assists the commander in understanding the environment and in focusing the staff to support critical decisions and actions. Through the cycle, the

command assesses progress, conducts planning based on this assessment, directs tasks to subordinates, requests or recommends actions to stakeholders, and monitors operations and the environment to support assessment. Communications, within the headquarters and with higher, adjacent, and subordinate commands, are vital to the success of the decision cycle.

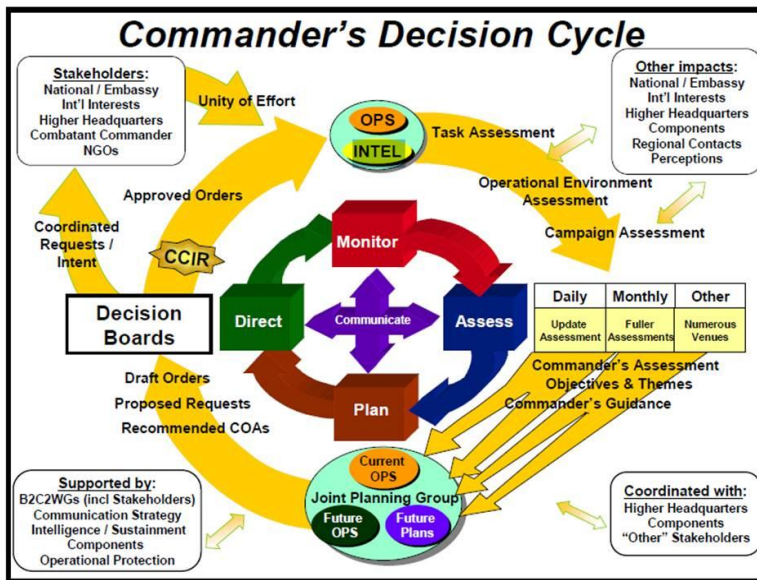

Figure 5: Commander's Decision Cycle

The decision cycle operates across three event horizons—current operations, future operations, and future plans—each of which moves at a different rate as they go through the key aspects of the cycle. Each event horizon requires battle-rhythm events to support planning, execution, and assessment.

- The *current operations* event horizon focuses on the 'what is,' and can rapidly progress through the decision cycle—sometimes minutes for quick breaking events.
- The *future operations* event horizon focuses on the 'what's next,' and normally moves slower with more deliberate assessment and planning activities.
- The *future plans* event horizon focuses on the 'what if,' interacts with higher headquarters planning efforts, and moves very deliberately through the decision cycle.

The Commander's Decision Cycle is synchronized with higher, adjacent, and subordinate echelon headquarters' decision cycles across all three event horizons.

The Battle Rhythm represents a logical arrangement of the B2C2WGs over time (days, weeks, months), based on the support needed at various phases by the Commander's Decision Cycle. The Battle Rhythm schedule also includes time for creative thought; unforeseen events; rest, stress relief and physical training; interaction with other commands; and the commander's battlefield circulation.

Reference:

Joint Operations: Best Insights and Practices, 2nd Edition, July 2008. GEN (Ret) Gary Luck, COL (Ret) Mike Findlay and the JWFC Joint Training Division.

2.3 Coordinating with other Directorates

Staff officers have identified that one of the biggest obstacles of getting work completed is coordinating input from other personnel. Often a junior officer leads a task that requires input from more senior personnel or from government civilians and interagency personnel over whom they have no authority.

Coordination is a crucial task that permits the stakeholders of an issue to participate and contribute to the decision-making process. Effective staff officers identify the participants required in an action early on and keep the communications channels open—receiving as well as sending updates and other pertinent information. Typically there are three or more rounds of coordination. In the first round, by including peers and subject matter experts early in the process, good staff officers identify weaknesses of the project and are able to make adjustments in a staffing package before moving up the chain.

In the second round, other directorates and organizations disagreeing with a particular action may recommend or request changes to the text. The staffing officer is responsible, sometimes with guidance from his or her immediate supervisor, for making appropriate changes and then notifying stakeholders of changes made before moving forward.

The final round of coordination is a formal request to the designated Point of Contact (POC) within a specific group for either concurrence or non-concurrence. For this final round, the POC coordinates within his own group as needed and then responds back representing the voice

of the senior person in his or her group to the AO managing the task. When a staff officer must non-concur with an issue he or she should provide specific comments, objections, and rationales for non-concurrence. With non-concurrence from one or more organizations, the lead organization reviews the reasons, considers options, and then makes a final recommendation on the issue.

It takes a little time to understand the general interactions, interdependencies, and coordination requirements within a combatant command. During your orientation courses you will begin to get a feel for the structure of the command and how the coordination process is supposed to work, but much of what you learn will be on the job training—learning by doing. The people around you want you to succeed, and are willing to help, so begin early in your assignment building a strong network of subject matter experts within the command, across the other combatant commands, and among other joint personnel.

Ask questions up front rather than when you get behind schedule; try to gain as clear an understanding as possible of each task—do not be afraid to ask for clarification. Frequently the expectation for staff officers is that they are able to answer each task gaining consensus in the process without GO/FO involvement.

Staff officers have to learn how to work effectively across directorates and to get people in other groups to share information; it is not always easy if departments get “turf protective.” But sharing information with others, instead of hoarding it, and using compromise and cooperation as the main approach to business will help you get accurate information in a timely manner. Open communications builds trust, and having others trust you is one of the most valuable assets you can have in the coordination process.

It is important to find ways to get cooperation from the many individuals you will need to help you complete work tasks. The following strategies are offered to help you get the collaboration you need:

- Remember that other people are working just as hard as you, are professionals, and that you are all on the same team.
- Be respectful of other people’s workloads and time.
- Make efforts to get to know people from other directorates with whom you will be working. It helps for you to meet them face-to-face, see their work environment, and have them meet you.
- When asking for action or input from someone (within your combatant command or outside of it):

- Clearly state your objective;
- As precisely as possible, identify what action you need and by when;
- Ask if they need anything else from you in order to take the requested action (e.g., another new staff officer may ask for some background information to be better prepared to brief his supervisor in order to meet your requested action).
- Ask for information or action, don't command or demand.
- Do not "name-drop" or "rank drop;" appeal to the individual by stating something to the effect, "My task is to ____, and I need input from your directorate by (date). Your name was given to me as the POC. Can you help me?" If the answer is no, ask them to help you find who can help you. Thank the person for their assistance—they may be your contact on the next action.
- Use a phone call instead of an e-mail when feasible—personal communication allows you to clarify your request for action; follow-up with an e-mail thanking them for their help and restating their commitment for requested action.
- Make a list of contacts and their e-mail and phone numbers for each project; keep the list in your electronic folder and write it on the front of your hard copy file folder. Keep track of those contacts helpful in completing your task; follow-up with a "thank you" e-mail.
- When feasible, send a reminder of an expected action before it is due, asking if any complications have arisen to prevent or delay the action. If problems have arisen, determine the criticality and ask if there is anything you can do to facilitate. If necessary, call a meeting of those involved to see if there are ways to overcome obstacles to completion of the task.
- If you do not get participation from others, or do not get action by the requested time, do not let emotion get in the way—sometimes there are legitimate reasons. Be assertive and firm, but not attacking or blaming, saying, for example, "My department needs your department's input by close of business today; if you are unable to follow through who will be responsible for the input from your office?" Always try to be polite and professional, even if you don't feel like it sometimes; thank the individual for their time.
- Do not hide behind e-mails; if you cannot get the commitment you need from a department, get up and go to the office for a face-to-face request; for communicating with geographically distant personnel, pick up the telephone.
- Set the example; help people even when they did not help you—establish your reputation as a "go-to person," as

someone who is mission-focused, willing to help, and a team-player.

Section 3. Joint Military Knowledge

3.1 Foundational Joint Knowledge

3.1.1 Organization for National Security

Overview of National Security Structure

National strategic direction is governed by the Constitution, federal law, U.S. Government (USG) policy regarding internationally-recognized law and the national interest. This direction leads to unified action. The result of effective, unified action is unity of effort to achieve national goals. At the strategic level, unity of effort requires coordination among government departments and agencies within the executive branch, between the executive and legislative branches, with non-governmental organizations, inter-governmental organizations, the private sector, and among nations in any alliance or coalition.

The security environment is extremely fluid, with continually changing coalitions, alliances, and partnerships. New (both national and transnational) threats are constantly appearing, disappearing, or in remission. The U.S. military is well positioned to conduct operations, but must also be prepared to address emerging peer competitors and irregular, catastrophic, and disruptive challenges.

The ability of the United States to achieve its national strategic objectives is dependent on the effectiveness of the USG in employing the instruments of national power. These instruments of national power (diplomatic, informational, military, and economic), are normally coordinated by the appropriate governmental officials, often with National Security Council (NSC) direction. They are the tools the United States uses to apply its sources of power, including its culture, human potential, industry, science and technology, academic institutions, geography, and national will.

As the military instrument of national power, the Armed Forces must ensure their adherence to U.S. values, constitutional principles, and standards for the profession of arms. The United States wields the military instrument of national power at home and abroad in support of its national security goals in a variety of military operations.

Numerous governmental organizations are involved in the formulation and implementation of U.S. national military strategy. To best understand the explanation of the role of the Joint Chiefs of Staff in national security, you first need to become familiar with those organizations and agencies responsible for the planning and execution of military operations, including their history, organizational structure, and command relationships.

The President and Secretary of Defense

Constitutionally, the ultimate authority and responsibility for the national defense rests with the president. Since the passage of the National Security Act of 1947, the president has used the Secretary of Defense (SecDef) as his principal assistant in all matters relating to the National Military Establishment (NME)—later the Department of Defense. The Secretary has statutory authority, direction, and control over the Military Departments and is responsible for the effective, efficient, and economical operation of the department.

The president and SecDef, through the Chairman of the Joint Chiefs of Staff (CJCS), provide direction for Service Secretaries and Combatant Commanders (CCDRs). The National Security Strategy (NSS), signed by the president, addresses the tasks that, as a nation, are necessary to shape the global environment and provide enduring security for the American people. It provides a broad strategic context for employing military capabilities in concert with other instruments of national power. The National Strategy for Homeland Security, also signed by the president, provides national direction to secure the homeland through a comprehensive framework for organizing the efforts of federal, state, local, and private organizations whose primary functions are often unrelated to national security.

The president and SecDef exercise authority and control of the Armed Forces through two distinct branches of the chain of command. One branch runs from the president, through the SecDef, to the CCDRs for missions and forces assigned to their commands. The other branch used for purposes other than operational direction of forces assigned to the Combatant Commands (CCMDs), runs from the president, through the SecDef, to the Secretaries of the Military Departments. The Military Departments, organized separately, operate under the authority, direction, and control of the Secretary of that Military Department. The Secretaries of the Military Departments exercise authority through their respective Service Chiefs over Service forces not assigned to the CCDRs. The Service Chiefs, except as otherwise prescribed by law, perform their duties under the authority, direction, and control of the

Secretaries of the respective Military Departments to whom they are directly responsible.

National Security Council (NSC)

The NSC is the president's principal forum for considering national security and foreign policy matters with his senior national security advisors and cabinet officials. Since its inception under President Truman, the Council's function has been to advise and assist the president on national security and foreign policies. The Council also serves as the president's principal arm for coordinating these policies among various government agencies.

The NSC is chaired by the president. Its regular attendees (both statutory and non-statutory) are the vice president, the Secretary of State, the Secretary of the Treasury, the SecDef, and the Assistant to the President for National Security Affairs. The CJCS is the statutory military adviser to the Council, and the Director of National Intelligence (DNI) is the intelligence adviser. The chief of staff to the president, counsel to the president, and the assistant to the president for economic policy are invited to attend any NSC meeting. The Attorney General and the Director of the Office of Management and Budget (OMB) are invited to attend meetings pertaining to their responsibilities. The heads of other executive departments and agencies, as well as other senior officials, are invited to attend meetings of the NSC when appropriate.

The National Security Council was established by the National Security Act of 1947 (PL 235 - 61 Stat. 496; U.S. Code 402), amended by the National Security Act Amendments of 1949 (63 Stat. 579; 50 USC 401 et seq.). Later in 1949, as part of the Reorganization Plan, the council was placed in the executive office of the president.

Department of Defense (DOD)

The United States DOD is the federal department charged with coordinating and supervising all agencies and functions of the government relating directly to national security and the military. The organization and functions of the DOD are set forth in Title 10 of the United States Code.

The DOD is the major tenant of the Pentagon building near Washington, D.C., and has three major components—the Department of the Army, the Department of the Navy, and the Department of the Air Force. Among the many DOD agencies are the Missile Defense Agency, the Defense Advanced Research Projects Agency (DARPA),

the Pentagon Force Protection Agency (PFPA), the Defense Intelligence Agency (DIA), the National Geospatial-Intelligence Agency (NGA), and the National Security Agency (NSA). The department also operates several joint service schools, included in the National Defense University (NDU).

World War II and its aftermath furnished the impetus for unification of the Military Departments under a single cabinet-level secretary. Anticipating the needs of a peacetime military organization, an in-depth review by congressional, executive, and military groups began even before the end of the war. The studies were influenced by Service interests that reflected the opinions of experienced wartime military and civilian leaders with vastly different views of the postwar future. Issues that dominated the search for a consensus included retention of air power in the Navy, maintenance of a separate Marine Corps, and the form and responsibilities of the new Department of the Air Force.

The National Security Act of 1947 was monumental legislation. After almost 50 years that included overseas wartime experience beginning with the Spanish-American War, a modern military organization came into existence. Unification of the Services under a single department was law and the powers of the Secretary of National Defense were identified but subject to broad interpretation. The roles and missions of the Military Services were defined by Executive Order but would not be statutorily defined until 1958. The act created the National Military Establishment (NME) under the leadership of a civilian secretary and created secretaries for the new Departments of the Army, Navy, and Air Force.

In 1949, the National Security Act was amended to change the name of the NME to the Department of Defense and to recognize it as an executive department. Further, it changed the role of the Services to Military Departments within DOD. The DOD Reorganization Act of 1958 strengthened the SecDef's direction, authority, and control over the department and clarified the operational chain of command from the president and SecDef to the CCDRs.

The role of the SecDef has changed since the position was established in 1947. Originally, the Secretary had only general authority over the NME, an authority shared with the civilian secretaries of the Military Departments. In 1949, the position was strengthened with an appointment as head of an executive department, reduction of the role of Military Department heads, and the Secretary's assumption of budgeting responsibilities. Today, the SecDef is the principal assistant

to the president for all matters relating to the DOD. He has nearly plenary authority, direction, and control of the entire department. Moreover, the Goldwater-Nichols DOD Reorganization Act of 1986 makes clear his position in the operational chain of command.

Military Departments

The Military Departments (Department of the Army, Department of the Navy, and Department of the Air Force) are organized separately under civilian secretaries who are responsible for and have authority to conduct the affairs committed to their departments. The Service secretaries are not in the operational chain of command.

The Military Departments have been significantly altered by legislation and Executive Order since the National Security Act of 1947. The Key West Agreement of March 1948 clarified the roles of the Military Departments and amplified their responsibilities. In 1953, the president and the SecDef agreed to designate a Military Department to function as "executive agent" for the unified commands. The Reorganization Act of 1958 removed the Military Departments from the operational chain of command and clarified their support and administrative responsibilities for the unified commands. In 1986 the Goldwater-Nichols DOD Reorganization Act clarified civilian control of the Military Services.

Agencies of the Joint Chiefs of Staff

The diversity of offices and organizations within the Joint Staff illustrates a wide range of functions and responsibilities. Among other organizations reporting to the CJCS are the CJCS representatives to international negotiations, including treaties and agreements, and activities involved with politico-military affairs and defense in the Western Hemisphere and North Atlantic Treaty Organization (NATO). Other activities include the National Defense University (NDU), the Joint Materiel Priorities and Allocations Board (JMPAB), the Joint Transportation Board (JTB), and the Joint Requirements Oversight Council (JROC).

Organizations Reporting to the SecDef

By presidential directive, the CCDRs communicate to the SecDef and president through the CJCS. The CJCS also oversees the support of the following agencies to the CCMDs, although they report to their OSD Principal Staff Assistants (PSAs):

- Defense Information Systems Agency (DISA)
- Defense Threat Reduction Agency (DTRA)
- Defense Logistics Agency (DLA)

- Defense Intelligence Agency (DIA)
- National Security Agency (NSA)
- National Geospatial-Intelligence Agency (NGA)
- Defense Contract Management Agency (DCMA)

The CJCS gives policy guidance and direction to other supporting organizations, including:

- Joint Tactical Command, Control, and Communications Agency (JTC3A)
- Electromagnetic Compatibility Analysis Center (ECAC)
- Military Communications Electronics Board (MCEB)
- Joint Doctrine, Education and Training Division (JDETD)

Combatant Commands

The president, through the SecDef and with the advice and assistance of the CJCS, establishes combatant (unified) commands for the performance of military missions and prescribes the force structure of such commands. Commanders (CDRs) in the chain of command exercise combatant command (COCOM, command authority), Operational Control (OPCON), Tactical Control (TACON), or a support command relationship as prescribed by law or a superior CDR over the military force under their command. The CJCS assists the president and the SecDef in performing their command functions. The CJCS transmits to the CCDRs the orders given by the president, or the SecDef and, as directed by the SecDef, oversees the activities of those commands. Orders issued by the president or the SecDef normally are conveyed by the CJCS under the authority and direction of the SecDef. Unified and specified combatant commands were first described by statute in the National Security Act of 1947:

- Unified Combatant Command. A command which has a broad, continuing mission under a single commander composed of forces from two or more Services and that is established and so designated by the president through the SecDef with the advice and assistance of the CJCS.
- Specified Combatant Command. A command which has a broad, continuing (usually functional) mission normally composed of forces from a single Military Department, and is established and so designated by the president through the SecDef with the advice and assistance of the Chairman of the Joint Chiefs of Staff. Currently, there are no specified commands.

Chain of Command

By the Goldwater-Nichols DOD Reorganization Act of 1986, Congress

clarified the command line to the combatant commanders and preserve civilian control of the military. The Act states that the operational chain of command runs from the president to the SecDef to the CCDRs. The Act permits the president to direct that communications pass through the CJCS; it is the authority placing the CJCS in the communications chain. Further, the Act gives the SecDef wide latitude to assign oversight responsibilities to the Chairman for the activities of the CCDRs.

Authority

The effective use of the nation's Armed Forces requires a unity of effort in the operation of diverse military resources. This goal is achieved through:

- Strategic direction of the Armed Forces;
- Operations under unified command;
- Integration into an efficient team of land, naval, and air forces;
- Prevention of unnecessary duplication of efforts or resources, coordination of operations; and
- Effective combined operations.

Commensurate with the responsibility placed on CCDRs to achieve unity of effort, they have been given increased authority by law (Title 10, USC) and DOD Directive.

The DOD Reorganization Act of 1986 makes the CCDRs accountable to the president and SecDef for performing their assigned missions. With this accountability comes the assignment of all authority, direction, and control that Congress considers necessary to execute the responsibilities of the combatant commanders. The Act defines the command authority of the CCDRs to give authoritative direction to subordinate commands, including all aspects of military operations, joint training, and logistics:

- Prescribe the chain of command within the command;
- Organize commands and forces to carry out assigned missions;
- Employ forces necessary to carry out assigned missions;
- Coordinate and approve administration, support, and discipline; and,
- Exercise authority to select subordinate commanders and combatant command staff. (Note: List not complete; see DODD 5100.01, Functions of the Department of Defense and Its Major Components, page 21.)

This authority is termed "combatant command" and resides only in the combatant commander.

Combatant Command Authority (COCOM)

Combatant command (command authority) is the command authority over assigned forces vested in the combatant commander by Title 10, U.S. Code, Section 164, and is not transferable. Combatant command is exercised only by the CDRs of unified and specified CCMDs. It is the authority of a CDR to perform those functions of command over assigned forces involving organizing and employing commands and forces, assigning tasks, designating objectives, and giving authoritative direction over all aspects of military operations, joint training, and logistics necessary to accomplish the missions assigned to the command. COCOM furnishes full authority to organize and employ commands and forces as the CDR considers necessary to accomplish assigned missions. COCOM is not shared with other echelons of command. It should be exercised through the commanders of subordinate organizations, normally the Service component commanders, subordinate unified commanders, commanders of joint task forces, and other subordinate commanders.

Directive authority for logistics supports the CDR's responsibility to execute effectively operational plans, maintain effectiveness and economy of operation, and prevent duplication of facilities and resources. Military Departments are still responsible for logistics and administrative support of forces assigned or attached to the combatant commands.

In peacetime, the scope of the logistic and administrative authority exercised by the CDR is consistent with legislation, DOD policy or regulations, budgetary considerations, local conditions, and other specific conditions prescribed by the SecDef or the CJCS. The CDR refers disputes to the Military Department, if he fails to receive timely resolution there, he may forward the matter through the CJCS to the SecDef for resolution.

During crisis or war, the CDRs' authority and responsibility are expanded to include use of facilities and supplies of all forces under their command. Joint logistics doctrine developed by the CJCS establishes wartime logistics policy.

The CDRs have approval authority over Service logistics programs that affect operational capability or sustainability within their theaters

(e.g., base adjustments, force beddowns). Disputes in this area may be settled by the SecDef through the CJCS.

Operational Control (OPCON)

Operational control is another level of authority used frequently in the execution of joint military operations. OPCON authority may be delegated to echelons below the combatant commander. Normally, this is authority exercised through component commanders and the commanders of established subordinate commands. Limitations on OPCON, as well as additional authority not normally included in OPCON, can be specified by a delegating commander.

OPCON is the authority delegated to a commander to perform those functions of command over subordinate forces involving the composition of subordinate forces, the assignment of tasks, the designation of objectives, and the authoritative direction necessary to accomplish the mission. It includes directive authority for joint training. Commanders of subordinate commands and joint task forces will normally be given OPCON of assigned or attached forces by a superior commander. OPCON normally provides full authority to organize forces as the operational commander deems necessary to accomplish assigned missions and to retain or delegate OPCON or tactical control as necessary. OPCON may be limited by function, time, or location. It does not include such matters as administration, discipline, internal organization, and unit training.

Tactical Control (TACON)

The term tactical control is used in execution of operations and is defined as: "the detailed and, usually, local direction and control of movements or maneuvers necessary to accomplish missions or tasks assigned."

Role of CJCS

The role of CJCS in the chain of command of the combatant commands is threefold: communications, oversight, and spokesman.

- Communications between the president and SecDef and the combatant commanders may pass through CJCS. The Goldwater-Nichols DOD Reorganization Act of 1986 permits the president to place the Chairman in the communications chain and the president has in fact directed that such communications pass through the Chairman.
- Oversight of the activities of combatant commands may be delegated by the SecDef to CJCS.

- CJCS is the spokesman for the CCDRs on the operational requirements of their commands.

Forces

The Goldwater-Nichols Act requires that forces under the jurisdiction of the Military Departments be assigned to the combatant commands, with the exception of forces assigned to perform the mission of the Military Department, (e.g., recruit, supply, equip, maintain). In addition, forces within a CCDR's geographic Area of Responsibility (AOR) fall under the command of the CCDR except as otherwise directed by the SecDef.

Organizational Relationships

The unified command structure is flexible and changes as required to accommodate evolving U.S. national security needs. The Unified Command Plan (UCP) establishes the combatant commands, identifies geographic AORs, assigns primary tasks, defines authority of the CDRs, establishes command relationships, and gives guidance on the exercise of combatant command. It is approved by the president, published by the CJCS, and addressed to the commanders of combatant commands.

Six combatant commanders have geographic AORs. These CCDRs are assigned an area of operations by the UCP and are responsible for all operations within their designated areas:

- U.S. Africa Command (USAFRICOM) (<http://www.africom.mil>)
- U.S. Central Command (USCENTCOM) (<http://www.centcom.mil>)
- U.S. European Command (USEUCOM) (<http://www.eucom.mil>)
- U.S. Northern Command (USNORTHCOM) (<http://www.northcom.mil>)
- U.S. Pacific Command (USPACOM) (<http://www.pacom.mil>)
- U.S. Southern Command (USSOUTHCOM) (<http://www.southcom.mil>)

The CCDRs of the remaining three functional combatant commands have worldwide functional responsibilities not bounded by any single area of operations:

- U.S. Special Operations Command (USSOCOM) (<http://www.socom.mil>)
- U.S. Strategic Command (USSTRATCOM) (<http://www.stratcom.mil>)
- U.S. Transportation Command (USTRANSCOM) (<http://www.transcom.mil>)

Organization for National Security

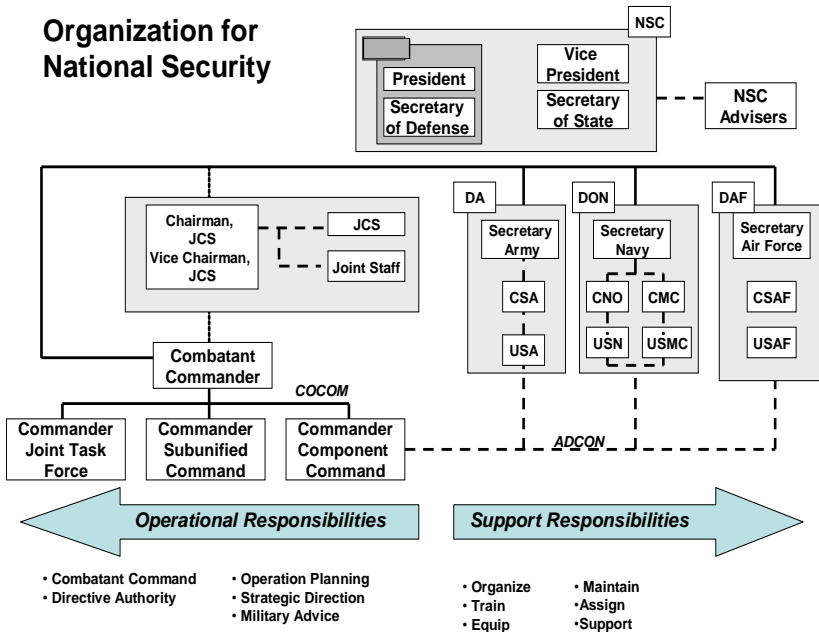

Figure 6: Organization for National Security

- **National Strategic Direction:** The president, advised by the NSC, is responsible to the American people for national strategic direction.
- **National Security Council:** The NSC was established by 1947 National Security Act as the principal forum to consider national security issues requiring presidential decision. Current membership includes four statutory members: the president, vice president, Secretary of State, and SecDef. The CJCS and the DNI serve as statutory advisers.

3.1.2 The National Intelligence Community

Under Secretary of Defense for Intelligence

The Under Secretary for Intelligence or USD(I) is a position within the USG that acts as the principal adviser to the SecDef on matters relating to intelligence. The USD(I) is also dual-hatted, serving as the Director

of Defense Intelligence under the Director National Intelligence (DNI). The Under Secretary is a civilian-appointed by the president and confirmed by the Senate.

The USD(I) position was created by the National Defense Authorization Act (NDAA) for Fiscal Year 2003. It became second in the line of succession for the SecDef, after the deputy SecDef, after an executive order was made by the president on December 22, 2005. When it was created, the legislation described it as taking precedence in the Department behind the Under Secretary for Personnel and Readiness.

On November 23, 2005, a Department of Defense Directive, which was made by then Secretary Donald Rumsfeld, stated that the Under Secretary shall serve as the Secretary's primary representative to the Office of the Director of National Intelligence. It also stated the Under Secretary shall provide policy and oversight on the training and career development of personnel in DOD's counterterrorism, intelligence, and security components. The Under Secretary has the duty of finding candidates to be nominated to serve as Directors of DIA, NGA, the National Reconnaissance Office (NRO), and NSA, and of overseeing their performance.

The USD(I) became a dual-hatted position as Director of Defense Intelligence (DDI), acting as the primary military intelligence adviser to the DNI. This additional position follows a May 2007 memorandum of agreement between the SecDef and the Director of National Intelligence to create the position.

Director of National Intelligence (DNI)

The Director of National Intelligence (DNI) in the Office of the Director of National Intelligence serves as the head of the Intelligence Community. The DNI also acts as the principal adviser to the president, the National Security Council (NSC) and the Homeland Security Council (HSC) for intelligence matters related to national security; and oversees and directs the implementation of the National Intelligence Program. The president appoints the DNI with the advice and consent of the Senate. The Director is assisted by a Principal Deputy Director of National Intelligence, appointed by the president with the advice and consent of the Senate.

Under Secretary of Defense for Intelligence - USD(I)

The DNI coordinates intelligence matters related to the DOD with the USD(I). This individual serves as the Principal Staff Assistant and adviser to the SecDef and the deputy SecDef on all intelligence,

counterintelligence and security, and other intelligence-related matters. The USD(I) provides oversight and policy guidance for all DOD intelligence activities.

Defense Intelligence Agency (DIA)

DIA is responsible for Defense Attachés (DATT) and for providing DOD with a variety of intelligence products. The Director of DIA is the primary adviser to the SecDef and the CJCS on military intelligence matters. DIA assesses foreign militaries, focusing on Weapons of Mass Destruction (WMD), missile systems, terrorism and defense-related medical issues. Although the Intelligence Reform Act provides extensive budgetary and management authorities over these agencies to the DNI, it does not revoke the responsibilities of the SecDef for these agencies.

National Security Agency (NSA), National Reconnaissance Office (NRO), National Geospatial-Intelligence Agency (NGA)

Three major intelligence agencies in the DOD—NSA, NRO, and NGA make up the larger part of the national intelligence budget. NSA is the U.S. cryptologic organization, with responsibility for protecting the U.S. Government's information systems and producing foreign signals intelligence information. Areas of expertise include cryptanalysis, cryptography, mathematics, computer science, and foreign language analysis. The NRO designs, builds, and operates the nation's signals and imagery reconnaissance satellites. Information collected using NRO satellites is used for a variety of tasks such as warning of potential foreign military aggression, monitoring weapons of mass destruction programs, enforcing arms control and environmental treaties, and assessing the impact of natural and manmade disasters. The NGA collects and creates information about the Earth for navigation, national security, U.S. military operations, and humanitarian aid efforts.

Service Intelligence Organizations

The intelligence organizations of the Air Force, Army, Navy, and Marines concentrate largely on concerns related to their specific missions. Their analytical products, along with those of DIA, supplement the work of Central Intelligence Agency (CIA) analysts and provide greater depth on key technical issues.

Central Intelligence Agency (CIA)

Most intelligence offices or agencies are components of cabinet departments with other roles and missions. The Office of the DNI and

the CIA are the only members of the Intelligence Community (IC) that are not part of a cabinet department.

The CIA's primary mission is to collect, analyze, evaluate, and disseminate foreign intelligence to assist government policymakers in making decisions related to national security. The CIA has all-source analytical capabilities that cover the whole world outside U.S. borders. It produces a range of studies that cover virtually any topic of interest to national security policymakers. The CIA also collects intelligence with human sources and, on occasion, undertakes covert actions at the direction of the president. (A covert action is an activity or activities of the U.S. Government to influence political, economic, or military conditions abroad, where it is intended that the U.S. role will not be apparent or acknowledged publicly). The CIA's role is to report only information and not to make policy recommendations.

State Department's Bureau of Intelligence and Research (INR)

The INR provides interpretative analysis of global developments to the State Department and contributes its unique perspective to the Community's National Intelligence Estimates and other products. INR's written products cover the full range of geographic and functional areas of expertise. It serves as the focal point within the State Department for all policy issues and activities involving the Intelligence Community and is the secretary of state's principal adviser on all intelligence matters.

Federal Bureau of Investigation (FBI)

The FBI, as an intelligence and law enforcement agency, is responsible for understanding threats to our national security and penetrating national and transnational networks that have a desire and capability to harm the U.S. The FBI coordinates these efforts with its intelligence community and law enforcement partners. FBI focuses on terrorist organizations, foreign intelligence services, WMD proliferators, and criminal enterprises.

Department of Homeland Security (DHS)

The Homeland Security Act provided the DHS responsibilities for fusing law enforcement and intelligence information relating to terrorist threats to the homeland. The Information Analysis and Infrastructure Protection Directorate in DHS participates in the inter-agency counterterrorism efforts and, along with the FBI, has focused on ensuring that state and local law enforcement officials receive information on terrorist threats from national-level intelligence agencies. The Office of Intelligence and Analysis (OIA) focuses on threats related

to border security; Chemical, Biological, Radiological, Nuclear and Explosives (CBRNE); critical infrastructure; extremists within the homeland; and travelers entering the homeland. U.S Customs and Border Protection (CBP), is responsible for protecting the nation's borders in order to prevent terrorists and terrorist weapons from entering the United States, while facilitating the flow of legitimate trade and travel. U.S. Immigration Customs Enforcement (ICE), the largest investigative arm of DHS, is responsible for identifying and shutting down vulnerabilities in the nation's border, economic, transportation, and infrastructure security.

U.S. Coast Guard

The U.S. Coast Guard, now part of DHS, deals with information relating to maritime security and homeland defense. The Coast Guard's missions include port security, search and rescue, maritime safety, counter-narcotics, and alien migration interdiction.

Department of Energy (DOE)

The DOE focuses on assessing worldwide nuclear terrorism threats, nuclear proliferation, and evaluation of foreign technology threats.

Department of Treasury (Treasury)

Treasury collects and processes information that may affect U.S. fiscal and monetary policies. Treasury also covers terrorist financing issues.

Drug Enforcement Administration (DEA)

The DEA is the agency responsible for enforcing the controlled substances laws and regulations of the United States. DEA provides drug-related information for the IC acquired during its drug enforcement duties.

3.1.3 Department of Defense Organization

The Reorganization Act of 1958 asserted and enhanced the direction, authority, and control of the SecDef over the executive department and clarified the operational chain of command running from the president and SecDef to the combatant forces. The DOD Reorganization Act of 1986 further strengthened and clarified the SecDef's position in the operational chain of command.

Functions of the Department of Defense

As prescribed by higher authority, the Department of Defense shall maintain and use armed forces to:

- Support and defend the Constitution of the United States

against all enemies, foreign and domestic.

- Ensure, by timely and effective military action, the security of the United States, its possessions, and areas vital to its interest.
- Uphold and advance the national policies and interests of the United States.

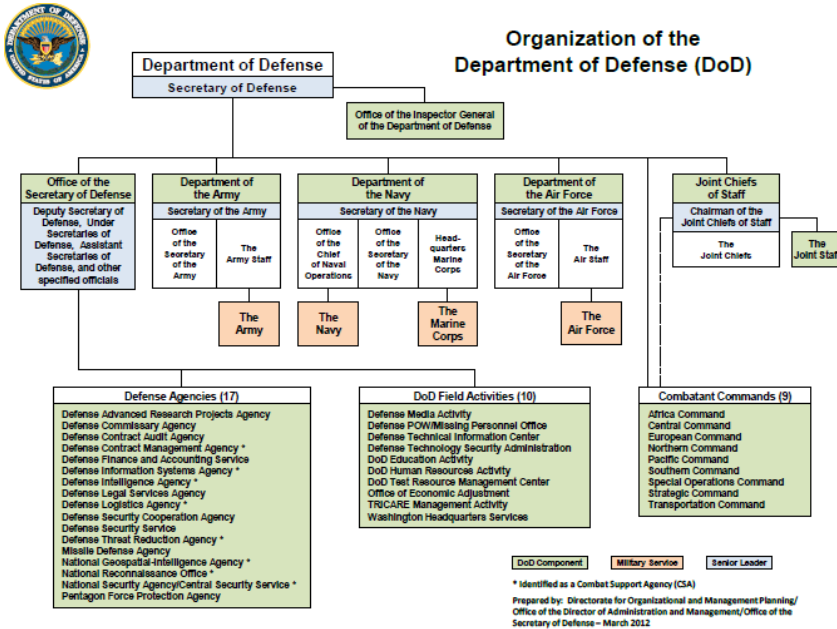

Figure 7: The Department of Defense Organization Structure

Military Departments

The chain of command for purposes other than the operational direction of combatant commands runs from the president, to the SecDef, to the secretaries of the Military Departments, to the chiefs of the Service forces. The Military Departments, separately organized, are led by civilian secretaries with authority to conduct all affairs of their respective departments, including the following:

- Recruiting
- Training
- Organizing
- Supplying
- Equipping

The Joint Chiefs of Staff (JCS) and the Joint Staff

The JCS consist of the Chairman, the Vice Chairman, the Chief of Staff of the Army (CSA), the Chief of Naval Operations (CNO), the Chief of Staff of the Air Force (CSAF), the Commandant of the Marine Corps (CMC) and the Chief of the National Guard Bureau. The collective body of the JCS is headed by the Chairman (or the Vice Chairman in the Chairman's absence), who sets the agenda and presides over JCS meetings.

Responsibilities as members of the JCS take precedence over duties as the Chiefs of Military Services. The CJCS is the principal military adviser to the president, SecDef, and the NSC, however, all JCS members are by law military advisers and they may respond to a request or voluntarily submit, through the Chairman, advice or opinions to the president, the SecDef, or NSC.

The executive authority of the JCS has changed. In World War II, the JCS acted as executive agents in dealing with theater and area commanders, but the original National Security Act of 1947 saw the JCS as planners and advisers, not as commanders of combatant commands. In spite of this, the 1948 Key West Agreement allowed members of the JCS to serve as executive agents for unified commands, a responsibility that allowed the executive agent to originate direct communication with the combatant command. Congress abolished this authority in a 1953 amendment to the National Security Act. Today, the JCS has no executive authority to command combatant forces.

The issue of executive authority was clearly resolved by the Goldwater-Nichols DOD Reorganization Act of 1986 "The Secretaries of the Military Departments shall assign all forces under their jurisdiction to unified and specified combatant commands to perform missions assigned to those commands..."; the chain of command "runs—(1) from the president to the SecDef; (2) and from the SecDef to the commander of the combatant command."

Chairman of the Joint Chiefs of Staff (CJCS)

The Goldwater-Nichols DOD Reorganization Act of 1986 identifies the CJCS as the senior ranking member of the Armed Forces. As such, the CJCS is the principal military adviser to the president. He may seek the advice of and consult with the other JCS members and combatant commanders. When he presents his advice, he presents the range of advice and opinions he has received, along with any individual comments of the other JCS members.

Under the DOD Reorganization Act, the Secretaries of the Military Departments assign all forces to combatant commands except those assigned to carry out the mission of the Services, i.e., recruit, organize, supply, equip, train, service, mobilize, demobilize, administer and maintain their respective forces. The chain of command to these combatant commands runs from the president to the SecDef, directly to the commander of the combatant command. The CJCS may transmit communications to the commanders of the combatant commands from the president and SecDef but does not exercise military command over any combatant forces.

The Act also gives to the CJCS some of the functions and responsibilities previously assigned to the corporate body of the JCS. The broad functions of the CJCS are set forth in Title 10, United States Code, and detailed in DOD Directive 5100.1. In carrying out his duties, the CJCS consults with and seeks the advice of the other members of the JCS and the combatant commanders, as he considers appropriate.

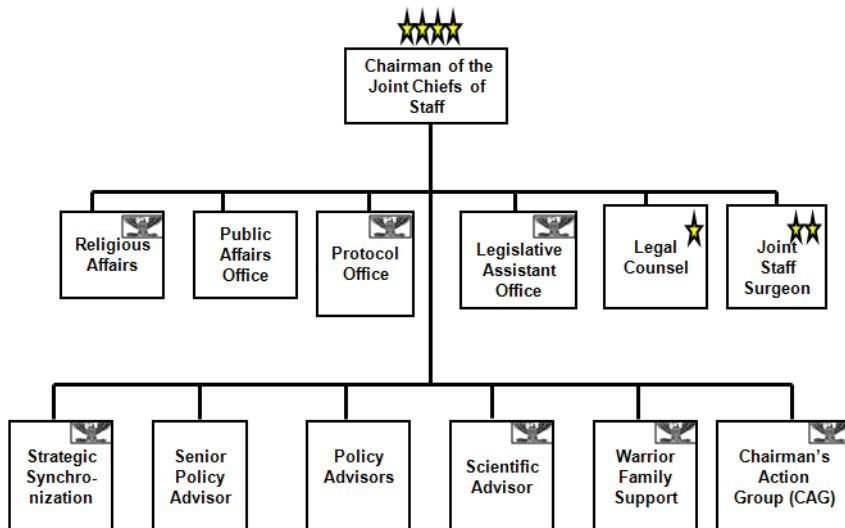

Figure 8: Office of the CJCS

Vice Chairman of the Joint Chiefs of Staff (VCJCS)

The DOD Reorganization Act of 1986 created the position of VCJCS, who performs such duties as the CJCS may prescribe. By law, he is the second ranking member of the Armed Forces and replaces the CJCS in his absence or disability. Though the VCJCS was not originally included as a member of the JCS, Section 911 of the National

Defense Authorization Act of 1992 made him a full voting member of the JCS.

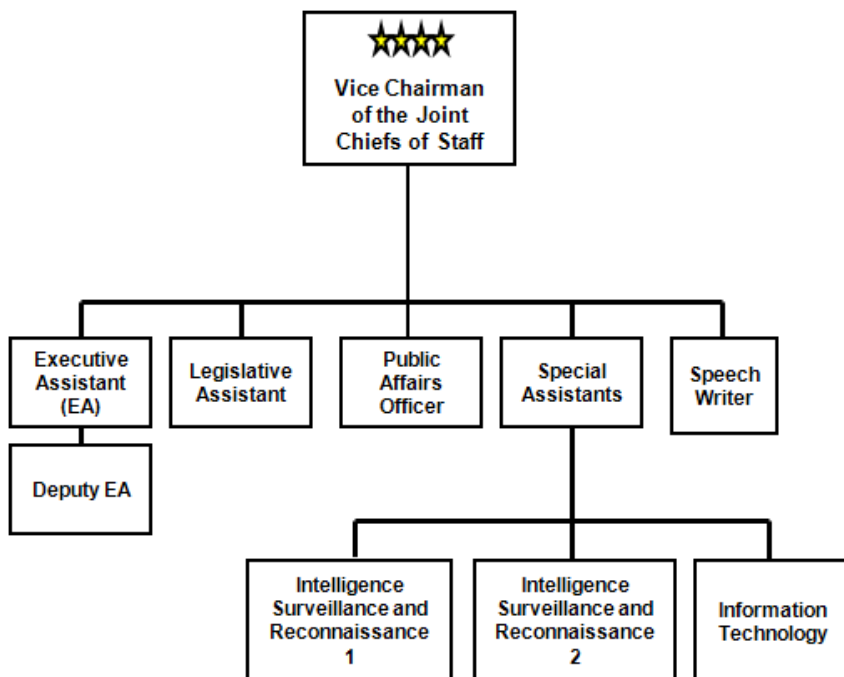

Figure 9: VCJCS Special Staff

Military Service Chiefs

The Military Service Chiefs are often said to "wear two hats." As members of the JCS, they offer advice to the president, the SecDef, and the NSC. As the chiefs of the Military Services, they are responsible to the Secretaries of their Military Departments for management of the Services. The Service Chiefs serve for 4 years. By custom, the Vice Chiefs of the Services act for their chiefs in most matters having to do with day-to-day operation of the Services. The duties of the Service Chiefs as members of the JCS take precedence over all their other duties.

3.1.4 The Joint Staff

The JCS is the group of Military Department (Army, Navy, Air Force, and Marines) and Uniformed Service Staff Chiefs who advise the president of the United States on the military aspects of national

defense policy. The JCS is defined by statute and consists of a chairman and vice chairman who are nominated by the president (with confirmation by the United States Senate); plus the chiefs of staff of the three (3) Military Departments; plus the Commandant of the Marine Corps and the Chief, National Guard Bureau. Since its creation, by statute, the Chairman, is now designated as the principal military adviser to the president. This latter change (from 1986 onward) was made to ensure that the military advice the president received as Commander-in-Chief would be from a single source. That by definition represented the combined, and Joint, military assessment and recommendation of the armed forces of the United States.

In addition, the independence of the Chief's military assessment(s) and/or recommendation(s), with respect to national defense issues and policy; is also required by statute. And, it is required to be given, if requested, to the relevant Committees of the Congress. The president, as Commander-in-Chief may accept, modify, or disregard their assessments or recommendations, as he/she sees fit, and the Chiefs are required to accept and support the decisions of their Commander-in-Chief. But the statutes require that the Congress (who has ultimate responsibility under the Constitution for questions of peace or war) have the ability to hear (through the Joint Chiefs) the U.S. armed forces' assessments and recommendations with respect to national military affairs and policy.

Similar organizations, sometimes known as Chiefs of Staff Committees (COSCs) in the Commonwealth of Nations, are common in other countries.

As the military of the United States grew in size following the American Civil War, joint military action between the Army and Navy became increasingly difficult. The joint Army and Navy cooperation were unresponsive at either the planning or operational level and were constrained over disagreements during the Spanish-American War in the Caribbean campaigns. The Joint Army and Navy Board was established in 1903 by President Theodore Roosevelt, comprising representatives from the military heads and chief planners of both the Navy's General Board and the Army's General Staff. The Joint Board acting as an "advisory committee" was created to plan joint operations and resolve problems of common rivalry between the two services.

Yet, the Joint Board accomplished little as its charter gave it no authority to enforce its decisions. The Joint Board also lacked the ability to originate its own opinions and was thus limited to commenting

only on the problems submitted to it by the Secretaries of War and Navy. As a result, the Joint Board had little to no impact on how the United States conducted World War I.

After World War I, in 1919, the two Secretaries agreed to reestablish and revitalize the Joint Board. This time, the Joint Board's membership would include the Chiefs of Staff, their deputies, and the Chief of War Plans Division for the Army and Director of Plans Division for the Navy. Under the Joint Board would be a staff called the Joint Planning Committee to serve the Board. Along with new membership, the Joint Board could initiate recommendations on its own initiative. However, the Joint Board still did not possess the legal authority to enforce its decisions.

In 1942, President Franklin D. Roosevelt and Prime Minister of the United Kingdom Winston Churchill established the Combined Chiefs of Staff (CCS) following the attack on Pearl Harbor and the United States' entrance into World War II. The CCS would serve as the supreme military body for strategic direction of the U.S.-British Commonwealth war effort. While the United Kingdom (UK) had the Chiefs of Staff Committee, the United States had no equivalent agency with which to provide the CCS with American services.

Though the Joint Board did exist, its authority and services were of little use to the CCS. Although its 1935 publication, Joint Action of the Army and Navy, gave some guidance for the joint operations during World War II, the Joint Board held little influence in that war. Following the end of WWII, the Joint Board was officially disbanded in 1947.

To fill the need for a coordinated effort and to provide coordinated staff work, Admiral William D. Leahy proposed a concept of a "unified high command" in what would be called the Joint Chiefs of Staff. On 20 July 1942, Admiral Leahy became the Chief of Staff to the Commander in Chief of the Army and Navy and created a staff of the chiefs of staff of the Services to serve under him.

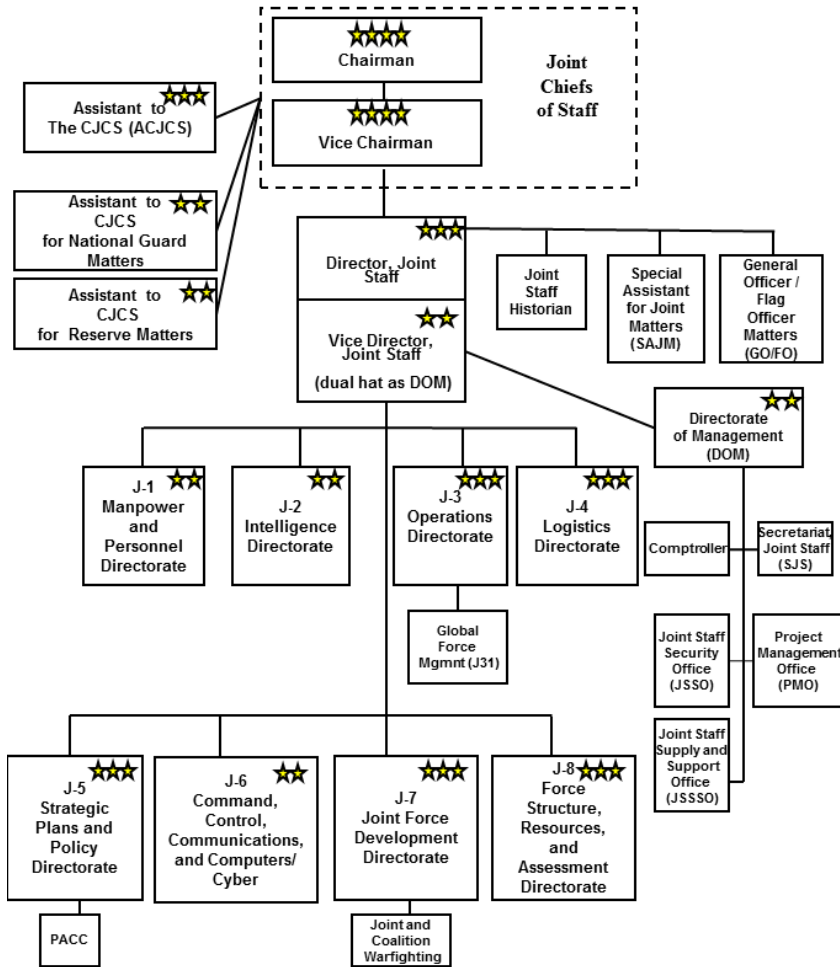

Figure 10: Joint Staff Organization

Roles and Responsibilities of the JCS

After the 1986 reorganization of the military undertaken by the Goldwater-Nichols Act, the Joint Chiefs of Staff does not have operational command of U.S. military forces. Responsibility for conducting military operations goes from the president, to the secretary of defense, directly to the commanders of the unified combatant commands and thus bypasses the JCS completely.

Today, their primary responsibility is to ensure the personnel readiness, policy, planning and training of their respective Military Services for the combatant commanders' use. The JCS also act in a military advisory capacity for the president and the SecDef. In addition, the CJCS acts as the chief military adviser to the president and the SecDef. In this strictly advisory role, the Joint Chiefs constitute the second-highest deliberative body for military policy, after the NSC, which includes the president and other officials besides the CJCS.

The Joint Staff Roles and Functions

The Joint Staff assists the CJCS in accomplishing his responsibilities for:

- the unified strategic direction of the combatant forces;
- their operation under unified command; and
- their integration into an efficient team of land, naval, and air forces.

The "Joint Staff" is composed of approximately equal numbers of officers from the Army, Navy and Marine Corps, and Air Force. In practice, the Marines make up about 20 percent of the number allocated to the Navy. Since its establishment in 1947, statute has prohibited the Joint Staff from operating or organizing as an overall armed forces general staff; therefore, the Joint Staff has no executive authority over combatant forces.

The CJCS, after consultation with other JCS members and with the approval of the SecDef, selects the Director, Joint Staff, to assist in managing the Joint Staff. By law, the direction of the Joint Staff rests exclusively with the CJCS. As the Chairman directs, the Joint Staff also may assist the other JCS members in carrying out their responsibilities.

In the joint arena, a body of senior flag or general officers assists in resolving matters that do not require JCS attention. Each Service Chief appoints an operations deputy who works with the Director, Joint Staff, to form the subsidiary body known as the Operations Deputies (OPSDEPs). They meet in sessions chaired by the Director, Joint Staff, to consider issues of lesser importance or to review major issues before they reach the JCS. With the exception of the Director, this body is not part of the Joint Staff. There is also a subsidiary body known as the Deputy Operations Deputies (DEPOPSDEPs), composed of the Vice Director, Joint Staff, and a two-star flag or general officer appointed by each Service Chief. Currently, the DEPOPSDEPs are the Service directors for plans. Issues come before the DEPOPSDEPs to

be settled at their level or forwarded to the OPSDEPS. Except for the Vice Director, Joint Staff, the DEPOPSDEPs are not part of the Joint Staff.

Matters come before these bodies under policies prescribed by the JCS. The Director, Joint Staff, is authorized to review and approve issues when there is no dispute between the Services, when the issue does not warrant JCS attention, when the proposed action is in conformance with CJCS policy, or when the issue has not been raised by a member of the JCS. Actions completed by either the OPSDEPs or DEPOPSDEPs will have the same effect as actions by the Joint Chiefs of Staff.

Directorates of the Joint Staff

The separate divisions of the Joint Staff are called directorates and are where all the Joint Staff's planning, policies, intelligence, manpower, communications and logistics functions are translated into military and military support action. The directorates are:

- Director of the Joint Staff
- DOM- Directorate of Management
- J1 - Personnel and Manpower
- J2 - Intelligence
- J3 - Operations
- J4 - Logistics
- J5 - Strategic Plans and Policy
- J6 - Command, Control, Communications, and Computers/Cyber
- J7 - Joint Force Development
- J8 - Force Structure, Resources, and Assessment

Functions of the Joint Staff Directorates

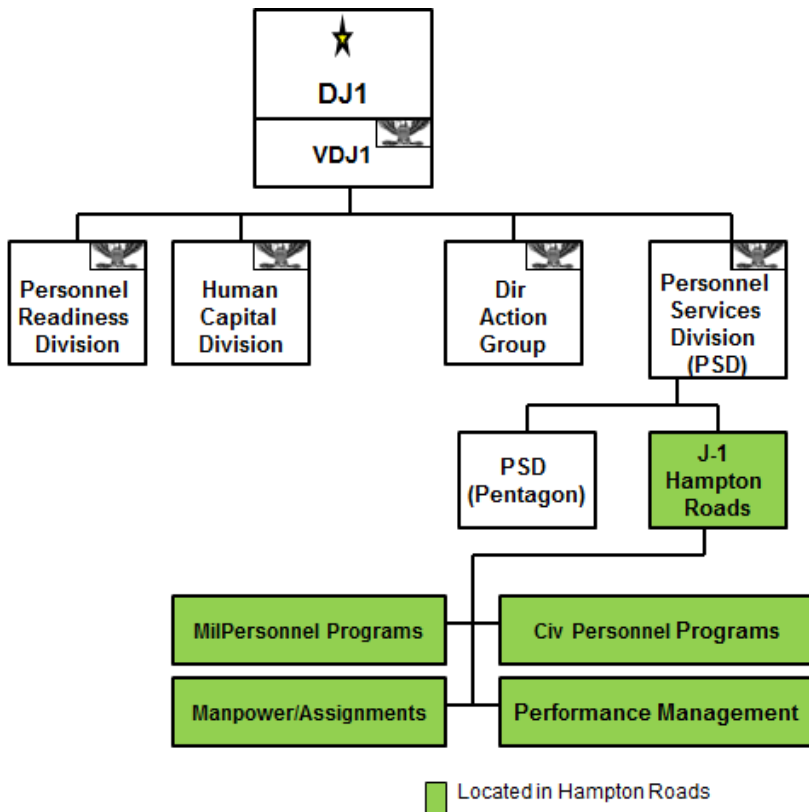

Figure 11: J-1 Manpower and Personnel

J-1 Manpower and Personnel

- Joint personnel readiness
- Manpower management
- Policy Guidance
- Personnel Programs
- Service promotions and Joint Specialty Officer lists program
- Joint Specialty Officer career guidance

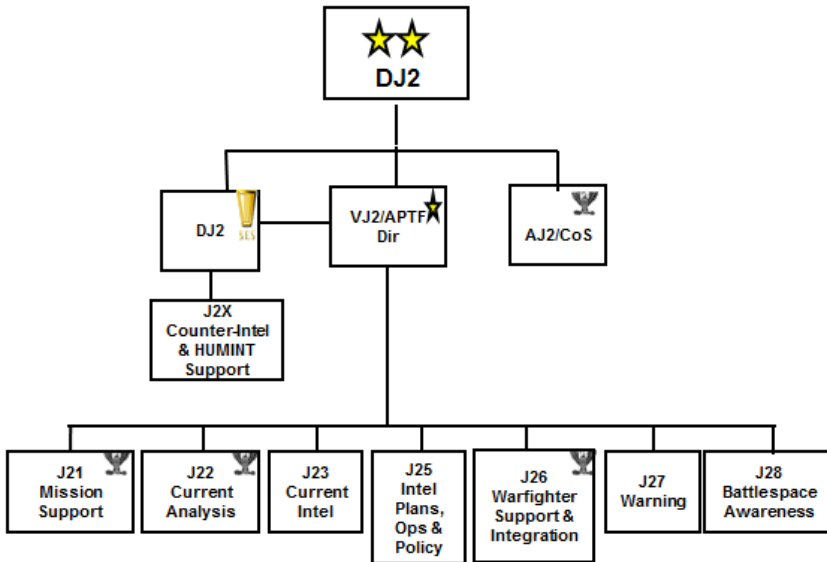

Figure 12: J-2 Intelligence

J-2 Intelligence

- Operates National Military Command Center (NMCC)–Support Division as part as part of the NMCC
- Provides support to SecDef, Chairman, Joint Staff, combatant commands, and Military Services
- Provides all source intelligence and staff support to the Chairman and Joint Staff
- Serves as the Intel Community Coordinator for Support to Military Operations
- Operates Joint Intel Task Force for Combating Terrorism
- Coordinates and Develops Joint Intel Doctrine and architecture
- Sponsors the “Battle space Awareness” Joint Warfighting Capabilities Assessment (JWCA)

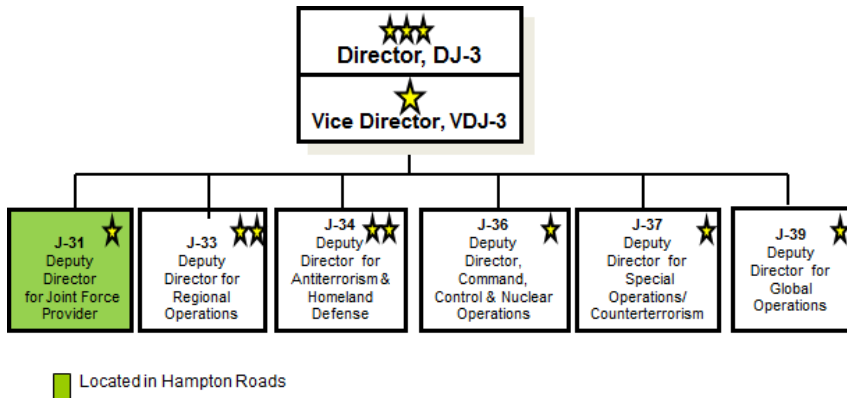

Figure 13: J-3 Operations

J-3 Operations

- Provides Operational Guidance to combatant commanders
- Joint readiness and capabilities
- Operational Planning and Execution
- Coordination of military support
- National Military Command Center (NMCC) system

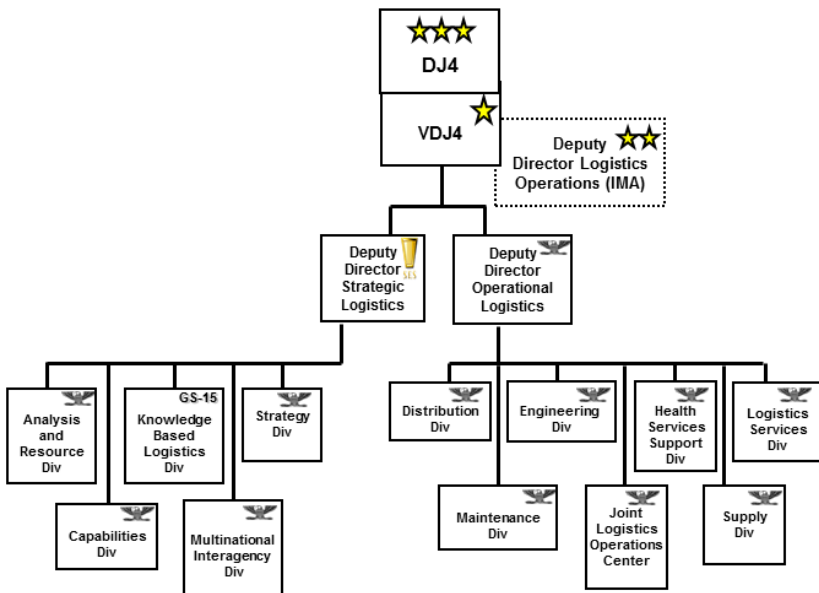

Figure 14: J-4 Logistics

J-4 Logistics

- Establishes joint logistics doctrine
- Logistics and mobility asset prioritization and logistics, mobility, and mobilization annexes
- Force health protection
- Joint Logistics Operations Center (JLOC)
 - Current and Future Operations
 - Short notice emergencies
- Operational Engineering
- Sponsors the Focused Logistics JWCA

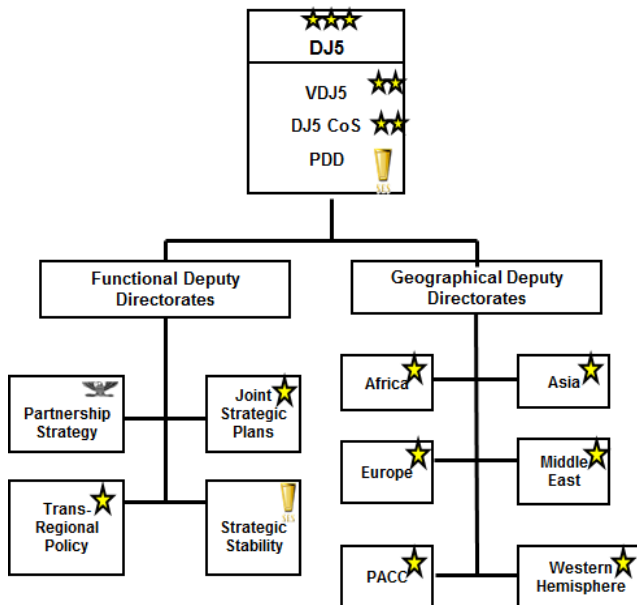

Figure 15: J-5 Strategic Plans and Policy

J-5 Strategic Plans and Policy

- Joint Strategic Planning System (National Military Strategy, National Security Strategy, Defense Planning Guidance, Chairman’s Program Assessment)
- Theater Engagement Planning, a new strategic planning system that parallels existing deliberate planning process for contingencies
- Chairman’s strategic long-range vision (current document, Joint Vision 2020)
- Joint Strategic Capabilities Plan that apportions forces to the Warfighting Commanders-in-Chief.
- Recommends inputs to the SecDef for contingency planning guidance.
- Joint Organizational Relationships/ Functions [Unified Command Plan (UCP), Roles & Missions]
- International Arms Control Negotiations (UN, NATO, OSCE, SHAPE)
- Interagency (NSC/HSC) National Security Policy (CBRNE, WMD, Strategic Missile Defense, Counterdrug)
- International Politico-Military Affairs (Regional Country Desk Officers)

- Joint and Combined Military Strategic Guidance

J6 Command, Control, Communications, & Computers/Cyber

(Recently re-established)

- Represents the Joint Warfighter in support of the command, control, communications, and computers/cyber (C4) requirements validation and capability development processes while ensuring joint interoperability.
- Promulgates guidance and provides functional expertise to the Chairman in order to shape the joint information environment.
- As the Joint Staff Chief Information Officer (CIO), provides business class Information Technology (IT) services and support to the Chairman and the entire Joint Staff.

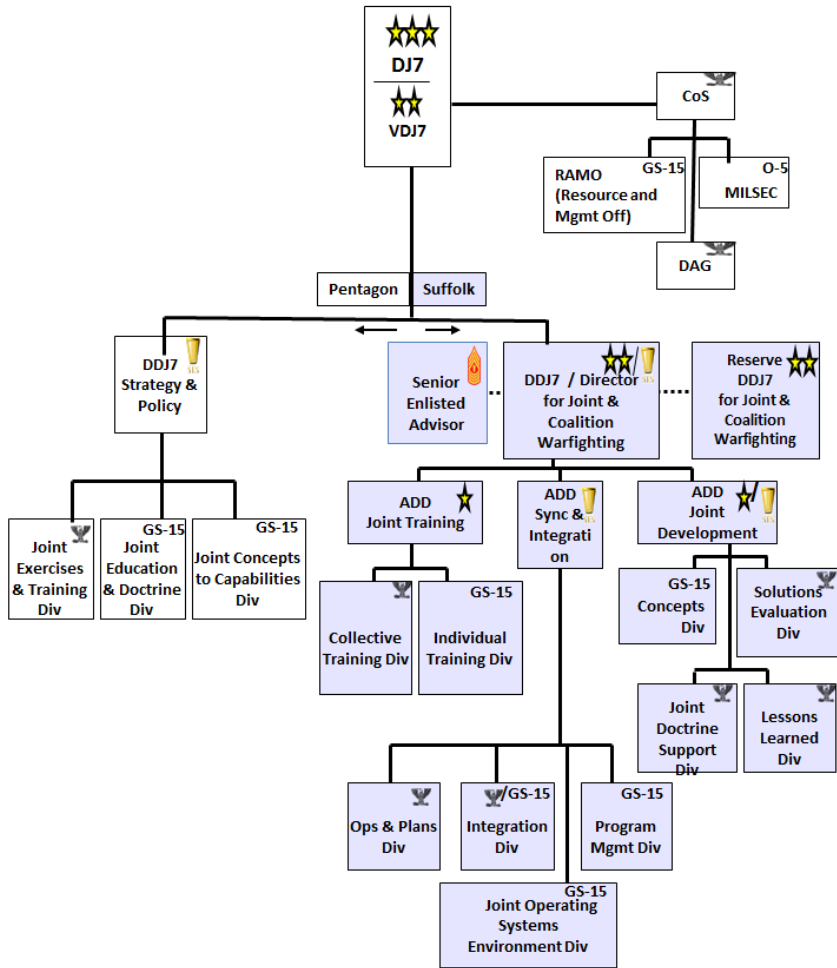

Figure 16: J-7 Joint Force Development

J-7 Joint Force Development

- Joint Force Development
- Joint Capabilities development, assessment, and transition; strategy and planning; program development and execution; analysis and reporting
- Joint Interoperability Improvements
- Joint Professional Military Education policy
- Joint Individual and Staff Training strategy and policy and program management

- Joint Doctrine Development process
- Joint Warfighting Requirements for Training
- CJCS–sponsored exercises management

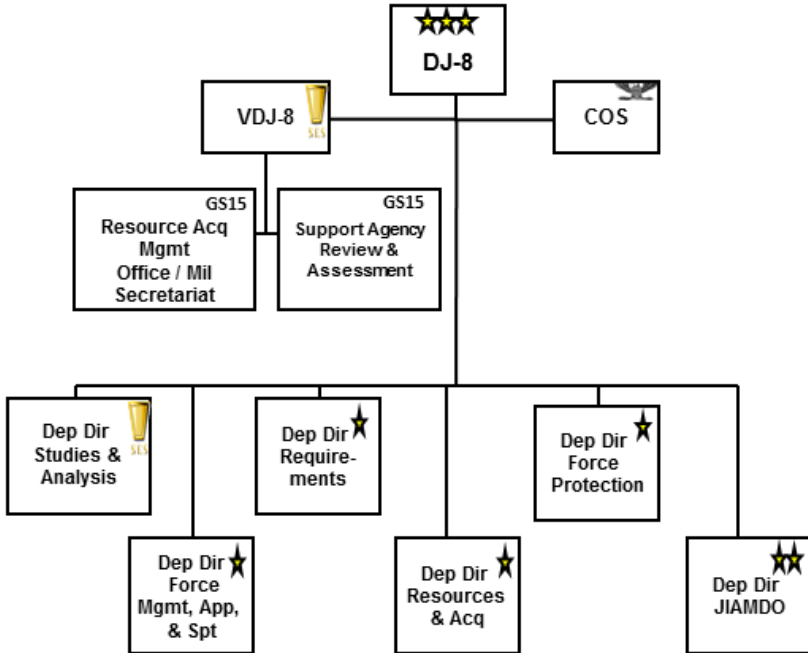

Figure 17: J-8 Force Structure, Resources, and Assessment

J-8 Force Structure, Resources, and Assessment

- Develops force structure requirements
- Conducts studies, analyses, and assessments and evaluates military forces, plans, programs, and strategies
- Conducts war games, seminars and simulations
- Assesses DOD acquisition policy change
- Evaluates major acquisition programs
- Represents Chairman and combatant command interests in the Planning, Programming, Budgeting and Execution System (PPBES)
- Joint Integrated Air and Missile Defense Organization (JIAMDO)
- Joint Requirements Office for Chemical, Biological, Radiological, Nuclear and Explosives (CBRNE) Defense

- Secretary of Joint Requirements Oversight Council (JROC)
- Chairman of the Joint Requirements Board (JRB)
- Sponsor for the Force Application and Protection JWCA

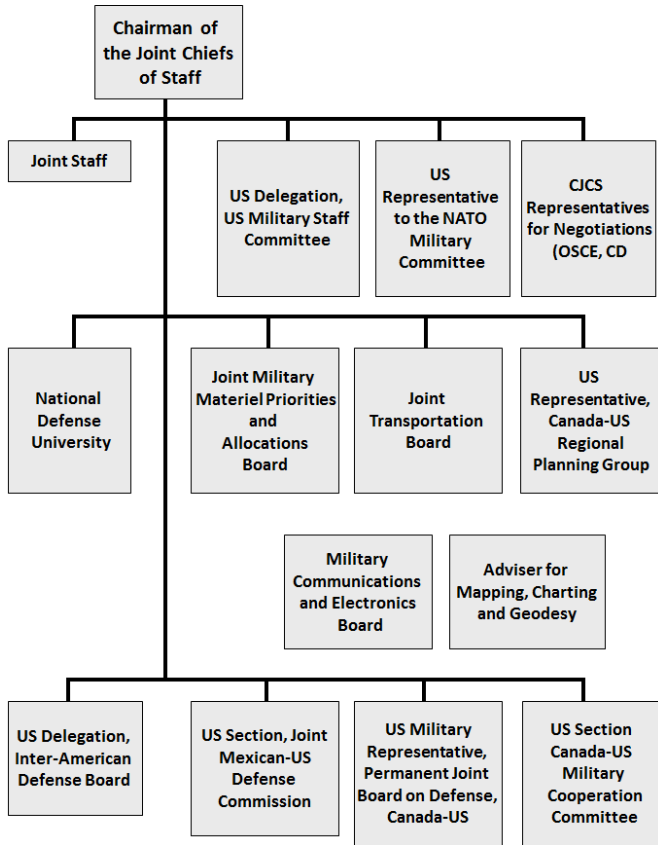

Figure 18: Organizations Reporting to the Chairman of the Joint Chiefs of Staff

The CJCS has **operational responsibilities** for:

- the Defense Information Systems Agency (DISA)
- the Defense Logistics Agency (DLA)
- the Defense Intelligence Agency (DIA)
- the Defense Contract Management Agency (DCMA)
- the Defense Threat Reduction Agency (DTRA)
- the National Security Agency (NSA)
- the National Geospatial-Intelligence Agency (NGA)

CJCS gives **policy guidance and direction** to other supporting organizations, including:

- Joint Tactical Command, Control, and Communications Agency;
- Electromagnetic Compatibility Analysis Center; and
- Military Communications-Electronics Board.

3.1.5 A Traditional Combatant Command Joint Staff Organization

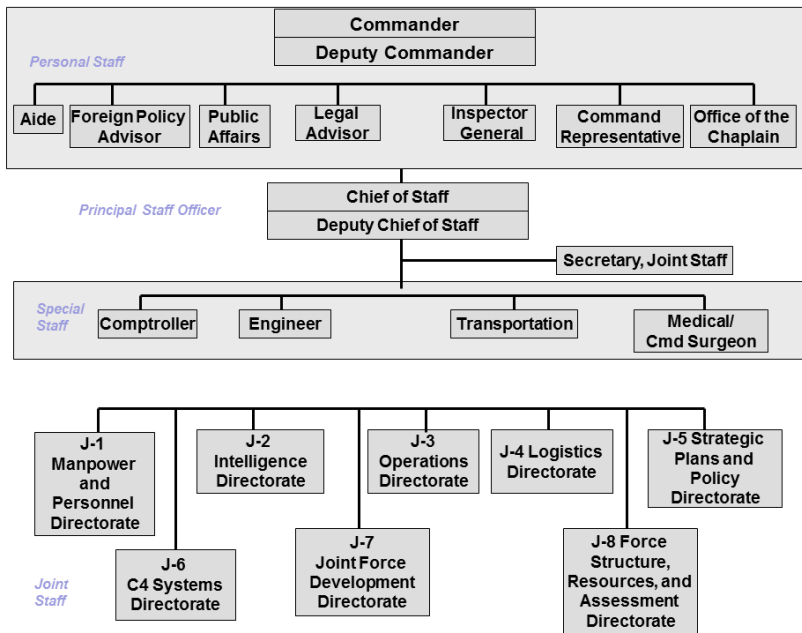

Figure 19: A Traditional Combatant Command Joint Staff Organization

(NOTE: Titles above are generic; exact titles may vary among commands)

The chart above illustrates the broad functional subdivisions of a typical joint staff organization as might be seen in a combatant command. The commander's staff is broadly categorized into **personal staff**, **special staff**, and **general or joint staff divisions**.

- The Chief of Staff (COS) is the **principal staff officer, assistant, and adviser to the JFC** and coordinates and directs the work of the staff directorates. For internal administrative matters, the COS may be assisted by a secretary of the joint staff who is responsible for routing and

forwarding correspondence and papers, and for maintaining office records. Some staffs have one or more deputy chiefs of staff to assist the COS. Deputy chiefs of staff normally should be from a Service other than that of the COS.

- The **personal staff group** is directly responsible to the commander; includes any assistants needed to handle matters requiring close personal control by the commander. The commander's aide or aide-de-camp, staff judge advocate, foreign policy advisor, public affairs officer, inspector general, provost marshal, chaplain, surgeon and historian are generally on the commander's personal staff.
- The **special staff group** assists the commander and joint staff with technical, administrative, or tactical matters, (e.g., comptroller, facility engineering, medical, weather, quartermaster, and transportation affairs), and is usually small, to avoid unnecessary duplication of corresponding staff sections or divisions within the Service component headquarters. When a commander's headquarters is organized without a special staff group, the officers who might otherwise compose a special staff group may be organized as branches of the divisions of the joint staff or as additional joint staff divisions.

A combatant command's principal functional divisions (or directorates), the **joint staff group**, execute responsibilities of the commander such as developing policy, preparing and coordinating plans, and overseeing functions assigned to the commander. Each directorate may be headed by an assistant chief of staff or director. Joint Force Commanders (JFC) have authority and latitude to organize the staff as necessary; some JFC's have combined directorates, have added others, or reorganized into different specialty groups.

Non-traditional divisions are also found in many commands, such as:

- **Security assistance division:** supporting military and economic aid to countries within a joint commander's area of operations; may be found in a separate division or as part of the logistics division.
- **Interoperability division:** responsibility for joint planning, plans evaluation and analysis, development of joint doctrine, coordinating joint education and training, and the conduct of joint training exercises.
- **Force structure, resources, and assessment division.** The Reorganization Act of 1986 brought added responsibility to combatant commanders for critical involvement in the Planning,

Programming, Budgeting and Execution System, creating a need for dedicated staff support.

References:

- *Joint Pub 1; JFSC Pub 1*

3.1.6 Planning, Programming, Budgeting and Execution System (PPBES)

According to the Department of Defense:

The ultimate objective of PPBES is to provide the operational commanders the best mix of forces, equipment, and support attainable within fiscal constraints. Based on the anticipated threat, a strategy is developed. The purpose of the PPBES is to produce a plan, a program, and finally, a budget for the Department of Defense.

The PPBES was originally the PPBS, first implemented in the early 1960s by then Secretary of Defense Robert McNamara. The policy documents that govern PPBES are DOD Directive (DODD) 7045.14 and DOD Instruction (DODI) 7045.7 though neither document has been updated since PPBS was modified to become the PPBES via Management Initiative Decision 913 of 22 May 2003. DOD planning, programming, budgeting and execution activities occur each year. The figures below illustrate the PPBES process and where it fits into the overall Defense Acquisition process.

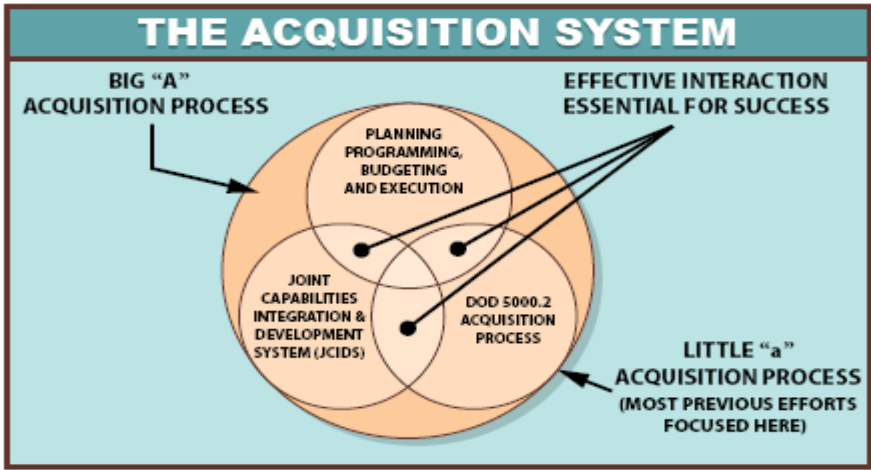

Figure 20: PPBES—Acquisition System

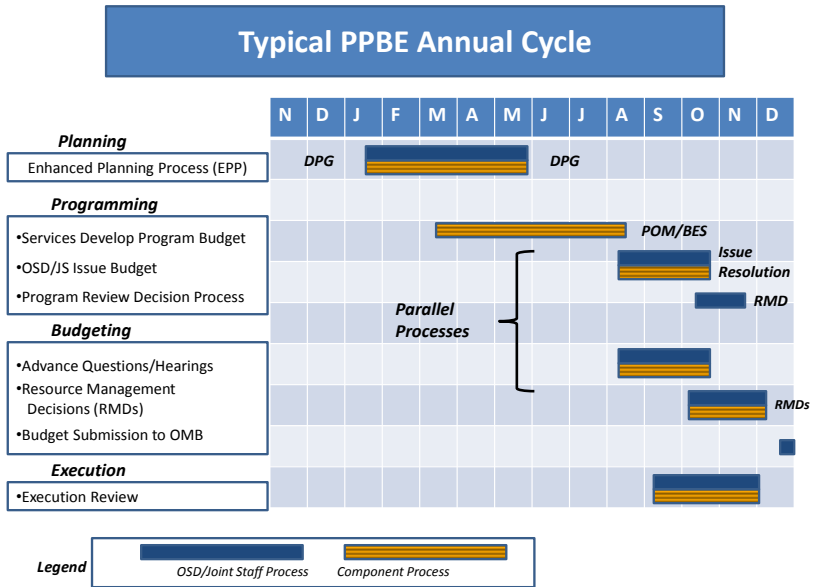

Figure 21: Typical PPBES Annual Cycle

3.1.7 Types of Appropriations

Relevant Terms:

- Appropriation bill—a legislative act proposing to authorize the expenditure of public funds for a specified purpose.
- Line item—an item in an appropriation bill.
- Bill, measure—a statute in draft before it becomes law.
- Law, jurisprudence—the collection of rules imposed by authority.

Most AOs will have to address funding questions during a combatant command tour and even may be the overseer of budget inputs for their organizations. Often, the term “colors of money” is used in meetings, planning sessions, and in developing products for taskers. The term can be confusing, frustrating, and even frightening to think about administering. Just remember that there is always help—your first line supervisor, the comptroller’s office, or your legal department.

DOD funds are broken down into various types of appropriation accounts. The primary ones are:

- Procurement
- Research, Development, Test, and Evaluation (RDT&E)
- Operations and Maintenance (O&M)
- Military Personnel (MILPERS)
- Military Construction (MILCON)

Funds are further separated into various “lines of accounting” within each of these appropriations depending on the functional area or product to which they have been allocated. Of importance, each appropriation type has statutory time limits on use: e.g., Procurement funds are good for three years, RDT&E two years, and O&M one year. These various cycles create problems because almost all of the activities funded by these different colors of money are used for the effective support and sustainment of DOD weapon systems. Fewer problems are created with traditional support strategies because they are more attune with how funds are aligned since traditional support is purchased as discrete amounts of functional transactions; such as number of items repaired, supply parts purchased, or hours of engineering support, for example.

Types of Funds

To execute an acquisition program, budget authority provided by Congress is needed in order to incur obligations and make payments. Budget authority is most commonly provided by an appropriations act, in which Congress specifies the purpose(s) for which each particular

appropriation may be used as well as the amount of budget authority provided under each appropriation. DOD receives many appropriations, most of which can be grouped into the five major categories: RDT&E; Procurement; O&M; MILPERS; and MILCON. Volume 2A, Chapter 1, of the DOD Financial Management Regulation [DOD 7000.14-R (FMR)] (<http://comptroller.defense.gov/fmr/>) provides guidance as to the proper use of these appropriations categories to finance program efforts.

- **RDT&E** appropriation accounts finance research, development, test, and evaluation efforts performed by contractors and government installations to develop equipment, material, or computer application software; its Development Test and Evaluation (DT&E); and its Initial Operational Test and Evaluation (IOT&E). These efforts may include purchases of end items, weapons, equipment, components, and materials as well as performance of services—whatever is necessary to develop and test the system. This applies to automated information systems as well as weapon systems. RDT&E funds are also used to pay the operating costs of dedicated activities engaged in the conduct of Research and Development programs. RDT&E funds are used for both investment-type costs (e.g., sophisticated laboratory test equipment) and expense-type costs (e.g., salaries of civilian employees at R&D-dedicated facilities). There is an RDT&E appropriation for each service (Army, Navy, and Air Force) as well as one to cover other Defense agencies as well as separate ones for both operational test and developmental test activities.
- The **Procurement** category consists of a number of procurement appropriation account titles such as Shipbuilding and Conversion Navy, Aircraft Procurement Air Force, Missile Procurement Army, Procurement Marine Corps, etc. Procurement appropriations are used to finance investment items and should cover all costs necessary to deliver a useful end item intended for operational use or inventory. Items classified as investments and financed with Procurement appropriations include those whose system unit cost exceeds \$250K; all centrally managed end items not purchased from Defense Working Capital Funds, regardless of unit cost (e.g., handguns); purchases from the Defense Working Capital Fund furnished as part of a system acquisition, system modification, major service life extension program and initial spares. With certain limited exceptions, the cost of fabricating and installing additions or modifications to existing end items is also funded

- with procurement appropriations.
- The **O&M** category is also composed of many appropriation account titles, e.g., Operation and Maintenance Army, Operation and Maintenance Marine Corps Reserve, Operation and Maintenance Air National Guard, etc. O&M appropriations traditionally do not finance investments, but rather those things whose benefits are derived for a limited period of time, i.e., expenses. Examples of costs financed by O&M funds are headquarters operations, civilian salaries and awards, travel, fuel, minor construction projects of \$750K or less, expenses of operational military forces, training and education, recruiting, depot maintenance, purchases from Defense Working Capital Funds (e.g., spare parts), base operations support, and assets with a system unit cost less than the current procurement threshold (\$250K).
 - **MILPERS** appropriation accounts are similar in nature to those of O&M in that both are considered expense accounts. MILPERS appropriations are used to fund the costs of salaries and compensation for active military and National Guard personnel as well as personnel-related expenses such as costs associated with Permanent Change of Duty Station (PCS), training in conjunction with PCS moves, subsistence, temporary lodging, bonuses, and retired pay accrual.
 - **MILCON** appropriation accounts receive considerable attention from Congress, and are enacted separately from the Defense Appropriations Act. These appropriations fund the costs of major construction projects such as bases, facilities, military schools, etc. Project costs include architecture and engineering services; construction design; real property acquisition costs; and land acquisition costs necessary to complete the construction project. MILCON is considered an investment account. Examples of projects properly financed in the MILCON appropriations include missile storage facilities, intermediate maintenance facilities, medical/dental clinics, technical libraries, and physical fitness training centers.

Direct Resource: ACQuipedia

<https://acc.dau.mil/CommunityBrowser.aspx?id=362551>

3.1.8 Joint Strategic Planning System (JSPS)

JSPS is the primary means by which the CJCS carries out statutory responsibilities assigned in Titles 6, 10, 22, and 50 of the USC to conduct risk assessment, advise the president, SecDef, NSC, and

HSC; and assist the President of the United States (POTUS) and SecDef to provide strategic direction to the Armed Forces. In addition to the five documents previously listed—National Military Strategy (NMS), Joint Planning Document (JPD), Chairman’s Program Recommendation (CPR), Joint Strategic Capabilities Plan (JSCP), and Chairman’s Program Assessment (CPA)—the JSPS produces several strategic planning documents.

UNCLASSIFIED



Joint Strategic Planning System (JSPS)

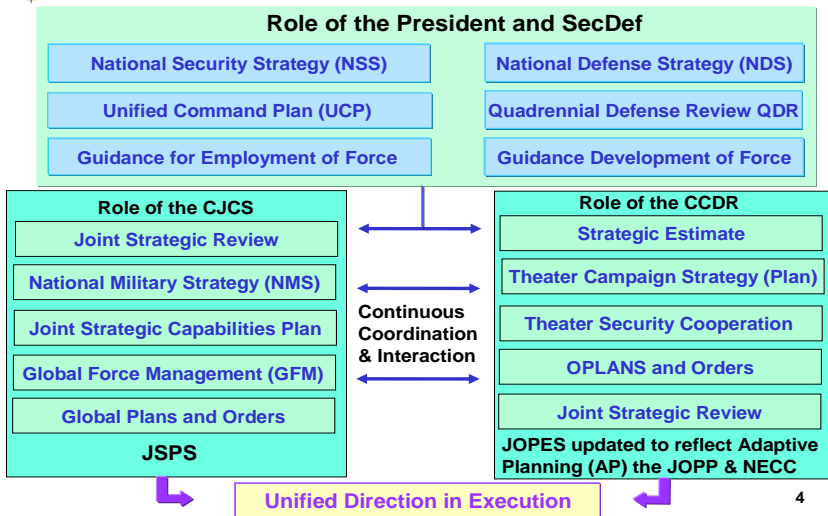

Figure 22: Joint Strategic Planning System Roles

- **National Security Strategy (NSS)**—The president publishes the NSS and outlines the major security concerns of the U.S. and the necessary military actions to protect vital U.S. interests and promote peace and justice abroad. The NSS reflects doctrine and has moved the U.S. from the cold war doctrine of deterrence to a proactive policy to confront and counter the threats of the 21st century.
- **Defense Planning Guidance (DPG)**-SecDef developed document that conveys the SecDef vision for the future force and the evolution the DOD will undertake in the coming years. The DPG is “informed” by the NSS and is intended to focus DOD resources on the missions and capabilities that will be most relevant to meeting the nation’s current and future needs.

- **National Defense Strategy (NDS)**—SecDef-approved document that describes broad policy and strategy to establish key planning parameters and policies. The NDS identifies and prioritizes major ends, ways, and means to guide defense policy and planning. The Guidance for Employment of the Force (GEF) translates the ends and ways identified in the NDS into Global Strategic End States to guide combatant command contingency planning.
- **Guidance for Employment of the Force (GEF)**—The GEF merges Contingency Planning Guidance (CPG), Global Force Management (GFM) and Security Cooperation Guidance (SCG) into one document that provides comprehensive, near-term planning guidance. The GEF and JSCP will become the principal sources of presidential and SecDef politico-military guidance for combatant command steady-state campaign, contingency and posture planning efforts [allocation of forces against the full Range of Military Options (ROMO)].
- **Unified Command Plan (UCP)**—Approved by the president, establishes missions, responsibilities, and force structure of the unified combatant commanders; delineates the general geographical AOR for the Geographic Combatant Commanders (GCC); specifies functional responsibilities for Functional Combatant Commanders (FCC). The UCP and NSS are components of U.S. Grand Strategy.
- **Quadrennial Defense Review (QDR)**—The Office of the SecDef (OSD) (supported by the Joint Staff) executes the QDR to operationalize strategy, reshape/reorient/reconfigure capabilities and forces to achieve unity of effort through interagency operations and working with International Allies and partners.
- **Adaptive Planning and Execution (APEX)**—Volumes will consist of Chairman of the Joint Chiefs of Staff Manuals (CJCSM 3122 series) and ultimately replace Joint Operation Planning and Execution System (JOPES). The APEX promotes adaptability of plans with multiple options, rapid feasibility analysis, and expanded application of Adaptive Planning (ADP) to facilitate revision and frequent and early interagency exchange and coordination.
- **JSPS Battle Rhythm**—The JSPS cycle is based on a 4-year battle rhythm. Year 1, the president publishes the NSS and OSD executes the QDR. Years 1 and 3, a formal Joint Strategic Review (JSR) report is prepared and tailored to inform strategy development and military direction. In years 2 and 4, formal strategic guidance is produced to include the

UCP from the president; the NDS, GDF, and GEF from the SecDef and the NMS and JSCP from the Chairman. The JSPS cycle is repeated annually to support the Chairman's assessment and direction, statutory responsibilities.

References:

- *Guidance for Employment of the Force (GEF), draft, Secret*
- *National Military Strategy of the U.S.—Feb. 2011*
<https://acc.dau.mil/adl/en-US/425505/file/55897/2011%20National%20Military%20Strategy.pdf>
- *National Security Strategy...May 2010:*
http://www.whitehouse.gov/sites/default/files/rss_viewer/national_security_strategy.pdf
- *Joint Strategic Capabilities Plan, FY2008 draft, Secret*
- *Global Force Management Guidance, FY2008, Secret*
- *Unified Command Plan, 8 February 2011, For Official Use Only (FOUO)*
- *Quadrennial Defense Review...Feb 2010*
<http://www.defense.gov/qdr/QDR%20as%20of%2026JAN10%200700.pdf>
- *CJCSM 3122.01A JOPES Volume I, 29 Sept 2006*

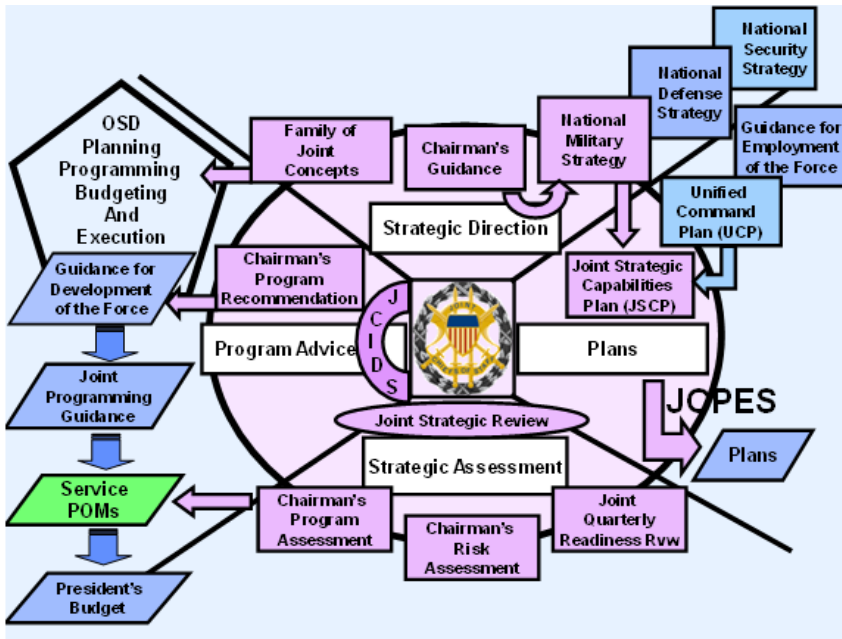

Figure 23: Joint Strategic Planning System

The CJCS establishes JSPS procedures and processes to formulate vision, strategy, planning guidance, program recommendations, and assessments. The JSPS is a collaborative process among the president, SecDef, CJCS, the Joint Staff, Service Chiefs, combatant commanders and other stakeholders. The JSPS is used in conjunction with other systems such as JOPEs, the budgeting process (PPBES), and the NSC System.

The JSPS process produces five core documents:

- **The National Military Strategy (NMS):** provides advice, to include recommended military objectives, from the CJCS to the president, the SecDef, and the other NSC members. The CJCS uses the NMS to help develop the JSCP; and the SecDef uses it to help formulate the Defense Planning Guidance (DPG).
- **Joint Planning Document (JPD):** The CJCS uses the JPD to prepare programming priorities, requirements, and recommendations for the SecDef, who then takes those recommendations into consideration for development of the DPG, which then initiates the PPBES.

- **Chairman's Program Recommendation (CPR):** The CJCS uses this document to provide emphasis on and support for continuous improvement for joint readiness, training, and capabilities. This document takes the JPD and makes adjustments to its recommendations, either modifying or expanding JPD initiatives.
- **Joint Strategic Capabilities Plan (JSCP):** supports the Chairman's NMS to direct the CCDRs to accomplish strategic planning. CCDRs translate the NSS and the NMS national security objectives into military capabilities organized in Operational Plans (OPLANS). The JSCP details planning guidance and the apportionment of forces generically (USAF Fighter Wing/USA Division) to conduct conceptual force planning ISO OPLANS. The JSCP is the connector between the JSPS and JOPES.
- **Chairman's Program Assessment (CPA):** is the CJCS capabilities assessment and used to identify how well the PPBES program supports program priorities. This document is used to advise the SecDef on the Program Objectives Memoranda (POMs) which affect support levels required for supporting national security objectives.

References:

- *JP 1, Doctrine for Joint Warfare of the Armed Forces of the United States*
- *JP 5-0, Doctrine For Joint Operational Planning*
- *JFSC Pub 1, The Joint Staff Officer's Guide*
- *CJSCI 3100.01, Joint Strategic Planning System*

3.2 Joint Publication System

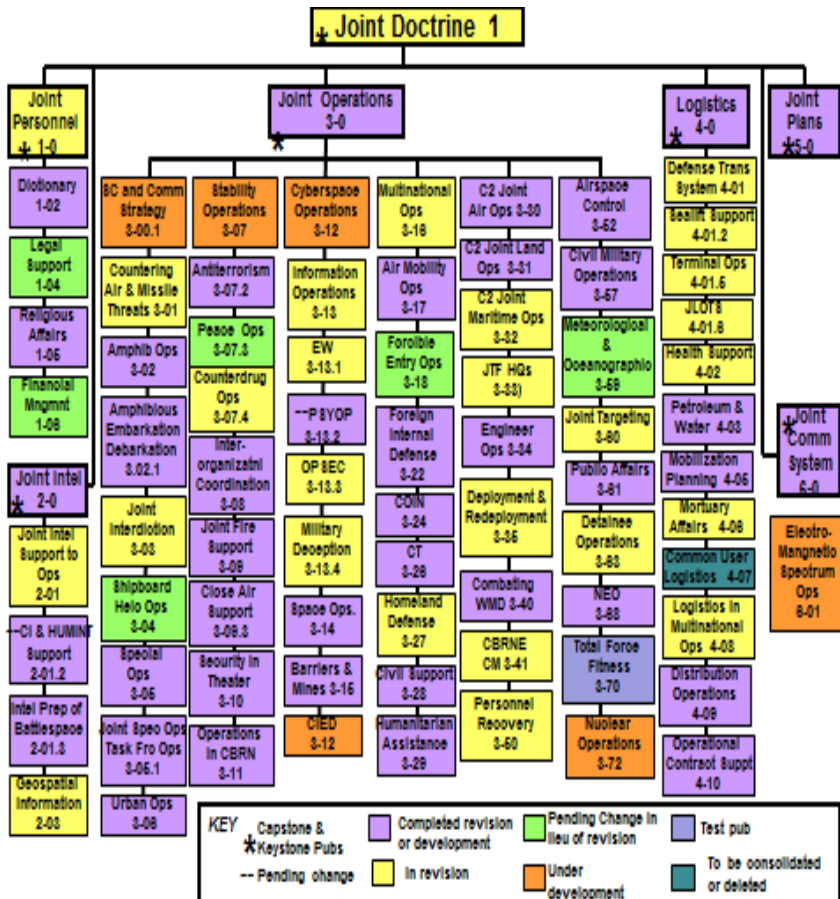

Figure 24: Joint Publication Hierarchy

The Joint Publication System (JPS) furnishes the principles, guidelines, and conceptual framework for initiating, validating, developing, coordinating, evaluating, approving, and maintaining joint doctrine; Joint Tactics, Techniques, and Procedures (JTTP); and joint technical publications for the Armed Forces. The Joint Staff J-7 manages the joint doctrine and JTTP program for CJCS.

The joint publication hierarchy furnishes a framework for organizing joint doctrine and JTTP publications into functional series. The organizational structure generally follows traditional joint staff lines of

responsibility. Each series, except the 0 and 1 series, includes a keystone manual as the first publication in the series as the doctrinal foundation of its series. The following delineates the organization of the functional publications:

- **Joint Pub 1 Series, Joint Personnel Publications:** includes a joint publication guide and index and publications for legal and religious support, and for financial management.
- **Joint Pub 2 Series, Doctrine for Intelligence Support of Joint Operations:** establishes joint doctrine, tactics, techniques, and procedures for intelligence support of joint operations, including direction, planning, collection, processing, production, and dissemination.
- **Joint Pub 3 Series, Doctrine for Joint Operations:** establishes joint doctrine, tactics, techniques, and procedures for directing, planning, and executing joint military operations.
- **Joint Pub 4 Series, Doctrine for Joint Logistics:** establishes joint doctrine, tactics, techniques, and procedures for directing, planning, and carrying out logistics support of joint operations.
- **Joint Pub 5 Series, Doctrine for Joint Operation Planning:** establishes the joint planning processes relating to the conduct of joint military operations, such as deliberate and crisis action planning.
- **Joint Pub 6 Series, Doctrine for Joint Communications System:** establishes joint doctrine, tactics, techniques, and procedures for C4 systems support to joint operations.

(Note: The publications in each series can be found at: http://www.dtic.mil/doctrine/new_pubs/jointpub.htm)

Selected Joint Publications Used in Staff Work

An understanding of joint publications and associated procedures is critical to the success of an officer serving in a Joint Staff Officer role on the Joint Staff, at a combatant command or with Joint Task Forces. Printed versions of these documents are no longer available, but electronic versions may be accessed via the Joint Doctrine, Education, and Training Electronic Information System (JDEIS) at: http://www.dtic.mil/doctrine/s_index.html.

The Doctrine Networked Education and Training (DOCNET) website offers a series of short courses and podcasts that summarize the Joint Publications at <http://www.dtic.mil/doctrine/docnet/>.

The following joint publications are widely used for references and research:

- **Joint Doctrine Capstone and Keystone Primer** (includes the approved executive summaries of all capstone and keystone publications, as well as those of Joint Publications 1, 2-0, 3-07, 3-08, 3-16, 3-33, and 4-0).
- **JP 1**, *Doctrine for Joint Warfare of the Armed Forces of the United States*, the capstone baseline document for joint publications
- **JP 1-02**, *DOD Dictionary of Military and Associated Terms*
- **JP 2-0**, *Doctrine for Intelligence Support of Joint Operations*
- **JP 2-01**, *Joint Intelligence and National Support to Military Operations*
- **JP 3-0**, *Doctrine for Joint Operations*
- **JP 3-01**, *Joint Doctrine for Countering Air and Missile Threats*
- **JP 3-02**, *Joint Doctrine for Amphibious Operations*
- **JP 3-05**, *Doctrine for Joint Special Operations Task Force Operations*
- **JP 3-07.1**, *Joint Tactics, Techniques, and Procedures for Foreign Internal Defense (FID)*,
- **JP 3-07.2**, *Joint Doctrine for Antiterrorism*
- **JP 3-07.3**, *Joint Doctrine for Peace Operations*
- **JP 3-08**, *Volumes I & II, Interagency, Intergovernmental and Nongovernmental Coordination during Joint Operations*
- **JP 3-13**, *Joint Doctrine for Information Operations*
- **JP 3-16**, *Joint Doctrine for Multinational Operations*
- **JP 3-29**, *Foreign Humanitarian Assistance*
- **JP 3-33**, *Joint Task Force Headquarters*
- **JP 3-52**, *Doctrine for Joint Airspace Control in the Combat Zone*
- **JP 3-57**, *Doctrine for Joint Civil Military Operations*
- **JP 4-0**, *Doctrine for Joint Logistics*
- **JP 4-01**, *Joint Doctrine for the Defense Transportation System*
- **JP 4-05**, *Joint Doctrine for Mobilization Planning*
- **JP 5-0**, *Doctrine for Joint Operation Planning*
- **JP 6-0**, *Doctrine for Joint Communications System*

The following are widely used reference pubs:

- CJCSI 5120.02, *Joint Doctrine Development System*
(http://www.dtic.mil/doctrine/new_pubs/cjcsi5120_02b.pdf)
- CJCSI 5705.01, *Standardization of Military and Associated Terminology*
(http://www.dtic.mil/doctrine/new_pubs/cjcsi5705_01d.pdf)

- JP 1-02, DOD Dictionary of Military and Associated Terms, (http://www.bits.de/NRANEU/others/jp-doctrine/jp1_02%2805%29.pdf)
- CJCSI 3500.02, Universal Joint Task List (UJTL) Policy and Guidance for the Armed Forces Of The United (http://www.dtic.mil/cjcs_directives/cdata/unlimit/3500_02.pdf)
- CJCSM 3500.04, Universal Joint Task Manual (http://www.dtic.mil/cjcs_directives/cdata/unlimit/m350004.pdf)

Reference:

- JDEIS <https://jdeis.js.mil/jdeis/generic.jsp>

3.3 Joint Logistics

The Nation's ability to project and sustain military power depends on effective joint logistics. Joint logistics delivers sustained logistic readiness for the CCDR and subordinate JFCs through the integration of national, multinational, Service, and CSA capabilities. The integration of these capabilities ensures forces are physically available and properly equipped, at the right place and time, to support the joint force.

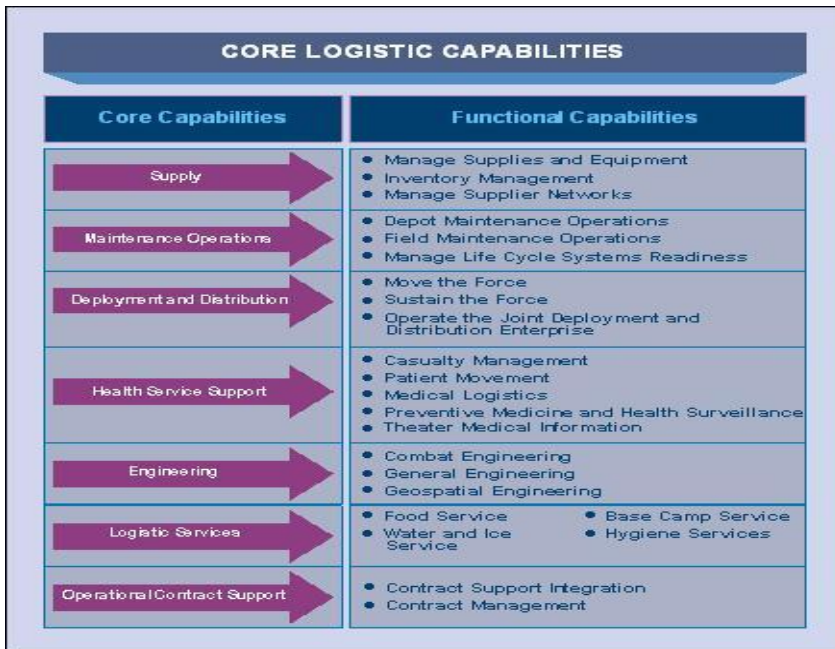

Figure 25: Joint Core Logistic Capabilities

Joint Logistics Environment

Political and military leaders conduct operations in a complex, interconnected, and increasingly global operational environment, characterized by uncertainty and surprise. Operations are conducted simultaneously across multiple Joint Operations Areas (JOAs) within a single theater or across boundaries of more than one geographic combatant commander and can involve a large variety of military forces and multinational and Other Government Agencies (OGAs). The Joint Logistics Environment (JLE) exists within this operational environment and consists of the conditions, circumstances and influences that affect the employment of logistic capabilities. It exists at the strategic, operational, and tactical levels of war; and includes the full range of logistic capabilities, stakeholders and end-to-end processes.

Joint Logistics Imperatives

The value of joint logistics can be determined by how well three imperatives are attained: **unity of effort**, **JLE-wide visibility**, and **rapid and precise response**. These imperatives define the desired attributes of a federation of systems, processes, and organizations that

effectively adapt within a constantly changing environment to meet the emerging needs of the supported CCDR.

- To achieve **unity of effort**, joint logisticians develop a clear understanding of how joint and multinational logistic processes work; know the roles and responsibilities of the providers executing tasks in those processes; build agreement around common measures of performance (process outcomes); and ensure appropriate members of the JLE have visibility into the processes.
- **JLE-wide visibility** is having assured access to logistic processes, resources, and requirements in order to gain the knowledge necessary to make effective decisions. JLE-wide visibility provides the means to optimize logistic processes to maximize outcomes, increase readiness, and build confidence in joint logisticians.
- **Rapid and precise response** is the ability of the core logistics capability areas to meet the constantly changing needs of the joint force.

Integrating Functions

Sustained logistic readiness is driven by the effective and efficient delivery of joint logistics through coordinating and integrating Service, agency, and other capabilities to meet the supported commander's requirements. To achieve this level of integration, commanders and their staffs, especially logisticians, must be able to effectively and efficiently plan, execute, control, and assess joint logistic operations.

- **Planning** for joint logistic support links the mission, commander's intent, and operational objectives to core logistic capabilities, procedures, and organizations. Joint logistic planning defines joint processes to establish an effective concept for logistic support.
- **Executing** joint logistics involves the employment of capabilities and resources to support joint and multinational operations.
- Effective **control** of joint logistic operations results from the exercise of authority and direction for the sustained logistic readiness of the joint force.

Core Logistic Capabilities

The core logistic capabilities provide a framework to facilitate integrated decision-making, enable effective synchronization and allocation of resources, and optimize joint logistic processes. Integrating the logistics capabilities is critical to effectively sustaining the joint force, and the complexity of this integration requires continuous collaboration

between key stakeholders to maximize effectiveness and economy of resources, and to best support the JFC. The core logistic capabilities include:

- **Supply:** involves operations that include identifying requirements, selecting supply sources, scheduling deliveries, receiving, verifying and transferring product, inspection and acceptance, and authorizing supplier payments. It includes the following functions: management of supply operations, inventory management and the management of DOD's supplier networks.
- **Maintenance Operations:** encompass key functions executed by the Services to deliver systems readiness and enable the JFC's freedom of action. Field maintenance operations are focused on rapidly returning systems to the user. Depot maintenance operations are focused on rebuilding/repairing systems and components to sustain long-term life cycle readiness. Total life cycle systems management is focused on the readiness and the integrated control of systems' long-term health by maximizing availability and reliability of systems at best value to the Military Departments.
- **Deployment and Distribution Operations:** include planning, coordinating, synchronizing, moving forces, sustainment, and operating the Joint Deployment and Distribution Enterprise (JDDE) in support of military operations. Distribution capabilities are a part of joint logistics, while the full range of deployment activities are a series of operational events enabled by logistics. The portion of deployment that falls within the logistics capabilities is the movement of forces and materiel.
- **Health Service Support:** provides services that promote, improve, conserve, or restore the mental or physical well-being of personnel. These services include, but are not limited to, the management of health services resources, such as manpower, monies, and facilities; preventive and curative health measures; evacuation of the wounded, injured, or sick; selection of the medically fit and disposition of the medically unfit; blood management; medical supply, equipment, and maintenance thereof; combat stress control; and medical, dental, veterinary, laboratory, optometric, nutrition therapy, and medical intelligence services.
- **Engineering Operations:** assure mobility, provide the infrastructure necessary to position, project, protect and sustain the joint force, and enhance visualization of the operational area across the full range of military operations. Operational

engineering is the integration of combat, general, and geospatial engineering to meet national and CCDR requirements.

- **Logistic Services:** are essential to the technical management and support of the joint force. Logistic Services includes food, water and ice, base camp, and hygiene services in an expeditionary environment.
- **Operational Contract Support:** provides the ability to orchestrate and synchronize the provision of integrated contract support and management of contractor personnel providing that support to the joint force in a designated operational area. As indicated, the major functional capabilities are support integration and contractor (personnel) management. Contract support integration gives the CCDR the ability to synchronize and integrate contract support in support of mission requirements. Contractor management provides the CCDR with the ability to manage and maintain visibility of the associated contractor personnel in the designated operational area.

Planning and Executing Joint Logistics

In today's ever-changing operating environment, planning and executing operations often occur simultaneously. Even though these two functions may be running concurrently, it is critical that planning outputs serve as inputs to the execution function. Planning fidelity must translate into executable actions for those forces assigned to the JFC to accomplish the stated mission. A current logistic concept of support is the critical planning output that serves as the "expectation" against which the logistician measures execution. The logistician must monitor, assess, and direct (when required) logistical operations in order to assure that the concept of support is being effectively executed.

(Note: See Joint Publication 4-0 Joint Logistics for additional information)

3.4 Understanding the Organizations and Missions of the Combatant Commands

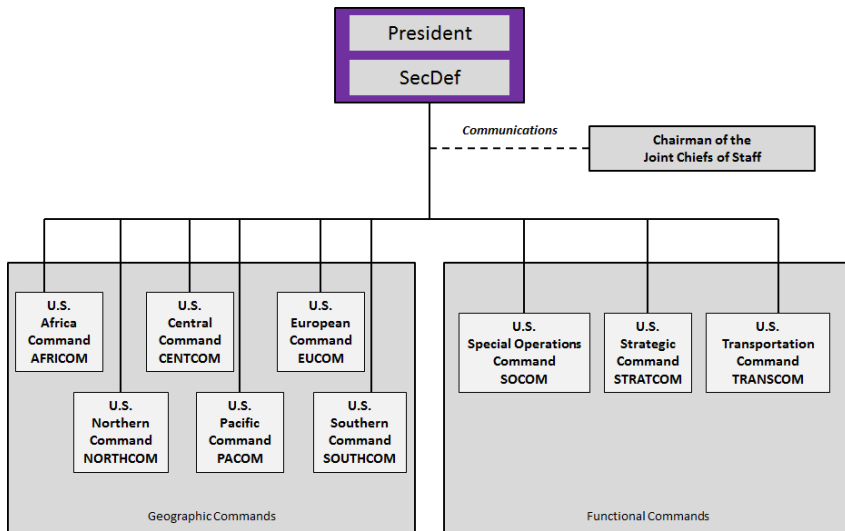

Figure 26: Combatant Command Reporting Organization

Establishment of the Combatant Commands

The 1947 National Security Act set the responsibility of the JCS to “establish unified commands in strategic areas when in the interest of national security,” and the president would establish unified and specified combatant commands to perform military missions. The Military Departments would assign forces to the combatant commands; the responsibility for their support and administration would be assigned by the SecDef to a Military Department. Forces not assigned would remain under the authority of the Military Department. (Joint Pub 1-0)

The president, through the UCP, has directed that communications between the president and SecDef to the combatant commands will be through the CJCS. DOD Directive 5100.1 gives the SecDef wide latitude to assign oversight responsibilities to the CJCS. Combatant commanders, however, determine the chain of command at all levels within their commands. They also have command authority for assigned forces and are directly responsible to the president and SecDef for their specific assigned missions and for the readiness of their commands.

Geographic commands are determined by directives that establish each command's AOR. Combatant commanders are not limited by geographic boundaries, as they may operate forces any place needed to achieve their missions. In 2007, a new geographical command for Africa was authorized. This proposed significant changes to the areas of responsibility for other adjacent geographical commands as shown in the accompanying graphic. The geographic commands are USAFRICOM, USCENTCOM, USEUCOM, USNORTHCOM, USPACOM, and USSOUTHCOM.

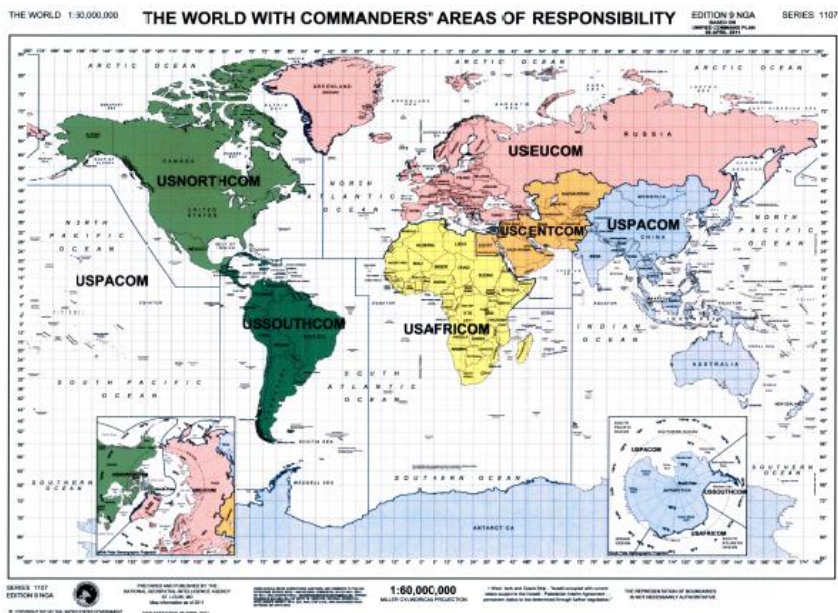

Figure 27: Geographic Combatant Commanders' AORs

Functional commands are determined by directive based on the need for specific capabilities or functions for continuing operations. The functional commands are USSOCOM, USSTRATCOM, and USTRANSCOM.

All combatant commanders provide strategic direction; assign missions, tasks, forces, and resources; designate objectives; provide authoritative direction; promulgate rules of engagement; establish constraints and restraints; and define policies and concepts of operations to be integrated into OPLANs. Supporting combatant

commanders and their subordinates ensure that their actions are consistent with the supported commander's strategy.

Chain of Command and Control

Commanders in the chain of command exercise command authority (COCOM, OPCON, TACON), or a support relationship as prescribed by law or a superior commander over the military force under their command. Unless otherwise directed by the president or SecDef, COCOM over assigned forces is reserved for the combatant commander (CCDR). The CCDR organizes and assigns tasks to his assigned forces based on his strategic vision and concept of operations in order to achieve his assigned and/or anticipated mission(s). During contingency planning, generic forces are apportioned to specific plans according to global force management procedures. This requires supported combatant commanders to coordinate with the supporting combatant commanders on required capabilities during planning and on mission criteria for specific units once they have been allocated. (Joint Pub 1)

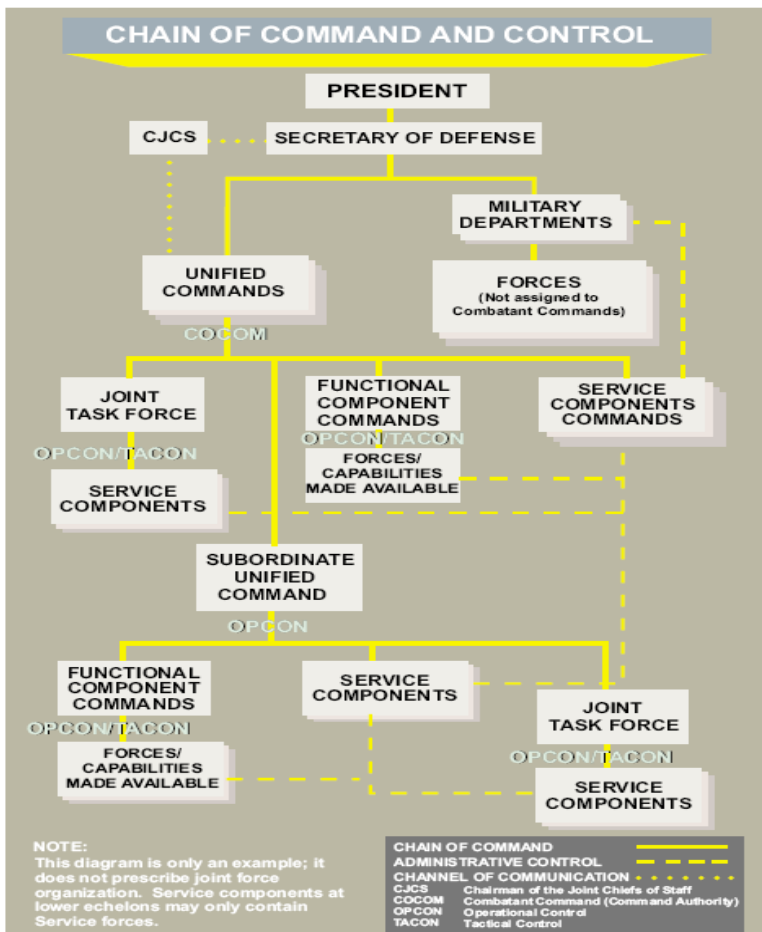

Figure 28: Chain of Command and Control

References:

- <http://www.dtic.mil/whs/directives/corres/pdf/510001p.pdf>, DOD directive 5100.1, JFSC Pub 1

The Unified Command Plan (UCP)

The UCP establishes basic guidance to combatant commands by establishing missions, responsibilities, force structure, geographic areas of responsibility for geographic commands, and functional responsibilities for functional commands.

'Roles' are the broad and enduring purposes for which the Services and the USSOCOM were established in law. 'Missions' are the tasks assigned by the president or SecDef to the combatant commanders. 'Functions' are specific responsibilities assigned by the president or SecDef to enable the Services to fulfill their legally established roles. Simply stated, the primary function of the Services and USSOCOM is to provide forces organized, trained, and equipped to perform a role—to be employed by the combatant commander in the accomplishment of a mission.

By mandate of Title 10 USC, the CJCS conducts a review of the UCP and submits any recommended changes to the president through the SecDef.

Significant changes made by UCP 2011 include:

- Shifting areas of responsibilities boundaries in the Arctic region to leverage long-standing relationships and improve unity of effort. As a result of this realignment, responsibility for the Arctic region is now shared between USEUCOM and USNORTHCOM rather than USEUCOM, USNORTHCOM and USPACOM as directed in previous UCPs.
- Giving USNORTHCOM responsibility to advocate for Arctic capabilities.
- Codifying the president's approval to disestablish U.S. Joint Forces Command.
- Expanding U.S. Strategic Command's responsibility for combating weapons of mass destruction and developing Global Missile Defense Concept of Operations.
- Giving U.S. Transportation Command responsibility for synchronizing planning of global distribution operations.

UCP 2011 continues to support U.S. defense security commitments around the world while improving military responsiveness to emerging crises.

References:

- Joint Publication 1, Doctrine for the Armed Forces of the United States
- www.defenselink.mil
- <http://www.dtic.mil/doctrine/>

3.5 The Unified Combatant Commands

There are nine unified combatant commands; six regional and three functional.

Command	Location	Area of Responsibility
United States Africa Command (AFRICOM)	<u>Kelley Barracks, Stuttgart, Germany</u>	<u>Africa</u> ; relationship and activities with Egypt are codified in a memorandum of agreement between USAFRICOM and USCENTCOM
<u>United States Central Command (CENTCOM)</u>	<u>MacDill Air Force Base, Florida</u>	<u>Egypt</u> through the Arabian Gulf region, into <u>Central Asia</u>
<u>United States European Command (EUCOM)</u>	<u>SHAPE (Supreme Headquarters Allied Powers Europe), Mons, Belgium; USEUCOM Headquarters, Patch Barracks, Stuttgart, Germany</u>	<u>Europe</u> (includes <u>Israel</u>) and Black Sea-Eurasia
<u>United States Northern Command (NORTHCOM)</u>	<u>Peterson Air Force Base, Colorado</u>	<u>North American homeland defense</u> and coordinating homeland security with civilian forces.
<u>United States Pacific Command (PACOM)</u>	<u>Camp H. M. Smith, Oahu, Hawaii</u>	The <u>Asia-Pacific</u> region including Hawaii.
<u>United States Southern Command (SOUTHCOM)</u>	<u>Miami, Florida</u>	<u>South, Central America</u> and the surrounding waters
<u>U.S. Special Operations Command (SOCOM)</u>	<u>MacDill Air Force Base, Florida</u>	Provides special operations for the Army, Navy, Air Force and Marine Corps.
<u>United States Strategic Command (STRATCOM)</u>	<u>Offutt Air Force Base, Nebraska</u>	Covers the strategic deterrent force and coordinates the use of space assets.
<u>United States Transportation Command (TRANSCOM)</u>	<u>Scott Air Force Base, Illinois</u>	Covers global mobility of all military assets for all regional commands.

Figure 29: Combatant Command Information

DOD Directive 5100.03, *Support of the Headquarters of Combatant and Subordinate Unified Commands* establishes policy and assigns responsibilities for the administrative and logistical support of combatant command headquarters and subordinate unified command headquarters through Combatant Command Support Agents (CCSAs). The secretaries of the Military Departments, while performing their duties as CCSAs program and budget to fund, without reimbursement, the administrative and logistical support required by the supported headquarters of the combatant commands, the U.S. Element of the North American Aerospace Defense Command (USELEMNORAD), and the subordinate unified commands. The commanders of the combatant commands and the Commander, USELEMNORAD, identify their requirements to the applicable secretary of the Military Department and coordinate for the required administrative and logistical support. A list of the commands and CCSAs is provided below.

COMMAND	CCSA
HQ U.S. Africa Command	Secretary of the Army
HQ Special Operations Command Africa	Secretary of the Army
HQ U.S. Central Command	Secretary of the Air Force
HQ Special Operations Command Central	Secretary of the Air Force
HQ U.S. Element, North American Aerospace Defense Command	Secretary of the Air Force
HQ U.S. European Command	Secretary of the Army
HQ Special Operations Command Europe	Secretary of the Army
HQ U.S. Northern Command	Secretary of the Air Force
HQ U.S. Pacific Command	Secretary of the Navy
HQ U.S. Forces Korea	Secretary of the Army
HQ U.S. Forces Japan	Secretary of the Navy
HQ Alaskan Command	Secretary of the Navy
HQ Special Operations Command Pacific	Secretary of the Navy
HQ Special Operations Command Korea	Secretary of the Army
HQ U.S. Southern Command	Secretary of the Army
HQ Special Operations Command South	Secretary of the Army
HQ U.S. Special Operations Command	Secretary of the Air Force
Joint Special Operations Command	Secretary of the Army
HQ Special Operations Command – Joint Capabilities	Secretary of the Air Force
HQ U.S. Strategic Command	Secretary of the Air Force

COMMAND	CCSA
HQ U.S. Cyber Command	Secretary of the Air Force
HQ U.S. Transportation Command	Secretary of the Air Force

Figure 30: Combatant Commands and CCSAs

References:

- [DOD Directive 5100.03](#)
- [Joint Publication 1-02](#)

3.5.1 United States Africa Command (USAFRICOM)

USAFRICOM is one of the Department of Defense’s six geographic or regional military headquarters and was declared a Unified Command on October 1, 2008. As such, USAFRICOM has administrative responsibility for U.S. military support to U.S. government policy in Africa, to include military-to-military relationships with 54 African nations.

On February 6, 2007, President Bush and Defense Secretary Robert Gates announced the creation of U.S. Africa Command. The decision was the culmination of a 10-year development process within the DOD acknowledging the emerging strategic importance of Africa, and recognizing that peace and stability on the continent impacts not only Africans, but the interests of the U.S. and international community as well. Prior to the establishment of USAFRICOM, the department’s regional command structure did not comprehensively account for Africa, with three different U.S. military headquarters maintaining relationships with African countries. The creation of USAFRICOM enables the DOD to better focus its resources to support and enhance existing U.S. initiatives that help African nations, the African Union, and the regional economic communities succeed. It also provides African nations and regional organizations an integrated DOD coordination point to help address security and related needs.

Mission: Africa Command protects and defends the national security interests of the United States by strengthening the defense capabilities of African states and regional organizations and, when directed, conducts military operations, in order to deter and defeat transnational threats and to provide a security environment conducive to good governance and development.

Overview of Commander’s Intent: Africa Command was founded on the central idea that U.S. interests would be best served through

sustained military engagement with our African partners. Relationships formed, programs executed and activities engaged in with our African counterparts must be effective, enduring and focused on a shared end state. When we do this right, both the U.S. and our partners benefit.

Africa Command's purpose is twofold: 1) protect the U.S. homeland, American citizens abroad and national interests from transnational threats emanating from Africa; and 2) through sustained engagement, enable African partners to create a security environment that promotes stability, improved governance, and continued development. Should preventative or enabling efforts fail, we must always be prepared to prevail against any individual or organization that pose a threat to the United States, our national interests or our allies and partners.

Africa Command's activities, plans and operations are centered on two guiding principles:

- A safe, secure and stable Africa is in our national interest
- Over the long run, it will be Africans who will best be able to address African security challenges and that AFRICOM most effectively advances U.S. security interests through focused security engagement with our African partners.

Africa Command Presence: U.S. Africa Command is headquartered at Kelley Barracks in Stuttgart, Germany. The command inherited a small but meaningful U.S. military presence already existing in numerous African nations, to include Camp Lemonnier in Djibouti, as well as Defense Department personnel assigned to U.S. Embassies and diplomatic missions to coordinate DOD programs supporting U.S. diplomacy. Any additional presence on the continent will take place only in full diplomatic consultation and agreement with potential host nations.

Organization: The commander of U.S. Africa Command reports to the SecDef, who reports to the President of the United States. In individual countries, U.S. Ambassadors continue to be the President's personal representatives in diplomatic relations with host nations. U.S. Africa Command is organized into seven directorates, Special Staff, Offices of Security Cooperation (OSC) that represent U.S. Africa Command in the Area of Activity (AoA), four component commands, a sub-unified Special Operations Command Africa and the Combined Joint Task Force in the Horn of Africa. U.S. Africa Command is a joint command with a staff of 2,000 authorized personnel, almost half of whom are civilian personnel, including representatives from non-military agencies of the U.S. Government.

U.S. Africa Command Components



U.S. Army Africa (USARAF)—enables full spectrum operations while conducting sustained security engagement with African land forces to promote security, stability, and peace. As directed, deploys a contingency headquarters in support of crisis response.



U.S. Naval Forces Africa (NAF)—conducts maritime operations and theater security cooperation activities in concert with Allied, coalition, joint, interagency and other partners to advance maritime security and stability in Africa.



U.S. Air Forces Africa (AFAF)—charged with supporting U.S. Africa Command via command and control of air forces to conduct sustained security engagement and operations as directed to promote air safety, security and development (now a dual hat with USAFE).



Marine Forces Africa (MARFORAF)—exercises command and control over all assigned and attached forces; conducts planning in support of Africa Command operations; advises the commander, Africa Command, other Component Commanders and Task Force Commanders on the capabilities and proper employment of U.S. Marine Corps forces; and validates, deploys, sustains and redeploys all operational and logistical requirements for assigned and attached forces in order to accomplish missions in the Africa Command area of activity.



Special Operations Command Africa (SOCAFRICA)—leads, plans, coordinates, and, as directed, executes the full spectrum of Special Operations in USAFRICOM's area of responsibility as part of an integrated Theater Strategy to combat terrorism and advance USAFRICOM's strategic objectives.



Combined Joint Task Force Horn of Africa (CJTF-HOA)—CJTF-HOA conducts operations in the East Africa region to build partner nation capacity in order to promote regional security and stability, prevent conflict, and protect

U.S. and coalition interests.

Vision:

CJTF-HOA builds and strengthens partnerships to contribute to security and stability in East Africa. The task force’s efforts, as part of a comprehensive whole-of-government approach, are aimed at increasing our African partner nations’ capacity to maintain a stable environment, with an effective government that provides a degree of economic and social advancement to its citizens. An Africa that is stable, participates in free and fair markets, and contributes to global economic development is good for the United States as well as the rest of the world. Long term stability is a vital interest of all nations.

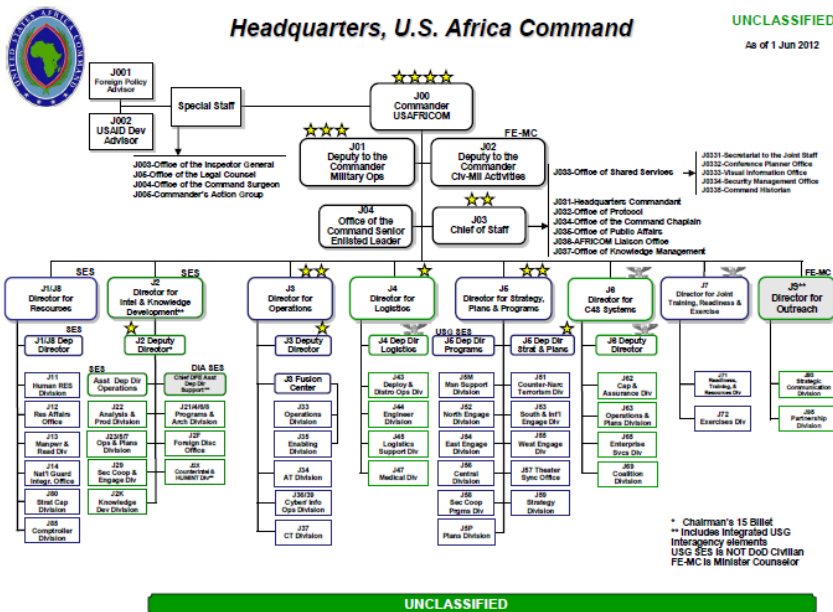

Figure 31: USAFRICOM HQ Organization

Headquarters Organizational Structure

Chief of Staff—acts as the principal agent of the Commander for coordination and administration of U.S. Africa Command. The Chief of Staff directs, integrates, supervises Headquarters elements, and ensures continuity of operations in the event of an emergency.

J1/8 Resources Directorate—the “primary source” for financial, manpower, and personnel information and services. Resources, obtains and controls financial authority; provides expert and timely manpower and financial management planning, guidance, advice, and analysis to support the U.S. Africa Command mission; facilitates, and coordinates capability development through the Joint Capabilities Integration Group (JCIG) process; utilizes science and technology to develop rapid solutions for the command’s capability shortfalls.

J2 Intelligence and Knowledge Development Directorate—in concert with other U.S. Government agencies and international partners, executes intelligence operations and manages intelligence collection, analysis, production, dissemination, and knowledge development for HQ Africa Command, its components, and designated partners in order to enhance the planning and conduct of operations, exercises, and sustained security engagement activities to promote a stable and secure African environment in support of U.S. foreign policy.

J3 Operations Directorate—conducts operational and cyber planning; organizes forces for assigned missions; coordinates employment of forces and resources; and monitors, directs, and synchronizes current operations, exercises and security cooperation events in order to support stability in the USAFRICOM area of responsibility.

J4 Logistics Directorate—provides mission support to U.S., allied, and coalition operations within the command’s area of responsibility and leverages its capabilities as a means of strategic engagement on the continent. Through cooperation and coordination with other U.S. government agencies and international partners, enhances African logistics and capabilities.

J5 Strategy, Plans and Programs Directorate—responsible for developing and directing the United States Africa Command strategy, policy, plans, and programs for international cooperation. It plans, manages, and implements Theater Security Cooperation (TSC) activities. It is also responsible for coordination/implementation of security assistance and defense cooperation in armaments, humanitarian assistance and de-mining programs, TSC liaison, and synchronization and coordination of Inter-Agency assistance programs. It develops and staffs the command’s deliberate plans.

J6 C4S Systems Directorate—provides U.S. Africa Command with C4 policy, plans, programs, and systems support to enhance the strategic environment for U.S. policy. C4S is responsible for ensuring

interoperable C4 Systems for full range of military/civilian requirements of the command; ensuring compliance with single integrated architecture concept; providing Computer Network Defense; providing Spectrum Management support; providing Network Operations (NETOPS) oversight of our connectivity to the Global Information Grid (GIG); working with DIA for full spectrum of data/video services; providing C2 Systems Support/Planning and providing Communications Security (COMSEC) support.

J7 Joint Training, Readiness and Exercise Directorate—the office of primary responsibility for joint training, education, exercises, assessments and readiness. J7 increases AFRICOM readiness through development, implementation and use of the CJCS Joint Training System and execution of the Joint Training and Exercise Program (JTEP) policy and supporting programs.

J9 Outreach Directorate—has two major responsibilities: facilitating the strategic communication process within the command, and supporting working relationships with partners outside the command in the United States Government, non-governmental organizations, the private sector and academia.

Offices of Security Cooperation (OSCs)—U.S. Africa Command has a staff presence in 33 countries, operates seventeen OSCs, one Security Assistance Office, and has three permanent Liaison Officers within the AoA. These offices are the command's presence within our AoA and are responsible for coordinating bi-lateral activities with their host nations and are active in assisting their sponsors with improving their security capabilities. The command is working to expand this program with other nations within the AoA that are deemed good partners.

3.5.2 United States Central Command (USCENTCOM)

USCENTCOM, located at MacDill Air Force Base in Tampa, Florida is one of the unified combatant commands in the DOD. The Commanders of the combatant commands are responsible to the president and the SecDef for accomplishing the military missions assigned to them and exercise command authority over forces assigned to them as directed by the SecDef pursuant to section 10 USC. 164 [reference (b)]. USCENTCOM is responsible for all U.S. security interests in 20 nations that stretch from Egypt and the Red Sea through the Arabian Gulf Region, into Central Asia. The command was activated in 1983 as the successor to the Rapid Deployment Joint Task Force (RDJTF).

Mission: With national and international partners, U.S. Central Command promotes cooperation among nations, responds to crises, and deters or defeats state and non-state aggression, supports development, and, when necessary, reconstruction in order to establish the conditions for regional security, stability, and prosperity.

Organization: Under the leadership of a 4-star Commander, the command is organized into directorates, special staff, component commands, and military groups that represent USCENTCOM in the AOR. USCENTCOM is a joint command comprised of more than 3,300 military and civilian personnel from the Army, Navy, Air Force, Marine Corps, and Coast Guard at its headquarters. The command also employs other U.S. government agency civilians as well as various contractors. Military personnel from other Allied and Coalition nations are also assigned to USCENTCOM as exchange officers, liaison officers, senior national representatives and other personnel in support thereof. The Services (minus the Coast Guard) provide USCENTCOM with component commands, which along with the Joint Special Operations component perform USCENTCOM missions and security cooperation activities. USCENTCOM exercises combatant command authority through the commanders of its components, Joint Task Forces (JTFs), an Interagency Action Group, and Security Assistance Organizations.

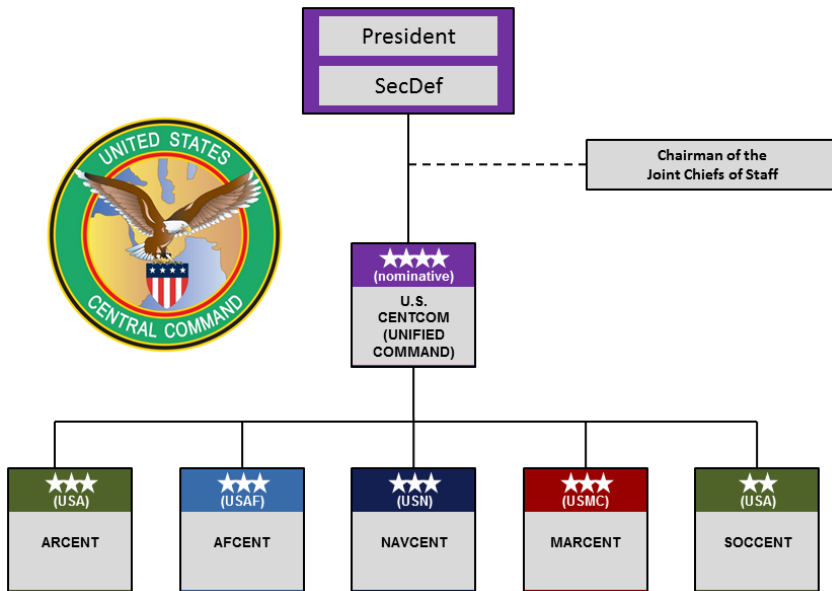

Figure 32: USCENTCOM Command Relationships

USCENTCOM Components



U.S. Army Central (USARCENT)/U.S. Third Army(3d Army)—dual-hatted as U.S. Third Army, is the Army Service Component Command of USCENTCOM and supports ground operations throughout the USCENTCOM AOR. It is the only Army-level, expeditionary war-fighting

headquarters and has been continuously deployed since 2001. USARCENT forces include aviation, intelligence, communication, and logistics units, offering full spectrum capability ranging from humanitarian assistance/disaster relief to combat operations. USARCENT relocated from Fort McPherson to Shaw Air Force Base, South Carolina in late 2011 per BRAC 2005.



U.S. Naval Forces Central Command (USNAVCENT)/U.S. 5th Fleet (USFIFTHFLT)—headquartered at Naval Support Activity Manama, Bahrain and is the only USCENTCOM component permanently based overseas. USNAVCENT/

USFIFTHFLT exercises command and control over all forward-deployed U.S. naval task forces, strike groups, naval units (to include U.S. Coast Guard ships/units and embarked U.S. Marine Corps elements) and naval operations in the USCENTCOM AOR, including naval exercises, maritime air operations, surface, and subsurface operations, and port visits.



U.S. Air Forces Central (USAFCENT)/9th Air Force (9 AF)—Previously known as U.S. Central Command Air Forces (USCENTAF) until March 2008, USAFCENT is the air component of USCENTCOM and is normally dual-hatted as 9th Air Force, with a primary headquarters at

Shaw Air Force Base, South Carolina and a forward headquarters and Air and Space Operations Center at Al Udeid Air Base, Qatar. USAFCENT provides land-based combat air and space power, plans for, and executes contingency operations, and integrates USAF, Naval Aviation and multinational air forces into coherent air operations in support of major theater war. USAFCENT also serves as support agent for numerous air bases and forward operating locations in the USCENTCOM AOR. In August 2009, a temporary separation between USAFCENT and 9th Air Force was put into effect to allow the USAFCENT commander to focus on duties as the warfighting component to USCENTCOM and the 9 AF commander to focus on oversight of stateside Air Force wings. In this arrangement, USAFCENT is currently headquartered at Al Udeid AB and 9 AF at Shaw AFB. When contingency operations in the USCENTCOM AOR subside, the Air Force will reset USAFCENT and 9 AF to their peacetime configuration.



U.S. Marine Corps Forces Central Command (USMARCENT)—commands all U.S. Marine Corps forces assigned to USCENTCOM, advises USCENTCOM on proper employment and support of said forces, conducts

deployment/employment/redeployment planning and execution for assigned and attached forces, and accomplishes assigned operational missions. USMARCENT is physically headquartered at MacDill AFB, Florida.



Special Operations Command Central (SOCCENT)—exercises operational control of assigned and attached Special Operations Forces (SOF) deployed for execution of training or operational missions in the USCENTCOM AOR. When directed by USCENTCOM, SOCCENT forms the

nucleus of a Joint Special Operations Task Force. SOCCENT is headquartered at MacDill AFB, Florida.

Headquarters Organizational Structure

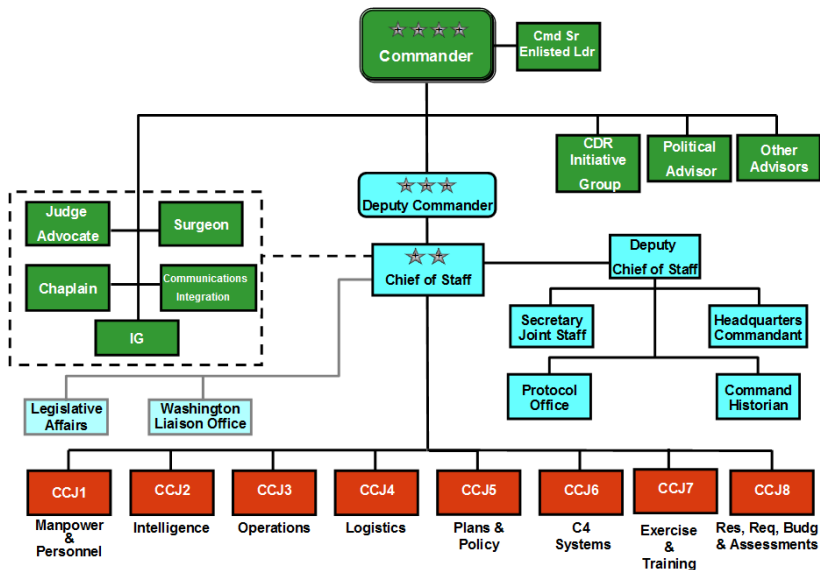

Figure 33: USCENTCOM HQ Organization

Chief of Staff—The USCENTCOM Chief of Staff is a two-star officer and functions as the Commander’s and the Deputy Commander’s direct conduit to the Directorate Directors and the various Special Staffs for the coordination and synchronization of staff activities.

CCJ1, Manpower and Personnel—formulates and implements manpower and personnel policy and provides manpower and personnel support for USCENTCOM and subordinate units from the Active Components and Reserve Components; CCJ1 is the only directorate not headed by a General Officer, Flag Officer or SES.

CCJ2, Intelligence—provides a full range of advanced threat warning, targeting intelligence, assessments, and reports to the Commander, USCENTCOM, and coordinates intelligence policy throughout the USCENTCOM AOR; CCJ2 is headed by a one-star officer with an SES deputy.

CCJ3, Operations—plans, organizes, directs, and controls joint and combined military operations at the direction of the Commander, USCENTCOM and advises the Commander on all matters pertaining to strategic and operational employment of assigned forces, conduct of joint/combined operations; and other functions as necessary to accomplish assigned tasks and missions; CCJ3 is headed by a two-star officer with a United Kingdom or Australian two-star equivalent deputy and two U.S. one-star deputies.

Interagency Action Group (IAG) - functionally resides in CCJ3 and facilitates planning by coordinating information sharing between the U.S. military and multiple U.S. governmental agencies, to include activities of the Department of Homeland Security, Department of Justice, Department of State and Department of the Treasury. The AIG is headed by an SES.

CCJ4, Logistics—develops and implements logistics, engineering, contracting, host nation support, pre-positioning plans, programs, policies, and procedures in support of war and peacetime operations; CCJ4 is headed by a two-star officer with a one-star deputy and an SES deputy.

CCJ5, Strategy, Plans and Policy—develops joint military strategies, policies, resource allocations and Theater Security Cooperation activities to support U.S. objectives in the USCENTCOM AOR; prepares and maintains operations, contingency and bilateral plans; coordinates planning, policy and program matters with JCS, DOD and Department of State; CCJ5 is headed by a two-star officer with a one or two-star deputy from the Reserve Component (“Chairman’s 16” billet), a one-star deputy from the Active Component, and a one-star equivalent deputy (or deputies) from the United Kingdom and/or Australia; an additional two-star U.S. officer serves as the Director of the Coalition Coordination Center (CCJ5-CCC).

CCJ6, Command & Control, Communications and Computer (C4) Systems—plans, programs and directs USCENTCOM’s headquarters and joint theater-level communications and computer networks; ensures C4 reliability and interoperability; guides and monitors service C4 system acquisitions; CCJ6 is headed by a one-star officer.

CCJ7, Exercises and Training—designs, coordinates, and conducts exercises to improve war fighting capabilities, advance theater security cooperation goals, and maintain joint/combined readiness; facilitates the USCENTCOM Joint Training Plan, and conducts joint training and

battle staff training management oversight; CCJ7 is headed by a two-star officer.

CCJ8, Resource and Analysis—conducts warfighting analysis and technology assessments; leads programming actions, and provides financial management; CCJ8 is headed by an SES.

Special Staffs

CCJA, Judge Advocate—Counsels the Commander, the USCENTCOM Staff, USSOCENT, and deployed task forces on civil, military, international, and operational law matters.

CCSG, Command Surgeon—Principal adviser on all medical matters, plans, and direct health services support for USCENTCOM missions.

CCCH, Command Chaplain—Principal adviser on the role of religion, religious support requirements, and the spectrum of moral and ethical issues.

CCCI, Communications Integration—Provides information liaison with news organizations and the local community. CCCI also synchronizes the delivery of factual information, command themes and messages on USCENTCOM to external DOD, domestic and international media audiences; CCCI is unique among the special staffs in that it is headed by a one-star officer.

CCIG, Inspector General—Reports on state of economy, efficiency, discipline, morale, training, and readiness of command; provides assistance and performs inspections and investigations as directed.

CCHC, Headquarters Commandant—Provides continuous, efficient and responsive base operations support to the USCENTCOM Headquarters in garrison/at home station and when forward deployed.

SJS, Secretary of the Joint Staff—Provides administrative support for Commander, USCENTCOM.

CCHO, Command Historian—Ensures USCENTCOM historical records are valued, preserved and widely used; provides planners and decision makers with an archived document system to support current and ongoing operations.

CCSP, Protocol Office—Executes USCENTCOM Distinguished Visitor (DV) Program, ensuring cross-directorate coordination and completion of all administrative requirements in support of visits by U.S. and international leaders/political figures, diplomats, government officials, and U.S., NATO, Allied and Coalition General Officers, Flag Officers and equivalents.

CCLA, Legislative Affairs—Advises the Commander and the USCENTCOM Staff on all Congressional matters; coordinates all interactions between USCENTCOM and the United States Congress.

Centers

The USCENTCOM Headquarters also maintains three standing Centers comprised of personnel from two or more directorates:

- Joint Operations Center (JOC)—24/7/365 operations center activity under aegis of CCJ3, comprised of representatives from all directorates and most special staffs.
- Joint Intelligence, Surveillance and Reconnaissance Center (JISRC)—CCJ2 and CCJ3 activity providing single source for theater ISR management.
- Strategic Movements Center—CCJ3, CCJ4 and USTRANSCOM Liaison Team activity providing single source for policy and process oversight for strategic and theater movements.

USCENTCOM Forward Headquarters (CFH)

Since late 2009, USCENTCOM has maintained an additional CFH facility at Al Udeid Air Base, Qatar. This facility is capable of providing work spaces and billeting for the entire USCENTCOM staff, replacing an expeditionary CFH facility on the USARCENT-Qatar compound at Camp As Sayliyah in Doha, Qatar that had been in place since late 2002. The CFH supports the USCENTCOM Commander and Deputy Commander during their travel in the AOR and also functions as a headquarters facility for contingency operations or designated exercises.

3.5.3 United States European Command (USEUCOM)

Background: Established 1 August, 1952, U.S. European Command is located at Patch Barracks, in Stuttgart, Germany. USEUCOM is a regional combatant command with a headquarters forward deployed outside the United States. The diversity of the security environments, regional political relations, culture, geography, and our partners' needs make it useful to divide our area of focus into two regions—Europe and

Black Sea-Eurasia. Commander, USEUCOM also serves as NATO's Commander, Supreme Allied Command for Operations. USEUCOM is a joint command comprised of military and civilian personnel representing the Army, Navy, Air Force, Marine Corps, Special Operation Forces and several federal agencies.

**Command Relationships
US European
Command**

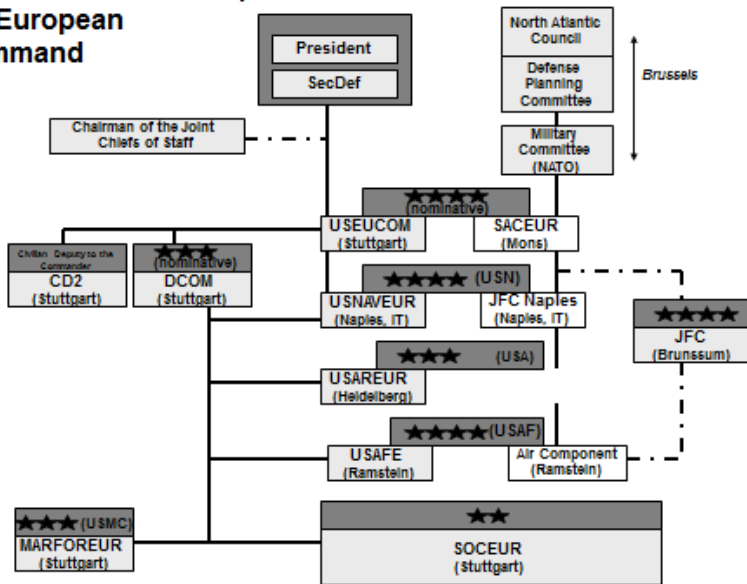

Figure 34: USEUCOM Command Relationships

USEUCOM's Mission: The mission of the U.S. European Command is to conduct military operations, international military partnering, and interagency partnering, to enhance transatlantic security and defend the United States forward.

It does this by establishing an agile security organization able to conduct full spectrum activities as part of whole of government to solutions to secure enduring stability in Europe and Eurasia.

USEUCOM Components:



NAVEUR—U.S. Naval Forces Europe (NAVEUR) plans, conducts and supports naval operations in the European theater during peacetime and as tasked by the EUCOM commander. With its headquarters at Naval Support Activity in Naples, Italy, NAVEUR directs all its naval operations through the U.S. Sixth Fleet (COMSIXTHFLT) commander. Though not a NATO command, NAVEUR ensures ready and logistics support of U.S. Navy ships and aircraft regardless if they were nationally or NATO assigned. NAVEUR also works with NATO commands and member governments in planning, operating and funding NATO facilities the U.S. Navy uses.



USAFE—U.S. Air Forces in Europe (USAFE) is a major air force command and also EUCOM's primary air component, planning and executing air and space operations in Europe and Asia to achieve NATO and U.S. objectives based on the EUCOM commander's taskings.



USAREUR—U.S. Army Europe (USAREUR) trains, equips, deploys and provides command and control of forward-deployed land forces, able to support and conduct the full spectrum of joint and combined multi-national operations and engagement activities.



MARFOREUR—U.S. Marine Corps, Europe (MARFOREUR) supporting in EUCOM operations by advising the commander, other component commanders and task force commanders on the capabilities and proper employment of U.S. Marine Corps forces. It validates, deploys, sustains and redeploys all operational and logistical requirements for assigned and attached forces to accomplish missions in the EUCOM theater.



SOCEUR—Special Operations Command Europe provides tremendous flexibility throughout a full range of military operations including combat, special operations, humanitarian assistance, non-combatant evacuations and joint-combined military operations. SOCEUR exercises operational control of European theater Army, Navy and Air Force Special Operation Forces (SOF) and is responsible for SOF readiness, targeting, exercises, plans, joint and combined training, NATO and partnership activities, and execution of counterterrorism, peacetime and contingency operations.

The Headquarters Structure

ECJ1 Mission: Perform theater-level military and civilian personnel planning and develops personnel policies and programs for U.S. forces and their families. Integrates total personnel operations support through the U.S. European Plans and Operations Center (EPOC). Provides direct personnel service support, administration and develops manpower requirements for HQ USEUCOM. ECJ1 provides Combatant-Command level management for U.S. NATO manpower and strength accounting.

ECJ2 Mission: Provide intelligence support to Headquarters, USEUCOM, component commands, and Allied Forces operation the European Theater. Coordinate all intelligence, surveillance, and reconnaissance activities throughout the European Theater in support of U.S. and Allied requirements. Plan, program, and budget for resources necessary to conduct HQ USEUCOM's peacetime, contingency, and wartime intelligence missions.

ECJ3 Mission: The European Plans and Operations Center (EPOC) is USEUCOM's 24 x 7 warfighting command and control headquarters. More than 300 people in ten divisions form the core of cross-functional planning teams that focus on potential trouble spots in the theater, plan and conduct effects-based operations. The EPOC is USEUCOM's Standing Joint Force Headquarters and focal point for theater operational planning, intelligence and execution. The EPOC is the Commander's, U.S. European Command (CDRUSEUCOM's) organization within HQ USEUCOM for implementation of directed Standing Joint Force Headquarters concept. CDRUSEUCOM uses the EPOC to synchronize and integrate the actions for air, land, sea, space, nuclear, and special operations forces, either directly or through subordinate commanders.

ECJ4 Mission: Enhance force readiness by coordinating and synchronizing Component, Interagency, and National Provider Logistics capabilities to maximize the Joint Forces' ability to accomplish effects.

ECJ5/8 Mission: The Director for Strategy, Policy, and Assessments is responsible to CDRUSEUCOM for formulation and staff direction of the execution of basic military/political policy and planning for command activities involving relations with other U.S. Unified Commands, allied military and international military organizations and subordinate commands.

ECJ6 Mission: Provide the policy, plans, program, and systems support to shape the C4 environment, ensuring information dominance and interoperable C4 systems. Ensure that EUCOM has integrated Command, Control and Communications systems to prevent conflict, respond to crisis, and prepare for combat and to fight to win.

ECJ7 Mission: Conduct Strategic and Operational analysis and assessments and make recommendations based upon the analysis to ensure effective decision making and resource allocation.

ECJ9 Mission: ECJ9 leads the EUCOM effort to integrate interagency, academia, Non-Governmental Organizations (NGOs), International Organizations (IOs), and private sector partners to better execute the EUCOM mission through a "Whole of Government Approach."

Joint Interagency Counter-Trafficking Center, Europe (JICTC)

Mission: Support U.S. Interagency and U.S. Country Team efforts, and collaborate with similar international organizations, to effectively and efficiently counter illicit trafficking and terrorism in USEUCOM's area of interest, and assist Eurasian nations in building self-sufficient counter-trafficking and counter-terrorism skills, competencies, and capacity in support of defending the Homeland forward.

Special Staff: The Special Staff provides staff support to the command and is comprised of the following elements: Deputy Commander, Chief of Staff, Special Assistance to the Commander, Command Chaplain, Command Historian, Protocol Office, Staff Judge Advocate, Headquarters Commandant, Public Affairs, Comptroller, Strategic Communication, Deputy Commander's Action Group, Secretary of the Joint Staff, Foreign Policy Advisor, Inspector General, European Liaison Office, Command Surgeon, Congressional Affairs, and Staff Civil Engineer.

3.5.4 United States Northern Command (USNORTHCOM)

United States Northern Command (USNORTHCOM), located at Peterson Air Force Base in Colorado Springs, Colorado, is one of nine unified combatant commands in the DOD. USNORTHCOM was established October 1st, 2002 to provide command and control of Department of Defense (DOD) homeland defense efforts and to coordinate defense support of civil authorities. USNORTHCOM defends America's homeland—protecting our people, national power, and freedom of action.

The commander of USNORTHCOM also commands the North American Aerospace Defense Command (NORAD), a bi-national command responsible for aerospace warning, aerospace control, and maritime warning for Canada, Alaska and the continental United States.

Vision:

With our trusted partners, we will defend North America by outpacing all threats, maintaining faith with our people, and supporting them in

their times of greatest need. "WE HAVE THE WATCH."

Missions:

The NORAD Mission: The North American Aerospace Defense Command conducts aerospace warning, aerospace control, and maritime warning in the defense of North America.

The USNORTHCOM Mission: United States Northern Command partners to conduct homeland defense, civil support, and security cooperation to defend and secure the United States and its interests.

Commander's Priorities:

- Expand and strengthen our trusted partnerships
- Advance and sustain the bi-national military command
- Gain and maintain all-domain situational awareness
- Advocate and develop capabilities in our core mission areas to outpace all threats
- Take care of our people; they are our foundation

Responsibilities:

USNORTHCOM's AOR includes air, land and sea approaches and encompasses the continental United States, Alaska, Canada, Mexico, and the surrounding water out to approximately 500 nautical miles. It also includes the Gulf of Mexico, the Straits of Florida, and portions of the Caribbean region to include The Bahamas, Puerto Rico, and the U.S. Virgin Islands. The commander of USNORTHCOM is responsible for theater security cooperation with Canada, Mexico, and the Bahamas.

USNORTHCOM consolidates under a single unified command existing missions that were previously executed by other DOD organizations. This provides unity of command, which is critical to mission accomplishment.

USNORTHCOM plans, organizes and executes homeland defense and civil support missions, but has few permanently assigned forces. The command is assigned forces whenever necessary to execute missions, as ordered by the president or secretary of defense.

USNORTHCOM's civil support mission includes domestic disaster relief operations that occur during fires, hurricanes, floods and earthquakes. Support also includes counterdrug operations and managing the consequences of a terrorist event employing a weapon of mass destruction. The command provides assistance to a Primary Agency

when tasked by DOD. Per the Posse Comitatus Act, military forces can provide civil support, but cannot become directly involved in law enforcement.

In providing civil support, USNORTHCOM generally operates through established Joint Task Forces subordinate to the command. An emergency must exceed the capabilities of local, state and federal agencies before the President will direct USNORTHCOM to become involved. In most cases, support will be limited, localized and specific. Federal military assistance withdraws upon completion of assigned missions.

Headquarters Organizational Structure



Figure 35: NORAD and USNORTHCOM Organizations

The HQ organizational structure for USNORTHCOM differs from other combatant commands in that many of the Primary and Special Staff sections are combined in support of both USNORTHCOM missions and NORAD missions. However, there is a separate deputy commander and J3 for each command. Another difference is that the Interagency Coordination Director is a principal staff member whereas in other commands it is usually located under the J3 or J5.

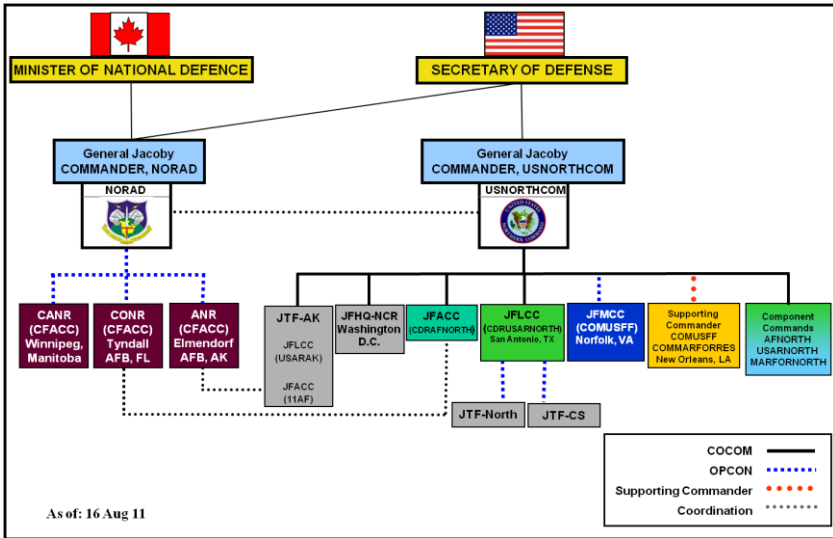

Figure 36: NORAD and USNORTHCOM Command Relationships

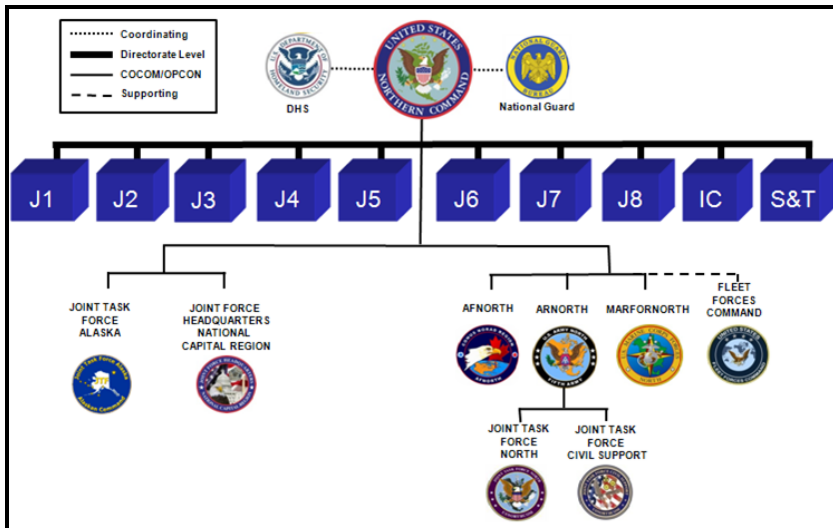

Figure 37: USNORTHCOM Headquarters Organizations

HQ organization members include the following:

Chief of Staff – The Chief of Staff coordinates and synchronizes

staff activities for both NORAD and USNORTHCOM and is normally a National Guard Officer.

N-NC/J1 – Manpower and Personnel

N-NC/J2 – Intelligence

NC/J3 – Operations

N-NC/J4 – Logistics and Engineering

N-NC/J5 – Plans, Policy and Strategy

N-NC/J6 – Command and Control Systems

N-NC/J7 – Training and Exercises

N-NC/J8 – Programs, Resources and Analysis

N-NC/IC – Interagency Coordination

N-NC/S&T – Science and Technology

Special Staff: Other staff sections include the Chief of Staff (CS), Chaplain (HC), Command Protocol (CP), History Office (HO), Inspector General (IG), Judge Advocate (JA), National Guard Advisor (NG), Public Affairs (PA), Reserve Forces (RF), Strategic Communications (SC), Command Surgeon (SG), Washington Office (WO), and US and Canada Political Advisors (POLAD).

USNORTHCOM Components



U.S. Army North (USARNORTH)—Located at Ft. Sam Houston, Texas, USARNORTH conducts Homeland Defense (HLD), Civil Support (CS) operations, and Theater Security Cooperation (TSC) activities as the Army Service Component Command (ASCC) to U.S. Northern Command in order to protect the American people and their way of life. On order, USARNORTH commands and controls deployed forces as a Joint Task Force (JTF) or Joint Force Land Component Command (JFLCC).



U.S. Fleet Forces Command (USFF)—Located at Norfolk, Virginia, USFF's mission is to provide maritime forces prepared to conduct homeland defense, civil support operations and theater security cooperation activities when directed by USNORTHCOM. Additionally, USFF has responsibilities to generate ready Navy forces for assignment to global Regional Combatant Commanders, execute the Fleet Response Plan (FRP) using the Fleet Training Continuum, articulate to the Chief of Naval Operations the integrated Fleet warfighting requirements as coordinated with all Navy Component Commanders, and provide operational planning support to Commander, U.S. Joint Forces Command, and United States Strategic Command.



Continental U.S. NORAD Region (CONR) and Air Forces Northern (AFNORTH)—Located at Tyndall AFB, Florida, AFNORTH has the responsibility of ensuring the air sovereignty and air defense of the continental United States. As the CONUS geographical component of the bi-national North American Aerospace Defense Command, it provides airspace surveillance and control and directs all air sovereignty activities for the continental United States.



U.S. Marine Forces North (MARFORNORTH)—Located in New Orleans, Louisiana, MARFORNORTH executes antiterrorism program and force protection responsibilities; plans for the use of USMC Forces and advises on the proper employment of USMC Forces; coordinates with and supports USMC Forces when attached to USNORTHCOM within USNORTHCOM'S area of responsibility in order to conduct homeland defense operations and provide defense support to civil authorities.

Task Forces

Task Forces with specific missions in the region that report to U.S. Northern Command



Joint Task Force Alaska (JTF-AK)—Located at Elmendorf AFB, Alaska, JTF-AK's mission is to, in coordination with other government agencies, deter, detect, prevent and defeat threats within the Alaska Joint Operations Area (AK JOA) in order to protect U.S. territory, citizens, and interests, and as directed, conduct Civil Support.



Joint Force Headquarters National Capital Region (JFHQ-NCR)—Located at Ft. McNair, Washington, D.C., JFHQ-NCR is responsible for land-based homeland defense, defense support of civil authorities (DSCA), and incident management in the National Capital Region. JFHQ-NCR is responsible for protecting the District of Columbia and neighboring counties and cities of Maryland and Virginia, including Loudon, Fairfax and Prince William Counties in Virginia. JFHQ-NCR draws together the existing resources of the Army, Navy, Air Force, Marine Corps, Coast Guard and NORAD into a single point headquarters for planning, coordination and execution of the mission in the National Capital Region.

Task Forces that report to U.S. Army North



Joint Task Force Civil Support (JTF-CS)—Located at Ft. Monroe in Hampton, Virginia, JTF-CS plans and integrates DOD support to the designated Primary Agency for domestic chemical, biological, radiological, nuclear, or high-yield explosive (CBRNE) consequence management operations. When approved by the secretary of defense and directed by the commander of USNORTHCOM, JTF-CS deploys to the incident site and executes timely and effective command and control of designated DOD forces, providing support to civil authorities to save lives, prevent injury and provide temporary critical life support.



Joint Task Force North (JTF-N)—Located at Biggs Army Airfield, Ft. Bliss, Texas, JTF North, is the Department of Defense (DOD) organization tasked to support our nation's federal law enforcement agencies in the interdiction of suspected transnational threats within and along the approaches to the continental United States. As directed, JTF North employs military capabilities to support law enforcement agencies and supports interagency synchronization within the USNORTHCOM area of responsibility to deter and prevent transnational threats to the homeland. This mission aligns JTF North closely with USNORTHCOM, its higher headquarters.

NORAD Regions



Alaskan NORAD Region (ANR)—The Alaskan NORAD Region (ANR) conducts airspace control within its area of operations and contributes to NORAD's aerospace warning mission. With its headquarters located at Elmendorf Air Force Base, Alaska, ANR provides an ongoing capability to detect, validate, and warn of any aircraft and/or cruise missile threat in its area of operations that could threaten North American security. ANR is supported by both active duty and Air National Guard units. Both 11th AF and the Canadian Forces provide active duty forces to the Alaskan Air and Space Operations Center. National Guard forces provide manning for the Alaskan Air Defense Sector to maintain continuous surveillance of Alaskan airspace with Alaskan Radar System long and short-range radars.



Canadian NORAD Region (CANR)—The Canadian NORAD Region (CANR) is headquartered with the 1 Canadian Air Division in Winnipeg, Manitoba, CANR

executes a variety of tasks to defend Canadian airspace, including identifying and tracking all aircraft entering Canadian airspace, exercising operational command and control of all air defense forces in CANR and operations in support of other government departments and agencies. The 1 Canadian Air Division is responsible for providing CANR with combat-ready air forces to meet Canada's commitment to the defense of North America and maintain the sovereignty of North American airspace. CANR CF-18 Hornet fighter aircraft are on continuous alert to respond to any potential aerial threat to the safety of Canada and Canadians.



Continental NORAD Region (CONR)—The Continental NORAD Region (CONR) provides airspace surveillance and control and directs air sovereignty activities for the continental United States (CONUS). Co-located with Headquarters First Air Force at Tyndall Air Force Base, Florida, a Combined Air Operations Center coordinates CONR sector activities and executes the NORAD air sovereignty mission for the continental United States. CONR plans, conducts, controls, and coordinates all Air Force forces for the Commander of NORAD. The best of the US Air Force and Air National Guard fighter inventory, the F-15 Eagle, F-16 Fighting Falcon and F-22 Raptor, fly as CONR's primary weapons systems. CONR is presently divided into two defense sectors: the Western Defense Sector, with its headquarters located at McChord Air Force Base, Washington; and the Eastern Defense Sector, with its headquarters located at Rome, New York. Within CONR is the National Capital Region (NCR) in the Washington DC area, which is protected by the NCR Integrated Air Defense System (NCR IADS) consisting of a system of radars, cameras, visual warning system, alert aircraft and Army air defense artillery assets.

References:

- www.norad.org
- www.northcom.mil

3.5.5 United States Pacific Command (USPACOM)

USPACOM was established as a unified command on January 1, 1947 and is the oldest and largest of the U.S. Unified Commands. The Commander, U.S. Pacific Command (CDRUSPACOM) is the senior U.S. military authority in the Pacific AOR.

Organization: CDRUSPACOM reports to the President of the United States through the SecDef and is supported by four component commands: U.S. Pacific Fleet (PACFLT), U.S. Pacific Air Forces (PACAF), U.S. Army Pacific (USARPAC), and U.S. Marine Forces Pacific (MARFORPAC). These commands are headquartered in Hawaii and have forces stationed and deployed throughout the region.

Mission: USPACOM, together with other U.S. government agencies, protects and defends the United States, its territories, Allies, and interests; alongside Allies and partners, promotes regional security and deters aggression; and, if deterrence fails, is prepared to respond to the full spectrum of military contingencies to restore Asia-Pacific stability and security.

Method:

- Synchronize USPACOM actions across the U.S. government, associated CCMDs, regional Allies, and partners.
- Through continual forward presence enabled by an adaptive regional military posture and enhanced by synergy with capable partners, maintain security of the regional commons.
- Provide conventional and strategic military capabilities for extended deterrence of aggression against the United States, its territories, Allies, and interests.
- Maintain ready forces and plan, train, and exercise to accomplish the full range of military contingencies.
- In particular, concentrate on five Focus Areas: Allies and Partners, China, India, North Korea, and Transnational Threats.



Figure 38: USPACOM Command Structure

Strategy: USPACOM focuses on the strategic level of leadership, engagement, planning, and war-fighting. Our strategic behavior is shaped and informed by an analysis and assessment effort that seeks to understand fully the complex and dynamic Asia-Pacific security environment by concentrating on the five Focus Areas. The USPACOM strategy is based on partnership, presence, and military readiness. This strategy flows from U.S. government policy and strategic guidance and shapes the USPACOM Theater Campaign Plan (TCP).

Five Strategic Focus Areas

1. **Strengthen and Advance Alliances and Partnerships**
 - Strengthen existing Alliances and leverage them to shape the environment for building multilateral relationships and a more effective presence.
 - Enhance Alliances and partnerships to build capacity over the full spectrum of military activities.
 - Promote military professionalism and enhance interoperability among Allies and partners to build trust and increase multilateral effectiveness.
2. **Mature the U.S.-China Military-to-Military Relationship**
 - Sustain a consistent military-to-military relationship to prevent miscommunication and miscalculation.

- Pursue opportunities for increased military cooperation in areas of mutual interest.
 - Monitor China's military modernization program and prepare accordingly.
3. **Develop the U.S.-India Strategic Partnership**
 - Deepen military-to-military interaction and interoperability.
 - Encourage military-to-civilian relationships to counter common threats.
 - Support India's evolution as a leading and stabilizing force in South Asia.
 4. **Remain Prepared to Respond to Korean Peninsula Contingency**
 - Leverage multilateral engagement to address North Korea challenges, ensure stability in Northeast Asia, and support international diplomatic efforts.
 - Anticipate the military implications of dynamic changes on the Korean Peninsula.
 - Stand with Allies to deter aggression, and if necessary, defeat aggression.
 5. **Counter Transnational Threats**
 - Work with Allies and partners to build capacity and share information to counter violent extremism, transnational crime, and proliferation of weapons of mass destruction.
 - Disrupt violent extremist organization networks and defeat the threats they pose.
 - Partner with other nations to counter the proliferation of weapons of mass destruction and associated technologies.

Posture: USPACOM military personnel number approximately 250,000, or about one-fifth of total U.S. military strength. U.S. Navy and Marine forces are numerically the largest elements in the AOR. PACFLT includes five aircraft carrier strike groups and MARFORPAC possesses about two-thirds of U.S. Marine Corps combat strength. The entire U.S. Navy-Marine Corps team comprises more than 135,000 personnel, 180 ships, and 1,400 aircraft. PACAF comprises approximately 39,000 airmen and 350 aircraft; and USARPAC has about 50,000 personnel, including four Stryker brigades. USPACOM also has more than 1,200 Special Operations Command, Pacific (SOCPAC) personnel. Finally, there are more than 13,000 U.S. Coast Guard personnel available to support U.S. military forces in the region.

Organizations embedded within USPACOM

Subordinate Unified Commands:

- U.S. Forces Korea (USFK)
- U.S. Forces Japan (USFJ)
- Alaska Command (ALCOM)
- SOCPAC

Service Component Commands:

- USARPAC
- MARFORPAC
- PACFLT
- PACAF

Direct Reporting Units (DRU):

- Center of Excellence in Disaster Management and Humanitarian Assistance (COE)
- Joint Intelligence Operations Center (JIOC)
- Joint POW/MIA Accounting Command (JPAC)
- Asia Pacific Center for Security Studies (APCSS)

Standing Joint Task Force:

- Joint Interagency Task Force - West (JIATF-W)

USPACOM Service Component Commands



Pacific Air Forces (PACAF)—PACAF, headquartered at Joint Base Pearl Harbor/Hickam, Hawaii, is one of nine Major Commands (MAJCOMs) of the USAF and is the Air Component of USPACOM.

Mission: Provide ready air and space power to promote U.S. interests in the Asia-Pacific region during peacetime, through crisis and in war.

Area of Responsibility (AOR): Extends from the west coast of the United States to the east coast of Africa and from the Arctic to the Antarctic, more than 100 million square miles. The area is home to nearly two billion people who live in 44 countries. PACAF maintains a forward presence to help ensure stability in the region.

Personnel and Resources: There are approximately 50,000 military and civilian personnel, serving in nine major locations and numerous

smaller facilities, primarily in Hawaii, Alaska, Japan, Guam and South Korea; approximately 300 fighter and attack aircraft are assigned to the command.

Organization: PACAF's major units are 5th Air Force (5 AF), Yokota Air Base, Japan; 7th Air Force (7 AF), Osan AB, South Korea; 11th Air Force (11 AF), Elmendorf Air Force Base, Alaska; and 13th Air Force (13 AF), Hickam AFB, Hawaii. Major units also include 3rd Wing, Elmendorf AFB; 8th Fighter Wing, Kunsan AB, South Korea; 15th Airlift Wing, Hickam AFB; 18th Wing, Kadena AB, Japan (Okinawa); 51st Fighter Wing, Osan AB, South Korea; 354th Fighter Wing, Eielson AFB, Alaska; 35th Fighter Wing, Misawa AB, Japan; 374th Airlift Wing, Yokota AB, Japan; and the 36th Wing, Andersen AFB, Guam.



U.S. Army Forces Pacific (USARPAC)—USARPAC as the Army Service Component Command (ASCC) to USPACOM, provides forces, commands assigned forces, and conducts full spectrum operations to deter aggression, advance regional security/cooperation, respond to crisis and fight to win. On order, USARPAC serves as a Combined/Joint Forces Land Component Command (C/JFLCC) or Combined Joint Task Force (C/JTF) headquarters.

- Commands most Army forces in the Asia-Pacific region with the exception of Korea. The command can trace its lineage to 1910 and has continually evolved to meet mission requirements;
- Headquartered on Fort Shafter, Hawaii, with more than 5,000 soldiers, civilians, contractors, and military families living and working on the 589-acre post. If USARPAC were a business, it would rank as one of the state's largest employers with more than 25,000 full-time soldiers and civilians employed throughout the Pacific and 9,000 more in the National Guard and Army Reserve.



U.S. Marine Corps Forces Pacific (MARFORPAC)—The Marine Corps has established two combatant command-level Service component commands: Marine Corps Forces, Atlantic (MARFORLANT) and MARFORPAC. MARFORPAC is composed of two Marine Air-Ground Task Forces (MAGTF) and the I and III Marine Expeditionary Forces (I MEF and III MEF). Each MEF comprises a Command Element (CE), a ground combat element (GCE) an Aviation Combat Element (ACE) and a Logistics Combat Element (LCE). MARFORPAC, headquartered at Camp H. M. Smith in Hawaii, is the

largest field command in the U.S. Marine Corps. MARFORPAC commands all Marine Corps bases and stations on the west coast of the United States and throughout the Pacific.



United States Pacific Fleet (USPACFLT)—USPACFLT is the world’s largest fleet command and encompasses 100 million square miles, more than half the Earth’s surface, from the West Coast of the United States to the eastern shore of Africa. The Pacific Fleet consists of

approximately 180 ships, 1,500 aircraft and 125,000 sailors, marines and civilians.

The USPACFLT staff reports administratively to the CNO and operationally to the USPACOM, whose headquarters are at nearby Camp H.M. Smith. Commands that fall directly under the Pacific Fleet include “type” commands for surface ships, submarines, and aircraft as well as Navy construction. Operational commands that report directly to the USPACFLT include Third Fleet in the Eastern Pacific and Seventh Fleet in the Western Pacific and Indian Ocean.

Pacific Fleet deploying forces generally follow a few standard configurations:

- **Carrier Strike Groups (CSG):** These groups are led by an aircraft carrier and include a carrier air-wing and a contingent of cruisers, destroyers, and an attack submarine to act as carrier escorts. When the escort ship contingent is designed to accommodate destroyers as well as cruisers, the group is referred to as a Cruiser-Destroyer (CRUDES) Group.
- **Destroyer Squadrons (DESRON):** DESRON, composed of destroyers, frigates, or a combination of both type ships, can operate independently or as part of a battle group or task force. When a DESRON deploys with a carrier and its escort ships, the combined force is called a CGS.
- **Amphibious Groups:** Ships designed to transport and support Marine Corps amphibious operations are grouped into amphibious groups. Typically three or four ships from an amphibious group will deploy together to form an Amphibious Ready Group (ARG). The ARG configuration will vary with each deployment, but the configuration will always provide the ARG commander the ability to launch and recover Marine helicopters and deploy landing craft, including the Landing Craft Air Cushioned (LCAC), the Navy’s amphibious hovercraft. When an ARG is led by a flag officer, it will be known as an Expeditionary Strike Group (ESG).

- **Combat Support Ships:** These ships deploy alongside the combatant ships of the Pacific Fleet to provide logistics and replenishment support during the deployment. These ships include oilers, ordnance ships and other supply vessels.
- **Naval Mobile Construction Battalions (NMCB):** Pacific Naval Construction Force units deploy to Pacific and Atlantic Fleet forward logistics support bases in order to provide construction support to Navy, Marine Corps and other organizations. Seabees provide needed construction and repair to military operational and community support facilities, as well as disaster relief and construction training to U.S. communities and Pacific island nations.

USPACOM Direct Reporting Units



Asia Pacific Center for Security Studies (APCSS)—The APCSS is a U.S. Department of Defense academic institute that officially opened Sept. 4, 1995 in Honolulu, Hawaii. The APCSS addresses regional and global security issues, inviting military and civilian representatives of the United States and Asia-Pacific nations to its comprehensive program of executive education and conferences, both in Hawaii and throughout the Asia-Pacific region.

The Center is a direct reporting unit to HQ USPACOM and supports the USPACOM objective of developing professional and personal ties among national security establishments throughout the region. The Center offers several academic courses available to the USPACOM Joint Staff and components to orient the staff to Asia-Pacific culture, politics, protocols, and challenges, while addressing U.S. interests in the region.

APCSS provides a focal point where USPACOM senior officers, national officials, decision makers and policy makers can gather to exchange ideas, explore pressing issues and achieve a greater understanding of the challenges that shape the security environment of the Asia-Pacific region.



Center for Excellence (COE) In Disaster Management and Humanitarian Assistance (DMHA)—A U.S. COE directed to educate, train, research, and assist in disaster management and humanitarian assistance operations. Established in 1994 by the U.S. Congress as part of the DOD, the COE reports directly to the USPACOM and receives policy

guidance from the Assistant SecDef for Global Security Affairs; its mission is to educate, train, conduct research, and assist in international disaster preparedness, disaster management, and disaster response.



Joint POW-MIA Accounting Command (JPAC)—the mission of the JPAC is to achieve the fullest possible accounting of all Americans missing as a result of the nation's past conflicts. The highest priority of the organization is the return of any living Americans that remain prisoners of war. To date, the U.S. government has not found any evidence that there are still American Prisoners of War (POWs) in captivity from past U.S. conflicts. JPAC is located at Joint Base Pearl Harbor - Hickam, Hawaii and was activated on Oct. 1, 2003, created from the merger of the 30-year-old USARCENT Identification Laboratory, Hawaii, and the 11-year-old JTF—Full Accounting. Commanded by a flag or general officer, JPAC is manned by approximately 400 handpicked Soldiers, Sailors, Airmen, Marines, and Department of the Navy civilians. The laboratory portion of JPAC, referred to as the Central Identification Laboratory (CIL), is the largest forensic anthropology laboratory in the world.

JPAC also maintains three permanent overseas detachments, each commanded by a lieutenant colonel, to assist with command and control, logistics, and in-country support during investigation and recovery operations. They are Detachment One located in Bangkok, Thailand; Detachment Two in Hanoi, Vietnam; and Detachment Three in Vientiane, Laos. JPAC has a fourth detachment, Detachment Four, located at Camp Smith, Hawaii, responsible for recovery team personnel when they are not deployed.

Pacific Command Joint Intelligence Operations Center (JIOC-P)—provides end-to-end, all source analysis and political developments in South Asia, Southeast Asia, Oceania, Northeast Asia and China, ISO USPACOM war-fighters (J3), planners (J5), and PACOM Command Leadership. JIOC-P personnel also work with J1, J4, J6 (Cyber), J7 (exercise support), J8 (assessments) and J9 in staff supporting roles. JIOC-P supports each of the PACOM Strategic Focus Groups (SFG) and houses the China and India SFGs. Finally, JIOC-p maintains a close relationship with PACOM component (USARPAC, MARFORPAC, PACFLT, PACAF, SOCPAC) intelligence organizations and hosts a daily Morning Intelligence Brief (MIB) to Joint Staff and component intelligence organizations. The main JIOC-P facility is on the Makalapa, COMPACFLT compound.

Joint Interagency Task Force West (JIATF-W)—JIATF-West’s mission is to conduct activities to detect, disrupt, and dismantle drug-related transnational threats in Asia and the Pacific by providing interagency intelligence fusion, supporting U.S. law enforcement, and developing partner nation capacity in order to protect U.S. security interests at home and abroad.

The JIATF West staff consists of approximately 82 uniformed and civilian members of all five Military Services as well as representatives from the national intelligence community and U.S. federal law enforcement agencies. Law enforcement representatives include the DEA, FBI, and ICE.

3.5.6 United States Southern Command (USSOUTHCOM)

The United States Southern Command, located in Miami, Florida, is one of nine unified combatant commands in the Department of Defense. It is responsible for providing contingency planning, operations, and security cooperation for Central and South America, the Caribbean (except U.S. commonwealths, territories, and possessions), Cuba; as well as for the force protection of U.S. military resources at these locations. USSOUTHCOM is also responsible for ensuring the defense of the Panama Canal and canal area.

Vision: We are a joint and interagency organization supporting U.S. national security interests, and with our partners, fostering security, stability and prosperity in the Americas.

Mission: We are ready to conduct joint and combined full-spectrum military operations and support whole-of-government efforts to enhance regional security and cooperation.

Strategic Objectives:

- Defend the United States
- Foster Regional Security
- Be an Enduring Partner

Focus Areas:

- Countering Transnational Organized Crime (C-TOC)
- Humanitarian Assistance/Disaster Relief
- Peace Support Operations

Command Themes:

- Latin America, the Caribbean, and the U.S. share common interests and security concerns
- Transnational challenges require cooperative action with and among nations
- Security is the foundation for stable, prosperous and democratic institutions
- SOUTHCOM is committed to building and sustaining enduring relationships
- Illicit trafficking provides a possible nexus for transnational terrorism and the proliferation of weapons of mass destruction. This nexus presents a potentially serious threat to the U.S. and our partners.

Organization: Under the leadership of a four-star commander, USSOUTHCOM staff is organized into directorates, special staff, component commands and military groups that represent USSOUTHCOM in the region of Central America, South America & the Caribbean. USSOUTHCOM is a joint command comprised of more than 1,200 military and civilian personnel representing the Army, Navy, Air Force, Marine Corps, Coast Guard, and several other federal agencies.

The Services provide USSOUTHCOM with component commands which, along with the Joint Special Operations component, two Joint Task Forces, one Joint Interagency Task Force, and Security Assistance Offices, perform USSOUTHCOM missions and security cooperation activities.

USSOUTHCOM exercises its COCOM authority through the commanders of its components, Joint Task Forces/Joint Interagency Task Force, and Security Assistance Organizations.



USSOUTHCOM Headquarters

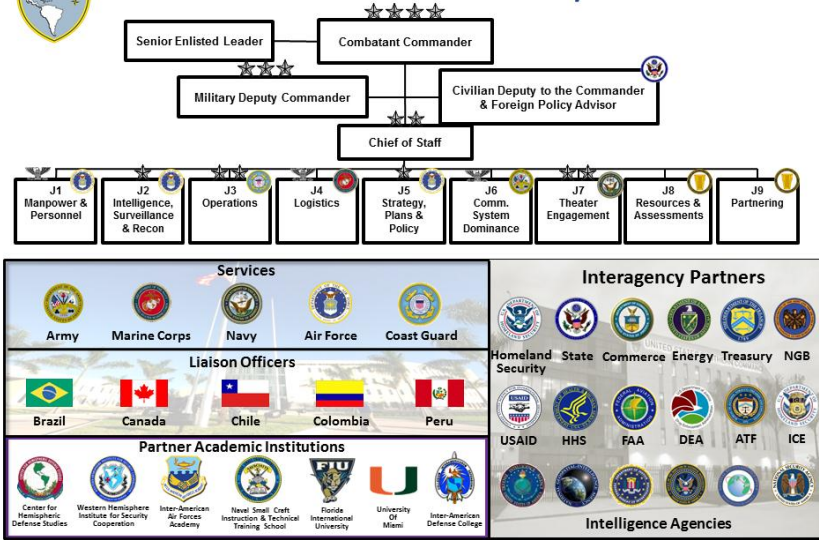

Figure 39: USSOUTHCOM Command Relationships

USSOUTHCOM Components



U.S. Army South (ARSOUTH)—located at Fort Sam Houston, Texas, ARSOUTH forces include aviation, intelligence, communication, and logistics units. ARSOUTH supports regional disaster relief and counterdrug efforts. ARSOUTH also exercises oversight, planning, and logistical support for humanitarian and civic assistance projects throughout the region in support of the USSOUTHCOM Theater Security Cooperation Strategy. ARSOUTH provides Title X and support agent responsibilities throughout the Latin American and Caribbean region.



U.S. Naval Forces Southern Command (NAVSO) and U.S. 4th Fleet—located at Mayport Naval Base, Florida, COMUSNAVSO / COMFOURTHFLT supports U.S. Southern Command joint and combined full-spectrum military operations by providing principally sea-based, forward presence to ensure freedom of maneuver in the maritime domain, to foster and sustain cooperative relationships with

international partners and to fully exploit the sea as maneuver space in order to enhance regional security and promote peace, stability, and prosperity in the Caribbean, Central and South American regions.



U.S. Southern Command Air Forces (AFSOUTH) and Twelfth Air Force—located at Davis-Monthan Air Force Base, Arizona, AFSOUTH consists of a staff; an Air and Space Operations Center for command and control of air activity in the USSOUTHCOM area and an Air Force operations group responsible for Air Force forces in the area. The Secretary of the Air Force, as the DOD Executive Agent for Counterdrug Forward Operating Locations, has delegated to AFSOUTH the authority and responsibility for maintaining and staffing the Counterdrug Forward Operating sites. AFSOUTH provides joint/combined radar surveillance architecture oversight; provides intra-theater airlift; and supports USSOUTHCOM's Theater Security Cooperation Strategy through regional disaster relief exercises and counterdrug operations. AFSOUTH also provides oversight, planning, execution, and logistical support for humanitarian and civic assistance projects and hosts a number of Airmen-to-Airmen conferences.



U.S. Marine Corps Forces South (USMARFORSOUTH)—Located in Miami, Florida, USMARFORSOUTH commands all United States Marine Corps Forces (MARFORs) assigned to USSOUTHCOM; advises USSOUTHCOM on the proper employment and support of MARFORs; conducts deployment/redeployment planning and execution of assigned/attached MARFORs; and accomplishes other operational missions as assigned.



Special Operations Command South (SOCSOUTH)— Located at Homestead Air Reserve Base near Miami, Florida, USSOCSOUTH provides the primary theater contingency response force and plans, prepares for, and conducts special operations in support of USSOUTHCOM. USSOCSOUTH controls all Special Operations Forces in the region and also establishes and operates a Joint Special Operations Task Force when required.



Joint Interagency Task Force South (JIATF-South)— Located in Key West, Florida, JIATF South is an interagency task force that serves as the catalyst for integrated and synchronized interagency counterdrug operations and is responsible for the detection and

monitoring of suspect air and maritime drug activity in the Caribbean Sea, Gulf of Mexico, and the eastern Pacific. JIATF-South also collects, processes, and disseminates counterdrug information for interagency operations.



Joint Task Force Bravo (JTF-Bravo)—Located at Soto Cano Air Base, Honduras, JTF-Bravo operates a forward, all-weather day/night C-5-capable airbase. JTF-Bravo organizes multilateral exercises and supports, in cooperation with our partner nations, humanitarian and civic assistance, counterdrug, contingency and disaster relief operations in Central America.



Joint Task Force Guantanamo Bay (JTF-GTMO)—Located at U.S. Naval Station Guantanamo Bay, Cuba, JTF-Guantanamo conducts detention and interrogation operations in support of the War on Terrorism, coordinates and implements detainee screening operations, and supports law enforcement and war crimes investigations as well as Military Commissions for Detained Enemy Combatants. JTF-Guantanamo is also prepared to support mass migration operations at Naval Station GTMO.

Direct Reporting Unit



Center for Hemispheric Defense Studies (CHDS)—located in Washington D.C.; provides education, and conducts outreach, research, and knowledge-sharing activities on defense and international security policy-making with military and civilian leaders of the Western Hemisphere.

Headquarters Organizational Structure

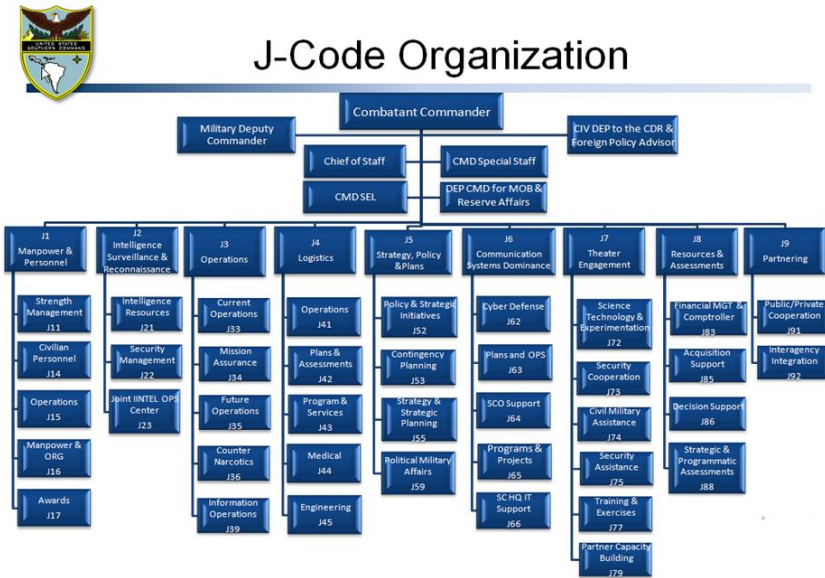

Figure 40: USSOUTHCOM Internal Organization

COS (Office of the Chief of Staff)—The Office of the Chief of Staff coordinates, synchronizes, and enables the activities and strategic communication efforts of the enterprise in order to achieve the command's vision and objectives.

CDC/POLAD (Civilian Deputy to the Commander & Foreign Policy Advisor)—The Civilian Deputy to the Commander (CDC) is the principal Foreign Policy Advisor (POLAD) to the Commander, and advises on U.S. Foreign Policy issues relating to national security. The CDC also serves as the primary liaison with the Department of State and all the U.S. Missions in the region.

CAG (Commander's Action Group)—Provides focused action, correspondence, and messaging support for the combatant commander. The CAG also identifies, develops, and articulates ideas, special requirements and initiatives of interest to the combatant commander for command process and mission execution improvement.

J1 (Manpower & Personnel)—Responsible for oversight of manpower, personnel, administration, and reserve functions for United States Southern Command affecting over 2,000 personnel at HQ SOUTHCOM, Special Operations Command South, Joint Task Force Guantanamo, Joint Interagency Task Force South, and security cooperation offices in 32 countries throughout the Caribbean, Central and South America.

J2 (Intelligence, Surveillance and Reconnaissance)—Execute all-source, multi-discipline intelligence operations, fully synchronized and integrated with theater, component, national, interagency, and partner nation organizations. Fully inform and enhance senior leader decision-making and enable theater and regional campaign plans and operations to shape the environment and conduct ISR operations in support of the Commander's Priorities.

J3 (Operations)—Shapes the environment within the AOR in support of the combatant commander by conducting theater engagement, Counter-Narco Terrorism (CNT) activities, humanitarian assistance, and disaster relief in order to promote democracy, stability, and collective approaches to regional security. When required, responds unilaterally or multilaterally to crises that threaten regional stability or national interest, and prepares to meet future hemispheric challenges.

J4 (Logistics)—Provide strategic logistics, medical and engineering capabilities in support of the combatant command's mission requirements, through innovative partnership with DOD, interagency, and the public sector. Key capabilities include: Supply Operations, Maintenance Operations, Distribution and Deployment, Logistics Services, and Operational Contract Support.

J5 (Strategy, Policy & Plans)—The Strategy, Policy, and Plans Directorate provides input into and translates national-level strategies, policies and plans into strategic-operational level long-range guidance. Develops concepts and ideas into staff and component actionable issues in support of the command's objectives. Develops initiatives for building partner nations' and U.S. capabilities and capacities in the air, space, land, sea, and cyber domains. Provides overarching national-level inputs to subject-matter specific policies owned by other USSOUTHCOM directorates.

Leads the overarching Campaign and Strategic Planning Process. Integrates interagency and command efforts toward the attainment of the command's vision, goals, and objectives. Develops

comprehensive plans to shape the environment within the AOR in support of the combatant commander to conduct theater engagement activities in order to promote democracy, stability, and collective approaches to regional security.

Provides subject matter expertise and country insight on all military and political aspects for the region. Provides command, Joint Staff, Congressional, Ambassadorial, Service and Component Staffs with tailored, coordinated products on partner-nation issues.

J6 (Communication Systems Dominance)—Provides C4I architecture, governance, portfolio management, information technology investment strategy, and operational capabilities to enable joint coalition and interagency information dominance.

J7 (Theater Engagement)—Executes theater engagement operations and activities that build partner nation capacity for maintaining democracy, enhancing stability, and establishing collective approaches to regional security.

J8 (Resources & Assessments)—Manages and advocates for resources to achieve enterprise strategic goals by executing the following functions:

- Program Management Services
- Planning, Programming, Budgeting and Execution System (PPBES) Activities
- Operational, Strategic and Programmatic Assessments
- Acquisition and Contracting Services
- Provide MS& A support for contingency plan analysis, complex decision-making, and the Command exercise program

J9 (Partnering)—Fosters “whole-of-government” solutions for 21st century challenges by integrating the U.S. Government, private sector, and public-private organizations into the shared mission of ensuring security, enhancing stability, and enabling prosperity.

3.5.7 United States Special Operations Command (USSOCOM)

DOD activated USSOCOM April 16, 1987, at MacDill Air Force Base, Florida. DOD created the new unified command in response to congressional action in the Goldwater-Nichols Defense Reorganization Act of 1986 and the Nunn-Cohen Amendment to the National Defense Authorization Act of 1987. Congress mandated a new four-star command be activated to prepare SOF to carry out assigned missions

and, if directed by the president or SecDef, to plan for and conduct special operations.

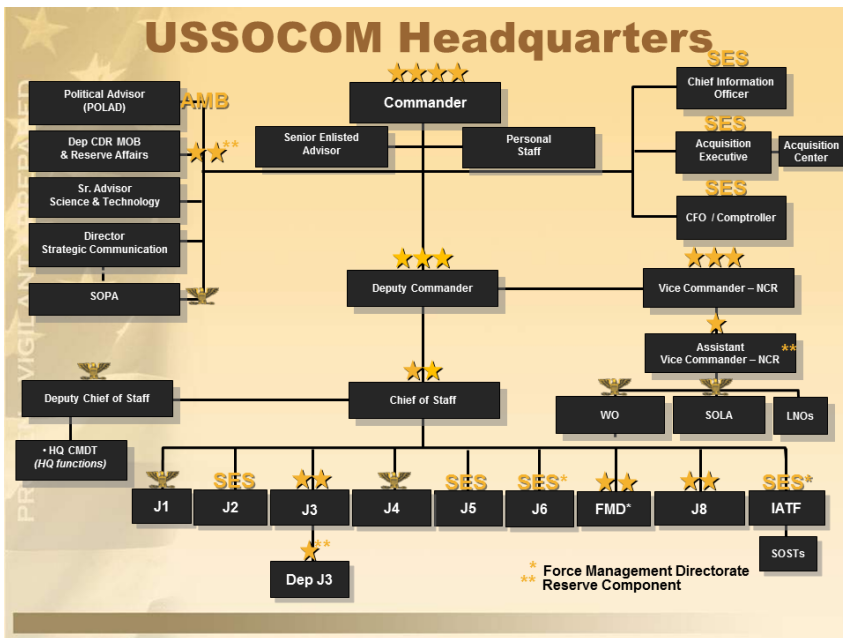

Figure 41: USSOCOM Headquarters

Mission: Provide fully capable Special Operations Forces to defend the United States and its interests. Plan and synchronize operations against terrorist networks.

Missions	Collateral Activities
<ul style="list-style-type: none"> • Unconventional Warfare (UW) • Foreign Internal Defense (FID) • Military Information Support Operations (MISO) • Civil Affairs (CA) • Information Operations (IO) • Direct Action (DA) • Special Reconnaissance (SR) • Combatting Terrorism (CBT) • Counterproliferation (CP) of Weapons of Mass Destruction (WMD) 	<ul style="list-style-type: none"> • Coalition Support • Combat Search and Rescue (CSAR) • Counterdrug (CD) Activities • Humanitarian Assistance (HA) • Security Assistance (SA) • Special Activities

Figure 42: USSOCOM Missions and Collateral Activities

To enable USSOCOM to carry out its mission, Congress gave the new command specific Title 10 authorities and responsibilities:

- Develop special operations strategy, doctrine and tactics;
- Prepare and submit budget proposals for SOF;
- Exercise authority, direction and control over special operations expenditures;
- Train assigned forces;
- Conduct specialized courses of instruction;
- Validate requirements;
- Establish requirement priorities;
- Ensure interoperability of equipment and forces;
- Formulate and submit intelligence support requirements;
- Monitor Special Operations officers' promotions, assignments, retention, training and professional military education;
- Ensure SOF's combat readiness;
- Monitor SOF's preparedness to carry out assigned missions;
- Develop and acquire special operations peculiar equipment, materiel, supplies and services

In addition to the Service-like authorities of developing training and monitoring readiness, some of the authorities Congress gave USSOCOM are unique responsibilities for a unified command. USSOCOM is not dependent on the Army, Navy, Marine Corps or Air Force for its budget or to develop and buy new equipment, supplies or services for the command. USSOCOM has its own budgetary authorities and responsibilities through a specific Major Force Program

(MFP-11) in DOD's budget. Additionally, USSOCOM has its own acquisition authorities, so it can develop and buy special operations-peculiar equipment, supplies or services.

Before the Sept. 11, 2001, terrorist attacks on the United States, USSOCOM's primary focus was on its supporting command mission of organizing, training, and equipping SOF and providing those forces to support the geographic combatant commanders and U.S. ambassadors and their country teams. The president further expanded USSOCOM's responsibilities in the 2004 Unified Command Plan. The UCP assigned USSOCOM responsibility for synchronizing DOD plans against global terrorist networks and, as directed, conducting global operations. USSOCOM receives, reviews, coordinates, and prioritizes all DOD plans supporting the global campaign against terror and then makes recommendations to the Joint Staff regarding force and resource allocations to meet global requirements.

Vision: Special Operations Forces must be highly trained, properly equipped, and deployed to the right place at the right time for the right missions. Commanders and staffs must capably plan and lead the full range of lethal and non-lethal special operations missions in complex, ambiguous environments. Personnel will be professional, diplomatically and culturally astute, responsive, and innovative. As key members of Joint, Interagency, and International teams, SOF will employ all assigned authorities and apply all available elements of power to accomplish assigned missions.

SOF Core Activities

- **Direct Action:** Short-duration strikes and other small-scale offensive actions taken to seize, destroy, capture or recover in denied areas.
- **Special Reconnaissance:** Acquiring information concerning the capabilities, intentions, and activities of an enemy.
- **Unconventional Warfare:** Operations conducted by, through and with surrogate forces that are organized, trained, equipped, supported and directed by external forces.
- **Foreign Internal Defense:** Providing training and other assistance to foreign governments and their militaries to enable the foreign government to provide for its country's national security.
- **Civil Affairs Operations:** Activities that establish, maintain, or influence relations between U.S. forces and foreign civil

authorities and civilian populations to facilitate U.S. military operations.

- **Counterterrorism:** Measures taken to prevent, deter and respond to terrorism.
- **Military Information Support Operations:** Operations that provide truthful information to foreign audiences that influence behavior in support of U.S. military operations.
- **Information Operations:** Operations designed to achieve information superiority by adversely affecting enemy information and systems while protecting U.S. information and systems.
- **Counter Proliferation of Weapons of Mass Destruction:** Actions taken to locate, seize, destroy or capture, recover, and render such weapons safe.
- **Security Force Assistance:** Unified action by joint, interagency, intergovernmental, and multinational community to sustain and assist host nation or regional security forces in support of a legitimate authority.
- **Counterinsurgency Operations:** Those military, paramilitary, political, economic, psychological, and civic actions taken by a government to defeat insurgency.
- **Activities Specified by the president or SecDef**



Figure 43: USSOCOM Command Relationships

USSOCOM and its Major Component Organizations

USSOCOM has approximately 61,000 active duty, Reserve and National Guard Soldiers, Sailors, Airmen, Marines, and DOD civilians assigned to the headquarters, its four components and one sub-unified command. USSOCOM’s components are U.S. Army Special Operations Command (USASOC), Naval Special Warfare Command (NAVSPECWARCOM), Air Force Special Operations Command (AFSOC) and Marine Corps Forces Special Operations Command (MARSOC). The Joint Special Operations Command (JSOC) is a USSOCOM sub-unified command.

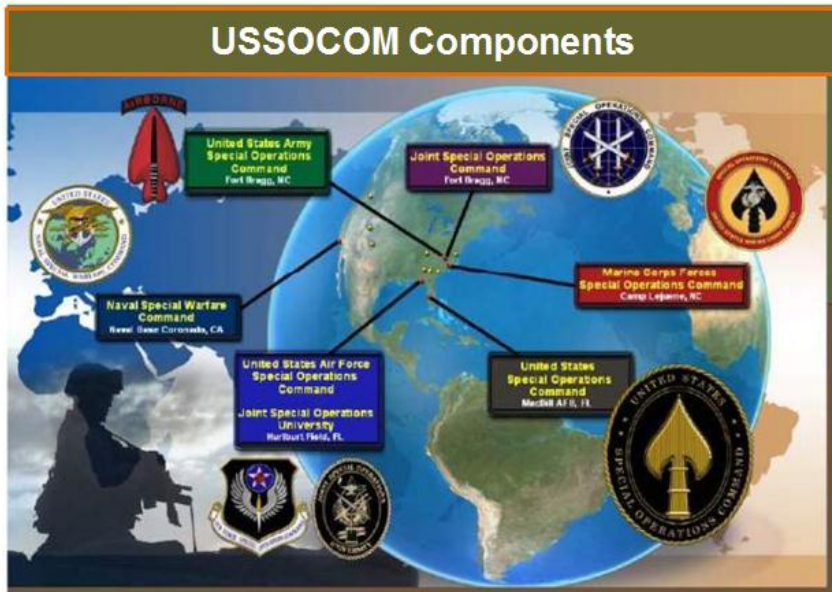

Figure 44: USSOCOM Component Organizations

Subordinated Commands

- **Air Force Special Operations Command (AFSOC)**—located at Hurlburt Field, Florida., and established May 22, 1990; the air component to USSOCOM and responsible for the readiness of active duty, Air Force Reserve and Air National Guard SOF for worldwide deployment. AFSOC is comprised of highly-trained, rapidly-deployable Airmen, equipped with highly-specialized, fixed-wing aircraft. AFSOC’s aerospace warriors deliver the nation’s specialized airpower to provide SOF mobility, specialized intelligence support, forward presence and engagement with coalition partners. AFSOC Forces’ missions include close air support/precision firepower, infiltration, exfiltration, resupply, aerial refueling, air/ground interface (Battlefield Airmen), aviation foreign internal defense, intelligence support to special operations (including unmanned aerial surveillance), and airborne radio and television broadcast for psychological operations.
 - **Special Tactics**, AFSOC’s Battlefield Airmen, is comprised of combat control, pararescue and special operations weather, and tactical air control party personnel capable of providing terminal guidance for weapons, control of assault zone aircraft, fire support, mission planning, medical, and weather support.

Special Tactics Teams frequently operate with Navy SEALs, Army Rangers, and Special Forces in direct action, airfield seizure, and personnel recovery missions in hostile territory.

- **The Air Force Special Operations Training Center** is a primary support unit of AFSOC. The training center mission is to recruit, assess, select, and conduct AFSOC-specific training, including aircrew qualification, special tactics, Combat Aviation Advisor, and courses conducted at the Air Force Special Operations School. The 19th Special Operations Squadron is an advanced weapons instruction and mission rehearsal unit and is AFSOC's formal school for AC-130H, AC-130U, MC-130E, U-28 and Combat Aviation Advisors. The squadron teaches more than 1,100 classes in 70 distinct syllabi of instruction for initial mission qualification, instructor upgrade and continuation refresher training. The Special Tactics Training Squadron conducts advanced skills training for combat controllers, pararescuemen, and special tactics officers before they depart for operational special tactics squadrons. The STTS mission will expand to train special operations weather Airmen, AFSOC's Deployed Aircraft Ground Response Element, integrated combat skills for Combat Aviation Advisors, and will integrate Tactical Air Control Party Airmen into the third phase of the special tactics advanced skills training curriculum. The Air Force Special Operations School offers focused education in irregular warfare, regional studies and cultural awareness, Special Operations Forces professional development to educate Air Commandos, the special operations community, services, and other U.S. government agencies. A total force integration effort, the AFSOTC brings together the strengths of active duty, Reserve, Air National Guard, DOD civilians, and contract personnel to form an integrated education team dedicated to training new Air Commandos and building warrior ethos to navigate uncertain times ahead.
- **Combat Aviation Advisors** of the 6th Special Operations Squadron (SOS) help U.S. global partners to wield airpower. These Air Commandos are culturally savvy, linguistically-trained, and politically-astute Airmen, hand selected for their skill, maturity, and professionalism to advise foreign forces in rotary and fixed-wing combat aviation, maintenance, base support, security, and tactics. They execute the aviation foreign internal defense mission and train foreign units in specialized and unconventional tactics. The 6th SOS is the only combat aviation advisory unit in the DOD. Every day, the

6th SOS has Air Commandos deployed to any given theater of the globe and who maintain instructor qualifications on numerous foreign-made aircraft.

- **Combat Controllers** are Special Operators and certified air traffic controllers who are an integral part of the Air Force Battlefield Airmen team. Their motto, "First There," indicates the Combat Control Team (CCT) commitment to be the first deployed into restricted environments by air, land, or sea to establish assault zones. The assault zone is a drop zone for parachute operations, a landing zone for fixed wing or helicopter operations, or an extraction zone for low altitude resupply. They set up navigational aid equipment anywhere in the world to guide aircraft for landing on makeshift runways without the benefit of a tower or large communications system. CCT also control air attacks from all military services aircraft. In addition, CCT are qualified in demolition to clear hazards and obstructions from runways and landing zones and provide vital command and control, intelligence gathering, surveying capabilities, limited weather observations.
- **Pararescuemen (PJs)** are the only DOD specialty specifically trained and equipped to conduct conventional and unconventional recovery operations. A PJ's primary function is as a personnel recovery specialist, with emergency trauma medical capabilities in humanitarian and combat environments. They deploy in any available manner, from any available platform, to include air-land-sea tactics, into restricted environments to contact, authenticate, extract, treat, stabilize and evacuate injured personnel, while acting in an enemy-avoiding, recovery role. PJs participate in combat search and rescue, peacetime search and rescue, and protection of the president of the United States, and conduct other operations at the commander's direction. Their motto, "That Others May Live," reaffirms the PJs' commitment to saving lives and self-sacrifice.
- **Special Operations Weathermen** are trained meteorologists with forward ground combat capabilities. They interpret weather data and provide intelligence from deployed locations. Working with Special Operations teams, they collect localized weather intelligence, assist mission planning, generate accurate, and mission-tailored target and route forecasts in support of global special operations, conduct special weather reconnaissance, and train foreign national forces. The 10th Combat Weather Squadron motto, "Coela Bellatores" or "Weather Warriors," confirms the commitment to deploy into

restricted environments by air, land or sea to observe and analyze all weather data from “mud to sun.”

- **U.S. Army Special Operations Command (USASOC):** was established Dec. 1, 1989, by the Department of the Army at Fort Bragg, North Carolina, as an Army Service Component Command to enhance the readiness of SOF. USASOC is home to the elite fighting forces who conduct operations across the full spectrum of warfare, including unconventional warfare, counter proliferation, direct action, psychological operations, special reconnaissance, civil affairs, foreign internal defense, and information operations. USASOC commands and controls two component subordinate commands, and four component subordinate units, which in turn train and maintain forces for deployment by USSOCOM to combatant command theaters worldwide. USASOC’s two component subordinate commands are U.S. Army Special Forces Command (Airborne), and the U.S. Army John F. Kennedy Special Warfare Center and School, both headquartered at Fort Bragg. The component subordinate units include the Sustainment Brigade (Special Operations) (Airborne) at Fort Bragg; 75th Ranger Regiment, headquartered at Fort Benning, Georgia; 160th Special Operations Aviation Regiment (Airborne) at Fort Campbell, Kentucky; 95th Civil Affairs Brigade (Airborne) at Fort Bragg; and 4th Military Information Support Group (MISO) (Airborne) at Fort Bragg. The command also provides oversight of Army National Guard Special Forces’ readiness, organization, training and employment in coordination with the National Guard Bureau and state adjutants general.
 - **Special Forces**—plan, prepare for, and when directed, deploy to conduct unconventional warfare, foreign internal defense, special reconnaissance and direct actions in support of U.S. national policy objectives within designated areas of responsibility. The units continually train to conduct unconventional warfare in any of its forms—guerrilla warfare, subversion and sabotage. The Soldiers are also trained in direct-action operations and special reconnaissance. Approximately 1,400 Soldiers are assigned to each group. The 12-man “A” Team is the key operating element of the Special Forces group.
 - **Rangers**—the masters of special light infantry operations. These include attacks to temporarily seize and secure key objectives and other light infantry operations requiring unique capabilities. Like their Special Forces counterparts, Rangers can infiltrate into an area by land, sea or air.

- **The 160th Special Operations Aviation Regiment (Airborne)**—a unique unit which provides support to Special Operations Forces on a worldwide basis with three types of modified helicopters. The capabilities of the aviation units include inserting, resupplying and extracting U.S. and Allied SOF personnel. They also assist in SOF search and rescue, and escape and evasion activities. In addition to general aviation support to SOF, these units provide airborne command and control, and fire support.
- **Military Information Support Operations (MISO)**—disseminates truthful information to foreign audiences in support of U.S. goals and objectives. MISO units accomplish their mission by disseminating messages in the form of leaflets, posters, broadcasts, and audiovisual tapes.
- **Civil Affairs (CA)** units—designed to prevent civilian interference with tactical operations, to assist commanders in discharging their responsibilities toward the civilian population and to provide liaison with civilian government agencies.
- **Sustainment Brigade, Special Operations (Airborne) (SBSO(A))**—activated Dec. 2, 2005, as part of the overall Army Special Operations Forces logistics transformation. SBSO(A) provides combat service support and combat health support to Army SOF in the full spectrum of conflict.
- **The U.S. Army John F. Kennedy Special Warfare Center and School**—USASOC's special operations university; responsible for special operations training, leader development, doctrine, and proponent for personnel for Special Forces, CA, and MISO. The Center and School's training group conducts the complete spectrum of special operations training. The Group's 1st Battalion conducts four of the six phases of training in the Special Forces training pipeline:
 - Phase I: three-week Special Forces Assessment and Selection course;
 - Phase II: small Unit Tactics training;
 - Phase IV: unconventional warfare exercise known as "Robin Sage."
 - Phase VI: the Survival, Escape, Resistance and Evasion course.

The 2nd Battalion teaches advanced Special Operations skills in weapons training; military free fall and combat diving. They also teach all Special Forces Warrant Officer courses and the 18F Military Occupational Skills course, or Special Forces Intelligence Sergeant's course. The 3rd Battalion conducts

Phase V of the Special Forces training pipeline—language training. Additionally, 3rd Battalion is responsible for all civil affairs and MISO training and conducts an extensive regional studies program. The 4th Battalion conducts Phase III of the SF training pipeline including the Weapons, Engineer, Communications, and Medical Sergeant's courses and the Officer Qualification course.

The Support Battalion, consisting of 29 different combat service support MOSs allows the training battalions to focus on quality training by providing the logistical, administrative, transportation, and facility management support to the Center and School. The Joint Special Operations Medical Training Center is responsible for all U.S. Military Special Operations Forces' combat medical training including Army Rangers and Navy SEALs. The Noncommissioned Officer Academy prepares enlisted Soldiers for leadership positions in all Army Special Operations Forces including Special Forces, Civil Affairs, and MISO. Soldiers receive training in leadership skills, military studies, resource management, effective communication, operations and intelligence, unconventional warfare, operational planning, military information support operations and advanced military occupational skills. The Center and School conducts more than 100 different courses and trains over 14,000 students annually. Since 1963, the John F. Kennedy Special Warfare Center and School has trained Special Operations Forces.

- **The 75th Ranger Regiment** is a lethal, agile, and flexible force, capable of conducting direct-action raids, and forced entry operations across the entire spectrum of combat. The Regiment sustains deployed forces conducting combat operations in Iraq and Afghanistan. It is also transforming to meet future operational requirements, without sacrificing mission success. Each of the three geographically dispersed Ranger battalions can deploy anywhere in the world for no-notice missions. Their capabilities include direct-action raids, seizing key terrain such as airfields, and destroying strategic facilities. Rangers are capable of conducting squad-through regimental-size operations using a variety of infiltration techniques including airborne, air assault and ground platforms. The Regiment has an intensive screening and selection process. Rangers are resourced to maintain exceptional proficiency, experience and readiness. Their training encompasses arctic, jungle, desert and mountain

operations, as well as amphibious instruction. Training and executing missions at night and during adverse weather demonstrates their motto, "Rangers lead the way."

- **U.S. Army Special Forces Command (Airborne) (USASFC(A))**—The Army 1st Special Operations Command was redesignated the U.S. Army Special Forces Command (Airborne) Nov. 27, 1990. The mission of USASFC(A) is to organize, equip, train, validate and prepare Special Forces units to deploy and execute operational requirements for the U.S. military's warfighting geographical combatant commanders throughout the world.

Within USASFC(A), there are five active component groups and two U.S. Army National Guard groups. Each group has three line battalions, a group support battalion, and a headquarters company. The companies within the line battalions have six Operational Detachment Alphas (ODAs), or A-teams, assigned to them. The ODA is the heart and soul of SF operations. Unlike any other divisional-sized unit, USASFC(A) components are not located in one place, but spread out from coast-to-coast and throughout the world. Each Special Forces Group is regionally oriented to support one of the warfighting GCCs. Special Forces Soldiers routinely deploy in support of the GCCs of USEUCOM, USPACOM, USSOUTHCOM, USCENTCOM, and USAFRICOM. Special Forces units perform seven doctrinal missions: unconventional warfare, foreign internal defense, special reconnaissance, direct action, combatting terrorism, counter proliferation, and information operations. These missions make Special Forces unique in the U.S. military because they are employed throughout the three stages of the operational continuum: peacetime, conflict and war. Special Forces Command's unconventional warfare capabilities provide a viable military option for a variety of operational taskings that are inappropriate or infeasible for conventional forces, making it the U.S. military's premier unconventional warfare force.

Foreign internal defense operations, SF's main peacetime mission, are designed to help friendly developing nations by working with their military and police forces to improve their technical skills, understanding of human rights issues, and to help with humanitarian and civic action projects. SF units are often required to perform additional, or collateral, activities outside their primary missions. These collateral activities are

coalition warfare/support, combat search and rescue, security assistance, peacekeeping, humanitarian assistance, humanitarian de-mining, and counterdrug operations. On an everyday basis, Soldiers of the U.S. Army Special Forces Command (Airborne) are deployed around the world, living up to their motto—"De Oppresso Liber" or "To Free the Oppressed."

- **4th Military Information Support Group**—a vital part of the broad range of U.S. political, military, economic and ideological activities used by the U.S. government to secure national objectives. MISO units develop, produce and disseminate information to foreign audiences in support of U.S. policies and national objectives. Used during peacetime, contingency operations and declared war, these activities are not a form of force, but are force multipliers that use nonviolent means in often violent environments. Persuading rather than compelling physically, they rely on logic, fear, desire or other motivational factors to promote specific emotions, attitudes or behaviors. The ultimate objective of U.S. military MISO is to influence target audiences to take action favorable to the policies of the United States and its allies.
- **Sustainment Brigade (Special Operations) (Airborne) (SBSO(A))**—activated Dec. 2, 2005, as part of the overall Army Special Operations Forces logistics transformation. SBSO(A) provides combat service support and combat health support to Army SOF in the full spectrum of conflict. It also plans, coordinates and provides operational and tactical communications for Joint Special Operations Task Force commanders with the 112th Special Operations Signal Battalion (Airborne), the Brigade Troops Battalion, the Army SOF Support Cell, two Medical Level II teams, and five Special Operation Liaison Elements.
- **95th Civil Affairs Brigade**—Civil Affairs units support military commanders by working with civil authorities and civilian populations in the commander's area of operations during peacetime, contingency operations and war. Civil Affairs specialists identify critical requirements needed by local citizens in war or disaster situations. They also locate civilian resources to support military operations, help minimize civilian interference with operations, support national assistance activities, plan and execute noncombatant evacuation, support counterdrug operations and establish and maintain liaison with civilian aid agencies and other nongovernmental organizations. In support of Special Operations, these culturally oriented,

linguistically capable soldiers may also be tasked to provide functional expertise for foreign internal defense operations, unconventional warfare operations and direct action missions. The functional structure of Civil Affairs Forces and their expertise, training and orientation provide a capability for emergency coordination and administration where political-economic structures have been incapacitated.

- **The 160th Special Operations Aviation Regiment (Airborne) (SOAR(A))** began as an emergency deployment from Fort Campbell, Kentucky, in 1980 evolving into a highly specialized SOF rotary wing aviation capability today. The 160th SOAR is the USASOC's special operations aviation unit specifically manned, equipped and trained to provide precision aviation support to SOF worldwide under any operational and threat environment. To accomplish its mission, the 160th SOAR employs a unique combination of sophisticated, highly modified and combat proven aircraft, (MH-60/MH-47/MH-6/AH-6). These aircraft, coupled with the regiment's stringently selected and highly trained aircrews, provide SOF with an ever-expanding array of reliable aviation capabilities. This includes precision rotary wing operations; long-range infiltrations/exfiltration, performing in adverse weather and all terrain/environmental conditions. The regiment can also conduct long-range precision attack and close air support for ground SOF and personnel recovery.
- **Naval Special Warfare Command (NAVSPECWARCOM)**—the maritime component of USSOCOM. Established at Naval Amphibious Base, Coronado, California in April 1987, NAVSPECWARCOM's mission is to organize, train, man, equip, educate, sustain, maintain combat readiness, and deploy Naval Special Warfare Forces to accomplish Special Operations missions worldwide. NSW Forces operate independently or in conjunction with other SOF, allied units, and coalition forces. A tactical force with strategic impact, NSW mission areas include special reconnaissance, direct action, unconventional warfare, combating terrorism, foreign internal defense, information warfare, security assistance, counterdrug operations, personnel recovery, and hydrographic reconnaissance. NSW core training is focused on strategic reconnaissance and direct action—critical skills needed to combat current and future terrorists' threats.
 - Naval Special Warfare Groups are major commands that train, equip and deploy components of NSW squadrons to meet the exercise, contingency and wartime requirements of geographic combatant commanders, Theater Special Operations

Commands, and numbered fleets located around the world. Two logistical support units are responsible for equipping the teams, and two detachments assume responsibility for individual, unit and squadron level training. This allows NSW Operators to maintain a strong operational focus. Naval Special Warfare Combat Service Support Teams provide full spectrum logistics support to SEAL Teams, Special Boat Teams, and NSW Task Groups/Task Units. Tasking for each Combat Service Support Team (CSST) includes crisis-action and logistics planning and coordination; in-theater contracting, small purchase, and leasing actions; and comprehensive forward operating base support.

- **Naval Special Warfare Center (NSWC)**—provides basic and advanced instruction and training in maritime Special Operations to U.S. military and government personnel and members of select foreign armed forces. NSWC is responsible for the oversight of all courses that lead to individual SEAL and Special Warfare Combatant-craft Crewmen qualifications or certifications.
- **Naval Special Warfare Development Group (NSWDG)**—located at Naval Amphibious Base, Little Creek, Virginia; manages the test, evaluation and development of technology applicable to Naval Special Warfare forces. The command also develops maritime ground and airborne tactics for NSW and DOD-wide application.
- **The SEAL Teams**—the heart of the NSW force, a multipurpose combat force organized and trained to conduct a variety of special operations missions in all environments; SEALs conduct clandestine missions infiltrating their objective areas by fixed- and rotary-wing aircraft, Navy surface ships, combatant craft, submarines and ground mobility vehicles.
 - **Special Boat Teams (SBT)**—manned by Special Warfare Combatant-craft Crewmen (SWCC) who operate and maintain state-of-the-art surface craft to conduct coastal patrol and interdiction and support special operations missions. Focusing on infiltration and exfiltration of SEALs and other SOF, SWCCs provide dedicated rapid mobility in shallow water areas where larger ships cannot operate. They also bring to the table a unique SOF capability: Maritime Combatant Craft Aerial Delivery System—the ability to deliver combat craft via parachute drop.
 - **SEAL Delivery Vehicle (SDV) Teams (SDVTs)**—specially trained SEALs and support personnel who conduct undersea operations from SDVs, Dry Deck Shelters (DDS),

and the Advanced SEAL Delivery System (ASDS). DDS deliver SDVs and specially trained forces from modified submarines. When teamed with their host submarines, the ASDS and SDV platforms provide the most clandestine maritime delivery capability in the world.

- **Marine Corps Forces Special Operations Command**—In October 2005, the SecDef directed the formation of a Marine component of USSOCOM. It was determined the Marine Corps would initially form a unit of approximately 2,500 to serve with USSOCOM. MARSOC reached full operational capability in October 2008. On Feb. 24, 2006, MARSOC activated at Camp Lejeune, North Carolina. MARSOC initially consisted of a small staff and the Foreign Military Training Unit, which had been formed to conduct foreign internal defense. Foreign Military Training Unit (FMTU) is now designated as the **Marine Special Operations Advisor Group**. Following the activation of MARSOC, the structure and personnel of both 1st and 2nd Force Reconnaissance Company transferred to MARSOC to form the **1st and 2nd Marine Special Operations Battalions**.

MARSOC also formed the **Marine Special Operations Support Group** (MSOSG) and the **Marine Special Operations School** (MSOS). The MSOSG provides combat support and combat service support to MARSOC Units, to include: logistics, communication and intelligence. The MSOS screens, assesses, selects, trains and certifies Marine Special Operations Forces and has responsibility for doctrine development.

As a Service component of USSOCOM, MARSOC is tasked by the commander of USSOCOM to train, organize, equip and when directed by commander of USSOCOM, deploy task organized, scalable, and responsive U.S. Marine Corps Special Operations Forces worldwide in support of combatant commanders and other agencies. MARSOC has been directed to conduct foreign internal defense, direct action and special reconnaissance. Commander, USSOCOM assigns MARSOC missions based on USSOCOM priorities. MARSOC units then deploy under USSOCOM deployment orders. MARSOC deployed its first units in August 2006, six months after initial activation. Since then, MARSOC has continuously deployed. MARSOC's current deployments include **Marine Special Operations Advisor Group** (MSOAG) Teams conducting foreign internal defense and Marine Special Operations Companies from the Marine Special Operations battalions

conducting direct action, strategic reconnaissance and foreign internal defense.

- **The Marine Special Operations Advisor Group**, which consists of a Headquarters Company and 3rd and 4th Marine Special Operations Battalions, provides tailored military combat-skills training and advisor support for identified foreign forces in order to enhance their tactical capabilities and to prepare the environment as directed by USSOCOM. Marines and Sailors of the MSOAG train, advise, and assist friendly host nation forces—including naval and maritime military and paramilitary forces—to enable them to support their governments' internal security and stability, to counter subversion and to reduce the risk of violence from internal and external threats. MSOAG deployments are coordinated by MARSOC, through USSOCOM, in accordance with engagement priorities within the Global War on Terrorism.
- **The 2d Marine Special Operations Battalion (2d MSOB)**—activated May 15, 2006, and headquartered at Camp Lejeune, N.C. The 2d MSOB is organized, trained and equipped to deploy for worldwide missions as directed by MARSOC. The battalion consists of four Marine Special Operations Companies and is task organized with personnel uniquely skilled in special equipment support, intelligence and fire-support.
- **1st MSOB (1st MSOB)**—activated on Oct. 26, 2006, with four MSOCs and headquartered at Camp Pendleton, Calif. 1st Force Reconnaissance Company was used as their starting base of operators. Each MSOC is commanded by a Marine major and capable of deploying task-organized expeditionary Special Operations Forces for special reconnaissance and direct-action missions in support of the geographic combatant commanders.
- **The Marine Special Operations Support Group** provides specified support capabilities for worldwide Special Operations missions as directed by MARSOC. The MSOSG specifically provides combined arms planning and coordination, K-9 support, special operations communications support, combat service support (including logistics) and all-source intelligence fusion capability. The MSOSG can deploy tailored support detachments as directed by MARSOC.
- **The Marine Special Operations School** performs the screening, training, assessment and doctrinal development functions for MARSOC. The school has a Special Operations Training Branch (SOTB) provides Special Operations training

in tactics, techniques, and procedures and evaluation and certification of MARSOC Forces to specified conditions and standards for SOF. The Marines of MSOS are Operators with the training, experience and mature judgment to plan, coordinate, instruct and supervise development of SOF special reconnaissance, and direct action skills.

- **Joint Special Operations Command (JSOC)**—a sub-unified command of USSOCOM, established in 1980; provides a joint headquarters to study Special Operations requirements, ensures interoperability and equipment standardization, develops joint Special Operations plans and tactics, and conducts joint Special Operations exercises and training.

Joint Special Operations Task Force (JSOTF)

The Joint Force Commander (JFC), using SOF independently or integrated with conventional forces, gains an additional and unique capability to achieve objectives that may not otherwise be attainable. Circumstances may dictate that SOF support conventional forces; and conversely, that conventional forces support SOF. Integration enables the JFC to take fullest advantage of conventional force and SOF core competencies. SOF are most effective when SO are fully integrated into the overall plan and the execution of SO is through proper SOF Command and Control (C2) elements responsive to the needs of the supported commander. SOF C2 elements are provided to the supported or the supporting conventional force commanders and include JSOTFs (or combined Joint Special Operations Task Forces [CJSOTFs] when organized with coalition or multinational SOF) to conduct a specific SO or prosecute SO in support of a larger joint operation or theater campaign; Special Operations Command and Control Elements (SOCCEs) to synchronize integrated SOF/conventional force operations; and Special Operations Liaison Elements (SOLEs) to coordinate, deconflict, and integrate SO air, surface, and subsurface operations with conventional air operations. Exchange of SOF and conventional force Liaison Officers (LNOs) is also essential to enhance situational awareness and facilitate staff planning and training for integrated operations. (JP 3-05.1)

A JSOTF normally is established by a JFC to plan and conduct SO. The JSOTF, when established, is a JTF composed of SOF from more than one Service to carry out a specific operation or prosecute SO in support of the theater campaign or other operations as directed. It may have conventional forces assigned or attached to support the conduct of specific missions. It may be established subordinate to another JTF or directly subordinate to a geographic combatant command or

subunified command. A Commander, Joint Special Operations Task Force (CDRJSOTF) may organize the JSOTF HQ as necessary to carry out all assigned duties and responsibilities. There are several options that may be used to organize a JSOTF HQ (use a theater special operations command [TSOC] HQ, augment a core SOF component HQ, or organize an ad hoc HQ from various SOF contributors). Whichever the option, a building process will be necessary. Additionally, this process must support the JSOTF mission and provide the best opportunity for success. When fully organized, the JSOTF staff will be composed of appropriate members in key positions of responsibility from each Service SOF having significant forces assigned to the command. (JP 3-05.1)

3.5.8 United States Strategic Command (USSTRATCOM)

U.S. Strategic Command is a functional combatant command headquartered at Offutt Air Force Base, near Omaha, Nebraska. Established 1 June 1992, the command has significantly changed during the last decade. With over 4,000 military and civilian personnel, USSTRATCOM combines the synergy of the U.S. legacy nuclear command and control mission with responsibility for seven other distinct mission areas: space operations; cyberspace operations and defense; global strike; integrated missile defense; combating weapons of mass destruction; Intelligence, Surveillance and Reconnaissance (ISR); and Defense Department information operations. This dynamic command gives National Leadership a unified resource for greater understanding of specific threats around the world and the means to respond to those threats rapidly.

 USSTRATCOM UCP (2011) Responsibilities	
Strategic Deterrence	Lead strategic deterrence planning, execute strategic deterrence operations; plan, advocate for & employ nuclear forces – as directed
Space Operations	Plan & conduct space force enhancement, space support, defensive space control, space situational awareness and – as directed – offensive space control & space force application
Cyberspace Operations	Synchronize planning for cyberspace ops; direct DOD information networks operations & defense; execute cyberspace operations – as directed
Joint Electronic Warfare	Plan and advocate for joint electronic warfare, and operations security capabilities; support combatant command plans and training for electronic spectrum as directed
Global Strike	Plan, coordinate, & execute kinetic (nuclear & conventional) & non-kinetic global strike
Missile Defense (MD)	Synchronize planning for global MD; develop and maintain global MD CONOPS; provide missile warning information
Intelligence, Surveillance & Reconnaissance (ISR)	Plan, integrate, & coordinate ISR for strategic and global ops
Combating Weapons of Mass Destruction (CWMD)	Synchronize planning for DOD CWMD efforts; coordinate global CWMD ops support; plan against designated global WMD threats; develop and maintain global CWMD concept of operations; execute CWMD ops as directed
Analysis and Targeting	Provide in-depth analysis and precision targeting

What We Are Assigned To Do

Figure 45: USSTRATCOM UCP 2011 Responsibilities

USSTRATCOM Mission: Detect, deter, and prevent attacks against the United States and its allies—join with the other combatant commands to defend the nation should deterrence fail.

USSTRATCOM Priorities:

1. Deter nuclear attack with a safe, secure, effective nuclear deterrent force.
2. Partner with the other combatant commands to win today.
3. Respond to the new challenges in space.
4. Build cyberspace capability and capacity.
5. Prepare for uncertainty.

USSTRATCOM Organization:

Under the leadership of a 4-star Commander, the day-to-day planning and execution of U.S. Strategic Command's mission areas is done by the organizations listed below (descriptions on subsequent pages):

- 11 Headquarters Directorates—organized under a modified J-code structure
- 1 Sub-unified Command
- 4 Joint Functional Component Commands (JFCCs)

- 2 Component Centers
- 5 Service Components
- 6 Task Forces

USSTRATCOM Functional Components

Leading, planning, and executing strategic deterrence operations; advocating for capabilities as assigned



Headquarters, U.S. Strategic Command - Offutt AFB, NE

USSTRATCOM integrates and coordinates the necessary command and control capability to provide support with the most accurate and timely information for the President, the Secretary of Defense, other National Leadership, and regional combatant commanders. The command headquarters oversees the command's operationally focused global strategic mission and is organized under a modified J-code structure.

Ensuring US freedom of action in space and cyberspace



U.S. Cyber Command - Fort Meade, MD

A sub-unified command subordinate to USSTRATCOM. USCYBERCOM plans, coordinates, integrates, synchronizes, and conducts activities to direct operations and defense of specified DoD information networks and to prepare for and conduct, when directed, full-spectrum military cyberspace operations in order to enable actions in all domains, ensure US/Allied freedom of action in cyberspace and deny the same to our adversaries.



JFCC - Space - Vandenberg AFB, CA

Responsible for executing continuous, integrated space operations to deliver theater and global effects in support of national and combatant commander objectives. JFCC-SPACE coordinates space operational-level planning, integration, and coordination to ensure unity of effort in support of military and national security operations, and support to civil authorities.

Provide in-depth analysis and precision targeting



Joint Warfare Analysis Center (JWAC) Dahlgren, VA

JWAC provides component commands, Joint Staff (JS), and other customers with effects-based, precision targeting options for selected networks and nodes in order to carry out the national security and military strategies of the United States during peace, crisis, and war. JWAC maintains and enhances its ability to conduct comprehensive technical analysis to identify critical networks, nodes, and points of influence within a threat's infrastructure and other systems.

Delivering integrated kinetic and non-kinetic effects in support of US Joint Force Commanders



JFCC Global Strike - Offutt AFB, NE

Conducts kinetic (nuclear and conventional) and non-kinetic effects planning. JFCC-GS manages global force activities to assure allies and to deter and dissuade actions detrimental to the United States and its global interests; should deterrence fail, employs global strike forces in support of combatant commander.



Joint Information Operations Warfare Command - Lackland AFB, TX

Provides comprehensive joint information operations advocacy, planning, execution, and operational-level integration of Electronic Warfare, Operations Security, and Military Deception. JIOWC uses information as a tool to change attitudes or perceptions, creating desired results. Information Operations tactics help protect United States interests while disrupting the adversary's capabilities.

Synchronizing global missile defense plans and operations



JFCC Integrated Missile Defense - Schriever AFB, CO

JFCC-IMD is constantly monitoring for any missile activity or threat against the United States and its allies. In the event of an attack, plans and coordinates the necessary actions to counter the threat. Synchronizes operational-level global missile defense planning, operations support, and the development of missile defense effects for DoD. When directed, also provides alternate missile defense execution support.

Synchronizing regional plans for combating of weapons of mass destruction



USSTRATCOM Center for Combating Weapons of Mass Destruction - Fort Belvoir, VA

SCC-WMD integrates and synchronizes DoD efforts to combat worldwide WMD in support of U.S. government objectives. The Center advises combatant commands on WMD-related matters, provides critical planning expertise, and develops recommendations to reduce vulnerabilities and improve DoD effectiveness in combating WMD.

Planning, integrating, & coordinating ISR in support of strategic and global operations



JFCC Intelligence, Surveillance and Reconnaissance - Bolling AFB, Washington, D.C.

As directed by CDR USSTRATCOM, JFCC-ISR recommends allocation of ISR capabilities to satisfy strategic/high-priority combatant command and national operational and intelligence requirements; advocates for ISR capabilities; and provides functional support for USSTRATCOM's other missions.

USSTRATCOM Service Components

Service specific component commands fulfill an important role in training, equipping and resourcing the forces necessary to carry out USSTRATCOM's global missions.

- **U.S. Army Space and Missile Defense Command/Army Forces Strategic Command (SMDC/ARSTRAT)**—a Major Army Command (MACOM) and the Army service component to USSTRATCOM, conducts space operations and provides planning, integration, control, and coordination of Army forces and capabilities in support of USSTRATCOM missions; serves as proponent for space and ground-based midcourse defense and as Army operational integrator for global missile defense; conducts mission-related research, development, and acquisition in support of Army Title 10 responsibilities and serves as the focal point for desired characteristics and capabilities in support of USSTRATCOM missions. The command is headquartered in Arlington, VA.
- **U.S. Fleet Forces Command (USFF)**—headquartered at Naval Station Norfolk, VA. USFF is the U.S. Navy component of U.S. Strategic Command. Fleet Forces Command is responsible for the entire Atlantic Ocean, the Caribbean Sea and the waters around Central and South America extending in the Pacific to the Galapagos Island. The U.S. Atlantic Fleet provides fully trained, combat-ready forces to support United States and NATO commanders in regions of conflict throughout the world. From the Adriatic Sea to the Arabian Gulf, Atlantic Fleet units are called upon to support U.S. Combatant Commanders and joint task force commanders for unified operations anywhere in the world. Additionally, the Fleet Forces Command provides readiness training, and logistical and administrative support for its surface ships, submarines and aviation squadrons.
- **U.S. Marine Corps Forces, U.S. Strategic Command (MARFORSTRAT)**—serves as the U. S. Marine Corps service component to the Commander, USSTRATCOM. Headquarters, MARFORSTRAT is collocated with Headquarters, USSTRATCOM. MARFORSTRAT brings to USSTRATCOM a resident knowledge and access to Marine Corps capabilities that can support all USSTRATCOM mission areas. Particular focus is advising USSTRATCOM, subordinate Joint Force Commanders, functional component and service component commanders on the proper employment of U.S. Marine Corps forces and capabilities.

MARFORSTRAT also fulfills the USMC advocacy role for USSTRATCOM.

- **Air Force Space Command (AFSPC)**, headquartered at Peterson Air Force Base, Colorado—provides space and cyber forces for USSTRATCOM. AFSPC has two numbered air forces. Fourteenth Air Force (14 AF) provides space warfighting forces to USSTRATCOM, and is located at Vandenberg AFB, CA. Fourteenth Air Force manages the generation and employment of space forces to support USSTRATCOM operational plans and missions. Twenty-fourth Air Force (24 AF) is located at Lackland AFB, TX. Twenty-fourth Air Force provides network warfare, information operations and combat communications systems and capabilities in support of USSTRATCOM war plans. AFSPC supports USSTRATCOM with ballistic missile warning information and operates the Space Innovation and Development Center to develop space applications for direct warfighter support. AFSPC also operates and supports the Global Positioning System, Defense Support Program Satellite System, Defense Satellite Communications System Phase III, Defense Meteorological Satellite Program, Wideband Global Satellite Communications System, NATO III and IV communications and Fleet Satellite Communications System Ultra High Frequency (UHF) and Military Strategic, Tactical and Relay (MILSTAR) Communications satellites. AFSPC also operates the Ground-Based Deep Space Electro-Optical Deep Space Surveillance System, as well as the Delta and Atlas family of launch vehicles. This includes all of the nation's primary boosters from the Eastern and Western ranges and range support for NASA manned and unmanned spaceflight operations. AFSPC also operates the nation's primary source of continuous, real-time solar flare warnings and the Air Force Satellite Control Network (AFSCN), a worldwide network of satellite tracking stations to provide communications links to satellites.
- **Air Force Global Strike Command (AFGSC)**—headquartered at Barksdale AFB, LA. AFGSC provides trained strategic bomber and Intercontinental Ballistic Missile (ICBM) forces for USSTRATCOM. AFGSC has two numbered air forces. Eighth Air Force (8 AF) is located at Barksdale AFB, LA and operates and maintains AFGSC's B-2 and B-52 manned bomber weapon systems and provides combat-ready forces to conduct strategic nuclear deterrence and global strike operations in support of USSTRATCOM and other combatant commanders.

Twentieth Air Force (20 AF) is located at F. E. Warren AFB, WY and operates and maintains AFGSC's ICBM weapon systems in support of USSTRATCOM war plans and provides on-alert, combat-ready ICBMs to the president of the United States. AFGSC is also responsible for the Department of Defense's ICBM follow-on operational test and evaluation program.

USSTRATCOM Task Forces

USSTRATCOM continues to rely on various task forces for the planning and execution of its global missions. These include:

- **Aerial Refueling/Tankers:** Air Force refueling aircraft greatly enhance the command's capability to conduct global combat and reconnaissance operations. Tankers are assigned to 18th Air Force, Scott AFB, IL, with headquarters at Air Mobility Command, Scott AFB, IL.
- **Airborne Communications:** The Navy's E-6B Mercury aircraft provide a survivable communications link between national decision-makers and the nation's strategic forces. An airborne command post, the E-6B enables the president and the SecDef to directly contact crews on the nation's ballistic missile submarines, land-based intercontinental ballistic missiles and long-range bombers. E-6B aircraft are assigned to Strategic Communications Wing One, Tinker AFB, OK.
- **Ballistic Missile Submarines:** Considered the most survivable leg of the nation's strategic forces, Navy ballistic missile submarines, or SSBNs, provide launch capability from around the globe using the Trident missile weapon system. Atlantic SSBNs are based at Naval Submarine Base Kings Bay, GA., with headquarters at Commander, Submarine Forces U.S. Atlantic Fleet, Naval Station Norfolk, VA; Pacific SSBNs are based at Naval Submarine Base Bangor, WA, with headquarters at Commander Submarine Forces U.S. Pacific Fleet, Naval Base Pearl Harbor, Hawaii.
- **Strategic Bomber and Reconnaissance Aircraft:** Aircraft assigned to Air Force Global Strike Command's 8th Air Force at Barksdale AFB, LA, are capable of deploying air power to any area of the world. B-52 Stratofortress heavy bombers are based at Barksdale AFB, LA and Minot AFB, ND. B-2 Spirit stealth bombers are stationed at Whiteman AFB, MO. Worldwide reconnaissance aircraft assigned to Air Combat Command's 12th Air Force that support the USSTRATCOM mission include the RC-135 Rivet Joint at Offutt AFB, NE and

the U-2S Dragon Lady and RQ-4 Global Hawk at Beale AFB, CA.

- **Land-based Intercontinental Ballistic Missiles:** Air Force ICBMs, dispersed in hardened silos across the nation's central tier, provide a quick-reacting and highly reliable component to the nation's strategic forces. Minuteman III missile launch control centers are based from F.E. Warren AFB, WY; Malmstrom AFB, MT.; and Minot AFB, ND. ICBM crews report to 20th Air Force, F.E. Warren AFB.

USSTRATCOM Headquarters Organizational Structure

- **J0 The office of the Commander and the staff support agencies**—establishes the goals, mission, vision and leadership of the command. To help the commander, the immediate staff also includes the deputy commander in chief and a group of special advisers.
- **J1 (Manpower and Personnel)**—develops and administers USSTRATCOM manpower and personnel policies, human resources and personnel assignment programs.
- **J2 (Intelligence)**—apprises the commander of foreign situations and intelligence issues relevant to current operational interests and potential national security policies, objectives and strategy. This includes providing indications, warning and crisis intelligence support, supporting unified command intelligence requirements, developing doctrine, developing joint architecture, coordinating support requirements and providing targeting support.
- **J3 (Global Operations)**—coordinates the planning, employment and operation of DOD strategic assets and combines all current operations, global command and control and intelligence operations.
- **J4 (Logistics)**—Plans, coordinates and executes logistics functions for mobility, maintenance, engineering, readiness and sustainment and munitions management in support of command missions.
- **J5 (Plans and Policy)**—responsible for coordinating the development and implementation of national security policy as it applies to the command and the execution of its mission. Develops future concepts and policy formulation for military space operations; global strike; information operations; global missile defense; and command and control, communications, computers, intelligence, surveillance and reconnaissance as outlined in the most recent Unified Command Plan. Integrates and synchronizes deliberate planning efforts across all

USSTRATCOM missions. Prepares and maintains the nation's strategic nuclear war plan, and provides integrated global strike planning to deliver rapid, extended range, precision kinetic (nuclear and conventional) and non-kinetic (elements of space and information operations) effects in support of theater and national objectives. Performs day-to-day activities required for crisis-action and deliberate planning and execution, with updates to plans as necessary.

- **J6 (C4 Systems)**—coordinates, facilitates, monitors and assesses systems, networks and communications requirements.
- **J7 (Joint Exercises and Training)**—manages USSTRATCOM Commander's Joint Training Program and Exercise Program in order to ensure readiness to perform the command's missions.
- **J8 (Capability and Resource Integration)**—conducts force management and analysis to include integrating, coordinating, prioritizing, and advocating USSTRATCOM future concepts, mission capability needs, weapons system development, support for emerging technologies, and command and control architecture across the mission areas. Responsible for the articulation and development of all command requirement processes to ensure that USSTRATCOM has the tools to accomplish its mission, and ensures appropriate decision support tools and assessment processes are in place to enhance operational capabilities. The directorate includes comptroller support, concepts and experimentation, and force assessments. USSTRATCOM exercises command authority over various task forces and service components in support of the command's mission. During day-to-day operations, service component commanders retain primary responsibility for maintaining the readiness of USSTRATCOM forces and performing their assigned functions. Their primary function is to provide organized, trained, and equipped forces for employment when called upon to support USSTRATCOM's global mission.
- **J9 (Mission Assessment and Analysis)**—conducts operational and strategic assessments and leverages industry, academia, U.S. Government agencies, and Allies to improve USSTRATCOM's warfighting capabilities.
- **J10 (Reserve Directorate)**—advises CDRUSSTRATCOM and staff on matters related to the Army, Navy, Marine Corps, and Air Force Reserve Personnel assigned and attached to USSTRATCOM.

As the Department of Defense's key advocate for global capabilities, the command has extensive ties with defense agencies, the Department of Energy's national laboratories, and other sources of support. Through its many contacts and interagency relationships, the command facilitates planning, enhances information sharing between the military and other government agencies and streamlines decision making.

Reference:

- www.stratcom.mil

3.5.9 United States Transportation Command (USTRANSCOM)



United States Transportation Command, located at Scott AFB, IL, was established in 1987. As the single manager of America's global defense transportation system, USTRANSCOM is tasked with the coordination of people and transportation assets to allow our country to project and sustain forces, whenever, wherever, and for as long as they are needed.

Every day, across the globe, USTRANSCOM provides transportation, sustainment and distribution to our nation's warfighters. USTRANSCOM fully supports and is on the leading edge of DOD transformation efforts for a seamless, wholly integrated, synchronized end-to-end deployment and distribution system under a single unified commander providing responsive, support to the warfighter throughout the continuum of peace and war. These transformational efforts are at the heart of the command's Distribution Process Owner initiatives.

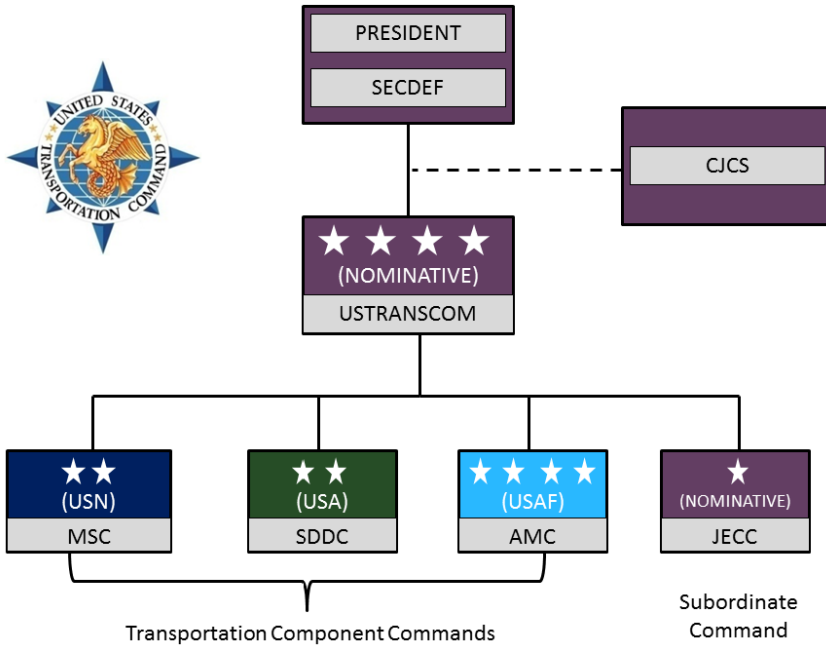

Figure 46: USTRANSCOM Command Relationships

Vision: USTRANSCOM is responsible to synchronize and deliver unrivaled, full-spectrum, deployment and distribution solutions.

Mission: Develop and direct the Joint Deployment and Distribution Enterprise (JDDE) to globally project strategic national security capabilities; accurately sense the operating environment; provide end-to-end distribution process visibility; and responsive support of joint, U.S. government and SecDef-approved multinational and non-governmental logistical requirements.

Transportation Assets: At every moment of every day, around the globe, USTRANSCOM's superb force of soldiers, sailors, airmen, Marines, Coast Guardsmen, DOD civilians and commercial partners accomplishes a wide array of joint mobility missions. With its people, trucks, trains, aircraft, ships, information systems and infrastructure, USTRANSCOM provides the U.S. with the most responsive strategic mobility capability the world has ever seen. USTRANSCOM currently controls a fleet of military assets valued in excess of \$52 billion, including: 87 ships; 1,269 aircraft; 2,150 railcars and assorted equipment, and \$1.4 billion in infrastructure, as well as access through

our commercial partners to more than 1,001 aircraft and 360 vessels in the Civil Reserve Air Fleet (CRAF) and Voluntary Intermodal Sealift Agreement (VISA), respectively.

Military Workforce and Commercial Partners: USTRANSCOM's total wartime capability consists of a diverse force: 51,853 active duty; 88,089 reserve and Guard, and 16,606 civilian personnel. Similarly, USTRANSCOM relies on its commercial partners to meet 88 percent of continental U.S. land transport, 50 percent of global air movement, and 64 percent of global sealift.

DOD Distribution Process Owner: Since becoming DOD's Distribution Process Owner in September 2003, USTRANSCOM is the single entity to direct and supervise execution of the strategic distribution system. The command also manages the supply chain related Information Technology systems, and has the authority to establish a contracting activity for procurement of commercial transportation services. As Distribution Process Owner, USTRANSCOM is DOD's supply chain manager and responsible for the entire distribution process—not just the old "port-to-port" portion. The command is expanding supply chain visibility and is crafting a true sense-and-respond logistics reach all the way back to suppliers and forward to the point of the spear in combat. For the first time in history, with the cooperation and collaboration of all players—DOD, the Services, the Defense Logistics Agency, the Joint Chiefs of Staff and commercial partners—supported commands have a truly synchronized, visible, and simplified distribution pipeline. USTRANSCOM is committed to the continuing advantages that this provides them.

Global Distribution Synchronizer: Provides responsibility for the alignment of distribution planning and related activities of the other combatant commands, Services, Defense agencies and activities to facilitate coordinated and decentralized execution across geographic boundaries.

Component Commands

USTRANSCOM's three Service component commands—the Air Force's Air Mobility Command, Scott AFB, IL; the Navy's Military Sealift Command, Washington, DC; and the Army's Military Surface Deployment and Distribution Command, Scott AFB, IL—provide intermodal transportation across the spectrum of military operations.



Air Mobility Command (AMC)—Provides strategic and tactical airlift, air refueling, and aeromedical evacuation services for deploying, sustaining and redeploying U.S. forces wherever they are needed. Many special duty and operational support aircraft are also assigned to AMC (including Air Force One). In addition, AMC contracts with commercial air carriers through Civil Reserve Air Fleet (CRAF) and other programs for movement of DOD passengers and cargo. AMC's air fleet provides swift response as an element of America's global reach.



Military Sealift Command (MSC)—Provides sealift transportation services to deploy, sustain and redeploy U.S. forces around the globe. MSC provides sealift with a fleet of government-owned and chartered U.S.-flagged ships. MSC executes VISA contracts for chartered vessels. Sealift ships principally move unit equipment from the U.S. to theaters of operation all over the world. In addition to sealift ships, MSC operates a fleet of prepositioned ships strategically placed around the world and loaded with equipment and supplies to sustain Army, Navy, Marine Corps, Air Force and Defense Logistics Agency operations. These ships remain at sea, ready to deploy on short notice, which significantly reduces the response time for the delivery of urgently needed equipment and supplies to a theater of operation.



Surface Deployment and Distribution Command (SDDC)—Provides ocean terminal, commercial ocean liner service and traffic management services to deploy, sustain and redeploy U.S. forces on a global basis. The command is responsible for surface transportation and is the interface between DOD shippers and the commercial transportation carrier industry. This includes movement of DOD member household goods and privately owned vehicles. SDDC is the nation's largest customer to the moving industry with more than 500,000 household goods moves a year. The command also provides transportation for troops and materiel to ports of departure in the U.S. and overseas and manages 24 ports worldwide, including military terminals at Sunny Point, NC, and Concord, CA.

Subordinate Command

USTRANSCOM's joint subordinate command Joint Enabling Capabilities Command employs and manages joint enabling capabilities for global response force execution and emerging operational requirements.



Joint Enabling Capabilities Command (JECC): Provides joint force commanders with distinct capabilities that offer short-duration support to establish, organize and operate a joint force headquarters. The JECC combines capabilities across six unique functional areas to bring tailored, mission-specific and high demand forces to a joint force commander within hours of notification. The mission is to employ, manage and develop existing joint enabling capabilities as well as identifying new requirements and developing new capabilities for joint force commanders worldwide.

Operations Tempo: During an average week, USTRANSCOM and its component commands operate in 75 percent of the world's countries, conduct more than 1,900 air missions (including medical air- evacuation and transportation for the president and other VIPs), have 25 ships underway, and track 10,000 ground shipments.

Internal Organization

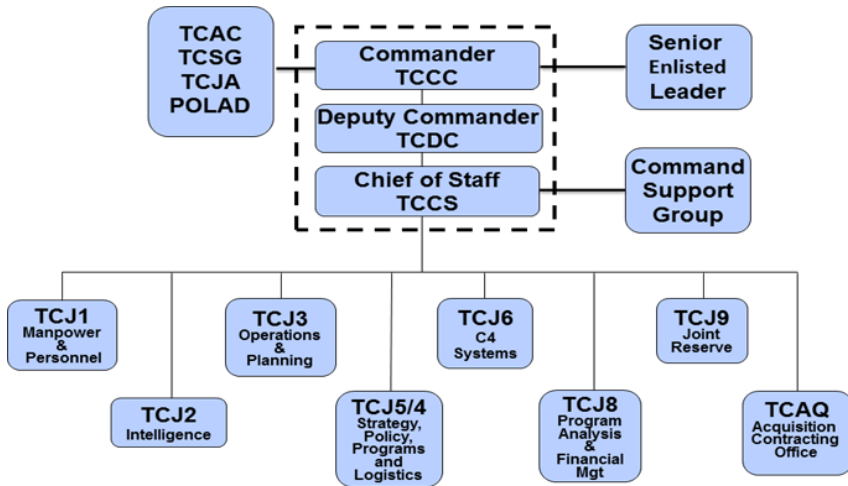

Figure 47: USTRANSCOM Internal Organization

Command Support Group (TCCC)—Commander (TCCC), Deputy Commander (TCDC), Chief of Staff (TCCS), Senior Enlisted Leader (TCCC-SEL), Command First Sergeant (TCCS-FS), Joint Secretariat (TCCS-JS), Protocol (TCCS-P), Public Affairs (TCPA), Research Center/Historian (TCRC), Inspector General (TCIG), Information Management (TCCS-IM), Joint Interagency Coordination Group (JIACG), Chaplain (TCCC-HC), Legislative Affairs (TCCC-LA),

Commander's Action Group (TCCC-X), Command Change Management (TCCS-CM).

Joint Distribution Process Analysis Center (TCAC)—Provides Analysis and Engineering Support to Improve the Nation's Ability to Move and Sustain the Joint Force and Operate the Joint Deployment and Distribution Enterprise (JDDE).

Command Acquisition (TCAQ)—serves as business adviser to and external liaison with AMC, MSC, SDDC, acquisition components and other contracting agencies. TCAQ provides expertise on various acquisition policies, procedures, and strategies to Department of Defense organizations, federal agencies, and the commercial transportation industry. TCAQ analyzes and proposes acquisition-related legislative and regulatory changes to increase the efficiency and effectiveness of the Defense Transportation System (DTS). TCAQ also ensures compliance with these regulations. TCAQ serves as the focal point for TRANSCOM acquisition by managing the command's internal acquisition and contracting process. Additionally, the Acquisition Chief chairs both the Defense Acquisition Regulation (DAR) Council Transportation Committee and the Acquisition Strategy Review Panel (ASRP).

Staff Judge Advocate (TCJA)—Provides legal expertise in its Core Competency of Transportation Law for USTRANSCOM and DOD. Provides full spectrum of legal services to the command to include transportation acquisition, fiscal, international, personnel, military justice, environmental, operations and Law of War, intellectual property, administrative law, and transportation related insurance law.

Command Surgeon (TCSG)—The Command Surgeon's Office, in addition to providing normal Headquarters staff functions, serves as DOD's single manager for the development of policy and standardization of procedures and information support systems for global patient movement.

Manpower & Personnel (TCJ1)—Develops plans, policies, and procedures for the administration of the command's manpower and personnel programs, provides personnel support services, manages individual training and advises the Commander on all matters concerning military and civilian personnel relating to the mission of USTRANSCOM.

Intelligence Directorate (TCJ2)—Responsible for all peacetime and

wartime intelligence activities for USTRANSCOM and subordinate Transportation Component Commands. Develops intelligence policy, programs, doctrine, organizational concepts and implementation strategies; directs development and implementation of intelligence support to USTRANSCOM's global operations, plans, Crisis Action Teams (CAT), exercises and deployments. Directs the development and implementation of coherent transportation intelligence to support USTRANSCOM's global mobility mission as part of U.S. national security policy. Directs operational intelligence activities, including threat and transportation intelligence analysis and dissemination, to meet the needs of USTRANSCOM and supported command mobility forces.

Operations and Plans Directorate (TCJ3)—Directs and synchronizes the Defense Transportation System with national distribution processes to meet national security objectives; maintains command and control of strategic forces and logistics infrastructure. TCJ3 sets operations policy and conducts crisis action and adaptive planning to deploy/sustain forces and directs and monitors process improvements for global Distribution Process Owner (DPO) operations. TCJ3 is primarily responsible to develop and design the operational architecture and integrate the Automated Information Systems (AIS) and other Information Technology (IT) capabilities to support global warfighting requirements. It acts as the DOD functional proponent for In-Transit Visibility and schedules/manages all CONUS Operational Support Airlift (OSA) in support of DOD wartime readiness requirements.

Strategy, Policy, Programs & Logistics Directorate (TCJ5/4)—The Strategy, Policy, Programs, and Logistics Directorate is the center of the United States Transportation Command's strategic planning, logistics, and policy efforts. The Directorate is forward-looking, working to enhance the U.S. military's deployment and distribution capabilities. As part of USTRANSCOM, the Directorate measures its success by the service it provides to the American Warfighter.

Specifically, the USTC J5/4 Directorate is USTRANSCOM's focal point for future-facing initiatives, including strategic planning, force programming, policy development to ensure readiness and capability to meet current, projected, and emerging requirements. It is the hub for transportation initiatives including organizational developments, process enhancements, advocacy of key enablers, and system developments to advance global Warfighting capabilities.

The USTRANSCOM J5/4 Directorate coordinates with the Office of the

Secretary of Defense, the Joint Staff, unified commands, component commands, other government agencies, and industry to enhance logistic support to the America's Warfighters. The Directorate develops integrated business case analyses and strategies for the command.

The Directorate is the center of the command's coordinating review authority for development of joint doctrine and joint tactics, techniques, and procedures which enhance the nation's strategic transportation system.

The Directorate is USTRANSCOM's lead for the Joint Requirements Oversight Council/Joint Warfighting Capability Assessment issues including advanced concepts of operations, technology development, and mobility modeling and analysis to develop and promote global mobility Warfighting requirements. It is also the lead for the Joint Strategic Capabilities Plan and contingency planning guidance for airlift, sealift, and aerial refueling force apportionments.

Command, Control, Communications, & Computer Systems Directorate (TCJ6)—Plans and programs for, implements, and manages command, control, communications, and computer (C4) systems, products, and services for the U.S. Transportation Command Commander and staff. Additionally, TCJ6 is responsible for long-range planning, policy, technical integration and interoperability, life-cycle support, and program management for major transportation C4 systems DOD-wide.

Program Analysis & Financial Management Directorate (TCJ8)—Responsible for development and integration of command's strategic goals, operational plan, and expected outcomes in budget formulation and management of command resources. Develops command policy and issues guidance on use of command-wide \$10.3 billion Transportation Working Capital Fund (TWCF) budget. Prepares command positions for the USTRANSCOM Commander throughout Planning, Programming and Budgeting (PPBE) and Congressional hearing process. Coordinates and develops USTRANSCOM positions on mobility issues and programs with the Office of the OSD, the Joint Staff, Commander's, Services and Components. Directorate is the focal point for TWCF policies and procedures in coordination with Component Commanders and OSD. Receives and promulgates OSD funding guidance; develops standardized transportation rates; analyzes and reviews Component rate proposals; reviews and consolidates Component budgets for submission to OSD; defends budget before OSD; and controls the TWCF execution through oversight of

Components. As the single point of contact for all program and financial management issues in USTRANSCOM, TCJ8 advocates and defends programs important to the Defense Transportation System (DTS); performs budgeting and budget execution for USTRANSCOM and the Transportation Component Commands; develops financial management guidance, policy, and procedures for the Transportation Working Capital Fund (TWCF); validates DPO savings and provides financial management advice to the command.

Reserve Component Directorate (TCJ9)—advises the commander on all matters related to Reserve Component support to USTRANSCOM and component commands. TCJ9 will effectively and efficiently provide USTRANSCOM directorates support with trained, ready Reserve Component Forces in support of the USTRANSCOM mission.

Transportation Working Capital Fund (TWCF)

Working Capital Funds (WCFs) are revolving funds that exist to finance government business units and are managed like a commercial business. USTRANSCOM “sells” transportation service to its customers with the intent of recovering the total cost incurred in providing that service. The command uses the “income” from the service to operate the business unit and the basic tenet is to create a customer-provider relationship between USTRANSCOM and its customers. The TWCF helps provide total cost visibility, improves the focus on costs, and stabilizes transportation rates and prices for USTRANSCOM’s customers. In addition the TWCF provides the ability to respond to changes in requirements and operations tempo. The FY11 TWCF cost projection is nearly \$12 billion with 87% of that amount dedicated to operations (government and chartered/leased aircraft and ships, fuel, maintenance, canal/port fees, etc.). Additional information on WCFs may be found in the DOD Financial Management Regulation (DOD 7000.14-R), Volume 2B, Chapter 9.

3.6 Authorities and Legal Requirements Affecting the Combatant Commands

For your staff work you should develop an understanding of specific U.S. Codes, treaties, Memoranda of Understanding (MOUs), Memoranda of Agreement (MOAs) and other binding or legal requirements pertaining to your combatant command. Other federal agencies also use Letters of Intent (LOIs) or Memoranda of Intent (MOIs). Check with your Staff Judge Advocate (SJA) office for specifics associated with your command.

3.6.1 Code of Law of the United States

The Code of Law of the United States, also known as the "U.S. Code," contains 50 titles, each of which covers a subject area such as Agriculture, Labor, and Public, Health and Welfare. The U.S. House of Representatives, Office of Law Revision Counsel prepares the U.S. Code which is published by the Government Printing Office every six years. As each new law is passed, the relevant sections of the code are modified and updated, both in the printed codes and in the online databases.

Some of the titles affecting the combatant commands include:

- **Title 10 of the United States Code**—outlines the role of armed forces. Title 10 establishes the legal basis for the roles, missions and organization of U.S. Department of Defense and each of the Services. Title 10 is subdivided into five areas, each addressing individual elements of the armed forces:
 - Subtitle A – General and Military Law
 - Subtitle B – Army
 - Subtitle C – Navy and Marine Corps
 - Subtitle D – Air Force
 - Subtitle E – Reserve Components
- **Title 14 of the United States Code**—outlines the role of the United States Coast Guard when operating under the Department of Homeland Security and codifies its relationship to the Department of Homeland Security and the Department of the Navy in peace and war.
- **Title 32 of the United States Code**—outlines the role of the United States National Guard—Organization; Personnel; Training; Service, Supply, and Procurement; and Homeland Defense Activities.
- **Title 50 of the United States Code**—outlines the role of War and National Defense, and contains 42 chapters.

References:

- www.businessdictionary.com
- www.ll.georgetown.edu/
- www.senate.gov

3.6.2 Foreign Disclosure and Classification of Information

Foreign Disclosure

Military information is a national security asset which must be conserved and protected and which may be shared with foreign

representatives only when there is a **clearly defined advantage** to the United States. Such disclosures must be consistent with U.S. foreign policy objectives and military security requirements, and be confined to information necessary to the purpose of the disclosure. No foreign government is entitled to receive U.S. classified military information or materiel. However, in recognition that it may be in our national interests to share such information and materiel with our NATO allies and other friendly nations, the National Security Council with the approval of the President, has established a national policy governing the disclosure of classified military information to foreign governments and international organizations. It is United States policy to avoid creating false impressions of its readiness to make defense articles, technologies, services or information available. Only designated Foreign Disclosure Officers (FDOs) may approve the disclosure of classified and controlled unclassified military information to foreign representatives.

The Foreign Disclosure process provides timely decisions on the disclosure or release of U.S. Classified Military Information (CMI), and Controlled Unclassified Information (CUI) to foreign entities in support of national interests. In support of this process, the staff officer must follow guidelines set out by the command's FDO office.

Classified Military Information (CMI)

CMI is information which is originated by or for the DOD or its Components or is under their jurisdiction or control and which requires protection in the interests of national security. It is designated TOP SECRET, SECRET and CONFIDENTIAL as described in E.O. 12958. Classified military information may be disclosed in oral, visual, or documentary form and is divided into eight categories:

- Category 1: Organization, Training and Employment of Military Forces
- Category 2: Military Materiel and Munitions
- Category 3: Applied Research and Development Information
- Category 4: Production Information
- Category 5: Combined Military Operations, Planning and Readiness
- Category 6: U.S. Order of Battle
- Category 7: North American Defense
- Category 8: Military Intelligence.

Controlled Unclassified Information (CUI)

Controlled unclassified information is a new category of unclassified information that replaced the various categories used for sensitive but

unclassified information. CUI is unclassified information relating to the interests of the U.S. federal government or outside entities it believes should be protected. As such, DOD CUI must go through the FDO process before disclosure or release to foreign government entities or NGOs.

Disclosure Decisions

The National Disclosure Policy establishes the framework in which foreign disclosure decisions are made by Principal or Designated Disclosure Authorities. It is derived from the requirements of the Arms Export Control Act (AECA) E.O. 12958, and National Security Decision Memorandum (NSDM) 119.

Disclosure Authority

The SecDef and the Deputy SecDef hold original authority to disclose CMI and grant exceptions to disclosure policy. The SecDef, through DOD Directive 5230.11 has delegated authority to the following DOD officials to disclose CMI originated by or under the control of their organizations:

- The Secretaries of the Military Departments.
- The Chairman of the Joint Chiefs of Staff.
- The Under Secretary of Defense for Policy.
- The Under Secretary of Defense for Acquisition, Technology and Logistics.
- The Assistant Secretary of Defense for Networks and Information Integration.
- The Director, Defense Intelligence Agency.
- The Director, National Security Agency/Central Security Service.

Each of these officials must appoint a senior official in writing to be the Principal Disclosure Authority (PDA) within that Component. They may also delegate disclosure authority to the heads of commands, agencies and major staff elements under their authority. These heads of commands, agencies and major staff elements must then in turn appoint a Designated Disclosure Authority (DDA) to control disclosures of CMI by his or her organization.

Classification of Information

It is DOD policy that:

- National security information shall be classified, safeguarded, and declassified in accordance with national level policy issuances;
- Declassification of information shall receive equal attention with

classification so that information remains classified only as long as required by national security considerations;

- Information may not be classified or designated CUI to:
 - Conceal violations of law, inefficiency, or administrative error;
 - Prevent embarrassment to a person, organization, or agency;
 - Restrain competition; or
 - Prevent or delay the release of information that does not require protection in the interests of national security or as required by statute or regulation.
- The volume of classified national security information and CUI, in whatever format or media, shall be reduced to the minimum necessary to meet operational requirements;
- The DOD Information Security Program, established to assure the protection of collateral, Sensitive Compartmented Information (SCI), Special Access program (SAP), and Controlled Unclassified Information (CUI), shall harmonize and align processes to the maximum extent possible to promote information sharing, facilitate judicious use of scarce resources, and simplify its management and implementation;
- SCI shall be safeguarded in accordance with policies and procedures established by the DNI;
- Classified information released to industry shall be safeguarded in accordance with DODD 5220.22;
- Responsibilities for protecting classified and CUI from unauthorized disclosure shall be emphasized in DOD Component training programs;
- Consistent with applicable laws, partnerships with appropriate DOD, government, industry, professional, academic, and international organizations should be established and fostered to gain insights to approaches, technologies, or techniques that may be of use in establishing common security practices and improving the DOD Information Security Program.

Original vs. Derivative Classification

Original classification is the decision to designate a certain item of information as classified, at a particular level, and for a certain duration of time. Often these decisions are communicated in a published Security Classification Guide (SCG). These decisions can only be made by persons designated in writing as Original Classification Authorities (OCA).

Derivative classification is the incorporating, restating, paraphrasing, or generating in new form, information that has already been determined to be classified, and ensuring that it is classified and handled at the level that the OCA has already determined will be done. Derivative classification can be accomplished by any properly cleared personnel. Derivative classifiers are not required to be appointed or designated unless so directed by command option.

To review classifications and classification markings, refer to the Controlled Access Program Coordination Office (CAPCO) website on SIPRNet.

Reference:

- *National Disclosure Policy*

3.7 Knowledge, Organization, Capabilities and Business Practices of the Services

3.7.1 The Department of the Army



It is the intent of Congress to provide an Army that is capable, in conjunction with the other armed forces, of—

- (1) preserving the peace and security, and providing for the defense, of the United States, the Territories, Commonwealths, and possessions, and any areas occupied by the United States;*
- (2) supporting the national policies;*
- (3) implementing the national objectives; and*
- (4) overcoming any nations responsible for aggressive acts that imperil the peace and security of the United States.*

Title 10, U.S. Code, Section 3062 (a)

Title 10 of the United States Code states the purpose of Congress in establishing the Army and its guidance on how the Army is to be organized, trained, and equipped. Title 10 states that the Army includes land combat and service forces, and organic aviation and water transport. Army forces are to be organized, trained, and equipped primarily for prompt and sustained combat incident to operations on land. The Army is responsible for preparing the land forces necessary to effectively prosecute war except as otherwise assigned. It is also responsible, in accordance with integrated joint mobilization plans, for its expansion to meet the needs of war.

The Army exists to serve the American people, protect enduring national interests, and fulfill the Nation's military responsibilities.

Specifically, the Army mission is to provide to combatant commanders the forces and capabilities necessary to execute the National Security, National Defense, and National Military Strategies.

Army forces provide the capability—by threat, force, or occupation—to promptly gain, sustain, and exploit comprehensive control over land, resources, and people. This landpower capability compliments the other Services' capabilities. Furthermore, the Army is charged to provide logistic and other support agent functions to enable the other Services to accomplish their missions. The Army is organized to accomplish this mission.

Soldiers are the centerpiece of Army organizations. Professional Soldiers—warriors well trained, well equipped, and well led—serve as the ultimate expression of what the Army provides to the Nation and the joint force. They are the engine behind Army capabilities. However, the Army is more than a collection of individuals. It is a complex institution comprising many diverse types of organizations. Its Soldiers are both “full-time” Regulars and Reserve Component citizen-Soldiers. Army civilians are members of the force as well, serving in leadership and support functions at all levels. The Army is all these people and organizations, united by a common purpose in service to the Nation. In addition, civilian contractors augment Army organizations, providing specialized support that sustains readiness and operations.

The spectrum of conflict is the backdrop for Army operations. It places levels of violence on an ascending scale marked by graduated steps. The spectrum of conflict spans from stable peace to general war. It includes intermediate levels of unstable peace and insurgency. In practice, violent conflict does not proceed smoothly from unstable peace through insurgency to general war and back again. Rather, general war and insurgencies often spark additional violence within a region, creating broad areas of instability that threaten U.S. vital interests. Additionally, the level of violence may jump from one point on the spectrum to another. For example, unstable peace may erupt into general war, or general war may end abruptly in unstable peace. Therefore, the four levels are not an exclusive set. Nonetheless, the spectrum of conflict provides a tool to understand and visualize the level of violence and the corresponding role of the military in resolving a conflict.

Army forces affect the operational environment as they operate to accomplish their mission. Commanders seek to establish conditions

favorable for conducting subsequent operations and tasks. They consider not only their follow-on missions but also how to restore a stable peace. If stable peace is not readily attainable, commanders design operations so that in the end, they lower the violence level as much as possible. When operating anywhere on the spectrum, commanders and staffs consider how to move the level of violence toward stable peace.

Military power cannot, by itself, restore or guarantee stable peace. It must, however, establish global, regional, and local conditions that allow the other instruments of national power—diplomatic, informational, and economic—to exert their full influence. For example, the Nation's air, land, and sea power deter threats posed by hostile powers by holding their homeland and vital interests at risk. This creates avenues for diplomacy to resolve disputes. Multinational forces may separate warring factions to stop a civil war that threatens regional peace. Their actions allow international aid organizations to reach masses of refugees and an international commission to seek some sort of equitable settlement. On a local level, an Army task force suppresses terrorism and lawlessness so other government agencies can work freely with host-nation officials to restore self-sustaining governance. In each case, achieving stable peace requires expertise and capabilities beyond those developed in the military force. Every use of military force to restore stable peace requires the other three instruments of national power. Conversely, diplomatic, informational, and economic efforts to restore a stable peace are usually futile unless backed by effective military power, military power with global reach and endurance. In every campaign and major operation, success, as characterized by a stable peace, depends on unified action involving concerted efforts by multinational military and civilian partners.

The Army Staff, an executive component of the Department of the Army, exists to assist the Secretary of the Army in his/her responsibilities, and includes:

- Chief of Staff
- Vice Chief of Staff
- Director of the Army Staff
- Deputy Chiefs of Staff: G-1, Human Resources; G-2, Intelligence; G-3/5/7, Operations, Plans and Training; G-4, Logistics; G-6, Chief Information Officer; G-8, Programs
- Assistant Chief of Staff: Installation Management
- Special Staff
 - Chief of Engineers
 - Surgeon General

- Judge Advocate General
- Chief of Chaplains
- Chief, National Guard Bureau
- Chief, Army Reserve
- Provost Marshall General

Army Modernization

Land campaigns predominately involve the Army. During campaigns, Army forces combine offensive, defensive, and stability or civil support operations simultaneously as part of an interdependent joint force to seize, retain, and exploit the initiative, accepting prudent risk to create opportunities to achieve decisive results. The types of operations vary according to the JFC's campaign design. The Army's ability to conduct sustained operations allows it to preserve the gains achieved during joint operations. If necessary, the other instruments of national power can then be used to achieve the strategic objectives. Army forces are able to remain until the strategic goals are met, thus making permanent the effects of joint operations.

Future conflicts, more than likely, will be joint expeditionary operations conducted with little-to-no warning, in austere theatres, and with incomplete planning information. Therefore, the cornerstone of Army capabilities is the Brigade Combat Team (BCT). BCTs are modular organizations that provide the division, Land Component Commander (LCC), or Joint Task Force (JTF) commander with close combat capabilities. BCTs are the primary organizations for fighting tactical engagements and battles. There are three types of BCTs:

- Heavy
- Infantry
- Stryker

All BCTs include maneuver, fires, reconnaissance, sustainment, military intelligence, military police, signal, and engineer capabilities.

BCTs often operate as part of a division. The division acts as a tactical headquarters that can control up to six BCTs in high- or mid-intensity combat operations, plus a number of supporting brigades. These supporting brigade types include the combat aviation brigade, the battlefield surveillance brigade (or the reconnaissance, surveillance and target acquisition brigade), the maneuver enhancement brigade, the fires brigades, and the sustainment brigade. These brigades support BCTs and carry out specific tasks in support of echelons above BCTs.

After ten years at war, the Army continues to confront a series of complex, dynamic, and unanticipated challenges to both our national security and the collective security of our allies and partners. These challenges are occurring in many forms and will be waged across the spectrum of conflict—ranging from peaceful competition to general war, and at all points in between, and in all domains: land, sea, air, space, and cyberspace.

In this uncertain and dynamic environment, the Army's mission endures: protect the Nation by providing ground forces to conduct prompt and sustained operations across the spectrum of conflict in support of combatant commanders and U.S. Code, Title 10 statutory requirements. To meet this requirement, the Army will: prevail in today's wars, prevent and deter conflict, prepare to defeat adversaries and succeed in a wide range of contingencies, and preserve and enhance the All-Volunteer Force.

References:

- www.army.mil
- Field Manual (FM) 1, The Army (<http://www.army.mil/fm1/>)
- 2011 Army Strategic Planning Guidance (http://usarmy.vo.llnwd.net/e1/info/references/docs/2011%20ASPG_25%20Mar_Signed.pdf)

3.7.2 The Department of the Navy



Functions of the Department of the Navy

The Department of the Navy is composed of naval, land, air, space, and cyberspace forces, both combat and support, not otherwise assigned, to include those organic forces and capabilities necessary to operate, and support the Navy and Marine Corps, the other Military Services, and joint forces. The Navy and Marine Corps comprise the Nation's principal maritime force. They employ the global reach, persistent presence through forward-stationed and rotationally-based forces, and operational flexibility to secure the Nation from direct attack; secure strategic access and retain global freedom of action; strengthen existing and emerging alliances and partnerships; establish favorable security conditions; deter aggression and violence by state, non-state, and individual actors and, should deterrence fail, prosecute the full range of military operations in support of U.S. national interests.

The functions of the Navy within the Department of the Navy are:

- The Navy, within the Department of the Navy, shall develop

- concepts, doctrine, tactics, techniques, and procedures and organize, train, equip, and provide forces.
- Conduct offensive and defensive operations associated with the maritime domain including achieving and maintaining sea control, to include subsurface, surface, land, air, space, and cyberspace.
 - Provide power projection through sea-based global strike, to include nuclear and conventional capabilities; interdiction and interception capabilities; maritime and/or littoral fires, to include naval surface fires; and close air support for ground forces.
 - Conduct ballistic missile defense.
 - Conduct riverine operations.
 - Establish, maintain, and defend sea bases in support of naval, amphibious, land, air, or other joint operations as directed.
 - Provide naval expeditionary logistics, to include joint sea bases, and provide sea transport for the Armed Forces other than that organic to the individual Military Services and USSOCOM.
 - Provide support for joint space operations to enhance naval operations, in coordination with the other Military Services, combatant commands, and U.S. Government departments and agencies.
 - Conduct nuclear operations in support of strategic deterrence, to include providing and maintaining nuclear surety and capabilities.

The functions of the Marine Corps within the Department of the Navy are:

- Pursuant to Section 5063 of Title 10 USC, the Marine Corps, within the Department of the Navy, shall develop concepts, doctrine, tactics, techniques, and procedures and organize, train, equip, and provide forces, normally employed as combined arms air ground task forces, to serve as an expeditionary force-in-readiness.
- Seize and defend advanced naval bases or lodgments to facilitate subsequent joint operations
- Provide close air support for ground forces.
- Conduct land and air operations essential to the prosecution of a naval campaign or as directed.
- Conduct complex expeditionary operations in the urban littorals and other challenging environments.
- Conduct amphibious operations, including engagement, crisis response, and power projection operations to assure access.

The Marine Corps has primary responsibility for the development of amphibious doctrine, tactics, techniques, and equipment.

- Conduct security and stability operations and assist with the initial establishment of a military government pending transfer of this responsibility to other authority.
- Provide security detachments and units for service on armed vessels of the Navy, provide protection of naval property at naval stations and bases, provide security at designated U.S. embassies and consulates, and perform other such duties as the president or the SecDef may direct. These additional duties may not detract from or interfere with the operations for which the Marine Corps is primarily organized.

The functions of the Coast Guard when operating within the Department of the Navy are:

- As directed by the president, and in accordance with the Memorandum of Agreement between DOD and the Department of Homeland Security (DHS) on the use of Coast Guard Capabilities and Resources in Support of the National Military Strategy, the Department of the Navy shall coordinate with DHS regarding Coast Guard military functions in time of limited war or defense contingency, without transfer of Coast Guard authority to the Secretary of the Navy. As directed, the Department of the Navy will provide intelligence, logistical support, and specialized units to the Coast Guard, including designated ships and aircraft, for overseas deployment required by naval component commanders, maritime search and rescue, integrated port security, and coastal defense of the United States. The Coast Guard shall maintain a state of readiness to function as a specialized Military Service in the Department of the Navy in time of war or national emergency. If specified in a declaration of war by Congress or if directed by the president, the Coast Guard shall operate as a Military Service in the Department of the Navy, and shall continue to do so until the president transfers the Coast Guard back to DHS by Executive Order pursuant to Section 3 of Title 14 USC.
- The Coast Guard shall organize, train, equip, and provide forces to perform the following specific functions when providing direct or cooperative support to DOD:
 - Conduct coastal sea control, maritime and air interception, and interdiction operations.
 - Conduct maritime homeland security and counterterrorism operations.

- Provide for port operations, security, and defense.
- Provide maritime operational threat response.
- Conduct counter-illicit trafficking operations.
- Conduct military environmental response operations.
- Conduct theater security cooperation operations.
- Conduct search and rescue operations.
- Conduct ice operations.
- Provide for marine safety, including aids to navigation.
- The Coast Guard will coordinate with DOD, including the Department of the Navy, to provide specialized Coast Guard units, or obtain Navy units, including designated ships and aircraft, for deployment as requested by Military Service component or joint commanders.

Organization

The Chief of Naval Operations (CNO) is the senior military officer in the Navy. The CNO is a four-star admiral and is responsible to the Secretary of the Navy for the command, utilization of resources and operating efficiency of the operating forces of the Navy and of the Navy shore activities assigned by the Secretary. A member of the Joint Chiefs of Staff, the CNO is the principal naval advisor to the president, the Secretary of Defense and the Secretary of the Navy on the conduct of war, and is the principal advisor and naval executive to the Secretary of the Navy on the conduct of naval activities of the Department of the Navy. Assistants are the Vice Chief of Naval Operations (VCNO), the Deputy Chiefs of Naval Operations (DCNOs) and a number of other ranking officers. These officers and their staffs are collectively known as the Office of the Chief of Naval Operations (OPNAV). OPNAV is organized as follows:

- Chief of Naval Operations (N00)
- Vice Chief of Naval Operations (N09)
- Deputy Chiefs of Naval Operations for:
 - DCNO Manpower, Personnel, Education and Training / Chief of Naval Personnel (N1)
 - DCNO Information Dominance (N2/N6)
 - DCNO Operations, Plans & Strategy (N3/N5)
 - DCNO Fleet Readiness & Logistics (N4)
 - DCNO Integration of Capabilities & Resources (N8)
- Assistant Chief of Naval Operations for:
 - ACNO for Next Generation Enterprise Network System Program Office (NGEN SPO)
- Directors or Chiefs of:
 - Director, Navy Staff (DNS)
 - Director, Naval Nuclear Propulsion Program (N00N)

- Director, Test and Evaluation and Technology Requirements (N091)
- Director, Quadrennial Defense Review Integration Group (Navy QDR)
- Chief of Navy Reserve (N095)
- Surgeon General (N093)
- Chief of Chaplains (N097)
- Master Chief Petty Officer of the Navy (MCPON)

The CNO also oversees the training and equipping of the operating forces, collectively known as the Fleet, with the exception of units of the Fleet Marine Forces (FMF) that fall under the purview of the Commandant of the Marine Corps. This oversight is conducted via the Commander, Fleet Forces Command (CFFC), a 4-star admiral principally assisted by three 3-star Type Commanders (TYCOMs): Commander, Naval Air Forces (COMNAVAIRFOR); Commander, Naval Surface Forces (COMNAVSURFOR); and Commander, Naval Submarine Forces (COMNAVSUBFOR).

The United States depends upon transoceanic links (both commercial and military) to protect its strategic interests and to maintain relationships with allies and trading partners. The U.S. Navy and U.S. Marine Corps provide organized, trained and equipped forces to promote and defend U.S. national interests by maintaining maritime superiority; contributing to regional stability; conducting operations, on and from the sea; and providing logistic support to other forces. At the operational level of war, the JFC tasks the Navy-Marine Corps team to respond in a unilateral, joint or combined role. Naval forces can function within a JTF in two ways: as a Navy Service component (with or without Marine Corps units or forces), or as a joint force maritime component.

In October 2007, the CNO, the Commandant of the Marine Corps and the Commandant of the Coast Guard signed ***A Cooperative Strategy for 21st Century Seapower*** (CS-21). A subordinate document to CS-21, ***Naval Operating Concepts 2010*** (NOC 2010), describes when, where and how U.S. naval forces will contribute to preventing conflict and prevailing in war in order to guide Maritime Strategy implementation in a manner consistent with national strategy.

These documents define the Naval Service as comprised of the Active and Reserve Components of the United States Navy, United States Marine Corps, and United States Coast Guard, operating in the maritime domain, consisting of the oceans, seas, bays, estuaries,

islands, coastal areas and the airspace above these, including the littorals. In this manner, the Naval Service provides the U.S. a multi-purpose team whose capabilities are applicable across the range of military operations (ROMO). While most frequently employed to prevent conflict, the Naval Service is manned, trained and equipped to prevail in conflict. This approach is embodied as follows:

- **The Sea as Maneuver Space**

Naval forces use the sea as maneuver space—it is the overarching concept of NOC 10. The Naval Service provides a sea-based force free from reliance on local ports and airfields. Naval forces continuously operate forward—and additional forces surge when necessary—to influence adversaries and project power.

- **Forward Presence**

The Naval Service employs globally distributed, mission-tailored forces to accomplish a wide range of missions that promote stability, prevent crises and combat terrorism; while maintaining the capability to regionally concentrate credible combat power to protect U.S. vital interests; assure friends; and deter, dissuade, and if necessary, defeat adversaries. Persistent forward presence, generated through a combination of forward stationed and rotationally deployed naval forces, provides American policymakers with an expansive range of options to shape and respond to the security challenges of the 21st century.

- **Maritime Security**

Global maritime security can only be achieved through the integration of national and regional maritime cooperation, awareness and response initiatives. To this end, unprecedented coordination among governments, the private sector, and multinational organizations; including naval and maritime security forces, is required. The Naval Service plays a critical role in facilitating this coordination, and is uniquely manned, trained and equipped to help allies and partners develop the maritime professionals, infrastructure, awareness and response capabilities that are a prerequisite for maritime security.

- **Humanitarian Assistance and Disaster Response (HA/DR)**

Operating without reliance on local ports and airfields ashore, both globally-distributed and regionally concentrated naval forces are ideally suited for HA/DR missions, either in the lead or in support of an international effort. Given their forward presence, inherent mobility and flexible capabilities, U.S. naval forces are frequently the “force of choice” for such missions.

- **Sea Control**
Sea control is the foundation of seapower—the ability of U.S. naval forces to establish local and regional sea control is fundamental to exploiting the maritime domain as maneuver space, protecting critical sea lines of communication, and projecting and sustaining combat power overseas. Naval forces achieve sea control by neutralizing or destroying threats in the maritime, space and cyberspace domains that constrain our freedom to maneuver, conduct follow-on missions, or restore maritime security.
- **Power Projection**
Globally distributed, mission tailored naval forces and regionally concentrated naval forces both routinely project power. The character of a power projection operation reflects the mission and the operating environment—permissive, uncertain or hostile. Naval forces must accomplish three major, overlapping tasks to project power:
 - Gain and maintain operational access
 - Conduct littoral maneuver
 - Enable the arrival of Joint or multinational forces
- **Deterrence**
Effective deterrence requires a comprehensive effort that includes all elements of national power. The Naval Service employs a broad set of capabilities to assure partners, dissuade adversaries, and deter or limit hostile action. These include continued nuclear and conventional combat preeminence, as well as new capabilities to deter evolving threats posed by an array of current and potential adversaries.
- **Force Structure**
The Naval Service is employed in a security environment characterized by an increasing number of concurrent, diverse nuclear, conventional and irregular challenges. To this end, the Naval Service is rebalancing its force structure to address the blue, green and brown water threats posed by very capable state adversaries, as well as the maritime security and irregular littoral challenges posed by both state and non-state adversaries. While armed conflicts between states occur infrequently, they are the greatest threat to the United States and demand sufficient numbers of technologically advanced “high-end” capabilities to ensure the United States can effectively deter, dissuade and if necessary defeat a peer competitor.

References:

- DODD 5100.01
- www.navy.mil
- www.navy.mil/navydata/organization/org-cno.asp
- <http://www.navy.mil/maritime/Maritimestrategy.pdf>
- <http://www.navy.mil/maritime/noc/NOC2010.pdf>

3.7.3 The Marine Corps



Functions of the Marine Corps

Specific responsibilities of the Department of the Navy toward the Marine Corps include the maintenance of not less than three combat divisions and three air wings and such other land combat, aviation, and other services as may be organic therein.

Some of the major functions of the Marine Corps are to:

- organize, train, and equip Fleet Marine Forces of combined arms, together with supporting air components, for service with the fleet in the seizure or defense of advanced naval bases and for the conduct of such land operations as may be essential to the prosecution of a naval campaign;
- furnish security detachments and organizations for service on naval vessels of the Navy;
- furnish security detachments for protection of naval property at naval stations and bases;
- perform other duties as the president may direct;
- develop landing force doctrines, tactics, techniques, and equipment that are of common interest to the Army and Marine Corps.

Organization

The Department of the Navy, led by the Secretary of the Navy (SECNAV), oversees both the Marine Corps and the Navy. The **Headquarters, Marine Corps**, in the executive part of the Department of the Navy, furnishes professional assistance to the Secretary of the Navy, accomplishes all Military Department support duties that deal with the Marine Corps, coordinates the action of Marine Corps organizations, prepares instructions for the execution of approved plans, and investigates and reports efficiency of the Marine Corps in support of combatant commands. The most senior Marine officer is the Commandant of the Marine Corps, responsible for organizing, recruiting, training, and equipping the Marine Corps so that it is ready

for operation under the command of the unified combatant commanders.

The Marine Corps is organized into four principal subdivisions: Headquarters Marine Corps (HQMC), the Operating Forces, the Supporting Establishment, and the Marine Forces Reserve (MARFORRES or USMCR). The Headquarters Marine Corps current organization includes the following:

- Commandant of the Marine Corps
- Assistant Commandant of the Marine Corps
- Director Marine Corps Staff
- Deputy Commandants for:
 - Aviation
 - Installation and Logistics
 - Manpower and Reserve Affairs
 - Plans, Policies and Operations
 - Programs and Resources
- Assistant Commandant for Command, Control, Communications, Computers, and Intelligence (C4I)

The Operating Forces are further subdivided into three categories: Marine Corps Forces (MARFOR) assigned to unified commands, Marine Corps Security Forces guarding high-risk naval installations, and Marine Corps Security Guard detachments at American embassies. Under the "Forces for Unified Commands" memo, Marine Corps Forces are assigned to each of the regional unified commands at the discretion of the SecDef with the approval of the president. Since 1991, the Marine Corps has maintained component headquarters at each of the regional unified combatant commands. Marine Corps Forces are further divided into Marine Forces Command (MARFORCOM) and Marine Forces Pacific (MARFORPAC), each headed by a Lieutenant General. MARFORCOM has operational control of the II Marine Expeditionary Force; MARFORPAC has operational control of the I Marine Expeditionary Force and III Marine Expeditionary Force.

The Supporting Establishment includes Marine Corps Combat Development Command (MCCDC), Marine Corps Recruit Depots, Marine Corps Logistics Command, Marine bases and air stations, Recruiting Command, and the Marine Band.

- **Marine Expeditionary Force (MEF):** The MEF is the principal war fighting element in the active force structure of the Marine Corps and is usually commanded by a lieutenant general. The size and composition of a deployed MEF varies depending on

the needs of the mission.

- **Marine Division:** There are three Marine divisions in the active force and one in the reserve. It is the largest Marine ground combat organization of a MEF and is usually commanded by a major general.
- **Marine Expeditionary Brigade (MEB):** A MEB, usually led by a brigadier general, is built around a reinforced infantry regiment, an aircraft group and a Service Support Group. Capable of rapid deployment and employment via amphibious or airlift methods, it is the first echelon of a Marine Expeditionary Force.
- **Marine Expeditionary Unit (MEU):** The smallest task force unit, the MEU has approximately 2,200 personnel and is built around a reinforced infantry battalion, a composite aircraft squadron and a support group. It is commanded by a colonel and is routinely deployed with an Amphibious Ready Group. The ground element of a MEU is a Battalion Landing Team (BLT), comprised of a reinforced infantry battalion of approximately 1,200 Marines, including three Rifle Companies. The aviation unit of a MEU is a reinforced medium helicopter squadron.
- **Marine Aircraft Wing (MAW):** The largest Marine aviation organization of the MEF, each MAW has a unique organizational structure and is commanded by a major general or brigadier general.
- **Marine Aircraft Group (MAG):** Similar to an Air Force Wing and commanded by a colonel, a MAG is the smallest aviation unit that is designed for independent operations.

Operating Forces

While the Marine Corps does not employ any unique combat arms, as a force it has the unique ability to rapidly deploy a combined-arms task force to almost anywhere in the world within days. The basic structure for all deployed units is a Marine Air-Ground Task Force (MAGTF) that integrates a ground combat element, an aviation combat element, and a logistics combat element combat component under a common command element. While the creation of joint commands under the Goldwater-Nichols Act has improved inter-Service coordination between the U.S. Military Services, the Corps' ability to permanently maintain integrated multi-element task forces under a single command provides a smoother implementation of combined-arms warfare principles.

Reference:

- DODD 5100.01, www.usmc.mil

3.7.4 The Department of the Air Force



The Air Force includes aviation and space forces, both combat and service, not otherwise assigned. The Air Force is responsible for the preparation of the air and space forces necessary for the effective prosecution of war and military operations short of war, except as otherwise assigned and, according to integrated joint mobilization plans, for the expansion of the peacetime components of the Air Force to meet the needs of war.

The U.S. Air Force is an integrated air and space force, which operates in a domain stretching from the earth's surface into space. It is directed to "organize, train, equip, and provide forces for the conduct of prompt and sustained offensive and defensive combat operations in the air and space"; and for strategic air and missile warfare. To do this, the Air Force employs its air and space assets—globally and jointly—to achieve strategic, operational, and/or tactical objectives.

Primary Functions of the Air Force

- Organize, train, equip, and provide forces for the conduct of prompt and sustained offensive and defensive combat operations in the air and space—specifically, forces to defend the U.S. against air and space attack, gain and maintain general air and space supremacy, defeat enemy air and space forces, conduct space operations, control vital air areas, and establish local air and space superiority, except as otherwise assigned herein.
- Organize, train, equip, and provide interoperable forces for:
 - appropriate air and missile defense and space control operations, including the provision of forces in accordance with joint doctrines.
 - strategic air and missile warfare.
 - joint amphibious, space, and airborne operations, in coordination with the other Military Services,
 - close air support and air logistic support to the Army and other forces, including airlift, air and space support, resupply of airborne operations, aerial photography, tactical air reconnaissance, and air interdiction of enemy land forces and communications.

- transport for the Armed Forces, except as otherwise assigned.
- in-flight refueling support of strategic operations and deployments of aircraft of the Armed Forces and Air Force tactical operations, except as otherwise assigned.
- operating air and space lines of communications.
- support and conduct of special operations.
- support and conduct of psychological operations.
- provide launch and space support for the Department of Defense, except as otherwise assigned.
- develop, in coordination with the other Services, doctrines, procedures, and equipment employed by Air Force forces in the conduct of space operations.
- provide equipment, forces, procedures, and doctrine necessary for the effective prosecution of electronic warfare operations and, as directed, support of other forces.

In recent years, the Air Force has restructured and reorganized under the **Air Expeditionary Force (AEF)** concept. In it, combat and mobility forces are organized into equal force packages, each with set deployment windows. There are also two on-call Air Expeditionary Wings (AEWs) to handle unexpected crises. The AEF concept allows personnel to plan for deployments, bringing some order to a world with increased operating tempo.

The Air Force will also form an Air and Space Expeditionary Task Force (AETF) to support the JFC. The AETF is scalable in size and normally encompasses all USAF forces assigned or attached to the joint operation. Within the AETF, there will be AEWs, groups, and squadrons, and it will be task organized to meet the needs of the JFC (similar to a MAGTF). These new organizations allow Air Force forces to function within a JTF in two different ways: as an Air Force Service component, or as a joint force air component.

The JFC designates a Joint Force Air Component Commander (JFACC) based on the mission, his concept of operations, the missions assigned to subordinate commanders, forces available, duration and nature of joint air operations desired, and the degree of control of joint air operations required. The JFC assigns JFACC responsibilities to the component commander who has the preponderance of air assets and the ability to plan, task, and control joint air operations; typically this is the Air Force component commander. The U.S. Air Force possesses robust command and control assets and staffs to support the

significantly high sortie rates of a joint air tasking order. In smaller scale contingencies where the sortie rates are lower, the JFACC or Combined Forces Air Component Commander (CFACC) could be a Navy or Marine Corps aviator or flight officer.

The **Air Staff**, an executive part of the Department of the Air Force, assists the Secretary of the Air Force in carrying out his responsibilities and is organized as follows:

- Chief of Staff of the Air Force
- Vice Chief of Staff
- Deputy Chiefs of Staff for: Personnel, Installations and Logistics, Plans and Programs, Air and Space Operations
- Director of Headquarters, Communications and Information
- Assistant Chief of Staff for Intelligence
- Special Staff:
 - Surgeon General
 - Judge Advocate General
 - Chief of Chaplains
 - Director Air National Guard
 - Chief of Safety
 - Director of Manpower and Organization
 - Chief of Security Police
 - Director of Programs and Evaluation
 - Director of Test and Evaluation
 - Civil Engineer
 - Chief of Air Force Reserve
 - Director of Morale, Welfare, Recreation and Services
 - Air Force Historian

References:

- *DODD 5100.01*
- www.af.mil

3.7.5 The Coast Guard



Functions of the U.S. Coast Guard

Founded in 1790—and having participated in every American war since—the U.S. Coast Guard is an armed Service in all respects. It is multi-mission capable—providing unique, complementary capabilities in support of the National Military Strategy. In recent combat operations, Coast Guard forces have provided a valuable capability to JFCs in maritime intercept operations, port operations and security, and coastal sea control. The Coast Guard may also perform its military functions in

times of limited war or defense contingency, in support of naval component commanders, without transfer to the Department of the Navy.

The Coast Guard's extensive peacetime responsibilities for coastal and port maritime functions and a variety of country-to-country operations provide broad-spectrum capabilities for responding to different threats and crises. The Coast Guard maintains a high state of readiness because of its responsibilities for the U.S. Maritime Defense Zones. Moreover, its operational capabilities figure importantly in:

- Small-scale contingencies,
- Humanitarian assistance efforts,
- in support of UN sanctions,
- Port security in overseas theaters,
- Other important crisis response contingencies.

Coast Guard tasks in the maritime aspects of major theater warfare include critical elements of naval operations in littoral regions: port security and safety, military environmental response, maritime interception, coastal sea control, and force protection.

On 1 March 2003, the Coast Guard was transferred to the Department of Homeland Security, the lead federal agency for maritime homeland security and defense. Its strategic objectives within their Maritime Strategy for Homeland Security consist of:

- Preventing terrorist attacks and terrorist exploitation within the U.S. maritime domain;
- Reducing America's vulnerability to terrorism within the U.S. maritime domain;
- Protecting U.S. population centers, critical infrastructure, maritime borders; and port coastal approaches, boundaries, and seams;
- Protecting the U.S. maritime transportation system, while preserving the U.S. maritime domain for legitimate pursuits;
- Minimizing the damage from terrorist attacks and managing the recovery in the U.S. maritime domain, as either the lead or a supporting agency.

The United States Coast Guard is a military, multi-mission, maritime service, with the power to arrest, within the Department of Homeland Security and one of the nation's five armed services. Its core roles are to protect the public, the environment, and U.S. economic and security interests in any maritime region in which those interests may be at risk,

including international waters and America's coasts, ports, and inland waterways.

The United States Coast Guard (USCG) is involved in maritime law, mariner assistance, and search and rescue, among other duties. The smallest armed U.S. service, its stated mission is to protect the public, the environment, and the United States economic and security interests in any maritime region in which those interests may be at risk, including international waters and America's coasts, ports, and inland waterways.

The USCG has a broad and important role in homeland security, law enforcement, search and rescue, marine environmental pollution response, and the maintenance of river, intra-coastal and offshore Aids to Navigation (ATON).

The Coast Guard has five fundamental roles:

- **Maritime Safety:** Eliminate deaths, injuries, and property damage associated with maritime transportation, fishing, and recreational boating.
- **Maritime Security:** Protect America's maritime borders from all intrusions by: (a) halting the flow of illegal drugs, aliens, and contraband into the United States through maritime routes; (b) preventing illegal fishing; and (c) suppressing violations of federal law in the maritime arena.
- **Maritime Mobility:** Facilitate maritime commerce and eliminate interruptions and impediments to the efficient and economical movement of goods and people, while maximizing recreational access to and enjoyment of the water.
- **National Defense:** Defend the nation as one of the five U.S. armed services. Enhance regional stability in support of the National Security Strategy, utilizing the Coast Guard's unique and relevant maritime capabilities.
- **Protection of Natural Resources:** Eliminate environmental damage and the degradation of natural resources associated with maritime transportation, fishing, and recreational boating.

While these expanded duties have placed increased demands on the small Service, the Coast Guard received additional funding after 9/11, which allowed them to expand by 25 percent.

Currently, the Coast Guard is re-capitalizing its entire fleet in the largest acquisition program in its history—the Deepwater Project. This includes the purchase of 93 new cutters and 190 aircraft. Additionally,

improvements in command and control, communication, computers, and intelligence capabilities will facilitate a network-centric operational doctrine, allowing the Coast Guard to integrate and operate in conjunction with all 21st century naval assets.

References:

- DODD 5100.01
- www.uscg.mil

3.8 Effective Participation in Exercise Preparation and Planning

Joint staff officers are involved in Joint Exercises, as planners or as participants. Either way, it is important to be familiar with the key Joint Training and Exercise processes and terminology. For more detailed information refer to Chairman Joint Chiefs of Staff Manual (CJCSM) 3500.03B, the Joint Training Manual of the Armed Forces of the United States.

3.8.1 Joint Training Overview

Combatant commanders ensure the readiness of forces assigned to their command. Combatant commanders provide authoritative direction over all aspects of military operations, joint training, and logistics within their commands; and coordination and approval of aspects of administration, support (including control of resources and equipment, internal organization, and training), and discipline necessary to carry out missions assigned to the command. Training is a key element of readiness. Military readiness is defined in two parts—unit and joint. As defined in the DOD Dictionary of Military and Associated Terms, readiness is:

The ability of U.S. military forces to fight and meet the demands of the national military strategy. Readiness is the synthesis of two distinct but interrelated levels:

(a.) unit readiness—This is derived from the ability of each unit to deliver the capabilities for which it is designed (core mission), and capabilities required to execute either a major plan or named operation.

(b.) joint readiness—The combatant commander's ability to integrate and synchronize ready combat and support forces to execute his or her assigned missions.

DOD components are required to use the processes of the Joint Training System (JTS) to develop training programs; plan, execute, and assess training based on Mission Essential Tasks (METs) that comprise the organization's Joint or Agency Mission Essential Task List (J/AMETL); and determine training status input for readiness reporting. In accordance with CJCSI 3500.01F, Joint Training Policy And Guidance For The Armed Forces Of The United State, and DoDD 7730.65, J/AMETLs must be developed using Universal Joint Tasks (UJTs) published within the Universal Joint Task List (UJTL), a menu of mission tasks in a common language. A Universal Joint Task (UJT) is an action or activity assigned to an individual or organization to provide a capability. Commanders and directors apply standards and conditions to tailor the universal joint task for their mission. Standards, defined as measures and criteria of performance, describe how well an organization must perform a task under a specific set of conditions. The methodology and processes of the JTS are designed to improve the CJCS and combatant command joint operational readiness linking joint plans, joint training, and joint readiness to Joint Mission Essential Task List (JMETL) by identifying mission-based training requirements, selecting tasks from the Universal Joint Task List (UJTL), creating standards, developing Joint Training Plans (JTPs) to support these requirements, executing planned training events, and assessing training proficiencies.

All personnel and components train on their METs to established standards to provide the capabilities that support the combatant commanders and the Joint Operations Concepts across all phases of Joint Campaigns and throughout the spectrum of service, joint, interagency, intergovernmental, and multinational operations.

DOD uses the JTS in supporting the president's National Exercise Program (NEP). The NEP consists of annual operations-based exercises, either a functional Command Post Exercise (CPX) or a Full Scale Exercise (FSE), involving cabinet and presidential participation. The NEP is congressionally directed whole of government exercises focused on homeland security and incident response activities; senior level participation is key. DOD participates in the NEP through the Chairman's Exercise Program (CEP), which is the only dedicated means for the CJCS, through the Joint Staff, to coordinate interagency and combatant command participation in strategic-national level joint exercises. The Joint Exercise Program (JEP) is the principal means for achieving joint and multinational/combined training and a key component of the JTS. JEP and CEP events are listed in the Joint Training Information Management System (JTIMS) and are resourced

by the Joint Staff, Services, and United States Special Operations Command (USSOCOM).

Combatant commanders must synchronize the command's joint training programs, Security Cooperation Plans (SCPs), Service component training programs, as well as external support from other combatant commands, Combatant Support Agencies (CSAs), and supporting joint organizations.

Types of Joint Training

Joint learning encompasses training, education, and self-development. Each element of joint training must be matched with the appropriate training methods, requirements, and audiences:

- **Individual Joint Training:** Training that prepares individuals to perform their job or to operate uniquely joint systems. Individual staff training ensures that individuals know, are proficient in, and have the joint competencies and skills to apply joint doctrine and procedures necessary to function as staff members.
- **Staff Joint Training:** Joint individual or collective training conducted by an organization's or operational unit's staff.
- **Collective Joint Training:** Instruction and applied exercises that prepare an organizational team to complete required tasks as a unit.

The Universal Joint Task List (UJTL)

The Chairman of the Joint Chiefs of Staff's UJTL Program is managed and executed by the Joint Staff J7 UJTL Program Manager (PM). Understanding the UJTL Program and its developmental processes is necessary to effectively interact with the joint community and participate in joint processes. The UJTL serves as a library of mission tasks in a common "universal" language, and functions as the foundation for planning, readiness reporting, joint training, and joint military operations across the range of military operations. The UJTL enables retrieval of information related to specific task accomplishments, allowing users to review planning, training, readiness, and lessons learned. Further, the UJTL supports the Department of Defense in joint capabilities-based planning, joint force development, experimentation, joint lessons learned, joint training and education. Knowledge of the UJTL process is vital when working with readiness and training communities abroad.

The UJTL Development Community (UDC) has designated representatives (referred to as Organizational Points of Contact-

OPOCs), from the Joint Staff, combatant commands and components, Services, joint organizations, the National Guard Bureau (NGB) and Combat Support Agencies (CSAs). The OPOCs provide UJTL development, support, management, and education for their organizations and are also responsible for submitting new organizational candidates and change requests within the UJTL Task Development Tool (UTDT). OPOCs meet biannually at the Worldwide Joint Training and Scheduling Conference (WJTSC) as members of the UJTL Users Advisory Group (UUAG).

- **UJTL Relationship to Joint/Agency Mission Essential Task Lists (J/AMETLs)**

Entries to the joint/agency mission-essential task list (J/AMETL) are those selected by a commander/director to accomplish an assigned or anticipated mission. Following mission analysis, commanders/directors select tasks from the published UJTL database for their respective J/AMETL, in accordance with CJCSI 3500.01 and DoDD 7730.65. UJTs selected from the UJTL for a joint or agency mission are called “mission essential tasks” (METs) and are tailored by the organization for its mission by applying relevant standards and conditions. Standards are the minimum level of acceptable performance directed by the commander for a given task and consist of a description (referred to as measure) and criterion (minimum level/value of performance). The UJTL provides sample measures for each task, but organizations may also develop their own. Conditions are variables in relation to the prevailing military, civil, and physical environments impacting the execution of the task. A menu of conditions is located on the Joint Doctrine, Education, and Training Electronic Information System (JDEIS) UJTL Portal. Thus, a UJT is a “universal” task—adaptable and adjustable to describe the mission requirements of any appropriate organization through the application of tailored conditions and standards.

- **UJTL Linkage to the Joint Training System (JTS)** DOD components are required to use the processes of the Joint Training System (JTS) to develop training programs; plan, execute, and assess training based on METs that comprise the organization’s J/AMETL; and determine training status input for readiness reporting. A UJT is an action or activity assigned to an individual or organization to provide a capability. Commanders and directors apply a JMETL by identifying mission-based training requirements, selecting tasks from the UJTL, creating standards, developing joint training plans (JTPs) to support these requirements, executing planned

training events, and assessing training proficiencies.

For more on the UJTL Development Process go to the following references:

- UJTL Policy: CJCSI 3500.02
- UJT Manual: CJCSM 3500.04

To review or search the UJTL, menu of conditions and measures, go to the following links:

- JDEIS UJTL Portal (SIPR)*: <http://jdeis.js.smil.mil/jdeis/index.jsp>
- JDEIS UJTL Portal (NIPR)*: <https://jdeis.js.mil/jdeis/index.jsp>

Joint Training Information Management System (JTIMS)

JTIMS is designed to assist combatant commanders and Services in managing their joint training programs. JTIMS software automates elements of the four phases of the JTS with the Universal Joint Task List (UJTL) as the common language. It is available to all government users via SIPRnet and will be available to selected users on the NIPRnet.

JTIMS is an important tool that automates and supports the JTS in data gathering, alignment, priority ranking, and coordination of resources. The Joint Staff, J7, vision of JTIMS is two-fold:

- Provide advanced information management technology that provides the capability to plan, manage, execute, and assess mission-based training.
- Enable on-demand access to appropriate information relating to doctrine, organization, training, materiel, leadership and education, personnel, and facilities (DOTMLPF), and other resources through integration of data that is transparent to the functional user.

The JTIMS mission is to:

- Support the joint community with a suite of tools that supports an organization's capability to identify, collect, analyze, store, and disseminate data required to execute the Chairman of the Joint Chiefs of Staff (CJCS) JTS.
- Identify functional automation requirements needed for improvements to the existing software to support the JTS in support of joint training readiness; and
- Identify future requirements for the integration of JTIMS data into other joint information systems.
- Note: The Defense Readiness Reporting System (DRRS) and

the Joint Doctrine, Education, and Training Electronic Information System (JDEIS) are examples of systems that are integrated with JTIMS.

Resource: JTIMS Guide <http://www.jtimsguide.us/introduction.html#>

3.8.2 Joint Training System (JTS) Overview

The JTS is a 4-phased methodology that aligns training strategy with assigned missions to produce trained and ready individuals, units, and staffs. The procedures are designed to assist commanders at all echelons in: defining the required level of individual, collective, and staff performance; determining the current level(s) of performance; executing training programs to improve performance; and finally, assessing those levels of performance relative to the required level. The JTS provides data related to Doctrine, Organization, Training, Materiel, Leadership and Education, Personnel, and Facilities (DOTMLPF). A complete readiness assessment must include all DOTMLPF elements. In short, the JTS addresses the “training readiness” of a military capability.

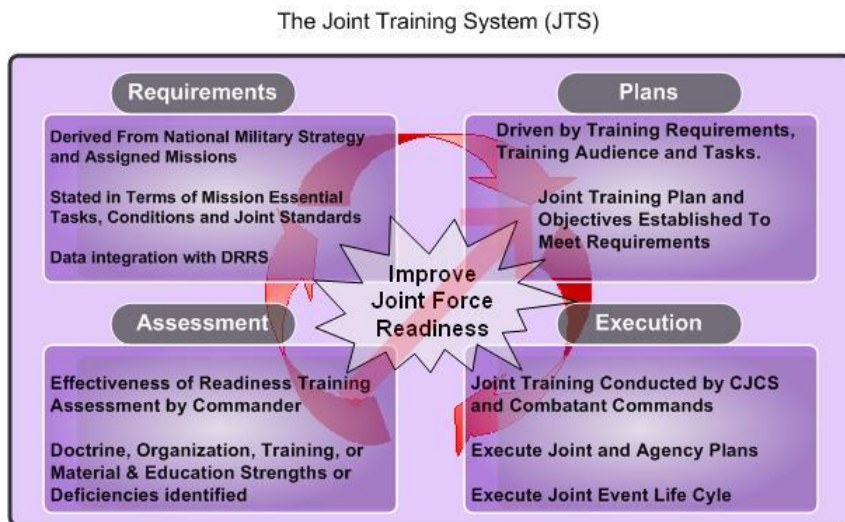

Figure 48: The Joint Training System

The JTS (Figure 48) provides an integrated, requirements-based methodology for aligning joint training programs with assigned missions, consistent with command priorities and available resources.

JTIMS, an integral part of the JTS supports each phase of the process:

- **Phase I (Requirements):** In this phase, the capabilities required of joint force organizations to accomplish their assigned missions are identified in terms of mission essential tasks (METs), conditions, standards, and organizations.

JTIMS supports linkage to DRRS/ESORTS. Combatant commanders', Service component commanders', Combat Support Agencies', and subordinate joint force commanders' Joint/Agency Mission Essential Task Lists (J/A/METLs) are developed in ESORTS and imported into the JTIMS.

- **Phase II (Plans):** In this phase, the commands and CSAs develop their Joint and/or Agency Training Plans (J/ATPs) defining their training requirements, and containing the preliminary development of training event design, estimation and scheduling of resources, and general timelines of training events.

JTIMS supports the preparation of Joint Force Commanders'; supporting commanders' and CSAs' integrated Joint/Agency Training Plan (J/ATP). It also supports the collaborative development/production of global and local joint training schedules to include an online scheduling and deconfliction application. Finally, JTIMS automates the initial development of Joint Training Events (to include Joint Exercises).

- **Phase III (Execution):** In this phase, the detailed event planning and resource scheduling are finalized and the planned events are executed, evaluated, and the results reported. This phase will be covered in more detail next.

JTIMS supports training event planning, coordination, execution, review and analysis. It will automate the Joint Event Life Cycle (JELC) down to the Joint Task Force (JTF) component and unit level. This will include stand-alone capabilities to support execution (i.e. Joint Master Scenario Event List (JMSEL) and Observation Collection).

- **Phase IV (Assessment):** In this phase, the Commander/Director reviews joint training performance relative to mission Joint and/or Agency Mission Essential Task (J/AMET) requirements to produce both Task Proficiency Assessments (TPAs) and Mission Training Assessments (MTAs). This

training assessment provides input to Joint and/or Agency Mission Essential Task List (J/AMETL) refinement, JTP adjustment, and other data users as shown in the figure.

JTIMS supports assessment of joint training events by automating combatant command, supporting command, CSA and the National Guard's ability to produce Training Proficiency Assessments (TPAs), derived from the Training Proficiency Evaluations (TPEs) from the Execution Phase. JTIMS will then export TPA information to the DRRS training tab and in support of Mission Training Assessment (MTA) development.

Joint staff officers will be more directly involved with Phase III (Execution). The following information will provide a basic understanding of what is required of you in this activity:

- **Introduction:** Within the JTS, joint training events are conducted in Phase III (Execution) to achieve the requirements-based combatant command, CSA or supporting unit annual training objectives derived in Phase II (Plans). Upon completion of each training event during Phase III, observations are analyzed and evaluated to determine if event training objectives were met and how they apply to overall combatant command, CSA or supporting unit training objectives. Issues, lessons learned, and observations are also identified during each training event. The products of Phase III are used in Phase IV (Assessment) to determine whether a combatant command is trained to perform the required mission capabilities, defined by JMETS, to standard. This assessment is then used to plan for the next training cycle, to support joint readiness reporting, to identify procedural practical solutions, and to support issue identification and resolution. The building block approach to prepare for joint training events by Service components, CSAs, and other supporting organizations supports evaluation and assessment at each successive level so that subordinate commanders can evaluate their preparedness for joint training events and combatant commander missions.
- **Purpose:** This section describes the methodology for designing, planning, preparing, executing, analyzing, evaluating, and reporting training events. Academic and/or exercise methods are used to support each training event.
- **Discrete events are orchestrated using the J/ATP:** Pertinent lessons learned are used to identify areas for additional emphasis or revision following publication of the JTP.

The processes, whether academic or exercise, support the training requirements and provide the following output: Task Performance Observations (TPOs), Training Proficiency Evaluations (TPEs), and Doctrine, Organization, Training, Materiel, Leadership and Education, Personnel, and Facilities (DOTMLPF) issues which reflect successes or opportunities for training improvement.

- **Academic Instruction:** Academic instruction is conducted either as stand-alone events or as a precursor, often in a building block approach, in preparation for a larger event such as an exercise. This method should be selected if the desired outcome is one of the following: moving from a current level of knowledge to a higher level; filling gaps in knowledge from previous knowledge level; or achieving the ability to apply the knowledge. A Learning Management System (LMS) can be used to track the progress of individuals to prepare them for formal academics.
- **Joint Exercises and Events:** Joint exercises are characteristically resource-intensive (time, personnel, and equipment), requiring extensive coordination and preparation. However, exercises provide a valuable venue for collective training.
- **Joint Event Life Cycle (JELC):** Often, large exercises and joint training events are designed, planned, executed, and evaluated using the JELC as a flexible guide that can be modified to apply to various levels of joint event intensity. The JELC, not to be confused with the four phases of the JTS, provides an orderly sequence of the inputs, process steps, and outputs necessary to assure successful execution for any size training event. The JELC provides a methodology for joint-event development, resident within Phase III (Execution). The JELC (Figure 49) consists of five stages: design; planning; preparation; execution; and analysis, evaluation, and reporting. A series of event-planning conferences or collaborative sessions provide discrete breakpoints between each stage. In practice, the JELC “flows” as a nearly continuous process from one stage to the next, and the boundaries between stages become nearly indistinguishable.

The individual JELC stages are briefly described in the following paragraphs and reflect the methodology used to conduct an exercise supported by a computer simulation. The JELC, however, provides sufficient flexibility for exercise and event planners to modify the process as needed to meet specific training requirements. Given the

complexity of the JELC, the JTIMS provides assistance in JELC management, and the JTIMS execution phase includes many of these activities to include MSEL and observation collection tool automation.

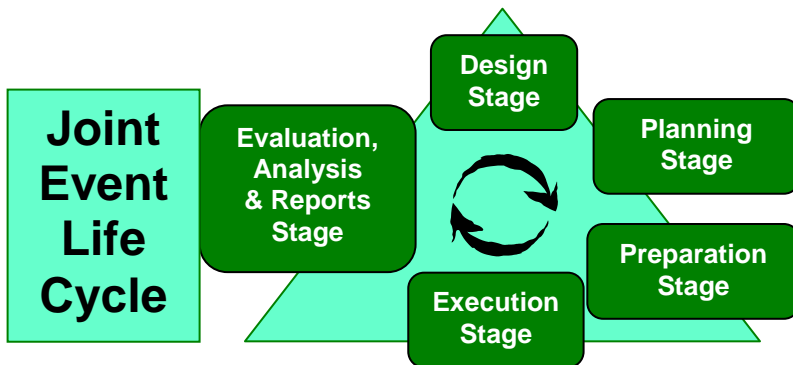

Figure 49: Joint Event Life Cycle

- Design Stage. The design stage commences with preparations for, and completion of, the Concept Development Conference (CDC) and ends following the Initial Planning Conference (IPC). Most activities span all facets of the design stage. A formal CDC is conducted at the discretion of the combatant command's Event Team Leader (ETL). Key outcomes of the design phase are exercise objectives, training objectives, training audience and support identification, proposed command and control architecture (exercise control and participant command support requirements), event flow, and scenario and/or environment.
- Planning Stage. The planning stage officially begins following conclusion of the IPC and ends with completion of the Main Planning Conference (MPC). In addition, this stage normally includes the Master Scenario Event List (MSEL) development conference. During this stage, approved products from the CDC and IPC are presented, an exercise directive is drafted, concepts and supporting plans are developed and finalized, MOAs (if required) between supported command and supporting agencies are signed, database build begins, and a site survey is conducted. In addition, MSEL development process is initiated and the MSEL development conference completed. A MSEL is a collection of pre-scripted events

- intended to guide an exercise toward specific outcomes.
- Preparation Stage. Completion of the MPC ends the planning stage and initiates the preparation stage. During this stage, the exercise concepts, exercise directive, supporting plans, MSEL, and training plans are finalized, approved, and published; the Time-Phased Force Deployment Document (TPFDD) is ready for validation; and the construct of the mini-exercise is completed. The exercise milestones are reviewed and dates are set for additional database tests in JTIMS. The exercise control plan is completed. The Final Planning Conference (FPC) is convened to confirm completion of all required milestones prior to Start of Exercise (STARTEX) and/or event and to distribute the required plans and orders. Following the FPC, the site is prepared, training is conducted, and a final modeling and simulation testing is completed as necessary.
 - Execution Stage. The execution stage begins with deployment to the joint exercise or event site and ends with the facilitated After Action (AAR) and End of Exercise (ENDEX) or event activities. Redeployment normally indicates the transition from execution to the final stage: analysis, evaluation, and reporting (Stage 5). Both deployment and redeployment are often phased depending on the number and complexity of setup and takedown functions that need to be performed. During the execution stage, final preparations are made at the exercise site—including communications and simulation setup and checks and various execution rehearsals. The actual exercise, including participant training when required, is conducted. The JTIMS JMSEL module will assist with exercise execution and will require 24 hour technical support to respond to any disruptions that might preclude exercise success. Following ENDEX, the facilitated AAR is convened for the benefit of the training audience. (Generally, the AAR is considered an extension of the training process.) Redeployment of equipment and personnel marks the official conclusion of the execution stage.
 - Analysis, Evaluation, and Reporting. Stage 5 completes the JELC. The evaluation stage begins with redeployment and ends when finalized data and products are distributed to the end users, to include feedback into the Joint Training Plan (JTP). Upon completion of redeployment and

equipment recovery, all exercise and event information (observations, documents, model applicable data, discussion at the facilitated AAR, etc.) is analyzed, evaluations are determined, where appropriate, and entered into JTIMS, and written reports (such as the commander's summary report and the AAR) are prepared. The products, in turn, are used to feed Phase IV (Assessment) of the JTS/JTIMS and JLLIS. The operative construct for the JELC is not a closed loop, but a spiral that moves forward in a process of continual learning, growth, and improvement for the joint community.

Summary. Discrete events identified in the JTP are conducted in the JTS execution phase. Execution of academic and exercise events provides the opportunity to train and verify the training audiences are trained to the proficiency levels identified in Phase II (Plans). Execution of a training event follows the same methodology that supports the JTS. The products from all events are aggregated to support assessment in Phase IV (Assessment).

Section 4. Critical Mission Areas for the 21st Century

A secure United States homeland is the nation's first priority, and is a fundamental aspect of the national military strategy. It is also essential to America's ability to project power, sustain a global military presence, and honor its global security commitments. The military will continue to play a vital role in securing the homeland through the execution of Homeland Defense (HD) and Civil Support (CS) missions. Department of Defense (DOD) contributes to Homeland Security (HS) by conducting HD operations overseas and in the approaches to the U.S., and by providing CS for disasters and declared emergencies, to designated Law Enforcement Agencies (LEAs), and to other activities. DOD Emergency Preparedness (EP) contributes to HD and CS missions since it includes all measures to be taken by DOD in advance of an emergency to reduce the loss of life and property and to protect our nation's institutions.

Likewise, to support U.S. interests around the world and sustain a global environment compatible with those interests, it is essential for the U.S. military to be prepared to conduct Foreign Humanitarian Assistance (FHA). FHA consists of DOD activities, normally in support of the United States Agency for International Development (USAID) or Department of State (DOS), conducted outside the United States, its territories, and possessions to relieve or reduce human suffering, disease, hunger, or privation as result of natural or man-made disasters or endemic conditions. The foreign assistance provided is designed to supplement or complement the efforts of the Host Nation (HN) civil authorities or agencies that may have the primary responsibility for providing that assistance. Military organization, structure, and readiness enable commanders to respond rapidly and effectively when time is of the essence.

Preparation for and execution of operations in both of these critical mission areas can be expected to continue to be of utmost importance to the Joint Staff Officer.

4.1 Civil Support

The military plays a vital role in the execution of HD and CS missions. CS capabilities are derived from DOD warfighting capabilities that could be applied to foreign/domestic assistance or law enforcement support

missions. CS focuses in a domestic context, but extends beyond the standard domestic definition. DOD contributes to HS by conducting HD operations overseas and in the approaches to the U.S., and by providing CS for disasters and declared emergencies, to designated law enforcement agencies, and to other activities. DOD emergency preparedness contributes to HD and CS missions since it includes all measures to be taken by DOD in advance of an emergency to reduce the loss of life and property and to protect our nation's institutions. While the HD and CS missions are distinct, some department roles and responsibilities overlap, and operations require extensive coordination between lead and supporting agencies. The HD, CS, and HS missions are separate, but have areas where roles and responsibilities may overlap and/or lead and supporting roles may transition between organizations. DOD serves as the federal department with lead responsibility for HD, which may be executed by DOD alone or include support provided to DOD by other agencies. CS is the overarching term for DOD's support to civilian authorities. DOD's role in the CS mission consists of support to U.S. civil authorities [Department of Homeland Security (DHS) or other agency] for domestic emergencies and for designated law enforcement and other activities. HD and CS operations may occur in parallel and require extensive integration and synchronization. In addition, operations may transition from HD to CS to HS and vice versa with the lead depending on the situation and U.S. Government's desired outcome.

Management of Domestic Incidents

The National Response Framework (NRF) was a result of Homeland Security Presidential Directive-5, Management of Domestic Incidents and is a single, comprehensive approach to domestic incident management built on the template of the National Incident Management System (NIMS). The NRF is an all-hazards approach that provides the structure and mechanisms for national-level policy and operational direction for incident management to ensure timely and effective federal support. The NRF is applicable to all federal departments and agencies that have primary jurisdiction for or participate in operations requiring coordinated federal response. The NRF identifies how federal departments and agencies will respond to state, tribal, and/or local Requests for Assistance (RFAs). A basic premise of both the NIMS and the NRF is that incidents are generally handled at the lowest jurisdictional level possible. The NRF is coordinated and managed by the Federal Emergency Management Agency (FEMA). The overall coordination of federal incident management activities is executed through the Secretary of Homeland Security. NIMS is a consistent doctrinal framework for incident

management at all jurisdictional levels. It includes a core set of concepts, principles, terminology, and technologies covering the incident command system; multiagency coordination systems; unified command; training; identification and management of resources (including systems for classifying types of resources); qualifications and certification; and the collection, tracking, and reporting of incident information and incident resources.

Department of Defense Operational Environment

Because the public, media, and perhaps local and state officials, may not clearly understand constitutional limits, expectations must be managed and communicated. Military units tasked to support civil authorities during domestic disasters enable rapid and effective response operations that limit loss of life, mitigate suffering, and curtail further significant property damage. The challenge remains integrating military and civil capabilities within a disaster stricken operating environment with little intact infrastructure while urgently and efficiently executing relief operations. Authority over and control of DOD forces/capabilities shall be maintained by the president, as commander in chief, through the Secretary of Defense (SecDef) and the chain of command as established by law. When emergency conditions dictate, and when time does not permit approval from higher headquarters, local military commanders and responsible DOD component officials are authorized to respond to requests from local authorities and to initiate immediate response actions to save lives, prevent human suffering, or mitigate great property damage under imminently serious conditions.

Requests for Assistance

The Robert T. Stafford Disaster Relief and Emergency Assistance Act (Public Law 93-288) (Title 42 U.S. Code, Section 5121), authorizes the Federal Government to help state and local governments alleviate the suffering and damage caused by disasters. Requests for DOD assistance may occur under Stafford Act or non-Stafford Act conditions.

A Stafford Act incident is one in which state and local authorities declare a state of emergency and request federal assistance. This type of emergency is an incident of national significance for which the Stafford Act establishes programs and processes for the Federal Government to provide major disaster and emergency assistance to states, local governments, tribal nations, individuals, and qualified private nonprofit organizations.

A non-Stafford Act incident is essentially all of the other emergencies that occur each year and do not necessarily overwhelm state and local authorities and where the event would benefit from federal assistance and coordination. The Secretary of Homeland Security is responsible for overall coordination of Federal Stafford and non-Stafford incident management activities.

Request for Assistance Process

Federal agencies or state governors request DOD capabilities to support their emergency response efforts by using a formal RFA process. How DOD handles RFAs depends on various factors, such as: Stafford Act or non-Stafford Act situation, urgency of the incident, establishment of a joint field office, if a Defense Coordinating Officer (DCO) or joint task force has been appointed, and originator of the request (incident command, state, regional, or national). In general, the federal coordinating officer at the incident site receives RFAs from civil authorities and submits them to the Office of the Executive Secretary of the Department of Defense, who forwards them to the Assistant SecDef for Homeland Defense and Americas' Security Affairs [ASD(HD&ASA)] and the Joint Director of Military Support for validation and order processing, respectively. When a DCO is at the incident site, RFAs are submitted directly to ASD(HD&ASA). Once the SecDef approves the request, an order is issued to combatant commands, Services, and/or agencies to accomplish the mission.

Immediate Response

Under imminently serious conditions, when time does not permit approval from higher headquarters, any local military commander, or responsible officials of other DOD components may, subject to any supplemental direction provided by their higher headquarters, and in response to a request from civil authorities, provide immediate response to save lives, prevent human suffering, or mitigate great property damage. Immediate response is situation-specific and may or may not be associated with a declared or undeclared disaster, civil emergency, or attack.

Categories and Types of Civil Support Operations

CS operations are divided into three broad categories of domestic emergencies, designated law enforcement support, and other activities, based on the CS definition. These categories, in many cases, can overlap or be in effect simultaneously, depending on the particular circumstances of the incident. Under the categories, there are broad types of CS missions as described below:

- **Disasters and Declared Emergencies:** DOD support in a domestic disaster or a presidential declaration of emergency is in support of the primary or coordinating agency(ies). Military commanders and responsible DOD civilians may, under certain conditions, respond under immediate response authority in order to save lives, prevent suffering, and mitigate great property damage under imminently serious conditions. Without a disaster declaration, the president may also direct DOD to support the response to a disaster or emergency for a period not to exceed 10 days.
- **Support and/or Restore Public Health and Services, and Civil Order:** DOD support and/or assistance in restoring public health and services, and civil order may include augmentation of local first responders and equipment. It may include law enforcement support, continuity of operations/continuity of government measures to restore essential government services, protect public health and safety, and provide emergency relief to affected governments, businesses, and individuals. Responses occur under the primary jurisdiction of the affected state and local government, and the Federal Government provides assistance when required. When situations are beyond the capability of the state, the governor requests federal assistance through the president.
- **National Special Security Events:** Special events are categorized by the DHS Special Events Working Group (SEWG). Usually, other military operations will have priority over these missions, unless directed otherwise by the SecDef. These events will be assigned a priority by the SEWG and will normally be monitored by the combatant command responsible for the area of responsibility in which they are conducted. National Special Security Event (NSSE) is a designation given to certain special events that, by virtue of their political, economic, social, or religious significance, may be the target of terrorism or other criminal activity. The Secretary of Homeland Security, after consultation with the Homeland Security Council, is responsible for designating special events as NSSEs.
- **Periodic Planned Support:** Periodic planned support is conducted to enhance civil military relations within local communities. Military involvement could include: sensitive support operations; military training exchanges; community relations; military laboratory support and/or testing and evaluation in DOD facilities; military working dog support; support provided to the U.S. Secret Service; Civil Air Patrol/Air

Force Auxiliary support; aerial damage assessment; and, civilian critical infrastructure protection.

References:

- Joint Pub 3-28, Civil Support
(http://www.dtic.mil/doctrine/new_pubs/jp3_28.pdf)

4.2 Foreign Humanitarian Assistance

The following is an extract from JP 3-29, Foreign Humanitarian Assistance (2009):

Foreign humanitarian assistance (FHA) consists of Department of Defense (DOD) activities, normally in support of the United States Agency for International Development (USAID) or Department of State (DOS), conducted outside the United States, its territories, and possessions to relieve or reduce human suffering, disease, hunger, or privation. While, U.S. military forces are not the primary U.S. Government (USG) means of providing FHA, the foreign assistance they are tasked to provide is designed to supplement or complement the efforts of the host nation (HN) civil authorities or agencies that may have the primary responsibility for providing that assistance.

DOD has unique assets for effective response and can play a key role in foreign humanitarian crises. For example, the U.S. military possesses exceptional operational reach that can be employed to enhance an initial response. Additionally, the U.S. military augments private sector capability and thus limits threats to regional stability. Furthermore, the U.S. military's unmatched capabilities in logistics, command and control (C2), communications, and mobility are able to provide rapid and robust response to dynamic and evolving situations among vastly different military, civilian, and government entities.

*FHA operations require coordination and collaboration among many agencies, both governmental and nongovernmental, with U.S. military forces when tasked in a supporting role. Because DOD is in a supporting role during FHA, the joint force commander may not be responsible for determining the mission or specifying the participating agencies. During FHA operations **unity of command** may not be possible, but the requirement for **unity of effort** becomes paramount.*

Statutory authority for USG agencies to provide FHA is contained in the **Foreign Assistance Act of 1961**, as amended, in Title 22, U.S. Code. This legislation provides a blueprint for USG engagement with friendly nations. **DOD Directive 5100.46, Foreign Disaster Relief**, establishes policy and provides for component participation in foreign disaster relief operations only after a determination is made by DOS that foreign disaster relief shall be provided.

Relief missions include **prompt aid** that can be used to alleviate the suffering of disaster victims. Potential relief roles for U.S. forces include immediate response to prevent loss of life and destruction of property, construction of basic sanitation facilities and shelters, and provision of food and medical care.

Dislocated civilian support missions are specifically designed to support the assistance and protection for dislocated civilians. Support missions may include **camp organization** (basic construction and administration); **provision of care** (food, supplies, medical attention, and protection); and **placement** (movement or relocation to other countries, camps, and locations).

Security missions may include **establishing and maintaining conditions for the provision of FHA** by organizations of the world relief community. In some cases, the affected country will not be able to meet the required conditions and may request assistance from U.S. military forces to **secure areas for storage of relief material** until it can be distributed to the affected population. Other tasks may involve providing protection and armed escorts for convoys and personnel delivering emergency aid, protection of shelters for dislocated civilians, and security for multinational forces, NGOs, and intergovernmental organizations (IGOs).

Technical assistance and support functions may take the form of advice and selected training, assessments, manpower, and equipment. Based upon Secretary of Defense (SecDef) and combatant commander (CCDR) guidance, the FHA force commander (CDR) should **establish operational procedures regarding technical advice and assistance** to the affected country, NGOs, and IGOs as soon as possible.

Foreign consequence management (FCM) is DOD assistance provided by the USG to a HN to mitigate the effects of a deliberate or inadvertent chemical, biological, radiological, nuclear, and high-

yield explosives attack or event and to restore essential government services. When requested by the lead federal agency (LFA) and directed by SecDef, DOD will support USG FCM operations to the extent allowed by law and subject to the availability of forces.

Although FHA operations may be executed simultaneously with other types of operations, each type has unique characteristics. Military CDRs conducting FHA simultaneously with other operations must develop end state, transition, and termination objectives as well as measures of effectiveness (MOEs) complementary to simultaneous military operations.

References:

- Chairman of the Joint Chiefs of Staff Instruction (CJCSI) 3214.01. Defense Information System Network (DISN): Policy And Responsibilities (http://www.dtic.mil/cjcs_directives/cdata/unlimit/6211_02.pdf)
- DOD Directive 2205.2. Humanitarian and Civic Assistance (HCA) Activities. (<http://www.dtic.mil/whs/directives/corres/pdf/220502p.pdf>)
- JP 3-0. Joint Operations. (http://www.dtic.mil/doctrine/new_pubs/jp3_0.pdf)
- JP 3-29. Foreign Humanitarian Assistance. (http://www.dtic.mil/doctrine/new_pubs/jp3_29.pdf)
- JP 3-41 Chemical, Biological, Radiological, Nuclear, and High-Yield Explosives Consequence Management. (http://www.dtic.mil/doctrine/new_pubs/jp3_41.pdf)
- JP 3-57. Civil-Military Operations. (http://www.dtic.mil/doctrine/new_pubs/jp3_57.pdf)

Additional Resources:

- Defense Security Cooperation Agency Office of Humanitarian Assistance, Disaster Relief, and Mine Action (<http://www.dsca.osd.mil/programs/HA/HA.htm>)
- International Committee of the Red Cross (<http://www.icrc.org/>)
- Pan American Health Organization (PAHO) (<http://new.paho.org/>). Assistance in Disaster Situations-A Guide for Effective Aid (<http://helid.digicollection.org/en/d/Jh0185e/>).
- USAID (<http://www.usaid.gov/>). Field Operations Guide for Disaster Assessment and Response

http://www.usaid.gov/our_work/humanitarian_assistance/disaster_assistance/resources/pdf/fog_v4.pdf).

- *Inter-Agency Standing Committee Working Group – Civil-Military Relationship in Complex Emergencies*
(<http://www.humanitarianinfo.org/iasc/pageloader.aspx?page=content-products-products&sel=8>).

(Intentionally Blank)

Section 5. Lifelong Learning

"After 37 years of service, I am convinced that learning and leadership are at the core of our profession." Chairman's Strategic Direction to the Joint Force.....signed GEN Martin E. Dempsey, 6 Feb 2012

5.1 Joint Officer Development

The Chairman's new approach for joint officer development focuses on developing leaders who are:

- **Strategically minded:** cross-cultural communicators, able to foster trust, self-aware and at ease with decision making without complete information, able to work adeptly in multicultural environments, able to access and apply resources without ownership, and able to build teams through good communication skills, persuasive influence, collaboration, negotiation, and consensus building.
- **Critical thinkers:** decisive, intelligent, and able to make decisions with cultural contexts, able to assess the environment and recognize patterns and changes, comfortable with ambiguity and uncertainty, a systems thinker—able to link cause and effects, capable of developing innovative solutions, and an expert learner.
- **Skilled joint warfighters:** able to conduct campaigning and statecraft, understands the roles of war and politics, an operational artist able to integrate joint, interagency, and multinational capabilities to meet objectives.

It is the Chairman's intent that *"Every officer who takes advantage of the opportunity to learn must receive recognition and professional reward for the quality of that learning."*

Joint staff officers are part of an elite team of professionals. No organization surpasses the military in the amount of time and resources spent on training and educating its personnel in order to develop them into experts and leaders in their fields. You have invested heavily in your own development - both professionally and personally—but your work is not done.

The future of a global environment depends on those people who can navigate a wide range of subject matters and who can work with a broad variety of people from very diverse cultural and organizational backgrounds. Experts say that today's adults, on the average, will change **careers**—not jobs, but careers—approximately five times during their work lives; as old jobs fade away, requirements for new ones arise. Just look at how technology has changed the world and the workplace in the last 20 years—from landlines, to car phones, to cell phones, to PDAs, for example—creating new jobs and ending others.

Educators, business leaders, and military leaders agree that individuals who develop lifelong learning skills will be the successes of the future. Your job is to prepare yourself for living and working in a dynamic global environment. Whether you stay in the military or choose to go into other work, your focus should be on preventing your own obsolescence by developing lifelong learning skills which transverse across all professions. Being a staff officer is the perfect opportunity for you to work on development of the “softer side” of business skills such as interpersonal communications and collaboration and to develop new “hard skills” such as more global military knowledge, strategic thinking, and using new and more complex technology systems.

5.2 What is lifelong learning?

Lifelong learning is the continuous integration of formal and informal education for promoting personal and professional development, citizenship, and human value throughout one's life. One of the principal objectives is to equip people with the capacity to manage their own self-education. From about the age of 25 to retirement, people primarily learn from their occupations, technologies, colleagues, and life experiences.

The work life of joint staff officers provides the opportunity for cultivating the two types of behaviors required for becoming successful lifelong learners:

- Recognizing the importance of and the need for lifelong learning, an affective-driven, or emotional/values-driven, behavior, and
- Developing the capacity for continuous learning, a cognitive- or reasoning-driven behavior.

Joint staff officers committed to lifelong learning will readily pursue the following actions:

- Seek opportunities for intellectual and technical knowledge growth;
- Self-select new materials from which to learn—will not wait for someone to tell them what to study;
- Reflect on the learning process and learning styles—will not limit themselves in the way they learn, but will seek new ways, (e.g., classroom, web-based only, group study, independent study);
- Participate in professional associations (e.g. Toastmasters, the Bar Association, attend conferences);
- Read professional articles/books of their own volition;
- Attend additional training or achieve higher levels of professional and civilian education;

For the affective domain, associated with feelings, preferences, attitudes, and values, Dr. Benjamin Bloom, renowned educational psychologist, categorizes five levels of educational competency: receiving, responding, valuing, organization of values into a system, and characterization by a value complex (ethics, integrity, honesty). Without the proper affective behaviors—that is, the interest in learning, and the desire to learn—an individual will be unable to achieve lifelong learning.

Bloom constructed six levels of learning for the cognitive domain (thinking, getting, evaluating and synthesizing information):

- *Knowledge*—recognition, recall, rote memory;
- *Comprehension*—understands information and has the ability to explain it to others or apply it in a new situation;
- *Application*—uses information appropriately for problem solving;
- *Analysis*—formulating or selecting and applying mental models to bring understanding and resolution to ambiguous and poorly defined situations ; able to separate or break down concepts or materials into component parts; distinguish between facts and inferences;
- *Synthesis*—pulls parts *together* from diverse elements to create new meanings or ideas;
- *Evaluation*—Judge the worth of ideas, theories, and opinions; choose among alternatives; and justify their choice based on specific criteria.

The following skills and attitudes are common to lifelong learners:

- *Able to communicate in a clear, organized, and persuasive manner;*
- *Writes clearly and concisely, with the ability to use a variety of styles for work products;*
- *Listens attentively;*
- *Takes accurate notes in meetings;*
- *Masters efficient and effective memory strategies;*
- *Demonstrates critical thinking skills for problem solving;*
- *Submits work assignments on time in the appropriate format;*
- *Behaves in a responsible, punctual, mature, and respectful manner;*
- *Manages stress and conflict successfully;*
- *Organizes physical environment (work and home) to maximize efficiency;*
- *Finds suitable role models and mentors, then observes and evaluates the attitudes and behaviors;*
- *Observant of activities and people around them;*
- *Looks for root causes to problems and issues;*
- *Maintains an accurate planning system or calendar;*
- *Works as a productive member of a team;*
- *Interacts successfully with a wide variety of people;*
- *Seeks feedback about performance, receives it well, and uses it to improve future performance;*
- *Accepts responsibility for own behavior and attitudes and takes ownership of personal success;*
- *Utilizes technology to manage work tasks and access information;*
- *Knows how to use a variety of resources to get to information needed;*
- *Reads critically and can discern the value and validity of resources;*
- *Able to analyze situation using logic and reasoning skills;*
- *Visualizes and creates mental pictures and models to explain ideas and processes;*
- *Reasons through a situation using a variety of techniques (e.g., if-then, deductive-inductive, questioning).*

What lifelong learning skills are evident in model staff officers? From the 2008 Joint Staff Officer Study, senior leaders identified the following skills and abilities which differentiate exceptional staff officers from their

peers:

- *Open-minded, and use well-developed critical thinking skills for analysis and problem solving;*
- *Willing to learn from others—military, civilian, interagency and foreign militaries;*
- *Skilled in quantitative and qualitative abilities—quantitative, such as engineering, math, hard sciences and qualitative, such as social sciences, humanities;*
- *Able to absorb a broad spectrum of information—they do not pigeon hole themselves;*
- *Educated, intelligent, and well-rounded with varied experiences;*
- *Willing to participate, to be part of a team, or to make individual contributions as needed;*
- *Avid readers/well read on current related topics, world affairs , and current events;*
- *Willing to teach, and have an eagerness to be taught and take advantage of learning opportunities such as command reading lists, courses, training, on the job experience;*
- *Intellectual curious with an intense drive to learn; they do not take the first answer as ground truth, and often press for a deeper understanding of the operating environment; with a willingness to question;*
- *Willing and able to learn from experience and to accept change*
- *Understanding that learning never stops.*

Lifelong learners are capable of self-directed learning and share the following skills:

- The ability to develop and be in touch with curiosities—"the ability to engage in divergent thinking."
- The ability to perceive one's self objectively and accept feedback about one's performance non-defensively.
- The ability to diagnose one's learning needs in the light of models of competencies required for performing life roles.
- The ability to formulate learning objectives in terms that describe performance outcomes.
- The ability to identify human, material, and experiential resources for accomplishing various kinds of learning objectives.
- The ability to design a plan of strategies for making use of appropriate learning resources effectively.

- The ability to carry out a learning plan systematically and sequentially. This skill is the beginning of the ability to engage in convergent thinking.
- The ability to collect evidence of the accomplishment of learning objectives and have it validated through performance.

Lifelong learners are actively involved in society in different roles:

ROLES	COMPETENCIES
Learner	Reading, writing, computing, perceiving, conceptualizing, imagining, inquiring, aspiring, diagnosing, planning, getting help, evaluating.
Being a Self (with a unique self-identity)	Self-analyzing, sensing, goal-building, objectivizing, value-clarifying, expressing, accepting, being authentic.
Friend	Loving, empathizing, listening, collaborating, sharing, helping, giving constructive feedback, supporting.
Citizen	Caring, participating, leading, decision making, acting, being sensitive to one's conscience, discussing, having perspective (historical and cultural), being a global citizen.
Family Member	Maintaining health, planning, managing, helping, sharing, buying, saving, loving, taking responsibility.
Worker	Career planning, using technical skills, accepting supervision, giving supervision, getting along with people, cooperating, planning, delegating, managing.
Leisure-time user	Knowing resources, appreciating the arts and humanities, performing, playing, relaxing, reflecting, planning, risking.

Figure 50: Knowles' Lifelong Learning Competencies

The information and lists of attributes above are intended to provide informal self-assessment checklists for taking ownership of your personal development while serving as a joint staff officer. Working in a combatant command is fast-paced, dynamic, and relevant—on a daily basis you reach around the world to seek information and find solutions for dealing with military, humanitarian, and political challenges. The combatant command poses a challenging environment, but one from which you can leave with highly enhanced and newly developed lifelong learning competencies.

Exemplary staff officers are those who understand the role of the warrior as diplomat, the power of intellectual curiosity, and the need for continuous self-development. They are willing to take any task, are focused on the mission, and use even the most unpleasant assignments to add to their lifelong learning (which will continue to set them apart throughout their military careers and beyond).

References:

- Appleby, D. **The Covert Curriculum:** The Lifelong Learning Skills You Can Learn in College. In *Eye on Psi Chi* (Vol. 5, No. 3, pp. 28-31, 34)
- Bloom, B.S., "Taxonomy of Educational Objectives, Handbook 1, Cognitive Domain," *Addison Wesley*, New York, 1984.
- Bloom, B.S., Karthwohl, D.R., Massia, B.B., "Taxonomy of Educational Objectives, Handbook 2, Affective Domain," *Addison Wesley*, New York, 1984.
- Candy, P., "Self-Direction for Lifelong Learning: A Comprehensive Guide to Theory and Practice," *Jossey-Bass*, San Francisco, 1991.
- CJCS, November 2005, Chairman's Vision for Joint Officer Development
- Dickinson, D., ed. *Creating the Future: Perspectives on Educational Change*
(<http://education.jhu.edu/newhorizons/future/index.html>)
- Felder, R.M., Brent R. "Designing and Teaching Courses to Satisfy the ABET Engineering Criteria," *ASEE Journal of Engineering Education*, vol.92, no.1, January 2003, pp.7-25.
- Knowles, M. *Lifelong Learning: A Dream*
- Learning Styles Inventory
 - <http://www.personal.psu.edu/bxb11/LSI/LSI.htm>
 - <http://people.usd.edu/~bwjames/tut/learning-style/>
 - <http://ttc.coe.uga.edu/surveys/LearningStyleInv.html>
- Mourtos, N.J., Furman, B.J., "Assessing the Effectiveness of an Introductory Engineering Course for Freshmen," *Proceedings, ASEE/IEEE Frontiers in Education Conference*, 2002.
(<http://www.fie-conference.org/fie2002/papers/1321.pdf>)

(Intentionally Blank)

Section 6. Useful Support Information and References

6.1 *Commander's Critical Information Requirements Process*

Intelligence provides the combatant commander and subordinate joint force commanders with an understanding of the operational environment. Commander's Critical Information Requirements (CCIR) are elements of information required by the commander that directly affect decision making. CCIRs are a key information management tool for the commander and help the commander assess the operational environment and identify decision points throughout the conduct of operations. CCIRs belong exclusively to the commander. Understanding and effectively facilitating the CCIR process are essential attributes of every Joint Staff Officer.

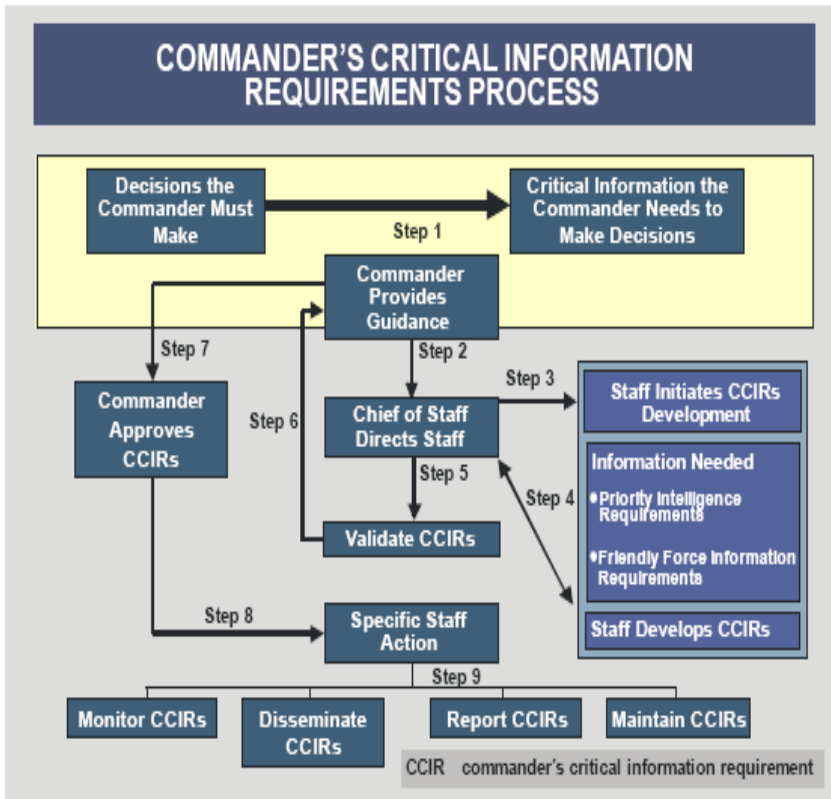

Figure 51: Commander's Critical Information Requirements Process

A CCIR is an information requirement identified by the commander as being critical to facilitating timely decision-making. CCIRs are situation dependent, focused on predictable events or activities, time-sensitive, and always established by an order or plan. The CCIR list is normally short so that the staff can focus its efforts and allocate scarce resources. The CCIR list is not static; joint force commanders add, delete, adjust, and update CCIRs throughout an operation based on the information needed for decision making. Key elements consist of friendly force information requirements (FFIRs) and priority intelligence requirements (PIRs). Where applicable, CCIRs may also include host nation information requirements (HNIR).

Friendly Force Information Requirement (FFIR): Information the commander and staff need to understand the status of friendly force

and supporting capabilities. (JP 3-0)

Priority Intelligence Requirement (PIR): An intelligence requirement, stated as a priority for intelligence support, that the commander and staff need to understand the adversary or the operational environment. (JP 2-0)

Each CCIR should have an established Office of Primary Responsibility (OPR) providing the commander with a centralized point of contact (POC) on the staff for working the information analysis.

Although CCIRs are focused on deliberate and/or crisis action planning and on operational and tactical matters, the concept also has applications for a peacetime staff environment and routine staff work. During the decision making process it is critical to understand the commander's intent in all matters and then ensure the appropriate type of information is provided to the commander at the right level of detail and at the right time.

Reference:

- Joint Publication 3.0, Joint Operations

6.2 Acronyms and Abbreviations

Three very helpful websites for looking up military topics, terms, and acronyms are:

- **Acronym Finder.** a searchable database of over 4 million acronyms, abbreviations and meanings www.acronymfinder.com
- The **DOD Dictionary of Military and Associated Terms.** The DOD Dictionary and the Joint Acronyms and Abbreviations master data base are managed by the Joint Doctrine Division, J-7, Joint Staff. All approved joint definitions are contained in Joint Publication 1-02, "DOD Dictionary of Military and Associated Terms. http://www.dtic.mil/doctrine/jel/DODdict/acronym_index.html
- The **Pentagon Library** provides the following on-line services: current news, dictionaries, directories, forms and tax, government access (federal and military locators), library links, live weather, map locator, military sources (acronyms, gateways, services, images, clip art, .coms, listservs, music), and search engines. <http://www.whs.mil/library/research.htm>

A

AAR – After Action Review

ACC – Air Combat Command

ACE – Aviation Combat Element

ACJCS – Assistant to the Chairman Joint Chief of Staff

AD – Active Duty

ADCON – Administrative Control

ADOS – Active Duty for Operation Support

ADP – Adaptive Planning

ADSW – Active Duty for Special Work

AECA – Arms Export Control Act

AEF – Air Expeditionary Force

AETF – Air Expeditionary Task Force

AEW – Air Expeditionary Wings or Airborne Early Warning

AFAFRICA – Air Forces Africa/17th Air Force

AFCENT – U.S. Air Forces Central/9th Air Force

AFB – Air Force Base

AFGSC – Air Force Global Strike Command

AFNORTH – Air Forces North/1st Air Force

AFRC – Air Force Reserve Command

AFS – Air Force Station
AFSC – Air Force Specialty Code
AFSOC – Air Force Special Operations Command
AFSOUTH – Air Forces Southern/12th Air Force
AFSPC – Air Force Space Command
AIS – Automated Information Systems
AK JOA – Alaska Joint Operations Area
ALCOM – Alaska Command
AMC – Air Mobility Command
ANG – Air National Guard
ANGB – Air National Guard Base
AO – Action Officer
AoA – Area of Activity
AOF – Area of Focus
AOR – Area of Responsibility
APCSS – Asia Pacific Center for Security Studies
APEX – Adaptive Planning and Execution
APOD – Aerial Port of Debarkation
APOE – Aerial Port of Embarkation
ARB – Air Reserve Base
ARG – Amphibious Ready Group
ARNG – Army National Guard
ARSOUTH – U.S. Army South
ASAP – As Soon As Possible
ASCC – Army Service Component Command
ASD(HD&ASA) – Assistant Secretary of Defense for Homeland
Defense and America’s Security Affairs
ASDS - Advanced SEAL Delivery System
ASRP – Acquisition Strategy Review Panel
ATO – Air Tasking Order
ATON – Aids to offshore Navigation
ATRRS – Army Training Requirements and Resources System
AUTODIN – Automated Digital Network

B

B2C2WG – Boards, Bureaus, Cells, Centers, and Working Groups
Bcc – Blind Courtesy Copy
BCGT – Boards, Councils, Groups, and Teams
BCP – Budget Change Proposal
BCT – Brigade Combat Team
BLUF – Bottom Line Up Front
BRAC – Base Realignment and Closure

C

C2 – Command and Control
C4 – Command, Control, Communications, Computers
CA – Civil Affairs
CAG – Commander's Action Group
CAT – Crisis Action Team
CBP – U.S. Customs and Border Protection
CBRNE –Chemical, Biological, Radiological, Nuclear, Explosive
CbT – Combatting terrorism
Cc – Carbon copy or courtesy copy
CCCI – Command and Control Communications Intelligence
CCDR – Combatant Commander
CCIR – Commander's Critical Information Requirement
CCMD – Combatant Command (see glossary for distinction from COCOM)
CCS – Combined Chiefs of Staff
CCSA – Combatant Command Support Agency
CCT – Combat Control Team
CD – Counterdrug
CDC – Concept Development Conference
CDR – Commander
CDRJSOTF - Commander, Joint Special Operations Task Force
CDRUSEUCOM – Commander, U.S. European Command
CDRUSPACOM – Commander, U.S. Pacific Command
CE – Command Element
CEP – Chairman's Exercise Program
CFACC – Combined Forces Air Component Command, or Commander
CFH – CENTCOM Forward Headquarters
CHDS – Center for Hemispheric Defense Studies
CIA – Central Intelligence Agency
CIL – Central Identification Laboratory
CJCS – Chairman Joint Chiefs of Staff
CJCSI – Chairman Joint Chiefs of Staff Instruction
CJCSM – Chairman Joint Chiefs of Staff Manual
C/JFLCC – Combined/Joint Forces Land Component Command
CJSOTF - Joint Special Operations Task Force
C/JTF – Combined Joint Task Force
CJTF-HOA – Combined Joint Task Force Horn of Africa
CKW – Commander's Knowledge Wall
CMC – Commandant of the Marine Corps
CMI – Classified Military Information
CMO – Civil Military Operations
CMOC – Civil-Military Operations Center
CNO – Chief of Naval Operations

COA – Course of Action
COCOM – combatant command (command authority), (see glossary for distinction from CCMD)
COE – Center for Excellence
COMPACFLT – Commander, U.S. Pacific Fleet
COMSEC – Communications Security
CONPLAN – Concept of Operations Plan
CONR – Continental U.S. NORAD
CONUS – Continental United States
COS – Chief of Staff
COSCs – Chiefs of Staff Committees
CP – Command Protocol
CP - Counterproliferation
CPA – Chairman’s Program Assessment
CPC – Chairman’s Public Correspondence
CPG – Contingency Planning Guidance
CPR – Chairman’s Program Recommendation
CPX – Command Post Exercise
CRAF – Civil Reserve Air Fleet
CS – Chief of Staff
CS – Civil Support
CSA – Chief of Staff of the Army
CSA – Combat Support Agencies
CSAF – Chief of Staff of the United States Air Force
CSAR - Combat Search and Rescue
CSG – Carrier Strike Group
CSST – Combat Service Support Team
CUI – Controlled Unclassified Information

D

DA – Department of the Army
DA – Direct Action
DAF – Department of the Air Force
DAO – Defense Attaché Office
DAR – Defense Acquisition Regulation
DARPA – Defense Advanced Research Projects Agency
DART – Disaster Assistance Response Team
DATT – Defense Attaché
DCO – Defense Connect Online
DCMA – Defense Contract Management Agency
DDA – Designated Disclosure Authority
DDI – Director of Defense Intelligence
DDS - Dry Deck Shelters
DEA – Drug Enforcement Administration

DEPOPSDEPS – Deputy Operations Deputies
DESRONS – Destroyer Squadrons
DHS – Department of Homeland Security
DIRLAUTH – Direct Liaison Authorized
DISA – Defense Information Systems Agency
DIA – Defense Intelligence Agency
DJS – Director Joint Staff
DLA – Defense Logistics Agency
DMHA – Disaster Management and Humanitarian Assistance
DMS – Defense Military Message System
DNA – Defense Nuclear Agency
DNI – Director of National Intelligence
DOA – Department of Agriculture
DOC – Department of Commerce
DOCNET – Doctrine Networked Education and Training
DOD – Department of Defense
DODD – Department of Defense Directive
DODI – Department of Defense Instruction
DOE – Department of Energy
DOJ – Department of Justice
DOI – Department of Interior
DOL – Department of Labor
DOM – Directorate of Management
DON – Department of the Navy
DOS – Department of State
DOTMLPF – Doctrine, Organization, Training, Materiel, Leadership and Education, Personnel, and Facilities
DOT – Department of Transportation
DPG – Defense Planning Guidance
DPO – Distribution Process Owner
DRRS – Defense Readiness Reporting System
DRU – Direct Reporting Units
DSCA – Defense Support of Civil Authorities
DT&E – Developmental Test and Evaluation
DTRA – Defense Threat Reduction Agency
DTS – Defense Transportation System or Defense Travel System
DV- Distinguished Visitor

E

ECAC – Electromagnetic Compatibility Analysis Center
ED – Department of Education
EHCC – Explosive Hazards Coordination Cell
ENDEX – End of Exercise
E.O. – Executive Order

EP - Emergency Preparedness
EPA – Environmental Protection Agency
EPOC – European Plans and Operations Center
ESG – Expeditionary Strike Group

F

I MEF – First Marine Expeditionary Force
1st MSOB – First Marine Special Operations Battalion
FAA – Federal Aviation Administration
FBI – Federal Bureau of Investigation
FCC – Federal Communication Commission
FCC – Functional Combatant Commander
FCG – Foreign Clearance Guide
FDO – Foreign Disclosure Office
FEMA - Federal Emergency Management Agency
FFIR – Friendly Force Information Requirement
FHA – Foreign Humanitarian Assistance
FID – Foreign Internal Defense
FM – Field Manual
FMTU – Foreign Military Training Unit
FOIA – Freedom of Information Act
FOUO – For Official Use Only
FPA – Foreign Policy Advisor (see POLAD also)
FPC – Final Planning Conference
FPWG – Force Protection Working Group
FRP – Fleet Response Plan
FSE – Full Scale Exercise
FTA – Federal Transit Administration
FTC – Federal Trade Commission
FVS – Foreign Visit System

G

GCC – Geographic Combatant Commander
GCCS – Global Combat & Control System
GCE – Ground Combat Element
GEF – Guidance for Employment of the Force
GEOINT – Geospatial Intelligence
GFM – Global Force Management
GIG – Global Information Grid
GO/FO – General Officer/Flag Officer
GS – Government Service
GSA – General Services Administration

H

HA – Humanitarian Assistance
HACC – Humanitarian Assistance Coordination Center
HC - Chaplain
HCA – Humanitarian and Civic Assistance
HD – Homeland Defense
HHS – Health and Human Services
HLD – Homeland Defense
HN – Host Nation
HO – History Office
HS – Homeland Security
HSC – Homeland Security Council
HQ – Headquarters
HUD – Department of Housing and Urban Development

I

IA—Interagency
IAG – Interagency Action Group
IC – Intelligence Community
ICBM – Intercontinental Ballistic Missile
ICE – U.S. Immigration Customs Enforcement
IG – Inspector General
IM – Information Management
INR – State Department’s Bureau of Intelligence and Research
IO – International Organization
IO – Information Operations
IOT&E – Initial Operational Test and Evaluation
IOWG – Information Operations Working Group
IP – Internet Protocol
IPC – Initial Planning Conference
IPL – Integrated priority list
ISO – International Standards Organization
ISR – Intelligence, Surveillance, and Reconnaissance
IT – Information Technology
IWG – Intelligence Working Group

J

JA – Judge Advocate
JAG – Judge Advocate General
JAOC – Joint Air Operations Center
J/ATPs – Joint and/or Agency Training Plans
J/AMET – Joint and/or Agency Mission Essential Task
J/AMETL – Joint and/or Agency Mission Essential Task Lists
JCIDS – Joint Capabilities Integration and Development System
JCIG – Joint Capabilities Integration Group

JCMEB – Joint Civil-Military Engineer Board
JCS – Joint Chiefs of Staff
JDDE – Joint Deployment and Distribution Enterprise
JDDOC – Joint Deployment Distribution Operations Center
JDEIS – Joint Doctrine Education and Training Electronic Information System
JDETD – Joint Doctrine, Education and Training Division
J Directorate – Joint Directorate
JELC – Joint Event Life Cycle
JEP – Joint Exercise Program
JFACC – Joint Force Air Component Command, or Commander
JFC – Joint Force Commanders, or Commands
JFCC-GS – Joint Functional Component-Global Strike
JFCC-IMD – Joint Functional Component-Global Strike Integrated Missile Defense
JFCC-ISR – Joint Functional Component-Global Strike Intelligence, Surveillance and Reconnaissance
JFCC-NW – Joint Functional Component-Global Strike - Network Warfare
JFCC-SPACE – Joint Functional Component-Global Strike Space
JFHQ-NCR – Joint Force Headquarters National Capital Region
JFLCC – Joint Force Land Component Command
JFMCC – Joint Force Maritime Component Command or Commander
JFSC – Joint Forces Staff College
JFSOCC – Joint Forces Special Operations Component Command or Commander
JFUB – Joint Facilities Utilization Board
JIACG – Joint Interagency Coordination Group
JIAMDO – Joint Integrated Air and Missile Defense Organization
JIATF-South – Joint Interagency Task Force-South
JIATF-W – Joint Interagency Task Force-West
JIOC – Joint Intelligence Operations Center
JIOC-P – Pacific Command Joint Intelligence Operations Center
JIOWC – Joint Information Operations Warfare Command
JISRC – Joint Intelligence, Surveillance and Reconnaissance Center
JKDDC – Joint Knowledge Development and Distribution Capability
JKO – Joint Knowledge Online
JLE – Joint Logistics Environment
JLLP – Joint Lessons Learned Program
JLLIS – Joint Lessons Learned Information System
JLOC – Joint Logistics Operation Center
JMPAB – Joint Materiel Priorities and Allocations Board
JNTC – Joint National Training Capability
JOA – Joint Operations Area

JOC – Joint Operations Center
JOH – Joint Officer Handbook
JOPES – Joint Operation Planning and Execution System
JP – Joint Publication
JPAC – Joint POW/MIA Accounting Command
JPD – Joint Planning Document
JPG – Joint Planning Group
JPME – Joint Professional Military Education
JPOB – Joint Plans and Operations Board
JPOC – Joint Plans and Operations Council
JPS – Joint Publication System
JRB – Joint Requirements Board or Joint Reserve Base
JROC – Joint Requirements Oversight Council
JS – Joint Staff
JSAP – Joint Staffing Action Processing
JSCP – Joint Strategic Capabilities Plan
JSG – Joint Steering Group
JSO – Joint Staff Officer
JSOC – Joint Special Operations Command
JSOTF – Joint Special Operations Task Force
JSPS – Joint Strategic Planning System
JSR – Joint Strategic Review
JTB – Joint Transportation Board
JTC3A – Joint Tactical Command, Control & Communications Agency
JTEP – Joint Training and Exercise Program
JTF – Joint Task Force
JTF-AK – Joint Task Force Alaska
JTF-Bravo – Joint Task Force Bravo
JTF-CS – Joint Task Force-Civil Support
JTF-GTMO – Joint Task Force Guantanamo Bay
JTF HQ – Joint Task Force Headquarters
JTF-N – Joint Task Force North
JTFS – Joint Training Facilitator Specialist
JTIMS – Joint Training Information Management System
JTPs – Joint Training Plans
JTS – Joint Training System
JTTP – Joint Tactics, Techniques, and Procedures
JTWG – Joint Training Working Group
JWCA – Joint Warfighting Capabilities Assessment

K

KSA – Knowledge, Skills, and Abilities
KTO – Korean Theater of Operations

L

LCAC – Landing Craft Air Cushioned
LCE – Logistics Combat Element
LEA - Law Enforcement Agency
LMS – Learning Management System
LNO - Liaison Officer

M

MA – Maritime Association
MAAG – Military Assistance Advisory Group
MACOM – Major Army Command
MAG – Marine Aircraft Group
MAGTF – Marine Air-Ground Task Forces
MAJCOM – Major Command (USAF)
MARAD – Maritime Administration
MARCENT – U.S. Marine Corps Forces Central Command
MARFOR – Marine Corp Forces
MARFORAF – Marine Corps Forces Africa
MARFORCOM – Marine Forces Command
MARFOREUR – Marine Corps Forces Europe
MARFORPAC – U.S. Marine Corps Forces Pacific
MARFORRES – Marine Forces Reserve
MARFORs – Marine Corps Forces
MARFOR SOUTH – Marine Corps Forces South
MARFORSTRAT – U.S. Marine Corps Forces U.S. Strategic
Command
MARSOC – Marine Special Operations Command
MAW – Marine Aircraft Wing
MCAS – Marine Corps Air Station
MCB – Marine Corps Base
MCCDC – Marine Corps Combat Development Command
MCCISWG – Military Command, Control and Information Systems
Working Group
MCEB – Military Communications-Electronics Board
MEB – Marine Expeditionary Brigade
MEF – Marine Expeditionary Force
MET – Mission Essential Task
MEU – Marine Expeditionary Unit
MFP – Major Force Program
MIA – Missing in Action
MILCON – Military Construction
MILDEPS – Military Departments
MILGRP – Military Group

MILPERS – Military Personnel
MilSecs – Military Secretariats
MIL-SPEC – Military Specification
MILSTAR – Military Strategic Tactical Relay
MIL-STD – Military Standard
MISO – Military Information Support Operations
MLO – Military Liaison Office
MNF – Multinational Forces
MNFC – Multinational Force Commander
MOI – Memorandum of Intent
MOS – Military Occupational Specialty
MOU – Memorandum of Understanding
MP – Military Police
MPA – Military Personnel Appropriation
MPC – Main Planning Conference
MPS – Maritime Prepositioning Ship(s)
MSC – Military Sealift Command
MSEL – Master Scenario Event List
MSOAG – Marine Special Operations Advisor Group
MSOS – Marine Special Operations School
MSOSG – Marine Special Operations Support Group
MSS – Maritime Safety and Security
MTAs – Mission Training Assessments

N

NAS – Naval Air Station
NASA – National Aeronautics and Space Administration
NATO – North Atlantic Treaty Organization
NAVAF – U.S. Naval Forces Africa
NAVCENT – U.S. Naval Forces Central Command
NAVEUR – U.S. Naval Forces Europe
NAVRESFOR – Naval Reserve Force
NAVSO – U.S. Naval Forces Southern Command
NAVSPECWARCOM – Naval Special Warfare Command
NDAA – National Defense Authorization Act
NDS – National Defense Strategy
NDU – National Defense University
NEO – Noncombatant Evacuation Operations
NEP – the President's National Exercise Program
NETOPS – Network Operations
NG – National Guard
NG – National Guard Advisor
NGA – National Geospatial-Intelligence Agency
NGB – National Guard Bureau

NGO – Non-Governmental Organization
NHTSA – National Highway Traffic Safety Administration
NIMS – National Incident Management System
NIPRNet – Non-Secure Internet Protocol Router Network
NMCB – Naval Mobile Construction Battalions
NMCC – National Military Command Center
NME – National Military Establishment
NMS – National Military Strategy
NORAD – North American Aerospace Defense Command
NRF – National Response Framework
NRO – National Reconnaissance Office
NSA – National Security Agency or Naval Support Activity
NSA/CSS – National Security Agency/Central Security Service
NSC – National Security Council
NSDM – National Security Decision Memorandum
NSF – National Science Foundation
NSS – National Security Strategy
NSSE – National Special Security Event
NSWC – Naval Special Warfare Center
NSWDG – Naval Special Warfare Development Group
NTSB – National Transportation Safety Board

O

O&M – Operations and Maintenance
OCA – Original Classification Authorities
ODA – Operational Detachment Alpha (A Team)
ODC – Office of Defense Cooperation
OEF – Operation Enduring Freedom
OFDA – Office of U.S. Foreign Disaster Assistance
OGA – Other Government Organization
OIA – Office of Intelligence and Analysis
ONCIX – Office of the National Counterintelligence Executive
OND – Operation New Dawn
OPCON – operational control
OPLAN – Operational Plan
OPM – Office of Personnel Management
OPNAV – Office of the Chief of Naval Operations
OPR – Office of Primary Responsibility
OPSDEPs – Operations Deputies
ORI – Operational Readiness Inspection
OSA – CONUS (Continental U.S.) Operational Support Airlift
OSCE – Organization for Security and Cooperation in Europe
OSC – Office of Security Cooperation
OSD – Office of Secretary of Defense

OST – Office of the Secretary

P

PA – Public Affairs

PAO – Public Affairs Office

PACAF – Pacific Air Forces

PACFLT – U.S. Pacific Fleet

PC – Personal Computer

PCS – Permanent Change of Station

PD – Position Description

PDA – Principal Disclosure Authority

PEP – Personnel Exchange Program

PFPA – Pentagon Force Protection Agency

PIR – Priority Intelligence Requirement

PJs – USAF Pararescuemen

PM – Program Manager

PME – Professional Military Education

POC – Point of Contact

POLAD – Foreign Policy Advisor (see FPA also)

POMs – Program Objectives Memoranda

POTUS – President of the United States

POW – Prisoner of War

PPBES – Planning, Programming, Budgeting and Execution System

PSA – Principal Staff Assistant

PVO – Private Voluntary Organization

PWS – Performance Work Statement

Q

QDR – Quadrennial Defense Review

R

RC – Reserve Component

RDJTF – Rapid Deployment Joint Task Force

RDO – Regional Desk Office

RDT&E – Research, Development, Test, and Evaluation

REFAD – Release from Active Duty

RF – Reserve Forces

RFA – Request for Assistance

RGS – Requirements Generation System

ROEWG – Rules of Engagement Working Group

ROMO – Range of Military Options

RSTA – Reconnaissance, Surveillance, and Target Acquisition

S

II MEF – Second Marine Expeditionary Force

2nd MSOB – 2nd Marine Special Operations Battalion Command
S&E – Scientific and Engineering
SA – Seaman Apprentice
SA – Security Assistance
SAF – Secretary of the Air Force
SAO – Security Assistance Office
SAP – Special Access Program
SBSO(A) – Sustainment Brigade, Special Operations (Airborne)
SBT – Special Boat Teams
SCC-WMD – USSTRATCOM Center for Combating Weapons of Mass Destruction
SCG – Security Cooperation Guidance
SCI – Special Compartmented Information
SCPs – Security Cooperation Plans
SDV – SEAL Delivery Vehicle
SDVT – SEAL Delivery Vehicle Team
SDDC – Surface Deployment and Distribution Command
SEAC – Senior Enlisted Advisor to the Chairman
SECAR – Secretary of the Army
SECAF – Secretary of the Air Force
SecDef – Secretary of Defense
SECNAV – Secretary of the Navy
SETAF – Southern European Task Force or U.S. Army Africa
SEWG – Special Events Working Group
SF – Special Forces
SHAPE – Supreme Headquarters Allied Powers, Europe
SIPRNet – Secure Internet Protocol Network
SITREP – Situation Report
SJA – Staff Judge Advocate
SJFHQ-P – Standing Joint Force Headquarters-Pacific
SJS – Secretary Joint Staff
SMDC/ARSTRAT – U.S. Army Space and Missile Defense Command, Army Forces Strategic Command
SOAR(A) – Special Operations Aviation Regiment (Airborne)
SOCAFRICA – Special Operations Command Africa
SOCCE – Special Operations Command and Control Element
SOCCENT – Special Operations Command Central
SOCEUR – Special Operations Command Europe
SOCJFCOM – Special Operations Command
SOCKOR – Special Operations Command Korea
SOCPAC – Special Operations Command, Pacific
SOC SOUTH – Special Operations Command South
SO F – Special Operations Forces
SOFA – Status of Forces Agreement

SOS – Special Operations Squadron
SOTB – Special Operations Training Branch
SOW – Statement of Work
SPOD – Seaport of Debarkation
SPOE – Seaport of Embarkation
SR – Seaman Recruit
SR – Special Reconnaissance
SSBNs – Navy Ballistic Missile Submarines
SSS – Selective Service System
STARTEX – Start of Exercise
STB – Surface Transportation Board
STO – Special Technical Operations
SWCC – Special Warfare Combatant-craft Crewmen

T

III MEF – Third Marine Expeditionary Force
TACON – tactical control
TCP – Theater Campaign Plan
ToL – Teams of Leaders
TPFDD – Time-Phased Force & Deployment Data (or Document)
Treasury – U.S. Department of Treasury
TSC – Theater Security Cooperation
TSOC – Theater Special Operations Command
TWCF – Transportation Working Capital Fund

U

UCP – Unified Command Plan
UHF – Ultra High Frequency
UJTL – Universal Joint Task List
UN – United Nations
USA – United States Army
USAID – U.S. Agency for International Development
USAF – United States Air Force
USAFCENT – U.S. Air Force Central
USAFE – U.S. Air Forces in Europe
USAFRICOM – United States Africa Command
USANG – Air National Guard of the United States
USAR – U.S. Army Reserve
USARAF – U.S. Army Africa (see SETF)
USARCENT – U.S. Army Central
USAREUR – U.S. Army Europe
USARNORTH – U.S. Army North
USARPAC – U.S. Army Pacific
USARSOUTH – U.S. Army South

USASFC(A) – U.S. Army Special Forces Command (Airborne)
USASOC – U.S. Army Special Operations Command
USC – United States Code
USCENTAF – U.S. Central Command Air Forces
USCENTCOM – United States Central Command
USCG – United States Coast Guard
USCGR – U.S. Coast Guard Reserve
USDA – United States Department of Agriculture
USD(I) – Under Secretary of Defense for Intelligence
USEUCOM – United States European Command
USFF – U.S. Fleet Forces Command (see USFLTFORCOM)
USFJ – U.S. Forces Japan
USFK – U.S. Forces Korea
USFLTFORCOM – U.S. Fleet Forces Command (see USFF)
USFIFTHFLT – U.S. 5th Fleet
USFOURTHFLT – U.S. 4th Fleet
USG – United States Government
USITC – United States International Trade Commission
USMARCENT – U.S. Marine Corps Forces Central Command
MARFORNORTH – U.S. Marine Forces North
USMARFORRES – U.S. Marine Forces Reserve
USMARFORSOUTH – U.S. Marine Forces South
USMC – United States Marine Corps
USMCR – U.S. Marine Corps Reserves
USN – United States Navy
USNAVCENT – U.S. Naval Forces Central Command
USNAVEUR – U.S. Naval Forces Europe
USNAVSO – U.S. Naval Forces Southern Command
USNORTHCOM – United States Northern Command
USPACOM – United States Pacific Command
USSEVENTHFLT – U.S. 7th Fleet
USSIXTHFLT – U.S. 6th Fleet
USSOCCENT – U.S. Special Operations Command Central
USSOCOM – United States Special Operations Command
USSOCSOUTH – Special Operations Command South
USSOUTHCOM – United States Southern Command
USSTRATCOM – United States Strategic Command
USTDA – U.S. Trade and Development Agency
USTENTHFLT – U.S. 10th Fleet
USTHIRDFLT – U.S. 3rd Fleet
USTRANSCOM – United States Transportation Command
UW – Unconventional Warfare

V

VA – Veterans Administration
VCJCS – Vice Chairman Joint Chiefs of Staff
VDJS – Vice Director joint Staff
VISA – Voluntary Intermodal Sealift Agreement
VTC – Video Teleconference or Teleconferencing

W

WCFs – Working Capital Funds
WG – Working Group
WMD – Weapons of Mass Destruction
WO – Washington Office

X

XO – Executive Officer

#'s

1 AF – First Air Force
I MEF – First Marine Expeditionary Force
1st MSOB – First Marine Special Operations Battalion
II MEF – Second Marine Expeditionary Force
2nd MSOB – 2nd Marine Special Operations Battalion
3 AF – Third Air Force
III MEF – Third Marine Expeditionary Force
5 AF – Fifth Air Force
7 AF – Seventh Air Force
8 AF – Eighth Air Force
9 AF – Ninth Air Force
11 AF – Eleventh Air Force
12 AF – Twelfth Air Force
13 AF – Thirteenth Air Force
17 AF – Seventeenth Air Force
18 AF – Eighteenth Air Force
20 AF – Twentieth Air Force

6.3 Glossary of Terms

acceptability: (DOD) The joint operation plan review criterion for assessing whether the contemplated course of action is proportional and worth the cost in personnel, equipment, materiel, time involved, or position; is consistent with the law of war; and is militarily and politically supportable. See also adequacy; feasibility. (JP 1-02)

adaptive planning: The joint capability to create and revise plans rapidly and systematically, as circumstances require. (JP 5-0)

adequacy: (DOD) The joint operation plan review criterion for assessing whether the scope and concept of planned operations can accomplish the assigned mission and comply with the planning guidance provided. See also acceptability; feasibility. (JP 1-02)

Administrative Control: (ADCON). (DOD) Direction or exercise of authority over subordinate or other organizations in respect to administration and support, including organization of Service forces, control of resources and equipment, personnel management, unit logistics, individual and unit training, readiness, mobilization, demobilization, discipline, and other matters not included in the operational missions of the subordinate or other organizations. Also called ADCON. (JP 1-02)

Agency Mission Essential Task List (AMETL): see JMETL.

Air Expeditionary Force: (AEF). (DOD) Deployed U.S. Air Force wings, groups, and squadrons committed to a joint operation. Also called AEF. See also air and space expeditionary task force. (JP 1-02)

air superiority: That degree of dominance in the air battle of one force over another that permits the conduct of operations by the former and its related land, sea and air forces at a given time and place without prohibitive interference by the opposing force. (JP 1-02)

air supremacy: (DOD, NATO) That degree of air superiority wherein the opposing air force is incapable of effective interference. (JP 1-02)

Air Tasking Order: (ATO) A method used to task and disseminate to components, subordinate units, and command and control agencies projected sorties, capabilities and/or forces to targets and specific missions. Normally provides specific instructions to include call signs,

targets, controlling agencies, etc., as well as general instructions. Also called ATO. (JP 1-02)

alert order: 1. A crisis-action planning directive from the SecDef, issued by the Chairman of the Joint Chiefs of Staff that provides essential guidance for planning and directs the initiation of execution planning for the selected course of action authorized by the SecDef. 2. A planning directive that provides essential planning guidance and directs the initiation of execution planning after the directing authority approves a military course of action. An alert order does not authorize execution of the approved course of action. Also called ALERTORD. See also course of action; execution planning. (JP 1-02)

alliance: The relationship that results from a formal agreement (i.e., treaties) between two or more nations for broad, long-term objectives that further the common interests of the members. See also coalition; multinational. (JP 1-02)

allocation: In a general sense, distribution for employment of limited forces and resources among competing requirements. Specific allocations (e.g., air sorties, nuclear weapons, forces, and transportation) are described as allocation of air sorties, nuclear weapons, etc. See also allocation (air); allocation (nuclear); allocation (transportation); apportionment. (JP 1-02)

amphibious objective area (AOA): (DOD) A geographical area (delineated for command and control purposes in the order initiating the amphibious operation) within which is located the objective(s) to be secured by the amphibious force. This area must be of sufficient size to ensure accomplishment of the amphibious force's mission and must provide sufficient area for conducting necessary sea, air, and land operations. Also called AOA. See also amphibious force; mission. (JP 1-02)

apportionment: (DOD) In the general sense, distribution for planning of limited resources among competing requirements. Specific apportionments (e.g., air sorties and forces for planning) are described as apportionment of air sorties and forces for planning, etc. See also allocation; apportionment (air). (JP 1-02)

area of influence: (DOD, NATO) A geographical area wherein a commander is directly capable of influencing operations by maneuver or fire support systems normally under the commander's command and control. (JP 1-02)

area of interest: (DOD) That area of concern to the commander, including the area of influence, areas adjacent thereto, and extending into enemy territory to the objectives of current or planned operations. This area also includes areas occupied by enemy forces that could jeopardize the accomplishment of the mission. Also called AOI. See also area of influence. (JP 1-02)

area of operations: An operational area defined by the joint force commander for land and maritime forces. Areas of operation do not typically encompass the entire joint operational area of the joint force commander, but should be large enough for component commanders to accomplish missions and protect their forces. Also called AO. See also area of responsibility; joint operations area; joint special operations area. (JP 1-02)

area of responsibility: (DOD) The geographical area associated with a combatant command within which a geographic combatant commander has authority to plan and conduct operations. Also called AOR. See also combatant command. (JP 1-02)

arranging operations: Joint Force Commanders must determine the best arrangement of operations to accomplish the assigned tasks and joint force mission. This arrangement often will be a combination of simultaneous and sequential operations to achieve full-spectrum superiority and the military end state conditions. Commanders consider a variety of factors when determining this arrangement including geography of the operational area, available strategic lift, Service-unique deployment capabilities, diplomatic agreements, changes in command structure, protection, level and type of OGA and NGO participation, distribution and sustainment capabilities, enemy reinforcement capabilities, and public opinion. Thinking about the best arrangement helps determine the tempo of activities in time, space, and purpose. (JP 3-0)

assembly area: (DOD, NATO) 1. An area in which a command is assembled preparatory to further action. 2. In a supply installation, the gross area used for collecting and combining components into complete units, kits, or assemblies. (JP 1-02)

assign: (DOD, NATO) 1. To place units or personnel in an organization where such placement is relatively permanent, and/or where such organization controls and administers the units or personnel for the primary function, or greater portion of the functions, of the unit or personnel. 2. (DOD Only) To detail individuals to specific

duties or functions where such duties or functions are primary and/or relatively permanent. See also attach. (JP 1-02)

assumption: (DOD) A supposition on the current situation or a presupposition on the future course of events, either or both assumed to be true in the absence of positive proof, necessary to enable the commander in the process of planning to complete an estimate of the situation and make a decision on the course of action. (JP 1-02)

attach: (DOD) 1. The placement of units or personnel in an organization where such placement is relatively temporary. 2. The detailing of individuals to specific functions where such functions are secondary or relatively temporary, e.g., attached for quarters and rations; attached for flying duty. See also assign. (JP 1-02)

augmentation forces: (DOD) Forces to be transferred from a supporting Combatant Commander to the Combatant Command (command authority) or operational control of a supported Combatant Commander during the execution of an operation order approved by the president and SecDef. (JP 1-02)

battle damage assessment (BDA): (DOD) The estimate of damage resulting from the application of lethal or nonlethal military force. Battle damage assessment is composed of physical damage assessment, functional damage assessment, and target system assessment. Also called BDA. See also combat assessment. (JP 1-02)

battlespace: (DOD) The environment, factors, and conditions that must be understood to successfully apply combat power, protect the force, or complete the mission. This includes the air, land, sea, space, and the included enemy and friendly forces; facilities; weather; terrain; the electromagnetic spectrum; and the information environment within the operational areas and areas of interest. See also electromagnetic spectrum; information environment; joint intelligence preparation of the battlespace. (JP 1-02)

branch: (DOD) 1. A subdivision of any organization. 2. A geographically separate unit of an activity, which performs all or part of the primary functions of the parent activity on a smaller scale. Unlike an annex, a branch is not merely an overflow addition. 3. An arm or service of the Army. 4. The contingency options built into the base plan. A branch is used for changing the mission, orientation, or direction of movement of a force to aid success of the operation based

on anticipated events, opportunities, or disruptions caused by enemy actions and reactions. See also sequel. (JP 1-02)

budget authority: The authority conferred by law to enter into obligations, that is, appropriations, authority to borrow, or contract authority, that will result in immediate or future outlays involving Government funds.

budget estimates submission: Service and DOD agency budget estimates based on approved programs in the Program Decision Memorandums and the most recent fiscal and monetary guidelines and assumptions.

campaign: (DOD) A series of related military operations aimed at achieving strategic and operational objectives within a given time and space. See also campaign plan. (JP 1-02)

campaign plan: (DOD) A joint operation plan for a series of related major operations aimed at achieving strategic or operational objectives within a given time and space. See also campaign; campaign planning. (JP 1-02)

campaign planning: (DOD) The process whereby Combatant Commanders and subordinate joint force commanders translate national or theater strategy into operational concepts through the development of an operation plan for a campaign. Campaign planning may begin during contingency planning when the actual threat, national guidance, and available resources become evident, but is normally not completed until after the president or SecDef selects the course of action during crisis action planning. Campaign planning is conducted when contemplated military operations exceed the scope of a single major joint operation. See also campaign; campaign plan. (JP 1-02)

center of gravity: (DOD) The source of power that provides moral or physical strength, freedom of action, or will to act. Also called COG. See also decisive point. (JP 1-02)

Chairman of the Joint Chiefs of Staff (CJCS): Principal military adviser to the president, the National Security Council, and the SecDef.

Chairman's Program Assessment (CPA): (DOD) Provides the Chairman of the Joint Chiefs of Staff's personal appraisal on alternative program recommendations and budget proposals to the SecDef for consideration in refining the defense program and budget in

accordance with 10 United States Code. The Chairman's program assessment comments on the risk associated with the programmed allocation of Defense resources and evaluates the conformance of program objective memoranda to the priorities established in strategic plans and Combatant Commanders' priority requirements. Also called CPA. (JP 1-02)

Chairman's Program Recommendations (CPR): (DOD) Provides the Chairman of the Joint Chiefs of Staff's personal recommendations to the SecDef for the programming and budgeting process before publishing the Defense Planning Guidance (DPG) in accordance with 10 United States Code. The Chairman's program recommendations articulates programs the Chairman deems critical for the SecDef to consider when identifying Department of Defense priorities and performance goals in the DPG and emphasizes specific recommendations that will enhance joint readiness, promote joint doctrine and training, improve joint warfighting capabilities, and satisfy joint warfighting requirements within DOD resource constraints and within acceptable risk levels. Also called CPR. (JP 1-02)

Chairman's Readiness System (CRS): The Chairman's Readiness System is designed to provide DOD leadership a current, macro-level assessment of the military's readiness to execute the National Military Strategy (NMS). The Joint Quarterly Readiness Review (JQRR) does this through the combination of the Services' readiness assessments, to include Global Status of Resources and Training System (GSORTS) data, the unified Combatant Commands' readiness assessments of their joint mission-essential tasks (JMETS) and the Combat Support Agencies' (CSAs) agency mission-essential task (AMET) readiness assessments. (CJCSI 3401.01D)

Civil Affairs (CA): (DOD) Designated Active and Reserve Component forces and units organized, trained, and equipped specifically to conduct civil affairs operations and to support civil-military operations. Also called CA. See also civil affairs activities; civil-military operations. (JP 1-02)

civil affairs activities: (DOD) Activities performed or supported by civil affairs that (1) enhance the relationship between military forces and civil authorities in areas where military forces are present; and (2) involve application of civil affairs functional specialty skills, in areas normally the responsibility of civil government, to enhance conduct of civil-military operations. See also civil affairs; civil-military operations. (JP 1-02)

civil-military operations: (DOD) The activities of a commander that establish, maintain, influence, or exploit relations between military forces, governmental and nongovernmental civilian organizations and authorities, and the civilian populace in a friendly, neutral, or hostile operational area in order to facilitate military operations, to consolidate and achieve operational U.S. objectives. Civil-military operations may include performance by military forces of activities and functions normally the responsibility of the local, regional, or national government. These activities may occur prior to, during, or subsequent to other military actions. They may also occur, if directed, in the absence of other military operations. Civil-military operations may be performed by designated civil affairs, by other military forces, or by a combination of civil affairs and other forces. Also called CMO. See also civil affairs; operation. (JP 1-02)

Civil-Military Operations Center (CMOC): (DOD) An organization normally comprised of civil affairs, established to plan and facilitate coordination of activities of the Armed Forces of the United States with indigenous populations and institutions, the private sector, intergovernmental organizations, nongovernmental organizations, multinational forces, and other governmental agencies in support of the joint force commander. Also called CMOC. See also civil affairs activities; civil-military operations; operation. (JP 1-02)

classes of supply: (DOD) There are ten categories into which supplies are grouped in order to facilitate supply management and planning. I. Rations and gratuitous issue of health, morale, and welfare items. II. Clothing, individual equipment, tentage, toolsets, and administrative and housekeeping supplies and equipment. III. Petroleum, oils, and lubricants. IV. Construction materials. V. Ammunition. VI. Personal demand items. VII. Major end items, including tanks, helicopters, and radios. VIII. Medical. IX. Repair parts and components for equipment maintenance. X. Nonstandard items to support nonmilitary programs such as agriculture and economic development. See also ammunition; petroleum, oils, and lubricants. (JP 1-02)

closure: (DOD) In transportation, the process of a unit arriving at a specified location. It begins when the first element arrives at a designated location, e.g., port of entry/port of departure, intermediate stops, or final destination, and ends when the last element does likewise. For the purposes of studies and command post exercises, a unit is considered essentially closed after 95 percent of its movement requirements for personnel and equipment are completed. (JP 1-02)

coalition: (DOD) An ad hoc arrangement between two or more nations for common action. See also alliance; multinational. (JP 1-02)

coalition action: (DOD) Multinational action outside the bounds of established alliances, usually for single occasions or longer cooperation in a narrow sector of common interest. See also alliance; coalition; multinational operations. (JP 1-02)

coalition force: A force composed of military elements of nations that have formed a temporary alliance for some specific purpose.

combat service support: (DOD) The essential capabilities, functions, activities, and tasks necessary to sustain all elements of operating forces in theater at all levels of war. Within the national and theater logistic systems, it includes but is not limited to that support rendered by service forces in ensuring the aspects of supply, maintenance, transportation, health services, and other services required by aviation and ground combat troops to permit those units to accomplish their missions in combat. Combat service support encompasses those activities at all levels of war that produce sustainment to all operating forces on the battlefield. Also called CSS. See also combat support. (JP 1-02)

combat support: (DOD) Fire support and operational assistance provided to combat elements. Also called CS. See also combat service support. (JP 1-02)

combat support agency: (DOD) A Department of Defense agency so designated by Congress or the SecDef that supports military combat operations. Also called CSA. (JP 1-02)

combatant command (CCMD): (DOD) A unified or specified command with a broad continuing mission under a single commander established and so designated by the president, through the SecDef and with the advice and assistance of the Chairman of the Joint Chiefs of Staff. Combatant commands typically have geographic or functional responsibilities. See also specified command; unified command. (JP 1-02)

combatant command (command authority) (COCOM): (DOD) Nontransferable command authority established by title 10 ("Armed Forces"), United States Code, section 164, exercised only by commanders of unified or specified combatant commands unless otherwise directed by the president or the SecDef. Combatant

command (command authority) cannot be delegated and is the authority of a combatant commander to perform those functions of command over assigned forces involving organizing and employing commands and forces, assigning tasks, designating objectives, and giving authoritative direction over all aspects of military operations, joint training, and logistics necessary to accomplish the missions assigned to the command. Combatant command (command authority) should be exercised through the commanders of subordinate organizations. Normally this authority is exercised through subordinate joint force commanders and Service and/or functional component commanders. Combatant command (command authority) provides full authority to organize and employ commands and forces, as the combatant commander considers necessary to accomplish assigned missions. Operational control is inherent in combatant command (command authority). Also called COCOM. See also combatant command; combatant commander; operational control; tactical control. (JP 1-02)

combatant commander (CCDR): (DOD) A commander of one of the unified or specified combatant commands established by the president. See also combatant command; specified combatant command; unified combatant command. (JP 1-02)

combating terrorism: (DOD) Actions, including antiterrorism (defensive measures taken to reduce vulnerability to terrorist acts) and counterterrorism (offensive measures taken to prevent, deter, and respond to terrorism), taken to oppose terrorism throughout the entire threat spectrum. Also called CBT. See also antiterrorism; counterterrorism. (JP 1-02)

combined: (DOD) Between two or more forces or agencies of two or more allies. (When all allies or services are not involved, the participating nations and services shall be identified, e.g., combined navies.) (JP 1-02)

combined operations: (DOD, NATO) An operation conducted by forces of two or more allied nations acting together for the accomplishment of a single mission. (JP 1-02)

Command and Control (C2): (DOD) The exercise of authority and direction by a properly designated commander over assigned and attached forces in the accomplishment of the mission. C2 functions are performed through an arrangement of personnel, equipment, communications, facilities, and procedures employed by a commander in planning, directing, coordinating, and controlling forces and

operations in the accomplishment of the mission. Also called C2. (JP 1-02)

command and control system: (DOD) The facilities, equipment, communications, procedures, and personnel essential to a commander for planning, directing, and controlling operations of assigned and attached forces pursuant to the missions assigned. (JP 1-02)

Commander's Critical Information Requirements (CCIR): (DOD) An information requirement identified by the commander as being critical to facilitating timely decision-making. The two key elements are friendly force information requirements and priority intelligence requirements. See also information; information requirements; intelligence; priority intelligence requirement. (JP 1-02)

commander's estimate: (DOD) In the context of the Joint Operation Planning and Execution System level 1 planning detail for contingency planning, a developed course of action. The product for this level can be a course of action briefing, command directive, commander's estimate, or a memorandum. The commander's estimate provides the SecDef with military courses of action to meet a potential contingency. See also commander's estimate of the situation. (JP 1-02)

commander's estimate of the situation: (DOD) A process of reasoning by which a commander considers all the circumstances affecting the military situation and arrives at a decision as to a course of action to be taken to accomplish the mission. A commander's estimate, which considers a military situation so far in the future as to require major assumptions, is called a commander's long-range estimate of the situation. (JP 1-02)

commander's intent: (DOD) A concise expression of the purpose of the operation and the desired end state. It may also include the commander's assessment of the adversary commander's intent and an assessment of where and how much risk is acceptable during the operation. See also assessment; end state. (JP 1-02)

completeness: (DOD) The joint operation plan review criterion for assessing whether operation plans incorporate major operations and tasks to be accomplished and to what degree they include forces required, deployment concept, employment concept, sustainment concept, time estimates for achieving objectives, description of the end state, mission success criteria, and mission termination criteria. (JP 1-02)

component: (DOD) 1. One of the subordinate organizations that constitute a joint force. Normally a joint force is organized with a combination of Service and functional components. (JP 1) 2. In logistics, a part or combination of parts having a specific function, which can be installed or replaced only as an entity. (JP 4-0) Also called COMP. See also functional component command; Service component command. (JP 1-02)

condition: Those variables of an operational environment or situation in which a unit, system, or individual is expected to operate and may affect performance. (JP 1-02). Also, variables of the operational environment, including scenario that affects task performance. (CJCSM 3500.04F, CJCSI 3500.02A)

contingency: (DOD) A situation requiring military operations in response to natural disasters, terrorists, subversives, or as otherwise directed by appropriate authority to protect U.S. interests. See also contingency contracting. (JP 1-02)

contingency planning: (DOD) The Joint Operation Planning and Execution System planning activities that occur in non-crisis situations. The Joint Planning and Execution Community uses contingency planning to develop operation plans for a broad range of contingencies based on requirements identified in the Contingency Planning Guidance, Joint Strategic Capabilities Plan, or other planning directive. Contingency planning underpins and facilitates the transition to crisis action planning. (JP 1-02)

Contingency Planning Guidance (CPG): (DOD) The CPG fulfills the statutory duty of the SecDef to furnish written policy guidance annually to the Chairman of the Joint Chiefs of Staff for contingency planning. The Secretary issues this guidance with the approval of the president after consultation with the Chairman of the Joint Chiefs of Staff. The CPG focuses the guidance given in the National Security Strategy and Defense Planning Guidance, and is the principal source document for the Joint Strategic Capabilities Plan. Also called CPG. (JP 1-02)

control: (DOD) 1. Authority that may be less than full command exercised by a commander over part of the activities of subordinate or other organizations. 2. In mapping, charting, and photogrammetry, a collective term for a system of marks or objects on the Earth or on a map or a photograph, whose positions or elevations (or both) have been or will be determined. 3. Physical or psychological pressures exerted with the intent to assure that an agent or group will respond as

directed. 4. An indicator governing the distribution and use of documents, information, or material. Such indicators are the subject of intelligence community agreement and are specifically defined in appropriate regulations. See also administrative control; operational control; tactical control. (JP 1-02)

coordinating authority: (DOD) A commander or individual assigned responsibility for coordinating specific functions or activities involving forces of two or more Military Departments, two or more joint force components, or two or more forces of the same Service. The commander or individual has the authority to require consultation between the agencies involved, but does not have the authority to compel agreement. In the event that essential agreement cannot be obtained, the matter shall be referred to the appointing authority. Coordinating authority is a consultation relationship, not an authority through which command may be exercised. Coordinating authority is more applicable to planning and similar activities than to operations. (JP 1-02)

country team: (DOD) The senior, in-country, U.S. coordinating and supervising body, headed by the Chief of the U.S. diplomatic mission, and composed of the senior member of each represented U.S. department or agency, as desired by the Chief of the U.S. mission. (JP 1-02)

Course of Action (COA): (DOD) 1. Any sequence of activities that an individual or unit may follow. 2. A possible plan open to an individual or commander that would accomplish, or is related to the accomplishment of the mission. 3. The scheme adopted to accomplish a job or mission. 4. A line of conduct in an engagement. 5. A product of the Joint Operation Planning and Execution System concept development phase and the course-of-action determination steps of the joint operation planning process. (JP 1-02)

crisis: (DOD) An incident or situation involving a threat to a nation, its territories, citizens, military forces, possessions, or vital interests that develops rapidly and creates a condition of such diplomatic, economic, political, or military importance that commitment of military forces and resources is contemplated to achieve national objectives. (JP 1-02)

Crisis Action Planning (CAP): (DOD) One of the two types of joint operation planning. The Joint Operation Planning and Execution System process involving the time-sensitive development of joint operation plans and operation orders for the deployment, employment,

and sustainment of assigned and allocated forces and resources in response to an imminent crisis. Crisis action planning is based on the actual circumstances that exist at the time planning occurs. See also contingency planning; joint operation planning; Joint Operation Planning and Execution System. (JP 1-02)

criticism: The minimum acceptable level of performance associated with a particular measure of task performance. It is often expressed as a specific number of hours, days, percent, occurrences, minutes, miles, or some other form of command stated measure. (CJCSM 3500.04F, CJCSI 3500.02A)

critical capability: (DOD) A means that is considered a crucial enabler for a center of gravity to function as such and is essential to the accomplishment of the specified or assumed objective(s). (JP 1-02)

critical item: (DOD) An essential item which is in short supply or expected to be in short supply for an extended period. See also critical supplies and materiel; regulated item. (JP 1-02)

critical joint duty assignment billet: (DOD) A joint duty assignment position for which, considering the duties and responsibilities of the position, it is highly important that the assigned officer is particularly trained in, and oriented toward, joint matters. Critical billets are selected by heads of joint organizations, approved by the SecDef and documented in the Joint Duty Assignment List. (JP 1-02)

critical requirement: (DOD) An essential condition, resource, and means for a critical capability to be fully operational. (JP 1-02)

decision: (DOD) In an estimate of the situation, a clear and concise statement of the line of action intended to be followed by the commander as the one most favorable to the successful accomplishment of the assigned mission. (JP 1-02)

decision point: (DOD) A point in space and time when the commander or staff anticipates making a key decision concerning a specific course of action. See also course of action; decision support template; target area of interest. (JP 1-02)

Defense Planning Guidance (DPG): (DOD) This document, issued by the SecDef, provides firm guidance in the form of goals, priorities, and objectives, including fiscal constraints, for the development of the

Program Objective Memorandums by the Military Departments and Defense agencies. (JP 1-02)

defense support of civil authorities: (DOD) Civil support provided under the auspices of the National Response Plan. Also called DSCA. (JP 1-02)

Deployable Joint Task Force Augmentation Cell (DJTFAC): (DOD) A Combatant Commander asset composed of personnel from the Combatant Command and components' staffs. The members are a joint, multi-disciplined group of planners and operators who operationally report to the Combatant Commander's operations directorate until deployed to a joint task force. (JP 1-02)

deployment database: (DOD) The Joint Operation Planning and Execution System database containing the necessary information on forces, materiel, and filler and replacement personnel movement requirements to support execution. The database reflects information contained in the refined time-phased force and deployment data from the contingency planning process or developed during the various phases of the crisis action planning process, and the movement schedules or tables developed by the transportation component commands to support the deployment of required forces, personnel, and materiel. See also time-phased force and deployment data. (JP 1-02)

deployment order: (DOD) A planning directive from the SecDef, issued by the Chairman of the Joint Chiefs of Staff that authorizes and directs the transfer of forces between Combatant Commands by reassignment or attachment. A deployment order normally specifies the authority that the gaining Combatant Commander will exercise over the transferred forces. Also called DEPORD. See also deployment; deployment planning; prepare to deploy order. (JP 1-02)

deterrence: (DOD) The prevention from action by fear of the consequences. Deterrence is a state of mind brought about by the existence of a credible threat of unacceptable counteraction. (JP 1-02)

Direct Liaison Authorized (DIRLAUTH): (DOD) That authority granted by a commander (any level) to a subordinate to directly consult or coordinate an action with a command or agency within or outside of the granting command. Direct liaison authorized is more applicable to planning than operations and always carries with it the requirement of keeping the commander granting direct liaison authorized informed.

Direct liaison authorized is a coordination relationship, not an authority through which command may be exercised. (JP 1-02)

direct support: (DOD) A mission requiring a force to support another specific force and authorizing it to answer directly to the supported force's request for assistance. Also called DS. See also close support; general support; mission; mutual support; support. (JP 1-02)

directive authority for logistics: (DOD) Combatant commander authority to issue directives to subordinate commanders, including peacetime measures, necessary to ensure the effective execution of approved operation plans. Essential measures include the optimized use or reallocation of available resources and prevention or elimination of redundant facilities and/or overlapping functions among the Service component commands. Also called DAFL. See also combatant command (command authority); logistics. (JP 1-02)

Disaster Assistance Response Team (DART): (DOD) United States Agency for International Development's (USAID) Office of Foreign Disaster Assistance (OFDA) provides this rapidly deployable team in response to international disasters. A DART provides specialists, trained in a variety of disaster relief skills, to assist U.S. embassies and USAID missions with the management of U.S. Government response to disasters. See also foreign disaster; foreign disaster relief. (JP 1-02)

doctrine: (DOD) Fundamental principles by which the military forces or elements thereof guide their actions in support of national objectives. It is authoritative but requires judgment in application. See also multinational doctrine; joint doctrine; multi-Service doctrine. (JP 1-02)

effective U.S. controlled ships: (DOD) U.S.-owned foreign flagships that can be tasked by the Maritime Administration to support Department of Defense requirements when necessary. Also called EUSCS. (JP 1-02)

Electronic Warfare (EW): (DOD) Military action involving the use of electromagnetic and directed energy to control the electromagnetic spectrum or to attack the enemy. Electronic warfare consists of three divisions: electronic attack, electronic protection, and electronic warfare support. See also directed energy; electromagnetic spectrum; electronic attack; electronic protection; electronic warfare support. (JP 1-02)

emergency action committee: (DOD) An organization established at a foreign service post by the chief of mission or principal officer for the purpose of directing and coordinating the post's response to contingencies. It consists of consular representatives and members of other local U.S. Government agencies in a foreign country who assist in the implementation of a Department of State emergency action plan. Also called EAC. (JP 1-02)

Emergency Action Plan (EAP): Reference materials maintained by U.S. Embassies that support the formulation of a NEO operation plan. One section addresses the military-assisted evacuation of U.S. citizens and designated foreign nationals. Included are possible courses of action for different threat environments, location of evacuation sites, location of assembly areas and major supply routes, key personnel, and amount of Class I on hand.

employment: (DOD) The strategic, operational, or tactical use of forces. (JP 1-02)

end state: (DOD) The set of required conditions that defines achievement of the commander's objectives. (JP 1-02)

engagement: All military activities involving other nations intended to shape the theater security environment in peacetime.

essential task: (DOD) In the context of joint operation planning, a specified or implied task that an organization must perform to accomplish the mission. An essential task is typically included in the mission statement. See also implied task; specified task. (JP 1-02)

execute order: (DOD) 1. An order issued by the Chairman of the Joint Chiefs of Staff, at the direction of the SecDef, to implement a decision by the president to initiate military operations. 2. An order to initiate military operations as directed. Also called EXORD. (JP 1-02)

execution planning: (DOD) The Joint Operation Planning and Execution System translation of an approved course of action into an executable plan of action through the preparation of a complete operation plan or operation order. Execution planning is detailed planning for the commitment of specified forces and resources. During crisis action planning, an approved operation plan or other approved course of action is adjusted, refined, and translated into an operation order. Execution planning can proceed on the basis of prior contingency planning, or it can take place in the absence of prior

planning. Also called EP. See also Joint Operation Planning and Execution System. (JP 1-02)

executive agent: (DOD). The Head of a DOD Component to whom the Secretary of Defense or the Deputy Secretary of Defense has assigned or delegated specific functions, responsibilities, and authorities to act on their behalf to perform a range of activities that involve two or more of the DOD Components. Designation as a DOD Executive Agent, in and of itself, confers no function, responsibility, or authority. The exact nature and scope of the DOD Executive Agent functions, responsibilities, and authorities must be stated in the establishing document.

force list: (DOD) A total list of forces required by an operation plan, including assigned forces, augmentation forces, and other forces to be employed in support of the plan. (JP 1-02)

force projection: (DOD) The ability to project the military instrument of national power from the United States or another theater, in response to requirements for military operations. See also force. (JP 1-02)

force protection: (DOD) Preventive measures taken to mitigate hostile actions against Department of Defense personnel (to include family members), resources, facilities, and critical information. Force protection does not include actions to defeat the enemy or protect against accidents, weather, or disease. Also called FP. See also force; force protection condition; protection. (JP 1-02)

foreign disclosure: the transfer of classified military information (CMI) or Controlled Unclassified Information (CUI) to a foreign government or international organization through approved government-to-government channels. Disclosures may be accomplished through oral, visual or documentary modes.

foreign internal defense: (DOD) Participation by civilian and military agencies of a government in any of the action programs taken by another government or other designated organization to free and protect its society from subversion, lawlessness, and insurgency. Also called FID. (JP 1-02)

fragmentary order: (DOD) An abbreviated form of an operation order issued as needed after an operation order to change or modify that

order or to execute a branch or sequel to that order. Also called FRAGORD. (JP 1-02)

functional component command: (DOD) A command normally, but not necessarily, composed of forces of two or more Military Departments which may be established across the range of military operations to perform particular operational missions that may be of short duration or may extend over a period of time. See also component; Service component command. (JP 1-02)

Future Years Defense Program (FYDP): The program and financial plan for the Department of Defense as approved by the SecDef. The FYDP arrays cost data, manpower and force structure over a 6-year period (force structure for an additional 3 years), portraying this data by major force program for DOD internal review for the program and budget review submission. It is also provided to the Congress in conjunction with the president's budget. (DOD 7000.14-R)

Global Command and Control System (GCCS): highly mobile, deployable command and control system supporting forces for joint and multinational operations across the range of military operations, anytime and anywhere in the world with compatible, interoperable, and integrated command, control, communications, computers, and intelligence systems.

Global Transportation Network (GTN): (DOD) The automated support necessary to enable U.S. Transportation Command and its components to provide global transportation management. The Global Transportation Network provides the integrated transportation data and systems necessary to accomplish global transportation planning, command and control, and in-transit visibility across the range of military operations. The designated Department of Defense in-transit visibility system provides customers with the ability to track the identity, status, and location of Department of Defense units and non-unit cargo, passengers, patients, forces, and military and commercial airlift, sealift, and surface assets from origin to destination across the range of military operations. The Global Transportation Network collects, integrates, and distributes transportation information to Combatant Commanders, Services, and other Department of Defense customers. Global Transportation Network provides U.S. Transportation Command with the ability to perform command and control operations, planning and analysis, and business operations in tailoring customer requirements throughout the requirements process. Also called GTN.

See also global transportation management; in-transit visibility; United States Transportation Command. (JP 1-02)

hostile act: (DOD) An attack or other use of force against the U.S., U.S. forces, or other designated persons or property. It also includes force used directly to preclude or impede the mission and/or duties of U.S. forces, including the recovery of U.S. personnel or vital U.S. Government property. (JP 1-02)

hostile intent: (DOD) The threat of imminent use of force by a foreign force, terrorist(s), or organization against the United States and U.S. national interests, U.S. forces and, in certain circumstances, U.S. nationals, their property, U.S. commercial assets, and other designated non-U.S. forces, foreign nationals, and their property. When hostile intent is present, the right exists to use proportional force, including armed force, in self-defense by all necessary means available to deter or neutralize the potential attacker or, if necessary, to destroy the threat. A determination that hostile intent exists and requires the use of proportional force in self-defense must be based on evidence that an attack is imminent. Evidence necessary to determine hostile intent will vary depending on the state of international and regional political tension, military preparations, intelligence, and indications and warning information. (JP 1-02)

host-nation support: (DOD) Civil and/or military assistance rendered by a nation to foreign forces within its territory during peacetime, crises or emergencies, or war based on agreements mutually concluded between nations. Also called HNS. See also host nation. (JP 1-02)

humanitarian and civic assistance: (DOD) Assistance to the local populace provided by predominantly U.S. forces in conjunction with military operations and exercises. This assistance is specifically authorized by title 10, U.S. Code, section 401, and funded under separate authorities. Assistance provided under these provisions is limited to (1) medical, dental, and veterinary care provided in rural areas of a country; (2) construction of rudimentary surface transportation systems; (3) well drilling and construction of basic sanitation facilities; and (4) rudimentary construction and repair of public facilities. Assistance must fulfill unit training requirements that incidentally create humanitarian benefit to the local populace. Also called HCA. See also foreign humanitarian assistance. (JP 1-02)

implementation: (DOD) Procedures governing the mobilization of the force and the deployment, employment, and sustainment of military

operations in response to execution orders issued by the SecDef. Also called IMP. (JP 1-02)

indications and warning (I&W): (DOD) Those intelligence activities intended to detect and report time-sensitive intelligence information on foreign developments that could involve a threat to the United States or allied and/or coalition military, political, or economic interests or to U.S. citizens abroad. It includes forewarning of hostile actions or intentions against the United States, its activities, overseas forces, or allied and/or coalition nations. Also called I&W. See also information; intelligence. (JP 1-02)

information operations (IO): (DOD) The integrated employment of the core capabilities of electronic warfare, computer network operations, psychological operations, military deception, and operations security, in concert with specified supporting and related capabilities, to influence, disrupt, corrupt or usurp adversarial human and automated decision making while protecting our own. Also called IO. See also computer network operations; electronic warfare; military deception; operations security; psychological operations. (JP 1-02)

in-place force: (DOD) 1. A NATO assigned force that, in peacetime, is principally stationed in the designated combat zone of the NATO command to which it is committed. 2. Force within a combatant commander's area of responsibility and under the combatant commander's Combatant Command (command authority). (JP 1-02)

integrated priority list (IPL): (DOD) A list of a combatant commander's highest priority requirements, prioritized across Service and functional lines, defining shortfalls in key programs that, in the judgment of the combatant commander, adversely affect the capability of the combatant commander's forces to accomplish their assigned mission. The integrated priority list provides the combatant commander's recommendations for programming funds in the planning, programming, and budgeting system process. Also called IPL. (JP 1-02)

intelligence estimate: (DOD) The appraisal expressed in writing or orally, of available intelligence relating to a specific situation or condition with a view to determining the courses of action open to the enemy or adversary and the order of probability of their adoption. (JP 1-02)

interagency coordination: (DOD) Within the context of Department of Defense involvement, the coordination that occurs between elements of Department of Defense, and engaged U.S. Government agencies for the purpose of achieving an objective. (JP 1-02)

interagency operations: operations in which government or nongovernment agencies interact with the Armed Forces of the United States. These agencies may include the National Security Council, headquarters of operating elements of the Department of State and Transportation, the Central Intelligence Agency, and the Adjutants General of the 50 states and four territories; and other U.S. government agencies; agencies of partner nations; nongovernmental organizations; regional and international organizations such as the North Atlantic Treaty Organization and the United Nations; and the agencies of the host country.

internal defense and development (IDAD): (DOD) The full range of measures taken by a nation to promote its growth and to protect itself from subversion, lawlessness, and insurgency. It focuses on building viable institutions (political, economic, social, and military) that respond to the needs of society. Also called IDAD. See also foreign internal defense. (JP 1-02)

international logistics: (DOD) The negotiating, planning, and implementation of supporting logistics arrangements between nations, their forces, and agencies. It includes furnishing logistic support (major end items, materiel, and/or services) to, or receiving logistic support from, one or more friendly foreign governments, international organizations, or military forces, with or without reimbursement. It also includes planning and actions related to the intermeshing of a significant element, activity, or component of the military logistics systems or procedures of the United States with those of one or more foreign governments, international organizations, or military forces on a temporary or permanent basis. It includes planning and actions related to the utilization of United States logistics policies, systems, and/or procedures to meet requirements of one or more foreign governments, international organizations, or forces. (JP 1-02)

joint: (DOD) connotes activities, operations, organizations, etc., in which elements of two or more Military Departments participate. (JP 1-02)

Joint After-Action Reporting System (JAARS): (DOD) formal process for the collection and dissemination of observations, lessons

learned, and issues generated from joint operations and exercises. (CJCSI 3150.25/JAARS)

joint doctrine: (DOD) fundamental principles that guide the employment of forces of two or more Services in coordinated action toward a common objective. It will be promulgated by the Chairman of the Joint Chiefs of Staff, in coordination with the Combatant Commands, Services, and Joint Staff. (JP 1-02)

joint duty assignment (JDA): (DOD) an assignment to a designated position in a multi-Service, joint or multinational command or activity that is involved in the integrated employment or support of the land, sea, and air forces of at least two of the three Military Departments. Such involvement includes, but is not limited to, matters relating to national military strategy, joint doctrine and policy, strategic planning, contingency planning, and command and control of combat operations under a unified or specified command. (JP 1-02)

Joint Duty Assignment List (JDAL): (DOD) positions designated as joint duty assignments are reflected in a list approved by the SecDef and maintained by the Joint Staff. The Joint Duty Assignment List is reflected in the Joint Duty Assignment Management Information System. (JP 1-02)

joint force: (DOD) a general term applied to a force composed of significant elements, assigned or attached, of two or more Military Departments, operating under a single joint force commander. (JP 1-02)

joint force commander (JFC): (DOD) general term applied to a combatant commander, sub-unified commander, or joint task force commander authorized to exercise Combatant Command (command authority) or operational control over a joint force. (JP 1-02)

joint force special operations component commander: The commander within a unified command, subordinate unified command, or joint task force responsible to the establishing commander for making recommendations on the proper employment of assigned, attached, and/or made available for tasking special operations forces and assets; planning and coordinating special operations; or accomplishing such operational missions as may be assigned. The joint force special operations component commander is given the authority necessary to accomplish missions and tasks assigned by the establishing commander. Also called JFSOCC. (JP 3-0)

Joint Integrated Prioritized Target List (JIPTL): (DOD) prioritized list of targets and associated data approved by a joint force commander, and maintained by a joint task force. Targets and priorities are derived from the recommendations of components in conjunction with their proposed operations supporting the joint force commander's objectives and guidance. (JP 1-02)

Joint Intelligence Preparation of the Battlespace (JIPB): (DOD) the analytical process used by joint intelligence organizations to produce intelligence assessments, estimates and other intelligence products in support of the joint commander's decision making process. It is a continuous process that includes defining the total battlespace environment; describing the battlespace's effects; evaluating the adversary; and determining and describing adversary potential courses of action. The process is used to analyze the air, land, sea, space, electromagnetic, cyberspace, and human dimensions of the environment and to determine an opponent's capabilities to operate in each. Joint intelligence preparation of the battlespace products are used by the joint force and component command staffs in preparing their estimates and are also applied during the analysis and selection of friendly courses of action. (JP 1-02)

Joint Lessons Learned Information System (JLLIS): The JLLIS supports the Director, DLA in the execution of his responsibilities and to help enable continuous process improvement by gathering observations and recommendations and making that data available across the enterprise. These lessons learned, after action reviews, and knowledge claims may be from operations, exercises, and other activities as well as from partner organizations in order to identify emerging issues, collect and manage the DLA JLLIS database, and report findings, trends, and issues through electronic media.

Joint Lessons Learned Program (JLLP): The JLLP provides the joint community a method to identify, capture, and share information collected as a result of operations, exercises, training events, and other sources for the purpose of enhancing an organization's performance to accomplish warfighting tasks. The JLLP is comprised of a set of interrelated systems, formal and informal, designed to collect, analyze, and share information. The JLLP capitalizes on the lessons learned process at work in these interrelated systems to improve warfighting capabilities. Similar processes occur at all levels within the program. The JLLP consists of four principal components: user, input, process, and output. The process stage is comprised of four primary

procedures: collection, analysis, maintaining, and the dissemination of information.

joint logistics: (DOD) art and science of planning and carrying out, by a joint force commander and staff, logistic operations to support the protection, movement, maneuver, firepower, and sustainment of operating forces of two or more Services of the same nation. (JP 1-02)

joint mission essential task (JMET): (DOD) mission task selected from the Universal Joint Task List (UJTL) by a joint force commander deemed essential to mission accomplishment. Force providers will also select additional tasks in accordance with their joint training mission for assigned combatant headquarters and forces and deemed essential to the mission of the combatant headquarters and forces. (CJCSI 3500.01F/JTP, CJCSI 3500.02A/UJTL POLICY & CJCSM 3500.04F/UJTL MANUAL)

Joint Mission Essential Task List (JMETL): A list of JMETs/AMETs selected by a commander or agency director to accomplish an assigned or anticipated mission that includes associated tasks, conditions, and standards, and requires the identification of command linked and supporting tasks. Also called JMETL or AMETL. (CJCSI 3500.01F/JTP, CJCSI 3500.02A/UJTL POLICY & CJCSM 3500.04F/UJTL MANUAL)

Joint Monthly Readiness Review (JMRR): (DOD) provides the CJCS a current and broad assessment of the military's readiness to fight, across all three levels of war [*Strategic, Operational and Tactical*]. (CJCS Guide 3401A/CRS)

joint operation planning: (DOD) planning for contingencies which can reasonably be anticipated in an area of responsibility or joint operations area of the command. Planning activities exclusively associated with the preparation of operation plans, operation plans in concept format, campaign plans, and operation orders (other than the single integrated operation plan) for the conduct of military operations by the Combatant Commanders in response to requirements established by the Chairman of the Joint Chiefs of Staff. Joint operation planning is coordinated at the national level to support SecDef Contingency Planning Guidance, strategic requirements in the National Military Strategy, and emerging crises. As such, joint operation planning includes mobilization planning, deployment planning, employment planning, sustainment planning, and redeployment planning procedures. Joint operation planning is

performed in accordance with formally established planning and execution procedures. (JP 1-02)

Joint Operation Planning and Execution System (JOPES): (DOD) continuously evolving system that is being developed through the integration and enhancement of earlier planning and execution systems: Joint Operation Planning System and Joint Deployment System. It provides the foundation for conventional command and control by national and theater-level commanders and their staffs. It is designed to satisfy their information needs in the conduct of joint planning and operations. Joint Operation Planning and Execution System (JOPES) includes joint operation planning policies, procedures, and reporting structures supported by communications and automated data processing systems. JOPES is used to monitor, plan, and execute mobilization, deployment, employment, and sustainment activities associated with joint operations.

joint operation planning process: a coordinated Joint Staff procedure used by a commander to determine the best method of accomplishing assigned tasks and to direct the action necessary to accomplish the mission. (JP 1-02)

joint operations: (DOD) a general term to describe military actions conducted by joint forces, or by Service forces in relationships (e.g., support, coordinating authority), which, of themselves, do not create joint forces. (JP 1-02)

Joint Operations Area (JOA): (DOD) an area of land, sea, and airspace, defined by a geographic Combatant Commander or subordinate unified commander, in which a joint force commander (normally a joint task force commander) conducts military operations to accomplish a specific mission. Joint operations areas are particularly useful when operations are limited in scope and geographic area or when operations are to be conducted on the boundaries between theaters. (JP 1-02)

Joint Planning and Execution Community (JPEC): (DOD) those headquarters, commands, and agencies involved in the training, preparation, movement, reception, employment, support, and sustainment of military forces assigned or committed to a theater of operations or objective area. It usually consists of the Joint Staff, Services, Service major commands (including the Service wholesale logistics commands), unified commands (and their certain Service component commands), subunified commands, transportation

component commands, joint task forces (as applicable), Defense Logistics Agency, and other Defense agencies (e.g., Defense Intelligence Agency) as may be appropriate to a given scenario. (JP 1-02)

Joint Planning Document (JPD): (DOD) the JPD represents the earliest formal, authoritative planning and broad programming advice from the Chairman to the SecDef. OSD begins the process of developing the initial draft of the Defense Planning guidance (DPG). The JPD articulates the Chairman's strategy-based planning, broad programming direction, and priorities while taking into account coordinated inputs from the Services and Combatant Commanders. (CJCSI 3100.01/JSPS)

Joint Planning Group (JPG): (DOD) a joint force planning organization consisting of designated representatives of the joint force headquarters principal and special staff sections, joint force components (Service and/or functional), and other supporting organizations or agencies as deemed necessary by the joint force commander (JFC). Joint planning group membership should be designated spokespersons for their respective sections or organizations. Responsibilities and authority of the joint planning group are assigned by the JFC. Normally headed by the joint force chief planner, joint planning group responsibilities may include, but are not limited to, crisis action planning (to include course of action development and refinement), coordination of joint force operation order development, and planning for future operations (e.g., transition, termination, follow-on). (CJCSI 3100.01/JSPS)

Joint Professional Military Education (JPME): (DOD) that portion of professional military education concentrating on the instruction of joint matters. (CJCSI 3500.01F, CJCSM 3500.03/JTM, CJCSM 3500.04B/UJT)

Joint Requirements Board (JRB): (DOD) the council of one- and two-star officers who consider and prepare issues for JROC consideration. (CJCSI 3100.01/JSPS)

Joint Requirements Oversight Council (JROC): (DOD) an advisory council to the CJCS to provide assistance in: identifying and assessing the priority of joint military requirements and acquisition programs to meet the national military strategy, considering alternatives to any acquisition program that has been identified to meet military requirements, and assigning joint priority among existing and future

major programs meeting valid requirements identified by the Combatant Commands, Services, and other DOD agencies. (CJCSI 3137.01/JWCA)

Joint Special Operations Area: An area of land, sea, and airspace assigned by a joint force commander to the commander of a joint special operations force to conduct special operations activities. It may be limited in size to accommodate a discrete direct action mission or may be extensive enough to allow a continuing broad range of unconventional warfare operations. Also called JSOA. (JP 3-0 and JP 3-05.1)

Joint Special Operations Task Force (JSOTF): a joint task force composed of special operations units from more than one Service, formed to carry out a specific special operation or prosecute special operations in support of a theater campaign or other operations. The joint special operations task force may have conventional non-special operations units assigned or attached to support the conduct of specific missions. (JP 3-05.1)

joint staff: 1. The staff of a commander of command, or of a joint task force, which includes members from the several Services comprising the force. These members should be assigned in such a manner as to ensure that the commander understands the tactics, techniques, capabilities, needs, and limitations of the component parts of the force. Positions on the staff should be divided so that Service representation and influence generally reflect the Service composition of the force. 2. Joint Staff. The staff under the Chairman of the Joint Chiefs of Staff as provided for in the National Security Act of 1947, as amended by the DOD Reorganization Act of 1986. The Joint Staff assists the Chairman, and, subject to the authority, direction, and control of the Chairman, the other members of the Joint Chiefs of Staff and the Vice Chairman in carrying out their responsibilities. (JP 1-02)

Joint Strategic Capabilities Plan (JSCP): (DOD) The Joint Strategic Capabilities Plan provides guidance to the Combatant Commanders and the Joint Chiefs of Staff to accomplish task and missions based on current military capabilities. It apportions resources to Combatant Commanders, based on military capabilities resulting from completed program and budget actions and intelligence assessments. The JSCP provides a coherent framework for capabilities-based military advice provided to the National Command Authorities. (JP 1-02)

Joint Strategic Planning System (JSPS): primary means by which the Chairman, in consultation with the other members of the Joint Chiefs of Staff and the Combatant Commanders, carries out his statutory responsibilities to assist the president and SecDef in giving strategic direction to the Armed Forces; prepares strategic plans; prepares and reviews contingency plans; advises the president and SecDef on requirements, programs, and budgets; and gives net assessment on the capabilities of the Armed Forces of the United States and its allies as compared with those of their potential adversaries. (JP 1-02)

Joint Strategy Review (JSR): The JSR provides the primary means for the Chairman, in consultation with the Combatant Commanders, Services, and Defense agencies, to analyze strategic concepts and issues relevant to strategy formulation. This analysis provides a basis for changes to the Joint Vision and National Military Strategy. (CJCSI 3100.01/JSPS)

Joint Tactics, Techniques, And Procedures (JTTP): the actions and methods which implement joint doctrine and describe how forces will be employed in joint operations. They will be published by CJCS, in coordination with the Combatant Commands, Services, and Joint Staff. (JP 1-02)

Joint Task Force (JTF): (DOD) joint force constituted and so designated by the SecDef, a Combatant Commander, a subunified commander, or an existing joint task force commander. (JP 1-02)

Joint Theater Missile Defense (JTMD): (DOD) the integration of joint force capabilities to destroy enemy theater missiles in flight or prior to launch or to otherwise disrupt the enemy's theater missile operations through an appropriate mix of mutually supportive passive missile defense; active missile defense; attack operations; and supporting command, control, communications, computers, and intelligence measures. Enemy theater missiles are those that are aimed at targets outside the continental United States. (JP 1-02)

Joint Training Information Management System (JTIMS): web-based system used by the Joint Staff, combatant commanders, Combat Support Agencies, and the National Guard Bureau to manage all large-scale, military training exercises and operational events. JTIMS supports the JTS by facilitating the development of an integrated, task-based thread to guide all four JTS phases.

Requirements, plans, execution, and assessments are all linked to mission and mission-essential task list (METL).

Joint Universal Lessons Learned System (JULLS): (DOD) software package designed to create, modify, and display observations, lessons learned, and issues from joint exercises and operations. (CJCSI 3150.25/JAARS)

Joint Warfighting Capabilities Assessments (JWCA): (DOD) continuous assessments conducted by teams of warfighting and functional area experts from the Joint Staff, unified commands, Services, Office of the SecDef, Defense agencies, and others as required. JWCA products and recommendations are used to assist the Chairman in the development of the CPR and CPA. (CJCSI 3150.25/JAARS)

JOPES ADP: the Global Command and Control System (GCCS) standard computer-based system consisting of standard data files, standard ADP programs, and instructions for the reporting and exchange of data used to develop, analyze, refine, review, and maintain joint operation plans.

lead agency: (DOD) designated among U.S. Government agencies to coordinate the interagency oversight of the day-to-day conduct of an ongoing operation. The lead agency is to chair the interagency working group established to coordinate policy related to a particular operation. The lead agency determines the agenda, ensures cohesion among the agencies and is responsible for implementing decisions. (JP 1-02)

lead nation: (DOD) one nation assumes the responsibility for procuring and providing a broad spectrum of logistic support for all or part of the multinational force and/or headquarters. Compensation and/or reimbursement will then be subject to agreements between the parties involved. The lead nation may also assume the responsibility to coordinate logistics of the other nations within its functional and regional area of responsibility. (JP 1-02)

logistics: (DOD) science of planning and carrying out the movement and maintenance of forces. In its most comprehensive sense, those aspects of military operations which deal with: a. design and development, acquisition, storage, movement, distribution, maintenance, evacuation, and disposition of materiel; b. movement, evacuation, and hospitalization of personnel; c. acquisition or

construction, maintenance, operation, and disposition of facilities; and
d. acquisition or furnishing of services. (JP 1-02)

logistic support: (DOD) encompasses the logistic services, materiel, and transportation required to support the continental United States-based and worldwide deployed forces. (JP 1-02)

major defense program or major force program: category of program elements that represents a major force, mission, or support function, e.g., strategic forces, intelligence and communications, research and development, supply and maintenance, etc. (adapted from DOD Instruction 7045.7)

Major Theater War (MTW): (DOD) a regionally centered crisis based on a significant threat to U.S. vital interests in a region that warrants the deployment of forces greater than division-wing-battle group combinations. (CJCSM 3110.01A/JSCP)

materiel: (DOD) all items (including ships, tanks, self-propelled weapons, aircraft, etc., and related spares, repair parts, and support equipment, but excluding real property, installations, and utilities) necessary to equip, operate, maintain, and support military activities without distinction as to its application for administrative or combat purposes. (JP 1-02)

measure: A parameter that provides the basis for describing varying levels of task accomplishment. (CJCSM 3500.04F, CJCSI 3500.02A)

Military Assistance Program: (DOD) that portion of the U.S. security assistance authorized by the Foreign Assistance Act of 1961, as amended, which provides defense articles and services to recipients on an unreimbursable (grant) basis. (JP 1-02)

military capability: (DOD) ability to achieve a specified wartime objective (win a war or battle, destroy a target set). It includes four major components: force structure—Numbers, size, and composition of the units that comprise our Defense forces; e.g., divisions, ships, air wings; modernization—technical sophistication of forces, units, weapon systems, and equipment; unit readiness—ability to provide capabilities required by the combatant commanders to execute assigned missions, derived from the ability of each unit to deliver the outputs for which it was designed; and sustainability—the ability to maintain the necessary level and duration of operational activity to achieve military objectives, a function of providing for and maintaining those levels of ready forces,

materiel, and consumables necessary to support military effort. (JP 1-02)

Military Department: one of the departments within the Department of Defense created by the National Security Act of 1947, as amended (Department of the Army, Navy, or Air Force). (JP 1-02)

Military Information Support Operations (MISO): (DOD) planned operations to convey selected information and indicators to foreign audiences to influence their emotions, motives, objective reasoning, and ultimately the behavior of foreign governments, organizations, groups, and individuals. The purpose of MISO is to induce or reinforce foreign attitudes and behavior favorable to the originator's objectives. Note: MISO replaces the term psychological operations. (JP 1-02)

military objectives: (DOD) the derived set of military actions to be taken to implement National Command Authorities guidance in support of national objectives. Defines the results to be achieved by the military and assigns tasks to commanders. (JP 1-02)

military operations other than war (MOOTW): (DOD) operations that encompass the use of military capabilities across the range of military operations short of war; can be applied to complement any combination of the other instruments of national power and occur before, during, and after war. (JP 1-02)

military options: (DOD) range of military force responses that can be projected to accomplish assigned tasks. Options include one or a combination of the following: civic action, humanitarian assistance, civil affairs, and other military activities to develop positive relationships with other countries; confidence building and other measures to reduce military tensions; military presence; activities to convey threats to adversaries and truth projections; military deceptions and psychological operations; quarantines, blockades, and harassment operations; raids; intervention campaigns; armed conflict involving air, land, maritime, and strategic warfare campaigns and operations; support for law enforcement authorities to counter international criminal activities (terrorism, narcotics trafficking, slavery, and piracy); support for law enforcement authorities to suppress domestic rebellion; and support for insurgencies, counterinsurgency, and civil war in foreign countries. (JP 1-02)

military strategy: (DOD) art and science of employing the armed forces of a nation to secure the objectives of national policy by the

application of force or the threat of force. (JP 1-02)

military support to civil authorities (MSCA): (DOD) activities and measures taken by the Department of Defense to foster mutual assistance and support between the Department of Defense and any civil government agency in planning or preparedness for, or in the application of resources for response to, the consequences of civil emergencies or attacks, including national security emergencies. (JP 1-02)

mission: (DOD) 1. The task, together with the purpose, that clearly indicates the reason for and action to be taken. 2. In common usage, especially when applied to lower military units, a duty assigned to an individual or unit; a task. 3. The dispatching of one or more aircraft to accomplish one particular task. (JP 1-02)

Mission Essential Task (MET): see JMETL.

mobilization: (DOD) 1. The act of assembling and organizing national resources to support national objectives in time of war or other emergencies. 2. The process by which the Armed Forces or part of them are brought to a state of readiness for war or other national emergency. This includes activating all or part of the Reserve Components as well as assembling and organizing personnel, supplies, and materiel. Mobilization of the Armed Forces includes, but is not limited to, the following categories: a. *selective mobilization*—Expansion of the active Armed Forces resulting from action by Congress and/or the president to mobilize Reserve Component units, individual ready reservists, and the resources needed for their support to meet the requirements of a domestic emergency that is not the result of an enemy attack. b. *partial mobilization*—Expansion of the active Armed Forces resulting from action by Congress (up to full mobilization) or by the president (not more than 1,000,000 for not more than 24 consecutive months) to mobilize Ready Reserve Component units, individual reservists, and the resources needed for their support to meet the requirements of a war or other national emergency involving an external threat to the national security. c. *full mobilization*—Expansion of the active Armed Forces resulting from action by Congress and the president to mobilize all Reserve Component units in the existing approved force structure, all individual reservists, retired military personnel, and the resources needed for their support to meet the requirements of a war or other national emergency involving an external threat to the national security. Reserve personnel can be placed on active duty for the duration of the emergency plus six

months. *d. total mobilization*—Expansion of the active Armed Forces resulting from action by Congress and the president to organize and/or generate additional units or personnel, beyond the existing force structure, and the resources needed for their support, to meet the total requirements of a war or other national emergency involving an external threat to the national security. (JP 1-02)

nation assistance: (DOD) civil and/or military assistance rendered to a nation by foreign forces within that nation's territory during peacetime, crises or emergencies, or war based on agreements mutually concluded between nations. Nation assistance programs include, but are not limited to, security assistance, foreign internal defense, other U.S. Code title 10 (DOD) programs, and activities performed on a reimbursable basis by Federal agencies or international organizations. (JP 1-02)

national emergency: (DOD) a condition declared by the president or the Congress by virtue of powers previously vested in them that authorize certain emergency actions to be undertaken in the national interest. Action to be taken may include partial, full, or total mobilization of national resources. (JP 1-02)

national intelligence estimate (NIE): (DOD) a strategic estimate of the capabilities, vulnerabilities, and probable courses of action of foreign nations which is produced at the national level as a composite of the views of the intelligence community. (JP 1-02)

National Military Command System (NMCS): (DOD) The priority component of the Global Command and Control System designed to support the National Command Authorities and Joint Chiefs of Staff in the exercise of their responsibilities. (JP 1-02)

National Military Strategy (NMS): (DOD) The CJCS document prepared in consultation with the Combatant Commanders and the JCS that conveys advice on strategic direction for the Armed Forces. (CJCSI 8501.01/PBBS)

national objectives: (DOD) the aims, derived from national goals and interests, toward which a national policy or strategy is directed and efforts and resources of the nation are applied. (JP 1-02)

National Security Council (NSC): (DOD) governmental body specifically designed to assist the president in integrating all spheres of national security policy. The president, vice president, secretary of

state, and secretary of defense are statutory members. The chairman of the joint chiefs of staff; director, Central Intelligence Agency; and the assistant to the president for National Security Affairs serve as advisers. (JP 1-02)

national security interests: (DOD) foundation for the development of valid national objectives that define U.S. goals or purposes. National security interests include preserving U.S. political identity, framework, and institutions; fostering economic well-being; and bolstering international order supporting the vital interests of the United States and its allies.

national security strategy (national strategy, grand strategy): art and science of developing, applying, and coordinating the instruments of national power (diplomatic, economic, military and informational) to achieve objectives that contribute to national security. (JP 1-02)

NEOPACK: (DOD) an assembled package of selected maps, charts, and other geographic materials of various scales to support the planning and conduct of noncombatant evacuation operations in selected countries or areas. See also noncombatant evacuation operations. (JP 1-02)

Non-Governmental Organization (NGO): (DOD) transnational organizations of private citizens that maintain a consultative status with the Economic and Social Council of the United Nations. Nongovernmental organizations may be professional associations, foundations, multinational businesses, or simply groups with a common interest in humanitarian assistance activities (development and relief). "Nongovernmental organizations" is a term normally used by non-United States organizations. See also private voluntary organizations. (JP 1-02)

normal operations: (DOD) generally and collectively, the broad functions which a Combatant Commander undertakes when assigned responsibility for a given geographic or functional area. Except as otherwise qualified in certain unified command plan paragraphs which relate to particular commands, "normal operations" of a Combatant Commander include: planning for and execution of operations throughout the range of military operations; planning and conduct of cold war activities; planning for and administration of military assistance; and maintaining the relationships and exercising the directive or coordinating authority prescribed in Joint Pub 0-2, Admin. Pub 1.1, and Joint Pub 4-01. (JP 1-02)

Office of U.S. Foreign Disaster Assistance (OFDA): (DOD) The United States government agency [within the U.S. Agency for International Development (USAID)] that administers the president's authority to provide emergency relief and long-term humanitarian assistance in response to disasters declared by the Ambassador (also known as the Chief of Mission) within the affected country or higher Department of State authority. USAID/OFDA may also expedite interventions at the operational and tactical levels through NGOs, PVOs, regional and international organizations, and other sources of relief capacity. (JP 3-08, Vol. II)

operation: (DOD) a military action or the carrying out of a strategic, tactical, service, training, or administrative military mission; the process of carrying on combat, including movement, supply, attack, defense and maneuvers needed to gain the objectives of any battle or campaign. (JP 1-02)

operation plan: (DOD) any plan, except for the Single Integrated Operation Plan, for the conduct of military operations. Plans are prepared by combatant commanders in response to requirements established by the Chairman of the Joint Chiefs of Staff and by commanders of subordinate commands in response to requirements tasked by the establishing unified commander. Operation plans are prepared in either a complete format (OPLAN) or as a concept plan (CONPLAN). The CONPLAN can be published with or without a time-phased force and deployment data (TPFDD) file. *a. Operation Plan (OPLAN)*—An operation plan for the conduct of joint operations that can be used as a basis for development of an operation order (OPORD). An OPLAN identifies the forces and supplies required to execute the combatant commander's strategic concept and a movement schedule of these resources to the theater of operations. The forces and supplies are identified in TPFDD files. OPLANs will include all phases of the tasked operation. The plan is prepared with the appropriate annexes, appendixes, and TPFDD files as described in the Joint Operation Planning and Execution System manuals containing planning policies, procedures, and formats. *b. Concept Plan (CONPLAN)*—An operation plan in an abbreviated format that would require considerable expansion or alteration to convert it into an OPLAN or OPORD. A CONPLAN contains the CINC's Strategic Concept and those annexes and appendixes deemed necessary by the combatant commander to complete planning. Generally, detailed support requirements are not calculated and TPFDD files are not prepared. *c. Concept Plan with Time-Phased Force Deployment Database (CONPLAN with TPFDD)*—A CONPLAN with TPFDD is the

same as a CONPLAN except that it requires more detailed planning for phased deployment of forces. (JP 1-02)

operational authority: (DOD) authority exercised by a commander in the chain of command, defined further as combatant command (command authority), operational control, tactical control, or a support relationship. (JP 1-02)

operational chain of command: (DOD) chain of command established for a particular operation or series of continuing operations. (JP 1-02)

operational control: (DOD) Command authority that may be exercised by commanders at any echelon at or below the level of combatant command. Operational control is inherent in combatant command (command authority). Operational control may be delegated and is the authority to perform those functions of command over subordinate forces involving organizing and employing commands and forces, assigning tasks, designating objectives, and giving authoritative direction necessary to accomplish the mission. Operational control includes authoritative direction over all aspects of military operations and joint training necessary to accomplish missions assigned to the command. Operational control should be exercised through the commanders of subordinate organizations. Normally this authority is exercised through subordinate joint force commanders and Service and/or functional component commanders. Operational control normally provides full authority to organize commands and forces and to employ those forces as the commander in operational control considers necessary to accomplish assigned missions. Operational control does not include authoritative direction for logistics or matters of administration, discipline, internal organization, or unit training. Also called OPCON. (JP 1-02)

peace building: (DOD) post-conflict actions, predominately diplomatic and economic, that strengthen and rebuild governmental infrastructure and institutions in order to avoid a relapse into conflict. (JP 1-02)

Peace Enforcement (PE): (DOD) application of military force or the threat of its use, normally pursuant to international authorization, to compel compliance with resolutions or sanctions designed to maintain or restore peace and order. (JP 1-02)

Peace Operations (PO): (DOD) broad term encompassing peacekeeping operations and peace enforcement operations

conducted in support of diplomatic efforts to establish and maintain peace. (JP 1-02)

Peacekeeping (PK): (DOD) military operations undertaken with the consent of all major parties to a dispute designed to monitor and facilitate implementation of an agreement (cease-fire, truce, or other such agreement) and support diplomatic efforts to reach a long-term political settlement. (JP 1-02)

peacemaking: (DOD) process of diplomacy, mediation, negotiation, or other forms of peaceful settlements that arranges an end to a dispute, and resolves issues that led to it. (JP 1-02)

Plan Identification Number (PID): (DOD) 1. A command-unique four-digit number followed by a suffix indicating the Joint Strategic Capabilities Plan (JSCP) year for which the plan is written, e.g., “2220-95.” 2. In the Joint Operation Planning and Execution System (JOPES) data base, a five-digit number representing the command-unique four digit identifier, followed by a one character, alphabetic suffix indicating the operation plan option, or a one-digit number numeric value indicating the JSCP year for which the plan is written. (JP 1-02)

planning order: (DOD) 1. An order issued by the Chairman of the Joint Chiefs of Staff to initiate execution planning. The planning order will normally follow a commander’s estimate and a planning order will normally take the place of the Chairman of the Joint Chiefs of Staff alert order. National Command Authorities approval of a selected course of action is not required before issuing a Chairman of the Joint Chiefs of Staff planning order. 2. A planning directive that provides essential planning guidance and directs the initiation of execution planning before the directing authority approves a military course of action. (JP 1-02)

Planning, Programming, Budgeting and Execution System (PPBES): a system based on a cyclic decision-making process with three distinct but interrelated phases of planning, programming, and budgeting. The process involves the development of all Service and defense agency budgets, their review and consolidation to produce the DOD portion of the president’s budget submission to Congress. (DOD Instruction 7045.14 and CJCSI 8501.01/PPBES)

Posse Comitatus Act: a United States federal law passed in 1878 that limits the powers of the U.S. government in the use of the military for law enforcement. It says that military forces can provide civil

support, but cannot become directly involved in law enforcement.

Presidential Decision Directive (PDD): (DOD) one of a series of directives that announce presidential decisions implementing national policy objectives in all areas of national security. All PDDs in this series are individually identified by number and signed by the president. (Prior administrations had different names for them, such as “national security directive.”)

Presidential Callup: (DOD) procedures by which the president brings all or part of the Army National Guard or Air National Guard to active Federal service under section 12406 and Chapter 15 of title 10, U.S. Code. (JP 1-02)

Principal Staff Assistant (PSA): The Office of the Secretary of Defense (OSD) PSAs are the Under Secretaries of Defense (USDs); the Assistant Secretaries of Defense (ASDs); the Director, Operational Test and Evaluation (DOT&E); the General Counsel of the Department of Defense; the Inspector General (IG) of the Department of Defense; and the OSD Directors or equivalents, who report directly to the SECDEF or the Deputy Secretary of Defense (DEPSECDEF).

prioritized regional objectives: (DOD) Theater Engagement Plans are based on prioritized regional objectives contained in the contingency planning guidance (CPG) and the JSCP. Combatant Commanders and executive agents derive their engagement objectives relating specifically to the theater, region, or countries within their AOR. Objectives are prioritized by the national interest they seek to advance and defined in the Defense Planning Guidance: Vital - Tier I; Important - Tier II; Lesser - Tier III. (CJCSM 3110.01A/JSCP)

priority intelligence requirements: (DOD) intelligence requirements for which a commander has an anticipated and stated priority in the task of planning and decision making. (JP 1-02)

Private Voluntary Organizations (PVO): (DOD) private, nonprofit humanitarian assistance organizations involved in development and relief activities. Private voluntary organizations are normally U.S.-based. “Private voluntary organization” is often used synonymously with the term “nongovernmental organizations.” Also known as PIR. (JP 1-02)

procedure: (DOD) a procedure begins with a specific, documented event that causes an activity to occur. The activity must produce a

product that normally affects another external organization. Frequently, that product will be the event that causes another procedure to occur. It is important to recognize that a procedure determines “what” an organization must do at critical periods but does not direct “how” it will be done. (JP 1-02)

Program Decision Memoranda (PDMs): (DOD) a set of documents within which Defense Resource Board (DRB) program review decisions are recorded, signed by the SecDef or DepSECDEF, and issued to the Services and DOD components. The PDMs are the basis for development of the DOD budget estimate submission (BES). (CJCSI8501.01/PBBS)

program element: (DOD) a primary data element in the Future-Years Defense Program that represents (1) DOD missions or (2) units and their resources. (DODI7045.7/PPBS))

Program Objectives Memoranda (POM): (DOD) Recommendation of the DOD components [*Services and defense agencies*] to the SecDef on the allocation of resources for proposed programs to achieve assigned missions and objectives. Proposed programs are consistent with the strategy and guidance stated in the Defense Planning Guidance (DPG) and constrained by FG [Fiscal Guidance]. (CJCSI 8501.01/PBBS)

public affairs guidance (PAG): (DOD) a package of information to support public discussion of defense issues and operations; guidance can range from a telephonic response to a specific question to a more comprehensive package; may include an approved public affairs policy, news statements, answers to anticipated media questions, and community relations guidance. The public affairs guidance also addresses method(s), timing, location, and other details governing the release of information to the public. Public affairs guidance is approved by the Assistant to the Secretary of Defense for Public Affairs. (JP 1-02)

readiness planning: (DOD) operational planning required for peacetime operations; its objective is the maintenance of high states of readiness and the deterrence of potential enemies and includes planning activities that influence day-to-day operations and the peacetime posture of forces. As such, its focus is on general capabilities and readiness rather than the specifics of a particular crisis, either actual or potential. The assignment of geographic responsibilities to Combatant Commanders, establishment of readiness

standards and levels, development of peacetime deployment patterns, coordination of reconnaissance and surveillance assets and capabilities, and planning of joint exercises are examples of readiness planning. No formal joint planning system exists for readiness planning such as exists for contingency and execution planning. (JP 1-02)

record: a collection of data elements pertaining to one logical subject. In JOPEs, for example, all the data elements used to describe a force requirement and its routing are stored in the “force record.” For resupply and replacement personnel, all the data elements are stored in non-unit-related cargo records and non-unit-related personnel records.

Report of Potential Evacuees (F-77 Report): (DOD, DOS) a Department of State (DOS) document that identifies the potential number of evacuees in each American Embassy’s area of responsibility. (JP 3-07.5)

requirements capability: (DOD) provides a Joint Operation Planning and Execution System user the ability to identify, update, review, and delete data on forces and sustainment required to support an operation plan or course of action. (JP 1-02)

reserve component category: (DOD) category that identifies an individual’s status in a reserve component. The three reserve component categories are Ready Reserve, Standby Reserve, and Retired Reserve. Each reservist is identified by a specific reserve component category designation. (JP 1-02)

resources: (DOD) forces, materiel, and other assets or capabilities apportioned or allocated to the commander of a unified or specified command. (JP 1-02)

Rules of Engagement (ROE): (DOD) Directives issued by competent military authority which delineate the circumstances and limitations under which U.S. forces will initiate and/or continue combat engagement with other forces encountered. (JP 1-02, CJCSI 3121.01/CJCS Standing ROE)

safe haven: (DOD) For Noncombatant Evacuation Operation (NEO) planning—Designated area(s) to which noncombatants of the U.S. Government’s responsibility, and commercial vehicles and materiel, may be evacuated during a domestic or other valid emergency. (JP 1-02)

security assistance: (DOD) group of programs authorized by the Foreign Assistance Act of 1961, as amended, and the Arms Export Control Act of 1976, as amended, or other related statutes by which the U.S. provides defense articles, military training, and other defense-related services, by grant, loan, credit, or cash sales in furtherance of national policies and objectives. (JP 1-02)

Senior Readiness Oversight Council (SROC): (DOD) An executive readiness overview briefed to senior OSD officials, including the Deputy Secretary of Defense. These presentations give OSD leadership increased visibility on current readiness of the force and provide a forum to address near-term readiness concerns. (CJCS Guide 3401A/CRS)

Service component command: (DOD) command consisting of the Service component commander and all those Service forces, such as individuals, units, detachments, organizations, and installations under the command, including the support forces that have been assigned to a combatant command, or further assigned to a subordinate unified command or joint task force. (JP 1-02)

SIGINT operational control: (DOD) The authoritative direction of signals intelligence (SIGINT) activities, including tasking and allocation of effort, and the authoritative prescription of those uniform techniques and standards by which SIGINT information is collected, processed, and reported. (JP 1-02)

small scale contingency (SSC): (DOD) A regionally centered crisis based on a less compelling national interest or threat than those involved in a MTW. Smaller-scale contingency operations encompass the full range of military operations short of major theater warfare, including humanitarian assistance, peace operations, enforcing embargoes and no-fly zones, evacuating U.S. citizens, reinforcing key allies, protection of U.S. and U.S. allied space systems and negation of enemy. (National Security Strategy [NSS], CJCSM 3110.01A/JSCP)

Special Operations (SO): operations conducted by specially organized, trained, and equipped military and paramilitary forces to achieve military, political, economic, or psychological objectives by unconventional military means in hostile, denied, or politically sensitive areas. These operations are conducted during peacetime competition, conflict, and war, independently or in coordination with operations of conventional, non-special operations forces. Politico-military

considerations frequently shape special operations, requiring clandestine, covert, or low visibility techniques and oversight at the national level. Special operations differ from conventional operations in degree of physical and political risk, operational techniques, mode of employment, independence from friendly support, and dependence on detailed operational intelligence and indigenous assets.

Special Operations Command (SOC): (DOD) a subordinate unified or other joint command established by a joint force commander to plan, coordinate, conduct, and support joint special operations within the joint force commander's assigned operational area. (JP 1-02)

Special Operations Command and Control Element: A special operations element that is the focal point for the synchronization of special operations forces activities with conventional forces activities. It performs command and control functions according to mission requirements. It normally collocates with the command post of the supported force. It can also receive special operations forces operational, intelligence, and target acquisition reports directly from deployed special operations elements and provide them to the supported component headquarters. It remains under the operational control of the joint force special operations component commander or commander, joint special operations task force. Also called SOCCE. (This term and its definition modify the existing term and its definition and are approved for inclusion in the next edition of JP 1-02.)

Special Operations Liaison Element: A special operations liaison team provided by the joint force special operations component commander to the joint force air component commander (if designated), or appropriate Service component air command and control organization, to coordinate, deconflict, and integrate special operations air, surface, and subsurface operations with conventional air operations. Also called SOLE. (JP 3-05.1)

specified command (specified combatant command): (DOD) a command that has a broad, continuing mission, normally functional, and is established and so designated by the president through the SecDef with the advice and assistance of the Chairman of the Joint Chiefs of Staff; normally composed of forces from a single Military Department. (JP 1-02)

staff estimates: (DOD) assessments of courses of action by the various staff elements of a command that serve as the foundation of the commander's estimate. (JP 1-02)

standard: Quantitative or qualitative measures for specifying the levels of performance of a task. (CJCSM 3500.04F, CJCSI 3500.02A)

Status Of Forces Agreement (SOFA): an agreement which defines the legal position of a visiting military force deployed in the territory of a friendly state. Agreements delineating the status of visiting military forces may be bilateral or multilateral. Provisions pertaining to the status of visiting forces may be set forth in a separate agreement, or they may form a part of a more comprehensive agreement. These provisions describe how the authorities of a visiting force may control members of that force and the amenability of the force or its members to the local law or to the authority of the local officials. (JP 1-02)

strategic direction: (DOD) the guidance expressed through national security strategy, national military strategy, and theater strategy relative to the attainment of strategic goals and objectives. (JP 5-00.1)

strategic estimate: (DOD) estimate of the broad strategic factors that influence the determination of missions, objectives, and courses of action. The estimate is continuous and includes the strategic direction received from the president or SecDef or the authoritative body of an alliance or coalition. See also commander's estimate of the situation. (JP 1-02)

strategic intent: (DOD) expression of the goals and desired ends of a strategy.

strategic level of war: level of war at which a nation, often as a member of a group of nations, determines national or multinational (alliance or coalition) security objectives and guidance, and develops and uses national resources to accomplish these objectives. Activities at this level establish national and multinational military objectives; sequence initiatives; define limits and assess risks for the use of military and other instruments of national power; develop global plans or theater war plans to achieve these objectives; and provide military forces and other capabilities in accordance with strategic plans. (JP 5-00.1)

strategic logistics: in general, the art and science of harnessing the economic and societal strengths of a nation for national defense; specifically, strategic logistics is the process of planning for, coordinating, and allocating the manpower, materiel, infrastructure, and services required for military, war production, and civil sector needs. It requires coordination between the executive and legislative branches,

state governments, and industry. Force generation and mobilization are inclusive components of strategic logistics. (JP 5-00.1)

strategic mobility: capability to deploy and sustain military forces worldwide in support of national strategy. (JP 1-02)

strategic vulnerability: susceptibility of vital elements of national power to being seriously decreased or adversely changed by the application of actions within the capability of another nation to impose. Strategic vulnerability may pertain to political, geographic, economic, scientific, sociological, or military factors. (JP 1-02)

subordinate command: (DOD) a command consisting of the commander and all those individuals, units, detachments, organizations, or installations that have been placed under the command by the authority establishing the subordinate command. (JP 1-02)

subordinate unified command (sub-unified command): (DOD) a command established by commanders of unified commands, when so authorized through the Chairman of the Joint Chiefs of Staff, to conduct operations on a continuing basis in accordance with the criteria set forth for unified commands. A subordinate unified command may be established on an area or functional basis. Commanders of subordinate unified commands have functions and responsibilities similar to those of the commanders of unified commands and exercise operational control of assigned commands and forces within the assigned joint operations area. (JP 1-02)

suitability: (DOD) operation plan review criterion; determination that the course of action will reasonably accomplish the identified objectives, mission, or task if carried out successfully. (JP 1-02)

supporting commander: (DOD) commander who provides augmentation forces or other support to a supported commander or who develops a supporting plan; includes the designated combatant commands and Defense agencies as appropriate. (JP 1-02)

tactical control: command authority over assigned or attached forces or commands, or military capability or forces made available for tasking, that is limited to the detailed direction and control of movements or maneuvers within the operational area necessary to accomplish missions or tasks assigned. Tactical control is inherent in operational control. Tactical control may be delegated to, and exercised

at any level at or below the level of combatant command. Tactical control provides sufficient authority for controlling and directing the application of force or tactical use of combat support assets within the assigned mission or task. (JP1-02)

task: (DOD) discrete event or action, not specific to a single unit, weapon system, or individual, that enables a mission or function to be accomplished by individuals and/or organizations. (CJCSM 3500.03/JTM)

theater: (DOD) geographical area for which a commander of a combatant command has been assigned responsibility. (JP 1-02)

theater engagement plan (TEP): (DOD) engagement plans reflect a combatant commander's deliberate proactive intent and planned military activities which are intended to shape the theater security environment in ways favorable to U.S. interests and theater objectives. The elements of an engagement plan may be included in the overall theater strategic plan. (CJCSI 3100.01/JSPS)

theater of focus: theater in which operations are most critical to national interests and are assigned the highest priority for allocation of resources.

theater of operations: sub-area within a theater of war defined by the geographic combatant commander required to conduct or support specific combat operations. Different theaters of operations within the same theater of war will normally be geographically separate and focused on different enemy forces. Theaters of operations are usually of significant size, allowing for operations over extended periods of time.

theater of war: (DOD) defined by the National Command Authorities or the geographic combatant commander, the area of air, land, and water that is, or may become, directly involved in the conduct of the war. A theater of war does not normally encompass the geographic combatant commander's entire area of responsibility and may contain more than one theater of operations. (JP 1-02)

Theater Special Operations Command: A subordinate unified command established by a combatant commander to plan, coordinate, conduct, and support joint special operations. Also called TSOC. See individual TSOC descriptions under USAFRICOM, USCENTCOM, USEUCOM, USPACOM, and USSOUTHCOM.

theater strategy: (DOD) art and science of developing integrated strategic concepts and courses of action directed toward securing the objectives of national and alliance or coalition security policy and strategy by the use of force, threatened use of force, or operations not involving the use of force within a theater. (JP 1-02)

threat identification and assessment: (DOD) the Joint Operation Planning and Execution System function that provides timely warning of potential threats to U.S. interests; intelligence collection requirements; the effects of environmental, physical, and health hazards, and cultural factors on friendly and enemy operations; and determines the enemy military posture and possible intentions. (JP 1-02)

Time-Phased Force And Deployment Data (TPFDD): the Joint Operation Planning and Execution System data base portion of an operation plan; it contains time-phased force data, non-unit-related cargo and personnel data, and movement data for the operation plan, including: a. In-place units; b. Units to be deployed to support the operation plan with a priority indicating the desired sequence for their arrival at the port of debarkation; c. Routing of forces to be deployed; d. Movement data associated with deploying forces; e. Estimates of non-unit-related cargo and personnel movements to be conducted concurrently with the deployment of forces; f. Estimate of transportation requirements that must be fulfilled by common-user lift resources as well as those requirements that can be fulfilled by assigned or attached transportation resources.

time-phased force and deployment list (TPFDL): Appendix 1 to Annex A of the operation plan. It identifies types and/or actual units required to support the operation plan and indicates origin and ports of debarkation or ocean area. It may also be generated as a computer listing from the time-phased force and deployment data.

total obligation authority or obligation authority: sum of (1) budget authority conferred for a given fiscal year, (2) balances of amounts brought forward from prior years that remain available for obligation, and (3) amounts authorized to be credited to a specific fund or account during that year.

TPFDD Letter of Instruction: (DOD) provides planning and execution instructions to the supported combatant command's components, supporting combatant commands, and supporting agencies as they refine, verify, and manifest their portion of the joint force TPFDD. The

intent of the supported combatant commander's TPFDD LOI is to eliminate confusion, facilitate parallel planning, and expedite TPFDD refinement by providing component commands, supporting commands, and agencies with a single set of instructions for TPFDD input and management. Prudent use of the TPFDD LOI ensures that actual OPORD movement requirements are properly documented and validated for transportation scheduling. (JP 1-02)

transportation system: (DOD) all the land, water, and air routes and transportation assets engaged in the movement of U.S. forces and their supplies during peacetime training, conflict, or war, involving both mature and contingency theaters and at the strategic, operational, and tactical levels of war. (JP 1-02)

type unit: (DOD) type of organizational or functional entity established within the Armed Forces and uniquely identified by a five-character, alphanumeric code called a unit type code. (JP 1-02)

Unified Action Armed Forces (UNAAF): (DOD) A publication (*JP 0-2*) setting forth the policies, principles, doctrines, and functions governing the activities and performance of the Armed Forces of the United States when two or more Military Departments or Service elements thereof are acting together.

unified command (unified combatant command): (DOD) a command with a broad continuing mission under a single commander and composed of significant assigned components of two or more Military Departments, and which is established and so designated by the president, through the SecDef with the advice and assistance of the Chairman of the Joint Chiefs of Staff. (JP 1-02)

Unified Command Plan (UCP): (DOD) document, approved by the president, which sets forth basic guidance to all unified combatant commanders; establishes their missions, responsibilities, and force structure; delineates the general geographical area of responsibility for geographic combatant commanders; and specifies functional responsibilities for functional combatant commanders. (JP 1-02)

Unit Identification Code (UIC): (DOD) a six-character, alphanumeric code that uniquely identifies each Active, Reserve, and National Guard unit of the Armed Forces. (JP 1-02)

Universal Joint Task: A Universal Joint Task (UJT), or UJTL task, is an action or activity assigned to an individual or organization to provide

a capability. UJTs only describe in broad and universal terms “what” must be done. References linked to a UJT detail “how” to perform the task. The “why” the task is important and “who” should accomplish the task is defined after the task is selected by an organization for their Joint or Agency Mission Essential Task List (J/AMETL). In other words, a UJT that conforms to guidance should only contain the broad action, or the “what” must be accomplished. The elements of a UJT include the task number, task title, task description, measures, and joint doctrinal references. The authoritative elements are the task number, task title, and task description whereas measures, task note/background and references are non-authoritative.

Universal Joint Task List (UJTL): (DOD) menu of mission tasks in a common language that may be selected by a joint force commander to accomplish the assigned mission. Once identified as essential to mission accomplishment, the tasks are reflected within the command’s joint mission essential task list. (CJCSI 3500.02A/UJTL POLICY & CJCSM 3500.04F/UJTL MANUAL)

U.S. Agency for International Development (USAID): (DOD) administers and directs the U.S. foreign economic assistance program and acts as lead Federal agency for U.S. foreign disaster assistance. USAID works largely in support of the Department of State and manages a worldwide network of country programs for economic and policy reforms that generates sound economic growth, encourages political freedom and good governance, and invests in human resource development. (JP 3-08, Vol. II)

U.S. Country Team: (DOD) the senior, in-country, United States coordinating and supervising body, headed by the Chief of the United States diplomatic mission, and composed of the senior member of each represented United States department or agency, as desired by the Chief of the U.S. diplomatic mission.

wargaming: (DOD) Wargaming is a conscious attempt to visualize the flow of an operation, given own strengths and weaknesses and dispositions, enemy assets and possible COAs. It attempts to foresee the action, reaction, and counteraction dynamics of an operation. This process highlights tasks that appear to be particularly important to the operation and provides a degree of familiarity with operational-level possibilities that might otherwise be difficult to achieve. (JP 5-00.2)

warning order: (DOD, NATO)1. A preliminary notice of an order or action which is to follow. 2. A crisis action planning directive issued by









the Chairman of the Joint Chiefs of Staff that initiates the development and evaluation of courses of action by a supported commander and requests that a commander's estimate be submitted. 3. A planning directive that describes the situation, allocates forces and resources, establishes command relationships, provides other initial planning guidance, and initiates subordinate unit mission planning. (JP 1-02)















6.4 Comparative Ranks: Services and Government Civilians













In the Army, Air Force, and Marine Corps, officers in pay grades O-1 to O-3 are called **company grade** officers, O-4 to O-6 are **field grade** officers, and pay grades O-7 and higher are **general officers**. Traditionally, the Navy (and by default, the Coast Guard) has referred to all O-4s and below as **junior officers**, O-5s and O-6s as **senior officers**, and O-7s and above as **flag officers**.

Naval officers wear distinctively different rank devices depending upon the uniform worn: collar insignia devices similar to the other services with khakis; shoulder boards with gold stripes (or solid gold with silver stars for flag officers) with whites; and gold stripes sewn on the lower coat sleeves of blues. Coast Guard officers wear similar insignia with their equivalent blue and white uniforms.

Officers





<i>R a n k</i>	<i>Army</i>	<i>Navy/ Coast Guard</i>	<i>Air Force/ Marines</i>	<i>Government Civilian & Foreign Service</i>
O-1	 2LT Second Lieutenant	 ENS Ensign	 2d Lt/2ndLt Second Lieutenant	
O-2	 1LT First Lieutenant	 LTJG Lieutenant Junior Grade	 1st Lt/1stLt First Lieutenant	GS-12(=O4) GS-11(=O4) GS-10(=O3) GS09(=O2/O1)
O-3	 CPT Captain	 LT Lieutenant	 Capt Captain	And FS-03(=O4) FS-04(=O3) FS05(=O2/O1)





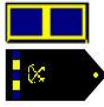





R a n k	Army	Navy/ Coast Guard	Air Force/ Marines	Government Civilian & Foreign Service
O-4	 MAJ Major	 LCDR Lieutenant Commander	 Maj Major	
O-5	 LTC Lieutenant Colonel	 CDR Commander	 Lt Col/LtCol Lieutenant Colonel	GS-15(=O6) GS-14(=O5) GS-13(=O5) And
O-6	 COL Colonel	 CAPT Captain	 Col Colonel	FS-01(=O6) FS-02(=O6)
O-7	 BG Brigadier General	 RDML Rear Admiral (Lower Half)	 Brig Gen/BGen Brigadier General	SFS(Senior Foreign Service) And SES (Senior Executive Service) GS 16-18
O-8	 MG Major General	 RADM Rear Admiral (Upper Half)	 Maj Gen/ MajGen Major General	

<i>R a n k</i>	Army	Navy/ Coast Guard	Air Force/ Marines	Government Civilian & Foreign Service
O-9	 LTG Lieutenant General	   VADM Vice Admiral	 Lt Gen/LtGen Lieutenant General	
O-10	 GEN General	   ADM Admiral	 Gen General	
	 General of the Army (wartime only)	 Fleet Admiral (wartime only)	 General of the Air Force (wartime only)	

Warrant Officers

















Warrant officers hold warrants from their Service Secretary and are specialists and experts in certain military technologies or capabilities. The lowest ranking warrant officers serve under a warrant, but receive commissions from the president upon promotion to Chief Warrant Officer 2. Commissioned warrant officers are direct representatives of the president and derive their authority from the same source as commissioned officers, but remain specialists, in contrast to commissioned officers, who are generalists. There are no warrant officers in the Air Force.









Rank	Army	Navy/Coast Guard	Marines	FS & GS
W-1	 Warrant Officer 1 WO1	 USN Warrant Officer 1 WO1 (No longer used)	 Warrant Officer 1 WO1	FS05 and GS09
W-2	 Chief Warrant Officer 2 CW2	 USN Chief Warrant Officer 2 CWO2 USCG	 Chief Warrant Officer 2 CWO2	FS05 and GS09

Rank	Army	Navy/Coast Guard	Marines	FS & GS
W-3	 Chief Warrant Officer 3 CW3	 USN Chief Warrant Officer 3 CWO3  USCG	 Chief Warrant Officer 3 CWO3	GS10
W-4	 Chief Warrant Officer 4 CW4	 USN Chief Warrant Officer 4 CWO4  USCG	 Chief Warrant Officer 4 CWO4	FS03 FS04 and GS12 GS11
W-5	 Chief Warrant Officer 5 CW5	 USN Chief Warrant Officer 5 CWO5	 Chief Warrant Officer 5 CWO5	

Enlisted Ranks: E-1 – E7

Enlisted pay grades E-1 through E-3 are usually in training status or on initial assignment. Training includes basic training where recruits are immersed in military culture and values, and taught required core skills. Basic training is followed by specialized or advanced training for a specific area of expertise, for the Army and Marines called a Military Occupational Specialty (MOS); for the Navy/Coast Guard, a rating; and for the Air Force, an Air Force Specialty Code (AFSC).

Rank	Army	Navy/ Coast Guard	Marines	Air Force
E-1	Private (PVT)	Seaman Recruit (SR)	Private (Pvt)	Airman Basic (AB)
E-2	 Private E-2 (PV2)	 Seaman Apprentice (SA)	 Private First Class (PFC)	 Airman (Amn)
E-3	 Private First Class (PFC)	 Seaman (SN)	 Lance Corporal (LCpl)	 Airman First Class (A1C)
E-4	 Corporal (CPL) / Specialist (SPC)	 Petty Officer Third Class (PO3) **	 Corporal (Cpl)	 Senior Airman (SrA)
<p>Leadership responsibility significantly increases in mid-level enlisted ranks and is given formal recognition by use of the terms noncommissioned officer and petty officer. An Army sergeant, an Air Force staff sergeant, and a Marine corporal are considered NCO ranks. The Navy NCO equivalent, petty officer, is achieved at the rank of petty officer third class. Some Air Force E-7s, E-8s and E-9s serve as First Sergeants and provide advice to a unit commander on issues affecting enlisted personnel.</p>				
E-5	 Sergeant (SGT)	 Petty Officer Second Class (PO2) **	 Sergeant (Sgt)	 Staff Sergeant (SSgt)

Rank	Army	Navy/ Coast Guard	Marines	Air Force
E-6	 Staff Sergeant (SSG)	 Petty Officer First Class (PO1) **	 Staff Sergeant (SSgt)	 Technical Sergeant (TSgt)
E-7	 Sergeant First Class (SFC)	 Chief Petty Officer (CPO) **	 Gunnery Sergeant (GySgt)	 Master Sergeant (MSgt)  First Sergeant

ARMY—

* For rank and precedence within the Army, specialist ranks immediately below corporal. Among the Services, however, rank and precedence are determined by pay grade.

NAVY/COAST GUARD—

*A specialty mark in center of rating badge indicates wearer's particular rating.

** Gold stripes indicate 12 or more years of good conduct.







*** 1. Master Chief Petty Officer of the Navy or Coast Guard and Fleet and Force Master Chief Petty Officers wear gold stars in lieu of a specialty mark.









2. Command Master Chief Petty Officers wear silver stars in lieu of a specialty mark.

3. Master Chief Petty Officers wear silver stars and silver specialty marks.

Enlisted Ranks: E-8 to E-9

At the E-8 and E-9 level, the Army, Marines and Air Force have two or three positions at the same pay grade. For the Air Force, E-8 and E-9, a Senior Master Sergeant or Chief Master Sergeant versus a First Sergeant (or Command Chief Master Sergeant at the E-9 level) depends on the job. Marine Corps Master Gunnery Sergeants and Sergeants Major receive the same pay but have different responsibilities. E-8s and E-9s have 15 to 30 years of service, and are commanders' senior advisers for enlisted matters. The most senior enlisted person of each Service, an E-9, serves as the spokesperson of the enlisted force at each Service's highest levels.

Rank	Army	Navy/ Coast Guard	Marines	Air Force
E-8	 Master Sergeant (MSG)  First Sergeant (1SG)	 Senior Chief Petty Officer (SCPO) **	 Master Sergeant (MSgt)  First Sergeant (1st SGT)	 Senior Master Sergeant (SMSgt)  First Sergeant

Rank	Army	Navy/ Coast Guard	Marines	Air Force
E-9	 Sergeant Major (SGM)  Command Sergeant Major (CSM)	 Master Chief Petty Officer (MCPO) **/***  Fleet/Force/Command Master Chief Petty Officer **/*** (FLTCM) (FORCM) (CMDCM)	 Sergeant Major (SgtMaj)  Master Gunnery Sergeant (MGySgt)	 Chief Master Sergeant (CMSgt)  First Sergeant  Command Chief Master Sergeant (CCM)

E-9	 Sergeant Major of the Army (SMA)	 ** *** Master Chief Petty Officer of the Navy (MCPON) or Coast Guard (MCPOCG)	 Sergeant Major of the Marine Corps (SgtMajMC)	 Chief Master Sergeant of the Air Force (CMSAF)
-----	---	---	--	---

6.5 Index

1

160th Special Operations Aviation Regiment (Airborne), 202, 203, 207
1947 National Security Act, 103, 146
1948 Key West Agreement, 109
1st MSOB, 210, 291, 302

2

2008 Joint Staff Officer Study, 9, 279
2d Marine Special Operations Battalion, 210

7

75th Ranger Regiment, 202, 204

A

ABC approach, 19
action packages, 12, 13
Adaptive Planning and Execution APEX, 134
Aerial Refueling/Tankers, 218
Affinity Diagrams, 21
air and space expeditionary task force
AETF, 249, 303
Air expeditionary force
AEF, 249, 303
air expeditionary wing
AEW, 249
Air Force Reserve, 61
Air Force Space Command, 217, 287
Air Mobility Command, 218, 223, 224, 287
Airborne Communications, 218
alliance, 61, 93, 304, 310, 345, 348

Army Reserves, 57, 58, 61, 182, 237, 300

B

Background Paper, 16
Ballistic Missile Submarines, 218
Battle Rhythm, 84, 89, 134
Better E-mail Ettiquette, 34
BLUF approach, 30
Brainstorming, 20, 21, 34

C

CCIR. See Commander's Critical Information Requirements (CCIR)
Center for Hemispheric Defense Studies
CHDS, 190, 288
Central Identification Laboratory, 288
Central Intelligence Agency
CIA, 55, 105, 288, 323, 336
Chairman's Exercise Program
CEP, 254, 288
Chairman's Program Assessment
CPA, 137, 289
Chairman's Program Recommendation
CPR, 137, 289
Chairman's Public Correspondence (CPC), 14, 289
Civil Affairs, 196, 202, 203, 204, 206, 288
Civil Affairs Operations, 196
CJCSI 3500.01, 256
CKW. See Commander's Knowledge Wall
Classified Military Information
CMI, 231, 288
coalition, 61, 62, 93, 199, 206, 207, 211, 304, 310, 322, 345, 348

Coast Guard
 U.S. Coast Guard, 51, 58, 59, 67, 68, 69, 107, 159, 161, 230, 250, 251, 252, 253, 301, 352, 355, 357, 358, 359, 360

Collective Joint Training, 255

Colonel Guillot, 24

Combat Aviation Advisors, 200

Combat Controllers, 201

Combat Support Agencies, 43, 44, 55, 289

Combatant command (command authority)
 COCOM, 100, 148, 187, 289, 306, 311, 322, 324

Combatant Command Directories, 72

Combatant Command Support Agency
 CCSA, 152

Combined Forces Air Component Commander
 CFACC, 250

command post exercise
 CPX, 254

Commander's Critical Information Requirements (CCIR), 8, 283, 285, 288, 312

Commander's Knowledge Wall, 72, 288

Content Management Tools, 74

Controlled Unclassified Information
 CUI, 231, 232, 233, 289

Coordination Papers, 15, 16

core competencies, 1, 211

Counter Proliferation of Weapons of Mass Destruction, 197

Counterinsurgency Operations, 197

Courses of Action, 5, 289

CPC. See Chairman's Public Correspondence (CPC)

D

Decision briefing, 32

Deepwater Project, 252

Defense Contract Management Agency, 44, 56, 289

defense coordinating officer
 DCO, 268

Defense Information Systems Agency, 44, 55, 97, 290

Defense Intelligence Agency, 44, 45, 56, 96, 98, 105, 232, 328

Defense Logistics Agency, 44, 45, 46, 56, 97, 224, 290, 328

Defense Military Message System (DMS), 75, 290

Defense Nuclear Agency, 97

Defense Planning Guidance
 DPG, 136, 290, 308, 313, 315, 340, 341

Defense Threat Reduction Agency, 44, 46, 47, 56, 125, 290

Department of Commerce, 48, 49, 290

Department of Energy, 48, 50, 107, 221, 290

Department of Homeland Security, 2, 48, 50, 51, 58, 106, 163, 230, 251, 266, 290

Department of Justice, 48, 51, 163, 290

Department of State, 48, 52, 163, 270, 290, 318, 323, 337, 342, 350

Department of the Air Force, 57, 95, 96, 97, 248, 250

Department of the Army, 57, 95, 97, 202, 234, 289, 333

Department of the Navy, 95, 97, 185, 230, 238, 245, 251, 290

Department of the Treasury, 2, 48, 53, 54, 107, 163

Department of Transportation, 48, 54, 55, 290

Deputy Operations Deputies
 DEPOPSDEPs, 115, 290

Derivative classification, 234

Designated Disclosure Authority, 232, 289

DHS Special Events Working Group, 269

Director of National Intelligence
 DNI, 45, 47, 95, 104, 290

Director of the Joint Staff, 116

Discussion Paper, 16
Discussion Threads, 74
DMS. See Defense Military
Message System (DMS)
Doctrine, Organization, Training,
Materiel, Leadership and
Education, Personnel, and
Facilities
DOTMLPF, 261
Document Repository, 74
DOD Directive 5100.1, 110, 146
DOD Directive 5100.46, Foreign
Disaster Relief, 271
DOD Directive 7730.65, 256
DOD Distribution Process Owner,
223
DoDD 5122.05, 36, 42
Dr. Benjamin Bloom, 277
Dr. Ken Blanchard's One Minute
Manager, 20
DRRS
Defense Readiness Reporting
System, 76, 290
Drug Enforcement Administration
DEA, 51, 107, 289

E

Effective Writing for Army Leaders,
30, 31
Electromagnetic Compatibility
Analysis Center, 98, 126, 290
E-mail Etiquette
26 Rules to Follow, 34
E-mail Etiquette - About.com, 34
Estimates, 106, 348

F

Fact Sheet, 15
Federal Bureau of Investigation
FBI, 51, 106, 291
Federal Emergency Management
Agency
FEMA, 266
Federal Executive Branch, 48
FHA
Foreign Humanitarian
Assistance, 270, 271, 272,

291
FOIA. See Freedom of Information
Act (FOIA)
Foreign Clearance Guide, 62, 291
Foreign Disclosure Office, 62, 291
Foreign disclosure officers
FDO, 231
Foreign Internal Defense, 140,
196, 291
Foreign Visit System, 62, 291
Freedom of Information Act
(FOIA), 14, 291
Friendly Force Information
Requirement (FFIR), 284, 291
full scale exercise
FSE, 254
Functional Commands, 147

G

General Schedule, 63
Geographic Commands, 147
Global Force Management
Guidance, 135
Goldwater-Nichols Act, 102, 114,
247
Goldwater-Nichols DOD
Reorganization Act of 1986, 97,
98, 101, 109
Guidance for Employment of the
Force
GEF, 134, 135, 291

H

Headquarters, Marine Corps, 245

I

immediate response, 267, 268,
269, 271
Individual Joint Training, 255
Information briefing, 32
Information Operations, 84, 140,
197, 292, 293
Information Papers, 15
instruments of national power, 93,
94, 333, 336, 345

interagency, 2, 5, 7, 31, 48, 57, 79, 80, 89, 134, 186, 197, 221, 254, 275, 279, 323, 331
intergovernmental organizations
IGOs, 271, 309

J

JCIDS. See Joint Capabilities Integration and Development System (JCIDS)
Joint Capabilities Integration and Development System (JCIDS), 71, 77, 292

JFC
Joint Force Commander, 126, 127, 144, 145, 211, 249, 270, 293, 324, 328

JFSC Pub1, 11

JKO
Joint Knowledge Online, 77, 293

JLE-wide Visibility, 142, 143

JLLIS. See Joint Lessons Learned Information System (JLLIS)

JLLP. See Joint Lessons Learned Program (JLLP)

Joint and/or Agency Mission Essential Task
J/AMET, 259, 260, 292

Joint Capabilities Integration and Development System (JCIDS), 44, 292

Joint Capabilities Integration Group
JCIG, 157, 292

Joint Deployment and Distribution Enterprise
JDDE, 144, 222, 293

Joint Doctrine, Education and Training Division, 98

Joint Doctrine, Education, and Training Electronic Information System, 139

Joint Event Life Cycle
JELC, 261, 293

Joint Exercise Program
JEP, 254

Joint Exercises, 220, 261

Joint Force Air Component
Commander
JFACC, 249

Joint Force Special Operations
Component Commander, 324

Joint Interagency Task Force
South
JIATF -South, 189

Joint Lessons Learned Information System (JLLIS), 76, 264, 293, 325

Joint Lessons Learned Program (JLLP), 76, 293, 325

joint logistics environment
JLE, 142

Joint Materiel Priorities and Allocations Board, 97, 293

Joint National Training Capability
JNTC, 293

Joint Operation Planning and Execution System, 44, 294, 312, 313, 314, 316, 318, 327, 337, 339, 342, 348

Joint Planning Document
JPD, 136, 294

Joint Pub 1, The Joint Staff Officer's Guide, 31

Joint Publication 3-61, Public Affairs, 42

Joint Publication System
JPS, 138, 294

Joint Requirements Oversight Council, 97, 294, 328

Joint Special Operations Area, 329

Joint Special Operations Command
JSOC, 198, 211, 294

Joint Special Operations Task Force
JSOTF, 140, 162, 206, 211, 294

Joint Staff., 6, 115, 286, 324, 329, 330

Joint Strategic Capabilities Plan, 135, 137, 294, 313, 329, 339

Joint Strategic Planning System, 44, 132, 294, 330

Joint Tactical Command, Control,
and Communications Agency,
98, 126

Joint Task Force Bravo
JTF-Bravo, 190, 294

Joint Task Force Guantanamo Bay
JTF - GTMO, 190, 294

Joint Training Facilitator Specialist
(JTFS), 3, 294

Joint Training Plan (JTP), 163,
254, 256, 260, 263, 264, 294

Joint Transition Course, 9

Joint Transportation Board, 97

JOPEs, 71, 75, 134, 135, 136,
137, 294, 327, 331, 339, 342,
See Joint Operation Planning
and Execution System

JP 3-0 Joint Operations, 87, 140,
272, 305

JSPS. See Joint Strategic
Planning System

JTFS. See Joint Training
Facilitator Specialist

JTIMS
Joint Training Information
Management System, 71,
76, 254, 257, 262, 263, 264,
294

JTP. See Joint Training Plan (JTP)

JTS
Joint Training System, 76, 254,
257, 258, 260, 261, 264, 294

K

Knowledge Management Tools, 8,
73

L

Land-based Intercontinental
Ballistic Missiles, 219

Leader-Team Room, 74

Learning Management System
LMS, 77, 261, 295

Lifelong learning, 276

M

Major Force Program, 195, 295

Marine Aircraft Group
MAG, 247, 295

Marine Aircraft Wing
MAW, 247, 295

Marine Air-Ground Task Force
MAGTF, 247

Marine Corps Forces Special
Operations Command, 198, 209

Marine Division, 247

Marine Expeditionary Brigade
MEB, 247, 295

Marine Expeditionary Force
MEF, 246, 247, 291, 298, 300,
302

Marine Expeditionary Unit
MEU, 247, 295

Marine Forces Reserve, 59, 61

Marine Special Operations Advisor
Group, 209, 210

Marine Special Operations School,
209, 210

Marine Special Operations Support
Group, 209, 210

measures of effectiveness, 272

Memorandum, 15, 59, 232, 240,
296, 297

Memorandum for the Record, 15

Messages, 37

Microsoft, 18, 19, 20, 32, 71
Excel, 18, 71
Outlook, 18, 19, 71
Power Point, 18, 31, 71
Word, 18, 30, 71

Military Communications
Electronics Board, 98

Military Information Support
Operations
MISO, 197, 203, 204

Military Sealift Command, 223,
224, 296

Mind Mapping, 21

Mission briefing, 32

mission essential tasks, 76

Multinational operations, 61

N

National Defense Strategy
NDS, 134, 296
National Defense University, 296
National Disclosure Policy, 232
National Exercise Program
NEP, 254, 296
National Geospatial-Intelligence Agency, 44, 47, 96, 98, 105, 125, 296
National Guard, 56, 57, 58, 59, 61, 182, 198, 199, 200, 202, 205, 230, 250, 287, 296, 340, 349
Air National Guard, 56, 57, 58, 340
Army National Guard, 56, 57
National Guard Bureau, 202
National Incident Management System
NIMS, 266, 297
National Military Strategy
NMS, 136, 250, 297, 308, 326, 330, 335
National Reconnaissance Office, 104, 105, 297
National Response Framework
NRF, 266, 297
National Security Act of 1947, 94, 95, 96, 97, 98, 109, 329, 333
National Security Agency, 44, 47, 48, 96, 98, 105, 125, 232, 297
National Security Council, 93, 95, 103, 104, 111, 136, 297, 307, 323, 335
National Security Strategy, 94, 133, 252, 297, 313, 343
National Special Security Event
NSSE, 269, 297
National Strategy for Homeland Security, 94
NATO, 67, 165, 216, 296, 303, 304, 305, 311, 322, 350
Naval Special Warfare Center
NSWC, 208, 297
Naval Special Warfare Command, 198, 207, 296
Naval Special Warfare Development Group

NSWDG, 208, 297
Navy Reserves, 61
NIPRNet, 75, 257, 297
nongovernmental organization
NGO, 336
North American Aerospace Defense Command
NORAD, 297
Nunn-Cohen Amendment to the National Defense Authorization Act of 1987, 193

O

Office of Personnel Management, 67
operational control, 98, 101, 161, 246, 297, 306, 311, 314, 324, 338, 343, 344, 346
Operations Tempo, 225
Original classification, 233

P

Pararescuemen, 201, 298
Paul model, 23
perfectionist syndrome, 20
Performance Work Statement, 64, 67, 298
Planning, Programming, Budgeting and Execution System
PPBES, 6, 128
Point Paper, 15
Politics and the English Language, George Orwell, 30
Position Paper, 15
Posse Comitatus Act, 339
Principal Disclosure Authority, 232, 298
Priority Intelligence Requirement (PIR), 285, 298, 340
Push-Pull-Prod, 74

Q

Quadrennial Defense Review
QDR, 134, 298

R

reading folders, 19
Reorganization Act of 1958, 96,
97, 107
Reorganization Act of 1986, 99,
107, 110, 127, 193, 329
Revising Business Prose, 31
RFA
Request for Assistance, 268

S

SEAL Delivery Vehicle (SDV)
Teams, 208
SEAL Teams, 208
Security Force Assistance, 197
senior leaders, 3, 5, 6, 7, 8, 9, 28,
31, 79, 80, 279
SIPRNet, 72, 73, 75, 257, 299
Special Boat Teams, 208, 299
Special Operation Liaison
Element, 206
Special Operations Command
Africa
SOCAFRICA, 155, 299
Special Operations Command and
Control Element, 344
Special Operations Command
Central
SOCCENT, 299
Special Operations Command
Europe
SOCEUR, 299
Special Operations Command
Korea
SOCKOR, 299
Special Operations Command
Pacific, 299
Special Operations Command
South
SOCSOUTH, 301
Special Operations Forces
SOF, 161, 194, 196, 200, 203,
204, 206, 209, 210, 299
Special Operations Liaison
Element, 344
Special Operations Weathermen,
201

Specified Combatant Command,
98
Staff briefing, 32
Staff Joint Training, 255
Staff Study, 17
Staff Summary Routing Sheets, 16
Stafford Act, 267, 268
Statement of Work
SOW, 64, 65
Stephen Covey's 7 Habits of
Highly Effective People., 20
Strategic Bomber and
Reconnaissance Aircraft, 218
Summary Sheet, 16, 17
Surface Deployment and
Distribution Command, 223,
224, 299
Systems Thinking, 21

T

tactical control, 98, 101, 300, 311,
314, 338, 346, 347
Talking Paper, 15, 16
Tasking management system, 18,
71, 77
Teams of Leaders, 74, 300
The Elements of Style, 30
The Naval Institute Guide to Naval
Writing, 31
The Tongue and Quill, 30, 31
Title 10, 43, 58, 95, 99, 100, 110,
150, 195, 216, 230
Title 10, U.S. Code, 99, 100
Title 10, United States Code, 110
Title 14, 230
Title 32, 230
Title 50, 230
Training Proficiency Evaluations,
261
Transportation Working Capital
Fund, 228, 229, 300
Types of Interviews
Ambush, 38
Press Conference, 38
Stand-Up, 38
Studio, 38

U

- U.S. Agency for International Development, 300, 337, 350
- U.S. Army John F. Kennedy Special Warfare Center and School, 202, 203
- U.S. Army Space and Missile Defense Command/Army Forces Strategic Command, 216
- U.S. Army Special Forces Command (Airborne), 202, 205, 206
- U.S. Army Special Operations Command
 - USASOC, 198, 202, 301
- U.S. Code, 55, 58, 267, 271, 321, 335, 340
 - United States Code, 230
- U.S. Fleet Forces Command, 174, 216, 301
- U.S. Marine Corps Forces, U.S. Strategic Command, 216
- UCP. See Unified Command Plan
- UJTL. See Universal Joint Task List (UJTL)
- Unconventional Warfare, 196
- Unified Combatant Command, 49, 98, 102, 114, 134, 135, 149, 151, 196, 219
- Unified Command Plan (UCP), 102, 121, 134, 135, 146, 149, 150, 196, 219, 300, 336, 349
- United States Africa Command
 - USAFRICOM
 - AFRICOM, 102, 151, 153, 154, 155, 156, 157, 158, 300
- United States Central Command
 - USCENTCOM
 - CENTCOM, 102, 151, 158, 159, 161, 301
- United States European Command
 - USEUCOM
 - EUCOM, 151, 301
- United States Northern Command
 - USNORTHCOM
 - NORTHCOM, 151, 170, 301
- United States Pacific Command
 - USPACOM
 - PACOM, 102, 151, 177, 181, 183, 205, 301
- United States Southern Command
 - USSOUTHCOM
 - SOUTHCOM, 151, 186, 301
- United States Special Operations Command
 - USSOCOM
 - SOCOM, 102, 151, 161, 189, 193, 207, 209, 255, 301
- United States Strategic Command
 - USSTRATCOM
 - STRATCOM, 151, 212, 301
- United States Transportation Command
 - USTRANSCOM
 - TRANSCOM, 151, 221, 301, 321
- Universal Joint Task List (UJTL), 141, 254, 255, 257, 300, 326, 350

V

- VTC, 34, 35, 302

W

- Wikipedia, 29, 73
- Working capital funds, 229

