

CHAPTER 3
DREDGING EQUIPMENT AND TECHNIQUES

3-1. Purpose. This chapter includes a description of the dredging equipment and techniques used in dredging activities in the United States and presents advantages and limitations for each type of dredge. Guidance is provided for selection of the best dredging equipment and techniques for a proposed dredging project to aid in planning and design.

3-2. Factors Determining Equipment Selection.

a. The types of equipment used, by both the Corps and private industry, and the average annual amount of dredging associated with each type are shown in Figure 3-1. The dredging methods employed by the Corps vary considerably throughout the United States. Principal types of dredges include hydraulic pipeline types (cutterhead, dustpan, plain suction, and sidecaster), hopper dredges, and clamshell dredge. The category of "other" dredges in Figure 3-1 includes dipper, ladder, and special purpose dredges. However, there are basically only three mechanisms by which dredging is actually accomplished:

(1) Suction dredging. Removal of loose materials by dustpans, hoppers, hydraulic pipeline plain suction, and sidecasters, usually for maintenance dredging projects.

(2) Mechanical dredging. Removal of loose or hard, compacted materials by clamshell, dipper, or ladder dredges, either for maintenance or new work projects.

(3) A combination of suction and mechanical dredging. Removal of loose or hard, compacted materials by cutterheads, either for maintenance or new work projects.

b. Selection of dredging equipment and method used to perform the dredging will depend on the following factors:

- (1) Physical characteristics of material to be dredged.
- (2) Quantities of material to be dredged.
- (3) Dredging depth.
- (4) Distance to disposal area.
- (5) Physical environment of and between the dredging and disposal areas.
- (6) Contamination level of sediments.
- (7) Method of disposal.

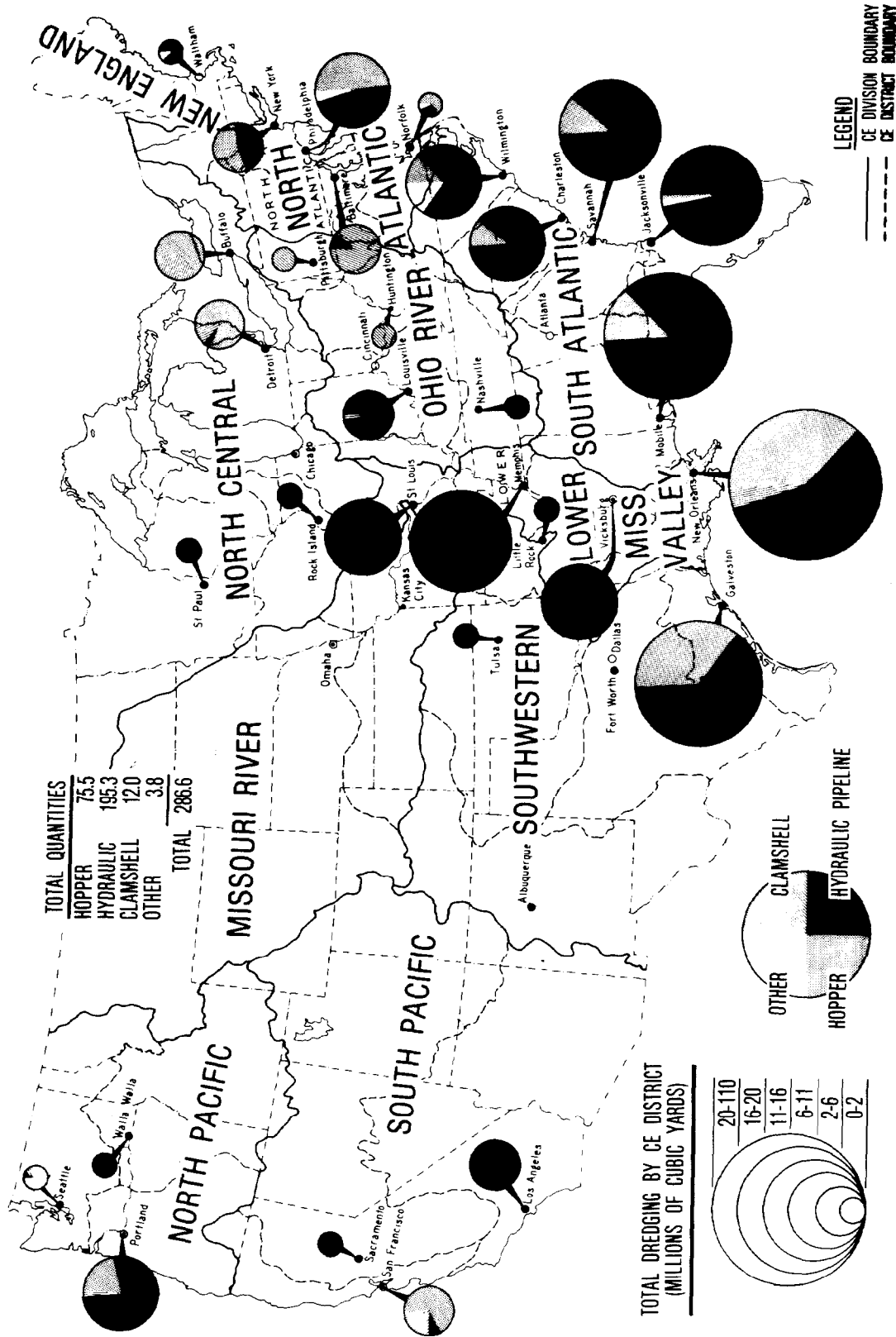

Figure 3-1. Types of dredges used and estimated quantities to be dredged by each District (FY 81).

(8) Production required.

(9) Type of dredges available.

3-3. Hopper Dredges.

a. General. Hopper dredges are self-propelled seagoing ships of from 180 to 550 ft in length, with the molded hulls and lines of ocean vessels (fig. 3-2). They are equipped with propulsion machinery, sediment containers (hoppers), dredge pumps, and other special equipment required to perform their essential function of removing material from a channel bottom or ocean bed. Hopper dredges have propulsion power adequate for required free-running speed and dredging against strong currents and excellent maneuverability for safe and effective work in rough, open seas. Dredged material is raised by dredge pumps through dragarms connected to drags in contact with the channel bottom and discharged into hoppers built in the vessel. Hopper dredges are classified according to hopper capacity: large-class dredges have hopper capacities of 6000 cu yd or greater, medium-class hopper dredges have hopper capacities of 2000 to 6000 cu yd, and small-class hopper dredges have hopper capacities of from less than 2000 to 500 cu yd. During dredging operations, hopper dredges travel at a ground speed of from 2 to 3 mph and can dredge in depths from about 10 to over 80 ft. They are equipped with twin propellers and twin rudders to provide the required maneuverability. Table 3-1 gives available specifications for all vessels in the Corps hopper dredge fleet.

b. Description of Operation.

(1) General. Operation of a seagoing hopper dredge involves greater effort than that required for an ordinary ocean cargo vessel, because not only the needs of navigation of a self-propelled vessel but also the needs associated with its dredging purposes must be satisfied. Dredging is accomplished by progressive traverses over the area to be dredged. Hopper dredges are equipped with large centrifugal pumps similar to those employed by other hydraulic dredges. Suction pipes (dragarms) are hinged on each side of the vessel with the intake (drag) extending downward toward the stern of the vessel. The drag is moved along the channel bottom as the vessel moves forward at speeds up to 3 mph. The dredged material is sucked up the pipe and deposited and stored in the hoppers of the vessel. Once fully loaded, hopper dredges move to the disposal site to unload before resuming dredging. Unloading is accomplished either by opening doors in the bottoms of the hoppers and allowing the dredged material to sink to the open-water disposal site or by pumping the dredged material to upland disposal sites. Because of the limitations on open-water disposal, most hopper dredges have direct pumpout capability for disposal in upland confined sites. Before there were environmental restrictions, hopper dredges were operated with the primary objective of obtaining the maximum economic load; i.e., removing the maximum quantity of material from the channel prism in the shortest pumping time during a day's operation.

(2) Hopper dredging is accomplished by three methods: (a) pumping past overflow, (b) agitation dredging, and (c) pumping to overflow. The

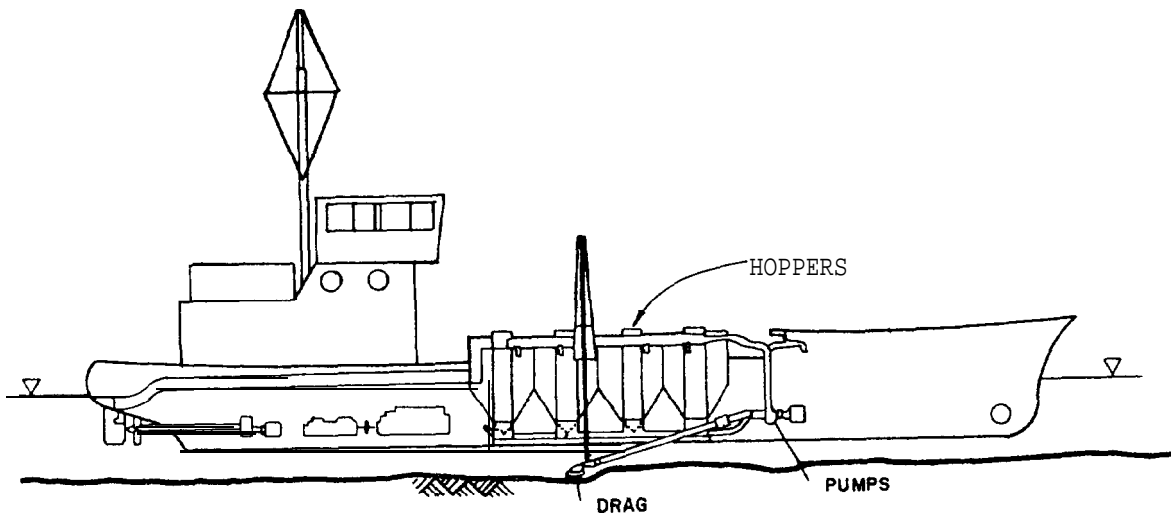
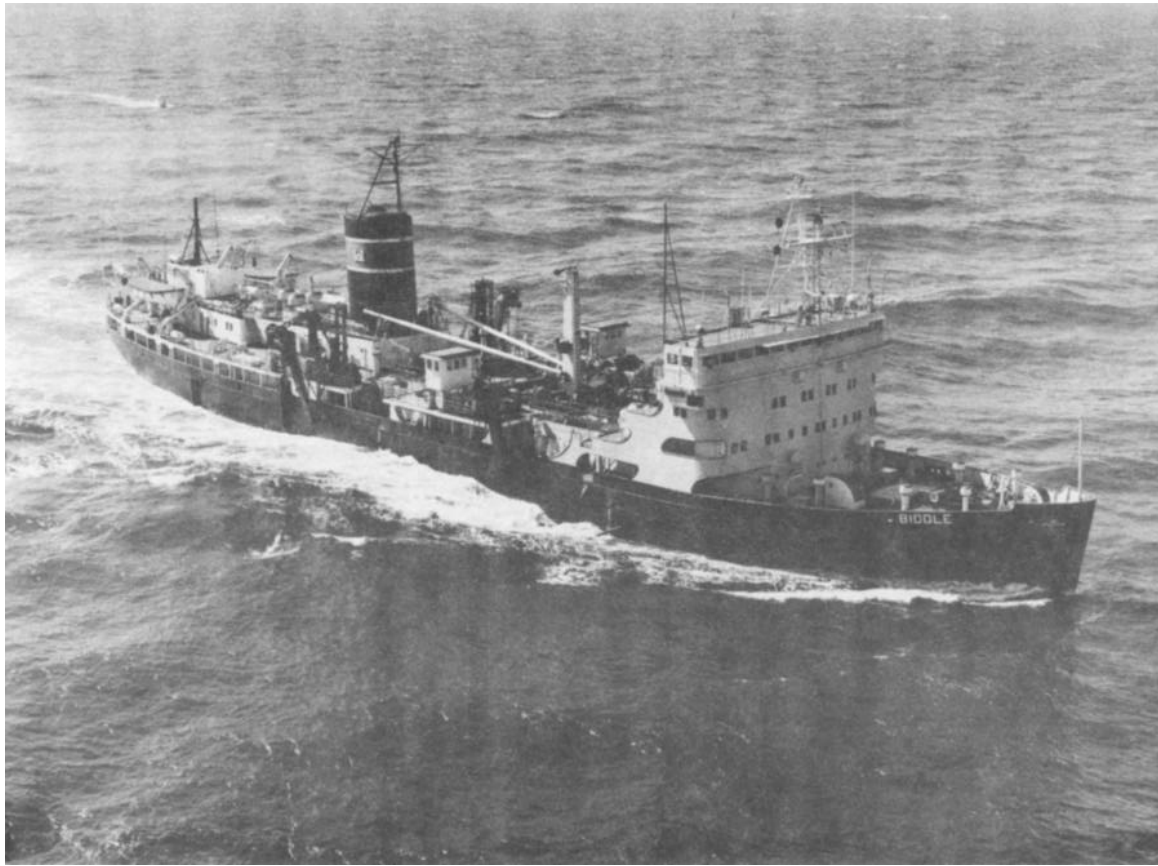

Figure 3-2. Self-propelled seagoing hopper dredge.

Table 3-1. Pertinent Characteristics of Corps of Engineers Hopper Dredges.

Name	Hopper Capacity cu yd	Dredged Pumps		Light Loaded Speed mph	Hull		Draft Loaded	Dredging Depth Max	Vertical Clearance Required	Regional Location	Special Capability
		Number hp	Size Drive		Material Length	Beam Depth					
BIDDLE	3060	2 1150	28" Electric	17.3 14.4	Steel 351'9"	60'0" 30'0"	24'9"	62'	83'	West Coast	None
ESSAYONS	6000	-- ^a	--	15.4	Steel 350'	68' 35'	27'	80'	--	Gulf Coast	Direct pumpout
HAINS	855	1 410	20" Electric	14.1 13.1	Steel 215'10"	40'4" 15'6"	13'0"	36'	69'	Great Lakes	Direct pumpout Sidecasting
WHEELER	8400	--	--	16.1	Steel 409'	78' 39'	29'5"	80'	--	Gulf Coast	Direct pumpout
YAQUINA	825	--	--	11.5	Steel 200'	58' 17'	12'	45'	--	West Coast	Direct pumpout
MACFARLAND	3140	2 1867	34" Electric	15.4 14.0	Steel 319'8"	72'0" 33'	22'0"	55'	90'	East Coast	Direct pumpout Sidecasting
MARKHAM	2780	2 650	23" Electric	16.7 14.4	Steel 339'6"	62'0" 28'0"	19'4"	45'	90'	Great Lakes	Direct pumpout
PACIFIC	500	1 340	18" Electric	11.5 9.8	Steel 180'3"	38'0" 14'0"	12'0"	45'	70'	West Coast	None

^aData unavailable.

use of these methods is controlled to varying degrees by environmental legislation and the water quality certification permits required by the various states in which dredging is being accomplished. The environmental effects of these methods must be assessed on a project-by-project basis. If the material being dredged is clean sand, the percentage of solids in the overflow will be small and economic loading may be achieved by pumping past overflow. When contaminated sediments are to be dredged and adverse environmental effects have been identified, pumping past overflow is not recommended. In such cases, other types of dredges may be more suitable for removing the contaminated sediments from the channel prism. If hopper dredges are not allowed to pump past overflow in sediments that have good settling properties, the cost of dredging increases. The settling properties of silt and clay sediments may be such that only a minimal load increase would be achieved by pumping past overflow. Economic loading, i.e. the pumping time required for maximum production of the hopper dredge, should be determined for each project. These determinations, along with environmental considerations, should be used to establish the operation procedures for the hopper dredge.

(3) Agitation dredging. Agitation dredging is a process which intentionally discharges overboard large quantities of fine-grained dredged material by pumping past overflow, under the assumption that a major portion of the sediments passing through the weir overflow will be transported and permanently deposited outside the channel prism by tidal, river, or littoral currents. Agitation dredging should be used only when the sediments dredged have poor settling properties, when there are currents in the surrounding water to carry the sediments from the channel prism, and when the risk to environmental resources is low. Favorable conditions may exist at a particular project only at certain times of the day, such as at ebb tides, or only at such periods when the streamflow is high. To use agitation dredging effectively requires extensive studies of the project conditions and definitive environmental assessments of the effects. Agitation dredging should not be performed while operating in slack water or when prevailing currents permit redeposit of substantial quantities of the dredged material in the project area or in any other area where future excavation may be required. Refer to para 3-12 for more information on this topic.

(4) Refer to ER 1125-2-312 for instructions for hopper dredge operations.

c. Application. Hopper dredges are used mainly for maintenance dredging in exposed harbors and shipping channels where traffic and operating conditions rule out the use of stationary dredges. The materials excavated by hopper dredges cover a wide range of types, but the hopper dredge is most effective in the removal of material which forms shoals after the initial dredging is completed. While specifically designed drags are available for use in raking and breaking up hard materials, hopper dredges are most efficient in excavating loose, unconsolidated materials. At times, hopper dredges must operate under hazardous conditions caused by fog, rough seas, and heavy traffic encountered in congested harbors.

d. Advantages. Because of the hopper dredge's design and method of

operation, the self-propelled seagoing hopper dredge has the following advantages over other types of dredges for many types of projects:

- (1) It is the only type of dredge that can work effectively, safely, and economically in rough, open water.
- (2) It can move quickly and economically to the dredging project under its own power.
- (3) Its operation does not interfere with or obstruct traffic.
- (4) Its method of operation produces usable channel improvement almost as soon as work begins. A hopper dredge usually traverses the entire length of the problem shoal, excavating a shallow cut during each passage and increasing channel depth as work progresses.
- (5) The hopper dredge may be the most economical type of dredge to use where disposal areas are not available within economic pumping distances of the hydraulic pipeline dredge.

e. Limitations. The hopper dredge is a seagoing self-propelled vessel designed for specific dredging projects. The following limitations are associated with this dredge:

- (1) Its deep draft precludes use in shallow waters, including barge channels.
- (2) It cannot dredge continuously. The normal operation involves loading, transporting material to the dump site, unloading, and returning to the dredging site.
- (3) The hopper dredge excavates with less precision than other types of dredges.
- (4) Its economic load is reduced when dredging contaminated sediments since pumping past overflow is generally prohibited under these conditions and low-density material must be transported to and pumped into upland disposal areas.
- (5) It has difficulty dredging side banks of hardpacked sand.
- (6) The hopper dredge cannot dredge effectively around piers and other structures.
- (7) Consolidated clay material cannot be economically dredged with the hopper dredge.

3-4. Cutterhead Dredges.

a. General. The hydraulic pipeline cutterhead suction dredge is the most commonly used dredging vessel and is generally the most efficient and versatile (fig. 3-3). It performs the major portion of the dredging

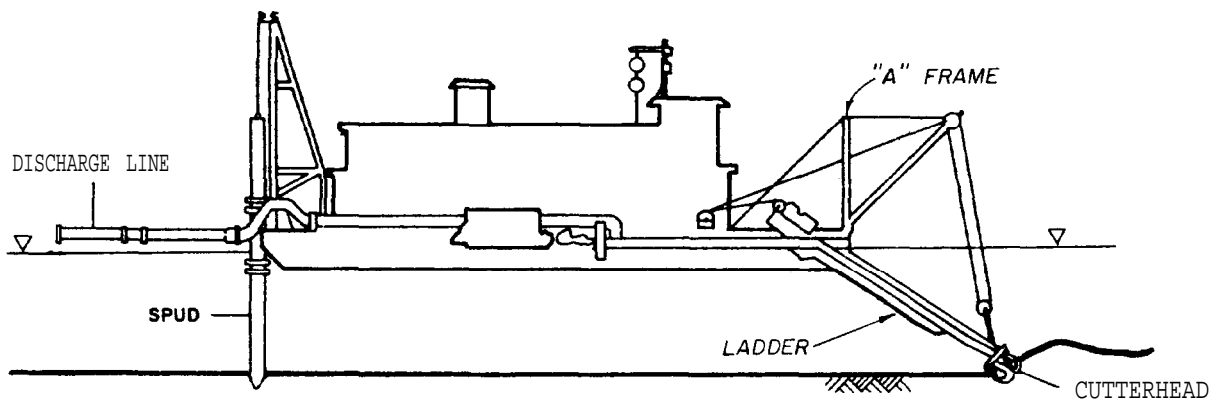
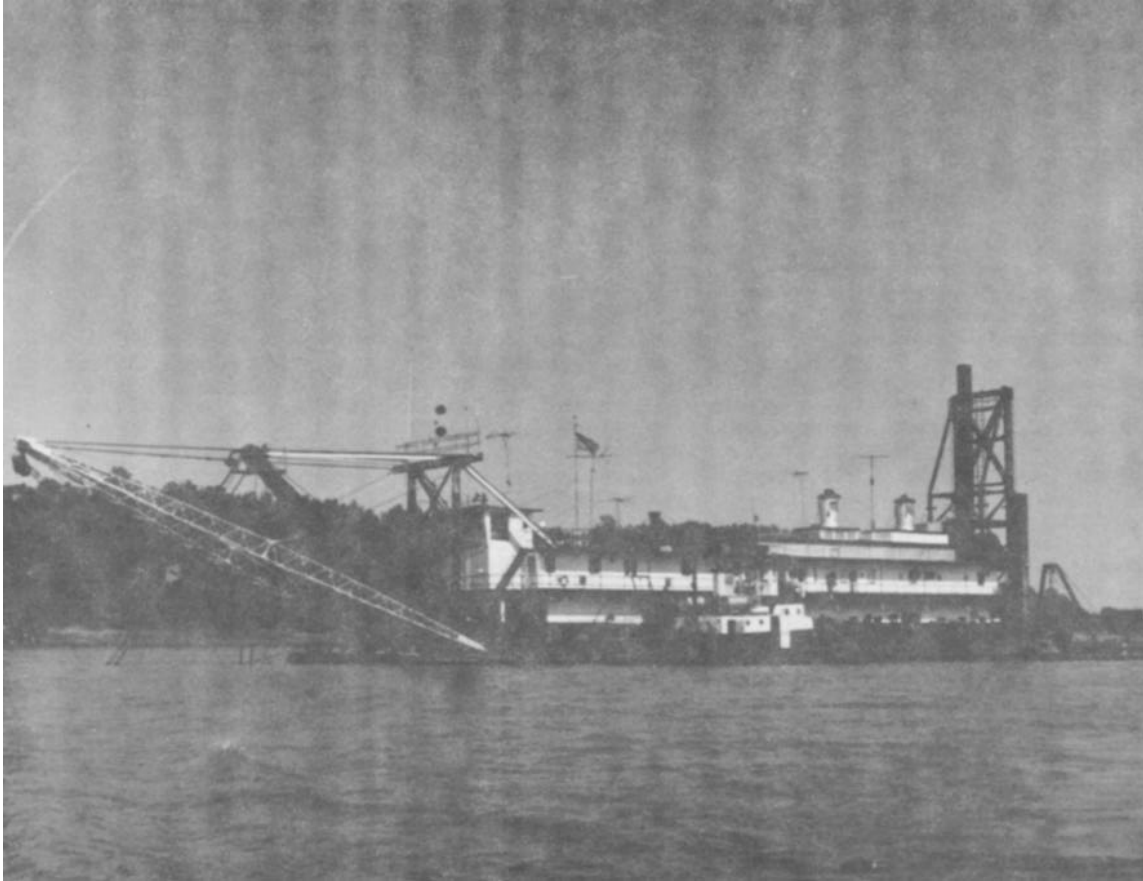

Figure 3-3. Hydraulic pipeline cutterhead dredge.

25 Mar 83

workload in the United States. Because it is equipped with a rotating cutter apparatus surrounding the intake end of the suction pipe, it can efficiently dig and pump all types of alluvial materials and compacted deposits, such as clay and hardpan. This dredge has the capability of pumping dredged material long distances to upland disposal areas. Slurries of 10 to 20 percent solids (by dry weight) are typical, depending upon the material being dredged, dredging depth, horsepower of dredge pumps, and pumping distance to disposal area. If no other data are available, a pipeline discharge concentration of 13 percent by dry weight (145 ppt) should be used for design purposes. Pipeline discharge velocity, under routine working conditions, ranges from 15-20 ft/sec. Table 3-2 presents theoretical pipeline discharge rates as functions of pipeline discharge velocities for dredges ranging in sizes from 8 to 30 in.

Table 3-2. Suction Dredge Pipeline Discharge Rates,^a
cu ft/sec

Discharge Velocity ft/sec	Discharge Pipe Diameter			
	a in.	18 in.	24 in.	30 in.
10	3.5	17.7	31.4	49.1
15	5.2	26.5	47.1	73.6
20	7.0	35.3	62.8	98.1
25	8.7	44.2	78.5	122.7

^aDischarge rate = pipeline area x discharge velocity.

Production rate is defined as the number of cubic yards of in situ sediments dredged during a given period and is usually expressed in cu yd/hr. Production rates of dredges vary according to the factors listed above and other operational factors that are not necessarily consistent between dredges of the same size and type. For example, a 16-in. dredge should produce between 240 and 875 cu yd of dredged material per hour, and a 24-in. dredge should produce between 515 and 1615 cu yd per hour. The range for typical cutterhead production as a function of dredge size is shown in figure 3-4. This figure illustrates the wide range of production for dredges of the same size. The designer can refer to figure 3-5, which shows the relationships among solids output, dredge size, and pipeline length for various dredging depths, as a preliminary selection guide for the size of dredge required for a given project. This is only a rough guide, and accurate calculations based not only on the type of material to be dredged but on the power available and other considerations should be completed before a final engineering recommendation can be made. The designer should refer to the data available from ENG Form 4267, "Report of Operations-- Pipeline, Dipper, or Bucket Dredges," for use in estimating production rates, effective working time, etc. These data on past dredging projects are available in the Construction-Operation Divisions of the Districts. Specifications and dimensions for several cutterhead dredges ranging in pipe diameter from 6 to 30 in. are presented in table 3-3.

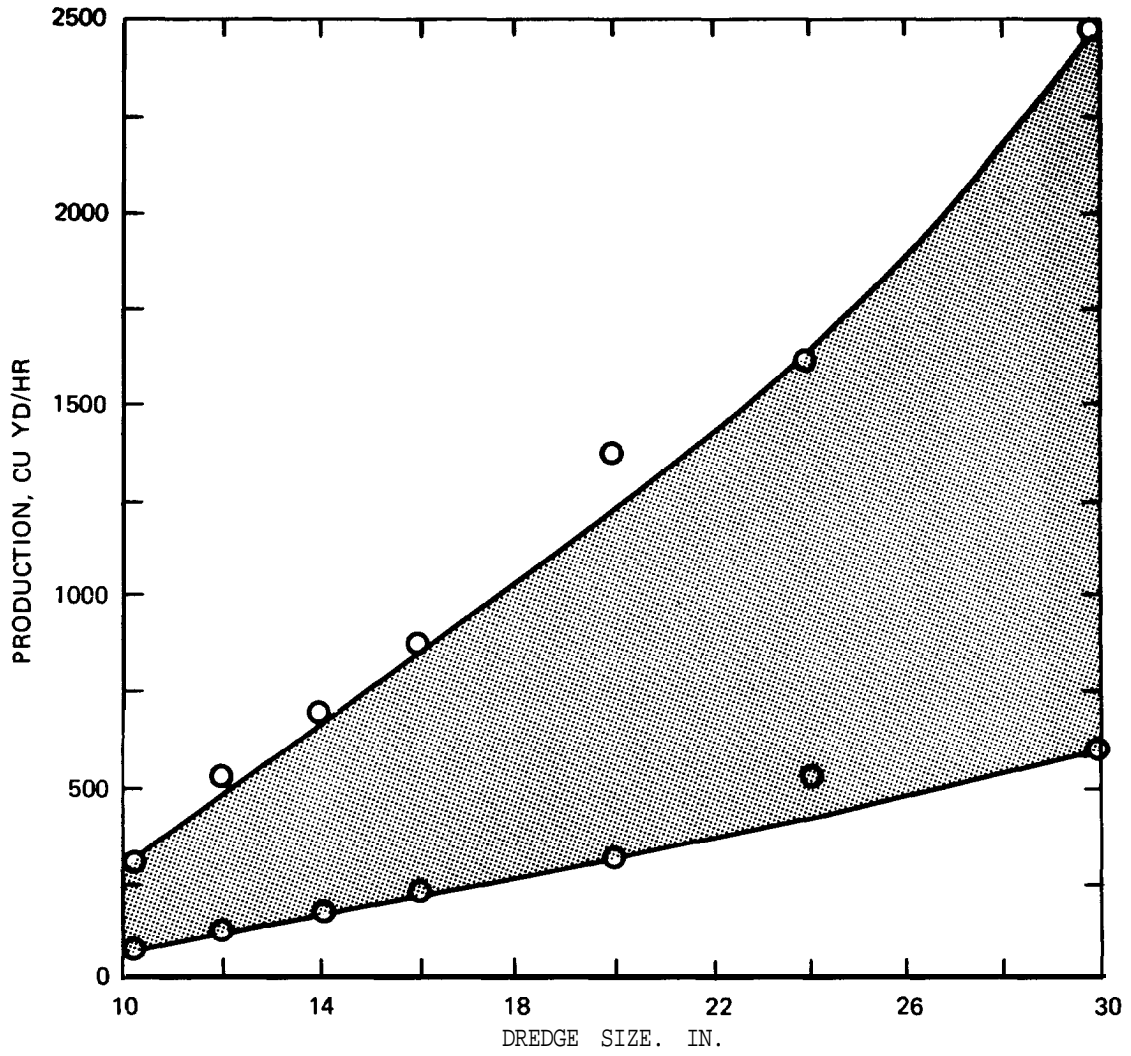

Figure 3-4. Typical cutterhead dredge production according to dredge size.

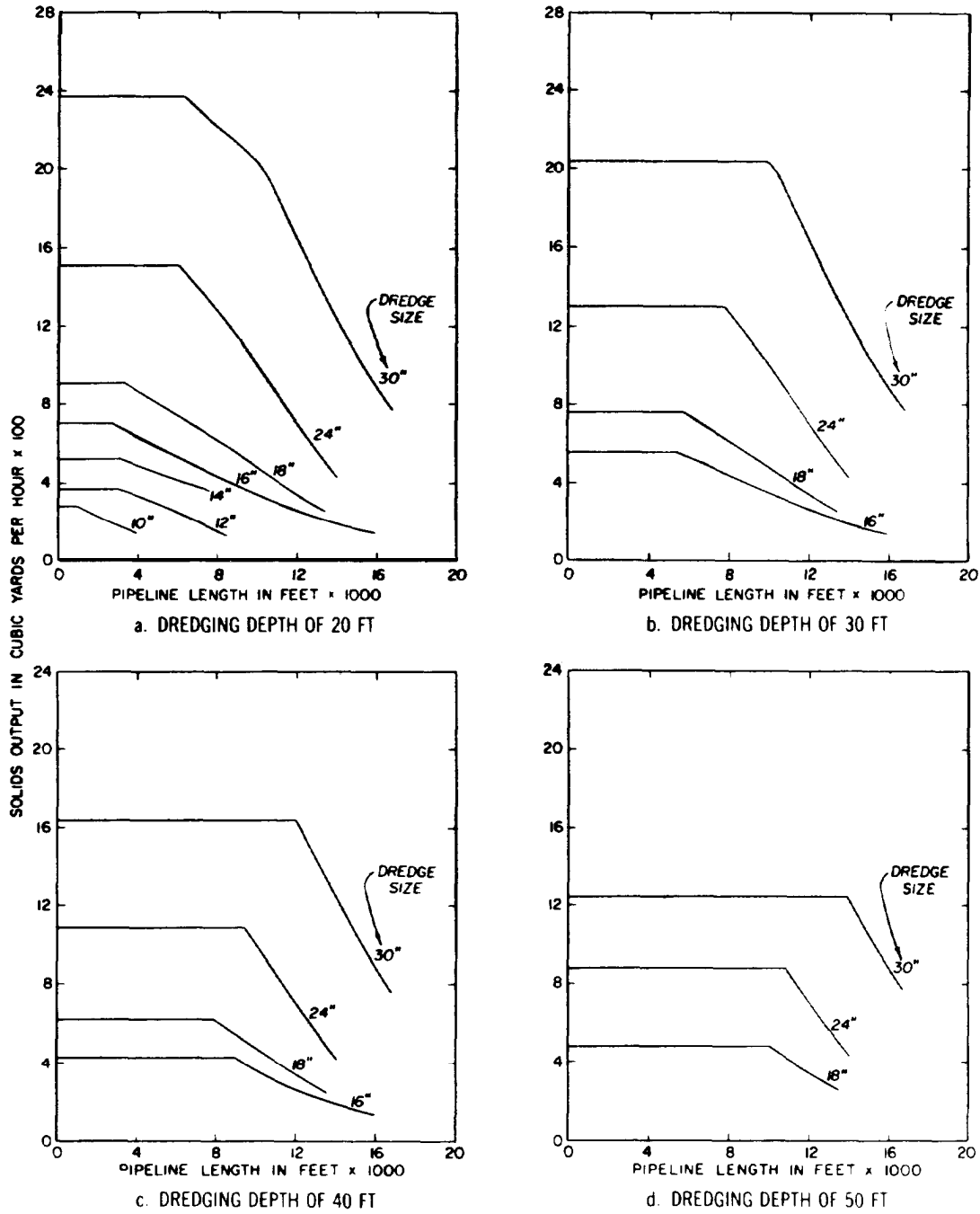

Figure 3-5. Relationships among solids output, dredge size, and pipeline length for various dredging depths- (WES TR DS-78-10)

Table 3-3. Specifications for Typical Dustpan and Cutterhead Dredges.

Dredge Type	Pipeline Diameter in.	Weight tons	Length ft	Width ft	Height ft	Draft in.	Freeboard in.	Dredge Pumps		Production Rate cu yd/hr	Dredging Depth ft	Depth of Single Pass Excavation in.		
								No.	hp					
Dustpan	32	--	244	50	60	60	48	1	2100	38	Steam	3500	60	60
Cutterhead	6	18.5	44	11	20	34	14	1	175	8	Diesel	25-95	12	18
Cutterhead	8	18.5	44	11	20	35	13	1	175	8	Diesel	45-105	12	18
Cutterhead	10	72.5	90	17	33	43	17	1	335	12	Diesel	60-300	25	18
Cutterhead	12	73.5	90	20	33	42	18	1	520	14	Diesel	120-540	25	18
Cutterhead	14	87	95	20	33	43	17	1	520	16	Diesel	160-700	25	21
Cutterhead	16	166	130	28	55	55	17	1	1125	18	Diesel	240-875	40	21
Cutterhead	20	316	180	32	70	54	42	1	1700	24	Diesel	310-1365	50	24
Cutterhead	24	326	185	32	70	56	40	1	2250	24	Diesel	515-1615	50	30
Cutterhead	30	350	225	36	67	60	36	1	3600	30	Diesel	575-2500	50	36

b. Description of Operation. The cutterhead dredge is generally equipped with two stern spuds used to hold the dredge in working position and to advance the dredge into the cut or excavating area. During operation, the cutterhead dredge swings from side to side alternately using the port and starboard spuds as a pivot, as shown in figure 3-6. Cables attached to anchors on each side of the dredge control lateral movement. Forward movement is achieved by lowering the starboard spud after the port swing is made and then raising the port spud. The dredge is then swung back to the starboard side of the cut centerline. The port spud is lowered and the starboard spud lifted to advance the dredge. The excavated material may be disposed of in open water or in confined disposal areas located upland or in the water. In the case of open-water disposal, only a floating discharge pipeline, made up of sections of pipe mounted on pontoons and held in place by anchors, is required. Additional sections of shore pipeline are required when upland disposal is used. In addition, the excavated materials may be placed in hopper barges for disposal in open water or in confined areas that are remote from the dredging area. In cutterhead dredging, the pipeline transport distances usually range up to about 3 miles. For commercial land reclamation or fill operations, transport distances are generally longer, with pipeline lengths reaching as far as 15 miles, for which the use of multiple booster pumps is necessary.

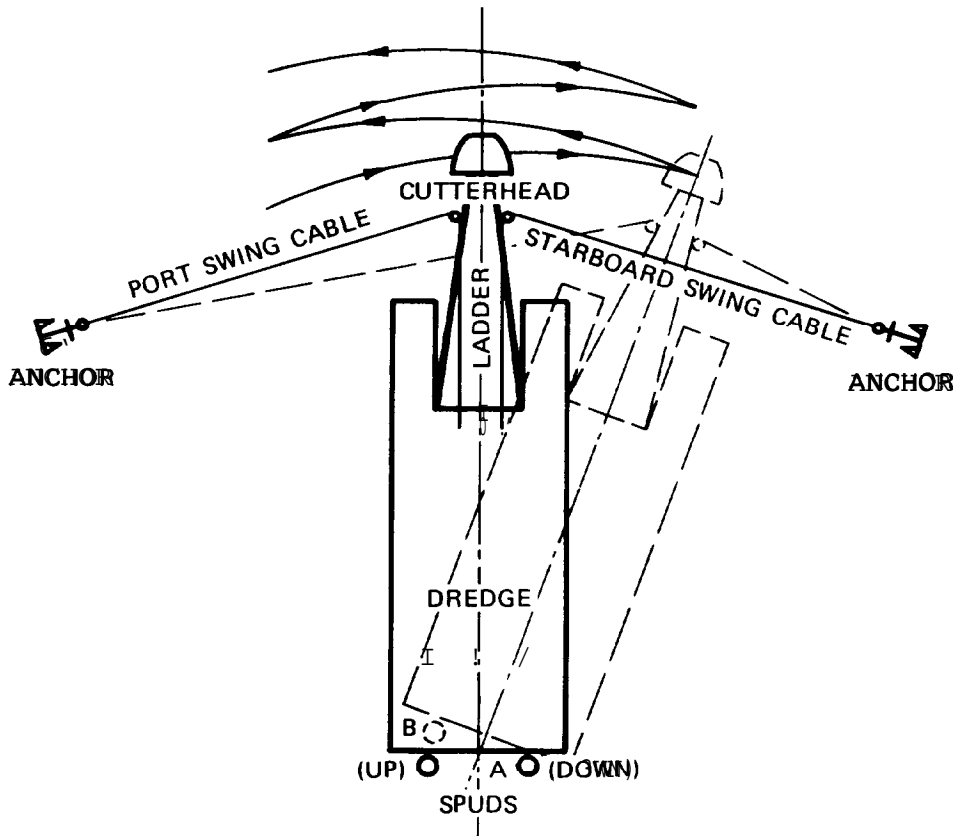

Figure 3-6. Operation of a cutterhead dredge (viewed from above).

c. Application. Although the cutterhead dredge was developed to loosen up densely packed deposits and eventually cut through soft rock, it can excavate a wide range of materials including clay, silt, sand, and gravel. The cutterhead, however, is not needed in maintenance dredging of most materials consisting of clay, silt, and fine sand because in these materials, rotation of the cutterhead produces a turbidity cloud and increases the potential for adverse environmental impacts. Common practice is to use the cutterhead whether it is needed or not. When the cutterhead is removed, cutterhead dredges become in effect plain suction dredges. The cutterhead dredge is suitable for maintaining harbors, canals, and outlet channels where wave heights are not excessive. A cutterhead dredge designed to operate in calm water will not operate offshore in waves over 2-3 ft in height; the cutterhead will be forced into the sediment by wave action creating excessive shock loads on the ladder. However, a cutterhead dredge designed to operate offshore can operate in waves up to about 6 ft.

d. Advantages. The cutterhead dredge is the most widely used dredge in the United States because of the following advantages:

(1) Cutterhead dredges are used on new work and maintenance projects and are capable of excavating most types of material and pumping it through pipelines for long distances to upland disposal sites.

(2) The cutterhead operates on an almost continuous dredging cycle, resulting in maximum economy and efficiency.

(3) The larger and more powerful machines are able to dredge rocklike formations such as coral and the softer types of basalt and limestone without blasting.

e. Limitations. The limitations on cutterhead dredges are as follows:

(1) The cutterhead dredges available in the United States have limited capability for working in open-water areas without endangering personnel and equipment. The dredging ladder on which the cutterhead and suction pipe are mounted is rigidly attached to the dredge; this causes operational problems in areas with high waves.

(2) The conventional cutterhead dredges are not self-propelled. They require the mobilization of large towboats in order to move between dredging locations.

(3) The cutterhead dredge has problems removing medium and coarse sand in maintaining open channels in rivers with rapid currents. It is difficult to hold the dredge in position when working upstream against the river currents since the working spud often slips due to scouring effects. When the dredge works downstream, the material that is loosened by the cutterhead is not pulled into the suction intake of the cutterhead. This causes a sandroll, or berm, of sandy material to form ahead of the dredge.

(4) The pipeline from the cutterhead dredge can cause navigation problems in small, busy waterways and harbors.

3-5. Dustpan Dredge.

a. General. The dustpan dredge is a hydraulic suction dredge that uses a widely flared dredging head along which are mounted pressure water jets (fig. 3-7). The jets loosen and agitate the sediments which are then captured in the dustpan head as the dredge itself is winched forward into the excavation. This type of dredge was developed by the Corps of Engineers to maintain navigation channels in uncontrolled rivers with bedloads consisting primarily of sand and gravel. The first dustpan dredge was developed to maintain navigation on the Mississippi River during low river stages. A dredge was needed that could operate in shallow water and be large enough to excavate the navigation channel in a reasonably short time. The dustpan dredge operates with a low-head, high-capacity centrifugal pump since the material has to be raised only a few feet above the water surface and pumped a short distance. The dredged material is normally discharged into open water adjacent to the navigation channel through a pipeline usually only 800 to 1000 ft long.

b. Description of Operation. The dustpan dredge maintains navigation channels by making a series of parallel cuts through the shoal areas until the authorized widths and depths are achieved. Typical operation procedures for the dustpan dredge are as follows:

(1) The dredge moves to a point about 500 ft upstream of the upper limit of the dredging area and the hauling anchors are set. Two anchors are used, as shown in Figure 3-8. The hauling winch cables attached to the anchors are crossed to provide better maneuverability and control of the vessel while operating in the channel prism.

(2) The dredge is then moved downstream to the desired location. The suction head is lowered to the required depth, dredge pump and water jet pumps are turned on, and the dredging commences. The dredge is moved forward by the hauling cables. The rate of movement depends on the materials being dredged, depth of dredging, currents, and wind. In shallow cuts, the advance may be as rapid as 800 ft/hr.

(3) When the upstream end of the cut is reached, the suction head is raised and the dredge is moved back downstream to make a parallel cut. This operation is repeated until the desired dredging widths and depths are achieved.

(4) The suction head may have to be lowered or raised if obstacles such as boulders, logs, or tree stumps are encountered. Experience with dustpan dredges indicates that the best results are obtained when the height of the cut face does not exceed 6 ft in depth.

(5) The dredge is moved outside the channel to let waterborne traffic pass through the area simply by raising the suction head and slacking off on one of the hauling winch cables. The propelling engines can be used to assist in maneuvering the dredge clear of the channel. The vessel is held in position by lowering the suction head or by lowering a spud.

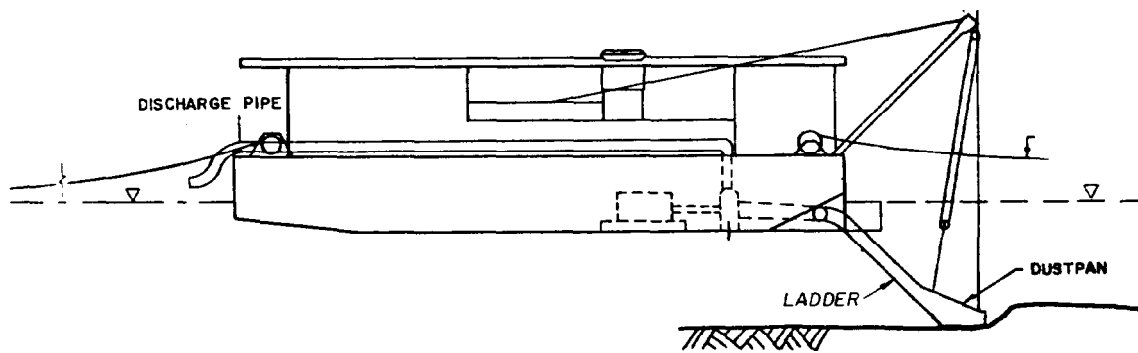
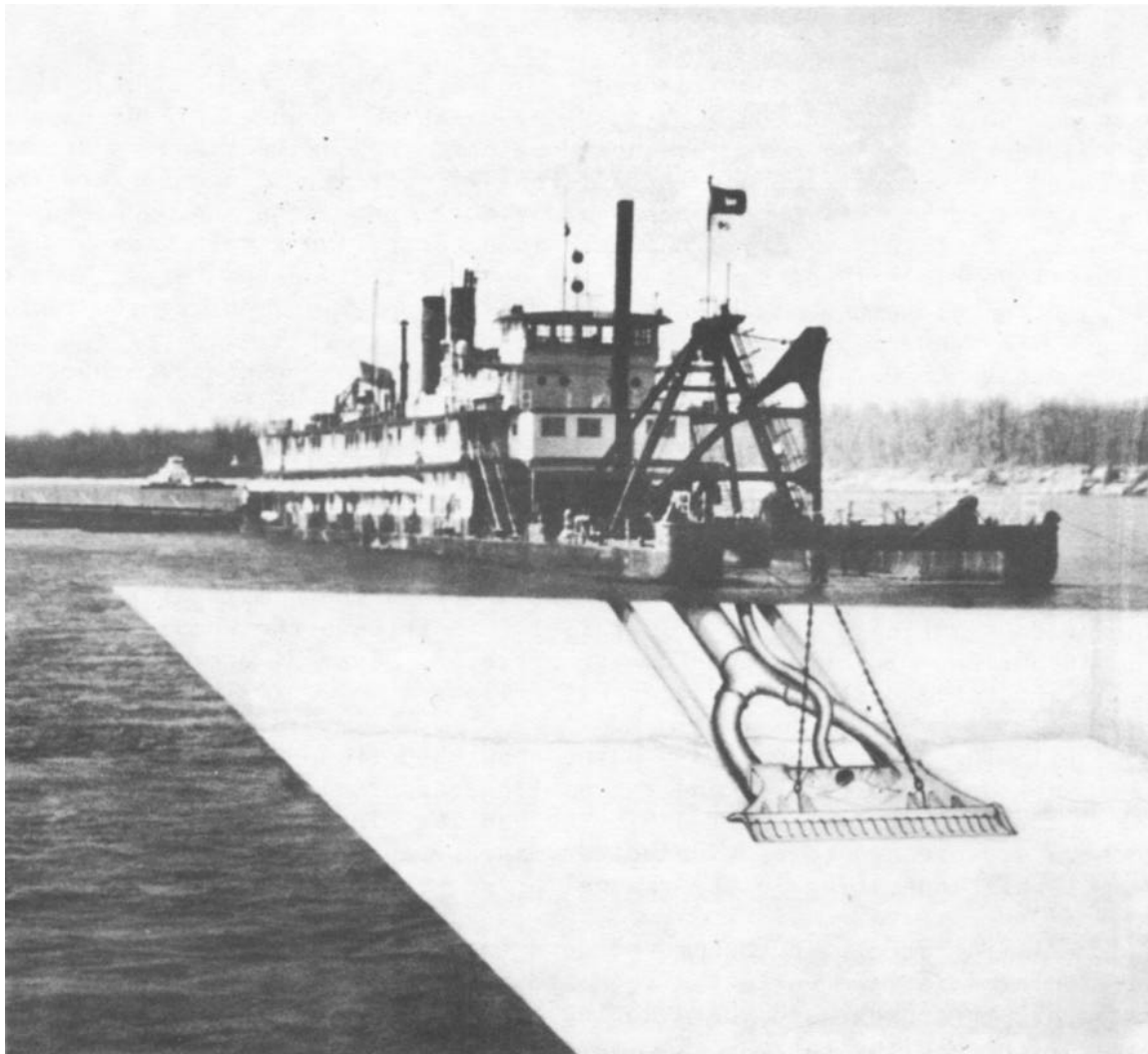

Figure 3-7. Dustpan dredge.

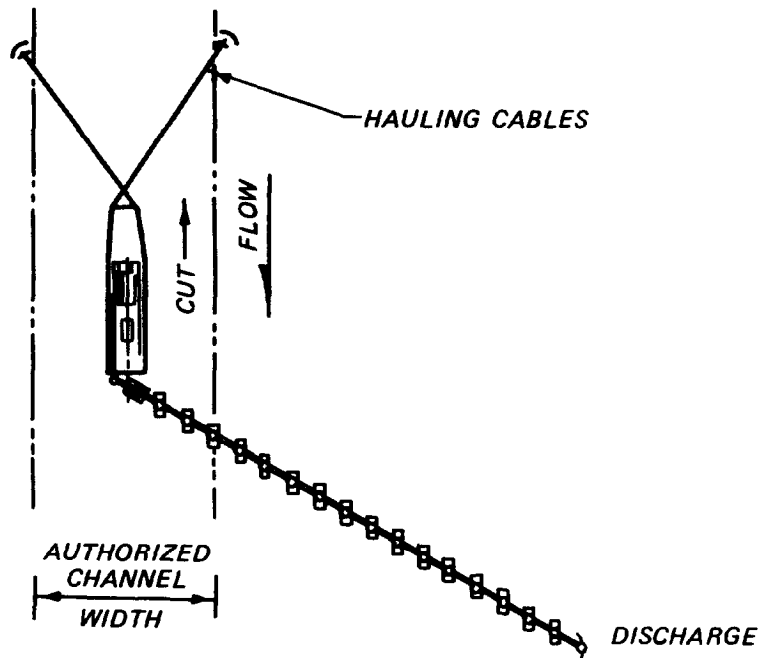

Figure 3-8. Operation of dustpan dredge (viewed from above).

c. Application. The pipeline system and the rigid ladder used with the dustpan dredge make it effective only in rivers or sheltered waters; it cannot be used in estuaries or bays where significant wave action occurs. Because it has no cutterhead to loosen hard, compact materials, the dustpan dredge is mostly suited for high-volume, loose-material dredging. Dustpan dredges are used to maintain the navigation channel of the uncontrolled open reaches of the Mississippi, Missouri, and Ohio Rivers. Dustpan dredging is principally a low-stage season operation. River channels are surveyed before the end of the high-stage season to determine the location and depths at the river crossings and sandbar formations, and dustpan dredging operations are planned accordingly. The existing fleet of Corps dustpan dredges is described briefly in table 3-4.

Table 3-4. Corps Dustpan Dredges.

<u>Name</u>	<u>District Location</u>	<u>Discharge Diameter, in.</u>	<u>Age, years</u>
Mitchell	Kansas City	34	47
Burgess	Memphis	32	47
Ockerson	Memphis	32	49
Potter	St. Louis	32	49
Jadwin	Vicksburg	32	47

These dredges are high-volume dredges capable of excavating a navigation channel through river sediment in a short time. During FY 71, the dredge Jadwin excavated over 6,200,000 cu yd, with an average production rate of approximately 3600 cu yd/hr. Detailed operations data for all the dustpan

dredges are reported on ENG Form 4267, "Report of Operations--Pipeline, Dipper, or Bucket Dredges." Refer to table 3-3 for specifications for a typical dustpan dredge.

d. Advantages. The dustpan dredge is self-propelled, which enables it to move rapidly over long distances to work at locations where emergencies occur. The attendant plant and pipeline are designed for quick assembly so that work can be started a few hours after arrival at the work site. The dustpan dredge can move rapidly out of the channel to allow traffic to pass and can resume work immediately. The high production rate and design of the dustpan dredge make it possible to rapidly remove sandbar formations and deposits from river crossings so that navigation channels can be maintained with a minimum of interruption to waterborne traffic.

e. Limitations. The dustpan dredge was designed for a specific purpose, and for this reason there are certain limitations to its use in other dredging environments. It can dredge only loose materials such as sands and gravels and only in rivers or sheltered waters where little wave action may be expected. The dustpan dredge is not particularly well suited for transporting dredged material long distances to upland disposal sites; pumping distances are limited to about 1000 ft without the use of booster pumps.

3-6. Sidecasting Dredges.

a. General. The sidecasting type of dredge (fig. 3-9) is a shallow-draft seagoing vessel, especially designed to remove material from the bar channels of small coastal inlets. The hull design is similar to that of a hopper dredge; however, sidecasting dredges do not usually have hopper bins. Instead of collecting the material in hoppers onboard the vessel, the sidecasting dredge pumps the dredged material directly overboard through an elevated discharge boom; thus, its shallow draft is unchanged as it constructs or maintains a channel. The discharge pipeline is suspended over the side of the hull by structural means and may be supported by either a crane or a truss-and-counterweight design. The dredging operations are controlled by steering the vessel on predetermined ranges through the project alignment. The vessel is self-sustaining and can perform work in remote locations with a minimum of delay and service requirements. The projects to which the sidecasters are assigned for the most part are at unstabilized, small inlets which serve the fishing and small-boat industries. Dangerous and unpredictable conditions prevail in these shallow inlets making it difficult for conventional plant to operate except under rare ideal circumstances.

b. Description of Operation. The sidecasting dredge picks up the bottom material through two dragarms and pumps it through a discharge pipe supported by a discharge boom. During the dredging process, the vessel travels along the entire length of the shoaled area casting material away from and beyond the channel prism. Dredged material may be carried away from the channel section by littoral and tidal currents. The construction of a deepened section through the inlet usually results in some natural scouring and deepening of the channel section, since currents moving through the prism tend to concentrate the scouring action in a smaller active zone. A typical sequence of events in a sidecasting operation is as follows:

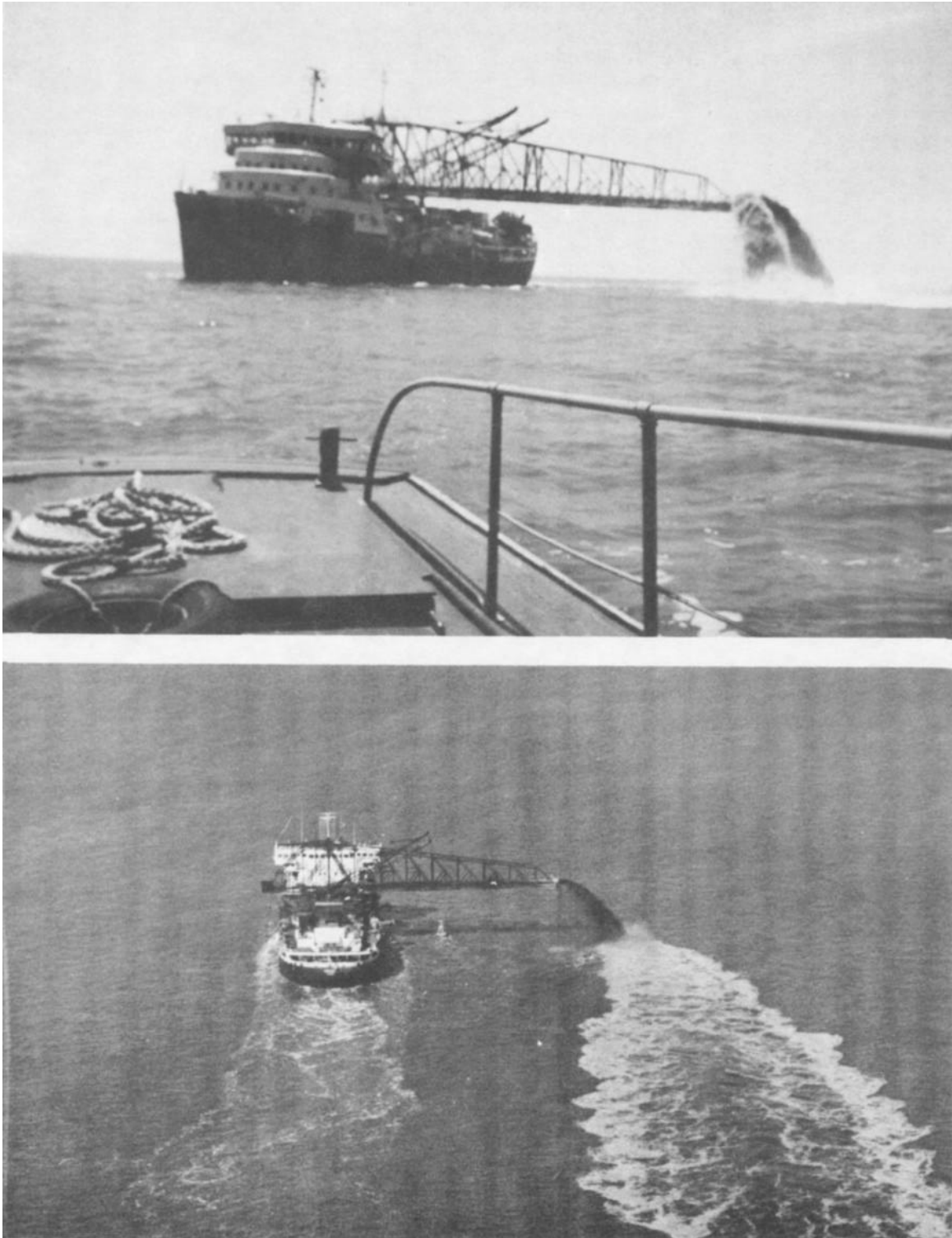

Figure 3-9. Sidecasting dredge.

- (1) The dredge moves to the work site.
- (2) The dragarms are lowered to the desired depth.
- (3) The pumps are started to take the material from the channel bottom and pump it through the discharge boom as the dredge moves along a designated line in the channel prism.
- (4) If adequate depths are not available across the bar during low tide levels, dredging must be started during higher tide levels. Under these conditions, the cuts are confined to a narrow channel width to quickly attain the flotation depth necessary for dredging to be continued during the low tidal periods.
- (5) The dredge continues to move back and forth across the bar until the channel dimensions are restored.
- (6) The discharge can be placed on either side of the dredge by rotating the discharge boom from one side of the hull to the other.

c. Application. The Corps of Engineers developed the shallow-draft sidecasting dredge for use in places too shallow for hopper dredges and too rough for pipeline dredges. The types of materials that can be excavated with the sidecasting dredge are the same as for the hopper dredges (para 3-3c).

d. Advantages. The sidecasting type of dredge, being self-propelled, can rapidly move from one project location to another on short notice and can immediately go to work once at the site. Therefore, a sidecasting dredge can maintain a number of projects located great distances from each other along the coastline.

e. Limitations. The sidecasting dredge needs flotation depths before it can begin to work because it dredges while moving over the shoaled area. Occasionally, a sidecaster will need to alter its schedule to work during higher tide levels periods only, due to insufficient depths in the shoaled area. Most areas on the seacoast experience a tidal fluctuation sufficient to allow even the shallowest shoaled inlets to be reconstructed by a sidecasting type of dredge. A shallow-draft sidecasting dredge cannot move large volumes of material compared to a hopper dredge, and some of the material removed can return to the channel prism due to the effects of tidal and littoral currents. The sidecasting dredge has only open-water disposal capability; therefore, it cannot be used for dredging contaminated sediments.

3-7. Dipper Dredges.

a. General. The dipper dredge is basically a barge-mounted power shovel. It is equipped with a power-driven ladder structure and operated from a barge-type hull. A schematic drawing and photograph of the dipper dredge are shown in figure 3-10. A bucket is firmly attached to the ladder structure and is forcibly thrust into the material to be removed. To

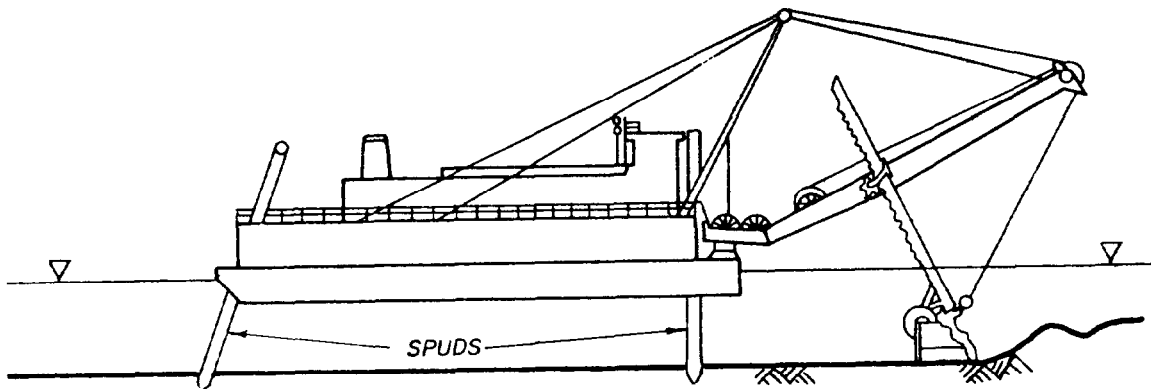
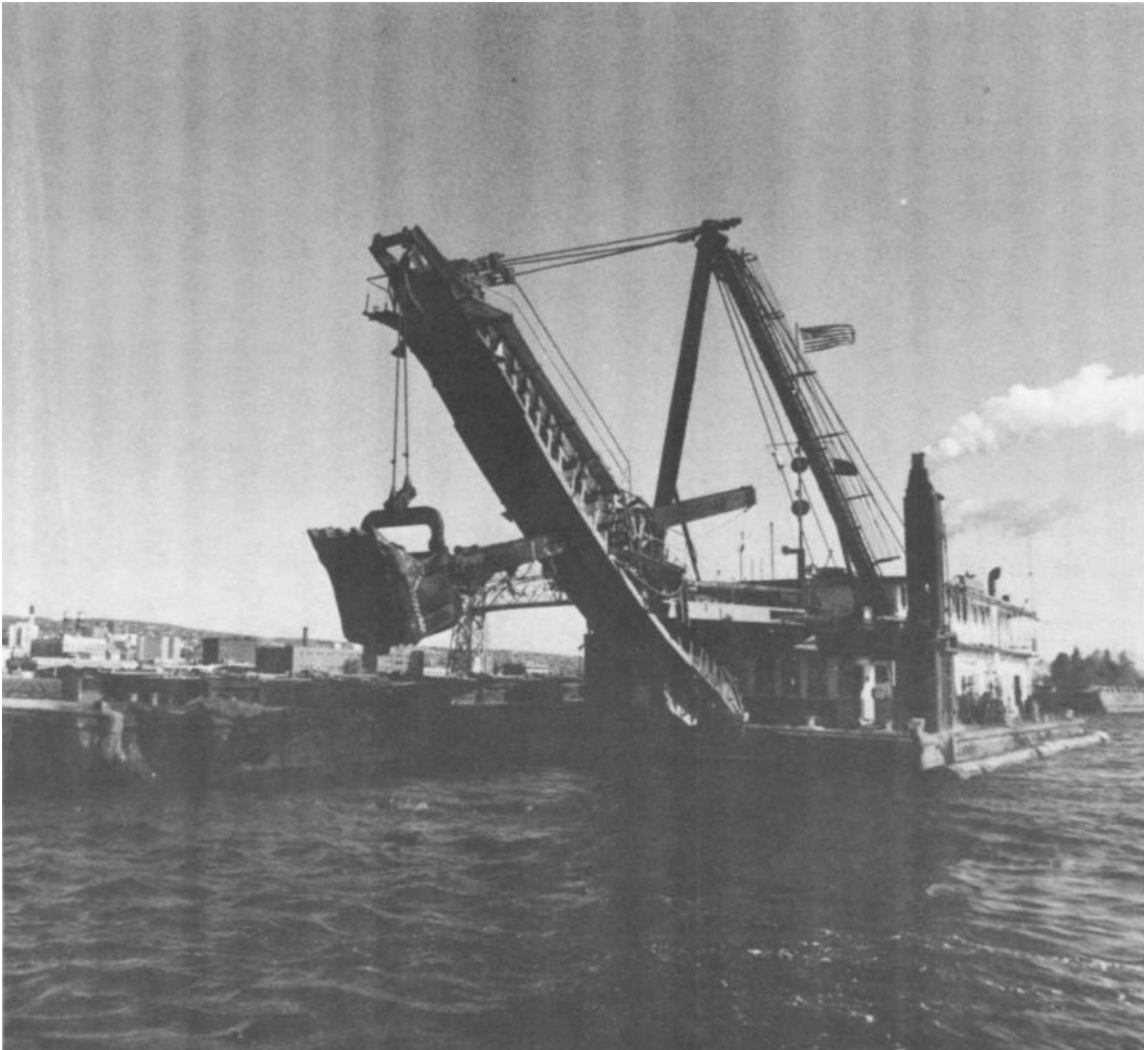

Figure 3-10. Dipper dredge.

increase digging power, the dredge barge is moored on powered spuds that transfer the weight of the forward section of the dredge to the bottom. Dipper dredges normally have a bucket capacity of 8 to 12 cu yd and a working depth of up to 50 ft. There is a great variability in production rates, but 30 to 60 cycles per hour is routinely achieved.

b. Description of Operation. The dipper type of dredge is not self-propelled but can move itself during the dredging process by manipulation of the spuds and the dipper arm. A typical sequence of operation is as follows :

(1) The dipper dredge, scow barges, and attendant plant are moved to the work site.

(2) The dredge is moved to the point where work is to start; part of the weight is placed on the forward spuds to provide stability.

(3) A scow barge is brought alongside and moored into place by winches and cables on the dipper dredge.

(4) The dredge begins digging and placing the material into the moored barge.

(5) When all the material within reach of the bucket is removed, the dredge is moved forward by lifting the forward spuds and maneuvering with the bucket and stern spud.

(6) The loaded barges are towed to the disposal area and emptied by bottom dumping if an open-water disposal area is used, or they are unloaded by mechanical or hydraulic equipment if diked disposal is required.

(7) These procedures are repeated until the dredging operation is completed.

c. Application. The best use of the dipper dredge is for excavating hard, compacted materials, rock, or other solid materials after blasting. Although it can be used to remove most bottom sediments, the violent action of this type of equipment may cause considerable sediment disturbance and resuspension during maintenance digging of fine-grained material. In addition, a significant loss of the fine-grained material will occur from the bucket during the hoisting process. The dipper dredge is most effective around bridges, docks, wharves, pipelines, piers, or breakwater structures because it does not require much area to maneuver; there is little danger of damaging the structures since the dredging process can be controlled accurately. No provision is made for dredged material containment or transport, so the dipper dredge must work alongside the disposal area or be accompanied by disposal barges during the dredging operation.

d. Advantages. The dipper dredge is a rugged machine that can remove bottom materials consisting of clay, hardpacked sand, glacial till, stone, or blasted rock material. The power that can be applied directly to the cutting edge of the bucket makes this type of dredge ideal for the removal

25 Mar 83

of hard and compact materials. It can also be used for removing old piers, breakwaters, foundations, pilings, roots, stumps, and other obstructions. The dredge requires less room to maneuver in the work area than most other types of dredges; the excavation is precisely controlled so that there is little danger of removing material from the foundation of docks and piers when dredging is required near these structures. Dipper dredges are frequently used when disposal areas are beyond the pumping distance of pipeline dredges, due to the fact that scow barges can transport material over long distances to the disposal area sites. The dipper type of dredge can be used effectively in refloating a grounded vessel. Because it can operate with little area for maneuvering, it can dig a shoal out from under and around a grounded vessel. The dipper dredge type of operation limits the volume of excess water in the barges as they are loaded. Dipper-dredged material can be placed in the shallow waters of eroding beaches to assist in beach nourishment.

e. Limitations. It is difficult to retain soft, semisuspended fine-grained materials in the buckets of dipper dredges. Scow-type barges are required to move the material to a disposal area, and the production is relatively low when compared to the production of cutterhead and dustpan dredges. The dipper dredge is not recommended for use in dredging contaminated sediments.

3-8. Bucket Dredges.

a. General. The bucket type of dredge is so named because it utilizes a bucket to excavate the material to be dredged (fig. 3-11). Different types of buckets can fulfill various types of dredging requirements. The buckets used include the clamshell, orangepeel, and dragline types and can be quickly changed to suit the operational requirements. The vessel can be positioned and moved within a limited area using only anchors; however, in most cases anchors and spuds are used to position and move bucket dredges. The material excavated is placed in scows or hopper barges that are towed to the disposal areas. Bucket dredges range in capacity from 1 to 12 cu yd. The crane is mounted on a flat-bottomed barge, on fixed-shore installations, or on a crawler mount. Twenty to thirty cycles per hour is typical, but large variations exist in production rates because of the variability in depths and materials being excavated. The effective working depth is limited to about 100 ft.

b. Description of Operation. The bucket type of dredge is not self-propelled but can move itself over a limited area during the dredging process by the manipulation of spuds and anchors. A typical sequence of operation is as follows:

(1) The bucket dredge, scows or hopper barges, and attendant plant are moved to the work site by a tug.

(2) The dredge is positioned at the location where work is to start and the anchors and spuds lowered into place.

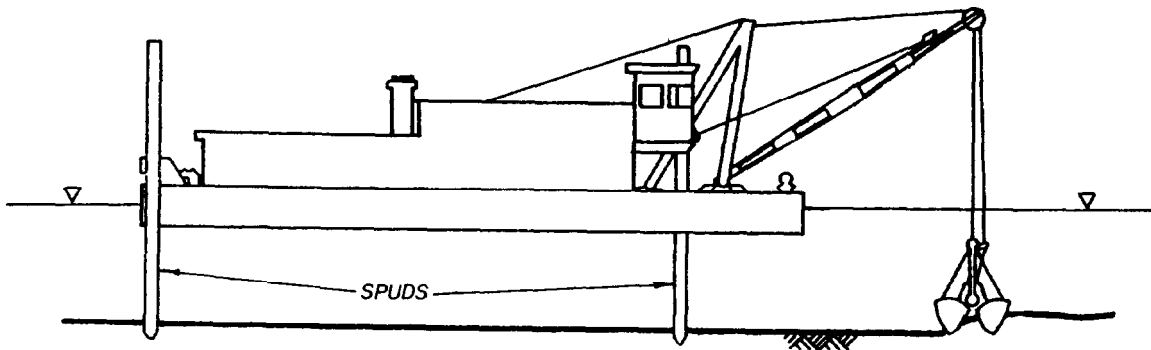

Figure 3-11. Bucket dredge.

(3) A scow or hopper barge is brought alongside and secured to the bucket dredge hull.

(4) The dredge begins the digging operation by dropping the bucket in an open position from a point above the sediment. The bucket falls through the water and penetrates into the bottom material. The sides or jaws of the bucket are then closed through the use of wire cables operated from the crane. As the sides of the bucket close, material is sheared from the bottom and contained in the bucket compartment. The bucket is raised above the water surface and swung to a point over the hopper barge. The material is then released into the hopper barge by opening the sides of the bucket.

(5) As material is removed from the bottom of the waterway to the desired depth at a given location, the dredge is moved to the next nearby location by using anchors. If the next dredging area is a significant distance away, the bucket dredge must be moved by a tug.

(6) The loaded barges are towed to the disposal area by a tug and emptied by bottom dumping if an open water disposal area is used. If a diked disposal area is used, the material must be unloaded using mechanical or hydraulic equipment.

(7) These procedures are repeated until the dredging operation is completed.

c. Application. Bucket dredges may be used to excavate most types of materials except for the most cohesive consolidated sediments and solid rock. Bucket dredges usually excavate a heaped bucket of material, but during hoisting turbulence washes away part of the load. Once the bucket clears the water surface, additional losses may occur through rapid drainage of entrapped water and slumping of the material heaped above the rim. Loss of material is also influenced by the fit and condition of the bucket, the hoisting speed, and the properties of the sediment. Even under ideal conditions, substantial losses of loose and fine sediments will usually occur. Because of this, special buckets must be used if the bucket dredge is to be considered for use in dredging contaminated sediments. To minimize the turbidity generated by a clamshell operation, watertight buckets have been developed (fig. 3-12). The edges seal when the bucket is closed and the top is covered to minimize loss of dredged material. Available sizes range from 2.6 to 26 cu yd. These buckets are best adapted for maintenance dredging of fine-grained material. A direct comparison of 1.3 cu-yd typical clamshell and watertight clamshell operations indicates that watertight buckets generate 30 to 70 percent less turbidity in the water column than typical buckets. This reduction is probably due primarily to the fact that leakage of dredged material from watertight buckets is reduced by approximately 35 percent. The bucket dredge is effective while working near bridges, docks, wharves, pipelines, piers, or breakwater structures because it does not require much area to maneuver; there is little danger of damaging the structures because the dredging process can be controlled accurately.

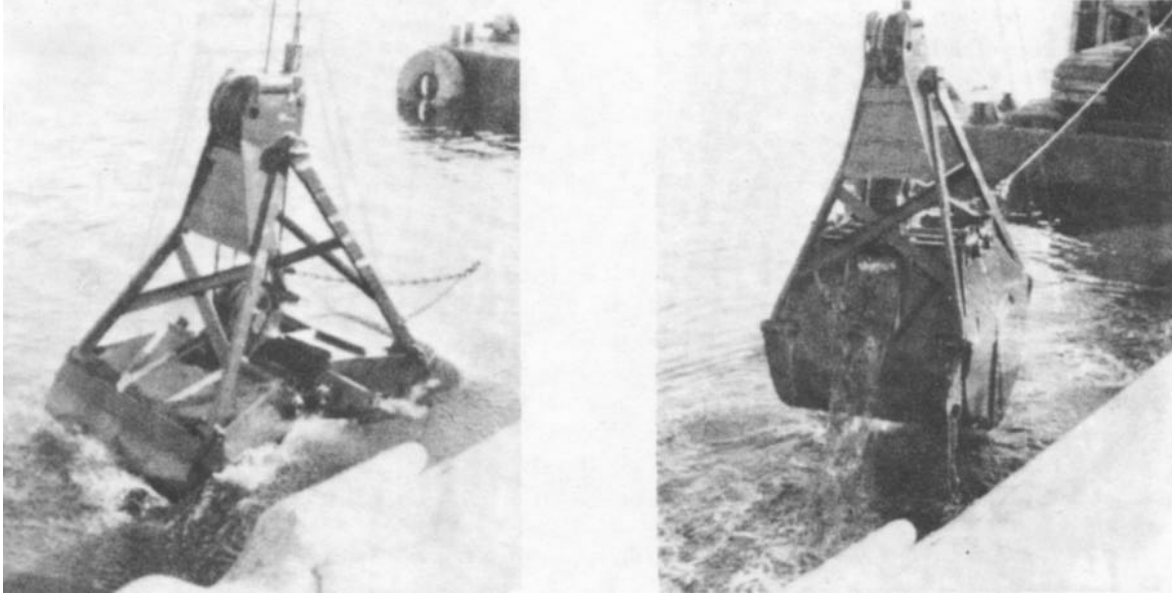

Figure 3-12. Open and closed positions of the watertight bucket.

d. Advantages. The bucket dredge has the same advantages cited for the dipper dredge, except that its capabilities in blasted rock and compact materials are somewhat less. The density of material excavated is about the same as the in-place density of the bottom material. Therefore, the volume of excess water is minimal, which increases the efficiency of operation in the transportation of material from the dredging area to the disposal area.

e. Limitations. The limitations of the bucket type of dredge are the same as those described for the dipper dredge (para 3-7e).

3-9. Special-Purpose Dredge

a. General. The Corps of Engineers Dredge CURRITUCK (fig. 3-13), assigned to the Wilmington District, is an example of a special-purpose type of dredge. Designed to work the same projects as sidecasting dredges, the CURRITUCK has the additional ability to completely remove material from the inlet complex and transport it to downdrift eroded beaches. It is a self-propelled split hull type of vessel, equipped with a self-leveling deck-house located at the stern, where all controls and machinery are housed. The vessel is hinged above the main deck so that the hull can open from bow to stern by means of hydraulic cylinders located in compartments forward and aft of the hopper section. The CURRITUCK has one hopper with a capacity of 315 cu yd. The hopper section is clearly visible to the operators in the pilot house, making production monitoring an easy task.

b. Description of Operation. The CURRITUCK operates in much the same way as a hopper dredge. The operator steers the vessel through the shoal

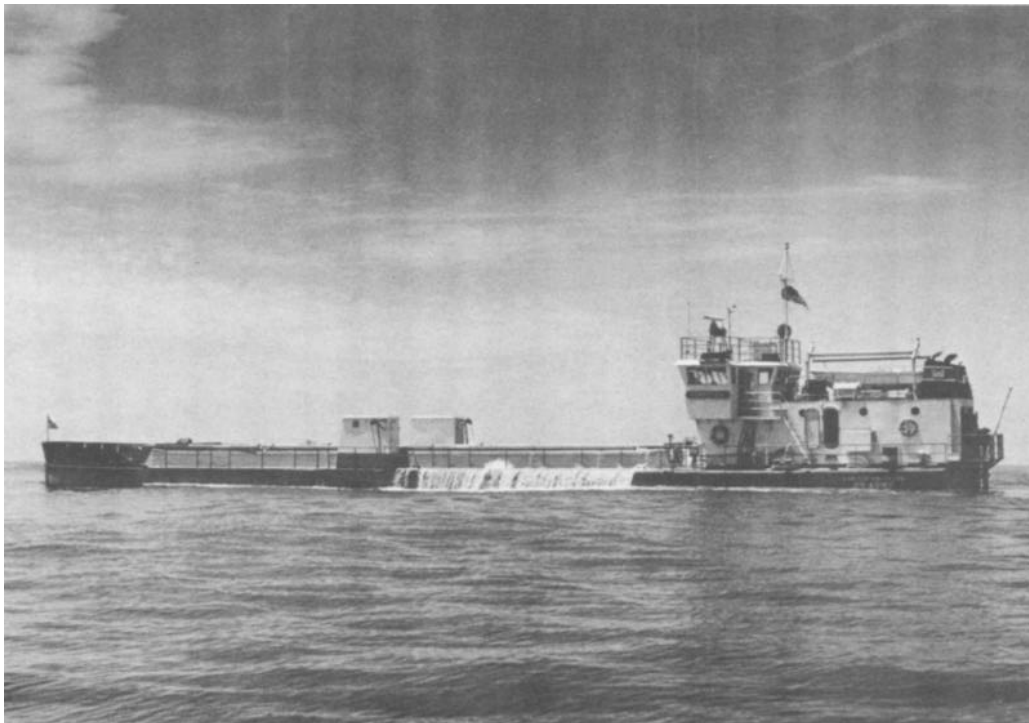

Figure 3-13. Corps special-purpose dredge.

areas of the channel. The dredge pumps, located in the compartments on each side of the hull, pump material through trailing dragarms into the hopper section. When an economic load is obtained, the dragarms are lifted from the bottom of the waterway and the dredge proceeds to the disposal area. A major difference between the operation of the CURRITUCK and that of a conventional hopper dredge is in the method of disposal; the CURRITUCK is designed to transport and deposit the dredged material close to the surf zone area.

c. Application. The CURRITUCK provides a sand-bypassing capability in addition to improving the condition of navigation channels. The CURRITUCK excavates material from navigation channels, transports it to downdrift eroded beaches, and releases it where it is needed to provide beach nourishment, rather than wasting it offshore. After the material has been deposited in the near-shore coastal areas, the dredge backs away and returns to the navigation channel.

d. Advantages. The CURRITUCK is an effective dredging tool for use in shallow-draft inlets. All of the dredged material is placed in the littoral zone. The CURRITUCK can also be used to supplement sidecasting dredges and to transport dredged materials from inlet channels to the near-shore areas of eroded beaches.

e. Limitations. The production rate of the CURRITUCK is limited by its small hopper capacity. Therefore, it is not effective on major navigation channels. In addition, when the flotation depths are minimal it is necessary to use a sidecasting dredge to provide access into the project.

3-10. Summary of Dredge Operating Characteristics. The important operating characteristics of each dredge presented in the preceding sections are summarized in table 3-5. In some cases, a wide range of values is given to account for the various sizes of plants within each class. In other instances, the information provides a qualitative judgement (high, low, average) of each dredge type's performance in a given area. Table 3-5 should be helpful in making quick assessments of the suitability of a given dredge type in a known physical setting.

3-11. Locations of Dredges in the United States. Figure 3-14 shows the distribution of dredging capability for the Corps and industry in the United States by region. Congress has determined (Public Law 95-269) that the Corps will operate a dredging fleet adequate to meet emergency and national defense requirements at home and abroad. This fleet will be maintained to technologically modern and efficient standards and will be kept in a fully operational status. The status of the United States dredging fleet as determined in the Corps of Engineers' National Dredging Study is comprehensively summarized in a paper of the same title (item 6). A detailed inventory of all dredges in the United States is published annually in World Dredging and Marine Construction (item 10). The designer can consult this source for information on the specific types of dredges available in the proposed project area.

Table 3-5. Summary of Dredge Operating Characteristics.^a

Dredge Type	Percent Solids		Turbidity Caused	Open-Water Operation	Vessel Draft ft	Approx. Range of Production Rates cu yd/hr	Dredging Depths ft		Limiting Wave Height ft	Limiting Current	Lateral Dredging Accuracy ft
	in Slurry by Weight ^b	in situ					Minimum	Maximum			
Dipper	in situ	high	yes ^d	e	30-500	0 ^f	50	<3 ^g	h	1/2	
Bucket	in situ	high ⁱ	yes ^d	e	30-500	0 ^f	100 ^j	<3 ^{g,k}	h	1	
Dustpan	10-20%	avg.	no	5-14	1200-5,700	5-14	50-60 ^l	<3	h	2-3	
Cutterhead	10-20%	avg.	yes ^d	3-14	25-10,000	3-14	12-65 ^l	<3	h	2-3	
Hopper	10-20%	avg.	yes	12-31	500-2,000	10-28	80	<7	h	10	
Sidecasting	10-20%	high	yes	5-9	325-650	6	25	<7	h	10	
Special-Purpose	10-20%	avg.	yes	5-8	250 avg.	8	20	<7	h	10	

^aPrepared by WES.

^bPercent solids could theoretically be 0, but these are normal working ranges. Percent solids = $\frac{\text{wt. of dry sediment}}{\text{wt. of wet slurry}}$.

^cVertical accuracies are generally within ±1 ft.

^dLimited operation in open water possible, depending on hull size and type and wave height.

^eDepends on floating structure; if barge-mounted, approximately 5- to 6-ft draft.

^fZero if used alongside of waterway; otherwise, draft of vessel will determine.

^gDepends on supporting vessel--usually barge-mounted.

^hLiterature implies that water current hinders dredging operations, but references avoid establishing maximum current limitations. For most dredges, limiting current is probably in the 3- to 5-knot range, with hopper and dustpan dredges able to work at currents of perhaps 7 knots.

ⁱLow, if watertight bucket is used.

^jDemonstrated depth; theoretically could be used much deeper.

^kTheoretically unaffected by wave height; digging equipment not rigid.

^lWith submerged dredge pumps, dredging depths have been increased to 100 ft or more.

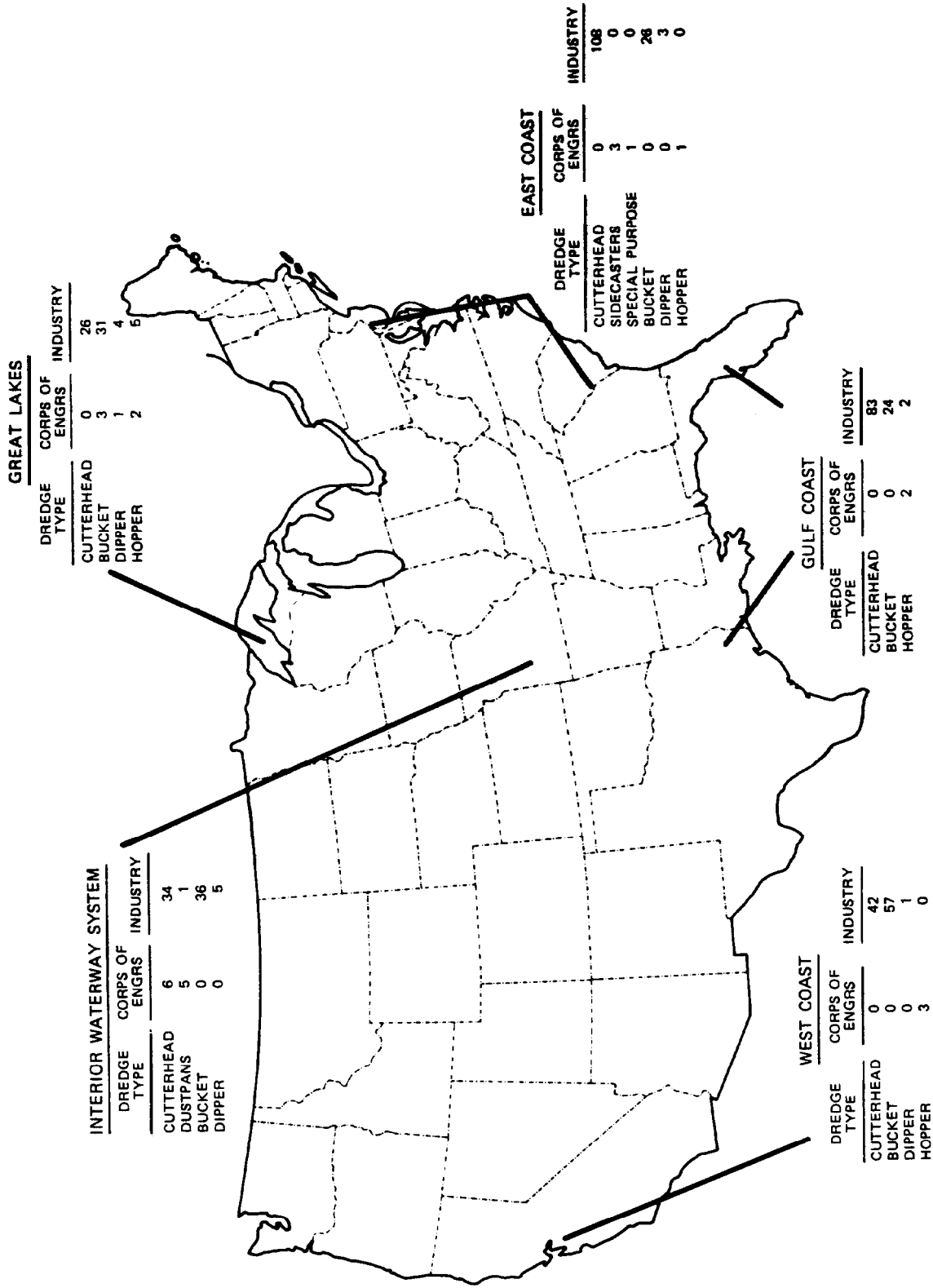

Figure 3-14. Distribution of dredging capability for the Corps and industry.
(data obtained from item 10)

3-12. Agitation Dredging Techniques.

a. General. Agitation dredging is the process of removing bottom material from a selected area by using equipment to raise it in the water column and allowing currents to carry it from the project area. In the most detailed study available on agitation dredging techniques, Richardson (item 7) evaluated past agitation dredging projects and presented guidelines and recommendations for using agitation dredging. Two distinct phases are involved in agitation dredging: (1) suspension of bottom sediments by some type of equipment, and (2) transport of the suspended material by currents. The main purpose of the equipment is to raise bottom material in the water column. Natural currents are usually involved in transporting the material from the dredging site, although the natural currents may be augmented with currents generated by the agitation equipment. Agitation dredging is accomplished by methods such as hopper dredge agitation, prop-wash, vertical mixers or air bubble, rakes or drag beams, and water jets. Based on the work done by Richardson (item 7), only hopper dredge, prop-wash, and rake or beam dragging agitation justify more detailed discussion in this EM.

b. Objectives. The main objective of agitation dredging is the removal of bottom material from a selected area. If the material is suspended but redeposits shortly in the same area, only agitation (not agitation dredging) has been accomplished. The decision to use agitation dredging should be based primarily on the following factors:

(1) Technical feasibility. The equipment to generate the required level of agitation must be available, and the agitated material must be carried away from the project area by currents.

(2) Economic feasibility. Agitation dredging must be determined the most cost-effective method for achieving the desired results; it should not affect the costs of other dredging projects downstream by increasing dredging volumes.

(3) Environmental feasibility. Agitation dredging should not cause unacceptable environmental impacts.

c. Hopper Dredge Agitation.

(1) General. Refer to para 3-3a for a general description of hopper dredges. In agitation dredging, hopper capacity is of secondary importance compared with pumping rates, mobility, and overflow provisions.

(2) Description of operation. The general operation of a hopper dredge is discussed in para 3-3b. In hopper dredge agitation, the conventional dredge-haul-dump operating mode is modified by increasing the dredging mode and reducing the haul-dump mode. It has been reported that hopper dredge agitation can allow a project to be maintained with a dredge which is relatively small compared with the size dredge required for a conventional dredge-haul-dump operation. Hopper dredge agitation is of

two types: (a) intentional agitation produced by hopper overflow; and (b) auxiliary agitation caused by dragheads and propeller wash. Since the latter is present in all hopper dredge operations and since it is difficult to quantify separately from hopper overflow, both types are measured together when reporting hopper dredge agitation effectiveness.

(3) Application. Agitation hopper dredging can perform the same maintenance functions as conventional hopper dredging if the following conditions are satisfied: (a) sediments are fine-grained and loosely consolidated, (b) currents are adequate to remove the agitated sediments from the project area, and (c) no unacceptable environmental impact results from the agitation dredging.

(4) Advantages. Because currents, not equipment, transport most of the sediment from the project area during agitation hopper dredging, the following advantages are realized: (a) hopper dredge agitation costs can be several times less per cubic yard than hopper dredge hauling costs and (b) smaller hopper dredges can be used to maintain certain projects.

(5) Limitations. Hopper dredge agitation should be applied only to specific dredging sites and not used as a general method to maintain large areas. The following limitations must be noted when considering this dredging technique for use at a site: (a) hopper dredge agitation cannot be used in environmentally sensitive areas where unacceptable environmental impacts may occur and (b) sediments and current conditions must be suitable for agitation dredging.

d. Prop-Wash Agitation.

(1) General. Prop-wash agitation dredging is performed by vessels especially designed or modified to direct propeller-generated currents into the bottom shoal material. The agitated material is suspended in the water column and carried away by a combination of natural currents and prop-wash currents. Unintentional prop-wash agitation dredging often occurs while vessels move through waterways. This type of sediment resuspension is uncontrolled and is often considered undesirable.

(2) Description of operation. The prop-wash vessel performs best when work begins at the upstream side of a shoal and proceeds downstream with the prop-wash-generated current directed downstream. The vessel is anchored in position, and prop-wash-generated currents are directed into the shoal material for several minutes. The vessel is then repositioned and the process is repeated.

(3) Application. Prop-wash agitation dredging has been successfully used in coastal harbors, river mouths, river channels, and estuaries. It is a method intended for use in loose sands and in maintenance dredged material consisting of uncompacted clay and silt. Cementing, cohesion, or compaction of the bottom sediment can make prop-wash agitation dredging difficult to perform. Waves may cause anchoring problems with the agitation vessel. Optimum water depths for prop-wash agitation dredging in sand

are between two and three times the agitation vessel's draft. Based on studies by Richardson (item 7), the average performance of vessels specially designed for prop-wash agitation range from 200 to 300 cu yd/hr in sand and are a little higher for fine-grained material.

(4) Advantages. The major advantages of prop-wash agitation dredging are related to economics. In some areas, prop-wash agitation dredging has been found to cost 40 to 90 percent less per cubic yard dredged than conventional dredging methods.

(5) Limitations. The limitations on prop-wash agitation dredging are as follows: (a) prop-wash agitation seems best suited for areas with little or no wave action, (b) prop-wash agitation should be applied in water depths less than four times the agitation vessel's draft, and (c) the sediments must be loose sands, silt, or clay.

e. Rakes and Drag Beams. Rakes, drag beams, and similar devices work by being pulled over the bottom (usually by a vessel), mechanically loosening the bottom material, and raising it into the water column to be carried away by natural currents. Since rakes and drag beams do not produce currents of their own and since they do not resuspend material as much as loosen it, these devices must be used in conjunction with currents strong enough to transport the loosened material away from the shoaling site; in addition, the vessel towing one of these devices may provide some resuspension and transport by its propwash. A wide range of dredging rates have been reported for agitation dredging by rakes and beams. Little value would be obtained by reporting these rates because they are highly dependent upon site conditions; however, it has been reported that the cost of agitation dredging by rakes and beams can be less than 10 percent of the cost for conventional dredging. Data show a definite correlation between dragging speed and dredging rate. The advantages and limitations for rake and drag beams are similar to those reported for other agitation dredging techniques.

f. Environmental Considerations. The environmental considerations discussed in Chapter 4 also apply to all agitation dredging techniques. The properties of sediments affect the fate of contaminants, and the short- and long-term physical and chemical conditions of the sediments at the agitation dredging site influence the environmental consequences of contaminants. These factors should be considered in evaluating the environmental risk of a proposed agitation dredging technique.

3-13. Advances in Dredging Technology. Advanced dredging technologies are generally directed toward one or more of the following areas of improvement: greater depth capability; greater precision, accuracy, and control over the dredging process; higher production efficiency; and decreased environmental harm. Following are brief descriptions of the major recent innovations in production dredging:

- a. Ladder-mounted submerged pumps for higher production.

- b. Improved designs of dredging heads to minimize material resuspension.
- c. Use of spud barges aft of the dredge to extend hull length and increase dredge swing. This will increase production efficiency of cutter-head dredges.
- d. Longer ladders, connected further aft on the dredge hull to increase depth and permit greater control.
- e. Tandem pump systems for greater production efficiency and reliability.
- f. Better hull designs equipped with liquid stabilizing systems (motion compensators) to allow use in heavier seas.
- g. Improved production instrumentation to monitor flow rates, densities, cumulative production, etc.
- h. Improved navigation, positioning, and bottom profiling instrumentation. The state of the art includes advanced laser, electronic, and acoustical systems.
- i. Closed-bucket modifications to reduce loss of fines and liquid from bucket dredges.
- j. Depth and swing indicators for mechanical dredges.
- k. Use of silt curtains during dredging and open-water disposal to restrict turbidity plumes and, in the case of contaminated materials, limit the added dispersion due to dredging.

3-14. Environmental Considerations. The adverse environmental effects normally associated with dredging operations are increases in turbidity, resuspension of contaminated sediments, and decreases in dissolved oxygen. Selection and operation of the type of dredge plant as well as the type of sediment being dredged affect the degree of adverse impacts during dredging. Investigations which have been conducted by WES under the DMRP have studied the environmental effects caused by dredging and disposal operations. The results of these studies have been published as WES Technical Reports. Guidance on the environmental aspects of dredging and disposal is presented in Chapter 4.