

NATIONAL TOXICOLOGY PROGRAM
Technical Report Series
No. 377



TOXICOLOGY AND CARCINOGENESIS
STUDIES OF
CS₂
(94% o-CHLOROBENZALMALONONITRILE,
CAS NO. 2698-41-1)
IN F344/N RATS AND B6C3F₁ MICE
(INHALATION STUDIES)

U.S. DEPARTMENT OF HEALTH AND HUMAN SERVICES
Public Health Service
National Institutes of Health

FOREWORD

The National Toxicology Program (NTP) is made up of four charter agencies of the U.S. Department of Health and Human Services (DHHS): the National Cancer Institute (NCI), National Institutes of Health; the National Institute of Environmental Health Sciences (NIEHS), National Institutes of Health; the National Center for Toxicological Research (NCTR), Food and Drug Administration; and the National Institute for Occupational Safety and Health (NIOSH), Centers for Disease Control. In July 1981, the Carcinogenesis Bioassay Testing Program, NCI, was transferred to the NIEHS. The NTP coordinates the relevant programs, staff, and resources from these Public Health Service agencies relating to basic and applied research and to biological assay development and validation.

The NTP develops, evaluates, and disseminates scientific information about potentially toxic and hazardous chemicals. This knowledge is used for protecting the health of the American people and for the primary prevention of disease.

The studies described in this Technical Report were performed under the direction of the NIEHS and were conducted in compliance with NTP chemical health and safety requirements and must meet or exceed all applicable Federal, state, and local health and safety regulations. Animal care and use were in accordance with the Public Health Service Policy on Humane Care and Use of Animals. All NTP toxicology and carcinogenesis studies are subjected to a comprehensive audit before being presented for public review. This Technical Report has been reviewed and approved by the NTP Board of Scientific Counselors' Peer Review Panel in public session; the interpretations described herein represent the official scientific position of the NTP.

These studies are designed and conducted to characterize and evaluate the toxicologic potential, including carcinogenic activity, of selected chemicals in laboratory animals (usually two species, rats and mice). Chemicals selected for NTP toxicology and carcinogenesis studies are chosen primarily on the bases of human exposure, level of production, and chemical structure. Selection per se is not an indicator of a chemical's carcinogenic potential.

These NTP Technical Reports are available for sale from the National Technical Information Service, U.S. Department of Commerce, 5285 Port Royal Road, Springfield, VA 22161 (703-487-4650). Single copies of this Technical Report are available without charge while supplies last from the NTP Public Information Office, NIEHS, P.O. Box 12233, Research Triangle Park, NC 27709 (919-541-3991).

NTP TECHNICAL REPORT
ON THE
TOXICOLOGY AND CARCINOGENESIS
STUDIES OF CS₂

**(94% o-CHLOROBENZALMALONONITRILE,
CAS NO. 2698-41-1)**

IN F344/N RATS AND B6C3F₁ MICE

(INHALATION STUDIES)

Kamal Abdo, Ph.D., Study Scientist

**NATIONAL TOXICOLOGY PROGRAM
P.O. Box 12233
Research Triangle Park, NC 27709**

March 1990

NTP TR 377

NIH Publication No. 90-2832

**U.S. DEPARTMENT OF HEALTH AND HUMAN SERVICES
Public Health Service
National Institutes of Health**

CONTENTS

	PAGE
ABSTRACT	3
EXPLANATION OF LEVELS OF EVIDENCE OF CARCINOGENIC ACTIVITY	6
CONTRIBUTORS	7
PEER REVIEW PANEL	8
SUMMARY OF PEER REVIEW COMMENTS	9
I. INTRODUCTION	11
II. MATERIALS AND METHODS	17
III. RESULTS	25
RATS	26
MICE	37
GENETIC TOXICOLOGY	46
IV. DISCUSSION AND CONCLUSIONS	47
V. REFERENCES	51

APPENDIXES

APPENDIX A SUMMARY OF LESIONS IN MALE RATS IN THE TWO-YEAR INHALATION STUDY OF CS2	57
APPENDIX B SUMMARY OF LESIONS IN FEMALE RATS IN THE TWO-YEAR INHALATION STUDY OF CS2	89
APPENDIX C SUMMARY OF LESIONS IN MALE MICE IN THE TWO-YEAR INHALATION STUDY OF CS2	121
APPENDIX D SUMMARY OF LESIONS IN FEMALE MICE IN THE TWO-YEAR INHALATION STUDY OF CS2	143
APPENDIX E SENTINEL ANIMAL PROGRAM	171
APPENDIX F INGREDIENTS, NUTRIENT COMPOSITION, AND CONTAMINANT LEVELS IN NIH 07 RAT AND MOUSE RATION	175
APPENDIX G CHEMICAL CHARACTERIZATION, GENERATION, AND MONITORING OF CHAMBER CONCENTRATIONS OF CS2 FOR THE TOXICOLOGY STUDIES	179
APPENDIX H GENETIC TOXICOLOGY OF CS2	195
APPENDIX I ORGAN WEIGHTS OF RATS AND MICE IN THE THIRTEEN-WEEK INHALATION STUDIES OF CS2	205
APPENDIX J AUDIT SUMMARY	209

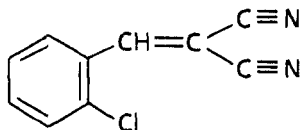

o-CHLOROBENZALMALONONITRILE (CS)

$C_{10}H_5ClN_2$ Molecular weight 188.6

CS2 is 94% *o*-chlorobenzalmalononitrile (CAS No. 2698-41-1) formulated in a mixture of 5% Cab-O-Sil® colloidal silica and 1% hexamethyldisilazane (CAS No. 999-97-3).

ABSTRACT

CS2 (94% *o*-chlorobenzalmalononitrile [CS]; 5% Cab-O-Sil® colloidal silica; 1% hexamethyldisilazane), an eye and respiratory irritant, is used as an aerosol to control riots. Toxicology and carcinogenesis studies were conducted by exposing groups of F344/N rats and B6C3F₁ mice of each sex for 6 hours per day, 5 days per week for 2 weeks, 13 weeks, or 2 years, to a CS2 aerosol. Genetic toxicology studies with CS2 were conducted in *Salmonella typhimurium*, mouse lymphoma cells, and Chinese hamster ovary (CHO) cells.

Fourteen-Day Studies: At exposure concentrations of 0, 1, 3, 10, 30, or 100 mg/m³ CS2, all rats exposed to 30 or 100 mg/m³ and all mice exposed to 10, 30, or 100 mg/m³ died before the end of the studies. Compound-related clinical signs observed included erythema, blepharospasm, listlessness, nasal discharge, and mouth breathing.

Thirteen-Week Studies: At exposure concentrations of 0, 0.4, 0.75, 1.5, 3, or 6 mg/m³, 1/10 male rats exposed to 6 mg/m³ died before the end of the studies. Final mean body weights of rats exposed to 1.5 mg/m³ or more were 17%-44% lower than that of controls for males and 10%-24% lower for females. The absolute and relative thymus weights were reduced for exposed male and female rats, particularly at 6 mg/m³. Compound-related lesions of the nasal passage in rats included focal erosion with regenerative hyperplasia and squamous metaplasia of the respiratory epithelium and suppurative inflammation. Acute inflammation and hyperplasia of the respiratory epithelium were seen in the larynx and trachea of some exposed rats.

All mice exposed to 6 mg/m³ and 1/10 males and 1/10 females exposed to 3 mg/m³ died before the end of the studies. Final mean body weights of mice exposed to 3 mg/m³ were 13% lower than that of controls for males and 9% lower for females. Compound-related lesions of the nasal passage in mice included squamous metaplasia of the nasal respiratory epithelium and inflammation.

Based on these results, CS2 exposure concentrations for the 2-year studies were 0, 0.075, 0.25, or 0.75 mg/m³ for 6 hours per day, 5 days per week for 105 weeks for groups of 50 rats of each sex. Groups of 50 mice of each sex were exposed to 0, 0.75, or 1.5 mg/m³ on the same schedule.

Body Weights and Survival in the Two-Year Studies: Final mean body weights of rats exposed to 0.75 mg/m³ were 7%-11% lower than those of controls. Final mean body weights of mice exposed to CS2 were lower than those of controls (male: 5% and 9%; female: 10% and 17%). No compound-related

clinical signs were observed. No significant differences in survival were seen for any group of rats or mice of either sex.

Nonneoplastic and Neoplastic Effects in the Two-Year Studies: Compound-related nonneoplastic lesions occurred in the nasal passage of exposed rats and mice. In exposed rats, hyperplasia and squamous metaplasia of the respiratory epithelium and degeneration of the olfactory epithelium with ciliated columnar and/or squamous metaplasia were observed. Focal chronic inflammation and proliferation of the periosteum of the turbinate bones were increased slightly in rats at the top exposure concentration. Suppurative inflammation with hyperplasia and squamous metaplasia of the respiratory epithelium occurred in exposed mice.

There were no compound-related increased incidences of neoplasms in rats or mice exposed to CS2. In exposed female mice, there were pronounced decreases in the incidences of adenomas of the pituitary pars distalis (control, 13/47; 0.75 mg/m³, 5/46; 1.5 mg/m³, 1/46) and decreased incidences of malignant lymphomas (21/50; 12/50; 8/50).

Genetic Toxicology: The responses in Salmonella gene mutation tests with CS2 were equivocal in one laboratory for strain TA100 in the absence of exogenous metabolic activation (S9) and equivocal in another laboratory for TA97 with S9; in all other strains tested, CS2 was clearly negative with or without S9. CS2 induced trifluorothymidine resistance in mouse L5178Y/TK lymphoma cells in the absence of S9; it was not tested with S9. CS2 induced both sister chromatid exchanges and chromosomal aberrations in CHO cells with and without S9.

Conclusions: Under the conditions of these inhalation studies, there was *no evidence of carcinogenic activity** of CS2 for male or female F344/N rats exposed to 0.075, 0.25, or 0.75 mg/m³ in air for up to 2 years. There was *no evidence of carcinogenic activity* for male or female B6C3F₁ mice exposed to 0.75 or 1.5 mg/m³ in air for up to 2 years. Concentration-related decreases in the incidences of pituitary gland adenomas and lymphomas were observed in female mice.

Exposure to CS2 caused degeneration and squamous metaplasia of the olfactory epithelium, hyperplasia and metaplasia of the respiratory epithelium, and proliferation of the periosteum of the nasal passage of rats. In mice, exposure to this compound caused suppurative inflammation and hyperplasia and squamous metaplasia of the respiratory epithelium of the nasal passage.

*Explanation of Levels of Evidence of Carcinogenic Activity is on page 6.

A summary of the Peer Review comments and the public discussion on this Technical Report appears on page 9.

SUMMARY OF THE TWO-YEAR INHALATION STUDIES OF CS₂

Male F344/N Rats	Female F344/N Rats	Male B6C3F₁ Mice	Female B6C3F₁ Mice
Exposure concentrations 0, 0.075, 0.25, or 0.75 mg/m ³ CS ₂ , 6 h/d, 5 d/wk	0, 0.075, 0.25, or 0.75 mg/m ³ CS ₂ , 6 h/d, 5 d/wk	0, 0.75, or 1.5 mg/m ³ CS ₂ , 6 h/d, 5 d/wk	0, 0.75, or 1.5 mg/m ³ CS ₂ , 6 h/d, 5 d/wk
Body weights in the 2-year study Highest exposure group lower than controls	Highest exposure group lower than controls	Exposed groups lower than controls	Exposed groups lower than controls
Survival rates in the 2-year study 26/50; 17/50; 21/50; 26/50	20/50; 24/50; 29/50; 27/50	38/50; 42/50; 40/50	33/50; 40/50; 40/50
Nonneoplastic effects Nasal passage: degeneration and squamous metaplasia of the olfactory epithelium; hyperplasia and metaplasia of the respiratory epithelium; proliferation of the periosteum in the nasal turbinate	Nasal passage: degeneration and squamous metaplasia of the olfactory epithelium; hyperpla- sia and metaplasia of the respi- ratory epithelium; proliferation of the periosteum in the nasal turbinate	Nasal passage: suppurative inflammation; hyperplasia and squamous metaplasia of the respiratory epithelium	Nasal passage: suppara- tive inflammation; hyper- plasia and squamous metaplasia of the res- piratory epithelium
Neoplastic effects None	None	None	None
Level of evidence of carcinogenic activity No evidence	No evidence	No evidence	No evidence
Other considerations None	None	None	Reduced incidences of pituitary pars distalis adenomas (13/47; 5/46; 1/46) and lymphomas (21/50; 12/50; 8/50)

EXPLANATION OF LEVELS OF EVIDENCE OF CARCINOGENIC ACTIVITY

The National Toxicology Program describes the results of individual experiments on a chemical agent and notes the strength of the evidence for conclusions regarding each study. Negative results, in which the study animals do not have a greater incidence of neoplasia than control animals, do not necessarily mean that a chemical is not a carcinogen, inasmuch as the experiments are conducted under a limited set of conditions. Positive results demonstrate that a chemical is carcinogenic for laboratory animals under the conditions of the study and indicate that exposure to the chemical has the potential for hazard to humans. Other organizations, such as the International Agency for Research on Cancer, assign a strength of evidence for conclusions based on an examination of all available evidence including: animal studies such as those conducted by the NTP, epidemiologic studies, and estimates of exposure. Thus, the actual determination of risk to humans from chemicals found to be carcinogenic in laboratory animals requires a wider analysis that extends beyond the purview of these studies.

Five categories of evidence of carcinogenic activity are used in the Technical Report series to summarize the strength of the evidence observed in each experiment: two categories for positive results ("Clear Evidence" and "Some Evidence"); one category for uncertain findings ("Equivocal Evidence"); one category for no observable effects ("No Evidence"); and one category for experiments that because of major flaws cannot be evaluated ("Inadequate Study"). These categories of interpretative conclusions were first adopted in June 1983 and then revised in March 1986 for use in the Technical Reports series to incorporate more specifically the concept of actual weight of evidence of carcinogenic activity. For each separate experiment (male rats, female rats, male mice, female mice), one of the following quintet is selected to describe the findings. These categories refer to the strength of the experimental evidence and not to either potency or mechanism.

- **Clear Evidence of Carcinogenic Activity** is demonstrated by studies that are interpreted as showing a dose-related (i) increase of malignant neoplasms, (ii) increase of a combination of malignant and benign neoplasms, or (iii) marked increase of benign neoplasms if there is an indication from this or other studies of the ability of such tumors to progress to malignancy.
- **Some Evidence of Carcinogenic Activity** is demonstrated by studies that are interpreted as showing a chemically related increased incidence of neoplasms (malignant, benign, or combined) in which the strength of the response is less than that required for clear evidence.
- **Equivocal Evidence of Carcinogenic Activity** is demonstrated by studies that are interpreted as showing a marginal increase of neoplasms that may be chemically related.
- **No Evidence of Carcinogenic Activity** is demonstrated by studies that are interpreted as showing no chemically related increases in malignant or benign neoplasms.
- **Inadequate Study of Carcinogenic Activity** is demonstrated by studies that because of major qualitative or quantitative limitations cannot be interpreted as valid for showing either the presence or absence of carcinogenic activity.

When a conclusion statement for a particular experiment is selected, consideration must be given to key factors that would extend the actual boundary of an individual category of evidence. This should allow for incorporation of scientific experience and current understanding of long-term carcinogenesis studies in laboratory animals, especially for those evaluations that may be on the borderline between two adjacent levels. These considerations should include:

- The adequacy of the experimental design and conduct;
- Occurrence of common versus uncommon neoplasia;
- Progression (or lack thereof) from benign to malignant neoplasia as well as from preneoplastic to neoplastic lesions;
- Some benign neoplasms have the capacity to regress but others (of the same morphologic type) progress. At present, it is impossible to identify the difference. Therefore, where progression is known to be a possibility, the most prudent course is to assume that benign neoplasms of those types have the potential to become malignant;
- Combining benign and malignant tumor incidences known or thought to represent stages of progression in the same organ or tissue;
- Latency in tumor induction;
- Multiplicity in site-specific neoplasia;
- Metastases;
- Supporting information from proliferative lesions (hyperplasia) in the same site of neoplasia or in other experiments (same lesion in another sex or species);
- The presence or absence of dose relationships;
- The statistical significance of the observed tumor increase;
- The concurrent control tumor incidence as well as the historical control rate and variability for a specific neoplasm;
- Survival-adjusted analyses and false positive or false negative concerns;
- Structure-activity correlations; and
- In some cases, genetic toxicology.

CONTRIBUTORS

The NTP Technical Report on the Toxicology and Carcinogenesis Studies of CS₂ is based on 13-week studies that began in February 1982 and ended in May 1982 and on 2-year studies that began in December 1982 and ended in January 1985 at Battelle Pacific Northwest Laboratories (Richland, WA).

National Toxicology Program (Evaluated Experiment, Interpreted Results, and Reported Findings)

Kamal Abdo, Ph.D., Study Scientist

Scot L. Eustis, D.V.M., Ph.D.
Joseph K. Haseman, Ph.D.

Micheal Jokinen, D.V.M.

(Discipline Leaders and Principal Contributors)

Charles Alden, Ph.D.
Jack Bishop, Ph.D.
G.A. Boorman, D.V.M., Ph.D.
Douglas W. Bristol, Ph.D.
Thomas J. Goehl, Ph.D.

R. Griesemer, D.V.M., Ph.D.
G.N. Rao, D.V.M., Ph.D.
J. Roycroft, Ph.D.
Douglas Walters, Ph.D.

NTP Pathology Working Group (Evaluated Slides and Prepared Pathology Report for Rats on 4/15/88)

Frank Voelker, D.V.M., D.A.C.V.P. (Chair)
Pathology Associates, Inc.
Micheal Jokinen, D.V.M. (NTP)
A.W. Macklin, D.V.M., Ph.D. (Burroughs
Wellcome Laboratories)
James Majka, D.V.M. (Merck, Sharp & Dohme
Research Laboratories)

Margarita McDonald, D.V.M., Ph.D. (NTP)
Rodney Miller, D.V.M., Ph.D. (Battelle
Pacific Northwest Laboratories)
Katsuhiko Yoshitomi, D.V.M., Ph.D.
Experimental Pathology Laboratories, Inc.

(Evaluated Slides and Prepared Pathology Report for Mice on 3/3/88)

L. Brennecke, D.V.M. (Chair)
Pathology Associates, Inc.
R. Cattley, V.D.M., Ph.D. (North Carolina State
University)
Michael Elwell, D.V.M., Ph.D. (NTP)
Bradley F. Hamilton, D.V.M., Ph.D.
Experimental Pathology Laboratories, Inc.

Takanori Harada, D.V.M., Ph.D. (NTP)
Micheal Jokinen, D.V.M. (NTP)
Margarita McDonald, D.V.M., Ph.D. (NTP)
Roger A. Renne, D.V.M. (Battelle Pacific
Northwest Laboratories)

Principal Contributors at Battelle Pacific Northwest Laboratories (Conducted Studies and Evaluated Tissues)

H.A. Ragan, D.V.M.
W.J. Clarke, D.V.M., Ph.D.
Rodney Miller, D.V.M., Ph.D.

F.G. Burton, Ph.D.
Roger A. Renne, D.V.M.

Principal Contributors at Experimental Pathology Laboratories, Inc. (Provided Pathology Quality Assurance)

Katsuhiko Yoshitomi, D.V.M., Ph.D.

Bradley F. Hamilton, D.V.M., Ph.D.

Principal Contributors at Carltech Associates, Inc. (Contractor for Technical Report Preparation)

William D. Theriault, Ph.D.
Abigail C. Jacobs, Ph.D.

John Warner, M.S.
Naomi Levy, B.A.

PEER REVIEW PANEL

The members of the Peer Review Panel who evaluated the draft Technical Report on CS2 on November 20, 1989, are listed below. Panel members serve as independent scientists, not as representatives of any institution, company, or governmental agency. In this capacity, Panel members have five major responsibilities: (a) to ascertain that all relevant literature data have been adequately cited and interpreted, (b) to determine if the design and conditions of the NTP studies were appropriate, (c) to ensure that the Technical Report presents the experimental results and conclusions fully and clearly, (d) to judge the significance of the experimental results by scientific criteria, and (e) to assess the evaluation of the evidence of carcinogenicity and other observed toxic responses.

National Toxicology Program Board of Scientific Counselors Technical Reports Review Subcommittee

Robert A. Scala, Ph.D. (Chair)
Senior Scientific Advisor, Medicine and Environmental Health Department
Research and Environmental Health Division, Exxon Corporation
East Millstone, NJ

Daniel S. Longnecker, M.D.
Professor, Department of Pathology
Dartmouth Medical School
Hanover, NH

Ellen K. Silbergeld, Ph.D.
Senior Scientist
Environmental Defense Fund
Washington, DC

Ad Hoc Subcommittee Panel of Experts

John Ashby, Ph.D.
Imperial Chemical Industries, PLC
Central Toxicology Laboratory
Alderley Park, England

David W. Hayden, D.V.M., Ph.D.
Professor, Department of Veterinary
Pathobiology
College of Veterinary Medicine
University of Minnesota, St. Paul, MN

Gary P. Carlson, Ph.D.
Professor of Toxicology, Department of
Pharmacology and Toxicology
Purdue University, West Lafayette, IN

Curtis D. Klaassen, Ph.D. (Principal
Reviewer) Professor, Department of
Pharmacology and Toxicology
University of Kansas Medical Center
Kansas City, KS

Harold Davis, D.V.M., Ph.D. (Principal Reviewer)
School of Aerospace Medicine
Brooks Air Force Base
San Antonio, TX

Barbara McKnight, Ph.D.
Associate Professor
Department of Biostatistics
University of Washington
Seattle, WA

Robert H. Garman, D.V.M.
Consultants in Veterinary Pathology
Murrysville, PA

Lauren Zeise, Ph.D.
California Department of Health
Services/RCHAS
Berkeley, CA

Lois Swirsky Gold, Ph.D.
University of California
Lawrence Berkeley Laboratory
Berkeley, CA

**SUMMARY OF PEER REVIEW COMMENTS
ON THE TOXICOLOGY AND CARCINOGENESIS STUDIES OF
CS2**

On November 20, 1989, the draft Technical Report on the toxicology and carcinogenesis studies of CS2 received public review by the National Toxicology Program Board of Scientific Counselors' Technical Reports Review Subcommittee and associated Panel of Experts. The review meeting was held at the National Institute of Environmental Health Sciences, Research Triangle Park, NC.

In the absence of Dr. K. Abdo, Dr. R. Melnick, NIEHS, began the discussion by reviewing the experimental design, results, and proposed conclusions (no evidence of carcinogenic activity for male or female rats, no evidence of carcinogenic activity for male or female mice).

Dr. Klaassen, a principal reviewer, agreed with the conclusions. He commented on the concentration-related decreased incidences of adenomas of the pituitary gland and of lymphomas in female mice and wondered if these decreases could be related to decreases in weight gain and longer life span. Dr. Melnick said that there was a suggestion that the decreased incidences of lymphomas could be related to body weight differences between exposed animals and controls. Dr. Klaassen noted the similarity of the nonneoplastic toxic changes in the respiratory epithelium of the nasal passages to those seen with formaldehyde and thought that a comparison of the respective toxicities would be of interest, especially in view of the differences in carcinogenicity. Dr. S. Eustis, NIEHS, commented that the most prominent analogous lesion was squamous metaplasia, which was extensive in the formaldehyde studies but was focal and limited in extent in the CS2 studies. However, without actual quantitative data obtained from morphometry or cell turnover studies, more than descriptive comparisons would be difficult.

Dr. Davis, the second principal reviewer, agreed with the conclusions. He asked why a low dose in mice more comparable to the lowest exposure concentration in rats was not used. Dr. Melnick reported that in rats there seemed to be a greater chemical-related effect on body weights, as well as on lesions within the respiratory tract, than in mice in short-term studies. Since a no-effect level (NOEL) was not achieved in rats in short-term studies, a lower concentration was used in the 2-year studies in an attempt to reach a NOEL. A much lower concentration in the 2-year studies in mice was not necessary because a NOEL had effectively been achieved in the short-term studies.

There was some discussion about the renal tubular cell adenomas seen in two female rats in the mid exposure concentration group. Dr. Eustis explained that the neoplasms were not considered to be related to exposure to CS2 because neoplasms were not seen in either the low or high exposure groups and because there was no supporting hyperplasia.

Dr. Klaassen moved that the Technical Report on *o*-chlorobenzalmalononitrile be accepted with the conclusions as written for male and female rats and mice, no evidence of carcinogenic activity. Dr. Davis seconded the motion, which was accepted unanimously.

I. INTRODUCTION

Chemical and Physical Properties

Production and Use

Human Exposure and Health Effects

Toxicity in Humans

Toxicity in Animals

Carcinogenicity

Absorption and Metabolism

Genotoxicity

Study Rationale

I. INTRODUCTION

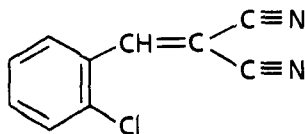

***o*-CHLOROBENZALMALONONITRILE (CS)**

$C_{10}H_5ClN_2$

Molecular weight 188.6

CS2 is 94% *o*-chlorobenzalmalononitrile (CAS No. 2698-41-1) formulated in a mixture of 5% Cab-O-Sil® colloidal silica and 1% hexamethyldisilazane (CAS No. 999-97-3).

o-Chlorobenzalmalononitrile aerosol (CS2), a mixture of 94% *o*-chlorobenzalmalononitrile (CS), 1% hexamethyldisilazane [$(CH_3)_3Si_2NH$], and 5% Cab-O-Sil® (colloidal silica), is used in riot control. The active component (CS) is a potent lacrimator and sternutator. It is a condensation product of chlorobenzaldehyde with malononitrile (Corson and Stoughton, 1928).

Chemical and Physical Properties

CS is a white, crystalline solid with an odor similar to that of pepper (ACGIH, 1980). It has a melting point of 94° C and a boiling point of 310°-315° C. It is sparingly soluble in water (2.0×10^{-4} M), with a half-life of 14 minutes at pH 7.4 and 25° C. The vapor pressure of the solid at 20° C is 3.4×10^{-5} mm mercury (Ballantyne and Swanston, 1978). Hydrolysis of CS produces *o*-chlorobenzaldehyde and malononitrile. Hexamethyldisilazane is a colorless, water-soluble liquid with a boiling point of 123°-125° C, which is added to deactivate the Cab-O-Sil® and slow the hydrolysis of CS in the environment. Cab-O-Sil® is an inert dust used as a carrier for CS.

Production and Use

No production data are available. The irritant properties of CS (Corson and Stoughton, 1928), together with its moderate degree of toxicity (Punte et al., 1962), have led to its use as a riot control agent (ACS, 1976). Aerosol concentrations of 4 mg/m³ will disperse the majority of rioters within 1 minute, and 10 mg/m³ will deter trained troops (Upshall, 1973).

Human Exposure and Health Effects

Although the number of humans exposed to this chemical has not been determined, human exposure does occur through its use as a riot control agent and during manufacture. The American Conference of Governmental Industrial Hygienists adopted a threshold limit value/time-weighted average of 0.4 mg/m³ (ACGIH, 1988).

Toxicity in Humans

CS is a peripheral sensory irritant. Typical symptoms of exposure to aerosols of this chemical include eye irritation, excess lacrimation, blepharospasm, burning sensations in the nose and throat, excess salivation, constricting sensations in the chest, sneezing and coughing, and stinging or burning sensations on the exposed skin (Ballantyne, 1977). Men exposed to 1.5 mg/m³ of CS in air developed headaches within 90 minutes. Concentrations of 4.3-6.7 mg/m³ were intolerable unless the increase in exposure had been gradual (Punte et al., 1963). Concentrations in excess of 14 mg/m³ for 1 hour under simulated tropical conditions produced extreme irritation, erythema, and vesication of the skin of volunteers. The cutaneous effects observed were a function of climatic conditions, race, and skin characteristics (Weigand, 1969). Volunteers exposed to dry CS for 1 hour developed mild irritation within 30 minutes (this disappeared after removal of the CS) and faint erythema, which faded over 1-2 days; moistened CS gave a somewhat greater response than did dry CS (Holland and White, 1972).

I. INTRODUCTION

Toxicity in Animals

Ballantyne and Swanston (1978) reported the LD₅₀ and LC_{t50} (median lethal toxicity) values for rats and mice given CS by various routes of administration (Table 1).

CS is equally toxic when given by the intravenous or intraperitoneal routes and less toxic when given orally or by inhalation. The high toxicity of CS when given by the intraperitoneal or intravenous routes is due to its rapid metabolism, which leads to high levels of cyanide and thiocyanate in the urine (Jones and Israel, 1970; Cucinell et al., 1971). There is evidence for the endogenous release of cyanide in rats exposed to air containing CS at high concentrations (21,000 mg-min/m³) (Frankenberg and Sorbo, 1973). Animals that died within 48 hours after inhalation exposure showed extreme congestion, marked congestion of the alveolar capillaries and intrapulmonary veins, interpulmonary and intrapulmonary hemorrhage, and excess secretions in the bronchioles and intrapulmonary bronchi (Himsworth, 1971). Male rats and mice exposed to CS at concentrations at or below 30 µg/liter for 1 hour per day did not show any harmful effects. The most frequent histologic finding observed at higher doses in mice was an increase in the incidence of laryngitis and tracheitis (Marrs et al., 1983).

Carcinogenicity

Human: No studies were found which indicate whether CS is carcinogenic to humans.

Animal: Sprague Dawley rats and A/J mice exposed to 21 mg/m³ CS for 2.5-25 minutes per day for 20 days (followed by histopathologic examinations at 6, 12, 18, or 24 months) did not show any compound-related increases in neoplasm incidences (McNamara et al., 1973). Rats and mice exposed at concentrations as high as 300 µg/liter for 1 hour per day, 5 days per week for 120 exposure days followed by a 60-day observation period, did not show dose-related increases in neoplasm incidences at any site (Marrs et al., 1983). In these studies, the exposure period was not sufficiently long nor were the exposure concentrations high enough to determine the carcinogenic potential of CS.

Degenerative changes in the thyroid follicular epithelium of the cellular material and hypertrophy of adrenal cortical and medullary epithelial cells were seen in female albino rats (strain not specified) given intraperitoneal injections of 10 or 20 mg CS/kg body weight per day for 10 days (Chowdhury et al., 1978a,b). These changes were attributed to stress resulting from the irritant properties of CS. Cytochemical examination of the adrenal glands revealed a significant increase in periodic acid-Schiff (PAS), sudanophilic, and alkaline phosphatase reactions in the medullary epithelial cells (Chowdhury et al., 1979). The increase in the PAS reaction was attributed to a stress-related inhibition of lysosomal enzymes and an accumulation of glucose-6-phosphate leading to increased glycogen synthesis. The increases in lipids (sudanophilic reaction) and alkaline phosphatase were attributed to a possible increased synthesis of corticosteroids under stress.

TABLE 1. LD₅₀ AND LC_{t50} VALUES FOR RATS AND MICE GIVEN CS BY VARIOUS ROUTES OF ADMINISTRATION

Route	Species	Sex	LD ₅₀ (mg/kg)	LC _{t50} (mg × min/m ³)
Intravenous	Rat	Female	28	
	Mouse	Male	48	
Intraperitoneal	Rat	Male	48	
Oral	Rat	Male	1,366	
	Rat	Female	1,284	
Inhalation	Rat	Male		88,480
	Mouse	Male		50,010

I. INTRODUCTION

The humoral immune response to sheep erythrocytes was suppressed in Swiss albino mice given CS in olive oil by intraperitoneal injection (8 or 16 mg/kg per day for 10 days) (Nagarkatti et al., 1981). Additionally, blood corticosterone levels were increased only in mice receiving the highest dose of CS and were more than twice those in controls. CS was found to inhibit cytochrome oxidase, pyruvate dehydrogenase, succinate dehydrogenase, lactate dehydrogenase, malate dehydrogenase, and glutamate dehydrogenase in the brain and liver of rats given an intraperitoneal injection of 10 or 20 mg/kg CS per day for 10 days (Dube, 1980). The inhibition of cytochrome oxidase was probably due to a reaction with cyanide produced during the metabolism of CS in the liver.

Absorption and Metabolism

In early studies with CS, 2-chlorohippuric acid was identified as the major urinary metabolite in the rat (Cucinell et al., 1971). In later studies, it was shown that CS can be absorbed from the respiratory tract, as indicated by the presence of two additional metabolites in the blood, 2-chlorobenzyl malonitrile and 2-chlorobenzaldehyde (Leadbeater, 1973; Leadbeater et al., 1973). Absorption of CS from the respiratory tract of rats was demonstrated by the increased urinary excretion of thiocyanate after exposure at high concentrations (3.5 g/m³ for 6 minutes) of an aerosol of this compound (Frankenberg and Sorbo, 1973). The fate of ³H-ring-labeled, ¹⁴C-cyanide-labeled, and (¹⁴C=C) side chain-labeled CS was studied in Porton rats given intraperitoneal or gavage doses ranging from 0.08 to 159 μmol/kg (Brewster et al., 1987). In most cases, the largest proportion (44%-100%) of the dose was eliminated in the urine. The major urinary metabolites identified were 2-chlorohippuric acid, 1-O-(2-chlorobenzyl)glucuronic acid, 2-chlorobenzyl cysteine, and 2-chlorobenzoic acid. Minor metabolites identified included 2-chlorobenzyl alcohol and 2-chlorophenyl-2-cyanopropionate. Urinary cyanate levels for rats at doses of 80 μmol/kg were two to five times higher than those

for controls. Urinary thiocyanate levels were increased with the increase in dose. These trends are similar to those observed with malonitrile (a hydrolysis product of CS). The proposed pathways for the metabolism of CS in rats are shown in Figure 1.

Genotoxicity

CS was found to bind to nuclear proteins but not to DNA in rats. In a study in which Sprague Dawley rats were administered an intraperitoneal injection of 13 mg/kg of CS with a ¹⁴C-label at the benzylic carbon, very little radioactivity was found in liver DNA 8 or 75 hours after the animals were dosed (von Daeniken et al., 1981). However, a considerable amount of radioactivity was observed in nuclear proteins isolated from liver and kidney at these times. The binding to protein may have occurred between the carbons at the double bond in CS and the sulfhydryl groups of proteins. Additionally, the binding could have occurred between *o*-chlorobenzaldehyde (a hydrolysis product) and the amino groups of proteins.

Results of bacterial mutagenicity assays with CS were generally negative (Rietveld et al., 1983; Wild et al., 1983), although there have been reports of equivocal to weakly positive responses observed in Salmonella strain TA100 in the absence of S9 activation (von Daeniken et al., 1981; Zeiger et al., 1987) and in TA97 with S9 (Zeiger et al., 1987). Administration of CS in feed did not result in an increase in sex-linked recessive lethal mutations in germ cells of male *Drosophila* (Wild et al., 1983). In mammalian cell cultures, positive results were reported for gene mutation induction in L5178Y mouse lymphoma cells (McGregor et al., 1988), and cytogenetic tests conducted by the National Toxicology Program in Chinese hamster ovary cells were positive for induction of sister chromatid exchanges and chromosomal aberrations in the presence and absence of S9 (Tables H3 and H4). However, Wild et al. (1983) reported no increase in micronucleated polychromatic erythrocytes in

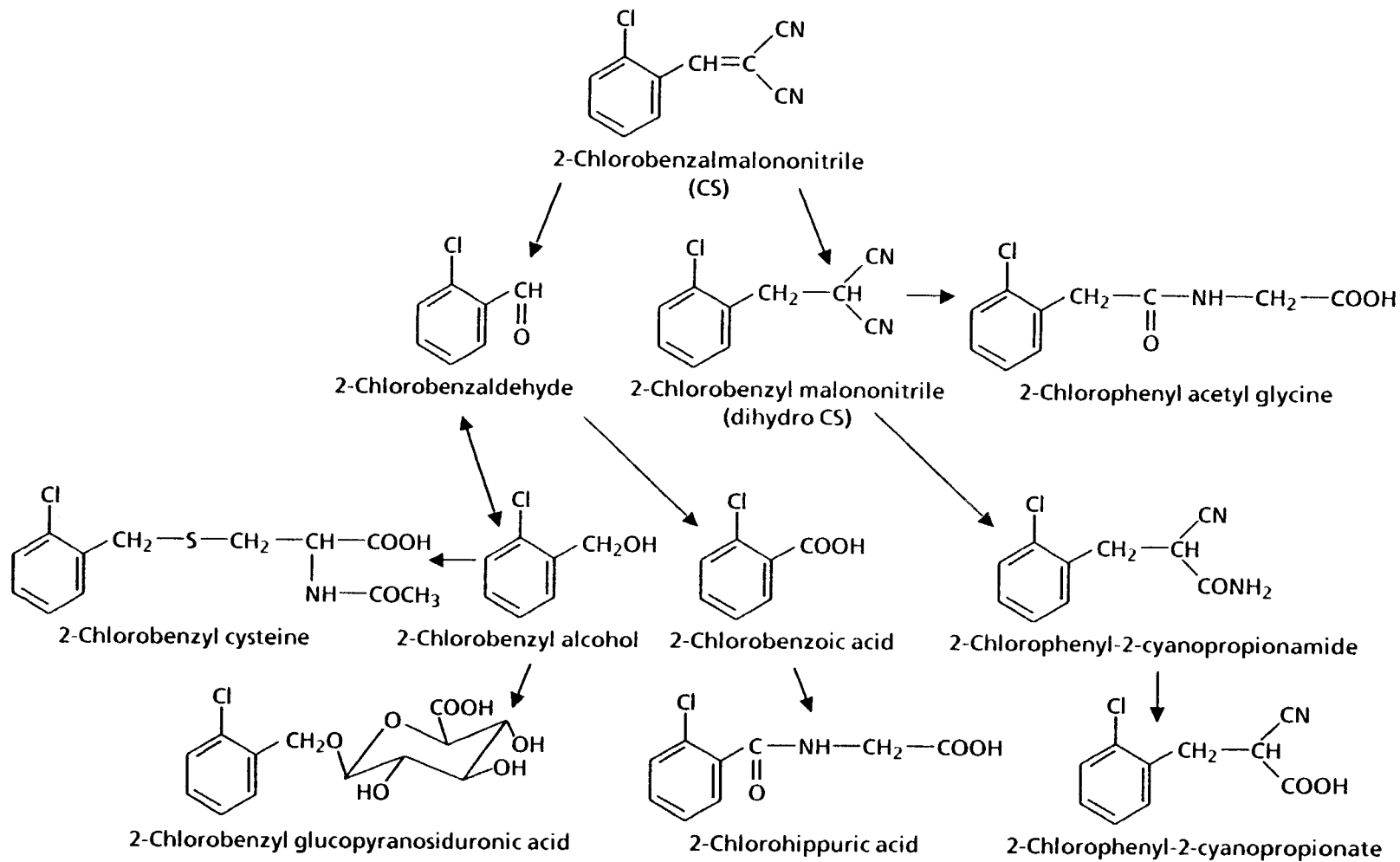

FIGURE 1. THE METABOLISM OF CS IN RATS

(from Brewster et al., 1987)

I. INTRODUCTION

the bone marrow of mice administered CS either by intraperitoneal injection or orally.

Limited mutagenicity data are available on several of the metabolites of CS; *o*-chlorobenzaldehyde, malononitrile, 2-chlorobenzoic acid, and 2-chlorobenzyl alcohol all were negative for induction of gene mutations in *Salmonella* (Nestmann et al., 1980; Sayler et al., 1982; Rietveld et al., 1983; Riggan et al., 1983; Zeiger et al., 1988).

Study Rationale

o-Chlorobenzaldehyd malononitrile (CS) was nominated by the National Cancer Institute for evaluation of its carcinogenic potential because of its use as a riot control agent and because of lack of adequate testing. The inhalation route of exposure was chosen because human exposure to this chemical occurs through its use as an aerosol during riot control.

II. MATERIALS AND METHODS

PROCUREMENT AND CHARACTERIZATION OF CS₂

GENERATION AND MONITORING OF CHAMBER

CONCENTRATIONS

Generation System

Concentration Monitoring

Chamber Concentrations

Chamber Atmosphere Characterization

FOURTEEN-DAY STUDIES

THIRTEEN-WEEK STUDIES

TWO-YEAR STUDIES

Study Design

Source and Specifications of Animals

Animal Maintenance

Clinical Examinations and Pathology

Statistical Methods

II. MATERIALS AND METHODS

PROCUREMENT AND CHARACTERIZATION OF CS2

CS2, a formulated mixture of 94% *o*-chlorobenzalmalononitrile, 1% hexamethyldisilazane, and 5% Cab-O-Sil® colloidal silica, was obtained in one lot (lot no. APG-55-MD) from Aberdeen Proving Ground (Aberdeen, MD). Purity and identity analyses were conducted at Midwest Research Institute (Kansas City, MO) (Appendix G).

The study chemical was identified as *o*-chlorobenzalmalononitrile by infrared, ultraviolet/visible, and nuclear magnetic resonance spectroscopy. The *o*-chlorobenzalmalononitrile content of the CS2 formulation was found to be approximately 94%, as determined by elemental analysis, thin-layer chromatography, and gas chromatography. Elemental analysis also established the presence of 5% silica. No hexamethyldisilazane was detected.

Stability studies based on *o*-chlorobenzalmalononitrile (CS) content indicated that the chemical was stable after storage in the dark for 2 weeks at up to 60° C. The purity and identity of CS were confirmed throughout the studies by gas chromatography and by infrared spectroscopy.

GENERATION AND MONITORING OF CHAMBER CONCENTRATIONS

Generation System

The CS2 aerosol was generated from the powder with a dual-brush dust feed mechanism (Table G1). Aerosol was then passed through a krypton-83 deionizer into a distribution line. Aerosol pumps for each chamber (Hazleton 2000®, Lab Products, Inc.) pulled a fraction of the aerosol from the distribution line and into the chamber after dilution with HEPA-filtered air.

The exposure atmosphere comprised four phases (*o*-chlorobenzalmalononitrile particles, *o*-chlorobenzalmalononitrile vapor, *o*-chlorobenzaldehyde [a degradation product] vapor, and colloidal silica particles). The proportion of the various phases differed at different chamber concentrations of CS2.

Concentration Monitoring

A RAM-S forward light-scattering monitor determined aerosol concentrations in each chamber approximately once per hour during the 2-year studies. The output of the monitor was used as an indication of the stability of the total aerosol concentration and for necessary concentration adjustments during the exposure period. Calibration of the RAM-S to determine chamber atmospheric *o*-chlorobenzalmalononitrile and *o*-chlorobenzaldehyde (referred to from this point as total organics) was accomplished by collecting samples in a bubbler containing chloroform, followed by gas chromatographic analysis. The relationship of total aerosol and total organics is complex and is described in detail in Appendix G.

Chamber Concentrations

During the 14-day and 13-week studies, only the aerosolized *o*-chlorobenzalmalononitrile was collected on the filter grab samples for gas chromatographic analysis, and the resultant data were used to define the chamber concentrations. The target aerosol concentrations for the 2-year studies were chosen based on data from the 14-day and 13-week studies. However, since the RAM-S monitor will only detect particulate *o*-chlorobenzalmalononitrile and silica particles, the actual concentration of *o*-chlorobenzalmalononitrile, as well as the degradation product *o*-chlorobenzaldehyde, in the chambers will be much higher than that indicated by the RAM-S monitor. It was subsequently determined that the target aerosol concentrations of 0.075, 0.25, 0.75, and 1.5 mg/m³ corresponded to actual total chamber organic concentrations of 0.15, 0.56, 1.9, and 2.7 mg/m³, respectively.

The percentage of total organics that was *o*-chlorobenzaldehyde was found to be related to the chamber concentration as well as to the animal species in the chambers. With mice present, the average percentage of *o*-chlorobenzaldehyde in the 1.9 and 2.7 mg/m³ (total organics) chambers were 9% and 10%, respectively. With rats in the chambers, the average percentage of *o*-chlorobenzaldehyde in the 0.15, 0.56, and 1.9 mg/m³ (total organics) chambers were 31%, 25%, and 21%, respectively. For comparison, the bulk chemical contained less than 0.05% *o*-chlorobenzaldehyde.

II. MATERIALS AND METHODS

The control limits for the RAM-S readings were set at $\pm 15\%$ of the target concentrations. Although the RAM-S readings were held to within these limits, the total organics concentrations occasionally drifted. Two causes of the drift were traced to the initial use of new containers of CS₂ and the periodic cleaning of the generator, both of which could have resulted in changes in particle size which would affect RAM-S response. Weekly mean exposure concentrations (total organics) for the 2-year studies are presented in Figures G6 through G10. A summary of the chamber concentrations is presented in Table G2.

Chamber Atmosphere Characterization

The results of several studies demonstrated that decomposition of the study material in the exposure chambers was due to hydrolysis of *o*-chlorobenzalmalononitrile vapor. To determine the extent and source of degradation of *o*-chlorobenzalmalononitrile within the chamber, chamber air samples during the short-term studies were taken (1) from a chamber containing animals, (2) from a chamber from which the animals had been removed but the dirty catch pans were left in place, and (3) from a clean chamber. Based on the analysis of bubbler samples, the degree of degradation was related to the amount of water vapor as well as feces and urine in the catch pans. In all cases, the major product detected by gas chromatography was *o*-chlorobenzaldehyde, the expected hydrolysis product of *o*-chlorobenzalmalononitrile.

Further characterization of the chamber atmosphere components was performed during the 2-year studies. This analysis demonstrated that the chambers having the lowest target concentration had the highest ratio of *o*-chlorobenzalmalononitrile vapor to total *o*-chlorobenzalmalononitrile present and the largest fraction of *o*-chlorobenzaldehyde. *o*-Chlorobenzaldehyde concentration was affected by animal loading (the mouse chamber produced less *o*-chlorobenzaldehyde than the rat chamber having the same target concentration), the presence of urine and feces, and the presence of excess water vapor.

The uniformity of aerosol chamber concentrations was checked with the RAM-S aerosol monitor at approximately 3-month intervals throughout the studies. As could be expected in studies with a complex atmosphere, the uniformity of chamber concentrations did not meet NTP specifications of $\pm 5\%$ relative standard deviation. The between-port variability was erratic, ranging from 2.7% to 35% relative standard deviation.

FOURTEEN-DAY STUDIES

Male and female F344/N rats and B6C3F₁ mice were obtained from Charles River Breeding Laboratories and were observed for 21 days before exposure began. The studies were conducted in two parts to allow for more efficient operation of the system that generated chamber concentrations of CS₂. Separate controls were included in each part of the studies. Groups of five rats and five mice of each sex were exposed to air containing CS₂ at target concentrations of 0, 1, 10, or 100 mg/m³ (first 14-day studies) or 0, 3, or 30 mg/m³ (second 14-day studies), 6 hours per day for 10 days of exposure over 14 days. Rats and mice were observed three times per day and were weighed before exposure, at week 1, and at necropsy. A necropsy was performed on all animals. Histopathologic examinations were performed on selected rats and mice exposed at concentrations up to 30 mg/m³. Further details are presented in Table 2.

THIRTEEN-WEEK STUDIES

Thirteen-week studies were conducted to evaluate the cumulative toxic effects of repeated exposure to CS₂ and to determine the concentrations to be used in the 2-year studies.

Male and female F344/N rats and B6C3F₁ mice were obtained from the Frederick Cancer Research Facility. Animals were observed for 20 days, distributed to weight classes, and assigned to groups according to tables of random numbers. Feed was available ad libitum during non-exposure periods; water was available at all times. Further experimental details are summarized in Table 2.

TABLE 2. EXPERIMENTAL DESIGN AND MATERIALS AND METHODS IN THE INHALATION STUDIES OF CS₂

Fourteen-Day Studies	Thirteen-Week Studies	Two-Year Studies
EXPERIMENTAL DESIGN		
Size of Study Groups 5 males and 5 females of each species	10 males and 10 females of each species	50 males and 50 females of each species
Exposure Concentrations First studies--0, 1, 10, or 100 mg/m ³ CS ₂ by inhalation; second studies--0, 3, or 30 mg/m ³	0, 0.4, 0.75, 1.5, 3, or 6 mg/m ³ CS ₂ by inhalation	Rats--0, 0.075, 0.25, or 0.75 mg/m ³ CS ₂ by inhalation; mice--0, 0.75, or 1.5 mg/m ³
Date of First Exposure First studies--7/15/81; second studies--9/30/81	2/9/82-2/11/82	Rats--12/22/82; mice--12/29/82
Date of Last Exposure First studies--7/28/81; second studies--10/13/81	5/11/82-5/13/82	Rats--12/28/84; mice--1/4/85
Duration of Exposure 6 h/d for 10 exposures over 14 d	6 h/d, 5 d/wk for 66 exposures	6 h/d, 5 d/wk for 105 wk
Type and Frequency of Observation Observed 3 × d; weighed initially and then 1 × wk	Observed 3 × d; weighed initially and then 1 × wk	Observed 2 × d; weighed 1 × wk for 12 wk and then 1 × mo
Necropsy and Histologic Examinations Necropsy performed on all animals; histologic exams performed on selected animals	Necropsy performed on all animals; the following tissues examined for all control and high dose animals, 3 mg/m ³ mice, and all animals dying before the end of the studies: adrenal glands, bone marrow, brain, colon, costochondral junction (rats), duodenum, epididymis/prostate/testes or ovaries/uterus, esophagus, gallbladder (mice), heart, ileum, jejunum, kidneys, larynx, liver, lungs and bronchi, mammary gland, mandibular lymph nodes, nasal passage, pancreas, parathyroid glands, pituitary gland, preputial gland, salivary glands, skin, spleen, stomach (rats), thymus, thyroid gland, trachea, urinary bladder, and Zymbal gland. Tissues examined for 0.4, 0.75, 1.5, and 3 mg/m ³ rats include: adrenal glands, bone marrow, costochondral junction, epididymis/testes, esophagus, kidneys, mammary gland, nasal passage, pancreas, parathyroid glands, preputial gland, salivary glands, skin, spleen, stomach, thymus, thyroid gland, trachea, and Zymbal gland. Nasal passage examined for all lower dose mice. Organ weights obtained at necropsy	Necropsy performed on all animals; the following tissues examined histologically for control and high dose groups: adrenal glands, brain, bronchial lymph nodes, cecum, colon, duodenum, epididymis/prostate/testes or ovaries/uterus, esophagus, eyes, gallbladder (mice), gross lesions and tissue masses with regional lymph nodes, heart, ileum, jejunum, kidneys, larynx, liver, lungs and mainstem bronchi, mammary gland, mandibular lymph nodes, nasal passage and turbinates, pancreas, parathyroid glands, pituitary gland, preputial or clitoral gland, rectum, salivary glands, skin, spleen, sternbrae including marrow, stomach, thymus, thyroid gland, trachea, and urinary bladder. The following tissues were examined for the lower dose groups: adrenal glands, liver, lungs, nasal passage, preputial gland, spleen, and thyroid gland for male rats; liver, lungs, lymph nodes, nasal passage, ovary, and spleen for female rats; kidneys, lungs, nasal passage, and stomach for male mice; and nasal passage, pituitary gland, stomach, and thyroid gland for female mice
ANIMALS AND ANIMAL MAINTENANCE		
Strain and Species F344/N rats; B6C3F ₁ mice	F344/N rats; B6C3F ₁ mice	F344/N rats; B6C3F ₁ mice

TABLE 2. EXPERIMENTAL DESIGN AND MATERIALS AND METHODS IN THE INHALATION STUDIES OF CS₂ (Continued)

Fourteen-Day Studies	Thirteen-Week Studies	Two-Year Studies
ANIMALS AND ANIMAL MAINTENANCE (Continued)		
Animal Source Charles River Breeding Laboratories (Portage, MI)	Frederick Cancer Research Facility (Frederick, MD)	Frederick Cancer Research Facility (Frederick, MD)
Study Laboratory Battelle Pacific Northwest Laboratories	Battelle Pacific Northwest Laboratories	Battelle Pacific Northwest Laboratories
Method of Animal Identification Ear tags and cage numbers	Ear tags	Ear tags and cage numbers
Time Held Before Study 21 d	20 d	Rats--21 d; mice--13 d
Age When Placed on Study First studies: rats--9-10 wk; mice-- 10-11 wk; second studies: rats--9 wk; mice--10 wk	8 wk	Rats--8-9 wk; mice--8 wk
Age When Killed First studies: rats--11-12 wk; mice-- 12-13 wk; second studies: rats--11 wk; mice--12 wk	21 wk	Rats--115-116 wk; mice--115 wk
Necropsy Dates First studies--7/29/81; second studies--10/14/81	5/12/82-5/14/82	Rats--1/7/85-1/10/85; mice--1/14/85-1/18/85
Method of Animal Distribution Assigned to groups by a table of random numbers	Distributed to weight classes and then assigned to groups by tables of random numbers	Same as 13-wk studies
Feed NIH 07 Rat and Mouse Ration (Zeigler Bros., Inc., Gardners, PA); available ad libitum during nonexposure periods	Same as 14-d studies	Same as 14-d studies
Water Automatic watering system (Edstrom Industries, Waterford, WI); available ad libitum	Same as 14-d studies	Same as 14-d studies
Chambers Stainless steel (Hazleton Systems, Inc., Aberdeen, MD)	Same as 14-d studies	Same as 14-d studies
Animals per Cage 1	1	1
Other Chemicals on Study in the Same Room None	None	None
Chamber Environment Temp--71°-73° F; hum--41%-64% (short periods to 70%); fluorescent light 12 h/d; 10 air changes/h	Temp--67°-77° F; hum--38%-85%; fluorescent light 12 h/d; 10 air changes/h	Temp--67°-81° F; hum--31%-84%; fluorescent light 12 h/d; 20 air changes/h

II. MATERIALS AND METHODS

Groups of 10 rats and 10 mice of each sex were exposed to air containing CS₂ at target concentrations of 0, 0.4, 0.75, 1.5, 3, or 6 mg/m³, 6 hours per day, 5 days per week for 66 exposures. Animals were observed three times per day; moribund animals were killed. Due to the persistence of CS₂ particles, the chambers remained closed during nonexposure periods. Individual animal weights were recorded once per week.

At the end of the 13-week studies, survivors were killed. A necropsy was performed on all animals. Tissues and groups examined are listed in Table 2.

TWO-YEAR STUDIES

Study Design

Groups of 50 rats of each sex were exposed to CS₂ at target concentrations of 0, 0.075, 0.25, or 0.75 mg/m³, 6 hours per day, 5 days a week for 105 weeks. Groups of 50 mice of each sex were exposed to 0, 0.75, or 1.5 mg/m³ on the same schedule.

Source and Specifications of Animals

The male and female F344/N rats and B6C3F₁ (C57BL/6N, female × C3H/HeN MTV⁻, male) mice used in these studies were produced under strict barrier conditions at Frederick Cancer Research Facility. Breeding stock for the foundation colonies at the production facility originated at the National Institutes of Health Repository. Animals shipped for study were progeny of defined microflora-associated parents that were transferred from isolators to barrier-maintained rooms. Rats were shipped to the study laboratory at 5-6 weeks of age and mice at 6 weeks of age. Rats were quarantined at the study laboratory for 3 weeks and mice for 2 weeks. Thereafter, a complete necropsy was performed on five animals of each sex and species to assess their health status. The rodents were placed on study at 8-9 weeks of age. The health of the animals was monitored during the course of the studies according to the protocols of the NTP Sentinel Animal Program (Appendix E).

Animal Maintenance

Rats and mice were housed individually. Feed was removed during exposure; otherwise feed and water were available ad libitum. Cages were rotated to different levels once per week during these studies. Further details of animal maintenance are given in Table 2. Ammonia levels in the chambers in the morning varied between 2 and 56 ppm for rats and up to 8 ppm for mice.

Clinical Examinations and Pathology

All animals were observed two times per day. Body weights were recorded once per week for the first 12 weeks of the study and once per month thereafter. Mean body weights were calculated for each group. Animals found moribund and those surviving to the end of the studies were humanely killed. A necropsy was performed on all animals, including those found dead.

During necropsy, all organs and tissues were examined for grossly visible lesions. Tissues were preserved in 10% neutral buffered formalin, embedded in paraffin, sectioned, and stained with hematoxylin and eosin. Histopathologic examination of tissues was performed according to an "inverse pyramid" design (McConnell, 1983a,b). That is, complete histopathologic examinations (Table 2) were performed on all high dose and control animals and on lower dose animals dying before the end of the study. In addition, histopathologic examinations were performed on all grossly visible lesions in all dose groups. Potential target organs for chemically related neoplastic and nonneoplastic effects were identified from the short-term studies, the literature, or were determined by examination of the pathology data; these target organs/tissues in the lower dose groups were examined histopathologically. Potential target organs/tissues examined in lower dose groups in these studies were: male rats--adrenal gland, liver, lung, nasal passage, preputial gland, spleen, thyroid gland; female rats--bronchial lymph nodes, liver, lung, mammary gland, nasal passage, ovary, spleen; male mice--kidney, lung,

II. MATERIALS AND METHODS

nasal passage, stomach; female mice--nasal passage, pituitary gland, stomach, and thyroid gland.

When the pathology evaluation was completed by the laboratory pathologist and the pathology data entered into the Toxicology Data Management System, the slides, paraffin blocks, and residual formalin-fixed tissues were sent to the NTP Archives. The slides, blocks, and residual wet tissues were audited for accuracy of labeling and animal identification and for thoroughness of tissue trimming. The slides, individual animal necropsy records, and pathology tables were sent to an independent pathology quality assessment laboratory. The individual animal records and pathology tables were compared for accuracy, slides and tissue counts were verified, and histotechnique was evaluated. All tissues with a tumor diagnosis, all potential target tissues, and all tissues from a randomly selected 10% of the animals were re-evaluated microscopically by a quality assessment pathologist. Potential target organs for rats were the nasal passage, lung, and thyroid gland for males and the nasal passage and lung for females. Potential target organs for mice were the nasal passage and lung for males and the nasal passage, lung, and pituitary gland for females. Nonneoplastic lesions were evaluated for accuracy and consistency of diagnosis only in the potential target organs and in the randomly selected 10% of animals.

The quality assessment report and slides were submitted to a Pathology Working Group (PWG) Chairperson, who reviewed microscopically all potential target tissues and any other tissues for which there was a disagreement in diagnosis between the laboratory and quality assessment pathologists. Representative examples of potential chemical-related nonneoplastic lesions and neoplasms and examples of disagreements in diagnosis between the laboratory and quality assessment pathologists were shown to the PWG. The PWG included the laboratory pathologist, the quality assessment pathologist, and other pathologists experienced in rodent toxicology, who examined the tissues without knowledge of dose group or previously rendered diagnoses. When the consensus diagnosis of the PWG differed from that of the laboratory pathologist, the diagnosis was changed to reflect the

opinion of the PWG. This procedure has been described, in part, by Maronpot and Boorman (1982) and Boorman et al. (1985). The final pathology data represent a consensus of contractor pathologists and the NTP Pathology Working Group. For subsequent analysis of pathology data, the diagnosed lesions for each tissue type are combined according to the guidelines of McConnell et al. (1986).

Statistical Methods

Survival Analyses: The probability of survival was estimated by the product-limit procedure of Kaplan and Meier (1958) and is presented in the form of graphs. Animals were censored from the survival analyses at the time they were found to be dead from other than natural causes; animals dying from natural causes were not censored. Statistical analyses for a possible dose-related effect on survival used the method of Cox (1972) for testing two groups for equality and Tarone's (1975) life table test for a dose-related trend. When significant survival differences were detected, additional analyses using these procedures were carried out to determine the time point at which significant differences in the survival curves were first detected. All reported P values for the survival analysis are two-sided.

Calculation of Incidence: The incidence of neoplastic or nonneoplastic lesions is given as the ratio of the number of animals bearing such lesions at a specific anatomic site to the number of animals in which that site was examined. In most instances, the denominators include only those animals for which the site was examined histologically. However, when macroscopic examination was required to detect lesions (e.g., skin or mammary tumors) prior to histologic sampling, or when lesions could have appeared at multiple sites (e.g., lymphomas), the denominators consist of the number of animals on which a necropsy was performed.

Analysis of Tumor Incidence: The majority of tumors in this study were considered to be incidental to the cause of death or not rapidly lethal. Thus, the primary statistical method used was a logistic regression analysis, which assumed that the diagnosed tumors were discovered as the result of death from an unrelated

II. MATERIALS AND METHODS

cause and thus did not affect the risk of death. In this approach, tumor prevalence was modeled as a logistic function of chemical exposure and time. Both linear and quadratic terms in time were incorporated initially, and the quadratic term was eliminated if it did not significantly enhance the fit of the model. The dosed and control groups were compared on the basis of the likelihood score test for the regression coefficient of dose. This method of adjusting for intercurrent mortality is the prevalence analysis of Dinse and Lagakos (1983), further described and illustrated by Dinse and Haseman (1986). When tumors are incidental, this comparison of the time-specific tumor prevalences also provides a comparison of the time-specific tumor incidences (McKnight and Crowley, 1984).

In addition to logistic regression, alternative methods of statistical analysis were used, and the results of these tests are summarized in the appendixes. These include the life table test (Cox, 1972; Tarone, 1975), appropriate for rapidly lethal tumors, and the Fisher exact test and the Cochran-Armitage trend test (Armitage, 1971; Gart et al., 1979), procedures based on the overall proportion of tumor-bearing animals.

Tests of significance include pairwise comparisons of each dosed group with controls and a test

for an overall dose-response trend. Continuity-corrected tests were used in the analysis of tumor incidence, and reported P values are one-sided. The procedures described above also were used to evaluate selected nonneoplastic lesions. (For further discussion of these statistical methods, see Haseman, 1984.)

Analysis of Continuous Variables: The statistical analysis of organ weight data was carried out by using the nonparametric multiple comparison procedures of Dunn (1964) or Shirley (1977) to assess the significance of pairwise comparisons between dosed and control groups. Jonckheere's test (Jonckheere, 1954) was used to evaluate the significance of dose-response trends and to determine whether Dunn's and Shirley's test was more appropriate for pairwise comparisons.

Historical Control Data: Although the concurrent control group is always the first and most appropriate control group used for evaluation, there are certain instances in which historical control data can be helpful in the overall assessment of tumor incidence. Consequently, control tumor incidences from the NTP historical control data base (Haseman et al., 1984, 1985) are included for those tumors appearing to show compound-related effects.

III. RESULTS

RATS

FIRST FOURTEEN-DAY STUDIES

SECOND FOURTEEN-DAY STUDIES

THIRTEEN-WEEK STUDIES

TWO-YEAR STUDIES

Body Weights and Clinical Signs

Survival

Pathology and Statistical Analyses of Results

MICE

FIRST FOURTEEN-DAY STUDIES

SECOND FOURTEEN-DAY STUDIES

THIRTEEN-WEEK STUDIES

TWO-YEAR STUDIES

Body Weights and Clinical Signs

Survival

Pathology and Statistical Analyses of Results

GENETIC TOXICOLOGY

III. RESULTS: RATS

FIRST FOURTEEN-DAY STUDIES

All rats exposed to 100 mg/m³ CS₂ died before the end of the studies (Table 3). Male rats exposed to 10 mg/m³ lost weight, whereas those exposed to 1 mg/m³ gained notably more than did controls (rats were fasted before the final body weights were recorded). Erythema, particularly of the ears and feet, and spasm of the orbicularis muscles with closure of the eyelids (blepharospasm) were observed in rats of all exposed groups. At exposure concentrations of 10 and 100 mg/m³, the rats were listless and exhibited nasal discharge and mouth breathing. Excessive lacrimation (dacryorrhea) occurred in rats at 100 mg/m³.

SECOND FOURTEEN-DAY STUDIES

In the second 14-day studies, all rats exposed to 30 mg/m³ died (Table 4), and those exposed to 3 mg/m³ lost weight. Erythema and blepharospasm were seen in rats of both exposure groups, but nasal discharge, dacryorrhea, and mouth breathing were seen only at 30 mg/m³.

THIRTEEN-WEEK STUDIES

One of 10 male rats exposed to 6 mg/m³ CS₂ died before the end of the studies (Table 5). Final mean body weights of rats exposed to 1.5, 3, or 6 mg/m³ were 17%, 24%, or 44% lower than that of controls for males and 10%, 16%, or 24% lower for females. During exposure, the rats maintained partial or complete closure of their eyelids. Erythema of the extremities, which persisted overnight during the nonexposure period, occurred in rats exposed to 6 mg/m³. The absolute and relative thymus weights of exposed rats were reduced, particularly at 6 mg/m³ (Table I1).

Compound-related lesions occurred in the nasal passage, larynx, and trachea (Table 6). Lesions

in the nasal passage were primarily in the anterior region and were often on the naso- and maxilloturbinates; the lesions were more frequent and/or more severe at the higher concentrations. Focal erosions with regenerative hyperplasia and focal squamous metaplasia of the respiratory epithelium were observed. The mucosa and submucosa contained an infiltrate of neutrophils, and in the more severely affected rats, an inflammatory exudate was present in the lumen (empyema). Proliferation of the periosteum and new bone formation (hyperostosis) were associated with the inflammation in the nasal turbinates. Inflammation and hyperplasia of the respiratory epithelium of the larynx and trachea were seen in a few animals at the higher concentrations, but they were minimal in severity compared with those in the nasal passage. Minimal focal squamous metaplasia also occurred in the larynx of a few exposed rats.

Dose Selection Rationale: Because of decreased body weight gain and deaths observed at higher concentrations, exposure concentrations selected for rats for the 2-year studies were 0.075, 0.25, and 0.75 mg/m³, 6 hours per day, 5 days per week. Even though the exposure at highest concentration selected (0.75 mg/m³) resulted in nasal lesions, their severity was minimal and they were not considered to be life threatening.

TWO-YEAR STUDIES

Body Weights and Clinical Signs

Mean body weights of male rats exposed to 0.75 mg/m³ were 5%-12% lower than those of controls after week 8 (Table 7 and Figure 2). Mean body weights of female rats exposed to 0.75 mg/m³ were 5%-10% lower than those of controls from weeks 9 to 31 and 11%-15% lower thereafter. No compound-related clinical signs were observed.

TABLE 3. SURVIVAL AND MEAN BODY WEIGHTS OF RATS IN THE FIRST FOURTEEN-DAY INHALATION STUDIES OF CS₂

Concentration (mg/m ³)	Survival (a)	Mean Body Weights (grams)			Final Weight Relative to Controls (percent)
		Initial (b)	Final	Change (c)	
MALE					
0	5/5	170 ± 5	181 ± 7	+11 ± 7	
1	5/5	170 ± 2	211 ± 5	+41 ± 5	117
10	5/5	171 ± 4	151 ± 13	-20 ± 13	83
100	(d) 0/5	171 ± 4	(e)	(e)	(e)
FEMALE					
0	5/5	134 ± 3	141 ± 4	+7 ± 5	
1	5/5	131 ± 2	148 ± 5	+17 ± 4	105
10	5/5	129 ± 4	135 ± 6	+6 ± 3	96
100	(f) 0/5	131 ± 4	(e)	(e)	(e)

- (a) Number surviving/number initially in the group
 (b) Initial group mean body weight ± standard error of the mean
 (c) Mean body weight change of the group ± standard error of the mean
 (d) Day of death: 4,4,4,7,8
 (e) No data are reported due to 100% mortality in this group.
 (f) Day of death: 4,4,4,4,10

TABLE 4. SURVIVAL AND MEAN BODY WEIGHTS OF RATS IN THE SECOND FOURTEEN-DAY INHALATION STUDIES OF CS₂

Concentration (mg/m ³)	Survival (a)	Mean Body Weights (grams)			Final Weight Relative to Controls (percent)
		Initial (b)	Final	Change (c)	
MALE					
0	5/5	165 ± 3	189 ± 6	+24 ± 3	
3	5/5	184 ± 5	(d) 182 ± 5	-5 ± 5	96
30	(e) 0/5	172 ± 6	(f)	(f)	(f)
FEMALE					
0	5/5	134 ± 3	149 ± 3	+15 ± 1	
3	5/5	135 ± 2	134 ± 1	-1 ± 1	90
30	(g) 0/5	126 ± 5	(f)	(f)	(f)

- (a) Number surviving/number initially in the group
 (b) Initial group mean body weight ± standard error of the mean
 (c) Mean body weight change of the group ± standard error of the mean
 (d) One final body weight not taken; body weight change based on remaining four animals.
 (e) Day of death: 8,9,10,12,12
 (f) No data are reported due to 100% mortality in this group.
 (g) Day of death: 9,10,11,11,15

TABLE 5. SURVIVAL AND MEAN BODY WEIGHTS OF RATS IN THE THIRTEEN-WEEK INHALATION STUDIES OF CS₂

Concentration (mg/m ³)	Survival (a)	Mean Body Weights (grams)			Final Weight Relative to Controls (percent)
		Initial (b)	Final	Change (c)	
MALE					
0	10/10	186 ± 3	347 ± 8	+161 ± 8	
0.4	10/10	185 ± 4	339 ± 6	+154 ± 6	98
0.75	10/10	182 ± 4	332 ± 5	+150 ± 6	96
1.5	10/10	185 ± 4	288 ± 5	+103 ± 7	83
3	10/10	184 ± 4	264 ± 5	+80 ± 5	76
6	(d) 9/10	183 ± 3	194 ± 11	+12 ± 9	56
FEMALE					
0	10/10	142 ± 3	202 ± 4	+60 ± 2	
0.4	10/10	143 ± 3	205 ± 5	+62 ± 4	101
0.75	10/10	141 ± 3	197 ± 4	+56 ± 2	98
1.5	10/10	141 ± 3	182 ± 5	+41 ± 3	90
3	10/10	143 ± 3	170 ± 4	+27 ± 3	84
6	10/10	142 ± 2	154 ± 6	+12 ± 5	76

(a) Number surviving/number initially in the group

(b) Initial group mean body weight ± standard error of the mean. Subsequent calculations are based on animals surviving to the end of the study.

(c) Mean body weight change of the survivors ± standard error of the mean

(d) Week of death: 1

TABLE 6. NUMBERS OF RATS WITH SELECTED LESIONS IN THE THIRTEEN-WEEK INHALATION STUDIES OF CS₂ (a,b)

Site/Lesion	Control	0.4 mg/m ³	0.75 mg/m ³	1.5 mg/m ³	3 mg/m ³	6 mg/m ³
MALE						
Nasal mucosa						
Inflammation (c)	0	*4	**8	**10	**10	**9
Erosion	0	0	2	**7	**7	*5
Epithelial hyperplasia (c)	0	**9	**10	**10	**10	**10
Squamous metaplasia (c)	0	**9	**10	**10	**10	**10
Nasal passage						
Empyema	0	0	1	1	*5	**6
Nasolacrimal duct						
Inflammation	0	0	1	*4	*4	*4
Epithelial hyperplasia	0	**6	**10	**9	**9	2
Epithelial squamous metaplasia	0	**6	**8	*5	**8	**6
Nasal turbinates						
Hyperostosis	0	2	*5	**10	**10	**9
Trachea						
Inflammation	0	1	0	1	1	0
Epithelial hyperplasia	0	0	0	*5	3	1
Larynx						
Inflammation	0	0	0	2	3	1
Epithelial hyperplasia	0	0	0	2	*5	**6
Epithelial squamous metaplasia	0	0	0	0	0	2
FEMALE						
Nasal mucosa						
Inflammation (c)	0	3	**8	**9	**10	**10
Erosion	0	0	0	1	**7	**8
Epithelial hyperplasia (c)	1	**9	**10	**10	**10	**10
Squamous metaplasia (c)	0	**8	**10	**10	**10	**10
Nasal passage						
Empyema	0	0	1	0	3	**7
Nasolacrimal duct						
Inflammation	0	0	0	3	*4	1
Epithelial hyperplasia	0	2	3	**7	*5	**10
Epithelial squamous metaplasia	0	2	3	*5	*4	3
Nasal turbinates						
Hyperostosis	0	0	2	**8	**10	**10
Trachea						
Inflammation	0	0	0	0	*4	0
Epithelial hyperplasia	2	0	0	0	3	5
Larynx						
Inflammation	0	0	0	0	1	3
Epithelial hyperplasia	0	0	0	1	1	**6
Epithelial squamous metaplasia	0	0	0	0	0	2

(a) Ten animals were examined in each group.

(b) Incidences represent the consensus of the study pathologist and quality assessment pathologist.

(c) The severity of the lesion was dose dependent.

*P<0.05 vs. controls

**P<0.01 vs. controls

TABLE 7. MEAN BODY WEIGHTS AND SURVIVAL OF RATS IN THE TWO-YEAR INHALATION STUDIES OF CS₂

Weeks on Study	Chamber Control		0.075 mg/m ³			0.25 mg/m ³			0.75 mg/m ³		
	Av. Wt. (grams)	No. of Survivors	Av. Wt. (grams)	Wt. (percent of ch. controls)	No. of Survivors	Av. Wt. (grams)	Wt. (percent of ch. controls)	No. of Survivors	Av. Wt. (grams)	Wt. (percent of ch. controls)	No. of Survivors
MALE											
0	179	50	180	101	50	177	99	50	179	100	50
1	217	50	220	101	50	213	98	50	211	97	50
2	232	50	248	107	50	235	101	50	236	102	50
3	250	50	263	105	50	254	102	50	250	100	50
4	262	50	278	106	50	268	102	50	255	97	50
5	277	50	295	106	50	274	99	50	267	96	50
6	291	50	297	102	50	284	98	50	277	95	50
7	297	50	303	102	50	295	99	50	292	98	50
8	310	50	313	101	50	304	98	50	296	95	50
9	321	50	324	101	50	314	98	50	299	93	50
10	329	50	328	100	50	321	98	50	309	94	50
11	335	50	340	101	50	332	99	50	315	94	50
12	345	50	349	101	50	339	98	50	322	93	50
18	381	50	379	99	50	364	96	50	347	91	50
22	391	50	381	97	50	388	99	50	355	91	50
26	400	50	389	97	50	396	99	50	365	91	50
31	419	50	410	98	50	414	99	50	381	91	50
35	430	50	429	100	50	419	97	50	390	91	50
40	438	50	432	99	50	426	97	50	401	92	50
44	443	50	437	99	50	435	98	50	399	90	50
48	453	50	446	98	50	443	98	50	407	90	50
53	458	50	460	100	50	454	99	50	417	91	50
57	464	50	463	100	50	444	96	50	421	91	50
61	466	50	468	100	49	457	98	49	418	90	50
65	471	49	473	100	49	460	98	48	425	90	50
69	478	48	480	100	48	467	98	47	431	90	49
73	475	47	482	101	48	466	98	47	437	92	49
77	483	44	483	100	48	466	96	44	436	90	48
83	489	38	487	100	44	463	95	42	437	89	45
86	491	38	484	99	42	469	96	38	433	88	45
91	485	36	472	97	40	458	94	37	430	89	40
96	468	34	469	100	34	449	96	32	430	92	35
100	447	31	448	100	29	435	97	28	423	95	32
104	441	29	436	99	22	426	97	24	410	93	30
Mean for weeks											
1-12	289		297	102.8		286	99.0		277	95.8	
18-48	419		413	98.6		411	98.1		381	90.9	
53-104	470		470	100.0		455	96.8		426	90.6	
FEMALE											
0	135	50	131	97	50	134	99	50	135	100	50
1	151	50	152	101	50	153	101	50	149	99	50
2	151	50	161	107	50	159	105	50	157	104	50
3	160	50	166	104	50	169	106	50	164	103	50
4	163	50	170	104	50	170	104	50	164	101	50
5	168	50	174	104	50	172	102	50	166	99	50
6	175	50	174	99	50	176	101	50	170	97	50
7	180	50	177	98	50	181	101	50	176	98	50
8	185	50	181	98	50	186	101	50	177	96	50
9	189	50	186	98	50	191	101	50	179	95	50
10	194	50	192	99	50	192	99	50	182	94	50
11	199	50	196	98	50	199	100	50	189	95	50
12	205	50	199	97	50	200	98	50	192	94	50
18	224	50	216	96	50	216	96	50	206	92	50
22	230	50	227	99	50	223	97	50	211	92	50
26	238	50	235	99	50	229	96	50	216	91	50
31	251	50	245	98	50	241	96	50	225	90	50
35	257	50	250	97	50	253	98	50	230	89	50
40	267	50	260	97	50	261	98	50	236	88	50
44	273	50	263	96	50	269	99	50	233	85	50
48	286	50	276	97	50	276	97	50	251	88	50
53	299	50	291	97	50	293	98	49	261	87	50
57	306	50	296	97	50	301	98	49	266	87	50
61	311	50	303	97	50	306	98	49	272	87	50
65	315	50	310	98	48	314	100	48	278	88	50
69	325	49	320	98	47	321	99	47	284	87	49
73	331	47	323	98	46	326	98	47	289	87	48
77	337	47	331	98	44	328	97	46	296	88	46
83	342	41	332	97	40	333	97	42	298	87	44
86	346	38	332	96	37	335	97	41	302	87	43
91	346	36	339	98	36	345	100	37	296	86	37
96	339	29	338	100	35	347	102	36	301	89	31
100	334	26	330	99	32	343	103	33	290	87	30
104	328	21	330	101	27	347	106	32	293	89	27
Mean for weeks											
1-12	177		177	100.0		179	101.1		172	97.2	
18-48	253		247	97.6		246	97.2		226	89.3	
53-104	328		321	97.9		326	99.4		287	87.5	

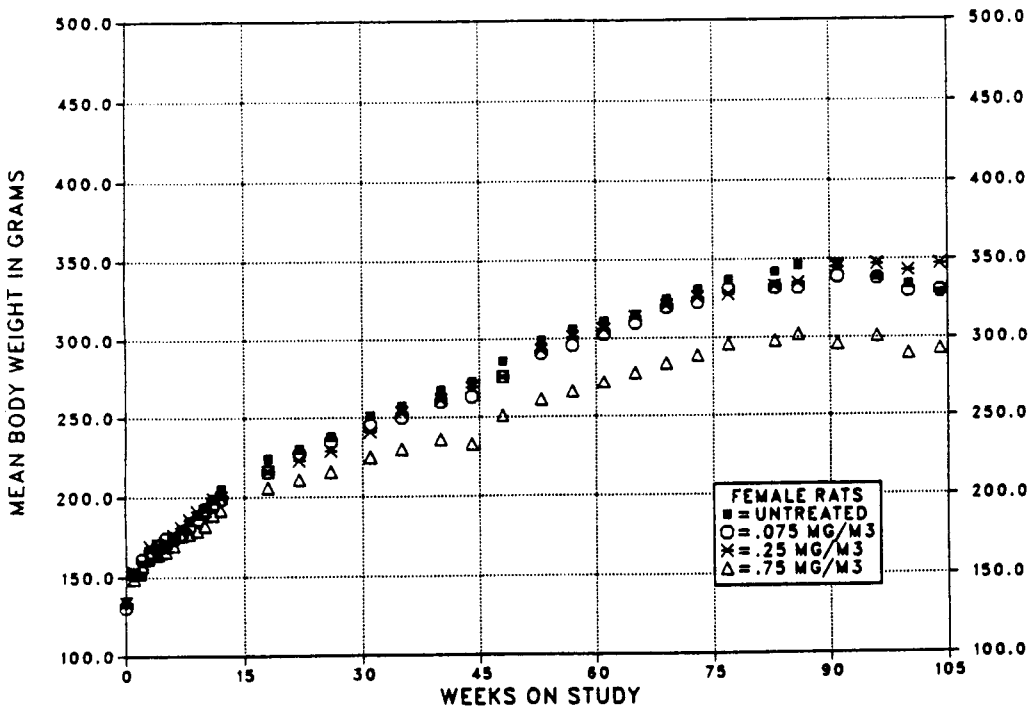
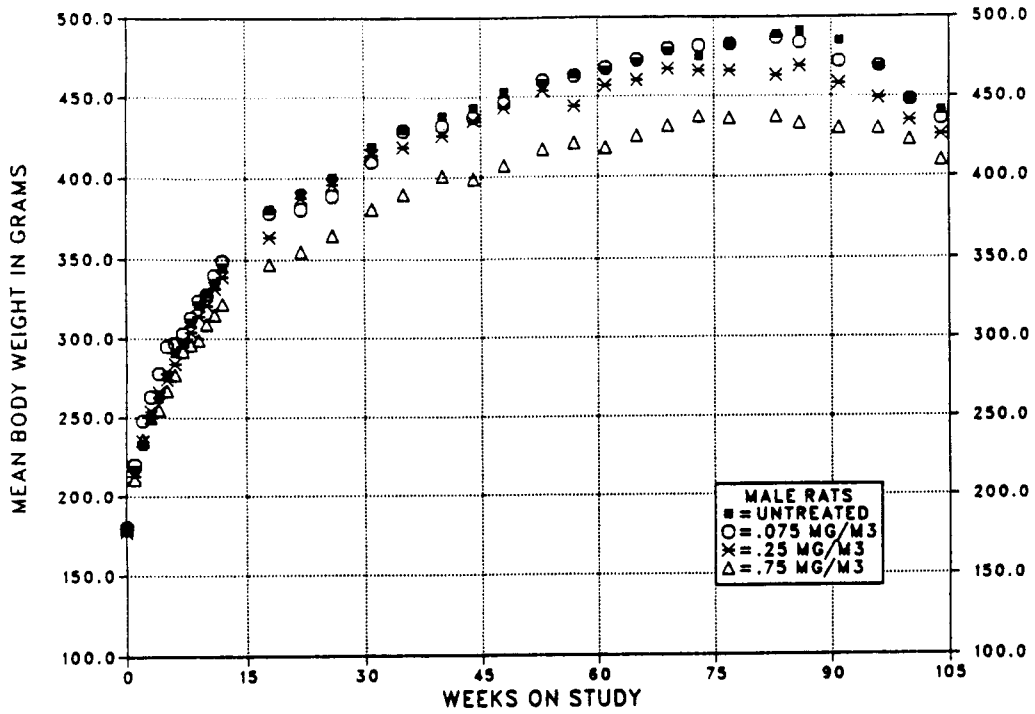

FIGURE 2. GROWTH CURVES FOR RATS EXPOSED TO CS₂ BY INHALATION FOR TWO YEARS

III. RESULTS: RATS

Survival

Estimates of the probabilities of survival for male and female rats exposed to CS₂ at the concentrations used in these studies and for controls are shown in Table 8 and in the Kaplan and Meier curves in Figure 3. No significant differences in survival were seen between any groups of either sex.

Pathology and Statistical Analyses of Results

This section describes the statistically significant

or biologically noteworthy changes in the incidences of rats with neoplastic or nonneoplastic lesions of the nasal passage, lung, thyroid gland, kidney, and testis.

Summaries of the incidences of neoplasms and nonneoplastic lesions, individual animal tumor diagnoses, statistical analyses of primary neoplasms that occurred with an incidence of at least 5% in at least one animal group, and historical control incidences for the neoplasms mentioned in this section are presented in Appendixes A and B for male and female rats, respectively.

TABLE 8. SURVIVAL OF RATS IN THE TWO-YEAR INHALATION STUDIES OF CS₂

	Chamber Control	0.075 mg/m ³	0.25 mg/m ³	0.75 mg/m ³
MALE (a)				
Animals initially in study	50	50	50	50
Natural deaths	5	6	8	4
Moribund kills	19	27	21	20
Animals surviving to study termination	26	17	21	26
Mean survival (days)	682	688	676	701
Survival P values (b)	0.396	0.247	0.509	0.909
FEMALE (a)				
Animals initially in study	50	50	50	50
Natural deaths	7	5	9	4
Moribund kills	23	21	12	19
Animals surviving to study termination	20	24	29	27
Mean survival (days)	676	682	690	691
Survival P values (b)	0.327	0.482	0.128	0.265

(a) First day of termination period: 749

(b) The result of the life table trend test is in the control column, and the results of the life table pairwise comparisons with the controls are in the dosed columns.

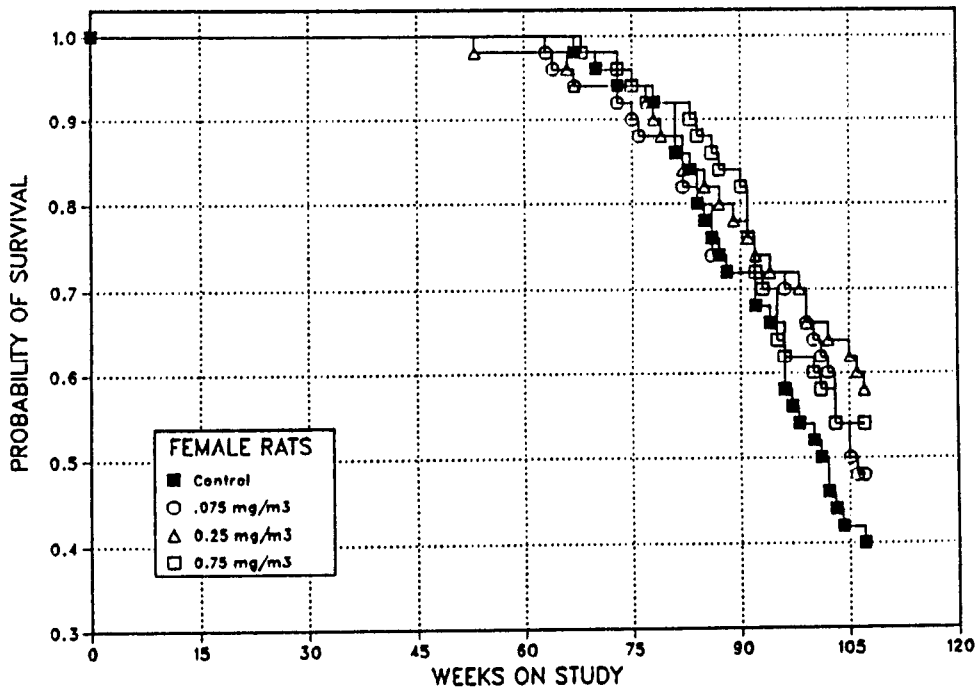
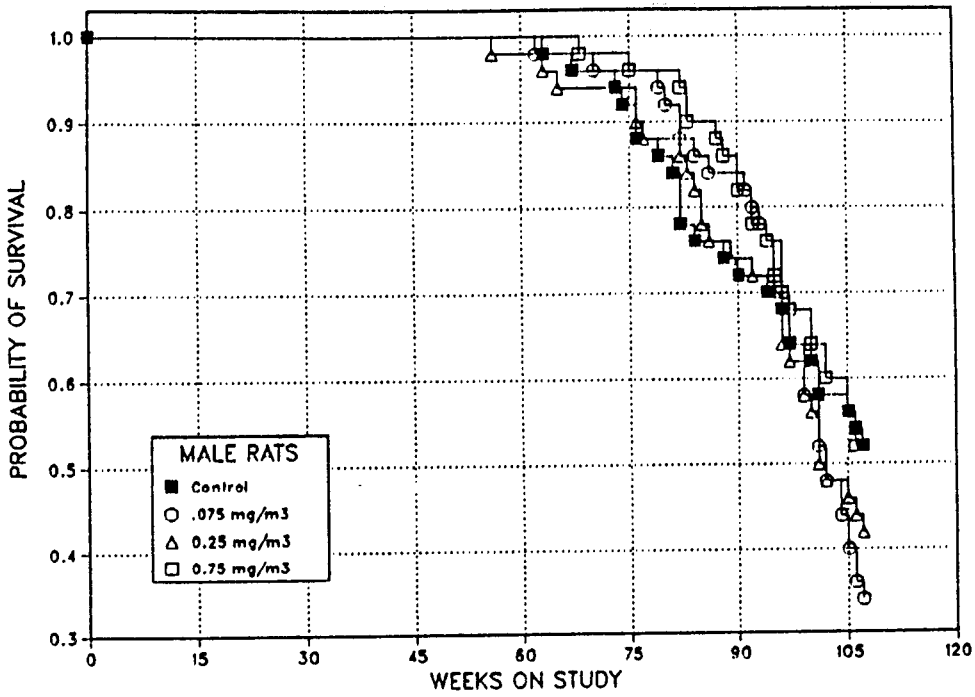

FIGURE 3. KAPLAN-MEIER SURVIVAL CURVES FOR RATS EXPOSED TO CS₂ BY INHALATION FOR TWO YEARS

III. RESULTS: RATS

Nasal Passage: The principal toxic lesions associated with inhalation exposure of rats to CS₂ were present in the tissues of the nasal passage (Table 9). The respiratory epithelium, particularly that on the nasal septum and the free margins of the naso- and maxilloturbinates, and the olfactory epithelium lining the dorsal meatus and tips of the ethmoid turbinates were affected. Hyperplasia and focal squamous metaplasia of the respiratory epithelium occurred at increased incidences in rats exposed to 0.75 mg/m³ CS₂. Hyperplasia was characterized by increased thickness and slight folding of the respiratory epithelium with increased numbers of goblet cells (Figure 4). Squamous metaplasia consisted of several layers of well-differentiated squamous cells replacing the pseudostratified columnar epithelium (Figure 5). Degeneration with ciliated columnar and/or squamous metaplasia of the

olfactory epithelium also occurred at increased incidences at the top concentration. The degeneration was characterized by the loss of olfactory sensory cells and atrophy of the submucosal nerve bundles. Focally, there was replacement of the olfactory epithelium by ciliated columnar cells (metaplasia) or by several layers of squamous cells (squamous metaplasia). Many of the columnar epithelial cells contained a large eosinophilic intracytoplasmic droplet (Figure 6). Downgrowth of the columnar epithelium into the Bowman's glands was associated with these lesions. Inflammation, characterized by focal accumulations of mononuclear inflammatory cells in the submucosa, and proliferation of the periosteum of the turbinate bones also occurred at increased incidences in rats at the top concentration.

TABLE 9. NUMBERS OF RATS WITH SELECTED LESIONS OF THE RESPIRATORY TRACT IN THE TWO-YEAR INHALATION STUDIES OF CS₂

Site/Lesion	Male (mg/m ³)				Female (mg/m ³)			
	0	0.075	0.25	0.75	0	0.075	0.25	0.75
Nasal passage								
Number examined	50	50	49	50	49	49	49	50
Squamous metaplasia	0	0	1	*6	0	0	0	3
Inflammation	28	19	24	**48	37	21	24	**48
Olfactory epithelium								
Degeneration	1	4	3	**27	0	0	1	**23
Metaplasia	2	4	**11	**19	3	1	1	**18
Respiratory epithelium								
Hyperplasia	12	11	12	**48	3	3	6	**46
Metaplasia	4	5	6	**44	0	2	*5	**49
Periosteum								
Proliferation	(a)3	(b)1	(c)0	** (a)15	(a)0	(c)0	(d)0	**18
Adenoma	0	0	0	0	0	1	0	0
Adenocarcinoma	0	0	0	1	0	0	0	0
Squamous cell carcinoma	0	0	0	(e)1	0	0	0	0
Lung								
Number examined	50	49	50	50	49	50	50	50
Chronic focal inflammation	13	11	14	9	16	7	24	**32
Alveolus								
Histocytic cellular infiltration	3	9	6	8	6	4	5	**20
Alveolar/bronchiolar adenoma	4	2	1	0	2	0	1	0
Alveolar/bronchiolar carcinoma	0	2	0	0	0	0	2	0

(a) Fifty animals examined microscopically.

(b) Thirty-three animals examined microscopically.

(c) Twenty-nine animals examined microscopically.

(d) Twenty-one animals examined microscopically.

(e) Occurred in same animal having an adenocarcinoma

*P < 0.05 vs. controls

**P < 0.01 vs. controls



Figure 4. Hyperplasia of the respiratory epithelium in the nasal passage of a male F344/N rat exposed to 0.75 mg/m^3 CS₂ by inhalation for 2 years. The pseudostratified columnar epithelium is thickened and folded, and there are clusters of goblet cells with abundant clear cytoplasm.



Figure 5. Squamous metaplasia of the respiratory epithelium in the nasal passage of a male F344/N rat exposed to 0.75 mg/m^3 CS₂ by inhalation for 2 years. Compare with Figure III-3. The pseudostratified columnar epithelium has been replaced by multiple layers of stratified squamous epithelial cells.



Figure 6. Degeneration of the olfactory epithelium in the nasal passage of a male F344/N rat exposed to 0.75 mg/m^3 CS₂ by inhalation for 2 years. There has been a loss of the olfactory sensory cells, leaving only the columnar supporting cells of the olfactory epithelium. Many of the supporting cells contain a large intracytoplasmic droplet.

III. RESULTS: RATS

The adenocarcinoma and the squamous cell carcinoma that occurred in the nasal passage of a single male rat at 0.75 mg/m³ and the adenoma in the 0.075 mg/m³ female rat were not considered to be caused by exposure to CS₂.

Lung: Chronic inflammation and histiocytic cellular infiltrates occurred in male and female rats of all exposure groups, including controls, and the incidences of these lesions were increased in females exposed to 0.75 mg/m³ (see Table 9). The chronic inflammation was generally minimal in severity and affected only a few scattered terminal bronchioles, alveolar ducts, and the adjacent alveoli in the histologic sections. It was characterized by small numbers of mononuclear cells and occasional neutrophils in the interstitium around the terminal bronchioles and alveolar macrophages in the alveolar lumina. The histiocytic cellular infiltrates were small, focal accumulations of alveolar macrophages in alveolar lumina in more distal portions of the lung, usually near the pleura.

Since the histologic appearance of the lesions in exposed rats was similar to that in controls, the lesions are not considered to be caused by the inhalation of CS₂ or of the particles of colloidal

silica that might be present in the aerosol. The chronic inflammation may be related to subclinical infection with rat coronavirus/sialodacryoadenitis virus (RCV/SDA), since positive serologic titers to RCV/SDA were observed in sentinel animals at the various time points sampled. RCV has been shown to replicate in the airways of the lungs and cause inflammatory lesions in the centriacinar regions (terminal bronchioles and alveolar ducts). The reason for the increased incidences of these lesions in female rats at the top concentration has not been determined. However, inhalation of CS₂ may have compromised local immune mechanisms and allowed for greater frequency of viral replication and higher incidences of lesions in female rats exposed to 0.75 mg/m³.

Thyroid Gland: The incidences of C-cell adenomas in male rats exposed to 0.075 mg/m³ and of C-cell adenomas or carcinomas (combined) in male rats exposed to 0.075 or 0.25 mg/m³, but not to 0.75 mg/m³, were significantly greater than those in controls (Table 10). Since incidences of these neoplasms did not increase in a dose-related fashion and since the marginal incidences in all groups are within the historical control range, the increases in the incidences of

TABLE 10. THYROID GLAND C-CELL LESIONS IN MALE RATS IN THE TWO-YEAR INHALATION STUDY OF CS₂ (a)

	Chamber Control	0.075 mg/m ³	0.25 mg/m ³	0.75 mg/m ³
Hyperplasia				
Overall Rates	8/48 (17%)	5/49 (10%)	10/46 (22%)	9/48 (19%)
Adenoma				
Overall Rates	2/48 (4%)	9/49 (18%)	7/46 (15%)	6/48 (13%)
Terminal Rates	2/26 (8%)	2/17 (12%)	2/20 (10%)	2/26 (8%)
Day of First Observation	749	702	571	577
Logistic Regression Tests	P = 0.450	P = 0.019	P = 0.071	P = 0.139
Carcinoma				
Overall Rates	0/48 (0%)	1/49 (2%)	2/46 (4%)	0/48 (0%)
Adenoma or Carcinoma (b)				
Overall Rates	2/48 (4%)	10/49 (20%)	9/46 (20%)	6/48 (13%)
Terminal Rates	2/26 (8%)	2/17 (12%)	2/20 (10%)	2/26 (8%)
Day of First Observation	749	702	571	577
Logistic Regression Tests	P = 0.521	P = 0.010	P = 0.023	P = 0.139

(a) For a complete explanation of the entries in this table, see Table A3 (footnotes); the statistical analyses used are discussed in Section II (Statistical Methods).

(b) Historical incidence in chamber controls at study laboratory (mean ± SD): 26/330 (8% ± 4%); historical incidence in untreated controls in NTP studies: 205/1,576 (13% ± 7%)

III. RESULTS: RATS

these neoplasms are not considered to be related to exposure to CS₂ aerosol. There was no increased incidence of C-cell neoplasms in any group of exposed female rats compared with that in controls.

Kidney: Renal tubular cell adenomas were seen in two female rats exposed to 0.25 mg/m³. The historical incidence of renal tubular cell neoplasms in chamber control female F344/N rats is 1/347 (0.3%), and the highest observed incidence is 1/50. The historical incidence of renal tubular cell neoplasms in untreated control female F344/N rats is 2/1,639 (0.1%), and the highest observed incidence is 1/50. The incidences of renal tubular cell hyperplasia in the current

study were: control, 3/49; 0.075 mg/m³, 2/37; 0.25 mg/m³, 1/30; 0.75 mg/m³, 1/50. Because the renal tubular cell neoplasms were restricted to the 0.25 mg/m³ exposure group and did not involve the low or high exposure groups, they were not considered to be related to exposure to CS₂.

Testis: A marginally significant increase in the incidence of interstitial cell adenomas occurred in the high dose male group compared with that in controls (control, 31/50; 0.075 mg/m³, 38/47; 0.25 mg/m³, 36/50; 0.75 mg/m³, 41/50). The incidence in controls is well below the average historical incidence for untreated controls in NTP studies. The marginal increase was not considered to be chemically related.

III. RESULTS: MICE

FIRST FOURTEEN-DAY STUDIES

All mice exposed to 10 or 100 mg/m³ died before the end of the studies (Table 11). Final mean body weights of mice exposed to 1 mg/m³ were greater than those of controls. Erythema, blepharospasm, and listlessness were observed in all exposed groups, but dacryorrhea and nasal discharge were only seen at 10 and 100 mg/m³.

SECOND FOURTEEN-DAY STUDIES

All mice exposed to 30 mg/m³ died before the end of the studies (Table 12), and final mean body weights of mice exposed to 3 mg/m³ were 8% lower than those of controls. Erythema, blepharospasm, and listlessness were observed in all exposed groups. Dacryorrhea and nasal discharge were seen at 30 mg/m³.

THIRTEEN-WEEK STUDIES

All mice exposed to 6 mg/m³ and 1/10 males and 1/10 females exposed to 3 mg/m³ died in the

second week of the studies (Table 13). Dehydration due to a malfunction in the automatic watering system caused the deaths of four mice exposed to 0.75 mg/m³. Final mean body weights of mice exposed to 3 mg/m³ were 13% lower than that of controls for males and 9% lower for females. Clinical signs included closed or partially closed eyes during exposure in all groups of mice through week 6 and during weeks 12 and 13 in mice exposed to 3 mg/m³. Increases in organ weight to body weight ratios were a consequence of marked lower body weights (Table 12). Compound-related lesions occurred in the nasal passage of mice exposed to 1.5 mg/m³ or more and included focal inflammation and squamous metaplasia, primarily in the nasal turbinates, and inflammation in the vomeronasal organ (Table 14).

Dose Selection Rationale: Because of body weight gain depression and deaths observed at higher concentrations, exposure levels selected for mice for the 2-year studies were 0.75 and 1.5 mg/m³, 6 hours per day, 5 days per week.

TABLE 11. SURVIVAL AND MEAN BODY WEIGHTS OF MICE IN THE FIRST FOURTEEN-DAY INHALATION STUDIES OF CS₂

Concentration (mg/m ³)	Survival (a)	Mean Body Weights (grams)			Final Weight Relative to Controls (percent)
		Initial (b)	Final	Change (c)	
MALE					
0	5/5	25.8 ± 0.2	22.6 ± 1.2	-3.2 ± 1.1	
1	5/5	26.0 ± 0.7	29.2 ± 1.2	+3.2 ± 0.7	129
10	(d) 0/5	27.0 ± 0.4	(e)	(e)	(e)
100	(f) 0/5	26.2 ± 0.4	(e)	(e)	(e)
FEMALE					
0	5/5	20.8 ± 0.4	21.8 ± 1.9	+1.0 ± 1.7	
1	5/5	20.2 ± 0.6	23.4 ± 0.8	+3.2 ± 0.5	107
10	(g) 0/5	21.2 ± 0.6	(e)	(e)	(e)
100	(h) 0/5	20.8 ± 0.7	(e)	(e)	(e)

- (a) Number surviving/number initially in the group
 (b) Initial group mean body weight ± standard error of the mean
 (c) Mean body weight change of the group ± standard error of the mean
 (d) Day of death: 7,7,7,7,8
 (e) No data are reported due to 100% mortality in this group.
 (f) Day of death: 4,4,4,4,5
 (g) Day of death: 7,8,8,9,10
 (h) Day of death: 4,5,5,5,7

TABLE 12. SURVIVAL AND MEAN BODY WEIGHTS OF MICE IN THE SECOND FOURTEEN-DAY INHALATION STUDIES OF CS₂

Concentration (mg/m ³)	Survival (a)	Mean Body Weights (grams)			Final Weight Relative to Controls (percent)
		Initial (b)	Final	Change (c)	
MALE					
0	5/5	21.4 ± 0.4	21.2 ± 1.0	-0.2 ± 0.8	
3	5/5	23.2 ± 1.3	19.6 ± 0.4	-3.6 ± 1.2	92
30	(d) 0/5	22.4 ± 0.7	(e)	(e)	(e)
FEMALE					
0	5/5	18.6 ± 0.4	19.2 ± 0.4	+0.6 ± 0.5	
3	5/5	17.0 ± 1.0	17.6 ± 0.5	+0.6 ± 1.4	91
30	(f) 0/5	18.0 ± 0.5	(e)	(e)	(e)

- (a) Number surviving/number initially in the group
 (b) Initial group mean body weight ± standard error of the mean
 (c) Mean body weight change of the group ± standard error of the mean
 (d) Day of death: 7,7,7,7,8
 (e) No data are reported due to 100% mortality in this group.
 (f) Day of death: 7,7,7,8,8

TABLE 13. SURVIVAL AND MEAN BODY WEIGHTS OF MICE IN THE THIRTEEN-WEEK INHALATION STUDIES OF CS₂

Concentration (mg/m ³)	Survival (a)	Mean Body Weights (grams)			Final Weight Relative to Controls (percent)
		Initial (b)	Final	Change (c)	
MALE					
0	10/10	24.1 ± 0.6	31.9 ± 0.4	+7.8 ± 0.9	
0.4	10/10	23.8 ± 0.4	29.6 ± 0.7	+5.8 ± 0.4	93
0.75	(d) 8/10	23.5 ± 0.3	29.6 ± 0.8	+6.1 ± 0.8	93
1.5	10/10	24.0 ± 0.4	29.6 ± 0.5	+5.6 ± 0.6	93
3	(e) 9/10	23.9 ± 0.4	27.7 ± 0.4	+3.9 ± 0.6	87
6	(e) 0/10	23.9 ± 0.3	(f)	(f)	(f)
FEMALE					
0	10/10	18.4 ± 0.3	26.4 ± 0.4	+8.0 ± 0.4	
0.4	10/10	17.9 ± 0.3	25.2 ± 0.5	+7.3 ± 0.5	95
0.75	(d) 8/10	17.9 ± 0.3	24.9 ± 0.4	+6.9 ± 0.4	94
1.5	10/10	18.0 ± 0.3	24.8 ± 0.5	+6.8 ± 0.5	94
3	(e) 9/10	18.1 ± 0.4	24.0 ± 0.4	+5.9 ± 0.7	91
6	(e) 0/10	18.5 ± 0.3	(f)	(f)	(f)

- (a) Number surviving/number initially in the group
 (b) Initial group mean body weight ± standard error of the mean. Subsequent calculations are based on animals surviving to the end of the study.
 (c) Mean body weight change of the survivors ± standard error of the mean.
 (d) Deaths were due to a malfunction in the automatic watering system.
 (e) Week of death: all 2
 (f) No data are reported due to 100% mortality in this group.

TABLE 14. NUMBERS OF MICE WITH SELECTED LESIONS IN THE THIRTEEN-WEEK INHALATION STUDIES OF CS₂ (a)

Site/Lesion	Control	0.4 mg/m ³	0.75 mg/m ³	1.5 mg/m ³	3 mg/m ³	6 mg/m ³
MALE						
Nasal turbinates						
Inflammation	0	0	(b)0	2	**7	*(b)5
Squamous metaplasia	0	0	(b)0	*4	**8	0
Vomeronasal organ						
Inflammation	0	0	(b)0	1	*5	** (b)8
FEMALE						
Nasal turbinates						
Inflammation	0	0	0	0	*4	3
Squamous metaplasia	0	0	0	1	*5	0
Vomeronasal organ						
Inflammation	1	0	0	1	4	**7

(a) Ten animals were examined unless otherwise noted.

(b) Nine animals were examined.

*P < 0.05 vs. controls

**P < 0.01 vs. controls

TWO-YEAR STUDIES

Body Weights and Clinical Signs

Mean body weights of male mice exposed to 1.5 mg/m³ were generally 9%-15% lower than those of controls after week 25; mean body weights of male mice exposed to 0.75 mg/m³ were 8%-13%

lower than those of controls during weeks 39-90 (Table 15 and Figure 7). Mean body weights of female mice exposed to 1.5 mg/m³ were 11%-20% lower than those of controls after week 21; mean body weights of female mice exposed to 0.75 mg/m³ were 8%-15% lower than those of controls after week 39. No compound-related clinical signs were observed.

TABLE 15. MEAN BODY WEIGHTS AND SURVIVAL OF MICE IN THE TWO-YEAR INHALATION STUDIES OF CS2

Weeks on Study	Chamber Control		0.75 mg/m ³			1.5 mg/m ³		
	Av. Wt. (grams)	No. of Survivors	Av. Wt. (grams)	Wt. (percent of chamber controls)	No. of Survivors	Av. Wt. (grams)	Wt. (percent of chamber controls)	No. of Survivors
MALE								
0	23.5	50	23.6	100	50	23.5	100	50
1	27.1	50	26.5	98	50	25.3	95	50
2	28.3	50	27.8	98	50	26.9	95	50
3	29.1	50	28.8	99	50	27.4	94	50
4	28.8	50	28.5	99	50	28.6	99	50
5	30.2	50	29.5	98	50	28.5	94	50
6	30.2	49	30.1	100	50	28.7	95	50
7	31.2	49	30.0	96	50	28.7	92	50
8	32.6	49	31.4	96	50	29.3	90	50
9	31.2	49	31.1	100	50	29.6	95	50
10	29.9	49	30.5	102	50	29.2	98	50
11	31.5	49	29.7	94	50	30.3	96	50
12	31.5	49	30.0	95	50	30.3	96	50
17	33.0	49	33.9	103	50	31.4	95	49
21	34.5	49	33.0	96	50	32.8	95	49
25	35.4	49	33.2	94	50	32.0	90	49
30	35.5	48	32.8	92	50	33.0	93	49
34	36.0	48	34.6	96	50	32.8	91	49
39	37.8	48	34.2	90	50	33.1	88	49
43	38.5	48	35.6	92	50	33.6	87	49
47	38.5	48	34.2	89	50	34.0	88	49
52	39.8	48	35.0	88	50	35.5	89	49
56	40.9	48	35.7	87	50	34.8	85	48
60	40.8	48	35.7	88	50	35.1	86	48
64	41.3	47	36.5	88	50	35.3	85	48
68	41.4	47	37.0	89	50	36.0	87	48
72	41.9	46	37.2	89	50	36.1	86	48
76	42.0	46	38.3	91	48	36.4	87	47
82	41.5	46	37.6	91	47	37.2	90	44
85	41.9	46	38.1	91	46	37.0	88	44
90	43.0	45	38.6	90	45	36.7	85	43
95	40.4	45	38.0	94	44	36.3	90	43
99	40.6	43	38.3	94	44	36.3	89	43
103	40.3	40	38.2	95	44	36.7	91	40
Mean for weeks								
1-12	30.1		29.5	98.0		28.6	95.0	
17-52	36.6		34.1	93.2		33.1	90.4	
56-103	41.3		37.4	90.6		36.2	87.7	
FEMALE								
0	18.7	50	18.8	101	50	18.8	101	50
1	21.6	50	21.3	99	50	19.9	92	50
2	23.1	50	22.3	97	50	21.6	94	50
3	23.4	50	23.8	102	50	22.8	97	50
4	23.8	50	24.1	101	50	23.1	97	50
5	24.9	50	24.7	99	50	23.3	94	50
6	25.3	50	24.4	96	50	22.6	89	50
7	25.6	50	25.2	98	50	23.4	91	50
8	25.7	50	25.4	99	49	24.6	96	50
9	27.0	50	25.3	94	49	25.6	95	50
10	26.5	50	25.0	94	49	25.6	97	50
11	27.2	50	26.8	99	49	25.7	94	50
12	27.4	50	26.8	98	49	29.2	107	50
17	29.4	50	28.2	96	49	26.7	91	50
21	30.6	50	28.6	93	49	27.1	89	50
25	30.6	50	29.5	96	49	27.0	88	50
30	31.8	50	29.2	92	49	27.8	87	50
34	33.4	50	32.0	96	49	28.6	86	49
39	35.4	49	30.7	87	48	30.9	87	49
43	35.2	49	31.6	90	48	29.2	83	49
47	35.3	49	31.1	88	48	28.7	81	49
52	35.6	49	32.9	92	48	31.0	87	49
56	37.0	48	32.3	87	48	30.1	81	49
60	37.5	48	31.7	85	48	30.1	80	49
64	37.7	48	32.5	86	48	30.5	81	49
68	38.0	46	33.6	88	48	31.7	83	49
72	39.7	46	34.3	86	48	31.6	80	49
76	39.3	46	34.5	88	48	31.4	80	49
82	39.9	45	34.9	87	48	31.9	80	48
85	39.6	45	35.1	89	48	32.1	81	48
90	39.2	43	35.3	90	48	31.7	81	47
95	38.0	43	34.4	91	46	32.1	84	47
99	38.4	39	34.6	90	46	31.7	83	46
103	38.2	36	34.5	90	42	31.6	83	42
Mean for weeks								
1-12	25.1		24.6	98.0		24.0	95.6	
17-52	33.0		30.4	92.1		28.6	86.7	
56-103	38.5		34.0	88.3		31.4	81.6	

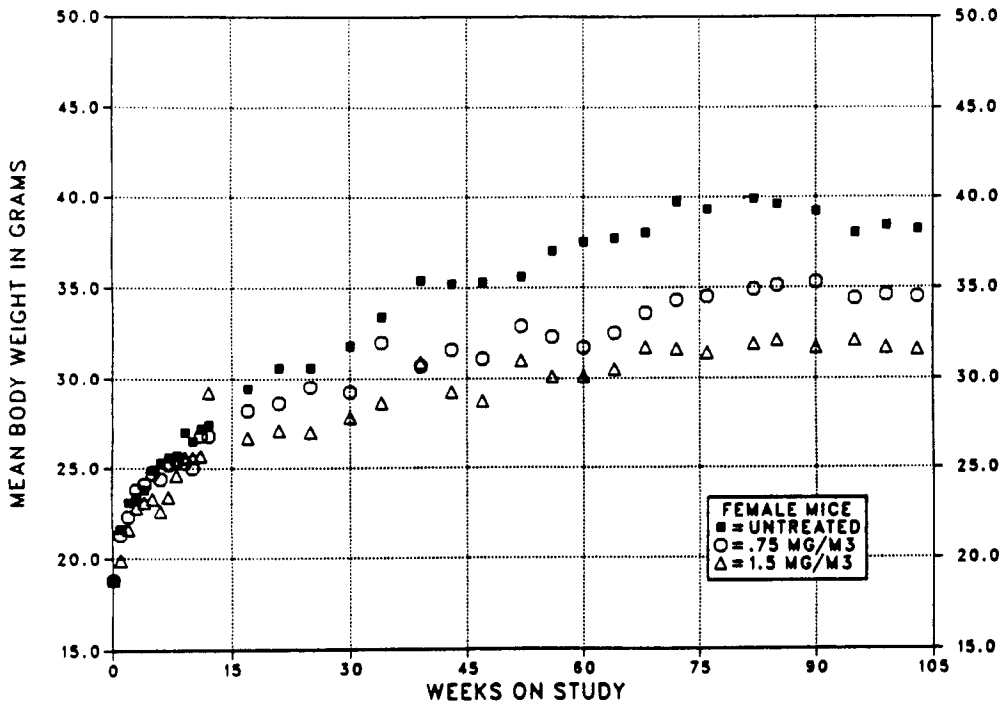
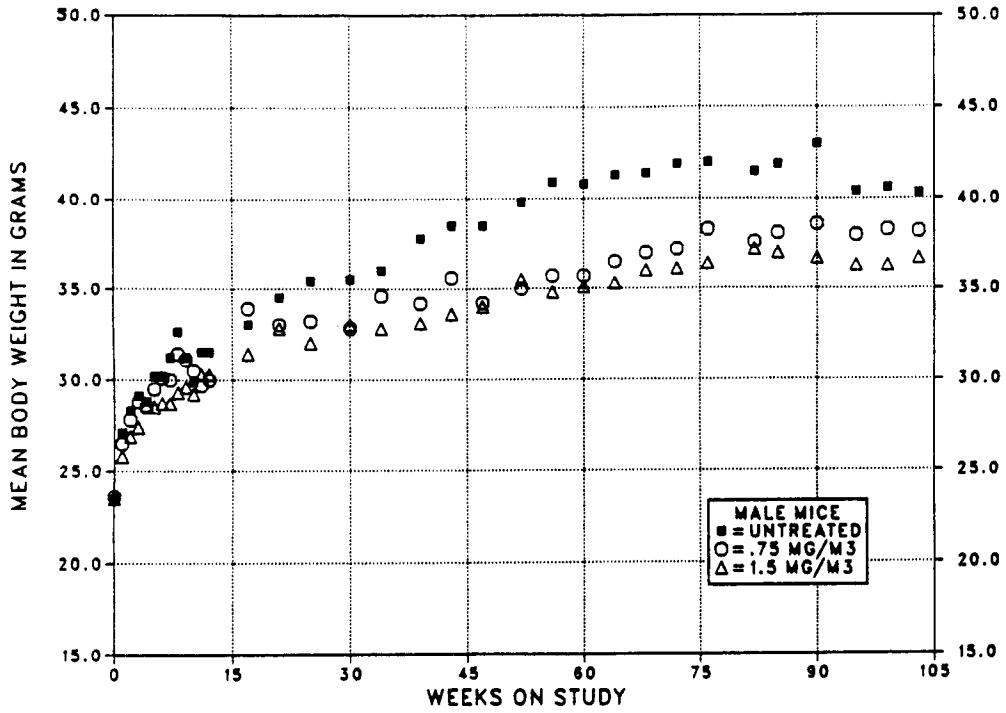

FIGURE 7. GROWTH CURVES FOR MICE EXPOSED TO CS₂ BY INHALATION FOR TWO YEARS

III. RESULTS: MICE

Survival

Estimates of the probabilities of survival for male and female mice exposed to CS₂ at the concentrations used in these studies and for controls are shown in Table 16 and in the Kaplan and Meier curves in Figure 8. No significant differences in survival were seen between any groups of either sex.

Pathology and Statistical Analyses of Results

This section describes the statistically significant

or biologically noteworthy changes in the incidences of mice with neoplastic or nonneoplastic lesions of the nasal passage, pituitary gland, and hematopoietic system.

Summaries of the incidences of neoplasms and nonneoplastic lesions, individual animal tumor diagnoses, statistical analyses of primary neoplasms that occurred with an incidence of at least 5% in at least one animal group, and historical control incidences for the neoplasms mentioned in this section are presented in Appendixes C and D for male and female mice, respectively.

TABLE 16. SURVIVAL OF MICE IN THE TWO-YEAR INHALATION STUDIES OF CS₂

	Chamber Control	0.75 mg/m ³	1.5 mg/m ³
MALE (a)			
Animals initially in study	50	50	50
Natural deaths	7	4	5
Moribund kills	5	4	5
Animals surviving to study termination	38	42	40
Mean survival (days)	705	721	708
Survival P values (b)	0.746	0.475	0.837
FEMALE (a)			
Animals initially in study	50	50	50
Natural deaths	9	5	7
Moribund kills	8	5	3
Animals surviving to study termination	33	40	40
Mean survival (days)	703	717	727
Survival P values (b)	0.109	0.157	0.147

(a) First day of termination period: male--750; female--749

(b) The result of the life table trend test is in the control column, and the results of the life table pairwise comparisons with the controls are in the dosed columns.

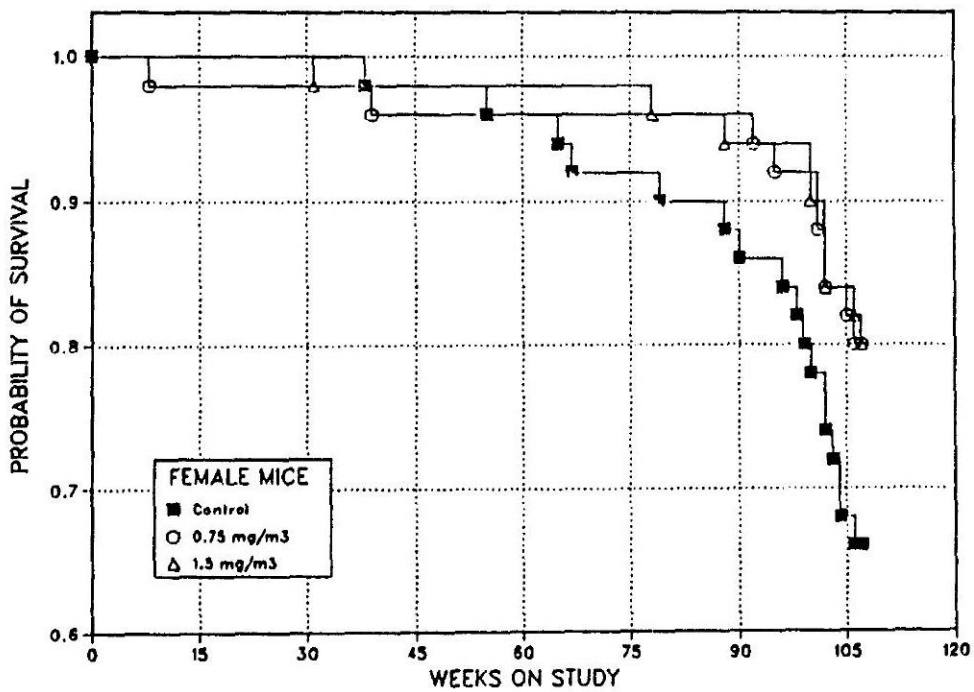
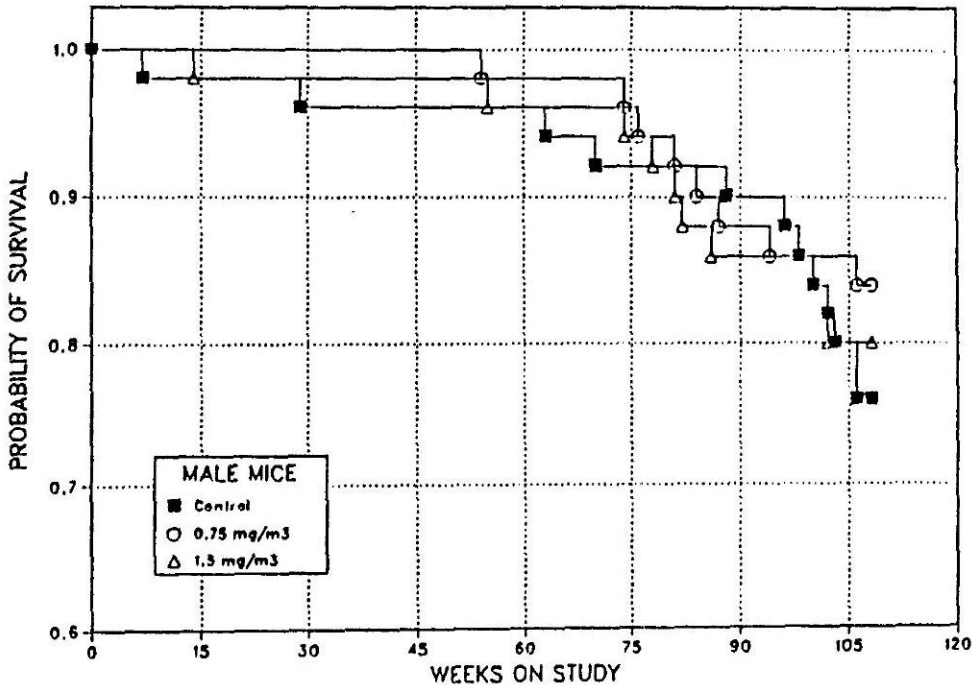

FIGURE 8. KAPLAN-MEIER SURVIVAL CURVES FOR MICE EXPOSED TO CS₂ BY INHALATION FOR TWO YEARS

III. RESULTS: MICE

Nasal Passage: Nonneoplastic lesions associated with inhalation exposure to CS₂ were present in mice (Table 17). The respiratory epithelium, particularly along the septum and the free margins and tips of the turbinates, was the main site affected. Minimal or mild suppurative inflammation (Figure 9) was present in the anterior and middle portions of the nasal passage and was characterized by focal accumulations of neutrophils, sometimes admixed with mucus, within the submucosal glands or nasal lumen. Small numbers of neutrophils and mononuclear cells were present in the submucosa. Focal hyperplasia and/or squamous metaplasia of the respiratory epithelium were seen, usually in areas of inflammation. The hyperplastic epithelium was thickened and contained increased numbers of goblet cells. Squamous metaplasia consisted of replacement of the pseudostratified columnar (respiratory) epithelium by stratified squamous cells.

Pituitary Gland: Adenomas of the pituitary gland pars distalis were markedly decreased in exposed female mice (Table 18). The decrease was significant by the trend test, and the incidences at both exposure concentrations were significantly lower than that in the controls. Furthermore, the incidences of hyperplasia in the exposed groups were decreased relative to controls.

In contrast to the pars distalis, rare adenomas of the pars intermedia were seen in three female mice exposed to 1.5 mg/m³; none was observed in animals exposed to 0.75 mg/m³ or in controls. Each neoplasm was a discrete mass of large cells with oval nuclei arranged in small packets separated by a delicate vascular stroma. The historical incidence of neoplasms of the pars intermedia in chamber controls is 1/370 (0.3%); the historical incidence in untreated controls is 3/1,528 (0.2%), and the highest observed incidence is 1/43. Examination of the pathology findings from 33 recent studies which have undergone the National Toxicology Program pathology peer review process, but which have not been incorporated into the historical control data base, revealed that adenomas of the pars intermedia occurred in control female mice in 10 studies. In 2 of the 10 studies, two neoplasms of the pars intermedia were seen in each group of control females. These findings suggest that pars intermedia adenomas are more common in recent studies than historical control values would indicate.

Hematopoietic System: Lymphomas in female mice occurred with a significant negative trend; the incidences in the exposed groups were significantly lower than that in the controls (Table 19).

TABLE 17. NUMBERS OF MICE WITH NASAL LESIONS IN THE TWO-YEAR INHALATION STUDIES OF CS₂

Site/Lesion	Male (mg/m ³)			Female (mg/m ³)		
	0	0.75	1.5	0	0.75	1.5
Number examined	50	47	50	50	49	49
Nasal passage						
Suppurative inflammation	3	**16	**23	8	9	*18
Respiratory epithelium						
Hyperplasia	1	*8	**12	0	4	**7
Squamous metaplasia	2	**12	**24	1	6	**17

*P < 0.05 vs. controls

**P < 0.01 vs. controls

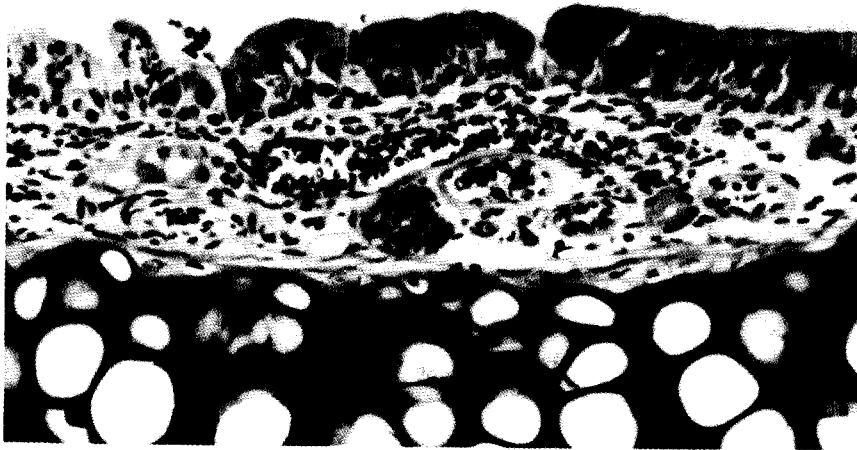

Figure 9. Suppurative inflammation and hyperplasia of the respiratory epithelium in the nasal passage of a male B6C3F₁ mouse exposed to 1.5 mg/m³ CS₂ by inhalation for 2 years. The respiratory epithelium is mildly and irregularly thickened, and there is a diffuse infiltrate of small numbers of neutrophils within the epithelial layer.

TABLE 18. PITUITARY PARS DISTALIS LESIONS IN FEMALE MICE IN THE TWO-YEAR INHALATION STUDY OF CS2 (a)

	Chamber Control	0.75 mg/m ³	1.5 mg/m ³
Hyperplasia			
Overall Rates	16/47 (34%)	8/46 (17%)	7/46 (15%)
Adenoma (b)			
Overall Rates	13/47 (28%)	5/46 (11%)	1/46 (2%)
Terminal Rates	10/33 (30%)	4/38 (11%)	1/40 (3%)
Day of First Observation	465	736	749
Logistic Regression Tests	P<0.001N	P=0.034N	P<0.001N

(a) For a complete explanation of the entries in this table, see Table D3 (footnotes); the statistical analyses used are discussed in Section II (Statistical Methods).

(b) Historical incidence of adenomas or carcinomas (combined) of the anterior pituitary gland in chamber controls at study laboratory (mean ± SD): 74/370 (20% ± 14%); historical incidence in untreated controls in NTP studies: 256/1,528 (17% ± 11%)

TABLE 19. HEMATOPOIETIC SYSTEM NEOPLASMS IN FEMALE MICE IN THE TWO-YEAR INHALATION STUDY OF CS2 (a)

	Chamber Control	0.75 mg/m ³	1.5 mg/m ³
Lymphoma (b)			
Overall Rates	21/50 (42%)	12/50 (24%)	8/50 (16%)
Terminal Rates	16/33 (48%)	6/40 (15%)	5/40 (13%)
Day of First Observation	452	640	694
Life Table Tests	P<0.001N	P=0.018N	P=0.001N
Logistic Regression Tests	P=0.002N	P=0.037N	P=0.003N

(a) For a complete explanation of the entries in this table, see Table D3 (footnotes); the statistical analyses used are discussed in Section II (Statistical Methods).

(b) Historical incidence of lymphomas or leukemia (combined) in chamber controls at study laboratory (mean ± SD): 84/398 (21% ± 6%); historical incidence in untreated controls in NTP studies: 537/1,689 (32% ± 12%)

III. RESULTS: GENETIC TOXICOLOGY

GENETIC TOXICOLOGY

CS2 was tested for induction of gene mutations in a total of five strains of *Salmonella typhimurium* in two different laboratories using a preincubation protocol with and without Aroclor 1254-induced male Sprague Dawley rat or Syrian hamster liver S9 (Zeiger et al., 1987; Table H1). In one laboratory, an equivocal response was noted in strain TA97, but only in the presence of 30% hamster liver S9; in the other four strains tested (TA98, TA100, TA1535, and TA1537), no mutagenic response was observed with or without S9 (10% or 30%). In the other laboratory, an equivocal response occurred with strain TA100 in the absence of S9 only; CS2 was clearly negative for gene mutation induction in all other strains tested in this laboratory (TA98,

TA1535, and TA1537) with or without S9. CS2 induced trifluorothymidine resistance in mouse L5178Y/TK lymphoma cells at the highest non-lethal dose tested (2.5 µg/ml) in each of two trials conducted in the absence of S9; it was not tested with S9 (McGregor et al., 1988; Table H2). In cytogenetic tests with Chinese hamster ovary cells, CS2 induced both sister chromatid exchanges (SCEs) and chromosomal aberrations with and without Aroclor 1254-induced male Sprague Dawley rat liver S9 (Tables H3 and H4). For both the SCE and the aberration tests, a delayed harvest protocol was used to offset CS2-induced cell cycle delay at each of the dose levels at which a positive response was demonstrated. The experimental procedures and results are presented in Appendix H.

IV. DISCUSSION AND CONCLUSIONS

Short-Term Studies

Two-Year Studies

Conclusions

IV. DISCUSSION AND CONCLUSIONS

CS2 (a mixture of 94% *o*-chlorobenzalmononitrile [CS], 5% Cab-O-Sil®, and 1% hexamethyldisilazane) was nominated by the National Cancer Institute for evaluation of its carcinogenic potential because of its use as a riot control agent and because of a lack of adequate testing. The inhalation route of exposure was chosen because human exposure to this chemical occurs through its use as an aerosol during riot control.

Short-Term Studies

The 14-day and 13-week inhalation studies of CS2 show that mice are more sensitive to the lethal effects of the compound than are rats. In the 14-day studies, all rats exposed to CS2 at concentrations of 30 or 100 mg/m³ died, whereas all mice exposed to 10 mg/m³ or more died. In addition, all mice exposed to 6 mg/m³ CS2 died in the 13-week studies; only one male rat died at this concentration. This finding is similar to that of Ballantyne and Swanston (1978), who reported that the LC₅₀ (median lethal toxicity) of CS for male mice was less than that for male rats.

The cause of deaths in rats and mice in these short-term studies is unknown. In the animals that died in the 13-week studies, there were no histopathologic lesions that would account for their deaths. Although accumulated serous or purulent exudate in the nasal passage could obstruct breathing, the lesions identified in the nasal passage of rats and mice were not considered to be directly lethal. It has been suggested that the lethal effects of CS given at high doses by intraperitoneal or intravenous injection are due to the rapid metabolism and release of cyanide and thiocyanate, which are found in the urine.

The clinical signs observed in rats and mice are similar to those reported in humans exposed to CS2. The irritant properties of the aerosol were evident by the excessive lacrimation, spasm and closure of the eyelids, nasal discharge, attempts at mouth breathing, and erythema of the extremities. To some extent, closure of the eyelids and mouth breathing may have been attempts to reduce exposure to more sensitive sites, such as eyes and the nasal passage.

In the 13-week studies, body weights were generally lower in exposed animals than in controls.

The observed increases in the organ weight to body weight ratios of the brain, heart, kidney, lung, and testis of rats and mice were a consequence of lower body weights.

Lesions caused by the inhalation of CS2 for 13 weeks were observed in the upper respiratory tract, primarily in tissues of the nasal passage, but not in the lung. The nasal passage is exposed to the highest concentration of inhaled gases, aerosols, or particles and is a frequent site of degenerative lesions in inhalation studies. The location of lesions in the nasal passage is due to regional variation in deposition of the material and/or to regional susceptibility and is influenced by physical and chemical features of the material, airflow patterns, and mucus flow. The squamous epithelium that lines the nasal vestibule and the floor of the ventral meatus is the most resistant of the nasal epithelia to compound-related effects; the respiratory epithelium that covers the septum and naso- and maxilloturbinate, the olfactory epithelium of the ethmoid turbinates, and the dorsal wall of the nasal passage are more commonly affected.

The lesions observed in the nasal passage of rats and mice exposed to CS2 for 13 weeks are similar to those seen with a wide variety of irritant compounds that are inhaled, including formaldehyde and methyl isocyanate (Swenberg et al., 1983; Jiang et al., 1986; Boorman et al., 1987). The erosion of the respiratory epithelium observed in rats is an indication of cell death and loss, and the hyperplasia is interpreted as a regenerative or reparative response. Squamous metaplasia is an alteration in cellular differentiation that often accompanies prolonged injury to the respiratory epithelium.

In general, the nasal passage of mice was less severely affected than that of rats. Lesions were observed in all rats exposed at concentrations as low as 0.75 mg/m³ but not in any mice exposed to 0.75 mg/m³. Furthermore, overt evidence of cell necrosis (erosion of the respiratory epithelium) was seen in rats but not in mice. This difference in susceptibility is possibly due to physiologic differences in the responses of rats and mice rather than to differences in tissue susceptibility to CS2. Mice have been shown to be able to reduce their minute volume (respiratory rate × tidal

IV. DISCUSSION AND CONCLUSIONS

volume) by 75% in response to the inhalation of sensory irritants (formaldehyde, for example), whereas rats reduced their minute volume by only 45% (Barrow et al., 1983). Thus, at the same concentration of compound in inhaled air, the nasal passage of rats may actually be exposed to a higher "dose" than that of mice. For rats in the current 13-week studies, the lowest concentration of CS₂ at which compound-related lesions were seen (0.4 mg/m³) is equal to the threshold limit value established by the American Conference of Governmental Industrial Hygienists (ACGIH, 1988).

In other studies (Marrs et al., 1983), the authors concluded that CS was not harmful to male mice, rats, or guinea pigs exposed to up to 30 mg/m³ for 1 hour per day for 120 days. However, nasal tissue was not examined in those studies, and the animals were histologically evaluated after a 6-month recovery period, by which time the lesions may have healed.

Changes in the adrenal gland and the thyroid gland were noted in other studies in which rats were given daily intraperitoneal injections of up to 20 mg CS/kg body weight for 10 days (Chowdhury et al., 1978a,b). In 13-week inhalation studies conducted by the National Toxicology Program, no changes were found in the adrenal gland or the thyroid gland of rats or mice. This discrepancy between studies may be related to the different routes of administration used. Additionally, Chowdhury et al. used CS, a formulation that is different from CS₂.

Two-Year Studies

No significant difference in survival was observed among rats exposed 6 hours per day, 5 days per week for up to 2 years to CS₂ aerosol concentrations of 0, 0.075, 0.25, or 0.75 mg/m³ or among mice exposed similarly to the aerosol at concentrations of 0, 0.75, or 1.5 mg/m³. Growth of rats exposed to 0.75 mg/m³ and of mice exposed to 0.75 or 1.5 mg/m³ was depressed relative to that of chamber controls (see Figures 2 and 7).

Nonneoplastic lesions associated with the exposure of rats and mice to CS₂ for up to 2 years were present only in the nasal passage. The

lesions in the respiratory epithelium were similar to those seen in the 13-week studies but varied in character, due to the duration of the injury. Hyperplasia of the respiratory epithelium in the 2-year studies consisted of increased height of the epithelial cells, increased numbers of goblet cells, and slight folding of the epithelium, due to its greater cellularity. In contrast, that in the 13-week studies appeared to be a focal regenerative response to necrosis of the epithelium and was characterized by increased numbers of less differentiated cells. The squamous metaplasia in the 2-year studies consisted of moderately differentiated to well-differentiated squamous cells with some keratinization, whereas in the short-term studies, the cells were not well differentiated. In rats, degenerative lesions of the olfactory epithelium were seen in the 2-year studies but not in the 13-week studies.

In the 13-week studies, compound-induced lesions of the nasal passage were seen in rats at all concentrations. Since a no-effect level was not reached, the 2-year rat studies included three concentration levels in order to determine whether prolonged exposure at concentrations producing these lesions was a prerequisite for the development of neoplasia in the nasal passage. A single male rat exposed to 0.75 mg/m³ developed an adenocarcinoma, which may have originated in the glands of the nasal passage, and a squamous cell carcinoma, which apparently arose in the vomeronasal organ. A female rat exposed at the lowest concentration developed an adenoma of the respiratory epithelium. Since only one male rat and one female rat developed neoplasms in the nasal passage, these lesions are not considered to be related to the administration of CS₂. Thus, the hypothesis regarding the lesions seen in the short-term studies was not tested.

None of the neoplasms seen in male or female rats was considered to be related to exposure to CS₂. Although the incidences of thyroid gland C-cell neoplasms were marginally increased in low and mid exposure groups of male rats, there was no dose response and the incidences were within the historical control range. Two rare renal tubular cell adenomas were seen in female rats exposed to 0.25 mg/m³, but none occurred at

IV. DISCUSSION AND CONCLUSIONS

the top concentration, and there was no supporting evidence of hyperplasia.

There were no compound-related increases in the incidences of neoplasms in male or female mice. In female mice, there was a pronounced concentration-related decrease in the incidence of adenomas of the pars distalis. Reductions in body weight occurred in female mice exposed to CS₂, but whether the weight reduction was associated with the decreased incidence of neoplasms of the pars distalis is unknown. Lifetime dietary restriction which led to reductions in body weight resulted in significantly decreased incidences of pituitary neoplasms in female Swiss mice (Tucker, 1979). Additionally, many workers have found an association between decreased body weight and decreased incidences of various neoplasms in rats (Tannenbaum, 1940, 1942; Ross and Bras, 1971; Rao et al., 1987).

Although there was a decreased incidence of adenomas of the pars distalis, three rare adenomas of the pars intermedia occurred in female mice at the top concentration. The pars intermedia and pars distalis are closely related anatomically and embryologically. Both are part of the adenohypophysis and originate from Rathke's pouch, a diverticulum of the ectodermal epithelium of the primitive oral cavity. The functions of the distalis and intermedia are similar; both produce polypeptide hormones that affect remote organs. Thus, it is difficult to attribute both the decrease in the incidences of adenomas of the pars distalis and the increase in neoplasms of the pars intermedia to exposure to CS₂. Furthermore, chemical induction of neoplasms of the pars intermedia has not been reported in the literature. Adenomas of the pars distalis can be induced by chemicals or procedures that suppress thyroid gland function or by the administration of estrogenic compounds, and

the induction of pituitary gland neoplasms by these methods apparently is the result of sustained hormonal imbalance (Carlton and Gries, 1983). Hyperplasia of the affected cells usually precedes the development of adenomas. In the 2-year studies of CS₂, hyperplasia of the pars intermedia was not observed. Thus, it was concluded that the occurrence of the three adenomas of the pars intermedia was unrelated to exposure to CS₂.

Malignant lymphomas also occurred with a concentration-related negative trend in female mice. The incidence in groups of females exposed to the chemical was significantly lower than that in controls. Whether the decrease in the incidences of these neoplasms was related to body weight depression of the exposed animals is not known.

Conclusions

Under the conditions of these inhalation studies, there was *no evidence of carcinogenic activity** of CS₂ for male or female F344/N rats exposed to 0.075, 0.25, or 0.75 mg/m³ in air for up to 2 years. There was *no evidence of carcinogenic activity* for male or female B6C3F₁ mice exposed to 0.75 or 1.5 mg/m³ in air for up to 2 years. Concentration-related decreases in the incidences of pituitary gland adenomas and lymphomas were observed in female mice.

Exposure to CS₂ caused degeneration and squamous metaplasia of the olfactory epithelium, hyperplasia and metaplasia of the respiratory epithelium, and proliferation of the periosteum of the nasal passage of rats. In mice, exposure to this compound caused suppurative inflammation and hyperplasia and squamous metaplasia of the respiratory epithelium of the nasal passage.

*Explanation of Levels of Evidence of Carcinogenic Activity is on page 6.

A summary of the Peer Review comments and the public discussion on this Technical Report appears on page 9.

V. REFERENCES

V. REFERENCES

1. American Chemical Society (ACS) (1976) *Chemical Carcinogens*. ACS Monograph No. 173. Washington, DC: ACS, p. 151.
2. American Conference of Governmental Industrial Hygienists (ACGIH) (1980) *Documentation of the Threshold Limit Values*, 4th ed. Cincinnati: ACGIH, p. 85.
3. American Conference of Governmental Industrial Hygienists (ACGIH) (1988) *Threshold Limit Values and Biological Indices for 1987-1988*. Cincinnati: ACGIH.
4. Ames, B.N.; McCann, J.; Yamasaki, E. (1975) Methods for detecting carcinogens and mutagens with the Salmonella/mammalian-microsome mutagenicity test. *Mutat. Res.* 31:347-364.
5. Armitage, P. (1971) *Statistical Methods in Medical Research*. New York: John Wiley & Sons, Inc., pp. 362-365.
6. Ballantyne, B. (1977) Biomedical and health aspects of the use of chemicals in civil disturbances. Scot, R.B.; Frazer, J., Eds.: *Medical Annual 1977*. Bristol, UK: Wright and Sons, p. 7.
7. Ballantyne, B.; Swanston, D.W. (1978) The comparative acute mammalian toxicity of 1-chloroacetophenone (CN) and 2-chlorobenzylidene malononitrile (CS). *Arch. Toxicol.* 40:75-95.
8. Barrow, C.S.; Steinhagen, W.H.; Chang, J.C.F. (1983) Formaldehyde sensory irritation. Gibson, J.E., Ed.: *Formaldehyde Toxicity*. New York: Hemisphere Publishing Corporation.
9. Boorman, G.A.; Montgomery, C.A., Jr.; Eustis, S.L.; Wolfe, M.J.; McConnell, E.E.; Hardisty, J.F. (1985) Quality assurance in pathology for rodent carcinogenicity studies. Milman, H.; Weisburger, E., Eds.: *Handbook of Carcinogen Testing*. Park Ridge, NJ: Noyes Publications, pp. 345-357.
10. Boorman, G.A.; Brown, R.; Gupta, B.N.; Uraih, L.C.; Bucher, J.R. (1987) Pathologic changes following acute methyl isocyanate inhalation and recovery in B6C3F1 mice. *Toxicol. Appl. Pharmacol.* 87:446-457.
11. Brewster, K.; Harrison, J.M.; Leadbeater, L.; Newman, J.; Upshall, D.G. (1987) The fate of 2-chlorobenzylidene malononitrile (CS) in rats. *Xenobiotica* 17:911-924.
12. Carlton, W.W.; Gries, C.L. (1983) Adenoma and carcinoma, pars distalis, rat. Jones, T.C.; Mohr, U., Eds.: *Endocrine System*. New York: Springer-Verlag.
13. Chowdhury, A.R.; Deshmukh, M.B.; Raghuvveeran, C.D.; Nashikkar, A.B.; Chatterjee, A.K. (1978a) Histological changes in thyroid of rat under the acute exposure of O-chloro-benzylidene malononitrile. *Experientia* 34:1327.
14. Chowdhury, A.R.; Deshmukh, M.B.; Nashikkar, A.B.; Raghuvveeran, C.D.; Chatterjee, A.K. (1978b) Cellular changes of adrenal under the acute stress of o-chlorobenzylidene malononitrile (CS). *Experientia* 34:494-495.
15. Chowdhury, A.R.; Chatterjee, A.K.; Raghuvveeran, C.D. (1979) Cytochemical changes of adrenal under the acute exposure of o-chlorobenzylidene malononitrile (CS). *Mikroskopie* 35: 183-189.
16. Clive, D.; Johnson, K.O.; Spector, J.F.S.; Batson, A.G.; Brown, M.M.M. (1979) Validation and characterization of the L5178Y/TK^{+/-} mouse lymphoma mutagen assay system. *Mutat. Res.* 59:61-108.
17. Corson, B.; Stoughton, R. (1928) Reactions of alpha, beta-unsaturated dinitriles. *J. Am. Chem. Soc.* 50:2825-2837.
18. Cox, D.R. (1972) Regression models and life tables. *J. R. Stat. Soc.* B34:187-220.
19. Cucinell, S.A.; Swentzel, K.C.; Biskop, R.; Snodgrass, H.; Lovre, S.; Stark, W.; Feinsilver, L.; Vocci, F. (1971) Biochemical reaction and metabolic fate of riot control agents. *Fed. Proc.* 30:86-91.
20. Dinse, G.E.; Haseman, J.K. (1986) Logistic regression analysis of incidental-tumor data from animal carcinogenicity experiments. *Fundam. Appl. Toxicol.* 6:44-52.

V. REFERENCES

21. Dinse, G.E.; Lagakos, S.W. (1983) Regression analysis of tumour prevalence data. *J. R. Stat. Soc. C32*:236-248.
22. Dube, S.N. (1980) Effect of *o*-chlorobenzylidene malononitrile (CS) on tissue glycolysis & oxidation. *Indian J. Exp. Biol.* 18:80-82.
23. Dunn, O.J. (1964) Multiple comparisons using rank sums. *Technometrics* 6:241-252.
24. Frankenberg, L.; Sorbo B. (1973) Formation of cyanide from *o*-chlorobenzylidene malononitrile and its toxicological significance. *Arch. Toxicol.* 31:99-108.
25. Galloway, S.M.; Bloom, A.D.; Resnick, M.; Margolin, B.H.; Nakamura, F.; Archer, P.; Zeiger, E. (1985) Development of a standard protocol for in vitro cytogenetic testing with Chinese hamster ovary cells: Comparison of results for 22 compounds in two laboratories. *Environ. Mutagen.* 7:1-51.
26. Galloway, S.M.; Armstrong, M.J.; Reuben, C.; Colman, S.; Brown, B.; Cannon, C.; Bloom, A.D.; Nakamura, F.; Ahmed, M.; Duk, S.; Rimpou, J.; Margolin, B.H.; Resnick, M.A.; Anderson, B.; Zeiger, E. (1987) Chromosome aberrations and sister chromatid exchanges in Chinese hamster ovary cells: Evaluations of 108 chemicals. *Environ. Molec. Mutagen.* 10(Suppl. 10):1-175.
27. Gart, J.J.; Chu, K.C.; Tarone, R.E. (1979) Statistical issues in interpretation of chronic bioassay tests for carcinogenicity. *J. Natl. Cancer Inst.* 62:957-974.
28. Haseman, J.K. (1984) Statistical issues in the design, analysis and interpretation of animal carcinogenicity studies. *Environ. Health Perspect.* 58:385-392.
29. Haseman, J.K.; Huff, J.; Boorman, G.A. (1984) Use of historical control data in carcinogenicity studies in rodents. *Toxicol. Pathol.* 12:126-135.
30. Haseman, J.K.; Huff, J.; Rao, G.N.; Arnold, J.; Boorman, G.A.; McConnell, E.E. (1985) Neoplasms observed in untreated and corn oil gavage control groups of F344/N rats and (C57BL/6N × C3H/HeN)F₁ (B6C3F₁) mice. *J. Natl. Cancer Inst.* 75:975-984.
31. Himsforth, H. (1971) Report of the Enquiry into the Medical and Toxicological Aspects of CS. Part II. Enquiry into Toxicological Aspects of CS and Its Use in Civil Purposes. Cmnd. 4775, Her Majesty's Stationery Office, London.
32. Holland, P.; White, R.G. (1972) The cutaneous reactions produced by *o*-chlorobenzylidene malononitrile and alpha-chloroacetophenone when applied directly to the skin of human subjects. *Br. J. Dermatol.* 86:150-154.
33. Jiang, X.; Morgan, K.T.; Beauchamp, R.O., Jr. (1986) Histopathology of acute and subacute nasal toxicity. Barrow, C.S., Ed.: *Toxicology of the Nasal Passages*. New York: Hemisphere Publishing Corporation.
34. Jonckheere, A. (1954) A distribution-free k-sample test against ordered alternatives. *Biometrika* 41:133-145.
35. Jones, G.R.N.; Israel, M.S. (1970) Mechanism of toxicity of injected CS gas. *Nature* 228:315-317.
36. Kaplan, E.L.; Meier, P. (1958) Nonparametric estimation from incomplete observations. *J. Am. Stat. Assoc.* 53:457-481.
37. Leadbeater, L. (1973) The absorption of ortho-chlorobenzylidene malononitrile (CS) by the respiratory tract. *Toxicol. Appl. Pharmacol.* 25:101-110.
38. Leadbeater, L.; Sainsbury, G.L.; Uttley, D. (1973) *o*-Chlorobenzyl malononitrile. A metabolite formed from *o*-chlorobenzylidene malononitrile (CS). *Toxicol. Appl. Pharmacol.* 25:111-116.

V. REFERENCES

39. Maronpot, R.R.; Boorman, G.A. (1982) Interpretation of rodent hepatocellular proliferative alterations and hepatocellular tumors in chemical safety assessment. *Toxicol. Pathol.* 10:71-80.
40. Marrs, T.C.; Colgrave, H.F.; Cross, N.L.; Gazzard, M.F.; Brown, R.F.R. (1983) A repeated dose study of the toxicity of inhaled 2-chlorobenzylidene malononitrile (CS) aerosol in three species of laboratory animal. *Arch. Toxicol.* 52:183-198.
41. McConnell, E.E. (1983a) Pathology requirements for rodent two-year studies. I. A review of current procedures. *Toxicol. Pathol.* 11:60-64.
42. McConnell, E.E. (1983b) Pathology requirements for rodent two-year studies. II. Alternative approaches. *Toxicol. Pathol.* 11:65-76.
43. McConnell, E.E.; Solleveld, H.A.; Swenberg, J.A.; Boorman, G.A. (1986) Guidelines for combining neoplasms for evaluation of rodent carcinogenesis studies. *J. Natl. Cancer Inst.* 76:283-289.
44. McGregor, D.B.; Brown, A.; Cattanach, P.; Edwards, I.; McBride, D.; Caspary, W.J. (1988) Responses of the L5178Ytk⁺/tk⁻ mouse lymphoma cell forward mutation assay: II. 18 coded chemicals. *Environ. Molec. Mutagen.* 11:91-118.
45. McKnight, B.; Crowley, J. (1984) Tests for differences in tumor incidence based on animal carcinogenesis experiments. *J. Am. Stat. Assoc.* 79:639-648.
46. McNamara, B.P.; Renne, R.A.; Rozmiarek, H.; Ford, D.F.; Owens, E.J. (1973) CS: A Study of Carcinogenicity. Iss. No. AD 770:365/5GA. U.S. Department of Commerce, National Technical Information Service.
47. Myhr, B.; Bowers, L.; Caspary, W.J. (1985) Assays for the induction of gene mutations at the thymidine kinase locus in L5178Y mouse lymphoma cells in culture. *Prog. Mutat. Res.* 5:555-568.
48. Nagarkatti, M.; Nagarkatti, P.S.; Raghuveeran, C.D. (1981) Short-term toxicity studies of o-chlorobenzylidene malononitrile on humoral immunity in mice. *Toxicol. Lett.* 8:73-76.
49. National Cancer Institute (NCI) (1976) Guidelines for Carcinogen Bioassay in Small Rodents. NCI Technical Report No. 1. U.S. Department of Health, Education, and Welfare, Public Health Service, National Institutes of Health, Bethesda, MD. 65 p.
50. National Institutes of Health (NIH) (1978) Open Formula Rat and Mouse Ration (NIH-07). Specification NIH-11-1335. U.S. Department of Health, Education, and Welfare, Public Health Service, National Institutes of Health, Bethesda, MD.
51. Nestmann, E.R.; Lee, E.G.-H.; Matula, T.I.; Douglas, G.R.; Mueller, J.C. (1980) Mutagenicity of constituents identified in pulp and paper mill effluents using the *Salmonella/mammalian-microsome* assay. *Mutat. Res.* 79:203-212.
52. Punte, C.L.; Weimer, J.T.; Ballard, T.A.; Wilding, J.L. (1962) Toxicologic studies on o-chlorobenzylidene malononitrile. *Toxicol. Appl. Pharmacol.* 4:656-662.
53. Punte, C.L.; Owens, J.E.; Gutentag, P.J. (1963) Exposure to o-chlorobenzylidene malononitrile: Controlled human exposures. *Arch. Environ. Health* 6:366-374.
54. Rao, G.N.; Piegorsch, W.W.; Haseman, J.K. (1987) Influence of body weight on the incidence of spontaneous tumors in rats and mice of long-term studies. *Am. J. Clin. Nutr.* 45:252-260.
55. Rietveld, E.C.; Delbressine, L.P.C.; Waegemaekers, T.H.J.M.; Seutter-Berlage, F. (1983) 2-Chlorobenzylmercapturic acid, a metabolite of the riot control agent 2-chlorobenzylidene malononitrile (CS) in the rat. *Arch. Toxicol.* 54:139-144.
56. Riggin, R.M.; Margard, W.L.; Kinzer, G.W. (1983) Characterization of impurities in commercial lots of sodium saccharin produced by the Sherwin-Williams process. II. Mutagenicity. *Food Chem. Toxicol.* 21:11-17.
57. Ross, M.H.; Bras, G. (1971) Lasting influence of early caloric restriction on prevalence of neoplasms in the rat. *J. Natl. Cancer Inst.* 47:1095-1113.

V. REFERENCES

58. Sadtler Standard Spectra. IR No. 46317; UV No. 24222; NMR No. 19105 M. Philadelphia: Sadtler Research Laboratories.
59. Sayler, G.S.; Reid, M.C.; Perkins, B.K.; Pagni, R.M.; Smith, R.L.; Rao, T.K.; Epler, J.L.; Morrison, W.D.; DuFrain, R. (1982) Evaluation of the mutagenic potential of bacterial polychlorinated biphenyls biodegradation products. *Arch. Environ. Contam. Toxicol.* 11:577-581.
60. Shirley, E. (1977) A non-parametric equivalent of Williams' test for contrasting increasing dose levels of a treatment. *Biometrics* 33:386-389.
61. Swenberg, J.A.; Gross, E.A.; Martin, J.; Popp, J.A. (1983) Mechanisms of formaldehyde toxicity. Gibson, J.E., Ed.: *Formaldehyde Toxicity*. New York: Hemisphere Publishing Corporation.
62. Tannenbaum, A. (1940) The initiation and growth of tumors. I. Effects of underfeeding. *Am. J. Cancer* 38:335-350.
63. Tannenbaum, A. (1942) The genesis and growth of tumors: Effects of calorie restriction per se. *Cancer Res.* 2:460-467.
64. Tarone, R.E. (1975) Tests for trend in life table analysis. *Biometrika* 62:679-682.
65. Tucker, M.J. (1979) The effect of long-term food restriction on tumors in rodents. *Int. J. Cancer* 23:803-807.
66. Upshall, D.G. (1973) Effect of *o*-chlorobenzylidene malonitrile (CS) and the stress of inhalation upon rat and rabbit development. *Toxicol. Appl. Pharmacol.* 24:45-59.
67. von Daeniken, A.; Friederich, U.; Lutz, W.K.; Schlatter, C. (1981) Tests for mutagenicity in *Salmonella* and covalent binding to DNA and protein in the rat of the riot control agent *o*-chlorobenzylidene malonitrile (CS). *Arch. Toxicol.* 49:15-27.
68. Weigand, D.A. (1969) Cutaneous reaction to the riot control agent CS. *Mil. Med.* 134:437.
69. Wild, D.; Eckhardt, K.; Harnasch, D.; King, M.-T. (1983) Genotoxicity study of CS (ortho-chlorobenzylidenemalonitrile) in *Salmonella*, *Drosophila*, and mice: Failure to detect mutagenic effects. *Arch. Toxicol.* 54:167-170.
70. Zeiger, E.; Anderson, B.; Haworth, S.; Lawlor, T.; Mortelmans, K.; Speck, W. (1987) *Salmonella* mutagenicity tests: III. Results from the testing of 255 chemicals. *Environ. Mutagen.* 9(Suppl. 9):1-110.
71. Zeiger, E.; Anderson, B.; Haworth, S.; Lawlor, T.; Mortelmans, K. (1988) *Salmonella* mutagenicity tests: IV. Results from the testing of 300 chemicals. *Environ. Molec. Mutagen.* 11(Suppl. 12):1-158.

APPENDIX A

SUMMARY OF LESIONS IN MALE RATS IN THE TWO-YEAR INHALATION STUDY OF CS₂

	PAGE	
TABLE A1	SUMMARY OF THE INCIDENCE OF NEOPLASMS IN MALE RATS IN THE TWO-YEAR INHALATION STUDY OF CS ₂	59
TABLE A2	INDIVIDUAL ANIMAL TUMOR PATHOLOGY OF MALE RATS IN THE TWO-YEAR INHALATION STUDY OF CS ₂	62
TABLE A3	ANALYSIS OF PRIMARY NEOPLASMS IN MALE RATS IN THE TWO-YEAR INHALATION STUDY OF CS ₂	78
TABLE A4a	HISTORICAL INCIDENCE OF THYROID GLAND C-CELL NEOPLASMS IN MALE F344/N RATS	82
TABLE A4b	HISTORICAL INCIDENCE OF TESTICULAR INTERSTITIAL CELL NEOPLASMS IN MALE F344/N RATS	83
TABLE A5	SUMMARY OF THE INCIDENCE OF NONNEOPLASTIC LESIONS IN MALE RATS IN THE TWO-YEAR INHALATION STUDY OF CS ₂	84

TABLE A1. SUMMARY OF THE INCIDENCE OF NEOPLASMS IN MALE RATS IN THE TWO-YEAR INHALATION STUDY OF CS₂

	Chamber Control	0.075 mg/m ³	0.25 mg/m ³	0.75 mg/m ³
DISPOSITION SUMMARY				
Animals initially in study	50	50	50	50
Early deaths				
Moribund	19	27	21	20
Dead	5	6	8	4
Survivors				
Terminal sacrifice	26	17	21	26
Animals examined microscopically	50	50	50	50
ALIMENTARY SYSTEM				
Intestine large, cecum	(44)	(26)	(21)	(44)
Intestine large, colon	(48)	(32)	(24)	(46)
Intestine small, duodenum	(50)	(30)	(23)	(46)
Intestine small, ileum	(42)	(22)	(18)	(43)
Intestine small, jejunum	(41)	(18)	(12)	(39)
Liver	(50)	(50)	(49)	(50)
Hepatocellular carcinoma	2 (4%)			
Hepatocellular adenoma		2 (4%)		
Neoplastic nodule	2 (4%)	1 (2%)		2 (4%)
Mesentery	(5)	(3)	(2)	(4)
Carcinoma, metastatic, kidney				1 (25%)
Pancreas	(50)	(33)	(26)	(48)
Carcinoma, metastatic, kidney				1 (2%)
Pharynx	(1)	(1)	(2)	(4)
Palate, adenoma	1 (100%)		1 (50%)	
Palate, papilloma			1 (50%)	
Salivary glands	(49)	(33)	(27)	(49)
Stomach, forestomach	(50)	(33)	(28)	(50)
Stomach, glandular	(50)	(32)	(28)	(49)
CARDIOVASCULAR SYSTEM				
Heart	(50)	(35)	(30)	(50)
ENDOCRINE SYSTEM				
Adrenal gland, cortex	(50)	(50)	(48)	(49)
Adenoma	1 (2%)		1 (2%)	1 (2%)
Adrenal gland, medulla	(42)	(46)	(47)	(38)
Pheochromocytoma malignant	3 (7%)		4 (9%)	3 (8%)
Pheochromocytoma complex	1 (2%)			
Pheochromocytoma benign	16 (38%)	12 (26%)	10 (21%)	12 (32%)
Bilateral, pheochromocytoma malignant	1 (2%)			
Bilateral, pheochromocytoma benign	2 (5%)	5 (11%)	3 (6%)	1 (3%)
Islets, pancreatic	(50)	(36)	(27)	(48)
Adenoma	1 (2%)	5 (14%)	2 (7%)	2 (4%)
Carcinoma		1 (3%)	2 (7%)	
Parathyroid gland	(42)	(32)	(27)	(41)
Adenoma	2 (5%)	1 (3%)		
Pituitary gland	(47)	(43)	(40)	(47)
Pars distalis, adenoma	25 (53%)	25 (58%)	25 (63%)	25 (53%)
Pars distalis, carcinoma	1 (2%)	3 (7%)	2 (5%)	2 (4%)
Thyroid gland	(48)	(49)	(46)	(48)
Bilateral, C-cell, adenoma		1 (2%)		
C-cell, adenoma	2 (4%)	8 (16%)	7 (15%)	6 (13%)
C-cell, carcinoma		1 (2%)	2 (4%)	
Follicular cell, adenoma		1 (2%)	1 (2%)	1 (2%)
Follicular cell, carcinoma		1 (2%)		

TABLE A1. SUMMARY OF THE INCIDENCE OF NEOPLASMS IN MALE RATS IN THE TWO-YEAR INHALATION STUDY OF CS₂ (Continued)

	Chamber Control	0.075 mg/m ³	0.25 mg/m ³	0.75 mg/m ³
GENERAL BODY SYSTEM				
Tissue, NOS	(1)			
Lipoma	1 (100%)			
GENITAL SYSTEM				
Preputial gland	(50)	(48)	(46)	(50)
Adenoma	3 (6%)	2 (4%)	2 (4%)	3 (6%)
Carcinoma		1 (2%)	1 (2%)	1 (2%)
Prostate	(50)	(34)	(27)	(50)
Seminal vesicle	(7)	(3)	(6)	(8)
Testes	(50)	(47)	(50)	(50)
Bilateral, interstitial cell, adenoma	22 (44%)	26 (55%)	26 (52%)	30 (60%)
Interstitial cell, adenoma	9 (18%)	12 (26%)	10 (20%)	11 (22%)
HEMATOPOIETIC SYSTEM				
Bone marrow	(50)	(33)	(26)	(49)
Lymph node	(50)	(35)	(30)	(49)
Lymph node, bronchial	(50)	(29)	(25)	(47)
Carcinoma, metastatic, kidney				1 (2%)
Carcinoma, metastatic, thyroid gland		1 (3%)		
Lymph node, mandibular	(47)	(27)	(28)	(46)
Spleen	(50)	(49)	(49)	(50)
Thymus	(39)	(26)	(25)	(39)
INTEGUMENTARY SYSTEM				
Mammary gland	(21)	(10)	(12)	(24)
Fibroadenoma	1 (5%)			1 (4%)
Skin	(49)	(32)	(30)	(50)
Basal cell carcinoma	1 (2%)			
Keratoacanthoma		1 (3%)	3 (10%)	3 (6%)
Papilloma squamous			1 (3%)	
Trichoepithelioma	1 (2%)			
Sebaceous gland, adenoma			1 (3%)	
Subcutaneous tissue, fibroma	1 (2%)	1 (3%)		3 (6%)
Subcutaneous tissue, fibroma, multiple	1 (2%)			
MUSCULOSKELETAL SYSTEM				
Bone	(50)	(33)	(29)	(50)
Osteosarcoma				1 (2%)
Skeletal muscle			(1)	(1)
Carcinoma, metastatic, kidney				1 (100%)
NERVOUS SYSTEM				
Brain	(50)	(33)	(30)	(50)
Astrocytoma, NOS	1 (2%)	1 (3%)		
Carcinoma, metastatic, pituitary gland	1 (2%)	2 (6%)	1 (3%)	1 (2%)
Carcinoma, metastatic, Zymbal gland		1 (3%)		
Oligodendroglioma malignant				1 (2%)
Meninges, carcinoma, metastatic, Zymbal gland				1 (2%)

TABLE A1. SUMMARY OF THE INCIDENCE OF NEOPLASMS IN MALE RATS IN THE TWO-YEAR INHALATION STUDY OF CS₂ (Continued)

	Chamber Control	0.075 mg/m ³	0.25 mg/m ³	0.75 mg/m ³
RESPIRATORY SYSTEM				
Lung	(50)	(49)	(50)	(50)
Alveolar/bronchiolar adenoma	4 (8%)	2 (4%)	1 (2%)	
Alveolar/bronchiolar carcinoma		2 (4%)		
Carcinoma, metastatic, kidney				1 (2%)
Carcinoma, metastatic, Zymbal gland				1 (2%)
Hepatocellular carcinoma, metastatic, liver	1 (2%)			
Pheochromocytoma malignant, metastatic, adrenal gland				1 (2%)
Squamous cell carcinoma	1 (2%)	1 (2%)		
Nose	(50)	(50)	(49)	(50)
Submucosa, adenocarcinoma				1 (2%)
Vomeronasal organ, squamous cell carcinoma				1 (2%)
SPECIAL SENSES SYSTEM				
Eye	(48)	(6)	(4)	(49)
Harderian gland	(7)			(1)
Adenocarcinoma				1 (100%)
Zymbal gland	(2)	(1)		(1)
Carcinoma	2 (100%)	1 (100%)		1 (100%)
URINARY SYSTEM				
Kidney	(50)	(44)	(39)	(50)
Renal tubule, adenoma	1 (2%)	1 (2%)	1 (3%)	
Renal tubule, carcinoma				1 (2%)
Urinary bladder	(49)	(31)	(27)	(49)
SYSTEMIC LESIONS				
Multiple organs	*(50)	*(50)	*(50)	*(50)
Leukemia mononuclear	29 (58%)	35 (70%)	30 (60%)	28 (56%)
Lymphoma malignant	1 (2%)			
Lymphoma malignant histiocytic	1 (2%)			
Mesothelioma benign		1 (2%)		
Mesothelioma malignant	1 (2%)	2 (4%)	3 (6%)	1 (2%)
TUMOR SUMMARY				
Total animals with primary neoplasms **	50	49	50	50
Total primary neoplasms	141	156	140	143
Total animals with benign neoplasms	46	45	47	48
Total benign neoplasms	96	107	96	101
Total animals with malignant neoplasms	33	42	37	37
Total malignant neoplasms	44	48	44	42
Total animals with secondary neoplasms ***	2	4	1	5
Total secondary neoplasms	2	4	1	14
Total animals with neoplasms--uncertain benign or malignant	1	1		
Total uncertain neoplasms	1	1		

* Number of animals receiving complete necropsy examination; all gross lesions including masses examined microscopically.

** Primary tumors: all tumors except secondary tumors

*** Secondary tumors: metastatic tumors or tumors invasive into an adjacent organ

TABLE A2. INDIVIDUAL ANIMAL TUMOR PATHOLOGY OF MALE RATS: CHAMBER CONTROL
(Continued)

DAYS ON STUDY	7	7	7	7	7	7	7	7	7	7	7	7	7	7	7	7	7	7	7	7	7	7	7	7	7	7	TOTAL TISSUES TUMORS	
CARCASS ID	0	0	0	0	0	1	1	1	2	2	2	2	2	3	3	3	3	3	3	4	4	4	4	4	4	4		
1	1	1	1	1	1	1	1	1	1	1	1	1	1	1	1	1	1	1	1	1	1	1	1	1	1	1		
ALIMENTARY SYSTEM																												
Esophagus	+	+	+	+	+	+	+	+	+	+	+	+	+	+	+	+	+	+	+	+	+	+	+	+	+	+	49	
Intestine large	+	+	+	+	+	+	+	+	+	+	+	+	+	+	+	+	+	+	+	+	+	+	+	+	+	+	49	
Intestine large, cecum	+	+	+	+	1	+	+	+	+	+	+	+	+	+	+	+	+	+	+	+	+	+	+	+	+	+	44	
Intestine large, colon	+	+	+	+	+	+	+	+	+	+	+	+	+	+	+	+	+	+	+	+	+	+	+	+	+	+	48	
Intestine large, rectum	+	+	+	+	+	+	+	+	+	+	+	+	+	+	+	+	+	+	+	+	+	+	+	+	+	+	45	
Intestine small	+	+	+	+	+	+	+	+	+	+	+	+	+	+	+	+	+	+	+	+	+	+	+	+	+	+	50	
Intestine small, duodenum	+	+	+	+	+	+	+	+	+	+	+	+	+	+	+	+	+	+	+	+	+	+	+	+	+	+	50	
Intestine small, ileum	+	+	+	+	+	+	+	+	+	+	+	+	+	+	+	+	+	+	+	+	+	+	+	+	+	+	42	
Intestine small, jejunum	+	+	+	+	+	+	+	+	+	+	+	+	+	+	+	+	+	+	+	+	+	+	+	+	+	+	41	
Liver	+	+	+	+	+	+	+	+	+	+	+	+	+	+	+	+	+	+	+	+	+	+	+	+	+	+	50	
Hepatocellular carcinoma																											2	
Neoplastic nodule	X									X																	2	
Mesentery					+				+																	+	5	
Pancreas	+	+	+	+	+	+	+	+	+	+	+	+	+	+	+	+	+	+	+	+	+	+	+	+	+	+	50	
Pharynx																											1	
Palate, adenoma																										X	1	
Salivary glands	+	+	+	+	+	+	+	+	+	+	+	+	+	+	+	+	+	+	+	+	+	+	+	+	+	+	49	
Stomach	+	+	+	+	+	+	+	+	+	+	+	+	+	+	+	+	+	+	+	+	+	+	+	+	+	+	50	
Stomach, forestomach	+	+	+	+	+	+	+	+	+	+	+	+	+	+	+	+	+	+	+	+	+	+	+	+	+	+	50	
Stomach, glandular	+	+	+	+	+	+	+	+	+	+	+	+	+	+	+	+	+	+	+	+	+	+	+	+	+	+	50	
CARDIOVASCULAR SYSTEM																												
Blood vessel								+																			3	
Heart	+	+	+	+	+	+	+	+	+	+	+	+	+	+	+	+	+	+	+	+	+	+	+	+	+	+	50	
ENDOCRINE SYSTEM																												
Adrenal gland	+	+	+	+	+	+	+	+	+	+	+	+	+	+	+	+	+	+	+	+	+	+	+	+	+	+	50	
Adrenal gland, cortex	+	+	+	+	+	+	+	+	+	+	+	+	+	+	+	+	+	+	+	+	+	+	+	+	+	+	50	
Adenoma								X																			1	
Adrenal gland, medulla	M	+	+	+	+	+	+	+	M	+	+	+	+	+	+	+	+	+	+	+	+	+	+	+	+	+	42	
Pheochromocytoma malignant	X																									X	3	
Pheochromocytoma complex																										X	1	
Pheochromocytoma benign	X	X		X	X		X	X			X	X		X											X	X	16	
Bilateral, pheochromocytoma malignant																											1	
Bilateral, pheochromocytoma benign																									X		2	
Islets, pancreatic	+	+	+	+	+	+	+	+	+	+	+	+	+	+	+	+	+	+	+	+	+	+	+	+	+	+	50	
Adenoma																											1	
Parathyroid gland	+	+	+	+	+	+	+	+	+	+	+	+	+	+	+	+	+	+	+	+	+	+	+	+	+	+	42	
Adenoma								X				I		+	+	+	+	+	+	+	+	+	+	+	+	+	2	
Pituitary gland	+	+	+	+	+	M	+	+	+	+	+	+	+	+	+	+	+	+	+	+	+	+	+	+	+	+	47	
Pars distalis, adenoma	X	X					X	X	X	X	X														X	X	25	
Pars distalis, carcinoma														X	X												1	
Thyroid gland	+	+	+	+	+	+	+	+	+	+	+	+	+	+	+	+	+	+	+	+	+	+	+	+	+	+	48	
C-cell, adenoma												X													X		2	
GENERAL BODY SYSTEM																												
Tissue, NOS																											1	
Lipoma																											1	
GENITAL SYSTEM																												
Epididymis	+	+	+	+	+	+	+	+	+	+	+	+	+	M	+	+	+	+	+	+	+	+	+	+	+	+	48	
Preputial gland	+	+	+	+	+	+	+	+	+	+	+	+	+	+	+	+	+	+	+	+	+	+	+	+	+	+	50	
Adenoma																										X	3	
Prostate	+	+	+	+	+	+	+	+	+	+	+	+	+	+	+	+	+	+	+	+	+	+	+	+	+	+	50	
Seminal vesicle	+	+	+	+	+	+	+	+	+	+	+	+	+	+	+	+	+	+	+	+	+	+	+	+	+	+	7	
Testes	+	+	+	+	+	+	+	+	+	+	+	+	+	+	+	+	+	+	+	+	+	+	+	+	+	+	50	
Bilateral, interstitial cell, adenoma	X		X	X	X	X	X								X	X	X				X	X			X	X	22	
Interstitial cell, adenoma		X					X						X										X	X			9	

TABLE A2. INDIVIDUAL ANIMAL TUMOR PATHOLOGY OF MALE RATS: CHAMBER CONTROL
(Continued)

DAYS ON STUDY	4	4	5	5	5	5	5	5	5	5	5	6	6	6	6	6	6	7	7	7	7	7	7		
CARCASS ID	3	6	0	1	2	2	5	6	6	7	7	8	1	3	5	6	7	7	9	0	0	3	3	4	4
	8	3	8	5	9	9	3	7	9	1	1	5	2	0	5	6	4	4	9	2	2	2	9	7	9
HEMATOPOIETIC SYSTEM																									
Bone marrow	+	+	+	+	+	+	+	+	+	+	+	+	+	+	+	+	+	+	+	+	+	+	+	+	+
Lymph node	+	+	+	+	+	+	+	+	+	+	+	+	+	+	+	+	+	+	+	+	+	+	+	+	+
Lymph node, bronchial	+	+	+	+	+	+	+	+	+	+	+	+	+	+	+	+	+	+	+	+	+	+	+	+	+
Lymph node, mandibular	+	+	+	+	+	+	+	+	+	+	+	+	+	+	+	+	+	+	+	+	+	+	+	+	+
Spleen	+	M	+	+	M	+	+	+	+	+	+	+	+	+	+	+	+	+	+	+	M	+	+	+	+
Thymus	+	+	+	+	+	+	+	+	+	+	+	+	+	+	+	+	+	+	+	+	+	+	+	+	+
M	M	+	M	+	+	+	+	+	+	M	+	+	+	+	+	+	+	M	+	M	M	+	+	M	+
INTEGUMENTARY SYSTEM																									
Mammary gland	M	+	M	M	M	M	M	+	M	+	M	M	M	M	M	M	M	+	+	+	+	+	+	+	M
Fibroadenoma	+	+	+	+	+	+	+	+	+	+	+	+	+	+	+	+	+	+	+	+	+	+	+	+	+
Skin																									
Basal cell carcinoma																									
Trichoepithelioma																									
Subcutaneous tissue, fibroma																									
Subcutaneous tissue, fibroma, multiple																									
MUSCULOSKELETAL SYSTEM																									
Bone	+	+	+	+	+	+	+	+	+	+	+	+	+	+	+	+	+	+	+	+	+	+	+	+	+
NERVOUS SYSTEM																									
Brain	+	+	+	+	+	+	+	+	+	+	+	+	+	+	+	+	+	+	+	+	+	+	+	+	+
Astrocytoma, NOS																									
Carcinoma, metastatic, pituitary gland																									
Spinal cord																									
RESPIRATORY SYSTEM																									
Larynx	+	+	+	+	A	+	+	+	+	+	+	+	+	+	+	+	+	+	+	+	+	+	+	+	+
Lung	+	+	+	+	+	+	+	+	+	+	+	+	+	+	+	+	+	+	+	+	+	+	+	+	+
Alveolar/bronchiolar adenoma																									
Hepatocellular carcinoma, metastatic, liver																									
Squamous cell carcinoma																									
Nose	+	+	+	+	+	+	+	+	+	+	+	+	+	+	+	+	+	+	+	+	+	+	+	+	+
Trachea	+	+	+	+	+	+	+	+	I	+	+	+	+	+	+	+	+	+	+	+	+	+	+	+	+
SPECIAL SENSES SYSTEM																									
Eye	+	+	+	+	+	+	+																		
Harderian gland																									
Zymbal gland																									
Carcinoma																									
URINARY SYSTEM																									
Kidney	+	+	+	+	+	+	+	+	+	+	+	+	+	+	+	+	+	+	+	+	+	+	+	+	+
Renal tubule, adenoma																									
Urinary bladder	+	+	+	+	+	+	+	+	A	+	+	+	+	+	+	+	+	+	+	+	+	+	+	+	+
SYSTEMIC LESIONS																									
Multiple organs	+	+	+	+	+	+	+	+	+	+	+	+	+	+	+	+	+	+	+	+	+	+	+	+	+
Leukemia mononuclear			X		X	X	X	X		X					X	X	X	X	X	X	X	X			
Lymphoma malignant																									
Lymphoma malignant histiocytic																									
Mesothelioma malignant																									

**TABLE A2. INDIVIDUAL ANIMAL TUMOR PATHOLOGY OF MALE RATS: CHAMBER CONTROL
(Continued)**

DAYS ON STUDY	7 7 7 7 7 7 7 7 7 7 7 7 7 7 7 7 7 7																		TOTAL: TISSUES TUMORS											
	9 9 9 9 9 9 9 9 9 9 9 9 9 9 9 9 9 9																													
CARCASS ID	0	0	0	0	0	1	1	1	2	2	2	2	2	3	3	3	3	3	4	4	4	4	4	4	4	4	4	4	4	4
	1	1	1	1	1	1	1	1	1	1	1	1	1	1	1	1	1	1	1	1	1	1	1	1	1	1	1	1	1	1
HEMATOPOIETIC SYSTEM																														
Bone marrow	+																												50	
Lymph node	+																												50	
Lymph node, bronchial	+																												50	
Lymph node, mandibular	+																												47	
Spleen	+																												50	
Thymus	+	+	M	+	+	+	+	+	+	+	M	+	+	M	+	+	+	+	+	+	+	+	+	+	+	+	+	+	+	
INTEGUMENTARY SYSTEM																														
Mammary gland	+	M	+	M	+	M	M	+	+	+	+	M	+	M	M	M	M	+	+	M	M	M	M	+	+	+	+	+	+	
Fibroadenoma																													21	
Skin	+	+	+	+	+	+	+	+	+	+	+	+	+	+	+	+	+	+	+	+	+	+	+	+	+	+	+	+	+	
Basal cell carcinoma	X																												1	
Trichoepithelioma																													1	
Subcutaneous tissue, fibroma																													1	
Subcutaneous tissue, fibroma, multiple																													1	
MUSCULOSKELETAL SYSTEM																														
Bone	+																												50	
NERVOUS SYSTEM																														
Brain	+																												50	
Astrocytoma, NOS																													1	
Carcinoma, metastatic, pituitary gland																													1	
Spinal cord																													1	
RESPIRATORY SYSTEM																														
Larynx	+																												49	
Lung	+	+	-	+	+	+	+	+	+	+	+	+	+	+	+	+	+	+	+	+	+	+	+	+	+	+	+	+	+	
Alveolar/bronchiolar adenoma	X																												50	
Hepatocellular carcinoma, metastatic, liver	X																												4	
Squamous cell carcinoma																													1	
Nose	+																												50	
Trachea	+																												49	
SPECIAL SENSES SYSTEM																														
Eye	+																												48	
Harderian gland																													7	
Zymbal gland																													2	
Carcinoma																													2	
URINARY SYSTEM																														
Kidney	+																												50	
Renal tubule, adenoma																													1	
Urinary bladder	+																												49	
SYSTEMIC LESIONS																														
Multiple organs	+																												50	
Leukemia mononuclear	X																												29	
Lymphoma malignant	X																												1	
Lymphoma malignant histiocytic	X																												1	
Mesothelioma malignant	X																												1	

TABLE A2. INDIVIDUAL ANIMAL TUMOR PATHOLOGY OF MALE RATS IN THE TWO-YEAR INHALATION STUDY OF CS2: 0.075 mg/m³

DAYS ON STUDY	4	4	5	5	5	5	5	5	6	6	6	6	6	6	6	6	6	6	6	6	6	6	6	7	7	7	7										
	3	8	5	8	7	7	8	8	3	3	4	5	6	6	6	6	6	6	7	7	7	7	7	7	7	7	7										
CARCASS ID	1	1	1	1	1	1	1	1	1	1	1	1	1	1	1	1	1	1	1	1	1	1	1	1	1	1	1										
	3	4	1	0	2	4	0	0	0	0	2	4	1	2	3	4	2	2	2	3	5	1	2	2	2	2	2										
	1	4	4	1	8	0	4	9	3	6	3	2	3	7	4	7	4	2	9	7	0	7	1	5	6	6											
	1	1	1	1	1	1	1	1	1	1	1	1	1	1	1	1	1	1	1	1	1	1	1	1	1	1	1										
ALIMENTARY SYSTEM																																					
Esophagus	+	+	+	+	+	+	+	+	+	+	+	+	+	+	+	+	+	+	+	+	+	+	+	+	+	+	+										
Intestine large	+	+	+	+	+	+	+	+	+	+	+	+	+	+	+	+	+	+	+	+	+	+	+	+	+	+	+										
Intestine large, cecum	M	+	+	A	+	+	A	A	+	+	+	+	+	+	+	+	+	A	+	I	+	+	+	+	+	+	A										
Intestine large, colon	+	+	+	+	+	+	+	+	+	+	+	+	+	+	+	+	+	+	+	+	+	+	+	+	+	+	+	A									
Intestine large, rectum	+	+	+	M	+	+	+	+	+	+	M	+	+	+	+	+	+	A	+	+	+	+	+	+	+	+	+	A									
Intestine small	+	+	+	+	+	+	+	+	+	+	+	+	+	+	+	+	+	A	+	I	+	+	+	+	+	+	+	+									
Intestine small, duodenum	+	+	I	+	+	+	+	+	+	I	+	+	+	+	+	+	+	A	+	I	+	+	+	+	+	+	+	+									
Intestine small, ileum	M	+	+	A	+	+	A	A	+	+	+	+	A	+	+	+	+	A	A	I	+	+	+	+	+	+	+	A									
Intestine small, jejunum	A	+	+	A	+	+	A	A	+	+	+	+	A	+	+	+	A	A	A	M	I	A	+	+	+	+	+	A									
Liver	+	+	+	+	+	+	+	+	+	+	+	+	+	+	+	+	+	+	+	+	+	+	+	+	+	+	+	+									
Hepatocellular adenoma																																					
Neoplastic nodule																																					
Mesentery																																					
Pancreas																													+								
Pharynx	+	+	+	+	+	+	+	+	+	+	+	+	+	+	+	+	+	+	+	+	+	+	+	+	+	+	+	+									
Salivary glands	+	+	+	+	+	+	+	+	+	+	+	+	+	+	+	+	+	+	+	+	+	+	+	+	+	+	+	+									
Stomach	+	+	+	+	+	+	+	+	+	+	+	+	+	+	+	+	+	+	+	+	+	+	+	+	+	+	+	+									
Stomach, forestomach	+	+	+	+	+	+	+	+	+	+	+	+	+	+	+	+	+	+	+	+	+	+	+	+	+	+	+	+									
Stomach, glandular	+	+	+	+	+	+	+	+	+	+	+	+	+	+	+	+	+	+	A	+	+	+	+	+	+	+	+	+									
Tooth	+																																				
CARDIOVASCULAR SYSTEM																																					
Heart	+	+	+	+	+	+	+	+	+	+	+	+	+	+	+	+	+	+	+	+	+	+	+	+	+	+	+	+									
ENDOCRINE SYSTEM																																					
Adrenal gland	+	+	+	+	+	+	+	+	+	+	+	+	+	+	+	+	+	+	+	+	+	+	+	+	+	+	+	+									
Adrenal gland, cortex	+	+	+	+	+	+	+	+	+	+	+	+	+	+	+	+	+	+	+	+	+	+	+	+	+	+	+	+									
Adrenal gland, medulla	+	+	+	+	+	+	+	+	+	+	+	+	+	+	+	+	+	+	+	+	+	+	+	+	+	+	+	+									
Pheochromocytoma benign																																					
Bilateral, pheochromocytoma benign							X										X								X			M	+	M							
Islets, pancreatic	+	+	+	+	+	+	+	+	+	+	+	+	+	+	+	+	+	+	+	+	+	+	+	+	+	+	+	+	+								
Adenoma																													+	+	+						
Carcinoma																																					
Parathyroid gland																																					
Adenoma				M																													M	+			
Pituitary gland	+	+	+	+	+	+	+	+	+	+	+	+	+	+	+	+	+	+	+	+	+	+	+	+	+	+	+	+	+	+	+	+	+	+			
Pars distalis, adenoma																																					
Pars distalis, carcinoma		X					X	X		X	X	X		X	X																			X			
Thyroid gland	+	+	X		+	+	+	+	+	+	+	+	+	+	+	+	+	+	A	+	+	+	+	+	+	+	+	+	+	+	+	+	+	+			
Bilateral, C-cell, adenoma																																					
C-cell, adenoma																																			X	X	
C-cell, carcinoma																																					
Follicular cell, adenoma																																					
Follicular cell, carcinoma																																					
GENERAL BODY SYSTEM																																					
None																																					
GENITAL SYSTEM																																					
Epididymis	+	M	+	+	+	+	+	+	+	+	+	+	+	+	+	+	+	+	+	+	+	+	+	+	+	+	+	+	+	+	+	+	+	+	+		
Preputial gland	+	+	+	+	+	+	+	+	+	+	+	+	+	+	+	+	+	+	+	+	+	+	+	+	+	+	+	+	+	+	+	+	+	+	+	+	
Adenoma																																				M	+
Carcinoma																																					
Prostate																																					
X																																					
Seminal vesicle	+	+	+	+	+	+	+	+	+	+	+	+	+	+	+	+	+	+	+	+	+	+	+	+	+	+	+	+	+	+	+	+	+	+	+	+	+
Testes	+	+	+	+	+	+	+	+	+	+	+	+	+	+	+	+	+	+	+	+	+	+	+	+	+	+	+	+	+	+	+	+	+	+	+	+	+
Bilateral, interstitial cell, adenoma							X	X												X	X	X	X														
Interstitial cell, adenoma							X	X																													

**TABLE A2. INDIVIDUAL ANIMAL TUMOR PATHOLOGY OF MALE RATS: 0.075 mg/m³
(Continued)**

DAYS ON STUDY	7	7	7	7	7	7	7	7	7	7	7	7	7	7	7	7	7	7	7	7	7	7	7	7	7
	1	2	2	3	3	3	4	4	5	5	5	5	5	5	5	5	5	5	5	5	5	5	5	5	5
CARCASS ID	4	4	8	0	2	7	1	4	2	2	2	2	2	2	2	2	2	2	2	2	2	2	2	2	
	1	1	1	1	1	1	1	1	1	1	1	1	1	1	1	1	1	1	1	1	1	1	1	1	
	0	3	2	5	0	5	5	9	2	5	7	8	1	2	6	8	9	0	3	6	8	1	6	8	
	1	1	1	1	1	1	1	1	1	1	1	1	1	1	1	1	1	1	1	1	1	1	1	1	
	TOTAL TISSUES TUMORS																								
ALIMENTARY SYSTEM																									
Esophagus	+	+	+	+	+	+	+	+																	
Intestine large	+	+	+	+	+	+	+	+												+					
Intestine large, cecum	+	+	+	+	+	+	I	+																	
Intestine large, colon	+	+	+	+	+	+	+	+											M						
Intestine large, rectum	+	+	+	+	+	+	+	+												+					
Intestine small	+	+	+	+	+	+	+	+												+					
Intestine small, duodenum	+	+	+	+	+	+	+	+												+					
Intestine small, ileum	+	+	I	+	A	+	A	+												+					
Intestine small, jejunum	+	+	A	+	+	+	A	+												+					
Liver	+	+	+	+	+	+	+	+												+		+	+	+	
Hepatocellular adenoma							X																		
Neoplastic nodule										X													X		
Mesentery														+									+		
Pancreas	+	+	+	+	+	+	+	+																	
Pharynx																									
Salivary glands	+	+	+	+	+	+	+	+																	
Stomach	+	+	+	+	+	+	+	+																	
Stomach, forestomach	+	+	+	+	+	+	+	+																	
Stomach, glandular	+	+	+	+	+	+	+	+																	
Tooth																									
CARDIOVASCULAR SYSTEM																									
Heart	+	+	+	+	+	+	+	+				+										+			
ENDOCRINE SYSTEM																									
Adrenal gland	+	+	+	+	+	+	+	+	+	+	+	+	+	+	+	+	+	+	+	+	+	+	+	+	
Adrenal gland, cortex	+	+	+	+	+	+	+	+	+	+	+	+	+	+	+	+	+	+	+	+	+	+	+	+	
Adrenal gland, medulla	+	+	+	+	+	+	+	+	+	+	+	M	+									+	+	+	
Pheochromocytoma benign	X						X		X		X		X							M		X	X		
Bilateral, pheochromocytoma benign				X			X		X		X											X	X	X	
Islets, pancreatic	+	+	+	+	+	+	+	+																	
Adenoma				X																					
Carcinoma																									
Parathyroid gland	+	+	+	+	+	+	+	+																	
Adenoma																									
Pituitary gland	+	+	+	+	+	+	+	+																	
Pars distalis, adenoma	X	X		X	X	X	X	X		X	X	X						X	X			X	X		
Pars distalis, carcinoma				X																					
Thyroid gland	+	+	+	+	+	+	+	+	+	+	+	+	+	+	+	+	+	+	+	+	+	+	+	+	
Bilateral, C-cell, adenoma																							X		
C-cell, adenoma	X	X		X			X	X				X													
C-cell, carcinoma							X																		
Follicular cell, adenoma																									
Follicular cell, carcinoma																			X						
GENERAL BODY SYSTEM																									
None																									
GENITAL SYSTEM																									
Epididymis	+	+	+	+	+	+	+	+																	
Preputial gland	+	+	+	+	+	+	M	+	+	+	+	+	+	+	+	+	+	+	+	+	+	+	+	+	
Adenoma																							X		
Carcinoma																								X	
Prostate	+	+	+	+	+	+	+	+																	
Seminal vesicle	+	+	+	+	+	+	+	+																	
Testes	+	+	+	+	+	+	+	+	+	+	+	+	+	+	+	+	+	+	+	+	+	+	+	+	
Bilateral, interstitial cell, adenoma		X	X	X	X	X	X	X		X	X	X	X	X				X		X		X	X	X	
Interstitial cell, adenoma	X				X	X			X												X			X	

TABLE A2. INDIVIDUAL ANIMAL TUMOR PATHOLOGY OF MALE RATS: 0.075 mg/m³
(Continued)

DAYS ON STUDY	4	4	5	5	5	5	5	5	6	6	6	6	6	6	6	6	6	6	6	6	6	6	7	7	7	7	
	3	8	5	6	7	7	8	9	3	3	4	5	6	6	6	6	7	7	8	8	9	0	0	0	0	1	
	1	5	3	0	1	1	6	8	1	9	8	5	7	7	7	7	4	8	7	7	7	0	2	2	2	1	
CARCASS ID	1	1	1	1	1	1	1	1	1	1	1	1	1	1	1	1	1	1	1	1	1	1	1	1	1	1	
HEMATOPOIETIC SYSTEM																											
Bone marrow	+	+	+	+	+	+	+	+	+	+	+	+	+	+	+	+	+	+	+	+	+	+	+	+	+	+	
Lymph node	+	+	+	+	+	+	+	+	+	+	+	+	+	+	+	+	+	+	+	+	+	+	+	+	+	+	
Lymph node, bronchial	M	+	+	+	+	+	+	+	+	+	+	+	+	+	+	+	+	+	+	+	M	+	+	+	+	M	
Carcinoma, metastatic, thyroid gland																											
Lymph node, mandibular	+	+	+	+	+	+	I	+	+	M	M	+	M	+	+	+	+	+	+	+	+	+	+	+	+	M	+
Spleen	+	+	+	+	+	+	+	+	+	+	+	+	+	+	+	+	+	+	A	+	+	+	+	+	+	+	+
Thymus	M	+	+	I	M	+	+	M	+	+	M	+	+	+	+	+	+	+	+	+	+	M	+	+	+	+	
INTEGUMENTARY SYSTEM																											
Mammary gland	M	+	+	M	M		M	+	M	M	M	M	M	+	M	M	M	M	M	+	+	M	M	M	M	M	
Skin	+	+	+	+	+	+	+	+	+	+	+	+	+	+	+	+	+	+	+	+	+	+	+	+	+	+	
Keratoacanthoma							X																				
Subcutaneous tissue, fibroma													X														
MUSCULOSKELETAL SYSTEM																											
Bone	+	+	+	+	+	+	+	+	+	+	+	+	+	+	+	+	+	+	+	+	+	+	+	+	+	+	
NERVOUS SYSTEM																											
Brain	+	+	+	+	+	+	+	+	+	+	+	+	+	+	+	+	+	+	+	+	+	+	+	+	+	+	
Astrocytoma, NOS																											
Carcinoma, metastatic, pituitary gland																											
Carcinoma, metastatic, Zymbal gland	X																										
RESPIRATORY SYSTEM																											
Larynx	+	+	+	A	+	+	+	+	+	+	+	+	+	+	+	+	+	+	A	+	+	+	+	+	+	A	
Lung	+	+	+	+	+	+	+	+	+	+	+	+	+	+	+	+	+	+	A	+	+	+	+	+	+	+	
Alveolar/bronchiolar adenoma																											
Alveolar/bronchiolar carcinoma													X														
Squamous cell carcinoma																											
Nose	+	+	+	+	+	+	+	+	+	+	+	+	+	+	+	+	+	+	+	+	+	+	+	+	+	+	
Trachea	+	+	+	+	+	+	+	+	+	+	+	+	+	+	I	+	+	A	+	+	I	+	+	+	+	A	
SPECIAL SENSES SYSTEM																											
Eye																											
Zymbal gland	+																										
Carcinoma	X																										
URINARY SYSTEM																											
Kidney	+	+	+	+	+	+	+	+	+	+	+	+	+	+	+	+	+	+	+	+	+	+	+	+	+	+	
Renal tubule, adenoma																											
Urinary bladder	+	+	+	+	+	+	+	+	+	+	+	+	+	+	+	+	+	A	+	I	+	+	+	+	+	+	
SYSTEMIC LESIONS																											
Multiple organs	+	+	+	+	+	+	+	+	+	+	+	+	+	+	+	+	+	+	+	+	+	+	+	+	+	+	
Leukemia mononuclear			X	X	X	X	X	X	X	X																	
Mesothelioma benign																											
Mesothelioma malignant																											

**TABLE A2. INDIVIDUAL ANIMAL TUMOR PATHOLOGY OF MALE RATS: 0.075 mg/m³
(Continued)**

DAYS ON STUDY	7	7	7	7	7	7	7	7	7	7	7	7	7	7	7	7	7	7	7	7	7	7	7	7	7	7	7	TOTAL TISSUES TUMORS			
	1	2	3	4	5	6	7	8	9	10	11	12	13	14	15	16	17	18	19	20	21	22	23	24	25	26	27		28		
CARCASS ID	4	4	8	0	2	7	1	4	2	2	2	2	2	2	2	2	2	2	2	2	2	2	2	2	2	2	2	2	2		
HEMATOPOIETIC SYSTEM																															
Bone marrow	+	+	+	+	+	+	+																							33	
Lymph node	+	+	+	+	+	+	+												+											35	
Lymph node, bronchial	+	+	+	I	+	+	+																								29
Carcinoma, metastatic, thyroid gland						X																								1	
Lymph node, mandibular	+	M	+	+	+	+	+																							27	
Spleen	+	+	+	+	+	+	+	+	+	+	+	+	+	+	+	+	+	+	+	+	+	+	+	+	+	+	+	+	+	49	
Thymus	+	+	+	+	M	+	+	+																						26	
INTEGUMENTARY SYSTEM																															
Mammary gland	M	+	M	+	M	+	+	M																						10	
Skin	+	+	+	+	M	+	+	+																						32	
Keratoacanthoma																														1	
Subcutaneous tissue, fibroma																														1	
MUSCULOSKELETAL SYSTEM																															
Bone	+	+	+	+	+	+	+	+																						33	
NERVOUS SYSTEM																															
Brain	+	+	+	+	+	+	+	+																						33	
Astrocytoma, NOS																														1	
Carcinoma, metastatic, pituitary gland						X																								2	
Carcinoma, metastatic, Zymbal gland																														1	
RESPIRATORY SYSTEM																															
Larynx	+	+	+	+	+	+	+	+																						30	
Lung	+	+	+	+	+	+	+	+	+	+	+	+	+	+	+	+	+	+	+	+	+	+	+	+	+	+	+	+	+	49	
Alveolar/bronchiolar adenoma				X																										2	
Alveolar/bronchiolar carcinoma								X																			X			2	
Squamous cell carcinoma																				X										1	
Nose	+	+	+	+	+	+	+	+	+	+	+	+	+	+	+	+	+	+	+	+	+	+	+	+	+	+	+	+	+	50	
Trachea	+	+	+	+	+	+	+	+																						29	
SPECIAL SENSES SYSTEM																															
Eye			+							+									+										+	6	
Zymbal gland																														1	
Carcinoma																														1	
URINARY SYSTEM																															
Kidney	+	+	+	+	+	+	+	+	+	+										+	+	+	+	+					+	44	
Renal tubule, adenoma																														1	
Urinary bladder	+	+	+	+	+	+	+	+																					X	31	
SYSTEMIC LESIONS																															
Multiple organs	+	+	+	+	+	+	+	+	+	+	+	+	+	+	+	+	+	+	+	+	+	+	+	+	+	+	+	+	+	50	
Leukemia mononuclear			X		X		X	X	X	+	X	X	X	+	X	X	X	X	+	X	X	X	X	X	X	X	X	X	X	35	
Mesothelioma benign																														1	
Mesothelioma malignant			X																											2	

TABLE A2. INDIVIDUAL ANIMAL TUMOR PATHOLOGY OF MALE RATS IN THE TWO-YEAR INHALATION STUDY OF CS2: 0.25 mg/m³

DAYS ON STUDY	3	4	4	5	5	5	5	5	5	5	5	5	5	6	6	6	6	6	6	6	6	6	6	7	7	7	
	8	3	5	2	2	3	7	7	8	9	9	9	9	2	4	6	6	6	6	7	8	8	8	9	0	0	0
	9	9	2	9	9	6	1	7	8	2	2	2	2	2	2	2	2	2	2	2	2	2	2	2	2	2	2
CARCASS ID	2	2	2	2	2	2	2	2	2	2	2	2	2	2	2	2	2	2	2	2	2	2	2	2	2	2	2
	1	2	2	3	3	3	5	0	1	0	4	1	3	4	2	0	2	3	3	2	4	2	0	0	0	4	4
	0	2	7	1	3	9	0	1	7	7	8	3	0	4	3	6	5	7	4	1	6	4	2	3	3	3	3
	1	1	1	1	1	1	1	1	1	1	1	1	1	1	1	1	1	1	1	1	1	1	1	1	1	1	1
ALIMENTARY SYSTEM																											
Esophagus	+	+	+	+	+	+	+	+	+	+	+	+	+	+	+	+	+	+	+	+	+	+	+	+	+	+	+
Intestine large	A	+	A	+	+	+	+	+	+	+	+	+	+	+	A	+	+	+	+	+	+	+	+	+	+	+	+
Intestine large, cecum	M	+	A	+	+	+	+	I	+	+	+	+	+	+	+	+	+	+	+	+	+	+	A	A	+	+	+
Intestine large, colon	A	+	A	+	+	+	+	+	+	+	+	+	+	+	+	+	+	+	+	+	+	+	+	+	+	+	+
Intestine large, rectum	A	+	A	+	+	+	+	+	+	+	+	+	+	+	M	M	+	+	I	+	+	+	M	A	+	+	M
Intestine small	+	+	A	+	+	+	+	+	+	+	+	+	+	+	+	+	+	+	+	+	+	+	+	+	+	+	+
Intestine small, duodenum	+	+	A	+	+	+	M	I	+	+	+	+	+	+	+	+	+	+	+	+	+	+	+	+	+	+	I
Intestine small, ileum	A	+	A	+	+	A	I	+	+	+	+	+	+	+	A	I	+	+	+	+	+	+	+	A	+	A	I
Intestine small, jejunum	A	+	A	+	+	I	I	A	+	+	+	I	I	A	I	+	+	+	+	A	+	+	A	A	A	A	+
Liver	+	+	A	+	+	+	+	+	+	+	+	+	+	+	+	+	+	+	+	+	+	+	+	+	+	+	+
Mesentery																											
Pancreas	M	+	A	+	+	+	+	+	A	+	+	+	+	+	+	+	+	+	+	+	+	+	+	+	+	+	+
Pharynx																											
Palate, adenoma																											
Palate, papilloma																											
Salivary glands	+	+	A	+	+	+	+	+	A	+	+	+	+	+	+	+	+	+	+	+	+	+	+	+	+	+	+
Stomach	+	+	A	+	+	+	+	+	A	+	+	+	+	+	+	+	+	+	+	+	+	+	+	+	+	+	+
Stomach, forestomach	+	+	A	+	+	+	+	+	A	+	+	+	+	+	+	+	+	+	+	+	+	+	+	+	+	+	+
Stomach, glandular	+	+	A	+	+	+	+	+	A	+	+	+	+	+	+	+	+	+	+	+	+	+	+	+	+	+	+
Tongue																											
CARDIOVASCULAR SYSTEM																											
Blood vessel	+	+	+	+	+	+	+	+	+	+	+	+	+	+	+	+	+	+	+	+	+	+	+	+	+	+	+
Heart																											
ENDOCRINE SYSTEM																											
Adrenal gland	+	+	+	+	+	+	+	+	A	+	+	+	+	+	+	+	+	+	+	+	+	+	+	+	+	+	+
Adrenal gland, cortex	+	+	A	+	+	+	+	+	A	+	+	+	+	+	+	+	+	+	+	+	+	+	+	+	+	+	+
Adenoma																											
Adrenal gland, medulla	+	+	+	M	+	+	+	+	A	+	+	+	+	+	+	+	+	+	+	+	+	+	+	I	+	+	
Pheochromocytoma malignant				X																							
Pheochromocytoma benign																											
Bilateral, pheochromocytoma benign											X					X			X			X					
Islets, pancreatic	M	+	A	+	+	+	+	+	A	+	+	+	+	+	+	+	+	+	+	+	+	+	+	+	+	+	X
Adenoma																											
Carcinoma																										X	
Parathyroid gland	+	+	+	+	+	+	+	+	A	+	+	+	+	+	+	+	+	+	+	+	+	M	+	+	+	+	+
Pituitary gland	+	+	+	+	+	+	+	+	A	+	+	+	+	+	+	+	+	+	+	+	+	+	+	+	+	+	+
Pars distalis, adenoma	X	X	X						X						X	X	X										
Pars distalis, carcinoma																											
Thyroid gland	A	+	M	+	+	+	+	+	A	+	+	+	+	+	+	+	+	+	+	+	+	+	+	+	+	+	+
C-cell, adenoma									X																		X
C-cell, carcinoma																										X	
Follicular cell, adenoma																											X
GENERAL BODY SYSTEM																											
None																											
GENITAL SYSTEM																											
Epididymis	+	M	M	+	I	+	+	+	+	+	+	+	+	+	+	+	+	+	+	+	+	+	+	+	+	+	+
Penis																											
Preputial gland	+	+	A	+	+	+	+	+	A	+	+	+	+	+	+	+	+	+	+	+	+	+	+	+	+	+	+
Adenoma																											
Carcinoma																											
Prostate	+	+	A	+	+	+	+	+	A	+	+	+	+	+	+	+	+	+	+	+	+	+	+	+	+	+	+
Seminal vesicle																											
Testes	+	+	+	+	+	+	+	+	+	+	+	+	+	+	+	+	+	+	+	+	+	+	+	+	+	+	+
Bilateral, interstitial cell, adenoma				X						X				X	X				X			X	X	X	X	X	X
Interstitial cell, adenoma							X		X																	X	

TABLE A2. INDIVIDUAL ANIMAL TUMOR PATHOLOGY OF MALE RATS: 0.25 mg/m³
(Continued)

DAYS ON STUDY	3 8 9	4 3 9	4 5 2	5 2 9	5 2 9	5 3 6	5 3 7	5 3 7	5 3 8	5 3 9	5 3 9	5 3 9	6 2 0	6 4 1	6 8 0	6 8 7	6 8 7	6 7 4	6 8 7	6 8 8	6 9 8	7 0 8	7 0 8	7 0 8		
CARCASS ID	2 1 1	2 2 1	2 2 1	2 3 1	2 3 1	2 3 1	2 3 1	2 3 1	2 3 1	2 3 1	2 3 1	2 3 1	2 3 1	2 3 1	2 3 1	2 3 1	2 3 1	2 3 1	2 3 1	2 3 1	2 3 1	2 3 1	2 3 1	2 3 1	2 3 1	
HEMATOPOIETIC SYSTEM																										
Bone marrow	+	+	A	+	+	+	+	+	A	+	+	+	A	+	+	+	+	+	+	+	+	+	+	+	+	
Lymph node	+	+	A	+	+	+	+	+	A	+	+	+	+	+	+	+	+	+	+	+	+	+	+	+	+	
Lymph node, bronchial	+	+	M	M	+	+	+	M	A	+	+	+	+	+	+	+	+	+	+	+	+	+	+	+	+	
Lymph node, mandibular	+	+	A	+	+	+	+	+	+	+	+	+	+	+	+	+	+	+	+	+	+	+	+	+	+	
Spleen	+	+	A	+	+	+	+	+	+	+	+	+	+	+	+	+	+	+	+	+	+	+	+	+	+	
Thymus	+	+	M	+	+	+	+	+	A	+	+	+	+	+	+	+	+	+	+	+	+	+	+	+	+	
INTEGUMENTARY SYSTEM																										
Mammary gland	+	M	M	M	M	+	+	M	M	+	M	+	+	+	+	+	M	M	M	M	+	M	+	+	M	
Skin	+	+	A	+	+	+	+	+	+	+	+	+	+	+	+	+	+	+	+	+	+	+	+	+	+	
Keratoacanthoma																										
Papilloma squamous																	X									
Sebaceous gland, adenoma																										
MUSCULOSKELETAL SYSTEM																										
Bone	+	+	+	+	+	+	+	+	+	+	+	+	+	+	+	+	+	+	+	+	+	+	+	+	+	
Skeletal muscle																										
NERVOUS SYSTEM																										
Brain	+	+	+	+	+	+	+	+	+	+	+	+	+	+	+	+	+	+	+	+	+	+	+	+	+	
Carcinoma, metastatic, pituitary gland																										
RESPIRATORY SYSTEM																										
Larynx	A	+	A	+	+	+	+	+	A	+	+	+	+	+	+	+	+	+	+	+	A	+	+	+	+	
Lung	+	+	+	+	+	+	+	+	+	+	+	+	+	+	+	+	+	+	+	+	+	+	+	+	+	
Alveolar/bronchiolar adenoma																										
Nose	+	+	A	+	+	+	+	+	+	+	+	+	+	+	+	+	+	+	+	+	+	+	+	+	+	
Trachea	+	+	A	+	+	+	+	+	A	+	+	+	+	+	+	+	+	+	+	+	A	+	+	+	+	
SPECIAL SENSES SYSTEM																										
Eye																										
URINARY SYSTEM																										
Kidney	+	+	+	+	+	+	+	+	A	+	+	+	+	+	+	+	+	+	+	+	+	+	+	+	+	
Renal tubule, adenoma																										
Urinary bladder	+	+	A	+	+	+	+	+	A	+	+	+	+	+	+	+	+	+	+	+	+	+	+	+	+	
SYSTEMIC LESIONS																										
Multiple organs	+	+	+	+	+	+	+	+	+	+	+	+	+	+	+	+	+	+	+	+	+	+	+	+	+	
Leukemia monoclonal	X				X	X	X	X					X	X	X	X	X	X	X	X	X	X	X	X	X	
Mesothelioma malignant					X																					

TABLE A2. INDIVIDUAL ANIMAL TUMOR PATHOLOGY OF MALE RATS: 0.25 mg/m³
(Continued)

DAYS ON STUDY	7	7	7	7	7	7	7	7	7	7	7	7	7	7	7	7	7	7	7	7	7	7	7	7	7	7	7	7	7	7	7	7	7	7	7	7	7	7	7	7	7	7	7	7	7	7	7	7				
	1	3	3	4	5	5	5	5	5	5	5	5	5	5	5	5	5	5	5	5	5	5	5	5	5	5	5	5	5	5	5	5	5	5	5	5	5	5	5	5	5	5	5	5	5	5	5	5	5	5	5	5
CARCASS ID	4	0	6	5	1	1	1	1	1	1	1	1	1	1	1	1	1	1	1	1	1	1	1	1	1	1	1	1	1	1	1	1	1	1	1	1	1	1	1	1	1	1	1	1	1	1	1	1	1	1	1	
HEMATOPOIETIC SYSTEM																																TOTAL: TISSUES TUMORS																				
Bone marrow																																26																				
Lymph node																																30																				
Lymph node, bronchial																																25																				
Lymph node, mandibular																																28																				
Spleen																																49																				
Thymus																																25																				
INTEGUMENTARY SYSTEM																																TOTAL: TISSUES TUMORS																				
Mammary gland																																12																				
Skin																																30																				
Keratoacanthoma																																3																				
Papilloma squamous																																1																				
Sebaceous gland, adenoma																																1																				
MUSCULOSKELETAL SYSTEM																																TOTAL: TISSUES TUMORS																				
Bone																																29																				
Skeletal muscle																																1																				
NERVOUS SYSTEM																																TOTAL: TISSUES TUMORS																				
Brain																																30																				
Carcinoma, metastatic, pituitary gland																																1																				
RESPIRATORY SYSTEM																																TOTAL: TISSUES TUMORS																				
Larynx																																25																				
Lung																																50																				
Alveolar/bronchiolar adenoma																																1																				
Nose																																49																				
Trachea																																26																				
SPECIAL SENSES SYSTEM																																TOTAL: TISSUES TUMORS																				
Eye																																4																				
URINARY SYSTEM																																TOTAL: TISSUES TUMORS																				
Kidney																																39																				
Renal tubule, adenoma																																1																				
Urinary bladder																																27																				
SYSTEMIC LESIONS																																TOTAL: TISSUES TUMORS																				
Multiple organs																																50																				
Leukemia mononuclear																																30																				
Mesothelioma malignant																																3																				

TABLE A2. INDIVIDUAL ANIMAL TUMOR PATHOLOGY OF MALE RATS IN THE TWO-YEAR INHALATION STUDY OF CS2: 0.75 mg/m³

DAYS ON STUDY	4	5	5	5	5	6	6	6	6	6	6	6	6	6	6	6	6	6	7	7	7	7	7	7	7
	7	2	7	7	8	0	1	2	2	3	4	5	6	6	7	9	9	1	1	3	3	3	3	4	5
CARCASS ID	3	3	3	3	3	3	3	3	3	3	3	3	3	3	3	3	3	3	3	3	3	3	3	3	3
ALIMENTARY SYSTEM	3	3	3	3	3	3	3	3	3	3	3	3	3	3	3	3	3	3	3	3	3	3	3	3	
Esophagus	4	4	0	4	3	2	4	2	4	1	2	2	0	1	1	0	0	3	0	1	3	3	4	2	
Intestine large	0	2	8	5	7	3	3	1	9	9	7	5	3	4	7	5	1	1	4	6	9	8	1	9	
Intestine large, cecum	1	1	1	1	1	1	1	1	1	1	1	1	1	1	1	1	1	1	1	1	1	1	1	1	
Intestine large, colon	+	+	+	+	+	+	+	+	+	+	+	+	+	+	+	+	+	+	+	+	+	+	+	+	
Intestine large, rectum	+	+	+	+	+	+	+	+	+	+	+	+	+	+	+	+	+	+	+	+	+	+	+	+	
Intestine small	+	+	+	+	+	+	+	+	+	+	+	+	+	+	+	+	+	+	+	+	+	+	+	+	
Intestine small, duodenum	+	+	+	+	+	+	+	+	+	+	+	+	+	+	+	+	+	+	+	+	+	+	+	+	
Intestine small, ileum	+	A	I	+	A	+	+	+	+	+	+	+	+	+	+	+	I	+	+	+	+	+	+	+	
Intestine small, jejunum	+	+	A	+	A	+	+	+	+	+	+	+	+	+	+	+	M	A	A	+	+	+	A	M	
Liver	+	+	+	+	+	+	+	+	+	+	+	+	+	+	+	+	+	+	+	+	+	+	+	+	
Neoplastic nodule					X																				
Mesentery																									
Carcinoma, metastatic, kidney																									
Mesothelioma malignant, metastatic, testes																									
Pancreas																									
Carcinoma, metastatic, kidney																									
Mesothelioma malignant, metastatic, testes																									
Pharynx																									
Salivary glands																									
Stomach																									
Stomach, forestomach																									
Stomach, glandular																									
Tongue																									
CARDIOVASCULAR SYSTEM																									
Heart	+	+	+	+	+	+	+	+	+	+	+	+	+	+	+	+	+	+	+	+	+	+	+	+	
ENDOCRINE SYSTEM																									
Adrenal gland	+	+	+	+	+	+	+	+	+	+	+	+	+	+	+	+	+	+	+	+	+	+	+	+	
Adrenal gland, cortex	+	+	+	+	+	+	+	+	+	+	+	+	+	+	+	+	+	+	+	+	+	+	+	+	
Adenoma																									
Adrenal gland, medulla	+	+	+	+	+	M	M	M	M	+	M	+	I	+	+	+	+	+	M	+	M	M	+	+	
Pheochromocytoma malignant																									
Pheochromocytoma benign	X		X																						
Bilateral, pheochromocytoma benign																									
Islets, pancreatic	+	+	+	+	+	+	+	+	+	+	+	+	+	+	+	+	+	+	+	+	+	+	+	+	
Adenoma																									
Parathyroid gland	M	+	M	+	+	+	+	+	+	+	+	+	+	+	+	+	+	+	+	+	+	+	+	+	
Pituitary gland	+	+	+	M	+	+	+	+	+	+	+	+	+	+	+	+	+	+	+	+	+	+	+	+	
Pars distalis, adenoma																									
Pars distalis, carcinoma																									
Thyroid gland	+	+	+	+	+	+	+	+	+	+	+	+	+	+	+	+	+	+	+	+	+	+	+	+	
C-cell, adenoma																									
Follicular cell, adenoma																									
GENERAL BODY SYSTEM																									
None																									
GENITAL SYSTEM																									
Epididymis	+	M	+	+	+	+	+	+	+	+	+	M	M	+	+	+	+	+	+	+	+	+	M	+	
Penis																									
Preputial gland	+	+	+	+	+	+	+	+	+	+	+	+	+	+	+	+	+	+	+	+	+	+	+	+	
Adenoma																									
Carcinoma																									
Prostate	+	+	+	+	+	+	+	+	+	+	+	+	+	+	+	+	+	+	+	+	+	+	+	+	
Seminal vesicle	+	+	+	+	+	+	+	+	+	+	+	+	+	+	+	+	+	+	+	+	+	+	+	+	
Testes	+	+	+	+	+	+	+	+	+	+	+	+	+	+	+	+	+	+	+	+	+	+	+	+	
Bilateral, interstitial cell, adenoma																									
Interstitial cell, adenoma	X	X	X	X	X	X	X																		

TABLE A2. INDIVIDUAL ANIMAL TUMOR PATHOLOGY OF MALE RATS: 0.75 mg/m³
(Continued)

DAYS ON STUDY	4	5	5	5	5	6	6	6	6	6	6	6	6	6	6	6	6	6	7	7	7	7	7	7	7	7		
	7	2	7	7	8	9	1	2	2	3	4	5	6	6	7	7	9	9	1	1	3	3	3	3	4	5	8	
CARCASS ID	3	3	3	3	3	3	3	3	3	3	3	3	3	3	3	3	3	3	3	3	3	3	3	3	3	3	3	
HEMATOPOIETIC SYSTEM																												
Bone marrow	+	+	+	+	+	+	+	+	+	+	+	+	+	+	+	+	A	+	+	+	+	+	+	+	+	+	+	
Lymph node	+	+	+	+	+	+	+	+	+	+	+	+	+	+	+	+	A	+	+	+	+	+	+	+	+	+	+	
Lymph node, bronchial	+	+	+	+	+	+	+	+	+	+	+	+	+	+	+	+	+	+	+	+	M	+	+	+	+	+	+	
Carcinoma, metastatic, kidney																												
Mesothelioma malignant, metastatic, testes																											X	
Lymph node, mandibular	+	+	+	+	+	+	+	+	+	+	+	+	+	+	I	A	+	+	+	+	+	+	+	+	+	+	+	
Spleen	+	+	+	+	+	+	+	+	+	+	+	+	+	+	+	+	+	+	+	+	+	+	+	+	+	+	+	
Mesothelioma malignant, metastatic, testes																												
Thymus	+	+	+	+	+	+	+	+	+	+	+	+	+	+	+	A	+	+	M	+	+	M	+	M	M	M	+	
INTEGUMENTARY SYSTEM																												
Mammary gland	M	+	M	M	M	M	M	M	M	+	M	M	M	M	+	M	+	M	M	+	+	+	+	+	M	+		
Fibroadenoma																												
Skin	+	+	+	+	+	+	+	+	+	+	+	+	+	+	+	+	+	+	+	+	+	+	+	+	+	+	+	
Keratoacanthoma																												
Subcutaneous tissue, fibroma						X	X				X																	
MUSCULOSKELETAL SYSTEM																												
Bone	+	+	+	+	+	+	+	+	+	+	+	+	+	+	+	+	+	+	+	+	+	+	+	+	+	+	+	
Osteosarcoma	X																											
Skeletal muscle																												
Carcinoma, metastatic, kidney																											+	
NERVOUS SYSTEM																												
Brain	+	+	+	+	+	+	+	+	+	+	+	+	+	+	+	+	+	+	+	+	+	+	+	+	+	+	+	
Carcinoma, metastatic, pituitary gland																												
Oligodendroglioma malignant																											X	
Meninges, carcinoma, metastatic, Zymbal gland																												
Zymbal gland																											X	
RESPIRATORY SYSTEM																												
Larynx	+	+	+	+	+	+	+	+	+	+	+	+	+	+	+	+	A	+	+	+	+	+	+	+	+	+	+	
Lung	+	+	+	+	+	+	+	+	+	+	+	+	+	+	+	+	+	+	+	+	+	+	+	+	+	+	+	
Carcinoma, metastatic, kidney																											M	
Carcinoma, metastatic, Zymbal gland																											X	
Mesothelioma malignant, metastatic, testes																												
Pheochromocytoma malignant, metastatic, adrenal gland																												
Nose	+	+	+	+	+	+	+	+	+	+	+	+	+	+	+	+	+	+	+	+	+	+	+	+	+	+	+	
Submucosa, adenocarcinoma																												
Vomerionasal organ, squamous cell carcinoma																												
Trachea	+	+	+	+	+	+	+	+	+	+	+	+	+	I	+	+	A	+	+	+	+	+	+	+	+	M	+	
SPECIAL SENSES SYSTEM																												
Eye	+	+	+	+	+	+	+	+	+	+	+	+	+	+	+	+	A	+	+	+	+	+	+	+	+	+	+	
Harderian gland																												
Adenocarcinoma																												
Zymbal gland																												
Carcinoma																												
URINARY SYSTEM																												
Kidney	+	+	+	+	+	+	+	+	+	+	+	+	+	+	+	+	+	+	+	+	+	+	+	+	+	+	+	
Renal tubule, carcinoma																												
Urinary bladder	+	+	+	+	+	+	+	+	+	+	+	+	+	+	+	+	A	+	+	+	+	+	+	+	+	+	+	
SYSTEMIC LESIONS																												
Multiple organs	+	+	+	+	+	+	+	+	+	+	+	+	+	+	+	+	+	+	+	+	+	+	+	+	+	+	+	
Leukemia mononuclear					X	X				X	X	X	X	X	X	X	X	X	X	X	X	X	X	X	X	X	X	
Mesothelioma malignant																												

TABLE A3. ANALYSIS OF PRIMARY NEOPLASMS IN MALE RATS IN THE TWO-YEAR INHALATION STUDY OF CS2

	Chamber Control	0.075 mg/m ³	0.25 mg/m ³	0.75 mg/m ³
Adrenal Medulla: Benign Pheochromocytoma				
Overall Rates (a)	18/42 (43%)	17/46 (37%)	13/47 (28%)	13/38 (34%)
Adjusted Rates (b)	60.6%	67.3%	43.3%	39.5%
Terminal Rates (c)	12/23 (52%)	8/15 (53%)	6/21 (29%)	6/23 (26%)
Day of First Observation	585	586	599	473
Life Table Tests (d)	P=0.092N	P=0.257	P=0.296N	P=0.193N
Logistic Regression Tests (d)	P=0.218N	P=0.483N	P=0.124N	P=0.241N
Cochran-Armitage Trend Test (d)	P=0.308N			
Fisher Exact Test (d)		P=0.364N	P=0.100N	P=0.287N
Adrenal Medulla: Malignant Pheochromocytoma				
Overall Rates (a)	4/42 (10%)	0/46 (0%)	4/47 (9%)	3/38 (8%)
Adjusted Rates (b)	17.4%	0.0%	14.3%	10.9%
Terminal Rates (c)	4/23 (17%)	0/15 (0%)	2/21 (10%)	2/23 (9%)
Day of First Observation	749		452	638
Life Table Tests (d)	P=0.554	P=0.125N	P=0.602	P=0.490N
Logistic Regression Tests (d)	P=0.426	P=0.125N	P=0.596N	P=0.520N
Cochran-Armitage Trend Test (d)	P=0.403			
Fisher Exact Test (d)		P=0.048N	P=0.578N	P=0.557N
Adrenal Medulla: Benign, Complex, or Malignant Pheochromocytoma				
Overall Rates (a)	20/42 (48%)	17/46 (37%)	16/47 (34%)	15/38 (39%)
Adjusted Rates (b)	65.0%	67.3%	49.8%	44.5%
Terminal Rates (c)	13/23 (57%)	8/15 (53%)	7/21 (33%)	7/23 (30%)
Day of First Observation	569	586	452	473
Life Table Tests (d)	P=0.126N	P=0.392	P=0.385N	P=0.196N
Logistic Regression Tests (d)	P=0.329N	P=0.278N	P=0.161N	P=0.267N
Cochran-Armitage Trend Test (d)	P=0.412N			
Fisher Exact Test (d)		P=0.213N	P=0.139N	P=0.306N
Preputial Gland: Adenoma				
Overall Rates (a)	3/50 (6%)	2/48 (4%)	2/46 (4%)	3/50 (6%)
Adjusted Rates (b)	8.1%	11.8%	10.0%	9.9%
Terminal Rates (c)	1/26 (4%)	2/17 (12%)	2/20 (10%)	2/26 (8%)
Day of First Observation	463	749	749	638
Life Table Tests (d)	P=0.588	P=0.603N	P=0.568N	P=0.637N
Logistic Regression Tests (d)	P=0.532	P=0.534N	P=0.538N	P=0.606
Cochran-Armitage Trend Test (d)	P=0.527			
Fisher Exact Test (d)		P=0.520N	P=0.540N	P=0.661N
Preputial Gland: Adenoma or Carcinoma				
Overall Rates (a)	3/50 (6%)	3/48 (6%)	3/46 (7%)	4/50 (8%)
Adjusted Rates (b)	8.1%	13.7%	12.2%	11.8%
Terminal Rates (c)	1/26 (4%)	2/17 (12%)	2/20 (10%)	2/26 (8%)
Day of First Observation	463	571	592	522
Life Table Tests (d)	P=0.490	P=0.581	P=0.608	P=0.528
Logistic Regression Tests (d)	P=0.380	P=0.620	P=0.624	P=0.388
Cochran-Armitage Trend Test (d)	P=0.423			
Fisher Exact Test (d)		P=0.641	P=0.621	P=0.500
Pancreatic Islets: Adenoma				
Overall Rates (a)	1/50 (2%)	(e,f) 5/36 (14%)	(e,g) 2/27 (7%)	2/48 (4%)
Adjusted Rates (b)	3.7%			7.7%
Terminal Rates (c)	0/26 (0%)			2/26 (8%)
Day of First Observation	747			749
Life Table Test (d)				P=0.496
Logistic Regression Test (d)				P=0.501
Fisher Exact Test (d)				P=0.485

TABLE A3. ANALYSIS OF PRIMARY NEOPLASMS IN MALE RATS IN THE TWO-YEAR INHALATION STUDY OF CS2 (Continued)

	Chamber Control	0.075 mg/m ³	0.25 mg/m ³	0.75 mg/m ³
Liver: Neoplastic Nodule or Hepatocellular Adenoma				
Overall Rates (a)	2/50 (4%)	3/50 (6%)	0/49 (0%)	2/50 (4%)
Adjusted Rates (b)	7.7%	16.2%	0.0%	5.9%
Terminal Rates (c)	2/26 (8%)	2/17 (12%)	0/21 (0%)	1/26 (4%)
Day of First Observation	749	737		581
Life Table Tests (d)	P = 0.480N	P = 0.318	P = 0.286N	P = 0.679N
Logistic Regression Tests (d)	P = 0.516N	P = 0.367	P = 0.286N	P = 0.682N
Cochran-Armitage Trend Test (d)	P = 0.549N			
Fisher Exact Test (d)		P = 0.500	P = 0.253N	P = 0.691N
Liver: Neoplastic Nodule, Hepatocellular Adenoma, or Hepatocellular Carcinoma				
Overall Rates (a)	4/50 (8%)	3/50 (6%)	0/49 (0%)	2/50 (4%)
Adjusted Rates (b)	13.4%	16.2%	0.0%	5.9%
Terminal Rates (c)	3/26 (12%)	2/17 (12%)	0/21 (0%)	1/26 (4%)
Day of First Observation	508	737		581
Life Table Tests (d)	P = 0.252N	P = 0.623	P = 0.086N	P = 0.324N
Logistic Regression Tests (d)	P = 0.289N	P = 0.500N	P = 0.066N	P = 0.350N
Cochran-Armitage Trend Test (d)	P = 0.302N			
Fisher Exact Test (d)		P = 0.500N	P = 0.061N	P = 0.339N
Lung: Alveolar/Bronchiolar Adenoma				
Overall Rates (a)	4/50 (8%)	2/49 (4%)	1/50 (2%)	0/50 (0%)
Adjusted Rates (b)	15.4%	10.0%	2.9%	0.0%
Terminal Rates (c)	4/26 (15%)	1/17 (6%)	0/21 (0%)	0/26 (0%)
Day of First Observation	749	728	667	
Life Table Tests (d)	P = 0.044N	P = 0.528N	P = 0.232N	P = 0.061N
Logistic Regression Tests (d)	P = 0.045N	P = 0.455N	P = 0.200N	P = 0.061N
Cochran-Armitage Trend Test (d)	P = 0.052N			
Fisher Exact Test (d)		P = 0.349N	P = 0.181N	P = 0.059N
Lung: Alveolar/Bronchiolar Adenoma or Carcinoma				
Overall Rates (a)	4/50 (8%)	4/49 (8%)	1/50 (2%)	0/50 (0%)
Adjusted Rates (b)	15.4%	17.8%	2.9%	0.0%
Terminal Rates (c)	4/26 (15%)	2/17 (12%)	0/21 (0%)	0/26 (0%)
Day of First Observation	749	667	667	
Life Table Tests (d)	P = 0.024N	P = 0.453	P = 0.232N	P = 0.061N
Logistic Regression Tests (d)	P = 0.024N	P = 0.589	P = 0.200N	P = 0.061N
Cochran-Armitage Trend Test (d)	P = 0.029N			
Fisher Exact Test (d)		P = 0.631	P = 0.181N	P = 0.059N
Pituitary Gland/Pars Distalis: Adenoma				
Overall Rates (a)	25/47 (53%)	25/43 (58%)	25/40 (63%)	25/47 (53%)
Adjusted Rates (b)	67.4%	94.2%	89.2%	69.9%
Terminal Rates (c)	14/25 (56%)	9/10 (90%)	10/12 (83%)	15/25 (60%)
Day of First Observation	438	485	389	612
Life Table Tests (d)	P = 0.181N	P = 0.050	P = 0.085	P = 0.525N
Logistic Regression Tests (d)	P = 0.382N	P = 0.375	P = 0.252	P = 0.547N
Cochran-Armitage Trend Test (d)	P = 0.447N			
Fisher Exact Test (d)		P = 0.398	P = 0.256	P = 0.582N
Pituitary Gland/Pars Distalis: Carcinoma				
Overall Rates (a)	1/47 (2%)	3/43 (7%)	2/40 (5%)	2/47 (4%)
Adjusted Rates (b)	2.8%	9.6%	16.7%	8.0%
Terminal Rates (c)	0/25 (0%)	0/10 (0%)	2/12 (17%)	2/25 (8%)
Day of First Observation	655	553	749	749
Life Table Tests (d)	P = 0.590N	P = 0.297	P = 0.335	P = 0.509
Logistic Regression Tests (d)	P = 0.608N	P = 0.277	P = 0.390	P = 0.517
Cochran-Armitage Trend Test (d)	P = 0.603			
Fisher Exact Test (d)		P = 0.275	P = 0.439	P = 0.500

TABLE A3. ANALYSIS OF PRIMARY NEOPLASMS IN MALE RATS IN THE TWO-YEAR INHALATION STUDY OF CS₂ (Continued)

	Chamber Control	0.075 mg/m ³	0.25 mg/m ³	0.75 mg/m ³
Pituitary Gland/Pars Distalis: Adenoma or Carcinoma				
Overall Rates (a)	26/47 (55%)	28/43 (65%)	27/40 (68%)	27/47 (57%)
Adjusted Rates (b)	68.3%	94.7%	100.0%	75.9%
Terminal Rates (c)	14/25 (56%)	9/10 (90%)	12/12 (100%)	17/25 (68%)
Day of First Observation	438	485	389	612
Life Table Tests (d)	P=0.170N	P=0.029	P=0.049	P=0.546
Logistic Regression Tests (d)	P=0.375N	P=0.218	P=0.160	P=0.544
Cochran-Armitage Trend Test (d)	P=0.453N			
Fisher Exact Test (d)		P=0.232	P=0.174	P=0.500
Skin: Keratoacanthoma				
Overall Rates (h)	0/50 (0%)	1/50 (2%)	3/50 (6%)	3/50 (6%)
Adjusted Rates (b)	0.0%	2.3%	12.1%	9.9%
Terminal Rates (c)	0/26 (0%)	0/17 (0%)	2/21 (10%)	2/26 (8%)
Day of First Observation		586	667	638
Life Table Tests (d)	P=0.145	P=0.529	P=0.100	P=0.130
Logistic Regression Tests (d)	P=0.113	P=0.461	P=0.111	P=0.128
Cochran-Armitage Trend Test (d)	P=0.107			
Fisher Exact Test (d)		P=0.500	P=0.121	P=0.121
Subcutaneous Tissue: Fibroma				
Overall Rates (h)	2/50 (4%)	1/50 (2%)	0/50 (0%)	3/50 (6%)
Adjusted Rates (b)	7.7%	2.6%	0.0%	7.4%
Terminal Rates (c)	2/26 (8%)	0/17 (0%)	0/21 (0%)	0/26 (0%)
Day of First Observation	749	667		581
Life Table Tests (d)	P=0.306	P=0.585N	P=0.286N	P=0.537
Logistic Regression Tests (d)	P=0.248	P=0.506N	P=0.286N	P=0.486
Cochran-Armitage Trend Test (d)	P=0.256			
Fisher Exact Test (d)		P=0.500N	P=0.247N	P=0.500
Testis: Interstitial Cell Adenoma				
Overall Rates (a)	31/50 (62%)	38/47 (81%)	36/50 (72%)	41/50 (82%)
Adjusted Rates (b)	83.2%	97.0%	97.1%	93.0%
Terminal Rates (c)	20/26 (77%)	13/14 (93%)	20/21 (95%)	23/26 (88%)
Day of First Observation	508	560	529	473
Life Table Tests (d)	P=0.465	P=0.004	P=0.063	P=0.096
Logistic Regression Tests (d)	P=0.137	P=0.033	P=0.150	P=0.041
Cochran-Armitage Trend Test (d)	P=0.069			
Fisher Exact Test (d)		P=0.033	P=0.198	P=0.022
Thyroid Gland: C-Cell Adenoma				
Overall Rates (a)	2/48 (4%)	9/49 (18%)	7/46 (15%)	6/48 (13%)
Adjusted Rates (b)	7.7%	35.5%	22.8%	17.2%
Terminal Rates (c)	2/26 (8%)	2/17 (12%)	2/20 (10%)	2/26 (8%)
Day of First Observation	749	702	571	577
Life Table Tests (d)	P=0.543	P=0.009	P=0.060	P=0.157
Logistic Regression Tests (d)	P=0.450	P=0.019	P=0.071	P=0.139
Cochran-Armitage Trend Test (d)	P=0.428			
Fisher Exact Test (d)		P=0.028	P=0.070	P=0.134
Thyroid Gland: C-Cell Adenoma or Carcinoma				
Overall Rates (a)	2/48 (4%)	10/49 (20%)	9/46 (20%)	6/48 (13%)
Adjusted Rates (b)	7.7%	38.7%	28.0%	17.2%
Terminal Rates (c)	2/26 (8%)	2/17 (12%)	2/20 (10%)	2/26 (8%)
Day of First Observation	749	702	571	577
Life Table Tests (d)	P=0.520N	P=0.005	P=0.021	P=0.157
Logistic Regression Tests (d)	P=0.521	P=0.010	P=0.023	P=0.139
Cochran-Armitage Trend Test (d)	P=0.496			
Fisher Exact Test (d)		P=0.015	P=0.021	P=0.134

TABLE A3. ANALYSIS OF PRIMARY NEOPLASMS IN MALE RATS IN THE TWO-YEAR INHALATION STUDY OF CS₂ (Continued)

	Chamber Control	0.075 mg/m ³	0.25 mg/m ³	0.75 mg/m ³
Hematopoietic System: Mononuclear Leukemia				
Overall Rates (h)	29/50 (58%)	35/50 (70%)	30/50 (60%)	28/50 (56%)
Adjusted Rates (b)	71.3%	86.0%	73.4%	72.2%
Terminal Rates (c)	15/26 (58%)	12/17 (71%)	11/21 (52%)	16/26 (62%)
Day of First Observation	508	553	389	577
Life Table Tests (d)	P=0.134N	P=0.054	P=0.311	P=0.440N
Logistic Regression Tests (d)	P=0.215N	P=0.155	P=0.493	P=0.453N
Cochran-Armitage Trend Test (d)	P=0.242N			
Fisher Exact Test (d)		P=0.149	P=0.500	P=0.500N
All Sites: Mesothelioma				
Overall Rates (h)	1/50 (2%)	3/50 (6%)	3/50 (6%)	1/50 (2%)
Adjusted Rates (b)	3.8%	12.8%	11.5%	2.2%
Terminal Rates (c)	1/26 (4%)	1/17 (6%)	2/21 (10%)	0/26 (0%)
Day of First Observation	749	690	536	606
Life Table Tests (d)	P=0.360N	P=0.216	P=0.252	P=0.742N
Logistic Regression Tests (d)	P=0.407N	P=0.288	P=0.300	P=0.756
Cochran-Armitage Trend Test (d)	P=0.414N			
Fisher Exact Test (d)		P=0.309	P=0.309	P=0.753N
All Sites: Benign Tumors				
Overall Rates (h)	46/50 (92%)	45/50 (90%)	47/50 (94%)	48/50 (96%)
Adjusted Rates (b)	100.0%	100.0%	100.0%	98.0%
Terminal Rates (c)	26/26 (100%)	17/17 (100%)	21/21 (100%)	25/26 (96%)
Day of First Observation	438	485	389	473
Life Table Tests (d)	P=0.319N	P=0.124	P=0.197	P=0.536
Logistic Regression Tests (d)	P=0.272	P=0.405N	P=0.478	P=0.412
Cochran-Armitage Trend Test (d)	P=0.200			
Fisher Exact Test (d)		P=0.500N	P=0.500	P=0.339
All Sites: Malignant Tumors				
Overall Rates (h)	33/50 (66%)	42/50 (84%)	37/50 (74%)	37/50 (74%)
Adjusted Rates (b)	79.6%	95.2%	81.5%	81.5%
Terminal Rates (c)	18/26 (69%)	15/17 (88%)	13/21 (62%)	18/26 (69%)
Day of First Observation	508	485	389	473
Life Table Tests (d)	P=0.282N	P=0.014	P=0.165	P=0.400
Logistic Regression Tests (d)	P=0.535	P=0.035	P=0.254	P=0.264
Cochran-Armitage Trend Test (d)	P=0.532			
Fisher Exact Test (d)		P=0.032	P=0.257	P=0.257
All Sites: All Tumors				
Overall Rates (h)	50/50 (100%)	49/50 (98%)	50/50 (100%)	50/50 (100%)
Adjusted Rates (b)	100.0%	100.0%	100.0%	100.0%
Terminal Rates (c)	26/26 (100%)	17/17 (100%)	21/21 (100%)	26/26 (100%)
Day of First Observation	438	485	389	473
Life Table Tests (d)	P=0.215N	P=0.151	P=0.254	P=0.454N
Logistic Regression Tests (d)	P=0.797	P=0.282N	P=5.000	P=5.000
Cochran-Armitage Trend Test (d)	P=0.576			
Fisher Exact Test (d)		P=0.500N	P=1.000N	P=1.000N

(a) Number of tumor-bearing animals/number of animals examined microscopically at the site

(b) Kaplan-Meier estimated tumor incidences at the end of the study after adjusting for intercurrent mortality

(c) Observed tumor incidence in animals killed at the end of the study

(d) Beneath the control incidence are the P values associated with the trend test. Beneath the dosed group incidence are the P values corresponding to pairwise comparisons between that dosed group and the controls. The life table analysis regards tumors in animals dying prior to terminal kill as being (directly or indirectly) the cause of death. The logistic regression test regards these lesions as nonfatal. The Cochran-Armitage and Fisher exact tests compare directly the overall incidence rates. A negative trend or lower incidence in a dosed group than in controls is indicated by (N).

(e) Incomplete sampling of tissues

(f) A carcinoma was observed in an additional animal.

(g) Carcinomas were observed in two additional animals.

(h) Number of tumor-bearing animals/number of animals examined grossly at the site

TABLE A4a. HISTORICAL INCIDENCE OF THYROID GLAND C-CELL NEOPLASMS IN MALE F344/N RATS (a)

Study	Incidence in Controls		
	Adenoma	Carcinoma	Adenoma or Carcinoma
Historical Incidence for Chamber Controls at Battelle Pacific Northwest Laboratories			
Propylene oxide	1/44	0/44	1/44
Methyl methacrylate	2/50	2/50	4/50
Propylene	2/45	2/45	4/45
1,2-Epoxybutane	4/49	0/49	4/49
Dichloromethane	1/49	1/49	2/49
Tetrachloroethylene	3/47	4/47	7/47
Bromoethane	4/46	0/46	4/46
TOTAL	17/330 (5.2%)	9/330 (2.7%)	26/330 (7.9%)
SD (b)	2.68%	3.18%	4.02%
Range (c)			
High	4/46	4/47	7/47
Low	1/49	0/49	1/44
Overall Historical Incidence for Untreated Controls in NTP Studies			
TOTAL	155/1,576 (9.8%)	51/1,576 (3.2%)	205/1,576 (13.0%)
SD (b)	5.94%	3.70%	6.55%
Range (c)			
High	11/49	6/49	15/50
Low	0/49	0/50	1/50

(a) Data as of March 1, 1989, for studies of at least 104 weeks
 (b) Standard deviation
 (c) Range and SD are presented for groups of 35 or more animals.

TABLE A4b. HISTORICAL INCIDENCE OF TESTICULAR INTERSTITIAL CELL NEOPLASMS IN MALE F344/N RATS (a)

Study	Incidence of Interstitial Cell Tumors in Controls
Historical Incidence for Chamber Controls at Battelle Pacific Northwest Laboratories	
Propylene oxide	29/49
Methyl methacrylate	35/50
Propylene	37/50
1,2-Epoxybutane	39/50
Dichloromethane	39/50
Tetrachloroethylene	35/50
Bromoethane	42/48
TOTAL	256/347 (73.8%)
SD (b)	8.81%
Range (c)	
High	42/48
Low	29/49
Overall Historical Incidence for Untreated Controls in NTP Studies	
TOTAL	1,401/1,582 (88.6%)
SD (b)	7.33%
Range (c)	
High	49/49
Low	32/50

(a) Data as of March 1, 1989, for studies of at least 104 weeks
 (b) Standard deviation
 (c) Range and SD are presented for groups of 35 or more animals.

TABLE A5. SUMMARY OF THE INCIDENCE OF NONNEOPLASTIC LESIONS IN MALE RATS IN THE TWO-YEAR INHALATION STUDY OF CS₂

	Chamber Control	0.075 mg/m ³	0.25 mg/m ³	0.75 mg/m ³
DISPOSITION SUMMARY				
Animals initially in study	50	50	50	50
Early deaths				
Moribund	19	27	21	20
Dead	5	6	8	4
Survivors				
Terminal sacrifice	26	17	21	26
Animals examined microscopically	50	50	50	50
ALIMENTARY SYSTEM				
Esophagus	(49)	(33)	(28)	(48)
Inflammation, suppurative			1 (4%)	
Intestine large, cecum	(44)	(26)	(21)	(44)
Hemorrhage	1 (2%)			
Inflammation, suppurative	2 (5%)			
Parasite metazoan	4 (9%)		1 (5%)	6 (14%)
Intestine large, colon	(48)	(32)	(24)	(46)
Parasite metazoan	6 (13%)	7 (22%)	3 (13%)	8 (17%)
Intestine large, rectum	(45)	(30)	(20)	(45)
Inflammation, suppurative	1 (2%)			
Parasite metazoan	3 (7%)	2 (7%)		4 (9%)
Ulcer	1 (2%)			
Intestine small, ileum	(42)	(22)	(18)	(43)
Hyperplasia, lymphoid	9 (21%)			4 (9%)
Parasite metazoan	1 (2%)			
Intestine small, jejunum	(41)	(18)	(12)	(39)
Parasite metazoan				1 (3%)
Liver	(50)	(50)	(49)	(50)
Angiectasis	3 (6%)	5 (10%)	8 (16%)	3 (6%)
Basophilic focus	17 (34%)	7 (14%)	10 (20%)	23 (46%)
Clear cell focus	9 (18%)	2 (4%)	3 (6%)	4 (8%)
Congestion				1 (2%)
Degeneration	3 (6%)		2 (4%)	
Degeneration, cystic	1 (2%)	7 (14%)	7 (14%)	3 (6%)
Degeneration, fatty	16 (32%)	24 (48%)	11 (22%)	10 (20%)
Eosinophilic focus				1 (2%)
Hematopoietic cell proliferation	1 (2%)	1 (2%)	5 (10%)	5 (10%)
Hepatodiaphragmatic nodule	7 (14%)	5 (10%)	7 (14%)	9 (18%)
Hyperplasia		1 (2%)	2 (4%)	
Inflammation, granulomatous, focal	14 (28%)	13 (26%)	8 (16%)	8 (16%)
Leukocytosis	5 (10%)	1 (2%)	1 (2%)	1 (2%)
Necrosis	8 (16%)	10 (20%)	11 (22%)	7 (14%)
Thrombus	1 (2%)			
Bile duct, hyperplasia	40 (80%)	32 (64%)	31 (63%)	31 (62%)
Mesentery	(5)	(3)	(2)	(4)
Hemorrhage			1 (50%)	
Fat, inflammation, chronic	2 (40%)	1 (33%)	1 (50%)	2 (50%)
Fat, necrosis	5 (100%)	2 (67%)	1 (50%)	2 (50%)
Pancreas	(50)	(33)	(26)	(48)
Hemorrhage	1 (2%)			
Thrombus			1 (4%)	
Acinus, atrophy	22 (44%)	10 (30%)	9 (35%)	15 (31%)
Acinus, necrosis				1 (2%)
Pharynx	(1)	(1)	(2)	(4)
Palate, cyst				1 (25%)
Palate, developmental malformation				2 (50%)
Palate, inflammation			1 (50%)	
Palate, inflammation, chronic		1 (100%)		1 (25%)
Salivary glands	(49)	(33)	(27)	(49)
Inflammation, suppurative	12 (24%)	6 (18%)	5 (19%)	13 (27%)
Duct, hyperplasia	15 (31%)	16 (48%)	9 (33%)	16 (33%)

TABLE A5. SUMMARY OF THE INCIDENCE OF NONNEOPLASTIC LESIONS IN MALE RATS IN THE TWO-YEAR INHALATION STUDY OF CS2 (Continued)

	Chamber Control	0.075 mg/m ³	0.25 mg/m ³	0.75 mg/m ³
ALIMENTARY SYSTEM (Continued)				
Stomach, forestomach	(50)	(33)	(28)	(50)
Inflammation, chronic	13 (26%)	9 (27%)	3 (11%)	3 (6%)
Inflammation, suppurative	1 (2%)		1 (4%)	1 (2%)
Mineralization			1 (4%)	
Ulcer	12 (24%)	7 (21%)	2 (7%)	4 (8%)
Epithelium, hyperplasia	13 (26%)	11 (33%)	4 (14%)	4 (8%)
Stomach, glandular	(50)	(32)	(28)	(49)
Ectopic tissue			1 (4%)	
Hemorrhage		1 (3%)		2 (4%)
Infiltration cellular, eosinophilic	1 (2%)			
Inflammation, chronic	1 (2%)	5 (16%)	1 (4%)	
Inflammation, suppurative	8 (16%)	4 (13%)		1 (2%)
Mineralization	4 (8%)		1 (4%)	1 (2%)
Pigmentation, hemosiderin		3 (9%)	1 (4%)	
Ulcer	8 (16%)	9 (28%)	2 (7%)	3 (6%)
Tooth		(1)		
Inflammation, chronic		1 (100%)		
CARDIOVASCULAR SYSTEM				
Blood vessel	(3)		(1)	
Mineralization	3 (100%)		1 (100%)	
Heart	(50)	(35)	(30)	(50)
Cardiomyopathy	47 (94%)	34 (97%)	30 (100%)	48 (96%)
Mineralization	1 (2%)		1 (3%)	
Atrium, congestion		1 (3%)	1 (3%)	
Atrium, thrombus	3 (6%)	1 (3%)	5 (17%)	3 (6%)
Ventricle, thrombus			1 (3%)	
ENDOCRINE SYSTEM				
Adrenal gland, cortex	(50)	(50)	(48)	(49)
Degeneration, fatty	22 (44%)	26 (52%)	21 (44%)	24 (49%)
Focal cellular change	3 (6%)	1 (2%)	2 (4%)	2 (4%)
Hematopoietic cell proliferation	6 (12%)	5 (10%)	4 (8%)	16 (33%)
Hyperplasia	4 (8%)	3 (6%)	2 (4%)	2 (4%)
Hypertrophy	1 (2%)			
Necrosis	1 (2%)	1 (2%)		
Adrenal gland, medulla	(42)	(46)	(47)	(38)
Hematopoietic cell proliferation				1 (3%)
Hyperplasia	15 (36%)	19 (41%)	19 (40%)	17 (45%)
Necrosis	1 (2%)		1 (2%)	
Islets, pancreatic	(50)	(36)	(27)	(48)
Hyperplasia	3 (6%)	1 (3%)		3 (6%)
Parathyroid gland	(42)	(32)	(27)	(41)
Hyperplasia	2 (5%)	4 (13%)	3 (11%)	3 (7%)
Thrombus			1 (4%)	
Pituitary gland	(47)	(43)	(40)	(47)
Pars distalis, angiectasis		1 (2%)		
Pars distalis, cyst	1 (2%)	1 (2%)	3 (8%)	1 (2%)
Pars distalis, hemorrhage	1 (2%)		1 (3%)	1 (2%)
Pars distalis, hyperplasia	12 (26%)	5 (12%)	9 (23%)	12 (26%)
Pars distalis, inflammation, suppurative	1 (2%)			
Pars intermedia, hyperplasia				1 (2%)
Thyroid gland	(48)	(49)	(46)	(48)
C-cell, hyperplasia	8 (17%)	5 (10%)	10 (22%)	9 (19%)
Follicular cell, hyperplasia	1 (2%)	1 (2%)	1 (2%)	
GENERAL BODY SYSTEM				
None				

TABLE A5. SUMMARY OF THE INCIDENCE OF NONNEOPLASTIC LESIONS IN MALE RATS IN THE TWO-YEAR INHALATION STUDY OF CS2 (Continued)

	Chamber Control	0.075 mg/m ³	0.25 mg/m ³	0.75 mg/m ³
GENITAL SYSTEM				
Penis			(1)	(1)
Inflammation, suppurative				1 (100%)
Preputial gland	(50)	(48)	(46)	(50)
Cyst	2 (4%)		1 (2%)	
Hyperplasia				1 (2%)
Hyperplasia, squamous				1 (2%)
Inflammation, suppurative	9 (18%)	8 (17%)	14 (30%)	10 (20%)
Prostate	(50)	(34)	(27)	(50)
Hyperplasia	6 (12%)	1 (3%)	1 (4%)	10 (20%)
Inflammation, suppurative	23 (46%)	21 (62%)	14 (52%)	18 (36%)
Seminal vesicle	(7)	(3)	(6)	(8)
Dilatation		2 (67%)	2 (33%)	1 (13%)
Inflammation, suppurative	6 (86%)	1 (33%)	2 (33%)	6 (75%)
Testes	(50)	(47)	(50)	(50)
Atrophy	14 (28%)	14 (30%)	17 (34%)	14 (28%)
Necrosis	1 (2%)			
Interstitial cell, hyperplasia	6 (12%)	10 (21%)	11 (22%)	6 (12%)
Perivascular, inflammation	5 (10%)	2 (4%)	4 (8%)	6 (12%)
Tunic, hyperplasia		1 (2%)		
HEMATOPOIETIC SYSTEM				
Bone marrow	(50)	(33)	(26)	(49)
Depletion	1 (2%)			
Hyperplasia, neutrophil	1 (2%)			
Myelofibrosis	2 (4%)	4 (12%)	2 (8%)	2 (4%)
Lymph node	(50)	(35)	(30)	(49)
Hyperplasia, plasma cell	1 (2%)			
Mediastinal, congestion		1 (3%)		
Mesenteric, angiectasis		1 (3%)		
Mesenteric, inflammation, granulomatous, focal	1 (2%)	1 (3%)		
Mesenteric, pigmentation, hemosiderin	1 (2%)			
Renal, congestion	1 (2%)			
Renal, hyperplasia	2 (4%)			
Lymph node, bronchial	(50)	(29)	(25)	(47)
Hyperplasia	5 (10%)		1 (4%)	8 (17%)
Inflammation, granulomatous, focal	1 (2%)			1 (2%)
Inflammation, suppurative			1 (4%)	
Pigmentation, hemosiderin	1 (2%)			
Lymph node, mandibular	(47)	(27)	(28)	(46)
Fibrosis			1 (4%)	
Hyperplasia	21 (45%)	6 (22%)	1 (4%)	18 (39%)
Inflammation, granulomatous, focal				2 (4%)
Spleen	(50)	(49)	(49)	(50)
Ectopic tissue	1 (2%)			
Fibrosis	3 (6%)	6 (12%)	7 (14%)	10 (20%)
Hematopoietic cell proliferation	1 (2%)	1 (2%)	1 (2%)	7 (14%)
Inflammation, granulomatous		1 (2%)	1 (2%)	1 (2%)
Metaplasia, osseous				1 (2%)
Necrosis	3 (6%)	1 (2%)	1 (2%)	2 (4%)
Pigmentation, hemosiderin		1 (2%)		
Thrombus				1 (2%)
INTEGUMENTARY SYSTEM				
Mammary gland	(21)	(10)	(12)	(24)
Galactocele	7 (33%)	6 (60%)	2 (17%)	8 (33%)
Hyperplasia	6 (29%)	1 (10%)	6 (50%)	8 (33%)
Inflammation, chronic		2 (20%)		1 (4%)

TABLE A5. SUMMARY OF THE INCIDENCE OF NONNEOPLASTIC LESIONS IN MALE RATS IN THE TWO-YEAR INHALATION STUDY OF CS2 (Continued)

	Chamber Control	0.075 mg/m ³	0.25 mg/m ³	0.75 mg/m ³
INTEGUMENTARY SYSTEM (Continued)				
Skin	(49)	(32)	(30)	(50)
Atrophy				1 (2%)
Cyst epithelial inclusion			1 (3%)	
Inflammation, suppurative	1 (2%)			
Ulcer	1 (2%)			
Epidermis, hyperplasia		1 (3%)		
Subcutaneous tissue, fibrosis			1 (3%)	
MUSCULOSKELETAL SYSTEM				
Bone	(50)	(33)	(29)	(50)
Fibrous osteodystrophy	5 (10%)	2 (6%)	1 (3%)	2 (4%)
Periosteum, proliferation	3 (6%)	1 (3%)		15 (30%)
NERVOUS SYSTEM				
Brain	(50)	(33)	(30)	(50)
Hemorrhage	2 (4%)	2 (6%)	4 (13%)	3 (6%)
Hydrocephalus				1 (2%)
Inflammation, suppurative	1 (2%)			
Necrosis		1 (3%)		
Meninges, pigmentation, hemosiderin	1 (2%)			
Meninges, thrombus				1 (2%)
RESPIRATORY SYSTEM				
Larynx	(49)	(30)	(25)	(48)
Inflammation			1 (4%)	
Inflammation, suppurative	22 (45%)	19 (63%)	13 (52%)	22 (46%)
Metaplasia, squamous			1 (4%)	3 (6%)
Epithelium, hyperplasia	1 (2%)		1 (4%)	
Lung	(50)	(49)	(50)	(50)
Congestion	1 (2%)	2 (4%)	2 (4%)	5 (10%)
Edema			1 (2%)	
Hemorrhage	3 (6%)	1 (2%)	3 (6%)	5 (10%)
Inflammation, chronic, focal	13 (26%)	11 (22%)	14 (28%)	9 (18%)
Inflammation, granulomatous, focal	1 (2%)			
Mineralization	2 (4%)		1 (2%)	
Pigmentation, hemosiderin			1 (2%)	
Alveolar epithelium, hyperplasia	5 (10%)	5 (10%)	4 (8%)	7 (14%)
Alveolus, infiltration cellular, histiocytic	3 (6%)	9 (18%)	6 (12%)	8 (16%)
Peribronchial, infiltration cellular, mononuclear cell	1 (2%)			
Perivascular, infiltration cellular, mononuclear cell	18 (36%)	12 (24%)	19 (38%)	24 (48%)
Nose	(50)	(50)	(49)	(50)
Hemorrhage				1 (2%)
Hyperplasia, adenomatous		1 (2%)		
Inflammation	28 (56%)	19 (38%)	24 (49%)	48 (96%)
Inflammation, suppurative	46 (92%)	45 (90%)	46 (94%)	47 (94%)
Thrombus	11 (22%)	10 (20%)	9 (18%)	1 (2%)
Nasolacrimal duct, inflammation, suppurative	17 (34%)	14 (28%)	14 (29%)	13 (26%)
Olfactory epithelium, degeneration	1 (2%)	4 (8%)	3 (6%)	27 (54%)
Olfactory epithelium, metaplasia	2 (4%)	4 (8%)	10 (20%)	13 (26%)
Olfactory epithelium, metaplasia, squamous			1 (2%)	6 (12%)
Respiratory epithelium, hyperplasia	12 (24%)	11 (22%)	12 (24%)	48 (96%)
Respiratory epithelium, metaplasia, squamous	4 (8%)	5 (10%)	6 (12%)	44 (88%)
Submucosa, hyperplasia				3 (6%)
Vomeronasal organ, inflammation, suppurative	3 (6%)	7 (14%)	6 (12%)	8 (16%)

TABLE A5. SUMMARY OF THE INCIDENCE OF NONNEOPLASTIC LESIONS IN MALE RATS IN THE TWO-YEAR INHALATION STUDY OF CS2 (Continued)

	Chamber Control	0.075 mg/m ³	0.25 mg/m ³	0.75 mg/m ³
RESPIRATORY SYSTEM (Continued)				
Trachea	(49)	(29)	(26)	(47)
Inflammation, suppurative	2 (4%)	3 (10%)	2 (8%)	5 (11%)
Epithelium, hyperplasia	1 (2%)			
SPECIAL SENSES SYSTEM				
Eye	(48)	(6)	(4)	(49)
Inflammation, chronic				1 (2%)
Synchia			1 (25%)	2 (4%)
Anterior chamber, inflammation, suppurative	3 (6%)	1 (17%)		3 (6%)
Cornea, degeneration	1 (2%)			2 (4%)
Cornea, inflammation, suppurative	2 (4%)	3 (50%)		4 (8%)
Cornea, mineralization	2 (4%)			2 (4%)
Lens, degeneration	3 (6%)	3 (50%)		2 (4%)
Lids, inflammation, suppurative	1 (2%)			
Retina, degeneration	2 (4%)	3 (50%)		2 (4%)
Harderian gland	(7)			(1)
Inflammation, suppurative	5 (71%)			
Metaplasia, squamous	1 (14%)			
Acinus, hyperplasia	1 (14%)			
URINARY SYSTEM				
Kidney	(50)	(44)	(39)	(50)
Cyst			2 (5%)	
Hematopoietic cell proliferation	1 (2%)			
Hemorrhage			1 (3%)	
Hydronephrosis		1 (2%)		
Infarct		1 (2%)		
Inflammation, suppurative		2 (5%)	2 (5%)	2 (4%)
Mineralization	1 (2%)	1 (2%)	1 (3%)	
Nephropathy	50 (100%)	43 (98%)	39 (100%)	50 (100%)
Pigmentation, hemosiderin		1 (2%)		
Papilla, necrosis			1 (3%)	
Pelvis, epithelium, hyperplasia	1 (2%)	2 (5%)		1 (2%)
Renal tubule, hyperplasia	1 (2%)	6 (14%)	1 (3%)	3 (6%)
Urinary bladder	(49)	(31)	(27)	(49)
Calculus gross observation			1 (4%)	
Calculus micro observation only			1 (4%)	
Hemorrhage			2 (7%)	
Inflammation		1 (3%)		1 (2%)
Inflammation, suppurative	1 (2%)	3 (10%)	4 (15%)	
Transitional epithelium, hyperplasia	1 (2%)	2 (6%)	1 (4%)	2 (4%)

APPENDIX B

SUMMARY OF LESIONS IN FEMALE RATS IN THE TWO-YEAR INHALATION STUDY OF CS₂

		PAGE
TABLE B1	SUMMARY OF THE INCIDENCE OF NEOPLASMS IN FEMALE RATS IN THE TWO-YEAR INHALATION STUDY OF CS ₂	91
TABLE B2	INDIVIDUAL ANIMAL TUMOR PATHOLOGY OF FEMALE RATS IN THE TWO-YEAR INHALATION STUDY OF CS ₂	94
TABLE B3	ANALYSIS OF PRIMARY NEOPLASMS IN FEMALE RATS IN THE TWO-YEAR INHALATION STUDY OF CS ₂	110
TABLE B4	HISTORICAL INCIDENCE OF KIDNEY TUBULAR CELL NEOPLASMS IN FEMALE F344/N RATS	114
TABLE B5	SUMMARY OF THE INCIDENCE OF NONNEOPLASTIC LESIONS IN FEMALE RATS IN THE TWO-YEAR INHALATION STUDY OF CS ₂	115

TABLE B1. SUMMARY OF THE INCIDENCE OF NEOPLASMS IN FEMALE RATS IN THE TWO-YEAR INHALATION STUDY OF CS₂

	Chamber Control	0.075 mg/m ³	0.25 mg/m ³	0.75 mg/m ³
DISPOSITION SUMMARY				
Animals initially in study	50	50	50	50
Early deaths				
Dead	7	5	9	4
Moribund	23	21	12	19
Survivors				
Terminal sacrifice	20	24	29	27
Animals examined microscopically	50	50	50	50
ALIMENTARY SYSTEM				
Intestine large, cecum	(40)	(20)	(10)	(46)
Intestine large, colon	(45)	(20)	(15)	(47)
Intestine large, rectum	(47)	(23)	(14)	(43)
Adenoma				1 (2%)
Intestine small, ileum	(31)	(18)	(4)	(40)
Leiomyosarcoma	1 (3%)			
Liver	(49)	(50)	(50)	(50)
Hepatocellular carcinoma		1 (2%)		
Neoplasm, NOS, metastatic, adrenal gland		1 (2%)		
Neoplastic nodule	3 (6%)			
Mesentery	(4)	(4)	(2)	
Pancreas	(49)	(25)	(19)	(50)
Salivary glands	(49)	(25)	(19)	(50)
Stomach, forestomach	(48)	(33)	(21)	(50)
Papilloma squamous	1 (2%)			
Stomach, glandular	(49)	(31)	(20)	(50)
CARDIOVASCULAR SYSTEM				
Heart	(49)	(28)	(21)	(50)
Sarcoma, metastatic, skin		1 (4%)		
ENDOCRINE SYSTEM				
Adrenal gland, cortex	(49)	(25)	(23)	(48)
Adenoma	2 (4%)		2 (9%)	
Carcinoma		1 (4%)		
Adrenal gland, medulla	(37)	(21)	(18)	(44)
Pheochromocytoma benign	5 (14%)	2 (10%)	3 (17%)	6 (14%)
Bilateral, pheochromocytoma malignant		1 (5%)		
Bilateral, pheochromocytoma benign		1 (5%)		
Islets, pancreatic	(48)	(24)	(20)	(49)
Adenoma			1 (5%)	
Carcinoma	1 (2%)		1 (5%)	
Parathyroid gland	(40)	(22)	(18)	(43)
Pituitary gland	(48)	(44)	(42)	(49)
Pars distalis, adenoma	28 (58%)	26 (59%)	32 (76%)	32 (65%)
Pars distalis, carcinoma	2 (4%)	3 (7%)	2 (5%)	3 (6%)
Thyroid gland	(48)	(26)	(18)	(50)
Bilateral, C-cell, adenoma				1 (2%)
C-cell, adenoma	4 (8%)	2 (8%)		2 (4%)
C-cell, carcinoma	1 (2%)	1 (4%)		
Follicular cell, adenoma		1 (4%)		
Follicular cell, carcinoma				1 (2%)
GENERAL BODY SYSTEM				
None				

TABLE B1. SUMMARY OF THE INCIDENCE OF NEOPLASMS IN FEMALE RATS IN THE TWO-YEAR INHALATION STUDY OF CS₂ (Continued)

	Chamber Control	0.075 mg/m ³	0.25 mg/m ³	0.75 mg/m ³
GENITAL SYSTEM				
Clitoral gland	(48)	(25)	(21)	(48)
Adenoma	4 (8%)	6 (24%)	1 (5%)	4 (8%)
Duct, carcinoma	1 (2%)			
Ovary	(49)	(49)	(50)	(50)
Granulosa cell tumor malignant			1 (2%)	1 (2%)
Granulosa cell tumor benign	1 (2%)			
Neoplasm, NOS, metastatic, adrenal gland		1 (2%)		
Uterus	(49)	(31)	(23)	(50)
Deciduoma benign	1 (2%)			
Polyp stromal	4 (8%)	7 (23%)	5 (22%)	8 (16%)
Polyp stromal, multiple	1 (2%)			
HEMATOPOIETIC SYSTEM				
Bone marrow	(49)	(26)	(19)	(49)
Lymph node	(49)	(48)	(49)	(50)
Mediastinal, carcinoma, metastatic, thyroid gland		1 (2%)		
Lymph node, bronchial	(47)	(47)	(47)	(46)
Neoplasm, NOS, metastatic, adrenal gland		1 (2%)		
Lymph node, mandibular	(45)	(25)	(19)	(47)
Fibrous histiocytoma, metastatic, skin		1 (4%)		
Spleen	(49)	(50)	(49)	(50)
Neoplasm, NOS, metastatic, adrenal gland		1 (2%)		
Thymus	(44)	(23)	(20)	(47)
INTEGUMENTARY SYSTEM				
Mammary gland	(48)	(50)	(49)	(49)
Adenocarcinoma	1 (2%)	2 (4%)	1 (2%)	
Adenoma		1 (2%)		
Fibroadenoma	15 (31%)	11 (22%)	13 (27%)	14 (29%)
Fibroadenoma, multiple	1 (2%)			3 (6%)
Skin	(50)	(33)	(30)	(50)
Basal cell adenoma			1 (3%)	
Basal cell carcinoma			1 (3%)	
Keratoacanthoma			1 (3%)	1 (2%)
Subcutaneous tissue, fibroma			1 (3%)	
Subcutaneous tissue, fibrosarcoma		1 (3%)		
Subcutaneous tissue, fibrous histiocytoma		1 (3%)		
MUSCULOSKELETAL SYSTEM				
Bone	(50)	(29)	(21)	(50)
Carcinoma, metastatic, Zymbal gland				1 (2%)
NERVOUS SYSTEM				
Brain	(49)	(28)	(21)	(50)
Carcinoma, metastatic, pituitary gland	2 (4%)	3 (11%)	2 (10%)	3 (6%)
Glioma, NOS			1 (5%)	
Granular cell tumor benign	1 (2%)			

TABLE B1. SUMMARY OF THE INCIDENCE OF NEOPLASMS IN FEMALE RATS IN THE TWO-YEAR INHALATION STUDY OF CS₂ (Continued)

	Chamber Control	0.075 mg/m ³	0.25 mg/m ³	0.75 mg/m ³
RESPIRATORY SYSTEM				
Lung	(49)	(50)	(50)	(50)
Alveolar/bronchiolar adenoma	2 (4%)		1 (2%)	
Alveolar/bronchiolar carcinoma			2 (4%)	
Carcinoma, metastatic, adrenal gland		1 (2%)		
Neoplasm, NOS, metastatic, adrenal gland		1 (2%)		
Nose	(49)	(49)	(49)	(50)
Adenoma		1 (2%)		
SPECIAL SENSES SYSTEM				
Eye	(48)	(5)	(3)	(49)
Zymbal gland		(1)		(2)
Carcinoma		1 (100%)		2 (100%)
URINARY SYSTEM				
Kidney	(49)	(37)	(30)	(50)
Neoplasm, NOS, metastatic, adrenal gland		1 (3%)		
Renal tubule, adenoma			2 (7%)	
Urinary bladder	(47)	(24)	(20)	(48)
SYSTEMIC LESIONS				
Multiple organs	*(50)	*(50)	*(50)	*(50)
Leukemia monocytic				1 (2%)
Leukemia mononuclear	24 (48%)	24 (48%)	21 (42%)	33 (66%)
Lymphoma malignant histiocytic			1 (2%)	
TUMOR SUMMARY				
Total animals with primary neoplasms **	47	47	47	50
Total primary neoplasms	104	94	94	113
Total animals with benign neoplasms	41	35	40	43
Total benign neoplasms	73	58	63	72
Total animals with malignant neoplasms	28	32	29	37
Total malignant neoplasms	31	36	30	41
Total animals with secondary neoplasms ***	2	8	2	4
Total secondary neoplasms	2	13	2	4
Total animals with neoplasms-- uncertain benign or malignant			1	
Total uncertain neoplasms			1	

* Number of animals receiving complete necropsy examination; all gross lesions including masses examined microscopically.

** Primary tumors: all tumors except secondary tumors

*** Secondary tumors: metastatic tumors or tumors invasive into an adjacent organ

TABLE B2. INDIVIDUAL ANIMAL TUMOR PATHOLOGY OF FEMALE RATS IN THE TWO-YEAR INHALATION STUDY OF CS2: CHAMBER CONTROL

DAYS ON STUDY	4	4	5	5	5	5	5	5	5	5	5	6	6	6	6	6	6	6	6	6	6	6	6	7	
CARCASS ID	6	8	0	4	6	6	6	7	8	8	8	0	0	1	4	4	5	6	6	6	7	8	9	0	
	5	7	7	3	1	3	7	6	3	8	9	1	6	6	1	1	2	6	7	7	8	9	1	4	2
ALIMENTARY SYSTEM																									
Esophagus	M	+	+	M	+	+	+	+	A	+	+	+	+	+	+	+	+	+	+	+	+	+	+	+	+
Intestine large	+	+	+	+	+	+	+	+	A	+	+	+	+	+	+	+	+	+	+	+	+	+	+	+	+
Intestine large, cecum	+	+	+	+	A	A	A	+	A	+	+	A	+	A	+	A	+	I	+	+	+	+	+	+	+
Intestine large, colon	+	+	+	+	A	I	A	+	A	+	+	+	+	+	+	+	+	+	+	+	+	+	+	+	+
Intestine large, rectum	+	I	+	+	+	+	+	+	A	+	+	+	+	+	+	+	+	+	+	+	+	+	+	+	+
Intestine small	+	I	+	+	+	+	+	+	A	+	+	+	+	I	A	+	+	+	+	+	+	+	+	+	+
Intestine small, duodenum	I	I	+	+	+	I	+	+	A	+	I	+	I	A	+	+	+	+	+	+	+	+	+	+	+
Intestine small, ileum	+	I	A	+	A	I	A	I	A	I	+	A	I	A	+	A	I	A	+	I	+	+	+	+	+
Leiomyosarcoma																									
Intestine small, jejunum	+	I	+	+	+	A	+	A	A	A	+	I	+	I	A	+	+	I	+	I	I	+	+	+	+
Liver	+	+	+	+	+	+	+	+	+	A	+	+	+	+	+	+	+	+	+	+	+	+	+	+	+
Neoplastic nodule												X												X	
Mesentery							+									+	+								
Pancreas	+	+	+	+	+	+	+	+	A	+	+	+	+	+	+	+	+	+	+	+	+	+	+	+	+
Pharynx																									
Salivary glands	+	+	+	+	+	+	+	+	A	+	+	+	+	+	+	+	+	+	+	+	+	+	+	+	+
Stomach	+	+	+	+	+	+	+	+	A	+	+	+	+	+	+	+	+	+	+	+	+	+	+	+	+
Stomach, forestomach	+	+	+	+	+	+	+	+	A	+	+	+	+	+	+	+	+	+	+	+	+	+	I	+	+
Papilloma squamous																									
Stomach, glandular	+	+	X	+	+	+	+	+	A	+	+	+	+	+	+	+	+	+	+	+	+	+	+	+	+
Tongue	+	+	+	+	+	+	+	+	A	+	+	+	+	+	+	+	+	+	+	+	+	+	+	+	+
CARDIOVASCULAR SYSTEM																									
Heart	+	+	+	+	+	+	+	+	A	+	+	+	+	+	+	+	+	+	+	+	+	+	+	+	+
ENDOCRINE SYSTEM																									
Adrenal gland	+	+	+	+	+	+	+	+	A	+	+	+	+	+	+	+	+	+	+	+	+	+	+	+	+
Adrenal gland, cortex	+	+	+	+	+	+	+	+	A	+	+	+	+	+	+	+	+	+	+	+	+	+	+	+	+
Adenoma																									
Adrenal gland, medulla	+	+	+	I	+	M	M	M	A	M	I	+	+	+	M	+	+	+	M	+	I	+	+	+	I
Pheochromocytoma benign	X																							X	
Islets, pancreatic	+	+	+	+	+	+	+	+	A	+	+	+	+	+	+	+	+	+	+	+	+	+	+	+	+
Carcinoma																									
Parathyroid gland	M	+	+	+	+	+	M	+	M	+	+	+	+	M	+	+	+	+	M	+	+	+	+	+	I
Pituitary gland	+	+	+	+	+	+	+	+	A	+	+	+	+	+	+	+	+	+	M	+	+	+	+	+	+
Pars distalis, adenoma			X		X		X			X			X									X	X	X	X
Pars distalis, carcinoma											X														
Thyroid gland	I	+	+	+	+	+	+	+	A	+	+	+	+	+	+	+	+	+	+	+	+	+	+	+	+
C-cell, adenoma																									
C-cell, carcinoma																	X								
GENERAL BODY SYSTEM																									
None																									
GENITAL SYSTEM																									
Clitoral gland	+	+	+	+	+	+	+	+	A	+	+	+	+	+	+	+	+	M	+	+	+	+	+	+	+
Adenoma										X	X														
Duct, carcinoma																									
Ovary	+	+	+	+	+	+	+	+	A	+	+	+	+	+	+	+	+	+	+	+	+	+	+	+	+
Granulosa cell tumor benign																									
Uterus	+	+	+	+	+	+	+	+	A	+	+	+	+	+	+	+	+	+	+	+	+	+	+	+	+
Deciduoma benign																									
Polyp stromal																									
Polyp stromal, multiple										X															X

+: Tissue examined microscopically
 -: Not examined
 -: Present but not examined microscopically
 I: Insufficient tissue

M: Missing
 A: Autolysis precludes examination
 X: Incidence of listed morphology

TABLE B2. INDIVIDUAL ANIMAL TUMOR PATHOLOGY OF FEMALE RATS: CHAMBER CONTROL (Continued)

DAYS ON STUDY	7 7 7 7 7 7 7 7 7 7 7 7 7 7 7 7 7 7 7 7																				TOTAL TISSUES TUMORS
	4 4 8 4 5 9 9 9 9 9 9 9 9 9 9 9 9 9 9 9																				
CARCASS ID	0 0 0 0 0 0 0 0 0 0 0 0 0 0 0 0 0 0 0 0																				
	2 9 0 4 4 1 5 6 9 5 6 5 6 8 9 0 1 5 6 7																				
	1 1 1 1 1 1 1 1 1 1 1 1 1 1 1 1 1 1 1 1																				
ALIMENTARY SYSTEM																					
Esophagus	+	+	+	+	+	+	+	+	+	+	+	+	+	+	+	+	+	+	+	+	47
Intestine large	+	+	+	+	+	+	+	+	+	+	+	+	+	+	+	+	+	+	+	+	49
Intestine large, cecum	I	+	+	+	A	+	+	+	+	+	+	+	+	+	+	+	+	+	+	+	40
Intestine large, colon	+	+	+	+	A	+	+	+	+	+	+	+	+	+	+	+	+	+	+	+	45
Intestine large, rectum	+	+	M	+	+	+	+	+	+	+	+	+	+	+	+	+	+	+	+	+	47
Intestine small	+	+	+	+	+	+	+	+	+	+	+	+	+	+	+	+	+	+	+	+	46
Intestine small, duodenum	+	+	+	+	+	+	+	+	+	+	+	+	+	+	+	+	+	+	+	+	43
Intestine small, ileum	I	I	I	+	A	+	+	+	+	+	+	+	+	+	+	+	+	+	+	+	31
Leiomyosarcoma																				X	1
Intestine small, jejunum	+	+	A	+	A	+	+	+	+	+	+	+	+	+	+	+	+	+	+	+	37
Liver	+	+	+	+	+	+	+	+	+	+	+	+	+	+	+	+	+	+	+	+	49
Neoplastic nodule	X																				3
Mesentery																				+	4
Pancreas	+	+	+	+	+	+	+	+	+	+	+	+	+	+	+	+	+	+	+	+	49
Pharynx																					1
Salivary glands	+	+	+	+	+	+	+	+	+	+	+	+	+	+	+	+	+	+	+	+	49
Stomach	+	+	+	+	+	+	+	+	+	+	+	+	+	+	+	+	+	+	+	+	49
Stomach, forestomach	+	+	+	+	+	+	+	+	+	+	+	+	+	+	+	+	+	+	+	+	48
Papilloma squamous																					1
Stomach, glandular	+	+	+	+	+	+	+	+	+	+	+	+	+	+	+	+	+	+	+	+	49
Tongue																				+	1
CARDIOVASCULAR SYSTEM																					
Heart	+	+	+	+	+	+	+	+	+	+	+	+	+	+	+	+	+	+	+	+	49
ENDOCRINE SYSTEM																					
Adrenal gland	+	+	+	+	+	+	+	+	+	+	+	+	+	+	+	+	+	+	+	+	49
Adrenal gland, cortex	+	+	+	+	+	+	+	+	+	+	+	+	+	+	+	+	+	+	+	+	49
Adenoma	X																				2
Adrenal gland, medulla	+	+	M	+	+	+	+	+	+	M	+	+	+	+	+	+	+	+	+	+	37
Pheochromocytoma benign			X							X											5
Islets, pancreatic	+	+	+	+	+	+	M	+	+	+	+	+	+	+	+	+	+	+	+	+	48
Carcinoma																					1
Parathyroid gland	M	+	+	+	+	+	+	+	+	+	M	+	+	+	M	+	+	+	+	+	40
Pituitary gland	+	+	+	+	+	+	+	+	+	+	+	+	+	+	+	+	+	+	+	+	48
Pars distalis, adenoma	X	X		X	X	X	X	X	X	X	X	X	X	X	X	X	X	X	X	X	28
Pars distalis, carcinoma																				X	2
Thyroid gland	+	+	+	+	+	+	+	+	+	+	+	+	+	+	+	+	+	+	+	+	48
C-cell, adenoma																			X	X	4
C-cell, carcinoma																				X	1
GENERAL BODY SYSTEM																					
None																					
GENITAL SYSTEM																					
Clitoral gland	+	+	+	+	+	+	+	+	+	+	+	+	+	+	+	+	+	+	+	+	48
Adenoma							X			X											1
Duct, carcinoma																				X	4
Ovary	+	+	+	+	+	+	+	+	+	+	+	+	+	+	+	+	+	+	+	+	49
Granulosa cell tumor benign																			X		1
Uterus	+	+	+	+	+	+	+	+	+	+	+	+	+	+	+	+	+	+	+	+	49
Deciduoma benign																					1
Polyp stromal																			X	X	4
Polyp stromal, multiple																					1

TABLE B2. INDIVIDUAL ANIMAL TUMOR PATHOLOGY OF FEMALE RATS: CHAMBER CONTROL
(Continued)

DAYS ON STUDY	4	4	5	5	5	5	5	5	5	5	5	6	6	6	6	6	6	6	6	6	6	6	6	7	
CARCASS ID	6	8	0	4	6	6	8	7	8	8	8	0	0	1	4	4	5	6	6	6	6	7	8	9	0
	5	7	7	3	1	3	7	6	3	8	9	1	6	6	1	1	2	6	7	7	8	9	1	4	2
HEMATOPOIETIC SYSTEM	0	0	0	0	0	0	0	0	0	0	0	0	0	0	0	0	0	0	0	0	0	0	1	0	0
Bone marrow	9	6	6	6	6	8	6	9	7	9	7	9	5	5	5	8	6	7	6	9	7	9	0	7	5
Lymph node	9	9	3	8	1	3	4	0	7	5	0	8	3	2	8	4	7	1	2	2	3	3	0	2	7
Lymph node, bronchial	1	1	1	1	1	1	1	1	1	1	1	1	1	1	1	1	1	1	1	1	1	1	1	1	1
Lymph node, mandibular																									
Spleen																									
Thymus																									
INTEGUMENTARY SYSTEM																									
Mammary gland																									
Adenocarcinoma																									
Fibroadenoma																									
Fibroadenoma, multiple																									
Skin																									
MUSCULOSKELETAL SYSTEM																									
Bone																									
NERVOUS SYSTEM																									
Brain																									
Carcinoma, metastatic, pituitary gland																									
Granular cell tumor benign																									
RESPIRATORY SYSTEM																									
Larynx																									
Lung																									
Alveolar/bronchiolar adenoma																									
Nose																									
Trachea																									
SPECIAL SENSES SYSTEM																									
Ear																									
Eye																									
Harderian gland																									
Lacrimal gland																									
URINARY SYSTEM																									
Kidney																									
Urinary bladder																									
SYSTEMIC LESIONS																									
Multiple organs																									
Leukemia mononuclear																									

TABLE B2. INDIVIDUAL ANIMAL TUMOR PATHOLOGY OF FEMALE RATS IN THE TWO-YEAR INHALATION STUDY OF CS₂: 0.075 mg/m³

DAYS ON STUDY	4	4	5	5	5	5	5	5	6	6	6	6	6	6	7	7	7	7	7	7	7		
3	4	6	0	1	2	6	7	7	8	0	0	0	1	6	8	9	9	0	1	1	1	1	
8	5	6	8	9	7	8	1	1	4	1	2	2	2	6	7	0	4	2	4	5	7	7	
CARCASS ID	1	1	1	1	1	1	1	1	1	1	1	1	1	1	1	1	1	1	1	1	1	1	
6	5	8	8	7	7	6	7	8	9	6	7	8	5	6	8	8	5	7	8	6	8	6	
6	7	6	4	2	0	3	1	8	4	5	9	7	2	2	3	5	3	3	9	1	2	4	
1	1	1	1	1	1	1	1	1	1	1	1	1	1	1	1	1	1	1	1	1	1	1	
1	1	1	1	1	1	1	1	1	1	1	1	1	1	1	1	1	1	1	1	1	1	1	
ALIMENTARY SYSTEM																							
Esophagus	M	+	+	+	+	+	+	+	+	+	+	+	+	+	+	+	+	+	+	+	+		
Intestine large	A	+	+	+	A	+	+	+	+	+	+	A	+	+	+	+	+	+	+	+	+		
Intestine large, cecum	A	+	+	+	A	+	+	+	I	A	+	+	+	I	+	+	+	+	+	+	A	+	
Intestine large, colon	A	+	+	+	A	+	+	+	+	A	+	+	+	A	+	M	I	+	+	+	+	A	+
Intestine large, rectum	A	+	+	+	A	+	+	+	+	A	+	+	+	+	+	+	+	+	+	+	+	M	
Intestine small	A	+	+	+	+	+	+	+	+	A	+	+	+	+	+	+	+	+	+	+	+	+	
Intestine small, duodenum	A	+	I	+	+	+	+	+	+	A	+	+	+	+	+	+	+	+	+	+	+	+	
Intestine small, ileum	A	+	+	+	A	+	+	I	+	A	+	+	A	I	+	+	I	A	+	+	+	+	
Intestine small, jejunum	A	I	+	I	A	+	+	A	+	A	A	I	+	+	+	+	I	I	+	+	I	A	
Liver	+	+	+	+	+	+	+	+	+	+	+	+	+	+	+	+	+	+	+	+	+	+	
Hepatocellular carcinoma																							
Neoplasm, NOS, metastatic, adrenal gland																						X	
Mesentery								+															
Pancreas	A	+	+	+	+	+	+	+	+	+	+	+	+	+	+	+	+	+	+	+	+	A	
Salivary glands	A	+	M	+	+	+	+	+	+	+	+	+	+	+	+	+	+	+	+	+	+	+	
Stomach	+	+	+	+	+	+	+	+	+	+	+	+	+	+	+	+	+	+	+	+	+	+	
Stomach, forestomach	+	+	+	+	+	+	+	+	+	+	+	+	+	+	+	+	+	+	+	+	+	+	
Stomach, glandular	A	+	+	+	+	+	+	+	+	+	+	+	+	+	+	+	+	+	+	+	+	+	
Tongue																							
CARDIOVASCULAR SYSTEM																							
Heart																							
Sarcoma, metastatic, skin																						X	
ENDOCRINE SYSTEM																							
Adrenal gland	A	+	+	+	+	+	+	+	+	+	+	+	+	+	+	+	+	+	+	+	+	A	
Adrenal gland, cortex	A	+	+	+	+	+	+	+	+	+	+	+	+	+	+	+	+	+	+	+	+	M	
Carcinoma																						A	
Adrenal gland, medulla	A	+	M	+	I	I	+	+	+	+	+	+	+	M	+	I	+	+	+	+	+	+	
Pheochromocytoma benign												X			X								
Bilateral, pheochromocytoma malignant																						X	
Bilateral, pheochromocytoma benign																						X	
Islets, pancreatic	A	+	+	+	+	+	+	+	+	+	+	+	+	+	+	+	+	+	+	+	+	+	
Parathyroid gland	A	+	+	+	I	M	+	M	+	+	+	+	M	+	+	M	+	+	+	+	+	+	
Pituitary gland	A	+	+	+	+	+	+	+	+	+	+	+	+	+	+	+	+	+	+	+	+	+	
Pars distalis, adenoma				X		X	X	X	X	X		X	X	X	X	X	X	X	X	X	X	X	
Pars distalis, carcinoma					X								X										
Thyroid gland	A	+	+	+	A	+	+	+	+	A	+	+	+	+	+	+	+	+	+	+	+	+	
C-cell, adenoma																							
C-cell, carcinoma																						X	
Follicular cell, adenoma																							
GENERAL BODY SYSTEM																							
None																							
GENITAL SYSTEM																							
Clitoral gland	M	+	+	+	+	+	+	+	+	+	+	+	+	M	+	+	+	+	+	+	+	+	
Adenoma			X			X										X						X	
Ovary	A	+	+	+	+	+	+	+	+	+	+	+	+	+	+	+	+	+	+	+	+	+	
Neoplasm, NOS, metastatic, adrenal gland																						X	
Uterus	+	+	+	+	+	+	+	+	+	+	+	+	+	+	+	+	+	+	+	+	+	+	
Polyp stromal							X						X								X		
Vagina																						+	

**TABLE B2. INDIVIDUAL ANIMAL TUMOR PATHOLOGY OF FEMALE RATS: 0.075 mg/m³
(Continued)**

DAYS ON STUDY	4	4	4	5	5	5	5	5	5	5	6	6	6	6	6	6	6	6	7	7	7	7	7	7	7	7	
CARCASS ID	3	4	6	0	1	2	6	7	7	8	0	0	0	1	6	8	9	9	0	1	1	1	1	2	2	3	
	8	5	6	8	9	7	8	1	1	4	1	2	2	2	6	7	0	4	2	4	5	7	0	9	0		
	1	1	1	1	1	1	1	1	1	1	1	1	1	1	1	1	1	1	1	1	1	1	1	1	1	1	
HEMATOPOIETIC SYSTEM																											
Bone marrow	A +																										
Lymph node	A +																										
Mediastinal, carcinoma, metastatic, thyroid gland																											
Lymph node, bronchial	M + M																										
Neoplasm, NOS, metastatic, adrenal gland																											
Lymph node, mandibular	A + M + X M + +																										
Fibrous histiocytoma, metastatic, skin																											
Spleen	+ +																										
Neoplasm, NOS, metastatic, adrenal gland																											
Thymus	M + + M + + + + + + + + + + + + + + + + + M + + + + M																										
INTEGUMENTARY SYSTEM																											
Mammary gland	+ +																										
Adenocarcinoma																											
Adenoma																											
Fibroadenoma																											
Skin	+ +																										
Subcutaneous tissue, fibrosarcoma																											
Subcutaneous tissue, fibrous histiocytoma																											
MUSCULOSKELETAL SYSTEM																											
Bone	+ +																										
NERVOUS SYSTEM																											
Brain	+ +																										
Carcinoma, metastatic, pituitary gland																											
RESPIRATORY SYSTEM																											
Larynx	A + + + A + A +																										
Lung	+ +																										
Carcinoma, metastatic, adrenal gland																											
Neoplasm, NOS, metastatic, adrenal gland																											
Nose	A + X + + +																										
Adenoma																											
Trachea	A + X + + + I +																										
SPECIAL SENSES SYSTEM																											
Eye																											
Harderian gland																											
Lacrimal gland																											
Zymbal gland																											
Carcinoma																											
URINARY SYSTEM																											
Kidney	+ +																										
Neoplasm, NOS, metastatic, adrenal gland																											
Urinary bladder	A + M M + X + + +																										
SYSTEMIC LESIONS																											
Multiple organs	+ +																										
Leukemia mononuclear	X X + + + X X X + + X X + X X + X X X X X X X X																										

TABLE B2. INDIVIDUAL ANIMAL TUMOR PATHOLOGY OF FEMALE RATS: 0.075 mg/m³
(Continued)

DAYS ON STUDY	7	7	7	7	7	7	7	7	7	7	7	7	7	7	7	7	7	7	7	7
	3	5	5	5	5	5	5	5	5	5	5	5	5	5	5	5	5	5	5	5
CARCASS ID	7	2	2	2	2	2	2	2	2	2	2	2	2	2	2	2	2	2	2	2
	1	1	1	1	1	1	1	1	1	1	1	1	1	1	1	1	1	1	1	2
TOTAL TISSUES TUMORS																				
HEMATOPOIETIC SYSTEM																				
Bone marrow	+																			
Lymph node	+	+	+	+	+	+	+	+	+	+	+	+	+	+	+	+	+	+	+	+
Mediastinal, carcinoma, metastatic, thyroid gland																				X
Lymph node, bronchial	+	+	+	+	+	+	+	+	+	+	+	+	+	+	+	+	+	+	+	+
Neoplasm, NOS, meta., adrenal gland																				
Lymph node, mandibular	I									+	+	+								
Fibrous histiocytoma, metastatic, skin																				
Spleen	+	+	+	+	+	+	+	+	+	+	+	+	+	+	+	+	+	+	+	+
Neoplasm, NOS, meta., adrenal gland																				
Thymus	+									+										
INTEGUMENTARY SYSTEM																				
Mammary gland	+	+	+	+	+	+	+	+	+	+	+	+	+	+	+	+	+	+	+	+
Adenocarcinoma																				
Adenoma					X											X				
Fibroadenoma		X	X				X	X				X				X			X	X
Skin	+	+	+					+												+
Subcutaneous tissue, fibrosarcoma																				
Subcutaneous tissue, fibrous histiocytoma																				
MUSCULOSKELETAL SYSTEM																				
Bone	+										+				+					+
NERVOUS SYSTEM																				
Brain	+											+								+
Carcinoma, metastatic, pituitary gland																			X	
RESPIRATORY SYSTEM																				
Larynx	+																			
Lung	+	+	+	+	+	+	+	+	+	+	+	+	+	+	+	+	+	+	+	+
Carcinoma, metastatic, adrenal gland																X				
Neoplasm, NOS, meta., adrenal gland																				
Nose	+	+	+	+	+	+	+	+	+	+	+	+	+	+	+	+	+	+	+	+
Adenoma																				
Trachea	+											+								
SPECIAL SENSES SYSTEM																				
Eye				+													+			
Harderian gland																				
Lacrimal gland												+								
Zybal gland																				
Carcinoma																				
URINARY SYSTEM																				
Kidney	+	+					+		+	+	+	+			+		+	+		+
Neoplasm, NOS, meta., adrenal gland																				
Urinary bladder	+										+									
SYSTEMIC LESIONS																				
Multiple organs	+	+	+	+	+	+	+	+	+	+	+	+	+	+	+	+	+	+	+	+
Leukemia mononuclear	X	X	X				X	X				X	X	X	X				X	X

TABLE B2. INDIVIDUAL ANIMAL TUMOR PATHOLOGY OF FEMALE RATS IN THE TWO-YEAR INHALATION STUDY OF CS₂: 0.25 mg/m³

DAYS ON STUDY	3	4	4	5	5	5	5	5	5	6	6	6	6	6	6	6	6	7	7	7	7	7	7	7	7	
CARCASS ID	7	5	6	3	4	4	6	7	9	0	1	3	3	5	8	9	9	0	3	3	4	5	5	5	5	
	0	7	5	6	6	9	3	1	1	6	7	1	9	8	0	0	0	1	9	2	9	4	1	1	1	1
	2	2	2	2	2	2	2	2	2	2	2	2	2	2	2	2	2	2	2	2	2	2	2	2	2	2
	8	6	8	5	6	8	9	7	9	8	5	8	8	6	5	5	7	7	8	9	6	5	5	5	5	5
	3	3	4	8	5	5	9	8	2	0	1	7	6	8	9	4	5	9	2	8	0	2	3	5	6	6
	1	1	1	1	1	1	1	1	1	1	1	1	1	1	1	1	1	1	1	1	1	1	1	1	1	1
ALIMENTARY SYSTEM																										
Esophagus	M	+	+	+	+	+	+	+	+	+	+	+	+	+	+	+	+	+	+	+	+	+	+	+	+	+
Intestine large	A	+	A	+	A	+	+	+	+	+	+	+	+	+	+	A	+	+	A	+	+	+	+	+	+	+
Intestine large, cecum	M	+	A	+	A	+	+	+	+	I	+	+	+	+	A	A	+	A	A	A	+	I	A			
Intestine large, colon	A	+	A	+	A	+	+	+	+	+	+	+	+	+	+	+	+	+	+	+	+	+	+	+	+	+
Intestine large, rectum	A	+	A	+	A	+	+	M	+	+	+	+	+	+	+	A	+	+	A	A	+	+	+	+	+	+
Intestine small	A	+	A	+	A	+	+	+	+	+	I	+	+	+	+	A	+	+	A	+	+	+	+	+	+	+
Intestine small, duodenum	A	+	A	+	A	+	+	+	+	I	+	+	+	+	+	A	+	+	A	+	+	+	+	+	+	+
Intestine small, ileum	A	+	A	M	A	A	I	I	I	I	+	A	A	A	+	A	+	A	A	+	I	I				
Intestine small, jejunum	A	+	A	+	A	I	+	I	A	I	I	+	I	A	+	A	+	A	+	+	A	I				
Liver	+	+	+	+	+	+	+	+	+	+	+	+	+	+	+	+	+	+	+	+	+	+	+	+	+	+
Mesentery																										
Pancreas	A	+	+	+	+	+	+	+	+	+	+	+	+	+	+	+	+	A	+	+	+	+	+	+	+	+
Pharynx																										
Salivary glands	+	+	+	M	M	+	+	+	+	+	+	+	+	+	+	+	+	+	+	+	+	+	+	+	+	+
Stomach	+	+	+	+	+	+	+	+	+	+	+	+	+	+	+	+	+	+	+	+	+	+	+	+	+	+
Stomach, forestomach	+	+	+	+	+	+	+	+	+	+	+	+	+	+	+	+	+	+	+	+	+	+	+	+	+	+
Stomach, glandular	A	+	+	+	A	+	+	+	+	+	+	+	+	+	+	+	+	+	+	+	+	+	+	+	+	+
CARDIOVASCULAR SYSTEM																										
Heart	+	+	+	+	+	+	+	+	+	+	+	+	+	+	+	+	+	+	+	+	+	+	+	+	+	+
ENDOCRINE SYSTEM																										
Adrenal gland	A	+	+	+	+	+	+	+	+	+	+	+	+	+	+	+	+	+	+	+	+	+	+	+	+	+
Adrenal gland, cortex	A	+	+	+	+	+	+	+	+	+	+	+	+	+	+	+	+	+	+	+	+	+	+	+	+	+
Adenoma																						X				
Adrenal gland, medulla	A	I	+	+	+	M	+	+	+	+	+	+	M	+	+	+	+	M	+	+	+					
Pheochromocytoma benign														X							X					
Islets, pancreatic	A	+	+	+	+	+	+	+	+	+	+	+	+	+	+	+	+	+	A	+	+	+	+	+	+	+
Adenoma																						X				
Carcinoma																										
Parathyroid gland	+	M	+	+	+	+	+	+	M	+	+	M	+	+	+	+	+	+	+	+	+	+	+	+	+	+
Pituitary gland	A	+	+	+	+	+	+	+	+	+	+	+	+	+	+	+	+	+	+	+	+	+	+	+	+	+
Pars distalis, adenoma	X			X	X				X	X		X			X		X	X	X	X						
Pars distalis, carcinoma					X							X													X	X
Thyroid gland	A	+	+	+	+	+	+	+	+	+	+	+	+	+	+	+	+	+	A	A	+	+	+	+	+	+
GENERAL BODY SYSTEM																										
None																										
GENITAL SYSTEM																										
Clitoral gland	M	+	+	+	+	+	+	+	+	+	+	+	+	+	+	+	+	+	+	+	+	+	+	+	+	+
Adenoma																										
Ovary	+	+	+	+	+	+	+	+	+	+	+	+	+	+	+	+	+	+	+	+	+	+	+	+	+	+
Granulosa cell tumor malignant																										
Uterus	+	+	+	+	+	+	+	+	+	+	+	+	+	+	+	+	+	+	+	+	+	+	+	+	+	+
Polyp stromal			X													X		X					X			
Vagina																										

TABLE B2. INDIVIDUAL ANIMAL TUMOR PATHOLOGY OF FEMALE RATS: 0.25 mg/m³
(Continued)

DAYS ON STUDY	3	4	4	5	5	5	5	5	5	6	6	6	6	6	6	6	6	7	7	7	7	7	7	7	7		
	7	5	6	3	4	4	6	7	9	0	1	3	3	5	8	9	9	0	3	3	4	5	5	5	5		
CARCASS ID	0	7	5	6	6	9	3	1	1	6	7	1	9	8	0	0	1	9	2	9	4	1	1	1	1		
	2	2	2	2	2	2	2	2	2	2	2	2	2	2	2	2	2	2	2	2	2	2	2	2	2		
	8	6	8	5	6	8	9	7	9	8	5	8	8	6	5	5	7	7	8	9	6	5	5	5	5		
	3	3	4	8	5	5	9	8	2	0	1	7	6	8	9	4	5	9	2	8	0	2	3	5	6		
	1	1	1	1	1	1	1	1	1	1	1	1	1	1	1	1	1	1	1	1	1	1	1	1	1		
HEMATOPOIETIC SYSTEM																											
Bone marrow	A	+	+	+	A	+	+	+	+	+	+	+	+	+	+	+	+	+	+	+	+	+	+	+	+		
Lymph node	+	+	+	+	+	+	+	+	+	+	+	+	+	+	+	+	+	+	+	+	+	+	+	+	+		
Lymph node, bronchial	+	M	+	+	+	+	+	+	+	+	+	M	+	+	+	+	+	+	+	+	+	+	+	+	+		
Lymph node, mandibular	+	+	+	M	M	M	+	+	+	+	+	+	+	+	+	+	+	+	+	+	+	+	+	+	+		
Spleen	A	+	+	+	+	+	+	+	+	+	+	+	+	+	+	+	+	+	+	+	+	+	+	+	+		
Thymus	M	+	+	+	+	+	+	+	+	+	+	+	+	+	+	+	+	+	+	+	+	+	+	+	+		
INTEGUMENTARY SYSTEM																											
Mammary gland	+	+	+	+	+	+	+	+	+	+	+	+	+	+	+	+	+	+	+	+	+	+	+	M	+		
Adenocarcinoma				X																							
Fibroadenoma						X												X		X							
Skin	+	+	+	+	+	+	+	+	+	+	+	+	+	+	+	+	+	+	+	+	+	+	+	+	+		
Basal cell adenoma																	X										
Basal cell carcinoma																											
Keratoacanthoma																											
Subcutaneous tissue, fibroma																											
MUSCULOSKELETAL SYSTEM																											
Bone	+	+	+	+	+	+	+	+	+	+	+	+	+	+	+	+	+	+	+	+	+	+	+	+	+		
NERVOUS SYSTEM																											
Brain	+	+	+	+	+	+	+	+	+	+	+	+	+	+	+	+	+	+	+	+	+	+	+	+	+		
Carcinoma, metastatic, pituitary gland						X					X																
Glioma, NOS	X																										
RESPIRATORY SYSTEM																											
Larynx	A	+	+	+	A	+	+	+	+	+	+	+	+	+	+	+	+	A	+	+	+	+	+	+	+		
Lung	+	+	+	+	+	+	+	+	+	+	+	+	+	+	+	+	+	+	+	+	+	+	+	+	+		
Alveolar/bronchiolar adenoma																											
Alveolar/bronchiolar carcinoma																											
Nose	A	+	+	+	+	+	+	+	+	+	+	+	+	+	+	+	+	+	+	+	+	+	+	+	+		
Trachea	A	+	+	+	A	+	+	+	+	+	+	+	+	+	+	+	+	A	+	+	+	+	+	+	+		
SPECIAL SENSES SYSTEM																											
Eye																											
Lacrimal gland			+				+												+								
URINARY SYSTEM																											
Kidney	A	+	+	+	+	+	+	+	+	+	+	+	+	+	+	+	+	+	+	+	+	+	+	+	+		
Renal tubule, adenoma																											
Urinary bladder	+	+	+	+	+	+	+	+	+	+	+	+	+	+	+	+	+	M	+	+	+	+	+	+	+		
SYSTEMIC LESIONS																											
Multiple organs	+	+	+	+	+	+	+	+	+	+	+	+	+	+	+	+	+	+	+	+	+	+	+	+	+		
Leukemia mononuclear						X	X	X	X								X	X	X		X	X	X				
Lymphoma malignant histiocytic																											

TABLE B2. INDIVIDUAL ANIMAL TUMOR PATHOLOGY OF FEMALE RATS: 0.25 mg/m³
(Continued)

DAYS ON STUDY	7 7																								TOTAL TISSUES TUMORS
	5 1 1																								
CARCASS ID	2 3 5 6 6 6 6 6 6 7 7 7 7 7 7 7 8 8 8 9 9 9 9 9 9 0 7 1 1 4 6 7 9 0 1 2 3 4 6 7 1 8 9 0 1 3 4 5 6 7 0 1																								TOTAL TISSUES TUMORS
HEMATOPOIETIC SYSTEM																									
Bone marrow																									19
Lymph node	+	+	+	+	+	+	+	+	+	+	+	+	+	+	+	+	+	+	+	+	+	+	+	+	+
Lymph node, bronchial	+	+	+	+	+	+	+	+	+	+	+	+	+	+	+	+	+	+	+	+	+	+	+	+	+
Lymph node, mandibular																									
Spleen	+	+	+	+	+	+	+	+	+	+	+	+	+	+	+	+	+	+	+	+	+	+	+	+	+
Thymus																									
INTEGUMENTARY SYSTEM																									
Mammary gland	+	+	+	+	+	+	+	+	+	+	+	+	+	+	+	+	+	+	+	+	+	+	+	+	+
Adenocarcinoma																									
Fibroadenoma	X	X		X					X				X			X			X				X		
Skin	+		+	+				+				+			+			+			+			+	
Basal cell adenoma																									
Basal cell carcinoma				X																					
Keratoacanthoma																									
Subcutaneous tissue, fibroma	X																			X					
MUSCULOSKELETAL SYSTEM																									
Bone																									21
NERVOUS SYSTEM																									
Brain																									21
Carcinoma, metastatic, pituitary gland																									2
Glioma, NOS																									1
RESPIRATORY SYSTEM																									
Larynx																									18
Lung	+	+	+	+	+	+	+	+	+	+	+	+	+	+	+	+	+	+	+	+	+	+	+	+	+
Alveolar/bronchiolar adenoma																X									
Alveolar/bronchiolar carcinoma																								X	
Nose	+	+	+	+	+	+	+	+	+	+	+	+	+	+	+	+	+	+	+	+	+	+	+	+	+
Trachea																									
SPECIAL SENSES SYSTEM																									
Eye	+							+																	
Lacrimal gland		+	+																				+		
URINARY SYSTEM																									
Kidney		+	+				+																		
Renal tubule, adenoma		X																							
Urinary bladder																									
SYSTEMIC LESIONS																									
Multiple organs	+	+	+	+	+	+	+	+	+	+	+	+	+	+	+	+	+	+	+	+	+	+	+	+	+
Leukemia mononuclear	X		X	X	X					X	X				X			X	X			X			
Lymphoma malignant histiocytic																									
																								X	

TABLE B2. INDIVIDUAL ANIMAL TUMOR PATHOLOGY OF FEMALE RATS IN THE TWO-YEAR INHALATION STUDY OF CS2: 0.75 mg/m³

DAYS ON STUDY	4	5	5	5	5	5	6	6	6	6	6	6	6	6	6	6	6	6	6	7	7	7	7	7
	6	5	2	6	8	4	9	6	4	3	3	4	9	1	8	0	0	2	7	4	2	6	9	0
CARCASS ID	3	3	3	3	3	3	3	3	3	3	4	3	3	3	3	3	3	3	3	3	3	3	3	3
	7	8	7	7	7	6	9	5	9	7	0	7	6	8	8	9	9	6	5	5	5	7	8	5
	4	1	8	9	3	3	3	1	0	5	0	0	8	6	9	1	9	9	8	3	5	6	3	2
	1	1	1	1	1	1	1	1	1	1	1	1	1	1	1	1	1	1	1	1	1	1	1	1
ALIMENTARY SYSTEM																								
Esophagus	+	+	+	+	+	+	+	+	+	+	+	+	+	+	+	+	+	+	+	+	+	+	+	+
Intestine large	+	+	+	+	+	+	+	+	+	+	+	+	+	+	+	+	+	+	+	+	+	+	+	+
Intestine large, cecum	+	+	+	+	+	+	+	A	+	+	+	+	+	A	+	A	+	+	+	+	+	+	A	+
Intestine large, colon	+	+	+	+	+	+	+	+	+	+	A	+	+	+	+	+	+	+	+	+	+	+	A	+
Intestine large, rectum	+	+	+	+	+	+	M	M	+	+	+	+	+	+	A	+	+	+	+	+	M	+	+	M
Adenoma																								
Intestine small	+	+	+	+	+	+	+	+	+	+	+	+	+	+	+	+	+	+	A	+	+	+	+	+
Intestine small, duodenum	+	+	M	+	+	I	+	+	+	+	+	+	+	+	+	+	+	+	I	+	+	I	+	+
Intestine small, ileum	+	+	+	I	+	A	+	A	+	A	+	+	I	A	+	A	A	A	+	+	+	A	A	+
Intestine small, jejunum	+	+	+	A	A	+	A	+	A	+	A	+	A	+	A	+	A	A	I	+	A	A	+	+
Liver	+	+	+	+	+	+	+	+	+	+	+	+	+	+	+	+	+	+	+	+	+	+	+	+
Pancreas	+	+	+	+	+	+	+	+	+	+	+	+	+	+	+	+	+	+	+	+	+	+	+	+
Salivary glands	+	+	+	+	+	+	+	+	+	+	+	+	+	+	+	+	+	+	+	+	+	+	+	+
Stomach	+	+	+	+	+	+	+	+	+	+	+	+	+	+	+	+	+	+	+	+	+	+	+	+
Stomach, forestomach	+	+	+	+	+	+	+	+	+	+	+	+	+	+	+	+	+	+	+	+	+	+	+	+
Stomach, glandular	+	+	+	+	+	+	+	+	+	+	+	+	+	+	+	+	+	+	+	+	+	+	+	+
CARDIOVASCULAR SYSTEM																								
Heart	+	+	+	+	+	+	+	+	+	+	+	+	+	+	+	+	+	+	+	+	+	+	+	+
ENDOCRINE SYSTEM																								
Adrenal gland	+	+	+	+	+	+	+	+	+	+	+	+	+	+	A	+	A	+	+	+	+	+	+	+
Adrenal gland, cortex	+	+	+	+	+	+	+	+	+	+	+	+	+	+	A	+	A	+	+	+	+	+	+	+
Adrenal gland, medulla	M	+	+	I	M	+	+	+	+	I	+	+	+	+	A	+	A	+	+	+	+	+	+	+
Pheochromocytoma benign																		X		X			X	
Islets, pancreatic	+	+	+	+	+	+	+	+	+	+	+	+	+	+	+	+	+	+	M	+	+	+	+	+
Parathyroid gland	M	M	+	+	+	M	+	+	+	I	+	+	+	M	+	+	+	+	+	+	+	+	+	+
Pituitary gland	+	+	+	+	+	+	+	+	+	+	+	+	+	+	+	A	+	+	+	+	+	+	+	+
Pars distalis, adenoma		X				X	X	X	X			X	X			X	X						X	X
Pars distalis, carcinoma						X				X								X						
Thyroid gland	+	+	+	+	+	+	+	+	+	+	+	+	+	+	+	+	+	+	+	+	+	+	+	+
Bilateral, C-cell, adenoma																								
C-cell, adenoma																								
Follicular cell, carcinoma																								
GENERAL BODY SYSTEM																								
None																								
GENITAL SYSTEM																								
Clitoral gland	+	+	+	+	+	+	+	M	M	+	+	+	+	+	+	+	+	+	+	+	+	+	+	+
Adenoma																								X
Ovary	+	+	+	+	+	+	+	+	+	+	+	+	+	+	+	+	+	+	+	+	+	+	+	+
Granulosa cell tumor malignant																								
Uterus	+	+	+	+	+	+	+	+	+	+	+	+	+	+	+	+	+	+	+	+	+	+	+	+
Polyp stromal			X		X		X						X					X						

TABLE B2. INDIVIDUAL ANIMAL TUMOR PATHOLOGY OF FEMALE RATS: 0.75 mg/m³
(Continued)

DAYS ON STUDY	7 7 7 7 7 7 7 7 7 7 7 7 7 7 7 7 7 7 7 7																				TOTAL: TISSUES TUMORS
	5 5 5 5 5 5 5 5 5 5 5 5 5 5 5 5 5 5 5 5																				
CARCASS ID	0 0 0 0 0 0 0 0 0 0 0 0 0 0 0 0 0 0 0 0																				
	3 3 3 3 3 3 3 3 3 3 3 3 3 3 3 3 3 3 3 3																				
	5 5 5 6 6 6 6 6 6 6 7 7 8 8 8 8 8 9 9 9																				
	6 7 9 0 1 2 4 5 6 7 1 2 7 0 2 4 5 7 8 2 4 5 6 7 8																				
	1 1 1 1 1 1 1 1 1 1 1 1 1 1 1 1 1 1 1 1																				
ALIMENTARY SYSTEM																					
Esophagus	+																				50
Intestine large	+																				50
Intestine large, cecum	+																				48
Intestine large, colon	+																				47
Intestine large, rectum	+																				43
Adenoma	X																				1
Intestine small	+																				49
Intestine small, duodenum	+																				46
Intestine small, ileum	+																				40
Intestine small, jejunum	+																				38
Liver	+																				50
Pancreas	+																				50
Salivary glands	+																				50
Stomach	+																				50
Stomach, forestomach	+																				50
Stomach, glandular	+																				50
CARDIOVASCULAR SYSTEM																					
Heart	+																				50
ENDOCRINE SYSTEM																					
Adrenal gland	+																				48
Adrenal gland, cortex	+																				48
Adrenal gland, medulla	+																				44
Pheochromocytoma benign	X X																				6
Islets, pancreatic	+																				49
Parathyroid gland	+																				43
Pituitary gland	+																				49
Pars distalis, adenoma	X X X X																				32
Pars distalis, carcinoma	X X X X X X X X X X X X X X X X X X																				3
Thyroid gland	+																				50
Bilateral, C-cell, adenoma	+																				1
C-cell, adenoma	X																				2
Follicular cell, carcinoma	X																				1
GENERAL BODY SYSTEM																					
None																					
GENITAL SYSTEM																					
Clitoral gland	+																				48
Adenoma	X X																				4
Ovary	+																				50
Granulosa cell tumor malignant	X																				1
Uterus	+																				50
Polyp stromal	X X																				8

TABLE B2. INDIVIDUAL ANIMAL TUMOR PATHOLOGY OF FEMALE RATS: 0.75 mg/m³
(Continued)

DAYS ON STUDY	4	5	5	5	5	5	5	6	6	6	6	6	6	6	6	6	6	6	6	7	7	7	7	7	7	7	7	
	7	0	2	3	7	8	9	0	2	3	3	3	3	4	4	6	6	6	6	9	0	1	1	5	5	5	5	
CARCASS ID	6	5	2	6	8	4	9	6	4	3	3	4	9	1	8	0	0	2	7	4	2	6	9	0	0	0	0	
HEMATOPOIETIC SYSTEM																												
Bone marrow	+	+	+	+	+	+	+	+	+	+	+	+	+	+	+	+	+	+	+	+	+	+	+	+	+	+	+	+
Lymph node	+	+	+	+	+	+	+	+	+	+	+	+	+	+	+	+	+	+	+	+	+	+	+	+	+	+	+	+
Lymph node, bronchial	M	+	+	+	+	+	+	+	+	+	+	+	M	+	+	+	+	+	+	+	+	+	+	+	+	+	+	+
Lymph node, mandibular	+	+	+	+	+	+	+	+	+	+	+	+	+	+	+	+	+	+	+	+	+	+	+	+	+	+	+	+
Spleen	+	+	+	+	+	+	+	+	+	+	+	+	+	+	+	+	+	+	+	+	+	+	+	+	+	+	+	+
Thymus	+	+	M	+	+	+	+	+	+	+	+	+	+	+	+	+	+	+	+	M	+	+	+	+	+	+	+	+
INTEGUMENTARY SYSTEM																												
Mammary gland	+	+	+	M	+	+	+	+	+	+	+	+	+	+	+	+	+	+	+	+	+	+	+	+	+	+	+	+
Fibroadenoma	X		X		X		X	X	X	X		+	+	+	+	+	+	+	X	X	X		+	+	+	+	+	+
Fibroadenoma, multiple																												
Skin	+	+	+	+	+	+	+	+	+	+	+	+	+	+	+	+	+	+	+	+	+	+	+	+	+	+	+	+
Keratoacanthoma																											X	
MUSCULOSKELETAL SYSTEM																												
Bone	+	+	+	+	+	+	+	+	+	+	+	+	+	+	+	+	+	+	+	+	+	+	+	+	+	+	+	+
Carcinoma, metastatic, Zymbal gland																											X	
NERVOUS SYSTEM																												
Brain	+	+	+	+	+	+	+	+	+	+	+	+	+	+	+	+	+	+	+	+	+	+	+	+	+	+	+	+
Carcinoma, metastatic, pituitary gland				X						X										X								
RESPIRATORY SYSTEM																												
Larynx	+	+	+	+	+	+	+	+	+	+	+	+	+	+	+	+	+	+	+	+	+	+	+	+	+	+	+	+
Lung	+	+	+	+	+	+	+	+	+	+	+	+	+	+	+	+	+	+	+	+	+	+	+	+	+	+	+	+
Nose	+	+	+	+	+	+	+	+	+	+	+	+	+	+	+	+	+	+	+	+	+	+	+	+	+	+	+	+
Trachea	+	+	+	+	+	+	+	+	+	+	+	+	+	+	+	+	+	+	I	+	+	+	+	+	+	A	+	+
SPECIAL SENSES SYSTEM																												
Eye	+	+	+	+	+	+	+	+	+	+	+	+	+	+	+	+	+	+	A	+	+	+	+	+	+	+	+	+
Harderian gland																			+									
Lacrimal gland																												
Zymbal gland																												
Carcinoma																												
URINARY SYSTEM																												
Kidney	+	+	+	+	+	+	+	+	+	+	+	+	+	+	+	+	+	+	+	+	+	+	+	+	+	+	+	+
Urinary bladder	+	+	+	+	+	+	+	+	M	+	+	+	+	+	+	+	+	+	+	+	+	+	+	+	M	+	+	+
SYSTEMIC LESIONS																												
Multiple organs	+	+	+	+	+	+	+	+	+	+	+	+	+	+	+	+	+	+	+	+	+	+	+	+	+	+	+	+
Leukemia monocytic																												
Leukemia mononuclear			X	X	X	X	X								X	X	X	X	X	X	X	X	X	X	X	X	X	X

**TABLE B2. INDIVIDUAL ANIMAL TUMOR PATHOLOGY OF FEMALE RATS: 0.75 mg/m³
(Continued)**

DAYS ON STUDY	7 5 0	7 5 0	7 5 0	7 5 0	7 5 0	7 5 0	7 5 0	7 5 0	7 5 0	7 5 0	7 5 0	7 5 0	7 5 0	7 5 0	7 5 0	7 5 0	7 5 0	7 5 0	7 5 0	7 5 0	7 5 0	TOTAL: TISSUES TUMORS	
CARCASS ID	3 6 1	3 7 1	3 9 1	3 0 1	3 1 1	3 2 1	3 4 1	3 5 1	3 6 1	3 6 1	3 7 1	3 7 1	3 8 1	3 8 1	3 8 1	3 8 1	3 8 1	3 8 1	3 9 1	3 9 1	3 9 1	3 9 1	49 50 46 47 50 47
HEMATOPOIETIC SYSTEM																							
Bone marrow	+																				49		
Lymph node	+																				50		
Lymph node, bronchial	+																			M	46		
Lymph node, mandibular	+																				47		
Spleen	+																				50		
Thymus	+																				47		
INTEGUMENTARY SYSTEM																							
Mammary gland	+																				49		
Fibroadenoma	+																			X	14		
Fibroadenoma, multiple	+																		X	X	3		
Skin	+																				50		
Keratoacanthoma	+																				1		
MUSCULOSKELETAL SYSTEM																							
Bone	+																				50		
Carcinoma, metastatic, Zymbal gland	+																				1		
NERVOUS SYSTEM																							
Brain	+																				50		
Carcinoma, metastatic, pituitary gland	+																				3		
RESPIRATORY SYSTEM																							
Larynx	+																				50		
Lung	+																				50		
Nose	+																				50		
Trachea	+																				48		
SPECIAL SENSES SYSTEM																							
Eye	+																				49		
Harderian gland	+																				1		
Lacrimal gland	+																		+	+	7		
Zymbal gland	+																				2		
Carcinoma	+																				2		
URINARY SYSTEM																							
Kidney	+																				50		
Urinary bladder	+																				48		
SYSTEMIC LESIONS																							
Multiple organs	+																				50		
Leukemia monocytic	+																		X	X	1		
Leukemia mononuclear	+																			X	X	33	

TABLE B3. ANALYSIS OF PRIMARY NEOPLASMS IN FEMALE RATS IN THE TWO-YEAR INHALATION STUDY OF CS2

	Chamber Control	0.075 mg/m ³	0.25 mg/m ³	0.75 mg/m ³
Adrenal Medulla: Pheochromocytoma				
Overall Rates (a)	5/37 (14%)	(b,c) 3/21 (14%)	(b) 3/18 (17%)	6/44 (14%)
Adjusted Rates (d)	19.4%			20.1%
Terminal Rates (e)	2/19 (11%)			4/27 (15%)
Day of First Observation	465			662
Life Table Test (f)				P=0.586N
Logistic Regression Test (f)				P=0.628
Fisher Exact Test (f)				P=0.623
Clitoral Gland: Adenoma				
Overall Rates (a)	4/48 (8%)	(b) 6/25 (24%)	(b) 1/21 (5%)	4/48 (8%)
Adjusted Rates (d)	14.4%			14.8%
Terminal Rates (e)	2/20 (10%)			4/27 (15%)
Day of First Observation	588			749
Life Table Test (f)				P=0.503N
Logistic Regression Test (f)				P=0.612N
Fisher Exact Test (f)				P=0.643N
Clitoral Gland: Adenoma or Carcinoma				
Overall Rates (a)	5/48 (10%)	(b) 6/25 (24%)	(b) 1/21 (5%)	4/48 (8%)
Adjusted Rates (d)	19.1%			14.8%
Terminal Rates (e)	3/20 (15%)			4/27 (15%)
Day of First Observation	588			749
Life Table Test (f)				P=0.345N
Logistic Regression Test (f)				P=0.455N
Fisher Exact Test (f)				P=0.500N
Liver: Neoplastic Nodule				
Overall Rates (a)	3/49 (6%)	0/50 (0%)	0/50 (0%)	0/50 (0%)
Adjusted Rates (d)	9.7%	0.0%	0.0%	0.0%
Terminal Rates (e)	0/20 (0%)	0/24 (0%)	0/29 (0%)	0/27 (0%)
Day of First Observation	589			
Life Table Tests (f)	P=0.127N	P=0.099N	P=0.095N	P=0.104N
Logistic Regression Tests (f)	P=0.136N	P=0.117N	P=0.121N	P=0.124N
Cochran-Armitage Trend Test (f)	P=0.132N			
Fisher Exact Test (f)		P=0.117N	P=0.117N	P=0.117N
Liver: Neoplastic Nodule or Hepatocellular Carcinoma				
Overall Rates (a)	3/49 (6%)	1/50 (2%)	0/50 (0%)	0/50 (0%)
Adjusted Rates (d)	9.7%	4.2%	0.0%	0.0%
Terminal Rates (e)	0/20 (0%)	1/24 (4%)	0/29 (0%)	0/27 (0%)
Day of First Observation	589	749		
Life Table Tests (f)	P=0.087N	P=0.256N	P=0.095N	P=0.104N
Logistic Regression Tests (f)	P=0.096N	P=0.297N	P=0.121N	P=0.124N
Cochran-Armitage Trend Test (f)	P=0.096N			
Fisher Exact Test (f)		P=0.301N	P=0.117N	P=0.117N
Lung: Alveolar/Bronchiolar Adenoma or Carcinoma				
Overall Rates (a)	2/49 (4%)	0/50 (0%)	3/50 (6%)	0/50 (0%)
Adjusted Rates (d)	10.0%	0.0%	10.3%	0.0%
Terminal Rates (e)	2/20 (10%)	0/24 (0%)	3/29 (10%)	0/27 (0%)
Day of First Observation	749		749	
Life Table Tests (f)	P=0.234N	P=0.198N	P=0.669	P=0.174N
Logistic Regression Tests (f)	P=0.234N	P=0.198N	P=0.669	P=0.174N
Cochran-Armitage Trend Test (f)	P=0.294N			
Fisher Exact Test (f)		P=0.242N	P=0.510	P=0.242N

TABLE B3. ANALYSIS OF PRIMARY NEOPLASMS IN FEMALE RATS IN THE TWO-YEAR INHALATION STUDY OF CS2 (Continued)

	Chamber Control	0.075 mg/m ³	0.25 mg/m ³	0.75 mg/m ³
Mammary Gland: Fibroadenoma				
Overall Rates (g)	16/50 (32%)	11/50 (22%)	13/50 (26%)	17/50 (34%)
Adjusted Rates (d)	51.0%	40.9%	39.8%	44.0%
Terminal Rates (e)	7/20 (35%)	9/24 (38%)	10/29 (34%)	8/27 (30%)
Day of First Observation	543	601	563	476
Life Table Tests (f)	P=0.441	P=0.100N	P=0.106N	P=0.437N
Logistic Regression Tests (f)	P=0.280	P=0.153N	P=0.262N	P=0.489
Cochran-Armitage Trend Test (f)	P=0.250			
Fisher Exact Test (f)		P=0.184N	P=0.330N	P=0.500
Mammary Gland: Adenoma or Fibroadenoma				
Overall Rates (g)	16/50 (32%)	12/50 (24%)	13/50 (26%)	17/50 (34%)
Adjusted Rates (d)	51.0%	44.8%	39.8%	44.0%
Terminal Rates (e)	7/20 (35%)	10/24 (42%)	10/29 (34%)	8/27 (30%)
Day of First Observation	543	601	563	476
Life Table Tests (f)	P=0.485	P=0.141N	P=0.106N	P=0.437N
Logistic Regression Tests (f)	P=0.319	P=0.212N	P=0.262N	P=0.489
Cochran-Armitage Trend Test (f)	P=0.286			
Fisher Exact Test (f)		P=0.252N	P=0.330N	P=0.500
Mammary Gland: Adenoma, Fibroadenoma, or Adenocarcinoma				
Overall Rates (g)	17/50 (34%)	13/50 (26%)	14/50 (28%)	17/50 (34%)
Adjusted Rates (d)	54.7%	46.3%	41.1%	44.0%
Terminal Rates (e)	8/20 (40%)	10/24 (42%)	10/29 (34%)	8/27 (30%)
Day of First Observation	543	601	536	476
Life Table Tests (f)	P=0.515N	P=0.141N	P=0.106N	P=0.355N
Logistic Regression Tests (f)	P=0.414	P=0.214N	P=0.277N	P=0.580
Cochran-Armitage Trend Test (f)	P=0.380			
Fisher Exact Test (f)		P=0.257N	P=0.333N	P=0.583N
Pituitary Gland/Pars Distalis: Adenoma				
Overall Rates (a)	28/48 (58%)	26/44 (59%)	32/42 (76%)	32/49 (65%)
Adjusted Rates (d)	83.7%	84.9%	93.4%	83.5%
Terminal Rates (e)	15/20 (75%)	15/19 (74%)	20/22 (91%)	21/27 (78%)
Day of First Observation	507	519	457	505
Life Table Tests (f)	P=0.375N	P=0.385N	P=0.539	P=0.396N
Logistic Regression Tests (f)	P=0.384	P=0.576	P=0.068	P=0.401
Cochran-Armitage Trend Test (f)	P=0.285			
Fisher Exact Test (f)		P=0.555	P=0.058	P=0.309
Pituitary Gland/Pars Distalis: Carcinoma				
Overall Rates (a)	2/48 (4%)	3/44 (7%)	2/42 (5%)	3/49 (6%)
Adjusted Rates (d)	7.4%	10.0%	4.7%	7.5%
Terminal Rates (e)	1/20 (5%)	1/19 (5%)	0/22 (0%)	0/27 (0%)
Day of First Observation	589	508	549	578
Life Table Tests (f)	P=0.544	P=0.511	P=0.671N	P=0.555
Logistic Regression Tests (f)	P=0.462	P=0.461	P=0.633	P=0.470
Cochran-Armitage Trend Test (f)	P=0.516			
Fisher Exact Test (f)		P=0.458	P=0.640	P=0.510
Pituitary Gland/Pars Distalis: Adenoma or Carcinoma				
Overall Rates (a)	30/48 (63%)	29/44 (66%)	34/42 (81%)	35/49 (71%)
Adjusted Rates (d)	87.3%	89.3%	93.7%	84.7%
Terminal Rates (e)	16/20 (80%)	16/19 (84%)	20/22 (91%)	21/27 (78%)
Day of First Observation	507	508	457	505
Life Table Tests (f)	P=0.404N	P=0.452N	P=0.546N	P=0.446N
Logistic Regression Tests (f)	P=0.314	P=0.458	P=0.051	P=0.302
Cochran-Armitage Trend Test (f)	P=0.239			
Fisher Exact Test (f)		P=0.451	P=0.044	P=0.236

TABLE B3. ANALYSIS OF PRIMARY NEOPLASMS IN FEMALE RATS IN THE TWO-YEAR INHALATION STUDY OF CS2 (Continued)

	Chamber Control	0.075 mg/m ³	0.25 mg/m ³	0.75 mg/m ³
Thyroid Gland: C-Cell Adenoma				
Overall Rates (a)	4/48 (8%)	(b) 2/26 (8%)	(b) 0/18 (0%)	3/50 (6%)
Adjusted Rates (d)	15.2%			11.1%
Terminal Rates (e)	2/20 (10%)			3/27 (11%)
Day of First Observation	641			749
Life Table Test (f)				P=0.385N
Logistic Regression Test (f)				P=0.441N
Fisher Exact Test (f)				P=0.477N
Thyroid Gland: C-Cell Adenoma or Carcinoma				
Overall Rates (a)	5/48 (10%)	(b) 3/26 (12%)	(b) 0/18 (0%)	3/50 (6%)
Adjusted Rates (d)	19.9%			11.1%
Terminal Rates (e)	3/20 (15%)			3/27 (11%)
Day of First Observation	641			749
Life Table Test (f)				P=0.241N
Logistic Regression Test (f)				P=0.292N
Fisher Exact Test (f)				P=0.335N
Uterus: Stromal Polyp				
Overall Rates (g)	5/50 (10%)	7/50 (14%)	5/50 (10%)	8/50 (16%)
Adjusted Rates (d)	19.2%	23.5%	13.8%	21.5%
Terminal Rates (e)	2/20 (10%)	4/24 (17%)	1/29 (3%)	3/27 (11%)
Day of First Observation	576	568	465	522
Life Table Tests (f)	P=0.378	P=0.482	P=0.472N	P=0.398
Logistic Regression Tests (f)	P=0.270	P=0.395	P=0.630	P=0.258
Cochran-Armitage Trend Test (f)	P=0.278			
Fisher Exact Test (f)		P=0.380	P=0.630	P=0.277
Hematopoietic System: Mononuclear Leukemia				
Overall Rates (g)	24/50 (48%)	24/50 (48%)	21/50 (42%)	33/50 (66%)
Adjusted Rates (d)	67.5%	61.3%	54.3%	79.8%
Terminal Rates (e)	10/20 (50%)	10/24 (42%)	12/29 (41%)	19/27 (70%)
Day of First Observation	487	438	563	522
Life Table Tests (f)	P=0.157	P=0.368N	P=0.099N	P=0.330
Logistic Regression Tests (f)	P=0.026	P=0.578N	P=0.306N	P=0.065
Cochran-Armitage Trend Test (f)	P=0.023			
Fisher Exact Test (f)		P=0.579N	P=0.344N	P=0.053
All Sites: Benign Tumors				
Overall Rates (g)	41/50 (82%)	35/50 (70%)	40/50 (80%)	43/50 (86%)
Adjusted Rates (d)	97.5%	84.8%	86.8%	97.6%
Terminal Rates (e)	19/20 (95%)	18/24 (75%)	23/29 (79%)	26/27 (96%)
Day of First Observation	465	466	457	476
Life Table Tests (f)	P=0.470N	P=0.062N	P=0.063N	P=0.208N
Logistic Regression Tests (f)	P=0.165	P=0.105N	P=0.455N	P=0.474
Cochran-Armitage Trend Test (f)	P=0.128			
Fisher Exact Test (f)		P=0.121N	P=0.500N	P=0.393
All Sites: Malignant Tumors				
Overall Rates (g)	28/50 (56%)	32/50 (64%)	29/50 (58%)	37/50 (74%)
Adjusted Rates (d)	75.5%	72.2%	69.9%	83.8%
Terminal Rates (e)	12/20 (60%)	12/24 (50%)	17/29 (59%)	20/27 (74%)
Day of First Observation	487	438	536	522
Life Table Tests (f)	P=0.309	P=0.554	P=0.212N	P=0.379
Logistic Regression Tests (f)	P=0.055	P=0.272	P=0.537	P=0.057
Cochran-Armitage Trend Test (f)	P=0.050			
Fisher Exact Test (f)		P=0.270	P=0.500	P=0.046

TABLE B3. ANALYSIS OF PRIMARY NEOPLASMS IN FEMALE RATS IN THE TWO-YEAR INHALATION STUDY OF CS2 (Continued)

	Chamber Control	0.075 mg/m ³	0.25 mg/m ³	0.75 mg/m ³
All Sites: All Tumors				
Overall Rates (g)	47/50 (94%)	47/50 (94%)	47/50 (94%)	50/50 (100%)
Adjusted Rates (d)	100.0%	94.0%	94.0%	100.0%
Terminal Rates (e)	20/20 (100%)	21/24 (88%)	26/29 (90%)	27/27 (100%)
Day of First Observation	465	438	370	476
Life Table Tests (f)	P=0.339N	P=0.254N	P=0.078N	P=0.245N
Logistic Regression Tests (f)	P=0.073	P=0.653	P=0.648	P=0.133
Cochran-Armitage Trend Test (f)	P=0.082			
Fisher Exact Test (f)		P=0.661N	P=0.661N	P=0.121

(a) Number of tumor-bearing animals/number of animals examined microscopically at the site

(b) Incomplete sampling of tissues

(c) A malignant pheochromocytoma was observed in an additional animal.

(d) Kaplan-Meier estimated tumor incidences at the end of the study after adjusting for intercurrent mortality

(e) Observed tumor incidence in animals killed at the end of the study

(f) Beneath the control incidence are the P values associated with the trend test. Beneath the dosed group incidence are the P values corresponding to pairwise comparisons between that dosed group and the controls. The life table analysis regards tumors in animals dying prior to terminal kill as being (directly or indirectly) the cause of death. The logistic regression test regards these lesions as nonfatal. The Cochran-Armitage and Fisher exact tests compare directly the overall incidence rates. A negative trend or lower incidence in a dosed group than in controls is indicated by (N).

(g) Number of tumor-bearing animals/number of animals examined grossly at the site

TABLE B4. HISTORICAL INCIDENCE OF KIDNEY TUBULAR CELL NEOPLASMS IN FEMALE F344/N RATS (a)

Study	Incidence of Adenomas or Adenocarcinomas in Controls
Historical Incidence for Chamber Controls at Battelle Pacific Northwest Laboratories	
Propylene oxide	(b) 1/50
Methyl methacrylate	0/50
Propylene	0/47
1,2-Epoxybutane	0/50
Dichloromethane	0/50
Tetrachloroethylene	0/50
Bromoethane	0/50
TOTAL	(b) 1/347 (0.3%)
SD (c)	0.76%
Range (d)	
High	1/50
Low	0/50
Overall Historical Incidence for Untreated Controls in NTP Studies	
TOTAL	(e) 2/1,639 (0.1%)
SD (c)	0.49%
Range (d)	
High	1/50
Low	0/50

(a) Data as of March 1, 1989, for studies of at least 104 weeks

(b) Tubular cell adenocarcinoma

(c) Standard deviation

(d) Range and SD are presented for groups of 35 or more animals.

(e) Includes one tubular cell adenoma and one adenocarcinoma, NOS

TABLE B5. SUMMARY OF THE INCIDENCE OF NONNEOPLASTIC LESIONS IN FEMALE RATS IN THE TWO-YEAR INHALATION STUDY OF CS2

	Chamber Control	0.075 mg/m ³	0.25 mg/m ³	0.75 mg/m ³
DISPOSITION SUMMARY				
Animals initially in study	50	50	50	50
Early deaths				
Dead	7	5	9	4
Moribund	23	21	12	19
Survivors				
Terminal sacrifice	20	24	29	27
Animals examined microscopically	50	50	50	50
ALIMENTARY SYSTEM				
Intestine large, cecum	(40)	(20)	(10)	(46)
Inflammation, suppurative		1 (5%)		
Parasite metazoan	4 (10%)	1 (5%)	1 (10%)	6 (13%)
Intestine large, colon	(45)	(20)	(15)	(47)
Parasite metazoan	2 (4%)	1 (5%)	2 (13%)	5 (11%)
Intestine large, rectum	(47)	(23)	(14)	(43)
Parasite metazoan	1 (2%)	1 (4%)		3 (7%)
Intestine small, duodenum	(43)	(24)	(15)	(46)
Ulcer			1 (7%)	1 (2%)
Intestine small, ileum	(31)	(18)	(4)	(40)
Hyperplasia, lymphoid	1 (3%)			3 (8%)
Parasite metazoan				1 (3%)
Intestine small, jejunum	(37)	(13)	(7)	(38)
Hyperplasia, lymphoid				1 (3%)
Liver	(49)	(50)	(50)	(50)
Angiectasis	5 (10%)	6 (12%)	6 (12%)	7 (14%)
Basophilic focus	25 (51%)	18 (36%)	24 (48%)	22 (44%)
Clear cell focus	2 (4%)	2 (4%)		1 (2%)
Congestion	1 (2%)		1 (2%)	1 (2%)
Degeneration, fatty	18 (37%)	19 (38%)	8 (16%)	11 (22%)
Eosinophilic focus				2 (4%)
Hematopoietic cell proliferation	7 (14%)	5 (10%)	9 (18%)	1 (2%)
Hemorrhage		1 (2%)		
Hepatodiaphragmatic nodule	6 (12%)	2 (4%)	8 (16%)	11 (22%)
Hyperplasia		3 (6%)		
Inflammation, granulomatous, focal	23 (47%)	23 (46%)	26 (52%)	28 (56%)
Leukocytosis	2 (4%)	1 (2%)		1 (2%)
Necrosis	10 (20%)	13 (26%)	9 (18%)	9 (18%)
Pigmentation, bile			1 (2%)	
Thrombus		1 (2%)		1 (2%)
Bile duct, hyperplasia	8 (16%)	10 (20%)	6 (12%)	8 (16%)
Mesentery	(4)	(4)	(2)	
Fat, hemorrhage	1 (25%)			
Fat, inflammation, chronic	3 (75%)	3 (75%)	2 (100%)	
Fat, necrosis	3 (75%)	3 (75%)	2 (100%)	
Pancreas	(49)	(25)	(19)	(50)
Acinus, atrophy	11 (22%)	3 (12%)	5 (26%)	10 (20%)
Acinus, fibrosis		1 (4%)		
Acinus, focal cellular change		1 (4%)		
Acinus, inflammation				1 (2%)
Pharynx	(1)		(1)	
Palate, developmental malformation			1 (100%)	
Palate, inflammation	1 (100%)			
Salivary glands	(49)	(25)	(19)	(50)
Inflammation, chronic	2 (4%)			
Inflammation, suppurative	16 (33%)	1 (4%)	3 (16%)	13 (26%)
Duct, hyperplasia	22 (45%)	8 (32%)	7 (37%)	25 (50%)

TABLE B5. SUMMARY OF THE INCIDENCE OF NONNEOPLASTIC LESIONS IN FEMALE RATS IN THE TWO-YEAR INHALATION STUDY OF CS2 (Continued)

	Chamber Control	0.075 mg/m ³	0.25 mg/m ³	0.75 mg/m ³
ALIMENTARY SYSTEM (Continued)				
Stomach, forestomach	(48)	(33)	(21)	(50)
Inflammation, chronic	3 (6%)	9 (27%)	1 (5%)	4 (8%)
Inflammation, suppurative	4 (8%)	2 (6%)	1 (5%)	1 (2%)
Ulcer	5 (10%)	10 (30%)	2 (10%)	5 (10%)
Epithelium, hyperplasia	10 (21%)	10 (30%)	2 (10%)	7 (14%)
Stomach, glandular	(49)	(31)	(20)	(50)
Hemorrhage	2 (4%)		1 (5%)	1 (2%)
Inflammation, chronic	5 (10%)	4 (13%)		1 (2%)
Inflammation, suppurative	2 (4%)	1 (3%)	1 (5%)	1 (2%)
Pigmentation, hemosiderin	1 (2%)	1 (3%)	1 (5%)	1 (2%)
Ulcer	9 (18%)	4 (13%)	3 (15%)	3 (6%)
Epithelium, hyperplasia	1 (2%)			1 (2%)
Tongue	(1)	(1)		
Epithelium, hyperplasia		1 (100%)		
CARDIOVASCULAR SYSTEM				
Heart	(49)	(28)	(21)	(50)
Cardiomyopathy	42 (86%)	21 (75%)	16 (76%)	49 (98%)
Inflammation, suppurative		1 (4%)		
Mineralization		1 (4%)		
Necrosis		1 (4%)		
Atrium, congestion		2 (7%)		
Atrium, inflammation				1 (2%)
Atrium, thrombus	3 (6%)	1 (4%)	1 (5%)	
ENDOCRINE SYSTEM				
Adrenal gland	(49)	(26)	(23)	(48)
Ectopic tissue				1 (2%)
Adrenal gland, cortex	(49)	(25)	(23)	(48)
Degeneration, fatty	26 (53%)	12 (48%)	7 (30%)	29 (60%)
Focal cellular change	6 (12%)	2 (8%)		8 (17%)
Hematopoietic cell proliferation	10 (20%)	4 (16%)	3 (13%)	10 (21%)
Hyperplasia	7 (14%)		3 (13%)	4 (8%)
Necrosis	3 (6%)	1 (4%)	1 (4%)	
Thrombus			1 (4%)	
Adrenal gland, medulla	(37)	(21)	(18)	(44)
Hyperplasia	10 (27%)	2 (10%)	7 (39%)	8 (18%)
Thrombus			1 (6%)	
Islets, pancreatic	(48)	(24)	(20)	(49)
Hyperplasia	1 (2%)			
Parathyroid gland	(40)	(22)	(18)	(43)
Hyperplasia	3 (8%)	2 (9%)		1 (2%)
Pituitary gland	(48)	(44)	(42)	(49)
Degeneration, cystic		3 (7%)	1 (2%)	
Pars distalis, angiectasis	3 (6%)	2 (5%)		1 (2%)
Pars distalis, cyst	3 (6%)			1 (2%)
Pars distalis, hemorrhage		2 (5%)		
Pars distalis, hyperplasia	10 (21%)	6 (14%)	6 (14%)	7 (14%)
Thyroid gland	(48)	(26)	(18)	(50)
C-cell, hyperplasia	10 (21%)	4 (15%)		4 (8%)
GENERAL BODY SYSTEM				
None				

TABLE B5. SUMMARY OF THE INCIDENCE OF NONNEOPLASTIC LESIONS IN FEMALE RATS IN THE TWO-YEAR INHALATION STUDY OF CS2 (Continued)

	Chamber Control	0.075 mg/m ³	0.25 mg/m ³	0.75 mg/m ³
GENITAL SYSTEM				
Clitoral gland	(48)	(25)	(21)	(48)
Cyst				2 (4%)
Hyperplasia	1 (2%)		1 (5%)	2 (4%)
Inflammation, suppurative	11 (23%)	1 (4%)	3 (14%)	7 (15%)
Duct, hyperplasia				1 (2%)
Ovary	(49)	(49)	(50)	(50)
Atrophy	1 (2%)	2 (4%)	1 (2%)	4 (8%)
Cyst	2 (4%)	3 (6%)	1 (2%)	6 (12%)
Hyperplasia				1 (2%)
Proliferation		1 (2%)		
Uterus	(49)	(31)	(23)	(50)
Dilatation	2 (4%)			2 (4%)
Hemorrhage			1 (4%)	2 (4%)
Hyperplasia, cystic	1 (2%)			1 (2%)
Submucosa, hyperplasia		1 (3%)		
Vagina		(1)	(1)	
Inflammation, suppurative		1 (100%)	1 (100%)	
HEMATOPOIETIC SYSTEM				
Bone marrow	(49)	(26)	(19)	(49)
Depletion				1 (2%)
Hyperplasia, neutrophil				2 (4%)
Inflammation, granulomatous, focal	1 (2%)			
Myelofibrosis	3 (6%)	1 (4%)	1 (5%)	2 (4%)
Lymph node	(49)	(48)	(49)	(50)
Mediastinal, inflammation, granulomatous, focal	1 (2%)			
Mesenteric, inflammation, granulomatous, focal		1 (2%)		
Lymph node, bronchial	(47)	(47)	(47)	(46)
Congestion	1 (2%)			
Hematopoietic cell proliferation	1 (2%)			
Hyperplasia	4 (9%)		3 (6%)	10 (22%)
Inflammation, granulomatous, focal		1 (2%)	1 (2%)	
Lymph node, mandibular	(45)	(25)	(19)	(47)
Congestion				1 (2%)
Hyperplasia	15 (33%)	3 (12%)	2 (11%)	19 (40%)
Inflammation, granulomatous, focal	1 (2%)			
Necrosis			1 (5%)	
Spleen	(49)	(50)	(49)	(50)
Developmental malformation	1 (2%)			
Fibrosis	5 (10%)	2 (4%)	3 (6%)	5 (10%)
Hematopoietic cell proliferation	6 (12%)	4 (8%)	7 (14%)	2 (4%)
Hemorrhage			3 (6%)	1 (2%)
Inflammation, granulomatous	1 (2%)	1 (2%)		2 (4%)
Necrosis	2 (4%)		1 (2%)	
Pigmentation, hemosiderin	1 (2%)	3 (6%)		
Thrombus			3 (6%)	
Capsule, inflammation, suppurative		1 (2%)		
Capsule, thrombus	1 (2%)			
Thymus	(44)	(23)	(20)	(47)
Degeneration, cystic				2 (4%)
Inflammation, chronic			1 (5%)	

TABLE B5. SUMMARY OF THE INCIDENCE OF NONNEOPLASTIC LESIONS IN FEMALE RATS IN THE TWO-YEAR INHALATION STUDY OF CS2 (Continued)

	Chamber Control	0.075 mg/m ³	0.25 mg/m ³	0.75 mg/m ³
INTEGUMENTARY SYSTEM				
Mammary gland	(48)	(50)	(49)	(49)
Galactocele	2 (4%)	3 (6%)		1 (2%)
Hyperplasia	6 (13%)	9 (18%)	10 (20%)	11 (22%)
Skin	(50)	(33)	(30)	(50)
Acanthosis		1 (3%)		
Cyst epithelial inclusion			1 (3%)	
Inflammation, suppurative			1 (3%)	
Necrosis			1 (3%)	
Ulcer		2 (6%)		
Epidermis, hyperplasia				1 (2%)
Subcutaneous tissue, inflammation, chronic		2 (6%)		
MUSCULOSKELETAL SYSTEM				
Bone	(50)	(29)	(21)	(50)
Fibrous osteodystrophy	3 (6%)	1 (3%)		
Osteopetrosis	4 (8%)	2 (7%)	1 (5%)	6 (12%)
Periosteum, proliferation				18 (36%)
NERVOUS SYSTEM				
Brain	(49)	(28)	(21)	(50)
Hemorrhage	6 (12%)	4 (14%)	3 (14%)	3 (6%)
Hydrocephalus	3 (6%)	1 (4%)		1 (2%)
Necrosis				1 (2%)
Meninges, inflammation, suppurative	1 (2%)			
RESPIRATORY SYSTEM				
Larynx	(49)	(24)	(18)	(50)
Inflammation			2 (11%)	
Inflammation, suppurative	22 (45%)	10 (42%)	6 (33%)	22 (44%)
Metaplasia, squamous	1 (2%)	1 (4%)		2 (4%)
Epithelium, hyperplasia				1 (2%)
Lung	(49)	(50)	(50)	(50)
Congestion	2 (4%)	4 (8%)	5 (10%)	3 (6%)
Edema			1 (2%)	
Hemorrhage	3 (6%)	1 (2%)	3 (6%)	8 (16%)
Infiltration cellular, mixed cell	3 (6%)	1 (2%)	2 (4%)	
Inflammation, chronic, focal	16 (33%)	7 (14%)	24 (48%)	32 (64%)
Inflammation, granulomatous, focal				2 (4%)
Inflammation, suppurative		1 (2%)		1 (2%)
Alveolar epithelium, hyperplasia	4 (8%)	4 (8%)	1 (2%)	5 (10%)
Alveolus, infiltration cellular, histiocytic	6 (12%)	4 (8%)	5 (10%)	20 (40%)
Mediastinum, inflammation, chronic	1 (2%)			
Perivascular, infiltration cellular, mononuclear cell	18 (37%)	10 (20%)	21 (42%)	23 (46%)
Nose	(49)	(49)	(49)	(50)
Inflammation	37 (76%)	21 (43%)	34 (69%)	48 (96%)
Inflammation, suppurative	46 (94%)	30 (61%)	43 (88%)	47 (94%)
Thrombus	8 (16%)	5 (10%)	3 (6%)	
Nares, inflammation, chronic	1 (2%)			
Nasolacrimal duct, inflammation, suppurative	14 (29%)	13 (27%)	11 (22%)	7 (14%)
Olfactory epithelium, degeneration			1 (2%)	23 (46%)
Olfactory epithelium, metaplasia	3 (6%)	1 (2%)	1 (2%)	15 (30%)
Olfactory epithelium, metaplasia, squamous				3 (6%)
Respiratory epithelium, hyperplasia	3 (6%)	3 (6%)	6 (12%)	46 (92%)
Respiratory epithelium, metaplasia, squamous		2 (4%)	5 (10%)	49 (98%)
Submucosa, hyperplasia				5 (10%)
Vomer nasal organ, inflammation, suppurative	12 (24%)	4 (8%)	6 (12%)	12 (24%)

TABLE B5. SUMMARY OF THE INCIDENCE OF NONNEOPLASTIC LESIONS IN FEMALE RATS IN THE TWO-YEAR INHALATION STUDY OF CS₂ (Continued)

	Chamber Control	0.075 mg/m ³	0.25 mg/m ³	0.75 mg/m ³
RESPIRATORY SYSTEM (Continued)				
Trachea	(48)	(25)	(18)	(48)
Inflammation, suppurative	3 (6%)	2 (8%)	2 (11%)	3 (6%)
Epithelium, hyperplasia				1 (2%)
SPECIAL SENSES SYSTEM				
Ear	(1)			
Inflammation, suppurative	1 (100%)			
Eye	(48)	(5)	(3)	(49)
Synechia		2 (40%)		3 (6%)
Anterior chamber, inflammation, suppurative	1 (2%)			
Cornea, hyperplasia				1 (2%)
Cornea, inflammation, suppurative			1 (33%)	3 (6%)
Lens, degeneration	5 (10%)	3 (60%)	1 (33%)	5 (10%)
Lens, mineralization				2 (4%)
Retina, degeneration	4 (8%)	3 (60%)	1 (33%)	6 (12%)
Harderian gland	(4)	(1)		(1)
Inflammation, suppurative	4 (100%)			
Metaplasia, squamous		1 (100%)		1 (100%)
Lacrimal gland	(3)	(3)	(7)	(7)
Inflammation, suppurative	1 (33%)	1 (33%)		
Acinus, atrophy	3 (100%)	3 (100%)	7 (100%)	7 (100%)
URINARY SYSTEM				
Kidney	(49)	(37)	(30)	(50)
Cyst			1 (3%)	
Hematopoietic cell proliferation	1 (2%)	1 (3%)		
Inflammation, suppurative			1 (3%)	
Mineralization	1 (2%)		1 (3%)	
Nephropathy	45 (92%)	34 (92%)	29 (97%)	48 (96%)
Artery, hyperplasia		1 (3%)		
Capsule, inflammation		1 (3%)		
Renal tubule, hyperplasia	3 (6%)	2 (5%)	1 (3%)	1 (2%)
Urinary bladder	(47)	(24)	(20)	(48)
Hemorrhage	2 (4%)			
Inflammation, suppurative			1 (5%)	
Transitional epithelium, hyperplasia				1 (2%)
Vein, ectasia				1 (2%)

APPENDIX C

SUMMARY OF LESIONS IN MALE MICE IN THE TWO-YEAR INHALATION STUDY OF CS₂

		PAGE
TABLE C1	SUMMARY OF THE INCIDENCE OF NEOPLASMS IN MALE MICE IN THE TWO-YEAR INHALATION STUDY OF CS ₂	123
TABLE C2	INDIVIDUAL ANIMAL TUMOR PATHOLOGY OF MALE MICE IN THE TWO-YEAR INHALATION STUDY OF CS ₂	126
TABLE C3	ANALYSIS OF PRIMARY NEOPLASMS IN MALE MICE IN THE TWO-YEAR INHALATION STUDY OF CS ₂	136
TABLE C4	SUMMARY OF THE INCIDENCE OF NONNEOPLASTIC LESIONS IN MALE MICE IN THE TWO-YEAR INHALATION STUDY OF CS ₂	139

TABLE C1. SUMMARY OF THE INCIDENCE OF NEOPLASMS IN MALE MICE IN THE TWO-YEAR INHALATION STUDY OF CS₂

	Chamber Control	0.75 mg/m ³	1.5 mg/m ³
DISPOSITION SUMMARY			
Animals initially in study	50	50	50
Early deaths			
Dead	7	4	5
Moribund	5	4	5
Survivors			
Terminal sacrifice	38	42	40
Animals examined microscopically	50	50	50
ALIMENTARY SYSTEM			
Gallbladder	(39)	(5)	(40)
Intestine small, duodenum	(44)	(5)	(44)
Polyp adenomatous		1 (20%)	
Intestine small, ileum	(43)	(3)	(44)
Intestine small, jejunum	(44)	(2)	(47)
Adenocarcinoma	1 (2%)		
Liver	(49)	(19)	(50)
Carcinoma, metastatic, lung	1 (2%)		
Hemangioma	1 (2%)		
Hemangioma, multiple			1 (2%)
Hemangiosarcoma, multiple			1 (2%)
Hepatocellular carcinoma	11 (22%)	5 (26%)	5 (10%)
Hepatocellular carcinoma, multiple	3 (6%)	2 (11%)	3 (6%)
Hepatocellular adenoma	3 (6%)	8 (42%)	5 (10%)
Hepatocellular adenoma, multiple	1 (2%)		
Histiocytic sarcoma	1 (2%)		
Mesentery		(1)	(1)
Sarcoma, metastatic, stomach			1 (100%)
Pancreas	(49)	(7)	(50)
Hemangiosarcoma, metastatic, spleen			1 (2%)
Salivary glands	(49)	(7)	(50)
Stomach, forestomach	(47)	(45)	(49)
Papilloma squamous			1 (2%)
Sarcoma			1 (2%)
Squamous cell carcinoma			1 (2%)
Stomach, glandular	(49)	(49)	(48)
Sarcoma, metastatic, stomach			1 (2%)
CARDIOVASCULAR SYSTEM			
Heart	(50)	(8)	(50)
Carcinoma, metastatic, lung	1 (2%)		
Hepatocellular carcinoma, metastatic, liver	1 (2%)		
ENDOCRINE SYSTEM			
Adrenal gland, cortex	(49)	(7)	(49)
Adenoma			1 (2%)
Adrenal gland, medulla	(49)	(7)	(49)
Pituitary gland	(46)	(7)	(46)
Pars distalis, adenoma		1 (14%)	
Thyroid gland	(48)	(7)	(50)
Follicular cell, adenoma	1 (2%)		1 (2%)
GENERAL BODY SYSTEM			
None			

TABLE C1. SUMMARY OF THE INCIDENCE OF NEOPLASMS IN MALE MICE IN THE TWO-YEAR INHALATION STUDY OF CS₂ (Continued)

	Chamber Control	0.75 mg/m ³	1.5 mg/m ³
GENITAL SYSTEM			
Epididymis	(46)	(7)	(49)
Prostate	(48)	(7)	(49)
Seminal vesicle	(47)	(9)	(49)
Testes	(48)	(7)	(50)
Interstitial cell, adenoma	1 (2%)		
HEMATOPOIETIC SYSTEM			
Bone marrow	(49)	(7)	(50)
Lymph node	(48)	(9)	(47)
Mediastinal, adenocarcinoma, metastatic, lung		1 (11%)	
Lymph node, bronchial	(47)	(5)	(43)
Carcinoma, metastatic, lung	2 (4%)		
Lymph node, mandibular	(42)	(4)	(35)
Spleen	(49)	(8)	(50)
Hemangiosarcoma			2 (4%)
Thymus	(38)	(5)	(43)
Carcinoma, metastatic, lung	1 (3%)		
INTEGUMENTARY SYSTEM			
Skin	(50)	(13)	(50)
MUSCULOSKELETAL SYSTEM			
Bone	(49)	(8)	(50)
Cranium, adenocarcinoma, metastatic, lung		1 (13%)	
Rib, carcinoma, metastatic, lung		1 (13%)	
Skeletal muscle	(2)		
Diaphragm, carcinoma, metastatic, lung	1 (50%)		
NERVOUS SYSTEM			
None			
RESPIRATORY SYSTEM			
Lung	(49)	(49)	(50)
Adenocarcinoma		1 (2%)	
Alveolar/bronchiolar adenoma	7 (14%)	7 (14%)	9 (18%)
Alveolar/bronchiolar carcinoma	5 (10%)	1 (2%)	2 (4%)
Alveolar/bronchiolar carcinoma, multiple	2 (4%)		
Hepatocellular carcinoma, metastatic, liver	4 (8%)	2 (4%)	1 (2%)
Nose	(50)	(47)	(50)
SPECIAL SENSES SYSTEM			
Harderian gland	(6)	(2)	(2)
Adenoma	6 (100%)	2 (100%)	2 (100%)
URINARY SYSTEM			
Kidney	(49)	(49)	(50)
Adenocarcinoma, metastatic, lung		1 (2%)	
Carcinoma, metastatic, liver			1 (2%)
Carcinoma, metastatic, lung	1 (2%)		
Urinary bladder	(48)	(7)	(49)

TABLE C1. SUMMARY OF THE INCIDENCE OF NEOPLASMS IN MALE MICE IN THE TWO-YEAR INHALATION STUDY OF CS2 (Continued)

	Chamber Control	0.75 mg/m ³	1.5 mg/m ³
SYSTEMIC LESIONS			
Multiple organs	*(50)	*(50)	*(50)
Histiocytic sarcoma	1 (2%)		
Lymphoma malignant mixed	1 (2%)	3 (6%)	1 (2%)
Lymphoma malignant undifferentiated cell	2 (4%)		1 (2%)
TUMOR SUMMARY			
Total animals with primary neoplasms **	31	24	30
Total primary neoplasms	46	31	37
Total animals with benign neoplasms	18	17	17
Total benign neoplasms	20	19	20
Total animals with malignant neoplasms	22	11	15
Total malignant neoplasms	26	12	17
Total animals with secondary neoplasms ***	6	3	3
Total secondary neoplasms	12	6	5

* Number of animals receiving complete necropsy examination; all gross lesions including masses examined microscopically.

** Primary tumors: all tumors except secondary tumors

*** Secondary tumors: metastatic tumors or tumors invasive into an adjacent organ

TABLE C2. INDIVIDUAL ANIMAL TUMOR PATHOLOGY OF MALE MICE IN THE TWO-YEAR INHALATION STUDY OF CS2: CHAMBER CONTROL

DAYS ON STUDY	0 1 4 4 6 6 6 6 7 7 7 7 7 7 7 7																												
	4 9 4 8 1 6 8 9 0 2 3 3 1 2 5 6 7 8 0 1 1 1 1 1 1 1 1 1																												
CARCASS ID	2 3 0 2 2 4 3 3 0 2 0 2 0 0 0 0 0 0 0 0 1 1 1 1 1 1 1 1 1 1 1 1																												
	1 1																												
ALIMENTARY SYSTEM																													
Esophagus	A	+	+	+	+	+	+	+	+	+	M	+	+	+	+	+	+	+	+	+	+	+	+	+	+	+	+	+	+
Gallbladder	A	A	A	M	+	+	A	+	A	+	M	A	+	M	+	+	+	+	+	+	+	+	+	+	+	+	+	+	+
Intestine large	A	+	+	+	+	+	+	+	+	+	+	+	+	+	+	+	+	+	+	+	+	+	+	+	+	+	+	+	+
Intestine large, cecum	A	M	M	+	+	+	+	+	A	+	+	+	+	+	+	+	+	+	+	+	+	+	+	+	+	+	+	+	+
Intestine large, colon	A	+	+	A	+	+	A	+	A	+	+	+	+	+	+	+	+	+	+	+	+	+	+	+	+	+	+	+	+
Intestine large, rectum	A	+	+	+	+	+	+	+	+	+	+	+	+	+	+	+	+	+	+	+	M	+	+	+	+	+	+	+	+
Intestine small	A	A	+	+	+	+	A	+	A	+	+	+	+	+	+	+	+	+	+	+	+	+	+	+	+	+	+	+	+
Intestine small, duodenum	A	A	+	M	+	+	A	+	A	+	+	A	+	+	+	+	+	+	+	+	+	+	+	+	+	+	+	+	+
Intestine small, ileum	A	A	+	+	+	+	A	+	A	+	+	A	+	+	+	+	+	+	+	+	+	+	+	+	+	+	+	+	+
Intestine small, jejunum	A	A	+	A	+	+	A	+	A	+	A	+	+	+	+	+	+	+	+	+	+	+	+	+	+	+	+	+	+
Adenocarcinoma															X														
Liver	A	+	+	+	+	+	+	+	+	+	+	+	+	+	+	+	+	+	+	+	+	+	+	+	+	+	+	+	+
Carcinoma, metastatic, lung												X																	
Hemangioma																													
Hepatocellular carcinoma					X	X		X		X	X							X			X								
Hepatocellular carcinoma, multiple											X																		X
Hepatocellular adenoma																													
Hepatocellular adenoma, multiple																													
Histiocytic sarcoma																								X					
Pancreas	A	+	+	+	+	+	+	+	+	+	+	+	+	+	+	+	+	+	+	+	+	+	+	+	+	+	+	+	+
Salivary glands	A	+	+	+	+	+	+	+	+	+	+	+	+	+	+	+	+	+	+	+	+	+	+	+	+	+	+	+	+
Stomach	A	+	+	+	+	+	+	+	+	+	+	+	+	+	+	+	+	+	+	+	+	+	+	+	+	+	+	+	+
Stomach, forestomach	A	+	M	I	+	+	+	+	+	+	+	+	+	+	+	+	+	+	+	+	+	+	+	+	+	+	+	+	+
Stomach, glandular	A	+	+	+	+	+	+	+	+	+	+	+	+	+	+	+	+	+	+	+	+	+	+	+	+	+	+	+	+
CARDIOVASCULAR SYSTEM																													
Heart	+	+	+	+	+	+	+	+	+	+	+	+	+	+	+	+	+	+	+	+	+	+	+	+	+	+	+	+	+
Carcinoma, metastatic, lung												X																	
Hepatocellular carcinoma, metastatic, liver																												X	
ENDOCRINE SYSTEM																													
Adrenal gland	A	+	+	+	+	+	+	+	+	+	+	+	+	+	+	+	+	+	+	+	+	+	+	+	+	+	+	+	+
Adrenal gland, cortex	A	+	+	+	+	+	+	+	+	+	+	+	+	+	+	+	+	+	+	+	+	+	+	+	+	+	+	+	+
Adrenal gland, medulla	A	+	+	+	+	+	+	+	+	+	+	+	+	+	+	+	+	+	+	+	+	+	+	+	+	+	+	+	+
Islets, pancreatic	A	+	+	+	+	+	+	+	+	+	+	+	+	+	+	+	+	+	+	+	+	+	+	+	+	+	+	+	+
Parathyroid gland	M	M	M	M	+	+	M	M	M	+	M	M	M	M	M	M	M	M	M	+	M	M	+	M	+	M	+	M	
Pituitary gland	A	+	+	+	+	+	+	+	A	+	+	+	+	+	+	+	+	+	+	+	+	+	+	+	+	+	+	+	+
Thyroid gland	A	+	+	+	+	+	+	+	+	+	+	+	+	+	+	+	+	+	+	+	+	+	+	+	+	+	+	+	+
Follicular cell, adenoma																													
GENERAL BODY SYSTEM																													
Tissue, NOS																													
GENITAL SYSTEM																													
Epididymis	A	+	+	+	+	+	+	+	+	+	+	+	+	+	+	+	+	+	+	+	+	+	+	+	+	+	+	+	+
Penis																													
Preputial gland																													
Prostate	A	+	+	+	+	+	+	+	A	+	+	+	+	+	+	+	+	+	+	+	+	+	+	+	+	+	+	+	+
Seminal vesicle	A	+	+	+	+	+	+	+	M	+	+	+	+	+	+	+	+	+	+	+	+	+	+	+	+	+	+	+	+
Testes	A	+	+	+	+	+	+	A	+	+	+	+	+	+	+	+	+	+	+	+	+	+	+	+	+	+	+	+	+
Interstitial cell, adenoma																													
HEMATOPOIETIC SYSTEM																													
Bone marrow	A	+	+	+	+	+	+	+	+	+	+	+	+	+	+	+	+	+	+	+	+	+	+	+	+	+	+	+	+
Lymph node	M	+	M	+	+	+	+	+	+	+	+	+	+	+	+	+	+	+	+	+	+	+	+	+	+	+	+	+	+
Lymph node, bronchial	M	+	M	+	+	+	+	+	+	+	+	+	+	+	+	+	+	+	+	+	+	+	+	+	+	+	+	+	+
Carcinoma, metastatic, lung												X																	
Lymph node, mandibular	A	M	M	+	+	+	+	+	+	+	M	+	+	M	+	+	+	+	+	+	+	+	+	+	M	+	+	+	+
Spleen	A	+	+	+	+	+	+	+	+	+	+	+	+	+	+	+	+	+	+	+	+	+	+	+	+	+	+	+	+
Thymus	M	M	+	M	M	+	+	+	M	+	+	+	+	+	+	+	+	+	+	+	+	+	+	+	M	+	+	M	+
Carcinoma, metastatic, lung												X																	
INTEGUMENTARY SYSTEM																													
Mammary gland	A	M	M	M	M	M	M	M	M	M	M	M	M	M	M	M	M	M	M	M	M	M	M	M	M	M	M	M	M
Skin	+	+	+	+	+	+	+	+	+	+	+	+	+	+	+	+	+	+	+	+	+	+	+	+	+	+	+	+	+

+: Tissue examined microscopically
 . : Not examined
 - : Present but not examined microscopically
 I: Insufficient tissue

M: Missing
 A: Autolysis precludes examination
 X: Incidence of listed morphology

TABLE C2. INDIVIDUAL ANIMAL TUMOR PATHOLOGY OF MALE MICE: CHAMBER CONTROL (Continued)

DAYS ON STUDY	7 7 7 7 7 7 7 7 7 7 7 7 7 7 7 7 7 7 7 7																				TOTAL: TISSUES TUMORS
	5 5 5 5 5 5 5 5 5 5 5 5 5 5 5 5 5 5 5 5																				
CARCASS ID	0 0 0 0 0 0 0 0 0 0 0 0 0 0 0 0 0 0 0 0																				
	1 1 1 2 2 2 2 3 3 3 3 3 3 3 4 4 4 4 4 4																				
	7 8 9 0 2 4 6 9 0 1 3 5 6 8 9 0 1 2 4 5 6 7 8 9 0																				
	1 1 1 1 1 1 1 1 1 1 1 1 1 1 1 1 1 1 1 1																				
ALIMENTARY SYSTEM																					
Esophagus	+																				48
Gallbladder	+																				39
Intestine large	+																				48
Intestine large, cecum	+																				46
Intestine large, colon	+																				46
Intestine large, rectum	+																				47
Intestine small	+																				46
Intestine small, duodenum	+																				44
Intestine small, ileum	+																				43
Intestine small, jejunum	+																				44
Adenocarcinoma																					1
Liver	+																				49
Carcinoma, metastatic, lung																					1
Hemangioma																					1
Hepatocellular carcinoma																					11
Hepatocellular carcinoma, multiple																					3
Hepatocellular adenoma	X																				3
Hepatocellular adenoma, multiple	X																				1
Histiocytic sarcoma																					1
Pancreas	+																				49
Salivary glands	+																				49
Stomach	+																				49
Stomach, forestomach	+																				47
Stomach, glandular	+																				49
CARDIOVASCULAR SYSTEM																					
Heart	+																				50
Carcinoma, metastatic, lung																					1
Hepatocellular carcinoma, metastatic, liver																					1
ENDOCRINE SYSTEM																					
Adrenal gland	+																				49
Adrenal gland, cortex	+																				49
Adrenal gland, medulla	+																				49
Islets, pancreatic	+																				49
Parathyroid gland	+																				20
Pituitary gland	I																				46
Thyroid gland	+																				48
Follicular cell, adenoma																					1
GENERAL BODY SYSTEM																					
Tissue, NOS																					1
GENITAL SYSTEM																					
Epididymis	+																				46
Penis	+																				5
Preputial gland	+																				4
Prostate	+																				48
Seminal vesicle	+																				47
Testes	+																				48
Interstitial cell, adenoma	X																				1
HEMATOPOIETIC SYSTEM																					
Bone marrow	+																				49
Lymph node	+																				48
Lymph node, bronchial	+																				47
Carcinoma, metastatic, lung																					2
Lymph node, mandibular	M																				42
Spleen	+																				49
Thymus	+																				38
Carcinoma, metastatic, lung																					1
INTEGUMENTARY SYSTEM																					
Mammary gland	M																				50
Skin	+																				50

**TABLE C2. INDIVIDUAL ANIMAL TUMOR PATHOLOGY OF MALE MICE: CHAMBER CONTROL
(Continued)**

DAYS ON STUDY	0	1	4	4	6	6	6	6	7	7	7	7	7	7	7	7	7	7	7	7	7	7	7	7	7	7	
	4	9	4	8	1	6	8	9	0	2	3	3	5	5	5	5	5	5	5	5	5	5	5	5	5	5	5
CARCASS ID	4	7	1	4	0	8	6	4	8	1	8	8	0	0	0	0	0	0	0	0	1	1	1	1	1	1	1
	2	3	0	2	2	4	3	3	0	2	0	2	0	0	0	0	0	0	0	0	1	1	1	1	1	1	1
	7	7	9	8	1	3	4	2	3	5	4	3	1	2	5	6	7	8	0	1	2	3	4	5	6	6	
	1	1	1	1	1	1	1	1	1	1	1	1	1	1	1	1	1	1	1	1	1	1	1	1	1	1	
MUSCULOSKELETAL SYSTEM																											
Bone	+	+	+	+	+	+	+	+	+	+	+	+	+	+	+	+	+	+	+	+	+	+	+	+	+	+	
Skeletal muscle																											
Diaphragm, carcinoma, metastatic, lung													X														
NERVOUS SYSTEM																											
Brain	A	+	+	+	+	+	+	+	+	+	+	+	+	+	+	+	+	+	+	+	+	+	+	+	+	+	
RESPIRATORY SYSTEM																											
Larynx	A	+	+	+	+	+	+	+	+	+	+	+	+	+	+	+	+	+	+	+	+	+	+	+	+	+	
Lung	A	+	+	+	+	+	+	+	+	+	+	+	+	+	+	+	+	+	+	+	+	+	+	+	+	+	
Alveolar/bronchiolar adenoma						X	X																				
Alveolar/bronchiolar carcinoma																										X	
Alveolar/bronchiolar carcinoma, multiple												X														X	
Hepatocellular carcinoma, metastatic, liver											X							X				X		X			
Nose	+	+	+	+	+	+	+	+	+	+	+	+	+	+	+	+	+	+	+	+	+	+	+	+	+	+	
Trachea	A	+	+	+	+	+	+	+	+	+	+	+	+	+	+	+	+	+	+	+	+	+	+	+	+	+	
SPECIAL SENSES SYSTEM																											
Eye	M	A	I	A	+	+	A	+	A	+	I	+	I	+	+	+	+	+	+	+	+	I	+	+	+	+	
Harderian gland																											
Adenoma						X				X					X												
URINARY SYSTEM																											
Kidney	A	+	+	+	+	+	+	+	+	+	+	+	+	+	+	+	+	+	+	+	+	+	+	+	+	+	
Carcinoma, metastatic, lung																											
Urinary bladder	A	+	+	+	+	+	+	+	A	+	+	+	+	+	+	+	+	+	+	+	+	+	+	+	+	+	
SYSTEMIC LESIONS																											
Multiple organs	+	+	+	+	+	+	+	+	+	+	+	+	+	+	+	+	+	+	+	+	+	+	+	+	+	+	
Histiocytic sarcoma																											
Lymphoma malignant mixed																											
Lymphoma malignant undifferentiated cell type																										X	

TABLE C2. INDIVIDUAL ANIMAL TUMOR PATHOLOGY OF MALE MICE: CHAMBER CONTROL
 (Continued)

DAYS ON STUDY	7	7	7	7	7	7	7	7	7	7	7	7	7	7	7	7	7	7	7	7	7	7	7	7	TOTAL: TISSUES TUMORS
CARCASS ID	5	5	5	5	5	5	5	5	5	5	5	5	5	5	5	5	5	5	5	5	5	5	5	5	49
	0	0	0	0	0	0	0	0	0	0	0	0	0	0	0	0	0	0	0	0	0	0	0	0	2
	1	1	1	2	2	2	2	2	3	3	3	3	3	3	4	4	4	4	4	4	4	4	4	5	1
	7	8	9	0	2	4	6	9	0	1	3	5	6	8	9	0	1	2	4	5	6	7	8	9	49
	1	1	1	1	1	1	1	1	1	1	1	1	1	1	1	1	1	1	1	1	1	1	1	1	7
MUSCULOSKELETAL SYSTEM																									5
Bone	+	+	+	+	+	+	+	+	+	+	+	+	+	+	+	+	+	+	+	+	+	+	+	+	2
Skeletal muscle																									1
Diaphragm, carcinoma, metastatic, lung																									
NERVOUS SYSTEM																									49
Brain	+	+	+	+	+	+	+	+	+	+	+	+	+	+	+	+	+	+	+	+	+	+	+	+	
RESPIRATORY SYSTEM																									49
Larynx	+	+	+	+	+	+	+	+	+	+	+	+	+	+	+	+	+	+	+	+	+	+	+	+	49
Lung	+	+	+	+	+	+	+	+	+	+	+	+	+	+	+	+	+	+	+	+	+	+	+	+	7
Alveolar/bronchiolar adenoma						X				X															5
Alveolar/bronchiolar carcinoma							X									X									2
Alveolar/bronchiolar carcinoma, multiple																									
Hepatocellular carcinoma, metastatic, liver																									4
Nose	+	+	+	+	+	+	+	+	+	+	+	+	+	+	+	+	+	+	+	+	+	+	+	+	50
Trachea	+	+	+	+	+	+	+	+	+	+	+	+	+	+	+	+	+	+	+	+	+	+	+	+	49
SPECIAL SENSES SYSTEM																									41
Eye	+	+	+	+	+	+	+	+	+	+	+	+	+	+	+	+	+	+	+	+	+	+	+	+	6
Harderian gland																									6
Adenoma								X									X						X		
URINARY SYSTEM																									49
Kidney	+	+	+	+	+	+	+	+	+	+	+	+	+	+	+	+	+	+	+	+	+	+	+	+	1
Carcinoma, metastatic, lung																									48
Urinary bladder	+	+	+	+	+	+	+	+	+	+	+	+	+	+	+	+	+	+	+	+	+	+	+	+	
SYSTEMIC LESIONS																									50
Multiple organs	+	+	+	+	+	+	+	+	+	+	+	+	+	+	+	+	+	+	+	+	+	+	+	+	1
Histiocytic sarcoma																									1
Lymphoma malignant mixed																							X		
Lymphoma malignant undifferentiated cell type																X									2

TABLE C2. INDIVIDUAL ANIMAL TUMOR PATHOLOGY OF MALE MICE IN THE TWO-YEAR INHALATION STUDY OF CS₂: 0.75 mg/m³

DAYS ON STUDY	3 5 5 5 5 6 6 7 7 7 7 7 7 7 7 7 7 7 7																			
	7	1	2	6	8	0	5	3	5	5	5	5	5	5	5	5	5	5	5	5
CARCASS ID	5 4 8 3 6 9 8 8 3 3 3 3 3 3 3 3 3 3 3 3																			
	1	1	1	1	1	1	1	1	1	1	1	1	1	1	1	1	1	1	1	1
	4	4	3	1	4	0	0	0	0	0	0	0	1	1	1	1	1	1	1	2
	2	8	1	2	5	5	4	2	1	3	6	7	8	9	0	1	3	4	5	6
	1	1	1	1	1	1	1	1	1	1	1	1	1	1	1	1	1	1	1	2
	1	1	1	1	1	1	1	1	1	1	1	1	1	1	1	1	1	1	1	1
ALIMENTARY SYSTEM																				
Esophagus	A	+	+	+	+	+	+	+												
Gallbladder	A	+	+	+	+	A	+	+	A											
Intestine large	A	+	+	+	+	A	+	+	+											
Intestine large, cecum	A	+	+	+	+	A	A	+	+											
Intestine large, colon	A	+	+	+	+	A	+	+	+											
Intestine large, rectum	A	+	+	+	+	A	M	+	+											
Intestine small	A	+	A	+	A	+	+	+	A											
Intestine small, duodenum	A	+	A	+	A	+	+	+	A											
Polyp adenomatous																				
Intestine small, ileum	A	+	A	+	A	+	A	A												
Intestine small, jejunum	A	+	A	+	A	M	A	A												
Liver	A	+	+	+	+	+	+	+						+						+
Hepatocellular carcinoma				X				X								+				
Hepatocellular carcinoma, multiple															X					
Hepatocellular adenoma							X										X			X
Mesentery																				
Pancreas	M	+	+	+	+	+	+	+												
Salivary glands	A	+	+	+	+	+	+	+												
Stomach	A	+	+	+	+	+	+	+												
Stomach, forestomach	A	+	+	M	+	+	+	+					I	+	+	+	+	+	+	+
Stomach, glandular	A	+	+	+	+	+	+	+					+	+	+	+	+	+	+	+
CARDIOVASCULAR SYSTEM																				
Heart		+	+	+	+	+	+	+												
ENDOCRINE SYSTEM																				
Adrenal gland	A	+	+	+	+	+	+	+												
Adrenal gland, cortex	A	+	+	+	+	+	+	+												
Adrenal gland, medulla	A	+	+	+	+	+	+	+												
Islets, pancreatic	M	+	+	+	+	+	+	+												
Parathyroid gland	M	+	M	M	M	M	M	M												
Pituitary gland	A	+	+	+	+	+	+	+												
Pars distalis, adenoma																				X
Thyroid gland	A	+	+	+	+	+	+	+												
GENERAL BODY SYSTEM																				
Tissue, NOS																				+
GENITAL SYSTEM																				
Epididymis	A	+	+	+	+	+	+	+												
Penis																				
Preputial gland			+					+												+
Prostate	A	+	+	+	+	+	+	+												
Seminal vesicle																				
Testes	A	+	+	+	+	+	+	+												
HEMATOPOIETIC SYSTEM																				
Bone marrow	A	+	+	+	+	+	+	+												
Lymph node	A	+	+	+	+	+	+	+												
Mediastinal, adenocarcinoma, metastatic, lung				X																
Lymph node, bronchial	A	M		+	+	+	+	+												
Lymph node, mandibular	A	+	+	+	+	M	M													
Spleen	M	M	+	+	+	+	+	+												
Thymus	M	+	M	+	+	+	M	+												
INTEGUMENTARY SYSTEM																				
Mammary gland	M	M	M	M	M	M														
Skin	A	+	+	+	+	+	+	+						+						+
MUSCULOSKELETAL SYSTEM																				
Bone																				
Cranium, adenocarcinoma, metastatic, lung																				
Rib, carcinoma, metastatic, lung						X														
NERVOUS SYSTEM																				
Brain	A	+	+	+	+	+	+	+												
RESPIRATORY SYSTEM																				
Larynx	A	+	+	+	+	+	+	+												
Lung	A	+	+	+	+	+	+	+												
Adenocarcinoma																				
Alveolar/bronchiolar adenoma																				
Alveolar/bronchiolar carcinoma																				
Hepatocellular carcinoma, metastatic, liver																				
Nose	A	+	+	I		+	+	+												
Trachea	A	+	+	+	+	+	+	+												
SPECIAL SENSES SYSTEM																				
Harderian gland																				+
Adenoma																				X
URINARY SYSTEM																				
Kidney	A	+	+	+	+	+	+	+												
Adenocarcinoma, metastatic, lung			X																	
Urinary bladder	A	+	+	+	A	+	+	+												
SYSTEMIC LESIONS																				
Multiple organs																				
Lymphoma malignant mixed					X	X														

TABLE C2. INDIVIDUAL ANIMAL TUMOR PATHOLOGY OF MALE MICE: 0.75 mg/m³
(Continued)

DAYS ON STUDY	7 7																												TOTAL TISSUES TUMORS	
	5 3	5 3	5 3	5 3	5 3	5 3	5 3	5 3	5 3	5 3	5 3	5 3	5 3	5 3	5 3	5 3	5 3	5 3	5 3	5 3	5 3	5 3	5 3	5 3	5 3	5 3	5 3	5 3		5 3
CARCASS ID	1 2 1	1 2 3	1 2 4	1 2 5	1 2 6	1 2 7	1 2 8	1 2 9	1 2 0	1 2 3	1 2 3	1 2 3	1 2 3	1 2 3	1 2 3	1 2 3	1 2 3	1 2 3	1 2 3	1 2 3	1 2 3	1 2 3	1 2 3	1 2 3	1 2 3	1 2 3	1 2 3	1 2 3	1 2 3	1 2 3
ALIMENTARY SYSTEM																														
Esophagus																													7	
Gallbladder																													5	
Intestine large																													6	
Intestine large, cecum																													5	
Intestine large, colon																													6	
Intestine large, rectum																													5	
Intestine small																													5	
Intestine small, duodenum																													5	
Polyp adenomatous																													1	
Intestine small, ileum																													3	
Intestine small, jejunum																													2	
Liver																													19	
Hepatocellular carcinoma																													5	
Hepatocellular carcinoma, multiple																													2	
Hepatocellular adenoma																													8	
Mesentery																													1	
Pancreas																													7	
Salivary glands																													7	
Stomach																													49	
Stomach, forestomach																													45	
Stomach, glandular																													49	
CARDIOVASCULAR SYSTEM																														
Heart																													8	
ENDOCRINE SYSTEM																														
Adrenal gland																													7	
Adrenal gland, cortex																													7	
Adrenal gland, medulla																													6	
Islets, pancreatic																													1	
Parathyroid gland																													7	
Pituitary gland																													1	
Pars distalis, adenoma																													7	
Thyroid gland																													7	
GENERAL BODY SYSTEM																														
Tissue, NOS																													1	
GENITAL SYSTEM																														
Epididymis																													7	
Penis																													1	
Preputial gland																													5	
Prostate																													7	
Seminal vesicle																													9	
Testes																													7	
HEMATOPOIETIC SYSTEM																														
Bone marrow																													7	
Lymph node																													9	
Mediastinal, adenocarcinoma, metastatic, lung																													1	
Lymph node, bronchial																													5	
Lymph node, mandibular																													4	
Spleen																													8	
Thymus																													5	
INTEGUMENTARY SYSTEM																														
Mammary gland																														
Skin																													13	
MUSCULOSKELETAL SYSTEM																														
Bone																													8	
Cranium, adenocarcinoma, metastatic, lung																													1	
Rib, carcinoma, metastatic, lung																													1	
NERVOUS SYSTEM																														
Brain																													7	
RESPIRATORY SYSTEM																														
Larynx																													7	
Lung																													49	
Adenocarcinoma																													1	
Alveolar/bronchiolar adenoma																													7	
Alveolar/bronchiolar carcinoma																													1	
Hepatocellular carcinoma, metastatic, liver																													2	
Nose																													47	
Trachea																													7	
SPECIAL SENSES SYSTEM																														
Harderian gland																													2	
Adenoma																													2	
URINARY SYSTEM																														
Kidney																													49	
Adenocarcinoma, metastatic, lung																													1	
Urinary bladder																													7	
SYSTEMIC LESIONS																														
Multiple organs																													50	
Lymphoma malignant mixed																													3	

TABLE C2. INDIVIDUAL ANIMAL TUMOR PATHOLOGY OF MALE MICE IN THE TWO-YEAR INHALATION STUDY OF CS2: 1.5 mg/m³

DAYS ON STUDY	0 3 5 5 5 5 6 6 7																											
	9 8 1 4 6 7 0 9 1 1 5																											
CARCASS ID	3 2 2 6 3 2 0 4 1 4 1																											
	2 2																											
4 3 2 4 2 3 3 1 2 1 0																												
3 3 3 1 5 7 2 0 2 2 1 2 3 4 5 6 7 8 9 1 3 4 5 6 7																												
1 1																												
ALIMENTARY SYSTEM																												
Esophagus	+ +																											
Gallbladder	+ + + A A M A A M + + M + + + M + + + + + + + + + + + + + + + + +																											
Intestine large	+ +																											
Intestine large, cecum	M M A + + + A +																											
Intestine large, colon	+ + + + + + A A +																											
Intestine large, rectum	+ + + + + + M +																											
Intestine small	+ + + A A + + + A +																											
Intestine small, duodenum	+ + + A A + + + A +																											
Intestine small, ileum	+ + + A A + + + A +																											
Intestine small, jejunum	+ + + A A + + + A +																											
Liver	+ +																											
Hemangioma, multiple																												
Hemangiosarcoma, multiple																												
Hepatocellular carcinoma	X X																											
Hepatocellular carcinoma, multiple																												
Hepatocellular adenoma																												
Mesentery																												
Sarcoma, metastatic, stomach																												
Pancreas	+ +																											
Hemangiosarcoma, metastatic, spleen																												
Salivary glands	+ +																											
Stomach	+ +																											
Stomach, forestomach	+ +																											
Papilloma squamous																												
Sarcoma																												
Squamous cell carcinoma																												
Stomach, glandular	+ + + + + + A + I +																											
Sarcoma, metastatic, stomach																												
CARDIOVASCULAR SYSTEM																												
Heart	+ +																											
ENDOCRINE SYSTEM																												
Adrenal gland	+ +																											
Adrenal gland, cortex	+ +																											
Adenoma																												
Adrenal gland, medulla	+ +																											
Islets, pancreatic	+ +																											
Parathyroid gland	M M M + M M + + M M + + + M + + M + M M M M + M + + + + + +																											
Pituitary gland	M + + I +																											
Thyroid gland	+ +																											
Follicular cell, adenoma																												
GENERAL BODY SYSTEM																												
None																												
GENITAL SYSTEM																												
Epididymis	+ +																											
Penis	+ +																											
Preputial gland	+ + + + + + A +																											
Prostate	+ + + + + + A +																											
Seminal vesicle	+ +																											
Testes	+ +																											
HEMATOPOIETIC SYSTEM																												
Bone marrow	+ +																											
Lymph node	+ + + + M + + + + + + + + M + + + + + + + + + + + + + + + + + + +																											
Lymph node, bronchial	+ + M + M + + + M + + M + + + + + + + M + + + + + + + + + + + +																											
Lymph node, mandibular	+ + + + M M + M + + + + M + + + M + + + M + + M + + + + + + + + + +																											
Spleen	+ +																											
Hemangiosarcoma																												
Thymus	M + + + M + + M M +																											
INTEGUMENTARY SYSTEM																												
Mammary gland	M M																											
Skin	+ +																											

TABLE C2. INDIVIDUAL ANIMAL TUMOR PATHOLOGY OF MALE MICE: 1.5 mg/m³
(Continued)

DAYS ON STUDY	7 7																												TOTAL TISSUES TUMORS							
	5 5																																			
CARCASS ID	1 1																																			
	2 2																																			
	8 9 0 1 4 6 7 8 9 0 1 4 5 6 8 9 0 2 4 5 6 7 8 9 0																																			
	1 1																																			
ALIMENTARY SYSTEM																																				
Esophagus	+	+	+	+	+	+	+	+	+	+	+	+	+	+	+	+	+	+	+	+	+	+	+	+	+	+	+	+	+	+	+	+	+	+	50	
Gallbladder	+	+	+	+	A	+	+	+	+	+	+	+	+	+	+	+	+	+	+	+	+	+	+	+	+	+	+	+	+	+	+	+	+	40		
Intestine large	+	+	+	+	+	+	+	+	+	+	+	+	+	+	+	+	+	+	+	+	+	+	+	+	+	+	+	+	+	+	+	+	+	50		
Intestine large, cecum	+	+	+	+	+	+	+	+	+	+	+	+	+	+	+	+	+	+	+	+	+	+	+	+	+	+	+	+	+	+	+	+	+	46		
Intestine large, colon	+	+	+	+	+	+	+	+	+	+	+	+	+	+	+	+	+	+	+	+	+	+	+	+	+	+	+	+	+	+	+	+	+	48		
Intestine large, rectum	+	+	+	+	M	+	+	+	+	+	+	+	+	+	+	+	+	+	+	+	+	+	+	+	+	+	+	+	+	+	+	+	+	48		
Intestine small	+	+	+	+	+	+	+	+	+	+	+	+	+	+	+	+	+	+	+	+	+	+	+	+	+	+	+	+	+	+	+	+	+	47		
Intestine small, duodenum	+	+	+	+	+	+	+	+	+	+	+	+	+	+	+	+	+	M	+	+	+	+	+	+	+	+	+	+	+	+	+	+	+	44		
Intestine small, ileum	+	+	+	+	+	+	+	+	+	+	+	+	+	+	+	+	+	+	+	+	+	+	+	+	+	+	+	+	+	+	+	+	+	44		
Intestine small, jejunum	+	+	+	+	+	+	+	+	+	+	+	+	+	+	+	+	+	+	+	+	+	+	+	+	+	+	+	+	+	+	+	+	+	47		
Liver	+	+	+	+	+	+	+	+	+	+	+	+	+	+	+	+	+	+	+	+	+	+	+	+	+	+	+	+	+	+	+	+	+	50		
Hemangioma, multiple																																		1		
Hemangiosarcoma, multiple																																		1		
Hepatocellular carcinoma										X																		X						5		
Hepatocellular carcinoma, multiple																																		3		
Hepatocellular adenoma			X																								X						X	5		
Mesentery																																			1	
Sarcoma, metastatic, stomach																																		X	1	
Pancreas																																			1	
Hemangiosarcoma, metastatic, spleen																																			50	
Salivary glands																																			50	
Stomach																																			50	
Stomach, forestomach																																			49	
Papilloma squamous												X																							1	
Sarcoma																																			1	
Squamous cell carcinoma																																		X	1	
Stomach, glandular																																			48	
Sarcoma, metastatic, stomach																																	X		1	
CARDIOVASCULAR SYSTEM																																				
Heart	+	+	+	+	+	+	+	+	+	+	+	+	+	+	+	+	+	+	+	+	+	+	+	+	+	+	+	+	+	+	+	+	+	50		
ENDOCRINE SYSTEM																																				
Adrenal gland	I	+	+	+	+	+	+	+	+	+	+	+	+	+	+	+	+	+	+	+	+	+	+	+	+	+	+	+	+	+	+	+	+	+	49	
Adrenal gland, cortex	I	+	+	+	+	+	+	+	+	+	+	+	+	+	+	+	+	+	+	+	+	+	+	+	+	+	+	+	+	+	+	+	+	+	49	
Adenoma											X																								1	
Adrenal gland, medulla	I	+	+	+	+	+	+	+	+	+	+	+	+	+	+	+	+	+	+	+	+	+	+	+	+	+	+	+	+	+	+	+	+	+	49	
Islets, pancreatic	+	+	+	+	+	+	+	+	+	+	+	+	+	+	+	+	+	+	+	+	+	+	+	+	+	+	+	+	+	+	+	+	+	+	+	50
Parathyroid gland	+	M	M	M	+	M	+	+	+	M	+	M	M	+	M	M	M	M	M	M	M	+	+	+	+	+	+	+	+	+	+	+	+	+	24	
Pituitary gland	+	M	+	+	+	+	+	+	+	+	+	+	+	+	+	+	+	+	+	+	+	+	+	+	+	+	+	+	+	+	+	+	+	I	46	
Thyroid gland	+	+	+	+	+	+	+	+	+	+	+	+	+	+	+	+	+	+	+	+	+	+	+	+	+	+	+	+	+	+	+	+	+	+	+	50
Follicular cell, adenoma																																	X		1	
GENERAL BODY SYSTEM																																				
None																																				
GENITAL SYSTEM																																				
Epididymis	+	+	M	+	+	+	+	+	+	+	+	+	+	+	+	+	+	+	+	+	+	+	+	+	+	+	+	+	+	+	+	+	+	49		
Penis																																			1	
Preputial gland			+																																4	
Prostate	+	+	+	+	+	+	+	+	+	+	+	+	+	+	+	+	+	+	+	+	+	+	+	+	+	+	+	+	+	+	+	+	+	+	49	
Seminal vesicle	+	+	+	+	+	+	+	+	+	+	+	+	+	+	+	+	+	+	+	+	+	+	+	+	+	+	+	+	+	+	+	+	+	+	49	
Testes	+	+	+	+	+	+	+	+	+	+	+	+	+	+	+	+	+	+	+	+	+	+	+	+	+	+	+	+	+	+	+	+	+	+	50	
HEMATOPOIETIC SYSTEM																																				
Bone marrow	+	+	+	+	+	+	+	+	+	+	+	+	+	+	+	+	+	+	+	+	+	+	+	+	+	+	+	+	+	+	+	+	+	+	50	
Lymph node	+	+	+	+	+	+	+	+	+	+	+	M	+	+	+	+	+	+	+	+	+	+	+	+	+	+	+	+	+	+	+	+	+	+	47	
Lymph node, bronchial	+	+	+	+	+	+	+	+	+	+	+	+	M	+	+	+	+	+	M	+	+	+	+	+	+	+	+	+	+	+	+	+	+	+	43	
Lymph node, mandibular	+	+	+	+	+	M	M	+	M	+	M	+	+	+	M	+	+	+	+	+	+	+	+	+	M	M	+	M	+	+	+	+	+	+	35	
Spleen	+	+	+	+	+	+	+	+	+	+	+	+	+	+	+	+	+	+	+	+	+	+	+	+	+	+	+	+	+	+	+	+	+	+	50	
Hemangiosarcoma																																		X	2	
Thymus	+	+	+	+	+	+	+	+	+	+	+	+	+	+	+	+	+	M	+	+	+	+	+	M	+	+	+	+	M	+	+	+	+	+	43	
INTEGUMENTARY SYSTEM																																				
Mammary gland	M	M	M	M	M	M	M	M	M	M	M	M	M	M	M	M	M	M	M	M	M	M	M	M	M	M	M	M	M	M	M	M	M	M		
Skin	+	+	+	+	+	+	+	+	+	+	+	+	+	+	+	+	+	+	+	+	+	+	+	+	+	+	+	+	+	+	+	+	+	+	+	50

TABLE C2. INDIVIDUAL ANIMAL TUMOR PATHOLOGY OF MALE MICE: 1.5 mg/m³
(Continued)

DAYS ON STUDY	0	3	5	5	5	5	6	6	7	7	7	7	7	7	7	7	7	7	7	7	7	7	7	7	7		
	9	8	1	4	6	7	0	9	1	1	5	5	5	5	5	5	5	5	5	5	5	5	5	5	5		
CARCASS ID	3	2	2	6	3	2	0	4	1	4	1	1	1	1	1	1	1	1	1	1	1	1	1	1	1		
	2	2	2	2	2	2	2	2	2	2	2	2	2	2	2	2	2	2	2	2	2	2	2	2	2		
	4	3	2	4	2	3	3	1	2	1	0	0	0	0	0	0	0	0	0	1	1	1	1	1	1		
	3	3	3	1	5	7	2	0	2	2	1	2	3	4	5	6	7	8	9	1	3	4	5	6	7		
	1	1	1	1	1	1	1	1	1	1	1	1	1	1	1	1	1	1	1	1	1	1	1	1	1		
MUSCULOSKELETAL SYSTEM																											
Bone	+	+	+	+	+	+	+	+	+	+	+	+	+	+	+	+	+	+	+	+	+	+	+	+	+	+	
NERVOUS SYSTEM																											
Brain	+	+	+	+	+	+	+	+	+	+	+	+	+	+	+	+	+	+	+	+	+	+	+	+	+	+	
RESPIRATORY SYSTEM																											
Larynx	+	+	+	+	+	+	+	+	+	+	+	+	+	+	+	+	+	+	+	+	+	+	+	+	+	+	
Lung	+	+	+	+	+	+	+	+	+	+	+	+	+	+	+	+	+	+	+	+	+	+	+	+	+	+	
Alveolar/bronchiolar adenoma																											
Alveolar/bronchiolar carcinoma													X				X			X							
Hepatocellular carcinoma, metastatic, liver							X																				
Nose	+	+	+	+	+	+	+	+	+	+	+	+	+	+	+	+	+	+	+	+	+	+	+	+	+	+	
Trachea	+	+	+	+	+	+	+	+	+	+	+	+	+	+	+	+	+	+	+	+	+	+	+	+	+	+	
SPECIAL SENSES SYSTEM																											
Eye	I	+	A	A	+	A	A	+	+	A	+	+	+	+	+	+	+	+	+	+	+	+	+	+	+	+	
Harderian gland Adenoma																											
													X														
URINARY SYSTEM																											
Kidney	+	+	+	+	+	+	+	+	+	+	+	+	+	+	+	+	+	+	+	+	+	+	+	+	+	+	
Carcinoma, metastatic, liver																											
Urinary bladder							X																				
								A	+	+	+	+	+	+	+	+	+	+	+	+	+	+	+	+	+	+	
SYSTEMIC LESIONS																											
Multiple organs	+	+	+	+	+	+	+	+	+	+	+	+	+	+	+	+	+	+	+	+	+	+	+	+	+	+	
Lymphoma malignant mixed																											
Lymphoma malignant undifferentiated cell type																											
							X																				

TABLE C3. ANALYSIS OF PRIMARY NEOPLASMS IN MALE MICE IN THE TWO-YEAR INHALATION STUDY OF CS2

	Chamber Control	0.75 mg/m ³	1.5 mg/m ³
Harderian Gland: Adenoma			
Overall Rates (a)	6/50 (12%)	2/50 (4%)	2/50 (4%)
Adjusted Rates (b)	14.6%	4.8%	5.0%
Terminal Rates (c)	4/38 (11%)	2/42 (5%)	2/40 (5%)
Day of First Observation	610	750	750
Life Table Tests (d)	P=0.074N	P=0.116N	P=0.129N
Logistic Regression Tests (d)	P=0.080N	P=0.129N	P=0.134N
Cochran-Armitage Trend Test (d)	P=0.080N		
Fisher Exact Test (d)		P=0.134N	P=0.134N
Liver: Hepatocellular Adenoma			
Overall Rates (e)	4/49 (8%)	(f) 8/19 (42%)	5/50 (10%)
Adjusted Rates (b)	10.5%		12.0%
Terminal Rates (c)	4/38 (11%)		4/40 (10%)
Day of First Observation	750		600
Life Table Test (d)			P=0.525
Logistic Regression Test (d)			P=0.501
Fisher Exact Test (d)			P=0.513
Liver: Hepatocellular Carcinoma			
Overall Rates (e)	14/49 (29%)	(f) 7/19 (37%)	8/50 (16%)
Adjusted Rates (b)	30.9%		18.3%
Terminal Rates (c)	7/38 (18%)		5/40 (13%)
Day of First Observation	484		563
Life Table Test (d)			P=0.122N
Logistic Regression Test (d)			P=0.100N
Fisher Exact Test (d)			P=0.103N
Liver: Hepatocellular Adenoma or Carcinoma			
Overall Rates (e)	18/49 (37%)	(f) 14/19 (74%)	13/50 (26%)
Adjusted Rates (b)	39.8%		29.2%
Terminal Rates (c)	11/38 (29%)		9/40 (23%)
Day of First Observation	484		563
Life Table Test (d)			P=0.192N
Logistic Regression Test (d)			P=0.175N
Fisher Exact Test (d)			P=0.175N
Lung: Alveolar/Bronchiolar Adenoma			
Overall Rates (e)	7/49 (14%)	7/49 (14%)	9/50 (18%)
Adjusted Rates (b)	17.0%	16.7%	22.5%
Terminal Rates (c)	5/38 (13%)	7/42 (17%)	9/40 (23%)
Day of First Observation	666	750	750
Life Table Tests (d)	P=0.371	P=0.549N	P=0.427
Logistic Regression Tests (d)	P=0.330	P=0.601N	P=0.386
Cochran-Armitage Trend Test (d)	P=0.355		
Fisher Exact Test (d)		P=0.613N	P=0.410
Lung: Alveolar/Bronchiolar Carcinoma			
Overall Rates (e)	7/49 (14%)	1/49 (2%)	2/50 (4%)
Adjusted Rates (b)	17.9%	2.4%	5.0%
Terminal Rates (c)	6/38 (16%)	1/42 (2%)	2/40 (5%)
Day of First Observation	738	750	750
Life Table Tests (d)	P=0.030N	P=0.024N	P=0.072N
Logistic Regression Tests (d)	P=0.033N	P=0.027N	P=0.077N
Cochran-Armitage Trend Test (d)	P=0.034N		
Fisher Exact Test (d)		P=0.030N	P=0.075N

TABLE C3. ANALYSIS OF PRIMARY NEOPLASMS IN MALE MICE IN THE TWO-YEAR INHALATION STUDY OF CS2 (Continued)

	Chamber Control	0.75 mg/m ³	1.5 mg/m ³
Lung: Alveolar/Bronchiolar Adenoma or Carcinoma			
Overall Rates (e)	14/49 (29%)	9/49 (18%)	10/50 (20%)
Adjusted Rates (b)	33.8%	20.7%	25.0%
Terminal Rates (c)	11/38 (29%)	8/42 (19%)	10/40 (25%)
Day of First Observation	666	528	750
Life Table Tests (d)	P=0.168N	P=0.125N	P=0.208N
Logistic Regression Tests (d)	P=0.199N	P=0.160N	P=0.246N
Cochran-Armitage Trend Test (d)	P=0.184N		
Fisher Exact Test (d)		P=0.170N	P=0.224N
Circulatory System: Hemangioma or Hemangiosarcoma			
Overall Rates (a)	1/50 (2%)	(f,g) 0/50 (0%)	3/50 (6%)
Adjusted Rates (b)	2.6%	0.0%	7.3%
Terminal Rates (c)	1/38 (3%)	0/42 (0%)	2/40 (5%)
Day of First Observation	750		714
Life Table Tests (d)	P=0.183	P=0.480N	P=0.321
Logistic Regression Tests (d)	P=0.173	P=0.480N	P=0.302
Cochran-Armitage Trend Test (d)	P=0.176		
Fisher Exact Test (d)		P=0.500N	P=0.309
Hematopoietic System: Lymphoma, All Malignant			
Overall Rates (a)	3/50 (6%)	(f,g) 3/50 (6%)	2/50 (4%)
Adjusted Rates (b)	7.5%	6.5%	4.5%
Terminal Rates (c)	2/38 (5%)	1/42 (2%)	1/40 (3%)
Day of First Observation	694	563	382
Life Table Tests (d)	P=0.403N	P=0.635N	P=0.484N
Logistic Regression Tests (d)	P=0.427N	P=0.640	P=0.507N
Cochran-Armitage Trend Test (d)	P=0.412N		
Fisher Exact Test (d)		P=0.661N	P=0.500N
All Sites: Benign Tumors			
Overall Rates (a)	18/50 (36%)	17/50 (34%)	17/50 (34%)
Adjusted Rates (b)	42.4%	38.6%	41.4%
Terminal Rates (c)	14/38 (37%)	15/42 (36%)	16/40 (40%)
Day of First Observation	610	658	600
Life Table Tests (d)	P=0.403N	P=0.387N	P=0.445N
Logistic Regression Tests (d)	P=0.465N	P=0.471N	P=0.505N
Cochran-Armitage Trend Test (d)	P=0.458N		
Fisher Exact Test (d)		P=0.500N	P=0.500N
All Sites: Malignant Tumors			
Overall Rates (a)	22/50 (44%)	11/50 (22%)	15/50 (30%)
Adjusted Rates (b)	47.8%	23.7%	33.0%
Terminal Rates (c)	14/38 (37%)	7/42 (17%)	10/40 (25%)
Day of First Observation	484	528	382
Life Table Tests (d)	P=0.087N	P=0.016N	P=0.114N
Logistic Regression Tests (d)	P=0.082N	P=0.016N	P=0.106N
Cochran-Armitage Trend Test (d)	P=0.082N		
Fisher Exact Test (d)		P=0.016N	P=0.107N
All Sites: All Tumors			
Overall Rates (a)	31/50 (62%)	24/50 (48%)	30/50 (60%)
Adjusted Rates (b)	66.0%	51.0%	65.1%
Terminal Rates (c)	22/38 (58%)	19/42 (45%)	24/40 (60%)
Day of First Observation	484	528	382
Life Table Tests (d)	P=0.397N	P=0.081N	P=0.426N
Logistic Regression Tests (d)	P=0.454N	P=0.096N	P=0.493N
Cochran-Armitage Trend Test (d)	P=0.460N		
Fisher Exact Test (d)		P=0.114N	P=0.500N

TABLE C3. ANALYSIS OF PRIMARY NEOPLASMS IN MALE MICE IN THE TWO-YEAR INHALATION STUDY OF CS₂ (Continued)

- (a) Number of tumor-bearing animals/number of animals examined grossly at the site
- (b) Kaplan-Meier estimated tumor incidences at the end of the study after adjusting for intercurrent mortality
- (c) Observed tumor incidence in animals killed at the end of the study
- (d) Beneath the control incidence are the P values associated with the trend test. Beneath the dosed group incidence are the P values corresponding to pairwise comparisons between that dosed group and the controls. The life table analysis regards tumors in animals dying prior to terminal kill as being (directly or indirectly) the cause of death. The logistic regression test regards these lesions as nonfatal. The Cochran-Armitage and Fisher exact tests compare directly the overall incidence rates. A negative trend or lower incidence in a dosed group than in controls is indicated by (N).
- (e) Number of tumor-bearing animals/number of animals examined microscopically at the site
- (f) Incomplete sampling of tissues
- (g) Nineteen livers, eight spleens, and nine lymph nodes were examined microscopically.

TABLE C4. SUMMARY OF THE INCIDENCE OF NONNEOPLASTIC LESIONS IN MALE MICE IN THE TWO-YEAR INHALATION STUDY OF CS₂

	Chamber Control	0.75 mg/m ³	1.5 mg/m ³
DISPOSITION SUMMARY			
Animals initially in study	50	50	50
Early deaths			
Dead	7	4	5
Moribund	5	4	5
Survivors			
Terminal sacrifice	38	42	40
Animals examined microscopically	50	50	50
ALIMENTARY SYSTEM			
Gallbladder	(39)	(5)	(40)
Infarct	1 (3%)		
Necrosis	1 (3%)		
Intestine large, rectum	(47)	(5)	(48)
Hemorrhage	1 (2%)		
Intestine small, duodenum	(44)	(5)	(44)
Developmental malformation			1 (2%)
Hyperplasia			1 (2%)
Inflammation, suppurative			1 (2%)
Intestine small, ileum	(43)	(3)	(44)
Hyperplasia, lymphoid	1 (2%)		
Liver	(49)	(19)	(50)
Angiectasis	1 (2%)		1 (2%)
Clear cell focus	2 (4%)		
Eosinophilic focus			1 (2%)
Hematopoietic cell proliferation	2 (4%)	1 (5%)	
Hepatodiaphragmatic nodule			1 (2%)
Hyperplasia	2 (4%)	3 (16%)	2 (4%)
Infarct	2 (4%)		1 (2%)
Inflammation, granulomatous	1 (2%)		
Inflammation, suppurative			1 (2%)
Leukocytosis	1 (2%)		1 (2%)
Necrosis	2 (4%)		1 (2%)
Mesentery		(1)	(1)
Artery, thrombus		1 (100%)	
Pancreas	(49)	(7)	(50)
Acinar cell, hypertrophy	1 (2%)		
Stomach, forestomach	(47)	(45)	(49)
Acanthosis	2 (4%)		
Inflammation, suppurative			1 (2%)
Stomach, glandular	(49)	(49)	(48)
Erosion	2 (4%)	1 (2%)	
Inflammation, suppurative	1 (2%)	1 (2%)	1 (2%)
Epithelium, hyperplasia		1 (2%)	1 (2%)
CARDIOVASCULAR SYSTEM			
Heart	(50)	(8)	(50)
Cardiomyopathy	1 (2%)		
Hemorrhage			1 (2%)
ENDOCRINE SYSTEM			
Adrenal gland	(49)	(7)	(49)
Capsule, hyperplasia	41 (84%)	4 (57%)	34 (69%)
Adrenal gland, cortex	(49)	(7)	(49)
Cyst	1 (2%)		
Cytomegaly	10 (20%)		6 (12%)
Hyperplasia	1 (2%)		

TABLE C4. SUMMARY OF THE INCIDENCE OF NONNEOPLASTIC LESIONS IN MALE MICE IN THE TWO-YEAR INHALATION STUDY OF CS2 (Continued)

	Chamber Control	0.75 mg/m ³	1.5 mg/m ³
ENDOCRINE SYSTEM (Continued)			
Adrenal gland, medulla	(49)	(7)	(49)
Karyomegaly			1 (2%)
Vacuolization cytoplasmic			1 (2%)
Parathyroid gland	(20)	(1)	(24)
Cyst			1 (4%)
Pituitary gland	(46)	(7)	(46)
Cyst			1 (2%)
Thyroid gland	(48)	(7)	(50)
Cyst			1 (2%)
Inflammation, suppurative			1 (2%)
Follicular cell, hyperplasia	4 (8%)	2 (29%)	6 (12%)
GENERAL BODY SYSTEM			
None			
GENITAL SYSTEM			
Epididymis	(46)	(7)	(49)
Inflammation, suppurative	1 (2%)		
Penis	(5)	(1)	(1)
Concretion	2 (40%)		
Inflammation, suppurative	4 (80%)	1 (100%)	1 (100%)
Necrosis		1 (100%)	
Preputial gland	(4)	(5)	(4)
Cyst	2 (50%)	3 (60%)	1 (25%)
Hyperplasia		1 (20%)	
Inflammation, chronic	1 (25%)	1 (20%)	
Inflammation, suppurative	1 (25%)	3 (60%)	3 (75%)
Prostate	(48)	(7)	(49)
Inflammation, suppurative	4 (8%)	1 (14%)	2 (4%)
Seminal vesicle	(47)	(9)	(49)
Dilatation	1 (2%)	1 (11%)	2 (4%)
Inflammation, suppurative	3 (6%)	1 (11%)	2 (4%)
Testes	(48)	(7)	(50)
Atrophy	9 (19%)	2 (29%)	5 (10%)
Inflammation, suppurative		1 (14%)	
Mineralization	2 (4%)		
HEMATOPOIETIC SYSTEM			
Bone marrow	(49)	(7)	(50)
Hyperplasia		1 (14%)	
Myelofibrosis	2 (4%)		
Lymph node	(48)	(9)	(47)
Inguinal, hematopoietic cell proliferation	1 (2%)		
Mesenteric, angiectasis	1 (2%)		
Mesenteric, hematopoietic cell proliferation		2 (22%)	
Spleen	(49)	(8)	(50)
Atrophy	2 (4%)		
Fibrosis	1 (2%)		
Hematopoietic cell proliferation	3 (6%)	2 (25%)	6 (12%)
Thrombus			1 (2%)
INTEGUMENTARY SYSTEM			
Skin	(50)	(13)	(50)
Acanthosis	1 (2%)		1 (2%)
Hemorrhage			1 (2%)
Inflammation, suppurative	4 (8%)	3 (23%)	6 (12%)
Ulcer	2 (4%)	1 (8%)	1 (2%)

TABLE C4. SUMMARY OF THE INCIDENCE OF NONNEOPLASTIC LESIONS IN MALE MICE IN THE TWO-YEAR INHALATION STUDY OF CS₂ (Continued)

	Chamber Control	0.75 mg/m ³	1.5 mg/m ³
MUSCULOSKELETAL SYSTEM			
Skeletal muscle	(2)		
Hemorrhage	1 (50%)		
NERVOUS SYSTEM			
Brain	(49)	(7)	(50)
Mineralization	17 (35%)	1 (14%)	16 (32%)
RESPIRATORY SYSTEM			
Larynx	(49)	(7)	(50)
Inflammation, suppurative	1 (2%)		
Lung	(49)	(49)	(50)
Hemorrhage			1 (2%)
Inflammation, granulomatous	1 (2%)		
Leukocytosis	2 (4%)	1 (2%)	2 (4%)
Alveolus, hyperplasia	6 (12%)	3 (6%)	2 (4%)
Alveolus, infiltration cellular, histiocytic	2 (4%)	1 (2%)	4 (8%)
Alveolus, inflammation, suppurative	1 (2%)		
Nose	(50)	(47)	(50)
Foreign body	1 (2%)	1 (2%)	
Inflammation, suppurative	3 (6%)	16 (34%)	23 (46%)
Nasolacrimal duct, inflammation, suppurative	2 (4%)	1 (2%)	
Olfactory epithelium, atrophy			1 (2%)
Respiratory epithelium, hyperplasia	1 (2%)	8 (17%)	12 (24%)
Respiratory epithelium, metaplasia, squamous	2 (4%)	12 (26%)	24 (48%)
Trachea	(49)	(7)	(50)
Inflammation, suppurative			1 (2%)
SPECIAL SENSES SYSTEM			
Eye	(41)		(43)
Cornea, inflammation, suppurative	1 (2%)		
Retina, vacuolization cytoplasmic	3 (7%)		5 (12%)
URINARY SYSTEM			
Kidney	(49)	(49)	(50)
Cyst			4 (8%)
Infiltration cellular, polymorphonuclear, diffuse			1 (2%)
Inflammation, suppurative	1 (2%)	1 (2%)	1 (2%)
Mineralization			2 (4%)
Nephropathy, chronic	43 (88%)	40 (82%)	47 (94%)
Artery, inflammation			1 (2%)
Pelvis, inflammation, suppurative	4 (8%)	2 (4%)	1 (2%)
Urinary bladder	(48)	(7)	(49)
Dilatation		1 (14%)	
Hemorrhage			1 (2%)
Hyperplasia	3 (6%)	2 (29%)	3 (6%)
Inflammation, suppurative	5 (10%)	2 (29%)	3 (6%)
Metaplasia, squamous	1 (2%)		
Ulcer	1 (2%)		1 (2%)

APPENDIX D

SUMMARY OF LESIONS IN FEMALE MICE IN THE TWO-YEAR INHALATION STUDY OF CS₂

	PAGE	
TABLE D1	SUMMARY OF THE INCIDENCE OF NEOPLASMS IN FEMALE MICE IN THE TWO-YEAR INHALATION STUDY OF CS ₂	145
TABLE D2	INDIVIDUAL ANIMAL TUMOR PATHOLOGY OF FEMALE MICE IN THE TWO-YEAR INHALATION STUDY OF CS ₂	148
TABLE D3	ANALYSIS OF PRIMARY NEOPLASMS IN FEMALE MICE IN THE TWO-YEAR INHALATION STUDY OF CS ₂	160
TABLE D4a	HISTORICAL INCIDENCE OF ANTERIOR PITUITARY GLAND NEOPLASMS IN FEMALE B6C3F ₁ MICE	164
TABLE D4b	HISTORICAL INCIDENCE OF INTERMEDIA PITUITARY GLAND NEOPLASMS IN FEMALE B6C3F ₁ MICE	165
TABLE D4c	HISTORICAL INCIDENCE OF HEMATOPOIETIC SYSTEM NEOPLASMS IN FEMALE B6C3F ₁ MICE	166
TABLE D5	SUMMARY OF THE INCIDENCE OF NONNEOPLASTIC LESIONS IN FEMALE MICE IN THE TWO-YEAR INHALATION STUDY OF CS ₂	167

TABLE D1. SUMMARY OF THE INCIDENCE OF NEOPLASMS IN FEMALE MICE IN THE TWO-YEAR INHALATION STUDY OF CS₂

	Chamber Control	0.75 mg/m ³	1.5 mg/m ³
DISPOSITION SUMMARY			
Animals initially in study	50	50	50
Early deaths			
Dead	9	5	7
Moribund	8	5	3
Survivors			
Terminal sacrifice	33	40	40
Animals examined microscopically	50	50	50
ALIMENTARY SYSTEM			
Esophagus	(50)	(10)	(47)
Gallbladder	(42)	(5)	(40)
Intestine large, cecum	(44)	(7)	(43)
Leiomyosarcoma		1 (14%)	
Intestine large, colon	(46)	(9)	(44)
Intestine large, rectum	(47)	(9)	(45)
Intestine small, duodenum	(43)	(7)	(44)
Intestine small, ileum	(44)	(9)	(44)
Intestine small, jejunum	(43)	(9)	(43)
Liver	(50)	(15)	(49)
Hepatocellular carcinoma	7 (14%)	1 (7%)	4 (8%)
Hepatocellular carcinoma, multiple		1 (7%)	2 (4%)
Hepatocellular adenoma	4 (8%)	2 (13%)	3 (6%)
Mesentery	(4)	(1)	
Pancreas	(50)	(11)	(49)
Salivary glands	(50)	(10)	(49)
Stomach, forestomach	(48)	(48)	(47)
Papilloma squamous	2 (4%)	4 (8%)	
Squamous cell carcinoma	1 (2%)		
Stomach, glandular	(49)	(48)	(47)
Adenoma			1 (2%)
CARDIOVASCULAR SYSTEM			
Heart	(50)	(10)	(49)
ENDOCRINE SYSTEM			
Adrenal gland	(50)	(10)	(49)
Osteosarcoma, metastatic, bone	1 (2%)		
Adrenal gland, cortex	(50)	(10)	(49)
Adrenal gland, medulla	(49)	(10)	(48)
Pheochromocytoma benign	2 (4%)		
Islets, pancreatic	(50)	(9)	(48)
Pituitary gland	(47)	(46)	(46)
Pars distalis, adenoma	13 (28%)	5 (11%)	1 (2%)
Pars intermedia, adenoma			3 (6%)
Thyroid gland	(49)	(49)	(49)
Follicular cell, adenoma	2 (4%)	2 (4%)	2 (4%)
Follicular cell, adenoma, multiple		1 (2%)	
GENERAL BODY SYSTEM			
None			

TABLE D1. SUMMARY OF THE INCIDENCE OF NEOPLASMS IN FEMALE MICE IN THE TWO-YEAR INHALATION STUDY OF CS2 (Continued)

	Chamber Control	0.75 mg/m ³	1.5 mg/m ³
GENITAL SYSTEM			
Ovary	(50)	(20)	(49)
Adenoma	1 (2%)		
Hemangioma		1 (5%)	
Teratoma	1 (2%)		1 (2%)
Teratoma malignant		1 (5%)	
Uterus	(49)	(15)	(48)
Hemangioma	1 (2%)	1 (7%)	1 (2%)
Hemangiosarcoma	1 (2%)		
Histiocytic sarcoma			1 (2%)
Leiomyoma	1 (2%)		
Polyp, adenoid	1 (2%)		
Polyp stromal	2 (4%)	1 (7%)	
Sarcoma stromal		1 (7%)	
Vagina			(1)
Polyp			1 (100%)
HEMATOPOIETIC SYSTEM			
Bone marrow	(50)	(10)	(49)
Lymph node	(50)	(15)	(48)
Teratoma, NOS, metastatic, ovary		1 (7%)	
Pancreatic, sarcoma	1 (2%)		
Lymph node, bronchial	(48)	(11)	(46)
Lymph node, mandibular	(44)	(11)	(38)
Squamous cell carcinoma, metastatic, skin	1 (2%)		
Spleen	(50)	(19)	(49)
Sarcoma	1 (2%)		
Thymus	(46)	(10)	(46)
INTEGUMENTARY SYSTEM			
Mammary gland	(45)	(10)	(47)
Adenocarcinoma	3 (7%)	1 (10%)	
Skin	(50)	(17)	(49)
Fibrosarcoma	1 (2%)		
Hemangiosarcoma	1 (2%)		
Papilloma	1 (2%)		
Sarcoma	1 (2%)		
Squamous cell carcinoma	1 (2%)		
MUSCULOSKELETAL SYSTEM			
Bone	(50)	(12)	(49)
Cranium, osteosarcoma		1 (8%)	1 (2%)
Vertebra, osteosarcoma	1 (2%)		
Skeletal muscle	(1)		
NERVOUS SYSTEM			
Brain	(50)	(11)	(49)
RESPIRATORY SYSTEM			
Larynx	(50)	(10)	(47)
Lung	(50)	(17)	(49)
Adenocarcinoma, metastatic, harderian gland	2 (4%)		1 (2%)
Adenocarcinoma, metastatic, mammary gland	1 (2%)		
Alveolar/bronchiolar adenoma	4 (8%)	2 (12%)	2 (4%)
Alveolar/bronchiolar carcinoma	1 (2%)		1 (2%)

TABLE D1. SUMMARY OF THE INCIDENCE OF NEOPLASMS IN FEMALE MICE IN THE TWO-YEAR INHALATION STUDY OF CS₂ (Continued)

	Chamber Control	0.75 mg/m ³	1.5 mg/m ³
RESPIRATORY SYSTEM			
Lung (Continued)	(50)	(17)	(49)
Carcinoma, metastatic, liver	2 (4%)		
Fibrosarcoma, metastatic, skin	1 (2%)		
Hemangiosarcoma, metastatic, uterus	1 (2%)		
Squamous cell carcinoma, metastatic, skin	1 (2%)		
Bronchus, alveolus, adenoma		1 (6%)	
Mediastinum, hemangioma		1 (6%)	
Nose	(50)	(49)	(49)
Adenocarcinoma, metastatic, harderian gland	1 (2%)		
Trachea	(50)	(10)	(48)
SPECIAL SENSES SYSTEM			
Harderian gland	(4)	(2)	(1)
Adenocarcinoma	2 (50%)		1 (100%)
Adenoma	2 (50%)	2 (100%)	
URINARY SYSTEM			
Kidney	(49)	(13)	(49)
Osteosarcoma, metastatic, bone	1 (2%)		
Urinary bladder	(48)	(8)	(47)
SYSTEMIC LESIONS			
Multiple organs	*(50)	*(50)	*(50)
Histiocytic sarcoma			1 (2%)
Lymphoma malignant	2 (4%)		
Lymphoma malignant histiocytic	2 (4%)	3 (6%)	1 (2%)
Lymphoma malignant mixed	6 (12%)	9 (18%)	4 (8%)
Lymphoma malignant undifferentiated cell	11 (22%)	1 (2%)	3 (6%)
TUMOR SUMMARY			
Total animals with primary neoplasms **	46	27	27
Total primary neoplasms	80	43	33
Total animals with benign neoplasms	23	17	13
Total benign neoplasms	37	23	15
Total animals with malignant neoplasms	35	17	16
Total malignant neoplasms	43	20	18
Total animals with secondary neoplasms ***	9	1	1
Total secondary neoplasms	12	1	1

* Number of animals receiving complete necropsy examination; all gross lesions including masses examined microscopically.

** Primary tumors: all tumors except secondary tumors

*** Secondary tumors: metastatic tumors or tumors invasive into an adjacent organ

TABLE D2. INDIVIDUAL ANIMAL TUMOR PATHOLOGY OF FEMALE MICE IN THE TWO-YEAR INHALATION STUDY OF CS₂: CHAMBER CONTROL

DAYS ON STUDY	2	3	4	4	5	6	6	6	6	6	7	7	7	7	7	7	7	7	7	7	7	7	7	7	
	6	8	5	6	5	1	2	6	8	9	9	1	1	1	2	2	4	5	5	5	5	5	5	5	5
CARCASS ID	4	2	2	6	7	1	8	4	3	2	0	5	9	4	7	1	1	1	2	3	6	7	8	9	0
	1	1	1	1	1	1	1	1	1	1	1	1	1	1	1	1	1	1	1	1	1	1	1	1	1
ALIMENTARY SYSTEM																									
Esophagus	+	+	+	+	+	+	+	+	+	+	+	+	+	+	+	+	+	+	+	+	+	+	+	+	+
Gallbladder	A	+	+	+	A	A	+	+	A	+	A	+	A	+	A	+	A	+	A	+	+	+	+	+	+
Intestine large	+	+	+	+	A	A	+	+	+	+	+	+	+	+	+	+	+	+	+	+	+	+	+	+	+
Intestine large, cecum	M	M	+	+	A	A	+	+	+	+	+	A	+	+	+	A	+	+	+	+	+	+	+	+	
Intestine large, colon	+	A	+	+	A	A	+	+	+	+	+	+	+	+	+	+	+	+	+	+	+	+	+	+	
Intestine large, rectum	+	+	+	+	A	A	+	+	+	+	+	+	+	+	+	+	+	+	+	+	+	+	+	+	
Intestine small	+	+	+	+	A	A	+	+	A	+	A	+	A	+	A	+	+	A	+	+	+	+	+	+	
Intestine small, duodenum	A	+	+	+	A	A	+	+	A	+	A	+	A	+	A	+	+	A	+	+	+	+	+	+	
Intestine small, ileum	+	+	+	+	A	A	+	+	A	+	A	+	A	+	A	+	+	A	+	+	+	+	+	+	
Intestine small, jejunum	+	+	+	+	A	A	+	+	A	+	A	+	A	+	A	+	+	A	+	+	+	+	+	+	
Liver	+	+	+	+	+	+	+	+	+	+	+	+	+	+	+	+	+	+	+	+	+	+	+	+	
Hepatocellular carcinoma								X							X	X		X							
Hepatocellular adenoma																			X					X	
Mesentery																									
Pancreas	+	+	+	+	+	+	+	+	+	+	+	+	+	+	+	+	+	+	+	+	+	+	+	+	
Salivary glands	+	+	+	+	+	+	+	+	+	+	+	+	+	+	+	+	+	+	+	+	+	+	+	+	
Stomach	+	+	+	+	A	+	+	+	+	+	+	+	+	+	+	+	+	+	+	+	+	+	+	+	
Stomach, forestomach	+	+	+	M	A	+	+	+	+	+	+	+	+	+	+	+	+	+	+	+	+	+	+	+	
Papilloma squamous																									
Squamous cell carcinoma																									
Stomach, glandular	+	+	+	+	A	+	+	+	+	+	+	+	+	+	+	+	+	+	+	+	+	+	+	+	
CARDIOVASCULAR SYSTEM																									
Heart	+	+	+	+	+	+	+	+	+	+	+	+	+	+	+	+	+	+	+	+	+	+	+	+	
ENDOCRINE SYSTEM																									
Adrenal gland	+	+	+	+	+	+	+	+	+	+	+	+	+	+	+	+	+	+	+	+	+	+	+	+	
Osteosarcoma, metastatic, bone																									
Adrenal gland, cortex	+	+	+	+	+	+	+	+	+	+	+	+	+	+	+	+	+	+	+	+	+	+	+	+	
Adrenal gland, medulla	+	M	+	+	+	+	+	+	+	+	+	+	+	+	+	+	+	+	+	+	+	+	+	+	
Pheochromocytoma benign																									
Islets, pancreatic	+	+	+	+	+	+	+	+	+	+	+	+	+	+	+	+	+	+	+	+	+	+	+	+	
Parathyroid gland	M	M	M	M	M	M	+	M	M	M	+	M	+	M	M	M	M	M	M	M	M	M	M	M	
Pituitary gland	+	I	M	+	+	+	+	+	+	+	I	+	+	+	+	+	+	+	+	+	+	+	+	+	
Pars distalis, adenoma				X				X								X									
Thyroid gland	M	+	+	+	+	+	+	+	+	+	+	+	+	+	+	+	+	+	+	+	+	+	+		
Follicular cell, adenoma																						X			
GENERAL BODY SYSTEM																									
None																									
GENITAL SYSTEM																									
Ovary	+	+	+	+	+	+	+	+	+	+	+	+	+	+	+	+	+	+	+	+	+	+	+	+	
Adenoma								X																	
Teratoma																									
Uterus	+	M	+	+	+	+	+	+	+	+	+	+	+	+	+	+	+	+	+	+	+	+	+	+	
Hemangioma																									
Hemangiosarcoma											X														
Leiomyoma																									
Polyp, adenoid																									
Polyp stromal								X																	
HEMATOPOIETIC SYSTEM																									
Bone marrow	+	+	+	+	+	+	+	+	+	+	+	+	+	+	+	+	+	+	+	+	+	+	+	+	
Lymph node	+	+	+	+	+	+	+	+	+	+	+	+	+	+	+	+	+	+	+	+	+	+	+	+	
Pancreatic, sarcoma																									
Lymph node, bronchial	+	+	+	+	+	+	+	M	+	+	+	+	+	+	+	+	+	+	+	+	+	+	+	+	
Lymph node, mandibular	M	M	+	+	+	+	M	+	+	M	M	+	+	+	+	+	+	+	+	+	+	+	+	+	
Squamous cell carcinoma, metastatic, skin																									
Spleen	+	+	+	+	+	+	+	+	+	+	+	+	+	+	+	+	+	+	+	+	+	+	+	+	
Sarcoma																									
Thymus	+	M	M	+	+	+	+	+	M	+	+	+	+	+	+	+	+	+	+	+	+	+	+	+	
INTEGUMENTARY SYSTEM																									
Mammary gland	+	M	+	+	+	+	+	+	M	+	+	+	M	+	+	+	+	+	+	+	+	+	+	+	
Adenocarcinoma					X			X					X								M	+	+	+	
Skin	+	+	+	+	+	+	+	+	+	+	+	+	+	+	+	+	+	+	+	+	+	+	+	+	
Fibrosarcoma									X																
Hemangiosarcoma																									
Papilloma																									
Sarcoma																									
Squamous cell carcinoma	X																								

+ : Tissue examined microscopically
: Not examined
- : Present but not examined microscopically
I : Insufficient tissue

M: Missing
A: Autolysis precludes examination
X: Incidence of listed morphology

TABLE D2. INDIVIDUAL ANIMAL TUMOR PATHOLOGY OF FEMALE MICE: CHAMBER CONTROL
(Continued)

DAYS ON STUDY	7 0																				TOTAL TISSUES TUMORS			
	0																							
CARCASS ID	1																							
ALIMENTARY SYSTEM																								
Esophagus	+																				50			
Gallbladder	+																				42			
Intestine large	+																				48			
Intestine large, cecum	+																				44			
Intestine large, colon	+																				46			
Intestine large, rectum	+																				47			
Intestine small	+																				44			
Intestine small, duodenum	+																				43			
Intestine small, ileum	+																				44			
Intestine small, jejunum	+																				43			
Liver	+																				50			
Hepatocellular carcinoma		X																					7	
Hepatocellular adenoma																							4	
Mesentery																							4	
Pancreas	+																				50			
Salivary glands	+																				50			
Stomach	+																				49			
Stomach, forestomach	+																				48			
Papilloma squamous																							1	
Squamous cell carcinoma																							1	
Stomach, glandular	+																				49			
CARDIOVASCULAR SYSTEM																								
Heart	+																				50			
ENDOCRINE SYSTEM																								
Adrenal gland	+																				50			
Osteosarcoma, metastatic, bone																								1
Adrenal gland, cortex	+																				50			
Adrenal gland, medulla	+																				49			
Pheochromocytoma benign																								2
Islets, pancreatic	+																				50			
Parathyroid gland		M	M	M	M	M	M	M	M	M	M	M	M	M	M	M	M	M	M	M	M	M		14
Pituitary gland	+																				47			
Pars distalis, adenoma		X																						13
Thyroid gland	+																				49			
Follicular cell, adenoma																								2
GENERAL BODY SYSTEM																								
None																								
GENITAL SYSTEM																								
Ovary	+																				50			
Adenoma	+																				1			
Teratoma												X												1
Uterus	+																				49			
Hemangioma																								1
Hemangiosarcoma																								1
Leiomyoma																								1
Polyp, adenoid																								1
Polyp stromal	X							X											X					2
HEMATOPOIETIC SYSTEM																								
Bone marrow	+																				50			
Lymph node	+																				50			
Pancreatic, sarcoma																								1
Lymph node, bronchial																								48
Lymph node, mandibular	+																				44			
Squamous cell carcinoma, metastatic, skin																								1
Spleen	+																				50			
Sarcoma																								1
Thymus	+																				46			
INTEGUMENTARY SYSTEM																								
Mammary gland	+																				45			
Adenocarcinoma	+																				3			
Skin	+																				50			
Fibrosarcoma	+																				1			
Hemangiosarcoma																								1
Papilloma																								1
Sarcoma																								1
Squamous cell carcinoma																								1

**TABLE D2. INDIVIDUAL ANIMAL TUMOR PATHOLOGY OF FEMALE MICE: CHAMBER CONTROL
(Continued)**

DAYS ON STUDY	2	3	4	4	5	6	6	6	6	6	6	7	7	7	7	7	7	7	7	7	7	7	7	7	7	
	6	8	5	6	5	1	2	6	8	9	9	1	1	1	2	2	4	5	5	5	5	5	5	5	5	5
CARCASS ID	4	2	2	5	3	6	6	9	0	3	4	0	0	6	4	8	1	0	0	0	0	0	0	0	0	0
	0	0	0	0	0	0	0	0	0	0	0	0	0	0	0	0	0	0	0	0	0	0	0	0	0	0
MUSCULOSKELETAL SYSTEM																										
Bone	+																									
Vertebra, osteosarcoma																										
Skeletal muscle	+																									
NERVOUS SYSTEM																										
Brain	+																									
RESPIRATORY SYSTEM																										
Larynx	+																									
Lung	+																									
Adenocarcinoma, metastatic, harderian gland																										
Adenocarcinoma, metastatic, mammary gland	X																									
Alveolar/bronchiolar adenoma	X																									
Alveolar/bronchiolar carcinoma	X																									
Carcinoma, metastatic, liver	X																									
Fibrosarcoma, metastatic, skin	X																									
Hemangiosarcoma, metastatic, uterus	X																									
Squamous cell carcinoma, metastatic, skin	X																									
Nose	+																									
Adenocarcinoma, metastatic, harderian gland	+																									
Trachea	+																									
SPECIAL SENSES SYSTEM																										
Eye	A																									
Harderian gland	A A I + A + + I A + + A A + + + + + I +																									
Adenocarcinoma	X																									
Adenoma																										
URINARY SYSTEM																										
Kidney	+																									
Osteosarcoma, metastatic, bone	+																									
Urinary bladder	+																									
SYSTEMIC LESIONS																										
Multiple organs	+																									
Lymphoma malignant	X																									
Lymphoma malignant histiocytic	X																									
Lymphoma malignant mixed	X																									
Lymphoma malignant undifferentiated cell type	X																									

TABLE D2. INDIVIDUAL ANIMAL TUMOR PATHOLOGY OF FEMALE MICE: CHAMBER CONTROL
(Continued)

DAYS ON STUDY	7 7 7 7 7 7 7 7 7 7 7 7 7 7 7 7 7 7 7 7																				TOTAL TISSUES TUMORS
	5 5 5 5 5 5 5 5 5 5 5 5 5 5 5 5 5 5 5 5																				
CARCASS ID	0 0 0 0 0 0 0 0 0 0 0 0 0 0 0 0 0 0 0 0																				
	2 3 5 6 7 8 0 1 4 5 6 7 8 9 0 3 4 5 6 8 9 3 5 9 0																				
MUSCULOSKELETAL SYSTEM																					
Bone																					
Vertebra, osteosarcoma																					50
Skeletal muscle																					1
																					1
NERVOUS SYSTEM																					
Brain																					50
RESPIRATORY SYSTEM																					
Larynx																					50
Lung																					50
Adenocarcinoma, metastatic, harderian gland																					2
Adenocarcinoma, metastatic, mammary gland																					
Alveolar/bronchiolar adenoma																					1
Alveolar/bronchiolar carcinoma																					4
Carcinoma, metastatic, liver																					1
Fibrosarcoma, metastatic, skin																					2
Hemangiosarcoma, metastatic, uterus																					1
Squamous cell carcinoma, metastatic, skin																					1
Nose																					50
Adenocarcinoma, metastatic, harderian gland																					1
Trachea																					50
SPECIAL SENSES SYSTEM																					
Eye																					33
Harderian gland																					4
Adenocarcinoma																					2
Adenoma																					2
URINARY SYSTEM																					
Kidney																					49
Osteosarcoma, metastatic, bone																					1
Urinary bladder																					48
SYSTEMIC LESIONS																					
Multiple organs																					50
Lymphoma malignant																					2
Lymphoma malignant histiocytic																					2
Lymphoma malignant mixed																					6
Lymphoma malignant undifferentiated cell type																					11

TABLE D2. INDIVIDUAL ANIMAL TUMOR PATHOLOGY OF FEMALE MICE IN THE TWO-YEAR INHALATION STUDY OF CS₂: 0.75 mg/m³

DAYS ON STUDY	0 2 6 6 7 7 7 7 7 7 7 7 7 7 7 7 7 7 7 7																			
	5 6 4 5 0 0 1 1 3 3 5 5 5 5 5 5 5 5 5 5																			
CARCASS ID	3 8 0 9 1 1 0 0 0 6 2 2 2 2 2 2 2 2 2 2																			
	1 1 1 1 1 1 1 1 2 1 1 1 1 1 1 1 1 1 1 1																			
CARCASS ID	9 7 5 7 5 9 6 7 0 5 5 5 5 5 5 5 6 6 6 6																			
	6 7 8 3 4 5 7 9 0 2 1 3 5 6 7 9 0 1 2 3																			
CARCASS ID	1 1 1 1 1 1 1 1 1 1 1 1 1 1 1 1 1 1 1 1																			
	1 1 1 1 1 1 1 1 1 1 1 1 1 1 1 1 1 1 1 1																			
ALIMENTARY SYSTEM																				
Esophagus	+	+	+	+	+	A	+	+	+	+										+
Gallbladder	M	+	+	+	A	A	+	+	A	M										A
Intestine large	+	+	+	+	+	A	+	+	+	+	+									A
Intestine large, cecum	M	M	+	+	A	A	+	+	+	+	+									A
Leiomyosarcoma																				X
Intestine large, colon	+	+	+	+	+	A	+	+	+	+										A
Intestine large, rectum	+	+	+	+	+	A	+	+	+	+										A
Intestine small	+	+	+	+	+	A	+	+	+	+										A
Intestine small, duodenum	+	+	A	+	+	A	+	+	A	+										A
Intestine small, ileum	+	+	+	+	+	A	+	+	+	+										A
Intestine small, jejunum	+	+	+	+	+	A	+	+	+	+										A
Liver	+	+	+	+	+	A	+	+	+	+										+
Hepatocellular carcinoma																				
Hepatocellular carcinoma, multiple																				
Hepatocellular adenoma																				X
Mesentery																				
Pancreas	+	+	+	+	+	A	+	+	+	+										+
Salivary glands	+	+	+	+	+	A	+	+	+	+										+
Stomach	+	+	+	+	+	A	+	+	+	+										+
Stomach, forestomach	+	+	+	+	+	A	+	+	+	+										+
Papilloma squamous						X														+
Stomach, glandular	+	+	A	+	+	A	+	+	+	+										+
Tooth																				+
CARDIOVASCULAR SYSTEM																				
Heart	+	+	+	+	+	A	+	+	+	+										+
ENDOCRINE SYSTEM																				
Adrenal gland	+	+	+	+	+	A	+	+	+	+										+
Adrenal gland, cortex	+	+	+	+	+	A	+	+	+	+										+
Adrenal gland, medulla	+	+	+	+	+	A	+	+	+	+										+
Islets, pancreatic	+	+	+	+	+	A	+	+	+	+										+
Parathyroid gland	+	+	M	M	M	A	+	M	M	+										+
Pituitary gland	M	+	+	+	+	A	+	+	+	+										+
Pars distalis, adenoma										X	X									+
Thyroid gland	+	+	+	+	+	A	+	+	+	+										+
Follicular cell, adenoma																				+
Follicular cell, adenoma, multiple																				+
GENERAL BODY SYSTEM																				
None																				
GENITAL SYSTEM																				
Ovary	+	+	+	+	+	A	+	+	+	+										+
Hemangioma																				+
Teratoma malignant	X									X										
Uterus	+	+	+	+	+	A	+	+	+	+										+
Hemangioma						X														
Polyp stromal																				
Sarcoma stromal																				
HEMATOPOIETIC SYSTEM																				
Bone marrow	+	+	+	+	+	A	+	+	+	+										+
Lymph node	+	+	+	+	+	A	+	+	+	+										+
Teratoma, NOS, metastatic, ovary	X																			
Lymph node, bronchial	+	+	+	+	+	A	+	+	+	+										+
Lymph node, mandibular	+	+	+	M	+	M	+	+	+	+										+
Spleen	+	+	+	M	+	A	+	+	+	+										+
Thymus	+	+	+	+	+	A	+	+	+	M										+
INTEGUMENTARY SYSTEM																				
Mammary gland	M	+	+	+	+	A	+	+	+	+										+
Adenocarcinoma																				
Skin	+	+	+	+	+	A	+	+	+	+										+

TABLE D2. INDIVIDUAL ANIMAL TUMOR PATHOLOGY OF FEMALE MICE: 0.75 mg/m³
(Continued)

DAYS ON STUDY	7	7	7	7	7	7	7	7	7	7	7	7	7	7	7	7	7	7	7	7	7	7	7	7	7	7			
	5	5	5	5	5	5	5	5	5	5	5	5	5	5	5	5	5	5	5	5	5	5	5	5	5	5	5		
CARCASS ID	2	2	2	2	2	2	2	2	2	2	2	2	2	2	2	2	2	2	2	2	2	2	2	2	2	2			
	1	1	1	1	1	1	1	1	1	1	1	1	1	1	1	1	1	1	1	1	1	1	1	1	1	1			
																												TOTAL TISSUES TUMORS	
ALIMENTARY SYSTEM																													
Esophagus																												10	
Gallbladder																													5
Intestine large																													10
Intestine large, cecum																													7
Leiomyosarcoma																													1
Intestine large, colon																													9
Intestine large, rectum																													9
Intestine small																													9
Intestine small, duodenum																													7
Intestine small, ileum																													9
Intestine small, jejunum																													9
Liver																													15
Hepatocellular carcinoma																													1
Hepatocellular carcinoma, multiple																													1
Hepatocellular adenoma																													2
Mesentery																													1
Pancreas																													11
Salivary glands																													10
Stomach																													49
Stomach, forestomach																													48
Papilloma squamous																													4
Stomach, glandular																													48
Tooth																													1
CARDIOVASCULAR SYSTEM																													
Heart																													10
ENDOCRINE SYSTEM																													
Adrenal gland																													10
Adrenal gland, cortex																													10
Adrenal gland, medulla																													9
Islets, pancreatic																													5
Parathyroid gland																													46
Pituitary gland																													5
Pars distalis, adenoma																													49
Thyroid gland																													2
Follicular cell, adenoma																													1
Follicular cell, adenoma, multiple																													
GENERAL BODY SYSTEM																													
None																													
GENITAL SYSTEM																													
Ovary																													20
Hemangioma																													1
Teratoma malignant																													1
Uterus																													15
Hemangioma																													1
Polyp stromal																													1
Sarcoma stromal																													1
HEMATOPOIETIC SYSTEM																													
Bone marrow																													10
Lymph node																													15
Teratoma, NOS, metastatic, ovary																													11
Lymph node, bronchial																													11
Lymph node, mandibular																													19
Spleen																													10
Thymus																													
INTEGUMENTARY SYSTEM																													
Mammary gland																													10
Adenocarcinoma																													1
Skin																													17

TABLE D2. INDIVIDUAL ANIMAL TUMOR PATHOLOGY OF FEMALE MICE: 0.75 mg/m³
(Continued)

DAYS ON STUDY	7 7																				TOTAL TISSUES TUMORS		
	5	5	5	5	5	5	5	5	5	5	5	5	5	5	5	5	5	5	5	5		5	5
CARCASS ID	2	2	2	2	2	2	2	2	2	2	2	2	2	2	2	2	2	2	2	2	2	2	
MUSCULOSKELETAL SYSTEM	1	1	1	1	1	1	1	1	1	1	1	1	1	1	1	1	1	1	1	1	1	1	12
Bone	7	7	7	7	7	7	7	8	8	8	8	8	8	8	8	8	8	8	9	9	9	9	1
Cranium, osteosarcoma	0	1	2	4	5	6	8	0	1	2	3	4	5	6	7	8	9	0	1	2	3	4	1
NERVOUS SYSTEM	1	1	1	1	1	1	1	1	1	1	1	1	1	1	1	1	1	1	1	1	1	1	11
Brain																							1
Spinal cord																							
RESPIRATORY SYSTEM																							10
Larynx																							17
Lung																							2
Alveolar/bronchiolar adenoma																							1
Bronchus, alveolus, adenoma																							1
Mediastinum, hemangioma																							49
Nose																							10
Trachea																							
SPECIAL SENSES SYSTEM																							2
Harderian gland																							2
Adenoma																							
URINARY SYSTEM																							13
Kidney																							8
Urinary bladder																							
SYSTEMIC LESIONS																							50
Multiple organs																							3
Lymphoma malignant histiocytic																							9
Lymphoma malignant mixed																							1
Lymphoma malignant undifferentiated cell type																							

TABLE D2. INDIVIDUAL ANIMAL TUMOR PATHOLOGY OF FEMALE MICE IN THE TWO-YEAR INHALATION STUDY OF CS2: 1.5 mg/m³

DAYS ON STUDY	2	5	6	6	7	7	7	7	7	7	7	7	7	7	7	7	7	7	7	7	7	7	7	7
CARCASS ID	6	4	6	4	8	0	0	0	7	6	9	9	9	9	9	9	9	9	9	9	9	9	9	9
ALIMENTARY SYSTEM																								
Esophagus	+	+	+	+	A	+	+	+	+	+	+	+	+	+	+	+	+	+	+	+	+	+	+	+
Gallbladder	A	A	A	A	A	+	+	A	A	+	M	+	+	+	+	+	+	+	+	+	+	+	+	+
Intestine large	A	A	A	+	A	+	+	+	A	+	+	+	+	+	+	+	+	+	+	+	+	+	+	+
Intestine large, cecum	A	A	A	+	A	+	+	+	A	M	+	+	+	+	+	+	+	+	+	+	+	+	+	+
Intestine large, colon	A	A	A	+	A	+	+	+	A	+	+	+	+	+	+	+	+	+	+	+	+	+	+	+
Intestine large, rectum	A	A	A	+	A	+	+	+	A	+	+	+	+	+	+	+	+	+	+	+	+	+	+	+
Intestine small	A	A	A	+	A	+	+	+	A	+	+	+	+	+	+	+	+	+	+	+	+	+	+	+
Intestine small, duodenum	A	A	A	+	A	+	+	+	A	M	+	+	+	+	+	+	+	+	+	+	+	+	+	+
Intestine small, ileum	A	A	A	+	A	+	+	+	A	+	+	+	+	+	+	+	+	+	+	+	+	+	+	+
Intestine small, jejunum	A	A	A	+	A	+	+	+	A	+	+	+	+	+	+	+	+	+	+	+	+	+	+	+
Liver	+	+	+	+	A	+	+	+	+	+	+	+	+	+	+	+	+	+	+	+	+	+	+	+
Hepatocellular carcinoma																								
Hepatocellular carcinoma, multiple																								
Hepatocellular adenoma				X																				
Pancreas	+	+	+	+	A	+	+	+	+	+	+	+	+	+	+	+	+	+	+	+	+	+	+	+
Salivary glands	+	+	+	+	A	+	+	+	+	+	+	+	+	+	+	+	+	+	+	+	+	+	+	+
Stomach	I	A	+	+	A	+	+	+	+	+	+	+	+	+	+	+	+	+	+	+	+	+	+	+
Stomach, forestomach	I	A	+	+	A	+	+	+	+	+	+	+	+	+	+	+	+	+	+	+	+	+	+	+
Stomach, glandular	A	A	+	+	A	+	+	+	+	+	+	+	+	+	+	+	+	+	+	+	+	+	+	+
Adenoma																								
CARDIOVASCULAR SYSTEM																								
Heart	+	+	+	+	A	+	+	+	+	+	+	+	+	+	+	+	+	+	+	+	+	+	+	+
ENDOCRINE SYSTEM																								
Adrenal gland	+	+	+	+	A	+	+	+	+	+	+	+	+	+	+	+	+	+	+	+	+	+	+	+
Adrenal gland, cortex	+	+	+	+	A	+	+	+	+	+	+	+	+	+	+	+	+	+	+	+	+	+	+	+
Adrenal gland, medulla	+	+	+	+	A	+	+	+	+	+	+	+	+	+	+	+	+	+	+	+	+	+	+	+
Islets, pancreatic	+	+	+	+	A	M	+	+	+	+	+	+	+	+	+	+	+	+	+	+	+	+	+	+
Parathyroid gland	M	+	+	+	M	M	M	+	M	M	M	+	+	+	+	+	+	+	+	+	+	M	M	+
Pituitary gland	A	+	M	+	A	+	I	+	+	+	+	+	+	+	+	+	+	+	+	+	+	+	+	+
Pars distalis, adenoma																								
Pars intermedia, adenoma																								X
Thyroid gland	+	+	+	+	A	+	+	+	+	+	+	+	+	+	+	+	+	+	+	+	+	+	+	+
Follicular cell, adenoma																								X
GENERAL BODY SYSTEM																								
None																								
GENITAL SYSTEM																								
Clitoral gland																								
Ovary	+	+	+	+	A	+	+	+	+	+	+	+	+	+	+	+	+	+	+	+	+	+	+	+
Teratoma			X																					
Uterus	+	+	+	+	A	+	+	+	+	+	+	+	+	+	+	+	+	+	+	+	+	+	+	+
Hamangioma																								
Histiocytic sarcoma																								
Vagina																								
Polyp																								+
HEMATOPOIETIC SYSTEM																								
Bone marrow	+	+	+	+	A	+	+	+	+	+	+	+	+	+	+	+	+	+	+	+	+	+	+	+
Lymph node	+	+	+	+	A	+	+	+	+	+	+	+	+	+	+	+	+	+	+	+	+	+	+	+
Lymph node, bronchial	+	+	+	+	A	+	+	+	+	+	+	+	+	+	+	+	+	+	+	+	+	+	+	+
Lymph node, mandibular	M	M	M	+	M	M	+	+	+	+	+	+	+	+	+	+	+	+	+	+	+	+	+	+
Spleen	+	+	+	+	A	+	+	+	+	+	+	+	+	+	+	+	+	+	+	+	+	+	+	+
Thymus	M	+	+	+	M	+	+	+	+	+	+	+	+	+	+	+	+	+	+	+	+	+	+	M
INTEGUMENTARY SYSTEM																								
Mammary gland	+	+	+	+	M	+	+	+	M	+	+	+	+	+	+	+	+	+	+	+	+	+	+	+
Skin	+	+	+	+	A	+	+	+	+	+	+	+	+	+	+	+	+	+	+	+	+	+	+	+

TABLE D2. INDIVIDUAL ANIMAL TUMOR PATHOLOGY OF FEMALE MICE: 1.5 mg/m³
(Continued)

DAYS ON STUDY	7 7 7 7 7 7 7 7 7 7 7 7 7 7 7 7 7 7 7 7																				TOTAL TISSUES TUMORS
	9 9 9 9 9 9 9 9 9 9 9 9 9 9 9 9 9 9 9 9																				
CARCASS ID	2 2 2 2 2 2 2 2 2 2 2 2 2 2 2 2 2 2 2 2																				
	7 7 7 7 7 7 7 7 8 8 8 8 8 8 9 9 9 9 9 9																				
	1 1 1 1 1 1 1 1 0 1 1 1 1 1 1 1 1 1 1 1																				
ALIMENTARY SYSTEM																					
Esophagus	+ + + + + + + M + M + + + + + + + + + + + + + + + +																				47
Gallbladder	+ + + + + + + + + M + + + + + + + + + + + + + + + +																				40
Intestine large	+ +																				45
Intestine large, cecum	+ + + + + M +																				43
Intestine large, colon	+ + + + + + + + + + M + + + + + + + + + + + + + + + + +																				44
Intestine large, rectum	+ +																				45
Intestine small	+ +																				45
Intestine small, duodenum	+ +																				44
Intestine small, ileum	+ +																				44
Intestine small, jejunum	+ +																				43
Liver	+ +																				49
Hepatocellular carcinoma																					4
Hepatocellular carcinoma, multiple																					2
Hepatocellular adenoma																					3
Pancreas	+ + + X +																				49
Salivary glands	+ +																				49
Stomach	+ +																				47
Stomach, forestomach	+ +																				47
Stomach, glandular	+ +																				47
Adenoma																					1
CARDIOVASCULAR SYSTEM																					
Heart	+ +																				49
ENDOCRINE SYSTEM																					
Adrenal gland	+ +																				49
Adrenal gland, cortex	+ +																				49
Adrenal gland, medulla	+ + + + + M +																				48
Islets, pancreatic	+ +																				48
Parathyroid gland	+ + + + + + + + M + + + M + + + + + + + + M + M + + +																				36
Pituitary gland	+ +																				46
Pars distalis, adenoma																					1
Pars intermedia, adenoma																					3
Thyroid gland	+ + + + + + + + + + + + + + + + + X + + + + X + + + + X																				49
Follicular cell, adenoma																					2
GENERAL BODY SYSTEM																					
None																					
GENITAL SYSTEM																					
Clitoral gland																					1
Ovary	+ +																				49
Teratoma																					1
Uterus	+ +																				48
Hemangioma																					1
Histiocytic sarcoma																					1
Vagina																					1
Polyp																					1
HEMATOPOIETIC SYSTEM																					
Bone marrow	+ +																				49
Lymph node	+ + + + + + + + + + + + + + + M + + + + + + + + + + + +																				48
Lymph node, bronchial	+ + + + + + + + + M + + + + + + + + + + + + + + + + + +																				46
Lymph node, mandibular	+ + + + + + + + + + + M + + + M + + + M M + M + M + M																				38
Spleen	+ +																				49
Thymus	+ M + + +																				46
INTEGUMENTARY SYSTEM																					
Mammary gland	+ +																				47
Skin	+ +																				49

TABLE D2. INDIVIDUAL ANIMAL TUMOR PATHOLOGY OF FEMALE MICE: 1.5 mg/m³
(Continued)

DAYS ON STUDY	7 7 7 7 7 7 7 7 7 7 7 7 7 7 7 7 7 7 7 7																				TOTAL: TISSUES TUMORS
	4 4 4 4 4 4 4 4 4 4 4 4 4 4 4 4 4 4 4 4																				
CARCASS ID	9 9 9 9 9 9 9 9 9 9 9 9 9 9 9 9 9 9 9 9																				
	2 2 2 2 2 2 2 2 2 2 2 2 2 2 2 2 2 2 2 2																				
																					3
																					0
																					1
MUSCULOSKELETAL SYSTEM																					
Bone																					
Cranium, osteosarcoma																					49
																					1
NERVOUS SYSTEM																					
Brain																					49
RESPIRATORY SYSTEM																					
Larynx																					47
Lung																					49
Adenocarcinoma, metastatic, harderian gland																					1
Alveolar/bronchiolar adenoma																					2
Alveolar/bronchiolar carcinoma																					1
Nose																					49
Trachea																					48
SPECIAL SENSES SYSTEM																					
Ear																					1
Eye																					38
Harderian gland																					1
Adenocarcinoma																					1
URINARY SYSTEM																					
Kidney																					49
Urinary bladder																					47
SYSTEMIC LESIONS																					
Multiple organs																					49
Histiocytic sarcoma																					1
Lymphoma malignant histiocytic																					1
Lymphoma malignant mixed																					4
Lymphoma malignant undifferentiated cell type																					3

TABLE D3. ANALYSIS OF PRIMARY NEOPLASMS IN FEMALE MICE IN THE TWO-YEAR INHALATION STUDY OF CS2

	Chamber Control	0.75 mg/m ³	1.5 mg/m ³
Harderian Gland: Adenoma or Adenocarcinoma			
Overall Rates (a)	4/50 (8%)	2/50 (4%)	1/50 (2%)
Adjusted Rates (b)	11.3%	5.0%	2.5%
Terminal Rates (c)	3/33 (9%)	2/40 (5%)	1/40 (3%)
Day of First Observation	680	749	749
Life Table Tests (d)	P=0.081N	P=0.261N	P=0.133N
Logistic Regression Tests (d)	P=0.098N	P=0.301N	P=0.156N
Cochran-Armitage Trend Test (d)	P=0.118N		
Fisher Exact Test (d)		P=0.339N	P=0.181N
Liver: Hepatocellular Adenoma			
Overall Rates (e)	4/50 (8%)	(f) 2/15 (13%)	3/49 (6%)
Adjusted Rates (b)	11.8%		7.0%
Terminal Rates (c)	3/33 (9%)		2/40 (5%)
Day of First Observation	741		694
Life Table Test (d)			P=0.400N
Logistic Regression Test (d)			P=0.454N
Fisher Exact Test (d)			P=0.511N
Liver: Hepatocellular Carcinoma			
Overall Rates (e)	7/50 (14%)	(f) 2/15 (13%)	6/49 (12%)
Adjusted Rates (b)	18.2%		15.0%
Terminal Rates (c)	3/33 (9%)		6/40 (15%)
Day of First Observation	626		749
Life Table Test (d)			P=0.373N
Logistic Regression Test (d)			P=0.468N
Fisher Exact Test (d)			P=0.516N
Liver: Hepatocellular Adenoma or Carcinoma			
Overall Rates (e)	11/50 (22%)	(f) 4/15 (27%)	9/49 (18%)
Adjusted Rates (b)	28.5%		21.7%
Terminal Rates (c)	6/33 (18%)		8/40 (20%)
Day of First Observation	626		694
Life Table Test (d)			P=0.253N
Logistic Regression Test (d)			P=0.349N
Fisher Exact Test (d)			P=0.421N
Lung: Alveolar/Bronchiolar Adenoma			
Overall Rates (e)	4/50 (8%)	(f,g) 3/17 (18%)	2/49 (4%)
Adjusted Rates (b)	12.1%		5.0%
Terminal Rates (c)	4/33 (12%)		2/40 (5%)
Day of First Observation	749		749
Life Table Test (d)			P=0.251N
Logistic Regression Test (d)			P=0.251N
Fisher Exact Test (d)			P=0.349N
Lung: Alveolar/Bronchiolar Adenoma or Carcinoma			
Overall Rates (e)	5/50 (10%)	(f,g) 3/17 (18%)	3/49 (6%)
Adjusted Rates (b)	14.3%		7.5%
Terminal Rates (c)	4/33 (12%)		3/40 (7%)
Day of First Observation	693		749
Life Table Test (d)			P=0.261N
Logistic Regression Test (d)			P=0.301N
Fisher Exact Test (d)			P=0.369N

TABLE D3. ANALYSIS OF PRIMARY NEOPLASMS IN FEMALE MICE IN THE TWO-YEAR INHALATION STUDY OF CS2 (Continued)

	Chamber Control	0.75 mg/m ³	1.5 mg/m ³
Mammary Gland: Adenocarcinoma			
Overall Rates (a)	3/50 (6%)	1/50 (2%)	0/50 (0%)
Adjusted Rates (b)	6.8%	2.5%	0.0%
Terminal Rates (c)	0/33 (0%)	1/40 (3%)	0/40 (0%)
Day of First Observation	553	749	
Life Table Tests (d)	P=0.051N	P=0.270N	P=0.110N
Logistic Regression Tests (d)	P=0.067N	P=0.309N	P=0.142N
Cochran-Armitage Trend Test (d)	P=0.060N		
Fisher Exact Test (d)		P=0.309N	P=0.121N
Pituitary Gland/Pars Distalis: Adenoma			
Overall Rates (e)	13/47 (28%)	5/46 (11%)	1/46 (2%)
Adjusted Rates (b)	35.3%	12.7%	2.5%
Terminal Rates (c)	10/33 (30%)	4/38 (11%)	1/40 (3%)
Day of First Observation	465	736	749
Life Table Tests (d)	P<0.001N	P=0.018N	P<0.001N
Logistic Regression Tests (d)	P<0.001N	P=0.034N	P<0.001N
Cochran-Armitage Trend Test (d)	P<0.001N		
Fisher Exact Test (d)		P=0.036N	P<0.001N
Pituitary Gland/Pars Distalis: Adenoma			
Overall Rates (e)	0/47 (0%)	0/46 (0%)	3/46 (7%)
Adjusted Rates (b)	0.0%	0.0%	7.5%
Terminal Rates (c)	0/33 (0%)	0/38 (0%)	3/40 (7%)
Day of First Observation			749
Life Table Tests (d)	P=0.048	(h)	P=0.157
Logistic Regression Tests (d)	P=0.048	(h)	P=0.157
Cochran-Armitage Trend Test (d)	P=0.036		
Fisher Exact Test (d)		(h)	P=0.157
Forestomach: Squamous Cell Papilloma			
Overall Rates (a)	(i) 2/50 (4%)	4/50 (8%)	0/50 (0%)
Adjusted Rates (b)	6.1%	9.5%	0.0%
Terminal Rates (c)	2/33 (6%)	3/40 (7%)	0/40 (0%)
Day of First Observation	749	701	
Life Table Tests (d)	P=0.169N	P=0.427	P=0.197N
Logistic Regression Tests (d)	P=0.190N	P=0.383	P=0.197N
Cochran-Armitage Trend Test (d)	P=0.222N		
Fisher Exact Test (d)		P=0.339	P=0.247N
Thyroid Gland: Follicular Cell Adenoma			
Overall Rates (e)	2/49 (4%)	3/49 (6%)	2/49 (4%)
Adjusted Rates (b)	6.1%	7.5%	5.0%
Terminal Rates (c)	2/33 (6%)	3/40 (7%)	2/40 (5%)
Day of First Observation	749	749	749
Life Table Tests (d)	P=0.513N	P=0.588	P=0.624N
Logistic Regression Tests (d)	P=0.513N	P=0.588	P=0.624N
Cochran-Armitage Trend Test (d)	P=0.594		
Fisher Exact Test (d)		P=0.500	P=0.691N
Uterus: Stromal Polyp			
Overall Rates (a)	3/50 (6%)	1/50 (2%)	0/50 (0%)
Adjusted Rates (b)	8.2%	2.5%	0.0%
Terminal Rates (c)	2/33 (6%)	1/40 (3%)	0/40 (0%)
Day of First Observation	626	749	
Life Table Tests (d)	P=0.045N	P=0.250N	P=0.098N
Logistic Regression Tests (d)	P=0.059N	P=0.300N	P=0.122N
Cochran-Armitage Trend Test (d)	P=0.060N		
Fisher Exact Test (d)		P=0.309N	P=0.121N

TABLE D3. ANALYSIS OF PRIMARY NEOPLASMS IN FEMALE MICE IN THE TWO-YEAR INHALATION STUDY OF CS2 (Continued)

	Chamber Control	0.75 mg/m ³	1.5 mg/m ³
Circulatory System: Hemangioma			
Overall Rates (a)	1/50 (2%)	(f,j) 3/50 (6%)	1/50 (2%)
Adjusted Rates (b)	3.0%	6.9%	2.5%
Terminal Rates (c)	1/33 (3%)	1/40 (3%)	1/40 (3%)
Day of First Observation	749	659	749
Life Table Tests (d)	P=0.548N	P=0.368	P=0.718N
Logistic Regression Tests (d)	P=0.598N	P=0.312	P=0.718N
Cochran-Armitage Trend Test (d)	P=0.610		
Fisher Exact Test (d)		P=0.309	P=0.753N
Circulatory System: Hemangioma or Hemangiosarcoma			
Overall Rates (e)	3/50 (6%)	(f,j) 3/50 (6%)	1/50 (2%)
Adjusted Rates (b)	8.4%	6.9%	2.5%
Terminal Rates (c)	2/33 (6%)	1/40 (3%)	1/40 (3%)
Day of First Observation	694	659	749
Life Table Tests (d)	P=0.184N	P=0.582N	P=0.244N
Logistic Regression Tests (d)	P=0.227N	P=0.654N	P=0.277N
Cochran-Armitage Trend Test (d)	P=0.238N		
Fisher Exact Test (d)		P=0.661N	P=0.309N
Hematopoietic System: Lymphoma, All Malignant			
Overall Rates (a)	21/50 (42%)	(f,j) 12/50 (24%)	8/50 (16%)
Adjusted Rates (b)	54.4%	26.0%	18.3%
Terminal Rates (c)	16/33 (48%)	6/40 (15%)	5/40 (13%)
Day of First Observation	452	640	694
Life Table Tests (d)	P<0.001N	P=0.018N	P=0.001N
Logistic Regression Tests (d)	P=0.002N	P=0.037N	P=0.003N
Cochran-Armitage Trend Test (d)	P=0.003N		
Fisher Exact Test (d)		P=0.044N	P=0.004N
All Sites: Benign Tumors			
Overall Rates (a)	23/50 (46%)	17/50 (34%)	13/50 (26%)
Adjusted Rates (b)	60.0%	39.3%	30.5%
Terminal Rates (c)	18/33 (55%)	14/40 (35%)	11/40 (28%)
Day of First Observation	465	659	616
Life Table Tests (d)	P=0.005N	P=0.047N	P=0.007N
Logistic Regression Tests (d)	P=0.014N	P=0.107N	P=0.018N
Cochran-Armitage Trend Test (d)	P=0.023N		
Fisher Exact Test (d)		P=0.154N	P=0.030N
All Sites: Malignant Tumors			
Overall Rates (a)	35/50 (70%)	17/50 (34%)	16/50 (32%)
Adjusted Rates (b)	74.2%	36.0%	37.0%
Terminal Rates (c)	21/33 (64%)	10/40 (25%)	13/40 (33%)
Day of First Observation	382	53	694
Life Table Tests (d)	P<0.001N	P<0.001N	P<0.001N
Logistic Regression Tests (d)	P<0.001N	P<0.001N	P<0.001N
Cochran-Armitage Trend Test (d)	P<0.001N		
Fisher Exact Test (d)		P<0.001N	P<0.001N
All Sites: All Tumors			
Overall Rates (a)	46/50 (92%)	27/50 (54%)	27/50 (54%)
Adjusted Rates (b)	93.9%	56.2%	61.1%
Terminal Rates (c)	30/33 (91%)	19/40 (48%)	23/40 (58%)
Day of First Observation	382	53	616
Life Table Tests (d)	P<0.001N	P<0.001N	P<0.001N
Logistic Regression Tests (d)	P<0.001N	P<0.001N	P<0.001N
Cochran-Armitage Trend Test (d)	P<0.001N		
Fisher Exact Test (d)		P<0.001N	P<0.001N

TABLE D3. ANALYSIS OF PRIMARY NEOPLASMS IN FEMALE MICE IN THE TWO-YEAR INHALATION STUDY OF CS2 (Continued)

- (a) Number of tumor-bearing animals/number of animals examined grossly at the site
- (b) Kaplan-Meier estimated tumor incidences at the end of the study after adjusting for intercurrent mortality
- (c) Observed tumor incidence in animals killed at the end of the study
- (d) Beneath the control incidence are the P values associated with the trend test. Beneath the dosed group incidence are the P values corresponding to pairwise comparisons between that dosed group and the controls. The life table analysis regards tumors in animals dying prior to terminal kill as being (directly or indirectly) the cause of death. The logistic regression test regards these lesions as nonfatal. The Cochran-Armitage and Fisher exact tests compare directly the overall incidence rates. A negative trend or lower incidence in a dosed group than in controls is indicated by (N).
- (e) Number of tumor-bearing animals/number of animals examined microscopically at the site
- (f) Incomplete sampling of tissues
- (g) Includes one alveolus bronchus adenoma
- (h) No P value is presented because no tumors were observed in the control and 0.75 mg/m³ groups.
- (i) A squamous cell carcinoma was observed in one of the animals bearing a squamous cell papilloma.
- (j) Fifteen livers, 19 spleens, and 15 lymph nodes were examined.

TABLE D4a. HISTORICAL INCIDENCE OF ANTERIOR PITUITARY GLAND NEOPLASMS IN FEMALE B6C3F₁ MICE (a)

Study	Incidence in Controls		
	Adenoma	Carcinoma	Adenoma or Carcinoma
Historical Incidence for Chamber Controls at Battelle Pacific Northwest Laboratories			
Propylene oxide	8/46	1/46	9/46
Methyl methacrylate	12/49	0/49	12/49
Propylene	(b) 13/41	0/41	13/41
1,2-Epoxybutane	19/47	3/47	22/47
Dichloromethane	4/46	0/46	4/46
Ethylene oxide	4/48	1/48	5/48
Bromoethane	2/48	0/48	2/48
Tetrachloroethylene	2/45	5/45	7/45
TOTAL	(b) 64/370 (17.3%)	10/370 (2.7%)	(b) 74/370 (20.0%)
SD (c)	13.55%	4.04%	13.97%
Range (d)			
High	19/47	5/45	22/47
Low	2/48	0/49	2/48
Overall Historical Incidence for Untreated Controls in NTP Studies			
TOTAL	(e) 244/1,528 (16.0%)	(f) 12/1,528 (0.8%)	(e,f) 256/1,528 (16.8%)
SD (c)	10.80%	1.42%	11.09%
Range (d)			
High	18/49	3/50	19/49
Low	0/48	0/50	0/48

- (a) Data as of March 1, 1989, for studies of at least 104 weeks
 (b) Includes 11 chromophobe adenomas
 (c) Standard deviation
 (d) Range and SD are presented for groups of 35 or more animals.
 (e) Includes four chromophobe adenomas
 (f) Includes three adenocarcinomas, NOS

TABLE D4b. HISTORICAL INCIDENCE OF INTERMEDIA PITUITARY GLAND NEOPLASMS IN FEMALE B6C3F₁ MICE (a)

Study	Incidence of Adenomas in Controls
Historical Incidence for Chamber Controls at Battelle Pacific Northwest Laboratories	
Propylene oxide	0/46
Methyl methacrylate	1/49
Propylene	0/41
1,2-Epoxybutane	0/47
Dichloromethane	0/46
Ethylene oxide	0/48
Bromoethane	0/48
Tetrachloroethylene	0/45
TOTAL	1/370 (0.3%)
SD (b)	0.72%
Range (c)	
High	1/49
Low	0/48
Overall Historical Incidence for Untreated Controls in NTP Studies	
TOTAL	3/1,528 (0.2%)
SD (b)	0.64%
Range (c)	
High	1/43
Low	0/50

(a) Data as of March 1, 1989, for studies of at least 104 weeks; no malignant tumors have been observed.

(b) Standard deviation

(c) Range and SD are presented for groups of 35 or more animals.

TABLE D4c. HISTORICAL INCIDENCE OF HEMATOPOIETIC SYSTEM NEOPLASMS IN FEMALE B6C3F₁ MICE (a)

Study	Incidence in Controls	
	Lymphoma	Lymphoma or Leukemia
Historical Incidence for Chamber Controls at Battelle Pacific Northwest Laboratories		
Propylene oxide	12/50	12/50
Methyl methacrylate	8/50	8/50
Propylene	16/50	16/50
1,2-Epoxybutane	13/50	13/50
Dichloromethane	7/50	7/50
Ethylene oxide	9/49	9/49
Bromoethane	11/50	11/50
Tetrachloroethylene	8/49	8/49
TOTAL	84/398 (21.1%)	84/398 (21.1%)
SD (b)	6.08%	6.08%
Range (c)		
High	16/50	16/50
Low	7/50	7/50
Overall Historical Incidence for Untreated Controls in NTP Studies		
TOTAL	523/1,689 (31.0%)	537/1,689 (31.8%)
SD (b)	12.73%	12.20%
Range (c)		
High	37/50	38/50
Low	5/50	6/50

(a) Data as of March 1, 1989, for studies of at least 104 weeks

(b) Standard deviation

(c) Range and SD are presented for groups of 35 or more animals.

TABLE D5. SUMMARY OF THE INCIDENCE OF NONNEOPLASTIC LESIONS IN FEMALE MICE IN THE TWO-YEAR INHALATION STUDY OF CS₂

	Chamber Control	0.75 mg/m ³	1.5 mg/m ³
DISPOSITION SUMMARY			
Animals initially in study	50	50	50
Early deaths			
Dead	9	5	7
Moribund	8	5	3
Survivors			
Terminal sacrifice	33	40	40
Animals examined microscopically	50	50	50
ALIMENTARY SYSTEM			
Gallbladder	(42)	(5)	(40)
Inflammation, suppurative			1 (3%)
Intestine small, ileum	(44)	(9)	(44)
Amyloid deposition	1 (2%)		
Liver	(50)	(15)	(49)
Angiectasis			1 (2%)
Basophilic focus	1 (2%)		
Clear cell focus			1 (2%)
Eosinophilic focus	1 (2%)		
Hematopoietic cell proliferation			1 (2%)
Hepatodiaphragmatic nodule	1 (2%)		
Leukocytosis	2 (4%)		1 (2%)
Necrosis	3 (6%)	1 (7%)	1 (2%)
Vacuolization cytoplasmic			1 (2%)
Mesentery	(4)	(1)	
Fibrosis	1 (25%)		
Inflammation, chronic		1 (100%)	
Necrosis	2 (50%)	1 (100%)	
Pancreas	(50)	(11)	(49)
Atrophy	1 (2%)		
Developmental malformation		1 (9%)	
Inflammation, chronic		1 (9%)	
Duct, dilatation	1 (2%)		
Stomach, forestomach	(48)	(48)	(47)
Acanthosis		3 (6%)	
Cyst		1 (2%)	
Inflammation, suppurative	1 (2%)		
Ulcer		1 (2%)	
Stomach, glandular	(49)	(48)	(47)
Erosion		2 (4%)	1 (2%)
Inflammation, suppurative	1 (2%)		1 (2%)
Epithelium, hyperplasia	2 (4%)		3 (6%)
Tooth		(1)	
Developmental malformation		1 (100%)	
CARDIOVASCULAR SYSTEM			
Heart	(50)	(10)	(49)
Cardiomyopathy	1 (2%)		
Hemorrhage	2 (4%)		
Inflammation, suppurative			1 (2%)
Artery, inflammation			1 (2%)
ENDOCRINE SYSTEM			
Adrenal gland	(50)	(10)	(49)
Capsule, hyperplasia	49 (98%)	9 (90%)	48 (98%)

TABLE D5. SUMMARY OF THE INCIDENCE OF NONNEOPLASTIC LESIONS IN FEMALE MICE IN THE TWO-YEAR INHALATION STUDY OF CS₂ (Continued)

	Chamber Control	0.75 mg/m ³	1.5 mg/m ³
ENDOCRINE SYSTEM (Continued)			
Adrenal gland, cortex	(50)	(10)	(49)
Angiectasis	1 (2%)		1 (2%)
Cyst			1 (2%)
Cytomegaly	4 (8%)		3 (6%)
Hematopoietic cell proliferation			1 (2%)
Hemorrhage			1 (2%)
Vacuolization cytoplasmic			1 (2%)
Adrenal gland, medulla	(49)	(10)	(48)
Inflammation, suppurative			1 (2%)
Karyomegaly	1 (2%)		
Parathyroid gland	(14)	(5)	(36)
Cyst			1 (3%)
Pituitary gland	(47)	(46)	(46)
Angiectasis	6 (13%)		
Cyst	1 (2%)	1 (2%)	
Pars distalis, hyperplasia	16 (34%)	8 (17%)	7 (15%)
Thyroid gland	(49)	(49)	(49)
Inflammation, suppurative	2 (4%)	1 (2%)	2 (4%)
C-cell, hyperplasia	1 (2%)		
Follicular cell, hyperplasia	17 (35%)	6 (12%)	5 (10%)
Follicular cell, hyperplasia, multiple		1 (2%)	
GENERAL BODY SYSTEM			
None			
GENITAL SYSTEM			
Clitoral gland			(1)
Inflammation, suppurative			1 (100%)
Ovary	(50)	(20)	(49)
Angiectasis			1 (2%)
Cyst	15 (30%)	10 (50%)	10 (20%)
Cyst, multiple	1 (2%)	1 (5%)	
Hemorrhage			4 (8%)
Mineralization			1 (2%)
Thrombus	1 (2%)		
Germinal epithelium, hyperplasia	3 (6%)		2 (4%)
Uterus	(49)	(15)	(48)
Angiectasis	1 (2%)		
Dilatation	2 (4%)	2 (13%)	8 (17%)
Hemorrhage	1 (2%)	1 (7%)	3 (6%)
Inflammation, suppurative			3 (6%)
Thrombus		1 (7%)	
Endometrium, hyperplasia	30 (61%)	5 (33%)	23 (48%)
Endometrium, metaplasia, squamous			1 (2%)
HEMATOPOIETIC SYSTEM			
Bone marrow	(50)	(10)	(49)
Myelofibrosis	36 (72%)	5 (50%)	42 (86%)
Myeloid cell, hyperplasia			2 (4%)
Lymph node	(50)	(15)	(48)
Hyperplasia, lymphoid		1 (7%)	
Mesenteric, hematopoietic cell proliferation		1 (7%)	
Pancreatic, angiectasis			1 (2%)
Pancreatic, inflammation, suppurative			1 (2%)
Lymph node, bronchial	(48)	(11)	(46)
Hematopoietic cell proliferation	3 (6%)		1 (2%)
Pigmentation			1 (2%)

TABLE D5. SUMMARY OF THE INCIDENCE OF NONNEOPLASTIC LESIONS IN FEMALE MICE IN THE TWO-YEAR INHALATION STUDY OF CS2 (Continued)

	Chamber Control	0.75 mg/m ³	1.5 mg/m ³
HEMATOPOIETIC SYSTEM (Continued)			
Lymph node, mandibular	(44)	(11)	(38)
Cyst			1 (3%)
Hematopoietic cell proliferation	5 (11%)		4 (11%)
Hyperplasia, lymphoid			1 (3%)
Inflammation, suppurative			1 (3%)
Spleen	(50)	(19)	(49)
Hematopoietic cell proliferation	9 (18%)	7 (37%)	10 (20%)
Infarct	2 (4%)		
Necrosis			1 (2%)
INTEGUMENTARY SYSTEM			
Mammary gland	(45)	(10)	(47)
Cyst	1 (2%)		
Skin	(50)	(17)	(49)
Acanthosis			2 (4%)
Hemorrhage			1 (2%)
Inflammation, suppurative			1 (2%)
Ulcer			2 (4%)
MUSCULOSKELETAL SYSTEM			
None			
NERVOUS SYSTEM			
Brain	(50)	(11)	(49)
Compression	5 (10%)		1 (2%)
Hemorrhage	2 (4%)		2 (4%)
Mineralization	20 (40%)	5 (45%)	17 (35%)
Necrosis	1 (2%)		
Vacuolization cytoplasmic	1 (2%)		
RESPIRATORY SYSTEM			
Larynx	(50)	(10)	(47)
Artery, inflammation			1 (2%)
Lung	(50)	(17)	(49)
Congestion			2 (4%)
Hemorrhage	1 (2%)		2 (4%)
Leukocytosis	4 (8%)		4 (8%)
Alveolus, hyperplasia	3 (6%)	1 (6%)	1 (2%)
Alveolus, infiltration cellular, histiocytic	5 (10%)	2 (12%)	5 (10%)
Alveolus, inflammation, suppurative	2 (4%)		2 (4%)
Artery, mineralization			1 (2%)
Pleura, fibrosis	1 (2%)		
Nose	(50)	(49)	(49)
Exudate, serous		1 (2%)	
Foreign body	1 (2%)		
Hemorrhage	2 (4%)	1 (2%)	
Inflammation, acute	1 (2%)		2 (4%)
Inflammation, suppurative	8 (16%)	9 (18%)	18 (37%)
Nasolacrimal duct, inflammation, suppurative	7 (14%)	2 (4%)	
Olfactory epithelium, atrophy			1 (2%)
Respiratory epithelium, hyperplasia		4 (8%)	7 (14%)
Respiratory epithelium, metaplasia, squamous	1 (2%)	6 (12%)	17 (35%)
Trachea	(50)	(10)	(48)
Hemorrhage	1 (2%)		
Inflammation, suppurative	1 (2%)		1 (2%)

TABLE D5. SUMMARY OF THE INCIDENCE OF NONNEOPLASTIC LESIONS IN FEMALE MICE IN THE TWO-YEAR INHALATION STUDY OF CS₂ (Continued)

	Chamber Control	0.75 mg/m ³	1.5 mg/m ³
SPECIAL SENSES SYSTEM			
Eye	(33)		(38)
Atrophy			1 (3%)
Hemorrhage			1 (3%)
Cornea, inflammation, suppurative	1 (3%)		
Lens, cataract			1 (3%)
Retina, vacuolization cytoplasmic			1 (3%)
URINARY SYSTEM			
Kidney	(49)	(13)	(49)
Developmental malformation			1 (2%)
Infiltration cellular, lymphocytic	1 (2%)		
Mineralization	1 (2%)		1 (2%)
Nephropathy, chronic	41 (84%)	7 (54%)	47 (96%)

APPENDIX E

SENTINEL ANIMAL PROGRAM

	PAGE
TABLE E1 MURINE ANTIBODY DETERMINATIONS FOR RATS AND MICE IN THE TWO-YEAR INHALATION STUDIES OF CS ₂	173

APPENDIX E. SENTINEL ANIMAL PROGRAM

Methods

Rodents used in the Carcinogenesis Program of the National Toxicology Program are produced in optimally clean facilities to eliminate potential pathogens that may affect study results. The Sentinel Animal Program is part of the periodic monitoring of animal health that occurs during the toxicologic evaluation of chemical compounds. Under this program, the disease state of the rodents is monitored via serology on sera from extra (sentinel) animals in the study rooms. These animals are untreated, and these animals and the study animals are both subject to identical environmental conditions. The sentinel animals come from the same production source and weanling groups as the animals used for the studies of chemical compounds.

Fifteen B6C3F₁ mice and 15 F344/N rats of each sex were selected at the time of randomization and allocation of the animals to the various study groups. Five animals of each designated sentinel group were killed at 6, 12, and 18 months on study. Data from animals surviving 24 months were collected from 5/50 randomly selected control animals of each sex and species. The blood from each animal was collected and clotted, and the serum was separated. The serum was cooled on ice and shipped to Microbiological Associates' Comprehensive Animal Diagnostic Service for determination of the antibody titers. The following tests were performed:

	<u>Hemagglutination Inhibition</u>	<u>Complement Fixation</u>	<u>ELISA</u>
Mice	PVM (pneumonia virus of mice) (a) Reo 3 (reovirus type 3) (a) GDVII (Theiler's encephalomyelitis virus) (c) Poly (polyoma virus) MVM (minute virus of mice) Ectro (infectious ectromelia) (a) Sendai (a)	M. Ad. (mouse adenovirus) (a) LCM (lymphocytic chorio- meningitis virus) <u>IFA</u> EDIM (epizootic diarrhea of infant mice) (b)	MHV (mouse hepatitis virus) PVM (b) Sendai (b) Ectro (b) GDVII (d) M. Ad. (b) Reo 3 (b) <i>M. arth.</i> (<i>Mycoplasma</i> <i>arthritidis</i>) (b) <i>M. pul.</i> (<i>Mycoplasma</i> <i>pulmonis</i>) (e)
Rats	PVM (a) KRV (Kilham rat virus) H-1 (Toolan's H-1 virus) Sendai (a)		RCV/SDA (rat corona- virus/sialodacryoaden- itis virus) Sendai (b) <i>M. arth.</i> (b) <i>M. pul.</i> (e) PVM (b)

Results

Results are presented in Table E1.

- (a) Test performed at 6, 12, and 18 months only
 (b) Test performed at 24 months only
 (c) Test performed at 6 and 12 months only
 (d) Test performed at 18 and 24 months only
 (e) Test performed at 6 and 24 months only

TABLE E1. MURINE ANTIBODY DETERMINATIONS FOR RATS AND MICE IN THE TWO-YEAR INHALATION STUDIES OF CS₂ (a)

Interval (months)	Number of Animals	Positive Serologic Reaction for
RATS		
6	10/10	PVM
	10/10	<i>M. pul.</i> (b)
	9/10	RCV/SDA
12	10/10	PVM
	10/10	RCV/SDA
18	9/9	PVM
	8/9	RCV/SDA
24	10/10	PVM
	9/10	RCV/SDA
MICE		
1	(c) 1	None
6	7/9	PVM
12	4/9	PVM
18	2/9	PVM
21-22	(d)	
24	10/10	PVM
	1/10	MHV (e)

(a) Blood samples were taken from sentinel animals at 6, 12, and 18 months after the start of dosing and from the control animals just before they were killed; samples were sent to Microbiological Associates, Inc. (Bethesda, MD) for determination of antibody titers.

(b) Further evaluation of this assay indicated that it was not specific for *M. pulmonis*, and these results were considered to be false positive.

(c) No antibody titers were observed for the sentinel mouse tested. The mouse was killed to investigate an abnormality in mouse hair coats.

(d) No MHV antibodies were observed for the five moribund mice tested.

(e) Probable false positive

APPENDIX F

INGREDIENTS, NUTRIENT COMPOSITION, AND CONTAMINANT LEVELS IN NIH 07 RAT AND MOUSE RATION

Pellet Diet: November 1982 to November 1984

(Manufactured by Zeigler Bros., Inc., Gardners, PA)

		PAGE
TABLE F1	INGREDIENTS OF NIH 07 RAT AND MOUSE RATION	176
TABLE F2	VITAMINS AND MINERALS IN NIH 07 RAT AND MOUSE RATION	176
TABLE F3	NUTRIENT COMPOSITION OF NIH 07 RAT AND MOUSE RATION	177
TABLE F4	CONTAMINANT LEVELS IN NIH 07 RAT AND MOUSE RATION	178

TABLE F1. INGREDIENTS OF NIH 07 RAT AND MOUSE RATION (a)

Ingredients (b)	Percent by Weight
Ground #2 yellow shelled corn	24.50
Ground hard winter wheat	23.00
Soybean meal (49% protein)	12.00
Fish meal (60% protein)	10.00
Wheat middlings	10.00
Dried skim milk	5.00
Alfalfa meal (dehydrated, 17% protein)	4.00
Corn gluten meal (60% protein)	3.00
Soy oil	2.50
Dried brewer's yeast	2.00
Dry molasses	1.50
Dicalcium phosphate	1.25
Ground limestone	0.50
Salt	0.50
Premixes (vitamin and mineral)	0.25

(a) NCI, 1976; NIH, 1978

(b) Ingredients ground to pass through a U.S. Standard Screen No. 16 before being mixed

TABLE F2. VITAMINS AND MINERALS IN NIH 07 RAT AND MOUSE RATION (a)

	Amount	Source
Vitamins		
A	5,500,000 IU	Stabilized vitamin A palmitate or acetate
D ₃	4,600,000 IU	D-activated animal sterol
K ₃	2.8 g	Menadione
<i>d</i> - α -Tocopheryl acetate	20,000 IU	
Choline	560.0 g	Choline chloride
Folic acid	2.2 g	
Niacin	30.0 g	
<i>d</i> -Pantothenic acid	18.0 g	<i>d</i> -Calcium pantothenate
Riboflavin	3.4 g	
Thiamine	10.0 g	Thiamine mononitrate
B ₁₂	4,000 μ g	
Pyridoxine	1.7 g	Pyridoxine hydrochloride
Biotin	140.0 mg	<i>d</i> -Biotin
Minerals		
Iron	120.0 g	Iron sulfate
Manganese	60.0 g	Manganous oxide
Zinc	16.0 g	Zinc oxide
Copper	4.0 g	Copper sulfate
Iodine	1.4 g	Calcium iodate
Cobalt	0.4 g	Cobalt carbonate

(a) Per ton (2,000 lb) of finished product

TABLE F3. NUTRIENT COMPOSITION OF NIH 07 RAT AND MOUSE RATION

Nutrients	Mean ± Standard Deviation	Range	Number of Samples
Protein (percent by weight)	22.90 ± 0.98	22.1-24.9	13
Crude fat (percent by weight)	5.32 ± 0.61	4.4-6.5	13
Crude fiber (percent by weight)	3.50 ± 0.68	2.8-5.6	13
Ash (percent by weight)	6.62 ± 0.30	6.3-7.2	13
Amino Acids (percent of total diet)			
Arginine	1.320 ± 0.072	1.310-1.390	5
Cystine	0.319 ± 0.088	0.218-0.400	5
Glycine	1.146 ± 0.063	1.060-1.210	5
Histidine	0.571 ± 0.026	0.531-0.603	5
Isoleucine	0.914 ± 0.030	0.881-0.944	5
Leucine	1.946 ± 0.056	1.850-1.990	5
Lysine	1.280 ± 0.067	1.200-1.370	5
Methionine	0.436 ± 0.165	0.306-0.699	5
Phenylalanine	0.938 ± 0.158	0.665-1.050	5
Threonine	0.855 ± 0.035	0.824-0.898	5
Tryptophan	0.277 ± 0.221	0.156-0.671	5
Tyrosine	0.618 ± 0.086	0.564-0.769	5
Valine	1.108 ± 0.043	1.050-1.170	5
Essential Fatty Acids (percent of total diet)			
Linoleic	2.290 ± 0.313	1.830-2.520	5
Linolenic	0.258 ± 0.040	0.210-0.308	5
Vitamins			
Vitamin A (IU/kg)	12,523 ± 4,549	3,600-24,000	13
Vitamin D (IU/kg)	4,450 ± 1,382	3,000-6,300	4
α-Tocopherol (ppm)	43.58 ± 6.92	31.1-48.0	5
Thiamine (ppm)	18.54 ± 3.28	13.0-24.0	13
Riboflavin (ppm)	7.6 ± 0.85	6.10-8.20	5
Niacin (ppm)	97.8 ± 31.68	65.0-150.0	5
Pantothenic acid (ppm)	30.06 ± 4.31	23.0-34.0	5
Pyridoxine (ppm)	7.68 ± 1.31	5.60-8.80	5
Folic acid (ppm)	2.62 ± 0.89	1.80-3.70	5
Biotin (ppm)	0.254 ± 0.053	0.19-0.32	5
Vitamin B ₁₂ (ppb)	24.21 ± 12.66	10.6-38.0	5
Choline (ppm)	3,122 ± 416.8	2,400-3,430	5
Minerals			
Calcium (percent)	1.30 ± 0.12	1.140-1.540	13
Phosphorus (percent)	0.97 ± 0.05	0.910-1.100	13
Potassium (percent)	0.900 ± 0.098	0.772-0.971	3
Chloride (percent)	0.513 ± 0.114	0.380-0.635	5
Sodium (percent)	0.323 ± 0.043	0.258-0.371	5
Magnesium (percent)	0.167 ± 0.012	0.151-0.181	5
Sulfur (percent)	0.304 ± 0.064	0.268-0.420	5
Iron (ppm)	410.3 ± 94.04	262.0-523.0	5
Manganese (ppm)	90.29 ± 7.15	81.70-99.40	5
Zinc (ppm)	52.78 ± 4.94	46.10-58.20	5
Copper (ppm)	10.72 ± 2.76	8.09-15.39	5
Iodine (ppm)	2.95 ± 1.05	1.52-3.82	4
Chromium (ppm)	1.85 ± 0.25	1.44-2.09	5
Cobalt (ppm)	0.681 ± 0.14	0.490-0.780	4

TABLE F4. CONTAMINANT LEVELS IN NIH 07 RAT AND MOUSE RATION

Contaminants	Mean ± Standard Deviation	Range	Number of Samples
Arsenic (ppm)	0.54 ± 0.18	0.17-0.74	13
Cadmium (ppm) (a)	<0.10		13
Lead (ppm)	0.60 ± 0.26	0.33-1.27	13
Mercury (ppm) (a)	<0.05		13
Selenium (ppm)	0.32 ± 0.08	0.13-0.41	13
Aflatoxins (ppb) (a)	<5.0		13
Nitrate nitrogen (ppm) (b)	9.07 ± 4.77	0.10-19.0	13
Nitrite nitrogen (ppm) (b)	1.08 ± 1.90	0.10-7.20	13
BHA (ppm) (c)	3.39 ± 4.17	2.00-17.0	13
BHT (ppm) (c)	2.69 ± 3.01	1.00-12.0	13
Aerobic plate count (CFU/g) (d)	52,192 ± 42,836	7,100-130,000	13
Coliform (MPN/g) (e)	14.23 ± 17.31	<3.00-43.0	13
<i>E. coli</i> (MPN/g)	<3.00		13
Total nitrosamines (ppb) (f)	6.42 ± 7.70	1.85-30.90	13
<i>N</i> -Nitrosodimethylamine (ppb) (f)	5.38 ± 7.74	0.95-30.00	13
<i>N</i> -Nitrosopyrrolidine (ppb) (f)	1.04 ± 0.24	0.90-1.70	13
Pesticides (ppm)			
α-BHC (a,g)	<0.01		13
β-BHC (a)	<0.02		13
γ-BHC (a)	<0.01		13
δ-BHC (a)	<0.01		13
Heptachlor (a)	<0.01		13
Aldrin (a)	<0.01		13
Heptachlor epoxide (a)	<0.01		13
DDE (a)	<0.01		13
DDD (a)	<0.01		13
DDT (a)	<0.01		13
HCB (a)	<0.01		13
Mirex (a)	<0.01		13
Methoxychlor (a)	<0.05		13
Dieldrin (a)	<0.01		13
Endrin (a)	<0.01		13
Telodrin (a)	<0.01		13
Chlordane (a)	<0.05		13
Toxaphene (a)	<0.1		13
Estimated PCBs (a)	<0.2		13
Ronnel (a)	<0.01		13
Ethion (a)	<0.02		13
Trithion (a)	<0.05		13
Diazinon (a)	<0.1		13
Methyl parathion	<0.02		13
Ethyl parathion (a)	<0.02		13
Malathion (h)	0.09 ± 0.06	0.05-0.25	13
Endosulfan I (a)	<0.01		13
Endosulfan II (a)	<0.01		13
Endosulfan sulfate (a)	<0.03		13

(a) All values were less than the detection limit, given in the table as the mean.

(b) Source of contamination: alfalfa, grains, and fish meal

(c) Source of contamination: soy oil and fish meal

(d) CFU = colony-forming unit

(e) MPN = most probable number

(f) All values were corrected for percent recovery.

(g) BHC = hexachlorocyclohexane or benzene hexachloride

(h) Six lots contained more than 0.05 ppm.

APPENDIX G

CHEMICAL CHARACTERIZATION, GENERATION, AND MONITORING OF CHAMBER CONCENTRATIONS OF CS₂ FOR THE TOXICOLOGY STUDIES

		PAGE
TABLE G1	AEROSOL GENERATION SYSTEM IN THE INHALATION STUDIES OF CS ₂	183
TABLE G2	SUMMARY OF CHAMBER CONCENTRATIONS IN THE TWO-YEAR INHALATION STUDIES OF CS ₂	188

APPENDIX G. CHEMICAL CHARACTERIZATION

PROCUREMENT AND CHARACTERIZATION OF CS2

CS2, a formulated mixture of 94% *o*-chlorobenzalmalonitrile, 1% hexamethyldisilazane, and 5% Cab-O-Sil® colloidal silica, was obtained in one lot (lot no. APG-55-MD) from Aberdeen Proving Ground (Aberdeen, MD) in 8-pound paper bags with plastic liners in a metal barrel. Purity and identity analyses were conducted at Midwest Research Institute (MRI) (Kansas City, MO). MRI reports on analyses performed in support of the CS2 studies are on file at the National Institute of Environmental Health Sciences.

Three individual bags, selected randomly, were homogenized by manual rolling and kneading. Samples were removed from the three bags and analyzed for homogeneity by gas chromatography performed with a 3% Dexsil 400 column, with nitrogen as the carrier at 70 ml/minute, and with flame ionization detection (system 1). The same major peak and three unresolved impurities were detected for each of the samples.

The study chemical, a cream-colored, microcrystalline powder, was identified as CS2 by spectroscopic analyses. The infrared (Figure G1), ultraviolet/visible, and nuclear magnetic resonance (Figure G2) spectra were consistent with the literature spectra (Sadtler Standard Spectra). The methyl peaks expected in the nuclear magnetic resonance spectrum for hexamethyldisilazane were not observed; highly reactive hexamethyldisilazane may have been lost to the system through reaction with water or other reactive hydroxyls.

The purity of CS2 was determined by elemental analysis, thin-layer chromatography, and gas chromatography with two systems. Thin-layer chromatography was performed on 0.25-mm silica gel plates with two solvent systems: 100% toluene and hexanes:diethylether (70:30). Visualization was by visible and ultraviolet light (254 nm) and a potassium permanganate in dilute sodium hydroxide spray. Gas chromatographic analysis was performed with flame ionization detection and the same system as previously described for homogeneity analysis or with a 20% SP2100/0.1% Carbowax 1500 column (system 2).

The results of elemental analysis of lot no. APG-55-MD were high for carbon and were in agreement with the theoretical values for hydrogen, nitrogen, chlorine, and silicon. No impurities were detected by either thin-layer chromatographic system. Gas chromatographic system 1 indicated three unresolved impurities after the major peak, with combined areas of 0.09% relative to the major peak area. Gas chromatographic system 2 indicated two impurities, one before and one after the major peak, with a combined relative area of 0.08%.

Stability studies, performed by gas chromatography and with the same column as previously described for system 1 and with 0.5% nonadecane as the internal standard, indicated that CS2 was stable in the dark for at least 2 weeks at temperatures up to 60° C.

The purity and identity of CS2 were confirmed throughout the studies by gas chromatographic system 1 and by infrared spectroscopy.

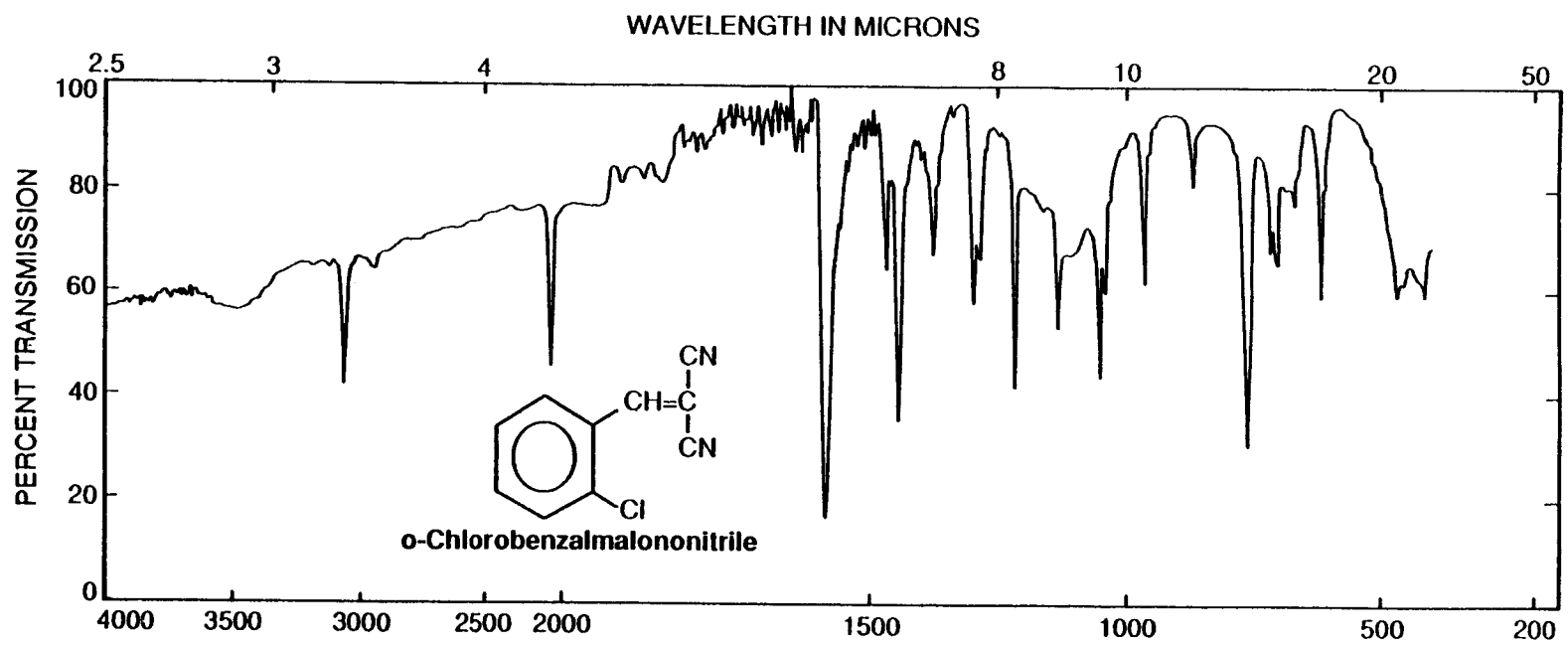

FIGURE G1. INFRARED ABSORPTION SPECTRUM OF CS2 (LOT NO. APG-55-MD)

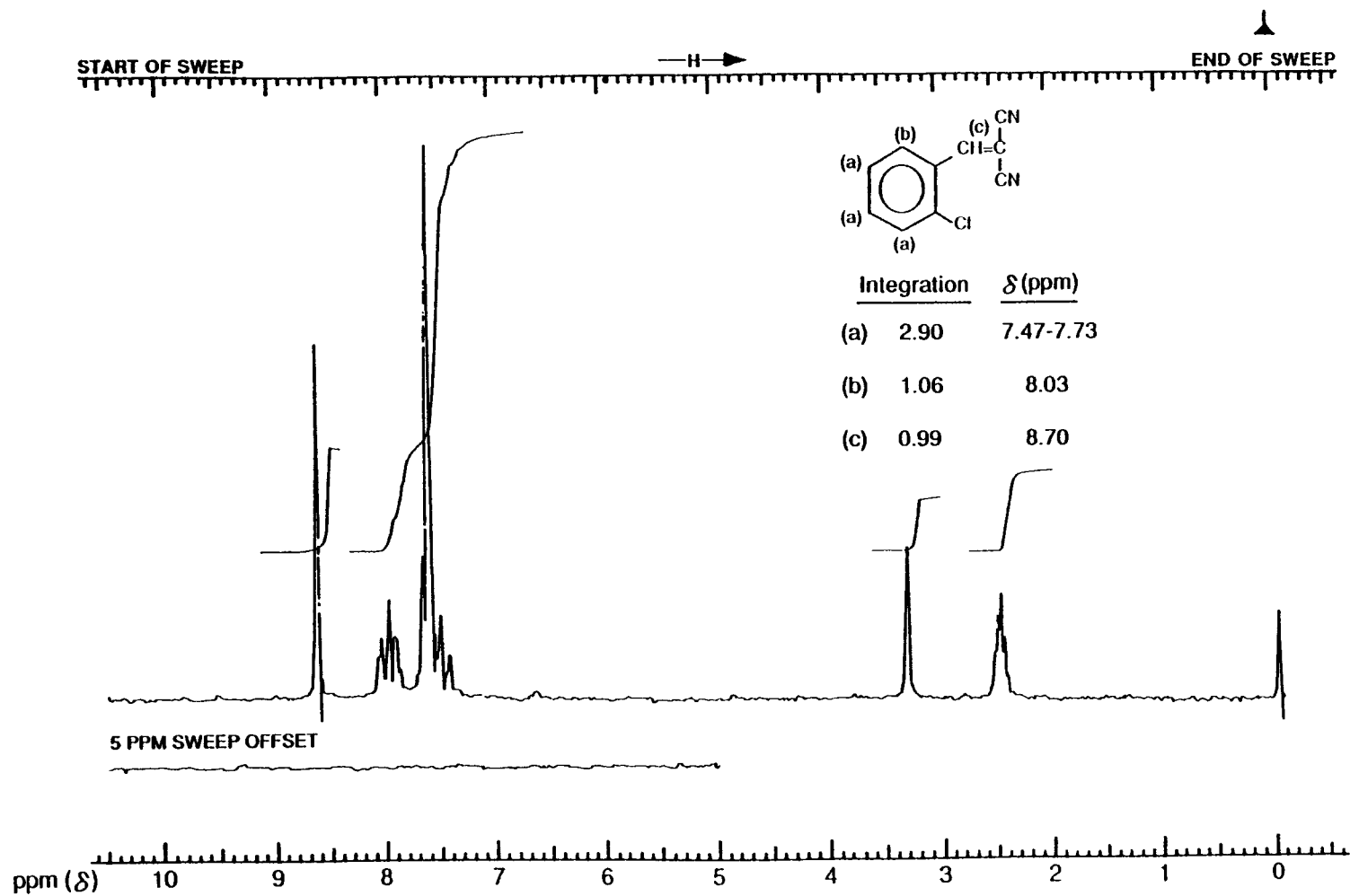

FIGURE G2. NUCLEAR MAGNETIC RESONANCE SPECTRUM OF CS2 (LOT NO. APG-55-MD)

APPENDIX G. CHEMICAL CHARACTERIZATION

GENERATION AND MONITORING OF CHAMBER CONCENTRATIONS

Generation System

The CS₂ aerosol was generated within a small glove box and passed through a krypton-83 deionizer into a distribution line. The CS₂ aerosol was generated from the original powder with a dual-brush dust feed mechanism (Table G1). The device (Figure G3) consisted of a cylindrical "main" hopper and a small delivery tube. The main hopper laid horizontally and contained a large randomly wound brush. This brush was rotated to keep the powder "fluidized." The delivery tube was perpendicular to the hopper and also in the horizontal plane. The two were connected by a hole at the bottom of the hopper. The delivery tube contained a spirally wound brush, which was rotated with a stepping motor to feed powder from the hole in the hopper to a point where the CS₂ was aspirated into an airstream.

The CS₂ dust distribution system is depicted schematically in Figure G4. Aerosol from the generator was diluted with HEPA-filtered room air and carried past each exposure chamber by a main duct that terminated with an absolute filter. Aerosol concentration in this main duct was controlled by adjusting the rotational speed of the generator feed brush or by changing the total airflow in the duct. Aerosol pumps for each chamber were used to pull a fraction of the aerosol from the main duct and to inject it into the exposure chamber, where further dilution air was added to achieve the desired concentration. The aerosol pumps, compressed-air-operated Venturi vacuum pumps with no moving parts, are designed to run maintenance free when pumping "dirty" atmospheres, such as the CS₂-air mixture coming from the main duct. Pump flow rates were determined by the pressure of the compressed air driving them and were adjustable by pressure regulators located at the front of each exposure chamber.

Aerosol concentrations in the exposure chambers were controlled primarily by adjusting the aerosol pump rates. Secondary adjustments were made by changing the dilution airflow into the chamber.

Hazleton 2000[®] steel chambers available from Lab Products, Inc., were used for the inhalation exposure. The chambers, with a total volume of 2.3 m³, have an active mixing volume of about 1.7 m³, the remainder being the nonmixing inlet and exhaust volumes.

Concentration Monitoring

Aerosol concentration was monitored continuously during the 14-day studies and periodically during the 13-week studies with a RAM-1 (GCA Corporation) forward light-scattering monitor (nephelometer). During the 2-year studies, a RAM-S forward light-scattering monitor determined aerosol concentrations approximately once per hour. The RAM-1 was calibrated by collecting filter grab samples

TABLE G1. AEROSOL GENERATION SYSTEM IN THE INHALATION STUDIES OF CS₂

Fourteen-Day Studies	Thirteen-Week Studies	Two-Year Studies
Powder was passed through a dual-brush dust feed generator. Agglomerates were broken up in an air jet disruptor. Electrostatic charge was neutralized by a radioactive deionizer. The aerosol was mixed with dilution air and entered the exposure chambers.	Similar to 14-d studies. The aerosol was injected into exposure chambers by aerosol pumps with adjustable flow rates to control aerosol concentration.	Similar to 14-d studies. The aerosol was diluted with HEPA-filtered room air. The aerosol was injected into exposure chambers by aerosol pumps with adjustable flow rates.

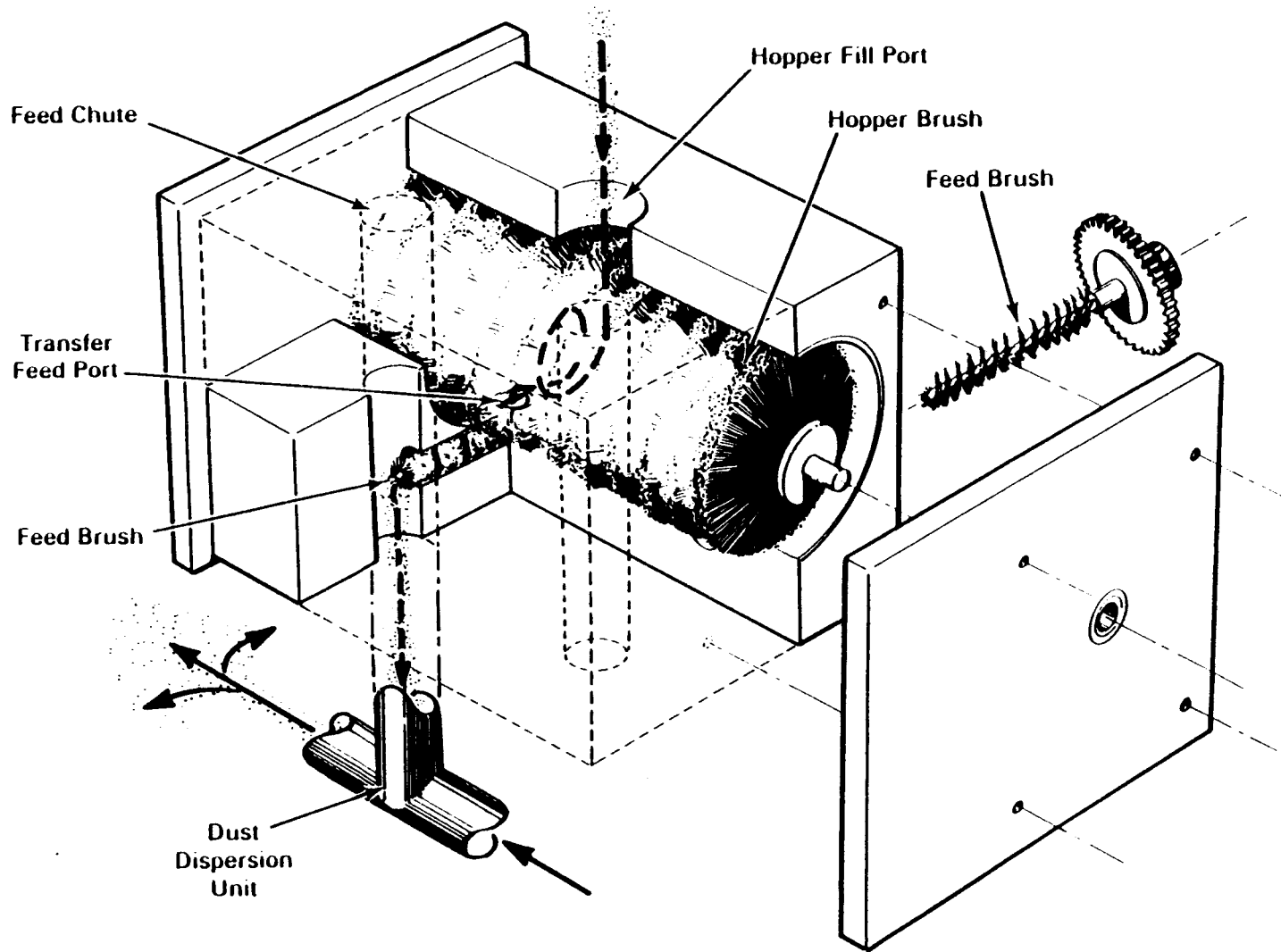

FIGURE G3. DUAL-BRUSH DUST FEED GENERATOR AND DUST DISPENSOR UNIT USED IN THE CS2 TWO-YEAR INHALATION STUDIES

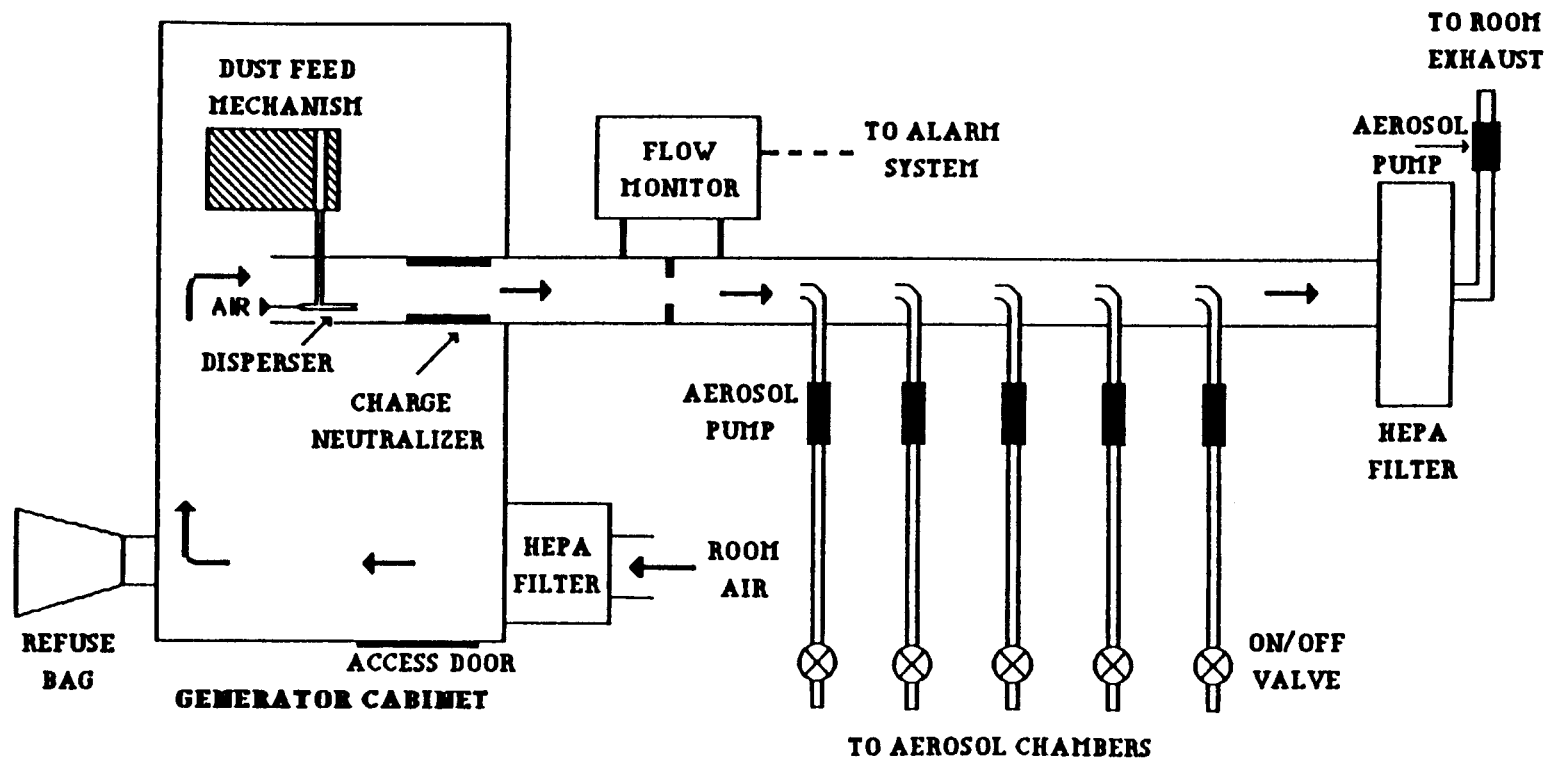

FIGURE G4. SCHEMATIC DIAGRAM OF THE SYSTEM USED TO GENERATE AND DELIVER CS₂ PARTICLES IN THE TWO-YEAR INHALATION STUDIES

APPENDIX G. CHEMICAL CHARACTERIZATION

from each chamber and by determining the amount of aerosolized *o*-chlorobenzalmalononitrile by gas chromatographic analysis (3% silar 5 CP on gas chrom Q column) with flame ionization detection. During the 2-year studies, the RAM-S was calibrated twice per month by collecting samples in a bubbler containing chloroform with known amounts of internal standard hexachlorobenzene added and quantification of the *o*-chlorobenzalmalononitrile and the hydrolysis product *o*-chlorobenzaldehyde by gas chromatographic analysis with an electron-capture detector.

During the 14-day and 13-week studies, only the aerosolized *o*-chlorobenzalmalononitrile was collected on the filter grab samples and the resultant data used to calibrate the RAM-1. During the 2-year studies, the RAM-S response was correlated with total *o*-chlorobenzalmalononitrile (aerosol and vapor) plus *o*-chlorobenzaldehyde concentrations. Since the relationship between the total aerosol and total organic components was relatively stable, the RAM-S monitor was calibrated to indicate total organic concentration in the chambers by correlation with the gas chromatographic analysis of the bubbler samples from the chambers. This relationship between the aerosol monitor readings and the bubbler sample analysis is discussed in detail below.

The study material in the atmosphere of the exposure chambers consisted of both organic and inorganic components. There were three organic components (*o*-chlorobenzalmalononitrile aerosol particles, *o*-chlorobenzalmalononitrile vapor, and *o*-chlorobenzaldehyde vapor) and one inorganic component (Cab-O-Sil® aerosol particles containing a molecular coating of hexamethyldisilazane). The aerosol monitor was able to detect only the solid airborne particles, *o*-chlorobenzalmalononitrile particles, and Cab-O-Sil® aerosol particles and could not respond to the *o*-chlorobenzalmalononitrile vapor or the *o*-chlorobenzaldehyde vapor. The bubblers, on the other hand, could detect all of the organic components (including the *o*-chlorobenzalmalononitrile aerosol particles) but could not detect the Cab-O-Sil® aerosol particles. Thus, it was necessary to develop a relationship between the aerosol monitor readings and the bubbler sample analysis.

This relationship is a complex one, consisting of two regions. For chamber concentrations of *o*-chlorobenzalmalononitrile below the saturation concentration (approximately 0.35 mg/m³ at 20° C), there will be no particles of *o*-chlorobenzalmalononitrile, only vapor. Thus, in this region, there will be a theoretical relationship (Figure G5A) between the Cab-O-Sil® aerosol particles detected by the RAM-S and the *o*-chlorobenzalmalononitrile vapor detected by the bubbler.

As the *o*-chlorobenzalmalononitrile concentration in the chamber approaches the saturation vapor pressure, an unstable aerosol of *o*-chlorobenzalmalononitrile particles will exist. The aerosol is unstable because the particles sublime until the saturation vapor concentration is achieved throughout the chamber volume. In this region, the RAM-S will detect both *o*-chlorobenzalmalononitrile particles and Cab-O-Sil® particles. The response of the RAM-S to the Cab-O-Sil® particles in this second region will be the same as in the first region. However, there will be an additional response of the RAM-S to the *o*-chlorobenzalmalononitrile particles. Figure G5B shows the theoretical RAM-S response to *o*-chlorobenzalmalononitrile particles only. Note that at the saturation concentration, where only vapor of *o*-chlorobenzalmalononitrile is present, the RAM-S will indicate zero particle concentration; however, there will be considerable *o*-chlorobenzalmalononitrile present. The two curves are combined in Figure G5C to depict the relationship between the RAM-S and the total *o*-chlorobenzalmalononitrile concentration in both regions.

Consequently, the equation used to describe the relationship between the RAM-S reading and the total organic concentrations (*o*-chlorobenzalmalononitrile and *o*-chlorobenzaldehyde particles and vapor) depends on the region in which the chamber concentration lies. In region 1 (*o*-chlorobenzalmalononitrile concentration less than the saturation concentration), the relationship is expressed as

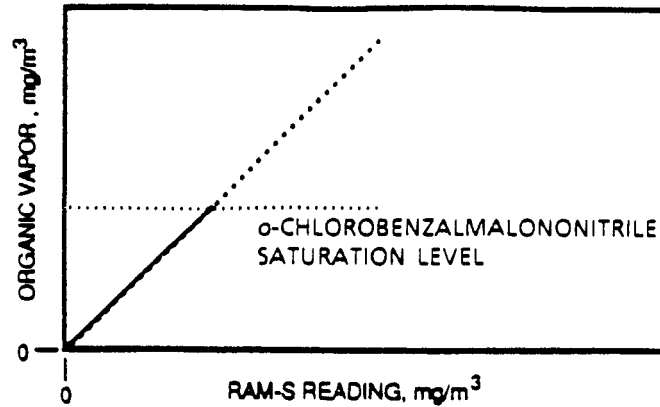

A. Response of RAM-S to Cab-O-Sil[®] aerosol (only vapor of *o*-chlorobenzal-malonitrile present)

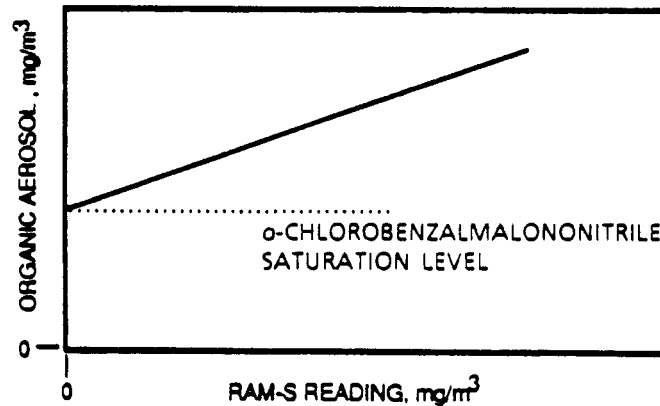

B. Response of RAM-S to aerosol (both vapor and particles of *o*-chlorobenzal-malonitrile present)

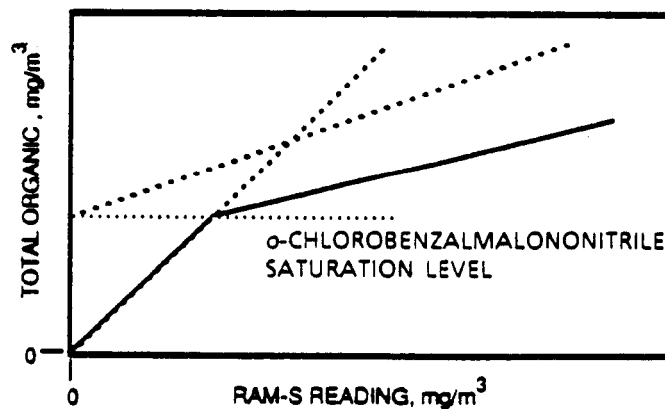

C. Response of RAM-S to a combination of Cab-O-Sil[®] and *o*-chlorobenzal-malonitrile aerosol (both vapor and particles of *o*-chlorobenzal-malonitrile present)

FIGURE G5. THEORETICAL RELATIONSHIP BETWEEN THE RAM-S READINGS AND THE TOTAL ORGANIC CONCENTRATION IN THE EXPOSURE CHAMBERS

APPENDIX G. CHEMICAL CHARACTERIZATION

$$Y_1 = B_1 X,$$

where

$$Y_1 = \text{total organic concentration,}$$

and

$$X = \text{RAM-S reading,}$$

whereas in region 2 (*o*-chlorobenzaldehyde concentration greater than the saturation concentration), the relationship is expressed as

$$Y_2 = A_2 + B_2 X.$$

The 0.075 and 0.25 mg/m³ target exposure concentrations fell in the region 1 curve, and the 0.75 and 1.5 mg/m³ exposure concentrations fell in the region 2 curve. Weekly mean exposure concentrations (total organics) for the 2-year studies are presented in Figures G6 through G10. A summary of the chamber concentrations is presented in Table G2.

TABLE G2. SUMMARY OF CHAMBER CONCENTRATIONS IN THE TWO-YEAR INHALATION STUDIES OF CS₂

Target Concentration Based on RAM Reading	Total Number of Readings	Mean Concentration of Total Organics (a) (mg/m ³)
Rat Chambers		
0.075	2,835	0.15 ± 0.029
0.25	2,861	0.56 ± 0.104
0.75	2,851	1.88 ± 0.282
Mouse Chambers		
0.75	2,848	1.89 ± 0.27
1.5	2,848	2.71 ± 0.34

(a) Total organics = CS₂ + *o*-chlorobenzaldehyde; mean ± standard deviation.

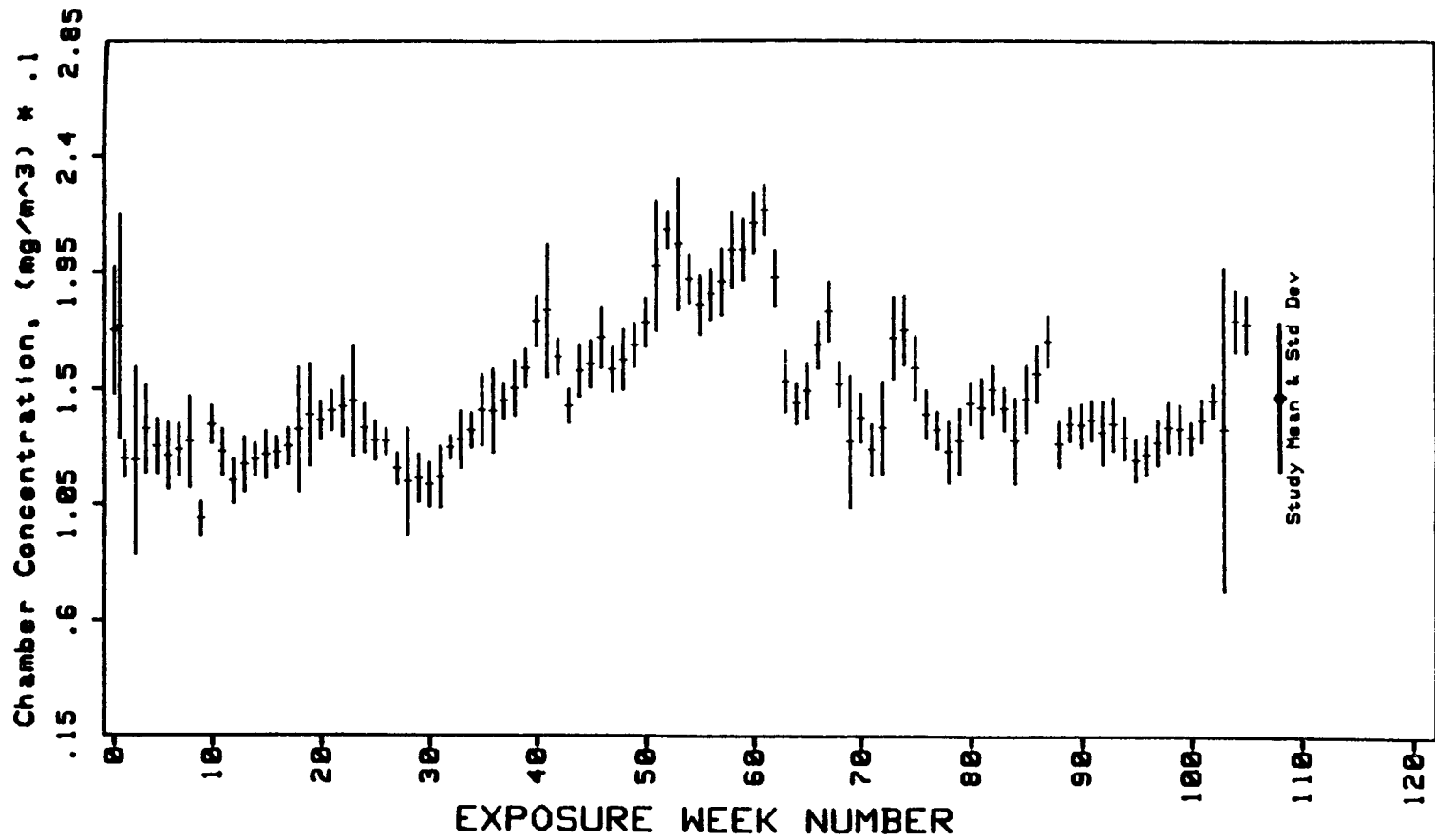

FIGURE G6. WEEKLY MEAN CONCENTRATION (AND STANDARD DEVIATION) OF *o*-CHLOROBENZALMALONONITRILE PLUS *o*-CHLOROBENZALDEHYDE IN THE 0.075 mg/m³ RAT EXPOSURE CHAMBER FOR ENTIRE 105-WEEK STUDIES

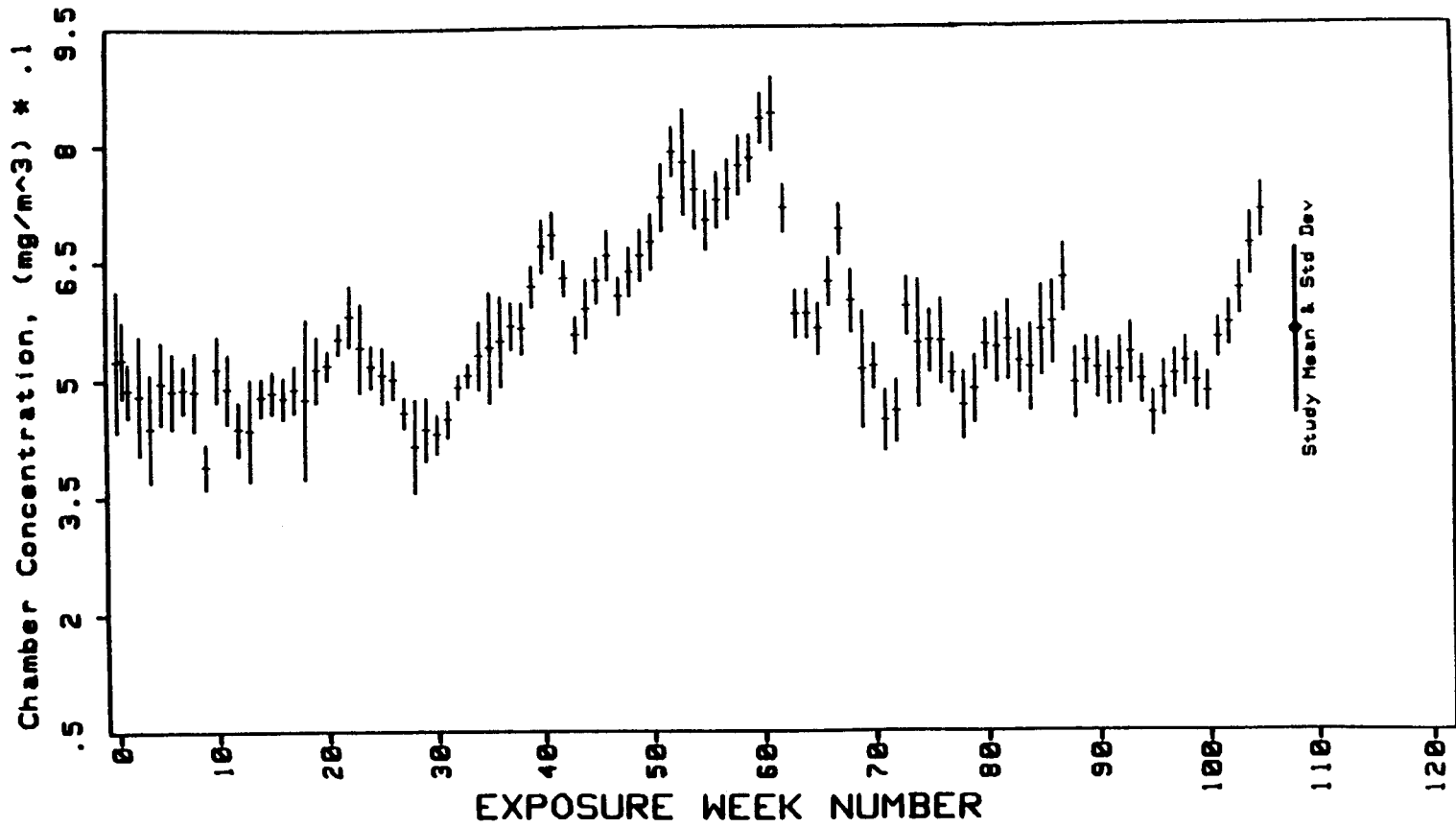

FIGURE G7. WEEKLY MEAN CONCENTRATION (AND STANDARD DEVIATION) OF o-CHLOROBENZALMALONONITRILE PLUS o-CHLOROBENZALDEHYDE IN THE 0.25 mg/m³ RAT EXPOSURE CHAMBER FOR ENTIRE 105-WEEK STUDIES

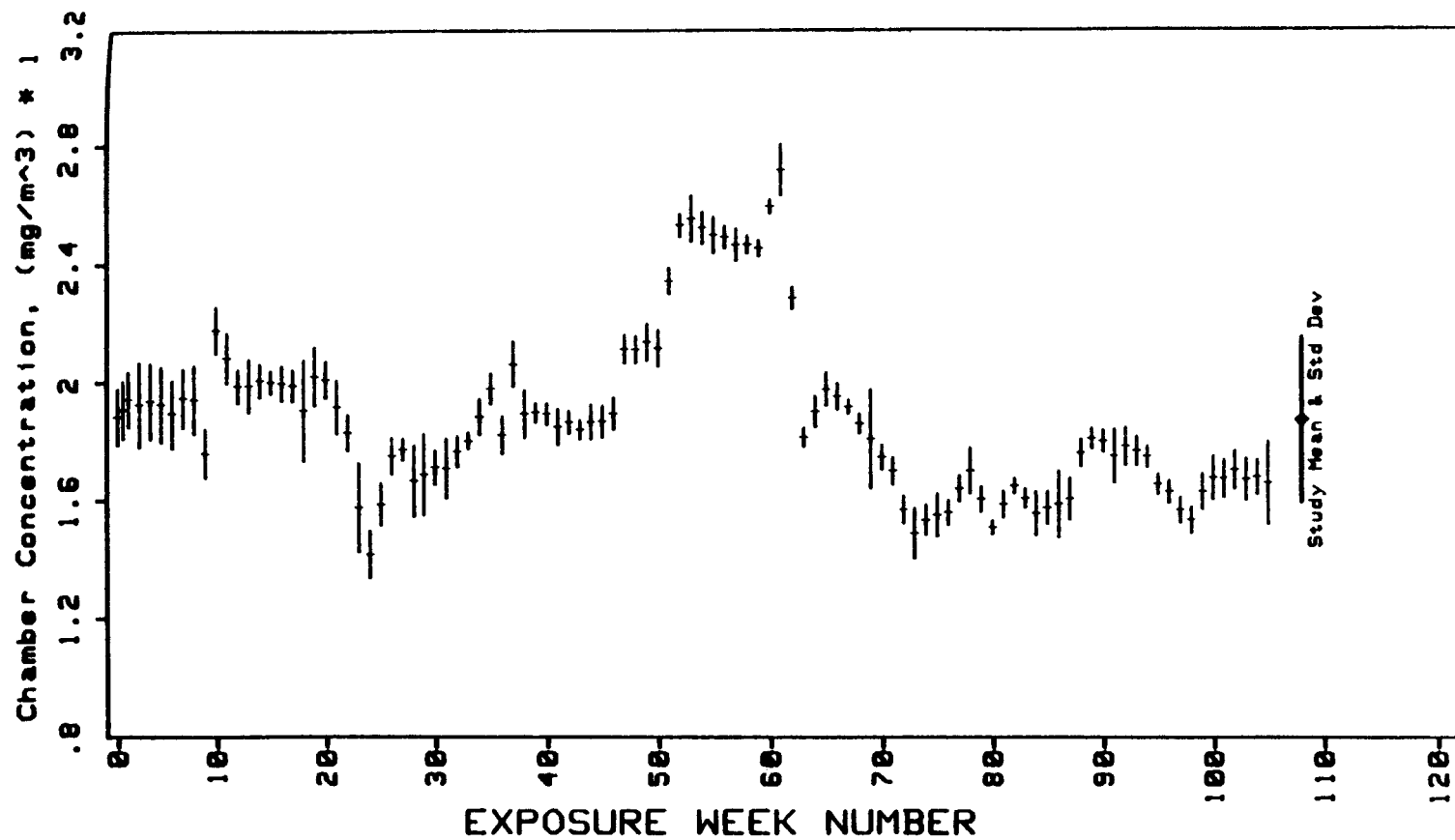

FIGURE G8. WEEKLY MEAN CONCENTRATION (AND STANDARD DEVIATION) OF *o*-CHLOROBENZALMALONONITRILE PLUS *o*-CHLOROBENZALDEHYDE IN THE 0.75 mg/m³ RAT EXPOSURE CHAMBER FOR ENTIRE 105-WEEK STUDIES

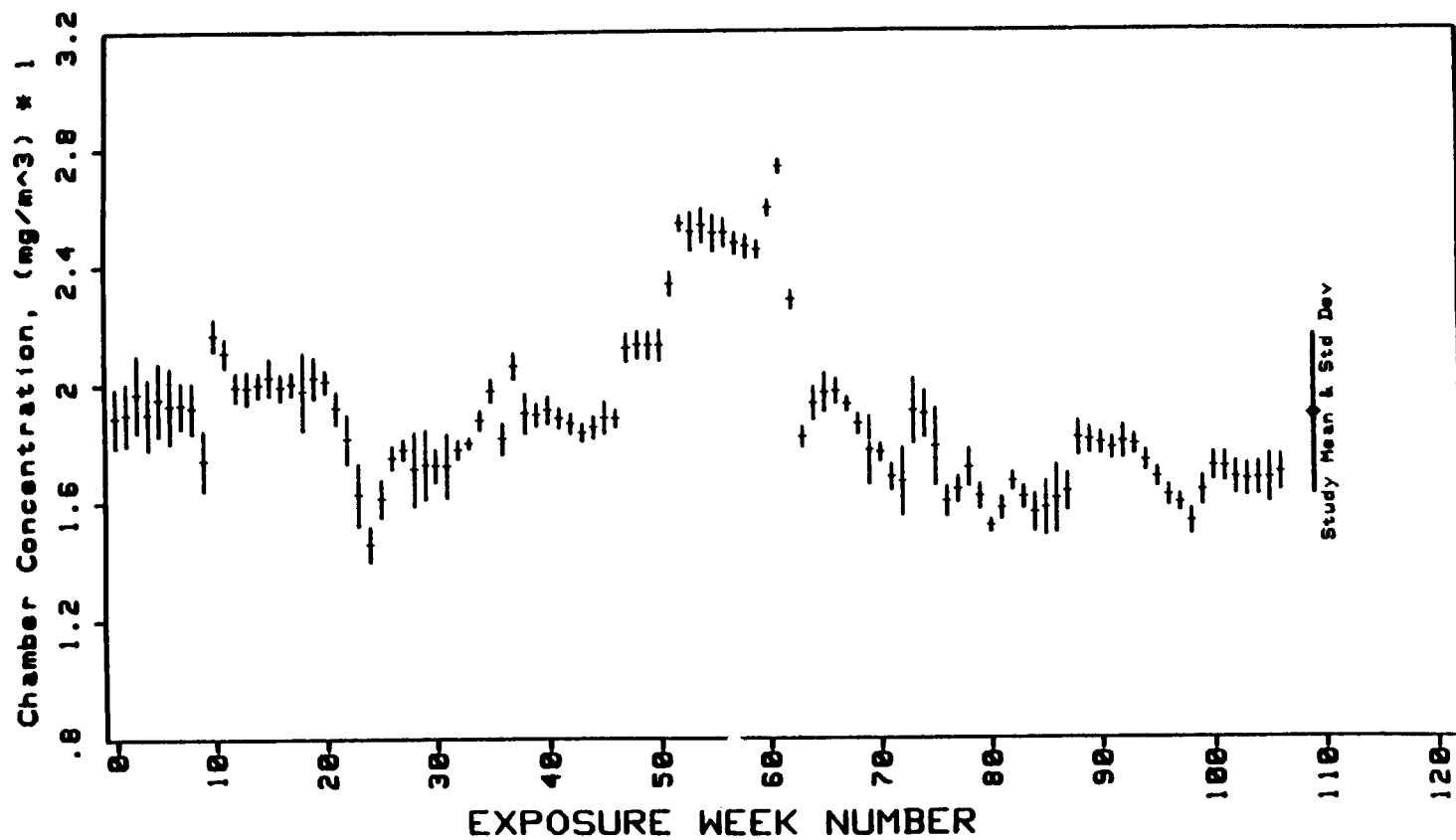

FIGURE G9. WEEKLY MEAN CONCENTRATION (AND STANDARD DEVIATION) OF o-CHLOROBENZALMALONONITRILE PLUS o-CHLOROBENZALDEHYDE IN THE 0.75 mg/m³ MOUSE EXPOSURE CHAMBER FOR ENTIRE 105-WEEK STUDIES

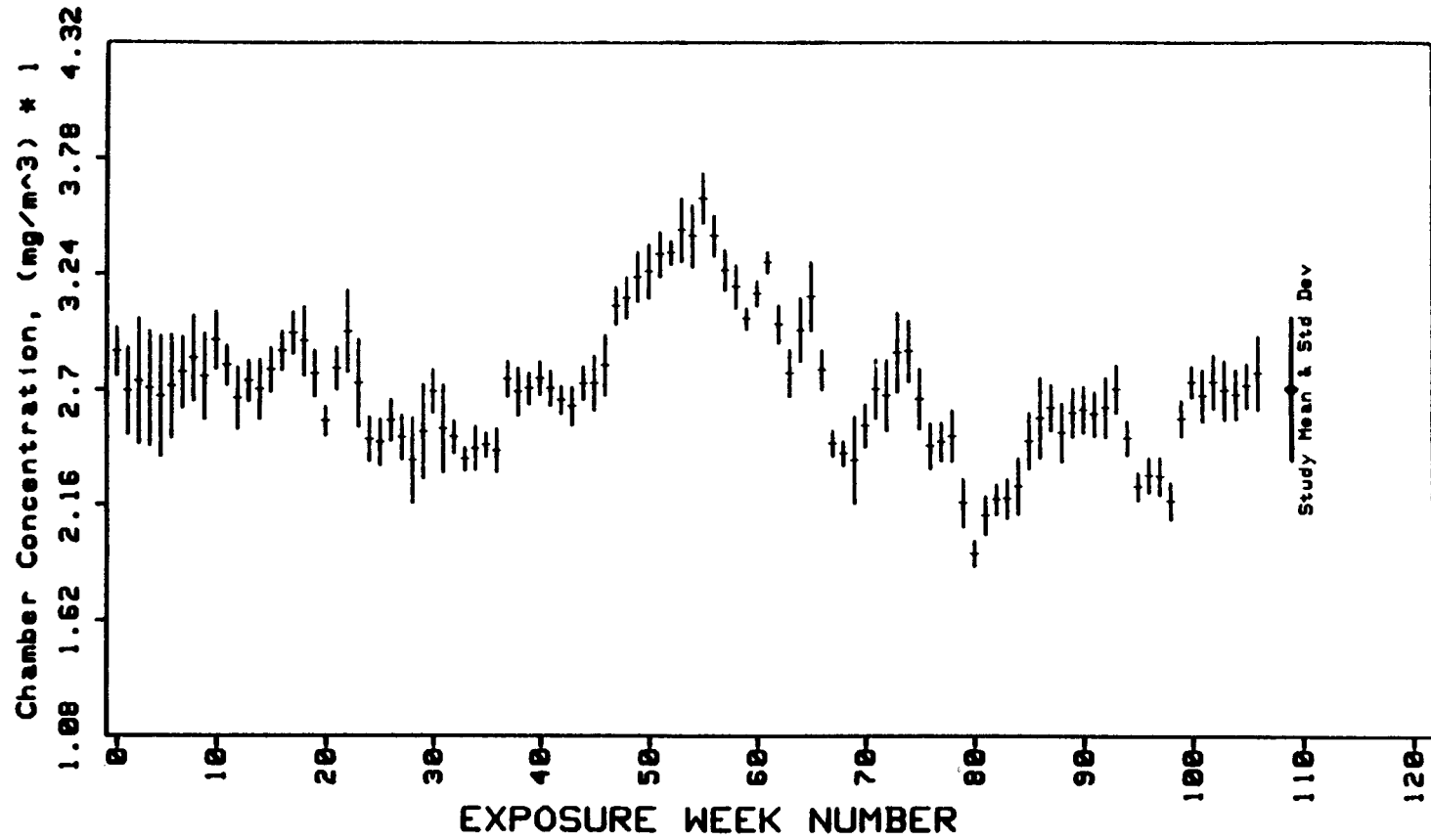

FIGURE G10. WEEKLY MEAN CONCENTRATION (AND STANDARD DEVIATION) OF *o*-CHLOROBENZALMALONONITRILE PLUS *o*-CHLOROBENZALDEHYDE IN THE 1.5 mg/m³ MOUSE EXPOSURE CHAMBER FOR ENTIRE 105-WEEK STUDIES

APPENDIX H

GENETIC TOXICOLOGY

OF CS2

	PAGE
TABLE H1 MUTAGENICITY OF CS2 IN <i>SALMONELLA TYPHIMURIUM</i>	199
TABLE H2 INDUCTION OF TRIFLUOROTHYMININE RESISTANCE IN MOUSE L5178Y LYMPHOMA CELLS BY CS2	202
TABLE H3 INDUCTION OF SISTER CHROMATID EXCHANGES IN CHINESE HAMSTER OVARY CELLS BY CS2	203
TABLE H4 INDUCTION OF CHROMOSOMAL ABERRATIONS IN CHINESE HAMSTER OVARY CELLS BY CS2	204

APPENDIX H. GENETIC TOXICOLOGY

METHODS

Salmonella Protocol: Testing was performed as reported by Ames et al. (1975) with modifications listed below and described in greater detail by Zeiger et al. (1987). Chemicals were sent to each of two laboratories as coded aliquots from Radian Corporation (Austin, TX). The study chemical was incubated with the *Salmonella typhimurium* tester strains (TA97, TA98, TA100, TA1535, and TA1537) either in buffer or S9 mix (metabolic activation enzymes and cofactors from Aroclor 1254-induced male Sprague Dawley rat or Syrian hamster liver) for 20 minutes at 37° C before the addition of soft agar supplemented with L-histidine and D-biotin and subsequent plating on minimal glucose agar plates. Incubation was continued for an additional 48 hours.

At Microbiological Associates, Inc., CS2 was tested in strains TA97, TA98, TA100, TA1535, and TA1537; all negative assays were repeated and retests with activation were performed with a different concentration of S9. At SRI International, CS2 was tested in strains TA98, TA100, TA1535, and TA1537; all assays were replicated.

Each test consisted of triplicate plates of concurrent positive and negative controls and of at least five doses of the study chemical. The high dose was limited by toxicity or solubility but did not exceed 2 mg/plate.

A positive response was defined as a reproducible, dose-related increase in histidine-independent (revertant) colonies in any one strain/activation combination. An equivocal response was defined as an increase in revertants which was not dose related, not reproducible, or of insufficient magnitude to support a determination of mutagenicity. A response was considered negative when no increase in revertant colonies was observed after chemical treatment.

Mouse Lymphoma Protocol: The experimental protocol is presented in detail by McGregor et al. (1988) and follows the basic format of Clive et al. (1979). All study chemicals were supplied as coded aliquots from Radian Corporation (Austin, TX). The highest dose of the study compound was determined by solubility or toxicity and did not exceed 5 mg/ml. Mouse L5178Y/TK lymphoma cells were maintained at 37° C as suspension cultures in Fischer's medium supplemented with 2 mM L-glutamine, 110 µg/ml sodium pyruvate, 0.05% pluronic F68, antibiotics, and heat-inactivated horse serum; normal cycling time was about 10 hours. To reduce the number of spontaneously occurring trifluorothymidine (Tft)-resistant cells, subcultures were exposed once to medium containing thymidine, hypoxanthine, methotrexate, and glycine for 1 day, to thymidine, hypoxanthine, and glycine for 1 day, and to normal medium for 3-5 days. For cloning, horse serum content was increased and Noble agar was added. Freshly prepared S9 metabolic activation factors were obtained from the liver of either Aroclor 1254-induced or noninduced male F344 rats.

All doses within an experiment, including concurrent positive and solvent controls, were replicated. Treated cultures contained 6×10^6 cells in 10 ml of medium. This volume included the S9 fraction in those experiments performed with metabolic activation. Incubation with the study chemical continued for 4 hours, after which time the medium plus chemical was removed and the cells were resuspended in 20 ml of fresh medium and incubated for an additional 2 days to express the mutant phenotype. Cell density was monitored so that log phase growth was maintained. After the 48-hour expression period, 3×10^6 cells were plated in medium and soft agar supplemented with Tft for selection of Tft-resistant cells (TK^{+/+}), and 600 cells were plated in nonselective medium and soft agar to determine cloning efficiency. Plates were incubated at 37° C under 5% carbon dioxide for 10-12 days. All data were evaluated statistically for both trend and peak response. Both responses had to be significant ($P < 0.05$) for a chemical to be considered capable of inducing Tft resistance; a single significant response led to an "equivocal" conclusion, and the absence of both a trend and a peak response resulted in a "negative" call.

APPENDIX H. GENETIC TOXICOLOGY

Minimum criteria for accepting an experiment as valid and a detailed description of the statistical analysis and data evaluation are presented in Myhr et al. (1985). This assay was initially performed without S9; if a clearly positive response was not obtained, the experiment was repeated with induced S9.

Chinese Hamster Ovary Cytogenetics Assays: Testing was performed as reported by Galloway et al. (1985, 1987) and is described briefly below. Chemicals were sent to the laboratories as coded aliquots from Radian Corporation (Austin, TX). Chemicals were tested in cultured Chinese hamster ovary (CHO) cells for induction of sister chromatid exchanges (SCEs) and chromosomal aberrations both in the presence and absence of Aroclor 1254-induced male Sprague Dawley rat liver S9 and cofactor mix. Cultures were handled under gold lights to prevent photolysis of bromodeoxyuridine (BrdU)-substituted DNA. Each test consisted of concurrent solvent and positive controls and of at least three doses of the study chemical; the high dose was limited by toxicity or solubility but did not exceed 5 mg/ml.

In the SCE test without S9, CHO cells were incubated for 26 hours with the study chemical in McCoy's 5A medium supplemented with 10% fetal bovine serum, L-glutamine (2 mM), and antibiotics. BrdU was added 2 hours after culture initiation. After 26 hours, the medium containing the study chemical was removed and replaced with fresh medium plus BrdU and colcemid, and incubation was continued for 2 more hours. Cells were then harvested by mitotic shake-off, fixed, and stained with Hoechst 33258 and Giemsa. In the SCE test with S9, cells were incubated with the chemical, serum-free medium, and S9 for 2 hours. The medium was then removed and replaced with medium containing BrdU and no study chemical; incubation proceeded for an additional 26 hours, with colcemid present for the final 2 hours. Harvesting and staining were the same as for cells treated without S9.

In the chromosomal aberration test without S9, cells were incubated in McCoy's 5A medium with the study chemical for 8 hours; colcemid was added, and incubation was continued for 2 hours. The cells were then harvested by mitotic shake-off, fixed, and stained with Giemsa. For the chromosomal aberration test with S9, cells were treated with the study chemical and S9 for 2 hours, after which the treatment medium was removed and the cells were incubated for 10 hours in fresh medium, with colcemid present for the final 2 hours. Cells were harvested in the same manner as for the treatment without S9.

For the SCE test, if significant chemical-induced cell cycle delay was seen, incubation time was lengthened to ensure a sufficient number of scorable cells. The harvest time for the chromosomal aberration test was based on the cell cycle information obtained in the SCE test; if cell cycle delay was anticipated, the incubation period was extended approximately 5 hours.

Cells were selected for scoring on the basis of good morphology and completeness of karyotype (21 ± 2 chromosomes). All slides were scored blind, and those from a single test were read by the same person. For the SCE test, 50 second-division metaphase cells were usually scored for frequency of SCEs per cell from each dose; 100 first-division metaphase cells were scored at each dose for the chromosomal aberration test. Classes of aberrations included simple (breaks and terminal deletions), complex (rearrangements and translocations), and other (pulverized cells, despiralized chromosomes, and cells containing 10 or more aberrations).

Statistical analyses were conducted on both the slopes of the dose-response curves and the individual dose points. An SCE frequency 20% above the concurrent solvent control value was chosen as a statistically conservative positive response. The probability of this level of difference occurring by chance at one dose point is less than 0.01; the probability for such a chance occurrence at two dose points is less than 0.001. Chromosomal aberration data are presented as percentage of cells with aberrations. As with SCEs, both the dose-response curve and individual dose points were statistically

APPENDIX H. GENETIC TOXICOLOGY

analyzed. A statistically significant ($P < 0.003$) trend test or a significantly increased dose point ($P < 0.05$) was sufficient to indicate a chemical effect.

RESULTS

CS2 was tested for induction of gene mutations in a total of five strains of *S. typhimurium* in two different laboratories using a preincubation protocol with and without Aroclor 1254-induced male Sprague Dawley rat or Syrian hamster liver S9 (Zeiger et al., 1987; Table H1). In one laboratory, an equivocal response was noted in strain TA97, but only in the presence of 30% hamster liver S9; in the other four strains tested (TA98, TA100, TA1535, and TA1537), no mutagenic response was observed with or without S9 (10% or 30%). In the other laboratory, an equivocal response occurred with strain TA100 in the absence of S9 only; CS2 was clearly negative for gene mutation induction in all other strains tested in this laboratory (TA98, TA1535, and TA1537) with or without S9. CS2 induced Tft resistance in mouse L5178Y/TK lymphoma cells at the highest nonlethal dose tested (2.5 µg/ml) in each of two trials conducted in the absence of S9; it was not tested with S9 (McGregor et al., 1988; Table H2). In cytogenetic tests with CHO cells, CS2 induced both SCEs and chromosomal aberration with and without Aroclor 1254-induced male Sprague Dawley rat liver S9 (Tables H3 and H4). For both the SCE and the aberration tests, a delayed harvest protocol was used to offset CS2-induced cell cycle delay at each of the dose levels at which a positive response was demonstrated.

TABLE H1. MUTAGENICITY OF CS2 IN SALMONELLA TYPHIMURIUM (a)

Strain	Dose (µg/plate)	Revertants/Plate (b)					
		-S9		+S9 (hamster)		+S9 (rat)	
		Trial 1	Trial 2	+10%	+30%	+10%	+30%
Study performed at Microbiological Associates, Inc.							
TA100	0	101 ± 4.9	89 ± 7.3	89 ± 0.9	115 ± 1.8	93 ± 7.4	104 ± 4.3
	3.3	105 ± 5.0	80 ± 4.8	--	--	--	--
	10	107 ± 4.4	76 ± 2.6	--	--	--	--
	33	113 ± 3.5	85 ± 8.4	94 ± 8.4	115 ± 2.6	89 ± 7.0	125 ± 9.2
	100	120 ± 3.5	100 ± 9.0	86 ± 4.4	110 ± 4.4	76 ± 2.3	115 ± 6.5
	333	(c)90 ± 0.9	(c)55 ± 4.9	(c)62 ± 4.0	110 ± 7.1	79 ± 7.8	118 ± 2.0
	1,000	--	--	(c)47 ± 3.8	(c)81 ± 1.2	(c)40 ± 3.7	(c)61 ± 1.5
	2,000	--	--	(c)19 ± 1.5	(c)56 ± 3.2	(c)4 ± 0.7	(c)44 ± 0.9
	Trial summary	Negative	Negative	Negative	Negative	Negative	Negative
	Positive control (d)	553 ± 24.3	387 ± 19.9	341 ± 79.5	847 ± 27.2	637 ± 28.8	1,060 ± 5.9
TA1535	0	21 ± 1.3	20 ± 1.5	9 ± 0.7	11 ± 0.9	9 ± 2.3	14 ± 1.0
	3.3	16 ± 1.5	21 ± 3.8	--	--	--	--
	10	18 ± 3.1	23 ± 2.0	--	--	--	--
	33	19 ± 4.5	17 ± 1.7	9 ± 1.5	11 ± 2.5	11 ± 2.3	12 ± 2.8
	100	20 ± 1.8	20 ± 5.0	11 ± 4.6	11 ± 2.3	14 ± 1.0	14 ± 2.7
	333	(c)16 ± 1.5	(c)19 ± 2.6	6 ± 1.0	11 ± 2.2	10 ± 1.2	13 ± 1.5
	1,000	--	--	(c)5 ± 0.9	11 ± 1.5	(c)10 ± 1.5	7 ± 1.7
	2,000	--	--	(c)1 ± 0.7	(c)3 ± 0.7	(c)3 ± 1.5	(c)3 ± 1.3
	Trial summary	Negative	Negative	Negative	Negative	Negative	Negative
	Positive control (d)	259 ± 3.5	221 ± 10.3	42 ± 1.8	88 ± 4.3	114 ± 4.0	169 ± 11.1
TA1537	0	-S9		+30% S9 (hamster)		+30% S9 (rat)	
	3.3	6 ± 1.5		9 ± 1.8		9 ± 1.5	
	10	8 ± 1.0		--		--	
	33	6 ± 0.6		--		--	
	100	9 ± 0.9		11 ± 3.2		9 ± 0.6	
	333	7 ± 1.5		8 ± 0.6		10 ± 1.8	
	1,000	(c)7 ± 3.0		8 ± 0.3		11 ± 2.1	
	2,000	--		4 ± 1.2		5 ± 0.9	
	Trial summary	Negative		Negative		Negative	
	Positive control (d)	26 ± 2.9		139 ± 9.7		67 ± 6.1	
TA97	0	-S9		+S9 (hamster)		+30%	
	3.3	86 ± 6.0	65 ± 1.2	82 ± 6.8	124 ± 10.4	93 ± 2.0	
	10	81 ± 2.6	68 ± 7.9	76 ± 5.9	--	98 ± 8.8	
	33	99 ± 5.2	61 ± 2.1	78 ± 6.3	--	104 ± 6.6	
	100	95 ± 12.4	57 ± 1.2	77 ± 11.3	159 ± 8.8	116 ± 7.8	
	333	77 ± 3.5	75 ± 9.1	69 ± 15.2	195 ± 10.4	172 ± 8.0	
	1,000	(c)49 ± 2.2	(c)15 ± 1.7	(c)25 ± 6.9	188 ± 11.3	172 ± 6.5	
	2,000	--	--	--	(c)25 ± 10.5	--	
	Trial summary	Negative	Negative	Negative	Equivocal	Weakly positive	
	Positive control (d)	240 ± 6	341 ± 64.1	456 ± 62.8	806 ± 23.6	719 ± 96.4	

TABLE H1. MUTAGENICITY OF CS2 IN *SALMONELLA TYPHIMURIUM* (Continued)

Strain	Dose (µg/plate)	Revertants/Plate (b)					
Study performed at Microbiological Associates, Inc. (Continued)							
		+ S9 (rat)					
		10%	10%	30%	30%	30%	
TA97	0	91 ± 11.3	119 ± 6.1	125 ± 10.4	93 ± 2.7	162 ± 3.2	
	3.3	74 ± 10.3	103 ± 5.2	--	113 ± 4.8	152 ± 6.1	
	10	95 ± 4.7	107 ± 3.8	--	97 ± 6.7	160 ± 12.5	
	33	86 ± 14.0	111 ± 4.7	138 ± 11.2	89 ± 18.2	169 ± 12.3	
	100	78 ± 18.2	111 ± 5.0	106 ± 14.1	144 ± 6.8	170 ± 8.4	
	333	90 ± 8.4	(c)69 ± 17.4	92 ± 10.5	174 ± 3.7	168 ± 3.7	
	500	--	(c)75 ± 3.4	--	--	128 ± 0.6	
	1,000	--	--	(c)12 ± 1.2	--	--	
	2,000	--	--	(c)0 ± 0.0	--	--	
Trial summary		Negative	Negative	Negative	Equivocal	Negative	
Positive control (d)		978 ± 87.6	884 ± 101.8	504 ± 19.1	431 ± 24.3	396 ± 24.8	
		- S9		+ S9 (hamster)		+ S9 (rat)	
		Trial 1	Trial 2	+10%	+30%	+10%	+30%
TA98	0	24 ± 2.4	12 ± 1.3	22 ± 0.6	34 ± 3.7	28 ± 3.2	33 ± 5.1
	3.3	22 ± 1.5	15 ± 1.5	--	--	--	--
	10	22 ± 2.6	18 ± 1.8	--	--	--	--
	33	27 ± 2.0	19 ± 1.5	23 ± 3.6	49 ± 2.4	25 ± 2.6	31 ± 6.5
	100	22 ± 3.0	17 ± 2.6	22 ± 2.7	39 ± 3.3	26 ± 1.0	31 ± 5.2
	333	(c)20 ± 3.1	(c)10 ± 2.8	17 ± 0.3	39 ± 4.2	19 ± 1.7	32 ± 1.2
	1,000	--	--	(c)10 ± 1.8	(c)21 ± 2.8	8 ± 2.1	(c)17 ± 5.0
	2,000	--	--	(c)7 ± 0.9	(c)18 ± 2.0	(c)2 ± 0.7	(c)15 ± 0.9
Trial summary		Negative	Negative	Negative	Negative	Negative	Negative
Positive control (d)		281 ± 4	154 ± 5.6	170 ± 9.5	153 ± 3.7	206 ± 12.5	277 ± 5.8
Study performed at SRI International							
		- S9		+10% S9 (hamster)		+10% S9 (rat)	
		Trial 1	Trial 2	Trial 1	Trial 2	Trial 1	Trial 2
TA100	0	105 ± 8.5	88 ± 0.6	122 ± 10.1	91 ± 11.3	133 ± 1.0	113 ± 7.6
	1	139 ± 4.7	138 ± 8.3	--	--	--	--
	3	137 ± 3.2	147 ± 9.5	--	128 ± 7.8	--	138 ± 3.8
	10	144 ± 7.7	135 ± 8.8	109 ± 3.0	121 ± 15.8	119 ± 10.3	121 ± 5.9
	33	140 ± 11.3	148 ± 4.5	113 ± 2.3	111 ± 6.5	130 ± 2.8	106 ± 6.9
	100	120 ± 3.2	132 ± 11.0	115 ± 0.9	128 ± 8.1	125 ± 12.8	130 ± 6.7
	333	--	--	105 ± 8.4	127 ± 8.4	94 ± 9.1	115 ± 4.4
	1,000	--	--	(c)0 ± 0.0	--	(c)0 ± 0.0	--
Trial summary		Equivocal	Equivocal	Negative	Equivocal	Negative	Negative
Positive control (d)		418 ± 10.1	292 ± 25.8	1,567 ± 87.1	1,007 ± 48.7	717 ± 159.7	518 ± 13.3
TA1535	0	29 ± 3.8	20 ± 4.4	12 ± 1.9	11 ± 2.4	9 ± 2.0	9 ± 1.7
	1	34 ± 3.9	33 ± 0.7	--	--	--	--
	3	38 ± 0.3	28 ± 3.8	--	9 ± 1.5	--	12 ± 1.5
	10	35 ± 1.2	31 ± 4.1	10 ± 3.3	12 ± 2.4	15 ± 1.0	8 ± 2.2
	33	32 ± 3.8	29 ± 4.9	14 ± 0.9	10 ± 2.3	13 ± 3.2	6 ± 0.7
	100	30 ± 3.9	28 ± 2.0	12 ± 1.9	8 ± 2.2	11 ± 3.0	11 ± 3.2
	333	--	--	11 ± 2.7	9 ± 2.4	8 ± 2.3	9 ± 2.2
	1,000	--	--	(c)0 ± 0.0	--	(c)0 ± 0.0	--
Trial summary		Negative	Negative	Negative	Negative	Negative	Negative
Positive control (d)		561 ± 17.6	342 ± 28.3	484 ± 13.0	461 ± 24.5	181 ± 29.5	169 ± 11.6

TABLE H1. MUTAGENICITY OF CS2 IN SALMONELLA TYPHIMURIUM (Continued)

Strain	Dose (µg/plate)	Revertants/Plate (b)					
		-S9		+10% S9 (hamster)		+10% S9 (rat)	
		Trial 1	Trial 2	Trial 1	Trial 2	Trial 1	Trial 2
Study performed at SRI International (Continued)							
TA1537	0	6 ± 0.9	3 ± 0.3	11 ± 1.8	9 ± 0.0	11 ± 2.1	6 ± 3.0
	1	5 ± 0.9	7 ± 0.9	--	--	--	--
	3	7 ± 2.4	4 ± 1.0	--	13 ± 0.3	--	9 ± 2.0
	10	5 ± 1.2	4 ± 1.2	10 ± 2.5	13 ± 0.3	6 ± 0.9	8 ± 1.5
	33	6 ± 0.6	6 ± 1.2	5 ± 1.5	10 ± 2.0	10 ± 2.4	8 ± 2.3
	100	5 ± 0.6	9 ± 1.5	12 ± 2.0	6 ± 1.2	7 ± 2.6	6 ± 1.0
	333	--	--	7 ± 0.9	7 ± 2.9	5 ± 0.6	9 ± 1.8
	1,000	--	--	(c)0 ± 0.0	--	(c)0 ± 0.0	--
Trial summary		Negative	Negative	Negative	Negative	Negative	Negative
Positive control (d)		222 ± 69.7	124 ± 9.3	410 ± 9.2	162 ± 7.8	115 ± 11.2	115 ± 12.4
TA98	0	16 ± 2.3	15 ± 1.2	33 ± 4.3	31 ± 1.2	30 ± 0.9	30 ± 4.9
	1	18 ± 0.9	19 ± 3.2	--	--	--	--
	3	14 ± 1.9	21 ± 3.7	--	35 ± 1.5	--	36 ± 2.0
	10	22 ± 2.2	21 ± 3.3	37 ± 2.5	29 ± 5.6	33 ± 4.0	30 ± 2.1
	33	15 ± 1.5	19 ± 3.5	35 ± 3.8	34 ± 2.5	37 ± 2.6	32 ± 4.0
	100	17 ± 1.7	23 ± 2.5	32 ± 0.0	29 ± 4.4	37 ± 1.2	32 ± 2.7
	333	--	--	27 ± 5.0	32 ± 3.8	28 ± 1.5	26 ± 3.3
	1,000	--	--	(c)0 ± 0.0	--	(c)0 ± 0.0	--
Trial summary		Negative	Negative	Negative	Negative	Negative	Negative
Positive control (d)		845 ± 25.8	637 ± 62.7	1,440 ± 143.0	990 ± 51.5	445 ± 115.4	389 ± 47.8

(a) The detailed protocol is presented by Zeiger et al. (1987). Cells and study compound or solvent (dimethyl sulfoxide) were incubated in the absence of exogenous metabolic activation (-S9) or with Aroclor 1254-induced S9 from male Syrian hamster liver or male Sprague Dawley rat liver. High dose was limited by toxicity or solubility but did not exceed 10 mg/plate; 0 µg/plate dose is the solvent control.

(b) Revertants are presented as mean ± standard error from three plates.

(c) Slight toxicity

(d) Positive control; 2-aminoanthracene was used on all strains in the presence of S9. In the absence of metabolic activation, 4-nitro-*o*-phenylenediamine was used with TA98, sodium azide was used with TA100 and TA1535, and 9-aminoacridine was used with TA97 and TA1537.

TABLE H2. INDUCTION OF TRIFLUOROTHYMININE RESISTANCE IN MOUSE L5178Y LYMPHOMA CELLS BY CS2 (a,b)

Compound	Concentration (µg/ml)	Cloning Efficiency (percent)	Relative Total Growth (percent)	Tft-Resistant Cells	Mutant Fraction (c)
Trial 1					
Dimethyl sulfoxide		64.0 ± 4.0	100.0 ± 4.0	52.0 ± 4.0	27.5 ± 0.5
CS2	0.3125	73.0 ± 1.0	98.0 ± 8.0	58.0 ± 4.0	26.5 ± 1.5
	(d) 0.625	68	94	174	85
	1.25	71.5 ± 2.5	61.5 ± 3.5	81.5 ± 10.5	38.0 ± 6.0
	2.5	67.5 ± 2.5	31.5 ± 0.5	151.5 ± 1.5	(e) 74.5 ± 3.5
	5	Lethal			
Ethyl methanesulfonate	250	61.0 ± 4.0	71.5 ± 3.5	262.5 ± 1.5	(e) 145.0 ± 9.0
Trial 2					
Dimethyl sulfoxide (f)		70.3 ± 6.5	100.0 ± 12.7	153.3 ± 20.7	74.0 ± 11.6
CS2	0.3125	72.5 ± 3.5	95.5 ± 8.5	171.0 ± 11.0	79.0 ± 1.0
	0.625	74.5 ± 10.5	84.5 ± 27.5	185.0 ± 21.0	82.5 ± 2.5
	1.25	73.0 ± 1.0	71.0 ± 0.0	178.5 ± 1.5	81.5 ± 0.5
	2.5	47.0 ± 1.0	17.5 ± 3.5	287.0 ± 4.0	(e) 204.0 ± 9.0
	5	Lethal			
Ethyl methanesulfonate	250	56.5 ± 1.5	70.0 ± 2.0	400.5 ± 77.5	(e) 239.0 ± 52.0

(a) Study performed at Inveresk Research International. The experimental protocol and data are presented in detail by McGregor et al. (1988) and follows the basic format of Clive et al. (1979). The highest dose of study compound is determined by solubility or toxicity and may not exceed 5 mg/ml. All doses are tested in duplicate, unless otherwise specified; the average for the tests is presented in the table. Cells (6×10^5 /ml) were treated for 4 hours at 37°C in medium, washed, resuspended in medium, and incubated for 48 hours at 37°C. After expression, 3×10^6 cells were plated in medium and soft agar supplemented with trifluorothymidine (Tft) for selection of Tft-resistant cells, and 600 cells were plated in nonselective medium and soft agar to determine the cloning efficiency.

(b) Mean ± standard error from replicate trials of approximately 1×10^6 cells each. All data are evaluated statistically for both trend and peak response ($P < 0.05$ for at least one of the three highest dose sets). Both responses must be significantly ($P < 0.05$) positive for a chemical to be considered capable of inducing Tft resistance. If only one of these responses is significant, the call is "equivocal"; the absence of both trend and peak response results in a "negative" call.

(c) Mutant fraction (frequency) is a ratio of the Tft-resistant cells to the cloning efficiency, divided by 3 (to arrive at MF per 1×10^6 cells treated); MF = mutant fraction.

(d) Data presented are the results of one test.

(e) Significant positive response; occurs when the relative mutant fraction (average MF of treated culture/average MF of solvent control) is greater than or equal to 1.6.

(f) Data presented are the results of four tests.

TABLE H3. INDUCTION OF SISTER CHROMATID EXCHANGES IN CHINESE HAMSTER OVARY CELLS BY CS2 (a)

Compound	Dose (µg/ml)	Total Cells	No. of Chromosomes	No. of SCEs	SCEs/Chromosome	SCEs/Cell	Hours in BrdU	Relative SCEs/Chromosome (percent) (b)
- S9 (c)--Summary: Positive								
Acetone		50	1,042	494	0.47	9.9	25.7	
CS2	6	50	1,046	640	0.61	12.8	(d) 32.0	*29.06
	7	50	1,048	730	0.69	14.6	(d) 32.0	*46.93
	8	50	1,036	757	0.73	15.1	(d) 32.0	*54.13
Mitomycin C	0.001	50	1,041	604	0.58	12.1	25.7	22.39
	0.01	5	105	165	1.57	33.0	25.7	231.47
Trend test: P<0.001								
+ S9 (e)								
Trial 1--Summary: Weakly positive								
Acetone		50	1,044	464	0.44	9.3	25.5	
CS2	1	50	1,035	494	0.47	9.9	25.5	7.39
	3.3	50	1,040	531	0.51	10.6	25.5	14.88
	10	50	1,044	799	0.76	16.0	(d) 33.0	*72.20
Cyclophosphamide	2	5	105	161	1.53	32.2	25.5	245.00
Trend test: P<0.001								
Trial 2--Summary: Positive								
Acetone		50	1,045	449	0.42	9.0	25.7	
CS2	10	50	1,042	605	0.58	12.1	(d) 32.0	*35.13
	12.5	50	1,040	729	0.70	14.6	(d) 32.0	*63.14
	15	50	1,043	730	0.69	14.6	(d) 32.0	*62.90
Cyclophosphamide	0.3	50	1,035	634	0.61	12.7	25.7	42.57
	2	5	104	139	1.33	27.8	25.7	211.07
Trend test: P<0.001								

(a) Study performed at Litton Bionetics, Inc. SCE = sister chromatid exchange; BrdU = bromodeoxyuridine. A detailed description of the SCE protocol is presented by Galloway et al. (1985, 1987). Briefly, Chinese hamster ovary cells were incubated with study compound or solvent (acetone) as described in (c) and (e) below and cultured for sufficient time to reach second metaphase division. Cells were then collected by mitotic shake-off, fixed, air dried, and stained.

(b) Percentage change in the value of SCEs/chromosome for exposed culture compared with that for solvent control culture. An increase of 20% or more was considered to be a significant response.

(c) In the absence of S9, Chinese hamster ovary cells were incubated with study compound or solvent for 2 hours at 37° C. Then BrdU was added, and incubation was continued for 24 hours. Cells were washed, fresh medium containing BrdU and colcemid was added, and incubation was continued for 2-3 hours.

(d) Because some chemicals induce a delay in the cell division cycle, harvest times are occasionally extended to maximize the proportion of second division cells available for analysis.

(e) In the presence of S9, cells were incubated with study compound or solvent for 2 hours at 37° C. Cells were then washed, and medium containing BrdU was added. Cells were incubated for a further 26 hours, with colcemid present for the final 2-3 hours. S9 was from the liver of Aroclor 1254-induced male Sprague Dawley rats.

*P<0.05

TABLE H4. INDUCTION OF CHROMOSOMAL ABERRATIONS IN CHINESE HAMSTER OVARY CELLS BY CS2 (a)

-S9 (b)					+S9 (c)				
Dose (µg/ml)	Total Cells	No. of Abs	Abs/Cell	Percent Cells with Abs	Dose (µg/ml)	Total Cells	No. of Abs	Abs/Cell	Percent Cells with Abs
Harvest time: 19.0 hours (d)					Harvest time: 19.0 hours (d)				
Acetone					Acetone				
	100	3	0.03	2.0		100	3	0.03	3.0
CS2					CS2				
6	100	24	0.24	*14.0	20	10	40	4.00	*100.0
7	100	40	0.40	*27.0	22.5	10	59	5.90	*100.0
9	25	9	0.36	*24.0	25	100	21	0.21	*19.0
10	100	26	0.26	*20.0					
Summary: Positive					Summary: Positive				
Mitomycin C					Cyclophosphamide				
0.065	50	26	0.52	36.0	20	25	13	0.52	28.0
Trend test: P < 0.001					Trend test: P = 0.002				

(a) Study performed at Litton Bionetics, Inc. Abs = aberrations. A detailed presentation of the technique for detecting chromosomal aberrations is found in Galloway et al. (1985, 1987). Briefly, Chinese hamster ovary cells were incubated with study compound or solvent as indicated in (b) and (c). Cells were arrested in first metaphase by addition of colcemid and harvested by mitotic shake-off, fixed, and stained in 6% Giemsa.

(b) In the absence of S9, cells were incubated with study compound or solvent for 8-10 hours at 37° C. Cells were then washed, and fresh medium containing colcemid was added for an additional 2-3 hours followed by harvest.

(c) In the presence of S9, cells were incubated with study compound or solvent for 2 hours at 37° C. Cells were then washed, medium was added, and incubation was continued for 8-10 hours. Colcemid was added for the last 2-3 hours of incubation before harvest. S9 was from the liver of Aroclor 1254-induced male Sprague Dawley rats.

(d) Because of significant chemical-induced cell cycle delay, incubation time prior to addition of colcemid was lengthened to provide sufficient metaphases at harvest.

*P < 0.05

APPENDIX I

ORGAN WEIGHTS OF RATS AND MICE IN THE THIRTEEN-WEEK INHALATION STUDIES OF CS₂

		PAGE
TABLE I1	ORGAN WEIGHTS OF RATS IN THE THIRTEEN-WEEK INHALATION STUDIES OF CS ₂	206
TABLE I2	ORGAN WEIGHTS OF MICE IN THE THIRTEEN-WEEK INHALATION STUDIES OF CS ₂	207

TABLE II. ORGAN WEIGHTS OF RATS IN THE THIRTEEN-WEEK INHALATION STUDIES OF CS₂ (a)

Organ	Control	0.4 mg/m ³	0.75 mg/m ³	1.5 mg/m ³	3 mg/m ³	6 mg/m ³
MALE						
Number weighed	10	10	10	10	10	9
Body weight (grams)	353 ± 7.8	345 ± 6.7	*334 ± 5.6	**292 ± 5.5	**262 ± 5.5	**188 ± 11.0
Brain						
Absolute	1,948 ± 30	1,950 ± 25	1,917 ± 27	1,911 ± 15	**1,865 ± 21	**1,778 ± 24
Relative	5.5 ± 0.15	5.7 ± 0.12	5.8 ± 0.07	**6.5 ± 0.09	**7.2 ± 0.17	**9.7 ± 0.58
Heart						
Absolute	995 ± 28	1,008 ± 23	1,009 ± 18	1,016 ± 31	964 ± 22	**891 ± 20
Relative	2.8 ± 0.04	*2.9 ± 0.04	**3.0 ± 0.05	**3.5 ± 0.09	**3.7 ± 0.08	**4.8 ± 0.24
Kidney						
Absolute	1,097 ± 47	1,186 ± 24	1,111 ± 25	1,057 ± 14	1,004 ± 27	**856 ± 31
Relative	3.1 ± 0.09	*3.5 ± 0.06	*3.3 ± 0.04	**3.6 ± 0.06	**3.8 ± 0.07	**4.6 ± 0.18
Liver						
Absolute	14,950 ± 810	16,320 ± 250	15,250 ± 430	13,770 ± 470	**12,270 ± 270	**8,060 ± 720
Relative	42.2 ± 1.68	47.4 ± 0.54	45.7 ± 0.90	47.0 ± 1.11	46.9 ± 0.57	42.3 ± 1.51
Lung						
Absolute	2,023 ± 126	2,036 ± 116	2,131 ± 73	1,891 ± 26	*1,722 ± 54	**1,452 ± 60
Relative	5.7 ± 0.30	5.9 ± 0.27	6.4 ± 0.25	6.5 ± 0.18	*6.6 ± 0.21	**7.8 ± 0.37
Right testis						
Absolute	1,508 ± 30	1,485 ± 15	1,456 ± 48	1,473 ± 22	**1,381 ± 23	**1,229 ± 85
Relative	4.3 ± 0.11	4.3 ± 0.08	4.4 ± 0.13	**5.0 ± 0.12	**5.3 ± 0.06	**6.5 ± 0.29
Thymus						
Absolute	391 ± 12	382 ± 25	*(b) 307 ± 21	**278 ± 18	**269 ± 12	**132 ± 12
Relative	1.1 ± 0.03	1.1 ± 0.07	(b) 0.9 ± 0.07	1.0 ± 0.05	1.0 ± 0.04	**0.7 ± 0.10
FEMALE						
Number weighed	10	10	10	10	10	10
Body weight (grams)	199 ± 4.6	213 ± 4.7	196 ± 3.2	*181 ± 5.1	**170 ± 3.8	**156 ± 5.3
Brain						
Absolute	1,843 ± 20	1,808 ± 15	1,817 ± 13	1,803 ± 17	*1,766 ± 29	**1,751 ± 9
Relative	9.3 ± 0.16	8.5 ± 0.17	9.3 ± 0.14	10.0 ± 0.24	**10.4 ± 0.24	**11.3 ± 0.35
Heart						
Absolute	684 ± 14	689 ± 17	682 ± 17	685 ± 22	683 ± 15	731 ± 21
Relative	3.4 ± 0.04	3.2 ± 0.04	3.5 ± 0.08	*3.8 ± 0.10	**4.0 ± 0.10	**4.7 ± 0.17
Kidney						
Absolute	657 ± 20	727 ± 22	685 ± 14	658 ± 13	653 ± 15	676 ± 19
Relative	3.3 ± 0.04	3.4 ± 0.06	**3.5 ± 0.04	**3.7 ± 0.06	**3.9 ± 0.06	**4.4 ± 0.08
Liver						
Absolute	7,937 ± 435	10,004 ± 342	7,567 ± 183	7,755 ± 224	6,949 ± 210	6,792 ± 305
Relative	39.7 ± 1.58	**46.9 ± 0.93	38.6 ± 0.66	42.9 ± 0.55	40.9 ± 0.58	*43.4 ± 0.75
Lung						
Absolute	1,451 ± 50	1,725 ± 62	1,514 ± 45	1,437 ± 39	1,468 ± 26	1,386 ± 40
Relative	7.3 ± 0.23	*8.1 ± 0.15	7.7 ± 0.20	*8.0 ± 0.18	**8.7 ± 0.14	**8.9 ± 0.22
Thymus						
Absolute	332 ± 12	299 ± 18	*271 ± 20	**250 ± 15	**244 ± 15	**180 ± 15
Relative	1.7 ± 0.06	*1.4 ± 0.07	*1.4 ± 0.10	*1.4 ± 0.09	*1.4 ± 0.08	**1.1 ± 0.07

(a) Mean ± standard error in milligrams (absolute) or milligrams per gram (relative) unless otherwise specified; P values vs. the controls by Dunn's test (Dunn, 1964) or Shirley's test (Shirley, 1977).

(b) Thymuses of nine animals were weighed.

* P < 0.05

** P < 0.01

TABLE 12. ORGAN WEIGHTS OF MICE IN THE THIRTEEN-WEEK INHALATION STUDIES OF CS₂ (a)

Organ	Control	0.4 mg/m ³	0.75 mg/m ³	1.5 mg/m ³	3 mg/m ³
MALE					
Number weighed	10	10	8	10	9
Body weight (grams)	32.2 ± 0.47	30.8 ± 0.70	**29.9 ± 0.52	**29.3 ± 0.50	**26.9 ± 0.35
Brain					
Absolute	477 ± 7	475 ± 6	484 ± 5	470 ± 4	461 ± 7
Relative	14.8 ± 0.31	15.5 ± 0.34	**16.2 ± 0.34	**16.1 ± 0.24	**17.2 ± 0.34
Heart					
Absolute	187 ± 11	207 ± 10	220 ± 13	*227 ± 8	196 ± 7
Relative	5.8 ± 0.29	6.7 ± 0.24	*7.4 ± 0.53	**7.8 ± 0.23	**7.3 ± 0.28
Kidney					
Absolute	294 ± 8	281 ± 8	291 ± 9	273 ± 8	**247 ± 7
Relative	9.1 ± 0.22	9.1 ± 0.17	9.8 ± 0.35	9.3 ± 0.20	9.2 ± 0.24
Liver					
Absolute	1,790 ± 46	1,937 ± 52	1,741 ± 55	1,908 ± 52	**1,411 ± 26
Relative	55.6 ± 1.04	*62.9 ± 1.02	58.5 ± 2.43	**65.1 ± 1.16	52.6 ± 1.29
Lung					
Absolute	283 ± 10	261 ± 15	273 ± 9	402 ± 33	(b) 250 ± 8
Relative	8.8 ± 0.24	8.5 ± 0.40	9.2 ± 0.43	**13.7 ± 1.12	(b) 9.4 ± 0.30
Right testis					
Absolute	(c) 119 ± 5	117 ± 2	127 ± 2	(d) 114 ± 2	117 ± 3
Relative	(c) 3.7 ± 0.14	3.8 ± 0.12	**4.3 ± 0.10	*(d) 3.9 ± 0.09	**4.4 ± 0.13
Thymus					
Absolute	34.7 ± 2.26	40.6 ± 2.63	45.5 ± 4.01	(d) 39.4 ± 4.16	35.7 ± 3.07
Relative	1.1 ± 0.07	*1.3 ± 0.09	**1.5 ± 0.12	*(d) 1.4 ± 0.16	1.3 ± 0.11
FEMALE					
Number weighed	10	10	8	10	9
Body weight (grams)	26.5 ± 0.48	26.9 ± 0.43	25.9 ± 0.35	**24.7 ± 0.30	**22.8 ± 0.40
Brain					
Absolute	495 ± 6	476 ± 6	488 ± 9	**446 ± 17	**453 ± 4
Relative	18.7 ± 0.42	17.8 ± 0.44	18.9 ± 0.43	18.0 ± 0.62	20.0 ± 0.43
Heart					
Absolute	152 ± 6	*182 ± 7	**200 ± 6	165 ± 6	153 ± 6
Relative	5.7 ± 0.22	**6.8 ± 0.22	**7.7 ± 0.24	**6.7 ± 0.24	**6.8 ± 0.29
Kidney					
Absolute	194 ± 6	189 ± 5	184 ± 4	186 ± 7	*179 ± 4
Relative	7.3 ± 0.15	7.0 ± 0.15	7.1 ± 0.17	7.5 ± 0.24	*7.9 ± 0.10
Liver					
Absolute	1,516 ± 45	1,782 ± 28	1,545 ± 29	1,567 ± 48	*1,314 ± 34
Relative	57.2 ± 1.09	**66.3 ± 0.65	59.7 ± 0.97	*63.5 ± 1.90	57.7 ± 1.15
Lung					
Absolute	253 ± 7	289 ± 18	279 ± 6	343 ± 32	249 ± 9
Relative	9.6 ± 0.32	10.7 ± 0.62	*10.8 ± 0.29	*13.9 ± 1.33	*10.9 ± 0.39
Thymus					
Absolute	45.4 ± 3.96	42.2 ± 4.45	55.3 ± 3.82	43.0 ± 2.62	40.6 ± 3.19
Relative	1.7 ± 0.14	1.6 ± 0.17	2.1 ± 0.16	1.7 ± 0.11	1.8 ± 0.15

(a) Mean ± standard error in milligrams (absolute) or milligrams per gram (relative) unless otherwise specified; P values vs. the controls by Dunn's test (Dunn, 1964) or Shirley's test (Shirley, 1977).

(b) Lungs of eight animals were weighed.

(c) Organs of nine animals were weighed.

* P < 0.05

** P < 0.01

APPENDIX J

AUDIT SUMMARY

APPENDIX J. AUDIT SUMMARY

The pathology specimens, experimental data, study documents, and draft NTP Technical Report for the 2-year studies of *o*-chlorobenzalmalononitrile in rats and mice were audited for the National Institute of Environmental Health Sciences (NIEHS) at the National Toxicology Program (NTP) Archives. The audit included review of:

- (1) All records concerning animal receipt, quarantine, randomization, and disposition prior to the start of dosing.
- (2) All inlife records including protocol, correspondence, animal identification, animal husbandry, environmental conditions, dosing external masses, mortality, and serology.
- (3) Body weight and clinical observation data; all data were scanned before individual data for the random 10% sample in each study group were reviewed in detail.
- (4) All study chemical records.
- (5) All postmortem records for individual animals concerning date of death, disposition code, condition code, tissue accountability, correlation of masses or clinical signs recorded at or near the last inlife observation with gross observations and microscopic diagnoses, consistency of data entry on necropsy record forms, and correlation between gross observations and microscopic diagnoses.
- (6) Inventory for wet tissue bags from all animals and residual wet tissues from a random 20% sample of animals in each study group, plus other relevant cases, to evaluate the integrity of individual animal identity and the thoroughness of necropsy and trimming procedure performance.
- (7) Blocks and slides of tissues from a random 20% sample of animals from each study group, plus animals with less than complete or correct identification, to examine for proper inventory, labeling, matching of tissue sections, and preservation.
- (8) All microscopic diagnoses for a random 10% sample of animals, plus 100% of the changes in diagnoses made to preliminary pathology tables, to verify their incorporation into the final pathology tables.
- (9) The extent of correlation between the data, factual information, and procedures for the 2-year studies as presented in the draft Technical Report and the study records available at the NTP Archives.

Procedures and events for the exposure phase of the studies were documented adequately by records at the Archives. Review of the archival records indicated that protocol-specified procedures for animal care were followed adequately. Records that documented the generation, analysis, distribution, and delivery of doses to animals were complete and accurate. Recalculation of the group mean body weight values in the Technical Report showed that 31/32 for rats and 24/24 for mice were correct.

Data entries on necropsy forms were made appropriately. The thoroughness for observation of external potential masses for rats and mice combined was adequate inlife and good at necropsy (84% of the external masses noted at necropsy had an inlife correlate, and 92% of those noted inlife correlated with a necropsy observation). The date of death recorded at necropsy for each unscheduled-death animal had matching entries among the inlife records for 208/210 rats and 65/67 mice; the differences in date-of-death entries for 1 mid dose rat (carcass ID no. 221) and 1 low dose male mouse (carcass ID no. 421) were 4 weeks and 1 year, respectively, and the remaining 2 differences involved 1 day. The reason for animal removal recorded among the inlife records was in agreement with the disposition code recorded at necropsy for all but one rat and four mice. The condition code for each animal was consistent with the disposition code and gross observations assigned at necropsy.

An individual animal identifier (ear tag) was present and correct in the residual tissue bag for each of the 93 rats and 44 mice examined. A total of 4 untrimmed potential lesions were found in the wet tissues of 93 rats, and 3 were found in those of 44 mice examined. The correspondence between individual gross observations made at necropsy and microscopic diagnoses was excellent. Blocks and slides

APPENDIX J. AUDIT SUMMARY

were present, and corresponding tissue sections matched each other properly. All post-Pathology Working Group changes in diagnoses had been incorporated into the final pathology tables. The P values and incidences of neoplasms given in the Technical Report were the same as those in the final pathology tables at the Archives.

This summary describes general audit findings and the extent to which the data and factual information presented in the Technical Report are supported by the records at the NTP Archives. Full details are presented in audit reports that are on file at the NIEHS.