

NATIONAL TOXICOLOGY PROGRAM

Technical Report Series

No. 311



TOXICOLOGY AND CARCINOGENESIS

STUDIES OF

TETRACHLOROETHYLENE

(PERCHLOROETHYLENE)

(CAS NO. 127-18-4)

IN F344/N RATS AND B6C3F₁ MICE

(INHALATION STUDIES)

U.S. DEPARTMENT OF HEALTH AND HUMAN SERVICES

Public Health Service

National Institutes of Health

NATIONAL TOXICOLOGY PROGRAM

The National Toxicology Program (NTP), established in 1978, develops and evaluates scientific information about potentially toxic and hazardous chemicals. This knowledge can be used for protecting the health of the American people and for the primary prevention of disease. By bringing together the relevant programs, staff, and resources from the U.S. Public Health Service, DHHS, the National Toxicology Program has centralized and strengthened activities relating to toxicology research, testing and test development/validation efforts, and the dissemination of toxicological information to the public and scientific communities and to the research and regulatory agencies.

The NTP is made up of four charter DHHS agencies: the National Cancer Institute (NCI), National Institutes of Health; the National Institute of Environmental Health Sciences (NIEHS), National Institutes of Health; the National Center for Toxicological Research (NCTR), Food and Drug Administration; and the National Institute for Occupational Safety and Health (NIOSH), Centers for Disease Control. In July 1981, the Carcinogenesis Bioassay Testing Program, NCI, was transferred to the NIEHS.

NTP TECHNICAL REPORT
ON THE
TOXICOLOGY AND CARCINOGENESIS
TETRACHLOROETHYLENE
(PERCHLOROETHYLENE)
(CAS NO. 127-18-4)
IN F344/N RATS AND B6C3F₁ MICE
(INHALATION STUDIES)



NATIONAL TOXICOLOGY PROGRAM
P.O. Box 12233
Research Triangle Park, NC 27709

August 1986

NTP TR 311

NIH Publication No. 86-2567

U.S. DEPARTMENT OF HEALTH AND HUMAN SERVICES
Public Health Service
National Institutes of Health

NOTE TO THE READER

These studies are designed and conducted to characterize and evaluate the toxicologic potential, including carcinogenic activity, of selected chemicals in laboratory animals (usually two species, rats and mice). Chemicals selected for testing in the NTP Carcinogenesis Program are chosen primarily on the bases of human exposure, level of production, and chemical structure. Selection per se is not an indicator of a chemical's carcinogenic potential. Negative results, in which the test animals do not have a greater incidence of cancer than control animals, do not necessarily mean that a test chemical is not a carcinogen, inasmuch as the experiments are conducted under a limited set of conditions. Positive results demonstrate that a test chemical is carcinogenic for animals under the conditions of the test and indicate that exposure to the chemical has the potential for hazard to humans. The determination of the risk to humans from chemicals found to be carcinogenic in animals requires a wider analysis which extends beyond the purview of this study.

Five categories of interpretative conclusions were adopted for use in June 1983 in the Technical Reports series to specifically emphasize consistency and the concept of actual evidence of carcinogenicity. For each definitive study result (male rats, female rats, male mice, female mice), one of the following quintet will be selected to describe the findings. These categories refer to the strength of the experimental evidence and not to either potency or mechanism.

- **Clear Evidence of Carcinogenicity** is demonstrated by studies that are interpreted as showing a chemically related increased incidence of malignant neoplasms, studies that exhibit a substantially increased incidence of benign neoplasms, or studies that exhibit an increased incidence of a combination of malignant and benign neoplasms where each increases with dose.
- **Some Evidence of Carcinogenicity** is demonstrated by studies that are interpreted as showing a chemically related increased incidence of benign neoplasms, studies that exhibit marginal increases in neoplasms of several organs/tissues, or studies that exhibit a slight increase in uncommon malignant or benign neoplasms.
- **Equivocal Evidence of Carcinogenicity** is demonstrated by studies that are interpreted as showing a chemically related marginal increase of neoplasms.
- **No Evidence of Carcinogenicity** is demonstrated by studies that are interpreted as showing no chemically related increases in malignant or benign neoplasms.
- **Inadequate Study of Carcinogenicity** demonstrates that because of major qualitative or quantitative limitations, the studies cannot be interpreted as valid for showing either the presence or absence of a carcinogenic effect.

Additionally, the following concepts (as patterned from the International Agency for Research on Cancer Monographs) have been adopted by the NTP to give further clarification of these issues:

The term *chemical carcinogenesis* generally means the induction by chemicals of neoplasms not usually observed, the earlier induction by chemicals of neoplasms that are commonly observed, or the induction by chemicals of more neoplasms than are generally found. Different mechanisms may be involved in these situations. Etymologically, the term *carcinogenesis* means induction of cancer, that is, of malignant neoplasms; however, the commonly accepted meaning is the induction of various types of neoplasms or of a combination of malignant and benign neoplasms. In the Technical Reports, the words *tumor* and *neoplasm* are used interchangeably.

This study was initiated by the National Cancer Institute's Carcinogenesis Bioassay Program, now part of the National Institute of Environmental Health Sciences, National Toxicology Program. The studies described in this Technical Report have been conducted in compliance with NTP chemical health and safety requirements and must meet or exceed all applicable Federal, state, and local health and safety regulations. All NTP toxicology and carcinogenesis studies are subjected to a data audit before being presented for peer review.

Although every effort is made to prepare the Technical Reports as accurately as possible, mistakes may occur. Readers are requested to identify any mistakes so that corrective action may be taken. Further, anyone who is aware of related ongoing or published studies not mentioned in this report is encouraged to make this information known to the NTP. Comments and questions about the National Toxicology Program Technical Reports on Toxicology and Carcinogenesis Studies should be directed to Dr. J.E. Huff, National Toxicology Program, P.O. Box 12233, Research Triangle Park, NC 27709 (919-541-3780).

These NTP Technical Reports are available for sale from the National Technical Information Service, U.S. Department of Commerce, 5285 Port Royal Road, Springfield, VA 22161 (703-487-4650). Single copies of this Technical Report are available without charge (and while supplies last) from the NTP Public Information Office, National Toxicology Program, P.O. Box 12233, Research Triangle Park, NC 27709.

CONTENTS

	PAGE
ABSTRACT	10
CONTRIBUTORS	12
PEER REVIEW PANEL	13
SUMMARY OF PEER REVIEW COMMENTS	14
I. INTRODUCTION	17
II. MATERIALS AND METHODS	23
PROCUREMENT AND CHARACTERIZATION OF TETRACHLOROETHYLENE	24
GENERATION AND MEASUREMENT OF CHAMBER CONCENTRATIONS	24
SINGLE-EXPOSURE STUDIES	25
FOURTEEN-DAY STUDIES	25
THIRTEEN-WEEK STUDIES	28
TWO-YEAR STUDIES	28
STUDY DESIGN	28
SOURCE AND SPECIFICATIONS OF ANIMALS	28
ANIMAL MAINTENANCE	29
CLINICAL EXAMINATIONS AND PATHOLOGY	29
STATISTICAL METHODS	30
III. RESULTS	33
RATS	34
SINGLE-EXPOSURE STUDIES	34
FOURTEEN-DAY STUDIES	34
THIRTEEN-WEEK STUDIES	34
TWO-YEAR STUDIES	36
BODY WEIGHTS AND CLINICAL SIGNS	36
SURVIVAL	39
PATHOLOGY AND STATISTICAL ANALYSES OF RESULTS	39
MICE	45
SINGLE-EXPOSURE STUDIES	45
FOURTEEN-DAY STUDIES	45
THIRTEEN-WEEK STUDIES	45
TWO-YEAR STUDIES	47
BODY WEIGHTS AND CLINICAL SIGNS	47
SURVIVAL	50
PATHOLOGY AND STATISTICAL ANALYSES OF RESULTS	50

CONTENTS (Continued)

	PAGE
IV. DISCUSSION AND CONCLUSIONS	55
V. REFERENCES	63

TABLES

TABLE 1	CHEMICAL AND PHYSICAL PROPERTIES OF TETRACHLOROETHYLENE	19
TABLE 2	GENERATION OF CHAMBER CONCENTRATIONS IN THE INHALATION STUDIES OF TETRACHLOROETHYLENE	24
TABLE 3	SUMMARY OF CHAMBER CONCENTRATIONS DURING THE TWO-YEAR INHALATION STUDIES OF TETRACHLOROETHYLENE	25
TABLE 4	DISTRIBUTION OF MEAN DAILY CONCENTRATIONS DURING THE TWO-YEAR INHALATION STUDIES OF TETRACHLOROETHYLENE	25
TABLE 5	EXPERIMENTAL DESIGN AND MATERIALS AND METHODS IN THE INHALATION STUDIES OF TETRACHLOROETHYLENE	26
TABLE 6	SURVIVAL AND MEAN BODY WEIGHTS OF RATS IN THE SINGLE-EXPOSURE INHALATION STUDIES OF TETRACHLOROETHYLENE	34
TABLE 7	SURVIVAL AND MEAN BODY WEIGHTS OF RATS IN THE FOURTEEN-DAY INHALATION STUDIES OF TETRACHLOROETHYLENE	35
TABLE 8	SURVIVAL AND MEAN BODY WEIGHTS OF RATS IN THE THIRTEEN-WEEK INHALATION STUDIES OF TETRACHLOROETHYLENE	35
TABLE 9	SEVERITY OF LIVER AND LUNG CONGESTION IN RATS IN THE THIRTEEN-WEEK INHALATION STUDIES OF TETRACHLOROETHYLENE	36
TABLE 10	MEAN BODY WEIGHTS AND SURVIVAL OF RATS IN THE TWO-YEAR INHALATION STUDIES OF TETRACHLOROETHYLENE	37
TABLE 11	SURVIVAL OF RATS IN THE TWO-YEAR INHALATION STUDIES OF TETRACHLOROETHYLENE	39
TABLE 12	ANALYSIS OF MONONUCLEAR CELL LEUKEMIA IN RATS IN THE TWO-YEAR INHALATION STUDIES OF TETRACHLOROETHYLENE	41
TABLE 13	CLASSIFICATION OF MONONUCLEAR CELL LEUKEMIA IN RATS IN THE TWO-YEAR INHALATION STUDIES OF TETRACHLOROETHYLENE	42
TABLE 14	ANALYSIS OF RENAL LESIONS IN RATS IN THE TWO-YEAR INHALATION STUDIES OF TETRACHLOROETHYLENE	43

TABLES (Continued)

		PAGE
TABLE 15	ANALYSIS OF GLIOMAS IN MALE RATS IN THE TWO-YEAR INHALATION STUDY OF TETRACHLOROETHYLENE	44
TABLE 16	ANALYSIS OF TESTICULAR INTERSTITIAL CELL LESIONS IN MALE RATS IN THE TWO-YEAR INHALATION STUDY OF TETRACHLOROETHYLENE	44
TABLE 17	SURVIVAL AND MEAN BODY WEIGHTS OF MICE IN THE SINGLE-EXPOSURE INHALATION STUDIES OF TETRACHLOROETHYLENE	45
TABLE 18	SURVIVAL AND MEAN BODY WEIGHTS OF MICE IN THE FOURTEEN-DAY INHALATION STUDIES OF TETRACHLOROETHYLENE	46
TABLE 19	SURVIVAL AND MEAN BODY WEIGHTS OF MICE IN THE THIRTEEN-WEEK INHALATION STUDIES OF TETRACHLOROETHYLENE	46
TABLE 20	INCIDENCE AND SEVERITY OF LIVER AND KIDNEY LESIONS IN MICE IN THE THIRTEEN-WEEK INHALATION STUDIES OF TETRACHLOROETHYLENE	47
TABLE 21	MEAN BODY WEIGHTS AND SURVIVAL OF MICE IN THE TWO-YEAR INHALATION STUDIES OF TETRACHLOROETHYLENE	48
TABLE 22	SURVIVAL OF MICE IN THE TWO-YEAR INHALATION STUDIES OF TETRACHLOROETHYLENE	50
TABLE 23	NUMBER OF MICE WITH NONNEOPLASTIC LESIONS OF THE KIDNEY IN THE TWO-YEAR INHALATION STUDIES OF TETRACHLOROETHYLENE	52
TABLE 24	ANALYSIS OF LIVER TUMORS IN MICE IN THE TWO-YEAR INHALATION STUDIES OF TETRACHLOROETHYLENE	53
TABLE 25	COMPARATIVE INCIDENCES OF STAGE-THREE MONONUCLEAR CELL LEUKEMIA IN RATS IN THE TWO-YEAR INHALATION STUDIES OF TETRACHLOROETHYLENE	57
TABLE 26	LIFE TABLE ANALYSIS OF THE INCIDENCES OF STAGE-THREE MONONUCLEAR CELL LEUKEMIA IN RATS IN THE TWO-YEAR INHALATION STUDIES OF TETRACHLOROETHYLENE	58
TABLE 27	CUMULATIVE INCIDENCES OF MONONUCLEAR CELL LEUKEMIA IN FEMALE RATS THE TWO-YEAR INHALATION STUDY OF TETRACHLOROETHYLENE	59

FIGURES

	PAGE
FIGURE 1 GROWTH CURVES FOR RATS EXPOSED TO TETRACHLOROETHYLENE BY INHALATION FOR TWO YEARS	38
FIGURE 2 KAPLAN-MEIER SURVIVAL CURVES FOR RATS EXPOSED TO TETRACHLOROETHYLENE BY INHALATION FOR TWO YEARS	40
FIGURE 3 GROWTH CURVES FOR MICE EXPOSED TO TETRACHLOROETHYLENE BY INHALATION FOR TWO YEARS	49
FIGURE 4 KAPLAN-MEIER SURVIVAL CURVES FOR MICE EXPOSED TO TETRACHLOROETHYLENE BY INHALATION FOR TWO YEARS	51
FIGURE 5 KAPLAN-MEIER CURVES FOR STAGE-THREE LEUKEMIA INCIDENCE IN RATS EXPOSED TO TETRACHLOROETHYLENE BY INHALATION FOR TWO YEARS	60
FIGURE 6 INFRARED ABSORPTION SPECTRUM OF TETRACHLOROETHYLENE (LOT NO. TA03116F-01)	169
FIGURE 7 INFRARED ABSORPTION SPECTRUM OF TETRACHLOROETHYLENE (LOT NO. TA03116F-01) SPECIAL BULK PURITY VERIFICATION	173
FIGURE 8 INFRARED ABSORPTION SPECTRUM OF TETRACHLOROETHYLENE (LOT NO. TA08190D)	175
FIGURE 9 TETRACHLOROETHYLENE VAPOR GENERATION SYSTEM	181
FIGURE 10 WEEKLY MEAN CONCENTRATION OF TETRACHLOROETHYLENE FOR RATS EXPOSED AT 200 ppm IN THE TWO-YEAR INHALATION STUDIES	182
FIGURE 11 WEEKLY MEAN CONCENTRATION OF TETRACHLOROETHYLENE FOR RATS EXPOSED AT 400 ppm IN THE TWO-YEAR INHALATION STUDIES	183
FIGURE 12 WEEKLY MEAN CONCENTRATION OF TETRACHLOROETHYLENE FOR MICE EXPOSED AT 100 ppm IN THE TWO-YEAR INHALATION STUDIES	184
FIGURE 13 WEEKLY MEAN CONCENTRATION OF TETRACHLOROETHYLENE FOR MICE EXPOSED AT 200 ppm IN THE TWO-YEAR INHALATION STUDIES	185

APPENDIXES

	PAGE
APPENDIX A	SUMMARY OF THE INCIDENCE OF NEOPLASMS IN RATS IN THE TWO-YEAR INHALATION STUDIES OF TETRACHLOROETHYLENE 69
TABLE A1	SUMMARY OF THE INCIDENCE OF NEOPLASMS IN MALE RATS IN THE TWO-YEAR INHALATION STUDY OF TETRACHLOROETHYLENE 70
TABLE A2	SUMMARY OF THE INCIDENCE OF NEOPLASMS IN FEMALE RATS IN THE TWO-YEAR INHALATION STUDY OF TETRACHLOROETHYLENE 73
TABLE A3	INDIVIDUAL ANIMAL TUMOR PATHOLOGY OF MALE RATS IN THE TWO-YEAR INHALATION STUDY OF TETRACHLOROETHYLENE 76
TABLE A4	INDIVIDUAL ANIMAL TUMOR PATHOLOGY OF FEMALE RATS IN THE TWO-YEAR INHALATION STUDY OF TETRACHLOROETHYLENE 82
APPENDIX B	SUMMARY OF THE INCIDENCE OF NEOPLASMS IN MICE IN THE TWO-YEAR INHALATION STUDIES OF TETRACHLOROETHYLENE 89
TABLE B1	SUMMARY OF THE INCIDENCE OF NEOPLASMS IN MALE MICE IN THE TWO-YEAR INHALATION STUDY OF TETRACHLOROETHYLENE 90
TABLE B2	SUMMARY OF THE INCIDENCE OF NEOPLASMS IN FEMALE MICE IN THE TWO-YEAR INHALATION STUDY OF TETRACHLOROETHYLENE 93
TABLE B3	INDIVIDUAL ANIMAL TUMOR PATHOLOGY OF MALE MICE IN THE TWO-YEAR INHALATION STUDY OF TETRACHLOROETHYLENE 96
TABLE B4	INDIVIDUAL ANIMAL TUMOR PATHOLOGY OF FEMALE MICE IN THE TWO-YEAR INHALATION STUDY OF TETRACHLOROETHYLENE 102
APPENDIX C	SUMMARY OF THE INCIDENCE OF NONNEOPLASTIC LESIONS IN RATS IN THE TWO-YEAR INHALATION STUDIES OF TETRACHLOROETHYLENE 109
TABLE C1	SUMMARY OF THE INCIDENCE OF NONNEOPLASTIC LESIONS IN MALE RATS IN THE TWO-YEAR INHALATION STUDY OF TETRACHLOROETHYLENE . 110
TABLE C2	SUMMARY OF THE INCIDENCE OF NONNEOPLASTIC LESIONS IN FEMALE RATS IN THE TWO-YEAR INHALATION STUDY OF TETRACHLOROETHYLENE . 116
APPENDIX D	SUMMARY OF THE INCIDENCE OF NONNEOPLASTIC LESIONS IN MICE IN THE TWO-YEAR INHALATION STUDIES OF TETRACHLOROETHYLENE 121
TABLE D1	SUMMARY OF THE INCIDENCE OF NONNEOPLASTIC LESIONS IN MALE MICE IN THE TWO-YEAR INHALATION STUDY OF TETRACHLOROETHYLENE . 122
TABLE D2	SUMMARY OF THE INCIDENCE OF NONNEOPLASTIC LESIONS IN FEMALE MICE IN THE TWO-YEAR INHALATION STUDY OF TETRACHLOROETHYLENE . 129

APPENDIXES (Continued)

	PAGE
APPENDIX E	
ANALYSES OF PRIMARY TUMORS IN RATS AND MICE IN THE TWO-YEAR INHALATION STUDIES OF TETRACHLOROETHYLENE	137
TABLE E1 ANALYSIS OF PRIMARY TUMORS IN MALE RATS IN THE TWO-YEAR INHALATION STUDY OF TETRACHLOROETHYLENE	138
TABLE E2 ANALYSIS OF PRIMARY TUMORS IN FEMALE RATS IN THE TWO-YEAR INHALATION STUDY OF TETRACHLOROETHYLENE	143
TABLE E3 ANALYSIS OF PRIMARY TUMORS IN MALE MICE IN THE TWO-YEAR INHALATION STUDY OF TETRACHLOROETHYLENE	146
TABLE E4 ANALYSIS OF PRIMARY TUMORS IN FEMALE MICE IN THE TWO-YEAR INHALATION STUDY OF TETRACHLOROETHYLENE	148
APPENDIX F	
HISTORICAL INCIDENCES OF TUMORS IN F344/N RATS AND B6C3F ₁ MICE RECEIVING NO TREATMENT	151
TABLE F1 HISTORICAL INCIDENCE OF LEUKEMIA IN MALE F344/N RATS RECEIVING NO TREATMENT	152
TABLE F2 HISTORICAL INCIDENCE OF ADRENAL GLAND TUMORS IN MALE F344/N RATS RECEIVING NO TREATMENT	153
TABLE F3 HISTORICAL INCIDENCE OF INTERSTITIAL CELL TUMORS OF THE TESTIS IN MALE F344/N RATS RECEIVING NO TREATMENT	154
TABLE F4 HISTORICAL INCIDENCE OF KIDNEY TUBULAR CELL ADENOMAS IN MALE F344/N RATS RECEIVING NO TREATMENT	155
TABLE F5 HISTORICAL INCIDENCE OF PREPUTIAL GLAND TUMORS IN MALE F344/N RATS RECEIVING NO TREATMENT	156
TABLE F6 HISTORICAL INCIDENCE OF BRAIN TUMORS IN MALE F344/N RATS RECEIVING NO TREATMENT	157
TABLE F7 HISTORICAL INCIDENCE OF LEUKEMIA IN FEMALE F344/N RATS RECEIVING NO TREATMENT	158
TABLE F8 HISTORICAL INCIDENCE OF HEPATOCELLULAR TUMORS IN MALE B6C3F ₁ MICE RECEIVING NO TREATMENT	159
TABLE F9 HISTORICAL INCIDENCE OF HEPATOCELLULAR TUMORS IN FEMALE B6C3F ₁ MICE RECEIVING NO TREATMENT	160
APPENDIX G	
GENETIC TOXICOLOGY OF TETRACHLOROETHYLENE	161

APPENDIXES (Continued)

		PAGE
TABLE G1	MUTAGENICITY OF TETRACHLOROETHYLENE IN <i>SALMONELLA</i> <i>TYPHIMURIUM</i>	162
TABLE G2	INDUCTION OF SISTER-CHROMATID EXCHANGES IN CHINESE HAMSTER OVARY CELLS BY TETRACHLOROETHYLENE	163
TABLE G3	INDUCTION OF CHROMOSOMAL ABERRATIONS IN CHINESE HAMSTER OVARY CELLS BY TETRACHLOROETHYLENE	163
TABLE G4	INDUCTION OF SEX-LINKED RECESSIVE LETHAL MUTATIONS IN DROSOPHILA BY TETRACHLOROETHYLENE	164
TABLE G5	MUTAGENICITY OF TETRACHLOROETHYLENE IN L5178Y/TK ^{+/-} MOUSE LYMPHOMA CELLS IN THE PRESENCE OF S9	165
TABLE G6	MUTAGENICITY OF TETRACHLOROETHYLENE IN L5178Y/TK ^{+/-} MOUSE LYMPHOMA CELLS IN THE ABSENCE OF S9	166
APPENDIX H	CHEMICAL CHARACTERIZATION OF TETRACHLOROETHYLENE	167
APPENDIX I	GENERATION AND MEASUREMENT OF CHAMBER CONCENTRATIONS AT BATTELLE PACIFIC NORTHWEST LABORATORIES	179
APPENDIX J	RESULTS OF SEROLOGIC ANALYSES	187
TABLE J1	MURINE VIRUS ANTIBODY DETERMINATIONS FOR RATS AND MICE IN THE TWO-YEAR INHALATION STUDIES OF TETRACHLOROETHYLENE	188
APPENDIX K	INGREDIENTS, NUTRIENT COMPOSITION, AND CONTAMINANT LEVELS IN NIH 07 RAT AND MOUSE RATION	189
TABLE K1	INGREDIENTS OF NIH 07 RAT AND MOUSE RATION	190
TABLE K2	VITAMINS AND MINERALS IN NIH 07 RAT AND MOUSE RATION	190
TABLE K3	NUTRIENT COMPOSITION OF NIH 07 RAT AND MOUSE RATION	191
TABLE K4	CONTAMINANT LEVELS IN NIH 07 RAT AND MOUSE RATION	192
APPENDIX L	DATA AUDIT SUMMARY	195

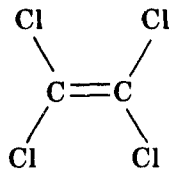

TETRACHLOROETHYLENE
(Perchloroethylene)

(CAS No. 127-18-4)

C₂Cl₄ Molecular weight 165.8

Synonyms: Carbon bichloride, carbon dichloride, ethylene tetrachloride, per, perc, perchlor, perchlorethylene, perchloroethylene, perk, tetrachlorethylene, 1,1,2,2-tetrachloroethylene

Trade names: Ankilostin, Antisal 1, Dee-Solv, Didakene, Dow-Per, ENT 1860, Fedal-Un, Nema, Perclene, Percosolv, Perklone, PerSec, Tetlen, Tetracap, Tetraleno, Tetravec, Tetroguer, Tetropil

ABSTRACT

Toxicology and carcinogenesis studies of tetrachloroethylene (99.9% pure) were conducted by inhalation exposure of groups of 50 male and 50 female F344/N rats and B6C3F₁ mice 6 hours per day, 5 days per week, for 103 weeks. The exposure concentrations used (0, 200, or 400 ppm for rats and 0, 100, or 200 ppm for mice) were selected on the basis of results from 13-week inhalation studies in which groups of 10 rats and 10 mice of each sex were exposed to tetrachloroethylene at 100-1,600 ppm for 6 hours per day, 5 days per week.

During the 13-week studies, 1,600 ppm tetrachloroethylene was lethal to 20%-70% of the rats and mice and reduced the final body weights of survivors. In rats, tetrachloroethylene at 200-800 ppm caused minimal to mild hepatic congestion. In dosed male and female mice, minimal to mild hepatic leukocytic infiltration, centrilobular necrosis, bile stasis (400-1,600 ppm), and mitotic alteration (200-1,600 ppm) were produced. Tetrachloroethylene exposure also caused minimal renal tubular cell karyomegaly in mice at concentrations as low as 200 ppm.

During the 2-year studies, exposure to tetrachloroethylene did not consistently affect body weight gains in either rats or mice. Exposure at 400 ppm tetrachloroethylene reduced the survival of male rats (control, 23/50; low dose, 20/50; high dose, 12/50). This reduced survival may have been related to an increased incidence of mononuclear cell leukemia. Tetrachloroethylene at both exposure concentrations reduced the survival of male mice (46/50; 25/50; 32/50), whereas exposure at 200 ppm reduced female mouse survival (36/50; 31/50; 19/50). Early deaths in mice may have been related to the development of hepatocellular carcinomas.

Both concentrations of tetrachloroethylene were associated with increased incidences of mononuclear cell leukemia in male rats (28/50; 37/50; 37/50). In female rats, tetrachloroethylene increased the incidence of leukemia (18/50; 30/50; 29/50) and decreased the time to occurrence of the disease. Tetrachloroethylene produced renal tubular cell karyomegaly in male and female rats, renal tubular cell hyperplasia in male rats, and renal tubular cell adenomas or adenocarcinomas (combined) in male rats (1/49; 3/49; 4/50). The incidence of the renal tubular cell tumors was not statistically significant; these uncommon tumors have been consistently found at low incidences in male rats in other 2-year studies of chlorinated ethanes and ethylenes. One low dose male rat had a kidney lipoma, and another had a nephroblastoma. Four high dose male and two high dose female rats had gliomas of the brain, whereas one control male and one control female had this tumor.

In male and female mice, tetrachloroethylene caused dose-related increases in the incidences of hepatocellular neoplasms. In males, tetrachloroethylene at 200 ppm increased the incidence of hepatocellular adenomas (11/49; 8/49; 18/50) and at both concentrations increased the incidence of hepatocellular carcinomas (7/49; 25/49; 26/50). In female mice, tetrachloroethylene at both concentrations increased the incidences of hepatocellular carcinomas (1/48; 13/50; 36/50). Tetrachloroethylene also produced renal tubular cell karyomegaly in both sexes of mice, and one low dose male mouse had a tubular cell adenocarcinoma.

In these inhalation studies, there were no neoplastic changes in the respiratory tracts of either species, but there was an increase in the incidence of squamous metaplasia in the nasal cavities in dosed male rats (0/50; 5/50; 5/50).

Tetrachloroethylene was not mutagenic in *Salmonella typhimurium* strains TA98, TA100, TA1535, or TA1537 in the presence or absence of male Syrian hamster or male Sprague-Dawley rat liver S9. Tetrachloroethylene was not mutagenic in L5178Y/TK^{+/-} mouse lymphoma cells with or without metabolic activation and did not induce sex-linked recessive lethal mutations in *Drosophila melanogaster*. Tetrachloroethylene did not induce sister-chromatid exchanges or chromosomal aberrations in Chinese hamster ovary cells in the presence or absence of metabolic activation.

An audit of the experimental data was conducted for these 2-year studies on tetrachloroethylene. No data discrepancies were found that influenced the final interpretations.

Under the conditions of these 2-year inhalation studies, there was *clear evidence of carcinogenicity** of tetrachloroethylene for male F344/N rats as shown by an increased incidence of mononuclear cell leukemia and uncommon renal tubular cell neoplasms. There was *some evidence of carcinogenicity* of tetrachloroethylene for female F344/N rats as shown by increased incidences of mononuclear cell leukemia. There was *clear evidence of carcinogenicity* for B6C3F₁ mice as shown by increased incidences of both hepatocellular adenomas and carcinomas in males and of hepatocellular carcinomas in females.

*Categories of evidence of carcinogenicity are defined in the Note to the Reader on page 2. A summary of the Peer Review comments and the public discussion on this Technical Report appears on pages 14-15.

CONTRIBUTORS

The NTP Technical Report on the Toxicology and Carcinogenesis Studies of Tetrachloroethylene is based on the 13-week studies that began in February 1980 and ended in May 1980 and on the 2-year studies that began in February 1981 and ended in February 1983 at Battelle Pacific Northwest Laboratories.

National Toxicology Program (Evaluated Experiment, Interpreted Results, and Reported Findings)

John H. Mennear, Ph.D., Chemical Manager

Gary A. Boorman, D.V.M., Ph.D.
Joseph K. Haseman, Ph.D.
James Huff, Ph.D.
E.E. McConnell, D.V.M.
G.N. Rao, D.V.M., Ph.D.

Joseph Roycroft, Ph.D.
B.A. Schwetz, D.V.M., Ph.D.
Raymond W. Tennant, Ph.D.
C.W. Jameson, Ph.D.

NTP Pathology Working Group for Rats (Evaluated Slides and Prepared Pathology Report on 7/17/84)

Robert Sauer, V.D.M. (Chair)
Clement Associates, Inc.
Gary A. Boorman, D.V.M., Ph.D. (NTP)
Richard Cardy, D.V.M.
Litton Bionetics, Inc.

Henk Solleveld, D.V.M., Ph.D. (NTP)
Linda Uraih, D.V.M. (IRDC)
Katsuhiko Yoshitomi, D.V.M., Ph.D.
NTP

NTP Pathology Working Group for Mice (Evaluated Slides and Prepared Pathology Report on 12/5/84)

Robert Maronpot, D.V.M. (Chair) (NTP)
Gary A. Boorman, D.V.M., Ph.D. (NTP)
Charles Frith, D.V.M., Ph.D.
Intox Laboratory
Robert Garman, D.V.M. (BRRC)
LeRoy Hall, D.V.M., Ph.D. (NTP)
Melvin Hamlin, D.V.M.
Experimental Pathology Laboratories

R. Miller, D.V.M., Ph.D.
Battelle Pacific Northwest
Laboratories
Kevin Morgan, Ph.D.
Chemical Industry Institute
of Toxicology
Greg Olson, D.V.M., Ph.D.
Iowa State University

Principal Contributors at Battelle Pacific Northwest Laboratories (Conducted Studies and Evaluated Tissues)

William Clarke, D.V.M., Ph.D., Principal Investigator
H. Ragan, D.V.M., Principal Investigator
R.B. Westerberg, Ph.D., Chemist
R. Miller, D.V.M., Ph.D., Pathologist

Principal Contributors at Experimental Pathology Laboratories (Provided Pathology Quality Assurance)

Jerry Hardisty, D.V.M.

Principal Contributors at Carltech Associates, Inc. (Contractor for Technical Report Preparation)

William D. Theriault, Ph.D., Project Manager
Abigail C. Jacobs, Ph.D., Senior Scientist

John Warner, M.S., Chemist/Statistician

PEER REVIEW PANEL

The members of the Peer Review Panel who evaluated the draft Technical Report on tetrachloroethylene on August 14, 1985, are listed below. Panel members serve as independent scientists, not as representatives of any institution, company, or governmental agency. In this capacity, Panel members have five major responsibilities: (a) to ascertain that all relevant literature data have been adequately cited and interpreted, (b) to determine if the design and conditions of the NTP studies were appropriate, (c) to ensure that the Technical Report presents the experimental results and conclusions fully and clearly, (d) to judge the significance of the experimental results by scientific criteria, and (e) to assess the evaluation of the evidence of carcinogenicity and other observed toxic responses.

National Toxicology Program Board of Scientific Counselors Technical Reports Review Subcommittee

Jerry B. Hook, Ph.D. (Chair)

Vice President, Preclinical Research and Development
Smith Kline & French Laboratories, Philadelphia, Pennsylvania

Frederica Perera, Dr. P.H.

Division of Environmental Sciences
School of Public Health, Columbia University
New York, New York

James Swenberg, D.V.M., Ph.D.

Head, Department of Biochemical
Toxicology and Pathobiology
Chemical Industry Institute of Toxicology
Research Triangle Park, North Carolina

Ad Hoc Subcommittee Panel of Experts

John J. Crowley, Ph.D.

Division of Public Health Science
The Fred Hutchinson Cancer Research Center
Seattle, Washington

Franklin E. Mirer, Ph.D.

Director, Health and Safety Department
International Union, United Auto
Workers, Detroit, Michigan

Kim Hooper, Ph.D.

Hazard Evaluation System and
Information Services
Department of Health Services
State of California
Berkeley, California

I.F.H. Purchase, Ph.D.

Central Toxicology Laboratory
Imperial Chemical Industries, PLC
Alderley Park, England

Thomas C. Jones, D.V.M.

Professor, Comparative Pathology
New England Regional Primate Research Center
Harvard Medical School
Southborough, Massachusetts

Robert A. Scala, Ph.D.*

Senior Scientific Advisor, Medicine and
Environmental Health Department
Research and Environmental Health
Division, Exxon Corporation
East Millstone, New Jersey

Richard J. Kociba, D.V.M., Ph.D.

Dow Chemical USA
Midland, Michigan

Steven R. Tannenbaum, Ph.D.

Professor, Department of Nutrition and
Food Science
Massachusetts Institute of Technology
Cambridge, Massachusetts

David Kotelchuck, Ph.D.

Environmental Health Science Program
Hunter School of Health Sciences
New York, New York

Bruce W. Turnbull, Ph.D.

Professor and Associate Director
College of Engineering
Cornell University
Ithaca, New York

*Unable to attend

**SUMMARY OF PEER REVIEW COMMENTS
ON THE TOXICOLOGY AND CARCINOGENESIS STUDIES OF
TETRACHLOROETHYLENE**

On August 14, 1985, the draft Technical Report on the toxicology and carcinogenesis studies of tetrachloroethylene (perchloroethylene) received peer review by the National Toxicology Program Board of Scientific Counselors' Technical Reports Review Subcommittee and associated Panel of Experts. The meeting was held at the National Institute of Environmental Health Sciences, Research Triangle Park, North Carolina.

Dr. J. Mennear, NTP, began the discussion with a summary of the study design, results, and conclusions. Dr. Swenberg, a principal reviewer, stated that the report should clearly note that the interpretation of mononuclear cell leukemia was based on the standard method of data evaluation supported by the dose-response effect on tumor latency and the staging evaluation. He pointed out that this is a preliminary attempt to develop staging criteria for mononuclear cell leukemia. Dr. Swenberg said the discussion should be expanded to examine possible mechanisms of carcinogenesis, noting that the mutagenicity studies were negative and that tetrachloroethylene caused tissue toxicity at the same site as neoplasia in two of the three tissues: mouse liver and rat kidney. Further, he recommended that studies be considered to determine the potential immunotoxicity of tetrachloroethylene.

As a second principal reviewer, Dr. Mirer agreed with the proposed conclusions in mice but thought that the conclusions in male and female rats should be changed from some evidence of carcinogenicity to clear evidence of carcinogenicity. He said that the mononuclear cell leukemia was malignant and present at increased incidence and that the increase appeared by all the usual criteria to be chemically related. Dr. Hooper supported the interpretation of clear evidence of carcinogenicity for male rats based on the statistical values, similar findings in female rats, and the 8% incidence of a rare tumor, glioma of the brain, in high dose male rats. Dr. Swenberg disagreed and stated that brain tumors are not as rare as previously believed and the high control incidences of mononuclear cell leukemia in these studies and in the concurrent dichloromethane (methylene chloride) studies argued against changing the conclusion. Dr. Mirer asked that greater emphasis be placed on the summary of the doses associated with the appearance of nontumor pathologic effects. He commented that tetrachloroethylene at the existing Occupational Health and Safety Administration (OSHA) human exposure limit (100 ppm) in mice showed a substantial effect at that level and should be noted.

As a third principal reviewer, Dr. Turnbull agreed with the conclusions as written. He asked whether the data from the control group for the inhalation studies on methylene chloride, reviewed and approved previously by the Panel, could be considered as a second concurrent control group to increase the power of the statistical tests. The studies on methylene chloride overlapped those on tetrachloroethylene at the same laboratory.

As a fourth principal reviewer, Dr. Jones also agreed with the conclusions.

Dr. T. Robinson, Vulcan Chemicals, representing the Halogenated Solvents Industry Alliance (HSIA), stated that the NTP conclusion of some evidence of carcinogenicity in rats was not supported by the data. In the opinion of HSIA, the appropriate conclusion was equivocal evidence of carcinogenicity based on lack of early mortality from mononuclear cell leukemia in exposed groups compared with control groups and the confounding high incidence in untreated controls. Secondly, Dr. Robinson said the current study was the first to base conclusions, at least in part, on the staging of mononuclear cell leukemia in F344 rats by a method that HSIA considers not well established. Dr. Mennear responded that the conclusions in rats were not based solely on staging of mononuclear cell leukemia but rather on the significantly increased incidences of mononuclear cell leukemia in

exposed animals. Further, examination of causes of early mortality showed a dose-related increase in the incidence of death considered due to mononuclear cell leukemia.

Dr. Swenberg moved that the conclusions as proposed, some evidence of carcinogenicity in rats and clear evidence of carcinogenicity in mice, be accepted. Dr. Jones seconded the motion, and it was defeated by five negative votes (Dr. Crowley, Dr. Hooper, Dr. Kotelchuck, Dr. Mirer, and Dr. Perera) to four affirmative votes (Dr. Jones, Dr. Swenberg, Dr. Tannenbaum, and Dr. Turnbull) with two abstentions (Dr. Kociba and Dr. Purchase). Dr. Hooper then moved that the conclusions in mice be accepted as written. Dr. Perera seconded the motion, and it was approved by nine affirmative votes with two abstentions (Dr. Kociba and Dr. Purchase). Dr. Hooper moved that the conclusions in female rats, some evidence of carcinogenicity, be accepted as written. Dr. Crowley seconded the motion, and it was approved by eight affirmative votes; there were one negative vote (Dr. Kotelchuck) and two abstentions (Dr. Kociba and Dr. Purchase). Dr. Mirer moved that the conclusion in male rats be changed to clear evidence of carcinogenicity. Dr. Perera seconded the motion, and it was approved by five affirmative votes (Dr. Crowley, Dr. Hooper, Dr. Kotelchuck, Dr. Mirer, and Dr. Perera) to four negative votes (Dr. Jones, Dr. Swenberg, Dr. Tannenbaum, and Dr. Turnbull) with two abstentions (Dr. Kociba and Dr. Purchase).

I. INTRODUCTION

Use, Manufacture, and Occurrence

Pharmacokinetics

Teratogenicity

Genetic Toxicology

Carcinogenicity

I. INTRODUCTION

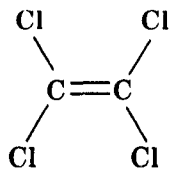

TETRACHLOROETHYLENE (Perchloroethylene)

(CAS No. 127-18-4)

C_2Cl_4

Molecular weight 165.8

Synonyms: Carbon bichloride, carbon dichloride, ethylene tetrachloride, per, perc, perchlor, perchlorethylene, perchloroethylene, perk, tetrachlorethylene, 1,1,2,2-tetrachloroethylene

Trade names: Ankilostin, Antisal 1, Dee-Solv, Didakene, Dow-Per, ENT 1860, Fedal-Un, Nema, Perclene, Percosolv, Perklone, PerSec, Tetlen, Tetracap, Tetraleno, Tetravec, Tetroguer, Tropil

Use, Manufacture, and Occurrence

Tetrachloroethylene is used primarily as a dry cleaning agent, an industrial solvent for fats, oils, tars, rubber, and gums, and a metal degreasing agent (Kirk-Othmer, 1979). Tetrachloroethylene had antihelminthic uses, particularly for hookworms (1.6-8 g/60 kg; Merck, 1976; Kirk-Othmer, 1979; Martindale, 1967), and was formerly used in combination with some grain protectants and fumigants (Farm Chemicals Handbook, 1982). Chemical and physical properties of tetrachloroethylene are listed in Table 1. Five reviews on tetrachloroethylene are available (Berkowitz, 1978; NIOSH, 1976; IARC, 1979; WHO, 1985; USEPA, 1985).

Tetrachloroethylene has been found in a wide variety of foods in England (McConnell et al., 1975). Individuals living near dry cleaning establishments can be exposed to sufficient amounts of tetrachloroethylene to result in measurable concentrations in expired breath. For example, the breath of residents living above dry cleaning shops in the Netherlands was found to contain a mean concentration of 5 mg/m³ (0.73 ppm), and the breath of residents living adjacent to the shops contained 1 mg/m³ (0.15 ppm) (Verberk and Scheffers, 1980).

In 1983, 265 million kilograms of tetrachloroethylene was produced in the United States (USITC, 1984). The 1985 production was projected to be 345-363 million kilograms (CEH,

1982). An estimated 85% of the tetrachloroethylene used annually is lost into the atmosphere (Fuller, 1976). Approximately 500,000 Americans are exposed to this chemical in the workplace (NIOSH, 1978). The present Occupational Safety and Health Administration standard for occupational exposure to tetrachloroethylene in workplace air is a time-weighted average concentration of 100 ppm (678 mg/m³).

Tetrachloroethylene has been detected in ambient air in a variety of urban and nonurban areas throughout the world. Levels range from trace amounts in rural areas to 10 ppb in some large urban areas. The global average background concentration has been estimated to be 25 parts per trillion. The chemical has also been detected in surface and drinking water, generally at levels between 1 and 2 ppb (USEPA, 1985).

Pharmacokinetics

The major route of human exposure to tetrachloroethylene is via inhalation, but the chemical is also absorbed after either oral or dermal administration. Absorption through human skin is minimal, and it is unlikely that systemic intoxication can be achieved by this route (Stewart and Dodd, 1964; Riihimaki and Pfaffli, 1978).

Absorption via the lungs is rapid. The exposure concentration has a greater effect on the blood levels achieved than does the duration of the exposure period. In humans, blood levels reach an

TABLE 1. CHEMICAL AND PHYSICAL PROPERTIES OF TETRACHLOROETHYLENE (a)

Description	Colorless liquid
Boiling point	121° C
Freezing point	-22.4° C
Density	1.625 g/ml at 20° C
Refractive index	n_D at 25° C = 1.5029
Solubility	Practically insoluble in water (0.015 g/100 ml water at 25° C); miscible with ethanol, diethyl ether, and oils in all proportions.
Volatility	Vapor pressure is 20 mm Hg at 26.3° C.
Stability	Nonflammable; decomposes slowly in contact with water to yield trichloroacetic and hydrochloric acids. At 700° C in contact with active carbon, it decomposes to hexachloroethane and hexachlorobenzene.
Reactivity	Oxidized by strong oxidizing agents (sulfuric and nitric acids, sulfur trioxide); reaction with excess hydrogen in the presence of reduced nickel catalyst produces total decomposition to hydrogen chloride and carbon.
Conversion factor	1 ppm in air at 25° C is equivalent to 6.78 mg/m ³

(a) IARC, 1979

equilibrium within 3 hours after exposure begins (Hake and Stewart, 1977). Respiratory absorption, as measured by venous blood levels, is increased by exercise (Monster, 1979; Hake and Stewart, 1977).

Like other lipid soluble materials, tetrachloroethylene is stored in tissues with high lipid content (Stewart, 1969). Savolainen et al. (1977) exposed rats to tetrachloroethylene at a concentration of 200 ppm (207 mg/kg) for 6 hours per day for 4 days and found tetrachloroethylene retained in perirenal fat, brain, and liver tissue.* Seventy-two hours after either oral or inhalation exposure of rats and mice to radiolabeled tetrachloroethylene, less than 5% of the administered radioactivity was retained by the body. In rats, most of the retained radioactivity was found in the fat, kidneys, and liver (Pegg et al., 1979; Frantz and Watanabe, 1983; Schumann et al., 1980). In humans, a limited amount of accumulation of tetrachloroethylene, as shown by slightly higher alveolar excretion after each daily exposure (100 ppm, 7.5 hours per day, 5 days per week), was demonstrated by Hake and Stewart (1977).

Tetrachloroethylene, either inhaled or ingested

by rats, is excreted primarily through the lungs. Male Sprague-Dawley rats exposed to ¹⁴C-tetrachloroethylene by either gavage (1.0 mg/kg) or inhalation (10 ppm, 10.4 mg/kg) excreted 70% of the dose unchanged in expired air (Pegg et al., 1979). Approximately 3% was excreted as carbon dioxide, and approximately 23% was excreted in the urine and feces as nonvolatile metabolites. When doses were increased to 500 mg/kg and 622 mg/kg (600 ppm), approximately 89% of the chemical was excreted unchanged from the lungs. When 1,000 mg/kg of tetrachloroethylene was administered to Wistar rats by gavage, 89% of the dose was excreted unchanged via the lungs (Daniel, 1963). The results reported by Pegg et al. (1979) are consistent with the hypothesis that the metabolism of tetrachloroethylene in the rat is a saturable process.

Mice (strain unspecified) that were exposed for 2 hours to radiolabeled tetrachloroethylene at 200 ppm (100 mg/kg) by inhalation excreted 70% of the administered radioactivity in expired air, 20% in the urine, and less than 0.5% in feces (Yllner, 1961). When exposed to tetrachloroethylene at lower concentrations (10 ppm for 6 hours, 16 mg/kg), B6C3F₁ mice excreted 12% of the dose via the lungs (Schumann et al., 1980).

*Throughout the text of this report, doses, expressed as milligrams per kilogram, in rats and mice have been estimated when chemical exposure was originally expressed as parts per million in air. This conversion was done to facilitate comparisons of doses used in inhalation studies with those used in gavage studies. The assumptions necessary to make these conversions introduce an undetermined margin of error. Therefore, it must be recognized that the calculated doses represent only approximations, and comparisons should be made with caution. (Assumptions: Body weights: male and female rats, 450 and 300 g, respectively; mice, 30 g. Minute volume: rats, 0.16 liter/minute per 250 g body weight; mice, 0.021 liter/minute per 32 g body weight. Chemical uptake from lungs: 100%.)

I. INTRODUCTION

The major metabolite of tetrachloroethylene found in the urine of rats, mice, and hamsters is trichloroacetic acid (Yllner, 1961; Daniel, 1963; Ikeda and Imamura, 1973; Moslen et al., 1977). Minor metabolites found by these investigators included oxalic acid and ethylene glycol. Pegg et al. (1979), however, found only oxalic acid in the urine of rats administered tetrachloroethylene.

B6C3F₁ mice were reported to metabolize tetrachloroethylene to a greater extent than Osborne-Mendel rats. When tetrachloroethylene was inhaled at a concentration of 10 ppm (16 mg/kg) for 6 hours, mice were estimated to metabolize 8.6 times more tetrachloroethylene per unit body weight than did rats (Schumann et al., 1980). When a single oral dose of 500 mg/kg was employed, the differential between the species was reduced to 1.6, with mice metabolizing less of the oral dose than of the inhaled dose.

In humans, trichloro compounds were identified as urinary metabolites of tetrachloroethylene. Urinary trichloroacetic acid was reported to appear in the urine of exposed workers (Weiss, 1969; Ikeda and Ohtsuji, 1972; Ikeda et al., 1972; Ikeda and Imamura, 1973; Munzer and Heder, 1973). Urinary trichloroethanol also was detected as a metabolite in exposed workers (Ikeda and Ohtsuji, 1972; Ikeda et al., 1972). In controlled inhalation experiments in humans (70-200 ppm for 1-8 hours), less than 2% of the absorbed dose was recovered as urinary trichloroacetic acid (Fernandez et al., 1976; Hake and Stewart, 1977; Monster, 1979). Ikeda et al. (1972) found that the trichloroacetic acid content of the urine reaches a plateau after repeated exposures at over 50 ppm. These results are suggestive of a saturable metabolic process for tetrachloroethylene in humans.

Teratogenicity

Tetrachloroethylene was not teratogenic for Swiss Webster mice or Sprague-Dawley rats exposed by inhalation at 300 ppm for 7 hours per day (560 mg/kg) on days 6-15 of gestation (Schwetz et al., 1975). However, the pups of exposed rats exhibited reduced body weights, and there was a slightly increased incidence of resorptions in dosed rats. In mice, tetrachloroethylene administration was associated with

reduced weight of pups, delayed ossification of skull bones, increased subcutaneous edema, and split sternbrae. Hardin et al. (1981) exposed pregnant rats and rabbits to tetrachloroethylene at 500 ppm (780 mg/kg) and found no evidence of reproductive toxicity or teratogenic potential.

Genetic Toxicology

Tetrachloroethylene (99.7% pure) was not mutagenic in *Salmonella* strain TA100 in the presence of phenobarbital-induced rat liver S9 (Bartsch et al., 1979), and tetrachloroethylene was not mutagenic in strain TA1535 in the absence of S9 (Kringstad et al., 1981). Tetrachloroethylene was not mutagenic in four strains of *Salmonella* in the absence or presence of hamster or rat liver S9 (Haworth et al., 1983; Appendix G). Tetrachloroethylene was also not mutagenic in L5178Y/TK^{+/-} mouse lymphoma cells with or without metabolic activation and did not induce sex-linked recessive lethal mutations in *Drosophila* (Appendix G).

Tetrachloroethylene was reported to induce two-fold increases in the reversion frequency in TA100; however, the tetrachloroethylene sample was only 99.0% pure, and the weak positive result may have been due to contaminants (Kringstad et al., 1981). The use of tetrachloroethylene of unknown purity increased the frequency of gene conversion and mitotic recombination in yeast (Callen et al., 1980).

Tetrachloroethylene did not induce chromosomal aberrations in bone marrow cells of mice (Cerna and Kypenova, 1977), but these findings are difficult to evaluate because details of the protocol and results are lacking. Additional studies showed that tetrachloroethylene did not induce chromosomal aberrations or sister-chromatid exchanges (SCE's) in Chinese hamster ovary cells in vitro (Appendix G). These results are consistent with the lack of cytogenetic effects of tetrachloroethylene in humans exposed in the workplace (Ikeda et al., 1980).

In conclusion, tetrachloroethylene appears to be nonmutagenic in bacteria and mouse lymphoma cells and does not cause chromosomal aberrations or SCE's. The few positive findings that tetrachloroethylene was genotoxic may be due to impurities in the compound tested.

Carcinogenicity

In an earlier study, administration of tetrachloroethylene in corn oil by gavage produced hepatocellular carcinomas in male and female B6C3F₁ mice (males received 450 or 900 mg/kg for 11 weeks, then 550 or 1,100 mg/kg for 67 weeks; females received 300 or 600 mg/kg for 11 weeks, then 400 or 800 mg/kg for 67 weeks) (NCI, 1977). In a simultaneous study in Osborne-Mendel rats, administration of tetrachloroethylene did not produce tumors (males were administered 500 or 1,000 mg/kg and females were administered 700 or 1,400 mg/kg for 78 weeks); however, survival in dosed rats was reduced. These studies were judged inadequate to assess carcinogenic potential in male and female Osborne-Mendel rats.

Exposure of male and female Sprague-Dawley rats to tetrachloroethylene (300 or 600 ppm, 6 hours per day [467 or 934 mg/kg], 5 days per week for 52 weeks) by inhalation did not increase the incidence of tumors in either sex (Rampy et al., 1978). However, the duration of dosing was only 1 year, although the animals were observed for the rest of their lives. Strain A/St mice did not develop an increase in pulmonary tumors after tetrachloroethylene administration (14 intraperitoneal injections of 80

mg/kg, 24 injections of 200 mg/kg, or 48 injections of 400 mg/kg (Theiss et al., 1977).

Tetrachloroethylene did not initiate skin tumors in female ICR/Ha Swiss mice (Van Duuren et al., 1979). The mice received either a single application of 163 mg of tetrachloroethylene followed by topical applications of phorbol myristate acetate three times per week until the end of the study (428-576 days) or three weekly applications of 18 or 54 mg of tetrachloroethylene in acetone for 440-594 days.

The International Agency for Research on Cancer (IARC, 1979) concluded that there was limited evidence that tetrachloroethylene was carcinogenic in mice. Because of the early deaths among Osborne-Mendel rats used in the earlier study (NCI, 1977), the rat portion of that study was considered to be inadequate for determining whether tetrachloroethylene caused cancer in rats. Consequently, the NCI initiated additional studies in which four strains of rats (Long-Evans, Sherman, Wistar, and F344/N) and female B6C3F₁ mice were to be given tetrachloroethylene by gavage and F344/N rats and B6C3F₁ mice were to be exposed by inhalation. The inlife portions of the gavage studies have been completed, and the data are being reviewed. The present report describes the results of the inhalation studies of tetrachloroethylene.

II. MATERIALS AND METHODS

**PROCUREMENT AND CHARACTERIZATION OF
TETRACHLOROETHYLENE
GENERATION AND MEASUREMENT OF CHAMBER
CONCENTRATIONS
SINGLE-EXPOSURE STUDIES
FOURTEEN-DAY STUDIES
THIRTEEN-WEEK STUDIES
TWO-YEAR STUDIES**

Study Design

Source and Specifications of Animals

Animal Maintenance

Clinical Examinations and Pathology

Statistical Methods

II. MATERIALS AND METHODS

PROCUREMENT AND CHARACTERIZATION OF TETRACHLOROETHYLENE

High-purity tetrachloroethylene (Dowper® stabilized) was obtained from the Dow Chemical USA (Midland, Michigan) in two lots. Lot no. TA03116F-01 was used for the single-exposure, 14-day, 13-week, and 2-year studies and lot no. TA08190D was used for the 2-year studies. Purity and identity analyses were conducted at Midwest Research Institute (Appendix H).

The identities of both lots were confirmed by spectroscopic analysis. The infrared spectra were consistent with that found in the literature. No peaks were observed in the nuclear magnetic resonance spectra, a finding consistent with the structure of tetrachloroethylene and suggesting the absence of major impurities. The cumulative data from elemental analyses and gas chromatography indicated that the purity of both lots was approximately 99.9%.

Tetrachloroethylene requires small quantities of inhibitors to prevent decomposition. The manufacturer stated that the lots used in the current

studies contained 53 ppm of *N*-methylnorpholine. Tetrachloroethylene was found to be stable for 2 weeks at 60° C (Appendix H). Tetrachloroethylene was stored at 0° C. Results of periodic analyses of the bulk chemical at the study laboratory by infrared spectroscopy and gas chromatography indicated that tetrachloroethylene was stable under these storage conditions.

GENERATION AND MEASUREMENT OF CHAMBER CONCENTRATIONS

Tetrachloroethylene was vaporized at 100°-110° C, diluted with air, and introduced into the chambers (Table 2; Appendix I). Concentrations in the exposure chambers were monitored 8-12 times per exposure period by a Hewlett-Packard 5840A Gas Chromatograph. Average weekly exposure concentrations are presented in Appendix I. On one occasion (September 13, 1982) in the 2-year studies, the concentration in the 400-ppm chamber was 800 ppm for 12 minutes and 2,400 ppm for 48 minutes. Animals were therefore not exposed at all on September 14, 1982. A summary and the distribution of the chamber concentrations in the 2-year studies are given in Tables 3 and 4.

TABLE 2. GENERATION OF CHAMBER CONCENTRATIONS IN THE INHALATION STUDIES OF TETRACHLOROETHYLENE

Single-Exposure Studies	Fourteen-Day Studies	Thirteen-Week Studies	Two-Year Studies
Tetrachloroethylene vapor generated by bubbling clean, dry air (-40° C dewpoint) through all glass impingers that contained tetrachloroethylene; the different concentrations obtained by varying the amount of air that was passed through the test material.	Same as the single-exposure studies	Tetrachloroethylene vaporized at 100°-110° C, diluted with air, and introduced into the chamber with a stable micrometering pump with adjustable drift-free pump rates. The vaporizer heated to 110° ± 3° C. The tetrachloroethylene vapor entered the fresh air duct and was led directly into the exposure chamber.	Tetrachloroethylene pumped from a stainless steel reservoir to a vaporizer by a stable micrometering pump

TABLE 3. SUMMARY OF CHAMBER CONCENTRATIONS DURING THE TWO-YEAR INHALATION STUDIES OF TETRACHLOROETHYLENE

Target Concentration (ppm)	Total Number of Readings	Mean Concentration (a) (ppm)
100	4,666	99.5 ± 6.6
200	4,649	201 ± 11
400	4,643	403 ± 36

(a) Mean ± standard deviation

TABLE 4. DISTRIBUTION OF MEAN DAILY CONCENTRATIONS DURING THE TWO-YEAR INHALATION STUDIES OF TETRACHLOROETHYLENE

Range of Concentration (percent of target)	Number of Days Mean within the Range		
	100 ppm	200 ppm	400 ppm
>150	0	0	0
130-150	0	0	1
120-130	0	0	0
110-120	1	5	0
100-110	203	260	286
90-100	279	224	200
80-90	7	1	3
70-80	2	2	2

SINGLE-EXPOSURE STUDIES

Male and female F344/N rats and B6C3F₁ mice were obtained from Frederick Cancer Research Center and observed for 16 days before being placed on study. The studies were conducted at Industrial Biotest Laboratories.

Groups of five rats of each sex were exposed to air containing tetrachloroethylene at concentrations of 2,445, 3,786, 4,092, 4,513, or 5,163 ppm for 4 hours. Groups of five mice of each sex were exposed at concentrations of 2,328, 2,445, 2,613, 2,971, or 3,786 ppm. Rats and mice were observed daily and weighed on days 0 and 15. A necropsy was performed on all animals. Details of animal maintenance are presented in Table 5.

FOURTEEN-DAY STUDIES

Male and female F344/N rats and B6C3F₁ mice were obtained from Charles River Breeding Laboratories and observed for 16 days before being placed on study. The animals were 6-8 weeks old when the studies began. The studies were conducted at Industrial Biotest Laboratories.

Groups of five rats and five mice of each sex were exposed to air containing tetrachloroethylene at target concentrations of 0, 100, 200, 425, 875, or 1,750 ppm, 6 hours per day, 5 days per week for 2 weeks (10 exposures). Rats and mice were observed daily and weighed on days 0, 5, 10, and 15. A necropsy was performed on all animals. Details of animal maintenance are presented in Table 5.

TABLE 5. EXPERIMENTAL DESIGN AND MATERIALS AND METHODS IN THE INHALATION STUDIES OF TETRACHLOROETHYLENE

Single-Exposure Studies	Fourteen-Day Studies	Thirteen-Week Studies	Two-Year Studies
EXPERIMENTAL DESIGN			
Size of Study Groups 5 males and 5 females of each species	5 males and 5 females of each species	10 males and 10 females of each species	50 male and 50 female rats; 49 or 50 male and female mice
Doses Rats--2,445, 3,786, 4,092, 4,513, or 5,163 ppm tetrachloroethylene by inhalation; mice--2,328, 2,445, 2,613, 2,971, or 3,786 ppm tetrachloroethylene by inhalation	Target--0, 100, 200, 425, 875, or 1,750 ppm tetrachloroethylene by inhalation	Target--0, 100, 200, 400, 800, or 1,600 ppm tetrachloroethylene by inhalation	Rats--0, 200, or 400 ppm tetrachloroethylene by inhalation; mice--0, 100, or 200 ppm tetrachloroethylene by inhalation
Date of First Dose 6/9/77; 6/12/77; 6/13/77; 6/16/77; 6/21/77	10/14/77	2/21/80	2/18/81
Date of Last Dose NA	10/27/77	5/21/80	2/4/83
Duration of Dosing One 4-h exposure	6 h/d, 5 d/wk for 2 wk (10 exposures)	6 h/d, 5 d/wk for 13 wk	6 h/d, 5 d/wk for 103 wk
Type and Frequency of Observation Weighed before and after exposure	Observed 1 × d; weighed on d 0, 5, 10, and 15	Observed continuously during the exposure period, 3 × d on non-exposure days; weighed 1 × wk	Same as 13-wk studies
Necropsy and Histologic Examination Necropsy performed on all animals	Necropsy performed on all animals; the following tissues were examined microscopically: skin, mandibular lymph node, salivary gland, bone marrow, thymus, trachea, lungs and bronchi, heart, thyroid gland, parathyroids, esophagus, stomach, duodenum, colon, liver, gallbladder (mice), pancreas, spleen, kidneys, adrenal glands, urinary bladder, seminal vesicles/prostate/testes or ovaries/uterus, nasal cavity, brain, and pituitary gland	Necropsy performed on all animals. The following tissues were examined microscopically in the control and high dose groups: skin, mandibular lymph node, mammary gland, salivary gland, bone marrow, thymus, larynx, trachea, lungs and bronchi, heart, thyroid gland, esophagus, stomach, duodenum, colon, liver, gallbladder (mice), pancreas, spleen, kidneys, adrenal glands, urinary bladder, seminal vesicles/prostate/testes or ovaries/uterus, nasal cavity, brain, and pituitary gland. Rats: 200, 400, 800 ppm--liver; 800 ppm lungs and bronchi; mice: 100 ppm--kidneys; 200, 400, 800 ppm--liver	Necropsy and histologic examination performed on all animals; the following tissues were examined: gross lesions and tissue masses, mandibular lymph node, sternbrae including marrow, thyroid gland, parathyroids, small intestine, rectum, colon, liver, mammary gland, prostate/testes or ovaries/uterus, lungs and mainstem bronchi, nasal cavity and nasal turbinates, skin, salivary gland, heart, esophagus, stomach, brain, thymus, trachea, pancreas, spleen, kidneys, adrenal glands, urinary bladder, pituitary gland, gallbladder (mice), and tracheobronchial lymph nodes

TABLE 5. EXPERIMENTAL DESIGN AND MATERIALS AND METHODS IN THE INHALATION STUDIES OF TETRACHLOROETHYLENE (Continued)

Single-Exposure Studies	Fourteen-Day Studies	Thirteen-Week Studies	Two-Year Studies
ANIMALS AND ANIMAL MAINTENANCE			
Strain and Species F344/N rats; B6C3F ₁ mice	F344/N rats; B6C3F ₁ mice	F344/N rats; B6C3F ₁ mice	F344/N rats; B6C3F ₁ mice
Animal Source Frederick Cancer Research Center	Charles River Breeding Laboratories (Wilmington, MA)	Charles River Breeding Laboratories (Portage, MI)	Charles River Breeding Laboratories (Kingston, NY)
Study Laboratory Industrial Biotest Laboratories	Industrial Biotest Laboratories	Battelle Pacific Northwest Laboratories	Battelle Pacific Northwest Laboratories
Method of Animal Identification Ear notch	Ear notch	Ear tags	Ear tags
Time Held Before Study 7 d	16 d	22 d	21 d
Age When Placed on Study 5-7 wk	6-8 wk	7-9 wk	8-9 wk
Age When Killed 7-9 wk	8-10 wk	20-22 wk	112-113 wk
Necropsy Dates NA	10/28/77	5/23/80	2/14/83-2/18/83
Method of Animal Distribution Stratified by weight and then assigned to groups according to a table of random numbers	Same as single-exposure studies	According to computer-generated tables of random numbers	Same as 13-wk studies
Feed Wayne Lab Blox® (Allied Mills, Chicago, IL); available ad libitum except during inhalation exposures	Same as single-exposure studies	NIH 07 Rat and Mouse Ration (Zeigler Bros., Gardners, PA); available ad libitum except during inhalation exposures	Same as 13-wk studies
Water Automatic watering system; provided ad libitum	Same as single-exposure studies	Automatic watering system (Edstrom Industries, Waterford, WI); available ad libitum	Same as 13-wk studies
Cages Stainless steel mesh (Unifab Corp., Kalamazoo, MI)	Same as single-exposure studies	Stainless steel wire	Same as 13-wk studies
Animals per Cage 1	1	1	1
Other Chemicals on Study in the Same Room Not available	Dichloromethane, d 1-11	Dichloromethane	Dichloromethane

TABLE 5. EXPERIMENTAL DESIGN AND MATERIALS AND METHODS IN THE INHALATION STUDIES OF TETRACHLOROETHYLENE (Continued)

Single-Exposure Studies	Fourteen-Day Studies	Thirteen-Week Studies	Two-Year Studies
ANIMALS AND ANIMAL MAINTENANCE (Continued)			
Animal Room Environment Not available	Not available	Temp--72°-80° F within exposure chambers, 72°-76° F during exposure period; humidity--40%-80% within exposure chambers, 40%-60% during postexposure period; fluorescent light 12 h/d	Temperature--67°-83° F; humidity range--20%-83%; fluorescent light 12 h/d

THIRTEEN-WEEK STUDIES

Thirteen-week studies were conducted to evaluate the cumulative toxic effects of repeated exposure to tetrachloroethylene and to determine the concentrations to be used in the 2-year studies. Four- to 6-week-old male and female F344/N rats and B6C3F₁ mice were obtained from Charles River Breeding Laboratories, observed for 22 days, and assigned to study groups according to a table of random numbers. Feed was available ad libitum during nonexposure periods, and water was available at all times.

Groups of 10 rats and mice of each sex were exposed to air containing tetrachloroethylene at target concentrations of 0, 100, 200, 400, 800, or 1,600 ppm, 6 hours per day, 5 days per week for 13 weeks. Animals were checked continually during exposure and three times per day on non-exposure days; moribund animals were killed. Individual animal weights were recorded weekly. At the end of the 13-week studies, survivors were killed. A necropsy was performed on all animals. Tissues and groups examined are listed in Table 5.

TWO-YEAR STUDIES

Study Design

Groups of 50 rats of each sex were exposed to air containing tetrachloroethylene at concentrations of 0 (chamber control), 200, or 400 ppm, 6 hours per day, 5 days per week for 103 weeks.

Groups of 49 or 50 mice of each sex were exposed at concentrations of 0, 100, or 200 ppm on the same schedule.

Source and Specifications of Animals

The male and female F344/N rats and B6C3F₁ (C57BL/6N, female, × C3H/HeN MTV⁻, male) mice used in this study were produced under strict barrier conditions at Charles River Breeding Laboratories under a contract to the Carcinogenesis Program. Breeding stock for the foundation colonies at the production facility originated at the National Institutes of Health Repository. Animals shipped for study were progeny of defined microflora-associated parents that were transferred from isolators to barrier-maintained rooms. Rats were shipped to the study laboratory at 5 weeks of age and mice at 5-6 weeks. The animals were quarantined at the study laboratory for 21 days. Thereafter, a complete necropsy was performed on five animals of each sex and species to assess their health status. The rats were placed on study at 8 weeks of age and mice at 9 weeks of age. The health of the animals was monitored during the course of the study according to the protocols of the NTP. Serologic analyses of control animals were performed at the end of the studies (Appendix J).

A quality control skin grafting program has been in effect since early 1978 to monitor the genetic integrity of the inbred mice used to produce the hybrid B6C3F₁ study animal. In mid-1981, data were obtained that showed incompatibility between the NIH C3H reference

II. MATERIALS AND METHODS

colony and the C3H colony from a Program supplier. In August 1981, inbred parental lines of mice were further tested for genetic integrity via isozyme and protein electrophoresis profiles that demonstrate phenotype expressions of known genetic loci.

The C57BL/6 mice were homogeneous at all loci tested. Eighty-five percent of the C3H mice monitored were variant at one to three loci, indicating some heterogeneity in the C3H line from this supplier. Nevertheless, the genome of this line is more homogeneous than that of randomly bred stocks.

Male mice from the C3H colony and female mice from the C57BL/6 colony were used as parents for the hybrid B6C3F₁ mice used in these studies. The influence of the potential genetic non-uniformity in the hybrid mice on these results is not known, but results of the studies are not affected because concurrent controls were included in each study.

Animal Maintenance

Rats and mice were housed individually. Feed and water were freely available except during exposure periods, when only water was available (see Table 5).

Clinical Examinations and Pathology

All animals were observed two times per day. Clinical signs were recorded at least once per month. Individual body weights were recorded once per week for the first 13 weeks of the study and once per month thereafter. Animals found moribund and those surviving to the end of the studies were humanely killed. A necropsy was performed on all animals, including those found dead, unless they were excessively autolyzed or cannibalized, missexed, or found missing. Thus, the number of animals from which particular organs or tissues were examined microscopically varies and is not necessarily equal to the number of animals that were placed on study.

During necropsy, all organs and tissues were examined for grossly visible lesions. Tissues were preserved in 10% neutral buffered formalin,

embedded in paraffin, sectioned, and stained with hematoxylin and eosin. Tissues examined microscopically are listed in Table 5.

When the pathology evaluation was completed, the slides, paraffin blocks, and residual wet tissues were sent to the NTP Archives for inventory, slide/block match, and wet tissue audit. The slides, individual animal data records, and pathology tables were sent to an independent quality assessment laboratory. The individual animal records and tables were compared for accuracy, slides and tissue counts were verified, and histotechnology was evaluated. All tumor diagnoses, all target tissues, and all tissues from a randomly selected 10% of the animals were evaluated by a quality assessment pathologist. The quality assessment report and slides were submitted to the Pathology Working Group (PWG) Chairperson, who reviewed all target tissues and those about which there was a disagreement between the laboratory and quality assessment pathologists.

Representative slides selected by the Chairperson were reviewed by the PWG, which includes the laboratory pathologist, without knowledge of previously rendered diagnoses. When the consensus diagnosis of the PWG differed from that of the laboratory pathologist, the laboratory pathologist was asked to reconsider the original diagnosis. This procedure has been described, in part, by Maronpot and Boorman (1982) and Boorman et al. (1985). The final diagnoses represent a consensus of contractor pathologists and the NTP Pathology Working Group. For subsequent analysis of pathology data, the diagnosed lesions for each tissue type are combined according to the guidelines of McConnell et al. (1986).

Slides/tissues are generally not evaluated in a blind fashion (i.e., without knowledge of dose group) unless the lesions in question are subtle or unless there is an inconsistent diagnosis of lesions by the laboratory pathologist. Nonneoplastic lesions are not examined routinely by the quality assessment pathologist or PWG unless they are considered part of the toxic effect of the chemical. Mean body weights were calculated for each group.

II. MATERIALS AND METHODS

Statistical Methods

Data Recording: Data on this experiment were recorded in the Carcinogenesis Bioassay Data System (Linhart et al., 1974). The data elements include descriptive information on the chemicals, animals, experimental design, survival, body weight, and individual pathologic results, as recommended by the International Union Against Cancer (Berenblum, 1969).

Survival Analyses: The probability of survival was estimated by the product-limit procedure of Kaplan and Meier (1958) and is presented in the form of graphs. Animals were censored from the survival analyses at the time they were found dead of other than natural causes or were found to be missing; animals dying from natural causes were not censored. Statistical analyses for a possible dose-related effect on survival used the method of Cox (1972) for testing two groups for equality and Tarone's (1975) life table test for a dose-related trend. When significant survival differences were detected, additional analyses using these procedures were carried out to determine the time point at which significant differences in the survival curves were first detected. All reported P values for the survival analysis are two-sided.

Calculation of Incidence: The incidence of neoplastic or nonneoplastic lesions is given as the ratio of the number of animals bearing such lesions at a specific anatomic site to the number of animals in which that site was examined. In most instances, the denominators include only those animals for which the site was examined histologically. However, when macroscopic examination was required to detect lesions (e.g., skin or mammary tumors) prior to histologic sampling, or when lesions could have appeared at multiple sites (e.g., lymphomas), the denominators consist of the number of animals on which a necropsy was performed.

Analysis of Tumor Incidence: Three statistical methods are used to analyze tumor incidence data. The two that adjust for intercurrent mortality employ the classical method for combining contingency tables developed by Mantel and Haenszel (1959). Tests of significance included pairwise comparisons of high dose and low dose

groups with controls and tests for overall dose-response trends.

For studies in which compound administration has little effect on survival, the results of the three alternative analyses will generally be similar. When differing results are obtained by the three methods, the final interpretation of the data will depend on the extent to which the tumor under consideration is regarded as being the cause of death. All reported P values for tumor analyses are one-sided.

*Life Table Analyses--*The first method of analysis assumed that all tumors of a given type observed in animals dying before the end of the study were "fatal"; i.e., they either directly or indirectly caused the death of the animal. According to this approach, the proportions of tumor-bearing animals in the dosed and control groups were compared at each point in time at which an animal died with a tumor of interest. The denominators of these proportions were the total number of animals at risk in each group. These results, including the data from animals killed at the end of the study, were then combined by the Mantel-Haenszel method to obtain an overall P value. This method of adjusting for intercurrent mortality is the life table method of Cox (1972) and of Tarone (1975). The underlying variable considered by this analysis is time to death due to tumor. If the tumor is rapidly lethal, then time to death due to tumor closely approximates time to tumor onset. In this case, the life table test also provides a comparison of the time-specific tumor incidences.

*Incidental Tumor Analyses--*The second method of analysis assumed that all tumors of a given type observed in animals that died before the end of the study were "incidental"; i.e., they were merely observed at necropsy in animals dying of an unrelated cause. According to this approach, the proportions of tumor-bearing animals in dosed and control groups were compared in each of five time intervals: weeks 0-52, weeks 53-78, weeks 79-92, week 93 to the week before the terminal-kill period, and the terminal-kill period. The denominators of these proportions were the number of animals actually examined for tumors during the time interval. The individual time interval comparisons were then

II. MATERIALS AND METHODS

combined by the previously described method to obtain a single overall result. (See Haseman, 1984, for the computational details of both methods.)

Unadjusted Analyses--Primarily, survival-adjusted methods are used to evaluate tumor incidence. In addition, the results of the Fisher exact test for pairwise comparisons and the Cochran-Armitage linear trend test (Armitage, 1971; Gart et al., 1979) are given in the appendix containing the analyses of primary tumor incidence. These two tests are based on the overall

proportion of tumor-bearing animals and do not adjust for survival differences.

Historical Control Data: Although the concurrent control group is always the first and most appropriate control group used for evaluation, there are certain instances in which historical control data can be helpful in the overall assessment of tumor incidence. Consequently, control tumor incidences from the NTP historical control data base (Haseman et al., 1984) are included for those tumors appearing to show compound-related effects.

III. RESULTS

RATS

SINGLE-EXPOSURE STUDIES

FOURTEEN-DAY STUDIES

THIRTEEN-WEEK STUDIES

TWO-YEAR STUDIES

Body Weights and Clinical Signs

Survival

Pathology and Statistical Analyses of Results

MICE

SINGLE-EXPOSURE STUDIES

FOURTEEN-DAY STUDIES

THIRTEEN-WEEK STUDIES

TWO-YEAR STUDIES

Body Weights and Clinical Signs

Survival

Pathology and Statistical Analyses of Results

III. RESULTS: RATS

SINGLE-EXPOSURE STUDIES

All the rats that were exposed at 5,163 ppm died before the end of the studies, and deaths also occurred in all but the lowest dose groups (Table 6). Mean body weight gain was not dose related. Hypoactivity, ataxia, and anesthesia were observed in all dosed groups.

FOURTEEN-DAY STUDIES

Two of five male rats and 3/5 female rats exposed at 1,750 ppm died before the end of the studies

(Table 7). No other deaths occurred. The final mean body weight of male rats exposed at 1,750 ppm was 72% that of the controls. Dyspnea, hypoactivity, and ataxia were observed in rats in the highest dose group.

THIRTEEN-WEEK STUDIES

Four of 10 male and 7/10 female rats exposed at 1,600 ppm died before the end of the studies (Table 8). Final mean body weights of rats exposed at 1,600 ppm were 20% lower than that of the controls for males and 11% lower for females.

TABLE 6. SURVIVAL AND MEAN BODY WEIGHTS OF RATS IN THE SINGLE-EXPOSURE INHALATION STUDIES OF TETRACHLOROETHYLENE

Concentration (ppm)	Survival (a)	Mean Body Weights (grams)		
		Initial (b)	Final	Change (c)
MALE				
2,445	5/5	87 ± 4	149 ± 4	+ 62 ± 4
3,786	4/5	95 ± 12	166 ± 5	+ 60 ± 3
4,092	3/5	107 ± 4	160 ± 10	+ 51 ± 3
4,513	3/5	124 ± 4	187 ± 5	+ 60 ± 2
5,163	0/5	150 ± 6	(d)	(d)
FEMALE				
2,445	5/5	74 ± 3	107 ± 1	+ 33 ± 3
3,786	1/5	90 ± 2	112	+ 30
4,092	2/5	88 ± 2	116 ± 4	+ 32 ± 1
4,513	2/5	100 ± 2	128 ± 10	+ 26 ± 6
5,163	0/5	109 ± 4	(d)	(d)

(a) Number surviving/number initially in group

(b) Initial mean group body weight ± standard error of the mean. Subsequent calculations are based on those animals surviving to the end of the study.

(c) Mean body weight change of the survivors of the group ± standard error of the mean

(d) No data are reported due to the 100% mortality in this group.

TABLE 7. SURVIVAL AND MEAN BODY WEIGHTS OF RATS IN THE FOURTEEN-DAY INHALATION STUDIES OF TETRACHLOROETHYLENE

Target Concentration (ppm)	Survival (a)	Mean Body Weights (grams)			Final Weight Relative to Controls (percent)
		Initial (b)	Final	Change (c)	
MALE					
0	5/5	115 ± 3	169 ± 5	+ 54 ± 2	--
100	5/5	118 ± 5	176 ± 7	+ 58 ± 4	104
200	5/5	115 ± 4	163 ± 5	+ 48 ± 2	96
425	5/5	110 ± 2	166 ± 3	+ 56 ± 2	98
875	5/5	112 ± 3	169 ± 3	+ 57 ± 2	100
1,750	(d) 3/5	108 ± 3	122 ± 3	+ 17 ± 1	72
FEMALE					
0	5/5	97 ± 4	124 ± 4	+ 27 ± 1	--
100	5/5	98 ± 3	124 ± 6	+ 26 ± 3	100
200	5/5	97 ± 3	122 ± 5	+ 25 ± 4	98
425	5/5	96 ± 3	121 ± 4	+ 25 ± 3	98
875	5/5	96 ± 3	122 ± 1	+ 26 ± 3	98
1,750	(e) 2/5	94 ± 4	129 ± 5	+ 26 ± 2	104

(a) Number surviving/number in group
 (b) Initial group mean body weight ± standard error of the mean. Subsequent calculations are based on those animals surviving to the end of the study.
 (c) Mean body weight change of the survivors of the group ± standard error of the mean
 (d) Days of death: 7, 8
 (e) Days of death: 7, 8, 13

TABLE 8. SURVIVAL AND MEAN BODY WEIGHTS OF RATS IN THE THIRTEEN-WEEK INHALATION STUDIES OF TETRACHLOROETHYLENE

Target Concentration (ppm)	Survival (a)	Mean Body Weights (grams)			Final Weight Relative to Controls (percent)
		Initial (b)	Final	Change (c)	
MALE					
0	10/10	194 ± 4	358 ± 6	+ 164 ± 5	--
100	10/10	204 ± 4	352 ± 8	+ 148 ± 8	98
200	10/10	197 ± 5	358 ± 6	+ 161 ± 7	100
400	10/10	200 ± 5	349 ± 8	+ 149 ± 7	97
800	10/10	202 ± 5	350 ± 6	+ 148 ± 7	98
1,600	(d) 6/10	199 ± 5	286 ± 3	+ 80 ± 7	80
FEMALE					
0	10/10	142 ± 3	206 ± 5	+ 64 ± 3	--
100	10/10	137 ± 3	197 ± 3	+ 60 ± 3	96
200	10/10	137 ± 3	202 ± 4	+ 65 ± 3	98
400	10/10	140 ± 3	206 ± 4	+ 66 ± 4	100
800	10/10	141 ± 2	204 ± 2	+ 63 ± 1	99
1,600	(e) 3/10	140 ± 3	183 ± 4	+ 37 ± 1	89

(a) Number surviving/number in group
 (b) Initial group mean body weight ± standard error of the mean. Subsequent calculations are based on those animals surviving to the end of the study.
 (c) Mean body weight change of the survivors of the group ± standard error of the mean
 (d) Week of death: 1, 11, 13, 13
 (e) Week of death: 5, 5, 5, 6, 7, 12, 13

III. RESULTS: RATS

Lung congestion was observed in rats exposed at 1,600 ppm. The incidence and severity of hepatic congestion in rats was dose related (Table 9). Congestion was most severe in animals that died before the end of the studies.

Dose Selection Rationale: Because of the incidence of deaths at 1,600 ppm and the incidence of liver lesions at lower concentrations, exposure concentrations of 200 and 400 ppm tetrachloroethylene were selected for rats for the 2-year studies. These exposure concentrations are twofold and fourfold higher than the OSHA

standard for occupational exposure of humans to tetrachloroethylene in the workplace. The estimated equivalents of these exposure concentrations are 311 mg/kg per day (200 ppm) and 622 mg/kg per day (400 ppm). (See footnote in Introduction, p. 19.)

TWO-YEAR STUDIES

Body Weights and Clinical Signs

Mean body weights of dosed and control groups were comparable throughout the studies (Table 10 and Figure 1).

TABLE 9. SEVERITY OF LIVER AND LUNG CONGESTION IN RATS IN THE THIRTEEN-WEEK INHALATION STUDIES OF TETRACHLOROETHYLENE

Group	Liver		Lung	
	Male	Female	Male	Female
Control	(a) 1/10 (2.0)	0/9	0/10	0/9
200 ppm	2/10 (2.0)	1/10 (1.0)	--	--
400 ppm	3/10 (1.7)	5/10 (1.8)	--	--
800 ppm	5/10 (1.6)	5/10 (1.6)	0/10	0/10
1,600 ppm	7/10 (2.0)	8/9 (1.8)	7/10 (2.4)	7/10 (3.0)

(a) Incidence of lesion; mean severity score of affected animals is in parentheses: 1 = minimal; 2 = mild; 3 = moderate; 4 = severe

TABLE 10. MEAN BODY WEIGHTS AND SURVIVAL OF RATS IN THE TWO-YEAR INHALATION STUDIES OF TETRACHLOROETHYLENE

Weeks on Study	Control		200 ppm (a)			400 ppm (b)		
	Av. Wt. (grams)	No. of Survivors	Av. Wt. (grams)	Wt. (percent of controls)	No. of Survivors	Av. Wt. (grams)	Wt. (percent of controls)	No. of Survivors
MALE								
0	162	50	164	101	50	165	102	50
1	182	50	191	105	50	194	107	50
2	212	50	219	103	50	221	104	50
3	234	50	241	103	50	245	105	50
4	255	50	260	102	50	264	104	50
5	274	50	277	101	50	275	100	50
6	284	50	292	103	50	289	102	50
7	295	50	300	102	50	295	100	50
8	308	50	313	102	50	309	100	50
9	309	50	293	95	50	290	94	50
10	316	50	292	92	50	295	93	50
11	329	50	325	99	50	324	98	50
12	333	50	329	99	50	336	101	50
13	341	50	344	101	50	340	100	50
17	387	50	370	101	50	369	101	50
21	396	50	397	100	50	394	99	50
25	418	50	412	99	50	408	98	50
28	424	50	419	99	50	418	99	50
34	425	50	423	100	49	420	99	50
38	431	50	426	99	49	428	99	50
43	447	50	440	98	48	437	98	50
47	452	50	447	99	48	452	100	50
51	460	50	457	99	48	457	99	50
55	468	50	465	99	47	463	99	50
60	471	50	471	100	47	469	100	50
64	477	50	471	99	47	471	99	50
69	483	48	477	99	46	475	98	49
73	486	48	479	99	45	471	97	49
76	484	48	476	98	45	477	99	47
82	484	48	475	98	43	466	96	45
86	480	46	469	98	40	470	98	37
90	471	42	445	94	36	464	99	34
95	456	38	455	100	34	447	98	31
99	448	33	441	98	28	435	97	27
FEMALE								
0	119	50	121	102	50	120	101	50
1	127	50	135	106	50	134	106	50
2	136	50	148	109	50	148	109	50
3	147	50	156	106	50	152	103	50
4	158	50	166	105	50	165	104	50
5	167	50	175	105	50	168	101	50
6	173	50	179	103	50	176	102	50
7	177	50	187	106	50	181	102	50
8	185	50	193	104	50	187	101	50
9	187	50	177	95	50	174	93	50
10	190	50	186	98	50	178	94	50
11	193	50	199	103	50	195	101	50
12	197	50	193	98	50	199	101	50
13	198	50	203	103	50	198	100	50
17	209	50	213	102	50	208	100	50
21	218	50	227	104	50	220	101	50
25	225	50	233	104	50	227	101	50
28	233	50	236	101	50	230	99	50
34	234	50	240	103	50	231	99	50
38	238	50	244	103	50	236	99	50
43	252	50	260	103	50	248	98	50
47	257	50	266	104	50	257	100	50
51	266	50	275	103	50	262	98	50
55	273	50	283	104	50	271	99	50
60	284	49	292	103	50	281	99	50
64	292	48	302	103	49	293	100	50
69	300	48	311	104	49	300	100	50
73	313	47	317	101	48	308	98	50
76	316	47	319	101	46	312	99	48
82	320	47	323	101	44	318	99	43
86	323	43	325	101	41	318	98	39
90	323	38	325	101	39	323	100	36
95	317	36	318	100	35	317	100	34
99	320	30	322	101	28	322	101	32

(a) Estimated equivalent dose: 311 mg/kg per day
 (b) Estimated equivalent dose: 622 mg/kg per day

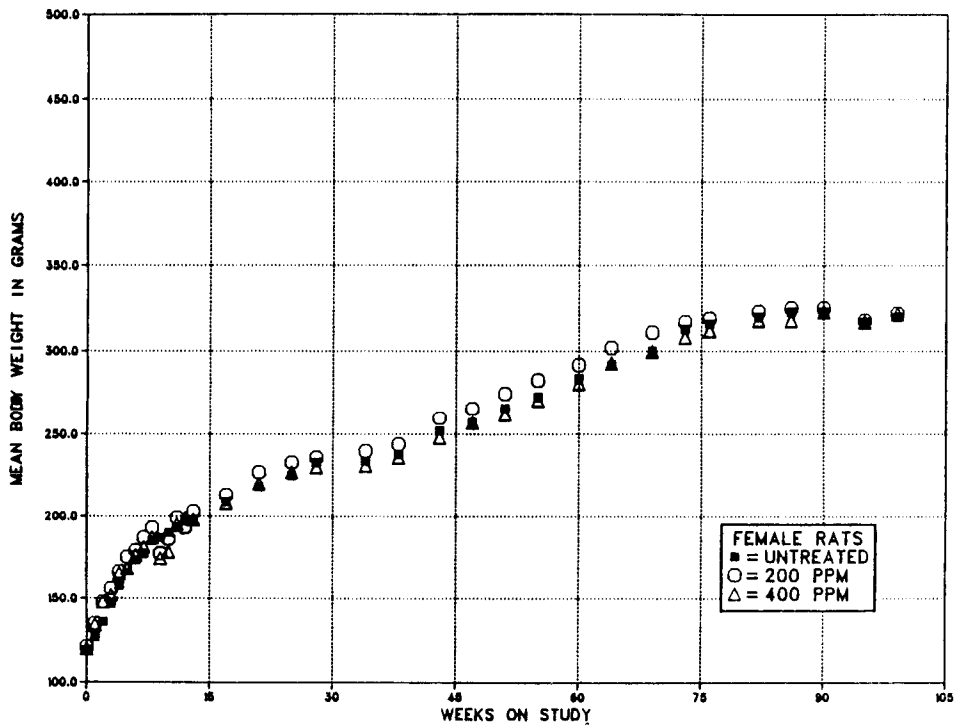
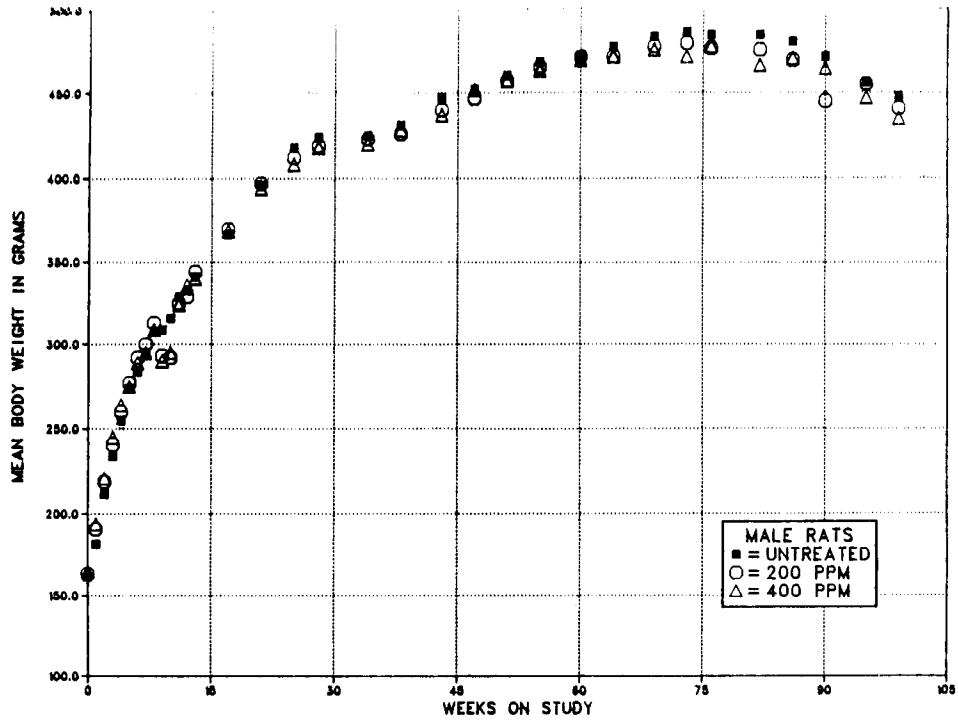

FIGURE 1. GROWTH CURVES FOR RATS EXPOSED TO TETRACHLOROETHYLENE BY INHALATION FOR TWO YEARS

Survival

Estimates of the probabilities of the survival for male and female rats exposed to tetrachloroethylene at the concentrations used in these studies and for the controls are shown in the Kaplan and Meier curves in Figure 2. The survival of the high dose male rats was significantly lower than that of controls after week 102 (Table 11).

Pathology and Statistical Analyses of Results

This section describes the significant or noteworthy changes in the incidences of rats with neoplastic or nonneoplastic lesions of the

hematopoietic system, kidney, brain, testis, preputial gland, nasal cavity, adrenal gland, and forestomach. Histopathologic findings on neoplasms in rats are summarized in Appendix A (Tables A1 and A2); Appendix A (Tables A3 and A4) also gives the survival and tumor status for individual male and female rats. Findings on nonneoplastic lesions are summarized in Appendix C (Tables C1 and C2). Appendix E (Tables E1 and E2) contains the statistical analyses of those primary tumors that occurred with an incidence of at least 5% in one of the three groups. The statistical analyses used are discussed in Chapter II (Statistical Methods) and Appendix E (footnotes). Historical incidences of tumors in control animals are listed in Appendix F.

TABLE 11. SURVIVAL OF RATS IN THE TWO-YEAR INHALATION STUDIES OF TETRACHLOROETHYLENE

	Control	200 ppm	400 ppm
MALE (a)			
Animals initially in study	50	50	50
Nonaccidental deaths before termination (b)	27	30	38
Died during termination period	0	1	1
Killed at termination	23	19	11
Survival P values (c)	0.024	0.432	0.023
FEMALE (a)			
Animals initially in study	50	50	50
Nonaccidental deaths before termination (b)	27	29	26
Killed at termination	23	21	24
Survival P values (c)	1.000	0.767	0.990

(a) Terminal-kill period: week 104

(b) Includes animals killed in a moribund condition

(c) The result of the life table trend test is in the control column, and the results of the life table pairwise comparisons with the controls are in the dosed columns.

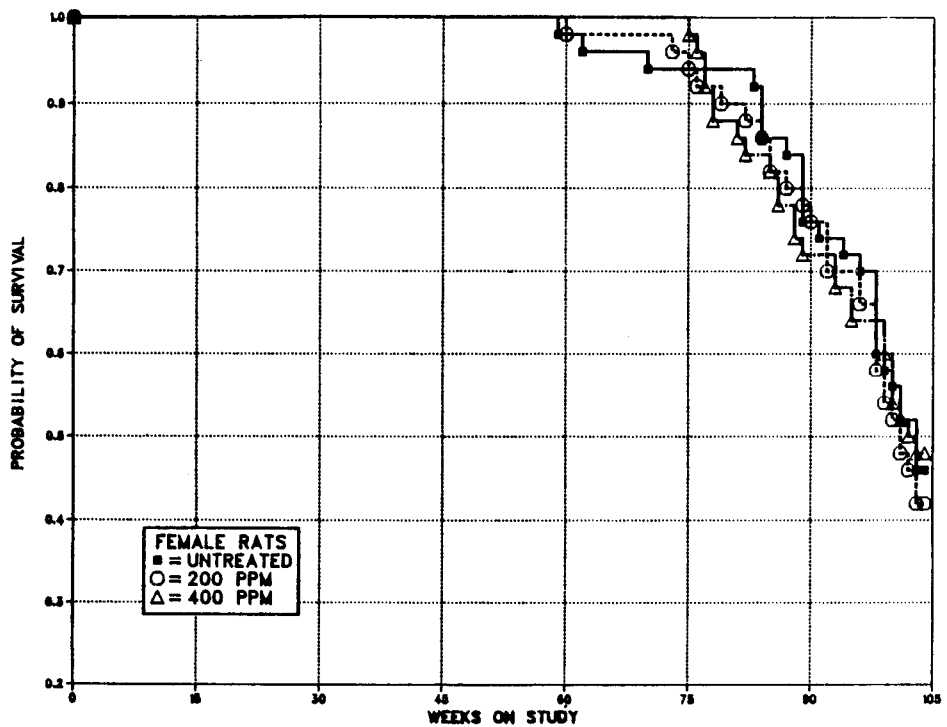
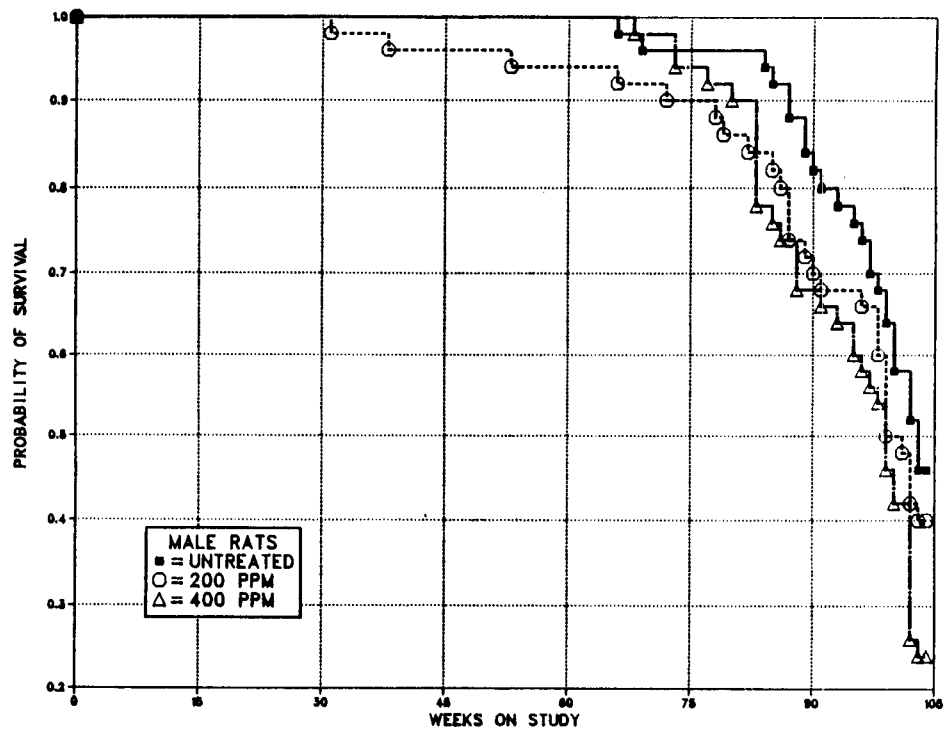

FIGURE 2. KAPLAN-MEIER SURVIVAL CURVES FOR RATS EXPOSED TO TETRACHLOROETHYLENE BY INHALATION FOR TWO YEARS

III. RESULTS: RATS

Hematopoietic System: Mononuclear cell leukemia occurred with positive trends in males and females, and the incidences in the dosed groups were greater than those in the controls (Table 12). This hematopoietic neoplasm was recognized in its earliest stage as a diffuse infiltration of atypical mononuclear cells in the sinusoids of the liver and the interfollicular pulp of the spleen. In more advanced cases, there were infiltrations into virtually all organs and tissues.

The diagnoses of mononuclear cell leukemia were classified according to the extent of the disease as stage 1 (early), stage 2 (intermediate), or stage 3 (advanced). The following criteria were used:

Stage 1--Spleen not enlarged or only slightly enlarged with small numbers of neoplastic mononuclear cells in the red pulp; no or very few mononuclear cells in the liver sinusoids. No identifiable neoplastic cells in other organs.

Stage 2--Spleen moderately enlarged with

moderate to large numbers of mononuclear cells in the red pulp; architectural features including lymphoid follicles and periarteriolar lymphocytic sheaths remain intact. Minimal to moderate involvement of the liver. Mononuclear cells may be evident in blood vessels in other organs, but aggregates/masses of neoplastic cells generally limited to spleen and liver.

Stage 3--Advanced disease with multiple organ involvement. Spleen usually markedly enlarged with effacement of normal architectural features by accumulated neoplastic cells. Liver moderately to markedly enlarged and nodular; hepatic parenchyma shows variable degenerative changes associated with the accumulation of neoplastic cells. Accumulations of neoplastic mononuclear cells in other organs including lung, lymph nodes, kidney, brain, adrenal gland, and others.

The distribution of stages of mononuclear cell leukemia in male and female rats is summarized in Table 13.

TABLE 12. ANALYSIS OF MONONUCLEAR CELL LEUKEMIA IN RATS IN THE TWO-YEAR INHALATION STUDIES OF TETRACHLOROETHYLENE (a)

	Control	200 ppm	400 ppm
MALE (b)			
Overall Rates	28/50 (56%)	37/50 (74%)	37/50 (74%)
Adjusted Rates	64.6%	80.1%	90.8%
Terminal Rates	9/23 (39%)	11/20 (55%)	9/12 (75%)
Week of First Observation	66	53	68
Life Table Tests	P=0.004	P=0.046	P=0.004
Incidental Tumor Tests	P=0.097	P=0.023	P=0.104
FEMALE (c)			
Overall Rates	18/50 (36%)	30/50 (60%)	29/50 (58%)
Adjusted Rates	53.8%	71.4%	66.3%
Terminal Rates	9/23 (39%)	10/21 (48%)	10/24 (42%)
Week of First Observation	84	60	76
Life Table Tests	P=0.053	P=0.023	P=0.053
Incidental Tumor Tests	P=0.012	P=0.013	P=0.014

(a) The statistical analyses used are discussed in Chapter II (Statistical Methods) and Appendix E (footnotes).

(b) Historical incidence at study laboratory (mean \pm SD): 117/250 (47% \pm 15%); historical incidence in NTP studies: 583/1,977 (29% \pm 12%)

(c) Historical incidence at study laboratory (mean \pm SD): 73/249 (29% \pm 6%); historical incidence in NTP studies: 375/2,021 (19% \pm 7%)

TABLE 13. CLASSIFICATION OF MONONUCLEAR CELL LEUKEMIA IN RATS IN THE TWO-YEAR INHALATION STUDIES OF TETRACHLOROETHYLENE

Group	Number of Rats with Mononuclear Cell Leukemia	Stage		
		1	2	3
MALE				
Control	28	5	3	20
200 ppm	37	6	7	24
400 ppm	37	4	6	27
FEMALE				
Control	18	3	5	10
200 ppm	30	6	6	18
400 ppm	29	2	6	21

Kidney: Both nonproliferative (karyomegaly and cytomegaly) and proliferative (tubular cell hyperplasia, adenomas, and adenocarcinomas) changes were found in the kidney (Table 14).

Karyomegaly (reported as nuclear enlargement in Appendix C) and cytomegaly were present primarily in the proximal convoluted tubules of the inner half of the cortex but were not necessarily limited to this area. Affected tubules showed two distinct patterns of changes. In one pattern, the cells were greatly enlarged and bulged into the lumens of the tubules. Cytoplasm was abundant, brightly eosinophilic, and granular. Basal striations and brush borders were frequently prominent. Nuclei were enlarged up to 10 times, rounded or oval, and contained deeply basophilic stippled or reticulated chromatin and a single nucleolus. Mitoses were occasionally present. In the second pattern, the lining cells of the tubules were flattened and spindle-shaped and were thinner at the ends than at the center, where the greatly enlarged, basophilic, elongated nucleus bulged into the lumen.

Tubular cell hyperplasias were small circumscribed lesions often only a few hundred microns in diameter. Typically the cells were small with poorly defined basophilic cytoplasm and round

open-faced nuclei. These lesions consisted of a nonseptated mass of cells which did not compress the surrounding parenchyma.

Tubular cell adenomas were well circumscribed and compressed the adjacent parenchyma. They were composed of variably sized cuboidal, columnar, or polygonal cells that formed solid lobules separated by delicate connective tissue septa. Occasionally the cytoplasm was basophilic and granular or vacuolated and reticular. The nuclei were round and open faced, and mitoses were infrequent.

Tubular cell adenocarcinomas were usually larger than adenomas and may have invaded the adjacent parenchyma. The cells were more pleomorphic than in the adenomas and often contained large bizarre nuclei. Mitoses, although not common, were more frequent than in adenomas. Necrosis, hemorrhage, and cholesterol clefts were often present.

Tubular cell karyomegaly was observed at increased incidences in dosed male and female rats. Tubular cell hyperplasia was seen in dosed males and in one high dose female. Tubular cell adenomas or adenocarcinomas (combined) were observed at increased (although not statistically significant) incidences in dosed male but not dosed female rats (Table 14).

TABLE 14. ANALYSIS OF RENAL LESIONS IN RATS IN THE TWO-YEAR INHALATION STUDIES OF TETRACHLOROETHYLENE

	Control	200 ppm	400 ppm
MALE			
Karyomegaly			
Overall Rates	1/49 (2%)	37/49 (76%)	47/50 (94%)
Tubular Cell Hyperplasia			
Overall Rates	0/49 (0%)	3/49 (6%)	5/50 (10%)
Tubular Cell Adenoma (a)			
Overall Rates	1/49 (2%)	3/49 (6%)	2/50 (4%)
Tubular Cell Adenocarcinoma			
Overall Rates	0/49 (0%)	0/49 (0%)	2/50 (4%)
Tubular Cell Adenoma or Adenocarcinoma			
Overall Rates	1/49 (2%)	3/49 (6%)	4/50 (8%)
Adjusted Rates	4.3%	10.8%	22.4%
Terminal Rates	1/23 (4%)	1/20 (5%)	2/12 (17%)
Week of First Observation	104	91	83
Life Table Tests	P=0.054	P=0.259	P=0.070
Incidental Tumor Tests	P=0.107	P=0.296	P=0.114
FEMALE			
Karyomegaly			
Overall Rates	0/50 (0%)	8/49 (16%)	20/50 (40%)
Tubular Cell Hyperplasia			
Overall Rates	0/50 (0%)	0/49 (0%)	1/50 (2%)

(a) Historical incidence at study laboratory (mean \pm SD): 1/249 (0.4% \pm 0.9%); historical incidence in NTP studies: 4/1,968 (0.2% \pm 0.6%); no malignant tubular cell tumors have been observed.

Brain: Gliomas in male rats occurred with a significant positive trend by life table analysis (Table 15). The incidences in the dosed groups were not significantly greater than that in the controls by statistical comparisons, but four of these tumors were observed in the high dose males. Gliomas were also found in one control and two high dose females.

Testis: Interstitial cell tumors in male rats occurred with a significant positive trend, and the

incidences in the dosed groups were significantly greater than that in the controls (Table 16).

Preputial Gland: Adenomas or carcinomas (combined) in male rats occurred with a positive trend by life table analysis (control, 3/50, 6%; low dose, 5/50, 10%; high dose, 6/50, 12%); the incidences in the dosed groups were not significantly greater than that in the controls.

TABLE 15. ANALYSIS OF GLIOMAS IN MALE RATS IN THE TWO-YEAR INHALATION STUDY OF TETRACHLOROETHYLENE (a)

	Control	200 ppm	400 ppm
Overall Rates	1/50 (2%)	0/50 (0%)	4/50 (8%)
Adjusted Rates	4.3%	0.0%	17.3%
Terminal Rates	1/23 (4%)	0/20 (0%)	0/12 (0%)
Week of First Observation	104		88
Life Table Tests	P=0.039	P=0.528N	P=0.083
Incidental Tumor Tests	P=0.103	P=0.528N	P=0.207

(a) Historical incidence of neuroglial cell tumors at study laboratory (mean): 3/247 (1.2%); historical incidence in NTP studies: 16/1,971 (0.8%). Gliomas were found in 1/50 control, 0/50 low dose, and 2/50 high dose female rats.

TABLE 16. ANALYSIS OF TESTICULAR INTERSTITIAL CELL LESIONS IN MALE RATS IN THE TWO-YEAR INHALATION STUDY OF TETRACHLOROETHYLENE

	Control	200 ppm	400 ppm
Hyperplasia			
Overall Rates	5/50 (10%)	6/49 (17%)	4/50 (8%)
Tumor (a)			
Overall Rates	35/50 (70%)	39/49 (80%)	41/50 (82%)
Adjusted Rates	91.4%	97.5%	100.0%
Terminal Rates	20/23 (87%)	19/20 (95%)	12/12 (100%)
Week of First Observation	69	82	68
Life Table Tests	P<0.001	P=0.093	P=0.001
Incidental Tumor Tests	P=0.012	P=0.047	P=0.024
Hyperplasia or Tumor			
Overall Rates	40/50 (80%)	45/49 (92%)	45/50 (90%)

(a) Historical incidence at study laboratory (mean \pm SD): 175/249 (70% \pm 7%); historical incidence in NTP studies: 1,729/1,949 (89% \pm 7%)

Nasal Cavity: Thrombosis was observed at increased incidences in high dose male and dosed female rats (male: control, 9/50, 18%; low dose, 11/50, 22%; high dose, 19/50, 38%; female: 3/50, 6%; 10/50, 20%; 7/50, 14%). Squamous metaplasia was observed at increased incidences in dosed male rats (male: 0/50; 5/50, 10%; 5/50, 10%; female: 2/50, 4%; 4/50, 8%; 2/50, 4%).

Adrenal Gland: The incidences of adrenal medullary hyperplasia in dosed males and adrenal cortical hyperplasia in high dose female rats were greater than those in the controls (medullary hyperplasia: male--5/49, 10%; 14/49, 29%; 12/49, 24%; female--7/50, 14%; 3/49, 6%; 4/47, 9%; cortical hyperplasia: male--11/49, 22%;

5/49, 10%; 7/49, 14%; female--4/50, 8%; 6/49, 12%; 11/47, 23%). Pheochromocytomas in male rats occurred with a significant positive trend by the life table test, and the incidence in the high dose group was significantly greater than that in the controls by the life table test (22/49, 45%; 21/49, 43%; 23/49, 47%), but not by the incidental tumor test, which is the more appropriate analysis for these generally nonlethal neoplasms.

Forestomach: Ulcers were observed at an increased incidence in high dose male rats (male: 0/48; 1/49, 2%; 5/49, 10%; female: 3/49, 6%; 4/49, 8%; 0/48).

SINGLE-EXPOSURE STUDIES

All mice exposed at 2,971 or 3,786 ppm died before the end of the studies; compound-related deaths also occurred at 2,613 ppm (Table 17). Mean body weight gain was not dose related. Hypoactivity and anesthesia in exposed animals were considered to be compound related.

FOURTEEN-DAY STUDIES

None of the mice died before the end of the studies (Table 18). Dyspnea, hypoactivity, hyperactivity, anesthesia, and ataxia were observed in mice in the highest dose group. The final mean body weights of mice exposed at 1,750 ppm were 6% lower than that of controls for males and 7% lower for females. Cytoplasmic vacuolation (fat) of the hepatocytes was observed in 4/5 males at 875 ppm and in 5/5 males and 5/5 females at 1,750 ppm.

THIRTEEN-WEEK STUDIES

Two of 10 males and 4/10 females that were exposed to tetrachloroethylene at 1,600 ppm died before the end of the studies (Table 19). On the second day of exposure only, all mice in the 1,600-ppm group were uncoordinated and unconscious, mice in the 800-ppm group were panting and appeared irritated, and mice in the 400-ppm group were hunched and did not move. The final mean body weight of males exposed at 1,600 ppm was 8% lower than that of the controls. Final mean body weights of dosed and control female mice were comparable. Liver lesions (leukocytic infiltration, centrilobular necrosis, and bile stasis) were seen in mice exposed at 400, 800, or 1,600 ppm (Table 20). Karyomegaly (nuclear enlargement) of the renal tubule epithelial cells was observed in 7/10 males and 7/10 females exposed at 1,600 ppm.

TABLE 17. SURVIVAL AND MEAN BODY WEIGHTS OF MICE IN THE SINGLE-EXPOSURE INHALATION STUDIES OF TETRACHLOROETHYLENE

Concentration (ppm)	Survival (a)	Mean Body Weights (grams)		
		Initial (b)	Final	Change (c)
MALE				
2,328	5/5	25.2 ± 0.9	27.0 ± 1.3	+1.8 ± 0.5
2,445	5/5	18.8 ± 0.7	24.4 ± 0.8	+5.6 ± 0.4
2,613	1/5	22.8 ± 1.1	21.0	+1.0
2,971	0/5	21.4 ± 0.5	(d)	(d)
3,786	0/5	19.2 ± 0.4	(d)	(d)
FEMALE				
2,328	3/5	21.0 ± 0.3	22.3 ± 0.3	+1.0 ± 0.6
2,445	5/5	16.6 ± 0.6	20.4 ± 0.4	+3.8 ± 0.4
2,613	3/5	19.4 ± 0.2	21.3 ± 0.3	+2.0 ± 0.0
2,971	0/5	19.2 ± 0.6	(d)	(d)
3,786	0/5	17.6 ± 0.5	(d)	(d)

(a) Number surviving/number initially in the group

(b) Initial mean group body weight ± standard error of the mean. Subsequent calculations are based on those animals surviving to the end of the study.

(c) Mean body weight change of the survivors of the group ± standard error of the mean

(d) No data are reported due to the 100% mortality in this group.

TABLE 18. SURVIVAL AND MEAN BODY WEIGHTS OF MICE IN THE FOURTEEN-DAY INHALATION STUDIES OF TETRACHLOROETHYLENE

Target Concentration (ppm)	Survival (a)	Mean Body Weights (grams)			Final Weight Relative to Controls (percent)
		Initial (b)	Final	Change (c)	
MALE					
0	5/5	25.4 ± 0.6	27.6 ± 1.0	+ 2.2 ± 0.7	--
100	5/5	25.2 ± 0.6	28.4 ± 0.7	+ 3.2 ± 0.2	102.9
200	5/5	25.4 ± 0.4	28.6 ± 0.2	+ 3.2 ± 0.5	103.6
425	5/5	24.8 ± 0.2	27.0 ± 0.7	+ 2.2 ± 0.6	97.8
875	5/5	25.0 ± 0.8	27.4 ± 0.7	+ 2.4 ± 0.4	99.3
1,750	5/5	24.4 ± 0.4	26.0 ± 0.8	+ 1.6 ± 0.4	94.2
FEMALE					
0	5/5	19.8 ± 0.5	24.8 ± 0.5	+ 5.0 ± 0.0	--
100	5/5	19.0 ± 0.6	23.6 ± 0.6	+ 4.6 ± 0.4	95.2
200	5/5	19.0 ± 0.5	24.2 ± 0.5	+ 5.2 ± 0.4	97.6
425	5/5	19.4 ± 0.4	23.2 ± 0.4	+ 3.8 ± 0.4	93.5
875	5/5	20.0 ± 0.3	24.6 ± 0.4	+ 4.6 ± 0.2	99.2
1,750	5/5	19.0 ± 0.3	23.0 ± 0.5	+ 4.0 ± 0.3	92.7

(a) Number surviving/number in group
 (b) Initial mean group body weight ± standard error of the mean
 (c) Mean body weight change ± standard error of the mean

TABLE 19. SURVIVAL AND MEAN BODY WEIGHTS OF MICE IN THE THIRTEEN-WEEK INHALATION STUDIES OF TETRACHLOROETHYLENE

Concentration (ppm)	Survival (a)	Mean Body Weights (grams)			Final Weight Relative to Controls (percent)
		Initial (b)	Final	Change (c)	
MALE					
0	10/10	27.4 ± 0.8	32.9 ± 0.8	+ 5.5 ± 0.3	--
100	10/10	27.4 ± 0.7	34.5 ± 0.8	+ 7.1 ± 0.9	104.9
200	10/10	26.3 ± 1.1	32.2 ± 0.8	+ 5.9 ± 1.6	97.9
400	10/10	25.4 ± 0.8	32.8 ± 0.6	+ 7.4 ± 0.6	99.7
800	10/10	27.0 ± 0.8	33.3 ± 0.6	+ 6.3 ± 0.7	101.2
1,600	(d) 8/10	27.4 ± 0.6	30.4 ± 1.5	+ 2.9 ± 1.3	92.4
FEMALE					
0	10/10	21.5 ± 0.5	27.5 ± 0.8	+ 6.0 ± 0.7	--
100	10/10	22.0 ± 0.6	28.6 ± 0.7	+ 6.6 ± 0.3	104.0
200	10/10	22.0 ± 0.4	28.2 ± 0.6	+ 6.2 ± 0.4	102.5
400	10/10	19.6 ± 0.6	29.5 ± 0.9	+ 9.9 ± 0.6	107.3
800	10/10	20.5 ± 0.6	28.2 ± 0.7	+ 7.7 ± 0.5	102.5
1,600	(e) 6/10	21.8 ± 0.4	27.5 ± 0.5	+ 5.5 ± 0.5	100.0

(a) Number surviving/number in group
 (b) Initial group mean body weight ± standard error of the mean. Subsequent calculations are based on those animals surviving to the end of the study.
 (c) Mean body weight change of the survivors of the group ± standard error of the mean
 (d) Week of death: 12, 14
 (e) Week of death: 1, 8, 12, 13

TABLE 20. INCIDENCE AND SEVERITY OF LIVER AND KIDNEY LESIONS IN MICE IN THE THIRTEEN-WEEK INHALATION STUDIES OF TETRACHLOROETHYLENE

Group	<u>Liver: Leukocytic Infiltration/ Centrilobular Necrosis/Bile Stasis</u>		<u>Liver Mitotic Alteration</u>		<u>Kidney Karyomegaly</u>	
	Male	Female	Male	Female	Male	Female
Control	(a) 0/10	0/10	0/10	0/10	0/10	0/10
100 ppm	--	--	--	--	0/10	0/10
200 ppm	0/10	0/10	3/10 (1.0)	0/10	6/10 (1.0)	8/10 (1.0)
400 ppm	8/10 (1.4)	5/10 (1.2)	5/10 (1.6)	0/10	10/10 (1.6)	10/10 (2.0)
800 ppm	10/10 (1.8)	10/10 (1.2)	5/10 (2.2)	0/10	10/10 (1.4)	10/10 (1.5)
1,600 ppm	10/10 (2.2)	8/9 (1.6)	1/10 (1.0)	0/9	7/7 (1.6)	6/7 (1.7)

(a) Incidence of lesion; mean severity score of affected animals is in parentheses: 1 = minimal; 2 = mild; 3 = moderate; 4 = severe

Dose Selection Rationale: Because of the incidence of deaths at 1,600 ppm and hepatic and renal lesions observed at lower doses, exposure concentrations selected for mice for the 2-year studies were 100 and 200 ppm tetrachloroethylene. The 200-ppm exposure concentration is twice the OSHA standard for occupational exposure of humans to tetrachloroethylene in the workplace. The estimated equivalents of these exposure concentrations are 160 mg/kg per day

(100 ppm) and 320 mg/kg per day (200 ppm). (See footnote in Introduction, p. 19.)

TWO-YEAR STUDIES

Body Weights and Clinical Signs

Mean body weights of dosed and control male and dosed and control female mice were comparable throughout the studies (Table 21 and Figure 3).

TABLE 21. MEAN BODY WEIGHTS AND SURVIVAL OF MICE IN THE TWO-YEAR INHALATION STUDIES OF TETRACHLOROETHYLENE

Weeks on Study	Control		200 ppm (a)			400 ppm (b)		
	Av. Wt. (grams)	No. of Survivors	Av. Wt. (grams)	Wt. (percent of controls)	No. of Survivors	Av. Wt. (grams)	Wt. (percent of controls)	No. of Survivors
MALE								
0	23.3	50	23.0	99	50	21.8	94	50
1	25.4	50	24.9	98	50	23.6	93	50
2	25.3	50	26.6	105	50	27.7	109	50
3	25.9	50	27.3	105	50	27.9	108	50
4	27.6	50	28.9	105	50	29.8	108	50
5	31.2	50	28.8	92	50	28.5	91	50
6	28.9	50	27.7	96	50	29.3	101	50
7	29.4	50	29.2	99	50	30.7	104	50
8	28.9	50	31.1	108	50	30.6	106	50
9	30.2	50	31.5	104	50	27.3	90	50
10	30.3	50	31.0	102	50	28.1	93	50
11	30.1	50	31.8	106	50	32.1	107	50
12	30.2	50	32.6	108	50	31.9	106	50
13	31.2	50	31.1	100	50	31.6	101	50
17	31.8	50	32.1	101	50	33.2	104	50
21	33.3	50	33.3	100	50	34.0	102	50
25	34.2	50	33.5	98	50	35.5	104	50
28	34.0	50	33.0	97	50	35.0	103	50
34	36.7	50	33.8	92	50	37.7	103	50
38	35.5	50	35.5	100	50	35.6	100	50
43	38.1	50	36.3	95	50	37.7	99	50
47	37.4	50	36.9	99	49	40.1	107	50
51	36.7	50	36.9	101	49	38.4	105	50
55	37.4	50	36.3	97	49	39.0	104	50
60	37.5	50	36.8	98	48	38.9	104	50
64	37.1	50	36.9	105	46	39.4	106	48
69	37.9	50	36.9	97	45	38.6	102	48
73	38.5	50	37.5	97	45	39.0	101	48
78	38.3	50	37.2	97	43	38.8	101	45
82	38.4	50	36.8	96	42	39.3	102	42
86	38.2	50	37.7	99	37	38.5	101	40
90	38.1	49	37.1	97	35	38.3	101	39
95	37.0	49	36.2	98	33	38.7	105	37
99	36.6	46	37.1	101	27	37.6	103	35
FEMALE								
0	18.0	49	18.0	100	50	18.2	101	50
1	20.0	49	18.9	95	50	19.8	99	49
2	20.0	49	20.9	105	50	20.4	102	49
3	21.1	49	21.2	100	50	22.5	107	49
4	22.0	48	22.7	103	50	23.0	105	49
5	23.5	47	23.3	99	50	23.0	98	49
6	22.0	47	22.3	101	48	24.0	109	49
7	23.0	47	22.8	99	48	24.2	105	49
8	23.5	47	24.0	102	48	24.3	103	49
9	24.1	47	25.8	107	48	19.8	82	49
10	24.1	47	25.6	106	48	25.9	107	49
11	24.6	47	26.2	107	46	26.1	106	49
12	25.6	47	25.9	101	48	26.2	102	49
13	24.9	47	24.6	99	45	27.9	112	49
17	26.2	46	26.9	103	44	27.5	105	49
21	27.1	46	27.5	101	44	27.7	102	49
25	27.8	46	28.0	101	43	28.4	102	49
28	28.9	46	28.4	98	43	28.9	100	49
34	30.0	46	28.9	96	43	30.0	100	49
38	30.0	46	29.5	98	42	28.6	95	48
43	32.0	46	30.0	94	42	30.8	96	48
47	32.0	46	30.0	94	42	31.4	98	48
51	32.0	46	30.8	96	42	31.5	98	48
55	32.0	46	30.3	95	42	32.0	100	47
60	31.9	45	31.7	99	42	31.9	100	47
64	32.0	45	31.7	99	42	33.7	105	47
69	33.6	45	32.5	97	42	33.1	99	46
73	33.2	44	31.8	96	42	33.5	101	44
78	33.8	44	32.0	95	40	33.7	100	43
82	34.3	44	31.5	92	40	33.6	98	42
86	33.4	43	32.2	96	39	33.1	99	40
90	32.9	43	32.4	98	38	30.6	93	36
95	32.7	42	32.3	99	35	31.8	97	33
99	32.4	39	32.3	100	35	32.1	99	27

(a) Estimated equivalent dose: 160 mg/kg per day
(b) Estimated equivalent dose: 320 mg/kg per day

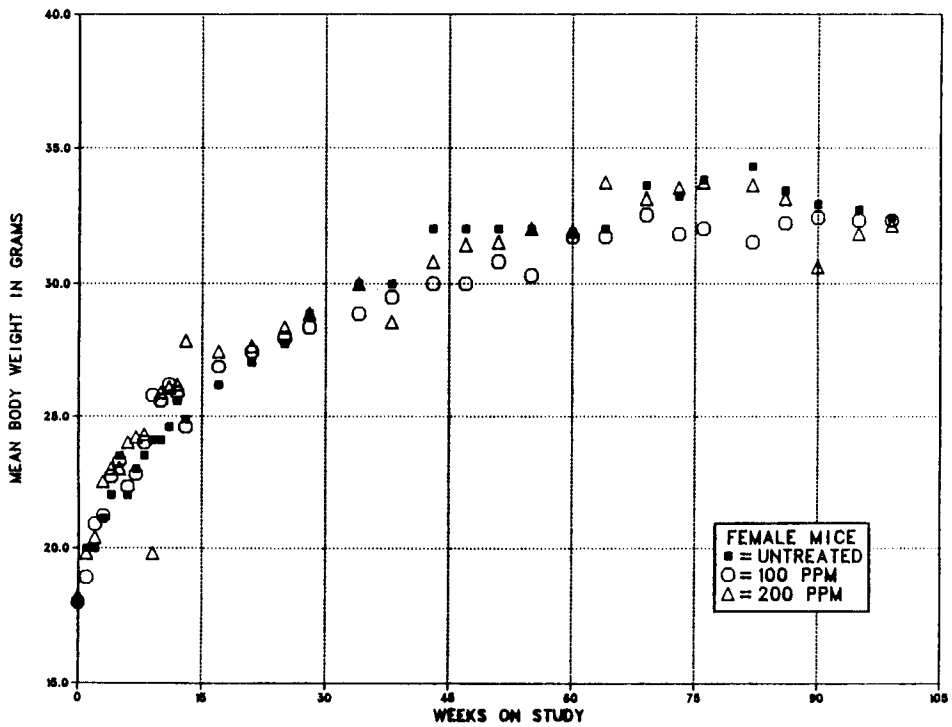
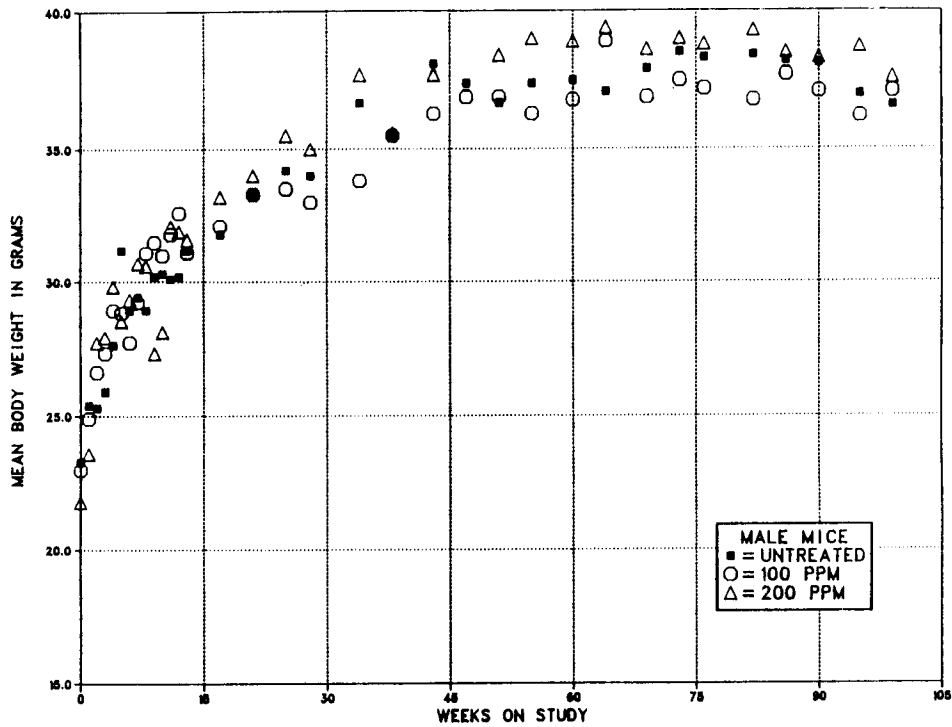

FIGURE 3. GROWTH CURVES FOR MICE EXPOSED TO TETRACHLOROETHYLENE BY INHALATION FOR TWO YEARS

III. RESULTS: MICE

Survival

Estimates of the probabilities of survival for male and female mice exposed to tetrachloroethylene at the concentrations used in these studies and for the controls are shown in the Kaplan and Meier curves in Figure 4. The survival of the low dose (after week 74) and high dose (after week 78) male groups and the high dose female group (after week 90) was significantly lower than that of the controls (Table 22).

Pathology and Statistical Analyses of Results

This section describes the significant or noteworthy changes in the incidences of mice with

neoplastic or nonneoplastic lesions of the liver, kidney, and lung. Histopathologic findings on neoplasms in mice are summarized in Appendix B (Tables B1 and B2); Appendix B (Tables B3 and B4) also gives the survival and tumor status for individual male and female mice. Findings on nonneoplastic lesions are summarized in Appendix D (Tables D1 and D2). Appendix E (Tables E3 and E4) contains the statistical analyses of those primary tumors that occurred with an incidence of at least 5% in one of the three groups. The statistical analyses used are discussed in Chapter II (Statistical Methods) and Appendix E (footnotes). Historical incidences of tumors in control animals are listed in Appendix F.

TABLE 22. SURVIVAL OF MICE IN THE TWO-YEAR INHALATION STUDIES OF TETRACHLOROETHYLENE

	Control	100 ppm	200 ppm
MALE (a)			
Animals initially in study	50	50	50
Nonaccidental deaths before termination (b)	3	25	18
Animals missexed	1	0	0
Killed at termination	46	25	32
Survival P values (c)	0.002	<0.001	<0.001
FEMALE (a)			
Animals initially in study	50	50	50
Nonaccidental deaths before termination (b)	11	17	30
Accidentally killed	2	2	1
Animals missexed	1	0	0
Killed at termination	36	31	17
Died during termination period	0	0	2
Survival P values (c)	<0.001	0.241	<0.001

(a) Terminal-kill period: week 104

(b) Includes animals killed in a moribund condition

(c) The result of the life table trend test is in the control column, and the results of the life table pairwise comparisons with the controls are in the dosed columns.

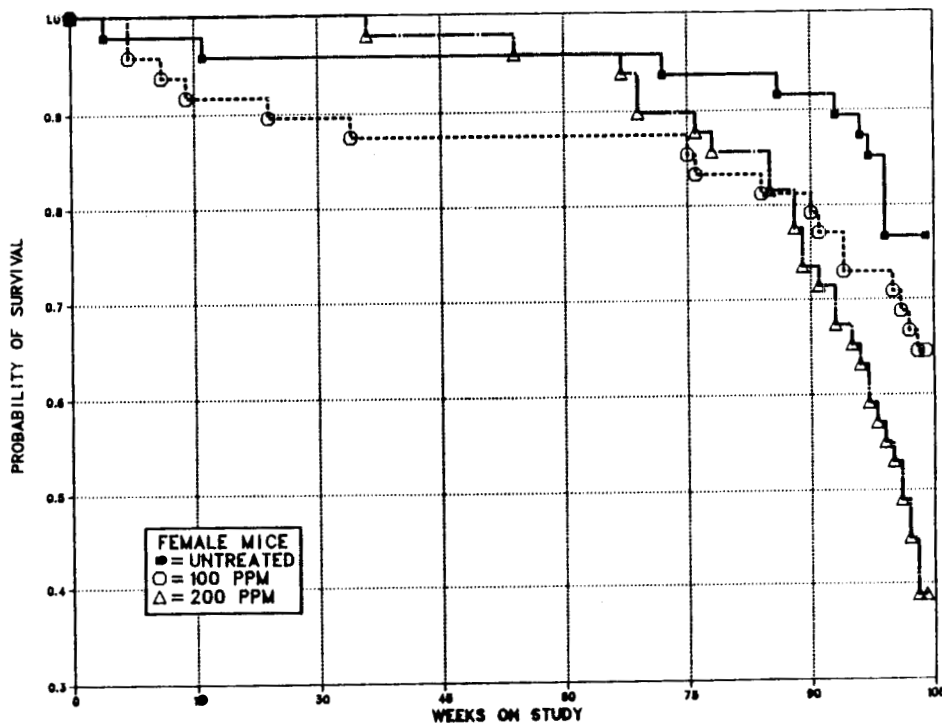
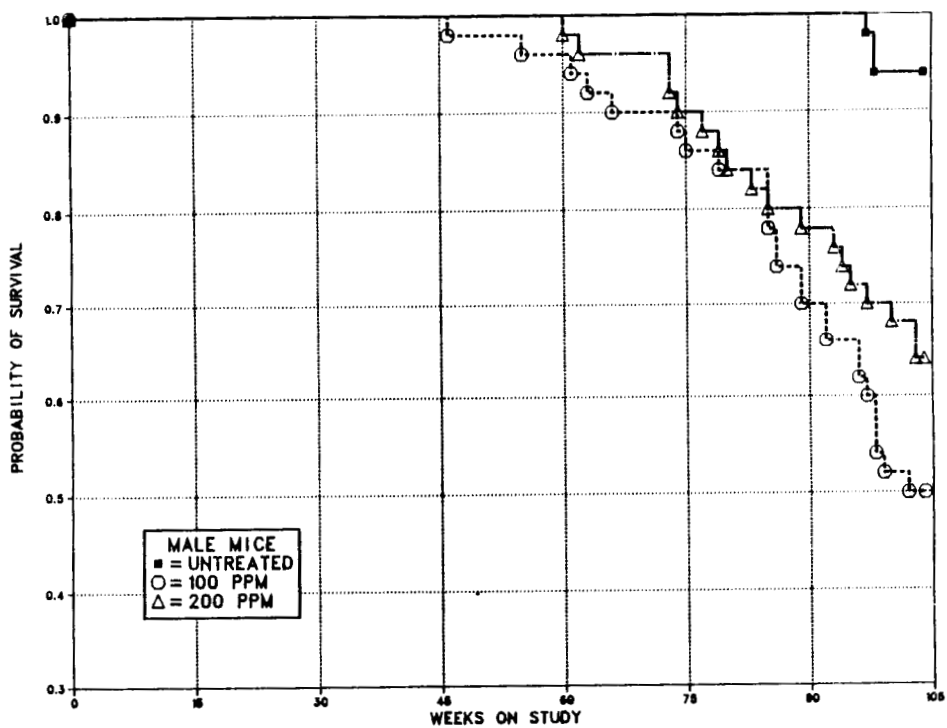

FIGURE 4. KAPLAN-MEIER SURVIVAL CURVES FOR MICE EXPOSED TO TETRACHLOROETHYLENE BY INHALATION FOR TWO YEARS

III. RESULTS: MICE

Kidney: Nephrosis was observed at increased incidences in dosed female mice, casts were observed at increased incidences in dosed male and high dose female mice, and karyomegaly of the tubular cells was observed at increased incidences in dosed mice (Table 23). The severity of the renal lesions was dose related. One low dose male had a renal tubular cell adenocarcinoma.

Liver: Degeneration was observed at increased incidences in dosed male mice (control, 2/49, 4%; low dose, 8/49, 16%; high dose, 14/50, 28%) and high dose female mice (1/49, 2%; 2/50, 4%; 13/50, 26%); necrosis was observed at increased incidences in dosed male (1/49, 2%; 6/49, 12%; 15/50, 30%) and high dose female mice (3/48, 6%; 5/50, 10%; 9/50, 18%); nuclear inclusions were observed at increased incidences in dosed male mice (2/49, 4%; 5/49, 10%; 9/50, 18%). Hepatic degeneration was characterized by a variety of histologic features, including cytoplasmic vacuolation, hepatocellular necrosis, inflammatory cell infiltrates, pigment in cells, oval cell hyperplasia, and regenerative foci.

Hepatocellular adenomas in males, hepatocellular carcinomas in males and females, and hepatocellular adenomas or carcinomas (combined) in males and females occurred with significant positive trends (Table 24). The incidences of hepatocellular adenomas in high dose males and hepatocellular carcinomas and hepatocellular adenomas or carcinomas (combined) in dosed mice were significantly greater than those in the controls.

Hepatocellular carcinomas metastasized to the lung in two control males and seven low dose and one high dose males and in two low dose and seven high dose females. Additional hepatocellular carcinomas metastasized to the pulmonary artery in one low dose male, to the pulmonary vein in one low dose and one high dose male, and to multiple organs in one low dose male mouse (Appendix B, Tables B3 and B4).

Lung: Acute passive congestion was observed at increased incidences in dosed mice (male: control, 1/49; low dose, 8/49; high dose, 10/50; female: 1/48; 5/50; 6/50).

TABLE 23. NUMBER OF MICE WITH NONNEOPLASTIC LESIONS OF THE KIDNEY IN THE TWO-YEAR INHALATION STUDIES OF TETRACHLOROETHYLENE

Lesion	Control	100 ppm	200 ppm
MALE			
Number of animals examined	49	49	50
Cast	3	9	15
Tubular cell karyomegaly	4	17	46
Nephrosis	22	24	28
FEMALE			
Number of animals examined	48	49	50
Cast	4	4	15
Tubular cell karyomegaly	0	16	38
Nephrosis	5	14	25

TABLE 24. ANALYSIS OF LIVER TUMORS IN MICE IN THE TWO-YEAR INHALATION STUDIES OF TETRACHLOROETHYLENE (a)

	Control	100 ppm	200 ppm
MALE			
Hepatocellular Adenoma			
Overall Rates	12/49 (24%)	8/49 (16%)	19/50 (38%)
Adjusted Rates	26.1%	29.9%	55.4%
Terminal Rates	12/46 (26%)	7/25 (28%)	17/32 (53%)
Week of First Observation	104	89	73
Life Table Tests	P=0.004	P=0.419	P=0.005
Incidental Tumor Tests	P=0.008	P=0.542	P=0.012
Hepatocellular Carcinoma			
Overall Rates	7/49 (14%)	25/49 (51%)	26/50 (52%)
Adjusted Rates	14.9%	58.3%	58.3%
Terminal Rates	6/46 (13%)	8/25 (32%)	14/32 (44%)
Week of First Observation	98	63	60
Life Table Tests	P<0.001	P<0.001	P<0.001
Incidental Tumor Tests	P=0.002	P=0.016	P=0.001
Hepatocellular Adenoma or Carcinoma (b)			
Overall Rates	17/49 (35%)	31/49 (63%)	41/50 (82%)
Adjusted Rates	36.1%	73.0%	89.0%
Terminal Rates	16/46 (35%)	14/25 (56%)	27/32 (84%)
Week of First Observation	98	63	60
Life Table Tests	P<0.001	P<0.001	P<0.001
Incidental Tumor Tests	P<0.001	P=0.026	P<0.001
FEMALE			
Hepatocellular Adenoma			
Overall Rates	3/48 (6%)	6/50 (12%)	2/50 (4%)
Adjusted Rates	7.5%	18.7%	6.1%
Terminal Rates	1/36 (3%)	5/31 (16%)	0/19 (0%)
Week of First Observation	96	102	78
Life Table Tests	P=0.479	P=0.182	P=0.641N
Incidental Tumor Tests	P=0.325N	P=0.193	P=0.213N
Hepatocellular Carcinoma			
Overall Rates	1/48 (2%)	13/50 (26%)	36/50 (72%)
Adjusted Rates	2.8%	35.5%	91.7%
Terminal Rates	1/36 (3%)	8/31 (26%)	16/19 (84%)
Week of First Observation	104	76	67
Life Table Tests	P<0.001	P<0.001	P<0.001
Incidental Tumor Tests	P<0.001	P<0.001	P<0.001
Hepatocellular Adenoma or Carcinoma (c)			
Overall Rates	4/48 (8%)	17/50 (34%)	38/50 (76%)
Adjusted Rates	10.1%	46.7%	92.2%
Terminal Rates	2/36 (6%)	12/31 (39%)	16/19 (84%)
Week of First Observation	96	76	67
Life Table Tests	P<0.001	P<0.001	P<0.001
Incidental Tumor Tests	P<0.001	P<0.001	P<0.001

(a) The statistical analyses used are discussed in Chapter II (Statistical Methods) and Appendix E (footnotes).

(b) Historical incidence at study laboratory (mean \pm SD): 83/249 (33% \pm 7%); historical incidence in NTP studies: 627/2,084 (30% \pm 8%)

(c) Historical incidence at study laboratory (mean \pm SD): 19/248 (8% \pm 4%); historical incidence in NTP studies: 181/2,080 (9% \pm 5%)

IV. DISCUSSION AND CONCLUSIONS

IV. DISCUSSION AND CONCLUSIONS

Toxicology and carcinogenicity studies were conducted by administering tetrachloroethylene (99.9% pure) by inhalation to groups of 50 male and 50 female F344/N rats and B6C3F₁ mice for 6 hours per day, 5 days per week, for 103 weeks. The exposure concentrations used in these studies (0 [chamber controls], 200, or 400 ppm in rats and 0, 100, or 200 ppm in mice) were selected on the basis of results of 13-week inhalation studies in which groups of rats and mice of each sex were exposed to tetrachloroethylene at concentrations ranging from 100 to 1,600 ppm for 6 hours per day, 5 days per week.

Thirteen-Week Studies

During the 13-week studies in rats, exposure to tetrachloroethylene at 1,600 ppm killed 4/10 males and 7/10 females. The final mean body weights of animals that survived exposure at the highest concentration were reduced relative to those of the controls (male, 20%; female, 11%). Histopathologic changes observed included pulmonary congestion in animals exposed at 1,600 ppm (male, 8/10; female, 7/10) but not at 800 ppm. A dose-related increase in the incidence of hepatic congestion was observed in both sexes, but the severity of this effect in animals exposed at 200-800 ppm was considered to be minimal to mild. Affected animals in the 1,600-ppm groups (male, 7/10; female, 8/9) exhibited mild to severe hepatic congestion.

In mice, exposure at 1,600 ppm for 13 weeks killed 2/10 males and 4/10 females. As in rats, the final mean body weights of male mice that survived exposure at 1,600 ppm were lower than those of the controls. Minimal to mild microscopic liver and kidney changes were observed in mice exposed at 200-1,600 ppm tetrachloroethylene. The liver changes included leukocytic infiltration, centrilobular necrosis, bile stasis, and mitotic alteration. The kidney changes were described as karyomegaly of the tubular epithelial cells and were considered to be of minimal severity in the affected 6/10 males and 8/10 females exposed at 200 ppm; at higher doses, the karyomegaly was more severe.

Karyomegaly has been observed in earlier gavage studies of tetrachloroethylene (NTP, unpublished), pentachloroethane (NTP, 1983), and

trichloroethylene (NTP, 1987, in preparation). These changes are the earliest renal effects produced by these chemicals and are associated with cytomegaly, tubular dilatation, and renal tubular epithelial cell hyperplasia. Although kidney lesions were not found in the rats exposed to tetrachloroethylene for 13 weeks in these studies, both rats and mice in the aforementioned studies were affected.

Selection of exposure concentrations for the 2-year studies in rats and mice was made on the basis of the lethality at 1,600 ppm in both species and the production of liver or kidney lesions at the lower concentrations. Although the changes produced at the lower concentrations were generally minimal to mild, earlier experiences with chlorinated ethanes and ethylenes indicated that these changes may be progressive. This is particularly true of the kidney lesions. In earlier 2-year gavage studies on trichloroethylene and tetrachloroethylene, the survival of rats and mice was not affected for approximately 40 weeks, and then high incidences of early deaths among dosed animals occurred for the remainder of the studies. Early deaths in dosed rats in the earlier studies compromised the sensitivity of the studies.

Two-Year Studies

Survival of Rats: Exposure at 400 ppm tetrachloroethylene reduced the survival of male rats (control, 23/50; low dose, 20/50; high dose, 12/50) but not that of the females (control, 23/50; low dose, 21/50; high dose, 24/50). Most of the unscheduled deaths in the high dose male group (33/38, 87%) occurred late in the study (week 82 or later) and may have been related to a high incidence of mononuclear cell leukemia. There were positive trends in the incidences of leukemia in male and female rats, and the incidences in the dosed males were greater than that in the control group by life table analysis (overall rates: control, 28/50; low dose, 37/50; high dose, 37/50).

Mononuclear cell leukemia develops spontaneously in F344 and Wistar Furth rats (Moloney and King, 1971; Moloney et al., 1969; Davey and Moloney, 1970) and has been estimated to be fatal within 2-6 weeks of onset (Stromberg and

IV. DISCUSSION AND CONCLUSIONS

Vogtsberger, 1983). To determine if the increased incidence of leukemia in the dosed males may have contributed to the excess in unscheduled deaths among high dose males, the stage of the disease in all affected animals was determined microscopically. The diagnoses of mononuclear cell leukemia were classified as stage 1 (early stage of the disease), stage 2 (intermediate stage), or stage 3 (advanced and probably fatal) according to the criteria detailed in the Results section.

The results summarized in Table 25 show the comparative incidences of stage-3 mononuclear cell leukemia in rats that died before the scheduled termination of the studies and in rats that lived to the end of the study. The percentage of animals in each dose group with stage-3 mononuclear cell leukemia was consistently higher among animals that died early than among animals that lived to the end of the study. When overall unexplained deaths are considered, 11 more high dose males than controls died before the scheduled termination of the study. If advanced stage leukemias are discounted, there were only three more unexplained deaths in the high dose male group. These facts suggest a relationship between the incidence of mononuclear cell leukemia and the excess early deaths in the high dose male group.

Survival of Mice: Exposure to tetrachloroethylene at 100 or 200 ppm reduced survival of male mice and at 200 ppm reduced survival of

female mice. As in the rat studies, most of the early deaths in dosed mice occurred after week 82. Among males, the survival rate at week 82 was 50/50 in controls, 42/50 in the low dose group, and 42/50 in the high dose group; among females, it was 44/50 in the controls, 40/50 in the low dose group, and 42/50 in the high dose group. The survival of the chamber control male mice was unusually high; 46/50 lived to the termination of the study. The unscheduled deaths in dosed mice may have been influenced by the high incidence of hepatocellular carcinomas. There were dose-related increases in the incidences of this tumor among early death mice (male: control, 1/3, 33%; low dose, 17/24, 71%; high dose, 12/18, 67%; female: control, 0/12; low dose, 5/19, 26%; high dose, 20/31, 65%). Because of the small number of early deaths in the male mouse controls, hepatocellular neoplasms observed in dosed male mice dying before the end of the study were given relatively little weight by the incidental tumor test. Nevertheless, the increased incidences of hepatocellular neoplasms in dosed male and female mice were clear-cut, regardless of which statistical test was used in the data analysis (see Table 22).

Body Weight Gains in Rats and Mice: Body weight gains of dosed rats and mice were not consistently affected by exposure to tetrachloroethylene. Mean body weights for dosed rats were never more than 8% lower than those of the chamber controls.

TABLE 25. COMPARATIVE INCIDENCES OF STAGE-THREE MONONUCLEAR CELL LEUKEMIA IN RATS IN THE TWO-YEAR INHALATION STUDIES OF TETRACHLOROETHYLENE (a)

Group	Animals That Died Before Week 104	Animals That Lived For 104 Weeks
MALE		
Control	15/27 (55%)	5/23 (22%)
200 ppm	21/30 (70%)	3/20 (15%)
400 ppm	23/38 (60%)	4/12 (33%)
FEMALE		
Control	7/27 (26%)	3/23 (13%)
200 ppm	15/29 (52%)	3/21 (14%)
400 ppm	19/26 (73%)	2/24 (8%)

(a) Number of animals with stage-3 mononuclear cell leukemia/number examined

IV. DISCUSSION AND CONCLUSIONS

Mononuclear Cell Leukemia in Rats: There were positive trends for the incidences of mononuclear cell leukemia in male and female rats exposed to tetrachloroethylene (male: control, 28/50; low dose, 37/50; high dose, 37/50; female: control, 18/50; low dose, 30/50; high dose, 29/50). The incidences of mononuclear cell leukemia in male and female control rats of these studies were greater than the mean historical chamber control incidences for inhalation studies at this laboratory (male: 117/250, 47%; female: 73/249, 29%) or for untreated controls from studies throughout the Program (male: 583/1,977, 29%; female: 375/2,021, 18%; Appendix F, Tables F1 and F7).

There is convincing evidence that these leukemias were related to many of the early deaths among both male and female rats exposed to tetrachloroethylene. Most leukemias were diagnosed as being in an advanced and probably fatal stage (see Table 12), and the incidences of these advanced neoplasms in animals that died early (between week 82 and 103) consistently exceeded the incidences observed in animals of the same dose groups that survived to the scheduled termination of the studies. Therefore, life table analyses are the appropriate statistical procedures for these lethal lesions, and these tests indicate increases in incidences of leukemia in

male rats dosed with either 200 ppm ($P=0.046$) or 400 ppm ($P=0.004$). In females, life table analysis of overall leukemia rates revealed a significant increase in the 200-ppm group ($P=0.023$) and a marginal effect ($P=0.053$) in the 400-ppm group.

Mononuclear cell leukemia in exposed rats occurred at significantly increased incidences; the high incidences of stage-3 leukemia in both sexes and the earlier onset of the disease in dosed female rats prompted additional evaluation. The results summarized in Table 25 show that, although there were no tetrachloroethylene-related differences in the numbers of females that died before the scheduled termination of the study, there was a dose-related increase in the percent of females that died early and had stage-3 mononuclear cell leukemia (control, 26%; low dose, 52%; high dose, 73%). Because of this observation, a more appropriate statistical analysis was conducted, in which only the incidences of stage-3 mononuclear cell leukemia in rats were considered. The results of this analysis are shown in Table 26. This analysis revealed positive trends and significant increases in the incidences of stage-3 mononuclear cell leukemia in male and female rats exposed at 400 ppm tetrachloroethylene.

TABLE 26. LIFE TABLE ANALYSIS OF THE INCIDENCES OF STAGE-THREE MONONUCLEAR CELL LEUKEMIA IN RATS IN THE TWO-YEAR INHALATION STUDIES OF TETRACHLOROETHYLENE

	Control	200 ppm	400 ppm
MALE			
Overall Rates	20/50 (40%)	24/50 (48%)	27/50 (54%)
Adjusted Rates	48.9%	54.8%	69.7%
Terminal Rates	5/23 (22%)	3/20 (15%)	4/12 (33%)
Trend Test	$P=0.024$		
Pairwise Comparison		$P=0.181$	$P=0.022$
FEMALE			
Overall Rates	10/50 (20%)	18/50 (36%)	21/50 (42%)
Adjusted Rates	30.7%	46.1%	47.1%
Terminal Rates	3/23 (13%)	3/21 (14%)	2/24 (8%)
Trend Test	$P=0.027$		
Pairwise Comparison		$P=0.065$	$P=0.029$

IV. DISCUSSION AND CONCLUSIONS

Examination of the time to diagnosis of stage-3 mononuclear cell leukemia in female rats also indicates a significant effect of tetrachloroethylene (Table 27). The results in Table 27 show no remarkable differences in the number of deaths among the female rats in the three groups between weeks 80 and 103. There was, however, a dose-related increase in the numbers of animals that died with stage-3 mononuclear cell leukemia. The initial stage-3 mononuclear cell leukemia in control rats was diagnosed in an animal that died during week 96 (when the 15th death among control females occurred). At week 96, there were eight advanced leukemias among 18 early death animals in the 400-ppm group. The first diagnoses of advanced leukemia in dosed animals were made during weeks 60 (200-ppm group) and 76 (400-ppm group). These results indicate that mononuclear cell leukemia, a spontaneously occurring neoplasm in F344/N rats, developed earlier in females that were exposed at 200 or 400 ppm tetrachloroethylene by inhalation. This observation is confirmed by the Kaplan-Meier curve for stage-3 mononuclear cell leukemia in female rats (Figure 5). The Kaplan-Meier curve for stage-3 mononuclear cell leukemia in male rats shows a less pronounced effect.

Kidney Effects in Rats: The nephropathy normally observed in aging F344/N rats was observed in the animals in these studies. In addition, both sexes exhibited renal tubular cell karyomegaly (male: control, 1/49; low dose, 37/49; high dose, 47/50; female: control, 0/50; low dose, 8/49; high dose, 20/50). In males, renal tubular cell hyperplasia was also observed

(control, 0/49; high dose, 3/49; low dose, 5/50). A single high dose female also had renal tubular cell hyperplasia. The effect is not unique to F344/N rats, as it has been observed in male and female rats of the Osborne-Mendel, August, Sprague-Dawley, ACI, and Marshall strains exposed to chlorinated ethylenes (NTP, unpublished results).

In the present studies, in addition to the renal tubular cell karyomegaly and hyperplasia, renal tubular cell adenomas and adenocarcinomas were detected in male rats. The combined incidences of the neoplasms were 1/49 for controls, 3/49 for the low dose group, and 4/49 for the high dose group. No renal tubular cell tumors were detected in female rats. The incidences of these neoplasms in male rats were not statistically significant ($P > 0.05$). However, the induction of these lesions in rats, like the nonproliferative lesions described above, are characteristic effects of the long-term administration of chlorinated ethanes and ethylenes. NTP has noted them in gavage studies of pentachloroethane (Mennear et al., 1982), trichloroethylene (in five strains of rats), and tetrachloroethylene (in five strains of rats).

Because these lesions appeared consistently in dosed animals but not in controls in the present studies and are considered uncommon tumors (historical incidence for chamber controls at this laboratory, 1/249, 0.4%; overall historical incidence for untreated controls in the Program, 4/1,968, 0.2%; Table F4), they are considered to be caused by exposure to tetrachloroethylene.

TABLE 27. CUMULATIVE INCIDENCES OF MONONUCLEAR CELL LEUKEMIA IN FEMALE RATS IN THE TWO-YEAR INHALATION STUDY OF TETRACHLOROETHYLENE

	Week on Study				
	80	85	90	96	103
Control	(a) 0/3	0/7	0/12	1/15	7/27
200 ppm	3/5	6/9	7/12	8/17	15/29
400 ppm	3/6	5/9	9/14	13/18	19/26

(a) Number of animals with stage-3 mononuclear cell leukemia/number of animals that died up to the week indicated

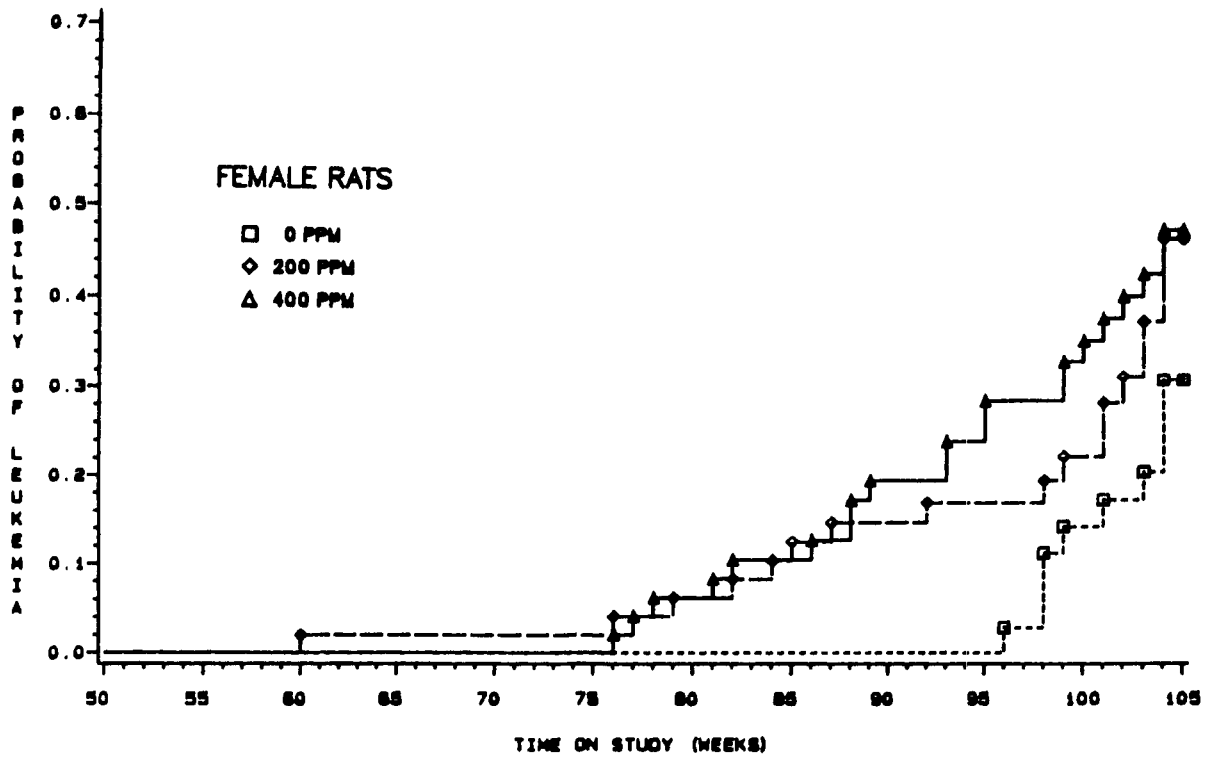
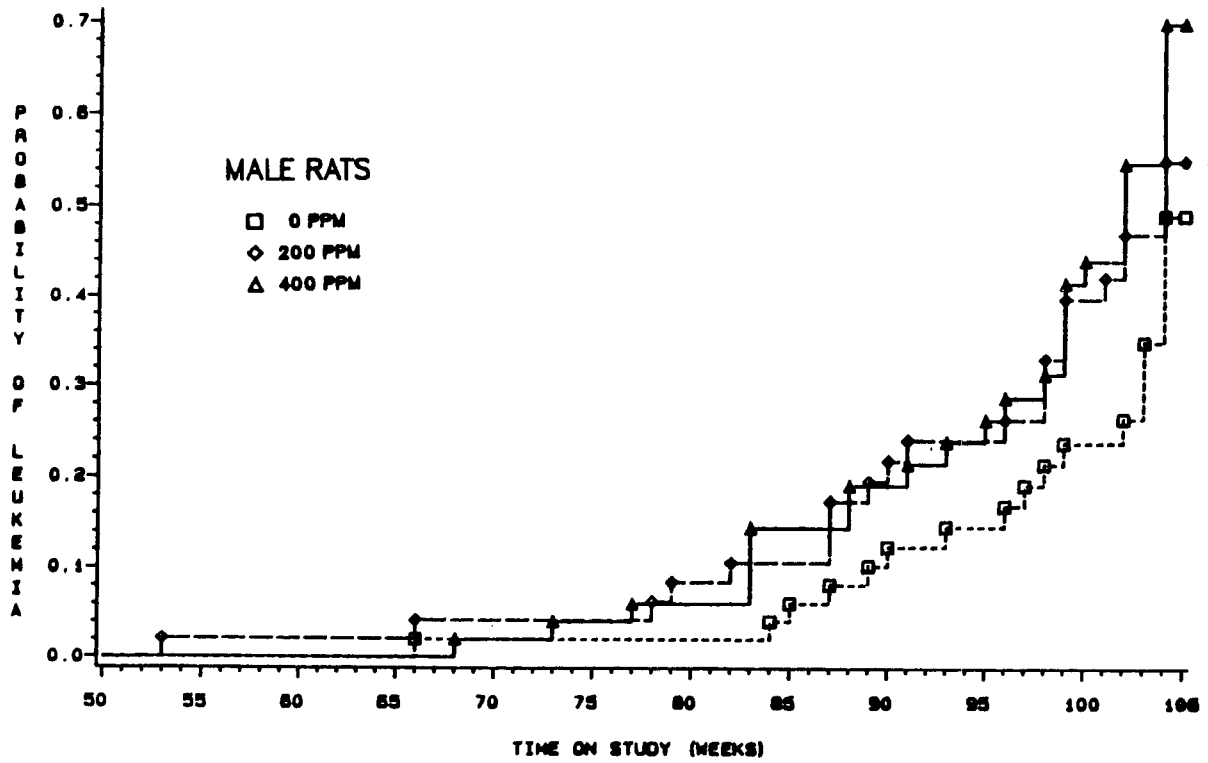

FIGURE 5. KAPLAN-MEIER CURVES FOR STAGE-THREE LEUKEMIA INCIDENCE IN RATS EXPOSED TO TETRACHLOROETHYLENE BY INHALATION FOR TWO YEARS

IV. DISCUSSION AND CONCLUSIONS

Both the nonproliferative and proliferative changes produced by tetrachloroethylene are similar to the renal lesions described in male rats exposed to petroleum products (Mehlman et al., 1984). There are also important differences between the renal lesions produced by petroleum products and by chlorinated ethanes and ethylenes. The changes produced by petroleum products appear only in male rats. In contrast, tetrachloroethylene-induced karyomegaly appears in both sexes of rats and mice. The petroleum product-induced lesion in male rats in subchronic studies features the presence of hyaline droplets, but this change was not found in either rats or mice in the tetrachloroethylene studies. The proliferative changes induced by petroleum products appear only in male rats, whereas proliferative changes were found in both male and female rats dosed with trichloroethylene (NTP, 1987, in preparation). Therefore, although the renal changes produced by petroleum products and chlorinated ethanes and ethylenes may be similar, certain subtle differences argue against classifying them as the same lesion.

Respiratory Tract Effects in Rats: The nasal cavities of both sexes of rats were observed to have dose-related increases in the incidences of thromboses and squamous metaplasia. The nasal thromboses are believed to be secondary to mononuclear cell leukemia. In the present study, only 2 of the 59 animals that had nasal thrombi did not have mononuclear cell leukemia (one control male and one low dose female). There were no neoplastic changes in the respiratory tracts of rats.

Other Findings in Rats: Four high dose male, two high dose female, one control male, and one control female rat exhibited gliomas of the brain. The incidence of this tumor in the male high dose group is above the control incidence at this laboratory (2/247, 0.8%) or in the overall Program (6/1,971, 0.3%). Unlike the kidney lesions described above, compound-related brain tumors have never been observed in earlier NTP studies of tetrachloroethylene, trichloroethylene, or pentachloroethane. The incidences of these tumors in the high dose groups in these studies were not statistically significant, and gliomas were observed in the control groups; for

these reasons, the gliomas are not considered to be tetrachloroethylene-induced neoplasms.

The incidence of testicular interstitial cell tumors in male rats was increased relative to the control incidence. This tumor is common in aging male F344/N rats, and the incidences in both dosed groups are similar to the overall incidence in the Program (1,729/1,949, 89%). Also, when interstitial cell hyperplasia is combined with interstitial cell tumors, the magnitude of the apparent effect is diminished (control, 40/50; low dose, 45/49; high dose, 45/50). Therefore, although the incidences in dosed rats exceed both concurrent controls and the historical control rate for this laboratory (175/249, 70%), the marginal increase is not considered to be related to tetrachloroethylene exposure.

Liver Effects in Mice: In male mice, exposure to tetrachloroethylene caused increased incidences of hepatic degeneration (control, 2/49; low dose, 8/49; high dose, 14/50), hepatic necrosis (1/49; 6/49; 15/50), and hepatic nuclear inclusion (2/49; 5/49; 9/50). Tetrachloroethylene increased the incidences of these lesions in female mice also (hepatic degeneration: 1/49; 2/50; 13/50; necrosis: 3/49; 5/50; 9/50; nuclear inclusion: 0/49; 1/50; 2/50). In addition, tetrachloroethylene at both concentrations increased the incidences of hepatocellular neoplasms in males and females (adenomas or carcinomas combined: male--17/49; 31/49; 41/50; female--4/48; 17/50; 38/50). In male mice, hepatocellular carcinomas metastasized to the lungs in 2/49 of the controls, 7/49 of the low dose group, and 1/50 of the high dose group. One hepatocellular carcinoma metastasized to the pulmonary artery in a low dose male mouse. Metastatic hepatocellular carcinomas were also found in the lungs of 0/48 of the female controls, 2/50 of the low dose female mice, and 7/50 of the high dose female mice.

Kidney Effects in Mice: Renal tubular cell karyomegaly was found in both male and female mice in dose-related incidences (male: control, 4/49; low dose, 17/49; high dose, 46/50; female: control, 0/48; low dose, 16/49; high dose, 38/50). This change is identical to that noted during the 13-week studies and in the 2-year rat studies. It was not, however, accompanied by proliferative changes (such as tubular epithelial cell

IV. DISCUSSION AND CONCLUSIONS

hyperplasia) as it was in rats. One of 49 low dose male mice exhibited a renal tubular cell adenocarcinoma.

Pulmonary Effects in Mice: Acute passive congestion was diagnosed in 10%-20% of dosed males and females and in 2% of the chamber controls, but there were no increases in the incidences of proliferative lesions of the respiratory system in mice.

Tetrachloroethylene produced significant increases in neoplasia in both rats and mice and dose-related incidences of biologically significant nonneoplastic lesions in two of the three organs in which tumors were detected (male rat kidney [see p. 59] and male and female mouse liver [*above*]). In contrast, tetrachloroethylene was not genotoxic in four strains of *Salmonella*, in L5178Y/TK^{+/-} mouse lymphoma cells, or in *Drosophila* (Appendix G).

The experimental and tabulated data for the NTP Technical Report on tetrachloroethylene

were examined for accuracy, consistency, and compliance with Good Laboratory Practice requirements. As summarized in Appendix L, the audit revealed no major problems with the conduct of the studies or with the collection and documentation of the experimental data. No discrepancies were found that influenced the final interpretation of the results of these studies.

Conclusions: Under the conditions of these 2-year inhalation studies, there was *clear evidence of carcinogenicity** of tetrachloroethylene for male F344/N rats as shown by an increased incidence of mononuclear cell leukemia and uncommon renal tubular cell neoplasms. There was *some evidence of carcinogenicity* of tetrachloroethylene for female F344/N rats as shown by increased incidences of mononuclear cell leukemia. There was *clear evidence of carcinogenicity* for B6C3F₁ mice as shown by increased incidences of both hepatocellular adenomas and carcinomas in males and of hepatocellular carcinomas in females.

*Categories of evidence of carcinogenicity are defined in the Note to the Reader on page 2.

A summary of the Peer Review comments and the public discussion on this Technical Report appears on pages 14-15.

V. REFERENCES

V. REFERENCES

1. Abrahamson, S.; Lewis, E. (1971) The detection of mutations in *Drosophila melanogaster*. Hollaender, A., Ed.: Chemical Mutagens: Principles and Methods for Their Detection, Vol. 2. New York: Plenum Press, pp. 461-487.
2. Armitage, P. (1971) Statistical Methods in Medical Research. New York: John Wiley & Sons, Inc., pp. 362-365.
3. Bartsch, H.; Malaveille, C.; Barbin, A.; Planche, G. (1979) Mutagenic and alkylating metabolites of halo-ethylenes, chlorobutadienes and dichlorobutenes produced by rodent or human liver tissues. Arch. Toxicol. 41:249-277.
4. Berkowitz, J. (1978) Literature Review--Problem Definition Studies on Selected Chemicals, Tetrachloroethylene. Cambridge, MA: Arthur D. Little, Inc., pp. 10-57.
5. Berenblum, I., Ed. (1969) Carcinogenicity Testing: A Report of the Panel on Carcinogenicity of the Cancer Research Commission of UICC, Vol. 2. Geneva: International Union Against Cancer.
6. Boorman, G.; Montgomery, C., Jr.; Eustis, S.; Wolfe, M.; McConnell, E.; Hardisty, J. (1985) Quality assurance in pathology for rodent carcinogenicity studies. Milman, H.; Weisburger, E., Eds.: Handbook of Carcinogen Testing. Park Ridge, NJ: Noyes Publications, pp. 345-357.
7. Callen, D.; Wolf, C.; Philpot, R. (1980) Cytochrome P-450 mediated genetic activity and cytotoxicity of seven halogenated aliphatic hydrocarbons in *Saccharomyces cerevisiae*. Mutat. Res. 77:55-63.
8. Cerna, M.; Kypenova, H. (1977) Mutagenic activity of chloroethylenes analyzed by screening system tests. Mutat. Res. 46:214-215.
9. Chemical Economics Handbook (CEH) (1982) Ethylenechloride. Menlo Park, CA: SRI International, Section 651:5032.
10. Clive, D.; Johnson, K.; Spector, J.; Batson, A.; Brown, M. (1979) Validation and characterization of the L5178Y/TK^{+/+} mouse lymphoma mutagen assay system. Mutat. Res. 59:61-108.
11. Cox, D. (1972) Regression models and life tables. J. R. Stat. Soc. B34:187-220.
12. Daniel, J. (1963) The metabolism of ³⁶C1-labelled trichloroethylene and tetrachloroethylene in the rat. Biochem. Pharmacol. 12:795-802.
13. Davey, F.; Moloney, W. (1970) Post mortem observations on Fischer rats with leukemia and other disorders. Lab. Invest. 23:327-334.
14. Decker, J.; Moss, O.; Kay, B. (1982) Controlled-delivery vapor generator for animal exposures. Am. Ind. Hyg. Assoc. J. 43:400-402.
15. Driesbach, R. (1959) Physical properties of chemical compounds. II. Adv. Chem. Ser. 22:411.
16. Eckart, H. (1923) Refractive index investigations of liquid power fuels. Brennstoff-Chem. 4:24-25.
17. Farm Chemicals Handbook (1982) Willoughby, OH: Meister Publishing Co., C283.
18. Fernandez, J.; Guberan, E.; Caperos, J. (1976) Experimental human exposures to tetrachloroethylene vapor and elimination in breath after inhalation. Am. Ind. Hyg. Assoc. 37:143-150.
19. Frantz, S.; Watanabe, P. (1983) Tetrachloroethylene: balance and tissue distribution in male Sprague-Dawley rats by drinking water administration. Toxicol. Appl. Pharmacol. 69:66-72.
20. Fuller, B. (1976) Air Pollution "Assessment of Tetrachloroethylene." Mitre Technical Report, 7143. February.
21. Gallant, R. (1966) Physical properties of hydrocarbons. VI. Chlorinated ethylenes. Hydrocarbon Process. Petrol. Refiner 45:153-160.

V. REFERENCES

22. Gart, J.; Chu, K.; Tarone, R. (1979) Statistical issues in interpretation of chronic bioassay tests for carcinogenicity. *J. Natl. Cancer Inst.* 62(4):957-974.
23. Goto, K.; Maeda, S.; Kano, Y.; Sugimura, T. (1978) Factors involved in differential Giemsa-staining of sister chromatids. *Chromosoma* 66:351-359.
24. Hake, C.; Stewart, R. (1977) Human exposure to tetrachloroethylene: inhalation and skin contact. *Environ. Health Perspect.* 21:231-238.
25. Hardin, B.; Bond, G.; Sikov, M.; Andrew, F.; Beliles, R.; Niemeier, R. (1981) Testing of selected workplace chemicals for teratogenic potential. *Scand. J. Work Environ. Health* 7 (Suppl. 4):66-75.
26. Haseman, J. (1984) Statistical issues in the design, analysis and interpretation of animal carcinogenicity studies. *Environ. Health Perspect.* 58:385-392.
27. Haseman, J.; Huff, J.; Boorman, G. (1984) Use of historical control data in carcinogenicity studies in rodents. *Toxicol. Pathol.* 12:126-135.
28. Haworth, S.; Lawlor, T.; Mortelmans, K.; Speck, W.; Zeiger, E. (1983) Salmonella mutagenicity test for 250 chemicals. *Environ. Mutagen.* (Suppl. 1) 5:3-142.
29. Ikeda, M.; Imamura, T. (1973) Biological half-life of trichloroethylene and tetrachloroethylene in human subjects. *Int. Arch. Arbeitsmed.* 31:209-224.
30. Ikeda M.; Ohtsuji, H. (1972) A comparative study of the excretion of Fujiwara reaction-positive substances in urine of humans and rodents given trichloro- or tetrachloro-derivatives of ethane and ethylene. *Br. J. Ind. Med.* 29:99-104.
31. Ikeda, M.; Ohtsuji, H.; Imamura, T.; Komoike, Y. (1972) Urinary excretion of total trichloro-compounds, trichloroethanol, and trichloroacetic acid as a measure of exposure to trichloroethylene and tetrachloroethylene. *Br. J. Ind. Med.* 29:328-333.
32. Ikeda, M.; Koizumi, A.; Watanabe, T.; Endo, A.; Sato, K. (1980) Cytogenetics and cytokinetics investigations on lymphocytes from workers occupationally exposed to tetrachloroethylene. *Toxicol. Lett.* 5:251-256.
33. International Agency for Research on Cancer (IARC) (1979) Some Halogenated Hydrocarbons. Tetrachloroethylene. IARC Monographs on the Evaluation of the Carcinogenic Risk of Chemicals to Humans. 20:491-514.
34. Kaplan, E.; Meier, P. (1958) Nonparametric estimation of incomplete observations. *J. Am. Stat. Assoc.* 53:457-481.
35. Kirk-Othmer Encyclopedia of Chemical Technology, 3rd ed. (1979). New York: John Wiley & Sons, 5:754; 8:60.
36. Kringstad, K.; Ljungquist, P.; deSousa, F.; Stromberg, L. (1981) Identification and mutagenic properties of some chlorinated aliphatic compounds in the spent liquor from kraft pulp chlorination. *Environ. Sci. Technol.* 15:562-566.
37. Linhart, M.; Cooper, J.; Martin, R.; Page, N.; Peters, J. (1974) Carcinogenesis bioassay data system. *Comput. Biomed. Res.* 7:230-248
38. Mantel, N.; Haenszel, W. (1959) Statistical aspects of the analysis of data from retrospective studies of disease. *J. Natl. Cancer Inst.* 22:719-748.
39. Margolin, B.; Collins, B.; Mason, J. (1983) Statistical analysis and sample-size determinations for mutagenicity experiments with binomial responses. *Environ. Mutagen.* 5:705-716.
40. Maronpot, R.; Boorman, G. (1982) Interpretation of rodent hepatocellular proliferative alterations and hepatocellular tumors in chemical safety assessment. *Toxicol. Pathol.* 10:71-80.
41. Martindale Extra Pharmacopeia (1967) London: Pharmaceutical Press, p. 1123.
42. McConnell, G.; Ferguson, D.; Pearson, C. (1975) Chlorinated hydrocarbons and the environment. *Endeavor* 34:13-18.

V. REFERENCES

43. McConnell, E.; Solleveld, H.; Swenberg, J.; Boorman, G. (1986) Guidelines for combining neoplasms for evaluation of rodent carcinogenesis studies. *J. Natl. Cancer Inst.* 76:283-289.
44. Mehlman, M.; Hemstreet, G.; Thorpe, J.; Weaver, N., Eds. (1984) *Advances in Modern Environmental Toxicology*, Vol. 7. Renal Effects of Petroleum Hydrocarbons. Princeton, NJ: Princeton Scientific Publishers, Inc.
45. Mennear, J.; Haseman, J.; Sullivan, D.; Bernal, E.; Hildebrandt, P. (1982) Studies on the carcinogenicity of pentachloroethane in rats and mice. *Fundam. Appl. Toxicol.* 2:82-87.
46. Merck Index, 9th ed. (1976) Rahway, NJ: Merck and Co.
47. Moloney, W.; King, V. (1971) Reduction of leukemia incidence following splenectomy in the rat. *Cancer Res.* 33:573-574.
48. Moloney, W.; Boschetti, A.; King, V. (1969) Observations on leukemia in Wistar Furth rats. *Cancer Res.* 29:938-946.
49. Monster, A. (1979) Difference in uptake, elimination, and metabolism in exposure to trichloroethylene, 1,1,1-trichloroethane and tetrachloroethylene. *Int. Arch. Occup. Environ. Health* 42:311-317.
50. Moslen, M.; Reynolds, E.; Szabo, S. (1977) Enhancement of the metabolism and hepatotoxicity of trichloroethylene and perchloroethylene. *Biochem. Pharmacol.* 26:369-375.
51. Münzer, V; Heder, K. (1972) Ergebnisse der Arbeitsmedizinischen und technischen Überprüfung chemischer Reinigungsbetriebe. *Zbl. Arbeitsmed.* 5:133-138.
52. National Cancer Institute (NCI) (1976) Guidelines for Carcinogen Bioassay in Small Rodents. NCI Carcinogenesis Technical Report Series No. 1. U.S. Department of Health, Education, and Welfare, Public Health Service, National Institutes of Health.
53. National Cancer Institute (NCI) (1977) Bioassay of Tetrachloroethylene for Possible Carcinogenicity. NCI TR 13. Department of Health, Education, and Welfare, Bethesda, MD.
54. National Institute for Occupational Safety and Health (NIOSH) (1976) Criteria for a Recommended Standard. . . Occupational Exposure to Tetrachloroethylene (Perchloroethylene). DHEW Publication No. (NIOSH) 76-185. Washington, DC: U.S. Department of Health, Education, and Welfare.
55. National Institute for Occupational Safety and Health (NIOSH) (1978) NIOSH Current Intelligence Bulletin 20. Tetrachloroethylene. Publication No. 78-112.
56. National Institutes of Health (NIH) (1978) NIH Specification, NIH-11-133f, November 1.
57. National Toxicology Program (NTP) (1983) Carcinogenesis Bioassay of Pentachloroethane in F344/N Rats and B6C3F₁ Mice. NTP TR 232. U.S. Department of Health and Human Services, Bethesda, MD.
58. National Toxicology Program (NTP) (1987) Carcinogenesis Bioassay of Trichloroethylene in Four Strains of Rats. NTP TR 273. U.S. Department of Health and Human Services, Bethesda, MD (in preparation).
59. Pegg, D.; Zempel, J.; Braun, W.; Watanabe, P. (1979) Disposition of tetrachloro(¹⁴C)ethylene following oral and inhalation exposure in rats. *Toxicol. Appl. Pharmacol.* 51:465-474.
60. Perry, P.; Wolff, S. (1974) New Giemsa method for the differential staining of sister chromatids. *Nature (London)* 251:156-158.
61. Rampy, L.; Quast, J.; Leong, B.; Gehring, P. (1978) Results of a long-term inhalation toxicity study on rats of a perchloroethylene (tetrachloroethylene) formulation. *Toxicol. Res. Lab. Health and Environ. Res.*, Dow Chemical USA, Midland, MI.

V. REFERENCES

62. Riihimaki, V.; Pfaffli, P. (1978) Percutaneous absorption of solvent vapors in man. *Scand. J. Work Environ. Health* 4:73-85.
63. Sadtler Standard Spectra: Sadtler Research Laboratories, Philadelphia, PA, IR No. 237.
64. Savolainen, H.; Pfaffli, P.; Tengen, M.; Vaino, H. (1977) Biochemical and behavioural effects of inhalation exposure to tetrachloroethylene and dichloromethane. *J. Neuropathol. Exp. Neurol.* 36:941-949.
65. Schumann, A.; Quast, J.; Watanabe, P. (1980) Pharmacokinetics and macromolecular interactions of perchloroethylene in mice and rats as related to oncogenicity. *Toxicol. Appl. Pharmacol.* 55:207-219.
66. Schwetz, B.; Leong, B.; Gehring, P. (1975) The effects of maternally inhaled trichloroethylene, perchloroethylene, methylchloroform, and methylene chloride on embryonal and fetal development in mice and rats. *Toxicol. Appl. Pharmacol.* 32:84-96.
67. Stewart, R. (1969) Acute tetrachloroethylene intoxication. *J. Am. Med. Assoc.* 208:1490-1493.
68. Stewart, R.; Dodd, H. (1964) Absorption of carbon tetrachloride, trichloroethylene, tetrachloroethylene, methylene chloride and 1,1,1-trichloroethane through human skin. *J. Ind. Hyg.* 25:439-446.
69. Stromberg, P.; Vogtsberger, L. (1983) Pathology of the mononuclear cell leukemia of Fischer rats. I. Morphologic studies. *Vet. Pathol.* 20:698-708.
70. Tarone, R. (1975) Tests for trend in life table analysis. *Biometrika* 62:679-682.
71. Theiss, J.; Stoner, G.; Shimkin, M.; Weisburger, E. (1977) Tests for carcinogenicity of organic contaminants of United States drinking waters by pulmonary response in Strain A mice. *Cancer Res.* 37:2717-2720.
72. U.S. Environmental Protection Agency (USEPA) (1985) Health Assessment Document for Tetrachloroethylene (Perchloroethylene). EPA/600/8-82/005F. Washington, DC: USEPA, Office of Health and Environmental Assessment.
73. U.S. International Trade Commission (USITC) (1984) Synthetic Organic Chemicals, United States Production and Sales 1983. USITC Publication No. 1588, Washington, DC: Government Printing Office.
74. Van Duuren, B.; Goldschmidt, B.; Lowengart, G.; Smith, A.; Melchionne, S.; Seldman, I.; Roth, D. (1979) Carcinogenicity of halogenated olefinic and aliphatic hydrocarbons in mice. *J. Natl. Cancer Inst.* 63:1433-1439.
75. Verberk, M.; Scheffers, T. (1980) Tetrachloroethylene in exhaled air of residents near dry-cleaning shops. *Environ. Res.* 21:432-437.
76. Weiss, V. (1969) Verlaufsbeobachtung der Trichloressigsäure-Ausscheidung bei berufsbedingter Perchloräthylen-Vergiftung. *Zbl. Arbeitsmed* 5:143-146.
77. World Health Organization (WHO) (1985) Environmental Health Criteria. 31. Tetrachloroethylene. Geneva: World Health Organization.
78. Yllner, S. (1961) Urinary metabolites of ¹⁴C-tetrachloroethylene in mice. *Nature* 191:820.

APPENDIX A

**SUMMARY OF THE INCIDENCE OF NEOPLASMS
IN RATS IN THE TWO-YEAR INHALATION STUDIES
OF TETRACHLOROETHYLENE**

TABLE A1. SUMMARY OF THE INCIDENCE OF NEOPLASMS IN MALE RATS IN THE TWO-YEAR INHALATION STUDY OF TETRACHLOROETHYLENE

	CONTROL (CHAMBER)	LOW DOSE	HIGH DOSE
ANIMALS INITIALLY IN STUDY	50	50	50
ANIMALS NECROPSIED	50	50	50
ANIMALS EXAMINED HISTOPATHOLOGICALLY	50	50	50
INTEGUMENTARY SYSTEM			
*Skin	(50)	(50)	(50)
Squamous cell papilloma	2 (4%)	1 (2%)	
Squamous cell carcinoma	1 (2%)		
Basal cell tumor			1 (2%)
Basal cell carcinoma			1 (2%)
Keratoacanthoma	3 (6%)	1 (2%)	
*Subcutaneous tissue	(50)	(50)	(50)
Fibroma	3 (6%)	1 (2%)	4 (8%)
Fibrosarcoma		1 (2%)	
Neurilemoma, malignant	1 (2%)		
RESPIRATORY SYSTEM			
#Lung	(50)	(47)	(50)
Hepatocellular carcinoma, metastatic		1 (2%)	
Alveolar/bronchiolar adenoma	1 (2%)	1 (2%)	2 (4%)
Alveolar/bronchiolar carcinoma		1 (2%)	
Nephroblastoma, metastatic		1 (2%)	
HEMATOPOIETIC SYSTEM			
*Multiple organs	(50)	(50)	(50)
Leukemia, mononuclear cell	27 (54%)	36 (72%)	37 (74%)
#Spleen	(50)	(50)	(49)
Leukemia, mononuclear cell		1 (2%)	
#Liver	(50)	(50)	(49)
Leukemia, mononuclear cell	1 (2%)		
CIRCULATORY SYSTEM			
#Kidney	(49)	(49)	(50)
Hemangioma	1 (2%)		
DIGESTIVE SYSTEM			
*Mouth	(50)	(50)	(50)
Squamous cell papilloma	1 (2%)		1 (2%)
Squamous cell carcinoma			1 (2%)
*Tongue	(50)	(50)	(50)
Squamous cell papilloma		1 (2%)	1 (2%)
#Liver	(50)	(50)	(49)
Neoplastic nodule	4 (8%)	7 (14%)	4 (8%)
Hepatocellular carcinoma		1 (2%)	1 (2%)
#Jejunum	(42)	(47)	(47)
Leiomyoma		1 (2%)	
URINARY SYSTEM			
#Kidney	(49)	(49)	(50)
Tubular cell adenoma	1 (2%)	3 (6%)	2 (4%)
Tubular cell adenocarcinoma			2 (4%)
Lipoma		1 (2%)	
Nephroblastoma		1 (2%)	
#Urinary bladder	(46)	(48)	(48)
Transitional cell papilloma	1 (2%)		

TABLE A1. SUMMARY OF THE INCIDENCE OF NEOPLASMS IN MALE RATS IN THE TWO-YEAR INHALATION STUDY OF TETRACHLOROETHYLENE (Continued)

	CONTROL (CHAMBER)	LOW DOSE	HIGH DOSE
ENDOCRINE SYSTEM			
#Anterior pituitary	(47)	(47)	(48)
Carcinoma, NOS	3 (6%)	2 (4%)	2 (4%)
Adenoma, NOS	17 (36%)	12 (26%)	16 (33%)
#Adrenal	(49)	(49)	(49)
Cortical adenoma	1 (2%)		
#Adrenal medulla	(49)	(49)	(49)
Pheochromocytoma	22 (45%)	21 (43%)	23 (47%)
Pheochromocytoma, malignant			1 (2%)
#Thyroid	(47)	(48)	(46)
Follicular cell carcinoma			1 (2%)
C-cell adenoma	3 (6%)	3 (6%)	4 (9%)
C-cell carcinoma	4 (9%)	6 (13%)	
#Parathyroid	(39)	(35)	(34)
Adenoma, NOS			2 (6%)
#Pancreatic islets	(43)	(46)	(46)
Islet cell adenoma	3 (7%)	2 (4%)	1 (2%)
REPRODUCTIVE SYSTEM			
*Mammary gland	(50)	(50)	(50)
Fibroadenoma	1 (2%)		
*Preputial gland	(50)	(50)	(50)
Carcinoma, NOS	2 (4%)	2 (4%)	3 (6%)
Adenoma, NOS	1 (2%)	3 (6%)	3 (6%)
#Testis	(50)	(49)	(50)
Adenocarcinoma, NOS	1 (2%)		
Interstitial cell tumor	35 (70%)	39 (80%)	41 (82%)
*Epididymis	(50)	(50)	(50)
Adenocarcinoma, NOS			1 (2%)
NERVOUS SYSTEM			
#Brain	(50)	(50)	(50)
Carcinoma, NOS, invasive	1 (2%)		1 (2%)
Glioma, NOS	1 (2%)		4 (8%)
SPECIAL SENSE ORGANS			
*Eyelid	(50)	(50)	(50)
Sebaceous adenocarcinoma	1 (2%)		
*Zymbal gland	(50)	(50)	(50)
Carcinoma, NOS			1 (2%)
Adenoma, NOS		1 (2%)	
MUSCULOSKELETAL SYSTEM			
None			
BODY CAVITIES			
*Peritoneal cavity	(50)	(50)	(50)
Leiomyosarcoma	1 (2%)		
*Tunica vaginalis	(50)	(50)	(50)
Mesothelioma, NOS	1 (2%)	1 (2%)	2 (4%)
Mesothelioma, malignant	1 (2%)		1 (2%)

TABLE A1. SUMMARY OF THE INCIDENCE OF NEOPLASMS IN MALE RATS IN THE TWO-YEAR INHALATION STUDY OF TETRACHLOROETHYLENE (Continued)

	CONTROL (CHAMBER)	LOW DOSE	HIGH DOSE
ALL OTHER SYSTEMS			
*Multiple organs	(50)	(50)	(50)
Tubular cell adenocarcinoma, invasive			1 (2%)
Chordoma	1 (2%)		
Foot			
Sebaceous adenoma		1	
ANIMAL DISPOSITION SUMMARY			
Animals initially in study	50	50	50
Natural death	9	5	3
Moribund sacrifice	18	26	36
Terminal sacrifice	23	19	11
TUMOR SUMMARY			
Total animals with primary tumors**	50	48	50
Total primary tumors	146	151	163
Total animals with benign tumors	45	42	47
Total benign tumors	96	92	101
Total animals with malignant tumors	36	41	42
Total malignant tumors	45	51	56
Total animals with secondary tumors##	1	2	2
Total secondary tumors	1	2	2
Total animals with tumors uncertain-- benign or malignant	4	7	5
Total uncertain tumors	5	8	6

* Number of animals receiving complete necropsy examination; all gross lesions including masses examined microscopically.

** Primary tumors: all tumors except secondary tumors

Number of animals examined microscopically at this site

Secondary tumors: metastatic tumors or tumors invasive into an adjacent organ

TABLE A2. SUMMARY OF THE INCIDENCE OF NEOPLASMS IN FEMALE RATS IN THE TWO-YEAR INHALATION STUDY OF TETRACHLOROETHYLENE

	CONTROL (CHAMBER)	LOW DOSE	HIGH DOSE
ANIMALS INITIALLY IN STUDY	50	50	50
ANIMALS NECROPSIED	50	50	50
ANIMALS EXAMINED HISTOPATHOLOGICALLY	50	50	50
INTEGUMENTARY SYSTEM			
*Skin	(50)	(50)	(50)
Squamous cell papilloma	1 (2%)	1 (2%)	1 (2%)
Keratoacanthoma		1 (2%)	
*Subcutaneous tissue	(50)	(50)	(50)
Sarcoma, NOS	1 (2%)		
Neurilemoma, malignant	1 (2%)		
RESPIRATORY SYSTEM			
#Lung	(50)	(49)	(49)
Alveolar/bronchiolar adenoma			1 (2%)
Alveolar/bronchiolar carcinoma	1 (2%)		
C-cell carcinoma, metastatic		1 (2%)	
HEMATOPOIETIC SYSTEM			
*Multiple organs	(50)	(50)	(50)
Leukemia, mononuclear cell	18 (36%)	29 (58%)	28 (56%)
#Spleen	(50)	(49)	(49)
Leukemia, mononuclear cell		1 (2%)	1 (2%)
CIRCULATORY SYSTEM			
None			
DIGESTIVE SYSTEM			
*Mouth	(50)	(50)	(50)
Squamous cell papilloma			1 (2%)
*Tongue	(50)	(50)	(50)
Squamous cell carcinoma			1 (2%)
#Liver	(50)	(50)	(49)
Neoplastic nodule	2 (4%)		2 (4%)
URINARY SYSTEM			
#Urinary bladder	(47)	(44)	(46)
Transitional cell papilloma			1 (2%)
Granular cell tumor, malignant			1 (2%)
ENDOCRINE SYSTEM			
#Pituitary intermedia	(50)	(48)	(50)
Carcinoma, NOS	1 (2%)		
Adenoma, NOS	1 (2%)		
#Anterior pituitary	(50)	(48)	(50)
Carcinoma, NOS	4 (8%)	2 (4%)	3 (6%)
Adenoma, NOS	19 (38%)	21 (44%)	20 (40%)
#Adrenal	(50)	(49)	(47)
Cortical adenoma	2 (4%)	1 (2%)	2 (4%)
#Adrenal medulla	(50)	(49)	(47)
Pheochromocytoma	1 (2%)		2 (4%)
Pheochromocytoma, malignant			1 (2%)

TABLE A2. SUMMARY OF THE INCIDENCE OF NEOPLASMS IN FEMALE RATS IN THE TWO-YEAR INHALATION STUDY OF TETRACHLOROETHYLENE (Continued)

	CONTROL (CHAMBER)	LOW DOSE	HIGH DOSE
ENDOCRINE SYSTEM (Continued)			
#Thyroid	(46)	(48)	(46)
Follicular cell adenoma			1 (2%)
C-cell adenoma	3 (7%)	1 (2%)	3 (7%)
C-cell carcinoma	1 (2%)	4 (8%)	1 (2%)
#Parathyroid	(27)	(27)	(34)
Adenoma, NOS			1 (3%)
#Pancreatic islets	(50)	(47)	(46)
Islet cell adenoma	1 (2%)		1 (2%)
Islet cell carcinoma	1 (2%)		
REPRODUCTIVE SYSTEM			
*Mammary gland	(50)	(50)	(50)
Adenoma, NOS			1 (2%)
Adenocarcinoma, NOS	2 (4%)	2 (4%)	
Fibroadenoma	7 (14%)	3 (6%)	6 (12%)
*Clitoral gland	(50)	(50)	(50)
Carcinoma, NOS	2 (4%)	3 (6%)	2 (4%)
Adenoma, NOS	3 (6%)	1 (2%)	2 (4%)
#Uterus	(49)	(49)	(50)
Fibroma	1 (2%)		
Leiomyosarcoma		1 (2%)	
Endometrial stromal polyp	5 (10%)	7 (14%)	7 (14%)
Endometrial stromal sarcoma		2 (4%)	1 (2%)
#Uterus/endometrium	(49)	(49)	(50)
Deciduoma		1 (2%)	
NERVOUS SYSTEM			
#Brain	(50)	(50)	(50)
Carcinoma, NOS, invasive		2 (4%)	
Glioma, NOS	1 (2%)		2 (4%)
SPECIAL SENSE ORGANS			
*Eyelid	(50)	(50)	(50)
Neurofibroma	1 (2%)		
*Zymbal gland	(50)	(50)	(50)
Carcinoma, NOS			1 (2%)
MUSCULOSKELETAL SYSTEM			
*Mandible	(50)	(50)	(50)
Odontoma, NOS	1 (2%)		
BODY CAVITIES			
*Mediastinum	(50)	(50)	(50)
Alveolar/bronchiolar carcinoma, invasive	1 (2%)		
*Peritoneal cavity	(50)	(50)	(50)
Granular cell tumor, invasive			1 (2%)
ALL OTHER SYSTEMS			
Tail			
Neurofibrosarcoma	1		

TABLE A2. SUMMARY OF THE INCIDENCE OF NEOPLASMS IN FEMALE RATS IN THE TWO-YEAR INHALATION STUDY OF TETRACHLOROETHYLENE (Continued)

	CONTROL (CHAMBER)	LOW DOSE	HIGH DOSE
ANIMAL DISPOSITION SUMMARY			
Animals initially in study	50	50	50
Natural death	6	5	5
Moribund sacrifice	21	24	21
Terminal sacrifice	23	21	24
TUMOR SUMMARY			
Total animals with primary tumors**	42	45	45
Total primary tumors	82	81	94
Total animals with benign tumors	32	30	32
Total benign tumors	45	37	50
Total animals with malignant tumors	30	39	38
Total malignant tumors	34	44	42
Total animals with secondary tumors##	1	3	1
Total secondary tumors	1	3	1
Total animals with tumors uncertain--			
benign or malignant	3		2
Total uncertain tumors	3		2

* Number of animals receiving complete necropsy examination; all gross lesions including masses examined microscopically.

** Primary tumors: all tumors except secondary tumors

Number of animals examined microscopically at this site

Secondary tumors: metastatic tumors or tumors invasive into an adjacent organ

TABLE A3. INDIVIDUAL ANIMAL TUMOR PATHOLOGY OF MALE RATS: CHAMBER CONTROL (Continued)

ANIMAL NUMBER	WEEKSON STUDY																				TOTAL TISSUES TUMORS
	0/6	0/8	0/4	0/5	0/6	0/7	0/8	0/1	0/1	0/1	0/1	0/1	0/1	0/1	0/1	0/1	0/1	0/1	0/1	0/1	
INTEGUMENTARY SYSTEM																					
Skin	+	+	+	+	+	+	+	+	+	+	+	+	+	+	+	+	+	+	+	+	+
Squamous cell papilloma																			X		
Squamous cell carcinoma																					
Keratoacanthoma	X																				X
Subcutaneous tissue	+	+	+	+	+	+	+	+	+	+	+	+	+	+	+	+	+	+	+	+	+
Fibroma																					
Neurilemoma, malignant																					
RESPIRATORY SYSTEM																					
Lungs and bronchi	+	+	+	+	+	+	+	+	+	+	+	+	+	+	+	+	+	+	+	+	+
Alveolar/bronchiolar adenoma																				X	
Trachea	+	+	+	+	+	+	+	+	+	+	+	+	+	+	+	+	+	+	+	+	+
HEMATOPOIETIC SYSTEM																					
Bone marrow	+	+	+	+	+	+	+	+	+	+	+	+	+	+	+	+	+	+	+	+	+
Spleen	+	+	+	+	+	+	+	+	+	+	+	+	+	+	+	+	+	+	+	+	+
Lymph nodes	+	+	+	+	+	+	+	+	+	+	+	+	+	+	+	+	+	+	+	+	+
Thymus	+	+	+	+	+	+	+	+	+	+	+	+	+	+	+	+	+	+	+	+	+
CIRCULATORY SYSTEM																					
Heart	+	+	+	+	+	+	+	+	+	+	+	+	+	+	+	+	+	+	+	+	+
DIGESTIVE SYSTEM																					
Oral cavity	N	N	N	N	N	N	N	N	N	N	N	N	N	N	N	N	N	N	N	N	N
Squamous cell papilloma																					
Salivary gland	+	+	+	+	+	+	+	+	+	+	+	+	+	+	+	+	+	+	+	+	+
Liver	+	+	+	+	+	+	+	+	+	+	+	+	+	+	+	+	+	+	+	+	+
Neoplastic nodule																					
Leukemia, mononuclear cell																					
Bile duct	+	+	+	+	+	+	+	+	+	+	+	+	+	+	+	+	+	+	+	+	+
Gallbladder & common bile duct	N	N	N	N	N	N	N	N	N	N	N	N	N	N	N	N	N	N	N	N	N
Pancreas	-	+	+	+	+	+	+	+	+	+	+	+	+	+	+	+	+	+	+	+	+
Esophagus	+	+	+	+	+	+	+	+	+	+	+	+	+	+	+	+	+	+	+	+	+
Stomach	+	+	+	+	+	+	+	+	+	+	+	+	+	+	+	+	+	+	+	+	+
Small intestine	+	+	+	+	+	+	+	+	+	+	+	+	+	+	+	+	+	+	+	+	+
Large intestine	+	+	+	+	+	+	+	+	+	+	+	+	+	+	+	+	+	+	+	+	+
URINARY SYSTEM																					
Kidney	+	+	+	+	+	+	+	+	+	+	+	+	+	+	+	+	+	+	+	+	+
Tubular cell adenoma																				X	
Hemangioma																					
Urinary bladder	+	+	+	+	+	+	+	+	+	+	+	+	+	+	+	+	+	+	+	+	+
Transitional cell papilloma																				X	
ENDOCRINE SYSTEM																					
Pituitary	+	+	+	+	+	+	+	+	+	+	+	+	+	+	+	+	+	+	+	+	+
Carcinoma, NOS	X																				
Adenoma, NOS				X		X		X					X	X		X	X				
Adrenal	+	+	+	+	+	+	+	+	+	+	+	+	+	+	+	+	+	+	+	+	+
Cortical adenoma																				X	
Pheochromocytoma	X	X	X	X	X	X	X	X	X	X	X	X	X	X	X	X	X	X	X	X	X
Thyroid	+	+	+	+	+	+	+	+	+	+	+	+	+	+	+	+	+	+	+	+	+
C-cell adenoma																					X
C-cell carcinoma				X	X																X
Parathyroid	-	-	+	+	+	+	+	+	-	+	+	+	+	+	+	+	+	+	+	+	-
Pancreatic islets	-	+	+	+	+	+	+	+	+	+	+	+	+	+	+	+	+	+	+	+	+
Islet cell adenoma			X							X										X	
REPRODUCTIVE SYSTEM																					
Mammary gland	+	N	+	N	N	+	+	N	+	N	+	N	N	+	+	N	+	N	N	N	N
Fibroadenoma																				X	
Testis	+	+	+	+	+	+	+	+	+	+	+	+	+	+	+	+	+	+	+	+	+
Adenocarcinoma, NOS																				X	
Interstitial cell tumor		X	X	X	X	X	X	X	X	X	X	X	X	X	X	X	X	X	X	X	X
Prostate	+	+	+	+	+	+	+	+	+	+	+	+	+	+	+	+	+	+	+	+	+
Preputial/vulvular gland	N	N	N	N	N	N	N	N	N	N	N	N	N	N	N	N	N	N	N	N	N
Carcinoma, NOS	X																			X	
Adenoma, NOS																					X
NERVOUS SYSTEM																					
Brain	+	+	+	+	+	+	+	+	+	+	+	+	+	+	+	+	+	+	+	+	+
Carcinoma, NOS, invasive																					
Glioma, NOS										X											
SPECIAL SENSE ORGANS																					
Eye appendages	N	N	N	N	N	N	N	N	N	N	N	N	N	N	N	N	N	N	N	N	N
Sebaceous adenocarcinoma																				X	
BODY CAVITIES																					
Peritoneum	N	N	N	N	N	N	N	N	N	N	N	N	N	N	N	N	N	N	N	N	N
Leiomyosarcoma																					
Tunica vaginalis	+	+	+	+	+	+	+	+	+	+	+	+	+	+	+	+	+	+	+	+	+
Mesothelioma, NOS																					
Mesothelioma, malignant																				X	
ALL OTHER SYSTEMS																					
Multiple organs, NOS	N	N	N	N	N	N	N	N	N	N	N	N	N	N	N	N	N	N	N	N	N
Chordoma																					
Leukemia, mononuclear cell	X	X	X	X	X							X			X					X	X

* Animals Necropsed

TABLE A3. INDIVIDUAL ANIMAL TUMOR PATHOLOGY OF MALE RATS IN THE TWO-YEAR INHALATION STUDY OF TETRACHLOROETHYLENE: HIGH DOSE

ANIMAL NUMBER	0136	0179	0146	0144	0101	0102	0122	0133	0144	0122	0133	0102	0144	0144	0111	0111	0144	0111	0111	0101
WEEKS ON STUDY	68	73	71	70	81	81	81	81	81	81	81	81	81	81	91	91	91	91	91	91
INTEGUMENTARY SYSTEM																				
Skin	+	+	+	+	+	+	+	+	+	+	+	+	+	+	+	+	+	+	+	+
Basal cell tumor																				
Basal cell carcinoma																				
Subcutaneous tissue	+	+	+	+	+	+	+	+	+	+	+	+	+	+	+	+	+	+	+	+
Fibroma																				X
RESPIRATORY SYSTEM																				
Lungs and bronchi	+	+	+	+	+	+	+	+	+	+	+	+	+	+	+	+	+	+	+	+
Alveolar/bronchiolar adenoma																				X
Trachea	-	+	+	+	+	+	+	+	+	+	+	+	+	+	+	+	+	+	+	+
HEMATOPOIETIC SYSTEM																				
Bone marrow	-	+	+	+	+	+	+	+	+	+	+	+	+	+	+	+	+	+	+	+
Spleen	-	+	+	+	+	+	+	+	+	+	+	+	+	+	+	+	+	+	+	+
Lymph nodes	-	+	+	+	+	+	+	+	+	+	+	+	+	+	+	+	+	+	+	+
Thymus	-	+	+	+	+	+	+	+	+	+	+	+	+	+	+	+	+	+	+	+
CIRCULATORY SYSTEM																				
Heart	+	+	+	+	+	+	+	+	+	+	+	+	+	+	+	+	+	+	+	+
DIGESTIVE SYSTEM																				
Oral cavity	N	N	N	N	N	N	N	N	N	N	N	N	N	N	N	N	N	N	N	N
Squamous cell papilloma																				
Squamous cell carcinoma			X																	
Salivary gland	-	+	+	+	+	+	+	+	+	+	+	+	+	+	+	+	+	+	+	+
Liver	-	+	+	+	+	+	+	+	+	+	+	+	+	+	+	+	+	+	+	+
Neoplastic nodule																				
Hepatocellular carcinoma																				X
Bile duct	-	+	+	+	+	+	+	+	+	+	+	+	+	+	+	+	+	+	+	+
Gallbladder & common bile duct	N	N	N	N	N	N	N	N	N	N	N	N	N	N	N	N	N	N	N	N
Pancreas	+	+	+	+	+	+	+	+	+	+	+	+	+	+	+	+	+	+	+	+
Esophagus	+	+	+	+	+	+	+	+	+	+	+	+	+	+	+	+	+	+	+	+
Stomach	-	+	+	+	+	+	+	+	+	+	+	+	+	+	+	+	+	+	+	+
Small intestine	-	+	+	+	+	+	+	+	+	+	+	+	+	+	+	+	+	+	+	+
Large intestine	-	+	+	+	+	+	+	+	+	+	+	+	+	+	+	+	+	+	+	+
URINARY SYSTEM																				
Kidney	+	+	+	+	+	+	+	+	+	+	+	+	+	+	+	+	+	+	+	+
Tubular cell adenoma																				
Tubular cell adenocarcinoma																				X
Urinary bladder	+	+	+	+	+	+	+	+	+	+	+	+	+	+	+	+	+	+	+	+
ENDOCRINE SYSTEM																				
Pituitary	+	+	+	+	+	+	+	+	+	+	+	+	+	+	+	+	+	+	+	+
Carcinoma, NOS																				
Adenoma, NOS																				X
Adrenal	-	+	+	+	+	+	+	+	+	+	+	+	+	+	+	+	+	+	+	+
Pheochromocytoma																				
Pheochromocytoma, malignant																				
Thyroid	-	+	+	+	+	+	+	+	+	+	+	+	+	+	+	+	+	+	+	+
Follicular cell carcinoma																				
C-cell adenoma																				
Parathyroid	-	-	-	-	+	-	-	-	+	+	+	+	+	+	+	+	+	+	+	+
Adenoma, NOS																				X
Pancreatic islets	+	+	+	+	+	+	+	+	+	+	+	+	+	+	+	+	+	+	+	+
Islet cell adenoma																				X
REPRODUCTIVE SYSTEM																				
Mammary gland	N	+	+	N	+	N	+	+	+	+	+	N	+	N	N	N	N	+	+	+
Testis	+	+	+	+	+	+	+	+	+	+	+	+	+	+	+	+	+	+	+	+
Interstitial cell tumor	X			X	X	X	X	X	X	X	X	X	X	X	X	X	X	X	X	X
Prostate	+	+	+	+	+	+	+	+	+	+	+	+	+	+	+	+	+	+	+	+
Preputial/clitoral gland	N	N	N	N	N	N	N	N	N	N	N	N	N	N	N	N	N	N	N	N
Carcinoma, NOS																				
Adenoma, NOS																				X
Epididymis	N	N	N	N	N	N	N	N	N	N	N	N	N	N	N	N	N	N	N	N
Adenocarcinoma, NOS																				
NERVOUS SYSTEM																				
Brain	+	+	+	+	+	+	+	+	+	+	+	+	+	+	+	+	+	+	+	+
Carcinoma, NOS, invasive																				
Glioma, NOS																				X
SPECIAL SENSE ORGANS																				
Zymbal gland	N	N	N	N	+	N	N	N	N	N	N	N	N	N	N	N	N	N	N	N
Carcinoma, NOS																				X
BODY CAVITIES																				
Tunica vaginalis	+	+	+	+	+	+	+	+	+	+	+	+	+	+	+	+	+	+	+	+
Mesothelioma, NOS																				
Mesothelioma, malignant																				
ALL OTHER SYSTEMS																				
Multiple organs, NOS	N	N	N	N	N	N	N	N	N	N	N	N	N	N	N	N	N	N	N	N
Tubular cell adenocarcinoma, invasive																				X
Leukemia, mononuclear cell	X	X	X	X	X	X	X	X	X	X	X	X	X	X	X	X	X	X	X	X

TABLE A4. INDIVIDUAL ANIMAL TUMOR PATHOLOGY OF FEMALE RATS IN THE TWO-YEAR INHALATION STUDY OF TETRACHLOROETHYLENE: CHAMBER CONTROL

ANIMAL NUMBER	0	1	2	3	4	5	6	7	8	9	10	11	12	13	14	15	16	17	18	19	20	21	22	23	24	25	26	27	28	29	30	31	32	33	34	35	36	37	38	39	40	41	42	43	44	45	46	47	48	49	50	51	52	53	54	55	56	57	58	59	60	61	62	63	64	65	66	67	68	69	70	71	72	73	74	75	76	77	78	79	80	81	82	83	84	85	86	87	88	89	90	91	92	93	94	95	96	97	98	99	100
WEEKSON STUDY	0	1	2	3	4	5	6	7	8	9	10	11	12	13	14	15	16	17	18	19	20	21	22	23	24	25	26	27	28	29	30	31	32	33	34	35	36	37	38	39	40	41	42	43	44	45	46	47	48	49	50	51	52	53	54	55	56	57	58	59	60	61	62	63	64	65	66	67	68	69	70	71	72	73	74	75	76	77	78	79	80	81	82	83	84	85	86	87	88	89	90	91	92	93	94	95	96	97	98	99	100
INTEGUMENTARY SYSTEM																																																																																																					
Skin																																																																																																					
Squamous cell papilloma																																																																																																					
Subcutaneous tissue																																																																																																					
Sarcoma, NOS																																																																																																					
Neurilemoma, malignant																																																																																																					
RESPIRATORY SYSTEM																																																																																																					
Lungs and bronchi																																																																																																					
Alveolar/bronchiolar carcinoma																																																																																																					
Trachea																																																																																																					
HEMATOPOIETIC SYSTEM																																																																																																					
Bone marrow																																																																																																					
Spleen																																																																																																					
Lymph nodes																																																																																																					
Thymus																																																																																																					
CIRCULATORY SYSTEM																																																																																																					
Heart																																																																																																					
DIGESTIVE SYSTEM																																																																																																					
Salivary gland																																																																																																					
Liver																																																																																																					
Neoplastic nodule																																																																																																					
Bile duct																																																																																																					
Gallbladder & common bile duct																																																																																																					
Pancreas																																																																																																					
Esophagus																																																																																																					
Stomach																																																																																																					
Small intestine																																																																																																					
Large intestine																																																																																																					
URINARY SYSTEM																																																																																																					
Kidney																																																																																																					
Urinary bladder																																																																																																					
ENDOCRINE SYSTEM																																																																																																					
Pituitary																																																																																																					
Carcinoma, NOS																																																																																																					
Adenoma, NOS																																																																																																					
Adrenal																																																																																																					
Cortical adenoma																																																																																																					
Pheochromocytoma																																																																																																					
Thyroid																																																																																																					
C-cell adenoma																																																																																																					
C-cell carcinoma																																																																																																					
Parathyroid																																																																																																					
Pancreatic islets																																																																																																					
Islet cell adenoma																																																																																																					
Islet cell carcinoma																																																																																																					
REPRODUCTIVE SYSTEM																																																																																																					
Mammary gland																																																																																																					
Adenocarcinoma, NOS																																																																																																					
Fibroadenoma																																																																																																					
Preputial/clitoral gland																																																																																																					
Carcinoma, NOS																																																																																																					
Adenoma, NOS																																																																																																					
Uterus																																																																																																					
Fibroma																																																																																																					
Endometrial stromal polyp																																																																																																					
Ovary																																																																																																					
NERVOUS SYSTEM																																																																																																					
Brain																																																																																																					
Glioma, NOS																																																																																																					
SPECIAL SENSE ORGANS																																																																																																					
Eye appendages																																																																																																					
Neurofibroma																																																																																																					
MUSCULOSKELETAL SYSTEM																																																																																																					
Bone																																																																																																					
Odontoma, NOS																																																																																																					
BODY CAVITIES																																																																																																					
Mediastinum																																																																																																					
Alveolar/bronchiolar ca, invasive																																																																																																					
ALL OTHER SYSTEMS																																																																																																					
Multiple organs, NOS																																																																																																					
Leukemia, mononuclear cell																																																																																																					
Tail																																																																																																					
Neurofibrosarcoma																																																																																																					

+ : Tissue Examined Microscopically
 - : Required Tissue Not Examined Microscopically
 X : Tumor Incidence
 N : Necropsy, No Autolysis, No Microscopic Examination
 S : Animal Mismatched
 C : Necropsy, No Histology Due To Protocol
 A : Autolysis
 M : Animal Missing
 B : No Necropsy Performed

TABLE A4. INDIVIDUAL ANIMAL TUMOR PATHOLOGY OF FEMALE RATS IN THE TWO-YEAR INHALATION STUDY OF TETRACHLOROETHYLENE: LOW DOSE

ANIMAL NUMBER	01 28	01 31	01 08	01 21	01 04	01 11	01 14	01 21	01 24	01 29	01 36	01 43	01 50	01 57	01 64	01 71	01 78	01 85	01 92	01 99	01 106	01 113	01 120	01 127	01 134	01 141	01 148	01 155	01 162	01 169	01 176	01 183	01 190	01 197	01 204	01 211	01 218	01 225	01 232	01 239	01 246	01 253	01 260	01 267	01 274	01 281	01 288	01 295	01 302	01 309	01 316	01 323	01 330	01 337	01 344	01 351	01 358	01 365	01 372	01 379	01 386	01 393	01 400	01 407	01 414	01 421	01 428	01 435	01 442	01 449	01 456	01 463	01 470	01 477	01 484	01 491	01 498	01 505	01 512	01 519	01 526	01 533	01 540	01 547	01 554	01 561	01 568	01 575	01 582	01 589	01 596	01 603	01 610	01 617	01 624	01 631	01 638	01 645	01 652	01 659	01 666	01 673	01 680	01 687	01 694	01 701	01 708	01 715	01 722	01 729	01 736	01 743	01 750	01 757	01 764	01 771	01 778	01 785	01 792	01 799	01 806	01 813	01 820	01 827	01 834	01 841	01 848	01 855	01 862	01 869	01 876	01 883	01 890	01 897	01 904	01 911	01 918	01 925	01 932	01 939	01 946	01 953	01 960	01 967	01 974	01 981	01 988	01 995	01 1002	01 1009	01 1016	01 1023	01 1030	01 1037	01 1044	01 1051	01 1058	01 1065	01 1072	01 1079	01 1086	01 1093	01 1100	01 1107	01 1114	01 1121	01 1128	01 1135	01 1142	01 1149	01 1156	01 1163	01 1170	01 1177	01 1184	01 1191	01 1198	01 1205	01 1212	01 1219	01 1226	01 1233	01 1240	01 1247	01 1254	01 1261	01 1268	01 1275	01 1282	01 1289	01 1296	01 1303	01 1310	01 1317	01 1324	01 1331	01 1338	01 1345	01 1352	01 1359	01 1366	01 1373	01 1380	01 1387	01 1394	01 1401	01 1408	01 1415	01 1422	01 1429	01 1436	01 1443	01 1450	01 1457	01 1464	01 1471	01 1478	01 1485	01 1492	01 1499	01 1506	01 1513	01 1520	01 1527	01 1534	01 1541	01 1548	01 1555	01 1562	01 1569	01 1576	01 1583	01 1590	01 1597	01 1604	01 1611	01 1618	01 1625	01 1632	01 1639	01 1646	01 1653	01 1660	01 1667	01 1674	01 1681	01 1688	01 1695	01 1702	01 1709	01 1716	01 1723	01 1730	01 1737	01 1744	01 1751	01 1758	01 1765	01 1772	01 1779	01 1786	01 1793	01 1800	01 1807	01 1814	01 1821	01 1828	01 1835	01 1842	01 1849	01 1856	01 1863	01 1870	01 1877	01 1884	01 1891	01 1898	01 1905	01 1912	01 1919	01 1926	01 1933	01 1940	01 1947	01 1954	01 1961	01 1968	01 1975	01 1982	01 1989	01 1996	01 2003	01 2010	01 2017	01 2024	01 2031	01 2038	01 2045	01 2052	01 2059	01 2066	01 2073	01 2080	01 2087	01 2094	01 2101	01 2108	01 2115	01 2122	01 2129	01 2136	01 2143	01 2150	01 2157	01 2164	01 2171	01 2178	01 2185	01 2192	01 2199	01 2206	01 2213	01 2220	01 2227	01 2234	01 2241	01 2248	01 2255	01 2262	01 2269	01 2276	01 2283	01 2290	01 2297	01 2304	01 2311	01 2318	01 2325	01 2332	01 2339	01 2346	01 2353	01 2360	01 2367	01 2374	01 2381	01 2388	01 2395	01 2402	01 2409	01 2416	01 2423	01 2430	01 2437	01 2444	01 2451	01 2458	01 2465	01 2472	01 2479	01 2486	01 2493	01 2500	01 2507	01 2514	01 2521	01 2528	01 2535	01 2542	01 2549	01 2556	01 2563	01 2570	01 2577	01 2584	01 2591	01 2598	01 2605	01 2612	01 2619	01 2626	01 2633	01 2640	01 2647	01 2654	01 2661	01 2668	01 2675	01 2682	01 2689	01 2696	01 2703	01 2710	01 2717	01 2724	01 2731	01 2738	01 2745	01 2752	01 2759	01 2766	01 2773	01 2780	01 2787	01 2794	01 2801	01 2808	01 2815	01 2822	01 2829	01 2836	01 2843	01 2850	01 2857	01 2864	01 2871	01 2878	01 2885	01 2892	01 2899	01 2906	01 2913	01 2920	01 2927	01 2934	01 2941	01 2948	01 2955	01 2962	01 2969	01 2976	01 2983	01 2990	01 2997	01 3004	01 3011	01 3018	01 3025	01 3032	01 3039	01 3046	01 3053	01 3060	01 3067	01 3074	01 3081	01 3088	01 3095	01 3102	01 3109	01 3116	01 3123	01 3130	01 3137	01 3144	01 3151	01 3158	01 3165	01 3172	01 3179	01 3186	01 3193	01 3200	01 3207	01 3214	01 3221	01 3228	01 3235	01 3242	01 3249	01 3256	01 3263	01 3270	01 3277	01 3284	01 3291	01 3298	01 3305	01 3312	01 3319	01 3326	01 3333	01 3340	01 3347	01 3354	01 3361	01 3368	01 3375	01 3382	01 3389	01 3396	01 3403	01 3410	01 3417	01 3424	01 3431	01 3438	01 3445	01 3452	01 3459	01 3466	01 3473	01 3480	01 3487	01 3494	01 3501	01 3508	01 3515	01 3522	01 3529	01 3536	01 3543	01 3550	01 3557	01 3564	01 3571	01 3578	01 3585	01 3592	01 3599	01 3606	01 3613	01 3620	01 3627	01 3634	01 3641	01 3648	01 3655	01 3662	01 3669	01 3676	01 3683	01 3690	01 3697	01 3704	01 3711	01 3718	01 3725	01 3732	01 3739	01 3746	01 3753	01 3760	01 3767	01 3774	01 3781	01 3788	01 3795	01 3802	01 3809	01 3816	01 3823	01 3830	01 3837	01 3844	01 3851	01 3858	01 3865	01 3872	01 3879	01 3886	01 3893	01 3900	01 3907	01 3914	01 3921	01 3928	01 3935	01 3942	01 3949	01 3956	01 3963	01 3970	01 3977	01 3984	01 3991	01 3998	01 4005	01 4012	01 4019	01 4026	01 4033	01 4040	01 4047	01 4054	01 4061	01 4068	01 4075	01 4082	01 4089	01 4096	01 4103	01 4110	01 4117	01 4124	01 4131	01 4138	01 4145	01 4152	01 4159	01 4166	01 4173	01 4180	01 4187	01 4194	01 4201	01 4208	01 4215	01 4222	01 4229	01 4236	01 4243	01 4250	01 4257	01 4264	01 4271	01 4278	01 4285	01 4292	01 4299	01 4306	01 4313	01 4320	01 4327	01 4334	01 4341	01 4348	01 4355	01 4362	01 4369	01 4376	01 4383	01 4390	01 4397	01 4404	01 4411	01 4418	01 4425	01 4432	01 4439	01 4446	01 4453	01 4460	01 4467	01 4474	01 4481	01 4488	01 4495	01 4502	01 4509	01 4516	01 4523	01 4530	01 4537	01 4544	01 4551	01 4558	01 4565	01 4572	01 4579	01 4586	01 4593	01 4600	01 4607	01 4614	01 4621	01 4628	01 4635	01 4642	01 4649	01 4656	01 4663	01 4670	01 4677	01 4684	01 4691	01 4698	01 4705	01 4712	01 4719	01 4726	01 4733	01 4740	01 4747	01 4754	01 4761	01 4768	01 4775	01 4782	01 4789	01 4796	01 4803	01 4810	01 4817	01 4824	01 4831	01 4838	01 4845	01 4852	01 4859	01 4866	01 4873	01 4880	01 4887	01 4894	01 4901	01 4908	01 4915	01 4922	01 4929	01 4936	01 4943	01 4950	01 4957	01 4964	01 4971	01 4978	01 4985	01 4992	01 4999	01 5006	01 5013	01 5020	01 5027	01 5034	01 5041	01 5048	01 5055	01 5062	01 5069	01 5076	01 5083	01 5090	01 5097	01 5104	01 5111	01 5118	01 5125	01 5132	01 5139	01 5146	01 5153	01 5160	01 5167	01 5174	01 5181	01 5188	01 5195	01 5202	01 5209	01 5216	01 5223	01 5230	01 5237	01 5244	01 5251	01 5258	01 5265	01 5272	01 5279	01 5286	01 5293	01 5300	01 5307	01 5314	01 5321	01 5328	01 5335	01 5342	01 5349	01 5356	01 5363	01 5370	01 5377	01 5384	01 5391	01 5398	01 5405	01 5412	01 5419	01 5426	01 5433	01 5440	01 5447	01 5454	01 5461	01 5468	01 5475	01 5482	01 5489	01 5496	01 5503	01 5510	01 5517	01 5524	01 5531	01 5538	01 5545	01 5552	01 5559	01 5566	01 5573	01 5580	01 5587	01 5594	01 5601	01 5608	01 5615	01 5622	01 5629	01 5636	01 5643	01 5650	01 5657	01 5664	01 5671	01 5678	01 5685	01 5692	01 5699	01 5706	01 5713	01 5720	01 5727	01 5734	01 5741	01 5748	01 5755	01 5762	01 5769	01 5776	01 5783	01 5790	01 5797	01 5804	01 5811	01 5818	01 5825	01 5832	01 5839	01 5846	01 5853	01 5860	01 5867	01 5874	01 5881	01 5888	01 5895	01 5902	01 5909	01 5916	01 5923	01 5930	01 5937	01 5944	01 5951	01 5958	01 5965	01 5972	01 5979	01 5986	01 5993	01 6000	01 6007	01 6014	01 6021	01 6028	01 6035	01 6042	01 6049	01 6056	01 6063	01 6070	01 6077	01 6084	01 6091	01 6098	01 6105	01 6112	01 6119	01 6126	01 6133	01 6140	01 6147	01 6154	01 6161	01 6168
---------------	----------	----------	----------	----------	----------	----------	----------	----------	----------	----------	----------	----------	----------	----------	----------	----------	----------	----------	----------	----------	-----------	-----------	-----------	-----------	-----------	-----------	-----------	-----------	-----------	-----------	-----------	-----------	-----------	-----------	-----------	-----------	-----------	-----------	-----------	-----------	-----------	-----------	-----------	-----------	-----------	-----------	-----------	-----------	-----------	-----------	-----------	-----------	-----------	-----------	-----------	-----------	-----------	-----------	-----------	-----------	-----------	-----------	-----------	-----------	-----------	-----------	-----------	-----------	-----------	-----------	-----------	-----------	-----------	-----------	-----------	-----------	-----------	-----------	-----------	-----------	-----------	-----------	-----------	-----------	-----------	-----------	-----------	-----------	-----------	-----------	-----------	-----------	-----------	-----------	-----------	-----------	-----------	-----------	-----------	-----------	-----------	-----------	-----------	-----------	-----------	-----------	-----------	-----------	-----------	-----------	-----------	-----------	-----------	-----------	-----------	-----------	-----------	-----------	-----------	-----------	-----------	-----------	-----------	-----------	-----------	-----------	-----------	-----------	-----------	-----------	-----------	-----------	-----------	-----------	-----------	-----------	-----------	-----------	-----------	-----------	-----------	-----------	-----------	-----------	-----------	-----------	-----------	-----------	------------	------------	------------	------------	------------	------------	------------	------------	------------	------------	------------	------------	------------	------------	------------	------------	------------	------------	------------	------------	------------	------------	------------	------------	------------	------------	------------	------------	------------	------------	------------	------------	------------	------------	------------	------------	------------	------------	------------	------------	------------	------------	------------	------------	------------	------------	------------	------------	------------	------------	------------	------------	------------	------------	------------	------------	------------	------------	------------	------------	------------	------------	------------	------------	------------	------------	------------	------------	------------	------------	------------	------------	------------	------------	------------	------------	------------	------------	------------	------------	------------	------------	------------	------------	------------	------------	------------	------------	------------	------------	------------	------------	------------	------------	------------	------------	------------	------------	------------	------------	------------	------------	------------	------------	------------	------------	------------	------------	------------	------------	------------	------------	------------	------------	------------	------------	------------	------------	------------	------------	------------	------------	------------	------------	------------	------------	------------	------------	------------	------------	------------	------------	------------	------------	------------	------------	------------	------------	------------	------------	------------	------------	------------	------------	------------	------------	------------	------------	------------	------------	------------	------------	------------	------------	------------	------------	------------	------------	------------	------------	------------	------------	------------	------------	------------	------------	------------	------------	------------	------------	------------	------------	------------	------------	------------	------------	------------	------------	------------	------------	------------	------------	------------	------------	------------	------------	------------	------------	------------	------------	------------	------------	------------	------------	------------	------------	------------	------------	------------	------------	------------	------------	------------	------------	------------	------------	------------	------------	------------	------------	------------	------------	------------	------------	------------	------------	------------	------------	------------	------------	------------	------------	------------	------------	------------	------------	------------	------------	------------	------------	------------	------------	------------	------------	------------	------------	------------	------------	------------	------------	------------	------------	------------	------------	------------	------------	------------	------------	------------	------------	------------	------------	------------	------------	------------	------------	------------	------------	------------	------------	------------	------------	------------	------------	------------	------------	------------	------------	------------	------------	------------	------------	------------	------------	------------	------------	------------	------------	------------	------------	------------	------------	------------	------------	------------	------------	------------	------------	------------	------------	------------	------------	------------	------------	------------	------------	------------	------------	------------	------------	------------	------------	------------	------------	------------	------------	------------	------------	------------	------------	------------	------------	------------	------------	------------	------------	------------	------------	------------	------------	------------	------------	------------	------------	------------	------------	------------	------------	------------	------------	------------	------------	------------	------------	------------	------------	------------	------------	------------	------------	------------	------------	------------	------------	------------	------------	------------	------------	------------	------------	------------	------------	------------	------------	------------	------------	------------	------------	------------	------------	------------	------------	------------	------------	------------	------------	------------	------------	------------	------------	------------	------------	------------	------------	------------	------------	------------	------------	------------	------------	------------	------------	------------	------------	------------	------------	------------	------------	------------	------------	------------	------------	------------	------------	------------	------------	------------	------------	------------	------------	------------	------------	------------	------------	------------	------------	------------	------------	------------	------------	------------	------------	------------	------------	------------	------------	------------	------------	------------	------------	------------	------------	------------	------------	------------	------------	------------	------------	------------	------------	------------	------------	------------	------------	------------	------------	------------	------------	------------	------------	------------	------------	------------	------------	------------	------------	------------	------------	------------	------------	------------	------------	------------	------------	------------	------------	------------	------------	------------	------------	------------	------------	------------	------------	------------	------------	------------	------------	------------	------------	------------	------------	------------	------------	------------	------------	------------	------------	------------	------------	------------	------------	------------	------------	------------	------------	------------	------------	------------	------------	------------	------------	------------	------------	------------	------------	------------	------------	------------	------------	------------	------------	------------	------------	------------	------------	------------	------------	------------	------------	------------	------------	------------	------------	------------	------------	------------	------------	------------	------------	------------	------------	------------	------------	------------	------------	------------	------------	------------	------------	------------	------------	------------	------------	------------	------------	------------	------------	------------	------------	------------	------------	------------	------------	------------	------------	------------	------------	------------	------------	------------	------------	------------	------------	------------	------------	------------	------------	------------	------------	------------	------------	------------	------------	------------	------------	------------	------------	------------	------------	------------	------------	------------	------------	------------	------------	------------	------------	------------	------------	------------	------------	------------	------------	------------	------------	------------	------------	------------	------------	------------	------------	------------	------------	------------	------------	------------	------------	------------	------------	------------	------------	------------	------------	------------	------------	------------	------------	------------	------------	------------	------------	------------	------------	------------	------------	------------	------------	------------	------------	------------	------------	------------	------------	------------	------------	------------	------------	------------	------------	------------	------------	------------	------------	------------	------------	------------	------------	------------	------------	------------	------------	------------	------------	------------	------------	------------	------------	------------	------------	------------	------------	------------	------------	------------	------------	------------	------------	------------	------------	------------	------------	------------	------------	------------	------------	------------	------------	------------	------------	------------	------------	------------	------------	------------	------------	------------	------------	------------	------------	------------	------------	------------	------------	------------	------------	------------	------------	------------	------------	------------	------------	------------	------------	------------	------------	------------	------------	------------	------------	------------	------------	------------	------------	------------	------------	------------	------------	------------	------------	------------	------------	------------	------------	------------	------------	------------	------------	------------	------------	------------	------------	------------	------------	------------	------------	------------	------------	------------	------------	------------	------------	------------	------------	------------	------------	------------	------------	------------

TABLE A4. INDIVIDUAL ANIMAL TUMOR PATHOLOGY OF FEMALE RATS: LOW DOSE
(Continued)

ANIMAL NUMBER	0 0 0 0 0 0 0 0 0 0 0 0 0 0 0 0 0 0 0 0																				TOTAL: TISSUES TUMORS	
	4 4 1 1 0 0 0 1 1 1 1 2 3 3 3 3 3 3 4 4 5 0 5 0 8 1 3 6 9 1 2 3 5 9 3 0 1 4 7 8 9 3 4 6 8 0																					
WEEKS ON STUDY	1 1 1 1 1 1 1 1 1 1 1 1 1 1 1 1 1 1 1 1																					
	1 2 3 3 4 4 4 4 4 4 4 4 4 4 4 4 4 4 4 4																					
INTEGUMENTARY SYSTEM																						
Skin		+ N																				*50
Squamous cell papilloma																						1
Keratoacanthoma		X																				1
RESPIRATORY SYSTEM																						
Lungs and bronchi		+ +																				49
C-cell carcinoma, metastatic																						1
Trachea		+ +																				49
HEMATOPOIETIC SYSTEM																						
Bone marrow		+ +																				48
Spleen		+ +																				49
Leukemia, mononuclear cell		X																				1
Lymph nodes		+ + + + - + + + + + + + + + + + + + + +																				44
Thymus		+ + + + - + + + + + + + + + + + + + + +																				39
CIRCULATORY SYSTEM																						
Heart		+ +																				50
DIGESTIVE SYSTEM																						
Salivary gland		+ +																				48
Liver		+ +																				50
Bile duct		+ +																				50
Gallbladder & common bile duct		N N																				*50
Pancreas		+ +																				47
Esophagus		+ +																				48
Stomach		+ +																				49
Small intestine		+ +																				49
Large intestine		+ +																				45
URINARY SYSTEM																						
Kidney		+ +																				49
Urinary bladder		+ +																				44
ENDOCRINE SYSTEM																						
Pituitary		+ + + + + + + + + + + + + + - + + + + + + + +																				48
Carcinoma, NOS																						2
Adenoma, NOS		X X X X X X X X																				21
Adrenal		+ +																				49
Cortical adenoma		X																				1
Thyroid		+ +																				48
C-cell adenoma																						1
C-cell carcinoma		X																				4
Parathyroid		- - + + + + - + + + + - + + + + - - + + -																				27
REPRODUCTIVE SYSTEM																						
Mammary gland		+ + N + + + + + + + + + + + + + + + + + N																				*50
Adenocarcinoma, NOS																						2
Fibroadenoma																						3
Preputial/clitoral gland		N N																				*50
Carcinoma, NOS		X																				3
Adenoma, NOS		X																				1
Uterus		+ +																				49
Leiomyosarcoma																						1
Endometrial stromal polyp		X X																				7
Endometrial stromal sarcoma		X																				2
Deciduoma																						1
Ovary		+ +																				49
NERVOUS SYSTEM																						
Brain		+ +																				50
Carcinoma, NOS, invasive																						2
ALL OTHER SYSTEMS																						
Multiple organs, NOS		N N																				*50
Leukemia, mononuclear cell		X X X X X X X X X X X X X X X X X X X X																				29

* Animals Necropsied

TABLE A4. INDIVIDUAL ANIMAL TUMOR PATHOLOGY OF FEMALE RATS IN THE TWO-YEAR INHALATION STUDY OF TETRACHLOROETHYLENE: HIGH DOSE

ANIMAL NUMBER	0	1	2	3	4	5	6	7	8	9	10	11	12	13	14	15	16	17	18	19	20	21	22	23	24	25	26	27	28	29	30	31	32	33	34	35	36	37	38	39	40	41	42	43	44	45	46	47	48	49	50	51	52	53	54	55	56	57	58	59	60	61	62	63	64	65	66	67	68	69	70	71	72	73	74	75	76	77	78	79	80	81	82	83	84	85	86	87	88	89	90	91	92	93	94	95	96	97	98	99	100
	WEEKS ON STUDY	0	1	2	3	4	5	6	7	8	9	10	11	12	13	14	15	16	17	18	19	20	21	22	23	24	25	26	27	28	29	30	31	32	33	34	35	36	37	38	39	40	41	42	43	44	45	46	47	48	49	50	51	52	53	54	55	56	57	58	59	60	61	62	63	64	65	66	67	68	69	70	71	72	73	74	75	76	77	78	79	80	81	82	83	84	85	86	87	88	89	90	91	92	93	94	95	96	97	98	99
INTEGUMENTARY SYSTEM																																																																																																					
Skin	+																																																																																																				
Squamous cell papilloma																																																																																																					
RESPIRATORY SYSTEM																																																																																																					
Lungs and bronchi	+																																																																																																				
Alveolar/bronchiolar adenoma																																																																																																					
Trachea	+																																																																																																				
HEMATOPOIETIC SYSTEM																																																																																																					
Bone marrow	+																																																																																																				
Spleen	+																																																																																																				
Leukemia, mononuclear cell																																																																																																					
Lymph nodes	+																																																																																																				
Thymus	+																																																																																																				
CIRCULATORY SYSTEM																																																																																																					
Heart	+																																																																																																				
DIGESTIVE SYSTEM																																																																																																					
Oral cavity	N																																																																																																				
Squamous cell papilloma																																																																																																					
Squamous cell carcinoma	X																																																																																																				
Salivary gland	+																																																																																																				
Liver	+																																																																																																				
Neoplastic nodule																																																																																																					
Bile duct	+																																																																																																				
Gallbladder & common bile duct	N																																																																																																				
Pancreas	+																																																																																																				
Esophagus	+																																																																																																				
Stomach	+																																																																																																				
Small intestine	+																																																																																																				
Large intestine	+																																																																																																				
URINARY SYSTEM																																																																																																					
Kidney	+																																																																																																				
Urinary bladder	+																																																																																																				
Transitional cell papilloma																																																																																																					
Granular cell tumor, malignant																																																																																																					
ENDOCRINE SYSTEM																																																																																																					
Pituitary	+																																																																																																				
Carcinoma, NOS																																																																																																					
Adenoma, NOS	X X																																																																																																				
Adrenal	+																																																																																																				
Cortical adenoma																																																																																																					
Pheochromocytoma																																																																																																					
Pheochromocytoma, malignant	X																																																																																																				
Thyroid	+																																																																																																				
Follicular cell adenoma																																																																																																					
C-cell adenoma																																																																																																					
C-cell carcinoma	X X																																																																																																				
Parathyroid	-																																																																																																				
Adenoma, NOS																																																																																																					
Pancreatic islets	+																																																																																																				
Islet cell adenoma																																																																																																					
REPRODUCTIVE SYSTEM																																																																																																					
Mammary gland	+																																																																																																				
Adenoma, NOS																																																																																																					
Fibroadenoma	X																																																																																																				
Preputial/clitoral gland	N																																																																																																				
Carcinoma, NOS																																																																																																					
Adenoma, NOS																																																																																																					
Uterus	+																																																																																																				
Endometrial stromal polyp																																																																																																					
Endometrial stromal sarcoma	X X																																																																																																				
Ovary	+																																																																																																				
NERVOUS SYSTEM																																																																																																					
Brain	+																																																																																																				
Glioma, NOS	X																																																																																																				
SPECIAL SENSE ORGANS																																																																																																					
Zymbal gland	N																																																																																																				
Carcinoma, NOS																																																																																																					
BODY CAVITIES																																																																																																					
Peritoneum	N																																																																																																				
Granular cell tumor, invasive																																																																																																					
ALL OTHER SYSTEMS																																																																																																					
Multiple organs, NOS	N																																																																																																				
Leukemia, mononuclear cell	X X																																																																																																				

APPENDIX B

**SUMMARY OF THE INCIDENCE OF NEOPLASMS
IN MICE IN THE TWO-YEAR INHALATION STUDIES
OF TETRACHLOROETHYLENE**

TABLE B1. SUMMARY OF THE INCIDENCE OF NEOPLASMS IN MALE MICE IN THE TWO-YEAR INHALATION STUDY OF TETRACHLOROETHYLENE

	CONTROL (CHAMBER)	LOW DOSE	HIGH DOSE
ANIMALS INITIALLY IN STUDY	50	50	50
ANIMALS NECROPSIED	49	50	50
ANIMALS EXAMINED HISTOPATHOLOGICALLY	49	50	50
INTEGUMENTARY SYSTEM			
*Multiple organs	(49)	(50)	(50)
Fibrous histiocytoma, malignant			1 (2%)
*Subcutaneous tissue	(49)	(50)	(50)
Sebaceous adenoma	1 (2%)	1 (2%)	
#Spleen	(49)	(48)	(50)
Fibrous histiocytoma, malignant	1 (2%)		
#Liver	(49)	(49)	(50)
Fibrous histiocytoma, malignant	1 (2%)		
RESPIRATORY SYSTEM			
#Lung	(49)	(49)	(50)
Hepatocellular carcinoma, metastatic	2 (4%)	7 (14%)	1 (2%)
Alveolar/bronchiolar adenoma	3 (6%)	5 (10%)	1 (2%)
Alveolar/bronchiolar carcinoma	4 (8%)	1 (2%)	4 (8%)
HEMATOPOIETIC SYSTEM			
*Multiple organs	(49)	(50)	(50)
Malignant lymphoma, NOS	1 (2%)	7 (14%)	1 (2%)
*Subcutaneous tissue	(49)	(50)	(50)
Malignant lymphoma, NOS	2 (4%)		
#Spleen	(49)	(48)	(50)
Sarcoma, NOS			1 (2%)
Malignant lymphoma, NOS			1 (2%)
#Mesenteric lymph node	(25)	(24)	(27)
Malignant lymphoma, NOS			1 (4%)
#Stomach wall	(48)	(44)	(49)
Mast cell tumor	1 (2%)		
*Preputial gland	(49)	(50)	(50)
Mast cell tumor			1 (2%)
CIRCULATORY SYSTEM			
#Heart	(49)	(50)	(50)
Hemangioma		1 (2%)	
*Pulmonary artery	(49)	(50)	(50)
Hepatocellular carcinoma, metastatic		1 (2%)	
*Pulmonary vein	(49)	(50)	(50)
Hepatocellular carcinoma, metastatic		1 (2%)	1 (2%)
#Liver	(49)	(49)	(50)
Hemangioma	2 (4%)	2 (4%)	2 (4%)
Hemangiosarcoma	1 (2%)		
DIGESTIVE SYSTEM			
#Liver	(49)	(49)	(50)
Hepatocellular adenoma	12 (24%)	8 (16%)	19 (38%)
Hepatocellular carcinoma	7 (14%)	25 (51%)	26 (52%)
#Ileum	(49)	(42)	(45)
Adenocarcinoma, NOS	2 (4%)		
URINARY SYSTEM			
#Kidney	(49)	(49)	(50)
Tubular cell adenocarcinoma		1 (2%)	

TABLE B1. SUMMARY OF THE INCIDENCE OF NEOPLASMS IN MALE MICE IN THE TWO-YEAR INHALATION STUDY OF TETRACHLOROETHYLENE (Continued)

	CONTROL (CHAMBER)	LOW DOSE	HIGH DOSE
ENDOCRINE SYSTEM			
#Pituitary	(47)	(41)	(44)
Carcinoma, NOS		1 (2%)	
Adenoma, NOS		1 (2%)	
#Adrenal	(49)	(48)	(49)
Cortical adenoma	2 (4%)	1 (2%)	1 (2%)
#Adrenal medulla	(49)	(48)	(49)
Pheochromocytoma		1 (2%)	
#Thyroid	(47)	(46)	(50)
Follicular cell adenoma			1 (2%)
C-cell carcinoma	1 (2%)		
REPRODUCTIVE SYSTEM			
#Testis	(49)	(48)	(49)
Interstitial cell tumor	1 (2%)		
NERVOUS SYSTEM			
None			
SPECIAL SENSE ORGANS			
*Harderian gland	(49)	(50)	(50)
Papillary adenoma		1 (2%)	
Papillary cystadenocarcinoma NOS	1 (2%)		1 (2%)
MUSCULOSKELETAL SYSTEM			
None			
BODY CAVITIES			
None			
ALL OTHER SYSTEMS			
*Multiple organs	(49)	(50)	(50)
Hepatocellular carcinoma, metastatic		1 (2%)	
ANIMAL DISPOSITION SUMMARY			
Animals initially in study	50	50	50
Natural death	3	18	7
Moribund sacrifice		7	11
Terminal sacrifice	46	25	32
Animal missexed	1		

TABLE B1. SUMMARY OF THE INCIDENCE OF NEOPLASMS IN MALE MICE IN THE TWO-YEAR INHALATION STUDY OF TETRACHLOROETHYLENE (Continued)

	CONTROL (CHAMBER)	LOW DOSE	HIGH DOSE
TUMOR SUMMARY			
Total animals with primary tumors**	29	38	43
Total primary tumors	43	56	61
Total animals with benign tumors	19	16	22
Total benign tumors	21	21	24
Total animals with malignant tumors	17	32	30
Total malignant tumors	21	35	36
Total animals with secondary tumors##	2	10	2
Total secondary tumors	2	10	2
Total animals with tumors uncertain-- benign or malignant	1		1
Total uncertain tumors	1		1

* Number of animals receiving complete necropsy examination; all gross lesions including masses examined microscopically.

** Primary tumors: all tumors except secondary tumors

Number of animals examined microscopically at this site

Secondary tumors: metastatic tumors or tumors invasive into an adjacent organ

TABLE B2. SUMMARY OF THE INCIDENCE OF NEOPLASMS IN FEMALE MICE IN THE TWO-YEAR INHALATION STUDY OF TETRACHLOROETHYLENE

	CONTROL (CHAMBER)	LOW DOSE	HIGH DOSE
ANIMALS INITIALLY IN STUDY	50	50	50
ANIMALS NECROPSIED	49	50	50
ANIMALS EXAMINED HISTOPATHOLOGICALLY	49	50	50
INTEGUMENTARY SYSTEM			
*Multiple organs	(49)	(50)	(50)
Fibrous histiocytoma, malignant	1 (2%)		
*Skin	(49)	(50)	(50)
Squamous cell papilloma			1 (2%)
*Subcutaneous tissue	(49)	(50)	(50)
Fibrous histiocytoma, malignant	1 (2%)		
RESPIRATORY SYSTEM			
#Lung	(48)	(50)	(50)
Adenocarcinoma, NOS, metastatic			1 (2%)
Hepatocellular carcinoma, metastatic		2 (4%)	7 (14%)
Alveolar/bronchiolar adenoma	4 (8%)	2 (4%)	1 (2%)
Alveolar/bronchiolar carcinoma	2 (4%)	1 (2%)	2 (4%)
Sarcoma, NOS, metastatic			1 (2%)
HEMATOPOIETIC SYSTEM			
*Multiple organs	(49)	(50)	(50)
Malignant lymphoma, NOS	8 (16%)	10 (20%)	7 (14%)
Malig. lymphoma, histiocytic type		1 (2%)	
#Spleen	(49)	(49)	(50)
Thymoma, metastatic	1 (2%)		
Malignant lymphoma, NOS		1 (2%)	1 (2%)
#Bronchial lymph node	(34)	(31)	(26)
Adenocarcinoma, NOS, metastatic			1 (4%)
Alveolar/bronchiolar carcinoma, metastatic			1 (4%)
#Ileum	(48)	(45)	(46)
Malignant lymphoma, NOS		1 (2%)	
#Thymus	(35)	(39)	(22)
Thymoma, malignant	1 (3%)		
CIRCULATORY SYSTEM			
*Eye	(49)	(50)	(50)
Hemangiosarcoma	1 (2%)		
#Spleen	(49)	(49)	(50)
Hemangioma		1 (2%)	
#Mesenteric lymph node	(34)	(31)	(26)
Hemangioma			1 (4%)
#Heart	(48)	(50)	(50)
Sarcoma, NOS			1 (2%)
*Pulmonary artery	(49)	(50)	(50)
Fibrous histiocytoma, metastatic	1 (2%)		
#Liver	(48)	(50)	(50)
Hemangiosarcoma		3 (6%)	
#Ovary	(48)	(49)	(43)
Hemangioma	1 (2%)		

TABLE B2. SUMMARY OF THE INCIDENCE OF NEOPLASMS IN FEMALE MICE IN THE TWO-YEAR INHALATION STUDY OF TETRACHLOROETHYLENE (Continued)

	CONTROL (CHAMBER)	LOW DOSE	HIGH DOSE
DIGESTIVE SYSTEM			
#Liver	(48)	(50)	(50)
Hepatocellular adenoma	3 (6%)	6 (12%)	2 (4%)
Hepatocellular carcinoma	1 (2%)	13 (26%)	36 (72%)
#Forestomach	(48)	(50)	(48)
Papilloma, NOS	1 (2%)		
*Rectum	(49)	(50)	(50)
Squamous cell carcinoma	1 (2%)		
URINARY SYSTEM			
None			
ENDOCRINE SYSTEM			
#Pituitary	(45)	(43)	(42)
Carcinoma, NOS	5 (11%)	3 (7%)	3 (7%)
Adenoma, NOS	2 (4%)		1 (2%)
Chromophobe adenoma			1 (2%)
#Adrenal medulla	(47)	(49)	(49)
Carcinoma, NOS			1 (2%)
Adenoma, NOS		1 (2%)	
Pheochromocytoma		1 (2%)	
#Periadrenal tissue	(47)	(49)	(49)
Fibrosarcoma, metastatic	1 (2%)		
#Thyroid	(48)	(48)	(48)
Follicular cell adenoma		1 (2%)	
REPRODUCTIVE SYSTEM			
*Mammary gland	(49)	(50)	(50)
Adenocarcinoma, NOS		1 (2%)	1 (2%)
Adenosquamous carcinoma		1 (2%)	1 (2%)
Fibrosarcoma	1 (2%)		
#Uterus	(43)	(44)	(48)
Leiomyoma		1 (2%)	
Leiomyosarcoma	1 (2%)	1 (2%)	
Endometrial stromal polyp	1 (2%)		
#Ovary	(48)	(49)	(43)
Papillary cystadenoma, NOS		1 (2%)	
Fibrous histiocytoma, metastatic	1 (2%)		
Mesothelioma, NOS		1 (2%)	
NERVOUS SYSTEM			
#Brain	(48)	(49)	(50)
Carcinoma, NOS, metastatic	1 (2%)		
SPECIAL SENSE ORGANS			
*Eye	(49)	(50)	(50)
Sebaceous adenoma			1 (2%)
*Harderian gland	(49)	(50)	(50)
Papillary carcinoma			1 (2%)
Adenoma, NOS	1 (2%)		1 (2%)
Papillary adenoma		1 (2%)	1 (2%)
*Ear	(49)	(50)	(50)
Squamous cell papilloma	1 (2%)		
MUSCULOSKELETAL SYSTEM			
None			

TABLE B2. SUMMARY OF THE INCIDENCE OF NEOPLASMS IN FEMALE MICE IN THE TWO-YEAR INHALATION STUDY OF TETRACHLOROETHYLENE (Continued)

	CONTROL (CHAMBER)	LOW DOSE	HIGH DOSE
BODY CAVITIES			
*Mediastinum	(49)	(50)	(50)
Fibrosarcoma, metastatic	1 (2%)		
*Peritoneal cavity	(49)	(50)	(50)
Hepatocellular carcinoma, invasive			1 (2%)
ALL OTHER SYSTEMS			
*Multiple organs	(49)	(50)	(50)
Carcinosarcoma	1 (2%)		
ANIMAL DISPOSITION SUMMARY			
Animals initially in study	50	50	50
Natural death	3	10	11
Moribund sacrifice	8	7	21
Terminal sacrifice	36	31	17
Accidentally killed, NOS	2	2	1
Animal missexed	1		
TUMOR SUMMARY			
Total animals with primary tumors**	27	35	43
Total primary tumors	38	52	64
Total animals with benign tumors	13	14	10
Total benign tumors	14	15	10
Total animals with malignant tumors	22	31	41
Total malignant tumors	24	36	54
Total animals with secondary tumors##	4	2	8
Total secondary tumors	6	2	12
Total animals with tumors uncertain-- benign or malignant		1	
Total uncertain tumors		1	

* Number of animals receiving complete necropsy examination; all gross lesions including masses examined microscopically.

** Primary tumors: all tumors except secondary tumors

Number of animals examined microscopically at this site

Secondary tumors: metastatic tumors or tumors invasive into an adjacent organ

TABLE B4. INDIVIDUAL ANIMAL TUMOR PATHOLOGY OF FEMALE MICE: CHAMBER CONTROL (Continued)

ANIMAL NUMBER	0 0 0 0 0 0 0 0 0 0 0 0 0 0 0 0 0 0 0 0																				TOTAL TISSUES TUMORS
	3 4 5 7 9 0 1 6 7 8 9 0 1 3 5 6 7 9 2 3 4 5 6 7 0																				
WEEKS ON STUDY	1 1 1 1 1 1 1 1 1 1 1 1 1 1 1 1 1 1 1 1																				TOTAL TISSUES TUMORS
	4 4 4 4 4 4 4 4 4 4 4 4 4 4 4 4 4 4 4 4																				
INTEGUMENTARY SYSTEM																					
Subcutaneous tissue	+ +																				*49
Fibrous histiocytoma, malignant	X																				1
RESPIRATORY SYSTEM																					
Lungs and bronchi	+ +																				48
Alveolar/bronchiolar adenoma	X X																				4
Alveolar/bronchiolar carcinoma	X X																				2
Tracheae	+ +																				48
HEMATOPOIETIC SYSTEM																					
Bone marrow	+ +																				48
Spleen	+ +																				49
Thymoma, metastatic	+ +																				1
Lymph nodes	- + - + - + - + - + - + - + - + - + - + - +																				34
Thymus	+ +																				35
Thymoma, malignant	+ +																				1
CIRCULATORY SYSTEM																					
Heart	+ +																				48
Blood vessels	N N																				*49
Fibrous histiocytoma, metastatic	X																				1
DIGESTIVE SYSTEM																					
Salivary gland	+ +																				47
Liver	+ +																				48
Hepatocellular adenoma	+ +																				3
Hepatocellular carcinoma	X																				1
Bile duct	+ +																				48
Gallbladder & common bile duct	+ N +																				*49
Pancreas	+ +																				47
Esophagus	+ +																				46
Stomach	+ +																				48
Papilloma, NOS	+ +																				1
Small intestine	+ +																				48
Large intestine	+ +																				48
Rectum	+ +																				*49
Squamous cell carcinoma	X																				1
URINARY SYSTEM																					
Kidney	+ +																				48
Urinary bladder	+ + + + + + + + - - + + + + + + + + + + + +																				48
ENDOCRINE SYSTEM																					
Pituitary	+ +																				45
Carcinoma, NOS	X X																				5
Adenoma, NOS	X																				2
Adrenal	+ +																				47
Fibrosarcoma, metastatic	+ +																				1
Thyroid	+ +																				48
Parathyroid	- - - - - + + + - - + + - - + + - - + + - - - -																				18
REPRODUCTIVE SYSTEM																					
Mammary gland	+ + + + + N + + + + N + N N + + + + N + + +																				*49
Fibrosarcoma	+ + - - - + + + + + + + + + + + + + + + +																				1
Uterus	+ + - - - + + + + + + + + + + + + + + + +																				43
Leiomyosarcoma	X																				1
Endometrial stromal polyp	+ +																				1
Ovary	+ +																				48
Fibrous histiocytoma, metastatic	X																				1
Hemangioma	X																				1
NERVOUS SYSTEM																					
Brain	+ +																				48
Carcinoma, NOS, metastatic	X																				1
SPECIAL SENSE ORGANS																					
Eye	N N N N N + N N N N N + N N N N N N N N N N N																				*49
Hemangioma	X																				1
Harderian gland	N N																				*49
Adenoma, NOS	N N																				1
Ear	N N																				*49
Squamous cell papilloma	X																				1
BODY CAVITIES																					
Mediastinum	N N																				*49
Fibrosarcoma, metastatic	N N																				1
ALL OTHER SYSTEMS																					
Multiple organs, NOS	N N																				*49
Fibrous histiocytoma, malignant	N N																				1
Carcinosarcoma	N N																				1
Malignant lymphoma, NOS	X X X X																				8

* Animals Necropsied

TABLE B4. INDIVIDUAL ANIMAL TUMOR PATHOLOGY OF FEMALE MICE: LOW DOSE
(Continued)

ANIMAL NUMBER	0 8	0 9	0 2	0 3	0 4	0 6	0 7	0 8	0 9	0 1	0 1	0 2	0 2	0 2	0 2	0 3	0 3	0 3	0 3	0 3	0 4	0 4	0 4	0 4	0 6	0 7	0 8	TOTAL TISSUES TUMORS
WEEKS ON STUDY	1 4	1 4	1 4	1 4	1 4	1 4	1 4	1 4	1 4	1 4	1 4	1 4	1 4	1 4	1 4	1 4	1 4	1 4	1 4	1 4	1 4	1 4	1 4	1 4	1 4	1 4	1 4	
RESPIRATORY SYSTEM																												
Lungs and bronchi	+	+	+	+	+	+	+	+	+	+	+	+	+	+	+	+	+	+	+	+	+	+	+	+	+	+	+	50
Hepatocellular carcinoma, metastatic																												2
Alveolar/bronchiolar adenoma																												2
Alveolar/bronchiolar carcinoma																												1
Trachea	+	+	+	+	+	+	+	+	+	+	+	+	+	+	+	+	+	+	+	+	+	+	+	+	+	+	+	50
HEMATOPOIETIC SYSTEM																												
Bone marrow	+	+	+	+	+	+	+	+	+	+	+	+	+	+	+	+	+	+	+	+	+	+	+	+	+	+	+	49
Spleen	+	+	+	+	+	+	+	+	+	+	+	+	+	+	+	+	+	+	+	+	+	+	+	+	+	+	+	49
Hemangioma																												1
Malignant lymphoma, NOS																												1
Lymph nodes	-	+	+	+	+	+	+	+	+	+	+	+	+	+	+	+	+	+	+	+	+	+	+	+	+	+	+	31
Thymus	+	+	+	+	+	+	+	+	+	+	+	+	+	+	+	+	+	+	+	+	+	+	+	+	+	+	+	39
CIRCULATORY SYSTEM																												
Heart	+	+	+	+	+	+	+	+	+	+	+	+	+	+	+	+	+	+	+	+	+	+	+	+	+	+	+	50
DIGESTIVE SYSTEM																												
Salivary gland	+	+	+	+	+	+	+	+	+	+	+	+	+	+	+	+	+	+	+	+	+	+	+	+	+	+	+	49
Liver	+	+	+	+	+	+	+	+	+	+	+	+	+	+	+	+	+	+	+	+	+	+	+	+	+	+	+	50
Hepatocellular adenoma	X																											6
Hepatocellular carcinoma		X																										13
Hemangiosarcoma																												3
Bile duct	+	+	+	+	+	+	+	+	+	+	+	+	+	+	+	+	+	+	+	+	+	+	+	+	+	+	+	50
Gallbladder & common bile duct	+	+	+	N	+	+	+	N	+	+	+	+	+	+	+	+	+	+	+	+	+	+	+	+	+	+	+	*50
Pancreas	+	+	+	+	+	+	+	+	+	+	+	+	+	+	+	+	+	+	+	+	+	+	+	+	+	+	+	49
Esophagus	+	+	+	+	+	+	+	+	+	+	+	+	+	+	+	+	+	+	+	+	+	+	+	+	+	+	+	44
Stomach	+	+	+	+	+	+	+	+	+	+	+	+	+	+	+	+	+	+	+	+	+	+	+	+	+	+	+	50
Small intestine	+	+	+	+	+	+	+	+	+	+	+	+	+	+	+	+	+	+	+	+	+	+	+	+	+	+	+	46
Malignant lymphoma, NOS																												1
Large intestine	+	+	+	+	+	+	+	+	+	+	+	+	+	+	+	+	+	+	+	+	+	+	+	+	+	+	+	46
URINARY SYSTEM																												
Kidney	+	+	+	+	+	+	+	+	+	+	+	+	+	+	+	+	+	+	+	+	+	+	+	+	+	+	+	49
Urinary bladder	+	+	+	+	+	+	+	+	+	+	+	+	+	+	+	+	+	+	+	+	+	+	+	+	+	+	+	48
ENDOCRINE SYSTEM																												
Pituitary	+	+	+	+	+	+	+	+	+	+	+	+	+	+	+	+	+	+	+	+	+	+	+	+	+	+	+	43
Carcinoma, NOS	X		X																									3
Adrenal	+	+	+	+	+	+	+	+	+	+	+	+	+	+	+	+	+	+	+	+	+	+	+	+	+	+	+	49
Adenoma, NOS																												1
Pheochromocytoma																												1
Thyroid	-	+	+	+	+	+	+	+	+	+	+	+	+	+	+	+	+	+	+	+	+	+	+	+	+	+	+	48
Follicular cell adenoma																												1
Parathyroid	-	-	-	+	-	+	-	+	+	+	+	+	+	+	+	+	+	+	+	+	+	+	+	+	+	+	+	17
REPRODUCTIVE SYSTEM																												
Mammary gland	+	+	+	+	N	N	N	+	+	+	+	+	+	+	+	+	+	+	+	+	+	+	+	+	+	+	+	*50
Adenocarcinoma, NOS																												1
Adenosquamous carcinoma																												1
Uterus	+	+	+	+	+	+	+	+	+	+	+	+	+	+	+	+	+	+	+	+	+	+	+	+	+	+	+	44
Leiomyoma																												1
Leiomyosarcoma																												1
Ovary	+	+	+	+	+	+	+	+	+	+	+	+	+	+	+	+	+	+	+	+	+	+	+	+	+	+	+	49
Papillary cystadenoma, NOS																												1
Mesothelioma, NOS																												1
NERVOUS SYSTEM																												
Brain	+	+	+	+	+	+	+	+	+	+	+	+	+	+	+	+	+	+	+	+	+	+	+	+	+	+	+	49
SPECIAL SENSE ORGANS																												
Harderian gland	N	N	N	N	N	N	N	N	N	N	N	N	N	N	N	N	N	N	N	N	N	N	N	N	N	N	N	*50
Papillary adenoma																												1
ALL OTHER SYSTEMS																												
Multiple organs, NOS	N	N	N	N	N	N	N	N	N	N	N	N	N	N	N	N	N	N	N	N	N	N	N	N	N	N	N	*50
Malignant lymphoma, NOS																												10
Malignant lymphoma, histiocytic type																												1

* Animals Necropsied

APPENDIX C

**SUMMARY OF THE INCIDENCE OF NONNEOPLASTIC
LESIONS IN RATS IN THE TWO-YEAR
INHALATION STUDIES
OF TETRACHLOROETHYLENE**

TABLE C1. SUMMARY OF THE INCIDENCE OF NONNEOPLASTIC LESIONS IN MALE RATS IN THE TWO-YEAR INHALATION STUDY OF TETRACHLOROETHYLENE

	CONTROL (CHAMBER)	LOW DOSE	HIGH DOSE
ANIMALS INITIALLY IN STUDY	50	50	50
ANIMALS NECROPSIED	50	50	50
ANIMALS EXAMINED HISTOPATHOLOGICALLY	50	50	50
INTEGUMENTARY SYSTEM			
*Skin	(50)	(50)	(50)
Inflammation, suppurative	1 (2%)	1 (2%)	
Abscess, NOS			1 (2%)
Inflammation, chronic			1 (2%)
Hyperplasia, basal cell	1 (2%)		
Hyperkeratosis	1 (2%)		
Acanthosis			1 (2%)
Parakeratosis			1 (2%)
*Subcutaneous tissue	(50)	(50)	(50)
Abscess, NOS			1 (2%)
RESPIRATORY SYSTEM			
*Nasal cavity	(50)	(50)	(50)
Foreign body, NOS	2 (4%)	1 (2%)	1 (2%)
Mineralization	34 (68%)	35 (70%)	34 (68%)
Inflammation, NOS	11 (22%)	9 (18%)	7 (14%)
Inflammation, suppurative	10 (20%)	14 (28%)	11 (22%)
Hyperplasia, epithelial	5 (10%)	5 (10%)	5 (10%)
Metaplasia, squamous		5 (10%)	5 (10%)
*Larynx	(50)	(50)	(50)
Foreign body, NOS		1 (2%)	
Inflammation, NOS		3 (6%)	2 (4%)
Inflammation, suppurative	9 (18%)	16 (32%)	7 (14%)
Hyperplasia, epithelial			1 (2%)
Metaplasia, squamous			2 (4%)
#Trachea	(48)	(48)	(49)
Inflammation, NOS		1 (2%)	
Inflammation, suppurative	2 (4%)	1 (2%)	1 (2%)
#Lung/bronchiole	(50)	(47)	(50)
Inflammation, NOS			1 (2%)
Hyperplasia, epithelial	1 (2%)		2 (4%)
#Lung	(50)	(47)	(50)
Foreign body, NOS		1 (2%)	
Congestion, NOS		1 (2%)	1 (2%)
Edema, NOS		1 (2%)	
Hemorrhage	4 (8%)	4 (9%)	4 (8%)
Inflammation, NOS			4 (8%)
Inflammation, suppurative	1 (2%)		1 (2%)
Inflammation, granulomatous focal	1 (2%)	2 (4%)	
Fibrosis	2 (4%)		7 (14%)
Perivascular cuffing			1 (2%)
Necrosis, NOS	1 (2%)		
Hyperplasia, alveolar epithelium	7 (14%)	3 (6%)	3 (6%)
Metaplasia, squamous	1 (2%)		
Metaplasia, osseous	2 (4%)	1 (2%)	
Histiocytosis	8 (16%)	7 (15%)	15 (30%)
HEMATOPOIETIC SYSTEM			
*Multiple organs	(50)	(50)	(50)
Hematopoiesis			1 (2%)
#Bone marrow	(48)	(46)	(48)
Fibrosis			4 (8%)

TABLE C1. SUMMARY OF THE INCIDENCE OF NONNEOPLASTIC LESIONS IN MALE RATS IN THE TWO-YEAR INHALATION STUDY OF TETRACHLOROETHYLENE (Continued)

	CONTROL (CHAMBER)	LOW DOSE	HIGH DOSE
HEMATOPOIETIC SYSTEM (Continued)			
#Spleen	(50)	(50)	(49)
Fibrosis	6 (12%)	4 (8%)	4 (8%)
Necrosis, NOS		3 (6%)	1 (2%)
Hemosiderosis	1 (2%)		1 (2%)
Metaplasia, osseous	1 (2%)		
Hematopoiesis		1 (2%)	1 (2%)
#Mandibular lymph node	(46)	(44)	(46)
Hyperplasia, NOS	8 (17%)	10 (23%)	12 (26%)
#Thoracic lymph node	(46)	(44)	(46)
Hemosiderosis	1 (2%)		1 (2%)
Hyperplasia, NOS		1 (2%)	1 (2%)
#Lung	(50)	(47)	(50)
Hyperplasia, lymphoid	1 (2%)		
#Liver	(50)	(50)	(49)
Leukocytosis, NOS	2 (4%)	1 (2%)	
Hematopoiesis			1 (2%)
#Colon	(41)	(44)	(45)
Hyperplasia, lymphoid		1 (2%)	
#Adrenal	(49)	(49)	(49)
Hematopoiesis	2 (4%)	2 (4%)	
#Thymus	(35)	(34)	(31)
Degeneration, cystic		1 (3%)	
CIRCULATORY SYSTEM			
#Brain	(50)	(50)	(50)
Thrombosis, NOS			1 (2%)
*Mediastinum	(50)	(50)	(50)
Thrombosis, NOS			1 (2%)
#Splenic capsule	(50)	(50)	(49)
Thrombosis, NOS		1 (2%)	
#Mandibular lymph node	(46)	(44)	(46)
Lymphangiectasis	1 (2%)	1 (2%)	2 (4%)
*Nasal cavity	(50)	(50)	(50)
Thrombosis, NOS	9 (18%)	11 (22%)	19 (38%)
#Lung	(50)	(47)	(50)
Thrombosis, NOS	1 (2%)	1 (2%)	2 (4%)
#Heart	(50)	(50)	(50)
Mineralization	1 (2%)		
Thrombosis, NOS	6 (12%)	4 (8%)	10 (20%)
Thrombus, organized	1 (2%)		
Inflammation, NOS	5 (10%)	7 (14%)	1 (2%)
Fibrosis	41 (82%)	32 (64%)	33 (66%)
Necrosis, NOS	1 (2%)		1 (2%)
*Blood vessel	(50)	(50)	(50)
Thrombosis, NOS			1 (2%)
Inflammation, chronic		3 (6%)	
Hypertrophy, NOS	1 (2%)	1 (2%)	3 (6%)
#Liver	(50)	(50)	(49)
Thrombosis, NOS	1 (2%)		1 (2%)
#Testis	(50)	(49)	(50)
Perivasculitis	2 (4%)		3 (6%)
DIGESTIVE SYSTEM			
*Oral mucosa	(50)	(50)	(50)
Inflammation, NOS			1 (2%)
Inflammation, suppurative	2 (4%)	1 (2%)	
Erosion			1 (2%)
Hyperplasia, epithelial			1 (2%)

TABLE C1. SUMMARY OF THE INCIDENCE OF NONNEOPLASTIC LESIONS IN MALE RATS IN THE TWO-YEAR INHALATION STUDY OF TETRACHLOROETHYLENE (Continued)

	CONTROL (CHAMBER)	LOW DOSE	HIGH DOSE
DIGESTIVE SYSTEM (Continued)			
*Tongue	(50)	(50)	(50)
Foreign body, NOS		1 (2%)	
Inflammation, granulomatous focal		1 (2%)	
Hyperplasia, epithelial			1 (2%)
*Tooth	(50)	(50)	(50)
Foreign body, NOS		1 (2%)	
Inflammation, NOS		1 (2%)	
Inflammation, suppurative	1 (2%)		
#Salivary gland	(48)	(48)	(48)
Inflammation, NOS	1 (2%)	1 (2%)	
Metaplasia, squamous	1 (2%)	3 (6%)	2 (4%)
#Liver	(50)	(50)	(49)
Hemorrhage		1 (2%)	
Inflammation, suppurative	1 (2%)		
Inflammation, granulomatous focal	2 (4%)	2 (4%)	2 (4%)
Degeneration, NOS	6 (12%)	5 (10%)	9 (18%)
Degeneration, cystic	8 (16%)	7 (14%)	9 (18%)
Degeneration, lipoid	7 (14%)	3 (6%)	10 (20%)
Necrosis, NOS	4 (8%)	4 (8%)	4 (8%)
Basophilic cyto change	22 (44%)	19 (38%)	16 (33%)
Eosinophilic cyto change		1 (2%)	
Clear cell change	2 (4%)	2 (4%)	1 (2%)
Hepatocytomegaly	1 (2%)		
Angiectasis	3 (6%)	8 (16%)	4 (8%)
Regeneration, NOS		1 (2%)	
#Liver/periportal	(50)	(50)	(49)
Inflammation, NOS		1 (2%)	
Fibrosis		1 (2%)	
#Bile duct	(50)	(50)	(49)
Hyperplasia, NOS	26 (52%)	36 (72%)	30 (61%)
#Pancreas	(43)	(46)	(46)
Inflammation, NOS			1 (2%)
Atrophy, focal	11 (26%)	5 (11%)	11 (24%)
Atrophy, diffuse	4 (9%)	4 (9%)	1 (2%)
#Pancreatic acinus	(43)	(46)	(46)
Focal cellular change	1 (2%)		
#Stomach	(48)	(49)	(49)
Ulcer, NOS		1 (2%)	
Hyperplasia, epithelial		1 (2%)	
#Glandular stomach	(48)	(49)	(49)
Hemorrhage	1 (2%)		
Ulcer, NOS	1 (2%)		
Inflammation, suppurative	1 (2%)	1 (2%)	
Erosion		2 (4%)	
Degeneration, cystic	1 (2%)		
#Forestomach	(48)	(49)	(49)
Inflammation, NOS			4 (8%)
Ulcer, NOS		1 (2%)	5 (10%)
Inflammation, suppurative		1 (2%)	1 (2%)
Hyperplasia, epithelial	2 (4%)	2 (4%)	6 (12%)
#Small intestine	(42)	(47)	(47)
Inflammation, NOS	1 (2%)		
#Colon	(41)	(44)	(45)
Parasitism	10 (24%)	10 (23%)	4 (9%)
*Rectum	(50)	(50)	(50)
Parasitism	4 (8%)	5 (10%)	4 (8%)

TABLE C1. SUMMARY OF THE INCIDENCE OF NONNEOPLASTIC LESIONS IN MALE RATS IN THE TWO-YEAR INHALATION STUDY OF TETRACHLOROETHYLENE (Continued)

	CONTROL (CHAMBER)	LOW DOSE	HIGH DOSE
URINARY SYSTEM			
#Kidney	(49)	(49)	(50)
Cyst, NOS			1 (2%)
Nephropathy	48 (98%)	49 (100%)	50 (100%)
Infarct, NOS	1 (2%)		
Nuclear enlargement	1 (2%)	37 (76%)	47 (94%)
Hyperplasia, tubular cell		3 (6%)	5 (10%)
#Kidney/tubule	(49)	(49)	(50)
Mineralization		1 (2%)	1 (2%)
#Kidney/pelvis	(49)	(49)	(50)
Inflammation, suppurative		2 (4%)	
Hyperplasia, epithelial		1 (2%)	
#Urinary bladder	(46)	(48)	(48)
Hemorrhage	1 (2%)		1 (2%)
Inflammation, NOS		1 (2%)	
Inflammation, suppurative		1 (2%)	2 (4%)
Inflammation, granulomatous focal	1 (2%)		
Hyperplasia, epithelial		1 (2%)	2 (4%)
*Urethra	(50)	(50)	(50)
Inflammation, NOS	1 (2%)		
ENDOCRINE SYSTEM			
#Anterior pituitary	(47)	(47)	(48)
Cyst, NOS	1 (2%)		
Degeneration, NOS			1 (2%)
Degeneration, cystic	4 (9%)	4 (9%)	8 (17%)
Pigmentation, NOS			1 (2%)
Hyperplasia, NOS	10 (21%)	10 (21%)	12 (25%)
#Adrenal	(49)	(49)	(49)
Congestion, NOS	1 (2%)		
Hemorrhage	1 (2%)		
Degeneration, cystic			2 (4%)
Degeneration, lipid	17 (35%)	6 (12%)	11 (22%)
Necrosis, NOS			1 (2%)
#Adrenal cortex	(49)	(49)	(49)
Hyperplasia, NOS	11 (22%)	5 (10%)	7 (14%)
#Adrenal medulla	(49)	(49)	(49)
Hyperplasia, NOS	5 (10%)	14 (29%)	12 (24%)
#Thyroid	(47)	(48)	(46)
Cyst, NOS		1 (2%)	
Degeneration, cystic	7 (15%)	3 (6%)	2 (4%)
Hyperplasia, C-cell	11 (23%)	8 (17%)	5 (11%)
Hyperplasia, follicular cell			1 (2%)
#Parathyroid	(39)	(35)	(34)
Hyperplasia, NOS	2 (5%)	1 (3%)	2 (6%)
#Pancreatic islets	(43)	(46)	(46)
Hyperplasia, NOS	5 (12%)	1 (2%)	2 (4%)
REPRODUCTIVE SYSTEM			
*Mammary gland	(50)	(50)	(50)
Galactocele	2 (4%)		1 (2%)
Hyperplasia, NOS	14 (28%)	27 (54%)	21 (42%)
*Preputial gland	(50)	(50)	(50)
Cystic ducts	2 (4%)	1 (2%)	
Inflammation, NOS	24 (48%)	21 (42%)	23 (46%)
Inflammation, suppurative	5 (10%)	3 (6%)	1 (2%)
Abscess, NOS	3 (6%)		1 (2%)
Inflammation, pyogranulomatous		1 (2%)	
Hyperplasia, epithelial	2 (4%)	4 (8%)	

TABLE C1. SUMMARY OF THE INCIDENCE OF NONNEOPLASTIC LESIONS IN MALE RATS IN THE TWO-YEAR INHALATION STUDY OF TETRACHLOROETHYLENE (Continued)

	CONTROL (CHAMBER)	LOW DOSE	HIGH DOSE
REPRODUCTIVE SYSTEM (Continued)			
#Prostate	(47)	(45)	(45)
Inflammation, NOS		1 (2%)	
Inflammation, suppurative	18 (38%)	10 (22%)	8 (18%)
Hyperplasia, epithelial	4 (9%)	2 (4%)	6 (13%)
*Seminal vesicle	(50)	(50)	(50)
Dilatation, NOS	1 (2%)		
Inflammation, NOS	2 (4%)	1 (2%)	4 (8%)
Inflammation, suppurative	14 (28%)	10 (20%)	15 (30%)
Abscess, NOS		1 (2%)	
Fibrosis	1 (2%)		
#Testis	(50)	(49)	(50)
Mineralization	1 (2%)	2 (4%)	3 (6%)
Atrophy, NOS	35 (70%)	38 (78%)	42 (84%)
Hyperplasia, epithelial	1 (2%)		
Hyperplasia, interstitial cell	5 (10%)	6 (12%)	4 (8%)
NERVOUS SYSTEM			
#Brain	(50)	(50)	(50)
Hemorrhage	2 (4%)	4 (8%)	1 (2%)
Necrosis, focal	2 (4%)	2 (4%)	
Hemosiderosis	1 (2%)		
Cytoplasmic vacuolization		1 (2%)	
Metaplasia, osseous			1 (2%)
*Olfactory sensory epithelium	(50)	(50)	(50)
Inflammation, suppurative		2 (4%)	
SPECIAL SENSE ORGANS			
*Eye	(50)	(50)	(50)
Hemorrhage	1 (2%)		
Degeneration, NOS			2 (4%)
*Eye/cornea	(50)	(50)	(50)
Inflammation, NOS			1 (2%)
*Eye/crystalline lens	(50)	(50)	(50)
Mineralization			1 (2%)
*Lacrimal apparatus	(50)	(50)	(50)
Inflammation, NOS		3 (6%)	
Hyperplasia, epithelial		1 (2%)	
Metaplasia, squamous	1 (2%)	3 (6%)	
*Nasolacrimal duct	(50)	(50)	(50)
Inflammation, suppurative	8 (16%)	7 (14%)	5 (10%)
MUSCULOSKELETAL SYSTEM			
None			
BODY CAVITIES			
*Peritoneal cavity	(50)	(50)	(50)
Inflammation, chronic	1 (2%)		
Necrosis, fat	1 (2%)	3 (6%)	
Pigmentation, NOS			1 (2%)
Angiectasis			1 (2%)

TABLE C1. SUMMARY OF THE INCIDENCE OF NONNEOPLASTIC LESIONS IN MALE RATS IN THE TWO-YEAR INHALATION STUDY OF TETRACHLOROETHYLENE (Continued)

	CONTROL (CHAMBER)	LOW DOSE	HIGH DOSE
ALL OTHER SYSTEMS			
*Multiple organs	(50)	(50)	(50)
Mineralization	1 (2%)		1 (2%)
Inflammation, active chronic		1 (2%)	
Tail			
Epidermal inclusion cyst	1		
Inflammation, chronic	1	1	
Foot			
Inflammation, chronic		2	
SPECIAL MORPHOLOGY SUMMARY			
None			

* Number of animals receiving complete necropsy examination; all gross lesions including masses examined microscopically.
 # Number of animals examined microscopically at this site

TABLE C2. SUMMARY OF THE INCIDENCE OF NONNEOPLASTIC LESIONS IN FEMALE RATS IN THE TWO-YEAR INHALATION STUDY OF TETRACHLOROETHYLENE

	CONTROL (CHAMBER)	LOW DOSE	HIGH DOSE
ANIMALS INITIALLY IN STUDY	50	50	50
ANIMALS NECROPSIED	50	50	50
ANIMALS EXAMINED HISTOPATHOLOGICALLY	50	50	50
INTEGUMENTARY SYSTEM			
*Skin	(50)	(50)	(50)
Inflammation, suppurative		1 (2%)	
Abscess, NOS		1 (2%)	
RESPIRATORY SYSTEM			
*Nasal cavity	(50)	(50)	(50)
Foreign body, NOS	1 (2%)		
Inflammation, NOS	11 (22%)	3 (6%)	12 (24%)
Inflammation, suppurative	8 (16%)	6 (12%)	5 (10%)
Necrosis, NOS		1 (2%)	
Hyperplasia, epithelial	1 (2%)	3 (6%)	
Metaplasia, squamous	2 (4%)	4 (8%)	2 (4%)
*Larynx	(50)	(50)	(50)
Inflammation, NOS	4 (8%)	1 (2%)	5 (10%)
Inflammation, suppurative	3 (6%)	5 (10%)	3 (6%)
Hyperplasia, epithelial	1 (2%)	1 (2%)	1 (2%)
#Trachea	(50)	(49)	(49)
Inflammation, NOS	3 (6%)		2 (4%)
Inflammation, suppurative		1 (2%)	
Hyperplasia, epithelial	1 (2%)		
#Lung/bronchiole	(50)	(49)	(49)
Hyperplasia, epithelial	1 (2%)		
#Lung	(50)	(49)	(49)
Congestion, NOS	1 (2%)	2 (4%)	
Edema, NOS		1 (2%)	1 (2%)
Hemorrhage	1 (2%)	1 (2%)	7 (14%)
Inflammation, NOS	2 (4%)		2 (4%)
Fibrosis	2 (4%)	2 (4%)	1 (2%)
Hyperplasia, alveolar epithelium	5 (10%)	4 (8%)	4 (8%)
Histiocytosis	3 (6%)	6 (12%)	6 (12%)
HEMATOPOIETIC SYSTEM			
#Bone marrow	(47)	(48)	(46)
Fibrosis	1 (2%)		1 (2%)
#Spleen	(50)	(49)	(49)
Hemorrhage			1 (2%)
Fibrosis			3 (6%)
Necrosis, NOS	1 (2%)		
Hemosiderosis	11 (22%)	3 (6%)	7 (14%)
Hematopoiesis	3 (6%)	2 (4%)	1 (2%)
#Lymph node	(47)	(44)	(45)
Hyperplasia, NOS		1 (2%)	2 (4%)
#Mandibular lymph node	(47)	(44)	(45)
Inflammation, suppurative	1 (2%)		
Hyperplasia, NOS	7 (15%)	9 (20%)	9 (20%)
#Thoracic lymph node	(47)	(44)	(45)
Inflammation, NOS	1 (2%)		
Hemosiderosis		2 (5%)	
Hyperplasia, NOS		1 (2%)	
#Mesenteric lymph node	(47)	(44)	(45)
Hemosiderosis	1 (2%)		
Histiocytosis	1 (2%)		
#Lung	(50)	(49)	(49)
Hyperplasia, lymphoid		1 (2%)	1 (2%)

TABLE C2. SUMMARY OF THE INCIDENCE OF NONNEOPLASTIC LESIONS IN FEMALE RATS IN THE TWO-YEAR INHALATION STUDY OF TETRACHLOROETHYLENE (Continued)

	CONTROL (CHAMBER)	LOW DOSE	HIGH DOSE
HEMATOPOIETIC SYSTEM (Continued)			
#Liver	(50)	(50)	(49)
Leukocytosis, NOS			1 (2%)
Hematopoiesis	1 (2%)	1 (2%)	1 (2%)
#Kidney	(50)	(49)	(50)
Hematopoiesis		1 (2%)	
#Adrenal	(50)	(49)	(47)
Hematopoiesis	1 (2%)	3 (6%)	
#Thymus	(40)	(39)	(35)
Degeneration, cystic	1 (3%)	3 (8%)	
Metaplasia, squamous		1 (3%)	
CIRCULATORY SYSTEM			
*Lacrimal apparatus	(50)	(50)	(50)
Thrombosis, NOS		1 (2%)	
*Multiple organs	(50)	(50)	(50)
Perivasculitis			1 (2%)
*Nasal cavity	(50)	(50)	(50)
Thrombosis, NOS	3 (6%)	10 (20%)	7 (14%)
#Heart	(50)	(50)	(49)
Mineralization	1 (2%)		
Thrombosis, NOS	1 (2%)	4 (8%)	2 (4%)
Inflammation, NOS	14 (28%)	19 (38%)	18 (37%)
Fibrosis	27 (54%)	28 (56%)	18 (37%)
*Blood vessel	(50)	(50)	(50)
Inflammation, chronic	2 (4%)		
Hypertrophy, NOS	1 (2%)		
#Liver	(50)	(50)	(49)
Thrombosis, NOS		1 (2%)	
DIGESTIVE SYSTEM			
*Oral mucosa	(50)	(50)	(50)
Foreign body, NOS		1 (2%)	
Inflammation, suppurative	1 (2%)	1 (2%)	
Inflammation, chronic	1 (2%)		
*Tongue	(50)	(50)	(50)
Granuloma, foreign body			1 (2%)
Hyperplasia, epithelial			1 (2%)
*Tooth	(50)	(50)	(50)
Necrosis, focal		1 (2%)	
#Salivary gland	(47)	(48)	(50)
Inflammation, NOS	1 (2%)	3 (6%)	3 (6%)
Hyperplasia, epithelial	1 (2%)	1 (2%)	3 (6%)
Metaplasia, squamous	1 (2%)	6 (13%)	4 (8%)
#Liver	(50)	(50)	(49)
Inflammation, NOS	1 (2%)		1 (2%)
Inflammation, suppurative		2 (4%)	
Inflammation, granulomatous focal	15 (30%)	14 (28%)	16 (33%)
Degeneration, NOS	1 (2%)	3 (6%)	6 (12%)
Degeneration, cystic		1 (2%)	
Degeneration, lipoid	8 (16%)	16 (32%)	8 (16%)
Necrosis, NOS	3 (6%)	6 (12%)	5 (10%)
Pigmentation, NOS	1 (2%)	3 (6%)	1 (2%)
Basophilic cyto change	28 (56%)	25 (50%)	23 (47%)
Eosinophilic cyto change	2 (4%)		
Clear cell change			1 (2%)
Angiectasis		1 (2%)	
Regenerative nodule			1 (2%)
#Liver/periportal	(50)	(50)	(49)
Inflammation, NOS	1 (2%)	1 (2%)	1 (2%)

TABLE C2. SUMMARY OF THE INCIDENCE OF NONNEOPLASTIC LESIONS IN FEMALE RATS IN THE TWO-YEAR INHALATION STUDY OF TETRACHLOROETHYLENE (Continued)

	CONTROL (CHAMBER)	LOW DOSE	HIGH DOSE
DIGESTIVE SYSTEM (Continued)			
#Bile duct	(50)	(50)	(49)
Hyperplasia, NOS	6 (12%)	6 (12%)	3 (6%)
#Pancreas	(50)	(47)	(46)
Atrophy, focal	10 (20%)	4 (9%)	6 (13%)
Atrophy, diffuse	3 (6%)		1 (2%)
#Pancreatic acinus	(50)	(47)	(46)
Focal cellular change	1 (2%)	1 (2%)	
*Pharyngeal mucous gland	(50)	(50)	(50)
Inflammation, NOS		1 (2%)	
Metaplasia, squamous		1 (2%)	
#Glandular stomach	(49)	(49)	(48)
Hemorrhage			1 (2%)
Inflammation, suppurative	1 (2%)		
Erosion	2 (4%)		2 (4%)
#Forestomach	(49)	(49)	(48)
Inflammation, NOS	2 (4%)	2 (4%)	
Ulcer, NOS	3 (6%)	4 (8%)	
Inflammation, suppurative	1 (2%)	1 (2%)	
Hyperplasia, epithelial	7 (14%)	5 (10%)	2 (4%)
#Ileum	(49)	(49)	(48)
Parasitism		1 (2%)	
#Colon	(46)	(45)	(42)
Parasitism	8 (17%)	8 (18%)	6 (14%)
*Rectum	(50)	(50)	(50)
Parasitism	1 (2%)		1 (2%)
*Anus	(50)	(50)	(50)
Parasitism			1 (2%)
URINARY SYSTEM			
#Kidney	(50)	(49)	(50)
Cyst, NOS			1 (2%)
Inflammation, suppurative	1 (2%)		
Inflammation, chronic focal			1 (2%)
Nephropathy	46 (92%)	46 (94%)	47 (94%)
Nephrosis, NOS		1 (2%)	
Nuclear enlargement		8 (16%)	20 (40%)
Hyperplasia, tubular cell			1 (2%)
ENDOCRINE SYSTEM			
#Pituitary intermedia	(50)	(48)	(50)
Hyperplasia, NOS	1 (2%)		1 (2%)
#Anterior pituitary	(50)	(48)	(50)
Cyst, NOS	1 (2%)		1 (2%)
Degeneration, cystic	21 (42%)	29 (60%)	30 (60%)
Hyperplasia, NOS	13 (26%)	13 (27%)	11 (22%)
#Adrenal	(50)	(49)	(47)
Fibrosis		1 (2%)	
Degeneration, cystic		1 (2%)	
Degeneration, lipoid	17 (34%)	16 (33%)	14 (30%)
Necrosis, NOS		1 (2%)	2 (4%)
#Adrenal cortex	(50)	(49)	(47)
Cytologic alteration, NOS		1 (2%)	
Hyperplasia, NOS	4 (8%)	6 (12%)	11 (23%)
#Adrenal medulla	(50)	(49)	(47)
Cytoplasmic vacuolization	1 (2%)		
Hyperplasia, NOS	7 (14%)	3 (6%)	4 (9%)
#Thyroid	(46)	(48)	(46)
Degeneration, cystic		1 (2%)	
Hyperplasia, C-cell	24 (52%)	12 (25%)	15 (33%)

TABLE C2. SUMMARY OF THE INCIDENCE OF NONNEOPLASTIC LESIONS IN FEMALE RATS IN THE TWO-YEAR INHALATION STUDY OF TETRACHLOROETHYLENE (Continued)

	CONTROL (CHAMBER)	LOW DOSE	HIGH DOSE
ENDOCRINE SYSTEM (Continued)			
#Parathyroid	(27)	(27)	(34)
Hyperplasia, NOS	1 (4%)		
#Pancreatic islets	(50)	(47)	(46)
Hyperplasia, NOS	2 (4%)	1 (2%)	
REPRODUCTIVE SYSTEM			
*Mammary gland	(50)	(50)	(50)
Galactocele			1 (2%)
Fibrosis		1 (2%)	
Hyperplasia, NOS	34 (68%)	39 (78%)	37 (74%)
*Clitoral gland	(50)	(50)	(50)
Inflammation, suppurative	2 (4%)		1 (2%)
Hyperplasia, focal	3 (6%)	1 (2%)	
#Uterus	(49)	(49)	(50)
Dilatation, NOS	2 (4%)		
Cyst, NOS		1 (2%)	
Hematoma, NOS		1 (2%)	
Inflammation, suppurative			1 (2%)
#Cervix uteri	(49)	(49)	(50)
Hyperplasia, NOS		1 (2%)	3 (6%)
#Uterus/endometrium	(49)	(49)	(50)
Inflammation, suppurative		1 (2%)	
Hyperplasia, NOS	1 (2%)	2 (4%)	1 (2%)
Hyperplasia, cystic			1 (2%)
#Ovary	(49)	(49)	(50)
Cyst, NOS	1 (2%)	1 (2%)	2 (4%)
Inflammation, chronic			1 (2%)
Degeneration, cystic			1 (2%)
Atrophy, NOS	10 (20%)	7 (14%)	8 (16%)
Hyperplasia, granulosa cell			1 (2%)
Hyperplasia, epithelial	1 (2%)	2 (4%)	3 (6%)
NERVOUS SYSTEM			
#Brain/meninges	(50)	(50)	(50)
Inflammation, NOS	1 (2%)		
#Brain	(50)	(50)	(50)
Hemorrhage	2 (4%)	3 (6%)	2 (4%)
Necrosis, focal	1 (2%)		1 (2%)
Malacia		1 (2%)	
Cytoplasmic vacuolization		1 (2%)	
*Olfactory sensory epithelium	(50)	(50)	(50)
Inflammation, suppurative		1 (2%)	
SPECIAL SENSE ORGANS			
*Eye	(50)	(50)	(50)
Degeneration, NOS		2 (4%)	1 (2%)
*Eye/crystalline lens	(50)	(50)	(50)
Mineralization		2 (4%)	1 (2%)
*Lacrimal apparatus	(50)	(50)	(50)
Dilatation/ducts		1 (2%)	2 (4%)
Inflammation, NOS	1 (2%)	6 (12%)	6 (12%)
Fibrosis		1 (2%)	
Metaplasia, squamous	3 (6%)	3 (6%)	5 (10%)
*Nasolacrimal duct	(50)	(50)	(50)
Inflammation, NOS	1 (2%)		1 (2%)
Inflammation, suppurative	8 (16%)	6 (12%)	10 (20%)
Hyperplasia, NOS		1 (2%)	

TABLE C2. SUMMARY OF THE INCIDENCE OF NONNEOPLASTIC LESIONS IN FEMALE RATS IN THE TWO-YEAR INHALATION STUDY OF TETRACHLOROETHYLENE (Continued)

	CONTROL (CHAMBER)	LOW DOSE	HIGH DOSE
MUSCULOSKELETAL SYSTEM			
*Bone	(50)	(50)	(50)
Osteosclerosis			1 (2%)
BODY CAVITIES			
*Peritoneal cavity	(50)	(50)	(50)
Inflammation, granulomatous focal		1 (2%)	1 (2%)
Necrosis, fat	1 (2%)	2 (4%)	3 (6%)
Hemosiderosis			1 (2%)
Angiectasis			1 (2%)
ALL OTHER SYSTEMS			
Adipose tissue			
Inflammation, NOS	1	1	1
Inflammation, granulomatous focal		1	
Degeneration, NOS	1	1	1
Pigmentation, NOS		1	
SPECIAL MORPHOLOGY SUMMARY			
None			

* Number of animals receiving complete necropsy examination; all gross lesions including masses examined microscopically.
 # Number of animals examined microscopically at this site

APPENDIX D

**SUMMARY OF THE INCIDENCE OF NONNEOPLASTIC
LESIONS IN MICE IN THE TWO-YEAR
INHALATION STUDIES
OF TETRACHLOROETHYLENE**

TABLE D1. SUMMARY OF THE INCIDENCE OF NONNEOPLASTIC LESIONS IN MALE MICE IN THE TWO-YEAR INHALATION STUDY OF TETRACHLOROETHYLENE

	CONTROL (CHAMBER)	LOW DOSE	HIGH DOSE
ANIMALS INITIALLY IN STUDY	50	50	50
ANIMALS NECROPSIED	49	50	50
ANIMALS EXAMINED HISTOPATHOLOGICALLY	49	50	50
INTEGUMENTARY SYSTEM			
*Skin	(49)	(50)	(50)
Abscess, NOS	1 (2%)		
Necrosis, focal	1 (2%)		
Atrophy, NOS	1 (2%)	2 (4%)	
Atrophy, focal	2 (4%)		
Hyperkeratosis	1 (2%)		
Acanthosis	1 (2%)		
*Subcutaneous tissue	(49)	(50)	(50)
Epidermal inclusion cyst		1 (2%)	
Abscess, NOS		2 (4%)	
Inflammation, chronic focal	1 (2%)	1 (2%)	
Inflammation, chronic diffuse	1 (2%)		
Granulation tissue	1 (2%)		
RESPIRATORY SYSTEM			
*Nasal cavity	(49)	(50)	(50)
Hematoma, NOS		1 (2%)	
Empyema			1 (2%)
Inflammation, chronic focal	30 (61%)	23 (46%)	30 (60%)
*Nasal gland	(49)	(50)	(50)
Cyst, NOS	2 (4%)		
*Nasal septum	(49)	(50)	(50)
Edema, NOS			1 (2%)
*Larynx	(49)	(50)	(50)
Inflammation, chronic focal	1 (2%)	1 (2%)	2 (4%)
*Laryngeal gland	(49)	(50)	(50)
Cyst, NOS	4 (8%)		3 (6%)
#Trachea	(49)	(48)	(50)
Inflammation, chronic focal	1 (2%)		
Hyperplasia, epithelial			1 (2%)
Hyperplasia, pseudoepitheliomatous	1 (2%)		
Polyp, NOS			1 (2%)
Metaplasia, squamous			1 (2%)
#Tracheal gland	(49)	(48)	(50)
Cyst, NOS	45 (92%)	26 (54%)	32 (64%)
Necrosis, focal	1 (2%)		
#Bronchial mucous gland	(49)	(49)	(50)
Cyst, NOS	15 (31%)	3 (6%)	6 (12%)
Inflammation, suppurative	1 (2%)		
Inflammation, acute		1 (2%)	
Inflammation, acute focal	2 (4%)		
Inflammation, chronic focal		1 (2%)	
#Lung/bronchiole	(49)	(49)	(50)
Cytoplasmic aggregate, NOS			1 (2%)

TABLE D1. SUMMARY OF THE INCIDENCE OF NONNEOPLASTIC LESIONS IN MALE MICE IN THE TWO-YEAR INHALATION STUDY OF TETRACHLOROETHYLENE (Continued)

	CONTROL (CHAMBER)	LOW DOSE	HIGH DOSE
RESPIRATORY SYSTEM (Continued)			
#Lung	(49)	(49)	(50)
Mineralization		1 (2%)	
Emphysema, NOS		6 (12%)	1 (2%)
Atelectasis	1 (2%)		
Congestion, acute passive	1 (2%)	8 (16%)	10 (20%)
Edema, NOS			1 (2%)
Hemorrhage		3 (6%)	2 (4%)
Inflammation, interstitial			1 (2%)
Inflammation, acute diffuse		2 (4%)	
Fibrosis, diffuse		1 (2%)	
Perivascular cuffing			1 (2%)
Hyperplasia, alveolar epithelium		2 (4%)	1 (2%)
Bronchiolization	1 (2%)		
Histiocytosis		1 (2%)	1 (2%)
HEMATOPOIETIC SYSTEM			
*Skin	(49)	(50)	(50)
Mastocytosis		1 (2%)	
#Bone marrow	(49)	(49)	(49)
Hemosiderosis			1 (2%)
Myelofibrosis			1 (2%)
#Spleen	(49)	(48)	(50)
Accessory structure		1 (2%)	
Congestion, acute passive	1 (2%)	1 (2%)	
Hematoma, NOS			1 (2%)
Necrosis, focal			1 (2%)
Atrophy, NOS		1 (2%)	1 (2%)
Hyperplasia, lymphoid	6 (12%)	2 (4%)	5 (10%)
Hematopoiesis	1 (2%)	4 (8%)	2 (4%)
#Lymph node	(25)	(24)	(27)
Histiocytosis	1 (4%)		
Plasmacytosis			1 (4%)
Hyperplasia, lymphoid	3 (12%)		
#Mandibular lymph node	(25)	(24)	(27)
Hemosiderosis	1 (4%)		
Histiocytosis			3 (11%)
Hyperplasia, lymphoid	2 (8%)		1 (4%)
Mastocytosis	1 (4%)		
#Bronchial lymph node	(25)	(24)	(27)
Necrosis, focal			1 (4%)
Histiocytosis			1 (4%)
Hyperplasia, lymphoid			1 (4%)
#Mediastinal lymph node	(25)	(24)	(27)
Plasmacytosis			1 (4%)
Hematopoiesis		1 (4%)	
#Mesenteric lymph node	(25)	(24)	(27)
Histiocytosis	1 (4%)		
Hyperplasia, lymphoid	3 (12%)		
Hematopoiesis	1 (4%)		1 (4%)
#Lung	(49)	(49)	(50)
Erythrophagocytosis			1 (2%)
Hyperplasia, lymphoid	16 (33%)	7 (14%)	11 (22%)
#Liver	(49)	(49)	(50)
Hematopoiesis	3 (6%)	1 (2%)	1 (2%)
#Peyer's patch	(49)	(42)	(45)
Hyperplasia, lymphoid	1 (2%)	1 (2%)	

TABLE D1. SUMMARY OF THE INCIDENCE OF NONNEOPLASTIC LESIONS IN MALE MICE IN THE TWO-YEAR INHALATION STUDY OF TETRACHLOROETHYLENE (Continued)

	CONTROL (CHAMBER)	LOW DOSE	HIGH DOSE
HEMATOPOIETIC SYSTEM (Continued)			
#Kidney	(49)	(49)	(50)
Hematopoiesis	1 (2%)	2 (4%)	
#Thymus	(25)	(18)	(27)
Cyst, NOS	1 (4%)		1 (4%)
CIRCULATORY SYSTEM			
*Peritoneum	(49)	(50)	(50)
Lymphangiectasis	1 (2%)		
Perivasculitis	1 (2%)		
*Larynx	(49)	(50)	(50)
Periarteritis			1 (2%)
#Lung	(49)	(49)	(50)
Thrombosis, NOS			1 (2%)
Perivasculitis	1 (2%)	1 (2%)	1 (2%)
#Heart	(49)	(50)	(50)
Thrombosis, NOS		2 (4%)	1 (2%)
Congestion, acute passive			1 (2%)
Hemorrhage			1 (2%)
Inflammation, acute focal		1 (2%)	
Inflammation, chronic			1 (2%)
Fibrosis		1 (2%)	
Fibrosis, focal		1 (2%)	
Degeneration, NOS			2 (4%)
Necrosis, NOS		1 (2%)	
Necrosis, focal		1 (2%)	
#Endocardium	(49)	(50)	(50)
Inflammation, NOS		1 (2%)	
#Cardiac valve	(49)	(50)	(50)
Degeneration, mucoid	30 (61%)	17 (34%)	25 (50%)
Hemosiderosis	2 (4%)	1 (2%)	1 (2%)
*Aorta	(49)	(50)	(50)
Inflammation, chronic focal	1 (2%)		
*Coronary artery	(49)	(50)	(50)
Inflammation, chronic focal	1 (2%)		
*Pulmonary artery	(49)	(50)	(50)
Periarteritis	1 (2%)		
*Pulmonary vein	(49)	(50)	(50)
Thrombosis, NOS		1 (2%)	
Inflammation, chronic		1 (2%)	
#Kidney	(49)	(49)	(50)
Thrombosis, NOS		1 (2%)	
#Testis	(49)	(48)	(49)
Perivasculitis		1 (2%)	
DIGESTIVE SYSTEM			
*Root of tooth	(49)	(50)	(50)
Deformity, NOS	1 (2%)		
Inflammation, acute focal	1 (2%)		
Abscess, NOS	2 (4%)	1 (2%)	1 (2%)
Inflammation, chronic focal	3 (6%)		
Necrosis, focal	3 (6%)		
*Periodontal tissues	(49)	(50)	(50)
Inflammation, chronic diffuse	1 (2%)		
Hyperplasia, focal	1 (2%)		
#Salivary gland	(49)	(48)	(48)
Lymphocytic inflammatory infiltrate	12 (24%)	12 (25%)	12 (25%)
Inflammation, chronic focal		1 (2%)	

TABLE D1. SUMMARY OF THE INCIDENCE OF NONNEOPLASTIC LESIONS IN MALE MICE IN THE TWO-YEAR INHALATION STUDY OF TETRACHLOROETHYLENE (Continued)

	CONTROL (CHAMBER)	LOW DOSE	HIGH DOSE
DIGESTIVE SYSTEM (Continued)			
#Liver	(49)	(49)	(50)
Cyst, NOS		1 (2%)	
Edema, NOS			1 (2%)
Hemorrhage	1 (2%)		2 (4%)
Inflammation, acute	1 (2%)	1 (2%)	
Inflammation, acute focal		2 (4%)	1 (2%)
Inflammation, chronic focal	1 (2%)		1 (2%)
Fibrosis, focal			1 (2%)
Degeneration, NOS	2 (4%)	4 (8%)	8 (16%)
Degeneration, lipoid		4 (8%)	6 (12%)
Necrosis, NOS	1 (2%)	2 (4%)	5 (10%)
Necrosis, focal		4 (8%)	10 (20%)
Inclusion, nuclear	2 (4%)	5 (10%)	9 (18%)
Cytoplasmic vacuolization			1 (2%)
Basophilic cyto change	2 (4%)	2 (4%)	
Focal cellular change		2 (4%)	1 (2%)
Eosinophilic cyto change	1 (2%)	2 (4%)	2 (4%)
Cytoplasmic aggregate, NOS	5 (10%)	2 (4%)	4 (8%)
Hyperplasia, focal			1 (2%)
Angiectasis			1 (2%)
Regeneration, NOS			1 (2%)
#Liver/Kupffer cell	(49)	(49)	(50)
Hyperplasia, focal		1 (2%)	1 (2%)
*Gallbladder	(49)	(50)	(50)
Cyst, NOS	1 (2%)		
#Bile duct	(49)	(49)	(50)
Hyperplasia, focal			1 (2%)
#Pancreas	(47)	(48)	(47)
Lymphocytic inflammatory infiltrate		1 (2%)	
Degeneration, NOS		1 (2%)	
Necrosis, NOS		1 (2%)	
Focal cellular change	1 (2%)		1 (2%)
#Stomach	(48)	(44)	(49)
Erosion			1 (2%)
#Glandular stomach	(48)	(44)	(49)
Mineralization	1 (2%)	1 (2%)	1 (2%)
Dilatation, NOS	1 (2%)		
Cyst, NOS	2 (4%)		2 (4%)
Inflammation, serous			1 (2%)
Inflammation, chronic focal			1 (2%)
Hyperplasia, focal	1 (2%)		2 (4%)
Polyp, NOS		1 (2%)	
Metaplasia, squamous	3 (6%)	1 (2%)	2 (4%)
#Forestomach	(48)	(44)	(49)
Hyperplasia, pseudoepitheliomatous		1 (2%)	
Hyperkeratosis		1 (2%)	1 (2%)
#Intestinal villus	(49)	(42)	(45)
Atrophy, NOS	1 (2%)		
#Duodenum	(49)	(42)	(45)
Inflammation, chronic focal			1 (2%)
#Ileum	(49)	(42)	(45)
Hyperplasia, epithelial	1 (2%)		
*Rectum	(49)	(50)	(50)
Cyst, NOS		2 (4%)	

TABLE D1. SUMMARY OF THE INCIDENCE OF NONNEOPLASTIC LESIONS IN MALE MICE IN THE TWO-YEAR INHALATION STUDY OF TETRACHLOROETHYLENE (Continued)

	CONTROL (CHAMBER)	LOW DOSE	HIGH DOSE
URINARY SYSTEM			
#Kidney	(49)	(49)	(50)
Cyst, NOS	3 (6%)	2 (4%)	1 (2%)
Hemorrhage	4 (8%)	2 (4%)	5 (10%)
Lymphocytic inflammatory infiltrate	38 (78%)	27 (55%)	28 (56%)
Inflammation, suppurative			2 (4%)
Nephrosis, NOS	22 (45%)	24 (49%)	28 (56%)
Glomerulosclerosis, NOS		1 (2%)	
Necrosis, NOS	1 (2%)		1 (2%)
Infarct, NOS		1 (2%)	
Hyperplasia, tubular cell	1 (2%)	2 (4%)	4 (8%)
#Kidney/glomerulus	(49)	(49)	(50)
Atrophy, focal			1 (2%)
#Kidney/tubule	(49)	(49)	(50)
Mineralization	1 (2%)		
Cast, NOS	3 (6%)	9 (18%)	15 (30%)
Necrosis, NOS		1 (2%)	
Nuclear enlargement	4 (8%)	17 (35%)	46 (92%)
Eosinophilic cyto change			1 (2%)
Atrophy, focal	1 (2%)		
#Kidney/pelvis	(49)	(49)	(50)
Inflammation, suppurative	1 (2%)		
Inflammation, acute focal		1 (2%)	
Inflammation, acute/chronic			1 (2%)
#Urinary bladder	(48)	(46)	(48)
Ulcer, NOS			1 (2%)
Inflammation, suppurative			1 (2%)
Inflammation, chronic			1 (2%)
Inflammation, chronic focal			1 (2%)
Inflammation, chronic diffuse	1 (2%)		
Granulation tissue			1 (2%)
Hyperplasia, epithelial	1 (2%)		2 (4%)
ENDOCRINE SYSTEM			
#Pituitary	(47)	(41)	(44)
Cyst, NOS	2 (4%)	3 (7%)	2 (5%)
#Adrenal	(49)	(48)	(49)
Accessory structure	1 (2%)		1 (2%)
Necrosis, NOS		2 (4%)	
Atrophy, NOS	1 (2%)		
#Adrenal/capsule	(49)	(48)	(49)
Hyperplasia, NOS	40 (82%)	27 (56%)	29 (59%)
Hyperplasia, focal	1 (2%)		
#Adrenal cortex	(49)	(48)	(49)
Cyst, NOS	1 (2%)	2 (4%)	3 (6%)
Fibrosis			2 (4%)
Degeneration, NOS	1 (2%)		2 (4%)
Hyperplasia, NOS	1 (2%)		
Hyperplasia, focal	3 (6%)	2 (4%)	1 (2%)
#Adrenal medulla	(49)	(48)	(49)
Cyst, NOS	2 (4%)	4 (8%)	1 (2%)
Degeneration, NOS		1 (2%)	
Hyperplasia, focal			3 (6%)
#Thyroid	(47)	(46)	(50)
Cyst, NOS	3 (6%)		1 (2%)
Lymphocytic inflammatory infiltrate			1 (2%)
Hyperplasia, follicular cell	1 (2%)		1 (2%)
#Parathyroid	(20)	(15)	(21)
Cyst, NOS			2 (10%)

TABLE D1. SUMMARY OF THE INCIDENCE OF NONNEOPLASTIC LESIONS IN MALE MICE IN THE TWO-YEAR INHALATION STUDY OF TETRACHLOROETHYLENE (Continued)

	CONTROL (CHAMBER)	LOW DOSE	HIGH DOSE
REPRODUCTIVE SYSTEM			
*Mammary gland	(49)	(50)	(50)
Cystic ducts	1 (2%)		
Inflammation, chronic focal	1 (2%)		
Fibrosis, focal	1 (2%)		
Hyperplasia, NOS	2 (4%)		
*Penis	(49)	(50)	(50)
Inflammation, suppurative			1 (2%)
Inflammation, chronic focal			1 (2%)
Necrosis, NOS			1 (2%)
*Prepuce	(49)	(50)	(50)
Ulcer, NOS			1 (2%)
Inflammation, suppurative		1 (2%)	1 (2%)
Abscess, NOS			1 (2%)
Necrosis, NOS			2 (4%)
*Preputial gland	(49)	(50)	(50)
Cyst, NOS	3 (6%)	2 (4%)	4 (8%)
Inflammation, suppurative			1 (2%)
Abscess, NOS	2 (4%)		1 (2%)
Inflammation, chronic diffuse			1 (2%)
#Prostate	(48)	(46)	(44)
Inflammation, suppurative		1 (2%)	
*Seminal vesicle	(49)	(50)	(50)
Dilatation, NOS	1 (2%)	1 (2%)	3 (6%)
Inflammation, suppurative	1 (2%)	1 (2%)	
Hyperplasia, epithelial			1 (2%)
#Testis	(49)	(48)	(49)
Mineralization	1 (2%)		
Inflammation, acute suppurative			1 (2%)
Atrophy, NOS	1 (2%)	4 (8%)	1 (2%)
Atrophy, focal	1 (2%)	1 (2%)	
Atrophy, diffuse		1 (2%)	
Hyperplasia, interstitial cell		4 (8%)	3 (6%)
#Interstitial cell of Leydig	(49)	(48)	(49)
Inclusion, nuclear		1 (2%)	
NERVOUS SYSTEM			
#Brain/meninges	(49)	(50)	(50)
Lymphocytic inflammatory infiltrate	1 (2%)		
#Fourth ventricle	(49)	(50)	(50)
Dilatation, NOS		1 (2%)	
#Cerebrum	(49)	(50)	(50)
Degeneration, NOS			1 (2%)
#Brain	(49)	(50)	(50)
Gliosis			1 (2%)
Fibrosis, focal		1 (2%)	
Cytoplasmic vacuolization		1 (2%)	
#Brain/thalamus	(49)	(50)	(50)
Corpora amylacea	18 (37%)	11 (22%)	25 (50%)
*Olfactory sensory epithelium	(49)	(50)	(50)
Atrophy, focal			1 (2%)
SPECIAL SENSE ORGANS			
*Nasolacrimal duct	(49)	(50)	(50)
Inflammation, suppurative		1 (2%)	
Inflammation, chronic focal	1 (2%)	1 (2%)	
Inflammation, chronic diffuse			1 (2%)
*Zymbal gland	(49)	(50)	(50)
Inflammation, chronic			1 (2%)

TABLE D2. SUMMARY OF THE INCIDENCE OF NONNEOPLASTIC LESIONS IN MALE MICE IN THE TWO-YEAR INHALATION STUDY OF TETRACHLOROETHYLENE (Continued)

	CONTROL (CHAMBER)	LOW DOSE	HIGH DOSE
MUSCULOSKELETAL SYSTEM			
*Skull	(49)	(50)	(50)
Hemorrhage		1 (2%)	
*Sternum	(49)	(50)	(50)
Hematoma, NOS	1 (2%)		
*Skeletal muscle	(49)	(50)	(50)
Fibrosis			1 (2%)
*Cartilage, NOS	(49)	(50)	(50)
Necrosis, focal	2 (4%)	1 (2%)	
*Perichondrium	(49)	(50)	(50)
Hyperplasia, NOS		1 (2%)	
BODY CAVITIES			
*Mediastinum	(49)	(50)	(50)
Inflammation, suppurative		1 (2%)	
Inflammation, chronic diffuse	1 (2%)		
*Peritoneum	(49)	(50)	(50)
Inflammation, suppurative	1 (2%)	1 (2%)	
Abscess, NOS		1 (2%)	
Inflammation, chronic diffuse		1 (2%)	
Necrosis, fat		1 (2%)	
*Pleura	(49)	(50)	(50)
Inflammation, chronic focal		1 (2%)	1 (2%)
ALL OTHER SYSTEMS			
*Multiple organs	(49)	(50)	(50)
Abscess, NOS		1 (2%)	
SPECIAL MORPHOLOGY SUMMARY			
Animal missexed/no necropsy	1		
Auto/necropsy/histo perf		1	

* Number of animals receiving complete necropsy examination; all gross lesions including masses examined microscopically.

Number of animals examined microscopically at this site

TABLE D2. SUMMARY OF THE INCIDENCE OF NONNEOPLASTIC LESIONS IN FEMALE MICE IN THE TWO-YEAR INHALATION STUDY OF TETRACHLOROETHYLENE

	CONTROL (CHAMBER)	LOW DOSE	HIGH DOSE
ANIMALS INITIALLY IN STUDY	50	50	50
ANIMALS NECROPSIED	49	50	50
ANIMALS EXAMINED HISTOPATHOLOGICALLY	49	50	50
INTEGUMENTARY SYSTEM			
*Skin	(49)	(50)	(50)
Inflammation, acute focal			1 (2%)
Inflammation, chronic	1 (2%)	1 (2%)	
Inflammation, chronic focal			1 (2%)
Degeneration, NOS	1 (2%)		
Necrosis, NOS		1 (2%)	
Atrophy, NOS	1 (2%)		
Hyperkeratosis		1 (2%)	
Acanthosis		1 (2%)	
Parakeratosis		1 (2%)	
*Subcutaneous tissue	(49)	(50)	(50)
Inflammation, chronic diffuse	1 (2%)		
RESPIRATORY SYSTEM			
*Nasal cavity	(49)	(50)	(50)
Inflammation, chronic	1 (2%)		
Inflammation, chronic focal	28 (57%)	29 (58%)	24 (48%)
Cytoplasmic aggregate, NOS		1 (2%)	
Hyperplasia, focal		1 (2%)	
*Nasal gland	(49)	(50)	(50)
Cyst, NOS		2 (4%)	
*Larynx	(49)	(50)	(50)
Inflammation, chronic focal			1 (2%)
Fibrosis, focal		1 (2%)	
Metaplasia, squamous			1 (2%)
*Laryngeal gland	(49)	(50)	(50)
Cyst, NOS	2 (4%)	4 (8%)	
#Trachea	(48)	(50)	(50)
Inflammation, chronic focal	1 (2%)		
Hyperplasia, epithelial		1 (2%)	
Metaplasia, squamous		1 (2%)	
#Tracheal gland	(48)	(50)	(50)
Cyst, NOS	33 (69%)	16 (32%)	12 (24%)
#Lung/bronchus	(48)	(50)	(50)
Inflammation, chronic focal			1 (2%)
#Bronchial mucous gland	(48)	(50)	(50)
Cyst, NOS	5 (10%)	1 (2%)	2 (4%)
#Lung	(48)	(50)	(50)
Mineralization	1 (2%)	1 (2%)	
Emphysema, NOS	2 (4%)	1 (2%)	2 (4%)
Congestion, acute passive	1 (2%)	5 (10%)	6 (12%)
Hemorrhage	3 (6%)	1 (2%)	1 (2%)
Inflammation, interstitial		1 (2%)	
Inflammation, acute focal	1 (2%)		1 (2%)
Inflammation, acute diffuse	2 (4%)		
Pneumonia, interstitial chronic			1 (2%)
Inflammation, chronic focal	2 (4%)	3 (6%)	1 (2%)
Thrombophlebitis			1 (2%)
Fibrosis, focal			2 (4%)
Fibrosis, multifocal	1 (2%)		1 (2%)
Fibrosis, diffuse	1 (2%)		
Perivascular cuffing	2 (4%)		
Hyperplasia, alveolar epithelium	1 (2%)		1 (2%)
Histiocytosis		1 (2%)	2 (4%)

TABLE D2. SUMMARY OF THE INCIDENCE OF NONNEOPLASTIC LESIONS IN FEMALE MICE IN THE TWO-YEAR INHALATION STUDY OF TETRACHLOROETHYLENE (Continued)

	CONTROL (CHAMBER)	LOW DOSE	HIGH DOSE
HEMATOPOIETIC SYSTEM			
#Brain	(48)	(49)	(50)
Hematopoiesis		1 (2%)	
*Multiple organs	(49)	(50)	(50)
Erythrophagocytosis			1 (2%)
Hyperplasia, lymphoid			4 (8%)
Hematopoiesis	1 (2%)		2 (4%)
#Bone marrow	(48)	(49)	(48)
Hyperplasia, NOS		1 (2%)	
Myelofibrosis	30 (63%)	30 (61%)	20 (42%)
Hyperplasia, hematopoietic		1 (2%)	
Hypoplasia, hematopoietic			1 (2%)
#Spleen	(49)	(49)	(50)
Necrosis, NOS		1 (2%)	
Hemosiderosis	2 (4%)		
Hyperplasia, lymphoid	3 (6%)	7 (14%)	3 (6%)
Hematopoiesis	6 (12%)	6 (12%)	17 (34%)
#Lymph node	(34)	(31)	(26)
Inflammation, chronic			1 (4%)
#Mandibular lymph node	(34)	(31)	(26)
Hemosiderosis	1 (3%)		
Histiocytosis		1 (3%)	1 (4%)
Hyperplasia, lymphoid	3 (9%)	1 (3%)	
#Bronchial lymph node	(34)	(31)	(26)
Edema, NOS	1 (3%)		
Inflammation, acute diffuse	1 (3%)		
Hemosiderosis	1 (3%)		
Histiocytosis			1 (4%)
Hyperplasia, lymphoid	2 (6%)		
#Mediastinal lymph node	(34)	(31)	(26)
Histiocytosis		1 (3%)	
Plasmacytosis			1 (4%)
#Mesenteric lymph node	(34)	(31)	(26)
Hematopoiesis		1 (3%)	1 (4%)
#Lung	(48)	(50)	(50)
Leukemoid reaction	1 (2%)		
Hyperplasia, lymphoid	21 (44%)	17 (34%)	7 (14%)
#Liver	(48)	(50)	(50)
Hematopoiesis	2 (4%)	3 (6%)	4 (8%)
#Peyer's patch	(48)	(45)	(46)
Hyperplasia, lymphoid			1 (2%)
#Kidney	(48)	(49)	(50)
Hematopoiesis	2 (4%)	1 (2%)	4 (8%)
#Adrenal	(47)	(49)	(49)
Hematopoiesis		1 (2%)	
#Adrenal cortex	(47)	(49)	(49)
Hematopoiesis	1 (2%)	1 (2%)	1 (2%)
#Thymus	(35)	(39)	(22)
Edema, NOS			1 (5%)
Inflammation, chronic			1 (5%)
Necrosis, NOS	1 (3%)	1 (3%)	
Atrophy, NOS			1 (5%)

TABLE D2. SUMMARY OF THE INCIDENCE OF NONNEOPLASTIC LESIONS IN FEMALE MICE IN THE TWO-YEAR INHALATION STUDY OF TETRACHLOROETHYLENE (Continued)

	CONTROL (CHAMBER)	LOW DOSE	HIGH DOSE
CIRCULATORY SYSTEM			
#Lung	(48)	(50)	(50)
Thrombosis, NOS		1 (2%)	1 (2%)
Perivasculitis			2 (4%)
#Heart	(48)	(50)	(50)
Thrombosis, NOS			1 (2%)
Inflammation, acute			1 (2%)
Inflammation, acute focal		1 (2%)	2 (4%)
Inflammation, chronic			1 (2%)
Inflammation, chronic focal	1 (2%)		2 (4%)
Fibrosis			1 (2%)
Necrosis, NOS			1 (2%)
#Heart/atrium	(48)	(50)	(50)
Inflammation, chronic focal	1 (2%)		
#Cardiac valve	(48)	(50)	(50)
Degeneration, mucoid	17 (35%)	17 (34%)	7 (14%)
Hemosiderosis	1 (2%)		2 (4%)
#Kidney	(48)	(49)	(50)
Thrombus, organized	1 (2%)		
#Urinary bladder	(46)	(48)	(47)
Periarteritis			1 (2%)
#Ovary	(48)	(49)	(43)
Thrombosis, NOS	2 (4%)		
Periarteritis	1 (2%)		
Perivasculitis	1 (2%)		
DIGESTIVE SYSTEM			
*Periodontal tissues	(49)	(50)	(50)
Abscess, NOS	1 (2%)		
#Salivary gland	(47)	(49)	(49)
Lymphocytic inflammatory infiltrate	6 (13%)	10 (20%)	10 (20%)
Inflammation, chronic focal			2 (4%)
Hemosiderosis		1 (2%)	
#Liver	(48)	(50)	(50)
Mineralization			1 (2%)
Cyst, NOS	1 (2%)	1 (2%)	2 (4%)
Hemorrhage		1 (2%)	
Lymphocytic inflammatory infiltrate			1 (2%)
Inflammation, acute focal		2 (4%)	1 (2%)
Abscess, NOS			1 (2%)
Inflammation, chronic focal	2 (4%)		3 (6%)
Fibrosis, focal		1 (2%)	
Degeneration, NOS	1 (2%)		12 (24%)
Degeneration, lipoid		2 (4%)	1 (2%)
Necrosis, NOS	1 (2%)	3 (6%)	7 (14%)
Necrosis, focal	2 (4%)	2 (4%)	2 (4%)
Inclusion, nuclear		1 (2%)	2 (4%)
Basophilic cyto change			1 (2%)
Focal cellular change		1 (2%)	3 (6%)
Eosinophilic cyto change	1 (2%)	2 (4%)	4 (8%)
Cytoplasmic aggregate, NOS			2 (4%)
Cytoplasmic lipid aggregate			1 (2%)
Angiectasis			2 (4%)
Histiocytosis			1 (2%)
#Hepatic capsule	(48)	(50)	(50)
Inflammation, chronic focal			1 (2%)
Fibrosis, focal	1 (2%)		
*Gallbladder	(49)	(50)	(50)
Dilatation, NOS			1 (2%)
Hypertrophy, NOS			1 (2%)

TABLE D2. SUMMARY OF THE INCIDENCE OF NONNEOPLASTIC LESIONS IN FEMALE MICE IN THE TWO-YEAR INHALATION STUDY OF TETRACHLOROETHYLENE (Continued)

	CONTROL (CHAMBER)	LOW DOSE	HIGH DOSE
DIGESTIVE SYSTEM (Continued)			
#Pancreas	(47)	(49)	(49)
Cyst, NOS		1 (2%)	
Inflammation, acute diffuse			1 (2%)
Inflammation, chronic focal	1 (2%)		
Inflammation, chronic diffuse	2 (4%)		1 (2%)
Necrosis, focal	1 (2%)		
Focal cellular change			2 (4%)
Atrophy, NOS	1 (2%)	2 (4%)	1 (2%)
Hyperplasia, focal			1 (2%)
#Stomach	(48)	(50)	(48)
Inflammation, acute focal		1 (2%)	
#Glandular stomach	(48)	(50)	(48)
Cyst, NOS	1 (2%)	2 (4%)	3 (6%)
Hyperplasia, focal	1 (2%)		
Metaplasia, squamous		2 (4%)	1 (2%)
#Forestomach	(48)	(50)	(48)
Cyst, NOS			2 (4%)
Hyperkeratosis	1 (2%)	5 (10%)	2 (4%)
#Duodenum	(48)	(45)	(46)
Inflammation, chronic focal	1 (2%)		
#Ileum	(48)	(45)	(46)
Amyloidosis		1 (2%)	
*Perirectal tissue	(49)	(50)	(50)
Inflammation, necrotizing	1 (2%)		
*Anus	(49)	(50)	(50)
Inflammation, suppurative			1 (2%)
URINARY SYSTEM			
#Kidney	(48)	(49)	(50)
Hydronephrosis	1 (2%)		
Cyst, NOS			2 (4%)
Congestion, acute passive			2 (4%)
Hemorrhage	1 (2%)	2 (4%)	5 (10%)
Lymphocytic inflammatory infiltrate	29 (60%)	26 (53%)	27 (54%)
Plasma cell infiltrate			1 (2%)
Nephrosis, NOS	5 (10%)	14 (29%)	25 (50%)
Amyloidosis		1 (2%)	
Hyperplasia, tubular cell		1 (2%)	
Metaplasia, osseous			1 (2%)
#Kidney/glomerulus	(48)	(49)	(50)
Atrophy, NOS			1 (2%)
Atrophy, focal	1 (2%)		1 (2%)
#Kidney/tubule	(48)	(49)	(50)
Cast, NOS	4 (8%)	4 (8%)	15 (30%)
Nuclear enlargement		16 (33%)	38 (76%)
Inclusion, nuclear		1 (2%)	
Cytoplasmic crystalline aggregate		1 (2%)	
#Kidney/pelvis	(48)	(49)	(50)
Dilatation, NOS			1 (2%)
#Urinary bladder	(46)	(48)	(47)
Lymphocytic inflammatory infiltrate	4 (9%)	1 (2%)	1 (2%)
Inflammation, chronic focal	5 (11%)	16 (33%)	4 (9%)
Inflammation, chronic diffuse			1 (2%)

TABLE D2. SUMMARY OF THE INCIDENCE OF NONNEOPLASTIC LESIONS IN FEMALE MICE IN THE TWO-YEAR INHALATION STUDY OF TETRACHLOROETHYLENE (Continued)

	CONTROL (CHAMBER)	LOW DOSE	HIGH DOSE
ENDOCRINE SYSTEM			
#Pituitary	(45)	(43)	(42)
Cyst, NOS	1 (2%)	1 (2%)	
Congestion, acute passive		1 (2%)	1 (2%)
Hemorrhage	1 (2%)		
Degeneration, NOS			1 (2%)
Hyperplasia, NOS	1 (2%)	3 (7%)	1 (2%)
Hyperplasia, focal	3 (7%)	7 (16%)	2 (5%)
#Pituitary intermedia	(45)	(43)	(42)
Cyst, NOS	1 (2%)		
#Pituitary cell	(45)	(43)	(42)
Inclusion, nuclear		1 (2%)	
Atypia, NOS		1 (2%)	
#Adrenal	(47)	(49)	(49)
Accessory structure		1 (2%)	1 (2%)
Hemorrhage		1 (2%)	2 (4%)
Necrosis, focal			1 (2%)
Angiectasis		1 (2%)	
#Adrenal/capsule	(47)	(49)	(49)
Hyperplasia, NOS	42 (89%)	41 (84%)	44 (90%)
#Adrenal cortex	(47)	(49)	(49)
Cyst, NOS	2 (4%)	3 (6%)	2 (4%)
Congestion, acute passive		1 (2%)	
Hemorrhage	4 (9%)		1 (2%)
Fibrosis	18 (38%)	26 (53%)	22 (45%)
Degeneration, NOS	19 (40%)	27 (55%)	23 (47%)
Necrosis, NOS	1 (2%)	1 (2%)	
Cytomegaly			1 (2%)
Hyperplasia, focal		1 (2%)	
Vascularization	1 (2%)		
#Adrenal medulla	(47)	(49)	(49)
Cyst, NOS	2 (4%)		2 (4%)
#Periadrenal tissue	(47)	(49)	(49)
Inflammation, suppurative	1 (2%)		1 (2%)
#Thyroid	(48)	(48)	(48)
Cyst, NOS	4 (8%)		
Hyperplasia, follicular cell	1 (2%)	3 (6%)	3 (6%)
#Thyroid follicle	(48)	(48)	(48)
Inflammation, acute focal	1 (2%)		
#Thyroid colloid	(48)	(48)	(48)
Degeneration, NOS	2 (4%)		
#Parathyroid	(18)	(17)	(23)
Cyst, NOS			1 (4%)
Hyperplasia, NOS	1 (6%)		
REPRODUCTIVE SYSTEM			
*Mammary gland	(49)	(50)	(50)
Dilatation/ducts	1 (2%)	1 (2%)	
#Uterus	(43)	(44)	(48)
Hydrometra		2 (5%)	
Hematoma, NOS	1 (2%)	1 (2%)	
Pyometra			3 (6%)
Abscess, NOS			1 (2%)
Necrosis, NOS	1 (2%)		
Hyperplasia, epithelial	1 (2%)		
Metaplasia, squamous	1 (2%)		
#Cervix uteri	(43)	(44)	(48)
Inflammation, chronic			2 (4%)

TABLE D2. SUMMARY OF THE INCIDENCE OF NONNEOPLASTIC LESIONS IN FEMALE MICE IN THE TWO-YEAR INHALATION STUDY OF TETRACHLOROETHYLENE (Continued)

	CONTROL (CHAMBER)	LOW DOSE	HIGH DOSE
REPRODUCTIVE SYSTEM (Continued)			
#Uterus/endometrium	(43)	(44)	(48)
Cyst, NOS	1 (2%)	1 (2%)	
Inflammation, suppurative	2 (5%)		3 (6%)
Inflammation, chronic		1 (2%)	1 (2%)
Inflammation, chronic diffuse			1 (2%)
Hyperplasia, NOS	1 (2%)		1 (2%)
Hyperplasia, cystic	31 (72%)	36 (82%)	33 (69%)
Metaplasia, squamous	1 (2%)		
#Uterus/myometrium	(43)	(44)	(48)
Mineralization			1 (2%)
Inflammation, acute			1 (2%)
Granuloma, NOS			1 (2%)
Necrosis, focal			1 (2%)
Cholesterol deposit			1 (2%)
Histiocytosis			1 (2%)
#Fallopian tube	(43)	(44)	(48)
Lymphocytic inflammatory infiltrate		1 (2%)	
Inflammation, chronic focal			2 (4%)
Inflammation, chronic diffuse			2 (4%)
#Ovary	(48)	(49)	(43)
Cyst, NOS	12 (25%)	8 (16%)	10 (23%)
Corpus luteum cyst		1 (2%)	
Hemorrhage			1 (2%)
Inflammation, necrotizing	1 (2%)		
Abscess, NOS	1 (2%)		5 (12%)
Inflammation, chronic focal	1 (2%)	2 (4%)	
Inflammation, chronic diffuse	1 (2%)		
Necrosis, focal			1 (2%)
Atrophy, NOS			1 (2%)
NERVOUS SYSTEM			
#Brain/meninges	(48)	(49)	(50)
Lymphocytic inflammatory infiltrate			2 (4%)
#Cerebral ventricle	(48)	(49)	(50)
Dilatation, NOS	1 (2%)	1 (2%)	
#Ependyma lateral ventricle	(48)	(49)	(50)
Perivascular cuffing		1 (2%)	
#Cerebrum	(48)	(49)	(50)
Cyst, NOS			1 (2%)
Perivascular cuffing		1 (2%)	
Metaplasia, osseous	2 (4%)	1 (2%)	
#Brain	(48)	(49)	(50)
Hemorrhage			1 (2%)
Perivascular cuffing		1 (2%)	
#Brain/thalamus	(48)	(49)	(50)
Corpora amylacea	15 (31%)	10 (20%)	18 (36%)
#Cerebellum	(48)	(49)	(50)
Perivascular cuffing	1 (2%)		
*Olfactory sensory epithelium	(49)	(50)	(50)
Cytoplasmic aggregate, NOS	1 (2%)		

TABLE D2. SUMMARY OF THE INCIDENCE OF NONNEOPLASTIC LESIONS IN FEMALE MICE IN THE TWO-YEAR INHALATION STUDY OF TETRACHLOROETHYLENE (Continued)

	CONTROL (CHAMBER)	LOW DOSE	HIGH DOSE
SPECIAL SENSE ORGANS			
*Eye	(49)	(50)	(50)
Microphthalmia			1 (2%)
Mineralization	1 (2%)		
*Nasolacrimal duct	(49)	(50)	(50)
Inflammation, suppurative	1 (2%)	2 (4%)	2 (4%)
Empyema		1 (2%)	1 (2%)
Inflammation, chronic		3 (6%)	
Hyperplasia, epithelial	1 (2%)	1 (2%)	1 (2%)
*External ear	(49)	(50)	(50)
Hemorrhage			1 (2%)
MUSCULOSKELETAL SYSTEM			
*Skull	(49)	(50)	(50)
Inflammation, chronic focal			1 (2%)
Fibrous osteodystrophy			1 (2%)
*Sternum	(49)	(50)	(50)
Fibrous osteodystrophy			1 (2%)
*Skeletal muscle	(49)	(50)	(50)
Inflammation, chronic			1 (2%)
*Costal cartilage	(49)	(50)	(50)
Necrosis, focal			1 (2%)
BODY CAVITIES			
*Mediastinum	(49)	(50)	(50)
Inflammation, chronic focal	1 (2%)	1 (2%)	
Inflammation, chronic diffuse		1 (2%)	
Inflammation chronic suppurative			1 (2%)
Inflammation, granulomatous focal	1 (2%)		
*Peritoneum	(49)	(50)	(50)
Mineralization	1 (2%)		
Lymphocytic inflammatory infiltrate			1 (2%)
Inflammation, acute focal			1 (2%)
Inflammation, acute diffuse			1 (2%)
Abscess, NOS			1 (2%)
Inflammation, chronic focal	8 (16%)	7 (14%)	7 (14%)
Inflammation, chronic diffuse	5 (10%)	3 (6%)	4 (8%)
Inflammation, chronic suppurative			1 (2%)
Necrosis, focal			1 (2%)
*Pleura	(49)	(50)	(50)
Inflammation, chronic			2 (4%)
Inflammation, chronic focal		1 (2%)	
Granulation tissue			1 (2%)
ALL OTHER SYSTEMS			
*Multiple organs	(49)	(50)	(50)
Lymphocytic inflammatory infiltrate	1 (2%)		
Inflammation, chronic			1 (2%)
Inflammation, chronic focal		2 (4%)	1 (2%)
Inflammation, chronic diffuse			2 (4%)
SPECIAL MORPHOLOGY SUMMARY			
No lesion reported	1	2	1
Animal missexed/no necropsy	1		

* Number of animals receiving complete necropsy examination; all gross lesions including masses examined microscopically.

Number of animals examined microscopically at this site

APPENDIX E

**ANALYSES OF PRIMARY TUMORS IN RATS AND MICE
IN THE TWO-YEAR INHALATION STUDIES OF
TETRACHLOROETHYLENE**

TABLE E1. ANALYSIS OF PRIMARY TUMORS IN MALE RATS IN THE TWO-YEAR INHALATION STUDY OF TETRACHLOROETHYLENE

	Control	200 ppm	400 ppm
Skin: Keratoacanthoma			
Overall Rates (a)	3/50 (6%)	1/50 (2%)	0/50 (0%)
Adjusted Rates (b)	10.1%	5.0%	0.0%
Terminal Rates (c)	1/23 (4%)	1/20 (5%)	0/12 (0%)
Week of First Observation	89	104	
Life Table Tests (d)	P=0.125N	P=0.368N	P=0.231N
Incidental Tumor Tests (d)	P=0.071N	P=0.329N	P=0.114N
Cochran-Armitage Trend Test (d)	P=0.060N		
Fisher Exact Test (d)		P=0.309N	P=0.121N
Skin: Squamous Cell Papilloma or Carcinoma			
Overall Rates (a)	3/50 (6%)	1/50 (2%)	0/50 (0%)
Adjusted Rates (b)	10.0%	5.0%	0.0%
Terminal Rates (c)	1/23 (4%)	1/20 (5%)	0/12 (0%)
Week of First Observation	95	104	
Life Table Tests (d)	P=0.112N	P=0.362N	P=0.200N
Incidental Tumor Tests (d)	P=0.081N	P=0.367N	P=0.130N
Cochran-Armitage Trend Test (d)	P=0.060N		
Fisher Exact Test (d)		P=0.309N	P=0.121N
Subcutaneous Tissue: Fibroma			
Overall Rates (a)	3/50 (6%)	(e) 1/50 (2%)	4/50 (8%)
Adjusted Rates (b)	9.1%	3.0%	23.6%
Terminal Rates (c)	0/23 (0%)	0/20 (0%)	2/12 (17%)
Week of First Observation	98	98	99
Life Table Tests (d)	P=0.260	P=0.358N	P=0.301
Incidental Tumor Tests (d)	P=0.423	P=0.373N	P=0.484
Cochran-Armitage Trend Test (d)	P=0.412		
Fisher Exact Test (d)		P=0.309N	P=0.500
Hematopoietic System: Mononuclear Cell Leukemia			
Overall Rates (a)	28/50 (56%)	37/50 (74%)	37/50 (74%)
Adjusted Rates (b)	64.6%	80.1%	90.8%
Terminal Rates (c)	9/23 (39%)	11/20 (55%)	9/12 (75%)
Week of First Observation	66	53	68
Life Table Tests (d)	P=0.004	P=0.046	P=0.004
Incidental Tumor Tests (d)	P=0.097	P=0.023	P=0.104
Cochran-Armitage Trend Test (d)	P=0.034		
Fisher Exact Test (d)		P=0.046	P=0.046
Oral Cavity: Squamous Cell Papilloma or Carcinoma			
Overall Rates (a)	1/50 (2%)	1/50 (2%)	3/50 (6%)
Adjusted Rates (b)	2.7%	5.0%	10.8%
Terminal Rates (c)	0/23 (0%)	1/20 (5%)	0/12 (0%)
Week of First Observation	97	104	77
Life Table Tests (d)	P=0.133	P=0.732	P=0.232
Incidental Tumor Tests (d)	P=0.241	P=0.723	P=0.428
Cochran-Armitage Trend Test (d)	P=0.202		
Fisher Exact Test (d)		P=0.753	P=0.309
Liver: Neoplastic Nodule			
Overall Rates (a)	4/50 (8%)	7/50 (14%)	4/49 (8%)
Adjusted Rates (b)	17.4%	30.6%	30.8%
Terminal Rates (c)	4/23 (17%)	5/20 (25%)	3/12 (25%)
Week of First Observation	104	91	103
Life Table Tests (d)	P=0.192	P=0.177	P=0.267
Incidental Tumor Tests (d)	P=0.285	P=0.195	P=0.330
Cochran-Armitage Trend Test (d)	P=0.553		
Fisher Exact Test (d)		P=0.262	P=0.631

TABLE E1. ANALYSIS OF PRIMARY TUMORS IN MALE RATS IN THE TWO-YEAR INHALATION STUDY OF TETRACHLOROETHYLENE (Continued)

	Control	200 ppm	400 ppm
Liver: Neoplastic Nodule or Hepatocellular Carcinoma			
Overall Rates (a)	4/50 (8%)	7/50 (14%)	5/49 (10%)
Adjusted Rates (b)	17.4%	30.6%	32.3%
Terminal Rates (c)	4/23 (17%)	5/20 (25%)	3/12 (25%)
Week of First Observation	104	91	83
Life Table Tests (d)	P=0.117	P=0.177	P=0.168
Incidental Tumor Tests (d)	P=0.201	P=0.195	P=0.243
Cochran-Armitage Trend Test (d)	P=0.422		
Fisher Exact Test (d)		P=0.262	P=0.487
Kidney: Tubular Cell Adenoma			
Overall Rates (a)	1/49 (2%)	3/49 (6%)	2/50 (4%)
Adjusted Rates (b)	4.3%	10.8%	12.7%
Terminal Rates (c)	1/23 (4%)	1/20 (5%)	1/12 (8%)
Week of First Observation	104	91	102
Life Table Tests (d)	P=0.242	P=0.259	P=0.316
Incidental Tumor Tests (d)	P=0.350	P=0.296	P=0.376
Cochran-Armitage Trend Test (d)	P=0.407		
Fisher Exact Test (d)		P=0.309	P=0.508
Kidney: Tubular Cell Adenoma or Adenocarcinoma			
Overall Rates (a)	1/49 (2%)	(f) 3/49 (6%)	4/50 (8%)
Adjusted Rates (b)	4.3%	10.8%	22.4%
Terminal Rates (c)	1/23 (4%)	1/20 (5%)	2/12 (17%)
Week of First Observation	104	91	83
Life Table Tests (d)	P=0.054	P=0.259	P=0.070
Incidental Tumor Tests (d)	P=0.107	P=0.296	P=0.114
Cochran-Armitage Trend Test (d)	P=0.138		
Fisher Exact Test (d)		P=0.309	P=0.187
Pituitary Gland: Adenoma			
Overall Rates (a)	17/47 (36%)	12/47 (26%)	16/48 (33%)
Adjusted Rates (b)	49.2%	50.9%	48.9%
Terminal Rates (c)	7/23 (30%)	9/20 (45%)	1/12 (8%)
Week of First Observation	90	98	73
Life Table Tests (d)	P=0.185	P=0.357N	P=0.238
Incidental Tumor Tests (d)	P=0.484N	P=0.293N	P=0.335N
Cochran-Armitage Trend Test (d)	P=0.429N		
Fisher Exact Test (d)		P=0.186N	P=0.470N
Pituitary Gland: Carcinoma			
Overall Rates (a)	3/47 (6%)	2/47 (4%)	2/48 (4%)
Adjusted Rates (b)	9.6%	7.3%	7.4%
Terminal Rates (c)	0/23 (0%)	1/20 (5%)	0/12 (0%)
Week of First Observation	99	86	85
Life Table Tests (d)	P=0.566N	P=0.575N	P=0.657N
Incidental Tumor Tests (d)	P=0.308N	P=0.514N	P=0.376N
Cochran-Armitage Trend Test (d)	P=0.397N		
Fisher Exact Test (d)		P=0.500N	P=0.490N
Pituitary Gland: Adenoma or Carcinoma			
Overall Rates (a)	20/47 (43%)	14/47 (30%)	18/48 (38%)
Adjusted Rates (b)	54.2%	56.5%	53.6%
Terminal Rates (c)	7/23 (30%)	10/20 (50%)	1/12 (8%)
Week of First Observation	90	86	73
Life Table Tests (d)	P=0.209	P=0.326N	P=0.259
Incidental Tumor Tests (d)	P=0.352N	P=0.233N	P=0.210N
Cochran-Armitage Trend Test (d)	P=0.346N		
Fisher Exact Test (d)		P=0.142N	P=0.385N

TABLE E1. ANALYSIS OF PRIMARY TUMORS IN MALE RATS IN THE TWO-YEAR INHALATION STUDY OF TETRACHLOROETHYLENE (Continued)

	Control	200 ppm	400 ppm
Adrenal Gland: Pheochromocytoma			
Overall Rates (a)	22/49 (45%)	21/49 (43%)	23/49 (47%)
Adjusted Rates (b)	64.7%	70.0%	78.0%
Terminal Rates (c)	12/23 (52%)	12/20 (60%)	7/12 (58%)
Week of First Observation	89	82	77
Life Table Tests (d)	P=0.041	P=0.420	P=0.049
Incidental Tumor Tests (d)	P=0.293	P=0.488	P=0.356
Cochran-Armitage Trend Test (d)	P=0.460		
Fisher Exact Test (d)		P=0.500N	P=0.500
Adrenal Gland: Pheochromocytoma or Malignant Pheochromocytoma			
Overall Rates (a)	22/49 (45%)	21/49 (43%)	24/49 (49%)
Adjusted Rates (b)	64.7%	70.0%	82.4%
Terminal Rates (c)	12/23 (52%)	12/20 (60%)	8/12 (67%)
Week of First Observation	89	82	77
Life Table Tests (d)	P=0.025	P=0.420	P=0.030
Incidental Tumor Tests (d)	P=0.212	P=0.488	P=0.259
Cochran-Armitage Trend Test (d)	P=0.380		
Fisher Exact Test (d)		P=0.500N	P=0.420
Thyroid Gland: C-Cell Adenoma			
Overall Rates (a)	3/47 (6%)	3/48 (6%)	4/46 (9%)
Adjusted Rates (b)	11.5%	12.0%	26.7%
Terminal Rates (c)	2/23 (9%)	1/20 (5%)	2/12 (17%)
Week of First Observation	99	99	102
Life Table Tests (d)	P=0.196	P=0.599	P=0.225
Incidental Tumor Tests (d)	P=0.329	P=0.614	P=0.357
Cochran-Armitage Trend Test (d)	P=0.409		
Fisher Exact Test (d)		P=0.651N	P=0.488
Thyroid Gland: C-Cell Carcinoma			
Overall Rates (a)	4/47 (9%)	6/48 (13%)	0/46 (0%)
Adjusted Rates (b)	16.4%	24.0%	0.0%
Terminal Rates (c)	3/23 (13%)	3/20 (15%)	0/12 (0%)
Week of First Observation	103	98	
Life Table Tests (d)	P=0.236N	P=0.288	P=0.176N
Incidental Tumor Tests (d)	P=0.139N	P=0.300	P=0.124N
Cochran-Armitage Trend Test (d)	P=0.083N		
Fisher Exact Test (d)		P=0.384	P=0.061N
Thyroid Gland: C-Cell Adenoma or Carcinoma			
Overall Rates (a)	7/47 (15%)	9/48 (19%)	4/46 (9%)
Adjusted Rates (b)	27.0%	33.7%	26.7%
Terminal Rates (c)	5/23 (22%)	4/20 (20%)	2/12 (17%)
Week of First Observation	99	98	102
Life Table Tests (d)	P=0.516	P=0.289	P=0.613
Incidental Tumor Tests (d)	P=0.373N	P=0.300	P=0.464N
Cochran-Armitage Trend Test (d)	P=0.242N		
Fisher Exact Test (d)		P=0.410	P=0.274N
Pancreatic Islets: Islet Cell Adenoma			
Overall Rates (a)	3/43 (7%)	2/46 (4%)	1/46 (2%)
Adjusted Rates (b)	13.6%	8.2%	3.1%
Terminal Rates (c)	3/22 (14%)	1/20 (5%)	0/12 (0%)
Week of First Observation	104	99	95
Life Table Tests (d)	P=0.375N	P=0.546N	P=0.496N
Incidental Tumor Tests (d)	P=0.297N	P=0.542N	P=0.438N
Cochran-Armitage Trend Test (d)	P=0.200N		
Fisher Exact Test (d)		P=0.468N	P=0.283N

TABLE E1. ANALYSIS OF PRIMARY TUMORS IN MALE RATS IN THE TWO-YEAR INHALATION STUDY OF TETRACHLOROETHYLENE (Continued)

	Control	200 ppm	400 ppm
Preputial Gland: Adenoma			
Overall Rates (a)	1/50 (2%)	3/50 (6%)	3/50 (6%)
Adjusted Rates (b)	4.3%	11.2%	19.8%
Terminal Rates (c)	1/23 (4%)	1/20 (5%)	2/12 (17%)
Week of First Observation	104	87	99
Life Table Tests (d)	P=0.107	P=0.255	P=0.137
Incidental Tumor Tests (d)	P=0.170	P=0.285	P=0.164
Cochran-Armitage Trend Test (d)	P=0.238		
Fisher Exact Test (d)		P=0.309	P=0.309
Preputial Gland: Carcinoma			
Overall Rates (a)	2/50 (4%)	2/50 (4%)	3/50 (6%)
Adjusted Rates (b)	8.0%	10.0%	15.0%
Terminal Rates (c)	1/23 (4%)	2/20 (10%)	1/12 (8%)
Week of First Observation	103	104	86
Life Table Tests (d)	P=0.205	P=0.637	P=0.285
Incidental Tumor Tests (d)	P=0.318	P=0.638	P=0.467
Cochran-Armitage Trend Test (d)	P=0.406		
Fisher Exact Test (d)		P=0.691	P=0.500
Preputial Gland: Adenoma or Carcinoma			
Overall Rates (a)	3/50 (6%)	5/50 (10%)	6/50 (12%)
Adjusted Rates (b)	12.2%	20.6%	33.0%
Terminal Rates (c)	2/23 (9%)	3/20 (15%)	3/12 (25%)
Week of First Observation	103	87	86
Life Table Tests (d)	P=0.047	P=0.277	P=0.063
Incidental Tumor Tests (d)	P=0.112	P=0.299	P=0.139
Cochran-Armitage Trend Test (d)	P=0.195		
Fisher Exact Test (d)		P=0.357	P=0.243
Testis: Interstitial Cell Tumor			
Overall Rates (a)	35/50 (70%)	39/49 (80%)	41/50 (82%)
Adjusted Rates (b)	91.4%	97.5%	100.0%
Terminal Rates (c)	20/23 (87%)	19/20 (95%)	12/12 (100%)
Week of First Observation	69	82	68
Life Table Tests (d)	P<0.001	P=0.093	P=0.001
Incidental Tumor Tests (d)	P=0.012	P=0.047	P=0.024
Cochran-Armitage Trend Test (d)	P=0.095		
Fisher Exact Test (d)		P=0.193	P=0.121
Brain: Glioma			
Overall Rates (a)	1/50 (2%)	0/50 (0%)	4/50 (8%)
Adjusted Rates (b)	4.3%	0.0%	17.3%
Terminal Rates (c)	1/23 (4%)	0/20 (0%)	0/12 (0%)
Week of First Observation	104		88
Life Table Tests (d)	P=0.039	P=0.528N	P=0.083
Incidental Tumor Tests (d)	P=0.103	P=0.528N	P=0.207
Cochran-Armitage Trend Test (d)	P=0.082		
Fisher Exact Test (d)		P=0.500N	P=0.181
All Sites: Mesothelioma			
Overall Rates (a)	2/50 (4%)	1/50 (2%)	3/50 (6%)
Adjusted Rates (b)	6.3%	4.8%	15.3%
Terminal Rates (c)	1/23 (4%)	0/20 (0%)	1/12 (8%)
Week of First Observation	69	103	91
Life Table Tests (d)	P=0.254	P=0.548N	P=0.342
Incidental Tumor Tests (d)	P=0.422	P=0.461N	P=0.509
Cochran-Armitage Trend Test (d)	P=0.399		
Fisher Exact Test (d)		P=0.500N	P=0.500

TABLE E1. ANALYSIS OF PRIMARY TUMORS IN MALE RATS IN THE TWO-YEAR INHALATION STUDY OF TETRACHLOROETHYLENE (Continued)

- (a) Number of tumor-bearing animals/number of animals examined at the site
- (b) Kaplan-Meier estimated tumor incidences at the end of the study after adjusting for intercurrent mortality
- (c) Observed tumor incidence at terminal kill
- (d) Beneath the control incidence are the P values associated with the trend test. Beneath the dosed group incidence are the P values corresponding to pairwise comparisons between that dosed group and the controls. The life table analysis regards tumors in animals dying prior to terminal kill as being (directly or indirectly) the cause of death. The incidental tumor test regards these lesions as nonfatal. The Cochran-Armitage and Fisher exact tests compare directly the overall incidence rates. A negative trend or lower incidence in a dosed group is indicated by (N).
- (e) A fibrosarcoma was also present in this animal.
- (f) A nephroblastoma and a lipoma were also observed in this group.

TABLE E2. ANALYSIS OF PRIMARY TUMORS IN FEMALE RATS IN THE TWO-YEAR INHALATION STUDY OF TETRACHLOROETHYLENE

	Control	200 ppm	400 ppm
Hematopoietic System: Mononuclear Cell Leukemia			
Overall Rates (a)	18/50 (36%)	30/50 (60%)	29/50 (58%)
Adjusted Rates (b)	53.8%	71.4%	66.3%
Terminal Rates (c)	9/23 (39%)	10/21 (48%)	10/24 (42%)
Week of First Observation	84	60	76
Life Table Tests (d)	P=0.053	P=0.023	P=0.053
Incidental Tumor Tests (d)	P=0.012	P=0.013	P=0.014
Cochran-Armitage Trend Test (d)	P=0.018		
Fisher Exact Test (d)		P=0.014	P=0.022
Anterior Pituitary Gland: Adenoma			
Overall Rates (a)	19/50 (38%)	21/48 (44%)	20/50 (40%)
Adjusted Rates (b)	55.6%	63.7%	60.9%
Terminal Rates (c)	9/23 (39%)	10/20 (50%)	12/24 (50%)
Week of First Observation	59	60	76
Life Table Tests (d)	P=0.471	P=0.304	P=0.514
Incidental Tumor Tests (d)	P=0.479	P=0.345	P=0.513
Cochran-Armitage Trend Test (d)	P=0.459		
Fisher Exact Test (d)		P=0.354	P=0.500
Anterior Pituitary Gland: Carcinoma			
Overall Rates (a)	4/50 (8%)	2/48 (4%)	3/50 (6%)
Adjusted Rates (b)	13.9%	5.6%	10.5%
Terminal Rates (c)	2/23 (9%)	0/20 (0%)	2/24 (8%)
Week of First Observation	87	90	85
Life Table Tests (d)	P=0.422N	P=0.376N	P=0.494N
Incidental Tumor Tests (d)	P=0.458N	P=0.357N	P=0.533N
Cochran-Armitage Trend Test (d)	P=0.417N		
Fisher Exact Test (d)		P=0.359N	P=0.500N
Anterior Pituitary Gland: Adenoma or Carcinoma			
Overall Rates (a)	23/50 (46%)	23/48 (48%)	23/50 (46%)
Adjusted Rates (b)	64.1%	65.8%	68.2%
Terminal Rates (c)	11/23 (48%)	10/20 (50%)	14/24 (58%)
Week of First Observation	59	60	76
Life Table Tests (d)	P=0.529N	P=0.426	P=0.554N
Incidental Tumor Tests (d)	P=0.539	P=0.493	P=0.575
Cochran-Armitage Trend Test (d)	P=0.540		
Fisher Exact Test (d)		P=0.505	P=0.579
Adrenal Gland: Pheochromocytoma or Malignant Pheochromocytoma			
Overall Rates (a)	1/50 (2%)	0/49 (0%)	3/47 (6%)
Adjusted Rates (b)	4.3%	0.0%	11.4%
Terminal Rates (c)	1/23 (4%)	0/21 (0%)	2/23 (9%)
Week of First Observation	104		95
Life Table Tests (d)	P=0.176	P=0.518N	P=0.300
Incidental Tumor Tests (d)	P=0.171	P=0.518N	P=0.292
Cochran-Armitage Trend Test (d)	P=0.162		
Fisher Exact Test (d)		P=0.505N	P=0.285
Thyroid Gland: C-Cell Adenoma			
Overall Rates (a)	3/46 (7%)	1/48 (2%)	3/46 (7%)
Adjusted Rates (b)	9.3%	4.8%	9.8%
Terminal Rates (c)	0/22 (0%)	1/21 (5%)	1/23 (4%)
Week of First Observation	89	104	89
Life Table Tests (d)	P=0.587	P=0.331N	P=0.650
Incidental Tumor Tests (d)	P=0.511	P=0.311N	P=0.547
Cochran-Armitage Trend Test (d)	P=0.595		
Fisher Exact Test (d)		P=0.292N	P=0.662

TABLE E2. ANALYSIS OF PRIMARY TUMORS IN FEMALE RATS IN THE TWO-YEAR INHALATION STUDY OF TETRACHLOROETHYLENE (Continued)

	Control	200 ppm	400 ppm
Thyroid Gland: C-Cell Carcinoma			
Overall Rates (a)	1/46 (2%)	4/48 (8%)	1/46 (2%)
Adjusted Rates (b)	3.8%	15.1%	4.3%
Terminal Rates (c)	0/22 (0%)	2/21 (10%)	1/23 (4%)
Week of First Observation	103	96	104
Life Table Tests (d)	P=0.596N	P=0.168	P=0.760N
Incidental Tumor Tests (d)	P=0.560	P=0.173	P=0.737
Cochran-Armitage Trend Test (d)	P=0.602		
Fisher Exact Test (d)		P=0.194	P=0.753
Thyroid Gland: C-Cell Adenoma or Carcinoma			
Overall Rates (a)	4/46 (9%)	5/48 (10%)	4/46 (9%)
Adjusted Rates (b)	12.9%	19.6%	13.9%
Terminal Rates (c)	0/22 (0%)	3/21 (14%)	2/23 (9%)
Week of First Observation	89	96	89
Life Table Tests (d)	P=0.567	P=0.464	P=0.632
Incidental Tumor Tests (d)	P=0.479	P=0.490	P=0.525
Cochran-Armitage Trend Test (d)	P=0.571		
Fisher Exact Test (d)		P=0.527	P=0.643
Mammary Gland: Fibroadenoma			
Overall Rates (a)	7/50 (14%)	3/50 (6%)	6/50 (12%)
Adjusted Rates (b)	21.1%	10.3%	18.5%
Terminal Rates (c)	3/23 (13%)	1/21 (5%)	2/24 (8%)
Week of First Observation	87	96	77
Life Table Tests (d)	P=0.457N	P=0.194N	P=0.517N
Incidental Tumor Tests (d)	P=0.465N	P=0.158N	P=0.532N
Cochran-Armitage Trend Test (d)	P=0.436N		
Fisher Exact Test (d)		P=0.159N	P=0.500N
Mammary Gland: Adenoma or Fibroadenoma			
Overall Rates (a)	7/50 (14%)	3/50 (6%)	7/50 (14%)
Adjusted Rates (b)	21.1%	10.3%	20.8%
Terminal Rates (c)	3/23 (13%)	1/21 (5%)	2/24 (8%)
Week of First Observation	87	96	77
Life Table Tests (d)	P=0.541	P=0.194N	P=0.590
Incidental Tumor Tests (d)	P=0.528	P=0.158N	P=0.575
Cochran-Armitage Trend Test (d)	P=0.563		
Fisher Exact Test (d)		P=0.159N	P=0.613
Mammary Gland: Adenoma, Fibroadenoma, or Adenocarcinoma			
Overall Rates (a)	8/50 (16%)	5/50 (10%)	7/50 (14%)
Adjusted Rates (b)	25.1%	14.4%	20.8%
Terminal Rates (c)	4/23 (17%)	1/21 (5%)	2/24 (8%)
Week of First Observation	87	73	77
Life Table Tests (d)	P=0.459N	P=0.318N	P=0.515N
Incidental Tumor Tests (d)	P=0.453N	P=0.262N	P=0.536N
Cochran-Armitage Trend Test (d)	P=0.442N		
Fisher Exact Test (d)		P=0.277N	P=0.500N
Clitoral Gland: Adenoma			
Overall Rates (a)	3/50 (6%)	1/50 (2%)	2/50 (4%)
Adjusted Rates (b)	11.3%	4.8%	8.3%
Terminal Rates (c)	2/23 (9%)	1/21 (5%)	2/24 (8%)
Week of First Observation	98	104	104
Life Table Tests (d)	P=0.392N	P=0.335N	P=0.493N
Incidental Tumor Tests (d)	P=0.395N	P=0.330N	P=0.498N
Cochran-Armitage Trend Test (d)	P=0.399N		
Fisher Exact Test (d)		P=0.309N	P=0.500N

TABLE E2. ANALYSIS OF PRIMARY TUMORS IN FEMALE RATS IN THE TWO-YEAR INHALATION STUDY OF TETRACHLOROETHYLENE (Continued)

	Control	200 ppm	400 ppm
Clitoral Gland: Carcinoma			
Overall Rates (a)	2/50 (4%)	3/50 (6%)	2/50 (4%)
Adjusted Rates (b)	6.4%	9.3%	8.3%
Terminal Rates (c)	1/23 (4%)	1/21 (5%)	2/24 (8%)
Week of First Observation	84	85	104
Life Table Tests (d)	P=0.588	P=0.475	P=0.691N
Incidental Tumor Tests (d)	P=0.567	P=0.510	P=0.686
Cochran-Armitage Trend Test (d)	P=0.594		
Fisher Exact Test (d)		P=0.500	P=0.691
Clitoral Gland: Adenoma or Carcinoma			
Overall Rates (a)	5/50 (10%)	4/50 (8%)	4/50 (8%)
Adjusted Rates (b)	17.4%	13.8%	16.7%
Terminal Rates (c)	3/23 (13%)	2/21 (10%)	4/24 (17%)
Week of First Observation	84	85	104
Life Table Tests (d)	P=0.427N	P=0.541N	P=0.492N
Incidental Tumor Tests (d)	P=0.447N	P=0.512N	P=0.505N
Cochran-Armitage Trend Test (d)	P=0.429N		
Fisher Exact Test (d)		P=0.500N	P=0.500N
Uterus: Endometrial Stromal Polyp			
Overall Rates (a)	5/49 (10%)	7/49 (14%)	7/50 (14%)
Adjusted Rates (b)	16.6%	23.1%	23.5%
Terminal Rates (c)	2/23 (9%)	2/21 (10%)	4/24 (17%)
Week of First Observation	96	85	88
Life Table Tests (d)	P=0.330	P=0.345	P=0.382
Incidental Tumor Tests (d)	P=0.272	P=0.343	P=0.334
Cochran-Armitage Trend Test (d)	P=0.340		
Fisher Exact Test (d)		P=0.380	P=0.394
Uterus: Endometrial Stromal Polyp or Sarcoma			
Overall Rates (a)	5/49 (10%)	9/49 (18%)	8/50 (16%)
Adjusted Rates (b)	16.6%	29.1%	27.3%
Terminal Rates (c)	2/23 (9%)	3/21 (14%)	5/24 (21%)
Week of First Observation	96	85	88
Life Table Tests (d)	P=0.250	P=0.177	P=0.283
Incidental Tumor Tests (d)	P=0.194	P=0.170	P=0.241
Cochran-Armitage Trend Test (d)	P=0.253		
Fisher Exact Test (d)		P=0.194	P=0.290

(a) Number of tumor-bearing animals/number of animals examined at the site

(b) Kaplan-Meier estimated tumor incidences at the end of the study after adjusting for intercurrent mortality

(c) Observed tumor incidence at terminal kill

(d) Beneath the control incidence are the P values associated with the trend test. Beneath the dosed group incidence are the P values corresponding to pairwise comparisons between that dosed group and the controls. The life table analysis regards tumors in animals dying prior to terminal kill as being (directly or indirectly) the cause of death. The incidental tumor test regards these lesions as nonfatal. The Cochran-Armitage and Fisher exact tests compare directly the overall incidence rates. A negative trend or lower incidence in a dosed group is indicated by (N).

TABLE E3. ANALYSIS OF PRIMARY TUMORS IN MALE MICE IN THE TWO-YEAR INHALATION STUDY OF TETRACHLOROETHYLENE

	Control	100 ppm	200 ppm
Lung: Alveolar/Bronchiolar Adenoma			
Overall Rates (a)	3/49 (6%)	5/49 (10%)	1/50 (2%)
Adjusted Rates (b)	6.5%	18.3%	3.1%
Terminal Rates (c)	3/46 (7%)	4/25 (16%)	1/32 (3%)
Week of First Observation	104	89	104
Life Table Tests (d)	P=0.446N	P=0.110	P=0.442N
Incidental Tumor Tests (d)	P=0.378N	P=0.196	P=0.442N
Cochran-Armitage Trend Test (d)	P=0.256N		
Fisher Exact Test (d)		P=0.357	P=0.301N
Lung: Alveolar/Bronchiolar Carcinoma			
Overall Rates (a)	4/49 (8%)	1/49 (2%)	4/50 (8%)
Adjusted Rates (b)	8.7%	4.0%	12.0%
Terminal Rates (c)	4/46 (9%)	1/25 (4%)	3/32 (9%)
Week of First Observation	104	104	103
Life Table Tests (d)	P=0.390	P=0.401N	P=0.440
Incidental Tumor Tests (d)	P=0.441	P=0.401N	P=0.522
Cochran-Armitage Trend Test (d)	P=0.573N		
Fisher Exact Test (d)		P=0.181N	P=0.631N
Lung: Alveolar/Bronchiolar Adenoma or Carcinoma			
Overall Rates (a)	6/49 (12%)	6/49 (12%)	5/50 (10%)
Adjusted Rates (b)	13.0%	22.2%	15.1%
Terminal Rates (c)	6/46 (13%)	5/25 (20%)	4/32 (13%)
Week of First Observation	104	89	103
Life Table Tests (d)	P=0.414	P=0.220	P=0.507
Incidental Tumor Tests (d)	P=0.502	P=0.335	P=0.578
Cochran-Armitage Trend Test (d)	P=0.423N		
Fisher Exact Test (d)		P=0.620	P=0.486N
Hematopoietic System: Lymphoma, All Malignant			
Overall Rates (a)	3/49 (6%)	7/50 (14%)	3/50 (6%)
Adjusted Rates (b)	6.5%	20.3%	9.4%
Terminal Rates (c)	3/46 (7%)	2/25 (8%)	3/32 (9%)
Week of First Observation	104	55	104
Life Table Tests (d)	P=0.378	P=0.043	P=0.487
Incidental Tumor Tests (d)	P=0.496N	P=0.406	P=0.487
Cochran-Armitage Trend Test (d)	P=0.558N		
Fisher Exact Test (d)		P=0.167	P=0.652N
Circulatory System: Hemangioma or Hemangiosarcoma			
Overall Rates (a)	3/49 (6%)	2/50 (4%)	2/50 (4%)
Adjusted Rates (b)	6.5%	7.7%	6.2%
Terminal Rates (c)	3/46 (7%)	1/25 (4%)	2/32 (6%)
Week of First Observation	104	102	104
Life Table Tests (d)	P=0.576N	P=0.601	P=0.662N
Incidental Tumor Tests (d)	P=0.517N	P=0.638N	P=0.662N
Cochran-Armitage Trend Test (d)	P=0.398N		
Fisher Exact Test (d)		P=0.491N	P=0.491N
Liver: Hepatocellular Adenoma			
Overall Rates (a)	12/49 (24%)	8/49 (16%)	19/50 (38%)
Adjusted Rates (b)	26.1%	29.9%	55.4%
Terminal Rates (c)	12/46 (26%)	7/25 (28%)	17/32 (53%)
Week of First Observation	104	89	73
Life Table Tests (d)	P=0.004	P=0.419	P=0.005
Incidental Tumor Tests (d,e)	P=0.008	P=0.542	P=0.012
Cochran-Armitage Trend Test (d)	P=0.077		
Fisher Exact Test (d)		P=0.226N	P=0.109

TABLE E3. ANALYSIS OF PRIMARY TUMORS IN MALE MICE IN THE TWO-YEAR INHALATION STUDY OF TETRACHLOROETHYLENE (Continued)

	Control	100 ppm	200 ppm
Liver: Hepatocellular Carcinoma			
Overall Rates (a)	7/49 (14%)	25/49 (51%)	26/50 (52%)
Adjusted Rates (b)	14.9%	58.3%	58.3%
Terminal Rates (c)	6/46 (13%)	8/25 (32%)	14/32 (44%)
Week of First Observation	98	63	60
Life Table Tests (d)	P<0.001	P<0.001	P<0.001
Incidental Tumor Tests (d,f)	P=0.002	P=0.016	P=0.001
Cochran-Armitage Trend Test (d)	P<0.001		
Fisher Exact Test (d)		P<0.001	P<0.001
Liver: Hepatocellular Adenoma or Carcinoma			
Overall Rates (a)	17/49 (35%)	31/49 (63%)	41/50 (82%)
Adjusted Rates (b)	36.1%	73.0%	89.0%
Terminal Rates (c)	16/46 (35%)	14/25 (56%)	27/32 (84%)
Week of First Observation	98	63	60
Life Table Tests (d)	P<0.001	P<0.001	P<0.001
Incidental Tumor Tests (d,g)	P<0.001	P=0.026	P<0.001
Cochran-Armitage Trend Test (d)	P<0.001		
Fisher Exact Test (d)		P=0.004	P<0.001

(a) Number of tumor-bearing animals/number of animals examined at the site

(b) Kaplan-Meier estimated tumor incidences at the end of the study after adjusting for intercurrent mortality

(c) Observed tumor incidence at terminal kill

(d) Beneath the control incidence are the P values associated with the trend test. Beneath the dosed group incidence are the P values corresponding to pairwise comparisons between that dosed group and the controls. The life table analysis regards tumors in animals dying prior to terminal kill as being (directly or indirectly) the cause of death. The incidental tumor test, which regards these lesions as nonfatal, lacks sensitivity because the unusually good survival in the control group creates unsatisfactory comparisons in the early time intervals. The Cochran-Armitage and Fisher exact tests compare directly the overall incidence rates. A negative trend or lower incidence in a dosed group is indicated by (N).

(e) P values determined with intervals of weeks 0-52 and 53-103 and week 104: 0.009, 0.438, 0.014

(f) P values determined with intervals of weeks 0-52 and 53-103 and week 104: 0.003, 0.021, 0.001

(g) P values determined with intervals of weeks 0-52 and 53-103 and week 104: <0.001, 0.020, <0.001

TABLE E4. ANALYSIS OF PRIMARY TUMORS IN FEMALE MICE IN THE TWO-YEAR INHALATION STUDY OF TETRACHLOROETHYLENE

	Control	100 ppm	200 ppm
Lung: Alveolar/Bronchiolar Adenoma			
Overall Rates (a)	4/48 (8%)	2/50 (4%)	1/50 (2%)
Adjusted Rates (b)	11.1%	6.2%	2.4%
Terminal Rates (c)	4/36 (11%)	1/31 (3%)	0/19 (0%)
Week of First Observation	104	102	85
Life Table Tests (d)	P=0.252N	P=0.403N	P=0.362N
Incidental Tumor Tests (d)	P=0.112N	P=0.396N	P=0.220N
Cochran-Armitage Trend Test (d)	P=0.108N		
Fisher Exact Test (d)		P=0.319N	P=0.168N
Lung: Alveolar/Bronchiolar Adenoma or Carcinoma			
Overall Rates (a)	6/48 (13%)	3/50 (6%)	3/50 (6%)
Adjusted Rates (b)	16.7%	9.3%	9.5%
Terminal Rates (c)	6/36 (17%)	2/31 (6%)	1/19 (5%)
Week of First Observation	104	102	67
Life Table Tests (d)	P=0.411N	P=0.317N	P=0.524N
Incidental Tumor Tests (d)	P=0.216N	P=0.311N	P=0.339N
Cochran-Armitage Trend Test (d)	P=0.162N		
Fisher Exact Test (d)		P=0.223N	P=0.223N
Hematopoietic System: Lymphoma, All Malignant			
Overall Rates (a)	8/49 (16%)	13/50 (26%)	8/50 (16%)
Adjusted Rates (b)	19.4%	35.2%	29.4%
Terminal Rates (c)	4/36 (11%)	8/31 (26%)	4/19 (21%)
Week of First Observation	93	34	54
Life Table Tests (d)	P=0.193	P=0.104	P=0.268
Incidental Tumor Tests (d)	P=0.418N	P=0.159	P=0.485N
Cochran-Armitage Trend Test (d)	P=0.531N		
Fisher Exact Test (d)		P=0.176	P=0.590N
Circulatory System: Hemangiosarcoma			
Overall Rates (a)	1/49 (2%)	3/50 (6%)	0/50 (0%)
Adjusted Rates (b)	2.8%	9.7%	0.0%
Terminal Rates (c)	1/36 (3%)	3/31 (10%)	0/19 (0%)
Week of First Observation	104	104	
Life Table Tests (d)	P=0.576N	P=0.253	P=0.627N
Incidental Tumor Tests (d)	P=0.576N	P=0.253	P=0.627N
Cochran-Armitage Trend Test (d)	P=0.372N		
Fisher Exact Test (d)		P=0.316	P=0.495N
Circulatory System: Hemangioma or Hemangiosarcoma			
Overall Rates (a)	1/49 (2%)	3/50 (6%)	1/50 (2%)
Adjusted Rates (b)	2.8%	9.7%	5.3%
Terminal Rates (c)	1/36 (3%)	3/31 (10%)	1/19 (5%)
Week of First Observation	104	104	104
Life Table Tests (d)	P=0.386	P=0.253	P=0.613
Incidental Tumor Tests (d)	P=0.386	P=0.253	P=0.613
Cochran-Armitage Trend Test (d)	P=0.603N		
Fisher Exact Test (d)		P=0.316	P=0.748N
Liver: Hepatocellular Adenoma			
Overall Rates (a)	3/48 (6%)	6/50 (12%)	2/50 (4%)
Adjusted Rates (b)	7.5%	18.7%	6.1%
Terminal Rates (c)	1/36 (3%)	5/31 (16%)	0/19 (0%)
Week of First Observation	96	102	78
Life Table Tests (d)	P=0.479	P=0.182	P=0.641N
Incidental Tumor Tests (d)	P=0.325N	P=0.193	P=0.213N
Cochran-Armitage Trend Test (d)	P=0.401N		
Fisher Exact Test (d)		P=0.264	P=0.481N

TABLE E4. ANALYSIS OF PRIMARY TUMORS IN FEMALE MICE IN THE TWO-YEAR INHALATION STUDY OF TETRACHLOROETHYLENE (Continued)

	Control	100 ppm	200 ppm
Liver: Hepatocellular Carcinoma			
Overall Rates (a)	1/48 (2%)	13/50 (26%)	36/50 (72%)
Adjusted Rates (b)	2.8%	35.5%	91.7%
Terminal Rates (c)	1/36 (3%)	8/31 (26%)	16/19 (84%)
Week of First Observation	104	76	67
Life Table Tests (d)	P<0.001	P<0.001	P<0.001
Incidental Tumor Tests (d)	P<0.001	P<0.001	P<0.001
Cochran-Armitage Trend Test (d)	P<0.001		
Fisher Exact Test (d)		P<0.001	P<0.001
Liver: Hepatocellular Adenoma or Carcinoma			
Overall Rates (a)	4/48 (8%)	17/50 (34%)	38/50 (76%)
Adjusted Rates (b)	10.1%	46.7%	92.2%
Terminal Rates (c)	2/36 (6%)	12/31 (39%)	16/19 (84%)
Week of First Observation	96	76	67
Life Table Tests (d)	P<0.001	P<0.001	P<0.001
Incidental Tumor Tests (d)	P<0.001	P<0.001	P<0.001
Cochran-Armitage Trend Test (d)	P<0.001		
Fisher Exact Test (d)		P=0.002	P<0.001
Pituitary Gland: Carcinoma			
Overall Rates (a)	5/45 (11%)	3/43 (7%)	3/42 (7%)
Adjusted Rates (b)	14.7%	9.7%	15.4%
Terminal Rates (c)	5/34 (15%)	3/31 (10%)	2/17 (12%)
Week of First Observation	104	104	102
Life Table Tests (d)	P=0.549	P=0.406N	P=0.573
Incidental Tumor Tests (d)	P=0.544N	P=0.406N	P=0.645N
Cochran-Armitage Trend Test (d)	P=0.316N		
Fisher Exact Test (d)		P=0.383N	P=0.396N
Pituitary Gland: Adenoma or Carcinoma			
Overall Rates (a)	7/45 (16%)	3/43 (7%)	5/42 (12%)
Adjusted Rates (b)	19.7%	9.7%	20.5%
Terminal Rates (c)	6/34 (18%)	3/31 (10%)	2/17 (12%)
Week of First Observation	97	104	88
Life Table Tests (d)	P=0.480	P=0.200N	P=0.473
Incidental Tumor Tests (d)	P=0.387N	P=0.193N	P=0.462N
Cochran-Armitage Trend Test (d)	P=0.349N		
Fisher Exact Test (d)		P=0.176N	P=0.429N
Harderian Gland: Adenoma or Carcinoma (e)			
Overall Rates (a)	1/49 (2%)	1/50 (2%)	3/50 (6%)
Adjusted Rates (b)	2.4%	3.2%	14.3%
Terminal Rates (c)	0/36 (0%)	1/31 (3%)	2/19 (11%)
Week of First Observation	97	104	102
Life Table Tests (d)	P=0.093	P=0.726	P=0.155
Incidental Tumor Tests (d)	P=0.202	P=0.726	P=0.325
Cochran-Armitage Trend Test (d)	P=0.207		
Fisher Exact Test (d)		P=0.747N	P=0.316

(a) Number of tumor-bearing animals/number of animals examined at the site

(b) Kaplan-Meier estimated tumor incidences at the end of the study after adjusting for intercurrent mortality

(c) Observed tumor incidence at terminal kill

(d) Beneath the control incidence are the P values associated with the trend test. Beneath the dosed group incidence are the P values corresponding to pairwise comparisons between that dosed group and the controls. The life table analysis regards tumors in animals dying prior to terminal kill as being (directly or indirectly) the cause of death. The incidental tumor test regards these lesions as nonfatal. The Cochran-Armitage and Fisher exact tests compare directly the overall incidence rates. A negative trend or lower incidence in a dosed group is indicated by (N).

(e) Includes adenoma, NOS, papillary adenoma, and papillary carcinoma

APPENDIX F

HISTORICAL INCIDENCES OF TUMORS IN F344/N RATS AND B6C3F₁ MICE RECEIVING NO TREATMENT

TABLE F1. HISTORICAL INCIDENCE OF LEUKEMIA IN MALE F344/N RATS RECEIVING NO TREATMENT (a)

Study	Incidence in Controls
Historical Incidence for Chamber Controls at Battelle Pacific Northwest Laboratories	
Propylene oxide	20/50
Methyl methacrylate	19/50
Propylene	16/50
Dichloromethane	34/50
Tetrachloroethylene	28/50
TOTAL	117/250 (46.8%)
SD (b)	14.81%
Range (c)	
High	34/50
Low	16/50
Overall Historical Incidence for Untreated Controls	
TOTAL	583/1,977 (29.5%)
SD (b)	11.59%
Range (c)	
High	30/50
Low	5/50

(a) Data as of August 30, 1985, for studies of at least 104 weeks
 (b) Standard deviation
 (c) Range and SD are presented for groups of 35 or more animals.

TABLE F2. HISTORICAL INCIDENCE OF ADRENAL GLAND TUMORS IN MALE F344/N RATS RECEIVING NO TREATMENT (a)

Study	Incidence in Controls		
	Pheochromocytoma	Malignant Pheochromocytoma	Pheochromocytoma or Malignant Pheochromocytoma
Historical Incidence for Chamber Controls at Battelle Pacific Northwest Laboratories			
Propylene oxide	3/48	0/48	3/48
Methyl metacrylate	0/49	0/49	0/49
Propylene	2/50	2/50	4/50
Dichloromethane	0/50	0/50	0/50
Tetrachloroethylene	0/49	0/49	0/49
TOTAL	5/246 (2.0%)	2/246 (0.8%)	7/246 (2.8%)
SD (b)	2.92%	1.79%	3.95%
Overall Historical Incidence for Untreated Controls			
TOTAL	427/1,950 (21.9%)	30/1,950 (1.5%)	452/1,950 (23.2%)
SD (b)	12.41%	2.00%	12.39%
Range (c)			
High	31/49	4/49	32/49
Low	2/50	0/50	3/50

(a) Data as of August 30, 1985, for studies of at least 104 weeks

(b) Standard deviation

(c) Range and SD are presented for groups of 35 or more animals.

TABLE F3. HISTORICAL INCIDENCE OF INTERSTITIAL CELL TUMORS OF THE TESTIS IN MALE F344/N RATS RECEIVING NO TREATMENT (a)

Study	Incidence in Controls
Historical Incidence for Chamber Controls at Battelle Pacific Northwest Laboratories	
Propylene oxide	29/49
Methyl methacrylate	35/50
Propylene	37/50
Dichloromethane	39/50
Tetrachloroethylene	35/50
TOTAL	175/249 (70.3%)
SD (b)	7.01%
Overall Historical Incidence for Untreated Controls	
TOTAL	(d) 1,729/1,949 (88.7%)
SD (b)	7.48%
Range (c)	
High	49/50
Low	34/50

- (a) Data as of August 30, 1985, for studies of at least 104 weeks
 (b) Standard deviation
 (c) Range and SD are presented for groups of 35 or more animals.
 (d) Total includes one malignant interstitial cell tumor

TABLE F4. HISTORICAL INCIDENCE OF KIDNEY TUBULAR CELL ADENOMAS IN MALE F344/N RATS RECEIVING NO TREATMENT (a)

Study	Incidence in Controls
Historical Incidence for Chamber Controls at Battelle Pacific Northwest Laboratories	
Propylene oxide	0/50
Methyl methacrylate	0/50
Propylene	0/50
Dichloromethane	0/50
Tetrachloroethylene	1/49
TOTAL	1/249 (0.4%)
SD (b)	0.91%
Range (c)	
High	1/49
Low	0/50
Overall Historical Incidence for Untreated Controls	
TOTAL	4/1,968 (0.2%)
SD (b)	0.61%
Range (c)	
High	1/50
Low	0/90

(a) Data as of August 30, 1985, for studies of at least 104 weeks. No malignant renal tubular cell tumors have been observed.

(b) Standard deviation

(c) Range and SD are presented for groups of 35 or more animals.

TABLE F5. HISTORICAL INCIDENCE OF PREPUTIAL GLAND TUMORS IN MALE F344/N RATS RECEIVING NO TREATMENT (a)

Study	Incidence in Controls		
	Adenoma	Carcinoma or Adenocarcinoma	Adenoma, Carcinoma, or Adenocarcinoma
Historical Incidence for Chamber Controls at Battelle Pacific Northwest Laboratories			
Propylene oxide	0/50	0/50	0/50
Methyl methacrylate	3/50	2/50	5/50
Propylene	0/50	0/50	0/50
Dichloromethane	0/50	3/50	3/50
Tetrachloroethylene	1/50	2/50	3/50
TOTAL	4/250 (1.6%)	7/250 (2.8%)	11/250 (4.4%)
SD (d)	2.61%	2.68%	4.34%
Range (e)			
High	3/50	3/50	5/50
Low	0/50	0/50	0/50
Overall Historical Incidence for Untreated Controls			
TOTAL	(d) 50/1,977 (2.5%)	(e) 65/1,977 (3.3%)	(d,e) 115/1,977 (5.8%)
SD (d)	3.61%	2.95%	4.44%
Range (e)			
High	8/50	5/50	8/50
Low	0/90	0/50	0/50

(a) Data as of August 30, 1985, for studies of at least 104 weeks

(b) Standard deviation

(c) Range and SD are presented for groups of 35 or more animals.

(d) Includes 48 adenomas, NOS, 1 papillary adenoma, and 1 cystadenoma, NOS

(e) Includes 53 carcinomas, NOS, 2 squamous cell carcinomas, 8 adenocarcinomas, NOS, and 2 sebaceous adenocarcinomas

TABLE F6. HISTORICAL INCIDENCE OF BRAIN TUMORS IN MALE F344/N RATS RECEIVING NO TREATMENT (a)

	No. of Animals Examined	No. of Tumors	Diagnosis
Historical Incidence for Chamber Controls at Battelle Pacific Northwest Laboratories			
Propylene oxide	47	1	Glioma, NOS
Propylene	50	1	Astrocytoma
Tetrachloroethylene	50	1	Glioma, NOS
All others	100	0	
TOTAL	247	3 (1.2%)	
Overall Historical Incidence for Untreated Controls			
	1,971	4	Glioma, NOS
		10	Astrocytoma
		2	Oligodendroglioma
		1	Granular cell tumor, benign
		2	Granular cell tumor, NOS
		1	Granular cell tumor, malignant
		2	Medulloblastoma
		1	Meningioma
TOTAL		(b) 16 (0.8%)	

(a) Data as of August 30, 1985. Totals and range are for neuroglial cell tumors (glioma, astrocytoma, and oligodendroglioma). Other tumors are reported for comparison purposes.

(b) The greatest incidence observed in any control group is 3/50.

TABLE F7. HISTORICAL INCIDENCE OF LEUKEMIA IN FEMALE F344/N RATS RECEIVING NO TREATMENT (a)

Study	Incidence in Controls
Historical Incidence for Chamber Controls at Battelle Pacific Northwest Laboratories	
Propylene oxide	14/50
Methyl methacrylate	11/50
Propylene	13/49
Dichloromethane	17/50
Tetrachloroethylene	18/50
TOTAL	73/249 (29.3%)
SD (b)	5.69%
Range (c)	
High	18/50
Low	11/50
Overall Historical Incidence for Untreated Controls	
TOTAL	375/2,021 (18.6%)
SD (b)	6.55%
Range (c)	
High	19/50
Low	3/50

(a) Data as of August 30, 1985, for studies of at least 104 weeks
 (b) Standard deviation
 (c) Range and SD are presented for groups of 35 or more animals.

TABLE F8. HISTORICAL INCIDENCE OF HEPATOCELLULAR TUMORS IN MALE B6C3F₁ MICE RECEIVING NO TREATMENT (a)

Study	Incidence in Controls		
	Adenoma	Carcinoma	Adenoma or Carcinoma
Historical Incidence for Chamber Controls at Battelle Pacific Northwest Laboratories			
Propylene oxide	8/50	6/50	14/50
Methyl methacrylate	9/50	8/50	16/50
Propylene	5/50	9/50	14/50
Dichloromethane	10/50	13/50	22/50
Tetrachloroethylene	12/49	7/49	17/49
TOTAL	44/249 (17.7%)	43/249 (17.3%)	83/249 (33.3%)
SD (b)	5.33%	5.36%	6.60%
Range (c)			
High	12/49	13/50	22/50
Low	5/50	6/50	14/50
Overall Historical Incidence for Untreated Controls			
TOTAL	228/2,084 (10.9%)	424/2,084 (20.3%)	627/2,084 (30.1%)
SD (b)	7.29%	6.85%	7.78%
Range (c)			
High	(d) 22/50	16/50	(e) 29/50
Low	0/49	4/50	8/50

(a) Data as of August 30, 1985, for studies of at least 104 weeks

(b) Standard deviation

(c) Range and SD are presented for groups of 35 or more animals.

(d) Second highest incidence: 11/50

(e) Second highest incidence: 20/50

TABLE F9. HISTORICAL INCIDENCE OF HEPATOCELLULAR TUMORS IN FEMALE B6C3F₁ MICE RECEIVING NO TREATMENT (a)

Study	Incidence in Controls		
	Adenoma	Carcinoma	Adenoma or Carcinoma
Historical Incidence for Chamber Controls at Battelle Pacific Northwest Laboratories			
Propylene oxide	1/50	2/50	3/50
Methyl methacrylate	7/50	0/50	7/50
Propylene	0/50	2/50	2/50
Dichloromethane	2/50	1/50	3/50
Tetrachloroethylene	3/48	1/48	4/48
TOTAL	13/248 (5.2%)	6/248 (2.4%)	19/248 (7.7%)
SD (b)	5.41%	1.67%	3.86%
Range (c)			
	High 7/50	2/50	7/50
	Low 0/50	0/50	250
Overall Historical Incidence for Untreated Controls			
TOTAL	91/2,080 (4.3%)	(d) 94/2,080 (4.5%)	(d) 181/2,080 (8.7%)
SD (b)	4.23%	2.99%	4.85%
Range (c)			
High	9/49	7/48	10/49
Low	0/50	0/50	0/50

(a) Data as of August 30, 1985, for studies of at least 104 weeks

(b) Standard deviation

(c) Range and SD are presented for groups of 35 or more animals.

(d) One hepatoblastoma was also observed; the inclusion of this tumor would not affect the reported range.

APPENDIX G

**GENETIC TOXICOLOGY OF
TETRACHLOROETHYLENE**

TABLE G1. MUTAGENICITY OF TETRACHLOROETHYLENE IN *SALMONELLA TYPHIMURIUM*

Strain	Dose ($\mu\text{g}/\text{plate}$)	Revertants/plate (a,b)		
		-S9	+S9 (rat)	+S9 (hamster)
TA100	0	83 \pm 3.7	143 \pm 6.7	97 \pm 16.2
	3.3	82 \pm 5.2	167 \pm 17.9	105 \pm 1.3
	10	87 \pm 2.0	168 \pm 6.1	92 \pm 6.8
	33	79 \pm 1.7	156 \pm 10.5	102 \pm 14.5
	100	75 \pm 5.6	159 \pm 3.9	118 \pm 8.1
	333	70 \pm 7.0	93 \pm 4.1	77 \pm 2.6
TA1535	0	22 \pm 2.3	18 \pm 1.5	9 \pm 0.6
	3.3	15 \pm 0.7	15 \pm 2.0	9 \pm 0.6
	10	17 \pm 2.7	16 \pm 1.5	8 \pm 0.9
	33	19 \pm 2.6	14 \pm 2.3	10 \pm 0.7
	100	23 \pm 3.5	17 \pm 1.2	11 \pm 3.2
	333	Toxic	12 \pm 2.1	8 \pm 1.8
TA1537	0	7 \pm 0.9	7 \pm 0.3	10 \pm 2.6
	3.3	7 \pm 1.2	7 \pm 0.6	7 \pm 0.3
	10	8 \pm 3.0	11 \pm 2.2	10 \pm 0.7
	33	9 \pm 0.3	7 \pm 1.5	14 \pm 1.2
	100	7 \pm 2.6	8 \pm 0.9	11 \pm 0.6
	333	Toxic	7 \pm 0.3	6 \pm 0.0
TA98	0	17 \pm 0.9	36 \pm 3.2	22 \pm 3.5
	3.3	15 \pm 2.6	39 \pm 1.5	24 \pm 2.6
	10	20 \pm 2.8	31 \pm 1.3	27 \pm 4.6
	33	16 \pm 2.2	36 \pm 7.3	29 \pm 3.2
	100	13 \pm 4.2	40 \pm 2.7	34 \pm 2.3
	333	10 \pm 0.5	31 \pm 2.1	26 \pm 1.7

(a) The S9 fractions were prepared from the livers of Aroclor 1254-induced male Sprague-Dawley rats and male Syrian hamsters. Cells and study compound or solvent (dimethyl sulfoxide) were incubated for 20 minutes at 37° C in the presence of either S9 or buffer. After the addition of soft agar, the contents of each tube were poured onto minimal medium, and the plates were incubated at 37° C for 48 hours (Haworth et al., 1983). The experiment was performed twice, each in triplicate; because the results were similar, data from only one experiment are shown.

(b) Mean \pm standard error

TABLE G2. INDUCTION OF SISTER-CHROMATID EXCHANGES IN CHINESE HAMSTER OVARY CELLS BY TETRACHLOROETHYLENE (a)

- S9 (b)		+ S9 (c)	
Dose (µg/ml)	SCE/Cell	Dose (µg/ml)	SCE/Cell
DMSO (10 µl) Tetrachloroethylene	9.1	DMSO (10 µl) Tetrachloroethylene	9.3
16.4	8.5	80.36	9.2
54.5	8.9	109.90	8.6
164.0	8.5	124.60	8.7
Triethylenemelamine (0.015)	50.6	Cyclophosphamide (1.5)	29.0

(a) SCE = sister-chromatid exchange; CHO = Chinese hamster ovary

(b) In the absence of S9, CHO cells were incubated with study compound or solvent for 2 hours at 37° C. Then BrdU was added, and incubation was continued for 24 hours. Cells were washed, fresh medium containing BrdU (10 µM) and colcemid (0.1 µg/ml) was added, and incubation was continued for 2-3 hours. Cells were then collected by mitotic shake-off, treated for 3 minutes with potassium chloride (75 mM), washed twice with fixative, and dropped onto slides and air-dried. Staining was by a modified technique (after Perry and Wolff, 1974; Goto et al., 1978).

(c) In the presence of S9, cells were incubated with study compound or solvent for 2 hours at 37° C. Then cells were washed, and medium containing 10 µM BrdU was added. Cells were incubated for a further 26 hours, with colcemid (0.1 µg/ml) present for the final 2-3 hours. S9 was from the livers of Aroclor 1254-induced male Sprague-Dawley rats.

TABLE G3. INDUCTION OF CHROMOSOMAL ABERRATIONS IN CHINESE HAMSTER OVARY CELLS BY TETRACHLOROETHYLENE (a)

- S9 (b)		+ S9 (c)	
Dose (µg/ml)	Abs/100 Cells (percent cells w/abs)	Dose (µg/ml)	Abs/100 Cells (percent cells w/abs)
DMSO (10 µl) Tetrachloroethylene	3 (1.0)	DMSO (10 µl) Tetrachloroethylene	4 (4)
17.0	5 (5.0)	17.0	1 (1)
34.1	2 (2.0)	34.1	1 (1)
68.1	1 (3.4)	68.1	2 (1)
136.3	5 (5.0)		
Triethylenemelamine (0.5)	23 (18.0)	Cyclophosphamide (25)	24 (21)

(a) Abs = aberrations; CHO = Chinese hamster ovary

(b) In the absence of S9, CHO cells were incubated with study compound or solvent for 8-10 hours at 37° C. Cells were then washed, and fresh medium containing colcemid (0.1 µg/ml) was added. After a further 2-3 hours of incubation, cells were harvested by mitotic shake-off, fixed, and stained in 6% Giemsa.

(c) In the presence of S9, cells were incubated with study compound or solvent for 2 hours at 37° C. Cells were then washed, medium was added, and incubation was continued for 8-10 hours. Colcemid (0.1 µg/ml) was added for the last 2-3 hours of incubation; then cells were harvested and fixed as above. S9 was from the livers of Aroclor 1254-induced male Sprague-Dawley rats.

TABLE G4. INDUCTION OF SEX-LINKED RECESSIVE LETHAL MUTATIONS IN DROSOPHILA BY TETROCHLOROETHYLENE

Route of Exposure	Dose (ppm)	No. of Lethals/No. of X Chromosomes Tested (a)			
		Mating 1	Mating 2	Mating 3	Total (percent)
Feeding	0	2/2,202	2/2,177	5/2,206	9/6,585 (0.14)
	4,000	3/2,166	3/2,145	1/2,238	7/6,549 (0.11)
Injection	0	3/3,295	3/2,868	4/2,482	10/8,654 (0.12)
	1,000	4/3,233	2/2,879	1/2,374	7/8,485 (0.08)

(a) The sex-linked recessive lethal assay was performed essentially as described by Abrahamson and Lewis (1971). Exposure by feeding was done by allowing 24-hour-old Canton-S males to feed for 3 days on a solution of the study chemical dissolved in 5% sucrose. The study chemical dissolved in 0.7% sodium chloride was injected into 72-hour-old adult males at the base of the halteres at a volume sufficient to distend the abdomen (approximately 0.3 µl). Injected flies were allowed to recover for 24 hours before being mated. Exposed males were mated to three *Basc* females for 3 days and given fresh females at 2-day intervals to produce three broods of 3, 2, and 2 days, after which the parents were discarded. F₁ heterozygous females were crossed to their sibs and placed in individual vials. F₁ daughters from the same parental males were kept together to identify clusters; none was found. After 17 days, presumptive lethal mutations were identified as vials containing no wild-type males; these were retested. Z values were -0.4893 for feeding and -0.6897 for injection. Analysis of the data according to Margolin et al. (1983) showed that the study chemical did not cause a significant increase in sex-linked recessive lethal mutations at the 5% level of significance.

TABLE G5. MUTAGENICITY OF TETRACHLOROETHYLENE IN L5178Y/TK^{+/-} MOUSE LYMPHOMA CELLS IN THE PRESENCE OF S9 (a)

Compound (Dose)	Total Mutant Clones	Cloning Efficiency (percent)	Relative Total Growth (percent)	Mutation Frequency (mutants/10 ⁶ clonable cells)	
DMSO (1%)	75	86.5	100	29	
	133	104.5	100	42	
	106	107.2	100	33	
	98	88.2	100	37	
3-Methylcholanthrene (2.5 µg/ml)	687	108.3	69.8	211	
	617	94.3	81.6	218	
	614	108.5	82.1	189	
Tetrachloroethylene (nl/ml)	6.25	90	79.5	98.8	38
		67	81.0	85.7	28
		92	80.0	86.2	38
	12.50	68	62.3	50.4	36
		44	54.3	55.8	27
		103	80.2	67.4	43
	25.00	71	61.8	64.1	38
		100	82.0	61.7	41
		112	93.7	72.5	40
	50.00	78	103.2	77.2	25
		86	81.7	40.7	35
	100.00	128	78.0	8.4	55
122		97.3	39.2	42	

(a) Experiments were performed twice, and all doses were tested in duplicate or triplicate. The protocol was basically that of Clive et al. (1979). Cells (6×10^5 /ml) were treated for 4 hours at 37° C in medium, washed, resuspended in medium, and incubated for 48 hours at 37° C. After expression, 3×10^6 cells were plated in medium supplemented with trifluorothymidine for selection of cells that were mutant at the thymidine kinase (TK) locus, and 600 cells were plated in nonselective medium to determine the percentage of viable cells. S9 was prepared from the livers of Aroclor 1254-induced male F/344 rats.

TABLE G6. MUTAGENICITY OF TETRACHLOROETHYLENE IN L5178Y/TK^{+/-} MOUSE LYMPHOMA CELLS IN THE ABSENCE OF S9 (a)

Compound	Total Mutant Clones	Cloning Efficiency (percent)	Relative Total Growth (percent)	Mutation Frequency (mutants/10 ⁸ clonable cells)	
DMSO (1%)	61	93.0	100	22	
	78	100.8	100	26	
	74	101.5	100	24	
Ethyl methanesulfonate (250 µg/ml)	976	79.8	76.5	408	
	947	96.2	92.1	328	
Tetrachloroethylene (nl/ml)	12.5	50	57.8	70.7	29
		69	70.8	72.1	32
		80	72.3	62.0	37
	25.0	76	79.0	57.5	32
		94	103.8	64.5	30
		91	95.5	64.4	32
	50.0	54	70.8	45.2	25
		76	96.5	64.1	26
		71	63.3	35.8	37
	75.0	64	71.0	38.9	30
		50	53.7	30.4	31
		82	74.8	30.9	37
	150.0	66	84.2	37.9	26
		79	75.8	32.3	35
		95	75.3	25.0	42

(a) Experiments were performed twice, all doses were tested in triplicate. Because the results were similar, data from only one experiment are shown. The protocol was basically that of Clive et al. (1979). Cells (6×10^5 /ml) were treated for 4 hours at 37° C in medium, washed, resuspended in medium, and incubated for 48 hours at 37° C. After expression, 3×10^6 cells were plated in medium supplemented with trifluorothymidine for selection of cells that were mutant at the thymidine kinase (TK) locus, and 600 cells were plated in nonselective medium to determine the percentage of viable cells.

APPENDIX H

CHEMICAL CHARACTERIZATION OF TETRACHLOROETHYLENE

APPENDIX H. CHEMICAL CHARACTERIZATION

I. Identity and Purity Determinations of Tetrachloroethylene Performed by the Analytical Chemistry Laboratory

A. Lot no. TA03116F-01

1. Physical properties

a. Boiling point:	<u>Determined</u> 118.8°-119° C (Dupont 900 DTA) 118.8° ± 0.3° C at 733 mm (visual, micro boiling point)	<u>Literature values</u> 120.97° C at 760 mm (Dreisbach, 1959)
b. Index of refraction:	$n_D^{20}: 1.5038 \pm 0.0003(\delta)$	$n_D^{20}: 1.50180$ (Eckart, 1923)
c. Density:	$d_{22}^{24}: 1.6143 \pm 0.0002(\delta) \text{ g/ml}$	$d^{24}: 1.613$ (Gallant, 1966)
d. Appearance:	Clear colorless liquid	

2. Spectral data

a. Infrared

Instrument:	Beckman IR-12	
Cell:	0.015 and 0.05 mm liquid cell, sodium chloride windows	
Results:	See Figure 6	Consistent with literature spectrum (Sadtler Standard Spectra)

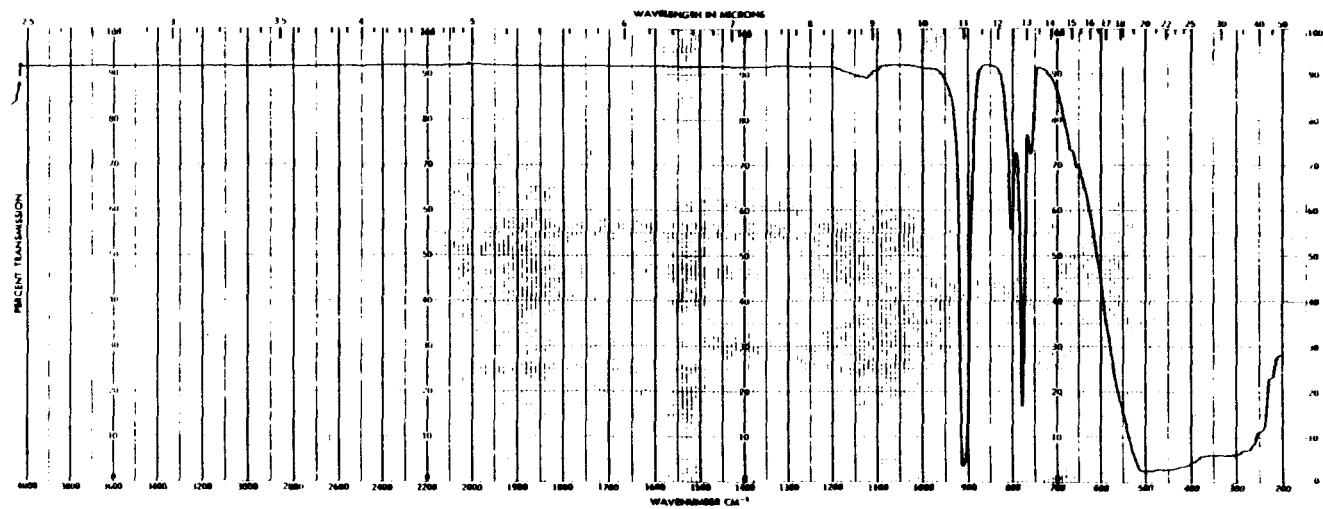

FIGURE 6. INFRARED ABSORPTION SPECTRUM OF TETRACHLOROETHYLENE (LOT NO. TA03116F-01)

APPENDIX H. CHEMICAL CHARACTERIZATION

	<u>Determined</u>	<u>Literature values</u>
b. Ultraviolet/visible		
Instrument:	Cary 118	
Solvent:	Methanol	
Results:	No absorbance between 350 and 800 nm at a concentration of 1.6 mg/ml. No maximum between 284 and 350 nm but a gradual increase in absorbance toward the solvent cutoff at 284 nm.	No literature reference found. Spectrum consistent with structure.

c. Nuclear magnetic resonance

Instrument:	Varian HA-100	
Solvent:	Neat, tetramethylsilane added	
Assignments:	No peaks observed	No literature reference found. Consistent with structure.

3. Water analysis (Karl Fischer): 0.0068% \pm 0.0009(8)%

4. Elemental analysis

Element	C	Cl
Theory	14.48	85.52
Determined	14.62 14.48	85.37 85.31

5. Gas chromatography

Instrument: Tracor MT 220
Detector: Flame ionization
Inlet temperature: 170° C
Detector temperature: 250° C

APPENDIX H. CHEMICAL CHARACTERIZATION

a. System 1

Column: GP 20% SP2100/0.1 Carbowax 1500 on 100/120 Supelcoport, 1.8 m × 4 mm ID, glass

Oven temperature program: 100° C for 5 minutes; then 100°-170° C at 10° C/minute

Results: Major peak and two impurities

<u>Peak No.</u>	<u>Retention Time (min)</u>	<u>Retention Time Relative to Major Peak</u>	<u>Area (percent of major peak)</u>
1	0.6	0.26	0.007
2	1.9	0.84	0.008
3	2.3	1.00	100

b. System 2

Column: 0.2% Carbowax 1500 on 80/100 Carbo-pack C, 1.8 m × 4 mm ID, glass

Oven temperature program: 50° C for 5 minutes; then 50°-170° C at 10° C/minute

Results: Major peak and three impurities

<u>Peak No.</u>	<u>Retention Time (min)</u>	<u>Retention Time Relative to Major Peak</u>	<u>Area (percent of major peak)</u>
1	1.1	0.09	0.001
2	1.3	0.10	<0.001
3	11.8	0.90	0.004
4	13.1	1.00	100

6. **Conclusions:** The results of the elemental analyses agreed with the theoretical values. Gas chromatography with one system indicated two impurities with areas totaling 0.015% of the major peak. A second system indicated three impurities with areas totaling <0.006% of the major peak. The infrared and nuclear magnetic resonance spectra were consistent with the structure.

APPENDIX H. CHEMICAL CHARACTERIZATION

B. Lot no. TA03116F-01--Special bulk purity verification

1. Gas chromatography

Instrument: Varian 3700

Detector: Flame ionization

Column: GP 20% SP2100/0.1% Carbowax 1500 on 100/120 Supelcoport, 1.8 m × 2 mm ID, glass

Inlet temperature: 249° C

Detector temperature: 299° C

Carrier gas: Nitrogen, 32 ml/min

Oven temperature program: 70° C for 5 minutes, then 10° C/minute to 170° C

Sample injected: 5 µl of a neat solution to detect and quantitate impurities; 5 µl of a 1% and 0.5% (v/v) solution to establish detector response linearity

Results: A major peak preceded by two impurities, each with a relative area of 0.003%.

<u>Peak No.</u>	<u>Retention Time (min)</u>	<u>Retention Time Relative to Major Peak</u>	<u>Area (percent of major peak)</u>
1	0.6	0.12	0.003
2	4.0	0.82	0.003
3	4.8	1.00	100

2. Infrared spectroscopy

Instrument: Beckman IR-12

Cell: Silver chloride, 0.025 mm path length

Results: The infrared spectrum (Figure 7) was consistent with a literature spectrum (Sadler Standard Spectra) and identical to a previously determined spectrum of the same lot.

- 3. Conclusions:** The infrared spectrum was consistent with a literature spectrum. Gas chromatography with a GP 20% SP2100/0.1% Carbowax 1500 column, detected a major peak preceded by two impurities each with a relative area of 0.003%. No decrease in the purity of lot no. TA03116F-01 was observed since the original analysis.

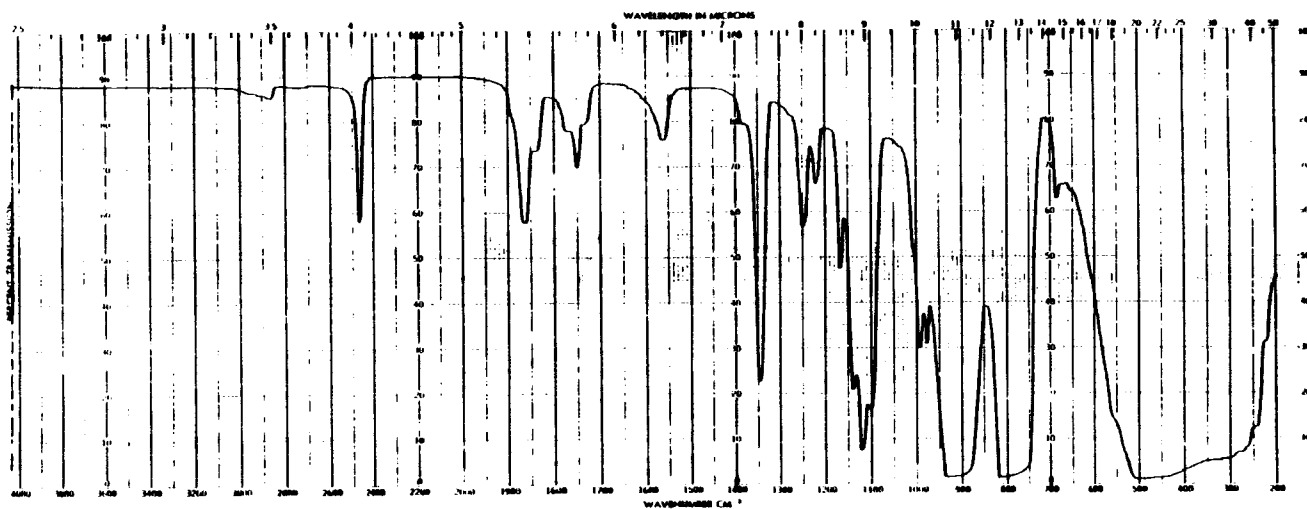

**FIGURE 7. INFRARED ABSORPTION SPECTRUM OF TETRACHLOROETHYLENE (LOT NO. TA03116F-01)
SPECIAL BULK PURITY VERIFICATION**

APPENDIX H. CHEMICAL CHARACTERIZATION

C. Lot no. TA08190D

1. **Appearance:** Clear colorless liquid

2. **Spectral data**

a. Infrared	<u>Determined</u>	<u>Literature values</u>
Instrument:	Perkin-Elmer 283	
Cell:	Thin film between silver chloride plates	
Results:	See Figure 8	Consistent with literature spectrum (Sadtler Standard Spectra)
b. Ultraviolet/visible		
Instrument:	Cary 219	
Solvent:	Methanol	
Results:	No absorbance between 800 and 350 nm at a concentration of 1% (v/v). No maximum from 350 to 215 nm but a gradual increase in absorbance toward 215 nm at a concentration of 0.0001% (v/v).	No literature reference found. Spectrum consistent with structure of tetrachloroethylene.
c. Nuclear magnetic resonance		
Instrument:	Varian EM360-A	
Solvent:	Neat, tetramethylsilane added	
Assignments:	There were no peaks in the spectrum other than the standard peak and side band. The absence of peaks would be expected from a molecule containing no hydrogen atoms.	No literature reference found. Consistent with structure.

3. **Water analysis (Karl Fischer):** 0.0039% \pm 0.0001(8)%

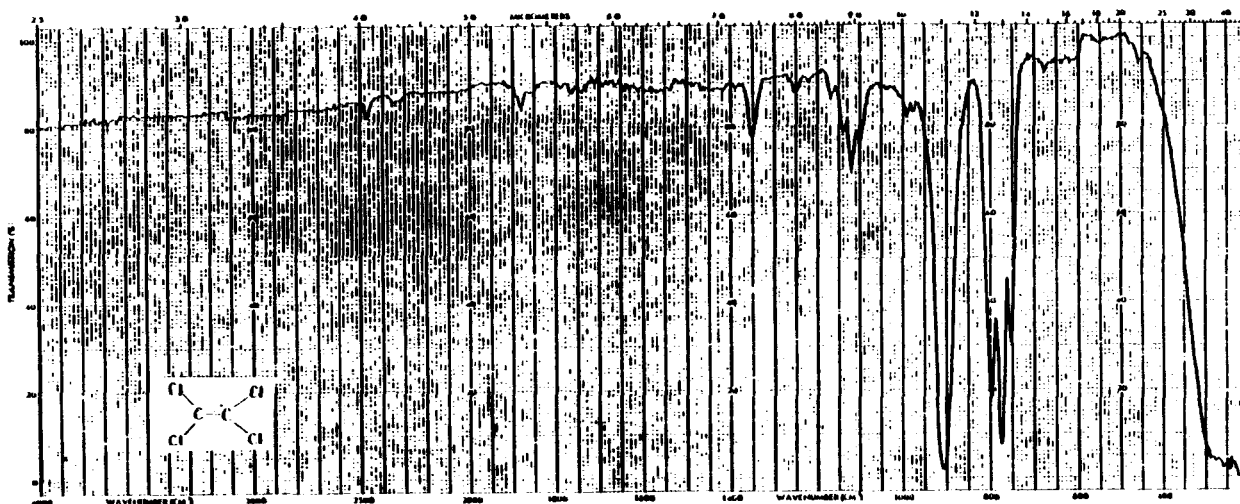

FIGURE 8. INFRARED ABSORPTION SPECTRUM OF TETRACHLOROETHYLENE (LOT NO. TA08190D)

APPENDIX H. CHEMICAL CHARACTERIZATION

4. Elemental analysis

Element	C	Cl
Theory (T)	14.48	85.52
Determined (D)	14.42 14.48	85.55 85.43
Percent D/T	99.79	99.96

5. Gas chromatography

Instrument: Varian 3700
Detector: Flame ionization
Inlet temperature: 200° C
Detector temperature: 250° C

a. System 1

Column: 20% SP2100/0.1% Carbowax 1500 on 100/120 Supelcoport, 1.8 m × 4 mm ID, glass

Oven temperature program: 50° C for 5 minutes; then 50°-170° C at 10° C/minute

Carrier gas: Nitrogen, 70 ml/minute

Samples injected: Neat liquid (4 µl) and solution of 1.0% (v/v) tetrachloroethylene in *o*-dichlorobenzene to detect impurities and quantitate the major peak.

Results: Major peak (retention time--9.3 minutes) with no impurities observed with an area $\geq 0.01\%$ of the major peak area. (One impurity was observed before the major peak but had an area $< 0.01\%$ of the major peak area.)

b. System 2

Oven temperature program: 50° C for 5 minutes; then 50°-200° C at 10° C/minute

Samples injected: Neat liquid (3 µl) and solution of 1.0% (v/v) tetrachloroethylene in *o*-dichlorobenzene to detect impurities and quantitate the major peak.

Results: Major peak (retention time--16.0 minutes) with no impurities observed with an area $\geq 0.01\%$ of the major peak area.

- 6. Conclusions:** The results of the elemental analyses for carbon and chlorine were in agreement with the theoretical values. Karl Fischer analysis indicated $0.0039\% \pm 0.0001(8)\%$ water. Gas chromatography with two systems indicated only a major peak with no impurities observed having an area $\geq 0.01\%$ of the major peak. The infrared, ultraviolet/visible, and nuclear magnetic resonance spectra are consistent with the structure of tetrachloroethylene.

APPENDIX H. CHEMICAL CHARACTERIZATION

II. Chemical Stability Study of Lot No. TA03116F-02 Performed by the Analytical Chemistry Laboratory (a)

A. **Sample storage:** Samples of tetrachloroethylene were stored in tightly screw-capped vials for 2 weeks at -20° , 5° , 25° , or 60° C.

B. **Analytical method: Gas chromatography**

Instrument: Bendix 2500 with Hewlett-Packard 3380A automatic integrator

Detector: Flame ionization

Column: Chromosorb 102, 100/120 mesh, glass, $1.8\text{ m} \times 4\text{ mm ID}$

Inlet temperature: 250° C

Detector temperature: 255° C

Oven temperature: 230° C

Compound retention time: 6.1 minutes

C. **Results**

<u>Storage Temperature</u>	<u>Relative Average Percent Compound Recovered</u>
-20° C	99.7 ± 5.4
5° C	96.8 ± 5.4
25° C	100.9 ± 5.4
60° C	106.8 ± 5.4

D. **Conclusion:** Tetrachloroethylene is stable when stored for 2 weeks at temperatures up to 60° C.

(a) This stability study was performed as a part of the characterization of tetrachloroethylene for a gavage study. The results of this study were considered to determine the storage conditions of the bulk chemical in the inhalation studies.

APPENDIX H. CHEMICAL CHARACTERIZATION

III. Chemical Stability Study of Lot No. TA08190D Performed by the Study Laboratory

A. Storage conditions: Bulk chemical, room temperature
Reference chemical, -20°C

B. Analytical methods

1. Gas chromatography

Instrument: Hewlett-Packard 5830 or 5840A

Column: 20% SP2100/0.1% Carbowax 1500 on 100/120 mesh Supelcoport, $1.7\text{ m} \times 4\text{ mm}$ ID, glass

Detector: Flame ionization

Oven temperature: 90°C , isothermal

Carrier gas: Helium

Sample injection: $0.1\ \mu\text{l}$ neat

2. Infrared spectroscopy

Instrument: Beckman Acculab 6 or 8

Cell: Neat liquid between sodium chloride plates

C. Results

1. Gas chromatography

<u>Date</u>	<u>Lot Number</u>	<u>Area Percent Purity (a)</u>	
		<u>Reference</u>	<u>Bulk Chemical</u>
12/10/80	TA03116F-01	99.99	99.99
01/14/81	TA03116F-01	99.99	99.99
04/23/81	TA03116F-01	99.90	99.89
08/14/81	TA03116F-01	99.99	99.98
12/01/81	TA03116F-01	99.99	99.94
04/14/82	TA08190D	99.96	99.98
08/11/82	TA08190D	99.96	(b) 99.97
12/08/82	TA08190D	99.97	99.98
02/10/83	TA08190D	99.96	99.98

(a) Three determinations were averaged.

(b) Five determinations were averaged.

2. Infrared spectroscopy: All bulk chemical spectra were consistent with those of the reference sample that was stored at -20°C and with spectra supplied by the analytical chemistry laboratory.

D. Conclusion: No significant degradation of the study material occurred during the studies.

APPENDIX I

GENERATION AND MEASUREMENT OF

CHAMBER CONCENTRATIONS AT

BATTELLE PACIFIC NORTHWEST LABORATORIES

APPENDIX I. GENERATION AND MEASUREMENT

I. Vapor Generation System

The liquid to be vaporized was contained in a 1.6-liter stainless steel reservoir that was housed in a vapor hood within the exposure room. The liquid was pumped from this reservoir to a stainless steel cylinder covered with a glass fiber wick from which the liquid was vaporized (Decker et al., 1982). An 80-watt heater and a temperature-sensing element were incorporated within the cylinder. The heater maintained the vaporizer at $110^{\circ} \pm 2^{\circ} \text{C}$. The surface temperature of the vaporizer was slightly less than this temperature. Each cylindrical vaporizer was positioned in the fresh air duct leading directly into the exposure chamber to minimize material loss due to condensation on duct walls (Figure 9).

II. Vapor Concentration Monitoring

A Hewlett-Packard Model 5840 gas chromatograph equipped with a flame ionization detector, a 10% UCW 982 or Chromosorb WAW DMCS 80/100 packed column, and an automatic sampling valve were used to monitor the concentration of tetrachloroethylene in the chambers. All chambers and the room air were sampled approximately twice during each exposure hour. Starting on the 278th exposure day, hexane in nitrogen was added to the sampling sequence to establish instrumental performance. The calibration of the monitoring gas chromatograph was confirmed and corrected as necessary by periodic assay of grab samples from the chambers analyzed on a second gas chromatograph.

Weekly concentrations are graphically presented in Figures 10-13.

III. Vapor Concentration Uniformity in Chamber

Uniformity of vapor concentration in each exposure chamber was measured periodically throughout the study with a portable photoionization detector (Model PI201, HNU Systems, Inc., Newton, MA). The standard deviations of the normalized average concentrations did not exceed $\pm 7\%$.

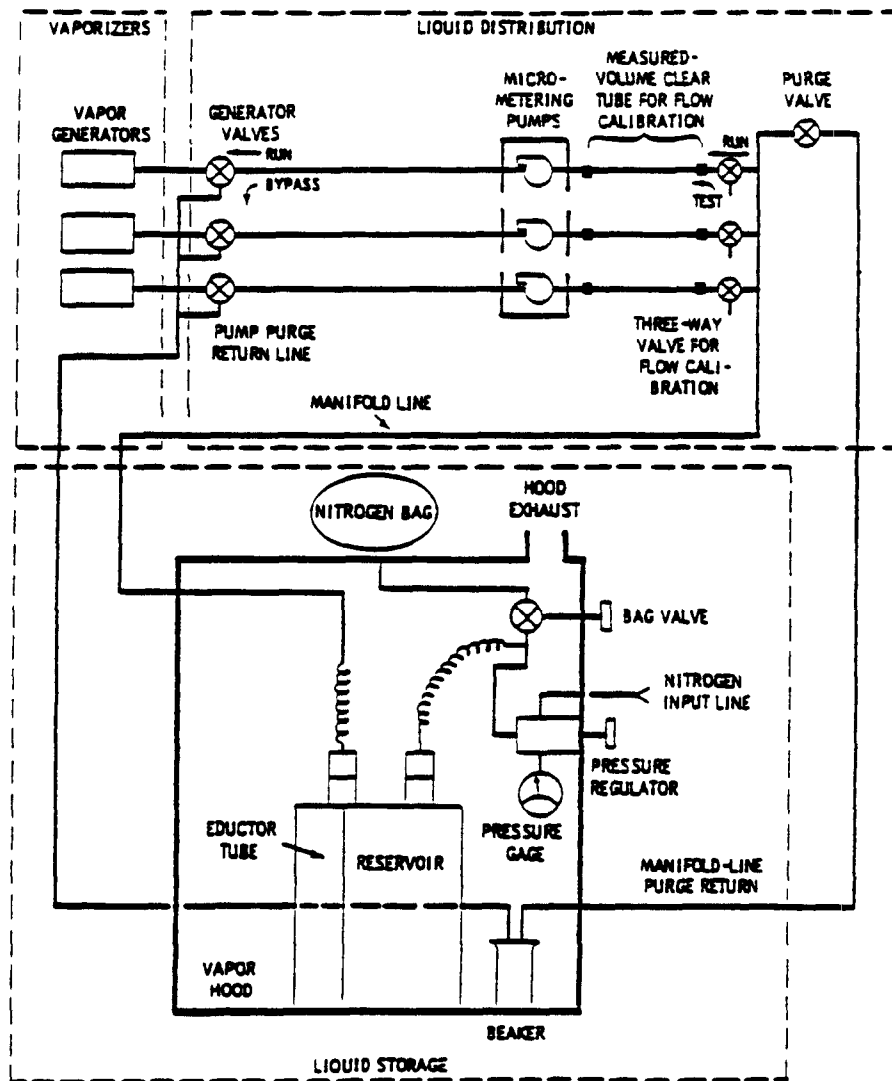

FIGURE 9. TETRACHLOROETHYLENE VAPOR GENERATION SYSTEM

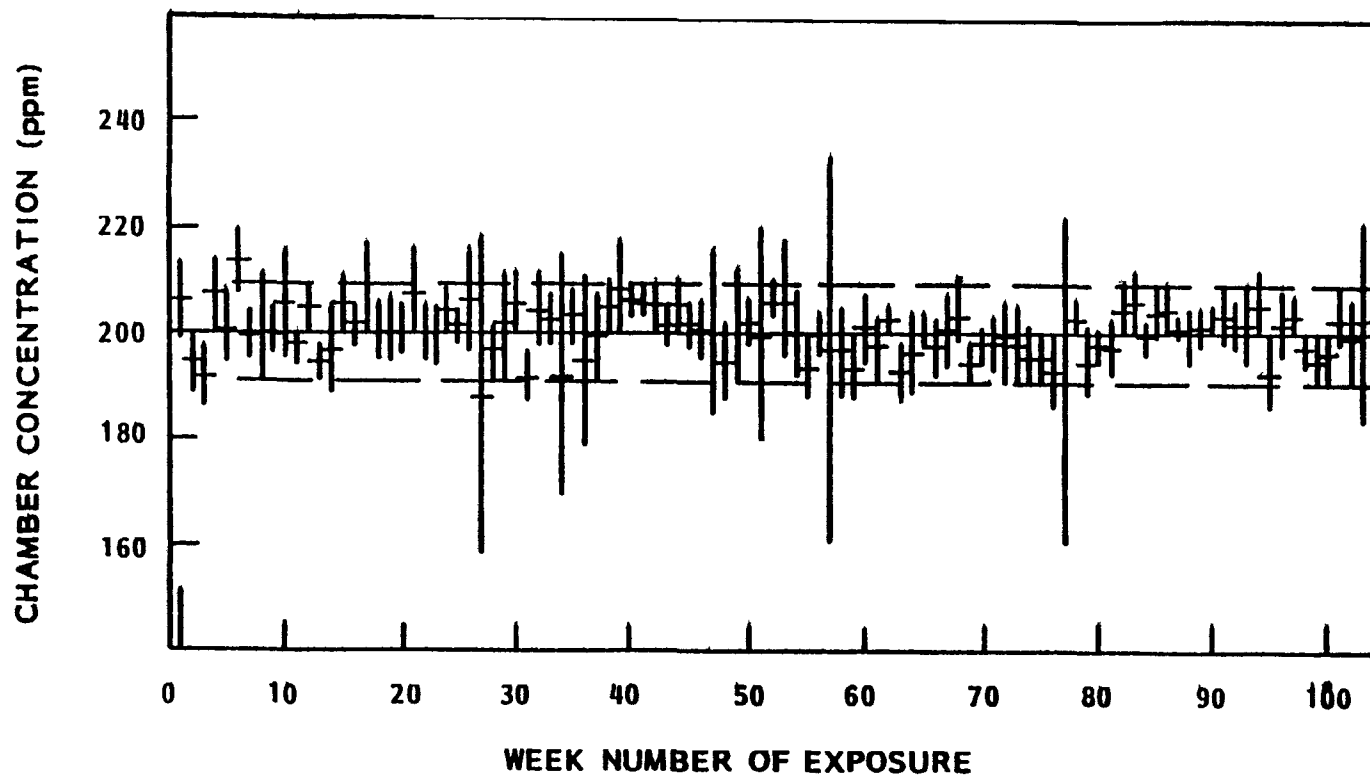

FIGURE 10. WEEKLY MEAN CONCENTRATION OF TETRACHLOROETHYLENE FOR RATS EXPOSED AT 200 ppm IN THE TWO-YEAR INHALATION STUDIES

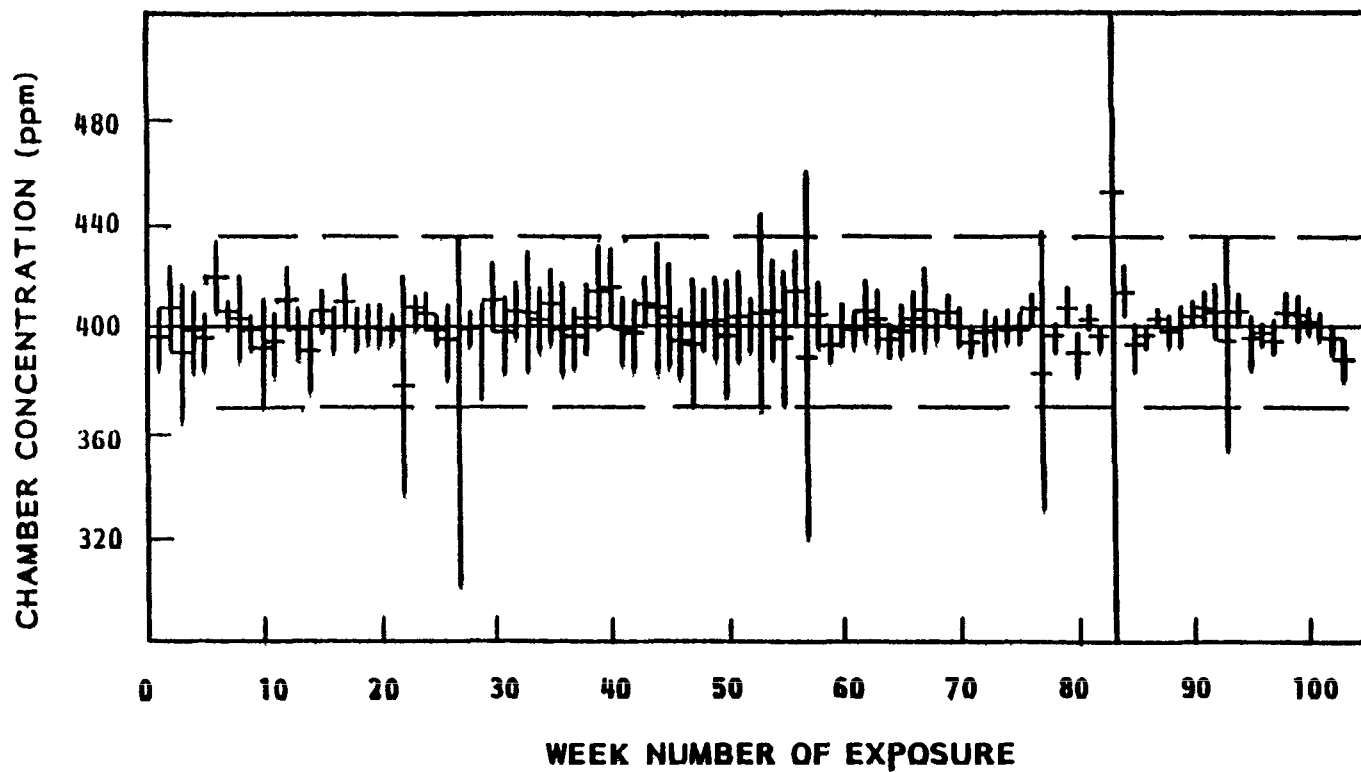

FIGURE 11. WEEKLY MEAN CONCENTRATION OF TETRACHLOROETHYLENE FOR RATS EXPOSED AT 400 ppm IN THE TWO-YEAR INHALATION STUDIES

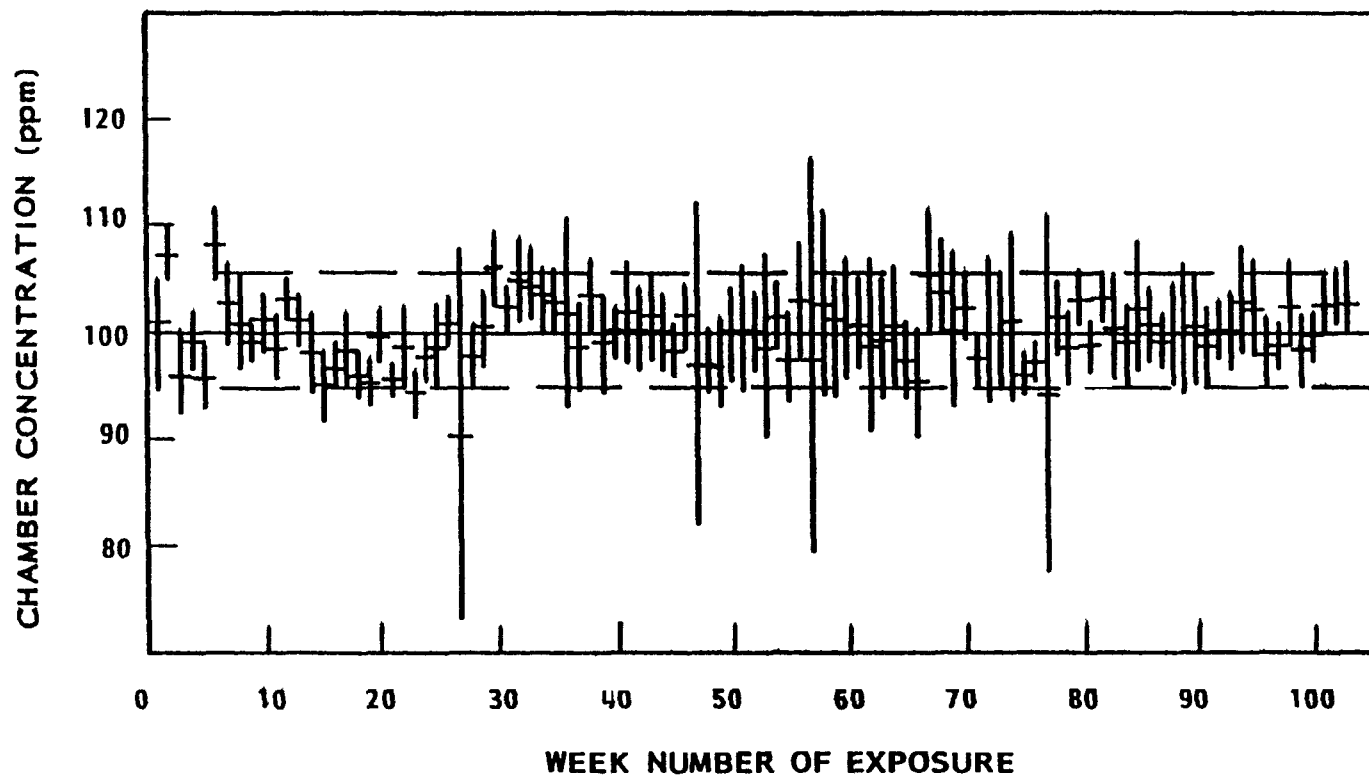

FIGURE 12. WEEKLY MEAN CONCENTRATION OF TETRACHLOROETHYLENE FOR MICE EXPOSED AT 100 ppm IN THE TWO-YEAR INHALATION STUDIES

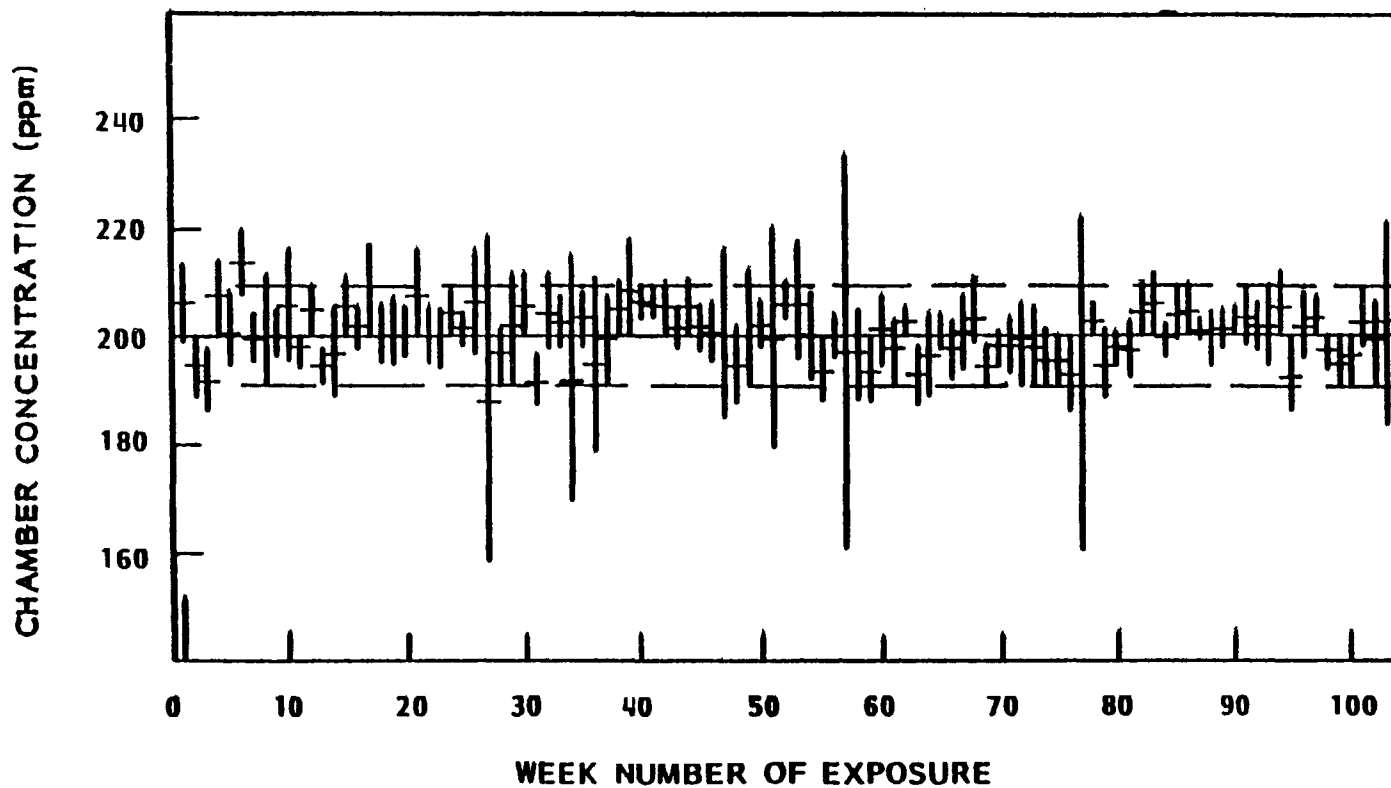

FIGURE 13. WEEKLY MEAN CONCENTRATION OF TETRACHLOROETHYLENE FOR MICE EXPOSED AT 200 ppm IN THE TWO-YEAR INHALATION STUDIES

APPENDIX J

RESULTS OF SEROLOGIC ANALYSES

APPENDIX J. SEROLOGIC ANALYSES

I. Methods

Rodents used in the Bioassay Program of the National Toxicology Program are produced in optimally clean facilities to eliminate potential pathogens that may affect test results.

Data from animals surviving 24 months were collected from 5/50 randomly selected control animals of each sex and species. The blood from each animal was collected and clotted, and the serum was separated. The serum was cooled on ice and shipped to Microbiological Associates' Comprehensive Animal Diagnostic Service for determination of the antibody titers. The following tests were performed:

	<u>Hemagglutination Inhibition</u>	<u>Complement Fixation</u>	<u>ELISA</u>
Mice	PVM (pneumonia virus of mice) Reo 3 (reovirus type 3) GDVII (Theiler's encephalomyelitis virus) Poly (polyoma virus) MVM (minute virus of mice) Ectro (infectious ectromelia) Sendai	M. Ad. (mouse adenovirus) LCM (lymphocytic choriomeningitis virus)	MHV (mouse hepatitis virus)
Rats	PVM Sendai KRV (Kilham rat virus) H-1 (Toolan's H-1 virus)	RCV (rat coronavirus)	

II. Results

TABLE J1. MURINE VIRUS ANTIBODY DETERMINATIONS FOR RATS AND MICE IN THE TWO-YEAR INHALATION STUDIES OF TETRACHLOROETHYLENE

	<u>Interval (months)</u>	<u>No. of Animals</u>	<u>Positive Serologic Reaction for</u>
RATS	24	7/10 3/10 1/10	PVM Sendai RCV
MICE	24	3/10 3/10	PVM MHV

(a) Blood samples were taken from control animals (5/sex) just before they were killed and sent to Microbiological Associates, Inc. (Bethesda, MD) for the Animal Disease Screening Program.

APPENDIX K

INGREDIENTS, NUTRIENT COMPOSITION, AND CONTAMINANT LEVELS IN NIH 07 RAT AND MOUSE RATION

Pelleted Diet: December 1980 to January 1983

(Manufactured by Zeigler Bros., Inc., Gardners, PA)

TABLE K1. INGREDIENTS OF NIH #7 RAT AND MOUSE RATION (a)

Ingredients (b)	Percent by Weight
Ground #2 yellow shelled corn	24.50
Ground hard winter wheat	23.00
Soybean meal (49% protein)	12.00
Fish meal (60% protein)	10.00
Wheat middlings	10.00
Dried skim milk	5.00
Alfalfa meal (dehydrated, 17% protein)	4.00
Corn gluten meal (60% protein)	3.00
Soy oil	2.50
Brewer's dried yeast	2.00
Dry molasses	1.50
Dicalcium phosphate	1.25
Ground limestone	0.50
Salt	0.50
Premixes (vitamin and mineral)	0.25

(a) NIH, 1978; NCI, 1976

(b) Ingredients should be ground to pass through a U.S. Standard Screen No. 16 before being mixed.

TABLE K2. VITAMINS AND MINERALS IN NIH #7 RAT AND MOUSE RATION (a)

	Amount	Source
Vitamins		
A	5,500,000 IU	Stabilized vitamin A palmitate or acetate
D ₃	4,600,000 IU	D-activated animal sterol
K ₃	2.8 g	Menadione activity
<i>d</i> - α -Tocopheryl acetate	20,000 IU	
Choline	560.0 g	Choline chloride
Folic acid	2.2 g	
Niacin	30.0 g	
<i>d</i> -Pantothenic acid	18.0 g	<i>d</i> -Calcium pantothenate
Riboflavin	3.4 g	
Thiamine	10.0 g	Thiamine mononitrate
B ₁₂	4,000 μ g	
Pyridoxine	1.7 g	Pyridoxine hydrochloride
Biotin	140.0 mg	<i>d</i> -Biotin
Minerals		
Iron	120.0 g	Iron sulfate
Manganese	60.0 g	Manganous oxide
Zinc	16.0 g	Zinc oxide
Copper	4.0 g	Copper sulfate
Iodine	1.4 g	Calcium iodate
Cobalt	0.4 g	Cobalt carbonate

(a) Per ton (2,000 lb) of finished product

TABLE K3. NUTRIENT COMPOSITION OF NIH 07 RAT AND MOUSE RATION (a)

Nutrient	Mean	Range	Number of Samples
Crude protein (percent by weight)	23.85 ± 0.78	22.7-25.3	24
Crude fat (percent by weight)	5.02 ± 0.44	4.2-5.7	24
Crude fiber (percent by weight)	3.31 ± 0.23	2.9-3.8	24
Ash (percent by weight)	6.44 ± 0.44	5.7-7.43	24
Essential Amino Acids (percent of total diet)			
Arginine	1.260	1.21-1.31	2
Cystine	0.395	0.39-0.40	2
Glycine	1.175	1.15-1.20	2
Histidine	0.553	0.530-0.576	2
Isoleucine	0.908	0.881-0.934	2
Leucine	1.905	1.85-1.96	2
Lysine	1.250	1.20-1.30	2
Methionine	0.310	0.306-0.314	2
Phenylalanine	0.967	0.960-0.974	2
Threonine	0.834	0.827-0.840	2
Tryptophan	0.175	0.171-0.178	2
Tyrosine	0.587	0.566-0.607	2
Valine	1.085	1.05-1.12	2
Essential Fatty Acids (percent of total diet)			
Linoleic	2.37		1
Linolenic	0.308		1
Arachidonic	0.008		1
Vitamins			
Vitamin A (IU/kg)	10,917 ± 1,876	8,210-15,000	24
Vitamin D (IU/kg)	6,300		1
α-Tocopherol (ppm)	37.6	31.1-44.0	2
Thiamine (ppm)	16.8 ± 2.0	14.0-21.0	23
Riboflavin (ppm)	6.9	6.1-7.4	2
Niacin (ppm)	75	65-85	2
Pantothenic acid (ppm)	30.2	29.8-30.5	2
Pyridoxine (ppm)	7.2	5.6-8.8	2
Folic acid (ppm)	2.1	1.8-2.4	2
Biotin (ppm)	0.24	0.21-0.27	2
Vitamin B ₁₂ (ppb)	12.8	10.6-15.0	2
Choline (ppm)	3,315	3,200-3,430	2
Minerals			
Calcium (percent)	1.25 ± 0.15	0.81-1.69	24
Phosphorus (percent)	0.98 ± 0.06	0.88-1.10	24
Potassium (percent)	0.809	0.772-0.846	2
Chloride (percent)	0.557	0.479-0.635	2
Sodium (percent)	0.304	0.258-0.349	2
Magnesium (percent)	0.172	0.166-0.177	2
Sulfur (percent)	0.278	0.270-0.285	2
Iron (ppm)	418	409-426	2
Manganese (ppm)	90.8	86.0-95.5	2
Zinc (ppm)	55.1	54.2-56.0	2
Copper (ppm)	12.68	9.65-15.70	2
Iodine (ppm)	2.58	1.52-3.64	2
Chromium (ppm)	1.86	1.79-1.93	2
Cobalt (ppm)	0.57	0.49-0.65	2

(a) One or two batches of feed analyzed for nutrients reported in this table were manufactured in January and/or April 1983.

TABLE K4. CONTAMINANT LEVELS IN NIH 07 RAT AND MOUSE RATION

Contaminant	Mean ± Standard Deviation	Range	Number of Samples
Arsenic (ppm)	0.48 ± 0.17	<0.29-1.06	24
Cadmium (ppm) (a)	<0.10		24
Lead (ppm)	1.00 ± 0.74	0.42-3.37	24
Mercury (ppm) (b)	< 0.05		24
Selenium (ppm)	0.29 ± 0.07	0.13-0.40	24
Aflatoxins (ppb) (a,b)	<10	<5.0- <10.0	24
Nitrate nitrogen (ppm) (c)	9.22 ± 3.62	3.8 -17.0	24
Nitrite nitrogen (ppm) (c)	2.16 ± 1.53	0.4 -6.9	24
BHA (ppm) (d)	6.68 ± 4.95	<0.4 -17.0	24
BHT (ppm) (d)	3.45 ± 2.56	0.9 -12.0	24
Aerobic plate count (CFU/g) (e)	40,557 ± 29,431	4,900 -88,000	23
Aerobic plate count (CFU/g) (f)	77,617 ± 183,824	4,900 -930,000	24
Coliform (MPN/g) (g)	16.6 ± 22.9	<3 -93	22
Coliform (MPN/g) (h)	80.2 ± 236.3	<3 -1,100	24
<i>E. coli</i> (MPN/g) (i)	<3		24
Total nitrosamines (ppb) (j,k)	4.63 ± 4.19	0.8 -18.5	21
Total nitrosamines (ppb) (j,l)	27.15 ± 64.35	0.8 -273.2	24
<i>N</i> -Nitrosodimethylamine (ppb) (j,k)	3.43 ± 3.96	0.8 -16.5	21
<i>N</i> -Nitrosodimethylamine (ppb) (j,l)	25.71 ± 64.90	0.8 -272	24
<i>N</i> -Nitrosopyrrolidine (ppb)	1.05 ± 0.49	0.3 -2.9	24
Pesticides (ppm)			
α-BHC (a,m)	<0.01		24
β-BHC (a)	<0.02		24
γ-BHC-Lindane (a)	<0.01		24
δ-BHC (a)	<0.01		24
Heptachlor (a)	<0.01		24
Aldrin (a)	<0.01		24
Heptachlor epoxide (a)	<0.01		24
DDE (a)	<0.01		24
DDD (a)	<0.01		24
DDT (a)	<0.01		24
HCB (a)	<0.01		24
Mirex (a)	<0.01		24
Methoxychlor (a,n)	<0.05	0.09 (8/26/81)	24
Dieldrin (a)	<0.01		24
Endrin (a)	<0.01		24
Telodrin (a)	<0.01		24
Chlordane (a)	<0.05		24
Toxaphene (a)	<0.1		24
Estimated PCB's (a)	<0.2		24
Ronnel (a)	<0.01		24
Ethion (a)	<0.02		24
Trithion (a)	<0.05		24
Diazinon (a,n)	<0.1	0.2 (4/27/81)	24
Methyl parathion (a)	<0.02		24
Ethyl parathion (a)	<0.02		24
Malathion (o)	0.10 ± 0.07	<0.05-0.27	24
Endosulfan I (a)	<0.01		24
Endosulfan II (a)	<0.01		24
Endosulfan sulfate (a)	<0.03		24

TABLE K4. CONTAMINANT LEVELS IN NIH 07 RAT AND MOUSE RATION (Continued)

- (a) All values were less than the detection limit, given in the table as the mean.
- (b) Detection limit reduced from 10 ppb to 5 ppb after 7/81
- (c) Source of contamination: Alfalfa, grains, and fish meal
- (d) Source of contamination: Soy oil and fish meal
- (e) Mean, standard deviation, and range exclude one very high value of 930,000 obtained for the batch produced on 12/22/82.
- (f) Mean, standard deviation, and range include the high value listed in footnote c.
- (g) Excludes one very high value of 1,100 obtained for the batch produced on 12/16/80 and one high value of 460 obtained for the batch produced on 9/23/82.
- (h) Includes the high values listed in footnote e
- (i) All values were less than 3 MPN/g (MPN = most probable number).
- (j) All values were corrected for percent recovery.
- (k) Mean, standard deviation, and range exclude three very high values in the range of 115-273.2 ppb for batches produced on 1/26/81, 2/23/81, and 4/27/81.
- (l) Mean, standard deviation, and range include the very high values given in footnote i.
- (m) BHC = hexachlorocyclohexane or benzene hexachloride
- (n) There was one observation above the detection limit. The value and the date it was obtained are given under the range.
- (o) Thirteen batches contained more than 0.05 ppm.

APPENDIX L

DATA AUDIT SUMMARY

APPENDIX L. DATA AUDIT SUMMARY

The experimental data, documents, and pathology materials from the NTP inhalation toxicology and carcinogenesis studies of tetrachloroethylene in F344/N rats and B6C3F₁ mice were examined for completeness, consistency, and accuracy and for procedures consistent with Good Laboratory Practice regulations. The experiments, conducted between February 1981 and February 1983 at Battelle Pacific Northwest Laboratories, Richland, Washington, were initiated before the NTP required compliance with Good Laboratory Practice regulations. The audit was conducted March 18-22, 1985, by the Dynamac Corporation. The following people were involved in the audit: L. Keifer, Ph.D.; J. Plautz, M.S.; R. Schueler, D.V.M.; M. Perreault, B.S.; C. Sexsmith, B.S.; and E. Zurek. An additional participant was M. Shoaf (Pathology Associates, Inc). Subsequently, the Halogenated Solvents Industry Alliance sponsored a third-party audit that was conducted by personnel from Clements Associates on November 18-20, 1985. To provide further clarification of issues raised, a supplemental audit was conducted for the NTP on May 29, 1986, by C. Sexsmith, B.S.; E. Zurek; and L. Plankenhorn, B.S., of Dynamac Corporation.

Reports for the two audits conducted by the NTP are on file at the NIEHS, Research Triangle Park, North Carolina. The combined audits consisted of an indepth review of the data and pathology materials collected during the conduct of the study as well as review of the correspondence. For the inlife toxicology data, the review involved examination of 100% of the records on animal receipt and husbandry, mortality, environmental conditions, and dosing. Body weight and clinical observation data were examined for 10% of the animals. For the chemistry data, all of the available records concerning receipt, initial analysis, and stability testing by Midwest Research Institute (MRI) were examined. In addition, records pertaining to receipt, bulk chemical analysis, generation of chamber concentrations, exposure chamber monitoring, and gas chromatographic calibration by the study laboratory were examined. The audit of the pathology materials included review of 100% of the Individual Animal Data Records for correlation between gross and microscopic diagnoses and clerical errors, examination of the wet tissues of 10% of the animals for unidentified potential lesions and correct identification, correlation of slides and tissue blocks for all control and high dose groups, and verification of the reported pathologic findings on a 10% sample of the animals.

Review of the inlife data and documents revealed that recordkeeping was not always complete and consistent for clinical signs, palpable masses, lesions involving eyes or skin, and observations of animal security. Records for animal security were made four times daily. Some animals escaped from and were returned to their cages, primarily during the first 12 months of exposures. All of the study records were reviewed in detail and analyzed by observation period within each day to evaluate the possibility that any animals were misidentified. Individual animals were identified by an ear tag that was unique for both the animal and the chemical being studied; a backup cage mapping system was used to identify animals without an ear tag.

In the rat study, there were 134 documented incidents of loose animals. Animals were identified by ear tags in 121 of these incidents. Of the 13 other incidents, 5 involved rats loose within specific chambers and 4 involved only a single animal loose on a given day, where the dose group, if not the individual animal number, could be verified. On only 1 day where four rats were noted as "out of cage," is there no record verifying either individual animal or group identity. Three rats were documented as being "out on floor" on three different study days; in each incident, the loose animal was identified by ear tag and returned to its group and cage.

Similarly, the likelihood of transposition of mice between dose groups was determined to be remote upon detailed analysis of the documents. A total of 50 mice were loose on 32 days. In 46 of these incidents, the individual animals were identified by ear tag. The remaining four incidents involved mice loose within specific chambers. One mouse was out on the floor, identified by ear tag, and returned to its group and cage.

APPENDIX L. DATA AUDIT SUMMARY

A complete review of the analytical chemistry data revealed that all documents were present except the original chromatograms from MRI analyses. Other records showed that the study material was received and was used to generate exposure atmospheres of 100-, 200-, and 400-ppm target concentrations. Records showed that the bulk chemical was reanalyzed as required. The chemical-use log showed that bulk chemical was regularly withdrawn to refill the vapor generator.

Review of the pathology data revealed that bags of wet tissue were present for all animals on which a necropsy was performed; 80/83 wet tissue bags examined contained correct identification (ear tags were not present for one rat and two mice); and questionable slide/block matches were noted for five mouse slides. Seven instances of gross observations suggesting lesions in the liver and spleen of rats were found. Review of the potential lesions for these animals by NTP pathology support staff indicated that the gross observations did not represent missed tumors. Nine gross observations suggesting undiagnosed or untrimmed potential lesions in nontarget organs were identified in mice. After examination of slides and wet tissues, the number of new diagnoses was not considered to be sufficient to influence the interpretation of the study results. Four cases of untrimmed potential lesions in mice were found. Residual livers from non-tumor-bearing mice were reviewed for possible untrimmed tumors. Any tumors found were examined microscopically, and the data were included in the pathology tables.

In conclusion, the audit revealed certain problems in the conduct and documentation of these experiments. Any discrepancies that might have influenced the results of the studies were resolved, and, where necessary, the data tables were corrected. Other findings that were considered not to affect the interpretation of the studies were not necessarily pursued to final resolution but are identified in the NTP audit reports. The study data, documents, and materials at the NTP Archives support the data and interpretations presented in this Technical Report.