

Soil Investigation

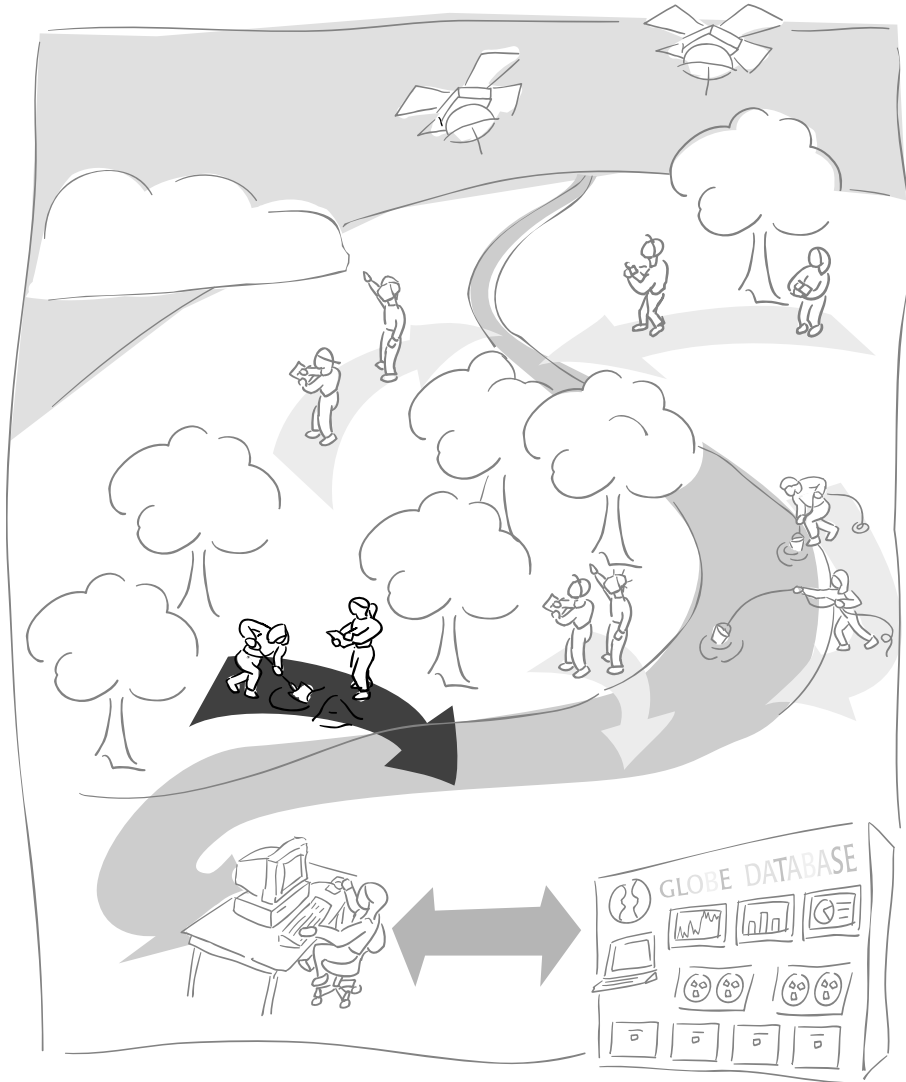

A GLOBE[®] Learning Investigation



Soil Investigation at a Glance



Protocols

Measurements taken at Soil Characterization Sites:

top and bottom depths for each horizon in the soil profile
structure, color, consistence, texture, and amounts of rocks, roots, and carbonates

bulk density, particle density, particle size distribution, pH, and fertility (N, P, K) of samples taken from each horizon

Measurements taken at Soil Moisture or Atmosphere Sites:

soil moisture during two annual campaigns, 12 times per year, or monitored

soil temperature, daily or weekly, with diurnal variation 2 days every 3 months or monitored every 15 minutes

Suggested Sequence of Activities

Read the *Introduction*.

Read the *Protocols* to learn precisely what is to be measured and how.

Choose any *Learning Activities* that might support the *Protocols*.

Make copies of the *Data Sheets* in the *Appendix*.

Perform the *Soil Characterization Protocols*.

Perform the *Soil Temperature Protocol*.

Perform the *Gravimetric Soil Moisture Protocol*.

Perform the *Bulk Density, Soil Particle Density, Particle Size Distribution, Soil pH, and Soil Fertility Protocols*.

Visit the GLOBE Web site with your students and review the data submission pages for Soils.

Submit your data to the GLOBE Student Data Server using the Web or email.



Special Notes

If you choose to dig a soil pit, you may require help with digging. It is also important to obtain permission from your local utility company to make sure that there is not a pipe or wire buried at that location.



Table of Contents



Introduction

Why Investigate Soils?.....	Introduction 1
The Big Picture.....	Introduction 2
GLOBE Measurements	Introduction 9
Individual Measurements	Introduction 9



Protocols

Selecting, Exposing and Describing a Soil Characterization Site	
Soil Characterization Protocol	
Soil Temperature Protocol	
Gravimetric Soil Moisture Protocol	
Bulk Density Protocol	
Soil Particle Density Protocol	
Particle Size Distribution Protocol	
Soil pH Protocol	
Soil Fertility Protocol	
Digital Multi-Day Max/Min/Current Air and Soil Temperature Protocol (see Atmosphere Chapter)	
Optional Digital Multi-Day Soil Temperatures Protocol*	
Optional Automated Soil and Air Temperature Monitoring Protocol*	
Optional Soil Moisture Sensor Protocol*	
Optional Water Infiltration Protocol*	
Optional Davis Soil Moisture and Temperature Station Protocol*	



Learning Activities

Why do We Study Soil?*	
Just Passing Through - Beginners	
Just Passing Through	
Soil and my Backyard*	
A Field View of Soil - Digging Around*	
Soils as Sponges: How Much Water Does Soil Hold?*	
Soil: The Great Decomposer*	
The Data Game*	



* See the full e-guide version of the *Teacher's Guide* available on the GLOBE Web site and CD-ROM.

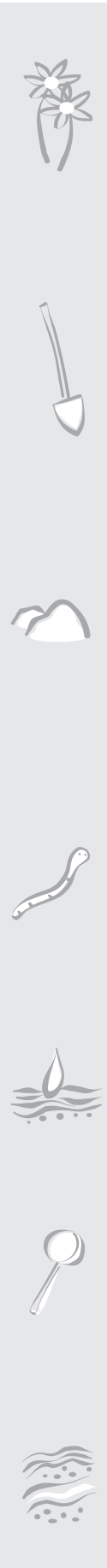

Appendix

Soil Characterization Site Definition Sheet.....	Appendix 2
Soil Characterization Data Sheet	Appendix 3
Soil Temperature Data Sheet	Appendix 4
Soil Moisture Site Definition Sheet.....	Appendix 5
Soil Moisture Data Sheet – Star Pattern	Appendix 7
Soil Moisture Data Sheet – Transect Pattern	Appendix 8
Soil Moisture Data Sheet – Depth Profile.....	Appendix 9
Bulk Density Data Sheet	Appendix 10
Soil Particle Density Data Sheet.....	Appendix 11
Soil Particle Size Distribution Data Sheet	Appendix 12
Soil pH Data Sheet.....	Appendix 13
Soil Fertility Data Sheet.....	Appendix 14
Digital Multi-Day Soil Thermometer Calibration and Reset Data Sheet	Appendix 15
Digital Multi-Day Soil Thermometer Data Sheet.....	Appendix 16
Daily Soil Moisture Sensor Data Sheet	Appendix 17
Biannual Soil Moisture Sensor Calibration Data Sheet.....	Appendix 18
Soil Infiltration Data Sheet.....	Appendix 20
Textural Triangle.....	Appendix 21
Glossary	Appendix 22

Introduction

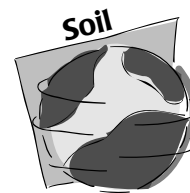

Soils are one of Earth's essential natural resources, yet they are often taken for granted. Most people do not realize that soils are a living, breathing world supporting nearly all terrestrial life. Soils and the functions they play within an ecosystem vary greatly from one location to another as a result of many factors, including differences in climate, the animal and plant life living on them, the soil's parent material, the position of the soil on the landscape, and the age of the soil.

Scientists, engineers, farmers, developers and other professionals consider a soil's physical and chemical characteristics, moisture content and temperature to make decisions such as:

- Where is the best place to build a building?
- What types of crops will grow best in a particular field?
- Will the basement of a house flood when it rains?
- How can the quality of the groundwater in the area be improved?

Using the data collected in the GLOBE *Soil Investigation*, students help scientists describe soils and understand how they function. They determine how soils change and the ways they affect other parts of the ecosystem, such as the climate, vegetation, and hydrology. Information about soils is integrated with data from the other GLOBE protocol investigations to gain a better view of Earth as a system.

Why Investigate Soils?

Soils develop on top of Earth's land surface as a thin layer, known as the *pedosphere*. This thin layer is a precious natural resource and so deeply affects every part of the ecosystem that it is often called the "great integrator." For example, soils hold nutrients and water for plants and animals. They filter and clean water that passes through them. They can change the chemistry of water and the amount that recharges the groundwater or returns to the atmosphere to form rain. The

foods we eat and most of the materials we use for paper, buildings, and clothing are dependent on soils. Soils play an important role in the amount and types of gases in the atmosphere. They store and transfer heat, affect the temperature of the atmosphere, and control the activities of plants and other organisms living in the soil. By studying these functions that soils play, students and scientists learn to interpret a site's climate, geology, vegetation, hydrology, and human history. They begin to understand soil as an important component of every ecosystem on Earth.

Scientists Need GLOBE Data

The data students collect through the GLOBE soil measurements are invaluable to scientists in many fields. For example, Soil scientists use the data to better understand how soils form, how they should be managed, and what their potential is for plant growth and other land use. Hydrologists use the data to determine water movement through a soil and a watershed and the effect of soils on water chemistry. They also examine the effects of different types of soil on the sedimentation in rivers and lakes. Climatologists use soil data in climate prediction models. Atmospheric scientists want to know the effect of soils on humidity, temperature, reflected light, and fluxes of gases such as CO₂ and methane. Biologists examine the properties of soil to understand its potential for supporting plant and animal life. Anthropologists study the soil in order to reconstruct the human history of an area.

When data are available for many areas of the world, scientists study the spatial patterns of soil properties. When a full set of GLOBE atmosphere, hydrology, land cover and soils data exists at a specific site, scientists can use the information to run computer models to understand how the whole ecosystem functions and to make predictions about what the ecosystem will be like in the future.



The Big Picture

Soil Composition

Soils are composed of four main components:

- Mineral particles of different sizes.
- Organic materials from the remains of dead plants and animals.
- Water that fills open pore spaces.
- Air that fills open pore spaces.

The use and function of a soil depends on the amount of each component. For example, a good soil for growing agricultural plants has about 45% minerals, 5% *organic matter*, 25% air, and 25% water. Plants that live in wetlands require more water and less air. Soils used as raw material for bricks need to be completely free of organic matter.

The Five Soil Forming Factors

The properties of a soil are the result of the interaction between the *Five Soil Forming Factors*. These factors are:

1. *Parent Material*: The material from which the soil is formed determines many of its properties. The parent material of a soil may be bedrock, organic material, construction material, or loose soil material deposited by wind, water, glaciers, volcanoes, or moved down a slope by gravity.
2. *Climate*: Heat, rain, ice, snow, wind, sunshine, and other environmental forces break down parent material, move loose soil material, determine the animals and plants able to survive at a location, and affect the rates of soil forming processes and the resulting soil properties.
3. *Organisms*: The soil is home to large numbers of plants, animals, and microorganisms. The physical and chemical properties of a soil determine the type and number of organisms that can survive and thrive in that soil. Organisms also shape the soil they live in. For example, the growth of roots and the movement of animals and microorganisms shift materials and chemicals around in the soil profile. The

dead remains of soil organisms become organic matter that enriches the soil with carbon and nutrients. Animals and microorganisms living in the soil control the rates of decomposition for organic and waste materials. Organisms in the soil contribute to the exchange of gases such as carbon dioxide, oxygen, and nitrogen between the soil and the atmosphere. They also help the soil filter impurities in water. Human actions transform the soil as well, as we farm, build, dam, dig, process, transport, and dispose of waste.

4. *Topography*: The location of a soil on a landscape also affects its formation and its resulting properties. For example, soils at the bottom of a hill will get more water than soils on the hillside, and soils on slopes that get direct sunlight will be drier than soils on slopes that do not.
5. *Time*: The amount of time that the other 4 factors listed above have been interacting with each other affects the properties of the soil. Some properties, such as temperature and moisture content, change quickly, often over minutes and hours. Others, such as mineral changes, occur very slowly over hundreds or thousands of years. Figure SOIL-I-1 lists different soil properties and the approximate time it takes for them to change.

Soil Profiles

The five soil-forming factors differ from place to place causing soil properties to vary from one location to another. Each area of soil on a landscape has unique characteristics. A vertical section at one location is called a *soil profile*. See Figure SOIL-I-2. When we look closely at the properties of a soil profile and consider the five soil forming factors, the story of the soil at that site and the formation of the area is revealed.

The chapters of the soil story at any location are read in the layers of the soil profile. These layers are known as *horizons*. Soil horizons can be as thin as a few millimeters or thicker than a meter. Individual horizons are identified by

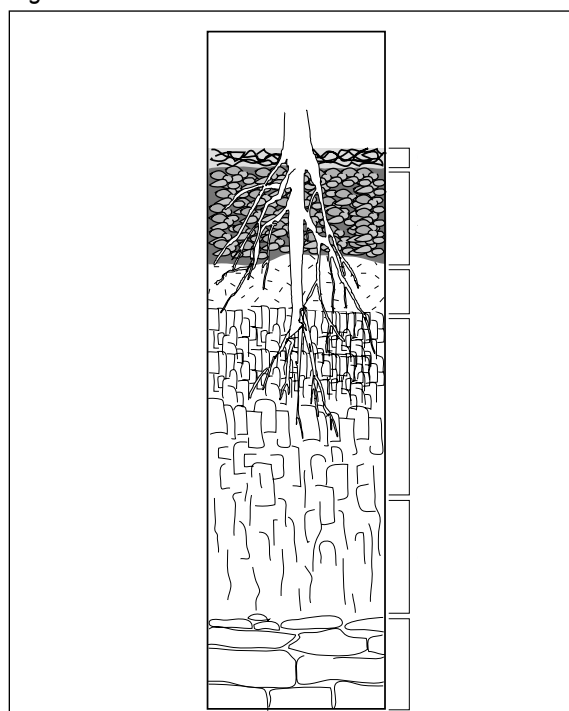

Figure SOIL-I-1

Soil Properties That Change Over Time		
Properties that change over minutes or hours	Properties that change over months or years	Properties that change over hundreds and thousands of years
Temperature Moisture content Local composition of air	Soil pH Soil color Soil structure Bulk density Soil organic matter Soil fertility Microorganisms, animals, plants	Mineral content Particle size distribution Horizons Particle density

the properties they contain that are different from the horizons above and below them. Some soil horizons are formed as a result of the weathering of minerals and decomposition of organic materials that move down the soil profile over time. This movement, called *illuviation*, influences the horizon's composition and properties. Other horizons may be formed by the disturbance of the soil profile from erosion, deposition, or biological activity. Soils may also have been altered by human activity. For example, builders compact soil, change its

Figure SOIL-I-2: Soil Profile



composition, move soil from one location to another, or replace horizons in a different order from their original formation.

Moisture in the Soil

Moisture plays a major role in the chemical, biological and physical activities that take place in the soil. Chemically, moisture transports substances through the profile. This affects soil properties such as color, texture, pH, and fertility. Biologically, moisture determines the types of plants that grow in the soil and affects the way the roots are distributed. For example, in desert areas where soils are dry, plants such as cacti must store water or send roots deep into the soil to tap water buried tens of meters below the surface. Plants in tropical regions have many of their roots near the surface where organic material stores much of the water and nutrients the plants need. Agricultural plants grow best in soils where water occupies approximately one-fourth of the soil volume as vapor or liquid. Physically, soil moisture is part of the hydrologic cycle. Water falls on the soil surface as precipitation. This water seeps down into the soil in a process called *infiltration*. After water infiltrates the soil, it is stored in the horizons, taken up by plants, moved upward by *evaporation*, or moved downward into the underlying bedrock to become *ground water*. The amount of moisture contained in a soil can change rapidly, sometimes increasing within minutes or hours. In contrast, it might take weeks or months for soils to dry out.



If a soil horizon is compacted, has very small pore spaces, or is *saturated* with water, infiltration will occur slowly, increasing the potential for flooding in an area. If the water cannot move down into the soil fast enough, it will flow over the surface as *runoff* and may rapidly end up in streams or other water bodies. When the soil is not covered by vegetation and the slope of the land is steep, *water erosion* occurs. Deep scars are formed in the landscape as a result of the combined force of the runoff water and soil particles flowing over the surface. When a soil horizon is dry, or has large pore spaces that are similar in size to the horizon above, water will infiltrate the horizon quickly. If the soil gets too dry and is not covered by vegetation, *wind erosion* may occur.



Soil Temperature

The temperature of a soil can change quickly. Near the surface, it changes almost as quickly as the air temperature changes, but because soil is denser than air, its temperature variations are less. Daily and annual cycles of soil temperature can be measured. During a typical day, the soil is cool in the morning, warms during the afternoon, and then cools down again at night. See Figure SOIL-I-3. Over the course of the year, the soil warms up or cools down with the seasons. Because soil temperature changes more slowly than air temperature, it acts as an insulator, protecting soil organisms and buried pipes from the extremes of air temperature variations. In temperate regions, the surface soil may freeze in winter and thaw in the spring, while in some colder climates, a permanent layer of ice, called *permafrost*, is found below the soil surface. In either case, the ground never freezes below a certain depth. The overlying soil acts as insulation so that the temperature of the deeper layers of soil is almost constant throughout the year. Temperature greatly affects the chemical and biological activity in the soil. Generally, the warmer the soil, the greater the biological activity of microorganisms living in the soil. Microorganisms in warm tropical soils break down organic materials much faster than microorganisms in cold climate soils. Near the surface, the temperature and moisture of the soil affect the atmosphere as heat and water vapor are exchanged between the land and the air. These



effects are smaller than those at the surfaces of oceans, seas, and large lakes, but can significantly influence local weather conditions. Hurricanes have been found to intensify when they pass over soil that is saturated with water. Meteorologists have found that their forecasts can be improved if they factor soil temperature and moisture into their calculations.

Soils Around the World

Following are examples of six different soil profiles and landscapes. See Figures SOIL-I-4 through I-9.

Figure SOIL-I-3

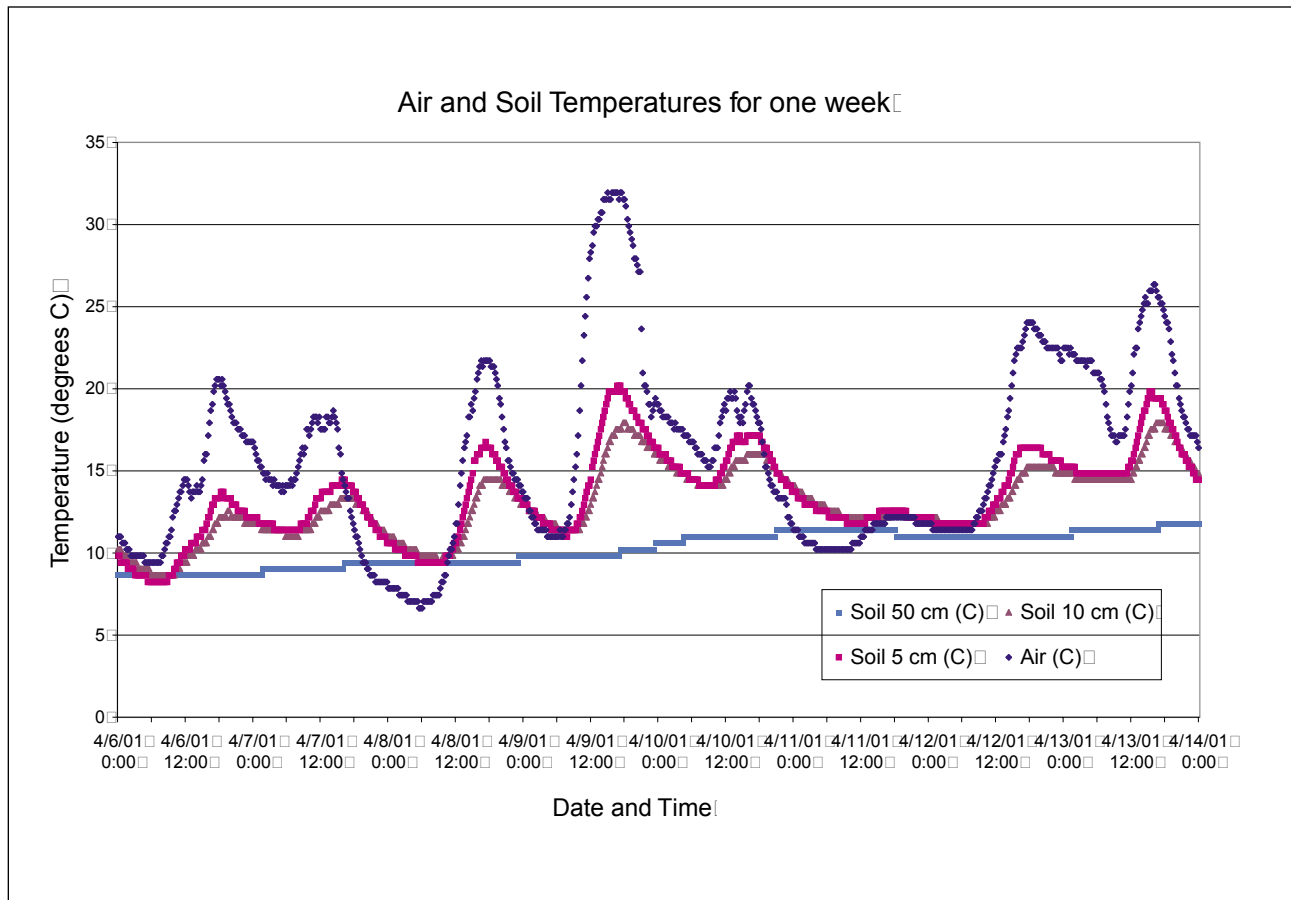

Figure SOIL-I-4: Grassland soils sampled in the southern part of Texas in the USA



These soils are common in the mid-western USA, and in the grasslands of Argentina and Ukraine. They are usually deep and dark in color, and are among the best soils for growing crops. Their dark color is caused by many years of grass roots dying, decomposing, and building up the organic matter content that allows the soil to hold the water and nutrients needed for excellent plant growth.

Figure SOIL-I-5: Soil formed under a forest in far eastern Russia, near the city of Magadan



Most of the organic matter in this soil comes from the leaves and roots of coniferous trees that die and decompose near the surface. When this decomposed organic matter mixes with rain, acids form that *leach*, or remove, materials from the top horizons of the soil. The white layer you see below the dark surface layer was caused by organic acids that removed the nutrients, organics, clays, iron, and other materials in the layer and left behind soil particles that are only mineral in composition.

Below this horizon is a dark horizon that contains materials that were leached from the horizon above and deposited or illuviated. This horizon has a dark color because of the organic matter deposited there. The next horizon has a red color due to iron oxide brought in from the horizon above and coating the soil particles. The horizon below this one has fewer or different types of iron oxides coating the inorganic soil particles creating a yellow color. The lowest horizon in the profile is the original parent material from which the soil formed. At this site, the parent material is a sandy deposit from glaciers. At one time, the whole soil looked like this bottom horizon, but over time, soil-forming processes changed its properties.

Figure SOIL-I-6: A tropical environment in Northern Queensland, Australia



Notice the bright red colors and the depth to which the soil is uniform. It is very difficult to distinguish unique horizons. Hot temperatures and lots of rain help to form weathered soils like this. In tropical climates, organic matter decomposes very quickly and transforms into inactive material that binds with clay. Most of the nutrients have been leached from this soil by intense rainfall. Left behind are weathered minerals coated by iron oxides giving the soil its bright red color.

Figure SOIL-I-7: Soil formed under a very cold climate near Inuvik in the Northwest Territory of Canada



The “hummocky” or wavy surface of this soil is caused by freezing and thawing of water stored in the soil year after year. The black zones indicate places where organic materials have accumulated during freezing and thawing cycles. The process of freezing and thawing and churning of the soil is called *cryoturbation*. This soil is not very developed and has only slight indications of horizons that can be seen by faint color differences. At the bottom of the profile is a layer called *permafrost*, which consists of ice, soil, or a mixture of both. The permafrost layer stays below 0°C throughout the year. The dark, thick organic material in this soil accumulates because decomposition is very slow in cold climates.

Figure SOIL-I-8: Soil formed under very dry or arid conditions in New Mexico, USA



A light brown horizon at the surface is often found in environments where organic matter is limited. High amounts of organic matter form dark soils. In dry places, organic matter is not returned to the soil because very little vegetation grows there. When rainfall does occur in this environment, the sandy texture of the soils allow materials to be carried downward into the lower horizons of the profile. The white streaks near the bottom of this profile are formed from deposits of calcium carbonate that can become very hard as they accumulate over time.

Figure SOIL-I-9: Wet soil sampled in Louisiana, USA



Wet soils are found in many parts of the world. The surface horizon is usually dark because organic matter accumulates when the soil is saturated with water. When these conditions occur, there is not enough oxygen for organisms to decompose the organic material. Colors of the lower horizon are usually grayish. Sometimes, as in this picture, the gray soil color has orange or brown streaks within it, which are called *mottles*. The gray colors indicate that the soil was wet for a long period of time, while the mottles show us where some oxygen was present in the soil.

Dr. John Kimble and Sharon Waltman of the USDA Natural Resources Conservation Service, National Soil Survey Center, Lincoln, Nebraska provided the photographs shown here.

GLOBE Measurements

What measurements are taken?

In the GLOBE Soil Investigation, two sets of soil measurements are made. The first set, known as Soil Characterization, describes the physical and chemical characteristics of each horizon in a soil profile. Some Soil Characterization measurements are carried out in the field, while others are done in a laboratory or classroom. Soil Characterization measurements are carried out one time for an identified site. The second set of measurements are Soil Moisture and Temperature, which determine the water and temperature properties of soil at specified depths. Soil moisture and temperature measurements are carried out repeatedly and can be directly compared with the air temperature and precipitation measurements that are described in the *Atmosphere Investigation*. Although these 2 sets of soil measurements are different, having both soil characterization and soil moisture at a given location provides the most amount of meaningful information. For example, differences in soil temperature and moisture between one site and another that have the same air temperature and precipitation may be due to differences in the soil characterization properties. Understanding the physical and chemical properties of the soil will help to interpret patterns in soil moisture and temperature.

Soil Characterization Measurements

Carried Out in the Field

- Site Description
- Horizon Depths
- Soil Structure
- Soil Color
- Soil Consistence
- Soil Texture
- Roots
- Rocks
- Carbonates

* Lab measurements use samples collected in the field.

Carried out in the Classroom or Lab*

- Bulk Density
- Particle Density
- Particle Size Distribution
- pH
- Soil Fertility (N, P, K)

Soil Moisture and Temperature Measurements

Carried out in the Field

- Soil Temperature
- Soil Moisture Monitoring

Carried out in the Classroom or Lab*

- Gravimetric Soil Moisture

Individual Measurements

Soil Characterization

At a soil site, horizons in a soil profile are distinguished from one another by differences in their structure, color, consistence, texture, and the amount of roots, rocks, and free carbonates they contain. Laboratory or classroom analyses of bulk density, particle density, particle size distribution, pH, and soil fertility also reveal differences among horizons.

Structure

Structure refers to the natural shape of aggregates of soil particles, called *peds*, in the soil. The soil structure provides information about the size and shape of pore spaces in the soil through which water, heat, and air flow, and in which plant roots grow. Soil ped structure is described as *granular*, *blocky*, *prismatic*, *columnar*, or *platy*. If the soil lacks structure, it is described as either *single grained* or *massive*.

Color

The color of soil is determined by the chemical coatings on soil particles, the amount of organic matter in the soil, and the moisture content of the soil. For example, soil color tends to be darker when organic matter is present. Minerals, such as iron, can create shades of red and yellow on the surface of soil particles. Soil in dry areas may appear white due to coatings of calcium carbonate



on the soil particles. Soil color is also affected by moisture content. The amount of moisture contained in the soil depends on how long the soil has been freely draining or whether it is saturated with water. Typically, the greater the moisture content of a soil, the darker its color.

Consistence

Consistence describes the firmness of the individual pedes and the degree to which they break apart. The terms used to describe soil consistence are *loose*, *friable*, *firm*, and *extremely firm*. A soil with friable consistence will be easier for roots, shovels, or plows to move through than a soil with a firm consistence.

Texture

The *texture* describes how a soil feels and is determined by the amounts of *sand*, *silt*, and *clay* particles present in the soil sample. The soil texture influences how much water, heat, and nutrients will be stored in the soil profile. Human hands are sensitive to the difference in size of soil particles. Sand is the largest particle size group, and feels gritty. Silt is the next particle size group, and feels smooth or *floury*. Clay is the smallest particle size group and feels sticky and is hard to squeeze. See Figure SOIL-I-10. The actual amount of sand, silt, and clay size particles in a soil sample is called the *particle size distribution* and is measured in a laboratory or classroom.

Figure SOIL-I-10: Particle Size Groups

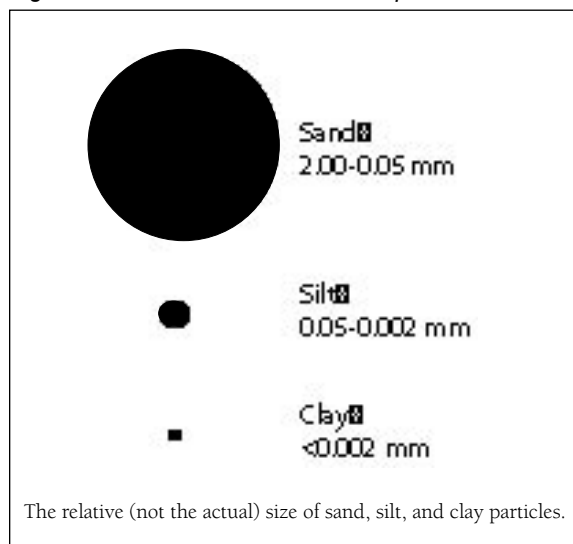

Roots

An estimate of the roots in each horizon in a soil profile illustrates the depth to which roots go to obtain nutrients and water. The more roots found in a horizon, the more water and nutrients being removed from the soil, and the more organic matter being returned. Knowing the amount of roots in each horizon allows scientists to estimate the soil's fertility, bulk density, water holding capacity, and its depth. For example, a very compact horizon will inhibit root development whereas a porous horizon will not.

Rocks

An estimate of the number of rocks in each horizon helps to understand the movement of water, heat, and air through the soil, root growth, and the amount of soil material involved in chemical and physical reactions.

Soil particles greater than 2 mm in size are considered to be rocks.

Carbonates

Carbonates of calcium or other elements accumulate in areas where there is little weathering from water. The presence of carbonates in soil may indicate a dry climate or a particular type of parent material rich in calcium, such as limestone. Free carbonates often coat soil particles in soils that are basic (i.e., pH greater than 7). These soils are common in arid or semi-arid climates. Carbonates are usually white in color and can be scratched easily with a fingernail. Sometimes in dry climates, carbonates form a hard and dense horizon similar to cement, and plant roots cannot grow through it. To test for carbonates, an acid, such as vinegar, is squirted on the soil. If carbonates are present, there will be a chemical reaction between the vinegar (an acid) and the carbonates (a base) to produce carbon dioxide. When carbon dioxide is produced, the vinegar bubbles or *effervesces*. The more carbonates present, the more bubbles or effervescence occurs.

Bulk Density

Soil *bulk density* is a measure of how tightly packed or dense the soil is and is measured by the mass of dry soil in a unit of volume (g/cm^3). See Figure SOIL-I-11. Soil bulk density depends on the composition of the soil, structure of the soil pedes,



the distribution of the sand, silt, and clay particles, the volume of pore space, and how tightly the particles are packed. Soils made of minerals (sand, silt, and clay) will have a different bulk density than soils made of organic material. In general, the bulk density of soils ranges from 0.5 g/cm^3 in soils with many spaces, to as high as 2.0 g/cm^3 or greater in very compact mineral horizons.

Knowing the bulk density of a soil is important for many reasons. Bulk density indicates how tightly soil particles are packed and the ease with which roots can grow through soil horizons. Bulk density is also used when converting between mass and volume for a soil sample. If the mass of a soil sample is known, its volume is calculated by dividing the sample mass by the bulk density of the soil. If the volume of a soil sample is known, the mass is calculated by multiplying the sample volume by the bulk density of the soil.

Particle Density

The *particle density* of a soil sample is the mass of dry soil in a particular volume of the soil when all of the air spaces have been removed. See Figure SOIL-I-11. The type of minerals the soil particles are made of affects the particle density. Soils consisting of pure quartz particles generally have a particle density of 2.65 g/cm^3 . Soils consisting of particles made of minerals other than quartz will have a different mass for the same volume of

particles. By knowing both the particle density and the bulk density, the *porosity* (the proportion of the soil volume that is pore space) can be calculated. Porosity establishes the amount of air or water that can be stored or moved through the soil.

Particle Size Distribution

The proportion of each particle size group (sand, silt, or clay) in the soil is called the soil *particle-size distribution*. Sand is the largest soil particle, silt is intermediate in size, and clay is the smallest. The particle-size distribution of a soil sample determines its exact textural class (which is “estimated” in the field by doing the Soil Texture Protocol). It also helps determine how much water, heat, and nutrients the soil will hold, how fast water and heat will move through the soil, and the structure and consistence of the soil.

The amount of sand, silt, and clay in a soil sample is determined by a settling method using an instrument called a *hydrometer*. A dried sample of soil is first dispersed so that none of the particles stick together, and then it is suspended in water and allowed to settle. The largest particles (sand) settle out in minutes while the smallest particles (clay) stay suspended for days. A hydrometer is used to measure the specific gravity of the soil suspension after settling has proceeded for specific amounts of time.

Figure SOIL-I-11: A Comparison of Bulk Density and Particle Density

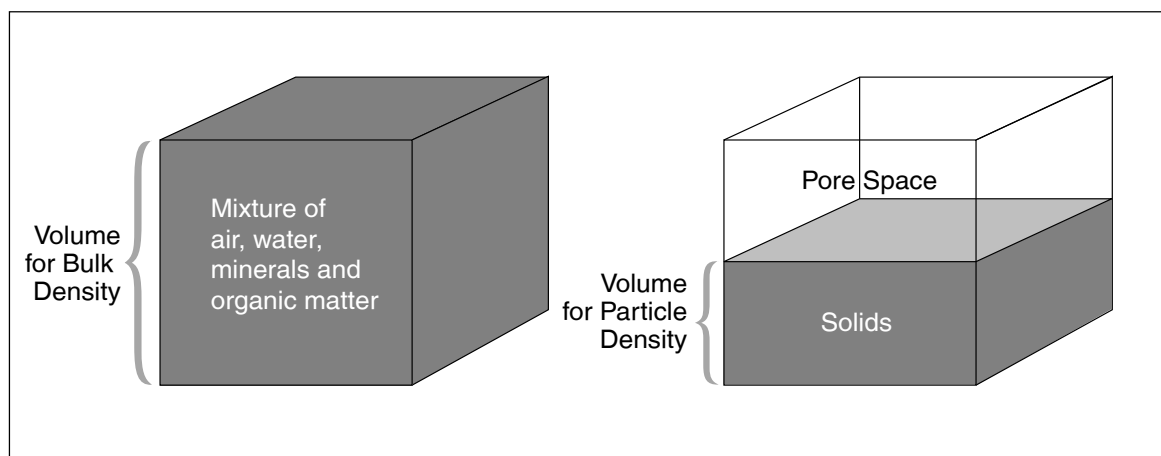

Bulk density is a measure of the mass of all the solids in a unit volume of soil including all the pore space filled by air and water. If the volume were compressed so that there were no pore spaces left for air or water, the mass of the particles divided by the volume they occupy would be the particle density.



pH

The *pH* of a soil horizon (how *acidic* or *basic* the soil is) is determined by the parent material from which the soil is formed, the chemical nature of the rain or other water entering the soil, land management practices, and the activities of organisms (plants, animals, and microorganisms) living in the soil. Just like the pH of water, the pH of soil is measured on a logarithmic scale (see the *Introduction* of the *Hydrology Investigation* for a description of pH). Soil pH is an indication of the soil's chemistry and fertility. The activity of the chemical substances in the soil affects the pH levels. Different plants grow at different pH values. Farmers sometimes add materials to the soil to change its pH depending on the types of plants they want to grow. The pH of the soil also affects the pH of ground water or nearby water bodies such as streams or lakes. Soil pH can be related to the water pH measured in the *Hydrology Investigation* and the precipitation pH measured in the *Atmosphere Investigation*.

Fertility

The *fertility* of a soil is determined by the amount of nutrients it contains. Nitrogen (N), phosphorus (P), and potassium (K) are three of the most important nutrients needed by plants for optimum plant growth. Each horizon in a soil profile can be tested for the presence of these nutrients. The results of these measurements help to determine the suitability of a soil for growing plants. Soil fertility can be related to water chemistry measurements carried out in the *Hydrology Investigation*.

Soil Moisture

Soil moisture, also known as *Soil Water Content* (SWC), is a ratio of the mass of water contained in a soil sample to the mass of dry matter in that sample. This ratio typically ranges from 0.05 g/g to 0.50 g/g. Only extremely dry soils that retain a small amount of water, such as those in a desert, have values below 0.05 g/g. Only organic-rich soils, peat or some clays absorb large amounts of water and have values above 0.50 g/g. In some very highly organic soils, the soil water content may actually be >1.0 g/g because the mass of the water is greater than the mass of the organic particles. The soil moisture measurement helps to define the role of the soil in the surrounding ecosystem.

For example, soil moisture measurements reveal the ability of the soil to hold or transmit water affecting groundwater recharge, surface runoff, and *transpiration* and evaporation of water into the atmosphere. It also describes the ability of the soil to provide nutrients and water to plants, affecting their growth and survival.

Soil Temperature

Soil acts as an insulator for heat flowing between the solid earth below the soil and the atmosphere. Thus, soil temperatures can be relatively cool in the summer or relatively warm in the winter. These soil temperature variations affect plant growth, the timing of bud-burst or leaf fall, and the rate of decomposition of organic materials.

Soil temperatures typically have a smaller daily range than air temperatures and deeper soil temperatures usually vary less. Soil temperature extremes range from 50° C for near-surface summer desert soils (warmer than the maximum air temperature!) to values below freezing in high latitude or high elevation soils in the winter.

Soil Study Site Selection

Soil study sites for carrying out soil characterization measurements and soil moisture and temperature measurements should be carefully selected.

For soil characterization measurements, a site should be considered that allows students to dig a hole with either a shovel or an auger. The purpose is to expose a soil profile that is one meter deep. If this is not possible, students have the option to sample the top 10 cm of the soil profile. It is important to check with local utility companies to be sure there are no pipes or wires buried at the site chosen for digging. A site that is chosen close to the site where soil moisture and temperature measurements are being made will help to understand these measurements better. A soil characterization site chosen near or in the Land Cover study site will help interpret the role that the soil properties play in controlling the type and amount of plant growth.

For soil moisture measurements, a site that is open should be considered. The site must not be irrigated, should have *uniform* soil characteristics, be relatively undisturbed, and be safe for digging. Soil moisture samples are



collected from the surface (0-5 cm) and 10 cm depths. Samples may also be collected at depths of 30 cm, 60 cm, and 90 cm to obtain a depth profile. If possible, the site should be within 100 m of a GLOBE Atmosphere Study Site or other location where precipitation measurements are being collected.

For soil temperature measurements, a site should be selected that is adjacent to a GLOBE Atmosphere Study site, or some other location where air temperature measurements are taken. Alternatively, soil temperature can be measured at a soil moisture study site. The site should be in the open and representative of the soils in the area. Soil temperature measurements are made at depths of 5 and 10 cm with all protocols and also at 50 cm with monitoring protocols.

Site Description

After students have selected a site for their soil measurements, they use the following identifying factors to define and describe the location they plan to study: latitude and longitude (using GPS receivers), elevation, slope, aspect (the direction of the steepest slope), type of vegetation covering the soil, parent material, current land use practices, and the position of the soil on the landscape. The students determine some of these properties at the site, while other properties are established using local resources such as maps, soil survey reports, and local experts.

Frequency of Measurements

Soil characterization measurements should be carried out one time for each Soil Characterization Study Site. More than one study site can be used in order to identify soil properties at different locations (such as at the soil moisture and temperature sites, land cover site, or along different parts of the landscape for example).

To help in understanding the global picture of soil moisture, GLOBE's highest priority is soil moisture measurements carried out during two primary collection campaigns each spring and fall.

To study local changes, soil moisture measurements should be taken twelve or more times per year for the same site at weekly or monthly intervals. With

soil moisture sensors, measurements should be taken daily or more frequently.

Soil temperature measurements are carried out at least once each week. Many schools take daily soil temperature measurements at the same time they collect daily atmospheric data. The *Digital Multi-Day Max/Min/Current Air and Soil Temperature Protocol* provides for daily measurement of the maximum and minimum soil temperatures from a depth of 10 cm. Optional protocols are available for measuring daily maximum and minimum soil temperatures at 5 cm and 50 cm depths and for collecting soil and air temperature automatically every 15 minutes using a data logger.

Field Considerations

Many teachers find that their students take great pride and satisfaction in digging a soil pit to expose a soil profile. Occasionally, adult volunteers are needed to assist, or someone in the area with a backhoe can be asked to help out. When digging, all necessary precautions should be taken to avoid buried utilities. To keep the hole from being a hazard to both people and animals, the pit should be open only while students are conducting their observations. It should be kept well covered when the class is not working in it.

Managing Students

Depending on the size of the soil pit and the number of students, it might be possible to work on the pit as a class. In other cases, it is better to allow groups of 3-5 students into the pit at a time. There are many strategies for using multiple groups of students to collect data from different horizons or to collect duplicate samples. Teachers should expect the soil characterization measurements and sampling procedures to take several hours. Some teachers choose to carry out the measurements on repeated visits. Experts in Soil Science from local Universities, the USDA Natural Resources Conservation Service, and other agricultural agencies can provide assistance with digging, describing the site, and characterizing the soil.

Soil moisture samples should be collected from as large an area around a school as possible during

Figure SOIL-I-12

National Science Education Standards	Basic Protocols					Advanced Protocols			Learning Activities	
	Charac-terization	Temperature	Soil Moisture	Bulk Density	Soil pH	Particle Size Distribution	Particle Density	Soil Fertility	Just Passing Through	Just Passing Through-Beg.
Earth and Space Science Concepts										
Earth materials are solid rocks, soil, water, biota, and the gases of the atmosphere.			■	■		■	■			
Soils have properties of color, texture, structure, consistence, density, pH, fertility; they support the growth of many types of plants.	■	■	■	■	■	■	■	■	■	■
The surface of Earth changes.	■	■	■		■			■		
Soils are often found in layers, with each having a different chemical composition and texture.	■				■			■	■	■
Soils consist of minerals (less than 2 mm), organic material, air and water.	■		■	■		■	■	■	■	■
Water circulates through soil changing the properties of both the soil and the water.	■	■	■	■	■			■	■	■
Physical Science Concepts										
Objects have observable properties.	■	■	■	■	■	■	■	■		
Energy is conserved.		■								
Heat moves from warmer to colder objects.		■								
Chemical reactions take place in every part of the environment.					■			■		
Life Science Concepts										
Atoms and molecules cycle among the living and nonliving components of the ecosystem.								■		
Scientific Inquiry Abilities										
Identify answerable questions.	■	■	■	■	■	■	■	■	■	■
Design and conduct an investigation.	■	■	■	■	■	■	■	■	■	■
Use appropriate tools and techniques including mathematics to gather, analyze, and interpret data.	■	■	■	■	■	■	■	■	■	■
Develop descriptions and explanations, predictions and models using evidence.	■	■	■	■	■	■	■	■	■	■
Communicate procedures and explanations.	■	■	■	■	■	■	■	■	■	■

the two target weeks. This allows all students (and parents) to participate. The class should decide upon a sample collection strategy and review the proper procedures to be used for data collection. Teams of students and parents can work together to collect site descriptions, GPS coordinates, near-surface *gravimetric* samples, and any other GLOBE data that interests the class. Other groups of students can be responsible for weighing the wet soil as soon after sample collection as possible and then beginning the drying process. It might be useful to contact and work with soil scientists from local colleges, the USDA Natural Resource Conservation Service and other agencies to help dry samples. Generally, a team of two or three students is appropriate for taking soil moisture samples or manually reading soil moisture sensors.

Soil temperature measurements are best made by small teams (2-3 students per team) on a daily or weekly schedule. One successful strategy is to have one experienced student helping a less experienced student, who later becomes the mentor to new team members. It takes 10-20 minutes for a team to collect a full set of measurements.

Combining the Measurements

In the GLOBE *Soil Investigation*, students study both the soil properties that change very slowly (soil characterization), and those that change rapidly (soil temperature and moisture). Without knowing the slowly changing properties of the soil profile, it is difficult to understand the dynamic moisture and temperature changes that occur. In the same way, the patterns in moisture and temperature in the soil over time, affect the formation of the soil. Teachers are encouraged to combine soil characterization measurements with soil temperature and moisture measurements so that students gain a true understanding of the way the pedosphere functions and affects the rest of the ecosystem.

Educational Objectives

Students participating in the activities presented in this chapter should gain scientific inquiry abilities and understanding of a number of scientific concepts. See Figure SOIL-I-12. These abilities include the use of a variety of specific instruments and techniques to take measurements and analyze the resulting data along with general approaches to inquiry. The Scientific Inquiry Abilities listed in Figure SOIL-I-12 and in the grey boxes at the beginning of each protocol are based on the assumption that the teacher has completed the protocol including the Looking at the Data section. If this section is not used, not all of the inquiry abilities will be covered. The Science Concepts included in the figure and grey boxes are outlined in the United States National Science Education Standards as recommended by the US National Research Council and include those for Earth and Space Science and Physical Science. Figure SOIL-I-12 provides a summary indicating which concepts and abilities are covered in which protocols or learning activities.

Protocols



Selecting, Exposing and Describing a Soil Characterization Site

Students will use a technique chosen by their teacher to expose a soil profile for characterization.

Soil Characterization Protocol

Students will identify horizons in a soil profile, observe the structure, color, consistence, texture, and the presence of rocks, roots, and carbonates of each horizon, and take samples for use in laboratory characterization protocols.

Soil Temperature Protocol

Students will measure near-surface soil temperature frequently near local solar noon and seasonally throughout two diurnal cycles.

Gravimetric Soil Moisture Protocol

Students will measure soil water content by comparing the wet and dry masses of samples.

Bulk Density Protocol

Students will measure the mass of a dry soil sample of known total volume including pore space to determine the density of the whole sample.

Soil Particle Density Protocol

Students will measure the volume of a known mass of dry soil particles and calculate the density of the particle portion only of a soil sample.

Particle Size Distribution Protocol

Students will suspend a known mass of dry soil in water and measure the specific gravity of the suspension after sand and then silt has settled out of the suspension to determine the amount of each soil particle size group in the sample.

Soil pH Protocol

Students will prepare a one-to-one mixture of dry soil and distilled water and then measure the pH of the liquid left after most of the soil has settled to the bottom of the mixture.

Soil Fertility Protocol

Students will use a GLOBE Soil Fertility Kit to prepare samples and determine whether nitrate, phosphate, and potassium are absent from a soil sample or present in low, medium or high concentrations.

Digital Multi-Day Max/Min/Current Air and Soil Temperature Protocol (see Atmosphere Chapter)

Students will use a digital multi-day maximum/minimum thermometer mounted in their instrument shelter to measure the maximum and minimum air and soil temperatures for up to six previous 24-hour periods.

Optional Digital Multi-Day Soil Temperatures Protocol *

Students will use a second digital multi-day maximum/minimum thermometer mounted in their instrument shelter to measure the maximum and minimum soil temperatures at 5 cm and 50 cm depths for up to six previous 24-hour periods.

Optional Automated Soil and Air Temperature Monitoring Protocol *

Students will use four temperature probes and a data logger to measure air temperature and soil temperatures at depths of 5 cm, 10 cm, and 50 cm every 15 minutes.

Optional Soil Moisture Sensor Protocol *

Students will develop a calibration curve and use it to determine soil water content at depths of 10 cm, 30 cm, 60 cm, and 90 cm from meter readings of four soil moisture sensor blocks.

Optional Water Infiltration Protocol *

Students will use a dual ring infiltrometer that they can construct from large food container cans to measure the rate at which water soaks into the soil during a roughly 45-minute period.

Optional Davis Soil Moisture and Temperature Station Protocol *

Students install soil moisture sensors and temperature probes and connect them to a Davis Soil Moisture and Temperature Station. Data are logged every 15 minutes and periodically students transfer these data to a computer and report them to GLOBE.

* See the full e-guide version of the *Teacher's Guide* available on the GLOBE Web site and CD-ROM.

Selecting, Exposing, and Defining a Soil Characterization Site



A. Selecting a Soil Characterization Site

Soil characterization measurements are taken for different reasons, including,

- supporting the interpretation of soil moisture and temperature, land cover, and atmosphere measurements;
- complementing and extending land cover mapping;
- developing soil maps of a region; and
- providing information for computer modeling.

For GLOBE, most schools focus on the first of these objectives, and for this a teacher must choose a site that is close to the school's Soil Moisture Study Site or to their Atmosphere Study Site where students are measuring soil temperature. These sites may be collocated (in the same place). If students will be doing the *Soil Characterization Protocol* together with the *Land Cover Sample Site Protocol*, then a place could be chosen within the Land Cover Sample Site that is representative of the site and where students can dig with minimum disturbance to the site and its natural vegetation (e.g., trees and perennial shrubs). If students will be developing a soil map of their region (e.g., watershed) or their GLOBE Study Site, or if they would like to use their data for computer modeling, sites should be chosen that represent different soil formation situations. For instance, students may wish to sample soil at the top, side, and bottom of a hill; or next to a stream or lake and upland on both sides of the water body. Comparisons of soil characteristics from two or more nearby sites can provide the basis for interesting inquiry or student research projects.

No matter which site location is chosen, the following steps should be considered:

1. The site needs to be safe for digging. Teachers and students should check with local utility companies and school maintenance staff to be sure that they do not dig into or disturb utility cables, water, sewer, or natural gas pipes, or sprinkler irrigation systems.
2. A site should be chosen that looks similar to the rest of the landscape and, if possible, is covered with natural vegetation. Lawns, agricultural sites, or other managed landscapes are acceptable if this is the cover that is located at the atmosphere and soil moisture and temperature measurement sites.
3. The site chosen should be relatively undisturbed. It should be at least 3 meters from buildings, roads, paths, playing fields, or other places where soils may have been compacted or disturbed by construction. If this is not possible, it is important to indicate that information in the metadata for the site.
4. The site should be oriented so that the sun shines on the soil profile at the time students carry out the soil characterization measurements to ensure the soil characteristics are clear for both naked-eye observations and photography. In some cases, sites are chosen where sunlight does not strike the soil profile (e.g., existing exposed profiles or pits dug under tree canopies). In these cases, students will need to take samples to a place where there is sunlight to determine the soil color.



B. Exposing the Profile of a Soil Characterization Site

There are three options for exposing the soil at a Soil Characterization Site:

1. **Pit Method:** Students dig a soil pit approximately 1 meter deep (or until an impenetrable layer is reached) and as big around as is necessary to easily observe all of the soil horizons from the bottom to the top of the pit (approximately 1.5 x 1.5 m wide). In some situations, students may be able to perform the soil characterization measurements at a site where the soil profile has already been exposed through human or natural action (e.g., a road cut or the side of a ravine). In these instances, teachers need to make sure that the site is safe for students and there is no objection to them scraping the surface soil away to expose a fresh soil *face*.
2. **Auger Method:** Students use a soil auger or probe to remove soil samples to a depth of 1 meter.
3. **Near Surface Method:** Students use a garden trowel or shovel to remove soil samples. Students dig to a depth of at least 10 cm. If deeper digging is possible, students should dig up to 1 meter.

Note: Some steps of the *Soil Characterization Protocol* vary depending upon which method students chose to expose their site.



C. Defining a Soil Characterization Site

After students have selected and exposed a soil characterization site, they define the site according to a number of factors. They record their descriptions in their GLOBE Science Notebooks and onto the *Soil Characterization Site Definition Sheet*. This information is important for students and scientists to understand the way the Earth system is functioning at that location. The following factors are defined:

Latitude, Longitude and Elevation: The location of the site is determined according to lines of latitude and longitude and elevation above sea level. These coordinates are established using a Global Positioning System (GPS) receiver if available. If not, students check the box labeled “Other” and record how they obtained latitude, longitude and elevation.

Site Exposure Method: The approach used by students to expose and study the soil is identified as the pit method, auger method or near surface method.

Site Location: Soil characterization data are important for interpreting soil moisture and temperature measurements, atmospheric measurements and land cover measurements. The location of the soil characterization site relative to these other measurement sites needs to be defined so that data collected for these measurements can be correlated.

Slope: The slope describes the angle at which the land of the site varies from a horizontal surface and is measured in degrees with an instrument called a clinometer. See *Land Cover/Biology Investigation Instruments*.

Aspect: The aspect is the direction of the steepest slope across the exposed soil site. This information indicates how the sun will influence soil properties. In the Northern Hemisphere, south facing slopes face the sun and tend to be drier and more weathered, while north facing slopes tend to be cooler. The opposite relationship occurs in the Southern Hemisphere.

Landscape Position: The landscape position describes the contours of the land at the soil characterization site. These descriptors, slope, aspect and landscape position, indicate the processes and inputs that helped form the soil at the site. For example, this information determines whether the soil was formed by erosion or deposition. It can also establish whether rain falling on the site will run off, settle into a pond, or infiltrate into the ground.

Cover Type: Cover type is a description of the vegetation or other material (such as pavement or gravel) on the surface of the soil. If nothing is covering the soil then it is described as bare soil. Otherwise, the material covering the soil can be described as rocks, grass, shrubs, trees or other.

Parent Material: The material from which the soil develops is called the parent material. Identifying the parent material of the soil helps to interpret its texture, mineralogy, weathering rate, and fertility.

Land Use: The manner in which the land is used at the soil site can be defined as urban, agricultural, recreational, wilderness or other. Land use can have a formidable effect on soil formation and help to interpret and explain a soil's properties and development.

Distance from Major Features and Other Distinguishing Characteristics of the Site: Other information or *metadata* about the site that does not fit into any of the above categories should also be recorded.

Suggestions for Digging and Managing a Soil Characterization Site

Pit Method

- Digging is much easier when the soil is moist. If possible, plan digging shortly after a rain.
- As soil is removed from the pit, place it carefully in piles representing each of the natural layers as they occur in the profile.
- The removed soil can be put on a tarp or other type of plastic sheet to make cleaning up the site easier.

- Cover piles of removed soil with plastic to prevent them from eroding away.
- Request help from parents, school personnel, students, or other volunteers.
- Contact a local USDA Natural Resources Conservation Service office (in the United States), or other agricultural organization or university. Many times, a soil scientist or other professional will be willing to assist you in digging a pit and helping describe the characteristics of the soil profile.
- Surround the pit with a fence and mark it with flags to alert people to where it is.
- Cover the pit with boards or some other material to keep animals or debris from falling in when it is not being used.
- When finished with the soil characterization measurements, the horizons need to be replaced into the soil pit in reverse order (last one out should be first one back in).
- Plan to plant a tree at the soil sampling site location. Once the pit for the tree has been dug, identify the horizons in the profile, conduct the soil characterization measurements, collect laboratory samples and then plant the tree in the soil pit.

Auger Method

- Identify an area where four auger holes can be dug and where the soil profiles are similar.
- A Dutch auger, as described in the Toolkit is best for most soil, especially for rocky, clay-rich, or dense soils.
- A sand auger is needed if the soil is very sandy in texture. In some places, the soil is mostly peat and a special peat auger should be used.
- A bucket auger may be better for dry, desert soils.
- Students need a horizontal surface (e.g., the ground) on which to display the vertical soil profile.
- Spread a plastic sheet, tarp, board, or other surface on the ground next to where the



auger holes are dug for laying out the profile.

- A rain gutter trough or other type of tube or container, one meter in length, can be used to lay out the soil sample removed from the auger. This allows for the sample to be labeled, transported and stored.
- Assemble a profile of the top 1 meter of soil by removing successive samples from the ground with the auger and laying them end-to-end.



Near Surface Method

- Use this method if digging deeper is not possible.
- Be sure to take triplicate (3) samples in the same area to obtain a good concept about the variability in soil properties that occurs across the surface of the study site.



Questions for Guiding Students

The following questions can be used to engage and guide students in selecting, exposing and defining their soil characterization site:

Is the soil moist or dry, difficult or easy to dig, warm or cool?



Can you distinguish differences in color, structure, roots, rocks, or other soil properties as the soil is being removed?

What is the parent material from which the soil was formed? Was it bedrock? If so, look for rocks on the surface to tell you something about the kind of rock. Could your soil have been deposited by water or wind, by a glacier or volcano?



What are the types of plants and animals you might find in the soil and the general area around your site? Include small organisms in the soil such as earthworms or ants.



Where is your soil located on the landscape? Is it on a hilltop, slope, or bottom of a hill? Is it next to a stream or on a flat plain? On what kind of landform is it found?



What is the general climate at your soil site? Is it sunny, shaded, hot, cold, moist, or dry?

What is the recent land use in this area? Has it been stable for a long time, or has it been plowed, its trees cut, used for construction, or undergone some other disturbance recently?

Questions for Further Investigation

How has the history of this area (human activity) affected this soil?

How has land cover affected this soil?

How has local climate (microclimate) affected this soil?

How has this soil affected local human history?

How has location in the landscape influenced this soil?

How would soils with different slopes differ from each other?

How does aspect affect soil properties?

Soil Characterization Site Exposure – Pit Method

Field Guide

Task

To dig a soil pit that exposes a soil profile for soil characterization measurements and to define the site

What You Need

- Shovels, trowels, backhoe or other digging implements
- Flags for marking the site
- Fence, boards, or other protection to surround and cover a pit when not in use
- Plastic tarp or other plastic sheet to cover piles of soil
- Soil Characterization Site Definition Sheet*
- Help with digging!
- Clinometer (made from materials described in the *Land Cover Investigation*)
- Local information about your site
- Compass
- GPS receiver or other means of determining coordinates

In the Field

Exposing the Soil Profile

1. Identify a location where you can dig a soil pit.
2. Dig the soil pit approximately 1 meter deep (or until a hard layer is reached). Make the pit as big around as is necessary to easily observe all of the soil horizons from the bottom to the top of the pit (approximately 1.5 m x 1.5 m).
3. As soil is removed from the pit, place it carefully on a plastic sheet like a tarp in piles representing each of the natural layers of the profile. The horizons need to be replaced in reverse order (last out, first in) once you are finished using the pit. Cover the pile of soil with plastic to prevent the soil from eroding (blowing or washing) away.
4. Surround the pit with a fence and mark it with flags to alert people of its location.
5. Cover the pit with boards or some other material to keep animals or debris from falling in when it is not being used.

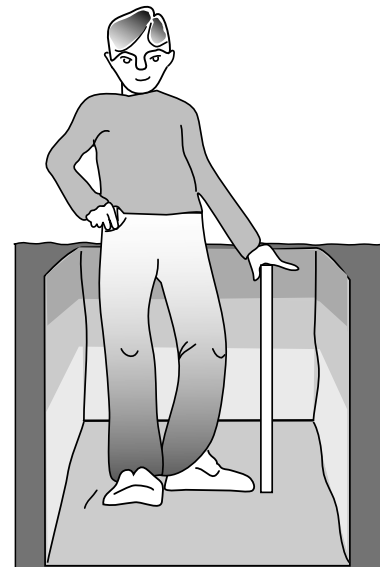

Defining the Soil Characterization Site

1. Give the site a name or number (e.g., SCS-01). Record this on the *Soil Characterization Site Definition Sheet*.
2. Determine the latitude, longitude, and elevation of the site using the *GPS Investigation* or other method such as a topographic map. Record this information on the *Site Definition Sheet*.
3. Identify the steepest slope that crosses the area of exposed soil.
 - a. Two students (A and B) are needed whose eyes are at about the same height to measure the slope. One other student (C) is needed to be the “reader” and “recorder”.
 - b. Student A holds the clinometer (made from materials described in the *Land Cover Investigation*) and stands down slope while Student B walks to the opposite side of the hole. Students A and B should be about 30 m apart (or as far apart as possible). Student C should stand next to Student A.
 - c. Looking through the clinometer, Student A sites the eye level of Student B. Student C reads the angle of slope on the clinometer in degrees, and records this reading on the *Site Definition Sheet*.
4. Identify the aspect of the steepest slope:
 - a. Face up the steepest slope across the exposed soil area.
 - b. Hold the compass in your hand so that the red arrow is lined up with the North position on the compass.
 - c. Read the number on the edge of the compass housing (which can range from 0 to 360).
 - d. Record this value on the *Site Definition Sheet*.
5. Record “Pit” as the method used to expose the soil profile.
6. Record whether the site is on or off school grounds.
7. Record a description of the site location. (Near the Soil Moisture Study Site, Near the Soil Moisture and Atmospheric Study Sites, Near the Atmosphere Study Site, In the Biology Study Site, or Other)
8. Describe and record the position on the landscape where the site is found. (Summit, Side Slope, Depression, Large Flat Area, or Stream Bank)
9. Describe and record the cover type of the site (Bare Soil, Rocks, Grass, Shrubs, Trees, or Other).
10. Describe and record the type of parent material from which the soil was formed at the site (Bedrock, Organic Material, Construction Material, Marine, Lake, Stream, Wind, Glaciers, Volcanoes, Loose Materials on Slope moved by gravity, or Other).
11. Describe and record the land use at the site (Urban, Agricultural, Recreation, Wilderness, or Other)
12. Measure and record the distance (up to 50 m) of the site from major features (e.g., buildings, power poles, roads, etc.).
13. Describe and record any other distinguishing characteristics of this site.

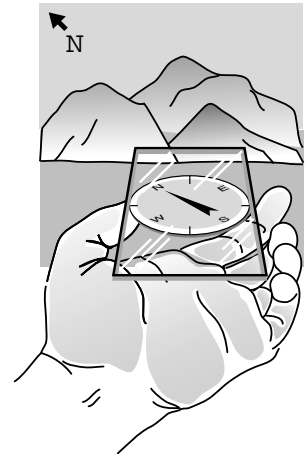

Soil Characterization Site Exposure – Auger Method

Field Guide

Task

Use an auger to expose a soil profile for characterization measurements and define the site.

What You Need

- Soil auger
- Clinometer (made from materials described in the *Land Cover Investigation*)
- Compass
- GPS receiver or other means of determining coordinates
- Meter Stick
- Local information about your site
- Plastic tarp or other plastic sheet to lay out the soil profile
- Soil Characterization Site Definition Sheet*

In the Field

Exposing the Soil Profile

1. Identify a location where an auger can be used to expose a soil profile.
2. Spread a plastic sheet, tarp, board, etc. on the ground next to where the first hole will be dug and where the sun will shine on the profile.
3. Remove the surface vegetation.
4. Place the auger at the top of the soil and turn the auger one complete revolution (360°) to dig into the ground. Do not turn the auger more than one complete circle (360°) to prevent the soil from being compacted.
5. Remove the auger with the sample from the hole and hold the auger over the plastic sheet.
6. Transfer the sample from the auger to the plastic sheet as gently as possible. Place the top of this sample just below the bottom of the previous sample.
7. Measure the depth of the hole with a metric ruler. Adjust the sample on the plastic bag, tarp, or board so that its bottom is no further from the top of the soil profile than this depth.
8. Record the depths at which there are differences in soil properties. (This will help to determine the top and bottom depths of the horizons for soil characterization.)

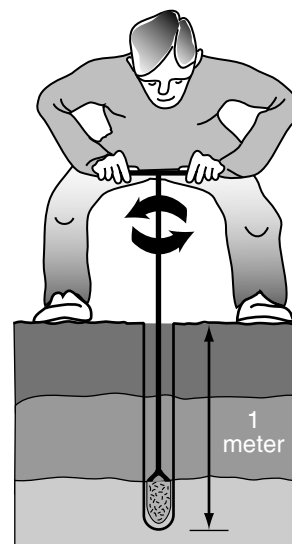
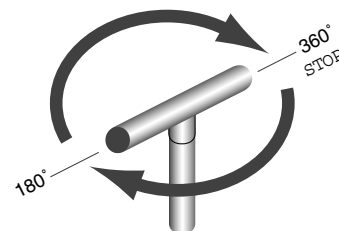

Defining the Soil Characterization Site

1. Give the site a name or number (e.g., SCS-01). Record this on the *Soil Characterization Site Definition Sheet*.
2. Determine the latitude, longitude, and elevation of the site using the *GPS Investigation* or other method such as a topographic map. Record this information on the *Site Definition Sheet*.
3. Identify the steepest slope that crosses the area of exposed soil.
 - a. Two students (A and B) are needed whose eyes are at about the same height to measure the slope. One other student (C) is needed to be the “reader” and “recorder”.
 - b. Student A holds the clinometer (made from materials described in the *Land Cover Investigation*) and stands down slope while Student B walks to the opposite side of the hole. Students A and B should be about 30 m apart (or as far apart as possible). Student C should stand next to Student A.
 - c. Looking through the clinometer, Student A sites the eye level of Student B. Student C reads the angle of slope on the clinometer in degrees, and records this reading on the *Site Definition Sheet*.
4. Identify the aspect of the steepest slope:
 - a. Face up the steepest slope across the exposed soil area.
 - b. Hold the compass in your hand so that the red arrow is lined up with the North position on the compass.
 - c. Read the number on the edge of the compass housing (which can range from 0 to 360).
 - d. Record this value on the *Site Definition Sheet*.
5. Record “Auger” as the method used to expose the soil profile.
6. Record whether the site is on or off school grounds.
7. Record a description of the site location. (Near the Soil Moisture Study Site, Near the Soil Moisture and Atmospheric Study Sites, Near the Atmosphere Study Site, In the Biology Study Site, or Other)
8. Describe and record the position on the landscape where the site is found. (Summit, Side Slope, Depression, Large Flat Area, Stream Bank)
9. Describe and record the cover type of the site (Bare Soil, Rocks, Grass, Shrubs, Trees, or Other).
10. Describe and record the type of parent material from which the soil was formed at the site (Bedrock, Organic Material, Construction Material, Marine, Lake, Stream, Wind, Glaciers, Volcanoes, Loose Materials on Slope moved by gravity, or Other).
11. Describe and record the land use at the site (Urban, Agricultural, Recreation, Wilderness, or Other)
12. Measure and record the distance (up to 50 m) of the site from major features (e.g., buildings, power poles, roads, etc.).
13. Describe and record any other distinguishing characteristics of this site.

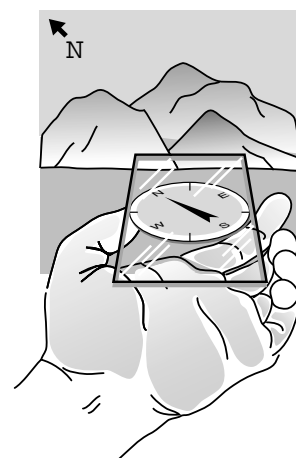

Soil Characterization Site Exposure – Near Surface Method

Field Guide

Task

Expose the top 10 cm of soil for soil characterization measurements and define the site.

What You Need

- Meter Stick or metric ruler
- Clinometer (made from materials described in the *Land Cover Investigation*)
- Local information about your site
- Compass
- GPS receiver or other means of determining coordinates
- Soil Characterization Site Definition Sheet*

In the Field

Exposing the Soil Profile

1. Identify a location where the surface of the soil can be exposed.
2. Remove the surface vegetation.
3. Use a garden trowel or shovel to carefully remove the top 10 cm of soil from a small area and set it on the ground.
4. Repeat Steps 1, 2, and 3 above for a location next to the original sample hole. Repeat again, and mix the three samples together. Treat this mixed sample as a horizon.

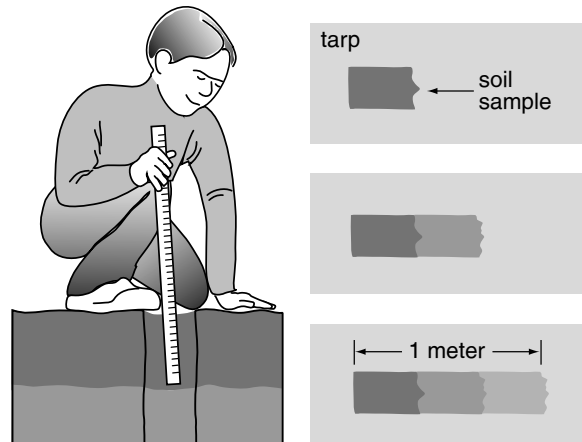

Defining the Soil Characterization Site

1. Give the site a name or number (e.g., SCS-01). Record this on the *Soil Characterization Site Definition Sheet*.
2. Determine the latitude, longitude, and elevation of the site using the *GPS Investigation* or other method such as a topographic map. Record this information on the *Site Definition Sheet*.
3. Identify the steepest slope that crosses the area of exposed soil.
 - a. Two students (A and B) are needed whose eyes are at about the same height to measure the slope. One other student (C) is needed to be the “reader” and “recorder”.
 - b. Student A holds the clinometer (made from materials described in the *Land Cover Investigation*) and stands down slope while Student B walks to the opposite side of the hole. Students A and B should be about 30 m apart (or as far apart as possible). Student C should stand next to Student A.

- c. Looking through the clinometer, Student A sites the eye level of Student B. Student C reads the angle of slope on the clinometer in degrees, and records this reading on the *Site Definition Sheet*.
 4. Identify the aspect of the steepest slope:
 - a. Face up the steepest slope across the exposed soil area.
 - b. Hold the compass in your hand so that the red arrow is lined up with the North position on the compass.
 - c. Read the number on the edge of the compass housing (which can range from 0 to 360).
 - d. Record this value on the *Site Definition Sheet*.
 5. Record “Near Surface” as the method used to expose the soil profile.
 6. Record whether the site is on or off school grounds.
 7. Record a description of the site location. (Near the Soil Moisture Study Site, Near the Soil Moisture and Atmospheric Study Sites, Near the Atmosphere Study Site, In the Biology Study Site, or Other)
 8. Describe and record the position on the landscape where the site is found. (Summit, Side Slope, Depression, Large Flat Area, Stream Bank)
 9. Describe and record the cover type of the site (Bare Soil, Rocks, Grass, Shrubs, Trees, or Other).
 10. Describe and record the type of parent material from which the soil was formed at the site (Bedrock, Organic Material, Construction Material, Marine, Lake, Stream, Wind, Glaciers, Volcanoes, Loose Materials on Slope moved by gravity, or Other).
 11. Describe and record the land use at the site (Urban, Agricultural, Recreation, Wilderness, or Other)
 12. Measure and record the distance (up to 50 m) of the site from major features (e.g., buildings, power poles, roads, etc.).
 13. Describe and record any other distinguishing characteristics of this site.

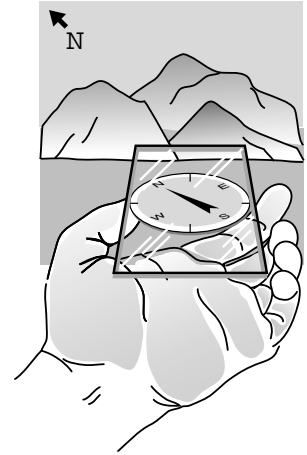

Soil Characterization Protocol



Purpose

To characterize the physical and chemical properties for each horizon in a soil profile and prepare samples for further analysis

Overview

Students identify the horizons of a soil profile at a soil characterization site, then measure and record the top and bottom depth for each horizon. For each horizon, students describe the structure, color, consistence, texture, and abundance of roots, rocks, and carbonates. Samples are collected and prepared for additional laboratory analysis.

Student Outcomes

Students will be able to carry out field methods for soil analysis, record field data, and prepare soil samples for laboratory testing. Students will be able to relate the physical and chemical properties of soil at a site to the climate, landscape position, parent material, and land cover of an area.

Science Concepts

Earth and Space Sciences

Soils have properties of color, texture, structure, consistence, density, pH, fertility; they support the growth of many types of plants.

The surface of Earth changes.

Soils are often found in layers, with each having a different chemical composition and texture.

Soils consist of minerals (less than 2 mm), organic material, air and water.

Water circulates through soil changing the properties of both the soil and the water.

Physical Sciences

Objects have observable properties.

Scientific Inquiry Abilities

Identify answerable questions.

Design and conduct an investigation.

Use appropriate tools and techniques including mathematics to gather, analyze, and interpret data.
Develop descriptions and explanations, predictions and models using evidence.
Communicate procedures and explanations.

Time

Two-three 45-minute class periods or one 90-minute session in the field

Level

All

Frequency

Soil characterization measurements are taken one time for a specific soil site.

Collected samples can be stored for study and analysis at another time during the school year.

Materials and Tools

Spray bottle full of water
Golf tees, nails, or other horizon markers
Soil color book
Pencil or pen
Trowel, shovel, or other digging device
Paper towels
Meter stick or tape measure
Sealable bags or containers
Marking pen
Camera
Latex gloves
Acid bottle filled with vinegar
Hammer or other crushing tool
Rubber gloves
#10 Sieve (2 mm mesh openings)
Sheets of paper or paper plates
Soil Characterization Data Sheet

Prerequisites

Selecting, Exposing, and Defining a Soil Characterization Site Protocol



Soil Characterization Protocol – Introduction

Soil can be characterized by its structure, color, consistence, texture, and abundance of roots, rocks, and carbonates. These characteristics allow scientists to interpret how the ecosystem functions and make recommendations for soil use that have a minimal impact on the ecosystem. For example, soil characterization data can help determine whether a garden should be planted or a school should be built. Soil characterization data can help scientists predict the likelihood of flooding and drought. It can help them to determine the types of vegetation and land use best suited to a location. Soil characteristics also help explain patterns observed from satellite imagery, vegetation growth across the landscape, or trends of soil moisture and temperature that might be related to weather.



Teacher Support

Advance Preparation

Before beginning the *Soil Characterization Protocol* follow the protocol for *Selecting, Exposing, and Defining a Soil Characterization Site*. The *Soil Characterization Protocol* can be performed on a soil profile that is exposed in a pit, from an auger, or from a sample taken at the soil surface.

Teachers should have students bring in soil samples from home or from the school yard to practice each soil characterization measurement before doing the soil characterization protocol in the field.

Before starting the soil characterization, teachers should have students step back from the exposed profile and observe any obvious characteristic changes that occur with depth such as changes in color and structure.

To help demonstrate to students what happens when an acid (vinegar) is added to a base (free soil carbonates) teachers can mix baking soda into a dry soil and squirt vinegar from an acid bottle on to the soil to illustrate strong effervescence.



Measurement Procedures

To help identify different horizons, teachers should have students look for changes that might be obvious with depth including color, structure, texture, number and kind of roots and rocks, temperature, moisture, smell, sound (determined by rubbing peds together with their fingers).

It is helpful if students reach a consensus about what they are observing. For example, they may discuss until they finally agree to the placement of horizon boundaries, soil color, structure, texture, or other characteristics. The results based on student consensus should be recorded.

Questions for Guiding Students

What prompted you to choose the different horizons? Were your choices based on soil characteristics such as color, structure, presence of animals or roots?

If there was anything unusual about the soil profile? What may have caused this?

What can you tell about the formation of the soil by looking at the horizons in the profile?

Questions for Further Investigation

What creates the different horizons in a soil profile?

What natural changes could alter the soil horizons?

How long might it take to alter the depths of the different horizons?

How do soil profiles change from one location to another?

How do soil horizons change from one location to another?

Soil Characterization Protocol

Field Guide

Task

Identify, measure and record the horizons in a soil profile at a Soil Characterization Site. Measure and record the physical and chemical properties that characterize each horizon. Photograph the soil profile. Collect soil samples from each horizon.

What You Need

- Spray mist bottle full of water
- Golf tees, nails or other marking device that can be pushed into a soil horizon
- Trowel, shovel, or other digging device
- Soil color book
- Marking pen
- Camera
- Acid bottle filled with distilled vinegar
- Soil Characterization Data Sheet*
- Pencil or pen
- Paper towels
- Meter stick or tape measure
- Rolling pin, hammer, or other utensil for crushing peds and separating particles

In the Field

Identifying and Measuring Horizons

1. Make sure the sun shines on the profile if possible.
2. Use a trowel to scrape a few centimeters of soil off of the profile to expose a fresh soil face.
3. Determine whether the soil profile is moist, wet, or dry. If the soil profile is dry, moisten it with the spray mist bottle.
4. Start at the top of the profile and observe the characteristics of the soil moving towards the bottom of the profile.
5. Look carefully at the soil profile for distinguishing characteristics such as color, texture, shapes, roots, rocks, small dark nodules (called *concretions*), worms, small animals, insects, and worm channels. These observations will help to define the horizons.
6. Working in a straight vertical line, place a marker (such as a golf tee or nail) at the top and bottom of each horizon to clearly identify it. Be sure there is a consensus from all of the students regarding the depths of the soil horizons.
7. Measure the top and bottom depth of each horizon beginning at the top (surface) of the profile. Start with the meter stick or tape measure at 0 cm at the top of the profile. Note the depths at which each horizon starts and ends.
8. Record the top and bottom depth of each horizon on the *Soil Characterization Data Sheet*.



Measuring Structure

1. Use a trowel or other digging device to remove a sample of soil from the horizon being studied.
2. Hold the sample gently in your hand and look closely at the soil to examine its structure.
3. Come to a consensus with other students in the group on the type of soil structure of the horizon. Possible choices of soil structure are:

Granular: Resembles cookie crumbs and is usually less than 0.5 cm in diameter. Commonly found in surface horizons where roots have been growing.

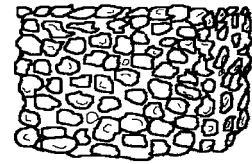

Blocky: Irregular blocks that are usually 1.5 - 5.0 cm in diameter.

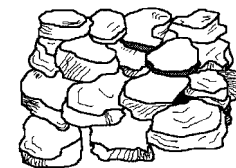
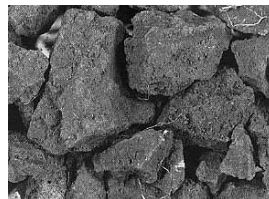

Prismatic: Vertical columns of soil that might be a number of cm long. Usually found in lower horizons.

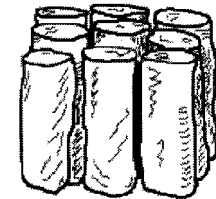

Columnar: Vertical columns of soil that have a white, rounded salt "cap" at the top. Found in soils of arid climates.

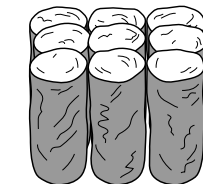

Platy: Thin, flat plates of soil that lie horizontally. Usually found in compacted soil.

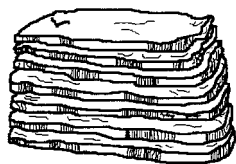

In certain cases, soil samples may have no structure. These would be classified as either:

Single Grained: Soil is broken into individual particles that do not stick together. Always accompanies a loose consistence. Commonly found in sandy soils.



Massive: Soil has no visible structure, is hard to break apart and appears in very large clods.



4. Record the structure type on the *Soil Characterization Data Sheet*.

Measuring Main Color and Second Color

1. Take a ped from the horizon being studied and note whether it is moist, dry, or wet. If it is dry, moisten it slightly with water from your water bottle.
2. Break the ped and hold it next to the color chart.
3. Stand with the sun over your shoulder so that sunlight shines on the color chart and the soil sample you are examining.
4. Find the color on the color chart that most closely matches the color of the inside surface of the ped. Be sure that all students agree on the choice of color.
5. Record on the *Soil Characterization Data Sheet* the symbol of the color on the chart that most closely matches the soil color that covers the largest area of the ped (dominant or main color). Sometimes, a soil sample may have more than one color. Record a maximum of two colors if necessary, and indicate (1) the dominant (main) color, and (2) the sub-dominant (second) color.

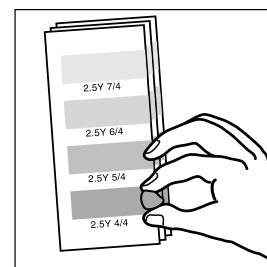
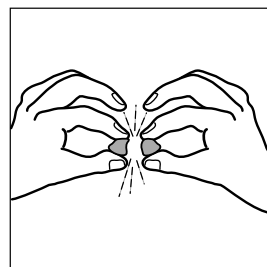
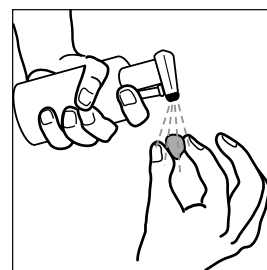

Measuring Soil Consistence

1. Take a ped from the soil horizon being studied. If the soil is very dry, moisten the face of the profile by squirting water on it, and then remove a ped for determining consistence.
2. Holding the ped between your thumb and forefinger, gently squeeze it until it pops or falls apart.
3. Record one of the following categories of soil ped consistence on the *Soil Characterization Data Sheet*.

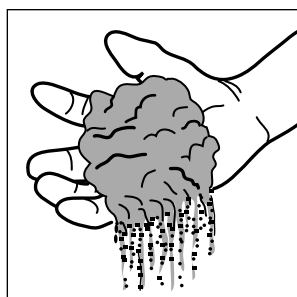

Loose: You have trouble picking out a single ped and the structure falls apart before you handle it. **Note:** Soils with **single grained structure** always have **loose consistence**.

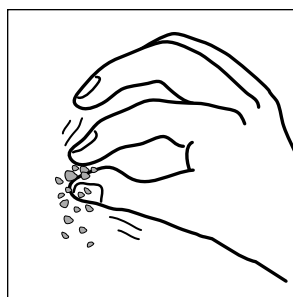

Firm: The ped breaks when you apply a larger amount of pressure and the ped dents your fingers before it breaks.

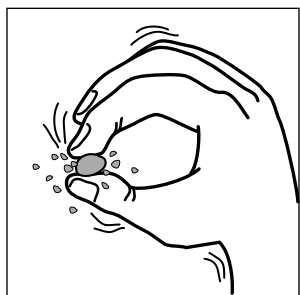

Friable: The ped breaks with a small amount of pressure.

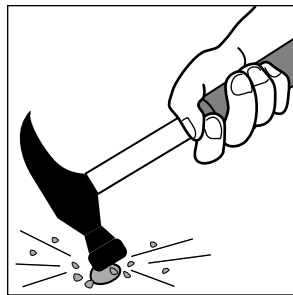

Extremely Firm: The ped can't be crushed with your fingers (you need a hammer!)

Measuring Soil Texture (for help with this category, refer to the Textural Triangle under “Frequently Asked Questions”)

Step 1

- Place some soil from a horizon (about the size of a small egg) in your hand and use the spray mist bottle to moisten the soil. Let the water soak into the soil and then work it between your fingers until it is thoroughly moist. Once the soil is moist, try to form a ball.
- If the soil forms a ball, go on to **Step 2**. If the soil does not form a ball, call it a **sand**. Soil texture is complete. Record the texture onto the *Soil Characterization Data Sheet*.

Step 2

- Place the ball of soil between your thumb and index finger and gently push and squeeze it into a ribbon. If you can make a ribbon that is longer than 2.5 cm, go to **Step 3**. If the ribbon breaks apart before it reaches 2.5 cm, call it a **loamy sand**. Soil texture is complete. Record the texture onto the *Soil Characterization Data Sheet*.

Step 3

- If the soil:
 - Is very sticky
 - Hard to squeeze
 - Stains your hands
 - Has a shine when rubbed
 - Forms a long ribbon (5+ cm) without breaking,

Call it a clay and go to Step 4.

Otherwise, if the soil:

- Is somewhat sticky
- Is somewhat hard to squeeze
- Forms a medium ribbon (between 2-5 cm)

Call it a clay loam and go to Step 4.

Otherwise, if the soil is:

- Smooth
- Easy to squeeze,
- At most slightly sticky,
- Forms a short ribbon (less than 2 cm)

Call it a loam and go to Step 4.

Step 4

- Wet a small pinch of the soil in your palm and rub it with a forefinger. If the soil:
 - Feels very gritty every time you squeeze the soil, go to **A**.
 - Feels very smooth, with no gritty feeling, go to **B**.
 - Feels only a little gritty, go to **C**.

A. Add the word **sandy** to the initial classification.

- Soil texture is either:
 - sandy clay,
 - sandy clay loam, or
 - sandy loam

- Soil texture is complete. Record the texture onto the *Soil Characterization Data Sheet*.

B. Add the word **silt** or **silty** to the initial classification.

- Soil texture is either:
 - silty clay,
 - silty clay loam, or
 - silt loam
- Soil texture is complete. Record the texture onto the *Soil Characterization Data Sheet*.

C. Leave the original classification.

- Soil texture is either:
 - clay, clay loam, or loam
- Soil texture is complete. Record the texture onto the *Soil Characterization Data Sheet*.

Measuring Rocks

1. Observe and record if there are **none**, **few**, or **many** rocks or rock fragments in the horizon. A rock or rock fragment is defined as being larger than 2 mm in size.
2. Record your observation on the *Soil Characterization Data Sheet*.

Measuring Roots

1. Observe if there are **none**, **few**, or **many** roots in each horizon.
2. Record your observation on the *Soil Characterization Data Sheet*.

Measuring Free Carbonates

1. Set aside a portion of the exposed soil to use for the free carbonates test. Make sure not to touch it with your bare hands.
2. Open the acid bottle and squirt vinegar on the soil particles, starting from the bottom of the profile and moving up. Be sure to use caution and point the bottle directly at the soil, not toward other students, especially toward eyes. If vinegar gets into your eyes, rinse with water for 15 minutes.
3. Look carefully for the presence of effervescence. The more carbonates that are present, the more bubbles (effervescence) you will observe.
4. For each horizon, record on the *Soil Characterization Data Sheet* one of the following as the result of the Free Carbonate Test:
 - **None:** if you observe no reaction, the soil has no free carbonates present.
 - **Slight:** if you observe a very slight bubbling action; this indicates the presence of some carbonates.
 - **Strong:** if there is a strong reaction (many, and/or large bubbles) this indicates that many carbonates are present.

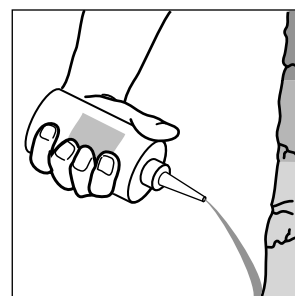

Photographing the Soil Profile

1. Place a tape measure or meter stick starting from the top of the soil profile next to where the horizons have been marked.
2. With the sun at your back, photograph the soil profile so that the horizons and depths can be seen clearly.
3. Take another photograph of the landscape around the soil profile.
4. Submit photos to GLOBE following directions outlined in the *How to Submit Photos and Maps* section of the *Implementation Guide*.

Horizon Sampling

Field Guide

Task

Collect soil samples of each horizon.

What You Need:

- Trowel, shovel or other digging device
- Latex gloves
- Sealable bag or container
- Marking pen
- Sheets of paper or paper plates for drying
- #10 Sieve (2 mm mesh openings)

In the Field

Collecting Soil Samples

1. Dig out a large soil sample from each soil horizon. Avoid the area of the soil face that was tested for carbonates and avoid touching the soil samples so that pH measurements will not be contaminated by acids on your skin.
2. Place each sample in a bag or other soil container
3. Label each bag with the site name, horizon name, and top and bottom depths.
4. Bring these samples from the field and into the classroom or laboratory.
5. Spread the samples on separate paper plates or sheets of paper to dry in the air. You can place the soil near a window where it will receive light from the sun to make the drying go faster.
6. Put on latex gloves so the acids on your skin do not contaminate the soil pH measurement.
7. Put the #10 (2 mm openings) sieve on top of clean sheets of paper and pour the dry soil sample into the sieve.
8. Carefully push the dried soil material through the mesh onto the paper. Do not force the soil through the sieve or you may bend the wire mesh openings. Rocks will not pass through the mesh and will stay on top of the sieve. Remove the rocks (and other pieces of debris) from the sieve and discard. If no sieve is available, carefully remove the rocks and debris by hand.
9. Transfer the rock-free, dry soil from the paper under the sieve into new, clean, dry plastic bags or containers.
10. Seal the containers, and label them the same way that they were labeled in the field (horizon name, top and bottom horizon depth, date, site name, site location). This is the soil that will be used for lab analyses.
11. Store these samples in a safe, dry place until they are used.

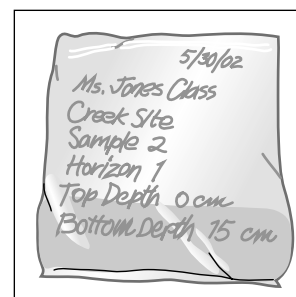
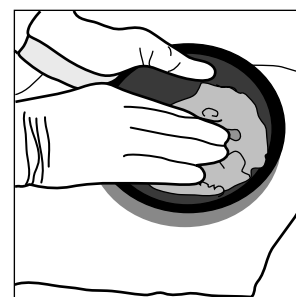
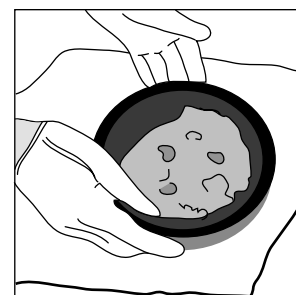
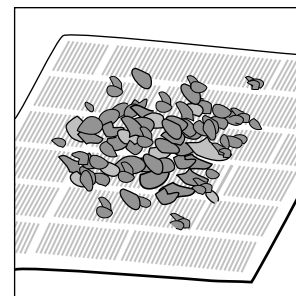

Frequently Asked Questions

What do the numbers and letters describing the soil color mean?

For GLOBE, the universal Munsell notation is used to identify the color of the soil.

The system is made up of 3 symbols representing the *hue*, *value*, and *chroma* of the soil color.

The **hue** is described by the first set of number and letter symbols in the Munsell system. Hue represents the position of the color on the color wheel (Y=Yellow, R=Red, G=Green, B=Blue, YR=Yellow Red, RY=Red Yellow).

The **value** is the number before the slash in the Munsell system. Value indicates the lightness of a color. The scale of value ranges from 0 for pure black to 10 for pure white.

The **chroma** is the number after the slash in the Munsell system. Chroma describes the “intensity” of a color. Colors of low chroma values are sometimes called weak, while those of high chroma are said to be highly saturated, strong, or vivid. The scale starts at zero, for neutral colors, but there is no arbitrary end to the scale.



7.5R 7/2

Hue Value Chroma



Welcome

Introduction

Protocols

Learning Activities

Appendix



What does it mean if I determine that my soil is a silty clay or a sandy loam?

The texture you determine from feeling your soil is a subjective measurement. This means that another person might not think that the soil has exactly the same texture as you do. The texture actually refers to the percentages of sand, silt, and clay present. The triangle below is called a

textural triangle and can be used to determine the approximate percentages of sand, silt, and clay in your soil from the texture you determined. For a more objective measure of soil texture, you should perform the *Particle Size Distribution Protocol* in which you determine the actual percentages of sand, silt, and clay in the soil.



Figure SO-SC-1: Soil Textural Triangle

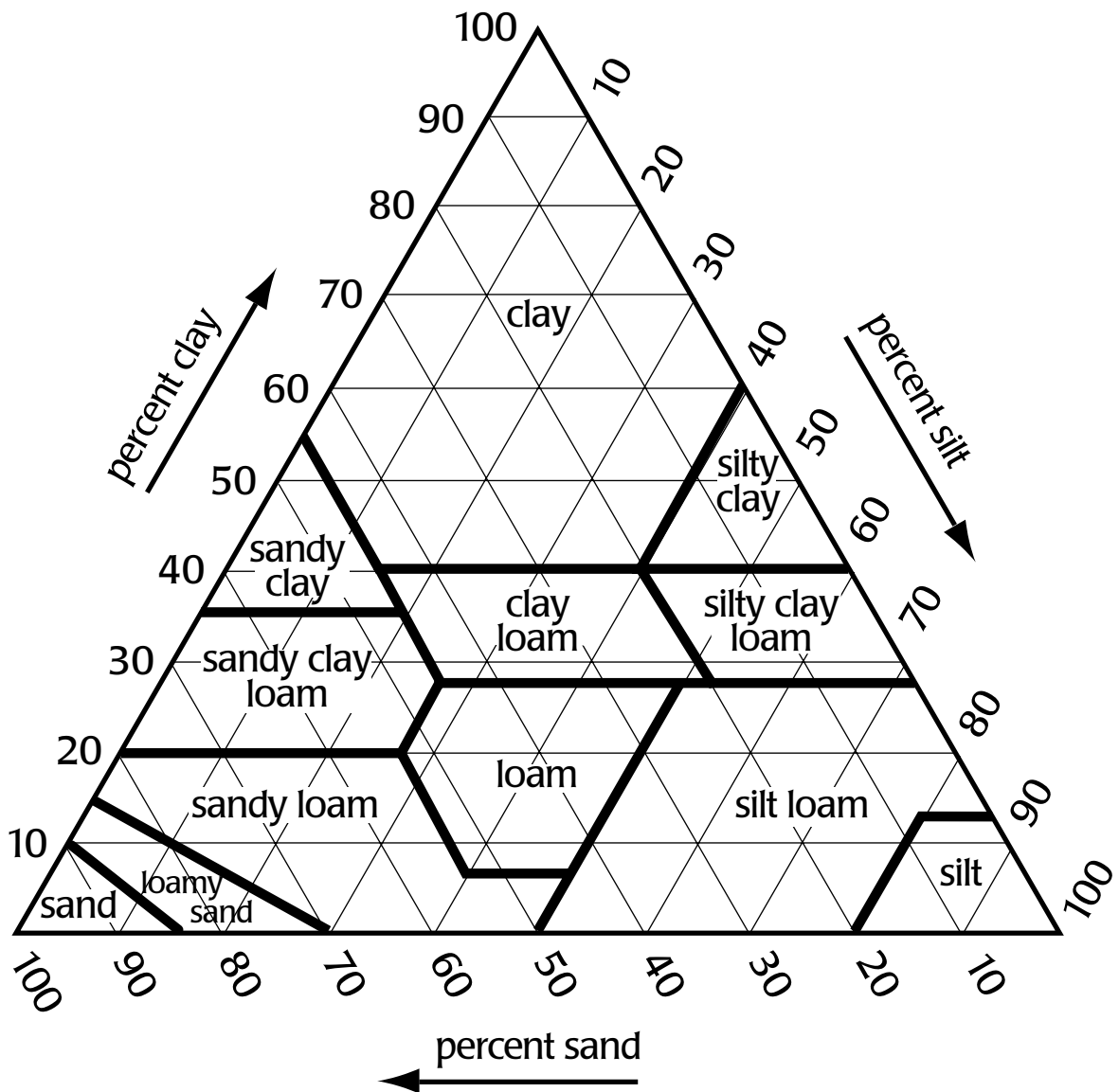

Soil Characterization Protocol – Looking at the Data

Are the data reasonable?

Soil profiles vary greatly from one region to another making it difficult to predict what students will see at their sites. There are certain things that teachers and students can look for to tell whether or not the data are reasonable.

Horizons

It is unlikely that large numbers of distinct horizons will be found in very young soils (recently deposited, or close to bedrock), or very highly developed soils (such as are found in tropical regions). More horizons are found in temperate climates under forest vegetation.

Color

Dark colored soil is usually found at the surface, unless there has been intense leaching of organic material, such as in a coniferous forest, or deposition has occurred where new parent material has been deposited on top of a soil profile that was already developed.

Texture

In general, soil texture is similar as you go deeper into the soil, with a gradual increase in clay. If there is a very sharp difference in texture (such as a clayey soil over a very sandy soil) this may also be an indication of a different parent material due to deposition. This may occur if you are in an area near a stream where flooding is common, or where human activity has disturbed the soil and *fill* has been added. It is helpful to complete the *Particle Size Distribution Protocol* for each horizon to check the texture data collected in the field with actual lab measurements of the amount of sand, silt, and clay.

Structure

Granular structure is generally found where there are many roots. Soils with high amounts of clay typically have blocky or massive structure.

Consistence

When the soil has single grained structure, the consistence is always loose and the texture is usually sand or other very sandy texture such as loamy sand. Testing for the bulk density of the soil can act as a check for the consistence since the denser the soil, the more firm the consistence will be.

Roots

Bulk density should be lower when there are many roots in the soil that add pore space to the horizon.

Carbonates

If free carbonates are present, the pH should be 7 or above since high amounts of calcium carbonate decrease the soil acidity and increase the pH.

Student Research

Students at Queen Mary School in Pennsylvania, USA wanted to compare the soil at two sites near their school. The first site was in a forested area that had not been disturbed for at least 100 years. The second site was in a field that had been used for agriculture, but then became a grass field.

Mr. Hardy, the teacher, did a few things to prepare for this study. First, he contacted the local USDA Natural Resources Conservation Service office and asked the local soil scientist to come out and help the class. Arrangements were made so that the soil scientist could spend a class period talking about soils in the county and show the students maps and other information about the soils near their school. She also agreed to help the students with their soil characterization measurements. Second, Mr. Hardy checked to make sure that it was safe to dig at these sites, and contacted the students' parents to help dig the soil pits. The parents waited until a few days after a good rainfall so that the soil would be moist and easy to dig, and soon had dug two soil characterization pits to a depth of 1 meter. As they removed the soil from the pit, it was stacked neatly in piles by horizon, so that when the characterization was done, they could return the soil in the same order in which it had been removed.



When the day for digging arrived, the students went out in two teams to characterize each of the sites. Team A was in charge of the site description and determined the GPS location, elevation, slope, aspect, landscape position, cover type, and land use. They also identified the soil parent material with the help of geologic maps they found in the library and help from the county soil scientist. Information about the site location and other notes were also recorded. Team B went into the pit and did the soil characterization and sampling of horizons, making sure there was consensus among all the students on the team about what they were observing. The students waited until the following day to complete the characterization at the grass field site. Each team then switched roles so that every student had a chance to do both the site description and soil characterization in the pit. The data collected by the students at each site are given below.

Site A:

Slope: 15 degrees

Aspect: 120 degrees

Landscape Position: Summit

Cover Type: Trees

Land Use: Forest

Parent Material: Sandstone Bedrock (hit bedrock at 86 cm)



Horizon	Top	Bottom	Rocks	Roots	Structure	Color	Consistence	Texture	Carbonates
1	0cm	6cm	Few	Many	Granular	10YR 2/1	Friable	Sandy Loam	None
2	6cm	20cm	Few	Many	Blocky	10YR 6/4	Friable	Sandy Loam	None
3	20cm	50cm	Few	Few	Blocky	7.5YR 6/6	Firm	Clay Loam	None
4	50cm	70cm	Many	Few	Blocky	7.5YR 7/8	Firm	Sandy Clay Loam	None
5	70cm	86cm	Many	None	Single Grained	7.5YR 8/4	Loose	Loamy Sand	None



Site B:

Slope: 3 degrees

Aspect: 120 degrees

Landscape Position: Large Flat Area

Cover Type: Grass

Land Use: School Grounds

Parent Material: Limestone Bedrock

Horizon	Top	Bottom	Rocks	Roots	Structure	Color	Consistence	Texture	Carbonates
1	0cm	20cm	None	Many	Granular	10YR 3/4	Friable	Loam	None
2	20cm	40cm	None	Many	Blocky	7.5YR 6/8	Friable	Clay Loam	None
3	40cm	75cm	None	Many	Blocky	5YR 6/8	Firm	Clay Loam	None
4	75cm	100cm	None	Few	Prismatic	5YR 6/6	Extremely Firm	Clay	None

The students examined the results of their soil site characterizations and made the following observations:

Site A: Site A is located on top of a hill and is presently forested. The soil was formed from sandstone bedrock. The color of the soil was darkest at the top and got lighter with depth. The structure was granular where there were many roots, and became blocky with depth. The number of rocks increased closer to the bedrock. The soil texture changed with depth, becoming more clay-rich and harder to squeeze, but then becoming more sandy closer to the horizon just above the bedrock. The soil scientist explained that in this type of climate, clay will move down through the soil profile over time and accumulate or build up in the lower horizons. She also said that the sandy and rocky horizon at the bottom was from the sandstone parent material breaking up into soil material. Because the bottom horizon was loamy sand and had single grained structure, its consistence was loose and fell apart easily. Also, there were no carbonates because the parent material was carbonate-free sandstone.

Site B: The soil at site B was very different than at Site A, even though they are both on the school grounds and formed under the same climate. This was probably due to the difference in parent materials at the two sites.

The soil at site B was formed from limestone parent material along a wide flat surface. The original vegetation here was probably forest at one time, as it was for most of the state of Pennsylvania, but the trees had probably been cut away to create an agricultural field since it was such a wide and flat area. Some of the parents remembered that the land where pit B was dug was once a farm, but was converted to a grassy field when the school was built. The pit dug here was deeper than the pit at Site A since, according to the soil scientist, limestone rock is more easily weathered than sandstone which is harder. In fact, there were no rock fragments in the profile from the original bedrock since the limestone rocks were so easily weathered.



The soils at both sites A and B were darkest at the surface, because of the input of organic material from the vegetation at the surface, although as they got deeper, the soil color at Site A got lighter and the soil color at Site B got redder. The texture of the horizons at Site B was much more clay-rich. Again the soil scientist explained that this was common in most soils of this region because small clay-sized particles move down through the soil profile over time. Since there were so many more clay-sized particles in the limestone parent material than in the sandstone, the texture of the soil at Site B was also much more clay-rich. She also stated that it was common for clay-rich soils in this part of the world to have a high amount of iron oxide coating the particles which is what gives them the reddish color. The high clay content made the consistence of the soil very firm and difficult to break, and so there were few roots in this horizon. One of the constituents of limestone is calcium carbonate but there were no carbonates present in this profile. The soil scientist explained that again, because of the temperate climate and materials such as acids in organic matter which leach through the soil, any carbonates that may have been in this soil originally have been removed. If a soil derived from this kind of limestone parent material was formed in a drier climate, carbonates would be expected in the soil profile.

Soil Temperature Protocol



Welcome

Introduction

Protocols

Learning Activities

Appendix

Purpose

To measure near-surface soil temperatures

Overview

Students measure soil temperatures at 5 cm and 10 cm depths using a soil thermometer.

Student Outcomes

Students will be able to perform a soil thermometer calibration, carry out soil temperature measurements accurately and precisely and record and report soil temperature data. Students will be able to relate soil temperature measurements to the physical and chemical properties of soil.

Science Concepts

Earth and Space Sciences

Soils have properties of color, texture, structure, consistence, density, pH, fertility; they support the growth of many types of plants.

The surface of Earth changes.

Water circulates through soil changing the properties of both the soil and the water.

Physical Sciences

Objects have observable properties.

Energy is conserved.

Heat moves from warmer to colder objects.

Scientific Inquiry Abilities

Identify answerable questions.

Design and conduct an investigation.

Use appropriate tools and techniques including mathematics to gather, analyze, and interpret data.

Develop descriptions and explanations, predictions and models using evidence.

Communicate procedures and explanations.

Time

10-15 minutes

Level

All

Frequency

Soil temperature measurements can be taken daily or weekly. Seasonal measurements are taken every three months at 2-3 hour intervals for two consecutive days (*diurnal cycle* measurement).

Materials and Tools

Dial or digital soil thermometer

12 cm nail or spike

500-mL beaker

Hammer

Spacers (for limiting soil thermometer insertion depth)

Calibration thermometer

Wrench for adjusting dial soil thermometer

Watch

GLOBE Science Log(s)

Soil Temperature Data Sheet

Preparation

Make spacers so that soil thermometer is inserted to the proper depths.

Prerequisites

None



Soil Temperature Protocol – Introduction

Soil temperature is an easy measurement to take and the data collected are useful to scientists and students. The temperature of the soil affects climate, plant growth, the timing of budburst or leaf fall, the rate of decomposition of organic wastes and other chemical, physical, and biological processes that take place in the soil.

The temperature of soil is directly linked to the temperature of the atmosphere because soil is an insulator for heat flowing between the solid earth and the atmosphere. For example, on a sunny day, soil will absorb energy from the sun and its temperature will rise. At night, the soil will release the heat to the air having a direct and observable affect on air temperature.

Soil temperatures can be relatively cool in the summer or relatively warm in the winter. Soil temperatures can range from 50° C for near-surface summer desert soils (warmer than the maximum air temperature) to values below freezing in the winter.

Soil temperature has a significant effect on the budding and growth rates of plants. For, example, as soil temperatures increase, chemical reactions speed up and cause seeds to sprout. Farmers use soil temperature data to predict when to plant crops.

Soil temperature also determines the life cycles of small creatures that live in the soil. For example, hibernating animals and insects emerge from the ground according to soil temperature.

Soil temperature also determines whether water in the soil will be in a liquid, gaseous, or frozen state. The amount and state of water in the soil affects the characteristics of each soil horizon in a soil profile. For example, in cold soils there is less decomposition of organic matter because the microorganisms function at a slower rate, resulting in a dark colored soil. Intense heating in tropical climates causes increased

weathering and the production of iron oxides, giving these soils a reddish color. In Northern and Southern latitudes and at high elevations, some soil layers are permanently frozen and are known as *permafrost*. Melting permafrost alters soil structure and horizon thickness, and causes damage to plant roots. At mid-latitudes and mid-elevations, near-surface soil freezes in the winter. Soil moisture evaporates from soil surfaces. The amount of evaporation depends on the vapor pressure of the water in the soil, and this depends on temperature. Once the moisture evaporates, it adds to the humidity of the air, affecting the climate.

Understanding how soils heat and cool helps to predict the length of growing seasons for plants, the types of plants and animals that can live in the soil, and the input of humidity into the atmosphere. The amount of moisture in the soil affects the rate at which the soil heats and cools. Wet soils heat slower than dry soils because the water in the pore spaces between the soil particles absorbs more heat than air.

Soil temperature data can be used to make predictions about how the ecosystem will be affected by warming or cooling global temperatures. Scientists use soil temperature data in their research on topics varying from pest control to climate change. By collecting soil temperature data, GLOBE students make a significant contribution to the understanding of our environment.



Teacher Support

Preparation

Before students collect data and once every three months thereafter, have students calibrate the soil thermometer following the *Calibrating the Soil Thermometer Lab Guide*. This will ensure that the students' measurements are accurate.

To ensure that students take soil temperature measurements at the correct depths, have them use spacers when they insert the thermometer into the ground. These spacers are easily made according to the following procedures. See Figure SO-TE-1.

5 cm Measurement

1. Measure 7 cm up from the tip of the soil thermometer and mark this spot. (Note that the location of the temperature sensor is typically 2 cm above the tip of the thermometer.)
2. Measure the distance from the base of the soil thermometer dial to the 7 cm mark.
3. Make a spacer by cutting a piece of plastic tubing or wood to this length. (If using wood, drill a hole through the center of the block).
4. Insert the soil thermometer through the spacer. 7 cm of the thermometer should be sticking out of the bottom of the spacer.
5. Label this spacer *5 cm Measurement*.

10 cm Measurement

1. Measure 12 cm up from the tip of the soil thermometer and mark this spot.
2. Measure the distance from the base of the soil thermometer dial to the 12 cm mark.
3. Make a spacer by cutting a piece of plastic tubing or wood to this length. (If using wood, drill a hole through the center of the block).
4. Insert the soil thermometer through the spacer. 12 cm of the thermometer should be sticking out of the bottom of the spacer.
5. Label this spacer *10 cm Measurement*.

Alternatively, students can mark their thermometers so they will be inserted to the proper depth in the soil. Thermometers can be marked with a permanent marker. The thermometer should be marked 7 cm from the tip to get a 5 cm measurement and 12 cm from the tip to get a 10 cm measurement.

Site Selection

Soil temperature data are collected in the vicinity of the Atmosphere Study Site or the Soil Moisture Study Site.

Managing Materials

The soil temperature measurement requires inexpensive equipment. Consider buying three soil thermometers. Since the data are collected in triplicate, having three thermometers reduces the

Figure SO-TE-1: Making Spacers for Your Soil Thermometer

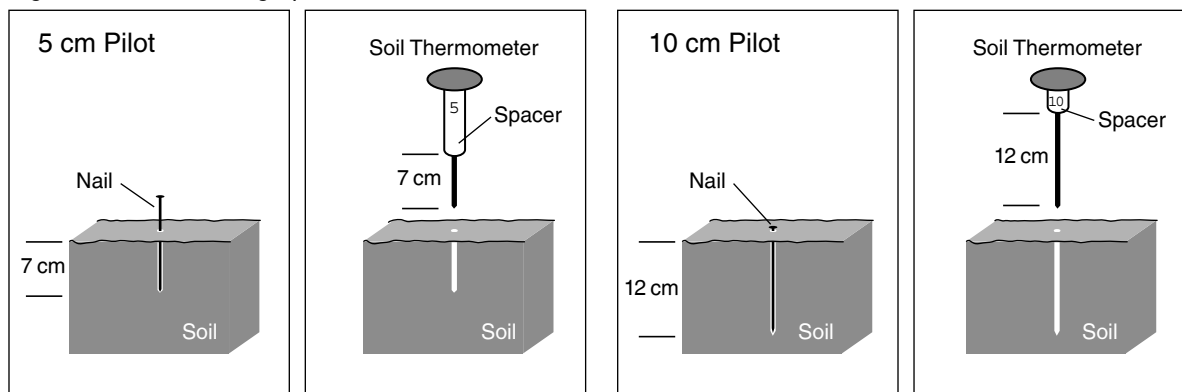



data collection time. This may allow collection of data daily – data collected more often are more useful for research and in the classroom.

Soil thermometers will break if students try to force them into the ground. It is advisable to have the students make pilot holes first with something sturdy like a large nail unless the soil is soft (i.e., loose or friable). Mark the nail for the pilot hole with a permanent marker or by scribing with a hacksaw at 5 cm, 7 cm, 10 cm, and 12 cm.

The soil thermometers should not be left permanently in the ground. The soil thermometers are not sealed to protect them against moisture, so it is not a good idea to leave them outside when not in use. (See the *Optional Automated Soil and Air Temperature Monitoring Protocol* or *Digital Multi-Day Max/Min/Current Air and Soil Temperature Protocol* for probes that can be left in the ground.)

Managing Students

Two or three students collect soil temperature data.

Frequency of Measurement

Soil temperature data are collected daily or weekly. Every three months, on two consecutive days, students should take measurements at least 5 times each day at intervals of approximately two to three hours following the *Soil Temperature Protocol – Diurnal Cycle Measurement Field Guide*. While a full daily cycle is typically 24 hours – the intention here is to capture the daytime part of this cycle.

Measurement Procedures

After selecting an appropriate site, a pilot hole is made to a depth of 5 cm and the temperature probe is inserted and read after 2-3 minutes. The pilot hole is then deepened to 10 cm and the temperature probe is again inserted and read after the temperature reading stabilizes. This process is repeated twice more within 25 cm of the original measurement and should take a total of about 20 minutes. Students measure the soil temperature three times at depths of 5 cm and 10 cm.

The three measurements taken at the same depth within 25 cm should be similar. If one data point

is anomalous (very different from the others), scientists using the data may question whether it is valid. Students should note in the metadata any reasons they suspect there may be an *anomaly*.

Soil temperature measurements can be used to begin quantitative GLOBE measurements on the school grounds before an atmosphere shelter is established. Equipment is taken outside for the measurements and then brought back to the classroom avoiding security issues.

Supporting Activities

Encourage students to examine the relationship between soil temperature and soil characteristics.

Have students compare soil temperatures to air and water temperatures.

Have students examine seasonal soil temperature fluctuations.

Have students describe or draw a graph of how they would expect soil temperatures to change at different depths. Students should explain why they have drawn the graphs as they have. They then compare their graphs to actual data from the GLOBE Web site visualizations. Have students discuss other variables that might be affecting the soil temperature pattern.

Have students do the *Surface Temperature Protocol* in the *Atmosphere Investigation*. In this protocol, students measure surface temperatures. These measurements can be related to soil temperatures.

Questions For Further Investigation

Is soil temperature or air temperature warmer at local solar noon?

How warm must soil get in your area before seeds sprout?

To what depth does your soil freeze?

How are other GLOBE measurements related to soil temperature?

Are the time of maximum air temperature and the time of maximum soil temperature at a 10 cm depth constant throughout the year?



Calibrating the Soil Thermometer

Lab Guide

Task

Calibrate the soil thermometer.

What You Need

- Soil thermometer
- Calibration thermometer (determined to be accurate to $\pm 0.5^\circ\text{C}$ using the ice bath method described in the *Atmosphere Investigation*)
- 500-mL beaker
- Water
- Wrench that fits nut on soil thermometer
- Science Log

In the Lab

1. Pour about 250 mL of water at room temperature into a beaker.
2. Place both the calibration thermometer and the soil thermometer into the water.
3. Check that the water covers at least the lower 4 cm of both thermometers. Add more water if needed.
4. Wait 2 minutes.
5. Read the temperatures from both thermometers.
6. If the temperature difference between the thermometers is less than 2°C , stop; your soil thermometer is calibrated.
7. If the temperature difference is greater than 2°C , wait two more minutes.
8. If the temperature difference is still greater than 2°C , adjust the soil thermometer by turning the calibration nut at the base of the dial with the wrench until the soil thermometer reading matches the calibration thermometer.

Soil Temperature Protocol

Field Guide

Task

Measure soil and air temperature.

What You Need

- Soil Temperature Data Sheet
- Soil Thermometer
- Thermometer spacers
- 12 cm or longer nail marked at 5 cm, 7 cm, 10 cm and 12 cm from its point (if soil is firm or extra firm)
- Watch
- Science Log
- Pen or pencil
- Hammer (if soil is extra firm)

In the Field

1. Fill in the top portion of the *Soil Temperature Data Sheet*.
2. Locate your sampling point (If soil is soft, skip step 3).
3. Use the nail to make a 5 cm deep pilot hole for the thermometer. If the soil is extra firm and you have to use a hammer, make the hole 7 cm deep. Pull the nail out carefully, disturbing the soil as little as possible. Twisting as you pull may help. If the soil cracks or bulges up, move 25 cm and try again.
4. Insert the thermometer through the longer spacer so that 7 cm of the probe extends below the bottom of the guide. The dial should be against the top of the spacer.
5. Gently push the thermometer into the soil.
6. Wait 2 minutes. Record the temperature and time in your Science Log.
7. Wait 1 minute. Record the temperature and time in your Science Log.
8. If the 2 readings are within 1.0° C of each other, record this value and the time on the *Soil Temperature Data Sheet* as Sample 1, 5 cm reading. If the 2 temperatures are not within 1.0° C, continue taking temperature readings at 1-minute intervals until 2 consecutive readings are within 1.0° C.
9. Remove the thermometer from the hole. (If the soil is soft, skip step 10.)

10. Use the nail to deepen the hole to 10 cm. If you have to use a hammer, deepen the hole to 12 cm.
11. Replace the long spacer with the shorter one so that 12 cm of the thermometer extends below the bottom of the spacer. Insert the thermometer in the same hole. Gently push down until the thermometer tip is 12 cm below the surface.
12. Wait 2 minutes. Record the temperature and time in your Science Log.
13. Wait 1 minute. Record the temperature and time in your Science Log.
14. If the 2 readings are within 1.0° C of each other, record this value and time on the *Soil Temperature Data Sheet* as Sample 1, 10 cm reading. If the 2 temperatures are not within 1.0° C, continue taking temperature readings at 1-minute intervals until 2 consecutive readings are within 1.0° C.
15. Repeat steps 2 – 14 for 2 other holes 25 cm away from the first hole. Record these data on the *Soil Temperature Data Sheet* as Sample 2, 5 and 10 cm and Sample 3, 5 and 10 cm.
Note: These three sets of measurements must all be made within 20 minutes.
16. If possible, read and record the current air temperature from the thermometer in the instrument shelter or by following the *Current Temperature Protocol* in the *Atmosphere Investigation*.
17. Wipe clean all the equipment.

Soil Temperature Protocol - Diurnal Cycle Measurement

Field Guide

Task

Measure soil and air temperature at least five times a day for two days.

What You Need

- Soil Temperature Data Sheet – Diurnal Cycle
- Hammer (if soil is extra firm)
- Soil thermometer
- Watch
- Soil Thermometer spacers
- Pen or pencil
- 12 cm or longer nail marked at 5 cm, 7 cm, 10 cm and 12 cm from its point (if soil is not soft)
- Science Log (notebook)
- Thermometer (for current air temperature)

In the Field

1. Fill in the top portion of the *Soil Temperature Data Sheet* and choose your first sampling point. Proceed to step 3 if soil is firm, or go to step 4. (Remember that you will be repeating steps 2-15 at least four more times.)
2. Locate your next sampling point 10 cm from your previous measurements. See Figure SO-TE-2. (If soil is soft, skip to step 4).
3. Use the nail to make a pilot hole 5 cm deep for the thermometer. If the ground is extra firm and you have to use a hammer, make the hole 7 cm deep. Pull the nail out carefully, disturbing the soil as little as possible. Twisting as you pull may help. If the soil cracks or bulges up, offset 10 cm and try again.
4. Insert the thermometer through the longer spacer so that 7 cm of the thermometer extends below the bottom of the guide. The dial should be against the top of the spacer.
5. Gently push the thermometer into the soil.
6. Wait 2 minutes. Record the temperature and time in your Science Log.
7. Wait 1 minute. Record the temperature and time in your Science Log.
8. If the 2 readings are within 1.0° C of each other, record this value and the time on the *Soil Temperature Data Sheet* for the current sample, 5 cm reading. If the 2 temperatures are not within 1.0° C, continue taking temperature readings at 1-minute intervals until 2 consecutive readings are within 1.0° C.

9. Remove the thermometer from the hole (If the soil is soft, skip step 10).
10. Use the nail to deepen the hole to 10 cm. If you have to use a hammer, deepen the hole to 12 cm.
11. Replace the long spacer with the short one so that 12 cm of the thermometer extends below the bottom of the spacer. Insert the thermometer in the same hole. Gently push down until the thermometer tip is 12 cm below the surface.
12. Wait 2 minutes. Record the temperature and time in your Science Log.
13. Wait 1 minute. Record the temperature and time in your Science Log.
14. If the 2 readings are within 1.0°C of each other, record this value and time on the *Soil Temperature Data Sheet* for the current sample, 10 cm reading. If the 2 temperatures are not within 1.0°C , continue taking temperature readings at 1-minute intervals until 2 consecutive readings are within 1.0°C .
15. Read and record the current air temperature from the thermometer in the instrument shelter by following the *Current Temperature Protocol* in the *Atmosphere Investigation*. The *Soil Temperature Data Sheet* allows students to plot their diurnal soil temperature data.
16. Repeat steps 2-15 every 2 to 3 hours for at least 5 measurement times. See Figure SO-TE-2. Note that the times in figure are suggestions only. Choose times that work with your schedule.
17. The next day, repeat steps 2-16. Note that you will need a new *Soil Temperature Data Sheet* for the second day.

Figure SO-TE-2: Soil Temperature: Layout of Diurnal Observation

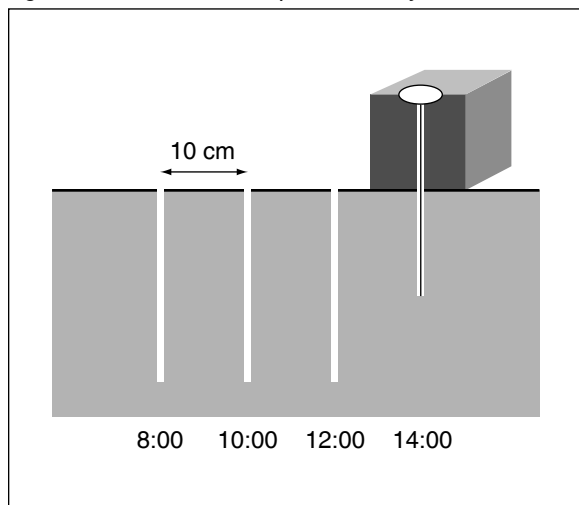



Soil Temperature Protocol – Looking at the Data

Are the Data Reasonable?

Graphing soil temperature data is a useful way to determine temperature trends and variations. For example, the graphs for one year of soil temperatures at 5 cm and 10 cm depths at three locations covering a wide range of latitudes show some interesting trends. See Valdres, Norway (61.13° N, 8.59° E: Figure SO-TE-3), Cleveland, OH, USA (61.13 N, -81.56° W: Figure SO-TE-4), and Kanchanaburi, Thailand (14.49° N, 99.47° E: Figure SO-TE-5). These graphs indicate that soil temperatures at 5 cm and 10 cm depths follow similar patterns in variation over time.

Soil temperature data generally show daily and seasonal trends that are similar to air temperature. The next set of graphs shows soil temperature at 5 cm and mean air temperature for the same schools as the previous graphs. See Figures SO-TE-6, SO-TE-7, SO-TE-8. Note that the axis for air temperature is on the left and the axis for soil temperature is on the right.

The following questions can be asked to determine whether the data in the graphs are reasonable:

- At which depth is the soil temperature generally warmer? Is this true for all three locations? Is this true throughout the entire year?
- What is the relationship between soil temperature and air temperature? Is it the same for all three locations? Is it the same throughout the course of the year?
- Which temperature, air or soil, has a greater annual temperature range in the graphs shown?

Students can determine whether their data are reasonable by comparing with data from other schools and asking similar questions.

By looking at graphs of their soil and air measurements, students will get a better understanding of the temperature trends at their site. Graphing their soil temperature data is also useful to identify data points that do not make sense. These data points are referred to

as *anomalies*. They can be the result of a natural phenomenon or a problem with the data collection procedure. Graphs also allow students to see annual or daily trends in the soil temperatures.

Questions students should ask when analyzing graphs of their soil temperature data include the following:

- What is the mean temperature?
- What is the range of the data (difference between maximum and minimum)?
- How variable are the data on different time scales (daily, weekly and monthly)?
- If a regular pattern is interrupted, is there a reason for this break in other data sets or in the metadata?
- Do the data represent a spatial or temporal average (Note that some scientists use equipment or data processing that automatically averages quantities such as temperature over longer time periods. In general, GLOBE data represent instantaneous measurements of a particular parameter)?

Following are some trends that students should notice in their soil temperature data:

- A correlation or similarity between the 5 and 10 cm soil temperature data.
- Soil temperature trends should appear similar to air temperature trends.

What Do Scientists Look for in the Data?

Scientists compare changes in soil temperature with soil characteristics to determine how different soils heat and cool. Since heat generally increases the speed of physical, chemical, and biological reactions, scientists use soil temperatures to predict the rate at which processes such as seed germination will occur.

Scientists are particularly interested in long-term soil temperature data. Comparing soil, air, and water temperatures over many years helps them to understand changes in global climate and the many processes related to it, such as soil and permafrost formation. Long-term data are needed to determine the persistence or trend of any observed changes.



Figure SO-TE-3

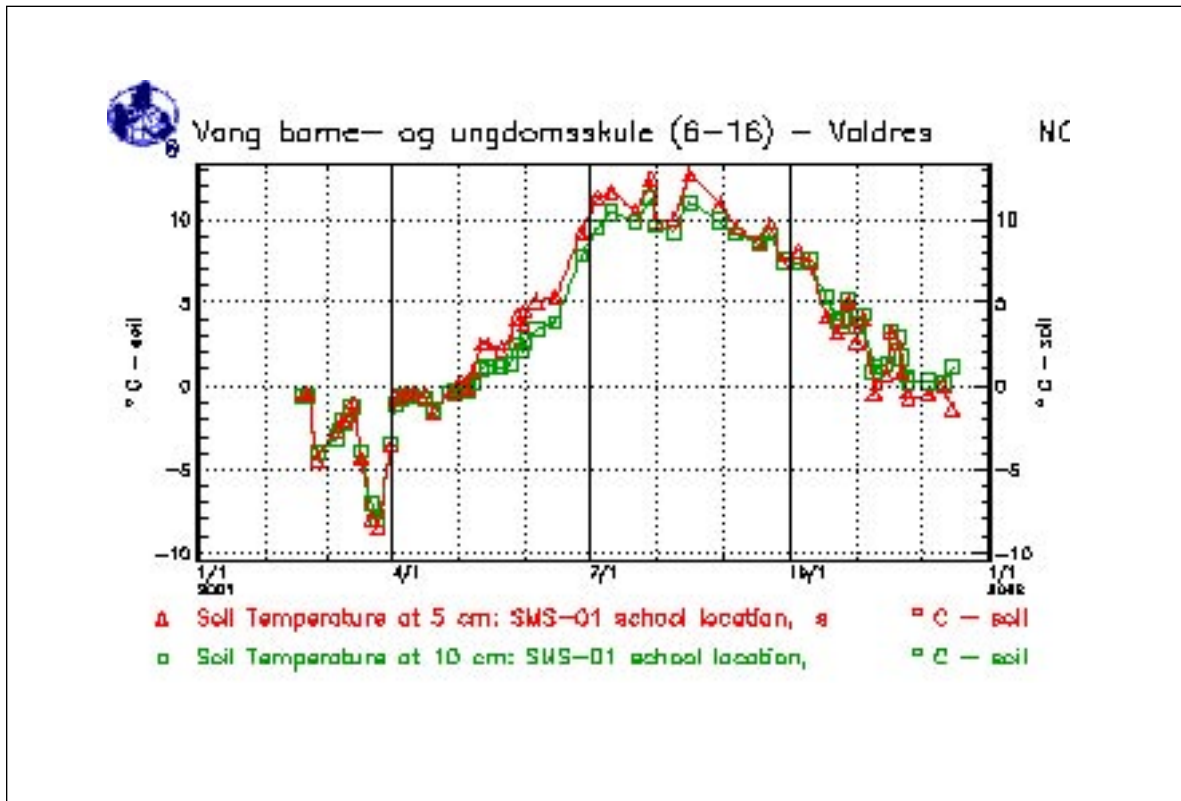

Figure SO-TE-4

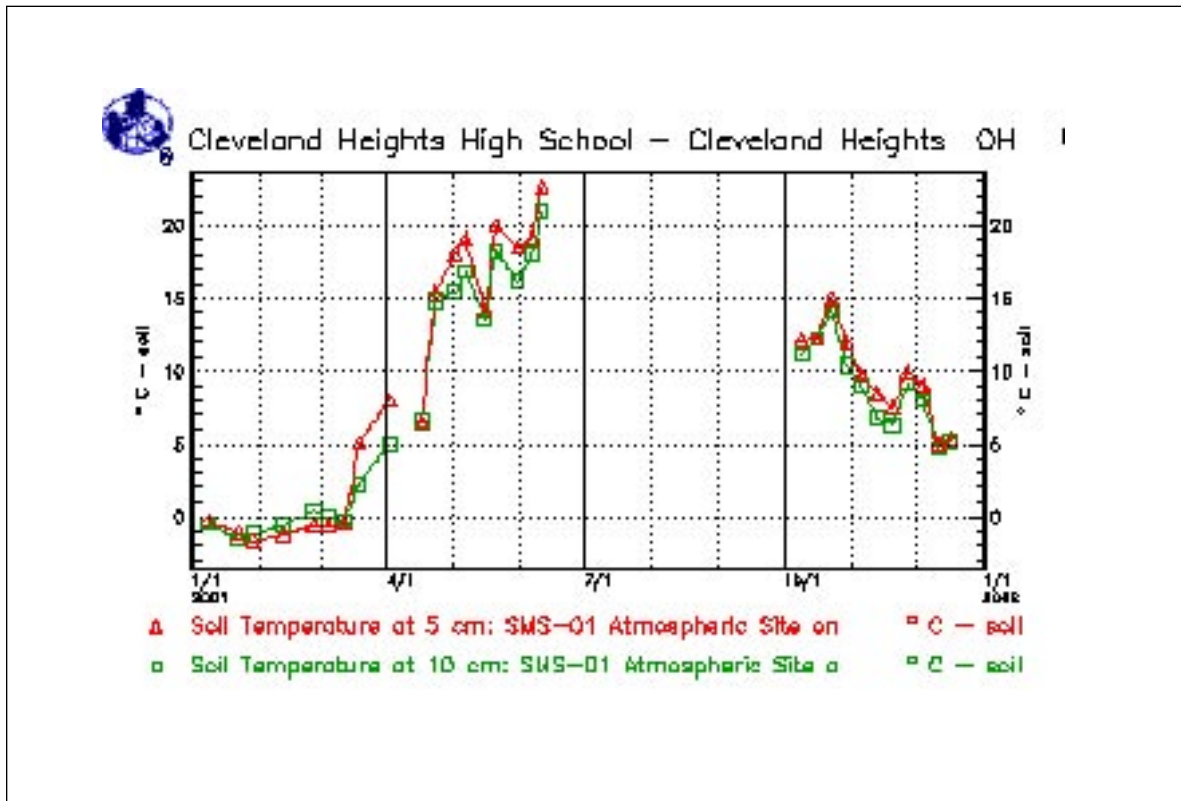

Figure SO-TE-5

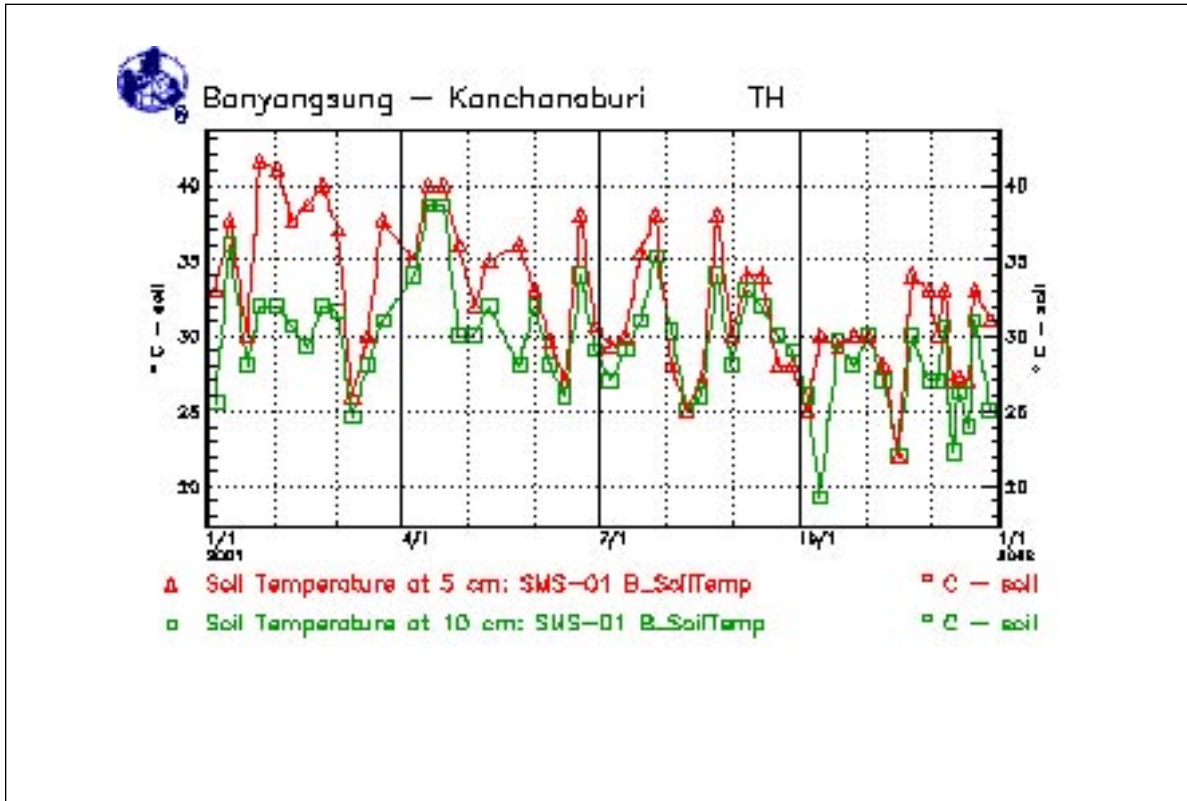

Figure SO-TE-6

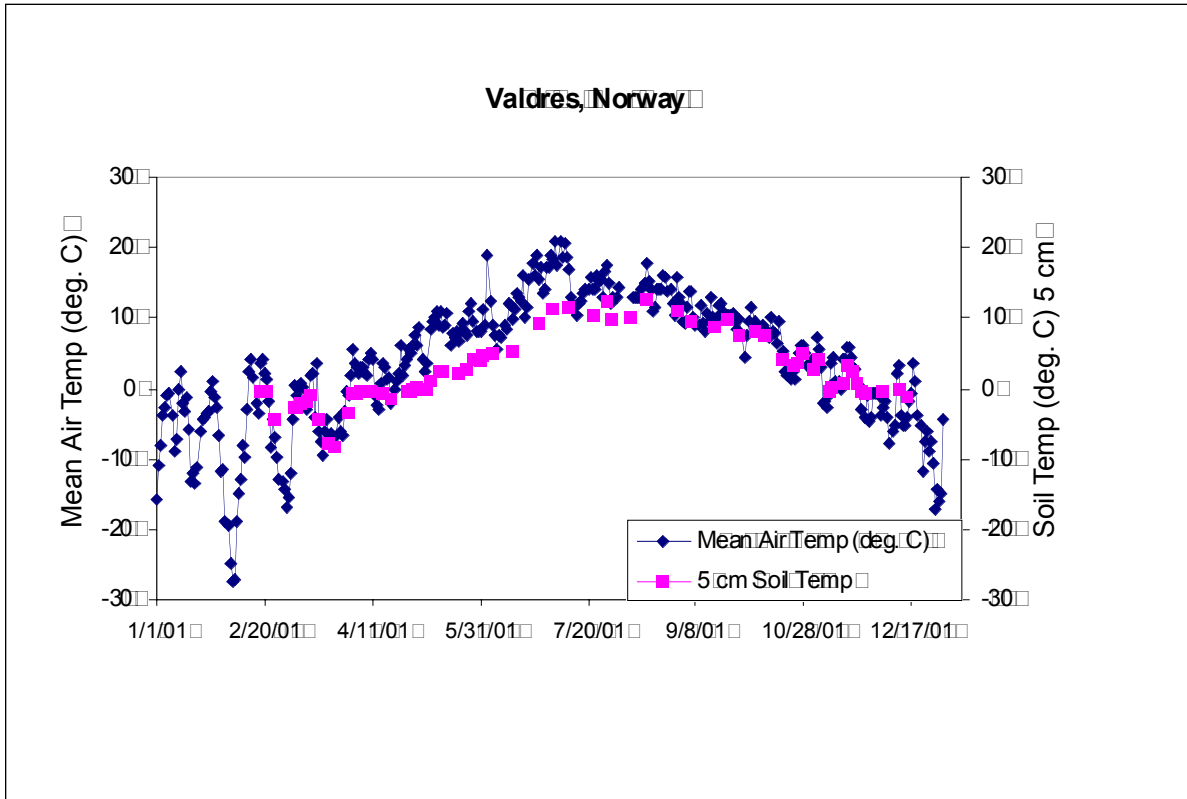

Figure SO-TE-7

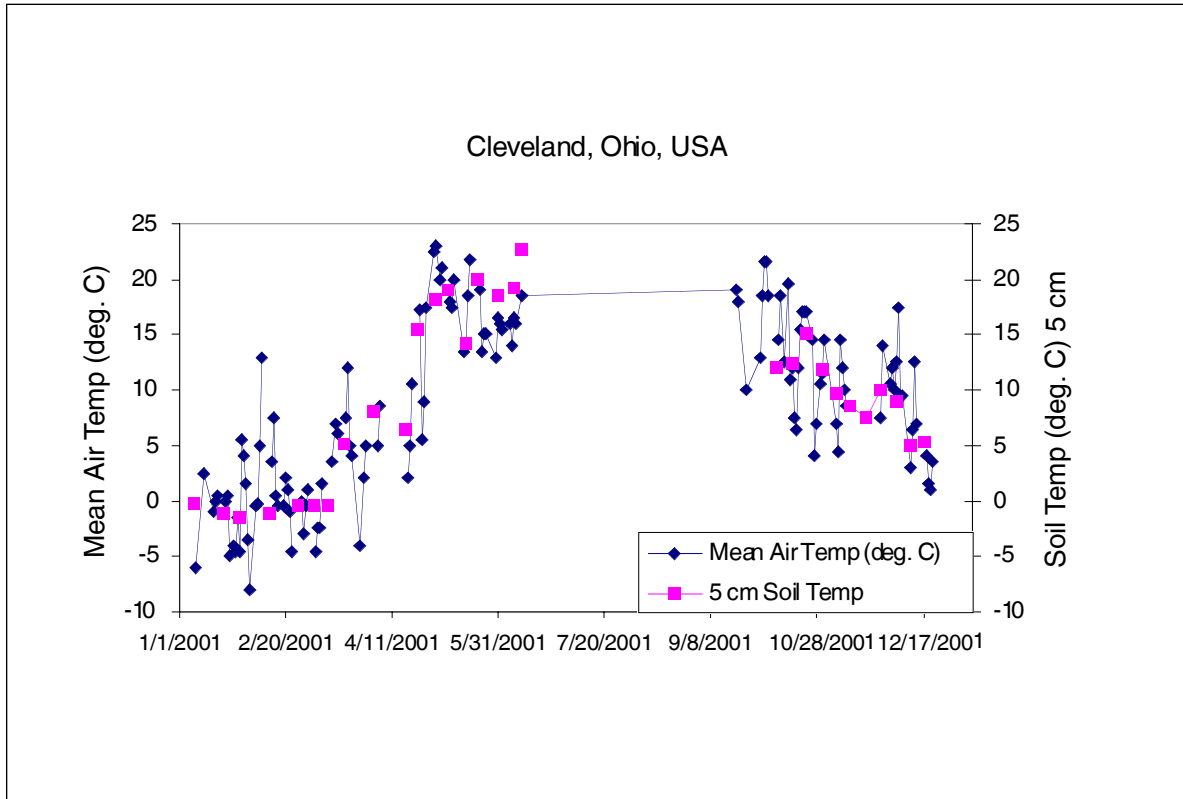
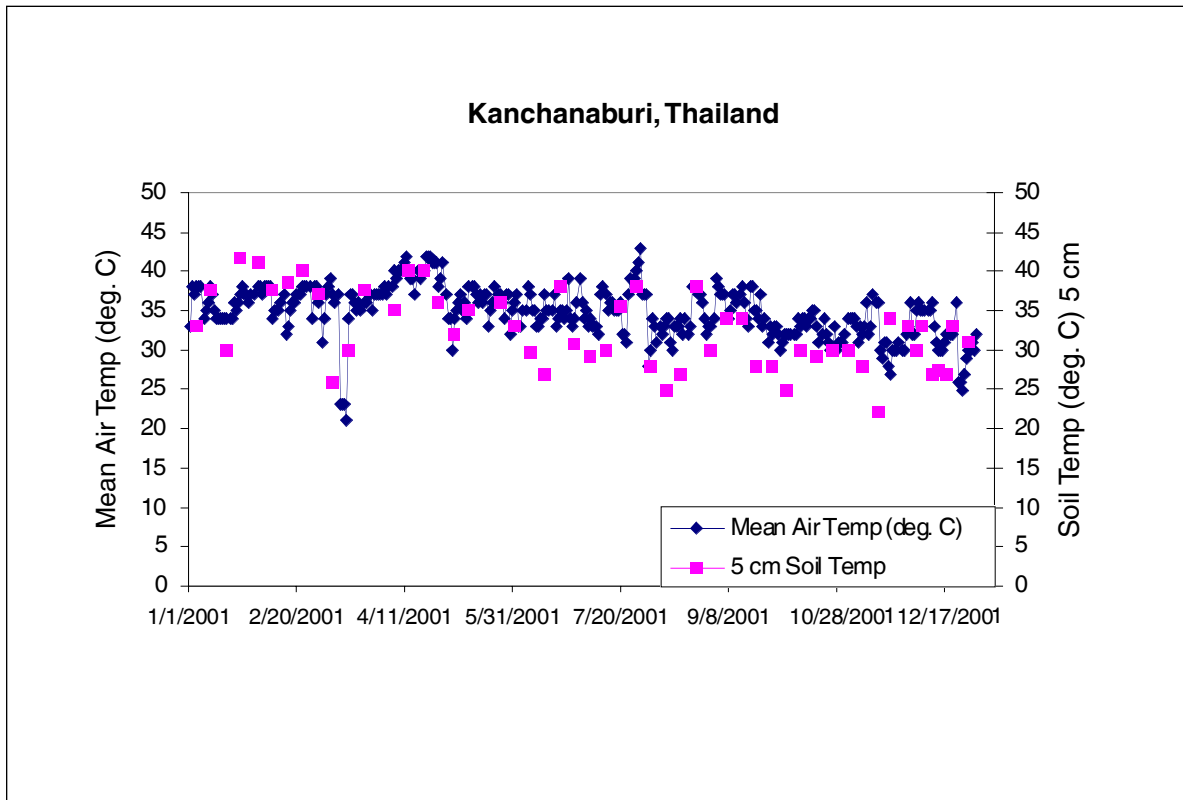

Figure SO-TE-8





Scientists also use ground observations together with models at different scales and with other data sets, such as satellite thermal infrared images to validate or extrapolate their understanding from one area to another.

An Example of a Student Research Project

Forming a Hypothesis

While looking at soil temperature data from a number of GLOBE schools, a group of students observed that at some schools the soil temperature at 5 cm was higher than the soil temperature at 10 cm but at other schools this pattern was reversed. The students wondered if this was random or if it was related to the time of year and air temperature. They looked at graphs of data from other GLOBE schools and decided to form a hypothesis based on their knowledge. Their hypothesis was: *Soil temperature at 5 cm depths will be greater (warmer) than soil temperature at 10 cm depths in the summer and less (colder) than soil temperature at 10 cm depths in the winter.*

Collecting Data

Because the students were located in a mid-latitude climate, they wanted to test their hypothesis with a school at a latitude similar to their own. The students chose Norfolk Elementary School, Norfolk, AR (36.20° N, 92.27° W), a mid-latitude school whose students had collected two years of soil temperature data (Figure SO-TE-9) and two years of air temperature data. The students plotted the soil temperature at 5 cm and 10 cm on the same graph to compare differences in these depths over the two years.

Analyzing Data

In looking at this graph, the students concluded that the data points were too close together to determine if their hypothesis was true or not. They decided to do some further data analysis. They began by subtracting the temperature at 10 cm from the temperature at 5 cm to calculate the temperature difference between the two depths. When the differences were negative, the deeper soil was warmer than the soil closer to the surface and when they got positive differences, the reverse was true. Then, they plotted the temperature

differences over time to determine whether their hypothesis was correct.

Conclusions

From Figure SO-TE-10, the students could see that the negative values, representing times when the 10 cm soil was warmer than the 5 cm soil, occurred primarily in the fall (September, October and November) and winter (December, January, and February) months. However, there were many instances during the winter when the differences were positive, that is, the temperature at 5 cm was warmer than the temperature at 10 cm. Therefore, the students concluded that the data refuted their original hypothesis that soil temperatures at 10 cm would be warmer in the winter, as this was not always true.

Although the students found that their hypothesis was not true all of the time, the graph they made did confirm their idea that the 10 cm soil temperatures would be warmer than the 5 cm soil temperatures but only during the cooler months. To get a better view of this, the students generated a plot that showed the difference between 5 cm and 10 cm soil temperatures and mean air temperature. See Figure SO-TE-11. Note that the axis for soil temperature difference is on the left and the axis for air temperature is on the right. From this graph the students were able to conclude that at this site, air temperature must be low ($< 5^{\circ}\text{C}$) for the soil temperature at 10 cm to be greater than the soil temperature at 5 cm. This conclusion made sense to the students. They reasoned that when the air temperature is warm, it warms the soil closer to the surface first, but when the air is cool, it will cool the soil closest to the surface first, leaving the more insulated deeper soil warmer.



Further Research

The students working on this project wondered if the relationship they observed would be the same in other parts of the world. They performed the same analysis on the soil and air temperature from two other schools, one in Norway, (Figure SO-TE-12) a much cooler climate, and one in Thailand, (Figure SO-TE-13) a much warmer climate.

The students saw from these graphs that the relationship between soil and air temperature that they observed in the data from Arkansas was similar to Norway's but not Thailand's. This led them to conclude that the climate and/or soil type of a region must affect this relationship. In particular, they speculated that many other warm and wet regions might not fit this pattern. The students were excited to collect enough data at their own school to study changes in 5 cm and 10 cm soil and air temperatures throughout the year.

Figure SO-TE-9

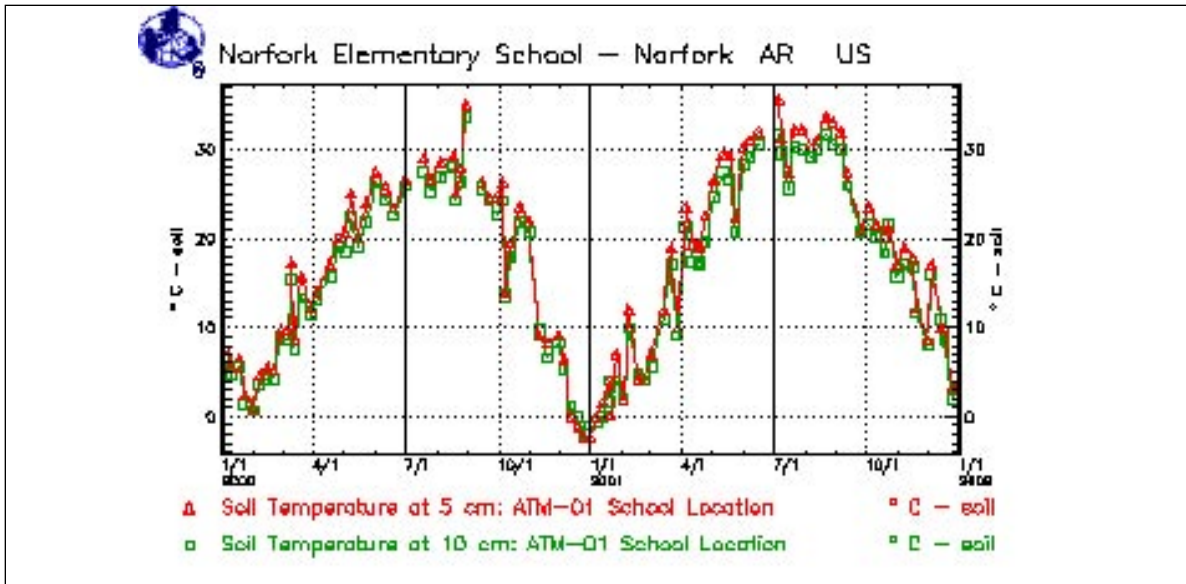

Figure SO-TE-10

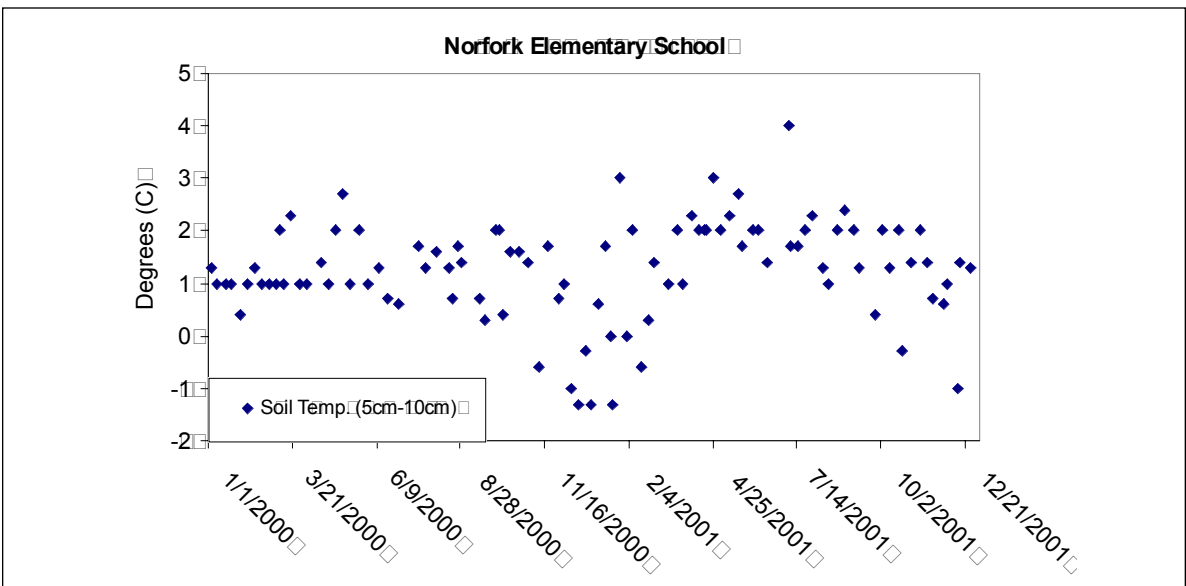

Figure SO-TE-11

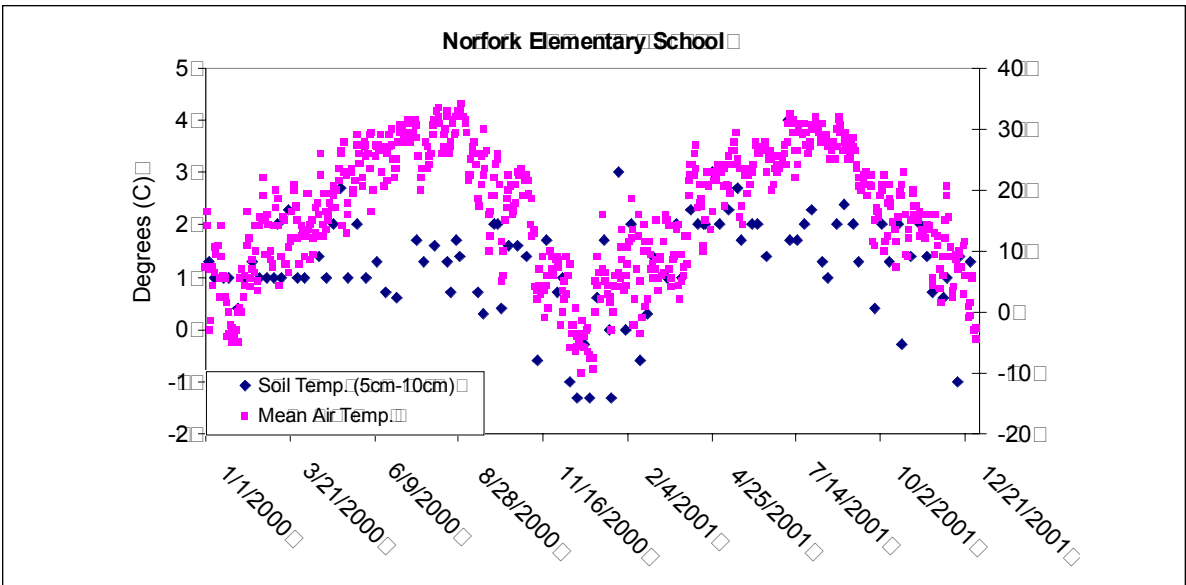

Figure SO-TE-12

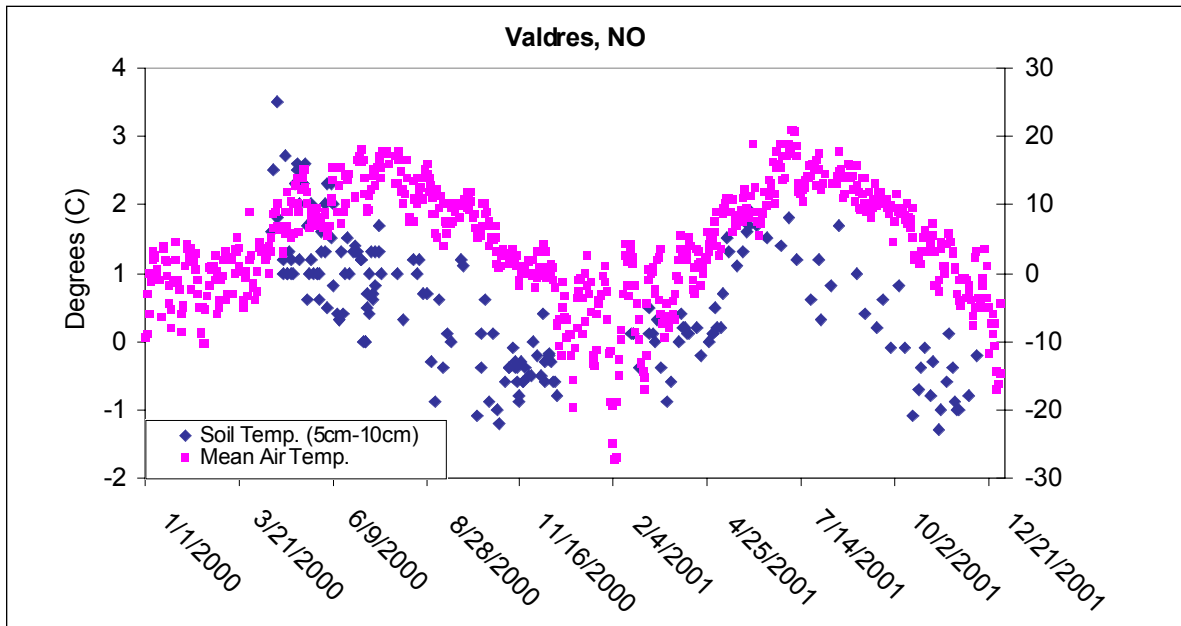
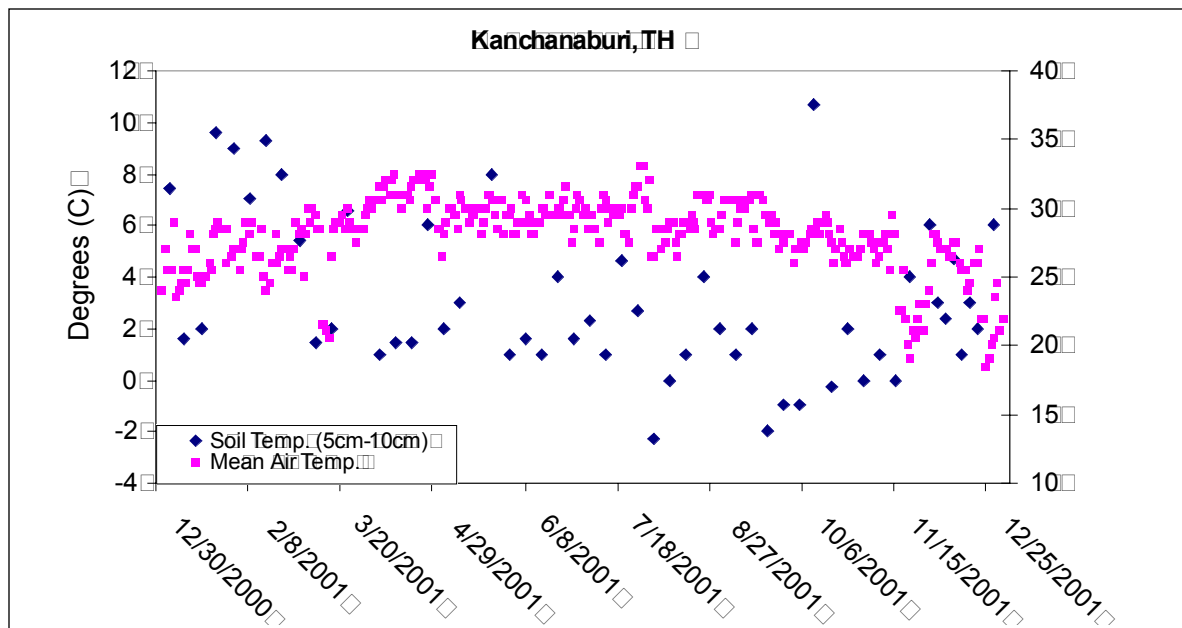

Figure SO-TE-13



Gravimetric Soil Moisture Protocols



Purpose

To measure soil water content by mass

Overview

Students collect soil samples with a trowel or auger and weigh them, dry them, and then weigh them again. The soil water content is determined by calculating the difference between the wet sample mass and the dry sample mass.

Student Outcomes

Students will be able to collect soil samples from the field and then measure their soil moisture and record and report soil moisture data.

Students will be able to relate soil moisture measurements to the physical and chemical properties of the soil.

Science Concepts

Earth and Space Sciences

Earth materials are solid rocks, soil, water, biota, and the gases of the atmosphere.

Soils have properties of color, texture, structure, consistence density, pH, fertility; they support the growth of many types of plants.

The surface of Earth changes.

Soils consist of minerals (less than 2 mm), organic material, air and water.

Water circulates through soil changing the properties of both the soil and the water.

Physical Sciences

Objects have observable properties.

Scientific Inquiry Abilities

Identify answerable questions.

Design and conduct an investigation.

Use appropriate tools and techniques including mathematics to gather, analyze, and interpret data.

Develop descriptions and explanations, predictions and models using evidence.

Communicate procedures and explanations.

Time

20-45 minutes to collect samples

5-15 minutes to weigh wet samples

5-15 minutes to weigh dry samples

Samples dry in a drying oven overnight.

Alternatively, samples can be dried in a microwave. They need to be weighed repeatedly during the drying process. This method requires more student time.

Level

All

Frequency

To support the GLOBE soil moisture campaign, the following time periods are encouraged for as many sites as possible:

First 2 weeks of October, in conjunction with World Space and Earth Science Week

Fourth week in April in conjunction with Earth Day

Alternatively, twelve or more times per year for the same site at daily, weekly or monthly intervals

Materials and Tools

Soil drying oven or microwave

Thermometer (capable of measuring to 110° C) if using a drying oven

Microwave-safe container if using a microwave oven for soil drying

Balance or scale with 0.1 g sensitivity (600 g capacity recommended, 400 g minimum capacity required)

Hot pad or oven mitt

Meter stick



Ruler marked in millimeters
Permanent markers to label soil containers

Compass
GLOBE Science Log (notebook)
Soil Moisture Site Definition Sheet

Star Pattern:

Soil Moisture Data Sheet - Star Pattern
Trowel

6 soil collection containers (sealable soil sample cans, jars or plastic bags)

Transect Pattern

Soil Moisture Data Sheet - Transect Pattern
Trowel

50 meter tape or 50 meter rope marked every 5 meters

13 soil collection containers (sealable soil sample cans, jars or plastic bags)

Depth Profile

Soil Moisture Data Sheet - Depth Profile
Auger

5 soil collection containers (sealable soil sample cans, jars or plastic bags)

Preparation

Decide upon the sampling frequency and method.

Weigh each soil sample container without its lid and record its mass and container number on the container.

Choose and define a soil moisture site.

Prerequisites

None



Gravimetric Soil Moisture Protocol Introduction

Soil acts like a sponge spread across the land surface. It absorbs rain and snowmelt, slows runoff and helps to control flooding. The absorbed water is held on soil particle surfaces and in pore spaces between particles. This water is available for use by plants during times of little precipitation. Some of this water evaporates back into the air; some drains through the soil into groundwater. Absorbent soils, like those found in wetlands, soak up floodwaters and release them slowly, preventing damaging runoff. Soils that are *saturated* with water have no available space to hold additional water causing new rainfall to flow across the surface to low lying areas. Measuring the amount of water stored in the soil determines the ability of soil to moderate the hydrologic cycle. This valuable environmental indicator also helps to estimate the soil-water balance – the pattern of how much water is stored in a soil over a year.

In order for most plants to grow, they need a place to take root, water, and nutrients. Generally, the nutrients come from dissolved soil minerals and organic matter and are carried to plants by soil water. Sometimes water flowing downward through the soil removes chemicals and nutrients from upper soil layers and deposits them deeper in the ground. The process by which materials are removed from the soil by water is known as *leaching*. Leached materials may be held in lower layers of the soil or may stay in the water and flow into rivers, lakes, and groundwater.

Water is an important element in the weathering processes that break rock apart to form soil. For example, in cold climates, water in cracks will freeze and expand, causing rocks to break apart. When water thaws and flows away, it moves broken rock parts with it. This *freeze-thaw* action is a primary soil builder. In tropical climates, water breaks rock apart and helps to form soil particles and minerals by dissolving the rock.

Water also supports the decay of dead plants and animals into soil organic matter but only when oxygen from the air is present. In some places, the soil is so waterlogged that oxygen is excluded and plant and animal remains are preserved for centuries because of their slow rate of decomposition.

Some of the water stored in the soil evaporates back into the atmosphere. This evaporation cools the soil and increases the relative humidity of the air, sometimes affecting local weather and climate. The amount of water in the soil also affects soil temperature. Because liquid water has a higher *heat capacity* than either air or soil, more heat is required to increase the temperature of moist soil. Similarly, more “cold” is required to decrease the temperature of moist soil. The net effect is that water in soil decreases the rate of soil warming and cooling.



Teacher Support

Preparation

Before beginning the *Soil Moisture Protocol*, have students fill out the *Soil Moisture Site Definition Sheet*. Have students weigh their soil sample containers in advance and write the mass on each container with a permanent marker. Mark each container with an identifying number.

Frequency of Measurement

The GLOBE soil moisture campaign, takes place twice a year during the first 2 weeks of October, in conjunction with World Space and Earth Science Weeks and the fourth week of April, in conjunction with Earth Day. This is also a good opportunity to collect land cover data at any soil moisture site that is homogenous over a 90 m by 90 m area.

Alternatively, soil moisture data are collected at a single site close enough to a school so that soil moisture data can be collected for at least 12 regularly spaced intervals. Students may want to coordinate their soil moisture sampling times with the collection of other GLOBE measurements that may affect soil moisture, such as precipitation. If students identify the annual pattern of precipitation at their school, then they may want to collect soil moisture samples when the soil changes from wet to dry conditions. For example, if the school receives rain in early March then less rain in May, students could do a 12-week study from March through May. If the rainy season is spread out, students might do a study taking samples every 2 weeks for 24 weeks, or even a monthly sample throughout the year.

The number of sampling times can always be increased, but students should try to sample the wet, intermediate and dry times surrounding major wet periods. Sampling once or twice a week all year will definitely provide students with valuable insights into patterns of soil moisture.

Measurement Procedures

It is important for students to place soil samples in well-sealed containers and to weigh the samples

(without their lids), as soon as possible after collecting them. If samples dry out even a little before being weighed, the soil moisture data will be wrong.

Samples are dried until all water is removed and then weighed for a second time. The difference in the mass before and after drying equals the mass of water that was present in the soil. Scientists call this the *gravimetric* technique, which means a measurement by weighing.

The ratio of the mass of water to the mass of dry soil is the *soil water content*. The mass of water is divided by the dry soil mass to get a normalized value for soil water content. This normalized value can be compared with other measurements on other days even though the size of the soil samples may vary from one day to the next. It also permits valid comparisons among different sites.

The *Soil Moisture Protocol* offers three choices for sampling: *the Star Pattern*, *the Transect*, and *the Depth Profile*. The purpose of the sampling patterns is to systematically avoid digging in the same place twice. Choose the sampling pattern that best complements the other GLOBE measurements students are taking, as well as educational objectives and students' research interests. A fourth sampling protocol is available on-line for the semi-annual soil moisture campaign, although it is very similar to the Star Pattern protocol described below.

1. *The Star Pattern* involves collecting soil samples from 12 different locations at twelve different time periods in a 2 m x 2 m star-shaped area. For each of the 12 locations, three spots are chosen within 25 cm of each other. Samples from the top 5 cm and from 10 cm deep are collected at each of the three spots, for a total of 6 samples at each location on the star. This sampling method can be easily coordinated with the *Soil Temperature Protocol*, whereby students collect their soil temperature measurements at the same depths and locations as the soil moisture measurements.



2. *The Transect Pattern* requires an open space of at least 50 m length. Thirteen samples are collected from the top 5 cm of soil. This pattern allows students to see spatial variations in surface soil moisture measurements. It is also useful for comparison with soil moisture data collected remotely from satellites or aircraft. These remote measurement techniques sense moisture contained in the top 5 cm of soil and their measurements are averaged over areas of 100's of square meters or more.
3. *The Depth Profile* involves taking a sample of the top 5 cm and the use of an auger to take soil samples at depths of 10 cm, 30 cm, 60 cm, and 90 cm. Using an auger takes a bit of extra time, but this effort gathers valuable data and complements the *Soil Characterization Protocol* and the *Optional Automated Air and Soil Temperature Monitoring Protocol*.

To reduce the labor involved in microwave oven drying, students should leave their soil samples to air dry uncovered for a few days after measuring their initial wet weights and then dry them in the microwave.

Gravimetric soil moisture sampling disturbs the natural state of the soil, so students should never sample twice from the same point within a period of several years. They can either offset the transect or shift the center of their star within a 10 m diameter area.

Managing Materials

Make sure that soil sample containers can be tightly sealed to prevent moisture from evaporating. Soil cans will rust unless they are thoroughly dried after each use.

If you must use labels on the containers, make sure that they will not come off during the oven drying process.

Remember that lids must be removed for drying, so weigh containers without their lids.

Balances should be placed on flat surfaces and calibrated before use.

Managing Students

Soil moisture samples can be collected most efficiently by small groups of students: one or two students for each pair of 5 cm and 10 cm samples in the Star Pattern, one or two students per station along the Transect, and two to four students for the depth profile samples. These same students or a few additional students can do the *Soil Temperature Protocol* at the same time.

Supporting Activities

To introduce students to the concepts that soil holds water, that there are many variables affecting how much water soil holds, and that water quality is affected as it passes through the soil, have them do the *Just Passing Though Learning Activity*.

To help students better understand the concept of soil water content, have them do the *Soils as Sponges Learning Activity*.

Questions For Further Investigation

What other GLOBE schools have patterns of soil moisture similar to yours?

How many weeks of the year is your soil relatively wet or relatively dry?

Does soil moisture change during the winter?

Which areas around your school are usually dry or wet? Why?

Which holds the most water: clay, sand, or silt? Why? Which provides the most moisture to plants?

Does the type of land cover affect the amount of water that enters the soil? Does it affect the rate at which soil dries out following a rainstorm?

How does the porosity of a soil horizon relate to the amount of water that horizon can hold?

How does soil water content change from one horizon to another in the same profile?

What happens to the downward flow of water if there is a coarse textured (sandy) horizon overlying a horizon with high clay content? What happens to water flow if a clayey horizon is found over a sandy horizon?

How are soil moisture and relative humidity related?

Star Pattern Soil Moisture Protocol

Field Guide

Task

Collect soil moisture samples at depths of 0-5 cm and 10 cm.

What You Need

- Soil Moisture Data Sheet – Star Pattern
- Compass (to locate sampling point)
- Trowel
- 6 soil sample containers weighed and labeled with their mass and container number
- Meter stick
- Ruler marked in millimeters
- Science Log
- Pen or pencil

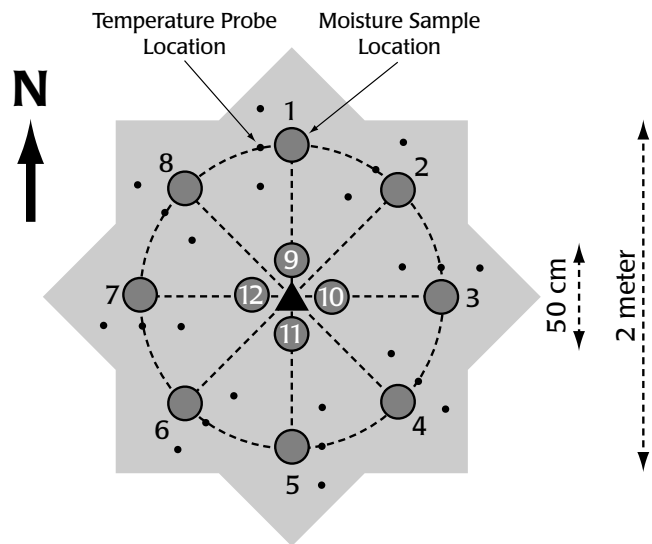

In the Field

1. Complete the top portion of the *Soil Moisture Data Sheet – Star Pattern*.
2. Locate your sampling point on the star and cut or pull away any grass or groundcover.
3. Dig a hole 10-15 cm in diameter down to 5 cm. Leave the soil loose in the hole.
4. Remove from the loose soil any rocks larger than a pea (about 5 mm), large roots, worms, grubs, and other animals.
5. Use your trowel to fill a soil container with at least 100 g of the loose soil.
6. Immediately seal the container to hold in the moisture.
7. Record the container mass and number on the *Data Sheet* next to Sample 1, 0-5 cm.
8. Remove all of the soil from the hole down to a depth of 8 cm.
9. In a clean container, collect a soil sample that contains the soil between 8 and 12 cm. Remember to remove rocks, large roots, and animals. Seal the container.
10. Record the container mass and number on the *Data Sheet* next to Sample 1, 10 cm.
11. Return remaining soil to the hole.
12. Repeat steps 3 – 11 twice in new holes within 25 cm of the original sample point filling the other four cans and recording the container numbers and masses for samples 2 and 3 at both depths. You should have six containers of soil taken from three holes.

Transect Soil Moisture Protocol

Field Guide

Task

Collect soil moisture samples at a depth of 0-5 cm along a 50 meter transect.

What You Need

- Soil Moisture Data Sheet – Transect Pattern
- Trowels (1 per student group)
- 13 soil sample containers weighed and labeled with their mass and a container number
- 50 meter tape or 50 meter rope marked every 5 meters
- Rulers marked in millimeters (1 per student group)
- Science Log
- Pen or pencil
- Compass

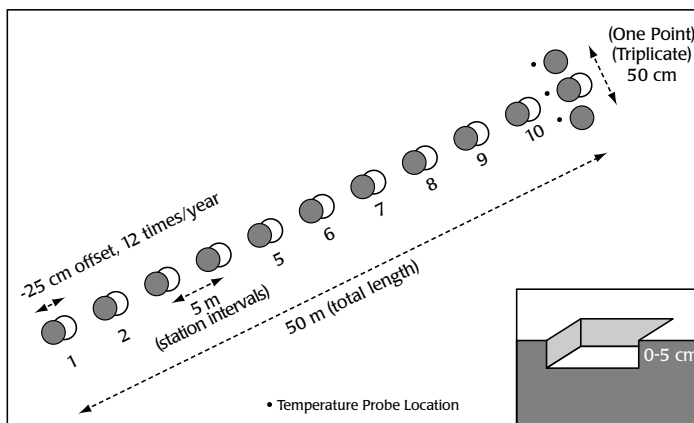

In the Field

1. Complete the top portion of the *Soil Moisture Data Sheet – Transect Pattern* including taking a compass reading along the transect line.
2. Stretch out your rope or measuring tape along the transect you will measure.
3. Locate your sampling point along the transect. Sample points should be every 5 meters along the transect, plus 2 extra samples taken at one end of the transect within 25 cm of the end point. Sample points should be numbered starting with Sample 1 at the beginning of the transect.
4. Cut or pull away any grass or groundcover above your sample point.
5. Dig a hole 10-15 cm in diameter down to 5 cm. Leave this soil loose in the hole.
6. Remove from the loose soil any rocks larger than a pea (about 5 mm), large roots, worms, grubs, and other animals.
7. Use your trowel to fill your soil container with at least 100 g of the loose soil.
8. Immediately seal the container to hold in the moisture.
9. Record the container number, mass, and distance to the start point of the transect on the *Data Sheet* next to the appropriate Sample Number.
10. Continue to collect a sample at each sampling point along the transect. Remember to remove rocks, large roots, and animals. Seal each container and record the sample number and distance from the start point of the transect on the *Data Sheet*.

Including the extra 2 samples taken near the end point, you should have 13 containers of soil taken from along your transect.

Depth Profile Soil Moisture Protocol

Field Guide

Task

Collect soil moisture samples at depths of 0-5 cm, 10 cm, 30 cm, 60 cm and 90 cm.

What You Need

- Soil Moisture Data Sheet – Depth Profile
- 5 soil sample containers weighed and labeled with their mass and a container number
- Compass (to locate sampling point)
- Meter stick
- Trowel
- Science Log
- Auger
- Pen or pencil

In the Field

1. Complete the top portion of the *Soil Moisture Data Sheet – Depth Profile*.
2. Locate your sampling point on the star and cut and pull away any grass or groundcover. See *Star Pattern Soil Moisture Protocol*.
3. With the trowel, dig a hole 10-15 cm in diameter down to 5 cm. Leave this soil loose in the hole.
4. Remove from the loose soil any rocks larger than a pea (about 5 mm), large roots, worms, grubs, and other animals.
5. Use your trowel to fill your soil container with at least 100 g of the loose soil.
6. Immediately seal the container to hold in the moisture.
7. Record the container number and mass on the *Data Sheet* next to Sample Depth 0-5 cm.
8. Use the auger or trowel to remove all of the soil from the hole down to a depth of 8 cm.
9. In a clean container, collect a soil sample that contains the soil between 8 and 12 cm deep. Remove rocks, large roots and animals. Seal the container.
10. Record the container number and mass on the *Data Sheet* next to Sample Depth 10 cm.
11. Continue to auger down to obtain samples centered at 30, 60, and 90 cm. Record the container numbers and mass values on the *Data Sheet*.
12. You should have 5 containers of soil taken from 1 hole. Return the remaining soil to the hole – last soil out, first in.

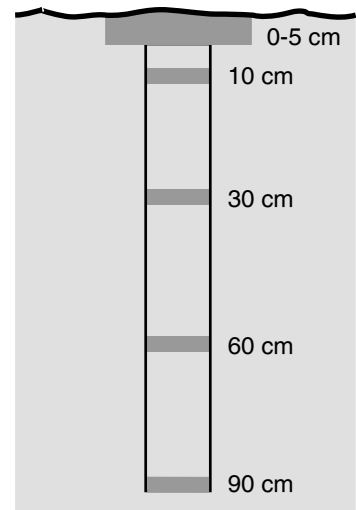

Gravimetric Soil Moisture Protocol

Lab Guide

Task

Weigh soil moisture samples, dry them completely, and weigh them again.

What You Need

- | | |
|--|---|
| <input type="checkbox"/> Soil drying oven
(conventional or microwave) | <input type="checkbox"/> Hot pads or oven mitts |
| <input type="checkbox"/> Thermometer capable of measuring to 110° C (if using a conventional drying oven) | <input type="checkbox"/> <i>Soil Moisture Data Sheet</i> with field information filled in |
| <input type="checkbox"/> Soil samples in containers suitable for your drying oven | <input type="checkbox"/> Science Log |
| <input type="checkbox"/> Balance or scale with 0.1 g sensitivity and at least 400 g capacity (600 g recommended) | <input type="checkbox"/> Pen or pencil |

In the Lab

1. Calibrate the balance according to the manufacturer's directions. In your science log, record the standard mass used to calibrate the balance. If using an electronic balance, check that the balance is measuring in grams and is zeroed properly.
2. Remove the lids from each soil sample.
3. Weigh the soil sample without the lid. Record the mass to the nearest 0.1 g as the *Wet Mass* next to the appropriate sample container number on the *Soil Moisture Data Sheet*. (Be sure to select the data sheet that corresponds to your collection method – Star Pattern, Transect Pattern, or Depth Profile.)
4. Repeat step 3 for the remaining soil samples.
5. Dry your samples in your soil-drying oven.
6. When your samples are dry, fill in drying time and drying method on the *Data Sheet*.
7. Carefully remove the samples from the oven using the hot mitts.
8. Weigh one of the dry soil samples. Record the *Dry Mass* next to the appropriate container number on the *Soil Moisture Data Sheet*.
9. Repeat step 8 for each soil sample.
10. Empty the soil from the containers. Clean and dry each container. (You may save the soil samples in other sealed bags or containers for further tests or return the soil to your site)

Note: Dried soil should be returned to the site to fill in holes so site may be used in future years.



Frequently Asked Questions

1. What should students do if they forgot to weigh the empty soil containers before filling them with samples in the field?

The soil collection containers can be weighed at the end of the soil moisture protocols after emptying the dried soil and cleaning the containers thoroughly. Remember that any dried soil left in the container will lead to an inaccurate container mass.



2. What should students do if the soil is frozen?

Take soil moisture measurements during times when the soil is thawed.



3. The soil moisture site was watered accidentally. Should students continue to collect the next regular sample?

Yes, but make a note in metadata comments regarding what happened and when it happened.

Gravimetric Soil Moisture Protocol – Looking At the Data

Are the Data Reasonable?

The first step a scientist takes when examining soil moisture data is to calculate the Soil Water Content (SWC) for each sample using the formula:

$$\text{Soil Water Content} = \frac{(\text{Wet mass} - \text{Dry mass})}{(\text{Dry mass} - \text{Container mass})}$$

Soil water content typically ranges between 0.05 and 0.50 g/g (grams of water per gram of dry soil). Even soils in dry (desert) regions retain a small amount of water, although surface soils in these regions can fall below 0.05 g/g. Soils with high organic matter or high clay contents can hold large amounts of water, so it is possible to measure values above 0.50 g/g.

The amount of water a soil horizon can hold depends on the amount of pore space (porosity) available. Porosity can be calculated by using the example given in the *Looking At the Data* section of the *Soil Particle Density Protocol*.

Total porosity of a soil can range from as low as 25% in compacted soils to more than 60% in well aerated, high-organic-matter soils.

Looking at some examples helps to understand what different values of soil water content might mean.

Soil Water Content and Soil Particle Density

Consider an organic layer of soil with 50% spaces or voids between the soil particles with half of these spaces filled with water. A 100 cm³ sample would contain 50 cm³ of soil, 25 cm³ of water, and 25 cm³ of air. Typical densities of two different soils and the density of water can be used to illustrate the value of the soil particle density. The mass of the air is negligible and the air will be present in both the wet and dry samples.

$$50 \text{ cm}^3 \text{ of soil} \times 1.0 \text{ g/cm}^3 \text{ soil particle density} = 50 \text{ g soil}$$

$$25 \text{ cm}^3 \text{ of water} \times 1.0 \text{ g/cm}^3 \text{ water density} = 25 \text{ g water}$$

In this case the Soil Water Content would be 25 g of water divided by 50 g of soil or 0.5 g/g.

Now consider a 100 cm³ sample of a mineral soil with a particle density of 2.5 g/cm³. Again the sample contains 50 cm³ of soil, 25 cm³ of water, and 25 cm³ of air.

$$50 \text{ cm}^3 \text{ of soil} \times 2.5 \text{ g/cm}^3 \text{ soil particle density} = 125 \text{ g soil}$$

$$25 \text{ cm}^3 \text{ of water} \times 1.0 \text{ g/cm}^3 \text{ water density} = 25 \text{ g water}$$

In this case the Soil Water Content would be 25 g of water divided by 125 g of soil or 0.2 g/g.



Different soils with the same porosity and the same amount of water present can vary significantly in the value of Soil Water Content, and understanding whether the values measured are reasonable or not is easier if the soil characterization protocols have been done for a horizon.



Soils are expected to show an increase in water content after a rain or during snowmelt, if the soil is not frozen or saturated. Soils gradually dry out during times with little or no precipitation. How the soil dries at different depths depends on the properties of the soil in each horizon. In some cases, water enters the soil from below, when the water table rises. The water content in these soils may be more variable lower in the soil profile than at the surface.



If it rains, some of the rainfall is expected to soak or infiltrate into the ground and increase soil moisture. This infiltration starts happening immediately and can continue for several hours if water continues to be available from a steady rain or puddles. If infiltration continues until all the pore space is filled, then the soil becomes *saturated*. Most soils drain rapidly, usually within hours or days. The field capacity of a soil is the amount of water a soil will hold without downward drainage or redistribution.



As the ground dries from evaporation and transpiration, soil moisture decreases slowly, with the soils closer to the surface usually drying faster than deeper soils. Soil moisture decreases from field capacity to a water content known as the *wilting point*, (the point at which the soil holds the water too tightly for plants to take it up). Depending on the soil properties, soil temperature, air temperature, and relative humidity, it may take from days to weeks for the wilting point to be reached. A general picture of how soil water content changes in a single horizon with time is illustrated in Figure SO-GR-1, however, there are times when the actual data do not follow this pattern.



Moisture content is affected by rainfall variation and soil properties. In a soil profile some horizons



retain more water and have a greater porosity than others, affecting the flow of water from one horizon to another.

For example, if a sandy horizon is located above a clayey horizon, water moving through the sandy horizon will enter the clayey horizon very slowly because of the difference between the large pores in the sandy soil and the very small pores in the clayey soil. The small pores act as a tight layer that only lets water move gradually, so that the sandy soil may actually be much wetter at a given time than the clay.

Examining graphs of data collected at three locations will help demonstrate the process to determine whether data are valid or not. The following graphs are used for this demonstration: Valdres, Norway (61.13 N, 8.59 E): Figure SO-GR-2, Stowe, Vermont, USA (44.48 N, 72.708 W): Figure SO-GR-3 and Herrenberg, Germany (48.59 N, 8.88 E): Figure SO-GR-4. Each data set includes rainfall, new snow rain equivalent, and soil moisture.

For the first two schools, the classes chose to take weekly measurements for three months. In this case, the protocol calls for taking measurements during periods when the soil moisture is changing. The students in Valdres, Norway knew from experience that melting winter snow would result in wet soils initially, then drying out gradually as summer approaches. Of course, near-surface soil moisture can also increase during spring rains (as happened on May 28 and later in July).

The students in Stowe, VT decided to monitor their soil moisture as it changed from dry summer conditions to wet fall conditions. Again, the near-surface soil moisture appears more variable, drying significantly for a short period early in October 2001. Conversely, the deeper 10 cm soil moisture shows fewer extreme changes.

The class in Herrenberg, DE decided to take monthly measurements for 12 months to investigate the seasonal cycle of soil moisture in their area. Despite a relatively wet climate, the soil moisture shows a gradual dry-down, particularly at the surface. The soil moisture at 10 cm shows less variation for most of the year.



Figure SO-GR-1

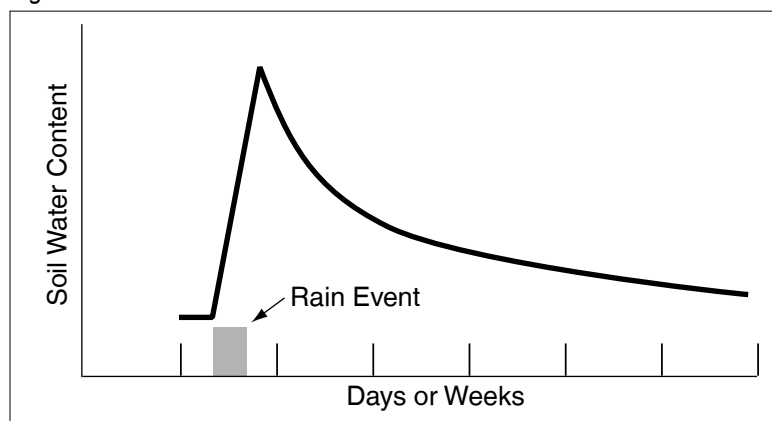

All three of these are interesting data sets. Comparison with precipitation has helped explain some of the variability while applying basic climatic knowledge has helped explain some of the longer-term trends. Knowing the soil characterization properties (texture, bulk and particle density, etc.) helps scientists and students understand more about how water is moving or stored in the soil.

What do scientists look for in the data?

Generally, scientists want to understand how water cycles through the local or regional environment. For example, they want to understand how precipitation and melting snow relate to increases in the water levels of streams, rivers, and lakes. Soil moisture measurements help to understand these processes. When soil moisture measurements are available for a whole profile, they can be used to predict floods, droughts, or the optimal timing for crop irrigation. Scientists also use soil moisture data with soil temperature, relative humidity and land cover data, to estimate the rate at which water is returned to the atmosphere through evaporation and transpiration.

Phenology scientists look at the effect of soil moisture on the annual cycles of plants, such

as trees and annual grasses. In some forested regions, tree growth begins in the spring when the soil becomes moist and then stops during the summer when the soil becomes dry.

Scientists are interested in soil moisture changes over time. They are also interested in examining the regional or spatial patterns of soil moisture changes. Scientists focus on patterns rather than the absolute values of the measurements because soil moisture is a function of precipitation, soil texture, infiltration rate and local weather conditions.

Scientists would like to know the soil water content over large areas and ultimately they hope to use remote sensing data from satellites to help measure this. Ground-based soil moisture data are required in order to develop and assess the methods for estimating soil moisture from satellites. By contributing to GLOBE's semiannual soil moisture campaign, students are helping with this exciting scientific advance.

Figure SO-GR-2

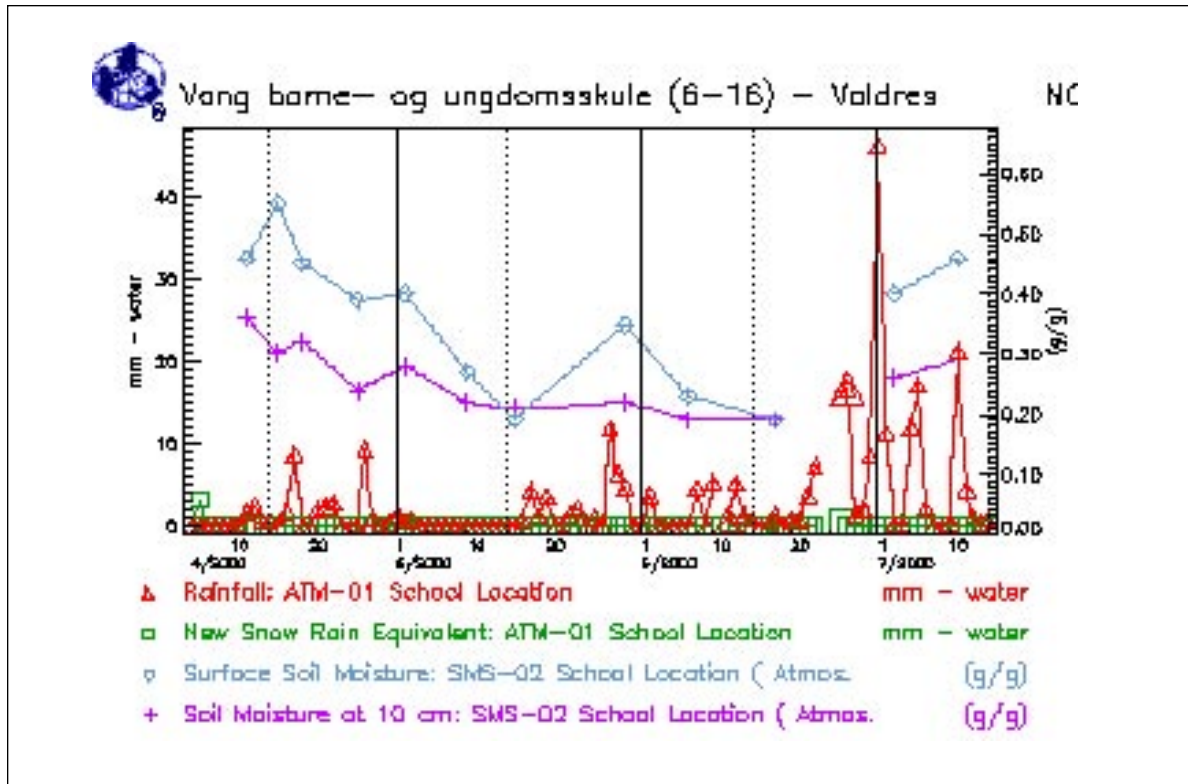

Figure SO-GR-3

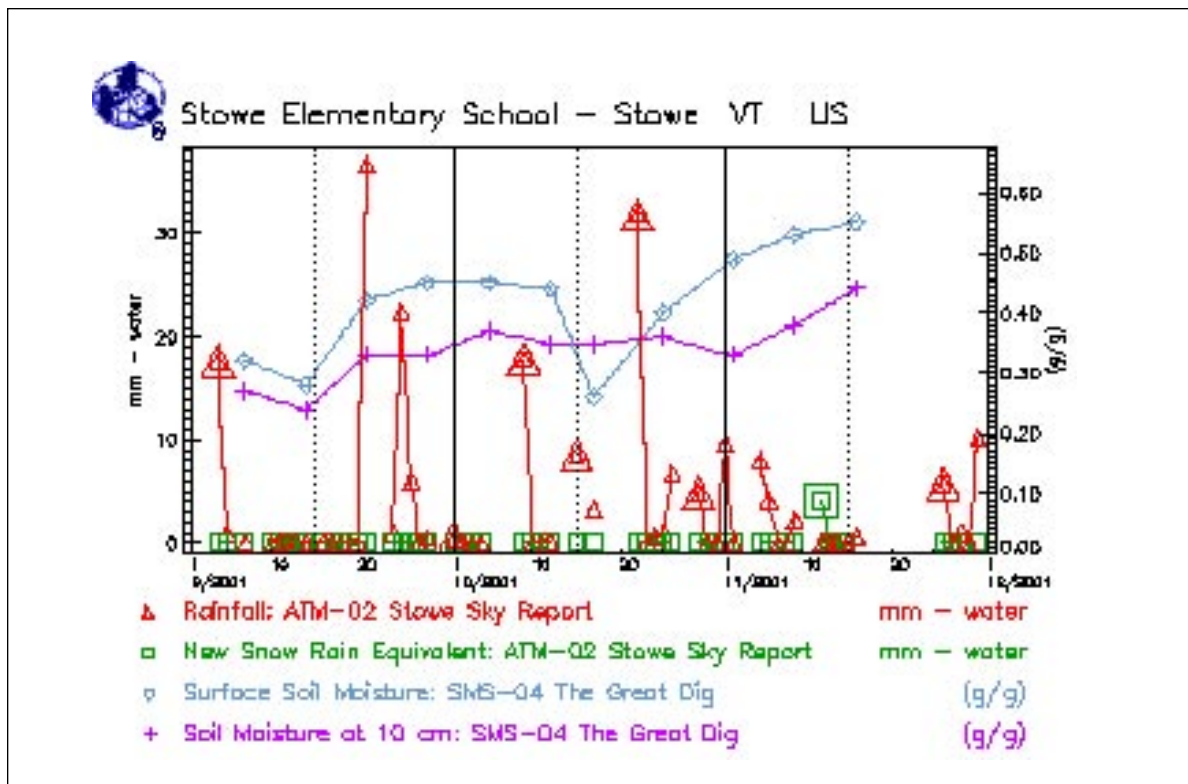
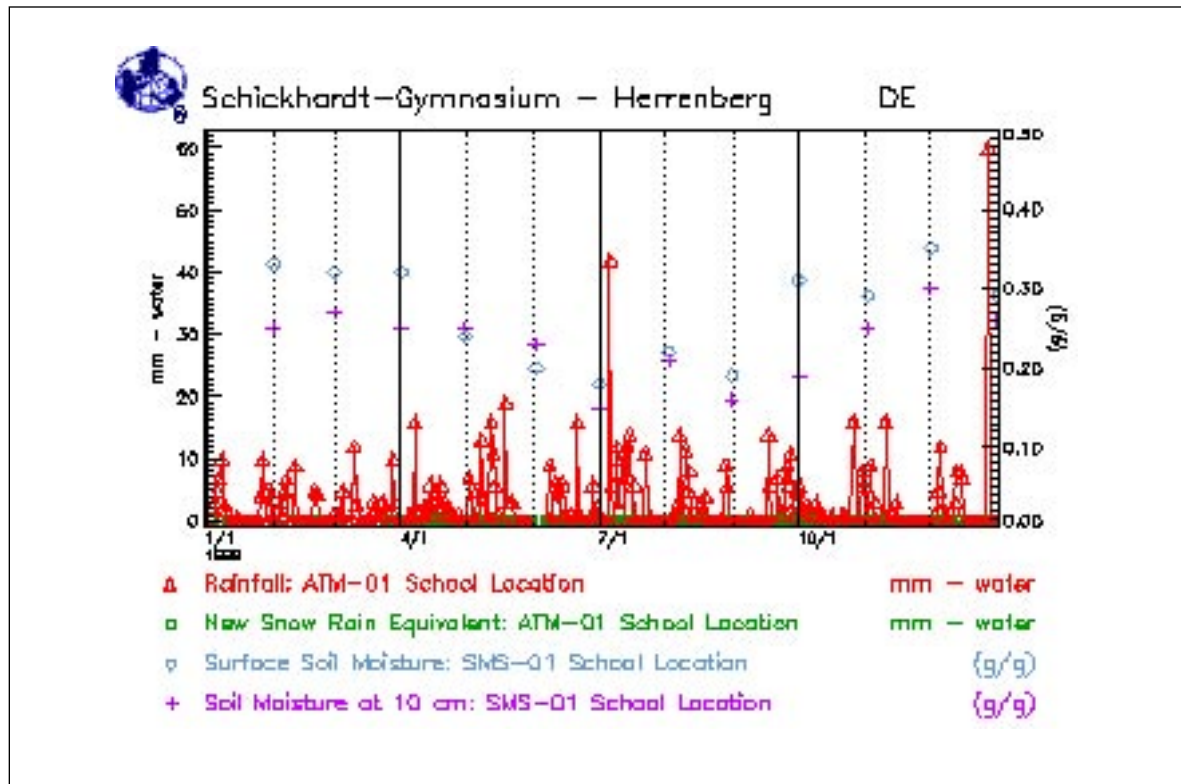

Figure SO-GR-4





An Example of a Student Research Project

Observations

Students at Stowe Elementary School in Vermont, USA collected ten gravimetric soil moisture samples over the autumn months (September-November). Figure SO-GR-3 shows a plot of their soil moisture and precipitation data.

Forming a Hypothesis

A common assumption is that soil moisture increases after a rainfall. While this tended to be the overall case for their surface soil moisture data, the students noticed that there were exceptions.

They predicted that these exceptions occurred when soil moisture samples were not collected immediately after precipitation events. The students felt that soil wetting and drying would take longer and require more rainfall at 10 cm depths than the near-surface soil. After looking at their data, the students decided to test the following hypothesis: *Soil moisture at the surface will increase if more than 10 mm of precipitation has fallen in the previous 5 days and soil moisture at 10 cm will increase if more than 20 mm of precipitation has fallen in the previous 10 days.*

Collecting Data

The students chose to analyze their data set first, and then look for other schools that had measured weekly near-surface soil moisture to see if they had similar relationships in their data. They separated into teams, one to analyze their data and the other to look for schools with at least 24 soil moisture observations and more than 100 precipitation observations in the same year. After printing the graph of their data, the students made a table of their data and downloaded it onto their computer.

Analyzing Data

One group of students used colored pencils to mark the five and ten-day periods that preceded each soil moisture observation and added the rainfall amounts for these times to get the total rainfall for each period. They organized their data into a new table, shown below (Table SO-GR-1). Another group of students calculated the change in soil moisture from one reading to the next and added this information to the table. Finally, the class decided whether the data supported their hypothesis or not. In a few cases, there was no change in soil moisture so they modified their original hypothesis to read, "...soil moisture should increase or stay the same ..."

Table SO-GR-1: Stowe, VT 2001 Soil Moisture and Precipitation Data

Date	5-day Precip. Sum (cm)	5 cm Soil Moisture (g/g)	Change in Soil Moisture	Agree?	10-day Precip. Sum (cm)	10 cm Soil Moisture (g/g)	Change in Soil Moisture	Agree?	
9/7/01	1.0	0.32			18.6	0.27			
9/14/01	0.2	0.28	-0.04	Y	1.2	0.24	-0.03	Y	
9/21/01	36.8	0.42	0.14	Y	37.0	0.33	0.09	Y	
9/28/01	30.0	0.45	0.03	Y	66.8	0.33	0	Y	
10/5/01	0.5	0.45	0	Y	30.5	0.37	0.04	Y	
10/12/01	17.8	0.44	-0.01	N	17.8	0.35	-0.02	Y	
10/17/01	11.8	0.26	-0.18	N	29.6	0.35	0	Y	
10/25/01	33.5	0.4	0.14	Y	36.7	0.36	0.01	Y	
11/2/01	14.5	0.49	0.09	Y	22.3	0.33	-0.03	N	
11/9/01	14.4	0.53	0.04	Y	24.0	0.38	0.05	Y	
11/16/01	4.8	0.55	0.02	N	7.0	0.44	0.06	N	
				70%					80%

Overall, the students' hypothesis was consistent with 70-80% of their observations. They considered the results to reformulate a better hypothesis. For example, they considered changing the surface precipitation threshold to 12 mm, or actually calculating the depth to which the soil would be wet based on the original soil moisture content and the amount of rain that had fallen. By carefully examining the situations where the hypothesis failed, they might learn more about soil moisture. For example, the surface data from 12 Oct. 2001 might be explained by the fact that all 17.8 mm fell on the first day of the 5-day period so it had time to evaporate or infiltrate into the ground. The students' hypothesis might not work on 16 Nov. 2001 because the weather was colder and the soil was approaching saturation.

Further Research

A similar analysis can be made of data from other schools. Table SO-GR-2 reveals results for springtime data collected in Valdres, Norway. The percentage correct in each column is the same as for the Stowe, VT data set. Students could look for other similarities or differences or try to find other locations around the world to see if this pattern is consistent. Although these students only looked at two years of data, they felt more confident about predicting the relationship between precipitation and soil moisture.

Table SO-GR-2: Valdres, NO 2000 Soil Moisture and Precipitation Data

Date	5-day Precip. Sum (cm)	5 cm Soil Moisture (g/g)	Change in Soil Moisture	Agree?	10-day Precip. Sum (cm)	10 cm Soil Moisture (g/g)	Change in Soil Moisture	Agree?
4/12/00	1.9	0.46			5	0.36		
4/16/00	5.5	0.55	0.09	N	5.6	0.3	-0.06	Y
4/19/00	11.2	0.45	-0.1	N	16.2	0.32	0.02	N
4/26/00	5.5	0.39	-0.06	Y	18.1	0.24	-0.08	Y
5/2/00	3	0.4	0.01	N	15.3	0.28	0.04	N
5/10/00	0	0.27	-0.13	Y	2.6	0.22	-0.06	Y
5/16/00	0	0.19	-0.08	Y	0	0.21	-0.01	Y
5/30/00	24.1	0.35	0.16	Y	28	0.22	0.01	Y
6/7/00	0	0.23	-0.12	Y	15	0.19	-0.03	Y
6/18/00	3.4	0.19	-0.04	Y	19	0.19	0	Y
7/3/00	68.5	0.4	0.21	Y	98.4	0.26	0.07	Y
7/11/00	24	0.46	0.06	Y	64.9	0.29	0.03	Y
				70%				80%

Bulk Density Protocol



Purpose

To measure the bulk density of each horizon in a soil profile

Overview

In the field, students collect three soil samples from each horizon in a soil profile using a container with a measured volume. In the classroom, students determine the mass of the samples, dry them, and determine the mass of them again to determine their dry mass and water content. Students then sieve the dry soil samples and measure the mass and volume of any rocks and material with dimensions greater than 2 mm. Students use the *Bulk Density Data Sheet* to calculate the soil bulk density for each sample.

Student Outcomes

Students will be able to collect soil samples from the field and then measure their bulk density. Students will be able to apply mathematical formulas to calculate soil bulk density. Students will be able to relate soil bulk density measurements to soil particle density and porosity. Students will understand that a mixture of solid, liquid and gaseous matter may fill a volume.

Science Concepts

Earth and Space Sciences

- Earth materials are solid rocks, soil, water, biota, and the gases of the atmosphere.
- Soils have properties of color, texture, structure, consistence, density, pH, fertility; they support the growth of many types of plants.
- The surface of Earth changes.
- Soils are often found in layers, with each having a different chemical composition and texture.
- Soils consist of minerals (less than 2 mm), organic material, air and water.

Water circulates through soil changing the properties of both the soil and the water.

Physical Sciences

- Objects have observable properties.
- Energy is conserved.
- Heat moves from warmer to colder objects.
- Chemical reactions take place in every part of the environment.

Scientific Inquiry Abilities

- Identify answerable questions.
- Design and conduct an investigation.
- Use appropriate tools and techniques including mathematics to gather, analyze and interpret data.
- Develop descriptions and explanations, predictions and models using evidence.
- Communicate procedures and explanations.

Time

2 or 3 (50-minute) class periods

Level

Middle and Secondary

Frequency

Once for a soil profile
Collected and prepared soil samples can be stored for study and analyses at any time during the school year.

Materials and Tools

- Balance
- Metal sampling cans or other containers
- Permanent marker
- Wood block
- Hammer
- Nail
- Pencil or pen
- Trowel, shovel, or other digging device
- Drying oven
- Graduated cylinder
- Water (or possibly alcohol if soil sample contains twigs)
- Sieve



Latex gloves
Paper or plate to catch sieved soil
Sealable plastic bags to store samples
Bulk Density Data Sheet

Preparation

Collect required equipment.
Calibrate the balance to 0.1 g.

Determine the mass and volume of each can *not including the lid* and mark the value clearly on the can.

Punch a small hole at the bottom of each can using a nail and hammer.

Prerequisites

Soil Characterization Protocol



Bulk Density Protocol – Introduction

Soil bulk density is a measure of how dense and tightly packed a sample of soil is. It is determined by measuring the mass of dry soil per unit of volume (g/mL or g/cm³). The bulk density of soil depends on the structure (shape) of the soil peds, how tightly they are packed, the number of spaces (pores), and the composition of the soil particles. Soils made of minerals will have a different bulk density than soils made of organic material. In general, soil bulk density can range from 0.5 g/mL or less in organic soils with many pore spaces, to as high as 2.0 g/mL or greater in very compact mineral horizons.

Bulk density is used to convert between mass and volume of a soil sample. The volume of a soil sample can be calculated by dividing the sample mass by the bulk density of the soil. Conversely, the mass of a soil sample can be calculated by multiplying the sample volume by the bulk density of the soil. The fraction of pore space in a soil, its porosity, is calculated as one minus the ratio of bulk density to particle density:

$$\text{Porosity} = 1 - (\text{Bulk Density}/\text{Particle Density})$$

The bulk density of a soil sample should be adjusted for any rocks or coarse fragments it contains. The bulk density measurement is a valuable tool for understanding soil processes such as heat, water and nutrient exchange, but only if measured for soil material less than 2 mm in size. The following equation helps to correct the bulk density for rocks in a soil sample:

$$\frac{\text{Mass of dry soil (g)} - \text{Mass of Rocks (g)}}{\text{Volume of dry soil (mL)} - \text{Volume of Rocks (mL)}} = \text{Bulk Density (g/mL or g/cm}^3\text{)}$$



Teacher Support

Preparation

Students should review the *Bulk Density Field and Lab Protocol* prior to collecting samples in the field.

Students should have a basic understanding of the concepts of mass and volume and density calculation before they begin this protocol.

Teachers should demonstrate the various methods that can be used to determine volume before students measure the volume of their sampling containers.

Holes need to be punched into the bottoms of the sample cans or containers before they are used in the field. This allows air to escape so that the soil completely fills the container. Students will know that the volume of the container has been completely filled when soil begins to appear through the hole.

As an alternative method, pipes can be used instead of cans to sample bulk density.

Measurement Procedures

In the field, metal cans or other containers are pushed into the soil horizons to obtain samples with specific volumes.

After bringing the soil samples back from the field, students measure the wet mass of the soil before drying. Although this information is not used in the bulk density calculation, it helps students make connections to soil moisture content.

Bulk density is calculated from the mass of a given volume of dry soil, including the air spaces, but excluding materials larger than soil, such as rocks or materials with dimensions greater than 2.0 mm.

In the lab, soil samples are dried in order to obtain the dry mass of the soil. After determining the mass of the dry samples, the samples are sieved and rocks or other material with dimensions greater than 2 mm are separated. The mass of all the material with dimensions greater than 2 mm is determined, and its volume is determined for the amount of water that it displaces.

The cans or pipes that were used for collecting the soil samples must be massed and their volumes measured. For a can, the first step in measuring volume is filling the can with water. The water is then poured from the can into a graduated cylinder and the volume is measured in mL. For a pipe, the volume of the pipe will have to be determined using the equation:

$$\text{Volume of a pipe} = \text{Pi} \times r^2 \times h \times 1 \text{ mL}/1 \text{ cm}^3$$

Where:

Pi is the mathematical constant
approximately equal to 3.141592654,

r is the radius of the base of the pipe (cm)

h is the height of the pipe (cm)

There are many potential sources of error for the measurements described in this protocol. Taking three replicate samples for each horizon helps to minimize the overall error. Errors may occur if the sampling containers are not completely filled with soil, if the sides of the sampling container are too thick and compress the soil, if the sampling container becomes badly deformed being pushed into the soil, if the soil is not completely dried, or if all rocks are not removed.

Sometimes, after sieving a soil sample, small twigs are left. When these twigs are put in water to measure their volume, they float. To measure their volume, a lower density liquid, such as alcohol, is used instead of water.

Managing Materials

Metal sampling cans, such as those used in the *Gravimetric Soil Moisture Protocol* can be used for bulk density sampling. Containers other than sample cans may also be used to obtain soil samples. These should be thin walled (so as not to compress the soil), and have a known volume. Possible materials may include thin walled pvc pipe or other pipe or pipes, and other types of metal cans with thick sides, such as those used for tuna fish or cat food. Do not use glass or other materials that may break or be easily deformed. As long as volume can be calculated for the container, and it can be completely filled with soil, it is acceptable to have both ends open (such as would occur if



using a pvc pipe or pipe). In this case, however, the formula $\text{Pi} \times \text{radius}^2 \times \text{height}$ must be used to calculate the pipe volume (see above).

Supporting Activities

Particle density is similar to bulk density, but it includes only the mass of the solid (mineral and organic) portion of the soil and the volume does not include the pore spaces where air and water are found. Bulk density and particle density data are used to determine the porosity of a soil. If your class is interested in porosity, have students measure particle density and calculate porosity (See *Particle Density Protocol*).

Students remove rocks and materials from the soil samples as part of the bulk density measurement. Have students follow the *Particle Size Distribution Protocol* to gain a better understanding of the distribution of different sizes of soil particles in each horizon of a soil profile.

Have students compare their bulk density data with the soil characterization data to determine whether there are correlations between the physical and chemical properties of each horizon and its bulk density.

Latex gloves are used to avoid contaminating the soil sample with acids from your skin.

Questions for Further Investigation

What human activities could change the bulk density of the soil?

What natural changes could alter the bulk density of a horizon?

How does bulk density affect the types of vegetation that can grow on a soil?

How does bulk density affect root growth and distribution?

How are soil texture and bulk density related?

How are soil structure and bulk density related?

How does bulk density affect the flow of water or heat in soil?

Soil Bulk Density

Field and Lab Guide

Task

To obtain three bulk density measurements for a given soil horizon in a soil profile

What You Need

- Balance
- Sampling cans or other containers or pipes (enough for three per horizon plus a few extra, in case some of the cans bend)
- Permanent marker
- Wood block
- Hammer
- Nail
- Pencil or pen
- Sealable plastic bags, jars, or other containers to store samples and extra soil
- Drying oven
- Graduated cylinder
- Water (or possibly alcohol if soil samples contain twigs)
- #10 Sieve (2 mm mesh openings)
- Latex gloves
- Paper to catch sieved soil
- Rolling pin, hammer, or other utensil for crushing peds and separating particles
- Trowel, shovel, or other digging device
- One copy of the *Bulk Density Data Sheet* per horizon
- paper or cloth wipe towel

In the Classroom Before Sampling

1. Collect required equipment. You will need 3 cans or pipes for each horizon that you identified at your *Soil Characterization Site*. If you think that the cans may bend as they are hammered into the soil at your site, you should prepare extra cans to bring to the field.
2. Punch a small hole into the bottom of each can using the nail and hammer. (**Note:** this is not necessary if using a pipe with two open ends).

In the Field

1. Go to your *Soil Characterization Study Site*. For each horizon in your soil profile, push a can or pipe into the side of the horizon. If necessary, wet the soil first in order to ease the can into the soil. Stop when soil pokes through the small hole in the bottom of the can (or has reached the edge of the pipe, so that the pipe is full of soil).

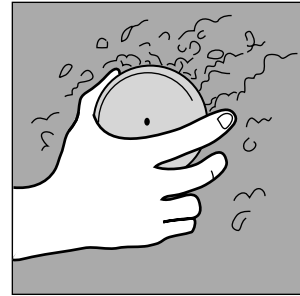

If it is difficult to push the can into the soil, place a piece of wood over the can and hit the wood with a hammer. This spreads the force of the hammer blow to all edges of the can at once and minimizes bending the can sides. If the sides of the can become bent, this will change the volume of the can and may compact the soil sample, affecting the measurement results. If the sides of a can bend beyond perpendicular, discard that can and use another.

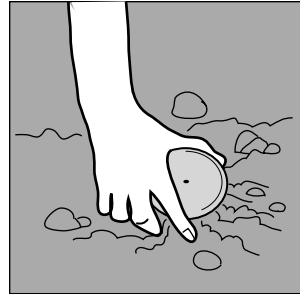

Note: If you do not have a pit or other exposed soil profile you can measure the bulk density of the soil surface as follows.

- a. Choose three locations close to the site where you performed the *Soil Characterization Protocol*. Remove vegetation and other material from the soil surface.
- b. At each of the three locations, push a can or pipe into the surface of the soil. If necessary, wet the soil first in order to ease the can into the soil. Stop when soil pokes through the small hole in the bottom of the can (or has reached the edge of the pipe, so that the pipe is full of soil).

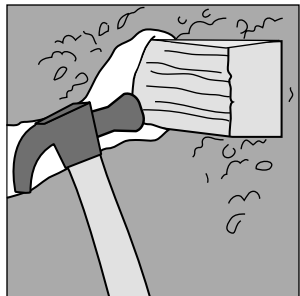

2. Using a trowel or shovel, dig around the can or pipe to remove it and the surrounding soil. Trim the soil from the top of the can (and bottom for a pipe) and around the edges of the can so that the volume of the soil is the same as the volume of the can or pipe.

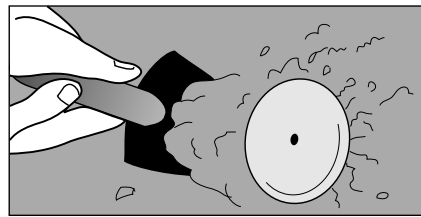

3. Cover the can with its lid or other cover. Label the can with a container number and record this number on your *Data Sheet*. If using a pipe, label it with a container number, record this number on your *Data Sheet*, and place the pipe in a plastic bag.

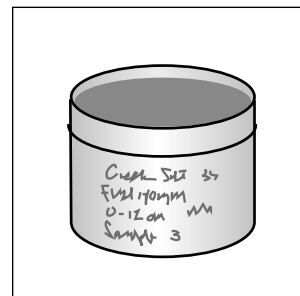

4. Repeat this procedure so that you have three bulk density samples for each horizon in your profile.

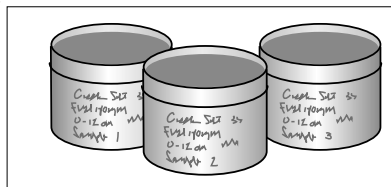

In the Classroom After Sampling

1. Calibrate the balance to 0.1 g.
2. Remove the lid of the can. Measure the mass of each sample in its can, and record this as the wet mass on the *Bulk Density Data Sheet*. If you used a pipe instead of a can, remove the pipe filled with soil from the plastic bag and weigh it to determine the wet mass, which should then be recorded on the *Bulk Density Data Sheet*.
3. Dry the samples in a soil-drying oven. See the *Gravimetric Soil Moisture Protocol* for instructions on drying soils.
4. After the soils have dried, determine the mass of each sample and its container and record this as the dry mass on the *Bulk Density Data Sheet*.
5. Place a sieve (#10, 2 mm mesh) on a paper plate or large piece of paper (such as newspaper) and pour one sample onto the sieve.
6. Wipe the inside of the can or pipe with a wipe towel. Measure the mass of the can or pipe without the lid on and record this mass on the *Data Sheet*.
7. Measure the volume of each can or pipe and record it on the *Data Sheet*. For cans, fill to the top with water, then pour the water into an empty graduated cylinder (the volume of water in the graduated cylinder will be equal to the volume of the can). For pipes, measure the mass and calculate the volume using the following equation:

$$\text{Volume pipe} = \text{Pi} \times r^2 \times h \times 1 \text{ mL/1 cm}^3$$

where Pi is the mathematical constant approximately equal to 3.141592654

r is the radius of the base of the pipe (cm)

h is the height of the pipe (cm)

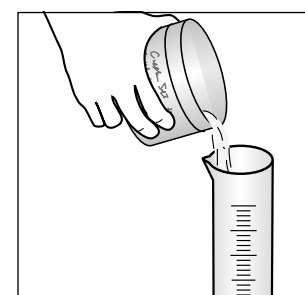
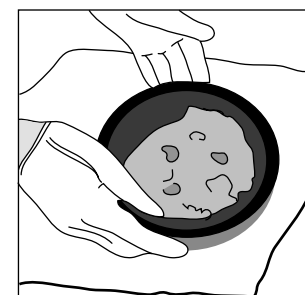
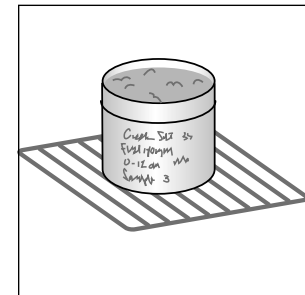

8. Put on latex gloves to avoid contaminating your sample with acids from your skin, and pick up the sieve full of soil.



9. Carefully push the dried soil material through the mesh onto the paper plate. Be careful not to bend the wire mesh by forcing the soil through. Rocks will stay on top of the sieve. If no sieve is available, carefully remove the rocks by hand. Save the sieved soil from each sample for other lab analyses.

10. If rocks are present, use the following procedure to determine the mass and volume of the rocks.

a. Measure the mass of these rocks and record on the *Bulk Density Data Sheet*.

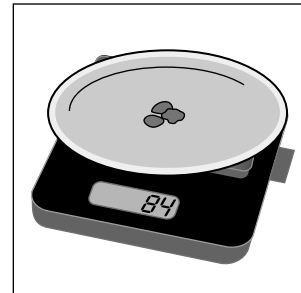

b. Place 30 mL of water in a 100 mL graduated cylinder. Record this volume of water on the *Bulk Density Data Sheet*. Gently place the rocks in the water. Read the level of the water after all the rocks have been added. Record this volume of water on the *Bulk Density Data Sheet*.

Note: As you add the rocks, if the volume of water and rocks in the cylinder comes close to 100 mL, record the increase in volume, empty the pipe and repeat the procedure for the remaining rocks. In this case, you must record the sum of the water volumes with the rocks and the sum of the water volumes without the rocks.

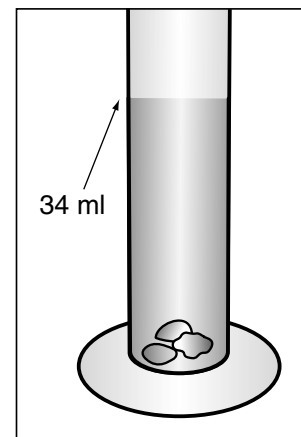
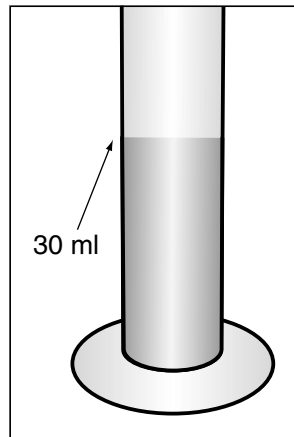

If you have sticks or other organic debris, substitute alcohol for water, and follow the same procedure.

11. Transfer the rock-free dry soil from the paper under the sieve to clean dry plastic bags or containers. Seal the containers, and label them with horizon number, top and bottom depth, date, site name, and site location. This soil can now be used for other lab analyses. Store these samples in a safe, dry place until they are used.

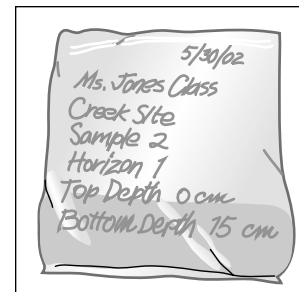



Bulk Density Protocol – Looking at the Data

Are the data reasonable?

Typical bulk density values for soils average around 1.3 g/mL (g/cm³) for soils composed mostly of mineral particles. However, they can be as high as 2.0 g/mL (g/cm³) for very dense horizons, and as low as 0.5 g/mL (g/cm³) or lower for organic soils.

To calculate the bulk density of a soil sample complete the calculations on the *Soil Bulk Density Data Sheet*.

What were the results of your data?

If the bulk density for a soil sample is <1.0, it has a very low density and may have a high organic matter content. In order to identify organic matter, look for a dark color and the presence of roots. Many times, soil horizons on the surface are high in organic matter.

If the bulk density for a soil sample is near 2.0 or greater, it is a very dense soil. Soils become dense if they have been compacted and do

not have a high organic matter content. This is common in surface soils on which people walk or where machinery has compressed the soil. Soils with massive or single grained structure will have higher densities than soils with granular or blocky structure. The texture of the soil can also affect the bulk density. In general, sandy soils have a higher bulk density than clayey or silty soils, because the porosity is lower although the size of the pores is larger in sandy soils.

If the bulk densities of soil samples do not seem to be consistent with the other properties of the same horizon (color, structure, texture, depth in the profile, root content), then there may be an error in the measurement. The methodology and calculations should be checked for errors.

What do scientists look for in these data?

Many different scientists use information about soil bulk density, particle density, and porosity. They use bulk density to estimate how tightly packed the soil components are in each horizon.



Soil Particle Density Protocol



Purpose

To measure the soil particle density of each horizon in a soil profile

Overview

Students weigh a sample of dry, sieved soil from a horizon, mix it with distilled water and then boil the mixture to remove any air. The mixture cools for a day and then students add water until the volume of the mixture is 100 mL. Students measure the temperature and mass of the final mixture and use the *Soil Particle Density Data Sheet* to calculate the soil particle density. Three samples should be measured for each horizon.

Student Outcomes

Students will be able to apply laboratory tests for particle density to soil samples. Students will be able to calculate soil particle density and porosity using mathematical formulas. Students will be able to relate soil particle density to bulk density and porosity.

Science Concepts

Earth and Space Sciences

Earth materials are solid rocks, soil, water, biota, and the gases of the atmosphere.

Soils have properties of color, texture, structure, consistence, density, pH, fertility; they support the growth of many types of plants.

Soils consist of minerals (less than 2 mm), organic material, air, and water.

Physical Sciences

Objects have observable properties.

Scientific Inquiry Abilities

Identify answerable questions.

Design and conduct an investigation.

Use appropriate tools and techniques including mathematics to gather, analyze, and interpret data.

Develop descriptions and explanations, predictions and models using evidence. Communicate procedures and explanations.

Time

Two 45-minute class periods

Level

Middle and Secondary

Frequency

Three times for each horizon in a soil profile

Collected and prepared soil samples can be stored for study and analyses at any time during the school year.

Materials and Tools

Oven-dried, sieved soil
100-ml volumetric or Erlenmeyer flask(s) with cap(s) or stopper(s)
Distilled water
Pencil or pen
Small funnel
Thermometer
Balance accurate to within 0.1 g
Squirt bottle for washing soil out of beaker
Hot plate or Bunsen burner or other heat source
Oven mitts or tongs
Soil Particle Density Data Sheet

Preparation

Dry and sieve soil samples; store them in sealed containers.

Collect required equipment.

Calibrate the balance to 0.1 g.

Prerequisites

Soil Characterization Protocol



Soil Particle Density Protocol – Introduction

The particle density of a soil measures the mass of a soil sample in a given volume of particles (mass divided by volume). Particle density focuses on just the soil particles and not the total volume that the soil particles and pore spaces occupy in the soil. Particle density differs from bulk density because bulk density includes the volume of the solid (mineral and organic) portion of the soil along with the spaces where air and water are found. The density of soil particles is a result of the chemical composition and structure of the minerals in the soil. See Figure SO-DE-1.

Particle density data are used to better understand the physical and chemical properties of the soil. For example, the particle density indicates the relative

amounts of organic matter and mineral particles in a soil sample. The chemical composition and structure of minerals in a soil sample can be deduced by comparing the soil's particle density to the known densities of minerals such as quartz, feldspar, micas, magnetite, garnet, or zircon.

Particle density data are also used with bulk density data to calculate the pore space (porosity) occupied by air and water in a soil sample. With this knowledge about the properties of a soil, students and scientists gain a better understanding of the soil's function within the ecosystem of an area and can better interpret soil moisture measurements.



Figure SO-DE-1

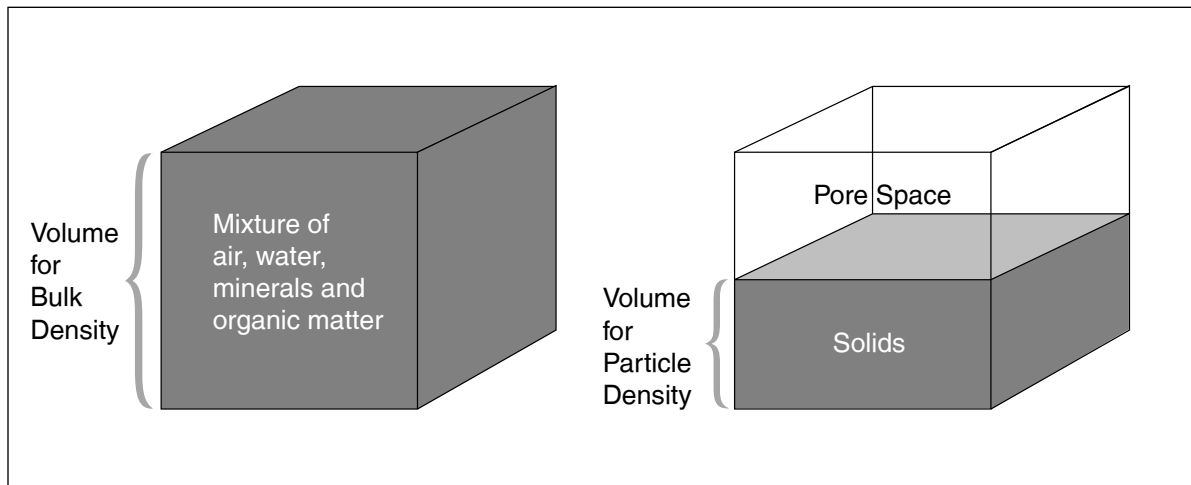

Teacher Support

Preparation

Have students conduct the *Bulk Density Protocol* in order to gain a better understanding of density as a measure of the amount of mass in a given volume. Students also need to measure bulk density in order to calculate soil porosity.

Measurement Procedures

To calculate soil particle density, students measure the mass and the volume of *only the solid particles* in a soil sample, not the air and water found within the pore spaces between the particles.

Students carry out this measurement by putting a soil sample in a flask with distilled water. The soil/water mixture is boiled to remove all air from the sample. After the mixture has cooled, water is added to the mixture to obtain a specified volume. The mass of this mixture is then measured. The mass of the water is then subtracted from the mass of the soil and water. The particle density is calculated from the mass of the solid particles in a specified volume.

Safety Precautions

Students need to know how to safely use Bunsen burners or other heating elements for boiling the soil/water mixtures.

Students should practice using tongs or oven mitts to lift the volumetric or Erlenmeyer flasks that hold the soil/water mixtures.

Students can boil practice mixtures of soil and water to ensure they do not let the actual soil samples boil over.

Supporting Activities

Have students compare their soil characterization data with soil particle density data to see if they can correlate the horizons' physical and chemical properties with their soil particle densities.

Questions for Further Investigation

What natural changes could alter the particle density of a horizon?

How does parent material affect the particle density of a horizon?

How does particle density affect soil temperature?

What is the relationship between particle density and plant growth?

How can particle density affect the way water moves through the soil?

Does particle density relate to soil color? If so, how?

Does particle density relate to the presence of carbonates? If so, how?

How does particle density relate to the uses of a soil?

Does particle density relate to particle size distribution? If so, how?

Soil Particle Density

Lab Guide

Task

To measure the particle density of a soil sample

What You Need

- Oven-dried, sieved soil
- Distilled water
- Small funnel
- Balance accurate to 0.1 g
- Squirt bottle
- Oven mitts or tongs
- Three 100 ml volumetric or Erlenmeyer flasks with caps or stoppers
- Pencil or pen
- Thermometer
- Squirt bottle for washing soil out of beaker
- Hot plate or Bunsen burner or other heat source
- Soil Particle Density Data Sheet*

In the Lab

1. Place distilled water in squirt bottle.
2. At the top of the *Data Sheet*, note the length of time since the soil was dried in an oven, and how the soil has been stored (e.g. in plastic bag, air tight container, other).
3. Measure the mass of the empty flask without its cap.
Record the mass on the *Soil Particle Density Data Sheet*.

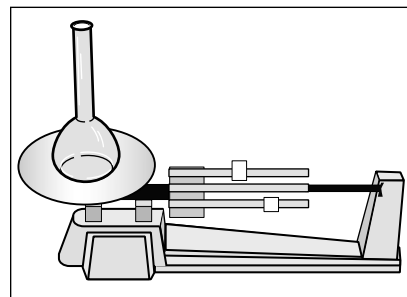

4. Measure 25 g of dried, sieved soil. Place soil in the flask using the funnel. Since it is important to have all 25 g of soil in the flask, be careful to transfer all the soil into the flask and not to spill any soil outside the flask (**Note:** if soil is spilled outside the flask, repeat this step with another 25 g sample).

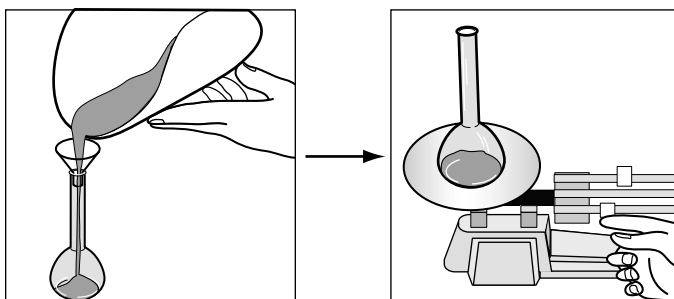

5. Measure the mass of the flask containing the soil (without the stopper/cap). Record the mass on the *Soil Particle Density Data Sheet*.

6. Use the squirt bottle to wash any soil sticking to the neck of the flask down to the bottom of the flask. Add about 50 ml of distilled water to the soil in the flask.

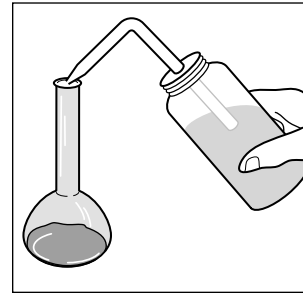

7. Bring the soil/water mixture to a gentle boil by placing the flask on a hot plate or holding it over a Bunsen burner. Gently swirl the flask for 10 seconds once every minute to keep the soil/water mixture from foaming over. Boil for 10 minutes to remove air bubbles.

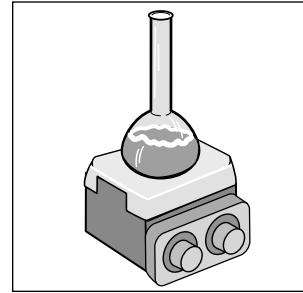

8. Remove the flask from the heat and allow the mixture to cool.

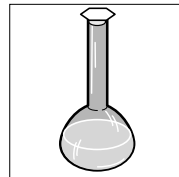

9. Once the flask has cooled, cap the flask and let it sit for 24 hours.

10. After 24 hours, remove the stopper/cap and fill the flask with distilled water so that the bottom of the meniscus is at the 100 mL line.

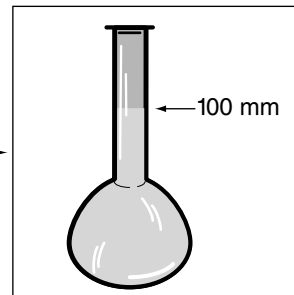
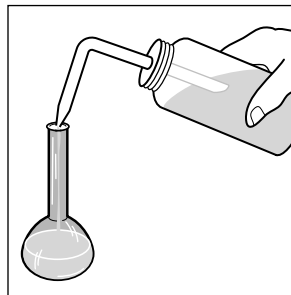

11. Weigh the 100 mL-soil/water mixture in the flask (without the stopper/cap). Record the mass of the mixture on the *Soil Particle Density Data Sheet*.

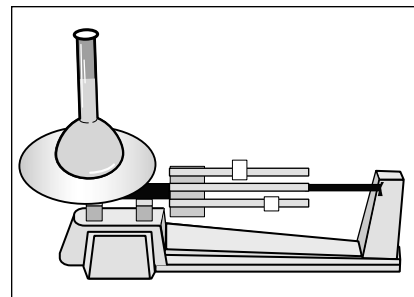

12. Place the bulb of the thermometer in the flask for 2-3 minutes. When the temperature has stabilized, record the temperature of the mixture on the *Soil Particle Density Data Sheet*.

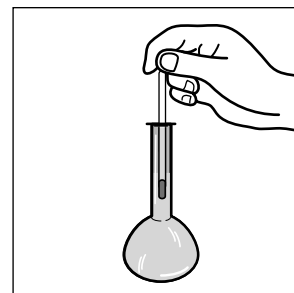



Particle Density Protocol— Looking at the Data

Are the data reasonable?

Typical particle densities for soils range from 2.60 to 2.75 g/cm³ for mineral particles. However, they can be as high as 3.0 g/cm³ for very dense particles and as low as 0.9 g/cm³ for organic particles. In order to calculate the soil particle density for your sample, use the information from the *Soil Particle Density Data Sheet* and follow the steps given in the *Calculation Work Sheet*.

What do scientists look for in these data?

Particle density measurements provide information about the kinds of material present in a soil. If the particle density is high, we know that the parent material of the soil consists of minerals that have a high density. This information provides insight into the geologic history of the soil. A low particle density (<1.0 g/cm³) indicates high organic matter content. It also provides information about the potential release of carbon from the soil into the atmosphere as the organic matter decomposes over time.

Scientists are also interested in knowing how much space is in the soil (porosity). This information tells them how much air and water can be stored in the soil profile. It also tells them the rate at which air, water and heat will move through the soil profile. By knowing this they can better understand the behavior of the soil, predict flooding, verify the types of life the soil can support, identify how the soil may change, and determine how the soil may be best used for human activities.



Calculating Soil Porosity

The amount of pore space, or porosity, of the soil is calculated according to the following equation:

$$\text{Porosity} = 1 - \left(\frac{\text{Bulk Density}}{\text{Particle Density}} \right) \times 100\%$$

Bulk Density = mass of dry soil / total volume of soil and air (g/cm³)

Particle Density = mass of dry soil / volume of soil particles only (air removed) (g/cm³)

$$\frac{\text{Bulk Density}}{\text{Particle Density}} = \frac{\text{Volume of dry soil}}{\text{Volume of dry soil and pore space}}$$

This value will always be less than or equal to 1. So the value (1 - Bulk Density/Particle Density) will be between 0 and 1. This value is then multiplied by 100 to calculate the percent porosity.

For example, students take three soil samples for bulk density and soil particle density for each horizon at the soil pit at their Land Cover Sample Site. After performing the *Bulk Density* and *Soil Particle Density Protocols*, they determine:

Bulk Density:

Mass of dry soil = 395 g

Total soil volume = 300 cm³

Bulk density (mass of dry soil/total soil volume):

$$395 \text{ g}/300 \text{ cm}^3 = 1.32 \text{ g/cm}^3$$

Particle Density:

Mass of dry soil = 25.1 g

Volume of dry soil = 9.5 mL (cm³)

To calculate particle density (mass of dry soil/volume of particles only):

$$25.1 \text{ g}/9.5 \text{ cm}^3 = 2.64 \text{ g/cm}^3$$

Porosity:

Using these values in the equation for porosity:

$$\text{Porosity} = 1 - \left(\frac{\text{Bulk Density}}{\text{Particle Density}} \right) \times 100\%$$

$$1 - \left(\frac{1.32}{2.64} \right) \times 100\% = 50\%$$

Figure SO-DE-2: A Good Soil for Most Plant Growth

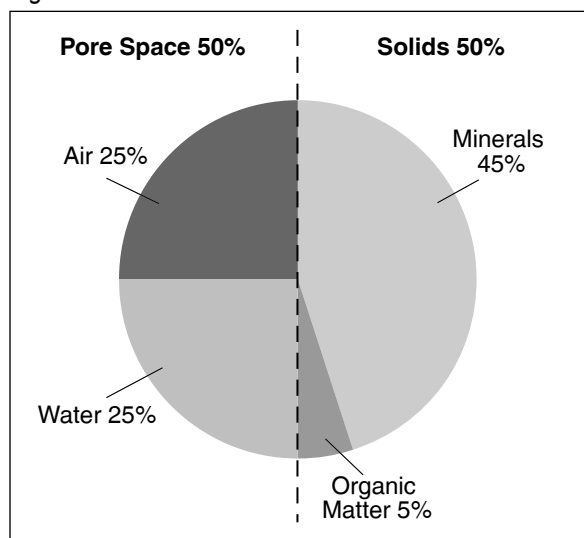

Thus, 50% of the total soil is pore space. The pore space at this site may be filled by either air or water or a combination of both.

A good soil for growing most plants contains about 50% pore space and 50% solids. The pore space should be filled half with air and half with water, and the solids should be a mixture of minerals with some organic matter. See Figure SO-DE-2.

In some cases, certain plants, such as rice or wetland species, require much more water than air in the soil pore spaces in order to grow properly. For other uses of the soil, such as for building roads or foundations, the soil should have much more air than water occupying its pore spaces.

While the porosity reveals the amount of total pore space the soil has, it does not tell exactly how much air or water is in the soil at a given time. The amount of water in the soil is determined through the methods of the *Soil Moisture Protocol*. The total pore space can be determined and the amount of that space occupied by air and water becomes known. This information determines how well plants will grow, whether the soil is dry or saturated, and what is the best plan for managing that particular soil.

How saturated is a soil?

The *Soil Moisture Protocol* measures Soil Water Content (SWC) as the ratio of the mass of water to the mass of dry soil in a sample. Knowing the soil particle density, the bulk density, and the density of water, the ratio of the volume of water to the volume of soil may be calculated along with the percentage of the pore space filled with water.

$$\frac{\text{Volume of Water (mL)}}{\text{Volume of Soil (mL)}} = \text{Soil Water Content (g/g)} \times \frac{\text{Bulk Density (g/cm}^3\text{)}}{\text{Density of Water (g/cm}^3\text{)}}$$

$$\text{Volume of Pore Space (mL)} = \text{Porosity} \times \text{Volume of Soil (mL)}$$

$$\frac{\text{Volume of Water (mL)}}{\text{Volume of Pore Space (mL)}} = \frac{\text{Soil Water Content (g/g)}}{\text{Porosity}} \times \frac{\text{Bulk Density (g/cm}^3\text{)}}{\text{Density of Water (g/cm}^3\text{)}}$$

So, if SWC = 0.20 g/g, Bulk Density = 1.32 g/cm³, Density of Water = 1.00 g/cm³, and Porosity = 0.50 (50%), then

$$\begin{aligned} \text{Percentage of Pores Filled with Water} &= \frac{\text{Volume of Water}}{\text{Volume of Pore Space}} \\ &= \frac{0.20 \text{ g/g}}{0.50} \times \frac{1.32 \text{ (g/cm}^3\text{)}}{1.00 \text{ (g/cm}^3\text{)}} \times 100 = 52.8\% \end{aligned}$$



Examples of Student Research Investigations

Students from the Grassland School in Illinois, USA, wanted to determine the amount of water their soil held. They were concerned about flooding during the approaching rainy season. They characterized the soil at their school and took samples from four horizons to a depth of 100 cm. They knew that if they calculated both the particle density and bulk density of each

horizon, they could determine the porosity of the soil. Knowing the porosity of the soil would allow the students to know how much space each horizon had to hold water. For each of the horizons, the students determined the particle density and bulk density following the GLOBE protocols. Soil Characterization data for each of the four horizons the students studied is given in Table SO-DE-1. Table SO-DE-2 shows how the students determined the Particle Density of the soil in Horizon 1.



Table SO-DE-1

Horizon #	Top depth (cm)	Bottom Depth (cm)	Thickness (cm) (bottom-top depth)	Texture (by feel)	Main Color
1	0	10	10	Silt loam	10YR 2/2
2	10	35	25	Silty clay loam	10YR 6/4
3	35	70	35	Silty clay	7.5YR 5/6
4	70	100	30	Clay	7.5YR 6/8



Horizon #	Structure	Consistence	Roots	Rocks	Bulk Density (mean)
1	granular	Friable	Many	None	0.8
2	blocky	Friable	Few	None	1.3
3	blocky	Firm	Few	Few	1.2
4	blocky	Firm	None	Few	1.1



Table SO-DE-2

Horizon 1		Sample Number		
		1	2	3
A	Mass of soil + empty flask (g)	82.0	83.0	81.0
B	Mass of empty flask (g)	57.0	58.0	56.0
C	Mass of soil (g) (A – B)	25.0	25.0	25.0
D	Mass of water + soil +flask (g)	169.5	169.9	169.0
E	Mass of water (D – A)	87.5	86.9	88.0
F	Water Temperature (° C)	20	20	20
G	Density of water (g/mL) (approximately 1.0)	1.0	1.0	1.0
H	Volume of water (mL) (E/G)	87.5	86.9	88.0
I	Volume of soil (mL) (100 mL – H)	12.5	13.1	12.0
J	Soil particle density (g/mL) (C/I)	2.0	1.9	2.1
Mean of Particle Density of Horizon (from 3 Replicates)		2.0 g/mL		



The students used the same method to calculate particle density values for the other three horizons. The results (based on the mean of three replicates for each horizon) were:

Horizon 1: 2.0 g/mL

Horizon 2: 2.6 g/mL

Horizon 3: 2.5 g/mL

Horizon 4: 2.5 g/mL

The students noticed that there were differences in the particle density values for the four horizons. The biggest difference was in the first horizon, which had the lowest particle density value. They investigated their soil characterization data for clues as to why the particle density of the first horizon was lower than the others. They noticed that the color of the first horizon was much darker than the others, indicating that this horizon had a higher organic matter content. The structure of the soil in the first horizon was granular while in the

other horizons it was blocky. Granular structures are common in soils where roots are abundant. The students had observed many roots in the first horizon as well. The first horizon also had a friable consistence and a lower bulk density than the other horizons. These properties allow roots to spread easily throughout this horizon.

The students hypothesized that the lower particle density value they found in Horizon 1 was the result of the roots at this depth in the soil. With this information, the students decided to calculate the porosity of each of the soil horizons. Using the mean values for particle density and bulk density, they calculated the porosity using the following equation:

$$\text{Porosity} = 1 - \left(\frac{\text{Bulk Density}}{\text{Particle Density}} \right) \times 100\%$$

Their results for porosity of each of the four horizons are given in Table SO-DE-3.

Table SO-DE-3

Horizon	Bulk Density (BD)	Particle Density (PD)	BD/PD	1- BD/PD	Porosity
1	0.8	2.0	0.40	0.60	60%
2	1.3	2.6	0.50	0.50	50%
3	1.2	2.5	0.48	0.52	52%
4	1.1	2.5	0.44	0.56	56%



After examining these data, the students could see that the first soil horizon, with its high organic matter content, was more porous than the lower horizons that consisted mainly of minerals. The lowest horizon, which had no roots, also had a relatively high porosity value. The students' hypothesis was that this horizon had small pores between each of its particles. They deduced this from their texture measurement of this horizon that indicated it was clay.



The students also reasoned that because there is more pore space in Horizons 1 and 4, these horizons have the capacity to hold more rainwater than Horizons 2 and 3. To test this hypothesis, they decided to determine the soil water content according to the *Soil Moisture Protocol*. They would then determine the bulk density and thickness of each horizon to convert from mass to volume, and calculate the amount of rain that would be needed to saturate the soil profile.



Particle Size Distribution Protocol



Purpose

To measure the distribution of different sizes of soil particles in each horizon of a soil profile

Overview

Using dry, sieved soil from a horizon, students mix the soil with water and a dispersing solution to completely separate the particles from each other. Students shake the mixture to fully suspend the soil in the water. The soil particles are then allowed to settle out of suspension, and the specific gravity and temperature of the suspension are measured using a hydrometer and thermometer. These measurements are taken after 2 minutes and 24 hours.

Student Outcomes

Students will be able to apply laboratory tests for particle size distribution to soil samples. Students will be able to apply mathematical formulas to calculate soil particle size distribution as a percent of sand, silt, and clay. Students will be able to relate soil particle size to suspensions, specific gravity, and settling rates.

Science Concepts

Earth and Space Sciences

Earth materials are solid rocks, soil, water, biota, and the gases of the atmosphere.

Soils have properties of color, texture, structure, consistence, density, pH, fertility; they support the growth of many types of plants.

Soils consist of minerals (less than 2 mm), organic material, air and water.

Physical Sciences

Objects have observable properties.

Scientific Inquiry Abilities

Identify answerable questions.

Design and conduct an investigation.

Use appropriate tools and techniques including mathematics to gather, analyze, and interpret data.

Develop descriptions and explanations, predictions and models using evidence. Communicate procedures and explanations.

Time

3 class periods

Level

Middle and Secondary

Frequency

Three times for each horizon in a soil profile

Materials and Tools

Oven-dried, sieved soil (sieved with a Number 10 sieve with 2 mm mesh attached to a frame)

500-ml graduated cylinders (minimum of three recommended)

Distilled water

1 empty plastic 2-liter bottle with top
Soil Dispersing Reagent (Sodium Hexametaphosphate or non-sudsing dish detergent such as is used in an automatic dishwasher)

Spoon or glass rod for mixing

250 mL or larger containers (minimum of three recommended)

Thermometer

Hydrometer

100-mL graduated cylinder

Pencil or pen

Squirt bottle for washing soil out of beaker

Meter stick

Plastic wrap (or other cover for cylinder)

Balance accurate to 0.1 g

Soil Particle Size Distribution Data Sheet

Preparation

Dry and sieve soil samples, and store them in sealed containers.

Collect required equipment.

Calibrate the balance to 0.1.

Prepare dispersing solution.

Prerequisites

Soil Characterization Protocol



Particle Size Distribution– Introduction

The amount of each particle size group (sand, silt, or clay) in a soil is known as the soil particle size distribution. The texture measurement in a soil characterization is only an approximate measure of the amount of each particle size group in a soil sample. By performing the *Particle Size Distribution Protocol*, these estimates can be checked by measuring quantitatively the amount of each of the particle sizes in a sample.

Sand is the largest soil particle size (2.0 mm - 0.05 mm), silt is intermediate in size (0.05 mm - 0.002 mm), and clay is the smallest (less than 0.002 mm). Particles greater than 2 mm are called stones, rocks or gravels and are not considered to be soil material.

	2.0 mm	0.05 mm	0.002 mm	
Stones	Sand	Silt	Clay	

When a mixture of particle sizes is suspended in a column of water, the heavy large particles settle first. When a soil sample is stirred or shaken, sand particles will settle to the bottom of the cylinder after 2 minutes, while the clay and silt size particles will stay in suspension. After 24 hours, the silt particles will settle, leaving only the clay in suspension.

By using tables and charts, the exact percentages of sand, silt, and clay can be calculated and the textural class name can be determined for a soil sample.

Teacher Support

Preparation

Before conducting the *Particle Size Distribution Protocol* have the students do the following activity:

1. Pour a mixture of sand, silt and clay into a glass jar until it is about 1/3 full.
2. Fill the jar with water.
3. Put a lid on the jar and shake it.
4. Observe what happens to the soil particles.

Teachers can relate student observations to the *Particle Size Distribution Protocol* by discussing how results will differ before and after a dispersing solution is added.

Before conducting the *Particle Size Distribution Protocol*, have students measure the texture of the soil horizon by feel.

Explain how to use a hydrometer and have students practice taking measurements.

Have students practice mixing a soil sample. Use plain water, a 500 mL graduated cylinder, and a plastic wrap cover.

Make sure students understand the concept of Specific Gravity. (See next section for definition.)

Measurement Procedures

Sand, silt, and clay particles are rarely found separately in soils. Instead, they are usually clumped together in aggregates called “peds.” A “dispersing” solution is used to break up the peds and separate the particles from each other.

The amounts of sand, silt and clay are measured according to the rate at which each particle type settles in water. If the particles are not separated completely from each other, results will be incorrect because aggregates of smaller particles will settle like larger particles.

A hydrometer measures the specific gravity of a liquid or suspension. Specific Gravity is defined as the mass of a liquid relative to the mass of an equal volume of water. In pure distilled water at 20° C, the hydrometer reading will be 1.000. When soil



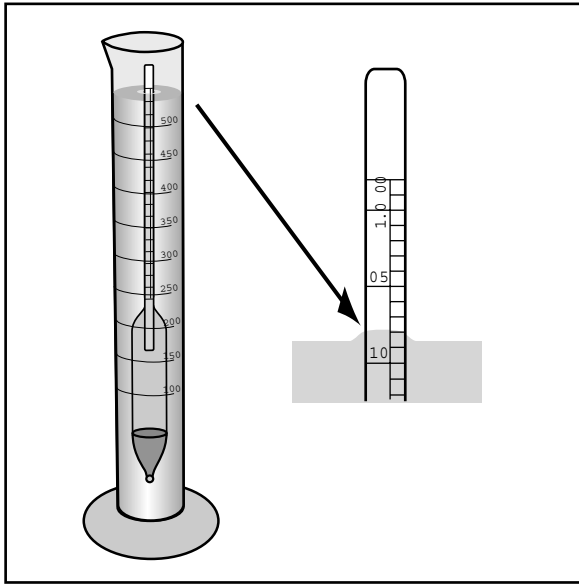

Figure-SO-PA-1

is suspended in the water, the specific gravity, and therefore the hydrometer reading, increases.

In order to measure the specific gravity of the soil/water suspension for this protocol, the hydrometer is placed in the soil suspension 30 seconds before the reading is to be made to allow the hydrometer to become still in the water. At the appointed time (at 2 minutes and again at 24 hours), the hydrometer is read at the level where the number scale touches the surface of the water.

To read the new value, always start with 1.0 and then add the last 2 numbers based on the position on the hydrometer. For example, the hydrometer reading in Figure SO-PA-1 and Figure SO-PA-2 is: 1.008

The initial sample preparation for this protocol may be done in advance. The protocol itself can be done in two class periods on successive days.

Managing Materials

The ideal material for dispersing soil is Sodium Hexametaphosphate. This compound can be purchased as “Soil Dispersing Material” from GLOBE equipment distributors or from a chemical supply house. An alternative for dispersing soil particles is a non-sudsing soap used for washing dishes, such as standard automatic dishwasher

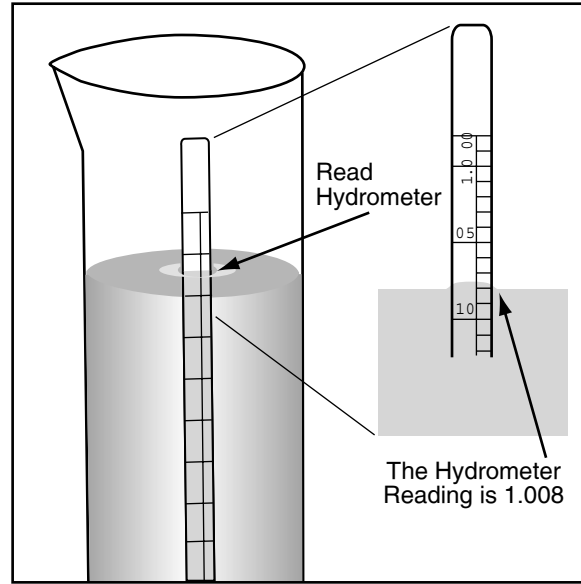

Figure-SO-PA-2

soap. It is important that this soap contains sodium and phosphate and does not produce suds that will make the hydrometer measurements difficult.

GLOBE wants students to do this protocol three times for each soil horizon. If teachers have three 500 mL cylinders and three 250 mL containers (jars or beakers), then students can measure three samples at the same time. If teachers have more equipment, students can measure multiple horizons at the same time.

Questions for Further Investigation

What natural changes could alter the particle size distribution of a horizon?

How does the particle size distribution affect the types of vegetation that can grow on a soil?

How does climate affect the particle size distribution of a horizon?

How does parent material affect the particle size distribution of a horizon?

How does particle size distribution affect soil temperature?

How does particle size distribution affect soil fertility?

How does particle size distribution affect soil moisture?

How do streams, rivers, and floodwaters affect the textures of soil in river deltas?

Soil Particle Size Distribution

Lab Guide

Task

To determine the particle size distribution for each horizon in a soil profile

What You Need

- Dry, sieved soil
- 2 Liters distilled water
- Three 250 mL or larger, beakers
- 1 empty plastic 2 liter bottle
- Hydrometer
- Thermometer
- Plastic wrap (or other cover for cylinder)
- Particle Size Distribution Data Sheet*
- 100-mL graduated cylinder
- Pencil or pen
- Soil dispersing reagent
- 500-mL clear cylinders
- Squirt bottle for washing soil out of beaker
- Meter stick
- Balance accurate to within 0.1 g

In the Lab

1. Prepare the dispersing solution by mixing 50 g of Sodium Hexametaphosphate (or other soil dispersing agent such as non-sudsing dishwater detergent) in 1 L of distilled water. Stir or shake until the dispersing agent has completely dissolved.



2. Weigh 25 g of dried, sieved soil and pour it into a 250 mL or larger container.

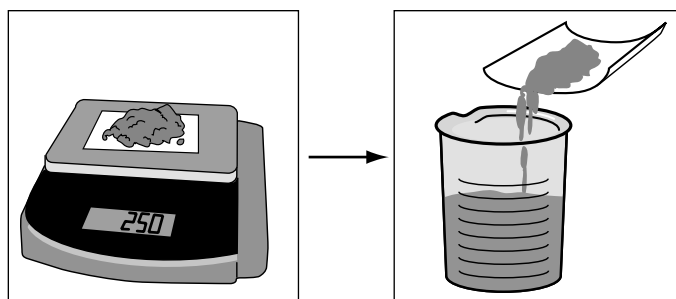

3. Add 100 mL of the dispersing solution and 50 mL of distilled water to the beaker. Stir vigorously with a spoon or stirring rod for at least one minute. Be sure the soil is thoroughly mixed and does not stick to the bottom of the beaker. Do not let any of the soil suspension spill out the top. Rinse any soil off the spoon or stirring rod into the container using a little distilled water.

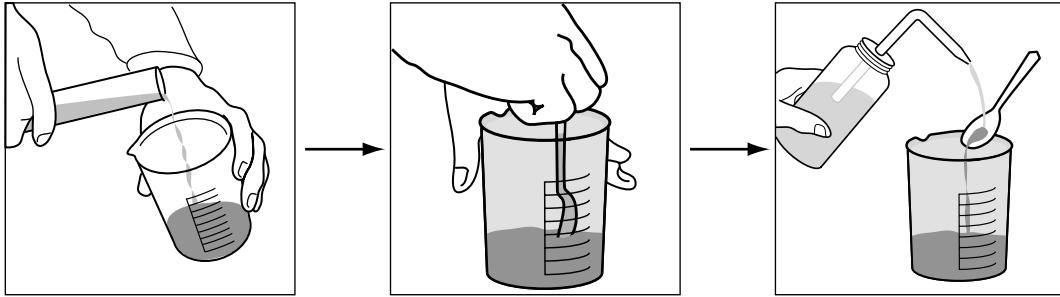

4. While the soil suspension is sitting, measure the distance between the base and the 500 mL mark of the cylinder. Place the meter stick inside the cylinder to get this measurement.

Read the temperature at which your hydrometer has been calibrated (such as 15.6° C [60° F] or 20° C). This value is found on the body of the hydrometer.

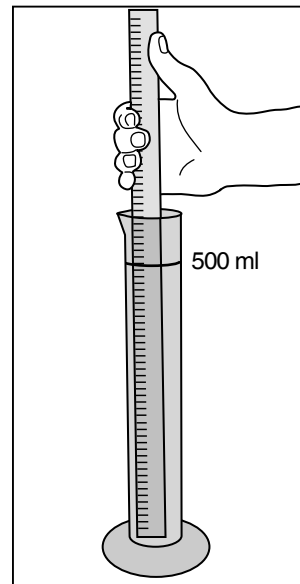

5. Complete the top section of the *Particle Size Distribution Data Sheet*.

6. After at least 24 hours, stir the suspension in the container and pour it into a 500 mL graduated cylinder. Use a squirt bottle to rinse all soil out of the container and into the cylinder.

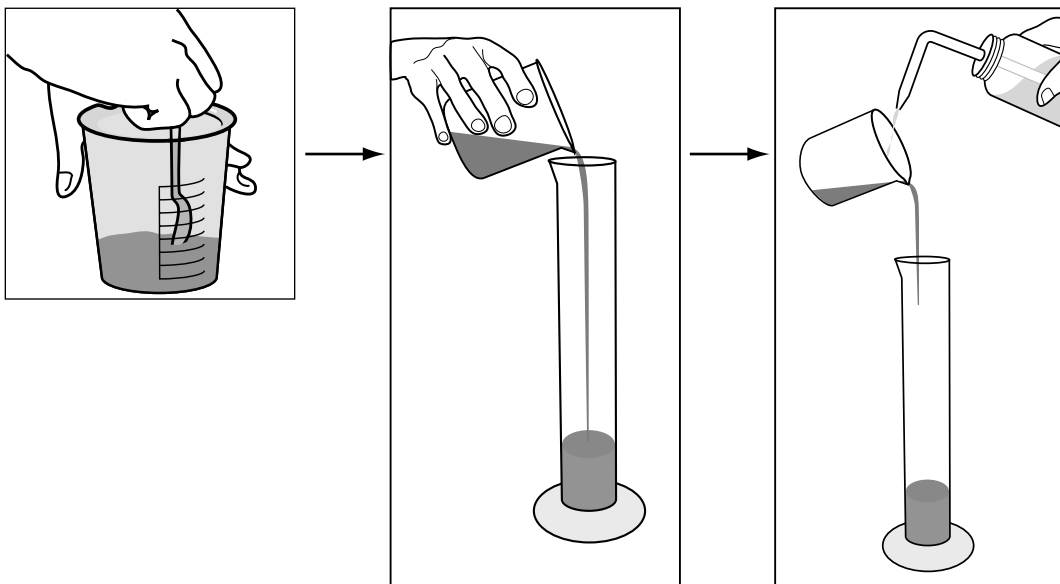

7. Add enough distilled water to fill the cylinder to the 500 mL mark.
8. Securely cover the top of the cylinder using plastic wrap or other cover. Place your hand over the mouth of the cylinder and mix the soil suspension vigorously by rotating the covered cylinder hand-over-hand at least 10 times. Be sure that the soil is thoroughly mixed in the suspension and that no soil is sticking to the bottom of the cylinder. Also, try not to let any of the soil suspension leak out of the top of the cylinder.
9. Gently set the cylinder down in a safe place and immediately begin timing with a stopwatch or clock that has a second hand.
10. Record the time that the cylinder was set down to the second. (In the example to the right, the starting time is: 10:05 and 0 seconds.)
11. After **1 minute and 30 seconds** has passed, carefully lower (do not drop) the hydrometer into the cylinder and let it float in the soil suspension. Carefully steady the hydrometer to stop its bobbing motion.

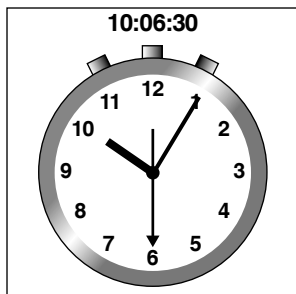
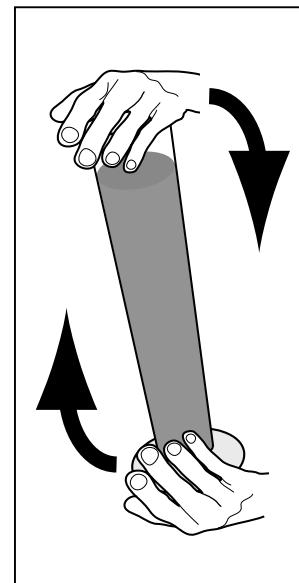
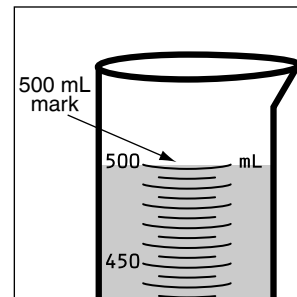

Time Cylinder was set down

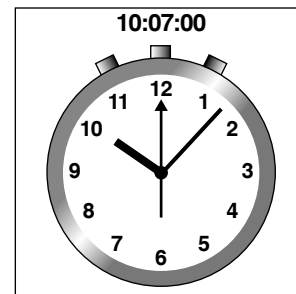
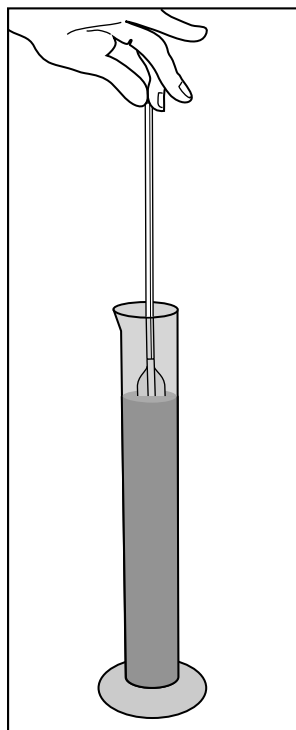

Time Hydrometer is read

12. At exactly **2 minutes** after the cylinder was set down, read the line on the hydrometer that is closest to the surface of the soil suspension and record that number on the *Particle Size Distribution Data Sheet*.

13. Remove the hydrometer, rinse it away from the cylinder, dry it and gently put it down in a safe place.
14. Suspend the thermometer in the suspension for about one minute.
15. At the end of a minute, lift the thermometer from the suspension enough so that you can read the temperature and record the result on the *Particle Size Distribution Data Sheet*.
16. Rinse the thermometer off and dry it.
17. Leave the cylinder undisturbed for 24 hours. After 24 hours, take another hydrometer and temperature reading. Record the results on the *Particle Size Distribution Data Sheet*. (The 24-hour hydrometer reading should be 24 hours from the initial timing start.)

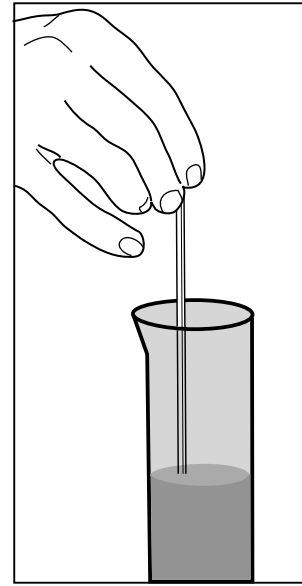

18. Discard the soil suspension by pouring it into a special pail and spill the contents outside in a special place for discarding soil materials.

Particle Size Distribution Protocol – Looking at the Data

Note: If you need help, see the example following this section.

A. Calculate the Percent Sand, Silt, and Clay in Your Soil Sample Using the Following Work Sheet:

1. In A, enter the 2-minute hydrometer reading. A. 2 minute hydrometer reading _____
2. In B, enter the 2-minute temperature reading. B. 2 minute temperature reading _____ °C
3. In C, enter the grams of soil/L in suspension using the hydrometer reading in A and converting it with Table SO-PA-1 following step 18. C. Grams/L of soil (silt + clay) from table _____ g
4. In D, multiply the difference between the temperature reading (from B) and 20° C by 0.36 to correct for temperatures above or below 20° C D. Temperature correction $[0.36 \times (B - 20^\circ \text{C})]$
 $[0.36 \times (B \text{ _____} - 20)] = \text{_____ g}$
5. In E, enter the sum of grams of soil/L (from C) and the temperature correction (from D). E. Corrected silt and clay in suspension (C+D)
 $C \text{ _____} + D \text{ _____} = \text{_____ g}$
6. In F, multiply the value for g/L of soil from E by 0.5 to correct for the fact that you have used a 500 mL cylinder. F. Grams of soil (silt + clay) in 500 mL
 $(E \text{ _____} \times 0.5) = \text{_____ g}$
7. In G, find the grams of sand in your sample, by subtracting grams of silt + clay in suspension (F) from the initial 25 g total soil in the sample. G. Grams of sand in sample
 $(25 \text{ g} - F \text{ _____}) = \text{_____ g}$
8. In H, determine the exact percentage of sand, by dividing grams of sand by the total amount of soil (25 g) and multiplying by 100. **H. Percent Sand**
 $[(G \text{ _____} / 25) \times 100] = \text{_____ \%}$
9. In I, enter the hydrometer reading measurement at 24 hours. I. 24-hour hydrometer reading _____
10. In J, enter the 24-hour temperature reading. J. 24-hour temperature reading _____ °C
11. In K, enter the grams of soil/L in suspension at 24 hours (clay) using the hydrometer reading in I and converting it with Table SO-PA-1 following step 18. K. Grams/L of soil (clay) from table _____ g

12. In L, multiply the difference between the temperature reading at 24 hours (from J) and 20° C by 0.36.

L. Temperature correction $[0.36 \times (B - 20^\circ \text{C})]$
 $[0.36 \times (J \text{ _____} - 20^\circ \text{C})] = \text{_____ g}$

13. In M, enter the sum of grams of soil/L (from K) and the temperature correction (from L).

M. Corrected clay in suspension (C+D)
 $K \text{ _____} + L \text{ _____} = \text{_____ g}$

14. In N, multiply the number in M by 0.5 to correct for the fact that you have used a 500 mL cylinder.

N. Grams of soil (clay) in 500 mL
 $(M \text{ _____} \times 0.5) = \text{_____ g}$

15. In O, determine the exact percentage of clay, by dividing grams of clay in suspension (from N) by the total amount of soil (25 g) and multiplying by 100.

O. Percent Clay
 $[(N \text{ _____} / 25) \times 100] = \text{_____ \%}$

16. In P, determine the grams of silt by adding the grams of sand (from G) and grams of clay (from N) and subtracting the result from 25.

P. Grams of silt
 $[25 - (G \text{ _____} + N \text{ _____})] = \text{_____ g}$

17. In Q, determine the exact percentage of silt, by dividing grams of silt by the total amount of soil (25 g) and multiplying by 100.

Q. Percent Silt
 $[(P \text{ _____} / 25) \times 100] = \text{_____ \%}$

18. See the Textural Triangle in Figure SO-PA-3 to determine the Soil Texture

Sample Number 1:

Sand: _____ % Silt: _____ % Clay _____ %

Soil Texture Class: _____

Sample Number 2:

Sand: _____ % Silt: _____ % Clay _____ %

Soil Texture Class: _____

Sample Number 3:

Sand: _____ % Silt: _____ % Clay _____ %

Soil Texture Class: _____



Table SO-PA-1: Conversion Table (specific Gravity to Grams of Soil/L)

Specific Gravity	Grams Soil/L	Specific Gravity	Grams Soil/L	Specific Gravity	Grams Soil/L
1.0024	0.0	1.0136	18.0	1.0247	36.0
1.0027	0.5	1.0139	18.5	1.0250	36.5
1.0030	1.0	1.0142	19.0	1.0253	37.0
1.0033	1.5	1.0145	19.5	1.0257	37.5
1.0036	2.0	1.0148	20.0	1.0260	38.0
1.0040	2.5	1.0151	20.5	1.0263	38.5
1.0043	3.0	1.0154	21.0	1.0266	39.0
1.0046	3.5	1.0157	21.5	1.0269	39.5
1.0049	4.0	1.0160	22.0	1.0272	40.0
1.0052	4.5	1.0164	22.5	1.0275	40.5
1.0055	5.0	1.0167	23.0	1.0278	41.0
1.0058	5.5	1.0170	23.5	1.0281	41.5
1.0061	6.0	1.0173	24.0	1.0284	42.0
1.0064	6.5	1.0176	24.5	1.0288	42.5
1.0067	7.0	1.0179	25.0	1.0291	43.0
1.0071	7.5	1.0182	25.5	1.0294	43.5
1.0074	8.0	1.0185	26.0	1.0297	44.0
1.0077	8.5	1.0188	26.5	1.0300	44.5
1.0080	9.0	1.0191	27.0	1.0303	45.0
1.0083	9.5	1.0195	27.5	1.0306	45.5
1.0086	10.0	1.0198	28.0	1.0309	46.0
1.0089	10.5	1.0201	28.5	1.0312	46.5
1.0092	11.0	1.0204	29.0	1.0315	47.0
1.0095	11.5	1.0207	29.5	1.0319	47.5
1.0098	12.0	1.0210	30.0	1.0322	48.0
1.0102	12.5	1.0213	30.5	1.0325	48.5
1.0105	13.0	1.0216	31.0	1.0328	49.0
1.0108	13.5	1.0219	31.5	1.0331	49.5
1.0111	14.0	1.0222	32.0	1.0334	50.0
1.0114	14.5	1.0226	32.5	1.0337	50.5
1.0117	15.0	1.0229	33.0	1.0340	51.0
1.0120	15.5	1.0232	33.5	1.0343	51.5
1.0123	16.0	1.0235	34.0	1.0346	52.0
1.0126	16.5	1.0238	34.5	1.0350	52.5
1.0129	17.0	1.0241	35.0	1.0353	53.0
1.0133	17.5	1.0244	35.5	1.0356	53.5
				1.0359	54.0
				1.0362	54.5
				1.0365	55.0



B. Determine the Textural Class of your Soil Sample using the Textural Triangle:

Soil Scientists have created classes that break the distribution of particle sizes (soil textures) into 12 categories. The textural triangle (Figure SO-PA-3) is one of the tools soil scientists use to visualize and understand the meaning of soil texture names. This textural triangle is a diagram that shows how each of these 12 textures is classified based on the percent of sand, silt, and clay in each.

Follow these steps to determine the textural class name of your soil sample:

1. Place a plastic sheet or tracing paper over the textural triangle.
2. Place the edge of a ruler at the point along the base of the triangle that represents the percent of sand in your sample. Position the ruler on the line that slants in the direction that the numbers are slanting for percent sand and draw a line along the ruler edge.
3. Place the edge of the ruler at the point along the right side that represents the percent silt in your sample. Position the ruler on the line that slants in the direction that the numbers are slanting for percent silt.
4. Mark the point along the ruler edge where the two lines cross. Place the top edge of one of the rulers on the mark, and hold the ruler parallel to the horizontal lines. The number on the left should be the percent of clay in the sample. Note that the sum of the percent of sand, silt, and clay should sum to 100%.
5. The descriptive name of the soil sample (textural class) is written in the shaded area where the mark is located. If the mark should fall directly on a line between two descriptions, record both names.

Figure SO-PA-3: Textural Triangle

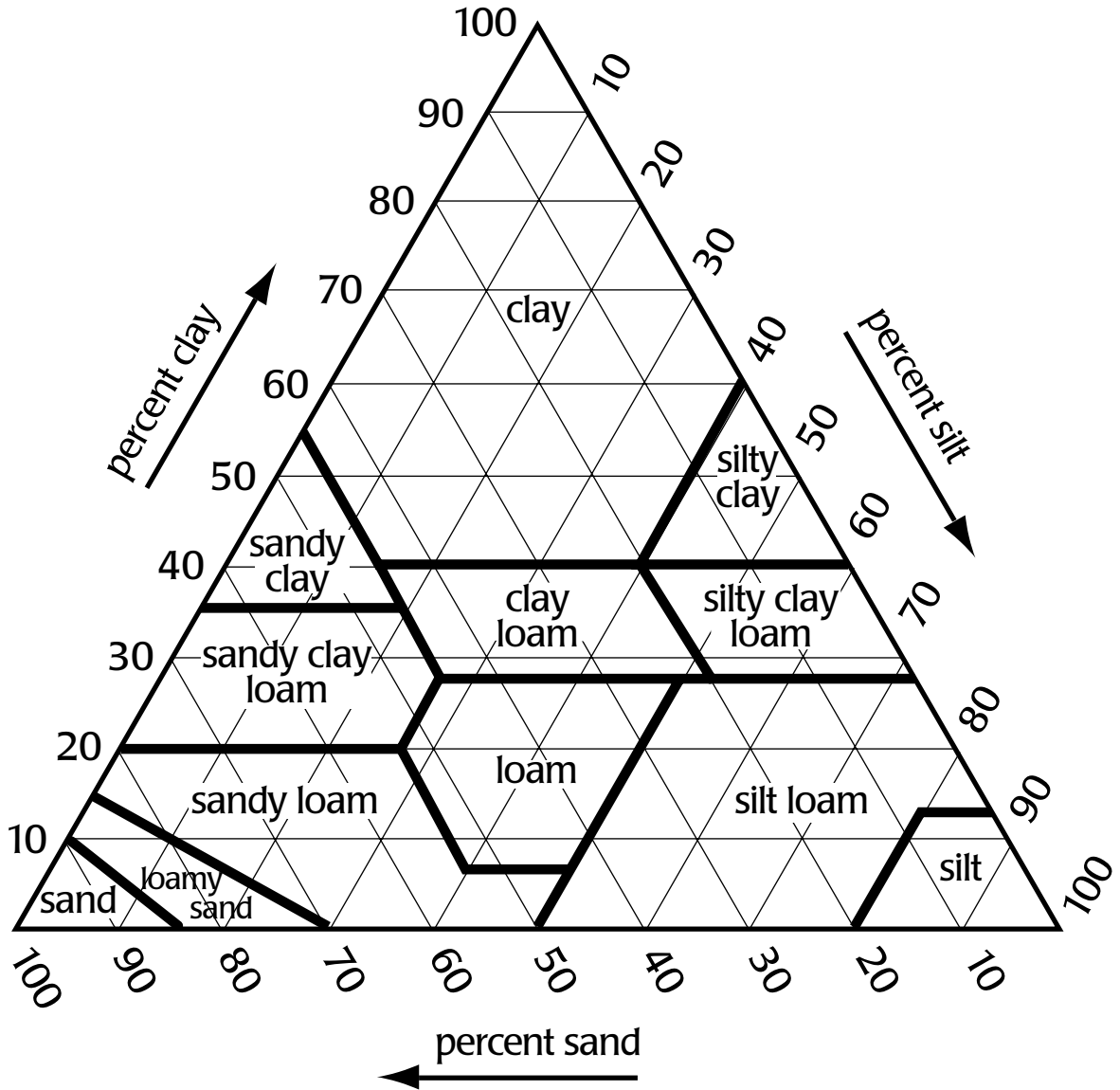

An Example of Student Research

A. Calculating the Percent Sand, Silt and Clay for their Soil Sample

Students recorded the following 2 minute and 24 hour hydrometer readings:

	Specific Gravity	Temperature
2 minutes:	1.0125	21.0
24 hours	1.0089	19.5

For each hydrometer reading of specific gravity, they converted to grams/liter of soil from the conversion table, and corrected for temperature.

For the 2 minute reading

The specific gravity reading is closest to 1.0126, which equals 16.5 grams of silt and clay per liter in suspension. They corrected this value for temperature. Since the temperature reading was 1 degree higher than 20° C, they added 0.36 to the 16.5 grams/liter:

$$16.5 + 0.36 = 16.86 \text{ g/L}$$

Next, they multiplied 16.86 g/L by 0.5 L (which was the volume of water used in the protocol) to change from grams/liter to grams:

$$16.86 \times 0.5 = 8.43 \text{ (8.4 g)}$$

This is the amount of silt and clay in suspension.

They determined the amount of sand, by subtracting 8.4 g from the original amount of soil added in the Protocol (25.0 g):

$$25.0 \text{ g} - 8.4 \text{ g} = 16.6 \text{ g of sand}$$

They calculated the percent of sand in the sample by dividing 16.6 g by the original amount of soil added in the Protocol (25.0 g) and multiplied by 100 to get percent:

$$(16.6 \text{ g}/25.0 \text{ g}) \times 100 = 66.4\% \text{ sand}$$

For the 24 hour reading

The specific gravity reading was 1.0089, which they read directly off the chart as 10.5 g/L. This value represents the amount of clay per liter in suspension. They then corrected the 10.5 g/L for temperature. Since the temperature reading was 0.5 degrees lower than 20° C, they subtracted 0.36×0.5 from the 10.5 grams/liter:

$$0.36 \times 0.5 = 0.18$$

$$10.5 - 0.18 = 10.32 \text{ g/L}$$

Next, they multiplied 10.32 g/L by 0.5 L (which was the volume of water used in the protocol) to change from grams/liter to grams:

$$10.32 \times 0.5 = 5.16 \text{ (rounded to 5.2 g)}$$

5.2 g is the amount of clay that was in the original 25 g of soil used in the Protocol.

They calculated the percent of clay in the sample by dividing 5.2 g by the original amount of soil added in the Protocol (25.0 g):

$$(5.2 \text{ g}/25.0 \text{ g}) \times 100 = 20.8\% \text{ clay}$$

They calculated the amount of silt by adding the grams of sand to the grams of clay, and subtracting that sum from the original amount of sample (25 g):

$$16.6 \text{ g (sand)} + 5.2 \text{ g (clay)} = 21.8$$

$$25 \text{ g} - 21.8 \text{ g} = 3.2 \text{ g silt}$$

which they converted to percent by dividing by 25:

For this sample, the final result was:

%Sand	%Silt	%Clay
66.4	12.8	20.8

B. Determining the Textural Class of Their Soil Sample

The students determined the textural class of their soil sample using the Textural Triangle.

1. First, they placed tracing paper over their Textural Triangle.
2. Second, they placed the edge of a ruler along the base of the Textural Triangle at the 66.4% sand mark and drew a line.

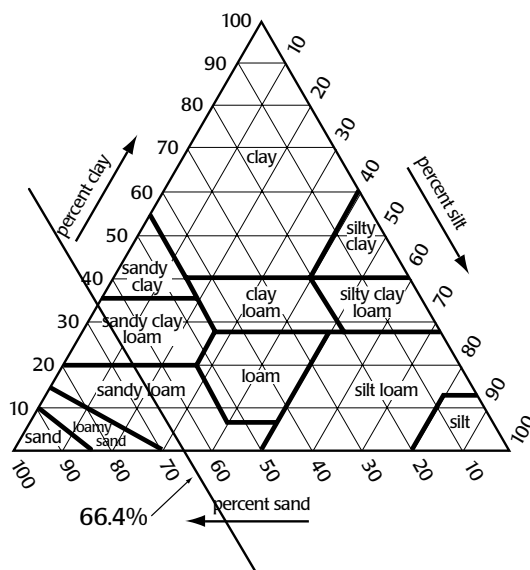

3. Third, they placed the edge of the ruler along the right side of the textured triangle at the 12.8% silt mark and drew a line.

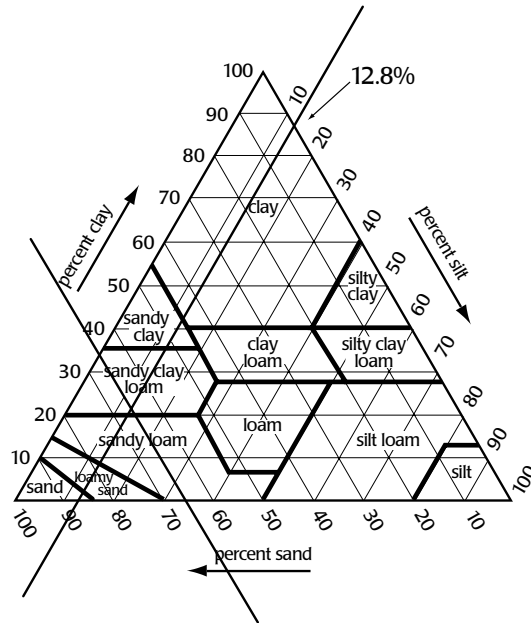

4. Fourth, they marked the point where the two lines crossed. Using their ruler, they matched this point with the % clay from their sample.

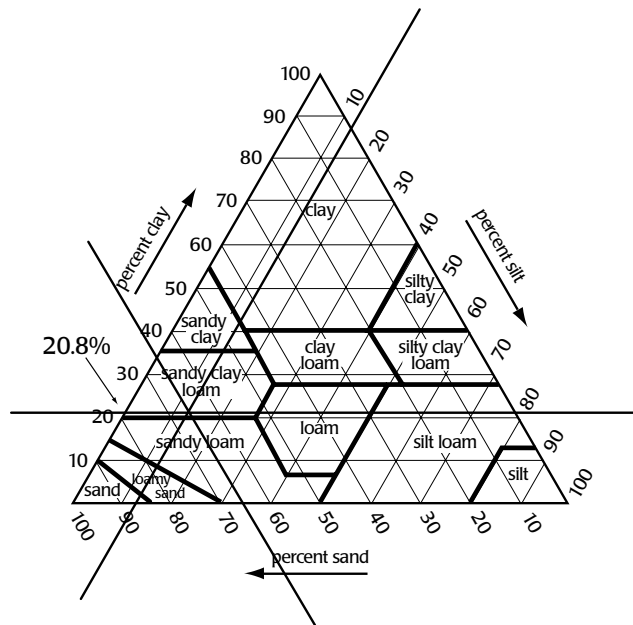

5. Finally, they determined the textural class of their sample to be Sandy Clay Loam by reading the class name where the two drawn lines met.

% Sand	% Silt	% Clay	Soil Texture Class
66.4	12.8	20.8	Sandy Clay Loam

Soil Texture Practice Sheet

Use the following numbers to determine the soil texture name using the textural triangle. In the places where a number is missing, fill in the blanks. **Note:** the sum of percent sand, silt and clay should always add up to 100 percent:

	% Sand	%Silt	%Clay	Texture Name
a.	75	10	15	sandy loam
b.	10	83	7	
c.	42		37	
d.		52	21	
e.		35	50	
f.	30		55	
g.	37		21	
h.	5	70		
i.	55		40	
j.		45	10	

Answers: b. silt loam; c. 21, clay loam; d. 27, silt loam; e. 15, clay; f. 15, clay; g. 42, loam; h. 25, silt loam; i. 5, sandy clay; j. 45, loam.

For Advanced Students

Stoke's Law: To Calculate the Settling Time of Soil Particles

In the Soil Particle Size Distribution Protocol, the readings of the hydrometer are taken at a very specific time to allow either the sand or silt to settle in the cylinder. In order to determine this time for each size particle, we use an equation derived from Stoke's Law. Stoke's Law describes how fast (the velocity) a particle will settle as a function of its diameter and the properties of the liquid in which it is settling. Once this velocity is known, you can calculate the time required for a particle of a certain diameter to settle in a given depth of water.

This activity may be interesting for students for a number of reasons. Students may want to investigate how the settling rates of different particle sizes differ under conditions that are different from the ones used in the GLOBE protocol. For example, if a larger cylinder is used, or the temperature was much hotter or colder, how long would it take for the sand, silt, and clay particles to settle? In the natural world, soil particles carried by moving water settle out when the water stops moving and becomes still. By using the Stoke's Law equation, students can understand the relationships between the amount of sand, silt, and clay carried in the water, the amount of turbidity, and the time it would take for the particles (especially clay) to settle to the bottom and make the water clear.

Stoke's Law can be written in the form of the following equation:

$$V = kd^2$$

where:

V = settling velocity (in cm/second)

d = particle diameter in cm (such as 0.2 cm - 0.005 cm for sand, 0.005 cm- 0.0002 cm for silt, and <0.0002 cm for clay)

k = a constant which depends on the liquid in which the particle is settling, particle density, the force of gravity, and the temperature ($8.9 \times 10^3 \text{ cm}^{-1} \text{ sec}^{-1}$ for soil in water at 20° C).

Example

Suppose you wanted to calculate the amount of time it would take a particle of fine sand (0.1 mm) to settle. The distance between the 500 mL mark on your graduated cylinder and the base of the cylinder is about 27 cm.

1. First, convert the diameter of the particle from mm to cm.

$$0.1 \text{ mm} \times 1 \text{ cm}/10 \text{ mm} = 0.01 \text{ cm}$$

2. Using the equation above, plug in values for the diameter of the particle, square it, and multiply by the constant.

$$\begin{aligned} V &= 8900 \times (0.01)^2 \\ &= 0.89 \text{ cm/second} \end{aligned}$$

3. Next, divide the distance between the 500 mL mark and the base on your cylinder by the velocity calculated in step 2.

$$27 \text{ cm}/0.89 \text{ cm second}^{-1} = 30.33 \text{ seconds}$$

Thus, it would take about 30 seconds for fine sand with a diameter of 0.1 mm to settle to the base of the 500 mL cylinder.

Soil pH Protocol



Welcome

Introduction

Protocols

Learning Activities

Appendix

Purpose

To measure the pH of a soil horizon

Overview

Students mix dried and sieved soil samples with distilled water. The mixture is allowed to settle until a relatively clear layer, called the supernatant, is formed. Students use a pH pen, pH meter, or pH paper to determine the pH of the sample. The procedure is done three times for each horizon.

Student Outcomes

Students will be able to apply laboratory tests for pH to soil samples. Students will be able to relate pH to the physical and chemical properties of a soil sample.

Science Concepts

Earth and Space Sciences

Soils have properties of color, texture, structure, consistence, density, pH, fertility; they support the growth of many types of plants.
The surface of Earth changes.

Water circulates through soil changing the properties of both the soil and the water.

Physical Sciences

Objects have observable properties.
Chemical reactions take place in every part of the environment.

Scientific Inquiry Abilities

Identify answerable questions.
Design and conduct an investigation.
Use appropriate tools and techniques including mathematics to gather, analyze, and interpret data.

Develop descriptions and explanations, predictions and models using evidence.
Communicate procedures and explanations.

Time

One 45-minute class period

Level

All

Frequency

Once for each soil horizon

Materials and Tools

Oven-dried, sieved soil
Distilled water
Pencil or pen
100-mL graduated cylinder
Glass stirring rod or other stirring device
100 mL beaker
pH meter, pH pen, or pH paper
Balance (accurate to 0.1 g)
Soil pH Data Sheet

Preparation

Collect required soil samples.

Review the *pH Protocol* in the *Hydrology Investigation*

Dry and sieve soil samples, and store them in a sealed container.

Calibrate the balance to 0.1 g.

Calibrate the pH pen or meter. (See procedure for calibration in the *pH Protocol* in the *Hydrology Investigation*.)

Prerequisites

Soil Characterization Protocol



Soil pH Protocol – Introduction

The pH, or the amount of hydrogen ions in a sample, is an important consideration when studying soil. As in the study of hydrology, the pH scale is used as an indication of the concentration of hydrogen ions in the soil. Dry, sieved soil is dissolved in a specified volume of water with a known pH. The extent to which the dissolved soil changes the pH of the water is an indicator of the number of hydrogen ions contained in the soil. pH is measured on a logarithmic scale and represents the negative logarithm of the hydrogen ion concentration in moles/L. For example, a pH of 2 represents a concentration of 1×10^{-2} moles/L (0.01) hydrogen ions, and pH 8 represents a concentration of 1×10^{-8} moles/L (0.00000001) hydrogen ions.



When soil contains a high concentration of hydrogen ions, it is considered to be *acidic* and when it has a low number of hydrogen ions, it is considered to be *basic*. pH 7 is considered to be “neutral” (neither acidic nor basic). The pH scale ranges from 1-14 with pH 1 being extremely acidic (1×10^{-1} or 0.1 moles of hydrogen ions per liter), and pH 14 being extremely basic (1×10^{-14} moles of hydrogen ions per liter or 0.000000000000001 moles/L).

Soil pH is an indication of the soil’s chemistry and fertility. The pH affects the chemical activity of the elements in the soil, as well as many of the soil properties. Different plants grow best at different pH values. See Figure SO-PH-1. Farmers and gardeners may add materials to their soil to change its pH depending upon the type of plants they want to grow. The pH of the soil may also affect the pH of ground water or of a nearby water body, such as a stream or lake.

Figure SO-PH-1

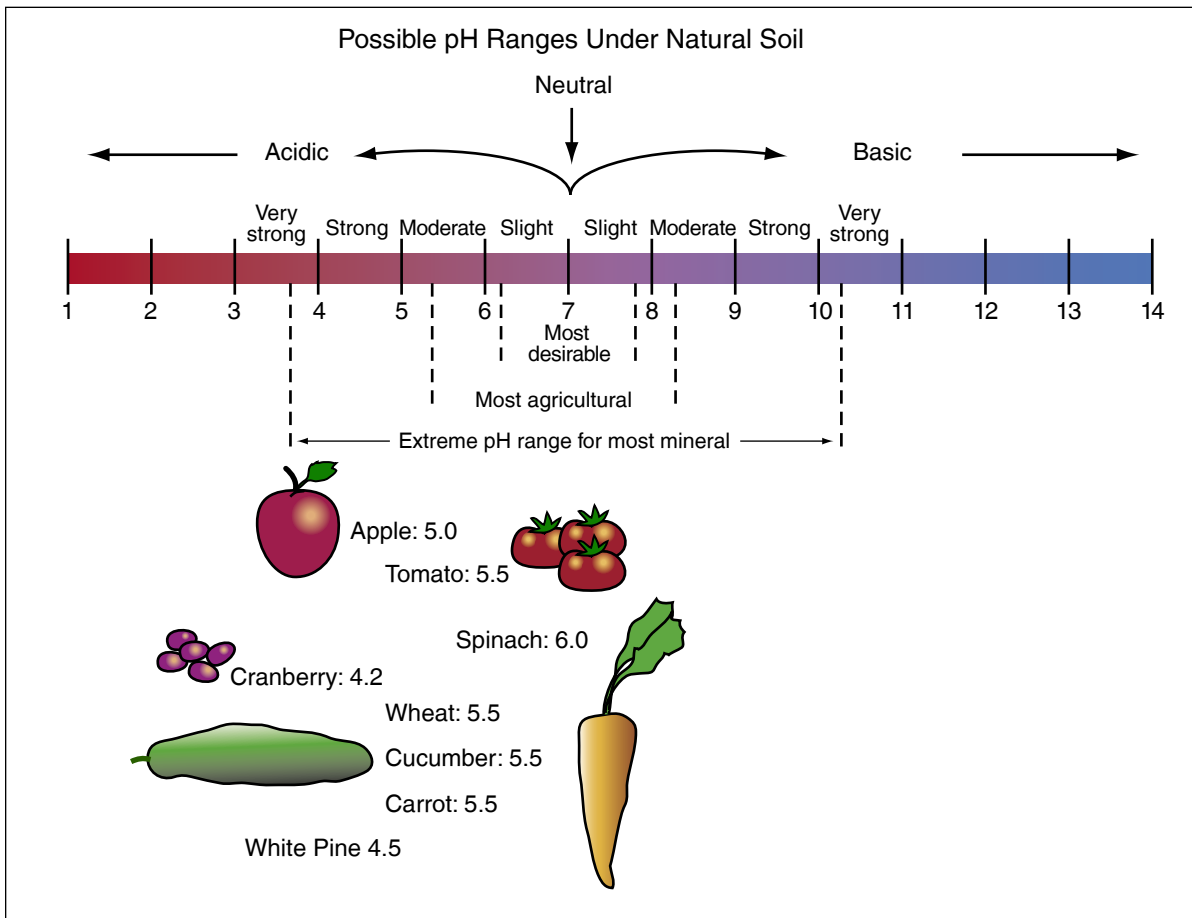

The pH of soil controls many of the chemical and biological activities that take place in the soil and also indicates something about the climate, vegetation, and hydrologic conditions under which the soil formed. The pH of a soil horizon (how acidic or basic the soil is) is affected by the parent material, the chemical nature of the rain and other water entering the soil, land management practices, and the activities of organisms (plants, animals, and microorganisms) living in the soil. For example, needles from pine trees are high in acids, and as they decay over time, they can lower the pH of the soil.

Teacher Support

Preparation

Have students review the *pH Protocol* in the *Hydrology Investigation* and practice using the pH equipment by testing the pH of different liquids at different pH levels.

Measurement Procedures

To measure pH, students mix dry soil samples with distilled water until the soil and liquid are in equilibrium and provide an accurate measurement of the soil pH. A 1:1 soil/water solution is used for this protocol because it is similar to a standard method for professional soil pH measurements.

Managing Materials

If students are going to use a pH meter to measure pH, while performing their soil pH measurements, students should be sure that the pH meter is working properly. They should calibrate it according to the directions given in the *pH Protocol* in the *Hydrology Investigation* and, if necessary, replace weak or dead batteries.

For some soil samples, especially those high in clay, the soil in the water will not settle after mixing and will not form a supernatant. In this case, after thorough mixing according to the protocol, place the pH meter or paper into the top of the soil/liquid suspension and take a reading.

Managing Students

If a single team of students is measuring all three samples of a horizon, have them process the samples in parallel, not in sequence. This will allow the protocol to be completed in less than 45 minutes.

Questions for Further Investigation

What natural changes could alter the pH of a horizon?

How does the pH of the rain affect the pH of a soil horizon?

How does the pH of the soil affect the pH of local water bodies?

How does climate affect the pH of a horizon?

How do slope and aspect affect the pH of a horizon?

How does the type of vegetation growing on the soil affect the pH of the soil?

Soil pH Protocol

Lab Guide

Task

To obtain three pH readings for a soil horizon

What You Need

- Dried sieved soil
- Distilled water
- 100-mL graduated cylinder
- Four 100-mL containers
- Balance (accurate to 0.1 g)
- pH Data Sheet
- Pencil or pen
- Glass stirring rod or other stirring device
- pH meter or pH paper

In the Lab

1. In a cup or beaker, mix 40 g of dried and sieved soil with 40 mL of distilled water (or other amount in a 1:1 soil to water ratio) using a spoon or other utensil to transfer the soil.

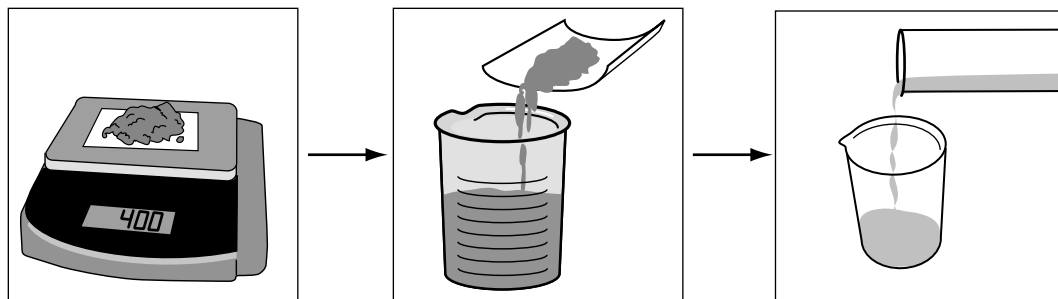

2. Stir the soil/water mixture with a spoon or other stirrer until it is thoroughly mixed. Stir the soil/water mixture for 30 seconds and then wait for three minutes for a total of five stirring/waiting cycles. Then, allow the mixture to settle until a supernatant (clearer liquid above the settled soil) forms (about 5 minutes).

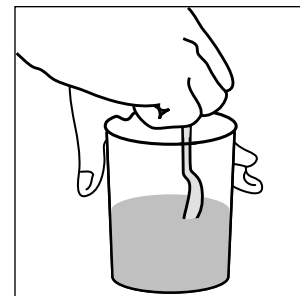

3. Measure the pH of the supernatant using the pH paper or meter. Dip the pH paper or calibrated pH meter in the supernatant. Record the pH value on the *Soil pH Data Sheet*. If pH meter requires calibration, gloves should be worn.

4. Repeat steps 1-3 for two more samples from the same horizon.

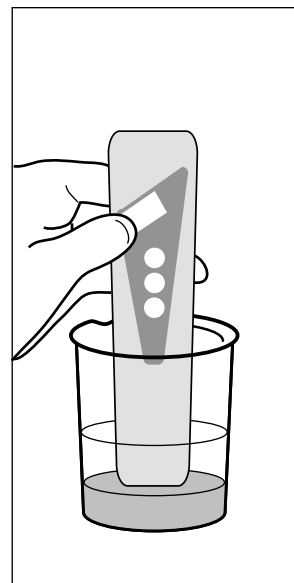



Soil pH Protocol— Looking at the Data

Are the data reasonable?

A soil's parent material, the climate under which it formed, the vegetation it supports and the amount of time it has had to develop, determines its pH. In general, soil pH values range from 4.0 for acidic, organic rich soils, to 8.5 for soils with a high number of free carbonates. Occasionally, the pH can go as low as 3.5 or as high as 10.

Generally, the pH will not vary much from horizon to horizon in a soil profile. This is because the pH scale is a base 10 logarithmic scale, so the differences of 1 unit in pH mean there are 10 times more hydrogen ions, or 10 times more acidity. In some cases, there might be a drastic change in parent material causing a very different pH between horizons. For example, materials may be deposited onto a horizon or some human intervention has occurred such as addition of limestone. Drastic changes in soil pH between soil horizons may help students to uncover clues about the story of the soil at that location. Students should expect some change in pH from the top to the bottom of the profile, depending on the amount of organic matter, free carbonates, and weathering of the soil. If there is a lot of organic matter at the surface, and no limestone has been added, the pH in the upper horizons may be lower than those below. Where carbonates are present, horizons tend to have high pH values.



What do scientists look for in the data?

Many different scientists are interested in soil pH data. Soil pH measurements, in combination with soil characterization measurements and other GLOBE measurements, provide scientists a great deal of information about the environment. For example, soil pH helps scientists understand the chemical properties of the soil and the potential for certain nutrients to be stored or released. With this information, scientists determine the suitability of a soil for plant growth.

Scientists also predict the movement of materials into the hydrologic system. They consider rainfall chemistry when they make predictions of changes in soil chemistry and soil pH over time.

Soil pH helps scientists to reconstruct the development of a soil and predict the nature of the soil in the future.

An Example of a Student Research Project

Middle school students from Keflavik, Iceland collected soil samples while carrying out soil characterization measurements on a soil pit. They dried and sieved three samples for each horizon in their sample site and performed the *Soil pH Protocol* on each sample.

In order to analyze their data, they decided to graph the pH measurements they collected. The graph plotted the pH measurements for each horizon at the mid-point depth of each soil horizon. The students calculated the mid-point depth according to the following equation:

$$\frac{(\text{Bottom Depth} - \text{Top Depth})}{2} + \text{Top Depth}$$

$$\text{Horizon 1: } \frac{(10-0)}{2} + 0 = 5.0 \text{ cm}$$

$$\text{Horizon 2: } \frac{(23-10)}{2} + 10 = 16.5 \text{ cm}$$

$$\text{Horizon 3: } \frac{(44-23)}{2} + 23 = 33.5 \text{ cm}$$

$$\text{Horizon 4: } \frac{(65-44)}{2} + 44 = 54.5 \text{ cm}$$

The results of their measurements are in the table below.

Horizon	Top Depth	Bottom Depth	Mid-Point Depth	pH (mean of 3 replicates)
1	0.0	10.0	5.0	5.5
2	10.0	23.0	16.5	5.6
3	23.0	44.0	33.5	5.8
4	44.0	65.0	54.5	5.9

Using the data in the table, the students plotted the mean pH at the mid-point depth of each horizon as shown in the graph below.

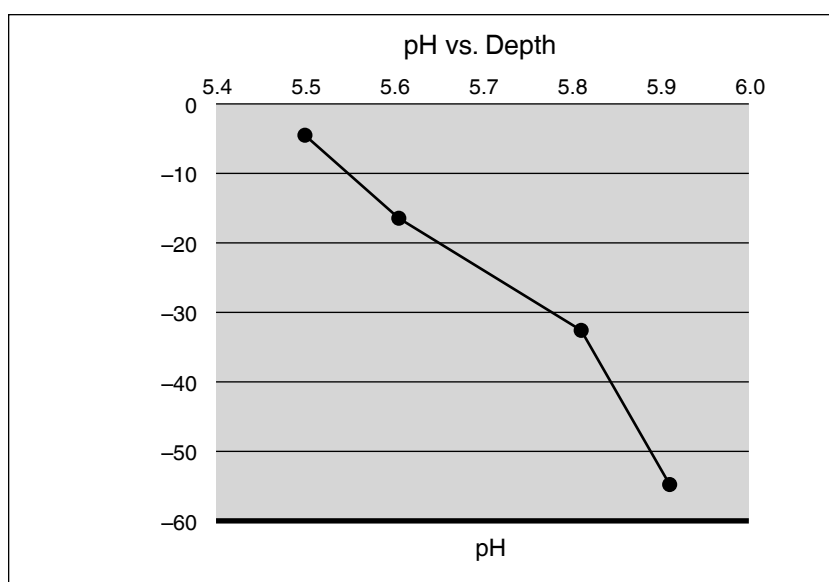

The students noticed that the pH was lowest at the top of the soil profile and increased with depth. They hypothesized that weathering of the soil at the surface and inputs of rain or organic matter caused the low pH at the top of the profile.

The students were interested in knowing whether the trend in pH they observed was typical of soils in other parts of the world with different climates and vegetation. According to the MUC classification guide, the land cover type at their site was dwarf-shrub/moss tundra. They used the GLOBE data archive to search for other schools that had made soil pH measurements, and found two schools in areas different from their own.



One school was a secondary School in Deir Allah, Jordan. The students at this school reported their vegetation type as row crop or pasture. The pH data reported by this school are given in the table below.

Deir Allah, Jordan

Horizon	Top Depth	Bottom Depth	Mid-Point Depth	pH (mean of 3 replicates)
1	0.0	20.0	10.0	8.0
2	20.0	33.0	26.5	8.2
3	33.0	44.0	38.5	8.5
4	44.0	100.0	72.0	8.5



The other school they chose was a middle school in New York, USA. The students at this school reported their vegetation type as evergreen-needled trees. The pH data reported by this school are given in the table below.

New York, USA

Horizon	Top Depth	Bottom Depth	Mid-Point Depth	pH (mean of 3 replicates)
1	0.0	13.0	6.5	2.9
2	13.0	23.0	18.0	3.4
3	23.0	35.0	29.0	3.4
4	44.0	60.0	52.0	4.0



The students then plotted the pH values at the midpoints for each of the three schools on one graph as shown below.

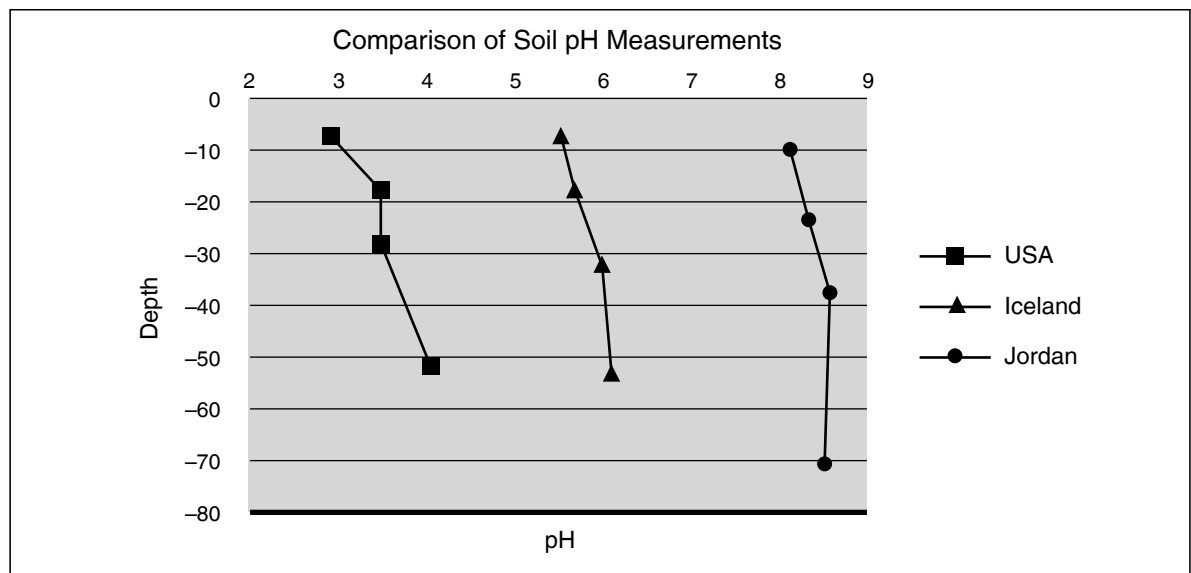

The students noticed considerable differences in the pH values at each of these locations. The soil in Jordan had much higher pH values than the soil in Iceland, while the New York school had much lower pH values. They noticed a trend of increasing pH with increasing depth at all three of schools. The students concluded that deeper soils have a higher pH in many different kinds of soils.

The students realized that more information about each location would help them better understand the pH differences at the sites. They decided that in the future, they would contact students at each school using GLOBE mail to find out more about their locations. They also planned to download precipitation and temperature data from the GLOBE data archive to see whether the differences in the amount and pH of annual rainfall and mean annual temperature at these schools would give an indication of why the pH values were so different in the soils.

Soil Fertility Protocol



Purpose

To measure the amounts of nitrogen (N), phosphorus (P), and potassium (K) in each horizon in a soil profile

Overview

Using a NPK test kit, students mix a dry, sieved soil sample into a solution and chemically extract the N, P, and K as nitrate, phosphate, and potassium. The N, P, and K amounts in the sample are determined by comparing the solution to a color chart. Students describe the N, P, K amounts as high, medium, low, or none. These measurements are conducted three times for each horizon.

Student Outcomes

Students will be able to measure the nitrate nitrogen, phosphate phosphorus and potassium contents of soils.

Students will be able to relate soil fertility to the physical and chemical properties of the soil.

Science Concepts

Earth and Space Sciences

Soils store nutrients in different amounts depending on the type of nutrient and the soil properties.

Soils have properties of color, texture, structure, consistence, density, pH, fertility; they support the growth of many types of plants.

The surface of Earth changes.

Soils are often found in layers, with each having a different chemical composition and texture.

Soils consist of minerals (less than 2 mm), organic material, air and water.

Water circulates through soil changing the properties of both the soil and the water.

Physical Sciences

Objects have observable properties.

Chemical reactions take place in every part of the environment.

Life Sciences

Atoms and molecules cycle among the living and nonliving components of the ecosystem.

Scientific Inquiry Abilities

Identify answerable questions.

Design and conduct an investigation.

Use appropriate tools and techniques including mathematics to gather, analyze, and interpret data.

Develop descriptions and explanations, predictions and models using evidence.

Communicate procedures and explanations.

Time

One 45-minute class period for three groups of students to analyze one horizon.

Level

Middle and Secondary

Frequency

Once for each soil profile

Materials and Tools

Oven-dried, sieved soil (sieved with a Number 10 sieve with 2 mm mesh attached to a frame)

GLOBE (or equivalent) NPK kit

Distilled water

Beaker

Teaspoon

Clock or stopwatch

Soil Fertility Data Sheet (more than one *Data Sheet* may be needed for each profile)

Latex gloves

Goggles

Preparation

Obtain dry, sieved soil samples.

Collect required equipment.

Spread out newspapers or other cover on table to keep area clean.

Prerequisites

Soil Characterization Protocol



Soil Fertility Protocol – Introduction

In order to grow, plants require sunlight, water, air, heat, and nutrients. Table SO-FE-1 lists the *macronutrients* (nutrients required in large amounts) and *micronutrients* (nutrients required in smaller quantities) required for plant growth. The fertility of a soil indicates the availability of these nutrients for plants to grow.



Table SO-FE-1

Macronutrients	Micronutrients
Nitrogen (N)	Iron (Fe)
Phosphorus (P)	Zinc (Zn)
Potassium (K)	Manganese (Mn)
Sulfur (S)	Copper (Cu)
Calcium (Ca)	Boron (B)
Magnesium (Mg)	Molybdenum (Mo)
	Chlorine (Cl)



Some soil nutrients are positively charged, while other nutrients are negatively charged. Nutrients that are positively charged, such as potassium, calcium, and magnesium, are held by negatively charged soil particles. These nutrients are removed from the soil by plants or by weathering processes. Negatively charged particles, such as nitrogen (in the common form of nitrate), phosphorus (in the common form of phosphate) and sulfur (in the common form of sulfate) are not held by negatively charged soil particles. These nutrients are more easily leached and removed from the soil. When a soil loses its nutrients or does not have the nutrients needed for plant growth, farmers and gardeners replenish nutrients by adding fertilizers



Figure SO-FE-1

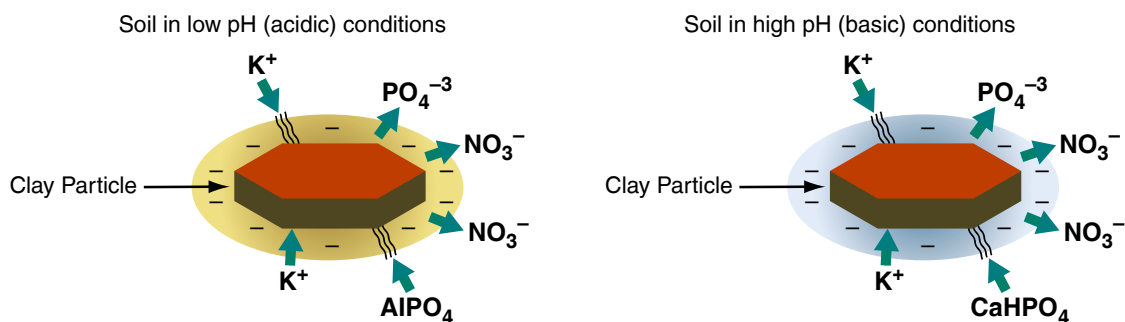

to soils.

The *Soil Fertility Protocol* measures the abundance of three nutrients: nitrate (nitrogen), phosphate (phosphorus), and potassium, in each horizon of a soil profile to determine if the soil is fertile for plant growth.

Nitrogen (N) is an element found in high concentrations in the atmosphere, but relatively low concentrations in soil. For nitrogen to be used by most living things, the N_2 molecules must be broken apart. In soil and water, this usable nitrogen takes the form of nitrate (NO_3^-), nitrite (NO_2^-) and ammonium (NH_4^+), with nitrate being the most common. In general, these forms of nitrogen are rapidly taken up by plants and are an important component of plant proteins. Nitrate (NO_3^-), because of its negative charge, is not held by negatively charged soil particles and is easily removed (*leached*) from the soil as water passes through it. Nitrate can also be converted to nitrogen gas (N_2) or ammonia (NH_3) and be *volatilized* (*evaporated or removed as a gas*) out of the soil. Therefore, it is important that farmers and gardeners add nitrogen fertilizers when plants need the nutrient the most and can absorb it before it is removed from the soil by leaching. When nitrogen is added to the soil in the form of organic matter, it is stored longer because it becomes available to plants slowly, as the organic matter decomposes.

Phosphorus (P) is used as part of the energy pathway in the plant. Plants use phosphorus in the form of phosphate (PO_4^{-3}). Because of its negative charge, phosphate is easily *leached* from the soil. Plants are only able to take up phosphate when soils are at neutral soil pH values of 5.0-8.0. At low pH values (<5.0), phosphate combines with iron (Fe) and aluminum (Al) to form phosphates that are not soluble and cannot be taken up by plants. At high pH values (>8.0), phosphate combines with calcium



(Ca) to form calcium phosphate, which is neither soluble nor available for plants to take up from the soil. When phosphate occurs in one of these insoluble compounds, it becomes easy to remove from the soil when the soil particles are eroded. Like nitrogen, phosphorus is also more slowly and easily available to plants when it is added as part of decomposing organic matter.

Potassium (K) plays the role of activating cell enzymes in plants. It is readily available to plants in its elemental state (K⁺), and because of its positive charge, is easily stored on negatively charged soil particles. The largest source of potassium is from the decomposition of potassium containing minerals, such as mica.

Teacher Support

Preparation

Make sure students understand the importance of each nutrient they are measuring before they conduct the *Soil Fertility Protocol*.

Have students review the NPK kit instructions before conducting the *Soil Fertility Protocol*.

Managing Materials

To measure soil fertility, students may use a GLOBE soil test kit or an equivalent product that produces a relative value for nitrate, phosphate, and potassium.

Measurement Procedures

The basic method for measuring soil fertility consists of mixing a soil sample with water and chemically extracting the N, P, and K as nitrate, phosphate, and potassium. The N, P, and K amounts in the sample are determined by comparing the solution to a color chart.

Using the GLOBE soil test kit to determine nitrogen (N), students compare the extraction solution with a pink color chart. To determine phosphorus (P), students compare the extraction with a blue color chart. To determine potassium (K), the students place the tube containing the extraction solution over a column of black boxes, and the amount of the blackness that can be observed through the cloudiness of the solution is compared with the column next to the tube.

Students should wait no more than 10 minutes to read the color change in each tube. Waiting longer may give erroneous results.

Based on previous experience with the GLOBE soil test kit, almost all readings for nitrate nitrogen result in values of none or low. This may be due to the rapid removal of nitrate from the soil once it has been added (either by plant uptake or leaching) or due to the lack of sensitivity of the kit to measure nitrate.

With some soil samples, especially those high in clay, students will need to repeat the extraction procedure more than once to obtain enough solution for the N, P, and K analysis.

Managing Students

In order to complete the analysis within a class period, have different students do the analysis for N, P, and K simultaneously after the extraction solution has been made.

Safety Procedures

1. Students should wear gloves when handling chemicals and the water sample.
2. Students should wear goggles when working with chemicals. They should also wear surgical masks when opening powdered reagents.
3. School authorities should be consulted on the proper disposal of used chemicals.

Questions for Further Investigation

How might natural changes affect the fertility of a horizon?

What differences between locations could affect the fertility of a horizon?

How does the soil fertility affect the types of vegetation that can grow on a soil?

How does the soil particle size distribution affect the nutrient content of a horizon?

How does climate affect the nutrient content of a horizon?

How does the type of vegetation growing on the soil affect the nutrient content of the soil?

Soil Fertility Protocol

Lab Guide

Task

To obtain three soil fertility readings for every horizon in a soil profile

What You Need

- Dried sieved soil
- Soil Fertility Data Sheet
- Plastic teaspoon
- GLOBE NPK test kit or equivalent kit (that measures the relative amount of nitrate, phosphate, and potassium in a soil sample)
- Distilled water
- Pencil or pen
- Latex gloves
- Goggles

Part 1. Nutrient Extraction:

1. Fill the extraction tube from your Soil Test Kit to the 30 mL line with distilled water.
2. Add 2 Floc-Ex tablets. Cap the tube and mix well until both tablets have disintegrated.
3. Remove the cap and add one heaping spoonful of dry, sieved soil.
4. Cap the tube and shake for one minute.
5. Let the tube stand until the soil settles out (usually about 5 minutes). The clear solution above the soil will be used for the nitrate nitrogen (N), phosphate phosphorus (P), and potassium (K) tests.

Note: For some soils, especially those high in clay, there may not be enough clear solution extracted. If more clear solution is needed, repeat steps 1-5.

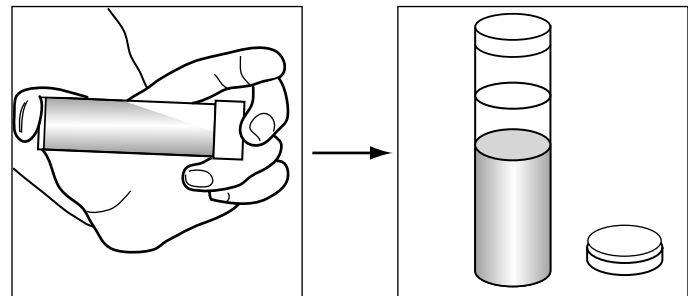
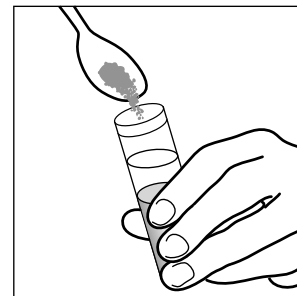
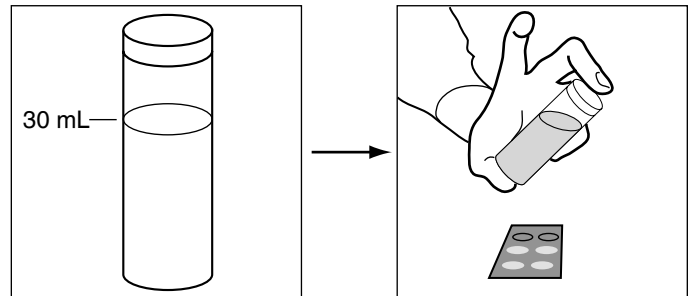

Part 2. Testing for Nitrate Nitrogen:

Use the pipette to transfer the clear solution above the soil to one of the test tubes in the Soil Test Kit until the tube is filled to the shoulder. (If more solution is needed, repeat Part 1).

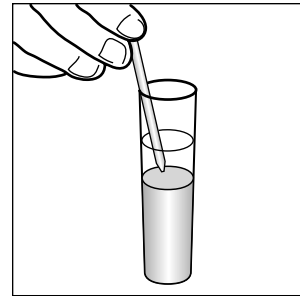

1. Add one Nitrate WR CTA Tablet. Be sure that all of the pieces of the tablet are added to the test tube and try not to touch the tablet as you place it into the tube.

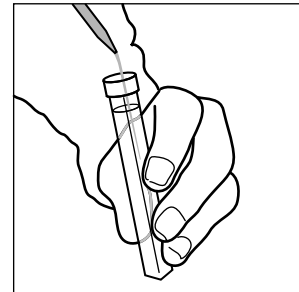

2. Cap and mix until the tablet disintegrates.

3. Rest the test tube in a cup or beaker. Wait 5 minutes for color to develop. (Do not wait longer than 10 minutes).

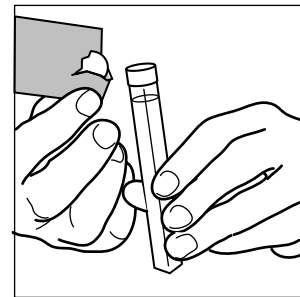

4. Compare the pink color of the solution to the Nitrogen Color Chart in the Soil Test Kit.

5. Record your results (High, Medium, Low, or None) on the *Soil Fertility Data Sheet*.

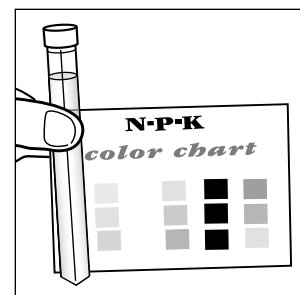

6. Discard the solution and wash the tube and the pipette with distilled water.

7. Repeat this procedure with the liquid from each of the soil samples. Be sure to rinse the pipette and tube with distilled water after they are used.

Part 3. Testing for Phosphate Phosphorus:

1. Use the clean pipette to transfer 25 drops of the clear solution above the soil to a clean test tube. (If more solution is needed, repeat Part 1).

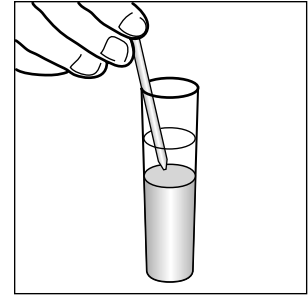

2. Fill the tube to the shoulder with distilled water.

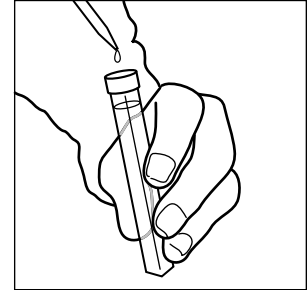

3. Add one Phosphorus Tablet to the tube and cap it. Be sure that all the pieces of the tablet are added to the test tube.

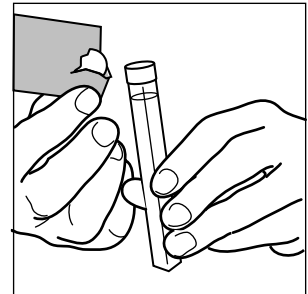

4. Mix until the tablet disintegrates.

5. Rest the test tube in a cup or beaker. Wait 5 minutes (but no more than 10 minutes) for color to develop.

6. Compare the blue color of the solution to Phosphorus on the color chart in the Soil Test Kit.

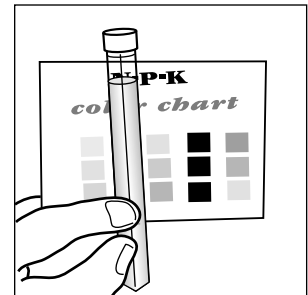

7. Record your results (High, Medium, Low, or None) on the *Soil Fertility Data Sheet*

8. Discard the solution and wash the tube and the pipette with distilled water.

9. Repeat this procedure with the liquid from each of the soil samples. Be sure to rinse the pipette and tube with distilled water after they are used.

Part 4. Testing for Potassium:

1. Use the clean pipette to transfer the clear solution above the soil to a clean test tube until it is filled to the shoulder. If more solution is needed, repeat Part 1.

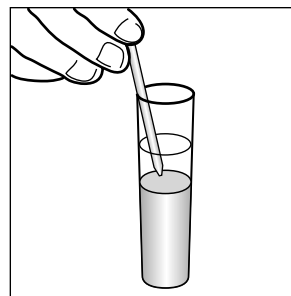

2. Add one Potassium Soil Tablet to the tube. Be sure that all the pieces of the tablet are added to the test tube. Cap and mix until the tablet disintegrates.

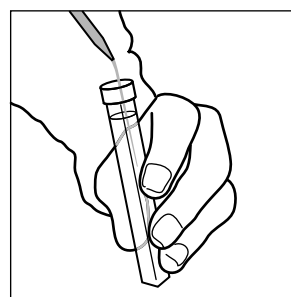
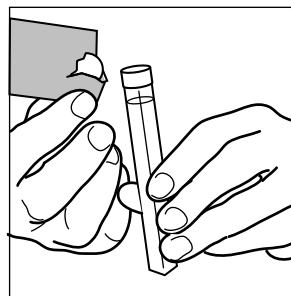

3. Hold the tube over the black boxes in the left column of the K portion of the color chart. Look through the “cloudiness” of the solution in the test tube and compare it to the shaded boxes in the right column. Record your results (High, Medium, Low, or None) on the *Soil Fertility Data Sheet*.

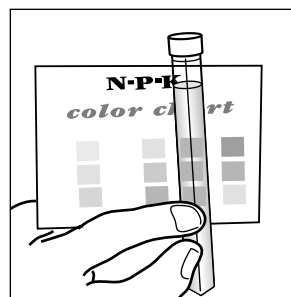

4. Discard the solution and wash the tube and the pipette with distilled water.

5. Repeat this procedure with the liquid from each of the soil samples. Be sure to rinse the pipette and tube with distilled water after they are used.



Soil Fertility Protocol – Looking at the Data

Are the data reasonable?

Nitrogen (N):

The soil test kit used in GLOBE measures nitrogen in the form of nitrate (NO_3^-). Because nitrate has a negative charge, it is not attracted to the negatively charged surfaces of the soil. As a result, any nitrate added to the soil is quickly taken up by plants, washed out with water passing through the soil, or removed (volatilized) as nitrogen gas. Therefore, nitrate values may be low or none for most soil samples. If the soil has recently been fertilized, or if there is a steadily available source of nitrogen, such as from the addition of organic material from compost or manure, the levels of nitrogen may be higher.

Phosphorus (P):

GLOBE soil test kits measure phosphate (PO_4^{3-}), the form of phosphorus that is most easily taken up by plants. Soil test kit readings of phosphate should be low if the soil pH is less than 5.0 or greater than 8.0. This is because at low and high pH levels, phosphate forms compounds with other elements in the soil making it difficult for plants to use. For example, when the soil pH is low and iron is present (making the soil look red), iron phosphate is formed which holds the phosphate very tightly, not freeing it for plants to use. At neutral pH levels (around pH 7), phosphate is more easily taken up by plants and usually shows up as a medium or high phosphate reading with the soil test kit.

Potassium (K):

The amount of potassium present in the soil depends on the availability of potassium minerals in the parent material of the soil. The largest natural sources of potassium are potassium rich minerals such as micas, which release potassium into the soil through weathering. Potassium can also be added to the soil as a fertilizer. Since potassium is a positively charged ion, it is attracted and held to the negatively charged soil surface. The fertility test kits will show medium or high readings for potassium for many soils. A low potassium reading may be an indication of an extremely weathered soil.

What do people look for in these data?

Knowing the relative amounts of nitrogen, phosphorus, and potassium in the soil helps scientists to recommend the type and amount of fertilizers or other nutrients farmers and gardeners should add to their soils for plant growth. For example, they may recommend adding fertilizers, composts or manure to make a soil more fertile. N, P, K measurements also help scientists to better understand other soil properties, such as the number of negatively charged soil surfaces, the amount of iron and organic matter in the soil and the degree to which a soil has been weathered. N, P, K measurements can also help scientists determine the type of parent material from which the soil formed.



Digital Multi-Day Max/Min/Current Air and Soil Temperatures Protocol



Purpose

To record daily measurements of maximum, minimum, and current air and soil temperatures at a common site

Overview

One temperature probe is placed inside the instrument shelter while another is installed at a 10 cm depth in the soil. A digital thermometer is used to measure current temperatures as well as daily minimum and maximum temperatures. The daily minimum and maximum temperatures are stored by the instrument for a period of six days and need to be read and recorded within this span of time.

Student Outcomes

Students gain insight into the relationships between air and soil temperatures over time and learn to use a digital thermometer.

Science Concepts

Earth and Space Science

- Weather can be described by quantitative measurements.
- Weather changes from day to day and season to season.
- Weather varies on local, regional, and global spatial scales.

Geography

- The variability of temperature of a location affects the characterization of Earth's physical geographic system.

Enrichment

- Soil temperature varies with air temperature.
- Soil temperature varies less than air temperature.

Scientific Inquiry Abilities

- Use a digital max/min thermometer.
- Identify answerable questions.
- Design and conduct scientific investigations.
- Use appropriate mathematics to analyze data.
- Develop descriptions and explanations using evidence.
- Recognize and analyze alternative explanations.
- Communicate procedures and explanations.

Time

10 minutes per measurement set

Level

All levels

Frequency

At least once every six days

Materials and Tools

- Digital multi-day max/min thermometer
- Instrument Shelter installed on a post
- Digging tools (site setup only)
- Calibration thermometer
- Soil probe thermometer

Preparation

- Set up the instrument shelter.
- Calibrate and install the digital max/min thermometer.
- Reset the digital max/min thermometer.
- Review the *Soil Temperature Protocol*.

Prerequisites

None



Digital Multi-Day Max/Min Thermometer Introduction

The digital multi-day max/min thermometer is an electronic instrument used to measure the current temperature and record the maximum and minimum temperatures reached during multiple 24-hour periods. It has two identical temperature probes. One probe is used to measure air temperature and the other to measure soil temperature.

The instrument records and stores the highest and lowest temperatures reached over six successive 24-hour periods. The start and end times for these periods correspond to the time of day at which the instrument was initially reset by the user (the *time of reset*). The instrument is reset once when it is first setup and again whenever the battery is changed. For use in GLOBE, the *time of reset* should be as close as possible to local solar noon, thereby causing each 24-hour period to span from approximately local solar noon to local solar noon of consecutive days. The thermometer displays the maximum

and minimum temperatures for the current day as well as for the previous five days as long as it is read at a time which is later than the time that the thermometer was initially reset (*time of reset*). If the thermometer is read after the *time of reset*, it will display the maximum and minimum temperatures for the previous six days.

The digital multi-day max/min thermometer is capable of measuring temperatures down to -20°C when run on a standard alkaline AA-size battery. Substitution of a lithium AA-size battery will allow the instrument to handle lower temperatures. Also, at low temperatures the digital display screen may become too dim to read, while the instrument is still recording temperatures.

Temperature Probes

The multi-day digital max/min thermometer has two sensor probes. Normally one probe will be used to measure air temperature while the other will be used to measure soil temperature. For the sake of consistency the probes should be placed as follows:

Left Sensor – air temperature,

Right Sensor – 10 cm depth in soil.

The display areas for the two sensors are labeled on the right side of the digital display screen for the instrument. The upper display area (which is for the left sensor) is labeled 'LF', while the lower display area (which is for the right sensor) is labeled 'RT'.

Hint: To help prevent confusion, label these display areas as 'air' and 'soil' respectively. This can be done by writing on a piece of tape attached to the left of the display screen.

Instrument Maintenance

The instrument shelter should be kept clean both inside and outside. Dust, debris, and spider webs should be removed from the inside of the shelter with a clean, dry cloth. The outside of the shelter may be lightly washed with water to remove debris, but try to avoid getting water inside the shelter. If the outside of the shelter becomes very dirty, it should be repainted white.

Figure AT-MU-1: Multi-Day Digital Max/Min Thermometer

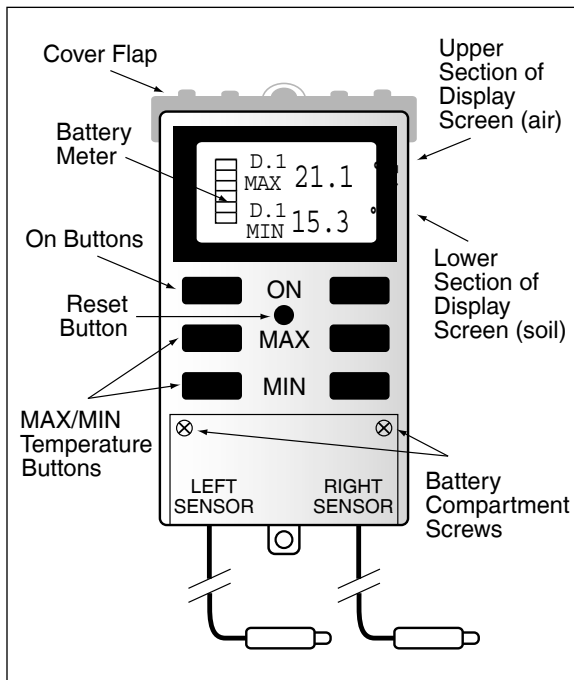

When the battery in the thermometer becomes low on power a low battery symbol will light. This symbol is located along the left side of the display screen and is shaped like a AA-size battery. Once this symbol becomes visible it is time to replace the battery. Follow the *Changing the Battery in the Digital Multi-Day Max/Min Thermometer Field Guide*.

Teacher Support

The instructions given in this protocol are specific to one brand of digital thermometer. They may be adapted to other equipment that meets the same specifications. If you have questions or require assistance with adapting these instructions to other instruments, contact the GLOBE Help Desk. The essential elements of this protocol, which must remain the same regardless of the equipment model, are the placement of the temperature probes and the $\pm 0.5^{\circ}\text{C}$ precision and accuracy of the temperature sensors.

Instructions for using alternative types of max/min thermometers are given in the *Single-Day Maximum, Minimum, and Current temperature Protocol*. The thermometers used in that protocol do not log data, so they need to be read and reset every day.

If your instrument shelter is in a location that makes it difficult to measure soil temperatures, or if you are only interested in taking air temperature measurements, it is acceptable to only take air measurements. To do so simply skip the portions of each field guide that pertain to the soil sensor.

Measurement Logistics

1. Review background in Atmosphere and Soil chapters.
2. Check a calibration thermometer following the *Thermometer Calibration Lab Guide*.
3. Calculate sensor correction offsets following the *Digital Multi-Day Max/Min Thermometer Sensor Calibration Field Guide*.
4. Install your digital multi-day max/min thermometer following the *Digital Multi-Day Max/Min Thermometer Installation Field Guide*.
5. Establish your *time of reset* by resetting the thermometer within one hour of local solar noon following the *Digital Multi-Day Max/Min Thermometer Reset Field Guide*.



6. Record current maximum and minimum temperatures following the *Digital Multi-Day Max/Min Temperature Protocol Field Guide* at least once every six days.
7. Record current temperatures following the *Digital Multi-Day Thermometer Current Temperature Protocol Field Guide* as desired.
8. Report your data to GLOBE.
9. Every six months, or whenever the battery is changed, check the accuracy of the soil probe following the *Digital Multi-Day Max/Min Thermometer Soil Sensor Error Check Field Guide*. If the magnitude of the soil sensor error that you calculate is two degrees Celsius or more, dig out the soil sensor and recalibrate both the soil and air sensors following the *Digital Multi-Day Max/Min Thermometer Sensor Calibration Field Guide*. If the magnitude of the soil sensor error that you calculate is less than two degrees Celsius, leave the soil sensor buried and recalibrate just the air sensor.
10. Engage students in looking at their data.

Calibration

Your digital thermometer must be calibrated before initial use. Every six months after installation and whenever the battery is changed the air sensor will need to be recalibrated and the soil sensor readings will need to be checked to see if the soil sensor needs to be dug out and recalibrated. These calibrations and checks are performed by comparing temperatures read by the two probes with readings from a calibration thermometer and the soil probe thermometer. See the *Soil Temperature Protocol*.



Helpful Hints

The goal of the calibrations is to obtain air and soil sensor correction offsets that account for differences between measured and actual temperatures. When you report your calibration data to the GLOBE database, the database automatically calculates these values and reports them to you. After you have completed your calibration and start entering temperature data to GLOBE, the database will automatically account for your correction offsets as your measurements are entered into the database. So, all the data in the GLOBE database have effectively been calibrated. However, take caution in accounting for the correction offsets when analyzing data not obtained from the GLOBE database (including data you have collected). **DO NOT APPLY THE OFFSETS TO DATA REPORTED TO GLOBE.**

Questions for Further Investigation

Which season has the greatest range of temperatures? Why?

How does the soil temperature range compare with the air temperature range?

What are the latitudes and elevations of other GLOBE schools with atmosphere and soil temperatures similar to yours?

What soil temperatures signal a new growing season in your area, as evidenced by new grass, weed growth and germination, or budburst?

Is your local environment affected more by average temperature or temperature extremes?

How does soil character affect soil temperature?

Thermometer Calibration

Lab Guide

Task

Check the calibration of the calibration thermometer.

What You Need

- Calibration thermometer
- Crushed ice
- Clean container at least 250 mL in size
- Water (distilled is ideal, but the key is that the water is not salty)

In the Lab

1. Prepare a mixture of fresh water and crushed ice with more ice than water in your container.
2. Put the calibration thermometer into the ice-water bath. The bulb of the thermometer must be in the water.
3. Allow the ice-water bath and thermometer to sit for 10 to 15 minutes.
4. Gently move the thermometer around in the ice-water bath so that it will be thoroughly cooled.
5. Read the thermometer. If it reads between -0.5°C and $+0.5^{\circ}\text{C}$, the thermometer is fine.
6. If the thermometer reads greater than $+0.5^{\circ}\text{C}$, check to make sure that there is more ice than water in your ice-water bath.
7. If the thermometer reads less than -0.5°C , check to make sure that there is no salt in your ice-water bath.
8. If the thermometer still does not read between -0.5°C and $+0.5^{\circ}\text{C}$, replace the thermometer. If you have used this thermometer for measurements report this to GLOBE.

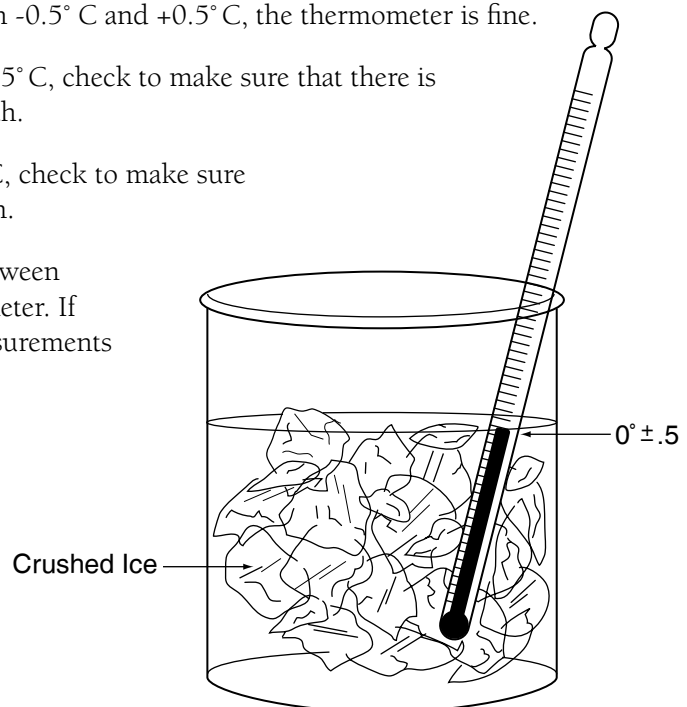

Digital Multi-Day Max/Min Thermometer Sensor Calibration

Field Guide

Task

Calculate the air and soil sensor correction offsets used to adjust for instrument accuracy errors.

What You Need

- Calibration thermometer that has been checked following the instructions in the *Thermometer Calibration Lab Guide*
- Digital Max/Min Thermometer Calibration and Reset Data Sheet*

Note: If you are only recalibrating the air sensor, skip the portions of this field guide that pertain to the soil sensor.

In the Field

1. Open the door to the instrument shelter and hang the calibration thermometer and the two probes, both air and soil, in the instrument shelter so that they have air flow all around them and do not contact the sides of the shelter. Close the door to the instrument shelter.
2. Wait at least an hour and then open the door to the instrument shelter. Read the temperature from the calibration thermometer and record it to the nearest 0.5° C on your *Digital Max/Min Thermometer Calibration and Reset Data Sheet*.
3. Turn on the air temperature display of the digital multi-day max/min thermometer by pressing the air sensor ON button (upper left in button cluster). Read and record the current air temperature.
4. Turn on the soil temperature display of the digital multi-day max/min thermometer by pressing the soil sensor ON button (upper right in button cluster). Read and record the current soil temperature.
5. Close the cover flap of the digital thermometer and the door of the instrument shelter.
6. Repeat steps 2 to 5 four more times, waiting at least one hour between each set of readings. Try to space out the five sets of readings over as much of a day as possible.
7. Report your calibration data to GLOBE.

Digital Multi-Day Max/Min Thermometer Installation

Field Guide

Task

Install the digital thermometer at your Atmosphere Study Site.

What You Need

- Drill with 12 mm spade bit (if doing soil measurements)
- Digging tools (if doing soil measurements)
- String or wire ties
- GLOBE instrument shelter (specifications are given in the *GLOBE Instrument List* in the *Toolkit* section)
- 120 cm x 2.5 cm PVC pipe (optional)

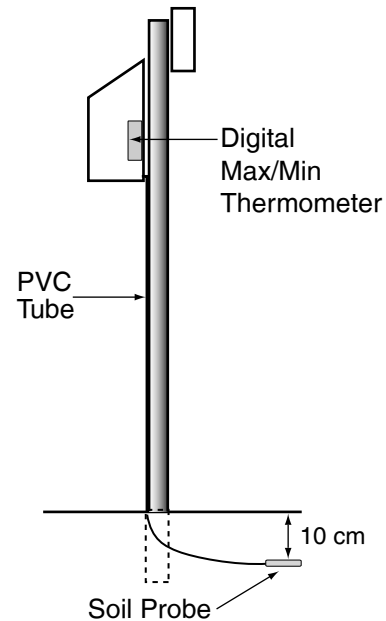

In the Field

1. Mount the digital thermometer housing to the rear wall of your instrument shelter. The housing should be placed so that the digital display may be read easily.
2. Hang the probe labeled *Left Sensor* so that no part of it contacts the walls and there is airflow all around it. This can be done simply by hanging the rolled-up cable for this sensor from the top of the shelter, with the probe itself hanging below.
3. If you will not be taking soil measurements, store the right sensor and its cable neatly in a corner of the shelter where it will be out of the way and skip the following steps.
4. If necessary drill a 12 mm hole, using a drill with a spade bit, in the bottom of the instrument shelter, near the back. Feed the right sensor probe through the hole, leaving as much cable as possible inside the shelter. You may wish to feed the sensor and wire through a thin PVC pipe that will then serve to protect the wire.
5. Choose a site to place the soil temperature probe nearby on the equatorward side (sunny-side) of the instrument shelter mounting post. Data collected from soil in unshaded locations are preferred. Comments in your site definition should include the amount of shade that the soil surface above the probe will experience during a year.
6. Dig a hole to a depth of a little over 10 cm at the chosen location.
7. Push the probe horizontally into the side of the hole at a depth of 10 cm. Use a nail or steel pin, with a slightly smaller diameter than the probe, to pilot an opening for the probe if needed.
8. Refill the hole with the soil that you removed.
9. Neatly secure all extra cable for the soil sensor using string or wire ties. Keep as much of the excess cable as possible within the shelter.

Digital Multi-Day Max/Min Thermometer Reset

Field Guide

Task

Reset the digital multi-day thermometer to establish the *time of reset*, which serves as the starting and ending time for the 24-hour intervals over which the instrument records maximum and minimum temperatures.

Note: The thermometer should only be reset when it is setup, when the battery is changed, or if your *time of reset* becomes more than one hour from local solar noon.

What You Need

- Pen or nail
- Digital Max/Min Thermometer Calibration and Reset Data Sheet*
- An accurate watch or other device that tells time

In the Field

1. Determine an appropriate *time of reset* that corresponds to the average time of local solar noon for your area. It is important that the *time of reset* is within one hour of local solar noon for every day that you will be taking measurements. If you find that this is not the case, then a new *time of reset* will need to be chosen and the instrument reset.
2. Go to the instrument shelter a little before your desired time of reset and open up the instrument shelter and the cover flap of the digital max/min thermometer.
3. At your desired time of reset, use a nail or the tip of a pen to press in and release the reset button, located as shown above.
4. The digital display screen will briefly flash and then begin reading the current temperature. The instrument has now been reset. Record the exact time of day, in the *Time of Reset* section of the *Digital Max/Min Thermometer Calibration and Reset Data Sheet*. This is your *time of reset*.
5. Report your *time of reset* and the date to GLOBE in both local and UT time.

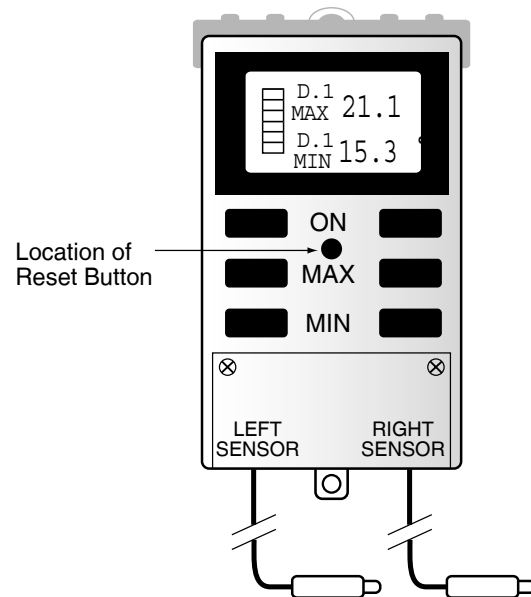

Digital Multi-Day Maximum and Minimum Temperature Protocol

Field Guide

Task

Measure the daily maximum and minimum air temperatures for the past six days.

Measure the daily maximum and minimum soil temperatures for the past six days.

What You Need

- A properly sited instrument shelter
- A properly calibrated and installed digital multi-day max/min thermometer
- Digital Multi-day Max/Min Thermometer Data Sheet*
- Pen or pencil
- An accurate watch or other device that tells time

In the Field

1. Maximum and minimum readings should be taken at least five minutes after your *time of reset*.
2. Open the instrument shelter and the cover flap of the digital max/min thermometer being careful not to breathe on or touch the air temperature sensor.
3. Record the time and date on your *Data Sheet* in both local and UT time. **Note:** GLOBE data entry should be UT time.
4. Turn the air temperature display of the thermometer on by pressing the air display ON button (upper left button labeled ON). **Note:** The temperature displayed will be the current air temperature.
5. Press the air sensor MAX button (middle left button labeled MAX) *twice*.
Note: The reading that appears after you press the MAX button once is the highest temperature that has occurred since the last *time of reset*, and is not for a full 24-hour period. It should not be recorded.
6. You should see the MAX symbol displayed on the digital display screen to the left of the temperature reading with the symbol D.1 displayed above. Record this temperature on your *Data Sheet*.
7. Press the air sensor MAX button again. The symbol D.2 should now be displayed in place of D.1. Record the accompanying temperature on your *Data Sheet*. Repeat this procedure to record data for as many of the past six days (D.1 – D.6) as needed.
8. To record minimum air temperatures repeat steps 5-7 pressing the air sensor MIN button (bottom left button labeled MIN) instead of the MAX button.
9. For the soil temperatures, repeat the above steps using the soil buttons on the right side and reading from the lower section of the display screen.
10. After all measurements have been taken close the cover flap of the instrument. It will shut off automatically after a short time.

Digital Multi-Day Max/Min Current Temperature Protocol

Field Guide

Task

Measure the current air temperature.

Measure the current soil temperature.

What You Need

- A properly sited instrument shelter
- A properly calibrated and installed digital multi-day max/min thermometer
- An accurate watch or other device that tells time
- Pen or pencil
- Digital Multi-Day Max/Min Thermometer Data Sheet, Integrated 1-Day Data Sheet, Integrated 7-Day Data Sheet, Aerosols Data Sheet, Ozone Data Sheet, or Water Vapor Data Sheet*

In the Field

1. Open the instrument shelter and the cover flap of the digital max/min thermometer being careful not to breathe on or touch the air temperature sensor.
2. Record the time and date on your *Data Sheet*.
3. Turn the air temperature display on by pressing the air sensor ON button (upper left button labeled ON on the front of the instrument casing).
4. Read the current air temperature shown in the upper section of the digital display. Record this temperature on your *Data Sheet*.
5. If soil measurements are being taken, turn the soil temperature display on by pressing the soil sensor ON button (upper right button labeled ON).
6. Read the current soil temperature from the lower section of the digital display. Record this temperature on your *Data Sheet*.
7. After all measurements have been taken close the cover flap of the instrument. It will shut off automatically after a short time.

Digital Multi-Day Max/Min Current Soil Sensor Error Check

Lab and Field Guide

Task

Check the accuracy of the soil sensor to see if it needs to be dug out and recalibrated.

What You Need

- Soil probe thermometer from *Soil Temperature Protocol*
- Digital Max/Min Thermometer Calibration and Reset Data Sheet*

In the Lab and Field

1. Calibrate a soil probe thermometer following the *Calibrating the Soil Thermometer Lab Guide* of the *Soil Temperature Protocol*.
2. Open the door to the instrument shelter.
3. Select an undisturbed place about 15 cm from the location of the soil temperature probe.
4. Measure the soil temperature at a depth of 10 cm at this spot following the *Soil Temperature Protocol Field Guide*.
5. Record this temperature in the Soil Sensor Error Check section of your *Digital Max/Min Thermometer Calibration and Reset Data Sheet*.
6. Turn on the soil temperature display of the digital multi-day max/min thermometer by pressing the soil sensor ON button (upper right button).
7. Read the temperature reported by the soil sensor of the digital thermometer and record it on your *Digital Max/Min Thermometer Calibration and Reset Data Sheet*.
8. Close the cover flap of the digital thermometer and the door of the instrument shelter.
9. Repeat steps 2 to 8 four more times, waiting at least one hour between measurements.
10. Calculate the average of the soil thermometer readings.
11. Calculate the average of the digital soil sensor readings.
12. Calculate the soil sensor error by subtracting the average of the five digital soil sensor readings (from step 10) from the average of the five soil sensor readings (from step 11)
13. If the absolute value of the soil sensor error is greater than or equal to 2° C, dig-out this sensor and recalibrate both the air and soil sensors following the *Digital Multi-Day Max/Min Thermometer Sensor Calibration Field Guide*. Otherwise, leave the digital soil sensor in the ground and recalibrate only the air sensor.

Changing the Battery in the Digital Multi-Day Max/Min Thermometer

Field Guide

Task

Change the battery in the digital multi-day max/min thermometer.

What You Need

- A new AA-size battery
- A small Phillips head screwdriver

In the Field

1. The battery is in the battery compartment in the lower section of the instrument casing.
2. Remove the two little screws located at the upper corners of the compartment cover and lift off the cover.
3. Change the battery, taking care to ensure correct polarity (negative end of battery contacting the spring).
4. Replace the compartment cover and secure with the two screws. After the battery has been changed be sure to recalibrate the instrument.
5. Recalibrate the air and soil sensors following the *Digital Multi-Day Max/Min Thermometer Sensor Calibration Field Guide*.
6. Reset the instrument using the *Resetting the Digital Multi-Day Max/Min Thermometer Field Guide*.

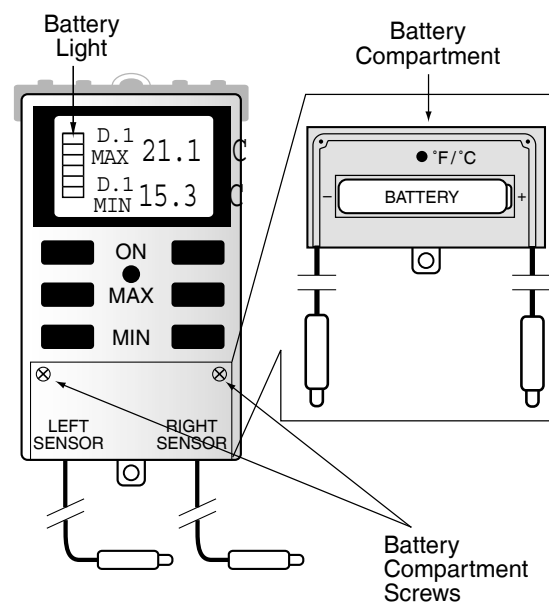

Frequently Asked Questions

1. What should I do if my digital max/min thermometer is reading temperatures in degrees Fahrenheit instead of Celsius?

You can change the units by pressing a small button located in the battery compartment. Open the battery compartment following the instructions given in the *Changing the Battery in the Digital Multi-Day Max/Min Thermometer Field Guide*. You should see a small round button, marked °F/°C (see figure below). Turn on at least one of the sensors and press this button. You will see the measurement units change from Fahrenheit to Celsius. Close the battery compartment. Be sure always to have your instrument in Celsius mode when taking GLOBE measurements!

Figure AT-MU-2: Multi-Day Digital Max/Min Thermometer Battery Compartment with cover removed.

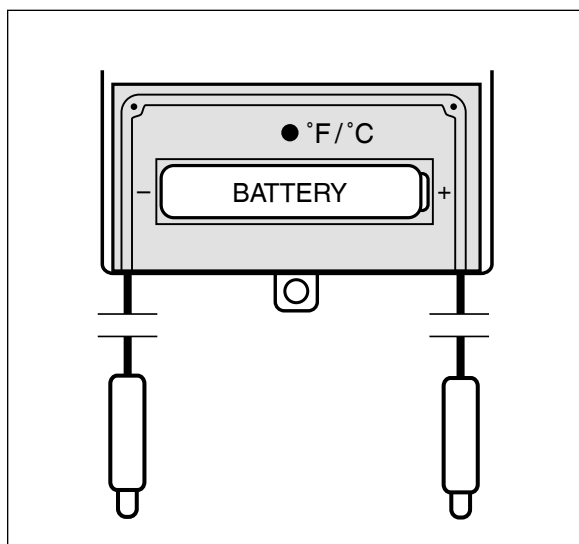

2. What if I find that as the time of local solar noon varies over the year it no longer is within an hour of my time of reset?

For your maximum and minimum temperature readings to be valid it is necessary for the *time of reset* to be within one hour of local solar noon. Reset your instrument using the *Digital Multi-Day Max/Min Thermometer Reset Field Guide* as close as possible to the time of local solar noon (within 15 minutes).

3. If I miss reading my maximum and minimum temperatures, can I still get the readings the next day?



The max/min temperatures stored in the instrument are updated every 24 hours at the *time of reset*. Therefore, these temperature values can be collected anytime from about 5 minutes after the *time of reset* on the desired day until 5 minutes before the *time of reset* on the next day. If you wait until after the time of reset on the 7th day, one day's data will be lost. However, if they are read on the next day, care must be taken to match temperatures read from the instrument to the days to which they correspond. Maximum and minimum temperatures displayed along with the D.1 symbol on the instrument display screen correspond to the current day when readings are being taken after *time of reset* (as recommended) and to the previous day when readings are being taken before the *time of reset*. See the following tables for clarification:

Readings taken AFTER time of reset (as recommended).

Digital Display			
Symbol:	D.1	D.2	D.3
Reading Corresponds to 24-hours Ending:	Today	Yesterday	2 days ago

Readings taken BEFORE time of reset

Digital Display			
Symbol:	D.1	D.2	D.3
Reading Corresponds to 24-hours Ending:	Yesterday	2 days ago	3 days ago

4. Can I read the thermometer in the morning before the time of reset?

If the thermometer is read in the morning, at least 5 minutes before the *time of reset*, it is possible to read the max/min temperatures for the past six days. However, the max/min temperatures for the current day cannot be read.



5. When I first press a MAX or MIN button, the instrument displays a reading which I am not supposed to record; what is this reading?

The reading displayed when you press a MIN or MAX button for the first time is the minimum or maximum temperature for the on-going 24-hour period. Since this period is not finished, the reading may not be the final maximum or minimum temperature for the 24-hours. While it is not a valid data measurement that you report to GLOBE, it can be used for your own inquiry purposes.



6. How does the digital thermometer work?

The thermometer works by measuring the change in current running through a constant-voltage circuit in which the sensor probe serves as a resistor. As the temperature of the sensor changes, its resistance changes. The change in current in the circuit is inversely proportional to the change in the sensor's resistance as described by Ohm's Law which explains that current is equal to voltage divided by resistance. So by measuring the current going through the circuit, and knowing the voltage, it is possible to calculate the resistance of the sensor. This is done by the instrument, which then reports the probe temperature corresponding to that level of resistance.



Digital Multi-Day Soil Temperatures Protocol



Welcome

Introduction

Protocols

Learning Activities

Appendix

Purpose

To record daily measurements of maximum, and minimum soil temperatures at depths of 5 and 50 cm

Overview

A digital thermometer is used to measure current temperatures as well as daily minimum and maximum temperatures. One temperature probe is placed at a depth of 5 cm in the soil while another is installed at a 50 cm depth. The daily minimum and maximum temperatures are stored by the instrument for a period of up to six days and need to be read and recorded at least this often to avoid loss of data.

Student Outcomes

Students gain insight into the relationships between soil temperatures at two depths over time and learn to use a digital thermometer.

Science Concepts

Geography

The variability of temperature of a location affects the characterization of Earth's physical geographic system.

Enrichment

Soil temperature varies with air temperature.

Soil temperature varies less than air temperature.

Scientific Inquiry Abilities

Use a digital Max/Min thermometer.

Identify answerable questions.

Design and conduct scientific investigations.

Use appropriate tools and techniques including mathematics to gather, analyze, and interpret data.

Develop descriptions and explanations, predictions and models using evidence.

Recognize and analyze alternative explanations.

Communicate procedures and explanations.

Time

10 minutes per measurement set

Level

All levels

Frequency

At least once every six days

Materials and Tools

Digital multi-day max/min thermometer

Instrument Shelter installed on a post

Digging tools (site setup only)

Calibration thermometer

Soil probe thermometer (recalibration only)

Preparation

Set up the instrument shelter.

Review material given in the *Soil Temperature Protocol*.

Prerequisites

None



Digital Multi-Day Soil Temperatures Protocol – Introduction

There are two protocols that utilize the digital multi-day max/min thermometer. This protocol details how to use the thermometer to measure soil temperatures at depths of 5 and 50 cm. The *Digital Multi-Day Max/Min/Current Air and Soil Temperatures Protocol* outlines how to use the thermometer to measure air temperature and soil temperature at a depth of 10 cm. If you purchase two thermometers, both protocols may be done at the same location, and you will be able to measure air temperature along with soil temperatures at three separate depths. This will allow you to construct and study a soil temperature profile.

This protocol is to be done at a Soil Moisture or Atmosphere Study Site. It makes your data more useful if you have this site at the same location as an atmosphere site that features a thermometer measuring air temperature. You may need to define a new soil moisture site specifically for your digital multi-day soil thermometer.

Digital Multi-Day Max/Min Thermometer

The digital multi-day max/min thermometer is an electronic instrument used to measure the current temperature and record the maximum and minimum temperatures reached during multiple 24-hour periods. It has two identical temperature probes.

The instrument records and stores the highest and lowest temperatures reached over six successive 24-hour periods. The start and end times for these periods correspond to the time of day at which the instrument was reset by the user (the *time of reset*). The instrument is reset when it is first setup and again whenever the battery is changed. For use in GLOBE, the reset time must be within one hour of local solar noon. If the reset time is within 15 minutes of local solar noon, all 24-hour periods throughout the year will begin and end within one hour of local solar noon even though the time of local solar noon varies.

The thermometer displays the maximum and minimum temperatures for the current day as well as for the previous five days as long as it is read at a time that is later than the *time of reset*. If the thermometer is read before the *time of reset*, it will display the maximum and minimum temperatures for the previous six days.

Figure SO-MU-1: Digital Multi-Day Max/Min Thermometer

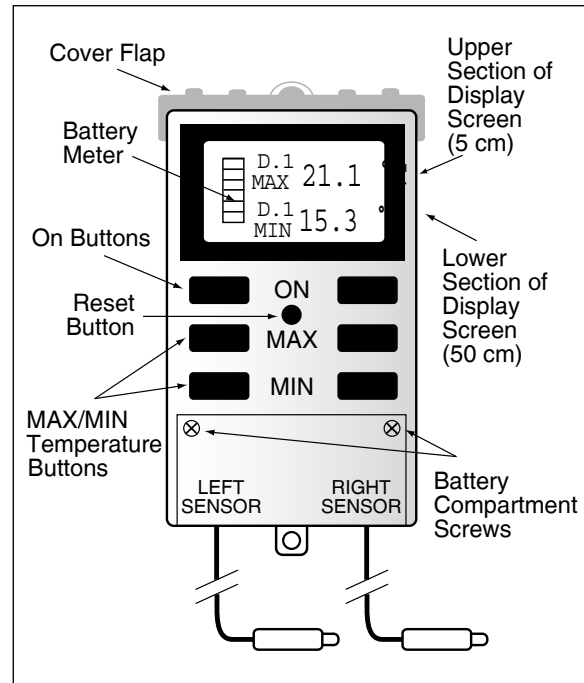

The digital multi-day max/min thermometer is capable of measuring temperatures down to -20°C when run on a standard alkaline AA-size battery. Substitution of a lithium AA-size battery will allow the instrument to handle lower temperatures. Also, at temperatures below zero, the digital display screen may become too dim to read, but the instrument is still recording temperatures. If your students need to read the thermometer they may hold it in their hands to warm it up; this won't affect the thermometer readings as the temperature probes are buried in the ground.



Temperature Probes

In this protocol, one probe of the digital thermometer is used to measure soil temperature at 5 cm depth and the other to measure soil temperature at 50 cm depth. For the sake of consistency the probes should be placed as follows:

Left Sensor – 5 cm depth in soil,

Right Sensor – 50 cm depth in soil.

The display areas for the two sensors are labeled on the right side of the digital display screen for the instrument. The upper display area (which is for the left sensor) is labeled 'LF', while the lower display area (which is for the right sensor) is labeled 'RT'.

Hint: To help prevent confusion, label these display areas as '5 cm' and '50 cm' respectively. This can be done by writing on a piece of tape attached to the left of the display screen.

Instrument Maintenance

The instrument shelter should be kept clean both inside and outside. Dust, debris, and spider webs should be removed from the inside of the shelter with a clean, dry cloth. The outside of the shelter may be lightly washed with water to remove debris, but avoid getting water inside the shelter. If the outside of the shelter becomes very dirty, it should be repainted white.

When the battery in the thermometer becomes low on power a low battery symbol will light. This symbol is located along the left side of the display screen and is shaped like a AA-size battery. Once this symbol becomes visible it is time to replace the battery. Follow the *Changing the Battery in the Digital multi-day Max/Min Thermometer Field Guide*.

Teacher Support

The instructions given in this protocol are specific to one brand of digital thermometer. They may be adapted to other equipment that meets the same specifications. If you have questions or require assistance with adapting these instructions to other instruments, contact the GLOBE Help Desk or your country coordinator. The essential elements of this protocol, which must remain the same regardless of the equipment model, are the placement of the temperature probes, the timing of the 24-hour periods, and the +/- 0.5° C precision and stability of calibration of the temperature sensors.

Measurement Logistics

1. Review background in Soil chapter.
2. Check a calibration thermometer following the *Thermometer Calibration Lab Guide*.
3. Calculate sensor correction offsets following the *Digital Multi-Day Soil Thermometer Sensor Calibration Field Guide*.
4. Install your digital multi-day max/min thermometer following the *Digital Multi-Day Soil Thermometer Installation Field Guide*.
5. Establish your *time of reset* by resetting the thermometer as close to local solar noon as possible following the *Digital Multi-Day Max/Min Thermometer Reset Field Guide*.
6. Record maximum and minimum temperatures following the *Digital Multi-Day Maximum and Minimum Soil Temperatures Field Guide* at least once every six days.
7. Record current temperatures following the *Digital Soil Thermometer Current Temperature Field Guide* as desired.
8. Every six months, or whenever the battery is changed, check the accuracy of the 5 cm soil probe following the *Digital Multi-Day Max/Min Thermometer 5 cm Sensor Error Check Field Guide*. GLOBE will advise you whether you need to dig out your soil sensors and recalibrate them.
9. Engage students in looking at their data.



Calibration

Your digital thermometer must be calibrated before initial use. Every six months after installation and whenever the battery is changed the soil sensor readings will need to be checked to see if the soil sensors need to be dug out and recalibrated. These calibrations and checks are performed by comparing temperatures read by the two probes with readings from a calibration thermometer and the soil probe thermometer (see the *Soil Temperature Protocol*).



Helpful Hints

- The goal of the calibrations is to obtain sensor correction offsets that account for differences between measured and actual temperatures. When you report your calibration data to the GLOBE database, the database automatically calculates these values and reports them to you. After you have completed your calibration and start reporting temperature data to GLOBE, the database will automatically account for your correction offsets as your measurements are entered into the database. So, all the data in the GLOBE database has effectively been calibrated. However, take caution to account for the correction offsets when analyzing data that was not obtained from the GLOBE database (including data that you have collected). **DO NOT APPLY THE OFFSETS TO DATA BEFORE REPORTING THEM TO GLOBE.**
- There is a battery low indicator on the left side of the display screen. It is shaped like a battery divided into sections (see thermometer diagram). When this indicator lights, it is time to replace the battery using the *Changing the Battery in the Digital Multi-Day Max/Min Thermometer Field Guide*.



Questions for Further Investigations

Which season has the greatest range of temperatures? Why?

How does the soil temperature range vary with soil depth?

What are the latitudes and elevations of other GLOBE schools with soil temperatures similar to yours?

What soil temperatures signal a new growing season in your area, as evidenced by grass or forb germination and growth, or budburst on trees or shrubs?

How does soil texture affect soil temperature?

How does soil temperature vary between sunny and cloudy days at your site and at the different depths?

Thermometer Calibration

Lab Guide

Task

Check the calibration of the calibration thermometer.

What You Need

- Calibration thermometer
- Clean container at least 250 mL in size
- Crushed ice
- Water (distilled is ideal, but the key is that the water is not salty)

In the Lab

1. Prepare a mixture of fresh water and crushed ice with more ice than water in your container.
2. Put the calibration thermometer into the ice-water bath. The bulb of the thermometer must be in the water.
3. Allow the ice-water bath and thermometer to sit for 10 to 15 minutes.
4. Gently move the thermometer around in the ice-water bath so that it will be thoroughly cooled.
5. Read the thermometer. If it reads between -0.5°C and $+0.5^{\circ}\text{C}$, the thermometer is fine.
6. If the thermometer reads greater than $+0.5^{\circ}\text{C}$, check to make sure that there is more ice than water in your ice-water bath.
7. If the thermometer reads less than -0.5°C , check to make sure that there is no salt in your ice-water bath.
8. If the thermometer still does not read between -0.5°C and $+0.5^{\circ}\text{C}$, replace the thermometer. If you have used this thermometer for measurements report this to GLOBE.

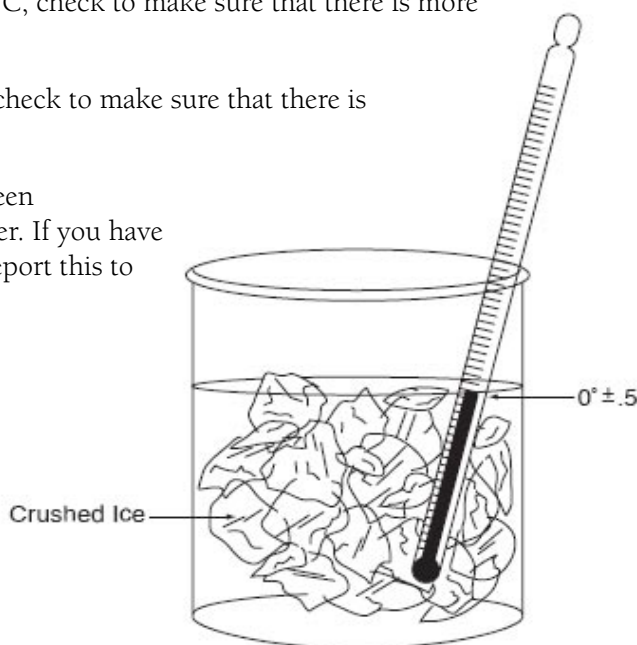

Digital Multi-Day Soil Thermometer Calibration

Field Guide

Task

Calculate the soil sensor correction offsets used to adjust for instrument inaccuracy.

What You Need

- Calibration thermometer that has been checked following the instructions in the *Thermometer Calibration Lab Guide*
- Digital Soil Thermometer Calibration and Reset Data Sheet*

In the Field

1. Open the door to the instrument shelter and hang the calibration thermometer and the two probes, both 5 cm and 50 cm, in the instrument shelter so that they have air flow all around them and do not contact the sides of the shelter. Close the door to the instrument shelter.
2. Wait at least an hour and then open the door to the instrument shelter.
3. Read the temperature from the calibration thermometer and record it to the nearest 0.5° C on your *Digital Soil Thermometer Calibration and Reset Data Sheet*.
4. Turn on the 5 cm temperature display of the digital multi-day max/min thermometer by pressing the 5 cm sensor ON button (upper left in button cluster)
5. Turn on the 50 cm temperature display of the digital multi-day max/min thermometer by pressing the 50 cm sensor ON button (upper right in button cluster).
6. Read the temperatures reported by the 5 cm sensor and the 50 cm sensor of the digital thermometer and record them on your *Digital Soil Thermometer Calibration and Reset Data Sheet*.
7. Close the cover flap of the digital thermometer and the door of the instrument shelter.
8. Repeat steps 2 to 7 four more times, waiting at least one hour between each set of readings. Try to space out the five sets of readings over as much of a day as possible.
9. Report your calibration data to GLOBE.

Digital Multi-Day Soil Thermometer Installation

Field Guide

Task

Install the digital soil thermometer at your atmosphere or soil moisture study site.

What You Need

- Drill with 12 mm spade bit
- Digging tools
- String or wire ties
- GLOBE instrument shelter (specifications are given in the *GLOBE Instrument List* in the *Toolkit*)
- 120 cm length of 2.5 cm diameter PVC pipe (optional)
- Two pieces of tape
- A writing instrument

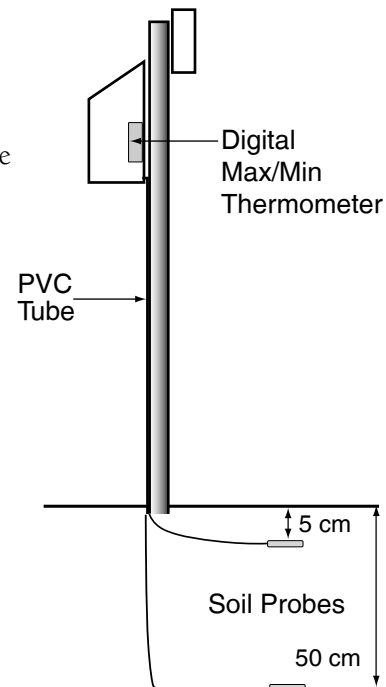

Note: If you are going to be using another digital multi-day thermometer to take air and 10 cm depth soil measurements, try to bury the 5 cm and 50 cm soil probes as close as possible to the 10 cm probe from the other thermometer. If you have not installed that 10 cm probe, this would be a good opportunity to bury all the soil probes in the same hole.

In the Field

1. Mount the digital thermometer housing to the rear wall of your instrument shelter. The housing should be placed so that the digital display may be read easily. If you are out of room on the rear wall, the housing may be left unmounted, lying on the bottom of the shelter.
2. Use two pieces of tape to label the left probe as '5 cm', and the right probe as '50 cm'. Be sure not to stick the tape to the metal tips of the probes.
3. If necessary drill a 12 mm hole, using a drill with a spade bit, in the bottom of the instrument shelter, near the back. Feed the sensor probes through the hole, leaving as much cable as possible inside the shelter. You may wish to feed the sensors through a PVC pipe that will then serve to protect the wires.
4. Bury the probes nearby on the equatorward side (sunny-side) of the instrument shelter mounting post. Data collected from soil in unshaded locations are preferred. Comments in your site definition should include the amount of shade that the soil surface above the probes will experience during a year.

5. Dig a hole to a depth of a little over 50 cm at the chosen location.
6. Push the probe labeled '5 cm' horizontally into the side of the hole at a depth of 5 cm. If needed, use a nail or steel pin, with a slightly smaller diameter than the probe, to pilot an opening for the probe.
7. Push the probe labeled '50 cm' horizontally into the side of the hole at a depth of 50 cm. Again, if necessary, use a nail or steel pin to pilot an opening for the probe.
8. Refill the hole with the soil that you removed (last out, first in).
9. Neatly secure all extra cable using string or wire ties. Keep as much of the excess cable as possible within the shelter.

Digital Multi-Day Max/Min Thermometer Reset

Field Guide

Task

Reset the digital multi-day thermometer to establish the *time of reset*, which serves as the starting and ending time for the 24-hour intervals over which the instrument records maximum and minimum temperatures.

Note: The thermometer should only be reset when it is setup, when the battery is changed, or if your *time of reset* becomes more than one hour from local solar noon.

What You Need

- Pen or nail
- Digital Max/Min Thermometer Calibration and Reset Data Sheet
- An accurate watch, GPS receiver, or other device that tells time

In the Field

1. Determine an appropriate *time of reset* that corresponds to the average time of local solar noon for your area. It is important that the *time of reset* is within one hour of local solar noon for every day that you will be taking measurements. If you find that this is not the case, then a new *time of reset* will need to be chosen and the instrument reset.
2. Go to the instrument shelter a little before your desired time of reset and open the instrument shelter and lift the cover flap of the digital max/min thermometer.
3. At your desired time of reset, use a nail or the tip of a pen to press in and release the reset button, located as shown above.
4. The digital display screen will briefly flash and then begin reading the current temperature. The instrument has now been reset. Record the exact time of day, in the *Time of Reset* section of the *Digital Max/Min Thermometer Calibration and Reset Data Sheet*. This is your *time of reset*.
5. Report your *time of reset* and the date to GLOBE in both local and UT time.

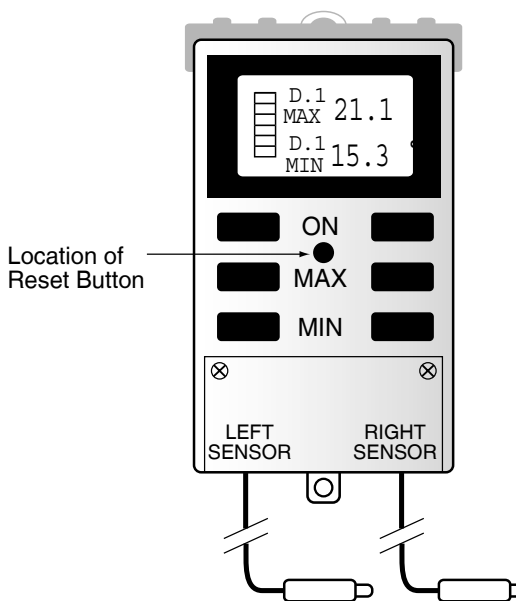

Digital Multi-Day Max/Min Soil Temperatures

Field Guide

Task

Measure the daily maximum and minimum soil temperatures, at depths of 5 cm and 50 cm, for the past six days.

What You Need

- A properly sited instrument shelter
- A properly calibrated and installed digital multi-day max/min thermometer
- Digital Multi-day Soil Thermometer Data Sheet
- Pen or pencil
- An accurate watch or other device that tells time

In the Field

1. Maximum and minimum readings should be taken at least five minutes after your *time of reset*.
2. Open the instrument shelter and the cover flap of the digital max/min thermometer.
3. Record the time and date on your data sheet in both local and UT time.
Note: GLOBE data entry should be UT time.
4. Turn on the 5 cm temperature display of the thermometer by pressing the 5 cm display ON button (upper left button labeled 'ON').
5. Press the 5 cm sensor MAX button (middle left button labeled 'MAX') **twice**.
Note: The reading that appears after you press the 'MAX' button once is the highest temp that has occurred since the time of reset, and is not for a full 24-hour period. It should not be recorded.
6. You should see the 'MAX' symbol displayed on the digital display screen to the left of the temperature reading with the symbol 'D.1' displayed above. Record this temperature on your data sheet.
7. Press the 5 cm sensor MAX button again. The symbol 'D.2' should now be displayed in place of 'D.1'. Record the accompanying temperature on your Data sheet. Repeat this procedure to record data for as many of the past six days as needed.
8. To record minimum 5 cm temperatures repeat steps 5-7 pressing the 5 cm sensor MIN button (bottom left button labeled 'MIN') instead of the MAX button.
9. For the 50 cm temperatures, repeat the above steps using the 50 cm buttons on the right side and reading from the lower section of the display screen.
10. After all measurements have been taken, close the cover flap of the instrument. It will shut off automatically after a short time. Shut the instrument shelter.

Digital Soil Thermometer

Current Temperature

Field Guide

Task

Measure the current soil temperatures, at depths of 5 cm and 50 cm.

What You Need

- A properly sited instrument shelter
- A properly calibrated and installed digital multi-day max/min thermometer
- An accurate watch or other device that tells time
- Digital Multi-Day Soil Thermometer Data Sheet*
- Pen or pencil

In the Field

1. Open the instrument shelter and lift the cover flap of the digital max/min thermometer.
2. Record the time and date on your data sheet.
3. Turn the 5 cm temperature display on by pressing the 5 cm sensor ON button (upper left rubber button labeled 'ON') on the front of the instrument casing.
4. The current 5 cm temperature will now be shown in the upper section of the digital display. Record this temperature on your data sheet.
5. For 50 cm measurements, repeat the above steps using the 50 cm display ON button (upper right button labeled 'ON') and read the value from the lower section of the display screen.
6. After all measurements have been taken close the cover flap of the instrument. It will shut off automatically after a short time. Close the instrument shelter.

Digital Multi-Day Soil Thermometer

5 cm Sensor Error Check

Field Guide

Task

Check that the 5 cm soil sensor is working properly.

What You Need

- Soil probe thermometer from *Soil Temperature Protocol*
- Digital Multi-day Soil Thermometer Calibration and Reset Data Sheet*

In the Field

1. Calibrate a soil probe thermometer following the *Calibrating the Soil Thermometer Lab Guide* of the *Soil Temperature Protocol*.
2. Open the door to the instrument shelter.
3. Select a place about 15 cm from the location of the soil temperature probes.
4. Measure the soil temperature at a depth of 5 cm at this spot following the *Soil Temperature Protocol*.
5. Record this temperature in the '5 cm Soil Sensor Error Check' section of your *Digital Multi-day Soil Thermometer Calibration and Reset Data Sheet*.
6. Turn on the soil temperature display of the multi-day max/min thermometer by pressing the soil sensor ON button (upper left button).
7. Read the temperature reported by the soil sensor of the digital thermometer and record it in the '5 cm Soil Sensor Error Check' section of your *Digital Multi-day Soil Thermometer Calibration and Reset Data Sheet*.
8. Close the cover flap of the digital thermometer and the door of the instrument shelter.
9. Repeat steps 2 to 8 four more times, waiting at least one hour between measurements.
10. Report these data to GLOBE. The GLOBE archive will determine if you need to dig out the soil sensors and recalibrate them following the *Digital Multi-Day Soil Thermometer Calibration Field Guide*.

Changing the Battery in the Digital Multi-Day Max/Min Thermometer

Field Guide

Task

Change the battery in the digital Max/Min Thermometer.

What You Need

- A new AA-size battery
- A small Phillips head screwdriver

In the Field

1. The battery is in the battery compartment in the lower section of the instrument casing.
2. Remove the two little screws located at the upper corners of the compartment cover and lift off the cover.
3. Change the battery, taking care to ensure correct polarity (negative end of battery contacting the spring).
4. Replace the compartment cover and secure with the two screws.
5. Recalibrate the sensors following the *Digital Multi-Day Soil Thermometer Calibration Field Guide*.
6. Reset the instrument using the *Digital Multi-Day Max/Min Thermometer Reset Field Guide*.

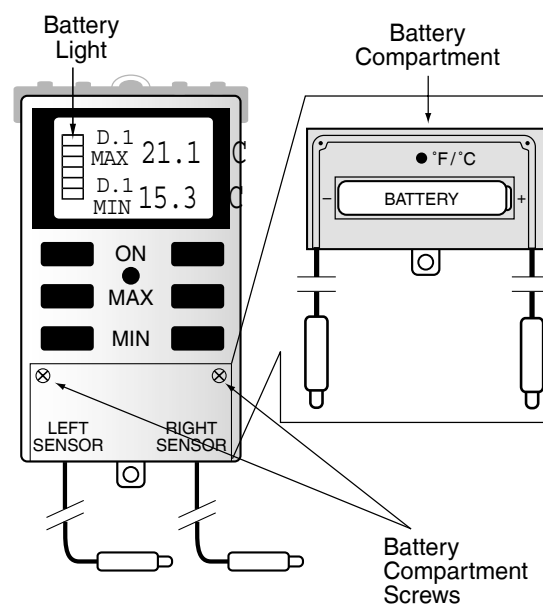



Frequently Asked Questions

1. What should I do if my digital max/min thermometer is reading temperatures in degrees Fahrenheit instead of Celsius?

You can change the units by pressing a small button located in the battery compartment. Open the battery compartment following the instructions given in the *Changing the Battery in the Digital Multi-Day Max/Min Thermometer Field Guide*. You should see a small round button, marked °F/°C (see figure below). Turn on at least one of the sensors and press this button. You will see the measurement units change from Fahrenheit to Celsius. Close the battery compartment. Be sure always to have your instrument in Celsius mode when taking GLOBE measurements!

Figure SO-MU-2: Multi-Day Digital Max/Min Thermometer Battery Compartment with cover removed.

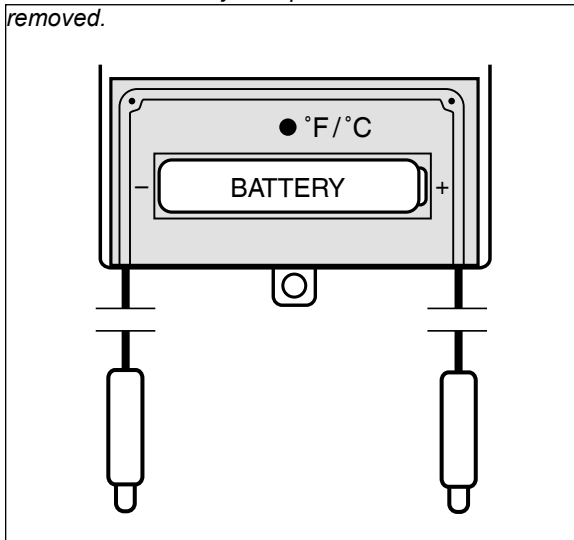

2. What if I find that my time of reset is no longer within one hour of local solar noon?

For your minimum and maximum temperature readings to be valid it is necessary for the *time of reset* to be within one hour of local solar noon. Reset your instrument using the *Digital Multi-Day Max/Min Thermometer Reset Field Guide* as close as possible to the time of local solar noon (preferably within 15 minutes).



3. If I miss reading my maximum and minimum temperatures, can I still get the readings the next day?

The max/min temperatures stored in the instrument are updated every 24 hours at the *time of reset*. Therefore, these temperature values can be collected anytime from about 5 minutes after the *time of reset* on the desired day until 5 minutes before the *time of reset* on the next day. If you wait until after the time of reset on the 7th day, one day's data will be lost. However, if they are read on the next day, care must be taken to match correctly temperatures read from the instrument to the corresponding days. Maximum and minimum temperatures displayed along with the 'D.1' symbol on the instrument display screen correspond to the current day when readings are being taken after *time of reset* (as recommended) and to the previous day when readings are being taken before the *time of reset*. See the following tables for clarification:

Readings taken AFTER time of reset (as recommended).

	Digital Display		
Symbol:	D.1	D.2	D.3
Reading Corresponds to 24-hours Ending:	Today	Yesterday	2 days ago

Readings taken BEFORE time of reset

	Digital Display		
Symbol:	D.1	D.2	D.3
Reading Corresponds to 24-hours Ending:	Yesterday	2 days ago	3 days ago

4. Can I read the thermometer in the morning before the time of reset?

If the thermometer is read in the morning, at least 5 minutes before the *time of reset*, it is possible to read the max/min temperatures for the past six days. However, the max/min temperatures for the current day cannot be read.



5. When I first press a MIN or MAX button, the instrument displays a reading which I am not supposed to record; what is this reading?

The reading displayed when you press a MIN or MAX button for the first time is the minimum or maximum temperature for the on-going 24-hour period. Since this period is not finished, the reading may not be the final maximum or minimum temperature for the 24 hours. While it is not valid data that you report to GLOBE, it can be used to for your own inquiry purposes.

6. How does the digital thermometer work?

The thermometer works by measuring the change in current running through a constant-voltage circuit in which the sensor probe serves as a resistor. As the temperature of the sensor changes, its electrical resistance changes. The change in current in the circuit is inversely proportional to the change in the sensor's resistance as described by Ohm's Law which explains that current is equal to voltage divided by resistance. So by measuring the current going through the circuit, and knowing the voltage, it is possible to calculate the resistance of the sensor. This is done by the instrument, which then reports the probe temperature corresponding to that level of resistance.

Soil Investigation

Digital Multi-Day Soil Thermometer Calibration and Reset Data Sheet

School Name: _____ Study Site: _____

Observer Names: _____

Calibration

<i>Thermometer Readings</i>						
Reading Number	Date (yy/mm/dd)	Local Time (hour:min)	Universal Time (hour:min)	Calibration Thermometer Readings (°C)	Digital 5 cm Sensor Readings (°C)	Digital 50 cm Sensor Readings (°C)
1						
2						
3						
4						
5						

Time of Reset

Note: The thermometer should be reset only when it is first setup, after the battery is changed, or if the time of local solar noon drifts to more than one hour from your *time of reset*.

Date: _____ Local time (Hour:Min) _____ Universal time (Hour:Min) _____

Was the reset due to a battery change? _____

5 cm Sensor Check

<i>Thermometer Readings</i>					
Reading Number	Date (yy/mm/dd)	Local Time (hour:min)	Universal Time (hour:min)	Soil Probe Thermometer Readings at 5 cm (°C)	Digital 5 cm Sensor Readings (°C)
1					
2					
3					
4					
5					

Soil Investigation

Digital Multi-Day Soil Thermometer Data Sheet

School Name: _____ Study Site: _____

Observer Names: _____

Date: Year _____ Month _____ Day _____

Local time (Hour:Min) _____ Universal time (Hour:Min) _____

Your *Time of Reset* in universal time (Hour:Min): _____

Current Temperatures

5 cm soil temperature (°C): _____

50 cm soil temperature (°C): _____

Maximum, Minimum Temperatures

Do not read the thermometer within 5 minutes of your *time of reset*.

	Label on Digital Display Screen					
	D1	D2	D3	D4	D5	D6
Maximum 5 cm Temperature (°C)						
Minimum 5 cm Temperature (°C)						
Maximum 50 cm Temperature (°C)						
Minimum 50 cm Temperature (°C)						
If you are reading thermometer AFTER your <i>time of reset</i> : Correspond to 24-hour Period Ending:	Today	Yesterday	Two days ago	Three days ago	Four days ago	Five days ago
If you are reading thermometer BEFORE your <i>time of reset</i> : Correspond to 24-hour Period Ending:	Yesterday	Two days ago	Three days ago	Four days ago	Five days ago	Six days ago

Automated Soil and Air Temperature Monitoring Protocol



Welcome

Introduction

Protocols

Learning Activities

Appendix

Purpose

To continuously measure soil and air temperature at one site

Overview

Students install four temperature probes; three are placed in the soil at three different depths and one is placed in an instrument shelter. Students use a data logger to record readings from the probes every 15 minutes. Students transfer the data to their school computers for analysis and submission to the GLOBE database.

Student Outcomes

Students will be able to use automated monitoring equipment to measure soil and air temperatures. Students will be able to manipulate extensive multivariable data sets.

Students will be able to create spreadsheets and time-series graphs and use them for data analyses.

Science Concepts

Earth and Space Science

Weather can be described by quantitative measurements.

Weather changes from day to day and season to season.

Weather varies on local, regional, and global spatial scales.

Soil temperature varies with depth, soil moisture, and air temperature.

Soil temperature varies less than air temperature.

Geography

The temperature variability of a location affects the characteristics of Earth's physical geographic system.

Scientific Inquiry Abilities

Use a data logger to measure temperature.

Identify answerable questions.

Design and conduct scientific investigations.

Use appropriate mathematics to analyze data.

Develop descriptions and explanations using evidence.

Recognize and analyze alternative explanations.

Communicate procedures and explanations.

Time

Set-up takes approximately 4 hours but may be spread over several days.

Data transfer - 10 minutes

Data analysis and submission to GLOBE – 30 minutes to 2 hours, depending on the amount of data and students' computing skills

Level

Middle, Secondary

Frequency

One-time set up

Battery needs to be changed yearly.

Data transfer, analysis, and submission to GLOBE - preferably weekly, but at least once per month

Materials and Tools

4-Channel data logger and software

1 air temperature sensor

3 soil temperature sensors

Data logger/computer interface cable

Watertight plastic box (~0.5 L volume)

CaSO₄ or other desiccant (100 mL)

4 Strain-relief connectors

Instrument shelter installed on a post

Digging tools

Preparation

Review the Maximum, Minimum, and Current Air Temperature Protocol and *Soil Temperature Protocol*.

Prerequisites

None



Optional Automated Soil and Air Temperature Monitoring Protocol—Introduction

A data logger is an electronic device that automatically collects data at a predetermined sampling rate. Data loggers allow scientists and students to collect valuable environmental measurements in remote locations. They also collect data continuously allowing for consistent data collection and analysis. With a data logger, students are able to collect data during weekends and school breaks. Data loggers can collect data for up to 84 days without daily readings and thermometer calibrations.

Students who use data loggers contribute important data to a worldwide dataset of soil and air temperatures. Scientists' understanding of climate has been determined by their access to a large number of air temperature data, but soil temperature datasets are not as extensive. Students using data loggers will be making significant contributions to these datasets and to our understanding of soil science.



Teacher Support

Materials Management

The procedures described in this protocol are specific to a particular brand of data logger and its temperature probes and software. They may be adapted to other equipment, as long as they meet the GLOBE data logger specifications. If teachers and students plan to use different equipment, they should contact the GLOBE Help Desk to learn how to adapt this protocol to their equipment. The essential elements of this protocol, which must remain the same regardless of the equipment model, are the placement of the temperature probes and the ± 0.5 °C precision and accuracy of the temperature sensors.

An Onset Computer HOBO® 4-channel external data logger is used to record air and soil temperatures at an Atmosphere Study Site every 15 minutes on the quarter hour. The Onset HA-type sensors have a range of -40 to 100° C and an accuracy of 0.5° C. This works well for most surface and near-surface applications. This data logger has 4 channels. For consistency, the data logger must be connected as follows:

Ch.1 -Air Temperature;

Ch.2 -5 cm depth;

Ch.3 -10 cm depth;

Ch.4 -50 cm depth.

Condensation can damage the data logger so it needs to be kept in a watertight container free of high humidity. A plastic box with a tight sealing lid containing a desiccant, such as CaSO_4 , works well to absorb moisture and protect the logger.

Students may assemble their own watertight box. If they choose to do this, they must purchase a set of strain relief connectors (refer to step 2, in the *Data Logger Preparation Lab Guide*). Students and teachers can make requests for these connectors with the GLOBE Help Desk (U.S. schools) or to with their Country Coordinators (all schools outside the U.S.).

Site Selection

For protection, the watertight data logger box should be kept out of direct sunlight and rain. The best place to install the soil data logger is inside a GLOBE instrument shelter. Students dig or auger a hole on the equator ward side (sunny-side) of the instrument shelter mounting post and place the probes at depths of 5 cm, 10 cm, and 50 cm. Data collected from soils in non-shaded locations are preferred. On their site definition sheets, students should comment on the amount of shade that the soil receives during the year.

Advance Preparation

Students should read the following sections in the BoxCar Pro® v.3.5+User's Manual: Installation, Launching HOBO® H8 loggers, Reading out data, Viewing your data, and Exporting data.

Students should complete the instrument assembly and software installation before they begin collecting data as detailed in the *Data Logger Preparation Lab Guide*.

Students should complete the Sensor Bias Test before they begin collecting data as detailed in the *Calibration and Lab Tests Lab Guide*. According to the Guide, students complete a Full Range Calibration and report it to GLOBE. The calibration and lab tests verify that the unit is working properly and provide an opportunity for students to practice using the logger before installing it in the field.

Students should install the data logger and sensors according to the instructions in the *Sensor Installation Field Guide*.

The science content for this protocol is the same as that for the *Maximum, Minimum and Current Air Temperature Protocol* and the *Soil Temperature Protocol*. Refer students to these sections for more background information.

Data Reporting

Students launch or initiate the data collection by following the *Data Logger Launching Lab or Field Guide*.

Students place the launched data logger in the instrument shelter and connect it to the temperature probes by following the *Data Logger Installation Field Guide*

Students download the stored data from the data logger and transfer them to a computer by following the *Data Collection Lab Guide*.

After collecting data, students re-launch and install the data logger in the instrument shelter by following the *Data Logger Launching Lab or Field Guide* and the *Data Logger Installation Field Guide*.

Students prepare their data for reporting and submit them to GLOBE by following the *Data Manipulation and Submission Lab Guide*.

Data should be transferred from the data logger in the field and sent to the GLOBE database every 1-2 weeks. Students should backup and save their .dtf raw data logger files.

The data logger may be unplugged and brought inside to download the data, but it is also possible to take a laptop computer or portable data caddy to the field and avoid disconnecting the logger.

Questions for Further Investigation

How do soil and air temperatures vary throughout the day?

How are soil temperature and air temperature related?

How are soil temperatures at different depths related?

How are changes in soil and air temperature affected by soil moisture?

How does soil texture affect soil temperature?

For influencing the timing of budburst and other phenologic changes in your area, are temperature averages or extremes more important?

Data Logger Preparation

Lab Guide

Task

Prepare and assemble the data logger and cables. Load the data logger software.

What You Need

Data Logger/Sensor Assembly

- H08-006-04 HOBO H8 4-Channel External
- TMC1-HA Wide-range temperature sensor, 0.3 m (1 ft) cable (1)
- TMC20-HA Wide-range temperature sensor, 6.1 m (20 ft) cable (3)
- Water tight box such as Rubbermaid #1 square sandwich box (~0.5 L volume)
- CaSO₄ or other dehydrating agent (100 mL)
- Strain-relief connectors (4)

Computer interface

- BoxCar Pro® v.3.5+ or v.4.0 software
- PC or MAC computer interface cable

In the Lab

1. Use a permanent marker to mark BOTH ends of four TMC6-HA sensor cables. Place marks about 1 cm from the reinforced plug tip. Use 1,2,3 or 4 lines drawn completely around each cable. Label the short cable number 1.

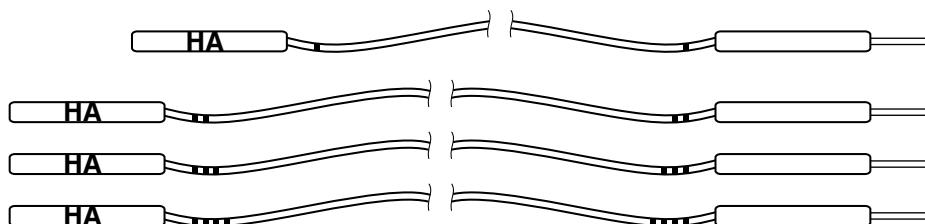

2. Seal cables and data logger in a water-tight box

Option A) Using strain relief connectors:

- Drill or punch out four equally-spaced, 12 mm (1/2") holes in sidewall.
- Install strain relief connectors, using a bit of silicon sealant around the threads.
- Insert sensor cables through connectors and plug into appropriate data logger sockets.

Note: a set of strain relief connectors can be obtained by sending your mailing address to: the GLOBE Help Desk (U.S. schools) or your Country Coordinator (all other schools).

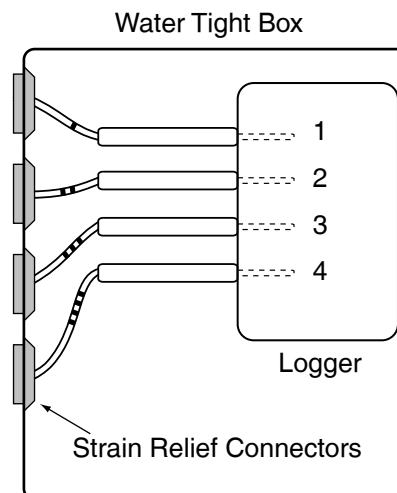

OR

Option B) Using wire ties and silicon sealant:

- Drill four equally-spaced, 5 mm (1/4") holes in a sidewall.
- Insert sensor cables through the sidewall and plug into appropriate data logger sockets.
- Fasten wire ties snugly against inside wall.
- Fasten wire ties snugly against outside wall.
- Apply silicon sealant around wires and between wire ties and hole in the side wall.
- Let dry/cure for 24 hrs.

3. Load the Boxcar Pro software on your computer. If you are using a MAC, you must download the software from: www.onsetcomp.com/Support/2543_MacBCP.html

- Follow the software installation instructions on page 1 of the BoxCar Pro® User's Manual.
- Connect the serial cable to a PC (9-pin, D-type) COM port OR to a MAC (8-pin, O-type) modem port.
- Check the date and time on your computer to ensure that they are correct.
- Run c:\Bxcrpro3\Bxcrpro.exe (default location) or double click on the BoxCar Pro® icon.

Note: Newer iMAC/G3 and G4 Apple computers with USB ports require additional cable adapters.

Calibration and Lab Tests

Lab Guide

Task

Verify that the data logger and sensors are operating normally.

What You Need

- Data logger assembly and cables
- Calibration thermometer
- Warm water (~50° C), Un-insulated cup, Ice

In the Lab

1. Record Sensor Bias – This test verifies that all four channels are recording the same approximate temperature by collecting data for a few minutes with all four sensors grouped together measuring air temperature. The bias or difference between each sensor should be less than 1° C.
 - a. Plug each sensor into the appropriate socket and place all four sensor tips together and away from any sources of heat (like a sunny spot).
 - b. Connect the logger to the serial cable.
 - c. Confirm that your computer's clock is showing the current local time.
 - d. Double click on the Boxcar® icon to run this software.
 - e. Select "Launch" (Ctrl L) under the "Logger" button on the main menu bar.
 - f. Change the file "Description" from "TEST" to "Day1bias".
 - g. Change the "Interval" to "6 sec"
 - h. Select the "Start" button, message should indicate the "program" is being loaded.
 - i. Wait 3 minutes. The data logger should be working!
 - j. Select "Readout" (Ctrl R) under the "Logger" button on the main menu bar.
 - k. Screen should indicate the data is being "Downloaded", then prompt you for a filename. The default should be Day1bias.dtf
 - l. Use View, Display Options to look at each temperature channel separately.

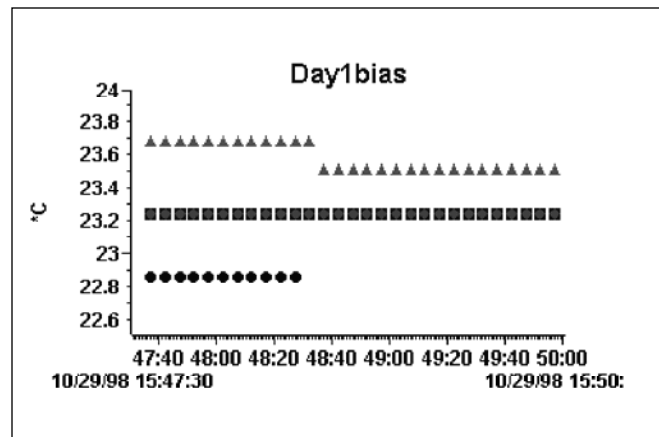

- m. Record the average value from each channel in your GLOBE Science Log , they should be within 1° C of each other.
- n. Make sure that you understand the time axis scale and that it is showing the correct time and date and how to save the data to an Excel file.

2. Full Range Calibration

- a. Place the four temperature sensors in a half-full, non-insulated cup of warm water (~50° C).
- b. Connect the logger to the serial cable.
- c. Confirm that your computer’s clock is showing the current local time.
- d. Select “Launch” under the “Logger” button on the main menu bar.
- e. Set the file “Description” to “CAyymmdd”, where yymmdd is today’s year, month and day.
- f. Set the “Interval” to “5 min” and launch the logger with a delayed start at the next regular 5 minute time mark (example: its now 10:17:00. So set the delayed start for 10:20:00).
- g. Record the calibration thermometer temperature every 5 min in conjunction with the loggers sampling time.
- h. After the temperature change slows to 1° C/5 min, add ice cubes and continue until the water approaches freezing.

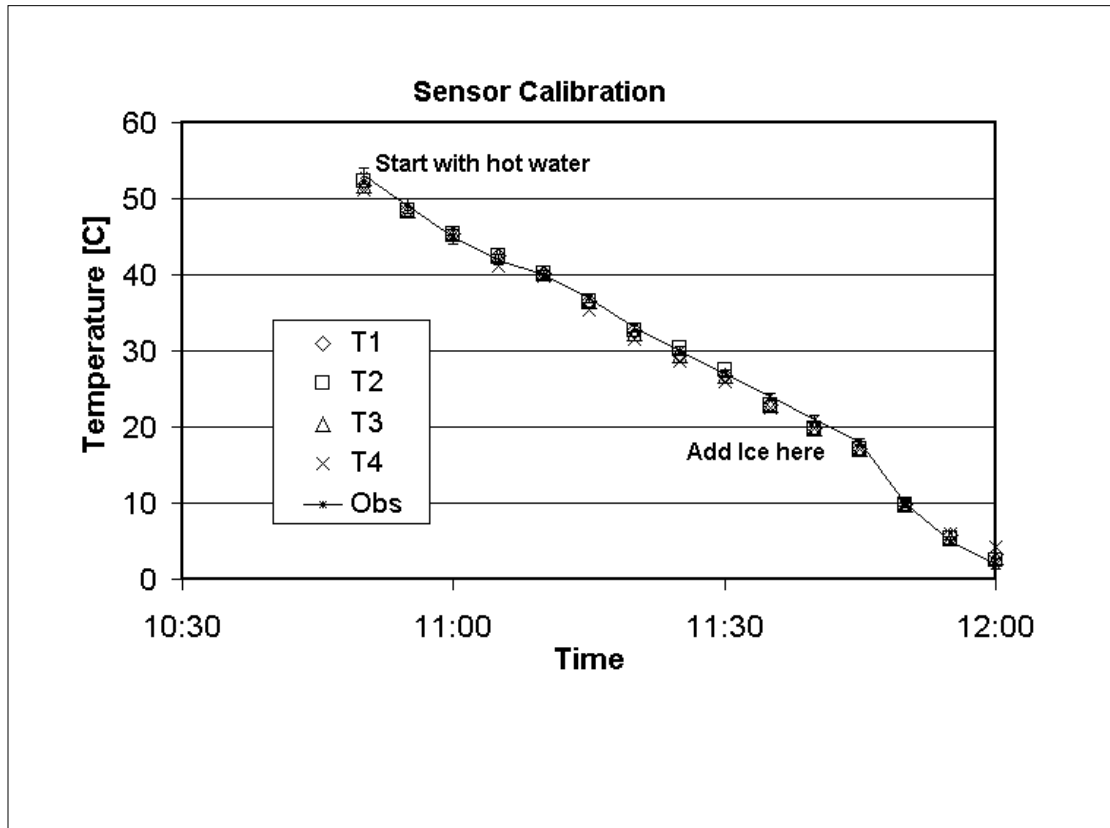

Sensor Installation

Field Guide

Task

Install the data logger and sensors at your atmosphere study site.

What You Need

- Meter stick
- Digging tools
- 120 cm x 2.5 cm PVC tube
- Data logger assembly and cables
- Drill with 12 mm spade bit
- Wire or brackets to secure PVC tube to post
- String or wire tie
- Desiccant

In the Field

1. Plan the installation. Make sure that the distance between your box and deepest sensor is less than 5.5 meters and that it is safe to dig a 50 cm deep hole.
2. Drill a 12 mm hole, if needed, through the bottom of your shelter, near the back.
3. Place the Data logger box inside the instrument shelter.
4. Use string or a wire tie to secure the air temperature sensor (#1) inside the instrument shelter.
5. Feed your 3 long cables through the 12 mm hole and pull them through the PVC tube (which protects the cables from excessive UV and animal bites). Plan on keeping any excess wire inside the shelter.
6. Secure the PVC tube to the shelter post.
7. Dig a hole 50 cm deep on the sunny (equatorward) side of the shelter post.
8. Push sensors horizontally into the side of the hole at 50 cm (#4), 10 cm (#3), and 5 cm (#2) depths, respectively. Use a nail or steel pin with a slightly smaller diameter to pilot these holes if the soil is hard.
9. Pour desiccant into a bag made of breathable fabric (e.g., cheese cloth or a cotton sock) and place it inside the watertight box so the air inside the box will be kept dry.
10. Seal the water tight box containing the data logger.

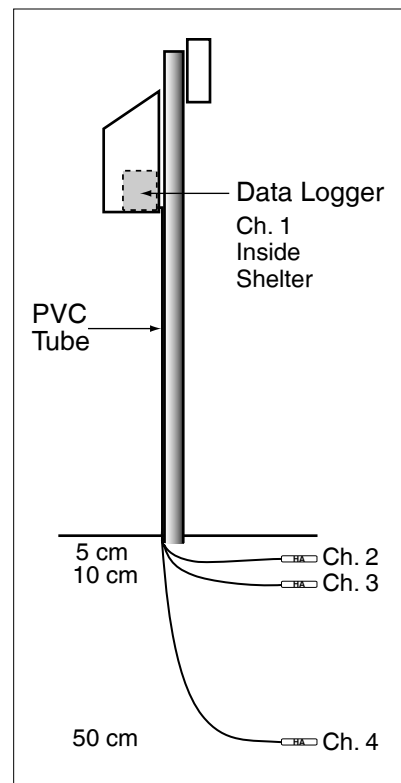

Data Logger Launching

Lab or Field Guide

Task

Launch your data logger for collecting diurnal soil and air temperature measurements.

What You Need

- Data logger disconnected from the four sensor cables
- Computer: 386 or better, 4 Mb RAM, Windows 3.1 or later, 1 available COM (serial) port
- Data Logger Data Sheet*

In the Lab or Field

1. Make sure that your computer's clock is reading the correct local time.
2. Run the BoxCar® software
3. Connect the HOBO® 4-Channel External logger to the serial cable using the bottom and largest plug.
4. Select "Launch" (Ctrl L) under "Logger" button on the main menu bar.
5. You should see or select the following:
 - a. Interval (duration) = 15 minutes (84 Days),
 - b. Measurement: Channels 1-4 recording Temperature (both °F and °C). Without the sensors connected, the values will be different but should be relatively constant.
 - c. Battery Level: full (replace the battery when level falls below 30%)
6. Select "Advanced Options".
7. You should see or select the following:
 - a. Wrap-around when full (unchecked)
 - b. Delayed Start (checked) Set to expected start time; Use this feature to start sampling times on the quarter hour, ex: XX:00:00, XX:15:00, XX:30:00, or XX:45:00. Select "am" or "pm".
8. Select "Enable/Disable Channels".
9. For Channels 1-4, you should see or select the following:
 - a. -40 °F to +212 °F [TMC6-HA]. (checked)
 - b. Select "Apply"
10. Select "Start".

Data Logger Installation

Field Guide

Task

Install the launched logger in the instrument shelter.

What You Need

- Launched data logger
- Desiccant
- Data Logger Data Sheet*

In the Field

1. Open the door of the instrument shelter and uncap the empty data logger box.
2. Make sure that the logger and cable plugs are dry. Replace the desiccant as is necessary.
3. Carefully plug each sensor cable into the appropriate data logger channel. Make sure that each plug is fully inserted and seated in its jack.
 - a. Plug cable #1 into jack #1 (air temperature sensor)
 - b. Plug cable #2 into jack #2 (5 cm sensor)
 - c. Plug cable #3 into jack #3 (10 cm sensor)
 - d. Plug cable #4 into jack #4 (50 cm sensor)
4. Carefully seal the water-tight data logger box and place out of the way in the instrument shelter.
5. The data logger is now collecting data. We recommend you download the data weekly when school is in session or at least monthly during longer vacations.

Data Collection

Lab Guide

Task

Download the data stored in your data logger to your computer.

What You Need

- Data logger disconnected from the four sensor cables
- Data Logger Data Sheet*
- Computer: 386 or better, 4 Mb RAM, Windows 3.1 or later, 1 available COM (serial) port

In the Lab

1. Make sure that your computer's clock is reading the correct local time.
2. Run BoxCar® software.
3. Connect the HOBO® 4-Channel External logger to the serial cable using the bottom and largest plug.
4. Select "Readout" (or Ctrl R) under the "Logger" button on the main menu bar.
5. You should see:
 - a. A pop-up box will indicate that the software is searching for the HOBO® data logger.
 - b. A pop-up box will indicate that the data are being downloaded.
 - c. A warning will be given if the data logger and shuttle clocks are unsynchronized.
 - d. Battery Level: replace the battery after saving the data if the battery level falls below 30%.
 - e. A "Save As" box.
6. Rename the data file (.dtf file) and save it. It is recommended to use a file name like "SSYYMMDD" where,
 - a. "SS" is a two character school or site code and "YYMMDD" are the two digit values for year, month and day (i.e., 010315) for the date that you downloaded (READOUT) these data from your logger. Note: this BoxCar® software is limited to 8 character filenames.
 - b. Make sure to select or take note of the output data directory.
7. Take time to preview the data using BoxCar's graphing capabilities.

Data Manipulation and Submission

Lab Guide

Task

Convert the data in the appropriate format for reporting to GLOBE.

What You Need

- Computer: 386 or better, 4 Mb RAM, Windows 3.1 or later, 1 available COM (serial) port
- Excel or other spreadsheet software
- BoxCar[®] software
- Data Logger Data Sheet*

In the Lab

You should send in your data to GLOBE as often as you download your logger, which should be approximately weekly to monthly.

1. Double click on the BoxCar[®] icon to run this software.
2. Under “File” select “Open” and open the BoxCar[®] file (.dtf) that contains the data you are preparing to submit to GLOBE
3. Under “File” select “Export” and then “Excel” or the appropriate spreadsheet choice (or just select the “Excel” icon on the shortcut toolbar).
4. The “Export Set-Up” box will appear
5. Select all four channels that contain Celsius measurements by selecting each channel marked “Temperature [*C]” in the “Units” box (be sure to deselect the first default value which is marked “Temperature [*F]”).
6. Select “Export”.
7. Maintain the name as “SSYYMMDD.txt”
8. Select “OK”.
9. Launch Excel or other spreadsheet software.
10. Under “File” select “Open” and choose the file that contains your data (SSYYMMDD.txt).
11. Make sure to select “All Files (*.*)” under “Files of Type”.
12. Select “Open”.
13. The “Text Import Wizard” should be set to “Delimited”, “Start Import at Row 1”, “File origin Windows (ANSI).
14. Select “Finish” directly without passing through the intermediate steps. You should see one column of time data and four columns of temperature data with units of [*C].
15. Graph your data following the steps in *Looking at the Data*.
16. If you have any data points that are unquestionably bad, replace those values with a “B”.

17. If one of your sensors was not connected or not working, place an “X” in the appropriate cells of your spreadsheet.
18. Select the whole first row that contains the titles (by clicking on “1”) and remove it, by selecting “Delete” under the “Edit” menu.
19. Format the whole first column that contains the time and date (by clicking on “A”) and choose “Cells” under the “Format” menu.
20. In the pop-up box that appears select “Custom” under “Category” and under “Type” enter yyyymmddhhmm. Hit “OK”. The date and time entries are now in the format required by GLOBE.
21. Select columns A,B,C and insert three new columns by selecting “Columns” under the “Insert” menu.
22. Scroll down to the last row of data.
23. Type “DLOG” in column A.
24. Enter your GLOBE School ID in column B.
25. Enter the GLOBE site type and number where the data logger is installed (atmosphere site = ATM-dd or soil moisture site = SMS-dd; e.g., ATM-01 or SMS-01) in column C.
26. Highlight the three cells containing “DLOG”, your GLOBE school ID, and the site type and number and select “Copy” under the “Edit” menu.
27. Highlight the first three columns in the second to last row of data and then use the following two keystrokes to highlight all the cells in columns A-C that contain data: “End”, “Shift Up Arrow”.
28. Select “Paste” under the “Edit” menu so that these three values are copied to the selected area of columns A-C.
29. Select column E and insert one new column by selecting “Columns” under the “Insert” menu.
30. Format the whole fifth column (by clicking on “E”) and choose “Cells” under the “Format” menu.
31. In the format cells “Number” pop-up box that appears, select “Text”. Move to the format cells “Alignment” tab and select “Right” within the “Horizontal” selection box. Hit “OK”
32. Scroll down to the last row of data, if necessary.
33. In column E, enter the UT offset between your site and the prime meridian ($UT_offset = UT_time - Local_time$). This will be a constant unless there has been a local time shift (ie. day light savings) during the period of observation. Enter this value using a ±hhmm scheme (example: +0400 for a 4 hour offset for the East coast of the U.S. or -1030 for a -10 hour 30 minute offset for central Australia). Note, the sign of these offsets are opposite the standard value. Unfortunately, the coming and going of daylight savings varies by country. Please consult local authorities as to what local time you need to make this adjustment (or visit www.worldtimezone.com/daylight.htm)
34. Highlight the cell containing your offset and select “Copy” under the “Edit” menu.
35. Highlight the empty cell in column E in the second to last row and then use the following two keystrokes to highlight all the cells in column E that contain data: “End”, “Shift Up Arrow”.

36. Select "Paste" under the "Edit" menu so that this value is copied to the selected area of column E.
37. Save this document by selecting "Save As" under the "File" menu.
48. Change the name of this GLOBE formatted file to "DLYYMMDD.txt" (ignore the warning about file format generated by "Excel") and save as a tab-delimited text file.
39. You are now ready to send your data to GLOBE by email.
40. Launch your email program without quitting Excel.
41. In the "To:" field of your message enter "DATA@GLOBE.GOV".
42. In the "Subject:" field enter "DATA".
43. The first line of the text of your message must be "//AA". This tells the GLOBE server that the lines that follow will contain data.
44. Copy and paste the nine columns of the spreadsheet file that contains your logger data:
 - a. Switch back to Excel or other spreadsheet and highlight the portion of the nine columns that contain information.
 - b. Select "Copy" under the "Edit" menu.
 - c. Switch back to your email program, put the cursor on the line below the "//AA" entry in the text portion of the message, and select "Paste" under the "Edit" menu. The whole table should now appear in the body of the email message.
45. After you insert the table with your data, type on the last line of your message "//ZZ". This tells the computer that there are no more data in your message. See an example of what your email should look like below.
46. Send the email to GLOBE.

Example of an email containing air and soil temperature data collected with a data logger

To: DATA@GLOBE.GOV								
From: GLOBE_School@Somewhere.edu								
Subject: DATA								
//AA								
DLOG	ZZUSTEST	ATM-01	200105141600	+0400	B	B	B	B
DLOG	ZZUSTEST	ATM-01	200105141615	+0400	24.79	24.79	24.79	24.79
DLOG	ZZUSTEST	ATM-01	200105141630	+0400	24.79	24.79	24.79	24.79
DLOG	ZZUSTEST	ATM-01	200105141645	+0400	24.79	24.79	24.79	24.79
DLOG	ZZUSTEST	ATM-01	200105141700	+0400	24.79	24.79	24.79	24.79
DLOG	ZZUSTEST	ATM-01	200105141715	+0400	24.79	24.4	24.79	24.79
DLOG	ZZUSTEST	ATM-01	200105141730	+0400	24.79	24.4	24.79	24.79
DLOG	ZZUSTEST	ATM-01	200105141745	+0400	24.79	24.4	24.79	24.79
DLOG	ZZUSTEST	ATM-01	200105141800	+0400	24.79	24.4	24.4	24.79
DLOG	ZZUSTEST	ATM-01	200105141815	+0400	24.79	24.4	X	24.79
DLOG	ZZUSTEST	ATM-01	200105141830	+0400	24.79	24.79	X	24.79
DLOG	ZZUSTEST	ATM-01	200105141845	+0400	24.79	24.79	X	24.79
DLOG	ZZUSTEST	ATM-01	200105141900	+0400	24.79	25.17	X	24.79
DLOG	ZZUSTEST	ATM-01	200105141915	+0400	24.79	25.17	X	24.79
//ZZ								



Frequently Asked Questions

1. When I try to download the logger, there is no data. What happened?

This could happen if you did not complete a proper launch sequence prior to setting your logger in the field. Make sure you do not try to launch a data logger that has not been downloaded as all the data will be lost.

2. How do you tell if one of your sensors is not working?

The two most common problems are a broken wire or an open circuit, usually due to an animal bite or because the connection between plug and socket is not good. An open circuit will produce a very unrealistic value, which might vary slightly. Another warning sign is a reading that does not change. Contact Onset or the GLOBE help desk if you need help.

3. We did not get our logger to the field site for two days after it was launched, should we delete the data during this time period when we know the logger was not plugged in to our sensors?

Never delete rows of data - we want to know when you were attempting to collect data. However, if you have any data that are unquestionably bad, replace those values with a "B". If one of your sensors was missing or not putting out data, place an "X" in these cells of your data sheet.

4. We managed to plug our sensors into the wrong channels. What should we do?

If you are comfortable transposing the columns of data, you can do this in a spreadsheet program. Otherwise, send the .dtf and .txt files to jwash@hwr.arizona.edu with a description of the problem and I will correct it. In general, the daily range of the data should decrease from the air temperature to the 50 cm soil temperature.

5. When do bad data usually occur?

Bad data usually occur at the beginning or the end of your data record due to sampling while the sensors were disconnected.

6. We have submitted air temperature data from our data logger for a specific day(s) but the maximum and minimum air temperature values for that day(s) do not appear in our school's data archive. Why?

If there are three or more bad or missing data points for any 24 hour period (noon to noon), the GLOBE server does not calculate the daily maximum and minimum values for that day(s).

Key Definitions

Attenuation: to reduce in magnitude, to lessen

Conduction: transmission of heat (or electricity) through a substance.

Data Logger: a microcomputer capable of recording and storing both time and measurement data in the field. The only system maintenance required is to periodically download the stored data.

Desiccant: a substance such as calcium sulfide which will repeatedly absorb excess humidity after it is oven dried.

Diurnal: varying regularly throughout the day.

Energy balance: a conservative balance between incoming and outgoing energy components (solar, sensible heat, latent heat, soil heat) at a point, such as the Earth's surface.

Phase-shift: the period of a wave-like phenomena (ocean waves, sound waves) determines how far it is between adjacent peaks (maxima). A phase shift occurs when two waves have the same period but the maxima occur at different times.

Sinusoidal: like a sine wave; many radiation phenomena are greatest midday and least at night.

Optional Soil Moisture Sensor Protocol



Purpose

To measure the water content of the soil based on the electrical resistance of soil moisture sensors.

Overview

Students install soil moisture sensors in holes that are 10 cm, 30 cm, 60 cm, and 90 cm deep. They take daily readings of soil moisture data by connecting a meter to the sensors and using a calibration curve to determine the soil water content at each depth.

Student Outcomes

Students will be able to measure soil moisture from a sensor and record and report soil moisture data. Students will be able to relate soil moisture measurements to precipitation, air temperature and the physical and chemical characteristics of the soil. Students will understand the role of soil moisture in the hydrologic cycle and in phenology.

Science Concepts

Earth and Space Sciences

Earth materials are solid rocks, soil, water, biota, and the gases of the atmosphere.

Soils have properties of color, texture, structure, consistence density, pH, fertility; they support the growth of many types of plants.

The surface of Earth changes.

Soils consist of minerals (less than 2 mm), organic material, air and water.

Water circulates through soil changing the properties of both the soil and the water.

Physical Sciences

Objects have observable properties.

Scientific Inquiry Abilities

Identify answerable questions.

Design and conduct an investigation.

Use appropriate tools and techniques including mathematics to gather, analyze, and interpret data.

Develop descriptions and explanations, predictions and models using evidence.

Communicate procedures and explanations.

Time

10 minutes per day

Level

Middle and Secondary

Frequency

Daily

Reinstallation and calibration every two years

Materials and Tools

Soil Auger

Meter stick

Four soil moisture sensors

Four 10 cm long x 7.6 cm diameter PVC tube or tin cans for wire holders at the surface

Two 4-L soil holding/mixing buckets

Water for making mud balls (0.5 L)

One 1 m x 2 cm PVC guide tube

Soil packing stick (e.g. an old broom handle)

Pen or pencil

Soil moisture meter

Graph paper

Calculator

Daily Soil Moisture Sensor Data Sheet

Semi-Annual Soil Moisture Sensor

Calibration Data Sheet

Materials for the *Gravimetric Soil Moisture Protocol*

Preparation

Locate a soil moisture study site and fill out a *Soil Moisture Site Definition Sheet*. Collect the tools and materials. Prepare the PVC guide tube. Soak the sensor blocks overnight.

Prerequisites

Gravimetric Soil Moisture Protocol



Optional Soil Moisture Sensor Protocol - Introduction

The *Gravimetric Soil Moisture Protocol* measures soil moisture as the amount of water per unit mass of soil (see the *Gravimetric Soil Moisture Protocol* for more information). The technique used in this protocol measures soil moisture through a sensor that is sensitive to the amount of water per unit volume as well as how tightly the water is bound to the soil. The sensor measures the electrical conductivity of moisture that enters a ceramic block from the surrounding soil. The sensor reading is a function of the ceramic porosity, the soil texture and the amount of total dissolved solids (TDS) in the soil water.

To be scientifically useful, the soil moisture readings must be converted to soil water content values. Because this conversion is sensitive to characteristics of the individual Soil Moisture Site, one or more calibration curves must be developed. Students take measurements at least 15 times following the appropriate parts of the *Gravimetric Soil Moisture Protocol – Depth Profile* to obtain the data to determine these curves.



Teacher Support

Measurement Procedures

Students use an auger to dig holes to depths of 10 cm, 30 cm, 60 cm and 90 cm. They install soil moisture ceramic block sensors in each hole following the *Installation of Soil Moisture Sensors Field Guide*. The soil moisture ceramic block sensors must be in complete contact with the surrounding soil. The soil should be broken up and slightly moist before packing it around the sensor during installation.

Once the soil moisture sensors are installed, students should wait at least one week before beginning to report the data to GLOBE. Students take daily readings of soil moisture from meters they connect to the sensors following the *Reading the Soil Moisture Meter Field Guide*.

Calibration curves must be created to convert soil moisture meter readings to soil water content. To do this, students will conduct gravimetric soil moisture measurements for one or more depths at their Soil Moisture Site. They will need to take measurements at least 15 times over a period of 6 – 8 weeks during which the soil moisture varies from wet to dry. The calibration curves do not have to be developed immediately but should be completed within about six months following installation of the soil moisture sensors. Therefore, time the collection of calibration data for a period when the soil moisture is likely to be changing significantly. Generally, this means start the measurements when the soil is wet and will be drying significantly over the coming two months. Obtaining the calibration data from a full drying cycle is desired.

There is no need to take calibration measurements when soil moisture meter readings are close to one another. The key is to cover as wide a range of moisture conditions as possible. Students can begin taking a calibration sample and then wait for the day when the meter reading has changed significantly before collecting another sample. What constitutes a significant change varies across the range of meter readings. If you are using a Delmhorst meter, you want 5 or more calibration points at meter readings from 85 to

100 while you only need 5 calibration points over the range of 1 to 40. For the Watermark and similar meters, you should obtain at least 5 calibration points at meter readings between 1 and 15 while 5 calibration points between meter readings of 100 and 199 should be enough. Regardless of the meter, the end-points of the meter (0 and 100 for Delmhorst and 0 and 200 for Watermark) should not be used in determining your calibration curves. Gravimetric soil moisture data collected for calibration should be reported to GLOBE.

If the soil profile is uniform and the sensors are identical, then calibration for all four sensors can be accomplished comparing sensor and gravimetric soil moisture samples at the 30 cm depth. To determine if the soil is uniform at the different depths, students should perform the *Soil Particle Density* and *Particle Size Distribution Protocols* on soil samples from the four depths – 10 cm, 30 cm, 60 cm, and 90 cm. The soil particle density and texture at 10 cm, 30 cm, 60 cm, and 90 cm are compared. If:

1. the soil particle density at two or more depths do not differ by more than 20%, and
2. the textures at these depths are either the same or fall in adjacent areas on the *Soil Texture Triangle*,

then the same calibration curve may be used for these depths. So, depending on the soil at your site, you only may need to determine one calibration curve (at 30 cm depth) or you may have to determine separate curves for up to four depths.

You may have students determine the soil particle density and texture from samples taken when the soil moisture sensors are installed or take gravimetric soil moisture samples from all four depths the first time calibration samples are taken and use the dried soil samples to perform the *Soil Particle Density* and *Particle Size Distribution Protocols*.

If you do not wish to have students perform the *Soil Particle Density* and *Particle Size Distribution Protocols* to determine the uniformity of your

soil, simply develop individual calibration curves for all four depths.

While GLOBE will create calibration curves for you using your calibration data, students can create their own calibration curves following the *Creating a Calibration Curve Lab Guide*.

Students should monitor the sensors daily for soil moisture variations. They report both the raw meter reading and calibrated values. If they have not finished their calibration curves, they should report the raw values and enter the calibrated values at a later time.

Students should not monitor the sensors when the ground is frozen because this limits the electrical conductivity of any pore waters.

Every two years students need to reinstall and recalibrate the soil moisture sensors.

Managing Materials

Students can use any ceramic block sensors that meet GLOBE specifications. Sensors manufactured by Watermark are known to meet GLOBE specifications and work well for this measurement. There are two soil moisture meters suggested for use with these sensors. One is manufactured by Delmhorst and reads 0 to 100 (dry to wet). The other is made by Watermark and reads 0 to 200 (wet to dry). Please contact the GLOBE soil moisture science team if you have a different kind of sensor or meter.

Supporting Activities

Students can examine the characteristics of the soil profile at their Soil Moisture Study Site. Students should follow the *Soil Characterization Site Exposure – Auger Method* procedures for digging the soil moisture sensor holes. They should follow the *Soil Characterization Protocol* when digging the 90 cm hole. Students should remember to place the extracted soil on a plastic sheet, tarp or board in the same order as it is removed from the hole. Students measure the depth of the hole after each auger extraction and adjust the area/length of the laid-out sample to preserve the profile-depth relationships.



Questions for Further Investigation

What is the annual cycle of soil moisture at your location? How consistent is this pattern from year to year? Can you explain the major differences between two consecutive annual cycles?

How much rain does it take before you see a change in your 90 cm reading? How long does it take to see this wetting front at each of the four depths?

What other parts of the world have soil moisture patterns that look like yours?

Try to find soil moisture data from part of the world in drought. How would you assess the magnitude of drought from the soil moisture record?



The following table describes seven possible situations and states what calibrations curves should be developed and how they should be used.

Situation	What to do
Each depth is different from all the others	Develop individual calibration curves for each depth.
30 cm, 60 cm, and 90 cm are similar but 10 cm is different	Develop a calibration curve for 10 cm and use it for 10 cm and develop a separate curve for 30 cm and use it for 30 cm, 60 cm, and 90 cm.
10 cm, 30 cm, and 60 cm are similar but 90 cm is different	Develop a calibration curve for 90 cm and use it for 90 cm and develop a separate curve for 30 cm and use it for 10 cm, 30 cm, and 60 cm.
10 cm and 30 cm are similar, 60 cm and 90 cm are similar but different from 10 cm and 30 cm	Develop a calibration curve for 30 cm and use it for 10 cm and 30 cm; develop a separate curve for 60 cm and use it for 60 cm and 90 cm.
30 cm and 60 cm are similar, but 10 cm and 90 cm differ from one another and from 30 cm and 60 cm	Develop separate calibration curves for 10 cm, 30 cm, and 90 cm; use the 30 cm curve for 30 cm and 60 cm.
10 cm and 30 cm are similar, but 60 cm and 90 cm differ from one another and from 10 cm and 30 cm	Develop separate calibration curves for 30 cm, 60 cm, and 90 cm; use the 30 cm curve for 10 cm and 30 cm.
60 cm and 90 cm are similar, but 10 cm and 30 cm differ from one another and from 60 cm and 90 cm	Develop separate calibration curves for 10 cm, 30 cm, and 60 cm; use the 60 cm curve for 60 cm and 90 cm.



Frequently Asked Questions



1. The soil particle density and texture differs at the different depths at our site. How many calibration curves must we develop?

All depths with similar soil particle densities (within 20%) and textures (the same or adjacent on the *Soil Texture Triangle*) may share the same calibration curve.

Installation of Soil Moisture Sensors

Field Guide

Task

To install the soil moisture sensors

What You Need

- Soil Auger
- Meter stick
- Four soil moisture sensors
- Four 10 cm long x 7.6 cm diameter PVC tube or tin cans for surface wire holders
- Two 4-L soil holding/mixing buckets
- Water for moistening the soil (0.5 L)
- One 1 m x 2 cm PVC guide tube
- Soil packing stick (e.g. an old broom handle)
- Pen or pencil

In the Field

1. Place the sensors into a container of water and **soak overnight**.
2. Auger 4 holes next to one another to the appropriate depth for each soil moisture sensor (10 cm, 30 cm, 60 cm or 90 cm). Each sensor will go in its own hole.
3. Place two large handfuls of soil extracted from the bottom of each hole into a small bucket or similar container. Remove any rocks. Add a small amount of water and stir to create soil that is moist enough that it stays together when pressed into a ball.
4. Drop the moist soil ball to the bottom of the hole. Make sure it reaches the bottom.
5. Push the wire lead from one of the sensors through the PVC guide tube.
6. Pull the end of the wire lead until the sensor fits firmly against the other end of the guide tube. Lower the tube into the hole with the sensor going in first. While holding the wire lead at the top of the pipe, gently push the tube down until the sensor is set into the moist soil at the bottom of the hole.
7. Hold the sensor in place with the guide tube while you begin to backfill the hole. As you slowly add soil to the hole, gently pack or tamp it with a broom handle or similar pole. After the sensor is covered, remove the guide tube. Continue adding soil a few handfuls at a time and tamping firmly as you backfill the hole. Hold on to the wire lead as you backfill so that it will come straight to the surface.
8. Place a short piece (about 10 to 20 cm long) of PVC pipe, tin can, or coffee can (with the top and bottom removed) around the wire lead at the surface to protect it and make it visible to anyone walking in the vicinity. Label the pipe or can with the appropriate sensor depth.

9. Put the wire through the pipe or can and press the pipe or can 2 to 5 cm into the soil to keep it in place. Do not cut the wire, but wind up the free end extending out of the ground and place it in the pipe or can to keep it out of the way between measurements. A small empty can (e.g. a soup can) should be inverted over the end of the PVC pipe to keep the rain out.
10. Repeat the above steps for each sensor.

Note: Do not report measurements for a week after installation. The sensors require at least one week to equilibrate to natural conditions. The wire leads are fragile, especially where they connect to the meter. If the end of the wire leads to the soil moisture sensors break, peel back the wire insulation and make new leads. It is important to leave enough wire above the ground for this.

Installed Soil Moisture Sensor Configuration

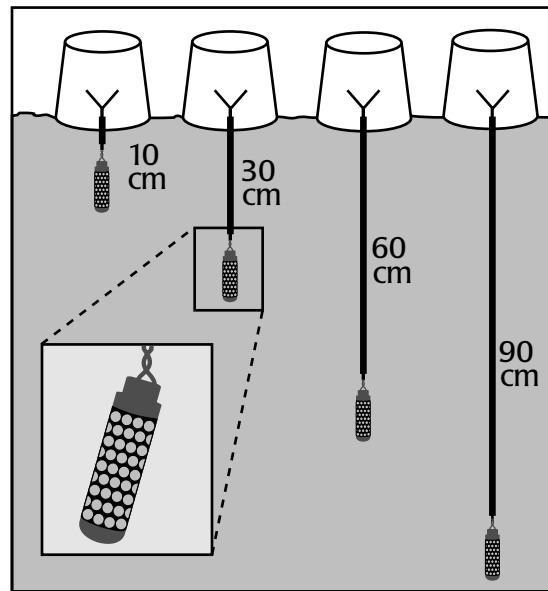

Determining Soil Uniformity With Depth

Field and Lab Guide

Task

Determine whether the soil particle density and texture are uniform at 10 cm, 30 cm, 60 cm, and 90 cm depths

What You Need

Soil auger

Meter stick

Four soil containers (bags or soil moisture sample cans)

Materials for the *Soil Particle Density Protocol*

Materials for the *Particle Size Distribution Protocol*

Soil drying oven

A calibration curve for your soil moisture sensor at 30 cm depth must be developed for conversion from meter readings to soil water content. There is no need to develop calibration curves for other depths unless they differ significantly in soil particle density or texture. The following steps are how you determine this.

In the Field

1. Near the holes where your soil moisture sensors are installed, use the auger to take samples from 10 cm, 30 cm, 60 cm, and 90 cm depths and store them for lab analysis. Samples should be at least 200 g each. Labels should give the date and depth.

Note: If you are using these samples for the *Gravimetric Soil Moisture Protocol*, follow the steps of that protocol for taking, storing, weighing, and drying the samples, and then, use the dry samples in the steps given below beginning with step 4.

2. Replace the remaining soil in the hole with soil from the deepest depth going in first and soil from near surface going in last.

In the Lab

3. Dry your soil samples.
4. Determine the soil particle density of each sample following the *Soil Particle Density Protocol*.
5. Determine the texture of each sample following the *Particle Size Distribution Protocol*.
6. Compare the particle densities at 10 cm, 60 cm, and 90 cm, with the value at 30 cm. If the value for a depth differs by more than 20% from the density at 30 cm, you should produce a separate calibration curve for that depth.
7. Locate the textures at the four depths on the *Soil Texture Triangle*. If the texture at 10 cm, 60 cm or 90 cm depth is not in the same area on the Triangle as the texture at 30 cm depth or if it is not in an area bordering the texture at 30 cm depth on the *Triangle*, produce a separate calibration curve for that depth.
8. You may wish to return your samples to the appropriate depths when you take samples for building your calibration curve.

Reading the Soil Moisture Meter

Field Guide

Task

To take daily measurements from the soil moisture sensors

What You Need

- Properly installed soil moisture sensors
- Pen or pencil
- Soil moisture meter
- Daily Soil Moisture Sensor Data Sheet*

Note: Test the soil moisture meter to ensure it is functioning properly according to the manufacturer's instructions. Do this before each use. Each meter has its own operating procedures. The instructions below are for the Delmhorst and Watermark meters.

In the Field

1. Complete the top of your *Daily Soil Moisture Sensor Data Sheet*.
2. Locate the sensor in the 10 cm deep hole.
3. Uncover the sensor's wire leads.
4. Connect the soil moisture meter to the wire leads of the sensor.
5. Push the READ button. Wait for the meter to reach a constant value.
6. Record the date, time, saturation conditions, and soil moisture meter reading on the *Daily Soil Moisture Sensor Data Sheet* in the appropriate depth column. If the Delmhorst meter reads a negative value (and the soil is dry), record a zero.
7. Disconnect the meter and store the wire leads.
8. Replace the cover over the PVC pipe and wire leads.
9. Repeat steps 3-8 for each of the remaining sensors (30 cm, 60 cm, and 90 cm).
10. Convert each meter reading to soil water content using your calibration curve.

Calibration of Soil Moisture Sensors

Field Guide

Task

To calibrate the soil moisture sensors.

What You Need

- Soil Auger
- Meter stick
- Pen or pencil
- Properly installed soil moisture sensors
- Soil moisture meter
- Materials for the *Gravimetric Soil Moisture Protocol* (i.e., cans, oven, trowel, marking pen)
- Biannual Soil Moisture Sensor Calibration Data Sheet(s)*

In the Field

1. Complete the top portion of your *Biannual Soil Moisture Sensor Calibration Data Sheet*.
2. Take readings from the soil moisture sensors following the process outlined in the *Reading the Soil Moisture Meter Field Guide*. Record this reading in column G, Corresponding Soil Moisture Meter Reading, of the *Biannual Soil Moisture Sensor Calibration Data Sheet(s)*.
3. Select a random location within 5 m of the sensor holes.
4. Clear away any surface debris.
5. Use the auger to collect samples for the *Gravimetric Soil Moisture Protocol* from each depth for which you are developing a calibration curve. Place each soil sample in a container and number the container.
6. Backfill the hole (last out, first in) and replace the surface cover.
7. Record the date, time, depth(s) and container number(s) in your science notebooks.
8. Determine the soil water content of each sample following the *Gravimetric Soil Moisture Protocol Lab Guide*.
9. Record the date and time of your measurement, the wet, dry, and container masses on the *Biannual Soil Moisture Sensor Calibration Data Sheet*. Calculate the water mass, dry soil mass and soil water content and record their values on the *Data Sheet*.
10. Report your gravimetric soil moisture data to GLOBE.
11. Repeat steps 2 – 10 about fourteen times as the soil moves through one or two complete drying cycles. Wait until your meter reading changes significantly before collecting another gravimetric sample.
12. Report your calibration data to GLOBE and a calibration curve will be created, used to convert your meter readings to soil water content and sent to your school.

Creating a Calibration Curve - Watermark Meter

Lab Guide

Task

To create a calibration curve

What You Need

- Pen or pencil
- Graph paper or appropriate spreadsheet graphing software
- Biannual Soil Moisture Sensor Calibration Data Sheet* with 15 or more pairs of readings for each depth for which you are developing a calibration curve
- Calculator or computer

In the Lab

1. Plot all the pairs of readings for a single depth with soil water content on the Y-axis and the corresponding soil moisture meter readings on the X-axis. This can be done using spreadsheet software.
2. Draw or calculate the *best-fit natural logarithmic curve* through your data points.

$$\text{Soil Water Content} = a \ln(\text{Soil Moisture Reading}) + b$$

Your data should span a broad range of soil moistures. This will be your calibration curve, which you will use to convert your meter readings to soil water content values.

Note: If you have any questions about creating your calibration curve or if you need any assistance with the curve, contact the GLOBE Help Desk or your country coordinator and ask for help from the appropriate GLOBE scientist.

3. Mail or email a copy of your curve and of your corresponding *Biannual Soil Moisture Sensor Calibration Data Sheet* to GLOBE following the directions for submitting maps and photos given in the *How to Submit Photos and Maps* section of the *Appendix* of the *Implementation Guide*. If while taking soil moisture measurements you get meter readings either higher or lower than any of the readings on your data sheet, take a gravimetric sample, and use the values you measure for this sample to extend your calibration curve. Send a copy of your revised calibration curve and extended *Biannual Soil Moisture Sensor Calibration Data Sheet* to GLOBE.

Example of a Soil Moisture Sensor Calibration Curve for a Watermark Meter

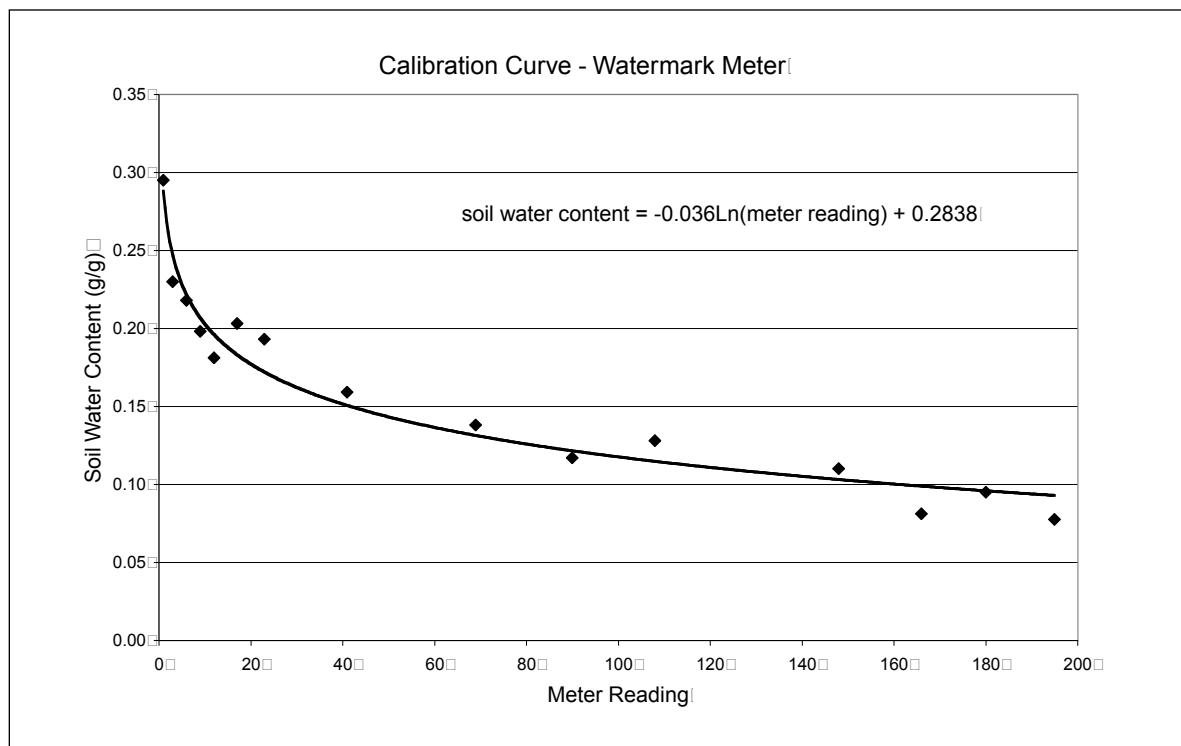

Creating a Calibration Curve - Delmhorst Meter

Lab Guide

Task

To create a calibration curve

What You Need

- Pen or pencil
- Graph paper or appropriate spreadsheet graphing software
- Biannual Soil Moisture Sensor Calibration Data Sheet* with 15 or more pairs of readings for each depth for which you are developing a calibration curve
- Calculator or computer

In the Lab

1. Plot all the pairs of readings for a single depth with soil water content on the Y-axis and the corresponding soil moisture meter readings on the X-axis. This can be done using a spreadsheet software.
2. Draw or calculate the *best-fit second order polynomial curve* through your data points.

$$\text{Soil Water Content} = a \cdot e^{b \cdot \text{meter reading}}$$

Your data should span a broad range of soil moistures. This will be your calibration curve, which you will use to convert your meter readings to soil water content values.

Note: If you have any questions about creating your calibration curve or if you need any assistance with the curve, contact the GLOBE Help Desk or your country coordinator and ask for help from the appropriate GLOBE scientist.

3. Mail or email a copy of your curve and of your corresponding *Biannual Soil Moisture Sensor Calibration Data Sheet* to GLOBE following the directions for submitting maps and photos given in the *How to Submit Photos and Maps* section of the *Appendix of the Implementation Guide*. If while taking soil moisture measurements you get meter readings either higher or lower than any of the readings on your data sheet, take a gravimetric sample, and use the values you measure for this sample to extend your calibration curve. Send a copy of your revised calibration curve and extended *Biannual Soil Moisture Sensor Calibration Data Sheet* to GLOBE.

Example of a Soil Moisture Sensor Calibration Curve for a Delmhorst Meter

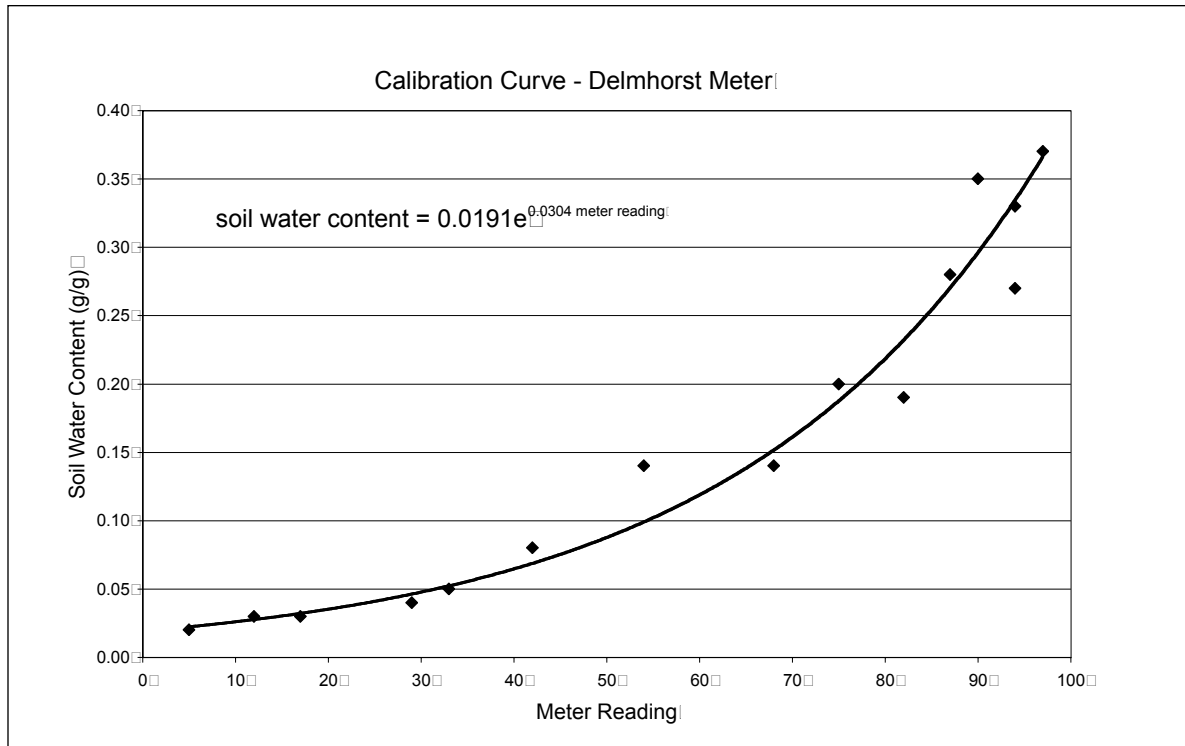

Soil Investigation

Daily Soil Moisture Sensor Data Sheet

School Name: _____

Study Site: _____

Date you started to use this SWC calibration curve: _____

Observations:

#	Measurement			Is the soil saturated? Yes or No	Observers' Names	Soil Moisture Meter Readings				SWC from Calibration Curve								
	Date	Local Time	Universal (UT)			10 cm	30 cm	60 cm	90 cm	10 cm	30 cm	60 cm	90 cm					
1																		
2																		
3																		
4																		
5																		
6																		
7																		
8																		
9																		
10																		

Soil Investigation

Biannual Soil Moisture Sensor Calibration Data Sheet

School Name: _____

Study Site: _____

Drying Method (check one): 95-105 °C oven ____; 75-95 °C oven ____; microwave ____

Average Drying Time: _____ (hours or minutes)

Depth (Check one): 10 cm 30 cm 60 cm 90 cm

Observations:

#	Measurement			Observers' Names	A. Wet Mass (g)	B. Dry Mass (g)	C. Water Mass (A-B)	D. Can Mass (g)	E. Dry Soil Mass (B-D)	F. Soil Water Content (C/E) Reading	G. Soil Moisture Meter Reading
	Date	Local Time Hour:min	Time (UT)								
1											
2											
3											
4											
5											
6											
7											
8											
9											
10											

Soil Investigation

Biannual Soil Moisture Sensor Calibration Data Sheet – Continued

School Name: _____

Study Site: _____

Depth (Check one): 10 cm 30 cm 60 cm 90 cm

Observations:

#	Measurement						A. Wet Mass (g)	B. Dry Mass (g)	C. Water Mass (A-B)	D. Can Mass (g)	E. Dry Soil Mass (B-D)	F. Soil Water Content (C/E) Reading	G. Soil Moisture Meter Reading
	Date	Local Time Hour:min	Time (UT)	Observers' Names									
11													
12													
13													
14													
15													
16													
17													
18													
19													
20													

Optional Infiltration Protocol



Welcome

Introduction

Protocols

Learning Activities

Appendix

Purpose

To determine the rate at which water soaks into the ground as a function of time

Overview

Students place two cans into the soil and add water to them to a depth of at least 5 cm. Students measure and record the time it takes the water level to drop a fixed 2 - 4 cm distance. Students repeat the measurement to determine how easily water moves vertically through the soil.

Student Outcomes

Students will be able to measure water infiltration into soil. Students will understand that the infiltration rate of water into soil changes depending upon the level of soil saturation. Students will understand that water that is not stored in the ground evaporates or becomes runoff and may pool on the surface for a time. Students will be able to determine how flood-prone an area is based on the infiltration rate of the soil.

Science Concepts

Physical Sciences

Objects have observable properties.

Earth and Space Sciences

Earth materials are solid rocks, soil, water, biota, and the gases of the atmosphere.

Soils have properties of color, texture, structure, consistence, density, pH, fertility; they support the growth of many types of plants.

The surface of Earth changes.

Soils consist of minerals (less than 2 mm), organic material, air and water.

Water circulates through soil changing the properties of both the soil and the water.

Scientific Inquiry Abilities

Identify answerable questions.

Design and conduct an investigation.

Use appropriate tools and techniques including mathematics to gather, analyze, and interpret data.

Develop descriptions and explanations, predictions and models using evidence.

Communicate procedures and explanations.

Time

One class period to build and test the double-ring infiltrometer.

45 minutes or one class period for the measurement.

Level

All

Frequency

Three or four times a year at the Soil Moisture Study Site

One time at a Soil Characterization Sample Site

In all cases, three sets of measurements should be taken within a radius of 5 m.

This protocol can be done while samples are collected for the *Gravimetric Soil Moisture Protocol*.

Materials and Tools

Metal ring with a diameter of 10 - 20 cm

Metal ring with a diameter 15 - 25 cm
(Coffee cans work!)

Buckets or other containers to transport a total of at least 8 L of water to the site

Ruler

Waterproof marker

Stop watch or watch with a second hand

Block of wood

Hammer

Three soil sample containers suitable for soil moisture measurement

Grass clippers

Funnel

Preparation

Build an infiltrometer.

Prerequisites

None



Optional Infiltration Protocol - Introduction

Infiltration rate is determined by measuring the time it takes for water sitting on a soil to drop a fixed distance. This rate changes with time as the soil pore spaces fill with water. There are three flow rates.

Unsaturated flow is the initial flow rate and is high as the dry soil pore spaces fill with water.

Saturated flow is a steady flow rate that occurs as water moves into the soil at a rate determined by soil texture and structure.

Ponding is the flow rate that occurs when the ground becomes totally saturated and is no longer able to conduct water through its pores.



Teacher Support

Site Selection

Students should select a location within 2 - 5 m of a Soil Moisture Site or a Soil Characterization Site. Students need to be careful that they do not leave a hose running where the water will flow over their soil moisture sampling points.



Advance Preparation

Before beginning the infiltration protocol, students need to construct an infiltrometer to measure the infiltration rates of the soil. Students should use the following procedure to construct their infiltrometers.



Construct a Dual Ring Infiltrometer

1. Cut the bottom out of your cans.
2. Use a permanent waterproof marker or paint to partially shade a band on the inside of the smaller can to use as a timing reference mark. The width of the band should be 20-40 mm and centered roughly 9 cm from the bottom of the can. Many cans have impressed ribs that make good reference marks but it is still necessary to mark them for good visibility.



Figure SOIL-IN-1: Double-ring infiltrometer

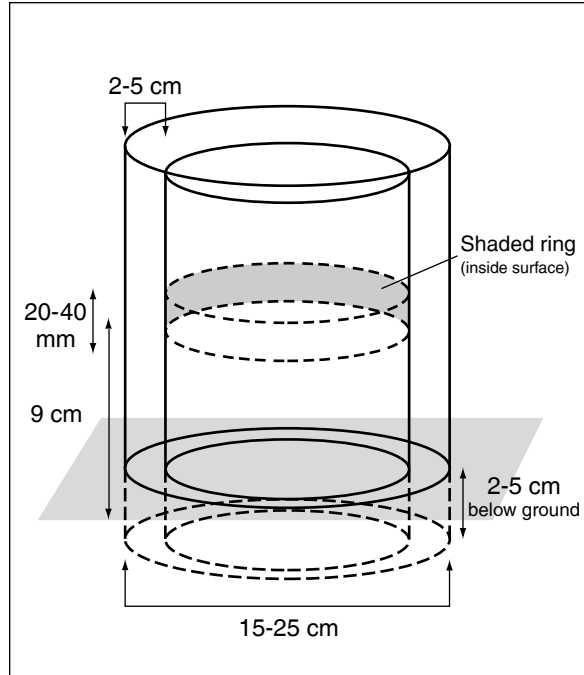

3. Measure and record the width of your reference band (in mm).
4. Measure and record the widths of your inner and outer rings (in cm).

Have students practice this protocol, including the timing, at a site where there is easy access to water so that they become comfortable taking the measurements. If students practice in a sandy location, the infiltration time intervals will be short and they will have more opportunities to practice taking measurements in a limited time period.

Managing Materials

Students can use either a stopwatch or a watch with a second hand to time the water flow into the soil. When students use a stopwatch, they should begin timing as water is first poured into the inner ring. They should record the elapsed time as the start time and end time of water moving over a fixed distance.

Infiltration Protocol

Field Guide

Task

To determine the rate at which water soaks into the ground as a function of time

What You Need

- Infiltrometer (see advanced preparation section)
- Buckets or other containers to transport a total of at least 8 L of water to the site
- Ruler
- Waterproof marker
- Stop watch or watch with a second hand
- Block of wood
- Hammer
- Three soil sample containers suitable for soil moisture measurement
- Grass clippers
- Funnel

In the Field

1. Clip any vegetation (grass) to the ground surface and remove all loose organic cover over an area just larger than your largest can. Try not to disturb the soil.
2. Starting with the smaller can, twist the cans 2 - 5 cm into the soil. A hammer may be used to pound the can into the surface. If you must use a hammer, a block of wood should be used between the hammer and the top of the can to distribute the force of the hammering. Do not hammer so hard that the can crumples.
3. Complete the upper section of the *Soil Infiltration Data Sheet*. If you are using a stop watch, start it.
4. Pour water into both rings. Maintain a level in the outer ring approximately equal to the level in the inner ring. Note that the water level in the outer ring tends to drop more quickly than that of the inner ring. In the inner ring, pour water to just above the upper reference band. **Note:** The outer ring should not be leaking water to the surface around its rim. If it is, start over in another location, push the outer ring deeper into the soil or pack mud around its base.
5. As the water level in the inner ring reaches the upper reference mark, read the stop watch or note the time to the second. This is your start time. Record this time on the *Infiltration Data Sheet*. During the timing interval, keep the water level in the outer ring approximately equal to the level in the inner ring, but be careful not to pour water into the inner ring (using a funnel can help) or to let either ring go dry.
6. As the water level in the inner can reaches the lower reference mark, record the time as your end time.
7. Calculate the time interval by taking the difference between the start and end times. Record this interval on your *Infiltration Data Sheet*.

8. Continue repeating steps 4 - 7 for 45 minutes or until two consecutive interval times are within 10 sec. of one another. Some clays and compacted soils will be impervious to water infiltration and your water level will hardly drop at all within a 45-minute time period. In this case, record the depth of water change, if any, to the nearest mm. Record the time at which you stopped your observations as the end time. Your infiltration measurement will consist of a single interval.
9. Remove the rings. WAIT FIVE MINUTES.
10. Measure the near-surface (0 - 5 cm depth) soil moisture from the spot where you just removed the rings. Follow the *Gravimetric Soil Moisture Protocol*. You only need take one sample.
11. Make two other infiltration measurements within a 5 m diameter area. These measurements can be done at the same time using other groups or over several days (if the near-surface soil water content is not changed by rain). It is not critical that multiple runs have the same number of reading sets, but do not submit runs that are incomplete (e.g. a run that was cut short due to lack of time). If you take more than three sets of measurements, submit your three best sets.

Infiltration Protocol – Looking at the Data

Infiltration rate is determined by dividing the distance that the water level decreases by the time required for this decrease. For GLOBE measurements this is equal to the width of the reference band on the infiltrometer divided by the difference between the start and end times for an interval.

The *Infiltration Data Sheet* can be used to record and help calculate the values needed to plot measurement results. The flow rate for each timing interval is the average value during an interval. The flow rate should be plotted at the *midpoint* of the interval times. Infiltration should decrease with time and it is important to keep track of the *cumulative* time from when water was first poured into the inner ring. The table and graph below demonstrate how to calculate infiltration rates and plot them on a graph.

Figure SOIL-IN-3: Infiltration

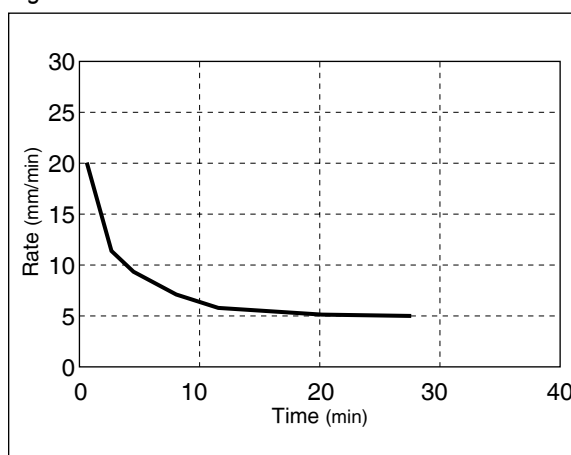

Figure SOIL-IN-2: Infiltration into Jim's Garden

Water Level Change = 20 mm

Time							Flow
Start		End		Interval	Midpoint	Cumulative	Rate
[min]	[sec]	[min]	[sec]	[min]	[min]	[min]	[mm/min]
31	00	32	00	1.00	31.50	0.50	20.0
32	30	34	15	1.75	33.38	2.38	11.43
34	30	36	45	2.25	35.62	4.62	8.89
37	15	40	00	2.75	38.62	7.72	7.27
40	45	44	00	3.25	42.38	11.38	6.15
44	15	47	45	3.50	46.00	15.00	5.71
48	15	52	00	3.75	50.12	19.12	5.33
52	15	56	15	4.00	54.25	23.25	5.00
56	30	00	30	4.00	58.50	27.50	5.00

Soil Investigation

Soil Infiltration Data Sheet

Site Name: _____

Name of Collector/Analyst/Recorder: _____

Sample collection

- date: _____
- time: _____ (hours and minutes) check one: UT _____ Local _____

Distance to Soil Moisture Site _____ m

Sample Set number: _____ Width of your reference band: _____ mm

Diameter: Inner Ring: _____ cm Outer Ring: _____ cm

Heights of reference band above ground level: Upper : _____ mm Lower : _____ mm

Directions:

Take 3 sets of infiltration rate measurements within a 5 m diameter area. Use a different data work sheet for each set. Each set consists of multiple timings of the same water level drop or change until the flow rate becomes constant or 45 minutes is up. Record your data below for one set of infiltration measurements you take.

The form below is setup to help you calculate the flow rate.

For data analysis, plot the Flow Rate (F) vs. Midpoint time (D).

Observations:

	A. Start		B. End		C. Interval (min)	D. Midpoint (min)	E. Water Level Change (mm)	F. Flow Rate (mm/min)
	(min)	(sec)	(min)	(sec)	(B-A)	(A+C/2)	(mm)	(E/C)
1	_____	_____	_____	_____	_____	_____	_____	_____
2	_____	_____	_____	_____	_____	_____	_____	_____
3	_____	_____	_____	_____	_____	_____	_____	_____
4	_____	_____	_____	_____	_____	_____	_____	_____
5	_____	_____	_____	_____	_____	_____	_____	_____
6	_____	_____	_____	_____	_____	_____	_____	_____
7	_____	_____	_____	_____	_____	_____	_____	_____
8	_____	_____	_____	_____	_____	_____	_____	_____
9	_____	_____	_____	_____	_____	_____	_____	_____

Saturated Soil Water Content below infiltrometer after the experiment:

A. Wet Weight: _____ g B. Dry Weight: _____ g C. Water Weight (A-B): _____ g

D. Container Weight: _____ g E. Dry Soil Weight (B-D): _____ g

F. Soil Water Content (C/E) _____

Daily Metadata/Comments: (optional) _____

Davis Soil Moisture and Temperature Station Protocol



Welcome

Introduction

Protocols

Learning Activities

Appendix

Purpose

To log soil data using a Davis soil moisture and temperature station

Overview

Soil moisture and temperature sensors are installed at multiple depths and a station is set up to measure and record measurements at 15 minute intervals. These measurements are transferred to your school's computer and then submitted to GLOBE via email data entry. Gravimetric soil moisture measurements must be taken to develop calibration curves for the soil moisture sensors.

Student Outcomes

Students can view data for their soil that are continuous and show variations within a day. This enables detailed study of soil moisture and temperature variations with time and depth.

Science Concepts and Scientific Inquiry Abilities

Science Concepts and *Scientific Inquiry Abilities* are gained through analyzing the data collected with the weather station. Refer to the *Gravimetric Soil Moisture and Soil Temperature Protocols* for the Science Concepts and Scientific Inquiry Abilities listed in their gray boxes.

Time

2 hours for site definition and set-up

Initial calibration requires doing the *Gravimetric Soil Moisture Protocol* for at least the 30 cm depth about 15 times over six or more weeks. This will take 15 - 45 minutes each time.

15 minutes to use email data entry to prepare and submit data to GLOBE periodically.

Level

Middle and Secondary

Frequency

Data reporting approximately once every week

Soil moisture sensor replacement and calibration every two years

Materials and Tools

Soil moisture and temperature station and a weather station with data logger

Computer capable of running weather station software

Appropriate soil auger

Meter stick

Four soil moisture sensors

4-L soil holding/mixing buckets Water for making mud balls (0.5 L)

One 120 cm x 2 cm PVC guide tube

Soil packing stick (e.g. an old broom handle)

Pen or pencil

Calculator and graph paper or computer

Biannual Soil Moisture Sensor Calibration Data Sheet

Materials for the *Gravimetric Soil Moisture Protocol*

Preparation

Set up the soil moisture and temperature station.

Prerequisites

Gravimetric Soil Moisture Protocol



Automated Soil Moisture and Temperature Stations – Introduction

Using automated soil moisture and temperature stations that record data can allow students to take soil measurements at much shorter time intervals than collecting data by hand. The large volume of data that can be collected allows for detailed study of soil conditions, including hourly variations, which are often significant near the surface.



The soil moisture and temperature stations used in this protocol are manufactured by Davis Instruments (<http://davisnet.com>). These soil moisture and temperature stations connect to weather stations that have a display screen that shows current soil conditions. Atmospheric sensors may also be connected to the weather station to collect atmospheric data as outlined in the *Davis Weather Station Protocol*.



Besides displaying current readings on the display screen, the weather station also records data over a long period of time using a data logger. This data logger is sold in a kit that also includes software that lets you download the data onto your computer and visualize it and is required for this protocol. The same software works for both the atmosphere and soil measurements, so if you are doing both, only one data logger and software package is needed.



Once the data are downloaded from the weather station to your computer, you can export it to a text file, ingest it to a spreadsheet program, and manipulate it to conform to the format required for GLOBE email data entry. Software is available for some models to export text files in GLOBE's email data entry format.



Teacher Support

The instructions given in this protocol are specific to one brand of soil moisture and temperature station. However, they may be adapted to other equipment that meets the same specifications. If you have questions or require assistance with adapting these instructions to other instruments, contact your Country Coordinator or, in the US, the GLOBE Help Desk. The essential elements of this protocol, which must remain the same regardless of the equipment model, are the placement of the station and sensors, the precision and accuracy of the sensors, and the sampling interval.

The soil moisture and temperature station reports soil moisture readings in units that correspond to centibars of water tension. To interpret these readings correctly in terms of soil water content (grams water/grams dry soil), it is necessary to construct a calibration curve. Once constructed, this curve is used to convert the meter readings to soil water content and both are reported to GLOBE. Details of the process for creating this curve are given in the *Soil Moisture Calibration Procedure* section below.

You may wish to collect data with your soil moisture and temperature station at an existing Atmosphere Study Site or Soil Moisture Study Site. This will make the data collected with the soil moisture and temperature station more readily comparable to other GLOBE measurements being taken at these sites. However, you also may choose to define a new site specifically for your soil moisture and temperature station. If so, please define this new site following the *Soil Moisture Site Definition Data Sheet*. If your station is not collocated with a device measuring current air temperature, an air temperature sensor may be added to your three soil temperature sensors provided you install an instrument shelter in which to mount this sensor.

Data Recording

The GLOBE database requires soil station data logged at 15-minute intervals, so make sure that the sampling interval for your station is set to 15 minutes. Also, the read-out should happen

on the quarter-hour (e.g., 10:00, 10:15, 10:30, 10:45, etc.) Ensure that measurements are being displayed and reported in degrees Celsius for temperature. Soil moisture should be displayed in units from 0 (wet) to 200 (dry).

Due to the quantity of data involved, soil moisture and temperature station data are reported to GLOBE only via email data entry. Software provided by Davis may allow data to be exported directly into the correct GLOBE email data entry format (see *Frequently Asked Questions* for information on the availability of this software). Use the “Export Records (GLOBE Format)” option from the Browse menu option in the export data pull-down menu. If you are using your weather station to record atmospheric data, then this atmospheric data will be exported at the same time. If the software for your weather station does not have this option, export your data to a text file, import the text file into a spreadsheet program, manipulate the columns to match the requirements for email data entry, and cut and paste the resulting lines of data into an email data entry message.

The time associated with each data point reported to GLOBE needs to be in Universal Time (UT). If you choose to have your weather station set to local time, you will need to make sure that you adjust the times reported to GLOBE. Some software packages will make this change for you automatically when outputting data in GLOBE email data entry format.

Measurement Logistics

1. Review background in the *Introduction* of the *Soil Temperature* and *Gravimetric Soil Moisture Protocols*.
2. Setup the weather station console and connect to your computer according to manufacturer's directions.
3. Install the temperature sensors according to the *Installation of Temperature Sensors Field Guide*.
4. Install soil moisture sensors according to the *Installation of Soil Moisture Sensors Field Guide*.
5. Log readings at 15-minute intervals and transfer data to your computer according

to the directions included with your software.

6. When you are ready to report the data to GLOBE (recommended once a week) export the data stored in your computer to a text file in the format for GLOBE email reporting following the *Logging and Reporting Soil Moisture and Temperature Station Data Lab Guide*.
7. Paste the text in this file into the body of an email. Send it to GLOBE following email data entry instructions available in the “Data Entry” section of the GLOBE Web site.
8. Collect gravimetric soil moisture readings following the *Collecting Soil Moisture Sensor Calibration Data Field Guide*.
9. As you collect gravimetric soil moisture readings report these data to GLOBE, and once you have about 15 calibration points, GLOBE will create a calibration curve for you. Students may follow the *Creating a Calibration Curve Lab Guide* and create a calibration curve for themselves.
10. Engage students in looking at the data.
11. Every two years, replace the soil moisture sensors and take new gravimetric soil moisture data to create your new calibration curve.

Soil Moisture Calibration Procedure

The soil moisture and temperature station reports soil moisture readings that correspond to centibars of water tension on a scale of 0-200. To be useful to the GLOBE science community they need to be in terms of soil water content (grams water/grams dry soil). The procedures for collecting calibration data and creating a calibration curve are the same as those given in the *Soil Moisture Sensors Protocol* for Watermark meters.

Every two years students need to install new Watermark soil moisture sensors and calibrate them.



Helpful Hints

- The day before you plan to install your sensors, place the soil moisture sensors in a bucket of water.
- When looking for a location to install your soil moisture and temperature station, be sure to account for the need for the station to communicate with your weather station.



Questions for Further Investigation

Which season has the greatest range of soil temperatures? Why?

What are the latitudes and elevations of other GLOBE schools with soil moisture and temperature patterns similar to yours?



Does soil temperature at 5 cm correlate strongly with air temperature or with surface temperature? At 10 cm? At 50 cm?

Is there a relationship between soil moisture and the time of budburst?

How long does it take for a precipitation event to affect soil moisture readings at various depths? Does precipitation affect soil temperature?



Installation of Soil Moisture Sensors

Field Guide

Task

To install the soil moisture sensors

What You Need

- Soil Auger
- Meter stick
- Soil Moisture and Temperature Station with 4 Watermark Soil Moisture Sensors
- 4-L soil holding/mixing buckets
- One 120 cm x 2 cm PVC or other tube for protecting wires
- Water for moistening the soil (0.5 L)
- One 1 m x 2 cm PVC guide tube
- Soil packing stick (e.g. an old broom handle)
- Permanent marker

In the Field

1. Place the sensors in water and **soak overnight**.
2. Use a permanent marker to place marks on the sensor cables near the contacts. Use 1 line drawn completely around the cable for the 10 cm sensor. Use 2 lines for 30 cm, 3 lines for 60 cm, and 4 lines for 90 cm.
3. Auger a hole to the appropriate depth for the soil moisture sensor (10 cm, 30 cm, 60 cm or 90 cm). Each sensor will go in its own hole. Make sure the cable can reach the Soil Moisture and Temperature Station with some slack.
4. Place two large handfuls of soil extracted from the bottom of each hole into a small bucket or similar container. Remove any rocks. Add a small amount of water and stir to create soil that is moist enough that it stays together when pressed into a ball.
5. Drop the moist soil ball to the bottom of the hole. Make sure it reaches the bottom.
6. Push the wire lead from one of the sensors through the PVC guide tube.
7. Pull the end of the wire lead until the sensor fits firmly against the other end of the guide tube. Lower the tube into the hole with the sensor going in first. While holding the wire lead at the top of the pipe, gently push the tube down until the sensor is set into the moist soil at the bottom of the hole.
8. Hold the sensor in place with the guide tube while you begin to backfill the hole. As you slowly add soil to the hole, gently pack or tamp it with a broom handle or similar pole. After the sensor is covered, remove the guide tube. Continue adding soil a few handfuls at a time and tamping firmly as you backfill the hole. Hold on to the wire lead as you backfill so that it will come straight to the surface.

9. Feed the wire through the protective PVC or other tube.
10. Repeat steps 2-9 for each sensor.
11. Connect the leads to the Soil Moisture and Temperature Station. The 10 cm sensor is connected to channel 1, 30 cm to channel 2, 60 cm to channel 3, and 90 cm to channel 4.

Note: Do not report measurements for a week after installation. The sensors require at least one week to equilibrate to natural conditions. The wire leads are fragile, especially where they connect to the meter. If the end of the wire leads to the soil moisture sensors break, peel back the wire insulation and make new leads.

Installed Soil Moisture Sensor Configuration

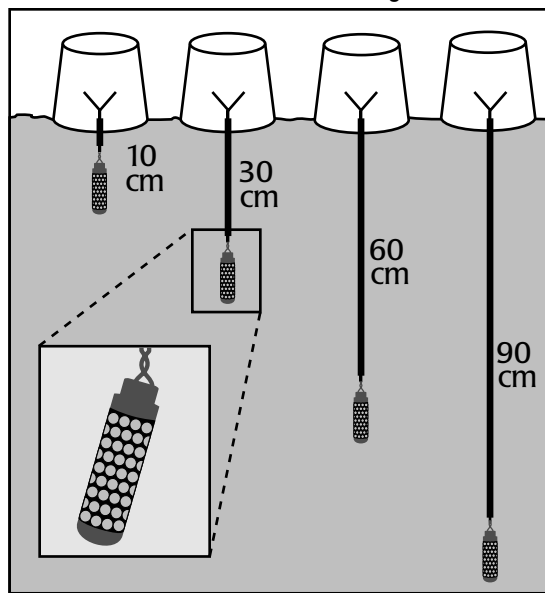

Installation of Temperature Sensors

Field Guide

Task

Install the soil temperature sensors of your soil moisture and temperature station.

Note: The following is written for an installation involving four temperature sensors, with one sensor used to measure air temperature and three sensors used to measure soil temperature at specified depths. If your soil moisture and temperature station is located at a site that has another instrument taking air temperature measurements, you may choose to omit the sensor for air temperature. If you choose not take air temperature readings, it is important that the sensors for soil temperature are still plugged into channels 2-4 of the Soil Moisture and Temperature Station.

What You Need

- Meter stick
- Digging tools
- Properly installed instrument shelter and 4th temperature sensor for air temperature (optional)
- Soil Moisture and Temperature Station with 3 temperature sensors
- One 120 cm x 2 cm PVC or other tube for protecting wires (may be same as for soil moisture sensor wires)
- String or wire ties
- Permanent marker

In the Field

1. Choose a location where the soil moisture and temperature station will be protected. If you have an instrument shelter you may choose to mount the soil moisture and temperature station on the pole. If you are using a wireless soil moisture and temperature station, make sure that it can communicate with your weather station from the chosen location.
2. Plug the temperature sensors into the soil moisture and temperature station. Use a permanent marker to place marks on the end of each cable about 1 cm from the sensor. Use 1,2,3 or 4 lines drawn completely around each cable, corresponding to the channel of the soil moisture and temperature station into which the cable is plugged. Feed the sensors through the PVC or other tube to protect them.
3. If you are taking air temperature measurements, use string or a wire tie to secure the air temperature sensor (#1) inside the instrument shelter, taking care that it does not contact the sides of the shelter.
4. Sensors # 2-4 will be used to measure soil temperatures. Dig a 50 cm deep hole close enough to the location of your Soil Moisture/Temperature Station that the sensors will reach. If you are digging near any obstructions, make sure to locate the hole on the sunny (equatorward) side of the obstructions.
5. Push the soil temperature sensors horizontally into this hole at depths of 50 cm (#4), 10 cm (#3), and 5 cm (#2). Use a nail or pin to pilot these holes if the soil is firm or extra firm.
6. Refill the hole with the soil that you removed (last out, first in).

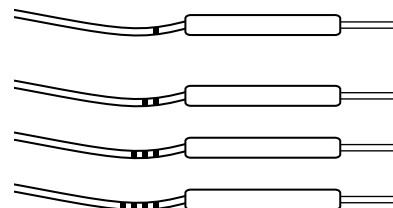

Determining Soil Uniformity With Depth

Field and Lab Guide

Task

Determine whether the soil particle density and texture are uniform at 10 cm, 30 cm, 60 cm, and 90 cm depths

What You Need

- Soil auger
- Meter stick
- Four soil containers (bags or soil moisture sample cans)
- Materials for the *Soil Particle Density Protocol*
- Materials for the *Particle Size Distribution Protocol*
- Soil drying oven

A calibration curve for your soil moisture sensor at 30 cm depth must be developed for conversion from meter readings to soil water content. There is no need to develop calibration curves for other depths unless they differ significantly in soil particle density or texture. The following steps are how you determine this.

In the Field

1. Near the holes where your soil moisture sensors are installed, use the auger to take samples from 10 cm, 30 cm, 60 cm, and 90 cm depths and store them for lab analysis. Samples should be at least 200 g each. Labels should give the date and depth.

Note: If you are using these samples for the *Gravimetric Soil Moisture Protocol*, follow the steps of that protocol for taking, storing, weighing, and drying the samples, and then, use the dry samples in the steps given below beginning with step 4.

2. Replace the remaining soil in the hole with soil from the deepest depth going in first and soil from near surface going in last.

In the Lab

3. Dry your soil samples.
4. Determine the soil particle density of each sample following the *Soil Particle Density Protocol*.
5. Determine the texture of each sample following the *Particle Size Distribution Protocol*.
6. Compare the particle densities at 10 cm, 60 cm, and 90 cm, with the value at 30 cm. If the value for a depth differs by more than 20% from the density at 30 cm, you should produce a separate calibration curve for that depth.
7. Locate the textures at the four depths on the *Soil Texture Triangle*. If the texture at 10 cm, 60 cm or 90 cm depth is not in the same area on the Triangle as the texture at 30 cm depth or if it is not in an area bordering the texture at 30 cm depth on the Triangle, produce a separate calibration curve for that depth.
8. You may wish to return your samples to the appropriate depths when you take samples for building your calibration curve.

Calibration of Soil Moisture Sensors

Field Guide

Task

To calibrate the soil moisture sensors.

What You Need

- Soil Auger
- Meter stick
- Pen or pencil
- Properly installed soil moisture sensors
- Soil moisture meter
- Materials for the *Gravimetric Soil Moisture Protocol* (i.e., cans, oven, trowel, marking pen)
- Biannual Soil Moisture Sensor Calibration Data Sheet(s)*

In the Field

1. Complete the top portion of your *Biannual Soil Moisture Sensor Calibration Data Sheet*.
2. Record the soil moisture reading from your computer for the date and time of your gravimetric sample in column G, Soil Moisture Meter Reading, of the *Biannual Soil Moisture Sensor Calibration Data Sheet(s)*.
3. Select a random location within 5 m of the sensor holes.
4. Clear away any surface debris.
5. Use the auger to collect samples for the *Gravimetric Soil Moisture Protocol* from each depth for which you are developing a calibration curve. Place each soil sample in a container and number the container.
6. Backfill the hole (last out, first in) and replace the surface cover.
7. Record the date, time, depth(s) and container number(s) in your science notebooks.
8. Determine the soil water content of each sample following the *Gravimetric Soil Moisture Protocol Lab Guide*.
9. Record the date and time of your measurement, the wet, dry, and container weights on the *Biannual Soil Moisture Sensor Calibration Data Sheet*. Calculate the water mass, dry soil mass and soil water content and record their values on the *Data Sheet*.
10. Report your gravimetric soil moisture data to GLOBE.
11. Repeat steps 2 – 10 about fourteen times as the soil moves through one or two complete drying cycles. Wait until your meter reading changes significantly before collecting another gravimetric sample.
12. Report your calibration data to GLOBE and a calibration curve will be created, used to convert your meter readings to soil water content and sent to your school.

Creating a Calibration Curve - Watermark Meter

Lab Guide

Task

To create a calibration curve

What You Need

- Pen or pencil
- Graph paper or appropriate spreadsheet graphing software
- Biannual Soil Moisture Sensor Calibration Data Sheet* with 15 or more pairs of readings for each depth for which you are developing a calibration curve
- Calculator or computer

In the Lab

1. Plot all the pairs of readings for a single depth with soil water content on the Y-axis and the corresponding soil moisture meter readings on the X-axis. This can be done using spreadsheet software.
2. Draw or calculate the *best-fit natural logarithmic curve* through your data points.

$$\text{Soil Water Content} = a \ln(\text{Soil Moisture Reading}) + b$$

Your data should span a broad range of soil moistures. This will be your calibration curve, which you will use to convert your meter readings to soil water content values.

Note: If you have any questions about creating your calibration curve or if you need any assistance with the curve, contact the GLOBE Help Desk or your country coordinator and ask for help from the appropriate GLOBE scientist.

3. Mail or email a copy of your curve and of your corresponding *Biannual Soil Moisture Sensor Calibration Data Sheet* to GLOBE following the directions for submitting maps and photos given in the *How to Submit Photos and Maps* section of the *Appendix* of the *Implementation Guide*. If while taking soil moisture measurements you get meter readings either higher or lower than any of the readings on your data sheet, take a gravimetric sample, and use the values you measure for this sample to extend your calibration curve. Send a copy of your revised calibration curve and extended *Biannual Soil Moisture Sensor Calibration Data Sheet* to GLOBE.

Example of a Soil Moisture Sensor Calibration Curve for a Watermark

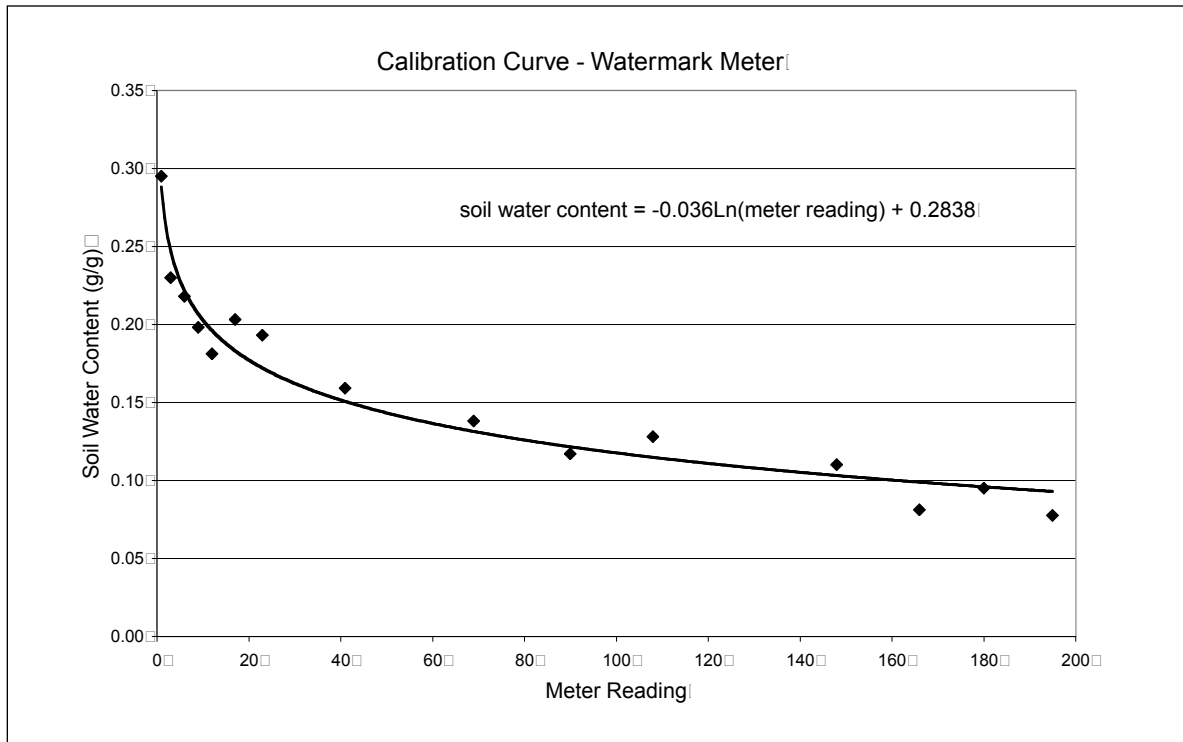

Logging and Reporting Soil Moisture/Temperature Station Data

Lab Guide

Task

Log and report data collected with your Soil Moisture/Temperature Station.

What You Need

- A setup and operating soil moisture and temperature station connected to a weather station.
- A suitable computer with email access.

In the Field

1. Set your weather station to log data at 15 minute intervals on the quarter hour (e.g., 15:15).
2. Download your soil moisture and temperature station data (and any atmospheric data taken following the *Davis Weather Station Protocol*) to your computer following the instructions for your weather station.

Note: some weather stations can be set-up to transfer these data automatically

3. Export a text file of your data. Save this file on your computer. (If your software has the ability to export a text file in the GLOBE email data entry format, skip to step 5).
4. Use spreadsheet or other software to edit the exported file into the GLOBE email data entry format. Save this spreadsheet file on your computer.
5. Copy and paste your data in GLOBE email data entry format into the body of a GLOBE data entry message.

Frequently Asked Questions



1. The soil particle density and texture differs at the different depths at our site. How many calibration curves must we develop?

All depths with similar soil particle densities (within 20%) and textures (the same or adjacent on the *Soil Texture Triangle*) may share the same calibration curve.

The following table describes seven possible situations and states what calibrations curves should be developed and how they should be used.

Situation	What to do
Each depth is different from all the others	Develop individual calibration curves for each depth.
30 cm, 60 cm, and 90 cm are similar but 10 cm is different	Develop a calibration curve for 10 cm and use it for 10 cm and develop a separate curve for 30 cm and use it for 30 cm, 60 cm, and 90 cm.
10 cm, 30 cm, and 60 cm are similar but 90 cm is different	Develop a calibration curve for 90 cm and use it for 90 cm and develop a separate curve for 30 cm and use it for 10 cm, 30 cm, and 60 cm.
10 cm and 30 cm are similar, 60 cm and 90 cm are similar but different from 10 cm and 30 cm	Develop a calibration curve for 30 cm and use it for 10 cm and 30 cm; develop a separate curve for 60 cm and use it for 60 cm and 90 cm.
30 cm and 60 cm are similar, but 10 cm and 90 cm differ from one another and from 30 cm and 60 cm	Develop separate calibration curves for 10 cm, 30 cm, and 90 cm; use the 30 cm curve for 30 cm and 60 cm.
10 cm and 30 cm are similar, but 60 cm and 90 cm differ from one another and from 10 cm and 30 cm	Develop separate calibration curves for 30 cm, 60 cm, and 90 cm; use the 30 cm curve for 10 cm and 30 cm.
60 cm and 90 cm are similar, but 10 cm and 30 cm differ from one another and from 60 cm and 90 cm	Develop separate calibration curves for 10 cm, 30 cm, and 60 cm; use the 60 cm curve for 60 cm and 90 cm.

Soil Investigation

Biannual Soil Moisture Sensor Calibration Data Sheet

School Name: _____

Study Site: _____

Drying Method (check one): 95-105 °C oven ____; 75-95 °C oven ____; microwave ____

Average Drying Time: _____ (hours or minutes)

Depth (Check one): 10 cm 30 cm 60 cm 90 cm

Observations:

#	Measurement				Observers' Names	A. Wet Mass (g)	B. Dry Mass (g)	C. Water Mass (A-B)	D. Can Mass (g)	E. Dry Soil Mass (B-D)	F. Soil Water Content (C/E) Reading	G. Soil Moisture Meter Reading
	Date	Local Time Hour:min	Time (UT)									
1												
2												
3												
4												
5												
6												
7												
8												
9												
10												

Soil Investigation

Biannual Soil Moisture Sensor Calibration Data Sheet – Continued

School Name: _____

Study Site: _____

Depth (Check one): 10 cm 30 cm 60 cm 90 cm

Observations:

#	Measurement						A. Wet Mass (g)	B. Dry Mass (g)	C. Water Mass (A-B)	D. Can Mass (g)	E. Dry Soil Mass (B-D)	E. Soil Water Content (C/E) Reading	G. Soil Moisture Meter Reading
	Date	Local Time Hour:min	Time (UT)	Observers' Names									
11													
12													
13													
14													
15													
16													
17													
18													
19													
20													



Why Study Soil?*

An activity which highlights the importance of learning about the soils on Earth. In this activity students explore some of the many uses of soils, learn the five soil-forming factors, and gain a better understanding of how little of Earth's surface is covered in soil.

Just Passing Through

Beginning students are introduced to the basic concepts of how water passes through soil in an activity which illustrates the scientific method. More advanced students investigate the effects of soil characteristics on water infiltration and the chemistry of water that has passed through soil.

Soil and My Backyard*

Students collect, describe and compare soils from their own backyards.

A Field View of Soil and Soil Moisture - Digging Around*

Students discover that soil properties such as moisture and temperature can vary considerably across a single landscape.

Soils as Sponges: How Much Water Does Soil Hold?*

Students explore soil moisture by weighing and drying sponges and then they explore their soil samples in the same way.

Soil: The Great Decomposer*

Students simulate environmental conditions in order to determine the key factors that affect the decomposition of organic material in soil.

The Data Game*

Teams of students play a game in which they gather data and distort the values of certain measurements. They then estimate the values of the measurements taken by other teams and try to detect their errors.

* See the full e-guide version of the *Teacher's Guide* available on the GLOBE Web site and CD-ROM.

Why Do We Study Soil?



Welcome

Introduction

Protocols

Learning Activities

Appendix

Purpose

To introduce students to the importance of soil and why it needs to be studied

Overview

In the first activity, students generate a list of why soils are important. In the second activity, students are asked to describe the five factors that form a unique soil profile and to explore these concepts. In the third activity, students are shown a demonstration of how much soil there is on Earth that is available for human use.

Student Outcomes

Students will understand the importance of soil science.

Students will be able to provide reasons for studying soil.

Students will understand how soil properties are determined by the five soil forming factors.

Students will appreciate the relative amounts of usable soil that exist on Earth.

Science Concepts

Earth and Space Sciences

Earth materials are solid rocks, soil, water, biota, and the gases of the atmosphere.

Soils have properties of color, texture, structure, consistence, density, pH, fertility; they support the growth of many types of plants.

The surface of Earth changes.

Soils are often found in layers, with each having a different chemical composition and texture.

Soils consist of minerals (less than 2 mm), organic material, air and water.

Water circulates through soil changing the properties of both the soil and the water.

Physical Sciences

Objects have observable properties.

Life Sciences

Organisms can only survive in environments where their needs are met.

Earth has many different environments that support different combinations of organisms.

All populations living together and the physical factors with which they interact constitute an ecosystem.

Scientific Inquiry Abilities

Identify answerable questions.

Design and conduct an investigation.

Use appropriate tools and techniques including mathematics to gather, analyze, and interpret data.

Develop descriptions and explanations, predictions and models using evidence.

Communicate procedures and explanations.

Time

One or two class periods (depending on level of exploration for second activity)

Level

All

Materials and Tools

Apple and small knife (or diagrams or overhead materials of apple activity)

Soil medicine examples (e.g. diarrhea medicine, antibacterial gel or cream, facial masks)

Soil art examples (e.g. mud cloth, sand painting, pottery)

Soil building material examples (e.g. red brick, photos of adobe and Earthship houses)

Makeup (e.g. foundation, blush)

Soil samples (if available, especially soils that match the colors or textures of the medicine, art, building material, or makeup examples)

Plant

Soil story example (e.g. Maryland Flood Plain Soil)

Prerequisites

None



Why are soils important?

Soils exist as natural ecosystems on the surface of Earth made up of macro and microorganisms, minerals, organic matter, air, and water. Soils are living systems that provide many of the most fundamental functions needed for life. Important functions of soil include:

- Providing the fertile medium in which we grow our food and fiber
- Producing and storing gases such as CO₂
- Storing heat and water
- Providing a home for billions of plants, animals and microorganisms
- Filtering water and wastes
- Providing the source material for construction, medicine, art, makeup, etc.
- Decomposing wastes
- Providing a snapshot of geologic, climatic, biological, and human history

Soil forms very slowly and comprises only about 10 or 11% of Earth's surface. So, it is important to study this essential natural resource and understand how it should be used and conserved properly.

What To Do and How To Do It

Activity One: Why are soils important?

1. Collect as many materials and tools as possible from list in Materials and Tools section of gray box.
2. Ask the class "Why are soils important?" and "Why do you think it is important to study soils?"
3. Record their answers on a blackboard or somewhere that all students can read the responses.
4. As students give answers that relate to the collected materials, bring out those materials and show them to the class. For example, if a student says that we use soil as art, have a clay pot available for viewing. If students run out of ideas about the uses of soils, ask them about soil as art (and bring out the African mud cloth [Bogolanfini] or a picture of one) or soil as medicine (for diarrhea, antibacterial gel, examples of people eating soil for digestive

problems, etc.) Also bring out soil samples that resemble these materials for comparison.

5. Lead the discussion to the many possible reasons why it is important to study soil (see above).

Activity Two: Are soils all the same?

1. Show students photographs from the *Soil Investigation Introduction* section titled *Soils Around the World*. Have students check the World Wide Web (e.g. soils.usda.gov or soils.gsfc.nasa.gov), library, and other sources for other photographs of soil profiles. Also, look for color drawings or photographs of soil properties by GLOBE students on the GLOBE Web site (try going to the data access page, then to *GLOBE Sites* and then to *Soil Profiles*).
2. Ask students why one soil profile looks different from another? What are some of the factors that would make a soil look the way it does? Help guide their responses by reading the *Five Soil Forming Factors* (parent materials, climate, topography, biota, and time) in the *GLOBE Soil Investigation Introduction*.
3. Have the students identify the 5 soil forming factors at their school and ask how they might differ at other locations, within the neighborhood, or around the world.
4. Discuss the concept that every soil tells a different story based on the properties that have formed it because of the 5 soil forming factors. As an example, use the following Maryland Flood Plain Soil photograph and story.

This soil profile is from a creek bed in College Park, Maryland, USA in the Chesapeake Bay watershed. When the soil scientists were studying this profile, they noticed that there was a black layer right in the middle of the profile. When the scientists looked at this layer with a hand lens (small magnifying glass) they could see that the black color was due to many tiny bits of charcoal and ash. Using different kinds of tests, they learned that this material was deposited about 300 - 350 years ago.



Figure-SO-WH-1: College Park, Maryland



Where would charcoal and ash have come from about 300-350 years ago? What was going on in the Chesapeake Bay region at about that time?

Settlers coming to this region for the first time were burning the forests to make room for farms. The residue from those forest fires flowed down into the rivers and creeks and eventually some of it was deposited in this creek bed and became part of this soil profile. The soil above this layer was created after the ash and charcoal were deposited by flooding of the river and the addition of sediments eroded from the local area on top of the charcoal layer. In soils, the youngest materials are found at the top of the profile. After the sediments were deposited by the flooding water, soil processes took over to form structure, color, and other soil properties that we can see and measure.

The scientists also noticed that in the horizon below the charcoal and ash layer, there were clam and oyster shells (as well as some pebbles rounded by washing down the river during flood events). With careful testing, they learned that the objects in this horizon were deposited here about 400 - 450 years ago.

What was going on in the Chesapeake Bay about 400 - 450 years ago?

The indigenous people who lived in this area before the settlers came would come to the Bay for their holiday feasts and they would celebrate and eat lots of clams and oysters. What we see here was what was left behind. These shells eventually flowed down into this creek bed and became part of the soil profile.

The last part of the story takes us to the beginning. The lowest two horizons in this profile are of an earlier soil that was buried under the river sediments of the newer soil. The buried soil shows structure, colors and other features that indicate it is many thousands of years old and was in a swampy area before the river changed its course and began to bury it.

This is an example of how a soil can be a record of the history of the area around it and can tell us its story. Other stories are available on the Soil Science Education Web page (soils.gsfc.nasa.gov) under the "Every Soil Tells a Story" feature.

5. Ask students to try to come up with "stories" about how other soils may have formed and the properties that they have.
6. Introduce the concept of diversity in soil which states that because every soil is different, each one can only be used in a certain way. For example, which kind of soils would be best for growing crops (flat, fertile, moist, deep, etc.)? Which soils would be best for building a pond or reservoir (clay with massive structure, high density, low porosity, flat or depressed area on the landscape, etc.)? Which would be best for filtering wastes (high surface area, lots of organisms, not too cold or wet, etc.)? Have the students think of other land uses and what kinds of soil properties would be best for those uses too cold or wet, etc.)? Have the students think of other land uses and what kinds of soil properties would be best for those uses.



Activity Three: How much soil is there on Earth?*

1. Take an apple and a small knife, or use the graphics below to conduct the following demonstration:



2. Teacher says: "Pretend that this apple is the planet Earth, round, beautiful, and full of good things. Notice its skin, hugging and protecting the surface."

3. Teacher asks and discusses:
 - a. "How much of the surface of the earth is covered by water?"
 - b. Answer: Water covers approximately 75% of the surface.

Action: Cut the apple in quarters. Toss three quarters (75%) away.

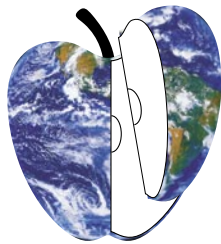

4. Teacher says: "The three quarters (75%) that was just removed represents how much of the earth is covered with water - oceans, lakes, rivers, streams. What is left (25%) represents the dry land. Fifty percent of that dry land is desert, polar, or mountainous regions where it is too hot, too cold or too high to be productive".

Action: Cut the "dry land" quarter in half and toss one piece away.



5. Teacher says: "When 50% of the dry land is removed, this is what is left (12.5% of the original). Of that 12.5%, 40% is severely limited by terrain, fertility or excessive rainfall. It is too rocky, steep, shallow, poor or too wet to support food production."

Action: Cut that 40% portion away.



6. Teacher says: "What is left is approximately 10% of the apple.

Action: Peel the skin from the tiny remaining sliver.



7. Teacher says: "The remaining 10% (approximately), a very small fragment of the land area, represents the soil we depend on for the world's food supply. This fragment competes with all other needs - housing, cities, schools, hospitals, shopping centers, land fills, etc., and, sometimes, it does not win."

Action: Discuss with students some ways in which they could be more mindful of the soil and the way soils are being used at their homes or in their town. For example, discuss the idea of composting to recycle wastes and help make the soil rich in organic matter, and about keeping soil covered with vegetation so that it will not erode away or become compacted.

* *How Much Soil Is There? Learning Activity* courtesy of: The Natural Resources Conservation Service, U.S. Department of Agriculture

(This material can be downloaded from soils.gsfc.nasa.gov.)



Just Passing Through (Beginner Version)



Welcome

Introduction

Protocols

Learning Activities

Appendix

Purpose

To develop an understanding of how water flows through different soils and how it is transformed when it flows through these soils

Overview

Students time the flow of water through different soils and observe the amount of water held in these soils. They will also observe the filtering ability of soils by noting the clarity of the water before and after it passes through the soil.

Student Outcomes

Students will be able to identify the physical and chemical changes that occur as water passes through soil.

Science Concepts

Earth and Space Science

Earth materials are solid rocks, soil, water, biota, and the gases of the atmosphere.

Soils have properties of color, texture, structure, consistence, density, pH, fertility; they support the growth of many types of plants.

The surface of Earth changes.

Soils consist of minerals (less than 2 mm), organic material, air and water.

Water circulates through soil changing the properties of both the soil and the water.

Scientific Inquiry Abilities

Identify answerable questions.

Design and conduct an investigation.

Use appropriate tools and techniques including mathematics to gather, analyze, and interpret data.

Develop descriptions and explanations, predictions and models using evidence.

Communicate procedures and explanations.

Time

One class period

Level

Beginning

Materials and Tools

(for each team of 3-4 students)

Clear 2 liter bottle

Three 500 mL beakers or similar size clear containers marked off in cm to pour and catch water

Soil sample (Bring in 1.2 L samples of different types of soil from around the school or from home. Possibilities include top soil (A horizons), subsoils (B horizons), potting soil, sand, soils that are compacted, soils with grass growing on top, soils with clearly different textures, colors, or structures)

Fine window screen or other fine mesh that does not absorb or react with water (1 mm or less mesh size)

Water

Clock or timer

Note: Smaller containers may be used if desired as long as the soil container sits firmly on the water catchment container. Reduce the amounts of soil and water - but remember that it is important for all students to start with the same amount.

For more advanced students:

pH paper, pen, or meter

Prerequisites

None



Background

What happens to water when it passes through soil depends on many things such as the size of soil particles (texture and particle size distribution), how the particles are arranged (structure), how tightly they are packed (bulk density), and the attraction between the soil particles and the water. Some types of soil let water flow in quickly, and then hold the water inside the soil like a sponge. This might give plants a better chance of using some of that water. Other types of soil may let the water go completely through in just a few seconds. Still other soils may keep the water from getting in at all. None of these soil types is better than the other - they are simply good for different reasons. Which soil property would you look for if you wanted to plant a garden? Build a driveway or a playground? What happens if the soil is full of water and a heavy rain falls on it? How can you change the way your soil holds water? What happens to the soil when organic matter is added, when plants are growing on top of it, when it is compacted, or when it is plowed?

Preparation

- Discuss some of the general characteristics of soils or do *Why We Study Soil* or *Soil in My Backyard Learning Activities* or the *Soil Characterization Protocols*.
- Bring in samples of different types of soil from school or from home.
- Remove the labels and lids and cut off the bottoms of the clear plastic 2 L bottles.
- Place a circle of screen inside the bottle so that it covers the cap opening.
- Pour 3-4 cm of sand onto the screen. The sand will keep the screen from becoming clogged.
- Place the bottle, mesh side down, on a beaker or clear container.
- Pour 1.2 L of soil into the bottle over the sand.
- Copy the *Work Sheets* for each student

Figure SOIL-PB-1

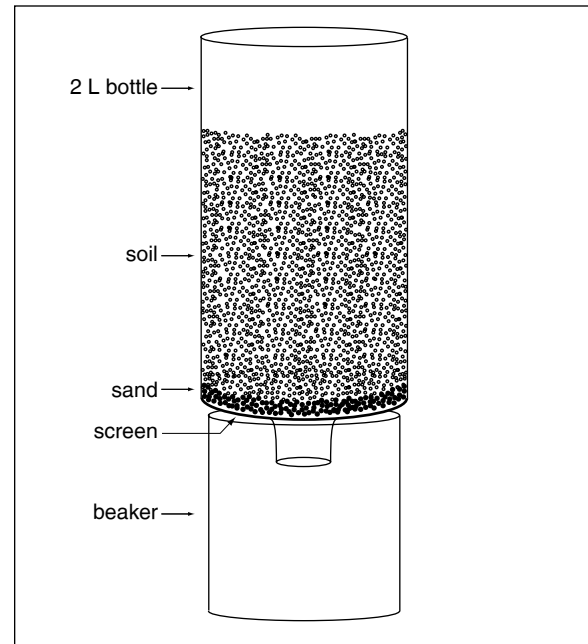

What To Do and How To Do It

Class Investigation

1. Choose a soil (a sandy soil works best) to use for demonstration and place 1.2 L of the soil into the 2 liter bottle.
2. Have students look closely at the soil. What do students notice: Color? Plant matter? Does it feel light or heavy? Is it granular (like cookie crumbs) or blocky (clumpy)? Record their observations about the soil on the board.
3. Pour 300 mL of water into a 500 mL beaker or other clear container for pouring. Have students notice the clarity of the water.
4. Use a black marker to draw a line showing the height of the water in the pouring container. Have students count the cm lines to reach the top of the water. Record this number on the board.
5. Ask the students “*What will happen when you pour the water onto this soil?*” Ask students to explain why they think the soil and water will behave this way when water is poured onto it. Some possible questions to ask are:
 - *Will the water run out through the bottom of the bottle?*



- *Will all of it run out? How much will run out? Make a mark on the pouring container with a red pen to show how much of the water students think will flow out.*
 - How fast will the water pass through the soil? *Older students may time with a clock or stopwatch. Younger students can time by marking the minutes off on a timer (like in the Work Sheets) as the teacher times.*
 - What will the water look like when it comes out the bottom? Clear? Murky? Very Dirty?
6. Record the class 'hypotheses' on the board.
 7. Pour the water onto the soil and begin timing. Ask students to describe what is happening as you pour the water:
 - Is all the water staying on top?
 - Where is it going?
 - Do you see air bubbles at the top of the water?
 - Does the water coming out of the soil look the same as the water going in?
 - Does the soil look different where the water has gone?
 8. Record the class observations on the board. Also record how long it takes for the water to pass through the soil.
 9. Ask students to compare their hypotheses and the results of the experiment.
 10. Once the water has stopped dripping from the bottom of the bottle, remove the soil bottle and hold up the beaker of water which has passed through the soil. Ask students:
 - Is this the same amount of water that we started with? How can we tell if it is the same amount?
 - *Pour the water back into the original container. Compare the amount left with the black line on the container. How much water is missing? How could we measure how much is missing?*
 - *Compare the water level to the red line on the container. Is there more or less water left*

- than we thought there would be? How could we measure the difference? Why did you think there would be more or less?
- What happened to the water that is missing?
 - Is the water more or less clear than before it passed through the soil? Why?
11. Keep the water that was poured through for comparison.
 12. Using the bottle of saturated soil, ask students what will happen if you pour another 300 mL of water into the soil. Record the class hypotheses on the board.
 - Will the same amount, more, or less water stay in the soil this time?
 - Will it move through faster or slower or at the same speed?
 - How clear will the water be? The same, more clear, or less clear than before?
 13. Pour the water through the saturated soil, keep the time, observe the results, and compare with the hypotheses. Ask students:
 - *Did the water flow through faster than before? How do you know? Compare the two times.*
 - *Did more of it flow through than before? How can we find out? Compare the amounts in the beakers.*
 - *Is the water as clear as the first time? Compare the color of the water in the two beakers.*



Group Investigation

Experimenting with different soils

Discussion

1. Review the properties of the various soil samples that were brought in.
2. Ask students if they think water would pass through all of the types of soils in the same amount of time and if all the soils would hold the same amount of water.
3. Discuss which soils they think might be different.
4. Provide each group of students with one of the various soils.

Observation and Hypotheses

1. Give each student the Look and Guess Work Sheet.
2. Ask the students to fill in the **Color** of their soil (in words or with a crayon).
3. Ask the students to circle the **Structure** which looks most like their soil.
4. Ask students to look for leaves or **Organic matter** in their soil. Circle YES if they find organic matter. Circle NO if they do not.
5. **Time:** Remind students of the observations which they made during the demonstration. Ask students to guess the amount of time it will take water to flow through their soil. Circle the time on the timer, then write the number in the blank.
6. **Amount:** Ask students to draw a RED line on the container showing the amount of water they think will flow through their soil.
7. **Clarity:** Ask students to put an X on the container which will look most like their water after it flows through their soil.

Experiment and Report

1. Explain that when you say 'GO' everyone will pour their water in together.
2. You will begin to time when the water is poured.
3. Have students fill in the Experiment and Report Work Sheet for their soil.

Have each group report on the results of their experiment to the class. Reports should include **Questions, Hypotheses, Observations and Conclusions** about the experiment. Students can use their Work Sheets to prepare their reports.

Further Investigations

1. Using distilled water, have students measure the pH of the water.
2. Predict whether the pH will be different after the water passes through the soil.
3. Pour the water through, then test the pH again.
4. Have students draw conclusions about the effect of soil on water pH.

Note: 1. Use this procedure to experiment with conductivity by measuring the conductivity of distilled water before passing it through the soil, then using saltwater and passing it through the soil. 2. Experiment with filtering by using very murky water and passing it through clean sand.

Ask students to perform the advanced version of the *Just Passing Through Learning Activity*.



Just Passing Through – Beginners

Work Sheet

Look and Guess

My soil is _____ color

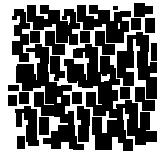
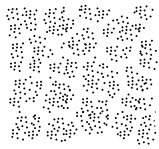

My soil looks granular blocky

My soil has  leaves. YES NO

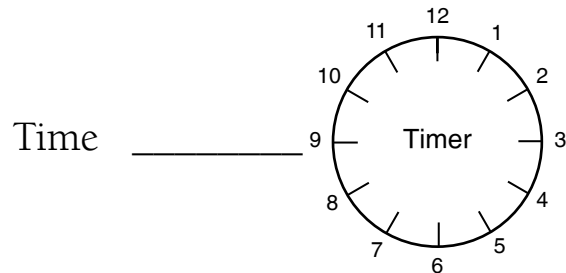

How much water will come out? Make your line RED.

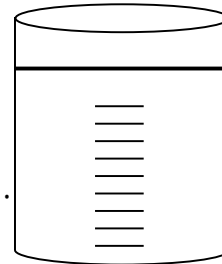

What will the water look like? (CIRCLE)

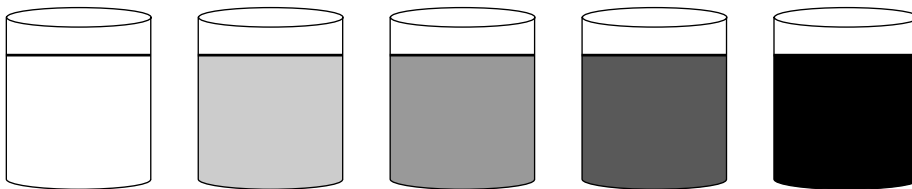

Experiment and Report

Time _____

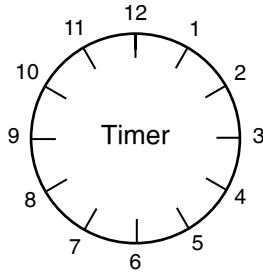

How much water came out?

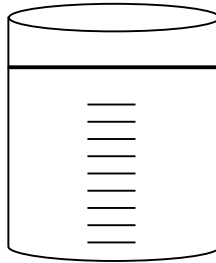

What did the water look like?

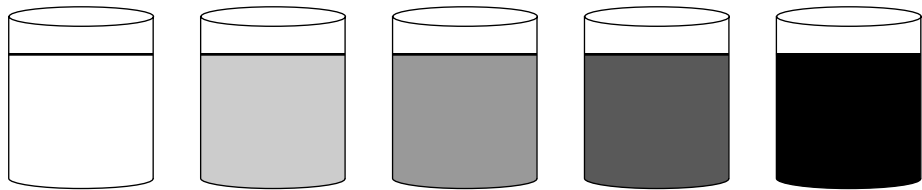

My Report

Just Passing Through



Purpose

To develop an understanding of some of the relationships between soils of different types and water

Overview

Students will time the flow of water through soils with different properties and measure the amount of water held in these soils. They will also experiment with the filtering ability of soils by testing the pH of the water before and after it passes through the soil and observing changes to the clarity of the water and to the characteristics of the soil.

Student Outcomes

Students will be able to identify the physical and chemical changes that occur as water passes through soil. Students will be able to design experiments that test soil and water properties. Students will be able to explore the concept of Earth as a system. Students will be able to apply the Scientific Method.

Science Concepts

Earth and Space Science

Earth materials are solid rocks, soil, water, biota, and the gases of the atmosphere.

Soils have properties of color, texture, structure, consistence, density, pH, fertility; they support the growth of many types of plants.

The surface of Earth changes.

Soils consist of minerals (less than 2 mm), organic material, air and water.

Water circulates through soil changing the properties of both the soil and the water.

Scientific Inquiry Abilities

Identify answerable questions.

Design and conduct an investigation.

Use appropriate tools and techniques including mathematics to gather, analyze, and interpret data.

Develop descriptions and explanations, predictions and models using evidence.

Communicate procedures and explanations.

Time

One class period for initial activity
2-3 class periods for *Further Investigations*

Level

All

Materials and Tools

(for each team of 3 - 4 students)

2 - 3 clear 2-liter bottles (such as soda or water comes in)*

4 - 6 500-mL beakers* or similar size clear containers to pour and catch water for the demonstration, more as needed for the class activity. The number of beakers will be dependent on the number of student groups. (Clear plastic bottles work well also.)

Soil samples (Bring in 1.2 L samples of different types of soil from around the school or from home (suggested amount – actual amount based on class size). A large plastic bag with a closeable top is a good way to transport soil samples. Possibilities include topsoil (A horizons), subsoils (B horizons), potting soil, sand, soils that are compacted, soils with grass or other plants growing on top, soils with distinctly different colors, textures, or structures, or cat litter (without additives).

Fine window screen or other fine mesh such as panty hose that does not absorb or react with water (1 mm or less mesh size)

Strong tape or rubber bands

Scissors

Water



Laboratory ring stands with rings, if available (enough to hold the number of plastic bottles to be used). Another approach is to rest the bottles in the top of the beaker or in a slightly smaller clear plastic bottle with the top cut off to resemble a beaker (these methods do not require laboratory ring stands). (Use waterproof marker or wax pencil to mark water levels on bottle side. Use graduated cylinder to determine increments.) With the soil weight, the bottles will be relatively stable setting in the beakers or bottle bottoms.

Waterproof marker or wax pencil (if plastic bottles used instead of beakers)

Graduated cylinder (if plastic bottles used instead of beakers)

pH paper, pen, or meter

Work Sheet

GLOBE Science Notebooks

For Further Investigations:

Distilled water, salt, vinegar, baking soda

Plastic wrap to cover bottles

Conductivity meter

NPK kit

Growing sod or mulch

Alkalinity kit

*You can use 1-liter bottles and either 400 or 250 mL beakers. The size of the beakers will be dependent on the diameter of the bottles. The bottle with the screen should not descend too deep into the beaker so that it impacts the reading of the volume of water. The smaller size bottle has the advantage of requiring less soil. Regardless of which size bottle is used, it is important that the amount of soil, water and size of the beakers and bottles used in comparative experiments are the same.

Or you can make your own beakers by using bottles with smaller diameters for the bases. This requires cutting the tops off of the bottles and using a waterproof marker or wax pencil to mark centimeters on the bottle sides. Use a graduated cylinder and water to determine increments.

Prerequisites

None

Background

What happens to water when it passes through soil depends on many things such as the size of the soil particles (texture and particle size distribution), how the particles are arranged (structure), how tightly they are packed (bulk density), and the attraction between the soil particles and the water. Some types of soil let water flow in quickly (infiltrate), then hold the water inside the soil (water holding capacity). This might give plants a better chance of using some of that water. Other types of soil may let the water go completely through in just a few seconds. Still other soils may keep the water from getting in at all. None of these soil types is better than the other - they are simply good for different reasons. Which soil property would you look for if you wanted to plant a garden? Build a driveway or a playground? What happens if the soil is full of water and a heavy rain falls on it? How can you change the way your soil holds water? What happens to the

soil when organic matter is added, when plants are growing on top of it, when it is compacted, or when it is plowed?

Water in soil is also a key to the transfer of nutrients from the soil to growing plants. Most plants do not eat solid food (although a few do digest insects!) Instead, they take in water through their roots and use the nutrients the water has obtained from the soil. How nutritious is soil? That depends on how the soil was formed, what it was formed from, and how it has been managed. Farmers and gardeners often add *nutrients* or fertilizer to soil so that the soil will store more nutrients for their plants.

Preparation

- Discuss with students some of the general characteristics of soils or do the *Why We Study Soil* or *Soil in My Backyard Learning Activities* or the *Soil Characterization Protocols*.

- Bring in samples of different types of soil from school or from home.
- Collect a number of clear plastic 2 liter bottles with straight sides. Remove the label and lid and cut off the bottom. The pour spout or top will fit into a 500 mL beaker or other clear container.
- Cut a circle of a fine mesh window screen, nylon net or panty hose about 3 cm larger than the opening made in the top of the bottle. Using strong tape (or rubberbands), secure the mesh circle around the end of the bottle top.
- Place the bottle, mesh side down, on a beaker or plastic bottle cut and marked to resemble a beaker or set it in a ring stand and place a catchment beaker under it.
- Use this opportunity to stress the importance of recycling.

What To Do and How To Do It

Class Investigation

1. Observe the properties of the soil samples that will be used. Use your GLOBE Science Notebooks to record information about the soil samples which you observe. Also record where each sample was found and the depth at which it was found. An alternative is to not tell the students anything about where the soil came from and let them make observations. If you have done the soil characterization protocols, you can also record the moisture status, structure, color, consistence, texture, and presence of rocks, roots and carbonates.
2. Choose one soil (a sandy loam works best) to use as a demonstration and place 1.2 L of the soil in one of the 2 liter bottles.
3. Pour 300 mL of water into 500 mL beaker or other clear container for pouring. A small plastic bottle labeled with mL or cm works well and does not spill easily. Measure the pH of the water. Also, notice the clarity of the water.
4. As an option, have the students design the experiment. They should answer

questions such as how to pour the water (fast, slow, in increments etc.)? What to measure as the water reaches the catchment container (first drop, first 100 mL, etc.)? Should they pour their water at the same time as other student groups?

5. Ask the students “What will happen when you pour the water onto this soil”? Ask students to explain why they think the soil will behave this way when water is poured onto it. Some possible questions to ask are:
 - How much water will flow out the bottom of the container?
 - How fast will the water pass through the soil?
 - Will the pH of the water change, and if so, how?
 - What will the water look like when it comes out the bottom (i.e. color, clarity)?
5. Record the class hypotheses and experimental designs on the board and ask the students to record the hypotheses and experimental designs in their GLOBE Science Notebooks.
6. Pour the water onto the soil and begin timing. Ask students to describe what is happening as you pour the water:
 - Is all the water staying on top?
 - Where is it going?
 - Do you see air bubbles at the top of the water?
 - Does the water coming out of the soil look the same as the water going in?
 - What is happening to the soil structure, especially at the soil surface?
7. Record the class observations on the board and have the students record the information in their GLOBE Science Notebooks. Also record how long it takes for the water to pass through the soil.
8. Ask students to compare their hypotheses and the results of the experiment.
9. Have students record their own conclusions in their GLOBE Science Notebooks about how the water and soil interacted.



Figure SOIL-PA-2

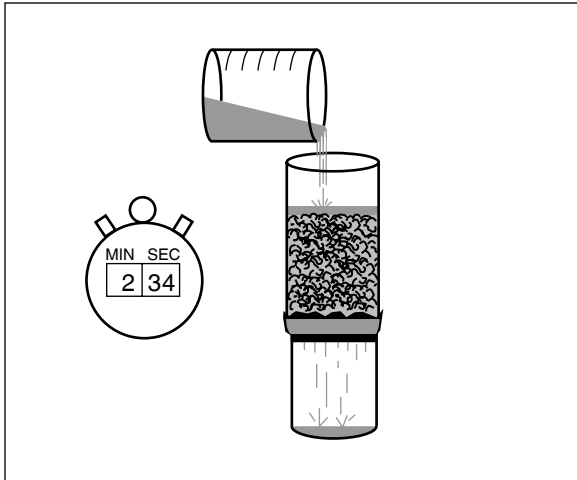

10. Once the water has stopped dripping from the bottom of the bottle, measure the amount of water that moved out of the soil into the beaker. Ask students:
 - How much water came out of the soil compared with what went in?
 - What happened to the water that is missing?
11. Notice the clarity of the water.
 - Is it more or less clear than before it passed through the soil?
12. Test the pH of the water in the beaker that has flowed through the soil, record the results, and compare the results with the pH of the water that was poured into the soil. Compare with the student hypotheses.
 - Did the pH change?
 - If so, what might have caused this change?
13. Using the bottle of saturated soil, ask students what will happen if you pour another 300 mL of water into the soil. Record the class hypotheses on the board.
 - How much water will stay in the soil?
 - How fast will it move through?
 - Will the pH change?
 - How clear will the water be?
14. Pour the water back through the soil, observe the results, and compare with the hypotheses.
15. Have students record their questions, hypotheses, observations and conclusions in their GLOBE Science Notebooks.

Group Investigations

Experimenting with different soils

1. Review the properties of the various soil samples that were brought in.
2. Ask students if they think water would pass through all of the types of soils in the same amount of time and if all the soils would hold the same amount of water.
3. Discuss which soils they think might be different and how.
4. Have each group of students select one of the various soils.
5. Have each group repeat steps 2 - 15 above on their own soil. Instead of writing hypotheses and observations on the board, the students will record the experiment in their GLOBE Science Notebooks.
6. Have each group report on the results of their experiment to the class. Reports should include questions, hypotheses, and observations regarding the following variables, as well as their conclusions about the variables and how they affected the results of their experiment.
 - soil characteristics
 - original water pH and clarity
 - amount of time for the water to pass through the soil
 - the amount of water which passed through the soil
 - changes in water pH and clarity
 - results of the saturation test.

Note: The information collected in the students' GLOBE Science Notebooks will be used to prepare their papers and reports.

7. Review all results with the class. Have the class determine the soil characteristics, such as different size of particles, space between the particles, organic material which may hold water, etc. associated with the fastest and slowest infiltration, retention of water in the soil, and changes in pH and clarity.

Figure SOIL-PA-3: Experimental Soil Column

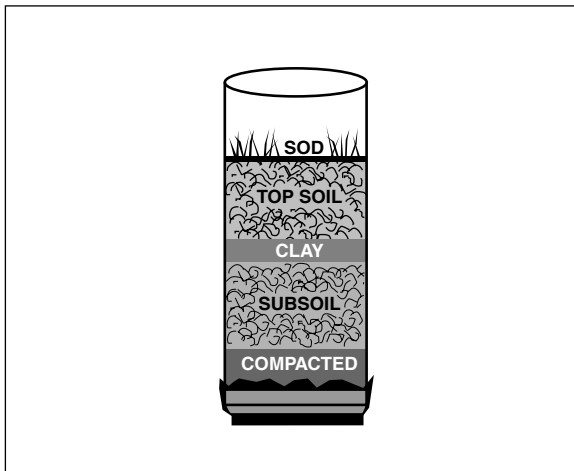

8. Based on the comparison of their hypotheses with the experimental results, record conclusions about how the water and soil interact and how diverse soils behave differently in their GLOBE Science Notebooks.
9. Ask the students to explore how what they have learned from their experiment may be used in real life circumstances to understand what might occur in their local watershed and land use questions in their community. They might explore questions such as:
 - What might happen if the soil in an area is tightly compacted and there is an extended heavy rain?
 - How does soil with vegetation on it vary from bare soil?
 - Does the atmosphere influence soil characteristics?
 - How does soil influence infiltration rates and groundwater?

Further Investigations

1. Challenge students to come up with strategies for building a soil column in a 2 liter clear, plastic bottle which will SLOW or SPEED UP the rate of water flow through a soil.

Brainstorm ideas for accomplishing the task. Have students record their method and measure and record the 'soil recipe' they use. Hint: Teachers may want to have students build their soil column one day,

then have a student come in before class the next day and start the water flow.

Record the results for the rates of water flow. Which strategies worked best?

Ask students to determine whether the same strategies work for moving water through the soil slowly and for holding water in the soil.

2. Build a soil column similar to the soil profile at one of your soil characterization sample sites (use the samples for each of the horizons in the same order they are found in the profile). Observe how the water-soil interaction occurs in a simulated profile.
3. Determine if the temperature of the soil differs with different types of soil and think about why.

More Advanced

Based on the observations and results of their experimentation, have students design experiments to test other hypotheses they may have developed. Some possible ideas include:

1. Have students hypothesize about how soil can affect other aspects of the chemistry of water. Take a reading of NPK using the Soil NPK kit with the soil alone, and with a water sample. Repeat the water measurement after it has passed through the soil.
2. Have students experiment with adding salt to the water and testing the conductivity or salinity of the water before and after it goes through the soil.
3. Add vinegar or baking soda to the water and test the pH and alkalinity before and after water is added to the soil.
4. Ask the students to hypothesize about the effect of evaporation on the amount of water the soil will hold. What are the factors that control evaporation? Use some soil of the same type in two bottles and saturate both with water. Leave one bottle open on top and cover the other bottle securely with plastic wrap or other cover. Place both in a sunny window. The weight



of the soil in each of the bottles will be a function of how much water it holds over time. Students can graph the difference in weight over time for the covered and uncovered bottles.

5. Place a mulch or growing sod over the soil in the bottle. How does this affect the rate at which water infiltrates the soil? How does it affect the clarity of the water that comes out the bottom? How is this related to erosion in the real world?
6. Ask students what changes may occur if the soil remains saturated with water over long periods of time. Place a soil sample in a bottle which has not had the bottom removed, then saturate it. Can they detect changes in structure, color, smell? How long does it take for changes to take place?
7. Have students examine soil moisture data for five GLOBE sites which have approximately the same amount of precipitation over a six month period. Graph the monthly soil moisture for each site. How do the graphs differ? What other GLOBE data can students find that might explain the variation?



Student Assessment

Students should know the scientific method and how to use it to set up an experiment as well as understand the scientific content relating to soil moisture. They should also be able to demonstrate higher order thinking skills such as drawing conclusions from experimental observations and they should be able to justify their conclusions with evidence. These can be assessed by using a portfolio assessment of their GLOBE Science Notebooks, class participation in discussions and the contribution of questions, hypotheses, observations and conclusions. The quality of their presentations are another mechanism for assessing their progress. It is also a good idea to have the students prepare a written report or a paper on their experiment. The experimental work should be done in groups as should the presentations and the reports so that their ability to work cooperatively in groups can also be assessed.

Note: This activity works nicely when done in conjunction with the soil moisture protocol. The activity can begin in the classroom before going out to set up the sampling strategy or take a soil moisture measurement. Additional observations and recording of flow rate, volume of water, pH, water clarity, etc. can be taken when returning to the classroom. (For some soils, it may take some time before all the water flows through the soil columns.) The activity also places both the soil moisture and soil characterization protocols in a conceptual context for the students. They will understand why the information and data they collect are important for developing hypotheses, designing experiments to test the hypotheses, interpreting observations, and making conclusions. They will also develop an understanding of the potential research significance of the soil moisture and characterization data.

From Mud Pies to Bricks



Purpose

To introduce the different particle sizes of soils and the properties which each contributes to the soil character

Overview

Students sift soil to remove organic materials and pebbles. They then sift the soil with smaller meshed sieves to separate clay and sand. Students make mud pies by adding water to the various soil components, letting them dry and observing the pie's characteristics. Finally, students create the perfect mud pie or building brick using combinations of soil components.

Student Outcomes

Students will be able to characterize soil.

Students will be able to identify soils based on their particle size distribution.

Students will be able to create building materials from soils.

Science Concepts

Earth and Space Science

Soil consists of weathered rocks and decomposed organic material.

Soils are a part of the rock cycle.

Science in Personal and Social Perspective

Building materials are made from basic resources.

Scientific Inquiry Abilities

Identify answerable questions.

Design and conduct an investigation.

Develop descriptions and explanations using evidence.

Communicate procedures and explanations.

Time

One class period to sift soils and make mud pies

Overnight to dry

One class period to experiment with creating bricks

Overnight to dry

Level

All

Materials and Tools

1 liter soil (loam) for each student group

Several sizes of mesh screen or sieves for sifting

Straw (dried grass clippings)

Additional powdered clay and sand

Old ice cube trays (for brick molds)

Small plastic lids or plates (for pies)

Plastic table cloth

Prerequisites

None

Background

Soil is composed of many different size grains of broken-down rock (sand, silt and clay). How much water a soil will hold, how easily water passes through the soil, and what happens to the soil as it dries depends on the combination of these materials in a particular soil. Soil with too much clay may crack as it dries, as demonstrated by ground with huge cracks or the cracking at the top of a mud puddle when larger, heavier particles have settled to the bottom. Soil with too much sand may not hold together well or be strong enough as a building material.

Soil has been used as a building material for thousands of years, and is still one of our most important building materials. In dry regions houses built of adobe bricks last hundreds of years. Concrete and bricks are common everywhere. Whether you are making concrete or adobe blocks, it is important to understand the importance of having the right elements in your soil mix.

What to Do and How to Do It

Observation

1. Ask students to examine the soil carefully using their eyes, hands, and a magnifying glass.



2. Make a list of the things students observe about the soil. For example: *different size, shape, color of grains, other soil materials such as sticks or leaves, 'dustiness', weight, etc.*
3. Ask students if they think the soil would be different if all of the particles were alike or if some parts were missing. How would it be different?
4. Starting with the largest mesh sieves, sift the soil.
5. Place what does not go through the sieve in one pile - these are the largest particles.
6. Ask students to examine the 2 piles. How are they alike and different? Can they think of reasons why different size particles would be good for different things?
7. Take the soil that passed through the sieve and sift it through the next smaller mesh.
8. Keep what did not go through the sieve separate, and continue sifting through smaller mesh screens. Students will now have several piles of soil separated by the size of the particles.
9. Ask students to identify words that describe the different piles of soil they now have. Identify the concept of particle size: sand, silt and clay. Words might include: *powdery, rough, smooth, dusty, etc.*

Experimenting

1. Discuss with students the importance of soil as a building material. Ask students to identify things that are built with soil. Example: *concrete sidewalks, brick buildings*
2. Have students describe how they would make a brick using the soil they have.
3. Ask students to describe the characteristics of a good mud pie or brick. For example: *hardness, cracking, resistance to breaking or water, etc.*
4. Ask students to guess which pile of soil would make the best mud pie or brick. Why did they choose the pile of soil that they did? What will happen to each pile when water is added to it?

5. Have students make mud pies or bricks from the soil in each pile by adding water then molding by hand or putting into a mold like an old ice cube tray.
6. Dry completely in the sun or in a warm place.
7. Ask students to test the mud pies or bricks that they made for breaking, cracking, smoothness, etc. List what is good or bad about each one.

More Challenging

1. Challenge students to create the perfect mud pie or brick by combining different amounts of the soil particles they sifted out. Additional sand, clay or organic material may be provided, especially if your original soil did not contain very much of one of these elements. Have students measure or weigh the different ingredients and write a 'recipe' so that they can compare with other students or recreate their creation.
2. Older students can figure the percent weight of each soil component in their recipe.

Further Investigations

1. What happens when the dried bricks get wet? Research how adobe houses are protected from rain.
2. Examine a piece of broken brick. What soil elements can you identify? Why are bricks water resistant?

Assessment

Have students observe soils around their school or at their biology site. Ask how they can determine areas which have more clay or more sand.

Recipe Card	amount
Ingredients:	
	<i>clay (smallest size particles)</i>
	<i>silt (medium size particles)</i>
	<i>sand (large size particles)</i>
	<i>other</i>
	<i>other</i>



Soil and My Backyard



Purpose

To explore soil and soil properties

Overview

Students discover the variability of soils, derive relationships among soils and the soil forming factors, and link the GLOBE Soil Investigation to the students' local environment. Students use soil samples from their homes to identify properties that characterize their soils. They compare and contrast their soils to those of their classmates. As a class, students describe relationships between the properties of their soils and how and where they were sampled. Older students construct a soil classification scheme.

Student Outcomes

Students will be able to characterize soils.

Students will be able to differentiate soils based on their physical properties.

Science Concepts

Earth and Space Science

Earth materials are solid rocks, soil, water, biota, and the gases of the atmosphere.

Soils have properties of color, texture, structure, consistence, density, pH, fertility; they support the growth of many types of plants.

The surface of Earth changes.

Soils are often found in layers, with each having a different chemical composition and texture.

Soils consist of minerals (less than 2 mm), organic material, air and water.

Water circulates through soil changing the properties of both the soil and the water.

Scientific Inquiry Abilities

Identify answerable questions.

Design and conduct an investigation.

Use appropriate tools and techniques including mathematics to gather, analyze, and interpret data.

Develop descriptions and explanations, predictions and models using evidence.

Communicate procedures and explanations.

Time

One class period to observe soil properties and one or two periods for discussion

If soils are to be dried and changes observed, an additional class period will be needed.

Level

All

Materials and Tools

Newspaper

1 liter plastic bags

Local map (topographic or road map which encompasses the school district)

Magnifying glass

Preparation

On the day of the activity, prepare an area in the room for observing the soils. For example, cover lab tables with newspaper. If students will be drying their samples, you will need to identify a place where soils can be left undisturbed for several days. See the instructions for drying soils in The Soil Protocols – *How to Perform Your Soil Measurement*.

Prerequisites

None

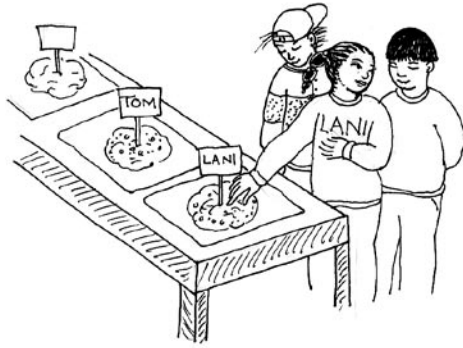

Background

Soils vary in their properties depending on where they have been sampled on a landscape and from what depth they were sampled.

What To Do and How To Do It

Ask students to hypothesize how many different types of soils the individuals in the class can find in their neighborhoods. They need to use previous experience or knowledge to answer the question.

Before Class

Have students bring soil samples from home, using 1 liter plastic bags. They should document their collection methods (such as noting the location from which each sample was taken, the depth of the soil, storage methods, etc.). For younger students you may want to establish a class protocol for sample collection – either through a brainstorming activity or by providing one.

During Class

1. In the classroom, students should spread out their soil samples and examine them closely. Record observations about the soil in the GLOBE Science Notebooks.
2. As your students examine their soils, help them to think about what they are observing by asking: What properties do you notice? Are the soils wet or dry? What colors do you see? Can you identify the components (organic material [both plant and animal], rock fragments, sand, clay, etc.) of your soils? How does the soil smell? How do the soils feel? How do dry soils differ from the original soil samples?

Are there differences within a single soil sample? How does your sampling procedure affect what you see? How would you group or classify the soils?

3. Have each student find one person in the class that has a soil similar to their own soil. Record how they determined that the soils were similar.
4. Have each student find one person in the class that has a soil that is different from their own soil. Record how they determined that the soils were different.
5. As a class, brainstorm and list on the board the different characteristics the students used to describe their soils. Ask the students to group characteristics that appear to belong together. Use words that describe these similarities, such as same color, same “feel,” a number of roots. Have students describe how the observed soil properties relate to the soil forming factors.
6. Discuss what factors could lead to the different characteristics (five soil forming factors, sampling effects, etc.).
7. Ask the students to compare their observations with their hypotheses about how many types of soil they are likely to have represented in the class samples.
8. Ask them to discuss how their knowledge of the soil characteristics changed based on their investigations. What did they learn? Be specific listing such things as soil characteristics, how soil may vary in characteristics within a relatively small area, etc.

Adaptations for Younger and Older Students

Younger students should focus on making observations and comparisons.

Older students can perform more in-depth investigations in teams or as a class by:

- Identifying resources for more information (e.g. county soil survey reports, soil maps, or other local information)

- Developing a standardized procedure for soil sampling and having your students bring in a second sample collected by following the class procedure. Compare each set of samples.

- Developing a scheme to classify soils based on soil properties.

- Drying the soil samples for different lengths of time and comparing physical differences between soil in various states of moisture.

- Plotting on a local map sample collection sites and the distribution of the various soil classes.

Further Investigations

Find out where there is digging (excavation) going on nearby and visit the site, comparing what you observe there with the soil characteristics described in your backyards.

Remember: Safety is always your first concern.

Select another school in a part of the world known for certain characteristics (e.g. a rainy season, thick vegetation, etc.). Pick a school that has a history of submitting messages and/or data. Write a message to the students via GLOBEMail, e-mail or regular mail describing your soil and asking them to describe their soil to you. How do the differences in your climates (for example types of seasonal cycles, temperature ranges, amounts of precipitation, types of land cover) relate to the differences in your soils? Compare your results with those of the other school and discuss any difference with your GLOBE colleagues at your school and the other school.

Investigate what kinds of soils make the best homes for earthworms or other soil-dwelling creatures.

Develop a scheme for grouping (classifying) soils based on soil properties.

Compare the class's classification scheme to GLOBE's (see *Soil Characterization Protocol*). Have the students compare the soil properties in the *Soil Characterization Protocol* to the properties that they chose for their scheme.

Student Assessment

Give students samples of a mystery soil. Depending on their ability, they could:

- Describe the soil in their GLOBE Science Notebooks, using as many adjectives as possible and covering as many soil characteristics outlined in the *Soil Characterization Protocol Field Guide* as can be observed.

- Consider the implications of the characteristics of the soil for its possible history and location.

A Field View of Soil - Digging Around



Purpose

To understand that variations in the landscape can affect soil properties

Overview

Students investigate variations in the soils around their school to discover that soil properties like moisture, temperature, color, and texture exhibit considerable variability across a single landscape. They also identify factors such as slope, shade, plants, and compaction, which affect the appearance of soils and their ability to hold moisture.

Student Outcomes

Students will be able to characterize soils.

Students will be able to relate the five soil forming factors to soil properties.

Science Concepts

Earth materials are solid rocks, soil, water, biota, and the gases of the atmosphere.

Soils have properties of color, texture, structure, consistence, density, pH, fertility; they support the growth of many types of plants.

The surface of Earth changes.

Soils are often found in layers, with each having a different chemical composition and texture.

Soils consist of minerals (less than 2 mm), organic material, air and water.

Water circulates through soil changing the properties of both the soil and the water.

Scientific Inquiry Abilities

Identify answerable questions.

Design and conduct an investigation.

Use appropriate tools and techniques including mathematics to gather, analyze, and interpret data.

Develop descriptions and explanations, predictions and models using evidence.

Communicate procedures and explanations.

Time

Two class periods: the first for the field trip; the second to discuss findings and causal connections

Level

All

Materials and Tools

Small shovel or trowel

GLOBE Science Notebooks

Prerequisites

None

Background

Factors Affecting Soil Properties

The soil is unique for every place on Earth. What makes each soil unique is the way the five soil forming factors work together at any particular place. These five soil forming factors are 1. parent materials from which the soil formed, 2. the position on the landscape where the soil is found (or the topography of the site), 3. the types of plants and animals that live in the soil, 4. the climate for the area where the soil formed, and 5. the amount of time that the other 4 factors have

been interacting. As you look around your site, notice whether the effects of the five soil-forming factors are different on one part of the site versus another.

Some properties that you may notice that change from one soil to the other are:

- the color
- the type and amount of vegetation on the soil surface
- the amount of roots in the soil surface
- the shape of the soil particles when you look at them (called the soil structure)



- the way the soil feels (called the soil texture)
- the amount and size of rocks in the soil
- the number of worms or other animals in the soil
- how warm or cool, wet or dry the soil feels. (Wet soil will be sticky and clump together, moist soil will feel wet and cool, and dry soil will feel like it has no water in it.)



Factors Affecting Soil Moisture

Because each soil is unique, each soil will also hold a certain amount of water. The amount of water held in the soil may depend on many things. Among these are the speed at which precipitation (rain, snow, sleet, etc.) enters (infiltrates) the soil or runs off, the temperature, and the plants. If soil is tightly compacted, as on a well-trodden path, the water will not be able to enter the ground as easily as in less traveled areas. Nature may increase runoff in some areas. For example, in dry climates, “desert pavement” (small rocks laid tightly across the sand like a tile floor) may increase the amount of runoff.



Wind and water may help to form crusts on some soils that prevent the infiltration of water. Slope also increases the speed at which water runs off the land. Rain will quickly disappear on a steep slope, but collect in puddles on the flat ground. The roots of plants help to break up the soil, creating a porous medium in which water can pass. Sandy soils usually let water in faster than clay-rich soils.



You might think that there is little variation between soil temperatures on your site. However, there may be quite a bit of difference from one place to another. Shade causes cooler temperatures. Shade is not found just under trees. It may be cooler in the shade under a rock or on the side of a rock away from the sunlight. The soil may be drier in warm places, and wetter in cool, shady places.



Plants may also affect soil moisture. They may provide shade. They also use water.



What To Do and How To Do It

Begin by Asking:

1. In your part of the world, which side of a slope gets the most sunlight - the north or the south?
2. If you were going to hunt for fishing worms (or other soil dwelling invertebrates), where would you look? Why would you look there? Remember, animals need water, air and nutrients, which are found in various soils. In compacted soils, it is more difficult for animals to survive.
3. Do more types of plants seem to grow on slopes or in valleys? Why?

At the Study Site

1. Divide the class into groups of 3 to 5 students. Each group should have a small shovel or trowel, and their GLOBE Science Notebooks.
2. Have groups look for differences in soil properties at different places in the site by digging up a small amount of soil, looking at it, and feeling it. Have them record what they find in their GLOBE Science Notebooks.

Ask them to note types of plants, presence of rocks, roots, and soil animals (such as earthworms), how hard or easy it is to dig, distances to items on the landscape or other things they notice. See the box, the *Five Soil-Forming Factors (after Student Assessment below)*, for guiding questions. Have students list the areas they investigated from the wettest to the driest. Note how the moisture content is affected by the location, the type of plant cover, the position, or other things at the site.

Extensions

1. Have students make a sketch map of soil characteristics on their site.
2. Have students “landscape” their site. If this site was going to become someone’s yard, where would you plant things?

Student Assessment

Ask Students:

1. In which parts of the site would you expect soils to be most alike? Consider regions with similar soil forming factors.
2. Where would you locate the soil that is the most typical for your area? Look for large areas within your site which have common characteristics.
3. What things on the landscape affect soil-moisture?
4. What things should you consider when choosing your soil-moisture site in your area?

The Five Soil-Forming Factors

Climate: Is one part of the site more shaded or sunnier, cooler or warmer, drier or wetter? How would the temperature and moisture be different in a sandy soil than in a clayey soil? How would this affect the way plants grow?

Topography: Are there different slopes on different parts of the site? Where is it flat on the site? Are there areas that rise up or slope down? What are the different types of positions on the landscape (high spots, middle of the slope, low areas)? Where are the highest places; the lowest?

Plants and animals: How do the types of vegetation change on the site? Can you see evidence of animal life? What kinds of insects are present? How is the site used by humans (such as: is it a park, a field, a lawn, a forest, a plantation, an urban area)?

Parent material: From what kind of material was your site formed? Do you see rocks at the surface that can give you an indication? Are these rocks near a stream so that they may have been deposited by water? Could they have been deposited by wind (such as a sand dune), or by gravity down a hill, or by a glacier, or by a volcano? (You may need to do some research to determine the geology of your area).

Time: How long has this site been undisturbed? Is there a lot of organic material on the soil surface? Are there grasses, trees, crops, or other plants that have been growing for a long time without being disturbed? Has there been recent building or construction? If it is a field, has it been recently plowed? Have trees been removed from the site? Has there been a recent flood or other natural disturbance that may have affected the formation of the soil?

Soils as Sponges: How Much Water Does Soil Hold?



Welcome

Introduction

Protocols

Learning Activities

Appendix

Purpose

To introduce students to gravimetric measurements of water content through calculating the amount of water in sponge and soil samples by weighing the samples before and after drying

Overview

Students determine the moisture content of a sponge after squeezing the water out of the sponge, and allowing water to evaporate from the sponge. Students also measure the amount of water that has evaporated from the soil samples.

Student Outcomes

Students will understand that objects can hold a measurable amount of water.

Students will be able to transfer this concept to soil by weighing wet and dry soil samples and calculating the amount of water held by the soil.

Science Concepts

Earth and Space Science

Earth materials are solid rocks, soil, water, biota, and the gases of the atmosphere.

Soils have properties of color, texture, structure, consistence, density, pH, fertility; they support the growth of many types of plants.

The surface of Earth changes.

Soils are often found in layers, with each having a different chemical composition and texture.

Soils consist of minerals (less than 2 mm), organic material, air and water.

Water circulates through soil changing the properties of both the soil and the water.

Scientific Inquiry Abilities

Identify answerable questions.

Design and conduct an investigation.

Use appropriate tools and techniques including mathematics to gather, analyze, and interpret data.

Develop descriptions and explanations, predictions and models using evidence.

Communicate procedures and explanations.

Time

Approximately two class periods for the initial sponge and soil activities; then 10-15 minutes per day for about 3 days, as objects dry

Level

Middle and Secondary

Materials and Tools

Scale or balance

Several sponges with different properties (e.g. size, shape, thickness, pore size and number of pores)

Soil samples

Paper towels, paper plates, newspaper, or other surface to dry soils on

Tray to place wet sponges and soils on

Graph paper (for intermediate or advanced)

Prerequisites

Knowledge of fractions, decimals, and simple algebra



Background

Many objects hold water. For living beings, this water is essential for survival. On Earth, soil has the ability to store significant amounts of water that can then become available to plants and animals that live in and on the soil. Moisture in the soil also affects weather, climate, and land use. Scientists use soil moisture data to predict what will grow in an area, how climate will change, when floods or droughts may occur, and what the best use of the soil is at a given location.

One way to calculate soil moisture is to take a gravimetric measurement of a soil sample. Gravimetric means to find the weight, or the pull of gravity, upon an object. Mass is the amount of matter in an object (or an object's resistance to acceleration). For GLOBE soil protocols, you measure mass rather than weight. Here is a formula to illustrate the relationship between mass and weight:

GSM (Gravimetric Soil Moisture) =

$$\frac{\text{Weight of moisture}}{\text{Weight of dry soil}} = \frac{g \times \text{mass of moisture}}{g \times \text{mass of dry soil}} = \frac{\text{mass of moisture}}{\text{mass of dry soil}}$$

g = gravitational constant which is equal to 9.81 m/second^2 at the surface of Earth

Note that the g 's cancel each other when gravity is the only force involved. The units associated with mass are kilograms and grams.

When calculating soil water content, we want to find the mass of the water contained in the soil. To get the absolute value of the mass of the soil, we measure the mass of a soil sample, dry it out, and then measure the mass of the dried soil. The difference in the mass between the wet and dry soil is the absolute value of the amount of water originally in the sample. Because soil samples have different properties and are at different initial water contents, we normalize this result to find the relative amount of soil moisture by dividing the absolute value by the mass of the dry sample.

For example, you might dig up a handful of soil and find that it has a mass of 100 grams. After the soil has dried, you weigh it again and find that it only weighs 90 grams. Ten grams of water

have evaporated from the soil, but this must be normalized, to remove sample size bias, by the mass of the dry soil ($100 - 10 = 90 \text{ g}$ assuming a 100 g can mass). We can then calculate the fraction $10/90=0.111$, which is a measure of how much water is in the soil (water content). Since we are using a balance, which depends upon gravity, this method of determining soil moisture is called the gravimetric water content.

Soil water content calculations are simple to do, as long as samples are measured accurately. When the air is dry, evaporation can happen quite rapidly. Think about how fast you dry off after getting out of the water on a hot, dry day. Soil samples will dry quickly in the air as well, if they are not placed in a sealed container as soon as they are removed from the ground.

Soil moisture is influenced by many environmental factors, such as temperature, precipitation and soil type, as well as topographic features, such as slope and elevation. Soil moisture is especially important for agriculture. Much of the hard work of farming, such as plowing and adding organic matter, is done to try to improve the soil-moisture related properties of the soil. Terracing (making ridges in a field) is done in some areas to prevent too much runoff, while fields are rounded in other places to keep the soil from staying too wet. Also, different crops require different amounts of water throughout their growing season. Understanding how the soil moisture changes throughout the year can help a farmer decide when and what to plant.

In this activity, students measure the moisture in sponges and soils. They do these experiments in stages of increasing difficulty:



Stage 1 — Squeezing water from sponges

Students weigh a wet sponge, squeeze it, then weigh the dry sponge and the water that was squeezed from the sponge. Doing this, they see that a wet sponge = dry sponge + water. Squeezing is a very visible and immediate way to release water.

Stage 2 — Evaporating water from sponges

Students do the same exercise as above, except that they let the sponge sit for several hours or a day to let the water evaporate. Students can compare the mass of the dry sponge measured after squeezing and after evaporating to determine how effective these 2 methods are in removing water from the sponge. Students can experiment by placing the wet sponge near a sunny window, in a cold area, or under different conditions to determine if these locations have an effect on the amount of water that evaporates.

Stage 3 — Measuring soil moisture

Students transfer the concept of evaporative drying to soil by letting moist soil samples dry for a day or two. They measure the mass of the soil before and after drying to determine the soil moisture. They compare several soil samples to get a sense of a typical range of values.

Stage 4 — Using GLOBE visualizations for worldwide soil moisture

Students use visualizations from the GLOBE Web site to study a map showing soil moisture in other parts of the world. They discuss why there are differences, and conduct further investigations.

What To Do and How To Do It**Preliminary Exercise**

Be sure that students are familiar with using a scale or balance and have them practice weighing objects.

Stage 1 – Squeezing water from sponges

1. Soak a sponge in water. Weigh it and record the wet mass. Ask your students how much they think it will weigh when it is dry. Record the estimates.
2. Squeeze the sponge and weigh it. Record the dry mass. Discuss with students how their estimates compared with the actual value.
3. Ask your students how much water was in the sponge and how they might determine this. This amount of water = wet sponge mass minus dry sponge mass. For example, 120 grams of water = 200 grams wet mass minus 80 grams dry mass.
4. Repeat the measurements with a sponge that has different characteristics (e.g. different thickness, size of pores, larger size, etc.). Have your students estimate which sponge will hold the most water and discuss why.

In discussion with your students, make sure that they understand the concept of water-holding capacity, and that capacity can differ from one type of sponge to another.

5. The measurement of water content using this equation (wet sponge mass-dry sponge mass) is an absolute measure of the water content. To find the relative measure of water content in order to compare water contents in sponges of different types, divide the absolute value by the dry sponge mass using the equation:

$$\text{relative water content} = \frac{(\text{wet sponge mass} - \text{dry sponge mass})}{\text{dry sponge mass}}$$



- To extend this activity, weigh an empty cup, collect the water that was squeezed from each sponge in the cup, and weigh the water and cup together. Determine the mass of the water by subtracting the mass of the water from the mass of the cup and water weighed together. Compare the actual mass of the water with the calculated mass obtained by the equation above.

Stage 2 – Evaporating water from sponges

- Ask your students what will happen if you leave the wet sponge on a tray overnight instead of squeezing it. Discuss the concept of evaporation and the conditions under which it is most effective.
- Have your students weigh the wet sponge, record the mass, and leave the sponge on a tray at a specific location in the room. To extend this activity, use different types of sponges in the same location, or use the same type of sponge in different locations (e.g. in a sunny window, in a dark corner, near a heater, etc.). Leave the sponges exposed until the next day.
- After the sponges have been left out for a day, have your students weigh the sponges to determine if any water was evaporated.
- Calculate the relative amount of water that evaporated from the sponges using the equation:

$$\text{relative water evaporated} = \frac{(\text{wet sponge mass} - \text{current sponge mass})}{\text{current sponge mass}}$$

Compare the results for each of the sponges and for each of the locations. Were these values different from the amount of water that was squeezed from the same sponges? Which was a more effective way of removing water? The evaporation experiment can be continued for another day with the same sponges to determine if additional water will be removed.

- The difference in the amount of water contained in a completely wet sponge and in a completely dry sponge is the sponge's water holding capacity. Ask your students how sponges of different types vary in their water holding capacity and why a high water-holding capacity is important for a sponge or similar object.

Homework

Explain to your students that they will soon be measuring how much water soil can hold. Ask them to bring in a soil sample from home in a small plastic sandwich bag, and to seal the bag to retain the soil's moisture. (If soil is not readily available, bring in potting or other soil from a garden store.)

Stage 3 — Measuring the moisture of soil

- After performing the sponge experiments, ask the students how they might determine the moisture of their soil samples. In their answers, the central concept to look for is that soil moisture can be measured in a



similar way by determining the mass of the wet soil, drying the soil, and determining the dry mass in the same way they did with the sponges.

2. Have each student or group of students open their sealed sample bag and weigh the wet soil sample. Be sure to account for the mass of the bag, or a container, piece of paper or other holder weighed with the soil by subtracting its mass from the total mass (of soil plus holder). After the mass of the wet soil is recorded, have the students spread their soil samples on a paper plate, newspaper, or other surface, and set it in a safe place to dry. Place the soil samples in a location where they will dry quickly or experiment with locations and conditions.
3. When the soil samples are dry (based on feeling the soil for dryness), have the students weigh each soil sample again and determine how much water was evaporated using the formula:
4. This is the formula used in the soil moisture protocol. For example, if the

wet soil mass is 100 grams and the dry soil mass is 90 grams, then the absolute soil water content will be 10 grams. To obtain the relative water content in order to compare different samples, divide the wet soil mass minus dry soil mass by dry soil mass (as in the previous step and in Background). Have your students calculate the relative water content of their soil samples and compare the values. Correct any errors in their calculations. Discuss the range of values and why they think there is such variety. Have them examine the properties of the different soils (e.g. color, texture) to help them think about why there is such a range. How did the amount of water held by the soil compare to the amount held by sponges?

Intermediate and Advanced Students

In the previous activities, older students can weigh the soil every hour, and then graph the rate at which evaporation takes place and identify whether the resulting plot is constant (a straight line) or not. Students may also consider how other factors including weather (humidity, wind,

$$\text{relative water content} = \frac{\text{mass of wet soil} - \text{mass of dry soil}}{\text{mass of dry soil}}$$

This is the soil moisture content.



rain, cloudiness, shadiness, sun intensity, etc.), vegetation, or land use may affect evaporation.

Brainstorm with your students about ways that soils can be dried and how they could speed up or slow down the process. Some ideas are: put the objects in direct sunlight; blow a fan over them; put them on a heater; put them in a microwave or oven; pour salt on them; cover them with a plastic container; point a light on them. The experiment can be repeated based on this discussion and results compared.

Stage 4 — Using GLOBE Visualizations for Worldwide Soil Moisture

Intermediate and Advanced Students

This activity is appropriate for intermediate and advanced students who have map-reading skills and a basic understanding of soil moisture concepts.

1. Use the GLOBE Web site to access and display a map showing soil water content around the world based on the most recent student measurements.
2. You can display the soil water content data either as values or as contours (with different colored bands corresponding to certain ranges of soil moisture values).
3. Have students compare their own soil water content measurements with the soil water content readings from other schools around the world.
4. There are many domains of investigation for your students. Here are some examples:
 - what is the range of soil water content values around the world?
 - where is it the lowest? the highest?
 - does this vary over time? (examine soil water content maps from other months)
 - what affects the soil water content at the different sites?
 - how do the soil properties at a site affect the soil moisture (e.g. sandy soils, clayey or silty soils, soils on steep areas and different landscape positions, etc.)?
 - how are soil water content values affected by recent weather conditions?

- how do soil moisture contents from a desert, a rain forest and a farming area compare?
 - what areas have about the same level of soil water content as your site?
5. Encourage your students to pursue further investigations using the GLOBE soil moisture visualizations.

Student Assessment

Bring a set of soil samples to school. Have your students estimate, and then calculate, the soil water content on their own. Check for reasonableness in their estimates, and watch the process to make sure they do it correctly.



Soil: The Great Decomposer



Purpose

To understand that soil, under different environmental conditions, changes its role in the decomposition of organic materials

Overview

Students use “bottle” experiments to observe changes in the decomposition of vegetable scraps.

Students vary temperature, moisture, and light conditions to determine the conditions that best facilitate the decomposition of organic material in soil.

Student Outcomes

Students will be able to identify soil conditions that promote the decomposition of organic matter in soils.

Science Concepts

Earth and Space Science

Earth materials are solid rocks, soil, water, biota, and the gases of the atmosphere.

Soils have properties of color, texture, structure, consistence, density, pH, fertility; they support the growth of many types of plants.

The surface of Earth changes.

Soils are often found in layers, with each having a different chemical composition and texture.

Soils consist of minerals (less than 2 mm), organic material, air and water.

Water circulates through soil changing the properties of both the soil and the water.

Scientific Inquiry Abilities

Identify answerable questions.

Design and conduct an investigation.

Use appropriate tools and techniques including mathematics to gather, analyze, and interpret data.

Develop descriptions and explanations, predictions and models using evidence.

Communicate procedures and explanations.

Time

One class period to discuss and plan experiment, one class period to set up experiment, part of class period at daily (or every other day) intervals to record results, and one class period 2 weeks later to observe and discuss final results. Additional time may be desired to perform further investigations.

Level

All

Materials and Tools

12 glass jars or beakers or 2-liter plastic bottles (more for additional studies)

Marking pen or labels

Enough dry soil to add 10 cm to each jar. Use the same soil (loam or potting soil) for each jar.

Enough chopped vegetable or fruit scraps (carrots, cucumbers, apples, etc.) to add two to three cm to each jar (use the same fruit or vegetable scrap mixture in all jars). Other sources of organic material include leaves (broken up), grass clippings, flowers, etc. *Do not use animal scraps.*

Graduated cylinder or measuring cup to add specific amount of water to soil

For further studies:

Earthworms (collect from local soil)

Soils with mostly sandy or clayey textures

Preparation

Have soils, bottles, and vegetable scraps available. Ask students to bring in vegetable scraps on the day of the experiment.

Locate areas in the classroom that will provide variable conditions required for the experiment (warm, sunny site; cool, sunny site; warm, shaded site; cool, shaded site).

Prerequisites

None



Background

Light, temperature and water content largely determine the rate of decomposition of organic matter in soil. Soil holds the moisture and heat required for microorganisms to thrive and perform the decomposition process, changing organic materials into soil material called humus.

Soils have different abilities to hold moisture, heat, and to support organisms. If the soil is too wet, too dry, or too cold, decomposition will be slow. Energy from the sun warms the soil and promotes evaporation, affecting the moisture content in the soil. Students will be asked to investigate what conditions contribute to rapid decomposition of organic material in soil.

What To Do and How To Do It

1. Set out 12 jars or beakers on table. Label each as follows:
 1. Dry, warm, sunny
 2. Moist, warm, sunny
 3. Wet, warm, sunny
 4. Dry, warm, shady
 5. Moist, warm, shady
 6. Wet, warm, shady
 7. Dry, cool, sunny
 8. Moist, cool, sunny
 9. Wet, cool, sunny
 10. Dry, cool, shady
 11. Moist, cool, shady
 12. Wet, cool, shady
2. Add equal amounts of soil (about 10 cm) to each jar.
3. Add equal amounts (about 2-3 cm) of vegetable material to each jar and evenly mix the soil and vegetable material. Use the same type of vegetable material in all jars.

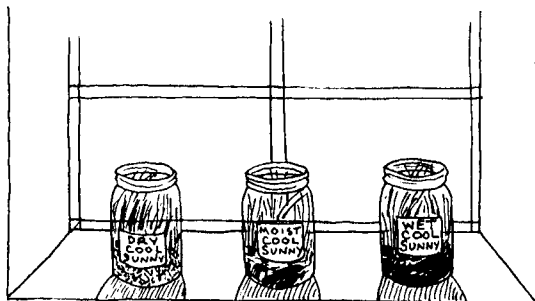

4. In each of the 4 jars marked “wet,” saturate the mixture with water (allow water to cover the surface of the soil).
5. In each of the 4 jars marked “moist,” moisten the mixture with water.
6. Leave the mixture to dry in the 4 jars marked “dry.”
7. Place one wet, one moist and one dry jar in a warm place that is shaded (as marked).
8. Place one wet, one moist and one dry jar in a warm place that also gets sun for part of the day (as marked).
9. Place one wet, one moist and one dry jar in a shaded, cool place.
10. Place one wet, one moist and one dry jar in a cool place that also gets sun for part of the day (as marked).
11. Cover the jars but poke small holes in the top for air to circulate.
12. Every other day, saturate soils in jars that are marked “wet,” and moisten soils in jars marked “moist.” At this time, stir the soil/vegetation mixture in each jar.
13. For a period of two weeks, observe the jars daily (or every other day) and record observations. Note changes in water content and the condition of organic matter.

Discuss with the class how light, temperature, and water content affected the amount of organic material left in the soil after 2 weeks. Which jars (conditions) show the most decomposition? Which jars show the least decomposition? Can you rank the jars from the least to most decomposition after 2 weeks? What other changes have been observed in the soil (such as color, ponding, others)?

Once students have discussed their observations, have them design their own optimal decomposer using any combination of the variables in the investigation. Have them justify their choice of conditions and predict how each factor will contribute to decomposition.



Adaptations for Younger and Older Students

For Younger Students

Reduce the number of jars to either:

1. moist, wet, and dry (same temperature and light conditions), or
2. moist, warm and moist, cool (same light conditions).

Discuss the climates across the globe that would have these conditions, and compare them to the climate in your local area.

For Older Students

Discuss and relate how decomposition of organic material varies across the globe. What are the sources of organic material in different areas? How does climate affect how fast the organic material will become humus? Have them speculate on what climate conditions will promote the decomposition of organic material and what will inhibit the decomposition of organic material? How would decomposition in a tropical soil differ from that in a northern forest?

Further Investigations

Using soils with “optimal conditions,” place earthworms in one jar and leave a second jar earthworm-free. Observe and record earthworm activity, rate of decomposition, and differences in soil properties after 2 weeks for each jar. You may also want to create a “worm farm” in a glass jar to observe worm behavior, decomposition, and changes in soil over a longer period of time.

Do a similar experiment as above but vary the soil texture. Include jars with predominantly sandy soil or clayey soil and observe differences as above.

Ask students to research composting.

The Data Game



Purpose

To learn how to estimate data results in order to minimize errors in reading or recording data

Overview

Students participate in a game in which they collect data using various instruments and calculations and then try to fool other data collection teams by exaggerating some of the data numbers. They do this activity first with data describing objects in the classroom, then with soil moisture measurements, and then with other GLOBE data.

Student Outcomes

Students will be able to recognize the accuracy of data.

Students will be able to analyze GLOBE data for outliers and accuracy.

Scientific Inquiry Abilities

- Identify answerable questions.
- Design and conduct an investigation.
- Use appropriate tools and techniques including mathematics to gather, analyze, and interpret data.
- Develop descriptions and explanations, predictions and models using evidence.
- Communicate procedures and explanations.

Time

One class period

Level

All

Materials and Tools

For younger students:

- Rulers
- Measuring tapes
- Measuring cups and spoons

For older students:

- Instruments for measuring:
 - distance
 - volume
 - circumference
 - weight

Prerequisites

None

Background

Scientists rely on the accuracy of the data submitted by schools. However, even the most careful observer can make a mistake in data collection and recording. It is essential to make sure your data are as accurate as possible. One way to avoid mistakes is to have students critically evaluate any number they write down. Does this number sound reasonable? Is it even possible to have this number? As students become more familiar with the measurements they are taking, they will get a feel for what to expect.

There are two elements necessary for students to judge the reasonableness of data values. First, students have to understand the units of measure: About how far is a meter? How much water is a liter? How much does a liter of water weigh? Second, students need to have a sense of the expected range of data values for the protocol: what are the lowest and highest values one might expect for soil water content? For air temperature?

In this activity, your students will deal with both elements in the form of a game. They will work



in groups to collect and record data. Then they change some of the values and have the other students guess which ones are wrong, based on a sense of “reasonableness” of the values.

Using this “reasonableness” criteria is a fundamentally important skill, as it requires students not only to know what values one might expect, but also to take personal responsibility for the accuracy of their data.

It should be stressed that your students may collect accurate data that is unexpected. Estimating what to expect will also help students recognize when their data are unusual and should prompt more investigation.

What To Do and How To Do It

Stage 1 — Estimating data about classroom objects

1. Divide your class into teams of four students. Provide each team with measuring instruments and have the teams collect classroom data. Each team should collect and record 5 to 10 classroom data values.

Beginning students might:

- count the number of books, tiles, fingers, etc. in the classroom
- measure the length of ten books, the room, around a desk, etc.
- measure the amount of water in a glass, the sink, etc.

Intermediate students might:

- measure and add distances (the height of a desk and all the desks in the room)
- calculate the height of all text books piled together.

Advanced students might:

- calculate square meters, cubic centimeters, volume, and weights.
2. Now have each team “disguise” part of their data by exaggerating the numbers. For instance, a cube with a volume of 10 centimeters should be changed to 20 or even 200 centimeters. The less the exaggeration, the greater the challenge

for the other students. (You may want to begin with the rule that the exaggerated value is at least double the measured value.)

3. Each team takes turns reporting their data. The other teams must guess whether or not the report is accurate. Each team that is correct gets one point.
4. After all teams have taken turns reporting their data, the team with the most points wins.
5. At the end of the activity, discuss the process of estimating, and the concept of reasonableness. You might want to repeat this activity to see if the students improve.

Stage 2 — Estimating soil water content data

Your students will apply the same concept to soil moisture (you can play the data game with any type of data). You can use soil moisture data that your students have already collected as part of the protocol, or with soil moisture data from the samples students brought from home as part of the learning activity *Soils as Sponges: How Much Water Does Soil Hold?*

As described in Stage 1 above, have your students change some of the data values for soil water content, and then have other students guess which values are accurate and which are exaggerated. Score as described above.

Stage 3 — Using data from the GLOBE Student Data Server

1. Have the students access the GLOBE Student Data Server to browse through soil water content data that have been gathered by other GLOBE sites. They should find:
 - the range of data for each depth
 - the range of data for schools nearby
 - the range of data for schools in arid regions or forests or grasslands
 - the most common values.
2. Discuss the ranges and common values, and have your students reflect on how this information would help them to do better in the data game.



3. Have your students play the data game again, using global data from the GLOBE Student Data Server.
4. Discuss with your students how this process – reviewing sample data first in order to get a sense of what to expect – is an essential step in estimating values and judging “reasonableness.”
5. You can repeat this activity with any of the GLOBE data sets.
6. It is also important to point out that abnormal data, often called “outliers,” are not necessarily wrong, but certainly need to be looked at closely. Outliers, in fact, are often the most interesting or important data to investigate further.
7. If any of the values in the GLOBE Student Data Server do not seem correct, then have your students send a GLOBEMail or regular e-mail message to the school which submitted the data, and ask the students if there are reasons for the abnormal value or if they might need to take more care in their next measurement. Also send a message to the GLOBE Help Desk or the Chief Scientist.

Adaptations for Intermediate and Advanced Students

With older students, you can have them try the same activity with soil texture or color to identify how variable these properties can appear from one student to another. Differences between soil texture measured in the field and the texture class determined by the particle size distribution method are also good places to look for differences in the same data measurement obtained by 2 different methods.

Students can also graph data (especially in Stage 3), and then do an analysis of the range, the outliers, the average values, the most common values, and so on. They might also discuss why there are variations from one site to another in the global data set. This in turn relies on a deeper understanding of the science domain, such as soil.

Further Investigations

Whenever your students have problems knowing what are typical values for a protocol, you can have them play the data game. Be sure they review the protocol and sample data sets first so that they will have a basis for assessing reasonableness.

On a regular basis, review the soil water content, soil texture, and other data submitted by other schools to look for errors or outliers, and communicate with the schools by GLOBEMail or regular e-mail to discuss any abnormal values.

Student Assessment

Periodically, when your students do the GLOBE protocols, have one of your students announce the values to the class, including an erroneous value, and see if any other students notice the error. You could reward the error-finding with a GLOBE star or other reward appropriate to the age level. Make sure that the error is corrected before your students submit the data to GLOBE!

Appendix

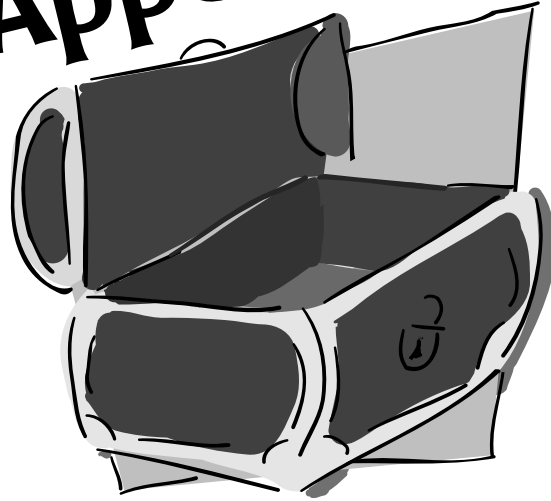

Soil Characterization Site Definition Sheet

Soil Characterization Data Sheet

Soil Temperature Data Sheet

Soil Moisture Site Definition Sheet

Soil Moisture Data Sheet – Star Pattern

Soil Moisture Data Sheet – Transect Pattern

Soil Moisture Data Sheet – Depth Profile

Bulk Density Data Sheet

Soil Particle Density Data Sheet

Soil Particle Size Distribution Data Sheet

Soil pH Data Sheet

Soil Fertility Data Sheet

Digital Multi-Day Soil Thermometer Calibration and Reset Data Sheet

Digital Multi-Day Soil Thermometer Data Sheet

Daily Soil Moisture Sensor Data Sheet

Biannual Soil Moisture Sensor Calibration Data Sheet

Soil Infiltration Data Sheet

Textural Triangle

Glossary

Soil Investigation

Soil Characterization Site Definition Sheet

Study Site Name: SCS-_____

Location: Latitude: _____° N or S Longitude: _____° E or W

Elevation: ___ meters Slope: _____° Aspect: _____°

Source of Location Data (check one): GPS Other _____

Method (choose one):

- Pit
- Auger
- Near Surface

Is Soil Characterization site:

- On School Grounds
- Off School Grounds

Site Location (choose one):

- Near the Soil Moisture Study Site
- Near the Soil Moisture and Atmospheric Study Sites
- Near the Atmosphere Study Site
- In the Biology Study Site
- Other _____

Landscape Position (choose one):

- A. Summit
- B. Slope
- C. Depression
- D. Large Flat Area
- E. Stream Bank

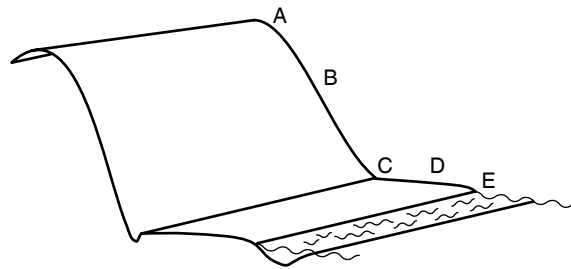

Cover Type:

- Bare Soil
- Rocks
- Grass
- Shrubs
- Trees
- Other _____

Parent Material:

- Bedrock
- Organic Material
- Construction Material
- Marine Deposits
- Lake Deposits
- Stream Deposits (Alluvium)
- Wind Deposits (Loess)
- Glacial Deposits (Glacial Till)
- Volcanic Deposits
- Loose Materials on Slope
- Other _____

Land Use:

- Urban
- Agricultural
- Recreation
- Wilderness
- Other _____

Distance from Major Features (up to 50 meters): _____

Other Distinguishing Characteristics of this Site: _____

Soil Investigation

Soil Characterization Data Sheet

Date of Characterization: _____ Local Time of Characterization: _____ (Hours:Min) UT of Characterization: _____ (Hours:Min)

Study Site: SCS-_____ Method (choose one): ___ Pit ___ Auger ___ Near Surface

Horizon Number	Top Depth (cm)	Bottom Depth (cm)	Moisture Status (wet, dry, moist)	Structure (granular, blocky, platy, prismatic, columnar, single grained, massive)	Main Color (code from color book)	Second Color (code from color book)	Consistence (loose, friable, firm, extremely firm)	Texture (sand, loamy sand, sandy loam, sandy clay loam, silty clay loam, silty clay loam, clay loam, clay)	Rocks (none, few, many)	Roots (none, few, many)	Carbonates (none, slight, strong)

Soil Investigation

Soil Temperature Data Sheet

Study Site: _____

Name of Collector/Analyst/Recorder: _____

Date: _____

Soil Thermometer: Dial _____ Digital _____ Other _____

Has there been precipitation within the last 24 hours? Yes _____ No _____

Daily/Weekly Measurements

Sample No.	Time		Temperature		
	(hr)	(min)	5 cm (° C)	10 cm (° C)	Air (° C)
1	_____	_____	_____	_____	_____
2	_____	_____	_____	_____	_____
3	_____	_____	_____	_____	_____

Diurnal Cycle Measurements

Sample No.	Time		Temperature		
	(hr)	(min)	5 cm (° C)	10 cm (° C)	Air (° C)
1	_____	_____	_____	_____	_____
2	_____	_____	_____	_____	_____
3	_____	_____	_____	_____	_____
4	_____	_____	_____	_____	_____
5	_____	_____	_____	_____	_____
6	_____	_____	_____	_____	_____
7	_____	_____	_____	_____	_____
8	_____	_____	_____	_____	_____

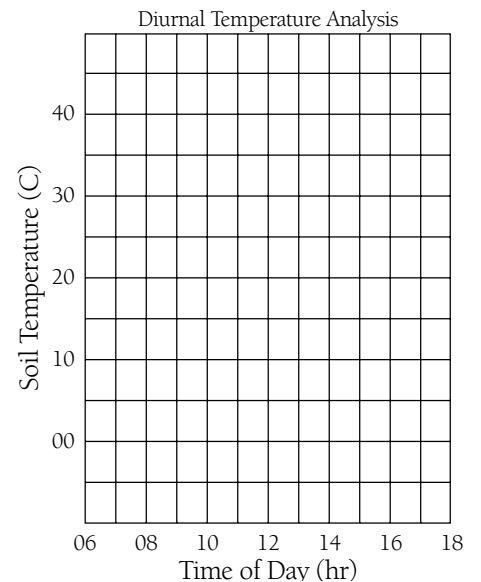

Daily Metadata/Comments: _____

Soil Investigation

Soil Moisture Site Definition Sheet

Create a unique name for your site and give concise directions to it.

Study Site: _____

Directions: _____

Location: Latitude: _____ ° N or S Longitude: _____ ° E or W

Elevation: ____ meters

Source of Location Data (check one): GPS Other _____

Site Metadata

Distance to nearest rain gauge or instrument shelter: _____ m; Direction _____

Distance to nearest Soil Characterization Sample Site: _____ m; Direction _____

State of Soil Moisture Study Site:

Natural Plowed Graded Backfill Compacted Other _____

Surface Cover:

Bare Soil Short grass (<10 cm) Long grass (10 cm) Other _____

Canopy Cover:

Open Canopy Overhead _____

Some Trees or Structures within 30 m: No Yes (describe size) _____

Soil Characterization:

(Soil characterization data will help you understand the soil moisture data. You may take these values from the appropriate horizon of the soil characterization data worksheet for A Soil Characterization Study site within 100 m. Otherwise we recommend you complete a soil characterization data worksheet for this site.)

	0-5 cm	10 cm	30 cm	60 cm	90 cm
Structure	_____	_____	_____	_____	_____
Color	_____	_____	_____	_____	_____
Consistence	_____	_____	_____	_____	_____
Texture	_____	_____	_____	_____	_____
Rocks	_____	_____	_____	_____	_____
Roots	_____	_____	_____	_____	_____
Carbonates	_____	_____	_____	_____	_____
Bulk Density	_____	_____	_____	_____	_____

Soil Particle Size Distribution:

% Sand	_____	_____	_____	_____	_____
% Silt	_____	_____	_____	_____	_____
% Clay	_____	_____	_____	_____	_____

Collector's comments:

Site Sketch:

(Scale 1 square = _____)

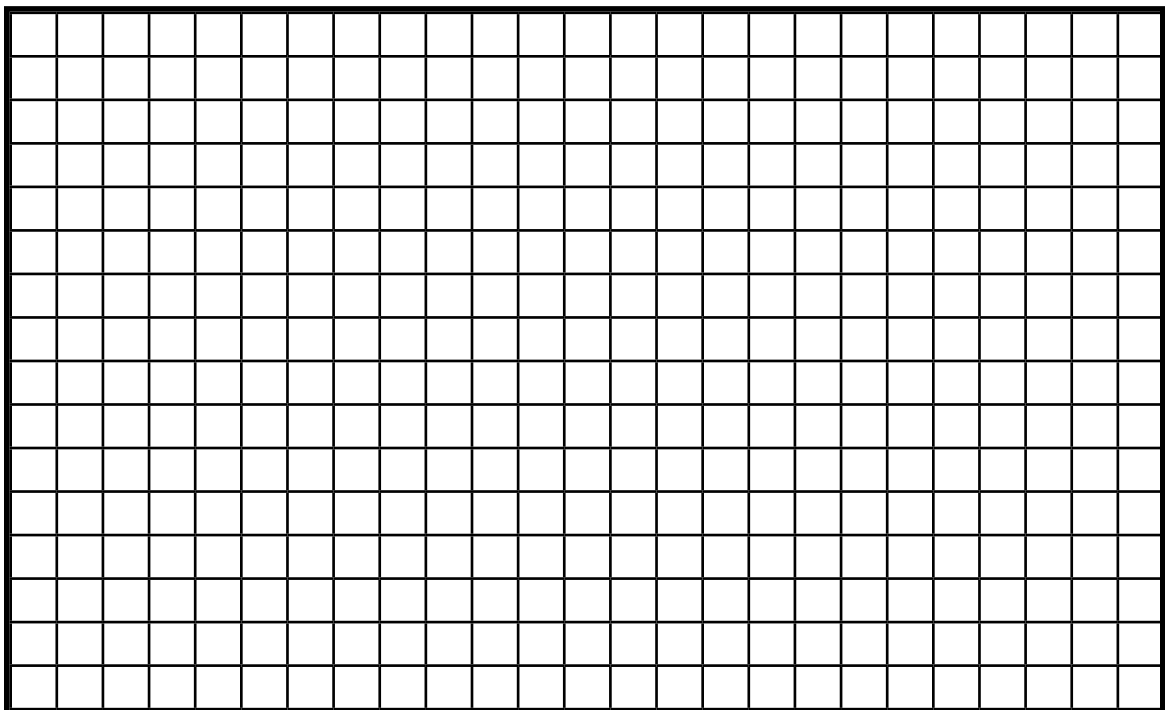

Soil Investigation

Soil Moisture Data Sheet - Star Pattern

Study Site: SMS-_____

Observer names: _____

Date samples collected: Year: _____ Month: _____ Day: _____

Local Time: ____:____ (Hours:Min) UT: ____:____ (Hours:Min)

Current Conditions: Is surface soil saturated? Yes No

Drying Method: (check one) 95-105° C oven 75-95° C oven microwave

Average drying time: Hours/minutes_____

Bearing from Star Center (optional): _____ Distance from Star Center: _____

Observations: _____

Near-Surface Samples:

		A	B	C	(A-B)/(B-C)
0-5 cm	Container ID#	Mass of wet soil and container (wet mass) (g)	Mass of dry soil and container (dry mass) (g)	Mass of empty container (g)	Soil Water Content (from calculations) (g/g)
Sample 1					
Sample 2					
Sample 3					

		A	B	C	(A-B)/(B-C)
10 cm	Container ID#	Mass of wet soil and container (wet mass) (g)	Mass of dry soil and container (dry mass) (g)	Mass of empty container (g)	Soil Water Content (from calculations) (g/g)
Sample 1					
Sample 2					
Sample 3					

Soil Investigation

Soil Moisture Data Sheet - Transect Pattern

Study Site: SMS-_____

Observer names: _____

Date samples collected: Year: _____ Month: _____ Day: _____

Local Time: ____:____ (Hours:Min) UT: ____:____ (Hours:Min)

Current conditions: Is soil saturated? Yes No

Drying method: (check one) 95-105° C oven 75-95° C oven microwave

Average drying time: Hours/minutes _____

Daily Metadata: (optional)

Length of Line: _____ m Compass Bearing: _____ Station Spacing: _____ m

Directions:

Transects should be 50 m long, located in an open field. Measurements are made 12 times/yr. during a regular interval of your choice. Enter the data for your samples collected between 0-5 cm (10 single samples plus 1 triple sample):

Observations:

Sample Number	Offset from end of Transect (m)	Container ID#	A	B	C	(A-B)/(B-C)
			Mass of wet soil and container (wet mass) (g)	Mass of dry soil and container (dry mass) (g)	Mass of empty container (g)	Soil Water Content (from calculations) (g/g)
1						
2						
3						
4						
5						
6						
7						
8						
9						
10						
11						
12						
13						

Soil Investigation

Soil Moisture Data Sheet - Depth Profile

Study Site: SMS-_____

Observer names: _____

Date samples collected: Year: _____ Month: _____ Day: _____

Local Time: ____:____ (Hours:Min) UT: ____:____ (Hours:Min)

Current Conditions: Is surface soil saturated? Yes No

Drying Method: (check one) 95-105° C oven 75-95° C oven microwave

Average drying time: Hours/minutes_____

Bearing from Star Center (optional): _____ Distance from Star Center: _____

Observations: _____

Depth Samples:

		A	B	C	(A-B)/(B-C)
Sample Depth	Container ID#	Mass of wet soil and container (wet mass) (g)	Mass of dry soil and container (dry mass) (g)	Mass of empty container (g)	Soil Water Content (from calculations) (g/g)
0-5 cm					
10 cm					
30 cm					
60 cm					
90 cm					

Soil Investigation

Bulk Density Data Sheet

Note: All measurements are done without the can lid!!

Date of sample collection: Year _____ Month _____ Day _____

Study Site: SCS- _____

Horizon Number: _____, Horizon Depth: Top _____cm, Bottom _____cm

	Sample Number		
	1	2	3
A Container #			
B Wet mass of soil and container (g)			
C Dry mass of soil and container (g)			
D Container volume (mL)			
E Container mass (g)			
F Mass of rocks (g)			
G Volume of water without rocks (mL)			
H Volume of water with rocks (mL)			
I Mass of dry soil (g) = C-E			
J Volume of rocks (mL) = H-G			
K Bulk Density (g/mL) = $\frac{I-F}{D-J}$			

Soil Investigation

Soil Particle Density Data Sheet

Note: All measurements should be made without the stopper/cap!!

Date soil is mixed with water: year _____ month _____ day _____

Study Site: _____

Horizon number: _____

How has the soil been stored since it came out of the oven? _____

Length of time since the soil was dried in the oven: _____

Other comments: _____

		Sample Number		
		1	2	3
Mass of empty flask (g)	(B below)			
Mass of soil + empty flask (g)	(A below)			
Mass of water + soil + flask (g)	(D below)			
Water Temperature (°C)	(F below)			

Calculation Work Sheet

		Sample Number		
		1	2	3
A	Mass of soil + empty flask (g)			
B	Mass of empty flask (g)			
C	Mass of soil (g) (A – B)			
D	Mass of water + soil + flask (g)			
E	Mass of water (D – A)			
F	Water Temperature (°C)			
G	Density of water (g/mL) (approximately 1.0)			
H	Volume of water (mL) (E/G)			
I	Volume of soil (mL) (100 mL – H)			
J	Soil particle density (g/mL) (C/I)			

Soil Investigation

Soil Particle Size Distribution Data Sheet

Date of sample collection: Year _____ Month _____ Day _____

Study Site: _____

Horizon Number: _____ Horizon Depth: Top _____ cm Bottom _____ cm

Sample Number 1

Distance from 500 mL mark to base of graduated cylinder: _____ cm

Hydrometer Calibration Temperature: _____ °C

A. 2 minute hydrometer reading: _____ C. 24 hour hydrometer reading: _____

B. 2 minute temperature: _____ °C D. 24 hour temperature: _____ °C

Sample Number 2

Distance from 500 mL mark to base of graduated cylinder: _____ cm

Hydrometer Calibration Temperature: _____ °C

A. 2 minute hydrometer reading: _____ C. 24 hour hydrometer reading: _____

B. 2 minute temperature: _____ °C D. 24 hour temperature: _____ °C

Sample Number 3

Distance from 500 mL mark to base of graduated cylinder: _____ cm

Hydrometer Calibration Temperature: _____ °C

A. 2 minute hydrometer reading: _____ C. 24 hour hydrometer reading: _____

B. 2 minute temperature: _____ °C D. 24 hour temperature: _____ °C

Soil Investigation

Soil pH Data Sheet

Date of sample collection: _____ Study Site: _____

Horizon Number: _____ Horizon Depth: Top _____ cm, Bottom _____ cm

Sample Number 1 – pH Measurement method (check one): paper meter

pH of soil and water mixture _____

Sample Number 2 – pH Measurement method (check one): paper meter

pH of soil and water mixture _____

Sample Number 3 - pH Measurement method (check one): paper meter

pH of soil and water mixture _____

Horizon Number: _____ Horizon Depth: Top _____ cm, Bottom _____ cm

Sample Number 1 – pH Measurement method (check one): paper meter

pH of soil and water mixture _____

Sample Number 2 – pH Measurement method (check one): paper meter

pH of soil and water mixture _____

Sample Number 3 - pH Measurement method (check one): paper meter

pH of soil and water mixture _____

Horizon Number: _____ Horizon Depth: Top _____ cm, Bottom _____ cm

Sample Number 1 – pH Measurement method (check one): paper meter

pH of soil and water mixture _____

Sample Number 2 – pH Measurement method (check one): paper meter

pH of soil and water mixture _____

Sample Number 3 - pH Measurement method (check one): paper meter

pH of soil and water mixture _____

Soil Investigation

Soil Fertility Data Sheet

Date of Sample Collection: _____ Study Site: _____

Horizon Number: _____ Horizon Depth: Top _____ cm Bottom _____ cm

Sample Number 1

Nitrate (N):

High__ Med__ Low__ None__

Phosphorus (P):

High__ Med__ Low__ None__

Potassium (K):

High__ Med__ Low__ None__

Sample Number 2

Nitrate (N):

High__ Med__ Low__ None__

Phosphorus (P):

High__ Med__ Low__ None__

Potassium (K):

High__ Med__ Low__ None__

Sample Number 3

Nitrate (N):

High__ Med__ Low__ None__

Phosphorus (P):

High__ Med__ Low__ None__

Potassium (K):

High__ Med__ Low__ None__

Date of Sample Collection: _____ Study Site: _____

Horizon Number: _____ Horizon Depth: Top _____ cm Bottom _____ cm

Sample Number 1

Nitrate (N):

High__ Med__ Low__ None__

Phosphorus (P):

High__ Med__ Low__ None__

Potassium (K):

High__ Med__ Low__ None__

Sample Number 2

Nitrate (N):

High__ Med__ Low__ None__

Phosphorus (P):

High__ Med__ Low__ None__

Potassium (K):

High__ Med__ Low__ None__

Sample Number 3

Nitrate (N):

High__ Med__ Low__ None__

Phosphorus (P):

High__ Med__ Low__ None__

Potassium (K):

High__ Med__ Low__ None__

Date of Sample Collection: _____ Study Site: _____

Horizon Number: _____ Horizon Depth: Top _____ cm Bottom _____ cm

Sample Number 1

Nitrate (N):

High__ Med__ Low__ None__

Phosphorus (P):

High__ Med__ Low__ None__

Potassium (K):

High__ Med__ Low__ None__

Sample Number 2

Nitrate (N):

High__ Med__ Low__ None__

Phosphorus (P):

High__ Med__ Low__ None__

Potassium (K):

High__ Med__ Low__ None__

Sample Number 3

Nitrate (N):

High__ Med__ Low__ None__

Phosphorus (P):

High__ Med__ Low__ None__

Potassium (K):

High__ Med__ Low__ None__

Soil Investigation

Digital Multi-Day Soil Thermometer Calibration and Reset Data Sheet

School Name: _____ Study Site: _____

Observer Names: _____

Calibration

<i>Thermometer Readings</i>						
Reading Number	Date (yy/mm/dd)	Local Time (hour:min)	Universal Time (hour:min)	Calibration Thermometer Readings (°C)	Digital 5 cm Sensor Readings (°C)	Digital 50 cm Sensor Readings (°C)
1						
2						
3						
4						
5						

Time of Reset

Note: The thermometer should be reset only when it is first setup, after the battery is changed, or if the time of local solar noon drifts to more than one hour from your *time of reset*.

Date: _____ Local time (Hour:Min) _____ Universal time (Hour:Min) _____

Was the reset due to a battery change? _____

5 cm Sensor Check

<i>Thermometer Readings</i>					
Reading Number	Date (yy/mm/dd)	Local Time (hour:min)	Universal Time (hour:min)	Soil Probe Thermometer Readings at 5 cm (°C)	Digital 5 cm Sensor Readings (°C)
1					
2					
3					
4					
5					

Soil Investigation

Digital Multi-Day Soil Thermometer Data Sheet

School Name: _____ Study Site: _____

Observer Names: _____

Date: Year _____ Month _____ Day _____

Local time (Hour:Min) _____ Universal time (Hour:Min) _____

Your *Time of Reset* in universal time (Hour:Min): _____

Current Temperatures

5 cm soil temperature (°C): _____

50 cm soil temperature (°C): _____

Maximum, Minimum Temperatures

Do not read the thermometer within 5 minutes of your *time of reset*.

	Label on Digital Display Screen					
	D1	D2	D3	D4	D5	D6
Maximum 5 cm Temperature (°C)						
Minimum 5 cm Temperature (°C)						
Maximum 50 cm Temperature (°C)						
Minimum 50 cm Temperature (°C)						
If you are reading thermometer AFTER your <i>time of reset</i> : Correspond to 24-hour Period Ending:	Today	Yesterday	Two days ago	Three days ago	Four days ago	Five days ago
If you are reading thermometer BEFORE your <i>time of reset</i> : Correspond to 24-hour Period Ending:	Yesterday	Two days ago	Three days ago	Four days ago	Five days ago	Six days ago

Soil Investigation

Daily Soil Moisture Sensor Data Sheet

School Name: _____

Study Site: _____

Date you started to use this SWC calibration curve: _____

Type of Sensor: Watermark Block/Delmerhorst meter Watermark Block/Irrrometer Watermark meter

Watermark Block/Spectrum Watchdog (logger) Other

Observations:

Measurement			Is the soil saturated? Yes or No	Observers' Names	Soil Moisture Meter Readings				SWC from Calibration Curve			
#	Date	Time (UT)			10 cm	30 cm	60 cm	90 cm	10 cm	30 cm	60 cm	90 cm
1												
2												
3												
4												
5												
6												
7												
8												
9												
10												

Calibration Curve

(created following the *Creating a Calibration Curve Lab Guide*)

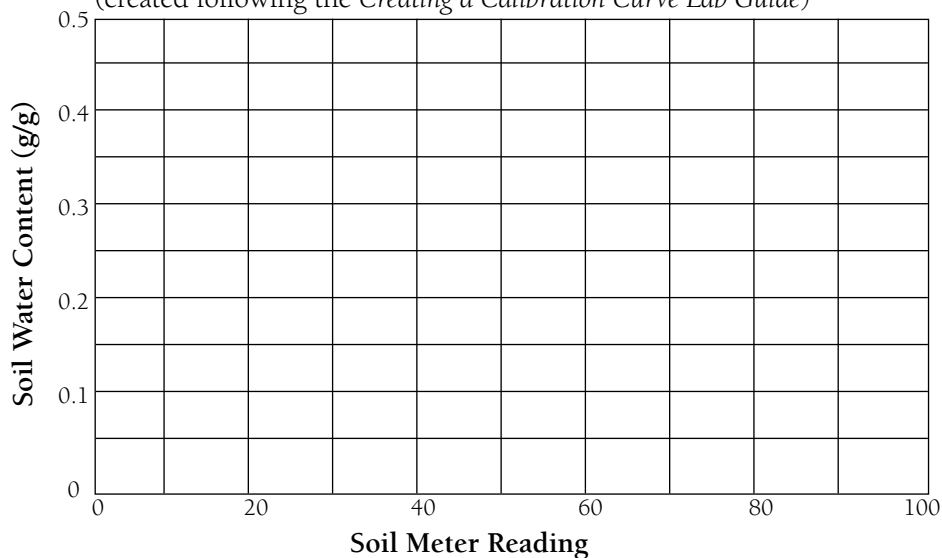

Soil Investigation

Biannual Soil Moisture Sensor Calibration Data Sheet

School Name: _____

Study Site: _____

Drying Method (check one): 95-105 °C oven ____; 75-95 °C oven ____; microwave ____

Average Drying Time: _____ (hours or minutes)

Depth (Check one): 10 cm 30 cm 60 cm 90 cm

Observations:

#	Measurement						G. Soil Moisture Meter Reading				
	Date	Local Time Hour:min	Time (UT)	Observers' Names	A. Wet Mass (g)	B. Dry Mass (g)		C. Water Mass (A-B)	D. Can Mass (g)	E. Dry Soil Mass (B-D)	F. Soil Water Content (C/E) Reading
1											
2											
3											
4											
5											
6											
7											
8											
9											
10											

Soil Investigation

Biannual Soil Moisture Sensor Calibration Data Sheet – Continued

School Name: _____

Study Site: _____

Depth (Check one): 10 cm 30 cm 60 cm 90 cm

Observations:

#	Measurement						A. Wet Mass (g)	B. Dry Mass (g)	C. Water Mass (A-B)	D. Can Mass (g)	E. Dry Soil Mass (B-D)	F. Soil Water Content (C/E) Reading	G. Soil Moisture Meter Reading
	Date	Local Time Hour:min	Time (UT)	Observers' Names									
11													
12													
13													
14													
15													
16													
17													
18													
19													
20													

Soil Investigation

Soil Infiltration Data Sheet

Site Name: _____

Name of Collector/Analyst/Recorder: _____

Sample collection

- date: _____
- time: _____ (hours and minutes) check one: UT _____ Local _____

Distance to Soil Moisture Site _____ m

Sample Set number: _____ Width of your reference band: _____ mm

Diameter: Inner Ring: _____ cm Outer Ring: _____ cm

Heights of reference band above ground level: Upper : _____ mm Lower : _____ mm

Directions:

Take 3 sets of infiltration rate measurements within a 5 m diameter area. Use a different data work sheet for each set. Each set consists of multiple timings of the same water level drop or change until the flow rate becomes constant or 45 minutes is up. Record your data below for one set of infiltration measurements you take.

The form below is setup to help you calculate the flow rate.

For data analysis, plot the Flow Rate (F) vs. Midpoint time (D).

Observations:

	A. Start	B. End	C. Interval	D. Midpoint	E. Water Level Change	F. Flow Rate
	(min) (sec)	(min) (sec)	(min) (B-A)	(min) (A+C/2)	(mm)	(mm/min) (E/C)
1	_____	_____	_____	_____	_____	_____
2	_____	_____	_____	_____	_____	_____
3	_____	_____	_____	_____	_____	_____
4	_____	_____	_____	_____	_____	_____
5	_____	_____	_____	_____	_____	_____
6	_____	_____	_____	_____	_____	_____
7	_____	_____	_____	_____	_____	_____
8	_____	_____	_____	_____	_____	_____
9	_____	_____	_____	_____	_____	_____

Saturated Soil Water Content below infiltrometer after the experiment:

A. Wet Weight: _____ g B. Dry Weight: _____ g C. Water Weight (A-B): _____ g

D. Container Weight: _____ g E. Dry Soil Weight (B-D): _____ g

F. Soil Water Content (C/E) _____

Daily Metadata/Comments: (optional) _____

Soil Investigation

Textural Triangle 3

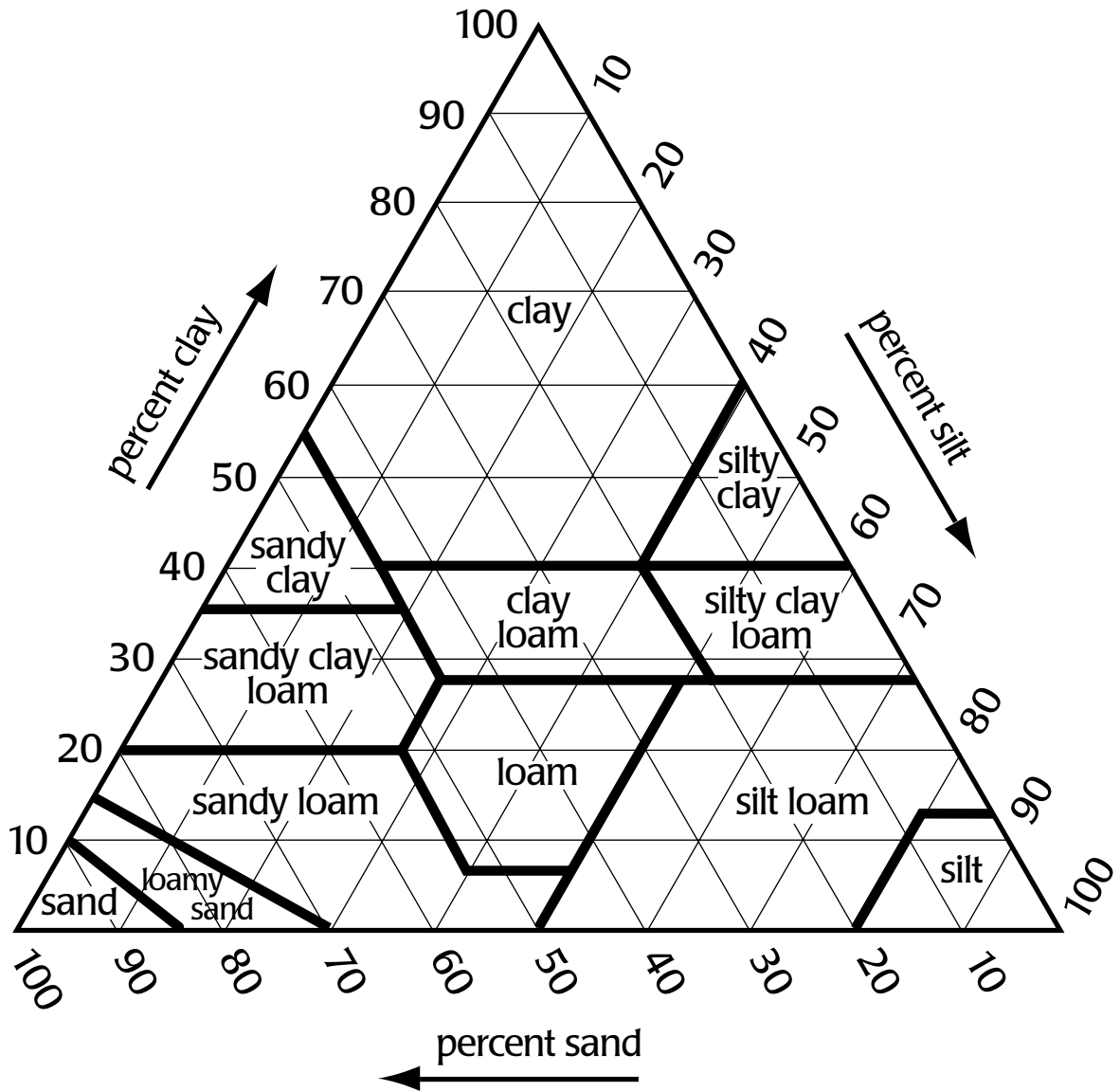

Glossary

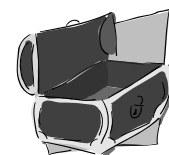

Acid Soil

A soil that contains more hydrogen ions than hydroxide ions and therefore has a pH less than 7.0

Alluvium

Sediment transported by flowing water (e.g. a stream)

Anomaly

Something irregular or abnormal

Basic Soil

A soil that contains more hydroxide ions than hydrogen ions and therefore has a pH greater than 7.0

Blocky Structure

Irregular block-like soil peds that are usually 0.5 cm to 5.0 cm in diameter

Bulk Density

Mass of dry soil per unit volume (expressed in GLOBE as grams per cubic centimeter)

Chroma

When referenced to hue, the level of saturation of a color

Clay

A mineral particle <.002 mm in size that has a “sticky and dense” feel when moistened and rubbed between the fingers

Columnar Structure

A type of soil structure where the soil peds (or chunks) are in the shape of a column with a rounded top. Columnar structure is found in arid regions and generally ranges between 1 and 10 cm long.

Concretion

A cemented mass of a chemical compound, such as iron oxide or calcium carbonate, that can be removed intact from the soil

Consistence

How easy or hard it is for a soil ped to break apart when it is squeezed

Cryoturbation

Process of freezing, thawing, and churning of a soil

Diurnal cycle

A daily cycle, a basic repetition period of 24 hours. All processes that are dominated by the sun are diurnal. Tides, in contrast, repeat cycles twice daily.

Effervescence

The bubbling action that occurs as a gas comes out of a liquid such as when carbon dioxide gas is produced by the reaction of carbonate coatings on soil being treated with an acid like vinegar

Eluviation

The removal of materials from one horizon which are then “illuviated” or deposited into a lower horizon

Erosion

The removal and movement of soil materials by water, wind, ice, or gravity as well as by human activities such as agriculture or construction

Evaporation

Water on Earth’s surface or in the soil absorbs heat from the sun to the point that it changes from a liquid to a gas and moves into the atmosphere

Extremely Firm

A type of soil consistence in which soil peds require extreme pressure, requiring the use of a tool (e.g., a hammer), to break

Face

The way an exposed section of soil or soil profile appears

Fertility

The ability of a soil to supply the elements and compounds needed for plant growth

Fill

Soil, rock, or other material that has been added to a site for construction purposes usually to bring the surface to a certain level

Firm

A type of soil consistence in which the soil peds require significant pressure before breaking



Floury

Having the feel of finely ground flour
– smooth and powdery

Free Carbonates

Carbonate materials that form coatings on soil that react with an acid, such as vinegar, to form carbon dioxide gas

Freeze-thaw

The mechanical break up of rock caused by the expansion of freezing water in cracks and crevices

Friable

A type of soil consistence in which the soil ped breaks easily when squeezed between the thumb and fore finger with a small amount of pressure

Glacial Till

Sediment deposited from a glacier

Granular Structure

Roundish soil peds with an appearance like “cookie crumbs” that are usually less than 1.0 cm in diameter

Gravimetric

Analysis of soil moisture that depends on weighing the soil in a moist and dry state and determining the difference

Ground Water

Water stored underground in a saturated zone of rock, sand, gravel or other material

Heat Capacity

The ratio of the heat required to raise the temperature of a unit volume of soil by one degree

Horizon

An individual layer within the soil which has its own unique characteristics (such as color, structure, texture, or other properties) that make it different from the other layers in the soil profile

Hue

A particular color as distinguished from other colors on the color wheel

Humus

The part of the soil profile that is composed of decomposed organic matter from dead and decaying plants and animals and is usually dark colored

Hydrometer

An instrument based on the principles of buoyancy used to measure the specific gravity of a liquid containing suspended soil particles in relation to the specific gravity of pure water at a specified temperature

Illuviation

The deposit of materials carried by water from one horizon into another within the soil (such as clay or nutrients)

Infiltration

Downward entry of water into the soil

In situ

Location at a particular site

Leaching

Removal of soluble material in solution from the soil by the movement of water through the soil

Lithosphere

The outer layer of soil and rock on a planet is called the “lithosphere” after the Greek word “lithos” meaning “stone.”

Litter

Leaves, needles, twigs, branches, stems, or fruits covering the soil from the surrounding trees in a forest

Loam

Soil that contains an approximately equal amount of sand, silt, and clay particles.

Loess

Fine sediment transported by wind

Loose

A type of soil consistence in which the soil grains do not stick to one another (i.e. structure is single grained).

Massive Structure

A structureless soil in which all soil particles are stuck together and there are no distinct peds

Metadata

Data about data. Soil moisture data requires metadata describing the vegetation cover and possible sources of water in order to be interpreted properly.

**Mottles**

Streaks of spots of different colors in a soil interspersed with the dominant soil color, usually indicating poor drainage

Organic Matter

Decomposed animal or plant material that is added to the soil and becomes a part of the soil profile. When it is fully decomposed and incorporated into the soil, organic matter becomes a dark, moist, nutrient rich substance called humus and the plant and animal material from which it formed can no longer be recognized

Particle Density

The mass per unit volume of soil particles, excluding pore space

Particle Size Distribution

The amount (percent) of each of sand, silt, and clay in a soil sample

Ped

An individual unit of natural soil structure or aggregation (such as granular, blocky, columnar, prismatic, or platy)

Pedosphere

The thin outer layer of the Earth which is made up of soil. The pedosphere acts as an integrator between the atmosphere, biosphere, lithosphere, and hydrosphere of the Earth.

Permafrost

A continuously frozen soil horizon

pH

Measure of the acidity of a soil

Platy Structure

Flat, plate-like soil peds

Porosity

Percentage of soil volume not occupied by solid material

Prismatic Structure

A type of soil structure in which the soil ped is in the shape of a prism, generally ranging from 1.0 – 10.0 cm

Profile

The “face” of a soil when it has been cut vertically that shows the individual horizons and soil properties with depth

Runoff

Water that falls on the land surface but does not infiltrate and therefore flows across the land surface

Sand

A mineral particle between 0.05 and 2.0 mm in size that has a “gritty” feel when moistened and rubbed between the fingers

Saturation

When the pores of a soil are completely filled with water

Single Grained Structure

A structureless soil in which each soil grain is individual and loose in the soil (i.e. there are no peds)

Silt

A mineral particle between 0.002 and 0.05 mm in size that has a “floury, smooth” feel when moistened and rubbed between the fingers

Soil Profile

The “face” of a soil when it has been cut vertically that shows the individual horizons and soil properties with depth

Soil Water Content (SWC)

A measure of how much water is present in the pores of a soil, specifically, the ratio of the mass of water to the mass of dry soil.

Structure

The shape of soil units (peds) that occur naturally in a soil horizon. Some possible soil structures are granular, blocky, prismatic, columnar, or platy. Soils can also be structureless if they do not form into peds. In this case, they may be a consolidated mass (massive) or stay as individual particles (single grained).

Subsoil

The common term for the layers beneath the topsoil

Supernatant

When soil particles are suspended and allowed to settle, the liquid above the settled soil is cleaner than the soil below



Texture

The way soil “feels” when it is squeezed between the fingers or in the hand. The texture depends on the amount of sand, silt, and clay in the sample (particle size distribution), as well as other factors (how wet it is, how much organic matter is in the sample, the kind of clay, etc.)

Topsoil

The common term for the top layer of soil

Transect

In any field (outdoor) study, a transect consists of a line of study, often divided into intervals where observations or samples are collected.

Transpiration

The transfer of water as a gas from plant leaves to the atmosphere through the stomates

Uniform

This term is used in its traditional sense when characteristics display similar properties. Two related words are homogeneous (distributed evenly) and normal (distributed about a central mean value and described by a statistical equation).

Value

When referenced to hue, an indication of the lightness of a color

Volatilization

Evaporation of water vapor or other gases from the soil

Water Erosion

The wearing away of the land surface by water creating the detachment and movement of soil from one location to another.

Wind Erosion

The wearing away of the land surface by wind creating the detachment and movement of soil from one location to another