Report of the
Secretary of Defense Task Force on
DoD Nuclear Weapons Management



Phase II:
Review of the DoD Nuclear Mission

December 2008

Secretary of Defense Task Force on DoD Nuclear Weapons Management

Chairman

The Honorable James R. Schlesinger

Task Force Members

General Michael P.C. Carns, USAF (Ret)

The Honorable J. D. Crouch II

The Honorable Jacques S. Gansler

Admiral Edmund P. Giambastiani, Jr., USN (Ret)

The Honorable John J. Hamre

The Honorable Franklin C. Miller

Mr. Christopher A. Williams

Executive Director

Dr. James A. Blackwell, Jr.



SECRETARY OF DEFENSE
TASK FORCE ON DOD NUCLEAR WEAPONS MANAGEMENT
1901 SOUTH BELL STREET, CRYSTAL MALL 4, SUITE 900-D, ARLINGTON, VA 22202-4521
PHONE: (703) 602-1450 FAX: (703) 602-0968

18 December 2008

The Honorable Robert M. Gates
Secretary of Defense
1000 Defense Pentagon
Washington, DC 20301-1000

Dear Mr. Secretary:

The Task Force, which you appointed in June, is pleased to submit its Phase II report on the nuclear mission in the DoD as a whole. As you well know, deterrence itself is as old as human conflict. Deterrence is not uniquely nuclear—though, due to the prominence of nuclear weapons in the Cold War, it became so identified in the minds of many. Since the end of the Cold War, the domain of nuclear weapons in our overall military posture has been circumscribed—reflected in changes in doctrine and a sharp reduction in both the number of weapons deployed and in the size of the stockpile. DoD spending on nuclear capabilities has shrunk to just two percent of the budget.

Nevertheless, nuclear weapons remain unique in their destructive power—and thus in their physical, military, and political effects. Moreover, they are unique in that the goal of our nuclear deterrent is to persuade others not to employ weapons of mass destruction against the United States or its interests. Thus, if our nuclear deterrent is sufficiently impressive and persuasive, the weapons themselves will not have to be employed in combat.

Within the DoD as a whole, the Task Force detected some of the same forces at work as were discerned in the case of the Air Force: loss of attention and focus, downgrading, dilution, and dispersal of officers and personnel. This reflected a failure to appreciate the larger role of deterrence—as opposed to warfighting capability. Consequently, both the Services and individual commands have diverted resources away from sustaining the deterrent to other purposes, which appeared more pressing.

Leadership on deterrence must come from the higher levels of the DoD and from the White House—to underscore the continuing role of deterrence, even as we hope that those capabilities will not have to be employed in combat. Some in the Services and Commands no longer adequately appreciate the larger political and psychological aspects of deterrence. Consequently, some capabilities have been weakened and some have been consciously undermined in the desire to remove a particular element from the force structure. But deterrence is a larger national and international mission; it cannot be viewed solely in terms of “military cost-effectiveness.”

To be sure, in the future our nuclear posture may be further reduced through negotiation. If that were to transpire, some elements of our nuclear posture might be eliminated. But that should be a reflection of policy decisions at the highest level rather than a result of Service preferences or budgetary concerns.

Still, however circumscribed its present role and whatever its future size, the Department must make sure that the resulting array of forces is seen to be sufficiently impressive to continue to deter possible antagonists and to reassure our allies.

The members of the Task Force are grateful that you have given us this opportunity and responsibility.

Respectfully yours,

A handwritten signature in black ink that reads "James Schlesinger".

James Schlesinger
Chairman

CHAIRMAN
THE HONORABLE JAMES R. SCHLESINGER

TASK FORCE MEMBERS
THE HONORABLE J. D. CROUCH II
THE HONORABLE JOHN J. HAMRE

EXECUTIVE DIRECTOR
DR. JAMES BLACKWELL

GENERAL MICHAEL P. C. CARNS, USAF (Ret)
ADMIRAL EDMUND P. GIAMBASTIANI, JR., USN (Ret)
MR. CHRISTOPHER A. WILLIAMS

THE HONORABLE JACQUES S. GANSLER
THE HONORABLE FRANKLIN C. MILLER



SECRETARY OF DEFENSE
TASK FORCE ON DOD NUCLEAR WEAPONS MANAGEMENT
 1901 SOUTH BELL STREET, CRYSTAL MALL 4, SUITE 900-D, ARLINGTON, VA 22202-4521
 PHONE: (703) 602-1450 FAX: (703) 602-0968

18 December 2008

The Honorable Robert M. Gates
 Secretary of Defense
 Department of Defense
 1000 Defense Pentagon
 Washington, DC 20301

Dear Mr. Secretary:

We, the appointed members of the Task Force on Nuclear Weapons Management, pursuant to our charter, do hereby submit the results of our findings on the second phase of our effort. This report represents our independent professional advice on the organizational, procedural, and policy improvements necessary to ensure that the highest levels of accountability and control are maintained in the stewardship and operations of the nuclear mission by the Department of Defense. In the course of our review, we were accorded full cooperation from across the Department in response to our requests for information, documents, and interviews. It is that same esprit de corps that must be embraced throughout the Department to sustain a robust and relevant nuclear mission.

Respectfully yours,

James Schlesinger
 Chairman

General Michael P. C. Carns
 USAF (Ret)
 Panel Member

The Honorable J. D. Crouch II
 Panel Member

The Honorable Jacques S. Gansler
 Panel Member

Admiral Edmund P. Giambastiani, Jr.
 USN (Ret)
 Panel Member

The Honorable John J. Hamre
 Panel Member

The Honorable Franklin C. Miller
 Panel Member

Mr. Christopher A. Williams
 Panel Member

CHAIRMAN
 THE HONORABLE JAMES R. SCHLESINGER

TASK FORCE MEMBERS
 THE HONORABLE J. D. CROUCH II
 THE HONORABLE JOHN J. HAMRE

THE HONORABLE JACQUES S. GANSLER
 THE HONORABLE FRANKLIN C. MILLER

GENERAL MICHAEL P. C. CARNS, USAF (Ret)
 ADMIRAL EDMUND P. GIAMBASTIANI, JR., USN (Ret)
 MR. CHRISTOPHER A. WILLIAMS

EXECUTIVE DIRECTOR
 DR. JAMES BLACKWELL

Contents

Executive Summary	iii
1 Background	1
2 Deterrence	5
Understanding U.S. Deterrence Policy	5
The Special Case of NATO	14
3 DoD Management	19
OSD Organization	19
Nuclear Capabilities Modernization and Sustainment	25
Oversight and Inspections	32
4 DoD Forces	39
Navy	39
USSTRATCOM	53
USEUCOM/USAFE	59
Geographic Combatant Commands	65
The Joint Staff	66
Army	68
Appendix A. Tasking Letter	A-1
Appendix B. Recommendations	B-1
Appendix C. Reference Documents	C-1
Appendix D. Abbreviations and Acronyms	D-1

Executive Summary

Background

- Incidents related to the Air Force's mishandling of nuclear weapons and components led to the creation of the Task Force in June 2008 to provide advice on nuclear matters for the Secretary of Defense. (See Appendix A.) This review was to be conducted in two phases: Phase I reviewed the Air Force's nuclear mission and was completed in September 2008; Phase II was directed at the stewardship of the nuclear mission more broadly throughout the Department of Defense (DoD). This report covers Phase II findings and recommendations.
- In the Phase I investigation, the Task Force found a serious erosion of senior-level attention, focus, expertise, mission readiness, resources, and discipline in the nuclear weapons mission area within the Air Force. Based on several previous investigations, the Air Force had already begun addressing problems in several key areas related to the nuclear mission. With the addition of findings from this Task Force, the Air Force developed its *Strategic Plan to Reinvigorate the Air Force Nuclear Enterprise*. Released on October 24, 2008, the strategic plan directs the Air Force's implementation of over 100 actions to restore the efficacy of its nuclear mission responsibilities. Moreover, the Air Force has moved forward with actions relating to 30 of the 33 Task Force Phase I recommendations. The Task Force recommendations not implemented by the Air Force Strategic Plan (involving deployment of critical nuclear personnel) are to be addressed through increased manning authorizations. The Task Force commends the Air Force for its immediate and responsive attention to the issues identified in the Phase I Report.
- In Phase II, the Task Force found that the lack of interest in and attention to the nuclear mission and nuclear deterrence, as discussed in our Phase I report, go well beyond the Air Force. This lack of interest and attention have been widespread throughout DoD and contributed to the decline of attention in the Air Force. This report details policy, organizational, and procedural issues that must be addressed across DoD in order to retain disciplined and effective nuclear forces. Implementation of the recommendations contained herein can help ensure a credible nuclear deterrent for the United States and our friends and allies, now and into the foreseeable future. A list of Phase II recommendations appears in Appendix B.

Deterrence

Understanding U.S. Deterrence Policy

- Current U.S. nuclear deterrence policy as set forth in a series of National Security Strategy and National Defense Strategy documents from 2001 to 2008 can be summarized as calling for safe, credible, and reliable offensive nuclear forces and defensive measures capable of deterring attacks against the United States, its vital interests, allies, and friends. These deterrence forces are tailored to fit particular threats and respond to a broad array of challenges to international security. Four specific missions for our nuclear establishment include: (1) deter weapons of mass destruction (WMD) threats, (2) assure allies of our continuing commitment to their security, (3) dissuade potential adversaries from embarking on programs or activities that could threaten our vital interests, and (4) defeat threats that are not deterred.

- The strategic role of nuclear capability is to deter and dissuade current and emergent enemies from attacking the United States and its vital interests. To be successful in this critical national objective, the nation’s nuclear forces must be demonstrative and credible, and—to be so—survivable against a preemptive attack. This combination of capability, credibility, and survivability presents high uncertainty to a potential adversary in attempting to anticipate the success of executing one or more courses of action.
 - **In formulating our national security strategy and national military strategy, the Task Force recommends that the incoming administration develop a strategic framework defining the unique role of nuclear weapons in deterring threats to the United States, our key interests, and our allies. The Task Force believes this framework would serve as an excellent foundation for the upcoming Nuclear Posture Review and Quadrennial Defense Review.**
- The United States has extended its nuclear protective umbrella to 30-plus friends and allies as an expression of commitment and common purpose as well as a disincentive for proliferation.
- The value of our deterrent is not primarily a function of the number of our warheads, but rather of the credibility of our nuclear capabilities in the minds of those we seek to deter, dissuade, or assure. To achieve its psychological and political objectives of deterring opponents and reassuring allies, deterrence requires nuclear capabilities that are visible and credible.
- The Task Force found a distressing degree of inattention to the role of nuclear weapons in deterrence among many senior DoD military and civilian leaders. Many lack the foundation of experience for understanding nuclear deterrence, its psychological content, its political nature, and its military role—which is to avoid the use of nuclear weapons. A lack of education on nuclear deterrence has contributed to this problem. This shortfall of experience and understanding will become even more acute among senior leaders in the future.
 - **Strengthening the credibility of our nuclear deterrent should begin at the White House. To that end, the Secretary of Defense and the Secretary of Energy should periodically brief the President with a review of nuclear capabilities and forces.**
 - **The Under Secretary of Defense for Policy, in collaboration with the Chairman of the Joint Chiefs of Staff, should initiate a series of analyses and senior seminar wargames to enhance understanding of nuclear deterrence and to develop new strategies and operational concepts regarding the role of nuclear weapons in deterrence.**
 - **Renewed emphasis should be placed on education in and advancement of deterrence theory, strategy, and policy. These concepts should be required in the curricula at all levels of DoD professional development.**
 - **Sufficient resources should be allocated to DoD components involved in efforts to increase the capability for nuclear detection and attribution. Other parts of the U.S. Government should also be involved in these efforts.**

Deterrence: The Special Case of NATO

- The North Atlantic Treaty Organization (NATO) represents a special case for deterrence, both because of history and the presence of nuclear weapons. Even though the number of weapons is modest when compared to total inventories—especially Russian inventories of tactical weapons—the presence of U.S. nuclear weapons in Europe remains a pillar of NATO unity. The deployment of nuclear weapons in Europe is not a Service or regional combatant command issue—it is an *Alliance* issue. As long as NATO members rely on U.S. nuclear weapons for deterrence—and as long as they maintain their own dual-capable aircraft as part of that deterrence—no action should be taken to remove them without a thorough and deliberate process of consultation.
 - **The Department of Defense, in coordination with the Department of State, should engage its appropriate counterparts among NATO Allies in reassessing and confirming the role of nuclear weapons in Alliance strategy and policy for the future.**
 - **The Department of Defense should ensure that the dual-capable F-35 remains on schedule. Further delays would result in increasing levels of political and strategic risk and reduced strategic options for both the United States and the Alliance.**

DoD Management

Office of the Secretary of Defense Organization

- The Task Force found widespread fragmentation, dispersal of responsibility, and weakening of authorities in the Office of the Secretary of Defense's (OSD) management of the nuclear mission and the nuclear weapons mission area. The decline in management attention to nuclear matters is evidenced by a dramatically reduced workforce, fragmentation of nuclear policy and guidance responsibility across the office, dilution of organizational focus because of proliferating missions, and relegation of nuclear-focused organizations to positions of lower authority. The remaining workforce lacks both depth and breadth of nuclear expertise.
 - **The Secretary of Defense should establish an Assistant Secretary of Defense for Deterrence (ASD(D)) in the Office of the Under Secretary of Defense for Policy (OUSD(P)). The Principal Deputy Assistant Secretary for Deterrence (PDASD(D)) should be an acquisition professional and should be dual-hatted within the OUSD(AT&L). All existing OUSD(P) offices that deal with nuclear, chemical, biological and missile defense issues should be realigned under the new ASD; similarly, the functions of the ATSD(NCB) (to include oversight of the Defense Threat Reduction Agency) should be assumed by the new ASD.**
 - **The Secretary of Defense should expand the responsibilities of the Nuclear Weapons Council to include issues involving the full range of nuclear capabilities, including weapons, delivery systems, infrastructure, policy implementation, and resources, under the chairmanship of the Deputy Secretary of Defense.**
 - **The Secretary of Defense should assign directorship of the Nuclear Command and Control System Support Staff (NSS) to the newly formed ASD(D).**

Nuclear Capabilities Modernization and Sustainment

- A holistic view of nuclear deterrence is neither reflected in policy guidance nor in acquisition decisions made by OSD and the Services. The current Capabilities Portfolio Management and Joint Capabilities Integrated Development System (JCIDS) processes are not designed to address deterrence as a unique capability. Although the Under Secretary of Defense for Acquisition, Technology & Logistics (USD(AT&L)) was able to secure increased resources for the Defense Threat Reduction Agency (DTRA) in FY09, nuclear deterrence capabilities and requirements are largely disregarded in the DoD competition for resources. This is especially evident in nuclear capabilities such as those provided by the Air-Launched Cruise Missile (ALCM) and Tomahawk Land-Attack Missile–Nuclear (TLAM-N). No long-range nuclear capabilities roadmap exists for ensuring the sustainment and modernization of nuclear weapons, weapons systems and delivery platforms.
 - **The Secretary of Defense should direct the NWC as newly rechartered to develop and maintain a nuclear capabilities roadmap for the modernization and sustainment of the nuclear deterrent force (deterrence policy, forces, and infrastructure). This roadmap should include specific recommended timelines.**
- Responsive infrastructure capabilities are not adequately addressed in the Department of Defense acquisition process. The scientific base supporting strategic nuclear deterrence capabilities, a key enabler for the design and sustainment of nuclear weapons and delivery platforms, has substantially eroded. There is legitimate near-term concern about the nation’s ability to design and build nuclear warheads, given the past and prospective loss of intellectual capital and critical skills.
 - **USD(P) and USD(AT&L) should ensure that guidance documents address nuclear deterrence and infrastructure capabilities, respectively.**
 - **The Chairman, Joint Chiefs of Staff (CJCS) should revise the JCIDS instructions to elevate deterrence capabilities to the same level as those for force employment. The Deputy Secretary of Defense should likewise revise the Capabilities Portfolio Management process.**
- Since the 1990s, there has been a shedding of nuclear capabilities by the Military Services. Such efforts are sometimes abetted by combatant commands and by service components in order to free up resources to use elsewhere. In some cases, the Services have perfected the art of starving a capability in order to justify shedding the associated mission, a phenomenon the Task Force observed in other areas, not just nuclear programs. For example, the criterion employed by some in the military for procuring a weapons system (specifically TLAM-N, ALCM, and dual-capable aircraft, especially in NATO) is whether it is “militarily cost-effective.” This ignores the weapon’s political value, overlooking the crucial deterrence and assurance elements that these nuclear deployments and capabilities provide. Nuclear deterrence is inherently a national mission, and neither a military service nor a combatant commander should make unilateral decisions regarding whether to retain particular nuclear capabilities.
 - **The Secretary of Defense should direct the ASD(D) to conduct a capability assessment of nuclear deterrence. The Secretary of Defense should also direct**

CJCS to develop validated operational requirements for providing those capabilities to include modernizing or replacing the capabilities now provided by Dual-Capable Aircraft (DCA), ALCM, and TLAM-N.

- **USD(P) should ensure that policy guidance documents define and emphasize the unique contributions made to deterrence by theater nuclear capabilities. These documents should specifically address the view of the 30-plus nations enjoying the benefit of the U.S. nuclear umbrella.**
- **The Task Force recommends that ASD(D) be responsible for oversight of funding execution of nuclear capabilities. This is to be accomplished by the creation of a new capability portfolio comprising all program elements directly related to nuclear deterrence, whether currently categorized in Major Force Program-1 (MFP-1) or elsewhere in the defense program and budget structure.**

Nuclear Mission Oversight and Inspection

- A rigorous inspection process is critical to maintaining a credible U.S. deterrent. However, the Task Force believes a significant shortfall exists in the DoD nuclear surety inspection process. DTRA currently inspects nuclear-capable Air Force and Navy units concurrent with the applicable Service evaluation team during a Defense Nuclear Surety Inspection (DNSI). DNSIs are largely duplicative because they overlap significantly with Service-conducted nuclear surety inspections, evaluating the same tasks using the same criteria. Surveillance Inspections, where DTRA evaluates Service inspection processes, have demonstrated their value as a more productive method for providing thorough, independent oversight of the Services' adherence to nuclear surety standards.
 - **The Secretary of Defense should direct DTRA to conduct only Service Proficiency Evaluations (formerly Surveillance Inspections) to ensure uniform DoD oversight of each Service's nuclear surety program by "inspecting the inspector." The Services would be solely responsible for rating the units while DTRA would only assess and rate the performance of the inspection team, not the unit.**
- The Task Force found that Navy nuclear inspection processes are appropriate for fleet and associated shore facilities, but that the TACAMO (Take Charge and Move Out) air wing nuclear-related command and control mission capability is not adequately inspected.
 - **The Chief of Naval Operations (CNO) should develop inspection programs for the E-6B TACAMO wing to ensure operational readiness and Personnel Reliability Program compliance for forces provided to U.S. Strategic Command (USSTRATCOM). Inspection intervals should mirror those of the fleet ballistic missile submarines and associated shore facilities.**

DoD Forces

The Navy's Nuclear Mission Stewardship

- The Task Force found that the Navy has maintained its commitment to the nuclear mission, although there is evidence of some "fraying around the edges."

- Although the Navy has several times been directed by the Secretary of Defense to maintain the TLAM-N program until a follow-on capability is developed, the Navy has failed to take the actions necessary to implement this decision. The matter was considered by the Deputy's Advisory Working Group (DAWG), with a decision deferred to the next administration. The situation requires Secretary of Defense involvement to monitor implementation of the decision.
 - **The Secretary of the Navy should conduct a comprehensive program review of TLAM-N and direct the Navy Acquisition Executive to develop a plan to maintain TLAM-N and to develop follow-on capabilities that can be fielded prior to expiration of TLAM-N effectiveness. Should there be a gap, the Navy should be directed to maintain TLAM-N to extend its service life to coincide with introduction of the new system.**
 - **Joint Staff (J5) should review and update the concept of operations for the TLAM-N system to make it a more responsive option for the national leadership during times of potential hostilities.**
- Recognizing a need to strengthen the oversight of the nuclear enterprise in the Navy, the CNO has directed the establishment of an OPNAV Nuclear Weapons Council (NWC) and a Senior Leadership Oversight Council (SLOC). The Task Force endorses these senior-level oversight groups and recommends the following additional actions to improve oversight of the Navy's nuclear weapons enterprise.
 - **The Secretary of the Navy should establish a requirement for a biennial self-assessment of the Navy nuclear weapons enterprise.**
 - **The Secretary of the Navy should expand the role of the Director of SSP as the single authority for nuclear weapons programs and operations, and elevate the position of the SSP to a three-star billet with appropriately increased staffing and authorities to oversee the Navy nuclear weapons enterprise.**
- With all remaining nuclear weapons concentrated in the fleet ballistic-missile submarine (SSBN) force, a significant future challenge for the Navy will be an inevitable decline in nuclear weapons and policy expertise at the flag officer level among officers from other branches.
 - **The Secretary of the Navy should direct a nuclear weapon enterprise manning and experience study to examine the shrinking experience base—particularly among aviation and surface Navy officers—forecast the trends, and provide appropriate recommendations.**
 - **The CNO should review and expand professional military education curricula on concepts of nuclear deterrence, strategy, planning, and operational theory.**
 - **The CNO should require a greater number of Naval officers to complete appropriate educational programs to sustain expertise required to support leadership and staff billets in deterrence policy and strategy positions as well as nuclear operations and technical matters. Such qualifications would be tracked by subspecialty codes.**

- Navy manning and resourcing for the SSBN mission are robust. However, the Task Force sees reason for concern for the near-term future in the following areas:
 - Unit and individual performance, over time, will be adversely affected by reduced manning at Trident Training Facilities, SSBN operational shore-based staffs, and SSP commands and facilities. Similarly, the performance of TACAMO aircrew and staffs will be adversely affected over time.
 - The Continuing Evaluation Program (CEP)/Strategic Communications Assessment Programs (SCAP) provide crucial analysis of the communications performance of the SSBN fleet and Nuclear Command and Control System (NCCS). However, CEP/SCAP programs already have been cut approximately 50 percent from the FY00 base year.
 - TACAMO mission support equipment and trainers are not adequately resourced.

Navy senior leadership should:

- **Conduct an assessment of the personnel assignments at the two Trident Training Facilities and provide adequate manning to support the unique concept of operations for the SSBN platform in addition to all the other training requirements levied on these facilities.**
 - **Implement the proposals for additional manpower billets required to restore SSBN squadrons and submarine groups, including the reestablishment of the group commander positions and full staffs on both coasts.**
 - **Review TACAMO wing manning and billet funding status to ensure the wings are appropriately manned at 100 percent of “wartime” levels.**
 - **Review SSP civilian and military manning and provide sufficient resources for proper oversight in light of additional missions.**
 - **Restore funding to the Type Commander (TYCOM) requested levels for the CEP and SCAP to meet all Combatant Command (COCOM) requirements.**
 - **Fully resource all support elements for the TACAMO mission, including trainers and mobile reconstitution capability equipment.**
- The Task Force found the SSBN force and supporting organizations highly motivated and fully engaged in their mission. However, very little intelligence support is provided to units. Greater access to intelligence related to their nuclear mission would enhance their sense of purpose and understanding of the mission.
 - **The CNO should direct the establishment of one intelligence officer manpower authorization, at a minimum, for each of the Trident submarine groups.**

USSTRATCOM

- Mission proliferation and headquarters downsizing have taken a significant toll on the ability of USSTRATCOM to maintain sufficient focus on nuclear deterrence. The Command’s leadership has recognized this overall decline and the imperative to restore the appropriate

level of emphasis to this critical mission. The Command has recently established a one-star flag/general officer position focused exclusively on the nuclear mission.

- **The Secretary of Defense should reduce the number of missions assigned to USSTRATCOM, limiting them primarily to the deterrence, global strike, and space missions. USSTRATCOM should continue to be the primary joint enabler for the integrated missile defense and combating weapons of mass destruction missions.**
- **The position of Commander, USSTRATCOM, if at all possible, should be filled with a general or flag officer with significant operational nuclear experience.**
- **The Secretary of Defense should direct a review of headquarters/Joint Functional Component Commands manpower and organizational structure of USSTRATCOM. The review should identify the manpower and organizational changes necessary to ensure that the command and its components are adequately resourced and structured to execute USSTRATCOM's nuclear mission responsibilities effectively.**
- **The Secretary of Defense, through the Unified Command Plan, should institutionalize the role of USSTRATCOM as the lead combatant command advocating for capability development, requirements, and resources for both strategic and theater nuclear systems.**

USEUCOM/USAFE

- The United States European Command (USEUCOM), long the principal advocate for nuclear weapons in Europe, now abstains from its advocacy role. It no longer recognizes the *political* role of U.S. nuclear weapons within the Alliance. USEUCOM's nuclear planning staff has been allowed to atrophy to the point where it has been diluted to unacceptable levels. Although USEUCOM has concerns about the cost of securing these weapons, the Task Force believes these costs are commensurate with the importance of the mission. The Task Force also notes that the security of weapons in Europe meets or exceeds both U.S. and NATO security standards.
 - **USEUCOM staff with nuclear weapons responsibilities should be fully manned with nuclear-experienced personnel. The staff should be appropriately sized to enable the performance of adequate levels of nuclear planning and development of concepts of operation in line with U.S. and NATO policy by the end of FY10.**
- The U.S. Air Forces in Europe (USAFE) nuclear weapons mission area suffers from many of the same resourcing and expertise difficulties described in the Task Force Phase I report. Nevertheless, the Task Force found the commitment of USAFE Airmen to the safe and secure storage of nuclear weapons in Europe to be encouraging.
 - **The Secretary of the Air Force should direct that USAFE retain control of the Weapons Storage Security Systems (WS3) in Europe rather than placing them under control of the Air Force Nuclear Weapons Center (as will be the case for Weapons Storage Areas in the United States).**

- **The Chief of Staff of the Air Force should direct the Air Force Education and Training Command to train all aircrew that will be assigned to DCA to be fully qualified in nuclear operations upon completion of initial qualification. All previously qualified aircrew must be retrained and certified prior to arrival on station to a nuclear tasked unit by the end of FY09.**
- **All new USAF Weapons School graduates from dual-capable systems (F-15E, F-16, B-52, and B-2) should acquire and demonstrate at least the same level of proficiency in nuclear weapons employment as they currently achieve in conventional operations. This certification and training process should be in place by the end of FY09.**

Geographic Combatant Commanders

- Since 1992, the nuclear planning capabilities of the Geographic Combatant Commands (GCCs) have been significantly reduced or eliminated. The Task Force noted gaps in the interfaces between USSTRATCOM and the GCCs as a consequence of the centralization of nuclear planning, execution, and advocacy for nuclear capabilities at USSTRATCOM.
 - **The CJCS should perform a comprehensive review of the relationship between USSTRATCOM and the GCCs regarding their respective roles in nuclear deterrence planning, requirements, and execution. The review should make recommendations for strengthening GCC focus, expertise, and participation in fulfilling their responsibilities for nuclear deterrence as well as identify appropriate mechanisms for collaborating with USSTRATCOM.**

Joint Staff

- The Joint Staff is now a minimal contributor to the nuclear deterrence process. The CJCS-sponsored exercise program rarely links OSD, Combatant Command, or Agency exercises with nuclear-related training objectives. The Joint Staff no longer conducts offensive nuclear analysis and modeling, relying instead on USSTRATCOM and DTRA to provide this expertise. The net effect of this diminished involvement in nuclear issues has been a Joint Staff that is significantly disadvantaged when it comes to influencing the development of nuclear deterrence capabilities, decisions regarding force levels, and participation in the operational planning process. This has also resulted in the decreased capability of the Joint Staff to support the Chairman in providing the best military advice on nuclear issues to the President.
 - **The Chairman, Joint Chiefs of Staff should designate a flag-level officer on the Joint Staff whose sole focus is the nuclear mission. Staffing and resourcing for the Joint Staff functions of nuclear strategy, plans, policies, exercises, and analysis should be increased.**
 - **The Joint Staff should sponsor senior level exercises on three levels: within the military, military/OSD, and whole of government.**

Army

- The Army retains core nuclear subject matter expertise and has distributed nuclear-trained officers throughout the DoD nuclear mission area to provide expertise for Joint Forces that may operate on hostile nuclear/radiological battlefields. The U.S. Army Nuclear and Combating Weapons of Mass Destruction Agency (USANCA) provides nuclear employment and counter-WMD capabilities, survivability, planning, training, and analysis functions. USANCA manages the Army's cadre of personnel with technical nuclear education and skills.
 - **The Army Chief of Staff should continue to support USANCA's contributions to the DoD nuclear mission and ensure the continued viability of the Nuclear and Counterproliferation Officer (FA52) career field.**

Conclusion

- One must not forget the psychological element of deterrence—it is in the eye of the beholder. But deterrence requires real and observable capability. Avoiding actual weapons employment is the purpose of deterrence. It requires a declaratory policy, visibility, and the will to carry out our expressed intent.
- Developing and sustaining nuclear deterrence capabilities require strong DoD leadership. Senior officials must be actively engaged in the nuclear weapons mission. Unless there is high-level attention, articulation, and oversight by the Secretary of Defense, the Department's motivation to sustain the deterrent may be weakened and resources diverted elsewhere. Senior military and civilian personnel focused on the nuclear mission, as recommended in this report, will significantly contribute to maintaining high morale and competency for this important national mission.
- To be fully credible, the role of nuclear deterrence should be firmly articulated by the White House itself. Deterrence has worked because the U.S. Government and its allies have supported it with resources and leadership. Deterrence must continue to have such support, including the visible public commitment of the President, the White House, as well as the Department of Defense.
- The changing political and threat environments will continue to challenge policymakers as to the size and character of the nuclear deterrent for ensuring the nation's security. While the nation's dependence on nuclear weapons has been reduced, nuclear weapons nevertheless remain fundamental to deterrence.

1 Background

Secretary of Defense Robert Gates created this Task Force on Nuclear Weapons Management in June 2008 following several mishaps in the DoD related to the handling of nuclear weapons and nuclear weapons-related materiel. (See Appendix A.) Directed to focus initially on the Air Force, the Task Force released its Phase I report in September 2008.

In the Phase I investigation, the Task Force found a serious erosion of senior-level attention, focus, expertise, mission readiness, resources, and discipline in the nuclear weapons mission area within the Air Force. Based on several previous investigations, the Air Force had already begun addressing problems in several key areas related to the nuclear mission. With the addition of findings from this Task Force, the Air Force developed its *Strategic Plan to Reinventorize the Air Force Nuclear Enterprise*. Released on October 24, 2008, the strategic plan directs the Air Force's implementation of over 100 actions to restore the efficacy of its nuclear mission responsibilities. Moreover, the Air Force has moved forward with actions relating to 30 of the 33 Task Force Phase I recommendations. The Task Force recommendations not implemented by the Air Force Strategic Plan (involving deployment of critical nuclear personnel) are to be addressed through increased manning authorizations. The Task Force commends the Air Force for its immediate and responsive attention to the issues identified in the Phase I Report.

The organizational decisions to create (1) Air Force Global Strike Command, (2) a new office in the Air Staff (A10) devoted exclusively to nuclear matters, and (3) the Air Force Nuclear Oversight Board should substantially help to restore the Air Force leadership's attention to and readiness for the nuclear mission. Other major actions related to the Task Force findings and recommendations include the following:

- Consolidating all nuclear sustainment functions at the Nuclear Weapons Center (NWC)
- Establishing positive inventory control measures for all nuclear weapons-related materiel
- Strengthening the nuclear inspection processes
- Aligning strategic deterrence/nuclear operations-based education, training, career development, and force development activities
- The Secretary of Defense continuing to monitor the Air Force's progress towards improving nuclear weapons management

For Phase II, Secretary Gates requested the Task Force to recommend the organizational, procedural, and policy improvements necessary across DoD more broadly to ensure that the highest levels of accountability, control, and oversight are maintained in the stewardship and operation of nuclear weapons, delivery vehicles, and sensitive components. The Task Force was also asked to recommend measures both to enhance public confidence in DoD's ability to handle its nuclear assets safely and to bolster a clear international understanding of the continuing role and credibility of the U.S. nuclear deterrent.

The DoD nuclear mission encompasses policy and acquisition elements of the Office of the Secretary of Defense (OSD), the Joint Staff, U.S. Strategic Command (USSTRATCOM), the

Geographic Combatant Commands (GCCs), and the nuclear-equipped forces of the Air Force and the Navy. The Task Force conducted extensive interviews and field visits within these organizations and others. The interviews were supplemented with an extensive documentation review on current and past policies, organizational structures, investigations, and studies related to nuclear matters in DoD.

In the course of their research, the Task Force members and staff visited the sites listed in Table 1-1 and interviewed the individuals listed in Table 1-2. The Task Force members' recommendations are listed in Appendix B. The Task Force consulted the reports listed in Appendix C to complement their experience, professional knowledge, and research over the past decades. Appendix D contains a list of abbreviations and acronyms used in this report.

Table 1-1. Sites Visited

Kings Bay Naval Submarine Base:

Submarine Group Trident
Submarine Squadron 16/20
Strategic Weapons Facility Atlantic

Europe:

North Atlantic Treaty Organization (NATO)
Supreme Headquarters Allied Powers Europe (SHAPE)
United States European Command (USEUCOM)
United States Air Forces in Europe (USAFE)

Offutt Air Force Base:

United States Strategic Command (USSTRATCOM)

Tinker Air Force Base:

Strategic Communications Wing One

Fort Belvoir:

Defense Threat Reduction Agency (DTRA)
U.S. Army Nuclear and Combating Weapons of Mass Destruction Agency

Table 1-2. Officials Consulted

-
- Colonel Paul Bell, Chief, SHAPE Nuclear Operations
 - General Roger Brady, Commander United States Air Forces in Europe
 - Mr. Gerald Cady, Counterproliferation Support Office, Defense Intelligence Agency
 - General James Cartwright, Vice Chairman of the Joint Chiefs of Staff
 - The Honorable Fred Celec, Assistant to the Secretary of Defense for Nuclear, Chemical, and Biological Defense Programs, OSD(AT&L)
 - Commander Robert Clark, Commanding Officer, USS Rhode Island SSBN 740(Blue)
 - Commander William Combes, Commanding Officer, USS Wyoming SSBN 742(Blue)
 - Dr. Scott Comes, Deputy Director Strategic C4&ISR Programs, OSD(PA&E)
 - General John Craddock, Commander United States European Command and Supreme Allied Commander Europe
 - The Honorable Thomas D'Agostino, Director National Nuclear Security Administration
 - Mr. Robert Daigle, Director Program Resources & Information Management Division, OSD(PA&E)
 - Brigadier General Dieter Dammjacob (DEU AF), SHAPE Assistant Chief of Staff for Operations (J3)
 - Rear Admiral Phil Davidson, Deputy Director for Strategy and Policy (JCS/J5)
 - Admiral Kirk Donald, Director of Naval Nuclear Propulsion Program
 - Lieutenant Colonel Max Dubroff, Commander 702d Munitions Support Squadron
 - The Honorable Eric Edelman, Undersecretary of Defense for Policy
 - Lieutenant General Karl Eikenberry, Deputy Chairman NATO Military Committee
 - Colonel Matthew Flood, USAFE Chief of Nuclear Operations (A3N)
 - General (Ret.) Ronald Fogelman, Former Chief of Staff of the Air Force
 - Vice Admiral Richard Gallagher, Deputy Commander, United States European Command
 - Lt Col Richard Gannon, Deputy Division Chief for Joint Operational War Plans Division (JCS/J7)
 - Rear Admiral Timothy Giardina, Commander Submarine Group Trident
 - Mr. Robert Gibney, Chief, WMD Division HQ USEUCOM ECJ5-W
 - Mr. Brian Green, Deputy Assistant Secretary of Defense for Strategic Capabilities, OSD(P)
 - Commander Jeffrey Grimes, Commanding Officer, USS Maryland SSBN 738(Gold)
 - Colonel Brian Groft, Deputy Director, USANCA
 - Colonel Shawn Harrison, Chief of Training Policy Branch (JCS/J7)
 - Dr. John Harvey, Deputy Director Policy, Plans, Assessment and Analysis, NNSA
 - The Honorable Ryan Henry, Former Principal Deputy Under Secretary of Defense for Policy
 - Mr. Jim Howard, Director Plans and Programs, Strategic Systems Program, USN
 - Commander Robert Hudson, Commanding Officer, USS Maryland SSBN 738(Blue)
 - Major General James Hunt, USAFE Director of Air and Space Operations
 - Ms. Sharon A. Huoy, Associate Deputy Director, Defense Intelligence Agency
 - Mr. Bruce Ianacone, Deputy Chief, Nuclear Programs Division, DTRA
-

Table 1-2. Officials Consulted (cont'd.)

-
- Commander Rhett Jaehn, Commanding Officer, USS Tennessee SSBN 734(Gold)
 - Commander James Jenks, Commanding Officer, USS Tennessee SSBN 734(Blue)
 - Rear Admiral Stephen Johnson, Director Strategic Systems Program, USN
 - The Honorable Dale Klein, Former Assistant Secretary of Defense for Nuclear, Chemical, and Biological Defense Programs (ATSD(NCB))
 - Dr. Adam Lowther, Faculty Researcher and Defense Analyst, Air Force Research Institute
 - Captain Daniel Mack, Commander Submarine Squadrons 16/20
 - Mr. Thomas Mahnken, Deputy Assistant Secretary of Defense, Policy Planning
 - Commander Mark Marty, Commanding Officer, USS Rhode Island SSBN 740(Gold)
 - Admiral (Ret.) Richard Mies, Former Commander, United States Strategic Command
 - Captain Martin Nagle, Commanding Officer Strategic Weapons Facility Atlantic, USN
 - Major General Larry New, Deputy Director for Force Protection, Force Structure, Resources and Assessment Directorate, (JCS/J8)
 - Mr. Guy Roberts , Director NATO Nuclear Policy
 - Brigadier General Lori Robinson, Deputy Director for Force Application, Directorate of Force Structure, Resources and Assessment, (JCS/J8)
 - Admiral Gary Roughead, Chief of Naval Operations
 - Brigadier General Michael Rounds, Director of Operational Plans & Joint Force Development (JCS/J7)
 - Lieutenant Colonel Christopher Smith, USA, Defense Plans Division, U.S. Mission to NATO
 - Lieutenant Colonel Ryan Smith, USAF, Logistics and Resources Team, U.S. Military Delegation to NATO
 - Mr. David Stein, Director Strike Policy and Integration, OSD(P)
 - Mr. Joseph Stein, Deputy Defense Advisor U.S. Mission to NATO
 - Vice Admiral William Sullivan, U.S. Representative to the NATO Military Committee
 - Dr. James Tegnalia, Director, Defense Threat Reduction Agency
 - Colonel Paul Tibbets, Chief NATO NBC Policy Branch IMS Plans and Policy Division
 - Commander Owen Travis, Commanding Officer, USS West Virginia SSBN 736(Blue)
 - Colonel Carey Tucker, Commander 52d Munitions Maintenance Group
 - Mr. Pete Verga, Acting Principal Deputy Under Secretary of Defense for Policy
 - Ambassador Kurt Volker, U.S. Permanent Representative to the North Atlantic Council
 - Admiral Patrick Walsh, Vice Chief of Naval Operations
 - Brigadier General Glenn Walters, Deputy Director for Resources and Acquisition (JCS/J8)
 - General (Ret.) Larry Welch, Chairman of Defense Science Board Permanent Task Force on Nuclear Weapons Surety
 - Lieutenant Colonel Dwayne Whiteside, Commanding Officer Marine Corps Security Battalion, Kings Bay, GA
 - The Honorable Donald Winter, Secretary of the Navy
 - Colonel Christopher Wrenn, Chief of Nuclear Capability Planning Division (AF/A5)
 - Major General Thomas Wright, SHAPE Deputy Chief of Staff for Operations
-

2 Deterrence

Understanding U.S. Deterrence Policy

Deterrence, which is a strategy deeply rooted in military history, means persuading an adversary not to take aggressive action or attack by convincing him that he will be denied success if he proceeds or will suffer punishment exceeding the value of the gains he hopes to achieve. Deterrence by punishment or denial could be done by using political, economic, military, or other offensive or defensive means. Deterrence is a matter of psychology, and we need to understand which means will deter a particular adversary. Potential adversaries decide if they are being deterred, not the United States.

With the development of nuclear weapons and their significant role in ending World War II, deterrence in the context of the Cold War became primarily nuclear in nature. The failures of the Lisbon Conference in 1952 and of the Allies to deliver the promised numbers of conventional forces for the defense of Europe made nuclear forces more central. During the early Cold War years, the United States had a virtual monopoly on nuclear capabilities, enabling the Eisenhower Administration to adopt a policy of preventing aggression by threatening massive retaliation with the destruction of high-value Soviet and Warsaw Pact targets, including cities and industrial facilities. The unique character of nuclear weapons meant that they provided the ultimate deterrent. Their purpose was and continues to be to avoid actual war. In the past, the potential for first use of nuclear weapons was an integral part of U.S. policy; today, however, there are very few circumstances imaginable when the United States might use them first. Yet the demonstrable warfighting capability remains essential to the credibility of the nuclear deterrent.

For the past seven years, U.S. deterrence policy has been based on DoD's December 2001 *Nuclear Posture Review* that reasserted the critical role nuclear weapons continue to play in the defense capabilities of the United States, its allies, and friends by deterring attack and dissuading potential adversaries from undertaking hostile actions. This position was further amplified in the White House's December 2002 *National Strategy to Combat Weapons of Mass Destruction*: "The United States will continue to make clear that it reserves the right to respond with overwhelming force—including through resort to all of our options—to the use of weapons of mass destruction against the United States, our forces abroad, and friends and allies." Subsequent national and defense strategy documents reflect this fundamental policy. The *2006 National Security Strategy*, for example, states the following:

Safe, credible, and reliable nuclear forces continue to play a critical role. We are strengthening deterrence by developing a New Triad composed of offensive strike systems (both nuclear and improved conventional capabilities); active and passive defenses, including missile defenses; and a responsive infrastructure, all bound together by enhanced command and control, planning and intelligence systems. These capabilities will better deter some of the new threats we face, while also bolstering our security commitments to allies. Such security commitments have played a crucial role in convincing some countries to forgo their own nuclear weapons programs, thereby aiding our nonproliferation objectives.

DoD's 2008 *National Defense Strategy* adds the following:

We must tailor deterrence to fit particular actors, situations, and forms of warfare. . . . Deterrence must remain grounded in demonstrated military capabilities that can respond to a broad array of challenges to international security. . . . The United States will maintain its nuclear arsenal as a primary deterrent to nuclear attack, and the New Triad remains a cornerstone of strategic deterrence.

Evolution of U.S. Nuclear Deterrence Policy

In the 1960s, the Soviet Union had few nuclear weapons. By the late 1960s, it had begun to develop a counter-city nuclear capability; and by the mid 1970s, it had roughly achieved a nuclear balance with the United States. Both the United States and the Soviet Union had developed the ability to inflict devastating nuclear retaliation upon each other if their vital interests were attacked. This “stable balance of terror” that had evolved included the United States defining—and the Soviets, in effect, accepting—its vital interests in such a way as to include preventing superior Soviet/Warsaw Pact conventional forces from overrunning Western Europe or its flanks. The United States retained a secure second-strike capability with the survivable triad of bombers, intercontinental ballistic missiles (ICBMs), and submarine-launched ballistic missiles (SLBMs) if subjected to a surprise attack. Our “extended deterrence” umbrella, initially formalized with NATO in the 1950s, has subsequently expanded to cover 30-plus nations.

Concerned that the threat of massive nuclear retaliation as a sole response to Soviet aggression lacked credibility, the Nixon Administration adopted a policy of adding limited nuclear options. This doctrine called for decreasing the chances of uncontrolled escalation by avoiding cities and instead targeting Soviet military sites in small initial strikes designed to control escalation. Building on this rationale, the Carter Administration held that while “assured destruction is necessary for nuclear deterrence, it is not sufficient. . . . Effective deterrence requires forces of sufficient size and flexibility to attack selectively a range of military and other targets yet enable us to hold back a significant and enduring reserve . . . measured retaliation is essential to credible deterrence.”¹

Continuity in nuclear deterrence policy generally marked the Reagan Administration years, but with a strong revival of interest in missile defenses embodied in the Strategic Defense Initiative. Although a viable strategic defense was then but a distant prospect, its achievement could provide an early form of what is now called deterrence by denial and could undermine the balance of terror that rested on mutual vulnerability. President Reagan proposed deep reductions in nuclear weapons at the Reykjavik Summit with Soviet Premier Gorbachev in 1986. These negotiations helped lead—a year later—to the elimination of intermediate-range missiles in Europe.

Arms control efforts beginning in the 1960s repeatedly sought to build mutual confidence between the United States and the Soviet Union that neither was planning a preemptive attack and to provide ways to discourage such suspicions. These included weapons limitation such as the Anti-Ballistic Missile Treaty and the Strategic Arms Limitation Treaty (SALT I), weapons testing restrictions such as the Limited Test Ban Treaty, and confidence-building measures such as the “Hot Line” Agreements. Nevertheless, the ominous nuclear threat never disappeared, with the necessity of nuclear deterrence remaining a given in all strategic calculations up to the present.

¹ Harold Brown, “The Department of Defense Statement on Strategic Military Balance,” U.S. Senate Committee on Foreign Relations, Hearing, 96th Congress, 1st Session, July 11, 1979, p. 3.

U.S. nuclear strategy and policy during the Cold War, almost entirely aimed at deterring Soviet nuclear and conventional aggression, rested on five pillars: (1) ability to target a large number of Soviet high-value targets, supplemented by selective and limited strikes; (2) capacity for retaliation after a first strike against the United States; (3) extension of the nuclear umbrella to threatened allies; (4) nonproliferation efforts; and (5) deployment of tactical nuclear weapons in Europe—earlier on in the Pacific area as well.

With the demise of the Soviet Union and the end of the Cold War, the geostrategic landscape shifted. The collapse of the primary threat and the emergence of a number of new threats necessitated rethinking the entire deterrence challenge. During the George H.W. Bush Administration, the greatly diminished likelihood of a nuclear exchange permitted reducing strategic and tactical nuclear forces, as well as conventional forces, while retaining a credible nuclear deterrent. The continuing role for nuclear threats in deterring weapons of mass destruction (WMD) use was demonstrated when Secretary of State James Baker warned the Iraqis not to use chemical or biological weapons during the Gulf War or they would pay a “terrible price.”² We learned after the war that the threat was taken seriously.

The first statement of U.S. national security strategy after the fall of the Soviet Union (1991) reaffirmed the necessity of nuclear deterrence: “Even in a new era, deterring nuclear attack remains the number one defense priority of the United States The modernization of our Triad of land-based missiles, strategic bombers and submarine-launched missiles will be vital to the effectiveness of our deterrent into the next century.”³

In the *1994 Nuclear Posture Review*, the Clinton Administration advanced a “lead and hedge” strategy that called for leading in arms reductions while hedging against negative developments in the geopolitical environment. In view of the greatly diminished Russian threat, the United States reduced its nuclear arsenal further in terms of both weapons and delivery systems, while retaining a substantially smaller number of weapons as a hedge.

Throughout the Clinton years, nuclear deterrence continued to be featured in official policy and doctrine—but with somewhat less emphasis. For instance, both the 1996 and 1997 Annual Defense Reports stated that “U.S. nuclear forces remain an important deterrent.” The 1998 Report added, “Nuclear forces remain an important disincentive to nuclear, biological, and chemical proliferation and a . . . hedge against an uncertain future.”

The George W. Bush Administration introduced the “New Triad” with the *2001 Nuclear Posture Review*, which laid out a roadmap for a new policy framework, and pointed to the capabilities to implement it. The first leg of the New Triad comprises ICBMs, bombers, and SLBMs, augmented by conventional strike forces and other measures. The second leg consists of passive and active defenses, in particular ballistic missile defenses. The third leg is a responsive nuclear infrastructure in case we have to rebuild our forces—it is to maintain the capability to research, develop, and maintain needed nuclear forces. These three legs are tied together by an enhanced command, control, and communications capability, plus strengthened reconnaissance and intelligence capabilities. The New Triad has four missions: (1) deter WMD threats, (2) assure allies of our continuing commitment to their security, (3) dissuade potential adversaries

² President George H. W. Bush letter to Iraqi President Saddam Hussein, dated January 5, 1991, delivered to Iraqi Foreign Minister Tariq Aziz who refused to forward the letter to President Hussein.

³ *National Security Strategy of the United States*, August 1991.

from embarking on programs or activities that could threaten our vital interests, and (4) defeat threats that are not deterred.

As previously noted, beyond the central task of deterrence, the U.S. nuclear posture assures allies that our security commitments are continuing and that our forces are sufficient to deter the use of WMD against them. Assurance is largely a matter of psychology: it is our allies who will ultimately decide whether our posture adequately assures, not the United States. Our nuclear deterrent has been the cornerstone of collective security in both NATO and our Asian alliances—in its absence, a number of allies in both Asia and Europe might be motivated to acquire their own nuclear weapons. Thus, our extended deterrent is important to our nonproliferation policy.⁴

The *2001 Nuclear Posture Review* also called for further reductions in operationally deployed strategic nuclear warheads, and later decisions resulted in a policy to reduce the number to 1,700–2,200, which is a level subsequently agreed upon with the Russians in the 2002 Treaty on Strategic Offensive Reductions. Many nondeployed weapons, retained as a hedge against various contingencies, have also been reduced and some have been scheduled for elimination, bringing the total U.S. warhead numbers to a level roughly one quarter of the number at the end of the Cold War. In fact, nuclear weapons have been reduced by about 90 percent since the height of the Cold War.

Understanding the New Deterrence Challenges

Dealing with nuclear deterrence has become far more complex because the challenge has changed from the primary focus on the Soviet Union to various regional threats of violent extremists and rogue states that have, or aspire to have, WMD. Reflecting on this increased complexity, a former Secretary of Defense asserted that the stability of even the one-on-one case depends on the internal stability, rationality, and command-and-control arrangements of the respective regimes. What works one-on-one does not necessarily work on many.⁵ Moreover, since some governments or their agents have supported terrorists, there is a strong possibility in the near future of facing terrorists armed with WMD. Furthermore, some regimes may be less prudent or rational than Soviet leaders were during the Cold War; since deterrence by threat of punishment depends upon sufficient prudence to avoid the likelihood of punishment; this is a caution worth underscoring in the new environment.

Deterring Established Major Nuclear Powers Outside of NATO

Currently, and for the incoming administration, it is essential to deter three quite different and distinct potential threats: (1) established major nuclear powers outside of NATO, (2) states of concern, and (3) violent extremists and nonstate actors. In these cases it is necessary to understand the motivations, priorities, values, vulnerabilities, and risk-taking propensities of each. As a cardinal example of this necessity, despite Russia's current greater weakness, its present proclivities nonetheless include strong pressures on its neighbors, modernization of its nuclear forces and changes in its nuclear doctrine, including the introduction of first strike options.

⁴ Secretaries of Defense and Energy, "National Security and Nuclear Weapons in the 21st Century," joint statement, September 2008.

⁵ Harold Brown, "New Nuclear Realities," *Washington Quarterly*, Winter 2007-08, p. 9-10.

Similarly, the China of the Cold War years has changed from when deterring it was considered a lesser included case of deterring the Soviet Union. The newly self-confident and economically vibrant China is modernizing and increasing its nuclear forces, as well as transforming its conventional military capabilities for force projection and access denial missions. Given these developments in both Russia and China, our allies in Europe and Asia understandably require reassuring.

Since there are important common interests among the United States, Russia, and China concerning such salient problems as terrorism, energy security, and nuclear proliferation, widespread cooperation among them is sensible. But both China and Russia remain committed to retaining an ability to put the United States at risk by nuclear means and to be able to credibly threaten escalation in time of crisis and war. Each has invested substantial resources in programs of strategic military modernization. Each also maintains the ability to strike by nuclear means at U.S. allies.

If deterrence is to continue to succeed, then appropriate U.S. forces must be built, sustained, modernized, and exercised, and targeting strategies must be developed that credibly threaten a response too painful for a potential attacker to contemplate. Such deterrence measures should not, of course, replace or even weaken efforts to strengthen dialogue and cooperative efforts wherever possible. Regenerating the Cold War makes no sense.

Deterring States of Concern

States that violate norms of international behavior and that are hostile to the United States—sometimes called rogue states—are of particular deterrence concern for two reasons. First, there is the primary danger of their providing terrorists with WMD, deliberately or by unauthorized or accidental leakage. Here, the offending entity must understand official U.S. policy under which it:

. . . reserves the right to respond with overwhelming force to the use of weapons of mass destruction against the United States, our people, our forces and our friends and allies. Additionally, the United States will hold any state, terrorist group, or other non-state actor fully accountable for supporting or enabling terrorist efforts to obtain or use weapons of mass destruction . . .⁶

Second, there is the danger that such a state will employ or make threats to employ WMD against an ally or even against the United States, or its forces in the context of a regional conflict. In the latter case, the United States could credibly counter with a tailored nuclear threat.

A relevant, tailored deterrent requires deep understanding of the concerned state's leadership, what particular threats, forces, or inducements are needed and what kinds of diplomacy and signals will best deliver the required deterrence message. In dealing with such states as North Korea and Iran, nuclear deterrence would be required only if and when they acquire nuclear weapons or threaten the use of other WMD.

U.S. policymakers need to focus on the challenge of developing strategic thinking and intelligence on nuclear deterrence that are relevant to the current geopolitical situation. As already noted, the size of our nuclear arsenal has been sharply reduced, but its significance has

⁶ Stephen Hadley, "Remarks by the National Security Advisor to the Center for International Security and Cooperation," Stanford University, Stanford, CA, February 8, 2008.

not. Threats have multiplied and emphasis has shifted to conventional missions in Afghanistan and Iraq. Although significant intelligence resources continue to be dedicated to nuclear matters, mostly to monitor foreign nuclear developments, the focus of these efforts has essentially shifted to counter proliferation rather than deterrence. Within DoD as a whole, the intelligence effort has mirrored this lack of emphasis on deterrence.

During the Cold War, robust intelligence efforts were concentrated on determining what was of value to the Soviets and how those assets could be targeted to make the nuclear deterrent credible. Today's deterrence challenges require a comparable focus designed to inform capabilities that provide a wider range of timely military options. Policy development depends on understanding the motivations for and possible roles of nuclear weapons in the hands of rogue state leadership, as well as identifying the options for countering the threat. Because there are multiple motivations differing from state to state for seeking nuclear weapons, effective deterrence requires detailed case-by-case intelligence analysis.

Because of its counterproliferation emphasis, there has been little concerted effort in the intelligence community to develop intelligence tailored to ascertaining how to deter specific adversaries from acquiring or using nuclear weapon capabilities and delivery systems, taking into consideration each adversary's unique culture, capabilities, and intentions.⁷ For instance, we need to know which positive or negative security assurance could usefully be given or which inducements would be considered valuable; which fears of neighboring states' possible threats, as well as fears of direct U.S. actions are motivations; which intermediaries would be trusted; how the leadership would weigh the risks and costs of not acting; and whether there are internal power struggles or divisions that could be exploited.

Deterring Terrorists

Deterring terrorists from using WMD once they have acquired them is especially challenging. And it is clear that their acquisition is a very high priority—in Osama bin Laden's words: "a sacred duty." Preventing the sale or acquisition of nuclear weapons remains the highest U.S. priority, with special attention given to the prevention of the spread of fissile material.

The relative ease or difficulty terrorists have in acquiring and using WMD varies widely with the kind of WMD. Chemical weapons have been the most widely used by terrorists, followed by biological agents. Evidence of terrorists' interest in and pursuit of chemical and biological weapons is plentiful. In the 1990s, Japanese religious extremists in the Aum Shinrikyo cult not only developed both chemical and biological agents, but in 1995 released sarin in Tokyo's subway system, killing a dozen, severely injuring many hundreds more. In northern Iraq's Kurdish region, Ansar al-Islam, a fundamentalist Muslim organization, reportedly experimented with biological and chemical agents including ricin and cyanide. At al Tarmak Farms in Afghanistan, al-Qa'ida systematically pursued its search for effective WMD, specifically anthrax. Although to date terrorists have not employed nuclear or radiological weapons, this situation is unlikely to persist indefinitely. The Director General of the International Atomic Energy Agency (IAEA) has estimated that up to 49 nations already know

⁷ Henry Chiles, Chairman, *Report of the Defense Science Board Task Force on Nuclear Deterrence Skills*, Washington, DC: Defense Science Board, September 2008, p. xii.

how to make nuclear weapons.⁸ That number will likely grow as the use of nuclear power for electricity generation expands and the associated technology spreads; preventing the leak of nuclear materials and weapons into terrorist hands will be an increasing challenge.

Work with the Russians to reduce and safeguard Cold War legacy nuclear weapons and fissile materials is proceeding; but checking general nuclear proliferation will remain difficult as a number of states have a variety of motives for acquisition. North Korea, India, and Pakistan have acquired both nuclear weapons and missile delivery systems, while Iran is apparently headed down the same road. Iranian nuclear capabilities could likely lead to further proliferation in the Middle East. The derivative danger from North Korea or Iran is that they may pass nuclear weapons or technology to others. Proliferation elsewhere remains a strong possibility, particularly in East Asia.

Since keeping nuclear weapons out of terrorist hands is of the highest priority, greater emphasis on multilateral checks on proliferation is warranted. Measures such as the Non-Proliferation Treaty need strengthening. In particular, the IAEA requires additional resources and technical capabilities to ensure that it can meet increasing demands. Further cooperative efforts such as the Global Security Initiative and the Nuclear Suppliers Group to check proliferation also need America's continued leadership and support.

The threat of retaliation is complicated by problems of attribution and targeting in deterring terrorists' use of WMD. Terrorists differ widely in a number of respects and some may not be deterrable by threats. Even in the case of al-Qa'ida, some elements of the organization may be deterrable by punishment threats—for example, financiers, suppliers, or state sponsors—while radical leaders and recruiters probably are not. Distinguishing among types of terrorist threats is essential.

More needs to be done on the rapid identification of forensic signatures of nuclear materials. Such signatures are essential to attribute any nuclear or radiological event to the source. Only if those who would use such materials or provide them to others are convinced of our capability for attribution can we expect them to be deterred by the threat of punishment. The U.S. Government is making progress in this regard and pursuing new technologies; however, continued efforts and resources are necessary.

In the case of those unlikely to be deterred by punishment threats, actions that reduce the probability of their success can be usefully pursued. If the terrorist has a small number of nuclear weapons, he is likely to regard them as highly valuable. If he believes that success has been reduced because of defensive measures or will be counterproductive or will prove too costly in resources or reputation, he is more likely to be deterred. Deterrence measures based on denial, such as enhanced intelligence efforts, checking supportive financial activities, and increased homeland security warrant further emphasis.

Deterrence Challenges Ahead

The most difficult challenge in maintaining a credible nuclear posture to deter WMD attacks upon the United States and its allies will be in persuading this nation of the abiding requirement for nuclear forces. Such leadership must come from the top. Deterrence has worked

⁸ William Broad and David Sanger, "Restraints Fray and Risks Grow as Nuclear Club Gains Members," *New York Times*, Oct. 15, 2006.

because the U.S. Government and its allies have supported it with resources and leadership. Deterrence must continue to have such support, including the visible public commitment of the President, the White House, and the Department of Defense.

The Secretaries of Energy and Defense have recently noted that the United States is the only nuclear state without the capacity to mass produce warheads. The problem is that we just do not want to think about nuclear capabilities.

Conclusion

Looking to the future, technological change and the complex and shifting international geopolitical situation will continue to require initiative, flexibility, and adaptability on the part of the stewards of our nation's security, if nuclear deterrence is to be sufficient now and in the future.

Developing and sustaining nuclear deterrence capabilities requires strong DoD leadership. Senior officials must be actively engaged in the nuclear weapons mission. Unless there is high-level attention, articulation, and oversight by the Secretary of Defense, the DoD may lose the motivation to sustain the deterrent—and use the resources elsewhere. Indeed to be fully credible, the role of nuclear deterrence needs to be firmly stated by the White House.

Perhaps the most important and demanding challenge ahead for the incoming administration is to persuade skeptics of the value of highly capable nuclear forces and the vital deterrent they provide. In that regard, there needs to be a renewed, common, national appreciation that our nuclear forces serve a vital function and that their central purpose is not warfighting but avoiding any nuclear weapons use.

The Task Force is hopeful that the incoming administration will devote the time and attention needed to provide the necessary guidance, direction, and leadership on nuclear matters. There should be a serious national debate over the role of nuclear weapons in U.S. national security strategy, future force structures and capabilities, arms control, and other issues that affect America's nuclear arsenal and the men and women who carry out vital deterrence missions on a daily basis.

Recommendations

1. In developing its national security strategy, the incoming administration should address the fundamental role of nuclear capabilities in deterring threats, assuring allies, and countering proliferation. This view should be reflected in the upcoming Nuclear Posture Review and Quadrennial Defense Review.
2. Strengthening the credibility of our nuclear deterrent should begin at the White House. To that end, the Secretary of Defense and the Secretary of Energy should periodically brief the President with a review of nuclear capabilities and forces.
3. The Secretary of Defense should direct a comprehensive review of the curricula of all academies, service schools, and senior-level professional military education institutions and provide recommendations for strengthening the understanding of deterrence theory, strategy and policy on the part of military leaders through revised or new courses, research, and analysis. The review should include such senior courses as CAPSTONE, KEYSTONE, and PINNACLE.

4. The Secretary of Defense should target funding, for example under the Minerva Initiative (Defense Department grants for research in the social and behavioral sciences), to support development of deterrence concepts in the civilian academic community. These concepts should be widely disseminated to stimulate richer thinking on deterrence in both civilian and military circles.
5. The Under Secretary of Defense for Policy, in collaboration with the Chairman of the Joint Chiefs of Staff, should initiate a series of analyses and senior seminar wargames to enhance understanding of nuclear deterrence and to develop new strategies and operational concepts regarding the role of nuclear weapons in deterrence.
6. Sufficient resources should be allocated to Department of Defense components involved in efforts to increase the capability for nuclear detection and attribution. Other parts of the U.S. Government should also be involved in these efforts.
7. The Secretary of Defense should establish demanding intelligence requirements across the Department to support the nuclear deterrence mission.
8. Increased priority should be given to the full range of nonproliferation efforts, particularly taking advantage of the forthcoming Non-Proliferation Treaty Review (2010) to do so. Combatant Commands should increase their efforts to help allies in their theaters strengthen counterproliferation efforts.

The Special Case of NATO

Even though their number is modest, U.S. nuclear capabilities in Europe remain a pillar of NATO unity. The manner in which they are geographically deployed and politically employed provides several benefits: (1) the weapons couple U.S. and NATO security, tangibly assuring our allies of the United States' commitment to their security; (2) by extension they serve as an antiproliferation tool by obviating allies' need to develop and field their own nuclear arsenals; (3) each member of the Alliance receives the benefits of increased protection and deterrence, while the burden of surety and security responsibilities and military risks associated with nuclear weapons are shared by many; (4) spread out across a wide area, nuclear weapons in Europe are less vulnerable than if they were concentrated at a single location; and (5) NATO Dual-Capable Aircraft (DCA) contribute directly to the nuclear deterrent mission and increase the deterrent value of the weapons. They convey the will of multiple allied countries, creating real uncertainty for any country that might contemplate seeking political or military advantage through the threat or use of weapons of mass destruction against the Alliance.

NATO Secretary General Jaap de Hoop Scheffer has called for a strategy review in 2009 and a revised Alliance strategic concept in 2010. Most senior U.S. officials understand the Allies continue to rely on the U.S. deterrent as a pillar of the Alliance; indeed, some Allies have asked for reassurance of late. In fact, the stabilizing effects of NATO's nuclear capabilities extend beyond NATO's borders.

As long as NATO members rely on U.S. nuclear weapons for deterrence, no action should be taken to remove them without a thorough and deliberate process of consultation. The deployment of nuclear weapons in Europe is not a Service or regional command issue—it is an *Alliance* issue. Moreover, actions concerning nuclear posture in NATO have an impact on the perceptions of our allies elsewhere.

NATO's nuclear forces continue to play a specific role in war prevention; but their role is now more fundamentally political. They are no longer directed towards a specific threat. That is, its nuclear forces are no longer targeted against any country. Today, the only theater-based nuclear weapons available to NATO are U.S. nuclear bombs capable of being delivered by DCA of several Allies and TLAM-N. The readiness requirements for these aircraft have been dramatically reduced since 1995. Their ability to assume combat readiness posture is now measured in months rather than minutes. The Allies have judged that this relaxed force posture will meet the Alliance's deterrence requirements for the foreseeable future. Nevertheless, future uncertainties exist.

The NATO Allies face the common challenge of maintaining a credible nuclear deterrent force in Europe. This includes both the weapons (B-61) and DCA. Immediate attention is required to support life extension programs for the B-61 nuclear gravity bomb. Power supply and radar systems service life extensions require funding in FY09. Concerning the delivery capability, fourth generation DCA in the Alliance will start to reach the end of their service lives within the next decade. Drastically shrinking defense budgets in Allied countries, some already below one percent of gross domestic product, complicate recapitalization of these nuclear-capable fighter aircraft. In addition, the introduction of advanced air defense systems may challenge the future penetration and delivery credibility of these nuclear forces and other supporting airborne assets in certain scenarios. A solution must be found that will continue to

link NATO countries through shared risks, costs, and deterrent benefits, while maintaining the credibility of the deterrent. Some Allies are already pursuing an option for replacing their DCA fighter forces by investing in the development of the F-35, which has an operational requirement for delivery of nuclear weapons. Although there is program uncertainty, the Department of Defense must ensure that the dual-capable F-35 remains on schedule. Further delays would result in increasing levels of political and strategic risk and reduced strategic options for both the United States and the Alliance.

NATO's nuclear posture provides security for all members of the Alliance; for members who feel vulnerable, it provides reassurance. The presence of U.S. nuclear forces based in Europe and committed to NATO remains an essential political and military link between the European and North American members of the Alliance. At the same time, participation in the Alliance by countries where nuclear weapons are not based demonstrates Alliance solidarity, the common commitment of its member countries to maintaining their security, and the widespread sharing among them of burdens and risks.

Political oversight of NATO's nuclear posture is also shared among member nations. NATO's Nuclear Planning Group provides a forum in which the Defense Ministers of nuclear and nonnuclear Allies alike participate in the development of the Alliance's nuclear policy and in decisions on NATO's nuclear posture. More frequent and intensive involvement is found in the Alliance's High Level Group, in which senior defense officials from member nations meet on a near-monthly basis to develop and discuss NATO nuclear policy. The Task Force found that NATO has recently developed another innovative approach to engaging nonnuclear Allies in the NATO nuclear posture through the program known as "SNOWCAT" (Support of Nuclear Operations With Conventional Air Tactics). This is a useful approach that should be supported by the United States.

The Task Force found at NATO Headquarters in Brussels some concern among NATO Allies about the credibility of the U.S. extended nuclear deterrent. The Allies believe in the U.S. nuclear deterrent as a pillar of the Alliance. Some Allies have been troubled to learn that during the last decade some senior U.S. military leaders have advocated for the unilateral removal of U.S. nuclear weapons from Europe. These Allies are convinced that the security of the United States is "coupled" to that of Europe. Moreover, these allies are aware of the greater symbolic and political value of allied aircraft employing U.S. nuclear weapons. So long as Allies continue to rely on the U.S. nuclear deterrent, the United States should take the lead to assure them, both publicly and privately, of our steadfast commitment to the security of NATO.

Much of the deterrent value of NATO's DCA deployment is derived from their in-theater presence, demonstrating and maintaining the capability to employ them. This creates in the minds of potential aggressors an unacceptable level of uncertainty concerning the success of any contemplated attack on NATO. This deterrent effect cannot be created by simply having nuclear weapons stored and locked up or relying exclusively on "over-the-horizon" nuclear delivery capabilities. It also means having written concepts of operation and doctrine, planning processes that are well exercised, nuclear planning offices that are staffed with well qualified personnel, and DCA crews demonstrably proficient in nuclear weapons employment. Over the last 15 years, as U.S. and NATO attention has shifted away from the nuclear posture, the staffs involved in nuclear matters have been downsized to the point of marginalization, and subject matter expertise is lacking.

While the people on these staffs are highly motivated and well trained, they are too few in number and lack the resources and senior-level military and political backing to be effective. The Task Force found that some U.S. senior leaders at SHAPE do not support the U.S. and NATO nuclear weapons posture in Europe. One general said, “NATO’s nuclear deterrent should be provided by weapons outside of Europe.” Such attitudes may help explain the emerging concerns among Allies about the commitment of the United States to NATO.

The Task Force concludes that this trend should be halted. Senior leaders should publicly support the purpose of and policy for U.S. nuclear weapons in Europe and must communicate that support throughout the ranks. Officers need to be educated in deterrence. Nuclear planning staffs should be resourced with the right number of appropriately experienced military and civilian professionals—including those experienced in DCA fighter operations. The nuclear-planning staffs should be well exercised to ensure they can produce an effective and adaptive plan in the event of a worst-case crisis scenario. To aid in this effort, the United States, through USSTRATCOM and USEUCOM, should redevelop the capability to support rapid and effective adaptive nuclear planning at SHAPE in contingency operations and to integrate and synchronize ICBMs, SLBMs, and CONUS-based nuclear bombers with submarine-launched TLAM-N and Europe-based NATO DCA.

Recommendations

1. The United States should recognize the importance NATO Allies place on extended deterrence represented by the forward basing of U.S. nuclear weapons in Europe and should take all necessary steps to support the “coupling effect” those weapons provide.
2. The United States may need to reaffirm privately its commitment to nuclear deterrence for Europe.
3. Manning levels and subject matter expertise at SHAPE’s Nuclear Operations Branch should be increased to enable the development of more robust concepts of operations, doctrine, and exercises. The new branch should be led by a one-star flag or general officer.
4. The Department of Defense, in coordination with the Department of State, should engage appropriate counterparts among the NATO Allies in developing the role of nuclear weapons in Alliance strategy and policy for the future. These actions will also affect the credibility of the U.S. extended deterrent to allies outside of NATO.
 - A. The Department of Defense should underwrite the development of curriculum at the NATO Defense College to educate officers in deterrence theory and operational nuclear doctrine.
 - B. The Department of Defense should continue its dialogue with allies on modernizing DCA forces and developing a long-term roadmap.
 - C. The Department of Defense should ensure that the dual-capable variant of the F-35 remains on track for operational capability.
5. SHAPE and USSTRATCOM should develop updated nuclear concepts of operation. Realistic training scenarios based on these concepts should be provided to operational units for training and inspections. Planning staffs should regularly and vigorously exercise the adaptive planning process.

6. USSTRATCOM and USEUCOM should redevelop the capability to support rapid and effective adaptive nuclear planning at SHAPE in contingency operations and to integrate and synchronize U.S. ICBMs, SLBMs, and CONUS-based nuclear bombers with submarine-launched TLAM-N and Europe-based NATO DCA.
7. The Nuclear Weapons Council should review the B-61 Life Extension Program to ensure these weapons are fully resourced to support the European DCA mission.

3 DoD Management

OSD Organization

The Task Force found a serious lack of attention to policy formulation and oversight of nuclear deterrence within the OSD. Responsibilities for the nuclear mission have been dispersed and downgraded throughout the Department. The decline is characterized by reduced staffs and substantially decreased subject matter expertise. Nuclear-focused elements have been relegated to lower organizational status, and organizational focus has been diluted with additional missions. Responsibilities and authorities for elements of the nuclear mission are matrixed throughout OSD—currently there are approximately 40 offices that deal with weapons of mass destruction and nuclear weapons. This leaves the Department with no primary owner who is accountable and responsible for the nuclear deterrent mission.

The Task Force identified the following objectives that should guide a revised organizational structure for the OSD:

- A cohesive and holistic view of the nuclear enterprise and mission that considers not only the weapons, but also the policy goals, delivery systems, supporting infrastructure, and other elements that comprise our deterrent capability
- Focused, senior-level advocacy for future needs that will ensure the Nation's continued ability to execute the nuclear mission and to retain the credibility of our strategic deterrent
- Regular senior-level attention and policy oversight for nuclear matters
- Improved cooperation and understanding among the major DoD offices that deal with nuclear weapons and systems
- Sufficient staffing by uniformed and civilian personnel with nuclear expertise, to include supervisory personnel

Current OSD Organization

In the past, the Office of the Under Secretary of Defense for Policy (USD(P)) had an Assistant Secretary of Defense for International Security Policy charged with management of critical interdependent and nuclear-related functions. This office served to ensure their integration into coherent policy with sufficient manpower and authority to ensure policy compliance. Currently, this authority for nuclear policy development and oversight is dispersed among various elements in the Office of the Under Secretary of Defense for Policy (OUSD(P)) and the Office of the Under Secretary of Defense for Acquisition, Technology & Logistics (OUSD(AT&L)).

USD(P) Roles, Responsibilities, and Organization

USD(P) is responsible for formulation of national security and defense policy and the integration and oversight of DoD policy and plans to achieve national security objectives. USD(P) is charged with (1) the development, coordination, and implementation of strategy and policy for deployment and employment of strategic and theater nuclear forces and missile defense

forces; (2) reviewing and evaluating plans, programs, and systems required for such forces and systems; (3) overseeing planning for nuclear deterrence, and (4) alliance implications for nuclear weapons and the extended nuclear umbrella.

Four primary offices in USD(P) deal with nuclear matters:

1. The Deputy Assistant Secretary of Defense for Strategic Capabilities (DASD(STR)) has primary responsibility for all nuclear policy issues within the Office of the Assistant Secretary of Defense for Special Operations and Low Intensity Conflict and Interdependent Capabilities (ASD(SOLIC&IC)).
2. The Deputy Assistant Secretary of Defense for Forces Transformation and Resources (DASD(FTR)), also under ASD(SOLIC&IC), has the policy lead for nuclear program and planning issues.
3. The Assistant Secretary of Defense for International Security Affairs is responsible for joint planning on nuclear policy and strategy with NATO allies, and chairs NATO's High Level Group.
4. The Deputy Assistant Secretary of Defense for Policy Planning (DASD(PP)) has the lead for the Secretary of Defense and OSD defense strategy and contingency war-planning oversight.

Nuclear matter subject expertise resides largely in DASD(STR). This office drafts the key policy guidance documents that establish the nuclear force posture and is the architect of the Nuclear Posture Review that goes to Congress. This office also directs the preparation of contingency planning for nuclear forces. Along with DASD(FTR), DASD(STR) acts as an advocate for nuclear forces in the Planning, Programming, Budgeting, and Execution (PPBE) process within the Department to ensure development of nuclear capabilities required to support U.S. national security strategy. Moreover, DASD(STR) is the lead office for working with allies concerning the U.S. commitment to extended deterrence, NATO nuclear policy and planning (Nuclear Planning Group and High Level Group), and bilateral/multilateral nuclear arms control negotiations and compliance. DASD(STR) also supports the USD(P) in his role as a statutory member of the joint DoD-Department of Energy (DOE) Nuclear Weapons Council (NWC) that oversees the stockpile of nuclear warheads.

Despite DASD(STR) primary expertise in nuclear matters, it is not well connected with other major policy functions in other USD(P) offices, such as: (1) strategic policy and planning, defense strategy and policy compliance of the war plans developed by DASD Policy Planning; (2) engagement with NATO through the High Level Group chaired by ASD International Security Affairs; and (3) programs and resources overseen by DASD Forces Transformation and Resources. Similarly, defense strategy and strategic planning are detached from resource oversight. The result is an organization that lacks functional alignment within Policy and across the Department for the primary nuclear responsibilities.

The overall trend in staffing and organization of offices involved in nuclear matters has been a steady accumulation of responsibilities with no increase in manpower. In 2005 and 2006, space policy and information operations policy were added to DASD(STR) responsibilities. The role of this office was further weakened when DASD(STR) was moved to ASD(SOLIC&IC) as part of a major reorganization of USD(P) in 2007. The reorganization eliminated a small team that performed technical analysis oversight of combatant commander nuclear plans. This has had an adverse impact on DASD(STR)'s ability to perform its operational planning oversight

function. The rationale for moving DASD(STR) to ASD(SOLIC&IC) with its responsibility for nuclear policy did not account for the political importance of nuclear deterrence relative to other military capabilities.

USD(AT&L) Roles, Responsibilities, and Organization

USD(AT&L) manages nuclear weapons and delivery system acquisition and oversight. The Assistant to the Secretary of Defense for Nuclear, Chemical, and Biological Defense Programs (ATSD(NCB)) is directly responsible to the Secretary of Defense and Deputy Secretary of Defense for matters associated with nuclear weapons safety and security, chemical weapons demilitarization, and chemical and biological defense programs; and the Deputy to the Assistant to the Secretary of Defense for Nuclear Matters (DTASD/NM) provides oversight of the nuclear weapons complex (safety, surety, stockpile management) including executive staff support to the DoD Nuclear Weapons Council. The Task Force noted that the ATSD(NCB) does not have sufficient stature within the OSD structure to provide overall direction for the nuclear enterprise within DoD. There were two important intervals in the last decade when the ATSD(NCB) position went unfilled for several years, underscoring the diminution of interest in nuclear weapons matters within the DoD organization.

The Defense Threat Reduction Agency (DTRA), reporting directly to ATSD(NCB), has a multitude of missions, most of which are related to Combating WMD. A small component, largely formed from what was formerly the Defense Nuclear Agency, provides operational and technical support for the nuclear mission. However, the agency's central priority is Combating WMD as opposed to nuclear weapons management and operational support. The Task Force recognizes that DTRA has created a Nuclear Support Center led by a general officer, consistent with the renewed emphasis on nuclear issues within DoD. The center will be responsible for DTRA's core nuclear stockpile and surety functions in concert with the military services.

Proposed OSD Organization

Nuclear capabilities, stockpile management, future technologies, and nuclear surety are all issues that require significant interaction between USD(P) and USD(AT&L). With responsibilities dispersed to numerous OSD offices within these elements, interactions and coordination are difficult.

Considering the unique and special nature of nuclear weapons, a single OSD advocate for the nuclear mission area is needed. The Task Force recommends the establishment of an Assistant Secretary of Defense for Deterrence (ASD(D)) in the Office of the Under Secretary of Defense for Policy (OUSD(P)). The Principal Deputy Assistant Secretary for Deterrence (PDASD(D)) should be an acquisition professional and should be dual-hatted within the OUSD(AT&L). This will ensure continued USD(AT&L) involvement and responsibility for all acquisition-related nuclear weapons and nuclear platform activities. All existing OUSD(P) offices which deal with nuclear, chemical, and biological issues should be realigned under the new ASD; similarly, the functions of the ATSD(NCB) (to include oversight of the Defense Threat Reduction Agency) should be assumed by the new ASD. Additionally, the Nuclear Command and Control Support Staff should be assigned to this new organization.

The Task Force recommends that the ASD(D) be responsible for the following functions:

International and Threat Reduction

- Nuclear Arms Reduction Treaties; Chemical Weapons Convention; Biological Weapons Convention; the Comprehensive Test Ban Treaty; Nuclear Non-Proliferation Treaty; Nuclear Non-Proliferation Treaty Review Conferences
- Nuclear Chemical Biological (NCB) Europe/International
- NCB Cooperative Threat Reduction

Deterrence Strategy/Policy

- Preparation, review, and implementation of Presidential and Secretary of Defense guidance documents
- Oversight of all Nuclear War Plans/Nuclear Contingency plans
- Maintenance of a vigorous analytic capability to support war and contingency planning
- Strategic studies on how to deter potential adversaries, to include make-up of the leadership; what the various leadership factions value; where fault-lines might exist; how best to use declaratory policy and signaling to achieve successful deterrence
- Extended Nuclear Umbrella, to include NATO nuclear policy, chairmanship of the NATO High Level Group; and leadership of US delegations meeting with Allies, both east and west, to discuss the credibility of the umbrella
- Ballistic Missile Defense strategy and acquisition policy oversight

Nuclear Delivery Systems

- Advocate for continued effectiveness of current nuclear delivery systems and for development and fielding of modernized replacement systems where needed; this is to be accomplished by the creation of a new capability portfolio comprising all program elements directly related to nuclear deterrence, whether currently categorized in Major Force Program-1 (MFP-1) or elsewhere in the defense program and budget structure.

Nuclear Stockpile

- Stockpile management, to include health, security, and safety of the current stockpile and advocacy for modernization or replacement where needed
- DoD support for the modernization of the nuclear weapons complex

Nuclear Command Control

- To include all nuclear-related issues currently assigned to Assistant Secretary of Defense for Networks and Information Integration (ASD(NII)) and to the Nuclear Command and Control Support Staff

The ASD(D) should be the senior-level official with sufficient authority to provide oversight and advocacy for future capabilities that will be needed to ensure the Nation's continued ability to execute the nuclear mission and to maintain the credibility of our strategic deterrent. Moreover, the ASD(D) would have primary responsibility for advocating nuclear

capabilities through the budget process. The scope of the position should be broad enough to encompass threats posed by other weapons of mass destruction—biological, radiological, and chemical—all of which are capable of producing large-scale casualties.

The creation of ASD(D) would provide a single OSD voice and single point of engagement for Joint Staff, USSTRATCOM, the Services, and other COCOMs on nuclear and WMD matters. In sum, creation of a single empowered integrator and advocate for the Nation's nuclear enterprise and mission would facilitate coherency and unity of effort in the Department.

The Nuclear Command and Control Support Staff

The Secretary of Defense should also assign directorship of the Nuclear Command and Control System Support Staff (NSS) to the newly formed ASD(D) along with its supporting role for the Committee of Principals. The NSS is an outgrowth of a 1986 Joint Chiefs of Staff Nuclear Command and Control Study that provided a detailed assessment of nuclear command and control (NC2). One of the study recommendations was that a staff was needed to monitor NC2 to ensure that it would function properly when needed. Initially this staff was an organic part of the JCS known as the Architecture Branch located within the J3. In 1987, National Security Decision Directive 281 established the U.S. Nuclear Command & Control System (NCCS); consolidated national policy; specified responsibilities for NCCS Departments/Agencies; defined NCCS elements and required characteristics; designated the Secretary of Defense as NCCS Executive Agent (EA); and required a Nuclear Support Staff (NSS) to support the EA. The composition and responsibilities of the NSS were codified in the 1988 DoD Directive DoDD 3150.6. At that time, the Assistant Secretary of Defense for Command, Control, Communications & Intelligence (ASD(C3I)) was designated as the Director, NSS. In 1997, the Defense Reform Initiative recommended that the Commander, Strategic Command become the Director, NSS. This move seems to have been part of an overall effort to divest OSD of operational functions and to reduce OSD manpower positions. The Directorship transferred from the ASD(C3I) to the Commander USSTRATCOM.

NSS has developed some useful practices, for example, it has begun to embed staff in other Federal Departments. However, a number of key functions have been neglected due to an apparent lack of direction and supervision over the NSS. It needs more effective oversight in order to perform its role in identifying and filling the gaps among all the Departments and Agencies involved in NC2, not just DoD and DOE, where NSS presently concentrates its efforts.

Expansion of the Nuclear Weapons Council

The Nuclear Weapons Council (NWC) was established by Congress to facilitate cooperation and coordination between the DoD and DOE. The NWC is currently chaired by USD(AT&L). Voting membership also includes the Vice Chairman of the Joint Chiefs of Staff, the Under Secretary of Energy for Nuclear Security/NNSA Administrator, CDR USSTRATCOM, and USD(P). Currently, the ATSD(NCB) serves as the Executive Secretary of the NWC with the DATSD(NM) providing day-to-day oversight of the Nuclear Weapons Council Staff. The NWC has focused primarily on interdepartmental nuclear stockpile management, surety, and security issues.

However, the nation's nuclear enterprise needs a key advisory body for a broader range of issues related to nuclear weapons, associated systems and the supporting industrial base. The

Task Force recommends that the scope of responsibility for the NWC be expanded to include issues involving the full range of nuclear capabilities, including weapons, weapon systems, delivery systems, responsive infrastructure, policy implementation, and resources. The Task Force recommends that the NWC be chaired routinely by the Deputy Secretary of Defense. The ASD(D) would be the Executive Secretary for the expanded NWC.

The Task Force recognizes that the Secretary himself has unique responsibilities relating to nuclear weapons matters with the Department, within NATO and within interagency forums. The effective fulfillment of these responsibilities makes it imperative that he receive regular updates on nuclear weapons matters broadly and particularly on the activities of the Nuclear Weapons Council. The Task Force urges the Secretary to put in place a set of rigorous internal reporting mechanisms that would ensure that he receives timely and accurate information concerning the full range of nuclear weapons issues affecting the Department, other government departments, as well as America's friends and allies.

The Task Force also recommends that a Nuclear Weapons Council Capabilities Review Board (NWCCRB) be created to support the NWC regarding capability and systems policy issues. The new NWCCRB should be chaired by the ASD(D) with appropriate Joint Staff, Service, and COCOM representation and would provide oversight and review of capabilities issues similar to the support provided by the NWC Standing and Safety Committee on stockpile issues.

Recommendations

1. The Secretary of Defense should establish an Assistant Secretary of Defense for Deterrence (ASD(D)) in the OUSD(P). The Principal Deputy Assistant Secretary for Deterrence (PDASD(D)) should be an acquisition professional and should be dual-hatted within the OUSD(AT&L). All existing OUSD(P) offices which deal with nuclear, chemical and biological issues should be realigned under the new ASD; similarly, the functions of the ATSD(NCB) (to include oversight of the Defense Threat Reduction Agency) should be assumed by the new ASD.
2. The Secretary of Defense should assign directorship of the Nuclear Command and Control System Support Staff (NSS) to the newly formed ASD(D).
3. The Secretary of Defense should expand the responsibilities of the Nuclear Weapons Council to include issues involving the full range of nuclear capabilities including weapons, delivery systems, infrastructure, policy implementation, and resources under the chairmanship of the Deputy Secretary of Defense.

Nuclear Capabilities Modernization and Sustainment

Strategic Policy Foundation for Nuclear Capabilities

Strategic policy guidance provides the framework for how the nation builds capabilities that will assure, dissuade, deter, and defeat. Policy documents provide DoD force employment commanders with a starting point from which to develop requirements and capabilities. Unambiguous department-level guidance is the mechanism through which effective capabilities are acquired to meet national objectives outlined in the policy documents. The Task Force reviewed key strategic documents to assess how they address nuclear deterrence capabilities.

Nuclear deterrence is inherently a national mission and should not be unilaterally weakened by either a military service or regional commander. There are established processes for maintaining OSD direction over developing requirements and acquiring capabilities. But in reality, despite a multitude of reforms over the past several decades, the Services retain considerable sway over the process of allocating resources; and since the dissolution of the Strategic Air Command in 1992, they have in many ways neglected nuclear capabilities.

Theater nuclear capabilities have been particularly neglected in strategic guidance, since they are only loosely affiliated with the nuclear triad composed of ICBMs, SLBMs, and bombers (B-52, B-2). The guidance that does exist for these capabilities is inconsistent and ambiguous, and there is little Combatant Command (COCOM) advocacy for theater nuclear capabilities. USSTRATCOM is the primary advocate for acquisition, sustainment, and modernization of strategic weapon systems and associated delivery platforms, but has had little involvement with theater systems. Thus the acquisition and modernization of theater nuclear capabilities has been neglected.

The Task Force found that over the past 15 years the military services have shed nuclear assets—or attempted to do so—in order to use the resources elsewhere. The Services perfected the art of starving a capability when they wished to shed the associated mission—and then recommending that the mission be abandoned on grounds that it has become inadequately resourced or the capability was no longer reliable. The case of the Tactical Land Attack Missile-Nuclear (TLAM-N) illustrates this point. Policy documents and a memo by the Secretary of Defense directed that the Navy should maintain the system until a follow-on program is developed. However, as viewed by the Navy, USSTRATCOM, and the Joint Staff, there is no specific military capability or gap identified that the TLAM-N would satisfy. To date, no follow-on program of record has been established and no funding has been programmed for long-term sustainment of this system.

The Air Force Air-Launched Cruise Missile, as discussed in our Phase I report, is another example of this problem. ALCMs provide the B-52 with a stand-off capability allowing the bomber to deliver nuclear weapons without having to penetrate air defenses of a potential adversary. If this stand-off capability is allowed to disappear, then the ability to signal strategic capability through the generation and dispersal of B-52s will be compromised.

Important national and DoD-level documents refer to nuclear deterrence with varying degrees of clarity. The 2006 QDR states that the nuclear deterrent will remain robust as a keystone of U.S. national power.⁹ Other policy documents subsume nuclear weapons in the

⁹ DoD, *2006 Quadrennial Defense Review*, p. 49.

terminology of kinetic strike or WMD. All make reference to nuclear deterrence but *stress* developing additional, nonnuclear capabilities to increase the number of options available to the President. Most of the documents deal with the strategic aspects of *force employment*. This results in deterrence capabilities being taken for granted. Recent history has demonstrated that without adequate policy articulation and oversight by the DoD, the military services will not be motivated to sustain the nuclear deterrent—and will use the resources elsewhere.

Current Capabilities-Based Acquisition Framework

Figure 3-1 represents a framework for ensuring that OSD can identify gaps to enable responsive infrastructure, deterrence, and nuclear force employment capabilities. The grey areas of the diagram show where current input is lacking in this regard.

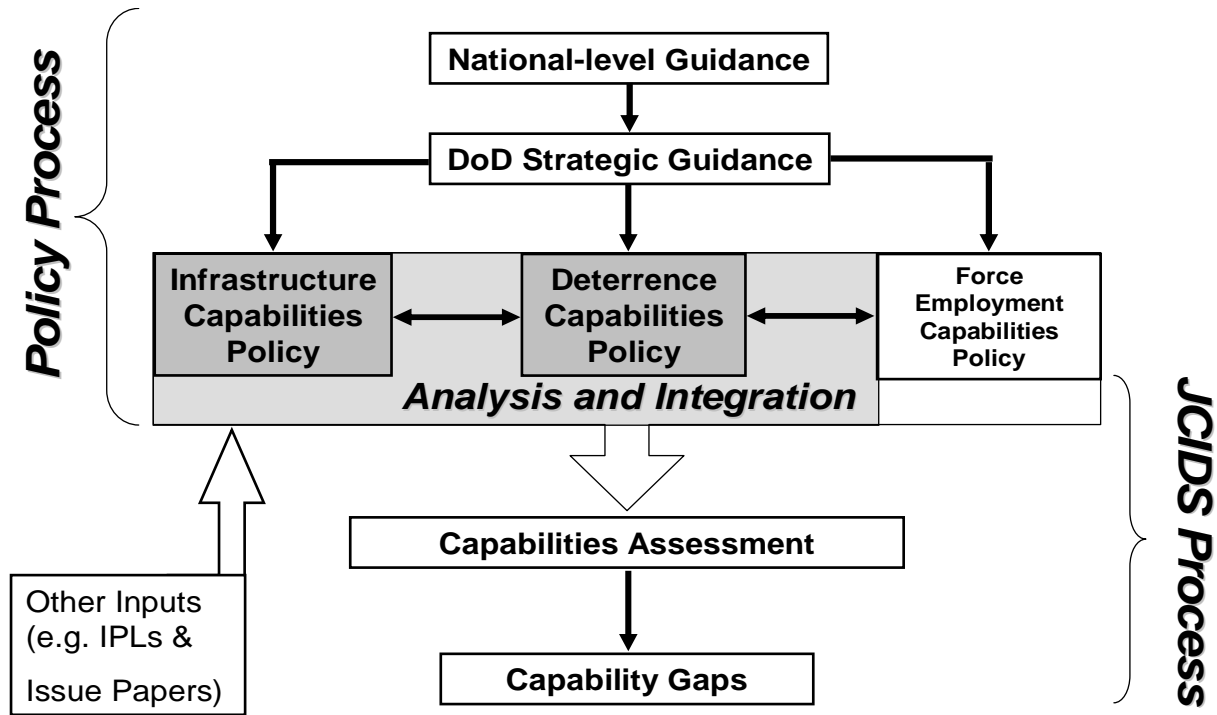

Figure 3-1. JCIDS Process/Policy Process

JCIDS Process

Capability planning has replaced threat-based planning in DoD for defining and funding operational requirements. This capabilities-based process is guided by OSD in the form of a portfolio management process that is supervised by the Deputy Secretary of Defense. The OSD process is mirrored by the Joint Capabilities Integration and Development System (JCIDS) managed by the Joint Staff (J8). The process, initiated with a capabilities-based assessment (CBA), is designed to address future needs. While the OSD and JCIDS capabilities management processes addresses needs of force employment, they fall short in addressing deterrence capabilities and associated infrastructure. This problem is compounded by the lack of a strong advocate to ensure deterrence capabilities are addressed.

The CBA process analyzes warfighting and other functional areas, their problems, and possible solutions as the first step in developing a requirements document based on capability gaps. A capability gap is the inability to achieve a desired effect under specified standards and conditions. The gap may be the result of no existing capability, lack of proficiency or sufficiency in existing capability, or the need to recapitalize an existing capability. The CBA uses Capability Portfolios within OSD and Joint Capability Areas (JCA) within the Joint Requirements Oversight Council to frame the identification of capabilities gaps. The problems identified by the capability gap are then considered in the acquisition process. Both the OSD and JCIDS processes employ the same categories of capabilities to facilitate capabilities-based planning, major trade analysis, and decision-making.¹⁰ All DoD capabilities are categorized under JCAs.

Force Employment

The force employment element of the JCIDS process addresses capabilities such as weapons systems, supporting systems, and nonmaterial solutions for identified gaps in force employment. This process is a collaborative effort by the Joint Staff, COCOMs, Services, and Defense Agencies. OSD and the Joint Requirements Oversight Council (JROC) have reviewed requirements and programs for the following nuclear and nuclear-related systems:

- Next Generation Bomber
- B-2 Modernization
- B-52 Modernization
- Sea-Based Strategic Deterrence (SSBN(X))
- Other systems (C2, etc.)

These processes have focused on developing force employment capabilities but do not take into consideration the fundamental role of nuclear capabilities in deterring threats. To resolve this issue, the Task Force recommends creating a high-level Capabilities Portfolio/JCA that would focus on deterrence. In conjunction with USSTRATCOM, the ASD for Deterrence (as recommended in the section on Proposed OSD Organization) would serve as a senior-level advocate for nuclear deterrence capabilities required in the capabilities-based acquisition process to ensure sufficiently high resource priority.

Deterrence

As opposed to force employment capabilities, in recent years the military has tended to discount the political and psychological element of deterrence and focus exclusively on whether there were sufficient weapons to threaten or attack a set of targets. Such a criterion, employed by some in the military for deciding whether a weapon system is “militarily cost-effective,” misses the crucial point of whether the weapon system can contribute to overall deterrence. This concept is important for the deterrence umbrella, because different capabilities provide different levels of deterrence, assurance, or dissuasion depending on the potential adversary or ally and its individual psychology. The same principle also holds true for the dissuasion of adversaries and provides greater political maneuverability to control escalation. The creation of the recommended

¹⁰ The eight Capabilities Portfolios and Joint Capabilities Areas are Command and Control, Battlespace Awareness, Focused Logistics, Force Management, Force Protection, Force Application, Net-Centric, and Joint Training.

Portfolio/JCA for deterrence and fenced funding for nuclear capabilities would help address these shortfalls in the current process.

Responsive Infrastructure

In the last two decades, funding has shifted from investing in new weapon systems to sustaining existing weapon systems. A much smaller nuclear deterrent capability, combined with a lack of consensus as to what was required to maintain credibility, has been a major contributor to the erosion of the infrastructure required to support the nuclear enterprise.¹¹

Nuclear weapons in the national stockpile need to be accurate, safe, and reliable.¹² However, the average age of the stockpile has tripled since the cessation of testing in 1991, and no new warhead production has occurred since the early 1990s. The United States invested heavily in transforming its military into a conventionally superior force, a focus that contributed to further erosion of nuclear experienced and trained personnel. Those who once devoted their careers to being experts in nuclear affairs turned their professional attention elsewhere.¹³ Consequently, the intellectual capacity to design and build nuclear weapons has been allowed to degrade, and the capability to produce nuclear weapons is declining. Since the United States has not produced any new nuclear weapons in the last decade, the industrial capability and skills for modernization are in a state of decay.

In contrast, the aircraft industry remains relatively robust and the skills required to design, build, and test aircraft capabilities are exercised regularly. Manufacturers that produce aircraft and possess the production capability and engineering expertise would by and large be the same manufacturers that would build airbreathing nuclear delivery systems like the B-52 and B-2. In the cruise missile industry, the ability to produce air- and sea-launched missiles is currently viable due to a strong conventional cruise missile demand. However, in the cruise missile programs, the design and system engineering skills important to nuclear standoff missile surety and survival are eroding.

Advocacy for Nuclear Capability

An expanded NWC could promote the analysis and integration of policy and acquisition to ensure that deterrence, force employment, and responsive infrastructure capabilities are addressed and fed into the CBA process as indicated in Figure 3-2. The NWC is uniquely positioned to address another deficiency in nuclear strategic guidance: the lack of a long-range nuclear capabilities roadmap for the U.S. nuclear mission area. This roadmap could provide a framework for formulating policy that addresses nuclear capabilities (deterrence, force employment, and responsive infrastructure) and ensure the development of deliberate and sustained modernization of nuclear weapons, weapon systems, and delivery platforms. The roadmap would also allow for more responsive programming of constrained resources in the PPBE process.

To support the NWC in accomplishing these added responsibilities, the Task Force recommends establishment of a Nuclear Weapons Council Capabilities Review Board (NWCCRB). Its role would be to analyze and integrate force employment, deterrence, and

¹¹ Chiles, *Nuclear Deterrence Skills*, p. 11.

¹² DoD, 2006 QDR, p. 49.

¹³ Chiles, *Nuclear Deterrence Skills*, p. 14.

responsive infrastructure capabilities according to the nuclear capabilities mission area roadmap. The NWCCRB would be an advisory board to the NWC and the NWC should delegate the appropriate level of review authority to them. The NWCCRB should assess information provided by the Joint Staff to ensure that the NWC requirements for nuclear capabilities are addressed prior to Joint Requirements Oversight Council (JROC) and OSD milestone reviews and approval. To accomplish these responsibilities, the NWCCRB members should include appropriate two-star level representatives from USD(P), USD(AT&L), J8, USSTRATCOM, DTRA, Air Force, Navy, and Army, and the board should be chaired by the proposed ASD(D).

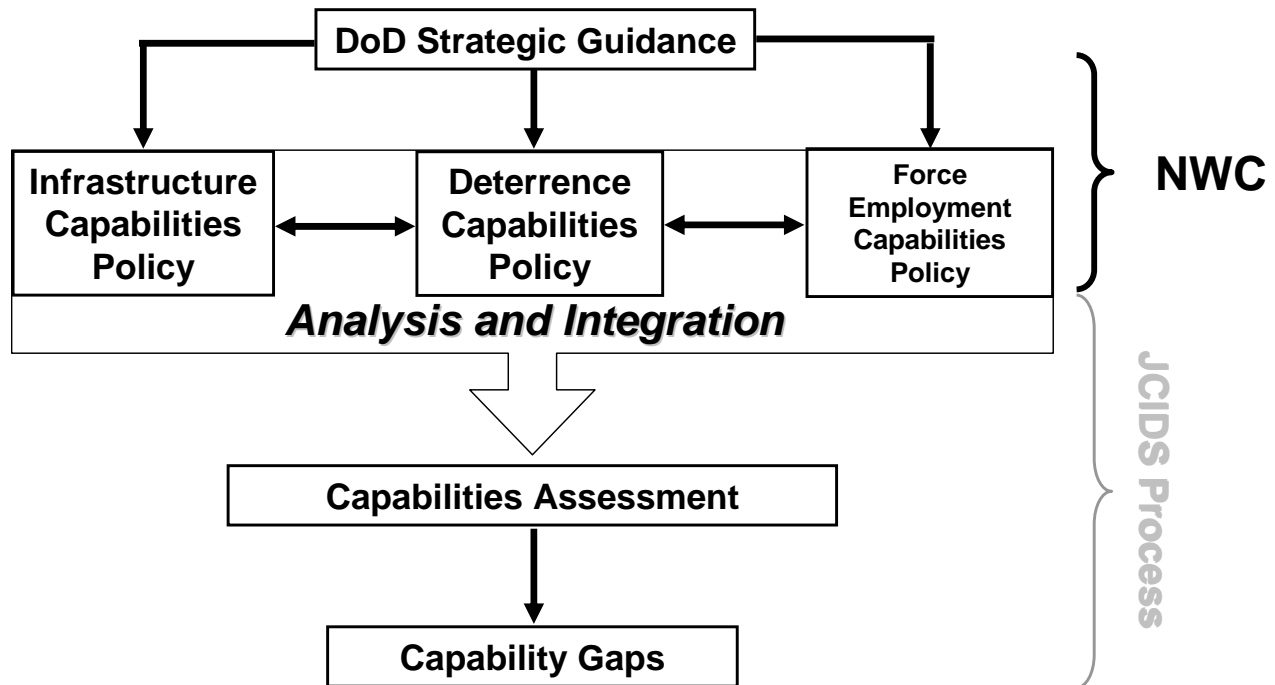

Figure 3-2. Coordinating Policy and Process

Recapitalization and Sustainment









Collectively, the Nation’s nuclear weapon systems and delivery platforms are almost 30 years old. To ensure the weapons remain viable, the National Nuclear Security Administration and DoD have developed a long-term plan for sustainment. However, the B-61 nuclear gravity bomb presents a particular concern to the Task Force. Immediate attention is required to support life extension programs to include the power supply and radar systems, both of which require funding in FY09.

Concerning delivery systems, some have received life-extension programs that will allow them to remain viable for some years into the future. However, nearly all delivery platforms are on a path to age out at approximately the same point in time. The Nuclear Force Modernization chart in Table 3-1 illustrates this point. Recapitalizing these forces within a few years of each other would put tremendous strain on the budget. Some new programs of record have been established, such as the SSBN(X) and the next generation bomber. However, other replacement programs have not materialized: the next generation ALCM never progressed past study; the follow-on

to the Minuteman ICBM had an initial study completed two years ago, but no follow-on actions resulted; the F-35 DCA remains unclear; and no follow-on TLAM-N program has been initiated.

At present there is no cohesive plan to modernize the nuclear force to ensure that force employment, deterrence, and responsive infrastructure capabilities remain sufficient to support national strategy. A long-range nuclear enterprise and mission capability roadmap is a solution that could guide decision-making regarding nuclear forces. Without a comprehensive plan and synchronized actions, the recapitalization of most if not all nuclear deterrence capabilities may occur across a very narrow time interval, creating a classic “bow wave” of resource demands. The roadmap would also provide a basis for better informed trade-off analyses. This would help ensure that a credible nuclear force is maintained and also that the industrial base is able to maintain manufacturing capability as well as continued expertise in the workforce.

Table 3-1. Nuclear Force Modernization

Nuclear Force Component	Estimated End of Life	Replacement Program of Record in Place	Issues
Missile Programs			
Minuteman III ICBM	2020-2030	No	 AoA completed 2 years ago
Trident II (D5) Missile	2040	No	 Low level production
Air-Launched Cruise Missile	2030	No	
TLAM-N	2013	No	 Neglected
Aircraft Programs			
B-52 Bombers	2035+	Yes	 Next Gen. Bomber
B-2 Bombers	2035+	No	 None
F-15/16 Dual Capable Aircraft	201X	Yes	 F-35 replacement—nuclear capability not funded
TACAMO E-6B Aircraft	2025+	No	 Modernization recently completed AoA funding for FY10 for follow-on
Submarine Programs			
Ohio Class Submarines	2027+	Yes	 Partnership with United Kingdom

Source: National Institute for Public Policy and Office of the Secretary of Defense for Programs, Analysis, and Evaluation. A traffic-light chart identifies whether a program has an adequate sustainment program (green circle), some unresolved issues (yellow square), or is at risk (red triangle). The colors assigned to a particular program are a subjective interpretation of the health of that program.

Fenced Funding for Nuclear Deterrence Capabilities

Because of Service indifference toward nuclear deterrence capabilities, the Secretary of Defense should fence funding and assign oversight responsibility to the ASD(D). Funding for strategic capabilities has traditionally been addressed in the account for strategic forces: MFP-1, “Strategic Programs.” Currently this budget program includes both nuclear and nonnuclear program elements. Nonnuclear programs have seen increases in funding as nuclear forces have

been decreased in funding over the last 15 years. Some nuclear deterrence capabilities are categorized in MFPs other than Strategic Programs. To avoid further erosion of resources to the nuclear mission, the Task Force recommends that ASD(D) be responsible for funding execution oversight of nuclear capabilities. This is to be accomplished by the creation of a new capability portfolio composed of all program elements (whether currently categorized in MFP-1 or elsewhere in the defense program and budget structure) directly related to nuclear deterrence. The expanded DoD Nuclear Weapons Council (NWC) would assist in the review and evaluation of nuclear-capable weapons systems, delivery platforms, and associated infrastructure providing senior-level input to nuclear deterrence requirements and capabilities.

Conclusion

The weapons systems that compose the nuclear triad were built and designed decades ago. If the United States is to maintain a strong nuclear deterrent for the foreseeable future, a strategic roadmap for nuclear weapons systems and delivery platforms should be developed. An expanded charter for the NWC would provide the forum for developing such a roadmap and for shepherding the capabilities needed through the resource and acquisition process. Fenced funding for nuclear deterrence capabilities under the oversight of the ASD(D) would check the surreptitious shedding of nuclear capabilities.

Recommendations

1. USD(P) should ensure that strategic guidance documents address nuclear deterrence and responsive infrastructure as capabilities.
2. The Secretary of Defense should direct an expanded NWC to develop and maintain a strategic roadmap for the modernization and sustainment of the nuclear forces (deterrence, force employment, and responsive infrastructure). The Task Force recommends that the Secretary of Defense review and approve this roadmap.
3. The proposed ASD(D) should establish a Nuclear Weapons Council Capabilities Review Board (NWCCRB) to support the NWC in accomplishing added responsibilities recommended in this report.
4. Prior to the JROC review of any nuclear weapons-related program at a milestone review, the Joint Staff should provide the NWCCRB with pertinent program information to allow appropriate input to the JROC process.
5. The Deputy Secretary of Defense should direct the creation of a Capabilities Portfolio for deterrence to elevate its importance to the same level as force employment capability within the OSD Capabilities Based Acquisition process.
6. The Chairman of the Joint Chiefs of Staff should direct the creation of a Joint Capabilities Area for deterrence to elevate its importance to the same level as force employment capability within the JCIDS process.
7. USD(P) should review and articulate department-level guidance regarding the unique capabilities provided by the TLAM-N to ensure that requirements for a follow-on capability are addressed.
8. The proposed ASD(D) should ensure appropriate funding for nuclear capabilities is fenced and provide execution oversight. This can be accomplished by the creation of a new

capability portfolio composed of all program elements (whether currently categorized in MFP-1 or elsewhere in the defense program and budget structure) directly related to nuclear deterrence.

Oversight and Inspections

A rigorous inspection process is critical to maintaining a credible U.S. deterrent. The OSD, the Joint Staff, USSTRATCOM, DTRA, and the military services play significant roles in assuring the safety and security of nuclear weapons while in DoD custody. Critical information is gained through three types of nuclear mission-related assessments: (1) nuclear surety inspections, (2) operational readiness inspections of nuclear forces, and (3) Personnel Reliability Program (PRP) evaluations. These provide DoD and senior Service leaders the confidence to certify the DoD's capability to maintain a nuclear deterrent that is credible, safe, secure, and reliable.¹⁴

By measuring technical compliance, a nuclear surety inspection evaluates a unit's capability to manage nuclear resources while complying with all nuclear surety standards. The Services or DTRA conduct these inspections on nuclear-capable units to examine all aspects of nuclear weapons surety: technical assembly, maintenance, storage functions, logistics movement, handling, safety, and security directly associated with these functions. Although inspection requirements are standardized, defense agency and Service terminology for Nuclear Weapons Technical Inspections (NWTIs) vary: DTRA, on behalf of the Chairman, Joint Chiefs of Staff, conducts Defense Nuclear Surety Inspections (DNSIs); the Air Force conducts NSIs; and the Navy conducts Navy Technical Proficiency Inspections (NTPIs). The Services conduct these inspections to carry out their Organize, Train, and Equip (OT&E) functions; DTRA conducts them to provide oversight of technical compliance. Commanders use these inspections as the basis for certifying facilities and organizations involved with nuclear weapons and weapons systems. The Services must conduct NWTIs at intervals not to exceed 18 months. DTRA is directed to inspect approximately 20 to 25 percent of certified nuclear-capable units annually.

The Services conduct operational readiness inspections of nuclear forces to assess a unit's ability to conduct operations for any assigned wartime nuclear mission (mission readiness) through an evaluation of its response, employment of forces, mission support, and ability to survive and operate in a combat environment. The Air Force evaluates mission execution and core competencies in a simulated wartime environment by conducting Nuclear Operation Readiness Inspections (NORIs). The Navy's Submarine Force, through Tactical Readiness Evaluations assesses the operational readiness of ballistic missile submarines. NATO also performs an operational readiness evaluation for European-based DCA.

As the Task Force concluded in the Phase I Report, operational readiness should be measured through a comprehensive, end-to-end simulation of force employment, beginning with mission planning and concluding with mission execution. An inspection frequency of two to three years ensures that all personnel are evaluated once during a typical assignment. Sufficient intervals between inspections allow for time to sustain training and certification of personnel and address lessons learned from previous inspections.

¹⁴ Recommendations on Air Force nuclear inspections were provided in the Leadership and Culture section of the Task Force's Phase I report.

Finally, there are the Personnel Reliability Program evaluations. Personnel reliability is vital to ensuring that only the most trustworthy individuals perform nuclear-related duties. The PRP is owned by commanders responsible for nuclear-related operations. Medical personnel advise commanders on health-related issues that could impair an individual's reliability; however, commanders are ultimately responsible for determining who will and who will not be certified to perform nuclear-related duties. DoD tasks the Services to ensure that the PRP is reviewed and evaluated during appropriate inspections and staff visits at all levels of command. This is critical for units who have PRP-certified personnel assigned to perform nuclear-related duties but do not require a nuclear surety inspection.¹⁵

Office of the Secretary of Defense

The Assistant to the Secretary of Defense for Nuclear, Chemical, and Biological programs (ATSD(NCB)) develops guidance for conducting NWTIs and assessing the Personnel Reliability Program for the Department of Defense. NWTI guidance is promulgated through DoD Manual 3150.2-M, *DoD Nuclear Weapon System Safety Program*, which establishes baseline policy and assigns responsibilities for the DoD NWTI program. Although DoD Manual 3150.2-M allows Service inspection intervals of their choosing, those intervals cannot exceed 18 months.

Guidance covering PRP is established in DoD Regulation 5210.42-R, *Nuclear Weapons Personnel Reliability Program*. The results of PRP inspections are required to be reviewed periodically at the highest level within the DoD Components to ensure effective and consistent application. While PRP programs for nuclear-capable units are evaluated in conjunction with NWTIs, non-nuclear units with PRP-certified personnel assigned must also have their programs periodically reviewed and evaluated. Because of the program's importance to the nuclear mission, it must be independently evaluated by qualified inspectors representing a command level above the inspected commander. However, the DoD regulation is ambiguous when addressing the requirement to evaluate units not inspected during an NWTI, resulting in different interpretations by the Services. The Navy's PRP instruction states that reviews must be performed by an appropriate senior official in the chain of command at intervals not to exceed 24 months for commands not inspected during DNSIs or NTPIs. However, the Air Force manual for PRP does not address inspection requirements for commands not inspected during NSIs. The ATSD(NCB) should develop specific guidance for evaluating PRP programs for units not subject to inspection under the NWTI system. The guidance set forth in the DoD regulation should direct that an independent assessment be conducted by a Service inspection agency outside the unit's chain of command as well as provide a minimum interval for these periodic evaluations.

The Joint Staff

The Joint Staff Director of Operations (J3) plays a key role in the nuclear surety inspections process. The Strategic Operations Division of the Deputy Director for Global Operations (J39) receives and reviews all DTRA DNSI reports and all Service inspection reports on behalf of the Chairman. Based on the ratings and content, the J39 determines which level of leadership should be briefed on the report. The Strategic Operations Division also provides guidance on nuclear surety inspections via Technical Publication (TP) 25-1, *DoD Nuclear*

¹⁵ PRP is a NWTI-inspectable area (as defined by TP 25-1, para 2-2.9.) conducted to assess the overall effectiveness of the unit's PRP implementation.

*Weapons Technical Inspections System.*¹⁶ Although the document is published by DTRA, it is coordinated and approved by the Joint Staff. Because this document provides policy and guidance for conducting nuclear weapons inspections, the J39 has recently determined that TP 25-1 should be converted to a Chairman, Joint Chiefs of Staff Manual. This change will clearly delineate DTRA's responsibility to conduct nuclear surety assessments on behalf of the Chairman. It simultaneously demonstrates the Joint Staff's responsibility to establish nuclear weapons technical inspection policy and monitor implementation of the inspection system. The Task Force endorses this change.

The J39 Strategic Operations Division also coordinates frequently with DTRA and, to a lesser extent, with Service inspection representatives to fulfill its requirement to review the NWTI system periodically for adequacy and to determine necessary improvements. The Strategic Operations Division sponsors annual symposiums involving stakeholders, such as OSD, COCOM, DTRA, and Service personnel, to discuss problems associated with the DoD NWTI system. The last NWTI symposium was held in October 2008 to discuss changes to the Nuclear Weapons Technical Inspections System publication.

U.S. Strategic Command

While not mandated by Department-level regulations, USSTRATCOM provides command representatives to observe Service-conducted NWTIs for assets assigned to its command. These personnel assigned to the Inspector General's office are experienced in nuclear surety inspection protocols. They provide the USSTRATCOM commander with an independent view of the inspection process and results, relaying important information about the status of the forces employing nuclear deterrence on a daily basis. The Inspector General's office had observed Service-conducted NWTIs since the Command's inception, but this practice was halted when USSTRATCOM absorbed additional nonnuclear missions. Lack of resources, combined with emphasis on other mission areas and a diminished focus on the nuclear mission, resulted in a substantial decrease in personnel assigned to the Inspector General's office. After the Minot-Barksdale unauthorized weapons transfer incident, the current USSTRATCOM commander reinstated the practice of having USSTRATCOM personnel observe Service inspections. Additionally, the Inspector General's office is being provided additional personnel for reestablishing this important oversight function. The Task Force did not find a similar institutionalized practice in the performance of NWTIs on U.S. European-based, DCA units. It therefore recommends that either USSTRATCOM or USEUCOM provide a similar oversight role for these units.

Defense Threat Reduction Agency

DTRA has maintained a requirement to conduct independent NWTIs since the inception of the Defense Nuclear Agency, which was a predecessor of DTRA. Independent assessments of a Service's nuclear surety programs are conducted through two distinct inspection processes: (1) Defense Nuclear Surety Inspections (DNSIs), and (2) Surveillance Inspections. DTRA's Inspections Branch conducts both of these inspections under the authority of TP 25-1 and as directed by DoD Manual 3150.2-M.

¹⁶ According to DoD Directive 5105.62, the Defense Threat Reduction Agency is responsible for conducting independent nuclear surety inspections on behalf of the Chairman of the Joint Chiefs of Staff.

The first type, the DNSI, ensures compliance with requirements specified in pertinent DoD and joint publications, as well as applicable portions of Service publications that directly implement DoD and joint requirements. During the course of an inspection, teams may evaluate any observed items that affect the safety, security, or reliability of nuclear weapons systems. These inspections are almost always conducted in conjunction with a Service NWTI, with each certified nuclear-capable unit normally being inspected at least every five years. DTRA is currently considering a revised inspection model to decrease the minimum interval to three years.

The second type, the Surveillance Inspection, consists of observing and evaluating Service inspection teams while they perform the NWTI portion of Service inspections. Separate agreements containing detailed procedures for surveillance inspections are made between DTRA and each Service. This inspection evaluates the adequacy of Service NWTIs, thus accomplishing the important function of “inspecting the inspector.” DTRA produces Surveillance Inspection reports that are provided to the following: (1) the headquarters of the Service inspection team, (2) the applicable major command headquarters, and (3) the Service headquarters.

During the past 10 years, DTRA conducted a total of 110 DNSIs: 71 Navy and 39 Air Force. Of these 110 inspections, the DTRA inspection team disagreed only once with a Service inspection team’s overall rating. This disagreement occurred during the Air Force Space Command Inspector General’s NSI on the 91st Space Wing at Minot Air Force Base in 2008. Over this same period, DTRA conducted five surveillance inspections not related to the Minot-Barksdale unauthorized weapons transfer incident.¹⁷ These inspections resulted in no disagreement with Navy or Air Force inspection team findings or ratings. However, in response to the unauthorized weapons transfer incident, DTRA conducted Surveillance Inspections as directed by the ATSD(NCB) on 13 Air Force units. DTRA did not concur with the results of five of these inspections—approximately 35 percent of the total Surveillance Inspections conducted. Each instance of nonconcurrency resulted from significant disagreement between DTRA and Air Force Major Command Inspectors General. DTRA disagreed with Inspector General findings and ratings involving maintenance technical operations, security, and PRP.

Several factors highlight a significant shortfall in the current DoD nuclear inspection process. The disproportionate number of DNSIs conducted compared to the number of Surveillance Inspections indicates that Service inspectors and inspection processes are rarely being evaluated by an independent oversight agency to ensure proficiency and adequacy. The absence of any disagreements between DTRA and the Services prior to the Minot-Barksdale unauthorized weapons transfer incident enters into question the value of duplicative inspection processes where DTRA and the Service evaluate the same tasks performed by the same people using the same criteria. The value of DNSIs is questioned further by the surprising number of disagreements resulting from DTRA’s Surveillance Inspections following the weapons transfer incident. However, these particular Surveillance Inspections demonstrate the value of an independent assessment of Service inspectors as they conduct NWTIs. This situation indicates that Surveillance Inspections are a more productive method for providing independent oversight of the Services’ adherence to nuclear surety standards.

Infrequent Surveillance Inspections have left Service commanders without a rigorous, independent assessment of the adequacy of their inspection programs as well as the proficiency of their inspectors. This is critically important when, based upon the results of NWTIs, Service

¹⁷ One in FY04 (Navy); two in FY06 (AF and Navy); one in FY07 (AF); and one in FY08 (Navy).

commanders certify units as capable of performing their assigned nuclear missions safely and securely. Therefore, the Task Force recommends DTRA be directed to conduct only Service Proficiency Evaluations (formerly called Surveillance Inspections). DTRA does provide a Mobile Training Team capability that brings inspector training classes to the units. DTRA intends to increase the availability of these inspector training classes by 50 percent in the near term with a goal to get to a 100 percent increase in a year's time. DTRA provides these instructors out of its current pool of nuclear inspections expertise and will need additional manpower resources to carry out its intended expansion.

Service Proficiency Evaluations would provide a thorough and independent assessment of Service inspectors and inspection processes, as well as ensure uniform DoD oversight of each Service's nuclear surety program. DTRA would assess and evaluate Service inspection teams as the Service conducts NWTIs on nuclear-capable units. The Services would be solely responsible for rating the units while DTRA would only assess and rate the performance of the inspection team, not the unit. DTRA should evaluate every Service inspection team during at least half of their annual NWTIs. Service commanders should receive a report and outbrief from the DTRA inspection team chief at the conclusion of Service Proficiency Evaluations covering both satisfactory elements as well as any noted deficiencies. The resulting Service Proficiency Evaluation reports should be sent to ATSD(NCB), CJCS, CDRUSSTRATCOM, and the Service Chief (or designee). Additionally, DTRA should provide the CJCS and the Services with a comprehensive assessment of Service Proficiency Evaluation trends (both positive and negative) and issues at intervals not to exceed 12 months.

Aligning DoD's nuclear surety oversight with Service Proficiency Evaluations has several benefits, the most important being to improve the credibility and effectiveness of those Service NWTIs conducted without the presence of DTRA evaluators. Further, it would enhance the validity of inspection results by overseeing the process and conduct of unit assessments. The result would be an increase in DoD confidence that all Service NWTIs are standardized and conducted with the consistent rigor necessary to assess nuclear surety. Conducting one type of assessment eliminates duplicate inspections on Air Force and Navy field units. DTRA inspection teams would still monitor each unit's performance by observing all inspectable areas evaluated during the Service NWTI. However, their evaluation would focus solely on how well Service inspectors conduct their assessments. Overall, Service Proficiency Evaluations would provide senior leaders with an independent mechanism for assessing the competence of their inspectors and the adequacy of the inspection process.

Navy

The Navy's Submarine Force and Strategic Systems Program (SSP) satisfactorily conducts NWTIs on fleet ballistic missile submarines and associated shore facilities. Inspection results shown in Figure 3-3 indicate standardized oversight by the inspection regime and consistent adherence to nuclear surety standards by forces assigned to the nuclear mission. PRP inspection requirements are met in conjunction with Service NWTIs. For those nonnuclear units with PRP-assigned personnel in SSP, the Navy's 24-month PRP review and evaluation requirement is met with annual assessments performed by the same NTPI inspectors that evaluate shore facilities. In his assessment of the Navy's nuclear enterprise, Admiral Donald recommended that NWTIs focus more on assessing standards during day-to-day nuclear work execution in order to identify systemic issues rather than isolated difficulties. This would

reinforce the sense of ownership by inspected activities of problem identification, root cause determination, and issue correction. The Task Force endorses Admiral Donald’s findings and recommends that the Navy incorporate them in its inspection processes.

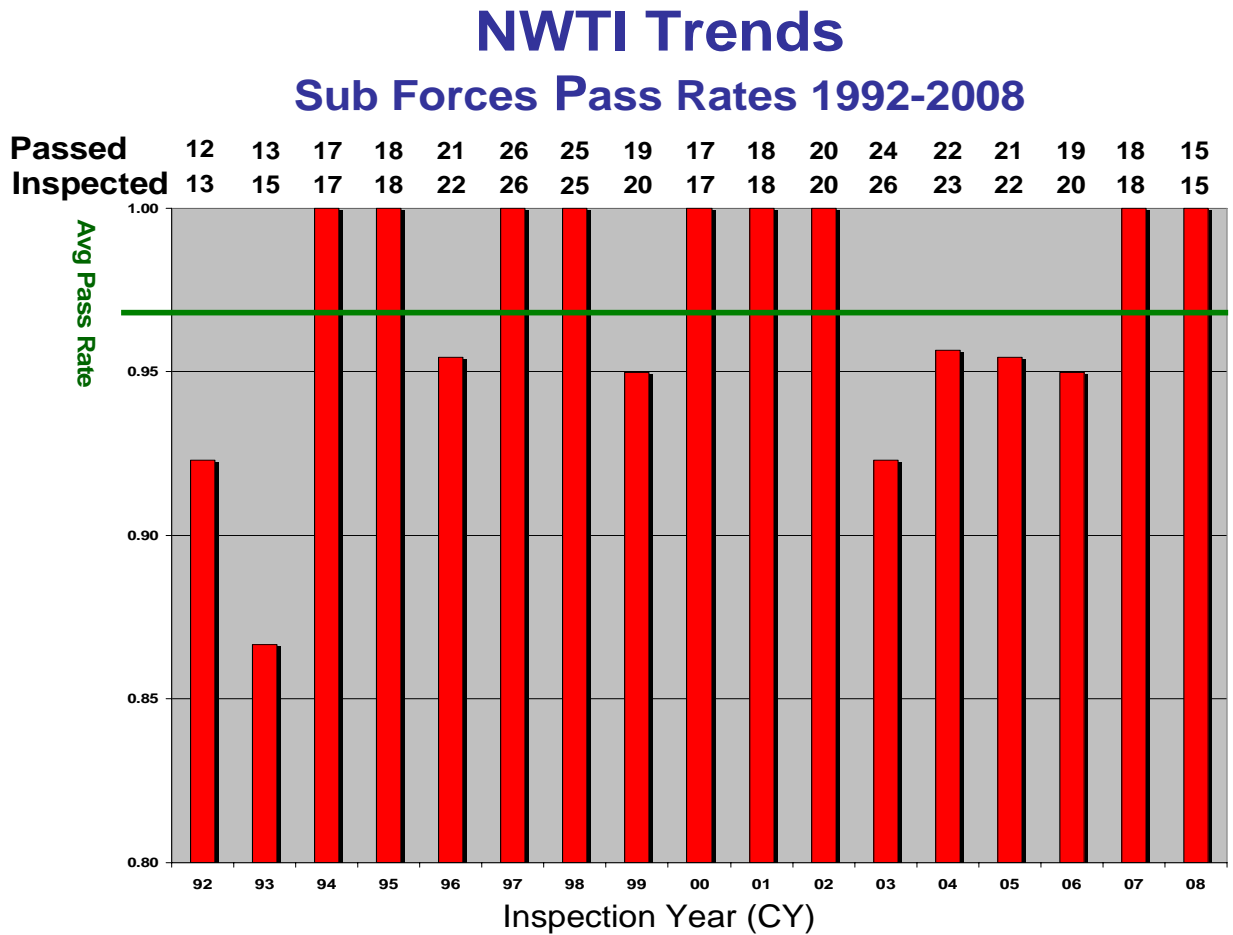

Figure 3-3. NWTI 1991–2008 Trends

While the fleet ballistic-missile submarines and associated shore facilities have satisfactory nuclear surety inspection and operational readiness assessment programs, other Navy nuclear-related forces are not similarly evaluated. For instance, the Navy wing responsible for communications relay and strategic airborne command post aircraft (E-6B or TACAMO) is charged with providing survivable, reliable, and continuous airborne command, control, and communications between the National Command Authority and U.S. strategic and nonstrategic forces. This wing, which is operationally subordinate to the Commander, Naval Air Forces, does not receive a higher headquarters PRP program review and evaluation. Because of the critical importance of the E-6B’s nuclear command and control mission, the Navy should regularly conduct comprehensive PRP evaluations on the TACAMO wing.

The TACAMO wing also does not undergo a higher headquarters-conducted operational readiness assessment. Fleet Forces Command Instruction 3000.15, *Fleet Response Plan (FRP)*, instructs Force/Type Commanders to establish FRP cycles, including operational readiness assessments, for all units assigned. This instruction applies to all naval forces, including fleet

ballistic-missile submarines and aircraft. In addition to a comprehensive PRP review, the Navy should also perform recurring, end-to-end operational readiness assessments on the E-6B TACAMO wing. Inspection intervals should mirror those of the fleet ballistic-missile submarines and their associated shore facilities.

The Task Force recommends that the Navy develop inspection programs for the E-6B TACAMO wing to validate mission capability and ensure provision of adequate and credible forces to USSTRATCOM. Additionally, these inspections would demonstrate the Navy's recognition of the critical role the E-6B TACAMO wing plays in U.S nuclear deterrence, thereby enhancing unit morale.

Recommendations

1. The Secretary of Defense should direct the Defense Threat Reduction Agency (DTRA) to cease conducting DNSIs and only conduct Service Proficiency Evaluations (formerly Surveillance Inspections) to ensure standardized Department-level oversight of each Service's nuclear surety program.
2. ATSD(NCB) should develop specific guidance for evaluating PRP programs for units not subject to inspection under the NWTI system. This guidance should direct that an independent assessment be conducted by a Service inspection agency outside the unit's chain of command as well as provide a minimum interval between assessments.
3. The Navy should develop higher headquarters-level inspection programs for the E-6B TACAMO wing to ensure operational readiness and PRP program compliance for forces provided to USSTRATCOM. Inspection intervals should mirror those of the fleet ballistic missile submarines and their associated shore facilities.
4. The Chairman, Joint Chiefs of Staff should direct either USSTRATCOM or USEUCOM to develop and institutionalize a formal program providing command representatives to observe Service-conducted NWTIs for European-based DCA.
5. The Service Chiefs should establish an operational readiness inspection frequency of two to three years for nuclear-tasked forces to ensure that all personnel are evaluated once during a typical assignment. They should also ensure that readiness is measured through a comprehensive, end-to-end simulation of force employment, beginning with mission planning, including nuclear surety, and concluding with mission execution.

4 DoD Forces

Navy

The Task Force finds the Navy has maintained its commitment to the nuclear mission. However, recent internal and external assessments have identified areas where improvement is required to sustain long-term performance and stewardship of the nuclear mission area. One senior leader characterized such areas as indications of “fraying at the edges”; nonetheless, the Task Force did not find in the Navy the kind of deterioration in morale that characterized Air Force nuclear units. The attitude in the Air Force was: “We know that the President and Secretary of Defense don’t give a damn about what we do.” General Larry Welch reported from a visit with a ballistic-missile submarine crew that, while they felt that senior leaders were disinterested in the strategic deterrence mission, the SSBN force chain of command—to include their skipper—is deeply committed to the mission, and therefore, they remain highly motivated to perform it well every day. The attitude in the Navy was: “We know that the President and Secretary of Defense don’t care—but we do.”

In contrast to the dispersal of authority the Task Force found in the Air Force, the Navy’s nuclear mission area has been consolidated within two functional elements: the operational force and the acquisition/lifecycle support organization. The operational nuclear deterrent forces are concentrated in the SSBN force. The Strategic Systems Program provides all acquisition, lifecycle, technical, and shore-based support for the strategic weapons system. In 1991, presidential directives removed deployed tactical nuclear weapons from aircraft carriers and surface combatants and discontinued routine deployment of nuclear weapons on fast-attack submarines. Subsequently, the aircraft carrier- and surface ship-based weapons were removed from the U.S. inventory entirely. Further consolidations and reductions of the existing fleet resulted in a single deployed strategic capability provided by the Trident II D5 missile system on the Ohio-class submarine. Additionally, the Navy is responsible for a single tactical nuclear weapon system: the Tomahawk Land-Attack Missile–Nuclear (TLAM-N) variant. This cruise missile is designed for deployment on the Los Angeles-class fast-attack submarine that will be replaced by Virginia-class submarines.

Operational Force Organization

The Navy performs two interdependent operational missions in the nation’s strategic deterrence force. The first and primary mission is the deployment and sustainment of the submarine-launched ballistic missile (SLBM) leg of the traditional nuclear triad in the SSBN fleet. Second, the Navy operates a strategic communications air wing providing survivable communications known as the TACAMO (Take Charge and Move Out). This air wing comprises two operational squadrons of E-6B aircraft and associated communications systems that support both the SSBN mission and the USSTRATCOM airborne command post mission.

The nuclear operational forces supporting these missions in the Navy are aligned for OT&E functions under two fleet commanders: (1) U.S. Fleet Forces Command (formerly Atlantic Fleet), and (2) Pacific Fleet. Both fleet commanders have responsibility for overall resourcing and training of the forces in their geographic areas and oversight of their respective

Type Commanders (TYCOMs). In order to provide operational forces to USSTRATCOM for execution of the deterrent mission, the Navy maintains three nuclear task forces: TF 144 (Atlantic SSBNs), TF 134 (Pacific SSBNs), and TF 124 (TACAMO). Note that the TYCOMs for submarines and the wing commander for TACAMO are dual-hatted with both OT&E and operational responsibilities. Figure 4-1 shows the current administrative and operational chains of command.

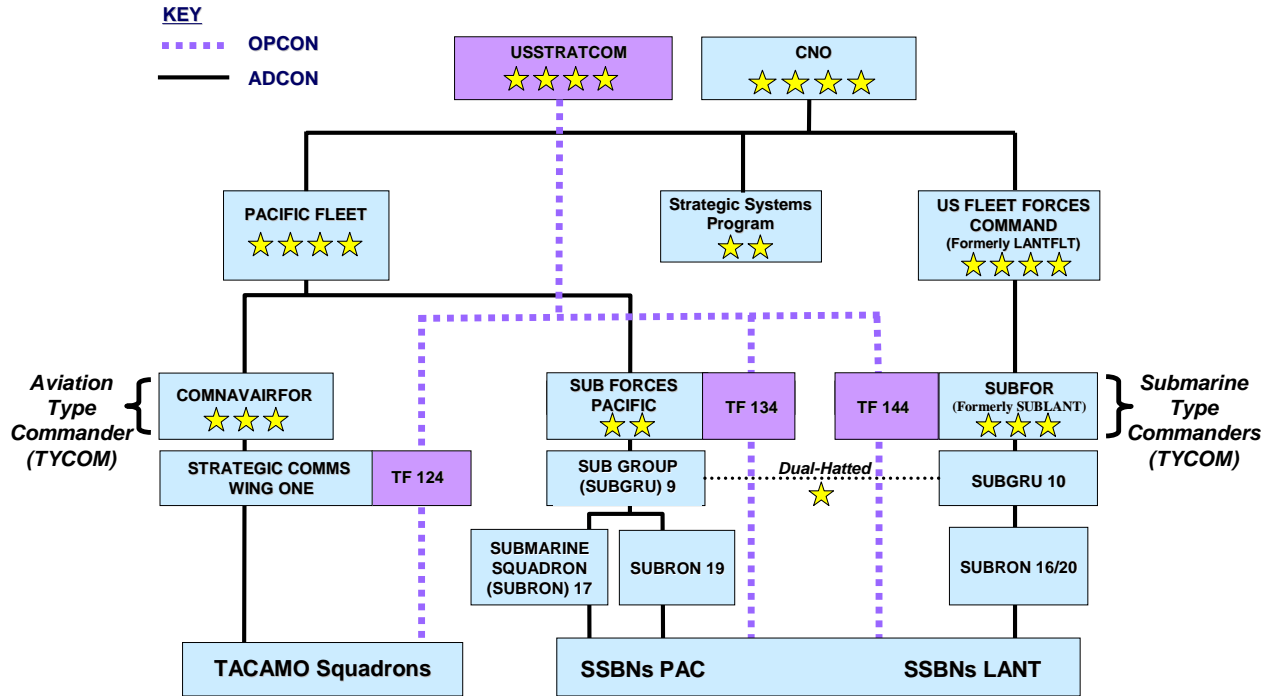

Figure 4-1. Navy ADCON and OPCON Chains of Command in the Nuclear Weapons Mission¹⁸

Acquisition and Lifecycle Support Organizations

The Strategic Systems Program (SSP) provides acquisition, program management, technical oversight and support, and shored-based nuclear weapons storage and maintenance for nuclear weapons systems in the Navy. SSP reports directly to the Chief of Naval Operations (CNO) for administrative issues and to the service acquisition executive for acquisition matters. Under the direct control of a two-star admiral, SSP is responsible for the one deployed strategic capability: the Trident II D5 Strategic Weapon System. Two Strategic Weapons Facilities (SWFs) reporting to SSP support the Atlantic and Pacific Trident fleets. These facilities provide

¹⁸ Submarine Group NINE (SUBGRU 9) and Submarine Group TEN (SUBGRU 10) are commanded by a dual-hatted flag officer who is assigned additional duty as Commander Submarine Group Trident. In these roles, he exercises administrative control of all SSBNs and guided-missile submarines (SSGNs), four SSBN/SSGN Submarine Squadrons, Trident Refit Facility at Kings Bay, GA, and Naval Submarine Support Centers in Bangor, WA, and Kings Bay, GA. Additionally, Commander Submarine Group NINE is Immediate Superior in Command for the submarine tender USS EMORY S. LAND (AS-39) and maintains administrative oversight for fast attack submarines undergoing maintenance at Puget Sound Naval Shipyard.

weapon systems shore support including storage, processing, and submarine load/offload of the missile and associated nuclear systems. The security forces supporting the Navy's weapons storage areas and waterfront restricted areas report to the SWF Commanding Officers.

For the existing theater nuclear weapons programs in the Navy, Naval Air Systems Command (NAVAIR), through Program Executive Officer for Unmanned Aviation and Strike Systems (PEO(U&W)), provides program and technical oversight for the submarine-launched cruise-missile program (TLAM-N), capitalizing on the strong similarity to the conventional cruise-missile programs. In 1997, the Navy consolidated day-to-day storage and maintenance of TLAM-N assets under the SSP-controlled SWFs. However, NAVAIR and PEO(U&W) continue to provide program management and technical support. Figure 4-2 illustrates the general relationships of NAVAIR and SSP for both their acquisition and service chains of command.

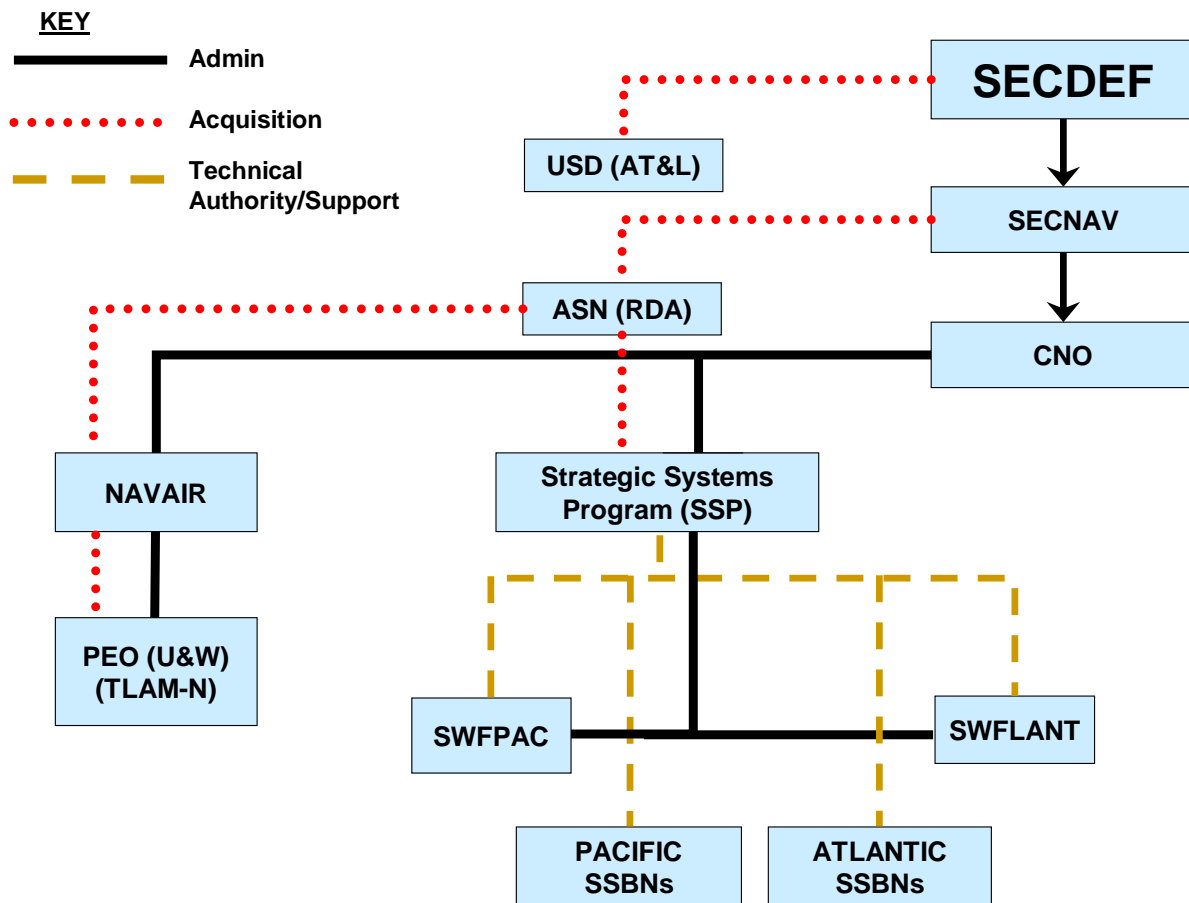

Figure 4-2. Navy Acquisition and Technical Support Organization Structure in the Nuclear Weapons Enterprise

Another noteworthy element of the U.S. Navy's role in deterrence is the strong tie with the United Kingdom through both the 1958 Mutual Defense Agreement and the 1963 Polaris Sales Agreement. These two agreements laid the framework for sale of Polaris missiles and supporting systems to the United Kingdom to maintain its independent nuclear deterrent. Amended in 1982, the Polaris agreement continued with the transition to the Trident D5 missile

system. Under the agreement, SSP provides the missiles, onboard strategic weapons system, and some shore support systems for the U.K. ballistic-missile submarine fleet, while the United Kingdom produces its own submarines and warheads. As a result of the United States' decision to extend the Ohio-class submarine hull life, the United Kingdom will require a replacement strategic submarine before the United States does. This situation has facilitated the start of the next generation U.S. SSBN program with a "common missile compartment" acquisition strategy in which the United States and the United Kingdom will share program costs and risks.

Health and Status of the Navy Nuclear Weapons Enterprise

A review of recent reports, investigations, and Task Force interviews confirms that the Navy continues to maintain a high degree of attention, readiness, and emphasis regarding its nuclear mission. The Navy's organizational structure, more tightly aligned than that of the Air Force, has facilitated continuing attention by the Navy senior leadership. However, the Task Force did find areas of concern. A number of actions have already been initiated by the Navy to correct some of these deficiencies.

Following Admiral Donald's May 2008 investigation of the Air Force's misshipment of reentry body components to Taiwan, the Secretary of the Navy directed SSP and PEO(U&W) to conduct self-assessments of their programs. The Secretary of the Navy further directed Admiral Donald to review the Navy nuclear enterprise and the SSP and PEO(U&W) self-assessments. In August 2008, Admiral Donald reported that the Navy's nuclear weapons and related components were controlled and managed in an overall satisfactory manner. However, Admiral Donald's review and the self-assessments identified 10 specific areas regarding the SSP and their fleet interface that require significant improvement. Analysis of these findings leads to two general themes: (1) insufficient oversight and rigor at some levels of the SSP and submarine force organizations, and (2) inadequate management of civilian and military personnel assignments and manning with potential adverse effects on mission performance. In a standalone finding, Admiral Donald discovered significant resource, execution, and program management issues with the TLAM-N program not identified by the PEO(U&W) management office. Based on the results of the self-assessment process and a follow-on independent review, the Task Force recommends formally establishing a biennial enterprise-wide review and assessment.

Theater Nuclear Cruise Missile Program

Although the Navy has been directed by the Secretary of Defense to maintain the TLAM-N program until a follow-on capability is programmed, the Task Force found the Navy has taken no such action. Lack of an overall national and departmental strategy for theater nuclear capabilities may have contributed to the Navy's resistance to resourcing this capability. The Task Force found no COCOM, Joint Staff, or Navy advocacy for the nuclear sea-launched cruise missile capability provided by the TLAM-N. This lack reflects a failure to recognize the important deterrent capability of the TLAM-N that would give the President a degree of flexibility for escalation control and extended deterrence on behalf of our allies. The matter was presented to the Deputy's Advisory Working Group (DAWG) and a decision was deferred for the next administration. The situation requires the Secretary of Defense to provide clear direction to the Navy for this program. In compliance with previous direction, the Secretary of the Navy should conduct a comprehensive program review of TLAM-N and instruct the Navy Acquisition Executive to develop a plan to maintain TLAM-N until follow-on capabilities are realized.

Additionally, the Navy and Joint Staff should review and update the concept of operations for the TLAM-N system to make it a more viable and responsive option for national leadership.

Advocacy, Leadership, and Nuclear Experience

The Task Force found that advocacy for the nuclear strategic deterrent mission requirements is largely effective across the Navy. The Navy continues to champion and support the follow-on SSBN program as it enters its initial stages of development and acquisition. In addition, the Navy has committed significant resources to the life-extension programs for the D5 missile, upgrades to onboard strategic weapons systems, and nuclear weapons security upgrades. The Navy's Resource and Requirements Review Board (R3B) has been successful in bringing nuclear-related resource issues to the attention of the Navy senior leadership. Healthy ties with the Secretary of Defense staff have allowed Navy programs to maintain a strong advocacy both within and outside of the service. With the notable exception of the nuclear cruise missile TLAM-N program, the Task Force believes that the Navy's leadership remains committed and engaged, working both within and outside service organizations to ensure the continued viability of its strategic nuclear deterrent programs.

Based on their analysis of Admiral Donald's report and the Navy self-assessment, the Navy staff concluded that stronger and more formalized leadership of the nuclear weapons enterprise was required at the headquarters level. To strengthen the oversight functions of the enterprise in the Navy, the CNO directed the establishment of a Navy Nuclear Weapons Senior Leadership Oversight Council (SLOC) and an OPNAV Nuclear Weapons Council (NWC). The Director of Navy Staff has been designated as the single flag officer responsible for staff action on nuclear matters. Additionally, Navy leadership is reviewing roles, responsibilities, and authorities regarding the nuclear mission in the Navy. The results of this review and recommendations are due to the CNO no later than April 2009. The Task Force supports the Navy's efforts in this area and recommends the OPNAV NWC and SLOC be appropriately staffed to provide a forum for all stakeholders, such as OPNAV staff, SSP, NAVAIR, and operational fleet, etc., to maintain coordinated oversight of the Navy's nuclear weapons enterprise and operations.

Admiral Donald also recommended that the Navy evaluate the establishment of the SSP Director as the Navy's dedicated authority for nuclear weapons. This expansion of SSP authority would cover all technical aspects of nuclear weapons work including radiological control programs, security, logistics, selection and qualification of personnel, and oversight of nuclear weapons activities executed by the operational fleet. The expansion of duties and increased responsibility warrants assignment of a three-star flag officer as the Director of SSP and additional staff support to undertake the expanded oversight role. Senior Navy officials noted that the Naval Reactors organizational model requires an eight-year tenure for the flag officer in charge of overseeing nuclear propulsion programs. This offers benefits in providing leadership continuity to crucial oversight functions. This same continuity of leadership could be provided by the Director of SSP by mandating a minimum tenure for this position—perhaps six years, or by establishing a senior executive civilian with open-ended tenure as the deputy to the Director of SSP. The Task Force recommends the Navy pursue the concept of establishing SSP as the Navy's dedicated technical authority for all nuclear weapons and systems not already aligned under their cognizance. Consequently, the rank of the Director of SSP should be elevated to a three-star flag officer. The Navy should weigh the benefits of extending the required tenure of

the Director of SSP or assigning a senior civilian executive as the deputy to provide leadership continuity. If the latter option is chosen, the deputy to the Director should be an individual with significant nuclear weapons program experience to provide sound advice to the Director and effective oversight and leadership of the SSP organization and its programs.

The greatest future challenge for the Navy regarding nuclear mission advocacy will be the inevitable decline in nuclear weapons experience at the captain and flag officer level. The current Navy senior leadership largely comprises flag officers from across its submarine, aviation, and surface combatant forces who served on nuclear-capable units when aircraft carriers and surface combatants carried tactical nuclear weapons. As noted previously, these weapons were withdrawn from the fleet in 1991. As a consequence, in approximately five years, the Navy will start to promote officers in significant numbers to flag ranks who will have had no exposure to the nuclear mission. The service should monitor the overall percentage of flag officers with nuclear weapons experience as a hedge against further dissolution of mission advocacy and expertise. This may require, as recommended to the Air Force, that the Secretary of the Navy and CNO stipulate nuclear deterrent/weapons experience as a desirable promotion criterion for consideration by promotion and selection boards. Some civilian billets requiring nuclear weapons experience at senior executive service levels of the staff may be needed to provide continuity over the long term in this critical area. OPNAV NWC and SLOC should periodically monitor this issue to maintain a pool of flag nuclear experience.

With a multitude of organizations, such as OSD, Joint Staff, COCOMs, NATO, OPNAV, SECNAV, etc., requiring nuclear weapons-experienced officers in the future, the Navy will have to manage its diminishing experience pool carefully to maximize the use of its nuclear expertise at senior levels. The first step in approaching this problem, similar to steps being taken in the Air Force, is to code all billets in the Navy that require nuclear weapons experience. The Task Force recommends that the Secretary of the Navy direct a study focused on future nuclear weapons enterprise manning and experience across all associated career fields and workforce constituents (such as line officers, engineering duty officers, limited duty officers, and civilians). The study should define the problem, forecast trends and shortfalls for satisfying service, joint, and international needs, and provide recommendations to the Secretary of the Navy concerning mitigating courses of action.

To ensure that the Navy's nuclear weapons mission area continues to enjoy senior-level advocacy in the future, the senior leadership should institutionalize changes to expose an appropriate number of its officers to nuclear deterrence and strategy concepts. It is therefore important to expand the Navy's professional military education (PME) programs to include curricula focusing on strategic deterrence concepts and theories. A review of current Navy PME indicates relatively little coverage of these topics. A program at the Naval Postgraduate School allows students majoring in National Security Affairs to pursue a degree emphasis in strategic nuclear planning.¹⁹ However, the optional nature of this curriculum limits its success in instilling these skills and knowledge into the larger body of the Navy officer communities. Similarly, the Naval War College has incorporated elements of nuclear strategy and deterrence into elements of its courses and lecture series including several electives on the topic. Finally, a strong tradition of technical and scientific education in nuclear fields exists in the submarine force and at the Naval Postgraduate School. However, no formal structure exists within the Navy to ensure the requisite

¹⁹ Naval Postgraduate School Academic Catalog, 7 November 2008.

numbers of personnel are exposed to these curricula to stem the tide and manage a shrinking nuclear experience base. The Task Force recommends that the Navy strengthen its PME in these areas as well as ensure that appropriate numbers of students are exposed to the curriculum once it is developed and implemented. Additionally, the Navy should develop subspecialty codes to identify nuclear weapons and deterrence strategy and policy experience and education to enable the Service to manage its personnel in this area. While some of these codes exist within the Navy's personnel system, their application and specificity have been diluted over the years.

Resourcing and Manning

Navy manning and resourcing for the nuclear mission are more robust than the Task Force found in corresponding programs in the Air Force. For example, security forces at both east and west coast weapons storage facilities and SSBN crews are adequately manned. Additionally, there is a plan of action resourced with several billion dollars (not including personnel costs) to upgrade security systems and procure new systems to meet increased nuclear weapons security requirements.²⁰ This represents an investment of nearly 25 percent of the entire Navy Military Construction budget over the next three to four years. However, the Task Force uncovered several activities and programs of potential impact upon the nuclear mission that it regarded as underfunded or otherwise problematic.

USSTRATCOM, TYCOM, and TACAMO staffs expressed concern over the planned level of funding for the Fleet Ballistic Missile Communications Continuing Evaluation Program (CEP) and the Strategic Communications Assessment Program (SCAP). Together, the CEP and SCAP provide crucial analysis of the communications performance of the SSBN fleet and the Nuclear Command and Control System (NCCS). A USSTRATCOM-directed program, the CEP provides day-to-day evaluations of the critical systems used for sending emergency action messages to SSBNs. As the architectures change through modernizations, CEP continues to measure the performance of these critical systems to ensure they meet the requirements to support presidential execution of nuclear weapons orders. The SCAP is a complementary effort and provides a modeling and simulation capability for planners to assess the ability of the NCCS to manage and direct strategic forces in support of national policy. These studies are used by the Navy and USSTRATCOM to evaluate existing programs, justify planned improvements, assess new procedures, and develop future system architectures. What is most important is that these relatively inexpensive programs can provide warnings of future or emerging potential problems with the NCCS.

With the numbers of upgrades and modernizations required of individual parts of the system, the SCAP/CEP is an investment well worth making to ensure that unexpected degradations are detected and corrected early, thus ensuring the reliability of critical communications links. As illustrated in Figure 4-3, SCAP/CEP programs have been cut approximately 50 percent from the FY00 base year (as adjusted for inflation). The TYCOM and others are concerned with an approximately 20 percent underfunding of projected steady-state requirements (2012 and afterward). The Task Force recommends that SCAP/CEP funding be restored, at a minimum, to TYCOM-requested levels to ensure that performance of this crucial communications link is monitored in a robust manner. Furthermore, an independent program

²⁰ As promulgated in DoD 5210.41-M, November 2004.

review should be done by USSTRATCOM to develop baseline requirements for the NCCS assessment capability provided by SCAP and CEP.

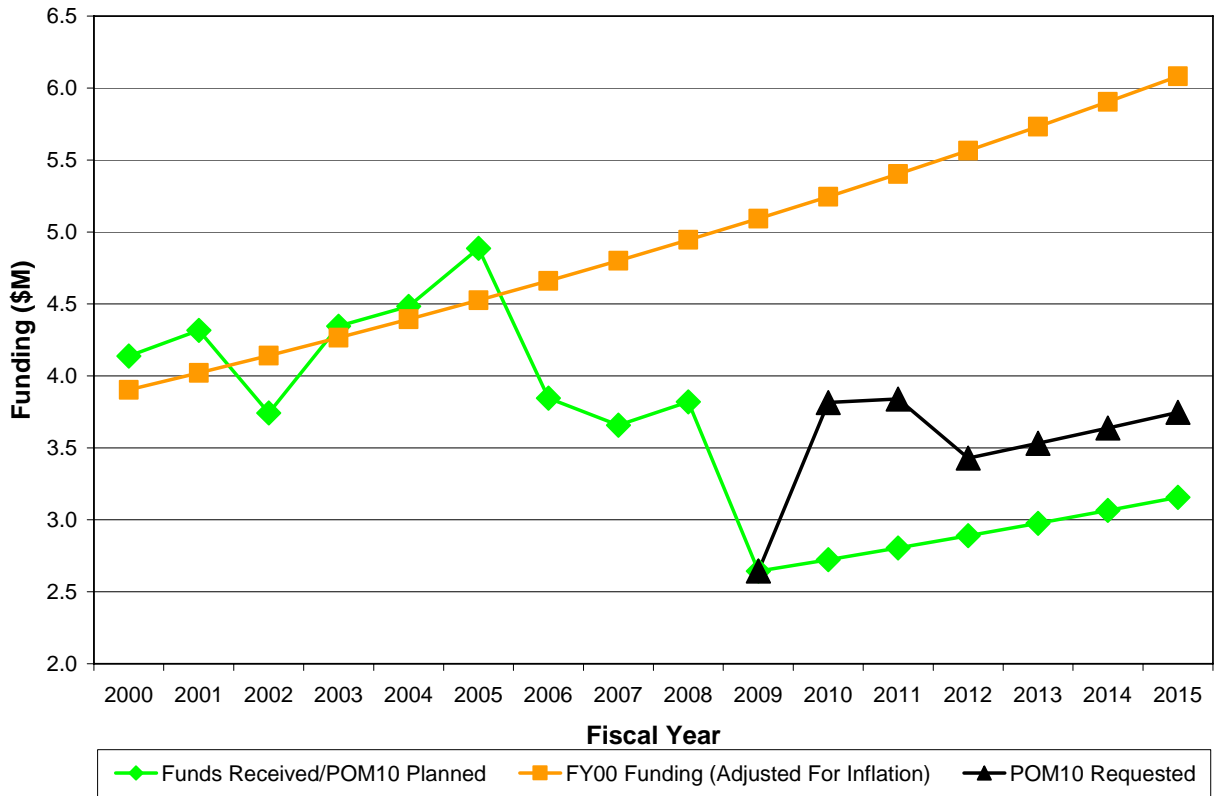

Figure 4-3. CEP and SCAP Funding²¹

Another program essential to the continued credibility of sea-based strategic deterrence is the SSBN Security Technology Program (SSTP). Examining technology vulnerabilities and operational patterns, this program analyzes potential threats to ensure the security and survivability of the SLBM leg of the Triad. With survivability being the single most important benefit provided by the SSBN force, the SSTP should be considered a mission essential element of the Navy’s nuclear deterrent capability. The Task Force recommends that Director of Submarine Warfare (OPNAV N87) provide oversight for the SSTP program to ensure that its health, viability, and funding continue to keep pace with program requirements.

The Task Force also noted resourcing issues related to the TACAMO mission. In their primary mission, the TACAMO squadrons provide a crucial survivable communications link to the SSBN forces. The Navy has funded the upgrades to the aircraft in a satisfactory manner, but several mission requirements remain of concern. USSTRATCOM recently endorsed funding for the mobile reconstitution capability which is now included in a POM10 submission by the Navy. Additionally, the currency of ground-based trainers used for certifying and training aircrews has not kept pace with the aircraft upgrades. Training resources need to be incorporated as part of a comprehensive package for technological upgrades. Since the TACAMO operation is akin to

²¹ Based on data provided by Commander, Submarine Forces, November 10, 2008.

synchronizing a robust symphony of multiple capabilities, it is imperative that the entire spectrum of their capabilities, both on the ground and in the air, be resourced fully in a timely manner. The Task Force recommends that the Secretary of the Navy continue advocacy for the TACAMO units with the aim of ensuring that all mission elements are fully funded in the future.

The Task Force discovered a manning issue with the training centers at the SSBN bases. In particular, the manning at Trident Training Facility in Kings Bay was reduced from some 340 instructors and staff to approximately 150 over a four-year period, a 56-percent reduction. While some compensatory plans have been put into effect, and no immediate mission performance degradation has been documented by submarine commanders, the reduction has limited the flexibility of submarine crews to build high-performance teams in all competency areas—strategic mission, navigation, sonar employment, and communications suite employment, etc. The SSBN concept of operations depends highly on shore-based training to maintain readiness. Upon transfer of the submarine from one crew to the other, the ship must return to sea on short notice, fully mission ready. A review of readiness inspection results indicates no immediate adverse performance impact; but submarine commanders were uniformly concerned that the Trident Training Facility was near a tipping point in this regard. The Task Force concludes that, in the long term, such undercutting of resources for training may eventually degrade performance of the SSBN fleet and therefore recommends a reversal of these personnel resource decisions.

The second manning issue brought to light during the Task Force review was with the submarine force operational shore-based staffs. Reductions in recent years may have been too drastic to allow consistently effective oversight of the SSBN mission, as well as other assigned units, by the group and squadron commanders.²² The submarine force leadership has noted this problem and is addressing it through an approved plan for additional personnel assignments to the submarine squadrons. The staffs of submarine groups on each coast were also significantly reduced including the removal of one group commander position and much of the associated staff. For example, the east coast SSBN group staff has no resident strategic weapons expertise. Several Navy leaders were concerned that oversight of the multiple squadrons assigned responsibility for training and certifying the SSBN/SSGN crews lacked a robust group level assessment of their certification processes. The Trident submarine group commander's recommendation to restore several critical billets to the east coast submarine group and add a few billets to both coasts' submarine group staffs is under review by the submarine force TYCOM. Additionally, the TYCOM is reviewing the possibility of restoring both groups to an alignment that existed prior to the establishment of the combined group commander concept in late 2006. This would reestablish a flag officer and full staffs on both coasts. The Task Force endorses this plan of action and strongly urges the Navy to address these staffing concerns including the reestablishment of group commanders on both coasts with fully manned staffs.

The Task Force is concerned with manning at TACAMO units. TACAMO requirements have remained largely unchanged since inception of the mission. However, the wing has experienced reductions in manning of aircrews and a growth of unfunded billets over the last three years. For example, a 24-percent decrease in aircrew manning occurred in 2006, while many other billets were shifted to an unfunded status in 2008. This degrades the performance of units that have a high operational tempo, with day-to-day alert status and requirements in support

²² See footnote 18. Additionally, Squadrons 16 and 20 on the east coast are commanded by a dual-hatted Captain with oversight of both SSBN and SSGN units, both in Kings Bay and Norfolk Naval Shipyard.

of both USSTRATCOM and USCENTCOM. The Task Force recommends that the Navy man the TACAMO operational squadrons at 100 percent of their “wartime” manning levels to recognize the personnel demands of the daily “deployed in place” status of the TACAMO forces supporting the nuclear deterrent mission.

For the SSP, new missions and programs have been added in recent years including: (1) the life extension program for the D5 missile and associated warheads, (2) an expanded nuclear weapons security role, (3) introduction of the SSGN Attack Weapon System, (4) assignment as integration agent for large diameter payloads for SSBN and SSGN launch tubes, and (5) future SSBN program support. Since no additional civilian billets were provided for these new missions, increased requirements were absorbed by the existing manpower. These civilian personnel shortfalls pose a significant risk to the continued successful execution of the SSP primary strategic mission. The SSP senior leadership has recognized this shortfall and estimates that an approximate 10-percent increase in civilian manning is prudent to oversee and execute the assigned programs adequately. SSP has requested additional senior executive billets to provide more consistent oversight and rigor within the program. Additional billets would allow SSP to provide experienced senior oversight of field activities and human capital management. Finally, SSP military manning for technical oversight, assessment, and program management of nuclear systems has suffered reductions in both the number and seniority of individuals assigned to SSP headquarters and field activities. This has reduced the overall experience level of the military workforce in SSP. The Task Force recommends that the Navy provide sufficient civilian and military billets to ensure the continued capability of the organization to provide consistent and rigorous oversight of nuclear weapons-related programs.

Further exacerbating the military manning issues, the Navy contributes personnel to supplement the force structure in Iraq and Afghanistan, Global War on Terrorism support roles elsewhere, and other staffs in various theaters. These Individual Augmentee assignments, which create unit vacancies until incumbents return, are in effect a “10 percent tax” on submarine force shore installations, with the exception of the nuclear weapons security forces. In particular, this manpower drain has had adverse effects on the training centers, where billet reductions have already decreased the number of available instructors. It is important to note that the Navy’s nuclear weapons security forces remain unaffected by the Individual Augmentee program. Likewise, operational SSBN crews have not been affected. The continued support of Global War on Terrorism operations by members of the nuclear weapons enterprise must be continuously assessed to ensure it does not undermine the oversight, daily standards, and credibility of the Navy’s strategic nuclear deterrence mission.

Contract Oversight

Defense Contract Management Agency (DCMA) support of the nuclear mission and performance was found to be lacking during the nuclear enterprise review conducted by the Navy.²³ DCMA provides oversight of the contractors for the Navy’s Strategic Systems Program (SSP) and other organizations. In the mid 1990s, SSP positions that provide oversight were transferred to DCMA in a DoD-wide consolidation of contract and quality assurance. This consolidation transferred these responsibilities to an organization with little experience in the nuclear enterprise.

²³ Admiral Kirk Donald, “Report of the Audit and Review of Strategic Systems Programs’ Self-Assessment and Review of Operation within the Navy’s Nuclear Weapons Enterprise,” N00N/08-0055, August 6, 2008.

In particular, DCMA was cited during the Admiral Donald review with lack of established surveillance plans, noncompliance with audit program requirements, failure to oversee contractor inventory management systems, poor documentation of inspections and tests, and complacent inspector oversight. For the Navy mission, the execution of the DCMA contract management responsibilities is crucial. In light of the identified deficiencies, the Task Force recommends that the Undersecretary of Defense for Acquisition, Technology, and Logistics conduct a review of DCMA's support for nuclear-related programs and provide adequate personnel and resources to address the shortfalls identified in Admiral Donald's review.

Classified Material Control

Admiral Donald's review of Navy facilities found shortfalls in procedures and standards in handling classified material in the Navy supply system and at several Navy commands. Inadequate procedural compliance and oversight in both the Navy and the Air Force indicate a potential systemic problem within DoD that requires further action. The Task Force recommends a department-wide effort to review and assess the requirements within all commands—and particularly in supply organizations—concerning the handling, storage, and transport of any classified material.

Mission Emphasis and Intelligence Support

The Task Force found that the SSBN force and supporting organizations are highly motivated and engaged in their missions. However, several factors limit the ability of the force leadership to instill pride and develop an underlying background in the nuclear deterrence mission. In visits to Navy operational units, the Task Force found that commanding officers have very little intelligence support to draw on for explaining the nuclear mission to their crews. During the visit to Kings Bay Naval Submarine Base, it was noted that the commanding officers sometimes felt compelled to resort to open source information as a substitute for classified intelligence information of mission importance. The current generation of Navy submarine personnel is highly competent and motivated by a sense of pride and purpose. Greater understanding of the intelligence underpinning their mission would enhance this sense of purpose and contribute to sustained superior performance and high standards. The Task Force recommends reinvigorating intelligence support to the SSBN force by establishing manpower authorizations for an intelligence officer at each Trident submarine group. These officers should provide intelligence to Navy personnel involved in the nuclear mission on foreign nuclear developments. The focus and purpose of this information should be to provide day-to-day operational information regarding the nuclear mission, provide critical mission background information prior to deterrent patrol periods, and ensure that our strategic deterrent forces understand how essential their contributions are to the national strategic deterrent mission.

Although SSBN and shore facility commanding officers continue to convey the importance of the role of SSBNs and their crews to deterrence, they expressed concern that DoD leaders are not consistently supporting them in this role. For example, some senior leaders have undermined the efforts of leaders within the Navy's nuclear deterrent forces with public statements equating the nuclear forces to "Cold War relics." The crews visited by the Task Force were keenly aware of such pronouncements. The far-reaching impact of such remarks on the readiness and motivation of the force is significant. The Task Force recommends regularly scheduled visits to nuclear-capable commands by senior DoD and service leaders as well as

high-level attention to significant achievements of the nuclear deterrent force. In particular, the Task Force recommends significant DoD participation in the upcoming milestone in February 2009 marking completion of the 1000th Ohio-class submarine strategic deterrent patrol.

Recommendations

1. The Secretary of the Navy should establish a requirement for biennial self-assessment reviews of the nuclear weapons mission area to keep the oversight of this critical area at the forefront of the organization's attention. The requirement should be implemented no later than February 2009.
2. The Secretary of the Navy should conduct a comprehensive program review of TLAM-N and direct the Navy Acquisition Executive to develop a plan to maintain TLAM-N and to develop follow-on capabilities that can come online prior to expiration of TLAM-N effectiveness. Should there be a gap, the Navy should be directed to maintain TLAM-N to extend its service life commensurate with introduction of the new system.
3. Joint Staff (J5) should direct a review and update the concept of operations for the TLAM-N system to make it a more viable and responsive option for national leadership.
4. The Secretary of the Navy should continue with the plan to implement the SLOC and OPNAV NWC. These panels should be appropriately staffed, providing representation of all Navy nuclear mission area stakeholders, such as operational, resource sponsors, acquisition, etc. Both panels should be chartered and functioning no later than April 2009.
5. The Secretary of the Navy should increase the rank for the position of the Director of Strategic Systems Program to a vice admiral, including extending the authorities of the position to include oversight of nuclear weapons radiological control programs, security, logistics, selection/qualification of personnel, and oversight of nuclear weapons activities executed by the operational fleet.
6. The Secretary of the Navy and CNO should evaluate the continuity of leadership for the Strategic Systems Program and prescribe a minimum tour length; alternatively, they could support the establishment of a senior executive deputy to the Director SSP for continuity. If the latter option is chosen, the Deputy to the Director should be an individual with significant nuclear weapons program experience to provide sound advice to the Director and effective oversight and leadership of the SSP organization and its programs.
7. OPNAV N1 should direct the identification and coding of all nuclear weapons-experienced billets in the Navy to be completed no later than April 2009.
8. The Secretary of the Navy should direct that a study of the nuclear weapons mission area manning and experience level be conducted. This study should focus on the projected inventory of nuclear weapons experienced officers. Additionally, the study should investigate the problem of a shrinking experience base in the future, forecast the trend and shortfalls, and provide recommendations to the SECNAV for mitigating the risks of a shrinking nuclear weapons-experience base. The review should be completed no later than June 2009.
9. The CNO should direct a curriculum review of all Navy professional military education with a view to expanding educational offerings and research opportunities on nuclear deterrence, strategy, planning, and operational theory. The review should encompass all career PMEs, including service academies, Reserve Officer Training Corps, post-graduate educational

institutions, and senior service colleges. The review and incorporation of new curricula should be completed by October 2009.

10. OPNAV N1 should implement sub-specialty codes to identify nuclear weapons and nuclear deterrent strategy/policy experience and education which can be utilized to manage the nuclear weapons experience/education within the Service.
11. The Commander, USSTRATCOM should undertake a program requirements review for the Strategic Communications Continuing Evaluation Program (CEP) and the Strategic Communications Continuing Assessment Program (SCAP), and then formally promulgate baseline requirements of both programs. The review should identify which program requirements lack funding. The review should be completed no later than April 2009.
12. OPNAV N8 and OPNAV N6, based on the requirements review by USSTRATCOM, should review funding and adjust the CEP and SCAP funding profile to meet all COCOM requirements for the two programs and, at a minimum, restore funding to the TYCOM requested levels. Full requirement funding should be in place by October 2009.
13. OPNAV N8 should conduct an in-depth program review of the SSBN Security Technology Program. The focus of the review should be to ensure that current and future requirements of the program are fully funded. This review should be completed prior to April 2009.
14. The Director of Navy Staff should conduct an assessment of the manning at both Trident Training Facilities to be completed and briefed to the CNO no later than March 2009. The assessment should evaluate the manning based on the unique concept of operations for the SSBN platform as well as all assigned training requirements related to these facilities, such as SSGN and pipeline courses, etc.
15. The Secretary of the Navy and the CNO should endorse the proposals for additional manpower billets required to resource SSBN squadron and submarine group staffs including the reestablishment of the group commander positions and full staffs on both coasts.
16. The CNO should direct a review of TACAMO wing manning and billet funding status to ensure that the wings are appropriately manned and that the funded billet structures support the mission requirements. This review should be completed no later than April 2009.
17. The CNO should direct OPNAV N8 and OPNAV N4 to conduct an in-depth review of the funding of the TACAMO program to ensure its sufficiency to execute its full concept of operations, both airborne and shore-based, including all ground-support equipment and trainers. In particular, the funding for high-fidelity trainers and support of ground reconstitution capability is of concern. This review should be conducted and briefed to the CNO no later than April 2009.
18. The Secretary of the Navy should direct a review of SSP manning in light of proliferating missions and programs, and increase civilian and military billets to ensure continued viability of the organization in providing consistent and rigorous oversight of nuclear weapons related programs. This review should be completed and briefed to the Secretary of the Navy and the CNO no later than April 2009.
19. The CNO should review the Individual Augmentee program to ensure that the nuclear weapons mission area is not assuming disproportionate risk in executing key nuclear support programs (acquisition, training, maintenance, etc.). The review should devote particular

attention to the training facilities which support the SSBN mission. This review should be completed no later than March 2009.

20. The Undersecretary of Defense for Acquisition, Technology and Logistics should conduct a review of DCMA's support for nuclear-related programs and provide adequate personnel and resources to address the shortfalls identified in Admiral Donald's review.
21. The Secretary of Defense should direct a classified material and stowage handling stand-down for all services and agencies. The goal should be for each service and agency to conduct a review of their practices for handling, storing, and transporting classified material as well as to provide training in these areas to the DoD workforce as a whole.
22. The CNO should direct the establishment of one intelligence officer manpower authorization each at a minimum at both Trident submarine groups. This program should be instituted by October 2009.
23. Senior DoD officials should participate in the February 2009 celebration of the 1000th Ohio-class submarine deterrent patrol.

USSTRATCOM

Since its creation in 1992, USSTRATCOM has been charged as the combatant command responsible for the Nation's strategic nuclear forces independent of geographic boundaries.²⁴ Despite multiple changes to the Unified Command Plan (UCP) since 1992 and the assignment of additional missions, USSTRATCOM's indicated responsibility for the nuclear mission has remained constant.

The Impact of Mission Proliferation

In 2002, the United States Space Command (USSPACECOM) was disestablished, and mission responsibilities for space operations (including missile defense and information operations) were transferred to USSTRATCOM.²⁵ The command gained approximately 450 additional personnel to accomplish the increased number of missions. USSTRATCOM assumed ownership of the conventional (nonnuclear) global strike and intelligence, surveillance, and reconnaissance (ISR) mission areas in 2003, along with expanded responsibilities for missile defense and information operations.²⁶ The most recent enlargement of missions came in 2006 when the command was tasked with global network operations and combating weapons of mass destruction.²⁷ As a result, USSTRATCOM's focus shifted from its core responsibility for the strategic nuclear mission to responsibilities that now include eight global missions. Since the addition of the six additional missions—global strike, global ISR, missile defense, information operations, global network operations, and combating WMD—the command's total manpower authorizations had a net increase of only 183 positions.

In response to the proliferation of responsibilities at USSTRATCOM, the command developed a distributed approach to operationalize each mission area through the creation of Joint Functional Component Commands (JFCCs) and Joint Task Forces (JTFs). Essentially, the JFCCs are sub-unified commands that accomplish the day-to-day planning and operations for USSTRATCOM's various missions. USSTRATCOM created the JFCC concept in an effort to leverage the expertise and capabilities of existing organizations already engaged in these mission areas. JFCC-Global Strike & Integration—the component responsible for executing the USSTRATCOM nuclear mission—was formed around 8th Air Force, the Air Force component with responsibility for nuclear-capable bombers. Key functions such as nuclear targeting and force monitoring once performed by USSTRATCOM personnel were transferred to JFCC Global Strike & Integration. While these functions are still performed within the USSTRATCOM headquarters building (specifically the Air Room and the Global Operations Center), their transfer from the headquarters organization to a JFCC represented a significant departure from the centralized management and control that once characterized USSTRATCOM. Similarly, responsibilities for Network Warfare and Intelligence, Surveillance, and Reconnaissance were assigned to JFCCs aligned with the National Security Agency (NSA) and the Defense Intelligence Agency (DIA), respectively. Today, the USSTRATCOM organization consists of a headquarters element, five JFCCs (Global Strike & Integration, Space, ISR, Network Warfare, and Integrated Missile Defense), the Joint Information Operation Warfare Command (JIOWC),

²⁴ Unified Command Plan, 7 April 1992, pp. 12-13.

²⁵ Unified Command Plan (Change 1), 30 July 2002, pp. 1-3.

²⁶ Unified Command Plan (Change 2), 10 January 2003, pp. 12-15.

²⁷ Unified Command Plan, 5 May 2006, pp. 14-15.

Joint Task Force-Global Network Operations (JTF-GNO), and the USSTRATCOM Center for Combating Weapons of Mass Destruction (SCC-WMD).

One perceived advantage to leveraging the existing capabilities resident in the Services and defense agencies was that the JFCCs could be established without a corresponding manpower increase. The objective, as the JFCCs came into being, was to reduce the size of the USSTRATCOM headquarters organization while leveraging existing capabilities within organizations outside of USSTRATCOM for certain mission areas. The Task Force believes that the JFCC construct was a reasonable approach to the number and diversity of the missions assigned to USSTRATCOM. However, the JFCC organizational structure resulted in a fragmentation of the organizations performing the nuclear mission at USSTRATCOM. It should also be noted that during the period when the JFCCs were established, USSTRATCOM and other military headquarters were under intense pressure from the Secretary of Defense to reduce the size of their staff organizations. Nevertheless, the combatant commander's staff must be appropriately sized to oversee JFCC operations. In the case of the nuclear mission, too many headquarters billets were divested, resulting in a lack of adequate oversight and support of the Task Forces and JFCCs. For example, the reduced manpower authorizations in its Nuclear Operations and Inspector General organizations contributed to the overall weakening of deterrence in the Department of Defense.

The Task Force has concluded that USSTRATCOM does not have the manpower necessary to execute all missions assigned by the current UCP. Given the importance of the nuclear mission, the Task Force recommends that the number of missions assigned to USSTRATCOM be reduced. The Task Force suggests that the missions assigned include deterrence, global strike, and space and that USSTRATCOM continues to be the primary joint enabler for the integrated missile defense and combating weapons of mass destruction missions. Reducing the scope of USSTRATCOM's mission would help stabilize its organization and institutionalize the focus required for its core nuclear mission.

OSD and the CJCS should review USSTRATCOM's implementation of its December 2007 organizational assessment of its headquarters nuclear mission and provide the additional manpower and resources necessary to restore mission focus. Additionally, the Task Force recommends that, when possible, future commanders of USSTRATCOM be chosen from among candidates with significant operational nuclear experience.

Intelligence

When USSTRATCOM was established in 1992, its Joint Intelligence Center (STRATJIC) was staffed by approximately 1,000 personnel performing functions largely supporting the nuclear mission. This organization (formerly the 544th Intelligence Wing) was the largest intelligence analysis activity in the Air Force.²⁸ Over time, the STRATJIC was steadily reduced in size until it was disbanded in 2006 with the understanding that USSTRATCOM would be able to leverage the capabilities of the Defense Joint Intelligence Operations Center (D-JIOC) run by the DIA.²⁹ This arrangement was codified in the DoD directive establishing

²⁸ Air Force Print News, "Strategic command intelligence role echoes its past," June 23, 1999.

²⁹ General James Cartwright, Speech at National Defense Industrial Association Conference, [http://www.stratcom.mil/Spch_test/Copy%20of%20CC_NDIA_6Mar07.html] March 6, 2007.

JIOCs at all unified combatant commands except USSTRATCOM.³⁰ As a result, the majority of the remaining intelligence positions went to the newly formed JFCCs and the D-JIOC, leaving USSTRATCOM without a robust intelligence capability focused on the nuclear mission. In December 2007, the functions performed by the D-JIOC were merged with those of USSTRATCOM's JFCC-ISR in a new organization, the Defense Intelligence Operation Coordination Center (D-IOCC). As a result of the command's divestiture of its organic intelligence functions, USSTRATCOM was left without a robust capability to focus on intelligence matters related to the nuclear mission.

Some intelligence functions, for example program management and counter-intelligence, were retained within the USSTRATCOM headquarters. However, the bulk of the intelligence analysis capability was distributed among the various JFCCs and the D-JIOC/D-IOCC. This dispersal of intelligence manpower resulted in the termination of direct intelligence support for the strategic nuclear mission within the command's headquarters. A JIOC implementation assessment conducted in December 2007 concluded that the intelligence function within the USSTRATCOM headquarters "does not have the cohesive intelligence framework necessary to enable comprehensive management of the Command's intelligence operations."³¹ During testimony before the Strategic Forces Subcommittee of the House Armed Services Committee in February 2008, the Commander, USSTRATCOM acknowledged that the command had divested key intelligence functions capabilities and concurred with the need to recoup the intelligence structure within USSTRATCOM.³² Working with DIA, the command has undertaken efforts to rebuild its headquarters intelligence capabilities.

Current Nuclear Operations

Mission proliferation and headquarters downsizing took a significant toll on the ability of USSTRATCOM to remain focused and actively engaged in the daily operation of the nuclear mission area. While some pockets of significant nuclear expertise were retained within the headquarters staff, many of those performing nuclear-related tasks were scattered throughout USSTRATCOM's functional directorates. JFCC-Global Strike and Integration assumed greater responsibilities for critical nuclear functions once managed by the headquarters. These included force monitoring, significant portions of the Global Operations Center, and the USSTRATCOM Airborne Command Post. In particular, the J3 division personnel cuts reduced the commander's insight into the daily operations and concerns of the nuclear task forces.

The task of providing unambiguous employment guidance regarding an increasingly complex plan has become more difficult with fewer nuclear-qualified and experienced personnel. Moreover, USSTRATCOM has had difficulty filling positions designated for rated aircrew personnel with nuclear experience. As a result, these billets are often filled by rated personnel without nuclear experience, requiring the incumbent to invest a great deal of time and energy to on-the-job training, hardly a satisfactory posture in a mission area with potentially little margin for error. Compounding this situation, the rapid turnover of personnel has resulted in a serious

³⁰ Chairman, Joint Chiefs of Staff, "Joint Intelligence Operations Center (JIOC) Execution Order (EXORD)," message, April 3, 2006, p. 5, para. 2G(1).

³¹ Office of the Undersecretary of Defense for Intelligence, "Assessment of Joint Intelligence Operations Center Implementation," December 6, 2007, p. 115.

³² General Kevin P. Chilton, Commander, USSTRATCOM statement before the Strategic Forces Subcommittee of the House Armed Services committee on United States Strategic Command, February 27, 2008.

deficiency in subject matter expertise and a lack of continuity for many USSTRATCOM headquarters functions. The Task Force recommends that manpower authorizations at USSTRATCOM that require prior nuclear experience be designated as must-fill positions within the Services' personnel systems.

Prior to the 2002 merger of USSPACECOM and USSTRATCOM, the senior leader with undivided daily focus on the nuclear mission area was the Commander, USSTRATCOM, a four-star general or flag officer. During the Task Force review, the most senior officer at USSTRATCOM with a purely nuclear focus was an Air Force colonel. As a result, the nuclear mission was severely disadvantaged when competing for the attention of senior leaders within the organization. The Task Force supports the recently established one-star flag/general officer position for USSTRATCOM nuclear operations (J3N) and is encouraged that this position was filled in early December 2008.

The Task Force recommends that the Commander, USSTRATCOM energetically fulfill his responsibility for monitoring the operational effectiveness of U.S. nuclear forces and intervene when deficiencies or lack of mission support occur. This will require additional personnel within the Nuclear Operations branch and the Inspector General division at USSTRATCOM, two initiatives already underway at the current commander's direction.

The Task Force identified a gap in the seam between USSTRATCOM and the Geographic Combatant Commands (GCCs) in planning and C2 of interregional and global operations. Circumstances may arise wherein nuclear capabilities required by one regional commander are under the command or operational control of another. In these circumstances, concepts of operation and expertise are required, both at the GCC and at USSTRATCOM in order to resolve quickly the matter of assigning and managing "supporting" and "supported" relationships. Regional deterrent and cultural expertise are required to plan and execute such missions and are most likely to be present in the GCC. USSTRATCOM has the nuclear effects planning tools (provided largely by DTRA through the USSTRATCOM Center for Combating WMD) and global strike synchronization skills. However, at present, no doctrine exists and no concepts of operation have been developed to guide and exercise the development of such relationships. The Task Force suggests that the CJCS address these issues in the next revision to the UCP.

Mission and Resource Advocacy

In the resource area, USSTRATCOM has not been specifically charged with the advocacy and capability development roles for the strategic nuclear mission, although USSTRATCOM is represented in the requirements process and on the NWC. While advocacy responsibilities may be implied, specific direction for USSTRATCOM to engage in these activities with respect to strategic nuclear forces is lacking.

USSTRATCOM's 276-person Capability and Resource Integration Directorate (J8) is quite large when compared to other geographic and functional combatant commands. USSTRATCOM has maintained most of its analytic capacity and provides direct support to the Services during their analyses of alternatives for future capability needs. USSTRATCOM must have an integral—if not the lead—role in defining future requirements for the Nation's strategic nuclear deterrent forces. However, the lack of a long-term strategy for maintaining and modernizing a credible nuclear deterrent has hampered the Command's efforts to advocate

effectively for the development of critical capabilities, such as the Land-Based Strategic Deterrent, a follow-on to the aging intercontinental ballistic missile system. In addition, the focus of USSTRATCOM planning and mission execution tends to be near or mid-term while the long-term responsibility to “organize, train, and equip” the forces remains with the Services. Combatant commanders must advocate for long-term capabilities required to support assigned missions. USSTRATCOM, as the lead combatant command for advocating nuclear capabilities, should also advocate for theater nuclear systems in coordination with the geographic combatant commanders. Failure to maintain existing nuclear capabilities or to advocate for future nuclear needs increases risk and reduces the range of potential options in the face of a dynamic security environment. The Task Force recommends that the Secretary of Defense institutionalize USSTRATCOM’s role with respect to nuclear capabilities—both theater and strategic—by directing the Command to adopt both advocacy and capability development responsibilities. This role should be codified in the UCP along with specific direction for USSTRATCOM to engage with other combatant commands and the Services regarding the entire spectrum of nuclear capabilities.

Other USSTRATCOM Initiatives

The USSTRATCOM leadership, under its present commander, has acknowledged the overall decline of the nuclear mission as well as the Command’s necessary role in restoring the appropriate level of emphasis to this critical mission. In 2007, the Commander, USSTRATCOM directed his staff to conduct a study and provide recommendations to ensure that the Command is positioned to execute its nuclear responsibilities. This effort found a number of shortcomings in the Command’s organizational structure as well as the need for additional leadership focus on nuclear matters. As previously discussed, USSTRATCOM has already started to implement the assessment’s findings by establishing a one-star flag/general officer position focused exclusively on the nuclear mission.

In an effort to increase attention and focus on the nuclear mission among USSTRATCOM leaders, the Command has also established two bodies to assist in command oversight and advocacy for the nuclear mission. The first of these groups, the Nuclear Enterprise Council (NEC) consists of senior USSTRATCOM general/flag officers as well as nuclear task force commanders. The NEC is a senior-level body that provides oversight to USSTRATCOM decision-making processes, integration, and involvement with regard to nuclear-related issues. The second body, the Nuclear Enterprise Board (NEB) comprises colonel/captain-level officers from across USSTRATCOM. The purpose of the NEB is to analyze issues, review solutions, and recommend courses of action that affect the nuclear mission. The NEB also has a number of functionally organized working groups. The interaction between the NEB and NEC shows promise for ensuring active, cross-functional involvement in the nuclear mission by the USSTRATCOM senior leadership.

The current Commander, USSTRATCOM has been a strong advocate for a strategically focused and proactive Nuclear Weapons Council (NWC) within OSD. By dealing with issues beyond those confined to the nuclear weapons stockpile (e.g., weapon delivery platforms, the nuclear workforce, long-term capability needs, etc.), the NWC will be better positioned to take a holistic approach to the long-term requirements for maintaining a credible nuclear deterrent. While a revitalized NWC with an expanded scope is necessary to restore senior-level attention to nuclear matters, USSTRATCOM must recognize and embrace its unique—and highly visible—

responsibility for sustaining the long-term viability of the Nation's nuclear forces and deterrent capability.

The Task Force heartily endorses these USSTRATCOM initiatives. Furthermore, the Task Force recommends that the Secretary of Defense support USSTRATCOM's effort to revitalize its nuclear mission by providing the resources necessary to implement the Command's nuclear initiatives identified in the organizational assessment study.

Recommendations

1. The Secretary of Defense should reduce the number of missions assigned to USSTRATCOM to include the deterrence, global strike, and space missions. USSTRATCOM should continue to be the primary joint enabler for the integrated missile defense and combating weapons of mass destruction missions.
2. The Secretary of Defense should direct a review of the USSTRATCOM headquarters and JFCC manpower, and organizational structure organizational assessment completed in 2007. The review should identify the manpower and organizational changes necessary to ensure that the command and its components are adequately resourced and structured to execute USSTRATCOM's nuclear mission responsibilities effectively.
3. The Commander, USSTRATCOM should identify to the Services those manpower authorizations at USSTRATCOM that require prior nuclear experience.
4. Service Chiefs should ensure all USSTRATCOM billets requiring nuclear experience are designated as must-fill positions within the military services' personnel systems.
5. The position of Commander, USSTRATCOM, if at all possible, should be filled with a general or flag officer with significant operational nuclear experience.
6. The Secretary of Defense, through the Unified Command Plan, should institutionalize the role of USSTRATCOM as the lead combatant command advocating for capability development, requirements and resources for both strategic and theater nuclear systems.
7. The Commander, USSTRATCOM should assume responsibility for directing the operational effectiveness of U.S. nuclear forces and ensure the command is actively involved in monitoring the readiness of nuclear forces, including the synchronization of corrective action for deficiencies and improvements.
8. To buttress the credibility of the U.S. deterrent, the Commander, USSTRATCOM should aggressively pursue the Command's responsibility to develop and conduct a robust and visible regimen for exercising and demonstrating the U.S. nuclear deterrent forces. This exercise program should be aggressively supported by the Joint Staff and Services.
9. The Task Force endorses the initiatives USSTRATCOM is pursuing to restore intelligence functions in support of the command's nuclear mission. The Task Force recommends the Director, Defense Intelligence Agency actively support the Commander, USSTRATCOM in this effort.

USEUCOM/USAFE

USEUCOM

USEUCOM, long the principal advocate for nuclear weapons in Europe, now abstains from its advocacy role. It no longer recognizes the *political* imperative of U.S. nuclear weapons within the Alliance. This attitude is held at the senior levels of USEUCOM and permeates the staffs. In the view of one senior leader referring to nuclear weapons in Europe: “We pay a king’s ransom for these things and . . . they have no military value.” Deployed weapons in Europe have been reduced by more than 97 percent since their peak in the 1970s, and expenditures on ready nuclear forces have likewise been dramatically reduced. In the long-held view of USEUCOM, deterrence provided by USSTRATCOM’s strategic nuclear capabilities outside of Europe are more cost effective. USEUCOM argues that an “over the horizon” strategic capability is just as credible. It believes there is no military downside to the unilateral withdrawal of nuclear weapons from Europe. This attitude fails to comprehend—and therefore undermines—the political value our friends and allies place on these weapons, the political costs of withdrawal, and the psychological impact of their visible presence as well as the security linkages they provide. Additionally, the removal of nuclear weapons from Europe is inconsistent with the U.S. National Security Strategy (NSS), the National Military Strategy (NMS), and NATO strategy and policy as well.

DCA fighters and nuclear weapons are visible, capable, recallable, reusable, and flexible and are a military statement of NATO and U.S. political will. These NATO forces provide a number of advantages to the Alliance that go far beyond USEUCOM’s narrow perception of their military utility. Nuclear weapons in Europe provide a continuous deterrence element; as long as our allies value their political contribution, the United States is obligated to provide and maintain the nuclear weapon capability.

In the past, Strategic Air Command (SAC) and USEUCOM held annual conferences in Omaha to integrate USEUCOM’s nuclear planning in the European theater. The formation of USSTRATCOM in 1992 continued the diverse and healthy dialogue between the two organizations that lasted for several years. Nuclear planning conferences and annual revisions of targeting plans were venues that enriched the dialogue. However, planning for nuclear weapons employment was eclipsed by planning for conventional operations. This is somewhat understandable given the recent NATO and USEUCOM focus on Afghanistan. But when these planning meetings were discontinued at USSTRATCOM, gaps in the seams between global and regional commands developed and today they continue to widen. Concurrently all nuclear planning staffs have been pared down and personnel reallocated.

The relationship between USEUCOM and USSTRATCOM emphasizes the need to renew dialogue between USSTRATCOM and each of the GCCs in an effort fill the gaps in these seams. When questioned about planning for the employment of nuclear weapons by DCA fighters, USEUCOM responded they would rely on a “fly-away team from USSTRATCOM” to provide the adaptive planning capability. However, USEUCOM believes that USSTRATCOM does not possess the manpower and DCA fighter planning expertise to provide such support to USEUCOM. USSTRATCOM acknowledged this deficiency in discussions with the Task Force. USEUCOM has taken no corrective action to address this problem. The Task Force concludes that USSTRATCOM, USEUCOM, nor any other GCC is capable of addressing these issues

alone; there is need for a new collaborative relationship on maintaining regional deterrent capabilities.

USEUCOM's organic nuclear planning staff has been allowed to atrophy to the point where it is largely ineffective. Several of the key nuclear planning staff officers had limited or no experience in nuclear weapons prior to assuming their positions, and the Task Force learned that they were unable to perform their adaptive planning duties adequately. The efforts of the staff, by direction of its senior leaders, are centered on counter proliferation, nuclear surety, and nuclear safety. Developing concepts of operation and doctrine, coordinating with SHAPE, USSTRATCOM, and other geographic commands, and exercising the adaptive nuclear planning process, for the most part, do not now happen.

The security of nuclear weapons in Europe, provided by highly motivated and dedicated Airmen and NATO Allies, meets or exceeds both U.S. and NATO security standards.³³ However, the emergence of new threats and new technologies may bring new challenges that some at USEUCOM suggest would cost between \$120 million and \$180 million to address adequately. In the Task Force's judgment, these costs are commensurate with the mission; another well-informed senior leader put the total cost at far less—"tens of millions." In any case, the political value of these weapons remains high—well worth the potential cost of any upgraded security measures that may be needed in the future. Because of political sensitivities, the removal of the weapons might constitute a one-way door that would undermine the NATO consensus on U.S. nuclear weapons in Europe with implications for regional deterrence more broadly. As one senior U.S. commander told the Task Force, the deterrence value of U.S. nuclear weapons in Europe may be less than before to the United States, but they are of greater value to Alliance solidarity, and the cost to maintain them in Europe is low and worth paying.

USAFE Stewardship of Forward-Deployed Nuclear Weapons

During Phase I, the Task Force postponed its examination of the United States Air Forces in Europe (USAFE). USAFE's nuclear weapons mission area suffers from many of the same resourcing and expertise difficulties found elsewhere in Phase I. Nevertheless the Task Force found USAFE's leadership and commitment to the safe and secure storage of nuclear weapons in Europe to be encouraging. USAFE was largely unaffected by the disestablishment of the Strategic Air Command (SAC) and the atrophy of the strategic nuclear mission within the Air Force. However, USAFE has been both affected by, and has contributed to, the weakening of deterrence within the DoD by insufficiently advocating for nuclear weapons and inadequately ensuring they remain viable political tools.

In 2004 and 2005, USAFE noticed disquieting trends of declining nuclear expertise and increasing inspection failure rates in several key areas, such as management and administration, security, and use control. Wide oscillations in overall pass rates for Nuclear Surety Inspections (NSIs) as shown in Figure 4-4 were indicative of an emerging problem.

³³ Aug. 25 2007 memo from the NATO High Level Group Vice-Chairman

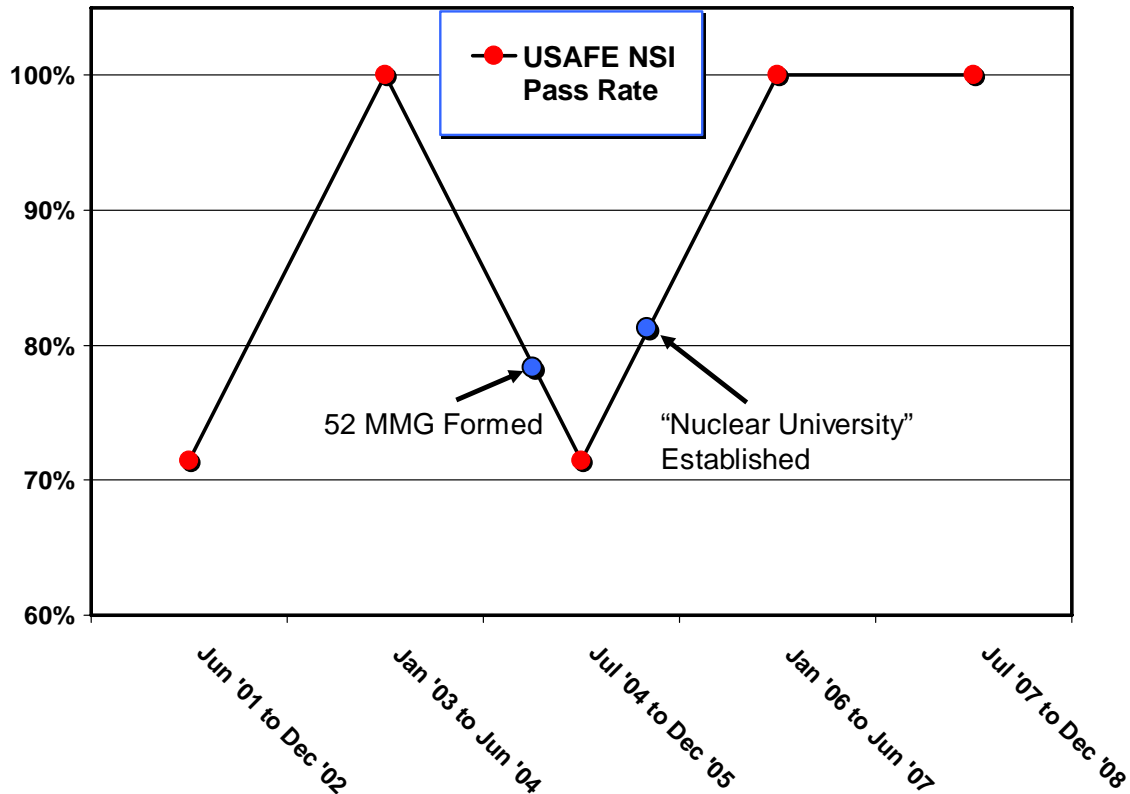

Figure 4-4. USAFE NSI Pass Rates 2001–2008

Accordingly, USAFE fought for additional resources and took others “out of hide” to establish USAFE’s “Nuclear University” and formed a consolidated nuclear maintenance organization for the munitions support squadrons (MUNSS)—the 52d Munitions Maintenance Group (52 MMG). The establishment of “Nuclear University,” taught by USAFE headquarters staff personnel, has been a resounding success, enabling USAFE to provide quality training for their personnel and keeping the staff engaged in the nuclear mission. The Task Force recommends that curricula and instructional approaches under development by the Air Force Nuclear Weapons Center (NWC) for CONUS-based nuclear weapons storage follow the USAFE blueprint. The 52 MMG provides a single organization to oversee and advocate for the geographically separated MUNSS. This organizational innovation may be uniquely applicable to the USAFE situation, but NWC should carefully examine it for adaptations where appropriate.

USAFE has unique requirements and operating environments for nuclear surety. In Europe, nuclear weapons are kept in individual underground weapons vaults (Weapon Security, Storage, and Survivability Systems or WS3s) rather than Weapons Storage Areas (WSAs) as used in CONUS. Security is provided by varying combinations of U.S. and host nation security forces. USAFE has worked these issues for years, and has demonstrated strong leadership in the surety of the nuclear weapons in Europe, always remaining cognizant of host nation perspectives. For these reasons, the Task Force recommends that USAFE retain control of the WS3s rather than placing them under the NWC. In addition, the Task Force urges that USAFE and the NWC recognize the synergies to be gained by coupling their expertise and sharing best practices.

Indeed, in the largest physical movement of nuclear weapons to occur in the Air Force after the Minot inadvertent transfer, several nuclear weapons were swapped at a base in Europe. The operation was conducted flawlessly by the U.S. custodian. The Task Force interviewed the Munitions Accountable Systems Officer (MASO), finding that she had organized and conducted this complex and demanding transfer flawlessly thanks in large measure to the professional expertise of her assigned non-commissioned officers (NCOs). These NCOs took professional pride in preparing “their” lieutenant, who had no formal nuclear training, for such a complex and difficult mission. Nonetheless, as the Task Force found in Phase I, the Air Force recognizes there is a training gap for MASOs and is currently addressing this issue.

Units reported to the Task Force that certain aspects of the Personnel Reliability Program (PRP) have become difficult to sustain. The concern arises from the fact that nearly all medical treatments, even those as benign as a dental visit, suspend PRP personnel from performing nuclear-related duties until they are returned to PRP status. This recertification process requires a competent medical authority (CMA) to review medical records and recommend to the unit commander that they return the individual to PRP duties. For geographically separated units without an organic CMA, such as MUNSS on NATO bases, this process is a major challenge. It is not uncommon for a simple medical procedure to keep key personnel from nuclear-related duties for a week or more, in effect levying a large tax on available manpower.

At locations with organic CMAs, the authorized medical staffing does not allocate dedicated CMAs to work exclusively on PRP-related duties. The Task Force found that medical staffs had taken doctors “out of hide” to ensure the priority of PRP certification was upheld, increasing workloads on the remaining staffs for non-PRP medical care. A review of PRP processes should be initiated by the Air Force A10 to explore the feasibility of allowing local commanders to recertify individuals temporarily after procedures without CMA input or, alternatively, provide organic CMAs (much like flight surgeons in flying units) to all units with PRP personnel. For those organizations that currently have CMAs, manning levels need to be increased, such that a dedicated CMA is present without compromising other medical services or staff. CMA positions should be designated as “must-fills,” manned at 100 percent and be exempt from deployment for conventional operations. PRP certification should be the highest medical mission priority after emergency care.

While USAFE’s surety appears sound, nuclear operations units have fallen victim to a similar weakening that afflicts their CONUS-based counterparts. USAFE headquarters staff lacks a requisite-level of operational DCA fighter expertise. The USAFE units that maintain nuclear operational readiness are uniquely challenged as they are the only such fighter units in the Air Force trained to perform the nuclear mission. From an aircrew perspective, the mission may be less operationally demanding than some other conventional missions; however, there is no margin for error. When aircrews arrive at nuclear-tasked units, they typically have had minimal (if any) training in nuclear weapons delivery procedures.

By default, the operational unit becomes a training unit. In order to ease the training challenge, ensure the highest levels of aircrew proficiency, and promote nuclear expertise in the fighter communities, all aircrew selected to fly dual-capable fighters (F-15E and F-16) should be nuclear certified by Air Education and Training Command (AETC). Moreover, graduates of the USAF Weapons School from dual-capable systems (F-15E, F-16, B-52, and B-2) must acquire and demonstrate at least the same level of proficiency in nuclear weapons employment as they

currently achieve in conventional operations. These new certification and training processes should be in place by the end of FY09.

Training for dual-capable fighters is hampered by a lack of simulators specifically designed to support training for employment of nuclear weapons and to address potential airborne weapons malfunctions safely. While high-quality simulators with conventional munitions have been developed and fielded in recent years, the software lacks adequate simulation for nuclear weapons. The Air Force should ensure by the end of FY10 that all nuclear tasked units have co-located high-fidelity simulators capable of simulating nuclear weapons operations, to include accurate replications of applicable system malfunctions and associated indications.

A compounding challenge for USAFE is the high personnel turnover rate in nuclear tasked units that complicates their ability to maintain sufficient numbers of trained and ready crews. The Air Force A1 and A10 should establish a minimum time on station requirement for all personnel assigned to units with nuclear missions, in coordination with the unit's Major Command (MAJCOM). The intent is to provide nuclear tasked units with personnel who spend extended lengths of time on station before rotating to their next duty assignment. Further, the Task Force found PRP administrative qualifications in accordance with DoD and Air Force regulations were inconsistently accomplished on Airmen before arriving at new assignments. This has resulted in some Airmen with disqualifying information being assigned to nuclear billets. The Air Force A1 must ensure PRP administrative qualification is accomplished before the Airmen arrive at their new duty station. Waivers to this policy should only be granted by the gaining numbered air force commander. The Air Force A10 should be responsible for Air Force-wide oversight and standardization of PRP policies and implementation. These processes should be implemented by the end of FY09.

The ability of these units to perform their DCA mission is further hindered by taskings outside of the normal Air Expeditionary Forces (AEF) cycles. To ensure nuclear-tasked units are not adversely affected, Air Force units tasked with nuclear missions should fulfill their commitments to the AEF cycle, but should be largely exempt from other taskings. Waiver authority for this requirement should reside with the MAJCOM commander.

The credibility of the U.S. DCA fighter force is also undermined by a lack of appropriate flight testing and certification for configuration with nuclear weapons. The Air Force Seek Eagle program conducts flight tests and certifies fighter aircraft weapons and systems configurations. As new capabilities have been added to fighters, many configurations with nuclear weapons have been left untested. As a result the units with nuclear missions are not able to fly and train with the most tactically beneficial configurations that include all of their desired combat systems and nuclear weapons. Starting in FY09, configurations with nuclear weapons should be given higher priority in these flight tests by Air Force Materiel Command (AFMC). A minimum of six nuclear configurations per year per fighter aircraft should be certified until all MAJCOM requests have been met.

Recommendations

1. U.S. commanders with nuclear responsibilities in Europe should ensure their forces act in accordance with the spirit and the letter of U.S. policy regarding extended deterrence.

2. The Commander, USEUCOM and the Commander, USAFE should reassure Allies of the safety, security, and reliability of U.S. nuclear weapons in Europe as validated during inspections conducted by the United States and assessed by the NATO/SHAPE Joint Theater Security Management Group.
3. USEUCOM staffs with nuclear weapons responsibilities should be fully manned with nuclear experienced personnel. The staff should be appropriately sized to enable the performance of adequate levels of nuclear planning and development of concepts of operation in line with U.S. and NATO policy by the end of FY10.
4. The Secretary of the Air Force should direct that USAFE retain control of the Weapons Storage Security Systems (WS3) rather than place them under control of the Air Force Nuclear Weapons Center as will be the case for Weapons Storage Areas in the United States.
5. USAF A10 should review PRP processes and adjust policy to alleviate burdens from geographically separated units and medical centers lacking dedicated PRP personnel. PRP administrative qualifications must be obtained by personnel going to PRP positions before arrival on station. PRP tasks should be the top medical mission priority after emergency care.
6. By the end of FY09, USAFE headquarters should have at least one theater-qualified, DCA fighter-experienced staff officer who maintains mission readiness currency while assigned to the A3.
7. The Chief of Staff of the Air Force should direct the Air Force Education and Training Command to train all aircrew that will be assigned to DCA to be fully qualified in nuclear operations upon completion of initial qualification. All previously qualified aircrew must be retrained and certified prior to arrival on station to a nuclear tasked unit by the end of FY09.
8. The Commander, Air Force Materiel Command should give priority to SEEK EAGLE nuclear fighter configurations as determined by MAJCOMs. A minimum of six nuclear configurations per aircraft per year should be tested starting in FY09.
9. The Air Force A1 and A10 should develop a policy by the end of FY09 which ensures personnel assigned to nuclear units remain on station for a minimum period of time as determined by the unit's MAJCOM.
10. The Air Force should ensure that it trains like it will fight by ensuring that all nuclear-tasked units have co-located high-fidelity simulators capable of simulating the carriage of nuclear weapons. These simulators should include the capability to replicate applicable system malfunctions and associated indications accurately. This action should be completed by the end FY10.
11. All new USAF Weapons School graduates from dual-capable systems (F-15E, F-16, B-52, and B-2) should acquire and demonstrate at least the same level of proficiency in nuclear weapons employment as they currently achieve in conventional operations. This certification and training process should be in place by the end of FY09.

Geographic Combatant Commands

Since 1992, the nuclear planning capabilities of the geographic combatant commands (GCCs) have been significantly reduced or eliminated. Over time, nuclear planning expertise and responsibilities were shifted to USSTRATCOM. For the most part, this was due to the changing geo-strategic environment, the redeployment of theater-level nuclear weapons, and the growing capability of and emphasis on conventional weapons. Today, GCC commanders are generally responsible for identifying nuclear requirements needed to support their own theater planning efforts. If a GCC identifies a requirement for nuclear capabilities, the GCC requests assistance from USSTRATCOM to provide the required nuclear effects and employment planning expertise and to ensure the plan reflects the GCC's requirements. Typically, requirements can be met through an existing USSTRATCOM plan. If a preexisting plan or strike option is not available to meet the GCC's requirements, USSTRATCOM provides support to the GCC using an adaptive planning process. By maintaining an intimate understanding of the role that nuclear weapons play in dissuading and deterring regional adversaries, GCCs are better positioned to assure our friends and allies who rely on the U.S. nuclear umbrella. Close cooperation between the GCCs and USSTRATCOM is critical to ensure theater commander "buy-in" for nuclear plans affecting their area of responsibility.

The Task Force noted gaps in the seam between USSTRATCOM and the GCCs as a consequence of the centralization of nuclear planning, execution, and advocacy for nuclear capabilities at USSTRATCOM. Planning for a tailored nuclear deterrent involves a deep understanding of regional dynamics. All GCCs are responsible for "Detecting, deterring, and preventing attacks against the United States, its territories, possessions and bases . . ." in the Unified Command Plan (UCP). However, the UCP does not clearly delineate the GCC's role in nuclear deterrence. The GCCs have the requisite regional expertise and detailed understanding of their region to plan for and execute day-to-day deterrence; however, to contribute effectively to nuclear deterrence, the GCCs must develop organic nuclear expertise within their staff organizations.

Recommendation

1. The Chairman, Joint Chiefs of Staff (CJCS) should perform a comprehensive review of the relationship between USSTRATCOM and the GCCs regarding their respective roles in nuclear deterrence planning, requirements, and execution. The review should make recommendations for strengthening GCC focus, expertise, and participation in fulfilling their responsibilities for nuclear deterrence as well as identify appropriate mechanisms to collaborate with USSTRATCOM.

The Joint Staff

The Task Force's assessment of the Joint Staff mirrors that of the wider DoD in terms of diminution of emphasis and declining levels of authority for nuclear matters. Reductions in the operational demand for nuclear capabilities and the consolidation of nuclear planning responsibilities at USSTRATCOM have significantly reduced the role of the Joint Staff in nuclear matters. This decline is characterized by reduced staffs and a diffusion of focus on nuclear issues. Nuclear-focused elements have been relegated to lower organizational status, as noted by a reduction in the seniority of personnel with day-to-day involvement in the nuclear mission. For example, in 1990 a senior flag officer was charged with responsibilities for nuclear matters; today these responsibilities are assigned to a colonel.³⁴ Additionally, organizational elements which had been focused exclusively on nuclear matters have been assigned additional missions. In many cases, the word "nuclear" was deleted from the office titles.³⁵ Today, the primary nuclear focal point within the Joint Staff is the Strategic Operations Division under the Deputy Director for Global Operations (J39).

There are numerous examples of the diminished focus and decreased capability of the Joint Staff to support the Chairman in providing the best military advice on nuclear issues to the President. The J5 Plans office is no longer a major player for many nuclear issues. Similarly, the Task Force learned that the CJCS-sponsored exercise program, managed by J7, rarely links OSD, Combatant Command, or Agency exercises with nuclear-related training objectives. Also, J8 no longer conducts independent offensive nuclear analysis and modeling, relying instead on USSTRATCOM and DTRA to provide this expertise.

The Joint Staff has halted its direct supervision of the development of concepts and doctrine on the nuclear mission. It essentially delegated to STRATCOM the development of the Deterrence Operations Joint Operations Concept (JOC), which is the publication that guides the development of future joint capabilities. The current version of the JOC pays far more attention to the non-DoD elements of deterrence—political, diplomatic, economic, information—and emphasizes the interdepartmental capabilities needed at the expense of addressing the joint capabilities that planners should consider in developing future DoD capabilities. The Joint Staff recently halted the development of Joint Nuclear Operations doctrine. The last edition of joint doctrine governing nuclear weapons was published in 1993. After years of attempts to revise the 1993 edition, the Joint Staff decided in 2005 to cancel the document, because they concluded that authoritative guidance was already contained in other materials.

During visits to nuclear units, the Task Force found these conclusions have been taken as a signal of Joint Staff disinterest. Doctrine and concepts are particularly important in this case since nuclear capable units do not routinely have access to or review other relevant policy documents. It is also important to have doctrine and concepts so that planning staffs are not left to improvise the employment of nuclear deterrent forces—especially during a crisis.

The net effect of this diminished involvement in nuclear issues has been a Joint Staff that is significantly disadvantaged when it comes to providing guidance on matters of nuclear policy,

³⁴ Defense Science Board, *The Defense Science Board Permanent Task Force on Nuclear Weapons Surety: Report on Unauthorized Movement of Nuclear Weapons*. Feb. 2008 (Revised Apr. 2008).

³⁵ Defense Science Board, *Report of the Defense Science Board Task Force on Nuclear Deterrence Skills*, Sept. 2008.

training, education, and analysis to the Chairman. The Chairman and the Joint Staff have a significant role in the management of the Department's nuclear responsibilities and the well-being of the nation's nuclear deterrent. To be effective in this role, the Joint Staff must reinvest in the intellectual capital and nuclear expertise necessary for the development of nuclear strategy, future capabilities, war plans, and assessment.

As a first step in this direction, the Chairman should designate a flag-level officer with appropriate nuclear experience and expertise whose sole focus and responsibility are nuclear operations, strategy and future capabilities. This new full-time, flag-level Joint Staff officer and staff would collaborate and coordinate nuclear policy and surety issues with the OSD office responsible for nuclear deterrence and foster an understanding of nuclear deterrence across elements of the Joint Staff. Additionally, the new office should provide the impetus for renewed Joint Staff engagement: J3 should continue to provide guidance and oversight of nuclear operations and participate in senior level exercises within the military, military and OSD, and whole of government; J5 should contribute to DoD nuclear strategy and concepts of operation; J7 should strengthen nuclear operations exercise programs and ensure policy and strategy alignment of USSTRATCOM war plans and doctrine; and J8 should test new concepts of operations for deterrence and future capabilities using both simulations and wargames.

Additionally, with the expansion of the NWC charter, the Joint Staff should continue to provide full support to the Vice Chairman of the Joint Chiefs of Staff (VCJCS) in his role as a member of the NWC. This may require a reevaluation of the level of staff support currently provided for the expanded number of issues addressed within the NWC. The CJCS should conduct a review of this staff support to ensure that the VCJCS is provided adequate staff to function effectively in this crucial executive forum.

Recommendations

1. The Chairman, Joint Chiefs of Staff should designate a flag-level officer on the Joint Staff whose sole focus is the nuclear mission. Staffing and resourcing for the Joint Staff functions of nuclear strategy, plans, policies, exercises, and analysis should be increased.
2. The Joint Staff should update joint nuclear operations doctrine and develop a Nuclear Deterrence Joint Operations Concept. These documents must be consistent with policy and appropriately classified.
3. The Commander, USSTRATCOM, in collaboration with Commander Joint Forces Command, should lead the revision of the Deterrence Joint Operations Concept to focus on the role of nuclear weapons for deterrence, even if the concept continues to advocate a broader approach to wielding influences as a means of deterring.
4. The Joint Staff should sponsor senior-level exercises on three levels: within the military, military/OSD, and whole of government.
5. The CJCS should conduct a review of the staff support provided to the VCJCS in his role as a member of the Nuclear Weapons Council.

Army

The Army has retained nuclear expertise in the staff and a field operating agency under the Deputy Chief of Staff of the Army G-3/5/7 (DCS G-3/5/7). This organization is responsible for preparing forces to operate on hostile nuclear/radiological battlefields. The Army has responsibilities to maintain competency for possible nuclear operations. It has maintained expertise in and provides support to the sustainment of nuclear weapons, survivability, nuclear operations planning, as well as tactical, operational, and strategic military effects of nuclear weapons.

The U.S. Army Nuclear and Combating Weapons of Mass Destruction (CWMD) Agency (USANCA) provides nuclear and CWMD capabilities, survivability, plans, operations, training, and analysis functions. This cadre of commissioned officers with technical nuclear education and skills is classified under Functional Area 52 (FA52): Nuclear and Counterproliferation Officer. As the central manager of the FA52 career field, USANCA directs career development plans for approximately 230 officers. This provides the Army with a distributed level of expertise to field commanders in the areas of nuclear targeting and nuclear weapons effects.

The Army made the decision in the early 1990s to maintain nuclear expertise in order to support Army component commanders. To ensure long-term viability, the Army consolidated the nuclear capabilities, survivability, plans, operations, training, and analysis support mission in USANCA, which reported directly to the Army Staff. This alignment, designed to ensure continued visibility and advocacy for nuclear issues, bolstered USANCA's position within the Army. USANCA continues to provide the following: (1) planning assistance to theater commanders regarding the unique employment considerations for nuclear weapons (e.g., weapons effects on military equipment, personnel, and operations); (2) training for officers engaged in nuclear targeting; (3) input to doctrine for nuclear weapons employment; and (4) nuclear weapons effects modeling/simulation for personnel and equipment.

As part of its mission, USANCA maintains Nuclear Employment Augmentation Teams (NEATs), which can be deployed in support of the geographic combatant commands, Army Service Component Commanders (ASCCs), and other senior level Army headquarters. The purpose of these teams is to provide the Joint Force Land Component Commander with expertise in nuclear weapons effects and the consequences of nuclear weapons employment in support of theater operations. However, the Task Force is aware of no instances in which the combatant commands have employed these Teams in support of nuclear exercises.

Army officers assigned to this career field are found throughout the DoD nuclear mission area and in those sections of the Department of Energy's National Nuclear Security Administration that support the DoD. These officers provide critical assistance to organizations engaged in nuclear stockpile issues, weapons targeting, effects modeling, survivability, joint capabilities development, and war planning. The Task Force supports the Army in developing and maintaining nuclear expertise through USANCA and the FA52 program.

Recommendations

1. The Army Chief of Staff should continue to support USANCA's contributions to the DoD nuclear mission and ensure the continued viability of the Nuclear and Counterproliferation Officer (FA52) career field.
2. USSTRATCOM and the GCCs should employ USANCA's NEATs during joint exercises and planning.

Appendix A. Tasking Letter



THE SECRETARY OF DEFENSE
1000 DEFENSE PENTAGON
WASHINGTON, DC 20301-1000

June 12, 2008

The Honorable James R. Schlesinger
c/o The Mitre Corporation
7515 Colshire Drive, N643
McLean, VA 22102

Dear Dr. Schlesinger:

On March 25, 2008, I appointed Admiral Kirkland H. Donald, U.S. Navy, to investigate the facts and circumstances surrounding the accountability for, and shipment of, sensitive missile components provided to the Government of Taiwan on or around August 2006. The following day, I directed the Secretaries of the Navy and Air Force, and the Director of the Defense Logistics Agency, to undertake a comprehensive review and physical inventory of all nuclear weapons and nuclear weapons-related materials under their possession or custody. I have reviewed those reports and am directing appropriate action.

It now would be helpful to me to have your independent, professional advice on the organizational, procedural and policy improvements necessary to ensure the highest levels of accountability and control are maintained in the stewardship and operation of nuclear weapons, delivery vehicles, sensitive components, and basing procedures by the Department of Defense (DoD). I appreciate your willingness to head the Task Force on Nuclear Weapons Management. Additional members include: General Michael Carns, Admiral Ed Giambastiani, John Hamre, Frank Miller, JD Crouch, Chris Williams, and Jacques Gansler.

Your advice should focus on enhancing the Department's ability to sustain public confidence in the safe handling of DoD nuclear assets and bolster a clear international understanding of the continuing role and credibility of the U.S. nuclear deterrent. In preparing your advice, you should consider Admiral Donald's investigative report as well as the reviews conducted by the Secretaries of the Navy and Air Force and the Director of the Defense Logistics Agency.

I request your initial assessment within 60 days from the date of this appointing letter, focusing on organizational, procedural, policy and other matters involving the Department of the Air Force. Your final report, addressing the entire Department, should be submitted within 120 days from the date of this letter. Your final report should include an executive summary and an unclassified version suitable for public release.



DoD personnel will collect information for your review and assist you as necessary. You are to have access to all relevant DoD investigations and other DoD information unless prohibited by law. Reviewing all written materials relevant to these issues should be sufficient to allow you to provide your advice. Should you believe it necessary to travel or conduct interviews, the Director of Administration and Management (DA&M) will make appropriate arrangements. DoD personnel will cooperate fully with your review and make available at your request all relevant documents and information.

By copy of this letter, I request the Under Secretary of Defense for Policy, in coordination with DA&M, establish the Task Force on DoD Nuclear Weapons Management as a subcommittee of the Defense Policy Board, which will review and consider your advice. I also request DA&M secure the necessary technical, administrative and legal support for your review. This support may be provided by the DoD Components on a non-reimbursable basis and may include consultant services and assistance from Federally-Funded Research and Development Centers and National Laboratories. DA&M will coordinate with you to develop a budget to support your efforts, and the Under Secretary of Defense (Comptroller) will provide the necessary budgetary resources.

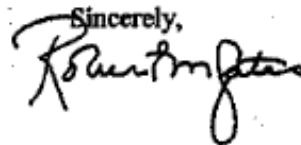
Sincerely,

cc:

Secretaries of the Military Departments
Chairman of the Joint Chiefs of Staff
Under Secretaries of Defense
Assistant Secretaries of Defense
General Counsel of the Department of Defense
Director, Operational Test and Evaluation
Inspector General of the Department of Defense
Assistants to the Secretary of Defense
Director, Administration and Management
Director, Program Analysis and Evaluation
Director, Net Assessment
Directors of the Defense Agencies
Directors of the DoD Field Activities

Appendix B. Recommendations

Deterrence

Understanding Deterrence

1. In developing its national security strategy, the incoming administration should address the fundamental role of nuclear capabilities in deterring threats, assuring allies, and countering proliferation. This view should be reflected in the upcoming Nuclear Posture Review and Quadrennial Defense Review.
2. Strengthening the credibility of our nuclear deterrent should begin at the White House. To that end, the Secretary of Defense and the Secretary of Energy should periodically brief the President with a review of nuclear capabilities and forces.
3. The Secretary of Defense should direct a comprehensive review of the curricula of all academies, service schools, and senior-level professional military education institutions and provide recommendations for strengthening the understanding of deterrence theory, strategy and policy on the part of military leaders through revised or new courses, research, and analysis. The review should include such senior courses as CAPSTONE, KEYSTONE, and PINNACLE.
4. The Secretary of Defense should target funding, for example under the Minerva Initiative (Defense Department grants for research in the social and behavioral sciences), to support development of deterrence concepts in the civilian academic community. These concepts should be widely disseminated to stimulate richer thinking on deterrence in both civilian and military circles.
5. The Under Secretary of Defense for Policy, in collaboration with the Chairman of the Joint Chiefs of Staff, should initiate a series of analyses and senior seminar wargames to enhance understanding of nuclear deterrence and to develop new strategies and operational concepts regarding the role of nuclear weapons in deterrence.
6. Sufficient resources should be allocated to Department of Defense components involved in efforts to increase the capability for nuclear detection and attribution. Other parts of the U.S. Government should also be involved in these efforts.
7. The Secretary of Defense should establish demanding intelligence requirements across the Department to support the nuclear deterrence mission.
8. Increased priority should be given to the full range of nonproliferation efforts, particularly taking advantage of the forthcoming Non-Proliferation Treaty Review (2010) to do so. Combatant Commands should increase their efforts to help allies in their theaters strengthen counterproliferation efforts.

The Special Case of NATO

1. The United States should recognize the importance NATO Allies place on extended deterrence represented by the forward basing of U.S. nuclear weapons in Europe and should take all necessary steps to support the “coupling effect” those weapons provide.

2. The United States may need to reaffirm privately its commitment to nuclear deterrence for Europe.
3. Manning levels and subject matter expertise at SHAPE's Nuclear Operations Branch should be increased to enable the development of more robust concepts of operations, doctrine, and exercises. The new branch should be led by a one-star flag or general officer.
4. The Department of Defense, in coordination with the Department of State, should engage appropriate counterparts among the NATO Allies in developing the role of nuclear weapons in Alliance strategy and policy for the future. These actions will also affect the credibility of the U.S. extended deterrent to allies outside of NATO.
 - A. The Department of Defense should underwrite the development of curriculum at the NATO Defense College to educate officers in deterrence theory and operational nuclear doctrine.
 - B. The Department of Defense should continue its dialogue with allies on modernizing DCA forces and developing a long-term roadmap.
 - C. The Department of Defense should ensure that the dual-capable variant of the F-35 remains on track for operational capability.
5. SHAPE and USSTRATCOM should develop updated nuclear concepts of operation. Realistic training scenarios based on these concepts should be provided to operational units for training and inspections. Planning staffs should regularly and vigorously exercise the adaptive planning process.
6. USSTRATCOM and USEUCOM should redevelop the capability to support rapid and effective adaptive nuclear planning at SHAPE in contingency operations and to integrate and synchronize U.S. ICBMs, SLBMs, and CONUS-based nuclear bombers with submarine-launched TLAM-N and Europe-based NATO DCA.
7. The Nuclear Weapons Council should review the B-61 Life Extension Program to ensure these weapons are fully resourced to support the European DCA mission.

DoD Management

OSD Organization

1. The Secretary of Defense should establish an Assistant Secretary of Defense for Deterrence (ASD(D)) in the OUSD(P). The Principal Deputy Assistant Secretary for Deterrence (PDASD(D)) should be an acquisition professional and should be dual-hatted within the OUSD(AT&L). All existing OUSD(P) offices which deal with nuclear, chemical and biological issues should be realigned under the new ASD; similarly, the functions of the ATSD(NCB) (to include oversight of the Defense Threat Reduction Agency) should be assumed by the new ASD.
2. The Secretary of Defense should assign directorship of the Nuclear Command and Control System Support Staff (NSS) to the newly formed ASD(D).
3. The Secretary of Defense should expand the responsibilities of the Nuclear Weapons Council to include issues involving the full range of nuclear capabilities including weapons, delivery systems, infrastructure, policy implementation, and resources under the chairmanship of the Deputy Secretary of Defense.

Nuclear Capabilities Modernization and Sustainment

1. USD(P) should ensure that strategic guidance documents address nuclear deterrence and responsive infrastructure as capabilities.
2. The Secretary of Defense should direct an expanded NWC to develop and maintain a strategic roadmap for the modernization and sustainment of the nuclear forces (deterrence, force employment, and responsive infrastructure). The Task Force recommends that the Secretary of Defense review and approve this roadmap.
3. The proposed ASD(D) should establish a Nuclear Weapons Council Capabilities Review Board (NWCCRB) to support the NWC in accomplishing added responsibilities recommended in this report.
4. Prior to the JROC review of any nuclear weapons-related program at a milestone review, the Joint Staff should provide the NWCCRB with pertinent program information to allow appropriate input to the JROC process.
5. The Deputy Secretary of Defense should direct the creation of a Capabilities Portfolio for deterrence to elevate its importance to the same level as force employment capability within the OSD Capabilities Based Acquisition process.
6. The Chairman of the Joint Chiefs of Staff should direct the creation of a Joint Capabilities Area for deterrence to elevate its importance to the same level as force employment capability within the JCIDS process.
7. USD(P) should review and articulate department-level guidance regarding the unique capabilities provided by the TLAM-N to ensure that requirements for a follow-on capability are addressed.
8. The proposed ASD(D) should ensure appropriate funding for nuclear capabilities is fenced and provide execution oversight. This can be accomplished by the creation of a new capability portfolio composed of all program elements (whether currently categorized in MFP-1 or elsewhere in the defense program and budget structure) directly related to nuclear deterrence.

Oversight and Inspections

1. The Secretary of Defense should direct the Defense Threat Reduction Agency (DTRA) to cease conducting DNSIs and only conduct Service Proficiency Evaluations (formerly Surveillance Inspections) to ensure standardized Department-level oversight of each Service's nuclear surety program.
2. ATSD(NCB) should develop specific guidance for evaluating PRP programs for units not subject to inspection under the NWTI system. This guidance should direct that an independent assessment be conducted by a Service inspection agency outside the unit's chain of command as well as provide a minimum interval between assessments.
3. The Navy should develop higher headquarters-level inspection programs for the E-6B TACAMO wing to ensure operational readiness and PRP program compliance for forces provided to USSTRATCOM. Inspection intervals should mirror those of the fleet ballistic missile submarines and their associated shore facilities.

4. The Chairman, Joint Chiefs of Staff should direct either USSTRATCOM or USEUCOM to develop and institutionalize a formal program providing command representatives to observe Service-conducted NWTIs for European-based DCA.
5. The Service Chiefs should establish an operational readiness inspection frequency of two to three years for nuclear-tasked forces to ensure that all personnel are evaluated once during a typical assignment. They should also ensure that readiness is measured through a comprehensive, end-to-end simulation of force employment, beginning with mission planning, including nuclear surety, and concluding with mission execution.

DoD Forces

Navy

1. The Secretary of the Navy should establish a requirement for biennial self-assessment reviews of the nuclear weapons mission area to keep the oversight of this critical area at the forefront of the organization's attention. The requirement should be implemented no later than February 2009.
2. The Secretary of the Navy should conduct a comprehensive program review of TLAM-N and direct the Navy Acquisition Executive to develop a plan to maintain TLAM-N and to develop follow-on capabilities that can come online prior to expiration of TLAM-N effectiveness. Should there be a gap, the Navy should be directed to maintain TLAM-N to extend its service life commensurate with introduction of the new system.
3. Joint Staff (J5) should direct a review and update the concept of operations for the TLAM-N system to make it a more viable and responsive option for national leadership.
4. The Secretary of the Navy should continue with the plan to implement the SLOC and OPNAV NWC. These panels should be appropriately staffed, providing representation of all Navy nuclear mission area stakeholders, such as operational, resource sponsors, acquisition, etc. Both panels should be chartered and functioning no later than April 2009.
5. The Secretary of the Navy should increase the rank for the position of the Director of Strategic Systems Program to a vice admiral, including extending the authorities of the position to include oversight of nuclear weapons radiological control programs, security, logistics, selection/qualification of personnel, and oversight of nuclear weapons activities executed by the operational fleet.
6. The Secretary of the Navy and CNO should evaluate the continuity of leadership for the Strategic Systems Program and prescribe a minimum tour length; alternatively, they could support the establishment of a senior executive deputy to the Director SSP for continuity. If the latter option is chosen, the Deputy to the Director should be an individual with significant nuclear weapons program experience to provide sound advice to the Director and effective oversight and leadership of the SSP organization and its programs.
7. OPNAV N1 should direct the identification and coding of all nuclear weapons-experienced billets in the Navy to be completed no later than April 2009.
8. The Secretary of the Navy should direct that a study of the nuclear weapons mission area manning and experience level be conducted. This study should focus on the projected inventory of nuclear weapons experienced officers. Additionally, the study should investigate

the problem of a shrinking experience base in the future, forecast the trend and shortfalls, and provide recommendations to the SECNAV for mitigating the risks of a shrinking nuclear weapons-experience base. The review should be completed no later than June 2009.

9. The CNO should direct a curriculum review of all Navy professional military education with a view to expanding educational offerings and research opportunities on nuclear deterrence, strategy, planning, and operational theory. The review should encompass all career PMEs, including service academies, Reserve Officer Training Corps, post-graduate educational institutions, and senior service colleges. The review and incorporation of new curricula should be completed by October 2009.
10. OPNAV N1 should implement sub-specialty codes to identify nuclear weapons and nuclear deterrent strategy/policy experience and education which can be utilized to manage the nuclear weapons experience/education within the Service.
11. The Commander, USSTRATCOM should undertake a program requirements review for the Strategic Communications Continuing Evaluation Program (CEP) and the Strategic Communications Continuing Assessment Program (SCAP), and then formally promulgate baseline requirements of both programs. The review should identify which program requirements lack funding. The review should be completed no later than April 2009.
12. OPNAV N8 and OPNAV N6, based on the requirements review by USSTRATCOM, should review funding and adjust the CEP and SCAP funding profile to meet all COCOM requirements for the two programs and, at a minimum, restore funding to the TYCOM requested levels. Full requirement funding should be in place by October 2009.
13. OPNAV N8 should conduct an in-depth program review of the SSBN Security Technology Program. The focus of the review should be to ensure that current and future requirements of the program are fully funded. This review should be completed prior to April 2009.
14. The Director of Navy Staff should conduct an assessment of the manning at both Trident Training Facilities to be completed and briefed to the CNO no later than March 2009. The assessment should evaluate the manning based on the unique concept of operations for the SSBN platform as well as all assigned training requirements related to these facilities, such as SSGN and pipeline courses, etc.
15. The Secretary of the Navy and the CNO should endorse the proposals for additional manpower billets required to resource SSBN squadron and submarine group staffs including the reestablishment of the group commander positions and full staffs on both coasts.
16. The CNO should direct a review of TACAMO wing manning and billet funding status to ensure that the wings are appropriately manned and that the funded billet structures support the mission requirements. This review should be completed no later than April 2009.
17. The CNO should direct OPNAV N8 and OPNAV N4 to conduct an in-depth review of the funding of the TACAMO program to ensure its sufficiency to execute its full concept of operations, both airborne and shore-based, including all ground-support equipment and trainers. In particular, the funding for high-fidelity trainers and support of ground reconstitution capability is of concern. This review should be conducted and briefed to the CNO no later than April 2009.

18. The Secretary of the Navy should direct a review of SSP manning in light of proliferating missions and programs, and increase civilian and military billets to ensure continued viability of the organization in providing consistent and rigorous oversight of nuclear weapons related programs. This review should be completed and briefed to the Secretary of the Navy and the CNO no later than April 2009.
19. The CNO should review the Individual Augmentee program to ensure that the nuclear weapons mission area is not assuming disproportionate mission risk in executing key nuclear support programs (acquisition, training, maintenance, etc.). The review should devote particular attention to the training facilities which support the SSBN mission. This review should be completed no later than March 2009.
20. The Undersecretary of Defense for Acquisition, Technology and Logistics should conduct a review of DCMA's support for nuclear-related programs and provide adequate personnel and resources to address the shortfalls identified in Admiral Donald's review.
21. The Secretary of Defense should direct a classified material and stowage handling stand-down for all services and agencies. The goal should be for each service and agency to conduct a review of their practices for handling, storing, and transporting classified material as well as to provide training in these areas to the DoD workforce as a whole.
22. The CNO should direct the establishment of one intelligence officer manpower authorization each at a minimum at both Trident submarine groups. This program should be instituted by October 2009.
23. Senior DoD officials should participate in the February 2009 celebration of the 1000th Ohio-class submarine deterrent patrol.

USSTRATCOM

1. The Secretary of Defense should reduce the number of missions assigned to USSTRATCOM to include the deterrence, global strike, and space missions. USSTRATCOM should continue to be the primary joint enabler for the integrated missile defense and combating weapons of mass destruction missions.
2. The Secretary of Defense should direct a review of the USSTRATCOM headquarters and JFCC manpower, and organizational structure organizational assessment completed in 2007. The review should identify the manpower and organizational changes necessary to ensure that the Command and its components are adequately resourced and structured to execute USSTRATCOM's nuclear mission responsibilities effectively.
3. The Commander, USSTRATCOM should identify to the Services those manpower authorizations at USSTRATCOM that require prior nuclear experience.
4. Service Chiefs should ensure all USSTRATCOM billets requiring nuclear experience are designated as must-fill positions within the military services' personnel systems.
5. The position of Commander, USSTRATCOM, if at all possible, should be filled with a general or flag officer with significant operational nuclear experience.
6. The Secretary of Defense, through the Unified Command Plan, should institutionalize the role of USSTRATCOM as the lead combatant command advocating for capability development, requirements and resources for both strategic and theater nuclear systems.

7. The Commander, USSTRATCOM should assume responsibility for directing the operational effectiveness of U.S. nuclear forces and ensure the command is actively involved in monitoring the readiness of nuclear forces, including the synchronization of corrective action for deficiencies and improvements.
8. To buttress the credibility of the U.S. deterrent, the Commander, USSTRATCOM should aggressively pursue the Command's responsibility to develop and conduct a robust and visible regimen for exercising and demonstrating the U.S. nuclear deterrent forces. This exercise program should be aggressively supported by the Joint Staff and Services.
9. The Task Force endorses the initiatives USSTRATCOM is pursuing to restore intelligence functions in support of the command's nuclear mission. The Task Force recommends the Director, Defense Intelligence Agency actively support the Commander, USSTRATCOM in this effort.

USEUCOM / USAFE

1. U.S. commanders with nuclear responsibilities in Europe should ensure their forces act in accordance with the spirit and the letter of U.S. policy regarding extended deterrence.
2. The Commander, USEUCOM and the Commander, USAFE should reassure Allies of the safety, security, and reliability of U.S. nuclear weapons in Europe as validated during inspections conducted by the United States and assessed by the NATO/SHAPE Joint Theater Security Management Group.
3. USEUCOM staffs with nuclear weapons responsibilities should be fully manned with nuclear experienced personnel. The staff should be appropriately sized to enable the performance of adequate levels of nuclear planning and development of concepts of operation in line with U.S. and NATO policy by the end of FY10.
4. The Secretary of the Air Force should direct that USAFE retain control of the Weapons Storage Security Systems (WS3) rather than place them under control of the Air Force Nuclear Weapons Center as will be the case for Weapons Storage Areas in the United States.
5. USAF A10 should review PRP processes and adjust policy to alleviate burdens from geographically separated units and medical centers lacking dedicated PRP personnel. PRP administrative qualifications must be obtained by personnel going to PRP positions before arrival on station. PRP tasks should be the top medical mission priority after emergency care.
6. By the end of FY09, USAFE headquarters should have at least one theater-qualified, DCA fighter-experienced staff officer who maintains mission readiness currency while assigned to the A3.
7. The Chief of Staff of the Air Force should direct the Air Force Education and Training Command to train all aircrew that will be assigned to DCA to be fully qualified in nuclear operations upon completion of initial qualification. All previously qualified aircrew must be retrained and certified prior to arrival on station to a nuclear tasked unit by the end of FY09.
8. The Commander, Air Force Materiel Command should give priority to SEEK EAGLE nuclear fighter configurations as determined by MAJCOMs. A minimum of six nuclear configurations per aircraft per year should be tested starting in FY09.

9. The Air Force A1 and A10 should develop a policy by the end of FY09 which ensures personnel assigned to nuclear units remain on station for a minimum period of time as determined by the unit's MAJCOM.
10. The Air Force should ensure that it trains like it will fight by ensuring that all nuclear-tasked units have co-located high-fidelity simulators capable of simulating the carriage of nuclear weapons. These simulators should include the capability to replicate applicable system malfunctions and associated indications accurately. This action should be completed by the end FY10.
11. All new USAF Weapons School graduates from dual-capable systems (F-15E, F-16, B-52, and B-2) should acquire and demonstrate at least the same level of proficiency in nuclear weapons employment as they currently achieve in conventional operations. This certification and training process should be in place by the end of FY09.

GCCs

1. The Chairman, Joint Chiefs of Staff (CJCS) should perform a comprehensive review of the relationship between USSTRATCOM and the GCCs regarding their respective roles in nuclear deterrence planning, requirements, and execution. The review should make recommendations for strengthening GCC focus, expertise, and participation in fulfilling their responsibilities for nuclear deterrence as well as identify appropriate mechanisms to collaborate with USSTRATCOM.

Joint Staff

1. The Chairman, Joint Chiefs of Staff should designate a flag-level officer on the Joint Staff whose sole focus is the nuclear mission. Staffing and resourcing for the Joint Staff functions of nuclear strategy, plans, policies, exercises, and analysis should be increased.
2. The Joint Staff should update joint nuclear operations doctrine and develop a Nuclear Deterrence Joint Operations Concept. These documents must be consistent with policy and appropriately classified.
3. The Commander, USSTRATCOM, in collaboration with Commander Joint Forces Command, should lead the revision of the Deterrence Joint Operations Concept to focus on the role of nuclear weapons for deterrence, even if the concept continues to advocate a broader approach to wielding influences as a means of deterring.
4. The Joint Staff should sponsor senior-level exercises on three levels: within the military, military/OSD, and whole of government.
5. The CJCS should conduct a review of the staff support provided to the VCJCS in his role as a member of the Nuclear Weapons Council.

Army

1. The Army Chief of Staff should continue to support USANCA's contributions to the DoD nuclear mission and ensure the continued viability of the Nuclear and Counterproliferation Officer (FA52) career field.
2. USSTRATCOM and the GCCs should employ USANCA's NEATs during joint exercises and planning.

Appendix C. Reference Documents

- Air Force Print News. "Strategic command intelligence role echoes its past." June 23, 1999.
- Broad, William and David Sanger. "Restraints Fray and Risks Grow as Nuclear Club Gains Members," *New York Times*, Oct. 15, 2006.
- Brown, Harold. "New Nuclear Realities," *Washington Quarterly*, Winter 2007–08, p.9–10.
- Brown, Harold. "The Department of Defense Statement on Strategic Military Balance," U.S. Senate Committee on Foreign Relations, Hearing, 96th Congress, 1st Session, July 11, 1979, p. 3.
- Bush, George H. W. January 5, 1991 letter to Iraqi President Saddam Hussein as delivered to Foreign Minister Tariq Aziz. Reprinted online at the UC Santa Barbara American Presidency Project <<http://www.presidency.ucsb.edu/ws/index.php?pid=19214>>.
- Bush, George H. W. "National Security Strategy of the United States." Washington, DC: The White House, August 1991.
- Bush, George W. "National Strategy to Combat Weapons of Mass Destruction." Washington, DC: The White House, December 2002.
- Bush, George W. "The National Security Strategy of the United States of America." Washington, DC: The White House, 2006.
- Cartwright, James. Speech at the National Defense Industrial Association Conference, [http://www.stratcom.mil/Spch_test/Copy%20of%20CC_NDIA_6Mar07.html] March 6, 2007.
- Center for Counterproliferation Research—National Defense University and Center for Global Security Research—Lawrence Livermore National Laboratory. *U.S. Nuclear Policy in the 21st Century: A Fresh Look at National Strategy and Requirements—Final Report*. Washington, DC: National Defense University, July 1998.
- Chairman, Joint Chiefs of Staff, "Joint Intelligence Operations Center (JIOC) Execution Order (EXORD)," April 3, 2006.
- Chiles, Henry. Chairman. *Report of the Defense Science Board Task Force on Nuclear Deterrence Skills*. Washington, DC: Defense Science Board, September 2008.
- Chilton, Kevin P. Commander, USSTRATCOM, Statement before the Strategic Forces Subcommittee of the House Armed Services committee on United States Strategic Command. Washington, DC, February 27, 2008.

Defense Science Board Permanent Task Force on Nuclear Weapons Surety: Report on Unauthorized Movement of Nuclear Weapons. Washington, DC: Defense Science Board, February 2008 (Revised April 2008).

Department of the Army. "Army Regulation 10-16: Organizations and Functions of U.S. Army Nuclear and Combating Weapons of Mass Destruction Agency." September 24, 2008.

Department of Defense. "2006 Quadrennial Defense Review." 2006.

Department of Defense. "Nuclear Posture Review." Washington, DC, December 2001.

Department of Defense. "Nuclear Posture Review: Implementation Plan." Washington, DC, March 2003.

Department of Defense. "National Defense Strategy." Washington, DC, June 2008.

Department of Defense. "Unified Command Plan" (Series) 1992, 2002(Change 1), 2003 (Change 2), 2006, 2008 (draft).

Department of Defense. DoD 5210.41-M, *Nuclear Weapons Security Manual*. November 2004.

Department of Defense. DoD Directive 5105.62, *Defense Threat Reduction Agency (DTRA)*. Washington, DC, November 28, 2005.

Department of Defense. *Technical Manual 25-1: Nuclear Weapons Technical Inspection System*. Washington, DC, January 1, 2007.

Department of Defense and Department of Energy. "National Security and Nuclear Weapons in the 21st Century," Joint Statement by the Secretaries of Defense and Energy [<http://www.defenselink.mil/news/nuclearweaponspolicy.pdf>], September 2008.

Department of State. *Treaty Between the United States of America and the Russian Federation on Strategic Offensive Reductions*. Washington, DC, May 24, 2002.

Donald, Kirkland H. "Report of the Audit and Review of Strategic Systems Programs' Self-Assessment and Review of Operation Within the Navy's nuclear Weapons Enterprise," N00N/08-0055, August 6, 2008.

Hadley, Stephen. "Remarks by the National Security Advisor to the Center for International Security and Cooperation." Stanford University, Stanford, CA, February 8, 2008.

Johnson, Stephen E. "Navy Inventory and Assessment: Nuclear Weapons and Nuclear Weapons-Related Material." May 2008.

Naval Postgraduate School Academic Catalog, November 7, 2008

Office of the Undersecretary of Defense for Acquisition and Technology. "Nuclear Deterrence." Defense Science Board Task Force on Nuclear Deterrence. Washington, DC, October 1998.

Office of the Undersecretary of Defense for Acquisition, Technology, and Logistics. “Nuclear Capabilities Report Summary.” Defense Science Board Task on Nuclear Capabilities. December 2006.

Office of the Undersecretary of Defense for Acquisition, Technology, and Logistics. “Report on Unauthorized Movement of Nuclear Weapons” Defense Science Board Permanent Task on Nuclear Weapons Surety. Revised April 2008.

Office of the Undersecretary of Defense for Intelligence, “Assessment of Joint Intelligence Operations Center Implementation,” December 6, 2007.

Schlesinger, James. Chairman. *Report of the Secretary of Defense Task Force on DoD Nuclear Weapons Management: Phase I: The Air Force’s Nuclear Mission*. Washington, DC, September 2008.

United States Air Force. “Reinvigorating the Air Force Nuclear Enterprise” October 24, 2008.

Appendix D. Abbreviations and Acronyms

ABM	Anti Ballistic Missile
ABNCP	Airborne Command Post
ADCON	Administrative Control
AEF	Air Expeditionary Forces (AF)
AETC	Air Education and Training Command (AF)
AFMAN	Air Force Manual
AFMC	Air Force Materiel Command
ALCM	Air Launched Cruise Missile
AOR	Area of Responsibility
ASD	Assistant Secretary of Defense
ASD(C3I)	Assistant Secretary of Defense for Command, Control, Communications & Intelligence
ASD(D)	Assistant Secretary of Defense for Deterrence
ASD(NII)	Assistant Secretary of Defense for Networks and Information Integration
ASD(SOLIC/IC)	Assistant Secretary of Defense for Special Operations, Low-Intensity Conflict, and Interdependent Capabilities
ASN(RDA)	Assistant Secretary of the Navy for Research, Development, & Acquisition
AT&L	Acquisition, Technology, and Logistics
ATSD(NCB)	Assistant to the Secretary of Defense for Nuclear, Chemical, and Biological Defense Programs
C2	Command and Control
C3	Command, Control, and Communications
C3I	Command, Control, Communications & Intelligence
C4	Command, Control, Communications & Computers
CBA	Capabilities-Based Assessment
CDR	Commander
CENTCOM	(U.S.) Central Command
CEP	Continuing Evaluation Program
CJCS	Chairman, Joint Chiefs of Staff
CJCSI	Chairman, Joint Chiefs of Staff Instruction
CMA	Competent Medical Authority
CNAF	Commander Naval Air Forces
CNO	Chief of Naval Operations
COCOM	Combatant Command
CONUS	Continental United States
CWMD	Combating Weapons of Mass Destruction
CY	Calendar Year
DASD	Deputy Assistant Secretary of Defense
DASD(FTR)	Deputy Assistant Secretary of Defense for Forces Transformation and Resources
DASD(PP)	Deputy Assistant Secretary of Defense for Policy Planning

DASD(STR)	Deputy Assistant Secretary of Defense for Strategic Capabilities
DAWG	Deputy's Advisory Working Group
DCA	Dual Capable Aircraft
DCMA	Defense Contract Management Agency
DIA	Defense Intelligence Agency
D-IOCC	Defense Intelligence Operation Coordination Center
D-JOIC	Defense Joint Intelligence Operations Center
DNSI	Defense Nuclear Surety Inspections
DoD	Department of Defense
DOE	Department of Energy
DOTMLPF	Doctrine, Organization, Training, Materiel, Leader Development, Personnel, and Facilities
DRPM	Direct Reporting Program Manager
DTASD/NM	Deputy to the Assistant to the Secretary of Defense for Nuclear Matters
DTRA	Defense Threat Reduction Agency
EUCOM	Short for USEUCOM (U.S. European Command)
FRP	Fleet Response Plan
FY	Fiscal Year
GAO	Government Accountability Office
GCC	Geographic Combatant Command
IAEA	International Atomic Energy Agency
ICBM	Intercontinental Ballistic Missile
IPL	Integrated Priority List
ISR	Intelligence, Surveillance, and Reconnaissance
JCA	Joint Capability Area
JCIDS	Joint Capabilities Integrated Development System
JFCC	Joint Functional Component Commands
JIC	Joint Intelligence Center
JIOC	Joint Intelligence Operations Center
JNWPS	Joint Nuclear Weapons Publication System
JROC	Joint Requirements Oversight Council
JSF	Joint Strike Fighter (F-35)
JTF	Joint Task Forces
MAD	Mutually Assured Destruction
MAJCOM	Major Command (AF)
MASO	Munitions Accountable Systems Officer
MFP	Major Force Program
NATO	North Atlantic Treaty Organization
NAVAIR	Naval Air Systems Command
NC2	Nuclear Command and Control
NCA	National Command Authority

NCB	Nuclear, Chemical, and Biological
NCCS	Nuclear Command and Control System
NEB	Nuclear Enterprise Board
NEC	Nuclear Enterprise Council
NETC	Naval Education and Training Command
NM	Nuclear Matters
NMS	National Military Strategy
NNSA	National Nuclear Security Administration
NORI	Nuclear Operation Readiness Inspections
NPR	Nuclear Posture Review
NSA	National Security Agency
NSI	Nuclear Surety Inspection
NSS	Nuclear Command and Control System Support Staff
NSS	National Security Strategy
NTPI	Navy Technical Proficiency Inspection
NWC	Nuclear Weapons Council
NWCCRB	Nuclear Weapons Council Capabilities Review Board
NWTI	Nuclear Weapons Technical Inspection
OPCON	Operational Control
OPNAV	Office of the Chief of Naval Operations
OSD	Office of the Secretary of Defense
OT&E	Organize, Train, and Equip
OUSD(AT&L)	Office of the Under Secretary of Defense for Acquisition, Technology, and Logistics
OUSD(P)	Office of the Under Secretary of Defense for Policy
PA&E	Program Analysis and Evaluation
PACOM	(U.S.) Pacific Command
PDASD(D)	Principal Deputy Assistant Secretary of Defense for Deterrence
PEO(U&W)	Program Executive Office (Unmanned Aviation and Strike Systems)
PME	Professional Military Education
POM	Program Objective Memorandum
PPBE	Planning, Programming, Budgeting, and Execution
PRP	Personnel Reliability Program
QDR	Quadrennial Defense Review
R3B	Resource and Requirements Review Board
RRW	Reliable Replacement Warhead
SAC	Strategic Air Command
SALT	Strategic Arms Limitation Treaty
SCAP	Strategic Communications Assessment Programs
SES	Senior Executive Service
SHAPE	Supreme Headquarters Allied Powers Europe
SLBM	Submarine-Launched Ballistic Missile

SLOC	Senior Leadership Oversight Council
SSBN	Ballistic-Missile Submarine
SSBN(X)	Sea-Based Strategic Deterrence
SSGN	Guided-Missile Submarine
SSP	Strategic Systems Program
STRATCOM	Short for USSTRATCOM (U.S. Strategic Command)
STRATJIC	STRATCOM Joint Intelligence Center
SWF	Strategic Weapons Facility
TACAMO	Take Charge and Move Out (E-6B Command and Control Aircraft)
TLAM-N	Tomahawk Land Attack Missile – Nuclear Variant
TP	Technical Publication
TTP	Tactics, Techniques, and Procedures
TYCOM	Type Commander
U.S.	United States
UAV	Unmanned Aerial Vehicle
UCP	Unified Command Plan
USAFE	United States Air Forces in Europe
USANCA	U.S. Army Nuclear and Combating Weapons of Mass Destruction Agency
USCENTCOM	U.S. Central Command
USD(AT&L)	Under Secretary of Defense for Acquisition, Technology & Logistics
USD(P)	Under Secretary of Defense for Policy
USEUCOM	U.S. European Command
USPACOM	U.S. Pacific Command
USSPACECOM	U.S. Space Command
USSTRATCOM	U.S. Strategic Command
VCJCS	Vice Chairman, Joint Chiefs of Staff
WMD	Weapons of Mass Destruction
WS3	Weapons Storage and Security System
WSA	Weapons Storage Area

Secretary of Defense Task Force on DoD Nuclear Weapons Management

Director of Analysis

Mrs. Margaret R. Munson

Executive Fellow

Dr. Amos A. Jordan

Director of Research

Col Randolph P. Miller, USAF

Executive Officer

LCDR Vanessa L. Ong, USN

Executive Assistant

Ms. Beverly M.P. Freeman

Staff Members

Task Force Security Manager

OSC (SW/AW) James Allen Cowling, USN

Navy Systems and Operations Subject Matter Expert (SME)

CDR John D. Gerken, USN

Nuclear Operations SME

Lt Col Craig A. Hansen, USAF

Air Force Operations SME

Capt Steven J. Leutner, USAF

Administration

SSgt Burnell L. McAllister, USAF

Nuclear Weapons Maintenance SME

Maj Thomas B. Vance, Jr., USAF

Director of Strategic Outreach and Public Affairs

Ms. Keysha J. Webb, OSD

Supply and Logistics SME

LCDR Christopher M. Wise, USN

Editors

Col Lloyd J. Matthews, USA (Ret)

Ms. Diane C. Williams

