



**Comments on the November 2010 Notification of
Intent for Cation Exchange Water Softeners**

July 25, 2011

Commenter

Barry Schultz.....	3
Steven Richards.....	4
Ken Hoffman.....	5
Thomas Griesbach.....	6
Ken Hoffman.....	7
Todd Fessenden.....	8
Kevin Wong.....	9
Multiple Authors.....	10
Jeff Hellenbrand.....	11
Mike Mormino.....	13
John Beaver.....	14
Steve Via.....	15
Gary Thundercliffe.....	16
Sharon Green.....	17
Larry Zinser.....	18
Nancy Stoner.....	19
Thomas Armon.....	20
Multiple Authors.....	21

Commenter: Barry Schultz

Affiliation: EarthSaversO2

Comment Date: November 22, 2010

As a plumbing contractor for the last 30 years, and cross training in 2007 to be a energy star HPS/BPS with my son Brook. I want to say..... Yes It would be nice to look into getting water softeners get watersence labeling. It would also be good to have them energy star labeled.I have seen some nice softeners out there. And I don't think there will be any problem.Except..... The in-expensive ones.WaterSence is a great program to add to the energy star program! Its a privileged to be a part of the programs that work, Its good to our earth and mankind.Keep up all the GOOD work! Barry Schultz Sr Earthsaverso2

Commenter: Steven Richards

Affiliation: The Aquasource Group, Inc.

Comment Date: November 24, 2010

Hello.

Please accept my comments regarding Ion Exchange water softener efficiencies.

1. Great Idea ! Not only will this reduce water useage, this action will also help the environment by reducing waste water for sewer plants as well as individual septic systems.
2. The water softener industry is made up of both manufacturers and assemblers. Assemblers should be able to leverage the certification of the manufactured components hat they use for certification of thier completed product. This will lower the cost of compliance and event he playing field.

Best Regards,

Steven L. Richards CWS VI
President

[The Aquasource Group Inc.](#)
The Water People

Main Office
8960 Main Street
Honeoye, NY 14471

Phone: 585.229.2500

Fax: 585.229.2465

stever@nicewater.com

www.nicewater.com

Commenter: Ken Hoffman
Affiliation: LifeSource Water Systems
Comment Date: November 29, 2010

Gentlemen,

With respect to the WaterSense NOI for cation exchange systems, I respectfully submit that:

1. The NOI category to be broadened to include all "point-of-entry" (whole house) water systems as both types of systems are installed on the main water line in a similar manner.
2. Consideration should be given to non-salt based, whole house water systems which can achieve zero water waste, thereby achieving the primary goal of the WaterSense program. In comparison, regenerative water softeners, for residential and commercial use, have been banned in many communities due to the chloride effluent's effect on reclaimed water usage and the environment.

Here are a few unintended consequences or negative results directly related to water softeners:

1. Usage of plastic bottled water to provide potable drinking water in homes using water softeners, specifically the negative effect that plastic bottles have in landfills.
2. Usage of high water wasting reverse osmosis systems to provide potable drinking water in homes using water softeners.
3. The negative health effects of "softened" water on several segments of the population.
4. The negative health effects of reverse osmosis water on several segments of the population.

At your request, I'd be happy to provide more information and direct you to various governmental, environmental, medical and private sources to support the above.

Cordially,
Ken Hoffmann
LifeSource Water Systems
Cell: 818-633-5162

Commenter: Thomas Griesbach
Affiliation: Diamond H2O
Comment Date: December 7, 2010

To whom it may concern

My company is an OEM located in Wisconsin and would like to better understand all the long term intentions with this project.

Also, I understand the watersense program is already being used for other products.

Do you have any testimonials or written comments from those manufacturers?

My concern: Are we writing the standards so that the EPA can enforce them upon us in the future?

If so, we need to SHRINK regulations/government not look for things to grow it and make it more difficult and expensive to conduct business.

Your prompt response would be greatly appreciated.

Regards,

Thomas G. Griesbach

President

Diamond H2O

Commenter: Ken Hoffman
Affiliation: LifeSource Water Systems
Comment Date: December 20, 2010

You may find the attached report to be of value as you consider the proposed Water Softener program

Cordially,
Ken Hoffmann
LifeSource Water Systems
Cell: 818-633-5162



(Attachment: Southern California Salinity Coalition Final Project Report: Automatic Water Softener Rebate Program – Phase II: Public Outreach Program). Electronic copy available at:
<http://socal.salinity.org/pdfs/SCSCReportWaterSoftenerOutreach12.20.10.pdf>)

Commenter: Todd Fessenden

Affiliation: Eagle River Water and Sanitation District

Comment Date: December 29, 2010

For us in the Vail Valley, softeners are more than just a wastewater issue. A large part of our service area comprises of second homes and resorts. Almost all of these locations are fitted with softeners for both aesthetic and perceived quality improvements. We have found that a large portion of our customer complaints derive from softener generated plumbing issues. Large homes with copper piping that has not had the opportunity to scale naturally sit for long periods without use. When the residents or visitors finally arrive and these systems fire up for the first time we see increases of copper loading to our wastewater plants. At the same time we get regular calls from customers with internal plumbing problems related to corrosion. Completely soft water is aggressive due to its lack of alkalinity and general chemical imbalance and does strange things to internal plumbing components. That problem is exacerbated by long periods of dormancy in homes and hotels. We add corrosion inhibitor, but that only goes so far when the systems are not being run regularly. This situation can also create higher copper levels in drinking water as well. I'd love to see the softener industry go away, or develop a system that leaves about 3 grains per gallon in the water to protect the piping, the customers and the watersheds.

Thank you,
Todd Fessenden
Water Division Manager
Eagle River Water and Sanitation District
970-477-5471

Commenter: Kevin Wong
Affiliation: Canadian Water Quality Association
Comment Date: January 19, 2011

Here you go

Kevin Wong, BSc, MBA, CAE
Executive Director
Canadian Water Quality Association
295 The West Mall, Suite 330
Toronto, ON M9C 4Z4
T: (416) 695-3068 ext 312 Toll Free: 1-866-383-7617
F: (416) 695-2945
E: k.wong@cwqa.com
Website: www.cwqa.com



Please consider the environment before printing this e-mail

(Attachments: Region of Waterloo Water Softener Study presentation for Canadian Water Quality Association July 28th, 2010; Guidance for the Use of Water Softening and Onsite Wastewater Treatment Equipment at the Same Site by WQA and NOWRA; Ontario Residential Fire Sprinklers & On-site Sewage Systems: A Consultation on Proposed Changes to Ontario's Building Code. Electronic copy available at www.ontario.ca/buildingcode)



Region of Waterloo Water Softener Study

July 28th 2010



Soft Water

- **Benefits**
 - Descaling Effects - saves energy & longevity of appliances
 - Soft water better for skin (UK Study- ongoing)
 - Aesthetic and health based effects
 - Costs and benefits in very hard water environments



Soft Water

- Challenges
 - Chlorides
 - Efficiency
 - Wastewater discharges
 - TDS difficult to remove from the waste water stream & may end up discharging to the natural environment (guidelines coming).
 - Implications to MOE objectives, Great Lakes and surface water agendas
 - Reg 903 and the Region's wells.



Background

- 2008
 - MOE alerts Region of increasing trends of chlorides at their surface water monitoring sites
(MOE surface water Monitoring data 2003-2008)
 - Potential sources
 - Road and winter de-icing salt
 - Potash fertilizers
 - Softeners

How do you manage all these sources?





Background

- Region Survey
 - 72% of residences have a water softener
 - Probably 100% of local businesses have one on their boilers for the hot water to protect the systems.
- Industry
 - >100 Water treatment companies serving the region (50% are members)
 - > 1000 people employed in the industry



Emerging Challenges for a Leading Municipality in Canada

- Water Conservation (softeners discharge regeneration waters)
- Energy Efficiency Challenges
- Wastewater Challenges
 - At the plant
 - Greywater policies forming



Softeners

- Theoretical limit
 - » 4400 grains of hardness per pound of salt used for regeneration.
 - » This works out to about 75,000ppm of hardness removed.
 - » At 600 ppm total hardness, this works out to about 125L/lb Salt.



Softeners

- Historical (old) performance
 - » 3000 grains of hardness per pound of salt used in regeneration
- Today's (average) performance
 - » 4000 grains of hardness per pound of salt used in regeneration
 - » This is at standard settings not a water conservative or salt saving settings
 - » This brings the water to 0-1 gr hardness
 - » People don't see/fell hard water till it's over 3 gr hard...





Region of Waterloo

The Water Trials

Objectives

1. To measure the efficiency of water softeners.
2. To verify the size of softener local homeowners need, based on usage and the relative performance of the recommended softeners.
3. To publish results that educate consumers, plumbers and retailers about water softeners.
4. To more accurately measure the impacts of residential water softening on drinking water demand and wastewater treatment.
5. To gather information for future Region of Waterloo policies and programs.



Region of Waterloo

Results

- This is an independent study and some good data was developed in the April 2010 Trial #1 report. Three water softeners were tested on 39 gpg hard water and all performed very well - all consistently providing softened water below 1 grain per gallon. The three residential softeners were 1) Culligan Medalist Plus 30 Model (labeled XXX), 2) EcoWater Automatic Model GS6225D (labeled XX), and 3) Novatek Model NT32SE with a WaterGroup Inc. control valve (labeled X). Important characteristics that they found are:
- For Brand XXX: 62 gallons per regeneration; regeneration discharges to wastewater = 2.7 gallons per each 1,000 grains of hardness exchange; salt used = 0.21 pounds of NaCl per each 1,000 grains of hardness exchanged.
1.08lb
- For Brand XX: 23 gallons per regeneration; regeneration discharges to wastewater = 2.5 gallons per each 1,000 grains of hardness exchange; salt used = 0.26 pounds of NaCl per each 1,000 grains of hardness exchange.
1.144lbs
- For Brand X: 54 gallons per regeneration; regeneration discharges to wastewater = 2.0 gallons per each 1,000 grains of hardness exchange; salt used = 0.25 pounds of NaCl per each 1,000 grains of hardness exchange.
1.1lbs
- These kinds of numbers, for example, may all be satisfactory for meeting USEPA WaterSense criteria and expectations. They all are about 50% lower (better) than the NSF/ANSI Standard 44 requirements for water efficiency ratings and they are all at or very near 4,000 grains of hardness exchange per pound of salt used.





The results look great

- 3.06 people per average household
- 61.8 gallons of water used per person per day
- 193 gallons of water used per household per day
- Peak water flow rate = 8.7 gallons per minute
- Average water flow rate = 4.5 gallons per minute
- Minimum water flow rate (assumed leaks) = 0.26 gallons per minute.



Next Steps

- Recommendations
 - Continue with the softener trials- CWQA's members are ready to assist and donate units for testing.
 - In future trials- move to a high efficiency settings to maximize the efficiency of the softeners
- Future strategies
 - Promote softener servicing – get homeowners and businesses to service their softeners and have the service person check for the settings





Questions?

We are here to help



*Water Quality Association
International Headquarters & Laboratory
4151 Naperville Road
Lisle, Illinois 60532-3696 USA
Phone 630 505 0160
Fax 630 505 9637
A not-for-profit organization*



Guidance for the Use of Water Softening and Onsite Wastewater Treatment Equipment at the Same Site.

by

Matt Byers, Joe Harrison, and Allison Blodig

This guidance document is a collaboration between the Water Quality Association (WQA) and the National Onsite Wastewater and Recycling Association (NOWRA)

The use of water softening and water conditioning equipment in America is necessary in many homes. The use of onsite and decentralized wastewater treatment technologies, commonly called septic systems, at American homes is also necessary. Both water softening/conditioning and onsite wastewater treatment systems are commonly used together, and in the majority of these cases no problems are indicated. Yet there have been sporadic, mostly anecdotal reports of issues related to the use of both kinds of equipment at some sites. Experts in both fields are working together to better understand the interactions involved between water softeners and onsite wastewater systems. In the mean time the WQA and NOWRA have collaborated herein to offer advice based on available knowledge.

1. All onsite wastewater systems require maintenance on a regular basis to ensure proper function. The nature and frequency of maintenance activities is dependent upon the type of system used. Seek guidance on this from state or local regulatory agencies, operation and maintenance manuals of treatment components, or through a qualified local service provider. Be sure your onsite wastewater system has adequate access points for maintenance that are watertight, secure and tamper-resistant. Access should be brought to grade. Potential maintenance points include septic tanks and effluent screens, pumps and controls, treatment devices, and soil distribution components. Service, repair, and replace equipment as recommended by the manufacturer, regulatory authority, or installer.
2. Maintain your water softener system on a regular basis. Ensure that your water softener is installed correctly and is functioning properly. Ensure that your softener has been set to reflect the water hardness and iron level in your water supply. If the unit is a timer operated softener, make sure you seek the help of your local water treatment dealer in setting up the regeneration frequency to the optimum level, and not more frequently than needed. When the system is not being used, such as during a vacation, be sure to temporarily turn it off. Replace equipment as needed.
3. The use of excessive bleaches & detergents, strong disinfectants, "every-flush" toilet disinfection chemicals, caustic drain cleaners should be avoided. Do not flush expired drugs, other pharmaceuticals, motor oil, brake fluid, paints and thinners, solvents, herbicides, pesticides, anti-freeze, gasoline, chemical wastes, and excess grease out to your onsite wastewater system. The items

listed should be excluded from ANY waste plumbing system, but can create significant problems and even ruin onsite wastewater treatment systems.

4. Be sure to inspect your home for possible sources of excess water consumption such as leaking toilet flappers and valves. Excess water flow to onsite wastewater systems is one of the largest issues related to onsite wastewater treatment system failures. Leaking household water can also create an extra and unnecessary load on your water treatment system. Be sure sump pumps, floor drains, and roof drains do not discharge to the wastewater system as well.
5. When selecting a new water softener, consider using equipment determined to be 'high efficiency'. These systems include the demand initiated regeneration (DIR) water softeners that regenerate only when needed thereby conserving both salt and water. Again, ensure that your water softener has been set to reflect the water hardness and iron level in your water supply.
6. When installing new onsite wastewater equipment, consider the fact that some onsite system manufacturers require that water softener regeneration water not be discharged in their wastewater treatment systems. Thus, ask that those manufacturers provide an alternative for routing the water softener regeneration water around the waste treatment device that meets your local regulations or requirements as well as your site conditions. The local wastewater system installer should be able to accommodate the manufacturer's instruction.
7. If an issue arises and a water softener/onsite wastewater system interaction is suspected, inspect and assess the onsite wastewater system with a local expert on onsite wastewater systems and the water softener with a local expert on water softening/water conditioning systems. Generally, there are very few experts that have skills in both areas. The local experts should consider using the screening tool that has been developed by this collaborative group as the guide and return the information to either the WQA or NOWRA for tracking and evaluation purposes.

If you have further questions and/or need more information please contact us.

The National Onsite Wastewater Recycling Association (NOWRA)

3540 Soquel Ave, Suite A
Santa Cruz, CA 95062
Phone: (800)966-2942 or (831)464-4884
Fax: (831)464-4881
Website: www.NOWRA.org

The Water Quality Association (WQA)

International Headquarters & Laboratory
4151 Naperville Road
Lisle, IL 60532-3696, USA
Telephone: (630)505-0160
Fax: (630)505-9637
Website: www.WQA.org

Commenter: Multiple Authors
Affiliation: Undersigned Agencies
Comment Date: January 25, 2011

Association of California Water Agencies (ACWA)
Association of Metropolitan Water Agencies (AMWA)
California Association of Sanitation Agencies (CASA)
California Municipal Utilities Association (CMUA)
City of Phoenix, Water Services Department
City of Scottsdale, Water Resources
Clean Water Action
Inland Empire Utilities Agency
Las Cruces Utilities
Metro Wastewater Reclamation District
Multi-State Salinity Coalition
National Association of Clean Water Agencies (NACWA)
National Water Research Institute
National Resources Defense Council
Planning and Conservation League
Sanitation Districts of Los Angeles County
Southern California Alliance of Publicly Owned Treatment Works (SCAP)
Southern California Salinity Coalition
Southern California Water Committee
Tri-TAC
WaterReuse Association
WaterReuse California
Western Coalition of Arid States (WESTCAS)

January 25, 2011

Peter S. Silva, Assistant Administrator
Office of Water
Environmental Protection Agency
Ariel Rios Building
1200 Pennsylvania Avenue, N.W.
Mailcode 4101M
Washington, DC 20460

Subject: WaterSense Notification of Intent to Develop Efficiency and Performance
Specifications for Residential Cation Exchange Water Softeners

Dear Mr. Silva:

The undersigned organizations are writing to call to your attention our concerns regarding the Notification of Intent (NOI) to Develop Efficiency and Performance Specifications for Residential Cation Exchange Water Softeners by the U.S. Environmental Protection Agency's (EPA's) WaterSense Program. For the reasons indicated below, we urge that the NOI be

Peter S. Silva
Page Two

expanded to include non-salt discharging appliances. We request the opportunity to meet with you, at your earliest convenience, to discuss potential solutions to these concerns. We believe that we can work with you to develop a fully integrated approach that will work for WaterSense Partners throughout the nation.

The undersigned organizations are all strong supporters of the Environmental Protection Agency's WaterSense program. We firmly believe in the importance of improving the water efficiency of appliances, buildings, and landscapes, and in the significance of creating an easily-recognizable "brand" for products with the highest water efficiency ratings. Indeed, many of the undersigned organizations are WaterSense Partners. We actively promote the water efficient products endorsed by the EPA through this program.

We understand that typical Cation Exchange Water Softeners (also known as Self-Regenerating Water Softeners (SRWS)) used in homes are water intensive. These devices are also very effective at removing hardness from water, which means they are useful for protecting other water and energy efficient appliances from the impacts of calcium and magnesium that are found in local water supplies. For WaterSense to identify self regenerating water softeners as candidates for evaluation is understandable.

The problem is the amount of salt that this type of water softener discharges to the sewer system on average 1 pound or more of salt per day. From a national perspective, this is a significant water quality concern, potentially contributing to impairments in surface and groundwater supplies. The EPA's 303 (d) impaired waters list shows almost 1,800 listings across the country due to salinity or related compounds (including total dissolved solids, chloride, sulfates, conductivity and/or combinations of these compounds). High levels of salt entering sewer systems also compromise the ability of communities to use recycled water when salinity in these supplies rises to unacceptable levels.

Salt management is a major water challenge facing our nation, especially, though not exclusively, in the arid West. The EPA, along with the Department of Agriculture and the Department of Interior, have congressional mandates for implementing programs to reduce salt impacts, including the Colorado River Salinity Control Act and the joint federal/California initiative to protect the San Francisco Bay Delta. In addition, these agencies, along with the U.S. Council on Environmental Quality, are promoting the use of recycled water as a water efficiency measure.

Many communities throughout the nation have found self-regenerating water softeners to be a significant contributor to pollutant loadings. Local and state agencies in California, Texas, Arizona, Montana, Kentucky, Michigan, Massachusetts, Connecticut, and New Jersey and elsewhere have at one time enacted or are now contemplating laws, regulations, and ordinances to limit or ban the use of self-regenerating water softeners.

Peter S. Silva
Page Three

Understandably, for those of us who have been working for decades and spending ratepayer dollars to reduce salt loadings into our systems, the possibility of an EPA WaterSense label limited to devices that discharge significant quantities of salt (even if the amount could be less than comparable softeners) is of profound concern. If approved as proposed by the NOI, such a WaterSense specification would preclude many WaterSense partners from promoting the water softener specification.

We have spoken with the WaterSense staff about this problem, and understand that the existing program guidelines currently preclude a better approach to identifying the appropriate water efficient product for the control of hardness or scale. Staff indicates that the WaterSense process is limited to a consideration of older technology that may be able to achieve a 20% or more improvement in water efficiency. *This means that the available alternative technologies (used in Europe and now starting to be introduced into the American market) that use neither water nor salt cannot be evaluated in the WaterSense Program – even though these appliances may achieve 100% water efficiency while protecting the nation's water quality.*

Our recommendation is that the WaterSense program guidelines be modified to permit evaluation of non-water using technologies **and** that the NOI be revised so that the EPA can evaluate and compare salt and non-salt discharging appliances.

Admittedly, this will be a somewhat more extensive and challenging task than the evaluation contemplated under the NOI, but the benefits to the public and to the implementation of the Clean Water Act will be substantial.

In summary, we strongly believe that there is a better way to integrate EPA's water resource and water quality goals through the WaterSense Program. We are committed to working with you and the WaterSense program to develop a broader water softener evaluation initiative.

Thank you for your consideration of our request to meet with you at your earliest convenience to discuss our concerns and a possible new joint initiative.

Sincerely,



Tim Quinn
Executive Director
Association of California Water Agencies



Catherine Smith
Executive Director
California Association of Sanitation Agencies

Peter S. Silva
Page Four

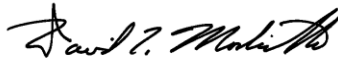

David Modisette
Executive Director
California Municipal Utilities Association



Marshal Brown
Water Resources Executive Director
City of Scottsdale



Jennifer Clary
Policy Analyst
Clean Water



Edmund G. Archuleta
MSSC Chairman
President and CEO
El Paso Water Utilities

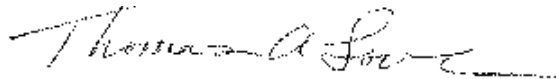

Thomas A. Love
General Manager
Inland Empire Utilities Agency

Joshua Rosenblatt

Joshua Rosenblatt
Regulatory & Environmental Analyst
Las Cruces Utilities

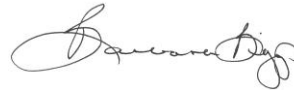

Barbara Biggs
Governmental Affairs Officer
Metro Wastewater Reclamation District



Ken Kirk
Executive Director
National Association of Clean Water Agencies
Owned Treatment Works



Ed Osann
Senior Policy Analyst
National Resources Defense Council

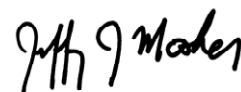

Jeff Mosher
Executive Director
National Water Research Institute



Jonas Minton
Senior Water Policy Advisor
Planning and Conservation League

Peter S. Silva
Page Five



John Pastore
Executive Director
Southern California Alliance of Publicly
Owned Treatment Works



Richard W. Atwater
Executive Director
Southern California Water Committee



Mark R. Norton
Chair
Southern California Salinity Coalition



Ben Horenstein
Chair
Tri-TAC

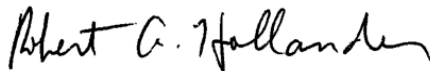

Robert Hollander
President
Western Coalition of Arid States



Dave Smith
Managing Director
WateReuse California



Wade Miller
Executive Director
WateReuse Association



Barbara Glaus
Acting Water Services Director
Phoenix Water Services Department



Diane Van De Hein
Executive Director
Association of Metropolitan Water Agencies



Philip L. Friess
Department Head, Technical Services
Sanitation Districts of Los Angeles County

cc: Nancy Stoner, Deputy Administrator
Bob Perciasepe, EPA Assistant Administrator for Water
Jim Hanlon, Director, EPA Office of Wastewater Management
Veronica Blette, WaterSense Program, EPA Office of Wastewater Management
Alexis Strauss, Director, EPA Region IX Water Division
Tom Howard, Executive Director, California Water Resources Control Board

Commenter: Jeff Hellenbrand
Affiliation: Hellenbrand, Inc.
Comment Date: January 31, 2011

Dear WaterSense,

First off thank you for the invitation to participate in the webinar/conference call on Wednesday 1/19. My understanding is that the two main goals of this possible program is to reduce water usage for regeneration purposes and to reduce the amount of chlorides. Several other items were brought up, including but not limited to the sodium and chloride impacts on septic tanks and chloride and tds impacts on wastewater treatment plants.

In general to accomplish these goals WaterSense wishes to expand on the existing NSF/ANSI 44 standard and is considering adopting a salt-efficiency requirement of at least 4,000 grains per lb. of salt, looking at a regeneration efficiency by not regenerating with "x" amount or less of capacity remaining, along with reducing the amount of water used during a regeneration process.

Based on testing we are presently doing, achieving both the salt efficiency and water usage are doable. Maintaining that salt efficiency over extended repeated regenerations without an occasional "boost" of salt is a concern to both us a manufacturer and our dealers, as it is well known that over period of time with low salt dosages these efficiencies cannot be maintained. This results in hardwater leakage before the next regeneration and unhappy customers, a "lose lose" for everyone in the chain, customer, dealer and manufacturer. Perhaps however that can be addressed in the standard.

Regarding the regeneration efficiency or not regenerating too soon based on the various mathematical formula's used by the control valve manufacturers, that one is really a tough one with a single tank system. Simply looking at a home application as the family size increases the accuracy of the various mathematical formula's used to determine the reserve required has a larger chance of having more wasted capacity. As does the type of family, age of the family members ...etc. Twin alternating systems are by far the most efficient as you are able to bascially exhaust the system to nearly zero, switch tanks and then regenerate the exhausted tank. Years ago I did a study of my single tank, electronic DIR with "variable reserve" and found my wife and I could save 15% on salt and water usage with a twin tank based on our erractic water usage patterns with frequent out of town travel.

One thing that I have not seen mentioned that I believe would have a positive impact on water savings, is how the various plumbing codes impact water higher water usage, larger footprints ...etc. which requires larger water softeners to be sized. I have attached a copy of a sizing chart that the State of WI uses to further assist you in understanding this, along with a spreadsheet showing how the gallon per minute or "gpm" requirement is calculated, for a 3.5 bath house, with a dishwasher, kitchen sink, ice-maker, clothes washer, with laundry tray and whirlpool bath. This "overkill" requires larger units to be installed to meet the service flow rate requirements, which in turn require more water to be used to regenerate the water softener. It also is less green because it requires a larger footprint, larger pipe size ...etc. Ironically WI adopted an "alternative sizing" for residential homes that has been in place for approximately ten-years that has worked very well. Basically it allows you to take a home that would normally require upto 24 gpm to be sized at an 8.5 gpm demand. Loretta Trapp and I were very involved in this process on behalf of the WQA several years ago. The entire plumbing code needs to be reviewed in this area, for both residential

applications, commercial and industrial jobs across the U.S. as it would more than likely result in less water usage, smaller pipe sizes which in turn would reduce the energy loss for hot water lines and reduced costs for the end-user which also includes the taxpayers for any state or federal projects.

I look forward to continuing this process.

Sincerely,

Hellenbrand, Inc.

Jeff Hellenbrand
President

(Attachment: Water Supply Fixture Units for Public and Nonpublic Use Fixtures)

WATER SUPPLY FIXTURE UNITS FOR PUBLIC USE FIXTURES

TYPE OF FIXTURE ^a	WATER SUPPLY FIXTURE UNITS (WSFU)		
	Hot	Cold	Total
Automatic Clothes Washer, Individual	2.0	2.0	3.0
Automatic Clothes Washer, Large Capacity	b	b	b
Bathub, with or without Shower Head	2.0	2.0	3.0
Coffeemaker		0.5	0.5
Dishwasher, Commercial	b	b	b
Drink Dispenser		0.5	0.5
Drinking Fountain		0.25	0.25
Glass Filler		0.5	0.5
Hose Bibb: 1/2" diameter		3.0	3.0
3/4" diameter		4.0	4.0
Icemaker		0.5	0.5
Lavatory	0.5	0.5	1.0
Shower, per Head	2.0	2.0	3.0
Sinks: Bar and Fountain	1.5	1.5	2.0
Barber and Shampoo	1.5	1.5	2.0
Cup		0.5	0.5
Flushing Rim		7.0	7.0
Kitchen and Food Preparation per faucet	2.0	2.0	3.0
Laboratory	1.0	1.0	1.5
Medical Exam and Treatment	.5	.5	1.0
Service	2.0	2.0	3.0
Surgeon Washup	1.5	1.5	2.0
Urinal: Siphon Jet		4.0	4.0
Washdown		2.0	2.0
Wall Hydrant, Hot and Cold Mix: 1/2" diamter	2.0	2.0	3.0
3/4" diameter	3.0	3.0	4.0
Wash Fountain: Semicircular	1.5	1.5	2.0
Circular	2.0	2.0	3.0
Water Closet: Flushometer		6.5	6.5
Gravity Type Flush Tank		3.0	3.0

WATER SUPPLY FIXTURE UNITS FOR NONPUBLIC USE FIXTURES

TYPE OF FIXTURE ^a	WATER SUPPLY FIXTURE UNITS (WSFU)		
	Hot	Cold	Total
Automatic Clothes Washer	1.0	1.0	1.5
Bar Sink	0.5	0.5	1.0
Bathub, with or without Shower Head	1.5	1.5	2.0
Bidet	1.0	1.0	1.5
Dishwasher Machine	1.0		1.0
Glass Filler		0.5	0.5
Hose Bibb: 1/2" diameter		3.0	3.0
3/4" diameter		4.0	4.0
Kitchen Sink	1.0	1.0	1.5
Laundry Tray, 1 or 2 Compartment	1.0	1.0	1.5
Lavatory	0.5	0.5	1.0
Shower, per Head	1.0	1.0	1.5
Water Closet: Flushometer		6.0	6.0
Gravity Type Flush Tank		2.0	2.0
Bathroom Groups:			
Bathub, Lavatory and Water Closet – Flushometer	2.0	7.5	8.0
Bathub, Lavatory and Water Closet – Flush Tank	2.0	3.5	4.0
Shower Stall, Lavatory and Water Closet – Flushometer	1.5	7.0	7.5
Shower Stall, Lavatory and Water Closet – Flush Tank	1.5	3.0	3.5

Note a: For fixtures not listed, factors may be assumed by comparing the fixture to a listed fixture which uses water in similar quantities and at similar rates.

Note b: Load factors in gallons per minute, gpm, based on manufacturer's requirements.

Source: Wisconsin Administrative Code, October, 2004, 82.40-2-3

CONVERSION OF WATER SUPPLY FIXTURE UNITS TO GALLONS PER MINUTES

Water Supply Fixture Units	GALLONS PER MINUTE	
	Predominately Flush Meter Type Water Closets	Predominately Flush Tank Type Water Closets
	Or Siphon Jet Urinals	Or Washdown Urinals
1	—	1
2	—	2
3	—	3
4	10	4
5	15	4.5
6	18	5
7	21	6
8	24	6.5
9	26	7
10	27	8
20	35	14
30	40	20
40	46	24
50	51	28
60	54	32
70	58	35
80	62	38
90	65	41
100	68	42
120	73	48
140	78	53
160	83	57
180	87	61
200	92	65
250	101	75
300	110	85
400	126	105
500	142	125
600	157	143
700	170	161
800	183	178
900	197	195
1000	208	208
1250	240	240
1500	267	267
1750	294	294
2000	321	321
2250	348	348
2500	375	375
2750	402	402
3000	432	432
4000	525	525
5000	593	593

Note: Values not specified in the table may be calculated by interpolation.

Source: Wisconsin Administrative Code, 2004 82.40-2-3

Alternate Plumbing, Point-of-Entry Water Treatment Device Sizing Method/ Wisconsin Department of Commerce

This approval is valid until the end of Dec. 2012.

- A point-of-entry water treatment device sized in accordance with this alternative method shall not serve exterior wall hydrants.
- Water supply fixture unit values, and the corresponding flow rates, for exterior wall hydrants shall be calculated using s. Comm 82.40 (6), converted using Table 82.40-3, and shall be added to the flow rate calculated using the alternate method.
- This alternate sizing method shall be used for sizing point-of-entry water treatment devices up to a maximum water supply fixture unit (WSFU) value of 40. For WSFU values exceeding 40, the load factors for water supply systems shall be calculated using s. Comm 82.40 (6).
- The maximum rated service flow rate(s) of a point-of-entry water treatment device, or multiple water treatment device's installed in parallel, shall be greater than or equal to the design flow rate derived by using this alternate sizing method.
- This alternate sizing method for point-of-entry water treatment devices shall be limited to single family homes and individual dwelling units in a multi-family dwelling.
- The flow rate calculated using this alternative sizing method for point-of-entry water treatment device's shall not be less than any minimum flow rate or corresponding pressure required by a fixture as specified by the fixture manufacturer.

Alternate Sizing	
Water Supply Fixture Units (WSFU's)	Gallons per Minute for Sizing
1	1
2	2
3	3
4	4
5	4.5
6	5
7	6
8	6.5
25	7
35	8
40	9

Commenter: Mike Mormino

Affiliation: Enpress

Comment Date: February 14, 2011

To whom it may concern, please find the attached documentation requested during your Notification of Intent for Cation Exchange Water Softeners.

Please advise if further questions or concerns.

Best Regards,
Michael P. Mormino
VP Sales & Marketing
ENPRESS LLC
440-510-0108 x108
Cell: 440-479-2684
Fax: 440-510-0202

(Attachments: ENPRESS LLC Vortech™ system data; [WCP Online Archives: Full Plate Distributor Vessel=Truly Green Water Treatment](#) Published in Water Conditioning & Purification Magazine February 2008; [The Next Generation of Water Conservation](#) Published in Water Quality Products Magazine January 2008, Volume: 13 Number: 1)



February 14, 2011

RE: ENPRESS Water and Salt Savings

To Whom it May Concern,

During your recent on-line presentation concerning the initiatives that the USEPA and in particular WaterSense is planning to develop a draft efficiency and performance specification for cation exchange water softeners, a request was made to those participating. Your request was for us to send market data that supports water and salt savings in our industry, along with data supporting the amount of hardness that is removed during the exchange cycle. We are here to present data to support our manufacturing technology.

Developed in 2006, ENPRESS LLC introduced a product to our industry called the Vortech™, a full plate distributor that created multiple levels of efficiencies in cation exchange water softeners, from increased capacity in the regeneration cycle, to the use of less water to drain required, by the use of this product. The patented and unique design of the Vortech™ creates fluidity of the media bed during backwash and regeneration cycles, which reduce channeling and improve the efficiencies of the systems. With the WaterSense target of achieving an efficiency of a maximum of 5 gallons of water used per 1000 grains of hardness removed, and a potential target of 4000 grains of hardness removed per pound of salt, we have achieved these data points in systems utilizing the Vortech™ distributor plate.

Please find the below summary of data provided from the WQA for NSF 44 testing of Vortech™ systems utilizing a DIR electronic control valve:

- I. Resin Capacity per pound of salt, NSF 44 Tested
 - a. Electronic system with cone and gravel distributor systems: 3472
 - b. Electronic system with **Vortech™** distributor systems: 4186

- II. Water usage (gal) per 1000 grains of capacity (3-5lbs.cuft)
 - a. Electronic System with cone and gravel distributor systems: 3.10
 - i. 15.5K grains
 - ii. 48 gallons to drain
 - b. Electronic System with **Vortech™** distributor systems: 1.65
 - i. 18.8K grains
 - ii. 31 gallons to drain

- III. Pressure/Delta P
 - a. Electronic System with cone and gravel distribution systems: 13.4 gpm @ 15psig Delta P
 - b. Electronic System with **Vortech™** distribution systems: 13.4 gpm @ 9.8psig Delta P
 - c. Electronic System with **Vortech™** distribution systems: 17.8 gpm @ 15psig Delta P

The data here shows increased resin capacity, a reduction of water usage per 1000 grains of capacity, a reduction of total gallons of water to drain during regeneration, and increased flow rate efficiency...all using the Vortech™.



Furthermore, we have data provided by other 3rd party testing that continues to support the testing done by WQA to the NSF 44 standard, showing savings of water gallons to drain. The summary below of one such test, shows that the switching of the distribution system to the Vortech™, could save a family of four 214 gallons of water per month, by allowing them to reduce the volume of water used during backwash, all due to the more efficient lifting of the media cation bed in backwash. (Please note that in the testing, we were looking at simply backwashing efficiencies, and not working on regeneration efficiencies, etc...) See the below and attached editorial article, where this first appeared in WC&P Magazine February 2008:

THE SYSTEM	
VORTECH™ DISTRIBUTOR TANK	STANDARD TANK
1 Cubic Foot of 10 % Resin	1 Cubic Foot of 10 % Resin
No Gravel Underbed required	5lbs of gravel underbed required
5600 metered valve	5600 metered valve
Distributor plate on bottom	Standard 1" Distributor tube
3/4" Hard water service line	3/4" Hard water service line
55psi Incoming pressure	55psi Incoming pressure
52 degree incoming city water	52 degree incoming city water
Incoming flow rate 15 gpm	Incoming flow rate 15 gpm
2.0 gpm drain flow control	2.0 gpm drain flow control
.5 Brine line flow control	.5 Brine line flow control
Standard piston	Standard piston

THE RESULTS	
VORTECH™ DISTRIBUTOR	STANDARD TANK
Bed Expansion in backwash 10.5" of lift	Bed Expansion in backwash 5" of lift
Time to lift bed to full expansion @ 2.0gpm = 2.0 min	Time to lift bed to full expansion @ 2.0gpm = 4.25min
4 min backwash time = 8.0 gallons	8 min backwash time = 16.0 gallons
Mineral bed had allot of turbulent action	Bed had little turbulent action
Fast rinse reduced from 6 minutes to 2 minutes @ 2.0 = 4.0 gal	Fast rinse had to stay at 6 minutes at 2.0 = 12.0 gallons

NOTES ON SYSTEM COMPARISON AND RESULTS	
VORTECH™ DISTRIBUTOR TANK	STANDARD TANK
Water used during backwash & fast rinse = 12.0 gallons	Water used during backwash & fast rinse = 28.0 gallons
Gallons of water used to fill brine tank = 3.0	Gallons of water used to fill brine tank = 3.0
Gallons of water used in slow rinse = 27.0	Gallons of water used in slow rinse = 27.0
Total water used for complete cycle = 42.0 gallons	Total water used for complete cycle = 58.0 gallons
Flow rate @ 10.7psi drop = 12.7gpm	Flow rate @ 10.7psi drop = 11.6gpm



EXAMPLE OF USAGE FOR FAMILY OF 4 ON 20 GRAIN HARD WATER
60.0 gallons per person per day X 4 = 240.0 gallons of water per day
240.0 X 20.0 grains of hardness = 4,800 grains of hardness removed per day
4,800 grains removed ~ capacity of 28,200 grains capacity = 5.88 days between regenerations
5.88 ~ 30 days per month = 5.10 regenerations per month
5.10 per month X 10.0 lbs of salt (medium setting) = 51.0 lbs of salt used
5.10 regenerations X 42.0 gallons used = 214 gallons used per month down the drain
214.0 gallons per month = 7.13 gallons per day savings, equivalent to each person in the family flushing a low consumption toilet (1.6 gallons) 1 time less per day.
<p>*** This system could have gone to a low water piston and saved another 4 gallons of water off of the backwash rates.</p> <p>***Vortech™ Distributor Plate bed expansion reached at 2.0gpm at 2 minutes and 10 ½" of lift, compared to standard tank of 2.0gpm at 4.25 minutes and 5" of lift.</p> <p>***Backwash time can be reduced from 8 minutes to 4, Fast rinse cycle could have been reduced from 6 minutes to 2, saving 8 gallons of water per regeneration.</p>

We thank you for your consideration and hope that we can work together to further help our industry save water and reduce any potential effects on the environment. Upon your request, further testing data and information can be provided.

Sincerely yours,

Michael P. Mormino
 VP Sales & Marketing
 ENPRESS LLC
 440-510-0108 x108
mikem@enpress.com

Full Plate Distributor Vessel

=

Truly Green Water Treatment

'Go green' efforts have recently become a major public initiative as a 'new' idea. Yet many water treatment dealers have experienced firsthand the negative impact water contamination has had on the environment for years. Their professional insights and expertise have led many to be proactive in demanding green water treatment solutions that will help the environment and in turn, benefit their customers.

Manufacturers and distributors have been responsive to these requests, engineering a multitude of products, systems and techniques that purport to reduce environmental impact and lower energy consumption.

One efficient green product is the full plate distributor vessel, currently the only one of its kind in the industry for residential and light commercial applications. It achieves optimal backwashing and cleaning action of medias by utilizing a high-flow, lift-and-bed fluidization that creates a scrubbing action and distributes water throughout the bed.

A brief history

The water treatment industry in the early 1950s almost exclusively utilized steel pressure vessels to build their systems. In 1954, Structural Fibers was incorporated and Jim Horner began to develop fiberglass reinforced products (FRPs). His efforts eventually found application in the water treatment industry as seamless, fiberglass-reinforced pressure vessels, which signaled the end of the residential steel vessel market. Culligan was the last high-volume steel manufacturer, well known for their triple-hull tanks.

By the late '60s and early '70s, the FRP-style vessels dominated the world residential water

By Douglas M. Horner and
Michael P. Mormino

Figure 1. Full plate distributor self-cleaning nozzle design

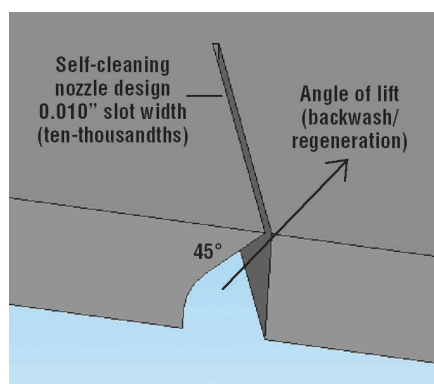
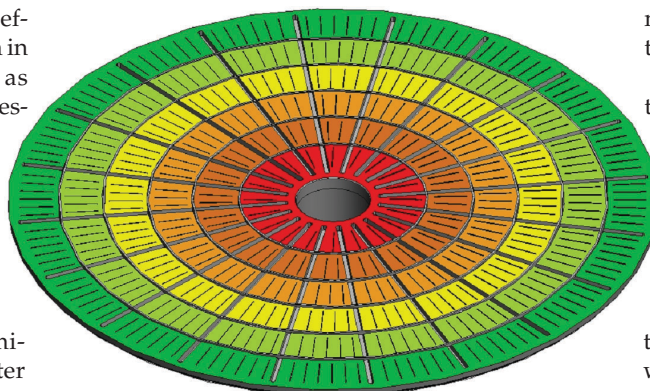

Figure 2. Full plate distributor design showing radial open area increase

	Array (starting at center)	Percent increase of open area with respect to Array No. 1
	Array No. 1	—
	Array No. 2	100
	Array No. 3	200
	Array No. 4	300
	Array No. 5	400
	Array No. 6	500



treatment market. Other companies, such as Apex and Park International, joined the field of manufacturers. During this time, engineering advances in manufacturing technologies led the industry's move toward blow mold and wind style pressure vessels.

Advances in winding technologies enabled the development of larger commercial pressure vessels with both threaded and flanged openings. Commercial fabricated steel pressure vessels have utilized elaborate distribution systems to carefully control the flow of water in and out of the vessels. Their higher flow rates required carefully controlling the flow (through the vessels and the media) to ensure effective and complete water treatment.

Commercial steel vessels had an advantage, in that sophisticated distribution systems could be readily fabricated inside the vessel prior to final dome assembly. FRP, blow mold and wind seamless composite vessels all required that internal distribution components fit through the vessels end fittings. These ranged in size from 2.5 inches (residential standard) to a maximum of six inches for commercial vessels. This limited both the design and the effectiveness of the distribution systems. Washed pea gravel and garnet, filled around and above the distributors, was one method used to improve their effectiveness.

In the 1980s, Brunner Corp. introduced a residential pressure vessel composed of multiple tank liner components that allowed for the installation of a flat plate style distributor in the bottom dome of the vessel. Many today remember vividly the plant tour that Lance Fitzgerald conducted introducing this revolutionary concept. The plate was injection molded and was com-

Figure 3. Mid-plate distributor fill assembly and center adapters

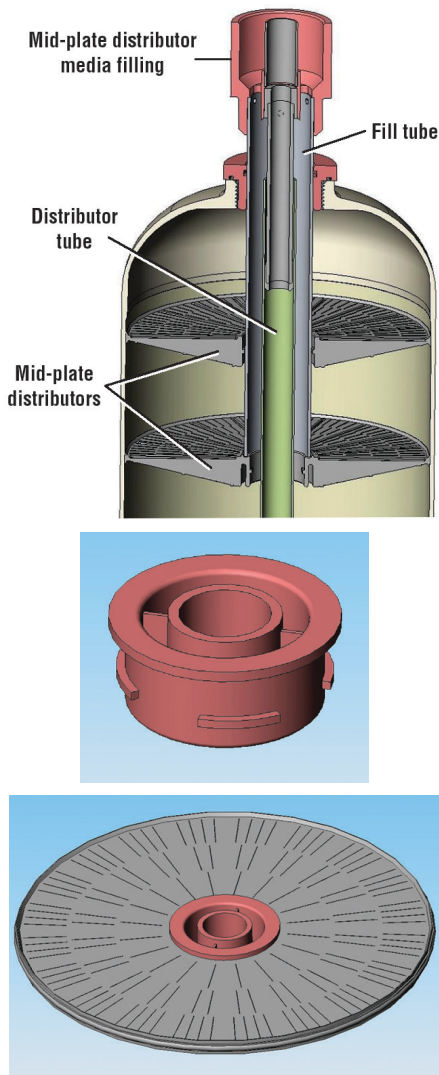

prised of a polymer mesh cloth adhered to the plate assembly, which was then glued into the bottom dome assembly. This style of distributor did not require gravel under-bedding to achieve the same flow and softener capacity effectiveness.

In the 1990s, Hague Quality Water International developed and introduced a multi-part injection molded pressure vessel that advanced the plate distributor concept to the next level by including both a bottom plate and the new concept of mid-plates that would allow non-mixed, multi-media beds to be contained in a single vessel. This plate assembly also utilized the molded plate with a mesh screen as the separation device.

Today

Recently, another significant advancement of the bottom plate concept was introduced. Advances in computer

aided three-dimensional design and precision CNC tooling have allowed for the bottom plate to be molded complete as a one-piece unit. With precise, uniform molded 10-thousandths (0.010") wide slots in a specific concentric grid pattern, it allows the designer to specifically control the flow of water through the plate more effectively than with a random gravel bed and cone style distributor (see Figure 1). The slot grid pattern is carefully modeled, much like true fractal distributors, previously only available in fabricated commercial vessels.

Increased bed capacities via uniform influent flow can be achieved, alleviating the premature breakthrough caused by channeling. Heavy filtration medias can now be backwashed at rates that are more consistent and in line with the flow rates of the majority of residential wells and homes, creating further system design options.

This new full plate distributor design has greater than 1.5 times the open area of a standard cone style distributor, decreasing pressure drop across the system (see Figure 2). The flow slots are specifically aligned and angled to more effectively and consistently fluidize the media bed during backwash and regen-

eration, utilizing a self-cleaning nozzle design. Initial testing has shown that backwash flow rates can be reduced by a minimum of 30 percent over cone and gravel style distribution systems.

With advances in composite pressure vessel manufacturing, the limitations on access to the internals of a residential or light commercial vessel are no longer defined by the openings of that vessel. Now, everything can be integrally placed inside the vessel prior to final fabrication and winding, allowing for a distributor plate design that can maximize flow and design characteristics. Bottom and mid-plate distributors can now be designed at the factory and consistently located to the customer's specific needs, while medias can still be easily removed for re-bedding (see Figure 3).

Lab tested

Independent third-party testing of standard basket distributors with underbedding versus the full distributor plate vessel without underbedding is graphed in Figure 4. Using this data, backwash rate can be reduced in this system design from 13 gpm/min to seven gpm/min, conserving thousands of gallons of water annually per system.

Figure 4. Backwash comparison of full plate distributor vessel versus standard basket distributor vessel with under-bedding

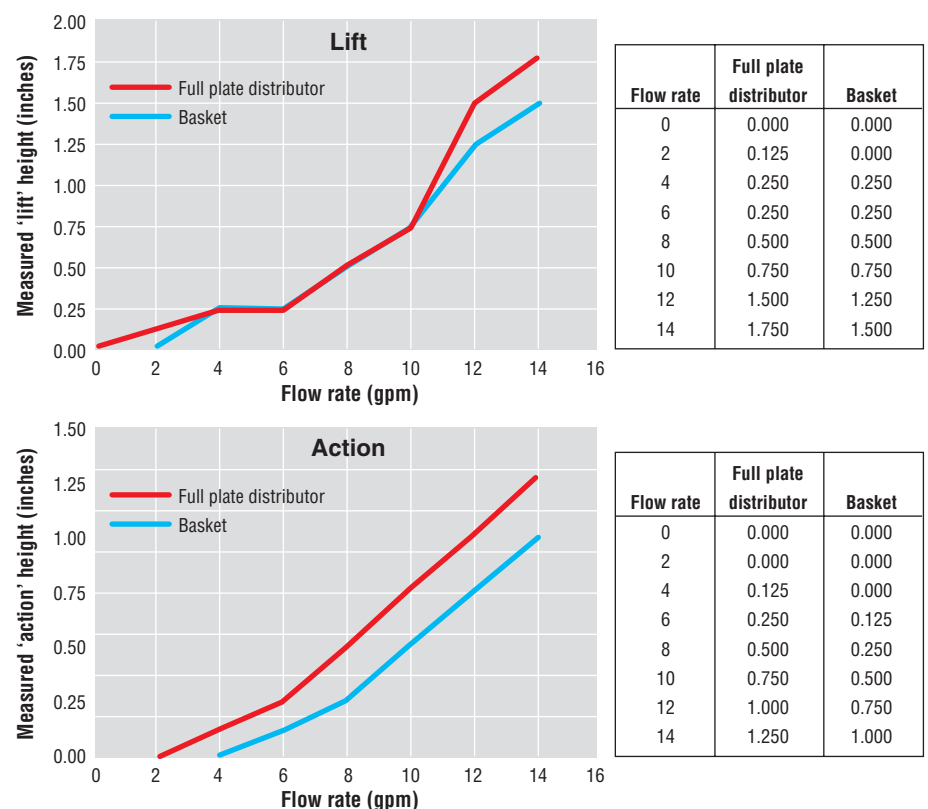

10-inch diameter vessel; 0.66 cu.ft. KDF 55; water temp. 52°F (Independent third-party testing: Data provided by KDF Fluid Treatment, Inc.)

Mike Trammell of Watts Water Quality Products, Inc. described the company's independent third-party testing of the device. "Using a full plate distributor tank, we have been able to increase the salt efficiency by nearly 80 percent over the generally accepted industry standard for conditioning systems. Its unique features allow us to employ assembly and operational techniques that were previously unavailable to independent OEMs. The average salt efficiency of a standard unit with gravel under-bedding is 3,333 grains per pound. We have been able to consistently achieve an 80 percent increase in grains per pound, reducing the amount of salt discharged to the environment—all gained through this system design."

Water and salt savings will be realized in filter and water conditioners through required flow rate reductions (see Figure 5); efficiencies gained through universal plate distribution.

Summary

With the current studies between NOWRA and WQA and water savings regulations being watched in all states, a new tank technology that improves on current designs is significant. A full plate distributor vessel can enable dealers to take the next step and rewrite the book of water treatment.

About the authors

◆ Corresponding author Michael P. Mormino is Vice President of Sales & Marketing of ENPRESS LLC, located just outside of Cleveland, Ohio. Mormino has a Bachelor's Degree in marketing and an MBA in entrepreneurship from Case Western Reserve University. He can be reached at mmormino@enpress.com or by telephone at (440) 510-0108 x108. Co-author Douglas M. Horner, Principal of ENPRESS LLC, is the son of the late James A. Horner, the founder of Structural Fibers.

About the company

◆ ENPRESS® LLC is a worldwide leading manufacturer of composite pressure vessels for use in water treatment. ENPRESS tanks are manufactured with an industry-exclusive liner design and formulation that offer superior benefits and features and is 100 percent 'Made in the USA'. For more information about the Vortech® (the full plate distributor discussed in this article) or any other products offered by ENPRESS, visit www.enpress.com or call (866) 859-9274.

Reprinted with permission of Water Conditioning & Purification Magazine ©2008

Figure 5. System comparison data, bottom distributor plate system versus cone and under-bedding conditioning system

The system	
Full plate distributor tank	Standard tank
One cubic foot of 10 percent resin	One cubic foot of 10 percent resin
No gravel underbed required	Five lbs. of gravel underbed required
5,600 metered valve	5,600 metered valve
Distributor plate on bottom	Standard one-inch distributor tube
3/4" hard water service line	3/4" hard water service line
55 psi incoming pressure	55 psi incoming pressure
52 degree incoming city water	52 degree incoming city water
Incoming flow rate 15 gpm	Incoming flow rate 15 gpm
2.0 gpm drain flow control	2.0 gpm drain flow control
0.5 brine line flow control	0.05 brine line flow control
Standard piston	Standard piston

The results

Full plate distributor tank	Standard tank
Bed expansion in backwash 10.5 inches of lift	Bed expansion in backwash five inches of lift
Time to lift bed to full expansion at 2.0 gpm = 2.0 min.	Time to lift bed to full expansion at 2.0 gpm = 4.25 min.
Four min. backwash time = 8.0 gal.	Eight min. backwash time = 16.0 gal.
Mineral bed had a lot of turbulent action	Bed had little turbulent action
Fast rinse reduced from six to two min. at 2.0 = 4.0 gal.	Fast rinse had to stay at six min. at 2.0 = 12.0 gal.

Notes on system comparison and results

Full plate distributor tank	Standard tank
Water used during backwash and fast rinse = 12.0 gal.	Water used during backwash and fast rinse = 28.0 gal.
Water used to fill brine tank = 3.0 gal.	Water used to fill brine tank = 3.0 gal.
Water used in slow rinse = 27.0 gal.	Water used in slow rinse = 27.0 gal.
Total water used for complete cycle = 42.0 gal.	Total water used for complete cycle = 58.0 gal.
Flow rate at 10.7 psi drop = 12.7 gpm	Flow rate at 10.7 psi drop = 11.6 gpm

Example of usage for family of four on 20-grain hard water

60.0 gal. per person per day x four = 240.0 gal. of water per day
240.0 x 20.0 grains of hardness = 4,800 grains of hardness removed per day
4,800 grains removed ~ capacity of 28,200 grains capacity = 5.88 days between regenerations
5.88 ~ 30 days per month = 5.10 regenerations per month
5.10 per month x 10.0 lbs of salt (medium setting) = 51.0 lbs of salt used
5.10 regenerations x 42.0 gal. used = 214 gal. used per month down the drain
214.0 gal. per month = 7.13 gal. per day savings, equivalent to each person in the family flushing a low consumption toilet (1.6 gal.) one time less per day.

This system could have gone to a low water piston and saved another four gal. of water off of the backwash rates. Distributor plate bed expansion reached at two gpm at two min. and 10-1/2 inches of lift, compared to standard tank of two gpm at 4.25 min. and five inches of lift. Backwash time can be reduced from eight to four min. Fast rinse cycle could have been reduced from six to two min., saving eight gal. of water per regeneration.

(Independent third party testing: Data provided by Abendroth Water Conditioning Inc.)

Commenter: John Beaver
Affiliation: Culligan International
Comment Date: February 15, 2011

Dear WaterSense Coordinator:

Culligan Int'l is pleased to submit the attached response to WaterSense's request for comments on the NOI and the cation water softener specification development process.

Please note that the attached letter with responses was originally mailed out to the following address, but unfortunately was returned:

U.S. Environmental Protection Agency
Office of WaterSense Management (4204M)
1200 Pennsylvania Avenue, N.W.
Washington, D.C. 20460

Please contact me if there is a change in address for future correspondence and if you should have any questions regarding our NOI responses.

Regards,

John Beaver

Product Regulatory Manager
Culligan International
9399 West Higgins Road, Suite 1100
Rosemont, IL 60018
Phone: 847-430-1317
Fax: 847-430-2317
e-mail: john.beaver@culligan.com

(Attachment: Culligan responses to water softener NOI summary of outstanding issues)



better water. pure and simple.™

WaterSense
U.S. Environmental Protection Agency
Office of Wastewater Management (4204M)
1200 Pennsylvania Avenue, N.W.
Washington, D.C. 20460

Re: Culligan International Company: Response to Notification of Intent (NOI) to Develop Draft Efficiency and performance Specifications for Cation Exchange Water Softeners

Culligan International Company (Culligan) is please to submit the attached response to EPA WaterSense's request for comments on the NOI and the cation exchange water softener specification development process.

Culligan International Co. is an industry leader in the manufacturing and distribution of water treatment products for residential and commercial use, worldwide. The company sells and installs various sizes of Water Softeners, Filtration Equipment, Reverse Osmosis (RO) Units, and specialized POE or Point of Entry Filters for Iron, Sulfur, and Arsenic removal. Culligan has been in the water treatment business for over 70 years.

Culligan operates about 100 Company Owned Dealerships (COD) in North America and has about 600 franchise dealers that provide similar services across North America.

If you have any questions or comments on Culligan's responses, please feel free to contact me.

Robert LaBoube
Director EH&S
Culligan International Company
9399 West Higgins Road
Rosemont, IL. 60018
(847)430-1272 Office
(847)430-2272 Fax
Email: rlaboube@culligan.com

cc: Kerry Quinn; Jim Stewart; John Beaver

Culligan International Company

Response to EPA WaterSense Notification of Intent (NOI) to Develop Draft Efficiency and Performance Specifications for Cation Exchange Water Softeners

I. Introduction

- How water intensive is a water softener during the regeneration process.

It is Culligan's experience that in most standard applications a properly sized water softener (demand initiated) will regenerate once every 3rd or 4th day (even less frequently when installed with Culligan's Aqua-Sensor probe). Depending on the size of the softener and application water consumption during regeneration per year is less than 4,500 gallons.

II Scope

- Are there aspects of commercial water softeners that are significantly different from residential water softeners that need to be addressed through a separate set of performance requirements? If so, what are they?

Commercial water softener performance is highly dependent on the water treatment application that they are being applied to. For instance, boiler feed applications require minimum hardness leakage and thus require regenerations at higher than normal salt dosages – thus having lower salt efficiencies. Soft water feed for boiler applications reduces the amount of blow downs and chemical cleaning over the life of the boiler which in itself conserves both the use of water and energy and reduce wastewater discharges.

Many commercial softeners utilize a brine reclaim system that recovers a portion of the regeneration brine to re-use during the next brine cycle. Brine reclaim improves both the salt efficiency (salt is re-captured) and water consumption during regeneration as a portion is re-used for the next regeneration.

Often commercial installations are set up utilizing multiple tank configurations where the systems can operate as alternating twin type or as progressive flow type systems. In alternating systems the first tank is exhausted before the next tank is brought into service while the exhausted tank regenerates. Progressive flow systems utilize multiple tanks where individual tanks are brought on line as the flow demand for the application increases. These systems allow for multiple smaller tanks to be utilized to meet peak flow requirements while using a smaller more efficient tank for lower flow demand times (such as occurs in a hotel operation).

NSF/ANSI Standard 44 currently does not apply to commercial cation water softeners so there are no 3rd party certification for the performance of the equipment. Certification testing for these larger units could get very expensive due to the higher softening capacity and flow rates of these units and the amount of water required to exhaust and regenerate them.

- Should water softeners designed to be installed on 1 1/4" nominal pipe size be included in the WaterSense Project?

Yes, water softeners designed to be installed on 1 1/4" nominal pipe size are sold for residential use (although it makes-up a small percentage of the residential water softeners we ship).

- Is there a threshold size or capacity for commercial water softeners below which products could meet the efficiency and performance requirements discussed in this NOI?

1 1/2" inch commercial softeners would typically have some settings that would be able to meet the same efficiency and performance requirements discussed in the NOI. Would it be allowed as part of the compliance to have the same softener have some settings that meet the EPA WaterSense criteria and others outside of the established parameters? This would also be a question for Residential softeners as mentioned throughout this feedback there are some applications where following the guidelines would cause the system to fail.

- Is it more common for commercial water softeners to be packaged and sold as a unit or as individual components (e.g., tank, controller, and valve) purchased and assembled on site? Do unit size, nominal pipe size, and/or capacity affect how the unit is packaged and sold?

It is common in the commercial industry for the units to be assembled on site due to the size and weight of commercial equipment. Culligan still sells these units as systems but ships them as individual components that require assembly at the point of installation. Many commercial systems are sold by assemblers that purchase the various components required from multiple sources and then just assemble on site.

III. Water Efficiency

- Is a range of regeneration water consumption of 1.5 gallons to 4.0 gallons per 1000 grains of hardness removal acceptable?

Yes, a range of regeneration water consumption of 1.5 gallons to 4.0 gallons per 1000 grains of hardness removal is acceptable.

- Additional market data on the water use of both residential and commercial water softeners.

Culligan is willing to provide additional data once it is determined what data is required.

IV. Softening Performance

- How does the current NSF/ANSI 44 hardness level of 1 gpg relate to consumer expectations for softened water?

There is a recently completed study performed by Battelle labs for the Water Quality Research Foundation that states the benefit of soft water over hard water. As the hardness increases over 1 gpg, the benefits of soft water are reduced accordingly. The study showed that an increase from 0 gpg soft water to 5 gpg hardness would increase the cost to run a tankless hot water heater by as much as 14% over the expected 15 year life of the heater. An additional study on the benefits of soft water and the usage of soaps and detergents is due to be released by WQA in the spring of 2011.

- How might a less stringent softening performance requirement impact water and salt efficiency?

The only true way to obtain >1 gpg hardness with a cation exchange softener is through a blending of the hard influent water with the treated soft water. Attempting to increase the capacity by allowing it to exhaust beyond 1 gpg does not provide much benefit as the hardness bleed through the softener increases rapidly once it reaches the exhaustion capacity. Blending will theoretically increase the capacity and efficiency of the softener as more “treated” water will be produced as all of the water will not pass through the ion exchange bed. However, the detrimental effects of the harder water should be considered as part of the trade off and other contaminants that the softener might remove would also be allowed to bypass through.

Salt Efficiency

- Additional market data on salt efficiency of both residential and commercial water softeners.

Culligan is willing to provide additional data. Please provide specifics on what type of information is required. Care must be taken when discussing salt efficiency as a general rule of thumb as the salt efficiency goes up the actual capacity of the softener tank goes down since it is regenerated at lower salt dosages. A lower capacity tank would result in more frequent regenerations which would then result in more water being used so there is a direct correlation between salt usage and regeneration water usage. High salt efficiency settings can typically only be used on municipal low water hardness applications.

Regeneration Efficiency

- Are data available regarding the percentage of the rated hardness removal capacity within which units typically regenerate?

These settings will vary depending on application. For typical softeners a reserve capacity of 20 – 30% is often used. The reserve is required for delayed regeneration to occur during the night hours when service water is typically not required. If the unit reaches the capacity setting during the first water use of the day the reserve is set to maintain soft water during the day while the regeneration is delayed. Various parameters are used to determine the best reserve capacity to use such as influent water hardness, additional impurities such as iron, the number of people in the household, etc.

There are several technologies in the field to obtain a more complete use of the projected tank capacity. A predict mode will account for the typical daily water usage and compare it to the remaining capacity of the system. If the prediction shows that at the time of regeneration the capacity will not be fully exhausted by the next day's normal water usage then it will delay the regeneration for another day's usage. Proportional brining technology is also available where the system sets a salt dosage to only regenerate the amount of capacity that has been exhausted rather than the entire bed. Twin tank systems are designed to exhaust the first tank at close to 100% capacity before the second tank is brought into service.

- How can regeneration efficiency be incorporated into testing protocol for volume and sensor based units and how would units specifically designed to regenerate before their rated capacity (e.g., twin tank systems) be accounted for?

All of the technologies discussed above are based on a volume (meter) based unit where the system keeps track of the water volume passed through the system at a known hardness level to determine the capacity that has been utilized. This can be done with known influent water characteristics where the hardness level is consistent throughout the year. A drawback of these units is where the influent hardness may vary seasonally as they may be required to be set for the highest hardness level to assure that they maintain soft water in all cases. They are also dependent on the accuracy of the flow meter utilized.

Sensor based technology overcomes the problem of varying influent hardness levels as they monitor the condition of the cation exchange resin to determine when the regeneration is required and will automatically adjust to the changing hardness conditions. The reserve capacity is typically determined by where the sensor is placed in the ion exchange resin bed.

Systems installed in problem water areas often require regeneration much more frequently and may only utilize 50% of the capacity in order to keep the systems operational and prevent the resin from becoming fouled.

- Is regeneration efficiency a function of product design or a user controlled setting?

Regeneration efficiency is really a function of both the product design and the user controlled setting. For instance in order to perform proportional bringing the softener must be designed to allow for counter current up flow brining. Many of the other salt efficiency capabilities are a function of the control electronics. In addition, many controls allow for customization in the settings in order to operate effectively for the given influent water characteristic.

Multiple Salt Dosage Settings

- What are the impacts of requiring water and salt efficiency requirements to be achieved at all salt dosage settings?

The same water softener is often designed to treat the full gamut of potential influent water characteristics. This would include easy treating low hardness applications as well as very high hardness problem water applications. Often setting a softener up to meet a high water and salt efficiency would cause the unit to fail over a short period of time in the problem water application. A Culligan water softener incorporates a wide range of potential settings so that it can be customized for the specific influent water characteristics on which it is installed. A low salt dosage setting will have a higher salt efficiency but will also require more water for regeneration as it will regenerate more frequently.

- Should the highest salt dosage setting be required to meet the WaterSense water-efficiency and performance requirements?

No, the highest salt dosage setting should not be required to meet the WaterSense water-efficiency and performance requirements. There are times when a water softener must be set at a high salt dosage to meet a specific water application problem (high hardness & high iron). A suggested scenario is the softener has a “WaterSense” setting which the installer/consumer can utilize if they meet specific feed water parameters.

- Are data available regarding the water and salt efficiency of products at their minimum, maximum and average salt dosage settings?

Water Softeners that are certified to NSF/ANSI Standard 44 typically have a minimum of three different salt dosages and capacities listed based on the requirements of the standard. The salt efficiency can easily be determined from the data. In addition, the water used during regeneration would be able to be obtained from the testing data.

V. Issues of Concern

- Are data available to show how improvements to the water, salt and regeneration efficiency affect the amount and concentration of sodium and chloride in water softener discharge?

Culligan has collected extensive data over the years that plot the regeneration discharge from residential softeners for various salt dosages. Culligan would be happy to share any available data that WaterSense may require.

Commenter: Steve Via
Affiliation: American Water Works Association
Comment Date: February 22, 2011

Attached are comments from the American Water Works Association (AWWA) on the WaterSense program's NOI regarding Water Softeners.

Thank you for your attention.
Steve

Steve Via
Regulatory Affairs Manager
American Water Works Association
1300 Eye Street, NW, Suite 701W
Washington DC 20005
Email: svia@awwa.org
Office: (202) 628-8303
Direct: (202) 326-6130
Cell: (703) 915-4387
Fax: (202) 628-2846

American Water Works Association
The Authoritative Resource on Safe Water (R)

(Attachment: AWWA letter response to water softener NOI)



**American Water Works
Association**

The Authoritative Resource on Safe Water SM

Government Affairs Office
1401 New York Avenue
Suite 640
Washington, DC 20005
T 202.628.8303
F 202.628.2846
www.awwa.org

Headquarters Office
6666 W. Quincy Avenue
Denver CO 80235
T 303.794.7711
F 303.347.0804

February 18, 2011

Veronica Blette
USEPA Headquarters
Ariel Rios Building
1200 Pennsylvania Avenue, N. W.
Mail Code: 4601M
Washington, DC 20460

RE: Notification of Intent to Develop Efficiency and Performance
Specifications for Residential Cation Exchange Water Softeners

Dear Ms. Blette:

The American Water Works Association (AWWA) appreciates the WaterSense program's interest in gathering information from interested citizens and stakeholders prior to pursuing development of a WaterSense standard for residential cation exchange water softeners (also known as Self-Regenerating Water Softeners (SRWS)). AWWA would appreciate your consideration of our attached comments. In summary we ask that EPA:

1. Expand WaterSense beyond household fixtures for which water efficiency standards are already in hand, and pursue developing water efficiency standards that represent new opportunities for significant water savings.
2. Evaluate indirect impacts of a WaterSense label when determining if the program should pursue developing a water efficiency standard.
3. Consider expanding the scope of WaterSense to encompass assisting consumers make efficient choices that conserve water and protect the environment.
4. If the program pursues a WaterSense label for softeners, that it specifically address the negative water quality impacts of softeners and reflect the latest available research.

Veronica Blette
February 18, 2011
Page 2

Thank you for your attention. Please contact me or Steve Via at (202) 628-8303 with any questions regarding these comments.

Best regards,

A handwritten signature in black ink that reads "Tom Curtis". The signature is written in a cursive style with a horizontal line extending from the start of the name.

Thomas W. Curtis
Deputy Executive Director
AWWA Government Affairs

cc: Jim Hanlon, EPA/OW/OWM
Cynthia Dougherty, EPA/ OW/OGWDW

Attachment 1

C:\Conservation\Softeners\2011 02 18 AWWA Letter to EPA on WaterSense Softener NOI Fin.doc

Attachment 1

Comments on WaterSense Notification of Intent to Develop Efficiency and Performance Specifications for Residential Cation Exchange Water Softeners

AWWA supports WaterSense moving beyond household fixtures for which water efficiency standards are already in hand, and pursuing developing water efficiency standards that represent new opportunities for significant water savings. In identifying additional devices for water efficiency standards, the program goal should be to target devices that are relatively ubiquitous across the United States, and for which providing a WaterSense label will not generate any unintended consequences. AWWA would be glad to be of assistance in helping the agency identify such opportunities.

The agency's Notice of Intent (NOI) for SRWSs illustrates some of the challenges associated with moving beyond the limited array of products for which there are existing conservation standards. This NOI raises the following questions:

- What steps are necessary to avoid EPA's "official license" being used to promote the sale of products with designs that are inherently detrimental to waters of the U.S. and an unnecessary challenge for National Pollutant Permit Discharge System (NPDES) permittees?
- Is there a role EPA, and WaterSense in particular, can play in assisting consumers make efficient choices that conserve water and protect the environment, in this instance by realizing that in many instances residential water softening is both expensive and unnecessary?
- How does WaterSense integrate research and innovation in the field as a critical step prior to developing a standard?
- How are potential WaterSense labeled products vetted and prioritized to maximize opportunities to advance water efficient markets across U.S. communities?
- How does WaterSense integrate and balance the advancement of water efficient products with potential unintended consequences toward overall water efficiency through water conservation and reuse at the local and regional level where technologies vary greatly in their application?

At present, the softening devices for which the agency believes there is adequate information to evaluate conservation standards is limited to SRWSs. Discharges from SRWSs contribute significant amounts of salt to receiving wastewater systems and cumulatively within a community, can lead to levels that impede water recycling programs where they exist. Although the Agency recognizes this in their

draft NOI, the challenge is to continue encouraging reuse and recycling of water both within the home and nationally, while minimizing impacts to water resources. Consequently, the challenges posed by water softeners that have been experienced to-date should not be viewed as a unique to a few communities, but a preview to what will become a national challenge.

Prior to WaterSense certification of SRWSs, EPA needs to consider impacts on local water resource management by endorsement of products that negatively affect local water resources. WaterSense should:

- Develop clear guidance regarding the conditions when water softeners offer a meaningful contribution to potable water quality and reliability.
- Give greater consideration to whether demonstrated technologies exist that do not result in disposal of brine to wastewater systems either through alternative technologies or operation and maintenance practices.
- Incorporate a label warning that reflects the potential detrimental impacts associated with use of SRWSs to be used in conjunction with the WaterSense label.

With respect to the potential inclusion of alternative technologies, the WaterReuse Research Foundation is currently funding a study with Arizona State University entitled, Evaluation of Alternatives to Domestic Ion Exchange Water Softeners. This study is substantially complete, and its findings will be released in 2011. The findings of this study and accompanying standard development by the International Association of Plumbing and Mechanical Officials may help clarify what are practical treatment objectives with respect to both water efficiency and minimization of effluent salt for alternatives to SRWS systems.

Commenter: Gary Thundercliffe
Affiliation: The PURLOTIE Company
Comment Date: February 24, 2011

Hello,

I read with interest the scope of the above project and noted that the performance and type of ion exchange softening resin was not specifically mentioned.

Waste water generation and brine consumption contribute a significant portion of the cost of ion exchange softening. They also contribute the bulk of the environmental footprint.

There are several different types of ion exchange resin that are and could be more widely used in softeners to maximize capacity/throughput and improve brine consumption or waste water regeneration. Thereby lowering overall costs and minimizing the environmental footprint.

I would like to offer assistance from Purolite to include these aspects in the project and would appreciate information as to how Purolite can best get involved.

Regards
GaryT

Gary Thundercliffe
email: gthundercliffe@puroliteusa.com

The PUROLITE Company
150 Monument Road
Bala Cynwyd, Pa 19004 USA
Tel: Office: +1 800 343 1500 or +1 610 668 9090
Direct: +1 484 384 2708
Cell: +1 484 477 3428
Fax: +1 610 668 8139
Website: www.purolite.com

Commenter: Sharon Green

Affiliation: Los Angeles County Sanitation District

Comment Date: March 3, 2011

Hi Stephanie & Veronica: I wanted to thank you so much for meeting with me when I was in Washington 2 weeks ago. I am glad I had the opportunity to sit down and explain some of the challenges my agency has faced in complying with stringent chloride water quality requirements, and specifically the challenges posed by the self-regenerating water softener loadings and our entire program to eliminate this type of softener from the sewerage system service area in the Santa Clarita Valley.

You had asked me for data regarding the chloride testing we did of other household products, so I wanted to follow up with you on that. A summary on that topic is included in the report that I gave you, and in some tables. These are excerpted below, along with a table containing additional information. If you have any questions, Ann Heil of our staff is our expert on this. If you have any other questions about the report or about any aspect of our program to remove SRWS, please let us know.

Also, I will be back in Washington in May for a NACWA conference, and I was wondering if it would be useful to work with Chris to organize a meeting with you that would include some other NACWA members who are interested in this issue, as well as me. I know that Barbara Biggs, the Chair of NACWA's Water Quality Committee, is interested in your WaterSense Water Softener specification project, and so we could see if she would be interested in meeting with you. (Barbara is with Metro Wastewater Reclamation District in Denver, by the way.) I believe the dates of the conference are May 8-10. If you would be available during that timeframe, I will work with Chris to see if there are other NACWA members who would be interested and we can set something up.

Thanks again for taking time to meet with me.

Regards,
Sharon

(Attachments: Santa Clarita Valley Joint Sewerage System Chloride Source Report pages 4-50 to 4-51; Table 4.6.6-2 Chloride Content of Household Cleaning Products; Table 4.6.6-3 SCVJSS Chloride Loadings from Household Cleaning Products; Table Santa Clarita Chloride Study Lab Results)

Section 4. Sources of Chloride Loadings

To further quantify residential non-SRWS chloride contributions, a study was conducted of residential non-SRWS sources of chloride. These sources can be divided into four major categories: human waste, laundry products, other cleaning products, and swimming pool backwash. Chloride loadings for each category was individually quantified, as discussed below.

Human waste is the largest non-SRWS source of chloride in residences. The average human excretes 6 grams of chloride per day, or 0.0132 pounds per day.¹⁰⁵ The total amount of chloride excreted by residents of the SCVJSS must be adjusted to take into account residents who commute out of the valley to work. Because 45% of Santa Clarita's population is employed¹⁰⁶ and approximately 50% of Santa Clarita Valley residents who are employed commute outside of the Santa Clarita Valley,¹⁰⁷ overall 22.5% of the residents commute. Assuming that half of the human waste produced by commuters is excreted at work, the chloride loading from human waste in the SCVJSS is 1,722 pounds per day.¹⁰⁸

The next largest non-SRWS source of chloride in residences is from laundering. Laundry detergents, fabric softeners, bleaches, and spotting agents can all contain chloride. To determine the added chloride load from laundering operations, the Districts sampled the potable water and wastewater discharge from a commercial laundromat for two consecutive days.¹⁰⁹ Because laundromats are used by residents and the wastewater discharged from them is essentially solely from clothes laundering, laundromat wastewater discharges should well represent household laundry wastewater. Additionally, laundromats are visited by a number of users each day, so wastewater from them should represent a variety of different laundry products and usage quantities. The sample results indicated an average discharge from the laundromat of 69.1 mg/L chloride above potable water supply. Applying this figure to all residents of the SCVJSS results in an added chloride loading from residential laundering of 1,271 pounds per day.¹¹⁰

Other cleaning products also contribute to the chloride load discharged from residences. These products include dishwashing detergents, bar soap, liquid hand soap, shampoo, abrasive cleaners, general purpose cleaners, toilet bowl cleaners, and drain cleaners. Because literature values for the chloride content of these products is not readily available, the Districts' Water Quality Laboratory analyzed typical examples of these products for chloride content. All products were analyzed via U.S. EPA Test Method 300.0 and all appropriate Quality Assurance/Quality Control procedures were followed.¹¹¹ The results are presented in Table 4.6.6-2. Per capita usage rates for the various products were primarily determined from literature values,¹¹² and where no literature values were available usage rates were estimated based on reasonable behavior patterns. Using the measured chloride concentrations for the consumer products in conjunction with the per capita usage rates, the overall residential chloride loading from non-laundry cleaning products in the

¹⁰⁵ Metcalf and Eddy, Inc., *Wastewater Engineering Treatment and Reuse*, 4th ed., McGraw-Hill, 2003. See also Guyton, M.D., Arthur C., *Textbook of Medical Physiology*, 4th ed., W.B. Saunders Company, Philadelphia which indicates that the chloride concentration of human urine is 134 mEq./L (4,750 mg/L) and that the amount of chloride in human feces is minimal as the human body retains electrolytes prior to elimination. Since the average adult excretes 800 to 2,000 mL of urine per day (MEDLINEplus Medical Encyclopedia/National Library of Medicine/National Institutes of Health – US Department of Health and Human Services), this amounts to 3.8 g to 9.5 g of chloride in human waste per person per day, agreeing well with the Metcalf and Eddy figure.

¹⁰⁶ www.santa-clarita.com/cityhall/demog.htm#econ

¹⁰⁷ www.santa-clarita.com/cityhall/demog.htm#trans

¹⁰⁸ Based on 147,000 residents in the SCVJSS. $(147,000 \text{ residents}) \times ((0.775 \text{ non-commuters/resident} \times 0.0132 \text{ lbs/day/non-commuter}) + (0.225 \text{ commuters/resident} \times 0.0066 \text{ lbs/day/commuter})) = 1,722 \text{ ppd}$.

¹⁰⁹ Newhall Laundry, 8-26-02 to 8-28-02.

¹¹⁰ Based on 147,000 residents in the SCVJSS and 15 gallons per capita per day of clothes washing water, per AWWA Research Foundation, *Residential End Uses of Water*, AWWA Research Foundation and American Water Works Association, 1999.

¹¹¹ For a more complete discussion of Quality Assurance/Quality Control measures for chloride analyses, see Appendix 4.2-A.

¹¹² Where two literature values were available, the most recent one was used.

Section 4. Sources of Chloride Loadings

SCVJSS is estimated at 165 pounds per day, as presented in Table 4.6.6-3.

Finally, the contribution to residential chloride loadings from swimming pool filter backwash was determined. Swimming pool owners run filters to clean their pool water, and these filters must be periodically backwashed to operate properly. When the backwash is discharged to a sewer cleanout, the backwash contributes chloride to the sewer system.¹¹³ The MetroScan® real property database was used to determine the number of swimming pools located in the six neighborhoods used in the residential field study. Eighty-two out of the 941 homes in the six field study neighborhoods have swimming pools, or 8.7%. The typical chloride concentration of pools in the SCVJSS was measured by sampling the chloride concentration of four pools in the SCVJSS. The chloride concentration of the pools ranged from 500 to 1,700 mg/L, with an average chloride concentration of 855 mg/L.¹¹⁴ To determine the frequency at which the pool filters are backwashed and the frequency of backwashes, four residential swimming pool supply stores were surveyed via phone. The results of the survey are included in Appendix 4.6-D. The pool supply stores recommended that pools be backwashed every six weeks to three months, or every 70 days on average, for 30 seconds to 3 minutes.¹¹⁵ Finally, a typical 1.5 horse power (hp) residential pool pump runs at approximately 80 gallons per minute.¹¹⁶ Combining this information to represent all residents of the SCVJSS results in an estimated load of 111 pounds per day from residential swimming pool filter backwash.¹¹⁷

Summing residential chloride loadings from human waste, laundering, other cleaning, and swimming pool filter backwash gives a non-SRWS residential chloride loading of 3,300 pounds per day. When this loading is allocated to the 12.7 MGD of residential wastewater flow, the added chloride concentration for residential non-SRWS sources is 31 mg/L. This concentration is in agreement with the 31 mg/L added daytime chloride concentration at Sites 1-4, as discussed above.

Therefore, to examine the overall contribution of residential non-SRWS operations to chloride loadings in the SCVJSS the non-SRWS water softener chloride loading of 3,300 pounds per day was used. When this loading is subtracted from the total estimated residential loading of 11,000 pounds per day, the SRWS contribution is 7,700 pounds per day or 70% of the residential chloride total. A breakdown of residential chloride loadings is presented in Figure 4.6.6-1. Based on this information, the estimated residential SRWS chloride mass loading is 33% of the total chloride mass present in the combined effluent from the Saugus and Valencia WRPs, while other residential operations contribute 14%.¹¹⁸ In terms of effluent concentration, 55 mg/L of the effluent chloride concentration at the Saugus and Valencia WRPs is from residential SRWS while 23 mg/L is from non-SRWS residential operations.

An estimate of the market penetration of SRWS in the residential sector was also conducted. This analysis assumed that a residential unit operating a SRWS contributes a daily chloride loading of 1.34 pounds per day above water supply. This SRWS loading rate was derived assuming a blended water supply hardness of 20 grains per gallon,¹¹⁹ an available SRWS capacity of 25,600 grains,¹²⁰ an aggregate residential water

¹¹³ Although the filter media itself should not accumulate chloride, the pool water used to perform the backwash contains chloride.

¹¹⁴ Samples collected 8-19-02. Individual sample concentrations were 501 mg/L, 549 mg/L, 711 mg/L, and 1,660 mg/L.

¹¹⁵ To be conservative, a backwash time of 3 minutes was used in the determination of chloride loadings from residential swimming pools.

¹¹⁶ See for example www.poolproducts.com/speckfilter_sand.html and shop.store.yahoo.com/kingpumps/spaandjettub.html.

¹¹⁷ $(3 \text{ minutes per backwash per pool})(80 \text{ gallons/minute})(1 \text{ backwash/70 days})(855 \text{ mg/L chloride})(8.34 \times 10^{-6} \text{ lb/mg/L-gal})(52,089 \text{ residences})(8.7 \text{ pools/100 residences}) = 111 \text{ pounds per day.}$

¹¹⁸ Based on the 2001 flow-weighted average effluent chloride concentrations from the Saugus and Valencia WRPs of 168 mg/L and the 2001 average total effluent flowrate from the Saugus and Valencia WRPs of 16.9 MGD.

¹¹⁹ The rationale for using 20 grains per gallon (gpg) for the blended water supply hardness is discussed in Section 4.7.

¹²⁰ As discussed in Section 4.7.2, SRWS have an available capacity between 75 and 80 percent of their total

TABLE 4.6.6-2 Chloride Content of Household Cleaning Products

Product Type	Product Name	Product Size	Sample Number	Chloride Content (mg/kg)
Powdered automatic dishwashing detergent	Cascade Pure Rinse Formula with Fresh Lemon Scent	45 oz	SJ69945	956
Liquid automatic dishwashing detergent	Cascade Pure Rinse Formula, Lemon	65 oz	SJ69946	9769
Automatic dishwashing rinse aid	Jet Dry with Baking Soda	4.22 fl oz	SJ69952	199
Liquid hand dishwashing detergent	Ultra Dawn, Original Scent	12.6 fl oz	SJ69949	6806
Shampoo	Clairol Herbal Essences Shampoo	12 fl oz	SJ69947	6428
Liquid hand soap	Softsoap Hand Soap Antibacterial with Light Moisturizers	7.5 fl oz	SJ69955	8520
Bar soap	White Dial Antibacterial Deodorant Soap	Three 4.5 oz bars	SJ69950	4541
Abrasive cleaner	Comet Liquid Gel with Bleach Cleaner	25 fl oz	SJ69948	11342
General purpose cleaner	Lysol Disinfectant Basin Tub and Tile Cleaner	17 fl oz	SJ69953	323
Toilet bowl cleaner	Lysol Disinfectant Toilet Bowl Cleaner	24 fl oz	SJ69953	94569
Drain cleaner	Drano Clog Remover	32 fl oz	SJ69951	30907

Table 4.6.6-3 SCVJSS Chloride Loadings from Household Cleaning Products

Category	Per Capita Usage Rate, kg/capita/year	SCVJSS Total Usage, lb/day	Chloride Content, mg/kg	SCVJSS Chloride Loading, lb/day	Usage Rate Basis
Dishwasher detergent	6.0	5,316	5,376	29	AMSA, 2000
Hand dishwashing detergent	2.7	2,392	6,806	16	AMSA, 2000
Dishwashing rinse aid	1.0	886	199	0.18	0.1 ounce per use (per manufacturer's instructions), one use per capita per day
Bar soap	0.36	319	4,541	1.4	AMSA, 2000
Liquid hand soap	4.2	3,721	8,520	32	0.1 ounce per hand wash, four hand washes per day per capita
Shampoo	6.1	5,405	6,428	35	AMSA, 2000
Abrasive cleaner	0.11	97	11,342	1.1	Gurnham, 1979
General purpose cleaner	1.5	1,329	323	0.43	Gurnham, 1979
Toilet bowl cleaner	0.43	381	94,569	36	Gurnham, 1979
Drain cleaner	0.54	478	30,907	15	AMSA, 2000
Total				165	

References:

AMSA, *Evaluation of Domestic Sources of Mercury*, American Metropolitan Sewerage Agency, August 2000

Gurnham, C.F, B. A. Rose, H. R. Ritchie, W. T. Fetherston, and A. W. Smith, *Control of Heavy Metal Content of Municipal Wastewater Sludge*, National Science Foundation, Applied Science and Research Applications, Washington D.C., 1979 (NTIS PB-295 917)

Santa Clarita Chloride Study (Household Products)

Log in Date : 08/08/02 Type : Misc Location : 3-IW03-000

Job No.	Description	Type	Sample aliquot g	Final** Vol mL	Test Results mg/L	Final Chloride Results mg/Kg	% Chloride	Density g/mL	Analysis Date
SJ69945	Cascade, 1.27 Kg	Solid	0.3108	100	2.97	956	0.10%	N/A	08/15
SJ69946	Cascade rinse aid, 1.84 Kg	Liq	1.0236	100	100	9769	0.98%		08/16
SJ69947	Clairol Herbal Essence, 355 mL	Liq	1.1513	100	74.0	6428	0.64%		08/19
SJ69948	Comet, 739 mL	Gel	1.0316	100	117	11342	1.13%		08/28
SJ69949	Ultra Dawn, 375 mL	Liq	0.9398	100	64.0	6806	0.68%		08/28
SJ69950	Dial (Soap), 126 g	Solid	0.2812	100	12.8	4541	0.45%	N/A	08/28
SJ69951	Drano, 946 mL	Liq	1.1033	100	341	30907	3.09%		08/21
SJ69952	Jet Dry rinse agent, 125 mL for 40 wash	Liq	1.0074	100	2.00	199	0.02%		08/21
SJ69953	Lysol Toilet cleaner, 709 mL, at least 4 oz (118.2 mL) for each usage	Liq	0.9961	100	942	94569	9.46%		08/21
SJ69954	Lysol Tub & Tile, 502 mL	Liq	1.0396	100	3.36	323	0.03%		08/21
SJ69955	Softsoap, 221 mL	Liq	0.8451	100	72.0	8520	0.85%		08/21
*****	10 drops of antifoam + 30 mL DI water	----	----	----	1.34	-----	----	N/A	08/09

** Each sample adds 10 drops of antifoam before adding DI water to 100 mL.

Commenter: Larry Zinser
Affiliation: The PURLOTIE Company
Comment Date: March 4, 2011

I appreciate your efforts. They are sorely needed. As you know, many of your Outstanding Issues are best answered by the Water Quality Association (NSF 44 Test Data) and by resin manufacturers (for optimizing the regeneration conditions for their resins).

As a manufacturer of completed water treatment systems, I offer the following comments plus an attached discussion of the variables of Regeneration Efficiency as I have learned them:

1. The proposed initial standards for salt use and water use are easily achieved by modern electronic, demand (DIR) systems provided that the flow controls and timer settings are properly selected, based upon an analysis of the raw water, and properly installed.
2. Better—more efficient—results may be achieved by “fine tuning” the system to the exact conditions of the application.
3. Residential systems are normally up to 1.25” inlet/outlet; commercial systems are normally 1.25” and higher. The 1.25” system is the transition system used in large residential and light commercial applications.
4. A factor that distinguishes commercial systems is the amount of maintenance attention the system receives, either by increased or by dedicated focus. The reason for this is the consequence of system failure. Another factor is that commercial systems are almost always packaged with all components separate, including the media. They are assembled on site. There are exceptions for skid-mounted (pre-assembled systems.)
5. The efficiency of multi-tank systems are determined and compared exactly as in single-tank systems. The difference is that the calculated period (capacity per salt, and gallon of water per capacity) includes a complete multi-tank cycle.
6. I recommend that Watersense consider efficiency labeling for only completed and fully specified systems, not components. Completed systems must contain all the flow controls and timer settings specified for the individual application and efficiency level, including the raw water analysis.

Thank you,
Larry Zinser
Master Water Conditioning
224 Shoemaker Road
Pottstown, PA 19446
610-323-8358
larry@masterwater.com

(Attachment: explanation of regeneration efficiency and other water softener characteristics that affect performance)

15 December, 2010

REGENERATION EFFICIENCY

Larry Zinser

Master Water Conditioning

The efficiency of regeneration in water softeners is influenced by nine principal factors. It has only been in the last decade however that these factors have been controllable by the development of modern control valves and timers. The older mechanical-electrical timers were designed under the principle that one size fits all. With the introduction of electronic timers, however, and with the improved engineering of injectors, the products of today's industry can directly apply the nine factors to achieve efficiencies in salt consumption, water and energy use that were impossible years ago.

The specification of the cation resin has an impact that can be best explained by a resin manufacturer. Although most cation resins (in the Sodium form) are similar, the manufacturers have determined the ideal conditions for use and regeneration conditions.

The kinetics of salt moving through a resin bed is also best explained by a resin manufacturer. However, it is a function of resin density, flow rates and salt concentration. For example, merely mixing resin in a brine solution will not cause regeneration. Rather, the brine must be flowing through the resin, and the resin must be compacted to a specified degree. Different resin manufacturers specify the ideal kinetics in different terms, from 0.5 to 1.5 gallons per minute per cubic foot of resin.

The salting dosage has a significant effect on efficiency. The dosage is a combination of salt concentration and the duration of the brine injection cycle.

The salt concentration must be high enough to encourage the removal of hardness ions from the resin, but not excessively high which would lead to waste. Typically, the salt is drawn from a pool of saturated brine, about 22% Sodium Chloride at ambient temperatures. Improved injectors are used to combine the saturated brine with "unsalted" water to achieve an ideal concentration in the range of 9 to 10 % brine. In this concentration factor, more is not better. There is an ideal percentage, and the efficiency decreases as the percentage is more or less than this ideal peak. The injector selection determines two factors: the percent of brine and the rate of flow for the brine. The percentage and the kinetics of flow through the resin is designed to achieve the most efficient and effective results.

The duration of the brining cycle determines the level of renewed capacity achieved by regeneration. 100% renewal is neither desired nor feasible because of the kinetics of the process. For practical purposes, the levels of salting range from about 4 pounds to 15 pounds per cubic foot of resin. Most researchers and NSF 44 test results have determined that the best efficiency (for capacity) is achieved at about 4.5 pounds per cubic foot of resin. Below this, there is not sufficient brine to have a regenerative effect; above this wastes brine without appreciable effect.

The backwash and rinse cycles determines the water used—and discarded—during the regeneration process. (The *frequency* of these cycles will be determined by the

salting dosage (and consequent capacity) as determined above. Therefore there is an efficiency relationship between the salting level efficiency and the water used and discarded.) The purposes of the backwash cycle are to remove any suspended particles from the resin bed and to make the bed uniform in preparation for regeneration. The generally accepted back wash rate is that flow necessary to expand the resin bed by 40 to 50%. This is a function of the resin density and the backwash water temperature. Resin manufacturers prescribe this data for their specific resin types. The duration of the backwash is generally prescribed between 6 and 10 minutes for residential systems. The only purpose of the brine slow-rinse cycle is to rinse the brine through and out of the resin bed. Once the brine is clear of the resin bed, the rinse cycle should cease. This time can be calculated based upon the injector flow characteristics, the size of the resin bed and the salting level. Continuation of the rinse cycle beyond this point is waste. The purpose of the fast-rinse cycle is to re-pack the resin bed for return to service. Since the bed has been somewhat compacted already by the brine and slow-rinse cycles (in co-current brining), this cycle should be very short, and at a typically service flow rate.

The reserve capacity affects the efficiency in most single-tank DIR systems. Demand systems count down the gallon capacity as water is treated. The count is determined by the regenerated capacity, the raw water hardness and the volume of water treated. Most demand systems do not count down all the way to zero ("0") before initiating regeneration. Rather, they develop a daily (day of the week) average for volume used, and then compare this expected volume of use with the remaining capacity. If the next day's expected (average) volume will exceed the remaining capacity, then the system will initiate a regeneration cycle to prevent exhaustion of the bed during the following day. Ideally the reserve will be minimal at the time of regeneration, because the excess capacity will be wasted by the salt dosage that is in excess of the true remaining capacity. This waste can be eliminated by having the system count all the way to zero capacity before initiating a regeneration cycle. (This is what happens with a twin-tank alternating water softener.) Since there is no usage data on new systems, the initial daily averages are generally set at 30% of the calculated gallon capacity (the timer assumes that the capacity will last for about three days.)

The distribution system within the resin tank can also play a major role in efficiencies. There are essentially three types of distributors: the turbulator, the screen and gravel bed and the distributor plate. The turbulator is designed for the purpose of physically cleaning the resin during backwash, and is not an efficient distributor. Channeling of water causes the loss of capacity because the resin at the bottom of the media bed is not fully utilized. The distributor (point-type or hub and lateral) with gravel underbed is an attempt to use all of the resin, but the kinetics of flow are uneven and somewhat random within the resin bed. Consequently, the resin bed is not fully used. The distributor plate, as in the Vortech system, resolves this issue. Water flow is directed to all points of the resin bed in all service and regeneration cycles. Testing of backwash and regeneration cycles has proven the efficiency of this technology.

The character of the raw water also plays an important role in efficiency. Obviously, the correct, tested hardness of the raw water must be entered for any DIR

system to operate effectively. Beyond that the total dissolved solids (TDS) and the iron content of the raw water also play a role. The TDS of the raw water affects both the leakage of hardness (after regeneration) and the ultimate resin capacity that can be achieved for a certain salting level. Essentially, the higher the salting level, the less leakage of hardness; and the higher the TDS, the lower the capacity achieved during regeneration. Additionally, if dissolved iron is present in the raw water, then the lower salt settings—those in the range of 4 to 7 pounds per cubic foot of resin—may not be sufficient to remove iron from the resin during the regeneration cycle. Higher salting levels are required to remove iron from the resin. All of these factors point to the necessity for professional analysis in the achievement of efficient results. One size does not fit all. Each water source requires professional analysis and prescription if efficient results are to be achieved.

Brine reuse has been proven to be another potential process for improvement of efficiency. Each regeneration system has a unique elution curve (salt and hardness concentrations versus time of regeneration) for the effluent of the regeneration cycle. Due to the kinetics of regeneration, there will always be excess brine being released to the drain. By analysis of the elution curve, certain portions of the regeneration effluent may be diverted and reused in subsequent regeneration cycles. The key factors are brine and hardness concentrations during the regeneration cycle. Once again, professional analysis and prescription are essential.

Upflow, or countercurrent, regeneration has proven advantageous in certain conditions. Since the regenerant is applied directly to the exhausted resin, and since the contaminants are immediately removed from the resin rather than pushing them throughout the resin bed, the regenerant kinetics are more effective. The danger with countercurrent is that the resin bed may be loosened (by upward flow) to a degree where regeneration does not occur effectively. This technology must again be prescribed by professionals.

Commenter: Nancy Stoner
Affiliation: U.S. Environmental Protection Agency
Comment Date: April 8, 2011

In response to comment submitted on January 25, 2011.



UNITED STATES ENVIRONMENTAL PROTECTION AGENCY
WASHINGTON, D.C. 20460

APR - 8 2011

OFFICE OF
WATER

Mr. Philip L. Friess
Dept. Head, Technical Services
Sanitation Districts of Los Angeles County
P. O. Box 4998
Whittier, CA 90607-4998

Dear Mr. Friess:

Thank you for your letter of January 25, 2011, to Peter S. Silva, former Assistant Administrator of the U.S. Environmental Protection Agency's (EPA) Office of Water. Your letter expressed concern about a recent notice of intent (NOI) to develop a WaterSense specification for cation exchange water softeners and suggested that EPA include the use of non water-using technologies in the specification.

Your letter highlighted concern about the potential impact softeners could have on surface water quality. EPA understands the concerns that some communities are facing due to increased loading of chlorides from softeners used within their service areas. We also recognize that increased salinity and total dissolved solids are a concern in many surface waters across the country. There are many sources responsible for elevated salinity levels and a comprehensive assessment of sources and appropriate controls on a watershed basis is an important step in improving water quality.

Encouraging water efficiency, while also maintaining product performance, is a key objective of the WaterSense program. Our NOI process is intended to provide notice to the public that the WaterSense program believes there may be an opportunity for significant water savings through the development of efficiency and performance standards for products. There is no commitment on the part of the agency to develop a specification within a certain time period after release of the NOI, if at all.

Our concern is that the technologies proposed as an alternative to traditional water softening products are not well-defined or understood. Efforts are currently underway on several fronts that could potentially give the WaterSense program the certainty it needs to ensure that products would perform in accordance with consumer expectations. The program is continuing to follow these developments, carrying out discussions with interested parties, and conducting additional research of available information to help it come to a decision on next steps with respect to a specification.

APR 18 2011 AM 09:53

DUC #
[] Friess L.

Internet Address (URL) • <http://www.epa.gov>

EPA and the WaterSense program staff appreciates the support expressed in your letter because it is critical to the success of the program. In the time since your letter was received, staff has met with representatives of the Inland Empire Utilities Agency and Sanitation Districts of Los Angeles County, and I understand plans may be underway to convene a meeting to further discuss this issue. Your letter will also be added to the record and inform our decision-making process.

Again, thank you for your letter. We hope that we may continue to depend on your support and that of the broader water efficiency community as we work to expand awareness about water issues. If you have further questions, please contact me or your staff may call Sheila Frace, Director of the Municipal Support Division, at (202) 564-0749.

Sincerely,

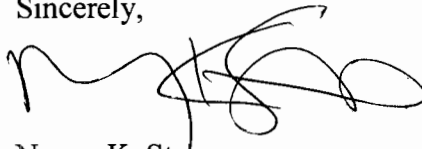
A handwritten signature in black ink, appearing to read 'Nancy K. Stoner', with a large, stylized flourish at the end.

Nancy K. Stoner
Acting Assistant Administrator

Commenter: Thomas Armon
Affiliation: H-O-H Water Technology
Comment Date: June 29, 2011

Dear WaterSense,

I read with great interest the NOI by Stephanie Tanner regarding ion exchange softening. It is about time someone other than California took a close look at this technology and its impacts of operation. In my business, we manage cooling tower water systems. As you probably know cooling towers are huge consumers of water in commercial, institutional, and light industrial facilities. In most facilities, cooling towers consume greater than 50% and possibly contribute as much as 90% of the water foot print. Many of these same facilities have Green or environmental initiatives in place (like LEED, Energy Star, etc..) and have installed high efficiency toilets and waterless urinals. Yet they continue to ignore the "low hanging fruit" in the cooling tower.

From a water efficiency view point, many facilities could easily reduce their water consumption by 50% or more, while others continue to install ion exchange softeners. The softeners are touted to improve cooling tower water efficiency, yet the softeners themselves can discharge on average 70 gallons of water/cubic foot of resin. In addition, the discharge from a water softener will contain anywhere from 5 to 15 pounds of salt per cubic foot.

There is a better way. Attached please find a peer reviewed document presented at ASHRAE 2009. This white paper details the fundamentals of a product we call the Green Machine. This product is a two time finalist for the Presidents Green Chemistry award.

I have two questions:

What is the EPA's (WaterSense) latest position on the operation of cation softeners & their discharge?

We are planning to launch a water conservation initiative of our own in 2012. What kind of support could we obtain from the EPA & WaterSense?

Thomas Armon
Manager, SouthEastern Division
H-O-H Water Technology, Inc.
847-436-7409
941-405-3435
Tampa, Florida

(Attachments: *Electrochemical Cooling Water Treatment: A New Strategy for Control of Hardness, Scale, Sludge and Reducing Water Usage. Published in ASHRAE Transactions Vol. 115, Part 1; Green Machine Technology Data Sheet*)

Electrochemical Cooling Water Treatment: A New Strategy for Control of Hardness, Scale, Sludge and Reducing Water Usage

Henry A. Becker
Member ASHRAE

Jon J. Cohen
Member ASHRAE

Alan D. Zdunek, PhD

ABSTRACT

Fouling due to calcium salts present in hard water has proven historically troublesome in metal plating, chlor-alkali production, and other electrolytic operations. It is perhaps ironic, this classical nuisance includes mechanisms for effective control of troublesome deposition throughout large, real-world recirculating water systems; effectively establishing a new water treatment strategy of environmental and economic benefit. An electrolytic process can be employed for evaporative cooling systems of all types to generate in-situ chemistry and physical activity totally controlling hard-water deposits and minimizing both corrosion and biofouling. This is accomplished without classical chemical treatment or water conditioning while also allowing substantial reduction in cooling system bleedoff.

INTRODUCTION

An evaporative cooling water system consists of a heat source, cooling tower, recirculating water pump, interconnecting piping, and water to transport heat from the heat source to the environment by evaporation taking place in the cooling tower. Water containing dissolved minerals (make-up water) is added to a cooling tower system to replace evaporative loss and maintain near constant water volume. As cooling tower water evaporates, dissolved minerals from the make-up concentrate and eventually become problematic. Dissolved mineral buildup is controlled through discharge of concentrated system water as bleedoff, subsequently replaced by relatively dilute make-up water. The volumetric ratio of make-up to bleedoff establishes an evaporative concentration factor of dissolved solids, termed cycles of concentration. Evaporation of water to dissipate heat is an ideal means of cooling because

each pound of water evaporated carries away almost 1,000 Btu's of heat. The more water can be concentrated without causing mineral deposition or other problems, the more cost and resource efficient the evaporative cooling system becomes.

Fresh water from almost all sources contains some level of dissolved minerals in the form of positively and negatively charged ions. Common positively charged ions include calcium (Ca^{+2}), magnesium (Mg^{+2}), sodium (Na^{+1}), and potassium (K^{+1}). Common negatively charged ions include chloride (Cl^{-1}), sulfate (SO_4^{-2}), and bicarbonate (HCO_3^{-1}). These species dissolve in water as rain interacts with the Earth's surface and subsurface over long periods of time. Of these species, calcium and bicarbonate are of chief interest when combating mineral deposition in evaporative cooling water systems. Calcium bicarbonate is quite soluble in water and is the chief troublesome component of what is termed hard water. Its presence in fresh water is the result of slow, low temperature reaction of acidic rain water, containing carbonic acid or dissolved carbon dioxide (CO_2), with limestone composed of calcium carbonate (CaCO_3). This process may be summarized as follows:

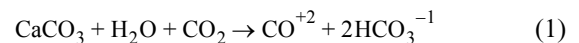

Hard water becomes problematic in cooling water and other energy transfer systems because bicarbonate ion is thermally unstable and easily decomposes to carbon dioxide and carbonate ion according to the following reaction:

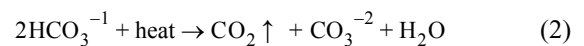

Note: Upward pointing arrow (↑) indicates liberated gas as result of reaction.

Henry A. Becker is vice president and technical director and **Jon J. Cohen** is director of engineering at H-O-H Water Technology, Inc., Palatine, IL. **Alan D. Zdunek** is an adjunct professor in the Department of Chemical and Biological Engineering, Illinois Institute of Technology, Chicago, IL.

Bicarbonate ion breakdown proceeds quickly under the conditions typically found with functioning cooling towers: modest water heating from tap water temperature to 95 °F, agitation that enhances surface release of carbon dioxide, and large air flow that readily accepts the release of CO₂. The natural solubility of calcium carbonate in distilled water at room temperature to its constituent ions with sufficient time is approximately ten parts per million (ppm) as CaCO₃, or 4 ppm as Ca⁺² and 6 ppm as CO₃⁻². Cooling tower make-up may easily contain from 50 to 300 ppm or more of calcium bicarbonate and is then concentrated several times by evaporation. Of the bicarbonate present, approximately 20 to 40% undergoes thermal decomposition to carbonate ion. This sets the stage for the recirculating cooling tower water to become highly supersaturated with respect to calcium and carbonate ions, either typically reaching concentrations in excess of 100 ppm or more.

Calcium carbonate deposit formation in practical cooling water systems proceeds slowly even though both ions are present far in excess of their theoretical saturation level because the rate of formation of the smallest constituents of deposition, nucleated crystals, can be quite slow. The process of calcium and carbonate ions coming together to begin building calcium carbonate to the point of nucleation occurs throughout the entire volume of cooling water and is the primary rate limiting step. The entire reaction can take hours to several days to produce significant precipitation depending on the thermal and mechanical loading of the cooling tower system and the amount of time the water is held in the system, defined by the time required to discharge one full system volume by normal bleedoff. It then becomes essential to deal with potential calcium loss due to supersaturation, or risk deposit formation as scale on heat exchange surfaces, as sludge settling in the cooling tower basin or elsewhere, as mineralization and bulking of biofilm, or as increased residue at wet/dry boundaries of the cooling tower.

Traditional cooling tower treatment makes use of bleedoff to transport make-up water calcium through the system so it may be discharged to waste with bleedoff. Calcium loss prior to discharge is either prevented or minimized employing one of two basic strategies. In light of ever increasing demand for and cost of resources as well as concern over use of chemical used in water treatment, need exists for an alternate treatment methodology to lessen evaporative cooling resources and reduce or eliminate need to introduce chemical additives to water eventually discharged to sanitary or surface waters.

TRADITIONAL DEPOSIT CONTROL STRATEGY

Two strategies of chemical water treatment have been employed for controlling calcium carbonate formation in cooling water systems. First, acid may be added to effectively reverse the formation of carbonate ion due to the thermal breakdown of bicarbonate and then remove bicarbonate by converting it to carbonic acid which in turn breaks down to carbon dioxide gas and water. Carbon dioxide then easily

escapes into cooling tower air flow. Acid introduction is used to change recirculating water chemistry so calcium carbonate cannot form by virtue of its carbonate formation potential being removed or significantly reduced. This is a very effective strategy for calcium carbonate control, but produces significant reduction in cooling water pH with an increase in corrosion potential and a need for corrosion inhibitors effective at the reduced pH established. Use of strong mineral acids such as sulfuric acid (H₂SO₄) also represents a hazard issue of increasing safety and liability scrutiny. The reactions involved are:

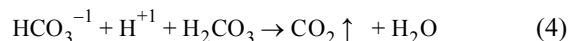
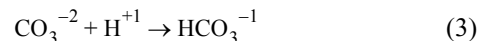

The second primary strategy for controlling calcium carbonate formation relies on coordinated introduction of two types of deposit inhibiting additives, anti-precipitants (crystallization modifiers) and dispersives. Anti-precipitants act on the very smallest components of crystalline calcium carbonate as they enter the nucleation process throughout the recirculating cooling water. By interfering with nucleation and orderly crystal development, anti-precipitants dramatically slow or delay formation of calcium carbonate crystals of sufficient size to be significant in deposit formation. Retarding crystal development permits greater calcium transport via bleedoff. Dispersives are typically polymeric compounds used to impart uniform negative charge on very small calcium carbonate crystals at the nucleation point. Uniform like-charge on small particles tends to hold them apart and retard aggregation into larger composites that are more likely to interact with cooling system surfaces. Deposit inhibiting additives are not as effective in transporting calcium through a cooling water system as acid, but they have the advantage of not lowering pH or contributing significantly to corrosion.

In summary, make-up water containing soluble calcium bicarbonate is subject to bicarbonate breakdown, and quickly enters a meta-stable, supersaturated state with potential over time to produce substantial insoluble calcium carbonate. If traditional chemical treatment strategies are not used, the process leading to observable precipitation starts homogeneously throughout the mass of recirculating cooling water. Calcium carbonate formation starts with calcium and carbonate ions coming together to form ion clusters of immense number, but limited number of constituents. Under supersaturation, the average number of calcium and carbonate ion components of ion clusters tends to slowly increase with time as the average number of ion clusters slowly falls. Eventually as the point of nucleation is reached and true micro crystals of calcium carbonate begin to form throughout the volume of cooling water, evidence of the crystallization process becomes noticeable as water turbidity. As average crystal size continues to grow, individual crystals begin to aggregate into particulate matter able to settle where water velocity or turbulence is low.

A NEW DEPOSIT CONTROL STRATEGY

Recently, another type of treatment has been shown to reduce scaling in cooling water systems (Becker and Cohen 2007). The treatment is based on an electrochemical process, water electrolysis, which increases the pH in the vicinity of an electrode surface, causing precipitation of CaCO_3 to occur at the electrode. It is well-known that calcium carbonate precipitation is a function of temperature; however it is also dependent on ion concentration, flow rate of the solution and the pH of the water (Devos et al 2003). Previously, electrochemical-based laboratory experiments have been used to study nucleation growth, crystallization, structure and morphology of calcareous deposits by exploiting the acceleration of the precipitation reaction by the electrochemical reactions occurring on the electrodes (Devos et al 2003, Pavez et al 2005, Xu et al 1999). In fact, the high pH (> 9.6) needed to precipitate the calcium carbonate has experimentally been verified in these type of electrochemical experiments (Cachet, H. et al 2001).

In the case of the commercial water treatment method, the same principles apply in accelerating the calcium carbonate precipitation reaction. Mineral ions preferentially deposit on the cathodic surface of an electrolysis unit rather than at the other surfaces in the main cooling flow stream. The process, in essence, concentrates the scale-formation into the electrolysis unit such that scale is reduced in the functional part of the cooling water system. The electrolysis process operates by reducing water to hydrogen gas and hydroxide ions at an electrode surface (cathode), thereby creating a localized environment at the cathode that is highly insoluble to scale-forming mineral deposits.

Electrolysis of water containing an electrolyte produces two chemical reactions:

Anodic Reaction (positive electrode), Oxidation of Water

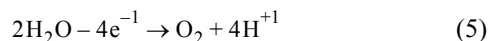

Cathodic Reaction (negative electrode), Reduction of Water



In hard water containing bicarbonate ion a secondary reaction occurs at the anode:

Secondary Anodic Reaction

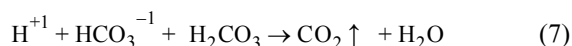

In hard water containing bicarbonate ion and calcium ion two secondary reactions occur at the cathode:

Secondary Cathodic Reaction #1

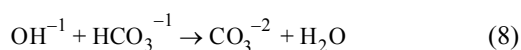

Secondary Cathodic Reaction #2

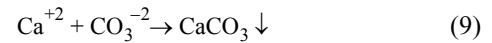

Note: Downward pointing arrow indicates formation of solid precipitate as a result of reaction.

The key phenomena governing the movement of the calcium ion/carbonate ion species towards the electrode and which influences the electrolysis precipitation reaction are ionic transport and the electrochemical charge transfer reactions occurring at the electrode/solution interface. Ionic mass transport in electrolyte solutions follows fundamental mass transfer laws (Fick's Law), but the mass flux equation now contains an additional force, called the migration term, that results from the electric field present between the electrodes (Newman 1973, Bockris). Migration of an ionic species is dependent on the electric field, the charge and ionic mobility of the ion, and its concentration. Migration can change the flux of a charged species in two ways. If the ionic species is positively charged, the migration flux is additive and enhances the overall flux. However, if the ions are negatively charged, migration works against the diffusional flux and decreases the overall flux. In addition, if solution flow and heat are also present, then a fluid convection and heat transfer term must also be taken into account to describe the ionic flux (Koryta and Dvorak 1987).

The charge transfer reactions occurring at the electrode also factor in to the transport and concentration distribution of the ionic species. The electrochemical reactions deplete the ionic reactants while causing an increase in the ionic products at the electrode surface. Hence, due to migration, diffusion, convection, and the charge-transfer reactions, concentration gradients of the various ionic species are formed near the electrode in a small thickness called the diffusion layer.

The established concentration gradients of the ionic species contribute towards the high pH at the cathode according to reaction 6 and also promote the formation of carbonate ion according to reaction 7. Hence, there is an abundance of negatively charged ions at the cathode that provides a driving force of positively charge calcium ions to migrate towards the cathode to maintain electro-neutrality in the solution. In actual cooling water systems, the ionic movement and transport phenomena becomes more complicated because of ion-clustering due to the supersaturated levels of calcium, bicarbonate and carbonate ions. However, the basic transport and charge-transfer principles still apply.

The net products from these reactions are three gasses (H_2 , O_2 & CO_2), which readily disengage from the anode and cathode, and one ionic species, hydroxyl ion that is of relatively limited mobility and at very high concentration the cathodic surface. Hydroxyl ion then reacts with bicarbonate ion to form carbonate ion at high concentration. Very high relative carbonate concentration induces rapid calcium carbonate precipitation directly on the cathode as in classical fouling of process electrolysis cathodes exposed to water containing calcium hardness.

This now signifies a new strategy for controlling calcium carbonate deposition that relies much less on bleedoff for calcium removal. This strategy relies on electrolysis to provide the chemistry and removal facility to capture calcium carbonate fast enough to effectively influence micro crystal development. Electrolysis can be used to establish a more intense calcium removal sink than found either in bulk phase precipitation or at heat exchange surfaces.

Water hardness deposits have historically been troublesome in electrochemical processes such as metal plating, chlor-alkali and bromine production requiring water conditioning and other measures to remove or control calcium. Recognizing that hydroxyl ion forms at the cathode of an aqueous electrolytic cell and that it freely acts to increase carbonate activity and cathodic scaling, a mechanism troublesome in one venue seemed to point to a means of capturing calcium potentially of value in other venues. Several years of experimentation and development showed that, indeed, calcium removal could be realized at a rate equal to or even greater than required for deposit free operation of evaporative cooling water and other water carrying systems.

Hydroxyl ion formation in the boundary layer of water in immediate contact with the cathode of an electrolysis cell can be projected to reach or exceed 10,000 ppm, or approximately 0.25 moles per liter. Given that bicarbonate and hydroxyl ions react very rapidly and quantitatively to produce carbonate ion, any bicarbonate very near a cathode will be rapidly converted to carbonate ion and cathodically localized carbonate concentration will rise and approach 10,000 ppm or more. Localized calcium ion saturation is therefore reduced proportionately as dictated by solubility product and common ion effect considerations.

Calcium carbonate saturation throughout a cooling water system is achieved theoretically with equal molar concentrations or about 4 ppm calcium and 6 ppm carbonate at 60 °F. Saturation requirements progressively decrease as water is warmed above 60 degrees. This is why scale tends to form on heat exchange surfaces where water is warmest throughout a cooling water loop.

In terms of solubility product and equal molar concentrations of Ca^{+2} and CO_3^{-2} (Dean 1999):

$$\begin{aligned} \text{At } 15^\circ\text{C}(59^\circ\text{F}) \quad & [\text{Ca}^{+2}] \times [\text{CO}_3^{-2}] = 0.99 \times 10^{-8} \\ [\text{Ca}^{+2}] = [\text{CO}_3^{-2}] & = 0.9949 \times 10^{-4} \quad (10) \\ \text{Ca}^{+2} = 4.0 \text{ ppm} \quad & \text{CO}_3^{-2} = 6.0 \text{ ppm} \end{aligned}$$

$$\begin{aligned} \text{At } 25^\circ\text{C}(77^\circ\text{F}) \quad & [\text{Ca}^{+2}] \times [\text{CO}_3^{-2}] = 0.87 \times 10^{-8} \\ [\text{Ca}^{+2}] = [\text{CO}_3^{-2}] & = 0.9327 \times 10^{-4} \quad (11) \\ \text{Ca}^{+2} = 3.7 \text{ ppm} \quad & \text{CO}_3^{-2} = 5.6 \text{ ppm} \end{aligned}$$

$$\begin{aligned} \text{At } 38^\circ\text{C}(100^\circ\text{F}) \quad & [\text{Ca}^{+2}] \times [\text{CO}_3^{-2}] = 0.55 \times 10^{-8} \\ [\text{Ca}^{+2}] = [\text{CO}_3^{-2}] & = 0.7416 \times 10^{-4} \quad (12) \end{aligned}$$

$$\text{Ca}^{+2} = 3.0 \text{ ppm} \quad \text{CO}_3^{-2} = 4.5 \text{ ppm}$$

Note: Value based on four-fold estimated solubility decrease relative 15°C to 25°C change.

Saturation at equal molar concentrations of calcium and carbonate ion limits calcium ion to 4.0 ppm at roughly 60 °F, falling to approximately 3.0 ppm at 100 °F. If either calcium or carbonate were to increase, the other species must fall to prevent supersaturation according to the solubility relationship for the waters' temperature.

$$\begin{aligned} \text{Cathodic Ca}^{+2} \text{ saturation at } 38^\circ\text{C} \\ \text{assuming localized cathodic CO}_3^{-2} = 10,000 \text{ ppm} \quad (13) \end{aligned}$$

$$\begin{aligned} \text{Ca}^{+2} \text{ saturation: } \quad & ([\text{Ca}^{+2}] = 0.55 \times 10^{-8} / [\text{CO}_3^{-2}]) \\ & = 0.55 \times 10^{-8} / 0.25 = 2.2 \times 10^{-8} \text{ moles/liter} \\ \text{Ca}^{+2} \text{ saturation} & = 0.0001 \text{ ppm} \end{aligned}$$

In comparison to calcium ion saturation at a heat transfer surface or in bulk phase water where Ca^{+2} & CO_3^{-2} ions are naturally found in roughly equal molar concentrations, calcium ion saturation at a cathodic surface is orders-of-magnitude less due to great molar excess of induced carbonate ion. The great difference between bulk phase calcium ion concentration and cathodic calcium saturation establishes by far the greatest precipitation driving force found anywhere in a cooling water loop, much greater than the relatively weak driving force created by reduction in solubility due to increased temperature.

With sufficient cathodic area and power, an excess amount of calcium carbonate above that theoretically anticipated to form on heat transfer surfaces or in the bulk phase per unit time can be captured electrolytically. Removing calcium at a rate exceeding the theoretical formation rate of ion clusters and subnucleated nanoparticles due to slow diffusion process draw upon subnucleated micro crystal resources and therefore starts a process retarding average crystal size development.

Initial ion clusters are equally apt to dissociate as they are to grow in size. As particle size increases, approaching nucleation, innate tendency to disassociate within a given cluster matrix diminishes. As ion clusters and sub-nucleated particles increase in size, there still remains some reverse equilibrium tendency that influences crystal development. If a force strong enough to influence equilibrium exists, the equilibrium governing precipitation may be reversed. High cathodic carbonate concentration lowers calcium tolerance to such an extent.

For any given cooling water system, characteristics governing natural precipitation tendencies are discreet and determined by water chemistry, heat transfer surfaces and

mechanical design. Therefore, the key to proper electrolytic prevention of scale precipitation will be governed by flow, current density and cathodic surface area of the electrolytic reaction cell. Electrolytic cells are incorporated into a cooling water loop in a side stream configuration. Figure 1 illustrates a typical installation of four electrolytic cells. The cathodic surface area required for any set of cooling system parameters is achieved by either varying the number of cells or the dimensions of the cells used. Variation of current is used to achieve precise control to match variation in cooling system load.

Current density, the amount of power supplied over the area of an electrolytic cell, is paramount when considering the reaction kinetics for electrochemical reactions. Caustic production at cathodic surfaces is determined by the hydrolysis reaction rate and thus, the amount of current supplied to the electrolytic cell. As mentioned earlier, electrolytic cells for cooling water treatment are designed to produce approximately 10,000 ppm hydroxyl ion at cathodic surfaces to achieve an appropriate reaction rate for carbonate ion production.

The effect of flow variation through side stream electrolytic process cells has been studied and field tested to maximize calcium carbonate capture. Flow optimization insures maximum presentation of ion clusters and time for positive fixed crystal growth to and on cathodic surfaces. Maximizing flow relative to capture also helps back mixing of ion clusters achieve homogeneous concentration throughout the cooling tower water and uniform net movement from tower water to the side stream capture process.

Cathodic collection of calcium carbonate effectively establishes calcium transport out of a cooling system apart from that provided by bleedoff. So long as sufficient cathodic area, driving force and residence time are available to limit microcrystal growth for a given set of cooling system operating conditions, there may be much less or no reliance on bleed-off to control residence time. Operating experience verifies this, indicating average water cycles of concentration to more than double without bulk phase precipitation or heat exchange deposition. Under some conditions zero discharge can be obtained.

In operation, a side stream electrolysis unit can accumulate a significant deposit and still function in a uniform manner. Eventually, though, accumulation must be removed to preserve operability. Deposition on cathodic surfaces can be seen in Figures 2 and 3. Deposit removal can be accomplished by various means, including electrolytic, mechanical and physical cleaning.

Along with calcium carbonate collection, there are additional benefits derived from continuous side stream electrolysis. The loosely packed crystals of calcium carbonate that form with rapid forced precipitation of calcium carbonate facilitate capture, co-precipitation and adsorption of organic contamination removed from air passing through a cooling tower. Organic contamination is troublesome due to its microbial nutrient potential. Since there is direct correlation between organic loading ('food') and biomass development, any removal of captured organics is beneficial in limiting biofilm and biomass.

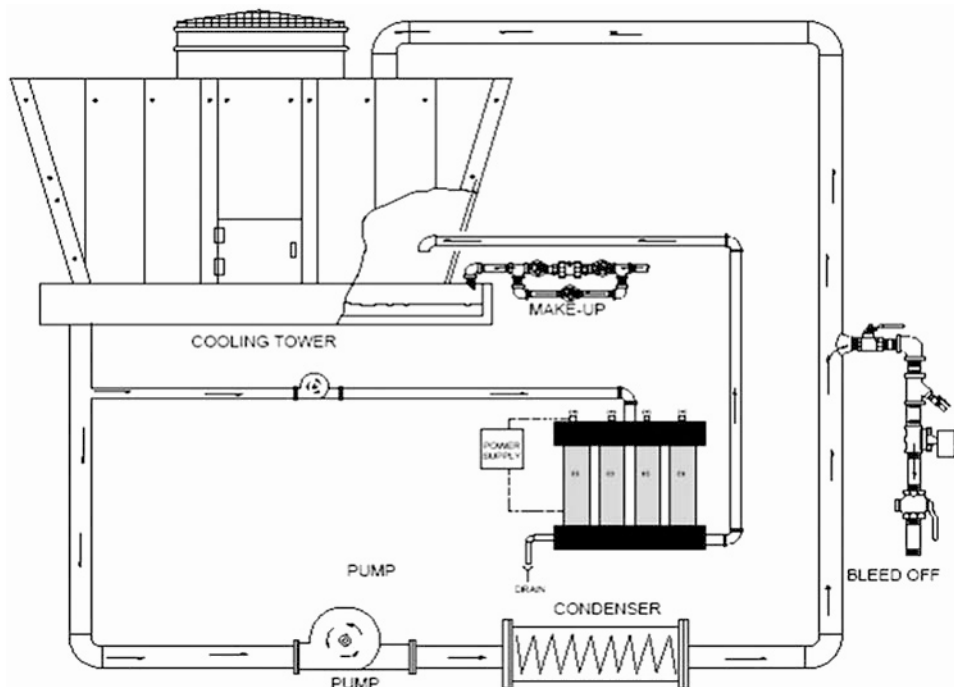

Figure 1 Typical cooling loop with side stream electrolysis capability.



Figure 2 An 8" diameter cell with approximately 2" of CaCO_3 after 3 months operation.



Figure 3 8 inch cells used to treat 450 ton industrial cooling tower under zero discharge mandate.

Electrolysis of halide containing water can, under certain conditions, lead to in-situ formation of chlorine or bromine; further aiding in controlling microbial growth. Controlling biofilm and organic filming of metals is generally beneficial in reducing corrosion of an active metal such as steel. Such metals are highly susceptible to microbiologically induced corrosion and under deposit corrosion.

CONCLUSION

Clearly, introduction of hydroxyl ion (caustic) to recirculating cooling water results in conversion of bicarbonate to carbonate, fostering calcium carbonate precipitation. Electrolysis can provide the caustic to promote precipitation, capture, retention and removal mechanisms necessary to create a fully functional treatment strategy. While there are other means to produce similar partial water softening effects, such as traditional municipal and industrial cold lime soda softening, electrochemical methods do not require addition of chemicals, pH control, filtration or additional means of mechanical solids separation.

Electrolysis provides a vehicle for rapid, clean capture and fixation of calcium that is simple, easy to maintain and requires no chemical introduction or handling. This "old" technology is proving to be a valuable new tool, effectively allowing cooling water to be treated under a new strategy that not only improves performance, but also significantly saves water and eliminated need for chemical. It does this because it has the robust power to fundamentally affect the basic mechanisms behind evaporative cooling system hardness precipitation in a uniquely clean and direct manner.

REFERENCES

Becker, H.A. and Cohen, J.J. Electrochemical Water Treatment: A New Strategy for Control of Hardness and

Sludge in Open Evaporative Cooling Water Systems. The Electrochemical Society Spring Meeting, May 2007, Chicago, Illinois, Paper #886.

Bockris, J. O'M. and Reddy, A.K.N. 1970. Modern Electrochemistry Volume 1. Chapter 4: Ion Transport in Solutions. New York: Plenum Publishing Corporation.

Cachet, H., El Moustafid, T., Herbert-Guillou, D., Festy, D., Touzain, S., Tribollet, B., 2001. Characterization of deposits by direct observation and by electrochemical methods on a conductive transparent electrode. Application to biofilm and scale deposit under cathodic protection. *Electrochimica Acta* 46 3851-3857.

Dean, J. A. 1999. *Lange's Handbook of Chemistry*, Fifteenth Edition, McGraw-Hill, ISBN: 0-07-016384-7.

Devos, O., Gabrielli, C., Tlili, M. and Tribollet, B. 2003. Nucleation-Growth Process of Scale Electrodeposition: Influence of Supersaturation. *Journal of the Electrochemical Society*, 150 (7) C494-C501.

Koryta, J. and Dvorak, J. 1987. *Principles of Electrochemistry*. Chapter 2: Transport Processes in Electrolyte Systems. Chichester, Great Britain: John Wiley & Sons.

Newman, J. 1973. *Electrochemical Systems Part C: Transport Processes in Electrolytic Solutions*. Englewood Cliffs, N.J.: Prentice-Hall, Inc.

Pavez, J., Silva, J.F., Melo, F., 2005. Homogeneous calcium carbonate coating obtained by electrodeposition: in situ atomic force microscope observations. *Electrochimica Acta* 50 3488-3494.

Xu, S., Melendres, C.A., Park, J.H., Kamrath, M.A., 1999. Structure and Morphology of Electrodeposited CaCO_3 : X-Ray Diffraction and Microscopy Studies. *Journal of the Electrochemical Society* 146 (9) 3315-3323.



DESCRIPTION:

H-O-H Water Technology's **GREEN MACHINE** utilizes direct current electrolysis to remove anions and cations (Ca^{+2} & CO_3^{-2}) from water systems in excess of calcium carbonate saturation. $CaCO_3$ deposited on the inner surface of the electrolysis chamber (cathode) of the **GREEN MACHINE** is flushed to drain as a daily procedure or can be manually cleaned. The resultant water requires no chemical inhibitors and eliminates the need for acid to reduce scaling tendency.

This **American Made** unit is designed to withstand even the most challenging industrial environments. UL certified electronics ensure reliable performance as well as the operational versatility to enable the **GREEN MACHINE** to meet almost any system's requirements.

This proven technology supplements our **One Design** Reverse Osmosis, Cold Lime Softening, Ion Exchange, Ultrafiltration and Water Softener products.

FEATURES:

- Factory Prewired and Preplumbed System
- Heavy Duty Carbon Steel Construction
- Dependable PLC based Controller
- Automatic Regeneration and Flushing Control
- Touch Screen displays Amperage, Flow Rates, Conductivity, Biocide Feed Programs and Totalizers
- Password Protected Software Allows On-site Adjustments
- Inputs for Three Hall-effect or Contacting Water Meters
- Reliable Spring Return Motorized Valves

SPECIFICATIONS:

	MIN	NORMAL	MAX
Oper. Pressure PSI	7	30	90
Oper. Temperature °F	40	100	160

TYPICAL APPLICATIONS:

Cooling Water Systems and Make-up Water where;

- Low discharge limits apply
- Acid handling and storage is problematic
- Other areas of environmental concern prevail
- Conventional water chemistry cannot be implemented

ADVANTAGES:

- Easily installed and serviced
- Safe environmentally friendly scale control
- Local service and parts decrease down-time
- Economical operation and maintenance costs



FACILITY REQUIREMENTS:

- Sanitary drain to handle backwash
- 120 VAC 1 phase 60 HZ power, 15Amps
- Sufficient system pressure and flow rate

MODEL	GMUS10-4
Number of Chambers	4 - 6" Dia
Max. Flow Rate, gpm	140
Approx. Purge Volume,	100 gal
In & Out Piping, NPT	2"
Flush Con., NPT	2"
Approx. Ship Wt., lbs.	650
Approx. Oper. Wt., lbs.	810
Approx. Chamber Assy. Dim., inches	49W x 24D x 72H
Electrical Req.	120V/1/60C
Amperage	15

See your H-O-H Representative for sizing to meet your system's needs.

PROCESS OPERATION:

Water is passed through a series of reaction chambers. By applying DC current to electrodes, OH⁻ ions are produced by partial electrolysis of water. Formation of OH⁻ ions at the inner surface of each cylinder (cathode) promotes scale-like formation of calcium carbonate ($Ca^{+2} + 2CO_3^{-2} + OH^- = CaCO_3 + CO_2 + H_2O$). Through this electrochemical process, a dynamic equilibrium shift is accomplished in resulting in effective diversion of scale from heat exchange surfaces to the cathodic surface of each electrochemical cell. Reversal of the polarity during the purge cycle sends concentrated water to the drain. During the purge cycle, a small amount of water, highly concentrated with minerals, is discharged; minimizing water lost to bleed and allowing increased cycles of concentration.

DYNAMIC EQUILIBRIUM SHIFT:

Water is naturally found in a state of equilibrium. In cooling water systems, minerals and other dissolved solids are concentrated due to evaporative losses. Traditional chemical treatment slows formation of solids in this supersaturated state. Water passed through an electrochemical precipitator reduces dissolved solids load, shifting cooling water towards its natural equilibrium, reducing any potential for deposition on heat exchange surfaces. We call this a dynamic equilibrium shift.

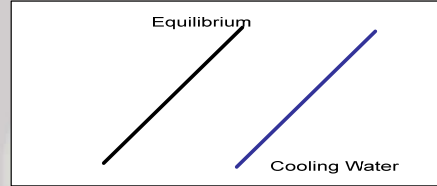

Water concentrated to supersaturation.

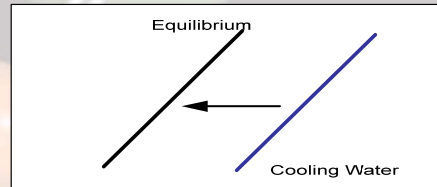

Dynamic equilibrium shift shifts cooling water towards calculated equilibrium.

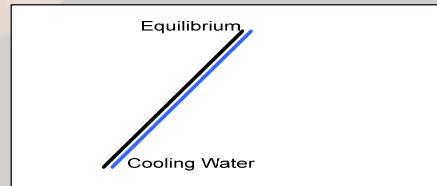

Water near equilibrium has little to no scaling potential.



Commenter: Multiple Authors
Affiliation: Undersigned Agencies
Comment Date: July 21, 2011

In response to comment submitted on April 8, 2011.

**ASSOCIATION OF CALIFORNIA WATER AGENCIES
ASSOCIATION OF METROPOLITAN WATER AGENCIES
CALIFORNIA ASSOCIATION OF SANITATION AGENCIES
CALIFORNIA MUNICIPAL UTILITIES ASSOCIATION
EASTERN MUNICIPAL WATER AGENCY
INLAND EMPIRE UTILITIES AGENCY
LAS CRUCES UTILITIES
NATIONAL WATER RESEARCH INSTITUTE
NATIONAL WATER RESOURCES ASSOCIATION
METRO WASTEWATER RECLAMATION DISTRICT
PLANNING AND CONSERVATION LEAGUE
SANITATION DISTRICTS OF LOS ANGELES COUNTY
SOUTHERN CALIFORNIA ALLIANCE OF PUBLICLY OWNED TREATMENT WORKS
SOUTHERN CALIFORNIA SALINITY COALITION
SOUTHERN CALIFORNIA WATER COMMITTEE
Tri-TAC
WATEREUSE ASSOCIATION
WATEREUSE ASSOCIATION, CALIFORNIA SECTION
WESTERN COALITION OF ARID STATES
WESTERN MUNICIPAL WATER DISTRICT**

July 21, 2011

Nancy Stoner, Acting Assistant Administrator
Office of Water
Environmental Protection Agency
Ariel Rios Building
1200 Pennsylvania Avenue, N.W.
Mailcode 4101M
Washington, DC 20460

WaterSense Notification of Intent to Develop Efficiency and
Performance Specifications For Residential Cation Exchange Water Softeners

Dear Assistant Administrator Stoner:

The undersigned organizations remain deeply concerned about the Notification of Intent (NOI) to Develop Efficiency and Performance Specifications for Residential Cation Exchange Water Softeners proposed by EPA's WaterSense Program last November. We are writing to ask that you direct the WaterSense Program to stop work on development of this standard. Instead, we recommend EPA develop a more fully integrated approach that both protects our nation's water quality and promotes water efficiency.

Please understand that the undersigned organizations are all strong supporters of the EPA's WaterSense program, and many are WaterSense Partners. We actively promote the water efficient products endorsed by the EPA through this program. Last January we wrote to Assistant Administrator Silva to express our concerns about this effort.

However, we feel our concerns still have not been adequately addressed (see attached correspondence).

Typical Cation Exchange Water Softeners (also known as Self-Regenerating Water Softeners (SRWS)) used in homes are water intensive. These devices are also very effective at removing hardness from water, which means they are useful for protecting other water and energy efficient appliances from the impacts of calcium and magnesium that are found in local water supplies. For WaterSense to identify self regenerating water softeners as candidates for evaluation is understandable.

The problem is the amount of salt that this type of water softener discharges to the sewer system (or to septic systems), which can average over 1 pound of salt per day. From a national perspective, salinity is a significant water quality issue, contributing throughout the country to impairments in surface and groundwater supplies. The EPA's 303 (d) impaired waters list shows almost 1,800 listings across the country due to salinity or related compounds (including total dissolved solids, chloride, sulfates, conductivity and/or combinations of these compounds). High levels of salt entering sewer systems also threaten the ability of communities to use recycled water when salinity in these supplies rises to unacceptable levels.

Salt management is a major water challenge facing our nation, especially, though not exclusively, in the arid west. Many communities throughout the nation have found self-regenerating water softeners to be a significant contributor to pollutant loadings. Local and state agencies in California, Texas, Arizona, Montana, Kentucky, Michigan, Massachusetts, Connecticut and New Jersey and elsewhere have at one time enacted or are now contemplating laws, regulations and ordinances to limit or ban the use of self-regenerating water softeners.

Thank you for your consideration of our request to immediately withdraw the WaterSense Notification of Intent to Develop Efficiency and Performance Specifications For Residential Cation Exchange Water Softeners. We recommend EPA develop a broader framework for salt management and would be happy to work with you on this initiative.

Sincerely,



Tim Quinn
Executive Director
Association of California Water Agencies



Diane Van De Hei
Executive Director
Association of Metropolitan Water Agencies



Catherine Smith
Executive Director
California Association of
Sanitation Agencies

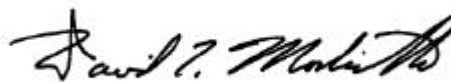

David Modisette
Executive Director
California Municipal Utilities Association

Anthony Pack
General Manager
Eastern Municipal Water Agencies

Thomas A. Love
General Manager
Inland Empire Utilities Agency

Joshua Rosenblatt

Joshua Rosenblatt
Regulatory and Environmental Analyst
Las Cruces Utilities

Jeff Mosher
Executive Director
National Water Research Institute

Barbara Biggs
Governmental Affairs Officer
Metro Wastewater Reclamation District

Thomas Donnelly
Executive Vice President
National Water Resources Association

Jonas Minton
Senior Water Policy Advisor
Planning and Conservation League

Philip L. Friess
Department Head, Technical Services
Sanitation Districts of Los Angeles County

John Pastore
Executive Director
Southern California Alliance of Publicly
Owned Treatment Works

Jeff Mosher
Administrative Director
Southern California Salinity Coalition

Richard Atwater
Executive Director
Southern California Water Committee

Ben Horenstein
Chair
Tri-TAC

Wade Miller
Executive Director
WaterReuse Association

Dave Smith
Managing Director
WaterReuse California

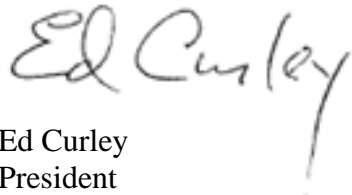

Ed Curley
President
Western Coalition of Arid States



John Rossi
General Manager
Western Municipal Water District

cc:

Jim Hanlon, Director, Office of Wastewater Management
Sheila Frace, Director, Municipal Support Division, Office of Wastewater
Management
Veronica Blette, WaterSense Program, Office of Wastewater Management

Attachment