

U.S. DEPARTMENT OF  
**ENERGY** | Energy Efficiency &  
Renewable Energy

**BUILDING  
TECHNOLOGIES  
PROGRAM**



# Lighting

Development, Adoption,  
and Compliance Guide



**Building Energy Codes**





# Lighting

Development, Adoption,  
and Compliance Guide

**BUILDING TECHNOLOGIES PROGRAM**

**September 2012**

Prepared for the U.S. Department of Energy under  
Contract DE-AC05-76RL01830 | PNNL-SA-90653

# Table of Contents

<b>Introduction and Acronyms</b> .....	IV
<b>1 Energy Code Origins, Development, and Adoption</b> .....	1
1.1 The Purpose of Building Energy Codes.....	1
1.2 Baseline Building Energy Code Origins and Development .....	2
1.3 Future Code and Standard Development.....	4
1.4 Lighting Power Density Limit Development .....	5
1.5 Building Energy Code Adoption.....	6
<b>2 ENERGY CODE COMPLIANCE/INSPECTION AND THE DESIGN PROCESS</b> .....	7
2.1 Working with Codes, Building Officials and Design Criteria .....	7
2.2 Compliance Coordination with the Building Design Process .....	8
2.3 Compliance Verification and Documentation.....	10
<b>3 LIGHTING CONTROL REQUIREMENTS</b> .....	11
3.1 Daylighting and Controls .....	11
3.1.1 Toplighting .....	11
3.1.2 Sidelighting .....	16
3.2 Interior Lighting Controls .....	20
3.2.1 Manual Controls .....	20
3.2.2 Lighting Reduction Controls .....	20
3.2.3 Automatic Lighting Shutoff Controls .....	22
3.2.4 Occupancy Controls.....	23
3.2.5 Additional Lighting Controls.....	24
3.3 Exterior Lighting Controls.....	24
3.3.1 Dusk to Dawn Controls.....	25
3.3.2 Lighting Power Reduction Controls .....	25
3.3.3 Parking Garage Controls.....	26
<b>4 LIGHTING POWER LIMITS</b> .....	28
4.1 Interior Lighting Power Density .....	28
4.2 Exterior Lighting Power Limits.....	31
<b>5 REQUIREMENTS FOR ALTERATIONS</b> .....	33
5.1 Code/Standard Application Examples .....	34
<b>6 COMPLIANCE BY ENERGY MODEL</b> .....	36
6.1 Addressing Credit for Lighting Control Use.....	36
<b>7 FUNCTIONAL TESTING</b> .....	38
<b>8 REFERENCES</b> .....	39







## Introduction and Acronyms

The design and implementation of lighting for buildings has many elements that must be coordinated in order to achieve quality lighting for the occupants and their intended use of the space.

Working to also maximize energy savings further complicates the process and introduces the need for compliance with energy code and standard requirements.

Striving to meet each of these needs creates a challenge for the building owner or designated lighting designer. This guide provides information for anyone dealing with a *lighting* energy code

or standard. It provides background and development information to help readers understand the basis for requirements and their intent. The guide also provides detailed explanations of the major types of requirements such that users can more effectively design to meet compliance while applying the most flexibility possible.

AF	area factor
ANSI	American National Standards Institute
ASHRAE	American Society of Heating, Refrigerating and Air-Conditioning Engineers
BCAP	Building Codes Assistance Project
BECP	U.S. Department of Energy, Building Energy Codes Program
CABO	Council of American Building Officials
CU	coefficient of utilization
DOE	U.S. Department of Energy
ECPA	Energy Conservation and Production Act
EPAct	Energy Policy Act of 2005
fc	foot-candles
HID	high-intensity discharge (lamps)
HVAC	heating, ventilation, and air conditioning

ICC	International Code Council
IECC	International Energy Conservation Code
IES	Illuminating Engineering Society
LDD	luminaire dirt depreciation
LE	luminous efficacy
LED	light-emitting diode
LLD	lamp lumen depreciation
LLF	light loss factors
LPD	lighting power density
RCR	room cavity ratio
RSDD	room surface dirt depreciation
SHGC	solar heat gain coefficient
VLT	visible light transmittance

# 1.0 Energy Code Origins, Development, and Adoption

## 1.1 THE PURPOSE OF BUILDING ENERGY CODES

Buildings have a fundamental impact on people's lives, affecting their home, work, and leisure environments. In the United States, residential and commercial buildings together use more energy and emit more carbon dioxide than either the industrial or the transportation sector.

Fundamental environmental issues, as well as the increasing cost of energy, has elevated building energy efficiency to a key component of sound public policy. While choosing less energy-efficient methods or materials may save money in the short term, it increases energy costs far into the future. The potential long-term impacts of our choices result in a unique role for government in setting and ensuring compliance with building codes and standards, promoting

improvements, and collecting and disseminating information on new technologies and best practices.

**Building energy codes and standards set minimum requirements for energy-efficient design and construction of new buildings as well as additions and renovations of existing buildings that impact energy use and emissions for the life of the building.<sup>1</sup>**

They are part of the overall set of building codes (structural, electrical, plumbing, etc.), that govern the design and construction of buildings. Building energy codes set a baseline for energy efficiency in new construction through energy use limits and control requirements.

Improving building energy codes generates consistent and long-lasting energy savings. Buildings last a long time, and an energy-efficient building can save energy throughout its lifespan. The benefits of more efficient construction today are enjoyed for 30–50 years.

**Energy-efficient buildings offer both tangible and intangible energy, economic, and environmental benefits.**

- Energy-efficient buildings are more comfortable and cost effective.
- Lower energy expenditures often correlate with a reduced dependency on foreign oil, which impacts national security.
- Studies show a significant correlation in building energy use and environmental pollutants.

- Energy-efficient buildings can create economic opportunities for business and industry by promoting new energy-efficient technologies.
- While the marketplace does not guarantee energy-efficient design and construction, studies on operating costs and resale of commercial spaces built to higher energy efficiencies indicate direct savings to building owners and occupants and financial benefits to building owners.



<sup>1</sup> The term "building energy codes" as used in this document includes model energy codes and standards developed in the private sector. These model energy codes and standards are a baseline for energy efficiency in new and certain existing buildings.

## Building Energy Codes and Lighting Quality

While the main purpose of building energy codes and standards is to save energy, there is a need to ensure that the requirements put in place do not inhibit the quality of the building environment for the well being of its occupants. This is particularly true with building lighting because of the significant effect lighting can have on human function and capability.

Beginning with ANSI/ASHRAE/IES Standard 90.1-1999, lighting power densities (LPDs) have been developed using the light level recommendations of the Illuminating Engineering Society (IES) as well as the availability of high- efficiency equipment and the latest in researched lighting loss factors and lighting design principles. This helps ensure that LPD values in properly applied energy codes and standards will provide sufficient power to accommodate quality lighting in buildings.

Because building lighting is commonly considered one of the easiest energy uses in which to find energy savings, it is often targeted in building energy codes and standards when energy reductions are sought. However, unless corresponding changes in lighting design and equipment capability can be effectively applied, the reduction of LPD limits in energy codes and standards will cause the lighting quality in a space to suffer.

**Therefore, it is important for lighting energy code developers and the lighting design community to coordinate efforts to ensure that lighting energy codes continue to be energy effective and do not inhibit quality lighting design and implementation.**

## 1.2 BASELINE BUILDING ENERGY CODE ORIGINS AND DEVELOPMENT

The requirement for states to adopt and enforce a building energy code is a direct result of the Energy Conservation and Production Act (ECPA) as amended by the Energy Policy Act of 2005 (EPAct). The legislation calls for the U.S. Department of Energy to make a determination of the energy efficiency level of new building energy standard versions (currently for versions of ASHRAE Standard 90.1). Based on this determination, the legislation then typically sets that new building energy standard version as the level of stringency that states must meet. This, in part, drives the development of building energy codes.

Initial development of commercial building energy codes began with the American Society of Heating, Refrigerating, and Air-Conditioning Engineers' (ASHRAE's) development of ASHRAE Standards 90-1975 and

90A-1980 with involvement of the IES in the lighting requirements. These requirements were based directly on IES LEM-1<sup>2</sup> which provided watts-per-square-foot limits for individual space types based on IES illuminance recommendations. These early standards required the calculation of the room cavity ratio (RCR) values for each space type and was further based on the simplified lumen method which provided the mathematical relationship between illuminance and energy use.<sup>3</sup> Neither ASHRAE Standard 90-75 nor Standard 90A-1980 included whole-building LPD values—each provided only individual space-type values. In the 1980s ASHRAE began to develop ASHRAE Standard 90.1-1989 as the latest commercial energy code. This standard included LPD values developed with a goal to simplify the process of calculating allowed wattage. The final ASHRAE Standard 90.1-1989 included space-type LPDs based on the then-current IES illuminance

<sup>2</sup> IES—Illuminating Engineering Society. Recommended Procedure for Determining Interior and Exterior Lighting Power Allowances. IES LEM-1, Illuminating Engineering Society, New York.

<sup>3</sup> Lumen method—a calculation assuming a uniform layout of luminaires to provide the average horizontal illuminance at the work plane.





recommendations and required the calculation of an area factor (AF) modifier based on ceiling height and area that mimicked the effect of an actual RCR.

The 1989 edition also included selected whole-building LPD values, providing one LPD value for an entire building for six different size categories but only a limited set of 11 building types. These values were not developed with any direct

relation to the calculated space-type values. Instead, they were developed primarily from case studies, limited building audit data, and committee consensus.

The 1999 edition of ASHRAE Standard 90.1 introduced a new method of LPD development based on individual space-type models using the lumen method formula for relating illuminance and energy use.

These models incorporate realistic space-type design input such as internationally recognized light level recommendations from IES, current lighting equipment efficiency characteristics, and common design practice. This edition also included an expanded set of whole-building LPDs based directly on the calculated space type LPD values and real building space-type square footage data from a database of current building projects.<sup>4</sup> Since the 1999 edition, 2001, 2004, 2007, and 2010 edition LPDs have been produced using the same basic methodology adopted for ASHRAE Standard 90.1-1999 but with periodic updates to the space-type models. The updates are triggered when inputs to the space-type models change, such as IES recommendations or improved equipment efficiency.

ASHRAE Standard 90.1 is developed by ASHRAE and the IES using a consensus process that meets American National Standards Institute (ANSI) requirements

for a balance of interests and open process. This means that the development committee is required to represent a cross-section of interests. It also means that interested parties including designers, code officials, builders and contractors, building owners and operators, manufacturers, utilities, and energy advocacy groups can participate by addressing the 90.1 project committee during deliberations, participating in subcommittees, or commenting during the public review process. The 90.1 project committee develops and finalizes the standard, which then receives additional approvals from ASHRAE Standards Committee and the Board of Directors. These approvals help ensure that appropriate process procedures, including those associated with ANSI, were followed.

<sup>4</sup> The National Commercial Construction Characteristics (NC3) Dataset. *National Commercial Construction Characteristics and Compliance with Building Energy Codes: 1999-2007*. American Council for an Energy Efficient Economy 2008 #250.

**Before adopting ASHRAE Standard 90.1, state and local governments can make changes to reflect regional building practices or state-specific energy-efficiency goals.**

The International Code Council (ICC) also develops and publishes model building energy codes that are available for state and local governments to adopt. Their most recent publication is the 2012 International Energy Conservation Code (IECC), which covers both residential and commercial buildings. The provisions therein for commercial buildings reference ASHRAE Standard 90.1-2010 as an alternative path to compliance with the model code.

All ICC model codes are developed through a governmental consensus process. Any interested party can submit code change proposals and public comments and testify at public hearings but the final decision on what is approved and therefore contained in the next edition of the IECC and other ICC model codes is made by ICC governmental

members employed by federal, state, or local government.

The first edition of the IECC was published in 1998. Prior to that, the Council of American Building Officials (CABO), which was comprised of the three legacy organizations that merged to form the ICC, published the Model Energy Code from 1982 until 1995. The first model building energy code was published in 1977 by the three legacy organizations and the National Conference of States on Building Codes and Standards and was based on ASHRAE Standard 90-75.

Where states do not adopt a model energy code or standard with or without amendment, they are likely to develop their own building energy code based in part on criteria in these documents. California Title 24 is one long-standing example of development and maintenance of a state energy code by a state without reference to or adoption of a model energy code or standard.

**Both the IECC and ASHRAE Standard 90.1 are revised and offered for use on a three-year cycle.**

**1.3 FUTURE CODE AND STANDARD DEVELOPMENT**

The future development of requirements for building lighting will depend on energy advocacy, industry trends, and user involvement in the process. The LPDs have generally hit a stable point where revisions will only be prompted by significant changes in design principles, accepted light level recommendations, and lighting technology. The current focus is on controls where large savings are possible and the technology has advanced to make control requirements generally cost effective and reasonable to implement.

Daylighting as one of the lighting controls is relatively new to codes and standards and will likely continue to be refined and required in more applications as users become more familiar with the nuances of its

effective use. Code and standard development to support good daylighting for energy savings is also likely to explore basic design requirements such as window sizing and location to support maximum daylighting capability.

There is also increasing interest in outcome-based type requirements that look at the buildings actual (future) energy use as a compliance target. This type of requirement initially appears simple and straightforward but involves much work on target development as well as future compliance infrastructure. Future compliance is also of interest with respect to code and standard application beyond building occupancy such that energy savings can continue through possible requirements for future commissioning and updates.





## Details on Model Calculations

The LPD calculation basis is a restructuring of the lumen method that provides the energy needed to provide the required light levels and quality design elements in a space according to the following basic formula:

$$LPD = \frac{fc_1}{TF_1} + \frac{fc_2}{TF_2} + \frac{fc_3}{TF_3}$$

where

**LPD** = lighting power density in watts per square foot

**fc<sub>1</sub>, fc<sub>2</sub>, fc<sub>3</sub>** = the illuminance in foot-candles or lumens per square foot that is assigned to be provided by each of up to three luminaires in the space. These are currently calculated as percent foot-candles (for each luminaire) times the total average weighted foot-candles for the space.

**TF<sub>1</sub>, TF<sub>2</sub>, + TF<sub>3</sub>** = the overall light output effectiveness of the light source that is based on light source luminous efficacy (LE), fixture coefficient of utilization (CU), and light loss factors (LLF) [lamp lumen depreciation (LLD), luminaire dirt depreciation (LDD), room surface dirt depreciation (RSDD)] as follows:

$$TF = LE \times CU \times LLD \times LDD \times RSDD.$$

## 1.4 LIGHTING POWER DENSITY LIMIT DEVELOPMENT

Lighting power density limits are a major part of all current building energy codes. They set maximums for installed power over a defined area expressed in watts per square foot (W/ft<sup>2</sup>) and known as the lighting power density (LPD). Since the 1990s the LPD values have predominately been developed within the committee responsible for updating and maintaining ASHRAE Standard 90.1.

The LPD limit values found in energy codes are typically based on a space-type lighting model system incorporating currently available lighting product characteristics, light loss factors, building construction data, and professional design experience to calculate appropriate values for each building space type.

**The calculation model for each space type incorporates four basic input elements.**

- The first element is manufacturer-supplied typical

CU values for each representative luminaire type that is commonly used in current lighting design.

- The second element is the use of typical LLFs and lamp efficacies associated with efficient luminaire and lamp product categories.
- A third element is the IES recommended light level data available from the Lighting Handbook<sup>5</sup>. These values provide the basis for making sure that the standard does not promote energy efficiency at the expense of internationally accepted lighting levels. They also make sure that the calculation of the power needed to provide the required lighting in the space incorporates all primary effects on light delivery.
- The fourth element is the application of professional lighting design consensus that makes sure the LPDs are based on real design experience, and apply energy-efficient equipment in achieving lighting quality and occupant comfort.

<sup>5</sup> The Lighting Handbook, 10th edition, 2011, Illuminating Engineering Society, New York, NY

A detailed examination of this basic process is available for review on the IES website at: <http://lpd.ies.org/cgi-bin/lpd/lpdhome.pl>.

**Current LPD development applied to ASHRAE Standard 90.1-2010 also includes further updates to the process and development including:**

- More precise modeling adjusted based on specific design modeling
- Inclusion of an RCR adjustment for spaces with difficult or unusual geometries.

## 1.5 BUILDING ENERGY CODE ADOPTION

Building energy codes are generally adopted at the state level through legislation or regulation. In the latter situation legislation has likely given a regulatory authority the responsibility for code development and adoption with possible oversight by the legislature. The state adoption is generally mandatory statewide but can also be a minimum adoption (e.g., local government can increase stringency) or only applicable in certain jurisdictions (e.g., only where the locality specifically adopts the code). Adoption at the state level with the least scope of coverage is for state-owned or funded buildings. Where buildings may not be addressed by a state adoption, local government has the freedom to adopt (or not) a code through legislation or regulatory rulemaking. In most cases state and local government adopting building energy codes for commercial buildings adopt ASHRAE Standard 90.1 either directly or by reference



through the adoption of the IECC. Adoption can be with or without amendments to these documents and in some cases the adoption is automatic because the enabling legislation or regulations will refer to “the latest edition” in their laws or regulations. Most state and local governments adopting building energy codes are generally 2 to 3 years “behind” the latest published edition of a model energy code or standard.

For more detailed information on the building energy code adopted in each state and the process by which codes are adopted, consult: [www.energycodes.gov](http://www.energycodes.gov)  
[www.iccsafe.org](http://www.iccsafe.org)  
[www.energycodesocrean.org](http://www.energycodesocrean.org)  
[www.reedconstructiondata.com](http://www.reedconstructiondata.com).



## 2.0 Energy Codes Compliance/Inspection and the Design Process

Energy code requirements are beginning to demand more from lighting practitioners through expanded compliance considerations—from installed load to multiple control components within the lighting system. It is extremely important to understand early in the design process what the requirements are for all of the facets of the lighting system so that decisions can be made from the start to meet the code.

### 2.1 WORKING WITH CODES, BUILDING OFFICIALS, AND DESIGN CRITERIA

The code compliance process should begin even before the initial design work is considered. The code requirements will depend on the location of the building (state or local jurisdiction), which determines which energy code is applicable. Corporate specifications may exceed the energy code adopted by a state or municipality. In other cases, corporate specifications may be at odds with mandated energy codes. In either case, it is important for the building team and lighting designer to understand any

conflicts to help prevent delays later in the design process. In addition, building owners may be interested in beyond-code opportunities. In these cases, both the energy code requirements and the beyond-code opportunities need to be integrated to enhance building performance potential.

**Critical to the design and code compliance process is working with the building official and owner or corporate representatives to resolve conflicts early.**



Most building officials are looking for reasonable solutions to tough applications that will meet the intent of the energy code and provide reasonable design flexibility for the building owner and contractor. Approaching a building official with clear identification of the issues and a reasonable solution will go a long way toward successful code compliance with minimal complications.

## 2.2 COMPLIANCE COORDINATION WITH THE BUILDING DESIGN PROCESS

Once the project is characterized and the applicable energy code and beyond-code programs (if applicable) are identified, coordination of compliance options with the design can begin. During this stage, the list of design considerations is developed. At the same time, the lighting practitioner should begin to review the system components that will be influenced by the code requirements.

**The design criteria need to be considered from a code compliance perspective, and the expectations of the lighting system need to be identified to accommodate both the lighting and code compliance needs of the building.**

Designers unfamiliar with the applicable code would be wise in this phase to become familiar with the code and its compliance options. Multiple resources can provide assistance with understanding code adoption and compliance, including

nationally available code assistance programs [DOE's Building Energy Codes Program (BECP) and the Building Codes Assistance Project (BCAP)], local building departments, and model code and standard developers (ICC, ASHRAE, IES).

Once the design and code compliance needs are identified, a preliminary lighting layout is developed and some basic calculations, mockups, or computer-aided models are completed. The code compliance path for the LPD limits for a given project (either space-by-space, whole building, or performance) may not be known or identified before design work begins. In many cases, the compliance path will be determined from experience or application of multiple options to determine the best fit. It is also important to coordinate compliance paths and any interactive effects the lighting design or contractor may have [daylighting architecture, heating, ventilation, and air conditioning (HVAC)] with other members of the design team.



Regardless of the compliance path, certain lighting system characteristics will need to be addressed. Lighting power densities are the most basic indicator for the lighting energy use, and proposed designs should be well documented so that watts per square foot can be easily and frequently determined for each design iteration.

Many energy codes and beyond-code programs require that the lighting system include daylighting controls. This requirement relies on the actual daylighting potential of the space based on building design

elements such as size, skylight area, window orientation and shading, and furniture layout. As soon as these elements are identified, compliance needs regarding daylighting controls can be determined.





For these controls requirements, it must first be determined whether daylighting integration is required (e.g., requirements to install skylights in a space); then lighting controls—including controls responsive to available daylight—must be considered. There are, of course, many possibilities for controlling the lighting in any given space. Often minimum control requirements will have more than one compliance option to provide design flexibility so that the needs of the building occupants can be considered in addition to the energy code requirements. Some above-code and green-code programs also have requirements for the capability of daylighting and views for building spaces. These should not be confused with the actual energy code daylighting controls requirements.

As the design transitions from the design development phase to the construction document phase, the lighting system becomes increasingly refined.

Basic calculations performed during preliminary design stages need to be re-computed as a finalized design takes shape.

As space types and characteristics are finalized, the various allowances and exemptions need to be carefully considered—particularly if using the space-by-space method—to achieve the maximum LPD allowance for design flexibility.

**Advanced control credits may be available and applicable that can also provide designers with increased power allowances if lighting controls superior to the minimum requirements are applied, or if certain strategies are incorporated.**

**Lighting controls are determined according to the space type of function; therefore it is important to understand space classifications and lighting uses so the appropriate controls can be implemented.**

All lighting controls features need to be well documented as the project transitions into the contract documents phase. Forms for energy compliance need to be completed prior to electrical permitting.

Once construction begins, the lighting practitioner's focus shifts from design to implementation. The appropriate equipment must be installed to achieve the necessary light and energy levels that were calculated and documented during the compliance determination phase. This stage is called compliance verification and is essentially the process in which the building owner or designee ensures that the lighting system is installed as specified and the lighting controls are commissioned and functioning properly.

**A final phase in a successful design implementation is post-occupancy evaluation, which typically occurs after code compliance has been verified, and as such is often skipped.**

However, it is in the best interest of building owners to incorporate this important phase into the design process to understand the successes and shortcomings of a given lighting design.

**There are many ways to achieve code compliance, and a successful design and its implementation should not ignore this final step.**

While this phase is not required by code, closing the loop on the design and implementation can increase user acceptance and can lead to many more successful and energy-efficient designs.

## 2.3 COMPLIANCE VERIFICATION AND DOCUMENTATION

Compliance with energy codes and standards is the primary responsibility of the building owner or designee such as the architect, designer, or engineer. Verification of compliance is commonly completed by the state or local building official. Some jurisdictions may contract energy code compliance support and verification to others with specific experience. In either case the requirements will be based on the code or standard that has been adopted by the state or local jurisdiction.

**Enforcement strategies will vary according to a state or local government's regulatory authority, resources, and manpower and may include all or some of the following activities:**

- Review of plans
- Review of products, materials, and equipment specifications

- Review of tests, certification reports, and product listings
- Review of supporting calculations
- Inspection of the building and its systems during construction
- Evaluation of materials substituted in the field
- Inspection immediately prior to occupancy, with verification of functional testing of lighting control systems.

Plan reviews are a first important step in documenting compliance and are typically also tied to the issuance of a building permit. The submitted plans can also serve as a verification schedule for the building official at the time of inspections. The format of field inspections for lighting energy code requirements will vary among jurisdictions but will likely follow the format for other code-related inspections such as for structural, electrical, and plumbing installation. The field inspections will commonly involve physical calculation of LPD as well as verification of control installation and functionality.

Final documentation of code compliance can come in different formats but is commonly completed as paper forms or a software printout that is typically accompanied by the initial plan review. The ASHRAE Standard 90.1 User's Manual provides a set of forms for compliance, including lighting requirements. Many jurisdictions have developed formats for showing compliance with the IECC. A common method of compliance documentation and accounting is the use of software that provides for construction inputs, which it uses to calculate compliance values and report the status of compliance. One such software product is the COMcheck™ tool developed by BECP ([www.energycodes.gov](http://www.energycodes.gov)). This tool supports compliance to a variety of versions of publicly available energy codes and standards (ASHRAE Standard 90.1 and the IECC) as well as some variations of these developed by states and local jurisdictions.

**It is important to remember that the building official is typically the final authority for interpreting the adopted code, verifying compliance, approving plans, and issuing the certificate of occupancy.**

When potential compliance issues arise, it is often very useful to communicate early with the building official to find a reasonable solution or compromise that is practical and meets the intent of the building energy code or standard compliance.





# 3.0 Lighting Control Requirements\*

## 3.1 DAYLIGHTING AND CONTROLS

Daylighting is a means of bringing natural light into a space to provide comfort and a connection to the outdoors. It has many benefits, including the ability to provide a better indoor environment as well as save energy by replacing electric lighting.

Studies indicate that daylighting can improve worker productivity in office buildings and student performance at schools, and it certainly provides a more natural lighted environment that is generally preferred by most occupants.

There are two ways to bring light into a space: from the top through a roof or ceiling or from the side through windows. Building energy codes generally refer to bringing daylight into a space from the

top as *toplighting* and from the side as *sidelighting*. Bringing light through the top typically provides a more even distribution of light than bringing light in from the side, where light levels drop with distance from the window wall.

### 3.1.1 TOPLIGHTING

To implement toplighting, a space must have roof access. Skylights are the simplest form of toplighting. A more complex way includes the use of roof monitors (also known as saw-tooth roof) with vertical glazing. Energy codes have begun requiring skylight installation in large spaces such as those typically found in warehouses, retail stores, and school gymnasiums. In spaces with tall ceilings, skylights can light a large portion of the floor area, allowing electric lighting to be turned off or down to save energy. Energy codes typically require automatic control or minimum manual control of general lighting in areas where daylighting is available.



\* Building energy code requirements change over time to meet newer federal requirements and address energy efficiency goals through revisions to the available codes and standards and their subsequent adoption by state and local jurisdictions. The guidance in this document is intended to be as broadly applicable as possible yet specific enough to provide practical application. To be most useful, the guidance is based on the current versions of the commonly available ASHRAE Standard 90.1-2010 and the 2012 IECC.

## DAYLIGHT AREA

To determine which lights will be required to be dimmed in response to daylighting, a *daylight area* must be established.

ASHRAE 90.1 defines the daylight area from skylights as the floor area directly underneath the skylight opening plus the floor area horizontally in each direction for a distance of 0.7 times the ceiling height beyond the edge of the skylight.

Daylighting only needs to be supplied from one source; overlapping daylight in an area (i.e., skylight plus sidelighting) is only counted once and typically controlled by one system. Also, partitions above a certain height are considered obstructions and bound the effective daylight area.

**Figure 3.1** illustrates how the skylight requirements are interpreted under different space layouts according to the requirements in ASHRAE 90.1.

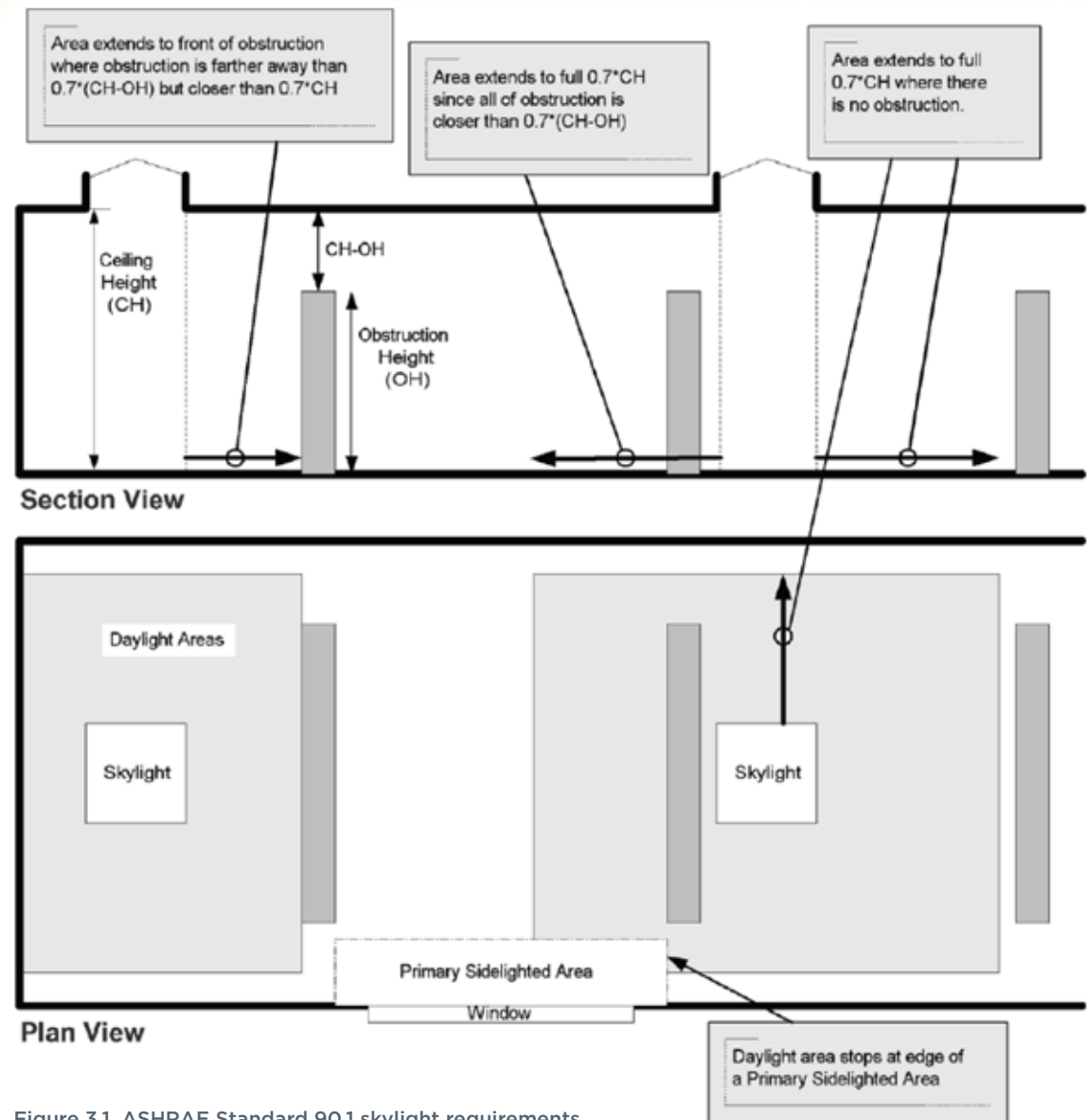
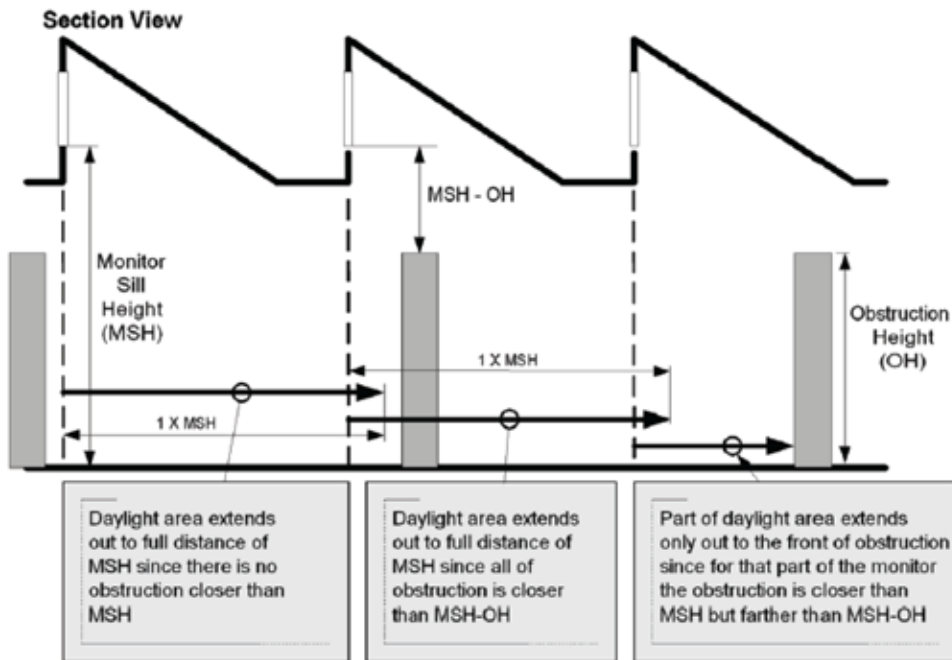

Figure 3.1. ASHRAE Standard 90.1 skylight requirements



**Figure 3.2** illustrates the daylight area interpretations for roof monitors. The IECC has a slightly different definition for daylight area under skylights with the added horizontal width under the skylights being equal to the floor-to-ceiling height. It is important to note that different versions of all energy codes will show some variance so it is important to check the specific code being applied to the project to get the exact requirements.

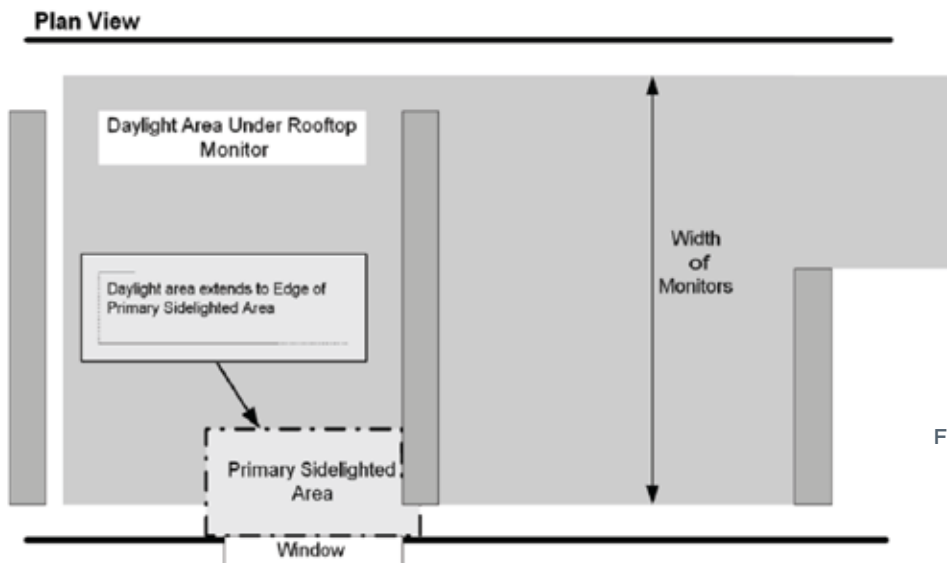

Figure 3.2. Daylight area interpretations for roof monitors



## CONTROLS

The availability of daylight allows electric lighting to be either turned off or turned down depending upon how much daylight is available, which then saves energy and reduces cooling loads.

To harvest the energy-saving potential of daylighting, energy codes require general electric lighting in the daylight area to be controlled by manual or automatic daylighting controls.

General lighting refers to lights that are used to provide uniform illumination within the space. Decorative or task lights are not typically included under general lighting for the purpose of daylighting controls.

Daylighting controls can be of two types: manual or automatic. ASHRAE Standard 90.1 requires automatic controls, whereas the 2012 IECC provides an option of either manual or automatic control. Automatic daylight controls can be either continuous dimming or stepped. Continuous dimming controls provide a finer control over light output and can also result in a smooth output level change when the daylight level changes suddenly. Stepped dimming controls are less expensive, do not offer as smooth a transition as continuous dimming systems, and commonly save slightly less energy compared to continuous dimming.

ASHRAE Standard 90.1 has different control requirements for toplighting and sidelighting. It also requires the toplighting daylight area to be greater than 900 ft<sup>2</sup> before daylighting controls are required. The 2012 IECC does not distinguish between toplighting controls and sidelighting controls. Moreover, it does not place a threshold on the minimum daylight area required to have daylight capability controls.



# Daylighting Controls and How They Work

**Daylighting controls** are based on the use of photocells that sense the amount of light reflecting off a daylighted surface or the intensity of light coming through an opening such as a window. A photocell sends a signal to a controller indicating the light level in the space. The controller adjusts the electric lighting output through direct dimming or switching that may involve dimming ballasts or drivers. The photocell and controller must be calibrated to desired illuminance levels prior to use.

For example, in a school gym, an illuminance level of 30 footcandles (fc) may be required at the floor level. The daylight dimming system must be calibrated such that when 15 fc of daylight is received at the floor level, light output of the overhead luminaires is reduced by half by the daylight dimming system. Calibration and commissioning of the dimming system is crucial for it to work as intended.

**Daylight responsive controls** work best when they are integrated into the lighting and luminaire design of the space. If the daylight area does not encompass the entire space, then the luminaires in the daylight area must be placed on a separate circuit for individual control. In sidelighted spaces, where the amount of daylight decreases with distance from the window, rows of luminaires parallel to the windows should be controlled separately. Some new daylight responsive control systems integrate the photocell, dimming ballast, and control into a single luminaire. This allows great flexibility in adjusting the light output of individual luminaires within a space.



### 3.1.2 SIDELIGHTING

Sidelighting refers to bringing daylight into a space through vertical fenestration (windows). As light travels deeper into the space from the perimeter, it is absorbed or blocked by the floor, ceiling, furniture, and partitions in the space. As a result, the total light level decreases for areas farther away from the windows. Window characteristics influence how deeply daylighting can effectively travel into a space.

These characteristics include the amount of window area on the perimeter wall, the height of the top edge of the window, and visible light transmittance (VLT) of the glass.

Energy codes rely on these parameters to predict the daylighting potential in a space and based on those parameters ensure the building is able to effectively use available daylighting.

### DAYLIGHT AREA

There is much debate about how much floor area can be daylighted using sidelighting. Placing windows higher on the wall allows daylight to penetrate more deeply into the space. Thus, a greater proportion of the space can be daylighted and more electric lighting can be turned down for increased energy savings. However, there are practical limits on how high windows can be placed on a wall, as well as the limit of VLT through glass products. The space type as well as ceiling height and construction cost usually limit the heights of windows. Also, the solar heat gain coefficient (SHGC) values for glass are strongly related to the VLT of the glass and are specific to climate zones and regulated by energy codes. Therefore, the VLT is indirectly regulated by code. Accordingly, the area that is required to be daylighted using sidelighting is specifically addressed in building energy codes and standards.

Both ASHRAE Standard 90.1 and the IECC provide clear definitions for daylight area from sidelighting but each definition is slightly different in each document.

Under ASHRAE Standard 90.1, the primary sidelighted area is the floor area adjacent to the window and is equal to the product of the width of sidelighting window plus 2 feet on both sides and the window head height. Vertical obstructions taller

than 5 feet also bound the primary sidelighted area along both the width and the depth.

**Figures 3.3 and 3.4** illustrate the primary and secondary sidelighted area calculations in ASHRAE Standard 90.1.





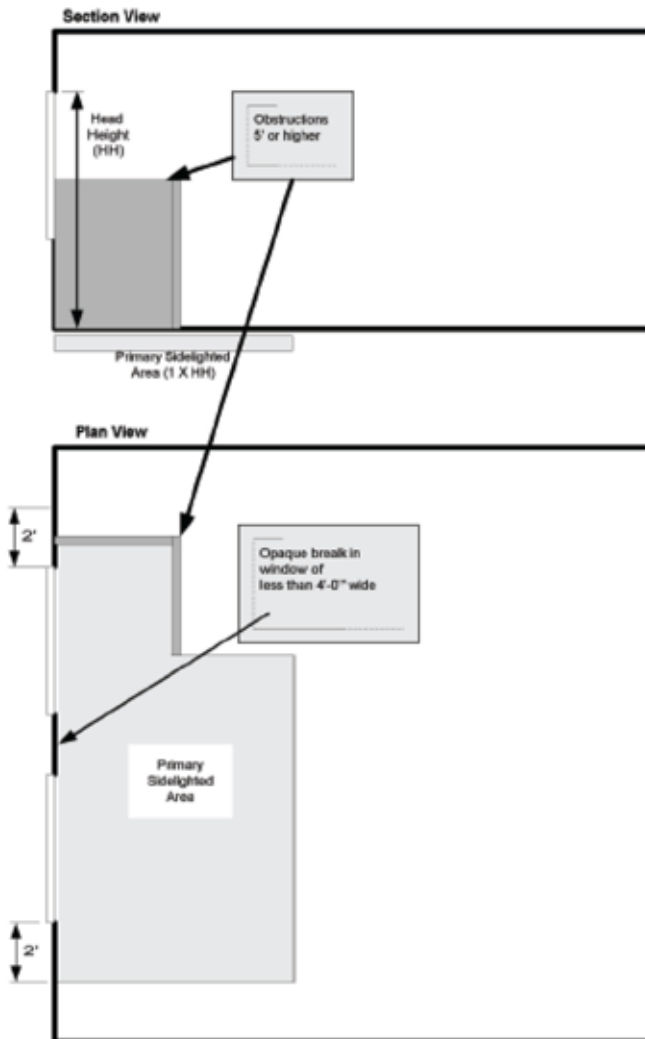

Figure 3.3. Primary sidelighted area calculations based on ASHRAE Standard 90.1

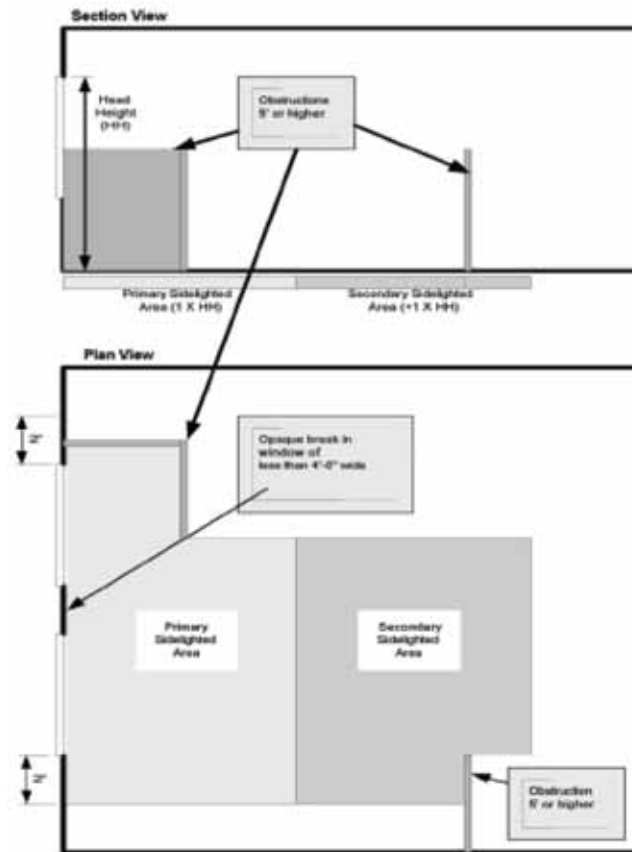

Figure 3.4. Secondary sidelighted area calculations based on ASHRAE Standard 90.1

## CONTROLS

Like the toplighted daylight areas, the sidelighted daylight areas need to be separately controlled by automatic control devices. As mentioned in Section 3.1.1, these controls can be either stepped or continuous dimming.

ASHRAE Standard 90.1, requires other criteria to be met before daylighting controls are required. One such requirement is that of effective aperture. Effective aperture is a term used to characterize the relationship between the window area, its location on the perimeter wall, and its ability to daylight a space. Here again, the definition of effective aperture varies from one standard to the other. Under ASHRAE Standard 90.1, daylighting controls are only required in those spaces where the effective aperture is greater than 0.1 (10%). The IECC has no requirement for a minimum effective aperture.

ASHRAE Standard 90.1 requires automatic daylight responsive controls but only when the daylight area from sidelighting is more than 250 ft<sup>2</sup>. The IECC only requires that general lighting in daylight areas have separate manual controls.

## Effective Sidelighting

**Figure 3.5** illustrates a typical sidelighting design that will meet the minimum requirements of ASHRAE/IES 90.1-2010. In this space, the window provides both view and daylighting. The graph overlay shows the rapid reduction in light level with increasing distance from the window. In these conditions the luminaire next to the window, which provides general lighting in the sidelighted area, must be controlled in response to the daylight. Based on input from a photocell, the controller can either lower the output of all three lamps in a continuous dimming strategy or shut off individual lamps successively for stepped dimming control. All three luminaires within the space are also controlled by a wall switch. This example shows how controls can be applied to meet minimum code requirements. Careful design can, however, lead to better daylighting and more savings while also meeting code.

**Figures 3.5 and 3.6** show the same space but Figure 3.6 shows expanded daylighting controls and design strategies.

First, the function of daylighting is separated from the function of providing view. The bottom window now provides view, while the top window provides daylighting. By placing the daylight window higher in the perimeter wall, daylight can penetrate deeper into the space. The view window is allowed to have user-controlled blinds, with the daylighting window providing daylight capability, even when the blinds on the view window are closed for privacy. Exterior and interior lightshelves are placed at the bottom end of the daylighting window. In the summer months, the exterior lightshelf redirects sunlight from high sun angles into the space, while also providing shade for the view window. In winter months, the interior lightshelf redirects sunlight from low sun angles deeper into the space and provides protection from direct sunlight or glare.

The combination of high daylight windows with interior and exterior lightshelves provides a more even distribution of light levels in the space. All three luminaires within the space must now be controlled to account for the increased daylight area. The controller is configured such that the light output of each of the three luminaires can be reduced independent of the others. Correctly calibrating the photocell and controller is crucial for this control strategy to work.

Once configured correctly, this space can provide much better quality of light all through the year, while delivering energy savings and meeting code requirements.

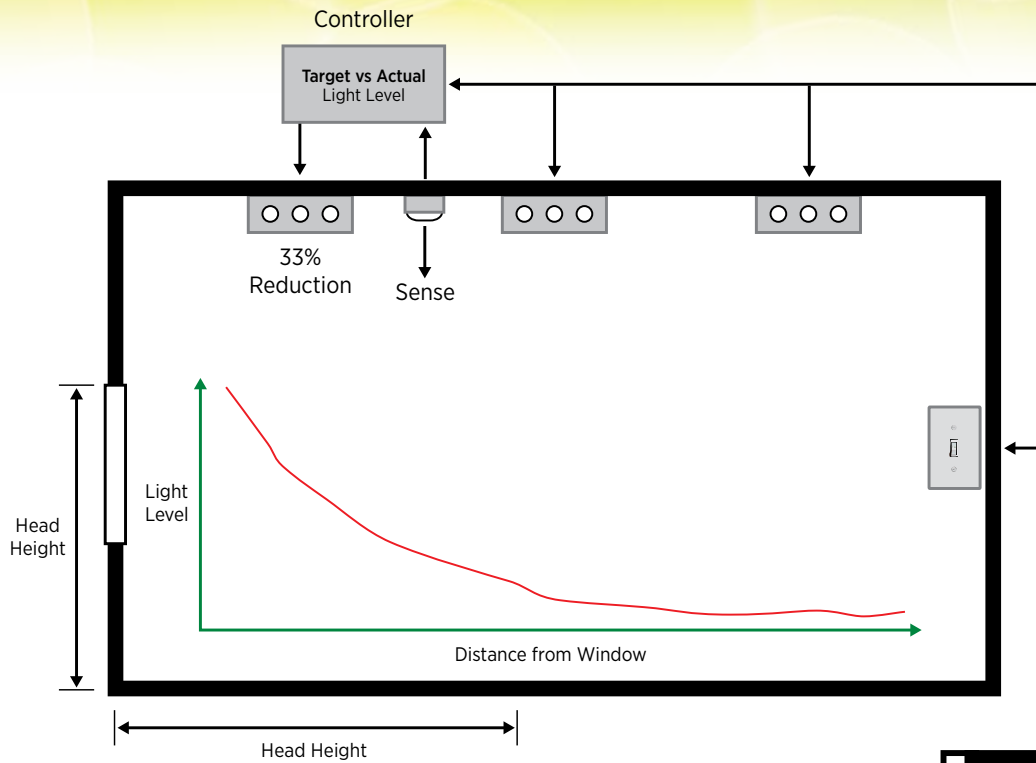
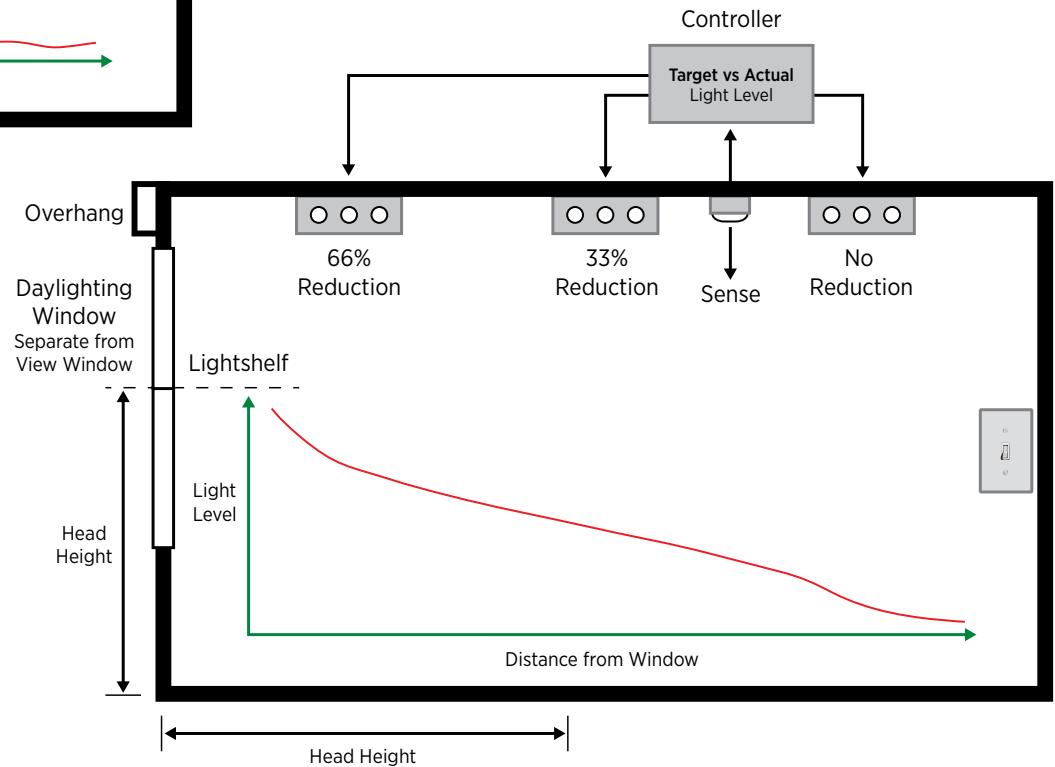

Figure 3.5. Daylighting controls meeting code minimum requirements for the sidelighted area

Figure 3.6. A more effectively sidelighted space. Note the increase (approximate) in light level with distance from the perimeter





## 3.2 INTERIOR LIGHTING CONTROLS

Interior lighting is one of the largest electricity energy end-uses in many commercial buildings. And controls can have a significant effect on their total use. Interior lighting controls give occupants control over the electric lighting in a space, and can be used to manage building lighting automatically. Effectively controlling the space lighting results not only in occupant comfort, but also in energy savings. Efficient lamps and light fixtures reduce the total installed lighting power, whereas controls generally reduce the amount of lighting used or the amount of time for which lighting is used. Lighting controls can be classified as those required across the entire building and those that must be applied space by space. The following sections describe the interior lighting controls required by building energy codes and standards.

### 3.2.1 MANUAL CONTROLS

The basic control provided in all spaces is a wall switch that allows occupants to turn general lighting on and off. This manual control device must be easily accessible and must be located such that the lights it controls are seen easily from the control location. Manual controls provide a minimum level of comfort for occupants. Manual control is not required in spaces such as corridors, stairwells, or other spaces where turning the lights off would be detrimental to egress and security. Lights in these spaces may be controlled separately using automatic controls, and lighting control requirements for these building areas are discussed in Section 3.2.3.

Under ASHRAE Standard 90.1, for spaces smaller than 10,000 ft<sup>2</sup>, one manual control device is required for every 2,500 ft<sup>2</sup>. For spaces larger than 10,000 ft<sup>2</sup>, one manual control device is required for every 10,000 ft<sup>2</sup>.

Manual controls are allowed to override automatic controls. For example, in an office building with a time-based operation schedule that turns off general lighting after 8 pm, cleaning staff that come in after 8 pm must be allowed to override the automatic control and turn on the lights using manual controls. However, the manual override is allowed to last for a maximum of 2 hours, after which automatic controls will again turn off the lights.

### 3.2.2 LIGHTING REDUCTION CONTROLS

Enclosed spaces with ceiling height partitions are good candidates for controlled reduction of lighting.

Providing occupants with the capability of reducing light levels manually can lead to energy savings and occupant comfort.

In ASHRAE Standard 90.1, the occupant must be able to reduce the lighting power to between 30% and 70% of full power using the manual control device. The IECC requires this stepped reduction to be lower than or equal to 50% of full power. Spaces such as corridors, stairways, electrical/mechanical rooms, public lobbies, restrooms, storage rooms, and sleeping units are exempted. Also exempted are spaces with only one luminaire with a rated power of less than 100 W and spaces with an LPD allowance of less than 0.6 W/ft<sup>2</sup>. The IECC exempts areas within spaces that are controlled either by an occupancy sensor or by daylighting controls.



## Lighting Power Reduction: Control Strategies

Many control strategies can be applied to reduce the light output of a lighting system. Figure 3.7 illustrates different control arrangements to reduce light levels from an array of luminaires in a space.

In **Figure 3.7.a**, the control switches off half of all the luminaires in the space, while keeping the other half on.

Another approach is shown in **Figure 3.7.b**, where dimming controls reduce the input power to individual lamps, reducing the light output. A third approach, shown in **Figure 3.7.c**, is to switch off alternate lamps between adjacent luminaires. All three strategies would qualify as lighting reduction controls.

a. Alternating Luminaires

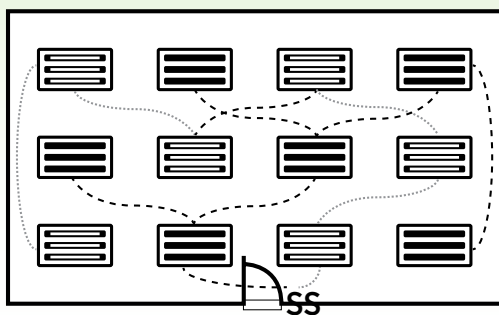

b. Dimming

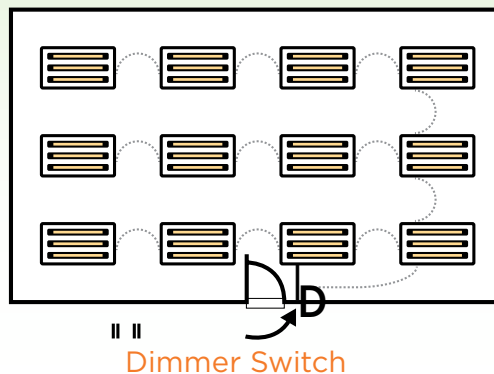

c. Alternating Lamps

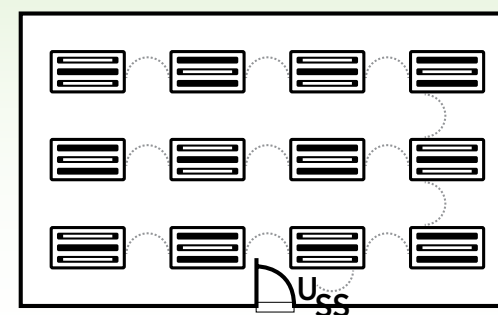

Figure 3.7. Control strategies for uniform light reduction

### 3.2.3 AUTOMATIC LIGHTING SHUTOFF CONTROLS

On/off controls and lighting reduction controls are manual controls that are needed in most spaces. However, these controls rely on occupants in order to obtain energy savings. There is no guarantee that these controls will save energy. When occupants are not present in a space and during the night, there is ample opportunity to turn lights off. Automatic lighting controls are required to control the lighting during these unoccupied periods. Automatic controls also guarantee energy savings from lighting.

Energy codes require that all building spaces be controlled by an automatic control device that shuts off general lighting. This control device must turn off lights in response to a time-based operation schedule, occupancy sensors that detect the absence of occupants, or a signal from the building's energy management system or some other system that indicates that the space is empty.

The automatic shutoff can be implemented by a single device or by multiple devices. For example, if the time-based operation schedule is used, a single control system can turn off the lighting in the entire building. If occupancy sensors are used to meet the requirement, then multiple sensors would be needed for different spaces within the building.

#### Certain spaces are exempted from the automatic shutoff control requirements.

Spaces that house 24-hour operations or where turning off lights would compromise security are exempted. Sleeping units and patient rooms are also exempted.

When a time-based operation schedule is used to control automatic shutoff, the controls must be able to use different schedules for every 25,000 ft<sup>2</sup> as well as for every floor in a building. If occupancy sensors are installed, they must turn all general lighting off no more than 30 minutes after the space becomes unoccupied. If occupancy sensors are used in a space, that space cannot have a separate automatic shutoff system. Occupancy sensors and their requirements are discussed in greater detail in Section 3.2.4.







### 3.2.4 OCCUPANCY CONTROLS

Occupancy sensors allow a more granular control of automatic lighting shutoff in buildings. They are typically based on sensing movement within a space.

With occupancy sensors, individual spaces can be controlled independently of each other. This allows the lights to be on at night in spaces such as lobbies that operate 24 hours per day, while lighting in other spaces in the building is turned off.

Apart from the greater flexibility, this also results in greater energy savings. Of course the extra savings come at the expense of more sensors, controllers, and wiring for the occupancy sensors.

#### Both IECC and ASHRAE Standard 90.1 require occupancy sensors in certain spaces.

ASHRAE Standard 90.1 requires occupancy sensors in classrooms, lecture halls, conference rooms, training rooms, lunch or break rooms, storage rooms between 50 ft<sup>2</sup> and 1,000 ft<sup>2</sup>, copy/print rooms, office spaces smaller than 250 ft<sup>2</sup>, restrooms, dressing rooms, locker rooms, and stairwells. IECC requires occupancy sensors in classrooms, conference rooms, lunch or break rooms, private offices, restrooms, storage rooms, and all other spaces smaller than 300 ft<sup>2</sup>. In these spaces, both documents require the occupancy sensor to turn off lights no more than 30 minutes after all occupants have left the space.

Most building energy codes also regulate the way occupancy sensors turn lights on. Lighting must be controlled such that when occupants enter a room where the lights have been turned off by occupancy sensors, the lights must be turned on manually, or they may be turned on automatically but only to 50% of full power.

By preventing the lights from coming on automatically, false turn-on of lighting is avoided. Turning the lights on to full power is allowed in public corridors, stairwells, restrooms, primary building entrances, and lobbies and in areas where manual-on operation is considered unsafe.





### 3.2.5 ADDITIONAL LIGHTING CONTROLS

Apart from general lighting within the building, energy codes require controls for other types of lighting.

Display, accent, and case lighting must be controlled using separate control devices. Similarly, lighting for nonvisual tasks such as food warming, plant growth, or lighting for demonstration purposes, must be controlled by separate control devices.

The control device must be capable of controlling these lighting types independently of the general lighting within the space. These requirements are part of both the IECC and ASHRAE Standard 90.1.

Guestrooms and suites in hotels and motels are required to have a master switch near the entry to the room that controls all permanently

installed luminaires and switched receptacles in the room except those in the bathroom. ASHRAE Standard 90.1 additionally requires automatic shutoff of bathroom lighting 60 minutes after motion is no longer detected. ASHRAE Standard 90.1 also requires task lighting, such as under-cabinet lights, to be controlled by a separate control device. This device must be accessible to the user and be either integral to the luminaire or located on a nearby wall or surface.

### 3.3 EXTERIOR LIGHTING CONTROLS

Exterior lighting includes lighting installed in parking lots, parking garages, building façades, walkways, entries, exits, canopies, and building grounds.

Exterior lighting may represent a significant portion of the building's total energy consumption.

Energy codes attempt to control exterior lighting consumption by regulating both the installed lighting power and the time for which the lights can be on. Each category of exterior lighting has specific limits on the power that can be installed. Similarly, separate control strategies are specified for the different categories of exterior lighting.

### 3.3.1 DUSK-TO-DAWN CONTROLS

For dusk-to-dawn lighting, all exterior lights must be turned off during the day.

This is achieved by using either astronomical time switches or photocell-based controls. Astronomical time switches work by storing or calculating the sunrise and sunset times for each day of the year. Photocell-based controls simply sense the exterior light level. Apart from astronomical time switches, ordinary schedule-based controllers can also be used for special purpose lighting. Building energy codes require all time-switch



controls to hold the programming and time settings for 10 hours in the event of a power loss.

ASHRAE Standard 90.1 simply requires all exterior lighting to be turned off during the day. The corresponding IECC requirement is more specific. Under the IECC, all lighting designated for dusk-to-dawn operation must be controlled by either an astronomical time switch or a photocell-based control. Lighting that is not intended to operate from dawn to dusk must be controlled by either a combination of a photocell-based control and a time switch or an astronomical time switch.

This type of lighting may be turned off any time during the night. For special cases, such as lighting for musical events, concerts, and sports events, the IECC requirement allows automatic turn-on and turn-off based on daylight availability as well as the event schedule.

### 3.3.2 LIGHTING POWER REDUCTION CONTROLS

The IECC has no requirements for reduction in exterior lighting power during operation. Under ASHRAE Standard 90.1, certain exterior lighting categories must reduce, and in some cases completely turn off, lighting in response to an operation schedule or actual occupancy. The following controls are required by ASHRAE Standard 90.1:

1. Building façade and landscape lighting is required to be shut off between midnight or business closing, whichever is later, and 6 a.m. or business opening, whichever is earlier. For example, the pharmacy building shown in Figure 3.8 closes at 2 a.m. and opens at 7 a.m. The façade and

landscape lighting at this building must be turned off from 2 a.m. through 6 a.m.

2. All other lighting must be reduced by at least 30% of full power using either occupancy sensors to turn lights off within 15 minutes of sensing zero occupancy, or from midnight or one hour from close of business, whichever is later, until 6 a.m. or business opening, whichever is earlier. For example, the pharmacy building shown in Figure 3.8 must turn down its parking lot lighting, walkway and canopy lighting, and the sign lighting to at most 70% of full power between 3 a.m. and 6 a.m.

Exterior lighting provided for security, safety, or eye adaptation, such as covered parking lot or building entrances and exits, is exempted from lighting reduction control requirements.





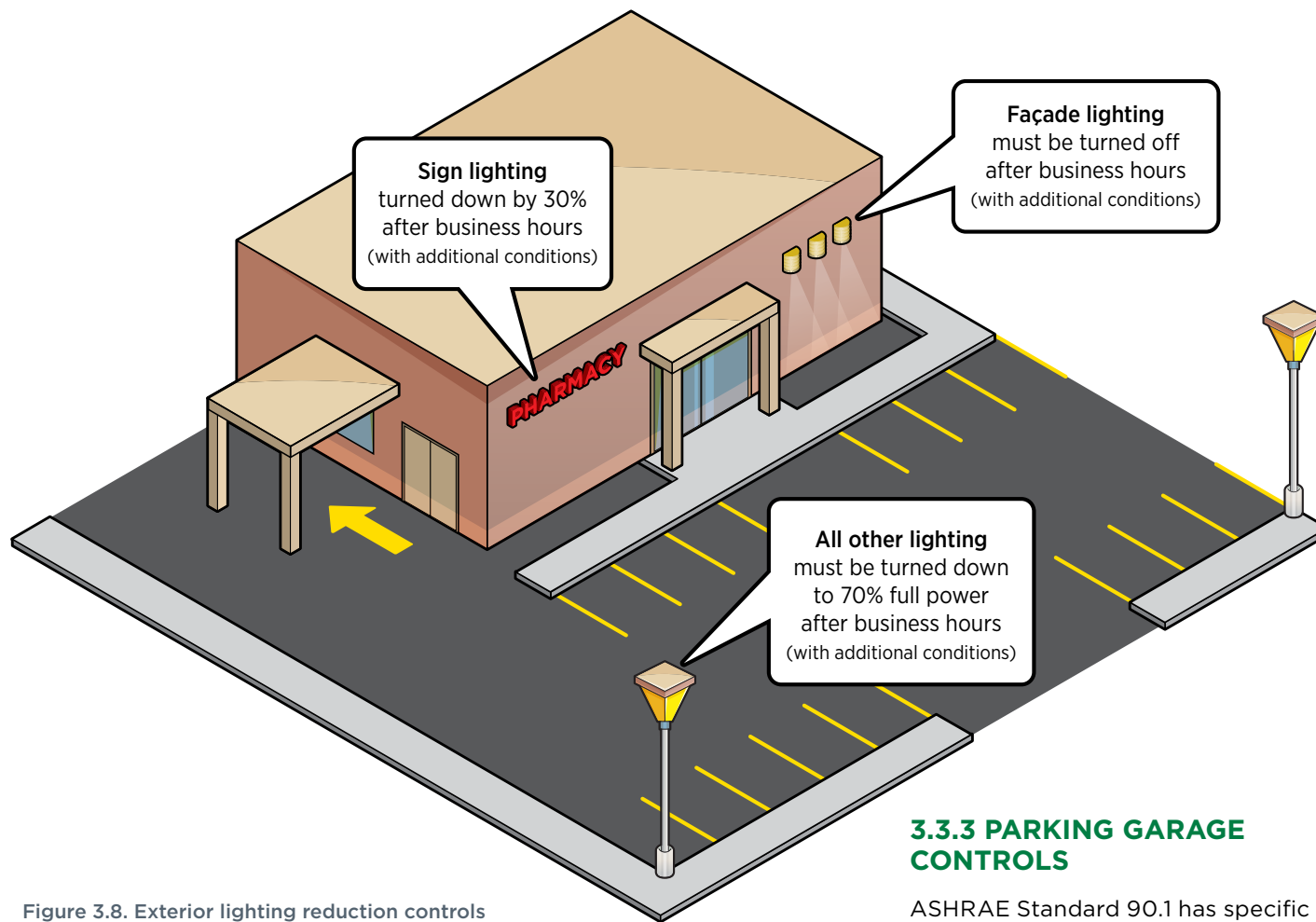

Figure 3.8. Exterior lighting reduction controls

There are three categories of controls required for parking garages:

1. **Daylight transition zones:** While entering or exiting a parking garage during the day, the eye must adapt to a large change in light level. To ease this transition, the area inside the garage near the vehicular entrances and exits is denoted as a “daylight transition zone.” Daylight transition zones can be a maximum of 66 feet deep and 50 feet wide. Lighting in these zones must be controlled separately from the rest of the garage. Lighting must remain on during daylight hours and must be turned off after sunset. Keeping the lighting on during the day makes entering the parking garage much easier on the eyes (see Figure 3.9).

2. **Daylight zones:** Areas extending up to 20 feet inside the parking garage perimeter are considered daylight zones. If the perimeter wall has openings that are greater than or equal to 40% of the total wall area, and if there are no exterior obstructions within at least 20 feet of the

### 3.3.3 PARKING GARAGE CONTROLS

ASHRAE Standard 90.1 has specific control requirements for parking garages, which are treated as interior spaces for the purpose of lighting control. This means that many of the controls required for interior spaces are applied to the parking garage.



perimeter, then lighting in the daylight zone must be reduced in response to daylight availability. This requirement attempts to harvest the daylighting potential in parking garages in a manner similar to the sidelighting requirements for interior spaces (see Figure 3.9).

**3. Automatic lighting shutoff:**

Parking garages must comply with the automatic lighting shutoff requirements in Section 3.2.3. At least one control device is required to turn all parking garage lighting off in response to an operation-based schedule or a signal that senses occupancy.

**4. Occupancy sensors:**

Lighting reduction controls, similar to those described in Section 3.2.2, are required in all parking garage areas, except daylight transition zones. One control device is allowed to control only 3,600 ft<sup>2</sup> of garage area. If the control area is unoccupied for 30 minutes, the control must be able to turn down lighting power to each luminaire by 30%. The manner in which lights are turned back on is not specified (see Figure 3.9).

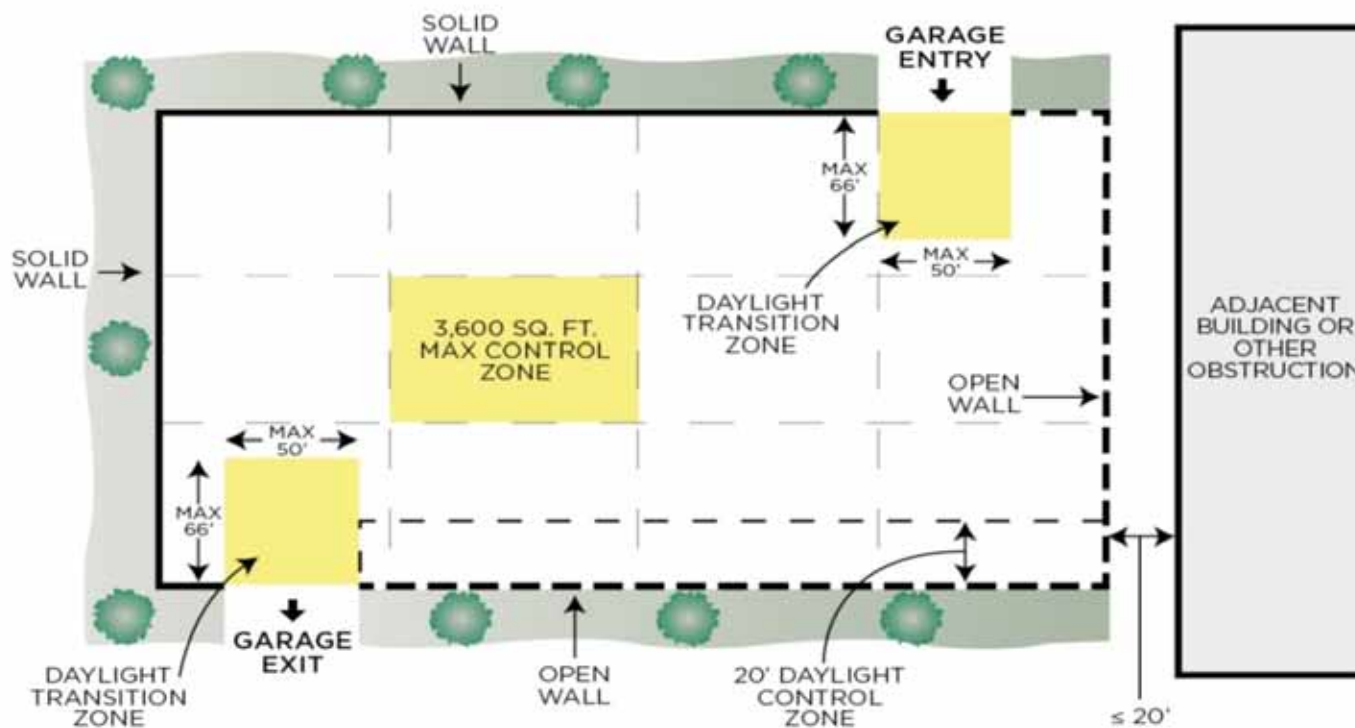

Figure 3.9. Parking garage lighting control requirements

Daylight transition zones and ramps without parking are exempted from the daylighting control and occupancy sensor requirements. Induction lamps and high-intensity discharge (HID) lamps rated less than 150 W are exempted from the occupancy sensor requirement.



# 4.0 Lighting Power Limits\*

The energy use of lighting systems is directly related to installed power (watts) and hours of use. The installed power over a defined area is expressed in watts per square foot (W/ft<sup>2</sup>) and is known as the lighting power density (LPD). The LPD is universally used for interior lighting power limits and most exterior limits. A few other limits for exterior applications are expressed in watts per linear foot and watts per location. As codes have progressed and interest in energy efficiency and savings has grown, the power limits set by the energy codes have become increasingly restrictive. The idea, of course, is for the code limits to reduce wasteful design by limiting power allowed for lighting. This can have the desired effect but can also create more difficult design challenges for many space types and task needs.

Designers and practitioners need to understand how the limits are applied, what lighting can be exempted from compliance, and where there are allowances that can be applied for special purposes.

## 4.1 INTERIOR LIGHTING POWER DENSITY

The interior LPD limits (watts per square foot) are presented by most energy codes as either whole building (building area) or space-by-space, or both. For whole-building compliance, the total lighting power designed for the building must be no greater than the allowed LPD for the building type. For space-by-space, the total power designed for the building must be no greater than the sum of the individual space allowances multiplied by the area of that space type in the building.

The LPD limits in most energy codes and standards are based on a set of space-type lighting models that mimic quality energy efficient design for that space type. These models incorporate all primary

elements involved in design, including current product lamp efficacy, luminaire efficiency, light loss factors, and common design practice. Values are developed for most expected space types within buildings such that reasonably efficient design that still maintains quality design elements can be accomplished. It is understood that in some applications, the configuration of an individual space or specific lighting needs may make it difficult to meet the allowance for that space. Therefore, most interior space-by-space LPD compliance is based on a total building trade-off principle. This means that the summed allowance for the entire building can be used anywhere in the building. For example, the allowance for office areas can be only partially or completely used for

office lighting design. Any unused allowance can be applied to other spaces in the building. It is the total allowance compared to the total designed watts that is important for compliance.



\* Building energy code requirements change over time to meet newer federal requirements and address energy efficiency goals through revisions to the available codes and standards and their subsequent adoption by state and local jurisdictions. The guidance in this document is intended to be as broadly applicable as possible yet specific enough to provide practical application. To be most useful, the guidance is based on the current versions of the commonly available ASHRAE Standard 90.1-2010 and the 2012 IECC.





### Partial List of ASHRAE Standard 90.1-2010 Interior Lighting Power Exemptions

- Lighting in spaces specifically designed for use by the visually impaired.
- Lighting in retail display windows, provided the display area is enclosed by ceiling-height partitions.
- Lighting in interior spaces that have been specifically designated as a registered interior historic landmark.
- Lighting that is an integral part of advertising or directional signage.
- Exit signs.
- Lighting that is for sale or lighting educational demonstration systems.
- Lighting for theatrical purposes, including performance, stage, and film and video production.

Whole building LPD compliance is a simpler method, in which allowances (typically one to three) are applied for each different building type area in the building and the total watts designed for the building must not exceed that value. While this method is easier to calculate, it does not offer the additional flexibility of the space-by-space method.

When completing designs that meet energy code limits, it is important to take advantage of any exemptions allowed. Most energy codes have a list of lighting applications that do not need to be counted when determining compliance. These applications are not counted as part of the designed watts per square foot for the building. Table 1 shows a partial list from the most recent ASHRAE 90.1 standard.

Exemptions will vary between building energy codes. It is important to review the list to make sure only required lighting power is used for compliance calculation.

In addition to exempted lighting, most energy codes also provide allowances for lighting needs that go beyond basic illuminance for standard visual tasks.

**One major allowance category is additional lighting used by retail establishments to highlight merchandise.**

This long-standing use of light is important to retail sales. The energy codes typically set a minimum LPD for retail that provides light for basic employee and customer use and then allows additional lighting if installed and used to highlight merchandise. This allowance is commonly only allowed when applying a space-by-space LPD method. Some retail establishments use little or no highlighting and would therefore not be able to

claim any additional watts. When additional highlighting watts are a part of the design, the energy code allowance is limited depending on the type of merchandise being highlighted and can only be used up to the actual amount of lighting watts installed.

One potential misconception is the dual use of lighting for general illumination and highlighting. In a case like this, the lighting is counted as general illumination and is not eligible for additional watts. The allowance is only applied to lighting that is in addition to general lighting, separately installed, and specifically oriented or aimed to highlight merchandise. One way to understand the application of the retail allowance is to consider what happens if all lighting that is being claimed as eligible for the highlighting allowance is turned off. In this situation, if the space is left dark or below the level of general illumination for occupant function, allowances are likely being applied beyond the intent of the standard.

### Another common allowance is applied to decorative lighting.

Again, this must be in addition to general lighting and for decorative purposes only. The same lights-off test described for the retail merchandise allowance can also be applied here.

ASHRAE Standard 90.1-2010 also incorporates a room geometry

adjustment. It is understood in lighting design that odd room geometries and particularly high ceilings generally increase the watts needed to provide equivalent illuminance levels. The tighter LPDs in current energy codes can make compliance difficult for unusual spaces. The room geometry adjustment is designed to provide relief in unusual cases and is based

on the room cavity ratio (RCR) calculated for a space (see figure 4.1). If the calculated RCR is above a specified threshold, the allowance for that space is increased by 20%. The thresholds are set above typical dimensions for most spaces of each type and are therefore not easily met, but they are available if needed.

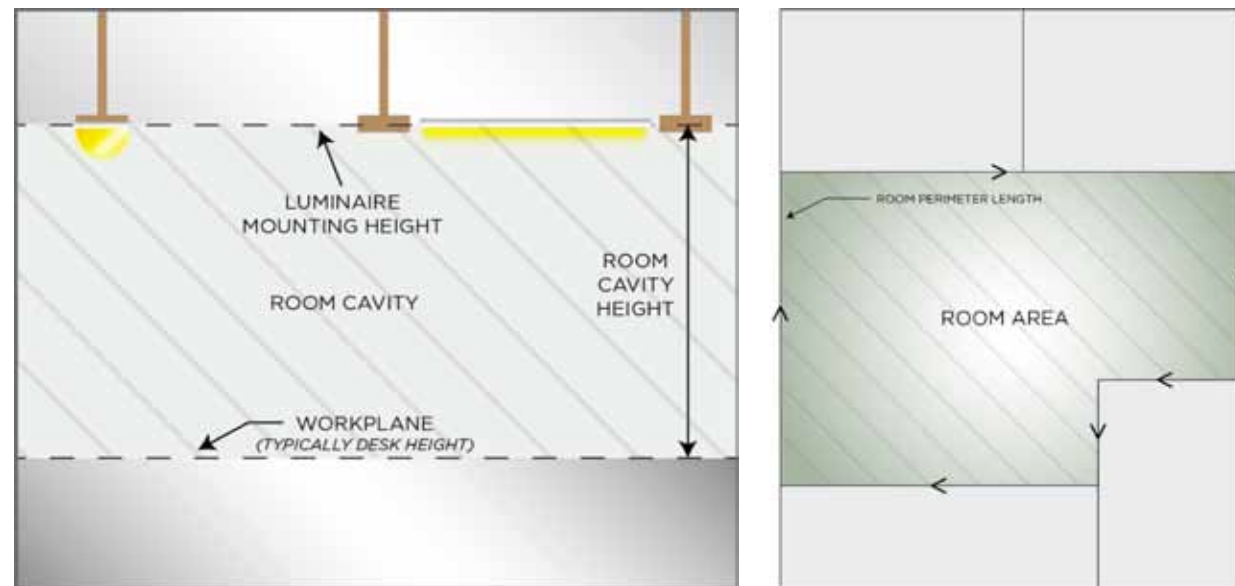

Figure 4.1. Typical room geometry related to room cavity ratio calculations

Not all building energy codes will offer this adjustment, so it is important to review the requirements, allowances, and adjustments provided in the code or standard that apply to the project before proceeding with design.

Compliance with energy code LPDs does promote the use of efficient equipment, but the technologies used on the project to meet the requirement are not specified. The codes and standards typically are written product neutral to allow for maximum designer flexibility. For example, some newer technologies such as LED, induction, and plasma have great potential efficacy and life attributes but may not always be the best fit or the most cost-effective option.

## 4.2 EXTERIOR LIGHTING POWER LIMITS

Exterior power limits come in up to three types for most building energy codes. These include watts per square foot, watts per linear foot, and watts per location or application.

**The exterior power limits are divided into two categories based primarily on the critical nature of the application.**

The first category includes tradable applications that function like interior LPDs where it is the total watts used across all lighted applications that must not exceed the combined allowance for those applications.

The second category includes non-tradable applications that are provided an allowance that can only be used for that application. Any unused watts cannot be applied to other applications. For these non-tradable applications, the allowances are truly use it or lose it.

For ASHRAE Standard 90.1 and the IECC, the allowances have also been categorized by exterior location. The surrounding ambient lighting has a definite effect on the amount of light needed to provide appropriate contrast and visual separation, and the power limits are adjusted depending on the expected surrounding lighting environment.







For example, the lighting needed for parking areas to maintain visual identification associated with confidence in safety and security will tend to be lower in more rural environments with darker surroundings and higher in brightly lit environments such as downtown business districts. The categorizations have been developed to try to match commonly understood zoning descriptions.

In a parking lot example for ASHRAE Standard 90.1, the area allowance ranges from 0.04 W/ft<sup>2</sup> in rural or park land areas up to 0.13 W/ft<sup>2</sup> for high-activity

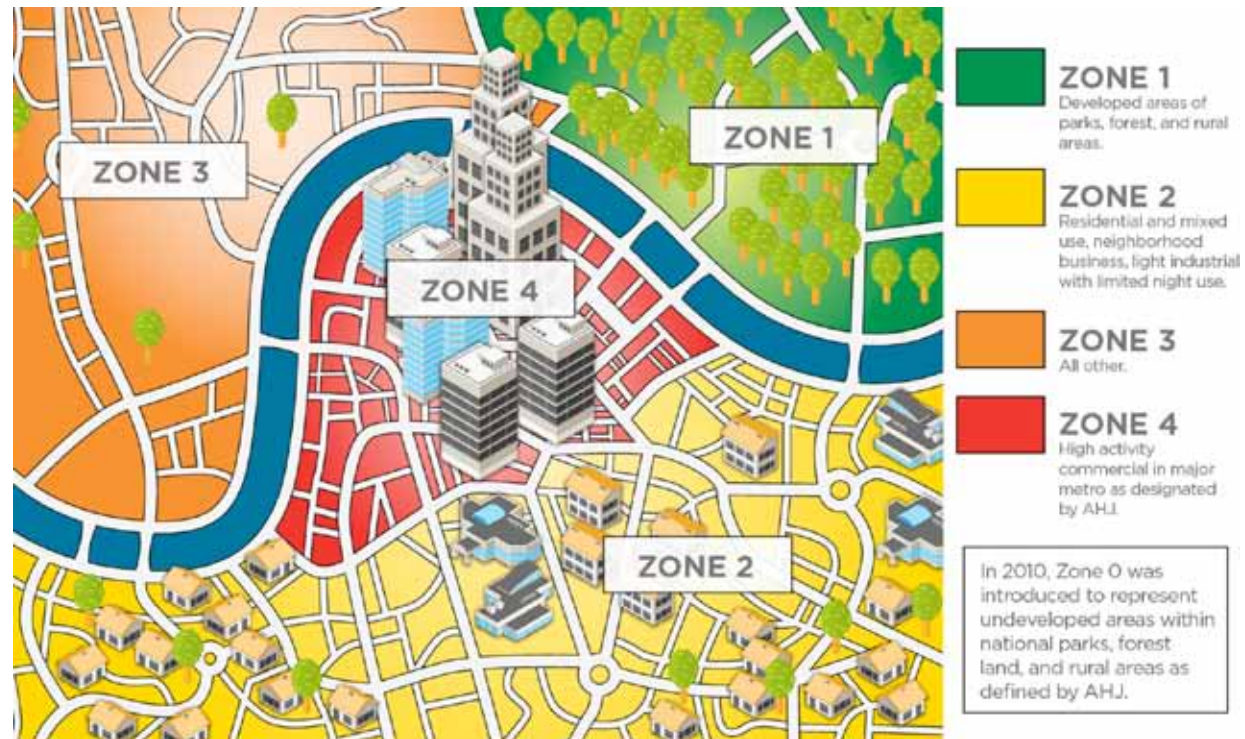

Figure 4.2. Representation of zone classification for exterior lighting limit application

commercial districts designated by the local building official. Identifying the proper zone for applying the code limits can be subjective, so agreeing on a zone type up front with the local building official is important.



## 5.0 Requirements for Alterations\*



Energy codes and standards were originally developed with new construction in mind. However, it is clear from construction activity history that retrofits and alterations to buildings comprise the largest percentage of construction activity and therefore a significant opportunity for energy savings. In the past, alteration requirements have generally been vague or simplistic and commonly unknown or ignored. However, ASHRAE Standard 90.1-2010 and the 2012 IECC have specific requirements and are easier to apply and understand.

**In general, if a building permit is required, the project needs to comply with the applicable energy code.**

This will typically include alterations from simple retrofits of equipment in existing spaces to major gutting and reconstruction of the space. For the most part, whatever applies to new construction applies to alterations, with some exceptions.

**Code requirements are written such that if a building feature that is covered under the energy code is altered or replaced, then it must comply.**

For lighting, the codes typically exempt certain activities such as simply moving fixtures or replacing just lamps or just ballasts. They also have exempted retrofits where less than half of the fixtures in a space are altered or replaced. However, the most current codes now include lamp-plus-ballast retrofits as an activity that triggers compliance and have reduced the previous 50% exemption to only 10%.

**This means that most often if the primary lighting system in a space is modified, it must be upgraded to meet the energy code.**

Controls that are part of the lighting system may also need to be upgraded, depending on code requirements. In some existing

\* Building energy code requirements change over time to meet newer federal requirements and address energy efficiency goals through revisions to the available codes and standards and their subsequent adoption by state and local jurisdictions. The guidance in this document is intended to be as broadly applicable as possible yet specific enough to provide practical application. To be most useful, the guidance is based on the current versions of the commonly available ASHRAE Standard 90.1-2010 and the 2012 IECC.



versions, the controls only need to be addressed if they are changed. Current code editions require some manner of basic automatic control (i.e., whole-building shutoff after business hours), but only require advanced controls such as daylight-responsive controls if the existing controls are replaced.

## 5.1 CODE/STANDARD APPLICATION EXAMPLES

### Project 1:

**A retrofit that involves a complete upgrade to more efficient lamps only.**

In this case, compliance with ASHRAE Standard 90.1-2010 or the 2012 IECC is not required because it involves only lamps and will not increase energy use. Similarly, an upgrade of only the ballasts (no lamps) would also not trigger compliance.



### Project 2:

**An alteration that involves an upgrade to more efficient lamps plus ballasts.**

In this case, compliance with the LPD requirements ASHRAE Standard 90.1-2010 would be required because both lamps and ballasts are being replaced. However, under the 2012 IECC, compliance would not be required because in that code, lamps-plus-ballast retrofits are exempted. Under 90.1-2010, the space must also comply with the automatic lighting shutoff control requirement. This may seem difficult to do because a

primary compliance option for this control is whole building scheduled shutoff that can affect more than one or several spaces. However, individual space occupancy sensor control is also an option and may be the preferred compliance application in this case.

### Project 3:

**An alteration that involves replacing fixtures or upgrading fixtures that comprise 25% of the total installed lighting power in the space (i.e., 20 of the 80 fixtures in the space where all fixtures have the same wattage).**

In this case compliance with the LPD requirements of ASHRAE Standard 90.1-2010 for that space would be required because more than 10% of the lighting load in the space is being modified. Compliance would be required regardless of whether the installed lighting power would be reduced or increased with the retrofit. However, under the 2012 IECC, compliance would not be required because the threshold for replacement is set at 50% instead of 10%. Under ASHRAE Standard 90.1-2010, the space must also comply with the automatic lighting shutoff control requirement. Other spaces in





the building that are not retrofitted do not require compliance because the requirements are applied on a space-by-space basis.

**Project 4:**

**The lighting controls in a space are replaced (either by themselves or with lighting fixture replacement).**

In this case compliance with the control requirements of either ASHRAE Standard 90.1-2010 or the 2012 IECC for that space would be required because the controls are replaced. This may seem difficult to do for automatic lighting shutoff control requirements because a primary compliance option is whole-building scheduled control that can affect more than one or several spaces. However, individual space occupancy sensor control is also an option and may be the preferred compliance application in this case.

Other spaces in the building that are not retrofitted do not require compliance because the requirements are applied on a space-by-space basis.



## 6.0 Compliance by Energy Modeling\*



The guidance in previous sections is based on the presentation of requirements separately for each major component of a building (e.g., envelope, HVAC, service water heating, lighting). The 2012 IECC and ASHRAE Standard 90.1-2010 have a compliance path that allows for a consideration of the total anticipated energy use of the building that allows “tradeoffs” between building components.. This method applies a sophisticated building energy use model that can assess the potential yearly energy use given the various building conditions, including HVAC equipment characteristics, envelope conditions (e.g., insulation, levels, windows), ventilation and air tightness, and scheduled loads such as lighting.

**Whole-building energy modeling provides advantages for compliance when specific prescriptive requirements are difficult to meet. The use of advanced energy-saving features (technologies, controls) can also be accommodated using this approach.**

### 6.1 ADDRESSING CREDIT FOR LIGHTING CONTROL USE

One potential difficulty in using modeling methods for compliance is making sure that controls are effectively modeled to provide accurate results. Building energy models are not typically effective at modeling lighting-related controls. Software programs are improving, but early versions only addressed lighting as an additional building load. It is very important to make sure that controls are properly credited because of the increasing focus of building energy codes on control requirements.

\* Building energy code requirements change over time to meet newer federal requirements and address energy efficiency goals through revisions to the available codes and standards and their subsequent adoption by state and local jurisdictions. The guidance in this document is intended to be as broadly applicable as possible yet specific enough to provide practical application. To be most useful, the guidance is based on the current versions of the commonly available ASHRAE Standard 90.1-2010 and the 2012 IECC.





Some modeling programs or systems may provide simplified credits for addressing lighting controls. These are typically in the form of adjustments to the LPD inputs to the models based on external analysis of energy savings associated with controls. These can be relatively crude adjustments that may not capture actual savings from the proposed control systems.

**The energy code requirements for whole-building energy modeling compliance (i.e., ASHRAE Standard 90.1-2010, Section 11) provide calculation methods for energy-related components or systems that are not directly addressed in the model.**

Developing a separate calculation is probably the best option for most lighting controls and certainly for combined or complicated systems. Compliance will require documentation to support the use and application of the separate calculation, so its development needs to be conducted similar to any other research analysis that includes assumptions, methods, and references.

Calculations can be completed via two basic approaches. One is a calculation that affects the LPD input. The other can be a modified lighting schedule that replaces the standard default schedule.

Some controls such as occupancy sensors can effectively be addressed using either method. For example, a review of research may determine that occupancy sensors for a particular application have a savings percentage of 15% over a typical workday. A 15% reduction could be applied to the LPD for working hours or to the lighting schedule on a flat 15% reduction basis. In other cases, such as daylighting, it may be more accurate to apply a sun availability factor for the building location against the lighting schedule. The accuracy of the control application will depend heavily on the type of control, the available research data, and the capability of the modeling software to process adjustments to inputs.

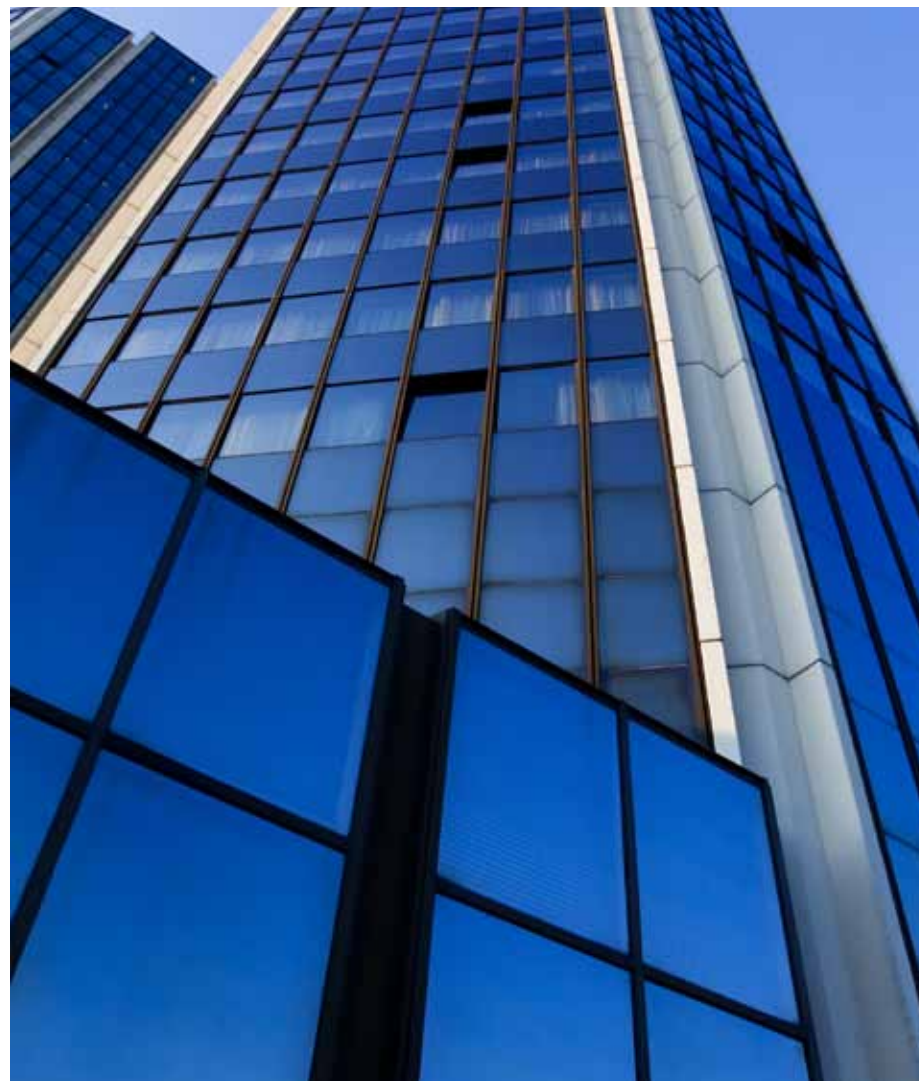



# 7.0 Functional Testing\*

Functional testing of energy components is very important to ensure that controls will operate and save energy after the building is occupied. The requirements focused on lighting power and controls are intended to ensure that when occupied the building can be operated in an energy efficient manner but the method of adoption and compliance verification cannot check to see after occupancy if that actually happens. ASHRAE Standard 90.1-2010 and the 2012 IECC both provide requirements in two areas that affect long-term equipment performance. The first is the requirement to provide documentation to the owner on equipment and operational plans. This gives the owner the information needed to support effective operation and correct repairs.

The other area of code requirement involves functional testing of equipment. This is similar to commissioning, but while commissioning typically



involves continuous verification of performance, functional testing is more limited to operational health at the time of building turnover to the owner.

The functional testing requirements for lighting involve basic verification of function as manufactured and as required to meet the provisions and limits in the code. Testing and verification typically include cycling tests for sensors and controls to verify that the equipment operates as designed.

For occupancy sensors, this may require multiple triggering tests for each application type to verify that sensors activate when desired. For photocells operating daylight-responsive controls, verification may need to be assessed over a complete day cycle or with a sun-blocking mechanism such as shades.

Functional testing can be completed by many different individuals or companies, but they should be different from those who directly designed and installed the equipment.

\* Building energy code requirements change over time to meet newer federal requirements and address energy efficiency goals through revisions to the available codes and standards and their subsequent adoption by state and local jurisdictions. The guidance in this document is intended to be as broadly applicable as possible yet specific enough to provide practical application. To be most useful, the guidance is based on the current versions of the commonly available ASHRAE Standard 90.1-2010 and the 2012 IECC.

## 8.0 References

ANSI/ASHRAE/IES 90.1-2010. 2010 Energy Conservation in New Buildings Except Low Rise and Residential Buildings. American Society of Heating, Refrigerating and Air-Conditioning Engineers, Atlanta, Georgia.

IECC. 2012. *International Energy Conservation Code*. International Code Council, Washington D.C.

IESNA DG-7-1994. 1994. *Lighting Design Process*. Illuminating Engineering Society of North America, New York, New York.

Reichardt JE. 2010. *The Lighting Design Process*. Wiley|Wilson Constant Progress, Alexandria, Virginia.





# Lighting

Development, Adoption,  
and Compliance Guide

U.S. DEPARTMENT OF  
**ENERGY** | Energy Efficiency &  
Renewable Energy

BUILDING TECHNOLOGIES PROGRAM

EERE Information Center  
1-877-EERE-INFO (1-877-337-3463)  
[www.eere.energy.gov/informationcenter](http://www.eere.energy.gov/informationcenter)

September 2012 PNNL-SA-90653



**Building Energy Codes**

For information on Building Energy  
Codes, visit [www.energycodes.gov](http://www.energycodes.gov)