

NOAA Protocols for Groundfish Bottom Trawl Surveys of the Nation's Fishery Resources

March 16, 2003

Gary Stauffer (Compiler)



U.S. Department of Commerce
National Oceanic and Atmospheric Administration
National Marine Fisheries Service

NOAA Technical Memorandum NMFS-SPO-65
October 2004

NOAA Protocols for Groundfish Bottom Trawl Surveys of the Nation's Fishery Resources

March 16, 2003

Compiled under the direction of:

Gary Stauffer
Leader of Trawl Survey Protocol Development
Alaska Fisheries Science Center

NOAA Technical Memorandum NMFS-SPO-65
October 2004



U.S. Department of Commerce
Donald L. Evans, Secretary

National Oceanic and Atmospheric Administration
Vice Admiral Conrad C. Lautenbacher, Jr., USN (Ret.)
Under Secretary for Oceans and Atmosphere

National Marine Fisheries Service
William T. Hogarth, Assistant Administrator for Fisheries

Suggested citation:

Stauffer, Gary (compiler). 2004. NOAA Protocols for Groundfish Bottom Trawl Surveys of the Nation's Fishery Resources. U.S. Dep. Commerce, NOAA Tech. Memo. NMFS-F/SPO-65, 205 p.

A copy of this report may be obtained from:

RACE Division, F/AKC1
NMFS, NOAA
7600 Sand Point Way NE
Seattle, WA 98115

Or online at:

<http://spo.nmfs.noaa.gov/tm/>

Table of Contents

INTRODUCTION	1
NOAA FISHERIES TRAWL SURVEY PROTOCOLS	3
Protocol 1: Length Measurement of Trawl Warps	3
Protocol 2: Use of Autotrawl Systems	5
Protocol 3: Survey Operational Procedures	6
Protocol 4: Trawl Construction and Repair	7
Protocol 5: Changes to Regional Trawl Survey Protocols	8
RECOMMENDATIONS FOR ADDITIONAL WORK TO IMPLEMENT PROTOCOLS	9
Wire Rope Specifications and Measurement Standards	9
Survey Standardization Working Group (SSWG)	9
Training in Trawl Construction and Repair Verification	9
WORKSHOP PARTICIPANTS	11
REGIONAL PROTOCOLS	15
Appendix 1 - Alaska Fisheries Science Center Standard Operating Protocols	17
Introduction	19
Protocol 1: Warp Measurement Standardization.	19
Protocol 2: Auto-trawl Standardization.	21
Protocol 3: Operations Procedures.	22
Protocol 4: Trawl Construction and Repair	42

Appendix 2 - Northwest Fisheries Science Center Standard Operating Protocols	81
Introduction	83
Protocol 1: Warp Measurement Standardization.	84
Protocol 2: Auto-trawl Standardization.	86
Protocol 3: Operations Procedures.	86
Protocol 4: Trawl Construction and Repair	94
Appendix 3 - Southwest Fisheries Science Center Standard Operating Protocols	103
Introduction	105
Protocol 1: Length Measurement of Trawl Warps	106
Protocol 2: Use of Auto-trawl Systems	106
Protocol 3: Survey Operations Procedures	107
Protocol 4: Trawl Construction and Repair	111
Appendix 4 - Northeast Fisheries Science Center Standard Operating Protocols	123
Introduction	127
Protocol 1: Length Measurement of Trawl Warps	127
Protocol 2: Use of Autotrawl Systems	129
Protocol 3: Survey Operations Procedures	130
Protocol 4: Trawl Construction and Repair	161
Protocol 5: Changes to Regional Trawl Survey Protocols	163

INTRODUCTION

The National Trawl Survey Standardization Workshop was convened 13-15 November 2002 with the directive, based on the 16 September 2002 V.ADM. Conrad Lautenbacher memo, to “review current protocols and directives regarding trawl survey operation, determine what changes are needed and publish a new protocol”. The objective of this effort was “to ensure that all aspects of preparation for trawl surveys and trawl survey procedures are consistent and in keeping with the highest quality standards to provide for survey data accuracy and consistency from one survey to the next”. For greater focus in the workshop, the definition of “trawl surveys” was narrowed to exclude surveys using towed sampling devices with rigid-frames, such as clam or scallop dredges, surveys not producing measures of catch per unit of effort as a product, such as the trawling associated with fishery-acoustic surveys and surveys not conducted with bottom trawls on groundfish. The focus was further narrowed to exclude catch sampling to allow the workshop sufficient time to adequately address issues influencing the trawling process itself.

Since the principal products of trawl surveys are fishery-independent indices of stock abundance used in stock assessment models, the essential feature of maintaining “consistency from one survey to the next” is that survey catchability (i.e., the relationship between the true population abundance and the survey index) must remain stationary and therefore lack any time trend. For surveys that geographically encompass the target stock, stationarity in survey catchability can often be achieved by ensuring constancy in the sampling efficiency of the trawl, which, in turn, can be achieved by ensuring constancy in the construction and repair of the trawl and the procedures used in its operation. The protocols proposed in this report are therefore focused on these issues.

NOAA Fisheries conducts groundfish trawl surveys with a wide variety of characteristics. Not only do the target species, and therefore the appropriate sampling methods, differ among surveys, but the characteristics of the survey vessels differ and include chartered fishing vessels as well as NOAA research vessels. Because of this variety, NOAA Fisheries protocols for standardization of groundfish trawl surveys are specified in general terms to establish the purpose of the protocol and delineate a strategy for its use. The implementation of the protocols for each trawl survey in each region is then provided in appendices. An overarching theme through this document is that the intent of standardization is not to eliminate variability in methodology among Science Centers, but to ensure that the methodology that is used by each Science Center is consistent over time.

NOAA FISHERIES TRAWL SURVEY PROTOCOLS

Protocol 1: Length Measurement of Trawl Warps

Problem Statement

For trawls having two warps (i.e., towing cables), consistency in the measurement of warp length is important for maintaining consistency in trawl performance in two distinct ways. First, the length of the warp relative to the water depth (i.e., scope ratio) influences door spread and other aspects of trawl geometry. Second, the length of the warp on one side of the vessel relative to that on the other side influences the symmetry of the trawl and, depending on the degree of net skew, potentially influences trawl efficiency by affecting footrope contact with the bottom, headrope height, or fish herding. Since trawl performance is relatively insensitive to small variations in scope ratio, all measurement methods currently used on NOAA or chartered vessels are considered sufficiently accurate for scope ratio determination. In contrast, trawl performance may be quite sensitive to differences in lengths of the warps relative to each other and additional measures to ensure that the difference is maintained within a specified tolerance is considered important. This is especially true for surveys in which trawling is conducted with a fixed length of warp throughout the tow (i.e., locked winches). For surveys using autotrawl systems, however, the warp length is dynamically increased or decreased on each side of the vessel during a tow in response to differences in tension and precise measurement of relative warp length is relatively unimportant.

Currently during NOAA trawl surveys, warp length is determined either statically by periodically measuring and marking the warps at fixed increments or dynamically by attaching some real-time measuring device to the warps. All of the currently used methods of measurement have inherent problems that can lead to inaccurate measurement. For example, differential warp length can result from inaccurate measurement before a survey begins, from differential warp stretch and contraction of marked warps during a survey or from inaccuracy and slippage of metering devices. As a consequence, the proposed protocol uses the comparison of redundant measuring systems to detect differences in warp length beyond a tolerance limit.

Procedures

For two warp trawling systems, two independently-calibrated measuring methods or devices shall be used on each warp, one of which will measure the warp in real time.

If the difference between the two measured distances, summed over both warps, becomes greater than 4% (or another value specified by each program and justified by independent research) of the door-to-door cable distance (i.e., sum of bridle lengths and the footrope), operations must be suspended until a cause is found and resolved.

When chartering vessels for surveys, programs will clearly specify and verify use of the same wire type and size consistently among vessels and years.

Specification of the warp measurement system used on each survey will be included in an Operations Plan provided by the Science Center to the officers and crew of the survey vessel.

Sub-protocols for Specific Warp Measurement Technologies

Protocol 1a: Physical Warp Markings

Physical marking of trawl warps generally involves spooling the wires off the drums and onto a flat surface to measure the wire relative to standard lengths. The NOAA standard for such measurements will be that both port and starboard wires will be measured and marked side-by-side to ensure that the relative warp measurements between wires are exact. The spacing of such marks, details of marking method (fiber marks interwoven in wire rope strands or painting of marks), and degree of tension on the wires will be specific to the application. These marks will be checked and recalibrated at least annually and rechecked after a survey or whenever unreconcilable discrepancies between warp marks and the redundant measurement system persist.

Under circumstances where remarking of warps side-by-side may be impossible, trawl warps may be measured and marked at sea using the following procedure. Calibrated in-line wire meters can be used to measure and mark length intervals of one warp at a time when deployed under tension (i.e., loaded with doors and trawl during a setting-retrieval exercise). Position of all marks should be confirmed by repeating the measurements. The wire meters will be calibrated at least annually using a known length of wire.

Protocol 1b: In-line Wire Meters

In-line wire meters measure wire lengths directly using running line tensiometers or instrumented blocks over which the warp travels as it is payed out or retrieved. Such systems deflect the running wire by a known amount to facilitate measuring under tension and may be subject to deviations from true measurements due to wire slippage. These devices should be calibrated using known lengths of wire at least annually, using manufacturer recommended procedures, with moving parts (bushings, sheaves, etc.) inspected and replaced, as required. Since some in-line wire meters are relatively small and portable, they may be provided to the vessels by the Science Centers provided they are appropriately calibrated.

Protocol 1c: Block Wire Counters

Block wire counters measure the length of wire passing over a trawl block or another wheel of known circumference which is equipped with a proximity counter to enumerate the number of revolutions of the sheave. Length of the wire is thus calculated by multiplying the number of block revolutions by the circumference of the sheave. These devices may be subject to deviations from true measurements due to wire slippage. Block counters should be calibrated at least annually with a known length of wire after assuring the proper functioning of the proximity counter and measuring sheave.

Protocol 1d: Geometric Wire Counters

Geometric wire counters (used as stand-alone wire measuring method or as a component of autotrawl systems) utilize the number of winch turns, diameter and width of the winch drum, diameter of wire and other parameters to compute the absolute amount of wire off each winch. These systems may lose calibration if the wire diameter decreases due to stretch or if the wires do not wrap properly on the winches. The counter can be recalibrated by using a known length of wire wrapped on the winches. These calibrations should be performed at least annually, or more frequently if there are changes in wire diameter or the performance of wire wrapping on the winches.

Discussion

The proposed protocol requires that the two independent warp measurements be reconciled when the differences in the warp lengths exceeds 4% of the cable distance (curved distance) from one door to the other aft of the doors (e.g., if the cable distance is 50 m, a warp difference greater than 2 m would be considered critical). The 4% standard is documented in the Northeast Fisheries Science Center Reference Document 02-15 - Report of the Workshop on Trawl Warp Effects on Fishing Gear Performance posted on the web October 25, 2002. This is a general guideline, and specific research on the effects of various wire offsets on trawl catch performance may document different critical warp offset distances, depending on the gear and target species for individual trawl survey programs.

Protocol 2: Use of Autotrawl Systems

Problem Statement

Autotrawls can be used in a static mode to spool out warp after a hang-up as a means of reducing trawl damage or in a dynamic mode to maintain equal tension on both warps. Autotrawl systems are quite common on large trawlers and are standard in most European trawl surveys. When used in a dynamic mode, autotrawls help preserve proper trawl function by adjusting the lengths of the two warps independently to correct for asymmetry of the trawl caused by a sloping bottom or oblique water flow and obviates the need for precise measurement of warp length. Although this leads to better standardization in trawl performance, such benefits are only realized when the autotrawl system is in good working condition and properly calibrated.

Procedures

NOAA vessels or chartered fishing vessels supporting trawl surveys using dynamic autotrawl systems must have the system tested and certified by a qualified technician at least annually, or more frequently, as required. Items inspected may include, but are not limited to, correct operation of pumps, motors and other moving components, and verification of parameters in controller software.

Protocol 3: Survey Operational Procedures

Problem Statement

Standardization of station selection, gear deployment, operation, and retrieval procedures are critical for maintaining consistency in survey catchability over time. Factors that can affect gear performance and catchability of marine organisms include selection of tow location; speed during setting, towing, and retrieval of gear; determination of scope ratio; estimation and standardization of tow distance; tow direction; and maximum sea state. Written unambiguous protocols specifying these and other issues that may affect survey consistency provide a mechanism for communication between scientific staff and the officers and crew of the research vessel which maintains continuity in procedures as personnel and vessels change over time.

Procedures

Each Science Center will provide a written Operations Plan to their staff and the crew of the survey vessels that provides clear and unambiguous definitions of all procedures required to properly conduct trawl sampling. The Operations Plan will be discussed by the Chief Scientist and the vessel crew at the start of each survey and again when crew changes occur. The Operations Plan may include, but is not limited to, the following issues:

- a. Scope ratio
- b. Speed of a tow
- c. Duration or distance of a tow
- d. Direction of tow
- e. Location of sampling sites, and procedures to use if stations are not suitable for towing.
- f. Criteria for determining the success of a tow and procedures to use if a tow was unsuccessful.
- g. Vessel and winch operation during trawl deployment and retrieval.
- h. Methodology for warp measurement and verification.
- i. Trawl construction plans, at-sea repair instructions and repair verification checklist.
- j. Defining responsibility (i.e., survey scientists or vessel crew) for decisions regarding various aspects of the operations.

Discussion

Although nearly all NOAA Fisheries trawl surveys provide some form of an operations plan to their staff and the officers and crew of the survey vessels, some aspects of the operation that potentially influence survey catchability may be omitted or specified in insufficient detail to eliminate individual interpretation. By increasing the level of detail, and formalizing the communication of procedures, the intent is to make operations consistent among members of scientific staff and vessel crew and consistent over time.

Protocol 4: Trawl Construction and Repair

Problem Statement

Standardization of trawl construction and repair is unquestionably the most critical element for survey standardization because, on NOAA Fisheries trawl surveys, trawls are not simply devices to capture fish but are scientific instruments used to sample fish populations. Our sampling trawls must conform to higher levels of tolerance in their construction and repair than commercial fishing gear. The difference in the objectives of commercial fishing and scientific sampling, and its concomitant effects on trawl design and repair, are rarely appreciated and often have contributed to misunderstanding between NOAA Fisheries and the commercial fishing industry. This misunderstanding can directly impact trawl survey standardization in two distinct ways. First, Science Centers lacking the capability to build their own survey trawls must instead rely on the services of trawl manufacturers whose primary customers are commercial fishermen. As a consequence, survey trawls may be constructed with the level of tolerance needed for commercial fishing rather than with the more rigorous level required for scientific sampling. Second, all members of the crew of NOAA or charter trawlers that make at-sea repairs to survey trawls have gained their expertise for doing so from their past experience as commercial trawl fishermen. The repair techniques used by commercial fishers, however, are typically those needed to return the gear to service as soon as possible rather than those needed to return it to service in the same condition as before damage. Because NOAA survey trawls are true scientific sampling instruments, the protocols considered in this section are designed so that survey trawls are constructed and repaired with a level of detail needed to ensure, within specified tolerances, that the identical trawl is used at every sampling site on every cruise.

Procedures

Construction plans for each survey trawl design will be maintained by each Science Center and included in an Operations Plan. The plans must include engineering drawings of the net, doors and rigging with a level of detail at least as specific as that in the ICES recommended standard (ICES C.M. 1989/B:44 Report of the Study Group on Net Drawing). In addition, each plan must contain a description of all materials used, and the qualities of these materials considered important for proper trawl function.

A checklist will be developed for each trawl design specifying the dimensions, and their tolerances, or other design features considered important for proper trawl function. The checklist will be used to verify that each newly constructed or repaired trawl is within operational tolerances before use.

Verification that trawls are within operational tolerances will be conducted by members of the scientific staff of each Science Center who are trained in trawl construction and repair verification.

Methodology for at-sea trawl repairs will be specified in an Operations Plan and communicated by the Chief Scientist to the crew of the vessel at the start of each cruise. A trawl repair checklist will be included in the Operations Plan and used by a member of the scientific staff to verify that repaired trawls are within operational tolerances.

A national training course in trawl construction and repair verification for both survey scientists and crews of NOAA vessels will be conducted at regular intervals.

Discussion

The intent of this protocol is to ensure that, through more exacting specification and verification, the trawls used in a survey will perform identically regardless of the circumstances under which the trawl was constructed and repaired.

Protocol 5: Changes to Regional Trawl Survey Protocols

Changes to trawl survey operational protocols will be at the discretion of the appropriate Science Director who may approve such changes directly or specify a peer review process to further evaluate the justification and impacts of the proposed changes.

RECOMMENDATIONS FOR ADDITIONAL WORK TO IMPLEMENT PROTOCOLS

Wire Rope Specifications and Measurement Standards

Given the requirements for accuracy and repeatability of wire rope performance and measurement, an engineering study to determine standards and specifications for wire ropes to be used in various trawling applications should be conducted. Additionally, a review of available wire rope measurement technologies and their accuracy, precision and re-calibration for trawling applications is deemed a high priority.

Survey Standardization Working Group (SSWG)

The Trawl Survey Standardization Workshop has identified an ongoing need to coordinate the development of national and regional standards and protocols, and to share information to improve the precision and accuracy of such surveys. Accordingly, the formation of an ongoing NOAA Fisheries Survey Standardization Working Group is recommended. In addition, information and technology exchange among Science Centers could be facilitated with National Marine Resource Survey Workshops, similar to those conducted periodically for stock assessments.

Training in Trawl Construction and Repair Verification

To improve quality control in the construction and repair of survey trawls, survey scientists have been assigned (Protocol 4) responsibility for verification that trawl dimensions and other important operational qualities remain within specified tolerances. To do this, survey scientists need additional training to obtain sufficient knowledge about trawl geometry to allow them to verify important dimensions and properties of a trawl against a checklist of standards. It is also recommended that the crews of NOAA vessels participating in at-sea trawl repair also take a more in-depth training course in trawl construction so that the more exacting methods needed for the repair of NOAA sampling trawls are clearly understood. A national training program must be implemented to achieve this goal.

WORKSHOP PARTICIPANTS

<u>Line Offices and Addresses:</u>	<u>Name:</u>	<u>Email:</u>
<p><u>Alaska Fisheries Science Center</u></p> <p>7600 Sand Point Way NE Seattle, WA 98115-0070</p>	<p>Erika Acuna</p> <p>Dave King</p> <p>Bob Lauth</p> <p>Michael Martin</p> <p>Dan Nichol</p> <p>David Somerton</p> <p>Gary Stauffer</p> <p>Paul Von Szalay</p> <p>Ken Weinberg</p> <p>Mark Wilkins</p>	<p>Erika.Acuna@noaa.gov</p> <p>David.L.King@noaa.gov</p> <p>Bob.Lauth@noaa.gov</p> <p>Michael.Martin@noaa.gov</p> <p>Dan.Nichol@noaa.gov</p> <p>David.Somerton@noaa.gov</p> <p>Gary.Stauffer@noaa.gov</p> <p>Paul.Von.Szalay@noaa.gov</p> <p>Ken.Weinberg@noaa.gov</p> <p>Mark.Wilkins@noaa.gov</p>
<p><u>Northeast Fisheries Science Center</u></p> <p><u>Woods Hole Laboratory</u></p> <p>166 Water Street Woods Hole, MA 02543-1026</p>	<p>John Boreman</p> <p>Russell Brown</p> <p>Charles Byrne</p> <p>Henry Milliken</p> <p>Steve Murawski</p>	<p>John.Boreman@noaa.gov</p> <p>Russell.Brown@noaa.gov</p> <p>Charles.Byrne@noaa.gov</p> <p>Henry.Milliken@noaa.gov</p> <p>Steve.Murawski@noaa.gov</p>
<p><u>NOAA Fisheries Headquarters</u></p> <p>1315 East West Highway, SSMC3 Silver Spring, MD 20910</p>	<p>John Herring</p>	<p>John.Herring@noaa.gov</p>

<p><u>Southeast Fisheries Science Center</u></p> <p><u>Mississippi Laboratories</u></p> <p>P.O. Drawer 1207</p> <p>Pascagoula, MS 39568-1207</p>	Terry	Henwood	Terry.Henwood@noaa.gov
	Gilmore	Pellegrin	Gilmore.Pellegrin@noaa.gov
	Charles	Taylor	Charles.W.Taylor@noaa.gov
	Perry	Thompson	Perry.A.Thompson@noaa.gov
	John	Watson	John.Watson@noaa.gov

<p><u>Northwest Fisheries Science Center</u></p> <p>2725 Montlake Boulevard East</p> <p>Seattle, WA 98112</p>	Elizabeth	Clarke	Elizabeth.Clarke@noaa.gov
	Teresa	Turk	Teresa.Turk@noaa.gov
<p><u>Newport Research Station Bldg 955</u></p> <p>2032 S. Oregon State Univ. Dr.</p> <p>Newport, OR 97365</p>	Vanessa	Tuttle	Vanessa.Tuttle@noaa.gov
	Rick	Brown	Rick.Brown@noaa.gov
	Jean	Rogers	Jean.Rogers@noaa.gov

<p><u>Office of Marine and Aviation Operations:</u></p> <p><u>Marine Operations Center, Pacific</u></p> <p>1801 Fairview Ave E</p> <p>Seattle, WA 98102-3722</p>	Tim	Clancy	Tim.Clancy@noaa.gov
	John	Clary	John.C.Clary@noaa.gov
	Mike	Francisco	Mike.Francisco@noaa.gov
	John	Mcadam	John.M.Mcadam@noaa.gov
	Frank	Wood	Frank.Wood@noaa.gov
<p><u>Northeast Marine Support Facility</u></p> <p>166 Water Street</p> <p>Woods Hole, MA 02543</p>	Michael	Abbott	Michael.S.Abbott@noaa.gov
	Ken	Rondeau	Kenneth.Rondeau@noaa.gov

<p><u>Southwest Fisheries Science Center</u></p> <p><u>La Jolla Laboratory</u></p> <p>8604 La Jolla Shores Drive La Jolla, CA 92037-1508</p>	<p>Dave Griffith Dave.Griffith@noaa.gov</p> <p>Chris Jones Chris.D.Jones@noaa.gov</p> <p>Wayne Perryman Wayne.Perryman@noaa.gov</p>
<p><u>Santa Cruz Laboratory</u></p> <p>110 Shaffer Road Santa Cruz, CA 95060</p>	<p>Keith Sakuma Keith.Sakuma@noaa.gov</p>
<p><u>Honolulu Laboratory</u></p> <p>2570 Dole Street Honolulu Hawaii, 96822-2396</p>	<p>Michael Seki Michael.Seki@noaa.gov</p>
<p><u>ICES Experts:</u></p> <p>Department of Fish and Oceans, MPO St. Johns, Newfoundland, Canada</p> <p>Fisheries Research Service Marine Lab Aberdeen, Scotland</p> <p>Institute of Marine Research Bergen, Norway</p>	<p>Barry McCallum McCallumB@DFO-MPO.gc.ca</p> <p>Derek Galbraith R.D.Galbraith@marlab.ac.uk</p> <p>John Willy Valdemarsen John.valdemarsen@imr.no</p>
<p><u>Gear Fabricators:</u></p> <p>Applied Fish Gear Technology 8775 Fletcher Bay Rd.</p> <p>Pacific Fishermen Inc. 5351 24th Ave. NW Seattle WA 98107</p>	<p>Gary Loverich Gloverich@oceanspar.com</p> <p>Doug Dixon DougD@Pacificfishermen.com</p>

REGIONAL PROTOCOLS

Because of the diversity among NOAA trawl surveys, the trawl standardization protocols were, in most cases, specified in general terms to allow each Science Center flexibility in its approach to standardization. In this section, the specific methodology used by each NOAA survey is detailed in either a complete Field Operations Plan or additions to existing Plans to bring them in conformity with the requirements of the protocols.

Appendix 1 Alaska Fisheries Science Center	17
Eastern Bering Sea Shelf Survey	
Gulf of Alaska Survey	
Aleutian Islands Survey	
Eastern Bering Sea Upper Continental Slope Survey	
Appendix 2 Northwest Fisheries Science Center	81
West Coast Survey	
Appendix 3 Southwest Fisheries Science Center	103
Antarctic Bottom Trawl Survey	
Appendix 4 Northeast Fisheries Science Center	123
Spring, Autumn and Other Bottom Trawl Surveys	

Appendix 1

Alaska Fisheries Science Center Standard Operating Protocols

Eastern Bering Sea Shelf Bottom Trawl Survey
Gulf of Alaska Bottom Trawl Survey
Aleutian Islands Bottom Trawl Survey
Eastern Bering Sea Upper Continental Slope Bottom Trawl Survey

Introduction

The Alaska Fisheries Science Center (AFSC) conducts four bottom trawl surveys, the Eastern Bering Sea Shelf Survey, which occurs annually, and the Gulf of Alaska, Aleutian Islands, and Eastern Bering Sea Upper Continental Slope Surveys, which are conducted biennially. Since there are many similarities in the characteristics of these surveys, rather than presenting the complete operations manual for each survey as evidence for their compliance with the new NOAA trawl survey standardization protocols, we have instead presented, for each protocol and survey, either excerpts of existing material from the current operations manuals or the new material to be inserted into the revisions of the manuals.

Protocol 1: Warp Measurement Standardization

NOAA trawl survey standardization protocols (Protocol 1) require that two independently-calibrated measuring methods or devices shall be used on each trawl warp, one of which will measure the warp in real time. For AFSC bottom trawl surveys, the two measurement methods will be: 1) warps measured and marked at sea using in-line Olympic trawl wire meters and 2) warps measured in real time using geometric wire meters associated with the auto-trawl system.

Calibration of Warp Measurement Devices

Calibration of the Olympic Model 750-N in-line wire meter will occur during annual maintenance and again at-sea. Annually, prior to the surveys, each meter will be returned to the manufacturer (Olympic Instruments Inc. 16901 Westside Highway S. W., Vashon, WA 98070) where broken or worn parts (wheels, springs, counters, etc.) will be replaced and the unit cleaned and lubricated. Each unit will be tested to determine whether it is performing within factory specifications and calibrated to a known length of cable of similar properties to the warps used on the surveys.

At sea, each in-line meter must first be inspected to ensure it has not been damaged during transport, then cleaned and again calibrated against a known length of warp (at least 50 m) measured using the tape measures provided to each field party. The calibration can be done as follows: 1) set the trawl with the doors just underwater at a speed of 2 knots, 2) mark the warp with a piece of tape near the trawl sheave, 3) measure from this mark forward, in increments, until a distance of at least 50 m of warp has been measured, then again mark with tape, 4) attach the meter to the warp in an accessible location and secure fore and aft with rope, 5) measure the marked distance with the in-line meter three times and 6) calculate a calibration coefficient (i.e., known length / measured length) from the average of the three measurements.

Warp Measurement with the In-line Meter

Using the same in-line meter calibrated as above, measure each warp separately as follows: 1) set the trawl, keeping the doors just below the sea surface and maintaining a speed of 2 knots, 2) attach the meter to the warp as described above and set the counter to zero, 3) let out warp until

the counter indicates the corrected distance (i.e., measured distance multiplied by the calibration coefficient) to the first mark, 4) mark the wire with paint at the reference position determined by the skipper (e.g., forward of the blocks) and dry with a heat gun if necessary, 5) repeat 3 and 4, until the last mark is applied using 25 fathom (45.73 m) intervals. After all marks are applied, haul the trawl back until the doors are again just below the sea surface, zero the counter and verify that the marks are in the correct positions. If the difference between the first and second measurement of any mark exceeds 1 m, the entire marking procedure must be repeated.

Calibration of the Geometric Counters

During the warp marking process, record the warp length measured by the geometric counter for each mark when the mark is at the reference position. Develop a table in which these reference lengths and the marked lengths are recorded for each warp. These reference lengths will be used during trawling operations to determine if stretching or shrinkage of the warps has occurred.

Warp Mark Verification During Survey Operations

During normal survey operations, the length of warp used on each tow will be verified by performing a test based on the left and right warp lengths measured by the geometric wire meters relative to the tabled values of the reference lengths. The procedure used will be as follows: 1) set the trawl with the warp mark in the standard position relative to the block or other reference point, 2) compare the length determined by the geometric meter for that tow with the tabled value and enter the signed difference on the Haul Form for each warp, 3) if the difference of the signed differences from both warps exceeds the critical value (see below), then retrieve and reset the trawl (for example, with the 200 m marks set at the blocks, the port tabular value was 202 and now reads 203. The signed difference is +1. The starboard tabular value was 197 and now reads 195, a signed difference of -2. The difference of the signed differences (+1 and -2) is 3. This is within the critical value listed below and is acceptable), 4) if, after resetting, an unacceptable difference persists then remark the warps. If a warp is damaged or repaired in any manner, it shall be recalibrated.

Determination of Critical Value

According to Protocol 1, the maximum allowable offset between trawl wires is 4% of the distance from door to door as measured around bridles and footrope. For the trawls used by the AFSC, this critical value is determined as follows:

Poly Nor' eastern trawl:

$$\begin{aligned} \text{Door legs} &= 50'/\text{side}, \text{bridles} = 180'/\text{side}, \text{footrope}=120' \\ \text{critical length} &= (50 + 50 + 180 + 180 + 120) * 0.04 \\ &= 23.2 \text{ ft} = 7.1 \text{ m} \end{aligned}$$

83-112 Eastern trawl:

$$\begin{aligned} \text{Door legs} &= 50'/\text{side}, \text{bridles} = 180'/\text{side}, \text{setback}= 2'/\text{side}, \text{footrope}=112' \\ \text{critical length} &= (50 + 50 + 180 + 180 + 2 + 2 + 112) * 0.04 \\ &= 23.0 \text{ ft} = 7.0 \text{ m} \end{aligned}$$

Proper Care and Stowage of In-line Meters

During use, avoid any rough treatment of wire counters (for example do not leave them laying out on deck, or allow them to slide around, or drop them between decks) and thoroughly clean after each use with undiluted Simple Green detergent with particular attention to remove warp grease buildup on roller. Allow the meter to dry completely before placing in case (dry in engine room) and store in dry area.

Protocol 2: Auto-trawl Standardization

Three of the four AFSC bottom trawl surveys, Aleutian Islands, Gulf of Alaska, and Eastern Bering Sea Upper Continental Slope, utilize auto-trawl systems in a dynamic mode and therefore require annual servicing of the auto-trawl system by the charter vessels. The fourth bottom trawl survey, the Eastern Bering Sea Shelf, maintains locked winches during trawling operations and therefore does not require annual servicing of the auto-trawl system. However, the geometric wire counters of the system are also used on the Eastern Bering Sea Shelf as an independent measure of the warps after calibration with the measured marks. When required, a description of the servicing of the auto-trawl system will be included in the vessel charter specifications. The auto-trawl servicing requirements will read as follows:

Prior to every trawl survey, NOAA and chartered fishing vessels must provide testing and certification of their autotrawl systems by a qualified autotrawl mechanic no more than 30 days prior to the start of the charter. Items inspected should include but are not limited to: 1) trawl winch motors, including tests for internal leaks, 2) trawl winch drums to ensure that both drums have equal widths and windings, 3) equalizing valve and all relief valves, 4) controller system to ensure proper function and that all operational parameters (e.g., wire diameter, drum dimensions) are correctly specified. In addition, sea trials are to be performed to verify proper winch function (level wire winding), and proper dynamic operation (equal tension is maintained).

Additional information will be added to each operations manual describing the standard use of an auto-trawl system. For each of the three surveys using auto-trawl systems the information will read as follows:

The auto-trawl wire tensioning system is designed to reduce net damage during hang-ups and help square the net when making turns, on uneven slopes, and in currents. To ensure consistency between vessels and over time, the Field Party Chief (FPC) will instruct the vessel crew to adjust the equalization valve to allow the winches to respond to rapid increases in tension when the trawl snags the bottom. However, the pressure differential needed to initiate winch adjustment should not be so low that the winches are frequently adjusting warp length. All vessels will use the same warp length difference as a parameter to initiate the offset alarm.

Protocol 3: Operations Procedures

Eastern Bering Sea Shelf (EBS) Bottom Trawl Survey

A. Scope

The following scope table will be used to determine the amount of warp to be set given the depth of the survey station location. The FPC will discuss this table with the skipper and ensure that this guideline is adhered to. It is understood that some events, including current velocity and weather, may create a need to deviate from the specified value of scope. Should a deviation occur, skippers must document and provide justification on the Haul Form.

Depth Range (fm)	Wire Out (fm)
1 to 21	75
22 to 29	100
30 to 38	125
39 to 47	150
48 to 57	175
58 to 67	200
68 to 78	225
79 to 90	250
91 to 102	275
103 to 114	300
115 to 128	325

B. Speed of tow

The skipper is responsible for maintaining a constant towing speed of 3 knots from the time of brake-set to haul back. Speed variations from 2.8 to 3.2 knots are acceptable, but the target is 3 knots and should be adhered to as closely as possible. Monitoring of tow speed will be accomplished in real time using the global positioning system (GPS) unit supplied by the scientific party. Should this NOAA provided GPS fail, the skipper should use the vessel instrumentation that he/she believes most closely matches that of the supplied unit. In such cases, the skipper/FPC will document in the Haul Form the instrumentation used to monitor tow speed.

C. Duration and distance of tow and use of trawl mensuration / performance monitoring instrumentation

The performance and geometry of trawls used during AFSC survey tows will be measured using several sensors. Net height and width will be measured in real time using Scanmar or Netmind sensors mounted on the center of the headrope and on the upper bridle just forward of the

wingtips. Depth and temperature data will be measured using a self-contained bathythermograph mounted near the center of the headrope. Bottom contact information will be measured with a self-contained Bottom Contact Sensor (BCS) mounted on the center of the footrope. Detailed descriptions of the rigging for each of these sensors is provided in the AFSC Net Mensuration Manual, which is carried aboard all survey vessels. Annual training is mandatory for all staff operating net mensuration and monitoring instruments and interpreting the data collected with them.

Target duration of all tows will be 30 minutes towing time, which equates to approximately 1.5 nmi or 2.8 km at the standard towing speed of 3 knots. The 30 minute tow time is a proxy for a target distance fished of 1.5 nmi at a speed of 3 knots, which is used in the swept area calculation of catch per unit of effort (CPUE). The tow time will begin when the brakes are set (on the relatively shallow Bering Sea Shelf it has been found that brake set and trawl touch down are usually within a minute of each other). Haulback will occur after 30 minutes. Tows may be shortened due to upcoming obstructions, inability to follow a depth contour, hangups, gear problems, or extremely large catches which affect the efficiency of the trawl.

After the haul is completed, data from each of the sensors will be synchronized with the GPS data and displayed simultaneously using custom designed software (ScanPlot). Using this software, the operator will determine the precise moments that the footrope initially contacts (On-Bottom) and leaves bottom (Off-Bottom) and calculate the duration, distance fished, and average net spread and height during each tow. The trace of the BCS data is the most useful tool for determining the On- and Off-Bottom times. The transition between when the net is on or off bottom is usually clearly signaled by an abrupt change in readings from around 40 degrees to around 60 degrees (vice versa when leaving bottom). Distance fished is determined from the GPS vessel track between the On- and Off-Bottom positions. All tows will be made between 0.5 hr after sunrise and 0.5 hr before sunset. Sunrise and sunset times at a given latitude-longitude are available on the AFSC GPS units.

D. Direction of tows

Tows will be made in the direction of the next tow. Due to the survey design, most tows will be made in either a north or south direction, with the exception of corner stations. Tow direction may be different from above if the skipper determines that safety is a concern, or if the net performance in terms of trawl configuration is severely compromised (e.g., doors falling over due to tow in direction of a strong current). The skipper must notify the FPC and document the reason in the Haul Form for any deviation of the standard towing direction.

E. Location of sampling sites and procedures to use if stations are not suitable for towing

Tow locations are predetermined stations at the centers of a 20 × 20 nmi grid, except where additional corner stations are allocated to obtain more precise estimates of king crab abundance near the Pribilof Islands and St. Matthew Island, and stations where known obstructions prevent using that location. All station locations are listed in Appendices of the Survey Operations Manual. Two vessels are used in the survey. The survey shall begin at the easternmost stations of Bristol Bay and the two vessels shall work alternate north-south columns toward the shelf edge in the west. It is understood that occasional alterations may occur at the extremities of a

column to save time, but effort should be made to maintain the alternate column sampling. The skipper shall begin the tow at a position before the station location, such that the middle of each approximately 1.5 nmi tow shall cross near the center point of that station location.

For stations that cannot be completed at the listed station due to untrawlable bottom, an alternate location shall be chosen which is no further than 1 nmi away from this center point (e.g., within the same grid square). A list of stations for which poor tow performances have occurred in past surveys is provided in a separate document (good-tow / bad-tow log). This document also provides a list of alternate locations for these poor performance stations. These alternate station locations were successfully completed within those grid squares during past EBS surveys.

F. Criteria for determining the success of a tow and procedures to use if a tow was unsuccessful

A successful tow is defined as a tow in which the trawl was maintained on the bottom in the standard fishing configuration as determined by net mensuration, bathythermograph, and bottom contact instrumentation. The FPC will assure himself that the trawl was in adequate fishing configuration, and preponderantly on bottom for the duration of the tow. As instructed above, 30 minute tows are the standard and should be completed as such unless otherwise instructed by the FPC. Tows as short as 10 minutes are acceptable under conditions described in Item C or below.

Tows with any loss of fish or invertebrates due to significant tears in the net or with improper fishing configuration are considered unsuccessful. Tows for which obstructions in the net (e.g., derelict crab pots) that could have potentially affected the CPUE are also considered unsuccessful.

In some cases, if a hang-up or gear obstruction has occurred at a time that is fairly obvious, such as a shudder or stopping of the vessel, and haulback is immediately started, the trawl should be examined. If any damage is minimal and restricted to forward parts of the trawl, then the tow may be considered successful. This assumes that at least 10 minutes of on bottom time was achieved. If a significant tear-up or obstruction occurs, or it cannot be determined when the tear or obstruction happened, then the tow must be considered unsuccessful.

Stations considered unsuccessful tows will be re-towed unless factors beyond the control of the survey party make it impossible to complete the station within the grid square (e.g., extreme current or ice coverage). The FPC will make the final decision as to whether the tow was successful or not and whether it will be re-towed.

G. Vessel and winch operation during deployment and retrieval

To ensure comparability between vessels and years, vessel operators will be asked to follow standard procedures when setting, towing, and retrieving the trawl gear. These procedures will be established before the beginning of the first leg by the captain and the FPC and must be maintained throughout the survey. The goals for each part of the standard tow are as follows:

Setting

Primary Goal

- To ensure that the trawl is in fishing configuration (height and width) when it makes bottom contact.
- To ensure that the procedure is easily repeatable.

Secondary Goals

- To ensure that the trawl reaches bottom quickly to minimize the midwater catch.

Towing

Goal

- To maintain the trawl in fishing configuration (height and width) at a continuous towing speed of 3 knots.

Haulback

Primary Goals

- To maintain the trawl in fishing configuration until it leaves the bottom.
- To ensure that the net leaves bottom quickly to avoid changes in fishing configuration due to decreased scope and changes in net speed over ground (this will usually require an increase in RPM).
- To ensure that the procedure is easily repeatable.

Implementation

Vessel speed, engine RPM, wire payout rate, etc., required to achieve these goals may require some experimentation at the beginning of the first leg of the survey on each vessel. The captain and the FPC should work out a standard procedure for setting, towing, and hauling back the gear. The procedures decided upon should facilitate consistently achieving the above stated goals and will be documented in writing on the Standard Trawling Procedures Form provided and adhered to thereafter. Since the power settings (RPM and/or propeller pitch) to achieve particular vessel speeds will change with the wind, sea state, and currents, approximate power settings used to achieve these speeds in good weather conditions (little wind, no current) should be recorded. If different procedures are developed for various depths, these should be recorded as well. Any procedural modifications during the survey must be mutually agreed upon between the FPC and the captain and must be carefully justified and documented in writing. It is particularly important to maintain the procedures should the vessel captain change during the survey.

H. Defining responsibility (e.g., survey scientist or vessel crew) for decisions regarding various aspects of the operation

All aspects of the survey operation will be overseen by the FPC. Final decisions regarding station locations and station scheduling are the responsibility of the FPC. Vessel operation, trawl gear deployment and retrieval, and all matters related to vessel safety will be the responsibility of the vessel Captain.

It is the responsibility of both the FPC and the captain of the vessel to keep lines of communication open between survey vessels, not only for safety purposes, but to ensure that all operations are proceeding in the manner outlined here.

I. Staff training

The scientific staff participating in AFSC trawl surveys will undergo periodic mandatory training which includes classes addressing use of net mensuration instrumentation and interpretation of the mensuration data, fish and invertebrate identification, survival skills, remote duty first aid, oxygen therapy, and principles of trawl net maintenance. In addition, the FPC leading each cruise leg will be trained to carry out the objectives and sampling instructions for the specific survey leg he/she is assigned to. Training of FPCs includes learning about the design, logistics, and sampling requirements of the survey; staff management; and evaluating survey fishing gear repairs. The FPC is responsible for working directly with the captain of the vessel to coordinate overall and daily work plans and coordinating with the FPCs of partner vessels to efficiently and successfully achieve the sampling objectives of the survey.

The AFSC surveys are conducted with chartered vessels, captains, and crew. As such, we have limited influence over the training requirements of the captains and crew. Our staff will work closely with vessel personnel before and during the charter periods to communicate with and educate them regarding matters important to the standard and proper sampling procedures required during groundfish bottom trawl surveys. AFSC Net Loft staff will review prescribed maintenance and repair objectives and standards with vessel personnel and FPCs will interact constantly with captains regarding survey objectives and standardized fishing protocols.

EBS Upper Continental Slope (EBSUCS) Bottom Trawl Survey

A. Scope

The EBSUCS survey utilizes the following scope ratio table that was empirically established to determine the amount of warp used at each trawling depth when the warps are constructed of 1 inch, die-formed, steel-core wire. When other types or sizes of warps are used, a new table should be re-established. Use warp marks to determine the amount of warp out during trawling operations. To prevent net collapse or door crossing, the warp should be let out evenly in the “free-wheel mode” while maintaining the vessel speed at least 1 knot above the payout rate. Gradually decrease vessel speed and payout rate as the desired amount of wire is approached.

Bottom Depth		Scope	
Minimum (m)	Maximum (m)	Meters	Fathoms
146	176	550	301
177	206	600	328
207	237	650	355
238	267	700	383
269	298	750	410
299	328	800	437
330	358	850	465
360	389	900	492
390	420	950	519
421	450	1000	547
451	481	1050	574
482	511	1100	601
512	542	1150	628
543	572	1200	656
573	603	1250	683
604	633	1300	710
634	664	1350	738
665	694	1400	765
695	725	1450	792
726	755	1500	820
756	786	1550	847
787	816	1600	874
817	847	1650	901
848	877	1700	930
878	908	1750	957
909	938	1800	984
939	969	1850	1012
970	999	1900	1039
1000	1030	1950	1066
1031	1060	2000	1094
1061	1091	2050	1121
1091	1121	2100	1148

B. Speed of tow

The EBSUCS survey targets an average towing speed over ground of 2.5 knots with an acceptable range of momentary towing speed between 2.2 knots and 2.8 knots when the net is in

contact with the bottom and in fishing configuration. It is important to keep the vessel speed as constant as possible and near 2.5 knots when the net is fishing on bottom. After brake-set, vessel speed can be used to regulate sink time of the trawl, however vessel speed should be as close to 2.5 knots as possible when the net reaches the bottom. Monitor vessel speed frequently during a tow using the NOAA supplied GPS unit.

C. Duration and distance of tow and use of trawl mensuration / performance monitoring instrumentation

The performance and geometry of the trawl are measured using several sensors. Net height and width is measured in real time using SCANMAR sensors mounted on the center of the headrope and on the upper bridle just forward of the wingtips. Depth and temperature data is measured using a self-contained bathythermograph mounted near the center of the headrope. Bottom contact information will be measured with a self-contained Bottom Contact Sensor (BCS) mounted at the center of the footrope. Detailed descriptions of the rigging for each of these sensors is provided in the AFSC Net Mensuration Manual, which is carried aboard all survey vessels. Annual training is mandatory for all staff operating net mensuration and monitoring instruments and interpreting the data collected with them.

Target tow duration is 30 minutes, which equates to approximately 1.3 nmi or 2.4 km at the standard towing speed of 2.5 knots. The start of the 30 minute towing period is determined from the net height data and is defined as when the height decreases to 8 m. Winches are engaged and haulback begins 30 minutes later. Tows may be shortened due to obstructions, inability to follow a depth contour, hangups, gear problems, or extremely large catches which affect the efficiency of the trawl.

After a haul is completed, data from each of the sensors will be synchronized with the GPS data and displayed simultaneously using custom designed software (ScanPlot). Using this software, the operator will determine the precise moments that the footrope initially contacts (On-Bottom) and leaves bottom (Off-Bottom) and calculate the duration, distance fished, and average net spread and height during each tow. The trace of the BCS data is the most useful tool for determining the On- and Off-Bottom times. The transition between when the net is on or off bottom is usually clearly signaled by an abrupt change in readings from around 40 degrees to around 60 degrees (vice versa when leaving bottom). Distance fished is determined from the vessel track between the On- and Off-Bottom positions.

D. Direction of tow

On the EBSUCS survey, the towing direction is dictated by bottom topography, current direction, wind speed and direction, and wave height and direction. Bottom topography often precludes all but a single towing direction to complete a tow successfully because of the need to follow a depth contour. In strong current, the tow is directed up-stream to prevent net distortion. In strong winds, the trawl is directed up-wind to allow the skipper better control of vessel direction and towing speed. In summary, tow direction is not a random variable, but it is not always predictable because of variation in wind and current.

E. Location of suitable sampling sites

The EBSUCS survey uses random sampling within strata defined by depth and sub-area. To minimize lost time in transit, stations should be completed in the order of proximity, proceeding from one station to the next closest station. Prior to trawling, each station should be surveyed, using a depth sounder, to determine if it is in the correct depth stratum and trawlable.

Unfortunately the best available bathymetry data is poor and the actual station location and depth must be changed from the redetermined stations. A successful sampling area with a good potential for success is characterized by relatively low relief substrate with at least 1.5 nmi of trawlable bottom within the depth stratum boundaries. If trawlable ground is not found at the predetermined site, a search should be conducted within the same sub-area and depth stratum to locate another site as close to the original site as possible. A site is designated as untrawlable if the skipper and/or FPC determine that the bottom topography precludes a successful tow due to potential net damage, insufficient distance, widely changing depth range, and obstruction in the tow path. Trawlable ground decisions are governed by the skipper and FPC's experience with the net and its ability to perform given the bottom topography.

F. Successful tow criteria

The success of a tow should be assessed considering events during the trawl operation as well as examination of data after the tow is completed. Attention to the net mensuration monitor may indicate a tear-up or obstruction causing the net to deviate from normal dimensions. Under some conditions it may be impossible to maintain proper speed during the tow. After the tow, examination of the net for evidence of damage and examination of the trawl mensuration data, bottom contact data and depth data are used to assess trawl performance. The following are minimal criteria which must be met to consider a haul satisfactory:

1. The BCS tilt angle should indicate proper footrope bottom contact (variable footrope contact indicates poor performance).
2. Net mensuration data should indicate the net dimensions are within those expected for the towing depth.
3. Trawl time should be > 15 minutes and < 35 minutes.

If the tow is deemed unsuccessful then a second attempt is made at the same location, or another location is found in the same depth and sub-area, to replace the unsuccessful tow.

At the end of the survey, mensuration data is reviewed by another party and any differences in opinion are discussed. The FPC has the final determination.

G. Vessel and winch operations

During trawl deployment, vessel speed should be maintained at least 1 knot faster than the net pay out rate (up to brake-set). Deploy the wire to the prescribed length using the painted marks on the wires. Set the brakes at the determined warp length and adjust the vessel speed to 2.5 knots as soon as possible. Use vessel speed to regulate settling rate of the trawl. Vessel speed should be as close to 2.5 knots as possible when the net is on the bottom. Speeds between 1 and 2 knots can be used to increase sink rate and speeds up to 3.5 knots can be used to decrease the sink rate. The auto-trawl system should be ON during the tow to avoid net damage if there should be a hang-up or a large catch. The skipper should haul back the trawl and end the tow by

“popping” the net off the bottom as quickly as possible. This is accomplished in most cases by increasing engine RPM when starting the winches. Use net mensuration data to verify that the skipper is quickly lifting the trawl net off bottom.

H. Defining responsibility for decisions

The FPC is responsible for every aspect of the survey from trawling operations to catch processing, and data entry. These responsibilities are often shared with members of the scientific party and vessel crew depending on the abilities of the people available, time and ability of the FPC to perform all tasks successfully. The catch processing, sample collections and data collection are handled entirely by members of the scientific crew on board. The EBSUCS survey utilizes a “deck boss” who is responsible for the catch processing and data entry and a FPC who is responsible for the net mensuration monitoring and trawling operations. The FPC determines when and where to trawl and the skipper and crew are responsible for actually carrying out this goal. The FPC defers many trawl decisions to the skipper who is often much more experienced with the vessel and fishing operations. The FPC provides the final decision on when to retire or repair a net but only after deliberating with the skipper and crew experienced in net repair and reaching a consensus.

I. Staff training

The scientific staff participating in AFSC trawl surveys will undergo periodic mandatory training which includes classes addressing use of net mensuration instrumentation and interpretation of the mensuration data, fish and invertebrate identification, survival skills, remote duty first aid, oxygen therapy, and principles of trawl net maintenance. In addition, the FPC leading each cruise leg will be trained to carry out the objectives and sampling instructions for the specific survey leg he/she is assigned to. Training of FPCs includes learning about the design, logistics, and sampling requirements of the survey; staff management; and evaluating survey fishing gear repairs. The FPC is responsible for working directly with the captain of the vessel to coordinate overall and daily work plans and coordinating with the FPCs of partner vessels to efficiently and successfully achieve the sampling objectives of the survey.

The AFSC surveys are conducted with chartered vessels, captains, and crew. As such, we have limited influence over the training requirements of the captains and crew. Our staff will work closely with vessel personnel before and during the charter periods to communicate with and educate them regarding matters important to the standard and proper sampling procedures required during groundfish bottom trawl surveys. AFSC Net Loft staff will review prescribed maintenance and repair objectives and standards with vessel personnel and FPCs will interact constantly with captains regarding survey objectives and standardized fishing protocols.

Gulf of Alaska (GOA) Bottom Trawl Survey

A. Scope

The length of trawl warp to be deployed during a tow of any given depth is specified in the following standard scope and depth table. In general, tows should not involve great depth changes (i.e., more than 20 m), but if the depth changes over the tow, the wire out should be adjusted to the new depth and the amount of wire change and time noted on the Haul Form. In cases where the depth falls in between wire amounts in the scope table, the captain should err on the side of too much wire out rather than too little.

Bottom Depth Range		Wire Out	Bottom Depth Range		Wire Out
(m)	(fm)	(fm)	(m)	(fm)	(fm)
10 - 11	5 - 6	75	469 - 491	257 - 268	600
12 - 34	7 - 19	100	492 - 520	269 - 284	625
35 - 57	19 - 31	125	521 - 547	285 - 299	650
58 - 80	32 - 43	150	548 - 574	300 - 313	675
81 - 102	44 - 55	175	575 - 601	314 - 328	700
103 - 125	56 - 68	200	602 - 627	329 - 342	725
126 - 148	69 - 80	225	628 - 654	343 - 357	750
149 - 171	81 - 93	250	655 - 681	358 - 372	775
172 - 194	94 - 106	275	682 - 708	373 - 387	800
195 - 217	107 - 118	300	709 - 734	388 - 401	825
218 - 240	119 - 131	325	735 - 761	402 - 416	850
241 - 262	132 - 143	350	762 - 788	417 - 430	875
263 - 285	144 - 155	375	789 - 815	431 - 445	900
286 - 308	156 - 168	400	816 - 841	446 - 459	925
309 - 331	169 - 181	425	842 - 868	460 - 474	950
332 - 354	182 - 193	450	869 - 895	475 - 489	975
355 - 377	194 - 206	475	896 - 922	490 - 504	1000
378 - 400	207 - 219	500	923 - 948	505 - 518	1025
401 - 422	220 - 230	525	949 - 975	519 - 533	1050
423 - 445	231 - 243	550	976 - 1002	534 - 547	1075
446 - 468	244 - 256	575	1003 - 1028	548 - 562	1100

B. Speed of tow

Bottom trawl hauls will be made at a constant speed of 3 knots (nmi/hr) over ground. The captain of the vessel is responsible for monitoring and maintaining the speed during the entire tow. Speed at any point during the tow can be verified using the continuous stream of GPS data, which is logged to a computer file. There is strong evidence that the center of the footrope begins to lose contact with the bottom at speeds over 3 knots, so speeds exceeding 3 knots should especially be avoided.

C. Duration and distance of tow and use of trawl mensuration/performance monitoring instrumentation

The performance and geometry of trawls used during AFSC survey tows will be monitored using several sensors. Net height and width will be monitored in real time using Scanmar or Netmind sensors mounted on the center of the headrope (height sensor) and just forward of the upper wingtips (width sensors). Depth and temperature data will be collected using a self-contained bathythermograph mounted near the center of the headrope. Bottom contact information will be logged with a self-contained Bottom Contact Sensor (BCS) mounted on the center of the footrope. Detailed descriptions of the rigging for each of these sensors is provided in the AFSC Net Mensuration Manual, which is carried aboard all survey vessels. Annual training is mandatory for all staff operating net mensuration and monitoring instruments and interpreting the data collected with them.

Target duration of all tows will be 15 minutes towing time, which equates to approximately 0.75 nmi or 1.4 km at the standard towing speed of 3 knots. This duration ensures an adequate sample of the biota and usually results in a catch that is a reasonably manageable size to sort and process. The start of the 15 minute towing period will be determined from the near-real-time readout of the net height instrumentation, which enables the operator to determine when the net approaches bottom and settles into its fishing configuration. The time that the footrope touches down can usually be detected by watching the headrope height measurements decrease rapidly from over 10 m to under 8 m as the net approaches bottom. The start of the tow should be defined as when the height decreases to 8 m. Winches are engaged 15 minutes later to haul back the net. Tows may be shortened due to upcoming obstructions, inability to follow a depth contour, hangups, gear problems, or extremely large catches which affect the efficiency of the trawl.

After the haul is completed, data from each of the sensors will be synchronized with the GPS data and displayed simultaneously using custom designed software (ScanPlot). Using this software, the operator will determine the precise moments that the footrope initially contacts (On-Bottom) and leaves bottom (Off-Bottom) and calculate the duration, distance fished, and average net spread and height during each tow. The trace of the BCS data is the most useful tool for determining the On- and Off-Bottom times. The transition between when the net is on or off bottom is usually clearly signaled by an abrupt change in readings from around 40 degrees to around 60 degrees (vice versa when leaving bottom). Distance fished is determined from the GPS vessel track between the On- and Off-Bottom positions.

D. Direction of tow

Tow direction is currently determined only by the directive to follow depth contours and by any conditions which might influence the decision of the captain and/or FPC, such as bottom obstructions, peculiarities of the substrate, wind, current, or sea state.

E. Location of sampling sites and procedures to use if sites are not suitable for towing

Stations to be sampled during the survey will be selected during the design process. The entire survey area is covered by an overlay of 25 km² grid cells based on lines of latitude and longitude (fishable area of a grid cell may be less than 25 km² due to land masses, stratum boundaries, or untrawlable areas). The exact location of a station is actually unspecified but must fall within a

chosen grid cell. Stations are allocated among strata using groundfish catch data from previous GOA bottom trawl surveys and Neyman allocation to minimize variance. Each stratum is required to have at least two samples.

Stations for each stratum are randomly selected without replacement from the set of full or partial grid cells falling within that stratum, excluding partial grid cells smaller than 5 km² and grid cells that had been deemed untrawlable in previous surveys. The stations in each stratum are then assigned among the vessels. Paper and electronic charts depicting station locations and successful tows made during previous surveys are used to guide sampling.

Within each assigned grid cell, the captain and FPC collaborate to find enough trawlable bottom to complete a standard 15-minute tow made at the standard speed of 3.0 knots (approximately 0.75 nmi or 1.4 km). Each tow should be surveyed before trawling operations begin in order to minimize time lost to gear damage and bad performance tows. However, because the goal is to maximize the coverage of the GOA with the survey trawl, some risk of gear damage is acceptable. While it is not necessary to begin the tow within the grid cell, at least half the tow (and preferably the entire tow) should be within the cell. A reasonable effort should be made to search the entire cell for trawlable bottom, but the search time should generally not exceed two hours.

If no trawlable bottom is found within an assigned grid cell, that cell should be designated as untrawlable in the station log, including any pertinent notes. An alternate grid cell should then be sampled. Alternate sites should be selected from unallocated grid cells in the correct stratum as close as possible to the abandoned grid cell. Historical successful tows shown on the paper and electronic charts should be used to locate nearby areas of potentially trawlable bottom within the correct stratum. If trawlable bottom is encountered while in transit to an alternate station, a haul should be conducted in that area provided it is in an unallocated grid cell and in the correct stratum. It is essential that the vessels communicate clearly whenever conducting hauls in alternate grid cells to avoid sampling the same grid cell twice.

F. Criteria for determining the success of a tow and procedures to use if tow was unsuccessful

The criteria that need to be met for a totally satisfactory tow are:

- 15 minutes towing time
- constant towing speed of 3 knots
- length of wire out as specified by the scope table
- net mensuration instruments indicate gear operating within normal limits (historical normal ranges: width = 12.9-17.5 m, height = 5.2-9.4 m)
- constant gear contact with the sea bottom
- no hang ups, gear damage, or gear conflicts (e.g., crab pots or longlines)
- all survey tows made during daylight hours (start and end times shall fall between 30 minutes after sunrise and 30 minutes before sunset, as determined by actual observation, Tides & Currents software, or other position-related means).

Acceptable performance includes tows with the following conditions: durations of between 10 and 20 minutes, occasional minor separations between bottom and the footrope, small tears

unlikely to significantly affect catch rates, gear conflicts unlikely to have affected the fishing efficiency of the trawl, etc. The net mensuration operator will use data collected with monitoring instrumentation to evaluate the performance of each trawl haul performed. Data streams from each of the net-mounted monitoring sensors will be synchronized and displayed simultaneously using ScanPlot software. Using this information, the operator will evaluate the quality of each tow considering whether the fishing dimensions fell within normal limits, whether the footrope maintained contact with the bottom, and the apparent consequences of encountering snags or obstructions. Based on this evaluation, each tow is judged to be either satisfactory or unsatisfactory. If it is judged to be unsatisfactory, it will be repeated until either a satisfactory tow is accomplished or the station is abandoned. Following completion of the survey, one person will review the mensuration and performance information for each haul. If the reviewer has a difference of opinion with the original operator about the success of the tow, they will discuss the issues and develop a consensus evaluation.

G. Vessel and winch operation during deployment and retrieval

To ensure comparability between vessels and years, vessel operators will be asked to follow standard procedures when setting, towing, and retrieving the trawl gear. These procedures will be established at the beginning of the first leg by the captain and the FPC and must be maintained throughout the survey and for all subsequent surveys. The goals for each part of the standard tow are as follows:

Setting

Primary Goal

- To ensure that the trawl is in fishing configuration (height and width) when it makes bottom contact.
- To ensure that the procedure is easily repeatable.

Secondary Goals

- To ensure that the trawl reaches bottom quickly to minimize the midwater catch.

Towing

Goal

- To maintain the trawl in fishing configuration (height and width) at a continuous towing speed of 3 knots.

Haulback

Goals

- To maintain the trawl in fishing configuration until it leaves the bottom.
- To ensure that the net leaves bottom quickly to avoid changes in fishing configuration due to decreased scope and changes in net speed over ground (this will usually require an increase in RPM).
- To ensure that the procedure is easily repeatable.

Implementation

Vessel speed, engine RPM, wire payout rate, etc., required to achieve these goals may require some experimentation at the beginning of the first leg of the survey on each vessel. The captain

and the FPC should work out a standard procedure for setting, towing, and hauling back the gear. The procedures decided upon should facilitate consistently achieving the above stated goals and will be documented in writing on the Standard Trawling Procedures Form and adhered to for the remainder of the survey and for all subsequent surveys. Since the power settings (RPM and/or propeller pitch) to achieve particular vessel speeds will change with the wind, sea state, and currents, approximate power settings used to achieve these speeds in good weather conditions (little wind, no current) should be recorded. If different procedures are developed for various depths, these should be recorded as well. Any procedural modifications during the survey must be mutually agreed upon between the FPC and the captain and must be carefully justified and documented in writing.

H. Defining responsibility for decisions regarding aspects of the operations

Vessels progress from west to east during the survey. Station selections for each day of work are made by the FPCs aboard all vessels working together through daily consultations. Daily plans are made considering the advice of vessel captains regarding weather, safety, and logistics.

I. Staff training

The scientific staff participating in AFSC trawl surveys will undergo periodic mandatory training which includes classes addressing use of net mensuration instrumentation and interpretation of the mensuration data, fish and invertebrate identification, survival skills, remote duty first aid, oxygen therapy, and principles of trawl net maintenance. In addition, the FPC leading each cruise leg will be trained to carry out the objectives and sampling instructions for the specific survey leg he/she is assigned to. Training of FPCs includes learning about the design, logistics, and sampling requirements of the survey; staff management; and evaluating survey fishing gear repairs. The FPC is responsible for working directly with the captain of the vessel to coordinate overall and daily work plans and coordinating with the FPCs of partner vessels to efficiently and successfully achieve the sampling objectives of the survey.

The AFSC surveys are conducted with chartered vessels, captains, and crew. As such, we have limited influence over the training requirements of the captains and crew. Our staff will work closely with vessel personnel before and during the charter periods to communicate with and educate them regarding matters important to the standard and proper sampling procedures required during groundfish bottom trawl surveys. AFSC Net Loft staff will review prescribed maintenance and repair objectives and standards with vessel personnel and FPCs will interact constantly with captains regarding survey objectives and standardized fishing protocols.

Aleutian Islands (AI) Bottom Trawl Survey**A. Scope**

The length of trawl warp to be deployed during a tow of any given depth is specified in a standard scope and depth table. In general, tows should not involve great depth changes (i.e., more than 20 m), but if the depth changes over the tow, the wire out should be adjusted to the new depth and the amount of wire change and time noted on the Haul Form. In cases where the depth falls in between wire amounts in the scope table, the captain should err on the side of too much wire out rather than too little.

Bottom Depth Range		Wire Out	Bottom Depth Range		Wire Out
(m)	(fm)	(fm)	(m)	(fm)	(fm)
10 - 11	5 - 6	75	469 - 491	257 - 268	600
12 - 34	7 - 19	100	492 - 520	269 - 284	625
35 - 57	19 - 31	125	521 - 547	285 - 299	650
58 - 80	32 - 43	150	548 - 574	300 - 313	675
81 - 102	44 - 55	175	575 - 601	314 - 328	700
103 - 125	56 - 68	200	602 - 627	329 - 342	725
126 - 148	69 - 80	225	628 - 654	343 - 357	750
149 - 171	81 - 93	250	655 - 681	358 - 372	775
172 - 194	94 - 106	275	682 - 708	373 - 387	800
195 - 217	107 - 118	300	709 - 734	388 - 401	825
218 - 240	119 - 131	325	735 - 761	402 - 416	850
241 - 262	132 - 143	350	762 - 788	417 - 430	875
263 - 285	144 - 155	375	789 - 815	431 - 445	900
286 - 308	156 - 168	400	816 - 841	446 - 459	925
309 - 331	169 - 181	425	842 - 868	460 - 474	950
332 - 354	182 - 193	450	869 - 895	475 - 489	975
355 - 377	194 - 206	475	896 - 922	490 - 504	1000
378 - 400	207 - 219	500	923 - 948	505 - 518	1025
401 - 422	220 - 230	525	949 - 975	519 - 533	1050
423 - 445	231 - 243	550	976 - 1002	534 - 547	1075
446 - 468	244 - 256	575	1003 - 1028	548 - 562	1100

B. Speed of tow

Bottom trawl hauls will be made at a constant speed of 3 knots (nmi/hr) over ground. The captain of the vessel is responsible for monitoring and maintaining the speed during the entire tow. Speed at any point during the tow can be verified using the continuous stream of GPS data, which is logged to a computer file. There is strong evidence that the center of the footrope

begins to lose contact with the bottom at speeds over 3 knots, so speeds exceeding 3 knots should especially be avoided.

C. Duration and distance of tow and use of trawl mensuration/performance monitoring instrumentation

The performance and geometry of trawls used during AFSC survey tows will be monitored using several sensors. Net height and width will be monitored in real time using Scanmar or Netmind sensors mounted on the center of the headrope (height sensor) and just forward of the upper wingtips (width sensors). Depth and temperature data will be collected using a self-contained bathythermograph mounted near the center of the headrope. Bottom contact information will be logged with a self-contained Bottom Contact Sensor (BCS) mounted on the center of the footrope. Detailed descriptions of the rigging for each of these sensors is provided in the AFSC's Net Mensuration Manual, which is carried aboard all survey vessels. Annual training is mandatory for all staff operating net mensuration and monitoring instruments and interpreting the data collected with them.

Target duration of all tows will be 15 minutes towing time, which equates to approximately 0.75 nmi or 1.4 km at the standard towing speed of 3 knots. This duration ensures an adequate sample of the biota and usually results in a catch that is a reasonably manageable size to sort and process. The start of the 15 minute towing period will be determined from the near-real-time readout of the net height instrumentation, which enables the operator to determine when the net approaches bottom and settles into its fishing configuration. The time that the footrope touches down can usually be detected by watching the headrope height measurements decrease rapidly from over 10 m to under 8 m as the net approaches bottom. The start of the tow should be defined as when the height decreases to 8 m. Winches are engaged 15 minutes later to haul back the net. Tows may be shortened due to upcoming obstructions, inability to follow a depth contour, hangups, gear problems, or extremely large catches which affect the efficiency of the trawl.

After the haul is completed, data from each of the sensors will be synchronized with the GPS data and displayed simultaneously using custom designed software (ScanPlot). Using this software, the operator will determine the precise moments that the footrope initially contacts (On-Bottom) and leaves bottom (Off-Bottom) and calculate the duration, distance fished, and average net spread and height during each tow. The trace of the BCS data is the most useful tool for determining the On- and Off-Bottom times. The transition between when the net is on or off bottom is usually clearly signaled by an abrupt change in readings from around 40 degrees to around 60 degrees (vice versa when leaving bottom). Distance fished is determined from the GPS vessel track between the On- and Off-Bottom positions.

D. Direction of tow

Tow direction is currently determined only by the directive to follow depth contours and by any conditions which might influence the decision of the captain and/or FPC, such as bottom obstructions, peculiarities of the substrate, wind, current, or sea state.

E. Location of sampling sites and procedures to use if site not suitable

Stations to be sampled during the survey will be selected during the design process. Stations are allocated among strata using groundfish data from previous Aleutian bottom trawl surveys and Neyman allocation to minimize the variance. Each stratum is required to have at least two samples.

The station locations are randomly selected without replacement from a collection of stations successfully sampled during the 1991 survey or thereafter. This collection covers virtually the entire survey area. The stations are assigned randomly between the two survey vessels. Each year several additional, previously unsampled stations must be added in various strata to satisfy the sample allocation scheme. Generally these additional tows come from strata that have proven to be difficult to sample in the past. Paper and electronic charts depicting station locations and successful tows made during previous surveys are used to guide sampling.

Each tow should be surveyed before trawling operations begin in order to minimize time lost to gear damage and bad performance tows. However, because the goal is to maximize the coverage of the Aleutian region with the survey trawl, some risk of gear damage is acceptable. It is not necessary to begin the tow at the exact location listed for the station. A reasonable effort should be made to search and locate a trawlable station within a 5-nmi radius of the listed station, but the search should generally not exceed two hours.

In most cases it will be unnecessary to locate alternate stations, since most stations have been sampled successfully before. Tows from previous surveys made by foreign vessels were usually conducted with larger trawls rigged with tire gear designed for very rough bottom conditions, but stations fished by U.S. vessels were sampled with our standard survey gear. Therefore, should the need arise to find an alternate station location, use the following rules:

- 1) When bottom conditions preclude sampling at an assigned station, choose an alternate station from the list of stations previously sampled by a U.S.-flagged vessel.
- 2) If no previously sampled (by U.S.-flagged vessel) station fulfills the requirements for an alternate haul, then stations sampled by foreign vessels should be used to narrow the search for areas with trawlable bottom.
- 3) To facilitate future surveys, strata being searched for new stations should be searched intensively, recording the search trackline with the electronic navigation system in a distinct color to distinguish it from other tracklines. A record of the trawlability of each assigned station, with other comments pertinent to the suitability of a given location, should be maintained in the station log. The beginning and end of the search trackline should be recorded, as well as whether or not the entire area was searched.

It is essential that the vessels communicate clearly whenever conducting hauls at alternate stations avoid sampling the same station twice.

F. Criteria for determining the success of a tow and procedures to use if tow was unsuccessful

The criteria that need to be met for a totally satisfactory tow are:

- 15 minutes towing time
- constant towing speed of 3 knots
- length of wire out as specified by the scope table
- net mensuration instruments indicate gear operating within normal limits (historical normal ranges: width = 12.9-17.5 m, height = 5.2-9.4 m)
- constant gear contact with the sea bottom
- no hang ups, gear damage, or gear conflicts (e.g., crab pots or longlines)
- all survey tows made during daylight hours (start and end times shall fall between 30 minutes after sunrise and 30 minutes before sunset, as determined by actual observation, Tides & Currents software, or other position-related means).

Acceptable performance includes tows with the following conditions: durations of between 10 and 20 minutes, occasional minor separations between bottom and the footrope, small tears unlikely to significantly affect catch rates, gear conflicts unlikely to have affected the fishing efficiency of the trawl, etc. The net mensuration operator will use data collected with monitoring instrumentation to evaluate the performance of each trawl haul performed. Data from each of the sensors will be synchronized and displayed simultaneously using ScanPlot software. Using this information, the operator will evaluate the quality of each tow considering whether the fishing dimensions fell within normal limits, whether the footrope maintained contact with the bottom, and the apparent consequences of encountering snags or obstructions. Based on this evaluation, each tow is judged to be either satisfactory or unsatisfactory. If it is judged to be unsatisfactory, it will be repeated until either a satisfactory tow is accomplished or the station is abandoned. Following completion of the survey, one person will review the mensuration and performance information for each haul. If the reviewer has a difference of opinion with the original operator about the success of the tow, they will discuss the issues and develop a consensus evaluation.

G. Vessel and winch operation during trawl deployment and retrieval.

To ensure comparability between vessels and years, captains will be asked to follow standard procedures when setting, towing, and retrieving the gear. These procedures will be established at the beginning of the first leg by the captain and the FPC and must be maintained throughout the survey and for all subsequent surveys. A standard tow should follow these guidelines:

Setting the trawl

- The trawl is in fishing configuration with respect to vertical opening and spread when it makes bottom contact and is moving across the bottom at 3 knots.
- The trawl reaches bottom quickly to minimize the midwater catch.
- The proper trawl warp length is used (from the scope table).
- To ensure that the procedure is easily repeatable.

Towing the trawl

- Maintain the trawl in fishing configuration relative to vertical opening and spread.

- Maintain a continuous towing speed of 3 knots.

Haulback

- Trawl maintains fishing configuration until it leaves the bottom.
- Trawl leaves bottom quickly to avoid changes in fishing configuration due to decreased scope and changes in net speed over ground. This will usually require an increase in RPM.
- To ensure that the procedure is easily repeatable.

Implementation

Vessel speed, engine RPM, wire payout rate, etc., required to achieve these goals may require some experimentation at the beginning of the first leg of the survey on each vessel. Given that different power settings (RPM and/or propeller pitch) will be needed in different depths, current, wind, and sea conditions, the captain and the FPC should develop a set of standard procedures for setting, towing, and hauling the gear by performing test tows, keeping in mind that those procedures should be easily repeatable. The procedures decided upon should facilitate consistently achieving the above stated goals and will be documented in writing on the Standard Trawling Procedures Form and adhered to for the remainder of the survey and for all subsequent surveys. If different procedures are developed for various depths, these should be recorded as well. Any procedural modifications during the survey must be mutually agreed upon between the FPC and the captain and must be carefully justified and documented in writing.

H. Defining responsibility (i.e., survey scientists or vessel crew) for decisions regarding various aspects of the operations.

Vessels will generally progress from east to west during the survey. Station selections for each day of work are made by the FPCs aboard all vessels working together through daily consultations. Daily plans are made considering the advice of vessel captains regarding weather, safety, and logistics.

I. Staff training

The scientific staff who participate in AFSC trawl surveys will undergo periodic mandatory training which includes classes addressing use of net mensuration instrumentation and interpretation of the mensuration data, fish and invertebrate identification, survival skills, remote duty first aid, oxygen therapy, and principles of trawl net maintenance. In addition, the FPC leading each cruise leg will be trained to carry out the objectives and sampling instructions for the specific survey leg he/she is assigned to. Training of FPCs includes learning about the design, logistics, and sampling requirements of the survey; staff management; and evaluating survey fishing gear repairs. The FPC is responsible for working directly with the captain of the vessel to coordinate overall and daily work plans and coordinating with the FPCs of partner vessels to efficiently and successfully achieve the sampling objectives of the survey.

The AFSC surveys are conducted with chartered vessels, captains, and crew. As such, we have limited influence over the training requirements of the captains and crew. Our staff will work closely with vessel personnel before and during the charter periods to communicate with and educate them regarding matters important to the standard and proper sampling procedures required during groundfish bottom trawl surveys. AFSC Net Loft staff will review prescribed

maintenance and repair objectives and standards with vessel personnel and FPCs will interact constantly with captains regarding survey objectives and standardized fishing protocols.

Protocol 4: Trawl Construction and Repair

Descriptions of Trawls and Their Rigging

The four bottom trawl surveys conducted regularly by the AFSC utilize three trawls, all of which are constructed at the AFSC Net Loft. The 83-112 Eastern trawl is used for the Eastern Bering Sea shelf survey. The Poly Nor'Eastern trawl is used for the Gulf of Alaska, and Aleutian Islands surveys where it is configured with bobbin ground gear and a two-point attachment of the otter doors to the bridles. The Poly Nor'Eastern trawl is also used for the Eastern Bering Sea upper continental slope survey where is rigged with 8" mudsweep groundgear and a four-point attachment of the otter doors. Information concerning trawl construction and repair is included in the operations manual for each survey. This information includes:

- Description of the construction of the trawl components
- Description of the materials used in the trawl construction
- Net plan
- Rigging plan
- Ground gear plan
- Checklist for verifying trawl dimensions and specifications.
- Trawl Repair Form

The AFSC Net Loft staff will inspect and measure each trawl prior to loading it onto the vessel to ensure that it conforms to the specifications set forth on the survey trawl checklist. In addition, each trawl will have an identification number, stamped on a metal tag, that will be included on all haul forms and trawl repair forms. Whenever the trawl requires repair during survey operations, such repairs will be done following the standards set forth in the following section and documented on the trawl repair form. Components potentially affected by at-sea repairs will be remeasured to confirm that the trawl is meeting specifications.

Gear Repairs Aboard Vessels

At the start of every survey, vessels will be provided with an inventory of supplies used to repair trawl gear during the survey. Materials include web, hardware, floats, breastlines, twine, pre-cut bottom panels (only for the Poly Nor'Eastern trawl), etc. These supplies should provide each vessel with the resources needed to make typical repairs. If a survey vessel has experienced frequent net damage, the FPC should transmit a list of trawl repair supplies to the AFSC Net Loft sufficiently far in advance of the next scheduled port of call to allow time to ship the supplies. To ensure quick access to spare nets, the FPC should locate, at the start of each cruise leg, where spare nets are stored and, if access to the nets could be difficult in less than ideal conditions, store at least one spare net on deck.

Net, doors, and bridles should be examined routinely during every haul back, checking for any damage and noting any repairs that are needed. When large rocks are dumped from the net, codend liners should be checked for damage. The FPC, in consultation with the vessel crew,

will determine whether it is more expedient to repair a damaged trawl or to replace the trawl with a spare.

Survey trawls are research sampling tools and the success of our surveys depends on maintaining our survey gear to AFSC standards. The FPC should stress this to fishers responsible for making trawl repairs to ensure that trawls will be replaced if they cannot be repaired to AFSC survey standards. Fishers must follow the trawl repair protocols provided to them at the pre-cruise meeting with personnel from the AFSC Net Loft. In particular, they must replace torn or abraded web with patches or new panels, rather than hand sewing new meshes. Straight tears, however, can be sewn as long as there is no need to build meshes to close the hole. Lacing of holes or tears is not allowed in the body, wings or codend of the trawl. Special attention should be given to repairs involving the inside of the bottom wings (where the bar cut and chaffing strips are sewn to the body). Poor repairs in this area may affect the way the footrope tends bottom. Repairs that should not be attempted aboard vessels include broken headropes, footropes, riblines or rehanging long sections of riblines (repairs that involve more than 25 benzels, approx. 40'). Given the limited deck space aboard our survey vessels, these repairs are difficult to do correctly to ensure the finished product meets our standards.

The FPC is responsible for overseeing net repairs and deciding if a net should be retired. When a net is damaged, repaired, or retired, the Net Repair Form should be completed, noting the net ID number and all damage and repairs made. When retired, the net should be picked and cleaned before it is bundled and stowed.

Eastern Bering Sea Shelf Bottom Trawl Survey Gear Description for 83-112 Eastern Trawl

- Netting:** Body and wing 4" stretched measure (including length of one knot) 60 T nylon, three-strand twist, preshrunk and dyed green.
Intermediate and codend - 3½" stretched measure 96 T nylon, three-strand, twist, preshrunk and dyed green.
Codend liner - 1¼" stretched measure 18 T nylon, three-strand twist, preshrunk and dyed green.
- Headrope:** 83' 9" of ½" (6×19) galvanized fiber core wire rope wrapped with ⅜" polypropylene rope.
Both eyes have ½" gusseted thimbles.
The headrope doesn't include the length of either eye.
Length is measured from the top of the micro sleeve to the top of micro at the other end.
Top wings are hung over 36'.
- Footrope:** 111' 9" plus thimble eyes of ⅝", (6×19) galvanized, fiber core wire rope, wrapped with ½" polypropylene rope.
Loops of 5/16" galvanized, proof coil chain, (approx. 170') are tied to wrapped footrope by passing two fathoms of double 21 T nylon twine through every tenth link starting at the top of the micro forming the eye splice.
Chain links are secured to footrope every 8" throughout length of wing forming 76 chain hangings over 50' each wing.
Busom has 16 chain hangings equally spaced over 11' 9".
There are four bars (2 meshes) per hanging in wings and 4 meshes per hanging in busom, hung with 96 T nylon round braid hanging twine.
After the net is hung, split pieces of heavy rubber hose are served around footrope, passing the hose twice between each chain hanging for the length of the footrope.
- Breastlines:** ½" (6×19) galvanized wire rope wrapped with ⅜" polypropylene rope.
Top and bottom breastlines are 8', measured from the top of the micro press forming one eye through the bearing point of the other eye.
- Riblines:** ¾" Samson 2 and 1® Duralon braided trawl rope.
Riblines are hung at 97% of stretched measure of the gored seam.
All measurements are made with 400 lbs of tension on rope.
Gored seams are attached to riblines using white, untreated 60 T braided nylon hanging twine used to tie a benzel every 16".

- Flotation:** Seventeen 8" aluminum side lug floats along each wing and seven 8" floats in center.
Total of 41 floats along headrope spaced 24 $\frac{1}{4}$ " apart.
Buoyancy of 6.3 lbs each (258 lbs total).
- Side seams:** Side seams are laced in top and bottom individually gathering 3 meshes (4 knots) using white, double 21 T perma-grip® (or like kind) nylon three-strand twine.
Top and bottom panels are then laced together using green, double 21 T perma-grip® (or like kind) nylon three-strand twine.
- Codend:** 3 $\frac{1}{2}$ " stretched measure (including one knot) nylon, dyed green, 96 T nylon three-strand mesh.
Codend is a "double wall" construction.
Four panels of 96 T web cut 64 meshes long by 120 meshes deep.
Two meshes on each side are laced together, leaving 60 "open meshes" per panel.
Gored seams are laced together using 60 T round braid hanging twine and hung to riblines of $\frac{3}{4}$ " Samson 2in1® Duralon braided trawl rope.
Riblines in codend are hung at 90% of stretched measurement of gored seams.
Riblines are measured under 400 lbs of tension.
Codend is closed at aft end using 24-2 $\frac{1}{2}$ " x $\frac{5}{16}$ " galvanized steel rings.
A $\frac{1}{4}$ " Duralon braided rope is passed through 5 selvage meshes and a ring is attached to the rope using a cow hitch every 12" leaving five open meshes between each ring.
The bag is then closed using a $\frac{5}{8}$ " - $\frac{3}{4}$ " hauling clip.
A liner of 1 $\frac{1}{4}$ " three strand twine nylon, 360 meshes long by 200 meshes deep is hung on the inside of the bag 78 meshes up from terminal end.

Eastern Bering Sea Shelf Bottom Trawl Survey Materials List for 83-112 Eastern Trawl

Specifications of wire, chain, and rope include rated breaking strength (BS), specific gravity (SG), and density.

- WEB:** Mesh sizes listed are given in “stretched measure”, a standard method of measuring mesh size that includes the length of one knot.
Body and wings ~ 4" # 60T three strand nylon - dyed green.
Intermediate ~ 3½" # 96T three strand nylon, dyed green, single wall construction.
Codend ~ 3½" # 96T three strand nylon, dyed green, double wall construction.
Liner ~ 1¼" # 18T three strand nylon - dyed green.
Chaffing gear ~ 6", 6-mm polyethylene knotted web.
- WIRE ROPE:** ½" 6×19 galvanized fiber core (BS 9,700 kg, 0.62 kg/m), eyes are formed using galvanized reinforced thimbles.
- CHAIN:** 5/16" galvanized proof coil (BS 4,750 kg, 1.21 kg/m).
- FLOATS:** 8" side lug trawl floats, depth rated to a minimum 400 fm, 258 lbs of total buoyancy.
- RIBLINES:** ¾" Samson Duralon™ 2-in-1® stable braid, white, light bonding (BS 8,800 kg, SG 1.83, 0.27 kg/m).
- TWINE:** Sewing panels together: # 60T three strand nylon.
Lacing seams: double, white # 21T three strand nylon.
Joining seams together: double, green # 21T three strand nylon.
Hanging on framing lines: white, # 96T round braid hanging twine.
Fly mesh at end of bag- # 182T round braid hanging twine
- ROPE:** Float lines - 1/4" polypropylene (BS 570 kg, SG 0.95).
Pucker ring lines- Samson 1/4" Duralon™ 2-in-1®(BS 1,270 kg, SG 1.38).
Restrictor rope- 1 1/8" Poly Plus™ three strand (BS 10,740 kg, SG 0.91).
Splitting strap- 3/4" Spectra™ braided rope with eye each end (BS 21,773 kg, SG 0.98).
Splitting ring lines- ½" Samson Duralon™ 2-in-1® stable braid (BS 4,477 kg, SG 1.38).
Hole through trawl float line- ½" hollow braid Poly-Plus™ (BS 2,721 kg, SG 0.91).

FOOTROPE: $\frac{5}{8}$ " 6×19 galvanized, fiber core wire rope with reinforced thimbled eyes.
 $\frac{1}{2}$ " three strand polypropylene rope served around wire rope.
 $\frac{5}{16}$ " galvanized proof coil chain.
Split heavy rubber hose served between chain hangings.
Footrope setback/extension, $\frac{1}{2}$ " long link alloy chain connected to footrope with a $\frac{5}{8}$ " hammer lock. Total length including connecting hardware - 24".
Splitting rings - $5\frac{1}{2}$ " × $\frac{3}{4}$ ".
Pucker rings at end of codend- $2\frac{1}{2}$ " × $\frac{1}{4}$ ".

Eastern Bering Sea Shelf Bottom Trawl Survey Framing Lines for 83-112 Eastern Trawl

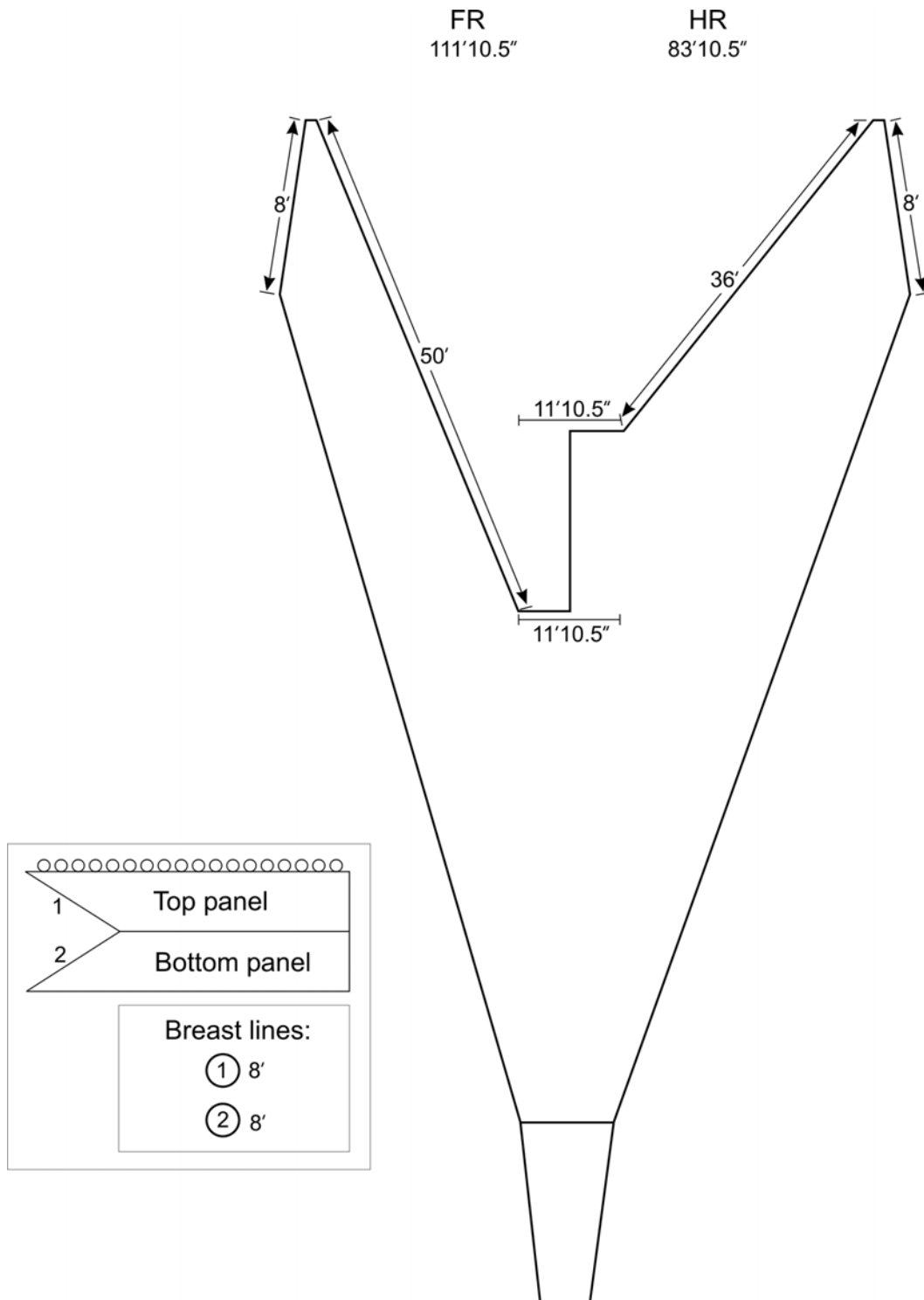

Eastern Bering Sea Shelf Bottom Trawl Survey Net Plan for 83-112 Eastern Trawl (“Cut Plan” = Total Mesh Counts)

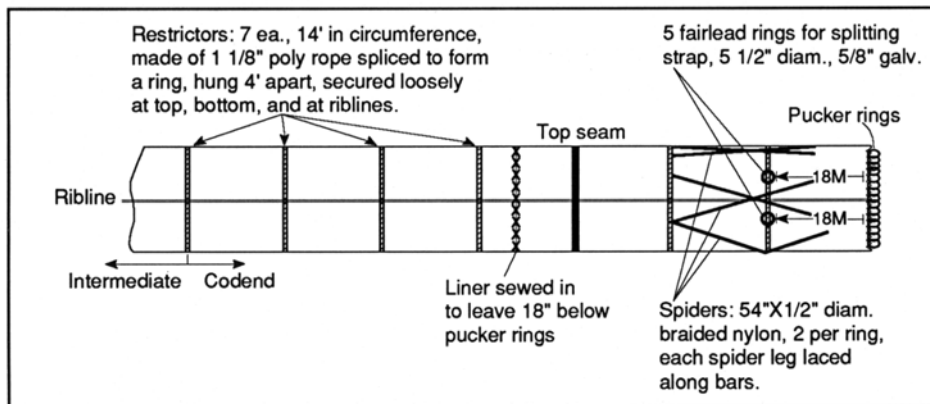
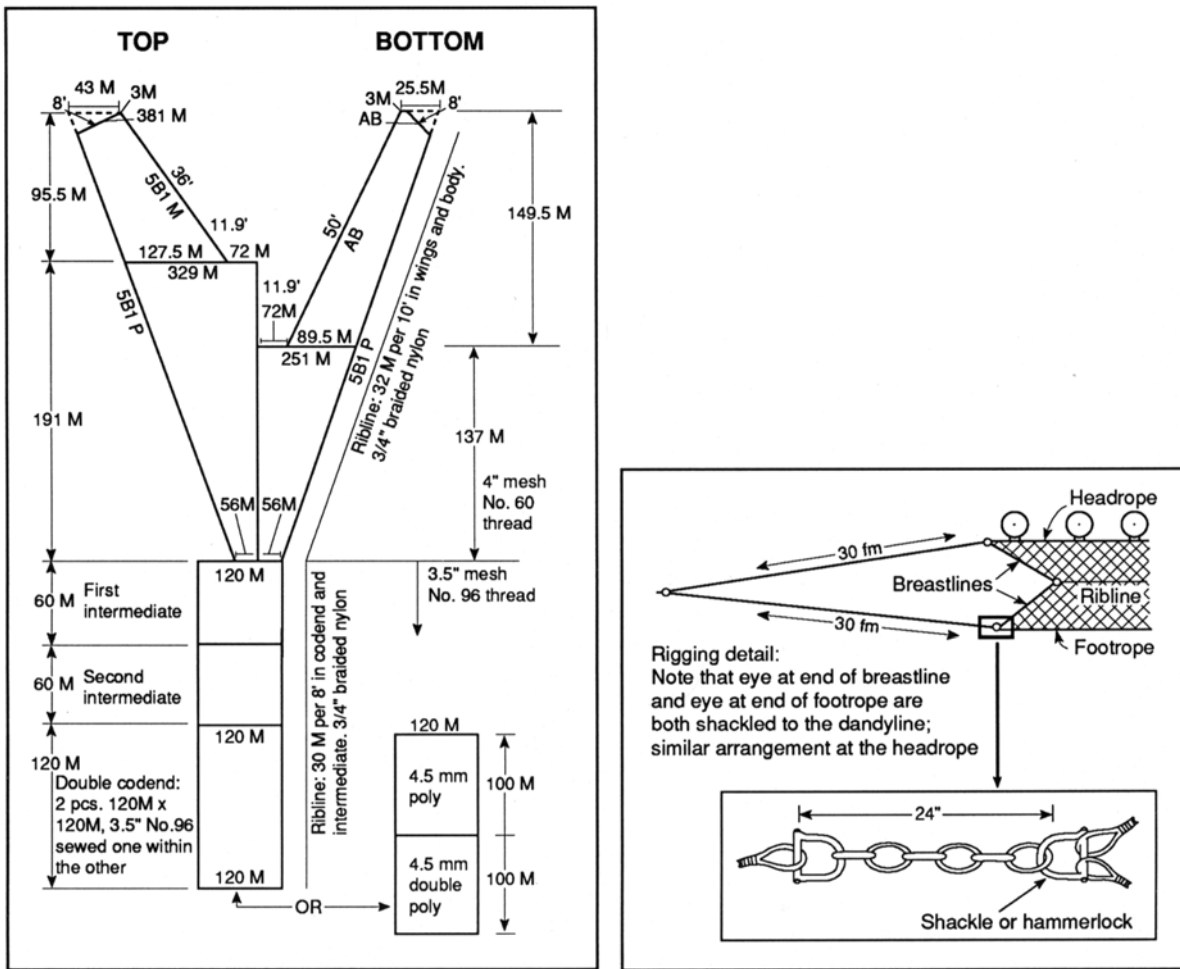

Eastern Bering Sea Shelf Bottom Trawl Survey Net Reel/Bridle Rigging Plan for 83-112 Eastern Trawl

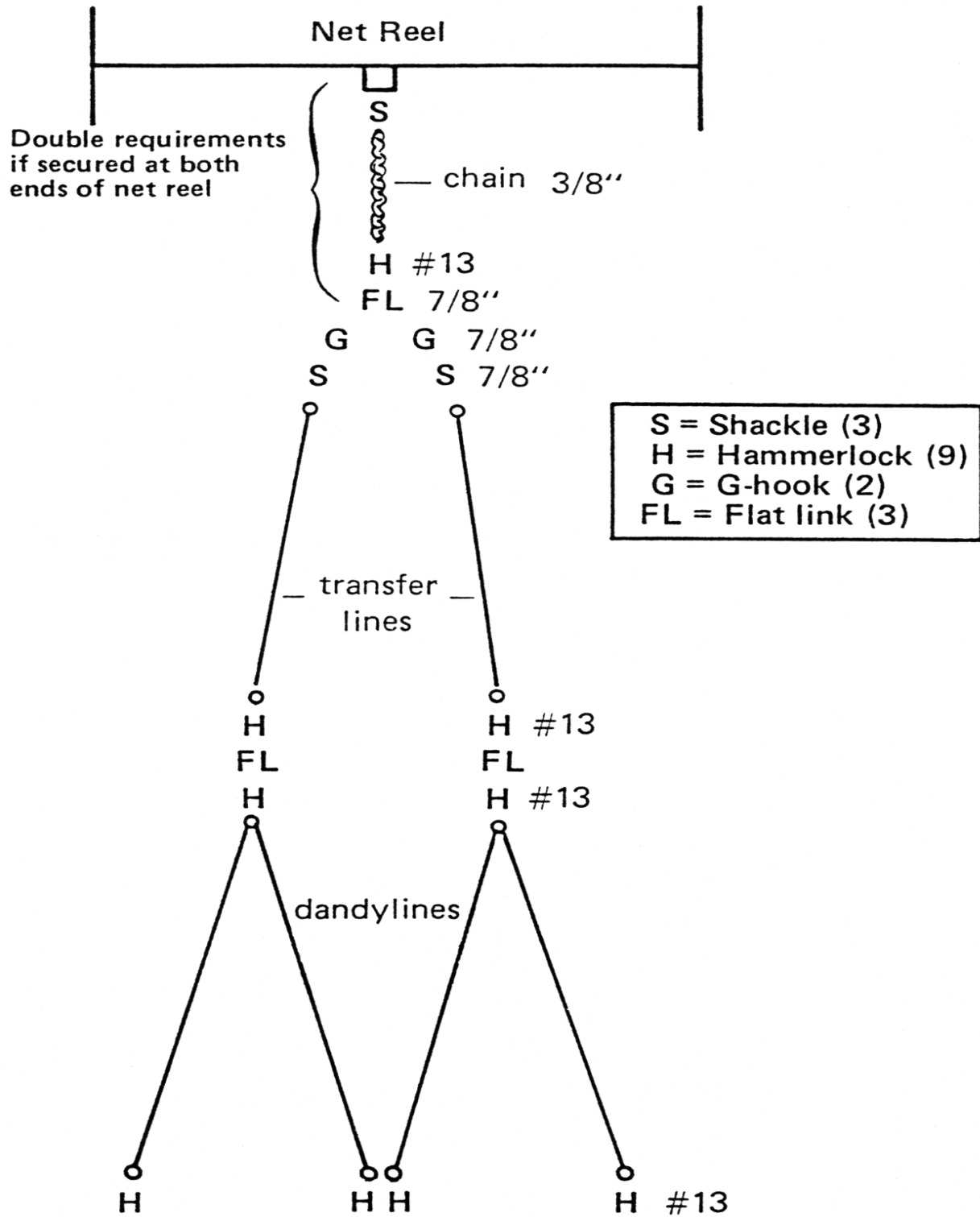

Eastern Bering Sea Shelf Bottom Trawl Survey
Trawl Door Rigging Plan Detail for 83-112 Eastern Trawl
Sole Manufacturer NET Systems, Inc., Bainbridge Island, WA

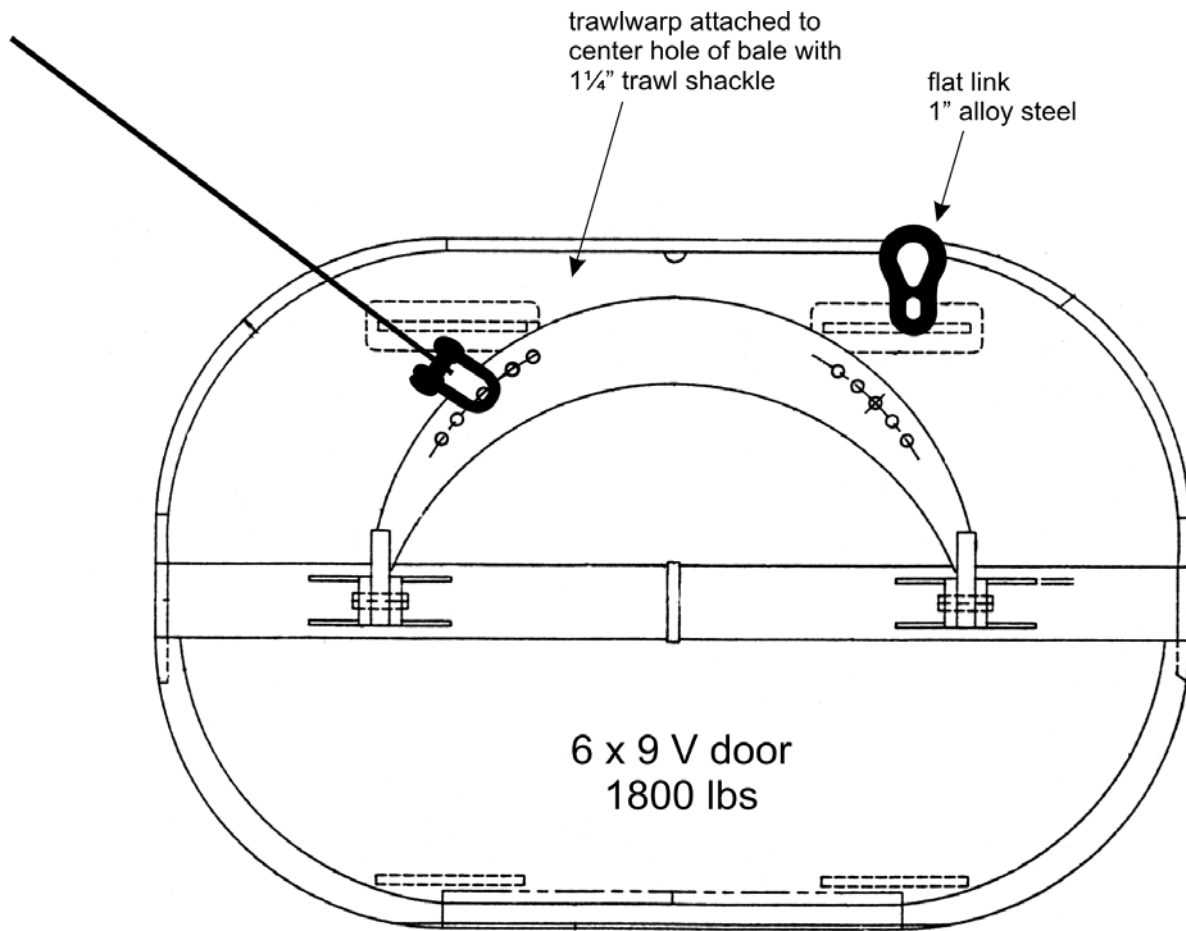

**Eastern Bering Sea Shelf Bottom Trawl Survey
Footrope Construction Plan for 83-112 Eastern Trawl**

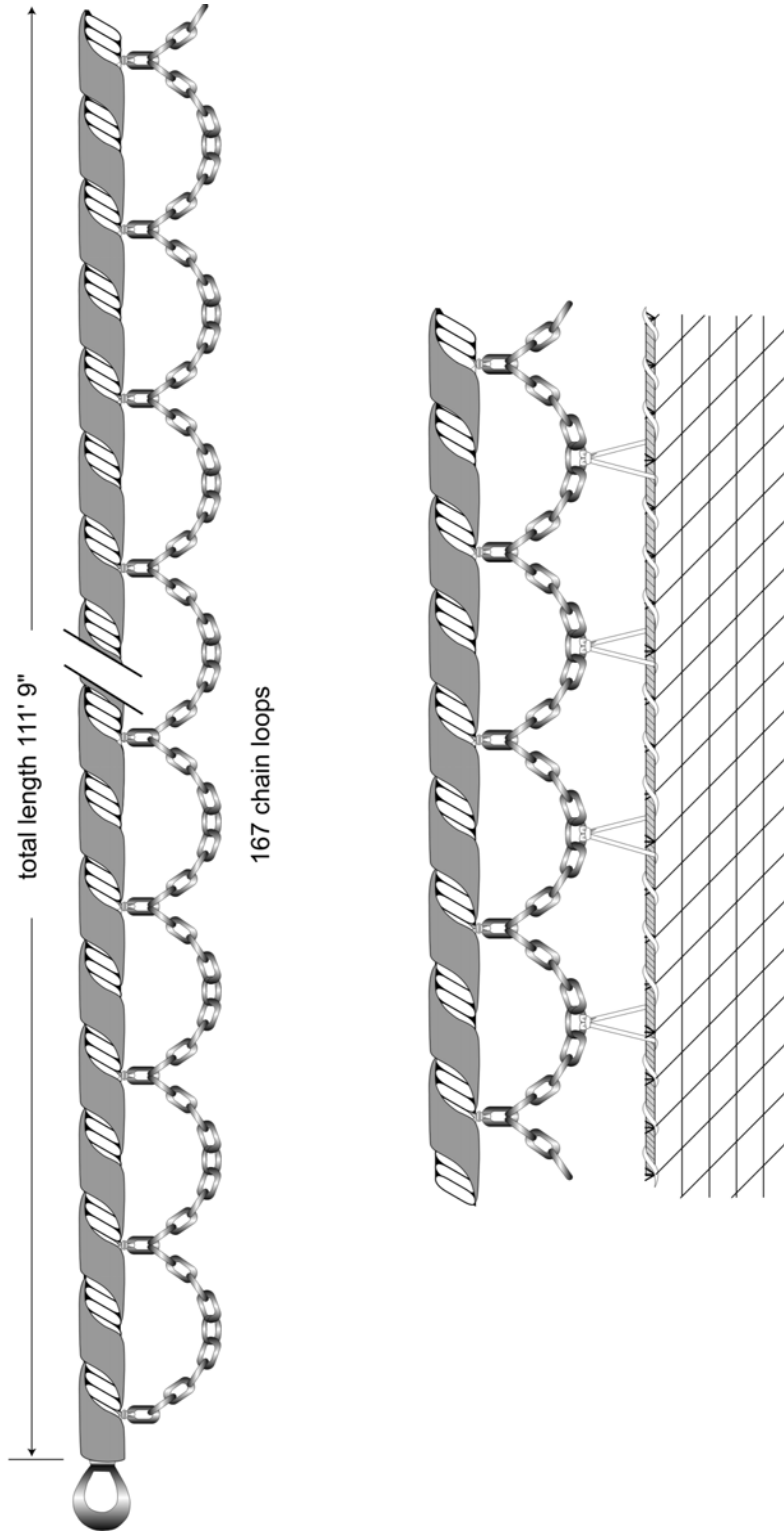

Survey Trawl Check List Eastern Bering Sea Shelf Bottom Trawl Survey 83-112 Eastern Trawl

Vessel	
Cruise	
Date	
Checked by	
Checked by	
Net I.D. number	

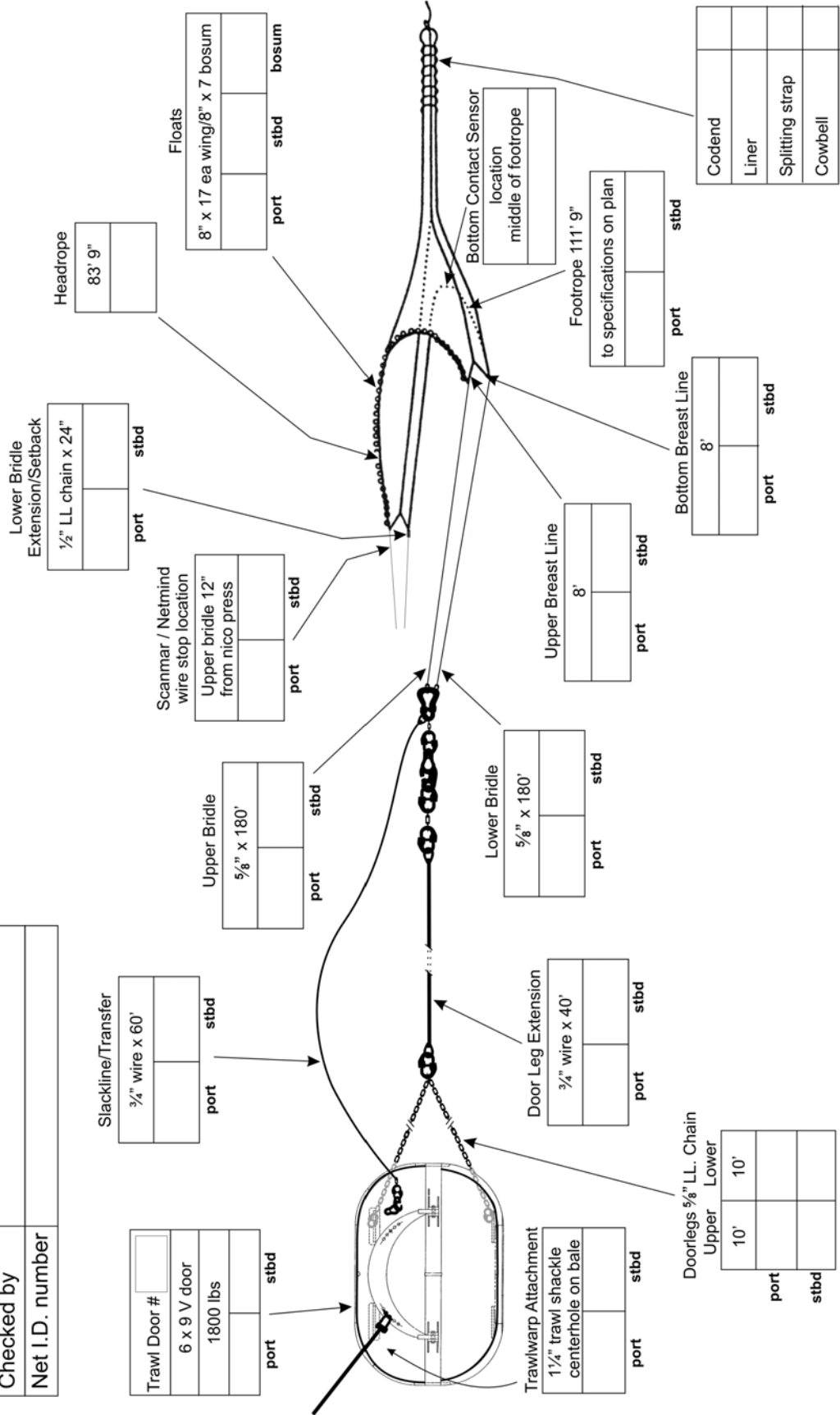

Eastern Bering Sea Shelf Bottom Trawl Survey Net Repair Form for 83-112 Eastern Trawl - Top Panel

83/112 - TOP VIEW

Net number _____

Vessel _____

Cruise _____

Haul _____

Date _____

Net was:

Repaired (Describe repair on form)

Replaced with net number _____

COMMENTS:

The diagram illustrates the top view of a trawl net. It features a large funnel-shaped section at the top, tapering downwards. The top edges of this funnel are marked with a width of 8 ft. The mesh in this section is labeled as 4" 60T. Below the funnel is a rectangular section, also labeled 4" 60T. At the bottom of the net, there are two stacked rectangular sections, both labeled 3.5" 96T. The bottom-most section is specifically labeled as 3.5" 96T DWB. The net is shown with several circular floats along its top edge.

Eastern Bering Sea Shelf Bottom Trawl Survey Net Repair Form for 83-112 Eastern Trawl - Bottom Panel

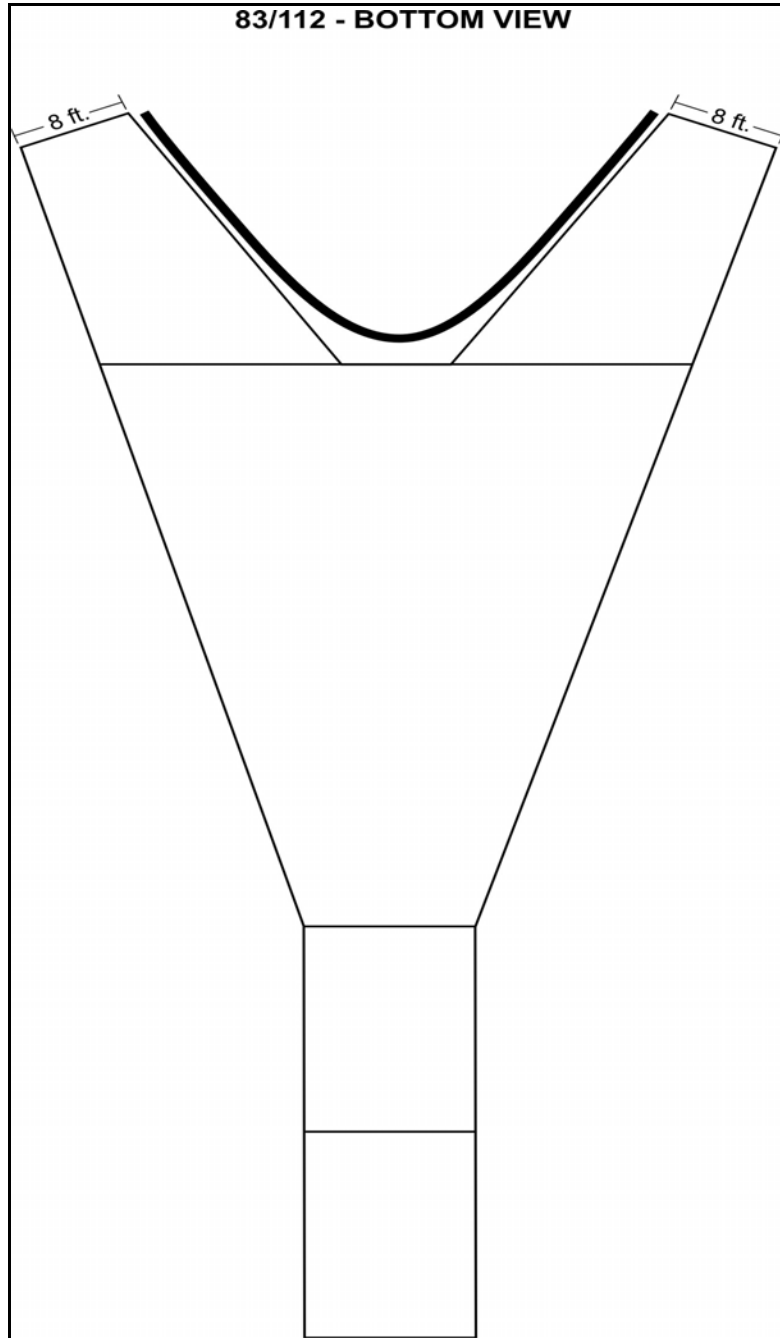

Eastern Bering Sea Slope Survey Gear Description for Poly Nor'Eastern Trawl

- Netting:** Polyethylene, 5" stretch measure - 4 mm top and sides, 5 mm bottom and intermediate.
- Headrope:** 89' 1" of ½" (6×19) galvanized wire rope wrapped with ¾" polypropylene rope.
Both eyes have ½" gusseted thimble; 89' 1" doesn't include the length of either eye.
Headrope length is measure from the top of the micro sleeve to the top of the micro at other end.
Top wing is hung over 16.31" per taper combination.
Headrope setback - 18" of ½" long link galvanized alloy chain and connecting hardware.
- Bolsh line:** 81' 7" plus thimbled eyes of ¾" (6×19) galvanized wire rope, wrapped with ¾" polypropylene rope.
- Fishing Line:** 81' of ½" long link galvanized alloy chain.
Safe working load of 11,300 lbs.
- Breastlines:** ½" (6×19) galvanized wire rope wrapped with ¾" polypropylene rope.
Top corner 19' 6", bottom corner 8' 8", bottom side panel 30' 6".
All lengths are measured from the top of micro sleeve at wing tip and including thimbled eye at ribline.
- Riblines:** ¾" Samson 2in1® Duralon braided trawl rope.
Riblines are hung at 98% of stretch measure of gored seam.
All measurements are made with 400 lbs of tension on rope.
Gored seams are attached to the ribline using white untreated 60 T braided nylon hanging twine used to tie a benzel every 16".
- Groundgear:** 8" rubber discs strung on ½" galvanized, long link marine deck lashing chain, grade 70, 79' 6" bearing to bearing (eye to eye). "Flying wing" outboard sections, 4" rubber discs strung on ¾" (6×19) fiber core wire rope.
See groundgear diagram for more detailed description.

- Side Seams:** Side seams are laced in each panel individually.
Seams are made by gathering 3 meshes (4 knots) and lacing them together using white, double 21 thread perma-grip® (or like kind) nylon, three-strand twine.
Individual panels are laced together using green, double 21 thread perma-grip® nylon, three-strand twine.
Panels which are secured to framing lines have selvage edge created by gathering 3 meshes as described above.
These selvage edges are hung tight to framing lines using 60 T braided nylon hanging twine.
- Flotation:** Ninety 8" side lug deep-water trawl floats (5.4 lbs of buoyancy each) hung evenly to headrope starting 1' from wing tip, leaving 3' open in the center of the headrope.
Total buoyancy - 486 lbs.
- Splitting Gear:** ¾" Spectra® rope spliced 21' with eyes in each end.
The rope is passed through four galvanized rings secured to each ribline 18 meshes from the bottom. A second identical splitting strap is located 38 meshes from the bottom.
- Codend:** 3½" stretched measure (including 1 knot) polyethelene 4 mm double bar mesh.
Four panels cut 30 meshes long by 100 meshes deep.
Two meshes in a gored seam each side, leaving 26 open meshes per panel.

Gored seams are laced together using double 21 T nylon twine.
Riblines in codend are ¾" 2in1® Duralon braided trawl rope, hung at 90% of the stretch measure of the gored seams.
Codend is closed at terminal end using 25 2½" X ¼" galvanized steel rings.
A ¼" Duralon rope is passed through the selvage mesh and a ring is attached to the rope using a cow hitch every 12", with five open meshes between each ring.
The bag is then closed using a ⅝"-¾" hauling clip.

Eastern Bering Sea Slope Survey Materials List for Poly Nor'Eastern Trawl

Specifications of wire, chain, and rope include rated breaking strength (BS), specific gravity (SG), and density.

- WEB:** All web in the trawl should be depth stretched and heat set in the manufacturing process. Mesh sizes listed in the plan are given in “stretched measure”, a standard method of measuring mesh size that includes the length of one knot.
Top, body and wings, side panels ~ 5", 4-mm polyethylene knotted web.
Bottom, body and wings, intermediate ~ 5", 5mm polyethylene knotted web. All polyethylene web in net panels is orange.
Liner ~ 1.25", # 18T three strand nylon knotted web - dyed green.
Chaffing gear ~ 6", 6mm double bar mesh, polyethylene knotted web - orange.
Chaffing strip, bottom~ 5", 5mm double bar mesh, polyethylene knotted web - orange.
- WIRE ROPE:** ½" 6×19 galvanized fiber core (BS 9,700 kg, 0.62 kg/m), eyes are formed using galvanized reinforced thimbles.
- CHAIN:** ½" (16 mm) galvanized, long link marine deck lashing chain, grade 70 (BS 20,500 kg, 3.42 kg/m).
- FLOATS:** Ninety 8" side lug deep-water trawl floats (5.4 lbs buoyancy each) depth rated to a minimum of 2,000 m.
- RIBLINES:** ¾" Samson Duralon™ 2-in-1® stable braid, white, light bonding (BS 8,800 kg, SG 1.83, 0.27 kg/m).
- TWINE:** Sewing panels together: 5-mm polyethylene twine, any color other than orange.
Lacing seams: # 21T white, three strand nylon.
Joining top and side seams together: # 21T green three strand nylon.
Joining bottom and intermediate seams: 60T white braided hanging twine.
- ROPE:** Float lines - 1/4" polypropylene (BS 570 kg, SG 0.95).
Pucker ring lines- Samson 1/4" Duralon™ 2-in-1®(BS 1,270 kg, SG 1.38)
Restrictor rope- 1 1/8" Poly Plus™ three strand (BS 10,740 kg, SG 0.91).
Splitting strap- 3/4" Spectra™ braided rope with eye each end (BS 21,773 kg, SG 0.98).
Rope to serve cables- 3/8" polypropylene three strand.
Chaffing gear- Poly hula skirt material.

FOOTROPE: $\frac{1}{2}$ " galvanized, long link marine deck lashing chain, grade 70, 79' 6".
8" rubber disc with a $2\frac{1}{2}$ " center hole.
Steel plate chain washers- 5" x $\frac{3}{8}$ " - $2\frac{1}{2}$ " center hole.
Chain toggles- 5.5 lbs. each, chain droppers are $6\frac{1}{2}$ " long, spaced 18"
on center along length of footrope. Toggles are attached to fishing line
with $\frac{5}{16}$ " import trawl shackles. Four hole triangle delta plate, $\frac{3}{8}$ " steel.

Eastern Bering Sea Slope Bottom Trawl Survey Framing Lines for Poly Nor'Eastern Trawl

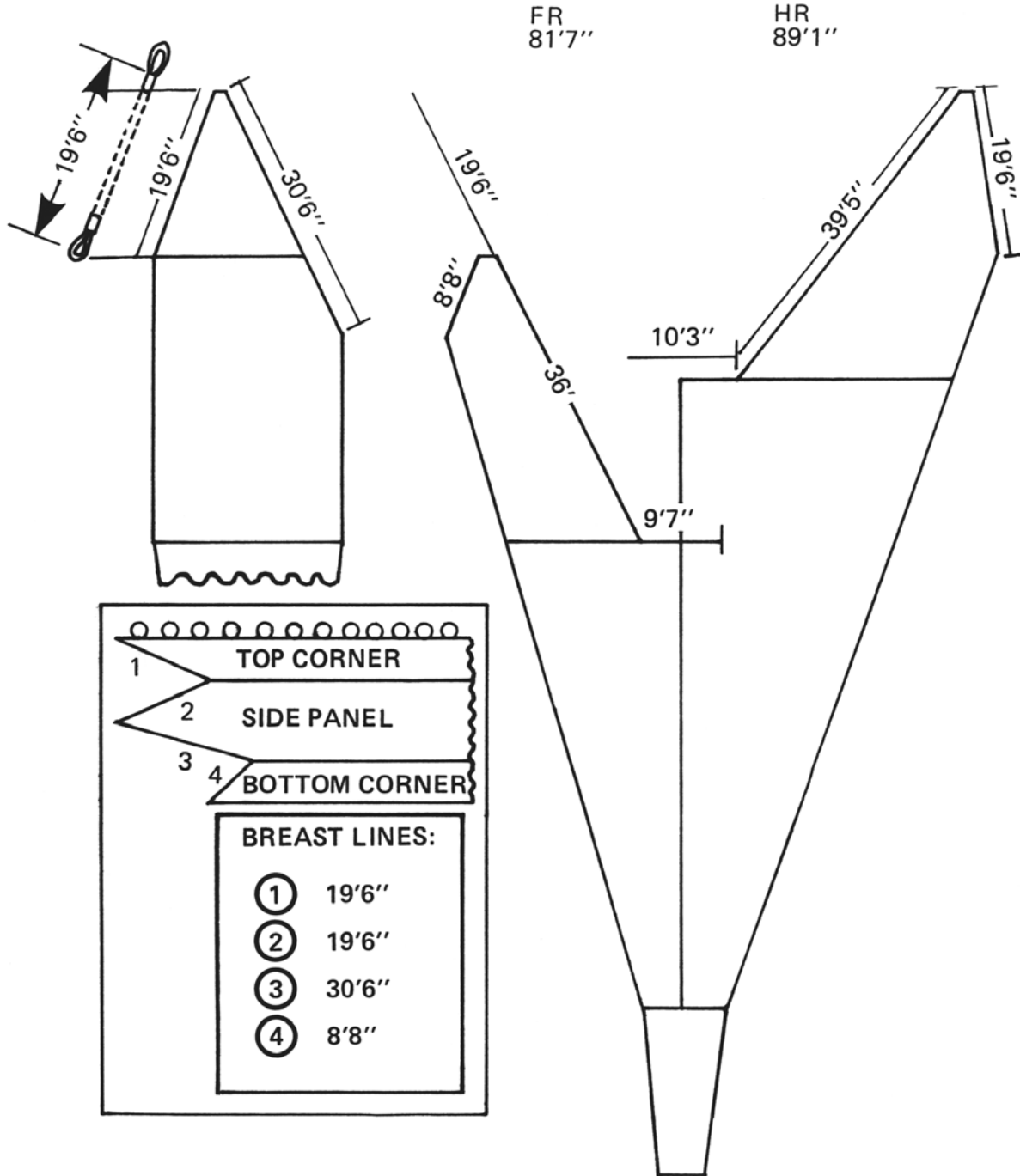

Eastern Bering Sea Slope Bottom Trawl Survey Net Plan for Poly Nor'Eastern Trawl (“Cut Plan” = Total Mesh Counts)

Twine Sizes: top and sides 4 mm
bottom and intermediate 5 mm

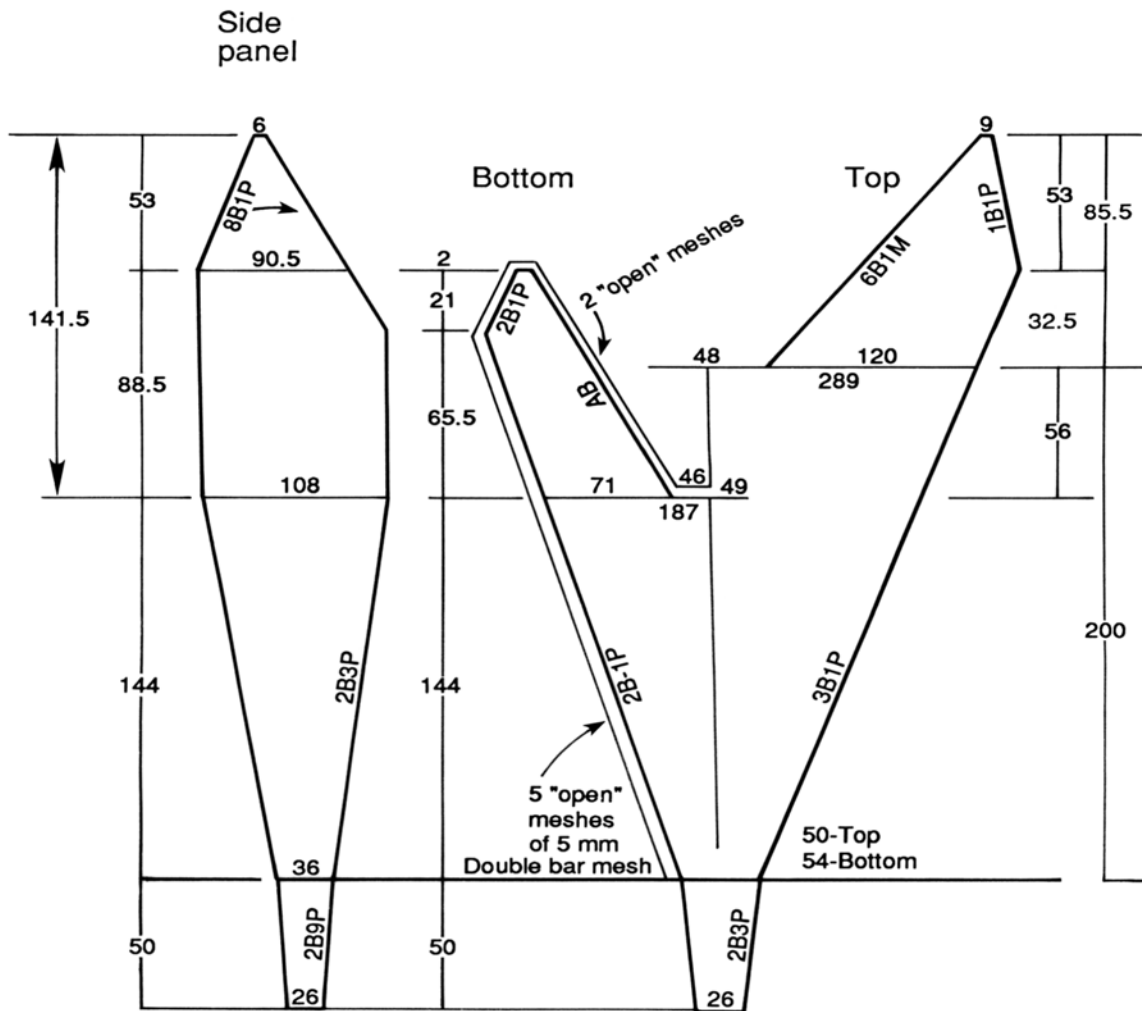

Web: Chaffing strip along inside of Bottom wings and Busom. Cut 8 meshes wide.
5 mm Double Bar mesh, goring 3 meshes on each side (leaving 2 open meshes).
Secure 3 mesh of gore on inside (Bar Cut) of Bottom wings, and securing other gore to footrope (Bolsh).

Eastern Bering Sea Slope Bottom Trawl Survey
Trawl Door Rigging Plan Detail for Poly Nor'Eastern Trawl
Sole Manufacturer NET Systems, Inc., Bainbridge Island, WA

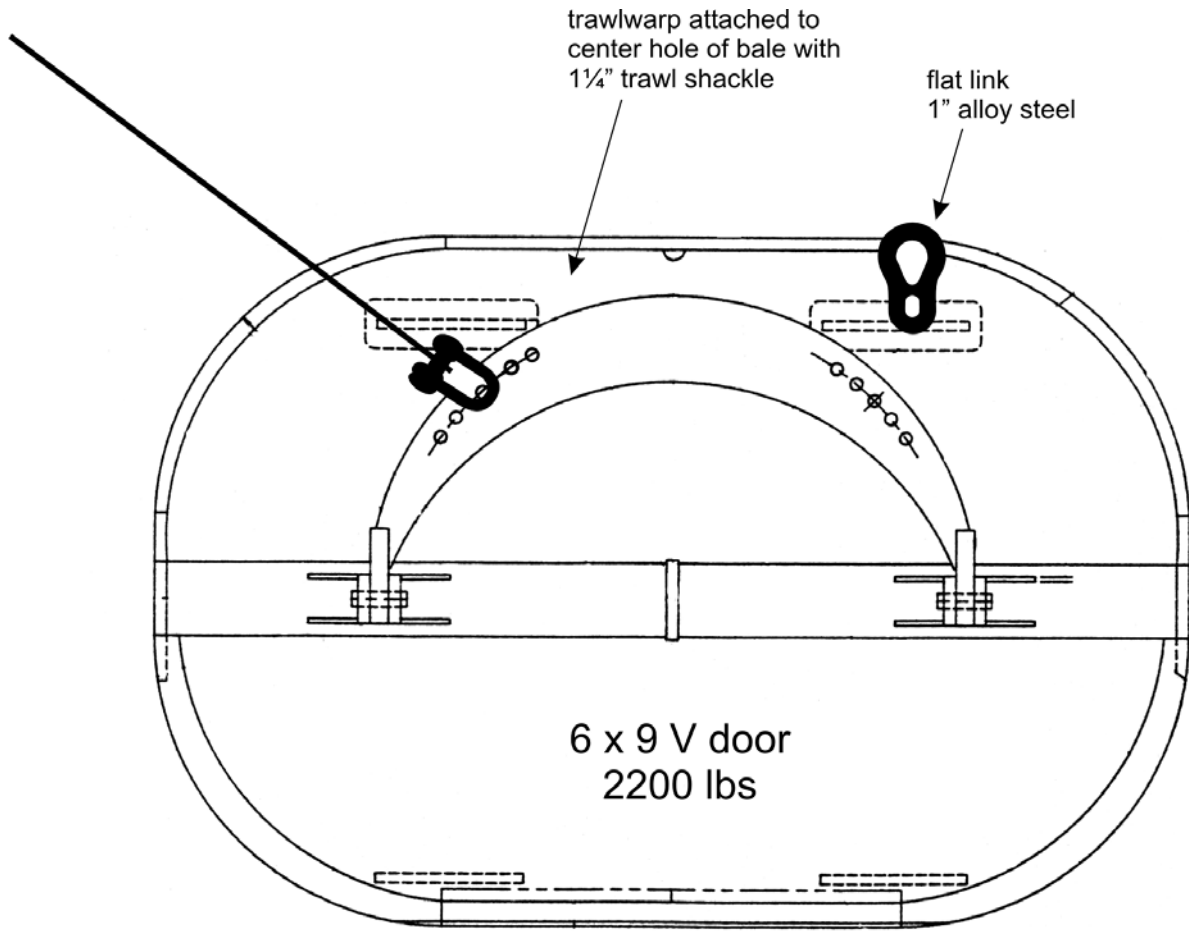

Eastern Bering Sea Slope Bottom Trawl Survey Trawl Door Rigging Plan for Poly Nor'Eastern Trawl

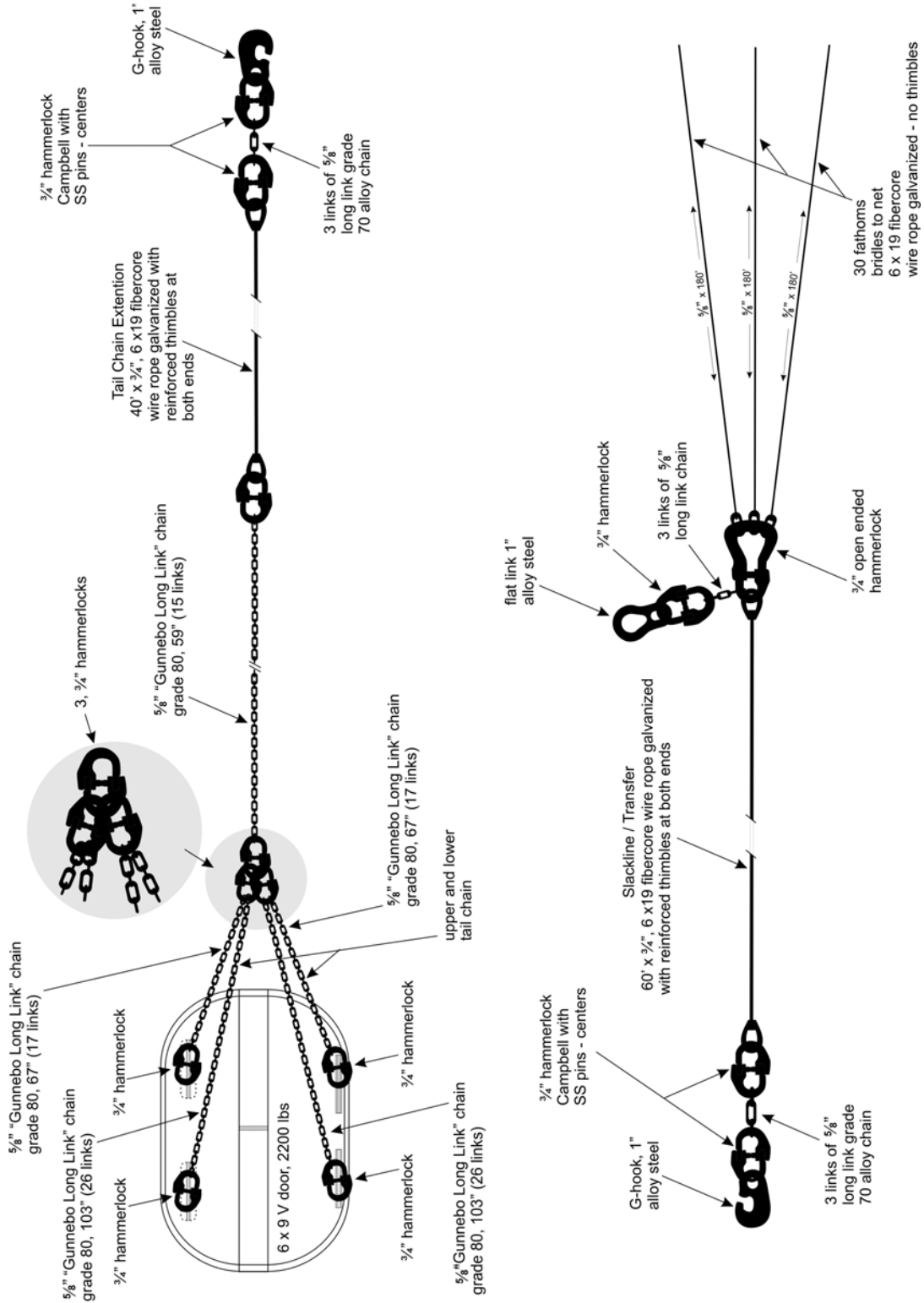

Eastern Bering Sea Slope Bottom Trawl Survey Groundgear Construction Plan for Poly Nor'Eastern Trawl

Outboard section

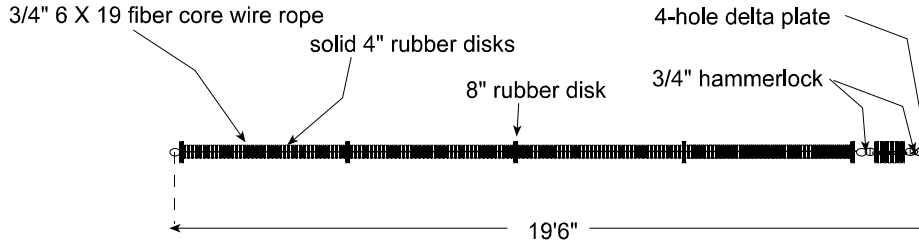

Middle section

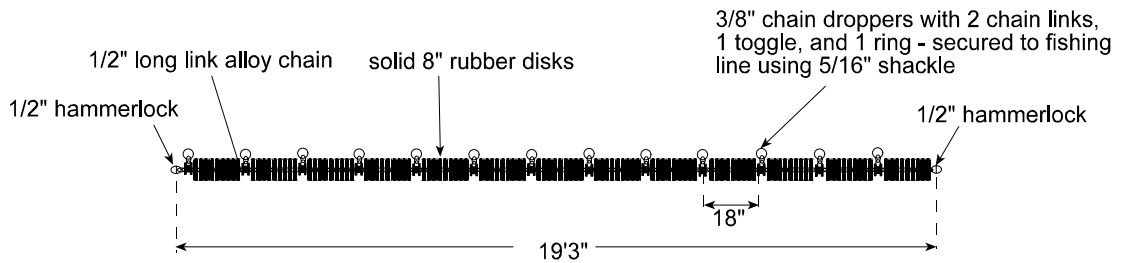

Inboard section

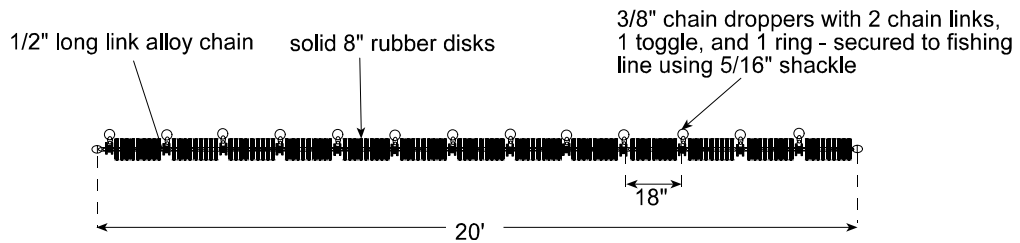

Survey Trawl Check List

Eastern Bering Sea Slope Bottom Trawl Survey Poly Nor'Eastern Trawl

Vessel	
Cruise	
Date	
Checked by	
Checked by	
Net I.D. number	

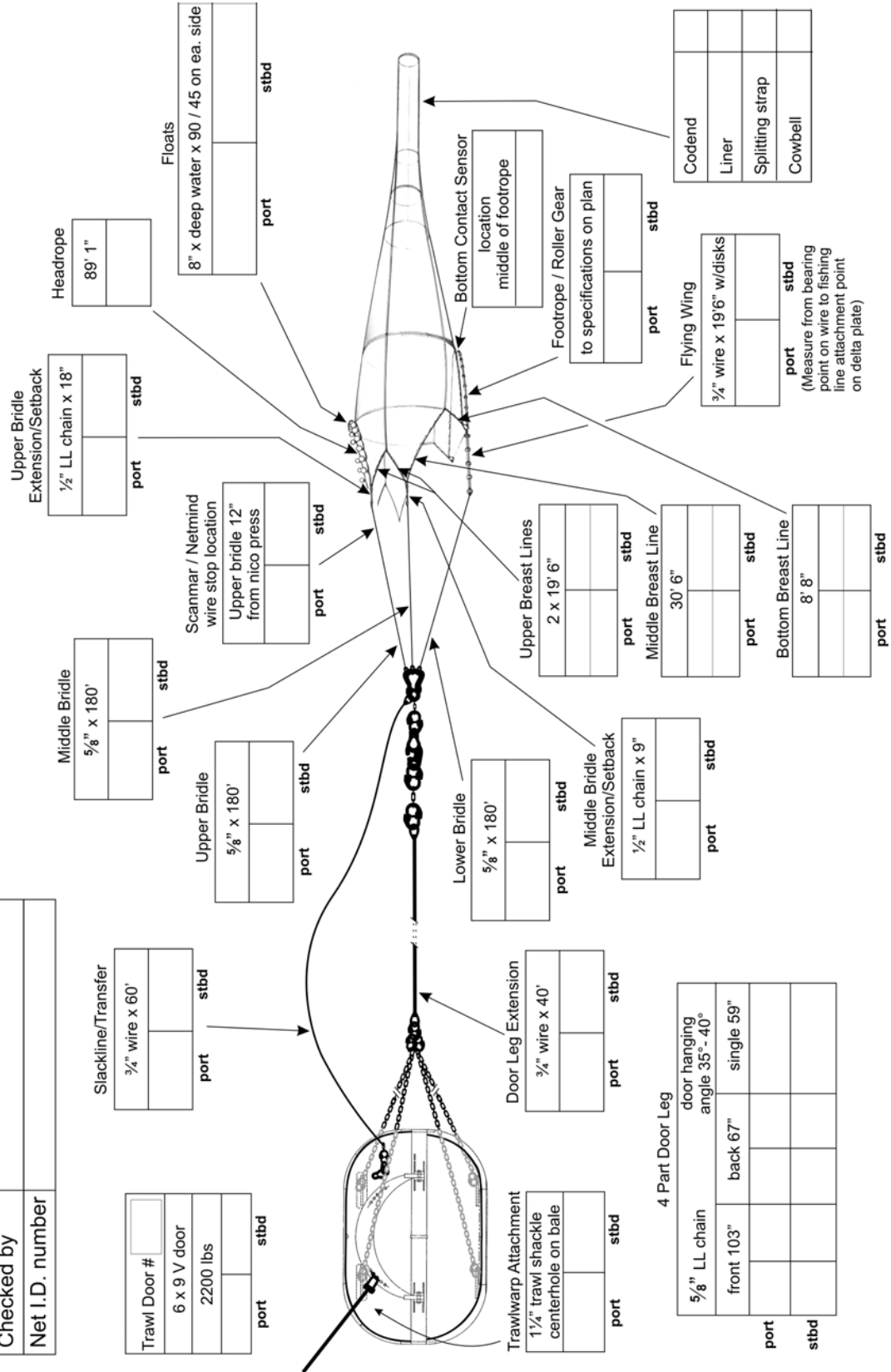

Trawl Door #	
6 x 9 V door	
2200 lbs	
port	stbd

Slackline/Transfer	
3/4" wire x 60'	
port	stbd

Upper Bridle Extension/Setback	
1/2" LL chain x 18"	
port	stbd

Headrope	
89' 1"	

Floats	
8" x deep water x 90 / 45 on ea. side	
port	stbd

Middle Bridle	
5/8" x 180'	
port	stbd

Scanner / Netmind wire stop location	
Upper bridle 12" from nico press	
port	stbd

Upper Bridle	
5/8" x 180'	
port	stbd

Lower Bridle	
5/8" x 180'	
port	stbd

Door Leg Extension	
3/4" wire x 40'	
port	stbd

Trawl Attachment	
1 1/2" trawl shackle centerhole on bale	
port	stbd

4 Part Door Leg	
5/8" LL chain door hanging angle 35°- 40°	
front 103"	back 67"
port	stbd
single 59"	

Upper Breast Lines	
2 x 19' 6"	
port	stbd

Middle Breast Line	
30' 6"	
port	stbd

Bottom Breast Line	
8' 8"	
port	stbd

Bottom Contact Sensor location	
middle of footrope	

Footrope / Roller Gear	
to specifications on plan	
port	stbd

Flying Wing	
3/4" wire x 19'6" w/disks	
port	stbd

(Measure from bearing point on wire to fishing line attachment point on delta plate)

Codend	
Liner	
Splitting strap	
Cowbell	

Eastern Bering Sea Slope Bottom Trawl Survey Net Repair Form for Poly Nor'Eastern Trawl - Top Panel

POLY-NOREASTERN - TOP VIEW

Haul# _____ Date ___/___/___
Net Number _____

Net was :

- Repaired (Describe repair on form)
- Replaced with net number _____

COMMENTS :

Eastern Bering Sea Slope Bottom Trawl Survey Net Repair Form for Poly Nor'Eastern Trawl - Bottom and Side Panels

**POLY NOREASTERN TRAWL
BOTTOM AND SIDE VIEWS**

Haul# _____ Net Number _____ Date ____/____/____

Net was: Repaired (Describe repair on this form)
 Replaced with net number _____

Comments: _____

The diagram illustrates the bottom and side views of a trawl net. The central section is the bottom view, showing a V-shaped net with a 5 mm mesh. The two side panels are shown on either side, each with a 4 mm mesh. Dimensions are provided for the side panels: the left panel is 30' 6" wide at the top, and the right panel is 19' 6" wide at the top. A dimension of 8' 8" is also shown for the right side panel. The bottom view shows a 5 mm mesh throughout, including the vertical sections at the bottom.

Gulf of Alaska and Aleutian Islands Bottom Trawl Surveys Gear Description for Poly Nor'Eastern Trawl

- Netting:** Polyethylene, 5" stretch measure - 4 mm top and sides, 5 mm bottom and intermediate.
- Headrope:** 89' 1" of ½" (6×19) galvanized wire rope wrapped with ⅜" polypropylene rope.
Both eyes have ½" gusseted thimble; 89' 1" doesn't include the length of either eye.
Headrope length is measure from the top of the micro sleeve to the top of the micro at other end.
Top wing is hung over 16.31" per taper combination.
Headrope setback - 18" of ½" long link galvanized alloy chain and connecting hardware.
- Bolsh line:** 81' 7" plus thimbled eyes of ⅜" (6×19) galvanized wire rope, wrapped with ⅜" polypropylene rope.
- Fishing Line:** 81' of ½" long link galvanized alloy chain.
Safe working load of 11,300 lbs.
- Breastlines:** ½" (6×19) galvanized wire rope wrapped with ⅜" polypropylene rope.
Top corner 19' 6", bottom corner 8' 8", bottom side panel 30' 6".
All lengths are measured from the top of micro sleeve at wing tip and including thimbled eye at ribline.
- Riblines:** ¾" Samson 2in1® Duralon braided trawl rope.
Riblines are hung at 98% of stretch measure of gored seam.
All measurements are made with 400 lbs of tension on rope.
Gored seams are attached to the ribline using white untreated 60 T braided nylon hanging twine used to tie a benzel every 16".
- Roller Gear:** 79' 6" bearing to bearing (eye to eye). ¾" (6×19) galvanized wire rope with 14" bobbins (Footrope) and 4" discs.
See attached diagram for more detailed description.

- Side Seams:** Side seams are laced in each panel individually. Seams are made by gathering 3 meshes (4 knots) and lacing them together using white, double 21 thread perma-grip® (or like kind) nylon, three-strand twine. Individual panels are laced together using green, double 21 thread perma-grip® nylon, three-strand twine. Panels which are secured to framing lines have selvage edge created by gathering 3 meshes as described above. These selvage edges are hung tight to framing lines using 60 T braided nylon hanging twine.
- Flotation:** Twenty 12" Cycolac® side lug trawl floats (23 lbs of buoyancy each) hung evenly to headrope starting 1' from wing tip, and four 8" side lug trawl floats (5.4 lbs buoyancy each) hung two each on both sides of center, leaving 3' open in the center of the headrope. Total buoyancy - 486 lbs.
- Splitting Gear:** ¾" Spectra® rope spliced 21' with eyes in each end. The rope is passed through four galvanized rings secured to each ribline 18 meshes from the bottom. A second identical splitting strap is located 38 meshes from the bottom.
- Codend:** 3½" stretched measure (including 1 knot) polyethelene 4 mm Double Bar mesh. Four panels cut 30 meshes long by 100 meshes deep. Two meshes in a gored seam each side, leaving 26 open meshes per panel. Gored seams are laced together using double 21 T nylon twine. Riblines in codend are ¾" 2in1® Duralon braided trawl rope, hung at 90% of the stretch measure of the gored seams. Codend is closed at terminal end using 25 2½" X ¼" galvanized steel rings. A ¼" Duralon rope is passed through the selvage mesh and a ring is attached to the rope using a cow hitch every 12", with five open meshes between each ring. The bag is then closed using a ⅝"-¾" hauling clip.

Gulf of Alaska and Aleutian Islands Bottom Trawl Surveys Materials List for Poly Nor'Eastern Trawl

Specifications of wire, chain, and rope include rated breaking strength (BS), specific gravity (SG), and density.

- WEB:** All web in the trawl should be depth stretched and heat set in the manufacturing process. Mesh sizes listed in the plan are given in “stretched measure”, a standard method of measuring mesh size that includes the length of one knot.
Top, body and wings, side panels ~ 5", 4-mm polyethylene knotted web - orange.
Bottom, body and wings, intermediate ~ 5", 5mm polyethylene knotted web - orange.
Liner ~ 1¼", # 18T three strand nylon knotted web - dyed green.
Chaffing gear ~ 6", 6mm double bar mesh, polyethylene knotted web - orange.
Chaffing strip, bottom~ 5", 5mm double bar mesh, polyethylene knotted web - orange.
- WIRE ROPE:** ½" 6×19 galvanized fiber core (BS 9,700 kg, 0.62 kg/m), eyes are formed using galvanized reinforced thimbles.
- CHAIN:** ½" (16 mm) galvanized, long link marine deck lashing chain, grade 70 (BS 20,500 kg, 3.42 kg/m).
⅝" (16 mm) galvanized, long link marine deck lashing chain, grade 70 (BS 28,670 kg, 5.06 kg/m).
- FLOATS:** Twenty 12" side lug trawl floats (23 lbs. buoyancy each) depth rated to a minimum of 450 fm. Four 8" side lug trawl floats (5.4 lbs buoyancy each).
- RIBLINES:** ¾" Samson Duralon™ 2-in-1® stable braid, white, light bonding (BS 8,800 kg, SG 1.83, 0.27 kg/m).
- TWINE:** Sewing panels together: 5-mm polyethylene twine, any color other than orange.
Lacing seams: # 21T white, three strand nylon.
Joining top and side seams together: # 21T green three strand nylon.
Joining bottom and intermediate seams: 60T white braided hanging twine.

ROPE:

Float lines - 1/4" polypropylene (BS 570 kg, SG 0.95).
Pucker ring lines- Samson 1/4" Duralon™ 2-in-1®(BS 1,270 kg, SG 1.38)
Restrictor rope- 1 1/8" Poly Plus™ three strand (BS 10,740 kg, SG 0.91).
Splitting strap- 3/4" Spectra™ braided rope with eye each end (BS 21,773 kg, SG 0.98).
Rope to serve cables- 3/8" polypropylene three strand.
Chaffing gear- Poly hula skirt material.

FOOTROPE: (GOA, Aleutian Islands, MACE)

3/4" 6×19 galvanized, fiber core wire rope 79' 6", (BS 21,600 kg, 1.41 kg/m) .
4" rubber disc with a 1" hole- wing extensions, center section between bobbins
8" rubber disc with a 2 1/4" hole - wing extensions.
5/8" Long link marine deck lashing chain, grade 70.
Laminated rubber "cone style" wing bobbins with a 2 1/2" steel reinforced hole.
Chain droppers 10" in length. Five links of 3/8" chain and one ring 2 1/2"×1/4"
3/4" barrel clamps
Steel plate wire rope washers- 5" ×3/8"- 1" center hole.
1 1/4" ID - 1 3/4" OD heavy hose over bare 3/4" wire.
Four hole triangle delta plate, 3/8" steel.

Gulf of Alaska and Aleutian Islands Bottom Trawl Surveys Framing Lines for Poly Nor'Eastern Trawl

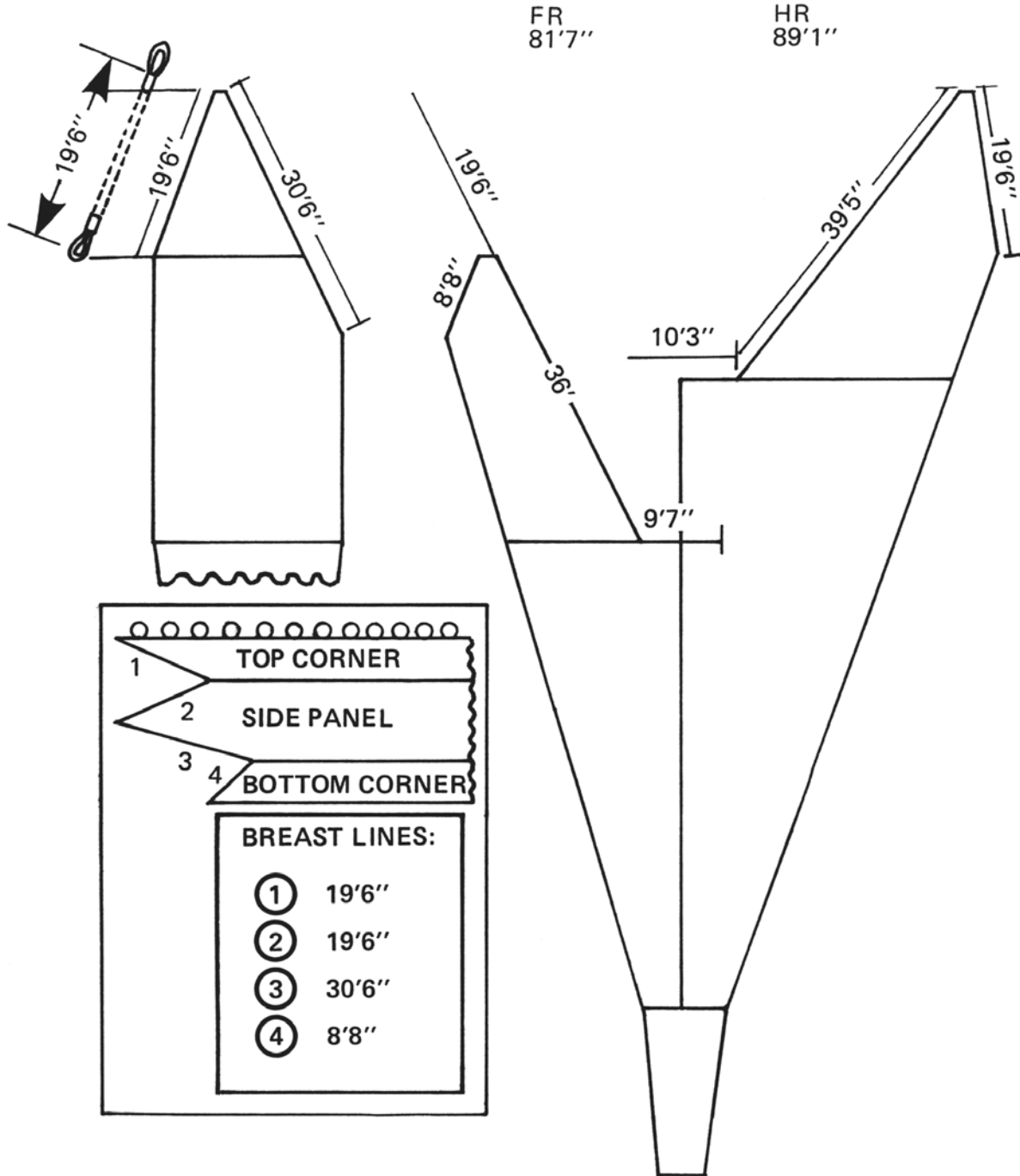

Gulf of Alaska and Aleutian Islands Bottom Trawl Surveys Net Plan for Poly Nor'Eastern Trawl (“Cut Plan” = Total Mesh Counts)

Twine Sizes: top and sides 4 mm
bottom and intermediate 5 mm

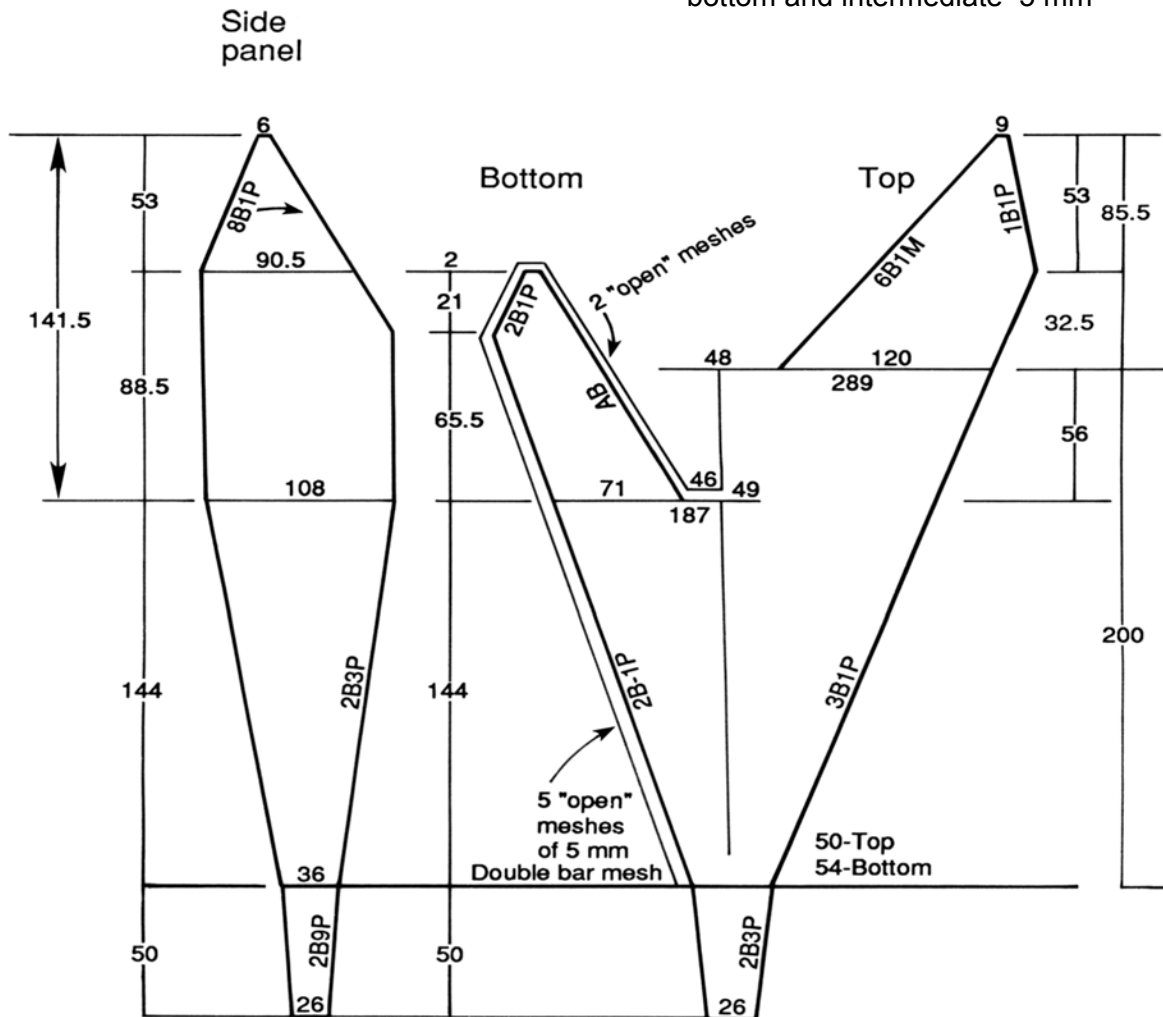

Web: Chaffing strip along inside of Bottom wings and Busom. Cut 8 meshes wide. 5 mm Double Bar mesh, goring 3 meshes on each side (leaving 2 open meshes). Secure 3 mesh of gore on inside (Bar Cut) of Bottom wings, and securing other gore to footrope (Bolsh).

Gulf of Alaska and Aleutian Islands Bottom Trawl Surveys
Trawl Door Rigging Plan Detail for Poly Nor'Eastern Trawl
Sole Manufacturer NET Systems, Inc., Bainbridge Island, WA

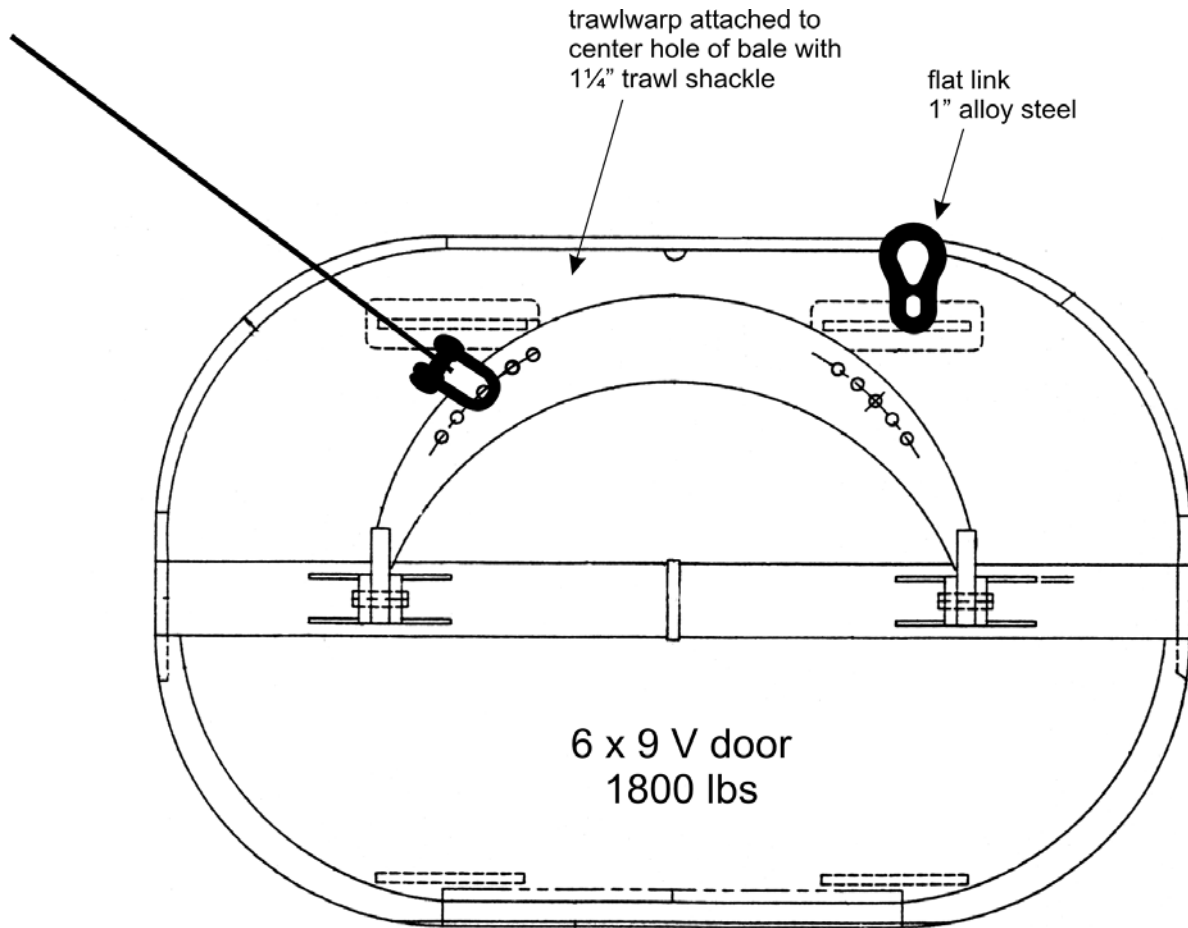

Gulf of Alaska and Aleutian Islands Bottom Trawl Surveys Trawl Door Rigging Plan for Poly Nor'Eastern Trawl

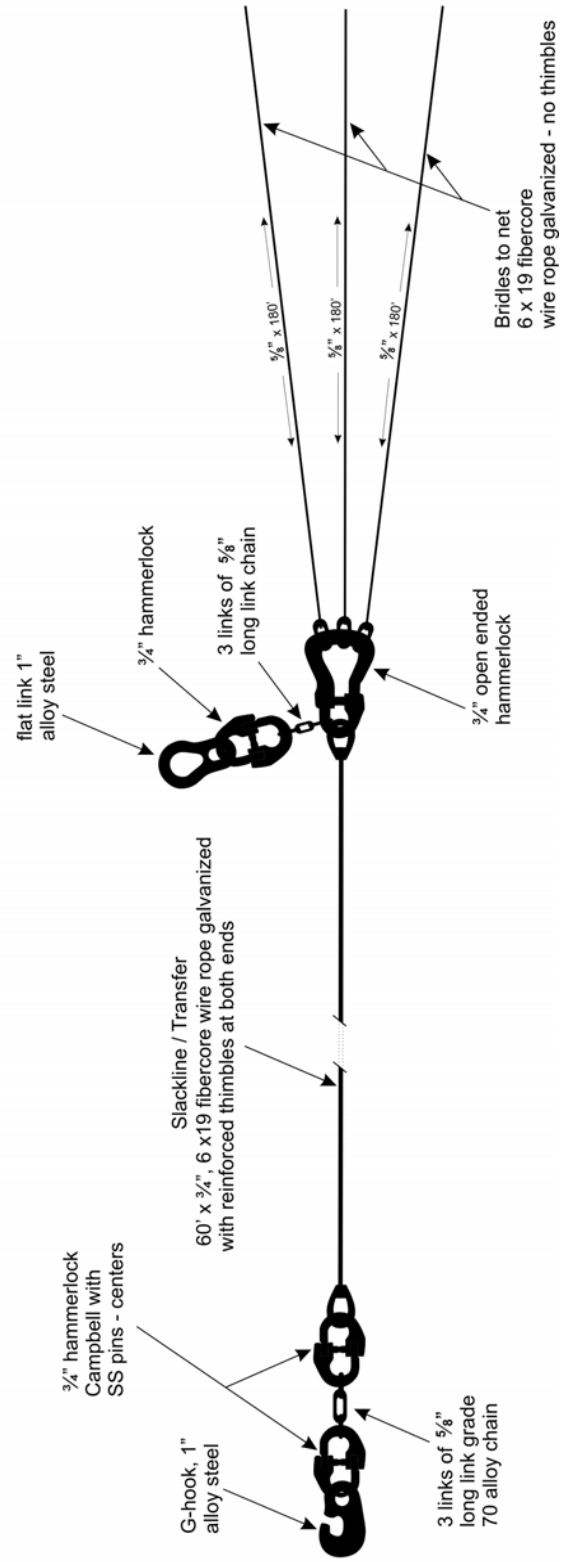
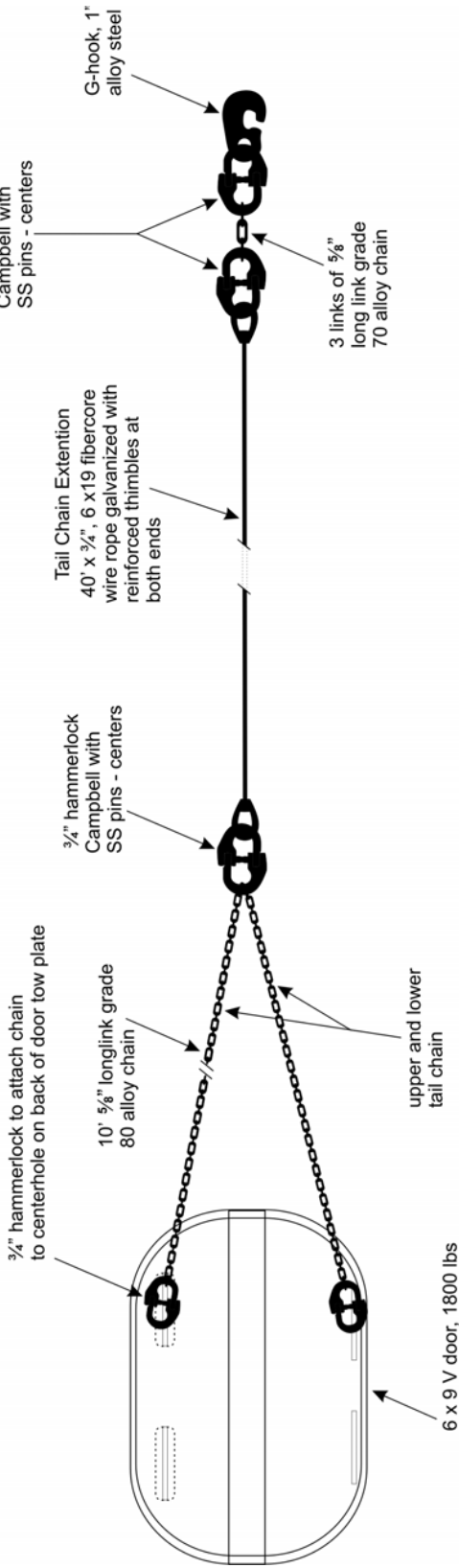

Gulf of Alaska and Aleutian Islands Bottom Trawl Surveys Bobbin Roller Gear Construction Plan for Poly Nor'Eastern Trawl

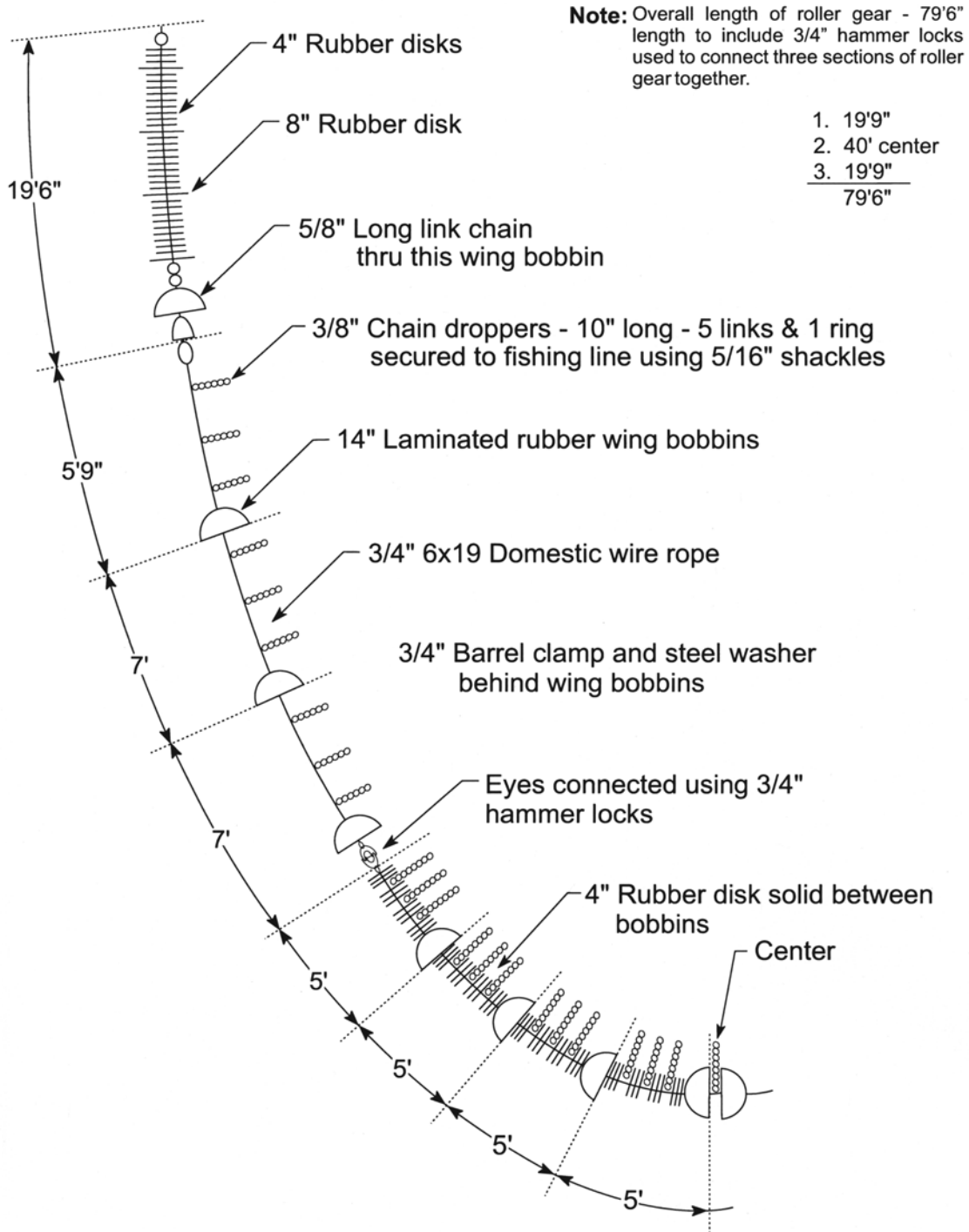

Survey Trawl Check List

Gulf of Alaska and Aleutian Islands Bottom Trawl Surveys

Poly Nor'Eastern Trawl

Vessel	
Cruise	
Date	
Checked by	
Checked by	
Net I.D. number	

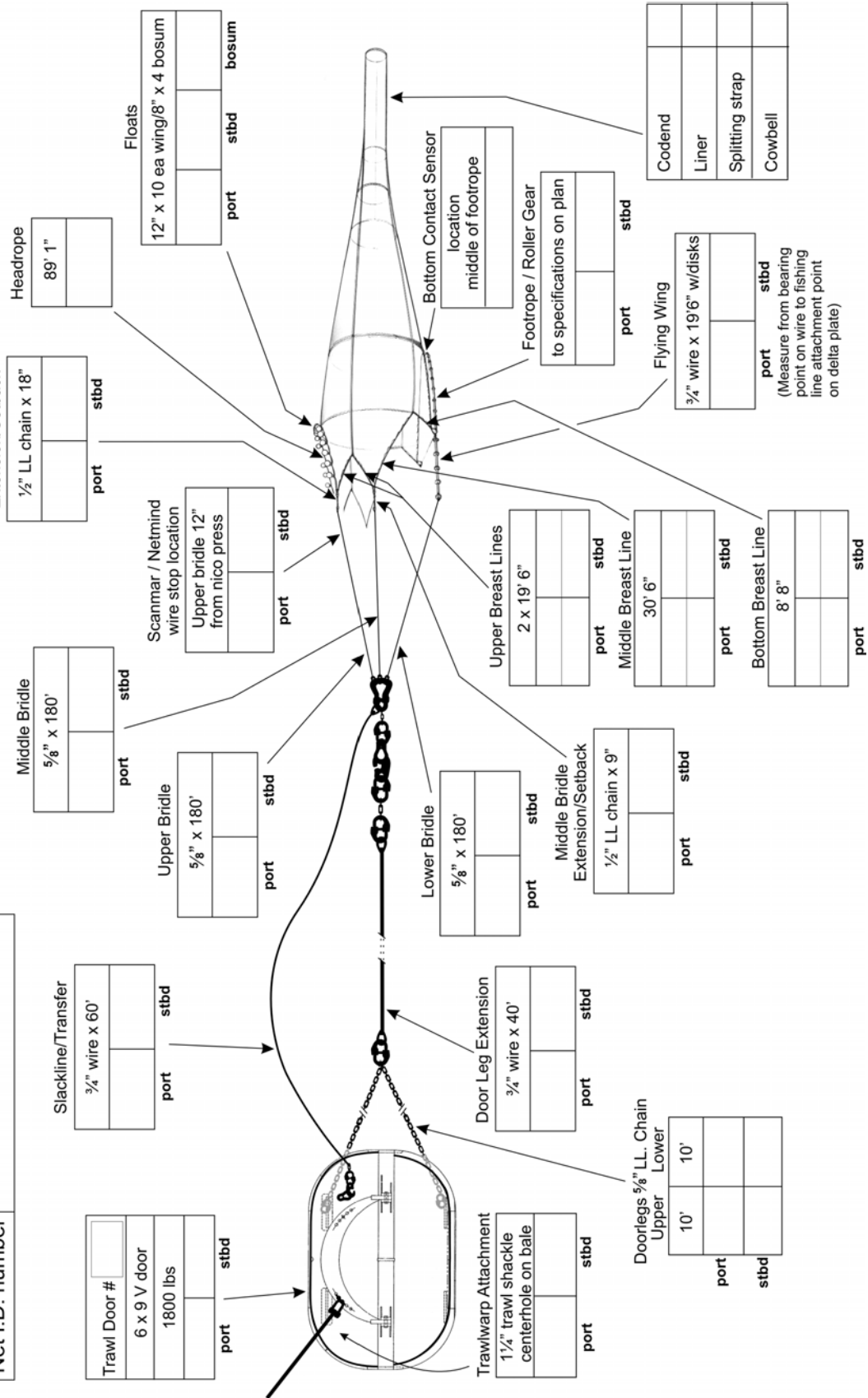

Gulf of Alaska and Aleutian Islands Bottom Trawl Surveys Net Repair Form for Poly Nor'Eastern Trawl - Bottom and Side Panels

POLY NOREASTERN TRAWL BOTTOM AND SIDE VIEWS

Haul# _____ Net Number _____ Date ___/___/___

Net was: Repaired (Describe repair on this form)
 Replaced with net number _____

Comments: _____

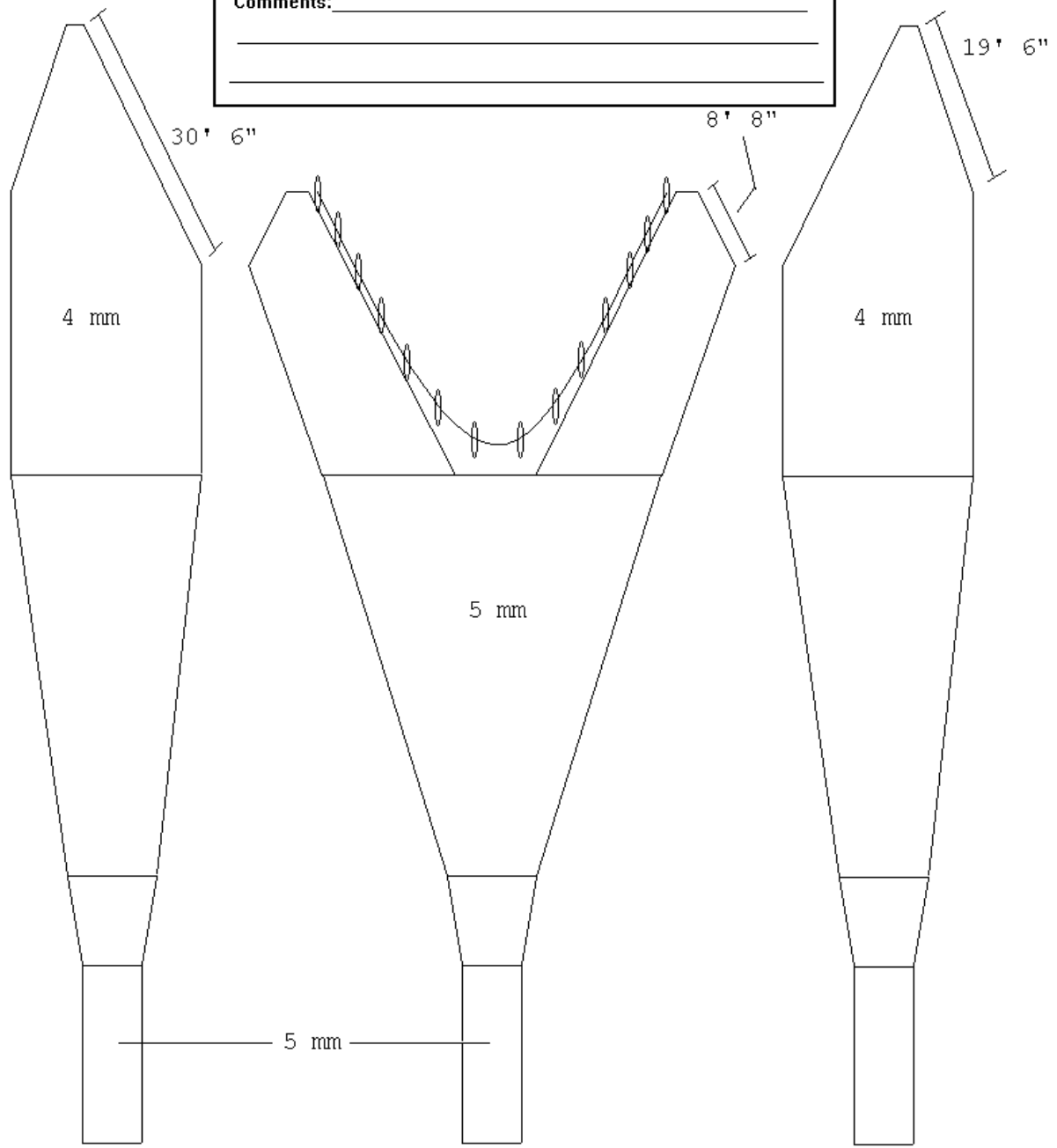

Gulf of Alaska and Aleutian Islands Bottom Trawl Surveys Net Repair Form for Poly Nor'Eastern Trawl - Top Panel

POLY-NOREASTERN - TOP VIEW

Haul# _____ Date ___/___/___
Net Number _____

The diagram illustrates the top view of a trawl net. It features a V-shaped upper section with a 4 mm mesh. The two sides of the V are labeled with a width of 19'6". The bottom of the V is also labeled with a 4 mm mesh. Below the V-shaped section is a large rectangular section, also labeled with a 4 mm mesh. At the very bottom of the net is a narrow rectangular section labeled with a 5 mm mesh.

Net was :

Repaired (Describe repair on form)

Replaced with net number _____

COMMENTS :

Appendix 2

Northwest Fisheries Science Center Standard Operating Protocols

West Coast Bottom Trawl Survey

Introduction

Scientists from the Northwest Fisheries Science Center (NWFSC) Fisheries Resources Analysis and Monitoring (FRAM) Division conduct annual bottom trawl surveys of the groundfish resources of the West Coast upper continental slope (WCUCS). These surveys comprise a series of standard tows at stations that extend from Cape Flattery, Washington (47° 20') to the US - Mexican border (32° 40') and encompass depths that range from 30 to 700 fathoms (fm). The resulting catch data are used to assess the status and trends of the various groundfish populations through application to population models that also incorporate data from the fishery and life-history studies. The surveys collect data on a variety of WCUCS fishes and invertebrates, but are principally focused on assessing the sablefish (*Anoplopoma fimbria*), the shortspine thornyhead (*Sebastolobus alascanus*), the longspine thornyhead (*Sebastolobus altivelis*), and the Dover sole (*Microstomus pacificus*), commonly referred to as the Dover-Thornyhead-Sablefish species complex (DTS), and the rockfishes (genus *Sebastes*).

The goal is to develop long-term indices of relative abundance for these species and to characterize their distribution. Moreover, specimens and other recorded data from the survey will be used to improve our understanding biological conditions, trends in population dynamics, and to identify community relationships. Specific objectives of these surveys include:

1. Quantify the distribution and relative abundance of commercially valuable groundfish species, with an emphasis on the fish of the DTS complex, as well as rockfish species of the genus *Sebastes*.
2. Obtain biological data from individual fish including length, weight, sex, and maturity stage for species of interest.
3. Gather ageing structures from Dover sole, sablefish, longspine thornyhead, and shortspine thornyhead.
4. Collect accurate net mensuration data on the trawls used in this survey.
5. Collect associated oceanographic data (i.e., water temperature, salinity).
6. Collect ancillary biological data and specimens for other projects.

Since 1998, The NWFSC has used chartered, commercial fishing vessels to conduct these surveys. The following operation protocols are designed to document our established survey standards, act as a reference to ensure data quality and consistency, and to show adherence to the NOAA Fisheries Trawl Survey Protocols.

Protocol 1: Warp Measurement Standardization

The NWFSC will provide each chartered survey vessel 2 spools of 1200 fm of 5/8" steel-core wire rope. Each warp should be attached to the winch on each vessel in the same fashion during vessel mobilization. At the completion of the survey, the wire cable will be taken off the vessel and retained by NMFS.

NOAA trawl survey standardization protocols (Protocol 1) require that two independently-calibrated measuring methods or devices shall be used on each trawl warp, one of which will measure the warp in real time. For NWFSC bottom trawl surveys, trawl warps will be measured by at least two of three procedures. (1) In all cases, trawl warps will be measured and marked side by side by a private vendor with FRAM supervision – the measurements and markings will be made prior to each cruise, and at the completion of the contract. The markings will be made in twenty-five fm increments. Also (2), an electronic trawl warp measurement system (e.g., 3 Point Systems Inc. via Sensors Northwest) will provide a real time digital display of amount (distance) of wire deployed for each tow, or (3) in-line trawl wire meters (e.g., Sensors Northwest or Olympic Instruments, Inc.) to provide a mechanical method of length determination for trawl warp deployment.

Length Measurement of Trawl Warps

We will measure and mark warps side-by-side prior to each deployment. This marking procedure, to be conducted by Englund Marine in Newport, Oregon or other appropriate vendor.

Trawl block or mechanical warp counters will be used for real-time measurement of trawl warps during each haul and retrieval event. NMFS scientists will monitor the real time information and measurement data will be stored either directly within SCS or recorded on data sheets and entered electronically at a later date. If at any time during a haul an observed difference between the two warps exceeds 20.7 ft. (based on 4% of the distance from trawl doors), all operations must cease and a determination made as to the cause of the discrepancy. This discrepancy must be remedied before survey operations can proceed.

During normal operations, some stretching of the warp will likely occur due to hanging the doors or footrope on the seafloor bottom. If more than 6 inches distance from the marked warp to the block counter occurs, the warp interval will be remarked with a different paint color. The real-time trawl warp counter will be re-calibrated whenever remarking of warps has occurred. Special attention should be paid to the monitoring system when door and footrope hangs occur to observe if stretching of the warp has taken place and remarking is necessary.

Calibration of Warp Measurement Devices

Calibration of the 3 Point Solution, Inc. electronic system and the Sensors Northwest in-line mechanical odometer trawl warp measurement system will be carried out by: (1) visual inspection to ensure that damage has not occurred during installation, (2) regular maintenance performed according to the manufacturer, and (3) making paired measures against a known

length section of warp as determined with a tape measure or equivalent (at least 50m) during each survey. If this procedure shows inaccuracy, a payout scaling correction will need to be made by the following calculation: $3.14159 \times (\text{root diameter of the sheave} + \text{line diameter}) / (\text{number of targets})$. The units for sheave diameter and line diameter in the above formula must be the same as the units for displaying payout on the display. For example, if the display units are feet, then the number for the line diameter in the formula must also be in feet. The payout scaling can be modified easily on the sensor unit at sea.

Calibration of the Olympic Model 750-N and the Systems Northwest in-line wire meters will occur during annual maintenance and again at-sea. Annually, prior to the surveys, each meter will be returned to the manufacturer (Olympic Instruments Inc. 16901 Westside Highway S. W., Vashon, WA 98070; Sensors Northwest, 23632 Highway 99, F-505, Edmonds, WA 98026) where broken or worn parts (wheels, springs, counters, etc.) will be replaced and the unit cleaned and lubricated. Each unit will be tested to determine whether it is performing within factory specifications and calibrated to a known length of cable of similar properties to the warps used on the surveys. At sea, each in-line meter must first be inspected to ensure it has not been damaged during transport, then cleaned and again calibrated against a known length of warp (at least 50 m) measured using the tape measures provided to each field party. The calibration can be done as follows: 1) set the trawl with the doors just underwater at a speed of 2 knots, 2) mark the warp with a piece of tape near the trawl sheave, 3) measure from this mark forward, in increments, until a distance of at least 50 m of warp has been measured, then again mark with tape, 4) attach the meter to the warp in an accessible location and secure fore and aft with rope, 5) measure the marked distance with the in-line meter three times and 6) calculate a calibration coefficient (i.e., known length / measured length) from the average of the three measurements.

Determination of Critical Value

According to Protocol 1, the maximum allowable offset between trawl wires is 4% of the distance from door to door as measured around bridles and footrope. For the trawl used by the NWFSC, this critical value is determined as follows:

Two door legs of twenty-five ft ($2 \times 25'$) + four ninety-ft sweeps (two on each side) ($4 \times 90'$), +Footrope, including extensions 104' [$(2 \times 20'6") + (4 \times 12') + (1 \times 15')$], + (4.67') for connection hardware which includes: 12 - 5/8" hammerlocks at 3.0" per hammerlock (3') + two delta plates at 4.0" per delta plate (8.0" or .67') + two butterfly plates at 6.0" per plate (1.0').
 $50 + 360 + 104 + 4.67 = 518.67'$ (ft) $\times 0.04 = 20.75$ ft or 6.3 m.

Proper Care and Stowage of In-line Meters

During use, avoid any rough treatment of wire counters (for example do not leave them laying out on deck, or allow them to slide around, or drop them between decks) and thoroughly clean after each use with undiluted Simple Green detergent with particular attention to remove warp grease buildup on roller. Allow the meter to dry completely before placing in case (dry in engine room) and store in a dry area.

Protocol 2: Auto-trawl Standardization

Auto-trawl systems are not used by vessels chartered by the NWFSC.

Protocol 3: Operations Procedures

A. Scope

To date, we have relied on the individual vessel operator's experience and judgment for choosing an initial scope ratio. In practice, scope ratio varies non-linearly with depth, from about 3:1 at 100 fm to 2.5:1 at 300 fm, 2:1 at 400-500 fm, and as low as 1.7:1 on out to 700 fm. We will continue to depend on these values until such time as a formal study of net performance and scope ratio over various depths is completed. Because the appropriate scope depends on other immediate factors (e.g., weather; the force and direction of any bottom currents), the final scope fished at any particular event will be based on the observed trawl geometry and bottom tending performance on each and every tow.

B. Speed of tow

Bottom trawl hauls will be made at a constant speed of 2.2 knots (nmi/hr) over ground. The Captain of the vessel is responsible for monitoring and maintaining the speed during the entire tow. Speed at any point during the tow can be verified using the continuous stream of GPS data, which is logged to a computer file. Speed variations of ± 0.5 knot are acceptable, but the target is 2.2 knots and should be adhered to as closely as possible. Monitoring and recording of tow speed will be accomplished in real time using the GPS unit supplied by the scientific party. Should this government provided GPS fail, the Captain should use the vessel instrumentation that he/she believes most closely matches that of the government unit. In such cases, the Captain/FPC will document in the instrumentation used to monitor tow speed.

C. Duration and distance of tow calculations and use of trawl mensuration / performance monitoring instrumentation

The performance and geometry of trawls used during NWFSC survey tows will be measured using several sensors. The Simrad Integrated Trawl Instrumentation (ITI) System, Bottom Contact Sensor (BCS), and a secondary temperature/depth recorder will be deployed on every haul. ITI data is logged continuously on a computer. The BCS and secondary temperature/depth data will be downloaded after every tow.

The ITI system consists of four sensors that are clearly marked with respect to their orientation (i.e., Up, Towards Vessel, Port, and Starboard). There is the Trawl Eye, which measures headrope height and footrope clearance; a temperature/depth recorder (TDR); and a pair of wing units (one master & one slave), which measures the wing spread. Together, all ITI data is automatically logged. The FPC will monitor the ITI display throughout each haul, and will periodically record the values on the Haul Data Form. Prior to the first haul, the Trawl Eye and TDR are mounted in mesh bags at the center of the head rope. These units can be left attached to the net between tows. The wing units are clearly marked Port and Starboard and are attached to the wing of the net. Always use a clip-on safety line attached to the vessel when attaching or

removing the sensors. The units are quite rugged and can stand the abuse of shooting and heaving the gear, but excessive and continuous rough treatment can affect their operation. The FPC is responsible for these operations, or delegating this responsibility to another person. All sensors must be recharged at the end of each day's fishing operations with the supplied battery chargers.

Two BCSs will be attached to drop chains on either side of center-point of the footrope. The FPC will provide the proper link for attachment. Each BCS will be designated port or starboard and the downloaded shuttles must be kept separate. Each BCS has an "up" and "down" orientation and should be attached so that it is oriented correctly, such that the BCS is horizontal as it is dragged across the seafloor and perpendicular when the net is off the seafloor. Directions for programming and downloading the BCS units are provided in a separate manual.

A Vemco TDR, secured in a section of pipe, will be attached to the center of the head rope using a snap shackle. This unit may be left on the net between tows and will be downloaded and backed up to a disk at the conclusion of each day's fishing operations. Instructions for downloading and maintenance of the unit are provided in the unit's operations manual.

Each vessel will be equipped with at least one backup PC, Fish Meter head and board, scale, battery pack, and flat screen monitor. There is one complete backup set for the ITI system and one ITI box for both vessels. If for whatever reason a backup system is unavailable, it will be necessary to use the BCS system for tow duration data during the sampling period. When this occurs it is critical that the FPC keep detailed records on the Haul Data Form of the exact times of the trawl events (i.e., Doors Fully Out, Gear On Bottom, Begin Tow, Start Haulback, Doors On Surface). It is essential that the clocks in the BCS, computer, and the FPC's time reference are precisely synchronized at all times in order to make later interpretation of BCS data possible. The time display on the GPS is the most accurate time reference on the vessel.

Target duration of all tows will be 15 minutes towing time. This duration ensures an adequate sample of the biota and usually results in a catch that is a reasonably manageable size to sort and process. The start of the 15 minute towing period will be determined from the near-real-time readout of the net height instrumentation, which enables the operator to determine when the net approaches bottom and settles into its fishing configuration. The time that the footrope touches down can usually be detected by watching the headrope height measurements decrease rapidly from over 10 m to under 8 m as the net approaches bottom. The start of the tow should be defined as when the height decreases to 8 m. Winches are engaged 15 minutes later to haul back the net. Tows may be shortened due to upcoming obstructions, inability to follow a depth contour, hangups, gear problems, or extremely large catches which affect the efficiency of the trawl.

After the haul is completed, data from each of the sensors will be synchronized with time stamps and displayed using an in-house, custom designed software package. Using this software, an initial computation of time of on bottom and off bottom is available in the field. Later, using the same software an operator will determine the precise points in time that the footrope initially contacts and leaves bottom and calculate the duration, distance fished, and average net spread

and height during each tow. The trace of the BCS data is the most useful tool for determining the on and off bottom times. The transition between when the net is on or off bottom is usually clearly signaled by an abrupt change in readings from around 0-20 degrees to around 60-80 degrees (vice versa when leaving bottom).

The data recorded from the sensor systems (BCS, ITI, and global positioning systems (GPS)) provide the principal data for effort related estimations. All sensor streams are reviewed to address spurious readings known to be related to the recordings from the electronics. In particular, because the computer system receiving the ITI sensor signals often record readings at a rate exceeding that at which new readings are delivered, some sensor readings are recorded multiple times. This "persistence" of a single sensor reading through several recordings is evident in the data streams as varying length strings of constant value.

Persistent strings that greatly distort the overall signal pattern are removed using a variety of techniques. They include objective statistical trimming methods and more subjective manual removal of data points. In particular, persistent strings that originated before and extended into the time intervals bounding subsamples used for estimation were routinely removed manually prior to analysis. But for the most part, the phenomena under observation vary little during the on-bottom time period of interest, so that the overall pattern of sensor readings was not substantially distorted by moderate periods of data repetition. Therefore, it is assumed that treating the members of a persistent string as independent samples within the sample set would not substantially affect the mean estimate. However, it would result in unacceptable underestimation of the standard error of the mean and, accordingly, standard error estimates are not reported for mean estimates.

Because none of the ITI sensor readings should ever be zero during the tow duration, such are considered missing values and are filtered out prior to all depth, net dimension, and temperature estimations. Large spikes in the depth, net dimension, and temperature signals are assumed to be the result of electronic noise and are filtered out prior to processing. Such data points are even more questionable when several isolated occurrences seem to be identical in value, as is apparent for various gear depth data sets. In contrast, sensor data streams also indicate that there can be large swings in the net during a tow, sloping and bumpy substrates, and trawl execution problems that manifest themselves in highly variable data sets. Extreme points that appeared to be part of some contiguous variation in magnitude, or some particularly variable stretch of readings are not excluded prior to analysis.

The sensor reading sample sets used to estimate depths and net width and height are limited to the center 80% of the tow duration to ensure only on-bottom readings are included. In the vast majority of tows, this boundary does not appreciably reduce the number of observations, but does effectively exclude small timing offsets between the BCS and ITI sensor systems and any instantaneous noise introduced by net touchdown and liftoff.

Tow duration is measured as the simple difference between the times marking touchdown and lift-off of the trawl net. Wherever possible, these times are determined from bottom contact sensor traces of tow progression from net deployment to retrieval. Gaps left by unrecorded or

otherwise suspect bottom contact sensor information are filled using either patterns in ITI sensor readings or field party chief observations of net touchdown and lift-off times.

Mean estimates of net width and height are calculated from trawl sensor readings of wingspread and headrope height from bottom, respectively. Electronically recorded sensor readings provide the preferred basis for estimation; hand recorded sensor readings are substituted where necessary and reasonable. When neither data set provides acceptable information, estimates are calculated by prediction from separate linear regressions over the width and height estimates of the other survey tows. Each dimension was regressed against tow depth, with vessel identification incorporated as an indicator variable. Net height predictions are made using robust linear regression. Although the interaction between vessel identification and depth proved to be significant by ANOVA, it neither added appreciably to the proportion of explained variation nor produced coefficients that were significantly different from zero. All estimates are tagged with qualifying information indicating estimation method.

To estimate distance fished, the period of time a net is dragged over the seafloor is split into two distinct phases. The first phase, defined as normal towing, starts when the net begins fishing as it reaches the seafloor and ends when net haulback is initiated. The length of the first phase is controlled by the FPC and, unless problems occur, is maintained for 15 minutes. The second phase follows the first and represents the time required for the net to lift off the seafloor in response to the haulback operation. Labeled "liftoff lag", the length of this phase varies by vessel and depth.

Smoothing of the trackline yields a reasonable estimate of the location of the net and an estimate of towing distance for the normal towing phase. However, typically the vessel is not moving forward during the liftoff lag phase, and consequently the survey's GPS sends erroneous bearing information to the ITI. The ITI, in turn, calculates an invalid geographical position of the trawl net. Hence, the distance and direction the net moves during the liftoff lag phase needs to be extrapolated.

The extrapolation technique begins by fixing the trawl's bearing at the average bearing from the last 5 minutes of normal towing. This is combined with the range information (the distance between the vessel and the net) and the geographic location of the vessel, to obtain the extrapolated location and distance covered by the net during the liftoff lag phase. This extrapolated trackline is connected to the end of the normal towing trackline, and the combined trackline is then smoothed with a two-dimensional Simple Exponential Smoother. Visual examination is used to determine the correct amount of smoothness that is needed for each haul. A default value for the smoothing parameter has been found to work in a majority of cases, including, but not limited to, those tows that were done in a relative straight line with good signal from the ITI system. The percent of tows for which the default smoothing parameter works varies by vessel, but all vessels have extreme cases for which the default value is not used.

The trigonometric method, developed for the 1998 survey analysis, is used when there is insufficient information for the above procedure. Within the database, all estimates were tagged with qualifying information indicating which estimation method was employed.

Gear depth and bottom depth are estimated from electronically recorded trawl sensor readings of headrope depth and headrope distance from bottom. Gear depth is taken as the headrope depth sensor reading and bottom depth is taken as the sum of headrope depth and headrope distance from bottom. Hand recorded data sets are substituted when necessary and reasonable. For cases where data of sufficient quality are available, mean estimates are calculated for each, using a subsample limited to the center 80% of the tow duration to ensure only on-bottom readings are included. In a few cases where no acceptable data exist within the center 80% of the tow duration in either the electronically or hand recorded sets of gear depth readings, estimation is made from observations just outside of it, but within what could reasonably be assumed to be the observed limits of net touchdown and lift-off. For some tows, few to no coincident records of headrope depth and headrope distance from bottom exist. In these cases, if gear depth and net height are estimable for a tow, bottom depth is estimated as the sum of these two endpoints, regardless of how the separate estimates had been derived. In cases where no reasonable observation of gear depth is recorded, but depth from the vessel navigational equipment is, bottom depth is estimated from these vessel records. All estimates are tagged with qualifying information to indicate estimation method.

D. Direction of tows

Due to the survey design, tows can be made any direct that allows the entire tow duration to occur with the pre-selected grid. Tows will be made in the direction determined to be best to accommodate a variety of local conditions: bottom obstructions, peculiarities of the substrate, wind, current, or sea state, and direction to next tow.

E. Location of sampling sites and procedures to use if stations are not suitable for towing

Stations to be sampled during the survey will be selected during the design process. The entire survey area is covered by an overlay of 2 nmi (latitude) \times 1.5 nmi (longitude) grid cells. The exact location of a tow is actually unspecified but must fall within a chosen grid cell.

Stations for each stratum are randomly selected without replacement from the set of full or partial grid cells falling within that stratum. The stations in each stratum are then assigned among the vessels. Paper and electronic charts depicting station locations and successful tows made during previous surveys are used to guide sampling.

Within each assigned grid cell, the captain and FPC collaborate to find enough trawlable bottom to complete a standard 15 minute tow made at the standard speed of 2.2 knots (approximately 0.55 nmi or 1.02 km). Each tow should be surveyed before trawling operations begin in order to minimize time lost to gear damage and bad performance tows. However, because the goal is to maximize the coverage of the area with the survey trawl, some risk of gear damage is acceptable. While it is not necessary to begin the tow within the grid cell, the majority of the tow (and preferably the entire tow) should be within the cell. A reasonable effort should be made to

search the entire cell for trawlable bottom, but the search time should generally not exceed 2 hours.

If no trawlable bottom is found within an assigned grid cell, that cell should be designated as untrawlable in the station log, including any pertinent notes. An alternate grid cell should then be sampled. Alternate sites will be selected from the list of secondary grid cells within in the correct stratum.

F. Criteria for determining the success of a tow and procedures to use if a tow was unsuccessful

A successful tow is defined as a tow in which the trawl was maintained on the bottom in the standard fishing configuration as determined by net mensuration and bottom contact instrumentation. The FPC will ensure that the trawl was in adequate fishing configuration, and preponderantly on bottom for the duration of the tow. As instructed above, 15 minute tows are the standard and should be completed as such unless otherwise instructed by the FPC. Tows are acceptable under conditions described below.

- If the net is off bottom less than 2 minutes during a tow (regardless of depth) then it is a good haul and work up the catch according to the operations manual.
- If the net is off bottom more than 2 minutes, but less than 5 minutes, work up the catch by only sorting, counting and weighing all species. No lengths, otoliths or any other special projects are to be collected from this haul.
- All net geometry readings within tolerance limits (opening 4.2-6.8 m, wingspread 12-16 m)
- Tow speed within tolerance limits (2.2 ± 0.5 knots)

Tows with any loss of fish or invertebrates due to significant tears in the net or with improper fishing configuration are considered unsuccessful. Tows for which obstructions in the net (e.g., fishing gear and other debris) that could have potentially affected the CPUE are also considered unsuccessful.

In some cases, if a hang-up or gear obstruction has occurred at a time that is fairly obvious, such as a shudder or stopping of the vessel, and haulback is immediately started, the trawl should be examined. If any damage is minimal and restricted to forward parts of the trawl, then the tow may be considered successful. This assumes that at least 12 minutes of on bottom time was achieved. If a significant tear-up or obstruction occurs, or it cannot be determined when the tear or obstruction happened, then the tow must be considered unsuccessful.

Stations considered unsuccessful will be re-towed unless factors beyond the control of the survey party make it impossible to complete the station within the grid square (e.g., extreme current). The FPC will make the final decision as to whether the tow was successful or not and whether it will be re-towed.

G. Vessel and winch operation during deployment and retrieval

To ensure comparability between vessels and years, vessel operators will be asked to follow standard procedures when setting, towing, and retrieving the trawl gear. These procedures will be established at the beginning of the first leg by the captain and the FPC and must be maintained throughout the survey and for all subsequent surveys. The goals for each part of the standard tow are as follows:

Setting

Primary Goal

- To ensure that the trawl is in fishing configuration (height and width) when it makes bottom contact.
- To ensure that the procedure is easily repeatable.

Secondary Goals

- To ensure that the trawl reaches bottom quickly to minimize the midwater catch.

Towing

Goal

- To maintain the trawl in fishing configuration (height and width) at a continuous towing speed of 3 knots.

Haulback

Goals

- To maintain the trawl in fishing configuration until it leaves the bottom.
- To ensure that the net leaves bottom quickly to avoid changes in fishing configuration due to decreased scope and changes in net speed over ground.
- To ensure that the procedure is easily repeatable.

Implementation

Vessel speed, engine RPM, wire payout rate, etc., required to achieve these goals may require some experimentation at the beginning of the first leg of the survey on each vessel. The captain and the FPC should work out a standard procedure for setting, towing, and hauling back the gear. The procedures decided upon should facilitate consistently achieving the above stated goals and will be documented in writing on the Standard Trawling Procedures Form and adhered to for the remainder of the survey and for all subsequent surveys. Since the power settings (RPM and/or propeller pitch) to achieve particular vessel speeds will change with the wind, sea state, and currents, approximate power settings used to achieve these speeds in good weather conditions (little wind, no current) should be recorded. If different procedures are developed for various depths, these should be recorded as well. Any procedural modifications during the survey must be mutually agreed upon between the FPC and the captain and must be carefully justified and documented in writing.

H. Defining responsibility (e.g., survey scientist or vessel crew) for decisions regarding various aspects of the operation

All aspects of the survey operation will be overseen by the FPC. Final decisions regarding station locations and station scheduling are the responsibility of the FPC. Vessel operation, trawl gear deployment and retrieval, and all matters related to vessel safety will be the responsibility of the vessel captain.

It is the responsibility of both the FPC and the captain of the vessel to keep lines of communication open between survey vessels, not only for safety purposes, but to ensure that all operations are proceeding in the manner outlined herein.

I. Staff training

The scientific staff participating in NWFSC trawl surveys will undergo periodic mandatory training which includes classes addressing use of net mensuration instrumentation and interpretation of the mensuration data, fish and invertebrate identification, survival skills, remote duty first aid, oxygen therapy, and principles of trawl net maintenance. In addition, the FPC leading each cruise leg will be trained to carry out the objectives and sampling instructions for the specific survey leg he/she is assigned to. Training of FPCs includes learning about the design, logistics, and sampling requirements of the survey; staff management; and evaluating survey fishing gear repairs. The FPC is responsible for working directly with the captain of the vessel to coordinate overall and daily work plans and coordinating with the FPCs of partner vessels to efficiently and successfully achieve the sampling objectives of the survey.

The NWFSC surveys are conducted with chartered vessels, captains, and crew. As such, we have limited influence over the training requirements of the captains and crew. Our staff will work closely with vessel personnel before and during the charter periods to communicate with and educate them regarding matters important to the standard and proper sampling procedures required during groundfish bottom trawl surveys. Consultation with AFSC Net Loft staff will be used to review prescribed maintenance and repair objectives and standards with vessel personnel and FPCs will interact constantly with captains regarding survey objectives and standardized fishing protocols.

Protocol 4: Trawl Construction and Repair

Descriptions of Trawls and Their Rigging

The NWFSC Slope Survey net is a 4-panel ‘Aberdeen’ trawl. This design trawl is used by West Coast chartered commercial trawlers, which range from 400 to 600 horsepower. The net is spread by 5' × 7' steel ‘Vee’ doors. The Aberdeen trawls are routinely used throughout the region where FRAM conducts its assessment and research activities (i.e., the waters off the West Coast of the continental United States, from nearshore environments out to depths of 700 fm) and are fished on all types of bottom types found in these areas. The FPC and captain must understand that our trawl is a research sampling tool and the success of our surveys rides on consistent deployment and maintenance of our nets. When a trawl is damaged, it is necessary to determine whether the trawl can be repaired to its original state. If there is any question of its suitability, the trawl net should be decommissioned and the back-up trawl rigged for service. If the damage can be repaired, all repairs must be documented on the net repair forms provided by the FPC. The FPC should work with either the Captain or the lead fisherman to fill out the form and document what was replaced or repaired and how this was accomplished.

Information concerning trawl construction and repair is included in the operations manual for each survey. This information includes:

- Description of the construction of the trawl components
- Description of the materials used in the trawl construction
- Net plan
- Rigging plan
- Ground gear plan
- Checklist for verifying trawl dimensions and specifications
- Trawl Repair Form

The FRAM staff will inspect and measure each trawl prior to loading it onto the vessel to ensure that it conforms to the specifications set forth on the survey trawl checklist. In addition, each trawl will have an identification number, stamped on a metal tag, that will be included on all haul forms and trawl repair forms. Whenever the trawl requires repair during survey operations, such repairs will be done following the standards set forth in the following section and documented on the trawl repair form. Components potentially affected by at-sea repairs will be measured again to confirm that the trawl is meeting specifications.

Gear Repairs Aboard Vessels

At the start of every survey, vessels will be provided with an inventory of supplies used to repair trawl gear during the survey. These supplies should provide each vessel with the resources needed to make typical repairs. If a survey vessel has experienced frequent net damage, the FPC should transmit a list of trawl repair supplies far in advance of the next scheduled port of call to allow time to ship the supplies.

Net, doors, and bridles should be examined routinely during every haul back, checking for any damage and noting any repairs that are needed. When large rocks are dumped from the net, codend liners should be checked for damage. The FPC, in consultation with the vessel crew, will determine whether it is more expedient to repair a damaged trawl or to replace the trawl with a spare.

Survey trawls are research sampling tools and the success of our surveys depends on maintaining our survey gear to NWFSC standards. The FPC should stress this to fishers responsible for making trawl repairs to ensure that trawls will be replaced if they cannot be repaired to NWFSC survey standards. Fishers must follow the trawl repair protocols provided to them at the pre-cruise meeting with personnel from the FRAM Division. In particular, they must replace torn or abraded web with patches or new panels, rather than hand sewing new meshes. Straight tears, however, can be sewn as long as there is no need to build meshes to close the hole. Lacing of holes or tears is not allowed in the body, wings or codend of the trawl. Special attention should be given to repairs involving the inside of the bottom wings (where the bar cut and chaffing strips are sewn to the body). Poor repairs in this area may affect the way the footrope tends bottom. Repairs that should not be attempted aboard vessels include broken headropes, footropes, riblines or rehanging long sections of riblines (repairs that involve more than 25 benzels, approx. 40'). Given the limited deck space aboard our survey vessels, these repairs are difficult to do correctly to ensure the finished product meets our standards.

The FPC is responsible for overseeing net repairs and deciding if a net should be retired. When a net is damaged, repaired, or retired, the Net Repair Form should be completed, noting the net ID number and all damage and repairs made. When retired, the net should be picked and cleaned before it is bundled and stowed.

**West Coast Slope Survey
Scientific Operations Plan**

Aberdeen Trawl Schematics

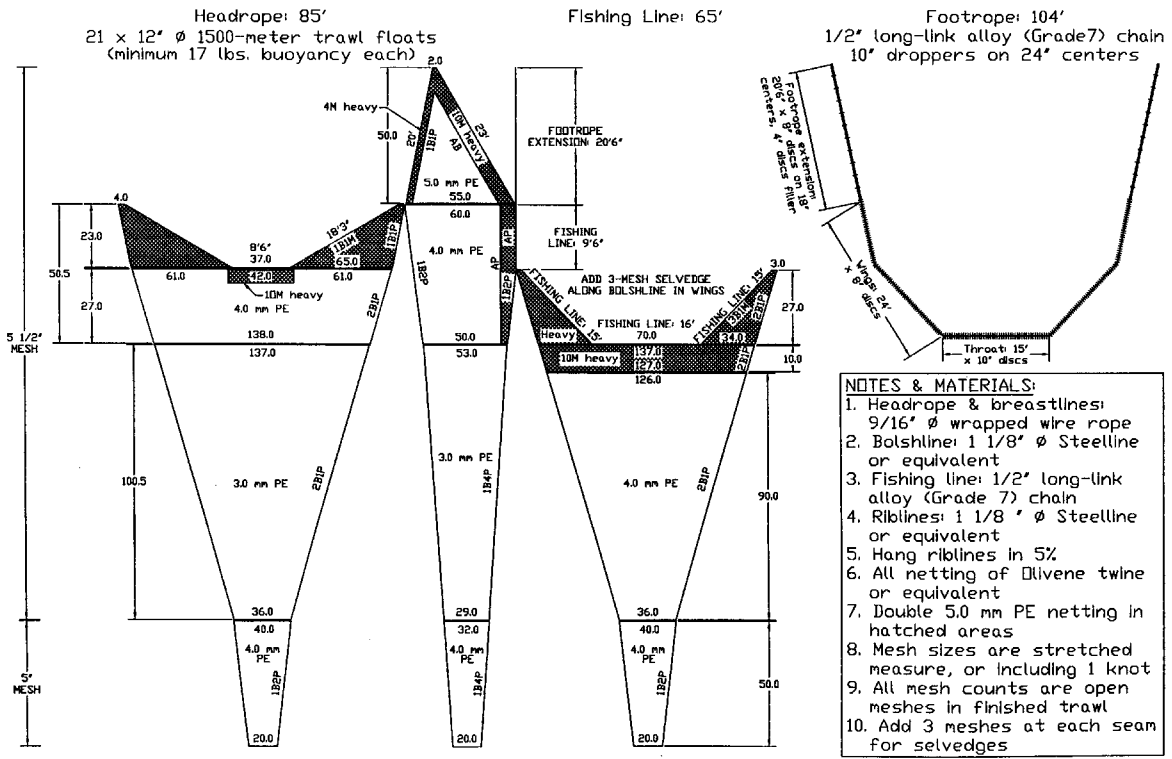
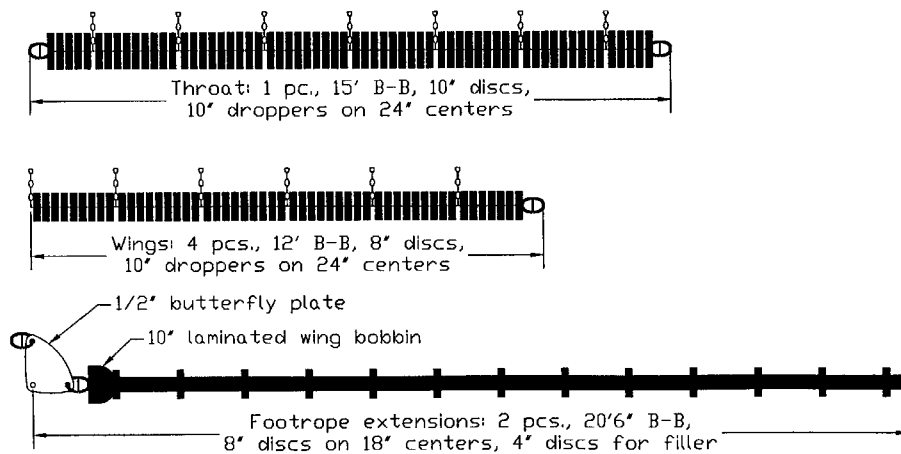

Figure 1. NMFS 85/104/5.5' Aberdeen sampling trawl

Figure 2. Footrope for NMFS 85'/104' Aberdeen Sampling Trawl
7 sections, 104' L.O.A.



NOTES:

- Footrope: 1/2" long-link alloy (grade 7) chain
- Connecters: Campbell 1/2" hammerlocks with stainless pins & spacers
- Dropper connecters: 1/2" black shackles
- All section lengths are bearing point to bearing point, including connecters

ABERDEEN TRAWL RIGGING

	<u>Per Trawl</u>
□ □ universal swivel	2 x 3/4" & 2 x 1"
⊙ flat link	2 each
⊙ G-hook	2 each
⊙ 1/2" hammerlock	14 each
⊙ 5/8" hammerlock	10 each
△ delta plate	4 each

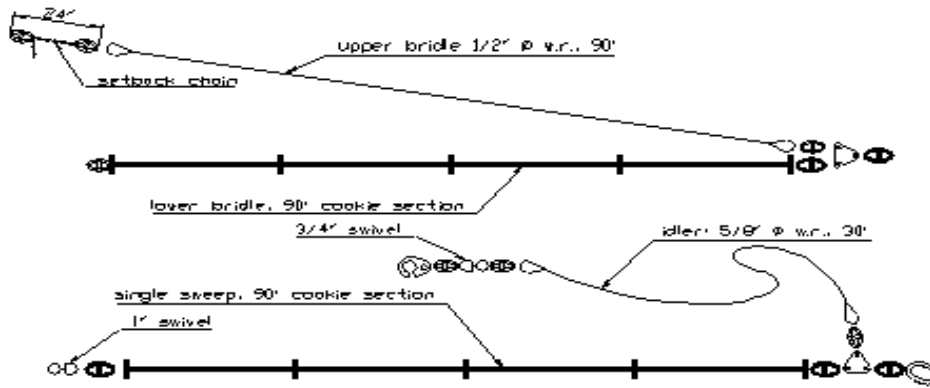

Aberdeen Trawl Rigging Diagram

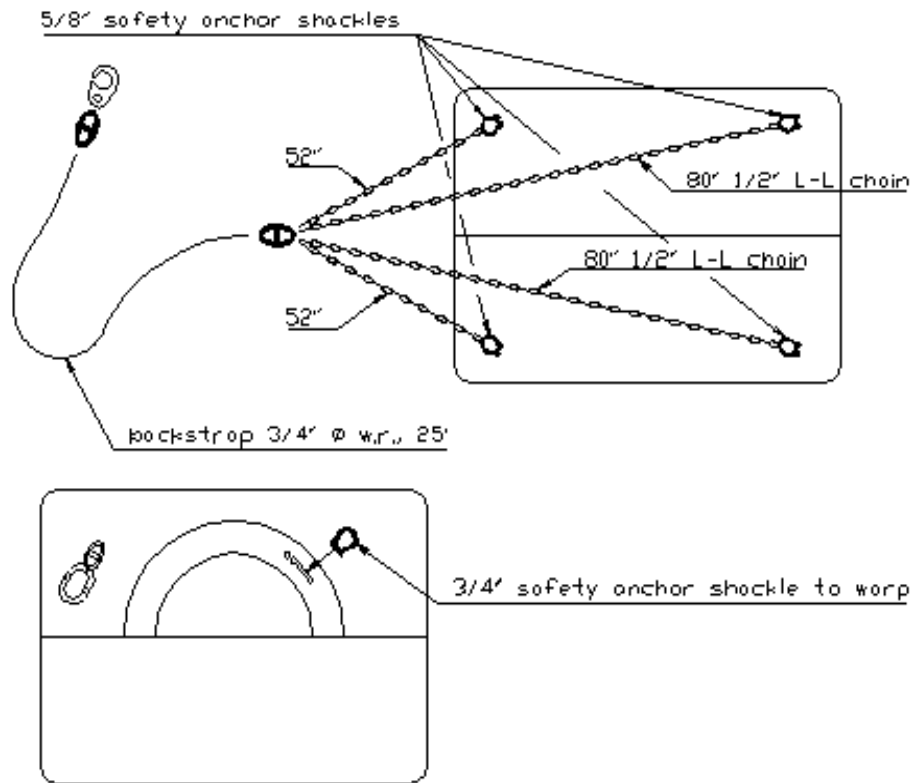

5' X 7' Vee-Door Rigging

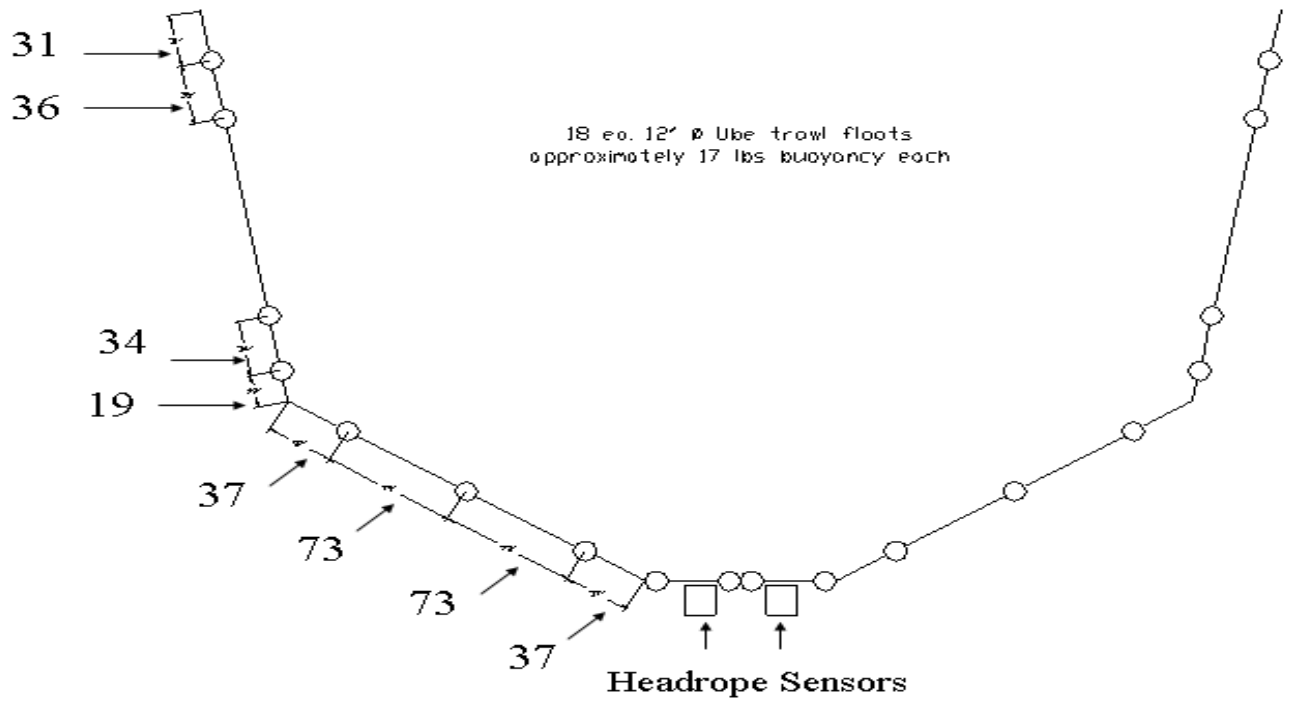

Float Placement on Aberdeen Trawl

Appendix 3

Southwest Fisheries Science Center Standard Operating Protocols

Antarctic Bottom Trawl Survey

Introduction

The U.S. Antarctic Marine Living Resources (AMLR) Program is a program mandated by the Antarctic Marine Living Resources Act of 1984, assigned to the Antarctic Ecosystem Research Group at the Southwest Fisheries Science Center. The AMLR Program provides a basis for U.S. policy on the management and conservation of Antarctic living resources and supports this nation's participation with international efforts to protect the Antarctic and its marine life under both the Commission for the Conservation of Antarctic Marine Living Resources (CCAMLR) and its Scientific Committee.

The U.S. AMLR Program concentrates research activity in CCAMLR Statistical Area 48, primarily in the Southern Scotia Arc Region of the Southern Ocean near the Antarctic Peninsula. Research cruises and land based operations are primarily directed at gathering biological information to prevent overexploitation of fish and krill, as well as assess seal, penguin, and pelagic seabird populations for their protection. In order to achieve these goals, several components of the Antarctic food web and ecosystem are sampled. These include collection of physical and chemical oceanographic information, primary and secondary productivity, and acoustic and net sampling of marine predators (finfish) and their prey.

To collect information on finfish and the role of finfish in the Antarctic ecosystem, the U.S. AMLR Program conducts periodic (non-annual) bottom trawl surveys which examine standing stocks, community structure, reproduction, feeding guilds, and other ecosystem related aspects of demersal and benthic marine organisms, as well as habitat characteristics of seabeds. These bottom trawl surveys are based on a random, depth stratified sampling design, and target shelf areas between 50 and 500 m. Sampling sites are situated in areas that are very poorly charted (to uncharted) regions of the Southern Ocean. The survey targets as many species as possible (about 45 species). In most cases, these species exhibit a patchy spatial distribution; the mechanisms that influence these distributions is the subject of ongoing research.

Since 1996, the U.S. AMLR Program has chartered a 104 meter, 5626 ton ice-class vessel, the R/V *Yuzhmorgeologiya*, to conduct the research cruises and resupply the land bases. The AMLR Program initiated the bottom trawl survey component during the 1996/1997 Austral summer, when seven hauls were conducted. During the 1997/1998 Austral summer, the first large-scale bottom trawl survey was initiated in CCAMLR Statistical Subarea 48.1 (the South Shetland Islands). These surveys have continued on a periodic basis in other CCAMLR Statistical Subareas within the Southern Ocean.

This document presents information on aspects of the bottom trawl survey component of the AMLR Program, and should be considered as one of the Southwest Fishery Science Center's Regional Protocols within the framework of the NOAA Trawl Survey Standardization Protocol.

Protocol 1: Length Measurement of Trawl Warps

The two trawl winches (STV-160) are installed at the port and starboard in 5 m from the stern, with a reel capacity of 32,000 m on each winch. The winches can run together or separately. We currently do not use an auto-trawling system.

The trawl warps are comprised of 25 mm diameter, 6 × 19 class, right and regular lay, fiber core wire rope (weight - 2.28 kg/m; breaking strength - 31 tons). Cables are continuously checked for damage, rust, and broken wires (no more than 15% on length equal to 8 diameters).

Line speed and line amount data are collected during deployment and retrieval by means of a Russian made magnetic block wire counter (SDT-SI2). The calculation of warp is realized by noncontact magnetic sensors installed on the block (sheave) and block frame. The conversion is based on the number of constant magnets, the circumference of the block groove, the number of revolutions, and the conversion efficiency parameter for each block. These wire counters are calibrated prior to each survey by passing a measured wire through the block. Parts are periodically inspected and replaced if needed during the course of the cruise.

As specified in Protocol 1 of the report of the National Trawl Survey Standardization Workshop, a pair of mechanical in-line wire counters (Olympic Model 750-N Trawl Cable Meter) will be installed and used to verify the readings of the primary wire counter. The primary wire counter will operate in real time and daily calibration checks between wires and between in-line and block wire counters will be undertaken. The mechanical in-line wire meters will undergo maintenance and calibration by the manufacturer between each survey to ensure accuracy of the instruments.

The port and starboard trawl warp lengths will be compared on a daily basis. If the average difference between trawl warps exceeds 4% of the groundgear distance measured from door to door, trawling operations will cease and the wire counters examined to determine whether discrepancies are due to mechanical or electronic failure. Should it be determined that wire counters are functioning properly and warp lengths continue to demonstrate a discrepancy, trawling operations will cease until the problem is resolved. In addition to the monitoring of warp length, the net configuration and trawl mouth geometry/symmetry will be monitored with a headrope mounted net sonar.

Protocol 2: Use of Auto-trawl Systems

An auto-trawl system is not used on the Antarctic Bottom Trawl Survey.

Protocol 3: Survey Operations Procedures

The AMLR finfish bottom trawl survey is conducted in remote regions of the Southern Ocean where sea state and weather can be severe, where bathymetric data has only been collected sporadically, and bottom conditions are extremely variable and largely unknown. In addition, icebergs, growlers, and sea ice can present considerable challenges while conducting the survey.

The survey design and sampling strategy is based on random depth stratified survey design, with stations positioned to account for wide geographic contrast across all accessible shelf areas. However, initial coordinates for fishing stations within a depth strata determined prior to the survey must be often be revised depending on sea, wind, bottom, and ice conditions. All final decisions regarding sampling operations during the survey are made by the chief scientist in consultation with the fishing master and ship captain. The following factors are significant in determining that tows are consistent within and between surveys.

1. Determination of Seabed Suitability for Bottom Trawling

The chief scientist will provide the officers and crew with a list of proposed starting and ending coordinates for a station. Due to sea state and other factors, there may need to be adjustments in these coordinates. Prior to the haul, an initial acoustic reconnaissance transect will be taken. The echogram shall be examined by the chief scientist and the trawl master to determine if the seafloor is within the targeted depth strata, and that there are no seafloor features which subject the trawl to a high risk of damage (e.g., pinnacles, steep ledges, large rock formations). After agreement from the chief scientist and trawl master that bottom conditions are suitable for trawling, the station will be taken.

2. Setting the Trawl

The procedure the vessel follows while setting, towing, and retrieving the trawl are highly dependent on weather conditions. In calms seas, the vessel should follow as close as possible the acoustic reconnaissance line. When wind is less favorable, the trawl should be set into wind, then the vessel turned while the trawl is being deployed to follow the acoustic reconnaissance course. Trawling operations will be suspended if the weather and seas expose substantial risk to the gear, fishing crew, or scientific party. The decision to suspend operations until weather calms is made by the chief scientist in consultation with the trawl master and ship's captain. Scope ratio data will be collected and used during future surveys to ensure that the same scope ration is maintained over time. Should a new net be required during the course of the survey, the gear will first be deployed and washed out pelagically. The net will then be deployed on the bottom for 30 minutes at least one time prior to a valid haul.

3. Speed of Vessel During Gear Deployment and Trawling Operations

The vessel speed while setting the net should be between 2.7 and 2.8 knots. While bottom trawling, vessel speed should slow to 2.3-2.4 knots. Upon net retrieval, the vessel should slow to 2.0-2.1 knots. All measurements are speed over ground measured with GPS.

4. Timing and Duration of Tow

All hauls are conducted during daylight hours, between nautical sunrise and nautical sunset. The target time for a successful tow is 30 minutes. Any haul less than 20 minutes is considered invalid, and discarded. Trawling starts as soon as the footrope is determined by the trawl master and chief scientist to make contact with the bottom. An Ocean Systems Netsweep 325 Trawl Sonar (325 Khz. Transducer) mounted to the headrope is used to monitor the mouth of the trawl as it is deployed, as well as when it makes contact with the bottom. The net sonar is also used to measure the trawl mouth dimensions in real time as it is deployed and while sampling. Once contact with the bottom is made, position, time, ship speed, bearing, headrope depth, bottom depth, and trawl mouth width (i.e., the widest point below the headrope-mounted net sonar transducer) and height (i.e., vertical distance between the headrope transducer and the seabed) are recorded. Recordings were made every 5 minutes thereafter, for a total of seven observations for each haul. The distance of seabed sampled is determined by the latitude longitude coordinates taken with GPS from the start to the end of bottom trawling.

5. Determination of Successful Haul

While the trawl is being retrieved and spooled onto the net reel, a visual inspection of the netting and gear is conducted by the trawl master to determine any damage was sustained during the haul (see Protocol 4, section on Quality Assurance Procedures for further details). A visual inspection of the 'shine' pattern on the trawl doors is also performed by the trawl master as an added assessment of proper gear deployment. If the above conditions regarding duration and deployment are met, and the net has not sustained a tear >15 cm in any dimension, the chief scientist will consult with the trawl master to determine if the haul is successful. If the haul was deemed problematic for any of the above reasons, the station will be dropped, repairs to the trawl will be made if necessary, and an alternate station near the coordinates of the discarded station and within the same depth strata will be taken.

6. Supplementary Data Collected at Each Station

Supplementary data collected for each haul includes ship course, air temperature, wind direction and speed, weather, cloud conditions, sea state, light and ice conditions. In addition, a CTD cast is taken at each strata/geographic shelf region during the course of the survey. The Station and Tow information sheet (Bridge Log) details information collected during each haul. This information is also entered into the AMLR bottom trawl survey database.

Station and Tow Information (Bridge Log)

CATCH RECORD				PAGE NO.
VESSEL NAME:		CRUISE:		
DATE	TIME ZONE	UTC	OTHER	
STATION NO.		HAUL NO.		
CCAMLR AREA/SUBAREA		STRATUM		
START NET ON BOTTOM	LATITUDE	°		
	LONGITUDE	°		
END NET OFF BOTTOM	LATITUDE	°		
	LONGITUDE	°		
BOTTOM DEPTH	FROM	M		
	TO	M		
FISHING DEPTH	START	M	END	M
MEAN FISHING DEPTH		M		
OPENING: HORIZONTAL		M	VERTICAL	M
TIME START NET ON BOTTOM		H		
END NET OFF BOTTOM		H		
DURATION OF HAUL		MIN		
COURSE		°		
TRAWLING SPEED	KN	TRAWLING DISTANCE	NM	
TEMP. FISHING DEPTH	FROM	°C	TO	°C
TEMP. BOTTOM		°C	TEMP. SURFACE	°C
SALINITY FISHING DEPTH	FROM	PSU	TO	PSU
SALINITY BOTTOM		PSU	SALINITY SURFACE	PSU
AIR TEMP.		°C		
WIND DIRECTION		°	WIND SPEED	KN
WAVE HEIGHT		M		
ICE CONDITIONS *)				
WEATHER *)		LIGHT *)		

Codes for Ice Conditions, Weather and Light

Ice Conditions:	Weather:	Light:
-----------------	----------	--------

- 0 : no ice
- 1 : ice present, but indeterminate
- 2 : < 10 icebergs
- 3 : > 10 icebergs
- 4 : < 6/10 sea-ice cover 1 nm from ship
- 5 : > 6/10 sea-ice cover 1nm from ship
- 6 : < 6/10 sea-ice close to ship
- 7 : > 6/10 sea-ice close to ship
- 8 : heavy pack-ice
- 9 : no observation

- 0 : clear sky, no clouds
- 1 : partly clouded
- 2 : overcast
- 3 : snowstorm
- 4 : fog or dense mist
- 5 : drizzle
- 6 : rain
- 7 : snow, sleet
- 8 : rain squalls
- 9 : no observation

- 1 : daylight
- 2 : dawn/dusk
- 3 : dark

Additional Comments:

Net Mensuration

Time	Net Height	Net Width	Tow Speed	Headrope	Comment
:					
:					
:					
:					
:					
:					
:					
Average					

Protocol 4: Trawl Construction and Repair

Specifications

The AMLR bottom trawl survey uses a NET Systems Hard Bottom Snapper Trawl rigged with tiregear ground tackle with a headrope length of 92.0 ft and a footrope length of 127.6 ft. The technical designs of the trawl are provided here in both engineering schematics and detailed part descriptions.

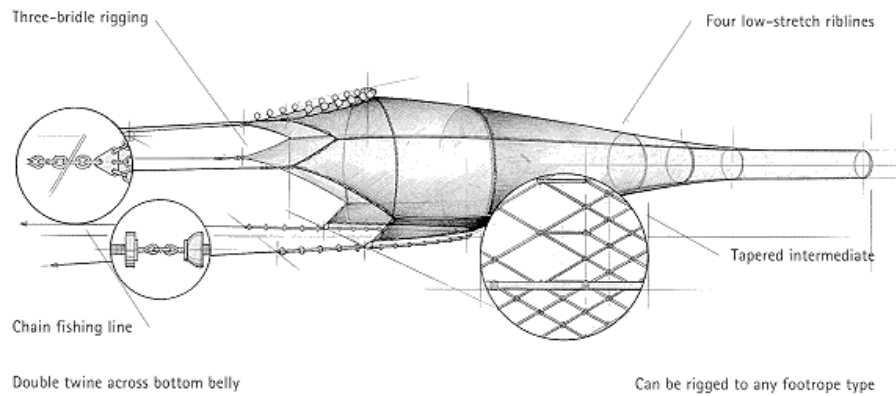

Drawings

The following are engineering drawings (obtained by the manufacturer NET Systems, Bainbridge Is., WA) of the gear used during all AMLR bottom trawl surveys.

Drawing	Sheet
Rigging Profile	A
Net Plan	B
Ground Gear	C
Intermediate	D
Codend	E
Rigging Hardware Detail	F
Door Design	G

	
RIGGING HARDBOTTOM SNAPPER TRAWLS	
DESIGNED BY: GARY LOVERICH	DATE: 2/12/88
COPYRIGHT © NET SYSTEMS INC. 1987 ALL RIGHTS RESERVED	
DWG NO.-	RGB330HS

NOTE:
 ALL CONNECTORS AND FITTINGS
 MUST BE GRADE 304 STAINLESS STEEL
 AND MUST BE PROVED TO MEET ALL
 SAFETY AND SYSTEM INTEGRITY AND SHOULD
 BE SIZED AND MAINTAINED
 ACCORDINGLY

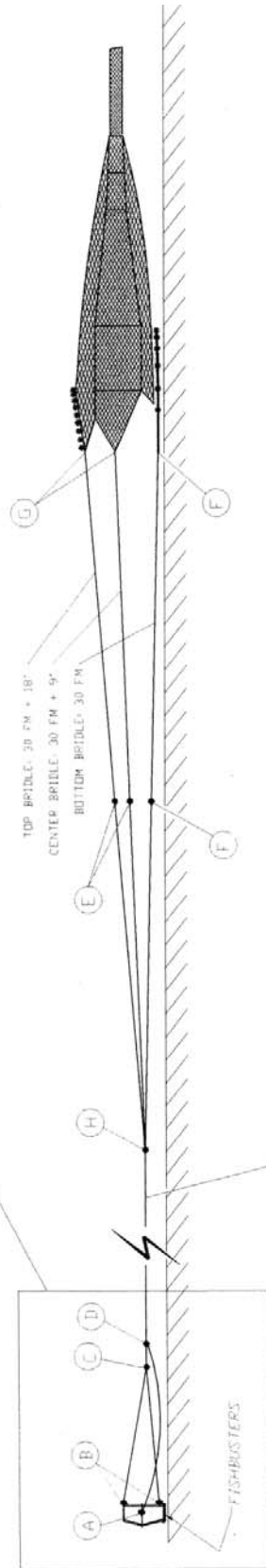

DOCUMENT B

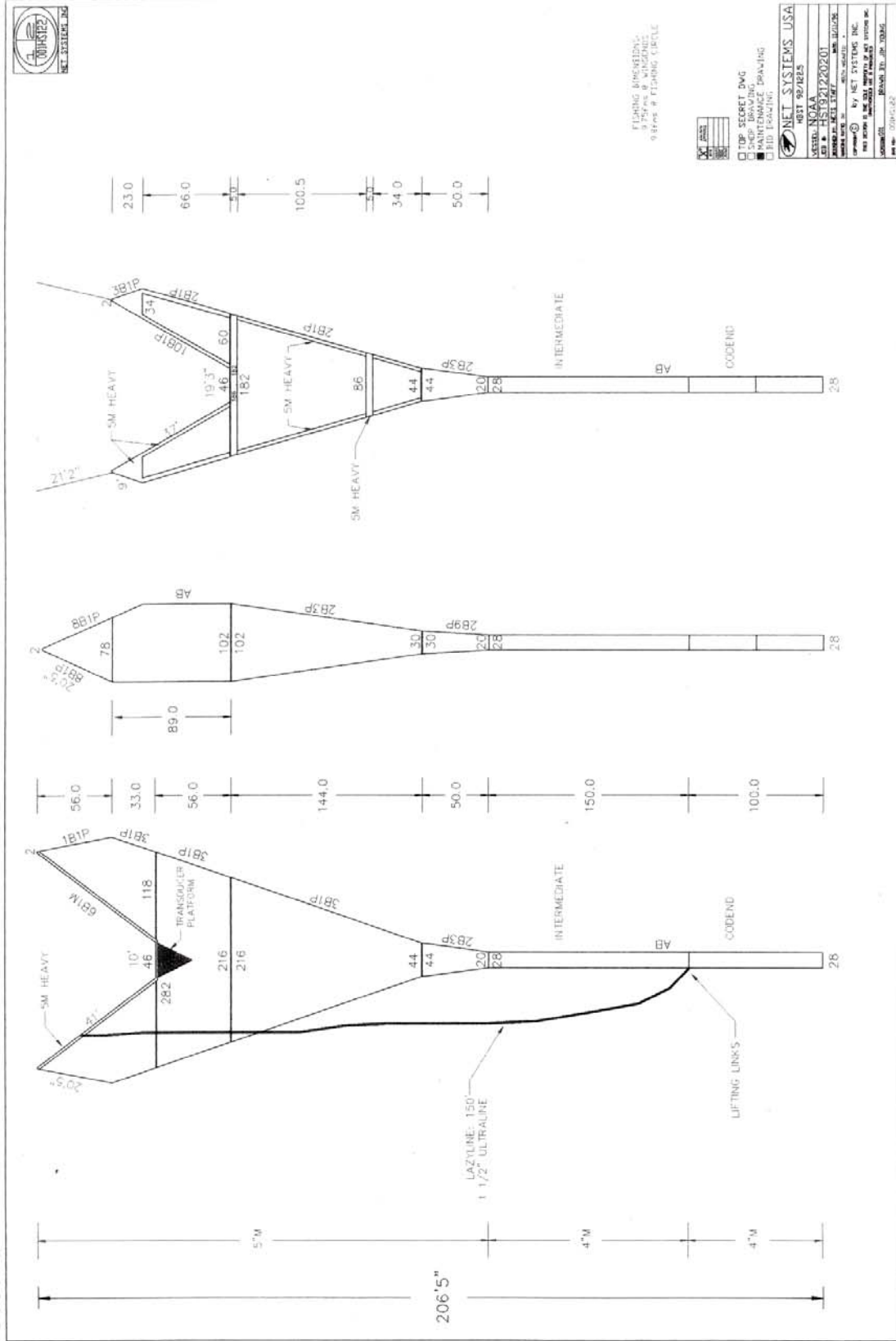

DOCUMENT D

NOTES

1. DIMENSIONS: 112MA X 150MD
2. NETTING: 4" 34.0MM PE

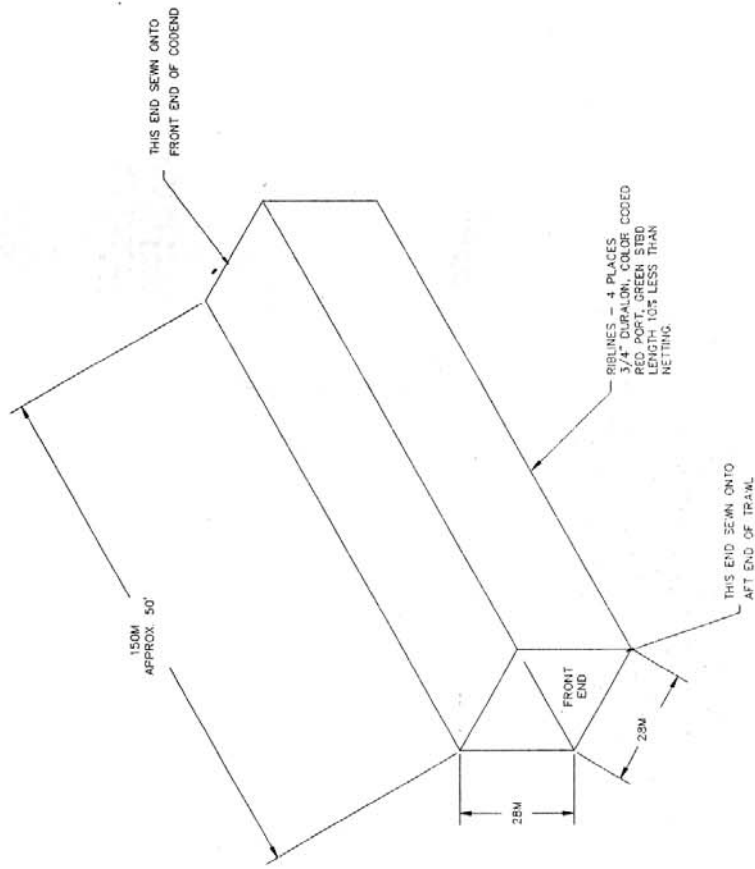

NET SYSTEMS USA	
INTERMEDIATE	
DESIGN: 112MA	
JOB #	
DESIGNED BY: NETS STAFF	DATE: 11/11/76
DRAWING MADE BY: M.J. WILSON	
COPYRIGHT © by NET SYSTEMS INC.	
THIS DESIGN IS THE SOLE PROPERTY OF NET SYSTEMS INC.	
DESIGN: 011	DRAWN BY: JIM YOUNG
DATE: 11/11/76	

DOCUMENT E

NOTES

1. ESTIMATED CAPACITY: 15 TONS
2. DIMENSIONS: 112M X 100MA
3. NETTING: 4" DSLO PE
4. HARDWARE: 7/8" SLING LINKS, 3/8" X 2" GALVANIZED RINGS
5. LINER: 1 1/2" #31 NYLON

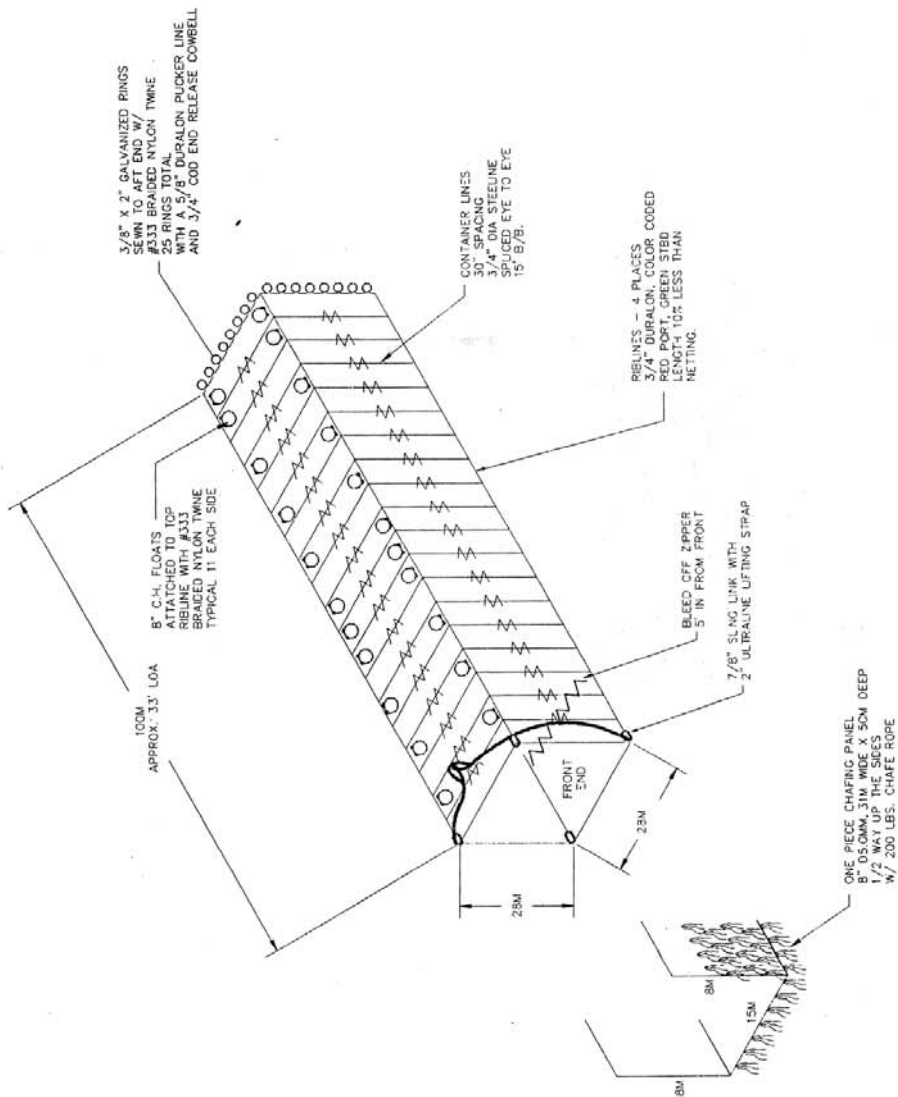

NET SYSTEMS USA	
SAMPLING CODED	
VESSEL: NOAA	
JOB #:	
DESIGNED BY: NETS STAFF	DATE: 11/11/75
DRAWING NO.:	
COPYRIGHT © by NET SYSTEMS INC.	
THIS DESIGN IS THE SOLE PROPERTY OF NET SYSTEMS INC.	
UNAUTHORIZED REPRODUCTION IS PROHIBITED	
VERSION: 017	DRAWN BY: JMI FOONG
2nd Ed.	

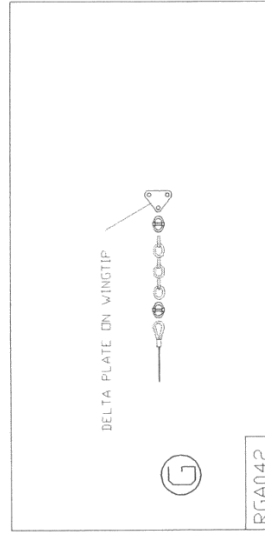
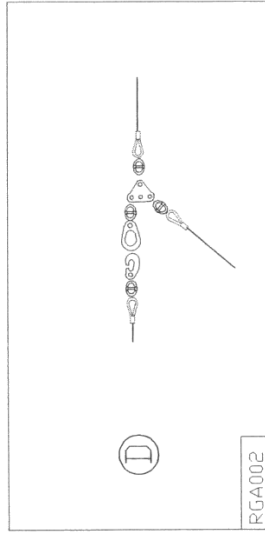
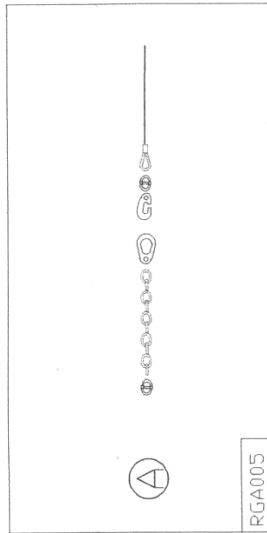
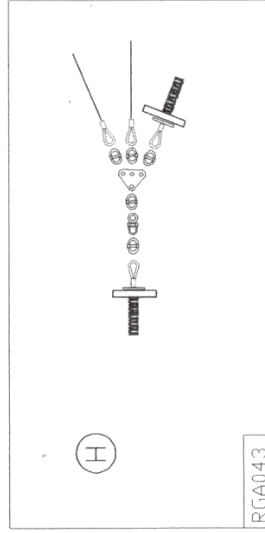
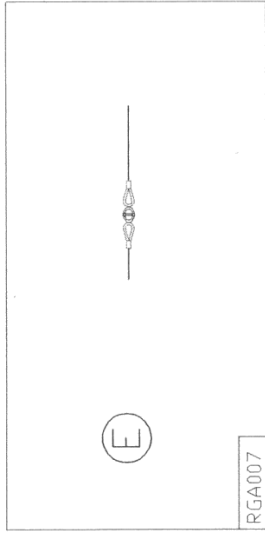
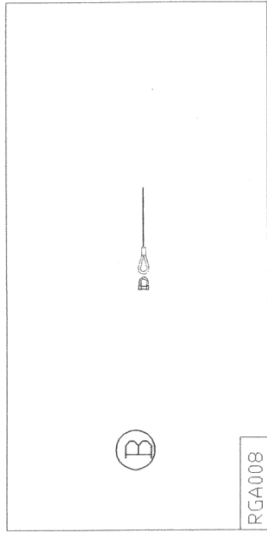
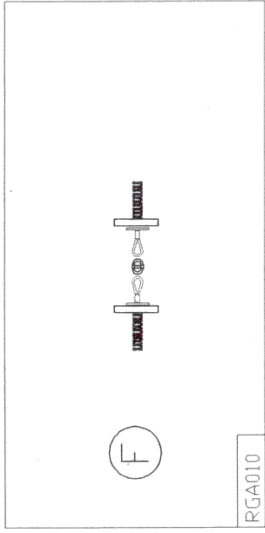
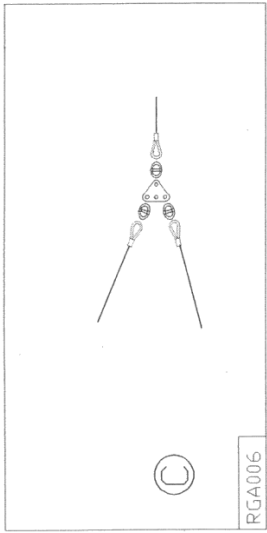

RIGGING HARDWARE DETAILS - HARDBOTTOM SNAPPER TRAWLS (DWG. # RGB330HS)

218

ALL CHAINS LONG LINK ALLOY
SHACKLES-ANCHOR SAFETY TYPE

TAIL CHAINS

5/8" LL

shackles
8ea-7/8"

BAILS

3/4" LL

shackles
6ea-1"

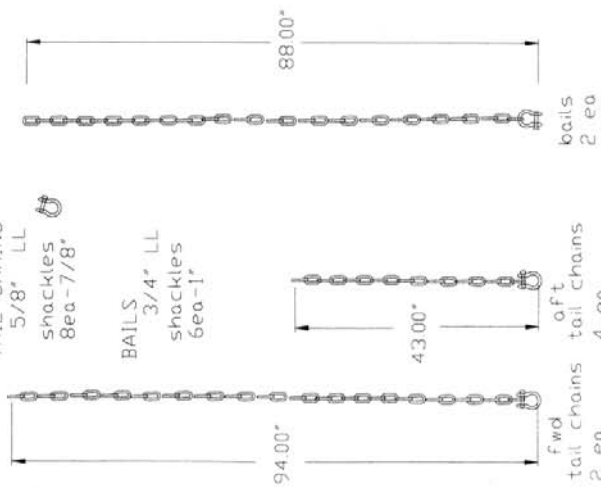

NOSE UP OR NOSE DOWN IS
ADJUSTED BY VARYING THE
RELATIVE LENGTH OF THE
BACKSTRAPS. TO NOSE UP
MAKE THE TOP BACKSTRAP
SHORTER.

TO INCREASE ANGLE OF ATTACK
SHORTEN FWD BACKSTRAP

TO DECREASE ANGLE OF ATTACK
LENGTHEN FWD BACKSTRAP

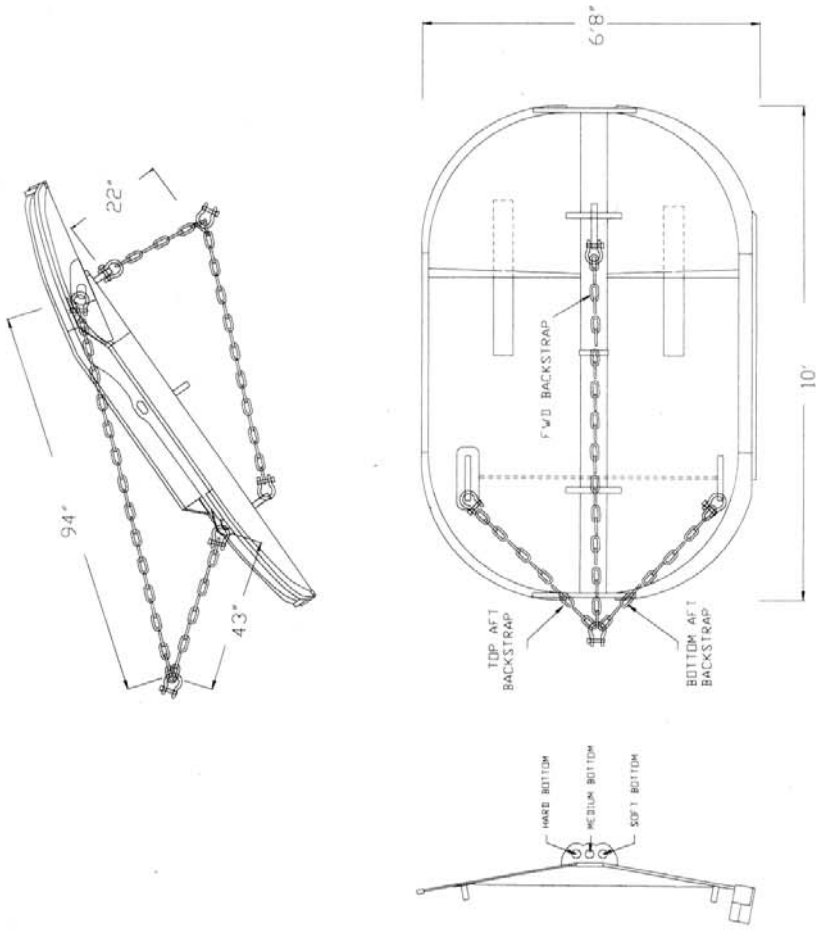

REGIONS SALES DIVISION / HERRING
MENNUCCI 12/96
VVR0055S
COPYRIGHT © M.T. SYSTEMS, INC. 1987 ALL RIGHTS RESERVED

Wt: 2300 LBS

Trawl Specifications and Parts List

The following list provides the details for the materials, design, and components required for the trawl that the AMLR Program uses during bottom trawl surveys, and serves as a checklist for verifying that newly constructed or repaired trawls are within operational tolerances.

Components list

The AMLR bottom trawl survey uses factory made NET System Hard Bottom Snapper Trawls – (# 92/122/5”). Refer to drawings A through F. All web in the trawl should be depth stretched and heat set in the manufacturing process. Mesh sizes listed in the plan are given in “stretched measure”, a standard method of measuring mesh size that includes the length of one knot.

<u>Net Mesh Component</u>	<u>Mesh Size</u>	<u>Twine Size & Type</u>
Top Wing Heavy	5”	D6.0 mm polyethylene knotted - orange
Top Wing	5”	5.0 mm polyethylene knotted - orange
Top Overhang	5”	5.0 mm polyethylene knotted - orange
Top Belly	5”	5.0 mm polyethylene knotted - orange
Bottom Wing Heavy	5”	D6.0 mm polyethylene knotted - orange
Bottom Wing	5”	5.0 mm polyethylene knotted - orange
Bottom Belly	5”	5.0 mm polyethylene knotted - orange
Bottom Belly Boson	5”	D6.0 mm polyethylene knotted - orange
Tear Seam	5”	#333 Nylon twine
Side Wing	5”	5.0 mm polyethylene knotted - orange
Side Overhang	5”	5.0 mm polyethylene knotted - orange
Side Belly	5”	5.0 mm polyethylene knotted - orange
Bottom Heavy Edge	5”	D6.0 mm polyethylene knotted - orange
Tapered Intermediate	5”	D4.0 mm polyethylene knotted - orange
Straight Intermediate	4”	D4.0 mm polyethylene knotted - orange
Codend	4”	D4.0 mm polyethylene knotted - orange
Codend Liner	1.5”	#21 Nylon three strand nylon web, green

Other Net Components

Specifications

Headrope	5/8” 6×19 PC (92’)
Breast Lines	5/8” 6×19 PC (2 × 9’, 2 × 30’, 4 × 20.5’)
Bolsh Line	1 ¼” Ultraline, 3 pieces
Fishing Line	½” Long Link B-7 Chain
Riblines	1” RP-12 Ultra Blue
Floats	22 Ube Eared, 12" side lug trawl floats, depth rated to minimum of 450 fm; 23 lbs buoyancy each.
Floats	Four 8” side lug trawl floats (headrope bosom) 5.5 lbs buoyancy each.

<u>Trawl Rigging Components</u>	<u>Number</u>	<u>Specifications</u>
Bare Sweeps	2	3/4" × 90' 8×19 Wire Rope
Mud Sweeps	2	3/4" × 90' IWRC w/3' Rubber Disks
Lower Bridles	4	3/4" × 180' IWRC w/3' Rubber Disks
Center Bridles	4	5/8" × 180' 8×19 Wire Rope
Upper Bridles	4	5/8" × 180' 8×19 Wire Rope
Idlers	2	3/4" × 60' 8×19 Wire Rope
Center Setbacks	2	1/2" × 9" Long Link Chain
Connectors	36	3/4" Hammerlocks
Connectors	8	5/8" Hammerlocks
Rigging Plates	4	3/4" 4-Hole Delta Plate
Links	4	1" G-hooks
Links	4	1" Flat Link

Footrope & Tiregear – NET Systems # XFTR1739804 - Refer to drawing C.

Rockhopper Line - Fiber core wire rope 3/4" 6×19 galvanized

Tiregear Bosom 24"

18" & 14" Cone bobbins for wings and extensions

1/2" decklashing chain

Reg. Toggles, 1/2"×4" dropper chains

14" & 5" rubber disks

5/8" butterfly plates

Codend – NET Systems # XCOD1739804 - Refer to drawing E

Characteristics: 112m × 50m

4"-D5.0 w/ 1 1/2" #21 Liner w/ 1 1/4" Ultraline Lift Strap

1" RP12 Ultra Blue Riblines 3/4"×15' Steeline Container Lines

3"×2" Galv. Pucker rings w/ 5/8" Puckerline & 3/4" codend release attached

Six 8" CH floats attached to each top ribline 6mm Double Bar Mesh

Polyethylene knotted web chaffing strip

Bottom - 5" 5mm Double Bar Mesh, polyethylene knotted w/ 100# of hula attached to bottom and 1/2 way up sides of chaffing.

Trawl Doors – NET Systems Vented-V 5.5 m² Refer to drawing G.

Air wgt - 2250 lbs (1023- kg), 2,025 lbs (920 kg) water weight.

Quality Assurance Procedures

At the start of every survey, the vessel will be provided with an inventory of supplies that may be needed to make any repairs to the trawl gear during the survey. The fishing crew will ensure that the trawl is in excellent condition prior to the start of the cruise by measuring all components listed on the trawl diagram to determine if they are within operational tolerances.

Materials supplied to the fishing crew includes net plans, web, hardware, floats, breastlines, twine, pre-cut bottom panels, floats etc. At the beginning of each survey, the cruise leader will verify that all spare nets and parts are on the vessel. At least one spare net will be stored on deck. This is essential if the crew potentially has a problem getting to stored replacement nets in less than ideal conditions.

When the trawling gear is spooled onto the net reel prior to the survey, there will be a detailed inspection by the trawl master and fishing crew of every component of the trawl to ensure that the gear is within operational tolerance. Net, doors, and bridles should be examined routinely during every haul back, checking for any damage and noting/performing any repairs needed. When large rocks are dumped from the codend, liners should be thoroughly checked for damage and any repairs will be noted/performed. The cruise leader will decide in consultation with the trawl master if the net requires changing or repairing given other time constraints imposed by survey objectives. Trawls will be individually identified with an affixed tag that will be entered into a history log describing damage sustained, repairs done, and number of hauls it was used.

Damage to netting (holes & breaches etc.) will be repaired prior to deployment of the next haul. Repairs that should not be attempted aboard vessels include broken headropes, footropes, riblines or rehanging long sections of riblines (repairs that involve more than 25 benzels, approx. 40'). Given the limited deck space, these repairs are difficult to do correctly to ensure the finished product meets sufficient standards. No lacing of holes or tears should be allowed in the body, wings or codend of the trawl. Special attention will be given to repairs involving the inside of the bottom wings (where the bar cut and chaffing strips are sewn to the body).

The cruise leader will emphasize the requirement with the trawl master and fishing crew that the gear must be maintained at the highest standards. If the fishing crew is unable to repair a net to sufficient standards, the net should be retired and a new one put on the reel. The fishing crew is encouraged to replace torn or abraded areas on the net with patches or new panels, rather than hand sewing new meshes. Straight tears, like those often seen in bottom bellies can be sewn as long as there is no need to build meshes to close the hole.

Trawl Repair Checklist

The trawl master and fishing crew in collaboration with the cruise leader will address all aspects of the trawl checklist prior to the cruise, and as repairs are required to the trawl during the course of the survey.

COMPONENT	SPECIFICATION	PORT	STARBOARD
Upper Bridle	5/8" × 180'		
Upper Bridle Setback	1/2 " LL Chain × 18"		
Middle Bridle	5/8" × 180'		
Middle Bridle Setback	1/2 " LL Chain × 9"		
Lower Bridle	3/4" × 180'		
Flying Wing*	3/4" wire × 19'6" w/ disks		
Lazyline (Transfer)	3/4" wire × 60"		
Door Leg Extension	3/4" wire × 40"		
Trawl Doors	6'8" × 10 Vented V-Door		
	1 1/8" trawl shackle		

		Upper	Lower	Upper	Lower
Doorlegs	5/8" LL Chain × 10'				

		Condition	Fully Repaired?
Top Wing Web	No tears, holes, breaches		
Top Overhang Web	"		
Top Belly Web	"		
Bottom Wing Web	"		
Bottom Belly Web	"		
Side Wing Web	"		
Side Overhang Web	"		
Side Belly Web	"		
Tapered Intermediate	"		
Straight Intermediate	"		
Codend	"		
Codend Liner	"		
Splitting Strap	"		

* Measure from bearing point on wire to fishing line attachment point on delta plate

Appendix 4

Northeast Fisheries Science Center Standard Operating Protocols for

Spring, Autumn and Other Bottom Trawl Surveys

Abbreviations

The abbreviations used in Appendix 4 (NEFSC Protocols) and associated attachments are defined below:

A&G	Age and Growth – an investigation in the Fishery Biology Branch of the Northeast Fisheries Science Center responsible for ageing material collected during bottom trawl surveys
CO	Commanding Officer
CS	Chief Scientist – designated person in charge of supervising all onboard scientific operations
CTD	Conductivity-Temperature-Depth – an instrument used to measure conductivity, temperature and depth
DGPS	Differential Global Positioning System
ESB	Ecosystem Surveys Branch
ET	Electronics Technician
ETA	Estimated Time of Arrival
fm	fathom
FRV	Fishery Research Vessel
FSCS	Fishery Scientific Computing System – a system of hardware, software and peripheral equipment utilized to measure and log data from sampled marine organisms
GPS	Global Positioning System
ITI	Integrated Trawl Instrumentation
m	Meter(s)
NEFSC	Northeast Fisheries Science Center
nmi	Nautical Mile
NMAO	NOAA Marina and Aviation Operations (a division of NOAA)
OOD	Officer of the Deck
OPS	Operations
OT	Overtime
QA	Quality Assurance
RPM	Revolutions per Minute
SCS	Scientific Computer System – a system of hardware, software and peripheral sensors utilized to measure and log ship and environmental characteristics during operations
SHG	Station-Haul-Gear – a standardized system for evaluating tow quality through specific coding of the station type, haul quality, and gear condition
SOP	Standard Operations Procedures
WC	Watch Chief – designated person in charge of supervising operations during a designated watch

Introduction

The Northeast Fisheries Science Center (NEFSC) currently conducts four bottom trawl surveys: an autumn bottom trawl survey conducted annually since 1963, a spring bottom trawl survey conducted annually since 1968, a winter bottom trawl survey conducted annually since 1991, and a Northern Shrimp survey (outlined under a separate set of protocols). The spring and autumn bottom trawl surveys provide synoptic coverage of continental shelf waters from Cape Hatteras, North Carolina, to the Scotian shelf in Canadian waters. The winter bottom trawl survey provides opportunistic coverage of the continental shelf from Cape Hatteras to along the southern flank of Georges Bank. Surveys are generally conducted aboard the FRV ALBATROSS IV and DELAWARE II.

The goal of each of these surveys is to provide long-term relative indices of abundance and biomass for finfish and key marine invertebrate species and to document their distribution. Core objectives of these surveys include:

1. Determine the distribution, relative abundance and biodiversity of fish and invertebrate species
2. Collect biological samples for studies of age and growth relationships, fecundity, maturity, and feeding ecology
3. Collect hydrographic and meteorological data
4. Collect data and samples for cooperative researchers and programs
5. Collect continuous hydroacoustic data along the cruise trackline
6. Perform evaluations of survey gear performance.

The spring and autumn surveys are conducted using a Yankee 36 Roller trawl while the winter survey is conducted using a NEFSC winter flat trawl. There are slight rigging differences when these trawls are utilized on the two primary research vessels and these differences are described within the Appendix. Other than these gear related differences, survey protocols included in this Appendix are generally applicable across all three bottom trawl surveys currently being conducted by the NEFSC.

Protocol 1: Length Measurement of Trawl Warps

1.1 Wire

Responsibility for procurement, installation, and maintenance of trawl warps currently resides with the NOAA Marine and Aviation Operations (NMAO), the division of NOAA currently responsible for the operation of fishery research vessels utilized to conduct NEFSC trawl surveys. The ALBATROSS IV currently utilizes 7/8" 6×19 Seale die-form strand, right hand lay, fiber core wire rope for trawling operations. The DELAWARE II currently utilizes 1" right hand lay, fiber core wire rope for trawling operations. The diameter and weight per unit length of wire rope utilized in trawling operations has an effect on catchability of marine organisms sampled by the survey.

Differences in wire rope diameter and weight per unit length between the two FRVs currently utilized to conduct bottom trawl surveys are accounted for in catchability coefficients developed through previous experimental work.

The lay direction of the wire rope is not known to have a direct effect on fishing gear performance, but use of the same lay wire in the both the port and starboard winches/blocks may result in differential stretching of wire rope over time. The NEFSC and NMAO are considering use of right hand laid wire in the starboard winch/block and left hand lay wire in the port winch/block in the future. This change can be expected to reduce the incidence of differential stretch between the starboard and port wires over time, but is not expected to have any effect on gear performance or catchability when wires are maintained within calibration standards.

Wire calibration methodology (wire marks and redundant shipboard wire measurement systems) shall be checked and recalibrated upon initial installation, at least biannually, and whenever shipboard wire measurement systems indicate that wire measurements fall outside of established standards. The established standard for NEFSC bottom trawl surveys is that starboard and port wire calibration systems should deviate by no more than either 4% of the door to door distance measured along the bridles and head rope of the net or a maximum deviation of 2.0 m. Calibration should be conducted more frequently if significant differences in warp length are detected, as might be expected following the initial installation of wire or onboard metering systems. Frequency of warp measurements may be reduced when an understanding of the variability in measurements is achieved and NEFSC and NMAO personnel determine that differences in measurements are primarily due to measurement error, temperature or other factors.

When marks are employed as a measurement or calibration tool on wire rope utilized to deploy bottom trawl gear, it is critical that marks on the starboard and port wires are paired and even with each other to ensure that equal lengths of wire are deployed at any depth or warp deployment. The following procedures should be employed during measurement or remarking operations:

- Wires may be measured from existing eye splices (as wire is unwound from the vessel's winches) or from a fixed existing mark in each wire (i.e., 1200-m mark, as wire is wound back onto the vessel's winches).
- If wire is measured or remarked as wire is wound back onto the vessel's winches, remaining wire at the terminal end should be cut at even distance intervals on both wires.
- During marking, measurement, or remarking operations, the starboard and port wires should be laid next to each other and measured, marked, or remarked simultaneously. Slight and equal tension on the wires is necessary to ensure that wires are straight when measured or compared.
- Measurement of wire should employ a measurement device not prone to measurement error, such as pre-marked length of thin diameter wire.
- During measurement or remarking operations, if differences between existing and true marks are detected, wire shall be remarked at correct distance intervals

- During measurement or remarking operations, a representative of the NEFSC or a designee shall record differences between existing marks and newly measured distance intervals.

The NEFSC and NMAO continue to investigate the properties of wire rope utilized on NEFSC bottom trawl surveys and methodology available to calibrate distance of wire rope deployed during trawling operations. As new information is obtained, methods used to calibrate wire rope will be updated in future revisions of these protocols.

Protocol 2: Use of Autotrawl Systems

Autotrawl systems are not currently used during the NEFSC bottom trawl surveys.

Protocol 3: Survey Operations

3.1 Station Selection

The NEFSC spring, autumn and winter bottom trawl surveys employ a stratified, random sampling design that has remained constant through each survey time series. Survey strata are based on fixed depth ranges and regions of bathymetry along the continental shelf of the survey area (Attachment G). Strata coverage and the target number of stations to be sampled within each stratum are determined prior to conducting each survey. The target number of stations currently utilized for the spring, autumn, and winter surveys is shown in Attachment F.

3.1.1 Subdivision of strata -- All strata are subdivided into blocks 5 minutes of latitude by 10 minutes of longitude. These large blocks are further subdivided into 10 small blocks measuring 2.5 minutes of latitude by 2.0 minutes of longitude. The large blocks are defined as being the largest area that can be characterized by one tow.

Exceptions occur with very long, narrow strata, and strata with irregular borders. In these cases, the strata are subdivided directly into 2.5 × 2.0 minute blocks. These smaller blocks are then grouped into larger blocks so that the numbers of small ones are evenly distributed throughout the large ones. At least two large blocks are formed within each stratum. Each large block is composed of, as nearly as possible, 10 small ones. No large blocks are formed if there are an insufficient number of small blocks.

3.1.2 Random station selection and plotting -- Stations selected within each stratum are determined using a Perl program called `sta_selector`. This program was written to generate a random selection of stations within each stratum. Each small block within a stratum is numbered sequentially. The number of small blocks contained within the stratum in which the numbers are being selected determines the range of random numbers. A random number selected then corresponds with a numbered small block. The center point of the selected small block will be the starting location of the tow. The numbering of tows is directly related to the order of random number selection (tow no. 1 is selected first and so on). A stratum number and the tow number within that stratum then identify stations. Once a small block is selected, all members of the corresponding large block are excluded from the selection population until there is at least one station selected in every large block within the stratum.

The `sta_selector` program creates several output files: a station data file (`station_location.xls`), `nav.txt` file, and a `station.dat` file. The Chief Scientist uses the station data file in Excel, in conjunction with charts, to create the cruise track by visually determining the most efficient or shortest distance between two stations. The `nav.txt` file is imported into a navigation software package (Navtrek), which is used by the bridge officers to set up the routes once the Chief Scientist has provided the sequential list of stations to occupy. An Arc-Info

program employs the station.dat file to create 8" × 11" charts and the large bathymetric charts that have the station locations plotted.

Arc-info programs are employed to create strata lines and stations on digital rasterized copies of NOAA nautical charts (Attachment G). Rasterized renditions of the NOAA charts currently used are "Bay of Fundy to Cape Cod" (No. 13260); "Georges Bank and Nantucket Shoals" (No. 13200); "Approaches to New York, Nantucket Shoals to Five Fathom Bank" (No. 12300); "Cape May to Cape Hatteras" (No. 12200); and, "Cape Hatteras to Charleston" (No. 11520). The bridge officers continue to navigate by using the official NOAA charts.

Geographic positions, loran lines-of-position, and charts are saved internally at the NEFSC the completion of a cruise and made available to stakeholders.

3.2 Pre-Cruise Procedures

3.2.1 FSCS setup -- Currently responsibility for the maintenance of the Fisheries Scientific Computing System hardware and servers resides with the NOAA Marine and Aviation Operations (NMAO). Responsibility for setup and maintenance of peripheral equipment to the system (electronic balances, electronic measuring boards, bar code readers, calipers and printers) is an Ecosystem Surveys Branch function. Details concerning FSCS hardware and software can be found in the NEFSC FSCS manual, maintained as a separate document.

3.2.2 Survey supplies -- One week before a cruise is scheduled to depart staff of the Ecosystem Surveys Branch (ESB) are responsible for gathering and packing supplies using the supply list specific to the type of cruise (groundfish, scallop, shrimp, etc). These lists are located in `shared_files\pre_cruise_docs\supply_lists` and should be updated if additional supplies are needed for a cruise. ESB staff can reference the `inventorymaster.xls` and `gear shed inventory.ppt` documents under the same directory to attain a list of locations for supplies. ESB staff will arrange for pick-up or delivery of larger gear items stored at the warehouse and will load supplies onto the vessel one full business day before the scheduled departure. ESB staff will inventory supplies on board and restock as necessary between legs. The Chief Scientist should inform the ESB staff of any supplies needed for the next leg.

Mensuration system: Prior to sailing

- Charge sensors (the sensors should be recharged every week or when they cease to provide readings)
- Attach ropes to sensors for attachment to the net
- Test sensors to make sure they are operational
- Confirm with Electronics Technician (ET) that the event logger is working on the Scientific Computing System (SCS).
- Request that the ET setup the ITI system to record the sensors that you request be logged. This request needs to be submitted prior to sailing.

Directions for Data Logging:

The following three steps must be followed to monitor and automatically log Simrad ITI trawl mensuration data aboard the ALBATROSS IV and DELAWARE II.

On the FRV ALBATROSS IV and DELAWARE II, the Simrad ITI trawl mensuration system must be used to monitor trawl performance parameters. The data must be automatically logged with the SCS (Scientific Computer System) through use of the Event Logger. The event logger can be built with the help of the Electronics Technician or an existing event logger may already be available for use. On the ALBATROSS IV the event: *iti.tpl* should be used to log data on a per station basis. This event must be run from the "Event Logger OLD" application and is usually initiated just before the trawl doors are deployed:

- On any SCS terminal select Acquisition from the main menu
- Select Event Logger OLD
- Select Start Event Manager (OLD)
- Highlight *Iti. tpl* from the list of events
- Select *Initialize Event* OR double click on *Iti. tpl*
- Click on Start Event
- Click on *Station* and add the correct station number
- Click on *Notes* and add if any
- Exit the event (usually when the doors reach the surface) by clicking the Stop button

Outputting Data from Simrad ITI:

Four steps must be followed in order to send valid data from the Simrad ITI unit to the SCS system. From the main menu of the Simrad ITI unit located in the computer room of both ships:

- Select ACTIVE SENSORS
- Select each individual unit placed on the net, e.g. SPREAD2
- Select 1:1
- Make sure that all other units are set to OFF¹
- Return to the main menu
- Select RATE
- Select MAX
- Return to the main menu
- Select SERIAL OUT
- Select DUMP
- Select DUMP again
- Select CONTINUOUS
- Return to the first DUMP menu

¹ If a unit which is not deployed on the net is turned on, the ITI will keep searching for the unit, preventing other measurements from being taken

- Select a minimum of all codes representing the sensors placed on the net², e.g. IITDS
- Select ON
- Repeat this process until all desired data codes are turned on
- Return to the main menu
- Select SIMULATE:
- Select OFF
- Return to the main menu
- Exit the main menu

A data string starting with the characters \$PSIM followed by 16 comma delimited fields will now be sent to the SCS for logging. Under the settings listed above, data will be logged at the maximum rate of once every 30 seconds (that is, one complete data string with full sensor data). Depending on which codes were turned on in the SERIAL OUT > DUMP menu, either all or only some of the fields will contain data. If a code is not turned on, then its comma-delimited field will be blank. It is important to note when checking the files that the actual trawl performance data follows the \$PSIM character. SCS event logger programs may add data to the start of each line of records, giving the appearance that data is being logged properly - you must check to see that there is data immediately following the \$PSIM character. The three data files may be examined on the SCS server of the vessel under the following directory³:

(SCS server name) \DataLog\EventData\ (ITI event name)

Additionally, the raw Simrad ITI output may be viewed as files saved under (SCS server name) \DataLog\ITI-\$PSIM timestamp. RAW⁴

Sensor Deployment and Monitoring:

See survey ITI documentation for sensor placement on net. Fine-tuning of sensor placement may be necessary, and can be accomplished by trial and error (see below).

Important caveats in sensor attachment:

- Attachment must be made in a manner to prevent sensors from flipping
- Attachment points made to webbing should be checked to ensure that some slack exists - a tightened net will otherwise pull against the sensor attachments, deform the net or tear the webbing
- Attachments should never be made to webbing alone
- Attachments should be connected to the most solid net piece possible (i.e. a section of combination wire headrope is preferable to a rope float line)

² You must have access to the SIMRAD ITI manual in order to determine which codes represent the sensors you have on the net. If you do not have this manual, then select all of the codes

³ The exact name of the server can be obtained from the ET

⁴ The nomenclature for the filenames may change from vessel to vessel, ask the ET what the raw ITI sensor stream is called on that vessel - the directory structure will remain the same

- Attachments should be inspected after each tow - often forces on the net loosen shackles or undo clips
- Refer to the Simrad ITI manual for correct left-right orientation of spread sensors

To monitor the sensors during a tow:

- Select MODE in the main Simrad ITI menu
- Select TEST
- Remove the menu from the screen by using left pushes on the joystick that controls menu movement
- Observe the COMMENT and DATA fields

Common Display Messages:

START – SHOT: means the transducer on the vessel is initiating a search for the sensor on the net

SEARCHING: means the transducer is searching for a signal from the net sensor⁵

TIMEOUT _#: means problems with signal reception, and may suggest the need for a change in sensor placement

- The data field will display degrees in three planes when the transducer is still looking for a signal from the sensors
- Sensor data will be displayed when a good signal is being received from the sensor
- The headrope unit will display two numbers - the first is supposed to be distance to footrope, and second distance to bottom - for our trawls the first is distance to bottom
- The wingspread (and doorspread) sensors will display a value of 320 m when the receiver and transponder unit on the starboard and port wings can not properly send a signal to each other
- The SR column stands for slant range and represents the diagonal distance of the sensor from the vessel transducer - this value should reflect the approximate wire out, but is often way off when bottom trawling
- See the Simrad ITI manual for more information on error messages
- The STATUS mode under MODE in the main menu is also helpful and gives additional info on sensor performance (but not on a per query basis)
- If routine sensor values are not obtained, or if obviously incorrect values are obtained, the sensor placement will need to be adjusted. This is accomplished by trial and error. It is important to anticipate how the sensors will be riding on the net, and to try to ensure an unobstructed path from the transmitting ends of the sensor (or "transducer window") to the ship. See the ITI manual for more information.

⁵ As indicated earlier, a sensor that is turned on but not present, or turned on but no signal can be received from, will cause the ITI to search repeatedly and miss receiving data from other sensors

Inclinometer:

- Inclinometers are used periodically to evaluate bottom contact of the trawl gear.

Prior to deployment:

- The inclinometer must be initialized. To initialize, the optic base station should be attached to the cable that is attached to the COM port of the computer. Open the Boxcar program and hold the base station with the tidbit coupler attached to the inclinometer with the pin inserted in the hole at the window. In Boxcar, select “logger” and “launch”. The software will attempt to communicate with the inclinometer. Once open, you can modify the description and tow interval-recording time.

Troubleshooting connection problems:

- Check the cable from the computer to the base station and make sure all are properly connected.
- Make sure you are positioning the tidbit properly on the inclinometer and that the magnet is touching the metal.
- Make sure that the communications port is correct. Usually COM 1 is used but sometimes COM 2 needs to be selected.

Downloading data to shuttle:

- To read the inclinometer file you need to utilize the optic shuttle and tidbit coupler with magnet.
- Position the optic shuttle over the circular window of the inclinometer with the pin from the tidbit coupler inserted in the hole.
- Press the button on the optic shuttle to download data. The middle light on the shuttle should start blinking (XFER).
- Continue to hold the shuttle until the green “OK” light flashes. This can take over a couple of minutes.
- If the “fail” light flashes, you were not holding the shuttle properly or the magnet moved away from the housing. Repeat previous steps.

Downloading data to the computer:

- Bring the shuttle inside to the computer to download.
- Marry the shuttle to the base station using the “coupler” device.
- Open Boxcar Pro and select “logger” from the menu bar.
- Select “optic shuttle readout”.
- Press the button on the optic shuttle and the file should download to the program.
- The software will choose the filename and location. Change the filename to correspond to the file naming convention that you are using (usually the station number) and select the file folder that you would like it saved under. It is suggested that the file is saved in alfscserver (or DELAWARE equivalent)

\cruisecode\fscs\loggeddata\sampling location1\station_XXX before running data manager because the inclinometer files will be grouped with the rest of the data for that station. To open the file, select “file” and “open” and go to the folder that you saved. This folder usually will open automatically. Click on the file and view. You can select part of the graph with the mouse to zoom to that section.

3.3 Delineation of Responsibilities

The OOD (Officer on Deck) is the Captain’s designated representative on the bridge whose principal responsibility is the safe navigation of the vessel. This implicitly means that the ship, its people, its machinery, and other vessels shall not be put in peril. Safety always takes precedence over the ship’s mission.

The CO/OPS officer/OOD shall:

- Conduct mission operations that are consistent with the safe navigation of the vessel.
- Work closely with the Chief Scientist to determine the most efficient track line.

The Watch Chief is the Chief Scientist’s designated representative whose principal responsibility is the completeness and quality of data and samples being collected.

Only the Chief Scientist may:

- Change planned track-lines
- Change mission priorities (e.g., request change of course or speed to meet other objectives)
- Cancel stations

Only the Watch Chief or Chief Scientist may:

- Direct the work of the scientific party
- Relocate stations more than 1 mile

The Chief Scientist and/or Watch Chief may not:

- Direct or interfere with the work of the ship’s crew

Both the CO and the Chief Scientist have the authority to stop operations due to inclement weather; the CO because of potential danger to the ship or its people, the Chief Scientist because of compromised data quality. Neither person will override a decision to cancel operations made by the other.

3.4 Chief Scientist Duties

Pre Cruise Activities (One month before):

- Work with Cruise Staff Coordinator regarding staffing experience
- Identify Watch Chief (WC), Fisheries Scientific Computing System (FSCS), Bongo, Conductivity Temperature and Depth (CTD) staff and arrange for CTD training.

Pre Cruise Activities (One week before):

- Contact cruise staff to see if there are any questions & determine arrival time
- Verify that the Canadian Permits have been delivered to the ship
- Distribute Sampling Booklet to Watch Chief for review/discussion
- Send scientific roster to OPS officer and CO

Pre Cruise Activities (Workday before sailing):

- Assign/post watches/rooms and distribute watch schedule to timekeepers and Branch Chief
- Notify the ship's Operations Officer of cruise staff arriving early and notify the Chief Steward of any special dietary needs
- Attend post-cruise meeting from previous survey leg
- Notify cruise staff of maturity /fish identification workshop and requirement to be on board 1 hr before departure
- Final roster sent to Vessel Coordinator
- Discuss any FSCS related problems troubleshooting with previous Chief Scientist/Watch Chief/FSCS Specialist
- Make sure min/max Age and Growth (A&G) envelope numbers are on the vessel

Day of sailing:

- Attend maturity /fish identification workshop
- Meet with Captain and Branch Chief regarding location of first station
- Organize pre-cruise Fisheries Scientific Computing System (FSCS) training
- Discuss status/completion of special sample requests with previous Chief Scientist/Watch Chief
- Show volunteers where to park their vehicles, how to attain a parking permit and ensure that all car keys are left in Port Captain's office
- Make sure the Navigation Officer has a digital / electronic copy of the station locations
- Determine if all &/or additional supplies have been loaded
- Make sure that all charts are on board & know status of station sequence xls file
- Obtain Chief Scientist sea-pack binder from Ecosystem Surveys Branch (ESB)
- Send volunteers to obtain foul weather gear in cutting room
- Chief Scientist should attain a list of gear going aboard from the Gear Specialist.

Prior to sailing:

- Send scientist muster to bridge officer 30 minutes before sailing

Pre first tow activities (FSCS Related Tasks):

- Modify default values in SCS Event log metadata
- Ensure that RealTime plots have been set up/standardized
- Ensure that all computers (including bridge) are synchronized to network time server
- Review parent sensor displays
- Enter cruise init data for FSCS if first leg of the survey
- Modify deployed equipment table
- Modify species protocol table as needed
- Modify Scientists.csv file
- Ensure that all electronic devices are powered on and calibrated (e.g. scales & electronic fishboards)
- Assist Watch Chief/FSCS manager to solve FSCS problems

Pre first tow activities (Non-FSCS Related Tasks):

- Hold ship and scientific pre-cruise meeting with all staff (introductions and identification of the Watch Chiefs, announce ETA to first station, general cruise direction, area of operations, review special sample booklet)
- Call scientist muster to bridge during fire & boat drill
- Hold pre-first tow meeting with Watch Chiefs & emphasize sampling priorities (Age and Growth, Food Habits, NOAA Fisheries requests, outside requests)
- Select station sequence for bridge officers & assign random depth ranges to the stations in the outermost strata (100-125, 126-150, 151-175, 176-200 fms)
- Post station sequence on freezer wall, in CTD room, and give copy to Bridge Officer
- Arrange timing and station number of practice tow with Captain or OPS Officer
- Provide the setting and hauling log to the Chief Boatswain (Attachment H)
- Help to train scientific staff during practice sessions and general sampling operations
- Work on deck in absence of Bongo/CTD person
- Assist Watch Chief/FSCS manager to solve FSCS problems
- Help with fish/maturity/food habits identification

Daily activities during the cruise:

- Communicate with Woods Hole via email and cc the Master / Commanding Officer
- Update station sequence as needed
- Record extra over time for FSCS person and Watch Chiefs (if applicable)
- Document FSCS software/hardware problems in C:\FSCS\cruise_notes
- Look at RealTime displays of key sensors

- Review FSCS data using forms/reports. Sql queries will generate a variety of reports that will allow the Chief Scientist to examine station and biological data for a collective group of stations. Patterns of missing or questionable data can be quickly identified and corrected using the QA forms. It is strongly encouraged that time is taken while at sea to generate and review these forms. See FSCS Operating Manual for sql commands and examples.

What data should the Chief Scientist fix/leave alone?:

- Fix:
 - SHGs/missing comments (e.g. add reason for SHG not equal to 111, gear # changes)
 - Missing data (find and enter)
 - Special samples that were not entered
- Leave alone:
 - Species code changes (record info on log)
- Document:
 - All subsample and mixes (record details on log)
 - Any sampling problems
 - FSCS software operations problems (describe error messages and what you did to correct the problem). Make comments in C:\FSCS\cruise_notes\

End of Cruise Leg:

- Contact technicians in ESB branch regarding new office and gear supplies needed for the next leg
- Discuss with Watch Chief which ship areas will be cleaned by which watch & how to power down FSCS hardware
- Organize off loading/distribution of frozen (complete inventory form posted outside of lab freezer) and preserved samples/supplies
- Remind staff/volunteers to return cleaned foul weather gear to the wet lab.
- Consult with Watch Chiefs and fill out a Volunteer evaluation form (Attachment H) for each volunteer and contractor.

Post Cruise:

- Participate in post cruise meeting
- Provide date/time return to timekeeper
- Return all charts, reports, trawl logs, CTD logs, Chief Boatswain logs to the Ecosystem Surveys Branch
- Complete cruise evaluation form and return to the Branch Chief of the Ecosystem Surveys Branch
- Provide copies of tort claim info to Branch Chief of the Ecosystem Surveys Branch

3.5 Watch Chief Responsibilities:

Pre cruise activities (one week before):

- Request sampling booklet from Chief Scientist and review

Day of sailing:

- Attend Maturity /fish identification Workshop
- Check with Chief Scientist regarding supplies to put on ship
- Help to train new staff/volunteers with FSCS
- Discuss FSCS related problems and troubleshooting methods with the previous Chief Scientist/Watch Chief/FSCS Specialist

Once underway, meet with watch members & emphasize:

- Typical operation of a station; 10 minute warning to CTD/bongo, trawl, sort, weigh, cut, special sample workup, cleanup area & buckets/baskets, resupply, and warnings to stay clear of deck operations when winch is functioning
- Importance of asking for/verifying the station number at each station.
- Importance of collecting quality data (species identification guides, work methodically, ask questions, beware of scale tare).
- How to measure: fish are measured to the end of central caudal ray, shark total length, lobster and crab carapace length, ray wing span, skate total length, squid/octopus mantle length.
- Do not discard any species over the side without checking with Watch Chief.
- Do not discard anything over the side while the net is in the water.
- Everyone will help with cleanup and freezer runs (important to put samples in correct boxes).
- Importance of updating tallies on special requests.
- Describe differences between similar appearing species (e.g. red/white hake, little/big skates) and to use fish identification books.
- Review of maturity stages and prey identification.
- Use gloves to handle fish.
- Demonstrate proper way to handle equipment (e.g. how to set tare, how to read calipers).
- Cutting teams must wait for instructions from Watch Chief before proceeding to open their sampling location.
- Remind everyone to read the FSCS error messages carefully & to take all override messages seriously.
- Cutters must wait for the recorders to get to the length screen before measuring fish...cutters & recorders must still communicate biohazards with electronic boards (don't put torpedo rays on boards, keep lobster claws away from wires).
- Notify Watch Chief if fish measuring board is not responding quickly (buffer may need clearing).
- Notify Watch Chief if species are incorrectly identified at the sampling location.

- Care of scales, fishboards, magnets, calipers, monitors, barcode readers and label printers.
- Supervise organization/storage of chemicals & supplies, make & label freezer special sample boxes, set up plastic sampling boxes with knives, Food Habit's chimes, herring tags, misc. plastic bags, visual aids.
- Post/review status of special sample requests in wet lab.

Pre-First Tow Activities:

- Train/review with watch members FSCS standard processing procedures
- Monitor computer screen temperatures & adjust brightness
- Calibrate, clear buffer, verify correct mode for fish boards
- Calibrate scales
- Calibrate monitor screens
- Change printer ribbons and labels as needed
- Designate unique sounds for each sampling location
- Demonstrate the correct distance and angle the Age envelope should be oriented from the barcode scanner in order for the coded number to be registered. Records the species name on the first envelope of the first fish sampled of a given species and keeps all envelopes for that species together with a rubber band.

During Tow:

- Monitor RealTime plots & report bad sensor readings to ET/Chief Scientist

After a Tow:

- In the Computer Room: Check to see if EK500 is still running (ask ET for Instructions)
- Stop at the freezer to check the posted station, strata-tow numbers and record on log (if station has to be repeated, adjust tow and station sequence number)
- Look for special sampling, bongo, depth, or special sample comments on the list

On deck:

- Reset the Controller on FSCS SERVER1
- Make sure all sampling locations are offline
- Verify trawl event is stopped and exited after the tow is complete
- Initiate and oversee FSCS operations (Refer to FSCS manual for FSCS operations).
- Oversee and direct species identification & sorting
- Look at door edges to see shine on shoes
- Document all subsamples and mixes (record details on log)
- Inspect damage to the gear. Assess the severity of the damage to ascertain what SHG value to input
- If there is a question about if the tow needs to be repeated, contact Chief Scientist

- Contact bridge if difficult to work/stand in rough weather
- Determine if species will be part of mix or subsample
- Enter catch species into FSCS
- Begin entering species that were recorded on trawl log
- Make sure that all baskets and buckets are re-sorted before weighing
- Verify correct tare is on the large scale
- Verify that the correct species is called out during weighing by looking in each bucket/basket as it is being weighed.
- Weigh the buckets and baskets – it's very helpful to have an experienced watch member record the weights on the trawl log as they are automatically entered from the scale.
- Manually enter the weights, using small scale, for species too light for the large scale (check tare)
- If fixed gear is caught, document gear description and net/trap tag numbers.

Subsampling guidelines:

- As Watch Chief, maintain *control* of all subsampling
- No one is permitted to initiate a subsample or to initiate measurement of subsampled fish without approval of the Watch Chief
- Try to select all subsampling from the Species and Weights screen during the initial weighing of species
- You can reload at any workstation without problems
- Do not attempt a mix within a mix, sort instead
- If subsampling must be used at the fish sampling level:
 - Wait until all other fish are measured
 - Reload if necessary *before* any fish to be subsampled are measured
 - Use Remaining Weight
- If a species has already been started, and you must subsample immediately:
 - Stop measuring the species
 - Exit and save from the Lengths screen
 - Set aside the portion of fish that were NOT measured
 - Finish sampling on all other species
 - Reload if necessary
 - Perform remaining weight sub (use the Sub Sampling button on the main Fish Sampling screen and enter the weight of the fish that were set aside)

Option for large tows or time crunch:

- If you have a large amount of fish at a station, you can direct a sampling location to start working on a species before you have finished weighing all species. Only allow them to start after you have totally finished weighing the selected species, have chosen the desired subsampling method if any, have entered the weights, counts, or volume to be used if subsampling, and have clicked on the Save Data button on SL1.

- It is imperative that the Watch Chief communicates with the recorders at SL2 and SL3 about when to reload. The recorders should reload as soon as they have finished the species they are sampling after being told by the Watch Chief.

Data Quality Review:

- Load data
- Perform QA using forms
- Document FSCS software and hardware problems in C:\FSCS\cruise_notes\
 - Going through the QA process after the tow workup has been completed (and as time allows) is designed to:
 - Find missing and/or erroneous station and biological data while at sea
 - Identify special samples that may have not been entered at an individual sampling location. If special samples are not being recorded correctly, this could mean a procedural problem that should be addressed early with the sampling team
 - Alert the Watch Chief if certain teams are repeatedly overriding important error messages that may need further explanation as to their significance and ramification.
- At this time, it is requested that the Watch Chief continue to:
 - Double check expansion factors
 - View overrides to identify potential sampling errors
 - Examine the species processed at a sampling location more carefully if there are any problems encountered at a sampling location during the tow
 - Compare species between watches
 - View special sample data for proper “value” data

What the Watch Chief should fix/leave alone?

- Fix:
 - SHGs/missing comments (e.g. add reason for SHG not = to 111, gear # changes)
 - Special samples that were not entered
 - Leave alone:
 - Species code changes (record info on trawl log and in Cruise Notes file)
- Document:
 - All subsamples and mixes (record details on trawl log)
 - Unusual mix-ups
 - FSCS software operations problems (describe error and solution).
Make comments in c:\FSCS\cruise_note\
 -

Watch Change:

- Speak with other Watch Chief on status of station sequence, station workup, special sample request completion
- Calibrate scales

During Cruise:

- Speak with Chief Scientist regarding any personnel problems
- Clear electronic fishboard buffers daily

End of Cruise:

- Remind Scientists to clean staterooms and heads
- Speak with Chief Scientist regarding area cleanup responsibilities
- Help with offloading special samples
- Fill out freezer log in cutting room as samples are being stored

3.6 FSCS Manager Responsibilities:

Day of Sailing:

- Use HyperTerminal to test hardware connections (set up icon shortcuts)
- Make sure PC Anywhere/Terminal Services is on all computers
- Ensure FSCS.cfg file reflects the FSCS directories and environment being used
- Check with shore-side FSCS manager to see if previous cruise data has been deleted
- Ensure that the data drives on both the FSCS server and the local sampling workstation are not full

Assist Chief Scientist with FSCS-related review of files/directories:

- During cruise:
- Modify/generate reports (refer to FSCS manual)
- Help to train scientific staff in FSCS use
- Help Watch Chief or Chief Scientist to solve & document software and hardware problems in C:\FSCS\cruise_notes
- Transmit data if necessary
- Help Chief Scientist with any EventBuilder tasks
- Help with error checking
- Ensure Dimension 4 software is running

3.7 Bridge Officer Responsibilities:

3.7.1 Preparation and Setting Procedures -- Throughout the entire operation described below, the OOD (Officer on Deck) MUST exercise prudent seamanship and safe navigation, as well as maintaining all logs and performing bridge collateral duties.

Procedures When Approaching a Station:

- Make a PA system announcement, “10-minutes to station, 10-minutes to CTD (or) BONGO”.
- Notify engine room by sound powered phone, “10-minutes to CTD (or) BONGO.” After a long transit (> 2 hours), provide the engine room with a half hour notification in order to allow the trawl winch diesel and hydraulics to warm up.
- Plan the trawl run in accordance with the Fishing operations guidelines. It is preferable to start the trawl at the marked location and tow in a direction toward the next station. Review the paper chart for obstructions and the electronic chart for stratum boundaries when planning the trawl run. If a trawl cannot start at the marked location, it may be moved and/or the direction changed providing some portion of the trawl run passes within 1 nmi of the marked station. If the station must be moved more than 1 nmi, the Bridge Officer must consult with the Watch Chief or Chief Scientist
- Set up for and conduct the CTD or BONGO in accordance with their respective Standard Operating Procedures (SOP) .
- After the CTD or BONGO is completed, activate the Trawl Event window on the Scientific Computing System (SCS) computer and enter the Header and Weather information. Ensure the TRAWLTENSION window is active on the SCS computer.
- Set speed to maintain 2 to 3 knots through the water in preparation for streaming the net.

As applicable:

- Hoist Trawling Day Shapes (two cones with apexes together) and log .
- Energize Trawling Lights (Green over White, extinguish forward masthead light) and log.
- Sound Trawling Fog Signals (one prolonged and two short blasts) and log.
- Ensure the trawl timer is set for 30-minutes.
- Set the proper DGPS, LORAN, and SCS displays (ensure differential mode is active) .
- Ensure the Simrad EQ-50 is adjusted to accurately track the bottom.

CTD and or bongo deployment without trawling:

If a CTD and/or Bongo are performed but no trawl is set, the bridge officers must start the Trawl Event Logger and enter the station number and meta data prior to the CTD cast, then select Start Event followed by Start Trawl, let this run for 10 seconds and select Stop Trawl followed by Stop Event. A note that a CTD and/or Bongo was set and “trawl was not set” must be added to the ST-comments in the Meta Data window of the opened Trawl Event Logger for that station. After the Trawl Event Logger is closed, station initialize must be run and a note must be placed in the comments section indicating that the "trawl was not set". The trawls SHG code should be given a value of 551. If the station is revisited later in the cruise, the Chief Scientist will assign a new stratum and tow number.

Wire monitoring:

On the ALBATROSS IV and DELAWARE II marks and a wire metering system on each wire (warp) will measure the wire. If the difference between the two measured distances becomes greater than 4% of the door-to-door cable length or exceeds 2.0 meters, operations shall be suspended until a cause is found and resolved.

Marks are placed at fixed distances along the warp to allow for consistent deployment of known lengths of wire in fifty-meter (ALBATROSS IV) or 25-meter (DELAWARE II) increments along the warp. As the trawl is being set, the marks must be counted on the trawl wire. When the proper length has been deployed, a member of the deck crew must visually inspect the marks to insure that the final marks on both port and starboard cables come to rest parallel to one another. During this time, the readings from the wire metering system must be inspected and any discrepancies between the metering system and the marks must be noted on the setting and hauling log (Attachment H).

If the difference between the marks and the metering system are greater than the above tolerances, the following must occur:

- The net must be hauled back, wire measuring system reset and the gear reset to determine if the problem was a result of slippage of the wire metering system.

If this does not resolve the problem then the following procedures must be followed to ascertain where the problem originates:

- The marks and metering system should be visually compared as the net is retrieved and notes taken that can be used to indicate where the discrepancies appear.
- A separately marked cable should be used to verify the marks on the wire. When the wire marks are different that the pre measured cable, the wires should be remarked at sea or otherwise accounted for so that we can be certain that the above tolerances are not exceeded.

Streaming and setting/shooting:

- Prior to streaming the net, make sure it is safe to do so.
- Check for traffic and fixed gear, observe bottom on the sounder, be familiar with the chart of the area, and avoid obstacles.
- Check traffic conditions and look for fixed gear. If all is clear, notify the winch operator to “stream the net.”
- Avoid turning the vessel during this phase of the deployment.
- When the net has been streamed and the doors are at the trawl blocks, it is safe to maneuver the ship as necessary. Be sure to keep the winch operator informed of intended changes in speed or course.
- A speed of 6 knots will be maintained during setting to ensure adequate door spread.
- After the ship has steadied up on course and speed, note the depth from the

Simrad EQ-50. Using this depth, select the proper “wire-out” length from the Trawl Warp Scope table (Attachment E).

- The port and starboard marks will be aligned at either the winch or the blocks. The amount of wire set will never be less than that indicated in the scope table. Therefore, when the amount of wire has reached its predetermined length as dictated by the scope table, additional wire will be let out until the marks are aligned at either the blocks or the winch. This will ensure that the marks are evenly set.
- Notify the winch operator of the “wire-out” length. The winch operator will then begin “setting/shooting the net.” Avoid turning the ship during this phase of deployment also. If the depth changes significantly while shooting the net, you may give the winch operator a (timely) revised wire-out length.
- When the winch operator has paid out all but the last 50-meters of wire for the tow, he will instruct you to slow down. Reduce the speed to 3.8 knots.

Observations to ensure proper net deployment:

- As the trawl passes over the stern roller and down the ramp, attention should be directed to those areas where shackles, links, cable splices and roller gear meet the trawl webbing.
- Net meshes may become tangled, pinched, caught, snagged or otherwise snagged. Problem spots or areas appear as an unusual gathering of webbing or as a strain where the meshes of the webbing are tightly stretched from the point of origin, which usually leads forward toward the vessel. Left uncorrected, tears or rips in the webbing can result, or if not cleared, can prevent the trawl from attaining proper bottom configuration. To correct this situation haul-in the trawl before the door hook-up has been made and free the webbing. If a bad cable splice is the problem, wrap with electrical tape or cover appropriately with layers of mending twine.
- As the net is streaming and before the doors are deployed, a deck fisherman should inspect the floats to ensure that the net has been deployed correctly.

Configuration:

- Once the trawl wings have cleared the stern ramp and trail the vessel at towing length (under tension), but before the trawl door hook-up is made, be certain that a proper surface trawl configuration has been attained.
- Proper configuration is evidenced when the headrope floats all appear at the surface and not confined by webbing.
- Proper configuration will resemble a horseshoe.
- At this point, an inspection of the towing legs can be easily accomplished. Both port and starboard pairs (bottom and top) should nearly reflect the same wedge profile; the apex of the wedge appears at the leg attachment to the main towing cable, with top and bottom legs leading back to their respective attachments to the trawl wings.
- If it appears that due to twisting of the top and bottom legs the overall effective length of the legs will have been reduced in excess of two feet, the trawl should be hauled to such a point that the twists can be removed. Left

unattended, there remains the possibility that headrope overhang and/or headrope height could seriously be affected.

Setting the doors:

- Once the doors are lowered into the water by the winchman, note how the doors plane-off.
- If there appears to be instability or if the doors do not move evenly outboard, this may indicate that other than matched pairs of doors were used, or that towing brackets are worn or have become otherwise loose. If left uncorrected, instability of the doors while on the bottom could result in the doors riding on their side, or not providing the desired (or expected) trawl wingspread.

Depth:

- Winch operator should check station depth with officer on bridge.
- Depth multiplied by desired scope should approximately agree with the amount of cable accounted for on the scope chart (Attachment E).
- Some reasonable variation will occur since each shot of wire out is 50 meters (ALBATROSS IV) or 25 meters (DELAWARE II) in length with the final position of the markers being used to reflect the best approximation of the desired scope (i.e., markers may be over the deck, on the blocks, over the ramp, or at the water, depending on the judgment of the winch operator relative to attaining desired scope).

Wire-out and scope ratio:

- The wire-out length for a tow is based on the depth as read from the EQ-50. The wire-out scope table on the bridge (Attachment E) has been pre-calculated for the proper scope for each depth.
- The port and starboard marks will be aligned at either the winch or the blocks. The amount of wire set will never be less than that indicated in the scope table. Therefore, when the amount of wire has reached its predetermined length as indicated by the scope table, additional wire will be let out until the marks are aligned at either the blocks or the winch. This will ensure that the marks are evenly set.

Simplified trawling rules:

- Stay within stratum boundaries
- Tow shall start at the marked location and be towed in a direction towards the next station
- Tows shall be 30 minutes long
- Speed is 3.8 knots
- Don't move tow more than 1-mile from station without permission of the CS or WC
- Never tow in less than 30-feet/9-meters/5-fathoms of water
- Never tow in greater than 1200-feet/366-meters/200 fathoms
- Never change wire length after the trawl hits the bottom

There are eight fundamental rules that an OOD shall attempt to comply with when conducting a trawl survey as noted above. As with all rules, there are always special circumstances or allowable exceptions. These guidelines attempt to discuss the reasoning and thought processes the OOD must apply to the decision making process (tactics) when planning for, setting up for, and conducting a survey trawl.

One point that must be remembered is that the survey is based on “relative abundance”, not the number of fish caught. For statistical purposes, this is the reason why constant speed is more important than distance covered. OODs should avoid tactics aimed at catching the maximum amount of fish as this introduces a bias to the data set.

3.7.2 Directions for using the SCS TrawlEvent Application on a NEFSC Bottom Trawl Survey --

Overview (trawl event):

The officer on the bridge will start the Trawl Event application from the Event Logger in the Scientific Computer System (SCS) program prior to deploying the gear. Prior to deploying the net, the **Start Event** button will be pressed which will trigger the logging of meta-data and sensor stream data to specific output files. When the net is set and starts fishing, the officer will push the **Start Trawl** button to mark the data of the event. When the tow is complete, pushing the **Stop Trawl** button will mark the data of the event ending. Once the doors reach the surface of the water, the **Stop Event** button will be pushed to stop the logging of data to the output files. Once the **Stop Event** button has been pushed, the data for that tow will be available for the scientists on deck via the FSCS Station Initialize program.

Important Facts (trawl event):

Scientists will be unable to access the full data for a given station until the Trawl Event application has been stopped for the current trawl. Standard procedure for scientists will be to access the data for a given station by running the Station Initialize program at that point when the net is hauled aboard. (It is now possible to retrieve station data in the Station Initialize program for multiple stations with FSCS version 1.5 (instituted in February 2003).

Step-by-Step Instructions for Officer on Deck (trawl event):

At the first survey station, ensure that the Chief Scientist has updated the appropriate default values for the following fields: ST-CruiseCode, ST-VesselName, SequentialCruiseNumber, and ST-DesignatedSpeed. These values remain the same for the entire cruise, and are entered by the Chief Scientist using the Event Builder on SCS at the beginning of the cruise.

The bridge officer must be logged in as administrator:

- Double click on *SCS Menu* if the menu bar is not currently displayed.
- Pull down the *Acquisition* menu.
- Highlight Event Logger NEW and click once.
- Select ***TrawlEvent.tpl*** by double clicking on filename.
- Select ***Meta Data*** radio button of the ***Components*** block in the upper left corner of the screen.
- Select the ***Cruise*** tab by clicking once.
- Populate the following fields:
 - ST-StationNumber
 - ST-StratumType
 - ST-Stratum
 - ST-Tow
 - ST-Pitch (when determined)
 - ST-RPM (when determined)
 - ST-Comments (you may need to return to this field at the end of the event to add comments regarding the tow).
 - ST-DesignatedWireout
- Click on the *Weather* tab and populate the following fields:
 - ST-CloudCover
 - ST-WeatherCode
 - ST-WaveHeight
 - ST-SwellDirection
 - ST-SwellHeight
- Select radio button, ***Buttons***, located in the *Components* block.
- Push the ***Start Event*** button just prior to deployment of the doors (prior to doors entering the water, i.e. doors at surface).
- Push the ***Start Trawl*** button when the winch operator announces that all wire is paid out, and the brakes are set.
- If during the trawl, bad bottom is encountered or the gear hangs up enough to stop the tow, the ***Hang*** button should be pressed.
- If during the trawl, the doors should become crossed, the ***Doors Crossed*** button should be pressed.
- The ***Stop Trawl*** button should be pressed at the same moment that haulback begins.
- All comments should be entered in Bridge Comments field before the doors hit the surface.
- The ***Stop Event*** button should be pressed just after the doors hit the surface (all data entry must be complete before this point).

TIME SEQUENCE FOR TRAWLEVENT.TPL

EVENT BUTTONS	WHEN TO PRESS	YOUR TIMING	COMMENTS
Start Event	Prior to deploying doors	MODERATE	This can be pressed earlier if necessary
Start Trawl	Winch operator reports that all wire is paid out and brakes set (Tow timing begins)	CRITICAL	This button MUST be hit the same time as the brakes are set
Hang*	Net hangs on the bottom	MODERATE	Try to press this button as soon as possible after a hang is determined
Doors Crossed*	Winch operator reports crossed doors	MODERATE	Try to hit this button as soon as door cross is determined
Stop Trawl	Haulback begins	CRITICAL	This button must be hit the moment haulback begins
Stop Event	Doors hit the surface	IMPORTANT	Scientists can not access data until event is stopped
Exit	Catch is on deck and being sorted	MODERATE	Less problems likely if event is exited

* Pressing the **Hang** or **Doors Crossed** buttons only marks the data when the button is pressed. This action does not stop data collection.

3.7.3 Trawling --The winch operator will advise when the requested wire-out length has been paid out (plus an adjustment for “length at the water”) and the winch brakes have been set. **DO NOT** adjust wire-out after the brakes have been set. At that time do the following in rapid succession:

- Start the timer
- Press “save” on the DGPS
- Mouse-click “start” in the Trawl Event window button
- If a helmsman is present, they should assist you with initially fine tuning and maintaining the ships towing speed using DGPS while you are making the following log entries.
- Log the time, station #, position, and depth of the start of the tow in the SCS Trawl Event.
- Enter data in the SCS acquisition menu

During the tow, be alert for traffic and fixed gear, monitor and adjust the towing speed as necessary, watch for significant bottom topography variations, and complete all logs and perform bridge collateral duties. A constant over ground speed of 3.8 knots should be maintained during trawling and reasonable and practical efforts shall be made to maintain the desired towing speed. Vessel safety concerns always supercede scientific protocols. If a safety concern arises, the tow can be aborted.

Notify the winch operator at 5 minutes and 1 minute to the end of the tow. Note any special conditions or events encountered during the tow in the SCS Trawl Event bridge comment field.

Stratum boundaries:

- A “complete tow” begins with streaming the net over the stern and ends when the nets codend has been landed on deck. A “complete tow” track line should never cross a stratum boundary.
- An “official tow” starts when the trawl winch brakes are locked after paying out the designated trawl warp length, and ends when the trawl winch brakes are released and the trawl warps are engaged.
- An “official tow” track line shall never cross a stratum boundary.
- It takes approximately 3 nmi to conduct a “complete tow” with slightly less or more distance required for shallow or deep tows:
 - 0.5 nmi to stream and set the trawl
 - 2 nmi to conduct the “official” 30-minute standard survey trawl
 - 0.5 nmi to retrieve the trawl

Keeping a “complete tow” within the stratum boundaries requires planning when stations boundaries:

- Ensure there are 3 nmi available for towing
- Allow for the effects of set and drift of the vessel
- Avoid all obstructions such as land, vessels, wrecks, buoys, outfall pipes, fish haven and trap areas, fixed gear, cables, other charted obstructions, bad bottom topography, or stratum boundaries.
- The stratum boundaries are supposed to represent specific depth ranges, 0-5 fms, 5-10 fms, 10-15 fms, etc. These stratum boundaries were established many years ago, thus may not currently reflect the actual depths, most notably in the shallowest and deepest strata due to limitations in knowledge regarding bathymetry when the strata were created. It is critical that tows are made both within established stratum boundaries and at depths consistent with the depth range for the stratum. The only allowable exception to the “stay within the stratum boundaries” rule is when the Chief Scientist or Watch Chief requests a specific depth for a tow (generally only done for deep tows along canyon walls). This request should be noted on the station sequence list.

Start of tow:

- It takes approximately 0.5 nmi to stream and set the trawl. When preplanning the track line, the OOD may wish to veer off their course while transiting toward the next station in order to arrive 0.5 nmi from the station and going the correct speed and pointed in the correct direction. This set up will allow the doors to be set, and the “official tow” started, near the plotted station location.
- Bongo plankton casts, CTD casts, and/or water casts are usually performed before a tow. Generally, these should be conducted within the same stratum and at a similar depth as required for the tow. During the preplanning of a tow, the OOD should make allowances for the distance and ship direction these events require.
- Alternately, if the “official tow” cannot start at the plotted location, it is acceptable for some point on the 2 nmi “official tow” track line to pass over the plotted station location. Note that this permits towing toward the station as well as towing away from the station.
- Obstructions or traffic may make starting at, or towing over the plotted station location impossible. Protocol allows the OOD to relocate the tow track line within 1 nmi without permission providing the “official tow” is in the same stratum, is at approximately the same depth, and passes within 1 nmi of the original station.
- If, for any reason, any portion of an “official tow” cannot pass within 1 nmi of the original station, the chief scientist should be consulted. The OOD should explain why the original station location is unacceptable and offer alternative locations.

Tow Direction: Tow direction must be towards the next station unless one of the following occurs:

- When towing towards the next station would put you out of the stratum and into another.
- When following a depth curve, generally offshore.
- Bad bottom, wreck, cables or obstructions.
- Fixed gear in the tow path and a clear tow exists in another direction.
- Traffic in the area.
- Moderate to heavy seas.

Tow duration:

- Standard survey trawls are 30 minutes in duration.
- It is the NEFSC policy that a tow should not be shortened if there is a 50% chance or better of successfully completing a full 30-minute tow.
- Time starts when the trawl winch brakes are locked. Time stops when the trawl winch brakes are released for haul-back.
- Intentional or planned reductions in tow duration shall be avoided and only done after consultation with the chief scientists and/or watch chief. If unexpected obstacles are encountered, tows should be aborted.

Shortened or lengthened tow:

- If for any reason a tow has to be shortened or lengthened to ANY time other than 30 minutes, the scientists require that the Trawl Event still be completely filled out (even totally invalid tows for estimating abundance or biomass can be used for biological studies).
- If a tow has to be shortened or lengthened, note that the tow was a non-standard tow in the bridge comments field. If a re-tow is required, another Trawl Event with the next sequential Station number shall be generated (i.e., a new sequential number every time the net goes in the water). Contact the Chief Scientist for the new tow number because you cannot assign the next sequential number for that tow.

Tow speed:

- When streaming the net over the stern, the ship's speed through the water should be between 2 knots and 3 knots, adjusted for weather conditions and current. This is necessary to provide sufficient tension to pull the net over the roller without so much tension to hinder or endanger the deck force while connecting the doors.
- When initially placing the doors into the water and while shooting the net, the ship's speed should be at least 6 knots through the water in order to ensure proper door spread, prevent the likelihood of crossing the doors, and to provide sufficient tension to pull the net and wire off the trawl winch drums.
- During the initial phase of recovery, the ship's speed should be maintained at the 3.8-knot trawling speed settings or slightly reduced.
- Once the doors have cleared the water, the ship's speed should be reduced 3.0 knots to minimize tension while bringing the net aboard. Again, the OOD must correct for the speed and direction of the current.
- The "official NEFSC standardized trawling speed" is a constant 3.8 knots over the bottom (not through the water) as measured and monitored by DGPS.

Speed of the vessel during haulback varies between the ALBATROSS IV and DELAWARE II. It is important that each vessel continue to use their individual haulback protocols as the differences between the two vessels are accounted for in conversion coefficients that have been derived for the catch data. The historical reason that the speed at haulback varies between the two vessels is due to the different configurations of the hydraulics on each vessel.

ALBATROSS IV

During haulback, the vessel must not reduce trawling speed until the doors clear the water. After the doors have reached the surface, the vessel shall reduce speed to the minimum speed that will allow the vessel to maintain steerage.

DELAWARE II

During haulback, the vessel must reduce trawling speed as soon as the winches are engaged. The vessel must reduce RPMs to 110 or approximately 1 knot over the ground. After the doors have reached the surface, the vessel shall keep speed to

the minimum that will allow the vessel to maintain steerage.

During the initial minutes of the “official tow,” adjust speed settings to achieve the desired speed. Settings, which worked at the previous station or under similar weather conditions, are also very helpful. The ship will nearly always be traveling too fast when the doors are initially set on the bottom, but once the winch brakes have been set, the drag of the doors and net will slow the ship rapidly. DGPS speed is the standard and vessel speed should be determined using DGPS.

Tow distance should not be used as a primary indicator of over the ground speed, distance versus time can provide a convenient double check. The NEFSC’s survey standardizes speed which will result in a standard distance covered. The designated 3.8-knot speed equates to 1.9 nmi traveled during a 30 minute tow. Based on this speed, the approximate distance covered at various points in the tow are as follows:

@ 10 minutes into tow	0.63 nmi
@ 15 minutes into tow	0.95 nmi
@ 20 minutes into tow	1.27 nmi
@ 30 minutes	1.90 nmi

Distance traveled should only be used as a secondary check of primary speed indicators. Speed should never be adjusted during a tow to achieve a target distance.

Maneuvering during a tow:

Maneuvering (turning) during any portion of a tow greatly increases the likelihood of crossing the doors, or having them fall over and not recover leading to a net malfunction. The wire angle from the trawl blocks and low trawl warp tensions are not reliable indicators of a malfunctioning net. Although maneuvering the ship during any portion of a tow is discouraged, there are three times when it is relatively safe to do so:

- The most common reason for maneuvering during the deployment or recovery phase of a tow is to reduce the ideal 3 nmi straight run generally required for a 30-minute tow, usually to avoid an obstruction such as fixed gear.
- The only time it is safe to turn the ship during the deployment and recovery phases of a tow is when the trawl warps are connected to the doors and the doors are at the trawl blocks hanging over the stern.
- In some instances, it may be permissible to turn the ship during deployment or recovery so long as the doors are NOT connected to the net or trawl warps.

In all cases, ask the lead fisherman if it is okay to turn. Never turn while shooting the net.

Maneuvering while the net is on the bottom should be avoided, but can generally be safely accomplished in small, widely spaced increments, e.g., three 5-degree course changes over 5 minutes. Course changes greater than 15 degrees are not recommended. The most common reasons to maneuver while the net is on the bottom are to:

- Clear an obstruction or traffic.
- To maintain a constant depth when following a contour line.
- To stay within designated stratum boundaries

Hung net or crossed doors:

- Never back down.
- In the event of a hung net or crossed doors, slow the ship to bare steerage speed (no less than 10% to 20% pitch) and follow the winch operator's instructions. Ensure that the ship does not ride over the trawl warps.
- Hit the "HANG" button on the trawl event
- Have one of the fishermen at the transom to warn the winch operator and bridge if the trawl warps start to tend forward. If there is any chance of the net or the warps going under the ship, de-clutch the propeller.
- DO NOT try to turn to a reciprocal course. Be prepared to set *Not under Command* lights or shapes.
- The idea behind breaking a hung net free is to have the trawl winch pull the ship backwards until the stern of the ship is directly over the obstruction and the net can be pulled vertically off the obstruction.
- The idea behind uncrossing crossed doors is to minimize the tension in the trawl warps so the doors may be flipped over each other to undo the tangle.
- Be sure to annotate the Deck Log, and the SCS Trawl Event log of all events (sometimes a hang breaks free and you continue the tow). If the hang is the end of the tow, fill out the above as if it were the end of a normal tow, but noting the special events.

Depth changes:

- Radical depth changes during a tow affect the mouth opening of the trawl because the scope of wire out to depth becomes inconsistent. In the worst cases, the trawl may even lift off the bottom and not fish at all.
- If the charted contour lines indicate a steep depth gradient, the OOD must tow along a contour of (relatively) constant depth. This is particularly true near the canyons at the edge of the continental shelf. If depth changes cannot be avoided, it is best to tow from deeper to shallower depths because too much scope (too much wire out) is preferable to too little.
- Never adjust the wire-out scope during a tow to correct for changing depth although scope changes can be made while shooting the net.

Current:

Tow direction relative to prevailing current has historically been treated as a random variable. Conscious efforts to tow into the current or avoid cross currents will impart an undesirable bias to the data, which is to be avoided. The only

exceptions are avoiding a cross current severe enough to collapse the doors or avoiding a stern current that leaves the ship without steerage. Cross-current readings approaching 2 knots should be a concern to the OOD; (especially on hard bottoms) because the doors do not hold their set well in these conditions and will tend to fall over or cross.

Sea state:

Survey tow direction (or the ability to tow at all) may be determined by sea state. If the conditions are as severe as to pose a safety issue or data quality issue operations may be affected. Safety related decisions might be made by either the vessel Command or the Chief Scientist. The Chief Scientist will make data quality decisions.

Wind:

Wind direction is generally not a factor for trawling operations. Sustained high winds with a long fetch often cause the waves and swells to come from the same direction. In this case, the direction of tow may have to be based on the seas. In open waters, canceling of operations is considered when sustained winds of 35 knots are observed because this speed usually corresponds to sea states that are excessive for safe work on deck and proper gear performance.

Bottom Topography:

Bathymetry may become a factor in tow site location. If the alteration will result in a more than 1.0 nmi relocation of the station from the original station location the Watch Chief or Chief Scientist must be consulted. Areas of “bad bottom” may be determined to be untowable. This determination will be because of scouting the area, using all available navigation and scientific resources, and consultation between the Chief Scientist, the Officer of the Deck or Commanding Officer, and the Lead Fisherman. Barring safety issues, the Chief Scientist will make the final decision.

Traffic:

Tow direction and tow site may be altered by marine traffic. With regard to traffic as it affects the survey operations, the OOD will notify the Chief Scientist or Watch Chief if there is going to be a delay of more than 15 minutes due to other vessels in the area or if the alteration will result in a more than a 1.0 nmi relocation of the station. The OOD is primarily responsible for the safe navigation of the ship. Delays of this nature should be rare as tow direction may be changed to avoid any close quarters situations.

Fixed Gear:

Fixed gear may become a factor in tow site location. If the alteration will result in more than 1.0 nmi relocation, the Chief Scientist must be consulted. Areas of fixed gear may be determined to be untowable. This determination will be made after scouting the area, using all available navigation and scientific resources, and consultation between the Chief Scientist, the Officer of the Deck or Commanding

Officer, and the Lead Fisherman. Barring safety issues, the Chief Scientist will make the final decision. The mere presence of fixed gear in an area is not a sufficient condition to abandon attempts to complete a tow. Often, through scouting and/or communication with local fishery operators results in identification of a towable area, even when fixed gear is present. Efforts to locate towable area should be made for a period of up to one hour.

Trawl recovery (Haulback):

From the stern, observe the trawl trailing out behind the vessel and note any holes, tears or other gear damage requiring immediate attention.

Fixed gear retrieved from trawl:

When lobster traps or fishing gear is captured in the trawl, the following procedures shall take place:

- Chief Scientist or Watch Chief records on the trawl log and in the FSCS comments:
 - Trap or buoy number(s)
 - Contents (count and measure lobsters –these data are not included in the trawl catch)
 - Location
 - Presence or absence of buoys
 - Condition of the gear (i.e. ghost gear, new traps)

Hauling back:

Haulback procedures will be adhered to in order to minimize gear damage. The Watch Chief should observe this operation. As the codend becomes stationary in the water, just before being hauled aboard, note any loss of catch. If fish are escaping, there is a good chance that there may be some damage to the liner and/or codend. Once the catch has been placed in the checker, it may be necessary to cut several meshes in the belly section to remove larger entwined fish. If this becomes necessary, these holes should be immediately repaired and if necessary, inspected by a qualified Watch Chief.

Float Check:

Once the trawl is completely positioned on deck, the deck crew should inspect headrope floats for damage and physically position. If needed, they should be repositioned or replaced.

Proper repair:

When net damage requires more than 20% repair of any trawl mesh section or significant damage to any other trawl component, consultation will occur between the Lead Fisherman or Boatswain and the scientific Watch Chief. The decision as to whether repair or replace the damaged section or repair or replace the entire net will then be made. Authority for the final decision rests with the Chief Boatswain.

Once it has been determined that 20%, of any mesh section has been damaged or significant damage has been observed on other trawl components, the trawl repair Checklist will be used to assess the completed repairs or newly installed trawl. Proper repair requires that the gear be returned to its specified configuration (Attachment A and B).

Tie liner:

Before the codend is closed, the Watch Chief should inspect and ensure that the codend liner is properly closed to prevent escapement of any portion of the next catch.

When to repeat a tow:

Occasionally it is necessary to repeat a trawl haul because of malfunction or damage to the trawl. In cases of severe malfunction (crossed doors) or severe damage (whole sections torn out such as a wing or belly), the tow will not be counted as a standard haul and must be repeat although, it may be sampled for biological data which is independent of abundance and biomass information. For recording purposes, the tow is recorded as a valid station, but the coding for Station-Haul-Gear (SHG) value shall be greater than 1-3-6, indicating a non-valid catch for assessment purposes. Descriptions of the types of damage that constitute an SHG value of greater than 1-3-6 are given in the coding details (Attachment H).

In some cases, it may be difficult to determine how to properly code a haul that has encountered problems. The following guidelines should be used:

- It is essential to indicate a minimum of 2 for haul value, which flags data auditors that something abnormal occurred during the tow.
- If in doubt, about SHG coding consult with the Chief Scientist
- Ensure that the catch is worked up at least to the point of weights and lengths
- An accurate and complete account of what occurred to the gear must be given in the Station Initialize Watch Chief comments field; the lead fisherman or boatswain must be interviewed to determine details on gear condition.
- When gear significant gear damage occurs, the Chief Scientist should be informed, and the decision to re-tow must be made based on the severity of the damage.
- A plot of the starboard and port line tensions should be printed out and saved for the auditors, to help determine at what point the gear encountered problems.
- Note: The plot of tension may help to code a tow when on deck, for example, a severely damaged net with cod-end intact, and trawl tension plot showing heavy bottom contact at 29 minutes into the tow may be a good tow. The important point to remember is to provide enough information to allow independent evaluation (by those on land) of every station where an abnormality occurred.

The decision to repeat a tow is made by the Chief Scientist and is based on a coded SHG value greater than 1-3-6. The following factors may override this decision:

- The probability of the same or greater damage to the net occurring; in this case, the station location should be moved
- The current progress of the cruise as a whole (when time remaining in the cruise threatens the completion of the entire survey area)
- The status of shipboard gear inventory (i.e., how many undamaged nets are left?)

The following factors must be weighed with every decision to override a retow:

- The overall progress of the cruise (does time in the context of the entire survey permit extended effort on any one station?)
- The phase of the cruise (a subset of above) (e.g., risking the last undamaged net on the last day of leg III may not be a serious risk for the cruise at all, as the ship will return to port and can replenish the supply of nets without much loss of operational time)
- The number of stations completed in the stratum in question (higher priority would be placed on a station that represents the sole tow in the stratum, lower priority would be placed on a station that would represent the 8th successful tow in the stratum)
- The current relative importance of the stratum in question (is it a critical stratum for certain assessment species?)
- The geographic coverage within stratum that the tow represents

3.8 Post Trawling Activities

Gear condition report:

After conferring with the Chief Boatswain, the Chief Scientist or their designee must contact the NOAA Fisheries warehouse 2 days before return to Woods Hole to inform them of gear needs for the next leg. This communication should be by email and a copy of this information should be sent to Survey's Gear Specialist.

The Boatswain will ensure that all gear being returned to Woods Hole is tagged and that a record of its condition is supplied to both Survey's Gear Specialist and the Gear Warehouse. The form for this information is provided in Attachment D.

Post cruise meeting:

The Scientific Vessel Coordinator will hold a post cruise meeting the day the vessel arrives in port. Attendees shall include the Captain, Port Captain, Chief Scientist, oncoming Chief Scientist, and the Ecosystems Survey Branch Chief. Others may be directed to attend. The Port Captain will take the minutes.

The goal of the meeting is to discuss the overall success of the cruise and any problems, which may have arisen. The number of stations completed taking into

account weather conflicts, gear conflicts, and ship performance determines the success of the cruise. Also discussed at the meeting are electrical or sensor issues and any equipment that needs repair. A plan is discussed for the upcoming leg, as to the general cruise track and any coordination with other research vessels.

Return / notification of fixed gear:

- Traps or gear returned to shore will be brought to the gear shed in Pocasset.
- The Chief Scientist is responsible for passing the intercepted gear information to the person designated by the ESB Branch Chief.
- Assigned person will contact the fishermen and:
 - Explain the circumstances resulting in the interception of gear
 - Apologize for gear interception
 - Arrange for the return of undamaged gear if owner desires
 - Inform owner of right to file Tort claim
- If a Tort claim is filed:
 - The claim goes to the Branch Chief for signature and then to Washington, DC for approval.
 - The fishermen must supply an itemized cost breakdown of losses and signature.
 - The Branch Chief will review the information for fairness: (i.e. fair market value and probability of NOAA Fisheries involvement in the loss).
 - Copy of letter and cover letter is sent to Purchasing Department

Protocol 4: Trawl Construction and Repair

4.1 Trawl Nets

The NEFSC spring and autumn bottom trawl surveys utilize a Yankee 36 trawl with 16” rollers on the sweep while the NEFSC Winter bottom trawl survey employs a similar net with a 4” cookie sweep.

Construction plans for each survey trawl design are included in Attachments A and B. The plans include engineering drawings of the net, doors and rigging with a level of detail at least as specific as that in the ICES recommended standard (ICES C.M. 1989/B:44 Report of the Study Group on Net Drawing). In addition, each plan contains a description of all materials used, and the qualities of these materials considered important for proper trawl function.

A checklist is included in Attachment C, which was developed for each trawl design specifying the dimensions, and their tolerances, or other design features considered important for proper trawl function. The checklist is used to verify that each newly constructed or repaired trawl is within operational tolerances before use. Members of the scientific staff of each Science Center, who are trained in trawl construction and repair verification, will verify that trawls are within operational tolerances.

Methodology for at-sea trawl repairs will be specified in an Operations Plan and communicated by the Chief Scientist to the crew of the vessel at the start of each cruise. A trawl repair checklist will be included in the Operations Plan and used by a member of the scientific staff to verify that repaired trawls are within operational tolerances.

4.2 Trawl Doors

Trawl doors are critical to the performance of bottom trawl gear. Doors function to spread the trawl net and have a direct effect on net wingspread, head rope height, bottom tending, and mud cloud. The spring, autumn, and winter NEFSC bottom trawl surveys utilize 450-kg, Portuguese polyvalent (Euronete) doors (reference number 126) in the trawling systems (Attachment A and B). Doors shall be purchased in pairs and immediately numbered in a permanent manner to allow tracking during use and maintenance.

Trawl doors shall be maintained in a fashion to ensure proper paired functioning. Door pairs shall be certified by NEFSC personnel prior to deployment on fishery research vessels. Door pairs must have shoes that are in good condition, be free of dents and other significant changes in shape, and have brackets secured in a manner to eliminate shifting.

Door spread resulting from deployment of specific sets of doors will be measured using trawl mensuration equipment upon initial deployment and at intervals of a minimum of every 50 tows. When door spread is determined in successive tows to fall outside of target ranges, the corresponding door pair shall be removed from the trawling system until proper performance can be verified.

Backstrap chains shall be paired, measured for length and maintained within tolerances outlined in Attachments A and B. Backstraps will be attached to the doors in the hole closest to the back end of the door. Pairs of backstrap chains shall remain associated with a specific door pair during transport to and from fishery research vessels, and during deployment during trawling operations. If backstrap chains are removed from doors during trawl operations due to damage or determination that measured lengths are no longer within specified tolerances, removed backstrap chains shall be tagged with information including the door pair number, the date of removal, and reason for removal from the door pair. Removed backstrap chains shall be returned to NEFSC gear personnel for inspection.

4.3 Gear Certification / Inspection

Prior to being placed on the vessel, the trawl gear and equipment will be certified by two individuals. The attached checklist (Attachment C) will be used to evaluate the trawl gear. The trawl gear is described in detail in Attachment A (Groundfish net) and Attachment B (Flat net). A condition report form (Attachment D) will be forwarded to the Chief Boatswain. When the gear is returned, the Chief Boatswain is requested

to fill out this gear condition report form, return it with the gear, and supply a copy to the Branch Chief of the Ecosystems Surveys Branch.

Protocol 5: Changes to Regional Trawl Survey Protocols

Changes to trawl survey operational protocols will be at the discretion of the NEFSC's Science Director who may approve such changes directly or specify a peer review process to further evaluate the justification and impacts of the proposed changes.

ATTACHMENT A

Specifications for Construction of NEFSC Standard #36 Bottom Survey Trawl (60 - 80) Updated 4/22/03

Body of the Net

Dimensions of the sections are shown on the attached net plan and cutting diagram. Webbing for wings, square, and bellies is 5" stretched mesh measured knot center to knot center (or 4 3/4" inside measurement). It is single selvedge, stretched, and stabilized. The webbing is woven with white #96/108 (3 mm) (R5263tex), 16-carrier virgin braided nylon twine. Webbing in the codend is 4 1/2" stretched mesh, center-to-center, single selvedge, stretched, and stabilized. Twine for the codend webbing is white #182 (R11764tex), 16-carrier virgin braided nylon.

Net sections are joined together by sewing a half mesh row of double twine of a contrasting color for easy identification of sections (usually red shot cord).

The top and bottom sections of the net are joined together at their sides by a gore or laceage. Gathering six knots from each of the top and bottom sections makes the gore. These are seized every foot and wrapped in between the seizings using single #120 (R8333tex) thread-braided nylon twine.

Dog-ear meshes are sewn onto top and bottom wings with single #182 thread-braided nylon twine.

Gore Lines

Gore lines are 3/4" diameter PolyDacron ropes that run from the after end of the codend to the top of the wing end where the rope is tied into the head rope eye splice. The gore line is slightly shorter than the laceage and is seized to the laceage at intervals of 18 inches.

Footrope

The footrope is constructed from 120' (20 fathom) total length of 3/4" diameter polydacron (polyplus) rope. This length is used to construct the 100' (16.67 fathom) footrope including eye splices, and the seven-foot up-and down lines. The remainder of the rope at each end is tied into the wing end eye of the head rope, with the excess seized back down the door end line. Lower wings are hung in 45' (7 1/2 fathom) lengths while the lower belly is hung in a 10' (1.67 fathom) length.

Belly Lines

Belly lines are two strengthening lines on the bottom belly made of 5/8" Poly Dacron. They are seized to the footrope at the corner and run out and back to the gore line on the bar of the belly webbing. They are seized to the webbing and to the gore line.

Headrope

The headrope is made of 7/8" diameter nylon or polypropylene and steel combination rope with a fiber core. It consists of three 20' (31/3 fathom) sections. Each section has eyes spliced at each end without thimbles and sections are joined by 1/2" hammerlock links. The square is hung in 12' (2 fathom) and the wings are hung in 24' (4 fathom) lengths.

Hanging

The dogs on the wings are hung to the headrope and the footrope with hanging meshes of single #120 braided nylon twine. The belly and the square selvedge meshes are evenly hung on the bosom sections of the footrope and the headrope with single #120 braided nylon twine. The hanging lengths for the wings and bosom on the headrope and footrope are shown on the attached plan. Each dog is seized to the headrope with bar-tight seizings.

Up-and Down

Door end meshes of the bottom wing are evenly hung on the seven-foot up-and-down line that runs from the footrope to the headrope. The end meshes of the top wing are gathered together and seized into the headrope eye splice with single #120.

Floats

There are 36 eight-inch spherical aluminum floats. The floats have a 5/8" polypropylene line threaded through their double beackets. This poly line is then seized to the headrope. Float arrangement: 20 floats evenly spaced on the center 20' (31/3 fathom) section of headrope, and 8 floats evenly spaced on each 20' (31/3 fathom) side section. The first float is 18 inches from the wing end. Float line is seized to backside of the headrope, so floats lie above the webbing and behind the headrope.

Fishing line (Not the footrope and not a fishing line)

10/28/02 - The terminology for this piece is being changed from "traveler" to "fishing line". This was previously called a "fishing line" but was changed to "traveler" to differentiate it from the footrope. No change in the configuration of the net has resulted from the change in the terminology of this piece.

The Fishing line is made up of five lengths of 5/8" diameter combination rope with eyes spliced in each end without thimbles and joined with 1/2" hammerlocks. These lengths, from wing end to wing end are 23' (3.83 fathom), 9½' (1.58 fathom), 16' (2.67 fathom), 9½' (1.58 fathom), and 23' (3.83 fathom). Measurements are total overall length, including eye splices. Combination rope is a combination of nylon or polypropylene strands and steel wire with a fiber core.

Sweep

The sweep is made up of five sections of 3/4" diameter 6 x 19 fiber core, galvanized wire rope. The sections have eyes without thimbles. The sections are joined with 5/8" hammerlocks. The lengths of the sections from wing end to wing end are 22½'(33/4 fathom), 9½'(1.58 fathom), 16'(2.67 fathom), 9½'(1.58 fathom), and 22½'(33/4 fathom). Dimensions are total lengths including splices. The wing end sections 22½ feet each, have 4" diameter rubber tire stampings (cookies) on their entire length with 7 link roller chains (toggles) every 2'. The roller chains consist of a 3" I.D. ring of 3/8" steel rod at each end linked together by 7 links of 5/16" chain. The distance between the end rings is 8". The footrope is passed through the ring at one end of the roller chain. The fishing line is passed through the ring at the other end of the roller chain, except for the roller chains located at joins of the fishing line or the footrope; then the ring is inserted in the split link or the shackle used to join the two sections.

The two 9½' (1.58 fathom) long sections and the center 16' (2.67 fathom) section have 16" diameter by 5" wide "Fenner" or equivalent solid, hard rubber (no spokes) rollers on them. Two rubber spacers, each 7" in length by 5" in diameter, separate these rollers. They have a 2¼" hole through the center. Between each pair of spacers a roller chain is strung on the sweep. The rollers and spacers are arranged on the sweep sections so there is a single spacer at each end of the center 16' (2.67 fathom) sections. On each of the 9½' (1.58 fathom) sections there are two spacers at the outer, wing, end and no spacers at the inner end that is adjacent to the center section. Each outer section has five rollers and ten spacers on it and the center section has 9 rollers with 18 spacers. There is a 4½" diameter steel washer at each end of each of the 5 sections of the sweep.

There are 42 droppers used in the sweep. Eleven droppers are placed every two feet in each wingend starting 2 feet forward of a dropper that is placed between the 22 ½' wing section and the 9 ½' roller section (see sweep diagram). There are droppers placed between the two spacers that separate the rollers except for the forward most spacers. Thus, each wing section has 11 droppers, each 9 ½' roller section has five droppers, including the dropper between the wing section and the roller section, and there are 10 droppers in the 16' center section, including the droppers between the center section and the 9 ½' roller sections.

Seizings

Prior to 2001, the footrope was seized to the fishing line and not to the rings that are attached to the droppers. This change was made to eliminate the problem of the seizings slipping and bunching of the footrope.

The footrope is seized to rings that are used to attach the droppers to the sweep. The fishing line passes through the 3 ½" circular rings that the footrope is seized.

Liners

The after part of the upper belly is lined with ½" mesh liner material, as is the entire codend. Both liners are made of ½" mesh #147 knotless white nylon webbing. The belly liner is 30' (5 fathoms) across the leading edge, 21' (3½ fathoms) down each side, and 18' (3 fathoms) across the after edge. The codend liner is 30' (5 fathoms) around by 24' (4 fathoms) long. These measurements are made with the meshes open but without stretching the webbing

tightly. The belly liner is reinforced along the leading edge and down each side by gathering and seizing a 1/2' diameter roll of liner material. This roll of material is then seized to 54-thread strengthener that is knotted with an overhand knot every 8" along its length. The top belly liner is attached to the inside of the top belly 35 meshes up from the after end of the belly. It is also seized down the sides off the belly, 1 mesh in from the gore. The after end of the belly liner is not seized.

The codend liner is also reinforced along the forward edge by gathering and seizing a 1/2" roll of the material and then seizing onto a knotted 96/108 strengthener to it. This same technique is used down the gore of the liner where the two edges are joined, and down a false gore opposite the join. The after end is not reinforced. The codend liner is attached inside the codend to every mesh around the codend. This is done one and one-half mesh back from the codend - belly join.

Codend

The mesh in the codend is 4 1/2" stretched mesh, center-to-center, single selvedge, stretched, and stabilized. Twine for the codend webbing is white #182 (R11764tex), 16-carrier virgin braided nylon. Rings are hung to the codend with codend twine at a ratio of one ring for each 3 meshes. Rings are 2" diameter galvanized steel made from 5/16" rod stock. The codend measures 50 meshes deep by 80 meshes in circumference or 35 meshes between the gores. The remainders are taken up in the gore. Chaffing mat is constructed from 4 1/2" nylon and is 30Wx35D.

Legs & Ground cables

The upper legs are constructed from five fathoms of 5/8 in. wire. The lower legs are constructed from five fathoms of 1/2 in. chain. The backstraps are 9'6" of 1/2" Trawlex and are attached in the last aft hole closest to the aft end of the door.

Doors

The doors are Portuguese Polyvalent 450 kg (see door specifications).

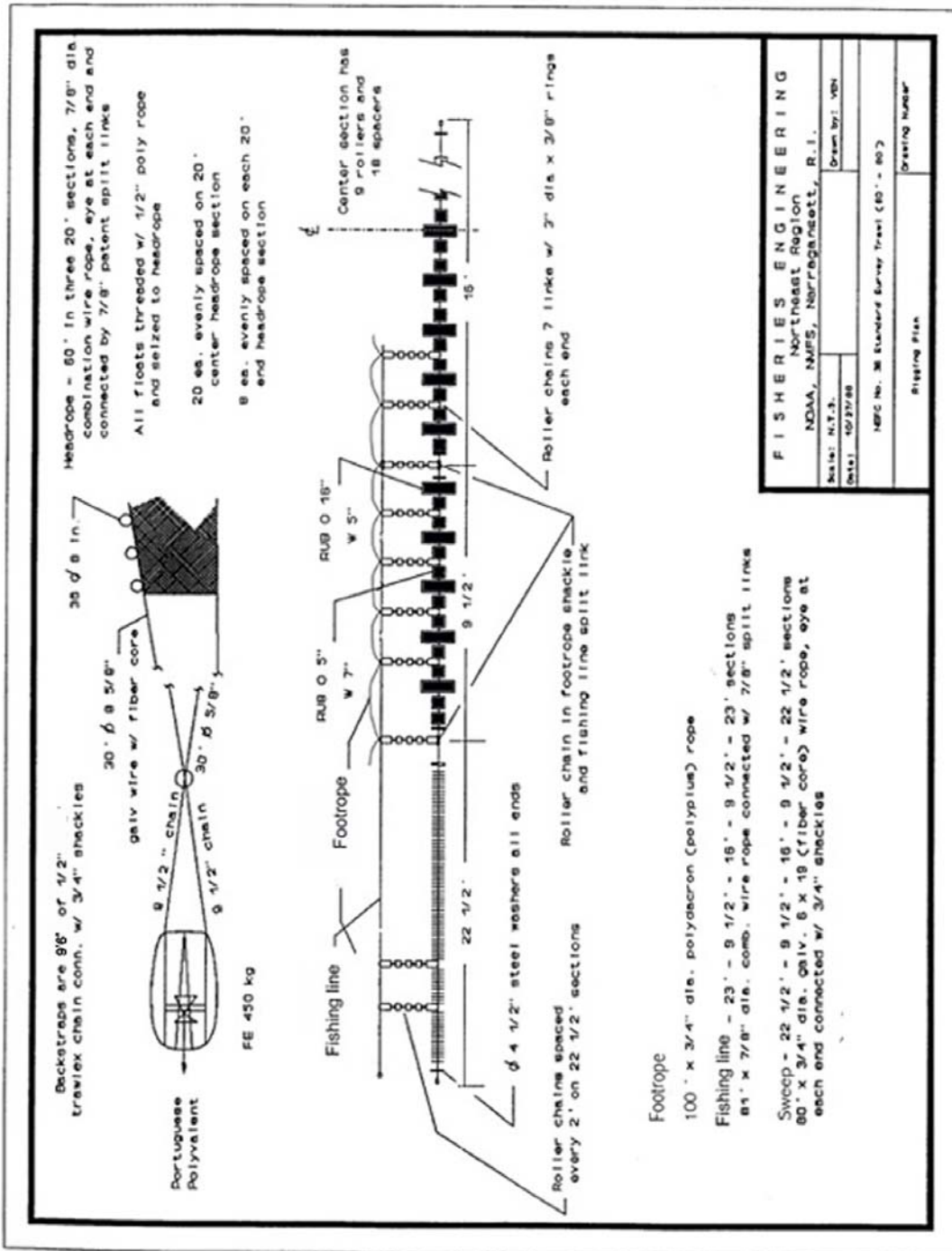

FISHERIES ENGINEERING
 Northeast Region
 NOAA, NMFS, Narragansett, R.I.
 Date: 02/27/88
 Drawn by: vph
 NDFC No. 38 Standard Survey Trawl (80' - 80')
 Rigging Plan
 Drawing Number

Roller net - Albatross IV

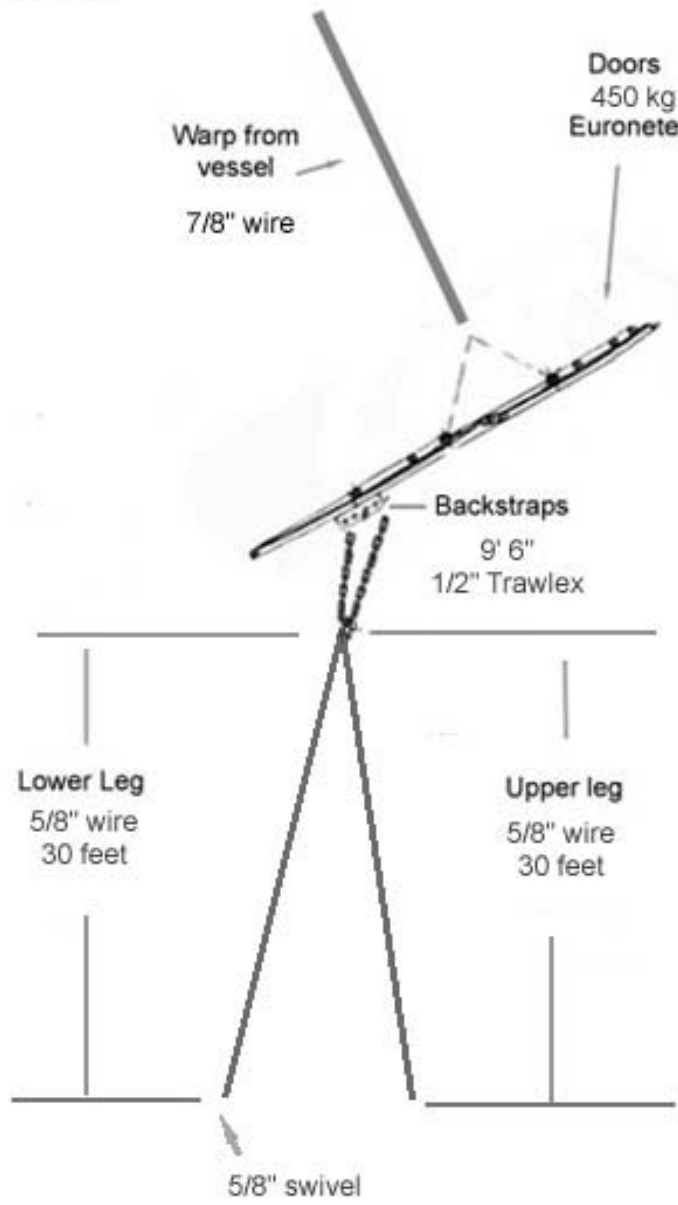

A 17' idler extends from the junction of the backstraps to the door

Roller net Delaware

The DELAWARE II uses an additional 11 foot extension between the backstraps and the legs to allow the crew to hook up the gear. Calibrations have been performed between the ALBATROSS IV and the DELAWARE II and a conversion factor is applied to data collected from the DELAWARE to account for differences in catchability between the two vessels.

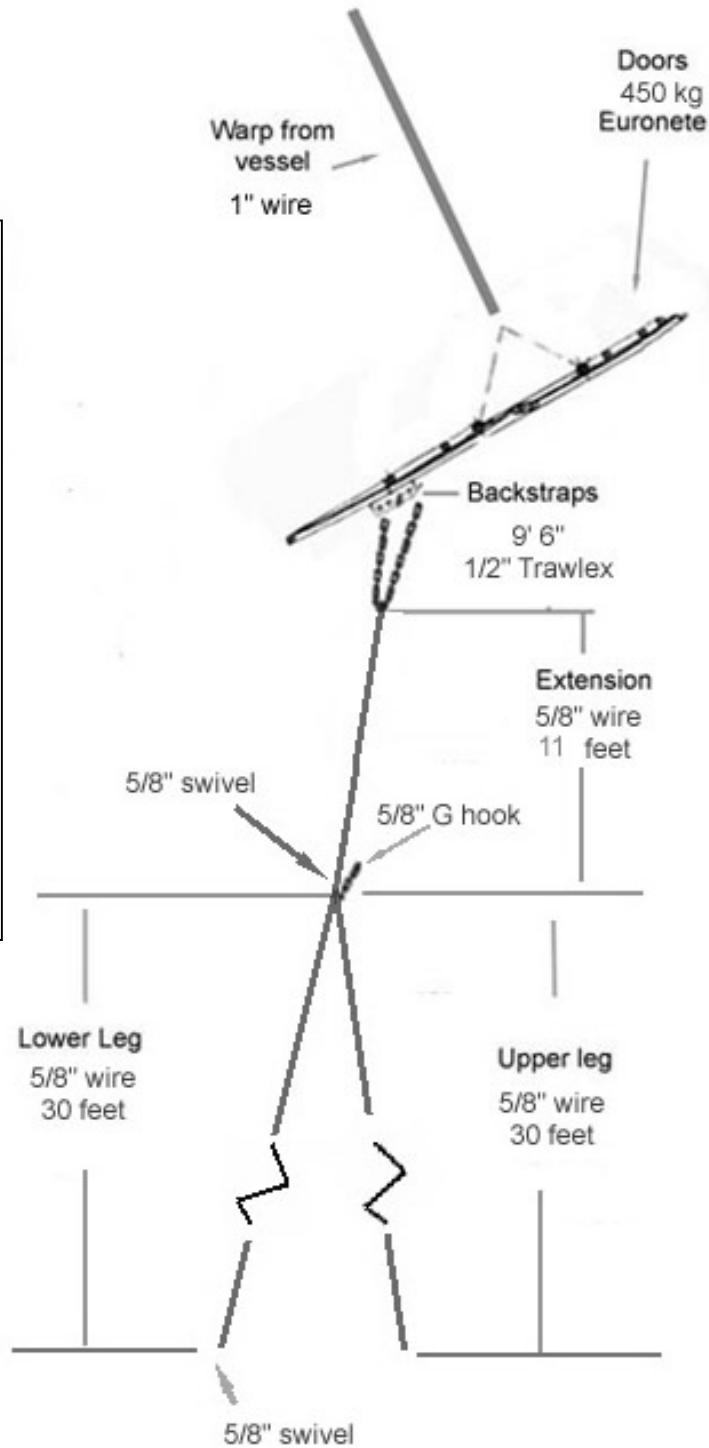

A 33' idler extends between the extension / legs and the door

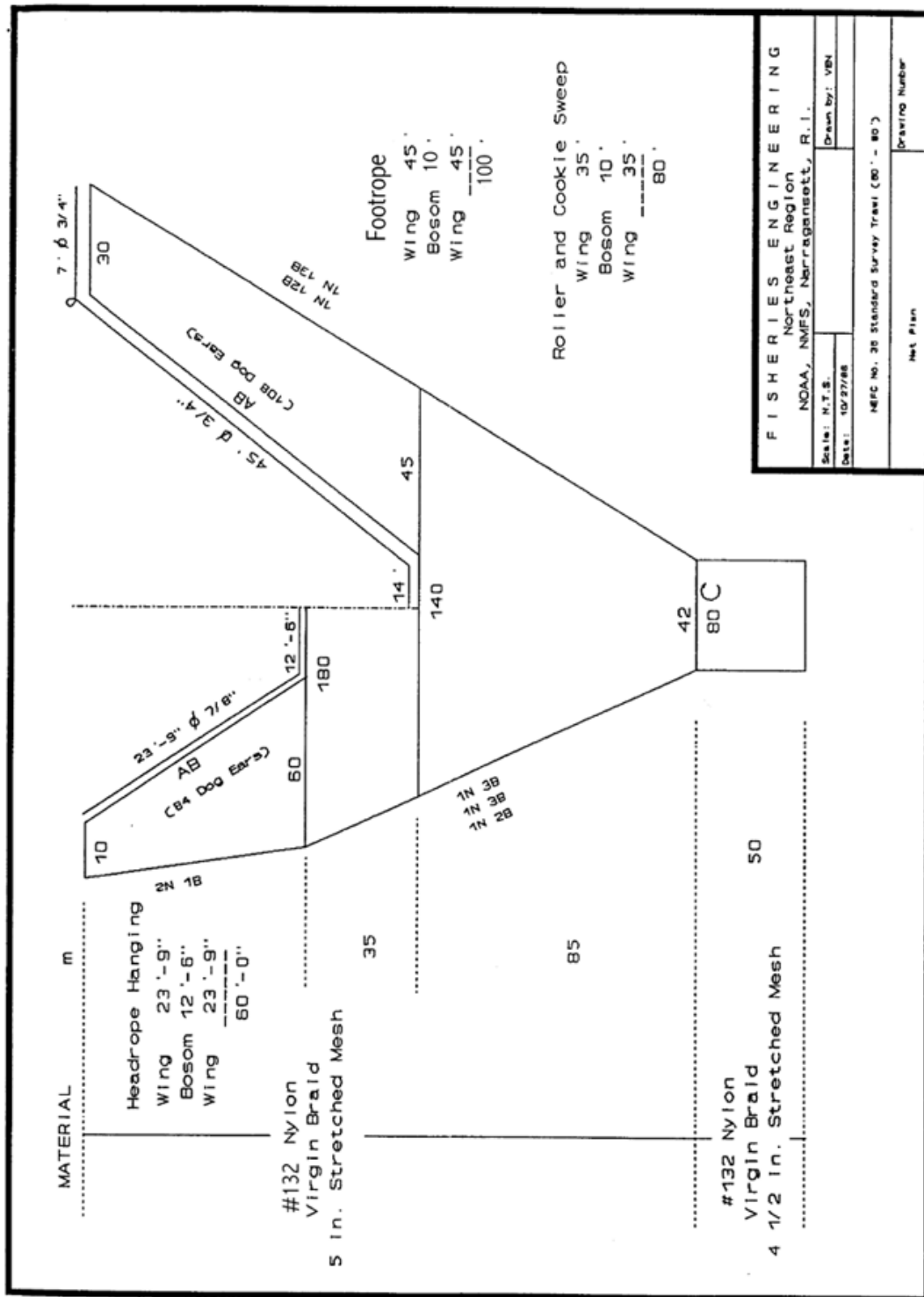

FISHERIES ENGINEERING
 Northeast Region
 NOAA, NMFS, Narragansett, R.I.

Scale: N.T.S.
 Date: 10/27/88
 Drawn by: VBN

NETC No. 35 Standard Survey Trawl (80' - 80')
 Net Plan
 Drawing Number

Portuguese Polyvalent Otter Doors

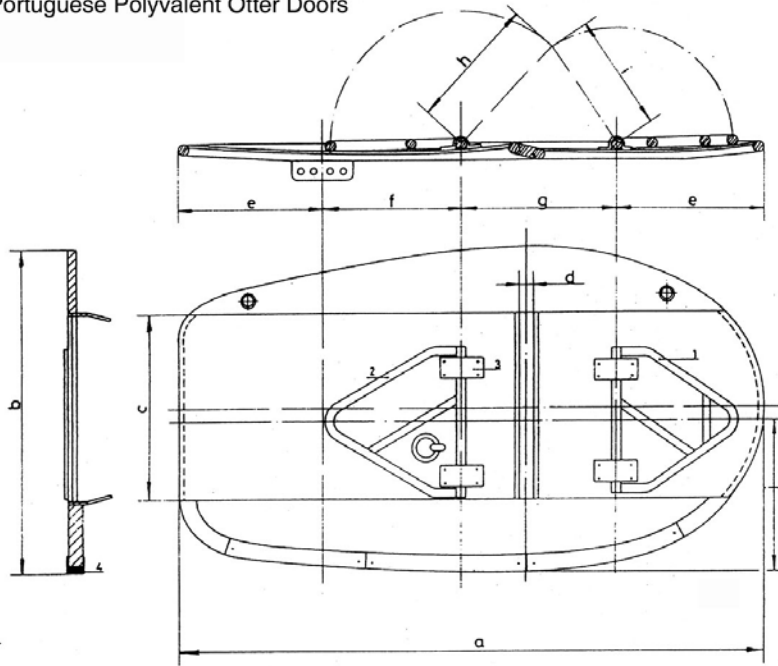

EURONETE TRAWL DOORS - METALLIC

Ref.	Weight Kg.	Weight inside water	Surface m ²	Sizes in mm									
				a	b	c	d	e	f	g	h	i	j
124	450	261	2,84	2530	1350	810	60	632,5	592,5	672,5	610	540	630

- REPLACEABLE PIECES:
- 1 - Front bracket.
 - 2 - Back bracket
 - 3 - Brackets clamps
 - 4 - Set of 3 steel shoes
 - 5 - All bolts

ATTACHMENT B
Specifications for Construction of NEFSC
Winter Survey Flat Net Trawl
(60-80)

Body of the net

The dimensions of the net sections are given in the accompanying net plans. The webbing for the upper and lower wings, square, and bellies is made of 4 mm dark green polyethylene 16 carrier braided twine. The webbing is depth stretched, heat stabilized and single selvedge. The mesh size is 5.5 in. knot center to knot center.

The net sections are joined together by sewing a half mesh row of double 3 mm Euro-flex twine green and white in color for easy identification of sections.

The top and bottom sections of the net are joined together at their sides by a gore or laceage that gathers four meshes from each of the top and bottom sections. These are seized every 18 inches and wrapped in between the seizings using single # 120 nylon twine.

Dog-ear meshes are woven onto the top and bottom wings with single 8 mm nylon twine.

Gore lines

Gore lines are 3/4 in. diameter polyplus Dacron ropes that are tied to the eye of the headrope and extend to the end of the belly, where another eye splice is made. The codend has a separate 3/4 in. gore line, which extends to two meshes from the aft end and is tied into the eye splice from the main gore line with a fisherman's bend. The gore lines are made slightly shorter than the laceage and are seized to it at intervals of approximately 18 inches with single #120 nylon.

Footrope

A 120-foot piece of 3/4 in. polyplus Dacron rope is used to construct the hanging line. The hanging line is marked in the middle at 60'. On either side of the middle mark, five-foot marks are made to hang the corners where the first dog-ear for each wing will be attached. Therefore, a total of 10' is used to attach the lower belly. From each corner, mark 42' towards the door end. The last dog is attached onto the mark of the lower wing. After the 42' mark on each side, a five inch eye is made by pinching the rope and tying it off with #120 nylon twine. The next section of rope immediately after the eye is measured and marked at seven feet and used for the up-and-down line, which is tied into the headrope eye by a clove hitch and is seven feet in length from eye to eye, not including the eyes.. The extra line is seized to the up and down line and used for future repairs. The hanging line is seized to the lower wings and belly using yorkings with a hitch.

Belly Lines

The belly lines are two strengthening lines on the bottom belly made out of 5/8 in. polyplus Dacron rope. They are seized to the hanging line at the corner and run out and back to the gore line on the bar of the belly webbing, where they are seized to the webbing and to the gore line.

Headrope

The headrope is made of 7/8 in. diameter combination manila/wire rope. It consists of three 20' sections. All sections have eyes swedged at each end without thimbles. The sections are joined by 1/2 in. marine grade hammerlocks.

Hanging

Dog-ear meshes on the upper and lower wings are hung to both the headrope and footrope with seizings of single #120 braided nylon twine. The square and lower belly selvedge meshes are evenly hung on the headrope and footrope with single #120 braided nylon twine. Hanging lengths for the headrope and footrope are shown on the attached plan.

Floats

Attached to the headrope are 13 eight-inch diameter spherical gray aluminum floats with double beackets. The floats are arranged with five evenly spaced in the bosom or center section of the net (the square), and four each evenly spaced on the wings, starting at 1.5' from the door end eye. Each float is attached with a 5/8 in. polyplus Dacron rope that is threaded through the beackets, and then seized to the backside of the headrope with #120 braided nylon twine.

Fishing line (Combination wire)

The Fishing line is made up of three lengths of 7/8 in. diameter combination manila/wire rope with swedged eyes. The wing sections are 32', and the center section is 16'; lengths include the swedged eyes. They are joined with 1/2 in. hammerlocks. The Fishing line is seized to the hanging line at evenly spaced intervals with double #54 braided nylon twine. The seizings are centered between the dog chains that connect the sweep at 1.5' intervals (approximately 12 links). The excess hanging line is evenly spread out in equal sized bights.

Sweep

The sweep consists of three lengths of chain with loosely spaced cookies. The center section of the sweep consists of 16' of 5/8 in (75 links) Trawlex chain with 6.5 in. rubber cookies with approximately 2 3/8 in. center holes. The wing sections are made from 1/2 in. Trawlex chain and are each 32' (183 links) in length, with 4.5 in. rubber cookies that have a center hole of approximately 2 1/8 in. The sections are joined with 5/8 in. hammerlocks. The rubber cookies are made from stamped rubber truck tires. The stamping process results in the cookies having varying diameters of $\square \frac{1}{2}$ in.. The sweep is connected to the Fishing line by droppers, which consist of a 5/16 in. shackle, one 5/16 in. chain link, and one 5/16 in. steel ring of three-inch inner diameter. The shackle is connected to the sweep, and the Fishing line is threaded through the rings. The droppers are spaced 18 in. apart (10 links) on the sweep starting one link back from the end of the sweep. There are a total of 47 droppers in the construction of the sweep.

1/2 in. chain extends nine feet down each wing starting eight links back from the end of the sweep. There are eight links between attachments and there are five attachments in the span. The mouth of the trawl has 23' of 1/2 in. tickler chain hung evenly on each side of the center of the sweep, with approximately 15 links between shackles for each bite.

Liners

The top belly is lined starting 30 meshes up from the bottom and sewn down the sides to the codend. The dimensions of the liner pieces are 30' (5 fathom) [top] x 21' (3.5 fathoms) deep x 18' (3 fathoms) [bottom]. The liner material is #147 knotless white nylon webbing, with a mesh size of 1/2 in.

The top belly liner is reinforced along the leading edge and down each side by gathering and seizing a 1/2 in. diameter roll. This roll is then seized to #18 braided nylon twine, used as a strengthener. The #18 strengthener is knotted with an overhand knot every eight-inch. The strengthened liner is then seized into the belly one mesh in from the gore. The remaining belly liner, at the start of the codend, is then left unseized and overlaps the codend liner.

The codend is lined with #147 knotless white nylon webbing, with a mesh size of 1/2 in. and is 15' (2.5 fathoms) across by 24' (4 fathoms deep).

The codend liner is reinforced along the forward edge by gathering and seizing a 1/2 in. roll. #18 braided nylon twine, with overhand knots every eight inch, is seized to the roll of liner material. This same technique is used to make a gore with the two edges of the liner. A false gore is then made opposite this by seizing another piece of the knotted #18 thread to the liner. The codend liner is attached by seizing to the codend starting at one and one half meshes from the top. The liner is seized at each codend mesh around the interior circumference of the codend, and then hangs down from this point

Codend

The webbing in the codend is double mesh, 5.5 inches measured between the center of the knots; depth stretched, and heat stabilized. The twine used to construct the webbing is made from 16-carrier dark green polyethylene braided twine, with a diameter of 5 mm.

The codend measures 36 meshes deep by 25 meshes across. There are five meshes gathered on each side in each gore. The codend is constructed from one panel of 60 meshes wide by 36 meshes deep.

Rings are hung at the end of the codend at a ratio of one ring for every three meshes. The rings are made from 5/16 in. galvanized steel, two inches ID.

Legs & Ground cables

The upper legs are constructed from five fathoms of 5/8 in. wire. The lower legs are constructed from five fathoms of 1/2 in. chain. The ground cables are constructed from 30 fathoms of 7/8 in. wire. The backstraps are 9'6" of 1/2" Trawlex and are attached in the last aft hole closest to the aft end of the door.

Doors

The doors are Portuguese Polyvalent 450 kg (see door specifications).

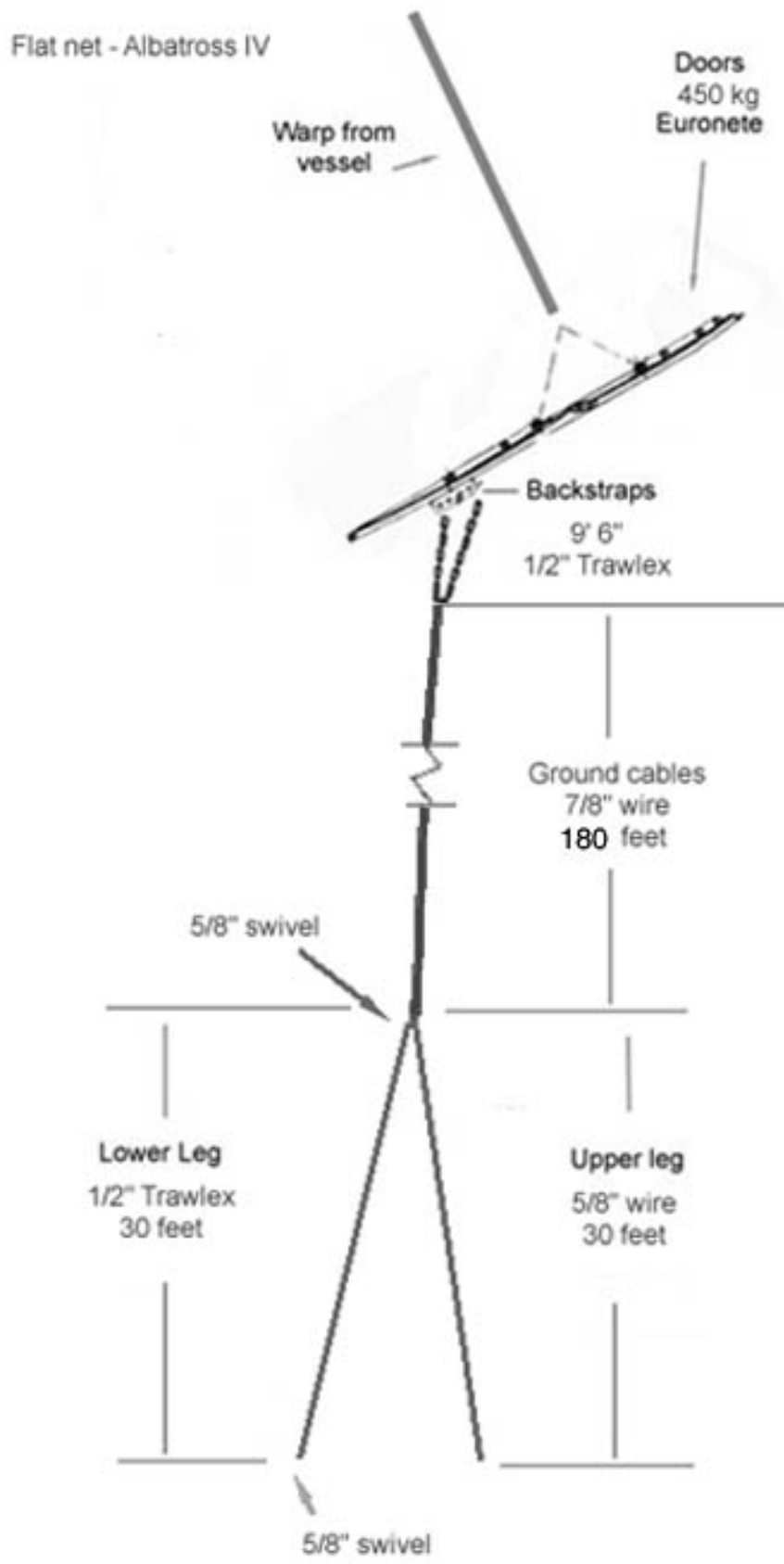

Flat net - Delaware II

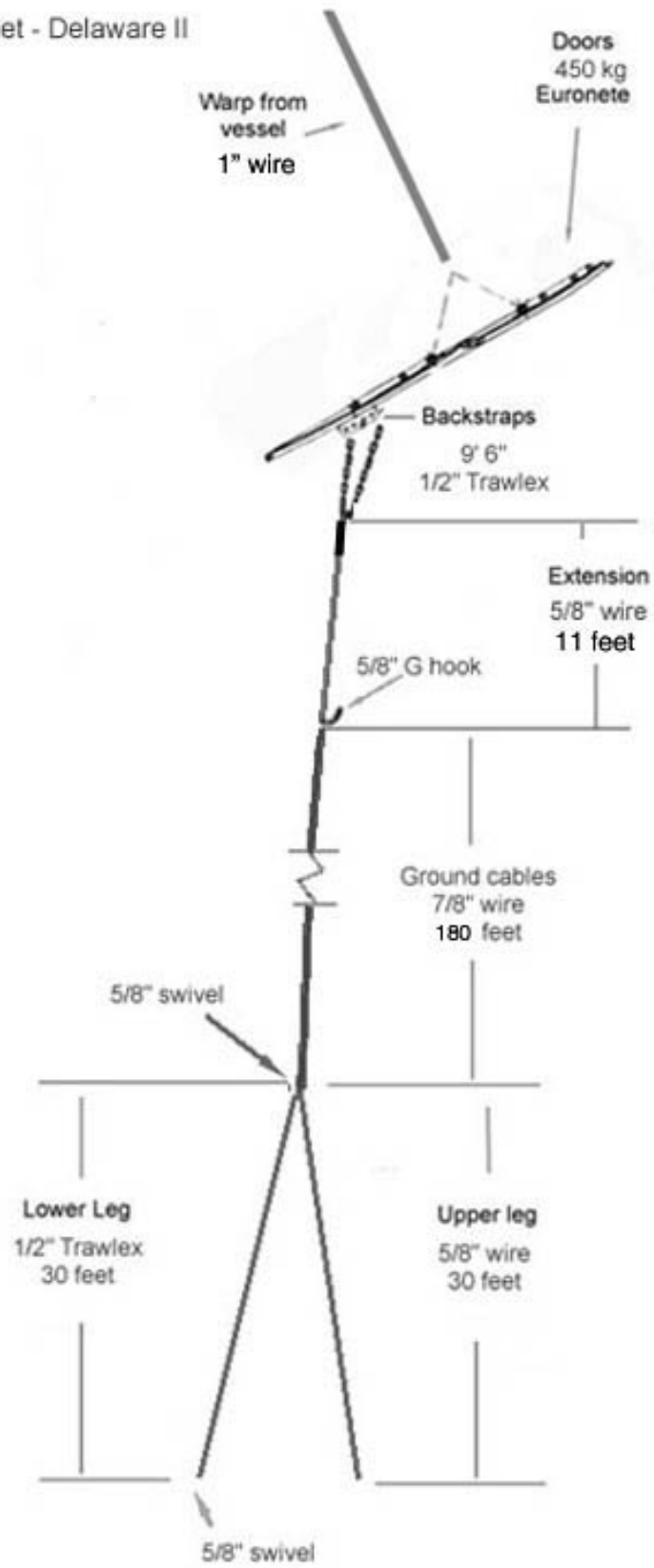

NOAA/NMFS Flat Net Specifications:

Net material

Size	5.5 in.
Material	4 mm 16 carrier braided Poly
Color	Dark Green

Headrope

Length (including eyes)	61' (three 20' sections + 6 in. past the eye)
Material (i.e. nylon, poly)	Combination manila/wire rope
Size (diameter)	7/8 in.
Other	Joined with paten links

Footrope

Length (including eyes)	80' - See spec on page 174
Material (i.e. nylon)	Poly Dacron
Size (diameter)	5/8 inch
Other	See spec on page 174

Ground Gear

Top leg -	
Size of wire	5/8 in. wire
Length of wire	30 feet
Other	

Bottom leg -

Size of wire / chain	1/2 in. Trawlex chain
Length of wire / chain	30 feet
Other	

Ground cables –

Size of wire	7/8 in. wire
Length of wire / chain	30 fathom
Other	

Gore Lines / belly strengthener

Material	5/8 poly-plus Dacron rope
----------	---------------------------

Flotation

Number of floats	13
Size of floats	8 in.
Buoyancy of floats	Aluminum (Uncertain of buoyancy)
Placement of floats	Placement shown on page 175

Sweep Design

Size of chain Middle = 5/8 in. Trawlex
Outers = 1/2 in. Trawlex
Length of wire Middle = 16 feet
Outers = 32 feet
Number of droppers or attachments Number shown on page 174
Placement of droppers or attachment Placement shown on page 174

Cookies

Number Variable
Size Middle = 6.5 in.
Outers = 4.5 in.

Chain Sweep

Link size 1/2 in. standard chain
Number of links
Wing sections 82
Center section 174
Attachments See figure on page 174

Codend

Material 5 mm Double mesh green poly 5.5 in.
Number of meshes deep 36
Number of meshes in circumference 60 = 25 top + 25 bottom and 5 in each gore
Liner Starts one and a half meshes back from the attachment to bellies. Made from #147 knotless white nylon webbing, with a mesh size of 1/2 in.

Lower Belly

Number of meshes deep 80.5
Tapers See drawing on page 176

SWEEP CONFIGURATION

(Drawing not to scale)

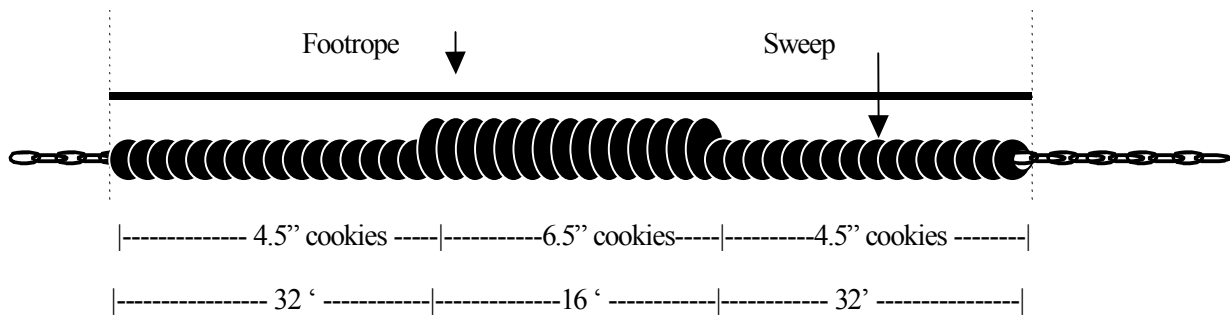

CHAIN SWEEP CONFIGURATION

(Drawings not to scale)

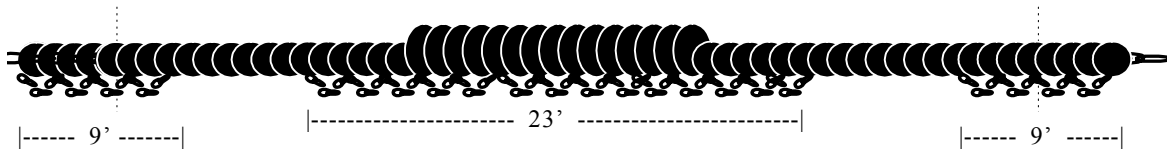

Chain is attached as follows:

Wing – the first attachment is 8 links (L) back from the end of the sweep. The next attachments are 9 L, 8 L, 8 L, 8 L.

Center – the first attachment is 15 L, then 14 L, all others are 15 L. There are a total of 15 attachments

DROPPER CONFIGURATION



Droppers are attached as follows:

The first dropper is attached 4 links back from the door end of the sweep. Thereafter, there is 10 links between droppers. There are 47 attachments.

HEADROPE CONFIGURATION

(Drawing not to scale)

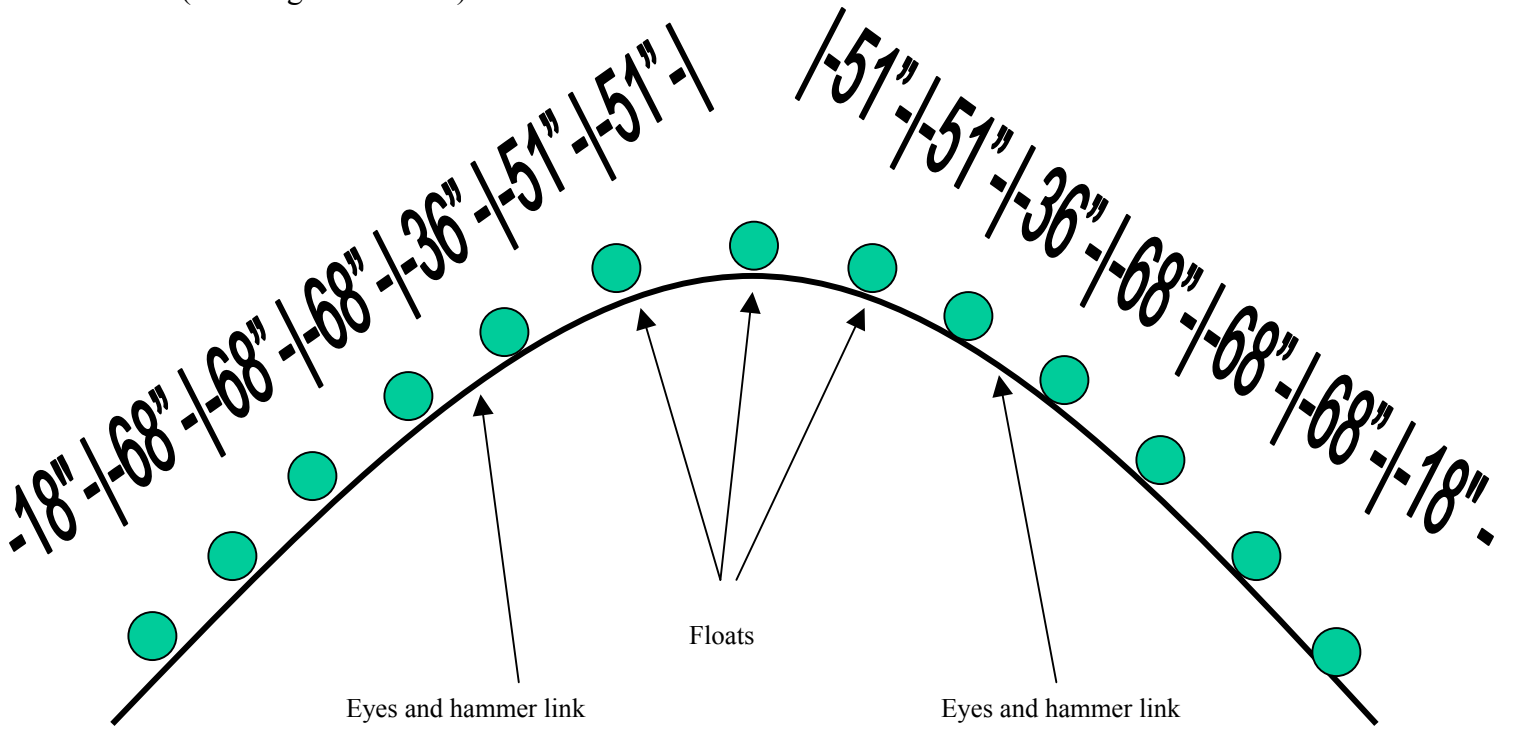

Total length of headrope = 61'2"

NET CONFIGURATION:

(Drawing not to scale)

Tapers:

Lower Wing = 1M, 10B, 1M, 10B, 1M, 10B, 1M, 9B.

Upper Wing = 3M, 1B

Square = 1M, 4B

Belly = 1M, 4B, 1M, 3B, 1M, 3B,

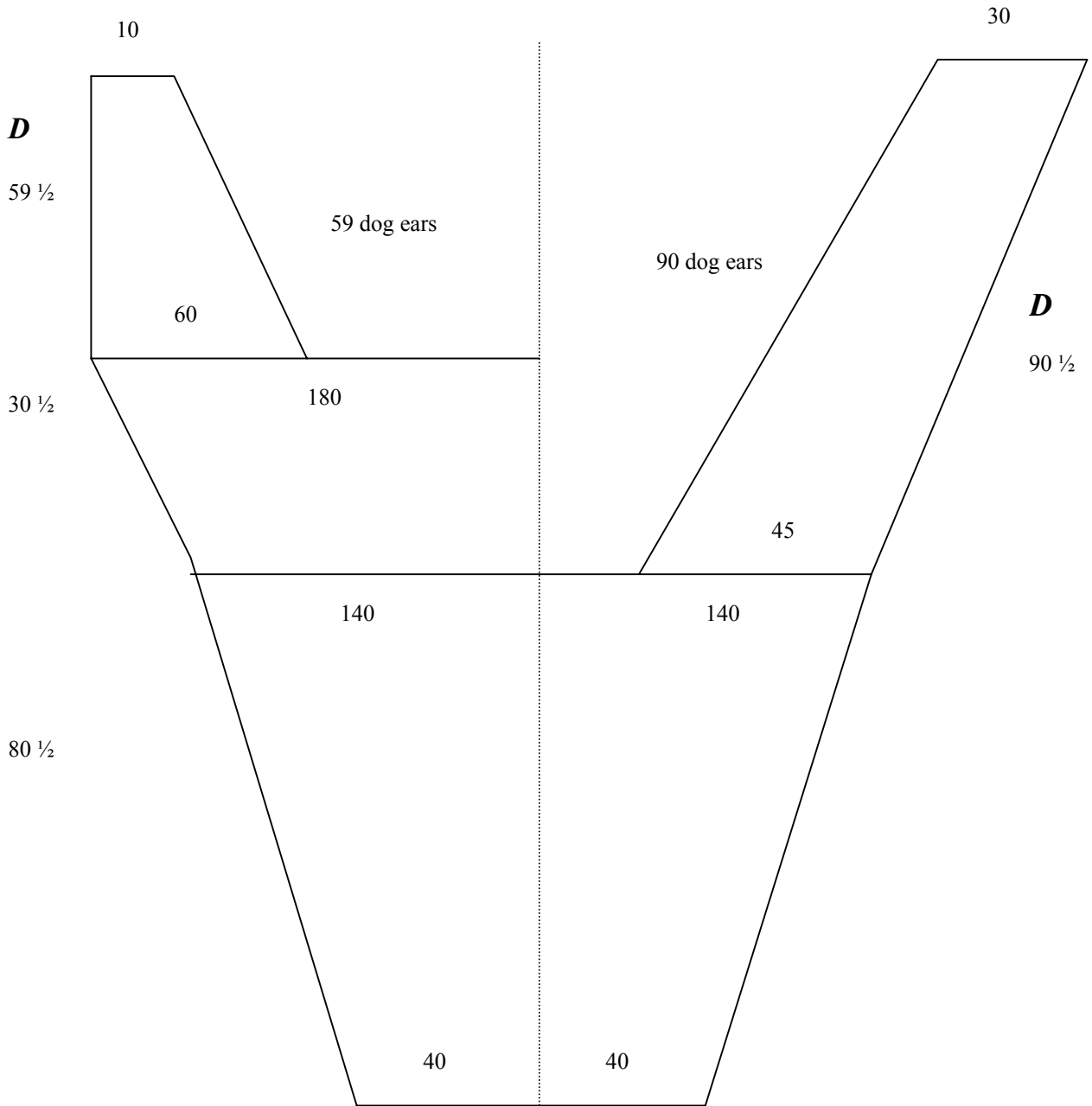

Portuguese Polyvalent Otter Doors

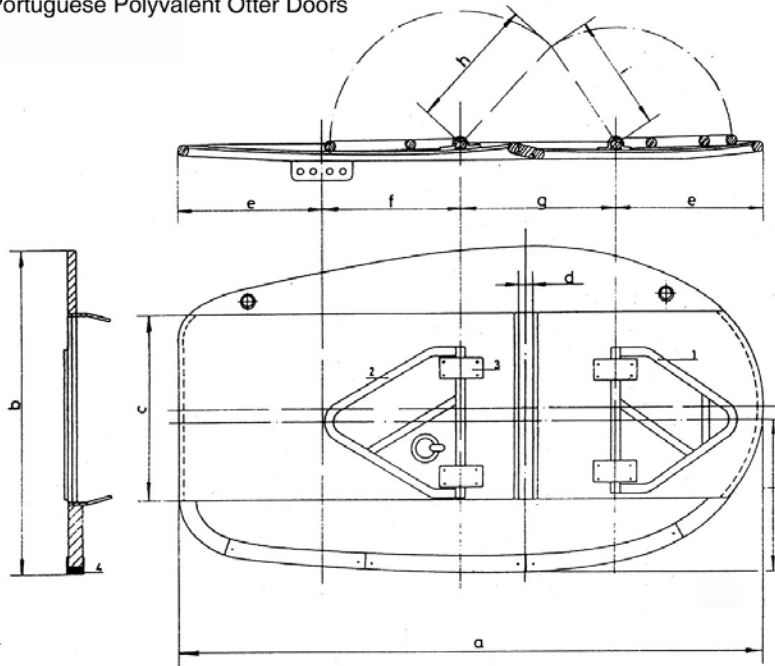

EURONETE TRAWL DOORS - METALLIC

Ref.	Weight Kg.	Weight inside water	Surface m ²	Sizes in mm									
				a	b	c	d	e	f	g	h	i	j
124	450	261	2,84	2530	1350	810	60	632,5	592,5	672,5	610	540	630

- REPLACEABLE PIECES:**
- 1 - Front bracket.
 - 2 - Back bracket
 - 3 - Brackets clamps
 - 4 - Set of 3 steel shoes
 - 5 - All bolts

ATTACHMENT C

Yankee 36 Checklist	Roller Net	Date ____/____/____	Net number:
Gear shed Inspectors:			
Woods Hole Inspector(s):			
	OK	Problems/Comments	FIXED
Up and Down line: Check for wear and make sure hangings are not bunched up. Also, check seizing at fishing line. The length including the eye should be 7 feet (6 ½' without the eye).			
Wings: Check dog-ear meshes to ensure they are hung evenly allowing for no "pockets" of twine. This allows the wings and floats to rise properly.			
Headrope: Check for wear or brittle strands of wire. Also, check eye splices for flattened strands where the wire's core is exposed or wire is broken.			
Float line: Check to ensure the line is secured and snug to the headrope and the floats do not have excessive play.			
Floats: Count floats to make sure all 36 are evenly spaced (20 located in the center and 8 on each wing). Check floats for cracks and flooding.			
Droppers: From wing end to wing end there are 42 dropper chains located in the sweep section. Make sure the small chain is not stretched, distorted, and that the rings have not broken off or split.			
Footrope: Check to ensure the center mark of the footrope is hung in the center of the roller sweep. Each corner mark is hung 5 feet from the center back towards the door end.			

Net number:	OK	Problems/Comments	FIXED
<p>Footrope Seizings: Check seizings for wear and to ensure the rings are evenly spaced and the seizings are tight. They should not slip.</p>			
<p>Fishing line (combo) Check for wear at eye splices and where it passes through dropper chain rings.</p>			
<p>Sweep: Check to ensure the correct amount of rollers (19) and spacers (38) are in use. Also, check for wear on rollers. After a hang, check rollers and metal sleeves for damage. Check the length of the wing end sections, these should measure 22 ½'.</p>			
<p>Square: Check to ensure the center of the square is hung in the center of the headrope. Count the meshes across from one wing corner to the other wing corner. There should be 60 meshes across (30 to the middle).</p>			
<p>Upper Belly: Check upper belly liner to ensure it is attached properly. It should start 35 meshes up from the end of the top belly where it joins the cod end. It is then sewn down each side one mesh in from the gore.</p>			
<p>Bottom Belly: Check for wear in the bosom section of bottom belly close to the roller sweep. Also, check for bunching of twine in the bosom area after a hang.</p>			
<p>Liners: Check liner for holes. Check to ensure that liner is of proper length. It should hang a minimum of three feet out of the bottom of the bag when it is empty.</p>			
<p>Mesh sizes: Periodically check the mesh size of the Standard #36 Bottom Trawl (body is 5-inch mesh and cod end is 4 1/2 inch). Look for deformity, slipped knots, and meshes made oversize or undersize during repair work.</p>			

Net number:	OK	Problems/Comments	FIXED
Gore Lines: Gore lines should be checked for wear and ensure there are no excess pockets of twine.			
Cod end: Check for appropriate amount of rings (minimum of 26, maximum of 30). Check length and width of codend. Codend should measure 50 meshes deep by 35 meshes across not including meshes in the gore.			
Doors: Check to make sure the shoes have an edge and are not rounded. Check the stops on the brackets to make sure they are present and there is no vertical movement of the brackets .			
Backstraps: Check to make sure backstraps are attached to the last hole on the door, are nine feet six inches long and that three swivels are present, two at the attachment to the door and one between the legs (or extension on the DE II) and the backstraps. Check the condition of the chain to ensure that it has not worn to a point where it is likely to break.			
Legs: Check to make sure all legs measure 30 feet and are constructed from 5/8 inch wire. This task is usually performed on the vessel.			
Extension (DE II only): Check to make sure both extensions measure 11 feet.			
After a Hang: If it is possible to determine what part of the net was caught, check the surrounding area for torn mesh, broken lines and combination wires, or knots that may have slipped. Otherwise, check the gear for signs of damage and pay close attention to the sweep, wings, and lower belly.			
Other Remarks			

ATTACHMENT D

Survey Trawl Condition Report

Cruise Number	<input type="text"/>	Date	<input type="text"/>
---------------	----------------------	------	----------------------

Net Number	<input type="text"/>	Used	<input type="text"/>	Unused	<input type="text"/>	Damaged	<input type="text"/>
Received Condition							

Work / Repairs

Bundled Condition

Net Number	<input type="text"/>	Used	<input type="text"/>	Unused	<input type="text"/>	Damaged	<input type="text"/>
Received Condition							

Work / Repairs

Bundled Condition

Net Number	<input type="text"/>	Used	<input type="text"/>	Unused	<input type="text"/>	Damaged	<input type="text"/>
Received Condition							

Work / Repairs

Bundled Condition

Door Number	<input type="text"/>	Used	<input type="text"/>	Unused	<input type="text"/>	Damaged	<input type="text"/>
Received Condition							

Returned Condition

Door Number	<input type="text"/>	Used	<input type="text"/>	Unused	<input type="text"/>	Damaged	<input type="text"/>
Received Condition							

Returned Condition

Reporter

Please return this form to Ace Nelson with a copy to Henry Milliken at the conclusion of each leg

ATTACHMENT E

NEFSC 36 YANKEE NET WIRE OUT TO DEPTH SCOPE											
<i>AMOUNT OF WIRE MEASURED FROM THE TRAWL DOORS TO THE SURFACE</i>											
DEPTH WIRE OUT		DEPTH WIRE OUT		DEPTH WIRE OUT		DEPTH WIRE OUT		DEPTH WIRE OUT		DEPTH WIRE OUT	
M	M	M	M	M	M	M	M	M	M	M	M
<18	75	77	231	137	411	197	493	257	643	317	793
18	72	78	234	138	414	198	495	258	645	318	795
19	76	79	237	139	417	199	498	259	648	319	798
20	80	80	240	140	420	200	500	260	650	320	800
21	84	81	243	141	423	201	503	261	653	321	803
22	88	82	246	142	426	202	505	262	655	322	805
23	92	83	249	143	429	203	508	263	658	323	808
24	96	84	252	144	432	204	510	264	660	324	810
25	100	85	255	145	435	205	513	265	663	325	813
26	104	86	258	146	438	206	515	266	665	326	815
27	108	87	261	147	441	207	518	267	668	327	818
28	84	88	264	148	444	208	520	268	670	328	820
29	87	89	267	149	447	209	523	269	673	329	823
30	90	90	270	150	450	210	525	270	675	330	825
31	93	91	273	151	453	211	528	271	678	331	828
32	96	92	276	152	456	212	530	272	680	332	830
33	99	93	279	153	459	213	533	273	683	333	833
34	102	94	282	154	462	214	535	274	685	334	835
35	105	95	285	155	465	215	538	275	688	335	838
36	108	96	288	156	468	216	540	276	690	336	840
37	111	97	291	157	471	217	543	277	693	337	843
38	114	98	294	158	474	218	545	278	695	338	845
39	117	99	297	159	477	219	548	279	698	339	848
40	120	100	300	160	480	220	550	280	700	340	850
41	123	101	303	161	483	221	553	281	703	341	853
42	126	102	306	162	486	222	555	282	705	342	855
43	129	103	309	163	489	223	558	283	708	343	858
44	132	104	312	164	492	224	560	284	710	344	860
45	135	105	315	165	495	225	563	285	713	345	863
46	138	106	318	166	498	226	565	286	715	346	865
47	141	107	321	167	501	227	568	287	718	347	868
48	144	108	324	168	504	228	570	288	720	348	870
49	147	109	327	169	507	229	573	289	723	349	873
50	150	110	330	170	510	230	575	290	725	350	875
51	153	111	333	171	513	231	578	291	728	351	878
52	156	112	336	172	516	232	580	292	730	352	880
53	159	113	339	173	519	233	583	293	733	353	883
54	162	114	342	174	522	234	585	294	735	354	885
55	165	115	345	175	525	235	588	295	738	355	888
56	168	116	348	176	528	236	590	296	740	356	890
57	171	117	351	177	531	237	593	297	743	357	893
58	174	118	354	178	534	238	595	298	745	358	895
59	177	119	357	179	537	239	598	299	748	359	898
60	180	120	360	180	540	240	600	300	750	360	900
61	183	121	363	181	543	241	603	301	753	361	903
62	186	122	366	182	546	242	605	302	755	362	905
63	189	123	369	183	549	243	608	303	758	363	908
64	192	124	372	184	460	244	610	304	760	364	910
65	195	125	375	185	463	245	613	305	763	365	913
66	198	126	378	186	465	246	615	306	765	366	915
67	201	127	381	187	468	247	618	307	768		
68	204	128	384	188	470	248	620	308	770		
69	207	129	387	189	473	249	623	309	773	M	SCOPE
70	210	130	390	190	475	250	625	310	775	<18	75M
71	213	131	393	191	478	251	628	311	778	18-27	4:1
72	216	132	396	192	480	252	630	312	780	28-183	3:1
73	219	133	399	193	483	253	633	313	783	≥184	2.5:1
74	222	134	402	194	485	254	635	314	785		
75	225	135	405	195	488	255	638	315	788		
76	228	136	408	196	490	256	640	316	790		

Version 3.2

ATTACHMENT F

Example of station allocation to strata:

Stratum	# Stations			Stratum	# Stations		
	Spring survey	Fall survey	Winter survey		Spring survey	Fall survey	Winter survey
1010	7	7	8	3060	1	1	0
1020	7	7	8	3070	2	2	0
1030	2	2	4	3080	2	2	0
1040	1	1	2	3090	1	1	0
1050	5	5	7	3100	2	2	0
1060	8	8	12	3110	2	2	0
1070	2	2	4	3120	1	1	0
1080	1	1	2	3130	2	2	0
1090	5	5	7	3140	2	2	0
1100	8	8	12	3150	1	1	0
1110	2	2	4	3160	2	2	0
1120	1	1	2	3170	2	2	0
1130	9	9	9	3180	1	1	0
1140	3	3	4	3190	2	2	0
1150	1	1	2	3200	2	2	0
1160	10	10	10	3210	1	1	0
1170	3	3	3	3220	2	2	0
1180	1	1	2	3230	2	2	0
1190	9	9	9	3240	2	2	0
1200	6	6	6	3250	2	2	0
1210	4	4	4	3260	2	2	0
1220	4	4	4	3270	1	1	0
1230	5	5	5	3280	2	2	0
1240	6	6	9	3290	2	2	0
1250	4	4	0	3300	1	1	0
1260	5	5	0	3310	2	2	0
1270	4	4	0	3320	2	2	0
1280	7	7	0	3330	1	1	0
1290	8	8	0	3340	2	2	0
1300	3	3	0	3350	2	2	0
1330	4	4	0	3360	2	2	0
1340	6	6	0	3370	2	2	0
1351	2	2	0	3380	2	2	0
1360	8	8	0	3390	1	1	0
1370	5	5	0	3400	2	2	0
1380	5	5	0	3410	2	2	0
1390	5	5	0	3420	1	1	0
1400	3	3	0	3430	2	2	0
1610	3	3	7	3440	2	2	0
1620	2	2	3	3450	2	2	0
1630	2	2	4	3460	2	2	0
1640	1	1	2	3550	5	5	0
1650	7	7	12	3560	1	1	0
1660	3	3	4	3580	1	1	0
1670	2	2	4	3590	1	1	0
1680	1	1	2	3600	2	2	0
1690	6	6	9	3610	2	2	0
1700	4	4	5	3630	1	1	0
1710	2	2	4	3640	1	1	0
1720	1	1	2	3650	1	1	0
1730	5	5	5	3660	2	2	0
1740	4	4	5	7510	2	2	0
1750	2	2	4	7520	2	2	0
1760	1	1	2	8500	4	4	0
3020	2	2	0	8510	2	2	0
3030	1	1	0	8520	2	2	0
3040	2	2	0				
3050	2	2	0				
				Sum all	332	332	213

ATTACHMENT G

Gulf of Maine

NEFSC Finfish Strata (inshore)

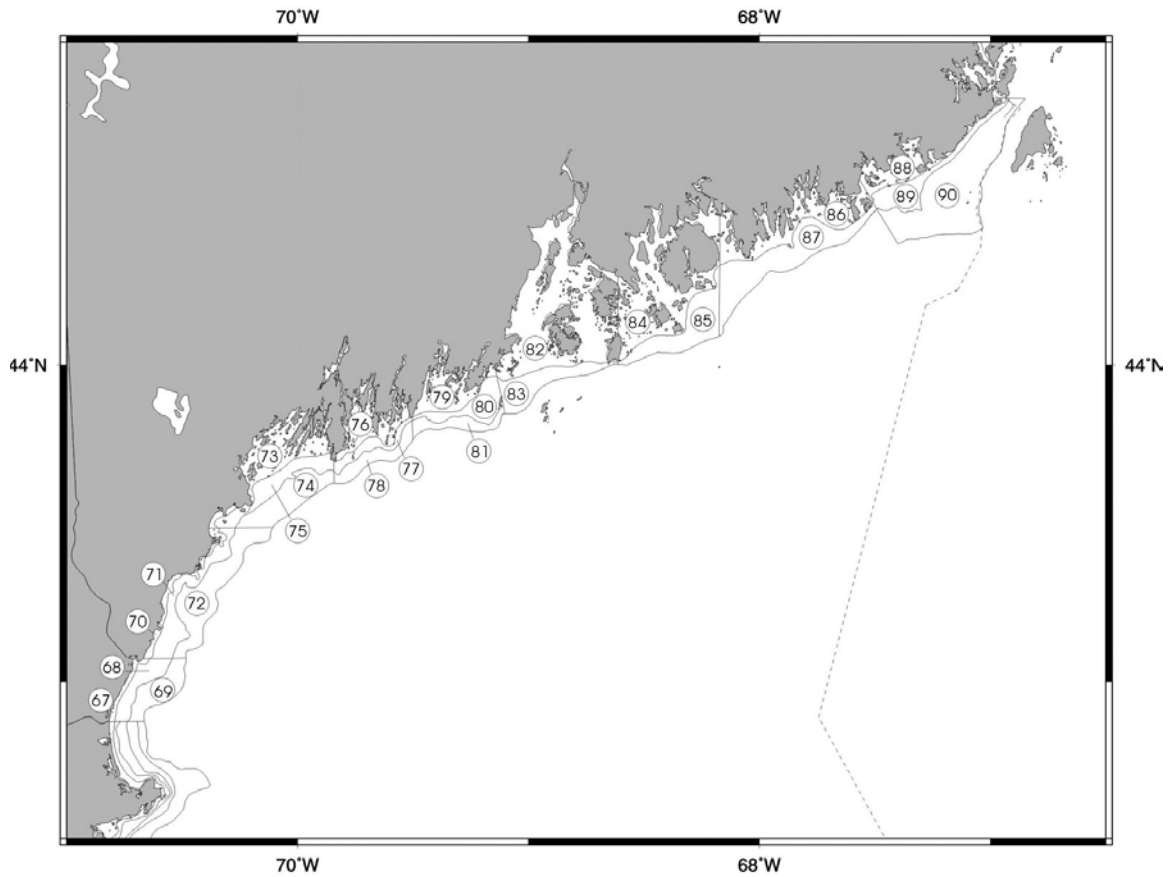

<u>Stratum</u>	<u>Sq. Nm.</u>	<u>Depth (m)</u>	<u>Stratum</u>	<u>Sq. Nm.</u>	<u>Depth (m)</u>
69	57	27 - 55	80	58	20 - 55
70	10	0 - 9	81	38	20 - 55
71	72	9 - 27	82	209	0 - 20
72	129	27 - 55	83	80	20 - 55
73	31	0 - 9	84	137	0 - 20
74	68	9 - 27	85	106	20 - 55
75	76	27 - 55	86	60	0 - 20
76	20	0 - 20	87	153	10 - 55
77	34	20 - 55	88	34	0 - 20
78	44	20 - 55	89	59	20 - 55
79	34	0 - 20	90	125	55 - 110

Mass Bay to Long Island

NEFSC Standard Bottom Trawl Survey Inshore Strata



<u>Stratum</u>	<u>Sq. Nm.</u>	<u>Depth (m)</u>	<u>Stratum</u>	<u>Sq. Nm.</u>	<u>Depth (m)</u>
1	44	0 - 18	51	117	9 - 18
2	62	18 - 27	52	521	9 - 18
3	13	0 - 9	53	142	0 - 9
4	26	9 - 18	54	277	9 - 18
5	62	18 - 27	55	495	18 - 27
6	26	0 - 9	56	57	9 - 27
7	35	9 - 18	57	34	0 - 9
8	150	18 - 27	58	88	9 - 18
9	40	0 - 9	59	93	18 - 27
10	48	9 - 18	60	126	27 - 46
11	242	18 - 27	61	133	46 - 55
45	170	18 - 27	62	62	0 - 9
46	273	18 - 27	63	78	9 - 18
47	45	0 - 18	64	90	18 - 27
48	113	0 - 9	65	75	27 - 46
49	299	0 - 9	66	151	46 - 55
50	15	0 - 9	91	941	0 - 9

Long Island to Delmarva

NEFSC Standard Bottom Trawl Survey Inshore Strata

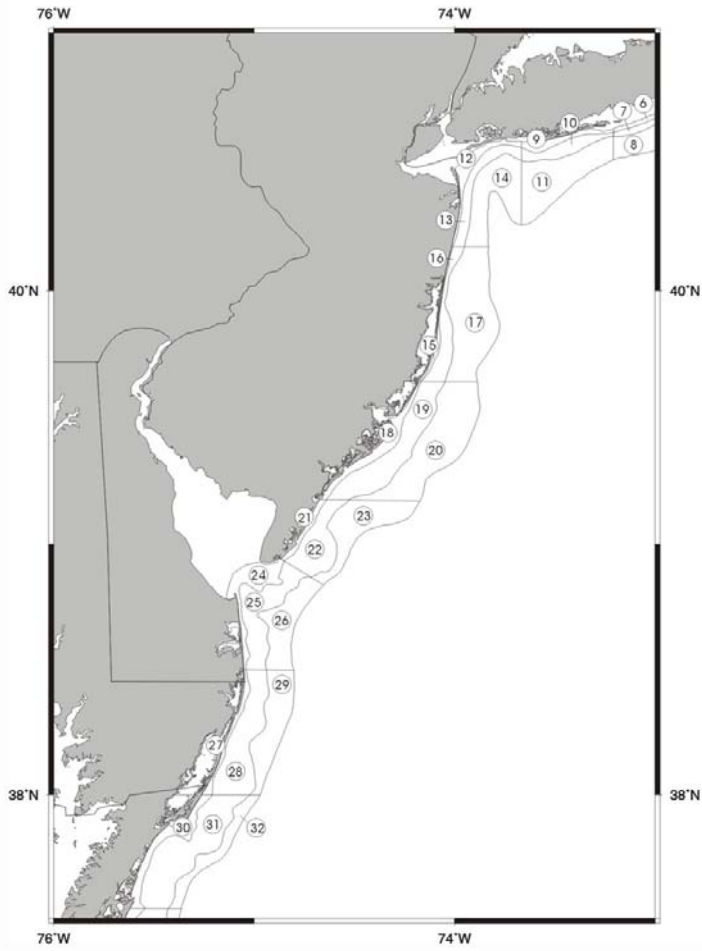

Stratum	Sq. Nm.	Depth (m)
6	26	0 - 9
7	35	9 - 18
8	150	18 - 27
9	40	0 - 9
10	48	9 - 18
11	242	18 - 27
12	44	0 - 9
13	88	9 - 18
14	110	18 - 27
15	22	0 - 9
16	62	9 - 18
17	238	18 - 27
18	97	0 - 9
19	216	9 - 18
20	356	18 - 27
21	22	0 - 9
22	154	9 - 18
23	167	18 - 27
24	53	0 - 9
25	172	9 - 18
26	154	18 - 27
27	35	0 - 9
28	220	9 - 18
29	185	18 - 27
30	75	0 - 9
31	299	9 - 18
32	106	18 - 27

Delmarva to Cape Fear

NEFSC Standard Bottom Trawl Survey Inshore Strata

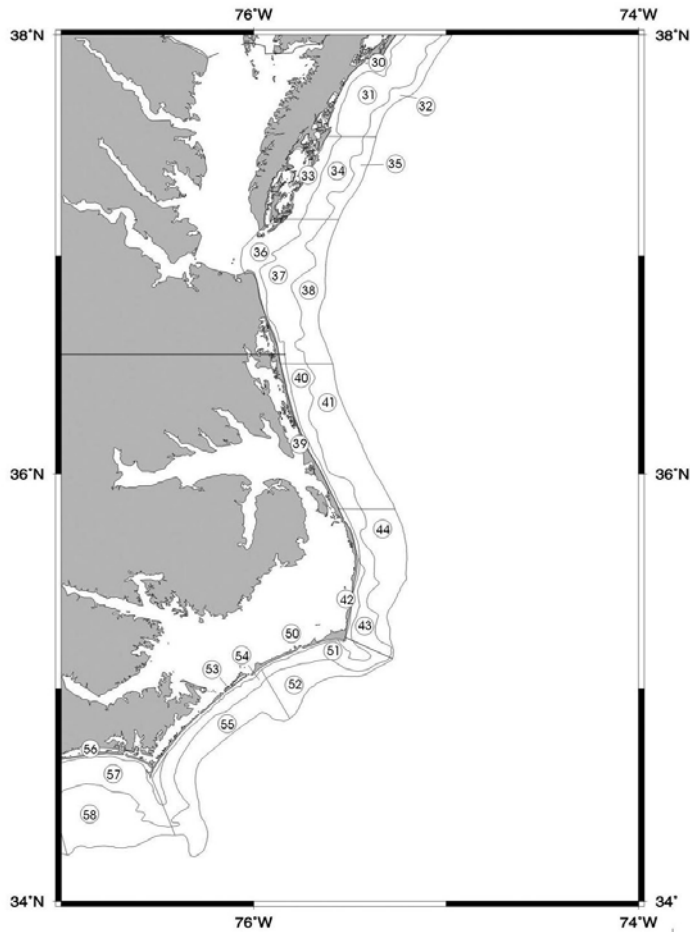

<u>Stratum</u>	<u>Sq. Nm.</u>	<u>Depth (m)</u>
30	75	0 - 9
31	299	9 - 18
32	106	18 - 27
33	92	0 - 9
34	167	9 - 18
35	88	18 - 27
36	119	0 - 9
37	312	9 - 18
38	224	18 - 27
39	35	0 - 9
40	176	9 - 18
41	383	18 - 27
42	40	0 - 9
43	172	9 - 18
44	304	18 - 27
50	48	2 - 11
51	128	9 - 22
52	163	9 - 35
53	53	2 - 13
54	198	7 - 22
55	352	15 - 33
56	26	2 - 13
57	304	9 - 22
58	400	6 - 31

Gulf of Maine

NEFSC Standard Bottom Trawl Survey Offshore Strata

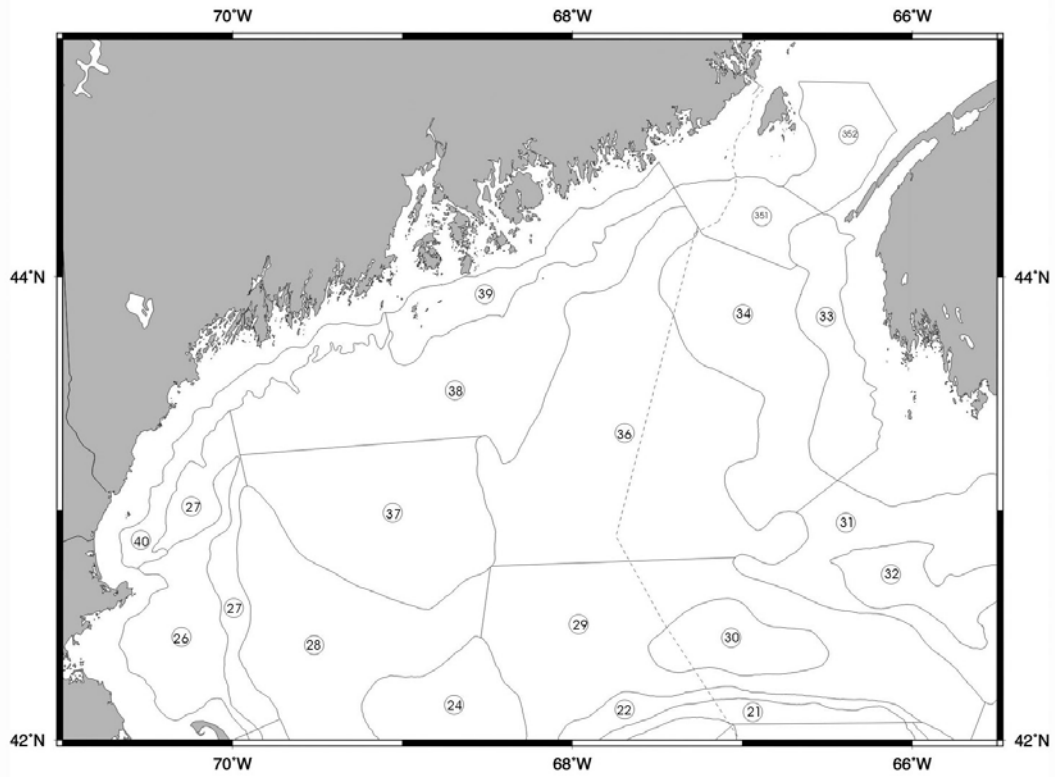

<u>Stratum</u>	<u>Sq. Nm.</u>	<u>Depth (m)</u>	<u>Stratum</u>	<u>Sq. Nm.</u>	<u>Depth (m)</u>
21	424	55 - 110	33	861	55 - 110
22	454	110 - 183	34	1766	110 - 183
24	2569	110 - 183	351	533	110 - 183
26	1014	55 - 110	352	600	110 - 183
27	720	110 - 183	36	4069	> 183
28	2249	> 183	37	2108	110 - 183
29	3245	> 183	38	2560	110 - 183
30	619	> 183	39	730	55 - 110
31	1875	110 - 183	40	578	55 - 110
32	655	55 - 110			

Georges Bank

NEFSC Standard Bottom Trawl Survey Offshore Strata



Stratum	Sq. Nm.	Depth (m)	Stratum	Sq. Nm.	Depth (m)	Stratum	Sq. Nm.	Depth (m)
9	1522	27 - 55	17	360	110 - 183	25	390	27 - 55
10	2722	55 - 110	18	172	> 183	26	1014	55 - 110
11	622	110 - 183	19	2454	27 - 55	27	720	110 - 183
12	176	> 183	20	1221	27 - 55	28	2249	> 183
13	2374	55 - 110	21	424	55 - 110	29	3245	> 183
14	656	110 - 183	22	454	110 - 183	30	619	> 183
15	230	> 183	23	1016	55 - 110	31	1875	110 - 183
16	2980	55 - 110	24	2569	110 - 183	32	655	55 - 110

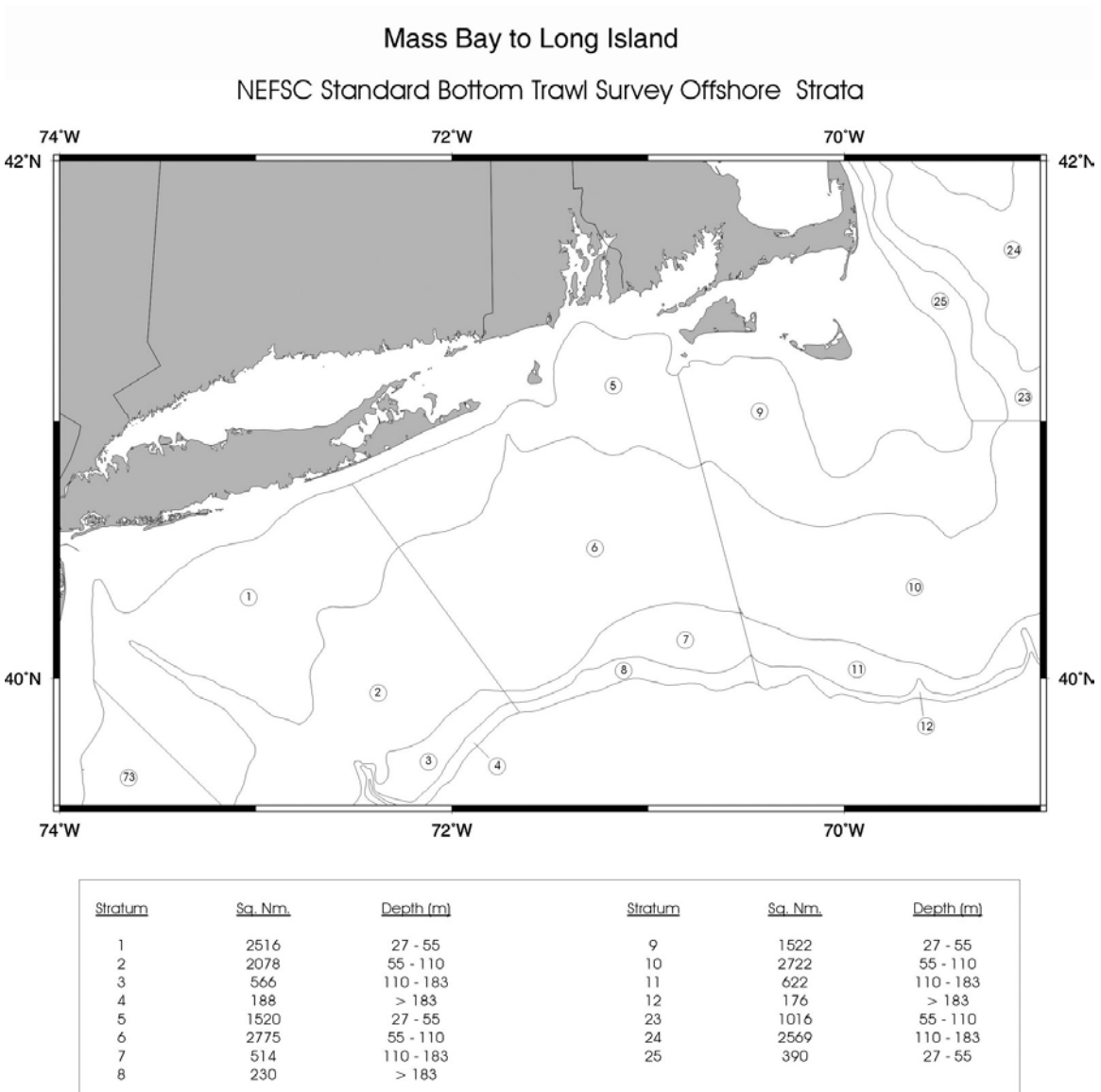

Mid Atlantic

NEFSC Standard Bottom Trawl Survey Offshore Strata

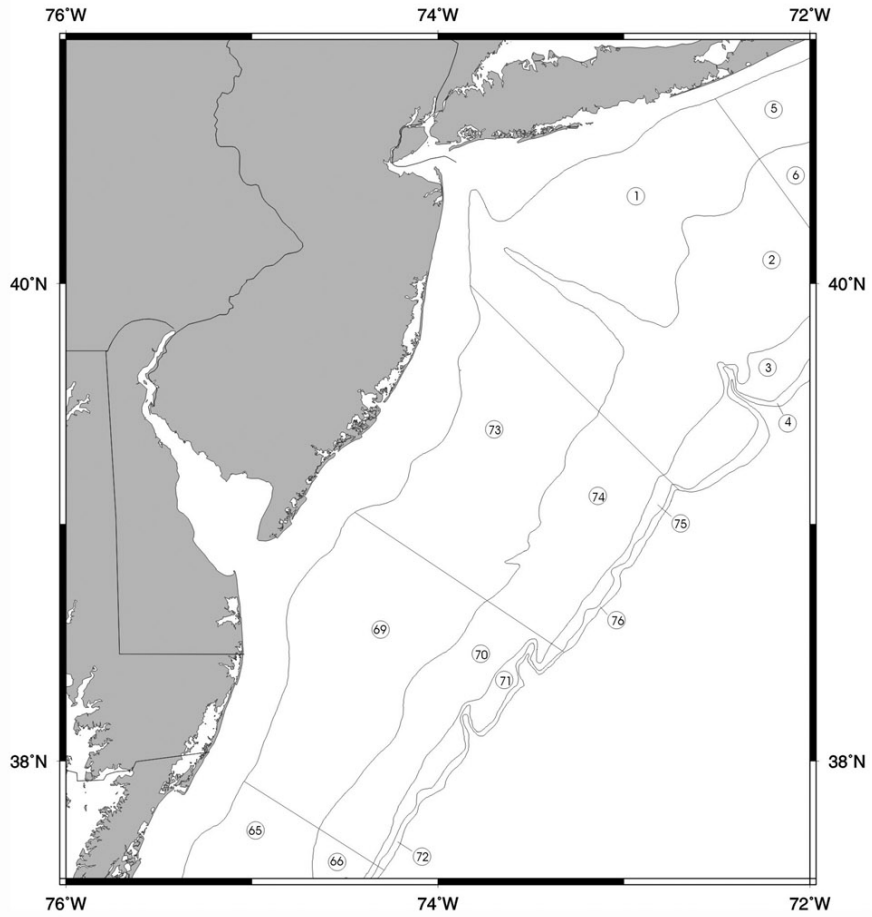

<u>Stratum</u>	<u>Sq. Nm.</u>	<u>Depth (m)</u>
1	2516	27 - 55
2	2078	55 - 110
3	566	110 - 183
4	188	> 183
5	1520	27 - 55
6	2775	55 - 110
69	2433	27 - 55
70	1024	55 - 110
71	281	110 - 183
72	105	> 183
73	2145	27 - 55
74	1273	55 - 110
75	139	110 - 183
76	60	> 183

Delmarva to Cape Fear NEFSC Standard Bottom Trawl Survey Offshore Strata

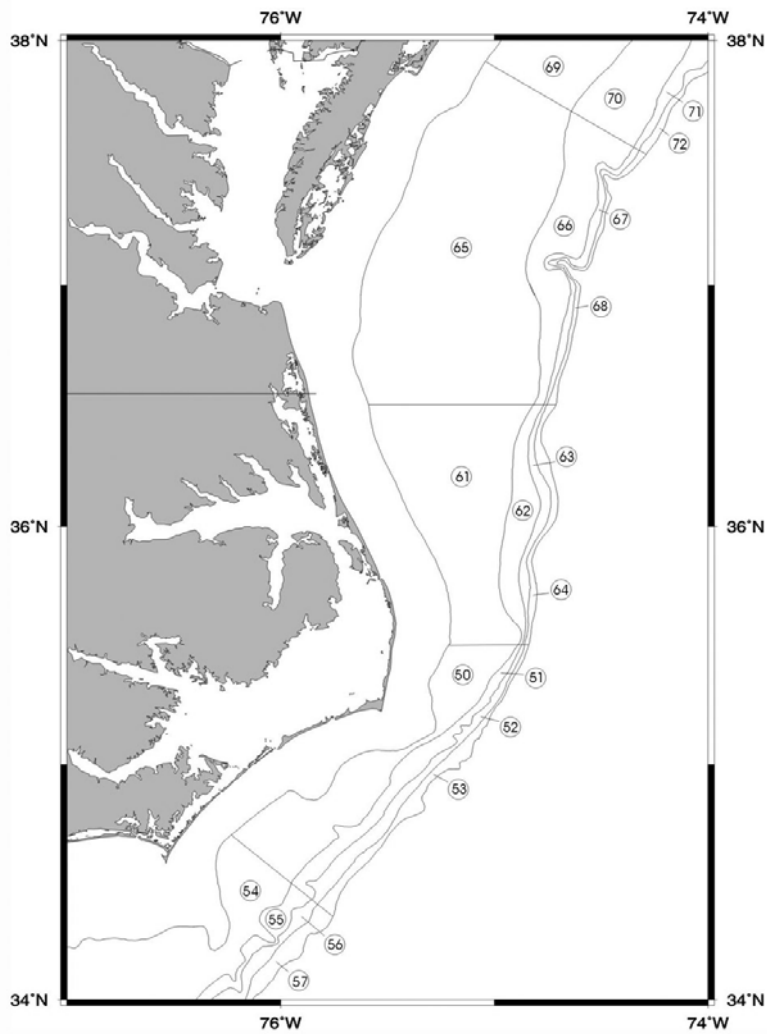

<u>Stratum</u>	<u>Sq. Nm.</u>	<u>Depth (m)</u>
50	796	27 - 55
51	268	55 - 110
52	216	110 - 183
53	150	> 183
54	1764	27 - 55
55	277	55 - 110
56	283	110 - 183
57	537	> 183
61	1318	27 - 55
62	243	55 - 110
63	86	110 - 183
64	60	> 183
65	2832	27 - 55
66	555	55 - 110
67	86	110 - 183
68	52	> 183
69	2433	27 - 55
70	1024	55 - 110
71	281	110 - 183
72	105	> 183

ATTACHMENT I

VOLUNTEER APPRAISAL

Volunteer / Contractor Name: _____

Cruise: _____ Leg #: _____ Start date of cruise: _____ / _____ / _____

Chief Scientist or Watch Chief: _____

I would would NOT (check one) recommend the above volunteer for future cruises.

Comments (please elaborate, especially if you would NOT recommend the volunteer):

When complete, please update Contractors.xls file in shared files\cruise_staffing\contractors.xls

ATTACHMENT J

STATION VALUE - STATION TYPE CODE:

- 1=Survey haul (random-stratified)
- 2=Non-random haul
- 3=Special random add-on station haul
- 4=Comparison haul
- 5=No trawl haul (e.g., bongo, CTD or XBT)
- 6=Site-specific
- 7=Systematic grid
- 8=Depletion site
- 9=Systematic parallel transects
- 0=Systematic zig zag transects

HAUL VALUE - CODE FOR RELATIVE SUCCESS OF HAUL:

- 1=Good tow. No gear or tow duration problem.
- 2=Representative, but some problem encountered due to gear or tow duration.
- 3=Problem tow. May or may not be representative due to gear or tow duration.
- 4=Not representative, due to gear or tow duration.
- 5=No bottom trawl (e.g., bongo, CTD or XBT ONLY).

GEAR CONDITION - CODE FOR GEAR CONDITION: (ALL GEAR PROBLEMS MUST BE NOTED ON TRAWL LOG OR IN FSCS WC COMMENTS SECTION)

- 1=No damage or insignificant damage.
- 2=Wing twisted or tears in upper or lower wings not exceeding 10 ft; tear in square not exceeding 5 ft; tears not exceeding 3 ft in upper belly, or 6 ft in lower belly; cod-end or liner with tears not exceeding 2 ft; parted idler; liner hanging out of cod-end; 1-2 floats missing, bottom falls out for a few minutes.
- 3=Hung up with no to minor damage or due to sand waves.
- 4=Parted legs, sweep or head-rope; cod-end liner untied; wire out slippage; floats, rope or buoys hung up on door, loss of a few cookies.
- 5=Tear-up exceeding limits for code 2, but not a total failure.
- 6=Significant obstruction in trawl, such as fixed gear, large rocks, mud, coral, tires, old anchors, timbers etc. Problem with third wire; unmatched doors; strong current throughout tow.
- 7=Crossed doors. Net was not on bottom or did not perform due to currents or other factors.
- 8=Open gear.
- 9=Hung up with major damage; total tear-up, rim-rack; loss of all gear; loss of trawl; loss of one or both doors.

(Note: This is version of the SHG coding details does not contain all coding criteria)