

**Report on  
U.S. Portfolio Holdings of  
Foreign Securities**

**as of December 31, 2010**

**Department of the Treasury  
Federal Reserve Bank of New York  
Board of Governors of the Federal Reserve System**

**October 2011**

## Table of Contents

Introduction.....	1
Chapter 1. Results of the December 31, 2010 Survey .....	3
<i>U.S. Holdings over Time by Type of Security</i> .....	3
Table 1. Market value of U.S. holdings of foreign securities, by type of security, as of the survey dates.....	3
<i>U.S. Portfolio Investment by Country</i> .....	4
Table 2. Market value of U.S. holdings of foreign securities, by country and type of security, for the countries attracting the most U.S. investment, as of December 31, 2010 .....	5
Table 3. Market value of U.S. holdings of foreign long-term securities, for the countries attracting the most U.S. investment, as of the survey dates.....	6
<i>Measured and Estimated Values of U.S. Holdings of Foreign Long-Term Securities</i> .....	6
Table 4. Measured and estimated market values of U.S. holdings of foreign long-term securities, by type of security, as of December 31, 2010.....	7
<i>U.S. Portfolio Investment Abroad Compared with Foreign Portfolio Investment in the United States</i> .....	7
Table 5. Market value of U.S. holdings of foreign long-term securities and foreign holdings of U.S. long-term securities, selected dates, 1994-2010 .....	9
<i>Details of U.S. Equity Investment by Country</i> .....	9
Table 6. Market value of U.S. holdings of foreign equity, by country, and type of equity, for the countries attracting the most U.S. investment, as of December 31, 2010 .....	10
Table 7. Market value of U.S. holdings of foreign equity, by country, size of domestic equity markets, and share of each market that is U.S. held, for selected countries and regions, as of December 31, 2010.....	12
Table 8. Market value of U.S. holdings of foreign equity, by country and amount held in depositary receipts, for the countries attracting the most U.S. investment, as of December 31, 2010 .....	14
<i>U.S. Investment in Foreign Debt Securities by Currency of Denomination</i> .....	14
Table 9. Market value of U.S. holdings of foreign debt securities, by currency of denomination, as of December 31, 2009 and December 31, 2010 .....	15
Table 10. Market value of U.S. holdings of foreign long-term debt securities, by currency, for selected regions and countries, as of December 31, 2010.....	16
<i>U.S. Holdings of Foreign Private and Government Debt</i> .....	16
Table 11. Market value of U.S. holdings of foreign debt securities, by country and sector of issuer, as of December 31, 2010 .....	17

Table 12. Market value of U.S. holdings of foreign long-term debt securities, by country and sector of issuer, denominated in U.S. dollars and in local currency, as of December 31, 2010 .....	18
<i>U.S. Holdings of Asset-Backed Securities</i> .....	18
Table 13. Market value of U.S. holdings of foreign long-term asset-backed securities, for the countries attracting the most U.S. investment, as of December 31, 2009 and December 31, 2010 .....	19
<i>Maturity Structure of U.S. Foreign Debt Holdings</i> .....	19
Table 14. Maturity structure of U.S. holdings of foreign long-term debt securities, by remaining maturity, as of December 31, 2009 and December 31, 2010.....	20
<i>U.S. Portfolio Investment Abroad by Type of Market and Geographic Region</i> .....	20
Table 15. Market value of U.S. holdings of foreign securities in advanced economies, Caribbean financial centers, and developing countries, as of December 31, 2009 and December 31, 2010 .....	21
Table 16. Market value of U.S. holdings of foreign securities, by geographic region, as of December 31, 2009 and December 31, 2010 .....	22
<i>U.S. Ownership of Foreign Securities by Industry</i> .....	22
Table 17. Market value of U.S. holdings of foreign securities, by industry, as of December 31, 2010 .....	23
<i>Comparison of different types of U.S. portfolio investment abroad as of selected dates</i> .....	23
Table 18. Forms of U.S. portfolio investment abroad, as of selected survey dates .....	24
Chapter 2. Data Collection Methodology .....	25
Statistical Appendix .....	28
Table A1. Market value of U.S. holdings of foreign securities, by country and type of security, as of December 31, 2010.....	29
Table A2. Market value of U.S. holdings of foreign long-term securities, by country, as of selected survey dates.....	33
Table A3. Market value of U.S. holdings of foreign equity, by country, as of selected survey dates.....	38
Table A4. Market value of U.S. holdings of foreign long-term debt securities, by country, as of selected survey dates .....	43
Table A5. Market value of U.S. holdings of foreign short-term debt securities, by country, as of selected survey dates .....	48
Table A6. Market value of U.S. holdings of foreign long-term debt securities, by country and currency, as of December 31, 2010.....	53
Table A7. Market value of U.S. holdings of foreign short-term debt securities, by country and currency, as of December 31, 2010.....	56

Table A8. Market value of U.S. holdings of foreign long-debt securities, by country and type of security, as of December 31, 2010.....	58
Table A9. Market value of U.S. holdings of foreign short-debt securities, by country and type of security, as of December 31, 2010.....	61
Table A10. Market value of U.S. holdings of foreign debt securities, by country and sector of issuer, as of December 31, 2010.....	63
Table A11. Market value of U.S. holdings of foreign long-term debt securities, by country and sector of issuer, denominated in U.S. dollars and in local currency, as of December 31, 2010 .....	66
Table A12. Market value of U.S. holdings of foreign equity, by country and type of security, as of December 31, 2010.....	69
Table A13. Market value of U.S. holdings of foreign equity, by country and amounts held as Depository Receipts, as of December 31, 2010.....	73
Table A14. Market value of U.S. holdings of foreign equity, by country, size of domestic equity markets, and percentage of each market that is U.S.-held, as of December 31, 2010 .....	76
Table A15. Market value of U.S. holdings of foreign securities, by industry, as of December 31, 2010 .....	81
Forms and Instructions.....	83

## Introduction

This report presents data and analyses regarding U.S. portfolio investment in foreign equity and debt securities.<sup>1</sup> The data are drawn primarily from the latest survey of U.S. holdings of foreign securities as of December 31, 2010, a joint undertaking of the U.S. Treasury Department, the Federal Reserve Bank of New York, and the Board of Governors of the Federal Reserve System. The 2010 survey was the eleventh survey of U.S. ownership of foreign securities conducted by the United States. Prior surveys measured holdings on March 31, 1994, December 31, 1997, December 31, 2001, December 31, 2003, and on the last business day of every year thereafter.<sup>2</sup>

The surveys were initiated in the 1990s, as the level of U.S. investment in foreign securities began to grow significantly. The first two U.S. surveys measured only holdings of foreign long-term securities. However, beginning with the 2001 survey, information has been collected on U.S. holdings of both foreign long-term and short-term securities.<sup>3</sup> The first three surveys were conducted at widely-spaced intervals and were “benchmark” surveys; that is, they collected data from a large number of institutions in an attempt to measure total U.S. holdings as comprehensively as practicable. Beginning with the December 2003 survey, surveys have been conducted annually. Full benchmark surveys continue to be conducted at five-year intervals. In the four years following each benchmark survey, annual data are collected primarily from the largest respondents in the preceding benchmark survey, with results grossed up to account for unmeasured holdings. The last full benchmark survey was the December 2006 survey. For the 2010 survey, data were collected from the respondents who collectively accounted for about 99 percent of the 2006 survey holdings, and thus the results presented in this report are grossed up to be comparable to the more comprehensive benchmark results. Details of the gross-up procedure are described in Chapter 2.

The surveys collect information at the individual security level, making possible both detailed analysis and the presentation of data in a wide variety of ways, such as by country, security type, currency, remaining term-to-maturity, and industry. Experience has shown that collecting security level data produces far more accurate survey results than can be obtained by collecting aggregate information. Significant errors are detected in the security-level data that may otherwise go undetected. In addition, the collection of security level data is efficient because survey respondents need to report data in only one format, instead of aggregating and reporting their holdings in different ways, such as those shown in the tables in this report.

---

<sup>1</sup> U.S. portfolio investment in foreign securities, for the purposes of this report, includes all foreign securities owned by U.S. residents except those that are part of a direct investment relationship between the U.S. resident owner of the foreign securities and the foreign issuer of the securities. Direct investment means the ownership or control, directly or indirectly, by one person or by a group of affiliated persons, of interest of 10 percent or more of the voting stock of an incorporated business enterprise, or the equivalent in an unincorporated enterprise. Data on direct investment are collected by the Bureau of Economic Analysis (BEA), Department of Commerce, and are published in the Survey of Current Business and on the BEA web site.

<sup>2</sup> The Treasury Department conducted a survey during World War II of all foreign assets owned by U.S. residents as of May 1943. That survey measured portfolio investment as well as other forms of investment, but it is removed in time and in purpose from the modern survey program that began with the 1994 survey.

<sup>3</sup> Long-term securities are defined as all equity and debt securities with an original term-to-maturity of more than one year. Short-term securities are debt securities with an original term-to-maturity of one year or less.

The U.S. surveys are part of an internationally-coordinated effort under the auspices of the International Monetary Fund (IMF) to improve the measurement of portfolio asset holdings.<sup>4</sup> The IMF Coordinated Portfolio Investment Surveys (CPIS) were initiated primarily because there has been a wide discrepancy between worldwide measured portfolio assets and worldwide measured portfolio liabilities, with reported liabilities exceeding reported assets. Seventy-four countries or geographic regions, including most of the industrial and financial center countries, participated in the most recent CPIS survey (measuring holdings as of December 2009). The data collected in this portfolio survey will serve as the basis of the U.S. submission to the December 2010 CPIS, and future U.S. asset surveys will also be part of this IMF-coordinated effort.

Chapter 1 of this report presents the 2010 survey findings. Chapter 2 discusses data collection methodology. Statistical Appendix A presents a variety of statistics not included elsewhere in the report. Appendix B contains a copy of the forms and instructions used by the survey.

The Treasury Department, the Federal Reserve Bank of New York, and the Board of Governors of the Federal Reserve System wish to express their appreciation to all survey respondents whose efforts and information have made this report possible.

---

<sup>4</sup> International Monetary Fund, Portfolio Investment: CPIS Data Results, which can be found on the web at <http://www.imf.org/external/np/sta/pi/datarsl.htm>. Also, refer to the discussion regarding the CPIS following Table 1 below.

## Chapter 1. Results of the December 31, 2010 Survey

The data presented in this report are drawn primarily from the survey of U.S. ownership of foreign securities conducted as of December 31, 2010. Data from previous surveys are also included in many of the tables. In all tables, components may not sum to totals because of rounding. All data are presented, to the extent possible, at market value as of the date of the survey. With the exception of zero-coupon securities, the market value of U.S. holdings of foreign securities in this report are given using “clean” prices; that is, values are computed exclusive of accrued and unpaid interest.

### *U.S. Holdings over Time by Type of Security*

Table 1 shows total U.S. holdings of foreign securities, by type of security held, as measured by the most recent eight surveys.

**Table 1. Market value of U.S. holdings of foreign securities, by type of security, as of the survey dates**

Billions of dollars

Type of security	Dec. 2003	Dec. 2004	Dec. 2005	Dec. 2006	Dec. 2007	Dec. 2008	Dec. 2009	Dec. 2010
Long-term securities <sup>1</sup>	2,954	3,553	4,346	5,623	6,863	4,009	5,589	6,362
Equity	2,079	2,560	3,318	4,329	5,253	2,748	3,995	4,647
Long-term debt	874	993	1,028	1,294	1,610	1,261	1,594	1,715
Short-term debt	199	233	263	368	357	282	387	402
<b>Total</b>	<b>3,152</b>	<b>3,787</b>	<b>4,609</b>	<b>5,991</b>	<b>7,220</b>	<b>4,291</b>	<b>5,977</b>	<b>6,763</b>

1. Long-term securities are defined as those without a stated maturity date (such as equities) or with an original term-to-maturity greater than one year.

In 2010, the market value of U.S. holdings of foreign securities increased by about \$0.8 trillion, to reach a level of \$6.8 trillion by December 2010. That continued the recovery from the reported holdings of \$4.3 trillion at end-2008, but holdings still remained below the value they had reached in December 2007 before the intensification of the global financial crisis. U.S. holdings of foreign equity, long-term debt, and short-term debt all increased from their values in December 2009. The increase was largest for holdings of foreign equity, which grew by about \$0.7 trillion. This increase was largely attributable to the gains in foreign equity prices in 2010. A more complete discussion of the factors affecting the change in U.S. holdings during 2010 accompanies Table 4.

At year-end 2010, roughly two-thirds of U.S. holdings of foreign securities were in the form of foreign equity. This share has been fairly constant since the 1994 survey. The U.S. preference for foreign equity (rather than foreign debt) is not generally shared by other major cross-border investing countries. The IMF's most recently completed Coordinated Portfolio Investment Survey (CPIS), which measured each participating country's holdings of foreign securities as of end-December 2009, shows that of the ten countries with the largest private sector holdings of foreign securities (United States, United Kingdom, France, Japan, Luxembourg, Germany,

Ireland, Netherlands, Italy, and Switzerland, respectively), only the United States held more foreign equity than foreign debt.<sup>5</sup>

### ***U.S. Portfolio Investment by Country***

Table 2 shows U.S. holdings of foreign securities, by country and type of security, for the countries attracting the most U.S. investment as of end-2010. U.S. residents' investments in U.K. securities reached a level of \$1 trillion at end-2010, making the United Kingdom the largest recipient of U.S. portfolio investment abroad. Canada had the next highest level of U.S. investment (\$695 billion), followed by Japan (\$519 billion), France (\$366 billion), and the Cayman Islands (\$366 billion). Japan had the second highest level of U.S. investments in foreign equity, and Canada had the largest level of U.S. investments in foreign long-term debt. Table A1 in the Statistical Appendix shows the data in Table 2 for an expanded list of countries.

Determining the residence of the foreign issuer of a security is straightforward in most cases, since information is collected at the individual security level. This point is made because determining foreign residence is not so certain in the companion surveys of foreign ownership of U.S. securities. In the companion surveys, chains of intermediaries involved in the custody or management of these securities can make it difficult to determine the country of residence of the ultimate beneficial owners of U.S. securities. Determining the ownership of U.S. securities is also difficult because ownership information typically is not available for U.S.-issued bearer (unregistered) securities.

---

<sup>5</sup> International Monetary Fund, Portfolio Investment: CPIS Data Results, Table 9, found on the web at <http://www.imf.org/external/np/sta/pi/global.htm>.



**Table 2. Market value of U.S. holdings of foreign securities, by country and type of security, for the countries attracting the most U.S. investment, as of December 31, 2010**

Billions of dollars

Country or category	Total	Equity	Debt		
			Total	Long-term	Short-term
United Kingdom	1,001	626	375	252	123
Canada	695	409	287	253	34
Japan	519	450	69	47	22
France	366	244	122	82	40
Cayman Islands	366	166	200	196	3
Switzerland	327	319	8	6	2
Australia	323	150	174	123	51
Germany	299	207	92	74	18
Brazil	235	194	41	41	1
Netherlands	233	120	112	103	9
Bermuda	160	134	25	25	*
Korea, South	148	122	26	25	1
Hong Kong	135	133	2	2	*
Ireland	132	101	31	27	3
Sweden	122	63	59	30	29
Rest of world	1,701	1,207	494	428	66
<b>Total</b>	<b>6,763</b>	<b>4,647</b>	<b>2,116</b>	<b>1,715</b>	<b>402</b>

\* Greater than zero but less than \$500 million.

Table 3 shows the countries attracting the most U.S. portfolio investment in their long-term securities as of the last eight survey dates.<sup>6</sup> In each of the surveys since 2003, the United Kingdom has occupied the top position, with Japan and Canada following in either position two or three. During 2010, U.S. residents' holdings of U.K. long-term securities grew by \$77 billion, while holdings of Canadian long-term securities grew \$146 billion. Of the countries shown in the table, those having the greatest growth rates for the 2003-2010 period are Brazil, Australia, and the Cayman Islands. The bulk of investment attributed to the Cayman Islands represents ownership of securities issued by entities that for tax or regulatory reasons are incorporated in the Cayman Islands (a so-called "offshore financial center") but whose center of economic activity is elsewhere. In recent years, many of these entities have been special-purpose vehicles established to issue asset-backed securities.

<sup>6</sup> Table A5 in the Statistical Appendix shows U.S. holdings of foreign short-term debt securities over the last seven surveys.

**Table 3. Market value of U.S. holdings of foreign long-term securities, for the countries attracting the most U.S. investment, as of the survey dates**

Billions of dollars

Country or category	Dec. 2003	Dec. 2004	Dec. 2005	Dec. 2006	Dec. 2007	Dec. 2008	Dec. 2009	Dec. 2010
United Kingdom	564	627	723	919	1,002	562	802	879
Canada	289	332	405	460	566	346	515	661
Japan	293	367	528	590	590	401	411	497
Cayman Islands	121	184	221	338	505	298	365	363
France	174	206	253	370	431	270	333	326
Switzerland	119	140	194	264	285	218	304	325
Germany	175	192	207	282	419	240	273	281
Australia	86	97	120	164	211	136	235	273
Netherlands	174	192	185	229	231	151	215	234
Brazil	50	63	90	110	189	91	213	224
Rest of world	843	1,053	1,325	1,801	2,350	1,295	1,924	2,298
<b>Total</b>	<b>2,954</b>	<b>3,553</b>	<b>4,346</b>	<b>5,623</b>	<b>6,863</b>	<b>4,009</b>	<b>5,589</b>	<b>6,362</b>

Tables A2-A5 in the Statistical Appendix show, respectively, historical data by country on U.S. ownership of total foreign long-term securities, foreign equity, foreign long-term debt, and foreign short-term debt. In these tables there are some patterns of holdings that may be explained by factors other than U.S. investor sentiment. For instance, a sharp rise or decline in the level of U.S. investment could be caused by a company in country A having been acquired by a company in country B, causing what had been U.S. investment in country A to become U.S. investment in country B.

### *Measured and Estimated Values of U.S. Holdings of Foreign Long-Term Securities*

The United States has a two-part system for measuring cross-border securities activity. In addition to annual surveys of *positions* discussed in this report, the Treasury International Capital (TIC) system also collects monthly data on cross-border *transactions* in long-term securities.<sup>7</sup> The monthly data are available with a lag of approximately 45 days and can be combined with the most recent position data to form more timely estimates of positions. The estimation procedure involves adjusting data from the preceding survey for price and exchange rate changes, adding price-adjusted transactions data, and making adjustments for estimated stock swaps and for transactions costs. There are inherent inaccuracies in such estimates. For

<sup>7</sup> For a detailed discussion on the U.S. system for measuring cross-border financial flows, refer to C. Bertaut, W. Grier, and R. Tryon, "Understanding U.S. Cross-Border Securities Data", Federal Reserve Bulletin, May 2006, 59-75, available online at [http://www.federalreserve.gov/pubs/bulletin/2006/cross\\_border\\_securities.pdf](http://www.federalreserve.gov/pubs/bulletin/2006/cross_border_securities.pdf).

example, it is not possible to know precisely which foreign securities U.S. residents buy or sell or the exact timing of the transactions. Table 4 presents both the estimated and directly measured positions. Errors are possible in all parts of such computations: the previous survey, the transactions data, the adjustments, and the current survey.

**Table 4. Measured and estimated market values of U.S. holdings of foreign long-term securities, by type of security, as of December 31, 2010**

Billions of dollars

Type of security	December 2009	January 2010 - December 2010				December 2010		
	Measured (1)	Net purchases (2)	Transaction costs <sup>1</sup> (3)	Stock swaps <sup>1</sup> (4)	Valuation adjustments <sup>1</sup> (5)	Estimated (1)+(2)+(3)+(4)+(5) (6)	Measured (7)	Measured less estimated (8)
Debt	1,594	55	-18	n.a.	46	1,677	1,715	38
Equity	3,995	61	-19	12	353	4,402	4,647	245
<b>Total</b>	<b>5,589</b>	<b>115</b>	<b>-37</b>	<b>12</b>	<b>399</b>	<b>6,078</b>	<b>6,362</b>	<b>284</b>

n.a. Not applicable.

1. Staff estimates.

U.S. holdings of foreign long-term securities, as measured by the two most recent portfolio asset surveys, grew by \$773 billion during 2010, from \$5,589 billion at end-2009 to \$6,362 billion at end-2010. The total estimated increase during the year is \$489 billion, composed of \$115 billion in net purchases of foreign long-term securities as measured by the TIC monthly transactions (column 2), estimated valuation gains of \$399 billion (column 5), and -\$25 billion in other adjustments (columns 3 and 4). The valuation gains (especially on holdings of foreign equity) account for most of the total estimated increase in 2010.

Comparing the estimates above with measured holdings, the survey measured U.S. holdings of foreign securities to be \$284 billion higher than estimated (column 8). U.S. holdings of foreign debt were \$38 billion more than estimated, while holdings of foreign equity were \$245 billion more than estimated. Such differences between the estimated and the measured positions are not unusual. Previous surveys of U.S. holdings of foreign securities have also tended to measure U.S. holdings higher than estimates. One explanation for the higher measured holdings of foreign equity in the survey may be that the actual valuation gains U.S. investors received were larger than the \$353 billion in estimated valuation gains, which are based on returns from equity price indexes.

### ***U.S. Portfolio Investment Abroad Compared with Foreign Portfolio Investment in the United States***

Table 5 shows both U.S. holdings of foreign long-term securities and foreign holdings of U.S. long-term securities over time. The dates correspond to those of the surveys of U.S. holdings of foreign securities. Because surveys of foreign holdings of U.S. securities were conducted on different dates, the figures reported for foreign holdings are estimates.

Foreign holdings of U.S. long-term securities increased more rapidly than did U.S. holdings of foreign long-term securities from 1994 to 2004, and as a result the ratio of U.S. holdings to foreign holdings decreased from 0.74 to 0.60 by 2004. Between December 2004 and December 2007, U.S. holdings of foreign long-term securities grew faster than foreign holdings of U.S. long-term securities, and the ratio of U.S. holdings to foreign holdings increased to 0.72 by December 2007. In 2008, the large decline in global equity prices caused U.S. holdings of foreign long-term securities to decline by more than 40 percent, while foreign holdings of U.S. securities declined only about 13 percent. As a result, the ratio of U.S. holdings to foreign holdings fell to 0.48. The decline was greater for U.S. holdings mainly because U.S. portfolio investment abroad is more weighted toward equity, while foreign investment in the United States is more weighted toward fixed income securities.<sup>8</sup> In 2009, when global stock markets rebounded, U.S. holdings grew by nearly 40 percent while foreign holdings grew by about 13 percent, and the ratio of U.S. holdings to foreign holdings increased to 0.59. In 2010, U.S. holdings of long-term securities and foreign holdings of U.S. long-term securities grew at the same pace, leaving the ratio of U.S. holdings to foreign holdings unchanged.

---

<sup>8</sup> The difference in the composition of U.S. and foreign holdings is in turn explained in part by the makeup of cross-border investors: almost all U.S. holdings represent investments made by U.S. private investors (both institutions and individuals), whereas about one-third of foreign holdings of U.S. securities are owned by foreign official institutions, such as central banks and other governmental entities. Because roughly 90 percent of foreign official holdings are in the form of debt securities, their holdings help to explain the overall foreign preference for U.S. debt securities.

**Table 5. Market value of U.S. holdings of foreign long-term securities and foreign holdings of U.S. long-term securities, selected dates, 1994-2010**

Billions of dollars except as noted

Date	U.S. holdings of foreign long-term securities	Foreign holdings of U.S. long-term securities <sup>1</sup>	Ratio of U.S. holdings to foreign holdings	Net foreign holdings of long-term securities <sup>2</sup>
Mar. 1994	870	1,181	0.74	311
Dec. 1997	1,755	2,561	0.69	806
Dec. 2001	2,170	3,932	0.55	1,763
Dec. 2003	2,954	4,976	0.59	2,023
Dec. 2004	3,553	5,964	0.60	2,411
Dec. 2005	4,346	6,777	0.64	2,431
Dec. 2006	5,623	8,239	0.68	2,616
Dec. 2007	6,863	9,515	0.72	2,652
Dec. 2008	4,009	8,324	0.48	4,315
Dec. 2009 <sup>r</sup>	5,589	9,483	0.59	3,894
Dec. 2010	6,362	10,836	0.59	4,475

r Revised

1. Staff estimates. Because surveys of foreign holdings of U.S. long-term securities were collected on different dates from the surveys of U.S. holdings of foreign securities, estimated positions are shown for the between-survey values of foreign holdings. These estimates are subject to revision.

2. Net foreign holdings are defined as foreign holdings of U.S. securities minus U.S. holdings of foreign securities.

### ***Details of U.S. Equity Investment by Country***

Table 6 ranks countries based on the level of U.S. investment in their equity, and shows holdings by type of equity (common stock shares, fund shares, and preferred stock and other forms of equity).

**Table 6. Market value of U.S. holdings of foreign equity, by country, and type of equity, for the countries attracting the most U.S. investment, as of December 31, 2010**

Billions of dollars except as noted

Country or region	Total Equity	Common Stock	Fund Shares	Preferred Stock and Other
United Kingdom	626	586	15	25
Japan	450	445	4	1
Canada	409	386	21	2
Switzerland	319	318	0	1
France	244	234	8	1
Germany	207	189	0	17
Brazil	194	120	3	71
Cayman Islands	166	98	41	27
Australia	150	144	5	1
Bermuda	134	124	3	8
Hong Kong	133	129	2	1
Korea, South	122	119	0	3
Netherlands	120	113	1	6
Ireland	101	92	8	1
China, mainland <sup>1</sup>	101	100	0	0
Taiwan	94	94	0	0
Rest of world	1,076	1,034	23	19
<b>Total</b>	<b>4,647</b>	<b>4,327</b>	<b>136</b>	<b>184</b>

1. Excludes Hong Kong and Macau, which are reported separately.

More than 90 percent of the \$4,647 billion in foreign equity held by U.S. investors is in the form of common stock. Holdings of fund shares (\$136 billion) account for only about 3 percent of U.S. holdings of foreign equity. In contrast, foreign investors hold less than 80 percent of their U.S. equity in the form of common stock and a much larger share (17 percent) in the form of fund shares.<sup>9</sup> However for some countries, fund shares account for a considerably larger share of equity held: 25 percent of Cayman Island equity held by U.S. investors is held in the form of fund shares. Other countries (not shown in the table) where a sizable share of U.S. equity investment is held in fund shares are the British Virgin Islands (47 percent), and Luxembourg (16 percent). Table A12 in the Statistical Appendix shows the detail of U.S. holdings of foreign equity by type of equity for all countries.

<sup>9</sup> Refer to Table 10 in the “Report on Foreign Portfolio Holdings of U.S. Securities as of June 30, 2010” at <http://www.treasury.gov/resource-center/data-chart-center/tic/Documents/shla2010r.pdf>.

Table 7 shows the common stock shares for the same countries, the relative size of each country's equity market, and the share that is owned by U.S. investors.<sup>10</sup> The share that is U.S.-owned can be misleading because in some instances companies are incorporated in one country but their securities primarily trade in another country. This practice can lead to odd results, such as those shown for Bermuda and the Cayman Islands, where U.S. investors' holdings exceed the size of the countries' domestic equity markets. This phenomenon has recently appeared for Ireland as well, as many multinational firms decided to move their country of incorporation from offshore financial centers to Ireland. Of the countries that account for the most U.S. equity investment (excluding the offshore financial centers of Bermuda and the Cayman Islands), U.S. investors typically held between 8 percent (Brazil) and 26 percent (Switzerland) of each country's equity market; one exception was that U.S. investors held only 2 percent of the market capitalization of China. Overall, U.S. investors held approximately 8 percent of the common stock issued by foreigners. By comparison, foreign investors held a similar 11 percent of total U.S. equity outstanding as of June 2010.<sup>11</sup>

Table 7 also shows that U.S. investors held relatively more of the market capitalization of advanced economies (14 percent) than they did of other countries excluding the Caribbean financial centers (2 percent). By region, U.S. investors held 15 percent of European equity market capitalization. They held somewhat smaller shares of the market capitalization of Asian and African countries (7 percent and 6 percent, respectively) than they did of Latin American and Caribbean market capitalization excluding the Caribbean financial centers (8 percent). The somewhat higher share for the Latin American and Caribbean region in large part reflects the fact that U.S. investors held a sizable 16 percent of Mexican market capitalization. U.S. investors also held an above-average share of Canadian market capitalization (18 percent).

---

<sup>10</sup> Market capitalization includes all of the equity of the firms listed in the relevant country exchanges, including some shares that may not be available for purchase by foreign investors.

<sup>11</sup> Refer to Table 2 in the "Report on Foreign Portfolio Holdings of U.S. Securities as of June 30, 2010" at <http://www.treasury.gov/resource-center/data-chart-center/tic/Documents/shla2010r.pdf>. This figure includes all forms of equity held by foreigners, including U.S. fund shares, but also includes a more comprehensive measure of U.S. market capitalization that accounts for fund shares outstanding.

**Table 7. Market value of U.S. holdings of foreign equity, by country, size of domestic equity markets, and share of each market that is U.S. held, for selected countries and regions, as of December 31, 2010**

Billions of dollars except as noted

Country or region	U.S. holdings of common stock	Country rank according to domestic market capitalization <sup>1</sup>	Percent of domestic market capitalization <sup>2</sup>
United Kingdom	586	4	19
Japan	445	3	11
Canada	386	5	18
Switzerland	318	11	26
France	234	6	12
Germany	189	10	13
Australia	144	9	10
Hong Kong	129	14	12
Bermuda	124	95	>100
Brazil	120	8	8
Korea, South	119	13	11
Netherlands	113	18	17
China, mainland <sup>3</sup>	100	2	2
Cayman Islands	98	110	>100
Taiwan	94	17	12
Ireland	92	56	>100
Rest of world	1,034	n.a.	4
<b>Total</b>	<b>4,327</b>	<b>n.a.</b>	<b>8</b>
<b>By type of market</b>			
Advanced economies <sup>4</sup>	3,299	n.a.	14
Caribbean financial centers <sup>5</sup>	331	n.a.	>100
Developing countries	696	n.a.	2
<b>By selected region</b>			
Europe	2,008	n.a.	15
<i>of which: euro area countries<sup>6</sup></i>	851	n.a.	14
Latin America and Caribbean, excluding Caribbean financial centers	216	n.a.	8
Asia	1,150	n.a.	7
Africa	81	n.a.	6

n.a. Not applicable.

1. Market capitalization data are from Standard & Poor's Global Stock Markets Factbook 2011 and are based on year-end 2010 total market values of domestic exchanges. Rank order excludes the United States, which has the largest equity market capitalization.

2. U.S. holdings include securities of companies registered in each country, some of which may not trade on domestic exchanges, thus U.S. holdings can exceed the total size of a country's domestically-traded securities.

3. Excludes Hong Kong and Macau, which are reported separately.

4. Australia, Austria, Belgium, Canada, Czech Republic, Cyprus, Denmark, Estonia, Finland, France, Germany, Greece, Hong Kong, Iceland, Ireland, Israel, Italy, Japan, Luxembourg, Malta, the Netherlands, New Zealand, Norway, Portugal, Singapore, Slovakia, Slovenia, South Korea, Spain, Sweden, Switzerland, Taiwan, and the United Kingdom.

5. Bahamas, Bermuda, British Virgin Islands, Cayman Islands, Netherlands Antilles, and Panama.

6. Austria, Belgium, Cyprus, Finland, France, Germany, Greece, Ireland, Italy, Luxembourg, Malta, Netherlands, Portugal, Slovakia, Slovenia, and Spain.



Table A14 in the Statistical Appendix shows the information contained in Table 7 for an expanded list of countries.

Table 8 ranks countries based on the level of U.S. investment in their equity as in Table 6 and presents the shares of depositary receipts (DRs), primarily American Depositary Receipts (ADRs). Depositary receipts are negotiable certificates held in a bank in one country that represent a specific number of shares of a stock that trades on an exchange in another country. They entitle their owners to all dividends, capital gains or losses, and voting rights, just as if the underlying shares were directly owned. ADRs are depositary receipts that trade on U.S. exchanges in U.S. dollars and that facilitate the holding and trading of foreign securities by U.S. residents. Overall, 16 percent of foreign equity held by U.S. investors in 2010 was in the form of DRs. However, the share is notably larger for some countries and regions: for example, almost 60 percent of Mexican equity is held as DRs, and nearly half of total Latin American equity is also held as DRs.

**Table 8. Market value of U.S. holdings of foreign equity, by country and amount held in depositary receipts, for the countries attracting the most U.S. investment, as of December 31, 2010**

Billions of dollars except as noted

Country or region	Equity	Depositary Receipts	Percentage Depositary Receipts
United Kingdom	626	148	24
Japan	450	28	6
Canada	409	1	0
Switzerland	319	39	12
France	244	25	10
Germany	207	15	7
Brazil	194	89	46
Cayman Islands	166	41	25
Australia	150	13	9
Bermuda	134	2	2
Hong Kong	133	20	15
Korea, South	122	16	13
Netherlands	120	27	22
Ireland	101	24	24
China, mainland <sup>1</sup>	101	6	6
Taiwan	94	13	14
Rest of world	1,076	220	20
<b>Total</b>	<b>4,647</b>	<b>728</b>	<b>16</b>

1. Excludes Hong Kong and Macau, which are reported separately.

Table A13 in the Statistical Appendix shows the information contained in the above table for an expanded list of countries.

### *U.S. Investment in Foreign Debt Securities by Currency of Denomination*

U.S. investors continue to have a strong preference for foreign debt securities denominated in U.S. dollars. As of year-end 2010, 76 percent of U.S.-owned foreign debt securities was denominated in U.S. dollars, a slight decrease from 78 percent at year-end 2009 (Table 9). The preference for U.S. dollar-denominated debt is strongest in short-term securities, with 90 percent of all such holdings denominated in U.S. dollars (Table A7), while 73 percent of long-term debt was U.S. dollar-denominated (Table 10). Of debt held in foreign currency, almost all was

denominated in one of the world's other major currencies (euro, yen, British pounds, and Canadian dollars), with only 7 percent of U.S. holdings denominated in other currencies (Table 9).

**Table 9. Market value of U.S. holdings of foreign debt securities, by currency of denomination, as of December 31, 2009 and December 31, 2010**

Billions of dollars except as noted

Currency	2010		2009	
	Amount	Percentage	Amount	Percentage
U.S. dollar	1,616	76	1,553	78
Euro	160	8	183	9
Canadian dollar	79	4	67	3
Yen	59	3	40	2
U.K. pound	45	2	37	2
Other currencies	158	7	101	5
<b>Total</b>	<b>2,116</b>	<b>100</b>	<b>1,981</b>	<b>100</b>

Table A6 in the Statistical Appendix shows U.S. holdings of foreign long-term debt securities by country and currency for an expanded list of countries. Table A7 shows the same data for holdings of foreign short-term debt securities.

Table 10 presents the currency distribution of U.S. holdings of foreign long-term debt securities by type of market (advanced economies, Caribbean financial centers, and developing countries excluding Caribbean financial centers). The table also shows the currency distribution of U.S. long-term debt holdings in the developing countries attracting the highest level of U.S. investment. Only long-term debt is shown because almost all U.S.-held foreign short-term debt is U.S.-dollar-denominated.

For U.S. holdings of long-term debt securities issued by advanced economies, 70 percent was denominated in U.S. dollars, a share unchanged since 2009, while the share denominated in euro was about 11 percent, down from 15 percent in 2009. A larger fraction (98 percent) of long-term debt issued by Caribbean financial centers was dollar-denominated, as was also the case in 2009. For U.S. investors' holdings of debt issued by developing countries, a notable factor has been the decline in the share of dollar-denominated debt and a corresponding increase in the share of own-currency denominated debt. The U.S.-dollar-denominated share, which was 90 percent in 2005, has steadily declined to 63 percent in 2010. During the period, the share of local currency denominated debt increased from 15 percent in December 2006 (the first date for which this information is available) to approximately 32 percent in December 2010. For Brazil, the percentage of long-term debt held that was denominated in local currency in December 2010 (61 percent) was higher than the percentage of long-term debt held in local currency for the advanced economies (28 percent).

The amounts in each row of Table 10 may not add up to the total amount. U.S. holdings will in some cases be counted in two columns. For example, U.S. residents' holdings of French debt securities denominated in euro will be counted under both the "euro" column and the "own

currency” column in the first row of the table. Also, holdings denominated in currencies other than the U.S. dollar, euro, yen, U.K. pounds, and the country’s own currency are not shown.

**Table 10. Market value of U.S. holdings of foreign long-term debt securities, by currency, for selected regions and countries, as of December 31, 2010**

Billions of dollars except as noted

Country or region	Total	\$U.S.	Euro	Japanese Yen	U.K. Pound	Own Currency
Advanced economies <sup>1</sup>	1,206	845	138	42	40	332
Caribbean financial centers <sup>2</sup>	231	227	1	*	2	4
Developing countries <sup>3</sup>	236	148	11	*	1	75
Of which:						
Mexico	32	24	*	0	*	8
Brazil	41	16	*	0	0	25
Argentina	8	6	1	*	0	1
International organizations	41	33	1	1	1	0
<b>Total</b>	<b>1,715</b>	<b>1,254</b>	<b>151</b>	<b>43</b>	<b>43</b>	<b>410</b>

n.a. Not applicable.

1. Australia, Austria, Belgium, Canada, Czech Republic, Cyprus, Denmark, Estonia, Finland, France, Germany, Greece, Hong Kong, Iceland, Ireland, Israel, Italy, Japan, Luxembourg, Malta, the Netherlands, New Zealand, Norway, Portugal, Singapore, Slovakia, Slovenia, South Korea, Spain, Sweden, Switzerland, Taiwan, and the United Kingdom.

2. Bahamas, Bermuda, British Virgin Islands, Cayman Islands, Netherlands Antilles, and Panama.

3. Excludes Caribbean financial centers.

### ***U.S. Holdings of Foreign Private and Government Debt***

U.S. investors’ holdings of foreign long-term debt securities are primarily those issued by foreign private institutions; at \$1,274 billion, such holdings account for 74 percent of total long-term debt holdings, a share slightly lower than in 2009 (Table 11). For some countries, such as Brazil, Japan, and Germany, the share of U.S. holdings of foreign long-term debt securities that are issued by the government sector is notably larger. However, this pattern represents a significant shift from the first survey of U.S. holdings of foreign securities conducted in 1994, when only about one-quarter of U.S. investors’ holdings of foreign long-term debt securities was issued by the private sector. U.S. holdings of foreign-issued short-term debt are highly concentrated in private sector issues.

**Table 11. Market value of U.S. holdings of foreign debt securities, by country and sector of issuer, as of December 31, 2010**

Billions of dollars

Country	Total	Long-term		Short-term	
		Private	Government <sup>1</sup>	Private	Government <sup>1</sup>
United Kingdom	375	232	20	122	1
Canada	287	187	65	29	5
Cayman Islands	200	196	*	3	0
Australia	174	106	17	50	1
France	122	56	26	29	11
Netherlands	112	100	3	8	1
Germany	92	33	41	18	*
Japan	69	9	37	6	16
Luxembourg	68	64	*	3	0
Sweden	59	24	6	29	*
Rest of world	559	265	224	63	7
<b>Total</b>	<b>2,116</b>	<b>1,274</b>	<b>441</b>	<b>360</b>	<b>41</b>

\* Greater than zero but less than \$500 million.

1. "Government" includes central, local, and provincial governments, and government-sponsored or guaranteed corporations. Debt issued by international and regional organizations is classified as "private".

Table A10 in the Statistical Appendix shows the information contained in the above table for an expanded list of countries.

Table 12 provides additional detail on the portions of U.S. holdings of foreign long-term government and private sector debt denominated in dollars and in the issuing country's own currency. About three-quarters of total foreign long-term debt securities held by U.S. investors was dollar-denominated. However, the dollar-denominated shares are different for government-issued and private-issued debt: about 30 percent of foreign government debt held by U.S. investors is dollar-denominated, whereas 88 percent of foreign private sector debt held is dollar-denominated. For government debt issued by advanced economies, an even smaller percentage held by U.S. investors is dollar-denominated (19 percent), while 86 percent is denominated in the currency of the issuing country. A notable exception to this pattern is Canada, where 39 percent of the government debt held by U.S. investors is denominated in U.S. dollars. The table also shows that most of the "own" currency long-term debt issued by developing countries and held by U.S. investors is government-issued debt. Table A11 in the Statistical Appendix provides information on dollar and "own currency" holdings of government-issued and private-issued debt for a larger group of countries.

**Table 12. Market value of U.S. holdings of foreign long-term debt securities, by country and sector of issuer, denominated in U.S. dollars and in local currency, as of December 31, 2010**

Billions of dollars

Country	Total Long-Term Debt	Government <sup>1</sup>			Private		
		Total	U.S. dollars	Own currency	Total	U.S. dollars	Own currency
United Kingdom	252	20	*	20	232	202	16
Canada	253	65	25	39	187	151	35
Cayman Islands	196	*	*	*	196	193	*
Australia	123	17	*	17	106	99	5
Netherlands	103	3	*	3	100	85	13
France	82	26	2	24	56	50	5
Germany	74	41	1	40	33	24	6
Luxembourg	65	*	*	*	64	60	5
Japan	47	37	1	37	9	6	3
International Organizations	41	*	*	*	41	33	*
Brazil	41	32	9	23	9	7	2
Bermuda	25	*	*	*	25	25	*
Rest of world	412	198	96	95	214	186	21
<b>Total</b>	<b>1,715</b>	<b>441</b>	<b>133</b>	<b>299</b>	<b>1,274</b>	<b>1,120</b>	<b>111</b>
Total Advanced economies <sup>2</sup>	1,191	275	51	222	916	790	99
Total Caribbean financial centers <sup>3</sup>	231	4	4	0	228	224	4
Developing countries <sup>4</sup>	293	162	78	77	130	107	8

\* Greater than zero but less than \$500 million.

1. "Government" includes central, local, and provincial governments, and government-sponsored or guaranteed corporations. Debt issued by international organizations is classified as "private".

2. Australia, Austria, Belgium, Canada, Czech Republic, Cyprus, Denmark, Estonia, Finland, France, Germany, Greece, Hong Kong, Iceland, Ireland, Israel, Italy, Japan, Luxembourg, Malta, the Netherlands, New Zealand, Norway, Portugal, Singapore, Slovakia, Slovenia, South Korea, Spain, Sweden, Switzerland, Taiwan, and the United Kingdom.

3. Bahamas, Bermuda, British Virgin Islands, Cayman Islands, Netherlands Antilles, and Panama.

4. Excludes Caribbean financial centers.

### ***U.S. Holdings of Asset-Backed Securities***

Although U.S. holdings of all foreign long-term debt securities increased \$121 billion between December 2009 and December 2010, holdings of foreign asset-backed securities (ABS) decreased \$45 billion, and the share of foreign-issued ABS in U.S. long-term debt portfolios declined to 11 percent (Table 13). Prior to the financial crisis that began in 2007, U.S. holdings of foreign-issued ABS had increased steadily from \$131 billion (13 percent of U.S. investors' holdings of foreign long-term securities) in December 2005 to reach \$330 billion, or 21 percent, in December 2007. As has been the case for the past several years, ABS continues to account for the majority of U.S. holdings of long-term debt issued in the Cayman Islands.

**Table 13. Market value of U.S. holdings of foreign long-term asset-backed securities, for the countries attracting the most U.S. investment, as of December 31, 2009 and December 31, 2010**

Billions of dollars except as noted

Country	2010			2009		
	Total long-term debt	ABS	Percent of long-term debt	Total long-term debt	ABS	Percent of long-term debt
Cayman Islands	196	131	67	217	157	72
United Kingdom	252	38	15	240	44	18
Ireland	27	6	23	26	9	35
Netherlands	103	6	6	106	9	8
Australia	123	4	4	107	7	7
Canada	253	2	1	220	3	1
Luxembourg	65	1	2	57	4	6
Jersey	12	1	10	13	2	13
Rest of world	682	3	<1	607	3	<1
<b>Total</b>	<b>1,715</b>	<b>193</b>	<b>11</b>	<b>1,594</b>	<b>238</b>	<b>15</b>

Table 26 in the Statistical Appendix shows U.S. holdings of long-term asset-backed securities as of December 31, 2010 for all countries.

Table A9 in the Statistical Appendix shows U.S. investors' holdings of short-term debt securities for all countries. U.S. holdings of foreign asset-backed commercial paper (ABCP) are included with holdings of conventional commercial paper in the first column. Total holdings of foreign commercial paper amounted to \$171 billion in 2010, compared to \$173 billion in 2009.

#### ***Maturity Structure of U.S. Foreign Debt Holdings***

Table 14 presents the maturity structure of U.S.-owned foreign long-term debt securities. The median time-to-maturity, or remaining maturity, for long-term debt securities (those issued with an original time-to-maturity in excess of one year) remained unchanged at 6 years in the 2010 survey. The median time-to-maturity of U.S.-owned foreign long-term debt securities issued by foreign governments (5 years) was somewhat shorter than that of U.S.-owned foreign long-term debt securities issued by the private sector (7 years).

**Table 14. Maturity structure of U.S. holdings of foreign long-term debt securities, by remaining maturity, as of December 31, 2009 and December 31, 2010**

Remaining years to maturity <sup>1</sup>	2010 Percent of total <sup>2</sup>	2009 Percent of total <sup>2</sup>
One or less	9.4	6.9
1 - 2	10.7	9.7
2 - 3	9.0	10.1
3 - 4	8.9	7.6
4 - 5	9.1	10.3
5 - 6	4.9	5.4
6 - 7	6.4	4.8
7 - 8	4.3	6.0
8 - 9	5.7	4.0
9 - 10	6.2	6.2
10 - 15	5.8	5.9
15 - 20	3.4	2.8
20 - 25	4.1	4.7
25 - 30	7.5	8.3
30 - 40	4.7	7.2
Total	100.0	100.0

1 Inclusive of the higher figure in the range.

2. Excludes perpetual bonds and securities with unknown maturity dates that together amounted to approximately \$43 billion (about 2.5 percent of total foreign long-term debt securities held by U.S. residents).

### ***U.S. Portfolio Investment Abroad by Type of Market and Geographic Region***

Table 15 presents U.S. foreign portfolio investment by type of foreign market: advanced economies, Caribbean financial centers, international organizations, and developing countries for the two most recent surveys.

Investment in the thirty-three advanced foreign economies continued to account for the bulk of U.S. foreign investment in 2010, but the share in 2010 (74 percent) was slightly smaller than in 2009 (75 percent). The share invested in developing countries increased slightly in 2010, while the share invested in Caribbean financial centers remained unchanged.



**Table 15. Market value of U.S. holdings of foreign securities in advanced economies, Caribbean financial centers, and developing countries, as of December 31, 2009 and December 31, 2010**

Billions of dollars except as noted

Market	2010				2009			
	Total	Percent of Total	Equity	Debt	Total	Percent of Total	Equity	Debt
Advanced economies <sup>1</sup>	5,014	74	3,440	1,574	4,473	75	2,994	1,479
Caribbean financial centers <sup>2</sup>	652	10	418	235	612	10	352	260
International organizations	55	1	*	55	49	1	*	48
Developing countries <sup>3</sup>	1,042	15	789	253	844	14	649	195
<b>Total</b>	<b>6,763</b>	<b>100</b>	<b>4,647</b>	<b>2,116</b>	<b>5,977</b>	<b>100</b>	<b>3,995</b>	<b>1,981</b>

\* Greater than zero but less than \$500 million.

1. Advanced economies comprise Australia, Austria, Belgium, Canada, Cyprus, Czech Republic, Denmark, Estonia, Finland, France, Germany, Greece, Hong Kong, Iceland, Ireland, Israel, Italy, Japan, Luxembourg, Malta, the Netherlands, New Zealand, Norway, Portugal, Singapore, Slovakia, Slovenia, South Korea, Spain, Sweden, Switzerland, Taiwan, and the United Kingdom.

2. Bahamas, Bermuda, British Virgin Islands, Cayman Islands, Netherlands Antilles, and Panama.

3. Excludes Caribbean financial centers.

U.S. holdings of foreign securities issued by the advanced economies have been consistently weighted towards holdings of equity. The share of foreign equity in U.S. holdings of all foreign securities issued by the advanced economies was roughly two-thirds in December of 2010, about the same as in the previous survey. The share of foreign equity in U.S. holdings of all securities issued by developing countries has increased notably over the last nine years, from just over 50 percent in 2001 to 77 percent in 2009 and nearly as high (76 percent) in 2010.

Table 16 shows the distribution of U.S. holdings of foreign securities by geographic region rather than by type of economy. Although Europe was still the largest destination for U.S. cross-border portfolio investment in 2010, its share of U.S. investment decreased slightly from 50 percent in 2009 to 47 percent in 2010. U.S. investors' equity holdings grew for every region during 2010 largely because of the global increase in stock prices. U.S. investors' debt holdings increased most notably for Asia, Canada, and Australia and Oceania, but were about unchanged for Europe, and decreased for the Caribbean.

**Table 16. Market value of U.S. holdings of foreign securities, by geographic region, as of December 31, 2009 and December 31, 2010**

Billions of dollars

Region/category	2010				2009			
	Total	Percent of total	Equity	Debt	Total	Percent of total	Equity	Debt
Europe	3,154	47	2,113	1,040	3,001	50	1,962	1,039
<i>Of which: euro area countries<sup>1</sup></i>	<i>1,392</i>	<i>21</i>	<i>903</i>	<i>489</i>	<i>1,401</i>	<i>23</i>	<i>893</i>	<i>507</i>
Asia	1,343	20	1,168	176	1,053	18	929	124
Caribbean <sup>2</sup>	631	9	396	236	596	10	335	261
Canada	695	10	409	287	540	9	295	245
Australia and Oceania	353	5	164	190	302	5	140	163
South America	297	4	216	80	260	4	194	66
Central America <sup>3</sup>	136	2	98	37	109	2	82	27
Africa	99	1	83	16	67	1	58	9
International organizations	55	1	*	55	49	1	*	48
<b>Total</b>	<b>6,763</b>	<b>100</b>	<b>4,647</b>	<b>2,116</b>	<b>5,977</b>	<b>100</b>	<b>3,995</b>	<b>1,981</b>

\* Greater than zero but less than \$500 million.

1. Austria, Belgium, Cyprus, Finland, France, Germany, Greece, Ireland, Italy, Luxembourg, Malta, Netherlands, Portugal, Slovakia (effective 2009), Slovenia, and Spain.

2. Includes Bermuda and the Bahamas as well as all Caribbean nations. This grouping is different than the Caribbean financial centers shown

3. Excludes Caribbean financial centers.

### ***U.S. Ownership of Foreign Securities by Industry***

Table 17 provides information on U.S. holdings of foreign securities by broad industry sector of the issuer. Combining investments in foreign equity and debt securities, the foreign industrial sector attracting the highest level of U.S. investment (based on the GICS<sup>12</sup> classification system) was by far the financial sector, with holdings of \$2,068 billion, accounting for about 30 percent of all U.S. holdings. As shown in Table A15 in the Statistical Appendix, within the financial sector U.S. equity holdings were especially large in commercial banking (\$439 billion) and capital markets (\$215 billion). Within the private (non-government) sectors, equity holdings accounted for about 75 percent of total holdings. Holdings of government sector securities (\$542 billion) were almost all in the form of foreign debt securities, and largely reflect holdings of foreign government sovereign debt. Though U.S. investors overall hold considerably more foreign equity than debt, only about half of financial sector investment was held in the form of equity (\$1,046 billion). Total holdings of financial sector foreign debt securities (\$697 billion in long-term debt and \$325 billion in short-term debt) accounted for nearly half of all U.S. holdings of foreign debt securities other than those issued by the government sector. U.S. investors also had sizable holdings in the energy sector (\$722 billion), the materials sector (\$658 billion), the

<sup>12</sup> The Global Industry Classification Standard (GICS) system, developed by Morgan Stanley Capital International and Standard & Poor's, was selected because it can be used to categorize security issuers worldwide, enabling both foreign holdings of U.S. securities and U.S. holdings of foreign securities to be shown using the same classification system.

industrial sector (\$540 billion), the consumer discretionary sector (\$497 billion), and the information technology sector (\$441 billion).

**Table 17. Market value of U.S. holdings of foreign securities, by industry, as of December 31, 2010**

Billions of dollars

GICS Code		Total	Equity	Debt	
				Long-term	Short-term
1010	Total Energy	722	606	111	5
1510	Total Materials	658	566	91	1
2000	Total Industrial	540	481	56	3
2500	Total Consumer Discretionary	497	455	41	2
3000	Total Consumer Staples	408	375	32	1
3500	Total Health Care	338	319	18	1
4000	Total Financial	2,068	1,046	697	325
4500	Total Information Technology	441	417	24	*
5010	Total Telecommunication Services	319	240	79	*
5510	Total Utilities	171	110	58	3
	Government <sup>1</sup>	542	*	487	55
	Industry unknown	59	33	22	5
	<b>Total</b>	<b>6,763</b>	<b>4,647</b>	<b>1,715</b>	<b>402</b>

\* Greater than zero but less than \$500 million.

1. Includes securities issued by local governments as well as government-sponsored or guaranteed corporations.

Table A15 in the Statistical Appendix provides information on holdings by detailed industry as well as broad industry sector.

### *Comparison of different types of U.S. portfolio investment abroad as of selected dates*

Table 18 presents a time-series of U.S. portfolio investment abroad and compares U.S. holdings of foreign securities with U.S. holdings of deposits, loans, and other investments reported by U.S. bank and non-bank institutions. The table shows that the share of securities in U.S. portfolio investment abroad increased from 58 percent in 1994 to 67 percent in 2007. In 2008, the share of securities in U.S. portfolio investment abroad declined to 55 percent, mainly because of the declines in global securities prices. With the rebound in equity prices in 2009 and 2010, the share accounted for by securities increased to 62 percent.

**Table 18. Forms of U.S. portfolio investment abroad, as of selected survey dates**

Billions of dollars

Date	Total Investment	Securities			Deposits, Loans, and Other <sup>1</sup>		
		Total	Long-term	Short-term	Total	Reported by banks	Reported by nonbanks
Mar. 1994	1,549	905	870	35	644	622	21
Dec. 1997	2,730	1,809	1,755	54	921	890	31
Dec. 2001	3,586	2,317	2,170	147	1,269	1,237	32
Dec. 2003	4,803	3,152	2,954	199	1,650	1,553	98
Dec. 2004	5,884	3,787	3,553	233	2,098	1,964	133
Dec. 2005	6,968	4,608	4,346	262	2,360	2,228	132
Dec. 2006	8,857	5,991	5,623	368	2,866	2,743	123
Dec. 2007	10,759	7,220	6,863	357	3,539	3,404	135
Dec. 2008	7,770	4,291	4,009	282	3,479	3,372	106
Dec. 2009 <sup>r</sup>	9,595	5,977	5,589	387	3,618	3,530	88
Dec. 2010	11,008	6,862	6,362	500	4,146	4,062	83

r Revised

1. Includes deposits, brokerage balances, loans, resale agreements, and trade receivables and advance payments.

Sources. Data on securities are from the surveys (except for short-term securities in 1994 and 1997); data on deposits, loans, and other are from the Department of the Treasury, Treasury Bulletin, various issues. Short-term securities for 1994 and 1997 are from the Treasury Bulletin. Numbers for prior years may be revised from those published in earlier survey reports.

## **Chapter 2. Data Collection Methodology**

The U.S. system for measuring U.S. holdings of foreign securities consists of “benchmark” surveys conducted at five-year intervals and smaller surveys conducted annually in non-benchmark years. The benchmark surveys collect data from a large number of institutions in an attempt to measure total U.S. holdings as comprehensively as practicable. In each of the four years following each benchmark survey, data are collected from only the largest respondents who collectively reported a very large share of data in the preceding benchmark survey.

The 2010 survey was a non-benchmark year. Data were collected primarily from U.S.-resident custodians, but also from some end-investors, who were required to report holdings of foreign securities at the individual security level. In total, 98 firms reported data. Reporting is quite concentrated: The ten largest custodians reported 90 percent of the total market value of security-by-security data submitted. In total, some 929,419 records were submitted by respondents, of which 682,807 were equity records and 246,612 were debt security records. Banks were the leading custodians, though broker-dealers also reported significant amounts of custodial holdings.

This Survey was conducted under the authority of the International Investment and Trade in Services Survey Act (22 U.S.C. 3101 et seq.). Reporting was mandatory, and subject to penalties for noncompliance. Data were collected for holdings as of December 31, 2010, and were to be reported to the Federal Reserve Bank of New York, acting as agent for the Department of the Treasury, no later than March 4, 2011. A copy of the forms and instructions is included in Appendix B.

### Data Analysis and Editing

The detailed security level data submitted by respondents were subjected to extensive analysis and editing. The first step in the process was to analyze respondent data to identify systematic errors within each respondent’s submission. Each respondent’s data were analyzed individually and compared with the data submitted in the previous year’s submission. Reported securities with the largest market values were analyzed in detail, and the other reported securities were analyzed in the aggregate to identify common types of reporting errors.

Once the analysis of the data for each respondent was completed, the data were analyzed on a security-by-security basis, across all reporters. Securities subject to particular attention included those with a large quantity or market value reported, those with particularly high or low prices, or those securities comprising a large percentage of the total amount outstanding.

The data were also examined by categories, such as country of issuer, type of security, and type of issuer. This review was especially useful in eliminating cases in which the mis-coding of a security with a small market value could have a relatively large impact upon a small category. Additionally, the data was compared to various TIC and regulatory reports to identify possible systemic issues.

### Avoidance of Data Gaps and Double Counting

Respondent's reports were examined to ensure that frequently omitted securities were included, such as those of international organizations resident in the United States, those issued by foreign conduits of U.S. entities, and those of former U.S. corporations that have re-incorporated outside of the United States. Checks were also made to detect and exclude securities issued by U.S.-resident entities. In addition, the security-by-security data provided by end-investors were examined to ensure that only securities held either directly by the end-investor or through foreign custodians were reported on a security-by-security basis.

In some cases, foreign securities may be entrusted to a U.S.-resident custodian which, in turn, entrusts the securities to another U.S.-resident custodian. To avoid double-counting in these instances, U.S.-resident custodians who passed the foreign securities to other U.S.-resident custodians were instructed not to provide security-by-security information on these securities, but instead only to identify the custodian(s) involved and the amount(s) entrusted. The reports provided by end-investors and U.S.-resident custodians using U.S.-resident sub-custodians were examined to ensure that all significant U.S.-resident custodians were included on the panel and to provide a crude check on the aggregate amounts reported by each custodian. Special analyses were performed to ensure that respondents excluded their foreign operations and foreign customers and that they included all of their U.S. organizational units.

### Estimate on Unreported Data and Calculation of Total U.S. Holdings of Foreign Securities

The December 2010 survey collected data from the largest U.S.-resident custodians and end-investors, based on the data reported in the 2006 benchmark survey. These respondents accounted for over 99 percent of the reported 2006 benchmark survey. The remaining 1 percent was accounted for in the December 2010 data by adding the securities reported in the 2006 survey by the respondents which are not part of the 2010 panel to the securities reported annually. The data added were adjusted to maintain the years to maturity originally reported for debt instruments. Additional adjustments were also made on these data to account for yearly changes in valuation, which were based on observed market conditions.

### Acknowledgments

The Department of the Treasury, the Federal Reserve Bank of New York and the Board of Governors of the Federal Reserve System wish to express their appreciation to the Securities Reports Division of the Federal Reserve Bank of New York for preparation of the U.S. portfolio data. Under the direction of Lessa Gomez, staff responsible for data analysis were: Lois Burns, Caroline Fernandez, Aaron Gononsky, Brian Goodwin, Hansy Hernandez, Gabriela Hill, Dawn Nannery, Jason Nuccio, Marc Plotsker, Gillian Stowe, and Paula Webster. Automation staff, working under the direction of Michele Waldman, responsible for obtaining properly formatted data files and for facilitating data loads and updates were: Frank Innocenti, David Carley, Samson Chan, Susan Gibson, Mike Hasell, Sharon McKenzie, Navin Persuad, Sophia Shi and Cecelia Valentin-Doval. Application Development staff, working under the direction of Julie Sun-Jannes, who developed and enhanced the database and reports, were: Yee Ying Chan and

## U.S. Holdings of Foreign Securities

Michael Eydelman. Staff who provided timely data entry and file loading support, working under the direction of Laura Iannolino, were: Mary Ann Campano, Natasha Fair, and Rita Cek-Dagostin. Hugh Montag at the Board of Governors of the Federal Reserve System provided excellent research assistance.

**Statistical Appendix**



**Table A1. Market value of U.S. holdings of foreign securities, by country and type of security, as of December 31, 2010**

Millions of dollars except as noted

Country or region of issuer	Total	Equity	Debt	
			Long-term	Short-term
Albania	15	*	15	0
Anguilla	*	*	0	0
Antigua and Barbuda	112	112	0	0
Argentina	10,795	2,599	8,177	19
Aruba	637	0	637	0
Australia	323,303	149,720	122,978	50,605
Austria	18,070	12,286	5,114	670
Bahamas	2,009	1,177	766	66
Bangladesh	69	69	0	0
Barbados	1,476	12	1,464	0
Belarus	109	*	109	0
Belgium	35,453	28,792	4,404	2,257
Belize	151	18	133	0
Bermuda	159,544	134,084	25,380	81
Bolivia	*	0	*	0
Bosnia and Herzegovina	29	0	29	0
Botswana	45	45	0	0
Brazil	235,128	193,900	40,571	658
British Virgin Islands	15,921	11,992	3,930	0
Bulgaria	254	135	119	0
Cameroon	1	1	0	0
Canada	695,214	408,631	252,770	33,812
Cayman Islands	366,025	166,372	196,476	3,177
Chile	22,531	12,757	9,679	95
China, mainland 1	102,226	100,624	1,572	30
Colombia	10,451	3,518	6,929	4
Comoros	*	*	0	0
Congo (Brazzaville)	149	*	149	0
Cook Islands	6	6	0	0
Costa Rica	122	1	121	0
Cote D'Ivoire	181	3	178	0
Croatia	984	110	850	24
Cuba	*	*	*	0
Cyprus	1,355	962	85	308
Czech Republic	4,872	4,553	320	0
Denmark	48,905	38,236	8,939	1,730
Dominica	*	*	0	0
Dominican Republic	815	*	815	0
Ecuador	307	*	305	2
Egypt	10,378	5,116	1,649	3,613
El Salvador	909	5	901	3
Estonia	130	74	56	0

\* Greater than zero but less than \$500,000.

1. Excludes Hong Kong and Macau, which are reported separately.

**Table A1. Market value of U.S. holdings of foreign securities, by country and type of security, as of December 31, 2010 (continued)**

Millions of dollars except as noted

Country or region of issuer	Total	Equity	Debt	
			Long-term	Short-term
Falkland Islands	29	29	0	0
Faroe Islands	27	27	0	0
Fiji	17	0	17	0
Finland	40,622	27,262	3,299	10,061
France	366,329	244,197	82,204	39,928
French Guiana	*	*	0	0
Gambia	*	*	0	0
Georgia	210	81	130	0
Germany	299,101	206,767	74,308	18,025
Ghana	367	32	335	0
Gibraltar	295	275	19	0
Greece	7,085	6,158	927	0
Grenada	19	0	19	0
Guatemala	55	0	55	0
Guernsey	14,796	11,811	2,985	0
Guinea	2	2	0	0
Guyana	*	*	0	0
Honduras	29	0	7	22
Hong Kong	134,817	132,520	2,228	69
Hungary	6,564	3,446	3,119	0
Iceland	1,644	73	1,520	51
India	91,486	86,477	4,395	614
Indonesia	34,861	25,239	9,582	40
Ireland	131,936	101,420	27,402	3,115
Isle of Man	2,843	2,084	758	0
Israel	63,502	44,798	16,703	2,001
Italy	65,638	51,211	14,416	11
Jamaica	315	*	315	0
Japan	518,907	450,096	46,619	22,191
Jersey	41,907	20,846	12,432	8,628
Jordan	118	87	31	0
Kazakhstan	2,993	724	2,269	*
Kenya	192	187	5	0
Kiribati	2	2	0	0
Korea, South	148,188	122,416	24,890	882
Latvia	13	13	*	0
Lebanon	463	166	297	0
Liberia	5,413	3,535	1,876	2
Liechtenstein	300	299	*	0

\* Greater than zero but less than \$500,000.

**Table A1. Market value of U.S. holdings of foreign securities, by country and type of security, as of December 31, 2010 (continued)**

Millions of dollars except as noted

Country or region of issuer	Total	Equity	Debt	
			Long-term	Short-term
Lithuania	1,518	18	1,499	0
Luxembourg	100,431	32,663	64,579	3,189
Macau	57	*	56	0
Macedonia	13	0	13	0
Madagascar	2	2	0	0
Malawi	1	1	0	0
Malaysia	32,210	20,270	10,017	1,923
Malta	88	1	87	0
Marshall Islands	11,174	9,412	1,762	0
Mauritius	2,289	2,255	35	0
Mexico	108,855	76,614	32,081	160
Moldova	*	*	0	0
Monaco	27	27	*	0
Mongolia	6	0	6	0
Morocco	475	383	92	0
Namibia	1	1	0	0
Netherlands	232,886	120,456	103,229	9,200
Netherlands Antilles	83,309	82,076	1,233	0
New Zealand	17,296	3,100	7,453	6,743
Nicaragua	24	0	24	0
Niger	3	3	0	0
Norway	56,074	23,008	23,600	9,466
Pakistan	1,174	886	288	0
Panama	25,609	21,842	3,641	126
Papua New Guinea	1,310	1,310	0	0
Paraguay	5	5	0	0
Peru	7,576	3,459	4,117	0
Philippines	16,533	9,026	7,419	87
Poland	21,810	8,756	12,979	75
Portugal	5,991	5,363	583	45
Reunion	*	0	*	0
Romania	211	203	5	3
Russia	62,285	55,553	6,732	0
Saint Lucia	19	0	19	0
Saint Vincent and the Grenadines	1	0	1	0
Senegal	36	21	15	0
Serbia and Montenegro	124	12	112	0
Seychelles	7	0	7	0
Singapore	63,907	56,356	7,190	362

\* Greater than zero but less than \$500,000.

**Table A1. Market value of U.S. holdings of foreign securities, by country and type of security, as of December 31, 2010 (continued)**

Millions of dollars except as noted

Country or region of issuer	Total	Equity	Debt	
			Long-term	Short-term
Slovakia	50	*	50	0
Slovenia	262	191	71	0
South Africa	77,934	70,343	7,591	0
Spain	87,078	65,510	21,209	359
Sri Lanka	1,832	704	1,106	22
Swaziland	3	3	0	0
Sweden	122,100	63,221	29,798	29,081
Switzerland	327,036	319,376	5,884	1,776
Taiwan	94,656	94,279	377	0
Thailand	23,034	20,999	1,953	82
Togo	8	8	0	0
Trinidad and Tobago	1,175	3	1,172	0
Tunisia	560	14	546	0
Turkey	40,088	30,579	9,435	74
Turks and Caicos Islands	1	*	1	0
Uganda	*	*	0	0
Ukraine	1,788	149	1,640	0
United Kingdom	1,001,456	626,428	252,478	122,549
Uruguay	1,812	1	1,798	13
Venezuela	7,954	92	7,670	192
Vietnam	1,080	407	674	0
Zambia	46	44	1	1
Zimbabwe	101	46	56	0
International Organizations	55,056	387	41,412	13,257
Middle East oil-exporters <sup>2</sup>	14,097	2,178	11,860	60
African oil-exporters <sup>3</sup>	882	676	205	0
Country unknown	169	0	169	0
<b>Total</b>	<b>6,763,362</b>	<b>4,646,908</b>	<b>1,714,815</b>	<b>401,639</b>
<b>Totals by Region</b>				
Total Africa	99,080	82,722	12,743	3,616
Total Asia	1,343,221	1,167,596	147,264	28,362
Total Caribbean	631,380	395,829	232,228	3,324
Total Europe	3,153,793	2,113,354	779,812	260,627
<i>Of which: Euro Area Countries<sup>4</sup></i>	1,392,372	903,236	401,967	87,169
Total Latin America	432,344	314,842	116,209	1,294
Canada	695,214	408,631	252,770	33,812
Total Other Countries	353,105	163,546	132,209	57,348
International Organizations	55,056	387	41,412	13,257

\* Greater than zero but less than \$500,000.

2. Bahrain, Iran, Iraq, Kuwait, Oman, Qatar, Saudi Arabia, United Arab Emirates.

3. Algeria, Gabon, Libya, Nigeria.

4. Austria, Belgium, Cyprus, Finland, France, Germany, Greece, Ireland, Italy, Luxembourg, Malta, Netherlands, Portugal, Slovakia, Slovenia, Spain.

**Table A2. Market value of U.S. holdings of foreign long-term securities, by country, as of selected survey dates**

Millions of dollars

Country or region of issuer	December 2004	December 2005	December 2006	December 2007	December 2008	December 2009	December 2010
Albania	5	6	12	13	13	6	15
Andorra	2	5	9	14	7	0	0
Angola	0	0	0	0	0	6	0
Anguilla	2	3	4	15	4	1	*
Antigua and Barbuda	12	33	33	128	29	114	112
Argentina	4,826	6,841	10,980	9,829	4,228	7,281	10,776
Aruba	1,114	1,189	1,272	1,102	908	848	637
Australia	97,418	119,701	163,624	211,467	136,273	235,198	272,698
Austria	13,659	15,836	23,144	26,522	9,711	14,609	17,400
Bahamas	2,650	3,257	1,522	2,221	1,126	2,155	1,943
Bangladesh	0	*	4	163	45	12	69
Barbados	256	272	323	426	400	1,366	1,476
Belarus	0	0	0	0	*	*	110
Belgium	23,297	24,162	34,459	36,777	22,617	35,853	33,196
Belize	60	50	52	88	73	76	151
Bermuda	163,411	185,074	205,419	273,125	162,556	147,962	159,464
Bolivia	0	*	0	10	*	0	*
Bosnia and Herzegovina	149	114	72	90	20	110	29
Botswana	7	5	4	6	11	40	45
Brazil	62,989	90,257	110,257	188,844	90,976	212,745	234,471
British Virgin Islands	4,463	8,348	10,996	14,979	8,876	10,313	15,921
Bulgaria	1,173	428	312	562	252	215	254
Burma	0	0	0	0	0	0	0
Burundi	0	0	0	4	4	0	0
Cambodia	0	0	0	0	0	0	0
Cameroon	0	0	0	0	0	0	1
Canada	332,249	405,332	460,210	565,679	346,057	514,609	661,401
Cayman Islands	184,128	221,003	338,444	504,779	297,549	364,979	362,848
Central African Republic	0	0	0	0	0	0	0
Chile	11,598	12,097	12,539	12,815	10,299	15,284	22,436
China, mainland <sup>1</sup>	12,710	28,432	75,217	97,159	54,876	102,286	102,196
Colombia	4,455	5,018	5,827	6,764	6,843	7,937	10,447
Comoros	0	0	0	*	*	*	*
Congo (Brazzaville)	0	0	0	0	44	128	149
Congo (Kinshasa)	0	0	0	0	0	0	0
Cook Islands	*	73	0	*	1	1	6
Costa Rica	241	420	317	373	255	171	122
Cote d'Ivoire	98	92	95	158	61	263	181
Croatia	716	703	400	469	270	779	960
Cuba	1	*	*	*	*	*	1
Cyprus	103	208	820	2,643	525	882	1,047

\* Greater than zero but less than \$500,000. n.a. Not available.

1. Excludes Hong Kong and Macau, which are reported separately.

**Table A2. Market value of U.S. holdings of foreign long-term securities, by country, as of selected survey dates (continued)**

Millions of dollars

Country or region of issuer	December 2004	December 2005	December 2006	December 2007	December 2008	December 2009	December 2010
Czech Republic	1,876	1,742	3,070	5,352	3,753	4,743	4,872
Denmark	22,780	24,623	33,042	45,809	30,224	34,518	47,175
Dominica	0	0	0	0	*	*	*
Dominican Republic	472	662	792	852	380	622	815
Ecuador	1,091	984	550	708	385	316	305
Egypt	1,149	3,549	5,651	10,623	4,070	5,478	6,765
El Salvador	658	822	932	831	485	735	906
Estonia	343	97	98	173	90	97	130
Ethiopia	0	0	0	0	0	0	0
Falkland Islands	*	1	2	4	1	3	29
Faroe Islands	0	0	*	14	6	3	27
Fiji	0	0	7	29	27	21	17
Finland	38,353	48,403	59,659	93,788	38,396	34,032	30,561
France	206,465	252,914	369,822	431,016	270,349	332,564	326,401
French Guiana	*	*	8	*	*	*	*
Gambia	0	0	*	*	*	*	*
Georgia	0	*	30	150	91	117	210
Germany	191,604	207,010	282,409	418,640	239,574	272,859	281,076
Ghana	4	3	3	193	114	230	367
Gibraltar	64	211	135	96	64	104	295
Greece	8,290	10,555	16,006	25,494	8,822	11,474	7,085
Greenland	0	0	0	0	0	*	0
Grenada	2	2	16	14	9	10	19
Guadeloupe	0	0	0	0	0	0	0
Guatemala	173	206	206	225	93	48	55
Guernsey	5,941	6,394	12,487	15,818	6,588	12,270	14,796
Guinea	0	0	0	3	2	2	2
Guyana	0	0	0	0	*	*	*
Haiti	0	0	0	0	0	0	0
Honduras	15	17	8	6	24	7	7
Hong Kong	37,328	46,197	87,493	121,321	64,783	92,846	134,748
Hungary	5,104	5,634	8,382	9,094	4,479	6,702	6,564
Iceland	243	3,229	6,051	7,253	2,044	1,444	1,593
India	23,515	33,226	48,957	85,124	31,404	65,397	90,872
Indonesia	6,985	9,001	14,072	18,356	11,160	22,729	34,821
Ireland	46,244	49,920	86,268	99,222	44,862	105,013	128,821
Isle of Man	15	61	569	1,295	510	1,301	2,843
Israel	34,308	44,308	41,506	54,209	46,043	58,653	61,501
Italy	74,845	75,953	104,678	118,868	60,490	74,940	65,627
Jamaica	195	442	591	663	336	382	315
Japan	366,860	528,415	589,677	589,756	401,308	411,382	496,716

\* Greater than zero but less than \$500,000. n.a. Not available.

**Table A2. Market value of U.S. holdings of foreign long-term securities, by country, as of selected survey dates (continued)**

Millions of dollars

Country or region of issuer	December 2004	December 2005	December 2006	December 2007	December 2008	December 2009	December 2010
Jersey	7,074	9,140	12,747	17,677	18,555	32,992	33,279
Jordan	41	72	61	110	77	91	118
Kazakhstan	346	336	1,281	1,317	745	1,414	2,993
Kenya	17	21	15	32	40	101	192
Kiribati	0	0	0	0	1	1	2
Korea, South	73,544	118,507	123,663	139,130	55,737	104,243	147,306
Kyrgyzstan	11	0	0	0	0	0	0
Latvia	8	12	13	18	4	10	13
Lebanon	223	408	375	432	284	295	463
Lesotho	26	0	0	*	*	0	0
Liberia	7,829	6,749	5,786	6,772	2,872	4,117	5,411
Liechtenstein	35	66	244	263	192	216	300
Lithuania	5	52	41	74	44	792	1,518
Luxembourg	34,181	40,463	52,697	83,918	52,381	88,538	97,242
Macau	0	0	0	0	0	13	57
Macedonia	40	53	0	0	0	1	13
Madagascar	0	0	0	0	*	*	2
Malawi	0	0	0	0	0	*	1
Malaysia	10,684	11,282	15,386	24,062	11,836	18,903	30,286
Maldives	0	0	0	0	0	0	0
Mali	0	0	0	0	0	0	0
Malta	17	96	155	122	101	82	88
Marshall Islands	4,475	5,546	7,462	13,603	5,330	7,221	11,174
Mauritania	0	*	*	*	0	0	0
Mauritius	325	237	638	1,664	956	1,484	2,289
Mexico	66,121	86,074	108,432	109,609	64,972	87,616	108,695
Moldova	0	0	*	*	*	*	*
Monaco	8	9	10	16	13	12	27
Mongolia	0	0	0	*	*	*	6
Morocco	228	440	415	455	381	293	475
Mozambique	0	0	0	0	0	0	0
Namibia	1	1	2	3	3	4	1
Nauru	0	0	*	*	*	0	0
Netherlands	191,544	184,530	229,364	230,609	151,490	214,975	223,685
Netherlands Antilles	30,252	47,223	58,171	89,349	38,473	57,307	83,309
New Caledonia	0	0	0	*	0	0	0
New Zealand	10,439	9,871	8,677	7,848	7,715	7,959	10,553
Nicaragua	37	30	28	29	1	27	24
Niger	0	0	0	0	2	3	3
Norway	28,422	31,478	46,728	61,643	23,984	39,909	46,608
Pakistan	147	389	1,026	1,759	631	785	1,174
Palau	0	0	0	0	0	0	0

\* Greater than zero but less than \$500,000. n.a. Not available.

**Table A2. Market value of U.S. holdings of foreign long-term securities, by country, as of selected survey dates (continued)**

Millions of dollars

Country or region of issuer	December 2004	December 2005	December 2006	December 2007	December 2008	December 2009	December 2010
Panama	24,279	25,938	26,068	29,451	14,812	20,443	25,484
Papua New Guinea	314	782	1,298	2,429	1,820	2,802	1,310
Paraguay	0	0	0	0	3	5	5
Peru	3,874	4,588	3,763	4,338	3,426	4,978	7,576
Philippines	5,690	7,179	10,989	14,470	7,095	9,326	16,445
Poland	5,624	7,536	11,816	13,866	7,834	13,961	21,735
Portugal	6,313	5,966	6,442	8,343	3,814	6,178	5,945
Reunion	0	0	0	0	2	1	*
Romania	172	251	380	613	151	184	208
Russia	21,314	28,764	48,421	80,934	24,596	50,814	62,285
Rwanda	0	0	0	0	0	0	0
Saint Kitts and Nevis	*	3	3	*	*	*	0
Saint Lucia	49	98	66	62	37	15	19
Saint Vincent and the Grenadines	0	0	0	0	10	10	1
Sao Tome and Principe	0	0	0	0	0	0	0
Senegal	*	*	*	2	1	11	36
Serbia and Montenegro	1	108	205	272	100	118	124
Seychelles	0	0	2	58	1	2	7
Sierra Leone	0	0	0	0	0	0	0
Singapore	29,081	36,047	52,428	64,667	30,480	52,073	63,546
Slovakia	190	309	299	71	32	31	50
Slovenia	37	79	144	351	164	222	262
Solomon Islands	0	0	0	0	0	0	0
Somalia	0	0	0	0	0	0	0
South Africa	24,647	34,211	42,546	53,064	32,168	53,519	77,934
Spain	68,074	69,226	109,773	144,509	88,139	113,250	86,718
Sri Lanka	79	93	183	281	145	1,016	1,810
Sudan	0	0	0	0	0	0	0
Suriname	0	0	0	0	0	0	0
Swaziland	0	0	0	0	2	3	3
Sweden	52,862	57,011	83,261	86,528	50,519	69,508	93,019
Switzerland	139,738	193,999	263,828	284,588	218,152	304,379	325,260
Taiwan	34,885	57,877	74,449	81,202	41,418	76,859	94,656
Tanzania	0	0	0	0	0	0	0
Thailand	7,097	10,392	12,756	16,833	7,543	14,201	22,952
Togo	0	0	0	0	2	1	8
Tokelau Islands	0	0	0	0	0	0	0
Tonga	0	0	0	0	0	0	0
Trinidad and Tobago	477	490	711	1,477	1,121	1,403	1,175
Tunisia	588	639	607	505	407	463	560
Turkey	8,137	14,179	15,225	25,093	15,846	28,485	40,014
Turks and Caicos Islands	*	*	*	*	*	*	1

\* Greater than zero but less than \$500,000. n.a. Not available.



**Table A2. Market value of U.S. holdings of foreign long-term securities, by country, as of selected survey dates (continued)**

Millions of dollars

Country or region of issuer	December 2004	December 2005	December 2006	December 2007	December 2008	December 2009	December 2010
Uganda	0	0	0	0	2	6	*
Ukraine	1,548	1,276	1,506	2,137	931	960	1,788
United Kingdom	627,365	722,849	919,343	1,002,156	562,247	801,922	878,906
Uruguay	1,303	1,073	1,694	1,962	1,244	1,714	1,799
Uzbekistan	0	0	0	0	0	0	0
Venezuela	6,863	6,003	6,097	5,426	3,594	9,646	7,762
Vietnam	113	306	238	248	199	419	1,080
Zambia	2	12	16	82	36	47	45
Zimbabwe	68	79	203	200	76	68	101
Country Unknown	*	*	0	0	0	0	41,799
International Organizations	18,162	18,986	19,369	22,548	20,694	40,516	14,038
Middle East oil-exporters <sup>2</sup>	1,454	2,693	5,829	10,467	7,102	12,709	882
African oil-exporters <sup>3</sup>	191	222	97	772	398	534	169
<b>Total</b>	<b>3,553,387</b>	<b>4,345,891</b>	<b>5,623,019</b>	<b>6,862,744</b>	<b>4,009,053</b>	<b>5,589,482</b>	<b>6,361,723</b>

\* Greater than zero but less than \$500,000. n.a. Not available.

2. Bahrain, Iran, Iraq, Kuwait, Oman, Qatar, Saudi Arabia, United Arab Emirates.

3. Algeria, Gabon, Libya, Nigeria.

**Table A3. Market value of U.S. holdings of foreign equity, by country, as of selected survey dates**

Millions of dollars

Country or region of issuer	December 2004	December 2005	December 2006	December 2007	December 2008	December 2009	December 2010
Albania	0	0	0	*	*	*	*
Andorra	2	5	9	14	7	0	0
Angola	0	0	0	0	0	0	0
Anguilla	2	3	4	15	4	1	*
Antigua and Barbuda	12	32	33	128	29	114	112
Argentina	1,161	1,144	1,844	1,931	719	1,168	2,599
Aruba	*	0	0	0	0	0	0
Australia	57,052	71,141	101,990	138,131	65,239	127,872	#N/A
Austria	8,976	10,724	18,144	20,075	5,564	9,876	12,286
Bahamas	1,779	2,327	1,064	1,313	601	1,494	1,177
Bangladesh	0	*	4	163	45	12	69
Barbados	10	*	25	58	44	61	12
Belarus	0	0	0	0	*	*	*
Belgium	18,083	19,947	28,805	31,671	15,794	28,257	28,792
Belize	26	41	27	57	23	17	18
Bermuda	153,549	173,842	191,853	256,399	143,342	121,133	134,084
Bolivia	0	0	0	0	0	0	0
Bosnia and Herzegovina	4	0	0	0	*	0	0
Botswana	3	3	4	5	11	40	45
Brazil	43,104	68,560	92,045	172,662	72,070	180,325	193,900
British Virgin Islands	3,716	5,899	8,178	11,292	6,747	8,193	11,992
Bulgaria	6	78	95	387	165	120	135
Burma	0	0	0	0	0	0	0
Burundi	0	0	0	0	0	0	0
Cambodia	0	0	0	0	0	0	0
Cameroon	0	0	0	0	0	0	1
Canada	180,398	247,823	298,137	379,655	180,175	295,078	408,631
Cayman Islands	69,750	102,603	160,555	232,994	95,181	147,514	166,372
Central African Republic	0	0	0	0	0	0	0
Chile	2,564	3,520	4,447	5,207	4,270	8,622	12,757
China, mainland <sup>1</sup>	11,645	26,888	73,912	95,693	53,269	101,616	100,624
Colombia	270	753	732	1,193	924	1,673	3,518
Comoros	0	0	0	*	*	*	*
Congo (Brazzaville)	0	0	0	0	*	*	*
Congo (Kinshasa)	0	0	0	0	0	0	0
Cook Islands	0	73	*	*	1	1	6
Costa Rica	5	20	2	*	*	1	1
Cote d'Ivoire	2	0	0	1	*	3	3
Croatia	234	189	74	164	62	87	110
Cuba	*	*	*	*	*	*	*
Cyprus	3	105	726	2,305	425	793	962

\* Greater than zero but less than \$500,000.

1. Excludes Hong Kong and Macau, which are reported separately.

**Table A3. Market value of U.S. holdings of foreign equity, by country, as of selected survey dates (continued)**

Millions of dollars

Country or region of issuer	December 2004	December 2005	December 2006	December 2007	December 2008	December 2009	December 2009
Czech Republic	1,843	1,727	3,045	5,155	3,682	4,567	4,553
Denmark	14,488	15,652	21,236	32,975	19,757	26,952	38,236
Dominica	0	0	0	0	*	*	*
Dominican Republic	*	*	1	*	1	*	*
Ecuador	25	41	*	*	*	*	*
Egypt	1,093	2,567	4,377	8,865	2,565	4,116	5,116
El Salvador	*	*	0	6	3	5	5
Estonia	304	62	63	135	55	56	74
Falkland Islands	*	1	2	4	1	3	29
Faroe Islands	0	0	*	14	6	3	27
Fiji	0	0	0	0	0	0	0
Finland	33,860	44,393	55,852	90,200	35,755	29,646	27,262
France	164,634	205,113	306,861	348,011	212,191	250,706	244,197
French Guiana	*	*	8	*	*	*	*
Gambia	0	0	*	*	*	*	*
Georgia	0	0	27	148	21	30	81
Germany	123,685	158,013	220,397	329,405	159,863	192,692	206,767
Ghana	3	2	2	20	15	15	32
Gibraltar	64	211	135	96	64	104	275
Greece	6,980	9,529	14,448	23,728	7,889	9,706	6,158
Greenland	0	0	0	0	0	*	0
Grenada	0	0	0	0	0	0	0
Guadeloupe	0	0	0	0	0	0	0
Guatemala	0	*	*	0	0	0	0
Guemsey	5,399	5,797	11,715	13,247	5,621	10,938	11,811
Guinea	0	0	0	3	2	2	2
Guyana	0	0	0	0	*	*	*
Haiti	0	0	0	0	0	0	0
Honduras	0	0	0	*	0	0	0
Hong Kong	35,395	44,465	85,833	119,583	61,483	91,391	132,520
Hungary	4,503	4,880	7,619	7,309	2,699	4,431	3,446
Iceland	2	14	29	32	2	22	73
India	23,152	32,753	47,932	81,829	29,041	62,045	86,477
Indonesia	6,116	7,127	11,490	15,079	7,018	15,467	25,239
Ireland	32,422	33,027	47,943	49,046	22,262	79,187	101,420
Isle of Man	*	36	541	1,146	345	1,112	2,084
Israel	19,054	29,125	26,019	38,931	30,913	44,284	44,798
Italy	57,494	63,915	92,733	96,974	46,997	59,343	51,211
Jamaica	2	2	2	*	1	3	*
Japan	330,427	493,343	543,506	529,431	347,600	370,850	450,096

\* Greater than zero but less than \$500,000.

**Table A3. Market value of U.S. holdings of foreign equity, by country, as of selected survey dates (continued)**

Millions of dollars

Country or region of issuer	December 2004	December 2005	December 2006	December 2007	December 2008	December 2009	December 2009
Jersey	436	824	2,848	5,436	10,858	19,784	20,846
Jordan	19	40	28	83	52	65	87
Kazakhstan	*	6	953	812	232	1,008	724
Kenya	2	3	7	24	32	95	187
Kiribati	0	0	0	0	1	1	2
Korea, South	66,639	110,264	114,155	129,272	45,287	87,915	122,416
Kyrgyzstan	*	0	0	0	0	0	0
Latvia	4	10	13	18	3	10	13
Lebanon	49	100	87	141	90	136	166
Lesotho	25	0	0	*	*	0	0
Liberia	5,866	5,172	4,253	5,054	1,834	2,153	3,535
Liechtenstein	35	66	241	253	183	206	299
Lithuania	3	20	9	29	12	21	18
Luxembourg	7,634	11,134	15,590	40,084	15,791	31,533	32,663
Macau	0	0	0	0	0	0	*
Macedonia	0	0	0	0	0	0	0
Madagascar	0	0	0	0	*	*	2
Malawi	0	0	0	0	0	*	1
Malaysia	6,474	6,934	10,781	17,674	6,673	12,133	20,270
Maldives	0	0	0	0	0	0	0
Mali	0	0	0	0	0	0	0
Malta	*	*	82	50	13	13	1
Marshall Islands	3,727	5,047	6,781	13,113	5,055	6,182	9,412
Mauritania	0	0	0	0	0	0	0
Mauritius	143	188	619	1,577	936	1,451	2,255
Mexico	37,516	57,876	84,620	85,698	46,021	65,061	76,614
Moldova	0	0	*	*	*	*	*
Monaco	8	9	10	16	13	12	27
Mongolia	0	0	0	0	0	0	0
Morocco	89	299	337	394	349	246	383
Mozambique	0	0	0	0	0	0	0
Namibia	1	1	2	3	3	4	1
Nauru	0	0	*	*	*	0	0
Netherlands	136,467	132,769	161,493	154,111	76,571	108,803	120,456
Netherlands Antilles	28,730	45,378	56,368	88,063	37,174	56,189	82,076
New Caledonia	0	0	0	*	0	0	0
New Zealand	4,720	4,633	4,671	3,947	1,709	2,710	3,100
Nicaragua	0	0	0	0	0	0	0
Niger	0	0	0	0	2	3	3
Norway	18,153	22,023	32,096	46,404	13,426	22,861	23,008
Pakistan	111	364	780	1,444	435	494	886
Palau	0	0	0	0	0	0	0

\* Greater than zero but less than \$500,000.

**Table A3. Market value of U.S. holdings of foreign equity, by country, as of selected survey dates (continued)**

Millions of dollars

Country or region of issuer	December 2004	December 2005	December 2006	December 2007	December 2008	December 2009	December 2009
Panama	19,450	20,998	21,340	25,305	11,718	17,339	21,842
Papua New Guinea	314	782	1,298	2,429	1,820	2,802	1,310
Paraguay	0	0	0	0	3	5	5
Peru	666	870	925	1,682	1,292	2,218	3,459
Philippines	2,222	3,068	6,050	9,910	4,279	6,110	9,026
Poland	3,072	4,562	7,384	9,082	4,383	5,243	8,756
Portugal	5,505	5,323	5,982	6,111	3,382	5,242	5,363
Reunion	0	0	0	0	*	0	0
Romania	120	249	372	612	151	184	203
Russia	10,775	18,631	40,291	74,412	19,764	45,355	55,553
Rwanda	0	0	0	0	0	0	0
Saint Kitts and Nevis	*	3	3	*	*	*	0
Saint Lucia	0	0	0	0	0	0	0
Saint Vincent and the Grenadines	0	0	0	0	0	0	0
Sao Tome and Principe	0	0	0	0	0	0	0
Senegal	*	*	0	2	1	3	21
Serbia and Montenegro	0	7	105	201	2	6	12
Seychelles	0	0	0	0	0	0	0
Sierra Leone	0	0	0	0	0	0	0
Singapore	23,968	29,109	43,911	55,598	24,028	45,424	56,356
Slovakia	*	1	*	*	*	*	*
Slovenia	1	48	116	318	133	182	191
Solomon Islands	0	0	0	0	0	0	0
Somalia	0	0	0	0	0	0	0
South Africa	21,600	31,605	39,586	49,147	29,639	49,465	70,343
Spain	63,002	63,514	85,600	106,666	63,299	87,442	65,510
Sri Lanka	31	74	152	166	64	223	704
Sudan	0	0	0	0	0	0	0
Suriname	0	0	0	0	0	0	0
Swaziland	*	0	0	0	2	3	3
Sweden	38,284	40,530	59,433	57,411	30,320	43,980	63,221
Switzerland	138,187	191,812	262,620	280,958	214,282	298,270	319,376
Taiwan	34,554	57,088	74,228	81,034	41,195	76,631	94,279
Tanzania	0	0	0	0	0	0	0
Thailand	5,961	8,992	11,054	15,998	6,670	12,962	20,999
Tokelau Islands	0	0	0	0	0	0	0
Togo	0	0	0	0	2	1	8
Tonga	0	0	0	0	0	0	0
Trinidad and Tobago	5	2	*	*	*	2	3
Tunisia	*	*	4	4	8	11	14
Turkey	5,561	11,122	11,180	19,705	9,908	21,302	30,579
Turks and Caicos Islands	*	*	*	*	*	*	*

\* Greater than zero but less than \$500,000.

**Table A3. Market value of U.S. holdings of foreign equity, by country, as of selected survey dates (continued)**

Millions of dollars

Country or region of issuer	December 2004	December 2005	December 2006	December 2007	December 2008	December 2009	December 2009
Uganda	0	0	0	0	1	1	*
Ukraine	25	50	235	643	115	110	149
United Kingdom	455,919	537,891	673,978	715,494	376,861	561,670	626,428
Uruguay	6	3	*	0	1	1	1
Uzbekistan	0	0	0	0	0	0	0
Venezuela	636	483	971	416	208	138	92
Vietnam	*	*	0	11	6	176	407
Zambia	2	11	16	80	35	46	44
Zimbabwe	14	32	135	157	40	35	46
Country Unknown	*	*	0	0	0	0	0
International Organizations	373	21	327	366	303	278	387
Middle East oil-exporters <sup>2</sup>	1	138	299	2,184	1,087	1,326	2,178
African oil-exporters <sup>3</sup>	12	11	18	252	108	277	676
<b>Total</b>	<b>2,560,418</b>	<b>3,317,712</b>	<b>4,328,960</b>	<b>5,252,941</b>	<b>2,748,428</b>	<b>3,995,295</b>	<b>4,646,908</b>

\* Greater than zero but less than \$500,000.

2. Bahrain, Iran, Iraq, Kuwait, Oman, Qatar, Saudi Arabia, United Arab Emirates.

3. Algeria, Gabon, Libya, Nigeria.

**Table A4. Market value of U.S. holdings of foreign long-term debt securities, by country, as of selected survey dates**

Millions of dollars

Country or region of issuer	December 2004	December 2005	December 2006	December 2007	December 2008	December 2009	December 2010
Albania	5	6	12	13	13	6	15
Andorra	0	0	0	0	0	0	0
Angola	0	0	0	0	0	6	0
Anguilla	0	0	0	0	0	0	0
Antigua and Barbuda	*	2	0	0	0	0	0
Argentina	3,664	5,696	9,135	7,898	3,508	6,113	8,177
Aruba	1,114	1,189	1,272	1,102	908	848	637
Australia	40,366	48,560	61,634	73,336	71,033	107,326	122,978
Austria	4,682	5,113	5,001	6,447	4,147	4,734	5,114
Bahamas	872	930	458	909	525	662	766
Bangladesh	0	0	0	0	0	0	0
Barbados	246	272	298	367	356	1,304	1,464
Belarus	0	0	0	0	0	0	109
Belgium	5,213	4,215	5,654	5,106	6,823	7,596	4,404
Belize	34	9	25	32	49	59	133
Bermuda	9,862	11,232	13,566	16,727	19,214	26,829	25,380
Bolivia	0	*	*	10	*	0	*
Bosnia and Herzegovina	145	114	72	90	20	110	29
Botswana	4	1	1	1	0	0	0
Brazil	19,885	21,697	18,211	16,181	18,906	32,420	40,571
British Virgin Islands	747	2,449	2,818	3,687	2,129	2,121	3,930
Bulgaria	1,167	350	217	175	87	95	119
Burma	0	0	0	0	0	0	0
Burundi	0	0	0	4	4	0	0
Cambodia	0	0	0	0	0	0	0
Cameroon	0	0	0	0	0	0	0
Canada	151,852	157,509	162,074	186,023	165,881	219,531	252,770
Cayman Islands	114,378	118,399	177,889	271,785	202,368	217,465	196,476
Central African Republic	0	0	0	0	0	0	0
Chile	9,034	8,577	8,092	7,609	6,029	6,662	9,679
China, mainland <sup>1</sup>	1,065	1,544	1,305	1,466	1,606	670	1,572
Colombia	4,185	4,266	5,096	5,571	5,919	6,264	6,929
Comoros	0	0	0	0	0	0	0
Congo (Brazzaville)	0	0	0	0	44	128	149
Congo (Kinshasa)	0	0	0	0	0	0	0
Cook Islands	0	0	0	0	0	0	0
Costa Rica	236	400	315	373	255	170	121
Cote d'Ivoire	95	92	95	158	61	261	178
Croatia	482	514	326	304	208	693	850
Cuba	1	0	0	0	0	0	*
Cyprus	100	103	93	338	100	89	85

\* Greater than zero but less than \$500,000.

1. Excludes Hong Kong and Macau, which are reported separately.

**Table A4. Market value of U.S. holdings of foreign long-term debt securities, by country, as of selected survey dates (continued)**

Millions of dollars

Country or region of issuer	December 2004	December 2005	December 2006	December 2007	December 2008	December 2009	December 2010
Czech Republic	33	15	26	196	71	177	320
Denmark	8,292	8,970	11,806	12,834	10,468	7,565	8,939
Dominica	0	0	0	0	0	0	0
Dominican Republic	472	662	791	852	379	622	815
Ecuador	1,066	942	550	708	384	316	305
Egypt	56	983	1,274	1,758	1,504	1,362	1,649
El Salvador	658	822	932	825	482	731	901
Estonia	39	35	35	38	35	42	56
Falkland Islands	0	0	0	0	0	0	0
Faroe Islands	0	0	0	0	0	0	0
Fiji	0	0	7	29	27	21	17
Finland	4,493	4,010	3,807	3,588	2,641	4,387	3,299
France	41,831	47,801	62,961	83,005	58,158	81,859	82,204
French Guiana	0	0	0	0	0	0	0
Gambia	0	0	0	0	0	0	0
Georgia	0	*	3	3	70	87	130
Germany	67,918	48,997	62,012	89,235	79,711	80,168	74,308
Ghana	1	1	1	173	99	214	335
Gibraltar	0	0	*	0	0	0	19
Greece	1,310	1,025	1,559	1,766	932	1,768	927
Greenland	0	0	0	0	0	0	0
Grenada	2	2	16	14	9	10	19
Guadeloupe	0	0	0	0	0	0	0
Guatemala	173	206	206	225	93	48	55
Guemsey	542	597	772	2,572	967	1,333	2,985
Guinea	0	0	0	0	0	0	0
Guyana	0	0	0	0	0	0	0
Haiti	0	0	0	0	0	0	0
Honduras	15	17	8	6	24	7	7
Hong Kong	1,933	1,731	1,660	1,739	3,300	1,456	2,228
Hungary	601	754	764	1,785	1,780	2,271	3,119
Iceland	241	3,215	6,022	7,221	2,042	1,422	1,520
India	363	473	1,025	3,296	2,362	3,352	4,395
Indonesia	869	1,874	2,582	3,276	4,142	7,261	9,582
Ireland	13,821	16,893	38,326	50,176	22,600	25,825	27,402
Isle of Man	15	26	28	149	165	189	758
Israel	15,254	15,183	15,487	15,278	15,130	14,369	16,703
Italy	17,352	12,038	11,945	21,894	13,493	15,597	14,416
Jamaica	193	440	590	663	336	379	315
Japan	36,433	35,072	46,171	60,325	53,708	40,532	46,619

\* Greater than zero but less than \$500,000.



**Table A4. Market value of U.S. holdings of foreign long-term debt securities, by country, as of selected survey dates (continued)**

Millions of dollars

Country or region of issuer	December 2004	December 2005	December 2006	December 2007	December 2008	December 2009	December 2010
Jersey	6,638	8,316	9,899	12,240	7,697	13,208	12,432
Jordan	22	32	33	28	26	26	31
Kazakhstan	346	330	328	505	513	406	2,269
Kenya	15	17	8	8	7	6	5
Kiribati	0	0	0	0	0	0	0
Korea, South	6,905	8,243	9,507	9,859	10,450	16,328	24,890
Kyrgyzstan	11	0	0	0	0	0	0
Latvia	4	3	*	*	1	*	*
Lebanon	174	308	288	291	193	160	297
Lesotho	1	0	0	0	0	0	0
Liberia	1,964	1,576	1,533	1,718	1,039	1,965	1,876
Liechtenstein	0	*	2	10	9	10	*
Lithuania	1	33	32	45	32	771	1,499
Luxembourg	26,547	29,329	37,108	43,834	36,590	57,005	64,579
Macau	0	0	0	0	0	13	56
Macedonia	40	53	0	0	0	1	13
Madagascar	0	0	0	0	0	0	0
Malawi	0	0	0	0	0	0	0
Malaysia	4,209	4,348	4,605	6,387	5,163	6,769	10,017
Maldives	0	0	0	0	0	0	0
Mali	0	0	0	0	0	0	0
Malta	17	96	73	71	88	69	87
Marshall Islands	748	498	680	490	275	1,039	1,762
Mauritania	0	*	*	*	0	0	0
Mauritius	183	48	19	87	20	33	35
Mexico	28,606	28,198	23,812	23,911	18,950	22,555	32,081
Moldova	0	0	0	0	0	0	0
Monaco	0	0	0	0	0	*	*
Mongolia	0	0	0	*	*	*	6
Morocco	139	141	79	61	32	47	92
Mozambique	0	0	0	0	0	0	0
Namibia	0	0	0	0	0	0	0
Nauru	0	0	0	0	0	0	0
Netherlands	55,077	51,760	67,871	76,497	74,919	106,172	103,229
Netherlands Antilles	1,522	1,844	1,803	1,287	1,299	1,119	1,233
New Caledonia	0	0	0	0	0	0	0
New Zealand	5,719	5,238	4,006	3,901	6,006	5,248	7,453
Nicaragua	37	30	28	29	1	27	24
Norway	10,270	9,455	14,632	15,239	10,558	17,048	23,600
Pakistan	36	25	246	315	196	290	288
Palau	0	0	0	0	0	0	0

\* Greater than zero but less than \$500,000.

**Table A4. Market value of U.S. holdings of foreign long-term debt securities, by country, as of selected survey dates (continued)**

Millions of dollars

Country or region of issuer	December 2004	December 2005	December 2006	December 2007	December 2008	December 2009	December 2010
Panama	4,830	4,940	4,728	4,146	3,094	3,104	3,641
Papua New Guinea	0	0	0	0	0	0	0
Paraguay	0	0	0	0	0	0	0
Peru	3,208	3,718	2,838	2,656	2,134	2,760	4,117
Philippines	3,468	4,111	4,939	4,560	2,816	3,216	7,419
Poland	2,552	2,974	4,432	4,784	3,451	8,718	12,979
Portugal	807	643	460	2,232	432	936	583
Reunion	0	0	0	0	2	1	*
Romania	52	2	9	1	*	*	5
Russia	10,540	10,133	8,130	6,523	4,832	5,459	6,732
Rwanda	0	0	0	0	0	0	0
Saint Kitts and Nevis	0	0	0	0	0	0	0
Saint Lucia	49	98	66	62	37	15	19
Saint Vincent and the Grenadines	0	0	0	0	10	10	1
Sao Tome and Principe	0	0	0	0	0	0	0
Senegal	0	0	*	0	0	8	15
Serbia and Montenegro	1	101	100	71	99	112	112
Seychelles	0	0	2	58	1	2	7
Sierra Leone	0	0	0	0	0	0	0
Singapore	5,113	6,938	8,518	9,069	6,453	6,649	7,190
Slovakia	190	309	299	70	31	31	50
Slovenia	36	31	28	34	31	40	71
Solomon Islands	0	0	0	0	0	0	0
Somalia	0	0	0	0	0	0	0
South Africa	3,047	2,607	2,960	3,917	2,529	4,054	7,591
Spain	5,072	5,712	24,172	37,843	24,840	25,808	21,209
Sri Lanka	49	19	30	115	80	793	1,106
Sudan	0	0	0	0	0	0	0
Suriname	0	0	0	0	0	0	0
Swaziland	3	0	0	0	0	0	0
Sweden	14,577	16,481	23,829	29,117	20,199	25,528	29,798
Switzerland	1,551	2,187	1,208	3,630	3,870	6,109	5,884
Taiwan	331	789	220	168	223	227	377
Tanzania	0	0	0	0	0	0	0
Thailand	1,136	1,400	1,702	835	873	1,239	1,953
Tokelau Islands	0	0	0	0	0	0	0
Tonga	0	0	0	0	0	0	0
Trinidad and Tobago	472	488	711	1,477	1,121	1,401	1,172
Tunisia	588	639	604	501	399	452	546
Turkey	2,577	3,056	4,045	5,388	5,939	7,183	9,435
Turks and Caicos Islands	0	0	0	0	0	0	1

\* Greater than zero but less than \$500,000.

**Table A4. Market value of U.S. holdings of foreign long-term debt securities, by country, as of selected survey dates (continued)**

Millions of dollars

Country or region of issuer	December 2004	December 2005	December 2006	December 2007	December 2008	December 2009	December 2010
Uganda	0	0	0	0	1	5	0
Ukraine	1,524	1,266	1,272	1,495	816	850	1,640
United Kingdom	171,446	184,958	245,365	286,662	185,386	240,252	252,478
Uruguay	1,297	1,070	1,694	1,962	1,244	1,713	1,798
Uzbekistan	0	0	0	0	0	0	0
Venezuela	6,226	5,520	5,125	5,009	3,386	9,508	7,670
Vietnam	113	306	238	237	193	243	674
Zambia	0	1	0	2	1	1	1
Zimbabwe	54	47	68	43	36	33	56
Country Unknown	*	*	0	0	0	0	169
International Organizations	17,789	18,965	19,042	22,182	20,391	40,238	41,412
Middle East oil-exporters <sup>2</sup>	1,453	2,555	5,530	8,283	6,015	11,384	11,860
African oil-exporters <sup>3</sup>	180	211	79	519	290	257	205
<b>Total</b>	<b>992,969</b>	<b>1,028,179</b>	<b>1,294,059</b>	<b>1,609,803</b>	<b>1,260,625</b>	<b>1,594,187</b>	<b>1,714,815</b>

\* Greater than zero but less than \$500,000.

2. Bahrain, Iran, Iraq, Kuwait, Oman, Qatar, Saudi Arabia, United Arab Emirates.

3. Algeria, Gabon, Libya, Nigeria.

**Table A5. Market value of U.S. holdings of foreign short-term debt securities, by country, as of selected survey dates**

Millions of dollars

Country or region of issuer	December 2004	December 2005	December 2006	December 2007	December 2008	December 2009	December 2010
Albania	0	0	0	0	*	0	0
Andorra	0	0	0	0	0	0	0
Angola	0	0	0	0	0	0	0
Anguilla	0	0	0	0	0	0	0
Antigua and Barbuda	0	0	*	0	0	0	0
Argentina	1	12	39	43	19	15	19
Aruba	0	0	0	0	0	0	0
Australia	5,994	8,501	9,529	11,217	9,270	41,233	50,605
Austria	1,591	1,444	3,424	2,486	212	364	670
Bahamas	1	9	152	52	158	15	66
Bangladesh	0	0	0	4	2	1	0
Barbados	0	0	0	0	0	0	0
Belarus	0	0	0	0	0	0	0
Belgium	677	502	1,509	1,127	614	898	2,257
Belize	0	0	0	0	0	0	0
Bermuda	663	1,588	2,631	149	572	*	81
Bolivia	0	0	0	0	0	0	0
Bosnia and Herzegovina	0	0	0	0	0	0	0
Botswana	0	0	0	0	0	0	0
Brazil	10	28	38	44	477	64	658
British Virgin Islands	4	34	0	*	0	*	0
Bulgaria	0	0	0	0	0	0	0
Burma	0	0	0	0	0	0	0
Burundi	0	0	0	0	0	0	0
Cambodia	0	0	0	0	0	0	0
Cameroon	0	0	0	0	0	0	0
Canada	12,419	13,593	17,678	22,244	32,379	25,646	33,812
Cayman Islands	11,549	27,768	37,098	40,673	17,679	8,337	3,177
Central African Republic	0	0	0	0	0	0	0
Chile	*	2	0	5	*	24	95
China, mainland <sup>1</sup>	12	11	97	125	27	17	30
Colombia	*	*	0	35	5	15	4
Comoros	0	0	0	0	0	0	0
Congo (Brazzaville)	0	0	0	0	0	0	0
Congo (Kinshasa)	0	0	0	0	0	0	0
Cook Islands	0	0	0	0	0	0	0
Costa Rica	19	19	23	6	5	0	0
Cote D'Ivoire	0	0	0	0	0	0	0
Croatia	0	0	0	0	0	0	24
Cuba	0	0	0	0	0	0	0
Cyprus	*	2	304	325	0	0	308

\* Greater than zero but less than \$500,000.

1. Excludes Hong Kong and Macau, which are reported separately.

**Table A5. Market value of U.S. holdings of foreign short-term debt securities, by country, as of selected survey dates (continued)**

Millions of dollars

Country or region of issuer	December 2004	December 2005	December 2006	December 2007	December 2008	December 2009	December 2010
Czech Republic	0	0	0	0	0	0	0
Denmark	1,103	653	936	1,356	2,112	3,065	1,730
Dominica	0	0	0	0	0	0	0
Dominican Republic	31	101	25	1	0	0	0
Ecuador	24	*	2	2	2	2	2
Egypt	3	205	1,035	1,245	723	300	3,613
El Salvador	16	16	3	8	5	3	3
Estonia	0	0	0	1	0	0	0
Falkland Islands	0	0	0	0	0	0	0
Faroe Islands	0	0	0	0	0	0	0
Fiji	0	0	0	0	0	0	0
Finland	543	375	275	428	2,563	764	10,061
France	10,142	20,965	31,566	17,466	15,133	29,818	39,928
French Guiana	0	0	0	0	0	0	0
Gambia	0	0	0	0	0	0	0
Georgia	0	0	0	0	0	0	0
Germany	9,772	9,717	9,694	7,918	15,140	20,739	18,025
Ghana	*	0	0	0	0	0	0
Gibraltar	0	0	0	0	0	*	0
Greece	0	0	6	0	0	0	0
Greenland	0	0	0	0	0	0	0
Grenada	0	0	0	0	0	0	0
Guadeloupe	0	0	0	0	0	0	0
Guatemala	0	0	0	0	0	0	0
Guernsey	*	2	6	29	1	0	0
Guinea	0	0	0	0	0	0	0
Guyana	0	0	0	0	0	0	0
Haiti	0	0	0	0	0	0	0
Honduras	28	28	21	20	16	22	22
Hong Kong	22	29	25	18	33	39	69
Hungary	*	1	27	131	70	98	0
Iceland	*	0	1,777	17	5	7	51
India	10	0	274	100	514	98	614
Indonesia	3	24	*	1	*	13	40
Ireland	9,020	25,448	34,244	32,729	17,947	15,008	3,115
Isle of Man	0	0	0	13	0	0	0
Israel	7	5	11	103	21	151	2,001
Italy	2,864	3,440	1,215	1,151	1,273	3,565	11
Jamaica	9	4	0	0	*	0	0
Japan	17,240	2,470	6,562	4,326	1,971	7,695	22,191

\* Greater than zero but less than \$500,000.

**Table A5. Market value of U.S. holdings of foreign short-term debt securities, by country, as of selected survey dates (continued)**

Millions of dollars

Country or region of issuer	December 2004	December 2005	December 2006	December 2007	December 2008	December 2009	December 2010
Jersey	5,278	9,917	8,703	10,982	18,752	12,964	8,628
Jordan	*	0	0	0	0	0	0
Kazakhstan	0	0	7	25	4	8	*
Kenya	0	0	0	0	0	2	0
Kiribati	0	0	0	0	0	0	0
Korea, South	70	0	213	476	319	583	882
Kyrgyzstan	0	0	0	0	0	0	0
Latvia	0	0	0	0	0	0	0
Lebanon	0	*	0	0	*	8	0
Lesotho	0	0	0	0	0	0	0
Liberia	0	0	0	0	0	3	2
Liechtenstein	0	0	0	0	0	0	0
Lithuania	0	0	0	0	0	0	0
Luxembourg	3,868	5,824	7,404	11,228	7,656	5,838	3,189
Macau	0	0	0	0	0	0	0
Macedonia	0	0	0	0	0	0	0
Madagascar	0	0	0	0	0	0	0
Malawi	0	0	0	0	0	0	0
Malaysia	6	0	18	1,179	100	15	1,923
Maldives	0	0	0	0	0	0	0
Mali	0	0	0	0	0	0	0
Malta	0	0	0	5	0	0	0
Marshall Islands	0	0	0	0	0	0	0
Mauritania	0	0	0	0	0	0	0
Mauritius	0	1	1	2	0	0	0
Mexico	195	34	18	432	211	38	160
Moldova	0	0	0	0	0	0	0
Monaco	0	0	0	0	0	0	0
Mongolia	0	0	0	0	0	0	0
Morocco	0	0	0	0	0	0	0
Mozambique	0	0	0	0	0	0	0
Namibia	0	0	0	0	0	0	0
Nauru	0	0	0	0	0	0	0
Netherlands	10,817	7,353	4,701	4,672	17,852	17,943	9,200
Netherlands Antilles	25	*	2	8	1	3	0
New Caledonia	0	0	0	0	0	0	0
New Zealand	1,595	2,064	2,695	1,958	4,525	7,685	6,743
Nicaragua	1	1	0	0	0	0	0
Norway	2,055	4,856	3,845	6,294	9,365	12,445	9,466
Pakistan	0	0	0	*	0	0	0
Palau	0	0	0	0	0	0	0

\* Greater than zero but less than \$500,000.

**Table A5. Market value of U.S. holdings of foreign short-term debt securities, by country, as of selected survey dates (continued)**

Millions of dollars

Country or region of issuer	December 2003	December 2004	December 2005	December 2006	December 2007	December 2008	December 2010
Panama	65	24	213	1	3	2	126
Papua New Guinea	0	0	0	0	0	0	0
Paraguay	0	0	0	0	*	0	0
Peru	0	1	0	0	274	150	0
Philippines	9	0	0	*	2	2	87
Poland	1	1	1	0	0	7	75
Portugal	199	73	87	43	370	8	45
Reunion	0	0	0	0	0	*	0
Romania	0	0	0	0	9	0	3
Russia	0	0	0	20	13	20	0
Rwanda	0	0	0	0	0	0	0
Saint Kitts and Nevis	0	0	0	0	0	0	0
Saint Lucia	0	0	0	0	0	0	0
Saint Vincent and the Grenadines	0	0	0	0	0	0	0
Sao Tome and Principe	0	0	0	0	0	0	0
Senegal	0	0	0	1	0	0	0
Serbia and Montenegro	0	0	0	0	0	0	0
Seychelles	0	0	0	0	0	0	0
Sierra Leone	0	0	0	0	0	0	0
Singapore	118	114	314	302	65	0	362
Slovakia	0	0	0	0	0	0	0
Slovenia	0	0	0	0	0	0	0
Solomon Islands	0	0	0	0	0	0	0
Somalia	0	0	0	0	0	0	0
South Africa	0	*	0	141	95	50	0
Spain	1,453	831	595	1,184	1,942	5,066	359
Sri Lanka	0	*	0	0	4	0	22
Sudan	0	0	0	0	0	0	0
Suriname	0	0	0	0	0	0	0
Swaziland	0	0	0	0	0	0	0
Sweden	4,973	9,537	17,608	18,805	25,553	8,840	29,081
Switzerland	715	2,274	2,139	415	3,290	236	1,776
Taiwan	2	2	*	0	0	0	0
Tanzania	0	0	0	0	0	0	0
Thailand	27	16	145	290	10	76	82
Tokelau Islands	0	0	0	0	0	0	0
Tonga	0	0	0	0	0	0	0
Trinidad and Tobago	26	26	26	0	0	0	0
Tunisia	0	0	0	0	0	0	0
Turkey	3	87	22	59	0	3	74
Turks and Caicos Islands	0	0	0	0	0	0	0

\* Greater than zero but less than \$500,000.

**Table A5. Market value of U.S. holdings of foreign short-term debt securities, by country, as of selected survey dates (continued)**

Millions of dollars

Country or region of issuer	December 2003	December 2004	December 2005	December 2006	December 2007	December 2008	December 2010
Uganda	*	0	0	0	1	0	0
Ukraine	0	3	0	0	0	0	0
United Kingdom	99,155	110,390	91,935	156,236	140,948	85,114	122,549
Uruguay	5	0	0	0	*	0	13
Uzbekistan	0	0	0	0	0	0	0
Venezuela	18	0	111	0	0	8	192
Vietnam	0	0	0	0	0	*	0
Zambia	0	0	0	3	2	3	1
Zimbabwe	0	0	0	*	0	0	0
Country Unknown	31	0	0	0	0	0	0
International Organizations	1,087	2,177	2,976	2,542	1,520	4,943	13,257
Middle East oil-exporters <sup>2</sup>	4	3	3	3	3	1	60
African oil-exporters <sup>3</sup>	0	0	0	0	1	88	0
<b>Total</b>	<b>198,502</b>	<b>233,248</b>	<b>263,221</b>	<b>367,877</b>	<b>356,963</b>	<b>282,354</b>	<b>401,639</b>

\* Greater than zero but less than \$500,000.

2. Bahrain, Iran, Iraq, Kuwait, Oman, Qatar, Saudi Arabia, United Arab Emirates.

3. Algeria, Gabon, Libya, Nigeria.



**Table A6. Market value of U.S. holdings of foreign long-term debt securities, by country and currency, as of December 31, 2010**

Millions of dollars

Country or region of issuer	Total	\$U.S.	Euro	Japanese Yen	U.K. Pound	Own Currency
Albania	15	15	0	0	0	0
Argentina	8,177	6,341	981	8	0	845
Aruba	637	637	0	0	0	0
Australia	122,978	99,016	779	5	397	22,317
Austria	5,114	3,634	1,306	119	14	1,306
Bahamas	766	660	0	0	*	0
Barbados	1,464	1,464	0	0	0	0
Belgium	4,404	2,470	1,923	0	12	1,923
Belize	133	133	0	0	0	0
Bermuda	25,380	25,017	108	26	79	7
Bosnia and Herzegovina	29	0	0	0	0	0
Brazil	40,571	15,604	323	0	0	24,644
British Virgin Islands	3,930	3,813	5	0	*	3,813
Bulgaria	119	116	3	0	0	0
Canada	252,770	176,641	544	138	490	74,216
Cayman Islands	196,476	193,172	1,221	196	1,542	19
Chile	9,679	8,840	0	0	0	839
China, mainland <sup>1</sup>	1,572	1,305	6	0	0	67
Colombia	6,929	3,998	11	0	0	2,920
Congo (Brazzaville)	149	149	0	0	0	0
Costa Rica	121	121	1	0	0	0
Cote D'Ivoire	178	178	0	0	0	0
Croatia	850	829	21	0	0	0
Cyprus	85	85	1	0	0	1
Czech Republic	320	0	181	0	0	139
Denmark	8,939	6,237	311	0	80	1,995
Dominican Republic	815	813	0	0	0	2
Ecuador	305	305	0	0	0	305
Egypt	1,649	1,440	0	1	0	209
El Salvador	901	901	0	0	0	0
Estonia	56	0	56	0	0	0
Fiji	17	17	0	0	0	0
Finland	3,299	2,551	683	0	10	683
France	82,204	52,002	29,433	195	400	29,433
Georgia	130	130	0	0	0	0
Germany	74,308	25,256	46,032	611	339	46,032
Ghana	335	226	0	0	0	3
Greece	927	55	866	7	0	866
Grenada	19	18	0	0	0	1
Guatemala	55	54	0	0	0	*
Guernsey	2,985	2,901	84	0	*	*

\* Greater than zero but less than \$500,000.

1. Excludes Hong Kong and Macau, which are reported separately.

**Table A6. Market value of U.S. holdings of foreign long-term debt securities, by country and currency, as of December 31, 2010 (continued)**

Millions of dollars

Country or region of issuer	Total	\$U.S.	Euro	Japanese Yen	U.K. Pound	Own Currency
Honduras	7	6	0	0	0	*
Hong Kong	2,228	1,256	0	3	*	925
Hungary	3,119	943	440	2	1	1,732
Iceland	1,520	849	148	80	41	385
India	4,395	4,017	*	8	0	366
Indonesia	9,582	4,466	0	4	0	5,111
Ireland	27,402	20,202	6,156	154	760	6,156
Isle of Man	758	758	0	0	0	0
Israel	16,703	15,137	10	0	0	1,556
Italy	14,416	3,817	10,361	80	157	10,361
Jamaica	315	310	5	0	0	0
Japan	46,619	6,464	66	40,080	9	40,080
Jersey	12,432	4,692	7,217	119	386	386
Jordan	31	31	0	0	0	0
Kazakhstan	2,269	2,239	14	0	11	5
Kenya	5	5	0	0	0	0
Korea, South	24,890	12,050	359	0	0	12,152
Latvia	*	0	*	0	0	0
Lebanon	297	296	1	0	0	0
Liberia	1,876	1,838	38	0	0	0
Liechtenstein	*	0	0	0	0	*
Lithuania	1,499	1,465	35	0	0	0
Luxembourg	64,579	59,659	4,698	0	60	4,698
Macau	56	56	0	0	0	0
Macedonia	13	0	13	0	0	0
Malaysia	10,017	3,274	13	0	0	6,729
Malta	87	87	0	0	0	0
Marshall Islands	1,762	1,751	0	0	0	1,751
Mauritius	35	22	2	0	0	0
Mexico	32,081	24,181	263	0	93	7,539
Monaco	*	*	0	0	0	0
Mongolia	6	6	0	0	0	0
Morocco	92	61	31	0	0	0
Netherlands	103,229	85,260	16,082	124	982	16,082
Netherlands Antilles	1,233	1,174	57	0	*	0
New Zealand	7,453	3,983	1	0	29	3,425
Nicaragua	24	24	0	0	0	0
Norway	23,600	17,343	300	91	31	5,764
Pakistan	288	288	0	0	0	*
Panama	3,641	3,615	0	0	0	26
Peru	4,117	3,712	43	0	0	363

\* Greater than zero but less than \$500,000.

**Table A6. Market value of U.S. holdings of foreign long-term debt securities, by country and currency, as of December 31, 2010 (continued)**

Millions of dollars

Country or region of issuer	Total	\$U.S.	Euro	Japanese Yen	U.K. Pound	Own Currency
Philippines	7,419	3,689	8	0	0	3,722
Poland	12,979	2,537	128	11	0	10,292
Portugal	583	211	371	0	1	371
Reunion	*	*	0	0	0	0
Romania	5	0	5	0	0	0
Russia	6,732	6,619	6	0	0	108
Saint Lucia	19	19	0	0	0	0
Saint Vincent and the Grenadines	1	1	0	0	0	0
Senegal	15	15	0	0	0	0
Serbia and Montenegro	112	111	1	0	0	0
Seychelles	7	7	0	0	0	0
Singapore	7,190	4,672	20	0	9	2,475
Slovakia	50	0	16	0	0	16
Slovenia	71	0	71	0	0	71
South Africa	7,591	2,814	790	0	0	3,987
Spain	21,209	16,655	4,250	13	191	4,250
Sri Lanka	1,106	367	0	0	0	739
Sweden	29,798	22,661	924	0	37	6,031
Switzerland	5,884	4,452	13	0	0	1,398
Taiwan	377	99	0	0	0	279
Thailand	1,953	588	0	0	0	1,365
Trinidad and Tobago	1,172	1,172	0	0	0	0
Tunisia	546	403	134	10	0	0
Turkey	9,435	5,691	24	0	0	80
Ukraine	1,640	1,624	15	0	0	0
United Kingdom	252,478	202,194	12,072	58	36,301	36,301
Uruguay	1,798	1,267	61	20	0	449
Venezuela	7,670	7,347	70	0	0	20
Vietnam	674	674	0	0	0	0
Zambia	1	1	0	0	0	0
Zimbabwe	56	56	0	0	0	0
International Organizations	41,412	32,930	825	737	554	0
Middle East oil-exporters <sup>2</sup>	11,860	11,810	31	0	11	2
African oil-exporters <sup>3</sup>	205	205	0	0	0	0
<b>Total</b>	<b>1,714,815</b>	<b>1,253,654</b>	<b>151,087</b>	<b>42,902</b>	<b>43,025</b>	<b>410,131</b>

## Totals by Region:

Total Africa	12,743	7,421	995	11	0	4,199
Total Asia	147,264	70,546	515	40,095	29	75,568
Total Caribbean	232,228	228,271	1,397	222	1,621	3,842
Total Europe	779,812	556,458	144,278	1,665	39,813	186,864
<i>Of which: Euro Area Countries<sup>4</sup></i>	401,967	271,944	122,248	1,303	2,926	122,248
Total Latin America	116,209	76,451	1,752	28	93	37,949
Canada	252,770	176,641	544	138	490	74,216
Total Other Countries	132,209	104,767	781	5	426	27,493
International Organizations	41,412	32,930	825	737	554	0

\* Greater than zero but less than \$500,000.

2. Bahrain, Iran, Iraq, Kuwait, Oman, Qatar, Saudi Arabia, United Arab Emirates.

3. Algeria, Gabon, Libya, Nigeria.

4. Austria, Belgium, Cyprus, Finland, France, Germany, Greece, Ireland, Italy, Luxembourg, Malta, Netherlands, Portugal, Slovakia, Slovenia, Spain.

**Table A7. Market value of U.S. holdings of foreign short-term debt securities, by country and currency, as of December 31, 2010**

Millions of dollars

Country or region of issuer	Total	\$U.S.	Euro	Japanese Yen	U.K. Pound	Own Currency
Argentina	19	*	0	0	0	19
Australia	50,605	50,392	76	0	0	137
Austria	670	668	1	0	0	1
Bahamas	66	66	0	0	0	0
Belgium	2,257	2,166	91	0	0	91
Bermuda	81	81	0	0	0	0
Brazil	658	658	*	0	0	0
Canada	33,812	30,125	0	0	0	3,687
Cayman Islands	3,177	3,112	49	1	13	0
Chile	95	95	0	0	0	0
China, mainland <sup>1</sup>	30	16	0	0	0	13
Colombia	4	0	0	0	0	4
Denmark	1,730	1,625	67	0	0	39
Ecuador	2	2	0	0	0	2
Egypt	3,613	0	0	0	0	3,613
El Salvador	3	3	0	0	0	0
Finland	10,061	9,605	456	0	0	456
France	39,928	37,724	2,205	0	0	2,205
Germany	18,025	16,913	1,083	0	0	1,083
Honduras	22	*	0	0	0	21
Hong Kong	69	26	0	0	0	41
Iceland	51	3	0	0	0	48
India	614	602	0	0	0	12
Indonesia	40	0	0	0	0	40
Ireland	3,115	2,960	155	0	0	155
Israel	2,001	6	0	0	0	1,995
Italy	11	0	11	0	0	11
Japan	22,191	6,086	58	16,047	0	16,047
Jersey	8,628	8,518	110	0	0	0
Kazakhstan	*	0	0	0	0	*
Korea, South	882	850	0	0	0	32
Liberia	2	0	0	0	0	0
Luxembourg	3,189	3,107	82	0	0	82
Malaysia	1,923	11	0	0	0	1,900
Mexico	160	1	0	0	0	160
Netherlands	9,200	7,487	1,584	1	10	1,584

\* Greater than zero but less than \$500,000.

1. Excludes Hong Kong and Macau, which are reported separately.

**Table A7. Market value of U.S. holdings of foreign short-term debt securities, by country and currency, as of December 31, 2010 (continued)**

Millions of dollars

Country or region of issuer	Total	\$U.S.	Euro	Yen	Pound	Currency
New Zealand	6,743	6,687	0	0	0	56
Norway	9,466	8,947	0	0	0	519
Panama	126	126	0	0	0	0
Poland	75	0	0	0	0	75
Singapore	362	300	0	0	0	61
Spain	359	347	12	0	0	12
Sri Lanka	22	0	0	0	0	22
Sweden	29,081	28,746	187	0	0	148
Switzerland	1,776	1,708	0	0	0	67
Thailand	82	0	0	0	0	82
Turkey	74	40	0	0	0	0
United Kingdom	122,549	118,678	2,079	0	1,608	1,608
Venezuela	192	192	0	0	0	0
Zambia	1	0	0	0	0	1
International Organizations	13,257	13,163	94	0	0	0
<b>Total</b>	<b>401,639</b>	<b>362,259</b>	<b>8,423</b>	<b>16,048</b>	<b>1,631</b>	<b>36,226</b>

## Totals by Region:

Total Africa	3,616	0	0	0	0	3,614
Total Asia	28,362	7,958	58	16,047	0	20,332
Total Caribbean	3,324	3,258	49	1	13	0
Total Europe	260,627	249,596	8,146	1	1,618	8,184
<i>Of which: Euro Area Countries<sup>4</sup></i>	87,169	81,332	5,680	1	10	5,680
Total Latin America	1,294	1,080	*	0	0	216
Canada	33,812	30,125	0	0	0	3,687
Total Other Countries	57,348	57,079	76	0	*	193
International Organizations	13,257	13,163	94	0	0	0

\* Greater than zero but less than \$500,000.

2. Bahrain, Iran, Iraq, Kuwait, Oman, Qatar, Saudi Arabia, and the United Arab Emirates.

3. Algeria, Gabon, Libya, Nigeria.

4. Austria, Belgium, Cyprus, Finland, France, Germany, Greece, Ireland, Italy, Luxembourg, Malta, Netherlands, Portugal, Slovakia, Slovenia, Spain.

**Table A8. Market value of U.S. holdings of foreign long-debt securities, by country and type of security, as of December 31, 2010**

Millions of dollars

Country or region of issuer	Total	Straight debt	Zero-coupon	Convertible	Asset-backed
Albania	15	1	14	0	0
Argentina	8,177	8,167	1	9	*
Aruba	637	637	0	0	0
Australia	122,978	118,396	9	87	4,486
Austria	5,114	5,033	24	57	0
Bahamas	766	642	20	44	60
Barbados	1,464	1,270	0	0	194
Belgium	4,404	4,227	65	106	5
Belize	133	133	0	0	0
Bermuda	25,380	23,634	85	783	878
Bosnia and Herzegovina	29	29	0	0	0
Brazil	40,571	37,413	3,148	*	10
British Virgin Islands	3,930	3,621	2	303	4
Bulgaria	119	119	0	0	0
Canada	252,770	244,340	3,197	2,977	2,256
Cayman Islands	196,476	60,805	778	3,532	131,360
Chile	9,679	9,679	0	0	0
China, mainland <sup>1</sup>	1,572	1,372	0	200	0
Colombia	6,929	6,929	0	0	0
Congo (Brazzaville)	149	149	0	0	0
Costa Rica	121	116	0	0	5
Cote D'Ivoire	178	178	0	0	0
Croatia	850	850	0	0	0
Cyprus	85	85	0	0	0
Czech Republic	320	320	0	0	0
Denmark	8,939	8,638	301	*	*
Dominican Republic	815	815	0	0	0
Ecuador	305	304	*	1	0
Egypt	1,649	1,649	0	0	0
El Salvador	901	901	0	0	0
Estonia	56	56	0	0	0
Fiji	17	17	0	0	0
Finland	3,299	3,280	2	17	0
France	82,204	80,657	544	709	295
Georgia	130	130	0	0	0
Germany	74,308	72,311	1,431	235	331
Ghana	335	335	0	0	0
Greece	927	927	*	*	0
Grenada	19	19	0	0	0
Guatemala	55	55	0	0	0
Guernsey	2,985	2,983	1	1	1

\* Greater than zero but less than \$500,000.

1. Excludes Hong Kong and Macau, which are reported separately.

**Table A8. Market value of U.S. holdings of foreign long-debt securities, by country and type of security, as of December 31, 2010 (continued)**

Millions of dollars

Country or region of issuer	Total	Straight debt	Zero-coupon	Convertible	Asset-backed
Honduras	7	7	0	0	0
Hong Kong	2,228	2,217	6	5	0
Hungary	3,119	3,115	0	4	0
Iceland	1,520	1,492	17	0	11
India	4,395	3,131	425	839	0
Indonesia	9,582	9,512	69	0	0
Ireland	27,402	20,867	131	13	6,390
Isle of Man	758	565	0	194	0
Israel	16,703	8,703	7,995	6	0
Italy	14,416	14,168	66	21	160
Jamaica	315	315	0	0	0
Japan	46,619	45,601	150	381	487
Jersey	12,432	10,157	245	822	1,209
Jordan	31	31	0	0	0
Kazakhstan	2,269	2,269	0	0	0
Kenya	5	5	0	0	0
Korea, South	24,890	24,795	8	88	0
Latvia	*	*	0	0	0
Lebanon	297	297	0	0	0
Liberia	1,876	1,820	0	56	0
Liechtenstein	*	*	0	0	0
Lithuania	1,499	1,499	0	0	0
Luxembourg	64,579	62,649	151	784	996
Macau	56	56	0	0	0
Macedonia	13	13	0	0	0
Malaysia	10,017	9,491	70	456	0
Malta	87	87	0	0	0
Marshall Islands	1,762	1,247	0	515	0
Mauritius	35	25	7	2	0
Mexico	32,081	31,600	*	395	86
Monaco	*	*	0	0	0
Mongolia	6	6	0	0	0
Morocco	92	92	0	*	0
Netherlands	103,229	96,315	735	219	5,960
Netherlands Antilles	1,233	791	5	422	15
New Zealand	7,453	7,453	0	*	0
Nicaragua	24	24	0	0	0
Norway	23,600	22,803	577	219	1
Pakistan	288	288	0	0	0
Panama	3,641	3,543	*	40	58
Peru	4,117	4,117	0	0	0

\* Greater than zero but less than \$500,000.

**Table A8. Market value of U.S. holdings of foreign long-debt securities, by country and type of security, as of December 31, 2010 (continued)**

Millions of dollars

Country or region of issuer	Total	Straight debt	Zero-coupon	Convertible	Asset-backed
Philippines	7,419	7,378	26	6	9
Poland	12,979	11,564	1,415	0	0
Portugal	583	567	5	*	11
Reunion	*	0	0	0	*
Romania	5	5	0	0	0
Russia	6,732	6,721	4	8	0
Saint Lucia	19	19	0	0	0
Saint Vincent and the Grenadines	1	1	0	0	0
Senegal	15	15	0	0	0
Serbia and Montenegro	112	112	0	0	0
Seychelles	7	7	0	0	0
Singapore	7,190	6,274	8	895	13
Slovakia	50	50	0	0	0
Slovenia	71	71	0	0	0
South Africa	7,591	7,552	2	37	0
Spain	21,209	20,904	79	136	89
Sri Lanka	1,106	1,106	0	0	0
Sweden	29,798	29,364	390	13	31
Switzerland	5,884	5,827	30	25	2
Taiwan	377	286	*	91	0
Thailand	1,953	1,941	0	13	0
Trinidad and Tobago	1,172	1,172	0	0	0
Tunisia	546	546	0	0	1
Turkey	9,435	8,409	1,016	10	0
Ukraine	1,640	1,640	0	0	0
United Kingdom	252,478	208,695	4,781	958	38,045
Uruguay	1,798	1,797	1	0	*
Venezuela	7,670	6,787	882	*	0
Vietnam	674	674	0	0	0
Zambia	1	0	0	1	0
Zimbabwe	56	56	0	0	0
International Organizations	41,412	40,340	1,073	0	0
Middle East oil-exporters <sup>2</sup>	11,860	11,845	0	12	3
African oil-exporters <sup>3</sup>	205	205	*	0	0
<b>Total</b>	<b>1,714,815</b>	<b>1,474,611</b>	<b>29,991</b>	<b>16,750</b>	<b>193,464</b>
Totals by Region:					
Total Africa	12,743	12,636	10	97	1
Total Asia	147,264	135,002	8,758	2,992	512
Total Caribbean	232,228	93,741	890	5,085	132,512
Total Europe	779,812	709,700	12,024	4,551	53,538
<i>Of which: Euro Area Countries<sup>4</sup></i>	401,967	382,197	3,233	2,298	14,238
Total Latin America	116,209	111,571	4,033	446	160
Canada	252,770	244,340	3,197	2,977	2,256
Total Other Countries	132,209	127,113	8	602	4,486
International Organizations	41,412	40,340	1,073	0	0

\* Greater than zero but less than \$500,000.

2. Bahrain, Iran, Iraq, Kuwait, Oman, Qatar, Saudi Arabia, United Arab Emirates.

3. Algeria, Gabon, Libya, Nigeria.

4. Austria, Belgium, Cyprus, Finland, France, Germany, Greece, Ireland, Italy, Luxembourg, Malta, Netherlands, Portugal, Slovakia, Slovenia, Spain.



**Table A9. Market value of U.S. holdings of foreign short-debt securities, by country and type of security, as of December 31, 2010**

Millions of dollars

Country or region of issuer	Total	Commercial Paper	Negotiable CDs	Other
Argentina	19	0	*	19
Australia	50,605	36,268	1,676	12,661
Austria	670	279	0	390
Bahamas	66	0	41	25
Belgium	2,257	1,019	640	598
Bermuda	81	0	0	81
Brazil	658	0	37	621
Canada	33,812	23,462	1,419	8,931
Cayman Islands	3,177	1,043	409	885
Chile	95	0	0	95
China, mainland <sup>1</sup>	30	0	28	2
Colombia	4	0	4	0
Denmark	1,730	100	1,592	39
Ecuador	2	1	0	1
Egypt	3,613	0	0	3,613
El Salvador	3	0	0	3
Finland	10,061	6,930	2,435	696
France	39,928	12,921	8,675	18,332
Germany	18,025	14,791	1,785	1,449
Honduras	22	0	0	22
Hong Kong	69	0	2	67
Iceland	51	0	0	51
India	614	175	59	380
Indonesia	40	0	0	40
Ireland	3,115	2,503	0	612
Israel	2,001	0	8	1,993
Italy	11	0	0	11
Japan	22,191	886	3,536	17,769
Jersey	8,628	7,399	0	1,229
Kazakhstan	*	0	0	*
Korea, South	882	0	0	882
Liberia	2	0	0	2
Luxembourg	3,189	2,476	100	613
Malaysia	1,923	0	12	1,911
Mexico	160	*	0	160
Netherlands	9,200	2,892	4,989	1,319

\* Greater than zero but less than \$500,000.

1. Excludes Hong Kong and Macau, which are reported separately.

**Table A9. Market value of U.S. holdings of foreign short-debt securities, by country and type of security, as of December 31, 2010 (continued)**

Millions of dollars

Country or region of issuer	Total	Commercial Paper	Negotiable CDs	Other
New Zealand	6,743	5,249	0	1,494
Norway	9,466	8,488	140	838
Panama	126	125	0	1
Poland	75	0	0	75
Singapore	362	300	3	58
Spain	359	0	312	48
Sri Lanka	22	0	0	22
Sweden	29,081	12,481	6,646	9,953
Switzerland	1,776	922	668	185
Thailand	82	0	*	81
Turkey	74	0	0	74
United Kingdom	122,549	21,422	92,595	8,260
Venezuela	192	192	0	0
Zambia	1	0	0	1
International Organizations	13,257	8,111	0	5,146
<b>Total</b>	<b>401,639</b>	<b>170,794</b>	<b>127,845</b>	<b>101,888</b>
<b>Totals by Region:</b>				
Total Africa	3,616	0	0	3,616
Total Asia	28,362	1,411	3,649	23,302
Total Caribbean	3,324	1,043	450	991
Total Europe	260,627	94,932	120,611	44,812
<i>Of which: Euro Area Countries<sup>4</sup></i>	87,169	44,119	18,970	24,079
Total Latin America	1,294	318	41	936
Canada	33,812	23,462	1,419	8,931
Total Other Countries	57,348	41,517	1,675	14,156
International Organizations	13,257	8,111	0	5,146

\* Greater than zero but less than \$500,000.

2. Bahrain, Iran, Iraq, Kuwait, Oman, Qatar, Saudi Arabia, and the United Arab Emirates.

3. Algeria, Gabon, Libya, Nigeria.

4. Austria, Belgium, Cyprus, Finland, France, Germany, Greece, Ireland, Italy, Luxembourg, Malta, Netherlands, Portugal, Slovakia, Slovenia, Spain.

**Table A10. Market value of U.S. holdings of foreign debt securities, by country and sector of issuer, as of December 31, 2010**

Millions of dollars

Country or region of issuer	Total	Long-term		Short-term	
		Government <sup>1</sup>	Private	Government <sup>1</sup>	Private
Albania	15	15	0	0	0
Argentina	8,196	7,041	1,136	4	15
Aruba	637	210	427	0	0
Australia	173,583	17,182	105,796	505	50,100
Austria	5,784	1,499	3,615	0	670
Bahamas	832	377	390	0	66
Barbados	1,464	176	1,289	0	0
Belgium	6,661	1,670	2,734	4	2,253
Belize	133	133	0	0	0
Bermuda	25,461	420	24,960	0	81
Bosnia and Herzegovina	29	29	0	0	0
Brazil	41,229	31,910	8,661	0	658
British Virgin Islands	3,930	0	3,930	0	0
Bulgaria	119	115	3	0	0
Canada	286,582	65,492	187,277	4,768	29,045
Cayman Islands	199,653	234	196,242	0	3,177
Chile	9,774	1,613	8,066	0	95
China, mainland <sup>2</sup>	1,601	869	703	10	20
Colombia	6,933	5,933	996	0	4
Congo (Brazzaville)	149	149	0	0	0
Costa Rica	121	103	19	0	0
Cote D'Ivoire	178	178	*	0	0
Croatia	874	840	10	24	0
Cyprus	393	1	85	0	308
Czech Republic	320	249	71	0	0
Denmark	10,669	1,974	6,965	138	1,592
Dominican Republic	815	715	100	0	0
Ecuador	307	260	45	0	2
Egypt	5,262	1,604	45	3,613	0
El Salvador	904	746	154	0	3
Estonia	56	56	0	0	0
Fiji	17	17	0	0	0
Finland	13,360	754	2,545	175	9,887
France	122,132	26,064	56,141	10,697	29,232
Georgia	130	106	24	0	0
Germany	92,333	41,322	32,986	425	17,600
Ghana	335	335	0	0	0
Gibraltar	19	0	19	0	0
Greece	927	881	46	0	0
Grenada	19	19	0	0	0

\* Greater than zero but less than \$500,000.

1. "Government" includes central, local, and provincial governments, and government-sponsored or guaranteed corporations. Debt issued by international organizations is classified as "private".

2. Excludes Hong Kong and Macau, which are reported separately.

**Table A10. Market value of U.S. holdings of foreign debt securities, by country and sector of issuer, as of December 31, 2010 (continued)**

Millions of dollars

Country or region of issuer	Total	Long-term		Short-term	
		Government <sup>1</sup>	Private	Government <sup>1</sup>	Private
Guatemala	55	48	7	0	0
Guernsey	2,985	0	2,985	0	0
Honduras	29	5	2	0	22
Hong Kong	2,297	986	1,242	41	27
Hungary	3,119	2,852	266	0	0
Iceland	1,571	407	1,113	48	3
India	5,009	58	4,337	6	608
Indonesia	9,622	9,117	465	38	2
Ireland	30,516	2,019	25,383	0	3,115
Isle of Man	758	0	758	0	0
Israel	18,704	15,564	1,140	1,990	11
Italy	14,427	10,610	3,806	11	0
Jamaica	315	213	102	0	0
Japan	68,810	37,380	9,239	16,047	6,144
Jersey	21,060	120	12,313	0	8,628
Jordan	31	10	21	0	0
Kazakhstan	2,269	0	2,269	0	*
Kenya	5	5	0	0	0
Korea, South	25,772	16,342	8,548	32	850
Latvia	*	*	0	0	0
Lebanon	297	297	0	0	0
Liberia	1,878	*	1,876	0	2
Liechtenstein	*	0	*	0	0
Lithuania	1,499	1,499	0	0	0
Luxembourg	67,768	128	64,451	0	3,189
Macao	56	0	56	0	0
Macedonia	13	13	0	0	0
Malaysia	11,940	6,935	3,082	44	1,880
Malta	87	0	87	0	0
Marshall Islands	1,762	0	1,762	0	0
Mauritius	35	0	35	0	0
Mexico	32,242	15,660	16,421	160	1
Monaco	*	0	*	0	0
Mongolia	6	0	6	0	0
Morocco	92	92	*	0	0
Netherlands	112,429	3,125	100,104	712	8,488
Netherlands Antilles	1,233	0	1,233	0	0
New Zealand	14,196	3,341	4,113	55	6,688
Nicaragua	24	24	0	0	0

\* Greater than zero but less than \$500,000.

1. "Government" includes central, local, and provincial governments, and government-sponsored or guaranteed corporations. Debt issued by international organizations is classified as "private".

**Table A10. Market value of U.S. holdings of foreign debt securities, by country and sector of issuer, as of December 31, 2010 (continued)**

Millions of dollars

Country or region of issuer	Total	Long-term		Short-term	
		Government <sup>1</sup>	Private	Government <sup>1</sup>	Private
Norway	33,066	7,324	16,276	519	8,947
Pakistan	288	244	44	0	0
Panama	3,767	2,591	1,050	0	126
Peru	4,117	3,649	468	0	0
Philippines	7,507	6,532	887	48	39
Poland	13,054	12,965	14	75	0
Portugal	628	349	234	0	45
Reunion	*	0	*	0	0
Romania	9	5	0	3	0
Russia	6,732	6,613	119	0	0
Saint Lucia	19	0	19	0	0
Saint Vincent and the Grenadines	1	1	0	0	0
Senegal	15	15	0	0	0
Serbia and Montenegro	112	109	3	0	0
Seychelles	7	7	0	0	0
Singapore	7,551	1,734	5,456	58	303
Slovakia	50	37	13	0	0
Slovenia	71	67	3	0	0
South Africa	7,591	6,487	1,103	0	0
Spain	21,568	1,585	19,624	0	359
Sri Lanka	1,127	1,106	0	22	0
Sweden	58,879	6,026	23,772	175	28,906
Switzerland	7,660	1,285	4,599	5	1,771
Taiwan	377	278	99	0	0
Thailand	2,035	1,338	616	2	80
Trinidad and Tobago	1,172	78	1,094	0	0
Tunisia	546	521	26	0	0
Turkey	9,509	9,158	277	35	40
Ukraine	1,640	1,206	434	0	0
United Kingdom	375,028	20,266	232,213	710	121,840
Uruguay	1,811	1,767	31	1	11
Venezuela	7,861	5,084	2,586	0	192
Vietnam	674	657	16	0	0
Zambia	2	0	1	1	0
Zimbabwe	56	56	0	0	0
International Organizations	54,669	0	41,412	0	13,257
Middle East oil-exporters <sup>3</sup>	11,920	3,568	8,292	0	60
African oil-exporters <sup>4</sup>	205	205	1	0	0
<b>Total</b>	<b>2,116,454</b>	<b>441,164</b>	<b>1,273,651</b>	<b>41,199</b>	<b>360,441</b>
<b>Totals by Region</b>					
Total Africa	16,358	9,656	3,087	3,614	2
Total Asia	175,626	103,015	44,249	18,336	10,025
Total Caribbean	235,552	2,443	229,785	0	3,324
Total Europe	1,040,439	163,451	616,361	13,755	246,872
<i>Of which: Euro Area Countries<sup>5</sup></i>	489,136	90,110	311,856	12,023	75,146
Total Latin America	117,502	76,567	39,642	165	1,128
Canada	286,582	65,492	187,277	4,768	29,045
Total Other Countries	189,558	20,540	111,669	560	56,788
International Organizations	54,669	0	41,412	0	13,257

\* Greater than zero but less than \$500,000.

1. "Government" includes central, local, and provincial governments, and government-sponsored or guaranteed

3. Bahrain, Iran, Iraq, Kuwait, Oman, Qatar, Saudi Arabia, and the United Arab Emirates.

4. Algeria, Gabon, Libya, Nigeria.

5. Austria, Belgium, Cyprus, Finland, France, Germany, Greece, Ireland, Italy, Luxembourg, Malta, Netherlands, Portugal, Slovakia, Slovenia, Spain.

**Table A11. Market value of U.S. holdings of foreign long-term debt securities, by country and sector of issuer, denominated in U.S. dollars and in local currency, as of December 31, 2010**

Billions of dollars

Country or region of issuer	Total Long-Term Debt	Government <sup>1</sup>			Private		
		Total	U.S. Dollars	Own Currency	Total	U.S. Dollars	Own Currency
Albania	*	*	*	0	0	0	0
Argentina	8	7	5	1	1	1	*
Aruba	1	*	*	0	*	*	0
Australia	123	17	*	17	106	99	5
Austria	5	1	*	1	4	3	*
Bahamas	1	*	*	0	*	*	0
Barbados	1	*	*	0	1	1	0
Belgium	4	2	*	1	3	2	*
Belize	*	*	*	0	0	0	0
Bermuda	25	*	*	0	25	25	*
Bosnia and Herzegovina	*	*	0	0	0	0	0
Brazil	41	32	9	23	9	7	2
British Virgin Islands	4	0	0	0	4	4	4
Bulgaria	*	*	*	0	*	*	0
Canada	253	65	25	39	187	151	35
Cayman Islands	196	*	*	0	196	193	*
Chile	10	2	1	1	8	8	*
China, mainland <sup>2</sup>	2	1	1	*	1	*	*
Colombia	7	6	3	3	1	1	*
Congo (Brazzaville)	*	*	*	0	0	0	0
Costa Rica	*	*	*	0	*	*	0
Cote D'Ivoire	*	*	*	0	*	*	0
Croatia	1	1	1	0	*	*	0
Cyprus	*	*	0	*	*	*	0
Czech Republic	*	*	0	*	*	0	0
Denmark	9	2	1	1	7	5	1
Dominican Republic	1	1	1	*	*	*	*
Ecuador	*	*	*	*	*	*	*
Egypt	2	2	1	*	*	*	0
El Salvador	1	1	1	0	*	*	0
Estonia	*	*	0	0	0	0	0
Fiji	*	*	*	0	0	0	0
Finland	3	1	*	1	3	2	*
France	82	26	2	24	56	50	5
Georgia	*	*	*	0	*	*	0
Germany	74	41	1	40	33	24	6
Ghana	*	*	*	*	0	0	0
Gibraltar	*	0	0	0	*	0	0
Greece	1	1	*	1	*	*	*
Grenada	*	*	*	*	0	0	0
Guatemala	*	*	*	0	*	*	*
Guernsey	3	0	0	0	3	3	*

\* Greater than zero but less than \$500 million.

1. "Government" includes central, local, and provincial governments, and government-sponsored or guaranteed corporations. Debt issued by international organizations is classified as "private".

2. Excludes Hong Kong and Macau, which are reported separately.

**Table A11. Market value of U.S. holdings of foreign long-term debt securities, by country and sector of issuer, denominated in U.S. dollars and in local currency, as of December 31, 2010 (continued)**

Billions of dollars

Country or region of issuer	Total Long-Term Debt	Government <sup>1</sup>			Private		
		Total	U.S. Dollars	Own Currency	Total	U.S. Dollars	Own Currency
Honduras	*	*	*	0	*	*	*
Hong Kong	2	1	*	1	1	1	*
Hungary	3	3	1	2	*	*	*
Iceland	2	*	0	*	1	1	*
India	4	*	*	*	4	4	*
Indonesia	10	9	4	5	*	*	*
Ireland	27	2	*	2	25	20	4
Isle of Man	1	0	0	0	1	1	0
Israel	17	16	14	2	1	1	*
Italy	14	11	3	8	4	1	2
Jamaica	*	*	*	0	*	*	0
Japan	47	37	1	37	9	6	3
Jersey	12	*	*	0	12	5	*
Jordan	*	*	*	0	*	*	0
Kazakhstan	2	0	0	0	2	2	*
Kenya	*	*	*	0	0	0	0
Korea, South	25	16	4	12	9	8	*
Latvia	*	*	0	0	0	0	0
Lebanon	*	*	*	0	0	0	0
Liberia	2	*	*	0	2	2	0
Liechtenstein	*	0	0	0	*	0	*
Lithuania	1	1	1	0	0	0	0
Luxembourg	65	*	*	*	64	60	5
Macau	*	0	0	0	*	*	0
Macedonia	*	*	0	0	0	0	0
Malaysia	10	7	*	7	3	3	*
Malta	*	0	0	0	*	*	0
Marshall Islands	2	0	0	0	2	2	2
Mauritius	*	0	0	0	*	*	0
Mexico	32	16	8	7	16	16	*
Monaco	*	0	0	0	*	*	0
Mongolia	*	0	0	0	*	*	0
Morocco	*	*	*	0	*	0	0
Netherlands	103	3	0	3	100	85	13
Netherlands Antilles	1	0	0	0	1	1	0
New Zealand	7	3	*	3	4	4	*
Nicaragua	*	*	*	0	0	0	0
Norway	24	7	2	6	16	16	*
Pakistan	*	*	*	0	*	*	*

\* Greater than zero but less than \$500 million.

1. "Government" includes central, local, and provincial governments, and government-sponsored or guaranteed corporations. Debt issued by international organizations is classified as "private".

**Table A11. Market value of U.S. holdings of foreign long-term debt securities, by country and sector of issuer, denominated in U.S. dollars and in local currency, as of December 31, 2010 (continued)**

Billions of dollars

Country or region of issuer	Total Long-Term Debt	Government <sup>1</sup>			Private		
		Total	U.S. Dollars	Own Currency	Total	U.S. Dollars	Own Currency
Panama	4	3	3	0	1	1	*
Peru	4	4	3	*	*	*	*
Philippines	7	7	3	4	1	1	*
Poland	13	13	3	10	*	*	0
Portugal	1	*	*	*	*	*	*
Reunion	*	0	0	0	*	*	0
Romania	*	*	0	0	0	0	0
Russia	7	7	7	*	*	*	*
Saint Lucia	*	0	0	0	*	*	0
Saint Vincent and the Grenadines	*	*	*	0	0	0	0
Senegal	*	*	*	0	0	0	0
Serbia and Montenegro	*	*	*	0	*	*	0
Seychelles	*	*	*	0	0	0	0
Singapore	7	2	0	2	5	5	1
Slovakia	*	*	0	*	*	0	0
Slovenia	*	*	0	*	*	0	*
South Africa	8	6	2	4	1	*	*
Spain	21	2	*	1	20	16	3
Sri Lanka	1	1	*	1	0	0	0
Sweden	30	6	1	5	24	22	1
Switzerland	6	1	0	1	5	4	*
Taiwan	*	*	0	*	*	*	*
Thailand	2	1	0	1	1	1	*
Trinidad and Tobago	1	*	*	0	1	1	0
Tunisia	1	1	*	0	*	*	0
Turkey	9	9	5	*	*	*	0
Ukraine	2	1	1	0	*	*	0
United Kingdom	252	20	*	20	232	202	16
Uruguay	2	2	1	*	*	*	*
Venezuela	8	5	5	*	3	3	0
Vietnam	1	1	1	0	*	*	0
Zambia	*	0	0	0	*	*	0
Zimbabwe	*	*	*	0	0	0	0
International Organizations	41	0	0	0	41	33	0
Middle East oil-exporters <sup>3</sup>	12	4	4	0	8	8	*
African oil-exporters <sup>4</sup>	*	*	*	0	*	*	0
<b>Total</b>	<b>1,715</b>	<b>441</b>	<b>133</b>	<b>299</b>	<b>1,274</b>	<b>1,120</b>	<b>111</b>

## Totals by Region:

Total Africa	13	10	5	4	3	2	*
Total Asia	147	103	32	71	44	39	5
Total Caribbean	232	2	2	*	230	226	4
Total Europe	780	163	29	129	616	528	57
<i>Of which: Euro Area Countries<sup>4</sup></i>	402	90	6	84	312	266	39
Total Latin America	116	77	39	36	40	37	2
Canada	253	65	25	39	187	151	35
Total Other Countries	132	21	*	20	112	105	7
International Organizations	41	0	0	0	41	33	0

\* Greater than zero but less than \$500 million.

1. "Government" includes central, local, and provincial governments, and government-sponsored or guaranteed corporations. Debt issued by international organizations is classified as "private".

3. Bahrain, Iran, Iraq, Kuwait, Oman, Qatar, Saudi Arabia, United Arab Emirates.

4. Austria, Belgium, Cyprus, Finland, France, Germany, Greece, Ireland, Italy, Luxembourg, Malta, Netherlands, Portugal, Slovakia, Slovenia, Spain.



**Table A12. Market value of U.S. holdings of foreign equity, by country and type of security, as of December 31, 2010**

Millions of dollars

Country or region of issuer	Total	Common Stock	Funds	Preferred & Other
Albania	*	*	0	0
Anguilla	*	*	0	0
Antigua and Barbuda	112	112	0	0
Argentina	2,599	2,397	*	202
Australia	149,720	144,152	4,989	578
Austria	12,286	12,280	4	1
Bahamas	1,177	1,050	84	43
Bangladesh	69	69	*	0
Barbados	12	11	0	1
Belarus	*	0	0	0
Belgium	28,792	28,662	125	4
Belize	18	18	0	1
Bermuda	134,084	123,512	3,021	7,551
Botswana	45	45	*	0
Brazil	193,900	120,098	2,727	71,074
British Virgin Islands	11,992	5,349	5,589	1,053
Bulgaria	135	120	0	15
Canada	408,631	385,656	20,663	2,312
Cayman Islands	166,372	98,017	41,030	27,325
Chile	12,757	12,376	6	374
China, mainland <sup>1</sup>	100,624	100,366	128	130
Colombia	3,518	3,444	0	75
Comoros	*	*	0	*
Congo (Brazzaville)	*	*	0	0
Cook Islands	6	*	6	0
Costa Rica	1	1	0	0
Cote D'Ivoire	3	3	0	0
Croatia	110	83	2	25
Cuba	*	*	0	0
Cyprus	962	956	4	2
Czech Republic	4,553	4,553	0	0
Denmark	38,236	38,215	*	21
Dominica	*	0	0	0
Dominican Republic	*	*	0	0
Ecuador	*	*	0	0
Egypt	5,116	5,113	3	0
El Salvador	5	5	0	*
Estonia	74	72	2	0
Falkland Islands	29	29	0	0
Faroe Islands	27	27	0	0
Finland	27,262	27,244	*	18
France	244,197	234,366	8,452	1,378

\* Greater than zero but less than \$500,000.

1. Excludes Hong Kong and Macau, which are reported separately.

**Table A12. Market value of U.S. holdings of foreign equity, by country and type of security, as of December 31, 2010 (continued)**

Millions of dollars

Country or region of issuer	Total	Common Stock	Funds	Preferred & Other
French Guiana	*	*	0	0
Gambia	*	*	0	0
Georgia	81	81	0	0
Germany	206,767	189,167	286	17,315
Ghana	32	32	0	0
Gibraltar	275	265	0	10
Greece	6,158	5,991	28	138
Guernsey	11,811	5,621	1,510	4,680
Guinea	2	*	2	0
Guyana	*	*	0	0
Hong Kong	132,520	129,493	2,461	566
Hungary	3,446	3,444	2	*
Iceland	73	73	0	*
India	86,477	86,286	103	89
Indonesia	25,239	25,237	2	*
Ireland	101,420	92,459	7,954	1,006
Isle of Man	2,084	1,691	84	309
Israel	44,798	44,684	11	103
Italy	51,211	50,941	65	206
Jamaica	*	*	0	0
Japan	450,096	445,144	4,427	525
Jersey	20,846	19,110	397	1,339
Jordan	87	87	*	0
Kazakhstan	724	696	3	26
Kenya	187	187	*	0
Kiribati	2	2	0	0
Korea, South	122,416	118,933	13	3,470
Latvia	13	13	0	0
Lebanon	166	166	0	0
Liberia	3,535	3,535	0	0
Liechtenstein	299	299	0	0
Lithuania	18	18	0	0
Luxembourg	32,663	25,797	5,092	1,774
Madagascar	2	2	0	0
Malawi	1	1	0	0
Malaysia	20,270	20,097	57	116
Malta	1	1	*	0
Marshall Islands	9,412	6,605	*	2,807

\* Greater than zero but less than \$500,000.

**Table A12. Market value of U.S. holdings of foreign equity, by country and type of security, as of December 31, 2010 (continued)**

Millions of dollars

Country or region of issuer	Total	Common Stock	Funds	Preferred & Other
Mauritius	2,255	1,282	373	599
Mexico	76,614	73,957	2,556	101
Moldova	*	0	0	0
Monaco	27	27	0	*
Morocco	383	383	0	0
Namibia	1	1	0	0
Netherlands	120,456	112,942	1,141	6,374
Netherlands Antilles	82,076	81,540	506	31
New Zealand	3,100	2,900	101	99
Niger	3	3	0	0
Norway	23,008	22,861	43	104
Pakistan	886	881	5	0
Panama	21,842	21,751	91	0
Papua New Guinea	1,310	1,310	0	0
Paraguay	5	5	0	*
Peru	3,459	3,459	0	*
Philippines	9,026	9,020	*	6
Poland	8,756	8,262	0	494
Portugal	5,363	5,357	1	4
Romania	203	188	12	3
Russia	55,553	54,178	4	1,371
Senegal	21	21	0	*
Serbia and Montenegro	12	12	0	0
Singapore	56,356	51,049	4,835	473
Slovakia	*	*	*	0
Slovenia	191	191	*	0
South Africa	70,343	69,795	471	78
Spain	65,510	64,215	94	1,201
Sri Lanka	704	704	*	0
Swaziland	3	3	*	0
Sweden	63,221	62,558	130	533
Switzerland	319,376	317,918	355	1,103
Taiwan	94,279	94,115	142	21
Thailand	20,999	20,988	10	1
Togo	8	8	0	0
Trinidad and Tobago	3	3	0	0
Tunisia	14	14	0	*
Turkey	30,579	30,322	173	83

\* Greater than zero but less than \$500,000.

**Table A12. Market value of U.S. holdings of foreign equity, by country and type of security, as of December 31, 2010 (continued)**

Millions of dollars

Country or region of issuer	Total	Common Stock	Funds	Preferred & Other
Turks and Caicos Islands	*	0	0	*
Uganda	*	*	0	0
Ukraine	149	149	0	0
United Kingdom	626,428	586,109	15,371	24,948
Uruguay	1	1	*	0
Venezuela	92	92	*	*
Vietnam	407	406	0	*
Zambia	44	44	0	0
Zimbabwe	46	46	*	0
International Organizations	387	380	0	7
Middle East oil-exporters <sup>2</sup>	2,178	2,170	3	5
African oil-exporters <sup>3</sup>	676	672	0	4
<b>Total</b>	<b>4,646,908</b>	<b>4,326,851</b>	<b>135,749</b>	<b>184,308</b>
Totals by Region:				
Total Africa	82,722	81,191	849	681
Total Asia	1,167,596	1,149,895	12,197	5,504
Total Caribbean	395,829	309,593	50,230	36,005
Total Europe	2,113,354	2,007,533	41,334	64,487
<i>Of which: Euro Area Countries<sup>4</sup></i>	903,236	850,568	23,246	29,422
Total Latin America	314,842	237,634	5,380	71,827
Canada	408,631	385,656	20,663	2,312
Total Other Countries	163,546	154,969	5,096	3,484
International Organizations	387	380	0	7

\* Greater than zero but less than \$500,000.

2. Bahrain, Iran, Iraq, Kuwait, Oman, Qatar, Saudi Arabia, and the United Arab Emirates.

3. Algeria, Gabon, Libya, Nigeria.

4. Austria, Belgium, Cyprus, Finland, France, Germany, Greece, Ireland, Italy, Luxembourg, Malta, Netherlands, Portugal, Slovakia, Slovenia, Spain.

**Table A13. Market value of U.S. holdings of foreign equity, by country and amounts held as Depository Receipts, as of December 31, 2010**

Millions of dollars except as noted

Country or region of issuer	Equity	Depository Receipts	Percentage
			Depository Receipts
Albania	*	0	0
Anguilla	*	0	0
Antigua and Barbuda	112	0	0
Argentina	2,599	2,342	90
Australia	149,720	13,175	9
Austria	12,286	238	2
Bahamas	1,177	*	n.a.
Bangladesh	69	*	n.a.
Barbados	12	0	0
Belarus	*	0	0
Belgium	28,792	3,400	12
Belize	18	6	34
Bermuda	134,084	2,414	2
Botswana	45	0	0
Brazil	193,900	88,961	46
British Virgin Islands	11,992	527	4
Bulgaria	135	0	0
Canada	408,631	822	0
Cayman Islands	166,372	41,388	25
Chile	12,757	6,328	50
China, mainland <sup>1</sup>	100,624	6,086	6
Colombia	3,518	2,251	64
Comoros	*	0	0
Congo (Brazzaville)	*	*	n.a.
Cook Islands	6	0	0
Costa Rica	1	0	0
Cote D'Ivoire	3	1	21
Croatia	110	4	3
Cuba	*	0	0
Cyprus	962	225	23
Czech Republic	4,553	25	1
Denmark	38,236	4,398	12
Dominica	*	*	n.a.
Dominican Republic	*	*	n.a.
Ecuador	*	0	0
Egypt	5,116	857	17
El Salvador	5	5	92
Estonia	74	0	0
Falkland Islands	29	0	0
Faroe Islands	27	0	0
Finland	27,262	5,812	21
France	244,197	24,798	10

\* Greater than zero but less than \$500,000.

1. Excludes Hong Kong and Macau, which are reported separately.

**Table A13. Market value of U.S. holdings of foreign equity, by country and amounts held as Depository Receipts, as of December 31, 2010 (continued)**

Millions of dollars except as noted

Country or region of issuer	Equity	Depository Receipts	Percentage Depository Receipts
French Guiana	*	0	0
Gambia	*	0	0
Georgia	81	81	100
Germany	206,767	14,958	7
Ghana	32	*	n.a.
Gibraltar	275	0	0
Greece	6,158	581	9
Guernsey	11,811	2	0
Guinea	2	*	n.a.
Guyana	*	0	0
Hong Kong	132,520	19,624	15
Hungary	3,446	164	5
Iceland	73	*	n.a.
India	86,477	19,026	22
Indonesia	25,239	1,910	8
Ireland	101,420	24,367	24
Isle of Man	2,084	50	2
Israel	44,798	25,638	57
Italy	51,211	3,278	6
Jamaica	*	*	n.a.
Japan	450,096	27,941	6
Jersey	20,846	6,862	33
Jordan	87	0	0
Kazakhstan	724	721	100
Kenya	187	0	0
Kiribati	2	2	100
Korea, South	122,416	16,343	13
Latvia	13	*	n.a.
Lebanon	166	149	89
Liberia	3,535	33	1
Liechtenstein	299	0	0
Lithuania	18	0	0
Luxembourg	32,663	9,377	29
Madagascar	2	0	0
Malawi	1	1	100
Malaysia	20,270	42	0
Malta	1	1	100
Marshall Islands	9,412	3	0

\* Greater than zero but less than \$500,000.

**Table A13. Market value of U.S. holdings of foreign equity, by country and amounts held as Depository Receipts, as of December 31, 2010 (continued)**

Millions of dollars except as noted

Country or region of issuer	Equity	Depository Receipts	Percentage Depository Receipts
Mauritius	2,255	*	n.a.
Mexico	76,614	44,418	58
Moldova	*	0	0
Monaco	27	0	0
Morocco	383	*	n.a.
Namibia	1	*	n.a.
Netherlands	120,456	26,824	22
Netherlands Antilles	82,076	10	0
New Zealand	3,100	460	15
Niger	3	3	100
Norway	23,008	2,428	11
Pakistan	886	30	3
Panama	21,842	1	0
Papua New Guinea	1,310	4	0
Paraguay	5	5	99
Peru	3,459	2,737	79
Philippines	9,026	1,498	17
Poland	8,756	60	1
Portugal	5,363	308	6
Romania	203	0	0
Russia	55,553	41,004	74
Senegal	21	*	n.a.
Serbia and Montenegro	12	0	0
Singapore	56,356	1,350	2
Slovakia	*	0	0
Slovenia	191	*	n.a.
South Africa	70,343	12,670	18
Spain	65,510	7,674	12
Sri Lanka	704	5	1
Swaziland	3	3	98
Sweden	63,221	4,197	7
Switzerland	319,376	39,435	12
Taiwan	94,279	13,199	14
Thailand	20,999	5,044	24
Togo	8	0	0
Trinidad and Tobago	3	0	0
Tunisia	14	*	n.a.
Turkey	30,579	1,233	4

\* Greater than zero but less than \$500,000.

**Table A13. Market value of U.S. holdings of foreign equity, by country and amounts held as Depository Receipts, as of December 31, 2010 (continued)**

Millions of dollars except as noted

Country or region of issuer	Equity	Depository Receipts	Percentage Depository Receipts
Turks and Caicos Islands	*	0	0
Uganda	*	0	0
Ukraine	149	50	33
United Kingdom	626,428	148,172	24
Uruguay	1	0	0
Venezuela	92	42	46
Vietnam	407	0	0
Zambia	44	29	66
Zimbabwe	46	0	0
International Organizations	387	*	n.a.
Middle East oil-exporters <sup>2</sup>	2,178	288	13
African oil-exporters <sup>3</sup>	676	85	13
<b>Total</b>	<b>4,646,908</b>	<b>728,482</b>	<b>16</b>
<b>Totals by Region:</b>			
Total Africa	82,722	13,684	17
Total Asia	1,167,596	138,174	12
Total Caribbean	395,829	44,340	11
Total Europe	2,113,354	370,724	18
<i>Of which: Euro Area Countries<sup>4</sup></i>	903,236	121,840	13
Total Latin America	314,842	147,097	47
Canada	408,631	822	0
Total Other Countries	163,546	13,641	8
International Organizations	387	*	n.a.

\* Greater than zero but less than \$500,000.

2. Bahrain, Iran, Iraq, Kuwait, Oman, Qatar, Saudi Arabia, and the United Arab Emirates.

3. Algeria, Gabon, Libya, Nigeria.

4. Austria, Belgium, Cyprus, Finland, France, Germany, Greece, Ireland, Italy, Luxembourg, Malta, Netherlands, Portugal, Slovakia, Slovenia, Spain.



**Table A14. Market value of U.S. holdings of foreign equity, by country, size of domestic equity markets, and percentage of each market that is U.S.-held, as of December 31, 2010**

Millions of dollars except as noted

Country or region of issuer	Common Stock	Country rank according to domestic market capitalization <sup>1</sup>	Percent of domestic market capitalization <sup>1</sup>
Anguilla	*	110	n.a.
Antigua and Barbuda	112	110	n.a.
Argentina	2,397	48	4
Australia	144,152	9	10
Austria	12,280	47	18
Bahamas	1,050	110	n.a.
Bangladesh	69	51	0
Barbados	11	82	0
Belgium	28,662	29	11
Belize	18	110	n.a.
Bermuda	123,512	95	>100
Botswana	45	85	1
Brazil	120,098	8	8
British Virgin Islands	5,349	110	n.a.
Bulgaria	120	74	2
Canada	385,656	5	18
Cayman Islands	98,017	110	n.a.
Chile	12,376	25	4
China, mainland <sup>2</sup>	100,366	2	2
Colombia	3,444	33	2
Costa Rica	1	96	0
Cote D'Ivoire	3	75	0
Croatia	83	60	0
Cyprus	956	76	14
Czech Republic	4,553	52	11
Denmark	38,215	31	16
Egypt	5,113	43	6
El Salvador	5	83	0
Estonia	72	93	3
Falkland Islands	29	110	n.a.
Faroe Islands	27	110	n.a.
Finland	27,244	38	23
France	234,366	6	12
Georgia	81	103	8
Germany	189,167	10	13
Ghana	32	87	1
Gibraltar	265	110	n.a.
Greece	5,991	45	8
Guernsey	5,621	110	n.a.

\* Greater than zero but less than \$500,000. n.a. Not available.

1. Market capitalization data are from Standard & Poor's Global Stock Markets Factbook 2010. Market capitalization based on year-end 2009 total market values of listed domestic companies. U.S. holdings include securities of companies registered in each country that may not trade on domestic exchanges, thus U.S. holdings can exceed the total size of a countries' total domestic market capitalization. Rank order excludes the United States, which has the largest equity market capitalization.

2. Excludes Hong Kong and Macau, which are reported separately.

**Table A14. Market value of U.S. holdings of foreign equity, by country, size of domestic equity markets, and percentage of each market that is U.S.-held, as of December 31, 2010 (continued)**

Millions of dollars except as noted

Country or region of issuer	Common Stock	Country rank according to domestic market capitalization <sup>1</sup>	Percent of domestic market capitalization <sup>1</sup>
Guinea	*	110	n.a.
Guyana	*	105	0
Hong Kong	129,493	14	12
Hungary	3,444	59	12
Iceland	73	94	4
India	86,286	7	5
Indonesia	25,237	23	7
Ireland	92,459	56	>100
Isle of Man	1,691	110	n.a.
Israel	44,684	32	20
Italy	50,941	26	16
Jamaica	*	77	0
Japan	445,144	3	11
Jersey	19,110	110	n.a.
Jordan	87	58	0
Kazakhstan	696	49	1
Kenya	187	65	1
Kiribati	2	110	n.a.
Korea, South	118,933	13	11
Latvia	13	100	1
Lebanon	166	66	1
Liberia	3,535	110	n.a.
Liechtenstein	299	110	n.a.
Lithuania	18	79	0
Luxembourg	25,797	40	26
Malawi	1	98	0
Malaysia	20,097	21	5
Malta	1	92	0
Marshall Islands	6,605	110	n.a.
Mauritius	1,282	78	20
Mexico	73,957	20	16
Monaco	27	110	n.a.
Morocco	383	46	1
Namibia	1	101	0
Netherlands	112,942	18	17
Netherlands Antilles	81,540	110	n.a.
New Zealand	2,900	55	8

\* Greater than zero but less than \$500,000. n.a. Not available.

1. Market capitalization data are from Standard & Poor's Global Stock Markets Factbook 2010. Market capitalization based on year-end 2009 total market values of listed domestic companies. U.S. holdings include securities of companies registered in each country that may not trade on domestic exchanges, thus U.S. holdings can exceed the total size of a countries' total domestic market capitalization. Rank order excludes the United States, which has the largest equity market capitalization.

**Table A14. Market value of U.S. holdings of foreign equity, by country, size of domestic equity markets, and percentage of each market that is U.S.-held, as of December 31, 2010 (continued)**

Millions of dollars except as noted

Country or region of issuer	Common Stock	Country rank according to domestic market capitalization <sup>1</sup>	Percent of domestic market capitalization <sup>1</sup>
Niger	3	110	n.a.
Norway	22,861	30	9
Pakistan	881	54	2
Panama	21,751	69	>100
Papua New Guinea	1,310	71	13
Paraguay	5	108	12
Peru	3,459	41	3
Philippines	9,020	35	6
Poland	8,262	34	4
Portugal	5,357	44	7
Romania	188	57	1
Russia	54,178	16	5
Senegal	21	110	n.a.
Serbia and Montenegro	12	72	0
Singapore	51,049	22	14
Slovakia	*	84	0
Slovenia	191	73	2
South Africa	69,795	15	7
Spain	64,215	12	5
Sri Lanka	704	64	4
Swaziland	3	110	n.a.
Sweden	62,558	19	11
Switzerland	317,918	11	26
Taiwan	94,115	17	12
Thailand	20,988	28	8
Togo	8	110	n.a.
Trinidad and Tobago	3	67	0
Tunisia	14	70	0
Turkey	30,322	27	10
Uganda	*	110	n.a.
Ukraine	149	53	0
United Kingdom	586,109	4	19
Uruguay	1	106	0
Venezuela	92	86	2
Vietnam	406	62	2
Zambia	44	89	2
Zimbabwe	46	68	0

\* Greater than zero but less than \$500,000. n.a. Not available.

1. Market capitalization data are from Standard & Poor's Global Stock Markets Factbook 2010. Market capitalization based on year-end 2009 total market values of listed domestic companies. U.S. holdings include securities of companies registered in each country that may not trade on domestic exchanges, thus U.S. holdings can exceed the total size of a countries' total domestic market capitalization. Rank order excludes the United States, which has the largest equity market capitalization.

**Table A14. Market value of U.S. holdings of foreign equity, by country, size of domestic equity markets, and percentage of each market that is U.S.-held, as of December 31, 2010 (continued)**

Millions of dollars except as noted

Country or region of issuer	Common Stock	Country rank according to domestic market capitalization <sup>1</sup>	Percent of domestic market capitalization <sup>1</sup>
International Organizations	380	n.a.	n.a.
Middle East oil-exporters <sup>3</sup>	2,170	n.a.	0
African oil-exporters <sup>4</sup>	672	n.a.	1
<b>Total</b>	<b>4,326,851</b>	<b>n.a.</b>	<b>8</b>
Totals by Region:			
Total Africa	81,191	n.a.	6
Total Asia	1,149,895	n.a.	7
Total Caribbean	309,593	n.a.	>100
Total Europe	2,007,533	n.a.	15
<i>Of which: Euro Area Countries<sup>5</sup></i>	850,568	n.a.	14
Total Latin America	237,634	n.a.	9
Canada	385,656	5	18
Total Other Countries	154,969	n.a.	1
International Organizations	380	n.a.	n.a.

\* Greater than zero but less than \$500,000. n.a. Not available.

1. Market capitalization data are from Standard & Poor's Global Stock Markets Factbook 2010. Market capitalization based on year-end 2009 total market values of listed domestic companies. U.S. holdings include securities of companies registered in each country that may not trade on domestic exchanges, thus U.S. holdings can exceed the total size of a countries' total domestic market capitalization. Rank order excludes the United States, which has the largest equity market capitalization.

3. Bahrain, Iran, Iraq, Kuwait, Oman, Qatar, Saudi Arabia, United Arab Emirates.

4. Algeria, Gabon, Libya, Nigeria.

5. Austria, Belgium, Cyprus, Finland, France, Germany, Greece, Ireland, Italy, Luxembourg, Malta, Netherlands, Portugal, Slovakia, Slovenia, Spain.

**Table A15. Market value of U.S. holdings of foreign securities, by industry, as of December 31, 2010**

Millions of dollars

GICS Code		Total	Equity	Debt	
				Long-term	Short-term
<b>1010</b>	<b>Total Energy</b>	<b>721,849</b>	<b>606,178</b>	<b>111,061</b>	<b>4,610</b>
101010	Energy Equipment & Services	184,410	165,696	18,490	224
101020	Oil & Gas	537,439	440,482	92,571	4,385
<b>1510</b>	<b>Total Materials</b>	<b>658,321</b>	<b>565,539</b>	<b>91,420</b>	<b>1,362</b>
151010	Chemicals	146,772	132,085	13,325	1,362
151020	Construction Materials	41,566	34,463	7,103	0
151030	Containers & Packaging	9,202	5,709	3,492	0
151040	Metals & Mining	438,182	379,784	58,397	0
151050	Paper & Forest Products	22,599	13,496	9,102	0
<b>2000</b>	<b>Total Industrial</b>	<b>539,682</b>	<b>480,645</b>	<b>56,433</b>	<b>2,604</b>
201010	Aerospace & Defense	29,366	24,490	4,877	0
201020	Building Products	16,876	16,415	461	0
201030	Construction & Engineering	38,144	36,562	1,578	3
201040	Electrical Equipment	53,959	52,503	1,456	0
201050	Industrial Conglomerates	89,612	76,516	13,096	0
201060	Machinery	113,315	106,761	5,906	648
201070	Trading Companies & Distributors	36,362	33,865	2,497	0
202010	Commercial Services & Supplies	28,615	22,382	6,153	80
202020	Professional Services	20,537	20,047	490	0
203010	Air Freight & Logistics	12,383	10,935	1,287	161
203020	Airlines	17,413	16,663	750	0
203030	Marine	20,686	16,758	3,088	840
203040	Road & Rail	41,430	28,442	12,116	872
203050	Transportation Infrastructure	20,984	18,307	2,678	0
<b>2500</b>	<b>Total Consumer Discretionary</b>	<b>497,281</b>	<b>454,704</b>	<b>40,566</b>	<b>2,013</b>
251010	Auto Components	35,824	28,556	7,268	0
251020	Automobiles	104,903	102,856	1,991	57
252010	Household Durables	43,503	41,493	1,710	300
252020	Leisure Equipment & Products	7,805	7,682	123	0
252030	Textiles, Apparel & Luxury Goods	44,394	43,531	863	*
253010	Hotels, Restaurants & Leisure	78,096	71,476	6,025	594
253020	Diversified Consumer Services	6,060	5,983	77	0
254010	Media	94,179	72,677	20,492	1,010
255010	Distributors	12,659	12,284	375	0
255020	Internet & Catalog Retail	5,946	5,946	*	0
255030	Multiline Retail	20,166	19,193	972	0
255040	Specialty Retail	43,746	43,025	669	52
<b>3000</b>	<b>Total Consumer Staples</b>	<b>407,978</b>	<b>375,009</b>	<b>31,582</b>	<b>1,386</b>
301010	Food & Staples Retailing	90,373	82,753	7,621	0
302010	Beverages	103,494	86,520	16,751	223
302020	Food Products	132,452	125,573	6,391	488
302030	Tobacco	38,720	38,078	641	0
303010	Household Products	22,023	21,863	159	0
303020	Personal Products	20,916	20,221	20	675

**Table A15. Market value of U.S. holdings of foreign securities, by industry, as of December 31, 2010 (continued)**

Millions of dollars

GICS Code		Total	Equity	Debt	
				Long-term	Short-term
<b>3500</b>	<b>Total Health Care</b>	<b>338,296</b>	<b>319,470</b>	<b>17,890</b>	<b>935</b>
351010	Health Care Equipment & Supplies	51,341	46,981	4,272	88
351020	Health Care Providers & Services	15,258	14,220	1,037	0
351030	Health Care Technology	1,869	1,856	13	0
352010	Biotechnology	8,948	8,862	86	0
352020	Pharmaceuticals	254,468	241,295	12,333	840
352030	Life Science Tools and Services	6,412	6,256	148	7
<b>4000</b>	<b>Total Financial</b>	<b>2,067,536</b>	<b>1,045,580</b>	<b>696,716</b>	<b>325,240</b>
401010	Commercial Banks	1,003,179	439,267	280,342	283,570
401020	Thrifts & Mortgage Finance	41,460	6,159	35,028	272
402010	Diversified Financial Services	162,988	54,569	84,986	23,433
402020	Consumer Finance	19,890	6,752	13,014	124
402030	Capital Markets (including Funds)	490,750	215,473	259,262	16,015
403010	Insurance	217,155	197,703	17,625	1,827
404020	Real Estate Investment Trust (REITs)	36,782	34,318	2,464	0
404030	Real Estate Management and Development	95,332	91,337	3,994	0
<b>4500</b>	<b>Total Information Technology</b>	<b>441,388</b>	<b>417,220</b>	<b>23,783</b>	<b>385</b>
451010	Internet Software & Services	40,027	39,750	277	0
451020	IT Services	54,415	53,521	894	0
451030	Software	47,123	45,925	1,198	0
452010	Communications Equipment	47,831	36,276	11,170	385
452020	Computers & Peripherals	37,484	35,376	2,108	0
452030	Electronic Equipment & Instruments	84,162	77,850	6,312	0
452040	Office Electronics	21,495	21,492	3	0
453010	Semiconductors & Semiconductor Equipment	108,851	107,030	1,821	0
<b>5010</b>	<b>Total Telecommunication Services</b>	<b>318,834</b>	<b>240,228</b>	<b>78,526</b>	<b>80</b>
501010	Diversified Telecommunication Services	159,860	107,178	52,657	25
501020	Wireless Telecommunication Services	158,974	133,050	25,869	55
<b>5510</b>	<b>Total Utilities</b>	<b>170,785</b>	<b>109,661</b>	<b>58,034</b>	<b>3,089</b>
551010	Utilities - Electric	82,474	54,892	25,742	1,840
551020	Utilities - Gas	29,323	10,663	18,659	0
551030	Utilities - Multi- & Unregulated Power	37,066	27,904	7,912	1,249
551040	Utilities - Water	6,112	3,875	2,237	0
551050	Independent Power Producers & Energy Traders	15,810	12,326	3,484	0
902010	<b>Government<sup>1</sup></b>	<b>542,223</b>	<b>75</b>	<b>487,162</b>	<b>54,986</b>
	<b>Industry unknown</b>	<b>59,191</b>	<b>32,599</b>	<b>21,643</b>	<b>4,949</b>
	<b>Total</b>	<b>6,763,364</b>	<b>4,646,908</b>	<b>1,714,815</b>	<b>401,639</b>

1. Includes securities issued by local governments as well as government-sponsored or guaranteed corporations.

**Forms and Instructions**

OMB NO. 1505-0146

Approval Expires: December 31, 2012

ANNUAL REPORT TO THE FEDERAL RESERVE BANK OF NEW YORK

**REPORT OF U.S. OWNERSHIP OF  
FOREIGN SECURITIES, INCLUDING  
SELECTED MONEY MARKET  
INSTRUMENTS (SHCA)**

**Mandatory Report  
Response Required By Law  
(22 U.S.C. 3101 et seq.)**



**Department of the Treasury  
Federal Reserve Bank of New York  
Board of Governors of the Federal Reserve System**



# TABLE OF CONTENTS

	<b>Page</b>
<b>I. INTRODUCTION</b>	
A. Purpose	1
B. Authority	1
C. Confidentiality of Data Reported	1
D. Penalties for Failure to Report	1
E. Paperwork Reduction Act Notice	2
<b>II. GENERAL INSTRUCTIONS</b>	
A. Who Must Report	2
B. Which Schedules to Report	3
C. Exemptions	4
D. Reporting Dates	4
E. Submission Instructions and Contact Information	4
<b>III. WHAT SECURITIES MUST BE REPORTED</b>	
A. Reportable Foreign Securities	6
B. Do Not Report	8
C. Funds and Related Equity Holdings	8
D. Securities Involved in Repurchase and Securities Lending Arrangements	9
E. Depositary Receipts/Shares	9
F. Stripped Securities	10
G. Direct Investment	10
H. Securities Held by Central Securities Depositories	10
I. Country Attribution	10
J. Limited Partnerships	11
K. Accounting Rules, Valuation of Securities, and Calculation of U.S. Dollar Values	11
L. Data Retention Period	12
M. Review of Data and Requests For Revised Data	12
<b>IV. INSTRUCTIONS FOR COMPLETING REPORTING SCHEDULES</b>	
A. Schedule 1 - Reporter Contact Identification and Summary of Financial Information	13
B. Schedule 2 - Details of Securities	16
C. Schedule 3 - Custodians Used	20
<b>APPENDICES</b>	
A. Sample Reporting Schedules	22
Reporter Contact Identification and Summary Financial Information	Schedule 1, Page 1 of 3
Details of Securities	Schedule 2, Page 1 of 2
Custodians Used	Schedule 3, Page 1 of 1
B. Reporting Requirement Flowcharts	28
C. List of Security Identification Systems	34
D. List of Country Codes	36
E. List of International and Regional Organizations	37
F. List of Currency Codes	38
G. List of Custodian Codes	40
H. Glossary	42
I. Technical Information for Electronic Submission	47

NOTE: Vertical bars in the left hand margin indicate changes from the reporting instructions for the previous year's report. There are bars on page 4 and Appendix F for SHCA(2009).

## **I. INTRODUCTION**

### **A. PURPOSE**

The Department of the Treasury, with the assistance of the Board of Governors of the Federal Reserve System and the Federal Reserve Bank of New York (FRBNY), is conducting a mandatory survey of the ownership of foreign securities, including selected money market instruments, by U.S. residents as of December 31. The data will be collected by the FRBNY, acting as fiscal agent for the Department of the Treasury. The data collected will be used by the U.S. Government in the computation of the U.S. balance of payments accounts and the U.S. international investment position, and in the formulation of international economic and financial policies. This report also is part of the Coordinated Portfolio Investment Survey (CPIS), an internationally coordinated effort under the auspices of the IMF, to improve the statistics on the holdings of foreign securities by major investing countries.

In order to reduce reporting burden and costs to the government, there will be a substantial reduction in the number of reporters in four out of every five years. A benchmark survey (Form SHC) of all significant U.S.-resident custodians and end-investors will continue to be held approximately every five years. In non-benchmark years, the annual survey (Form SHCA) will require reports from only the very largest U.S.-resident custodians and end-investors. The data reported under these annual surveys (Form SHCA) will be used in conjunction with the results of the previous benchmark survey to compute economy-wide estimates for the non-benchmark years.

The determination of who must report on the annual reports (Form SHCA) will be based upon the data submitted during the previous benchmark survey. Certain U.S.-resident custodians and end-investors (including fund managers) will be designated to file detailed foreign security data on Schedule 2 and data on foreign securities entrusted to U.S.-resident custodians on Schedule 3, i.e., they will be required to file in the same manner as they did on the December 31, 2006 benchmark survey.

### **B. AUTHORITY**

This survey is conducted under the authority of the *International Investment and Trade in Services Survey Act* (22 U.S.C. 3101 et seq., [the Act]) and *Executive Order 11961* of January 19, 1977. The Act specifies that the President has the authority to conduct a regular data collection program, including such studies and reports as may be necessary and feasible, to secure current information on international investment, including (but not limited to) such information as may be necessary for computing and analyzing the balance of payments and the international investment position of the United States (22 U.S.C. 3103). In *Executive Order 11961* §2, the President designated the Secretary of the Treasury to be responsible for collecting data on portfolio investment required by the Act.

### **C. CONFIDENTIALITY OF DATA REPORTED**

The information collected by this survey may be used only for analytical and statistical purposes and to enforce the Act. Access to the information is available only to officials and employees (including consultants and contractors and their employees) designated to perform functions under the Act. Persons having access to individual company information submitted pursuant to the Act are subject to penalties for unauthorized disclosure (22 U.S.C. §3104 and 18 U.S.C. §1905). The results of this survey will be made available to the general public at an aggregated level so that neither the U.S. persons or organizations providing information nor individual or organizational ownership of foreign securities can be identified.

### **D. PENALTIES FOR FAILURE TO REPORT**

Reporting as directed in this package is mandatory for any U.S. person or organization subject to the reporting requirements set forth in the report instructions. Failure by an organization to provide timely and accurate data can result in a civil penalty of not less than \$2,500 and not more than \$25,000, or injunctive relief ordering such person to comply, or both (22 U.S.C. §3105(a)).

Willfully failing to submit any required information under the Act can result in a fine of not more than \$10,000; and, if an individual, may result in imprisonment for not more than a year, or both. Any officer, director, employee or agent who knowingly participates in such violation, upon conviction, may be punished by a like fine, imprisonment, or both (22 U.S.C. §3105(c)).

## **E. PAPERWORK REDUCTION ACT NOTICE**

This report has been reviewed and approved by the Office of Management and Budget in accordance with the *Paperwork Reduction Act of 1995* and assigned OMB Control Number 1505-0146. The purpose is to collect accurate and complete data that will enable the Treasury Department to fulfill its responsibility under the Act. The estimated annual average preparation time per respondent (over five years) is about 84 hours, but this will vary widely from respondent to respondent. (a) In the year of a benchmark survey (using Form SHC), it is estimated that exempt SHC reporters will require an average of 16 hours; custodians of securities providing security-by-security information will require an average of 360 hours, but this figure will vary widely for individual custodians; end-investors providing security-by-security information will require an average of 120 hours; and end-investors and custodians employing U.S. custodians will require an average of 40 hours. (b) In a non-benchmark year (using Form SHCA), custodians of securities providing security-by-security information will require an average of 700 hours (because only the largest U.S.-resident custodians will report), end-investors providing security-by-security information will require an average of 145 hours; and SHCA reporters entrusting their foreign securities to U.S. custodians will require an average of 48 hours. Comments concerning the accuracy of this burden estimate and suggestions for reducing the burden should be directed to:

Administrator, International Portfolio Investment Data Systems  
U.S. Department of the Treasury  
1500 Pennsylvania Avenue NW, Room 4410-1440NYA  
Washington, DC 20220, or

The Office of Management and Budget  
Paperwork Reduction Project (1505-0146)  
Washington, DC 20503

No person is required to respond to any U.S. Government collection of information unless it displays a currently valid OMB control number.

## **II. GENERAL INSTRUCTIONS**

### **A. WHO MUST REPORT**

All U.S.-resident custodians and end-investors that receive a copy of this SHCA booklet of forms and instructions from the Federal Reserve Bank of New York or are notified by the Federal Reserve Bank of New York that they are required to file must report. (See Section II.C, Exemptions.) All other entities are exempt from reporting.

1) **Custodians** are all organizations that hold securities in safekeeping for other organizations. Most U.S.-resident custodians also invest in foreign securities for their own account, i.e., are also U.S.-resident end-investors for purposes of this report. U.S.-resident custodians should report both the foreign securities held in safekeeping for other U.S. residents and their own foreign securities.

2) **End-Investors** are U.S. resident organizations that invest in foreign securities for their own portfolio. This includes securities that are held-for-trading, available-for-sale, held-for-maturity, or which have been invested on behalf of others by managers of mutual funds, insurance companies, and pension funds. Collectively such investors are referred to as “end-investors” throughout these instructions. U.S.-resident end-investors include, but are not limited to:

Financial and non-financial organizations  
Managers of private and public pension funds  
Managers of mutual funds, country funds, unit-investment funds, exchange-traded funds, collective-investment trusts, or any other similarly pooled, commingled fund  
Insurance companies  
Foundations  
Institutions of higher learning (e.g., university endowments)  
Trusts and estates

Reports should include all reportable securities held or managed by all U.S.-resident parts of your organization, including all U.S.-resident branches, offices, and subsidiaries. U.S. residents include organizations located in the Commonwealth of Puerto Rico and U.S. territories and possessions. Please see Appendix H for the complete definition of United States. It is the responsibility of the parent entity in each organization to ensure that its report covers all applicable entities within the organization.

If any of the following conditions apply, please contact the FRBNY staff:

- Your organization is not the top parent U.S.-resident entity in your organization and has received the forms and instructions from, or has been notified of its obligation to report by, the Federal Reserve Bank of New York.
- Your organization cannot submit a single report for the entire organization.

Additional copies of the reporting forms and instructions may be printed from the Internet at:

<http://www.treas.gov/tic/forms.html#benchmark>

## **B. WHICH SCHEDULES TO REPORT**

- **Schedule 1**

Schedule 1 must be filed by all entities that 1) receive a copy of the SHCA forms and instructions from the Federal Reserve Bank of New York, or 2) are notified by the Federal Reserve Bank of New York that they are required to file the SHCA report.

Schedule 1 requests information that identifies the reporter. It also provides contact information, indicates the reporting status, and summarizes the data, if any, reported on Schedule 2 and/or Schedule 3.

- **Schedule 2:**

Schedule 2 is used to report detailed information on foreign securities (1) that the reporter safekeeps for itself or for its U.S.-resident clients or (2) for which the reporter directly employs foreign-resident sub-custodians or U.S.-resident or foreign-resident central securities depositories to manage the safekeeping of those securities (See Section III.H.).

- **Schedule 3:**

Schedule 3 is used to report summary amounts for all foreign securities entrusted to the safekeeping of a U.S.-resident custodian (excluding U.S.-resident central securities depositories) (See Section III.H.).

## C. EXEMPTIONS

- **Schedule 1**

If you have received these forms and instructions from the Federal Reserve Bank of New York, there is NO exemption level for **Schedule 1**. You must submit the reporter identification, the contact and certifying information parts of **Schedule 1**. However, items requesting aggregate data on foreign securities on Schedule 1 should be left blank if you are not required to report data on Schedule 2 or Schedule 3.

- **Schedule 2**

SHCA reporters are exempt from reporting on Schedule 2 if the total fair (market) value of foreign securities whose safekeeping they manage for themselves and for other U.S. residents or whose safekeeping the reporter has entrusted directly to foreign-resident custodians or U.S. or foreign-resident central securities depositories **is less than US\$ 100 million** (aggregated over all accounts) as of December 31.

- **Schedule 3**

SHCA reporters are exempt from reporting on a Schedule 3 holdings entrusted to another U.S.-resident custodian if the total fair (market) value of the foreign securities entrusted to that U.S.-resident custodian – aggregated over all accounts they own and all accounts they manage for other U.S. residents - **is less than US\$ 100 million** as of December 31.

## D. REPORTING DATES

Report data as of December 31. Data should be submitted to the Federal Reserve Bank of New York (FRBNY) no later than the first Friday of March.

## E. SUBMISSION INSTRUCTIONS AND CONTACT INFORMATION

**Schedule 1** must be submitted on paper, unless you are submitting Schedule 2 and/or 3 data via the IESUB application (see below). If you are submitting Schedule 2 and/or 3 data via the IESUB application, you must submit Schedule 1 via IESUB.

**Schedule 2** reports consisting of **200 or more** records, must be submitted electronically on diskette(s) or compact disk(s) (CDs) or via IESUB using the format specified in Appendix I.

**Schedule 2** reports consisting of **less than 200** records may be submitted electronically on diskette(s) or compact disk(s) (CDs) or via IESUB using the format specified in Appendix I, or on paper, using the form contained in Appendix A.

**Schedule 3** reports can be submitted either on paper using the form in Appendix A or via the IESUB application.

Reports can be mailed or sent by courier to:

**Federal Reserve Bank of New York  
Statistics Function, 4<sup>th</sup> Floor  
33 Liberty Street  
New York, NY 10045-0001**

## **IESUB**

The Federal Reserve System's Internet Electronic Submission (IESUB) System is fast, easy to use and secure. IESUB provides a confirmation of the receipt of the data at the Federal Reserve Bank of New York and performs a number of validity checks of your file format.

For more information on how to submit data using the IESUB system, contact the SHC staff at 212-720-6300 or 646-720-6300 or at [SHC.Help@ny.frb.org](mailto:SHC.Help@ny.frb.org). Alternatively, additional information and an application to register for IESUB can be obtained at:

<http://www.treas.gov/tic/forms.htm#benchmark>.

Completed applications should be sent to:

Federal Reserve Bank of New York  
Statistics Function, 4<sup>th</sup> Floor  
33 Liberty Street  
New York, New York 10045-0001

or faxed to 1-212-720-5030.

**If your business or technical contact information changes after submission of your Schedule 1 or if you have any questions pertaining to the report, please contact the FRBNY staff:**

Phone: (212) 720-6300  
(646) 720-6300

Email: [SHC.Help@ny.frb.org](mailto:SHC.Help@ny.frb.org)

### III. WHAT SECURITIES MUST BE REPORTED

This report collects information on U.S. resident holdings of foreign securities, including foreign equities, short-term debt securities (including selected money market instruments), and long-term debt securities. Asset-backed securities are to be reported separately from other debt securities. Foreign securities include all securities issued by entities that are established under the laws of a foreign country (i.e., any entity that is legally incorporated, otherwise legally organized, or licensed (such as branches) in a foreign country) and all securities issued by international organizations, such as the International Bank for Reconstruction and Development (IBRD or World Bank), and the Inter-American Development Bank (IADB), even if these organizations are located in the United States.

Reportable securities may be traded or issued in the United States and in foreign countries, and may be denominated in any currency, including euros and U.S. dollars. Neither the country in which the securities are traded or issued, nor the currency in which the securities are denominated, is relevant in determining whether the securities are reportable.

As an exception, foreign securities held by a U.S. depository to back depository receipts/shares should not be reported. Instead, the holders of the depository receipts/shares should report the receipts/shares. This exception is necessary to identify the portion of depository receipts/shares actually held by U.S. residents, because many depository receipts/shares are held by foreign residents.

#### A. REPORTABLE FOREIGN SECURITIES

##### **Reportable securities include:**

- Securities issued by international and regional organizations, such as the International Bank for Reconstruction and Development (IBRD or World Bank) or the Inter-American Development Bank (IDB).
- Securities issued in the United States by foreign-resident organizations (e.g., Canadian or Mexican firms), even if they are denominated in U.S. dollars and trade on U.S. securities exchanges.
- Securities issued by foreign-resident subsidiaries of U.S.-resident organizations (e.g., GMAC Canada) and foreign-resident offices of U.S. banks or U.S. broker/dealers, even if they are guaranteed by the U.S. parent company, or issued in the United States.
- Depository receipts/shares, including American Depositary Receipts (ADRs), American Depositary Shares (ADS), Global Depositary Receipts (GDRs), and International Depositary Receipts (IDRs), if the underlying securities are issued by foreign residents— (See Section III.E.).
- Securities issued by foreign-resident entities under Section 144A of the SEC Act.
- Money market instruments, including negotiable certificates of deposit (CDs), issued by foreign-resident entities.

**Equity securities** represent an ownership interest in foreign-resident organizations.

##### *Include as equities:*

- Common stock (ordinary shares);
- Preferred stock (participating and nonparticipating preference shares);
- Restricted stock;
- Depository receipts/shares (e.g., ADRs, ADSs, GDRs, IDRs) **provided** the underlying securities used to collateralize the receipts/shares **are** foreign securities (See Section III.E.);
- Shares/units in foreign-resident funds, investment trusts, and similar investment vehicles (including mutual funds and money market funds— (See Section III.C.);
- U.S.-resident limited partner ownership in foreign-resident limited partnerships (general partner ownership is excluded – (See Section III.J.); and
- Other equity securities.

**Short-Term Debt Securities** include bills, commercial paper, and other money market instruments specified below with an **original maturity of one year or less** that give the holder the unconditional right to financial assets. (Asset-backed short-term debt securities should be reported as asset-backed securities (see below).)

*Include as short-term debt securities:*

- Short-term foreign government securities;
- Short-term bankers' acceptances and trade acceptances;
- Short-term commercial and financial paper, including asset-backed commercial paper;
- Short-term **negotiable** certificates of deposit, bank notes, and deposit notes;
- Short-term notes issued under note issuance facilities and revolving underwriting facilities, even though the underlying facility may be for more than one year;
- Short-term medium-term notes;
- Short-term promissory notes;
- Stripped securities with an original maturity of one year or less; and
- Other short-term debt securities.

**Long-Term Debt Securities** (excluding asset-backed securities) include bonds and notes, with an **original maturity of over one year**, that usually give the holder the unconditional right to financial assets.

*Include as long-term debt securities:*

- Bonds such as foreign treasury, zero coupon, stripped, deep-discounted, currency-linked (e.g., dual-currency), floating rate, equity-related (e.g., convertible bonds) bonds and Eurobonds;
- Long-term index-linked debt securities;
- Long-term floating rate notes (FRN), such as perpetual notes (PRN), variable rate notes (VRN), structured FRN, reverse FRN, collared FRN, step up recovery FR (SURF), and range/corridor/accrual notes;
- Long-term medium-term notes;
- Bonds with multiple call options, the last of which is more than one year after issue;
- Long-term debentures;
- Long-term negotiable certificates of deposit, bank notes, and deposit notes;
- Long-term bearer depositary receipts denoting ownership of debt securities issued by nonresidents;
- Brady bonds;
- Covered bonds (e.g., Pfandbriefe);
- Long-term securities backed by a sinking fund; and
- Other long-term debt securities.

**Asset-Backed Securities** are securitized interests in a pool of assets, which give the purchaser a claim against the cash flows generated by the underlying assets. In many cases, the security's outstanding principal is reduced over time as principal repayments are received and passed on to the holders of the security. Securities backed by revolving credits, such as pools of credit card receivables, do not meet this criterion, but are still classified as ABS if the return to the holder is based upon these credits, (i.e., the credits do not merely serve as collateral). The ABS is reported if the **issuer securitizing the assets** is a foreign resident. The underlying asset should not be used to determine if the securities are reportable. Asset-backed commercial paper should be reported as commercial paper with other short-term debt.

*Include as asset-backed securities all collateralized mortgage obligations (CMOs), collateralized bond obligations (CBOs), collateralized loan obligations (CLOs), collateralized debt obligations (CDOs), and other securities which give the purchaser a claim against the cash flows generated by pools of:*

- Mortgages;
- Credit card receivables;
- Automobile loans;
- Consumer and personal loans;
- Commercial and industrial loans and other whole loans; and
- Other assets.



## **B. DO NOT REPORT**

Do not report any:

- Derivative contracts (including futures, forwards, swaps, options, and warrants) meeting the definition of a derivative under FAS 133. If the embedded derivative has not been bifurcated from the host contract under FAS 133, then the security should be reported without separating the embedded derivative from the host contract. However, if the embedded derivative is bifurcated from the host contract, then the derivative should be excluded from the report and the host security should be included on the report.
- Loans and loan participation certificates;
- Letters of credit;
- Non-negotiable certificates of deposit ;
- Bank deposits, including time deposits (except for negotiable CDs) and demand deposits;
- Foreign securities temporarily acquired under reverse repurchase, borrowing, or lending arrangements (See Section III.D.);
- The underlying security of a depositary receipt, even if a foreign security (See Section III.E.);
- Direct investments (See Section III.G.), including investments in real estate and general partner ownership in limited partnerships (however, limited partner ownership are reportable investments);and
- All U.S. securities, including:
  1. Securities issued by U.S.-resident organizations, even if they are denominated in foreign currencies or traded on foreign securities exchanges;
  2. Securities issued by U.S.-resident subsidiaries of foreign-resident organizations and U.S.-resident offices of foreign banks or foreign broker/dealers, even if they are guaranteed by the foreign parent company, or issued outside of the United States;
  3. Securities issued by U.S.-resident entities under Section 144A of the SEC Act;
  4. Ownership of shares of U.S.-resident funds, even if the fund invests in foreign securities (See Section III.C.); and
  5. Stripped securities issued by a U.S.-resident financial institution, even if the underlying security is a foreign security (See Section III.F.).

## **C. FUNDS AND RELATED EQUITY HOLDINGS**

1. Report U.S. residents' ownership of shares/units of funds legally established outside of the United States (foreign-resident funds) as equity securities. All U.S. residents' holdings of foreign-resident funds should be assigned security type 3 (fund shares), and not categorized as a debt security, regardless of the types of securities held by the fund.

For purposes of this report, funds include all investment vehicles that pool investors' money and invest the pooled money in one or more of a variety of assets. Funds include, but are not limited to:

- Mutual funds (including both closed-end and open-end mutual funds);
- Money market funds;
- Investment trusts;
- Index-linked funds;
- Exchange traded funds (ETFs); and
- Common trust funds.

The determination of whether fund shares are foreign securities is based on the country in which the fund is legally established, not on the type of securities the fund purchases. For example, a share in a fund organized in

Bermuda that purchases U.S. Treasury securities is a reportable foreign equity security. Likewise, a share in a fund established in the United States is a U.S. security and should be excluded from the report, even if the U.S.-resident fund invests in foreign securities.

Many funds established outside the United States have names that are similar to U.S.-resident fund names. This often occurs when the fund is managed by a group that manages many U.S.-resident funds and therefore may be thought of as managing only U.S.-resident funds. If there is doubt as to whether the investment should be classified as a fund or whether a fund is U.S. or foreign, please contact FRBNY report staff at (212) 720-6300 or (646) 720-6300.

## 2. Report U.S.-resident funds' ownership of foreign securities.

Although ownership of shares of U.S.-resident funds is excluded from this report, the foreign securities owned by U.S.-resident funds are reportable. These are distinct holdings and, therefore, are not duplicate reporting. Foreign securities owned by U.S.-resident funds should be classified as equity, debt, or asset-backed securities, as indicated in Section III.A.

### **D. SECURITIES INVOLVED IN REPURCHASE AND SECURITIES LENDING ARRANGEMENTS**

A repurchase agreement (repo) is an arrangement involving the sale of securities at a specified price for cash with a commitment to repurchase the same or similar securities at a specified price on a future date. A reverse repo is an agreement whereby a security is purchased at a specified price with a commitment to resell the same or similar securities at a specified price on a specified future date. Securities lending/borrowing arrangements are agreements whereby the ownership of a security is transferred in return for collateral, usually another security or cash, under condition that the security or similar security will revert to its original owner at a future date. All of these arrangements, as well as buy/sell agreements, should be treated as follows:

- Securities sold under repurchase agreements or lent under securities lending arrangements, or collateral provided, should be reported by the original owner of the securities (or their U.S.-resident custodian) as if the securities were continuously held; that is, as if the repurchase or security lending agreement did not exist. Thus, if a U.S. resident transferred a foreign security under a repurchase or securities lending arrangement, the U.S. resident (or their U.S.-resident custodian) transferring the security should include it in its Schedule 2 or Schedule 3 records. The country reported should be the country of the issuer of the security and not the country of the counterparty to the repo or other agreement.
- Securities, including collateral, temporarily acquired by U.S. residents under reverse repurchase or borrowing or lending arrangements should not be reported.
- However, if cash was temporarily received as collateral and was used to purchase securities, those securities should be reported.

### **E. DEPOSITARY RECEIPTS/SHARES**

Depositary receipts/shares, including American depositary receipts (ADRs) or bearer depositary receipts, should be attributed to the country of residence of the issuer of the security underlying the depositary receipt/share. Issuers of depositary receipts/shares should **not** report their holdings of the actual foreign securities. Only U.S. residents' holdings of depositary receipts/shares should be reported.

In addition, the security type reported should be determined based on the security underlying the depositary receipt/share. For example, if the underlying security is foreign common stock then the security type reported in Item 7 of the Schedule 2 should be 1 (common stock).

## F. STRIPPED SECURITIES

Stripped securities are securities that have been transformed from a principal amount with periodic interest coupons into a series of zero coupon securities, with the range of maturities matching the coupon payment dates and the redemption date of the principal amount.

The country of residence of a stripped security is the country of residence of the entity that issued the stripped security, not the country of residence of the entity that issued the underlying security. Stripped securities issued by foreign residents, (the interest-only (IO) component, the principal-only (PO) component and tranches of stripped asset-backed securities), and held by U.S. residents are reportable. If a U.S.-resident financial institution issued the stripped securities, the issuer of the stripped securities should report its ownership of the underlying foreign securities. Exclude U.S. residents' holdings of stripped securities issued by a U.S.-resident financial institution.

## G. DIRECT INVESTMENT

All holdings known to be direct investment should be excluded from the survey.

A direct investment relationship exists when a U.S. company owns 10% or more of the voting equity securities of an incorporated foreign business (or an equivalent interest in an unincorporated foreign business or branch. (See Section III.K.) If a direct investment relationship exists, then, in general, all securities held by the parent entity that were issued by the affiliate of the parent are considered to be direct investment. **However, if one of the entities is a banking or securities brokerage firm, then inter-company holdings are considered to be direct investment only if they provide permanent capital.** All holdings known to be direct investment should be excluded from this report.

## H. SECURITIES HELD BY CENTRAL SECURITIES DEPOSITORIES

Foreign securities entrusted to U.S.-resident custodians that are in turn held at a U.S.-resident central securities depository (such as the Depository Trust Company or the Federal Reserve Bank of New York), or a foreign-resident central securities depository (such as Euroclear or Clearstream), must be reported by the U.S.-resident custodian, not by the U.S. or foreign-resident central securities depository. Likewise, foreign securities held by a U.S.-resident end-investor directly with a U.S.-resident or foreign-resident central securities depository must be reported by the U.S.-resident end-investor, not by the central securities depository.

Foreign securities provided to the Federal Reserve Bank of New York (FRBNY) for discount window loan collateral must be reported by the "lender" of the securities, not by the FRBNY.

## I. COUNTRY ATTRIBUTION

Except for international and regional organizations, and depository receipts, securities should be reported based upon **the country of residence of the issuer of the securities**. The country of residence of any entity is where it is legally incorporated or otherwise legally organized, with the exception of bank branches, which are reported by where they are licensed. In cases where a foreign subsidiary of a U.S.-resident organization issues a reportable security, report these securities in the country where the foreign subsidiary is resident if the security is the direct legal obligation of the foreign subsidiary.

Securities issued by international and regional organizations are not allocated to the country in which the international or regional organization is located but rather to the separate code for international and regional organizations (79995). (Refer to Appendix E for a list of international and regional organizations.) Depository receipts should be attributed to the country of residence of the issuer of the security underlying the depository receipt.

Attribution of country of residence of the issuer should **not** be affected by the currency of issue or by the country of a guarantor.

## **J. LIMITED PARTNERSHIPS**

U.S.-resident limited partner ownership of foreign-resident limited partnerships should be reported as Other Equity (Schedule 2, Item 7 = 4). Limited partners' ownership does not carry voting rights; therefore, such ownership, even if greater than 10%, is reportable. The Number of Shares Held field on the Schedule 2 (Item 16) should be defaulted to the value reported in the US\$ Market Value field (Item 14a) because limited partnerships do not issue shares.

U.S.-resident general partner ownership of foreign-resident limited partnerships is always considered to be direct investment and is excluded from this report.

## **K. ACCOUNTING RULES, VALUATION OF SECURITIES, AND CALCULATION OF U.S. DOLLAR VALUES**

### **Accounting Rules**

All securities should be reported using settlement date accounting. Gross long positions should be reported. Do not net any short positions from long positions. Do not enter decimals or negative values in any cells.

### **Valuation of Securities**

Report the fair (market) value of securities as December 31. The fair (market) value follows the definition of FAS 157. Fair value is the amount at which an asset could be bought or sold in a current transaction between willing parties, other than in a forced or liquidation sale. If a quoted market price is available for an instrument, the fair (market) value is the product of the number of trading units times that market price. For securities that do not regularly trade, the estimate of fair value should be based on the best information available in the circumstances. The estimate of fair value should consider prices for similar assets and the results of valuation techniques to the extent available in the circumstances. Examples of valuation techniques include discounted cash flow, matrix pricing, option-adjusted spread models and fundamental analysis.

For asset-backed securities, the fair (market) value of the unpaid principal amount outstanding on December 31 should be reported; if principal has been repaid, this fair (market) value will **not** be the same as the original face value revalued at end-period market prices.

U.S.-resident custodians should, at a minimum, report the fair (market) value to the extent that it is available as part of their normal services provided to customers, even if the price available is prior to December 31. If there is doubt as to whether to report the available fair (market) value or to report a fair (market) value of zero, please contact FRBNY report staff at (212) 720-6300 or (646) 720-6300.

### **Foreign Currency Denominated Securities – Calculation Of U.S. Dollar Values**

If the security is not denominated in U.S. dollars (US\$) and a US\$ fair (market) value is not available in your system, convert the foreign currency denominated fair (market) value into US\$ using the spot exchange rate as of December 31. If you need assistance locating an exchange rate, please contact FRBNY staff at (212) 720-6300 or (646) 720-6300.

If the exchange rate is normally quoted in units of foreign currency per US\$, such as ¥105.75/US\$, divide foreign currency values by the foreign exchange rate to obtain the US\$ values. For example, if the value of a security issued in Japan is ¥ 200,000, divide ¥ 200,000 by 105.75 to obtain US\$ 1,891.

If the exchange rate is normally quoted in US\$ per units of the foreign currency, such as US\$1.75/UK£, then multiply foreign currency values by the US\$ exchange rate value of the foreign currency to obtain US\$ values.

For example, if the value of a security issued in the United Kingdom is UK £1,000, multiply UK £1,000 by 1.75 to obtain US\$ 1,750.

#### **L. DATA RETENTION PERIOD**

The reporter must retain all data used to create this report for a period of 36 months from the date of the report's submission.

#### **M. REVIEW OF DATA AND REQUESTS FOR REVISED DATA**

Data submitted on the reporting schedules are reviewed by FRBNY staff. As a result of this review, the reporter may be asked by FRBNY staff to provide supplemental information, including reasons for significant data changes between reporting periods, or corrected data. In addition, FRBNY staff may request: (1) information to ensure that all reportable foreign securities have been reported; (2) information to ensure that all reported foreign securities are held by U.S. residents; or (3) other information that helps to explain or corroborate the submitted data.

Entities filing data on electronic media that are not formatted per the specifications in Appendix I will be required to re-submit the data in the proper format.

## IV. INSTRUCTIONS FOR COMPLETING REPORTING SCHEDULES

### A. SCHEDULE 1 - REPORTER CONTACT IDENTIFICATION AND SUMMARY OF FINANCIAL INFORMATION

Schedule 1 must be completed by all organizations that meet the survey reporting requirements as specified in Section II.A. This schedule is used to provide basic identifying information and provide summaries of data reported on Schedule 2 and Schedule 3 records. Please type or print all information.

**1. Reporter Identification Number** - Enter your organization's ten-digit Reporter Identification Number. If you do not know the Reporter Identification Number for your organization, please contact FRBNY staff at (212) 720-6300 or (646) 720-6300.

**(Please enter your ten-digit Reporter Identification number at the top of each page of Schedule 1.)**

**2. Organization Name and Address** - Include the full legal name and mailing address of the reporting entity.

**3. Reporting Status**

Select **1** if your organization is Exempt from reporting on both Schedules 2 and 3 as defined in Section II.C  
**OR** if your organization's reportable foreign securities are included in the report of its U.S.-resident parent.

Select **2** if your organization is filing only Schedule 2 records.

Select **3** if your organization is filing only Schedule 3 records.

Select **4** if your organization is filing both Schedule 2 and Schedule 3.

**4. Industrial Classification Code** - Enter one of the following that best describes your organization.

1 = Bank	4 = Insurance Company	7 = Foundation, Trust, or Estate
2 = Mutual Fund or Investment Trust	5 = Other Financial Organization	8 = Institution of Higher Learning (e.g., university)
3 = Pension Fund	6 = Non-Financial Organization	9 = Other (not listed above)

A Bank is any depository institution (i.e., an institution that takes deposits), a bank holding company, or a financial holding company organized under Regulation Y of the Federal Reserve Act.

An Other Financial Organization is any other organization that acts as a financial intermediary, such as a finance company or a broker/dealer, which is operated separately from an organization in one of the other categories listed above.

A Non-Financial Organization is an organization that conducts commercial, industrial or trade activities.

**5. Name of Contact** - Enter the name of the person who will be the primary contact for this report and can answer questions about the data reported.

**6. Title** - Enter the job title of the contact identified in item 5.

**7. Telephone Number** - Enter the telephone number of the contact identified in item 5.

**8. Fax Number** - Enter the fax number of the contact identified in item 5.

**9. Email Address** - Enter the email address of the contact identified in item 5.

**10. Name of Service Provider or Vendor Used** - If a service provider or vendor was used to prepare the data reported, enter the name of the service provider.

- 11. Name of Technical Contact** - Enter the name of a person who will serve as a contact should any technical issues, such as incorrect file formats, arise. If a service provider was used to prepare the data reported, the technical contact may be a vendor employee.
- 12. Title** - Enter the job title of the technical contact identified in item 11.
- 13. Telephone Number** - Enter the telephone number of the technical contact identified in item 11.
- 14. Email Address** - Enter the email address of the technical contact identified in item 11.
- 15. Valuation Technique** - For each reporting unit, describe the valuation technique(s) used to calculate the reported market values. If securities are automatically valued at zero after a specified time period of inactivity, please specify the time period and whether this applies to the market value of the security or to the client's holdings (quantity) of the security. Also, please specify how securities not actively traded on the report date and those with internally generated security identification numbers are valued. If your organization has more than four reporting units, please attach additional copies of Schedule 1, page 2, with item 15 completed.

## **SUMMARY OF SCHEDULE 2 INFORMATION**

This section contains summary data for the information reported on **Schedule 2** records. If your organization submits Schedule 2 data on multiple media, the summary Schedule 2 data should represent aggregate data across all media submitted for the same reporter identification number.

- 16. Total Number of Schedule 2s Submitted** - Enter the total number of Schedule 2 records submitted.
- 17. Total US\$ Fair (Market) Value of All Equity Securities** - Enter the sum of the US\$ fair (market) value of all equity security records (records with Schedule 2, Item 7 = 1, 2, 3, or 4), rounded to the nearest U.S. dollar.
- 18. Total US\$ Fair (Market) Value of All Short-Term Debt Securities** (excluding asset-backed securities) - Enter the sum of the US\$ fair (market) value of all short-term debt security (including asset-backed commercial paper) records (records with Schedule 2, Item 7 = 5, 6, 7, 8, or 9 and Item 10 = 1), rounded to the nearest U.S. dollar.
- 19. Total US\$ Fair (Market) Value of All Long-Term Debt Securities** (excluding asset-backed securities) - Enter the sum of the US\$ fair (market) value of all long-term debt security (excluding asset-backed securities) records (records with Schedule 2, Item 7 = 6, 7, 8, or 9 and Item 10 = 2), rounded to the nearest U.S. dollar.
- 20. Total US\$ Fair (Market) Value of All Asset-Backed Securities** - Enter the sum of the US\$ fair (market) value of all asset-backed security records (records with Schedule 2, Item 7 = 10), rounded to the nearest U.S. dollar.

## **SUMMARY OF SCHEDULE 3 INFORMATION**

This section contains summary data for the information reported on **Schedule 3** records.

- 21. Total Number of Schedule 3s Submitted** - Enter the total number of Schedule 3 records submitted.
- 22. Total US\$ Fair (Market) Value of All Equity Securities** - Enter the sum of all Schedule 3 records, item 4.
- 23. Total US\$ Fair (Market) Value of All Short-Term Debt Securities** (excluding asset-backed securities) - Enter the sum of all Schedule 3 records, item 5.

**24. Total US\$ Fair (Market) Value of All Long-Term Debt Securities** (excluding asset-backed securities) - Enter the sum of all Schedule 3 records, item 6.

**25. Total US\$ Fair (Market) Value of All Asset-Backed Securities** - Enter the sum of all Schedule 3 records, item 7.

### **CERTIFYING INFORMATION**

**All reporters must complete this section.**

By signing and dating the certification, the Certifier acknowledges that:

- He/she has read and understood the reporting requirements of this report;
- He/she is aware that both civil and criminal penalties may be imposed for filing a false report; and
- He/she is sufficiently knowledgeable about the activities and functions of this organization that he/she can knowingly and with reasonable confidence certify that the information provided in this report is both accurate and complete.

**26 - 30** - Enter the name, job title, telephone number, and email address of the person in your organization who certifies that the information provided is complete and accurate, as well as the date and signature.



## B. SCHEDULE 2 - DETAILS OF SECURITIES

(Please enter your ten-digit Reporter Identification Number at the top of each page of Schedule 2.)

**1. Reporter Identification Number** - Enter your organization's ten-digit Reporter Identification Number. If you do not know the Reporter Identification Number for your organization, please contact FRBNY staff at (212) 720-6300 or (646) 720-6300.

**2. Sequence Number** - Enter the sequence number of this detail record, right justified. The first detail record should be assigned sequence number 1, and each succeeding Schedule 2 should be assigned a sequence number one higher than the previous record.

**3a. Reporting Unit Code** - If data being submitted are collected from multiple databases or reporting systems, please report the internal code used in your organization to identify the database or system from which the information on this Schedule 2 came. This information may greatly reduce the costs of identifying and fixing reporting errors that occur.

**3b. Name of Reporting Unit** - Enter a description or name of the reporting unit or area that corresponds to the code reported in item 3a.

**4. Security ID** - Enter the security ID code used to identify the security reported on this Schedule 2. ISIN codes are strongly preferred. If the ISIN code is not available, please use a code listed as "Primary" in Appendix C. If no "primary" code is available, please use a "secondary" code listed in Appendix C other than "internally generated." **Do not use internally generated codes unless this security has not been assigned a code by any recognized numbering agency (e.g., limited partnerships).** However, all records for securities for which a portion is restricted and a portion is not restricted should be reported with the numbering agency code assigned to the unrestricted portion. If excessive internal codes are used, we may have to contact you to help identify characteristics of certain individual securities. **Please include the security id's check digit and exclude any internal coding characters added to the ISIN, CUSIP, or other numbering agency code.**

**5. Security Description** - Briefly describe the security, providing any relevant descriptive information available. Ideally, this would include, but is not restricted to: (a) for preferred stock, the annual dividend; (b) for debt securities, the interest rate; (c) for floating rate notes, how the interest is calculated (e.g., Libor plus 1.5); and (d) for depositary receipts, the underlying security.

**6. Security ID System** - Select the appropriate number from the list provided in Appendix C. For example, if the Security ID Number entered in Item 4 was an ISIN number, enter "01"; if it was a CINS, enter "33." If the security ID system used is not listed, enter a code of 99 (other) and provide the name of the organization generating the code in item 6a. If the code is internally generated, enter a code of 98 and explain how your internal coding system assigns numbers in item 6a.

**6a. Comment Line** - If you entered a code of 99 (other) in item 6 you must provide the name of the organization generating the security ID code. If you entered a code of 98 (internally generated) in item 6 please explain how your internal coding system assigns numbers.

**7. Security Type** - Enter the appropriate Security Type code from the listed options below:

Equity	Non-asset-backed Debt	Asset-backed Securities
1 = Common stock	5 = Commercial paper	9 = Unstripped note or bond
2 = Preferred stock	6 = Negotiable CD	& all other
3 = Fund shares	7 = Convertible debt security	non-asset-backed debt
4 = All other equity	8 = Zero coupon & stripped security	10 = Asset-backed security

Common stock includes securities representing equity ownership in a foreign corporation. All foreign common stock, including restricted common stock and depositary receipts where the underlying security is common stock should be reported as security type 1.

Preferred stock includes securities representing equity ownership in a foreign corporation where the holder's claim is given priority over common shares. Preference shares, non-participating preference shares, convertible preferred stock, restricted preferred stock, and depositary receipts where the underlying security is preferred stock should be reported as security type 2.

Funds include all investment vehicles that pool investors' money and invest the pooled money in one or more of a variety of assets. All ownership interests in funds should be reported as security type 3, regardless of the securities held by the fund. (See Section III.C.)

All other equity includes U.S.-resident limited partner ownership of foreign-resident limited partnerships and any other form of equity not specified in Security Types 1, 2, and 3 and should be reported as security type 4.

Commercial paper, security type 5, includes **all** commercial paper, including asset-backed commercial paper.

Negotiable certificates of deposit, security type 6, includes negotiable bank notes and negotiable deposit notes.

Convertible debt securities, security type 7, includes all convertible debt such as convertible bonds and zero-coupon convertible debt. Note that non-convertible debt securities with embedded warrants or options should be reported as either security type 8, if a zero coupon bond or note, or as security type 9, if **straight debt**.

Zero coupon & stripped securities, security type 8, includes bonds and notes that do not provide explicit interest payments, such as discount notes and stripped, non-asset-backed securities (both the interest-only (IO) and principal-only (PO) components) **except** zero-coupon convertible debt, which should be reported as security type 7, and stripped asset-backed securities, (including their tranches, and all IO and PO components) which should be reported as security type 10.

Unstripped notes, bonds, and all other non-asset-backed debt, security type 9, includes non-asset-backed debt that is not covered in security types 5 through 8. These are bonds or notes that : (1) cannot be converted to equity securities; (2) provide explicit interest payments; (3) have not been stripped; and (4) do not give the owner a claim on cash flows generated by the underlying assets (i.e., are not asset-backed). These bonds and notes are commonly referred to as "straight debt."

Asset-backed securities, security type 10, includes securities that represent securitized interests in a pool of assets and that give the investor a claim against the cash flows generated by the underlying assets, **except** for asset-backed commercial paper, which should be reported as security type 5. All tranches of stripped asset-backed securities, as well as unstripped asset-backed securities, should be reported as security type 10. Debt which is collateralized by assets (real or financial), but only give the investor a claim against the underlying interest if the issuer defaults, should be reported as security types 5 through 9, as appropriate.

**8. Depositary Receipt/Share** - Enter **1** if the security is a depositary receipt/share. Enter **2** otherwise.

**9. Name of Issuer** - Enter the name of the organization that issued the security. Please try to provide the full legal name of the issuer. For branches of banks, please provide the location of the branch.

**10. Term Indicator** (based on original maturity) – Enter **1** (short-term) if the period from the issue date to the maturity date is one year or less, regardless if a leap year; enter **2** (long-term), if the period from the issue date to the maturity date is greater than one year. Term indicator only applies to debt, including asset-backed debt. If there are multiple issue dates or redemption dates, term should be determined by the length of the period between the initial/first issue date and the latest redemption date. Perpetual debt should be classified as long-term debt.

**11. Country of Issuer** - Enter the country code from Appendix D that corresponds to the country of residence of the entity that issued the security. (Refer to Section III.I, Country Attribution.)

**12. Currency of Denomination** - Enter the ISO code from Appendix F that corresponds to the currency in which the security being reported is denominated.

**13. Ownership Code** - Enter the appropriate code from the list below:

- 1 = if your organization is reporting as the owner of this security
- 2 = if your organization is reporting as the custodian for a U.S.-resident mutual fund for this security
- 3 = if your organization is reporting as the custodian for a U.S.-resident pension fund for this security
- 4 = if your organization is reporting as the custodian for a U.S.-resident insurance company for this security
- 5 = if your organization is reporting as the custodian for any other U.S. residents for this security
- 6 = if your organization is the custodian and the entity type of the beneficial owner is unknown

Ownership code 1 should be used if your organization is the owner of this security and either holds the security or uses a foreign-resident custodian or a U.S.-resident or foreign-resident central securities depository.

Ownership code 2 should be used if your organization is the custodian and the beneficial owner is identified as a U.S.-resident that is a mutual fund.

Ownership code 3 should be used if your organization is the custodian and the beneficial owner is identified as a U.S.-resident that is a pension fund.

Ownership code 4 should be used if your organization is the custodian and the beneficial owner is identified as a U.S.-resident that is an insurance company.

Ownership code 5 should be used if your organization is the custodian and the beneficial owner is identified as a U.S.-resident that is not a mutual fund, pension fund, or insurance company (which are reported as ownership codes 2 through 4). When your organization is the custodian and cannot identify the entity type of the beneficial owner, the ownership code should be reported as ownership code 6.

Ownership code 6 should be used if your organization is the custodian and the entity type of the beneficial owner is unknown.

**14a. US\$ Fair (Market) Value of Security Held** - Enter the US\$ fair (market) value of the security being reported, rounded to the nearest U.S. dollar. (See Section III.K, Accounting Rules, Valuation of Securities, and Calculation of U.S. Dollar Values, for more information on how to calculate the US\$ fair (market) value.)

**14b. Fair (Market) Value of Security Held Denominated in Currency of Issue** - Enter the fair (market) value of the security being reported, rounded to the nearest currency of issue unit. If the currency of issue is US\$, report the same value as in item 14a. (See Section III.K, Accounting Rules, Valuation of Securities, and Calculation of U.S. Dollar Values, for more information on how to calculate the fair (market) value.)

**15. Intentionally left blank.** Leave this field null or enter a blank space for each record.

#### **FOR EQUITY SECURITIES ONLY**

**16. Number of Shares Held** - Enter the number of shares held, rounded to the nearest share. Securities for which the amount of shares held is zero should not be reported.

**FOR SHORT-TERM AND LONG-TERM DEBT SECURITIES EXCLUDING ASSET-BACKED SECURITIES ONLY**

**17. Face Value in Currency of Denomination** - For both short-term and long-term securities, enter the face value held in the currency of denomination, rounded to the nearest whole currency unit. If a security is traded in units, then calculate the face value as: (face value of each unit) \* (the number of units held) and report the result in this field. Securities for which the amount held is zero should not be reported.

**18. Issue Date** - Enter the issue date of this security in MMDDYYYY format. For example, if the security was issued on October 4, 1985, enter 10041985. If there are multiple issue dates, enter the first such issue date.

**19. Maturity Date** - Enter the final maturity date (when all remaining principal and interest is due) of this security in MMDDYYYY format. For example, if the security's final maturity date is January 5, 2010, enter 01052010.

**FOR SHORT-TERM AND LONG-TERM ASSET-BACKED SECURITIES ONLY**

**20. Original Face Value in Currency of Denomination** - Enter the original face value in the currency of denomination, rounded to the nearest whole currency unit. This is the value that is (would have been) outstanding if no principal has been (had been) repaid. If a security is traded in units, then calculate the original face value as: (original face value of each unit) \* (the number of units held) and report the result in this field.

**21. Remaining Principal Outstanding in Currency of Denomination** - Enter the remaining principal outstanding as of December 31, in the currency of denomination, rounded to the nearest whole currency unit. This will equal the original face value if no principal has been repaid. If a security is traded in units, then calculate the remaining face value as: (remaining face value of each unit) \* (the number of units held) and report the result in this field. Securities for which the amount held is zero should not be reported.

**22. Issue Date** - Enter the issue date of this security in MMDDYYYY format. For example, if the security was issued on October 4, 1985, enter 10041985. If there are multiple issue dates, enter the first such issue date.

**23. Maturity Date** - Enter the final maturity date of this security in MMDDYYYY format. For example, if the security's final maturity date is January 5, 2010, enter 01052010.

## C. SCHEDULE 3 - CUSTODIANS USED

(Please enter your ten-digit Reporter Identification Number at the top of each page of Schedule 3.)

- 1. Reporter Identification Number** - Enter your organization's ten-digit Reporter Identification Number. If you do not know the Reporter Identification Number for your organization, please contact FRBNY staff at (212) 720-6300 or (646) 720-6300.
- 2. Sequence Number** - Enter the sequence number of this detail record, right justified. The first detail record should be assigned sequence number 1, and each succeeding Schedule 3 should be assigned a sequence number one higher than the previous record.
- 3. Custodian Code** - Please refer to Appendix G for a list of the major U.S.-resident custodians. If you do not see your U.S.-resident custodian listed in Appendix G, please enter 99 and complete items 9 through 14. (Items 4 through 8 should be completed on all Schedule 3s)
- 4. Total US\$ Fair (Market) Value of Equities Entrusted** - Enter the aggregate US\$ fair (market) value for all foreign equities that you entrusted to the organization(s) reported in the custodian code field, rounded to the nearest U.S. dollar.
- 5. Total US\$ Fair (Market) Value of Short-Term Debt (excluding asset-backed securities) Entrusted** - Enter the aggregate US\$ fair (market) value for all foreign short-term debt securities (excluding asset-backed securities) that you entrusted to the organization(s) reported in the custodian code field, rounded to the nearest U.S. dollar.
- 6. Total US\$ Fair (Market) Value of Long-Term Debt (excluding asset-backed securities) Entrusted** - Enter the aggregate US\$ fair (market) value for all foreign long-term debt securities (excluding asset-backed securities) that you entrusted to the organization(s) reported in the custodian code field, rounded to the nearest U.S. dollar.
- 7. Total US\$ Fair (Market) Value of Asset-Backed Securities Entrusted** - Enter the aggregate US\$ fair (market) value for all foreign asset-backed securities that you entrusted to the organization(s) reported in the custodian code field, rounded to the nearest U.S. dollar.
- 8. Reporting As** - Enter 1 if you are the U.S.-resident end-investor or fund manager or 2 if you are the U.S.-resident custodian that is entrusting foreign securities to the organization reported in the custodian code field. (See Appendix H for the definitions of end-investor and custodian.)

### COMPLETE ITEMS 9 THROUGH 14 ONLY IF THE CUSTODIAN CODE (ITEM 3) IS 99

- 9. Name of U.S.-Resident Custodian** - Enter the full legal name of the U.S.-resident custodian to which you entrusted the securities.
- 10. Street Address of U.S.-Resident Custodian** - Enter the mailing address of the U.S.-resident custodian identified in item 9.
- 11. City** - Enter the city in which the U.S.-resident custodian identified in item 9 is located.
- 12. State** - Enter the state in which the U.S.-resident custodian identified in item 9 is located.
- 13. Zip Code** - Enter the zip code for the address of the U.S.-resident custodian identified in item 9.
- 14. Telephone Number of U.S.-Resident Custodian** - Enter the telephone number of the U.S.-resident custodian identified in item 9.

## **APPENDIX A: SAMPLE REPORTING SCHEDULES**



Please enter your 10-digit Reporter Identification Number.....

--	--	--	--	--	--	--	--	--	--

15. Valuation Technique(s) Used to Determine Market Values

For each reporting unit, please describe the valuation technique(s) used to determine reported market values. If securities are automatically valued at zero after a specified time period of inactivity, please specify the time period and whether this applies to the security or to the client's holdings of the security. Also, please specify how securities not actively traded on the report date and those with internally generated security identification numbers are valued.

Reporting Unit                      Valuation Description

--	--	--

---

---

---

---

---

--	--	--

---

---

---

---

---

--	--	--

---

---

---

---

---

--	--	--

---

---

---

---

---



Please enter your 10-digit Reporter Identification Number.....

**SUMMARY OF SCHEDULE 2 INFORMATION**

- 16. Total Number of Schedule 2s Submitted.....
- 17. Total US\$ Fair (Market) Value of All Equity Securities ....., , , ,
- 18. Total US\$ Fair (Market) Value of All Short-Term Debt Securities..., , , ,
- 19. Total US\$ Fair (Market) Value of All Long-Term Debt Securities..., , , ,
- 20. Total US\$ Fair (Market) Value of All Asset-Backed....., , , ,

**SUMMARY OF SCHEDULE 3 INFORMATION**

- 21. Total Number of Schedule 3s Submitted.....,
- 22. Total US\$ Fair (Market) Value of All Equity Securities ....., , , ,
- 23. Total US\$ Fair (Market) Value of All Short-Term Debt Securities..., , , ,
- 24. Total US\$ Fair (Market) Value of All Long-Term Debt Securities..., , , ,
- 25. Total US\$ Fair (Market) Value of All Asset-Backed....., , , ,

**CERTIFYING INFORMATION**

By signing the certification below you acknowledge that:

- You have read and understood the reporting requirements of this survey.
- You are aware that both civil and criminal penalties may be imposed for filing a false report; and
- You are sufficiently knowledgeable about the activities and functions of your organization that you can knowingly and with reasonable confidence certify that the information provided in this report is both accurate and complete.

Certifier's Signature: \_\_\_\_\_

26. Certifier's Name: \_\_\_\_\_

27. Certifier's Title: \_\_\_\_\_

28. Certifier's Telephone Number: \_\_\_\_\_ 29. Date Signed: \_\_\_\_\_

30. Certifier's Email Address: \_\_\_\_\_

SCHEDULE 2: DETAILS OF SECURITIES

1. Reporter Identification Number: Enter your 10-digit identification number..... [grid]

2. Sequence Number: From 1 to the number of Schedule 2 records submitted..... [grid], [grid], [grid]

3a. Reporting Unit..... [grid]

3b. Name of Reporting Unit: \_\_\_\_\_

4. Security ID..... [grid]

5. Security Description: \_\_\_\_\_

6. Security ID System: Please select the appropriate code from the list in Appendix C..... [grid]

6a. For code of Other (99) enter the name of the organization or system that assigned the Security ID: \_\_\_\_\_

7. Security Type: Please enter one of the following..... [grid]

- Equity: 1 = Common stock, 2 = Preferred stock, 3 = Fund shares, 4 = All other equity
Debt (excluding asset-backed securities): 5 = Commercial paper, 6 = Negotiable CD, 7 = Convertible debt security, 8 = Zero-coupon & stripped security
Asset-Backed Securities: 9 = Unstripped bond or note & all other non-asset backed debt, 10 = Asset-backed security

8. Depository Receipt/Share: Please enter one of the following.....
1 = Yes, the security is a Depository Receipt/Share
2 = No, the security is NOT a Depository Receipt/Share

9. Name of Issuer: \_\_\_\_\_

10. Term Indicator (debt, including ABS, only; based on original maturity)..... [grid]
1 = Short Term 2 = Long Term

11. Country of Issuer:..... [grid]
Enter the code from Appendix D for the country of residence of the entity issuing the security.

12. Currency of Denomination:..... [grid]
Enter the code from Appendix F for the currency in which the security was issued.

13. Ownership Code: Please enter one of the following ..... [grid]
1 = If your organization is the owner of this security
2 = If your organization is the custodian for a U.S.-resident mutual fund for this security
3 = If your organization is the custodian for a U.S.-resident pension fund for this security
4 = If your organization is the custodian for a U.S.-resident insurance company for this security
5 = If your organization is the custodian for any other U.S. residents for this security
6 = If your organization is the custodian and the entity-type of the beneficial owner is unknown

Reporter Identification Number: Enter your 10-digit identification number.....

14a. US\$ Fair (Market) Value of Security Held..... , , ,

14b. Fair (Market) Value of Security Held Denominated in the  
Currency of Issue (If US\$ is the currency of issue, then enter the  
same value as item 14a.)..... , , ,

15. Intentionally Left Blank.

**FOR EQUITY TYPE SECURITIES ONLY**

(Security Types 1, 2, 3 or 4)

16. Number of Shares Held: Enter the number of shares held  
rounded to the nearest share..... , , ,

**FOR SHORT-TERM AND LONG-TERM DEBT SECURITIES EXCLUDING  
ASSET-BACKED SECURITIES**

(Security Types 5, 6, 7, 8, or 9)

17. Face Value in Currency of Denomination: Enter the face value in the  
currency of denomination..... , , ,

18. Issue Date: MMDDYYYY format.....

19. Maturity Date: MMDDYYYY format.....

**FOR SHORT-TERM AND LONG-TERM ASSET-BACKED SECURITIES**

(Security Type 10)

20. Original Face Value in Currency of Denomination: Enter the face value.....  
in the currency of denomination that would have been outstanding if no  
principal had been repaid. , , ,

21. Remaining Principal Outstanding in Currency of Denomination: Enter .....  
the remaining principal outstanding as of December 31 in the  
currency of denomination. , , ,

22. Issue Date: MMDDYYYY format.....

23. Maturity Date: MMDDYYYY format.....

**SCHEDULE 3: CUSTODIANS USED**

- 1. Reporter Identification Number: Enter your 10-digit identification number.....
- 2. Sequence Number: From 1 to the number of Schedule 3 records submitted: .....
- 3. Custodian Code: Please see Appendix G for a list of custodians. If the U.S.-resident custodian used is not on the list, please enter 99 and complete items 9 through 14.
- 4. Total US\$ Fair (Market) Value of Foreign Equity Securities Entrusted to this Custodian as of December 31.....
- 5. Total US\$ Fair (Market) Value of Foreign Short-Term Debt Securities (excluding asset-backed securities) Entrusted to this Custodian as of December 31 .....
- 6. Total US\$ Fair (Market) Value of Foreign Long-Term Debt Securities (excluding asset-backed securities) Entrusted to this Custodian as of December 31 .....
- 7. Total US\$ Fair (Market) Value of Foreign Asset-Backed Securities Entrusted to this Custodian as of December 31 .....
- 8. Reporting As: Please enter one of the following..... 
  - 1 = U.S.-resident end-investor (as defined in Appendix H)
  - 2 = U.S.-resident custodian (as defined in Appendix H), who is in turn entrusting these securities to another U.S.-resident custodian

**Complete only if the U.S.-Resident Custodian Code in Item 3 is 99:**

- 9. Name of U.S.-Resident Custodian: \_\_\_\_\_
- 10. Street Address of U.S.-Resident Custodian: \_\_\_\_\_  
\_\_\_\_\_
- 11. City: \_\_\_\_\_ 12. State: \_\_\_\_\_ 13. Zip Code: \_\_\_\_\_
- 14. Telephone Number of U.S.-Resident Custodian: \_\_\_\_\_

## **APPENDIX B: REPORTING REQUIREMENT FLOWCHARTS**

### **1. Reporting Requirements for Reporters that are U.S.-Resident Custodians (See Section II.A.)**

Flowchart 1a - Foreign securities held in custody for your own organization or for your U.S.-resident clients that are not in turn entrusted to any other organization

Flowchart 1b - Foreign securities entrusted to the safekeeping of a U.S.-resident central securities depository

Flowchart 1c - Foreign securities held abroad, either by employing a foreign-resident custodian or by directly entrusting to a foreign-resident central securities depository

Flowchart 1d - Foreign securities entrusted to the safekeeping of another U.S.-resident custodian (excluding U.S.-resident central securities depositories)

### **2. Reporting Requirements for Reporters that are U.S.-Resident End-Investors (See Section II.A.)**

Flowchart 2a - Foreign securities held for your own organization or for your U.S.-resident clients that are not in turn entrusted to any other organization (held in self-custody)

Flowchart 2b - Foreign securities entrusted to the safekeeping of a U.S.-resident central securities depository

Flowchart 2c - Foreign securities held abroad, either by employing a foreign-resident custodian or by directly entrusting to a foreign-resident central securities depository

Flowchart 2d - Foreign securities entrusted to the safekeeping of a U.S.-resident custodian (excluding U.S.-resident central securities depositories)

### **3. Determining Reportable Securities**

## Reporting Requirements for Reporters that are U.S.-Resident Custodians (See Section II.A.)

**Flowchart 1a - Foreign securities held in custody for your own organization or for your U.S.-resident clients that are not in turn entrusted to any other organization**

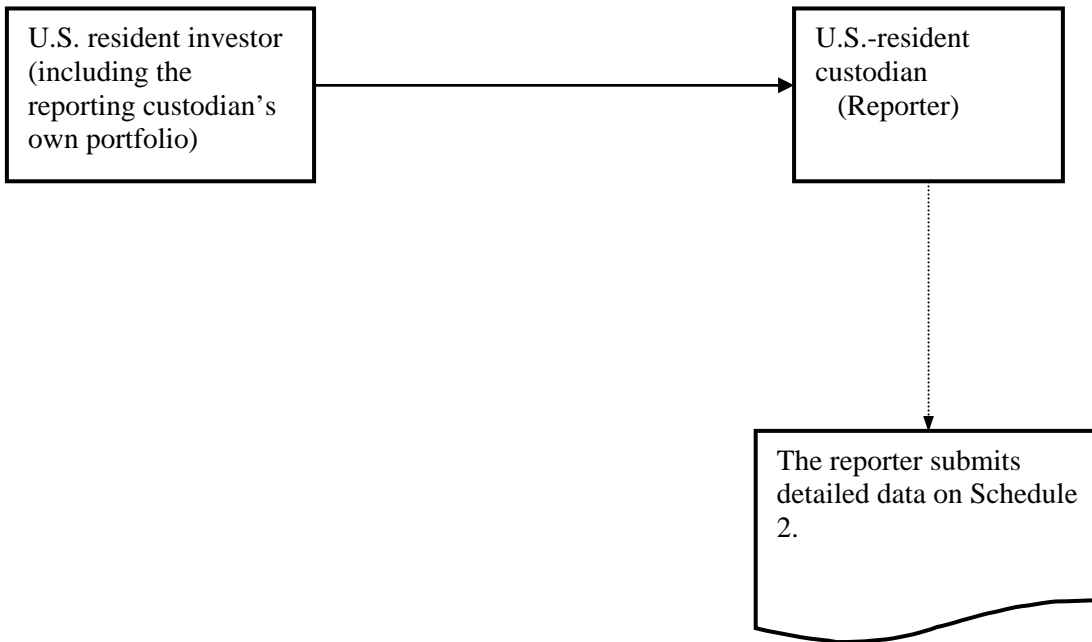

**Flowchart 1b - Foreign securities entrusted to the safekeeping of a U.S.-resident central securities depository**

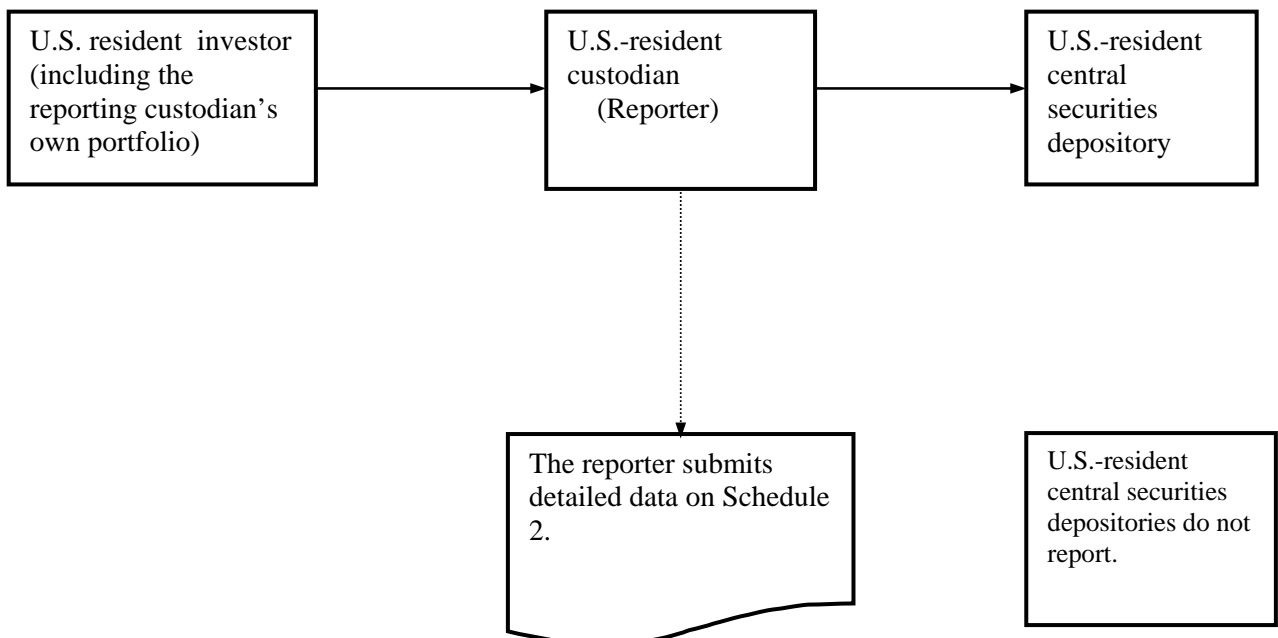

**Reporting Requirements for Reporters that are  
U.S.-Resident Custodians (See Section II.A.)**

**Flowchart 1c - Foreign securities held abroad, either by employing a foreign-resident custodian or by directly entrusting to a foreign-resident central securities depository**

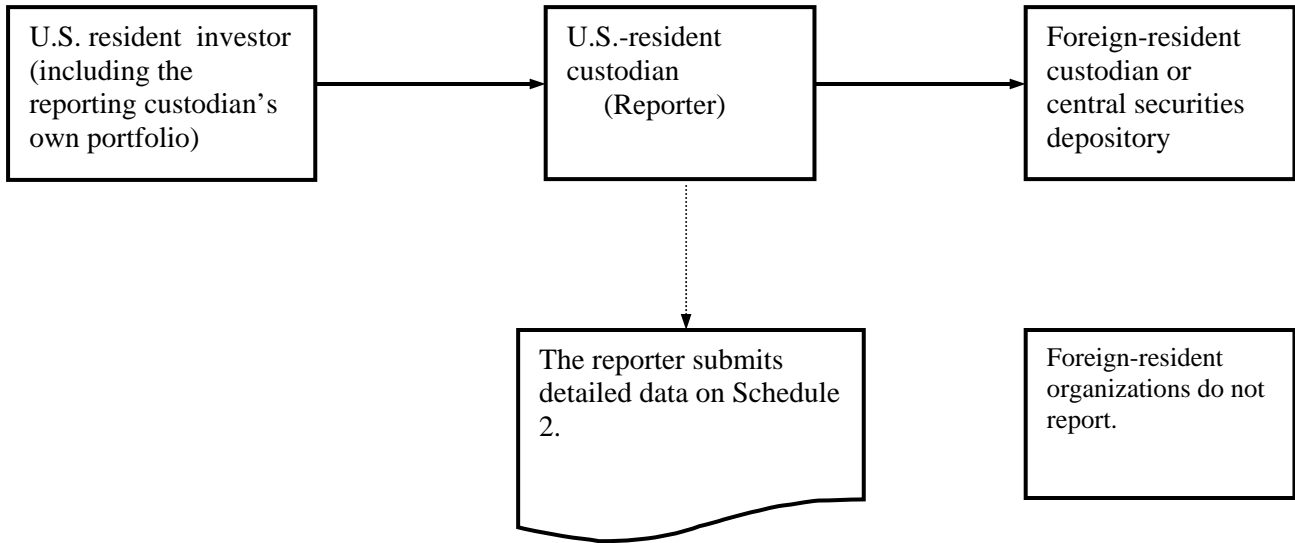

**Flowchart 1d - Foreign securities entrusted to the safekeeping of another U.S.-resident custodian (excluding U.S.-resident central securities depositories)**

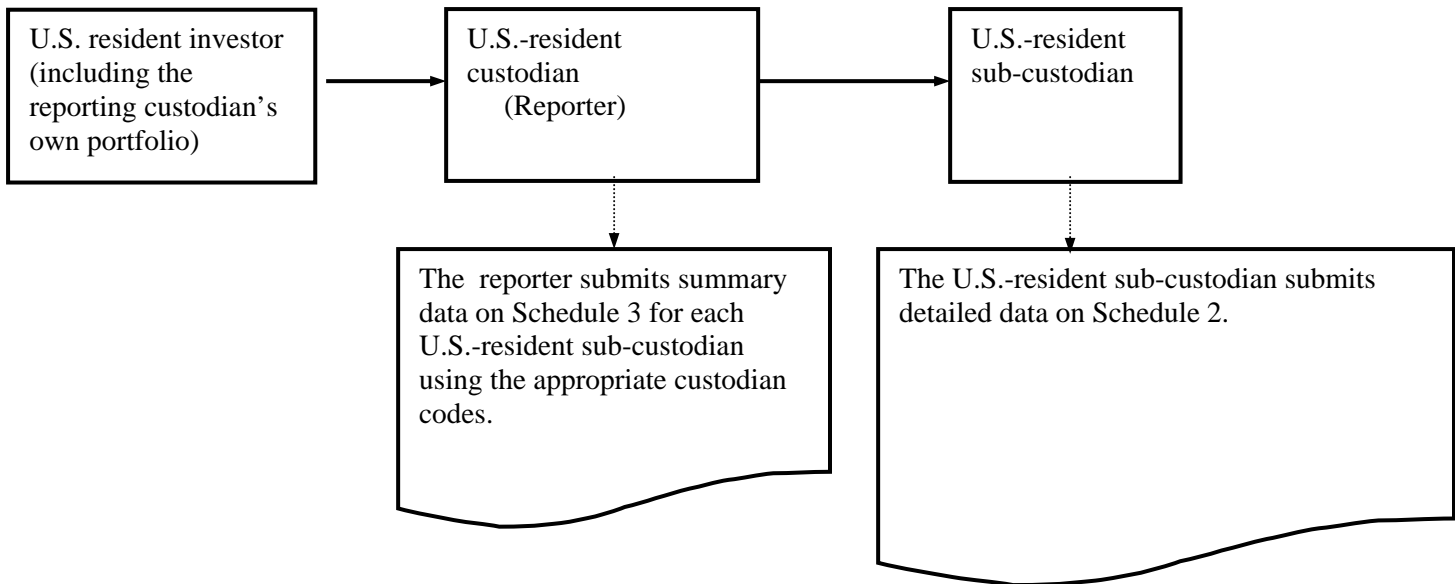

**Reporting Requirements for Reporters that are  
U.S.-Resident End-Investors, including Investment Managers (See Section  
II.A.)**

**Flowchart 2a - Foreign securities held for your own organization or for your U.S.-resident clients that are not in turn entrusted to any organization**

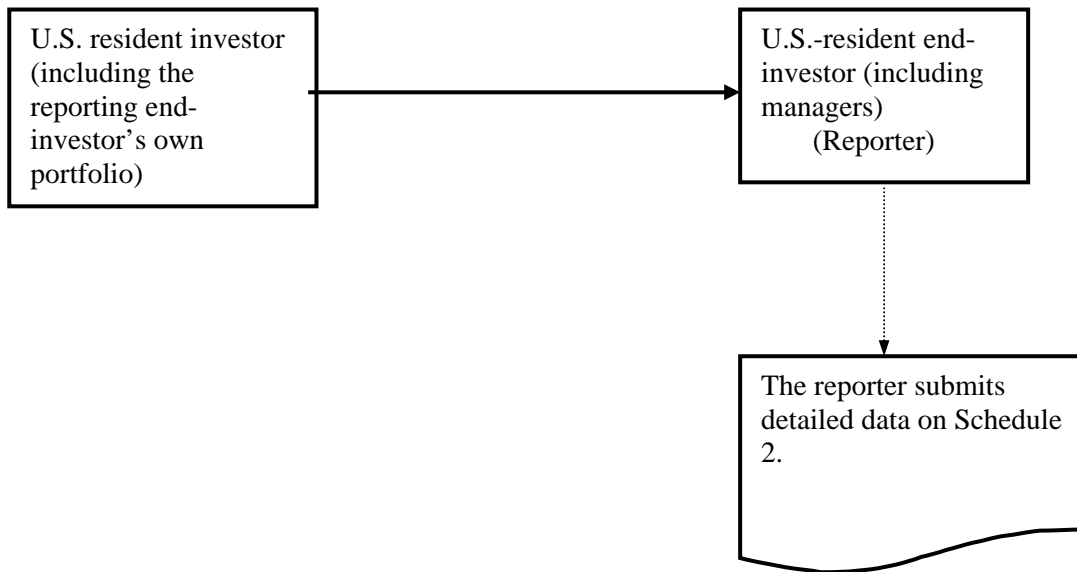

**Flowchart 2b - Foreign securities entrusted to the safekeeping of a U.S.-resident central securities depository**

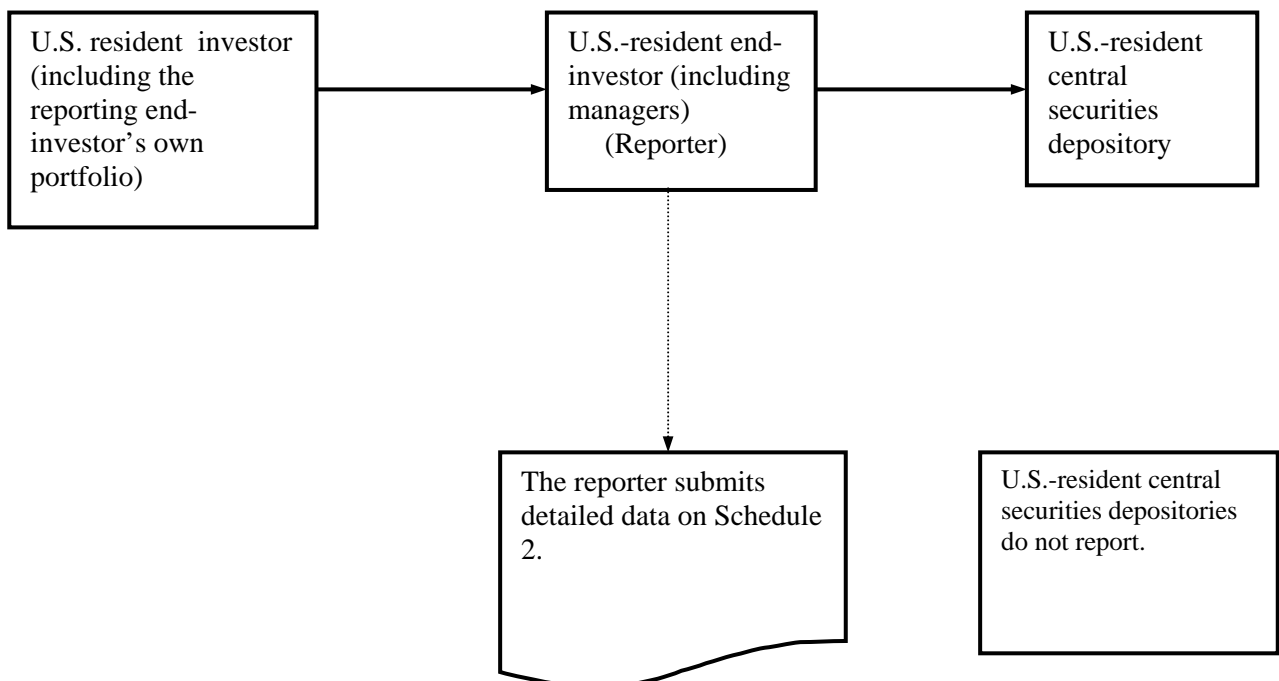



**Reporting Requirements for Reporters that are  
U.S.-Resident End-Investors (See Section II.A.) (cont'd)**

**Flowchart 2c - Foreign securities held abroad, either by employing a foreign-resident custodian or by directly entrusting to a foreign-resident central securities depository**

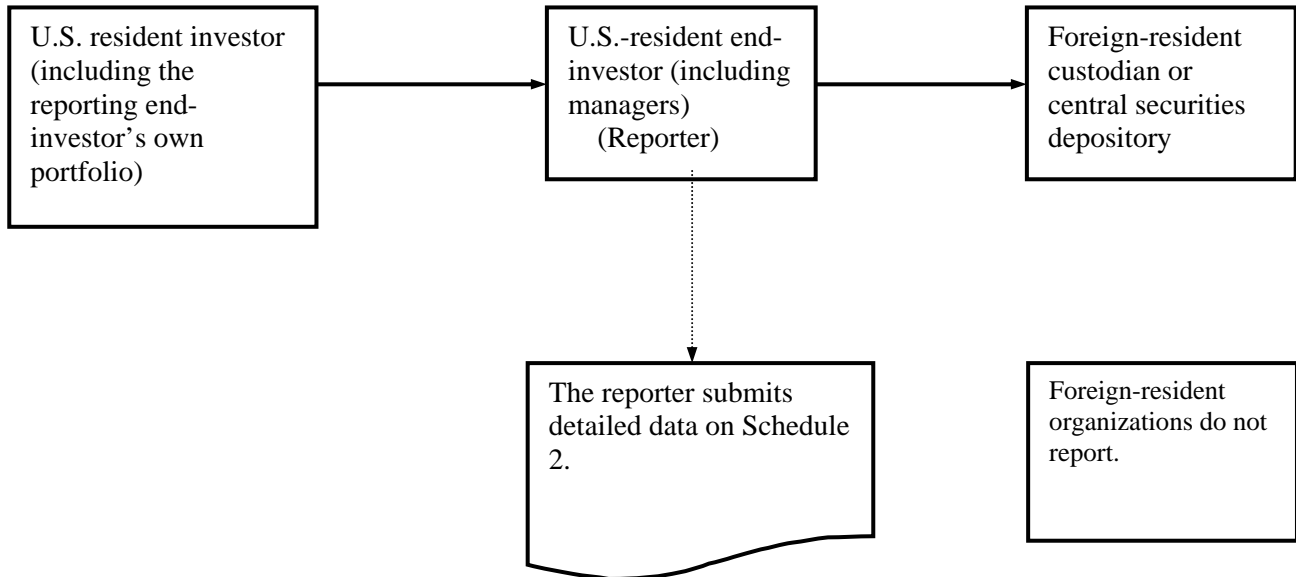

**Flowchart 2d - Foreign securities entrusted to the safekeeping of a U.S.-resident custodian (excluding U.S.-resident central securities depositories)**

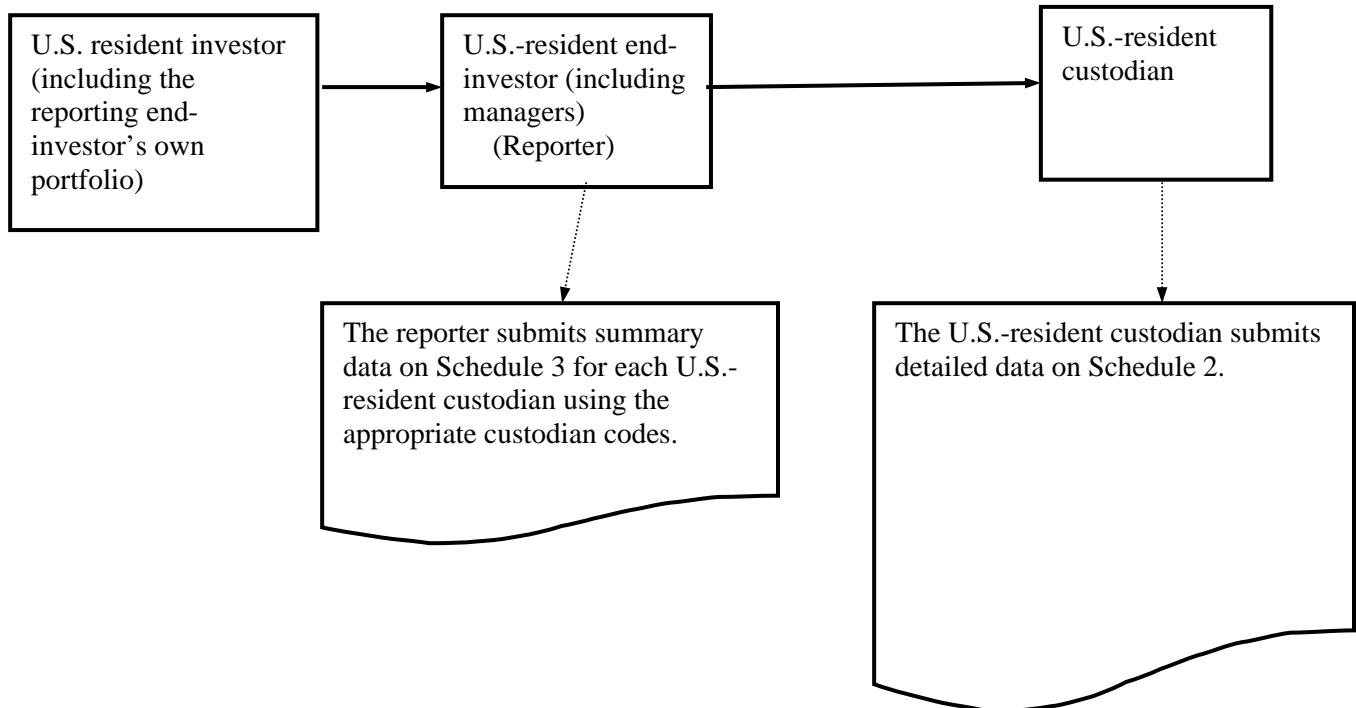

### Flowchart 3 Determining Reportable Securities

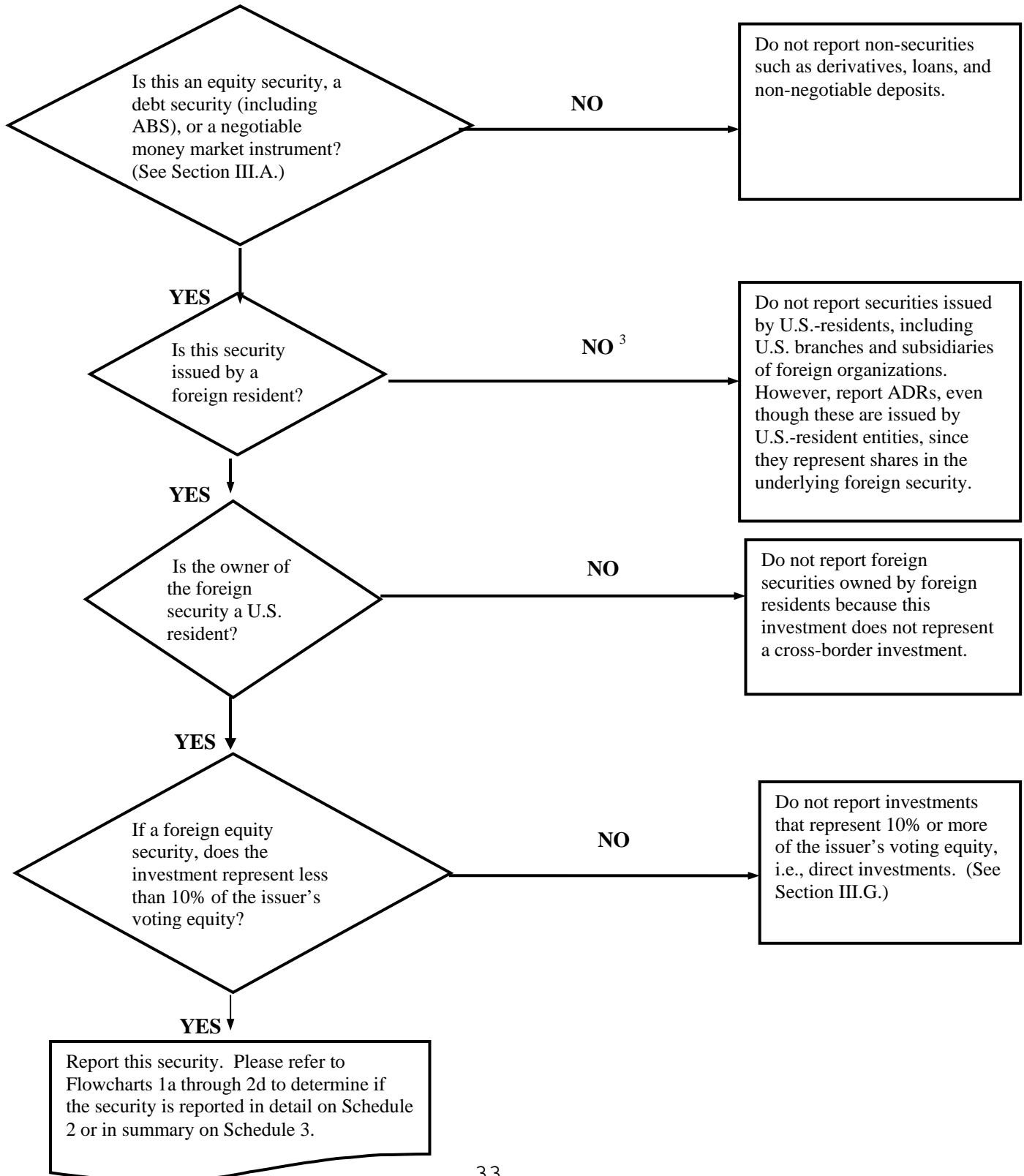

## APPENDIX C: LIST OF SECURITY IDENTIFICATION SYSTEMS

Code	Issuing Country/Agency	Security Identification Coding System
<b>Primary Codes-These codes are required; however, if they are not applicable use the secondary codes listed below.</b>		
01	International Organization for Standardization (ISO)	ISIN (International Securities Identification Number)
02	Common Code	"European" Common Code (Clearstream/CedeUEuroclear)
31	United Kingdom	SEDOL (Stock Exchange Daily Official List)
33	United States American Securities)	CINS (CUSIP International Numbering System for Non-North American Securities)
<b>Secondary Codes — Only use these codes if none of the primary codes listed above are available.</b>		
03	Euroclear	Euroclear Code (old)
04	Cedel	Cedel Code (old)
05	Australia	ASX Security Code (Australian Stock Exchange)
06	Austria	WPK Nummer (Wertpapier Kenn-Nummer)
07	Belgium	SVM Code (Secretariat des Valeurs Mobilieres)
08	Brazil	National Stock Exchange Association Code (Comissao Nacional de Bolsas de Valores)
09	Brazil	Rio de Janeiro Stock Exchange Code
10	Brazil	Sao Paulo Stock Exchange Code
11	Denmark	Fondskode
12	France	SICOVAM (Societe Interprofessionnelle pour la Compensation des Valeurs Mobilieres)
13	Germany	WKN Nummer (Wertpapier Kenn-Nummer)
14	Hong Kong	Stock Exchange of Hong Kong Code
15	Italy	UIC Code (Ufficio Italiano dei Cambi)
16	Italy	ABI Code (Codice Associazione Bancaria Italiana)
17	Japan	SICC Code (Security Identification Code Conference)
18	Japan	TSE Code (Tokyo Stock Exchange Code) (Toushou Code)
19	Korea	Clearing Code (Korean Stock Exchange Code)
20	Mexico	Mexican Stock Exchange Code (Clave de pizarra de la Bolsa Mexicana de Valores)
21	Netherlands	Clearing Code (Amsterdam Stock Exchange Code)
22	New Zealand	New Zealand Stock Exchange Code
23	Norway	Modified ISIN (Verdipapirsentralen) (VPS)
24	Portugal	Lisbon Stock Exchange Code
25	Portugal	Oporto Stock Exchange Code
26	South Africa	Clearing House Code (Johannesburg Stock Exchange Code)
27	Spain	CNMV Code (Comision Nacional del Mercado de Valores)
28	Sweden	VPC Number (Vardepapperscentralen)
29	Switzerland	VALOR (Valoren-Nummer)
30	Thailand	Stock Exchange of Thailand Code
32	United States	CUSIP Number (for North American Securities)
40	BB	Bloomberg security identification code issued by Bloomberg
50	RIC	Reuters Identification Code issued by Reuters

98	Your Company	Internally-Generated Code
99	Other	Other Coding System Not Specified Above

**APPENDIX D**

**DEPARTMENT OF THE TREASURY**

COUNTRY/AREA CODES

**CODES FOR COUNTRIES & AREAS TO BE USED FOR PURPOSES OF REPORTING ON TREASURY  
INTERNATIONAL CAPITAL FORMS**

APPENDIX

G E O G R A P H I C A L   C L A S S I F I C A T I O N

TO BE USED FOR PURPOSES OF REPORTING ON  
TREASURY INTERNATIONAL CAPITAL FORMS

THIS APPENDIX APPLIES ONLY TO REPORTS  
WITH AS-OF DATES ON OR AFTER JUNE 30, 2006

EXPLANATORY NOTE

This geographical classification is provided for the guidance of reporting institutions in preparing reports on the Treasury International Capital (TIC) Forms.

The coding system has been developed for use by the Federal Reserve Banks and the Treasury in processing the TIC Forms. Reporting institutions filing their reports on magnetic tape or other media that can be processed by data processing equipment are required to use these codes.

In addition to the codes shown for countries and areas listed separately on the reporting forms themselves, codes have also been assigned to certain named places that are components of those countries and geographical categories. The latter codes, which are followed by an asterisk (\*), are provided for the convenience of respondents, who may wish to adopt them for internal use.

The first four digits of the country code represent the actual code. The fifth number is a check digit calculated by the "Modulus 11 Method."

Short descriptions of the revisions are on the last page.

## Country, Area and Organizational Codes

### EUROPE

ALBANIA		15105
ANDORRA		10103
ARMENIA		16519
AUSTRIA		10189
AZERBAIJAN		16527
BANK FOR INTERNATIONAL SETTLEMENTS		13307
BELARUS		16209
BELGIUM		10251
BOSNIA AND HERZEGOVINA		14109
BULGARIA		15202
CROATIA		14214
CYPRUS		10405
CZECH REPUBLIC		15288
DENMARK	Excluding Faroe Islands and Greenland	10502
ESTONIA		15407
EUROPEAN CENTRAL BANK		13501
FAROE ISLANDS		10618
FINLAND:	Including Ahvenanamaa (Aland Islands)	10707
FRANCE	Excluding Andorra, French Guiana, Guadeloupe, Martinique, Mayotte, Monaco, Reunion, and St. Pierre and Miquelon	10804
GEORGIA		16535
GERMANY:	Comprises the Federal Republic of Germany and the former German Democratic Republic	11002
GIBRALTAR		11088
GREECE:	Including the Aegean Islands (Khios, Kikladhes, Evvoia, Lesvos, Samos, Samothraki, etc.), the Dodecanese Islands (and Rhodes), The Ionian Islands, and Crete	11207
GREENLAND		10545
GUERNSEY	Including islands of Alderney, Herm, Sark, and nearby smaller islands	13006
HOLY SEE	(Vatican City)	13102
HUNGARY		15504
ICELAND		11304
IRELAND		11401
ISLE OF MAN		13008
ITALY	Excluding San Marino	11509
JERSEY		13007
KAZAKHSTAN		16543
KYRGYZSTAN		16551

## Country, Area and Organizational Codes

### EUROPE – cont'd

LATVIA	15601
LIECHTENSTEIN	11606
LITHUANIA	15709
LUXEMBOURG	11703
MACEDONIA, FORMER YUGOSLAV REPUBLIC OF	14419
MALTA Including Gozo	11819
MOLDOVA	16306
MONACO	12009
NETHERLANDS	12106
NORWAY Including Bouvet Island, Jan Mayen, and Svalbard	12203
POLAND	15768
PORTUGAL: Including Azores and Madeira Islands	12319
ROMANIA	15806
RUSSIA	16101
SAN MARINO	12408
SERBIA AND MONTENEGRO (Formerly Yugoslavia <sup>1</sup> )	13218
SLOVAKIA	15318
SLOVENIA	14338
SPAIN: Including Canary Islands	12505
SWEDEN	12602
SWITZERLAND Excluding Liechtenstein	12688
TAJKISTAN	16578
TURKEY: Including Aegan Islands of Imbros and Bozcaada (Tenedos)	12807
TURKMENISTAN	16616
UKRAINE	16403
UNITED KINGDOM: Excluding Guernsey, Jersey, Isle of Man	13005
Including --	
England	13153*
Northern Ireland	13234*
Scotland	13382*
Wales	13455*
and Hebrides, Orkney Islands, Shetland Islands	
UZBEKISTAN	16705
TOTAL EUROPE	19992

---

<sup>1</sup> On February 4, 2003, Yugoslavia changed its name to Serbia and Montenegro. Data for other entities of the former Yugoslavia recognized as independent states by the United States are reported under "Other Europe" as follows: Beginning in December 1992 for Bosnia and Herzegovina, Croatia, and Slovenia; and beginning in June 1994 for the former Yugoslav Republic of Macedonia.



## Country, Area and Organizational Codes

### CANADA

CANADA	29998
--------	-------

### LATIN AMERICA

ARGENTINA	30104
BELIZE	35718
BOLIVIA	30201
BRAZIL	30309
CHILE	30406
COLOMBIA	30503
COSTA RICA	30589
ECUADOR: Including the Galapagos Islands	31003
EL SALVADOR	31089
FALKLAND ISLANDS (Islas Malvinas)	36307
FRENCH GUIANA	36404
GUATEMALA	31208
GUYANA, CO-OPERATIVE REPUBLIC OF	31305
HONDURAS	31488
MEXICO: Including Cozumel and Revillagigedo Islands	31704
NICARAGUA	31801
PANAMA: Including Canal Zone	31887
PARAGUAY	32107
PERU	32204
SURINAME	37702
URUGUAY	32603
VENEZUELA	32719
TOTAL LATIN AMERICA	39942

## Country, Area and Organizational Codes

### CARIBBEAN

ANGUILLA	30228
ANTIGUA AND BARBUDA	35203
ARUBA	35254
BAHAMAS, THE	35319
BARBADOS	30155
BERMUDA	35602
CAYMAN ISLANDS	36137
CUBA	30708
DOMINICA	36218
DOMINICAN REPUBLIC	30805
EASTERN CARIBBEAN CENTRAL BANK	35416
GRENADA	36706
GUADELOUPE and smaller French Islands in the West Indies: Including Marie-Galante, La Desirade, Iles des Saintes, Saint Barthelemy, and northern Saint Martin	36803
HAITI	31402
JAMAICA	31607
MARTINIQUE	37001
MONTSERRAT	37109
NETHERLANDS ANTILLES	37206
Including-- Curacao and other islands (Bonaire, Saba, St. Eustatius and southern St. Martin)	36188*
ST. KITTS AND NEVIS	37303
ST. LUCIA	37508
ST. VINCENT AND THE GRENADINES	37605
TRINIDAD AND TOBAGO	32409
Including -- Tobago Trinidad	32506* 32301*
TURKS AND CAICOS ISLANDS	37818
VIRGIN ISLANDS, BRITISH	35807
TOTAL CARIBBEAN	34401

## Country, Area and Organizational Codes

### ASIA

AFGHANISTAN	40401
BAHRAIN	40703
BANGLADESH	40746
BHUTAN	40819
BRUNEI	41009
BURMA (sometimes called Myanmar)	41106
CAMBODIA	41203
CHINA, PEOPLE'S REPUBLIC OF (China, Mainland): Including Inner Mongolia, Sinkiang (Chinese Turkistan), Tibet and Manchuria	41408
EAST TIMOR	45004
HONG KONG: Including Kowloon and the New Territories	42005
INDIA:	42102
Including –	
Sikkim	
Andaman and Nicobar Islands	40606*
Goa	41718*
Laccadive Islands (Union Territory of Lakshadweep)	43206*
INDONESIA	42218
Including --	
Timor (Western)	46507*
West New Guinea	47007*
IRAN	42307
IRAQ	42404
ISRAEL	42501
JAPAN	42609
JORDAN	42706
KOREA, NORTH	44407
KOREA, SOUTH	43001
KUWAIT	43109
LAOS	43303
LEBANON	43419
MACAU	43508
MALAYSIA	43605
Excluding Singapore	
Including --	
Labuan	45381*
Sabah (North Borneo)	45403*
Sarawak and former Federation of Malaya	45519*
MALDIVES	43702
MONGOLIA	43818
NEPAL	44202

## Country, Area and Organizational Codes

### ASIA – cont'd

OMAN: Including Muscat	44105
PAKISTAN	44709
PHILIPPINES	44806
QATAR	45101
SAUDI ARABIA	45608
SINGAPORE	46019
SRI LANKA	41319
SYRIA	46205
TAIWAN	46302
THAILAND	46418
UNITED ARAB EMIRATES	46604
Including --	
Abu Dhabi	40088*
Ajman	40509*
Dubai	41505*
Fujairah	41602*
Ras al Khaimah	45209*
Sharjah: Including Kalbah	45705*
Umm al Qaiwain	46701*
VIETNAM	46906
WEST BANK AND GAZA	47201
YEMEN: Comprises the former Yemen Arab Republic and the former People's Democratic Republic of Yemen	47104
TOTAL ASIA	49999

## Country, Area and Organizational Codes

### AFRICA

ALGERIA	50105
ANGOLA	50202
BANK OF CENTRAL AFRICAN STATES (BEAC - Banque des Etats de l'Afrique Centrale)	50318
BENIN	51802
BOTSWANA	50504
BURKINA FASO	57118
BURUNDI	50806
CAMEROON	51004
CAPE VERDE, REPUBLIC OF	51209
CENTRAL AFRICAN REPUBLIC	51306
CENTRAL BANK OF WEST AFRICAN STATES (BCEAO- Banque Centrale des Etats de l'Afrique de l'Ouest)	50644
CHAD	51403
COMOROS	51519
CONGO (Brazzaville)	51608
CONGO (Kinshasa)	51705
COTE D'IVOIRE (IVORY COAST)	53007
DJIBOUTI	52302
EGYPT	57002
EQUATORIAL GUINEA	51942
Including --	
Fernando Po	52205*
Rio Muni	54801*
ERITREA	52019
ETHIOPIA	52108
GABON	52418
GAMBIA, THE	52507
GHANA	52604
GUINEA	52701
GUINEA-BISSAU	54402
KENYA	53104
LESOTHO	53155
LIBERIA	53201
LIBYA	53309
MADAGASCAR	53406
MALAWI	53503
MALI	53589

## Country, Area and Organizational Codes

### AFRICA – cont'd

MAURITANIA	53708
MAURITIUS	53805
MAYOTTE	54518
MOROCCO	54003
Including --	
Tangier	56359*
Ifni	52809*
MOZAMBIQUE	54089
NAMIBIA	54127
NIGER	54208
NIGERIA	54305
REUNION	54607
Including islands of Bassas de India, Europa Island, Glorioso Island, Juan de Nova Island, and Tromelin Island	
RWANDA	55018
SAINT HELENA	55107
Including --	
Ascension Island	50288*
Tristan da Cunha Islands, including Gough Island	56588*
SAO TOME AND PRINCIPE	55204
SENEGAL	55301
SEYCHELLES	55409
SIERRA LEONE	55506
SOMALIA	55603
SOUTH AFRICA	55719
SUDAN	56103
SWAZILAND	56219
TANZANIA: Including Zanzibar	56405
TOGO	56502
TUNISIA	56707
UGANDA	56804
WESTERN SAHARA	56006
ZAMBIA	57207
ZIMBABWE	54704
TOTAL AFRICA	59994

## Country, Area and Organizational Codes

### OTHER COUNTRIES

AUSTRALIA Including Ashmore and Cartier Islands, Christmas Island, Cocos (Keeling) Islands, Coral Sea Islands, Heard Island and McDonald Islands, and Norfolk Island	60089
BRITISH INDIAN OCEAN TERRITORY (Chagos Archipelago, including Diego Garcia)	60208
COOK ISLANDS	60402
FIJI	60607
FRENCH POLYNESIA Including Clipperton Island	60704
KIRIBATI	60526
MARSHALL ISLANDS	61204
MICRONESIA, FEDERATED STATES OF	60305
NAURU	61301
NEW CALEDONIA	61409
NEW ZEALAND Excluding Cook Islands, Niue, and Tokelau Islands	61689
NIUE	61808
PALAU	62502
PAPUA NEW GUINEA	61751
PITCAIRN ISLANDS	62103
SAINT PIERRE AND MIQUELON	62219
SAMOA (Formerly Western Samoa)	62618
SOLOMON ISLANDS	62308
TOKELAU ISLANDS	62405
TONGA	62448
TUVALU	60518
VANUATU	61603
WALLIS AND FUTUNA	60119
TOTAL OTHER COUNTRIES	69906

**NOTE on Special Geographic Areas** for the purpose of reporting on TIC reports. This note applies to the following five geographic areas; they are without permanent occupants and/or are areas claimed/occupied by different countries: Antarctica; French Southern and Antarctic Lands (includes Ile Amsterdam, Ile Saint-Paul, Ile Crozet and Iles Kerguelen in southern Indian Ocean); the Paracel Islands; South Georgia and South Sandwich Islands; and the Spratly Islands. TIC respondents should allocate any TIC data related with these areas to the TIC country-code used by the foreign counterparties for tax purposes, or alternatively, the nationality of the foreign counterparties.

**APPENDIX E**

**DEPARTMENT OF THE TREASURY**

INTERNATIONAL & REGIONAL ORGANIZATIONS

**CODES FOR INTERNATIONAL & REGIONAL ORGANIZATIONS TO BE USED FOR PURPOSES OF  
REPORTING ON TREASURY INTERNATIONAL CAPITAL FORMS**



## Country, Area and Organizational Codes

### INTERNATIONAL AND REGIONAL

INTERNATIONAL ORGANIZATIONS	72907
Food and Agriculture Organization (FAO)	71102*
Franc Zone	71919*
Institute of International Finance (Ditchley Institute)	72214*
Intergovernmental Committee for Migration	72427*
International Atomic Energy Agency	71218*
International Bank for Reconstruction and Development (IBRD) (part of World Bank)	71307*
International Children's Emergency Fund	71404*
International Civil Aviation Organization	71412*
International Development Association (IDA) (part of World Bank)	71501*
International Finance Corporation (IFC)	71609*
International Fund for Agricultural Development	71927*
International Labor Organization (ILO)	71706*
International Monetary Fund (IMF)	71803*
International Red Cross	72222*
International Refugee Organization	72001*
Multilateral Investment Guaranty Agency (MIGA)	72818*
United Nations (UN), and Specialized Agencies and Commissions	72109*
Universal Postal Union	72206*
World Health Organization (WHO)	72303*
World Trade Organization (WTO)	72338*
EUROPEAN REGIONAL ORGANIZATIONS	73903
Council of Europe	73113*
Eurocontrol	73121*
Eurofima	73156*
European Atomic Energy Community (Euratom)	73105*
European Bank for Reconstruction and Development (EBRD)	73709*
European Coal and Steel Community (ECSC)	73202*
European Union (EU) (includes the EC)	73211*
European Development Fund (EDF)	73318*
European Free Trade Association (EFTA)	73326*
European Investment Bank (EIB)	73407*
European Investment Fund	73415*
Nordic Investment Bank	73229*
North Atlantic Treaty Organization (NATO)	73504*
Organization for Economic Cooperation and Development (OECD)	73601*
Tripartite Commission for the Restitution of Monetary Gold	73636*

## Country, Area and Organizational Codes

### INTERNATIONAL AND REGIONAL – cont'd

LATIN AMERICAN REGIONAL ORGANIZATIONS	74918
Andean Development Corporation	74004*
Andean Community of Nations (CAN) (formerly Andean Group)	74039*
Banco Latino Americano De Exportaciones, SA (BLADEX)	30317*
Central American Bank of Economic Integration (CABEI) (also: Banco Centroamericano de Integracion Economica (BCIE))	74101*
Central American Common Market (CACM)	74136*
Central American Development Corporation	74144*
Central American Fund for Monetary Stabilization	74179*
Central American Research Institute for Industry	74152*
Inter-American Development Bank (IDB)	74209*
Inter-American Investment Corporation	74233*
Inter-American Savings and Loan Bank	74217*
Latin American Integration Association	74373*
Latin American Reserve Fund (FLAR) (formerly Andean Reserve Fund)	74403*
North American Development Bank (NADBank)	74454*
Organization of American States (OAS) (Pan American Union) and affiliated organizations	74306*
Organization of Central American States (OCAS)	74314*
Pan American Health Organization (Pan American Sanitary Bureau)	74349*
Permanent Secretariat of the General Treaty on Central American Economic Integration	74322*
River Plate Basin Commission	74365*
Sistema Economico Latinamericano (SELA)	74519*
Venezuela Trust Fund	74608*
CARIBBEAN REGIONAL ORGANIZATIONS	74942
Caribbean Community and Common Market (CARICOM)	74047*
Caribbean Development Bank	74357*
Caribbean Investment Corporation	74071*
Caribbean Regional Development Agency	74098*
East Caribbean Development Bank	74381*
Organization of Eastern Caribbean States (OECS)	74438*
ASIAN REGIONAL ORGANIZATIONS	75906
Asia and Pacific Council	75019*
Asian Development Bank (ADB)	75108*
Association of Southeast Asian Nations (ASEAN)	75205*
Central Treaty Organizations (CENTO)	75302*
Colombo Plan for Co-Operative Economic and Social Development in Asia and the Pacific	75418*

## **Country, Area and Organizational Codes**

### **INTERNATIONAL AND REGIONAL – cont'd**

AFRICAN REGIONAL ORGANIZATIONS	76902
African Development Bank (AfDB)	76104*
Arab Bank for Economic Development in Africa (BADEA)	76201*
Conseil de l'Entente	76163*
East African Common Service Organization	76171*
East African Community	76317*
East African Development Bank	76244*
Organisation Commune Africaine et Mauricienne (OCAM)	76406*
Organization of African Unity (OAU)	76414*
Special Arab Fund for Africa	76309*
Union des Etats de l'Afrique Centrale	76619*
Union Douaniere des Etats de l'Afrique de l'Ouest	76635*
Union Douaniere et Economique de l'Afrique Centrale (UDEAC) (Customs and Economic Union of Central Africa)	76627*
Union Monetaire Ouest-Africaine (UMOA) (West African Monetary Union)	76708*
MIDDLE EASTERN REGIONAL ORGANIZATIONS	77909
Arab Authority for Agricultural Investment and Development	77038*
Arab Fund for Economic and Social Development (AFESD)	77208*
Arab Fund for Technical Assistance to Arab and African Countries	77046*
Arab Investment Company	77062*
Arab Joint Investment Company (U.A.E. - Egypt Investment Company)	77097*
Arab Monetary Fund	77305*
Arab Petroleum Investment Company	77089*
Cooperation Council for the Arab States of the Gulf (also Gulf Cooperation Council (GCC))	77313*
Gulf Investment Corporation	77232*
Inter-Arab Investment Guarantee Corporation	77437*
Islamic Development Bank	77518*
Islamic Solidarity Fund	77429*
Muslim World League	77542*
OPEC Special Fund	77917*
Organization of Arab Petroleum Exporting Countries (OAPEC) which includes:	77402*
Fund for Arab Oil Importing Countries	77321*
OAPEC Oil Facility	77356*
OAPEC Special Account	77348*
Special Fund for Arab Non-oil Producers	77364*
Organization of the Islamic Conference	77453*
Saudi-Egyptian Industrial Investment Company	77925*
Saudi-Egyptian Reconstruction Company	77933*
Solidarity Fund for Economic and Social Development in Non-aligned Countries	77941*
United Arab Shipping Company	77968*
TOTAL INTERNATIONAL AND REGIONAL ORGANIZATIONS	79995
GRAND TOTAL	99996

## APPENDIX F: LIST OF CURRENCY CODES

Code	Currency	Code	Currency
AFN	Afghanistan Afghani	CYP	Cyprus Pound
ALL	Albanian Lek	CZK	Czech Koruna
DZD	Algerian Dinar	DKK	Danish Krone
ADP	Andorran Peseta	DJF	Djibouti Franc
AOR	Angolan Kwanza Reajustado	DOP	Dominican Peso
ARS	Argentine Peso	XCD	East Caribbean Dollar
AMD	Armenian Dram	EGP	Egyptian Pound
AWG	Aruban Guilder	SVC	El Salvador Colon
AUD	Australian Dollar	ERN	Eritrea Nakfa
AZN	Azerbaijani New Manat	EEK	Estonia Kroon
BSD	Bahamian Dollar	ETB	Ethiopian Birr
BHD	Bahraini Dinar	EUR	European Union Euro
BDT	Bangladeshi Taka	FKP	Falkland Islands Pound
BBD	Barbados Dollar	FJD	Fiji Dollar
BYR	Belarussian Ruble	GMD	Gambia Dalasi
BZD	Belize Dollar	GEL	Georgia Lari
BMD	Bermudian Dollar	GHS	Ghana Cedi
BTN	Bhutan Ngultrum	GIP	Gibraltar Pound
BOB	Bolivian Boliviano	GTQ	Guatemala Quetzal
BWP	Botswana Pula	GWP	Guinea-Bissau Peso
BAM	Bosnia & Herzegovina Convertible Marks	GNF	Guinea Franc
BRL	Brazilian Real	GYD	Guyana Dollar
BND	Brunei Dollar	HTG	Haitian Gourde
BGN	Bulgarian Lev	HNL	Honduras Lempira
BIF	Burundi Franc	HKD	Hong Kong Dollar
KHR	Cambodian Riel	HUF	Hungarian Forint
CAD	Canadian Dollar	ISK	Iceland Krona
CVE	Cape Verde Escudo	INR	Indian Rupee
KYD	Cayman Islands Dollar	IDR	Indonesian Rupiah
XOF	CFA Franc BCEAO	IRR	Iranian Rial
XAF	CFA Franc BEAC	IQD	Iraqi Dinar
XPF	CFP Franc	JMD	Jamaican Dollar
CLP	Chilean Peso	JPY	Japanese Yen
CNY	Chinese Yuan Renminbi	JOD	Jordanian Dinar
COP	Colombian Peso	KZT	Kazakhstan Tenge
KMF	Comoro Franc	KES	Kenyan Shilling
CDF	Congolais Franc	KWD	Kuwaiti Dinar
CRC	Costa Rican Colon	KGS	Kyrgyzstan Som
HRK	Croatian Kuna	LAK	Laos Kip
CUP	Cuban Peso	LVL	Latvian Lats

Code	Currency	Code	Currency
LBP	Lebanese Pound	STD	Sao Tome & Principe Dora
LSL	Lesotho Lote	SAR	Saudi Arabian Riyal
LRD	Liberian Dollar	SCR	Seychelles Rupee
LYD	Libyan Dinar	SLL	Sierra Leone Leone
LTL	Lithuanian Litas	SGD	Singapore Dollar
MOP	Macau SAR Pataca	SKK	Slovak Koruna
MKD	Macedonian Denar	SIT	Slovenia Tolar
MGF	Malagasy Franc	SBD	Solomon Islands Dollar
MWK	Malawi Kwacha	SOS	Somali Shilling
MYR	Malaysian Ringgit	ZAR	South African Rand
MVR	Maldives Rufiyaa	KRW	South Korean Won
MTL	Maltese Lira	LKR	Sri Lanka Rupee
MRO	Mauritania Ouguiya	SDD	Sudanese Dinar
MUR	Mauritius Rupee	SRG	Suriname Guilder
MXN	Mexican Peso	SZL	Swziland Lilangeni
MDL	Moldovan Leu	SEK	Swedish Krona
MNT	Mongolian Tugrik	CHF	Swiss Franc
MAD	Moroccan Dirham	SDP	Syrian Pound
MZN	Mozambique New Metical	TWD	Taiwan New Dollar
MMK	Myanmar Kyat	TJS	Tajikistan Somoni
NAD	Namibia Dollar	TZS	Tanzanian Shilling
NPR	Nepalese Rupee	THB	Thailand Baht
ANG	Netherlands Antillean Guilder	TOP	Tongan Pa'anga
ILS	New Israeli Shekel	TTD	Trinidad and Tobago
TWD	New Taiwan Dollar	TND	Tunisian Dinar
NZD	New Zealand Dollar	TRY	Turkish Yani
NIO	Nicaraguan Cordoba Oro	TMM	Turkmenistan Manat
NGN	Nigerian Naira	UGX	Uganda New Shilling
KPW	North Korean Won	UAH	Ukrainian Hryvnia
NOK	Norwegian Krone	AED	United Arab Emirates
OMR	Omani Rial	USD	United States Dollar
PKR	Pakistani Rupee	UYU	Uruguayo Peso
PAB	Panamanian Balboa	UZS	Uzbekistan Sum
PGK	Papua New Guinea Kina	VUV	Vanuatu Vatu
PYG	Paraguay Guarani	VEB	Venezuelan Bolivar
PEN	Peruvian New Sol	VND	Vietnamese Dong
PHP	Philippine Peso	YER	Yemeni Rial
PLN	Polish Zloty	YUM	Yugoslavian Dinar
GBP	Pound Sterling	ZMK	Zambian Kwacha
QAR	Qatari Rial		
RON	Romanian Leu		
RUB	Russian Ruble		
RWF	Rwanda Franc		
SHP	Saint Helena Pound		
WST	Samoan Tala		

## APPENDIX G: LIST OF CUSTODIAN CODES

If your securities are held by any U.S. affiliate of one of these custodians listed below, please use the custodian code of that firm

### THE FOLLOWING CODES SHOULD BE USED BY ALL REPORTERS

<u>Name of U.S.-Resident Custodian</u>	<u>Custodian Code</u>
ABN-Amro Bank N.V. (U.S.-resident branches)	01
Bank Julius Baer & Co. Ltd (U.S.-resident branch)	02
Bank of Bermuda Limited, The	03
Bank of New York Mellon Corporation (including but not limited to Bank of New York , The and affiliates of the former Mellon Financial Corporation)	04
Barclays Global Investors Services	24
BNP Paribas (U.S.-resident branches)	07
Brown Brothers Harriman & Co.	08
Citigroup Inc./Citibank, N.A. (including but not limited to Salomon Smith Barney)	09
Credit Agricole Indosuez North America Inc.	10
Credit Lyonnais (U.S.-resident branches)	11
Deutsche Bank Aktiengesellschaft (U.S.-resident branches)	12
Dresdner Bank Aktiengesellschaft (U.S.-resident branches)	13
Fidelity Management and Research Corp.(FMR Corp.) (including but not limited to Fidelity Investments, Fidelity Management Trust Company, and National Financial Services Corporation)	26
Fifth Third Bancorp/Fifth Third Bank	25
Goldman Sachs Group L.P.	27
HSBC North America Inc./HSBC Bank USA, N.A.	14

<u>Name of U.S.-Resident Custodian</u>	<u>Custodian Code</u>
JPMorgan Chase & Co./JPMorgan Chase Bank	16
Merrill Lynch & Company, Inc.	28
Morgan Stanley, Dean Witter & Co.	29
Northern Trust Company, The	18
PNC Financial Services Group, Inc., The (including but not limited to PNC Bank, N.A., PFPC)	30
Societe Generale (U.S.-resident branches)	19
State Street Bank and Trust Company (including but not limited to International Fund Services, Investors Financial Services Corporation, Investors Bank and Trust , and Investors Trust Company)	20
Taunus Corporation/Deutsche Bank Trust Company Americas (including but not limited to Deutsche Bank Securities Inc.)	6
UBS AG (U.S.-resident branches)	21
UBS Financial Services Inc.	59
UBS Securities LLC	60
Union Bancorp/Union Bank of California, N.A.	22
UMB Financial Corporation/UMB Bank N.A.	33
U.S. Bancorp/U.S. Bank N.A.	32
Wachovia Corporation /Wachovia Bank N.A. (including but not limited to A.G. Edwards & Sons, Inc.)	34
Wells Fargo & Co./Wells Fargo Bank, N.A.	35
U.S.-Resident custodian that is not listed above	99

## APPENDIX H: GLOSSARY

**AMERICAN DEPOSITARY RECEIPT (ADR)** – Negotiable certificates, typically issued by a U.S.-resident company, for shares of stock issued by a foreign corporation. The securities are held in a custodial account, either at the issuing bank or by an agent. The ADR should be reported, not the foreign securities held by the depository. Report the ADR as common stock (security type=1) if the underlying foreign security is common stock or as preferred stock (security type =2) if the underlying foreign security is preferred stock. (See Section III.E for more information on the correct reporting of these securities.)

**AMERICAN DEPOSITARY SHARE (ADS)** – Negotiable securities certificate issued in the United States by transfer agents acting on behalf of foreign issuers, where the foreign issuers absorb part or all of the handling costs involved. The ADS should be reported, not the foreign securities held in custody. Report the ADS as common stock (security type =1) if the underlying foreign security is common stock or as preferred stock (security type =2) if the underlying foreign security is preferred stock. (See Section III.E for more information on the correct reporting of these securities.)

**ASSET-BACKED SECURITIES** – Securitized interests in a pool of assets, which give the purchaser a claim against the cash flows generated by the underlying assets. These pools may be derived from mortgage loans, auto loans, credit card receivables, vehicle and equipment leases, consumer loans, commercial loans or other assets. Include as asset-backed securities (ABS): CMOs, CLOs, CBOs and CDOs. ABS give the holder an undivided interest in the securitized assets and payments made from the cash flows received by the issuer from the payments of principal and interest from the borrowers. (ABS do not include securities, such as covered bonds or pfandbriefes, where the security is collateralized, but the holder of the security does not have a claim of the cash flows generated by the collateral.) ABS, including stripped ABS, are reported as security type 10 (asset-backed security), **except** for asset-backed commercial paper, which is reported as security type 5 (commercial paper).

**BEARER BOND** – Securities that are not registered in the name of their owner. The owner collects interest and dividends upon presentation of detachable coupons to a bank or fiduciary agent. These securities are reported as security type 9 (unstripped bond or note and all other long-term debt).

**BRADY BONDS** – Collateralized dollar-denominated bonds issued by a foreign government or central bank in exchange for loans under the Brady Plan. These securities are reported as all other long-term debt (security type = 9).

**COMMERCIAL PAPER** – A promissory note, either unsecured or backed by assets such as loans or mortgages. They are usually sold at a discount and customarily have a fixed maturity of 270 days or less. All commercial paper should be reported as security type = 5 (commercial paper)

**COMMINGLED ACCOUNT** – An account in which the investment funds of individual clients are pooled, with each client owning portions of the pooled account. Foreign securities held in commingled accounts should be reported.

**CONVERTIBLE BOND** – A bond that can be exchanged at a set price for equity securities by the holder under certain conditions. These securities are reported as convertible debt (security type = 7).

**COVERED BOND** – Also known as Mortgage Bond or Pfandbriefe. A bond that is backed by loans, typically mortgages, but does not give the purchaser a claim against the cash flows generated by the



underlying assets. These securities are reported as security type 9 (unstripped bond or note and all other long-term debt).

**CUSTODIAN** – A bank or other organization that manages or administers the custody or safekeeping of stock certificates, debt securities, or other assets for institutional and private investors.

**DEPOSITARY RECEIPTS** – See American Depositary Receipts (ADR). Related types of depositary receipts, such as Global Depositary Receipts, are reported in the same manner as ADRs.

**DEPOSITORY** – An entity that holds securities, either in certificated or uncertificated (dematerialized) form, to enable the transfer of ownership of securities. Depositories are not necessarily custodians, since they may be responsible only for registering and settling security transactions.

**DERIVATIVE CONTRACT** – Financial instrument or other contract with all three of the following characteristics:

1. (a) One or more underlyings; (b) one or more notional amounts; and (c) payment provisions. These terms determine the amount of the settlement or settlements, and, in some cases, whether or not a settlement is required.
2. Requires no initial investment, or an initial net investment that is much smaller than would be required for other types of contracts that would be expected to have a similar response to changes in market factors.
3. The terms require or permit net settlement, it can readily be settled net by a means outside the contract, or it provides for delivery of an asset that puts the recipient in a position not substantially different from net settlement.

Derivative contracts are excluded from the report. Embedded derivatives that are not bifurcated under FAS 133 should be reported without separating the embedded derivative from the host contract. However, if the embedded derivative is bifurcated from the host contract, then the derivative should be excluded from the report and the host security should be included on the report.

**DEVELOPMENT BANKS** – Entities owned by national governments and established to promote economic development of sectors of the economy, such as trade, housing, agriculture, finance and industry. Securities issued by foreign development banks should be reported.

**DIRECT INVESTMENT** – The beneficial ownership or control, by one person or by a group of affiliated persons, of 10 percent or more of the voting securities of another incorporated business, or an equivalent interest in an unincorporated business, including a branch. If a direct investment relationship exists, then generally, all financial flows between the firms are considered direct investment. However, for banking institutions, direct investment is limited to intercompany holdings that are permanent investment. Direct investment positions are excluded from this report.

**END-INVESTOR** – An entity that invests in foreign securities for its own account (for trading, investment, or any other purpose) or invests on behalf of others, including asset pools, such as managers of mutual funds, managers of insurance company policyholder assets, and pension fund managers. (See Section II.A for examples of end-investors.)

**FOREIGN RESIDENT** - Any individual, corporation, or other organization located outside the United States. A corporation incorporated outside the United States is a foreign resident even if it has no physical presence outside the United States. Foreigners/foreign residents include:

1. Individuals, including citizens of the United States, residing outside the United States.
2. Entities that have filed an IRS Form W-8, indicating that the individual or entity is a nonresident alien or foreign entity not subject to certain United States information return reporting or to backup withholding rules.
3. Any corporation or other organization located outside the United States, including branches, subsidiaries and other affiliates of U. S. entities located abroad.
4. Foreign governments and any subdivision, agency or instrumentality thereof, including all foreign official nonbanking institutions, even if located in the United States (e.g., an embassy, consulate, or other diplomatic establishment of a foreign country). (However, all U.S.-resident subsidiaries of foreign corporations, including government-owned foreign corporations, are U.S. residents.)
5. International or regional organizations or subordinate or affiliated agencies thereof, created by treaty or convention between sovereign states, even if located in the United States, including the International Bank for Reconstruction and Development (IBRD or World Bank), the International Monetary Fund (IMF), and the United Nations (UN). (See Appendix E for a list of international and regional organizations.)

**FOREIGN-RESIDENT CUSTODIAN** – A custodian located outside the United States, including a foreign affiliate of a U.S. custodian. Reporters should determine the location of a custodian according to the country in which the custodian is incorporated, or otherwise legally established, not according to the country of the custodian's parent firm, and not according to the location of the custodian's operations center.

**FOREIGN SUB CUSTODIAN** – A foreign institution that holds in safekeeping foreign securities for a U.S.-resident custodian.

**FUNDS** – Pooled, separate and general investment accounts of one or more of the following institutional and private investors: private and public pension funds; mutual funds, country funds, exchange traded funds, unit investment trusts, collective-investment trusts, and any other similarly pooled, commingled investment funds; insurance companies; foundations; institutions of higher learning; government-sponsored enterprises and other independently acting government agencies; financial and nonfinancial corporations; investment advisors; trusts and estates; and private individuals. U.S. ownership of shares of foreign-resident funds are reported as funds (security type= 3), regardless of the types of securities held by the fund. Foreign securities held in U.S.-resident funds should also be reported. (See Section III.0 for the correct reporting of funds.)

**INVESTMENT TRUST SHARE** – A share of a company bound by a trust deed issued in registered form, formed to invest in specific types of securities. Shares in an investment trust can usually be bought and sold only through the stock exchange. Sometimes referred to as a 'closed-end' fund. Investment trust shares are reported as fund shares (security type =3), regardless of the types of securities held by the trust.

**LONG-TERM** – No contractual maturity or an original maturity of more than one year.

**LONG-TERM DEBT SECURITY** – Debt security with no contractual maturity or with an original maturity of more than one year.

**NATIONALIZED BANK** – Institution owned by a foreign central government that is classified as a bank in its own country. A nationalized bank is considered to be an official organization only if it also performs the functions of a central bank.

**NEGOTIABLE CERTIFICATES OF DEPOSIT** – A negotiable (transferable) instrument or deposit in book entry form evidenced by a receipt or similar acknowledgement issued by a bank, which provides on its face that the amount of such deposit is payable to bearer or any specified person (e.g., deposit notes, bank notes). These negotiable money market instruments should be reported as security type 6.

**SECURITY** – Any bill, note, bond, debenture, equity, negotiable money market instrument, or similar instrument that is commonly referred to as a security, whether or not it is tradeable. Do not include loans, even if tradeable. See Section III.A for a list of reportable foreign securities.

**SETTLEMENT DATE** – The date a security is delivered to the purchaser.

**SETTLEMENT DATE ACCOUNTING** – Under settlement date accounting, the purchase and sale of assets are not recorded until the settlement date. Settlement date accounting should be used for purposes of this report.

**SHORT-TERM** – Original maturity of one year or less.

**SHORT-TERM DEBT SECURITY** – Debt security, including negotiable money market instruments, with an original maturity of one year or less.

**STRUCTURED NOTE OR BOND** – An over-the-counter financial instrument created specifically to meet the needs of one or a small number of investors. Some of the more common structures include: step-up bonds, index amortizing notes, dual index notes, deleveraged bonds, range bonds, and inverse floaters. These securities are reportable debt securities.

**SUBORDINATED DEBT** – A security evidencing debt that the holder agrees to rank after senior creditors, but before shareholders, in a bankruptcy.

**SUBSIDIARY** – A company in which another company (parent) owns 50 percent or more of the voting securities, or an equivalent interest.

**TREASURY BILL** – a common form of sovereign debt issued by many governments. Foreign treasury bills should be reported as security type 9 (unstripped bond or note and all other non-asset-backed debt).

**UNITED STATES** – The fifty (50) States of the United States, the District of Columbia, the Commonwealth of Puerto Rico, the Commonwealth of the Northern Mariana Islands, and the following: American Samoa, Baker Island, Guam, Howland Island, Jarvis Island, Johnston Atoll, Kingman Reef, Midway Islands, Navassa Island, Palmyra Atoll, the U.S. Virgin Islands, and Wake Island.

**UNIT INVESTMENT TRUST** – A fixed portfolio of securities that are assembled by an underwriter sponsor and upon completion of the underwriting, are deposited with an independent trustee. Unit investment trusts have a definite termination date, usually between 6 months and 10 years. U.S. ownership of shares of foreign-resident unit investment trusts are reported as fund shares (security type = 3), regardless of the types

of securities in held by the trust. Foreign securities held in U.S.-resident unit investment trusts should also be reported. (See Section III.0 for the correct reporting of unit investment trusts.)

**U.S. RESIDENT** – Any individual, corporation, or other organization located in the United States, including branches, subsidiaries and affiliates of foreign entities located in the United States. Corporations incorporated in the United States are considered to be U.S. residents even if they have no "physical presence" in the United States.

**U.S.-RESIDENT CUSTODIAN** – A custodian located in the United States, including a U.S.-resident affiliate of a foreign custodian.

**U.S.-RESIDENT END-INVESTOR** – An entity located in the United States, including a U.S. affiliate of a foreign end-investor, that either invests for its own account (for trading, investment and other purposes) or on behalf of others, including assets pools. U.S.-resident end-investors include managers of a mutual fund, managers of assets held for insurance company policyholders, and managers of pension and endowment funds.

**ZERO-COUPON BOND** – Bonds that do not provide interest payments. Zero coupon bonds usually have an issue price well below 100% of the face value with repayment on maturity at face value or par. The investors' return is the difference between the issue price and redemption value. These securities are reported as security type **8** (zero coupon & stripped security).

## **APPENDIX I: TECHNICAL INFORMATION FOR ELECTRONIC SUBMISSION**

Included in this appendix are instructions for how to properly prepare data in a file for submission. Your entity must retain a copy of the data for a period of 36 months from the date of the report's submission.

### **I. Requirements for submitting data via IESUB**

- ✓ Each file should contain data for only one Reporter Identification Number. If your entity will be reporting using multiple Reporter Identification Numbers, the data pertaining to each Reporter Identification Number must be reported in a separate file.
- ✓ Your entity must agree to the Terms and Use for Internet Reporting. This information can be found at: <http://www.treas.gov/tic/forms-sh.html>
- ✓ Your entity must have a connection to the Internet that supports the World Wide Web (WWW). Your connection must not block or disable JavaScript.
- ✓ Your entity must have a web browser program (e.g., Microsoft Internet Explorer 5.5 or higher) that supports 128-bit Secure Sockets Layer (SSL) encryption. 128-bit encryption is used for all communication between you and the Federal Reserve System.
- ✓ All Schedule 1 information must be data entered before Schedule 2 data can be submitted.
- ✓ All files must be text files and have file names ending with .TXT (e.g., Schedue\_2\_Company\_Name.TXT)

### **II. Requirements for submitting data via Diskette/CD**

- ✓ Each diskette/CD (media) should contain data for only one Reporter Identification Number. If your entity will be reporting using multiple Reporter Identification Numbers, the data pertaining to each Reporter Identification Number must be reported on separate media.
- ✓ Each media for a particular Reporter Identification Number must be accompanied by a paper format Schedule 1.

- ✓ A dump or print out that includes at least the first ten detail records should accompany each media.
- ✓ Include a printout of the command string used to create the file if the file was created directly from the mainframe.
- ✓ Include any special instructions on how to unload the file.
- ✓ All Schedule 2 data must be provided in a standard DOS, ASCII flat file on one of the following media:
  - High density, IBM PC-compatible diskette(s)
  - Standard 700 MB CD(s)

Data must be submitted to:

Federal Reserve Bank of New York  
Statistics Function, 4<sup>th</sup> Floor  
33 Liberty Street  
New York, NY 10045-0001

Should you have any questions concerning the instructions in this appendix, please contact the FRBNY automation staff at 212-720-1989 or 646-720-1989.

### III. Electronic File Formats for both IESUB and Diskette/CD Submissions for Schedule 2(s).

Reporters must use either a semicolon-delimited format or positional format. The layouts and examples of each follows.

#### Semicolon Delimited Format

<b>Data Field and Instructions</b>	<b>Field Format</b>	<b>Schedule 2 Item Number</b>
<b>Reporter Identification Number</b>	<b>N10</b>	<b>1</b>
Delimiter	Semi-colon	
<b>Sequence Number (value from 1 - maximum number of records)</b>	<b>N7</b>	<b>2</b>
Delimiter	Semi-colon	
<b>Reporting Unit</b>	<b>N3</b>	<b>3a</b>
Delimiter	Semi-colon	
<b>Name of Reporting Unit</b>	<b>A80</b>	<b>3b</b>
Delimiter	Semi-colon	
<b>Security ID</b>	<b>A12</b>	<b>4</b>
Delimiter	Semi-colon	
<b>Security Description</b>	<b>A80</b>	<b>5</b>
Delimiter	Semi-colon	
<b>Security ID System (Refer to Appendix C)</b>	<b>N2</b>	<b>6</b>
Delimiter	Semi-colon	
<b>Security ID System Description</b>	<b>A80</b>	<b>6a</b>
Delimiter	Semi-colon	
<b>Security Type (Refer to Schedule 2, Page1)</b>	<b>N2</b>	<b>7</b>
Delimiter	Semi-colon	
<b>Depository Receipt/Share (Refer to Schedule 2, Page1)</b>	<b>N1</b>	<b>8</b>
Delimiter	Semi-colon	
<b>Name of Issuer</b>	<b>A80</b>	<b>9</b>
Delimiter	Semi-colon	
<b>Term Indicator (Refer to Schedule 2, Page1)</b>	<b>N1</b>	<b>10</b>
Delimiter	Semi-colon	
<b>Country of Issuer (Refer to Appendix D)</b>	<b>N5</b>	<b>11</b>
Delimiter	Semi-colon	
<b>Currency of Denomination (Refer to Appendix F)</b>	<b>A3</b>	<b>12</b>
Delimiter	Semi-colon	
<b>Ownership Code (Refer to Schedule 2, Page1)</b>	<b>N1</b>	<b>13</b>
Delimiter	Semi-colon	
<b>US\$ Fair (Market) Value of Security Held</b>	<b>N12</b>	<b>14a</b>
Delimiter	Semi-colon	
<b>Fair (Market) Value of Security Held Denominated in the Currency of Issue</b>	<b>N12</b>	<b>14b</b>
Delimiter	Semi-colon	

<b>Intentionally Left Blank</b>	<b>N1</b>	<b>15</b>
Delimiter	Semi-colon	
<b>Number of Shares Held</b>	<b>N11</b>	<b>16</b>
Delimiter	Semi-colon	
<b>Face Value in Currency of Denomination (non-ABS debt only)</b>	<b>N12</b>	<b>17</b>
Delimiter	Semi-colon	
<b>Issue Date (MMDDYYYY) (non-ABS debt only)</b>	<b>N8</b>	<b>18</b>
Delimiter	Semi-colon	
<b>Maturity Date (MMDDYYYY) (non-ABS debt only)</b>	<b>N8</b>	<b>19</b>
Delimiter	Semi-colon	
<b>Original Face Value in Currency of Denomination (ABS only)</b>	<b>N12</b>	<b>20</b>
Delimiter	Semi-colon	
<b>Remaining Principal Outstanding in Currency of Denomination (ABS only)</b>	<b>N12</b>	<b>21</b>
Delimiter	Semi-colon	
<b>Issue Date (MMDDYYYY) (ABS only)</b>	<b>N8</b>	<b>22</b>
Delimiter	Semi-colon	
<b>Maturity Date (MMDDYYYY) (ABS only)</b>	<b>N8</b>	<b>23</b>

### Data Specifications

In addition to the instructions in the above table, follow these instructions:

- Semi-colons must be used as space-delimiters between fields.
- No special characters should be present in numeric fields (e.g. currency signs, commas, negative signs, slashes, etc.).
- All numeric fields should be unpacked, unsigned and with leading zeros.
- A format specification of N12 is numeric, with length of up to 12.
- A format specification of A80 is alphanumeric, with length of up to 80.
- Issue Date and Maturity Date fields should be in the format of MMDDYYYY with leading zero for months January-September and for the 1<sup>st</sup> to the 9<sup>th</sup> day of the month (e.g. 01092004 = January 9, 2004).



**External Label for Diskette/CD submissions** (affix to media, not to cover)

Company Name

Reporter Identification Number as assigned by the FRBNY

Data Processing Contact Name and Telephone Number

Diskette/CD Identification Number (as identified in your records)

Total Number of Diskette/CD: 1 of \_\_

Creation Date

Contents: Report of U.S. Ownership of Foreign Securities, Including Selected Money Market Instruments  
(SHC(A))

## Sample Equity Record

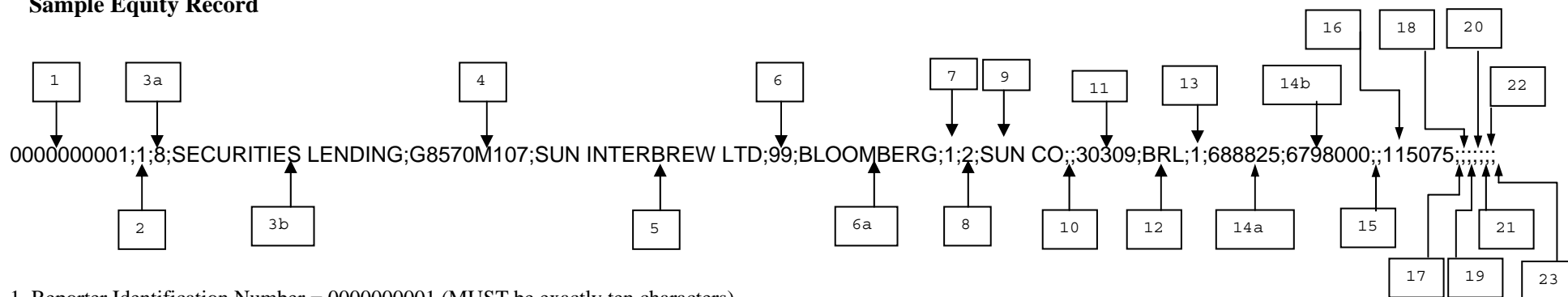

1. Reporter Identification Number = 0000000001 (MUST be exactly ten characters)
2. Sequence Number (can also be of format: 0000001)
- 3a. Reporting Unit (internal code to identify the area within your organization that the data came from)
- 3b. Name of Reporting Unit (can be up to 80 characters in length)
4. Security ID (can be up to 12 characters in length)
5. Security Description (can be up to 80 characters in length)
6. Security ID System (use security ID system codes from Appendix C)
- 6a. Security ID System "Other" (name of the organization or system that assigned the security ID)
7. Security Type (use security types listed on Schedule 2, Page 1)
8. Depository Receipt/Share (refer to Schedule 2, Page 1 for codes)
9. Name of Issuer (can be up to 80 characters in length)
10. Term Indicator – must be null for an equity record
11. Country of Issuer (use country codes listed in Appendix D)
12. Currency of Denomination (use currency codes listed in Appendix F)
13. Ownership Code (refer to Schedule 2, Page 1 for codes)
- 14a. US\$ Fair (Market) Value of Security Held (can be up to 12 characters in length)
- 14b. Fair (Market) Value of Security Held Denominated in the Currency of Issue (can be up to 12 characters in length)
15. Intentionally Left Blank
16. Number of shares held – (can be up to 11 characters in length) **Must have a value greater than zero for an equity record.**
17. Face Value in Currency of Denomination – must be null for an equity record
18. Issue Date – must be null for an equity record
19. Maturity Date – must be null for an equity record
20. Original Face Value in Currency of Denomination – must be null for an equity record
21. Remaining Principal Outstanding in Currency of Denomination – must be null for an equity record
22. Issue Date – must be null for an equity record
23. Maturity Date – must be null for an equity record

Null

Note: Null fields are to be included. They are represented by the inclusion of a delimiter as if a value were present. E.g. - ;desc;;

### Sample Short-term/Long-term Debt Record (excluding Asset-Backed securities)

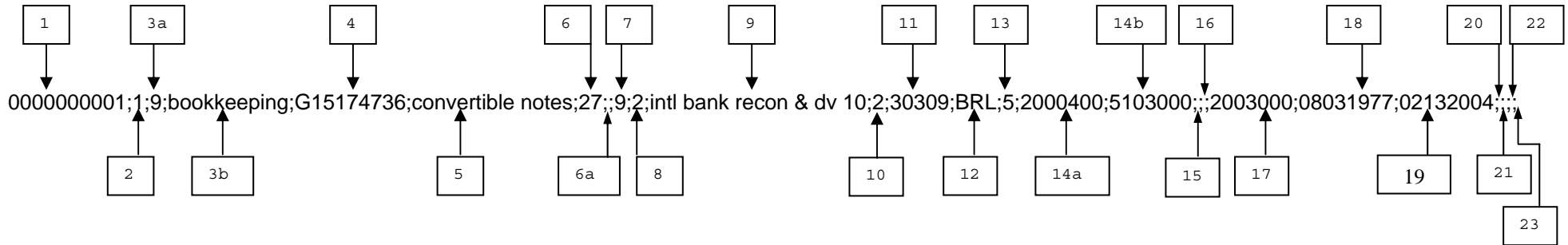

1. Reporter Identification Number = 0000000001 (MUST be exactly ten characters)
2. Sequence Number (can also be of format: 0000001)
- 3a. Reporting Unit (internal code to identify the area within your organization that the data came from)
- 3b. Name of Reporting Unit (can be up to 80 characters in length)
4. Security ID (can be up to 12 characters in length)
5. Security Description (can be up to 80 characters in length)
6. Security ID System (use security ID system codes from Appendix C)
- 6a. Security ID System "Other" (name of the organization or system that assigned the security ID)
7. Security Type (use security types listed on Schedule 2, Page 1)
8. Depository Receipt/Share (refer to Schedule 2, Page 1 for codes)
9. Name of Issuer (can be up to 80 characters in length)
10. Term Indicator (refer to Schedule 2, Page 1 for codes)
11. Country of Issuer (use country codes listed in Appendix D)
12. Currency of Denomination (use currency codes listed in Appendix F)
13. Ownership Code (refer to Schedule 2, Page 1 for codes)
- 14a. US\$ Fair (Market) Value of Security Held (can be up to 12 characters in length)
- 14b. Fair (Market) Value of Security Held Denominated in the Currency of Issue (can be up to 12 characters in length)
15. Intentionally Left Blank
16. Number of shares held – must be null for short-term/long-term debt record (excluding asset-backed securities)
17. Face Value in Currency of Denomination - (can be up to 12 characters in length). **Must have a value greater than zero for a short-term/long-term debt record (excluding asset-backed securities).**
18. Issue Date – MMDDYYYY format (08031977 = August 3, 1977)
19. Maturity Date – MMDDYYYY format (02132004 = February 13, 2004)
20. Original Face Value in Currency of Denomination – must be null for short-term/long-term debt record (excluding asset-backed securities)
21. Remaining Principal Outstanding in Currency of Denomination – must be null for short-term/long-term debt record (excluding asset-backed securities)
22. Issue Date – must be null for short-term/long-term debt record (excluding asset-backed securities)
23. Maturity Date – must be null for short-term/long-term debt record (excluding asset-backed securities)

### Sample Asset-Backed Long-term Debt Record

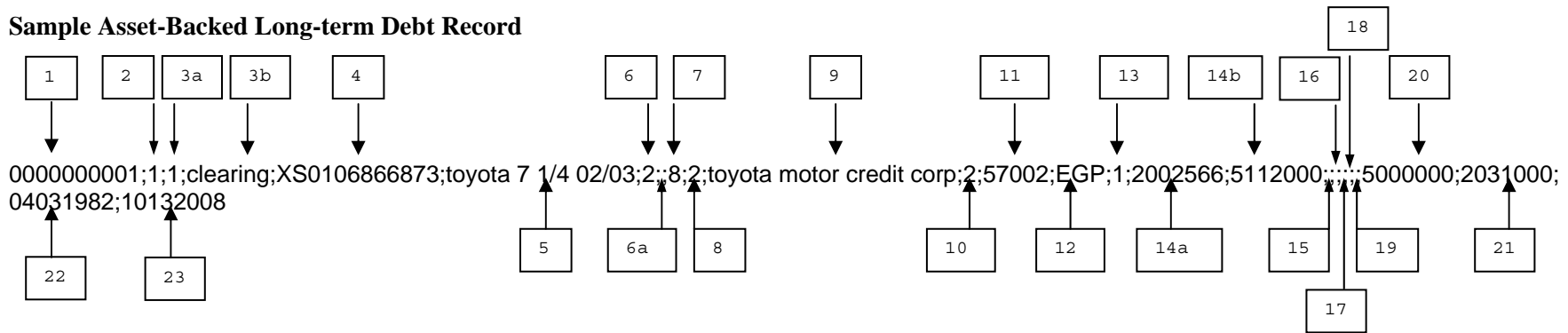

1. Reporter Identification Number = 0000000001 (MUST be exactly ten characters)
2. Sequence Number (can also be of format: 0000001)
- 3a. Reporting Unit (internal code to identify the area within your organization that the data came from)
- 3b. Name of Reporting Unit (can be up to 80 characters in length)
4. Security ID (can be up to 12 characters in length)
5. Security Description (can be up to 80 characters in length)
6. Security ID System (use security ID system codes from Appendix C)
- 6a. Security ID System "Other" (name of the organization or system that assigned the security ID)
7. Security Type (use security types listed on Schedule 2, Page 1)
- 8 Depository Receipt/Share (refer to Schedule 2, Page 1 for codes)
9. Name of Issuer (can be up to 80 characters in length)
10. Term Indicator (refer to Schedule 2, Page 1 for codes)
11. Country of Issuer (use country codes listed in Appendix D)
12. Currency of Denomination (use currency codes listed in Appendix F)
13. Ownership Code (refer to Schedule 2, Page 1 for codes)
- 14a. US\$ Fair (Market) Value of Security Held (can be up to 12 characters in length)
- 14b. Fair (Market) Value of Security Held Denominated in the Currency of Issue (can be up to 12 characters in length)
15. Intentionally Left Blank
16. Number of shares held – must be null for an asset-backed long-term debt record
17. Face Value in Currency of Denomination - must be null for an asset-backed long-term debt record
18. Issue Date – must be null for an asset-backed long-term debt record
19. Maturity Date – must be null for an asset-backed long-term debt record
20. Original Face Value in Currency of Denomination – for ABS debt only (can be up to 12 characters in length). **Must have a value greater then zero for an asset-backed long-term debt record.**
21. Remaining Principal Outstanding in Currency of Denomination – for ABS debt only (can be up to 12 characters in length). **Must have a value greater then zero for an asset-backed long-term debt record.**
22. Issue Date – MMDDYYYY format (04031982 = April 3, 1982)
23. Maturity Date – MMDDYYYY format (10132008 = October 13, 2008)

**Positional Format (Record length = 496 characters)**

<b>Position</b>	<b>Data Field and Instructions</b>	<b>Field Format</b>	<b>Schedule 2 Item Number</b>
1-10	<b>Reporter Identification Number</b>	<b>N10</b>	<b>1</b>
11	Filler (space)	Space	
12-18	<b>Sequence Number (value from 1 - maximum number of records)</b>	<b>N7</b>	<b>2</b>
19	Filler (space)	Space	
20-22	<b>Reporting Unit</b>	<b>N3</b>	<b>3a</b>
23	Filler (space)	Space	
24-103	<b>Name of Reporting Unit</b>	<b>A80</b>	<b>3b</b>
104	Filler (space)	Space	
105-116	<b>Security ID</b>	<b>A12</b>	<b>4</b>
117	Filler (space)	Space	
118-197	<b>Security Description</b>	<b>A80</b>	<b>5</b>
198	Filler (space)	Space	
199-200	<b>Security ID System (Refer to Appendix C)</b>	<b>N2</b>	<b>6</b>
201	Filler (space)	Space	
202-281	<b>Security ID System Description</b>	<b>A80</b>	<b>6a</b>
282	Filler (space)	Space	
283-284	<b>Security Type (Refer to Schedule 2, Page1)</b>	<b>N2</b>	<b>7</b>
285	Filler (space)	Space	
286	<b>Depository Receipt/Share (Refer to Schedule 2, Page1)</b>	<b>N1</b>	<b>8</b>
287	Filler (space)	Space	
288-367	<b>Name of Issuer</b>	<b>A80</b>	<b>9</b>
368	Filler (space)	Space	
369	<b>Term Indicator (Refer to Schedule 2, Page1)</b>	<b>N1</b>	<b>10</b>
370	Filler (space)	Space	
371-375	<b>Country of Issuer (Refer to Appendix D)</b>	<b>N5</b>	<b>11</b>
376	Filler (space)	Space	
377-379	<b>Currency of Denomination (Refer to Appendix F)</b>	<b>A3</b>	<b>12</b>
380	Filler (space)	Space	
381	<b>Ownership Code (Refer to Schedule 2, Page1)</b>	<b>N1</b>	<b>13</b>
382	Filler (space)	Space	
383-394	<b>US\$ Fair (Market) Value of Security Held</b>	<b>N12</b>	<b>14a</b>
395	Filler (space)	Space	
396-407	<b>Fair (Market) Value of Security Held Denominated in the Currency of Issue</b>	<b>N12</b>	<b>14b</b>
408	Filler (space)	Space	
409	<b>Intentionally Left Blank</b>	<b>N1</b>	<b>15</b>
410	Filler (space)	Space	
411-421	<b>Number of Shares Held</b>	<b>N11</b>	<b>16</b>
422	Filler (space)	Space	
423-434	<b>Face Value in Currency of Denomination (non-ABS debt only)</b>	<b>N12</b>	<b>17</b>
435	Filler (space)	Space	

436-443	<b>Issue Date (MMDDYYYY) (non-ABS debt only)</b>	<b>N8</b>	<b>18</b>
444	Filler (space)	Space	
445-452	<b>Maturity Date (MMDDYYYY) (non-ABS debt only)</b>	<b>N8</b>	<b>19</b>
453	Filler (space)	Space	
454-465	<b>Original Face Value in Currency of Denomination (ABS only)</b>	<b>N12</b>	<b>20</b>
466	Filler (space)	Space	
467-478	<b>Remaining Principal Outstanding in Currency of Denomination(ABS only)</b>	<b>N12</b>	<b>21</b>
479	Filler (space)	Space	
480-487	<b>Issue Date (MMDDYYYY) (ABS only)</b>	<b>N8</b>	<b>22</b>
488	Filler (space)	Space	
489-496	<b>Maturity Date (MMDDYYYY) (ABS only)</b>	<b>N8</b>	<b>23</b>

496 character logical records blocked at 60 logical records or a block size of 29,760 bytes.

### Data Specifications

In addition to the instructions in the above table, follow these instructions:

- No special characters should be present in numeric fields (e.g. currency signs, commas, negative signs, slashes, etc.).
- All numeric fields should be unpacked, unsigned, **right** justified with leading zeros, e.g., COBOL PIC 9(12). A format specification of N12 is numeric, with length of up to 12.
- Alphanumeric data should be **left** justified and blank filled, e.g., COBOL PIC X(50). A format specification of A80 is alphanumeric, with length of up to 80.
- Issue Date and Maturity Date fields should be in the format of MMDDYYYY with leading zero for months January-September and for the 1<sup>st</sup> to the 9<sup>th</sup> day of the month (e.g., 01092004 = January 9, 2004)
- The filler should be a space, e.g., in COBOL PIC X value spaces.
- Columns corresponding to null or not applicable items should be space filled

**External Label for Diskette/CD submissions** (affix to media, not to cover)

Company Name

Reporter Identification Number as assigned by the FRBNY

Data Processing Contact Name and Telephone Number

Diskette/CD Identification Number (as identified in your records)

Total Number of Diskette/CD: 1 of \_\_

Creation Date

Contents: Report of U.S. Ownership of Foreign Securities, Including Selected Money Market Instruments  
(SHC(A))

Below are sample equity, short-term/long-term debt (excluding asset-backed securities), and asset-backed debt records for the positional file layout. For purposes of *illustration only*, a darkened circle (●) represents the filler referred to on pages [\[enter pages\]](#) between fields and an open square ( ) represents a field position where information can be entered.

**Equity:**

0000000001•0000001•008•SECURITIES  
 LENDING  
 ●G8570M107 ●SUN INTERBREW LIMITED COMMON ●99•BLOOMBERG ●01  
 STOCK  
 ●2•SUN  
 COMPANYINCORPORATED  
 ●30309•BRL•1•000000688825•000006798000• ●00000115075•  
 ● ● ● ● ● ● ● ●

**Short-term/Long-term Debt Record (excluding Asset-Backed securities):**

0000000001•0000002•009•BOOKKEEPING ●G15174736 ●CONVERTIBLE  
 NOTES  
 ●27●  
 ●09•2•INTERNATIONAL BANK FOR RECONSTRUCTION  
 ANDDEVELOPMENT ●2•30309•BRL•5•000002000400•000005103000●  
 ● ●000002003000•08031977•02132004● ● ● ● ● ● ● ●

**Asset-Backed Long-term Debt Record:**

0000000001•0000003•010•CLEARING•XS0106866873 ●TOYOTA7  
 1/402/03  
 ●02●  
 ●08•2•TOYOTA MOTOR ●2•838  
 CREDITCORPORATION ●000 ●000 ● ●000  
 44•EGP•1•000002002566•000005112000● ● ● ● ● ● ● ●  
 005000000•000002031000•04031982•10132008 ●000



436-443	<b>Issue Date (MMDDYYYY) (non-ABS debt only)</b>	<b>N8</b>	<b>18</b>
444	Filler (space)	Space	
445-452	<b>Maturity Date (MMDDYYYY) (non-ABS debt only)</b>	<b>N8</b>	<b>19</b>
453	Filler (space)	Space	
454-465	<b>Original Face Value in Currency of Denomination (ABS only)</b>	<b>N12</b>	<b>20</b>
466	Filler (space)	Space	
467-478	<b>Remaining Principal Outstanding in Currency of Denomination(ABS only)</b>	<b>N12</b>	<b>21</b>
479	Filler (space)	Space	
480-487	<b>Issue Date (MMDDYYYY) (ABS only)</b>	<b>N8</b>	<b>22</b>
488	Filler (space)	Space	
489-496	<b>Maturity Date (MMDDYYYY) (ABS only)</b>	<b>N8</b>	<b>23</b>

496 character logical records blocked at 60 logical records or a block size of 29,760 bytes.

### Data Specifications

In addition to the instructions in the above table, follow these instructions:

- No special characters should be present in numeric fields (e.g. currency signs, commas, negative signs, slashes, etc.).
- All numeric fields should be unpacked, unsigned, **right** justified with leading zeros, e.g., COBOL PIC 9(12). A format specification of N12 is numeric, with length of up to 12.
- Alphanumeric data should be **left** justified and blank filled, e.g., COBOL PIC X(50). A format specification of A80 is alphanumeric, with length of up to 80.
- Issue Date and Maturity Date fields should be in the format of MMDDYYYY with leading zero for months January-September and for the 1<sup>st</sup> to the 9<sup>th</sup> day of the month (e.g., 01092004 = January 9, 2004)
- The filler should be a space, e.g., in COBOL PIC X value spaces.
- Columns corresponding to null or not applicable items should be space filled

**External Label for Diskette/CD submissions** (affix to media, not to cover)

Company Name

Reporter Identification Number as assigned by the FRBNY

Data Processing Contact Name and Telephone Number

Diskette/CD Identification Number (as identified in your records)

Total Number of Diskette/CD: 1 of \_\_

Creation Date

Contents: Report of U.S. Ownership of Foreign Securities, Including Selected Money Market Instruments  
(SHC(A))

Below are sample equity, short-term/long-term debt (excluding asset-backed securities), and asset-backed debt records for the positional file layout. For purposes of *illustration only*, a darkened circle (●) represents the filler referred to on pages [\[enter pages\]](#) between fields and an open square ( ) represents a field position where information can be entered.

**Equity:**

0000000001•0000001•008•SECURITIES  
 LENDING  
 ●G8570M107 ●SUN INTERBREW LIMITED COMMON  
 STOCK ●99•BLOOMBERG ●01  
 ●2•SUN  
 COMPANYINCORPORATED  
 ●30309•BRL•1•000000688825•000006798000• ●00000115075•  
 ● ● ● ● ● ● ● ●

**Short-term/Long-term Debt Record (excluding Asset-Backed securities):**

0000000001•0000002•009•BOOKKEEPING ●G15174736 ●CONVERTIBLE  
 NOTES ●27●  
 ●09•2•INTERNATIONAL BANK FOR RECONSTRUCTION  
 ANDDEVELOPMENT ●2•30309•BRL•5•000002000400•000005103000●  
 ● ●000002003000•08031977•02132004● ● ● ● ● ● ● ●

**Asset-Backed Long-term Debt Record:**

0000000001•0000003•010•CLEARING•XS0106866873 ●TOYOTA7  
 1/402/03 ●02●  
 ●08•2•TOYOTA MOTOR ●2•838  
 CREDITCORPORATION ●000 ●000 ●000 ●000 ●000  
 44•EGP•1•000002002566•000005112000● ● ● ● ● ● ● ●  
 005000000•000002031000•04031982•10132008 ●000