

DEPARTMENT OF TRANSPORTATION
National Highway Traffic Safety Administration

49 CFR Part 575

[Docket No. NHTSA-2001- 9663; Notice 3]

RIN 2127-AI81

Consumer Information;
New Car Assessment Program;
Rollover Resistance

AGENCY: National Highway Traffic Safety Administration (NHTSA), DOT.

ACTION: Final Policy Statement

SUMMARY: The Transportation Recall Enhancement, Accountability, and Documentation Act of 2000 requires NHTSA to develop a dynamic test on rollovers by motor vehicles for the purposes of a consumer information program, to carry out a program of conducting such tests, and, as these tests are being developed, to conduct a rulemaking to determine how best to disseminate test results to the public. This document modifies NHTSA's rollover resistance ratings in its New Car Assessment Program (NCAP) to include dynamic rollover tests after considering comments to our previous document. The changes described in this document will improve consumer information provided by NHTSA, but will not place regulatory requirements on vehicle manufacturers.

DATES: NCAP rollover resistance ratings in the 2004 model year will be determined using the system established by this document.

Petitions: Petitions for reconsideration must be received by **[insert date that is 45 days after date of publication in the Federal Register]**.

FOR FURTHER INFORMATION CONTACT: For technical questions you may contact Patrick Boyd, NVS-123, Office of Rulemaking, National Highway Traffic Safety Administration, 400 Seventh Street, SW, Washington, DC 20590 and Dr. Riley Garrott, NVS-312, NHTSA Vehicle Research and Test Center, P.O. Box 37, East Liberty, OH 43319. Mr. Boyd can be reached by phone at (202) 366-6346 or by facsimile at (202) 493-2739. Dr. Garrott can be reached by phone at (937) 666-4511 or by facsimile at (937) 666-3590.

SUPPLEMENTARY INFORMATION:

- I. Executive Summary
- II. Safety Problem
- III. Background
 - A. Existing NCAP Program and the TREAD Act
 - B. National Academy of Sciences Study
- IV. Notice of Proposed Rulemaking
- V. Results of Dynamic Maneuver Tests of 25 Vehicles
 - A. J-Turn Maneuver
 - B. Fishhook Maneuver
 - C. Loading Conditions
 - D. Test Results
- VI. Rollover Risk Model
- VII. Comments to the Previous Notice
 - A. Combined or Separate Rollover Resistance Ratings

- B. Crash Avoidance Technologies
 - C. The J-Turn and Fishhook Maneuvers
 - D. Tire Wear
 - E. Pavement Temperature
 - F. Surface Friction
 - G. Steering Reversal
 - H. Fifteen-Passenger Vans
 - I. Tip-up Criterion
 - J. Testing of Passenger Cars vs. Light Trucks
 - K. Testing with Electronic Stability Control Systems
- VIII. Final Form for Rollover Resistance Ratings – Alternative I
- A. Combined Ratings
 - B. Dynamic Testing
 - C. Demonstration Program
- IX. Cost Benefit Statement
- X. Rulemaking Analyses and Notices
- A. Executive Order 12866
 - B. Regulatory Flexibility Act
 - C. National Environmental Policy Act
 - D. Executive Order 13132 (Federalism)
 - E. Unfunded Mandates Act
 - F. Civil Justice Reform
 - G. Paperwork Reduction Act

H. Plain Language

Appendix I. Fishhook Test Protocol

Appendix II. Development of Logistic Regression Risk Model

I. Executive Summary

While the total number of highway fatalities has remained relatively stable over the past decade, the number of rollover deaths has risen substantially. According to NHTSA's National Center for Statistics and Analysis, from 1991 to 2001 the number of passenger vehicle occupants killed in all motor vehicle crashes increased 4 percent, while fatalities in rollover crashes increased 10 percent. In the same decade, passenger car occupant fatalities in rollovers declined 15 percent while rollover fatalities in light trucks increased 43 percent. In 2001, 10,138 people died in rollover crashes, a figure that represents 32 percent of occupant fatalities for the year.

In response to that trend, NHTSA has been evaluating rollover testing since 1993. In 2001, NHTSA began publishing rollover rating information for consumers, supplementing New Car Assessment Program (NCAP) frontal crashworthiness ratings that began in 1979 and side impact ratings that began in 1997.

When Congress approved the "Transportation Recall, Enhancement, Accountability and Documentation (TREAD) Act of November 2000", Section 12 directed the Secretary of Transportation to "develop a dynamic test on rollovers by motor vehicles for a consumer information program; and carry out a program conducting such tests. As the Secretary develops a [rollover] test, the Secretary shall conduct a rulemaking to determine how best to disseminate test results to the public."

On July 3, 2001, NHTSA published a Request for Comments notice (66 FR 35179)

discussing a variety of dynamic rollover tests that we had chosen to evaluate in our research program and what we believed were their potential advantages and disadvantages.

We published a Notice of Proposed Rulemaking on October 7, 2002 (67 FR 62528) that proposed alternative ways of using the dynamic maneuver test results in consumer information on the rollover resistance of new vehicles.

Beginning with rollover ratings for the 2004 model year, NHTSA will combine a vehicle's Static Stability Factor (SSF) measurement with its performance in the so-called "Fishhook" maneuver. The so-called "J-Turn" dynamic test maneuver discussed in previous notices will be not be used by NHTSA for rating rollover resistance. Our analysis has found that the J-Turn maneuver test does not add any meaningful information to what is obtained from the fishhook maneuver test alone (see Appendix II.B). The predicted rollover rate will be translated into a five-star rating system that is the same as the one now in use: One star is for a rollover rate greater than 40 percent; two stars, between 30 and 39 percent; three stars, between 20 and 29 percent; four stars, between 10 and 19 percent; and five stars for 10 percent or less.

This decision maximizes the vehicle information used to make the rollover rate prediction and will allow us to ensure that rollover NCAP information corresponds even more closely to real-world rollovers. We have also decided to present our rollover information as a single combined rollover rating that most commenters agreed would be more understandable to consumers.

This document also includes a test procedure (Appendix I) for conducting vehicle maneuver tests, and discusses testing regimes that have been incorporated to minimize variability in test data.

II. Safety Problem

Rollover crashes are complex events that reflect the interaction of driver, road, vehicle, and environmental factors. We can describe the relationship between these factors and the risk of rollover using information from the agency's crash data programs. We limit our discussion here to light vehicles, which consist of (1) passenger cars and (2) multipurpose passenger vehicles and trucks under 4,536 kilograms (10,000 pounds) gross vehicle weight rating.¹

According to the 2001 Fatality Analysis Reporting System (FARS), 10,138 people were killed as occupants in light vehicle rollover crashes, which represent 32 percent of the occupants killed that year in crashes. Of those, 8,407 were killed in single-vehicle rollover crashes. Seventy-eight percent of the people who died in single-vehicle rollover crashes were not using a seat belt, and 64 percent were partially or completely ejected from the vehicle (including 53 percent who were completely ejected). FARS shows that 54 percent of light vehicle occupant fatalities in single-vehicle crashes involved a rollover event.

Using data from the 1997-2001 National Automotive Sampling System (NASS) Crashworthiness Data System (CDS), we estimate that 281,000 light vehicles were towed from a police-reported rollover crash each year (on average), and that 30,000 occupants of these vehicles were seriously injured or killed (defined as any fatality or an injury with an Abbreviated Injury Scale (AIS) rating of at least AIS 3).² Of these 281,000 light vehicle rollover crashes, 225,000 were single-vehicle crashes. (The NCAP rollover resistance ratings estimate the risk of rollover if a vehicle is involved in a single-vehicle crash.) Sixty-one percent of those people

¹ For brevity, we use the term "light trucks" in this document to refer to vans, minivans, sport utility vehicles (SUVs), and pickup trucks under 4,536 kilograms (10,000 pounds) gross vehicle weight rating. NHTSA has also used the term "LTVs" to refer to the same vehicles.

² A broken hip with splintering of the bone is an example of an AIS 3 injury.

who suffered a serious injury in single-vehicle towaway rollover crashes were not using a seat belt, and 49 percent were partially or completely ejected (including 40 percent who were completely ejected). Estimates from NASS CDS indicate that 80 percent of towaway rollovers were single-vehicle crashes, and that 83 percent (168,000) of the single-vehicle rollover crashes occurred after the vehicle left the roadway. An audit of 1992-96 NASS CDS data showed that about 95 percent of rollovers in single-vehicle crashes were tripped by mechanisms such as curbs, soft soil, pot holes, guard rails, and wheel rims digging into the pavement, rather than by tire/road interface friction as in the case of untripped rollover events.

According to the 1997-2001 NASS General Estimates System (GES) data, 62,000 occupants annually received injuries rated as *K* or *A* on the police KABCO injury scale in rollover crashes. (The police KABCO scale calls *A* injuries "incapacitating," but their actual severity depends on local reporting practice. An "incapacitating" injury may mean that the injury was visible to the reporting officer or that the officer called for medical assistance. A *K* injury is fatal.) The data indicate that 215,000 single-vehicle rollover crashes resulted in 49,000 *K* or *A* injuries. Fifty percent of those with *K* or *A* injury in single-vehicle rollover crashes were not using a seat belt, and 24 percent were partially or completely ejected from the vehicle (including 21 percent who were completely ejected). Estimates from NASS GES indicate that 13 percent of light vehicles in police-reported single-vehicle crashes rolled over. The estimated risk of rollover differs by light vehicle type: 10 percent of cars and 10 percent of vans in police-reported single-vehicle crashes rolled over, compared to 18 percent of pickup trucks and 27 percent of SUVs. The percentages of all police-reported crashes for each vehicle type that resulted in rollover were 1.7 percent for cars, 2.0 percent for vans, 3.8 percent for pickup trucks and 5.5 percent for SUVs as estimated by NASS GES.

III. Background

A. Existing NCAP Program and the TREAD Act

NHTSA's NCAP program has been publishing comparative consumer information on frontal crashworthiness of new vehicles since 1979, on side crashworthiness since 1997, and on rollover resistance since January 2001 (66 FR 3388). This notice does not establish a new consumer information program on rollover resistance ratings. Rather, it refines our existing rollover resistance rating program in accordance with the requirements of the TREAD Act and the recommendations of the National Academy of Sciences.

The present NCAP rollover resistance ratings are based on the Static Stability Factor (SSF) of a vehicle, which is the ratio of one half its track width to its center of gravity (c.g.) height (see www.nhtsa.dot.gov/hot/rollover/ for ratings and explanatory information). After an evaluation of some driving maneuver tests in 1997 and 1998, we chose to use SSF instead of any driving maneuvers to characterize rollover resistance. As we explained in our notices establishing rollover NCAP, we chose SSF as the basis of our ratings because it represents the first order factors that determine vehicle rollover resistance in the vast majority of rollovers which are tripped by impacts with curbs, soft soil, pot holes, guard rails, etc. or by wheel rims digging into the pavement. In contrast, untripped rollovers are those in which tire/road interface friction is the only external force acting on a vehicle that rolls over. Driving maneuver tests directly represent on-road untripped rollover crashes, but such crashes represent less than five percent of rollover crashes³.

At the time, we believed it was necessary to choose between SSF and driving maneuver tests as the basis for rollover resistance ratings. SSF was chosen because it had a number of

advantages: it is highly correlated with actual crash statistics; it can be measured accurately and inexpensively and explained to consumers; and changes in vehicle design to improve SSF are unlikely to degrade other safety attributes. We also considered the fact that an improvement in SSF represents an increase in rollover resistance in both tripped and untripped circumstances while maneuver test performance can be improved by reduced tire traction and certain implementations of electronic stability control that we believe are unlikely to improve resistance to tripped rollovers.

Congress funded NHTSA's rollover NCAP program, but directed the agency to enhance the program. Section 12 of the "Transportation Recall, Enhancement, Accountability and Documentation (TREAD) Act of November 2000" directs the Secretary to "develop a dynamic test on rollovers by motor vehicles for a consumer information program; and carry out a program conducting such tests. As the Secretary develops a [rollover] test, the Secretary shall conduct a rulemaking to determine how best to disseminate test results to the public." The rulemaking was to be carried out by November 1, 2002.

On July 3, 2001, NHTSA published a Request for Comments notice (66 FR 35179) regarding our research plans to assess a number of possible dynamic rollover tests. The notice discussed the possible advantages and disadvantages of various approaches that had been suggested by manufacturers, consumer groups, and NHTSA's prior research. The driving maneuver tests to be evaluated fit into two broad categories: closed-loop maneuvers in which all test vehicles attempt to follow the same path; and open-loop maneuvers in which all test vehicles are given equivalent steering inputs. The principal theme of the comments was a sharp division of opinion about whether the dynamic rollover test should be a closed loop maneuver test like

3 NHTSA Research Note, "Passenger Vehicles in Untripped Rollovers," September 1999

the ISO 3388 double lane change that emphasizes the handling properties of vehicles or whether it should be an open loop maneuver like a J-Turn or Fishhook that are limit maneuvers in which vulnerable vehicles would actually tip up. Ford recommended a different type of closed loop lane change maneuver in which a path-following robot or a mathematical correction method would be used to evaluate all vehicles on the same set of paths at the same lateral acceleration. It used a measurement of partial wheel unloading without tip-up at 0.7g lateral acceleration as a performance criterion in contrast to the other closed loop maneuver tests that used maximum speed through the maneuver as the performance criterion. Another unique comment was a recommendation from Suzuki to use a sled test developed by Exponent Inc. to simulate tripped rollovers.

The subsequent test program (using four SUVs in various load conditions and with and without electronic stability control enabled on two of the SUVs) showed that open-loop maneuver tests using an automated steering controller could be performed with better repeatability of results than the other maneuver tests. The J-Turn maneuver and the Fishhook maneuver (with steering reversal at maximum vehicle roll angle) were found to be the most objective tests of the susceptibility of vehicles to maneuver-induced on-road rollover. Except for the Ford test, the closed loop tests were found not to measure rollover resistance. Instead, the tests of maximum speed through a double lane change responded to vehicle agility. None of the test vehicles tipped up during runs in which they maintained the prescribed path even when loaded with roof ballast to experimentally reduce their rollover resistance. The speed scores of the test vehicles in the closed loop maneuvers were found to be unrelated to their resistance to tip-up in the open-loop maneuvers that actually caused tip-up. The test vehicle that was clearly the poorest performer in the maneuvers that caused tip-ups achieved the best score (highest

speed) in the ISO 3388 and CU short course double lane change, and one vehicle improved its score in the ISO 3388 test when roof ballast was added to reduce its rollover resistance.

Due to the non-limit test conditions and the averaging necessary for stable wheel force measurements, the wheel unloading measured in the Ford test appeared to be more quasi-static (as in driving in a circle at a steady speed or placing the vehicle on a centrifuge) than dynamic. Sled tests were not evaluated because we believed that SSF already provided a good indicator of resistance to tripped rollover.

B. National Academy of Sciences Study

During the time NHTSA was evaluating dynamic maneuver tests in response to the TREAD Act, the National Academy of Sciences (NAS) was conducting a study of our SSF-based rollover resistance ratings and was directed to make recommendations regarding driving maneuver tests. We expected the NAS recommendations to have a strong influence on TREAD-mandated changes to NCAP rollover resistance ratings.

When NHTSA proposed the present SSF rollover resistance ratings in June 2000 (65 FR 34998), vehicle manufacturers generally opposed it because they believed that SSF as a measure of rollover resistance is too simple since it does not include the effects of suspension deflections, tire traction and electronic stability control (ESC). In addition, the vehicle manufacturers argued that the influence of vehicle factors on rollover risk is too slight to warrant consumer information ratings for rollover resistance. In the conference report of the FY2001 DOT Appropriations Act, Congress permitted NHTSA to move forward with its rollover rating program, but directed the agency to fund a National Academy of Sciences (NAS) study on vehicle rollover ratings. The study topics were “whether the static stability factor is a scientifically valid measurement that

presents practical, useful information to the public including a comparison of the static stability factor test versus a test with rollover metrics based on dynamic driving conditions that may induce rollover events.” The National Academy’s report was completed and made available at the end of February 2002.

The NAS study found that SSF is a scientifically valid measure of rollover resistance for which the underlying physics and real-world crash data are consistent with the conclusion that an increase in SSF reduces the likelihood of rollover. It also found that dynamic tests should complement static measures, such as SSF, rather than replace them in consumer information on rollover resistance. The dynamic tests the NAS recommended would be driving maneuvers used to assess “transient vehicle behavior leading to rollover.”

The NAS study also made recommendations concerning the statistical analysis of rollover risk and the representation of ratings. It recommended that we use logistic regression rather than linear regression for analysis of the relationship between rollover risk and SSF, and it recommended that we consider a higher-resolution representation of the relationship between rollover risk and SSF than is provided by the current five-star rating system.

We published a Notice of Proposed Rulemaking on October 7, 2002 (67 FR 62528) that proposed alternative ways of using the dynamic maneuver test results in consumer information on the rollover resistance of new vehicles. We chose the J-Turn and Fishhook maneuver (with roll rate feedback) as the dynamic maneuver tests because they were the type of limit maneuver tests that could directly lead to rollover as recommended by the NAS. We also proposed to use a logistic regression analysis to determine the relationship between vehicle properties and rollover risk, as recommended by the NAS. The resulting rollover resistance ratings were proposed to be

part of NHTSA's New Car Assessment Program (NCAP). Also, we proposed two methods for presenting rollover resistance ratings for consumer information.

IV. Notice of Proposed Rulemaking

The TREAD Act calls for a rulemaking to determine how best to disseminate rollover test results to the public, and our Notice of Proposed Rulemaking (NPRM) of October 7, 2002 (67 FR 62528) proposed two alternatives for using the dynamic test results in consumer information on the rollover resistance of new vehicles. In this case the term "rulemaking" refers more to the process than to the product. This document does not amend the code of Federal Register, but establishes NHTSA's policy on consumer information regarding the rollover resistance program. As mentioned above, this program places no requirements on vehicle manufacturers, only some on NHTSA.

While the TREAD Act calls for a rulemaking to determine how best to disseminate the rollover test results, the development of the dynamic rollover test is simply the responsibility of the Secretary. Based on NHTSA's recent research to evaluate rollover test maneuvers, the National Academy of Sciences' study of rollover ratings, comments to the July 3, 2000 notice, extensive consultations with experts from the vehicle industry, consumer groups and academia, and NHTSA's previous research in 1997-8, the agency chose the J-Turn and the Fishhook maneuvers as dynamic rollover tests. They are the limit maneuver tests that NHTSA found to have the highest levels of objectivity, repeatability and discriminatory capability. The notice announced that vehicles would be tested in two load conditions using the J-Turn at up to 60 mph and the Fishhook maneuver at up to 50 mph. Both maneuvers would be conducted with an automated steering controller, and the reverse steer of the Fishhook maneuver would be timed to coincide with the maximum roll angle to create an objective "worst case" for all vehicles

regardless of differences in resonant roll frequency. Figures 1 and 2 illustrate the open-loop steering wheel motions characterizing these maneuvers. The light load condition would be the weight of the test driver and instruments, approximating a vehicle with a driver and one front seat passenger. The notice announced that the heavy load condition would add additional 175 lb manikins in all rear seat positions.

The National Academy of Sciences recommended that dynamic maneuver tests be used to supplement rather than replace Static Stability Factor in consumer information on rollover resistance. NHTSA proposed two alternatives for consumer information ratings on vehicle rollover resistance that included both dynamic maneuver test results and Static Stability Factor. The first alternative was to include the dynamic test results as vehicle variables along with SSF in a statistical model of rollover risk that would combine their predictive power. This is conceptually similar to the present ratings in which a statistical model is used to distinguish between the effects of vehicle variables and demographic and road use variables recorded for state crash data on a large number of single-vehicle crashes. The National Academy of Sciences recommended using a logistic regression model for this purpose. Such a model would be used to predict the rollover rate in single-vehicle crashes for a vehicle considering both its dynamic maneuver test performance and its Static Stability Factor for an average driver population (as a common basis of comparison).

Under the first alternative, the “star rating” of a vehicle would be based on its rollover rate in single-vehicle crashes predicted by a statistical model. The format would be the same as for the present rollover ratings (for example, one star for a predicted rollover rate in single-vehicle crashes greater than 40 percent and five stars for a predicted rollover rate less than 10 percent). The present rollover ratings are based on a linear regression model using state crash

reports of 241,000 single-vehicle crashes of 100 make/model vehicles. We proposed to replace the current rollover risk model with one that uses the performance of the vehicle in dynamic maneuver tests as well as its SSF to predict rollover risk. The performance of a vehicle in dynamic maneuver tests would be simply whether it tipped up or not in each of the four maneuver/load combinations.

In order to compute this logistic model for rollover risk, it is necessary to have the dynamic maneuver test results as well as SSF for a number of vehicles with rollover rates established by state crash reports of single-vehicle crashes. We had the SSF measurements and established rollover rates for the 100 make/model vehicles upon which we based the static rating system but not their dynamic maneuver test results. Thus, we asked for comment on the suitability of a rating method that combines static and dynamic vehicle properties in a single rating and on the validity of logistic regression analysis for the risk model that combines the properties in a way that is predictive of real-world crash experience.

The NPRM notice announced that we were going to perform the dynamic maneuver tests on about 25 of the 100 make/model vehicles for which we had SSF measurements and substantial state crash data. Time and budget constraints would not permit testing all 100 vehicles. With these dynamic maneuver test results and our existing crash and SSF information we would be able to compute the new risk model using a standard statistical package of computer programs (SAS) for logistic regression analysis. This document notice presents the dynamic maneuver test results for 24 of the 100 vehicles, chosen to span the SSF range and to represent high production vehicles of each type (passenger car, van, pickup truck and sport utility vehicle (SUV)). An additional SUV with a lower SSF than found among the 100 vehicles was also included. The resulting risk model is presented in this document notice.

The second alternative we proposed was to have separate ratings for Static Stability Factor and for dynamic maneuver test performance. Dynamic maneuver tests directly represent on-road untripped rollovers. Under this alternative, the dynamic maneuver test performance would be used to rate resistance to untripped rollovers in a qualitative scale. Barring unforeseen results of the dynamic maneuver tests of the 25 vehicle group, the obvious qualitative scale would be: A for no tip-ups, B for tip-up in one maneuver, C for tip-ups in two maneuvers, D for tip-ups in three maneuvers and E for tip-ups in all four maneuvers/load combinations.

A statistical risk model is not possible for untripped rollover crashes, because they appear to be relatively rare events and they cannot be reliably identified in state crash reports. For this alternative, the current Static Stability Factor based system would be used to rate resistance to tripped rollovers (since we believe most of the rollovers reported in the state crash reports are tripped). Again we asked for comments on the usefulness and validity of the concept in the NPRM notice, but we could not offer examples of actual vehicle ratings because the tests had not yet been conducted.

V. Results of Dynamic Maneuver Tests of 25 Vehicles

This section presents an overview of the test maneuvers and the results for 25 vehicles that were used to develop the logistic regression risk model. A more extensive account of the test program is contained in the Phase VI and VII Report that has been placed in Docket NHTSA-2001-9663. A detailed description of how we will perform the maneuver tests for NCAP ratings is contained in Appendix I.

The NHTSA J-Turn and Fishhook (with roll rate feedback) maneuver tests were performed for 25 vehicles representing four vehicle types including passenger cars, vans, pickup

trucks and SUVs. We chose mainly high production vehicles that spanned a wide range of SSF values, using vehicles NHTSA already owned where possible. Except for four 2001 model year vehicles NHTSA purchased new, the vehicle suspensions were rebuilt with new springs and shock absorbers, and other parts as required for all the other vehicles included in the test program.

A. J-Turn Maneuver

The NHTSA J-Turn maneuver represents an avoidance maneuver in which a vehicle is steered away from an obstacle using a single input. The maneuver is similar to the J-Turn used during NHTSA's 1997-98 rollover research program and is a common maneuver in test programs conducted by vehicle manufacturers and others. Often the J-Turn is conducted with a fixed steering input (handwheel angle) for all test vehicles. In its 1997-98 testing, NHTSA used a fixed handwheel angle of 330 degrees. In the testing that preceded the NPRM notice, we developed an objective method of specifying equivalent handwheel angles for J-Turn tests of various vehicles, taking into account their differences in steering ratio, wheelbase and linear range understeer properties. (See NHTSA's Phase IV report docketed with the NPRM notice as item 38 in Docket No. NHTSA 2001-9663). Under this method, one first measures the handwheel angle that would produce a steady-state lateral acceleration of 0.3 g at 50 mph on a level paved surface for a particular vehicle. In brief, the 0.3 g value was chosen because the steering angle variability associated with this lateral acceleration is quite low and there is no possibility that stability control intervention could confound the test results. Since the magnitude of the handwheel position at 0.3 g is small, it must be multiplied by a scalar to have a high maneuver severity. In the case of the J-Turn, the handwheel angle at 0.3 g was multiplied

by eight. When this scalar is multiplied by the average handwheel angle at 0.3 g (observed during NHTSA's 1997-98 rollover research program), the result is approximately 330 degrees. Figure 1 illustrates the J-Turn maneuver in terms of the automated steering inputs commanded by the programmable steering machine. The rate of the handwheel turning is 1000 degrees per second.

To begin the maneuver, the vehicle was driven in a straight line at a speed slightly greater than the desired entrance speed. The driver released the throttle, coasted to the target speed, and then triggered the commanded handwheel input. The nominal maneuver entrance speeds used in the J-Turn maneuver ranged from 35 to 60 mph, increased in 5 mph increments until a termination condition was achieved. Termination conditions were simultaneous two inch or greater lift of a vehicle's inside tires (two-wheel lift) or completion of a test performed at the maximum maneuver entrance speed without two-wheel lift. If two-wheel lift was observed, a downward iteration of vehicle speed was used in 1 mph increments until such lift was no longer detected. Once the lowest speed for which two-wheel lift could be detected was isolated, two additional tests were performed at that speed to monitor two-wheel lift repeatability.

B. Fishhook Maneuver

The second maneuver test, the fishhook maneuver, uses steering inputs that approximate the steering a driver acting in panic might use in an effort to regain lane position after dropping two wheels off the roadway onto the shoulder. In the NPRM notice, we described it as a road edge recovery maneuver. As pointed out by some commenters, it is performed on a smooth pavement rather than at a road edge drop-off, but its rapid steering input followed by an over-correction is representative of a general loss of control situation. The original version of this test

was developed by Toyota, and variations of it were suggested by Nissan and Honda. NHTSA has experimented with several versions since 1997, and the present test includes roll rate feedback in order to time the counter-steer to coincide with the maximum roll angle of each vehicle in response to the first steer.

Figure 2 describes the Fishhook maneuver in terms of the automated steering inputs commanded by the programmable steering machine and illustrates the roll rate feedback. The initial steering magnitude and countersteer magnitudes are symmetric, and are calculated by multiplying the handwheel angle that would produce a steady state lateral acceleration of 0.3 g at 50 mph on level pavement by 6.5. The average steering input is equivalent to the 270 degree handwheel angle used in earlier forms of the maneuver but, as in the case of the J-Turn, the procedure above is an objective way of compensating for differences in steering gear ratio, wheelbase and understeer properties between vehicles. The fishhook maneuver dwell times (the time between completion of the initial steering ramp and the initiation of the countersteer) are defined by the roll motion of the vehicle being evaluated, and can vary on a test-to-test basis. This is made possible by having the steering machine monitor roll rate (roll velocity). If an initial steer is to the left, the steering reversal following completion of the first handwheel ramp occurs when the roll rate of the vehicle first equals or goes below 1.5 degrees per second. If an initial steer is to the right, the steering reversal following completion of the first handwheel ramp occurs when the roll rate of the vehicle first equals or exceeds -1.5 degrees per second. The handwheel rates of the initial steer and countersteer ramps are 720 degrees per second.

To begin the maneuver, the vehicle was driven in a straight line at a speed slightly greater than the desired entrance speed. The driver released the throttle, coasted to the target speed, and

then triggered the commanded handwheel input described in Figure 2. The nominal maneuver entrance speeds used in the fishhook maneuver ranged from 35 to 50 mph, increased in 5 mph increments until a termination condition was achieved. Termination conditions included simultaneous two inch or greater lift of a vehicle's inside tires (two-wheel lift) or completion of a test performed at the maximum maneuver entrance speed without two-wheel lift. If two-wheel lift was observed, a downward iteration of vehicle speed was used in 1 mph increments until such lift was no longer detected. Once the lowest speed for which two-wheel lift could be detected was isolated, two additional tests were performed at that speed to check two-wheel lift repeatability.

C. Loading Conditions

The vehicles were tested in each maneuver in two load conditions in order to create four levels of stringency in the suite of maneuver tests. The light load was the test driver plus instrumentation in the front passenger seat, which represented two occupants. A heavier load was used to create a higher level of stringency for each test. In our NPRM, we announced that the heavy load would include 175 lb anthropomorphic forms (water dummies) in all rear seat positions. During the test of the 25 vehicles, it became obvious that heavy load tests were being run at very unequal load conditions especially between vans and other vehicles (two water dummies in some vehicles but six water dummies in others). While very heavy passenger loads can certainly reduce rollover resistance and potentially cause special problems, crashes at those loads are too few to greatly influence the overall rollover rate of vehicles. Over 94% of van rollovers in our 293,000 crash database occurred with five or fewer occupants, and over 99% of rollovers of other vehicles occurred with five or fewer occupants. The average passenger loads

of vehicles in our crash database was less than two: 1.81 for vans; 1.54 for SUVs; 1.48 for cars; and 1.35 for pickup trucks. In order to use the maneuver tests to predict real-world rollover rates, it seemed inappropriate to test the vehicles under widely differing loads that did not correspond to the real-world crash statistics. Therefore, the tests used to develop a statistical model of rollover risk were changed to a uniform heavy load condition of three water dummies (representing a 5-occupant loading) for all vehicles capable of carrying at least five occupants. Some vehicles were loaded with only two water dummies because they were designed for four occupants. For pickup trucks, water dummies were loaded in the bed at approximately the same height as a passenger in the front seat.

To avoid disruption, the tests were completed under the original loading plan. Then we conducted tests at a 5-occupant heavy load only for those vehicles in which loading differences might influence tip-up. If the vehicle had completed the maneuver without tip-up with more than three water dummies in the rear it was not necessary to retest at a lighter load. Likewise, if the vehicle tipped up in the light load (no water dummies) condition, it was not necessary to retest with three water dummies in the rear. We have never observed a vehicle for which a greater passenger load improved performance in a tip-up test.

D. Test Results

The test results in Table 1 reflect the performance either measured or imputed as described for a heavy load condition representing 5 occupants except for the Ford Explorer 2DR, the Chevrolet Tracker and Metro that were designed for only four occupants, and the Honda CRV, Honda Civic and Chevrolet Cavalier that could not be loaded to the 5 occupant level without exceeding a gross axle weight rating because of the additional weight of the outriggers.

Note that Table 1 includes some results collected during tests performed with alternative steering angles. Although the steering angles used during these tests were still based on the handwheel angle that would produce a steady-state lateral acceleration of 0.3 g at 50 mph on a level paved surface, the scalars used to calculate the steering angles were smaller. These tests

Table 1. Dynamic Maneuver Test Results (the check mark indicates tip-up observed)

Veh. Group Number	Model Range / Make / Model	Nominal Static Stability Factor	Fishhook Light (FL) (2 occ.)	Fishhook Heavy (FH) (5 occ.)	J-Turn Light (JL) (2 occ.)	J-Turn Heavy (JH) (5 occ.)
--	'92 – '00 Mitsubishi Montero 4WD	0.95	✓	✓	--	✓
47	'95 – '03 Chevrolet Blazer 2WD	1.02	✓	✓	--	✓
43	'95 – '01 Ford Explorer 2dr 2WD	1.06	--	--	--	--
44	'95 – '01 Ford Explorer 4dr 4WD	1.06	--	✓	--	--
66	'96 – '00 Toyota 4Runner 4WD	1.06	--	✓	--	--
89	'93 – '97 Ford Ranger p/u 4WD	1.07	✓	✓	✓	✓
58	'88 – '97 Jeep Cherokee 4WD	1.08	--	--	--	--
59	'95 – '02 Acura SLX / Isuzu Trooper 4WD	1.09	✓	✓	✓	✓
70	'88 – '98 Ford Aerostar 2WD	1.10	✓	✓	✓	✓
74	'88 – '02 Chevrolet Astro 2WD	1.12	--	✓	--	--
53	'89 – '98 Chevrolet/Geo Tracker 4WD	1.13	--	✓	--	--
91	'88 – '98 Chevrolet K1500 p/u 4WD	1.14	--	--	--	--
88	'93 – '97 Ford Ranger p/u 2WD	1.17	--	✓	--	✓
85	'97 – '02 Ford F-150 p/u 2WD	1.18	--	--	--	--
54	'97 – '01 Honda CR-V 4WD	1.19	✓	✓	--	✓
83	'88 – '96 Ford F-150 p/u 2WD	1.19	--	--	--	--
67	'88 – '95 Dodge Caravan / Plymouth Voyager 2WD	1.21	--	--	--	--
90	'88 – '98 Chevrolet C1500 p/u 2WD	1.22	--	--	--	--
68	'96 – '00 Dodge Caravan / Plymouth Voyager 2WD	1.23	--	--	--	--
73	'95 – '98 Ford Windstar 2WD	1.24	--	--	--	--
22	'95 – '01 Chevrolet / Geo Metro	1.29	--	--	--	--
19	'88 – '94 Chevrolet Cavalier	1.32	--	--	--	--
18	'91 – '96 Chevrolet Caprice	1.40	--	--	--	--
7	'88 – '95 Ford Taurus	1.45	--	--	--	--
26	'92 – '95 Honda Civic	1.48	--	--	--	--

Total Tip-ups			6	11	3	7
----------------------	--	--	----------	-----------	----------	----------

were performed because, for some vehicles, the methods used to calculate the steering inputs used in the J-Turn and/or Fishhook maneuvers can produce “excessive” steering—steering angles so great that maneuver severity is actually reduced (i.e., the lateral force capability of the tires is exceeded). As an example, consider the Ford Ranger 4WD and Aerostar. These vehicles required a reduction of the J-Turn steering scalar from 8.0 to 7.0 (Ranger 4WD) or 6.0 (Aerostar) before J-Turn steering was able to produce two-wheel lift.

During some Fishhook tests, excessive steering caused some vehicles to reach their maximum roll angle response to the initial steering input before it had been fully completed (this is essentially equivalent to a “negative” T_1 in Figure 2). Since dwell time duration can have a significant effect on how the Fishhook maneuver’s ability to produce two-wheel lift, we believe that excessive steering may stifle the most severe timing of the counter steer for some vehicles. In an attempt to better insure high maneuver severity, a number of vehicles that did not produce two-wheel lift with steering inputs calculated with the 6.5 multiplier were also tested with lesser steering angles by reducing the multiplier to 5.5. This change reduced the likelihood of excessive steering, and increased the dwell times observed during the respective maneuvers. In the case of the Ford Ranger 4x2, Fishhook maneuvers with steering inputs based on the reduced multiplier were able to produce two-wheel lift. Such lift was not observed when the original steering was used (i.e., when a multiplier of 6.5 was used). We have modified the Fishhook test procedure to include tests at the steering angle determined by the 5.5 multiplier for vehicles that do not tip up using the original steering angle determination.

Each test vehicle in Table 1 represented a generation of vehicles whose model year range is given. Twenty-four of the vehicles were taken from 100 vehicle groups whose 1994-98 crash statistics in six states were the basis of the present SSF based rollover resistance ratings. The vehicle group numbers used to identify these vehicles in the prior notices (65 FR 34998 and 66 FR 3388) are given for convenience. The nominal SSFs used to describe the vehicle groups in the prior statistical studies are given. While there were some variations between the SSFs of the individual test vehicles and the nominal vehicle group SSF values, the nominal SSFs were retained for the present statistical analyses because they represent vehicles produced over a wide range of years in many cases and provide a simple comparison between the risk model presented in this notice and that discussed in the previous notices.

The check marks under the various test maneuver names indicate which vehicles tipped up during the tests. Eleven of the twenty-five vehicles tipped up in the Fishhook maneuver conducted in the heavy condition. The heavy condition represented a five-occupant load for all vehicles except the six mentioned above that were limited to a four-occupant load by the vehicle seating positions and GVWR. All eleven were among the sixteen test vehicles with SSFs less than 1.20. None of the vehicles with higher SSFs tipped up in any test maneuver. The fishhook test under the heavy load clearly had the greatest potential to cause tip-up. The groups of vehicles that tipped up in other tests were subsets of the larger group of eleven that tipped up in the fishhook heavy test. There were seven vehicles in the group that tipped up in the J-Turn heavy test, six of which also tipped up in the Fishhook light test. The J-Turn light test had the least potential to tip up vehicles. Only three vehicles tipped up, all of which had tipped up in every other test.

VI. Rollover Risk Model

In its study of our rating system for rollover resistance (Transportation Research Board Special Report 265), the National Academy of Sciences (NAS) recommended that we use logistic regression rather than linear regression for analysis of the relationship between rollover risk and SSF. Logistic regression has the advantage that it operates on every crash data point directly rather than requiring that the crash data be aggregated by vehicle and state into a smaller number of data points. For example, we now have state data reports of about 293,000 single-vehicle crashes of the hundred vehicle make/models (together with their corporate cousins) whose single-vehicle crashes we have been tracking in six states. The logistic regression analysis of this data would have a sample size of 293,000, producing a narrow confidence interval on the repeatability of the relationship between SSF and rollover rate. In contrast, the linear regression analysis operates on the rollover *rate* of the hundred vehicle make/models in each of the six states. It produces a maximum sample size of only 600 (100 vehicles times six states) minus the number of samples for which fewer than 25 crashes were available for determining the rollover rate (a data quality control practice). Confidence limits computed for a data sample size of 600 will be much greater than those based on a sample size of 293,000. On average, each sample in the linear regression analysis was computed from over 400 crash report samples. However, ordinary techniques to compute the confidence intervals of linear regression results do not take into account the actual sample size represented by aggregated data. The statistical model created to combine SSF and dynamic test information in the prediction of rollover risk was computed by means of logistic regression as recommended by the NAS. Logistic regression is well suited to the correlation with crash data of vehicle properties that

include both continuous variables like SSF and binary variables like tip-up or no tip-up in maneuver tests.

We had previously considered logistic regression during the development of the SSF based rating system (66 FR 3388, January 12, 2001, p.3393), but found that it consistently under-predicted the actual rollover rate at the low end of the SSF range where the rollover rates are high. The NAS study acknowledged this situation and gave the example of another analysis technique (non-parametric) that made higher rollover rate predictions at the low end of the SSF scale. In the NPRM, we discussed our plan to first examine ways to improve the fit of the logistic regression model to the actual rollover rates in the simpler model with SSF as the only vehicle attribute before expanding the logistic regression model to predict rollover rates using maneuver test results and SSF as vehicle attributes. In this way, the addition of maneuver test results is more likely to have an effect that reflects the additional information they represent on rollover causation.

Appendix II discusses the details of seeking a mathematical transformation of SSF to improve the accuracy of logistic regression models. We found that logistic regression on the transformation “ $\text{Log}(\text{SSF} - 0.9)$ ” rather than on SSF directly computed a risk model whose predictions of rollovers per single-vehicle crash more closely matched the relationship between vehicle SSF and actual rollover rates observed in state crash data. We sought to optimize the accuracy of the predictions in the SSF range between 1.0 and 1.25 that includes the vehicles with the highest rollover rates, even at the expense of accuracy in predicting the low rollover rates at high end of the SSF scale. The risk model that resulted from this exercise is equivalent to the SSF-based rating system used for 2001-2003 NCAP rollover resistance ratings except that it was computed using logistic regression rather than linear regression as the statistical technique.

Figure 3 compares the logistic regression model and linear regression model formerly used for NCAP ratings. The linear regression model is not in the form of a straight line because it also operated on a transformation of SSF (Log(SSF) in this case). The logistic regression model is the more accurate at lower half of the SSF range, and the linear regression model is the more accurate at the upper half of the SSF range. The two curves are quite similar.

A good logistic regression risk model using SSF only was the starting point for models using dynamic variables together with SSF. The dynamic maneuver test results (tip-up or no tip-up in each maneuver/load combination in Table 1) were used as four binary dynamic variables in the logistic regression analysis. The dynamic variables were entered in addition to SSF to describe the vehicle. The same driver and road variables from state crash reports discussed above were used. The state crash report data for twenty four of the vehicles used in the logistic regression analysis with dynamic maneuver test variables was a subset of the database of 293,000 single-vehicle crashes described above. One extra vehicle was added for the maneuver tests that was not among the 100 vehicle groups we had studied previously, but state crash report data from the same years and states was obtained for it. However, the database with SSF and dynamic maneuver test was much smaller than the 293,000 sample size available for the logistic regression model with SSF only. Its sample size was 96,000 single-vehicle crashes of 25 vehicles including 20,000 rollovers. Appendix II contains a more detailed discussion.

First, we tried each dynamic variable separately in conjunction with SSF. The models using variables for performance in the Fishhook heavy and J-Turn heavy maneuvers predicted a greater rollover risk for those vehicles that tipped up in the maneuver test. However, the models using variables for performance in the Fishhook light and J-Turn light maneuvers predicted a greater rollover risk for vehicles that did not tip up.

We do not believe vehicles that tip up in the least severe maneuvers are actually safer than those that do not tip up. A more rational interpretation is that the numbers of vehicle tipping up in these maneuvers were too few to establish a definitive correlation. Only three vehicles tipped up in the J-Turn light maneuver, and six vehicles tipped up in the Fishhook light maneuver. Only one more vehicle tipped up in the J-Turn heavy maneuver than in the Fishhook light, and the prediction of the model with J-Turn heavy was consistent with expectations that tip-up in the test predicts greater rollover risk. However, the extra vehicle in the J-Turn heavy tip-up group was the Ford Ranger 2 WD with a very large sample size of over 8,000 single-vehicle crashes (nearly 10 percent of the entire data base).

Next we computed a logistic regression model combining SSF with the dynamic variables for both maneuvers, Fishhook heavy and J-Turn heavy, that were observed to have a directionally correct result when entered into the model individually. The variable for J-Turn heavy was rejected by the logistic regression program as not statistically significant in the presence of the Fishhook heavy variable. In other words, the predictions based on tip-up in the Fishhook heavy maneuver do not change whether or not the vehicle also tips up in the J-Turn heavy maneuver.

Figure 4 shows the final model that uses Fishhook heavy as the only necessary dynamic variable. This model has a risk prediction for vehicles that tip up in the dynamic maneuver tests based on the greatest number of vehicles possible in our 25 vehicle data base. All 11 vehicles that tipped up in any maneuver are represented on the tip-up curve, and the 14 vehicles without tip-up are represented on the other curve. The risk curve in Figure 4 representing vehicles that tipped up in the Fishhook heavy maneuver is very similar to the logistic regression model based on SSF only in Figure 3 (that was based on the rollover rates of 100 vehicles). This result is

logical because the SSF only model was optimized for best fit in the 1.00 to 1.25 SSF range that included all vehicles tipping up in dynamic maneuver tests. Also, the fact that the risk curve of the logistic regression model in Figure 3 that was based on the SSF of 100 vehicles closely matches the risk curve in Figure 4 that was based on 11 vehicles that tipped up in the dynamic tests suggests that the curve in Figure 4 is robust. However, the small difference in Figure 4 between the risk curve for vehicles that tip up in the dynamic test and the risk curve for those that do not tip up suggests that the predictive power of tip-up in the dynamic test may not be great.

Our testing and logistic regression analysis was sufficient to assign a greater rollover risk to vehicles that tipped up in the most severe maneuver than to those that did not tip up at all. However, the extra risk was small, and we were not able to distinguish a rollover risk difference between vehicles that tipped up in the less severe Fishhook maneuver with a two occupant load from those that tipped up only with a five occupant load. In general, vehicles that tip up in the Fishhook maneuver with a two occupant load also tip up at a slower entry speed in the Fishhook maneuver with a five occupant load than those that do not. Therefore, our data does not allow us to distinguish rollover risk differences between vehicles on the basis of maneuver entry speed for tip-up. The objective of using different load conditions and different maneuvers instead of different speeds in a single maneuver to provide a range of test severity was to reduce the sensitivity of the result to extraneous factors such as tire wear.

It is noteworthy that the final rollover risk model required results from only the fishhook maneuver. This is an advantage from the standpoint of minimizing the practical problems of the effects of tire wear during a test series and of deviations from uniformity of surface friction at a test facility. The fishhook maneuver produces less wear on the test tires and requires only about

2 or 3 lane widths of uniform test surface versus 10 or more lane widths for the J-Turn maneuver. The commenters also considered it more representative of a real driving situation than the J-Turn.

VII. Comments to the NPRM Notice and Agency Response

We received 39 comments to the NPRM notice from vehicle manufacturers, equipment suppliers, test labs, public interest groups, the National Transportation Safety Board, the Insurance Institute for Highway Safety, attorneys, and members of the public. Mainly, the comments addressed whether the static and dynamic measurements should be used for separate ratings of rollover resistance or for a combined rating based on a risk model. The nature of the dynamic maneuver tests, testing of 15-passenger vans, and several practical testing issues such as the extraneous effects of tire wear, surface condition and ambient temperature were also addressed. The notice also introduced the related subject of handling ratings that was not part of the TREAD Act requirements. We received a number of valuable comments on handling tests, and we are still soliciting information. However, the subject of this notice is confined to the TREAD Act requirements for dynamic rollover ratings.

A. Combined or Separate Rollover Resistance Ratings

The main question posed in the NPRM notice was whether the rollover resistance ratings should reflect the combined statistical power of SSF and dynamic tests for predicting rollover risk or whether ratings of rollover risk using SSF alone should continue, supplemented with a qualitative comparison of dynamic test performance. The notice gave alternative A as a risk model determined by logistic regression analysis of state crash reports of single-vehicle crashes

for about 25 vehicles with known SSF and dynamic test results. That process led to the risk model described in Section VI, however the mathematical calculation of the model could not be performed until the completion of a lengthy dynamic test program. Alternative B in the notice was a continuation of rollover risk prediction using SSF-only plus qualitative separate dynamic scores of A, B, C, D, or E signifying the number of maneuvers in which the vehicle tripped up without a risk interpretation.

Commenters representing TRW Automotive, National Automobile Dealers Association (NADA), General Motors (GM), Alliance of Automobile Manufacturers (Alliance), Association of International Automobile Manufacturers (AIAM), Insurance Institute for Highway Safety (IIHS), Bosch, Consumers Union, Advocates for Highway and Auto Safety (Advocates), Toyota, Continental-Teves and Public Citizen remarked directly on the question of combined versus separate use of SSF and dynamic maneuver tests in rollover resistance ratings. Except for Continental-Teves and Bosch, the commenters were in favor of ratings that combined the SSF and dynamic maneuver tests in a single rating. Consumers Union specifically supported the logit risk model operating on a moderate risk scenario (in which rollover rates vary in the approximate range of 0.075 to 0.55 across the range of vehicles) as a way of combining the SSF and dynamic maneuver tests. It commented that using the risk model it described was consistent with the recommendations of the NAS study. We believe the risk model we have developed is consistent with recommendation of NAS and Consumers Union. It is the logit model with the risk scenario (of demographic and road condition variables) that represents the average crash conditions of 293,000 actual single-vehicle crashes. It produces predicted rollover rates in the range of 0.09 to 0.50 for vehicles ranging from tip-up to no tip-up in maneuvers and from 1.0 to 1.55 in SSF.

The other commenters in favor of combined ratings were primarily concerned that separate ratings would be too confusing to serve as consumer information. They believed a combined rating was the only viable option, but they did not comment specifically on the means used by NHTSA to develop the combined risk model. IIHS and the Alliance (along with Carr Engineering) suggested that another comment period following the notice containing the actual model (as opposed to the example given in the NPRM notice) would be necessary. GM suggested that the risk model be developed through a collaborative effort along the lines of the Motor Vehicle Safety Research Advisory Committee, and the Alliance suggested a working-level dialog between NHTSA and the auto industry to develop the risk model. TRW supported a single rating that would be computed on the basis of the SSF only model with a predetermined number of stars added or subtracted for dynamic maneuver performance (determined without a statistical relationship to risk). Advocates expressed wariness that the combined rating could be misleading to consumers unless it corresponded to real-world rollover rates. Public Citizen preferred the combined rating developed from a risk model. It was concerned that consumers would focus more attention on the dynamic maneuvers in separate ratings although the tests represent an event (on-road untripped rollover) that occurs in less than 5 percent of actual rollover crashes.

Continental-Teves and Bosch prefer separate ratings for SSF and dynamic maneuver tests. Continental-Teves stated that “the relative effects of SSF and dynamic performance are not well understood, and may not be the same for every vehicle or every driver.” Bosch stated that “static and dynamic ratings should be separate, as they are both equally important with regards to indicating stability and safety of the vehicle.” Bosch further explained that “a combined rating may not adequately show the influence of such systems [Electronic Stability

Control and Rollover Mitigation] which in turn would not encourage manufacturers to add systems to vehicles that increase overall vehicle safety in potential rollover as well as many other situations.”

B. Crash Avoidance Technologies

Some of the stated expectations of the commenters about rollover resistance ratings are unrealistic. The rollover resistance ratings predict the likelihood of a single-vehicle crash becoming a rollover. They do not predict the likelihood of the vehicle becoming involved in a single-vehicle crash. Similarly, the frontal and side NCAP crashworthiness ratings do not predict the likelihood of the vehicle striking an object head-on or being struck from the side. The Alliance comment anticipates the dilemma. While conceding that SSF is strongly correlated with a tripped rollover once the vehicle is already off-road, it states that “ the likelihood of being involved in a single-vehicle crash in the first place – particularly one involving off-road excursion – is influenced much more by demographic and environmental influences than is the scenario examined for SSF purposes.” The scenario used in the combined risk model is the same scenario used in the SSF model, namely the average demographic and environmental variables reported by the states for the entire 293,000 single-vehicle crash data base we have collected. We think this is the best scenario to characterize single-vehicle crashes.

The Alliance is concerned that our model “may fail to account for potentially beneficial technologies for avoiding single-vehicle and rollover crashes, such as electronic stability control and variable ride high suspension systems.” Its concern is unnecessary for variable ride-height suspension systems, which will be tested in the highway rather than off-road height for both SSF

and dynamic maneuver tests, and the technology will certainly improve the rating of vehicles so equipped.

However, the Alliance is right that the model does not predict the risk of a single-vehicle crash. NHTSA has been very clear in public notices, consumer information and web site presentations that neither the SSF risk model nor the proposed combined SSF and dynamic maneuver risk model predict the risk of having a single-vehicle crash. From the standpoint of rollover resistance, single-vehicle crashes are a measure of exposure. The prediction is of the risk of a rollover resulting from the exposure of the vehicle to a single-vehicle crash. The risk of rollover in the event of a single-vehicle crash is strongly influenced by vehicle properties, but the vehicle properties of modern vehicles have far less influence in comparison to demographic and environmental factors regarding the risk of a single-vehicle crash in the first place. However, electronic yaw stability control may provide a real-world reduction in single-vehicle crashes.

We have been optimistic about the potential of electronic yaw stability control to reduce single-vehicle crashes. NHTSA's consumer information identifies its availability as standard or optional equipment on individual vehicles and explains how it operates to help a driver maintain control in extreme circumstances. One of the reasons we are exploring the possibility of NCAP handling ratings is to describe the effect of yaw stability control on handling predictability. However, the technology has not been in widespread use long enough to produce much crash evidence for the evaluation of its real-world effectiveness in preventing single-vehicle crashes. Our previous attempts at evaluating its effectiveness were thwarted by insufficient data.

Part of the motivation for the NAS study of NHTSA's SSF-based rollover resistance ratings was the Alliance's concern that yaw stability control was not being considered. In its public oral presentation to the NAS study committee in May 2001, NHTSA said it did not expect

yaw stability control to have a large effect on the risk of rollover given a single-vehicle crash.

In its view, the large majority of rollovers were the result of various types of tripping, and SSF represented the most important vehicle attributes in those circumstances. NHTSA believes that the greatest potential effect of yaw stability control was in reducing single-vehicle crashes in the first place. Therefore, we suggested to the committee that rather than trying to predict rollovers per single-vehicle crash with dynamic maneuver tests, we should keep SSF for that purpose and adjust the comparative risk for vehicles with yaw stability control by the effect of yaw stability control to reduce exposure to single-vehicle crashes. However, establishing the effectiveness of yaw stability control would require data not available for at least two or three more years. Neither the NAS committee nor the Alliance, which was active in providing the committee information, expressed interest in this suggestion. But the present comments indicate that finding a way to include the crash avoidance potential of yaw stability control is a principal concern of the Alliance and several suppliers of these systems.

IIHS's comment also shows an expectation of more than what is possible for a rollover resistance rating. It discusses a comparison of the 1997 Jeep Grand Cherokee and 1997 Toyota 4Runner made in one its reports. In that report, the Toyota had four times the number of fatal rollovers per 100,000 registered vehicles as the Jeep, but they had very similar SSFs. They also had very similar rollover rates in terms of rollovers per single-vehicle crash that were consistent with their SSFs. IIHS expects a good dynamic rating to show a large difference between the Grand Cherokee and the 4Runner. That will not be possible because differences in dynamic maneuver test performance predict only small differences in rollover rate, and, in fact, there is not a large difference in rollover rate between these vehicles in terms of rollovers per single-vehicle crash in our six state crash data base. The difference is in the definition of rollover rate.

A rollover rate in terms of fatal rollovers per 100,000 vehicles depends on the rate of single-vehicle crashes per 100,000 vehicles and on the occurrence of a fatality in the rollover as well as on the rate of rollover per single-vehicle crash. The first two of these factors depend primarily on demographic and environmental influences and can mask actual differences or similarities between vehicles as in this case. Neither vehicle had yaw stability control, which would have created a plausible vehicle-related difference in single-vehicle crash rate. The difference in fatality rate could involve crashworthiness features, or particularly in the case of rollover, it could merely reflect the seat belt wearing habits of a risk taking demographic that also experienced a higher rate of single-vehicle crashes. The rate of rollovers per single-vehicle crash is much less sensitive to demographic influences than is the rate of fatal rollovers per 100,000 vehicles.

Carr Engineering and Suzuki commented that the agency was not following the recommendations of the NAS study by performing J-Turn and Fishhook maneuver tests. They believe that the NAS recommended handling tests to assess loss of control potential rather than limit maneuvers to assess the resistance of the vehicle to actual on-road tip-up. We agree that the language of the NAS study report is somewhat ambiguous. That is why we included in our NPRM notice the clarification the NAS study panel gave us during the presentation of the report to NHTSA in response to our direct questions about J-Turn and Fishhook tests versus handling tests. The NAS study committee clarified that it envisioned dynamic maneuver tests as limit maneuvers where loss of control and actual on-road vehicle tip-up can be expected for vulnerable vehicles. The NAS study panel stated it was not in a position to recommend a specific test because that would require study of discriminatory capability, repeatability and other properties, but J-Turns and Fishhooks were of the type of tests it had in mind. Two outside

experts in vehicle dynamics and testing reviewed our test plan before the Phase VI test of the 25 vehicles. One had been a member of the NAS study committee. Once again, we were assured that our tests were consistent with the NAS recommendations.

We believe that both our test selection and our analysis method of developing a rollover risk model to combine SSF and dynamic test results are entirely consistent with the recommendations of the NAS study and therefore appropriate to satisfy the requirements of the TREAD Act. We agree that it is important to inform consumers of the effectiveness of yaw stability control in reducing single-vehicle crashes, and we will determine its effectiveness from crash report data as sufficient data becomes available.

C. The J-Turn and Fishhook Maneuvers

There were a number of comments regarding the J-Turn and Fishhook test protocols from the Alliance, GM, Toyota, Honda, Nissan, Renfroe Engineering, Carr Engineering, Mechanical Systems Analysis Inc, and Automotive Testing Inc. In addition, Ford made a detailed presentation elaborating on some of the subjects introduced in the Alliance comment. The Ford presentation material was placed in Docket NHTSA-2001-9663.

A number of the commenters objected to the J-Turn maneuver because they thought it was not representative of real driving, involved too fast a steering movement, or was redundant. Since its results were not used in the risk model, we agree that it is redundant. As a result, we are no longer planning to use it in the NCAP testing program.

Except for Suzuki, Carr Engineering and Ford, those who commented on the maneuver tests supported the Fishhook maneuver. Carr Engineering and Advocates objected to calling the Fishhook maneuver a road edge recovery test as we had done in the NPRM notice. While the

Fishhook maneuver includes steering commands like a crash involving road edge recovery, it is performed on a smooth uniform surface instead of one with vertical drop-offs and friction coefficients differences that exist at road edges. To accommodate these concerns, we will refer to the maneuver as the Fishhook.

D. Tire Wear

The effect of tire wear on test results and the tire changing protocol was addressed by several commenters. Tire shoulder wear during limit maneuver tests is much more severe than in ordinary driving and has the effect of increasing the lateral acceleration capability of the vehicle. After a number of tests, the tire wear causes the vehicle to tip up more easily, and there is concern that a vehicle with test-worn tires does not represent a typical street driven vehicle. In the 25 vehicle test, new tires were used for each maneuver (FH, FL, JH, JL) which limited the tires to no more than 6 runs in each direction (4 for Fishhooks) before detecting tip-up if it occurred.

Ford gave an example using a Ford Ranger 4WD that was apparently known to tip up at 53 mph with worn tires in a J-Turn test. The vehicle was equipped with new tires and tested repeatedly at 53 mph. It did not tip up during the first three runs, but during the fourth run a large increase in lateral acceleration and sideslip angle occurred and the vehicle tipped up. It continued this behavior for two subsequent runs, and the tires exhibited a large amount of shoulder wear after only six runs. We have noticed similar tire wear effects, but not in so few runs. The J-Turn tests are of much longer duration than Fishhook tests and produce more wear per run. Also tests run at lower speeds approaching tip-up speed produce less wear than tests performed at a higher speed just below the tip-up speed. Ford's example of a worst case in

which the tire wear of just three runs changed vehicle behavior from no tip to tip-up is an effective illustration of the tire wear problem.

We believe this problem is much less acute for Fishhook tests. We performed a similar experiment using a 2001 Ford Explorer 4 door 4WD that we knew would tip up at 40 mph on worn tires in a Fishhook maneuver. We performed 18 test runs without tip-up and then experienced a 20 degree tip-up against the outriggers on the nineteenth run. We performed three more runs and experienced two more tip-ups. Renfroe Engineering also commented about tire wear effects citing an UMTRI study in which lateral tire forces remained steady for about 10 runs and then increased to a maximum force at about 20 runs.

Ford suggested a tire change protocol to limit tire wear. We intend to test a number of vehicles in the summer of 2003. During these tests we will use the tire change protocol of Appendix I because we believe this appropriately limits the effect of tire wear. However, we intend to confirm tip-ups using new (broken in but not worn) tires when appropriate to make sure that the vehicle scores have not been affected by tire wear. We will consider the results of this exercise in deciding whether any changes in the tire change protocol are necessary.

E. Pavement Temperature

The Alliance and Toyota commented on the potential effect of pavement temperature on Fishhook maneuver results. Toyota has observed increases in pavement friction as an apparent consequence of increases in pavement temperature. It also supplied a computer simulation of Fishhook tests that showed a large decrease in the speed at tip-up with increases in surface friction. Taken together, Toyota's information predicts a decrease in tip-up speed in a Fishhook maneuver of over 15 mph for a 70 degree F increase in pavement temperature. While the risk

model for ratings does not depend on tip-up speed, the temperature effects predicted by Toyota would prevent most of the vehicles that tipped up in a summer test from having tip-up in a winter test. NHTSA ran a number of tests to evaluate the temperature sensitivity of J-Turn and Fishhook tests (NHTSA Technical Report “Testing to Determine the Effects of Ambient Temperature on Dynamic Rollover Testing”, docketed with this notice). We tested the 2001 Toyota 4Runner 4WD (with and without yaw stability control enabled) and the 2001 Chevrolet Blazer 2WD on the same test track during cold, moderate and hot ambient temperature. The difference between cold and hot ambient temperature was about 60 degrees F. We do not have pavement temperatures, but there is no reason to believe that the range of pavement temperature is less than the range of ambient temperature. The whole test procedure including the determination of handwheel angles based on the 0.3g steady state curve was repeated at each temperature. The results are given in Table 2. Every test that failed to cause tip-up in cold weather also failed to cause tip-up in hot weather, and the two tests that caused tip-up in hot weather also caused tip-up in cold weather. Thus, the temperature effect predicted by the commenters did not occur. The tip-up speeds for the Blazer in the right and left Fishhooks repeated to within 1 mph despite differences in ambient temperature of 60 degrees F, seasonal differences in pavement surface, and the use of three different sets of tires. The only temperature

Table 2. Results from NHTSA J-Turn and Fishhook Tests at Various Ambient Temperature Conditions.

Test Vehicle and Configuration	Test Maneuver	Test Condition	Ambient Temperature (°F)	Commanded Handwheel Angle (degrees)	Initial Steer Left			Initial Steer Right		
					Wheel Lift, Front/Rear (inches)		Maneuver Entrance Speed (mph)	Wheel Lift, Front/Rear (inches)		Maneuver Entrance Speed (mph)
					Front	Rear		Front	Rear	
Toyota 4Runner,	NHTSA J-Turn ¹	Cold	30	345	0	0	62.1	0	0	61.7

		Moderate	79	354	0	0	60.4	0	0	60.0
		Hot	87	358	0	0	61.8	0	0	60.3
	Fishhook ²	Cold	32	280	1	0	51.1	0	1	51.7
		Moderate	74 – 73	287	0	0	48.0	0	0	48.5
		Hot	89	290	1	0	51.4	0	0	50.8
Toyota 4Runner, VSC enabled	NHTSA J-Turn ¹	Cold	28	345	0	0	61.8	0	0	62.4
		Moderate	75	354	0	0	59.4	0	0	58.2
		Hot	90	358	0	0	61.9	0	0	61.6
	Fishhook ²	Cold	31	280	0	0	51.3	0	0	51.7
		Moderate	72	287	0	0	48.8	0	0	50.1
		Hot	90	290	0	0	50.7	0	0	51.3
Chevrolet Blazer	NHTSA J-Turn ^{1,3}	Cold	29	381	5 – 8	5 – 8	58.0	5 – 8	5 – 8	54.8
		Moderate	83	401	0	0	60.9	0	0	62.2
		Hot	86	392	0	0	60.3	0	0	59.4
	Fishhook ^{2,3}	Cold	30	309	5 – 8	5 – 8	40.2	2 – 3	2 – 3	39.1
		Moderate	74	326	3 – 4	3 – 4	40.3	4 – 5	4 – 5	40.1
		Hot	90	319	2 – 3	2 – 3	39.4	2 – 3	2 – 3	38.8

¹NHTSA J-Turn maximum nominal entrance speed was 60 mph

²Fishhook maximum nominal entrance speed was 50 mph

³Two-wheel lift ≥ 2 inches was observed during tests highlighted in **bold**

effect observed was that the Blazer tipped up in the J-Turn in cold weather but did not in the moderate and hot weather tests. This is the opposite of the temperature effect predicted by the commenters and occurred during a maneuver we no longer intend to use. We do not think it is necessary to set tight surface temperature limits on the test protocol as suggested by the commenters.

F. Surface Friction

A practical problem for the repeatability of any limit maneuver test is the possibility that the surface friction properties of the test track will change. Ford commented that computer

simulations of several of its SUVs showed that a change in surface coefficient of 0.05 would change the tip-up speed in a fishhook test by as much as 12 mph in one example (6 mph and 4 mph respectively for two other example vehicles). It also commented that a seasonal variation in surface coefficient of 0.05 could be typical of test tracks, and that its own test track exhibited a long-term trend of an increase in coefficient of 0.02 per year (which would change the tip-up speed of the first example vehicle by 8 mph in Ford’s simulation). Ford’s simulations are even more pessimistic than Toyota’s regarding the possibility of repeatable Fishhook tip-up speeds given normal variations in surface properties and temperatures. However, we have not observed these large variations in tip-up speed in actual tests. The very close repeatability of tip-up speed for the Blazer in Table 2 extended over likely seasonal changes in the pavement as well as changes in ambient temperature.

Additionally, NHTSA performed a study using the same 4Runner and Blazer mentioned above for J-Turn and Fishhook tests at Daimler Chrysler’s Arizona Proving Grounds (APG) and General Motors Desert Proving Grounds (DPG) as well as TRC of Ohio, where our maneuver test development has been conducted (NHTSA Technical Report “Testing to Determine the Effects of Surface Variability on Dynamic Rollover Testing”, docketed with this notice). Table 3 shows the peak and slide braking coefficients (multiplied by 100) measured at these facilities.

Table 3. Friction Numbers for all Test Facilities

Test Facility	Peak Braking Coefficient		Skid Number	
	Dry	Wet	Dry	Wet
TRC	94 – 96	69 - 83	81 – 84	47 - 54
DPG	86 – 93	74 – 77	83 – 85	60 - 64
APG	90 – 93	75 – 80	81 – 84	56 - 59

Table 4 shows the results of the maneuver tests. As in Table 2, the vehicles were loaded with the equivalent of a 2-occupant load, like the light load condition of the 25 vehicle test. The 4Runner did not tip up at TRC and it did not tip up at the other facilities. The Blazer did not tip up in the J-Turn at TRC, but it did at the other facilities. We do not think that this is a result of the surface coefficient of friction (due to the similarities of the ranges) but rather due to the greater degree of vertical irregularities and pavement cracks at DPG and APG than at TRC. Tip-up is often triggered by vertical oscillations of the vehicle suspension during high cornering forces in maneuver tests. DPG had the most vertical surface irregularities that caused the Blazer to tip up most easily. The Blazer tipped up in the Fishhook at TRC, and it also tipped up in the Fishhook at the other facilities. Again, the tip-up speeds were lower at APG and DPG, which would be expected due to the greater surface irregularities.

Table 4. Results from NHTSA J-Turn and Fishhook tests

Test Vehicle and Configuration	Test Maneuver	Test Facility	Commanded Handwheel Angle, deg	Initial Steer Left		Initial Steer Right	
				Moderate or Major Lift Yes / No	Maneuver Entrance Speed, mph	Moderate or Major Lift Yes / No	Maneuver Entrance Speed, mph
Toyota 4Runner, VSC enabled	NHTSA J-Turn ¹	TRC	354	No	58.21	No	59.29
		DPG	402	No	61.56	No	61.21
		APG	362	No	61.68	No	62.11
	Fishhook ²	TRC	287	No	48.75	No	50.13

Formatted Table

Test Vehicle and Configuration	Test Maneuver	Test Facility	Commanded Handwheel Angle, deg	Initial Steer Left		Initial Steer Right	
				Moderate or Major Lift Yes / No	Maneuver Entrance Speed, mph	Moderate or Major Lift Yes / No	Maneuver Entrance Speed, mph
		DPG	327	No	53.05	No	50.94
		APG	294	No	52.63	No	51.44
Toyota 4Runner, VSC disabled	NHTSA J-Turn ¹	TRC	354	No	60.4	No	60.00
		DPG	402	No	60.97	No	61.63
		APG	362	No	62.38	No	62.27
	Fishhook ²	TRC	287	No	49.84	No	49.79
		DPG	327	No	52.20	No	51.93
		APG	294	No	51.04	No	51.14
Chevrolet Blazer	NHTSA J-Turn ¹	TRC	401	No	60.90	No	62.27
		DPG	382	Yes	49.80	Yes	44.90
		APG	395	Yes	57.36	Yes	58.68
	Fishhook ²	TRC	326	Yes	40.32	Yes	40.09
		DPG	311	Yes	37.80	Yes	38.01
		APG	321	Yes	35.52	Yes	38.54

Formatted Table

¹NHTSA J-Turn maximum nominal entrance speed is 60 mph ²Fishhook maximum nominal entrance speed is 50 mph

We recognize the potential difficulties caused by changes in surface friction coefficient, and we have tried to minimize them. We have observed the Fishhook maneuver to be less sensitive to surface conditions than the J-Turn, and we have used changes in vehicle load condition rather than changes in tip-up speed to signify degrees of test severity in a way least likely to be influenced by surface coefficient. None of the changes of pavement and temperature in our test experience has caused a change in the Fishhook result (tip-up or no tip-up) for a

vehicle. We believe the comments based on computer simulation overstate the sensitivity observed in our actual tests.

G. Steering Reversal

Honda commented that using a roll rate measurement within 1.5 degrees/sec of a zero crossing as shown in Figure 2 to trigger the reverse steering in a fishhook maneuver occasionally leads to an unusually long dwell time (T_1) for certain vehicles at certain load conditions. It suggested setting a default value for dwell time to force a reverse steering action if the absolute value of the vehicle roll rate stayed too long at a value that was very low but not low enough to trigger reversal. It explained that tests in which excessive dwell times occurred would be less severe and possibly not cause a tip-up that would have occurred with a shorter dwell.

Automotive Testing Inc. commented at length on the same phenomenon. It observed that the low but steady roll rate above 1.5 degrees/sec that can delay the triggering of steering reversal is a result of tire deflections continuing the roll motion of the whole vehicle after the point of maximum roll of the suspension system. It believes that a default trigger negates the design of the maneuver to let the vehicle motions select the steering response, but describes some ways of using filtering of the roll rate signal to cause the steering to trigger earlier in these cases. But it acknowledges that letting the vehicle react to the actual roll motion of the whole vehicle rather than to a roll signal distorted by signal processing may be preferable.

At this point we are preserving the consistent application of the fishhook steering algorithm. We do not believe that commenters have presented us a substantive reason to depart from this application. If the vehicle tips up despite a long dwell time, there is no change in test result. If the vehicle does not tip, it will be retested with a reduced steering angle according to

the current procedure, which may change the roll frequency harmonics and dwell time. We will observe the steering reversal dwell times during the first group of tests and, if necessary, reconsider the commenter's observations on this issue.

H. Fifteen-Passenger Vans

The National Transportation Safety Board, Public Citizen and others commented on the rollover issues surrounding fifteen-passenger vans. NHTSA agrees that it is important to investigate the commenters' concerns about the rollover susceptibility of fifteen-passenger vans. To do this, we will conduct an evaluation of fifteen-passenger vans' rollover susceptibility at different loading conditions and evaluate available electronic stability control systems on these vehicles.

I. Tip-up Criterion

Mechanical Systems Analysis, Inc. and several other commenters suggested that the tip-up criterion of 2 inches simultaneous wheel lift is too conservative. It recommended a criterion of 20 degrees body roll instead because suspension bouncing on test surface irregularities could influence performance under our criterion. Other similar recommendations were given for body roll angles between 15 and 20 degrees. The 2 inch wheel lift criterion is met at about 11 degrees of body roll on average.

NHTSA's tests were performed on a very smooth test area at TRC of Ohio. The tip-up criterion maximized driver safety and minimized tire wear by allowing us to increase speed in 5 mph increments with a reasonable expectation of avoiding sudden violent tip-ups that could 'pole-vault' the vehicle on its outriggers. However, we observed tip-ups at lower than expected

speeds during tests at other facilities (DPG and APG as described above) that were probably influenced by surface irregularity as described by the commenter. We believe that our tip-up criterion is appropriate for an excellent facility like TRC, but we agree that the criterion should be revisited if NCAP tests were to take place at a facility with a more irregular surface.

J. Testing of Passenger Cars v. Light Trucks

Consumers Union and IIHS recommended that we not test passenger cars in order to devote all the available time and resources for maneuver tests to light trucks. We agree that it is very unlikely that passenger cars will tip up in the maneuver test. We have tested passenger cars at the low end of the SSF range for passenger cars without observing any tip-ups. It seems reasonable to rate passenger cars using the “no tip-up” curve of the risk model along with SSF measurements. However, we prefer to track whether this continues to be true. Hence, we will continue to test a few passenger cars each year at the low end of the SSF range to reinforce the “no tip-up” assumption. Therefore, two passenger cars are listed in Table 5.

K. Testing with Stability Control Systems

Toyota suggested that NHTSA should selectively choose vehicles with optional equipment that assists the driver in controlling the vehicle such as electronic yaw stability control, while in a previous comment Honda suggested the opposite policy. Honda believed that even a vehicle with standard stability control should be tested with it turned off if the vehicle has an “off” switch. It has been NHTSA’s policy for rollover resistance ratings that we test vehicles most representative of those sold. Also, we are interested in the potential safety benefits of

electronic yaw stability control and have alerted consumers to its purpose and availability on individual models in our present consumer information. Therefore, when it is standard equipment or optional equipment found on the majority of vehicles of a particular model, we will test with stability control turned on and report that the test vehicle was so equipped. Also, if the market penetration of a stability control option is too low for NHTSA to choose it for inclusion on our test vehicle, we will consider optional NCAP tests at the manufacturer's expense.

VIII. Final Form for Rollover Resistance Ratings – Alternative I

A. Combined Ratings

NHTSA will use the statistical model shown in Figure 4 to combine the vehicle's SSF measurement and its performance in the Fishhook maneuver with 5-occupant loading as a prediction of its rollover rate per single-vehicle crash. The predicted rollover rate will be translated into a star rating in the same way used in the present rollover resistance ratings: one star for a rollover rate greater than 40 percent; two stars, greater than 30 percent; three stars, greater than 20 percent; four stars, greater than 10 percent; five stars, less than or equal to 10 percent.

The decision to combine the static (SSF) and the dynamic (maneuver test) vehicle measurements in a single rollover resistance rating is consistent with the view of most commenters that separate ratings would be confusing to consumers. It is also the best way of achieving NHTSA's goal of presenting risk-based ratings because it maximizes the vehicle information used to make the prediction of the rate of rollovers per single-vehicle crash. Those who favored separate static and dynamic ratings expressed concern that the influence of electronic stability control would be small in the combined rating. It is true that electronic

stability control will not have a great influence on rollover resistance ratings because the dynamic test result has less predictive power than the static measurement on rollover rate and the effect of electronic (yaw) stability control on the dynamic test is also modest. We believe that the potential benefit of electronic stability control lies in helping drivers to stay on the road and away from tripping devices rather than providing much increase in rollover resistance, especially regarding tripped rollovers. Rather than reduce the rate of rollovers in single-vehicle crashes, electronic stability control may reduce the number of single-vehicle crashes in the first place. However, its effectiveness in reducing single-vehicle crashes remains to be demonstrated by crash statistics.

For the present time, we will retain the use of five stars to express rollover resistance ratings. Focus groups consistently find that presentation understandable. However, the NAS and a number of commenters were in favor of presentations that are able to show smaller differences between vehicles, contrast the range of ratings between types of vehicles and show the relative position of a vehicle's rating among other vehicles of the same type. NHTSA is performing additional consumer research to determine the best approach to providing consumers with more detailed information to supplement the star ratings. Several presentation methods are being tested, and we will consider those test results and propose appropriate changes to how we present rollover information to consumers.

B. Dynamic Testing

The Fishhook maneuver test will be conducted according to the procedure in Appendix I, and we will discontinue the J-Turn maneuver test. This decision is a consequence of the logistic regression analysis of the crash data, SSF and results of the J-Turn and Fishhook tests at two

load conditions for 25 vehicles. From a statistical point of view, the J-Turn test results were redundant in the presence of the Fishhook test results. The J-Turn test also seems to be more sensitive to irregularities in pavement surface and friction and changes in ambient temperature than the Fishhook test. It also causes more concern about tire wear effects than the Fishhook, and it was criticized by some commenters as less representative of 'real-world' driving situations.

We have decided to change the heavy load condition from an anthropomorphic dummy (water dummy) in every rear seating position (along with the test driver and instruments of approximately a passenger weight in the front) to a standard load representing five occupants in all vehicles capable of at least that loading. During the test of the 25 vehicles, it became obvious that heavy load tests were being run at very unequal conditions especially between vans and other vehicles (two water dummies in some vehicles but six water dummies in others). While very heavy passenger loads can certainly reduce rollover resistance and potentially cause special problems, crashes at those loads are too few to greatly influence the overall rollover rate of vehicles. Over 94% of van rollovers in our 293,000 crash database occurred with five or fewer occupants, and over 99% of rollovers of other vehicles occurred with five or fewer occupants. The average passenger load of vehicles in our crash database was less than two: 1.81 for vans; 1.54 for SUVs; 1.48 for cars; and 1.35 for pickup trucks. In order to use the maneuver tests to predict real-world rollover rates rather than investigate possible poor performance at high occupancy levels, it is not useful to test the vehicles under widely differing loadings while there is much less loading variation represented in the crash statistics. Consequently, the maneuver test data used in the logistic regression analysis involving the 25 dynamic test vehicles in the

heavy load condition represented performance with a 5-occupant loading (obtained using three water dummies in the rear seating positions) for all vehicles capable of carrying at least that load.

The use of dynamic maneuver tests creates the need for a policy regarding tire de-beading. The tests are conducted using the tire pressure recommended by the vehicle manufacturer and labeled on the vehicle. We have experienced a number of instances in which the tire bead became unseated from the rim, resulting in total air loss and rim contact with the paved surface. This causes damage to the test facility and the possibility of a rollover of the test vehicle. For at least a year, we have been using inner tubes in all tires placed on rollover test vehicles. This action reduces the instances of total de-beading, but does not eliminate them entirely. In some instances, a tire with a tube that is not pinched during the process can experience a partial de-bead in which the rim makes contact with the pavement surface and then the tire becomes remounted on the rim by the pressure of the tube. It has been NHTSA's experience on the test track that if a maneuver results in rim contact without destroying the tube, the next run at a higher speed will destroy the tube and cause a complete de-beading of the tire and hard contact of the rim with risk to the driver, test surface and vehicle.

In the case of rim contact without total de-beading, it is a near certainty that total de-beading would have occurred without the tube, and total de-beading despite the tube is highly likely at the next speed increment. Thus, we consider rim contact to indicate de-beading, and it will be NHTSA's policy to terminate the test if rim contact with the pavement is observed even if the tube prevents total de-beading.

The vehicle did not actually tip up in the maneuver if the test is terminated as a result of rim contact indicating tire de-beading. However, de-beading is a bad outcome for the test because tire de-beading is associated with on-road tripped rollovers that actually outnumber on-

road untripped rollovers. Therefore, it would be improper to ignore tire debanding and predict the vehicle's rollover rate as if it had completed the test without tip-up or de-banding. The only alternative in the case of rim contact is to simply not compute a rollover resistance rating of the vehicle because the test was not completed. It will be reported that the dynamic test could not be completed because of tire debanding, but the SSF measurement will be retained in the detailed consumer information.

C. Demonstration Program

In April 2003, NHTSA's VRTC began the Demonstration Test program at TRC of Ohio using the test protocol of Appendix I for Fishhook maneuver tests of 18 new vehicles. Table 5 lists the vehicles in this group. We will verify tip-ups using new tires as explained in our answer to Ford's comments in Section VII. Unless we discover serious procedural problems, these vehicles will be given 2004 NCAP rollover resistance ratings according to the system established in this final notice.

Table 5. Vehicles included in Demonstration Test

	Make	Model	BodyStyle
1	Chevrolet	Silverado 4x2	PU ext. cab
2	Chevrolet	Silverado 4x4	PU ext. cab
3	Chevrolet	Trailblazer 4x2	4-dr Utility
4	Chevrolet	Trailblazer 4x4	4-dr Utility
5	Ford	Explorer 4x2	4-dr Utility
6	Ford	Explorer 4x4	4-dr Utility
7	Ford	Explorer SportTrac 4x2	4-dr Utility
8	Ford	Explorer SportTrac 4x4	4-dr Utility
9	Ford	Focus	4-dr wagon

	Make	Model	BodyStyle
10	Jeep	Liberty 4x2	4-dr Utility
11	Jeep	Liberty 4x4	4-dr Utility
12	Subaru	Outback (4x4)	4-dr wagon
13	Toyota	Echo	4-dr sedan
14	Toyota	4Runner 4x2	4-dr Utility
15	Toyota	4Runner 4x4	4-dr Utility
16	Toyota	Tacoma 4x2	PU ExCab
17	Toyota	Tacoma 4x4	PU ExCab
18	Volvo	XC90 (4x4)	4-dr Utility

X. Assessment of Costs and Benefits

Since this is a consumer information program, no Regulatory Evaluation was developed for this notice. Adding the dynamic maneuver tests to the Rollover NCAP will not require vehicle manufacturers to take any action. The costs are Federal Government costs for developing the test protocol and rating system, conducting the tests, and disseminating the information. The benefits are information to consumers. Consumers want additional information. It is impossible for us to quantify the effect on consumer behavior or on manufacturer behavior.

XI. Rulemaking Analyses and Notices

A. Executive Order 12866

Executive Order 12866, “Regulatory Planning and Review” (58 FR 51735, October 4, 1993), provides for making determinations whether a regulatory action is “significant” and therefore subject to Office of Management and Budget (OMB) review and to the requirements of

the Executive Order. The Order defines a “significant regulatory action” as one that is likely to result in a rule that may:

(1) Have an annual effect on the economy of \$100 million or more or adversely affect in a material way the economy, a sector of the economy, productivity, competition, jobs, the environment, public health or safety, or State, local, or Tribal governments or communities;

(2) Create a serious inconsistency or otherwise interfere with an action taken or planned by another agency;

(3) Materially alter the budgetary impact of entitlements, grants, user fees, or loan programs or the rights and obligations of recipients thereof; or

(4) Raise novel legal or policy issues arising out of legal mandates, the President’s priorities, or the principles set forth in the Executive Order.

NHTSA has considered the impact of this action under Executive Order 12866 and the Department of Transportation’s regulatory policies and procedures. This action has been determined to be economically not significant. However, because it is a subject of Congressional interest, this rulemaking document was reviewed by the Office of Management and Budget under Executive Order 12866, “Regulatory Planning and Review.”

B. Regulatory Flexibility Act

The Regulatory Flexibility Act of 1980 (5 U.S.C. § 601 et seq.) requires agencies to evaluate the potential effects of their proposed and final rules on small business, small organizations and small governmental jurisdictions. I hereby certify that the amendment will not have a significant economic impact on a substantial number of small entities. The proposed action does not impose regulatory requirements on any manufacturer or other party.

C. National Environmental Policy Act

NHTSA has analyzed this proposal for the purposes of the National Environmental Policy Act. The agency has determined that implementation of this action will not have any significant impact on the quality of the human environment.

D. Executive Order 13132 (Federalism)

The agency has analyzed this rulemaking in accordance with the principles and criteria contained in Executive Order 13132 and has determined that it does not have sufficient federal implications to warrant consultation with State and local officials or the preparation of a federalism summary impact statement. The action will not have any substantial impact on the States, or on the current Federal-State relationship, or on the current distribution of power and responsibilities among the various local officials.

E. Unfunded Mandates Act

The Unfunded Mandates Reform Act of 1995 requires agencies to prepare a written assessment of the costs, benefits and other effects of proposed or final rules that include a Federal mandate likely to result in the expenditure by State, local or tribal governments, in the aggregate, or by the private sector, of more than \$100 million annually (adjusted annually for inflation with base year of 1995). Adjusting this amount by the implicit gross domestic product price deflator for the year 2002 results in \$113 million ($110.66/98.11 = 1.13$). The assessment may be included in conjunction with other assessments, as it is here.

The action does not impose regulatory requirements on any manufacturer or other party.

F. Civil Justice Reform

This action will not have any retroactive effect. Under 49 U.S.C. 21403, whenever a Federal motor vehicle safety standard is in effect, a State may not adopt or maintain a safety standard applicable to the same aspect of performance which is not identical to the Federal standard, except to the extent that the state requirement imposes a higher level of performance and applies only to vehicles procured for the State's use. 49 U.S.C. 21461 sets forth a procedure for judicial review of final rules establishing, amending or revoking Federal motor vehicle safety standards. That section does not require submission of a petition for reconsideration or other administrative proceedings before parties may file suit in court.

G. Paperwork Reduction Act

This document does not contain "collections of information," as that term is defined in 5 CFR Part 1320 *Controlling Paperwork Burdens on the Public*.

H. Plain Language

Executive Order 12866 requires each agency to write all rules in plain language. This action will not result in regulatory language.

Issued on:

Jeffrey W. Runge, M.D.

Formatted: German (Germany)

Administrator

57

BILLING CODE: 4910-59P

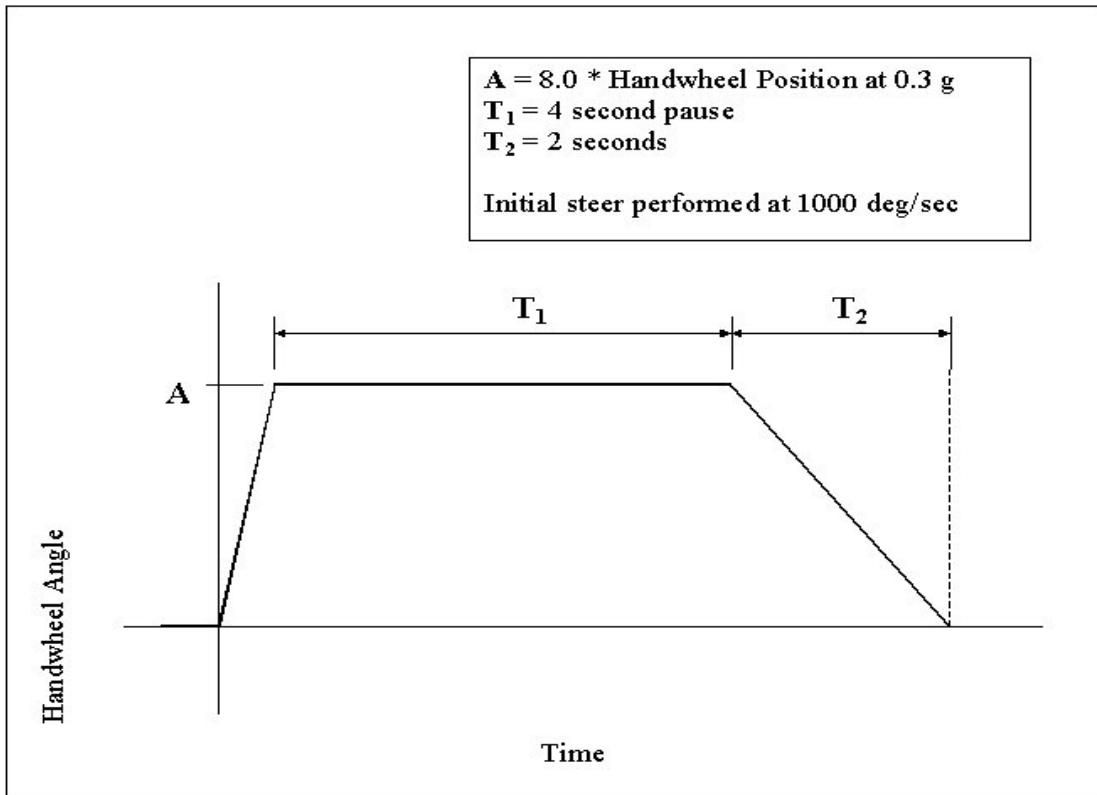

Figure 1. NHTSA J-Turn maneuver description.

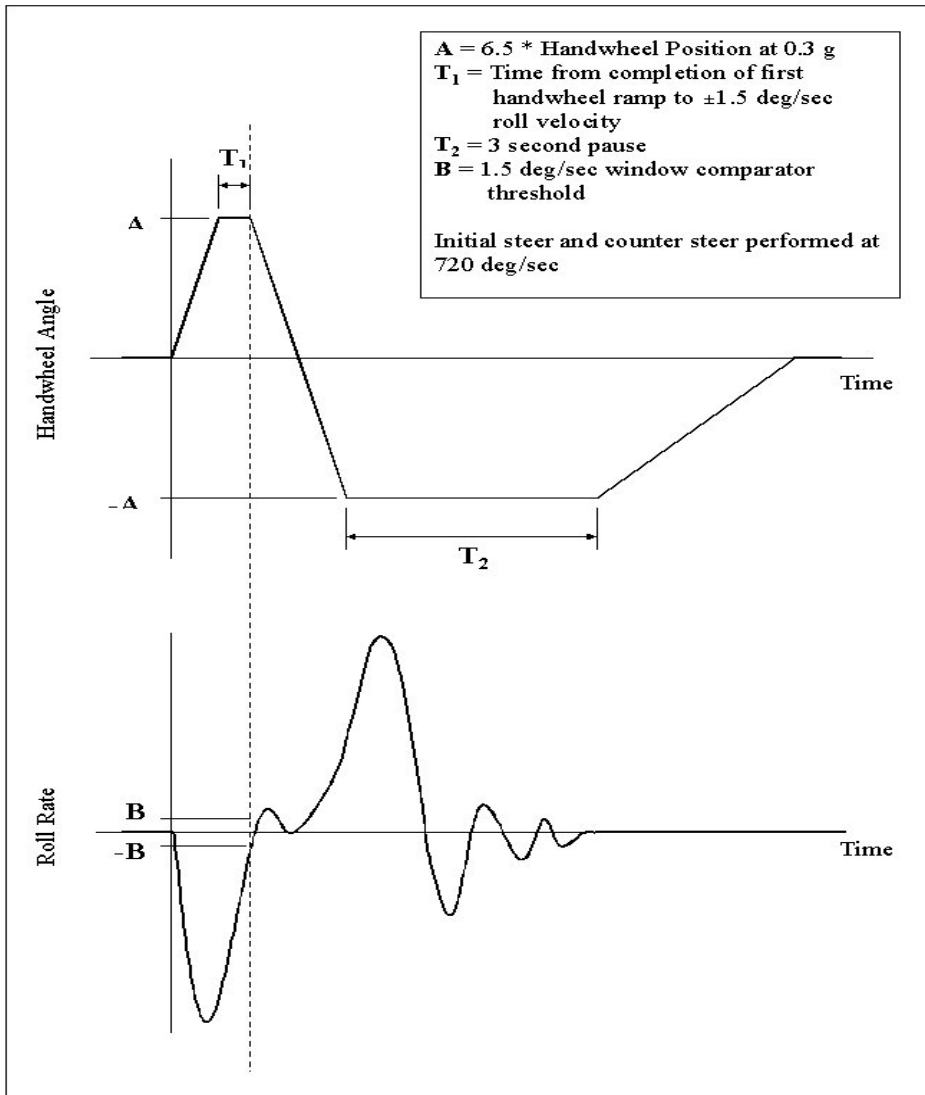

Figure 2. NHTSA Fishhook (with roll rate feedback) maneuver description.

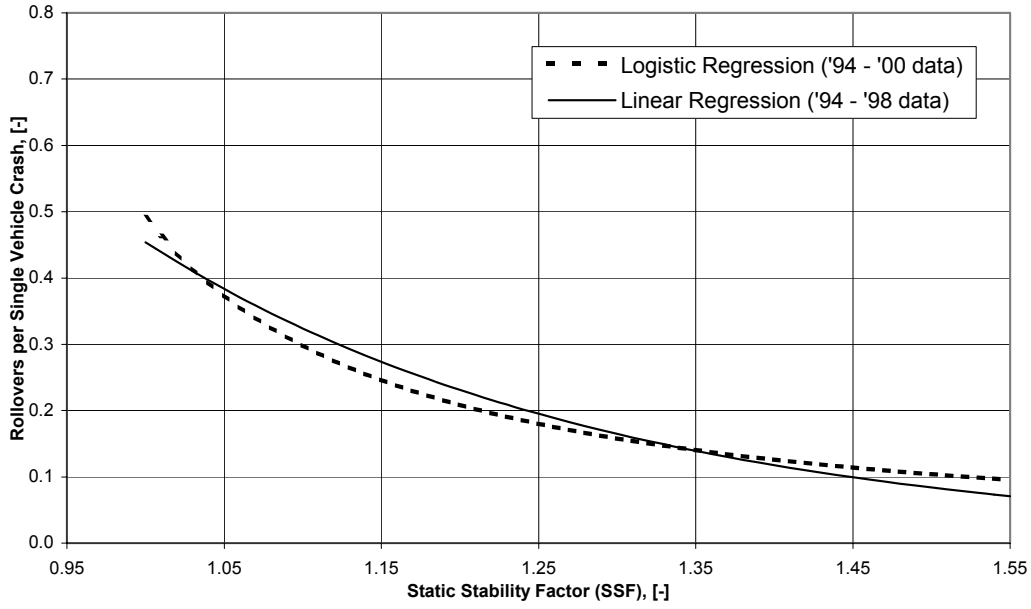

Figure 3: Logistic regression risk model using SSF only and Linear regression risk model for 2001-2003 NCAP Rollover Resistance

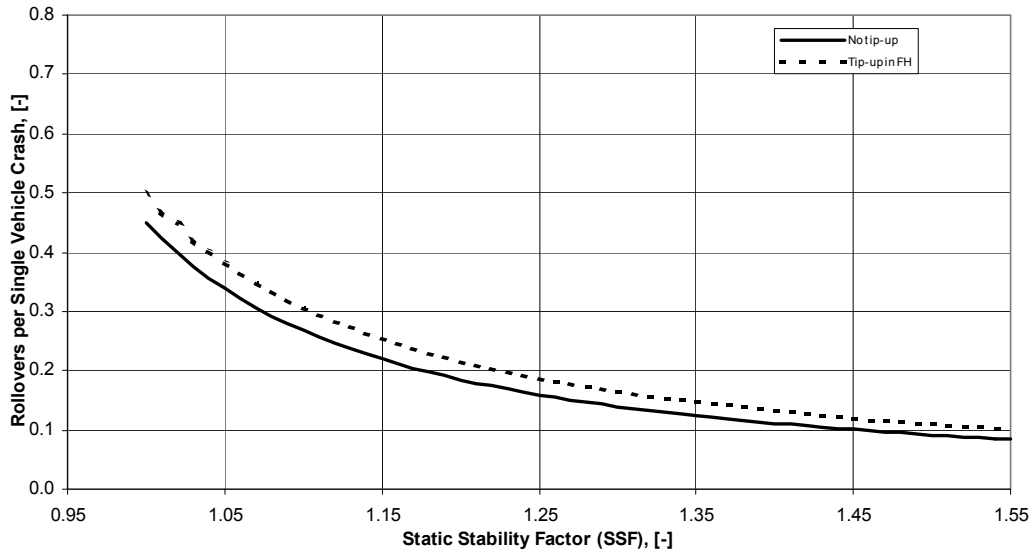

Figure 4: Final dynamic model using Fishhook maneuver with heavy load (FH) as the only necessary

dynamic variable

Appendix I. Fishhook Maneuver Test Procedure

1.0 INTRODUCTION

1.1 General

This document describes the test procedure used by the National Highway Traffic Safety Administration's (NHTSA) New Car Assessment Program (NCAP) to evaluate light vehicle dynamic rollover propensity. The procedure is comprised of one characterization maneuver and one rollover resistance maneuver.

1.2 Rollover Resistance Requirements of the TREAD Act

Section 12 of the "Transportation Recall, Enhancement, Accountability and Documentation (TREAD) Act of November 2000" reflects the desire of Congress to supplement SSF [Static Stability Factor] with a dynamic stability test using vehicle maneuvers. Congress directed NHTSA to "develop a dynamic test on rollovers by motor vehicles for a consumer information program; and carry out a program conducting such tests." NHTSA's NCAP Light Vehicle Dynamic Rollover Propensity Test Procedure described in this document was developed as part of NHTSA's effort to fulfill the requirements of the TREAD Act.

1.3 Recent NHTSA Light Vehicle Dynamic Rollover Propensity Research

During the spring through fall of 2001 NHTSA performed an extensive assessment of many test track maneuvers potentially capable of quantifying on-road, untripped rollover propensity. In brief, five vehicle characterization and nine dynamic rollover propensity maneuvers were studied. Each maneuver was either discarded or retained for subsequent program phases. The 2001 research project is documented in [1].

During the spring through fall of 2002 NHTSA performed a comprehensive evaluation of rollover resistance for a broad spectrum of twenty-six light vehicles. The test vehicles were evaluated with one Characterization maneuver and two Rollover Resistance maneuvers. Up to two load configurations per vehicle were used. The 2002 research project is documented in [2].

2.0 TEST EQUIPMENT

2.1 Vehicle Load Configurations

NHTSA's dynamic rollover propensity test procedure uses one of two loading configurations: Nominal or Multi-Passenger. A description of each configuration is provided below.

Both vehicle load configurations include instrumentation, a steering machine, and outriggers. Test vehicle bumper assemblies are removed for outrigger installation. The reduction in vehicle weight due to the removal of the bumpers is offset by the additional weight of the outriggers and

their mounting system. The outrigger system typically outweighs the bumper assemblies.

2.1.1 Nominal Load Configuration

The Nominal Load Configuration consists of the driver, instrumentation, steering machine, outriggers, and full tank of fuel. Weight and location specifications for the data acquisition system and steering machine are presented in Table I.1 and Figure I.1.

Table I.1. Equipment Location and Weight.

Equipment	Location	Weight, typical (lbs)
Data Acquisition System	Front passenger seat	58
Steering Machine	Handwheel	31
Steering Machine Electronics Box	Passenger row foot well behind the front passenger seat. If vehicle does not have a rear passenger row foot well, the Electronics Box should be placed in the front passenger seat foot well.	39

Non-pickup truck vehicles with only front designated seating positions use the Nominal Load Configuration.

2.1.2 Multi-Passenger Configuration

The Multi-Passenger Configuration includes all elements of the Nominal Load Configuration plus ballast in the form of water dummies. Water dummies are installed as follows:

For vehicles with three or more designated rear seating positions, three 175 lb water dummies are used. The water dummies shall be positioned on the rear seats (second seating row) closest to driver and front passenger seats (first seating row). If there are only two seating positions in the second seating row, the third water dummy shall be placed in the center of the third seating row, provided it is a designated seating position. Refer to Figure I.2.

For vehicles with two designated rear seating positions, two 175 lb water dummies shall be positioned in the rear seats. Refer to Figure I.3.

For pickups with only front designated seating positions, three 175 lb water dummies will be used. The water dummies shall be positioned behind the cab in a manner that emulates a second

seating row. If it is not possible to fit three water dummies directly behind the cab, the third water dummy shall be placed in the center of a simulated third seating row. Refer to Figure I.4.

For pickups with two seating rows, three 175 lb water dummies will be used. If the second seating row includes three designated seating positions, each water dummy shall be placed in these positions. If the second seating row includes two designated seating positions, two 175 lb water dummies shall be positioned in the second seating row of the cab, and the third water dummy shall be positioned behind the cab in a manner that emulates the center seating position of a third seating row. Refer to Figure I.5.

For all vehicles, if the Multi-Passenger Configuration results in the vehicle exceeding its Gross Vehicle Weight Rating (GVWR) and/or rear Gross Axle Weight Rating (GAWR), the weight of each dummy will be equally reduced until the GVWR and/or rear GAWR are no longer exceeded. The weight of the water dummies shall not be reduced if only the front GAWR is exceeded and the front axle weight does not exceed the front GAWR by more than 50 pounds, i.e., if the Multi-Passenger Configuration results in the vehicle exceeding its front GAWR, and its GVWR and/or rear GAWR, the weight of each dummy will be equally reduced until the GVWR and rear GAWR are no longer exceeded and the front GAWR is not exceeded by more than 50 pounds.

For non-pickup truck vehicles with only front designated seating positions, the Multi-Passenger Configuration is omitted from the test matrix.

2.2 Safety Outriggers

Safety outriggers are installed on all test vehicles during all test maneuvers. NHTSA uses outriggers machined from 6Al-4V titanium. NHTSA's "short" outriggers are used for vehicles with baseline weights under 3,500 pounds in a baseline condition (as delivered); "standard" outriggers are used for vehicles with baseline weights from 3,500 and 7,000 pounds; and "long" outriggers are used for vehicles with baseline weights from 7,001 to 10,000 pounds. Information on NHTSA's titanium outrigger system is documented in [3].

2.3 Tires

All tires must be new, and of the same make, model, size, and DOT specification of those installed on vehicles when purchased new. Tire inflation pressures are to be in accordance with the recommendations indicated on each vehicle's identification placard.

2.3.1 Tire Mounting Technique

When mounting tires to the rims used for testing, no tire mounting lubricant should be used. Lubricant is not used due to uncertainty surrounding the occurrences of tire debonding observed during NHTSA's rollover research. To eliminate the possibility of tire lubricant contributing to this phenomenon, it should not be used. Because no lubricant is used, care must be taken to confirm that the tire is fully seated on the wheel rim at the completion of the mounting procedure.

2.3.2 Frequency of Tire Changes

To minimize the effects of tire wear on vehicle response and rollover propensity, rollover research requires frequent tire changes. For each loading condition, the following guidelines must be followed:

- One set of tires is to be used for each Slowly Increasing Steer test series. Each series is comprised of left and right steer tests.
- Up to two tire sets are to be used for the Fishhook maneuver test series. The actual number of tire sets used is dependent on the response of each vehicle. The tire change protocol is presented in the Fishhook maneuver test procedure (Section 3.2). **Note:** A tire change between the completion of the Slowly Increasing Steer maneuver and initiation of Fishhook testing is not required provided the abbreviated Slowly Increasing Steer procedure described in Section 3.1.2 is used. If the abbreviated procedure is not used (i.e., the maneuver is performed such that maximum lateral acceleration is achieved), a tire change between the completion of the Slowly Increasing Steer maneuver and initiation of Fishhook testing is required, as tire wear associated with these tests may potentially confound Fishhook test outcome.

2.3.3 Use of Inner Tubes

Fishhook maneuvers have been shown to produce debanding of the outside front and rear tires. The occurrence of debands can result in significant damage to the test surface. NHTSA research has concluded the easiest, most cost effective way to minimize debanding is the use of inner tubes designed for radial tires. Inner tubes must be installed prior to any Fishhook test – one inner tube for each of the vehicle’s tires. Inner tubes should be appropriately sized for the test vehicle’s tires.

Installation of inner tubes is not required prior to Slowly Increasing Steer tests, regardless of vehicle or load condition.

2.4 Data Collection

All data is to be sampled at 200 Hz. NHTSA’s signal conditioning consists of amplification, anti-alias filtering, and digitizing. Amplifier gains are selected to maximize the signal-to-noise ratio of the digitized data. Filtering is performed with two-pole low-pass Butterworth filters with nominal cutoff frequencies selected to prevent aliasing. The nominal cutoff frequency is 15 Hz (calculated breakpoint frequencies are 18 and 19 Hz for the first and second poles respectively).

Data collection is initiated manually by the test driver immediately before the start of the maneuver or automatically by “Handwheel Command Flag” signal from the steering machine (refer to Section 3.2.4.2.2, Handwheel Command Flag).

2.5 Instrumentation

Each test vehicle is to be equipped with sensors, a data acquisition system, and a programmable

steering machine. Equipment location and weight specifications are presented in Table I.1 and Figure I.1.

2.5.1 Sensors and Sensor Locations

Table I.2 lists the sensors required by NHTSA's dynamic rollover propensity test procedure. A brief description of these sensors is provided in this section.

Table I.2. Recommended Sensor Specifications

Type	Output	Range	Resolution	Accuracy
Multi-Axis Inertial Sensing System	Longitudinal, Lateral, and Vertical Acceleration Roll, Yaw, and Pitch Rate	Accelerometers: ±2 g Angular Rate Sensors: ±100 deg/s	Accelerometers: ≤10 ug Angular Rate Sensors: ≤0.004 deg/s	Accelerometers: ≤0.05% of full range Angular Rate Sensors: 0.05% of full range
Angle Encoder	Handwheel Angle	±800 deg	0.25 deg	±0.25 deg
Ultrasonic Distance Measuring System	Left and Right Side Vehicle Height	5-24 inches	0.01 inches	±0.25% of maximum distance
Load Cell	Brake Pedal Force	0-300 lbf	N/A	N/A
Radar Speed Sensor	Vehicle Speed	0.1-125 mph	0.009 mph	±0.25% of full scale
Infrared Distance Measuring System	Wheel Lift	13.75-33.5 inches	0.01 in., short range 0.3 in., long range	±1% of full scale
Data Flag (Handwheel Command Flag)	Pauses in commanded steering inputs	0 – 10 V	N/A	Flag should respond within 10 ms
Data Flag (Roll Rate Flag)	Indication of ± 1.5 deg/s roll rate	0 – 10 V	N/A	Flag should respond within 10 ms

2.5.1.1 Handwheel Angle

Handwheel position is measured via an angle encoder integral with the programmable steering machines.

2.5.1.2 Vehicle Speed

Vehicle speed is measured with a non-contact speed sensor placed at the center rear of each vehicle. NHTSA has had good experiences with the use of Doppler radar based sensors. Sensor outputs are to be transmitted not only to the data acquisition system, but also to a dashboard display unit. This allows the driver to accurately monitor vehicle speed.

2.5.1.3 Chassis Dynamics

A multi-axis inertial sensing system is used to measure linear accelerations and roll, pitch, and yaw angular rates. The position of the multi-axis inertial sensing system must be accurately measured relative to the C.G. of the vehicle in the Nominal Load and Multi-Passenger Configurations. These data are required to translate the motion of the vehicle at the measured location to that which occurred at the actual C.G to remove roll, pitch, and yaw effects. NHTSA uses an independent laboratory to measure the C.G. of it's test vehicles.

The following equations are used to correct the accelerometer data in post-processing. They were derived from equations of general relative acceleration for a translating reference frame and use the SAE Convention for Vehicle Dynamics Coordinate Systems. The coordinate transformations are:

$$x''_{\text{corrected}} = x''_{\text{accel}} - (\Theta'^2 + \Psi'^2)x_{\text{disp}} + (\Theta'\Phi' - \Psi'')y_{\text{disp}} + (\Psi'\Phi' + \Theta'')z_{\text{disp}}$$

$$y''_{\text{corrected}} = y''_{\text{accel}} + (\Theta'\Phi' + \Psi'')x_{\text{disp}} - (\Phi'^2 + \Psi'^2)y_{\text{disp}} + (\Psi'\Theta' - \Phi'')z_{\text{disp}}$$

$$z''_{\text{corrected}} = z''_{\text{accel}} + (\Psi'\Phi' - \Theta'')x_{\text{disp}} + (\Psi'\Theta' + \Phi'')y_{\text{disp}} - (\Phi'^2 + \Theta'^2)z_{\text{disp}}$$

where

$x''_{\text{corrected}}$, $y''_{\text{corrected}}$, and $z''_{\text{corrected}}$ = longitudinal, lateral, and vertical accelerations, respectively, at the vehicle's center of gravity

x''_{accel} , y''_{accel} , and z''_{accel} = longitudinal, lateral, and vertical accelerations, respectively, at the accelerometer location

x_{disp} , y_{disp} , and z_{disp} = longitudinal, lateral, and vertical displacements, respectively, of the center of gravity with respect to the accelerometer location

Φ' and Φ'' = roll rate and roll acceleration, respectively

Θ' and Θ'' = pitch rate and pitch acceleration, respectively

Ψ' and Ψ'' = yaw rate and yaw acceleration, respectively

NHTSA does not use inertially stabilized accelerometers for this test procedure. Therefore, lateral acceleration must be corrected for vehicle roll angle during data post processing. This is discussed in Section 4.12.

2.5.1.4 Roll Angle

An ultrasonic distance measurement system is used to collect left and right side vertical displacements for the purpose of calculating vehicle roll angle. One ultrasonic ranging module is mounted on each side of a vehicle, and is positioned at the longitudinal center of gravity. With these data, roll angle is calculated during post-processing using trigonometry.

2.5.1.5 Wheel Lift

Wheel lift is measured individually with two height sensors attached to spindles installed at the wheel. Using trigonometry, the output of the two sensors can be used to resolve the camber angle of the wheel, and remove its influence from the uncorrected height sensor output. Information on NHTSA's wheel lift measurement system is documented in [4].

2.5.1.6 Brake Application

Brake pedal force is measured with a load cell transducer attached to the face of the brake pedal. While brake pedal force is not explicitly required by this test procedure, it is important to monitor the driver's braking activity during testing. No test included in this procedure requires brake application. If the driver applies force to the brake pedal before completion of a test, that test is not valid, and should not be considered in further analyses.

2.5.2 Additional Mnemonics

2.5.2.1 Handwheel Command Flag

Refer to Section 3.2.4.2.2, Handwheel Command Flag.

2.5.2.2 Roll Rate Flag

Refer to Section 3.2.4.2.3, Roll Rate Flag.

2.6 Steering Machine

A programmable steering machine is used to generate handwheel steering inputs for all test maneuvers. The machine must provide at least 35 lb_r-ft of torque at a handwheel rate of 720 deg/sec, be able to move each vehicle's steering system through its full range, and accept angular rate sensor feedback input for roll rate-induced steering reversals (refer to Section 3.2.4). It is recommended that the steering machine be capable of initiating steering programs at a preset road speed, and have the convenience of changing the steering program during test sessions.

3.0 TEST MANEUVERS

3.1 Slowly Increasing Steer

The Slowly Increasing Steer maneuver is used to characterize the lateral dynamics of each vehicle, and is based on the “Constant Speed, Variable Steer” test defined in SAE J266 [5]. The maneuver is used to determine the steering that produces a lateral acceleration of 0.3 g. This handwheel angle is used to define the magnitude of steering to be used for the NHTSA Fishhook maneuver.

3.1.1 Maneuver Description (Option #1)

To begin this maneuver, the vehicle is driven in a straight line at 50 mph. The driver must attempt to maintain this speed during and briefly after the steering is input using smooth throttle modulation. At time zero, handwheel position is linearly increased from zero to 270 degrees at a rate of 13.5 degrees per second. Handwheel position is held constant at 270 degrees for two seconds, after which the maneuver is concluded. The handwheel is then returned to zero as a convenience to the driver. The maneuver is performed three times to the left and three times to the right for each load configuration. Figure I.6 presents a description of the handwheel angles to be used during Slowly Increasing Steer, Option #1 tests.

3.1.2. Maneuver Description (Option #2, Preferred)

Historically, NHTSA has used Slowly Increasing Steer tests to measure linear range and maximum quasi steady state lateral acceleration. While maximum lateral acceleration data is interesting, it is not a required metric when determining a vehicles NCAP rollover resistance rating. For this reason, NHTSA recommends use of an “abbreviated” Slowly Increasing Steer maneuver. The handwheel angles used in this abbreviated procedure only steer the vehicle enough to assess its linear range lateral acceleration performance.

To determine the most appropriate Slowly Increasing Steer handwheel angle for a given vehicle, a preliminary left steer test is performed. The test speed during this test was held constant at 50 mph via throttle modulation, and the steering input ranged from 0 to 30 degrees, applied at 13.5 degrees per second. The magnitude of this input was selected because it was believed to be capable of producing a steady state lateral acceleration within the linear range for any light vehicle. Using the ratio of steady state handwheel position and lateral acceleration established by this test, the maximum steering input for the abbreviated Slowly Increasing Steer test was derived using the below equation:

Equation 3.1

$$\frac{30 \text{ degrees}}{a_{y,30 \text{ degrees}}} = \frac{\partial_{SS}}{0.55 \text{ g}}$$

where,

$a_{y,30 \text{ degrees}}$	was the <u>raw</u> lateral acceleration produced with a constant handwheel angle of 30 degrees during a test performed at 50 mph
d_{SIS}	was the steering input that, if the relationship of handwheel angle and lateral acceleration was linear, would produce a lateral acceleration of 0.55 g during a test performed at 50 mph

Note: $a_{y,30 \text{ degrees}}$ is “raw” data, not corrected for the effects of roll, pitch, and yaw. NHTSA acknowledges the relationship of handwheel angle and *corrected* lateral acceleration data is often not linear at 0.55 g. However, previously collected data indicates the magnitude of raw 0.55 g acceleration data is typically reduced by approximately 9.6 percent to 0.497 g, when corrected for roll, pitch, and yaw, just outside of the linear range for most vehicles. Removing the effect of accelerometer offset (error due to the accelerometer not being positioned at the vehicle’s actual center of gravity) typically reduces the magnitude of these data by an additional 0.07 percent. The importance of Equation 3.1 is that it simply provides experimenters with a direct, “in-the-field” way of determining an appropriate steering input for which to proceed with further tests for a given vehicle.

Figure I.7 presents a description of the handwheel angles to be used during the abbreviated Slowly Increasing Steer, Option #2 tests.

3.1.3 Measured Parameters

Analyses of Slowly Increasing Steer tests output overall average handwheel position at a specified lateral acceleration

When lateral acceleration data collected during Slowly Increasing Steer tests is plotted with respect to time, a first order polynomial best-fit line accurately describes the data from 0.1 to 0.375 g. NHTSA defines this as the linear range of the lateral acceleration response. A simple linear regression is used to determine the best-fit line, as shown in Figures I.8 and I.9.

Using the slope of the best-fit line, the average of handwheel position at 0.3 g is calculated using data from each of the six Slowly Increasing Steer tests performed for each vehicle. This average handwheel position is used to calculate NHTSA Fishhook maneuver steering inputs, as described in Section 3.2.

3.2 NHTSA Fishhook Maneuver

3.2.1 Maneuver Overview

To begin the maneuver, the vehicle is driven in a straight line at a speed slightly greater than the desired entrance speed. The driver releases the throttle, and when at the target speed, initiates the handwheel commands described in Figure I.10 using a programmable steering machine. Following completion of the countersteer, handwheel position is maintained for three seconds. As a convenience to the test driver, the handwheel is then returned to zero.

Each Fishhook maneuver test series contains two sequences (with exceptions noted in the following sections): tests performed with left-right steering (first sequence), and tests performed with right-left steering (second sequence). The sequence of left-right tests always precedes those performed with right-left steering.

3.2.2 Default Procedure

Fishhook maneuver handwheel angles are calculated with lateral acceleration and handwheel angle data (δ) collected during a series of six Slowly Increasing Steer tests (a total of three left-steer and three-right steer tests are performed). For each Slowly Increasing Steer test, a linear regression line is fitted to the lateral acceleration data from 0.1 to 0.375 g. Using the slopes of these regression lines, the handwheel angles at 0.3 g are determined for each individual test ($\delta_{0.3 \text{ g}}$). The six handwheel angles are then averaged to produce an overall value ($\delta_{0.3 \text{ g, overall}}$).

$$\delta_{0.3 \text{ g, overall}} = (|\delta_{0.3 \text{ g, left (1)}}| + |\delta_{0.3 \text{ g, left (2)}}| + |\delta_{0.3 \text{ g, left (3)}}| + \delta_{0.3 \text{ g, right (1)}} + \delta_{0.3 \text{ g, right (2)}} + \delta_{0.3 \text{ g, right (3)}}) / 6$$

The Fishhook maneuver steering angles are calculated by multiplying $\delta_{0.3 \text{ g, overall}}$ by a steering scalar (SS). The default steering scalar is 6.5.

$$\delta_{\text{Fishhook (Default)}} = 6.5 \times \delta_{0.3 \text{ g, overall}}$$

3.2.2.1 Maneuver Entrance Speed

For the sake of driver safety, and as a final step in the tire scrub-in procedure, each Default Procedure sequence begins with a Maneuver Entrance Speed (MES) equal to 35 mph. The MES is measured at the initiation of the first steering ramp, and is increased until a termination condition is satisfied. The order of MES for a sequence is, in mph: 35, 40, 45, 47.5, 50. For each test run, the actual MES must be within 1 mph of the target MES.

Note: NHTSA's experience with the Fishhook maneuver indicates that an incremental increase in MES of 5 mph, up to 45 mph, minimizes tire wear without compromising test driver safety. However, when a MES greater than 45 mph is used, the severity of the responses produced with some vehicles can increase substantially from that observed at lesser entrance speeds. This is especially true if a vehicle has a propensity to oscillate in roll, and/or is able to produce two-wheel lift slightly less than NHTSA's threshold criterion of two inches. In some of these cases, the driver and/or experimenter may not be comfortable with a final 5 mph upwards increment in MES, and might, for the sake of driver safety, deviate from a test procedure that requires it. Generally speaking, such a deviation typically involves the experimenter's use of a more gradual 2.5 mph increase in MES.

To promote driver safety while also eliminating inconsistencies in the way NHTSA's Fishhook maneuvers are performed, the test procedure *requires* a MES increment equal to 2.5 mph be used above 45 mph if a test performed at 45 mph does not produce two-wheel lift, regardless of the vehicle being evaluated.

3.2.2.2 Outrigger Contact

If either safety outrigger contacts the pavement without two-wheel lift during a Fishhook maneuver test run, the affected outrigger is raised 0.75 inches and the test is repeated at the same MES. If both safety outriggers contact the pavement without two-wheel lift, both outriggers are raised 0.75 inches and the test is repeated at the same MES.

3.2.2.3 Termination and Conclusion Conditions

A test sequence is terminated if the MES capable of producing two-wheel lift is observed and the MES is 45 mph or lower. If two-wheel lift is observed during a left-right sequence at 45 mph or lower, the [entire] series is terminated. If no two-wheel lift is observed during a left-right sequence, right-left tests are performed. If two-wheel lift is observed during a right-left sequence performed with a MES of 45 mph or lower, the test series is terminated.

If the MES capable of producing two-wheel lift during a left-right or right-left sequence is 47.5 mph or higher, a new set of tires is installed on the vehicle and the procedure described in Section 3.2.3.1 is implemented.

A test series is terminated if rim-to-pavement contact or tire debanding is observed during any test performed with either test sequence.

A test series is deemed complete if both test sequences within a given series have been performed at the maximum maneuver entrance speed without two-wheel lift, rim-to-pavement contact, tire debanding, or outrigger-to-pavement contact. If the Default Procedure is completed without encountering a termination condition, Supplemental Procedure Part 2, described in Section 3.2.3.2, is implemented.

The flowchart presented in Figure I.11 describes the sequence of events for the Default Test Series.

3.2.3 Supplemental Procedures

Note: If the results of the Default Test Series require the implementation of the Supplemental Procedure Part 1, neither Supplemental Procedure Part 2 nor Part 3 is used.

Note: Depending on the response of test vehicles to elements of the Fishhook maneuver protocol, Supplemental Procedure, Parts 1, 2, and 3 may require a change in the steering scalar. The steering machine used by NHTSA has the capability for making such changes in vehicles during test sessions via selection of a pre-programmed steering schedule and the adjustment of overall steering angles.

3.2.3.1 Supplemental Procedure Part 1

Following the tire scrub-in procedure outlined in Section 4.6, tests are performed with handwheel angles equal to $\delta_{\text{Fishhook (Default)}}$, as explained in Section 3.2.2. The steering combination (i.e., either left-right or right-left) that produced two-wheel lift in the Default Test Series is used. The first test is to be performed at a MES of 35 mph. This test is performed to ensure any mold sheen remaining

from the tire break-in procedure has been removed from the tires. The second test is to be performed at the MES at which two-wheel lift had been previously observed (i.e., with the previous tire set). If two-wheel lift is produced during the test performed with handwheel angles equal to $\delta_{\text{Fishhook (Default)}}$, the tip-up will be reported in the vehicle's NCAP Rollover Resistance Rating and the test series is deemed complete. If two-wheel lift is not produced and the MES is 47.5 mph, the MES is increased to 50 mph. If two-wheel lift is produced during the test performed with MES equal to 50 mph, the tip-up will be reported in the vehicle's NCAP Rollover Resistance Rating and the test series is deemed complete.

If two-wheel lift is not produced at 50 mph with handwheel angles equal to $\delta_{\text{Fishhook (Default)}}$, tests are performed with steering angles calculated by multiplying $\delta_{0.3 \text{ g, overall}}$ by a steering scalar of 5.5.

$$\delta_{\text{Fishhook (Supplemental)}} = 5.5 \times \delta_{0.3 \text{ g, overall}}$$

After the application of the reduced scalar, a test is to be performed, using the same steering combination (i.e., either left-right or right-left), at the MES at which two-wheel lift had been observed in the Default Test Series. If two-wheel lift is produced during the test performed with handwheel angles equal to $\delta_{\text{Fishhook (Supplemental)}}$, the tip-up will be reported in the vehicle's NCAP Rollover Resistance Rating and the test series is deemed complete. If two-wheel lift is not produced and the MES is 47.5 mph, the MES is increased to 50 mph. If two-wheel lift is produced during the test performed with MES equal to 50 mph, the tip-up will be reported in the vehicle's NCAP Rollover Resistance Rating and the test series is deemed complete. If two-wheel lift is not produced at 50 mph, the test series is deemed complete and no tip-up will be reported in the vehicle's NCAP Rollover Resistance Rating.

A test series is terminated if rim-to-pavement contact or tire debanding is observed during any Supplemental Procedure Part 1 test. The flowchart presented in Figure I.12 describes the sequence of events for the Supplemental Procedure Part 1.

3.2.3.2 Supplemental Procedure Part 2

If two-wheel lift is not produced during tests performed with the Default Procedure, the steering scalar is reduced from 6.5 to 5.5. Using the same tires used for tests performed with the Default Test Series, tests are performed with steering angles calculated by multiplying $\delta_{0.3 \text{ g, overall}}$ by a steering scalar of 5.5.

$$\delta_{\text{Fishhook (Supplemental)}} = 5.5 \times \delta_{0.3 \text{ g, overall}}$$

For the sake of driver safety, the first test of the left-right sequence with the reduced steering scalar applied is to be performed at a MES of 45 mph. If this test does not produce two-wheel lift, the MES is increased to 47.5 mph. If the test with MES equal to 47.5 mph does not produce two-wheel lift, the MES is increased to 50 mph (the maximum MES used for Fishhook maneuver testing). If no two-wheel lift is observed during the left-right sequence, the right-left test sequence is initiated using the same process as the left-right sequence. If any test in the Supplemental Procedure Part 2 test series produces two-wheel lift, a new set of tires is installed on the vehicle, and the procedure described Section 3.2.3.3 is implemented.

A test series is terminated if rim-to-pavement contact or tire debanding is observed during any test performed with either test sequence. A test series is deemed complete if both test sequences within the series have been performed at the maximum maneuver entrance speed without two-wheel lift. The flowchart presented in Figure I.13 describes the sequence of events for the Supplemental Procedure Part 2.

3.2.3.3 Supplemental Procedure Part 3

Following the tire scrub-in procedure outlined in Section 4.6, two tests are performed with handwheel angles equal to $\delta_{\text{Fishhook (Supplemental)}}$. The steering combination that produced two-wheel lift during Supplemental Procedure Part 2 testing is used (i.e., either left-right or right-left). The first test is to be performed at a MES of 35 mph. This test is performed to ensure any mold sheen remaining from the tire break-in procedure has been removed from the tires. The second test is to be performed at the MES that had produced two-wheel lift during Supplemental Procedure Part 2 testing (i.e., with the previous tire set). If two-wheel lift is produced during the test performed with handwheel angles equal to $\delta_{\text{Fishhook (Supplemental)}}$, the tip-up will be reported in the vehicle's NCAP Rollover Resistance Rating and the test series is deemed complete. If two-wheel lift is not produced and the MES is 45 mph, the MES is increased to 47.5 mph. If two-wheel lift is not produced and the MES is 47.5 mph, the MES is increased to 50 mph. If two-wheel lift is produced during any test performed during Supplemental Procedure Part 3, the tip-up will be reported in the vehicle's NCAP Rollover Resistance Rating and the test series is deemed complete. If two-wheel lift is not produced during Supplemental Procedure Part 3, the test series is deemed complete and no tip-up will be reported in the vehicle's NCAP Rollover Resistance Rating.

A test series is terminated if rim-to-pavement contact or tire debanding is observed during any Supplemental Procedure Part 3 test. The flowchart presented in Figure I.14 describes the sequence of events for the Supplemental Procedure Part 3.

3.2.4 Handwheel Inputs

3.2.4.1 Steering Rate

The handwheel rates of the initial steer and countersteer steering ramps are always to be performed with nominal steering rates of 720 degrees per second, regardless of what steering scalar is used.

3.2.4.2 Dwell Time

The Fishhook maneuver is designed to maximize the roll motion of the test vehicle. When left-right steering is used, this is accomplished by:

1. Steering the vehicle with an input equal to $\delta_{\text{Fishhook (Default)}}$ OR $\delta_{\text{Fishhook (Supplemental)}}$
2. Waiting until the vehicle achieves maximum roll angle

3. Reversing the direction of steer
4. Steering the vehicle with an input equal to $-\delta_{\text{Fishhook (Default)}}$ OR $-\delta_{\text{Fishhook (Supplemental)}}$

When right-left steering is used, the sign conventions indicated in Steps 1 and 4 above are switched from positive to negative (i.e., for Step 1) or from negative to positive (i.e., for Step 4).

Dwell time is defined as the time from the completion of the initial steering ramp to the initiation of the steering reversal. A roll rate “Window Comparator” is used to determine when the vehicle has achieved maximum roll angle. Since the programmable steering machine used by NHTSA has a mechanical overshoot after completion of the initial steer, dwell time is not measured directly with handwheel angle data. Rather, two signals output from the steering machine are used: “Handwheel Start” and “Roll Flag”.

3.2.4.2.1 Steering Machine Window Comparator

As indicated in Figure I.10, Fishhook maneuver steering reversals are commanded after the completion of the initial steering ramp and when the roll rate of the vehicle is very close to zero (because it is the derivative of roll angle, when roll rate is equal to zero at this point, roll angle is at its maximum). To minimize the likelihood of erroneous reversals, the reversals occur when the roll rate signal transmitted from a sensor positioned near the test vehicle’s center of gravity enters the window comparator. The window comparator is defined as ± 1.5 degrees per second, regardless of what steering scalar was used.

Examples: If an initial steer to the left is input, the reversal is initiated when the roll velocity of the vehicle is equal to 1.5 degrees per second. If an initial steer to the right is input, the reversal is initiated when the roll velocity of the vehicle is equal to -1.5 degrees per second.

3.2.4.2.2 Handwheel Command Flag

The programmable steering machine used by NHTSA outputs a “Handwheel Command Flag” signal based on the machine’s internal clock. The output of the Handwheel Command Flag signal ranges from 0 to 10 volts, and is binary. The signal is high (10 volts) when the steering machine is in the process of executing a commanded input, or low (0 volts) when the machine is not in use or a pause is commanded during the execution of a commanded input, as shown in Figure I.10. When the pause ends, and execution of the commanded steering inputs are resumed, the Handwheel Command Flag signal is once again set high. In a Fishhook maneuver, the duration of the pause is the dwell time.

3.2.4.2.3 Roll Rate Flag

The “Roll Rate Flag” signal output by the programmable steering machine used by NHTSA is monitored. Like that of the Handwheel Command Flag channel, the Roll Rate Flag output ranges from 0 to 10 volts, and is binary. The signal is high (10 volts) when the roll rate of the test vehicle is

within the window comparator, or low (0 volts) when roll rate is outside the window comparator, as shown in Figure I.10.

Fishhook maneuver steering reversals are to be initiated by the steering machine within 10 milliseconds of the roll rate entering the window comparator. Initiation of the steering reversal is defined as the instant the steering machine sets the Roll Rate Flag signal high.

Note: After completion of the initial steer, the instants that the steering machine sets the Roll Rate Flag and Handwheel Command Flag signals high should coincide.

3.2.4.3 Excessive Steering

In some cases, the magnitude of $\delta_{\text{Fishhook (Default)}}$ used during the Default Procedure may be so great that the vehicle reaches maximum roll angle before completion of the initial steer. This is defined as excessive steering; i.e., the vehicle cannot respond to the entire commanded steering input.

Excessive steering is also said to occur if the dwell time of a Fishhook test performed with the Default Procedure results in a dwell time less than 80 milliseconds. The mechanical overshoot of the steering machine that occurs after completion of the initial steer can prohibit the machine from accurately executing dwell times less than approximately 80 milliseconds. In such cases, the effect of the overshoot is that the actual dwell time is equal to zero (an immediate steering reversal).

NHTSA's experience with the Fishhook maneuver has demonstrated the effect of excessive steering on dynamic rollover resistance is vehicle-dependent. While it may not allow the roll motion of some test vehicles to be maximized, excessive steering has been shown to contribute to an increased tip-up propensity in others. For this reason, a test sequence for which excessive steering is observed should not be terminated. Testing should proceed as outlined in Section 3.2.2, Default Procedure. If two-wheel lift is not observed during either Default Procedure test sequence, the Supplemental Procedure beginning at Part 2, described in Section 3.2.3.2, is performed.

4.0 ITEMS PERTAINING TO TEST CONDUCT

4.1 Definition of Two-Wheel Lift

Two-wheel lift is defined as the occurrence of at least two inches of simultaneous lift of the inside wheels from the test surface. NHTSA does not consider two-wheel lift less than two inches when calculating a vehicle's NCAP rollover resistance rating. Two-wheel lift great enough to require outriggers to suppress further roll motion is to be reported simply as "two-wheel lift" as long as at least two inches of simultaneous two-wheel lift occurs before outrigger contact with the ground is made.

4.2 Vehicle Test Configurations

4.2.1 Load Configurations

All vehicles are to be evaluated with one of the two load configurations previously defined in Section 2.1.

4.2.2 Fuel Tank Loading

Prior to beginning a Slowly Increasing Steer or Fishhook maneuver test series, the fuel tank of the vehicle is to be completely filled at the beginning of testing and may not be less than 75% of capacity during any part of the testing. This criterion is in agreement with that defined in FMVSS 135.

4.2.3 Stability Control System

If equipped, vehicles are tested with stability control systems active. Stability control is not to be deactivated for any Slowly Increasing Steer or Fishhook maneuver.

4.3 Road Test Surface

Tests are conducted on a dry, uniform, solid-paved surface. Surfaces with irregularities, such as dips and large cracks, are unsuitable, as they may confound test results.

4.3.1 Pavement Friction

All maneuvers are to be performed on a dry, high-mu road test surface.

Unless otherwise specified, the road test surface produces a peak friction coefficient (PFC) of approximately 0.9 when measured using an American Society for Testing and Materials (ASTM) E1136 standard reference test tire, in accordance with ASTM Method E 1337-90, at a speed of 64.4 km/h (40 mph), without water delivery. This criterion is in agreement with that defined in FMVSS 135.

4.3.2 Slope

The test surface has a consistent slope between level and 2%. All tests are to be initiated in the direction of positive slope (uphill).

4.4 Ambient Conditions

4.4.1 Ambient Temperature

The ambient temperature shall be between 0° C (32° F) and 40° C (104° F). This criterion is in agreement with that defined in FMVSS 135.

4.4.2 Wind Speed

The maximum wind speed shall be no greater than 10 m/s (22 mph).

4.5 Calibration Data

It is strongly recommended that calibration data be collected prior to tests of each configuration to assist in resolving uncertain test data. NHTSA typically records the following data at the beginning of each test day for each test vehicle configuration.

- The distance measured by the speed sensor along a straight line between the end points of a surveyed linear roadway standard of 1000 feet or more (observed and recorded manually from the speed sensor display).
- Five to fifteen seconds of data from all instrument channels as the configured and prepared test vehicle is driven in a straight line on a level, uniform, solid-paved road surface at 60 mph.

4.6 Tire Break-In Procedure

Prior to each test series, the tires must be “scrubbed in” to wear away mold sheen and be brought up to operating temperature. Test vehicles are to be driven around a circle 100 feet in diameter at a speed that produces a lateral acceleration of approximately 0.5 to 0.6 g. Using this circle, three clockwise laps are to be followed by three counterclockwise laps. Once the six laps of the circle are complete, the driver is to input, sinusoidal steering at a frequency of 1 Hz and a handwheel amplitude (δ_{ss}) corresponding to 0.5-0.6 g for 10 cycles while maintaining a vehicle speed of 35 mph. A total of four passes using sinusoidal steering are to be used. The handwheel magnitude of the final cycle of the final pass is to be twice that of δ_{ss} . These four sinusoid passes typically require an area similar in size to that required by the Fishhook maneuver. The steering machine should be programmed to execute the sinusoids. There should be only a minimal delay between the completion of the tire break-in and the start of a test series to allow for the collection of a static data file, steering machine and data acquisition system adjustment, and final driver briefing.

4.7 Static Datums

At the completion of the tire break-in procedure and before the start of a test series, fifteen seconds of data are collected from all instrument channels with the test vehicle at rest, the engine running, the transmission in “Park” (automatic transmission) or in neutral with the parking brake applied (manual transmission), and the front of the test vehicle facing in the direction of positive gradient (uphill) on the test surface. The static data files are used in post processing establish datums for each instrument channel.

4.8 Vehicle Gear Selection

All tests are performed with automatic transmissions in “Drive” or with manual transmissions in

the highest gear capable of sustaining the desired test speed (Slowly Increasing Steer) or Maneuver Entrance Speed (Fishhook), with one exception:

Slowly Increasing Steer tests may be performed with automatic transmissions in lower gears if 50 mph cannot be maintained in “Drive” and the gear selection does not result in engine overspeeding. In some cases, 50 mph cannot be maintained through to the end of the steering schedule regardless of the gear selection due to low engine power or chassis responses that result in the loss of traction or spin out. It has been NHTSA’s experience, however, that maximum lateral acceleration is generally achieved well before the maneuver’s maximum handwheel angle is attained.

Manual transmission clutches are to remain engaged during all maneuvers.

4.9 Outrigger Adjustment

The initial clearance between the road surface and the bottom of the NHTSA outrigger skid pads is approximately 14 inches for the “standard” outriggers and approximately 12 inches for the “short” outriggers with the test vehicle at rest on a level surface. Note that the Multi-Passenger Configuration may compress the suspension more than the Nominal Load Configuration (reducing outrigger clearance). As such, outrigger height adjustment may be required when transitioning from one load configuration to the next.

Outrigger height adjustment may be required during a test series. If an outrigger skid pad contacts the road surface during a test run wherein there is no two-wheel lift, the outrigger at the effected end of the vehicle is raised 0.75 inches and the test run is repeated at the same maneuver entrance speed. If both outriggers make contact with the test surface during at test run wherein there is no two-wheel lift, both outriggers are raised 0.75 inches and the test run is repeated at the same maneuver entrance speed.

4.10 Videotape Documentation

It is recommended that all test runs be documented on videotape. NHTSA videotapes Slowly Increasing Steer tests from a viewpoint several hundred feet outside the circular path of the test vehicle. Fishhook maneuver tests are videotaped from a viewpoint that facilitates observation of the inboard side of the vehicle so as to best record instances of two-wheel lift. For both maneuvers, it is recommended the zoom of the camera be adjusted during each test such that the vehicle fills the view frame to the greatest extent possible.

4.11 Summary Of Tests To Be Performed For Each Vehicle

For each test vehicle, testing will be performed according to the following plan:

1. Installation of new tires
2. Tire break-in
3. Slowly Increasing Steer Maneuver test series in the Nominal Load or Multi-Passenger

Configuration

4. Tire change
5. Tire break-in
6. NHTSA Fishhook maneuver test series in the Nominal Load or Multi-Passenger Configuration with additional tire changes and break-ins as indicated in the maneuver protocol

4.12 Summary of Metrics Measured For Each Vehicle

1. Overall handwheel position at 0.3 g in the Nominal Load Configuration
2. Two-Wheel Lift in NHTSA Fishhook maneuver in Nominal Load or Multi-Passenger Configuration (Yes/No)
3. Rim-to-Pavement Contact or Tire Debeading in Nominal Load Nominal Load or Multi-Passenger Configuration (Yes/No)

4.13 Post Processing

Data are filtered in post processing with a 6-Hz 12-pole, 2-pass, phaseless digital Butterworth filter. All accelerations are corrected for CG displacement (see Section 2.5.1.3). Laser height measurements are filtered with a one-pass 200 ms running average technique.

Post processing also includes roll effects correction for lateral acceleration as follows.

$$a_{yc} = a_{ym}\cos\Phi - a_{zm}\sin\Phi$$

where,

- a_{yc} is the corrected lateral acceleration (i.e., the vehicle's lateral acceleration in a plane horizontal to the test surface)
- a_{ym} is the measured lateral acceleration in the vehicle reference frame
- a_{zm} is the measured vertical acceleration in the vehicle reference frame
- Φ is the vehicle's roll angle

Note: The z-axis sign convention is positive in the downward direction for both the vehicle and test surface reference frames.

5.0 REFERENCES

1. Forkenbrock, G.J., Garrott, W.R, Heitz, Mark, O'Harra, Brian C., "A Comprehensive Experimental Examination of Test Maneuvers That May Induce On-Road, Untripped Light Vehicle Rollover – Phase IV of NHTSA's Light Vehicle Rollover Research Program," NHTSA

Technical Report, DOT HS 809 513, October 2002.

2. Forkenbrock, G.J., O’Harra, Brian C., Elsasser, Devin, “An Experimental Examination of 26 Light Vehicles Using Test Maneuvers That May Induce On-Road, Untripped Light Vehicle Rollover – Phase VI of NHTSA’s Light Vehicle Rollover Research Program,” NHTSA Technical Report, DOT HS 809 547, 2003.
3. NHTSA, “NHTSA’s Experience With Outriggers Used For Testing Light Vehicle – A Brief Summary,” Docket No. NHTSA-2001-9663, January 2003.
4. NHTSA, “NHTSA’s Set-Up Procedures for Wheel Lift Sensors – A Brief Overview,” Docket No NHTSA-2001-9663, April 2003.
5. SAE J266, Surface Vehicle Recommended Practice, “Steady-State Directional Control Test Procedures For Passenger Cars and Light Trucks,” 1996.

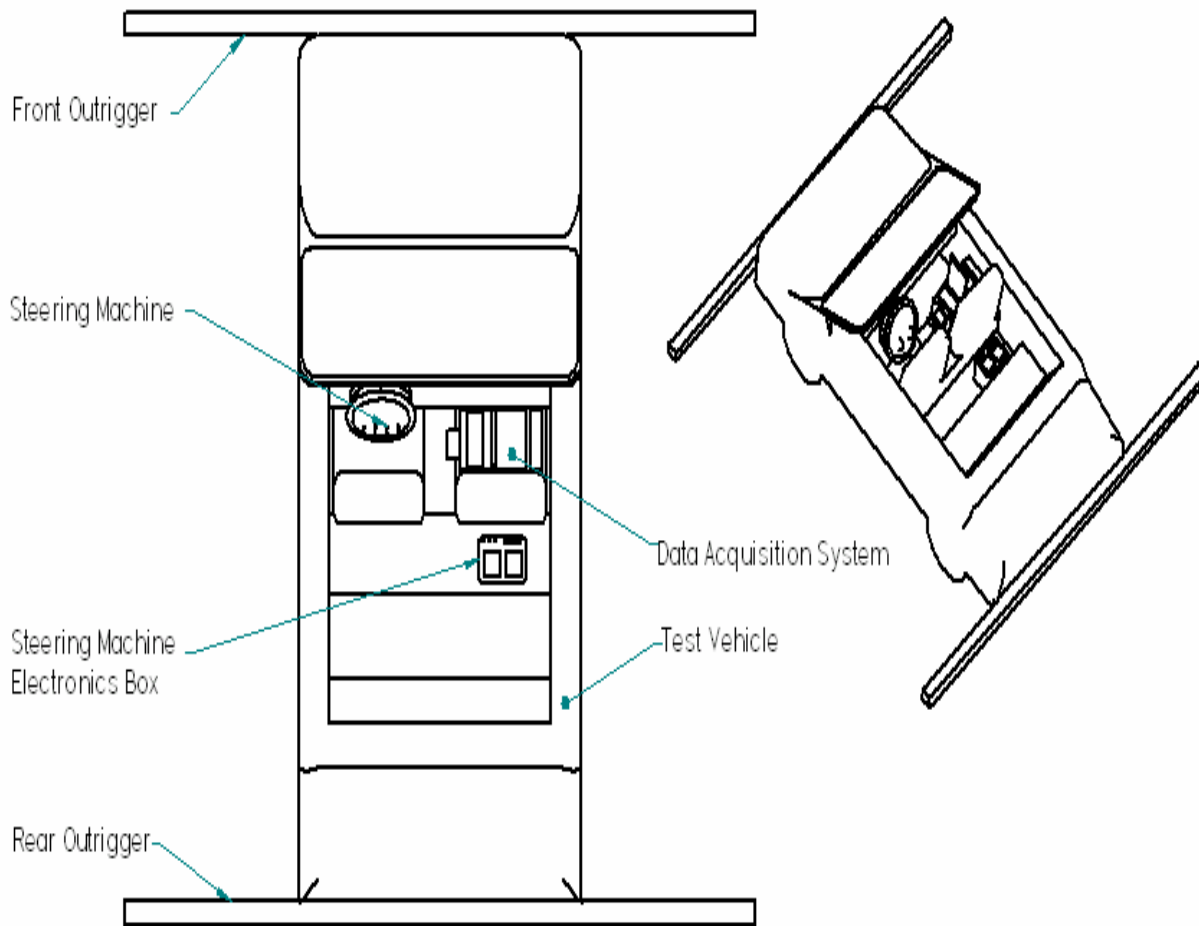

Figure I.1. Equipment location.

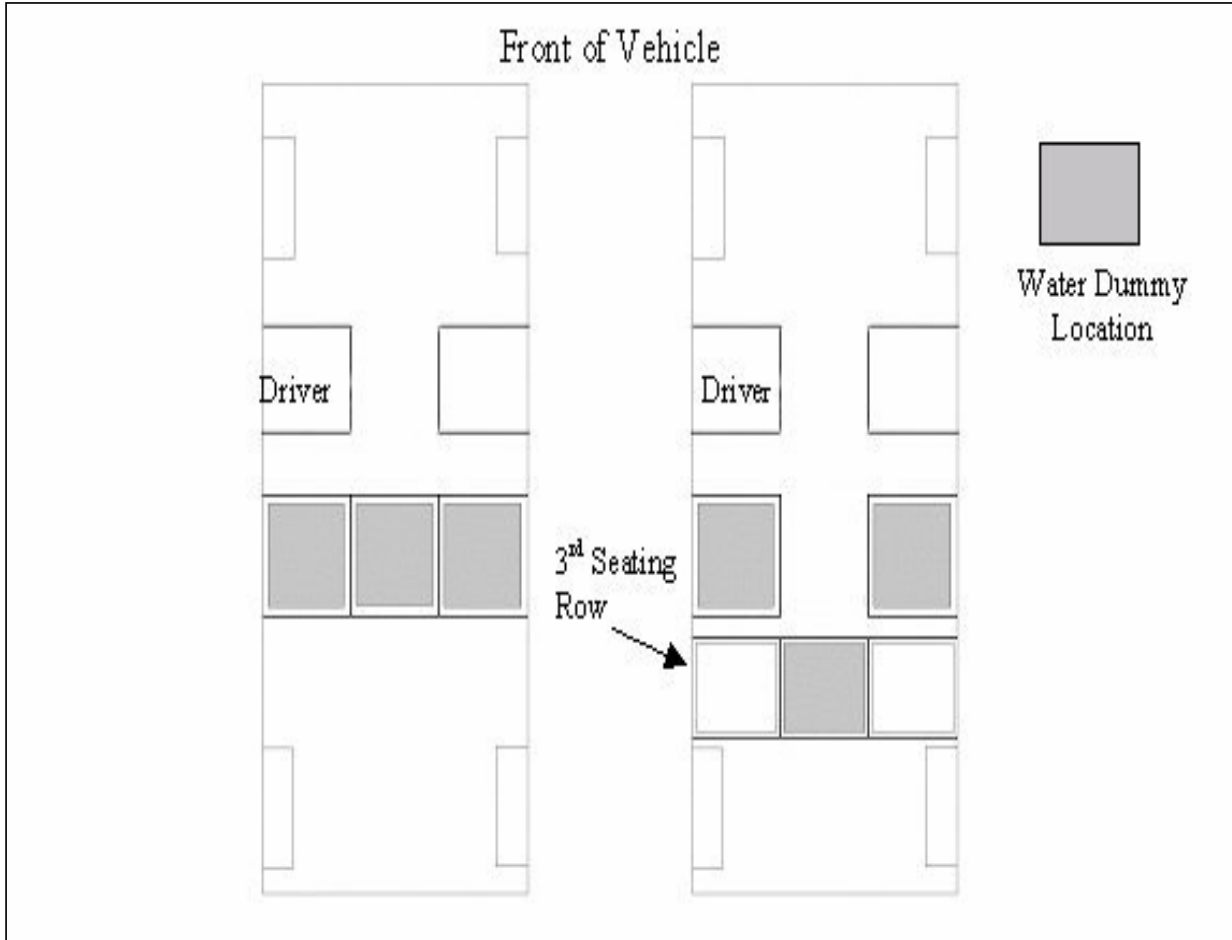

Figure I.2. Water dummy placement for vehicles with three or more designated rear seating positions, excluding pick-up trucks. **Note:** A water dummy is placed in the third seating row only when the second seating row is limited to two designated seating positions.

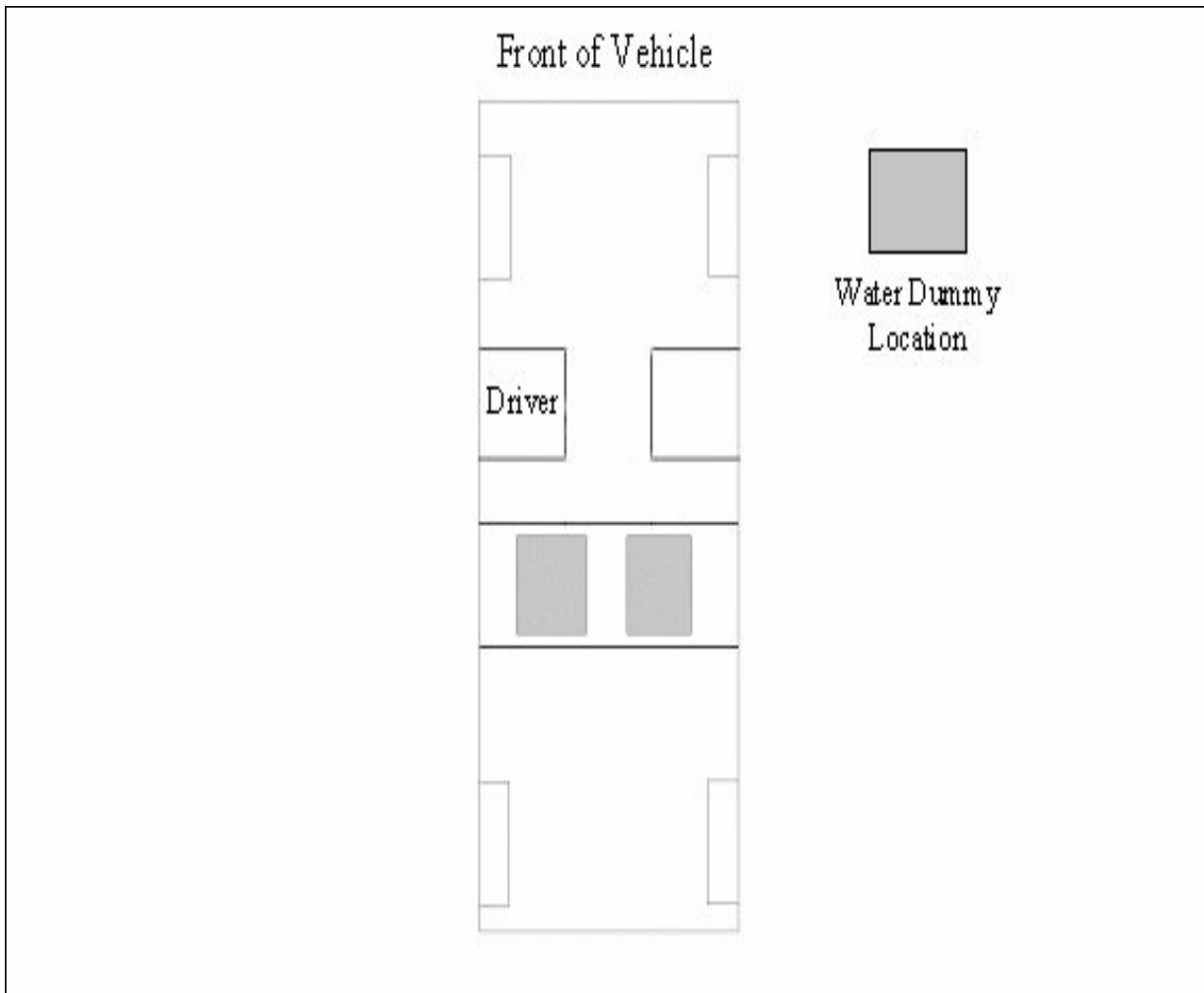

Figure I.3. Water dummy placement for vehicles with two designated rear seating positions, excluding pick-up trucks.

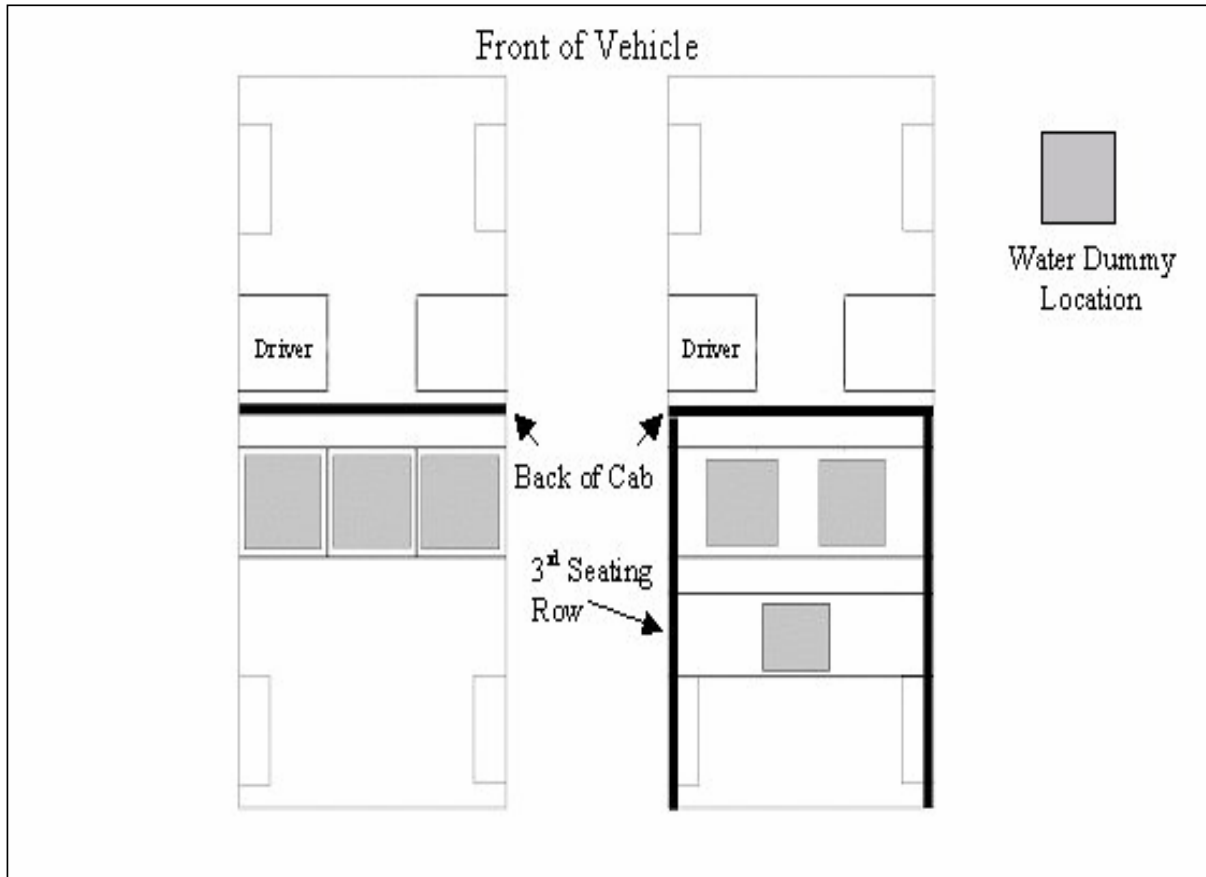

Figure I.4. Water dummy placement for pick-up trucks with no designated rear seating positions. **Note:** A water dummy is placed in a simulated third seating row only when the inside width of the cargo bed prevents the placement of three dummies side by side in the simulated second row.

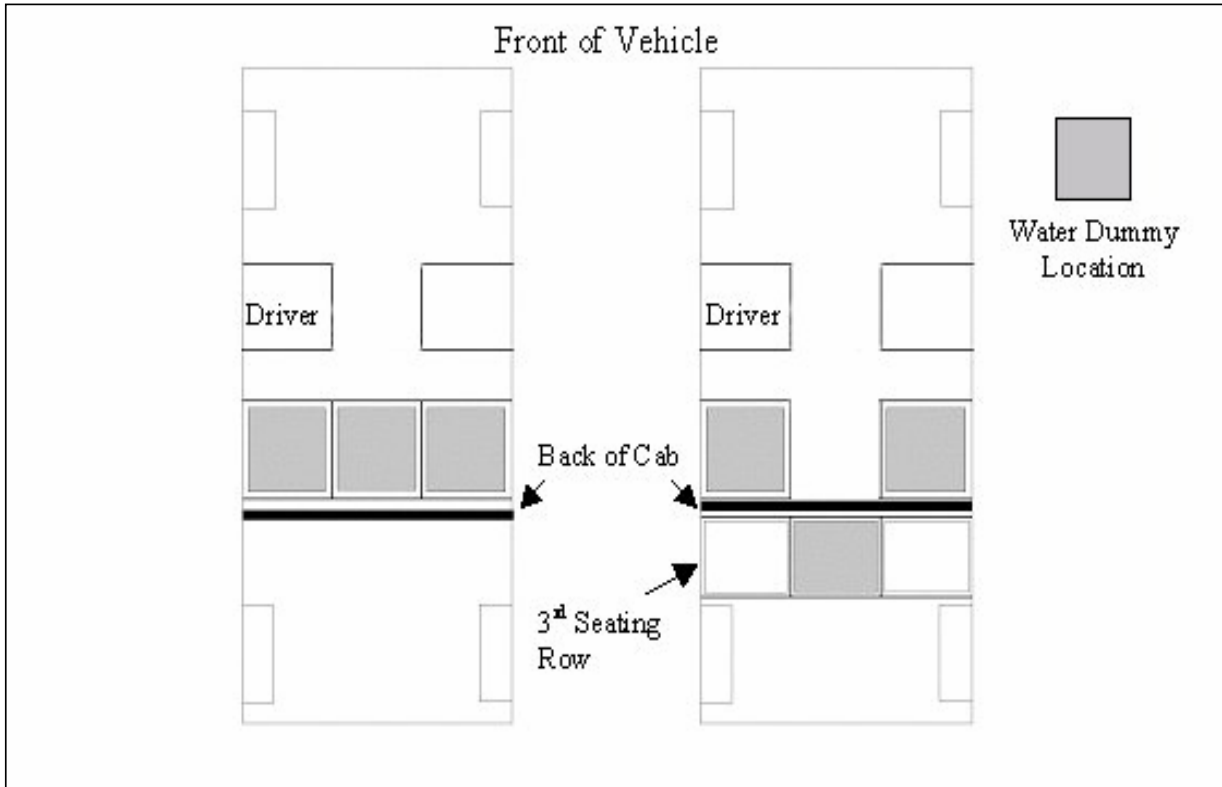

Figure I.5. Water Dummy Placement – pick-up trucks with two or more designated rear seating positions. **Note:** A water dummy is placed in a simulated third seating row only when the second seating row is limited to two designated seating positions

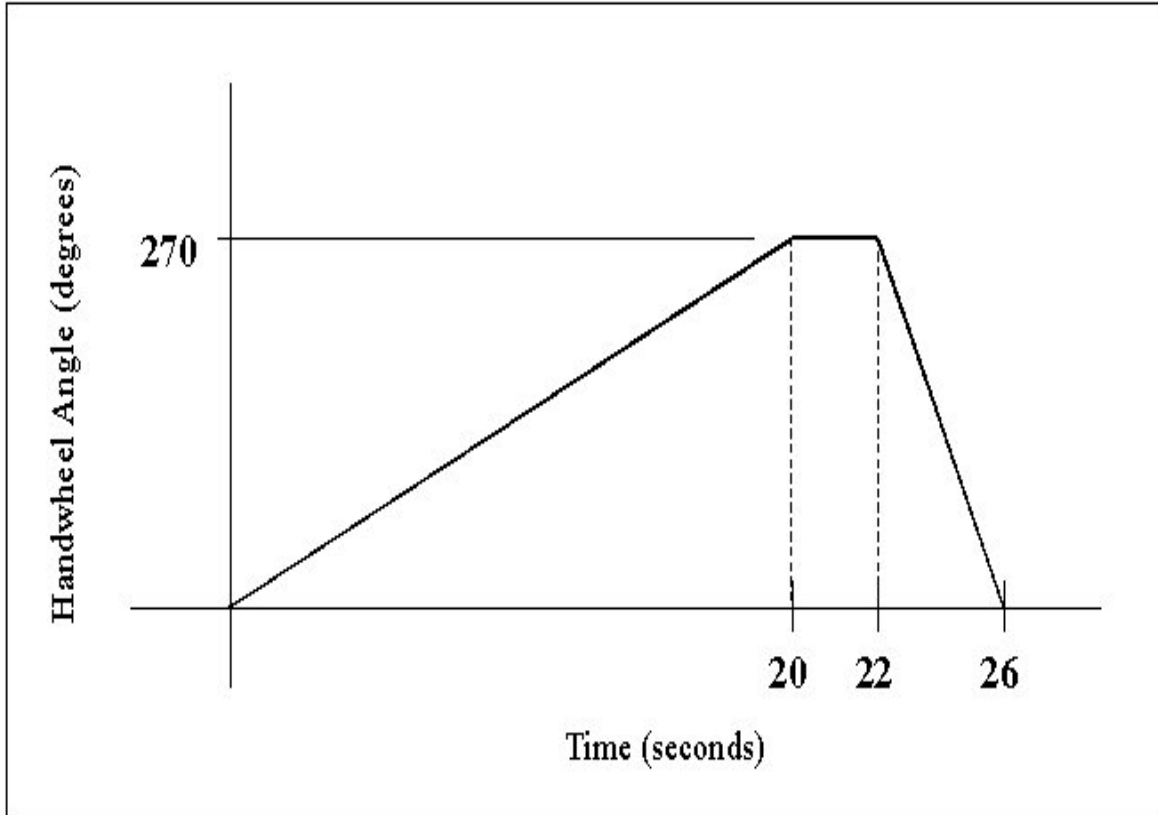

Figure I.6. Slowly Increasing Steer maneuver description (Option #1).

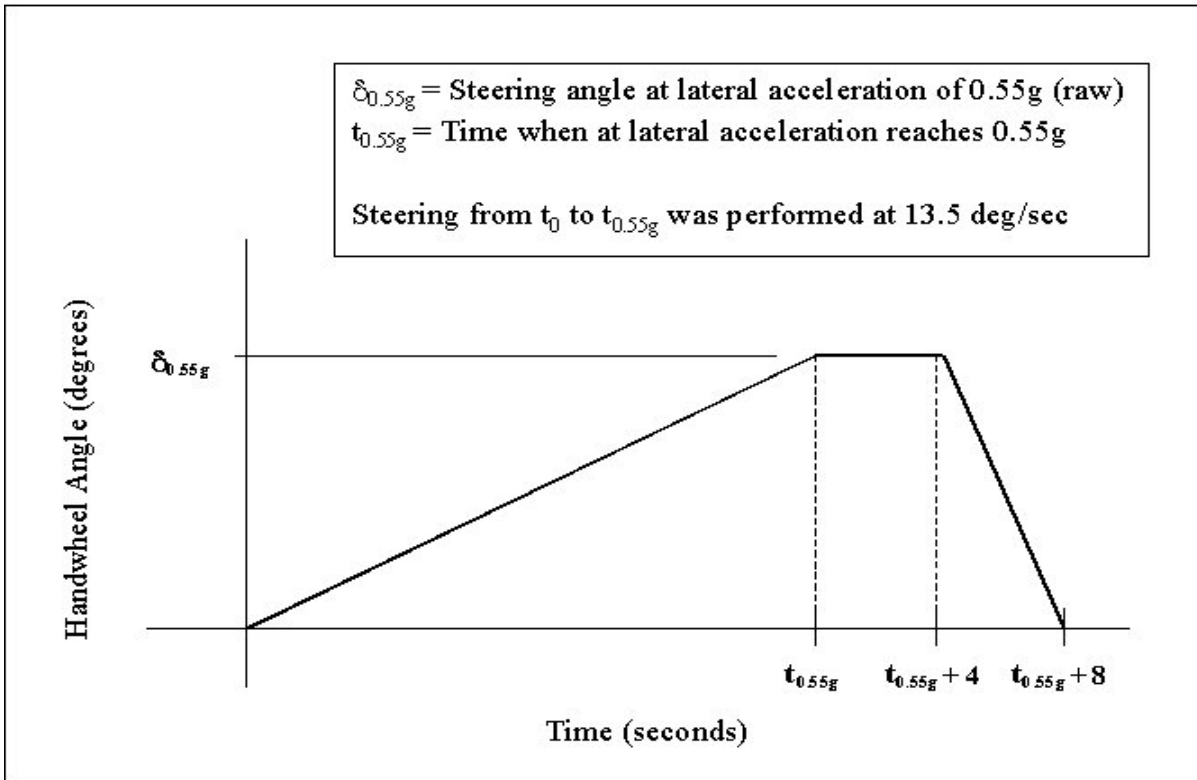

Figure I.7. Slowly Increasing Steer maneuver description (Option #2).

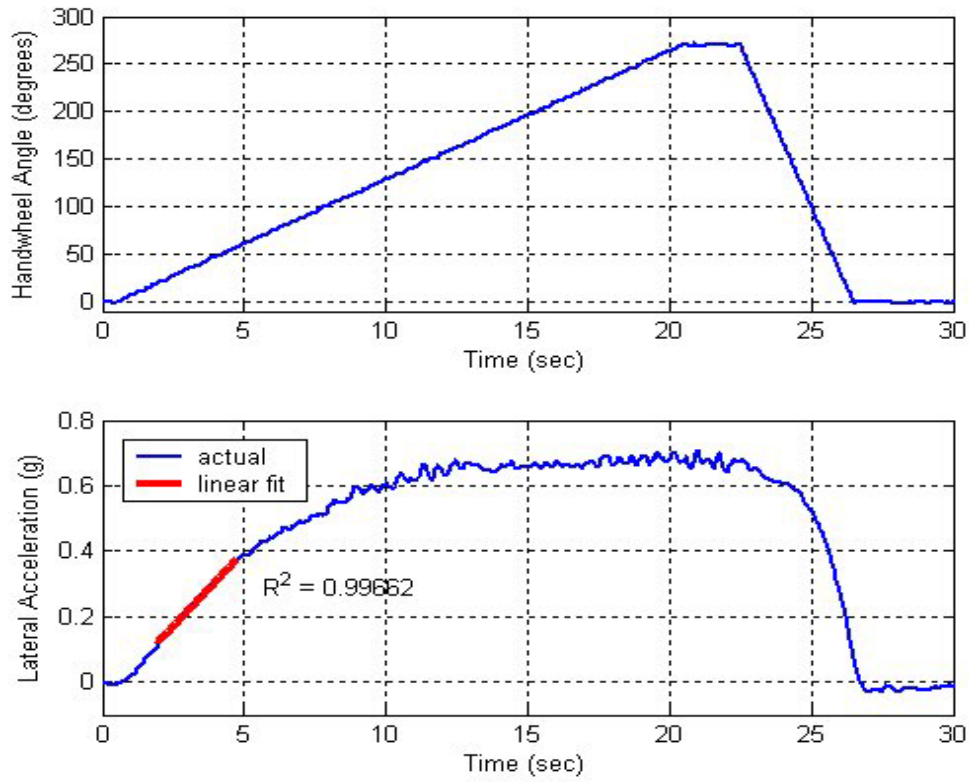

Figure I.8. Sample handwheel angle and lateral acceleration data (Option #1). The linear range used to define the lateral acceleration regression line is highlighted.

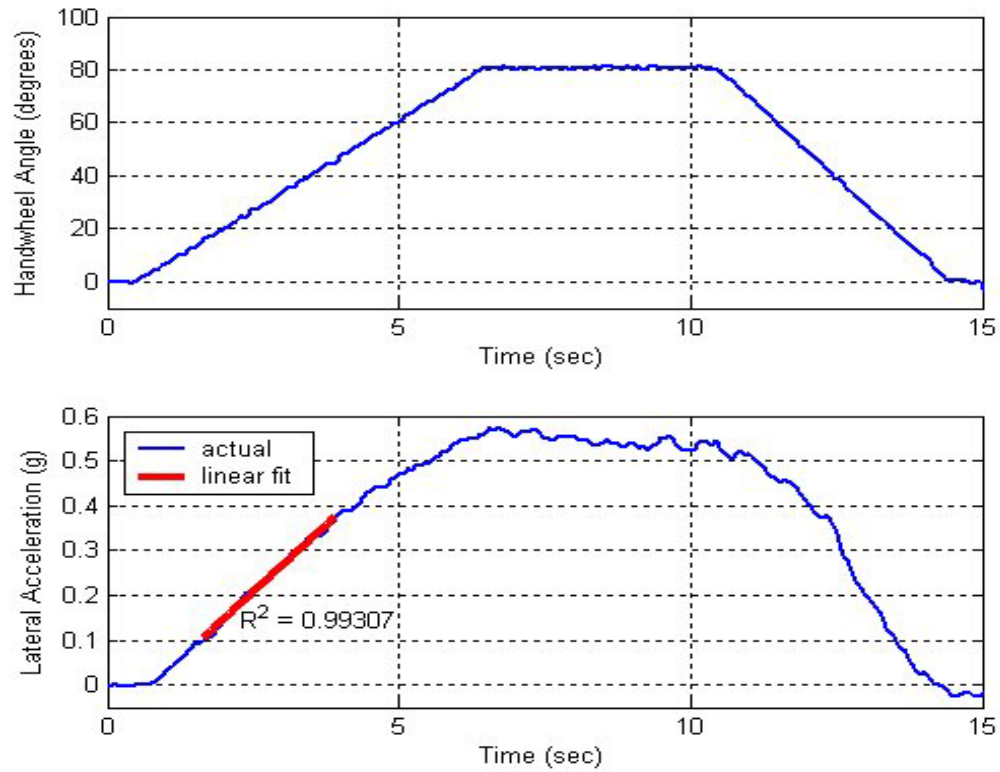

Figure I.9. Sample handwheel angle and lateral acceleration data (Option #2). The linear range used to define the lateral acceleration regression line is highlighted.

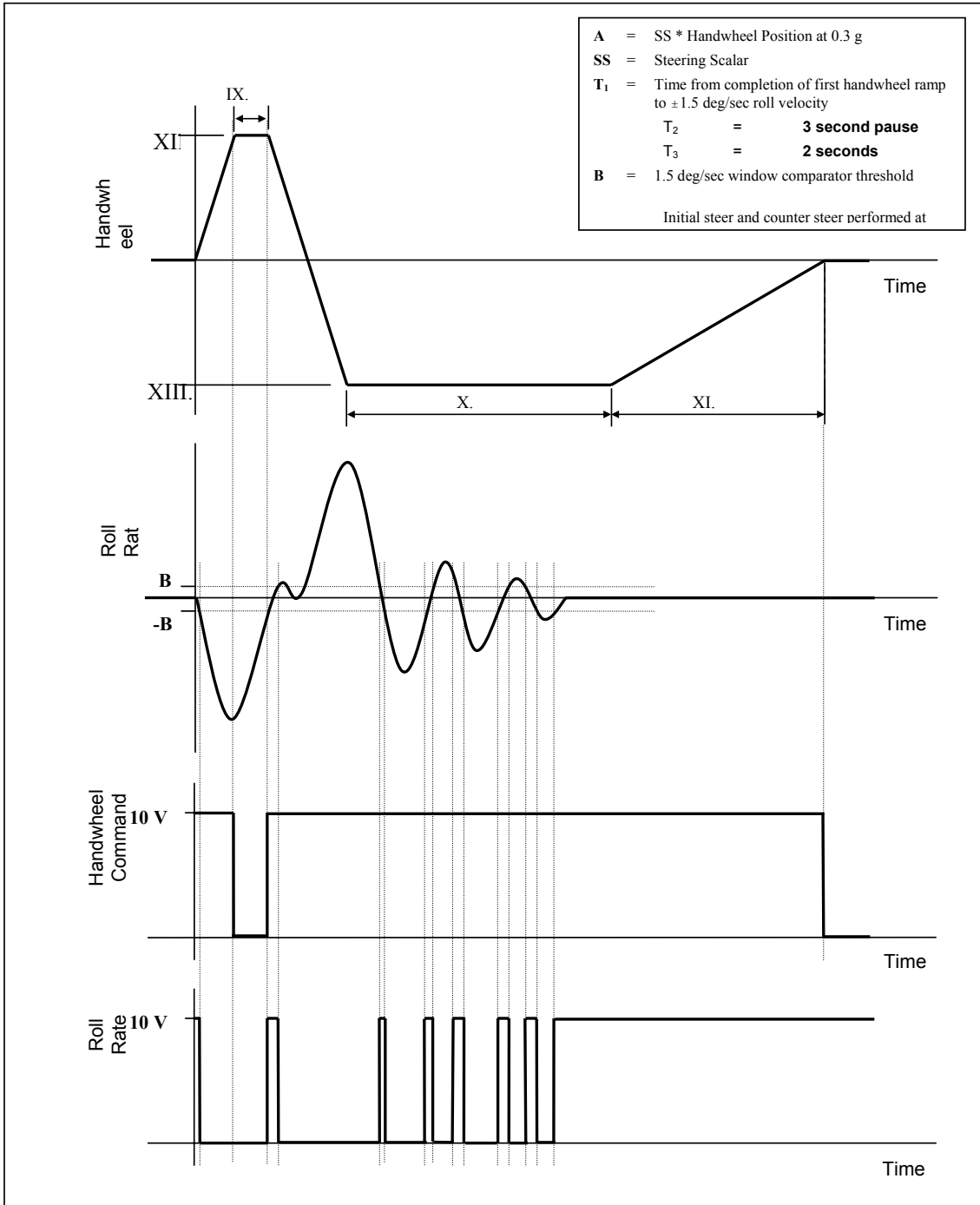

Figure I.10. NHTSA Fishhook maneuver description.

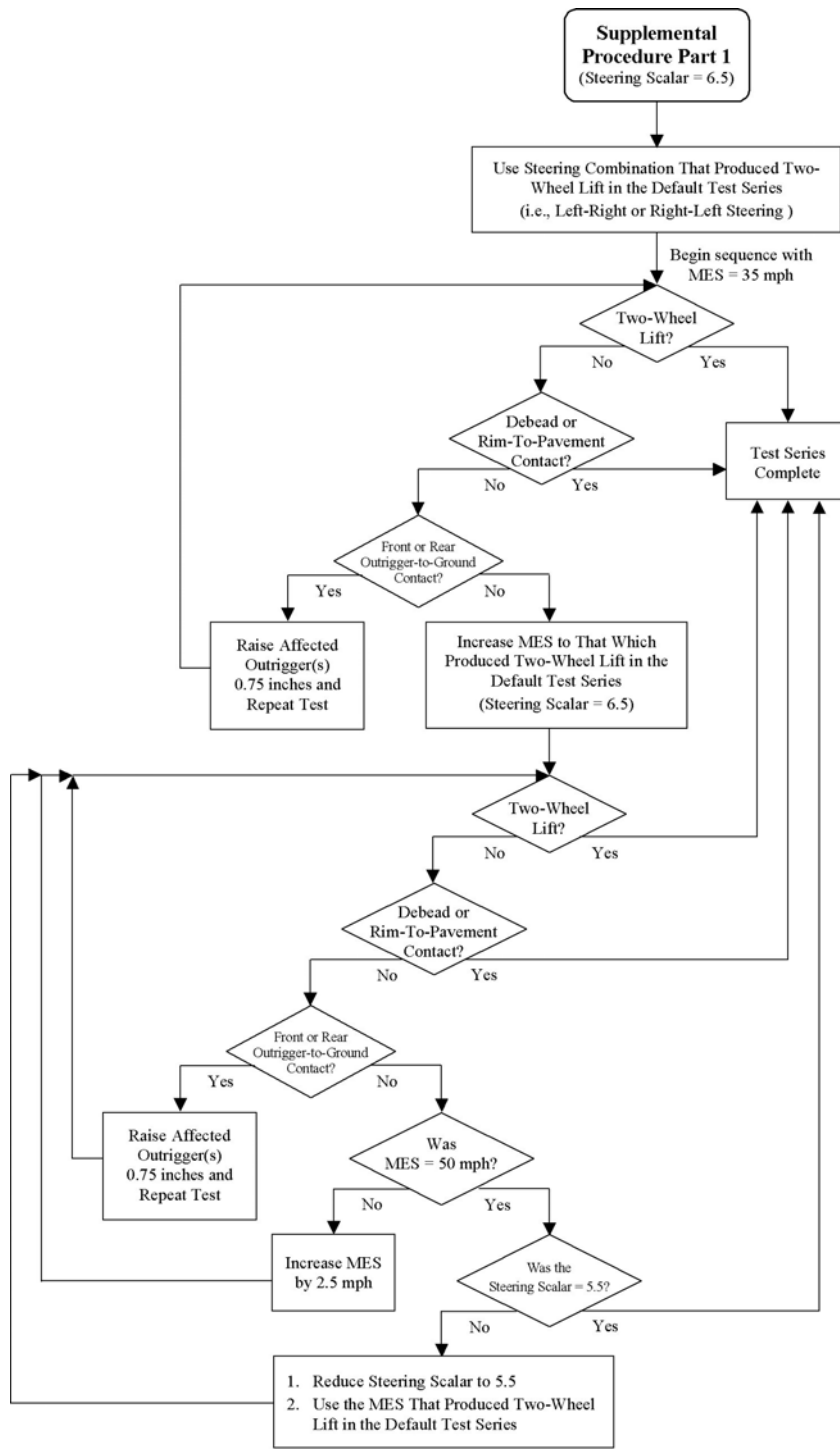

Figure I.12. Supplemental Procedure Part 1.

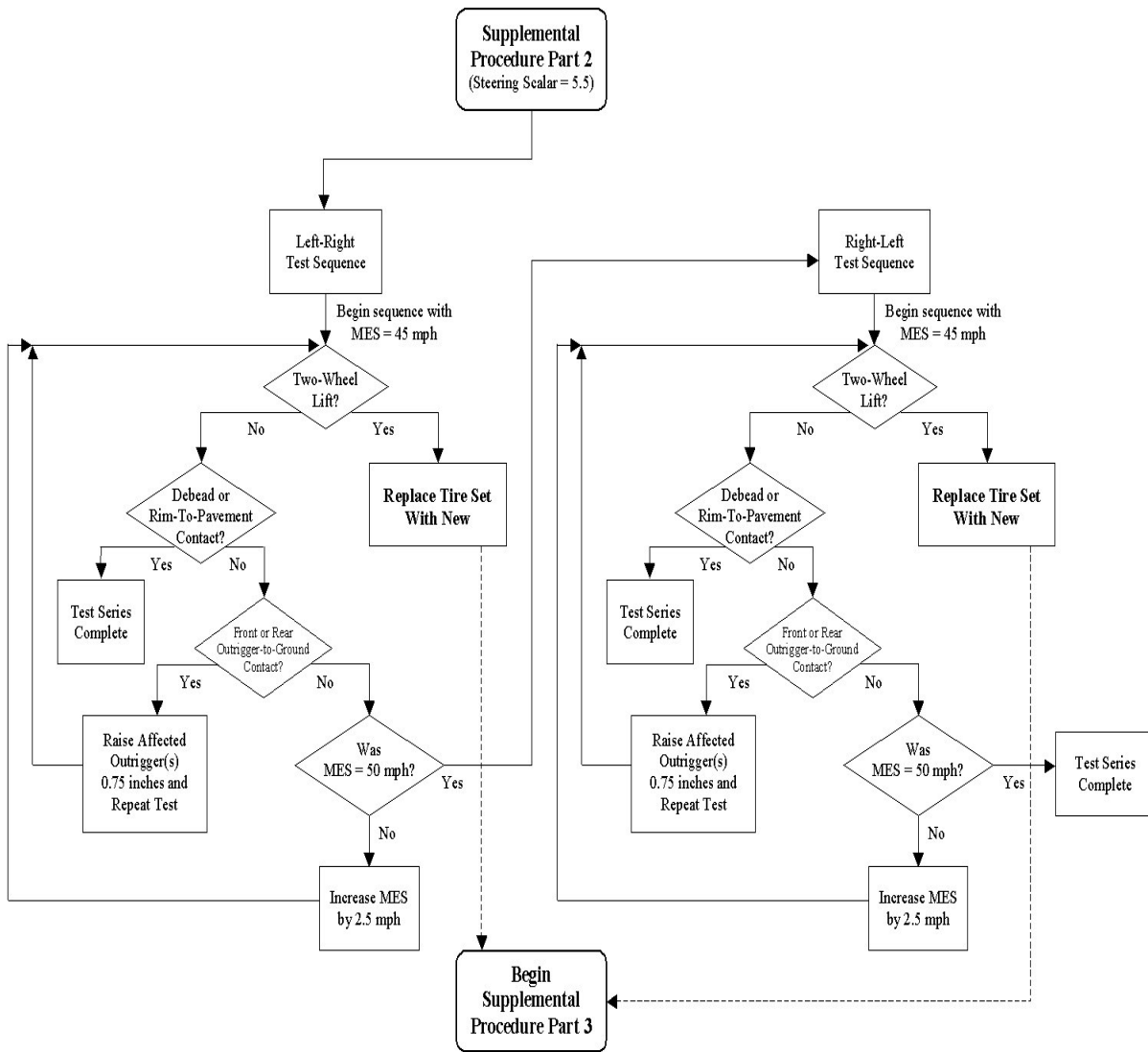

Figure I.13. Supplemental Procedure Part 2.

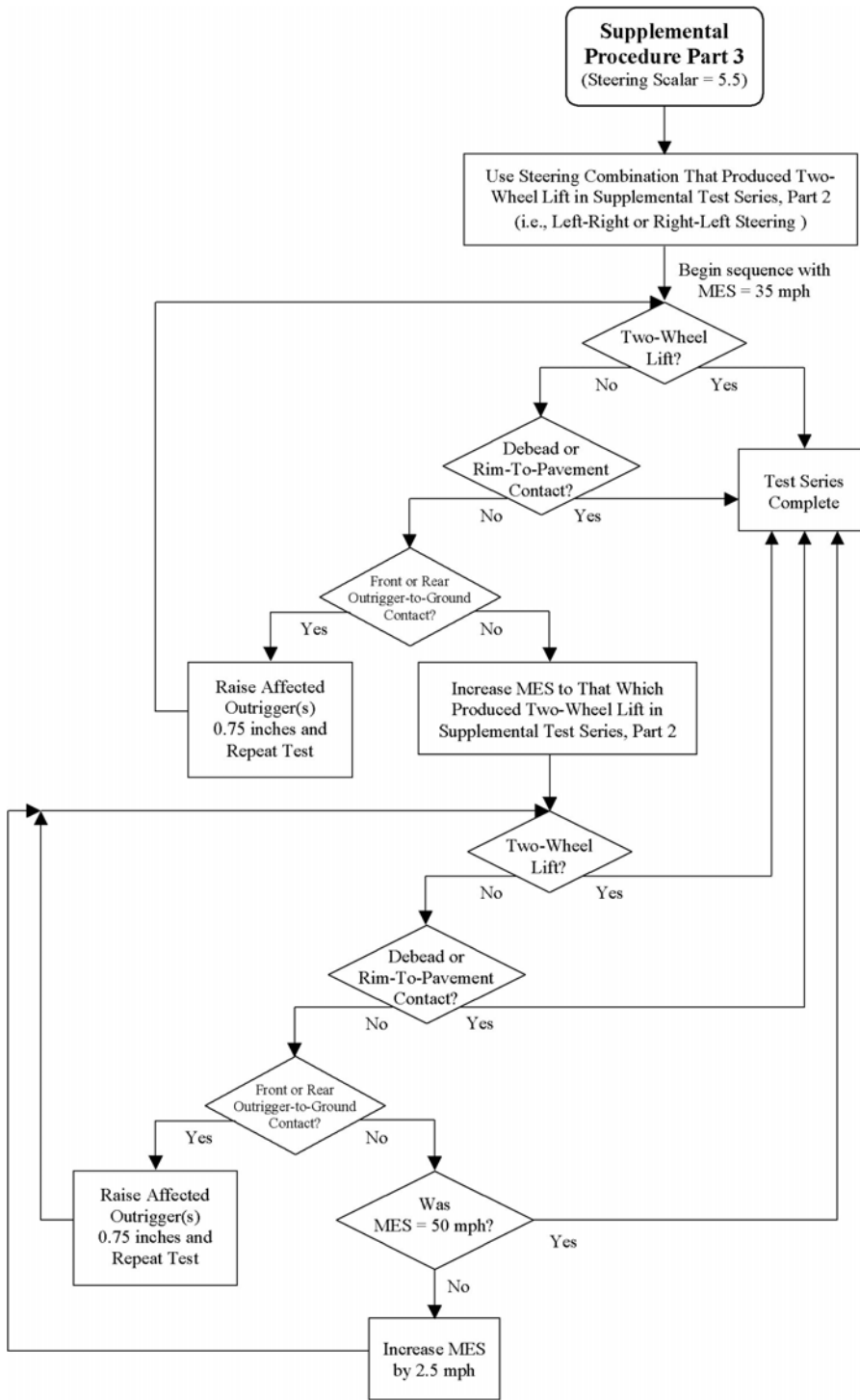

Figure I.14. Supplemental Procedure Part 3.

Appendix II. Development of a Rollover Risk Model

In its study of our rating system for rollover resistance (Transportation Research Board Special Report 265), the National Academy of Sciences (NAS) recommended that we use logistic regression rather than linear regression for analysis of the relationship between rollover risk and SSF. We had considered a logistic regression model during the development of the rollover resistance rating system used by NCAP for 2001 to 2003 vehicles, but we observed that it predicted rollover rates that were systematically lower than actual rollover rates for vehicles with low SSF. Our first step was to explore the use of transformations of SSF to create a logistic regression model that better matched actual rollover rates while following the recommendation of the NAS.

A satisfactory logistic regression model using SSF only was the starting point for developing a risk model that used both a vehicle's SSF and its performance in dynamic maneuver tests to predict its rollover rate. We used four binary variables to describe whether or not the vehicle tipped up in two dynamic maneuver tests each performed at two different occupant load conditions. The final model required the results of only the Fishhook maneuver test with the heavy five occupant load and the SSF of a vehicle. The predicted rollover rate determines the rollover resistance rating of the vehicle.

A. Improving the Fit of the Logistic Regression Model with SSF Only

We had considered logistic regression during the development of the SSF based rating system (66 FR 3393, January 12, 2001), but found that it consistently under-predicted the actual rollover rate at the low end of the SSF range where the rollover rates are high. The NAS study

acknowledged this situation and gave the example of another analysis technique (non-parametric) that made higher rollover rate predictions at the low end of the SSF scale. In the NPRM, we discussed our plan to first examine ways to improve the fit of the logistic regression model to the actual rollover rates in the simpler model with SSF as the only vehicle attribute before expanding the logistic regression model to predict rollover rates using maneuver test results and SSF as vehicle attributes. In this way, the addition of maneuver test results is more likely to have an effect that reflects the additional information they represent on rollover causation.

A consultant to the Bureau of Transportation Statistics who lectured on logistic regression suggested that we use a transformation of SSF, like $\text{Log}(\text{SSF})$, rather than SSF alone to change the shape of the trend line generated by the logistic regression in our range of interest of SSF. This technique is similar to what we used to improve the fit of the linear regression model in the SSF rating system (Figure II.1). Linear regression creates a “best fit” straight line to predict the relationship between the independent variable, SSF in this case, and the dependent variable, rollover rate per single vehicle crash in this case. However, the observations of rollover rate for groups of vehicles with a known SSF did not appear to lie on a straight line. The relationship appeared to be exponential with a reduction in rollover rate with increase in SSF much greater at low SSFs than at high SSFs. We used the transformation $\text{Log}(\text{SSF})$ to replace SSF alone in the linear regression model so that it would compute a “best fit” exponential curve instead of a best fit straight line in order better fit the prediction line to the observations. We referred to Figure II.1 in notices 65 FR 34998 and 66 FR 3388 as a linear regression model because of the analysis technique, but the NAS study refers to it as the exponential model because of its curve shape.

Figure II.2 plots the actual rollover rates as a function of SSF observed for 293,000 single vehicle crashes involving 100 vehicle groups in six states from 1994 to 2001 (not all state's data available in every year). The point designated "actual rate" at each value of SSF gives the proportion of single vehicle crashes for vehicles of that SSF that resulted in rollover. For example, the leftmost point shows that for all single vehicle crashes observed for vehicles with an SSF of 1.00, slightly less than 50% resulted in rollover. There are fewer than 100 data points because the data at each SSF often include the crashes of several vehicles with the same SSF.

Figure II.2 also plots the rollover rates predicted for the same 293,000 crashes by a logistic regression model operating on SSF without transformation as the only vehicle variable. The model was developed from a database that contained the driver characteristic and road condition variables in the state crash reports of 293,000 crashes in six states. Data from Maryland, Florida, North Carolina, Missouri, Utah and Pennsylvania were used because these were the only states with electronic records available to NHTSA in which we could identify the make/model of the vehicle and could be sure whether or not a rollover occurred. The driver variables were gender, age [young (less than 25), old (70 or older), neither], and evidence of alcohol or drug use. The road condition variables were weather, speed limit, curve, hill, darkness, wet or icy surface, and potholes or other bad surface conditions. The SAS logistic regression program used these driver and road variables, the vehicle SSF, the State and the outcome (rollover or not) for each of 293,000 single vehicle crashes to compute the risk model. Figure II.2 shows the exercise of inputting the driver, road, state and vehicle SSF circumstances for each individual crash of the 293,000 back into the risk model to test how well the model can predict the actual rollover outcomes.

In similar fashion as the “actual rate” points on Figure II.2, the “predicted rate” points at each value of SSF give the proportion of single vehicle crashes for vehicles of that SSF that resulted in rollover. The number and circumstances (as well as can be described from state crash report variables) of crashes represented by the actual and predicted rate points are identical. However, in one case the rollover outcomes are the actual outcomes reported in the state data. But in the other case, the rollover outcomes are the predictions of the risk model given the driver and road variables and vehicle SSF for each actual the crash. The predicted rate points do not lie on a continuous curve when plotted against SSF because the distribution of driver and road variables are different for the single vehicle crashes experienced by each group of vehicles represented by its SSF value.

Figure II.2 shows that the risk model obtained using the untransformed SSF computes predictions that match the actual rollover rates well at SSFs higher than 1.3, but its predictions are consistently low at the low end of the SSF range. The predictions also tend to be too high in the 1.15 to 1.25 SSF range. For this reason we described the form of the curve inherent to the logistic regression computation as being too flat or lacking sufficient curvature to represent rollover risk in our past notices.

Figure II.2 also lists an objective measure of the goodness of fit of the predictions to aid in the comparisons of models with and without using transformations of SSF. It is the R^2 value for linear regression between the predicted and actual rollover rates. Figure II.3 is a plot of predicted versus actual rollover rates taken from Figure II.2. It shows how the R^2 value was obtained. A linear regression of the form “ $y = mx$ ” computes the best fit line that passes through the origin. The R^2 value that describes the goodness of fit of the points to the line “ $y = 0.9673x$ ” is 0.752. A perfect set of predictions would cause an R^2 value of 1.0 on the line “ $y = 1.0x$ ”.

Figures II.4, II.5, and II.6 show the predictions of a series of risk models obtained in the same way as that shown in Figure II.2 except that transformations of SSF were used as the vehicle variable instead of just SSF. The first transformation, shown in Figure II.4, was $\text{Log}(\text{SSF})$. This is the transformation currently used in the linear regression rollover risk model. It makes a very small improvement both to the under-predictions at the low end of the SSF range and the over-predictions in the 1.15 to 1.25 SSF range. The R^2 goodness of fit indicator increased to 0.7975.

Next we tried the transformation $\text{Log}(\text{SSF} - \text{margin})$. Figure II.5 shows the predictions of a logistic regression model with a margin of 0.85. The subtraction of a margin from SSF makes a large improvement in the fit of the predicted rollover rates to the actual rollover rates in the SSF range of 1.0 to 1.25. The R^2 goodness of fit indicator increased to 0.8811 about the line “ $y = 1.0011 x$ ” for the whole SSF range of data base (1.0 to 1.53). This transformation caused a small sacrifice in the fit of the model at the high end of the SSF range. However, a good fit in the 1.0 to 1.25 SSF range is more important to a rating system because most of the consumer requests for rollover information involve vehicles in this range.

Figure II.6 shows the fit of the model with a margin of 0.9. The R^2 goodness of fit indicator increased slightly to 0.8948 about the line “ $y = 1.0091 x$ ”, but the sacrifice of fit at the high SSF end also increased. Figure II.7 is a plot of predicted versus actual rollover rates taken from Figure II.6. The use of the transformation $\text{Log}(\text{SSF} - 0.90)$ instead of SSF alone in the logistic regression gave us a risk model with the benefits of logistic regression recommended by the NAS and a goodness of fit with the actual rollover rate data at least equivalent to that of the linear regression model we have been using.

Figure II.8 shows the best logistic regression model (margin = 0.90) and the linear

regression model we have been using. In this presentation, the driver and road variables of the crashes for each SSF were the same so that the differences in predicted rollover rates along each line were a purely a function of SSF differences, and the risk curve is continuous. The common scenario of driver and road variables represented the average conditions for the entire 293,000 single vehicle crashes (only 20% of which resulted in rollover). The linear regression model represents the same scenario.

The line in Figure II.8 representing the linear regression model is described by the equation:

$$\text{Roll Rate} = 13.28e^{(-3.376 \times \text{SSF})}$$

Formatted: Font: 12 pt, Lowered by 3 pt

The line in Figure II.8 representing the logistic regression model is described by the following equation:

$$\text{Roll Rate} = \frac{1}{1 + e^{(2.7546 + 1.1814 \times \ln(\text{SSF} - 0.90))}}$$

Formatted: Font: 12 pt, Lowered by 12 pt

B. Adding Dynamic Maneuver Test Results to the Logistic Regression Model

The dynamic maneuver test results (tip-up or no tip-up in each maneuver/load combination in Table 1 of the main body of the notice) were used as four binary variables in the logistic regression analysis. They were entered in addition to SSF to describe the vehicle. The same driver and road variables from state crash reports discussed above were used. The state crash report data for twenty-four of the vehicles used in the logistic regression analysis with dynamic maneuver test variables was a subset of the database of 293,000 single vehicle crashes described above. One extra vehicle was added for the maneuver tests that was not among the 100 vehicle groups we had studied previously, but state crash report data from the same years

and states was obtained for it. However, the database with SSF and dynamic maneuver tests was much smaller than the 293,000 sample size available for the logistic regression model with SSF only. Its sample size was 96,000 single vehicle crashes of 25 vehicles including 20,000 rollovers.

The risk models combining SSF and dynamic maneuver test results (“dynamic results” for short) are computed in the same way as the logistic regression curve in Figure II.7. The logistic regression analysis of the database of 96,000 state reports of single vehicle crashes along with the dynamic results and SSF of each crashed vehicle provides a mathematical relationship between all of the vehicle, driver and road variables and a prediction of whether rollover will occur in a single vehicle crash described by any combination of the variables. Next, for the number of sets of driver and road variables that define the average crash scenario of the 293,000 single vehicle crash database, predictions of rollover or no rollover in the crash are made at each combination of SSF and dynamic results. The proportion of crashes that are predicted to result in rollover is plotted at each SSF and dynamic result. Continuous curves predicting rollover rate versus SSF for each combination of dynamic results is the form of the model. Since all of the predictions were made with the same driver and road scenario, the changes in rollover rate along each SSF curve or between dynamic results are functions of vehicle attributes.

Figure II.9 illustrates the form of the model with dynamic results. It shows the predicted rollover rate as a function of SSF and whether or not the vehicle tipped-up in the Fishhook maneuver with 5 occupant loading (fishhook heavy or FH). It predicts a rollover rate that is strongly dependant on SSF but higher for vehicles that tip-up in this severe maneuver than for vehicles that do not tip up in the test.

The intent of using dynamic results from four tests was to provide tests with a range of severity to best discriminate between vehicles on the basis of dynamic performance. The Fishhook heavy maneuver was the most severe, and the J-turn light was the least severe. The expectation was that tip-up in the least severe maneuver would predict a greater rollover risk than tip-up in the most severe maneuver.

Figures II.10, II.11 and II.12 show logistic regression models using each of the other maneuvers as a single variable for dynamic results. In Figure II.10, vehicles that tip-up in J-turn heavy are predicted to have a slightly greater rollover risk than those that do not tip. However, in the Fishhook light and J-turn light maneuvers, the logistic regression models of Figures II.11 and II.12 predicted a greater rollover risk for vehicles that did not tip-up.

We do not believe vehicles that tip up in the least severe maneuvers are actually safer than those that do not tip up. A more rational interpretation is that the numbers of vehicle tipping up in these maneuvers were too few to establish a definitive correlation. Only three vehicles tipped up in the J-turn light maneuver, and six vehicles tipped up in the Fishhook light maneuver. Only one more vehicle tipped up in the J-turn heavy maneuver than in the Fishhook light, and the prediction of the model with J-turn heavy was consistent with expectations that tip-up in the test predicts greater rollover risk. However, the extra vehicle in the J-turn heavy tip-up group was the Ford Ranger 2 WD with a very large sample size of over 8,000 single vehicle crashes (nearly 10 percent of the entire data base).

Next we computed a logistic regression using both dynamic results variables, Fishhook heavy and J-turn heavy, that were observed to have a directionally correct result when entered into the model individually. The result was that the variable, J-turn heavy, was rejected by the logistic regression program as not statistically significant in the presence of the Fishhook heavy

variable. In other words, the predictions based on tip-up in the Fishhook heavy maneuver do not change whether or not the vehicle also tips up in the J-turn heavy maneuver.

Figure II.13 shows the final model that uses only Fishhook heavy of the dynamic results variables. The printout of the SAS logistic regression procedure that establishes the coefficients of the model has been docketed separately. This model has a risk prediction for vehicles that tip up in the dynamic maneuver tests based on the greatest number of vehicles possible in our 25 vehicle data base. All 11 vehicles that tipped up in any maneuver are represented on the tip-up curve, and the 14 vehicles without tip-up are represented on the other curve. The logistic regression model based on SSF only for 100 vehicles is included for reference. It is very similar to the risk model with dynamic result variables for vehicles that tip up in the Fishhook heavy maneuver. This result is not surprising because the SSF only model was optimized for best fit in the 1.00 to 1.25 SSF range that included all vehicles tipping up in dynamic maneuver tests. The SSF only model was based on a vehicle sample that included 10 of the 11 vehicles that tipped up in the dynamic tests, but the sample included 90 additional vehicles. The fact that the prediction based on the SSF of 100 vehicles closely matches the prediction based on 11 vehicles that tipped up in the dynamic tests suggests that the small sample has produced a robust prediction although the predictive power of tip-up in the dynamic test may not be great.

In Figure II.13, the equation of the line representing the SSF only model (from the 100 vehicle database) is:

$$\text{Roll Rate} = \frac{1}{1 + e^{(2.7546 + 1.1814 \times \ln(\text{SSF} - 0.90))}}$$

Formatted: Font: 12 pt, Lowered by 12 pt

The equations for the final model representing a combination of SSF with dynamic scores for each of the dynamic results (tip-up and no tip-up) are:

$$\text{Roll Rate} = \frac{1}{1 + e^{(2.6968 + 1.1686 \times \ln(SSF - 0.90))}} \text{ for tip - up in FH}$$

Formatted: Font: 12 pt, Lowered by 12 pt

$$\text{Roll Rate} = \frac{1}{1 + e^{(2.8891 + 1.1686 \times \ln(SSF - 0.90))}} \text{ for no tip - up}$$

Formatted: Font: 12 pt, Lowered by 12 pt

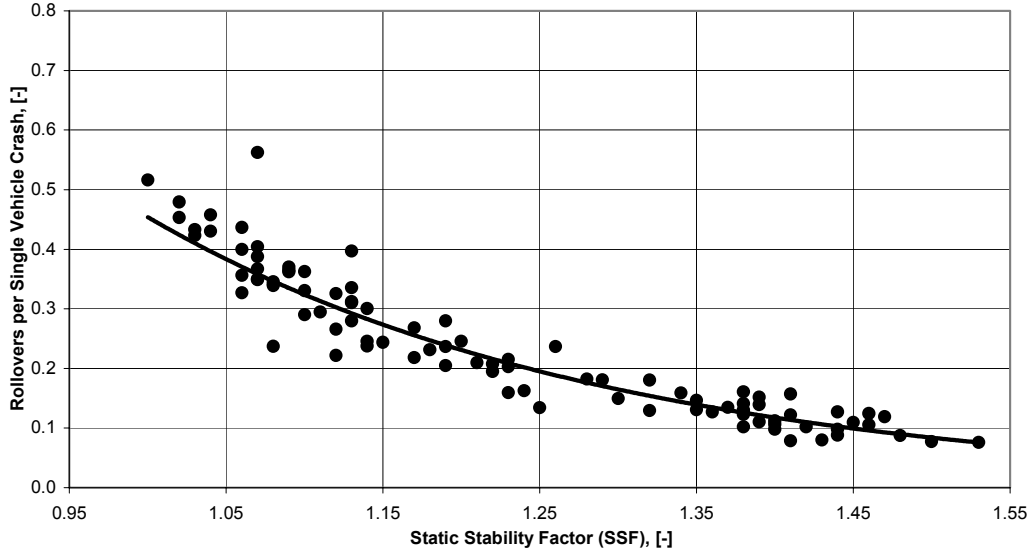

Figure II.1: Linear regression model for 2001-2003 SSF Rollover Resistance Rating (rollovers per single-vehicle crash estimated from six states adjusted to national average road use and for differences in state reporting)

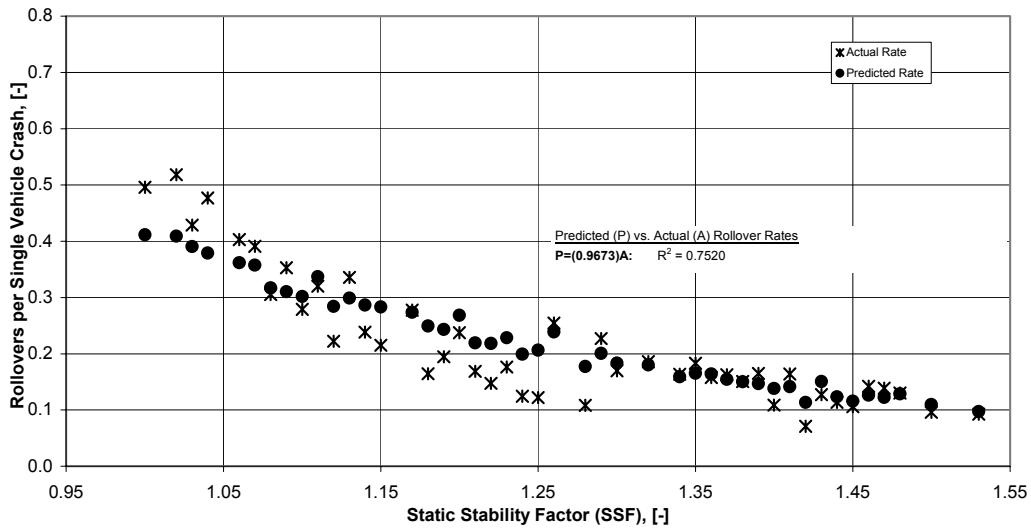

Figure II.2: Logistic regression model operating on SSF (w/o transformation) 100 vehicle database – SSF only

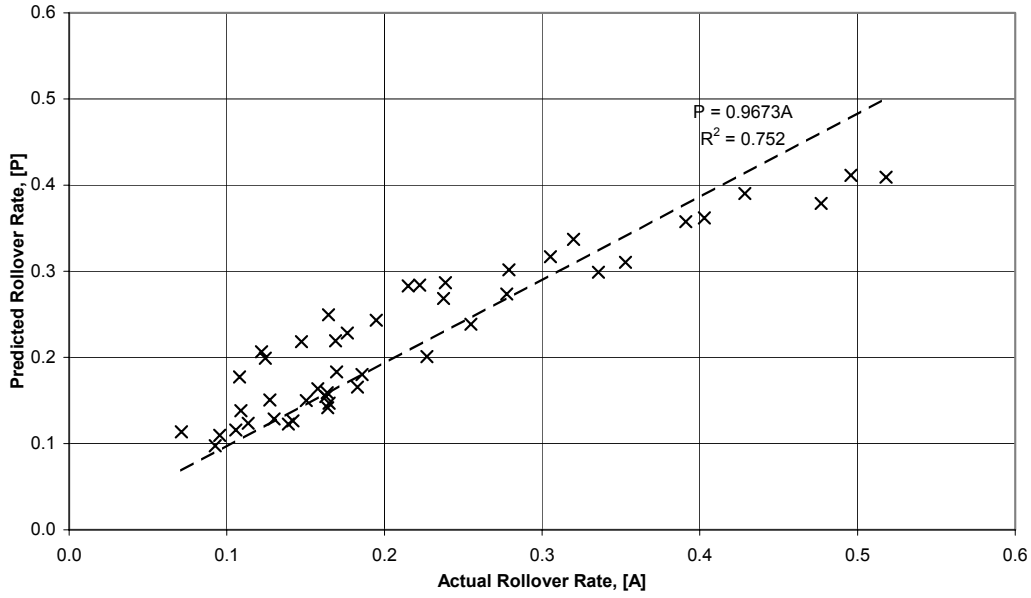

Figure II.3: Actual rollover rate vs. Predicted rollover rate (using model of Fig. II.2) - 100 vehicle database - SSF only

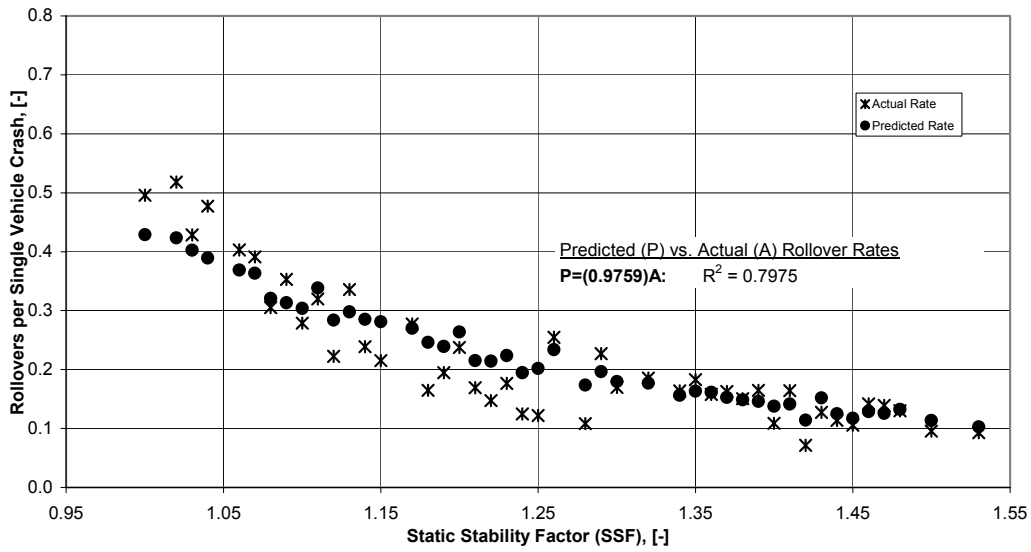

Figure II.4: Logistic regression model operating on the LOG(SSF) 100 vehicle database – SSF only

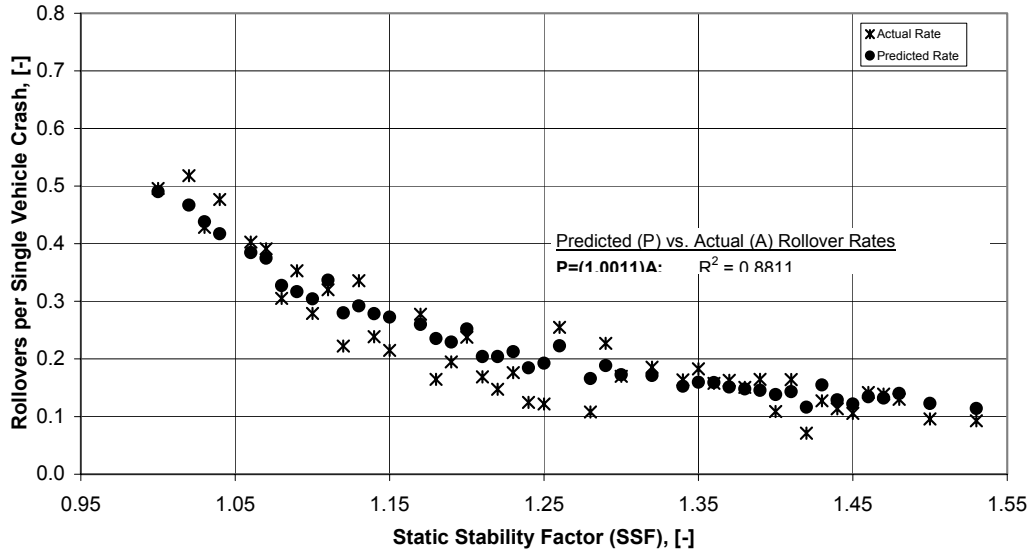

Figure II.5: Logistic regression model operating on the LOG(SSF-0.85)
100 vehicle database – SSF only

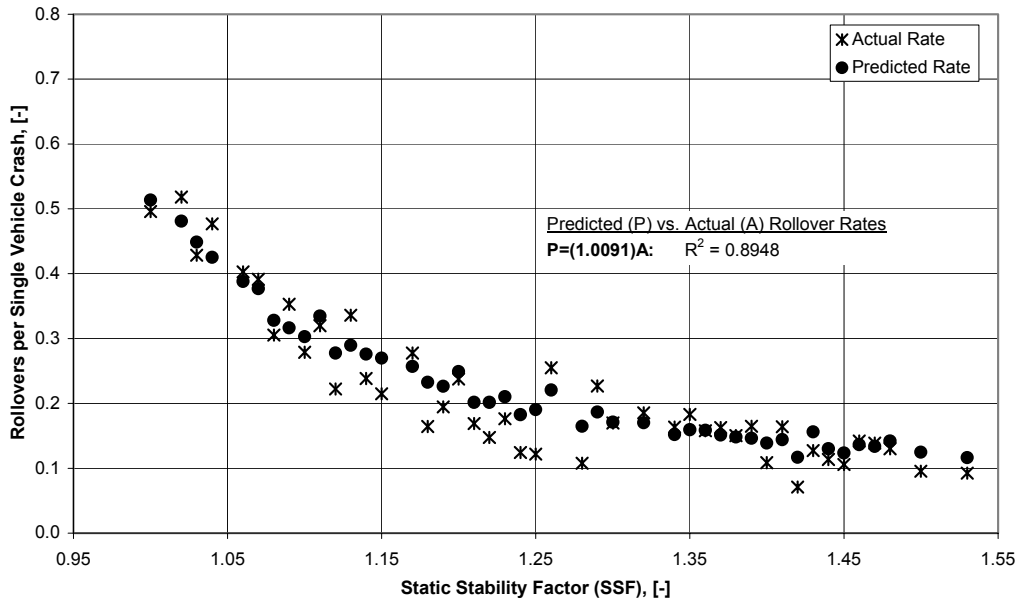

Figure II.6: Logistic regression model operating on the LOG(SSF-0.90)
100 vehicle database – SSF only

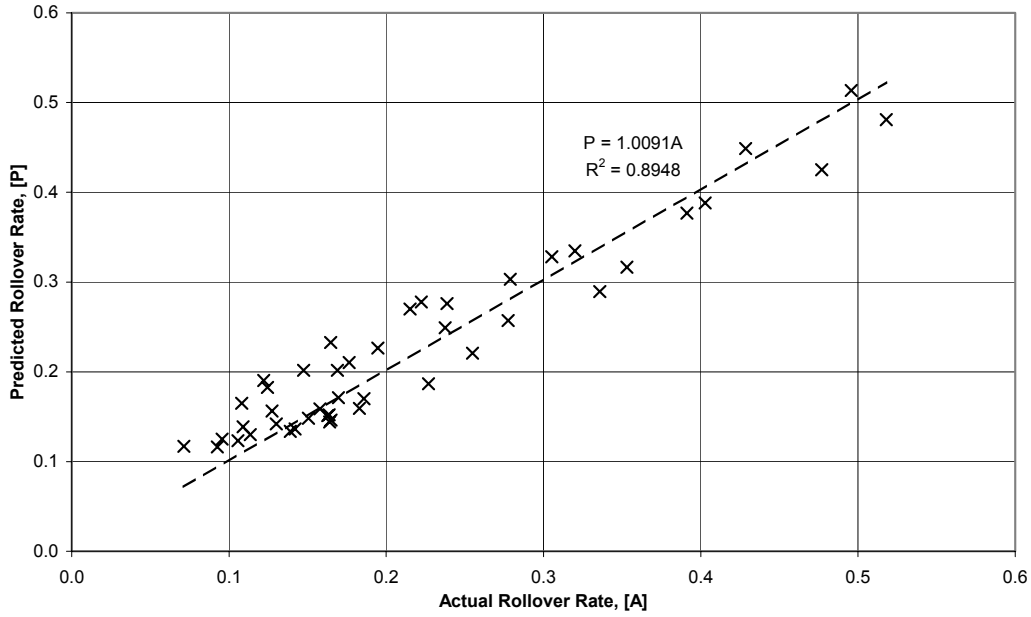

Figure II.7: Actual rollover rate vs. Predicted rollover rate (using model of Fig. II.6) - 100 vehicle database - SSF only

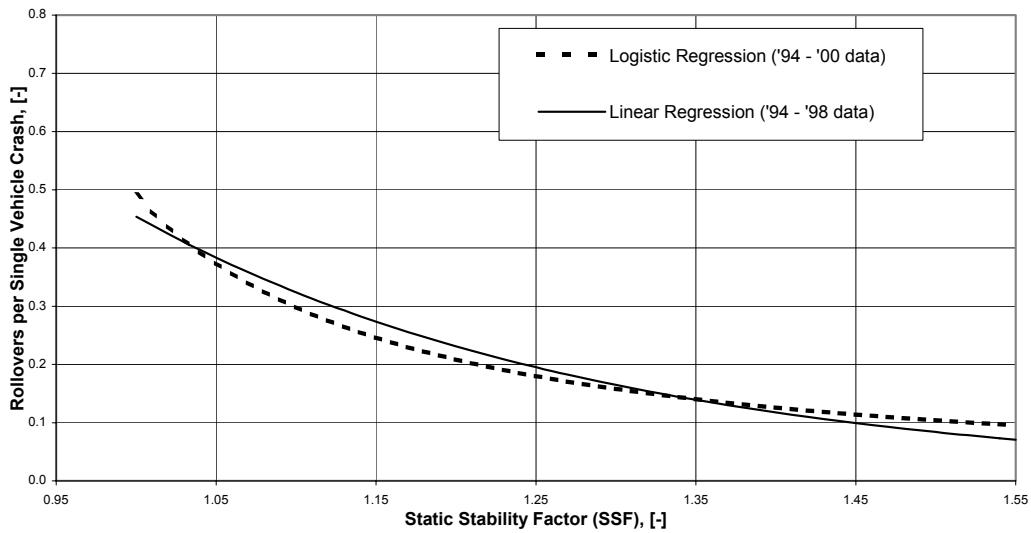

Figure II.8: Logistic regression risk model using SSF only and Linear regression risk model for 2001-2003 NCAP Rollover Resistance

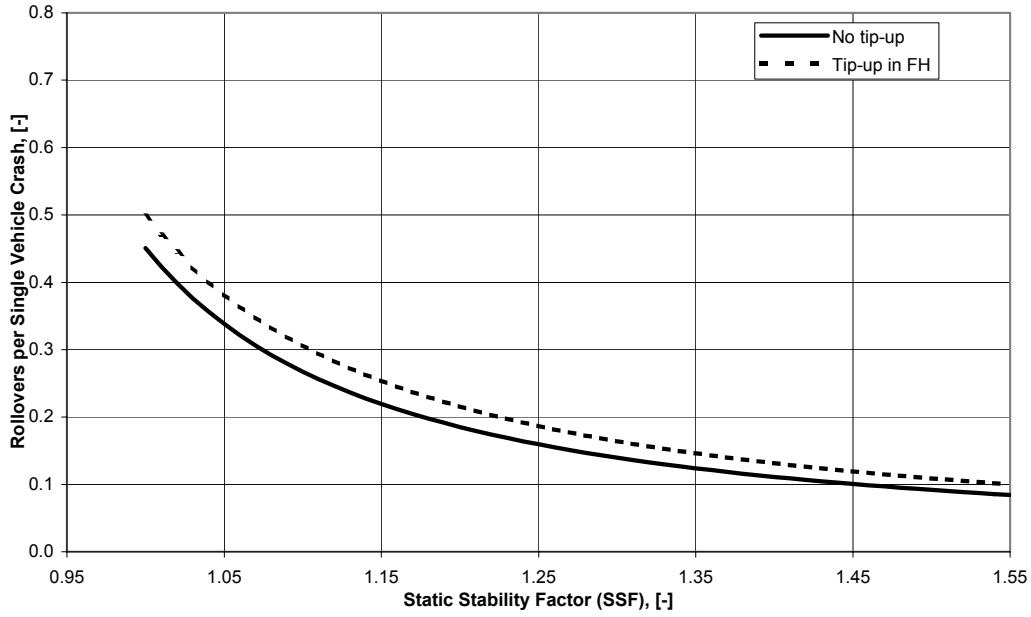

Figure II.9: Model with single dynamic variable – Fishhook, Heavy

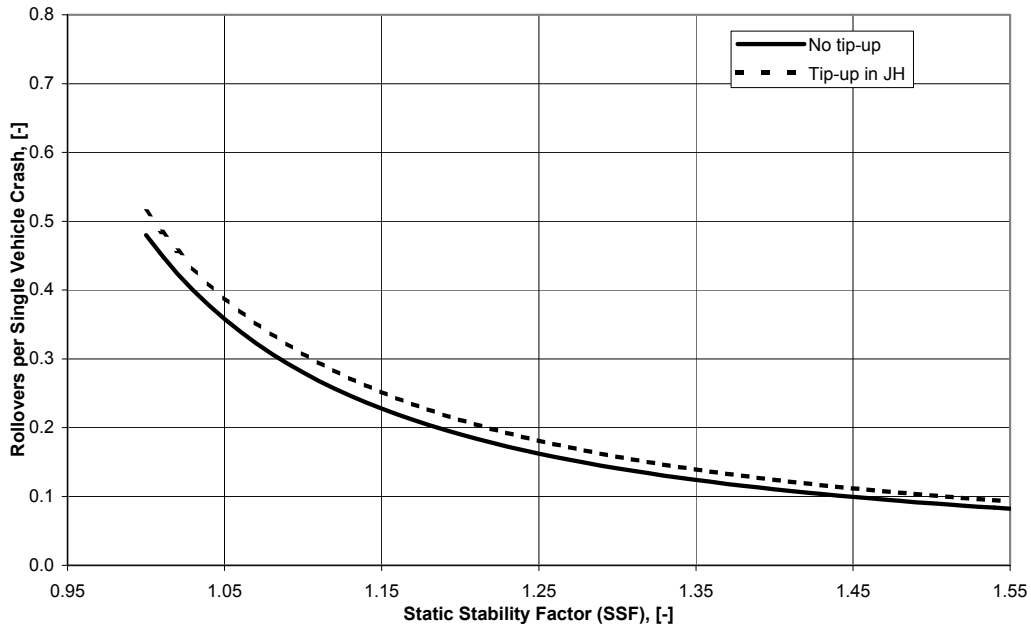

Figure II.10: Model with single dynamic variable – J-Turn, Heavy

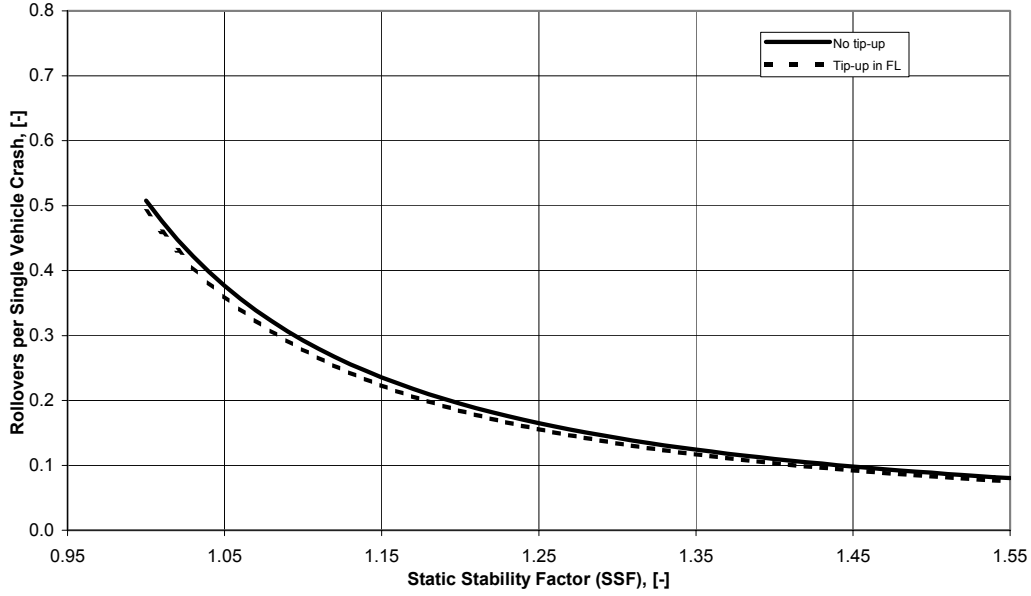

Figure II.11: Model with single dynamic variable – Fishhook, Light

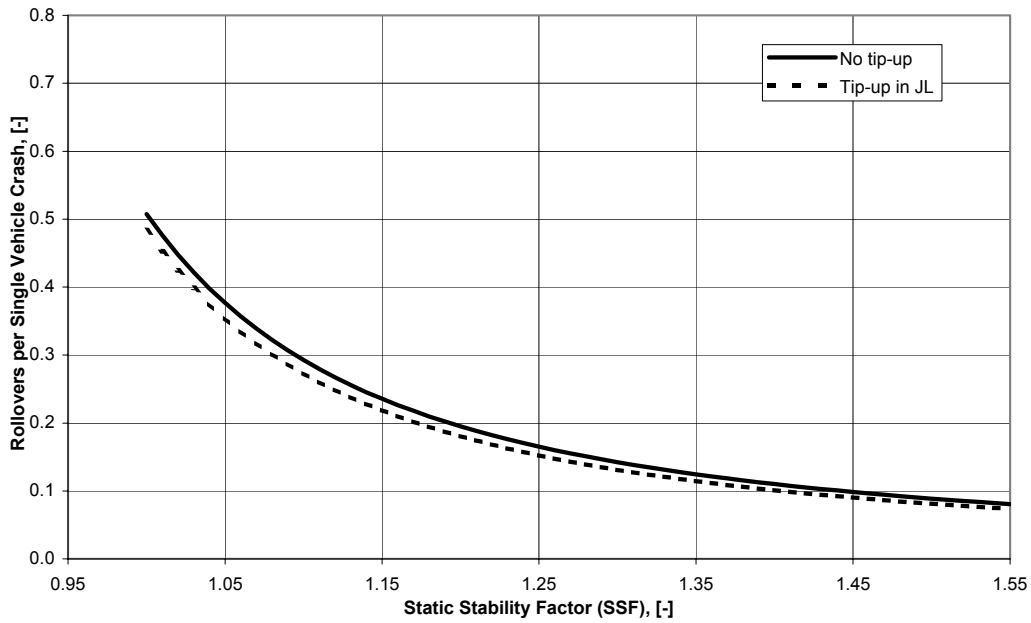

Figure II.12: Model with single dynamic variable – J-Turn, Light

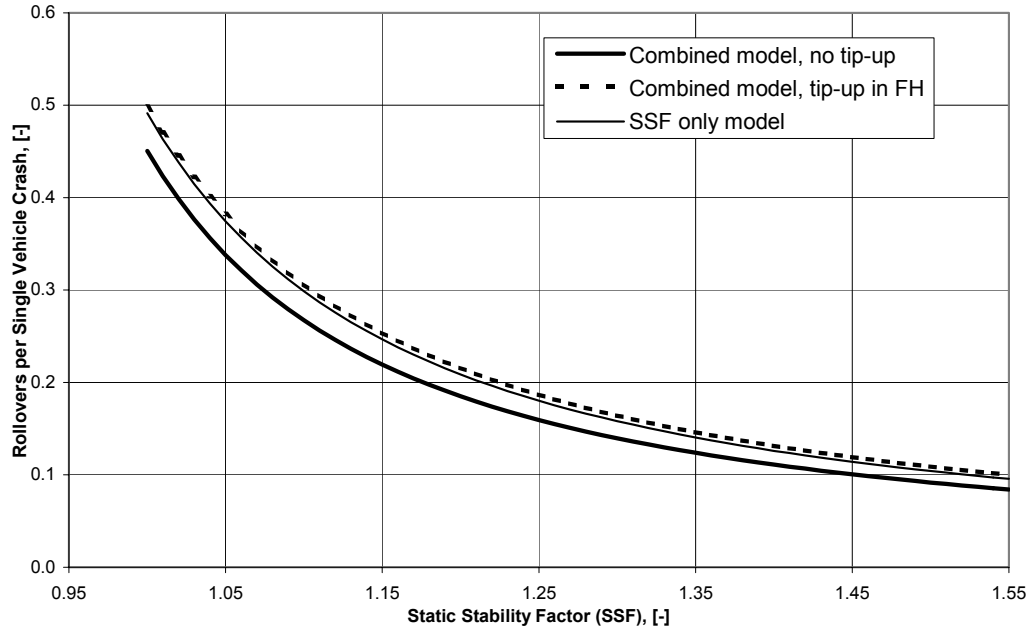

Figure II.13: Comparison of Combined Model with SSF only Model