

# TWIN

## approaches

### to Confinement Physics:

Experiment & Strong Coupling QCD

March 12-15, 2012

JEFFERSON LAB

Newport News, Virginia

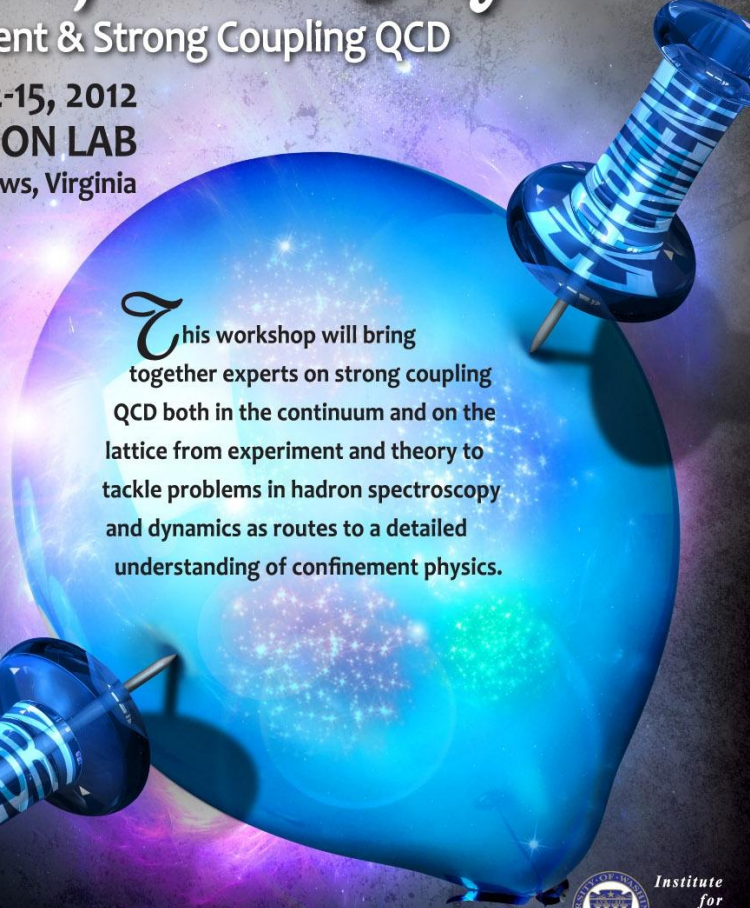

This workshop will bring together experts on strong coupling QCD both in the continuum and on the lattice from experiment and theory to tackle problems in hadron spectroscopy and dynamics as routes to a detailed understanding of confinement physics.



Institute  
for  
Nuclear  
Theory

The 14th Joint JLab/INT workshop

[www.jlab.org/conferences/confinement](http://www.jlab.org/conferences/confinement)

Jefferson Lab

# TWIN approaches

## to Confinement Physics:

Experiment & Strong Coupling QCD

March 12-15, 2012

JEFFERSON LAB

Newport News, Virginia

This workshop will bring together experts on strong coupling QCD both in the continuum and on the lattice from experiment and theory to tackle problems in hadron spectroscopy and dynamics as routes to a detailed understanding of confinement physics.

The 14th Joint JLab/INT workshop

[www.jlab.org/conferences/confinement](http://www.jlab.org/conferences/confinement)



Institute  
for  
Nuclear  
Theory

Jefferson Lab

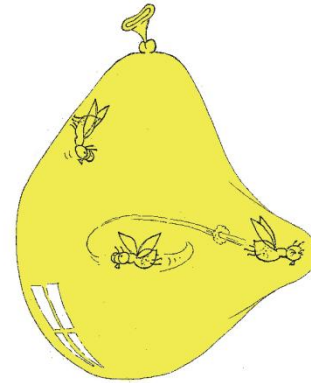

confinement

# TWIN approaches

## to Confinement Physics:

Experiment & Strong Coupling QCD

March 12-15, 2012

JEFFERSON LAB

Newport News, Virginia

This workshop will bring together experts on strong coupling QCD both in the continuum and on the lattice from experiment and theory to tackle problems in hadron spectroscopy and dynamics as routes to a detailed understanding of confinement physics.

The 14th Joint JLab/INT workshop

[www.jlab.org/conferences/confinement](http://www.jlab.org/conferences/confinement)



Institute  
for  
Nuclear  
Theory

Jefferson Lab

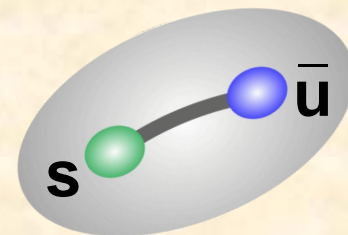
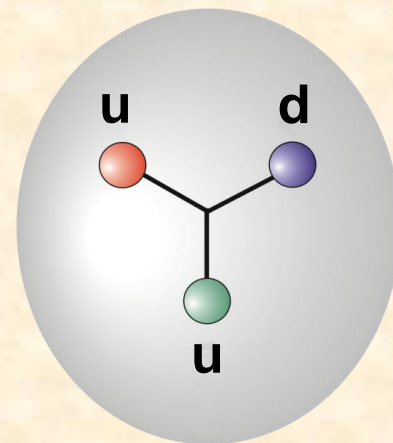
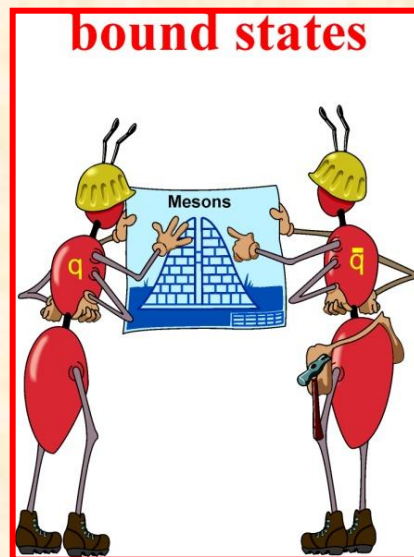
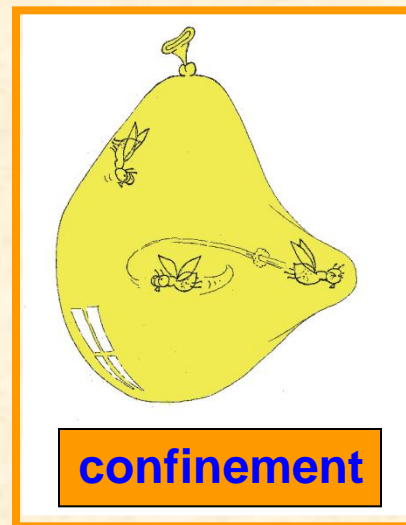

# TWIN approaches

## to Confinement Physics:

Experiment & Strong Coupling QCD

March 12-15, 2012

JEFFERSON LAB

Newport News, Virginia

This workshop will bring together experts on strong coupling QCD both in the continuum and on the lattice from experiment and theory to tackle problems in hadron spectroscopy and dynamics as routes to a detailed understanding of confinement physics.



Institute for Nuclear Theory

The 14th Joint JLab/INT workshop

[www.jlab.org/conferences/confinement](http://www.jlab.org/conferences/confinement)

Jefferson Lab

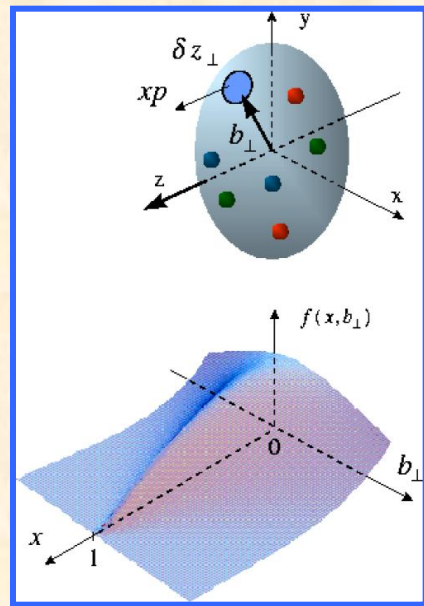
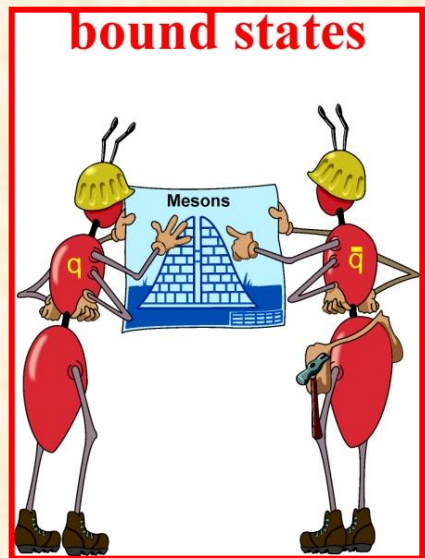
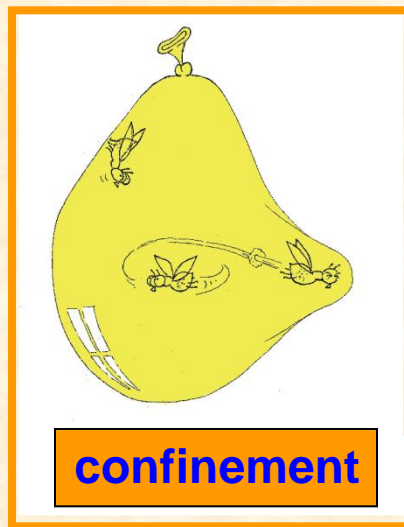

# TWIN

approaches

*to Confinement Physics:*

Experiment & Strong Coupling QCD



# TWIN

approaches

*to Confinement Physics:*

Experiment & Strong Coupling QCD



# TWIN

## approaches

*to Confinement Physics:*

Experiment & Strong Coupling QCD

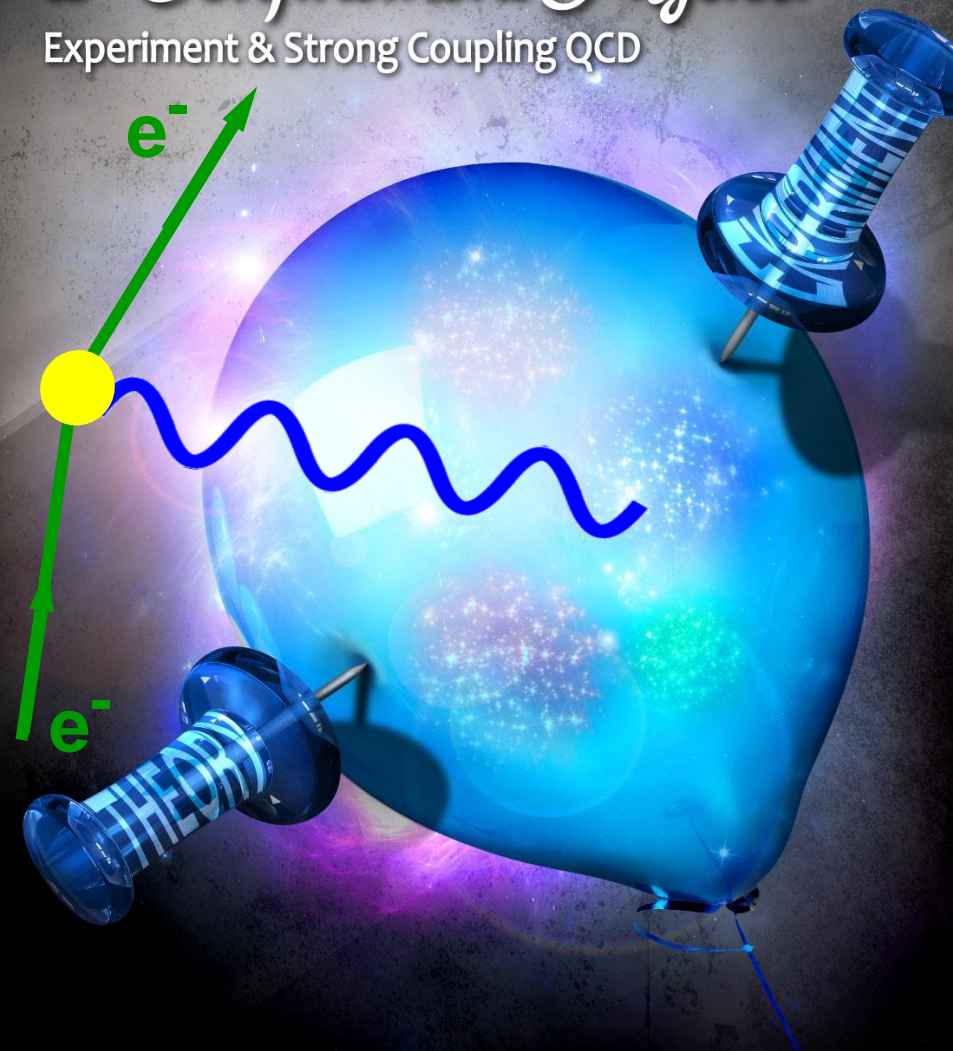

# TWIN

## approaches

*to Confinement Physics:*

Experiment & Strong Coupling QCD

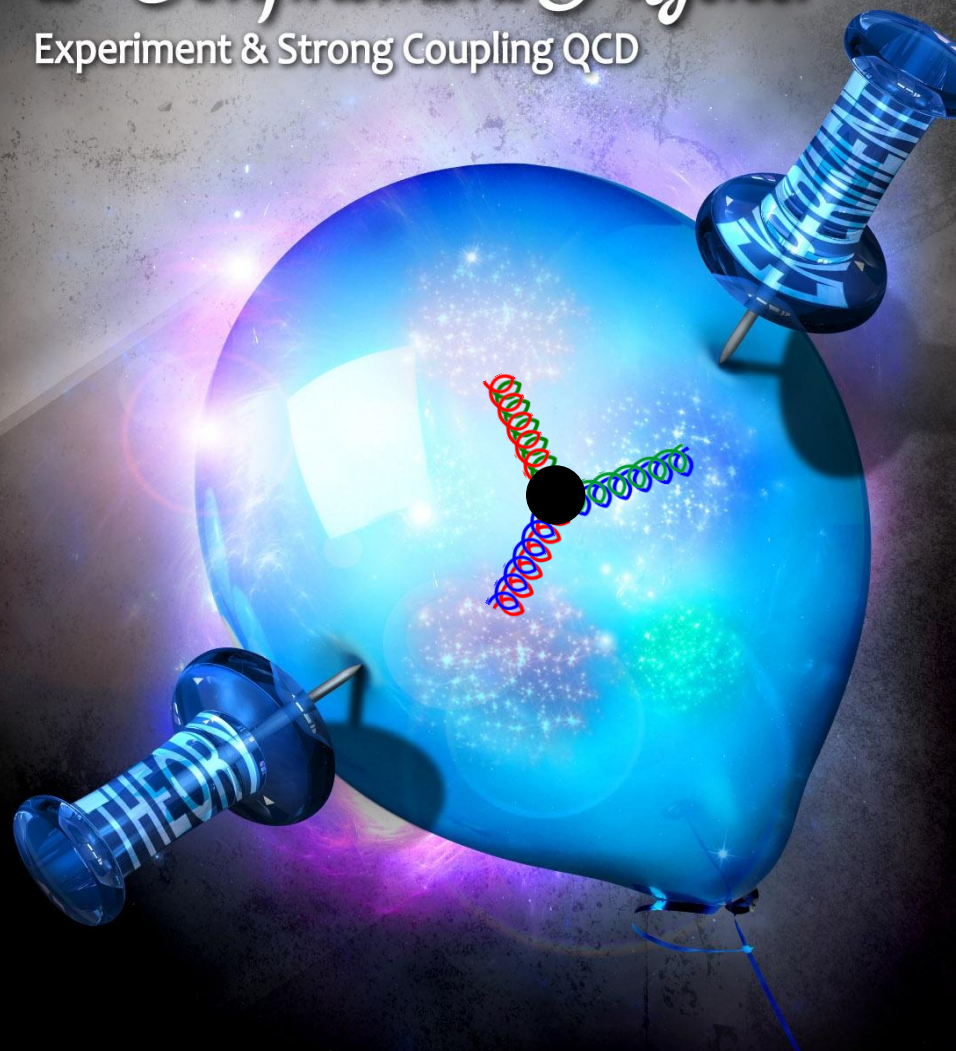

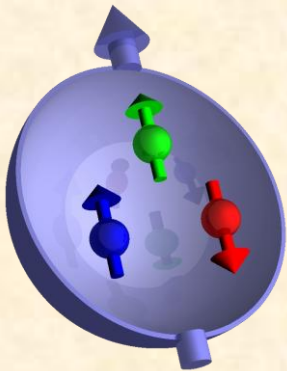

**proton**      **neutron**

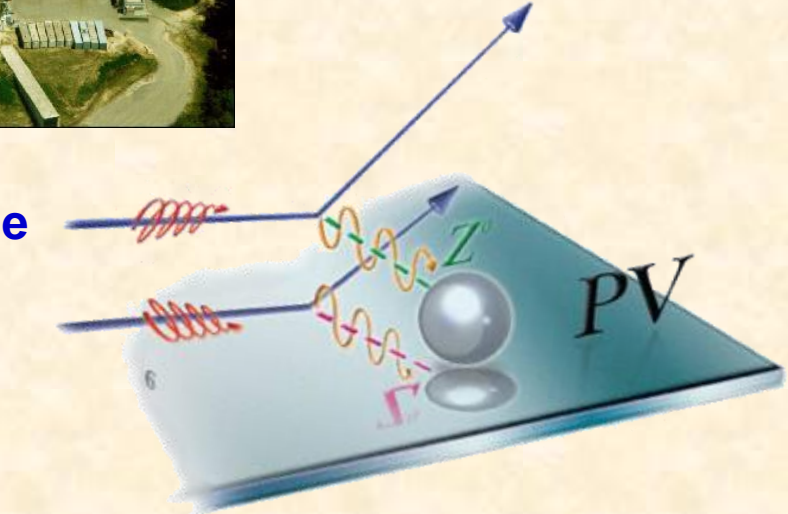
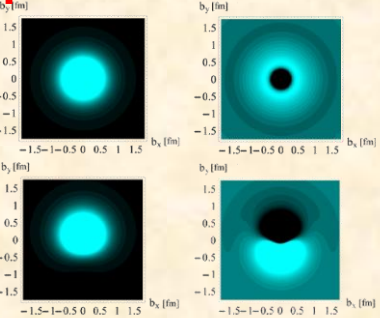

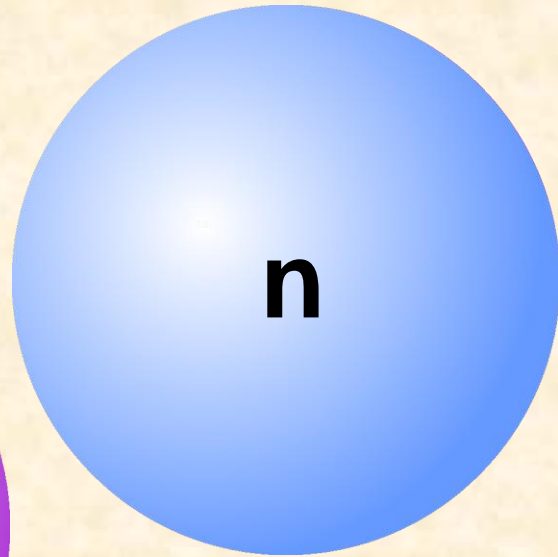
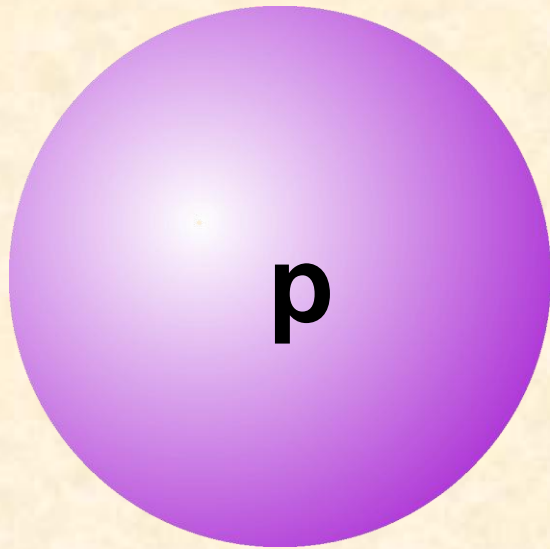



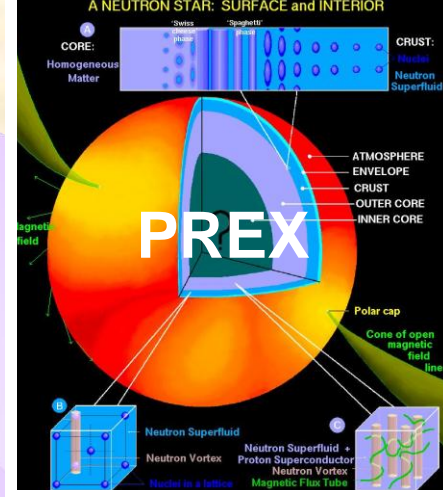
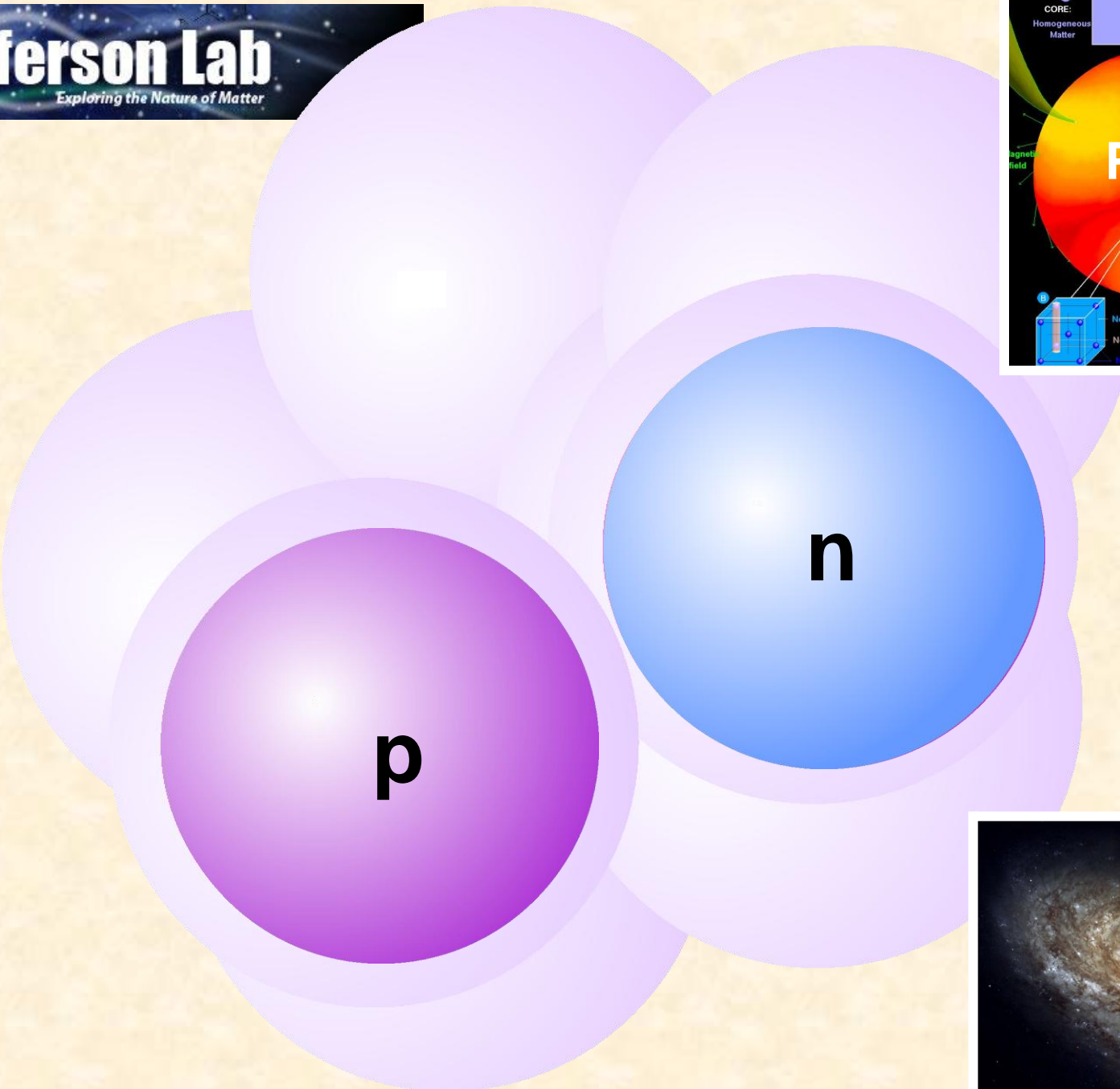

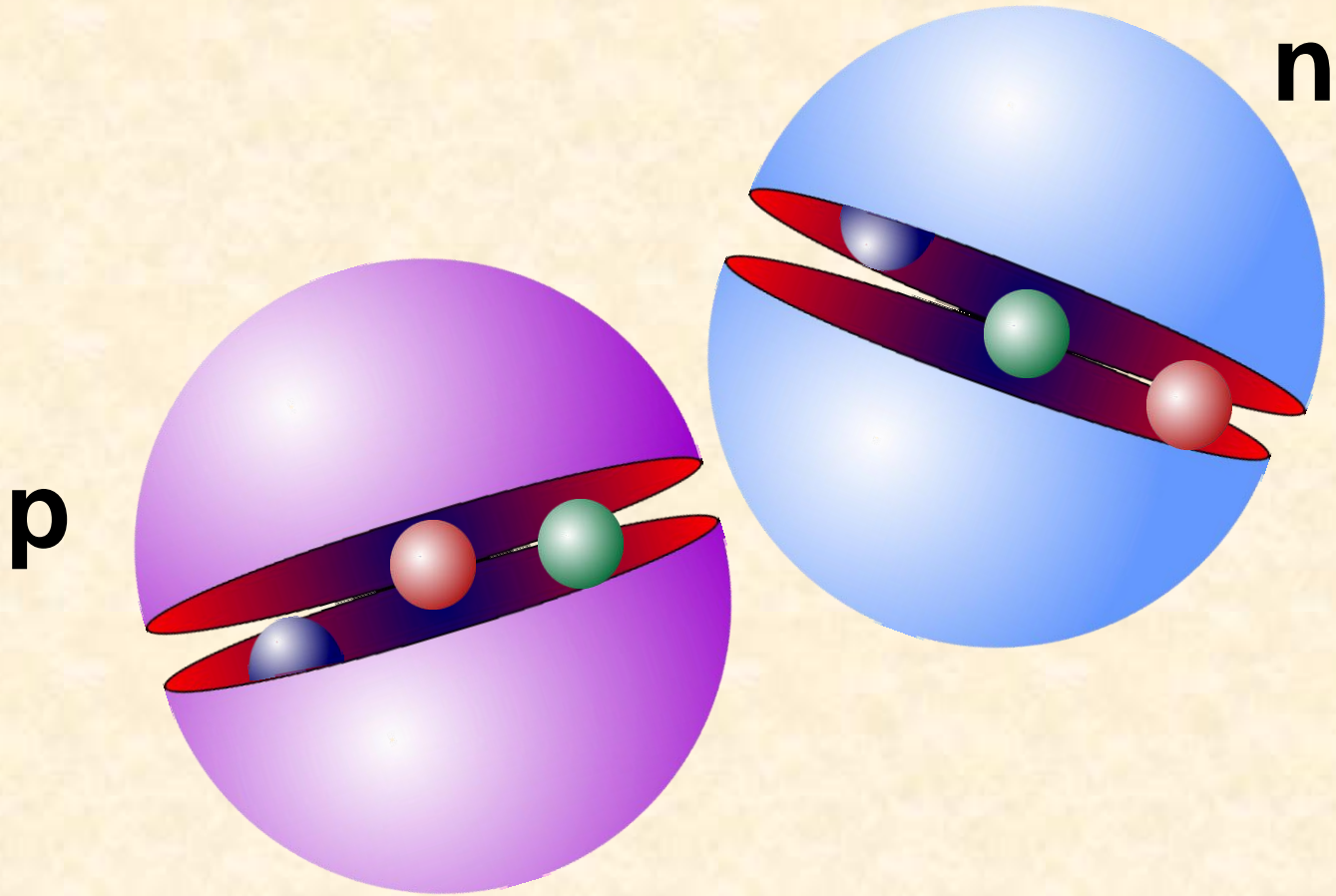

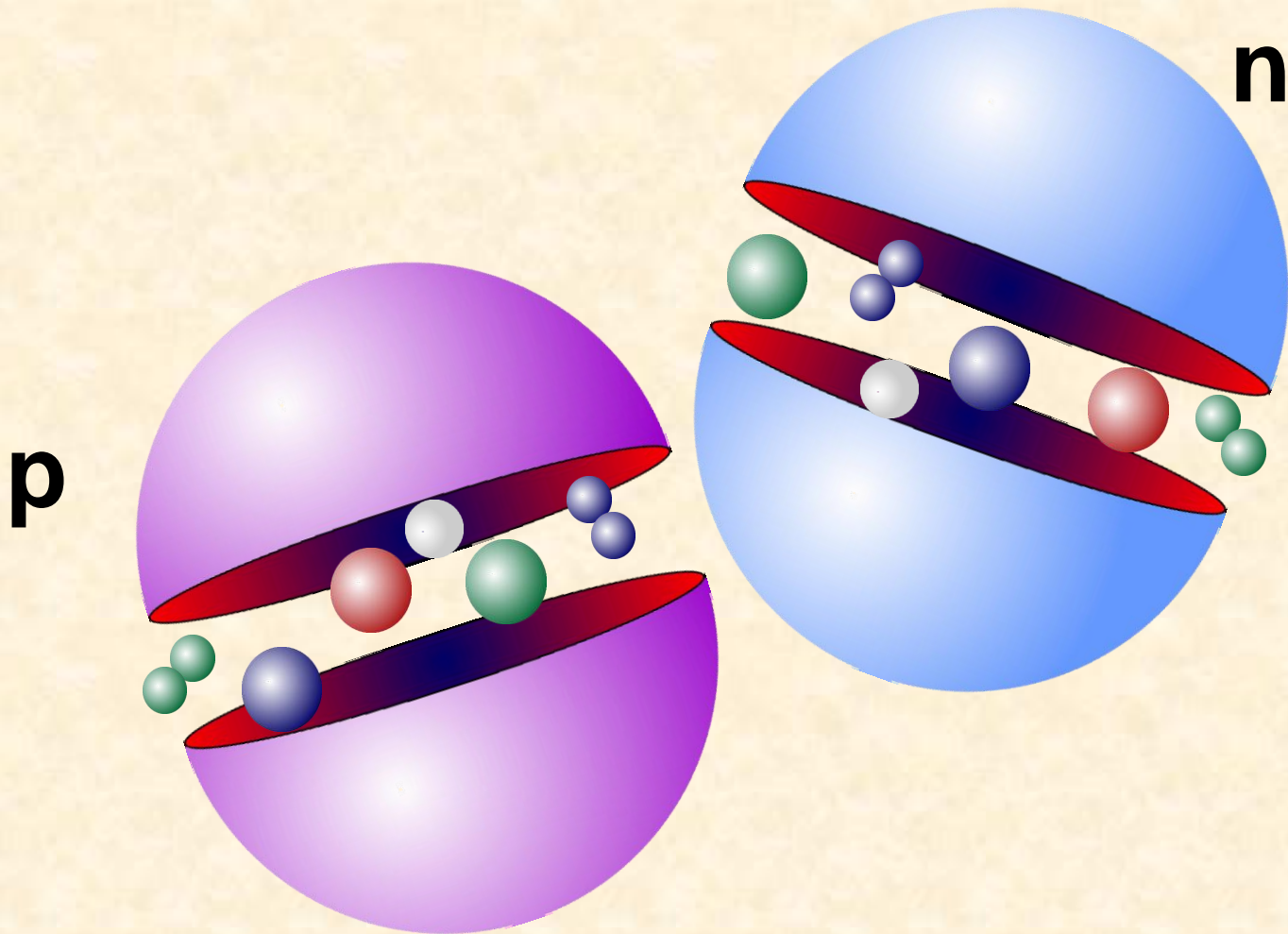

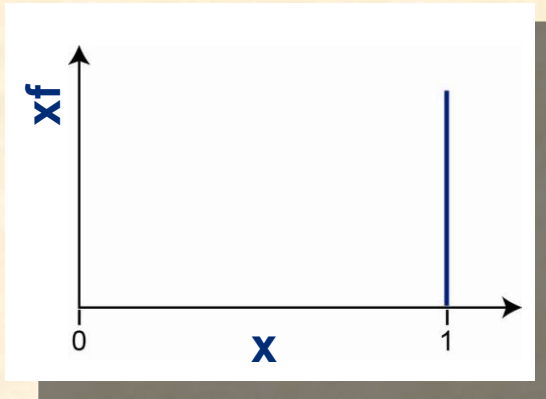

parton structure of the nucleon

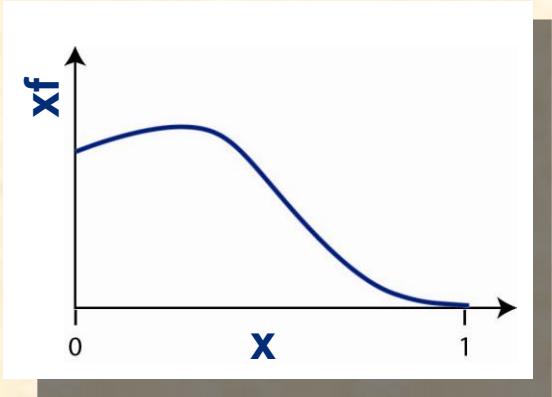
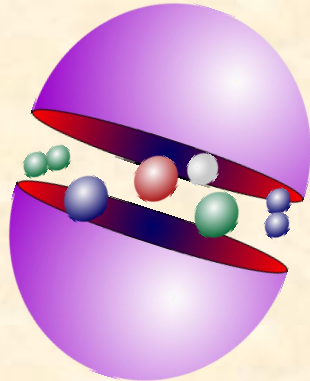
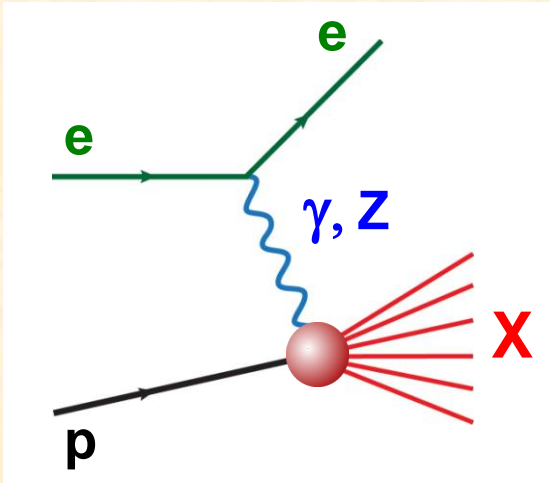
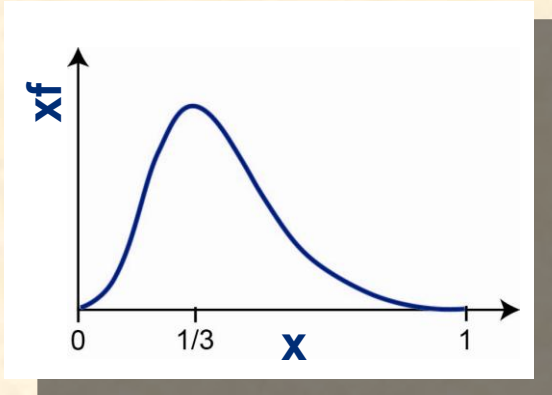
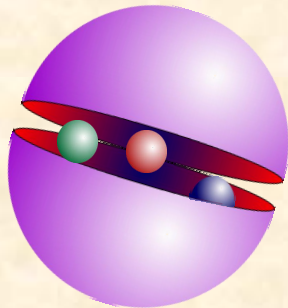

# Internal Landscape of the Hadron

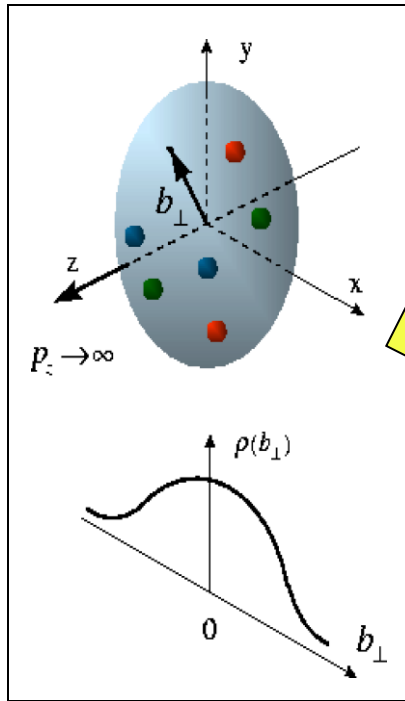

**Form factors**  
**transverse charge & current densities**  
 In coordinate space

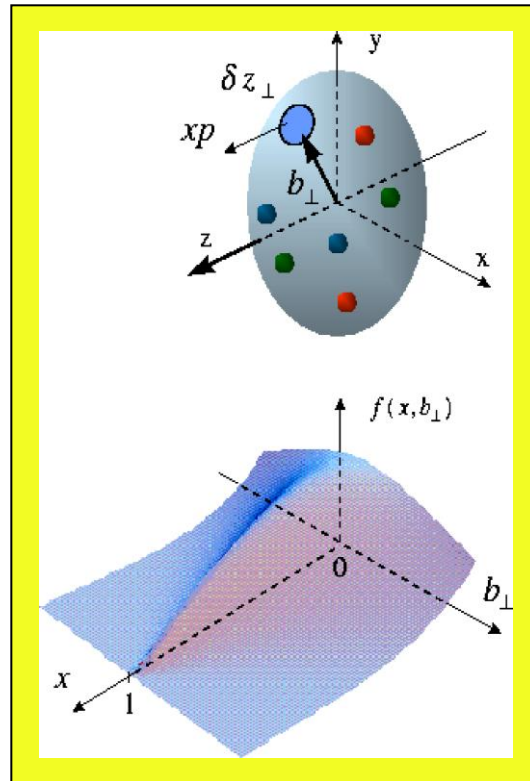

**GPDs, TMDs**  
 correlated quark distributions in  
**longitudinal & transverse space**

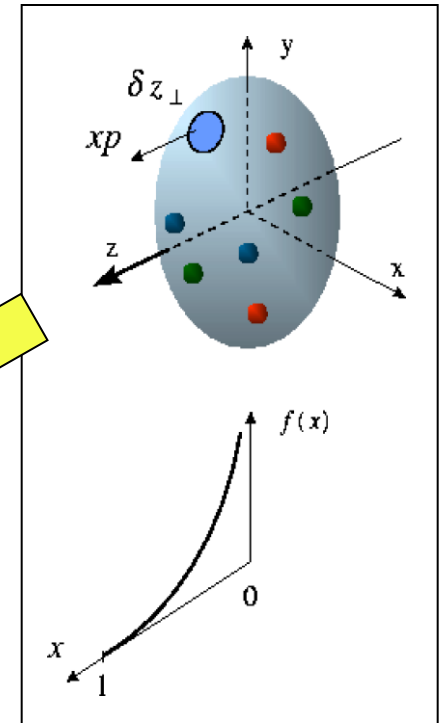

**Structure fns**  
**longitudinal quark momentum distributions**



# QCD

1971



Fritzsche

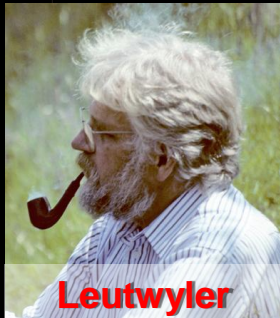

Leutwyler



Gell-Mann

$$\mathcal{L}_{\text{QCD}} = \sum_{q=u,d,s,c,b} \bar{q} (i\gamma_{\mu} D^{\mu} - m_q) q - \frac{1}{4} \mathcal{F}^{\mu\nu} \mathcal{F}_{\mu\nu}$$

# QCD

asymptotic freedom

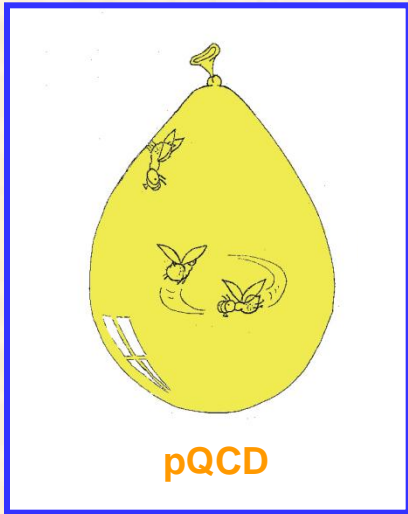

confinement

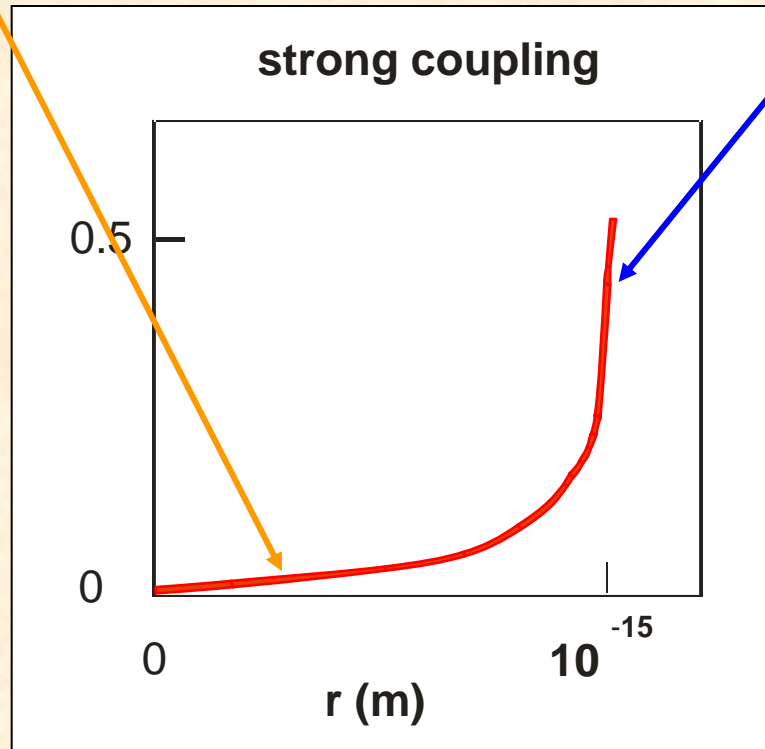

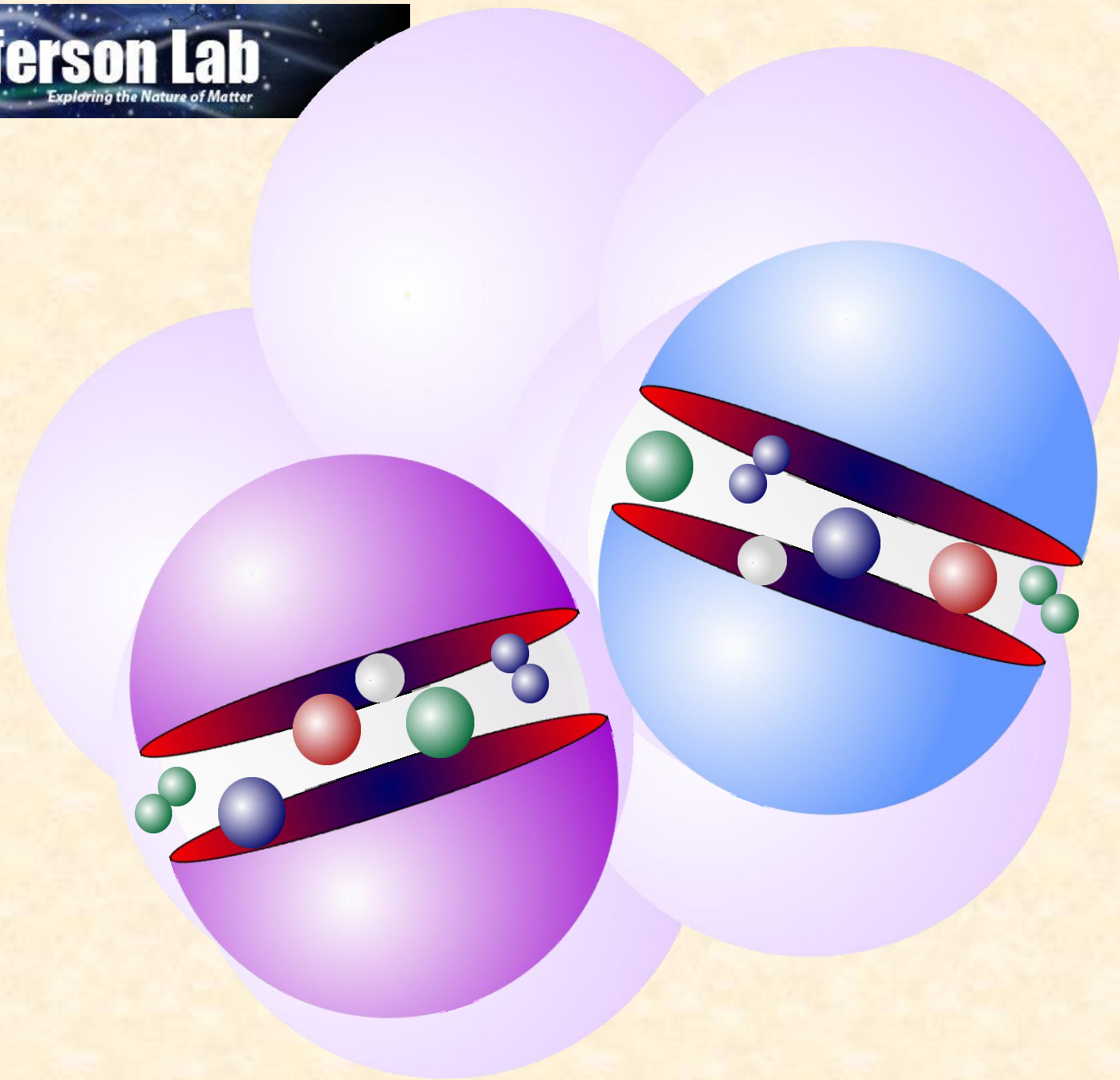



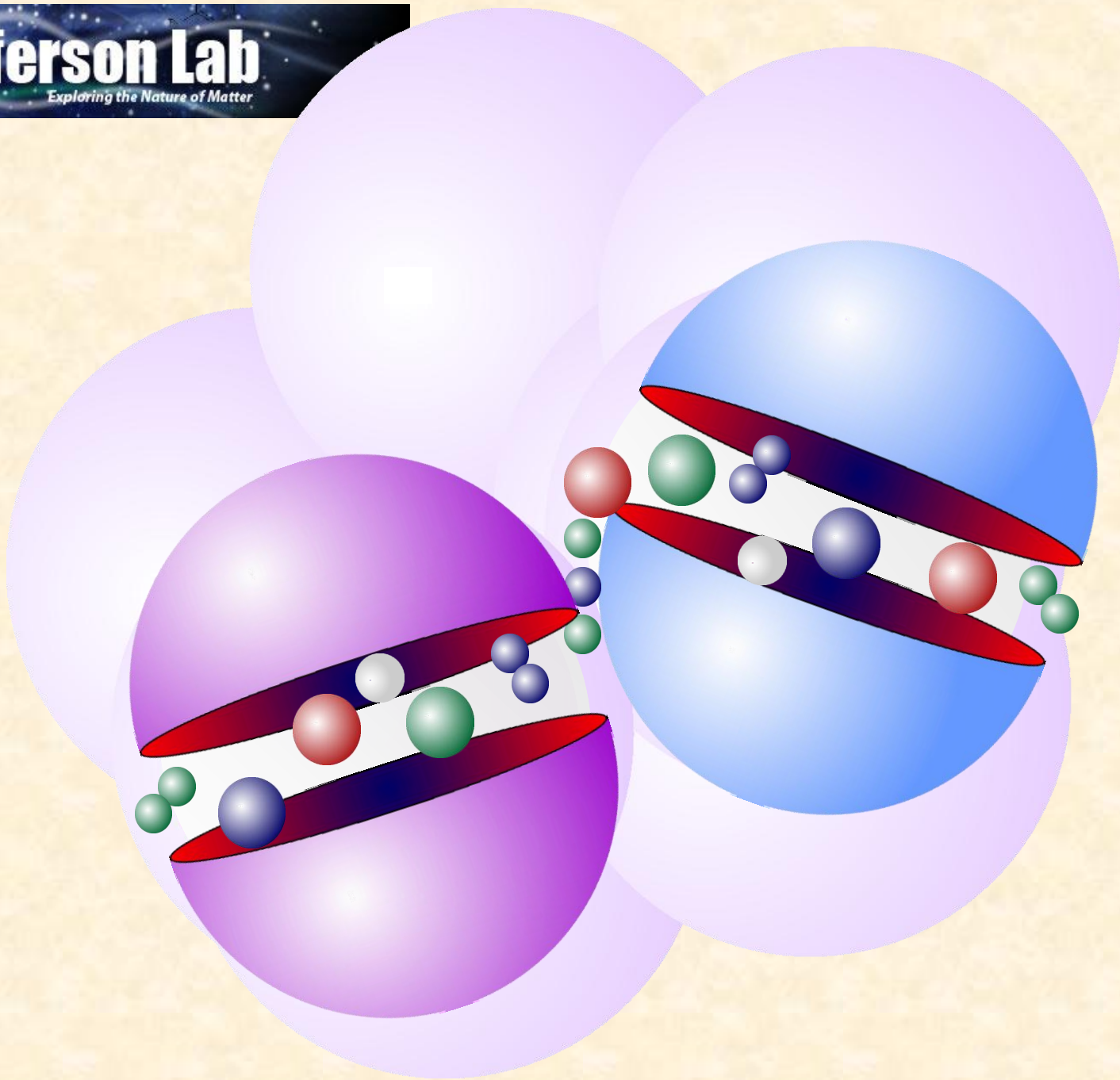

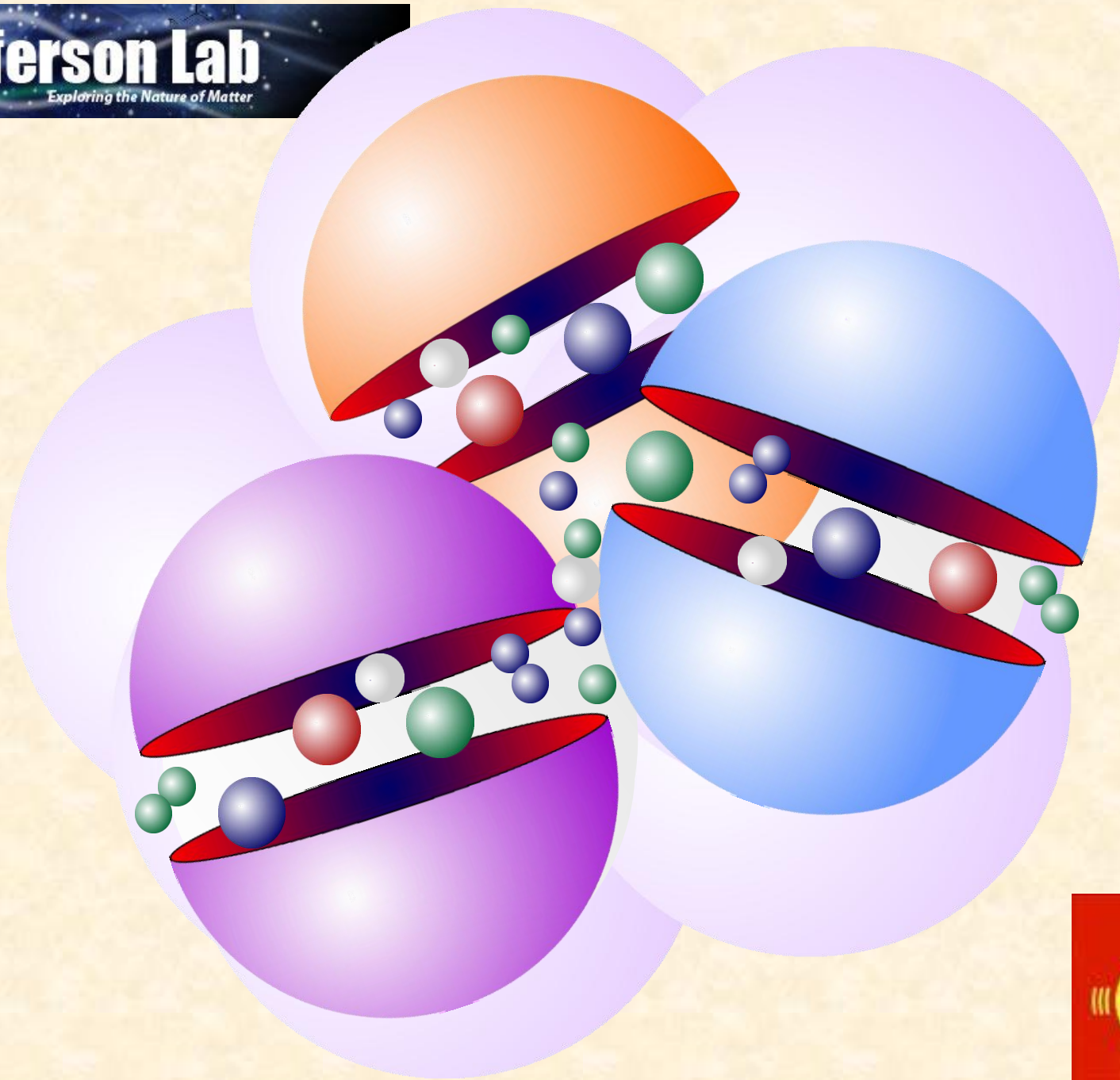

# cool/ QCD

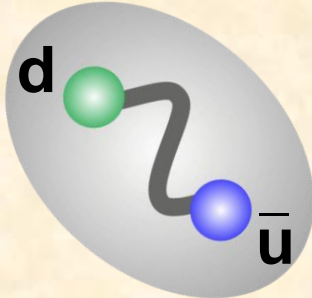
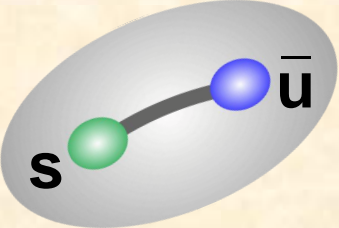
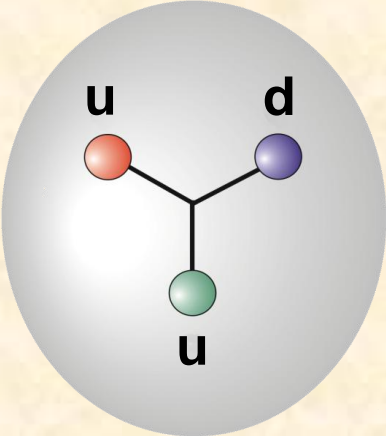

# QCD



Fritzsche

$$\mathcal{L}_{\text{QCD}} = \sum_{q=u,d,s,c,b} \bar{q} (i\gamma_{\mu} D^{\mu} - m_q) q$$

$$- \frac{1}{4} \mathcal{F}^{\mu\nu} \mathcal{F}_{\mu\nu}$$

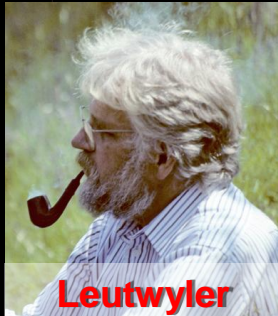

't Hooft



Gell-Mann

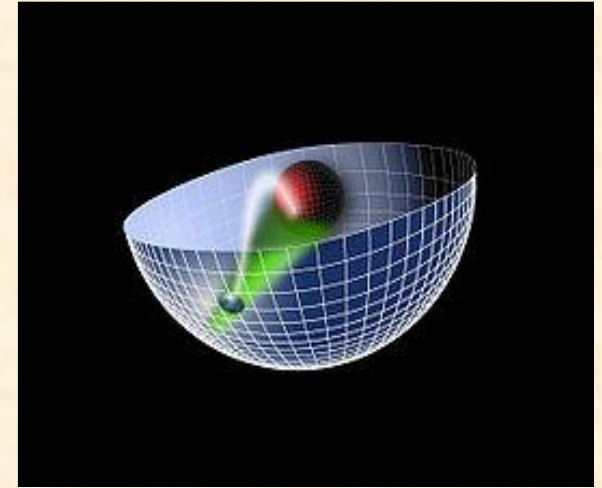
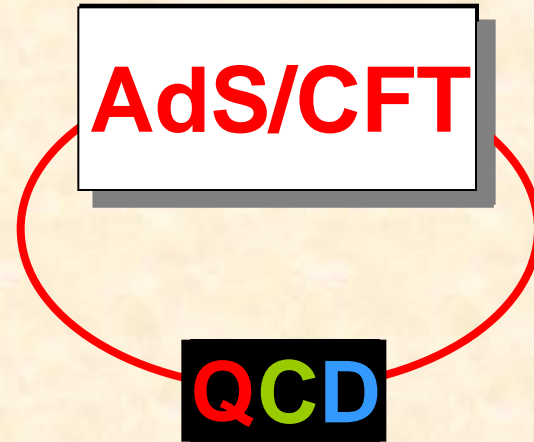
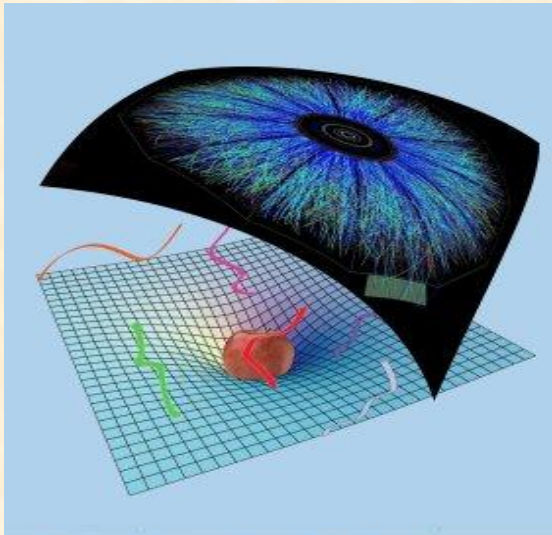

Fritzsche

$$\mathcal{L}_{\text{QCD}} = \sum_{q=u,d,s,c,b} \bar{q} (i\gamma_{\mu} D^{\mu} - m_q) q$$



Leutwyler



Gell-Mann

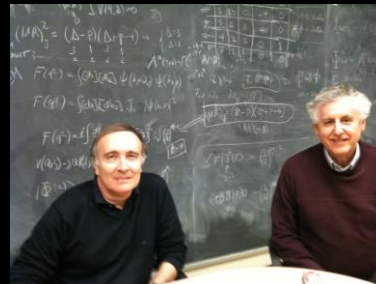

$$- \frac{1}{4} \mathcal{F}^{\mu\nu} \mathcal{F}_{\mu\nu}$$

# Hadron masses <sup>2</sup>

Mass<sup>2</sup>  
(GeV<sup>2</sup>)

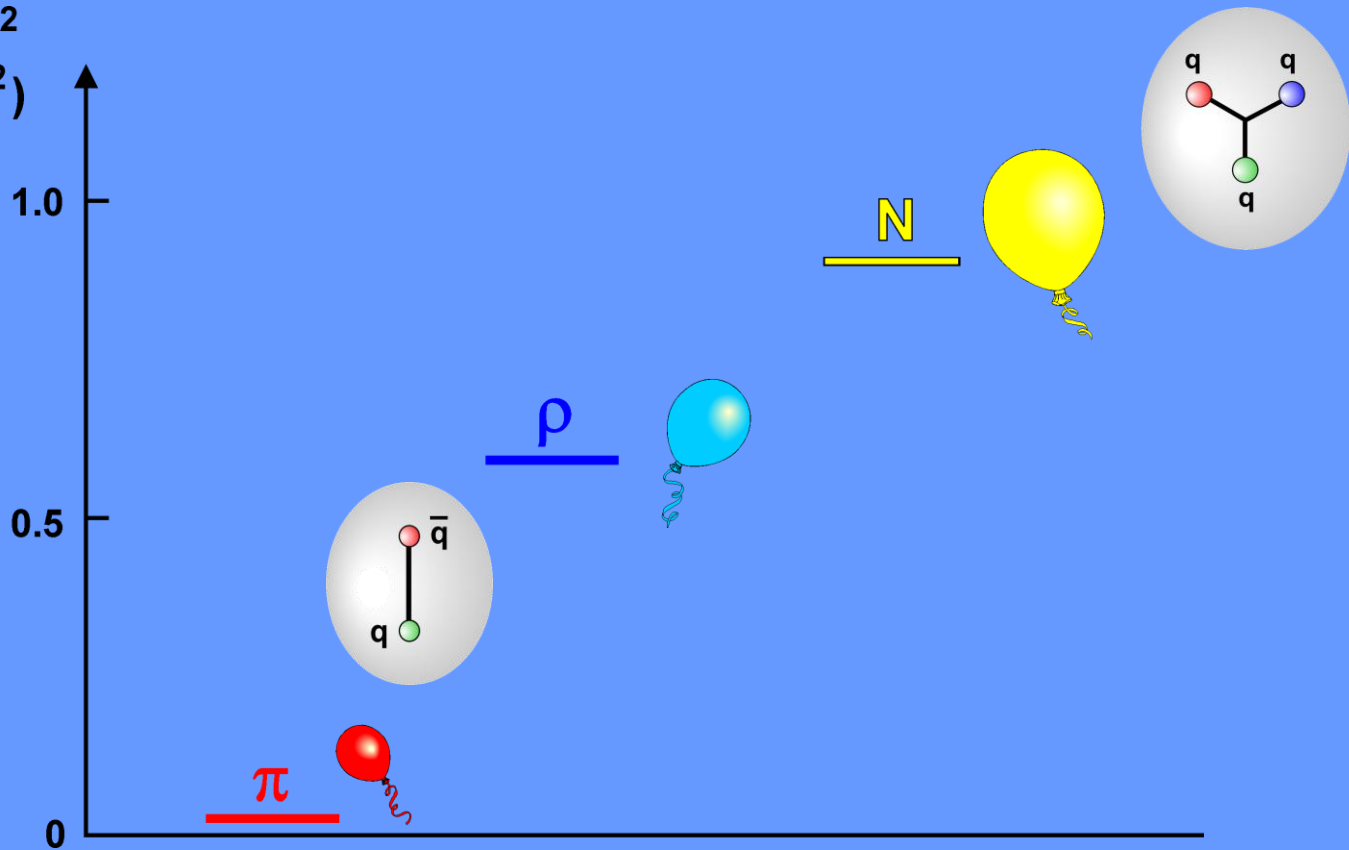

# $e^+e^-$ annihilation into hadrons

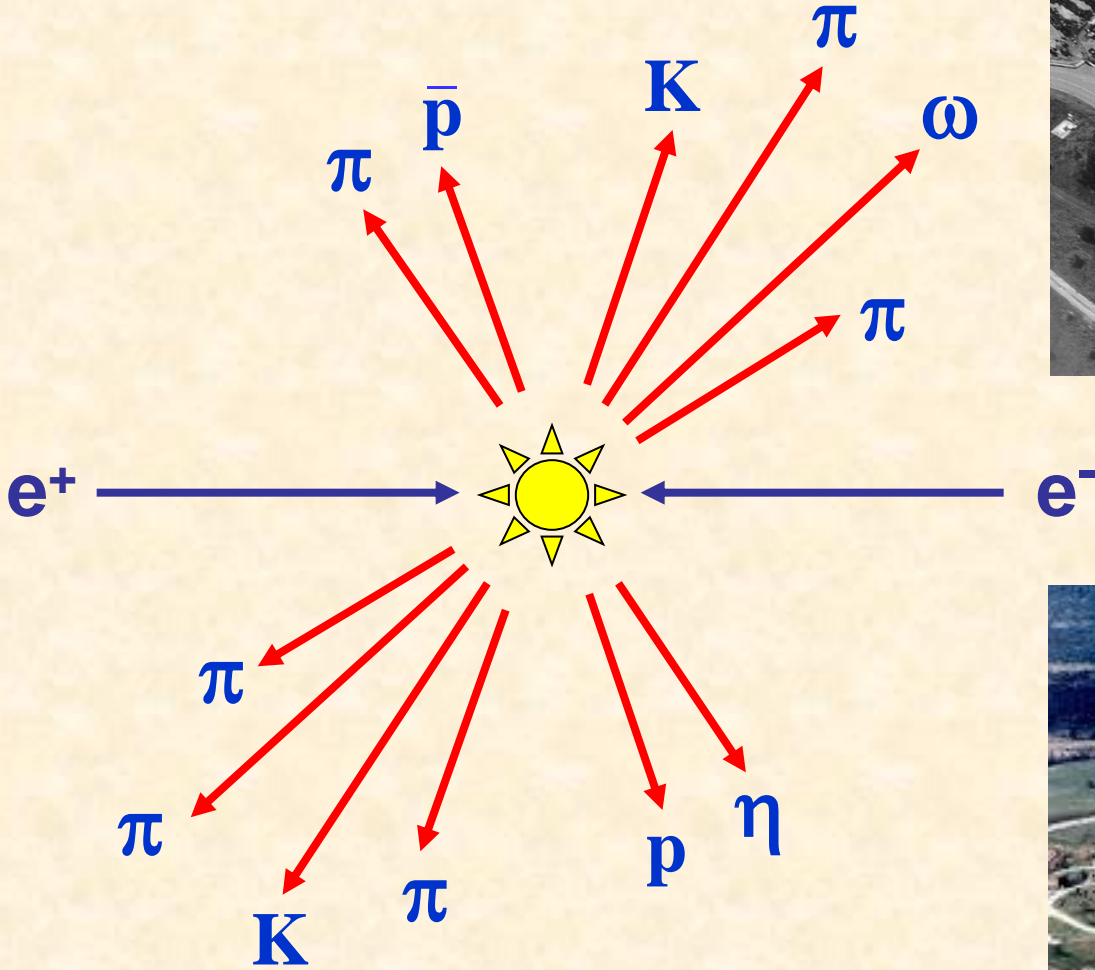

# $e^+e^-$ annihilation into hadrons

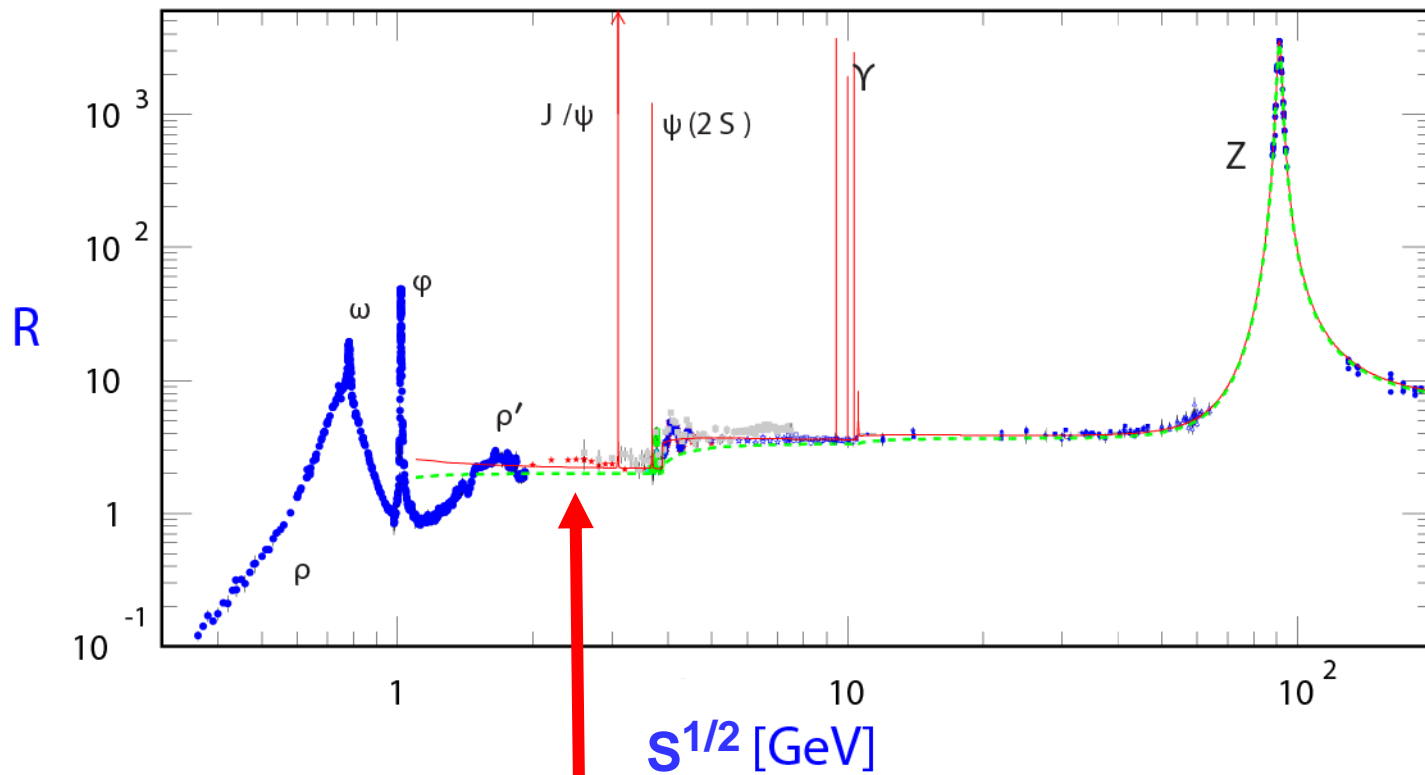



# $e^+e^-$ annihilation into hadrons

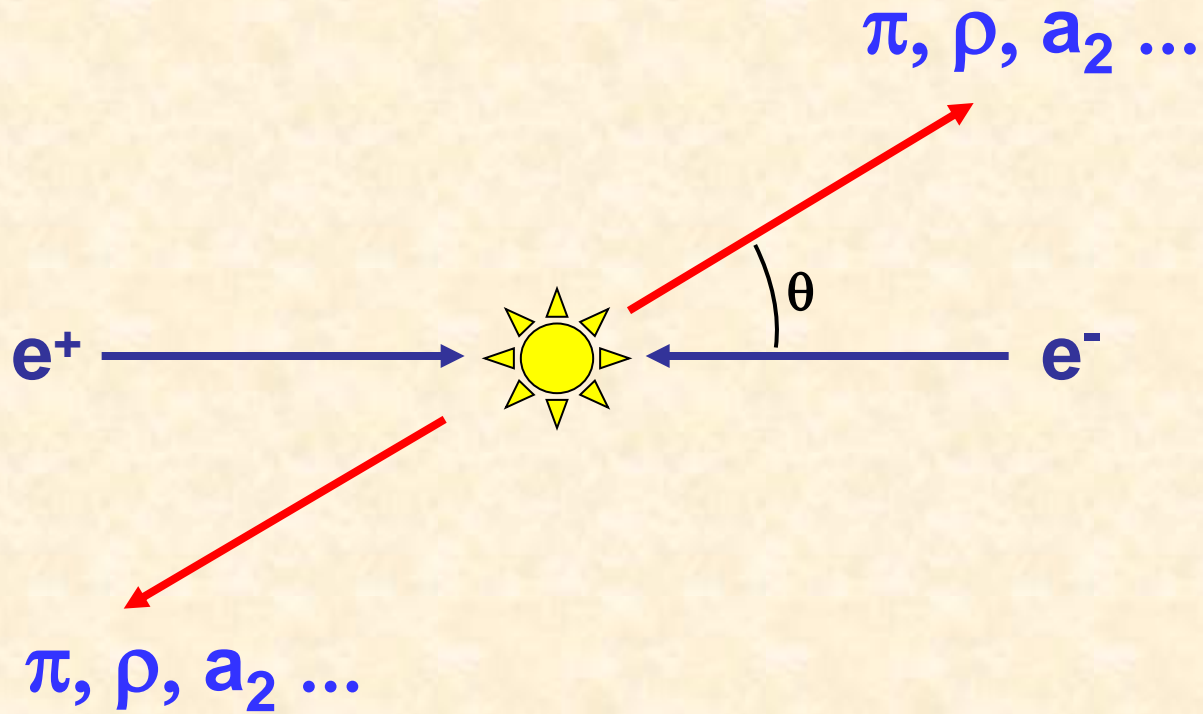

# $e^+e^-$ annihilation into hadrons

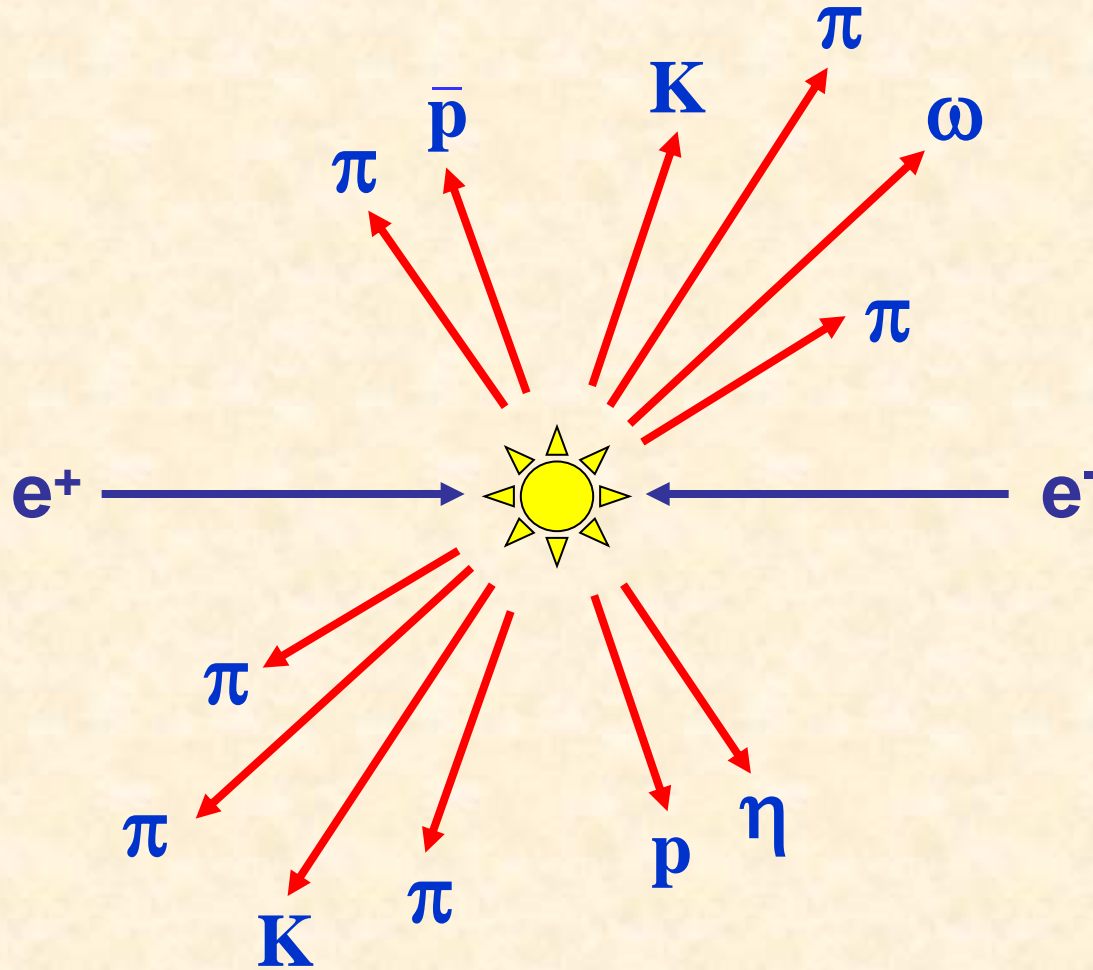

# $e^+e^-$ annihilation into hadrons

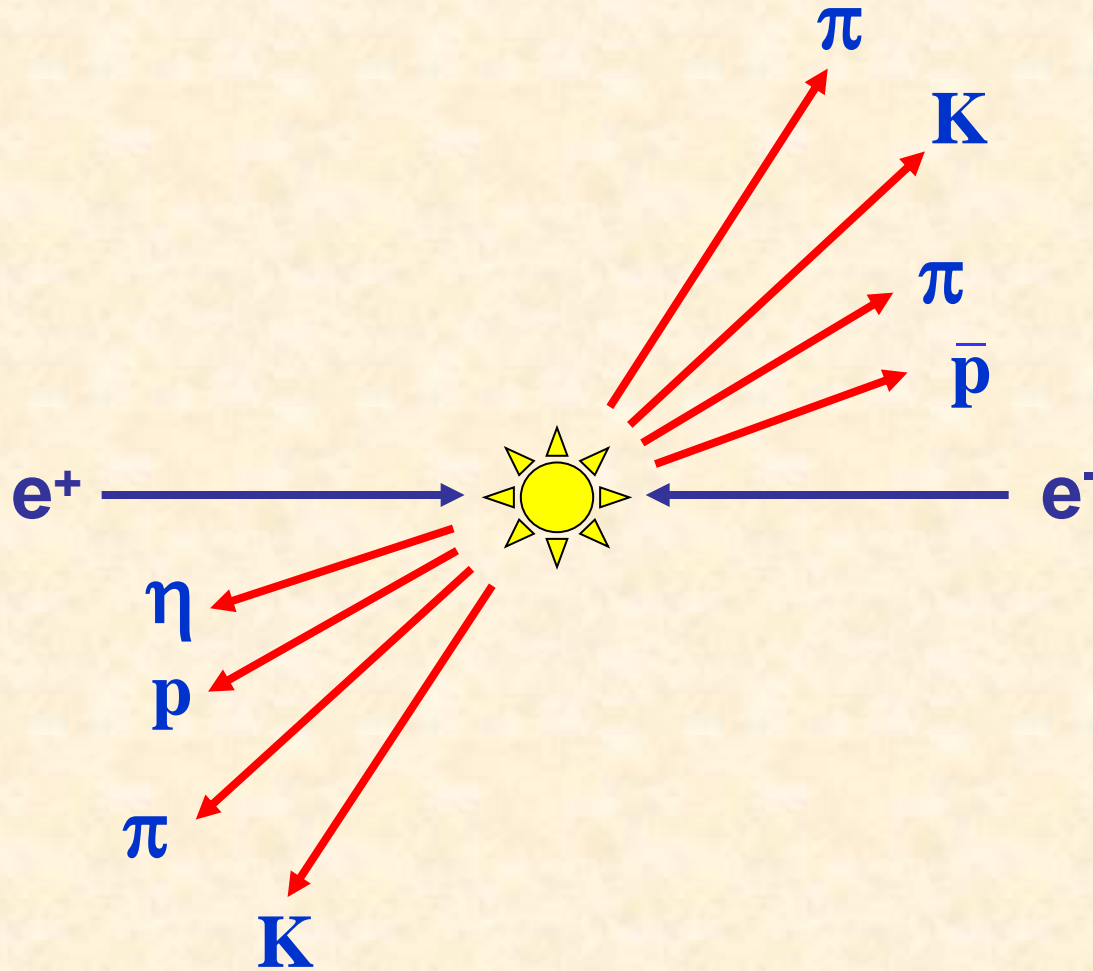

# $e^+e^-$ annihilation into hadrons

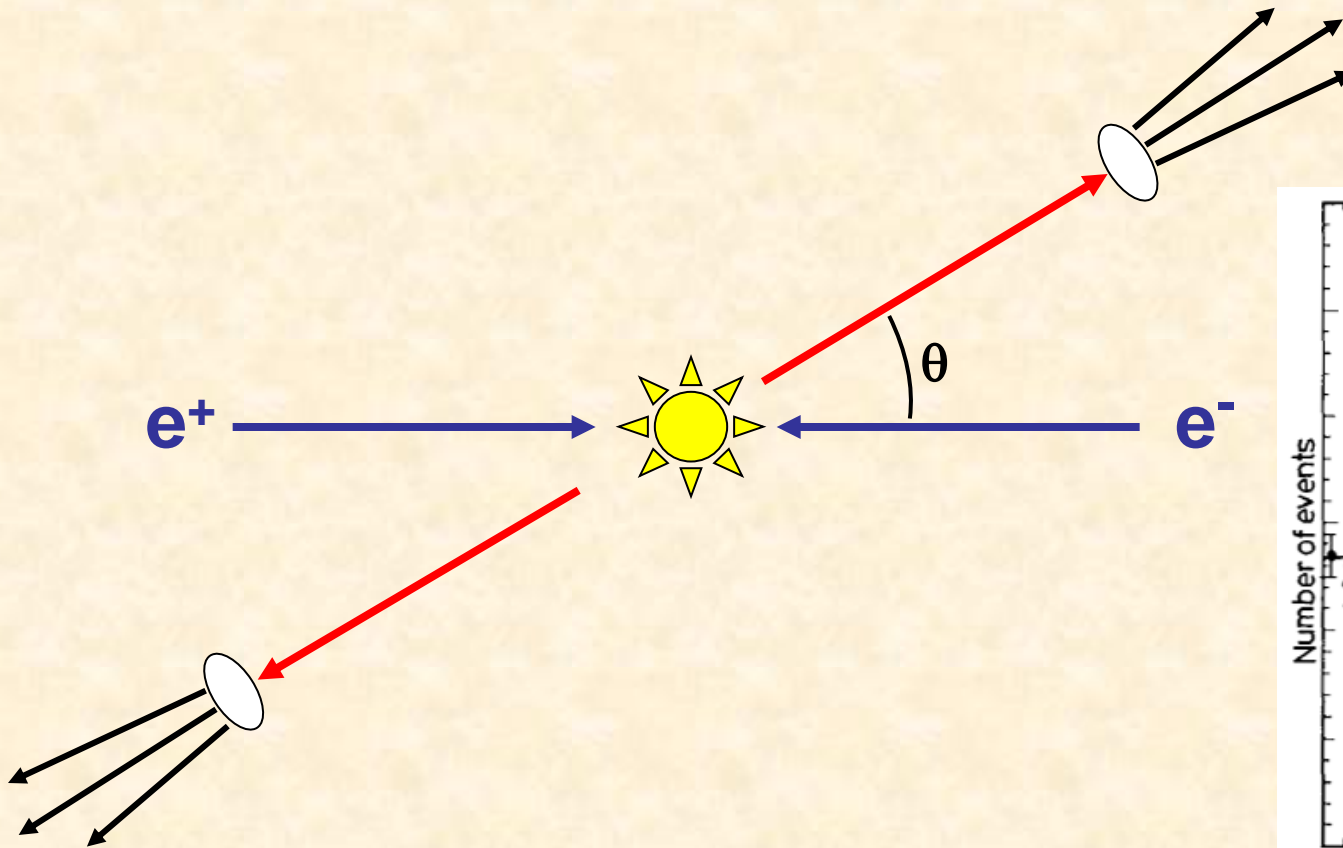

$$\frac{d\sigma}{d\Omega} \sim \rho_T (1 + \cos^2 \theta) + \rho_L \sin^2 \theta$$

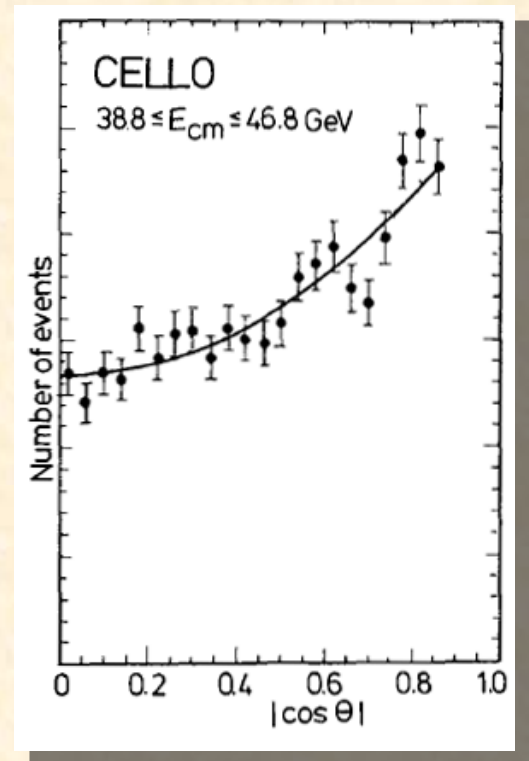

$$\rho_L / \rho_T \ll 1$$

# Hadron masses <sup>2</sup>

Mass<sup>2</sup>  
(GeV<sup>2</sup>)

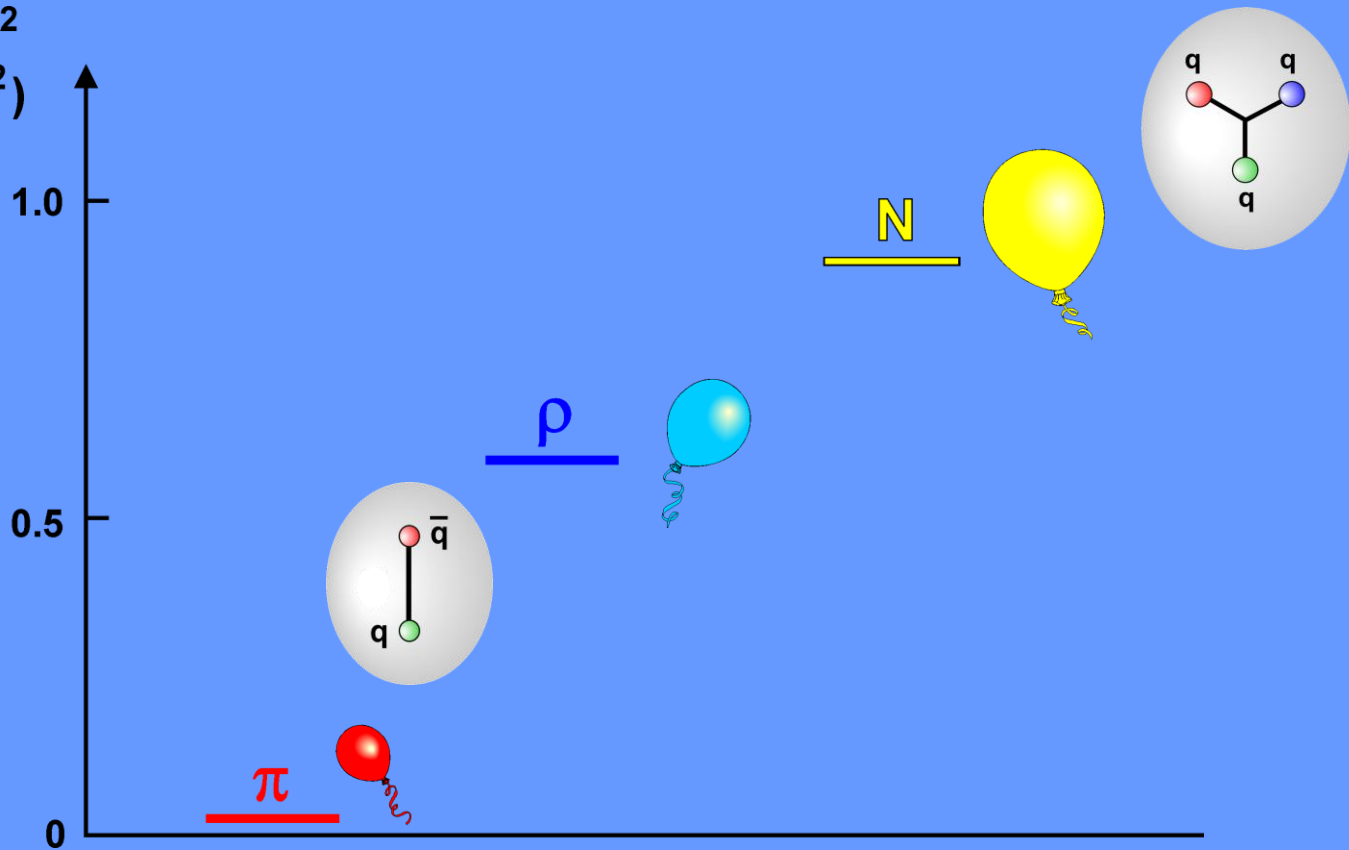



**b**

# heavy quark potential — spectrum

**Richardson Potential**

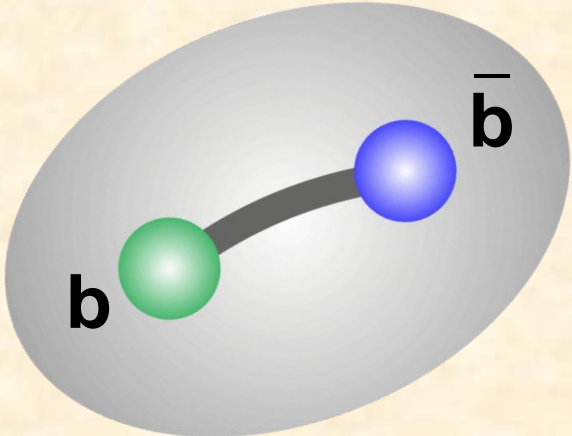
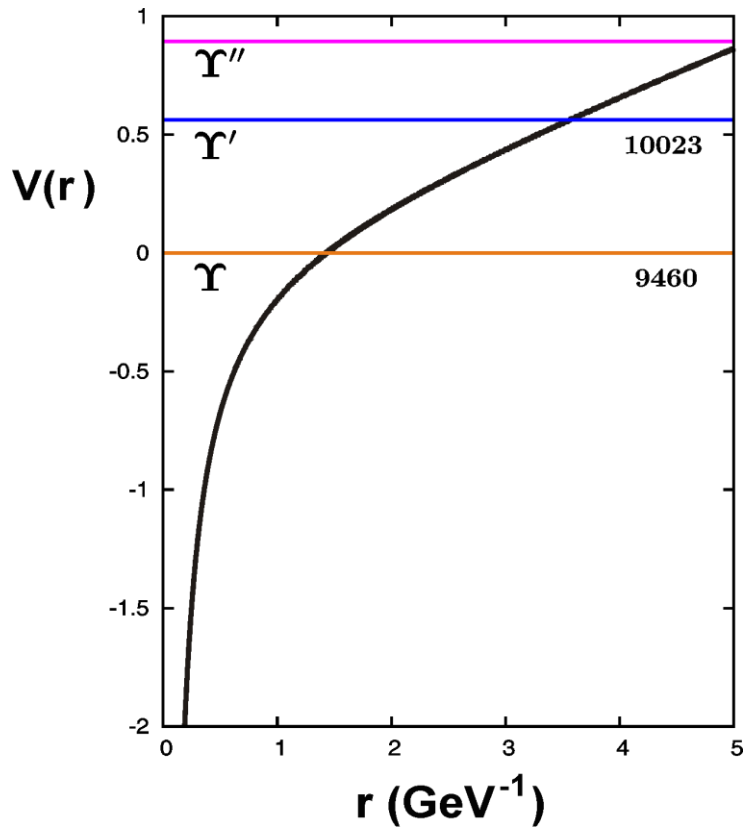

# positronium

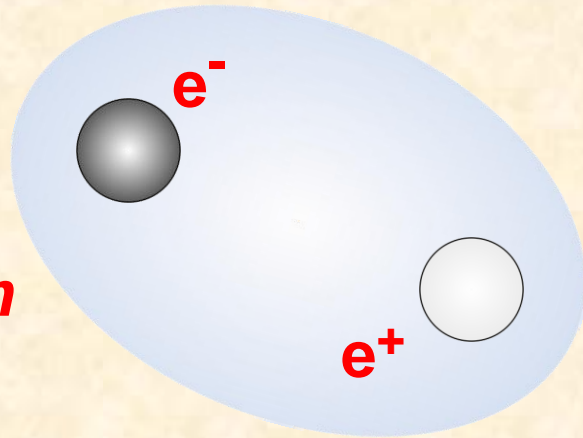

*0.1 nm*

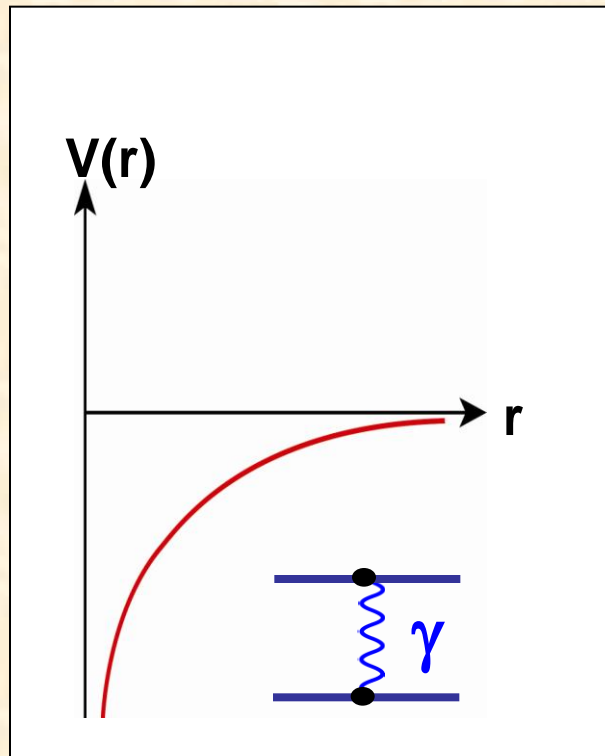

# charmonium

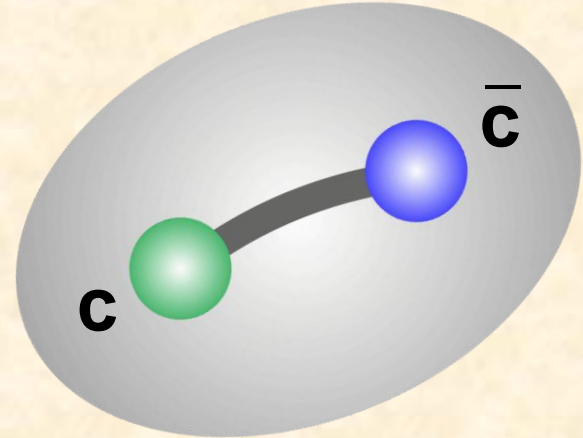

*1 fm*

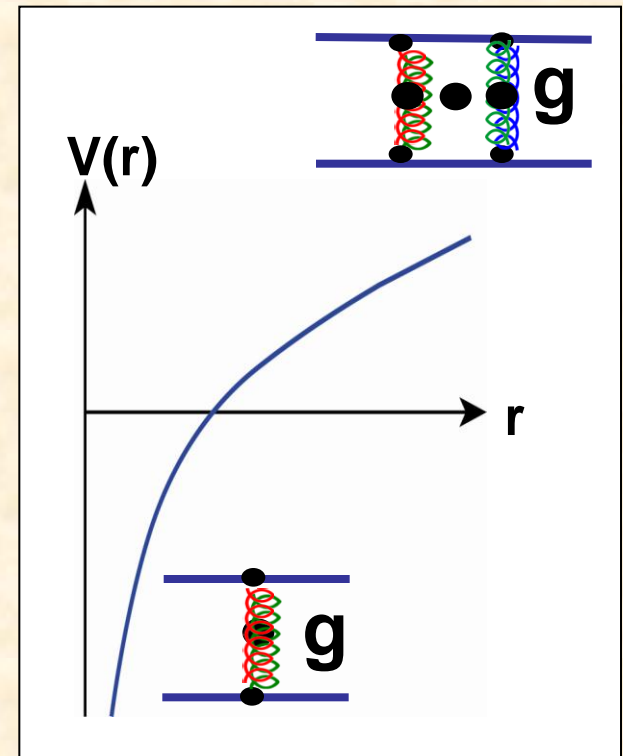



# positronium

Binding energy [meV]

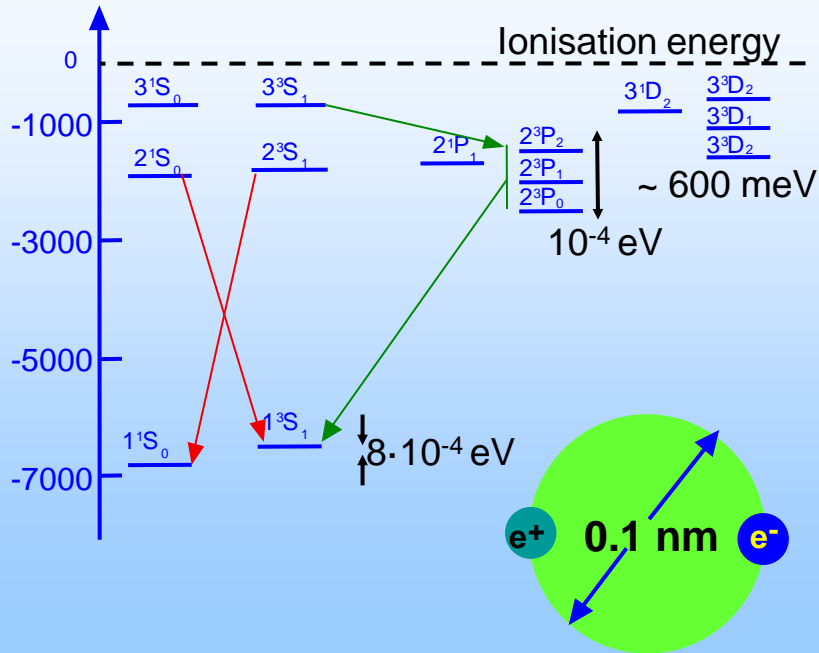

# charmonium

Mass [MeV]

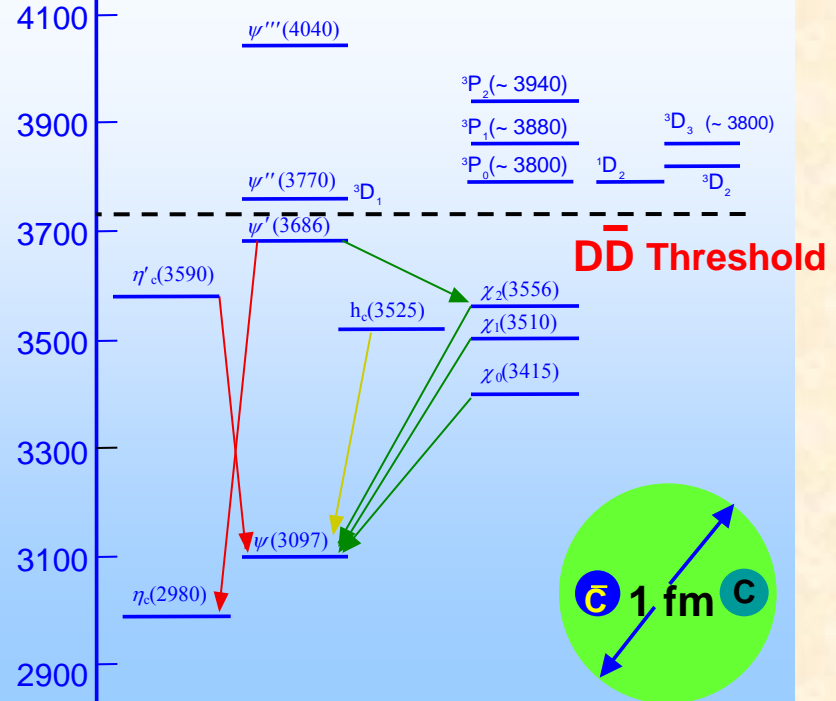

# positronium

Binding energy [meV]

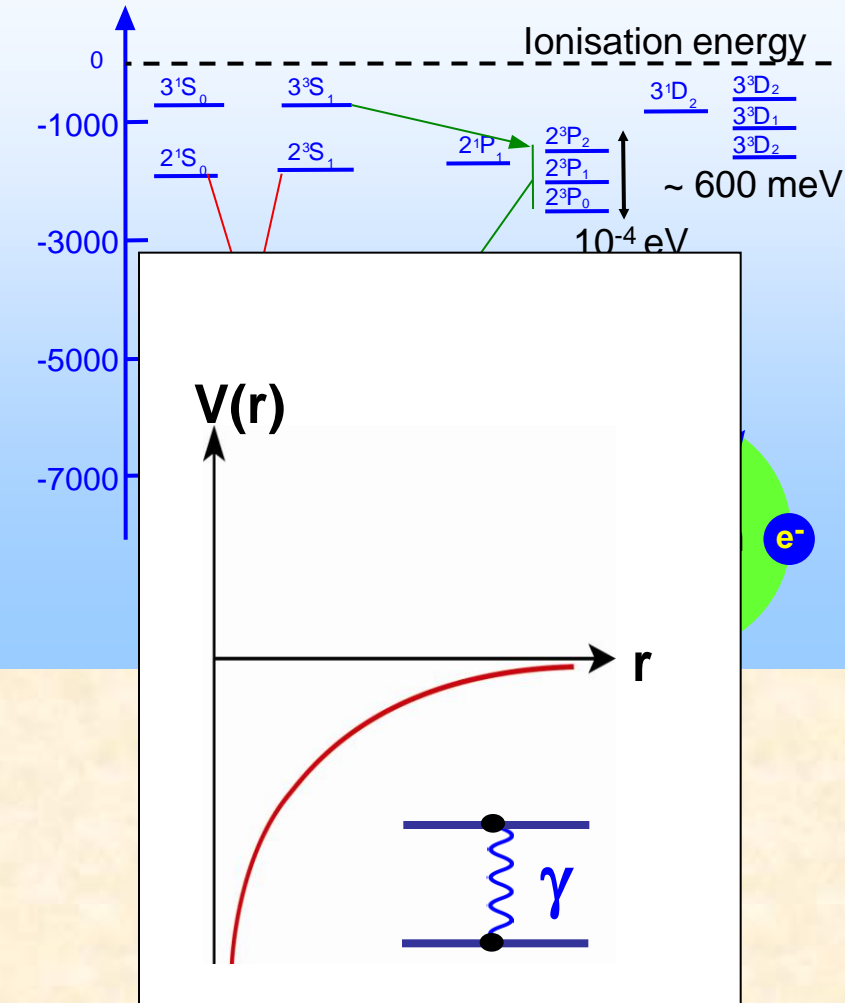

# charmonium

Mass [MeV]

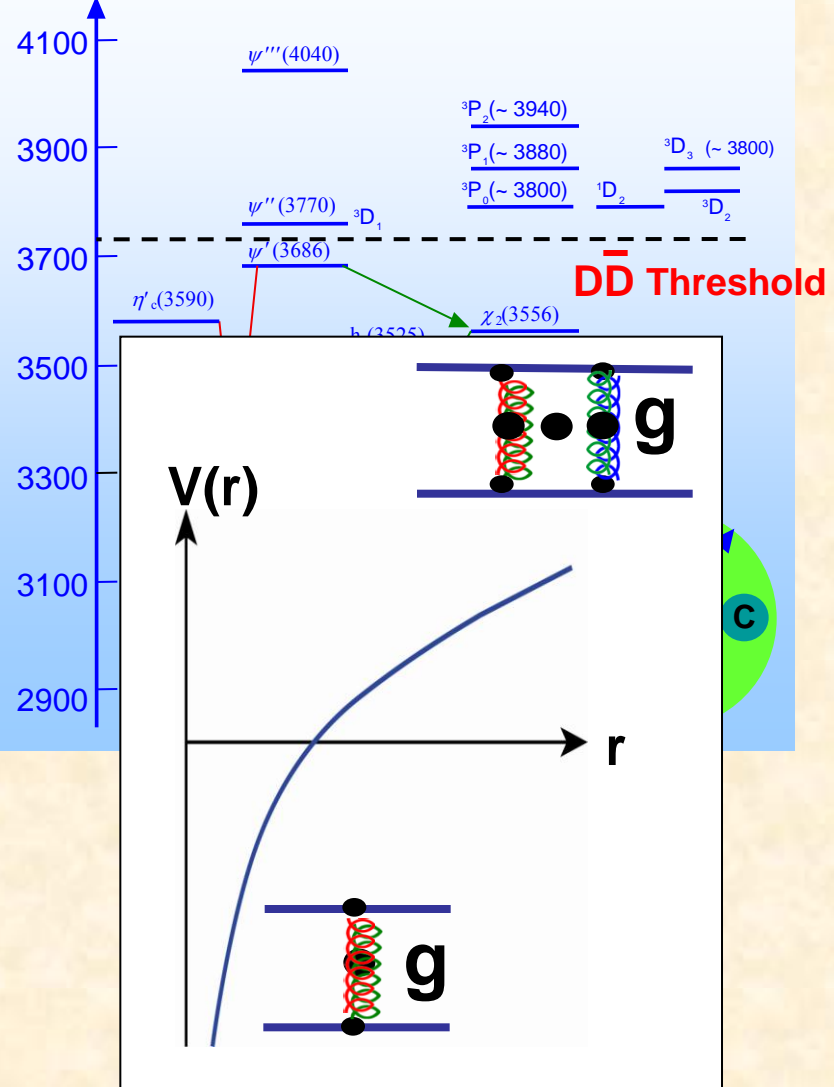

# charmonium

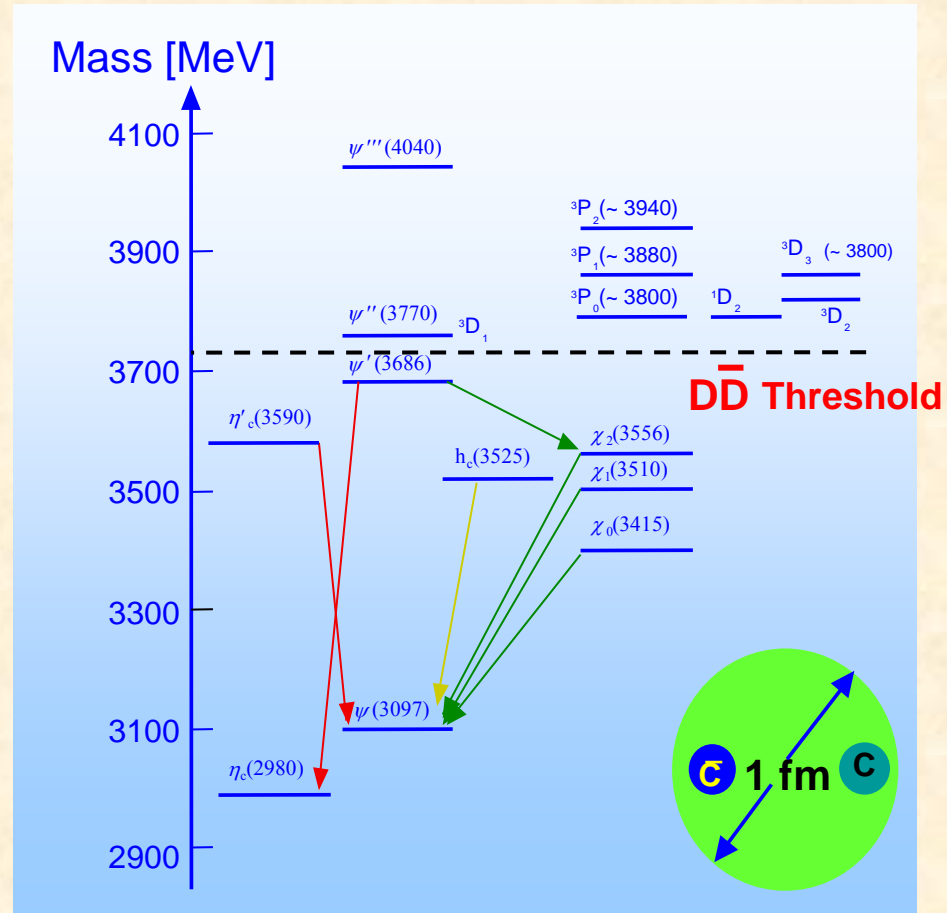
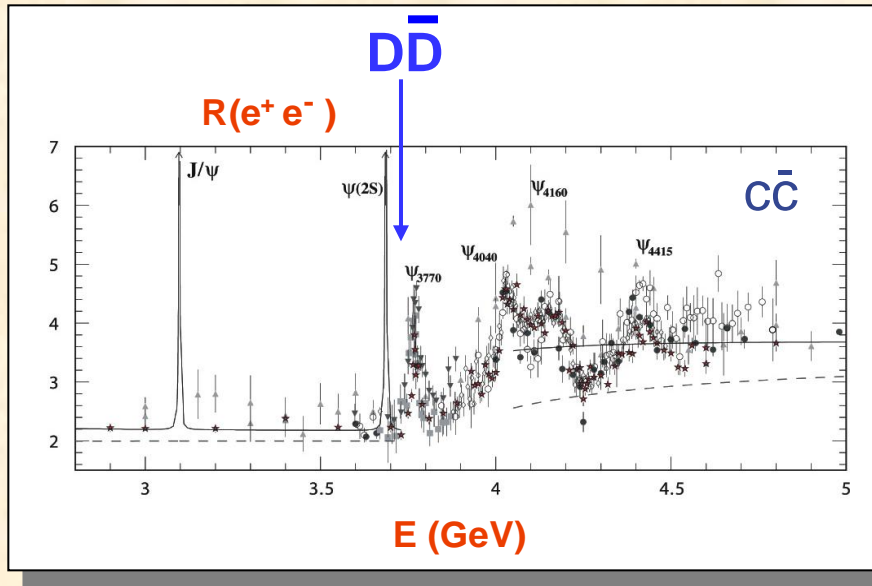

# Hadrons and confinement



# Hadrons and de-confinement



# Hadrons and de-confinement



# charmonium

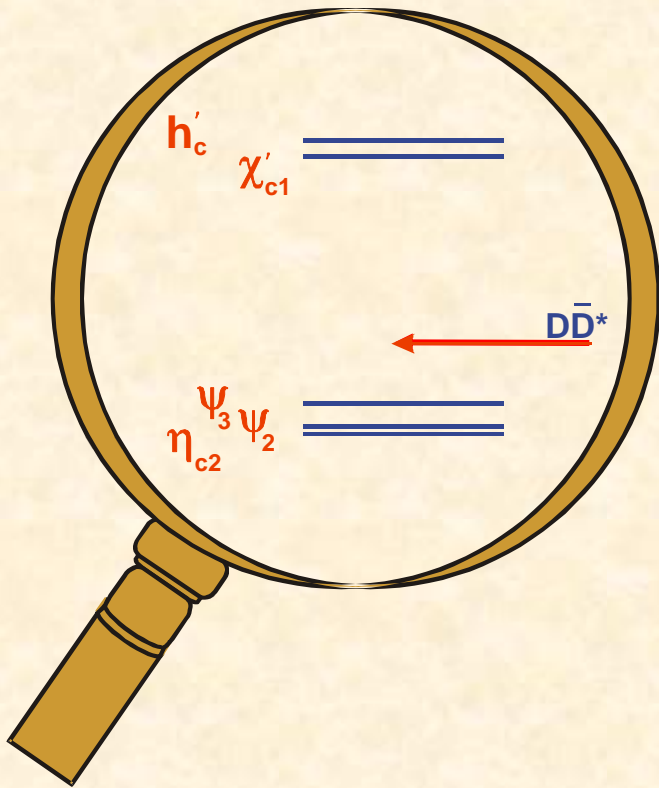

Mass [MeV]

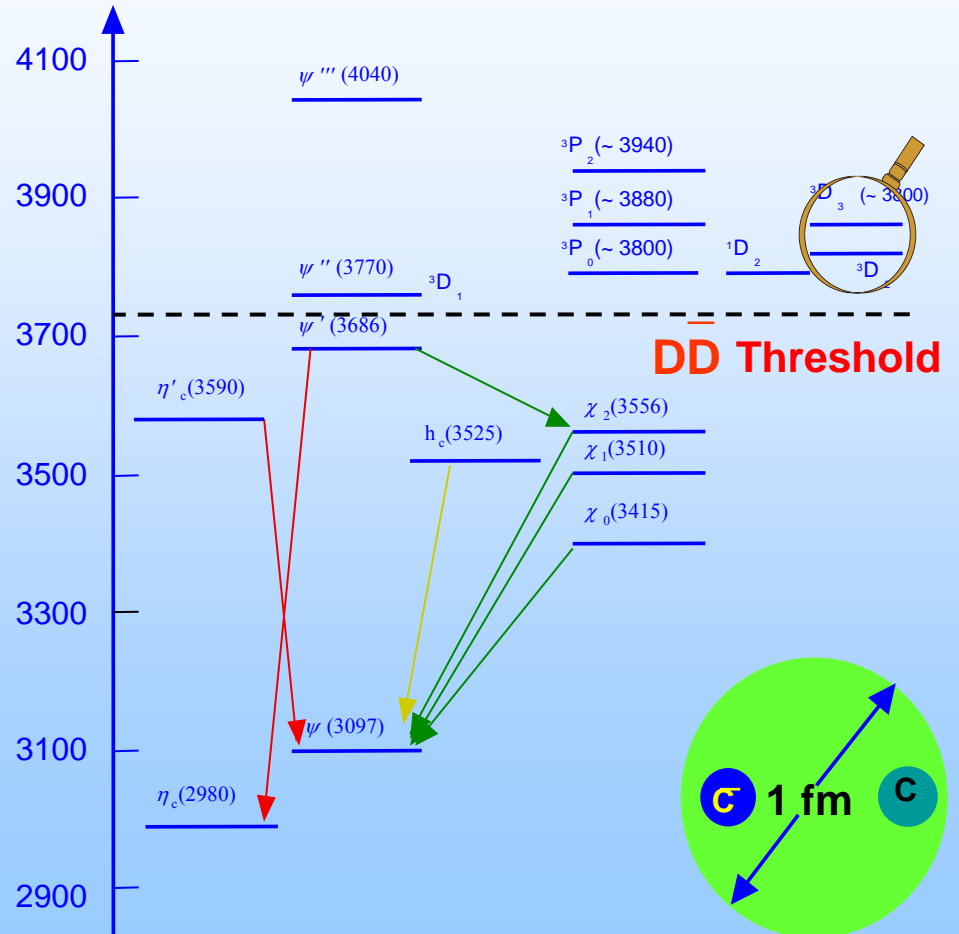



# gifts from B-factories

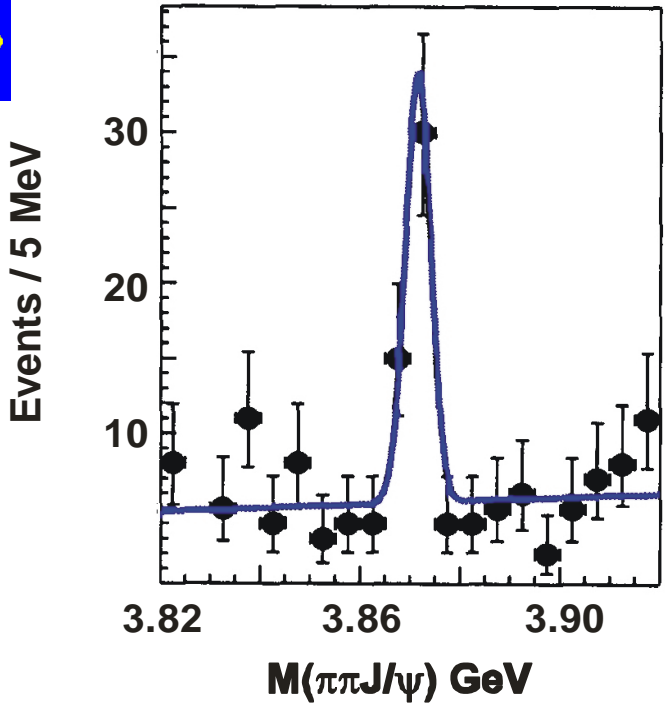

**X(3872)**

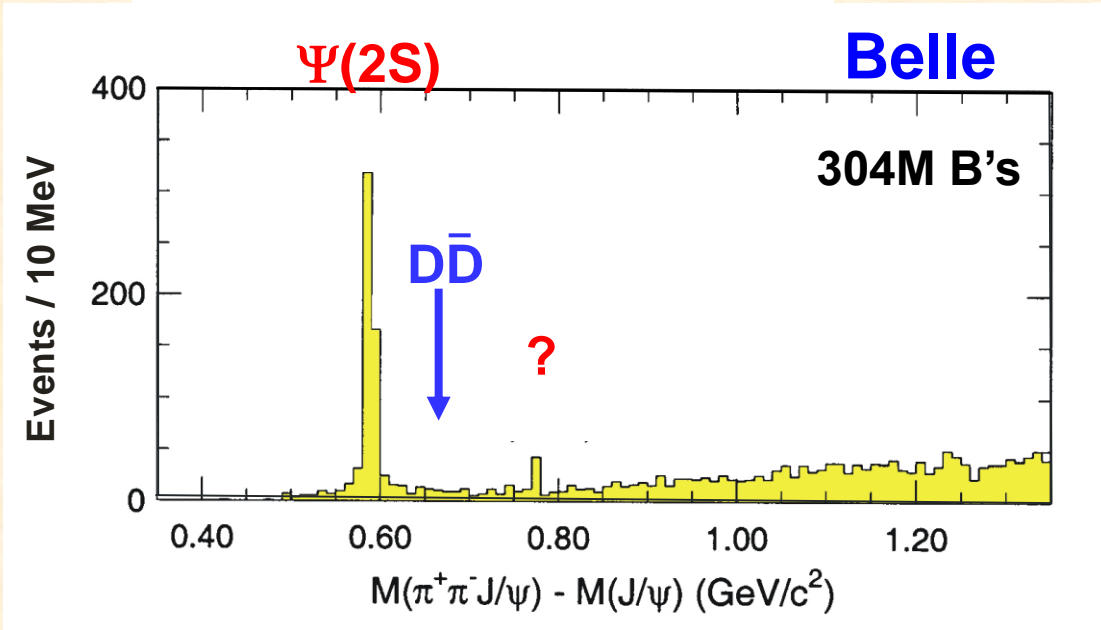

**$B \rightarrow KX$**   
 **$X \rightarrow \pi^+ \pi^- J/\psi$**

**$\Gamma < 2.3 \text{ MeV}$**



# X(3872) confirmed

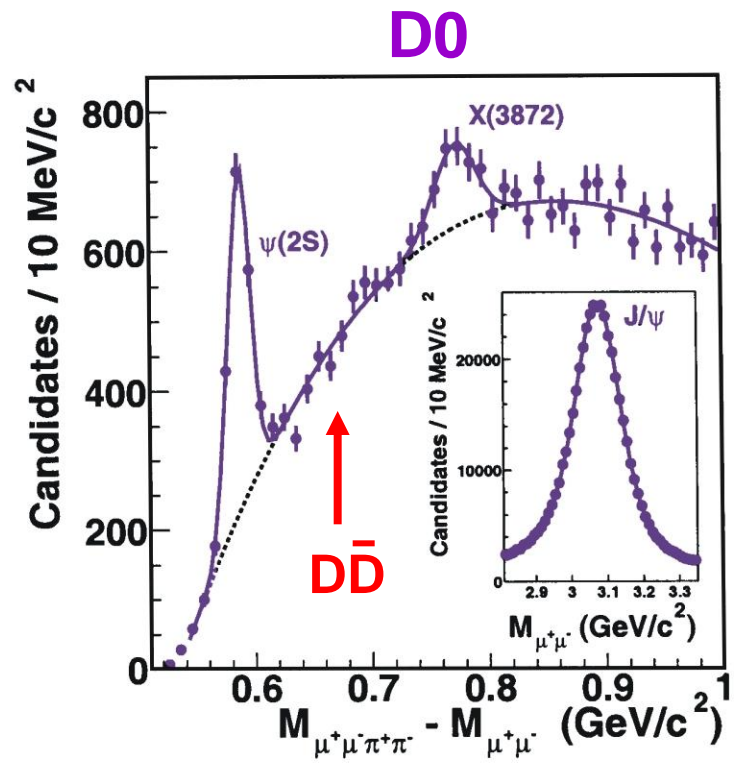
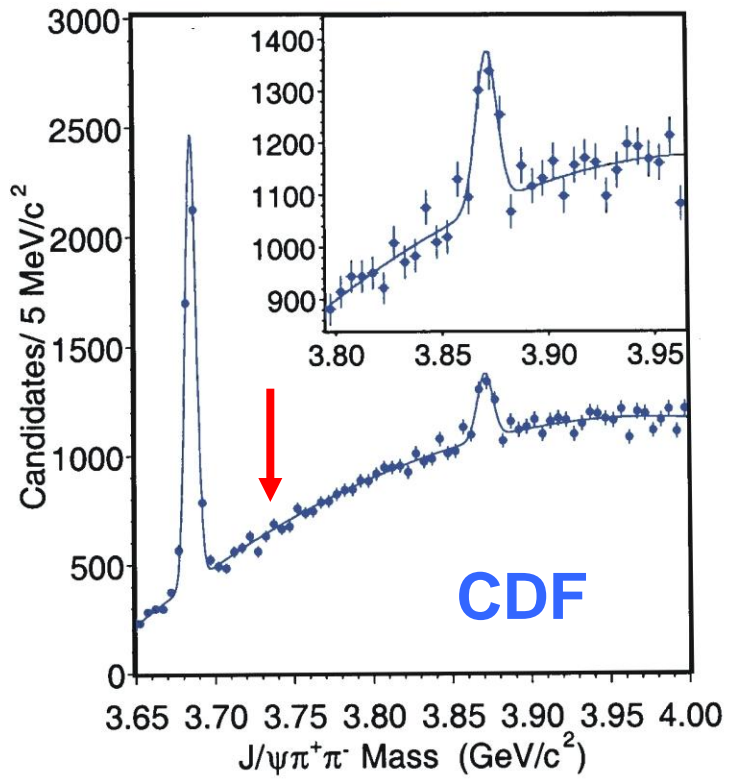
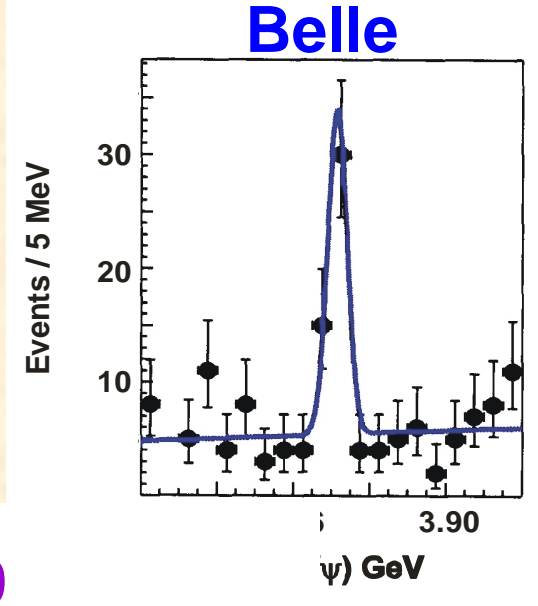

# Effect of Decay channels

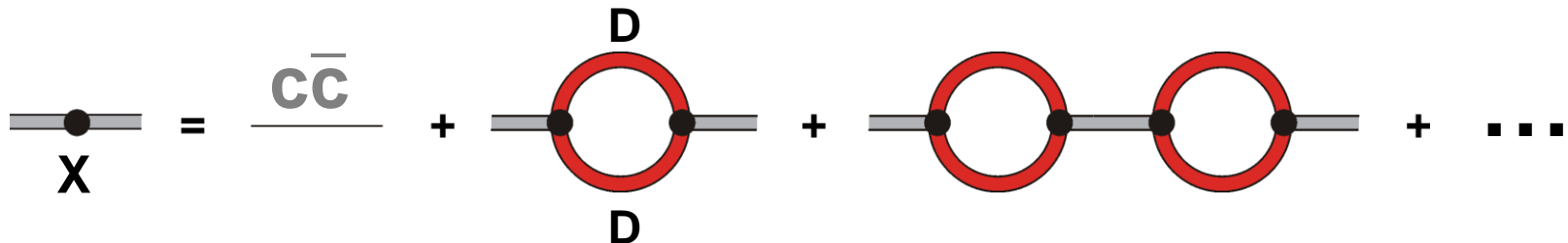
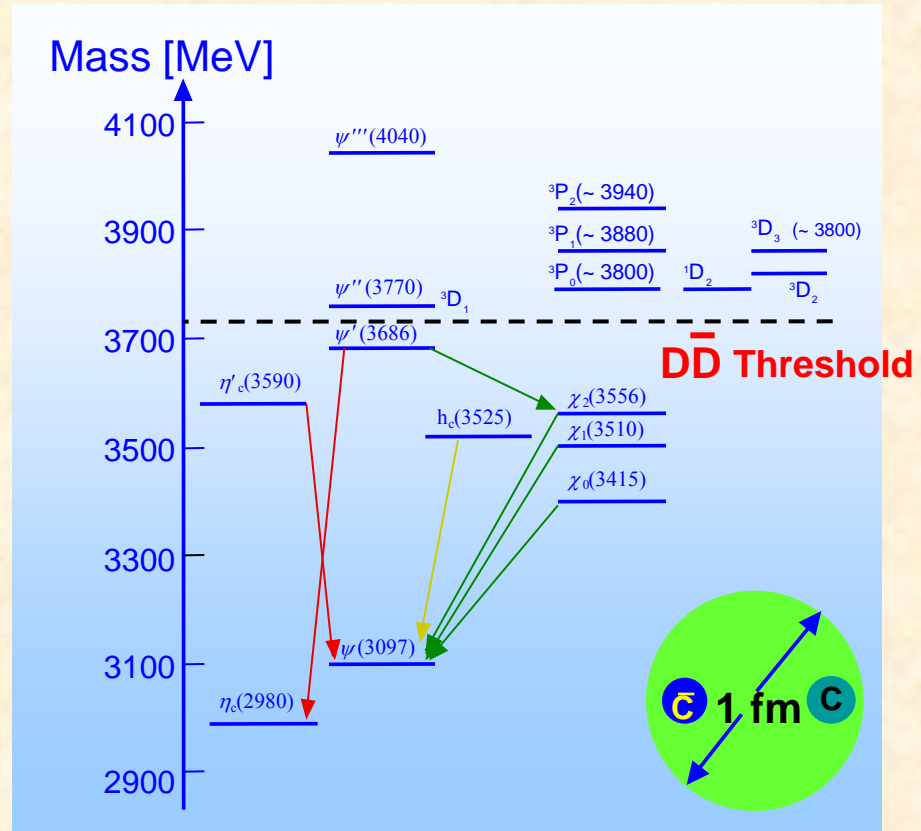

$c\bar{c}$

E

$3^1S_1$

$3^1S_0$

4

$3^3P_2$

$3^3P_1$

$3^3P_0$

3.8

$D^* \bar{D}^*$

$D_s \bar{D}_s$

$D \bar{D}^*$

$D \bar{D}$

$c\bar{c}$

experiment

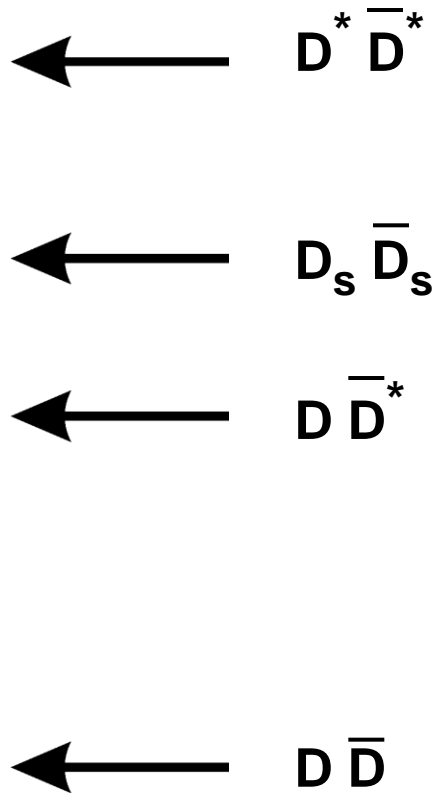
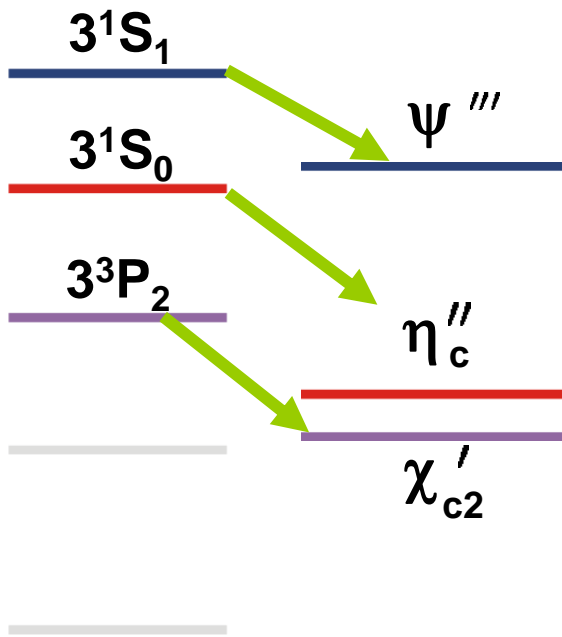
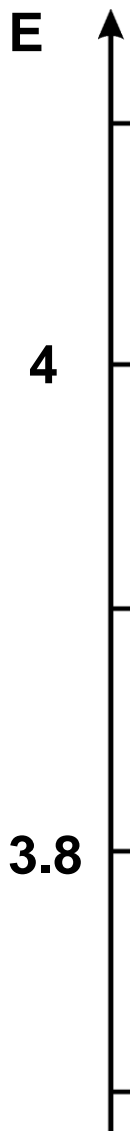

$c\bar{c}$

experiment

E

$3^1S_1$

$3^1S_0$

$3^3P_2$

$\psi'''$

$\eta''_c$

$\chi'_{c2}$

$D^* \bar{D}^*$

$D_s \bar{D}_s$

$D \bar{D}^*$

$D \bar{D}$

4

3.8

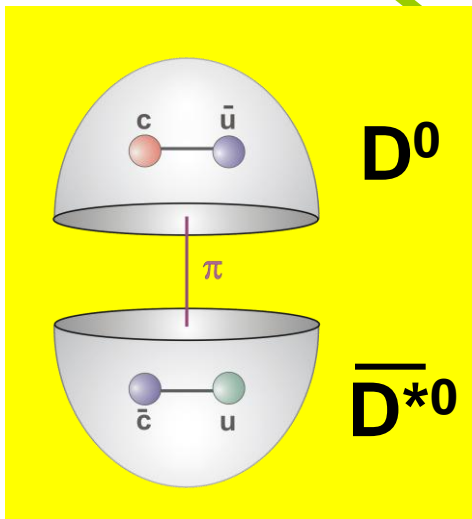

Tornqvist, ...

Barnes & Swanson

Wilson & P

# color wave-functions

$$\pi^+ = \frac{1}{\sqrt{N_c}} [ u\bar{d} + u\bar{d} + u\bar{d} + u\bar{d} + \dots ]$$

$$N_c = 3$$

$$p = \frac{1}{\sqrt{6}} [ uud + uud + uud \\ - uud - uud - uud ]$$

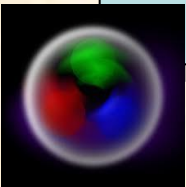

# Nucleon model states ( $\pi N$ couplings)

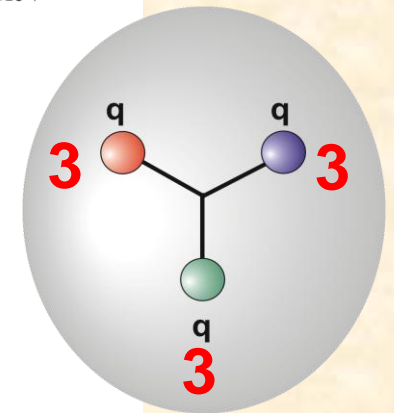
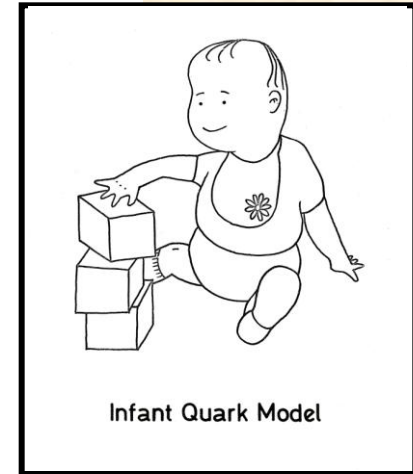
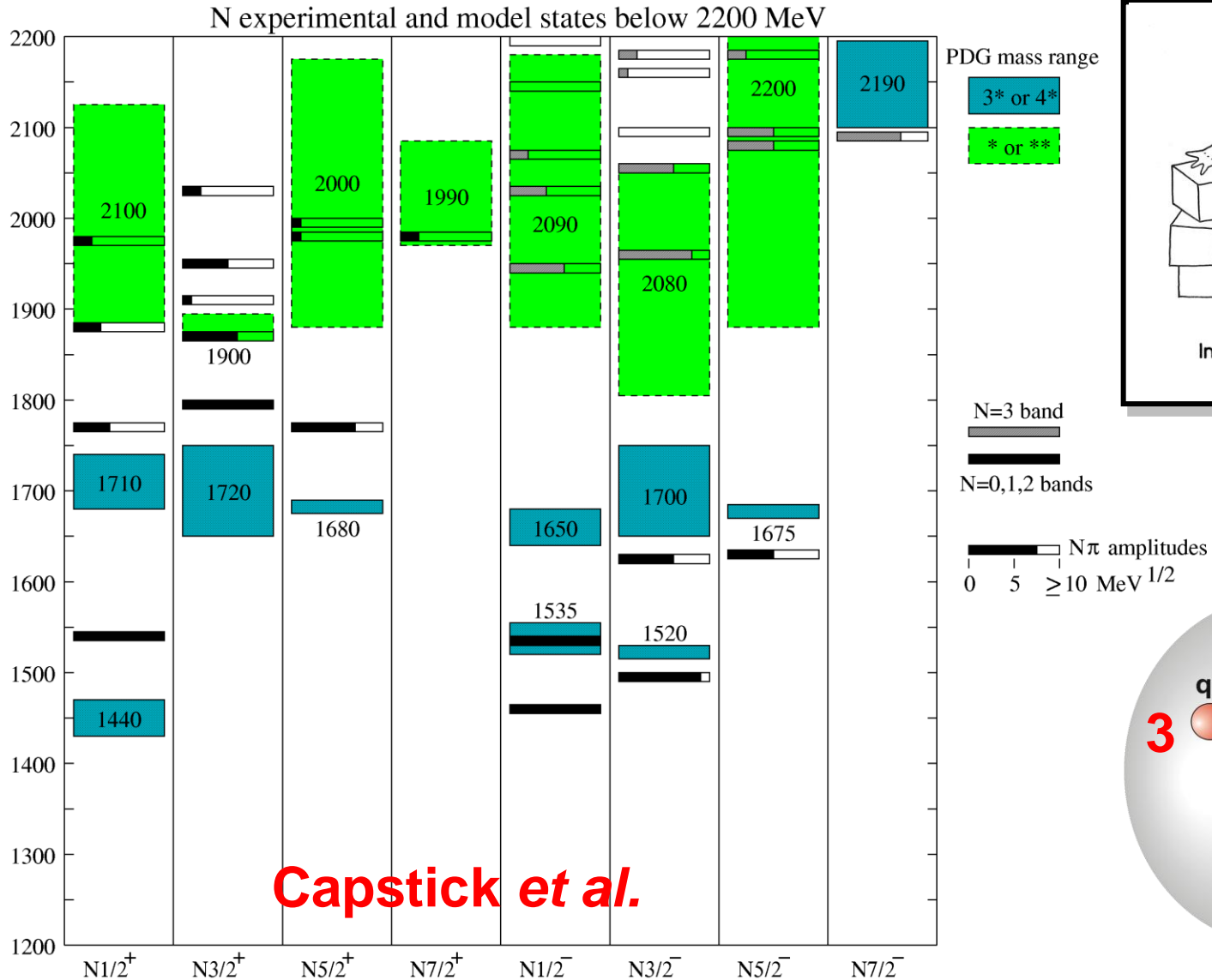

# search all channels: not just $\pi N$

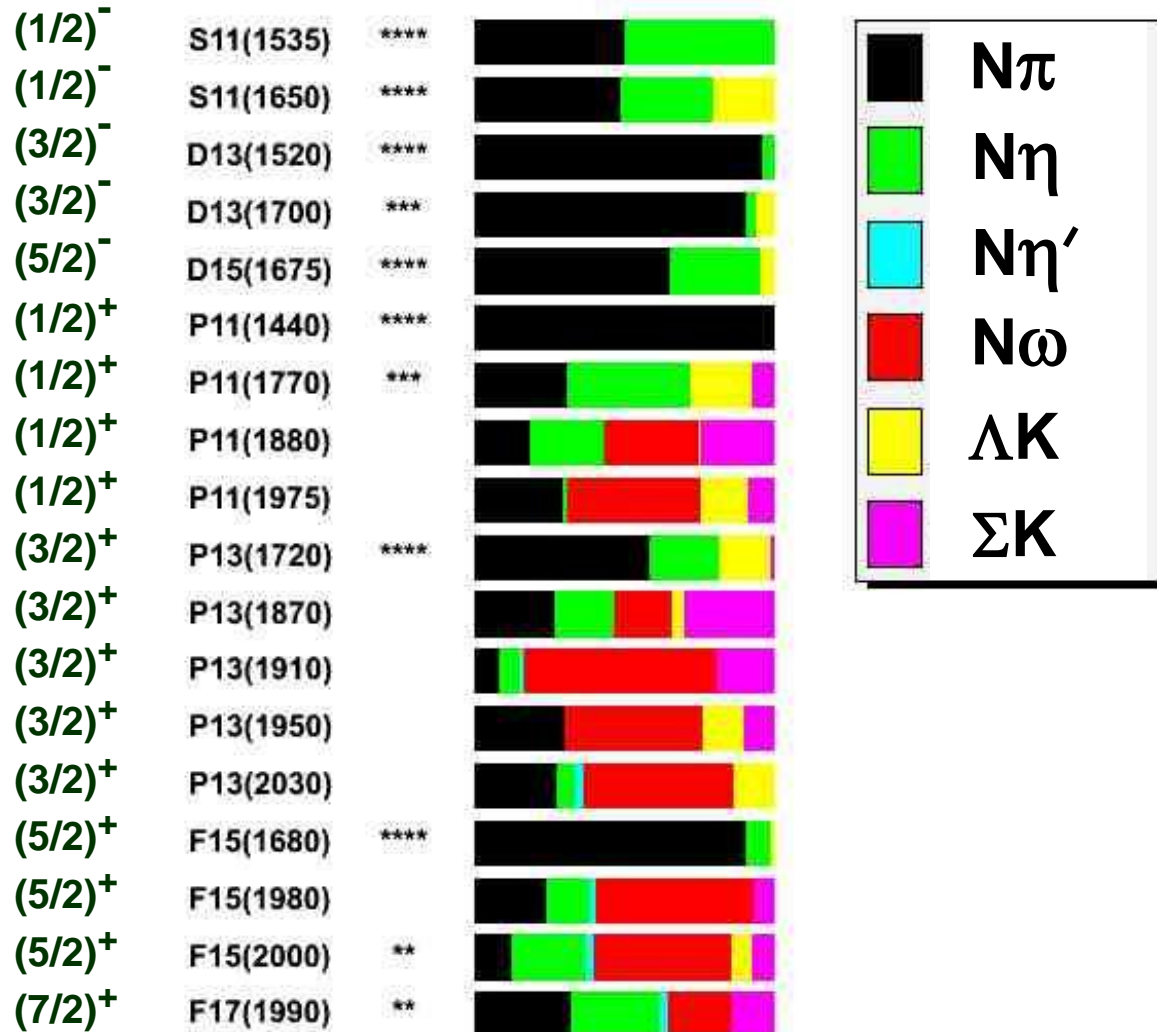



# $\Delta$ model states ( $\pi N$ couplings)

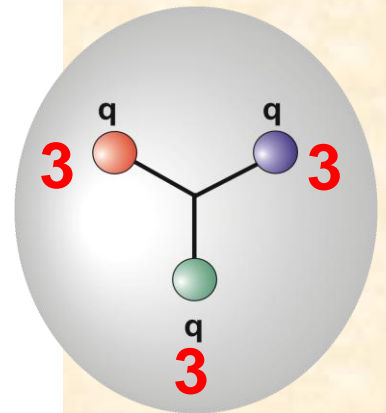
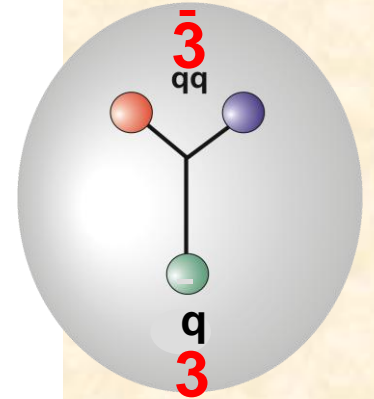
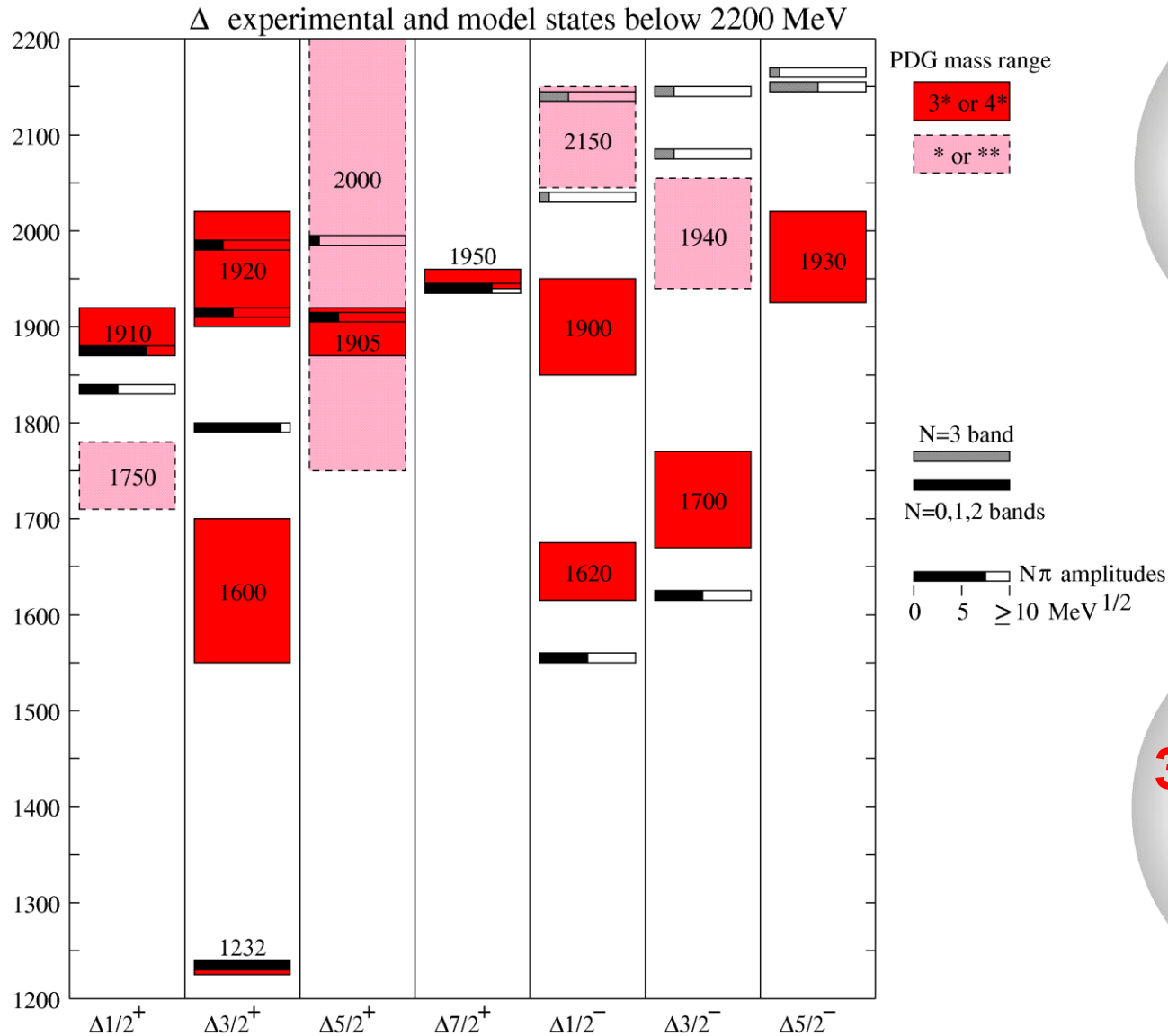

# $\Delta$ model states ( $\pi N$ couplings)

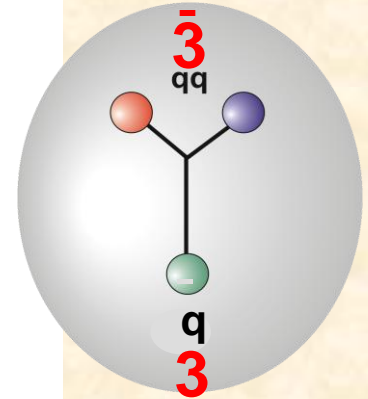
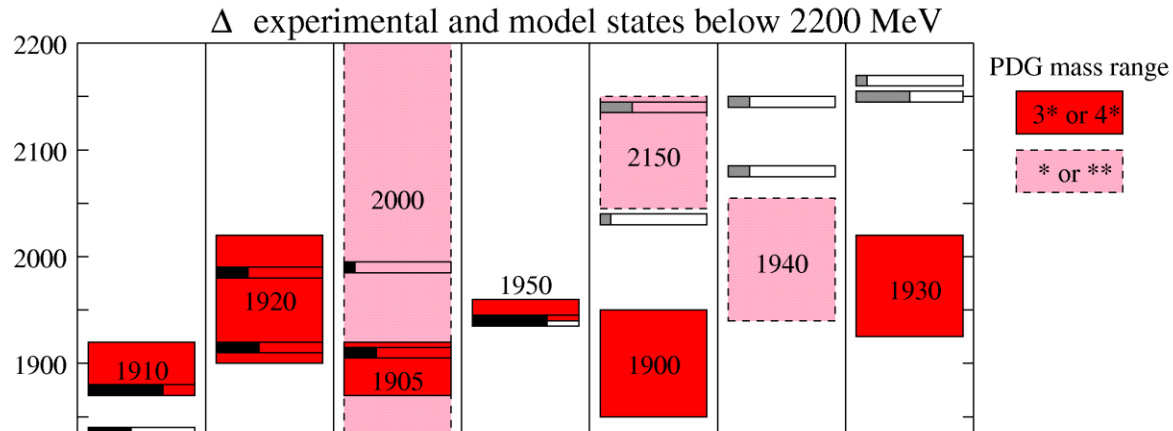

$$\mathcal{L}_{\text{QCD}} = \sum_{q=u,d,s,c,b} \bar{\psi}_q (i \gamma_\mu D^\mu - m_q) \psi_q - \frac{1}{4} \mathcal{F}_{\mu\nu} \mathcal{F}^{\mu\nu}$$

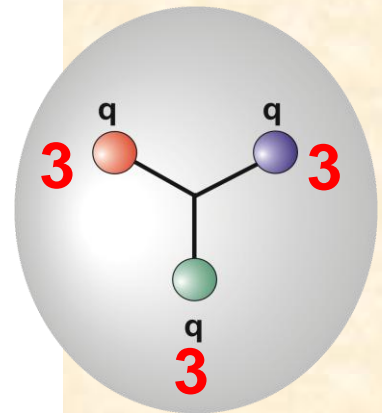
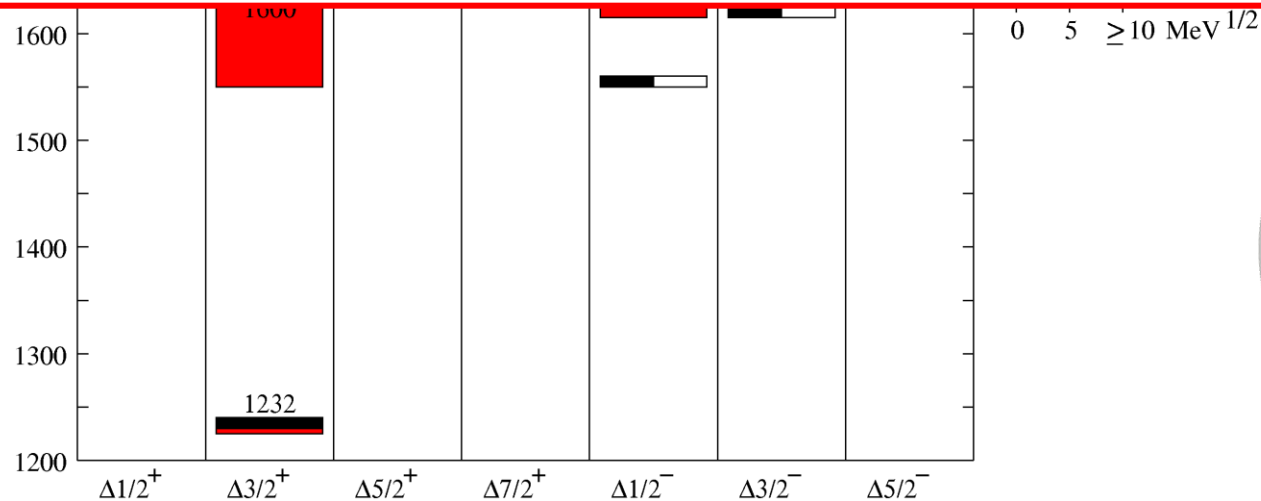

# $\Delta(1232)$ color wave-function

$$N_c = 3$$

$$\Delta^+ = \frac{1}{\sqrt{6}} \left[ \begin{aligned} & \text{uud} + \text{uud} + \text{uud} \\ & - \text{uud} - \text{uud} - \text{uud} \end{aligned} \right]$$

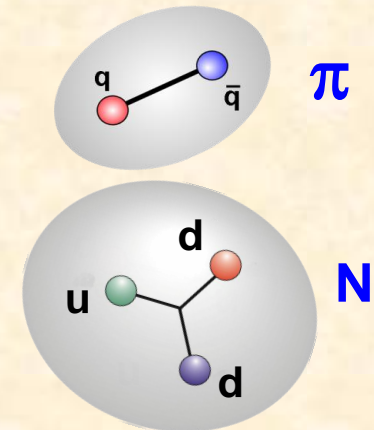
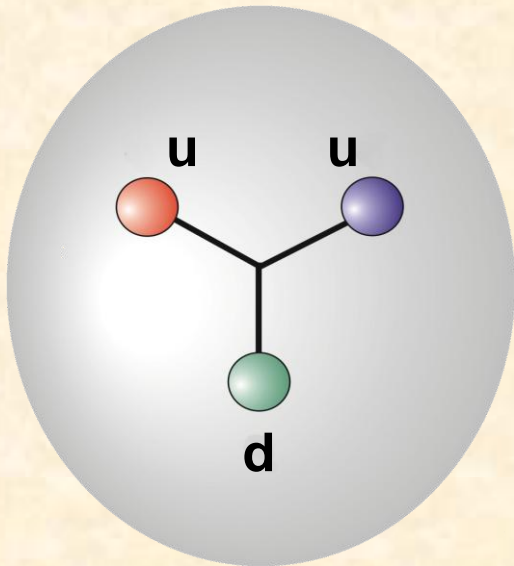

# $\pi N \rightarrow \pi N$ scattering

$d\sigma/d\Omega$

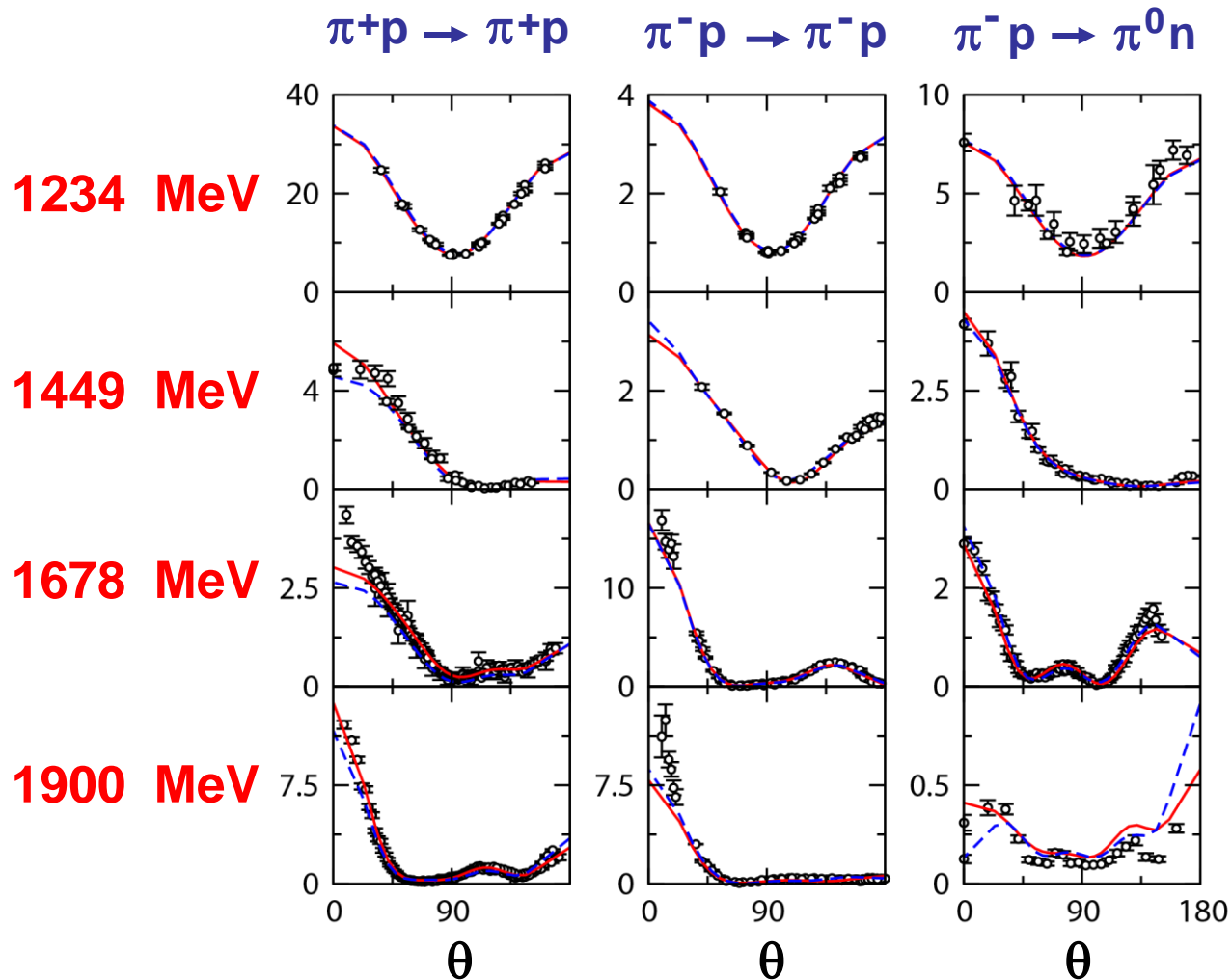

# $\pi N \rightarrow \pi N$ scattering

P

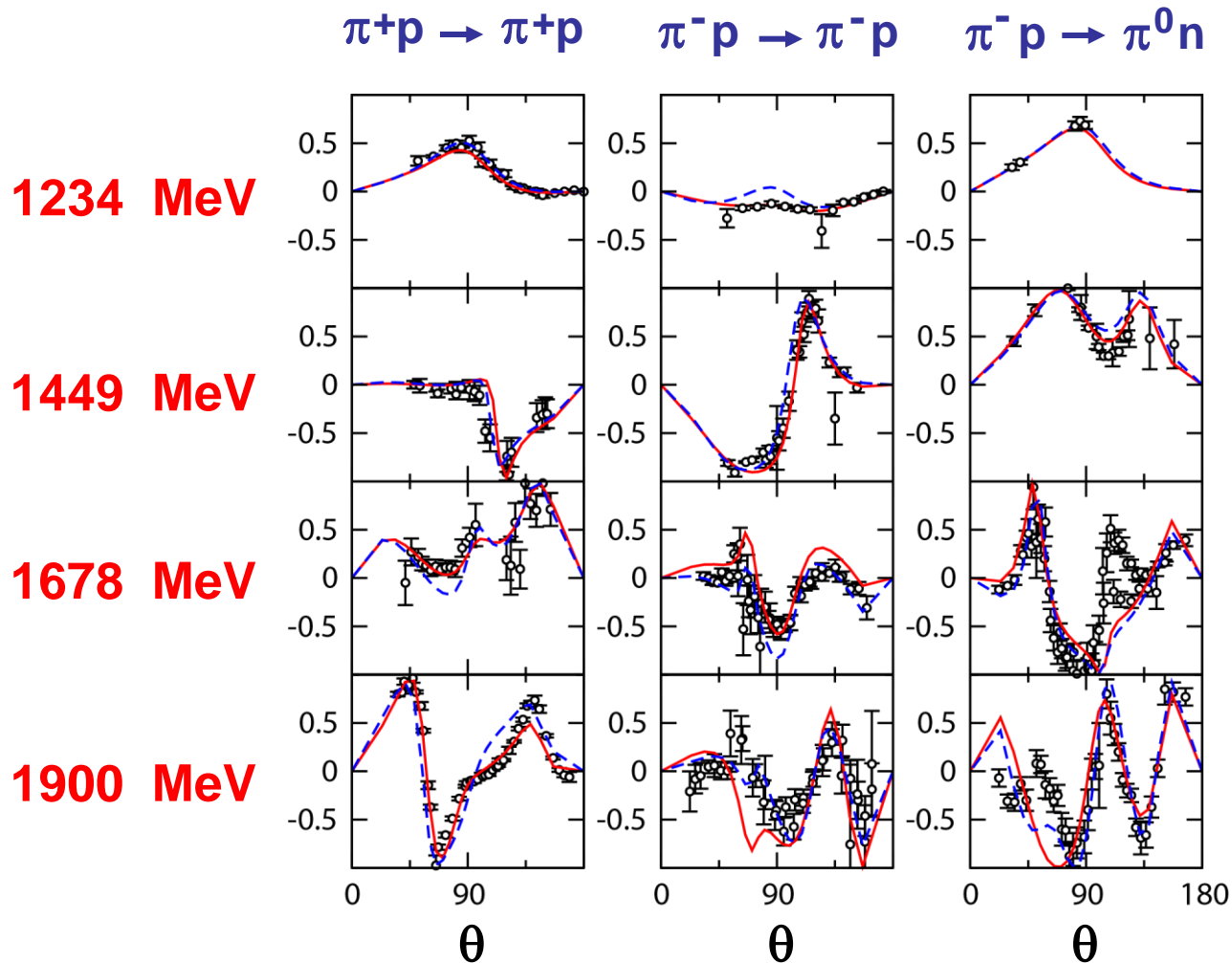

# $\pi N$ amplitudes

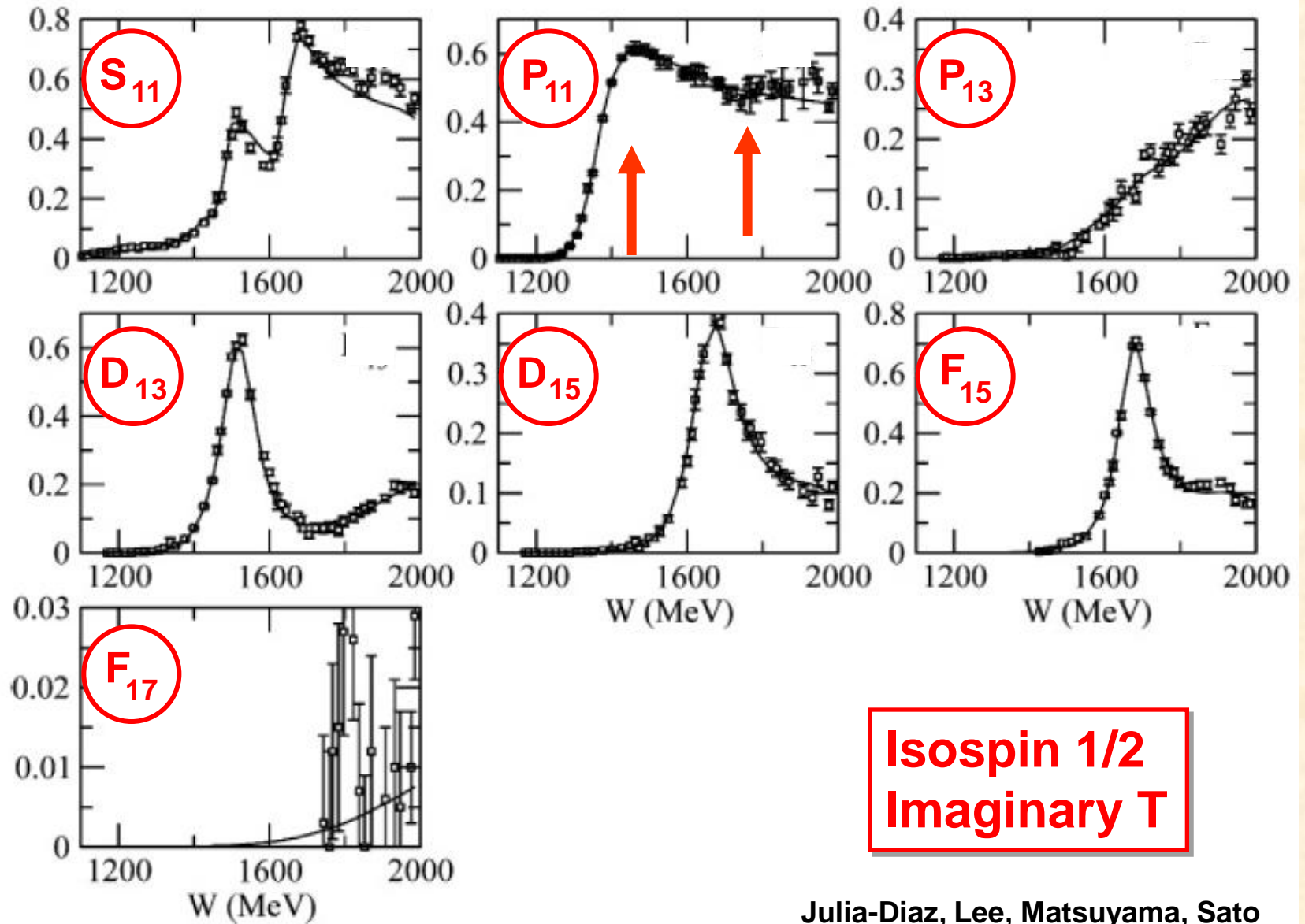

Isospin 1/2  
Imaginary T

# $N^*(1xxx)$

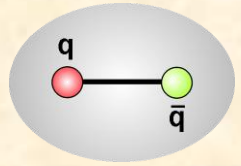
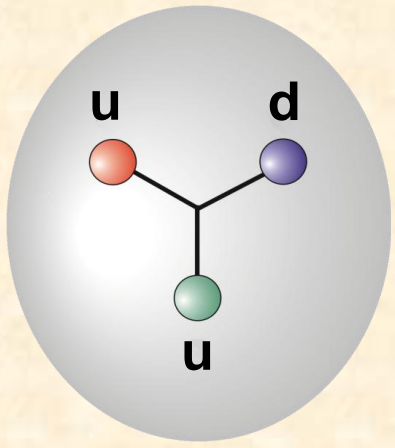

$\pi$

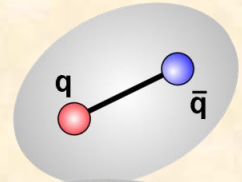

$\pi$

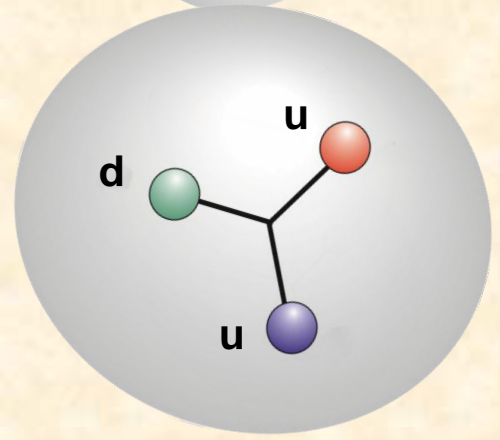

$N$

**Coupled channels**

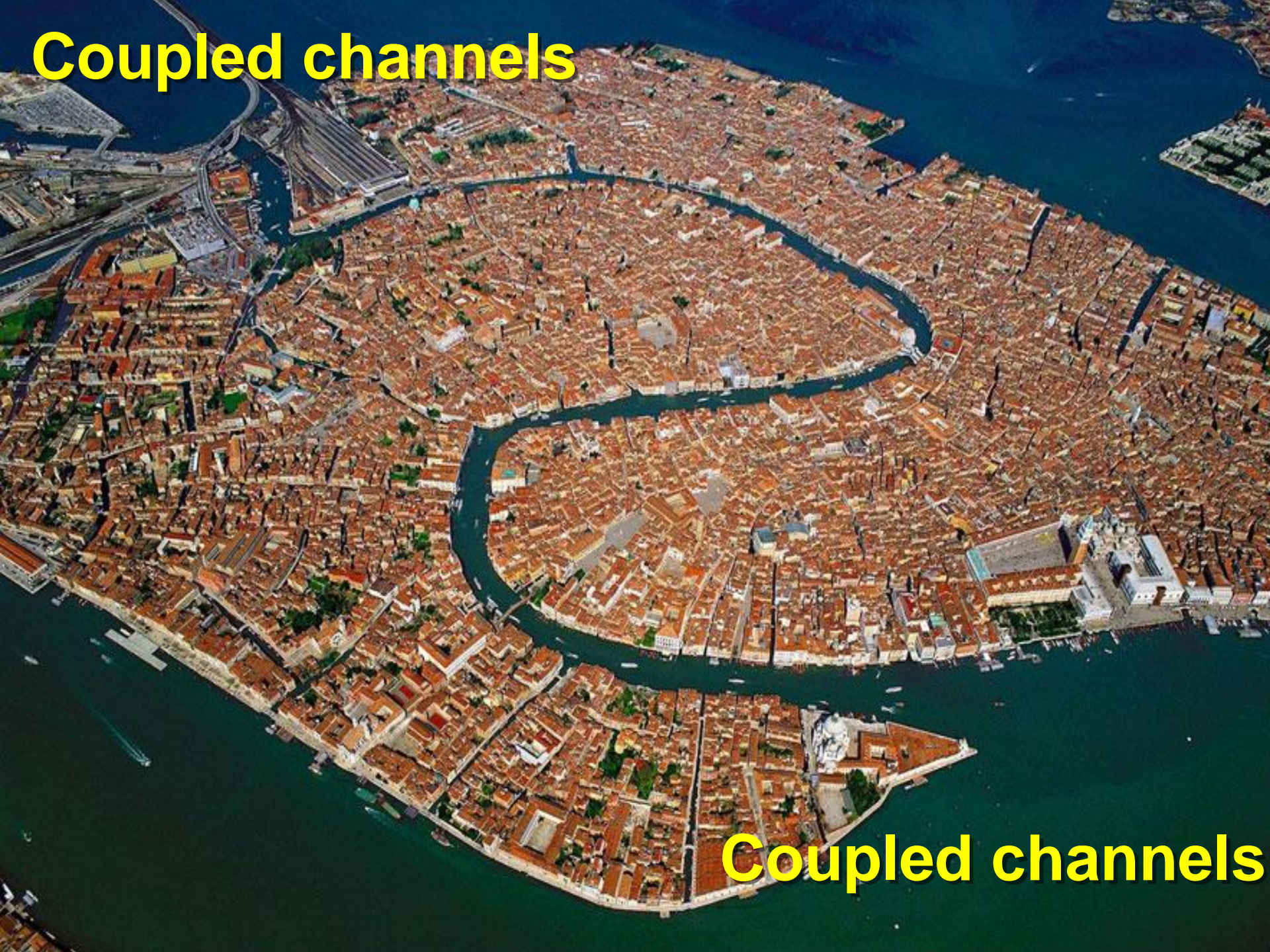

**Coupled channels**



# Properties of Excited Baryons

## Reaction Data

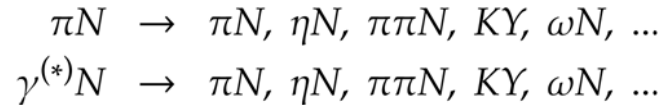

Dynamical Coupled-Channels Analysis @ EBAC

## Excited Baryon Program

N\* parameters

Hadron models

Strong QCD

QCD

**$\gamma p \rightarrow \pi^0 p$**

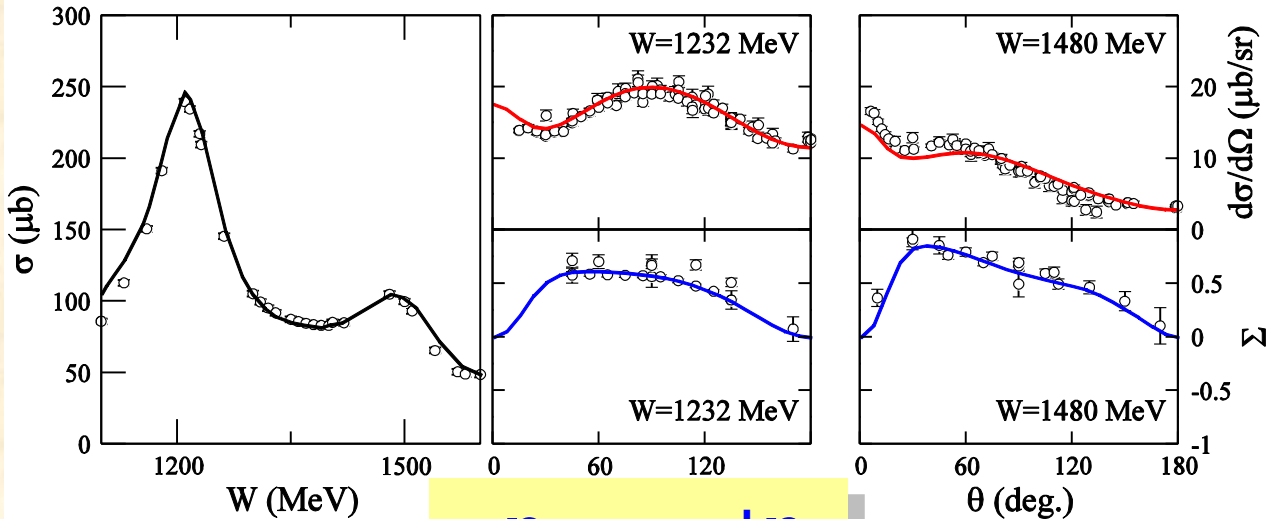
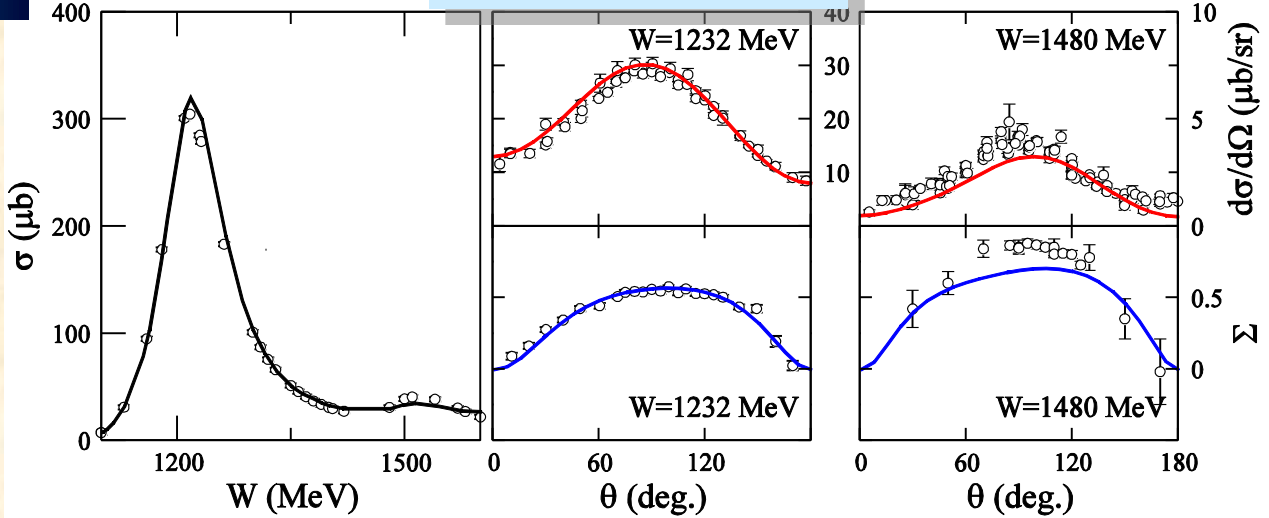

**$\gamma p \rightarrow \pi^+ n$**

# $P_{11}(1360)$ , $P_{11}(1820)$

EBAC

Suzuki et al.

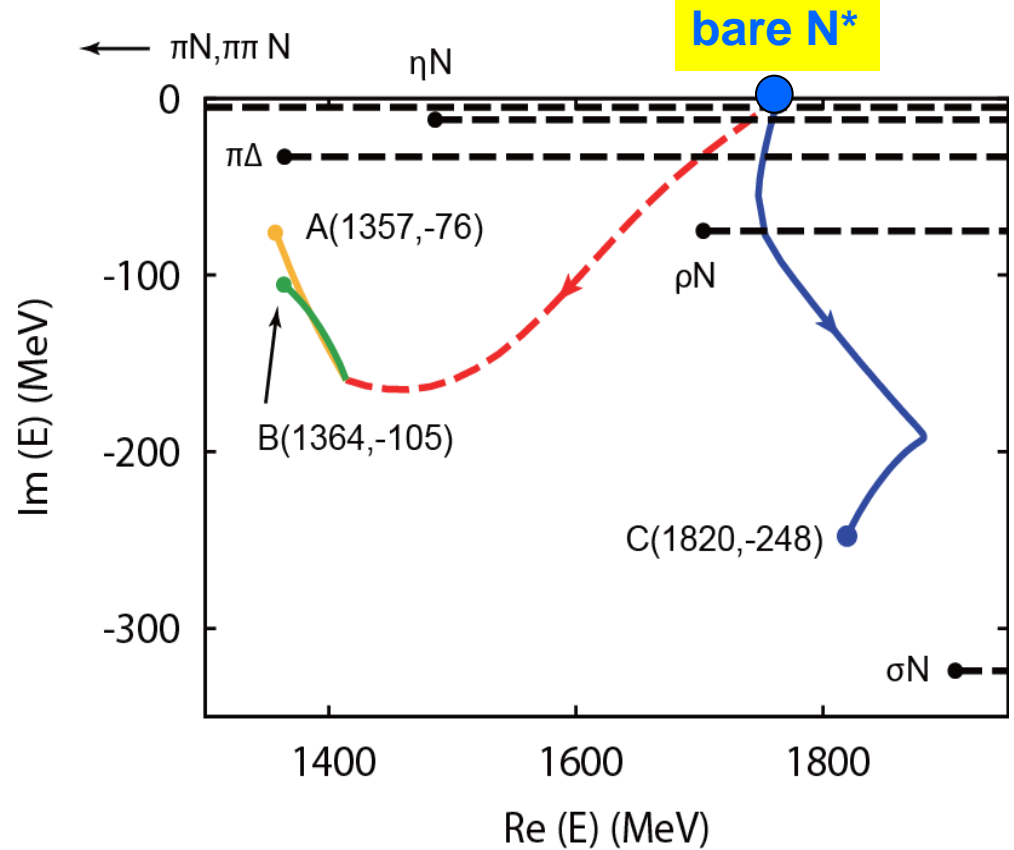
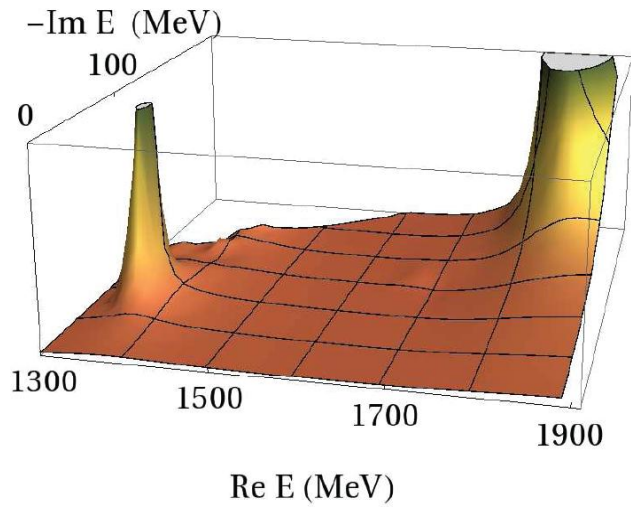

# $P_{11}(1360)$ , $P_{11}(1820)$

EBAC

Suzuki et al.

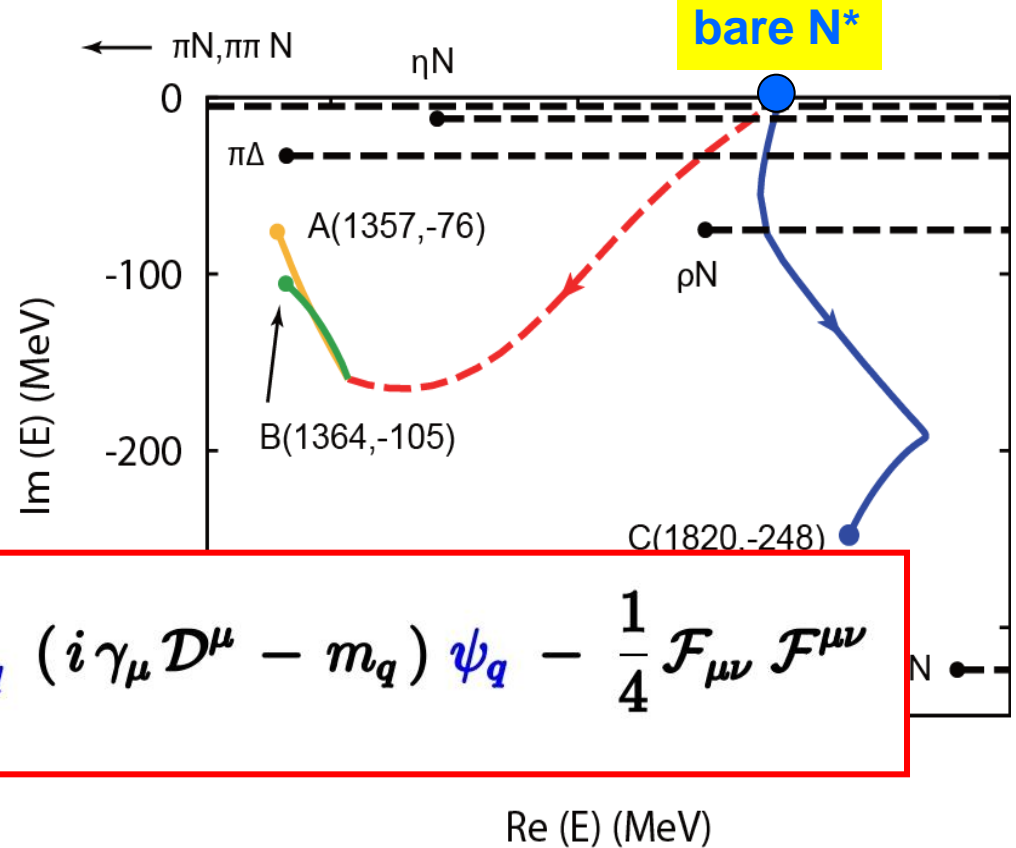
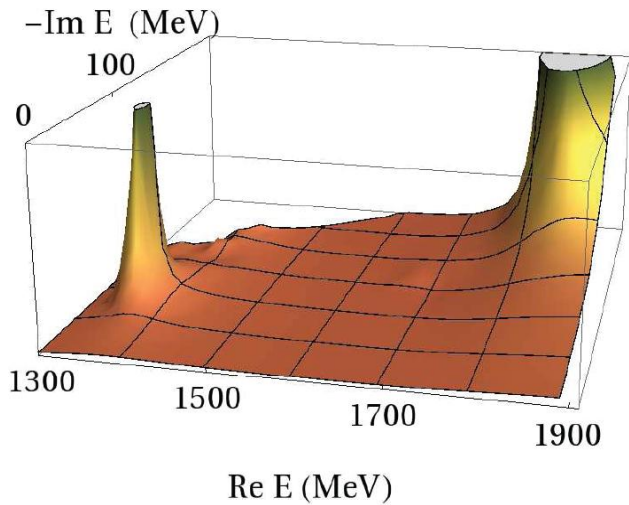

$$\mathcal{L}_{\text{QCD}} = \sum_{q=u,d,s,c,b} \bar{\psi}_q (i \gamma_\mu D^\mu - m_q) \psi_q - \frac{1}{4} \mathcal{F}_{\mu\nu} \mathcal{F}^{\mu\nu}$$

Re (E) (MeV)

# Spin identified $N^*$ and $\Delta$ states

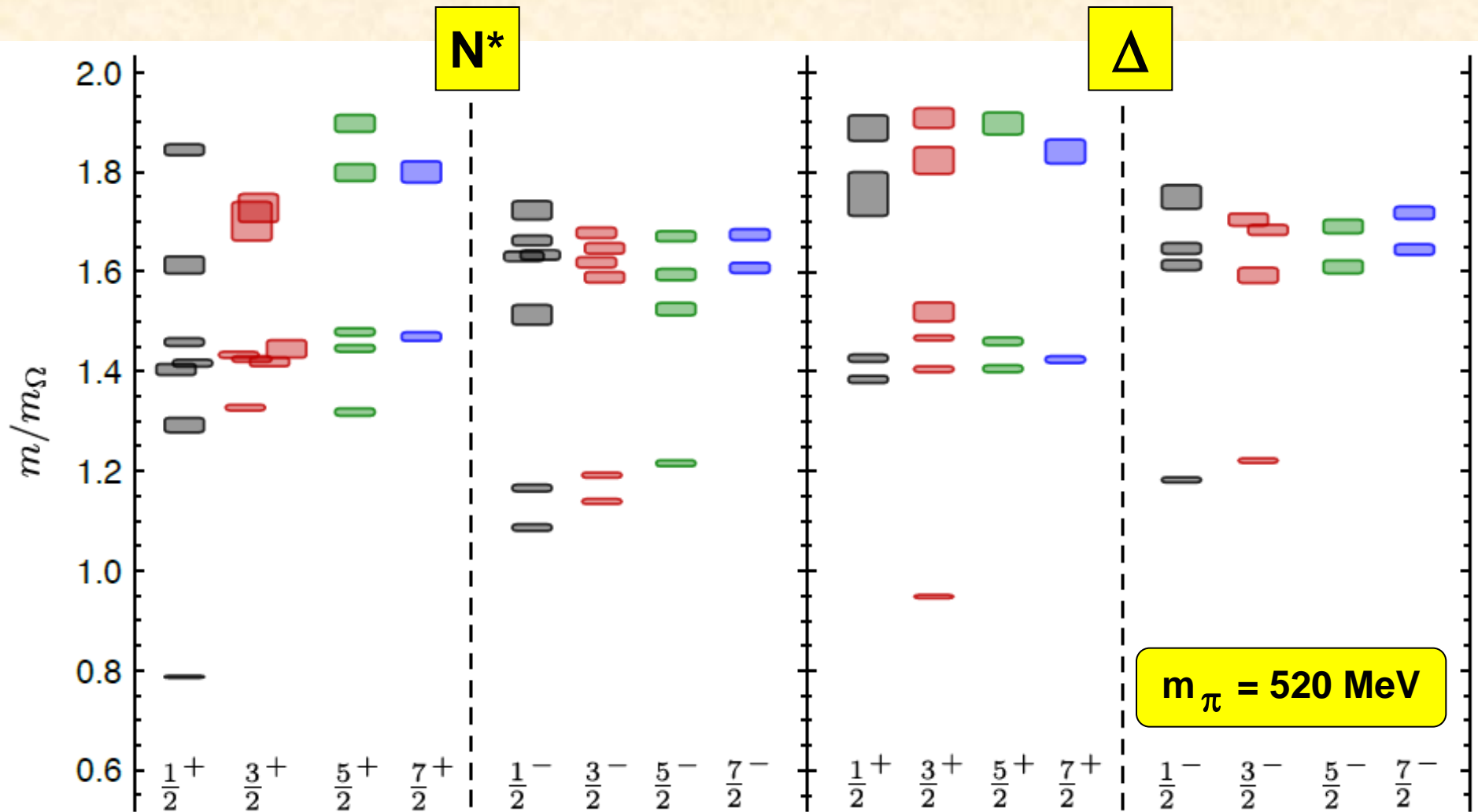

# Spin identified $N^*$ and $\Delta$ states

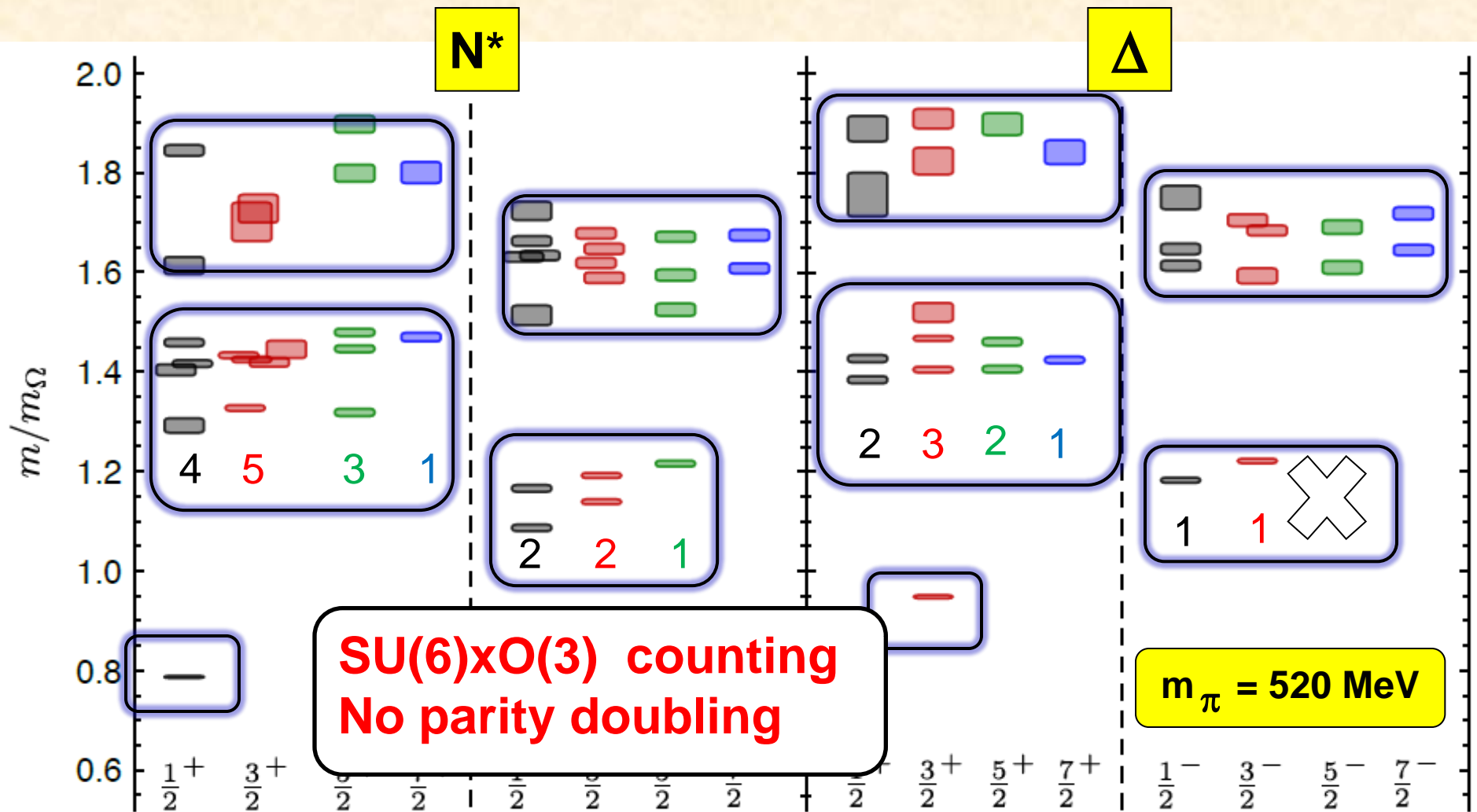

# Hadron Spectrum in ANL BS model

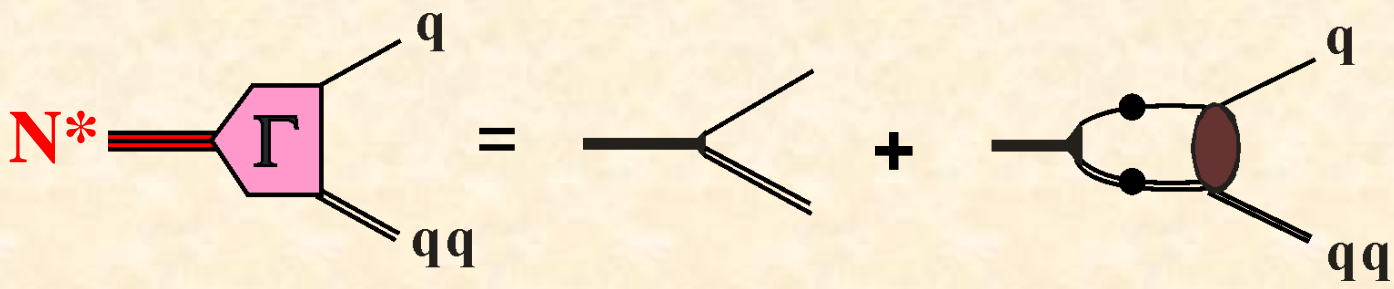
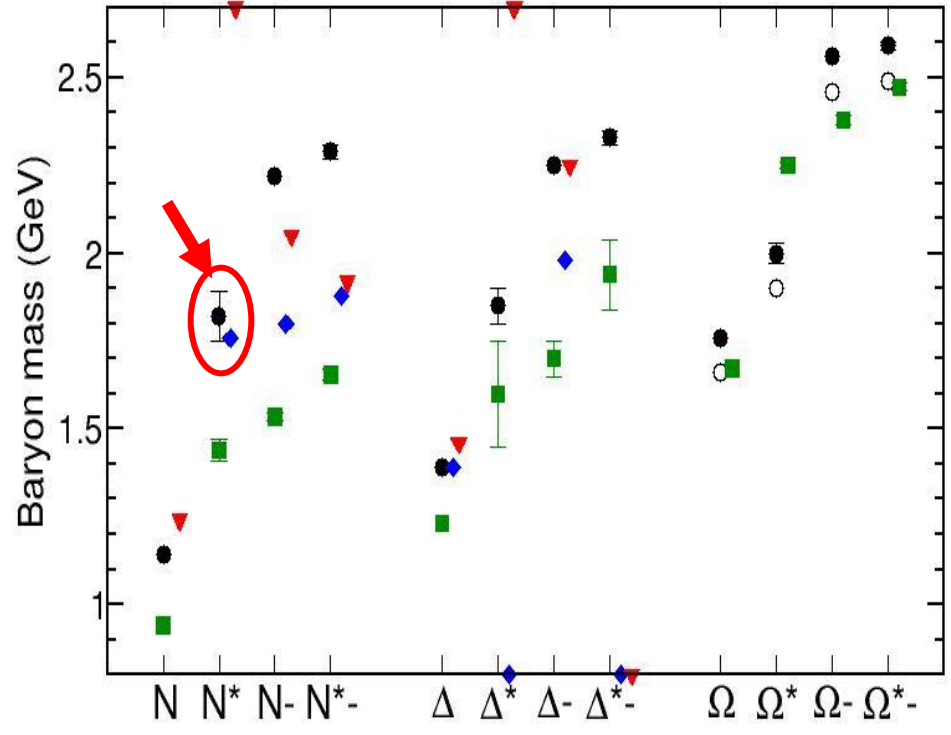
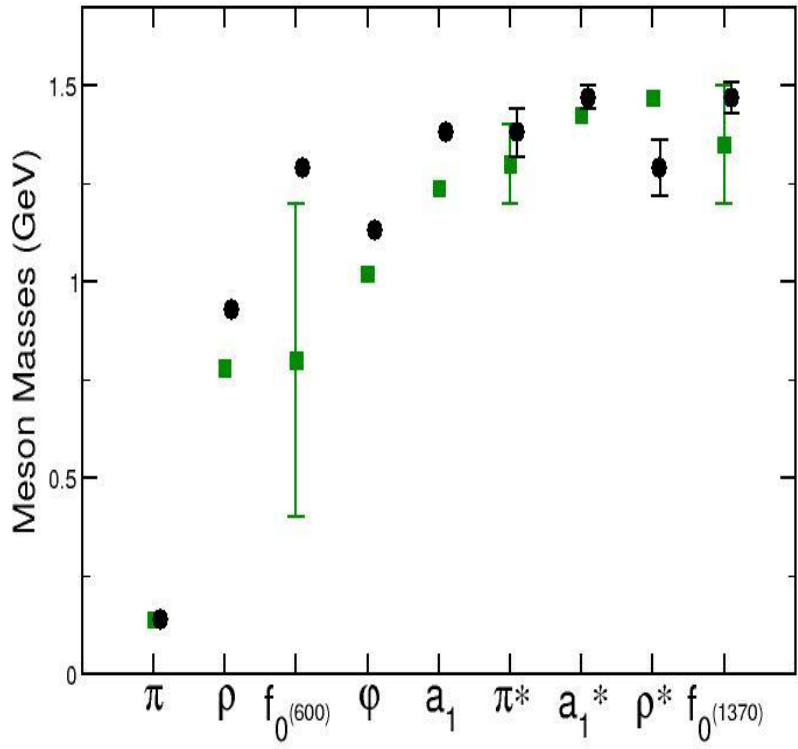

- Legend:**
- Particle Data Group
  - H.L.L. Roberts *et al.*
  - ◆ EBAC
  - ▼ Jülich

# Scalar mesons

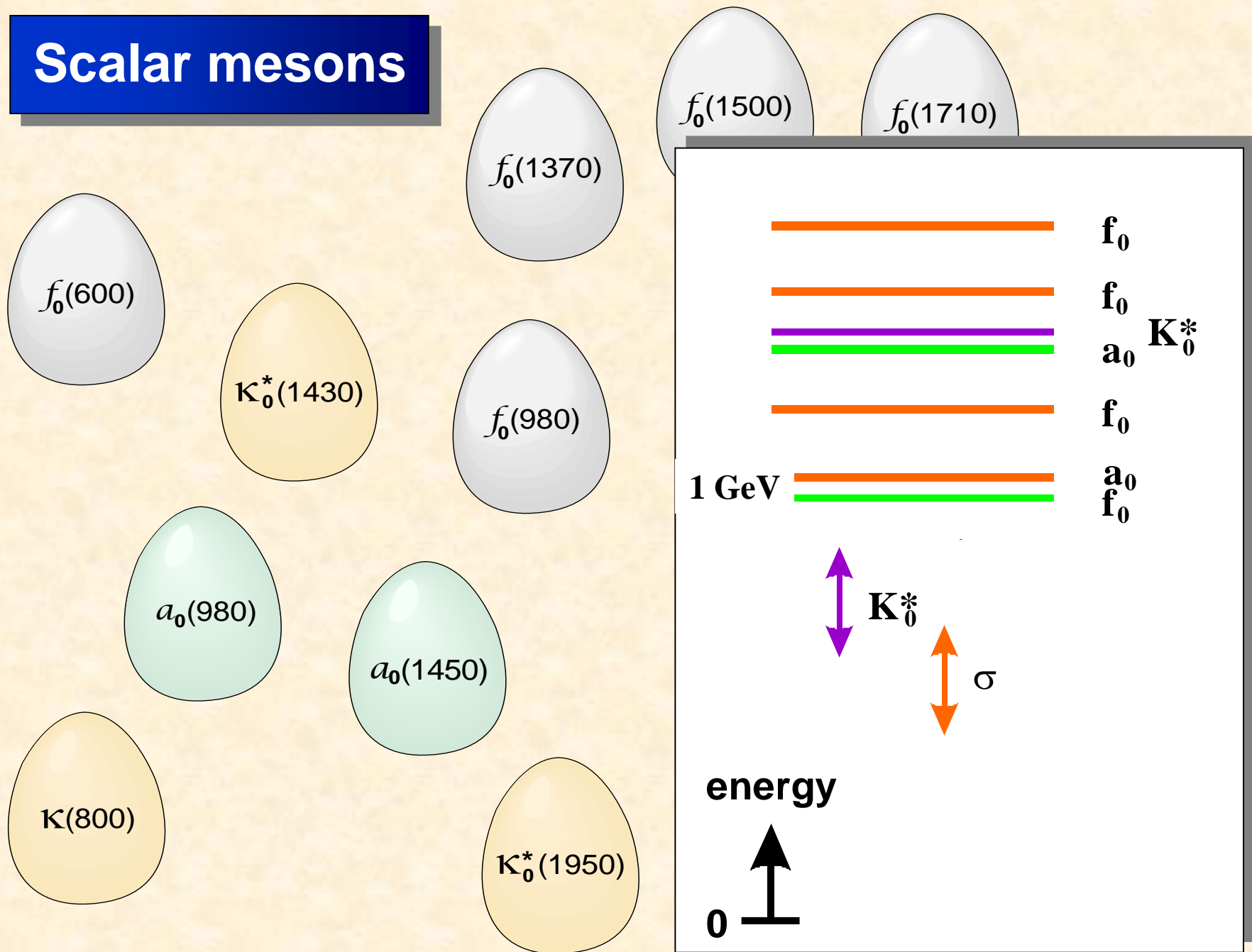



# Scalar mesons

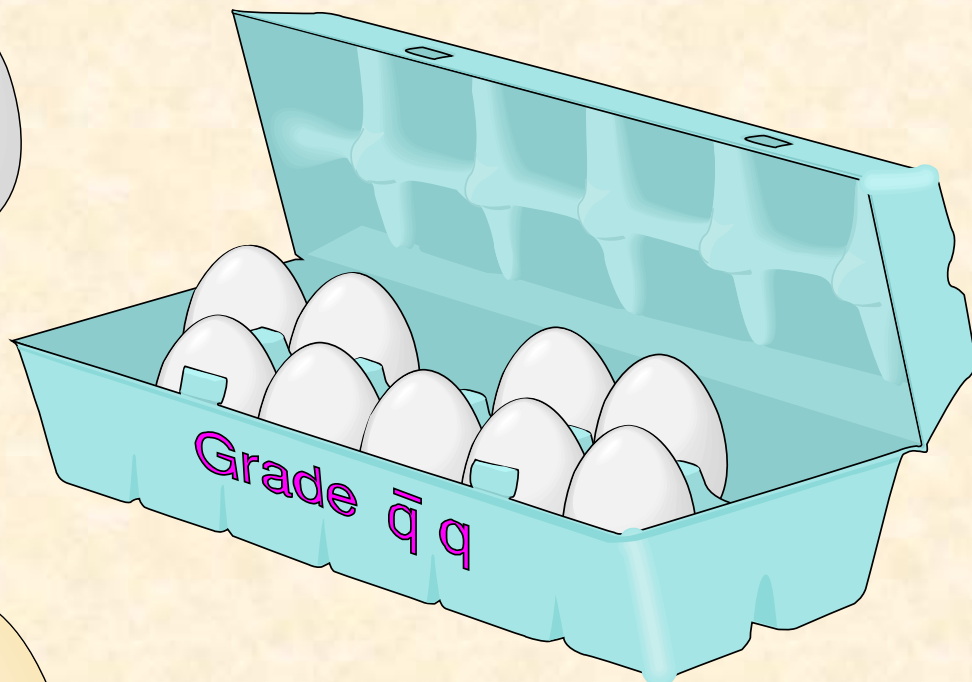
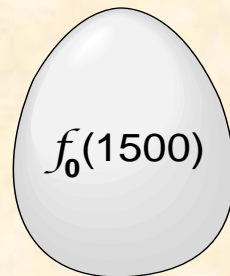
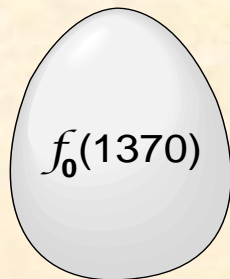
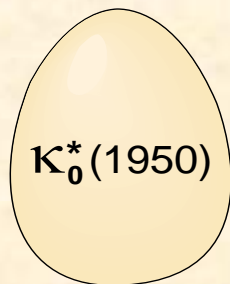
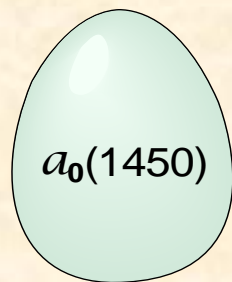
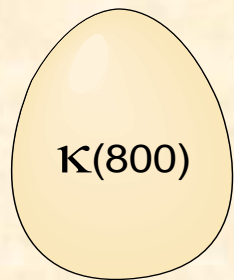
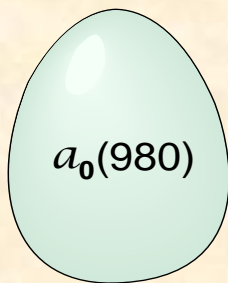
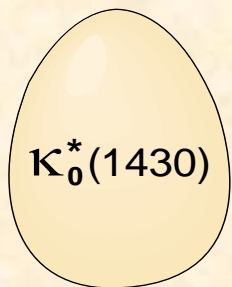
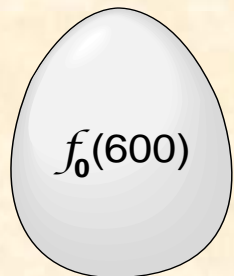

# Scalar meson multiplets

$q\bar{q}$

$q\bar{q}q\bar{q}$

$\bar{s}s$  —————  $f_0$   
 $\bar{s}n$  —————  $K_0$   
 $\bar{n}n$  —————  $a_0/f_0$

$\bar{s}s\bar{n}n$  —————  $a_0/f_0$   
 $\bar{s}n\bar{n}n$  —————  $K_0$   $\mathbf{K}$   
 $\bar{n}n\bar{n}n$  —————  $f_0$   $\mathbf{\sigma}$

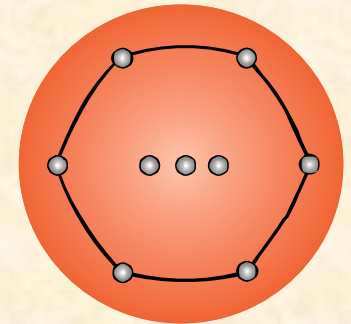
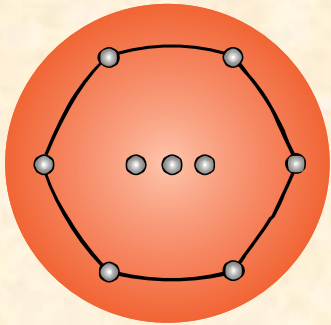

$n = u, d$

Jaffe

# Scalar mesons

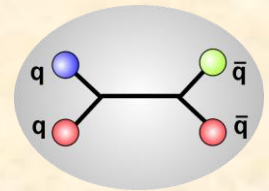
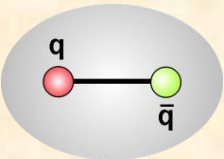
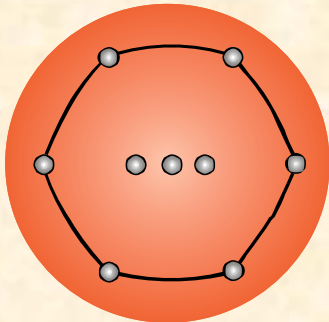
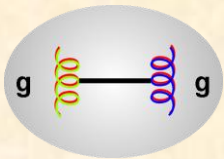

gg	—————	$f_0$
$\bar{s}s$	—————	$f_0$
$\bar{s}n$	—————	$K_0$
$\bar{n}n$	—————	$a_0/f_0$

$\bar{s}s\bar{n}n$	—————	$a_0/f_0$
$\bar{s}n\bar{n}n$	—————	$K_0$ $\kappa$
$\bar{n}n\bar{n}n$	—————	$f_0$ $\sigma$

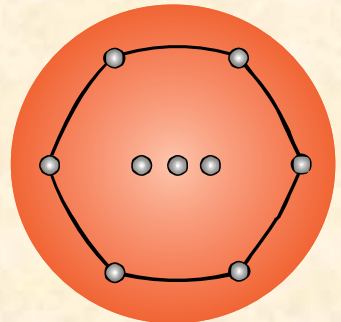

$n = u, d$

# Scalar multiplet



van Beveren  
Rupp



+Tornqvist

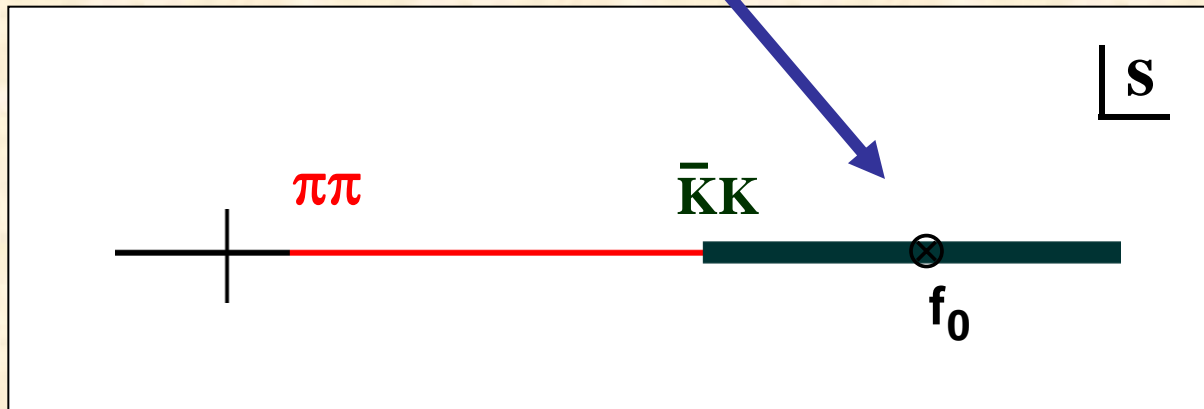
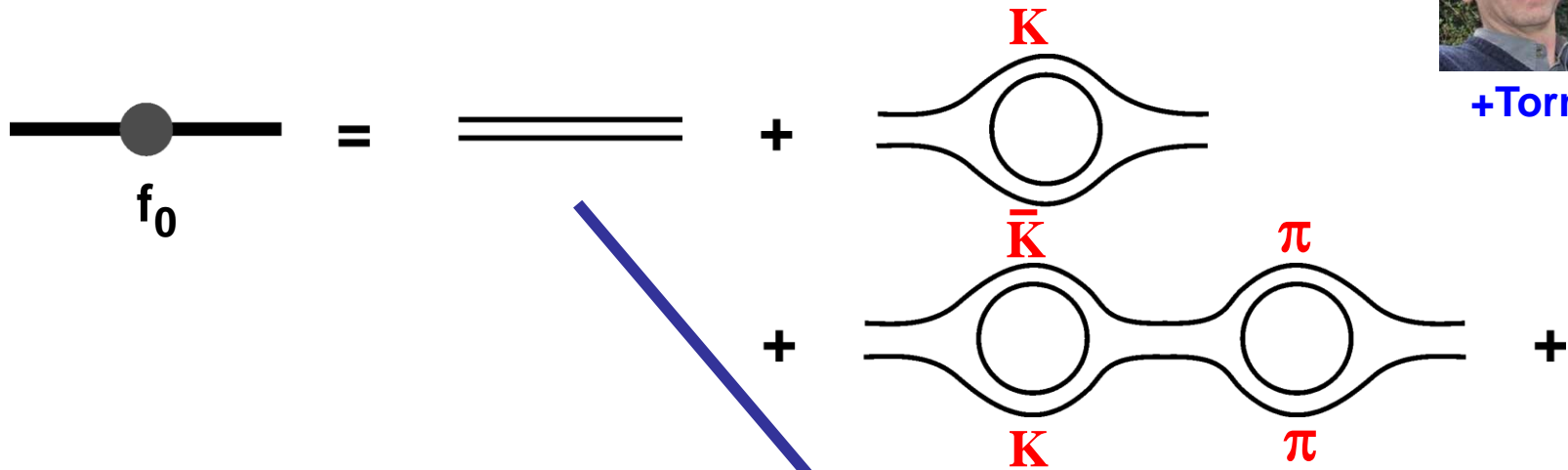

# Scalar multiplet



van Beveren  
Rupp



+Tornqvist

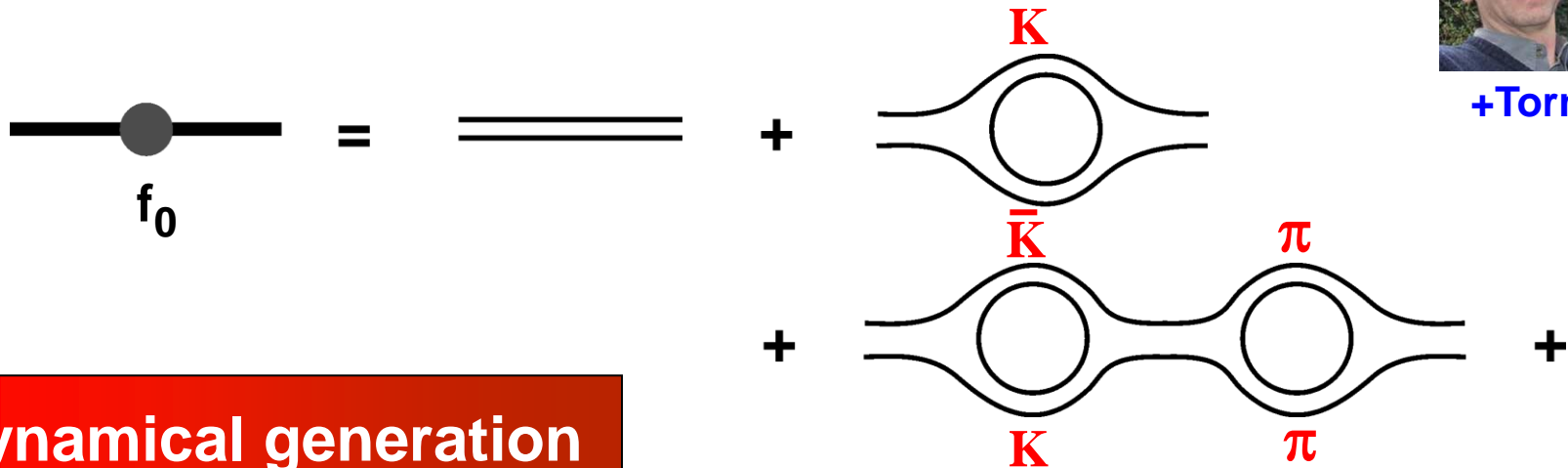

dynamical generation

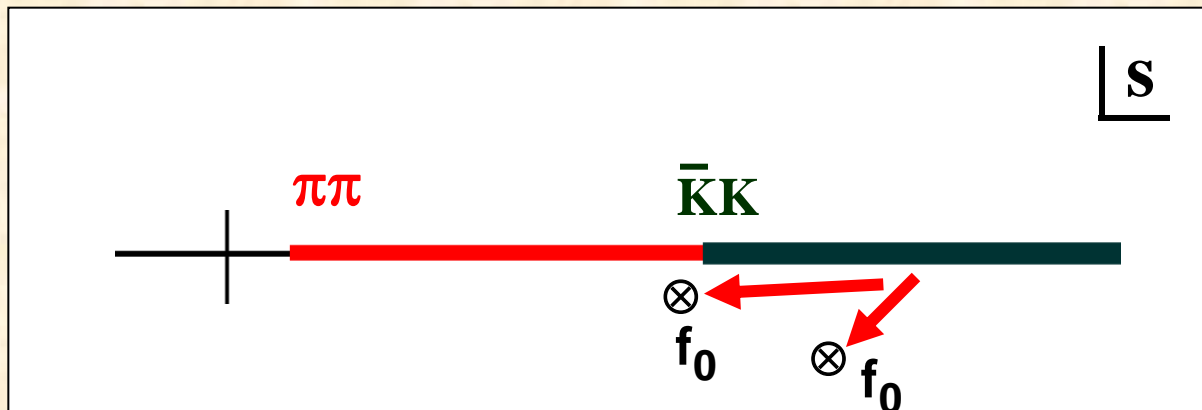

# Scalar mesons

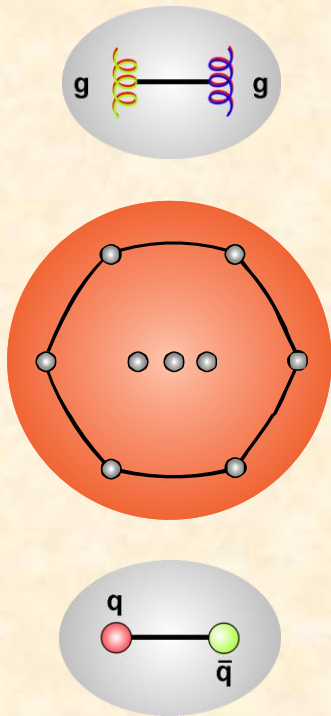

$gg$  —————  $f_0$   
 $\bar{s}s$  —————  $f_0$   
 $\bar{s}n$  —————  $K_0$   
 $\bar{n}n$  —————  $a_0/f_0$

$\bar{s}s\bar{n}n$  —————  $a_0/f_0$   
 $\bar{s}n\bar{n}n$  —————  $K_0$   $\mathbf{K}$   
 $\bar{n}n\bar{n}n$  —————  $f_0$   $\mathbf{\sigma}$

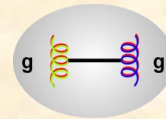
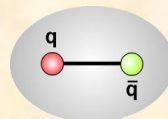
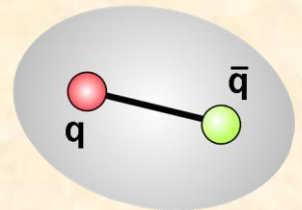
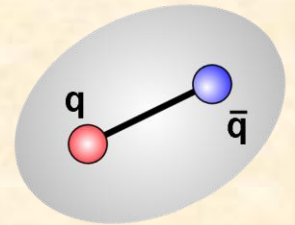
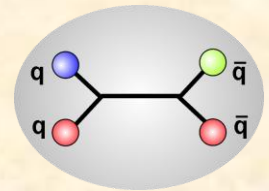

# Scalar mesons

$q\bar{q}$

$q\bar{q}q\bar{q}$

$\bar{s}s$  —————  $f_0$   
 $\bar{s}n$  —————  $K_0$   
 $\bar{n}n$  —————  $a_0/f_0$

$\bar{s}s\bar{n}n$  —————  $a_0/f_0$   
 $\bar{s}n\bar{n}n$  —————  $K_0$   $\mathbf{K}$   
 $\bar{n}n\bar{n}n$  —————  $f_0$   $\mathbf{\sigma}$

$N_c$  large  $\rightarrow$  stable

$N_c$  large  $\rightarrow$  meson continuum

# $1/N_c$ @ two loops

real axis

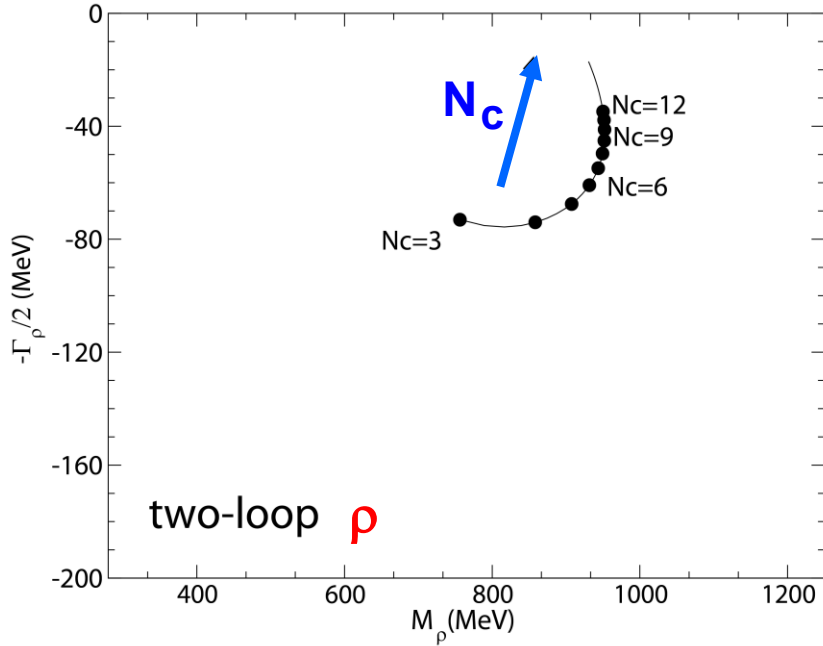

real axis

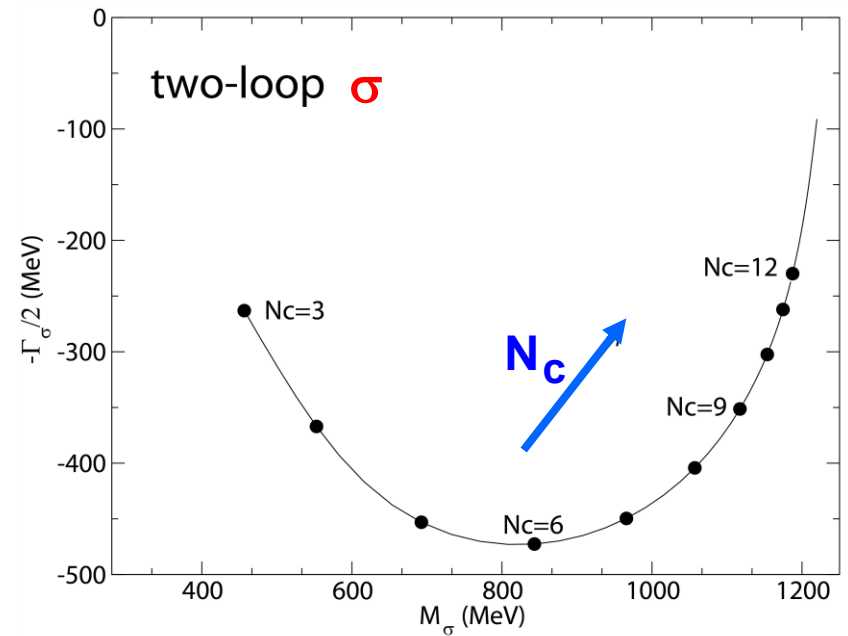



# Schwinger-Dyson Equations

QCD

## Slavnov-Taylor Identity

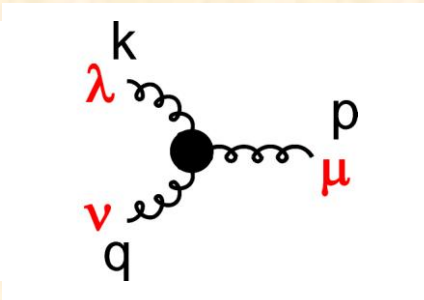

covariant gauges

$$k_\lambda \Gamma^{\lambda\mu\nu}(k, p, q) =$$

$$H(k^2) \left[ G_{\mu,\sigma}(q, -k) \Pi_{\sigma,\nu}^T(p) - G_{\nu\sigma}(p, -k) \Pi_{\sigma\mu}^T(q) \right]$$

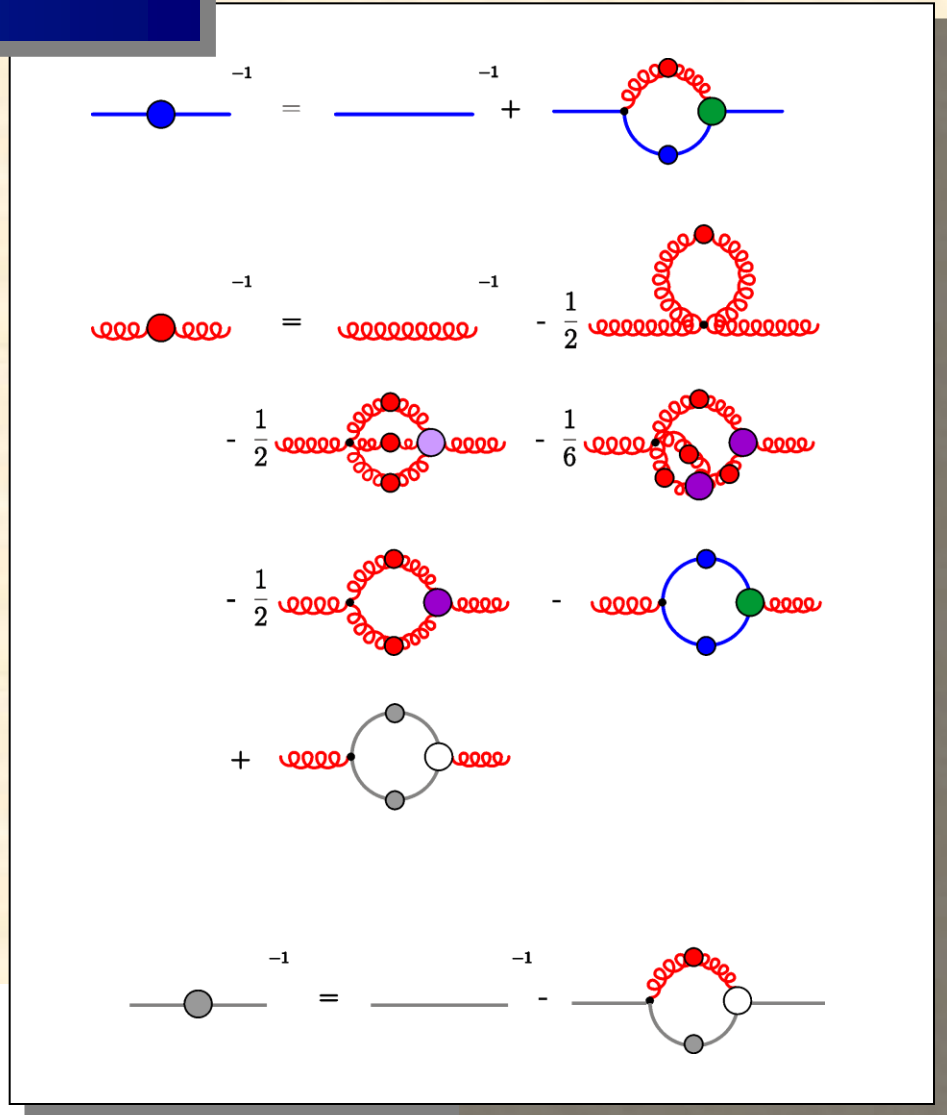

# Schwinger-Dyson Equations

*gluons & ghosts*

QCD

$$\Delta^{\mu\nu}(p) = \frac{\mathcal{G}l(p^2)}{p^2} T^{\mu\nu}(p)$$

$$D(p) = \frac{\mathcal{G}h(p^2)}{p^2}$$

$$T^{\mu\nu}(p) = g^{\mu\nu} - \frac{p^\mu p^\nu}{p^2}$$

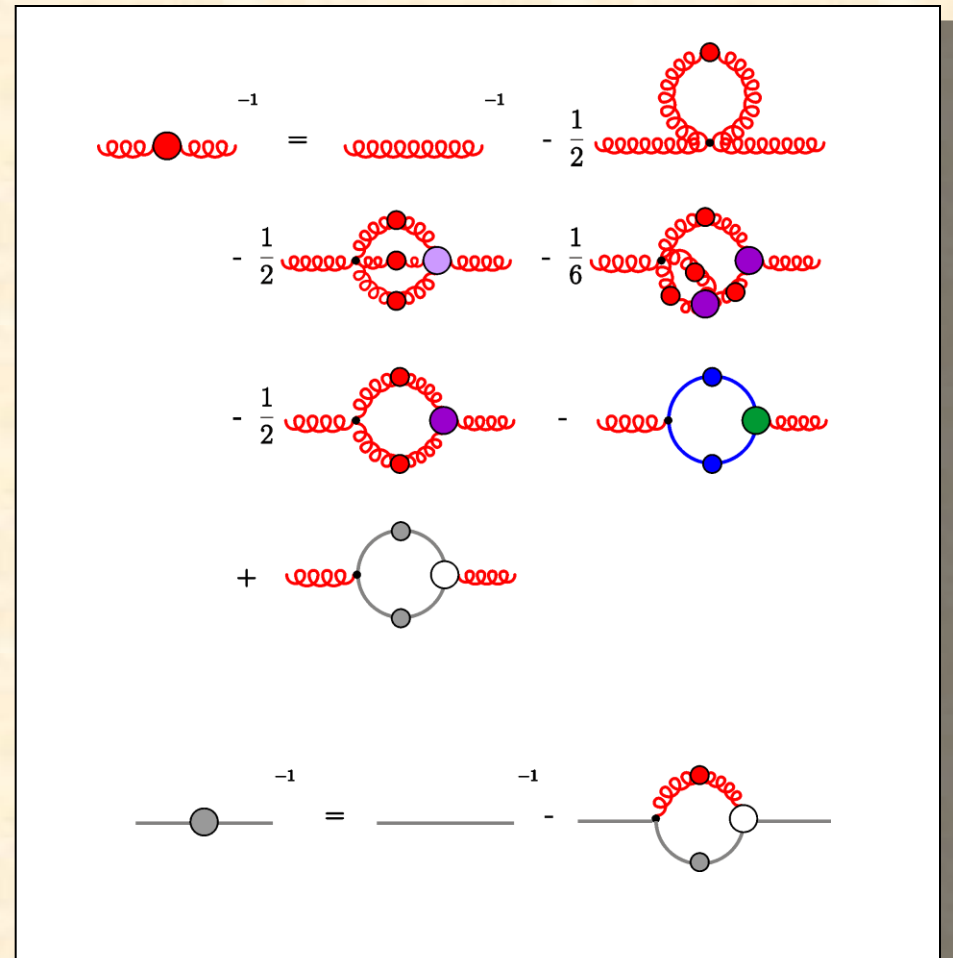

Landau gauge

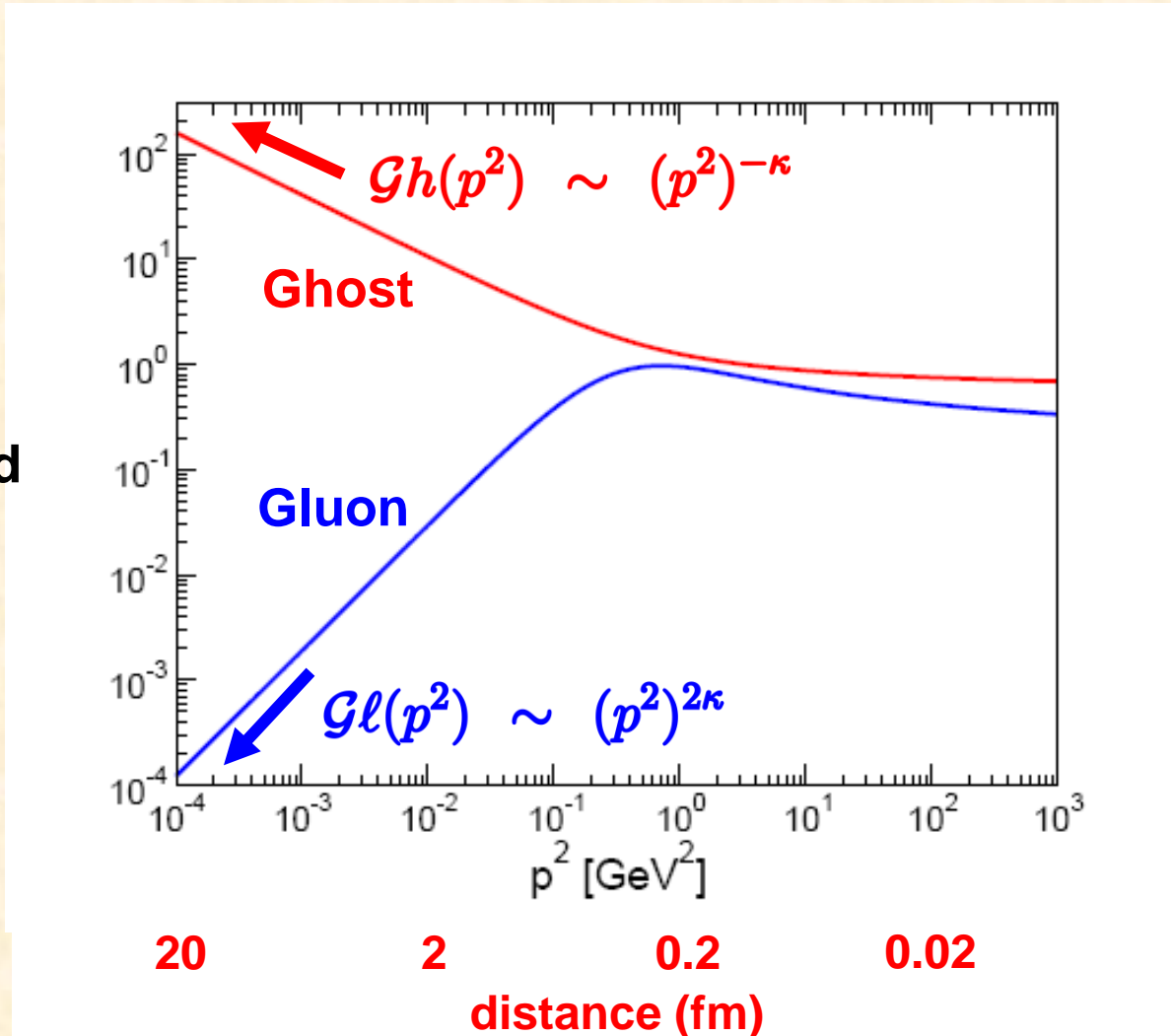

Deep Infrared

$\kappa \simeq 0.6$

von Smekal  
Fischer

Landau gauge

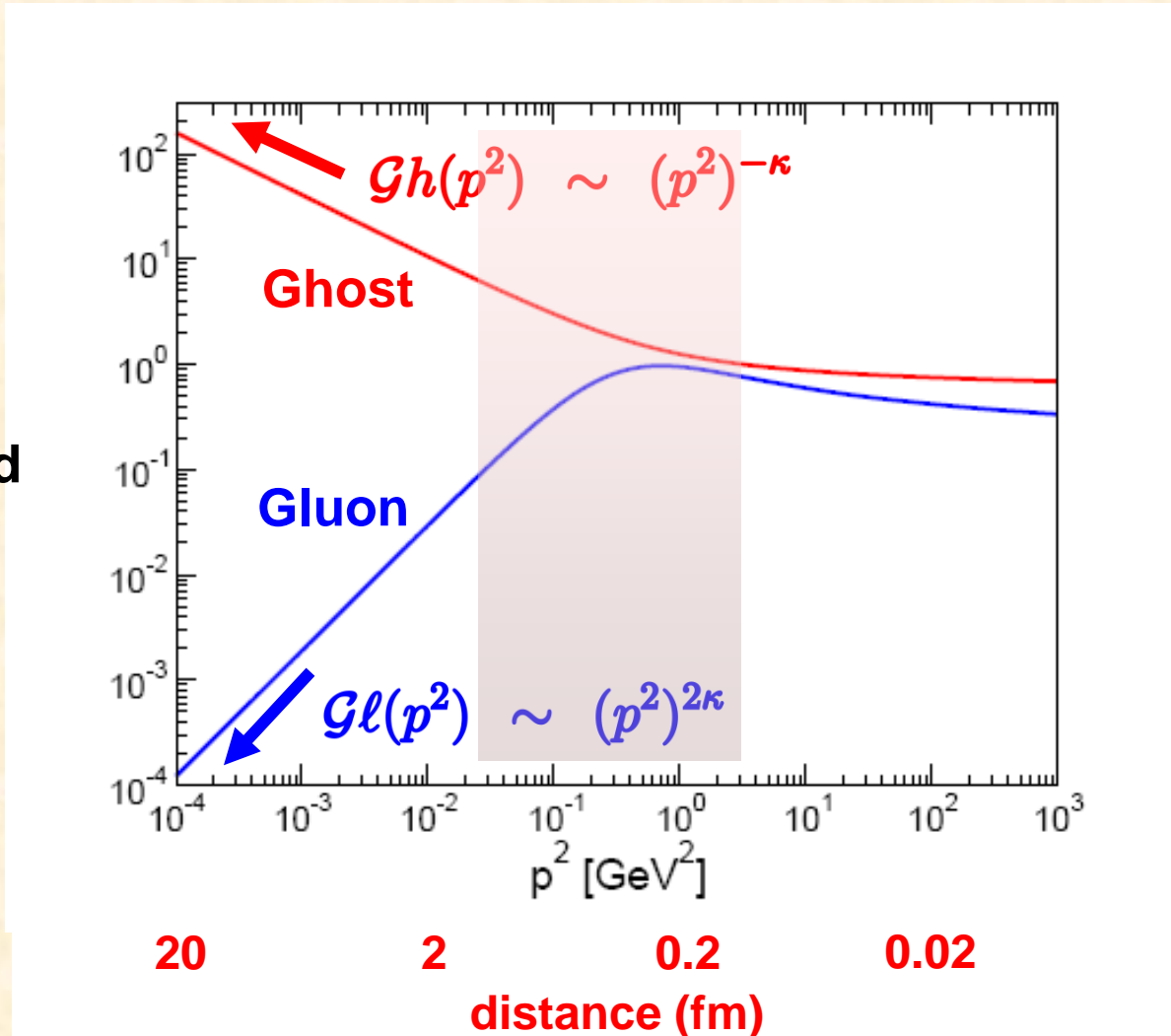

Deep Infrared

$\kappa \simeq 0.6$

von Smekal  
Fischer

Landau gauge

# Lattice Results: Cucchieri, Mendes

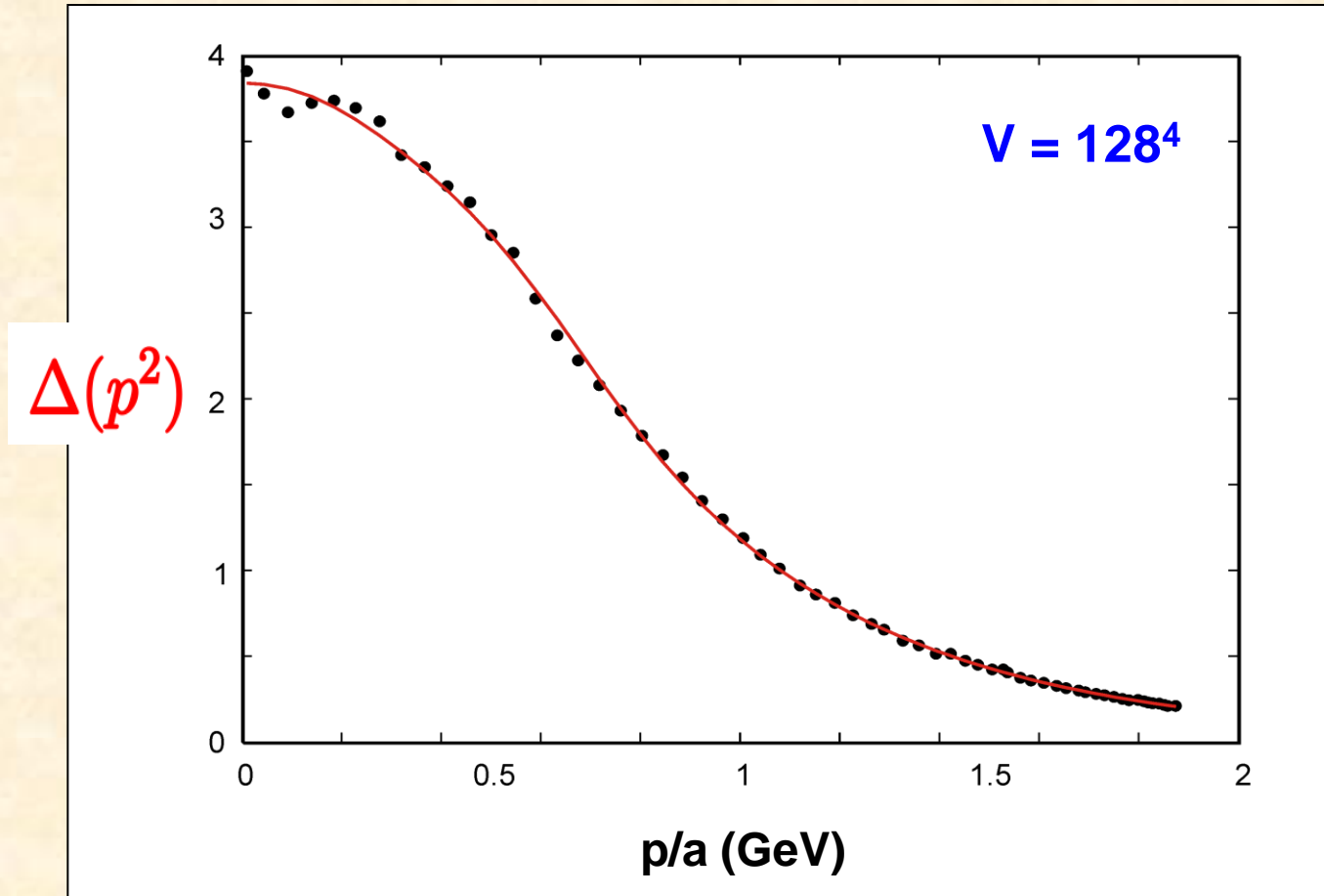

Landau gauge

$$\Delta(p^2) = \frac{G\ell(p^2)}{p^2}$$

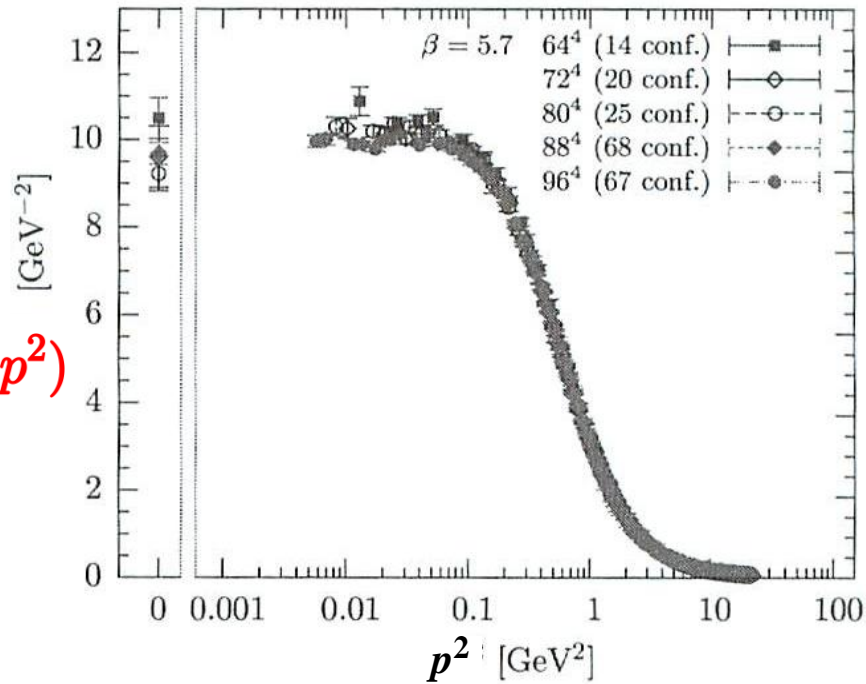

$\Delta(p^2)$

gluon

$$\Delta(p^2) = \frac{\mathcal{G}l(p^2)}{p^2} \quad \mathcal{G}h(p^2)$$

**Oliveira & Silva**

ghost

$$D(p) = \frac{\mathcal{G}h(p^2)}{p^2}$$

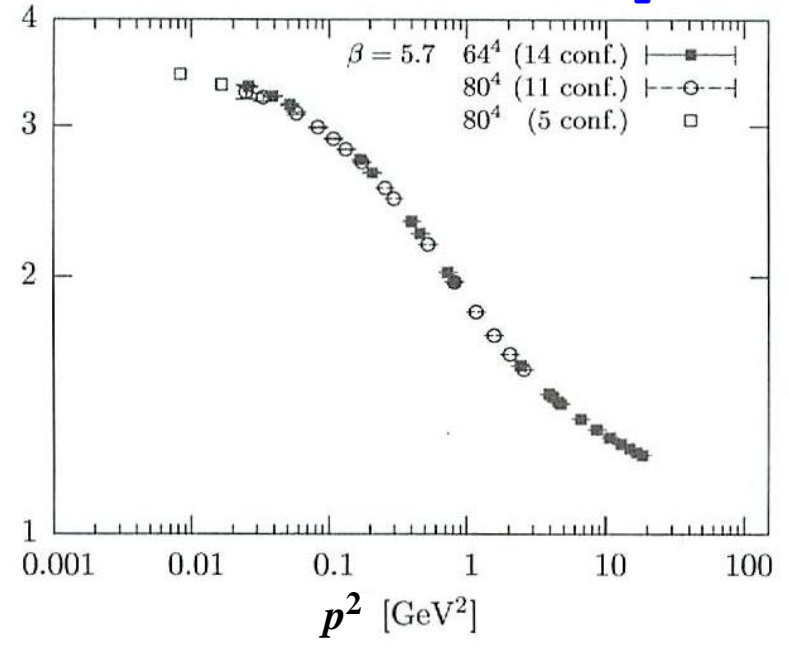

# Solution of Gluon & Ghost SDEs

“massive”

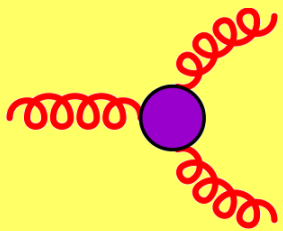
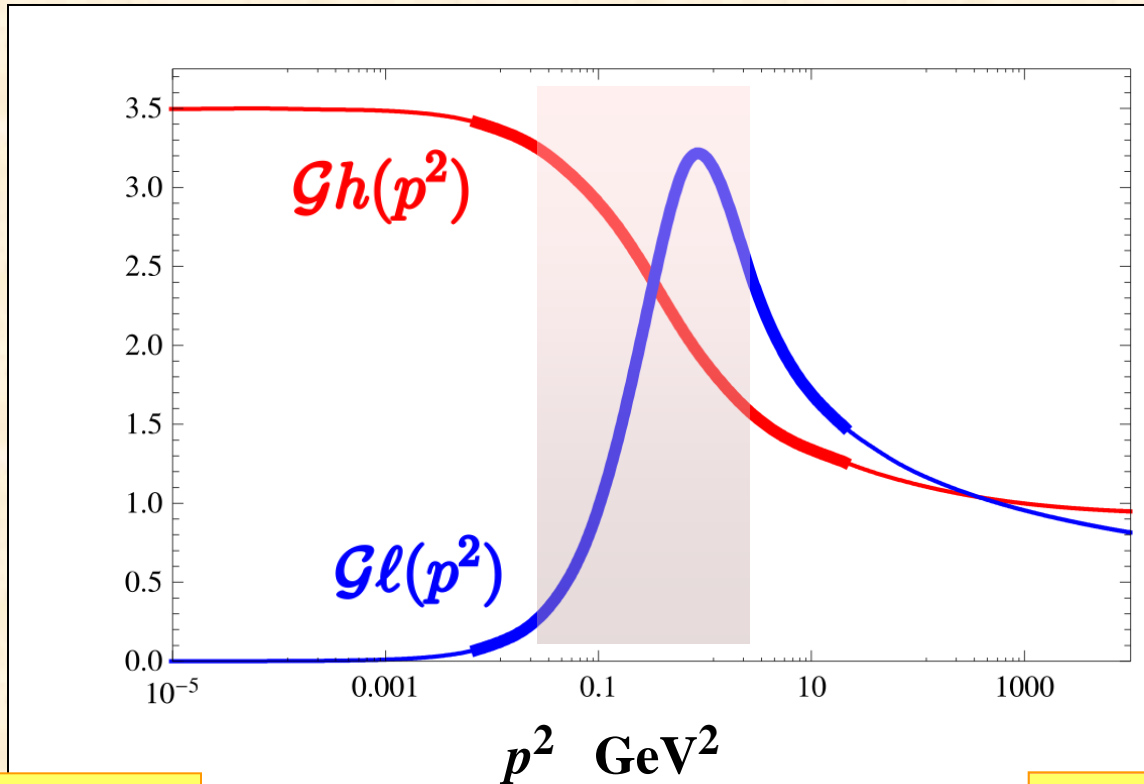

Aguilar, Papavassiliou, Binosi  
Boucaud *et al*  
Rodriguez Quintero

Wilson & P

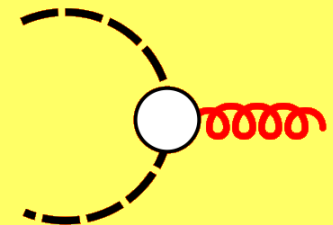

# Fermion mass generation

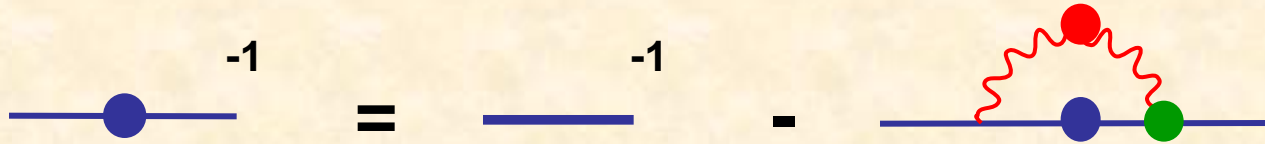

$$S_F(p) = \frac{\mathcal{F}(p)}{\not{p} - \mathcal{M}(p)}$$

wavefunction renormalisation

mass function

$$S_F(p)^{-1} = \not{p} - m_0 - \frac{\alpha}{4\pi} \int d^4k \gamma_\mu S_F(k) \Gamma_\nu(k, p) \Delta^{\mu\nu}(q)$$



# Quark mass function

$$\alpha_s > 1 \implies \chi\text{SB}$$

Williams,  
Fischer,  
P

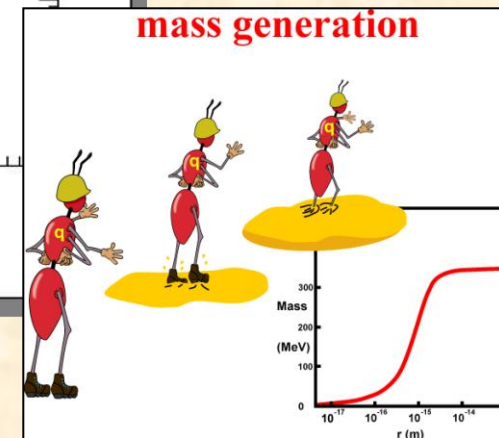
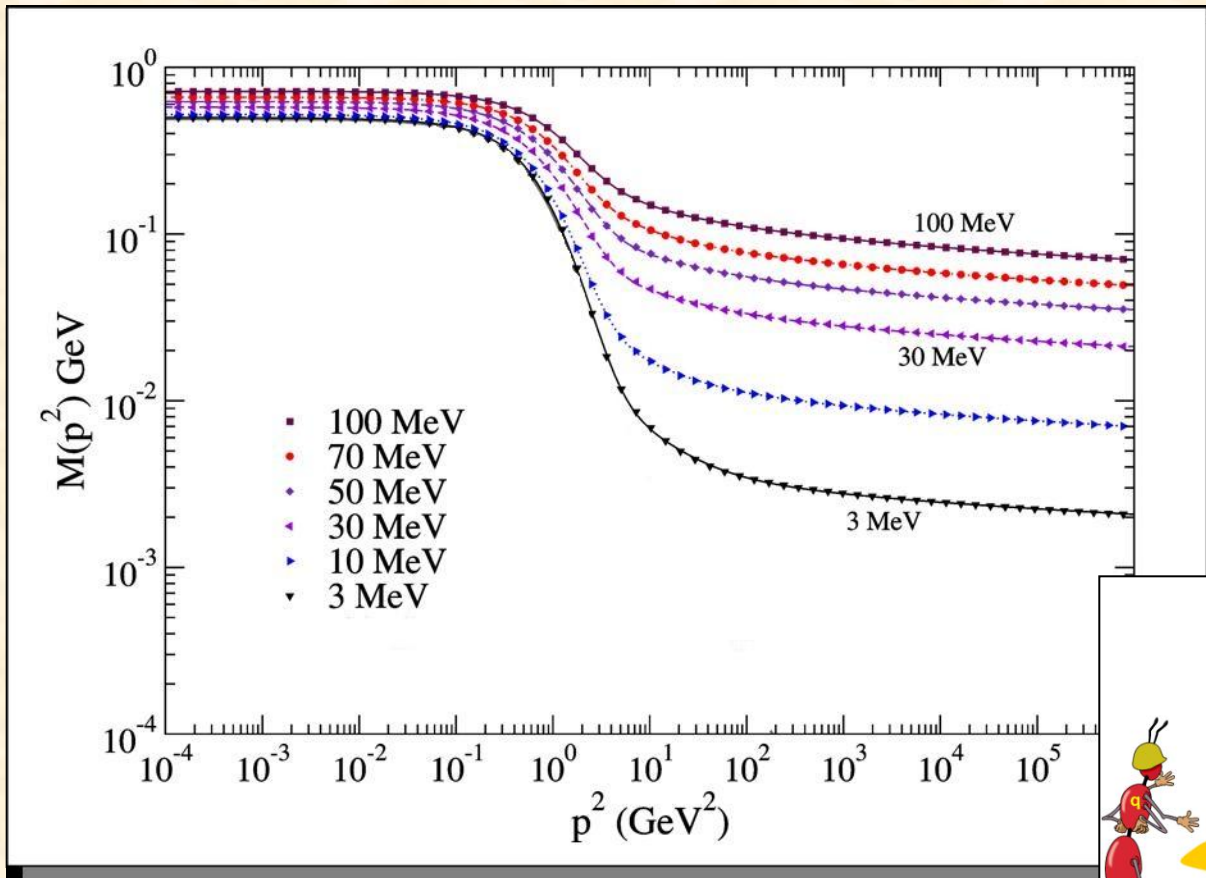

# Quark mass function

$$\alpha_s > 1 \implies \chi\text{SB}$$

Williams,  
Fischer,  
P

Maris &  
Roberts

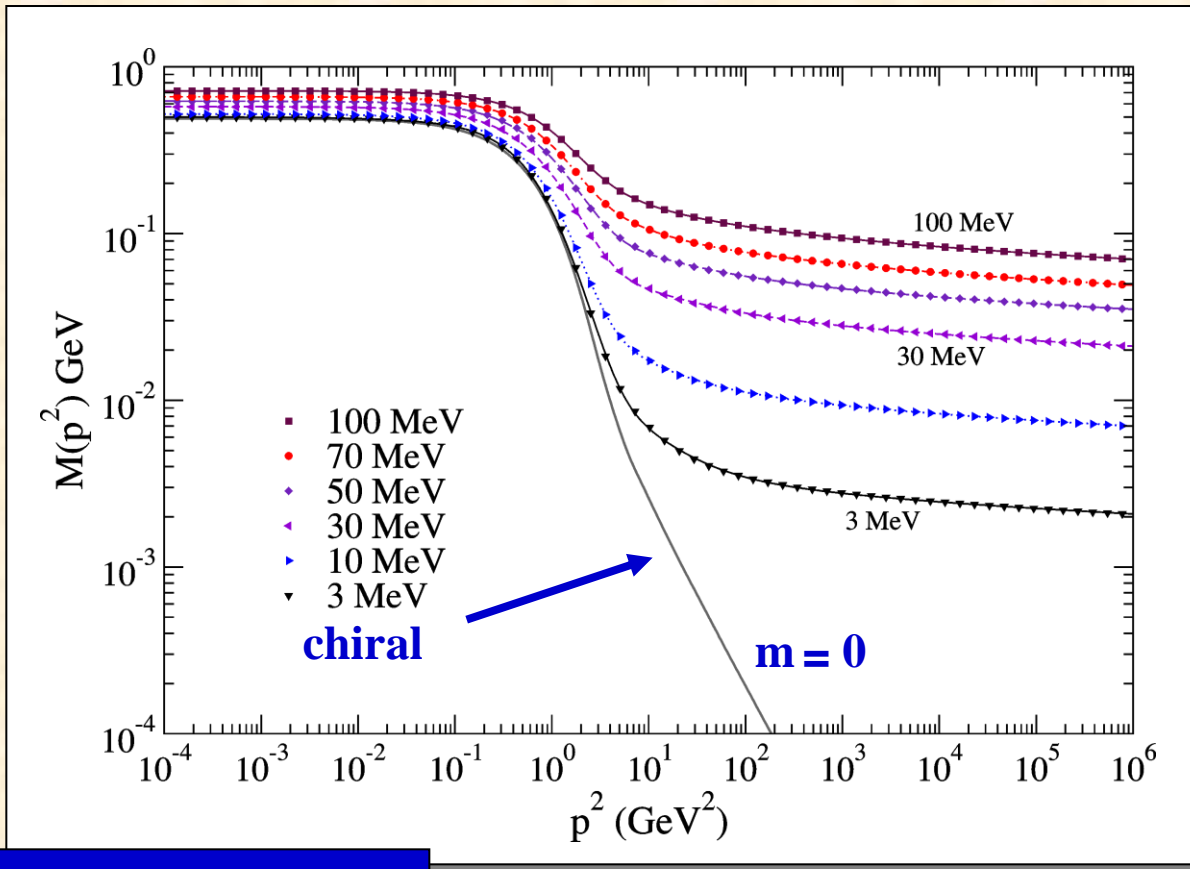

$$\langle \bar{q}q \rangle_0 \sim - (240 \text{ MeV})^3$$

mass generation

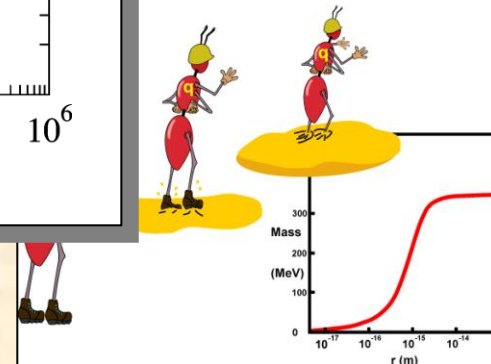

# QCD vacuum

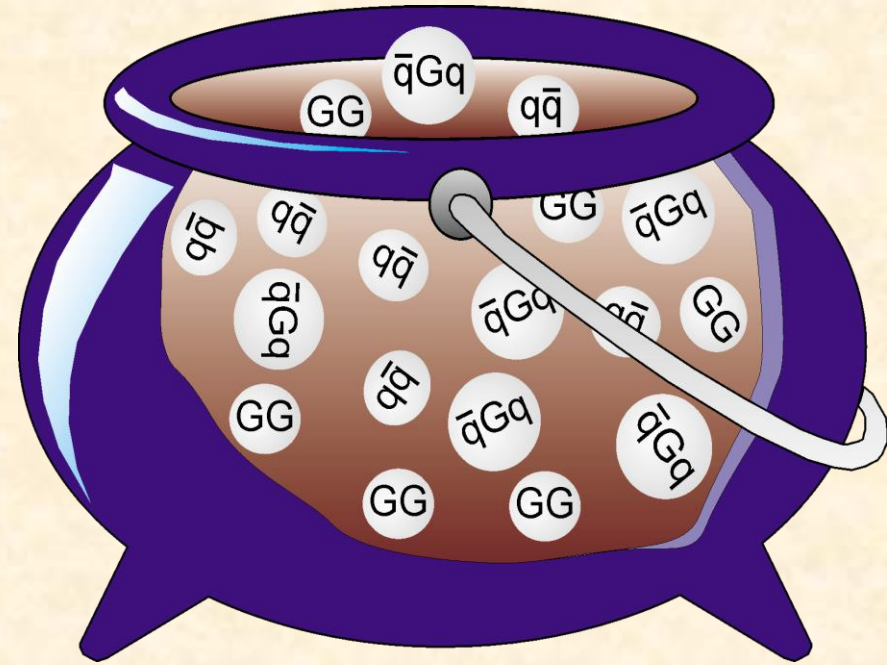
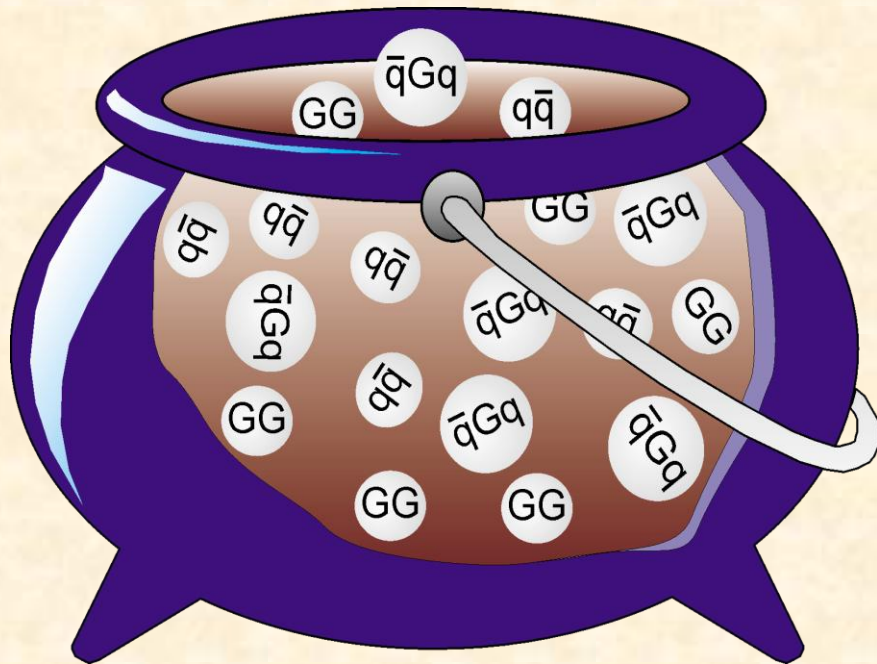

# Lattice and SDE results

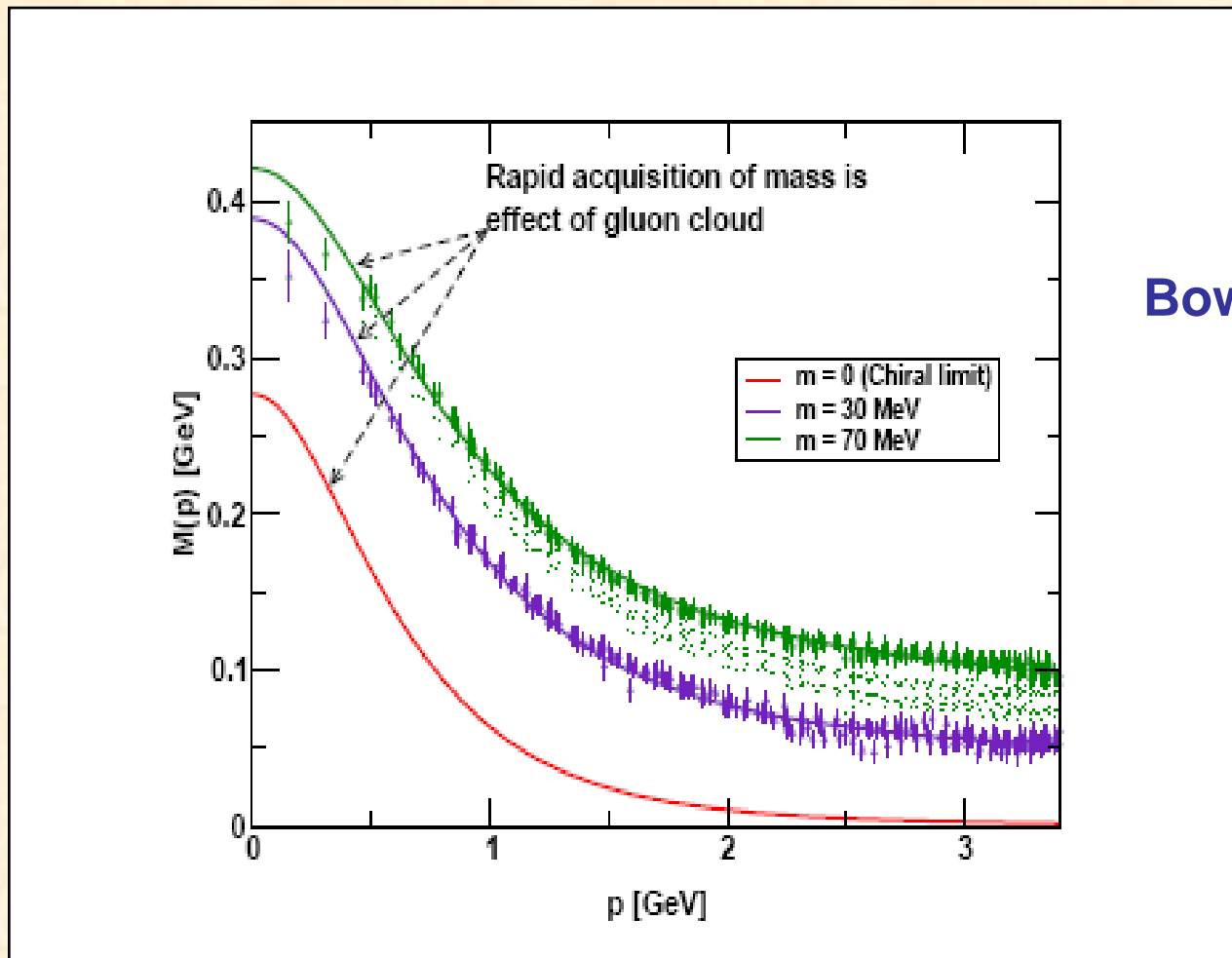

Bowman et al

Bhagwat & Tandy / Roberts et al

# Schwinger-Dyson Equations

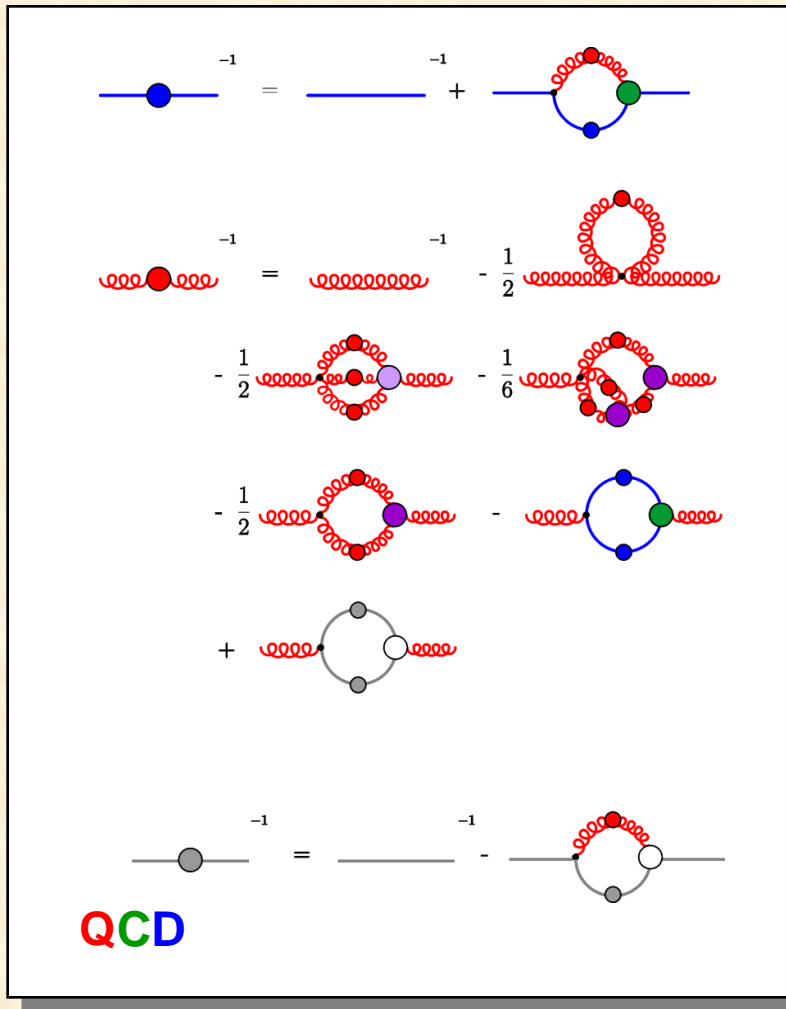

# Bound State Equations

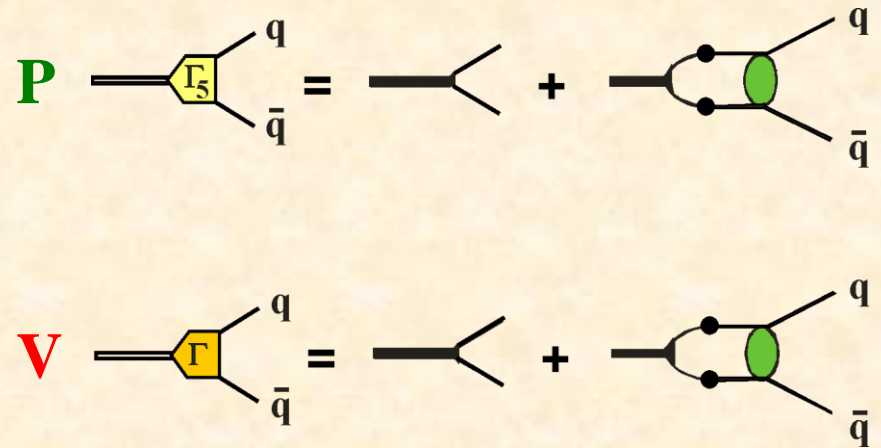

$$f_\pi, m_\pi$$

# effective interaction strength

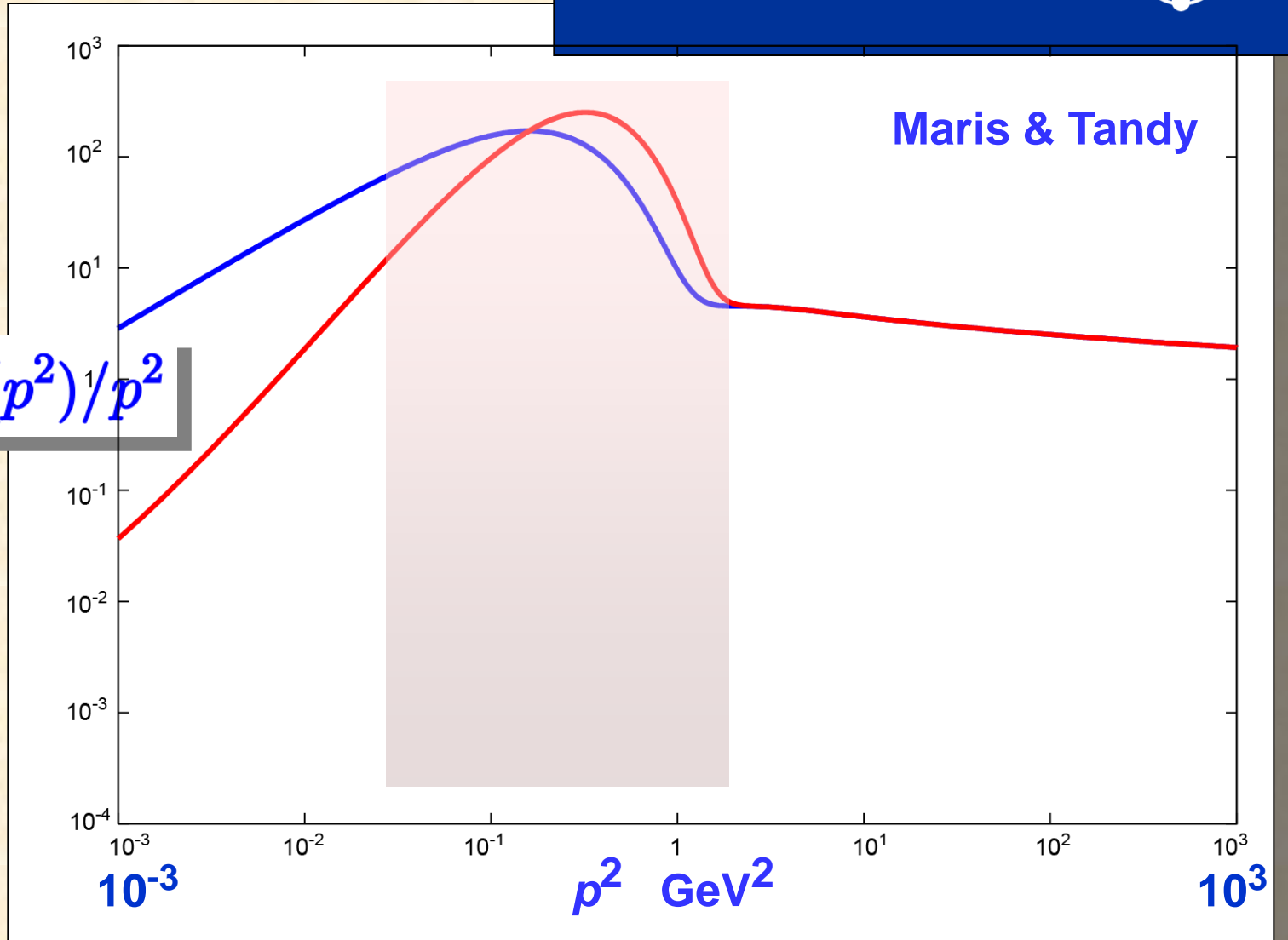

# quark propagator

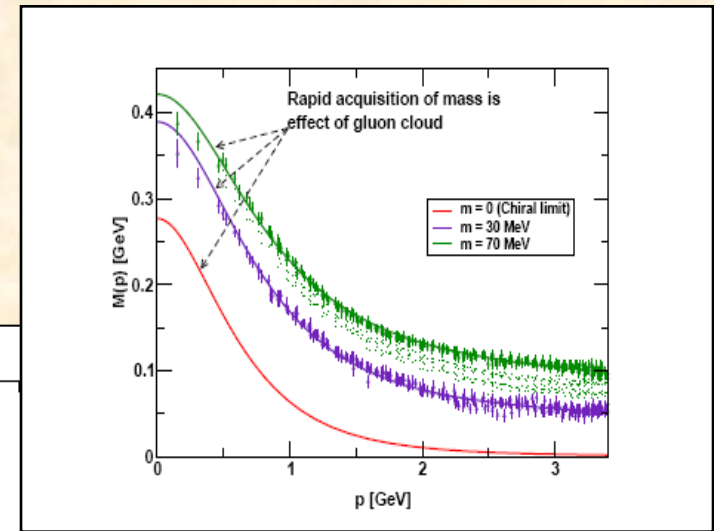
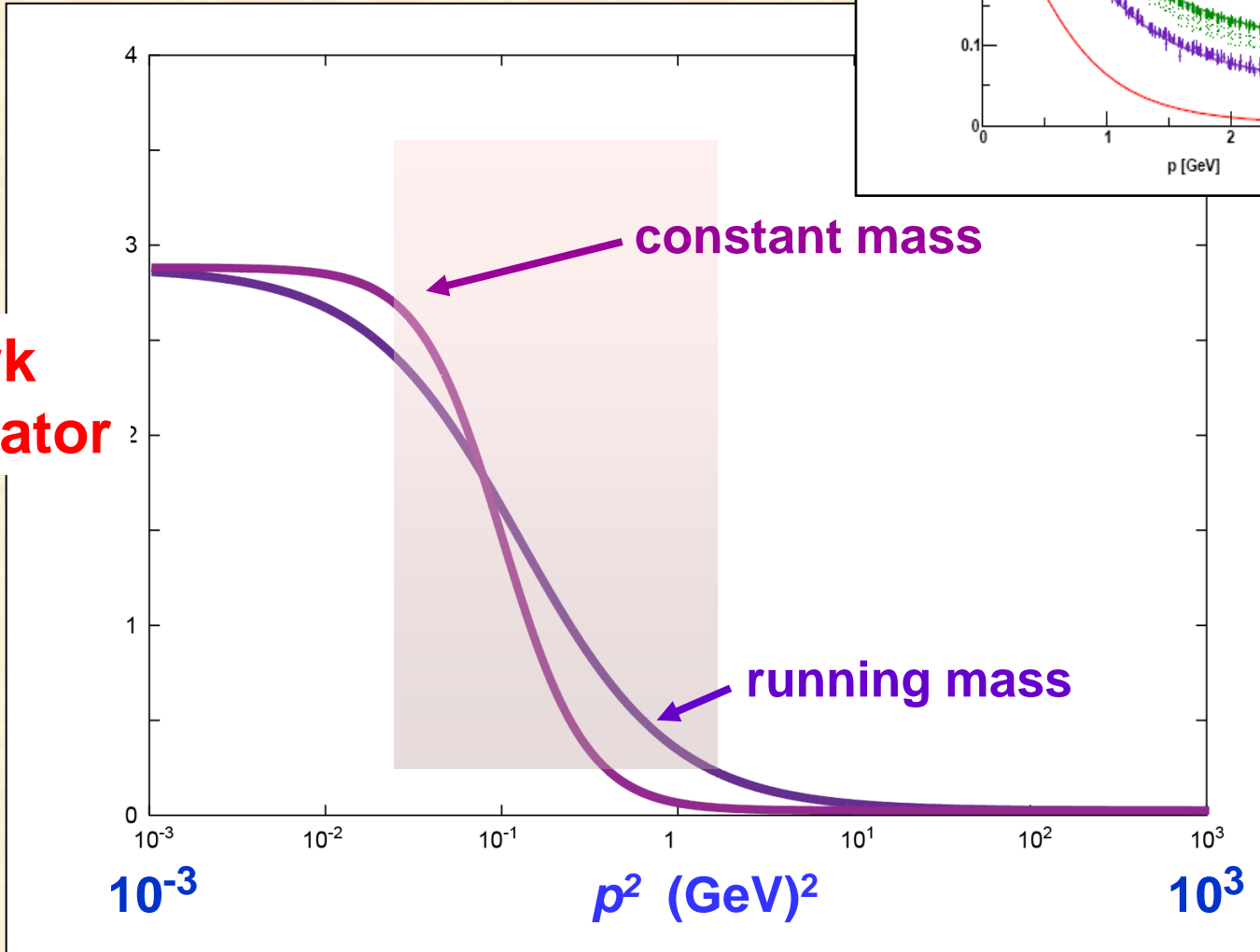

# effective interaction strength

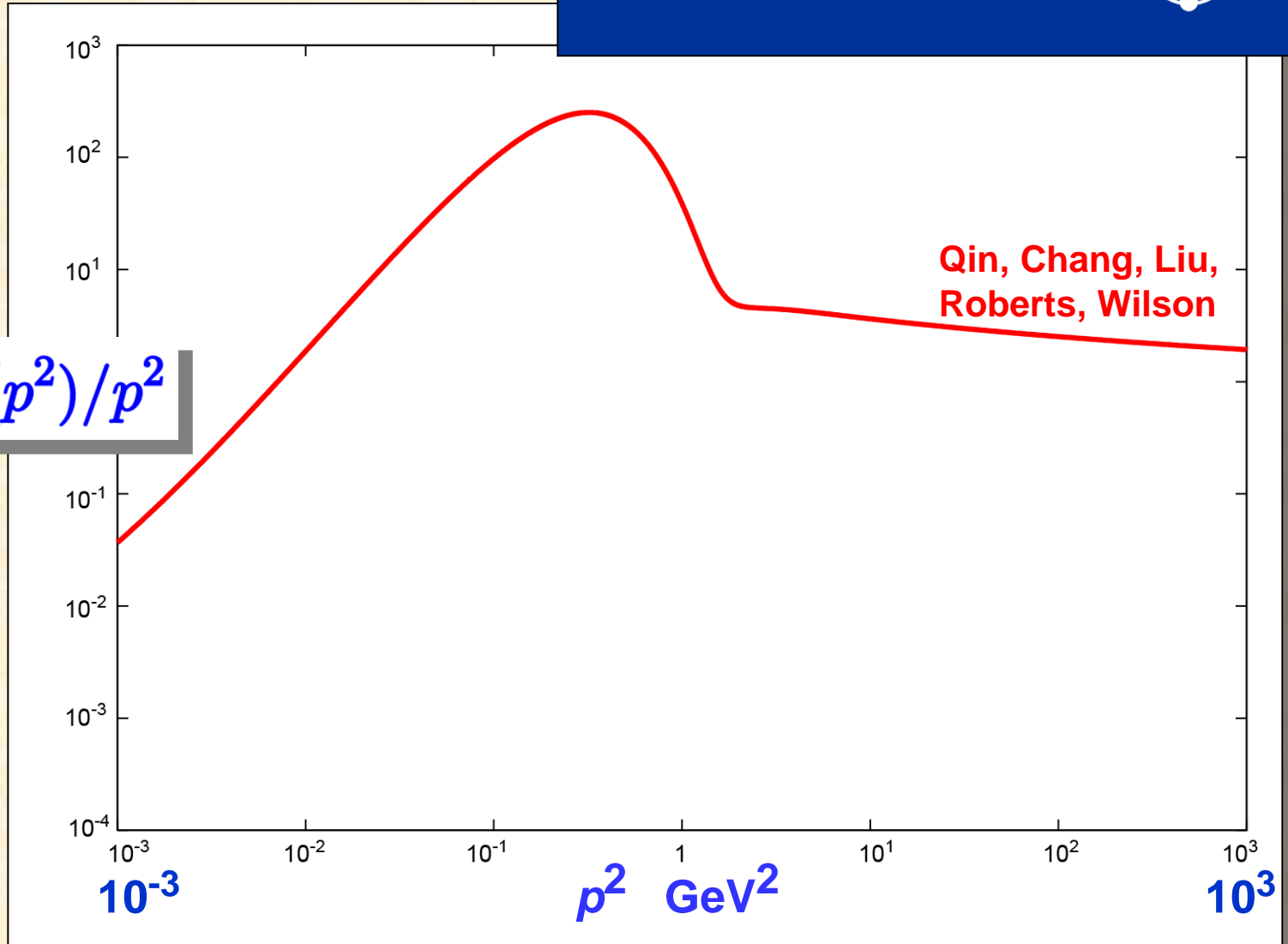

$$4\pi \alpha_{\text{eff}}(p^2)/p^2$$

Qin, Chang, Liu,  
Roberts, Wilson



# effective interaction strength

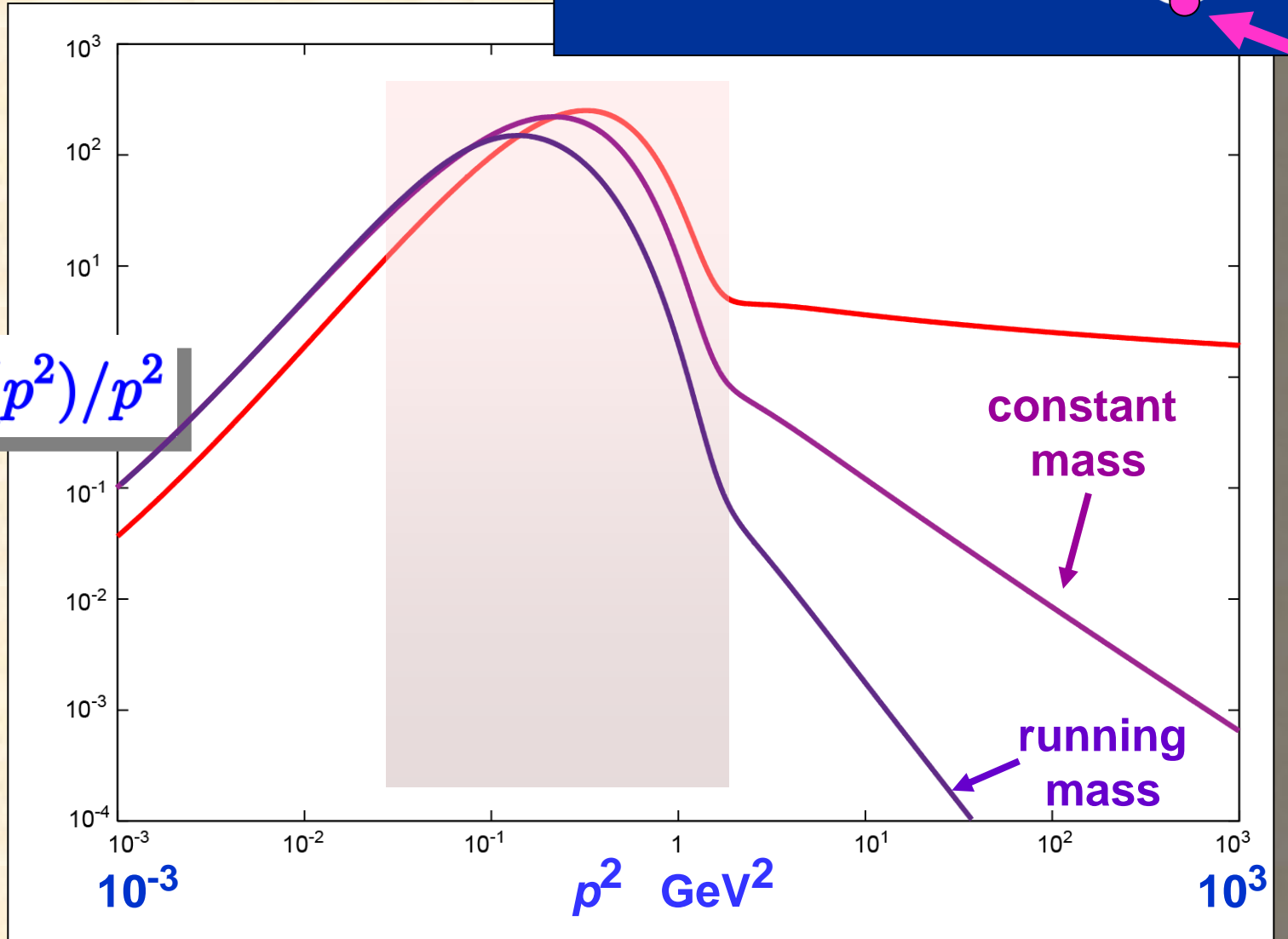

# electromagnetic formfactors

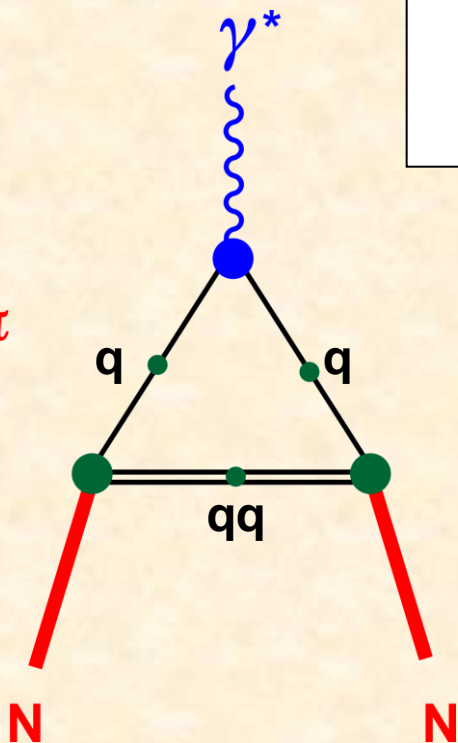
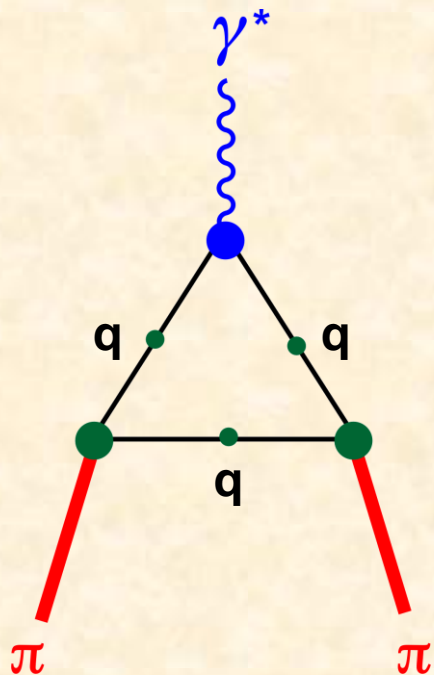

quark propagator

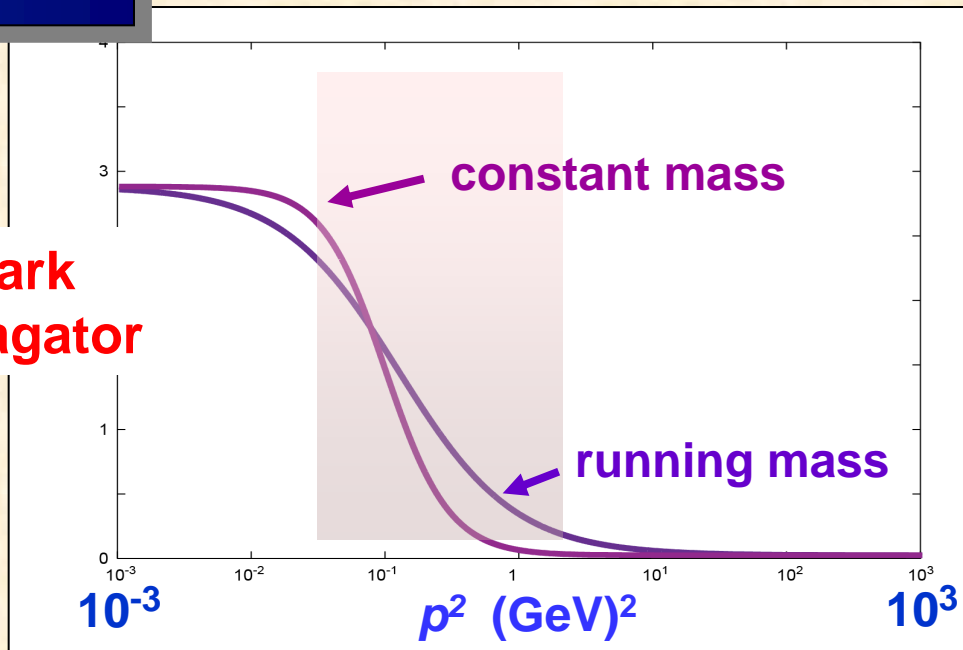

# electromagnetic formfactors

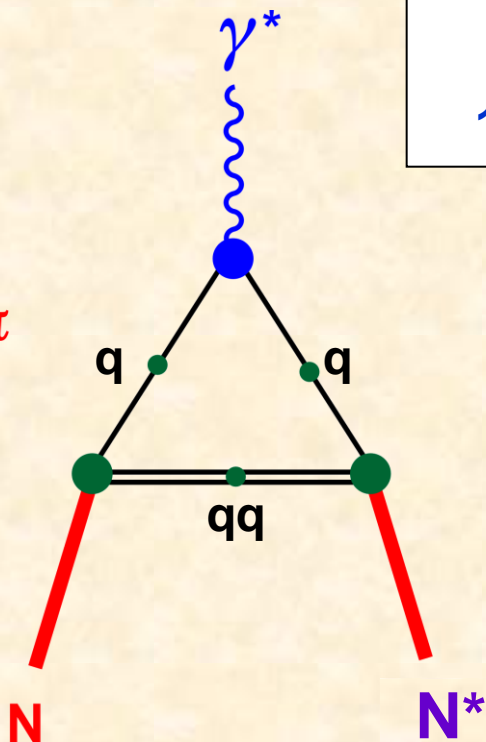
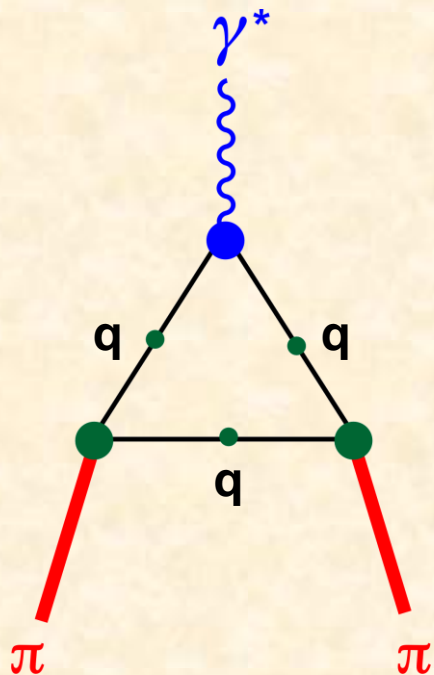

quark propagator

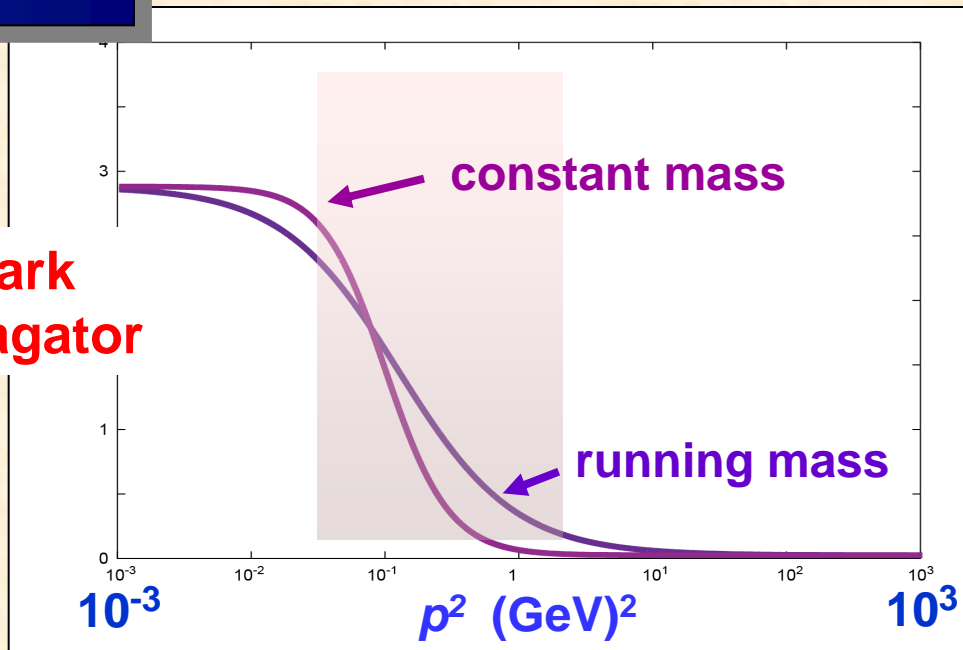

# Pion electromagnetic formfactor

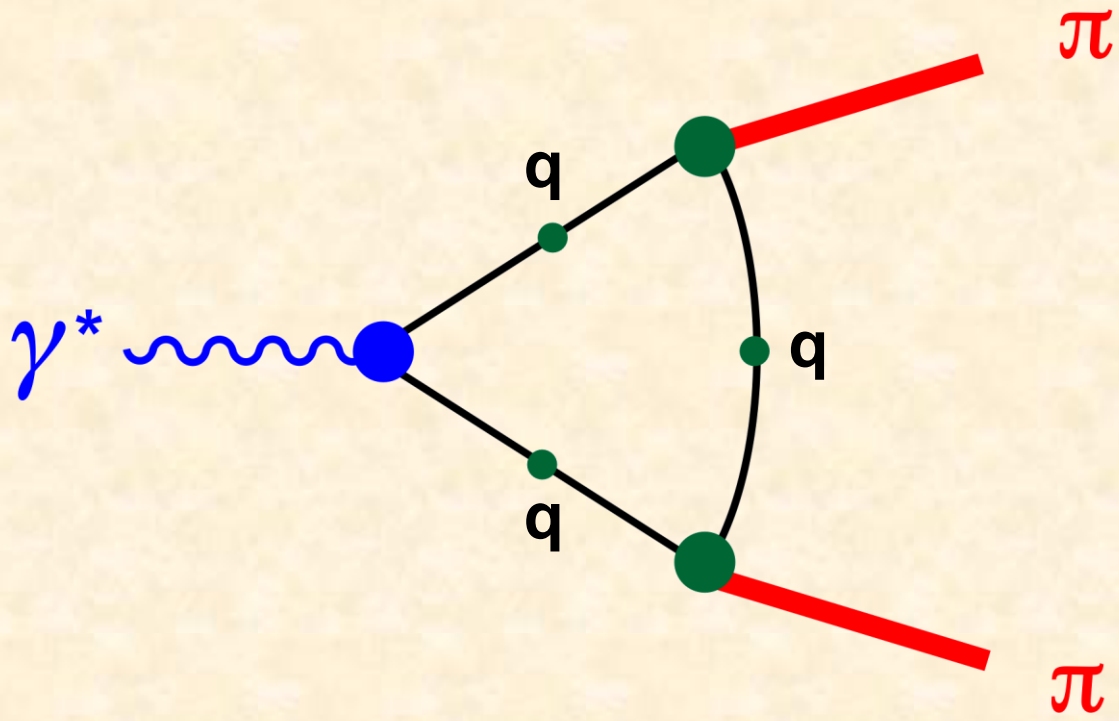

# Pion electromagnetic formfactor

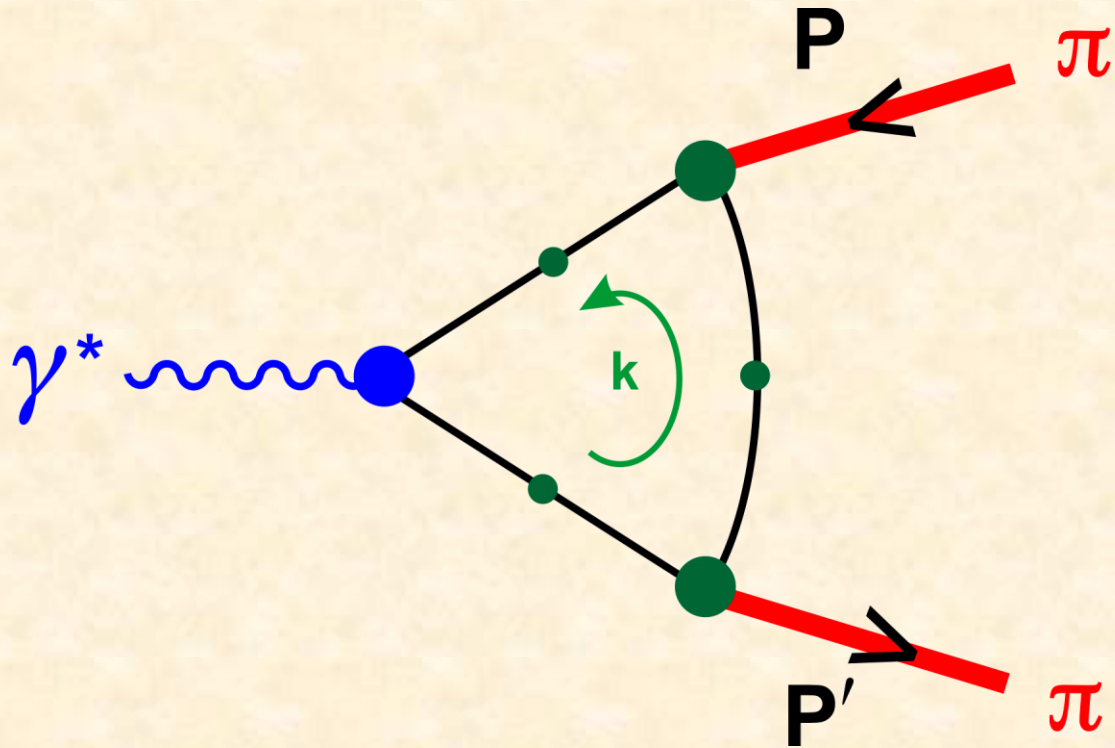

$$\Lambda_\mu = (P' + P)_\mu F_\pi(Q^2) = N_c \int \frac{d^4k}{(2\pi)^4} \text{Tr} [\bar{\Gamma}^\pi S i\Gamma_\mu S \Gamma^\pi S]$$

# Pion electromagnetic formfactor

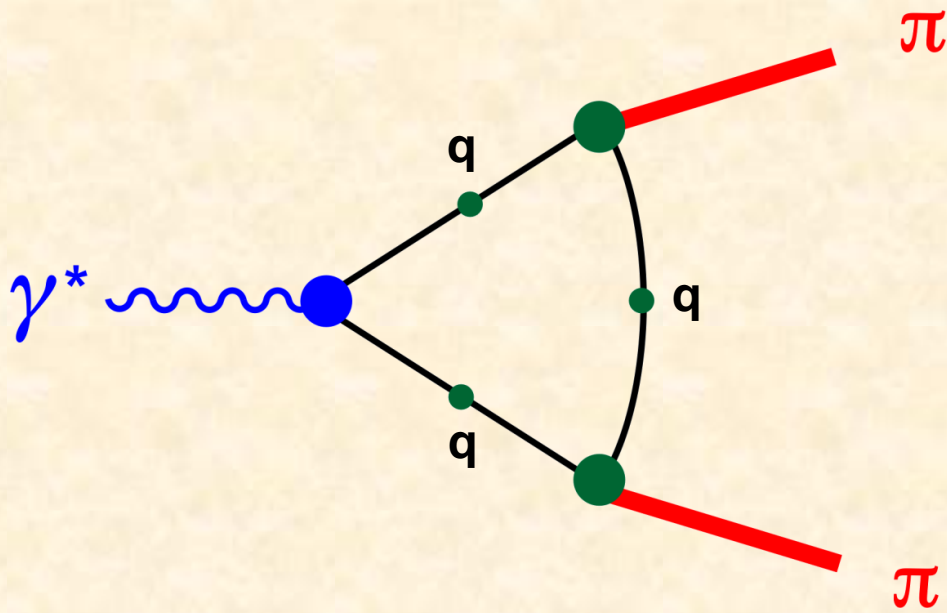

Maris, Tandy

$$\text{quark line with } q \text{ and } -1 \text{ superscript} = \text{quark line with } -1 \text{ superscript} + \text{quark loop with pion loop}$$

# Pion electromagnetic formfactor

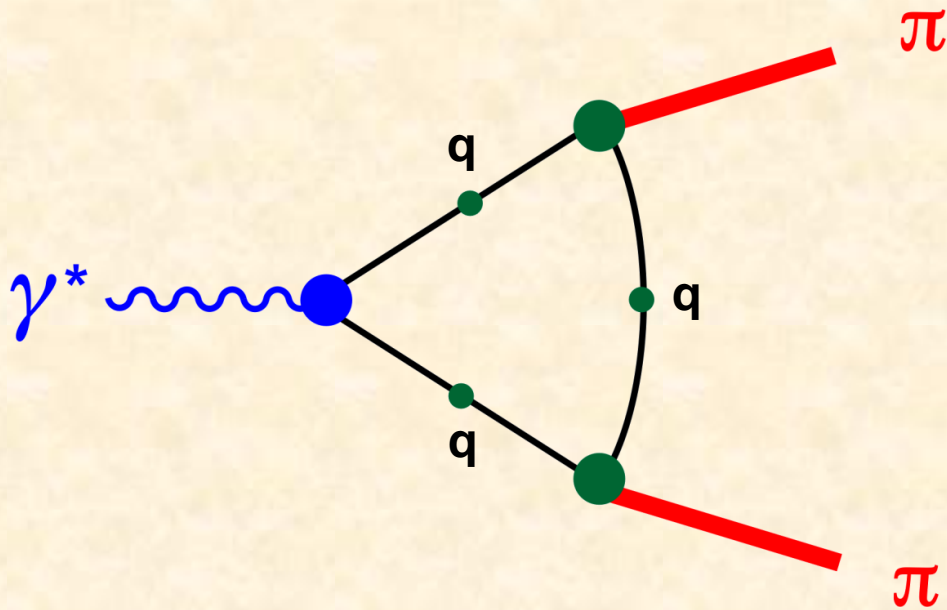

Maris, Tandy  
Fischer, Williams

An equation showing the operator product expansion (OPE) of the pion electromagnetic formfactor. On the left, a blue line with a blue vertex and a quark label  $q$  below it is followed by a superscript  $-1$ . This is equal to the sum of three terms:
 

- A blue line with a quark label  $q$  below it, followed by a superscript  $-1$ .
- A plus sign followed by a loop diagram: a blue line with a blue vertex and a quark label  $q$  below it, connected to a green vertex, which is connected to a red wavy loop (representing a gluon) with a red vertex, which is then connected back to the blue vertex.
- A plus sign followed by another loop diagram: a blue line with a blue vertex and a quark label  $q$  below it, connected to a blue vertex, which is connected to a red dashed loop (representing a pion) with a red vertex, which is then connected back to the blue vertex.

# Pion electromagnetic formfactor

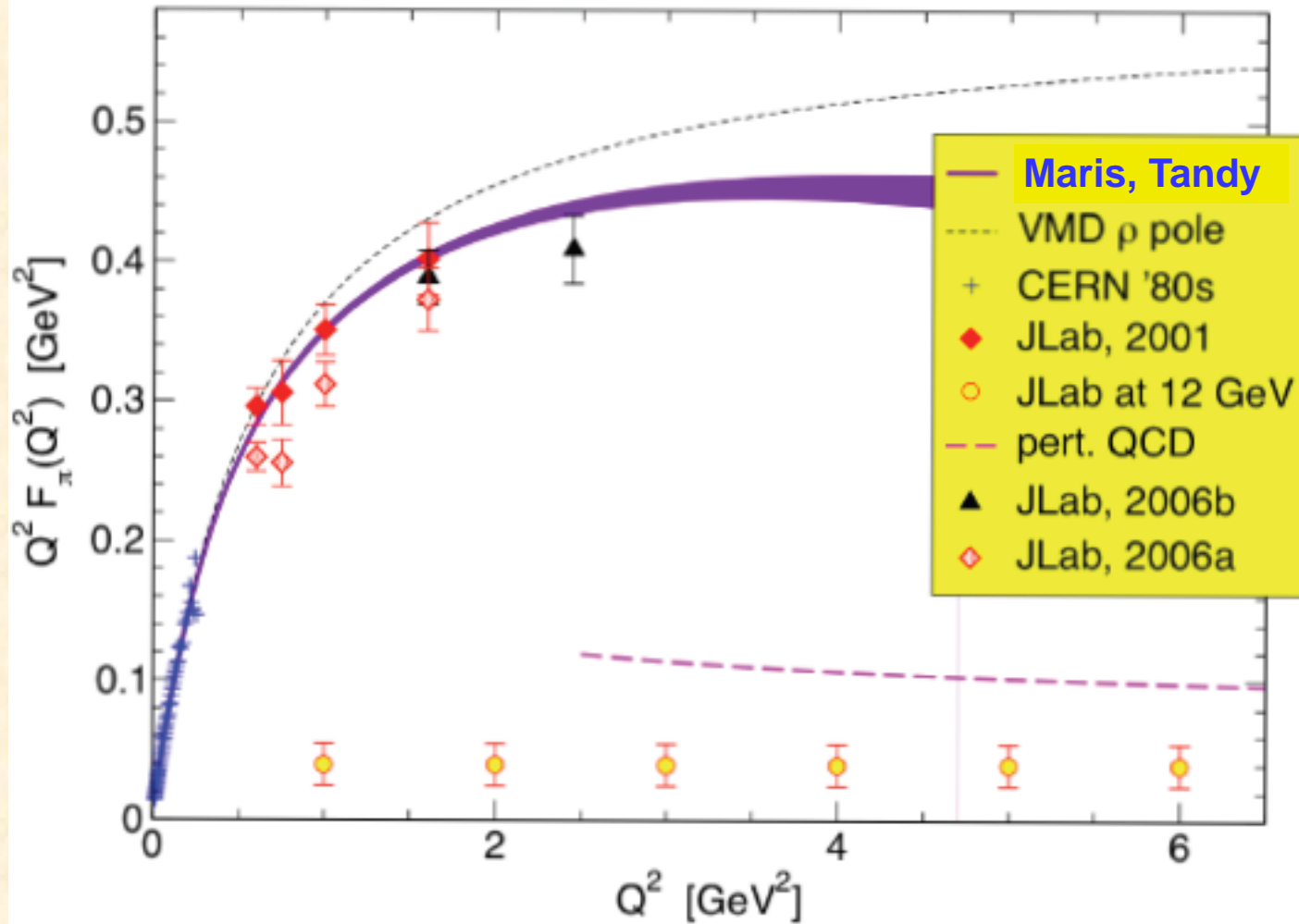



# Hadronization

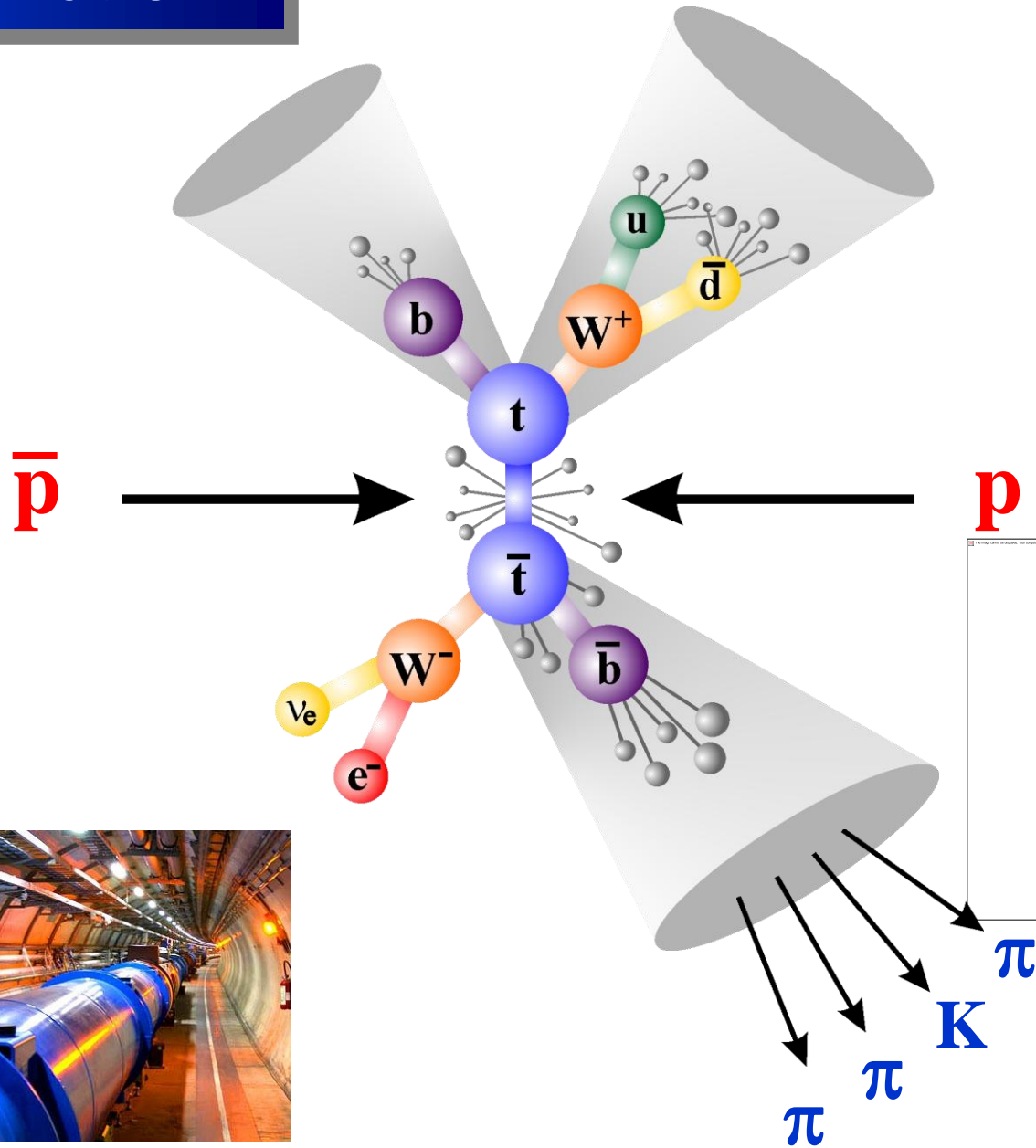



u

# TWIN

## approaches

*to Confinement Physics:*

Experiment & Strong Coupling QCD

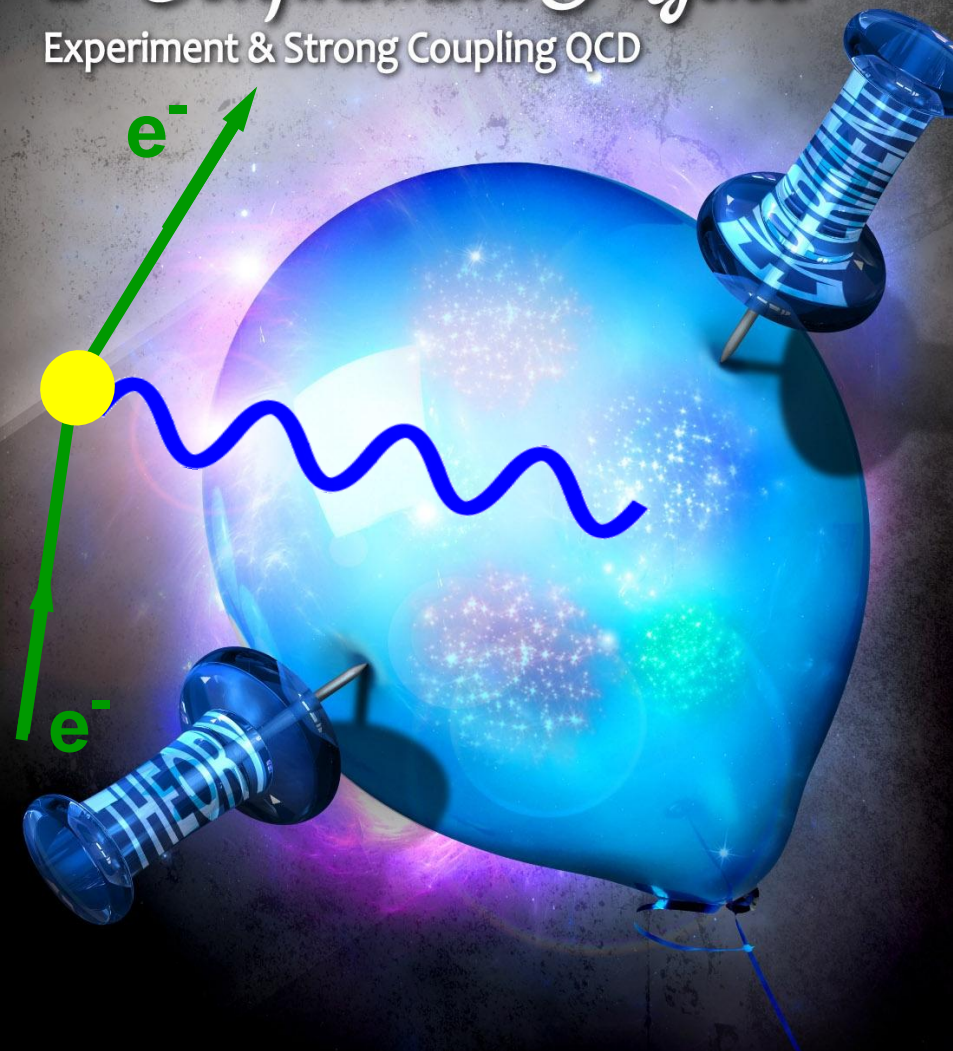

# TWIN

## approaches

*to Confinement Physics:*

Experiment & Strong Coupling QCD

