

Lignocellulosic Biomass to Ethanol Process Design and Economics Utilizing Co-Current Dilute Acid Prehydrolysis and Enzymatic Hydrolysis for Corn Stover

A. Aden, M. Ruth, K. Ibsen, J. Jechura,
K. Neeves, J. Sheehan, and B. Wallace
National Renewable Energy Laboratory

L. Montague, A. Slayton, and J. Lukas
Harris Group
Seattle, Washington



NREL

National Renewable Energy Laboratory

1617 Cole Boulevard
Golden, Colorado 80401-3393

NREL is a U.S. Department of Energy Laboratory
Operated by Midwest Research Institute • Battelle • Bechtel

Contract No. DE-AC36-99-GO10337

Lignocellulosic Biomass to Ethanol Process Design and Economics Utilizing Co-Current Dilute Acid Prehydrolysis and Enzymatic Hydrolysis for Corn Stover

A. Aden, M. Ruth, K. Ibsen, J. Jechura,
K. Neeves, J. Sheehan, and B. Wallace
National Renewable Energy Laboratory

L. Montague, A. Slayton, and J. Lukas
Harris Group
Seattle, Washington

Prepared under Task No. BFP2.A410



NREL

National Renewable Energy Laboratory

1617 Cole Boulevard
Golden, Colorado 80401-3393

NREL is a U.S. Department of Energy Laboratory
Operated by Midwest Research Institute • Battelle • Bechtel

Contract No. DE-AC36-99-GO10337

NOTICE

This report was prepared as an account of work sponsored by an agency of the United States government. Neither the United States government nor any agency thereof, nor any of their employees, makes any warranty, express or implied, or assumes any legal liability or responsibility for the accuracy, completeness, or usefulness of any information, apparatus, product, or process disclosed, or represents that its use would not infringe privately owned rights. Reference herein to any specific commercial product, process, or service by trade name, trademark, manufacturer, or otherwise does not necessarily constitute or imply its endorsement, recommendation, or favoring by the United States government or any agency thereof. The views and opinions of authors expressed herein do not necessarily state or reflect those of the United States government or any agency thereof.

Available electronically at <http://www.osti.gov/bridge>

Available for a processing fee to U.S. Department of Energy
and its contractors, in paper, from:

U.S. Department of Energy
Office of Scientific and Technical Information
P.O. Box 62
Oak Ridge, TN 37831-0062
phone: 865.576.8401
fax: 865.576.5728
email: reports@adonis.osti.gov

Available for sale to the public, in paper, from:

U.S. Department of Commerce
National Technical Information Service
5285 Port Royal Road
Springfield, VA 22161
phone: 800.553.6847
fax: 703.605.6900
email: orders@ntis.fedworld.gov
online ordering: <http://www.ntis.gov/ordering.htm>



Abstract

The U.S. Department of Energy (DOE) is promoting the development of ethanol from lignocellulosic feedstocks as an alternative to conventional petroleum-based transportation fuels. DOE funds both fundamental and applied research in this area and needs a method for predicting cost benefits of many research proposals. To that end, the National Renewable Energy Laboratory (NREL) has modeled many potential process designs and estimated the economics of each process during the last 20 years.

This report is an update of the ongoing process design and economic analyses at NREL. We envision updating this process design report at regular intervals; the purpose being to ensure that the process design incorporates all new data from NREL research, DOE funded research and other sources, and that the equipment costs are reasonable and consistent with good engineering practice for plants of this type. For the non-research areas this means using equipment and process approaches as they are currently used in industrial applications.

For the last report¹, published in 1999, NREL performed a complete review and update of the process design and economic model for the biomass-to-ethanol process utilizing co-current dilute acid prehydrolysis with simultaneous saccharification (enzymatic) and co-fermentation. The process design included the core technologies being researched by the DOE: prehydrolysis, simultaneous saccharification and co-fermentation, and cellulase enzyme production. In addition, all ancillary areas—feed handling, product recovery and purification, wastewater treatment (WWT), lignin combustor and boiler-turbogenerator, and utilities—were included. NREL engaged Delta-T Corporation (Delta-T) to assist in the process design evaluation, the process equipment costing, and overall plant integration. The process design and costing for the lignin combustor and boiler turbogenerator was reviewed by Reaction Engineering Inc. (REI) and Merrick & Company reviewed the wastewater treatment.

Since then, NREL has engaged Harris Group (Harris) to perform vendor testing, process design, and costing of critical equipment identified during earlier work. This included solid/liquid separation and pretreatment reactor design and costing. Corn stover handling was also investigated to support DOE's decision to focus on corn stover as a feedstock for lignocellulosic ethanol. Working with Harris, process design and costing for these areas were improved through vendor designs, costing, and vendor testing in some cases. In addition to this work, enzyme costs were adjusted to reflect collaborative work between NREL and enzyme manufacturers (Genencor International and Novozymes Biotech) to provide a delivered enzyme for lignocellulosic feedstocks. This report is the culmination of our work and represents an updated process design and cost basis for the process using a corn stover feedstock.

The process design and economic model are useful for predicting the cost benefits of proposed research. Proposed research results can be translated into modifications of the process design, and the economic impact can be assessed. This allows DOE, NREL, and other researchers to set priorities on future research with an understanding of potential reductions to the ethanol production cost.

To be economically viable, ethanol production costs must be below market values for ethanol. DOE has chosen a target ethanol selling price of \$1.07 per gallon as a goal for 2010. The conceptual design and costs presented here are based on a 2010 plant start-up date. The key research targets required to achieve this design and the \$1.07 value are discussed in the report.

Table of Contents

| | | |
|--------|--|----|
| I. | Introduction..... | 1 |
| I.1 | Approach..... | 3 |
| I.2 | Process Overview..... | 5 |
| I.3 | Plant Size | 7 |
| I.3.1 | Effect of Plant Size on Collection Distance..... | 7 |
| I.3.2 | Estimating Corn Stover Costs Today..... | 10 |
| I.3.3 | Effect of Distance on Stover Cost..... | 11 |
| I.3.4 | Cost of Ethanol as a Function of Plant Size..... | 12 |
| I.3.5 | Selecting the Right Plant Size..... | 15 |
| I.4 | Feedstock and its Composition..... | 16 |
| II. | Processing Design and Cost Estimating | 18 |
| II.1 | Feedstock Storage and Handling – Area 100 (PFD-P110-A101)..... | 18 |
| II.1.1 | Overview..... | 18 |
| II.1.2 | Design Basis..... | 18 |
| II.1.3 | Cost Estimation..... | 20 |
| II.2 | Pretreatment and Hydrolyzate Conditioning – Area 200 (PFD-P110-A201-3)..... | 20 |
| II.2.1 | Overview..... | 20 |
| II.2.2 | Design Basis..... | 22 |
| II.2.3 | Cost Estimation..... | 24 |
| II.2.4 | Achieving the Design Case..... | 26 |
| II.3 | Saccharification and Co-Fermentation – Area 300 (PFD-P110-A301-2)..... | 27 |
| II.3.1 | Overview..... | 27 |
| II.3.2 | Design Basis..... | 28 |
| II.3.3 | Cost Estimation..... | 33 |
| II.3.4 | Achieving the Design Case Targets..... | 34 |
| II.4 | Cellulase Enzyme..... | 36 |
| II.5 | Product, Solids, and Water Recovery (Distillation, Dehydration, Evaporation, and Solid-Liquid Separation) – Area 500 (PFD-P110-A501-5)..... | 36 |
| II.5.1 | Overview..... | 36 |
| II.5.2 | Design Basis Description..... | 38 |
| II.5.3 | Cost Estimation..... | 39 |
| II.6 | Wastewater Treatment – Area 600 (PFD-110-A601-2)..... | 40 |
| II.6.1 | Overview..... | 40 |
| II.6.2 | Design Basis..... | 42 |
| II.6.3 | Cost Estimation..... | 44 |
| II.7 | Product and Feed Chemical Storage – Area 700 (PFD-P110-A701) | 45 |
| II.7.1 | Overview..... | 45 |
| II.7.2 | Design Basis..... | 45 |
| II.7.3 | Cost Estimation..... | 46 |
| II.8 | Combustor, Boiler, and Turbogenerator – Area 800 (PFD-P110-A801-3) | 46 |
| II.8.1 | Overview..... | 46 |
| II.8.2 | Design Basis..... | 47 |
| II.8.3 | Cost Estimation..... | 49 |
| II.9 | Utilities – Area 900 (PFD-P110-A901-3)..... | 50 |

| | | |
|---------|--|----|
| II.9.1 | Overview..... | 50 |
| II.9.2 | Design Basis..... | 50 |
| II.9.3 | Cost Estimation..... | 52 |
| II.10 | Water and Carbon Balances and Energy Analysis | 52 |
| II.10.1 | Water Balance..... | 52 |
| II.10.2 | Carbon Balance..... | 53 |
| II.10.3 | Energy Analysis..... | 56 |
| III. | Process Economics..... | 60 |
| III.1 | Analysis Procedure | 60 |
| III.1.1 | Total Project Investment..... | 60 |
| III.1.2 | Variable Operating Costs..... | 64 |
| III.1.3 | Fixed Operating Costs..... | 65 |
| III.1.4 | Discounted Cash Flow Analysis and the Selling Cost of Ethanol..... | 66 |
| III.1.5 | The Cost of Sugar | 71 |
| IV. | Sensitivity Analysis | 72 |
| IV.1 | Stover Composition, Cost, and Handling | 72 |
| IV.2 | Pretreatment Yields and Cost..... | 73 |
| IV.3 | Gypsum..... | 73 |
| IV.4 | Saccharification and Fermentation Yields and Cost..... | 74 |
| IV.5 | Energy Production | 77 |
| IV.6 | Monte Carlo Analysis | 78 |
| IV.6.1 | Overview..... | 78 |
| IV.6.2 | Parameter Estimates..... | 79 |
| IV.6.3 | Results..... | 80 |
| V. | Planned Improvements and Extensions to the Model..... | 82 |
| V.1 | Water Balance and Optimization..... | 82 |
| V.2 | Fermentation pH Control | 82 |
| V.3 | Air Emissions..... | 82 |
| V.4 | Greenhouse Gas Emissions..... | 82 |
| V.5 | Lignin Gasification and Gas Turbine Power Generation..... | 83 |
| V.6 | Physical Properties of Corn Stover..... | 83 |
| | References and Notes..... | 83 |
| | Appendix A – NREL Biofuels Process Design Database Description and Summary | |
| | Appendix B – Individual Equipment Costs Summary | |
| | Appendix C – Chemical Costs and Sources | |
| | Appendix D – Discounted Cash Flow Rate of Return Summary | |
| | Appendix E – Process Parameters | |
| | Appendix F – Process Flow Diagrams (PFDs) | |
| | Appendix G – Changes from the 1999 Design Report | |
| | Appendix H – Chemical Formulas for Biomass Compounds | |
| | Appendix I – Physical Property Model and Parameters for Distillation | |

Figures

| | | |
|------------|---|----|
| Figure 1. | NREL's Approach to Process Design and Economic Analysis..... | 3 |
| Figure 2. | Overall Process, PFD-P100-A000 | 6 |
| Figure 3. | GIS Model Results Showing the Location of 35 2000 MT/d Ethanol Plants in Iowa..... | 8 |
| Figure 4. | The Effect of Plant Size on Collection Distance | 9 |
| Figure 5. | Typical Breakdown of Corn Stover Costs | 10 |
| Figure 6. | Hauling Charges for Corn Stover as a Function of Distance..... | 12 |
| Figure 7. | Ethanol Cost as a Function of Plant Size for 10% Availability of Corn Acres | 13 |
| Figure 8. | Ethanol Price as a Function of Plant Size and Percentage of Available Acres | 14 |
| Figure 9. | Ethanol Price as a Function of Plant Size and Hauling Cost (\$/ton-mile).... | 15 |
| Figure 10. | Pretreatment Process Area Overview, PFD-P100-A200 | 21 |
| Figure 11. | Corrosion Resistance of Incoloy 825 | 25 |
| Figure 12. | Distillation System Overview, PFD-P110-A500 | 37 |
| Figure 13. | Wastewater Treatment (WWT) Process Overview, PFD-P110-A600 | 41 |
| Figure 14. | Process Carbon Balance..... | 55 |
| Figure 15. | Process Energy Analysis Based on Higher Heating Value of Biomass Feed..... | 58 |
| Figure 16. | CFBC/Turbogenerator Energy Balance..... | 60 |
| Figure 17. | Effect of Varying IRR and Equity on Minimum Ethanol Selling Price | 67 |
| Figure 18. | Cost Contribution Details from Each Process Area..... | 71 |
| Figure 19. | SSF Yields for Multiple Enzyme Loadings..... | 75 |
| Figure 20. | MESPs for Multiple Enzyme Loadings..... | 76 |
| Figure 21. | MESPs for Multiple Residence Times | 76 |
| Figure 22. | Histogram of the Minimum Ethanol Selling Price | 80 |
| Figure 23. | Probability Curve of the Minimum Ethanol Selling Price..... | 81 |
| Figure 24. | Histogram of the Total Project Investment..... | 81 |

Tables

| | | |
|-----------|--|----|
| Table 1. | Feedstock Composition..... | 16 |
| Table 2. | Measured Stover Composition Ranges..... | 17 |
| Table 3. | Pretreatment Hydrolyzer Conditions..... | 22 |
| Table 4. | Pretreatment Hydrolyzer Reactions and Conversions..... | 23 |
| Table 5. | Experimental Pretreatment Reactor Conditions..... | 26 |
| Table 6. | Experimental Pretreatment Hydrolyzer Reactions and Conversions..... | 26 |
| Table 7. | Saccharification Conditions..... | 29 |
| Table 8. | Saccharification Reactions and Conversions..... | 29 |
| Table 9. | Seed Train Specifications..... | 30 |
| Table 10. | Seed Train Reactions and Conversions..... | 31 |
| Table 11. | Co-Fermentation Conditions..... | 32 |
| Table 12. | Co-Fermentation Reactions and Conversions..... | 32 |
| Table 13. | Co-Fermentation Contamination Loss Reactions..... | 33 |
| Table 14. | Experimental Saccharification Conditions..... | 34 |
| Table 15. | Experimental Saccharification Reactions and Conversions..... | 34 |
| Table 16. | Experimental Co-Fermentation Conditions..... | 35 |
| Table 17. | Experimental Co-Fermentation Reactions and Conversions..... | 35 |
| Table 18. | Comparison of Sending Evaporator Syrup to the Combustor or WWT..... | 44 |
| Table 19. | Boiler Costs..... | 49 |
| Table 20. | Ethanol Plant Overall Water Balance..... | 53 |
| Table 21. | Ethanol Plant Overall Carbon Balance..... | 54 |
| Table 22. | Feed Stream Carbon Composition..... | 56 |
| Table 23. | Ethanol Plant Overall Energy Analysis..... | 57 |
| Table 24. | Feed Stream Energy Analysis..... | 59 |
| Table 25. | Installation Factors..... | 62 |
| Table 26. | <i>Chemical Engineering</i> Purchased Equipment Index..... | 62 |
| Table 27. | Additional Cost Factors for Determining Total Project Investment..... | 63 |
| Table 28. | Total Installed Equipment Costs..... | 63 |
| Table 29. | Total Project Investment (TPI)..... | 64 |
| Table 30. | Variable Operating Costs..... | 64 |
| Table 31. | Inorganic Chemical Index..... | 65 |
| Table 32. | Fixed Operating Costs..... | 66 |
| Table 33. | Labor Index..... | 66 |
| Table 34. | Construction Activities and Cash Flow..... | 69 |
| Table 35. | Discounted Cash Flow Parameters..... | 70 |
| Table 36. | Summary of Yields, Rates and Conversion Costs..... | 70 |
| Table 37. | Mixed Sugar Stream Concentration from Saccharification..... | 72 |
| Table 38. | Effect of Pretreatment Yields on Minimum Ethanol Selling Price..... | 73 |
| Table 39. | Summary of Sensitivity Results by Cost Impact..... | 78 |
| Table 40. | Input Parameter Distribution for Monte Carlo Analysis..... | 79 |

Acronyms

| | |
|-------|---|
| ABB | ABB Power Generation Systems |
| ACFM | Actual Cubic Feet per Minute |
| ASPEN | Advanced Simulator for Process Engineering |
| ANSI | American National Standards Institute |
| API | American Petroleum Institute |
| BFW | Boiler Feed Water |
| B/MAP | Biomass AgriProducts |
| BOD | Biochemical Oxygen Demand |
| BTU | British Thermal Unit |
| CFBC | Circulating Fluidized Bed Combustor |
| CFM | Cubic Feet per Minute |
| CIP | Clean-in-place |
| COD | Chemical Oxygen Demand |
| CS | Carbon Steel |
| CSL | Corn Steep Liquor |
| CW | Cooling Water |
| DAP | Diammonium Phosphate |
| DB | Declining Balance |
| DOE | U.S. Department of Energy |
| EIA | Energy Information Administration |
| EPA | Environmental Protection Agency |
| EtOH | Ethanol |
| FPU | Filter Paper Units |
| FWE | Foster Wheeler Energy |
| GDS | General Depreciation System |
| GIS | Geographic Information System |
| GPM | Gallons per minute |
| HHV | Higher Heating Value |
| HMF | Hydroxymethyl Furfural |
| IFPU | International Filter Paper Units (see FPU) |
| IGCC | Integrated Gasification Combined Cycle |
| IRR | Internal Rate of Return |
| IRS | Internal Revenue Service |
| LHV | Lower Heating Value |
| MACRS | (IRS) Modified Accelerated Cost Recovery System |
| MESP | Minimum Ethanol Selling Price |
| MM | Million |
| MT | Metric Ton |
| NREL | National Renewable Energy Laboratory |
| NSPS | New Source Performance Standards |
| ORNL | Oak Ridge National Laboratory |
| P&ID | Piping and Instrument Diagram |
| PDU | Process Development Unit |

| | |
|------|---|
| PFD | Process Flow Diagram |
| REI | Reaction Engineering, Inc. |
| SCFM | Standard Cubic Feet per Minute |
| SS | Stainless Steel |
| SSCF | Simultaneous Saccharification and Co-Fermentation |
| ST | Short Ton |
| TPI | Total Project Investment |
| VOC | Volatile Organic Compound |
| WWT | Wastewater Treatment |

I. Introduction

The U.S. Department of Energy (DOE) is promoting the development of ethanol from lignocellulosic feedstocks as an alternative to conventional petroleum transportation fuels. Programs being sponsored by DOE range from fundamental and applied research for developing better cellulose hydrolysis enzymes and ethanol-fermenting organisms, to engineering studies of potential processes, to co-funding initial biomass-to-ethanol demonstration and production facilities. This research is being conducted by various national laboratories, including the National Renewable Energy Laboratory (NREL) and Oak Ridge National Laboratory (ORNL), as well as by universities and private industry. Engineering and construction companies and operating companies are generally conducting the engineering work.

There are two primary reasons for NREL to investigate the complete process design and economics of lignocellulosic ethanol plants. First, this effort helps to direct research by developing a benchmarking case for the current conceptual process design. Once the benchmark case is developed, the proposed research and its anticipated results are translated into a new design, the economics (the anticipated results of proposed research) are determined, and this new information is compared to the benchmark case. Following this process for several proposed research projects allows DOE to make funding decisions based on which projects have the greatest potential to lower the cost of ethanol production. Complete process design and economics are required for such studies because a new proposal in one research area may have a large effect on another process area that is not generally part of the research program, such as product recovery or waste treatment. The impact on other areas of the process can have a significant impact on the economics of the proposed research.

Second, this investigation allows us to develop an absolute cost of the production of ethanol based on process and plant design assumptions. In reviewing and establishing research directions, only relative cost differences are important. However, to be able to compare the economics of ethanol with other fuels, the absolute cost is required. An absolute cost is also needed to study the potential ethanol market penetration of the lignocellulosic biomass to ethanol process. Thus, we are making the best possible attempt to develop cost estimates that are consistent with applicable engineering, construction, and operating practices for facilities of this type. To do so, the complete process, including newly researched areas and industry-available process components must be designed and their costs determined. For the current level of design knowledge, we consider the capital cost estimate to be at the conceptual level.

To improve the plant cost estimates that affect the absolute cost of ethanol production, NREL contracts with companies such as Harris Group (Harris) and Delta-T Corporation (Delta-T) to assist in preparing, reviewing, and estimating costs for the process designs. Delta-T worked with NREL process engineers in 1998-99 to review all the process design and equipment costs (with the exclusion of wastewater treatment and the combustor-boiler system, which were reviewed by Merrick Engineering² and Reaction Engineering, Inc.³ [REI], respectively). At the conclusion of these efforts, the first design report was published¹.

As a result of the NREL/Delta-T work, several areas were identified that required more extensive study. Therefore, NREL worked with Harris to perform vendor testing, corrosion testing, process design, and costing of critical equipment identified from the earlier work. This included solid/liquid separation equipment and pretreatment reactors. Corn stover handling was also investigated to support DOE's decision to focus on stover in its efforts to commercialize lignocellulosic ethanol. Working with Harris, process design and costing for these areas was

improved. At the same time, DOE partnered with the two largest enzyme manufacturers in the world (Genencor International and Novozymes Biotech) to reduce the cost of cellulase enzymes by a factor of 10. It is assumed that these companies will produce the enzymes and sell them to ethanol producers. Therefore, the ethanol plant will no longer be responsible for enzyme production but will purchase them from off-site. This report is the culmination of this work and represents an updated process design and cost basis for the process using a corn stover feedstock.

To be economically viable, ethanol production costs must be below market values for ethanol. DOE has chosen a target ethanol selling price of \$1.07 per gallon as a goal for 2010. The conceptual design and costs presented here are based on a 2010 plant start-up date. The key research targets required to achieve this design and the \$1.07 value are discussed in the report.

We envision that this conceptual process design will be updated via an on-going process, and that reports will be released at regular intervals. The purpose is to ensure that the process design incorporates all new data from NREL research, DOE funded research and other sources, and that the equipment costs are reasonable and consistent with good engineering practice for plants of this type. For the non-research areas this means using equipment and process approaches as they are currently being used in industrial applications.

I.1 Approach

Developing a model that describes the chemical conversion process and its economics requires information from many different arenas. Figure 1 describes the approach used here for modeling the conversion of biomass to ethanol.

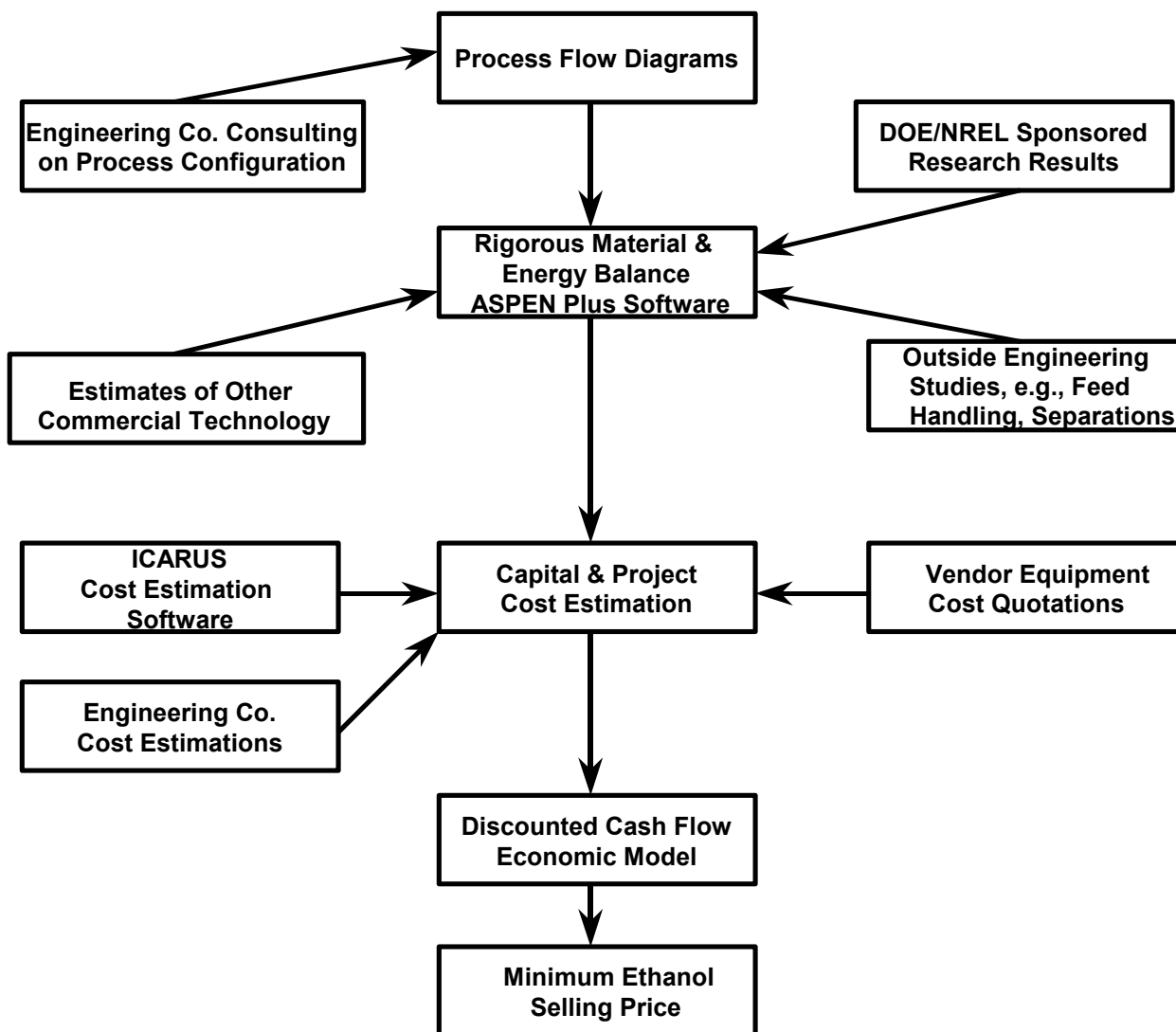

Figure 1. NREL's Approach to Process Design and Economic Analysis

The first step to any conceptual process design is to develop a set of process flow diagrams (PFDs). Appendix F contains the PFDs developed for this study. Using the arrangement of the equipment shown, a mass and energy balance was developed within an ASPEN Plus⁴ model. This model consists of 164 unit operation blocks, 457 streams (247 material and 210 heat or work), 63 components, and 82 control blocks. The overall model is thermodynamically rigorous and uses physical properties that are included in the ASPEN modeling software as well as property data developed at NREL⁵. The individual unit models are thermodynamically consistent and can be either rigorous (for example, the simulation of the distillation) or simple. The reactors could be modeled with kinetic expressions, but because of the level of development of the

experimental data, they were modeled as experimentally determined conversions of specific reactions. The chemical formulas for atypical compounds (not included in the ASPEN modeling software) are listed in Appendix H. This type of model still satisfies the rigorous mass and energy balance. Other unit operations, such as liquid-solid separations, are typically modeled with fixed solids removal and liquid retention (in the solids stream) data from vendor tests.

Using the PFDs and the mass and energy balance information from the ASPEN model, we developed specifications for each piece of equipment. The equipment specifications (and cost estimate) are detailed in the NREL process database (see Appendix A). Finally, within each equipment specification, we developed individual purchased equipment and installation costs.

Equipment costs were obtained from vendor quotations when possible, especially for uncommon equipment such as pretreatment reactors. These costs reflect the base case for which the equipment was designed. If process changes are made and the equipment size changes, the equipment is not generally re-costed in detail. Using the following exponential scaling expression, the cost was determined by scaling based on the new size or other valid size related characteristic.

$$New\ Cost = Original\ Cost \left(\frac{New\ Size\ *}{Original\ Size\ *} \right)^{exp}$$

* or characteristic linearly related to the size

If the size of the equipment is known to change linearly with the inlet flow, that information can be used for scaling. Another characteristic of the size might be the heat duty for a heat exchanger if the log-mean temperature difference is known not to change. Generally these related characteristics are easier to calculate and give the same result as resizing the equipment each time. For some equipment, nothing can be easily related to the size, so it must be resized with each process change. Heat exchangers with varying temperature profiles are one example. In this case, the heat exchanger area is calculated each time the model is run and the cost is scaled using the ratio of the new and original areas.

The scaling exponent (exp) was obtained from vendor quotes (if two quotes at different sizes were obtained), Harris, or from a standard reference, such as Garrett.⁶ The installation costs were primarily taken from Delta-T's experience and are explained in more detail in the process economics section (Section III).

Once the scaled, installed equipment costs were determined, we applied overhead and contingency factors to determine a total plant investment cost. That cost, along with the plant operating expenses (generally developed from the ASPEN model) was used in a discounted cash flow analysis to determine the cost of ethanol production, using a set discount rate. For the analysis done here, the ethanol production cost is the primary value used to compare designs.

Development of alternative designs is very useful in evaluating research proposals. Scenarios, based on technologies that might be developed after several years of research, are translated to process designs and the cost of ethanol production is evaluated. These projections are only as good as the estimation of the future technology developments.

Even though one aim of this work was to develop the absolute cost of ethanol for comparison to other fuels, it should be noted that ethanol and possibly electricity are the only products of these conceptual process designs. It is likely that smaller volume, niche products will emerge, such as products from the biomass-derived sugars that will have a significantly higher profit margin than

fuel-grade ethanol. When these other products and their selling prices are figured into the analysis, the cost of ethanol may decrease, just as the cost of gasoline is reduced by the sale of other petroleum refinery products. Likewise, co-location with existing producers of ethanol, power, or some other equally synergistic product slate will likely reduce the cost of ethanol.

1.2 Process Overview

The process being analyzed here can be described as using co-current dilute acid prehydrolysis of the lignocellulosic biomass with enzymatic saccharification of the remaining cellulose and co-fermentation of the resulting glucose and xylose to ethanol. The process design also includes feedstock handling and storage, product purification, wastewater treatment, lignin combustion, product storage, and all other required utilities. In all, the process is divided into eight areas (see Figure 2).

The feedstock, in this case corn stover (comprised of stalks, leaves, cobs, and husks), is delivered to the feed handling area (A100) for storage and size reduction. From there the biomass is conveyed to pretreatment and detoxification (A200). In this area, the biomass is treated with dilute sulfuric acid catalyst at a high temperature for a short time, liberating the hemicellulose sugars and other compounds. Separation with washing removes the acid from the solids for neutralization. Overliming is required to remove compounds liberated in the pretreatment that are toxic to the fermenting organism. Detoxification is applied only to the liquid portion of the hydrolysis stream.

Enzymatic hydrolysis (or saccharification) coupled with co-fermentation (A300) of the detoxified hydrolyzate slurry is carried out in continuous hydrolysis tanks and anaerobic fermentation tanks in series. A purchased cellulase enzyme preparation is added to the hydrolyzate in the hydrolysis tanks that are maintained at a temperature to optimize the enzyme's activity. The fermenting organism *Zymomonas mobilis* is first grown in a series of progressively larger batch anaerobic fermentations to make enough cells to inoculate the main fermenters. The inoculum, along with other nutrients, is added to the first ethanol fermenter along with the partially saccharified slurry at a reduced temperature. The cellulose will continue to be hydrolyzed, although at a slower rate, at the lower temperature. After several days of separate and combined saccharification and co-fermentation, most of the cellulose and xylose will have been converted to ethanol. The resulting beer is sent to product recovery.

Product recovery (A500) involves distilling the beer to separate the ethanol from the water and residual solids. A mixture of nearly azeotropic water and ethanol is purified to pure ethanol using vapor-phase molecular sieve. Solids from the distillation bottoms are separated and sent to the boiler. Concentration of the distillation bottoms liquid is performed by evaporation, using waste heat. The evaporated condensate is returned to the process and the concentrated syrup is sent to the combustor.

Part of the evaporator condensate, along with other wastewater, is treated by anaerobic and aerobic digestion (A600). The biogas (high in methane) from anaerobic digestion is sent to the combustor for energy recovery. The treated water is suitable for recycling and is returned to the process.

The solids from distillation, the concentrated syrup from the evaporator, and biogas from anaerobic digestion are combusted in a fluidized bed combustor (A800) to produce high-pressure steam for electricity production and process heat. The majority of the process steam demand is in the pretreatment reactor and distillation areas. Generally, the process produces excess steam that is converted to electricity for use in the plant and for sale to the grid.

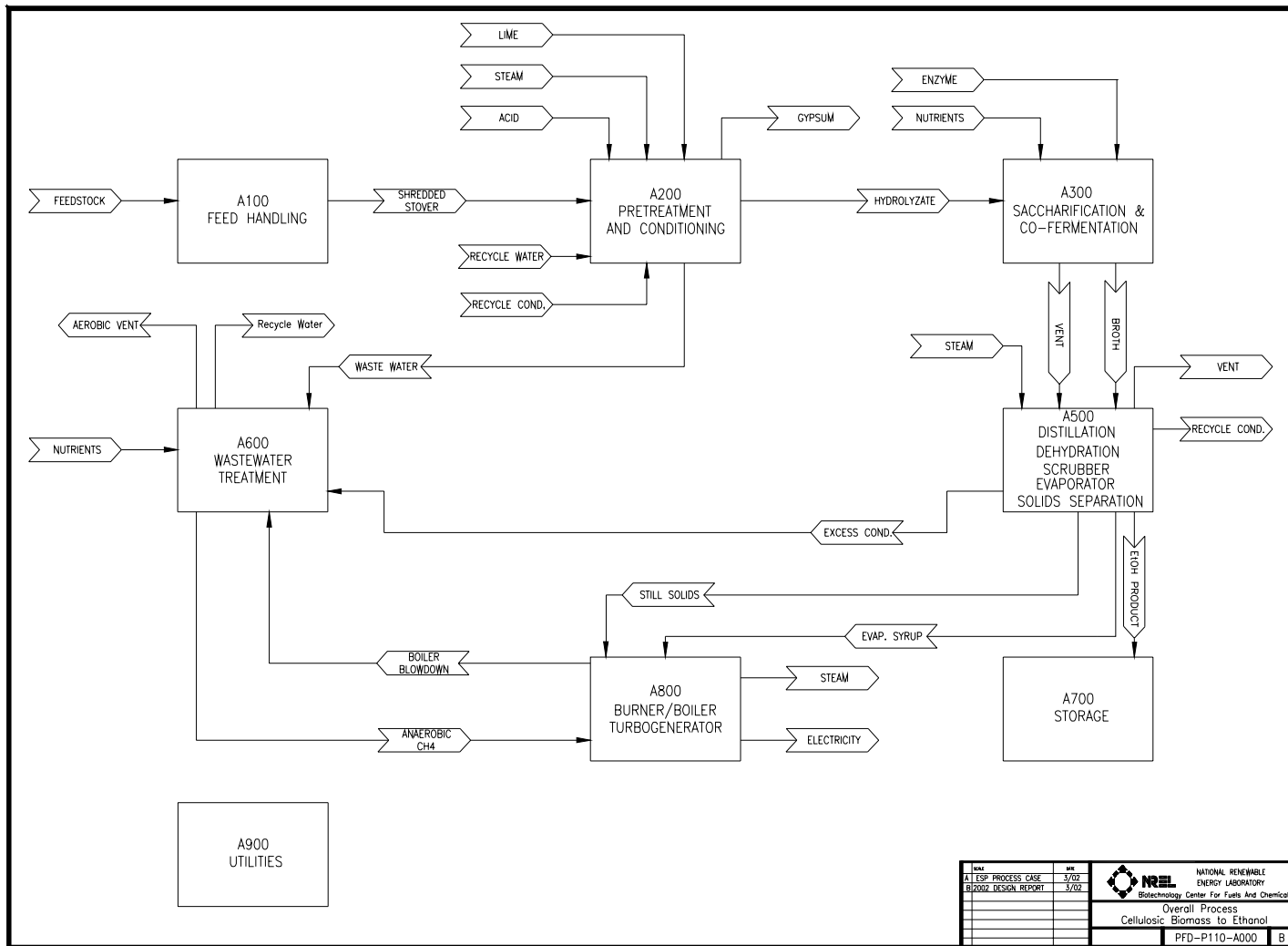

Figure 2. Overall Process, PFD-P110-A000

I.3 Plant Size

In establishing the appropriate size of a plant, we must consider the effects of a number of tradeoffs. Savings resulting from economies of scale (see discussion in section I.1) are offset by increased costs for feedstock transportation. Put quite simply, the more feedstock a plant demands, the farther out it must go to get it. Collection distance for a plant is highly site specific, but a simple analysis can be done to understand the range of plant sizes for which overall costs and the impact of feedstock transport are minimal. This requires understanding both the cost of feedstock transportation and the effect of plant size on capital and fixed operating costs for the ethanol plant.

On average, in the process industries, capital cost for equipment increases as a function of size or throughput according to the power law equation shown in section I.1 with an exponent of around 0.6. This means that, per unit of output, the cost of capital can drop dramatically for larger scale operations. An exponent of 1 would mean linear scaling is taking place. An exponent less than 1 means that the capital cost per unit size decreases as the equipment becomes larger. This concept is sometimes termed “economies of scale”. Economies of scale diminish when the equipment is as large as possible and multiple pieces of equipment become necessary.

In 1991, NREL first evaluated the size of an ethanol plant for our standard design by looking at the trade off between economies of scale and increased cost of delivering feedstock.⁷ That study compared a plant size of around 1,750 metric tons (1 MT is 1,000 kg) or 1,920 short tons (1 ST is 2000 lb) per day to one of 9,090 MT (10,000 ST), assuming an additional \$2/ton transport costs for the larger plant size. In this report, we have repeated that analysis in a more rigorous way to see if a plant size of 2,000 MT per day is appropriate in the current design for converting corn stover to ethanol.

I.3.1 Effect of Plant Size on Collection Distance

NREL and ORNL recently completed a life cycle analysis of corn stover-derived ethanol.⁸ As part of that study, researchers at ORNL used a GIS model known as ORIBUS to estimate energy demands, environmental flows and costs for collection and transportation of corn stover in the state of Iowa (Figure 3). The premise of this study was that the maximum amount of stover that could be collected should be constrained by soil erosion considerations. An analysis of the effects of stover removal on soil erosion found that, for Iowa farmers using low or no till practices and who are producing corn continuously on their land, an average of two metric tons (MT) per acre of stover can be removed without causing erosion rates to exceed USDA’s tolerable soil loss limits. ORIBUS was used to estimate transportation costs for a total of 35 potential ethanol plants sized to handle 2,000 MT (2,205 ST) per day of corn stover.

Though the life cycle study of corn stover-derived ethanol in Iowa did not look at the effect of locating plants of different sizes, we can use the results of this study to calibrate a much simpler analysis of stover transportation costs in order to understand the trade-offs of transportation costs and savings due to economies of scale.

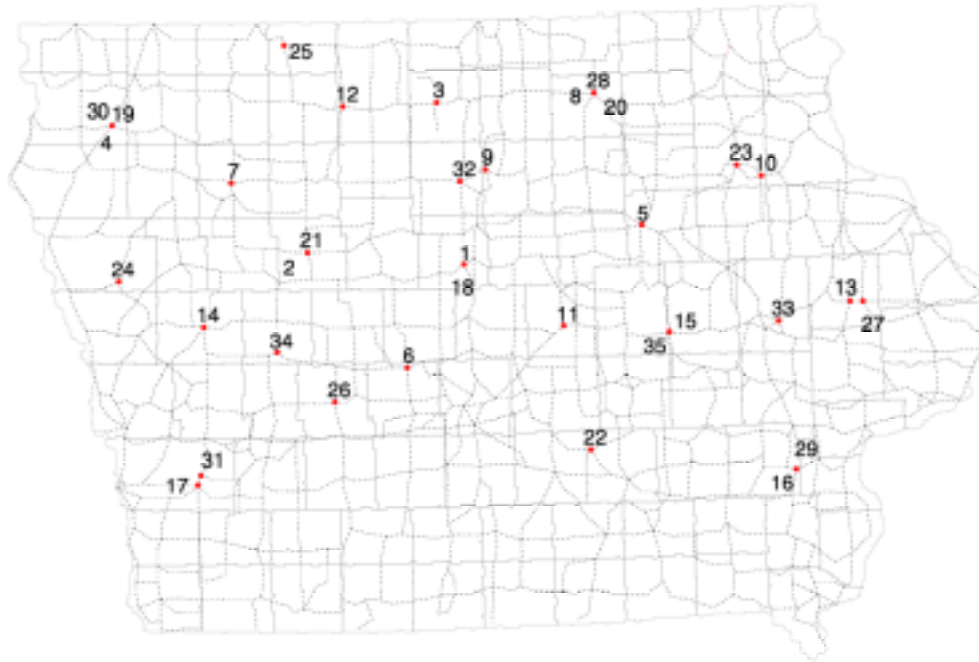

Figure 3. GIS Model results showing the location of 35 2000 MT/d ethanol plants in Iowa

For this analysis, we need to estimate the distance traveled to collect corn stover, which, obviously, increases as the size of the plant increases. We estimate the collection distance as the radius of a circle around the plant within which the stover is purchased. The area of this circle is a function of the residue that can be collected per acre, the fraction of surrounding farmland from which stover can be collected and the fraction of farmland dedicated to crops (versus infrastructure):

$$\text{Area}_{\text{collection}} = (D_{\text{stover}} / (Y_{\text{stover}} * F_{\text{availableacres}} * F_{\text{landincrops}}))$$

Where:

$\text{Area}_{\text{collection}}$ is the circle of collection around the plant

D_{stover} is the annual demand for stover by an ethanol plant

Y_{stover} is MT stover collected per acre per year

$F_{\text{availableacres}}$ is the fraction of total farmland from which stover can be collected

$F_{\text{landincrops}}$ is the fraction of surrounding farmland containing crops

The last two items warrant further explanation. In this simplified analysis we presume that the plant is located in the middle of corn farmland. Even so, not all of the land on a farm is available for planting crops. We assume that 25% of the land is tied up in infrastructure (e.g., roads and buildings), leaving 75% of the farm acres actually planted in corn. Thus, $F_{\text{landincrops}}$ is taken to be 0.75. Furthermore, we do not assume that all of the farms around the ethanol plant will want or be able to participate in the collection and sale of their corn stover. Thus, $F_{\text{availableacres}}$ is a parameter we vary in the analysis.

Figure 4 shows the radius of collection around the plant for different levels of access to acres for collection, assuming a maximum yield of 2 MT per acre (as found in the Iowa life cycle study). 100% access represents a scenario in which all farmers are practicing no till, growing corn continuously, and are willing to sell their stover. This is a highly unlikely scenario. 50% access represents a scenario in which farmers split their land between soybean and corn production. This scenario is also not very realistic because the corn-soybean rotations will not likely permit sustainable collection at a level of 2 MT (2.2 ST) per acre.

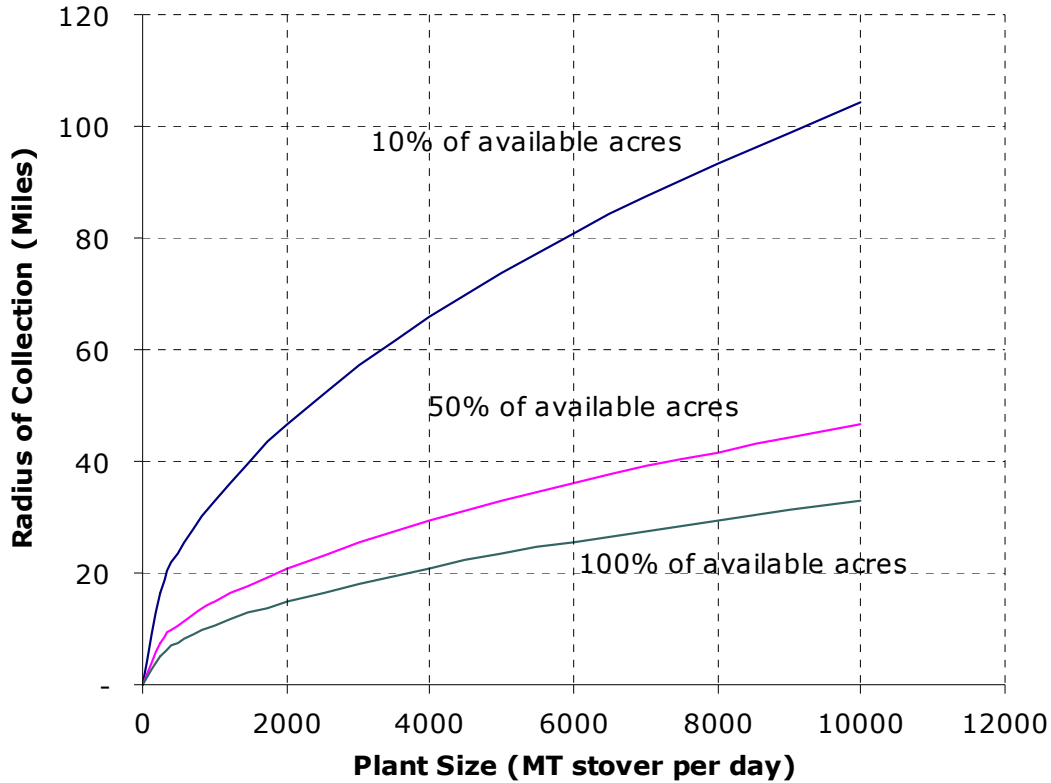

Figure 4. The Effect of Plant Size on Collection Distance

In the near term, the 10% availability scenario is closer to reality. Low till and no till practices do not represent a very substantial percentage of tilling practices for corn production in Iowa, or any where in the U.S.; and farmers using more intensive tilling practices will not be able to sustainably remove stover from their fields. In the future, it is very possible that farmers could be convinced of the financial, environmental and agronomic benefits of new tilling practices that lead to stover collection, but this is not a near term scenario.

As a rough rule of thumb, we have assumed that plants would likely not collect corn stover outside of a 50-mile radius around the plant. For the 10% availability scenario, this 50-mile radius corresponds to the 2,000 MT per day design we have been using for our process design. Rather than using a rule of thumb to determine the limits of plant size and collection radius, it makes more sense to base the plant size on the cost of collection, which we address in the following sections.

I.3.2 Estimating Corn Stover Costs Today

Collecting biomass for the plant has two main sources of direct costs:

- The cost of baling and staging stover at the edge of the field
- The cost of transportation from the farm to the plant gate

In the past two years, Oak Ridge National Lab has been quantifying the cost of collecting corn stover assuming the use of existing equipment; and, more importantly, assuming that stover would be collected in a second pass through the field after the grain has been harvested. We know that such an approach will not suffice as the industry develops, but it does reflect the costs that we can anticipate for farmers collecting stover today. Furthermore, we have documented experience with such collection schemes.⁹

Figure 5 shows the relative contribution of the sources of costs for stover collection and delivery, based on an analysis done by ORNL for our corn stover life cycle analysis:

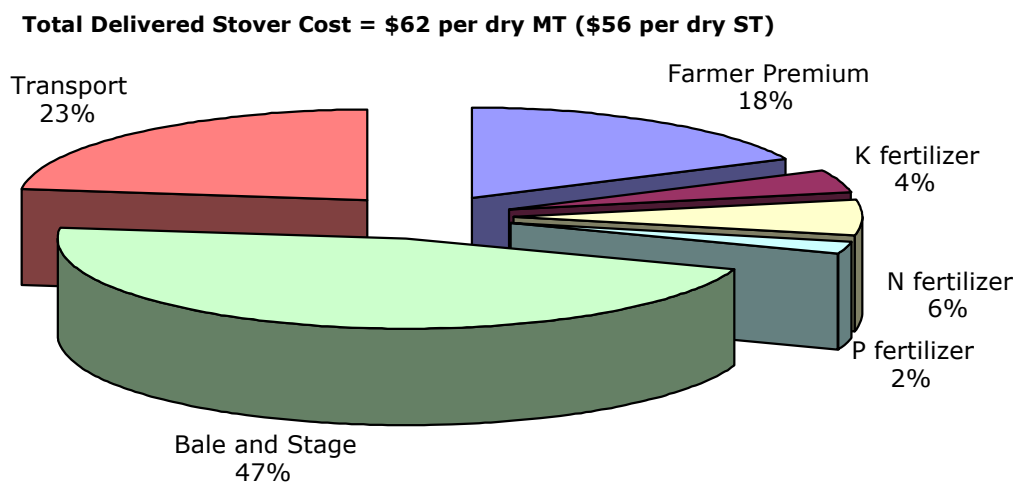

Figure 5. Typical Breakdown of Corn Stover Costs

These costs represent a specific set of conditions that correspond to the scenario of 100% availability of acres, maximum levels of stover removal, with all costs averaged across a total of 35 Iowa facilities processing 2,000 MT per day, as shown in Figure 3. Baling and staging, at \$29 per dry MT (\$26 per dry ST), represents almost half the cost of delivered feedstock. The analysis includes the payment of a premium to farmers of \$11 per dry MT (\$10 per dry ST). This payment is above and beyond the cost of stover collection. For a yield of 2 MT per acre (2.2 ST per acre), this corresponds to a profit of \$22 per acre. Informal discussions with the farm community suggest that \$20 per acre is the likely threshold above which farmers would accept the risk and added work of collecting and selling their residue. Note that we have also included costs for added fertilizer requirements associated with the loss of nitrogen, potassium and phosphorous contained in the removed stover. Added fertilizer costs amount to around \$8 per dry MT (\$7 per dry ST). Transportation cost in this scenario is \$14 per dry MT (\$13 per dry ST).

The average costs for transportation and baling costs are somewhat inflated in this analysis because they include costs for the last plants able to collect stover in Iowa. In the GIS analysis done for the life cycle study, individual 2,000 MT per day plants were located in sequence, with each new plant located to collect the lowest cost stover supplies. The last few plants have to go

much farther to obtain stover, and they must collect stover from the least cost effective sources of residue.

It is important to note that the feedstock costs shown in this section are not the same as the nominal cost used in the process design economic analysis presented at the end of this report. This design is built on a series of assumptions tied to the successful achievement of research and development goals for the conversion technology. We have not yet developed cost-based targets for reducing the cost of feedstock collection and transport. As a placeholder in the process economics presented here, we have assumed that the nominal cost of corn stover will be reduced to around \$33 per dry MT (\$30 per dry ST) through improved collection (e.g. single pass) techniques.

One final note about the cost of feedstock—the costs shown here are significantly higher than cost previously reported in the literature. That is because these costs include a premium paid to the farmer *on top of* the cost of collection and increased fertilizer application rates. Some estimates include no net payment to the farmer; while others include premiums, but assume that the cost of added fertilizer cost is hidden in the premium payment. One reason why these added costs for fertilizer and farmer premium have not been addressed is that there is tremendous uncertainty in these estimates. Nitrogen fertilizer cost, in particular, is hard to get a handle on. The composition data used to estimate fertilizer loss is sparse. The cost of stover collection presented here serve as a reasonable basis for testing the sensitivity of ethanol cost to plant size, but should not be regarded as an accurate assessment of corn stover collection costs.

I.3.3 Effect of Distance on Stover Cost

The only “real life” experience with transporting corn stover that has been documented in the published literature comes from the efforts by Biomass Agricultural Products (BMAP, LLC) in Harlan Iowa.⁹

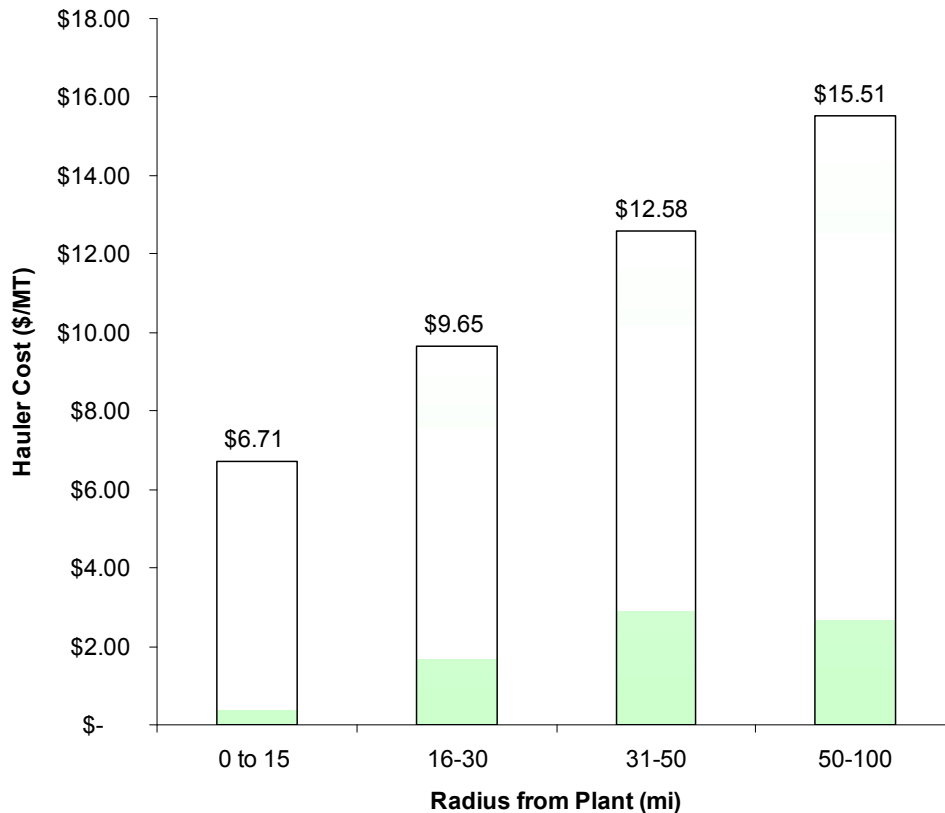

Figure 6. Hauling Charges for Corn Stover as a Function of Distance

In their collection study, BMAP established a pricing structure for corn stover that included hauler costs as a function of radial distance from the plant. Those costs are shown in Figure 6. In our evaluation of the trade-off of the costs of collection and the effect of plant size, we use the cost breakdown for stover shown in Figure 5, excluding the transportation cost. The linear relationship between cost and distance reported by BMAP is then substituted to predict a total cost of delivered corn stover that is a function of distance from the plant.

I.3.4 Cost of Ethanol as Function of Plant Size

The last piece of information required to conduct the analysis for choosing plant size requires estimates of the annualized cost and non-feedstock related operating costs of the plant. We use the costs as reported in the section on process economics later in this report (which are based on a 2,000 MT per day design). But, we need to be able to take into account the effect of plant size (economies of scale). To do this, we need to substitute the annualized costs calculated for the 2,000 MT per day design with an equation that recalculates annualized cost as a function of size using the power law type of equation for scale factor discussed earlier. In this analysis we used a capital cost scaling exponent of 0.7, which was calculated by rigorously modeling 2 different plant sizes and determining the exponent from each plant's capital cost and feed rate¹⁰.

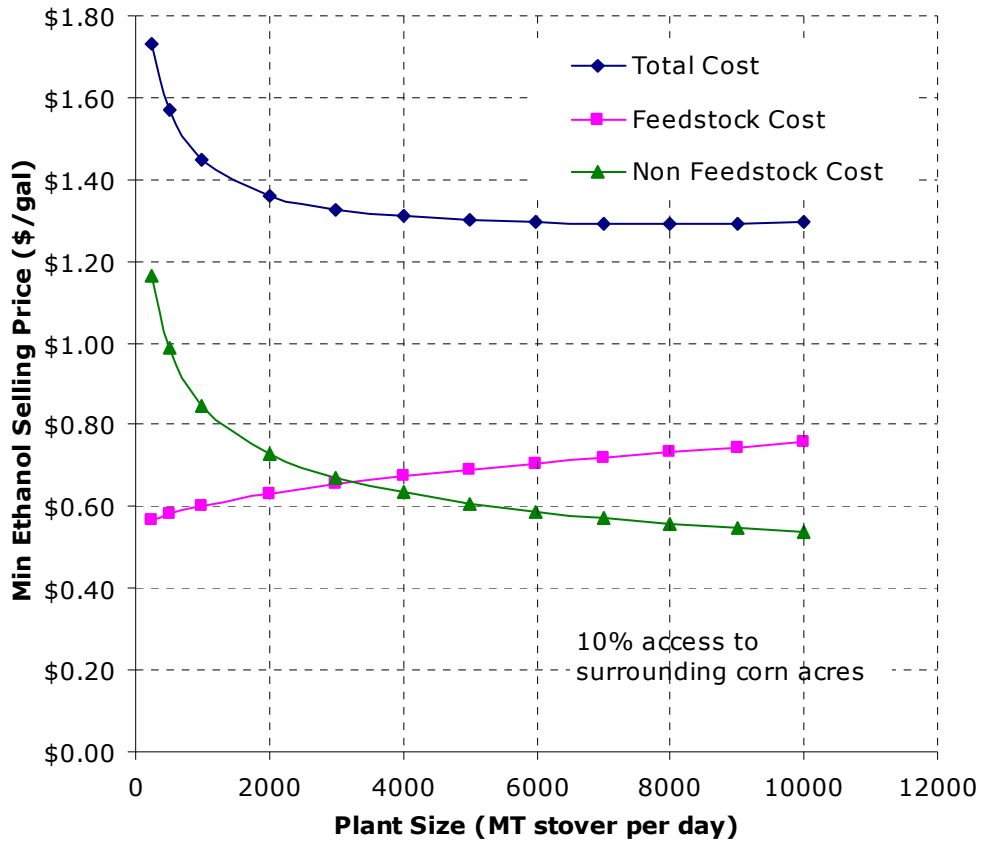

Figure 7. Ethanol Cost as a Function of Plant Size for 10% Availability of Corn Acres

Figure 7 shows the minimum selling price for ethanol as a function of plant size for the conservative, but more likely near term, scenario of collecting stover from only 10% of the corn acres around the conversion facility. The non-feedstock and feedstock-related cost components are plotted along with the total cost. This figure demonstrates the nature of the trade-off quite clearly. The non-feedstock cost curve reflects the conventional wisdom of economies of scale. An increase in plant size from 2,000 to 10,000 MT per day reduces non-feedstock costs by \$0.19 per gallon, savings that seem well worth capturing. But the increased cost of feedstock for the 10,000 MT per day design eliminates \$0.13 of these savings. In this scenario, the net savings of \$0.06 is achieved at a plant size between 6,000 and 8,000 MT per day, with no additional cost savings realized above that size. Plant sizes below the 2,000 MT per day design show rapidly increasing costs, suggesting that the 2,000 MT per day plant, under the assumed conditions, is a good choice for the minimum plant size. Thus, for the conservative scenario of collecting stover from 10% of the corn acres around a conversion plant, the optimal minimum plant size is in the 2,000 to 4,000 MT per day range.

As more acres of corn become available for stover collection, it is possible to increase the range of optimal plant designs, as shown in Figure 8. When available acres are increased from 10 to 25%, savings in cost due to increased plant size top out at \$0.10 per gallon up to a plant size of 10,000 MT per day. For the case of full access to stover on surrounding corn acres, increasing

plant size from 2,000 to 10,000 MT per day can realize savings of \$0.16 per gallon, however, the lion's share of these savings are achieved by the time you reach a plant size of 8,000 MT per day.

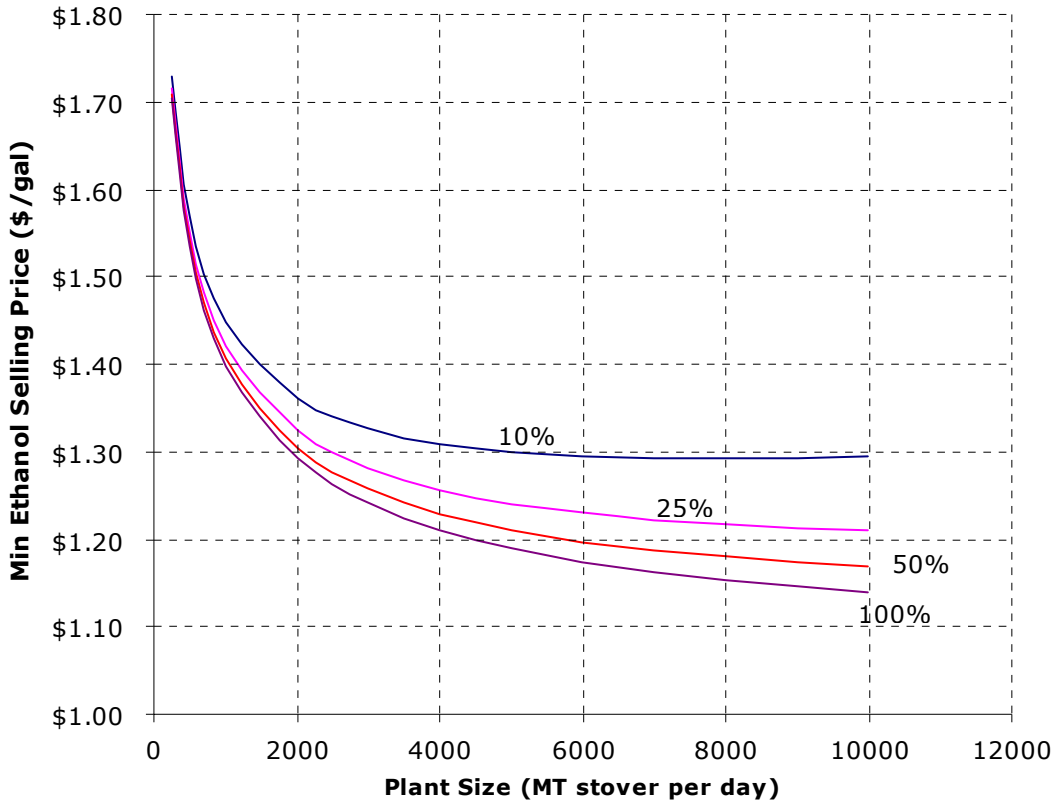

Figure 8. Ethanol Price as a Function of Plant Size and % of Available Acres

Another important factor impacting the cost of delivering feedstock is the cost per ton-mile. This cost is affected by the bulk density of the stover bales, the maximum number of bales per load and the road infrastructure itself. Lower bulk density and lower load capacity will increase the number of trips needed to deliver stover. Road infrastructure can be very important, as it impacts the maximum speed for haulers. The largest cost for hauling is in labor, which increases inversely as speed limit drops. Figure 9 shows the effect of the cost per ton-mile in the case of 10% access to surrounding corn acres. A 50% increase in hauling cost per ton-mile reduces the range of optimum plant sizes to 2,000 to 5,000 MT per day (versus 2,000 to 8,000 MT per day for the 1x cost per ton-mile). At twice our estimated cost per ton-mile, the range of optimal plant sizes not only shrinks to a maximum of around 3,000 MT per day, but higher plant sizes actually see significant increases in the minimum ethanol selling price.

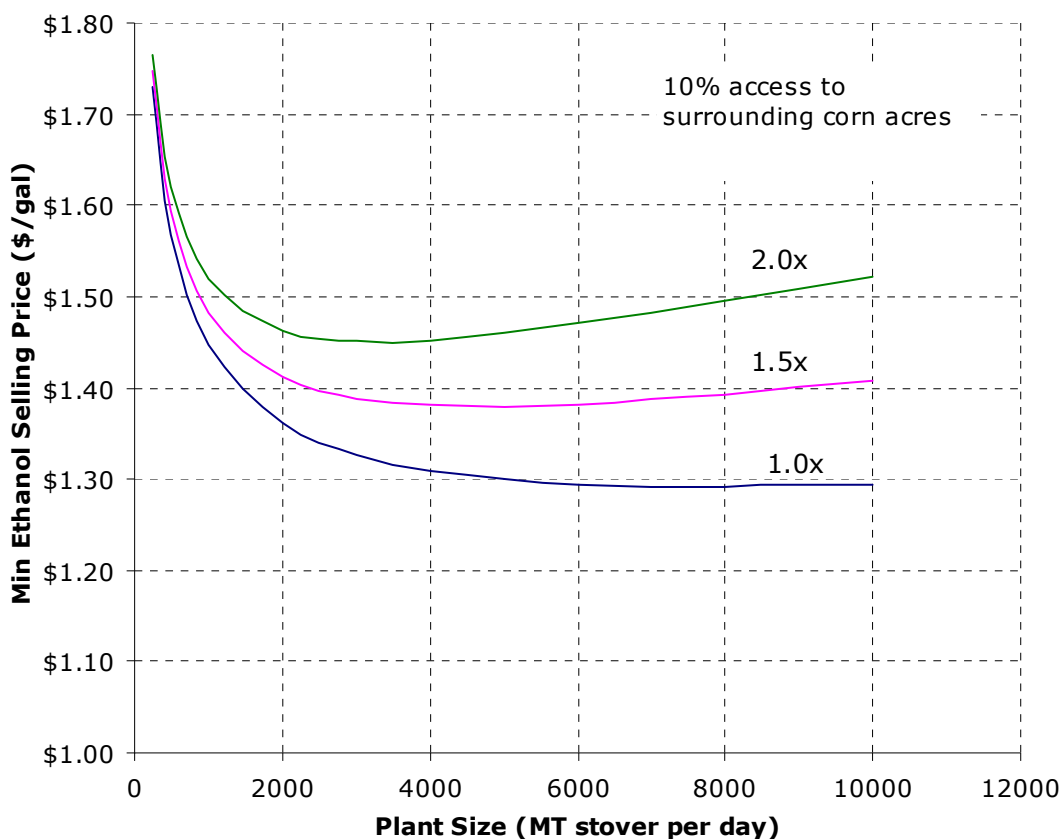

Figure 9. Ethanol Price as a Function of Plant Size and Hauling Cost (\$/ton-mile)

I.3.5 Selecting the Right Plant Size

The analysis presented here illustrates the need to understand and improve the technology and logistics of corn stover collection. Still, even when we consider a wide range of possible collection scenarios, we see that the minimum plant size of 2,000 MT per day holds reasonably well. Changes in assumptions about collection, however, can significantly impact the range of plant sizes over which it may be possible to realize cost savings. But the maximum plant size is unlikely to be above 8,000 MT per day. A more likely range for designs is 2,000 to 4,000 MT per day.

It bears repeating that the cost estimates for stover used in this plant size analysis do not correspond to the nominal feedstock costs assumed in the detailed process design and economics summarized in this report. For the purposes of the process design, we used a nominal cost of \$33 per MT (\$30 per ST); meaning that we implicitly assume that research going on at Oak Ridge National Lab and at USDA will lead to considerable cost reductions. The estimate of stover cost shown in this section is higher than previously reported stover costs, developed by Oak Ridge National Lab. ORNL has reported costs of \$38 to \$55 per MT of stover.¹¹ At a delivered cost of \$55 per MT, ORNL reports that almost all of the potential stover supply becomes available.

In addition, the perspective of our studies is that of “nth” plants using high-volume biomass sources. We assume that these plants are located in the best locations for access to these feedstocks. In the near term, many of the pioneer plants will rely on niche feedstocks, which are

often spread out over much larger distances. Such plants may indeed be much smaller in size than our base case design assumes.

I.4 Feedstock and its Composition

The feedstock chosen for the process design has a significant impact on the overall analysis. The type of feedstock used will have a large effect on the feedstock-handling portion of the process, and the composition will certainly have an impact on how much ethanol is produced.

The feedstock used for this analysis was corn stover; Table 1 shows the composition used. This composition is an average of the analyses of nine samples from two multi-ton batches of corn stover NREL received from Biomass AgriProducts (B/MAP) for use in lab and pilot studies¹². A feedstock analysis was converted to components that are used in the ASPEN model and normalized to 100%. In general, the component analysis of carbohydrates was used directly; other soluble compounds were combined under “extractives”. The unknown soluble solids component was used to normalize the composition to 100%; its heat of formation is calculated to balance the reported heating value of the feedstock with the calculated component heating values.

Table 1. Feedstock Composition¹²

| Component | % Dry Basis |
|--|--------------------|
| Glucan | 37.4 |
| Xylan | 21.1 |
| Lignin | 18.0 |
| Ash | 5.2 |
| Acetate* | 2.9 |
| Protein | 3.1 |
| Extractives | 4.7 |
| Arabinan | 2.9 |
| Galactan | 2.0 |
| Mannan | 1.6 |
| Unknown Soluble Solids** | 1.1 |
| Moisture | 15.0 |
| *Acetate represents the acetate groups present in the hemicellulose polymer. They are generally converted to acetic acid in the prehydrolysis reactor. | |
| **Unknown soluble solids are calculated by difference to close the mass balance. | |

Corn stover can vary in its composition and moisture content due to corn variety, region, weather, soil type, and harvesting and storage practices. NREL is working to bracket this variability and understand its effect on the process. Recent preliminary studies on corn variety¹³ and stover storage effects^{14,15} provide a larger range of data; the major constituents’ ranges are shown in Table 2.

Table 2. Measured Stover Composition Ranges

| Component | B/MAP batches¹² | Variety Studies¹³ | Storage Studies^{14,15} | |
|------------------|---------------------------------------|-------------------------------------|--|-------------|
| Glucan | 36.1-39.1 | 35.6-38.3 | 29-41 | 33.3 +/-2.8 |
| Xylan | 19.3-23.3 | 19.8-23.0 | 16-27.5 | 19.5 +/-2.8 |
| Lignin | 17.2-18.9 | Not reported | 14-30 | 21.1 +/-0.8 |

The mass balance data on corn stover presented here is preliminary and provides an estimate of its performance. We expect that as more research data on stover becomes available we will be able to make the process model more robust, tailoring its unique conversion reactions in the process to account for stover compositional effects.

II. Process Design and Cost Estimating

The following sections describe in detail the process design and cost estimation for a biomass-to-ethanol process based on core technology developed by NREL. Generally, the data used for design have been demonstrated in the laboratory or pilot plant. In some cases, we extrapolated current experimental results to take into account anticipated technology advances over the next 1 or 2 years of continued research (these extrapolations are noted in the text). More details of the design and cost estimation can be found in the NREL process engineering equipment database, which contains all engineering calculations and results from any vendors or costing programs. The database is described and partially summarized in Appendix A. Individual equipment information (costs, number of units, sparing) is listed in Appendix B. Process Flow Diagrams (PFDs) are contained in Appendix F.

The cost estimate is based on the assumption that this is the “nth” plant, meaning that several plants using this same technology will have already been built and are operating. This means that additional costs for risk financing, longer start-ups, and other costs associated with first-of-a-kind plants are not included.

The on-line time is 96%, which allows for a little more than two weeks of downtime. This was considered reasonable for an “nth” operating plant.

II.1 Feedstock Storage and Handling – Area 100 (PFD-P110-A101)

II.1.1 Overview

Corn stover bales are received by the plant on truck trailers. As the trucks are received, they are weighed and unloaded by forklifts. Some bales are sent to on-site storage while others are taken directly to the conveyors. From there, the bales are conveyed to an automatic unwrapping system that cuts away the plastic wrapping and/or net surrounding the bales. The unwrapped bales are conveyed to a wash table, which both breaks up bales and washes dirt and grit from the corn stover. The washed stover is then conveyed past a magnetic separator to remove tramp metal, after which it is introduced to primary and secondary shredders where the material is reduced in size. Finally, the washed and milled stover is conveyed to prehydrolysis. It is possible that washing and sizing requirements may be reduced as we learn how sensitive the process is to dirt and particle size for stover.

Dirty wash water is recycled and cleaned utilizing a clarifier-thickener system. The wash water is pumped to the clarifier where clean water is drawn off and recycled back to the wash tables. The underflow from the clarifier is then dewatered in a belt press. Because most of the wash water is recycled through this system, the fresh water requirement is low.

II.1.2 Design Basis

The as-received corn stover feed requirement for the plant is 98,039 kg/hr (216,178 lb/hr, 2,352 MT per day [2,594 ST per day]) feedstock at 15% moisture. The corn stover bales are wrapped with plastic net to ensure they don't break apart when handled, and may also be wrapped in plastic film to protect the bale from weather. The bales are either square or round, and the conceptual design applies equally to either shape. Square bales are typically 4 ft x 4 ft x 8 ft and weigh between 545 and 681 kg (1,200 and 1,500 lb). Round bales are approximately 70 inches in diameter, 5 ft long, and weigh around 545 kg (1,200 lb). The bales are received at the plant from off-site storage on large truck trailers.

Since corn stover is only harvested for a short period each year, long-term storage is required to provide feed to the plant year-round. Long-term storage will likely consist of 400-500 acres of uncovered piled rows of bales at a location (or multiple locations) reasonably close to the ethanol plant. On-site short-term storage is provided equivalent to 72 hours of production at an outside storage area. Bales and surrounding access ways as well as the transport conveyors will be on a concrete slab. A concrete slab is used because of the volume of traffic required to deliver the large amount of corn stover required. A concrete slab will minimize the amount of standing water in the storage area, as well as reduce the stover's exposure to dirt. The stored material provides a short-term supply for weekends, holidays, and when normal direct delivery of material into the process is interrupted. This stored material will be rotated continuously, with a first-in, first-out inventory management strategy.

In the projected design, trucks are received twelve hours daily, six days a week. After the trucks are weighed on the scales (M101) the bales are off-loaded by propane-fueled forklifts (M-102) and are placed directly onto two lines of bale transport conveyors (C-101) or in the short-term storage area. Bales are also reclaimed from short-term storage by forklifts (M-103) and loaded onto the bale transport conveyors. Each truck trailer holds 17 round bales, or 9.2 MT (10 ST), which is significantly below the weight limit for road considerations. To satisfy plant and storage requirements, the plant must receive 24 trucks every hour, with seven bales being unloaded every minute. Eight forklifts were deemed necessary to satisfy this schedule; four to unload trucks and four to draw bales from short-term storage. Each forklift is capable of operating with a 33-lb propane tank for an 8-hour shift. Individual propane canisters are refilled at bulk storage on-site. When trucks are not being unloaded, all eight forklifts are used to move feed from short-term storage.

The original stover handling design from Harris¹⁶ stated that each truck would hold 30 bales. However, the current stover harvesting operation in Harlan, Iowa, uses trailers that hold a maximum of 17 round bales⁹, and this is the number used by Oak Ridge National Laboratory in their feedstock logistics work. We feel that this information is the best currently available for baled stover transport. Thus, the Harris design was altered to accept 17 round bales per truck instead of the original 30 bales per truck.

Bales travel to one of two bale unwrapping stations (C-102), which are sized to handle 90 bales each per hour. Unwrapped bales are transported to wash tables (M-104). The wash tables break the bales with a spreader bar and pull the stover up a 45° incline using metal teeth attached to a drag chain. Water is sprayed on the corn stover as it is conveyed up the incline. This washes dirt and grit from the product and allows water to drain from the stover. Washing the stover prior to cutting or shredding minimizes the amount of moisture that is absorbed by the product.

The washed stover is then discharged onto a conveyor (C-104) and passes a magnetic separator (S-103) to remove tramp metal prior to shredding. The stover is introduced to a primary shredder and then a secondary shredder (M-105), which reduces the stover to the proper size for prehydrolysis. This size has not yet been optimized for prehydrolysis of corn stover; but the shredders were specified to produce material that is a maximum of 1.5 inches long. Each shredder is sized to process 25.2 MT (28 ST) of stover per hour. Without experience using this washing concept for corn stover, the estimated moisture content of the shredded stover is 30%-40%.

The wash table design was taken from the sugar cane processing industry where they wash the sugar cane prior to processing. A 24 ft wide cane table can typically handle up to 4,082 MT

(4,500 ST) per day of cane. Since stover is less dense than cane, 2,000 MT per day is a reasonable size for a 24 ft wide machine. Each table is capable of spraying approximately 568 m³/hr (2,500 gpm) of wash water; more water can be used by adding more or larger spray nozzles. The actual wash water requirement for stover has not been determined; 568 m³/hr was used in the design.

Dirty wash water is recycled through a clarifier-thickener (S-101, T-102) to remove solids with the help of a polymer. Underflow from the thickener is dewatered in a belt press (S-102). The dewatered underflow is primarily topsoil and corn stover fines. This is disposed of via land application to nearby fields. The amount of fresh water make-up will depend upon the belt-press efficiency and the absorption capacity of the stover. Because most of the water is recycled to a wash water tank (T-101) and back to the wash tables, fresh water consumption is approximately 43,000 kg/hr, or 4% of the total wash water. Approximately 1% of the wash water is expected to evaporate from the open wash system (11,400 kg/hr). The other 3% of the wash water consumed is mostly absorbed by the stover; a small portion of the water leaves with the topsoil and stover fines.

Most of the equipment specified has been used in commercial straw, corn stover, or sugar cane processing industries. The automatic unwrapping station is the only equipment that has not yet been commercially applied. Cross Wrap OY, Finland, has bale-wrapping systems for plastic film and has developed some de-baling technology, but this must be modified for stover bales wrapped with plastic net and film. Manual bale unwrapping is feasible but would be too labor intensive for an operation of this size.

Due to the bale handling, eight forklift operators each shift are envisioned to unload trucks and maintain the feedstock supply to the process.

II.1.3 Cost Estimation

Harris obtained vendor cost estimates for the forklifts, wash tables, shredders, clarifier-thickener, and belt press. Cross Wrap, OY, estimated the bale unwrapping equipment cost for an “nth” plant. Harris estimated the other equipment costs (pumps, conveyors, tank, concrete) based on their experience.

II.2 Pretreatment and Hydrolyzate Conditioning – Area 200 (PFD-P110-A201-3)

II.2.1 Overview

The pretreatment and hydrolyzate conditioning process area converts, by hydrolysis reactions, most of the hemicellulose portion of the feedstock to soluble sugars - primarily xylose, mannose, arabinose, and galactose. Glucan in the hemicellulose and a small portion of the cellulose are converted to glucose. This conversion is accomplished using dilute sulfuric acid and high temperature. These conditions also solubilize some of the lignin in the feedstock and “expose” the cellulose for subsequent enzymatic hydrolysis. In addition, acetic acid is liberated from the hemicellulose hydrolysis. Degradation products of pentose sugars (primarily furfural) and hexose sugars (primarily hydroxymethyl furfural (HMF)) are also formed.

Following the pretreatment reactor, the hydrolyzate liquid and solids are flash cooled, which vaporizes a large amount of water, a portion of the acetic acid, and much of the furfural and HMF (see Figure 10). Removing these heterocyclic aldehydes is beneficial, as they can be toxic to downstream fermentation microorganisms.

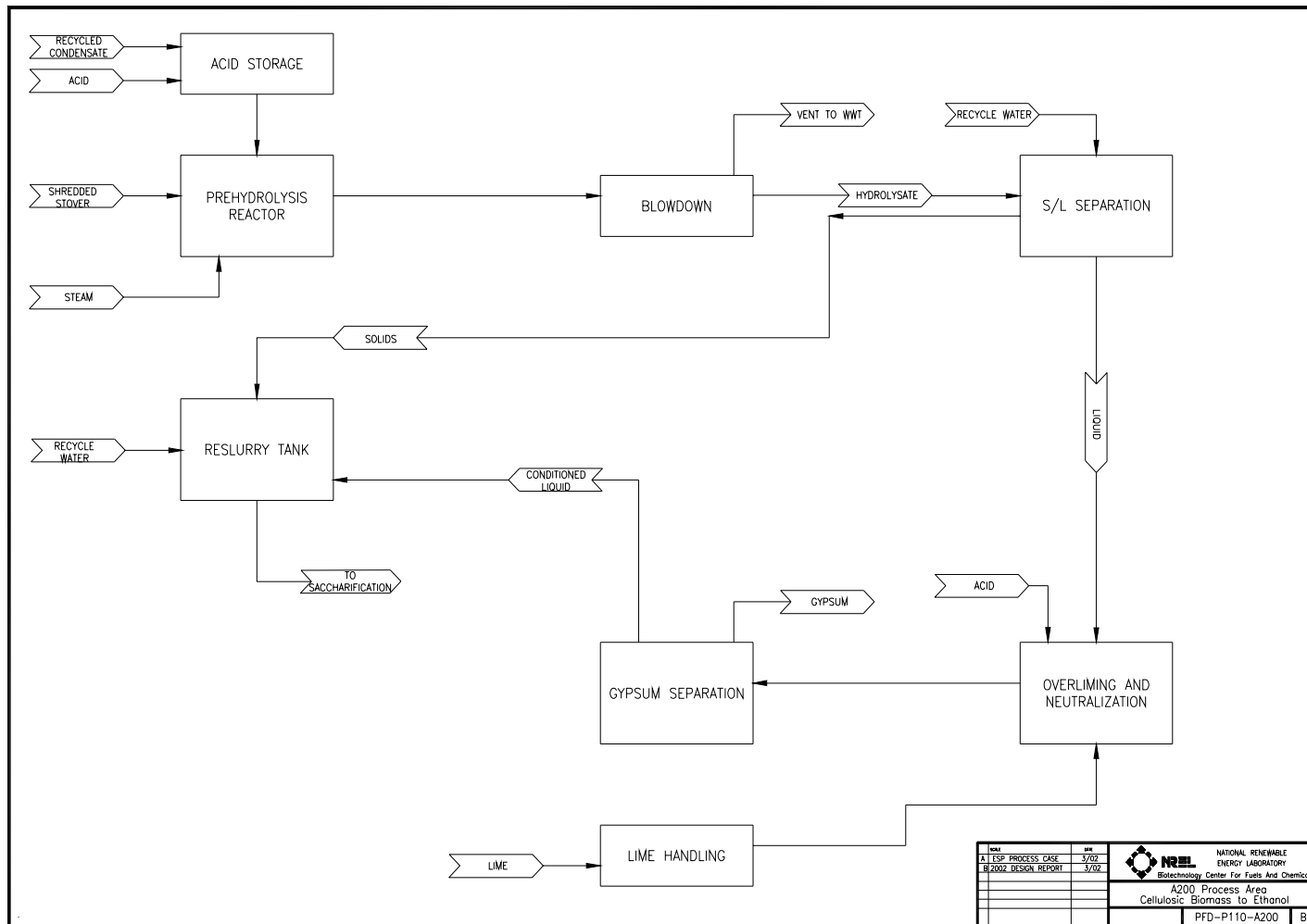

Figure 10. Pretreatment Process Area Overview, PFD-P110-A200

In addition to flash removal of aldehydes, the solids are washed and pressed to separate the liquid portion of the hydrolyzate, containing sulfuric acid, from the solids. The liquid is then “overlimed,” or raised to pH 10 (by adding lime) and held for a period of time. Neutralization and precipitation of gypsum follow the overliming step. The gypsum is filtered out and the hydrolyzate is mixed with the solids (cellulose) and dilution water before being sent to saccharification and co-fermentation (Area 300).

II.2.2 Design Basis

The washed, shredded corn stover is fed to pretreatment and first steamed with low-pressure steam in a presteamer to about 100°C (see PFD-P110-A201). This steam removes non-condensables that can take up space in the reactor and allows about one-third of the total prehydrolysis reaction heat requirement to be satisfied by low-pressure steam. The presteamer¹⁷ is fed by a set of screw conveyors with variable frequency drives to vary the feed rate as the process may dictate. The presteamer is a horizontal vessel with paddles on an interior center shaft to move the stover. The discharge from the presteamer is a variable-frequency screw conveyor leading to a blow tank. The blow tank is used as a seal between the presteamer and the reactor. The blow tank has a live bottom screw to feed the material to the reactor. Steam is injected into the screw to pressurize it on the way to the reactor. Anco-Eaglin, Inc. (Anco-Eaglin), the manufacturer, described the steam injection as a venturi-like arrangement. The steam acts as a motive force to pull the material into the reactor. A plug is formed in the screw, maintaining the pressure in the reactor. The reactor also has paddles on an interior center shaft to help move the material. The close-pitch flights in the discharge screw compact the material so that it acts as a seal coming out of the vessel.

The presteamer was designed for a maximum 20-minute residence time, which is used in pulping. The time could be shorter, depending on the particle size. The horizontal reactor vessel is designed to be 95% full with 10 minutes of residence time. Anco-Eaglin’s experience is that proper mixing and cooking can be achieved with this fill percentage. Because of the large vessel fill percentage, fewer vessels are required. The original Anco-Eaglin quote was for a 10-minute residence time; the reactor cost was adjusted for the shorter target residence time of 2 minutes. Three reactor trains (each including a presteamer, blow tank, reactor) are used. NREL and other pretreatment research groups are studying the operability of a continuous reactor at short residence times.

After the stover is steamed, acid is added to the reactor. Concentrated sulfuric acid is diluted with evaporator condensate (see Section II.5) until the mixture (the total water, including steam and acid) in the reactor is 1.1% sulfuric acid. The total stover mixture now constitutes 30% insoluble solids. The reactor is brought up to temperature by direct injection of 13 atm (191 psia) (192°C saturation temperature and 76°C superheat) turbine extraction steam. The pretreatment reactor (M-202) operates at 12.1 atm (177 psia) pressure and 190°C. Heat losses from the reactor were not accounted for in the energy balance calculations. Table 3 summarizes the conditions in the pretreatment reactor.

Table 3. Pretreatment Hydrolyzer Conditions

| | |
|-----------------------|---------------------|
| Acid Concentration | 1.1% |
| Residence Time | 2 minutes |
| Temperature | 190°C |
| Pressure | 12.1 atm (177 psia) |
| Solids in the Reactor | 30% |

Table 4 summarizes the resulting reactions and the conversions that take place in the pretreatment hydrolyzer. The conversion value is the fraction of reactant converted to product. The other hemicellulose carbohydrates (arabinan, mannan, galactan) are assumed to have the same reactions and conversions as xylan.

Table 4. Pretreatment Hydrolyzer Reactions and Conversions

| Reaction | Reactant | Fraction Converted to Product |
|--|----------|-------------------------------|
| $(\text{Glucan})_n + n \text{ H}_2\text{O} \rightarrow n \text{ Glucose}$ | Glucan | 0.07 |
| $(\text{Glucan})_n + m \text{ H}_2\text{O} \rightarrow m \text{ Glucose Oligomer}$ | Glucan | 0.007 |
| $(\text{Glucan})_n + \frac{1}{2}n \text{ H}_2\text{O} \rightarrow \frac{1}{2}n \text{ Cellobiose}$ | Glucan | 0.007 |
| $(\text{Xylan})_n + n \text{ H}_2\text{O} \rightarrow n \text{ Xylose}$ | Xylan | 0.90 |
| $(\text{Xylan})_n + m \text{ H}_2\text{O} \rightarrow m \text{ Xylose Oligomer}$ | Xylan | 0.025 |
| $(\text{Xylan})_n + \rightarrow n \text{ Furfural} + 2n \text{ H}_2\text{O}$ | Xylan | 0.05 |
| Acetate \rightarrow Acetic Acid | Acetate | 1.0 |
| $(\text{Lignin})_n \rightarrow n \text{ Soluble Lignin}$ | Lignin | 0.05 |
| Glucose and xylose oligomers are sugars bound in soluble oligomer form. | | |

The exiting material from the pretreatment reactor is flash cooled to 1 atm (14.7 psia) in T-203. The flash vapor is modeled with the Hayden and O'Connell¹⁸ equation of state to specifically model the vaporization of acetic acid. Acetic acid creates dimers in the vapor phase and this equation of state properly accounts for them. If the vapor phase dimerization of acetic acid is not accounted for, the loss of acetic acid in the vapor will be over estimated. In this flash, 7.8% of the acetic acid and 61% of the furfural and HMF are removed.

The flash vapor, about 53,000 kg/hr (117,000 lb/hr) of essentially 100°C steam, is used to preheat the beer column feed in H-201. During this exchange, the beer column feed is heated to 95°C and the entire flash vapor from T-203 is condensed. The condensed flash vapor is sent to wastewater treatment (Area 600).

After a residence time of 15 minutes in the flash tank, the hydrolyzate slurry with 21% insoluble solids is conveyed to a Pneumapress® pressure filter (S-205) to separate the solids and the liquids (see PFD-P110-202). The liquids are separated from the solids to facilitate conditioning of the liquid portion to reduce toxicity of the stream to downstream fermentation.

Harris considered different types of solid-liquid separation equipment¹⁹; two makes of decanter centrifuges and several types of filters (filter press, belt filter press, pressure filter). The Pneumapress, a pressure belt filter press, provided the best recovery of solids, and solubles with minimal wash water.

The Pneumapress pressure filter provides automated batch liquid-solid separation by forcing compressed air (125 psig) through the biomass slurry and filter media to displace liquid, maximizing the solid content of the cake on the filter. Very high cake solids levels and cake washing efficiencies are advantages to using this equipment. Bench scale testing¹⁹ has shown that dry cakes, near 55% insoluble solids with 99.5% insoluble solids recovery, are possible with this unit. Those tests also showed that 95%-96% cake washing efficiencies are possible in two wash cycles with a wash water to feed mass ratio of 0.58. The cycle times of this batch unit are

typically quite short (<10 minutes). The Pneumapress filter was also cost competitive with the other types of separation equipment.

The cyclic operation of the Pneumapress pressure filter system is as follows. Pretreated slurry is pumped from the blowdown tank into the hydrolyzate mixing tank (T-205) and mixed with recycled filtrate liquor (from tank T-213) to reduce the insoluble solids in the slurry to a pumpable level, having a suspended solids concentration that is capable of being fed to the Pneumapress, approximately 10%. That diluted slurry is pumped into the Pneumapress, building pressure in the Pneumapress and pushing filtrate through the filter. The filtrate flows to the wash filtrate tank (T-213). The cake is then washed with liquor that is pumped from the primary filtrate tank (T-211). Filtrate from that cycle also flows into the wash filtrate tank (T-213). Finally, the cake is washed with recycle water (stream 252) and air is blown through it to displace the liquor, which is primarily water. Filtrate from the final washing flows into the primary filtrate tank (T-211). The air is sent through a condenser to remove water and other condensables and then to the combustor as combustion air. Volatile organic compounds (VOC) in the air are combusted. Condensate is sent to wastewater treatment.

The final cake is conveyed off of the Pneumapress onto a transport conveyor and into the slurring tank (T-232) where it is mixed with conditioned hydrolyzate liquor and additional recycle water. Product liquor to be conditioned is pumped from both the primary filtrate tank and the wash filtrate tank to a heat exchanger (H-200) where it is cooled to 50°C using cooling water. The temperature of 50°C was chosen because the next unit operation, overliming, is run at that temperature. Liquor from the wash filtrate tank is also used to dilute the pretreated slurry.

The plant air compressor provides air at 9.5 atm (140 psia) to the Pneumapress filters.

After the separation step the material is overlimed (see PFD-P110-A203). Lime is added in tank T-209 to raise the pH to 10. The residence time in T-209 is one hour to allow for the overliming “reactions” to occur.²⁰ Based on the experience of Delta-T, the agitation for this application is assumed to be 98.5 W/m³ (0.5 hp/1000 gal). The liquid is then adjusted to the fermentation pH of 4.5 in tank T-224 and held for four hours. This long residence time allows the resulting gypsum crystals to form to a size that can be readily separated by hydrocyclone and rotary drum filtration in series.²¹ Agitation power for T-224 was set at 98.5 W/m³ (0.5 hp/1000 gal), again based on Delta-T’s experience. The filtration is assumed to remove 99.5% of the precipitated gypsum and the solids are assumed to contain 20% liquid.²² At 80% solids, gypsum can be handled as a dry solid. This approach was recommended by vendors and is typical of dewatering equipment used in the utility flue gas desulfurization industry to achieve high gypsum solids concentrations commercially.

After the gypsum is filtered, the conditioned hydrolyzate liquid is recombined with hydrolyzate solids (which were separated in S-205) in Tank T-232 (see PFD-P110-A202). The residence time in this tank is minimal (15 minutes) just long enough to afford good mixing. The agitation for this application is assumed to be 394 W/m³ (2 hp/1000 gal) based on the experience of Delta-T. The resulting slurry, now conditioned, pH-adjusted, and properly diluted, is pumped to fermentation (Area 300).

II.2.3 Cost Estimation

All pumps, tanks, screw conveyors, and agitators for this section were estimated using the ICARUS Process Evaluator.²³ The material of construction for all equipment except the pretreatment reactor (M-202), flash tank (T-203) and Pneumapress equipment is 304SS, based on

the experience of Delta-T. The material of construction of the flash tank is SS316 because additional acid resistance at temperatures higher than 100°C is necessary. Harris recommended mostly SS316 for the solid-liquid separation equipment in contact with the process.

Harris obtained quotes for the continuous pretreatment reactors from Anco-Eaglin, Inc. The construction materials were assumed to be Incoloy 825-clad steel for all parts in contact with acid, based on corrosion data generated by Intercorr of Houston via Harris¹⁷. This includes vessel paddles and shafts. Stainless steel (316L) was assumed for most other reactor parts including the presteamer. Anco-Eaglin felt the cost estimate provided reflected an nth plant cost because it was based on similarly designed equipment currently in service.

NREL engineers have developed a spreadsheet-based model to predict general corrosion rates in acid and temperature environments for various alloys, based on sets of corrosion data from various corrosion studies performed in the last several years.²⁴ While not rigorous, it can provide guidance when considering metallurgy for varying conditions. For solid Incoloy 825, the corrosion rate at the target pretreatment conditions is expected to be less than 20 mils per year (a mil is a thousandth of an inch), which is considered satisfactory resistance. Figure 11 shows the effect of temperature and acid concentration on corrosion rate for Incoloy 825. As either parameter increases, the corrosion resistance is reduced.

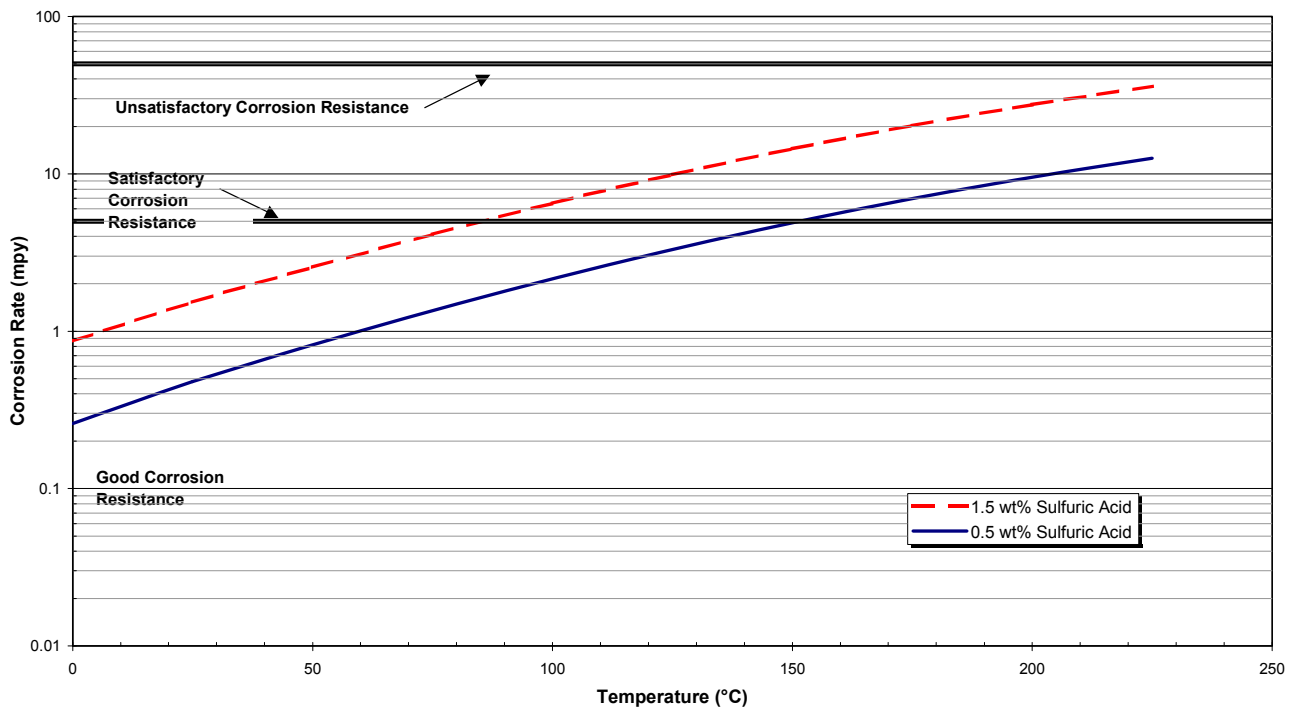

Figure 11. Corrosion Resistance of Incoloy 825

The cost estimate for the liquid solid separators S-205 and S-222 are based on vendor quotations from Pneumapress and Komline Sanderson respectively. Three Pneumapress units are required to accommodate the process flowrate.

II.2.4 Achieving the Design Case

Table 5 lists conditions that have produced good yields from NREL's 1 ton per day, continuous Sands vertical reactor and conditions that produced higher yields from the 4L steam gun.

Table 5. Experimental Pretreatment Hydrolyzer Conditions

| | Sunds Reactor ²⁵ | Steam Gun ²⁶ |
|-----------------------|-----------------------------|-------------------------|
| Acid Concentration | 1.16% | 1.1% |
| Residence Time | 6.2 minutes | 2 minutes |
| 125 Temperature | 179°C | 190°C |
| Pressure | 9.7 atm (142 psia) | 12.1 atm (177 psia) |
| Solids in the Reactor | 19% | 37 – 47% |

Table 6 summarizes the resulting reactions and the conversions for the experimental runs in each reactor. The measured values were taken from experiments conducted at the conditions in Table 5. For the Sands run, the total carbon recovery was approximately 105%, so about 5% more carbon was measured in the product streams than in the feed stream. This carbon recovery is slightly higher than previous experiments but is within a standard range of carbon mass balance closure of 90 to 105%. High or low carbon closure is typically caused by imprecision in the experimental and analytical methods, or the creation of degradation products that are not identified in the analysis.

Table 6. Experimental Pretreatment Hydrolyzer Reactions and Conversions

| Reaction | Reactant | Fraction Converted to Product | | |
|--|----------|-------------------------------|-------------------------|-------------|
| | | Sunds Reactor ²⁵ | Steam Gun ²⁶ | Design Case |
| $(\text{Glucan})_n + n \text{H}_2\text{O} \rightarrow n \text{Glucose}$ | Glucan | 0.0675 | 0.081 | 0.07 |
| $(\text{Glucan})_n + m \text{H}_2\text{O} \rightarrow m \text{Glucose Oligomer}$ | Glucan | 0.006 | 0.0 | 0.007 |
| $(\text{Glucan})_n + \frac{1}{2}n \text{H}_2\text{O} \rightarrow \frac{1}{2}n \text{Cellobiose}$ | Glucan | 0.008 | 0.0 | 0.007 |
| $(\text{Xylan})_n + n \text{H}_2\text{O} \rightarrow n \text{Xylose}$ | Xylan | 0.675 | 0.837 | 0.90 |
| $(\text{Xylan})_n + m \text{H}_2\text{O} \rightarrow m \text{Xylose Oligomer}$ | Xylan | 0.029 | 0.126 | 0.025 |
| $(\text{Xylan})_n + \quad \quad \quad \rightarrow n \text{Furfural} + 2n \text{H}_2\text{O}$ | Xylan | 0.159 | 0.03 | 0.05 |
| Acetate \rightarrow Acetic Acid | Acetate | 1.0 | 0.638 | 1.0 |
| $(\text{Lignin})_n \rightarrow n \text{Soluble Lignin}$ | Lignin | Not Reported | Not Reported | 0.05 |

Glucose and xylose oligomers are sugars bound in soluble oligomer form.

The design case conditions and conversions for the reactor are based on the experimental runs in the Sands and the 4L steam gun. Lignin solubilization and solids loading values are based on recent runs in the Sands pilot reactor²⁷. Conversion of the minor hemicellulose carbohydrates (arabinan, mannan and galactan) was assumed the same as xylan for the design case. Scale-up of these conditions to a continuous horizontal reactor is underway in addition to running these conditions in the vertical one dry ton per day Sands reactor. The xylose oligomers may be reduced via optimization of the pretreatment conditions, a hold tank, or hemicellulase activity in the enzyme preparation. The Anco-Eaglin reactor is a horizontal configuration with a throughput

of about 700 dry MT per day for one unit. Understanding how the reaction kinetics change with different reactor sizes and with configuration is important to know when the pretreatment has been scaled up adequately that accurate prediction is possible at larger scales. Data from these three reactors will be used to understand and predict conversion rates as a function of size and configuration in addition to process parameters like temperature. While Anco has not previously worked with corn stover, they are pursuing opportunities to do so.

The mechanism of detoxification by overliming is not completely understood. Overliming is a temperature and pH treatment designed to aid the conversion of hydrolyzate sugars to ethanol during fermentation²⁸. The procedure varies in the literature but always includes an adjustment of pH, a temperature increase, a hold at temperature for 15 to 30 minutes, and a hot filtration. Overliming was originally designed to limit the calcium concentration in solution to organism-tolerant levels. In many organisms calcium is involved in membrane transport, so minimum concentrations may be necessary for efficient sugar uptake.

Research is currently under way to determine if the overliming process is removing, adding, or changing the form of a component, or a combination of all of these.²⁹ We now know that controlling calcium concentrations is not the only advantage of overliming. Overliming also appears to catalyze condensation reactions in lignin-derived compounds. These reactions detoxify the hydrolyzate and the detoxification is more efficient at higher pH. Investigations into the specific functional groups involved in this detoxification are being performed under a NREL subcontract. We hope to use knowledge of the actual chemical reactions involved in lignin detoxification to guide selection of alternatives to overliming that do not require lime addition and gypsum removal. Enzyme systems that condense lignin or processes that remove very low molecular weight lignin are possible alternatives.

One of the biggest challenges in overliming at an industrial scale will be accurate pH control. By pH 11, as much as 30% of the glucose may be lost to HMF and other side reactions. Several factors increase the probability of overshooting pH endpoints during overliming. The natural buffering capacity of hydrolyzates causes neutralization reactions to be slow. Measurements using pH membrane probes are affected by temperature and the presence of dissolved organic compounds (sugars and lignin).

II.3 Saccharification and Co-Fermentation—Area 300 (PFD-P110-A301-2)

II.3.1 Overview

Two different operations are performed in this process area—saccharification of the cellulose to glucose using cellulase enzymes, and fermentation of the resulting glucose and other sugars (from the dilute acid pretreatment of hemicellulose, Area 200) to ethanol.

Hydrolysis, or saccharification, occurs first, separately from the fermentation. The separate saccharification step enables operation of the saccharification step at an elevated temperature to take advantage of increased enzyme activity and reduce the time and amount of enzyme required. The enzyme used to saccharify the cellulose is purchased from an enzyme manufacturer. The cellulase enzyme and diluted, detoxified hydrolyzate are continuously added to a train of five 1-million gallon vessels.

Cellulase enzyme is actually a collection of enzymes. This collection is comprised of: (1) endoglucanases, which attack randomly along the cellulose fiber to reduce polymer size rapidly; (2) exoglucanases, which attack the ends of cellulose fibers, allowing it to hydrolyze highly

crystalline cellulose; and (3) β -glucosidase, which hydrolyzes cellobiose to glucose. Several bacteria and fungi naturally produce these enzymes, including bacteria in ruminant and termite guts and white rot fungus.³⁰ The most common organism used to produce cellulase industrially is *Trichoderma reesei*. Genencor International and Novozymes Biotech, the two largest enzyme manufacturers in the world are developing more cost effective cellulase enzymes. DOE is funding this important work, which will improve the economic viability of biomass conversion.

For fermentation, the recombinant *Z. mobilis* bacterium³¹ is used as the biocatalyst. This form of *Z. mobilis* will ferment glucose and xylose to ethanol. It is assumed that mannose and galactose sugars are also fermented in this design. Several research institutions³² are genetically engineering strains, such as *Z. mobilis*, to utilize additional sugars, or are identifying naturally occurring organisms that metabolize hemicellulosic sugars.

The *Z. mobilis* must be “grown” in a seed fermentation train of vessels in this process area. Saccharified slurry and nutrients are combined with an initial seed inoculum (grown in the laboratory) in a very small vessel. The result of each seed batch is used as the inoculum for the next size seed increment. This series of scale-ups is continued until the last step is large enough to support the production fermentation.

Finally, the seed inoculum, nutrients, and saccharified slurry are added to a train of continuous fermentors. It is really a simultaneous saccharification and co-fermentation (SSCF) configuration at this point, because although the temperature in the fermentation tanks will be lower by necessity because of the ethanologen’s thermal tolerance, the enzyme will still continue to hydrolyze cellulose. The number of fermentors will be about five 1-million gallon vessels in a train or line. The resulting ethanol broth is collected in a beer well (storage tank) before it is pumped to distillation.

II.3.2 Design Basis

Detoxified and diluted hydrolyzate fed to the saccharification vessels is about 20% total solids³³ (soluble and insoluble solids) including the dilution that will occur when the cellulase stream is mixed in. The enzyme loading is determined by the amount of cellulose present in the hydrolyzate and the target hydrolysis conversion level with the combined residence time of the saccharification tanks and the fermentors. A heat exchanger (H-301) heats the 51°C hydrolyzate slurry exiting the re-acidification tank (T-224) to 65°C, the saccharification temperature, using low-pressure steam.

Saccharification takes place in five 950,000-gal vessels (see PFD-P110-A302). The total residence time is estimated at 36 hours. Because the cellulase enzyme is still being developed, the actual split of time between saccharification and fermentation (actually simultaneous saccharification and fermentation) is not known, but it is likely that some time in an SSF mode will be needed to reach 90% hydrolysis yields. The tanks are cooled using a pump-around loop that consists of a centrifugal pump (P-310) and heat exchanger (H-310). The heat exchanger is cooled with cooling water. For this design case, cellulase is fed at the rate of 12 international filter paper units (IFPU) per gram of cellulose assuming an enzyme concentration of 50 FPU/mL³⁴. Target conditions, developed with the enzyme manufacturers, take advantage of improved thermal tolerance to reduce the required time and loading; they are summarized in Table 7.

Table 7. Saccharification Conditions

| | |
|---------------------------------------|---|
| Temperature | 65°C |
| Initial Saccharification Solids Level | 20% total solids |
| Residence Time | 1.5 days |
| Size of Vessels | 3,596 m ³ (950,000 gal) each |
| Number of Vessels | 5 |
| Number of Continuous Trains | 1 |
| Cellulase Loading | 12 FPU/g cellulose |

Table 8 lists the reactions and conversions taking place in saccharification. The saccharified slurry contains 12.6% sugars including 7% glucose and 4% xylose. All of the cellulose hydrolysis is modeled to take place in the saccharification vessels until there is a better understanding of how much hydrolysis will occur at the fermentation conditions. The stream contains about 1% acetic acid and less than 0.5% of furfural and HMF combined, all of which can inhibit ethanologens at higher concentrations.

Table 8. Saccharification Reactions and Conversions

| Reaction | Reactant | Fraction Converted to Product |
|---|------------|-------------------------------|
| (Glucan) _n → n Glucose Oligomer | Glucan | 0.04 |
| (Glucan) _n + ½n H ₂ O → ½n Cellobiose | Glucan | 0.012 |
| (Glucan) _n + n H ₂ O → n Glucose | Glucan | 0.90 |
| Cellobiose + H ₂ O → 2 Glucose | Cellobiose | 1.0 |

Saccharified slurry is cooled (H-302) to 41°C and a portion is sent to the seed production area. The total amount of saccharified slurry split off to seed production is 10%. The required inoculum volume has been experimentally determined to be 10%,³⁵ both for the seed train and the production train. The seed train is operated in a batch mode (see PFD-P110-A301). The batch time for each step is 24 hr.³⁶ Delta-T Corporation decided two trains would be optimal using an assumed turn-around time for each seed fermenter of 12 hr. Using these conditions, Train A will complete its fifth stage of fermentation at 180 hours. Train B will then complete its final stage of fermentation 12 hours later. 24 hours after that, Train A is again complete and the cycle continues. Based on the production flow of about 8,700 m³/day (2.3 million gallons/day), the seed volume to be produced each day is 870 m³ (230,000 gal), or 435 m³ (115,000 gal) every 12 hr. Each batch must be 655 m³ (173,000 gal) to satisfy the 12-hr period that is skipped. If three trains were used, the maximum volume would be only 435 m³ (115,000 gal), but because there would be three trains it would be more costly. Considering a 90% working volume, the maximum size seed fermenter is 727 m³ (192,000 gal). Scaling down by a factor of 10 for each smaller stage results in four additional seed fermenters of 72.7, 7.6, 0.8, and 0.08 m³ (19,200, 2000, 200, and 20 gallons). Table 9 summarizes the seed train design specifications.

Table 9. Seed Train Specifications^{33,35,36}

| | |
|----------------------------------|----------------------------------|
| Inoculum Level | 10% of total |
| Batch Time | 24 hr |
| Fermenter Turn-Around Time | 12 hr |
| Number of Trains | 2 |
| Number of Fermenter Stages | 5 |
| Maximum Fermenter Volume (F-305) | 727 m ³ (173,000 gal) |
| Corn Steep Liquor (CSL) Level | 0.5% |
| Diammonium Phosphate (DAP) Level | 0.67 g/L fermentation broth |

The two largest seed fermenters are large tanks (F-304 and F-305) with internal cooling coils (H-304 and H-305) and agitators (A-304 and A-305) that are costed separately. The small fermenters are package units (agitator and jacket included). Well water at 13°C, supplemented with cooling water is used to maintain the fermenters at 41°C. The well water is then used as make-up water to the process. The coil size was calculated using a tank coil correlation from Kern³⁷. The agitators were sized based on Delta-T's experience with similar systems. The design numbers for agitation were 20 W/m³ (0.1 hp/1000 gal) for the largest fermenter (F-305) and 60 W/m³ (0.3 hp/1000 gal) for F-304. The three smaller seed fermenters (F-301-3) are designed as package-jacketed, agitated reactors. ICARUS²³ was used to estimate the agitation powers of 0.75 kW (1 hp) for F-301, 3.7 kW (5 hp) for F-302, and 18.6 kW (25 hp) for the F-303.

Table 10 gives the reactions and conversions used in the seed fermentations to describe the microorganism growth and sugar metabolism. Full mass balances have not been attempted for conditions that favor cell growth as they would in the seed train³⁸.

Table 10. Seed Train Reactions and Conversions

| Reaction | Reactant | Fraction Converted to Product ³⁸ |
|---|----------|---|
| Glucose → 2 Ethanol + 2 CO ₂ | Glucose | 0.90 |
| Glucose + CSL + 0.018 DAP → 6 <i>Z. mobilis</i> + 2.4 H ₂ O + 0.3 O ₂ | Glucose | 0.04 |
| Glucose + 2 H ₂ O → 2 Glycerol + O ₂ | Glucose | 0.004 |
| Glucose + 2 CO ₂ → 2 Succinic Acid + O ₂ | Glucose | 0.006 |
| Glucose → 3 Acetic Acid | Glucose | 0.015 |
| Glucose → 2 Lactic Acid | Glucose | 0.002 |
| 3 Xylose → 5 Ethanol + 5 CO ₂ | Xylose | 0.80 |
| Xylose + 0.835 CSL + 0.015 DAP → 5 <i>Z. mobilis</i> + 2 H ₂ O + 0.25 O ₂ | Xylose | 0.04 |
| 3 Xylose + 5 H ₂ O → 5 Glycerol + 2.5 O ₂ | Xylose | 0.003 |
| Xylose + H ₂ O → Xylitol + 9.5 O ₂ | Xylose | 0.046 |
| 3 Xylose + 5 CO ₂ → 5 Succinic Acid + 2.5 O ₂ | Xylose | 0.009 |
| 2 Xylose → 5 Acetic Acid | Xylose | 0.014 |
| 3 Xylose → 5 Lactic Acid | Xylose | 0.002 |
| Corn steep liquor (CSL) and Diammonium Phosphate (DAP) are both nitrogen sources required for <i>Z. mobilis</i> growth. The usage rates for these nutrients are the same as used in laboratory fermentations; however the stoichiometry used to model the reactions has not been experimentally verified. | | |

Two high-capacity transfer pumps are used (P-302) to transfer the seed to the seed hold tank (T-301) in a timely fashion (approximately 2.5 hr). Two pumps are required because this is the largest rotary lobe pump available from Waukesha Pump Company. A rotary lobe pump is used to avoid damaging the microorganisms by pump shear.

The seed hold tank (T-301) is sized to hold 20% more than the fifth seed reactor (F-305). A rotary lobe pump (P-301) is then used to continuously feed the seed to the production fermentation train.

Co-fermentation is conducted in 950,000-gal vessels (see PFD-P110-A302). The total residence time is estimated at 36 hours for the sugar fermentation. It is expected that saccharification will continue in the fermentors, slowed by the lower temperature, but perhaps enhanced by the removal of glucose. This SSCF aspect is not modeled. In all, five vessels are required for this residence time and are arranged in a continuous train. Table 11 summarizes the conditions in the fermentation vessels.

Table 11. Co-Fermentation Conditions

| | |
|-----------------------------------|---|
| Organism | <i>Zymomonas mobilis</i> strain |
| Temperature | 41°C |
| Initial Fermentation Solids Level | 20% total solids |
| Residence Time | 1.5 days |
| Size of Vessels | 3,596 m ³ (950,000 gal) each |
| Number of Vessels | 5 |
| Number of Continuous Trains | 1 |
| Inoculum Level | 10% |
| Corn Steep Liquor (CSL) Level | 0.25% |
| Diammonium Phosphate (DAP) Level | 0.33 g/L fermentation broth |

Inoculum from the seed train at a ratio of 1/10th of the hydrolyzate is fed along with corn steep liquor, added as a nutrient at a rate of 0.25%³⁹, and Diammonium Phosphate (DAP), added as a nutrient at a rate of 0.33 g/L⁴⁰. Table 12 lists the reactions and conversions in fermentation. Fermentation of the other hemicellulosic sugars (arabinose, mannose, and galactose) is assumed to have the same reactions and conversions as xylose.

Table 12. Co-Fermentation Reactions and Conversions

| Reaction | | Reactant | Fraction Converted to Product |
|---|---|----------|-------------------------------|
| Glucose | → 2 Ethanol + 2 CO ₂ | Glucose | 0.95 |
| Glucose + CSL + 0.018 DAP | → 6 <i>Z. mobilis</i> + 2.4 H ₂ O + 0.3 O ₂ | Glucose | 0.02 |
| Glucose + 2 H ₂ O | → 2 Glycerol + O ₂ | Glucose | 0.004 |
| Glucose + 2 CO ₂ | → 2 Succinic Acid + O ₂ | Glucose | 0.006 |
| Glucose | → 3 Acetic Acid | Glucose | 0.015 |
| Glucose | → 2 Lactic Acid | Glucose | 0.002 |
| 3 Xylose | → 5 Ethanol + 5 CO ₂ | Xylose | 0.85 |
| Xylose + 0.835 CSL + 0.015 DAP | → 5 <i>Z. mobilis</i> + 2 H ₂ O + 0.25 O ₂ | Xylose | 0.019 |
| 3 Xylose + 5 H ₂ O | → 5 Glycerol + 2.5 O ₂ | Xylose | 0.003 |
| Xylose + H ₂ O | → Xylitol + 0.5 O ₂ | Xylose | 0.046 |
| 3 Xylose + 5 CO ₂ | → 5 Succinic Acid + 2.5 O ₂ | Xylose | 0.009 |
| 2 Xylose | → 5 Acetic Acid | Xylose | 0.014 |
| 3 Xylose | → 5 Lactic Acid | Xylose | 0.002 |
| Corn steep liquor (CSL) and Diammonium Phosphate (DAP) are both nitrogen sources required for <i>Z. mobilis</i> growth. The usage rates for these nutrients are the same as used in laboratory fermentations; however the stoichiometry used to model the reactions has not been experimentally verified. | | | |

In addition to fermenting sugars to ethanol, sugars are converted to other products because of the presence of contaminating organisms. A total of 3% of the sugars available for fermentation are assumed lost to contamination.⁴¹ This is modeled as a side stream (bypassing fermentation) where sugars are reacted to form lactic acid. This allows the model to simply assign a percent

loss to contamination and the conversions in the fermentor model do not have to be adjusted. Table 13 shows the only contamination reactions.

Table 13. Co-Fermentation Contamination Loss Reactions ⁴¹

| Reaction | Reactant | Fraction Converted to Product |
|-----------------------------|-----------|-------------------------------|
| Glucose → 2 Lactic Acid | Glucose | 1.0 |
| 3 Xylose → 5 Lactic Acid | Xylose | 1.0 |
| 3 Arabinose → 5 Lactic Acid | Arabinose | 1.0 |
| Galactose → 2 Lactic Acid | Galactose | 1.0 |
| Mannose → 2 Lactic Acid | Mannose | 1.0 |

The fermenters are cooled using a pump-around loop that consists of a centrifugal pump P-300 and heat exchanger, H-300. The heat exchanger is generally cooled with well water at 13°C. When the well water is not sufficient for complete cooling, it is supplemented by cooling water. At the end of the fermentation train, a beer well (T-306) collects the fermented beer and scrubber bottoms. With a residence time of four hours (recommended by Vogelbusch⁴²), this tank allows for some surge capacity between fermentation and distillation. The effective ethanol concentration in the fermentation train is 5.7%; a minor amount of this is entrained in the CO₂ vent stream.

II.3.3 Cost Estimation

In general, the material of construction for all equipment in this section is 304SS, which is the most cost-effective material for the fermentation service.

We estimated all centrifugal pumps for this section using the ICARUS²³ cost estimation software. Costs of the rotary lobe pumps (P-301 and P-302) were obtained as verbal quotations from Waukesha Pump Company.

The cost for the major agitators, those for the larger fermenters (A-300, A-310) and other large applications (A-301, A-305), were based on vendor (Lightnin Corp.) quotes that Delta-T had obtained for a different project. The large agitators are side-mounted. This minimizes additional structural steel required for top-mounted agitator supports. These quotes were scaled using a scaling exponent from Garrett⁶ to fit the size required here. We used ICARUS to estimate the smaller agitators (A-304, A-306).

We obtained a quotation from Chattanooga Boiler and Tank Co. for the larger vessels (saccharification tanks, fermenters and seed hold tank (T-310, F-300, F-305, and T-301)). The smaller seed fermenters (F-301, F-302, and F-303) were estimated with ICARUS as jacketed, agitated packaged units. The other, medium-size tanks (F-304, T-306) were estimated with ICARUS as stand-alone tanks.

Several plate and frame heat exchangers in this area (H-300, H-301, and H-302) were costed by Delta-T from previous jobs. In the case of H-300, the cost from ICARUS was exactly the same as Delta-T's number and is used here. The seed fermenter coil coolers (H-304 and H-305) were costed with ICARUS.

II.3.4 Achieving the Design Case

Table 14 summarizes the experimental and design case conditions for the saccharification area. The research to date has been with SSCF at lab scale to test enzyme activity, since the optimized enzymes are not yet available.

Table 14. Experimental Saccharification Conditions

| | Experimental ⁴³ | Design Case |
|---------------------------------------|----------------------------|--|
| Mode | SSF | Saccharification |
| Temperature | 32°C | 65°C |
| Initial Saccharification Solids Level | 6% cellulose | 22% total solids |
| Residence Time | 7 days | 1.5 days |
| Size of Vessels | Shake flask | 3596 m ³ (950,000 gal) each |
| Number of Vessels | N/A | 5 |
| Number of Continuous Trains | N/A | 1 |
| Cellulase Loading | 15 FPU/g cellulose | 12 FPU/g cellulose |

Table 15 shows the reactions and experimental saccharification conversions for corn stover as measured using NREL's SSF experimental protocols. These conversions are used in the design case. The 90% cellulose to glucose yield has been achieved at 15 FPU/g cellulose in an SSCF mode and is considered achievable at a lower enzyme loading of an optimized enzyme. A separate saccharification step will allow better use of temperature to optimize enzyme performance.

Table 15. Experimental Saccharification Reactions and Conversions

| Reaction | Reactant | Fraction Converted to Product | |
|--|------------|-------------------------------|-------------|
| | | Experimental ⁴³ | Design Case |
| $(\text{Glucan})_n \rightarrow n \text{ Glucose Oligomer}$ | Glucan | 0.04 | 0.04 |
| $(\text{Glucan})_n + \frac{1}{2}n \text{ H}_2\text{O} \rightarrow \frac{1}{2}n \text{ Cellobiose}$ | Glucan | 0.012 | 0.012 |
| $(\text{Glucan})_n + n \text{ H}_2\text{O} \rightarrow n \text{ Glucose}$ | Glucan | 0.90 | 0.90 |
| $\text{Cellobiose} + \text{H}_2\text{O} \rightarrow 2 \text{ Glucose}$ | Cellobiose | 1.0 | 1.0 |

The seed train in NREL's pilot plant is similar to that outlined in the design, and has been run successfully to grow yeast for several campaigns, each lasting several weeks.

Table 16 summarizes the experimental and design case conditions for co-fermentation. The experimental conditions are from a yellow poplar run. This fermentation is reported because no fully mass-balanced fermentations using pretreated corn stover have been run to date.

Table 16. Experimental Co-Fermentation Conditions

| | Experimental ⁴⁴ | Design Case |
|-----------------------------------|--------------------------------------|--|
| Mode | SSCF | Co-fermentation |
| Organism | <i>Zymomonas mobilis</i> 39676-pZB4L | <i>Zymomonas mobilis</i> strain |
| Temperature | 32°C | 41°C |
| Initial Fermentation Solids Level | 12.6% | 20% |
| Residence Time | 7 days | 1.5 days |
| Size of Vessels | ~800 mL working volume fermenters | 3596 m ³ (950,000 gal) each |
| Number of Vessels | N/A | 5 |
| Number of Continuous Trains | N/A | 1 |
| Inoculum Level | 0.5 OD ~ 10% | 10% |
| Corn Steep Liquor (CSL) Level | 0.25% (clarified) | 0.25% |
| Diammonium Phosphate (DAP) Level | 0.33 g/L fermentation broth | 0.33 g/L fermentation broth |

Table 17 shows experimentally measured fermentation yields for glucose and xylose from the yellow poplar run⁴⁴ and the design case conversions. The conversions of sugars to other products resulting from *Z. mobilis* metabolism are also listed.

Table 17. Experimental Co-Fermentation Reactions and Conversions

| Reaction | Reactant | Fraction Converted to Product | |
|---|----------|-------------------------------|-------------|
| | | Experimental ⁴⁴ | Design Case |
| Glucose → 2 Ethanol + 2 CO ₂ | Glucose | 0.95 | 0.95 |
| Glucose + CSL + 0.018 DAP → 6 <i>Z. mobilis</i> + 2.4 H ₂ O + 0.3 O ₂ | Glucose | 0.02 | 0.02 |
| Glucose + 2 H ₂ O → 2 Glycerol + O ₂ | Glucose | 0.004 | 0.004 |
| Glucose + 2 CO ₂ → 2 Succinic Acid + O ₂ | Glucose | Not measured | 0.006 |
| Glucose → 3 Acetic Acid | Glucose | 0.015 | 0.015 |
| Glucose → 2 Lactic Acid | Glucose | 0.002 | 0.002 |
| 3 Xylose → 5 Ethanol + 5 CO ₂ | Xylose | 0.902 | 0.85 |
| Xylose + 0.835 CSL + 0.015 DAP → 5 <i>Z. mobilis</i> + 2 H ₂ O + 0.25 O ₂ | Xylose | 0.019 | 0.019 |
| 3 Xylose + 5 H ₂ O → 5 Glycerol + 2.5 O ₂ | Xylose | 0.003 | 0.003 |
| Xylose + H ₂ O → Xylitol + 0.5 O ₂ | Xylose | 0.046 | 0.046 |
| 3 Xylose + 5 CO ₂ → 5 Succinic Acid + 2.5 O ₂ | Xylose | Not measured | 0.009 |
| 2 Xylose → 5 Acetic Acid | Xylose | 0.014 | 0.014 |
| 3 Xylose → 5 Lactic Acid | Xylose | 0.002 | 0.002 |
| Corn steep liquor (CSL) and Diammonium Phosphate (DAP) are both nitrogen sources required for <i>Z. mobilis</i> growth. The usage rates for these nutrients are the same as used in laboratory fermentations; however the stoichiometry used to model the reactions has not been experimentally verified. | | | |

High glucose and xylose to ethanol yields been achieved on yellow poplar feedstock using *Z. mobilis* in the laboratory. However, an engineered organism may not achieve a xylose to ethanol yield that high in a less controlled fermentation, so the conversion was lowered slightly in the model. Organism development is a crucial activity in enabling fermentation of not only xylose at

high levels, but also the other sugars including the minor hemicellulose sugars: arabinose, mannose and galactose. Tolerance to compounds in the hydrolyzate, particularly acetic acid, may also be a key activity in strain development.

II.4 Cellulase Enzyme

Area 400, which was used for enzyme production in the 1999 hardwood design¹, has been removed. Enzyme will instead be purchased at an estimated cost of \$0.10 per gallon of ethanol. It will be produced on-site through licensing agreements with enzyme suppliers. This cost was developed from our current collaborations with enzyme manufacturers to develop commercially available enzyme preparations for lignocellulosic biomass. This equates to \$0.17 per gallon of cellulose-derived ethanol. If the xylose to ethanol yield is improved, the overall cost of enzyme decreases, but the cost per gallon of cellulose-derived ethanol stays constant. If the cellulose to ethanol yield is improved, both values will change.

II.5 Product, Solids, and Water Recovery (Distillation, Dehydration, Evaporation, and Solid-Liquid Separation) – Area 500 (PFD-P110-A501-5)

II.5.1 Overview

Distillation and molecular sieve adsorption are used to recover ethanol from the raw fermentation beer and produce 99.5% ethanol. Distillation is accomplished in two columns—the first, called the beer column, removes the dissolved CO₂ and most of the water, and the second concentrates the ethanol to a near azeotropic composition (see Figure 12).

All the water from the nearly azeotropic mixture is removed by vapor phase molecular sieve adsorption. Regeneration of the adsorption columns requires that an ethanol water mixture be recycled to distillation for recovery.

Fermentation vents (containing mostly CO₂, but also some ethanol) as well as the beer column vent are scrubbed in a water scrubber, recovering nearly all of the ethanol. The scrubber effluent is fed to the first distillation column along with the fermentation beer.

The bottoms from the first distillation contain all the unconverted insoluble and dissolved solids. The insoluble solids are dewatered by a Pneumapress pressure filter and sent to the combustor (Area 800). The liquid from the pressure filter that is not recycled is concentrated in a multiple effect evaporator using waste heat from the distillation. The concentrated syrup from the evaporator is mixed with the solids being sent to the combustor, and the evaporated condensate is used as relatively clean recycle water to the process.

Because the amount of stillage water that can be recycled is limited, an evaporator is included in the process. The total amount of the water from the pressure filter that is directly recycled is set at 25%. Organic salts like ammonium acetate or lactate, corn steep liquor components not utilized by the organism, or inorganic compounds in the biomass end up in this stream. Recycling too much of this material can result in levels of ionic strength and osmotic pressures that can be detrimental to the fermenting organism's efficiency. In a typical grain-to-ethanol facility, this recycle can be limited to as little as 10% of the centrifuge filtrate stream to minimize this effect. For the water that is not recycled, the evaporator concentrates the dissolved solids into a syrup that can be sent to the combustor, minimizing the load to wastewater treatment.

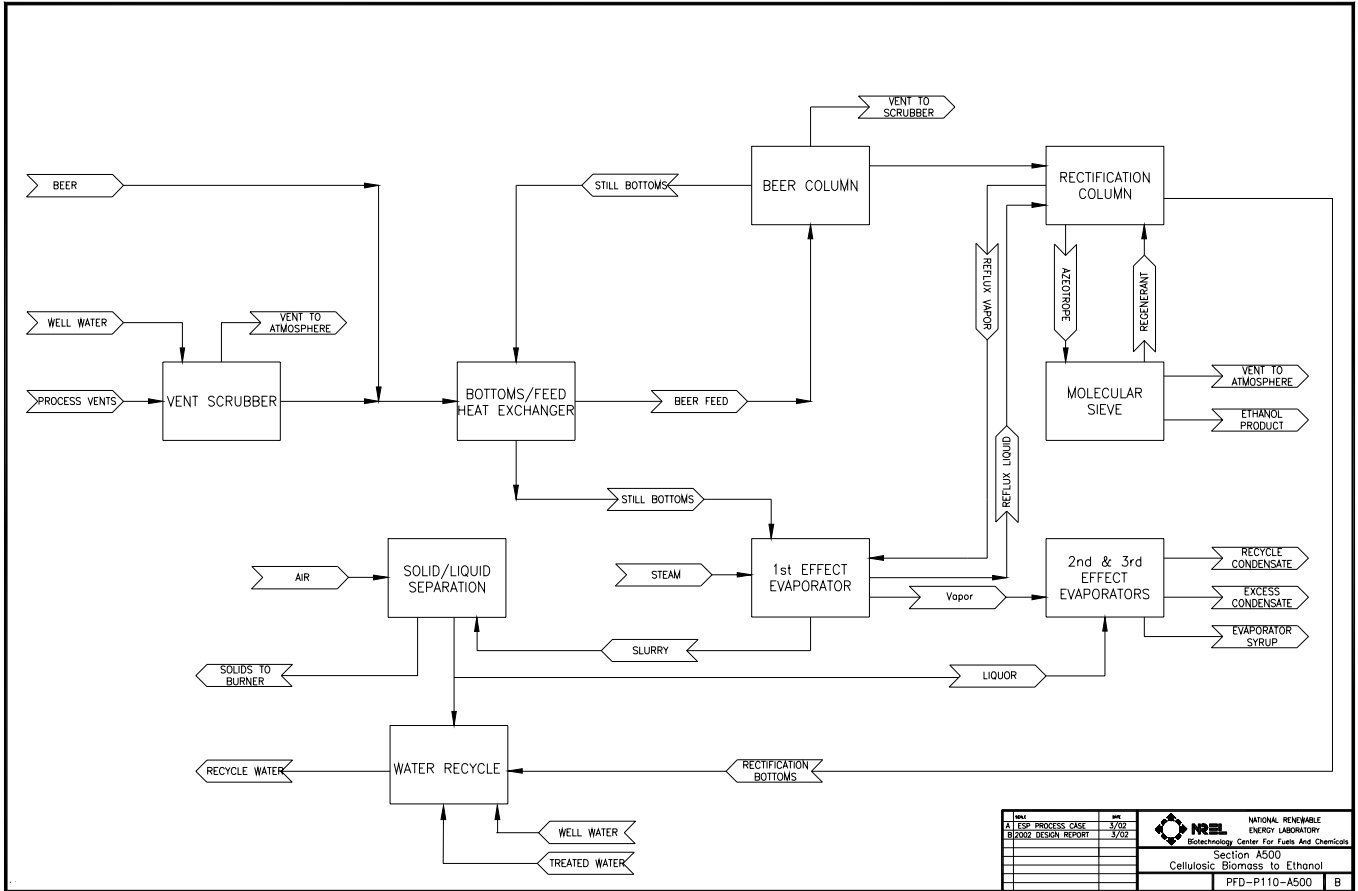

Figure 12. Distillation System Overview, PFD-P110-A500

II.5.2 Design Basis

Beer from the fermentation area is first preheated with flash vapor from the pretreatment reactor (H-201). This feed to the beer column (PFD-P110-A501) is then further heated by heat exchange with the bottoms from the beer column in H-512. The beer column (D-501) operates in a mode to remove the CO₂ and as little ethanol as possible overhead, while removing about 90% of the water to the bottoms. The ethanol is removed as a vapor side draw from the column and fed directly to the rectification column (D-502).

This separation (D-501) is accomplished with 32 actual trays at 48% efficiency with the feed entering on the fourth tray from the top. Nutter V-grid trays are used for this purpose. These trays have been found to tolerate the solids well and have a relatively good efficiency. Both columns (D-501 and D-502) are operated below 2 atm (30 psia) overhead pressure. This relatively low pressure keeps the reboiler temperature down and minimizes fouling. The tray spacing is 0.61 m (24 in.) and the column diameter is 4.37 m (14.3 ft). The reflux ratio required is 3:1. The overheads are vented to the scrubber and contain 83.7% CO₂, 12% ethanol, and 4% water. All the CO₂ and only 0.2% of the ethanol are vented here. Most of the ethanol vented (99%) will be recovered and recycled via the vent scrubber. In addition, about 0.7% of the ethanol fed is lost in the bottoms stream. Over 99% of the ethanol fed is removed as a 39.4% w/w mixture with water vapor side draw from the column at actual tray 8. Heat is supplied to a forced recirculation reboiler (H-501) by low-pressure (4.4 atm [65 psia]) steam. A forced circulation reboiler is used in an effort to accommodate the solids present in the bottoms. A spare reboiler, suggested by Vogelbusch⁴² to allow for cleaning due to the high-fouling service, is included in the design.

The vapor side draw from D-501 is fed directly to D-502, the rectification column (PFD-P100-A502). This column uses 60 Nutter V-Grid trays at a slightly higher efficiency of 57%. The D-501 vapor is fed on Tray 44 (from the top) and the recycle from adsorption, which is higher in ethanol (72% w/w versus 40% w/w), is fed on Tray 19 (from the top). The column above Tray 44 is 3.5 m (11.5 ft) in diameter; below Tray 44 it is 1.2 m (4 ft) in diameter. The required reflux ratio is 3.2:1 to obtain a vapor overhead mixture of 92.5% w/w ethanol and a bottoms composition of 0.05% w/w ethanol. Only 0.1% of the ethanol from fermentation is lost in the bottoms. The composition of 7.5% water in the feed to the adsorption column represents only 0.7% of the water originally entering distillation. Reflux for this distillation is supplied by interchange with the evaporator (E-501). An ancillary condenser (H-505) is supplied for start-up. Heat is supplied to the column in a thermosyphon reboiler (H-502) with low-pressure (4.4 atm [65 psia]) steam.

As mentioned in Section II.5.1, all ethanol-containing vents are collected and sent through a water scrubber (T-512). This is a packed column using Jaeger Tri-Pack plastic packing, and it recovers 99.5% of the ethanol with four theoretical stages and 7.6 m (25 ft) of packing. A flow rate of about 0.60 m³/min (158 gpm) of well water is used. The resulting effluent is 1.3% w/w ethanol and is sent to the beer well for feeding to D-501. The design basis is >98% ethanol adsorption in the vents and venting no more than 36.3 MT (40 ST) per year of VOC for air pollution considerations, specifically New Source Performance Standards criteria.

Overhead vapor from D-502 is fed to the Delta-T molecular sieve adsorption unit (M-503). The specifics of the design of this unit are proprietary to Delta-T, but the general arrangement is given on PFD-P110-A503. Saturated vapor from the distillation is first superheated and fed to one of two adsorption columns. The adsorption column removes 95% of the water and a small portion of ethanol. The 99.5% pure ethanol vapor is cooled by heat exchange against regenerate condensate and finally condensed and pumped to storage. While one bed is adsorbing water, the

other is regenerating. Passing a very small slipstream of pure ethanol vapor back through the loaded bed while a vacuum is applied carries out regeneration. The water is stripped off the adsorbent, and the mixture is condensed and returned to the rectification column (D-502).

Finally, the beer column (D-501) bottoms are sent to the first effect evaporator (E-501, PFD-P110-A504). This effect is heated by both condensing the reflux vapor to the rectification column (D-502) and by adding very low-pressure steam (1.7 atm [25 psia]). This dual heating is accomplished using a split tubesheet evaporator that prevents the steam from mixing with the reflux. About 24% (35% of the total evaporation) of the water entering this first effect is evaporated. In addition, the slurry is cooled from 117°C to 87°C, which is a more suitable temperature for liquid-solid separation. The slurry is sent to the Pneumapress (S-505, PFD-P110-A505) and the filtrate is returned to the second evaporator effect (E-502). No washing is used in this application of the Pneumapress; otherwise its operation is as described in Section II.2.2. In the second effect, 44% (33% of the total evaporation) of the water entering is evaporated. A third stage of evaporation (E-502) is used to evaporate 76% of the remaining water (32% of the total water evaporated). The final vapor is condensed in H-517. Of the total feed to the evaporator/separation system, 10.5% remains as syrup, 11.5% is removed as a wet cake in the pressure filter, 17% is recycled back to the process as recycle water, and 61% is evaporated. The final syrup (evaporator bottoms) is 60% water. Delta-T estimates that 60% water is the maximum dissolved solids level that can be achieved without rapid fouling of the evaporator, so the flow of very low-pressure steam to the evaporator is set to achieve this level. This syrup is mixed with the solids from the Pneumapress and sent to the combustor for disposal. Air from the Pneumapress is sent to the combustor as combustion air. The pressure of the third effect is set by the need to easily condense the evaporator vapor with cooling water at 0.21 atm (3 psia) or 64°C. The system uses high circulation pumps to minimize fouling on the heat transfer surfaces caused by solids adhering to or plating out on the hot surfaces. The pressures of the first and second effects were adjusted to make all five evaporators the same size: two units each are used for the first and third effects and one unit for the second effect.

The clean-in-place system services the equipment that handles stillage (beer column bottoms) by flushing with a hot caustic solution and recirculating the solution until heat transfer surfaces are clean. Manual acid cleaning, which must be performed occasionally, removes mineral scales. The frequency for this cleaning depends on the operating conditions.

Appendix I contains a discussion of the physical property model and parameters used for distillation.

II.5.3 Cost Estimation

The material of construction for equipment in the distillation area is generally 304SS. We used a correlation from Aersten and Street⁴⁵ to size the thermosyphon reboiler. The pumps, reflux drums, and the thermosyphon reboiler (H-502) were costed using ICARUS²³. Delta-T used information and experience gained in other projects to cost the rest of the equipment. The cost of the first evaporator effect (E-501) was increased by 25% to account for the complexity of two vapor feeds. Delta-T provided the quote for the molecular sieve package since they are a vendor of that equipment. Pneumapress Filter Corporation provided quotes for the pressure filters via Harris.

II.6 Wastewater Treatment (WWT) – Area 600 (PFD-P110-A601-2)

II.6.1 Overview

The wastewater treatment section treats process water for reuse to reduce the plant makeup water requirement. Figure 13 is a simplified flow diagram of the WWT design chosen. It shows that the plant wastewater (condensed pretreatment flash vapor, condensate from the hydrolyzate Pneumapress vent, boiler blowdown, cooling tower blowdown, CIP waste, and the non-recycled evaporator condensate) is initially screened to remove large particles, which are collected in a hopper and sent to a landfill. Screening is followed by anaerobic digestion and aerobic digestion to digest organic matter in the stream. Anaerobic digestion produces a biogas stream that is rich in methane so it is fed to the combustor. Aerobic digestion produces a relatively clean water stream for reuse in the process as well as a sludge that is primarily composed of cell mass. The sludge is also burned in the combustor.

In 1998, the wastewater treatment section was thoroughly studied by Merrick Engineering². They investigated all of the process wastewaters, selected the design, and estimated costs for this section. During their investigation of process streams, Merrick developed a map showing all the streams entering WWT and used that map for guidance in selecting the best treatment method for each. Merrick recommended an integrated evaporation and water recycle design that was implemented by NREL and Delta-T engineers into the process design (see Area 500). That improvement cut the loading to WWT dramatically. After reviewing the flow rates and waste strength of the remaining wastewater streams, Merrick recommended the screening / anaerobic digestion / aerobic digestion scheme for all of them. That waste treatment scheme is standard within the current ethanol industry and facilities in the 1-5 million gallons (4-19 million liters) per day range can be obtained as “off-the-shelf” units from vendors.

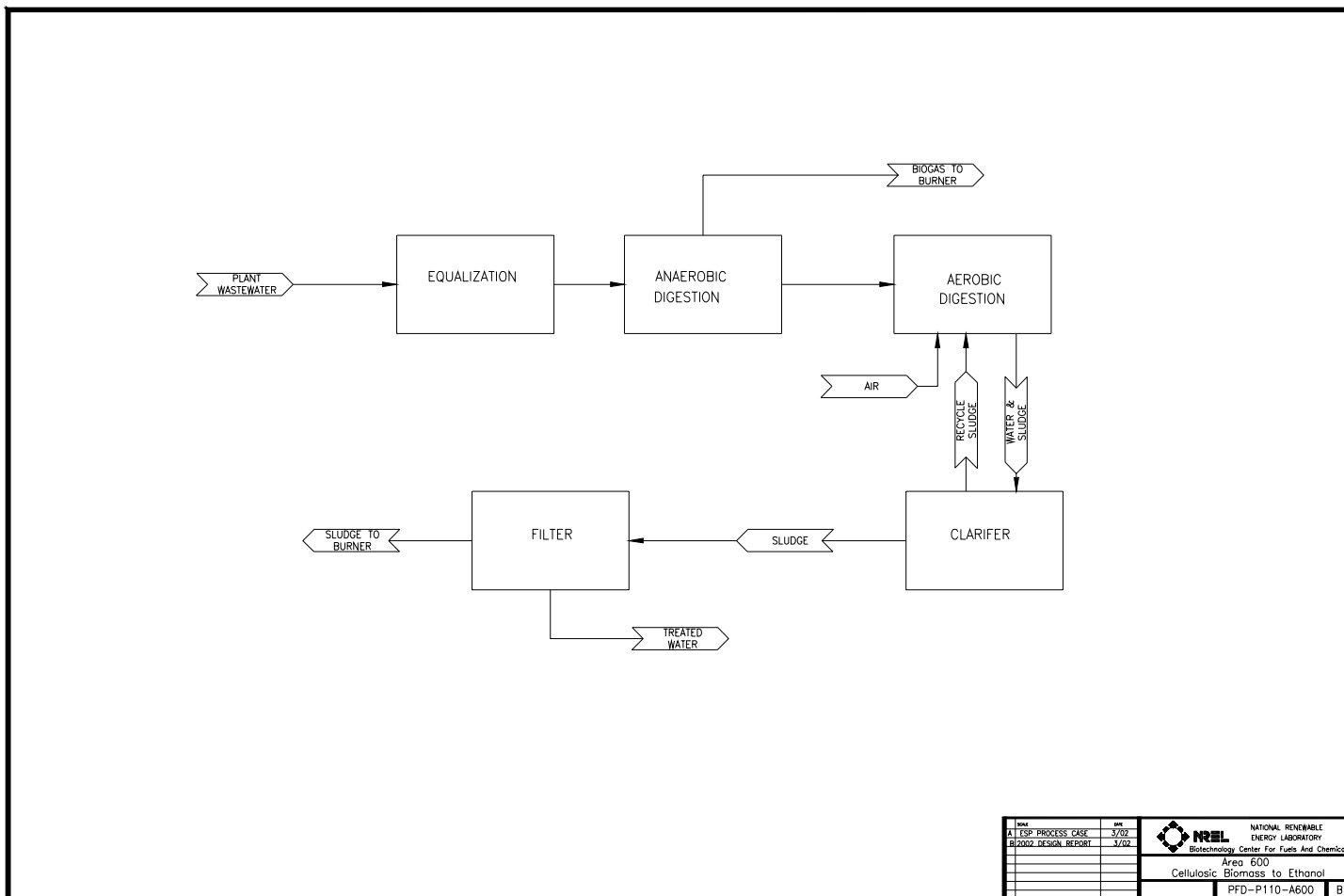

Figure 13. Wastewater Treatment (WWT) Process Overview, PFD-P110-A600

II.6.2 Design Basis

Merrick considered several alternate approaches and determined that screening followed by anaerobic digestion and aerobic digestion was the best method for all streams to be treated². Condensed pretreatment flash vapor, condensate from the hydrolyzate Pneumapress vent, boiler blowdown, cooling tower blowdown, CIP waste, and the non-recycled evaporator condensate are mixed together (stream 612) and flow through a bar screen (S-600) to an equalization basin (T-602). Since ASPEN Plus is a steady state modeling program, upsets (including unusual suspended solids) are not modeled, and treatment of the resulting wastewater is not accounted for in this design. Rain and snow run-off, equipment washing, and other non-process wastewater are assumed to flow to the municipal wastewater treatment system. Other intermittent loads (e.g., from process spills) were not considered in the design. The flows and loadings to WWT will not be at steady state either, so the equalization basin (T-602) is designed for a steady-state residence time of over 7 hours allowing dampening of flow problems downstream. The majority of the wastewater in the basin is condensate so it is too warm for biological treatment, so it is pumped through a heat exchanger (H-602) and cooled to 35°C.

The cooled stream then flows to the anaerobic digester. The total chemical oxygen demand (COD) is calculated for the stream entering anaerobic digestion (613) and is approximately 1,600 kg/hr (equivalent to 16 g/L). COD is defined as the amount of oxygen that would be necessary to combust all soluble organic components within the stream to carbon dioxide, nitrous oxide, and water and is used to determine residence time and nutrient requirements for digestion. Although insoluble components such as cellulose and xylan may be converted in anaerobic digestion they are not converted within the model making the estimate slightly conservative. No insoluble components are included in the COD calculation because of uncertainty of their reactivity. Merrick reports that ammonium ions are not converted in anaerobic digestion (although they are in aerobic digestion) and recommends that they not be included in this first COD calculation. However, the calculated COD is within 5% of the experimentally measured COD and the ammonium flowrate is low, so ammonium has been kept in the COD calculation⁴⁶. The biological oxygen demand (BOD) is a better predictor of efficacy of anaerobic digestion but it cannot be directly related to composition. It is assumed to be 70% of the COD.

Within anaerobic digestion, 90% of each organic component is converted to methane and carbon dioxide. Methane is produced from that organic matter at its maximum yield of 350 L per kg COD removed (0.229 kg/kg at 25°C). Carbon dioxide is also produced at a molar ratio of 1 mole carbon dioxide produced per 3 moles methane produced. Cell mass is produced at a yield of 30 g cell mass for each 1 kg COD that is removed resulting in a 93% removal of COD. Finally, all sulfates entering anaerobic digestion are converted to hydrogen sulfide. The anaerobic digesters are sized for a conversion rate of 12 g COD per L digester volume per day. Thirty-seven grams of nutrients (primarily caustic with some phosphoric acid, urea and micronutrients) are added per kilogram of COD to provide other nutrients the anaerobic organisms require.

Biogas from the digester contains approximately 75% methane and 25% carbon dioxide on a dry molar basis. Depending upon the complexity of the feed, the methane fraction may vary from 50% to 90%; technologies are available that may increase the methane fraction. During standard operation, the gas will flow to the combustor providing about 17.1 MMBTU/hr (5,010 kW) or 2.6% of the total fuel load supplied to the combustor. An emergency biogas flare is designed into the process to burn the biogas in case of a process upset in the combustor.

The liquid from the anaerobic digester is pumped to aerobic lagoons with floating aerators. In the aerobic lagoons 90% of the remaining soluble organic matter is converted with 60% producing water, carbon dioxide, nitrous oxide, and sulfur dioxide in stoichiometric amounts. The remaining 30% is modeled to produce cell mass on a mass basis (i.e., the atoms do not necessarily balance but the mass does). With a 93% reduction of the COD in anaerobic digestion followed by 90% reduction of the remaining COD in aerobic digestion, the total COD reduction is 99.4%. The aerobic lagoons are sized for a conversion rate of 0.55 g COD per liter lagoon volume per day and the aerators are sized to provide 50% more oxygen to the lagoon than is required by the COD.

The fully digested material is pumped to a clarifier (T-610) where the insoluble material, consisting primarily of cell mass, is separated from the clean liquor. The clean water has a COD of about 0.1 g/L and is mixed with process make-up water and recycled to the process (cooling tower, CIP, etc). Most of the sludge is recycled to the clarifier to keep the aerobic lagoons' cell mass loading high. The remaining portion is filtered using a belt filter press (S-614) to remove most of the water from the solids. To assist in dewatering, polymer is added to the filter press at a rate of 1.7 g / kg COD entering aerobic digestion. The pressed solids are primarily cell mass and are conveyed to the combustor for disposal. If higher value disposal options can be found (e.g., sale as fertilizer) those will be preferable. Filtrate from the filter press is recycled to the aerobic lagoons for additional treatment.

Because the evaporator syrup from area A500 contains 60% water, sending it to the combustor might not be the most economical alternative. As an alternative, we considered sending the evaporator syrup to wastewater treatment. This would increase the hydraulic and organic load to WWT, however it would also decrease the load to (and therefore cost of) the combustor. Another alternative is to send the distillation bottoms to WWT and removed the evaporators, which are costly. The results of a comparison of these two options against the design case of sending the syrup to the combustor are shown in Table 18.

Table 18. Comparison of Sending Evaporator Syrup to the Combustor or WWT

| | Destination of Evaporator Syrup | | | | |
|--|---------------------------------|-------------|--------------------------------------|----------------------------|----------------------------------|
| | Combustor (Design Case) | WWT | Change from the Design Case | WWT with no evaporators | Change from Design Case |
| Minimum Ethanol Selling Price (\$/gal) | \$1.07 | \$1.14 | +\$0.07 | \$1.10 | +\$0.03 |
| Total Operating Costs (cents/gal): | | | | | |
| Other Raw Materials | 5.5 | 6.9 | | 6.9 | |
| Waste Disposal | 2.9 | 2.9 | | 2.9 | |
| Electricity | -9.3 | -6.0 | | -7.0 | |
| Fixed Costs | 10.9 | 11.1 | | 10.9 | |
| Capital Depreciation | 14.3 | 14.9 | | 14.2 | |
| Average Income Tax | 10.6 | 10.8 | | 10.4 | |
| Average Return on Investment | 25.4 | 26.4 | | 25.3 | |
| Operating Costs (\$MM/yr) | 37.9 | 38.85 | +\$0.95 | 38.88 | +\$0.98 |
| Capital Cost Breakdown (\$MM): | | | | | |
| Distillation and Solids Recovery | \$21.8 | \$21.9 | | \$14.6 | |
| WWT | \$3.3 | \$10.6 | | \$13.5 | |
| Boiler/Turbogenerator | \$38.3 | \$35.5 | | \$36.1 | |
| Utilities | \$4.7 | \$4.4 | | \$3.7 | |
| Total Equipment Cost | \$113.7 | \$118.3 | | \$113.4 | |
| Total Project Investment | \$197.4 | \$203 | +\$5.6 | \$193.8 | -\$3.6 |
| Model | I0203I | I0203I_wwt1 | | I0203I_wwt_2 | |

As expected, the cost of wastewater treatment went up considerably when syrup was introduced. It went up even further when the evaporators were taken out of the process altogether; however, eliminating them reduced the capital costs by over \$3MM. The capital costs were lowest for the case where no evaporators were included, but the annual operating costs were \$0.98MM greater because more WWT chemicals were required, but more importantly, because less electricity was generated when the solids in the syrup were no longer combusted. Thus, the capital savings from removing the evaporators does not overcome the added operating costs plus lost revenue. One other impact of removing the evaporators is the loss of clean recycle water. The evaporator condensate (stream 534A) has no solids and few other impurities (1%). Without evaporators, the treated wastewater would be used for recycle water. This stream would have solubles and suspended solids in it (that were previously removed by the evaporators), which could adversely affect process conversions and equipment efficiency. This comparison shows that the overall economics as measured by the cost of ethanol production are most favorable when the syrup is sent to the boiler.

II.6.3 Cost Estimation

All cost estimations for this area were taken from the Merrick report². The primary equipment costs in this area are the anaerobic digesters, aerobic lagoons, and the belt filter press. The anaerobic digester cost was taken from a quote developed by Chattanooga Boiler and Tank Company for the SS304 fermentation vessels. Merrick quoted the aerobic lagoons as field-excavated, polymer-lined lagoons. The belt filter press was costed according to a scaled quote from Phoenix Biosystems.

ICARUS²³ was used to cost the remaining equipment including pumps, heat exchangers, and surge tanks.

II.7 Product and Feed Chemical Storage – Area 700 (PFD-P110-A701)

II.7.1 Overview

This portion of the plant provides for the bulk storage of chemicals used in the process and product ethanol. Storage of the biomass feedstock is handled in Section A100 of the process. Feed chemicals stored in this area include CSL, sulfuric acid, cellulase enzyme, propane (for feedstock handling forklifts), and gasoline (used as a denaturant for the product ethanol). Water for fire suppression is also stored here.

II.7.2 Design Basis

Ethanol product storage is based on Delta-T's experience with fuel ethanol production facilities. The recommended amount of storage (T-701) corresponds to 7 days of production or 4,540 m³ (1.2 million gal) in two 2,270 m³ (600,000 gal) carbon steel tanks.

Based on Delta-T's experience we used 5 days of storage for sulfuric acid (T-703), which corresponds to about 72 m³ (19,000 gal). Stainless steel (SS316) is used as the material of construction because of the corrosive nature of sulfuric acid. SS316 is the industry standard for ambient temperature sulfuric acid.

Using a flow rate of 568 m³/hr (2,500 gpm) of fire-fighting water (similar to another Delta-T project of about the same size), 2,270 m³ (600,000 gal) tank supplies 4 hr of operating time. The tank (T-704) is of carbon steel construction.

Corn steep liquor (CSL) is a nutrient source for fermentation seed growth and ethanol production. The storage time is 5 days or a 273 m³ (72,000 gal) tank (T-720). The tank is stainless steel (SS304) construction. CSL would likely be supplied by rail car. Standard rail tank car capacities range from 8,000 to 30,000 gallons with typical loads between 20,000 and 25,000 gallons⁴⁷ for products such as corn syrup, resins, oils, fertilizers, and petroleum. Therefore, 3 tank cars of CSL would be needed every 5 days.

Diammonium Phosphate (DAP) comes in solid form, probably pellets, via rail car. The usage rate of 4 MT per day will require solids handling and storage equipment similar to that for the lime in Area 200. The DAP storage bin (T-755) was sized at 40 m³ (10,500 gal) based on a 7-day storage time. From the storage bin, DAP is fed into a day tank (T-760) where it is mixed with CSL. The CSL/DAP mixture is then pumped to fermentation seed production and ethanol production.

Liquid cellulase enzyme is received from an enzyme producer either on-site or close-by. The storage time is set at 4 days in two 500 m³ (130,000 gal) tanks (T-750), which allows enzyme lots to be kept separate and identified. The tanks are stainless steel (SS304) construction.

Propane fuel for the forklifts is delivered in 7.6 m³ (2,000 gal) trucks. A 33-lb propane tank, which fuels the forklift, lasts approximately 8 hours according to the vendor⁴⁸. Therefore, the

approximate consumption rate of propane for 8 forklifts is 0.022 ft³/min (33 lb/hr). A 13 m³ (3,435 gal) tank (T-709) gives about 15 days of storage. This tank is pressurized to 250 psig.

Gasoline is used as a denaturant for the ethanol being loaded for transportation away from the plant. Five percent gasoline (v/v) is added to the ethanol. A 7-day storage time is used for the gasoline as for ethanol, or 241 m³ (63,600 gal) tank (T-710). Carbon steel is used for this tank.

The pumps in this section are generally sized for quickly loading trucks (P-701, P-710) or filling process day tanks (P-703 and P-720). The firewater pump is sized for 568 m³/hr (2,500 gpm). Other pumps are sized per the process requirements.

II.7.3 Cost Estimation

We used ICARUS to estimate the cost for all equipment in this section²³.

II.8 Combustor, Boiler, and Turbogenerator – Area 800 (PFD-P110-A801-3)

II.8.1 Overview

The purpose of the combustor, boiler, and turbogenerator subsystem is to burn various by-product streams for steam and electricity generation. All of the lignin and some of the cellulose and hemicellulose from the feedstock will remain unconverted through the hydrolysis process. The majority of wastewater from the process is concentrated to a syrup high in soluble solids. Anaerobic digestion of the remaining wastewater produces a biogas high in methane. Aerobic digestion produces a small amount of waste biomass (sludge). Burning these by-product streams to generate steam and electricity allows the plant to be self sufficient in energy, reduces solid waste disposal costs, and generates additional revenue through sales of excess electricity.

Reaction Engineering Inc. (REI)³ investigated the combined system of combustor, boiler, and turbogenerator. They contacted several vendors to obtain cost and operating information to identify a system suitable for the available fuel streams and steam requirements. REI also obtained quotes for support equipment including a deaerator, baghouse, and boiler feedwater pumps.

Three primary fuel streams (post-distillate solids, biogas, and evaporator syrup) are fed to a Circulating Fluidized Bed Combustor (CFBC). The small amount of waste biomass (sludge) from wastewater treatment is also sent to the combustor. The post-distillate solids' moisture content leaving the Pneumapress is 45%. The biogas and syrup enter the combustor at 4% and 60% moisture, respectively. The moisture of the combined feed to the combustor is 52%. A fan moves air into the combustion chamber. Treated water enters the heat exchanger circuit in the combustor and is evaporated and superheated to 510°C (950°F) and 86 atm (1265 psia) producing 184,771 kg/hr (407,420 lb/hr) of steam. Boiler efficiency, defined as the percentage of the feed heat that is converted to steam heat, is 68% (see Figure 16). Flue gas from the combustor preheats the entering combustion air then enters a baghouse to remove particulates, which are landfilled. The gas is exhausted through a stack.

A multistage turbine and generator are used to generate electricity. Steam is extracted from the turbine at three different conditions for injection into the pretreatment reactor and heat exchange in distillation and evaporation. The remaining steam is condensed with cooling water and returned to the boiler feedwater system along with condensate from the various heat exchangers in the process. Treated well water is used as makeup to replace steam used in direct injection.

Makeup water and condensate are softened, deaerated, and preheated with steam to 177°C. Chemicals for pH control, scale removal, and oxygen removal are added. Boiler blowdown is 3% of steam production. Section II.10.3 discusses the energy balance of the steam cycle.

II.8.2 Design Basis

The design of the combustor/boiler/turbogenerator system is changed somewhat from an earlier design by Radian Corporation⁴⁹. The previous design included a drum dryer that used the hot flue gas to reduce the moisture in the solids. However, since the Pneumapress pressure filter is capable of drying the post-distillate solids more efficiently than the centrifuge previously in the design, the drum dryer is no longer required, and the hot flue gas can be used to preheat the combustion air (H-801), which improves the boiler efficiency. When combined with maintaining a high solids content in the syrup, drying the solids helps to ensure a stable combustion bed temperature and improved boiler efficiency. Foster Wheeler Energy (FWE) suggested maximum feed moisture of 50%; other sources⁵⁰ suggest 60% is acceptable. There is a wide range of values reported, primarily due to the various combinations of combustor designs and feeds being used. Because of heightened interest in using biomass, pulping wastes, and sewage sludge in place of fossil fuels, new methods of handling higher moisture feeds are being developed such as in-bed drying and staged combustion⁵¹. Blending the wet feed with dry material or adding auxiliary fuel to maintain the combustion temperature are more traditional methods. A Lower Heating Value (LHV) of 1,111-1,389 kcal/kg (2,000-2,500 BTU/lb) is considered a minimum for maintaining combustion³. The combined feed to the combustor has a LHV of 2,322 kcal/kg (4,179 Btu/lb). The total energy (on a higher heating value basis) to the combustor in the combined feed streams is 178 MMkcal/hr (706 MMBtu/hr). The solids contribute 59% of this energy and the syrup contributes 37%.

Foster Wheeler Energy (FWE)³ confirmed the Radian design⁴⁹ of a circulating fluidized bed combustor (CFBC) (M-803). This type of combustor is suitable for varying feeds and feed characteristics; however, this flexibility is more expensive than a grate or pile combustor. Because the bed material is returned to the combustor after the cyclone, CFBCs have little unburned carbon in the ash. Compared to coal, the combined feed in this process has significantly less ash and could require supplementing the bed with sand to keep an adequate bed level. Two drawbacks to these units are the high power requirement for circulation and the potential for erosion due to high particulate velocities. Parameters for emissions and efficiency losses were supplied by FWE.

Because the steam pressure required by the process is not high (13 atm [191 psia]), NREL engineers originally envisioned a lower pressure system. FWE declined to quote on this system, citing it as non-standard due to the low operating pressure available to move the water/steam over the heating surfaces. After further study, FWE did state that a low-pressure system might be cost-effective because the lower materials cost may pay for the cost of added piping on the steam side, but they did not provide a cost estimate.

Another option, gasification of the waste streams to produce steam and electricity, is being studied at NREL. Gasification has the potential to produce enough steam and larger amounts of electricity through an integrated combined cycle (gas and steam turbine) system than conventional combustion with only a steam turbine.

The turbogenerator (M-811), which consists of a multistage turbine with extraction ports, generator, and condenser is the other main portion of this section, producing lower pressure steam

and electricity. Twenty-eight percent (28%) of the steam is extracted from the turbine at 13 atm (268°C [191 psia, 514°F]), 60% at 4.4 atm (164°C [65 psia, 327°F]), and 3% at 1.7 atm (115°C [25 psia, 239°F]) for process needs. The remaining steam (9%) is condensed at 0.1 atm (1.5 psia). ABB Power Generation Systems (ABB) provided cost, efficiency, and design information, which were used in the model³. ABB representatives, when asked about the low-pressure boiler discussed above, stated that the lower pressure option did not allow the most cost effective turbine system; higher-pressure systems supply more electricity on a power per capital cost basis. Badger,⁵² working with Turbodyne, came to the same conclusion, stating “for larger turbines of 8000 kW upward steam inlet pressure has little effect on capital costs over the range 200-1600 psig”. Per ABB, the turbine efficiency was set at 85%. For this design, a total of 30.4 MW of power is generated from the system. The process uses 11.7 MW, leaving 18.7 MW that is sold to the grid.

V. Putsche confirmed the FWE and ABB design parameters using an ASPEN combustor/boiler model showing good correlation of efficiencies, output flows, and temperatures⁵³.

The boiler feed water (BFW) system includes a softener (M-820) for the makeup and condensate water, a deaerator (T-826) to remove air and other non-condensables, surge tanks and pumps. The boiler feedwater pumps (P-826) produce 98 atm (1445 psia) of pressure and require 709 kW (951 hp) of power. Liquid hydrazine (T-830, PFD-P110-A804) is injected into the deaerator to remove oxygen, which can pit the boiler surfaces. Ammonia, which volatilizes with the steam, is added to control the pH and reduce the corrosive nature of the hot condensate. Phosphate is also added to control the formation of scale in the steam drum. The oxygen, pH, and hardness control systems were designed by Badger⁵² and follow conventional practice⁵⁴. The amount of water treatment necessary depends on the incoming water quality, metallurgy of the boiler, and the ratio of makeup to condensate in the feedwater. The current system contains some redundancy; however, the control systems' costs are low compared to the replacement cost of the boiler or its components.

The power usage estimate for the baghouse (M-804) cleaners (176 kW [236 hp]) was obtained from the vendor, Hamon Research-Cottrell. One induced draft fan was used to move the flue gas from the combustor cyclone through the baghouse.

Pollutant generation values were taken from information provided by FWE. Baghouse efficiency of 98.8% was taken from information supplied by the vendor. All of the emissions are below the current New Source Performance Standards (NSPS) limits⁵³ so no control measures other than the baghouse were added to the process. Pollutant flow rates are calculated from the generation rates discussed below and the higher heating value of the combustion feed stream.

Sulfur dioxide is assumed to be generated at a rate of 0.68 kg/MWhr (0.44 lb/MMBtu). All of the sulfur into the combustor is converted to sulfur dioxide; 1% of the generated sulfur dioxide is converted to sulfuric acid. The presence of this acid requires that the flue gas temperature be kept above the dew point to avoid corrosion. Sulfur comes from wastewater treatment (hydrogen sulfide), neutralization of sulfuric acid, and is present in the proteins within the cellulase and biomass entering the boiler with the pressure filter and spent biomass solids, respectively. Limestone, if it is needed to control sulfur dioxide to a stricter standard, can be purchased for about \$6 per ton for quarter-inch particle size.³ The amount of sulfur in the combustor feed streams is higher than untreated biomass, but lower than most coals.

Carbon monoxide is assumed to be generated at a rate of 0.31 kg/MWhr (0.2 lb/MMBtu).³ Unburned carbon (char) in the ash is low at 1%, owing to the circulation of the unburned carbon

back to the combustor bed from the cyclone. The flue gas composition of 804D on PFD-P110-A801 shows the remaining unreacted components; in actuality, these would be present in the flue gas as char.

NO_x is generated at 0.31 kg/MWhr (0.2 lb/MMBtu)³. Nitrogen oxide, or NO_x, formation is a complicated mechanism, and depends on the feed, combustion temperatures, excess air rate, combustor design and the presence of other control schemes like limestone injection for sulfur dioxide control. CFBCs are generally considered to have lower NO_x emissions due to lower combustion temperatures compared to traditional pile or grate combustors⁵⁰. The fate of the ammonia species in a combustor is not well understood, but there is evidence to suggest that some of the ammonia is converted to nitrous oxide (N₂O) while also acting to reduce NO_x formation.⁵⁵ Ammonia injection has long been a means of reducing NO_x emissions. The nitrogen level in the combined feed is similar to coal when the ammonia species are included, but is more like untreated biomass when they are not.

II.8.3 Cost Estimation

The costs for the CFBC, turbogenerator, boiler feedwater pumps, and deaerator are from vendor quotes. In addition, FWE and ABB provided scaling factor information. According to FWE, the CFBC should be scaled on steam production, but only for similar feed conditions such as moisture content. The cost obtained from FWE compared well with a previous 1994 quote, shown in Table 19. Other quotes obtained over the last decade are also listed in this table.

Boiler feedwater softening equipment was costed using Richardson⁵⁶, including the scaling factor. Other chemical treatment costs are from Chem Systems⁵⁷. ICARUS²³ was used to cost the remaining equipment including pumps, heat exchanger, and surge tanks.

For the baghouse, information on bag life and replacement cost from the vendor was incorporated into the capital costs.

Table 19. Boiler Costs

| Vendor/Requestor | Year | Steam Conditions Pressure/Temp | Steam Production (1000 lb/hr) | Total Cost (\$MM)* | Scope |
|---|------|--------------------------------|-------------------------------|--------------------|-----------|
| FWE/REI ³ | 1998 | 915-1265 psia/950°F | 752 | 24.9 | CFB |
| FWE/NREL ⁵⁸ | 1994 | 1515 psia/950°F | 694 | 22.9 | CFBC |
| Ahlstrom Pyropower/Radian ⁴⁹ | 1991 | 1515 psia/950°F | 279-385 | 18-24 | FBC |
| ABB/Chem Systems ⁵⁹ | 1990 | 1100 psia/875°F | 434 | 19.8 | Dryer/FBC |

*\$1998 dollars

II.9 Utilities – Area 900 (PFD-P110-A901-3)

II.9.1 Overview

This area provides all utilities required by the ethanol production facility except steam and electricity, which are provided by Area 800. The utilities provided include cooling water, chilled water, plant and instrument air, process water, and the clean-in-place (CIP) system.

Cooling water is provided to the following equipment items:

- H-200 to cool the pretreated hydrolyzate liquor before it enters overliming
- H-205 to condense the water from the Pneumapress air vent
- H-244 to cool the pretreatment flash vapor before it enters WWT
- F-301-5 on an as-needed basis to remove heat in the seed train
- H-300 on an as-needed basis to remove heat produced in the co-fermentation production train
- H-302 to cool the saccharified slurry to fermentation temperature
- H-310 to remove heat produced in the saccharification production train
- H-504 to condense the beer column reflux
- H-505 to condense the rectification column reflux during start-up
- H-517 to condense vapors from the third evaporator effect
- M-503 to provide some cooling and condensation in the molecular sieve
- H-602 to cool wastewater before anaerobic digestion
- M-811 to condense the remaining steam after the steam turbine

No chilled water is used in the plant; the required process temperatures can be achieved by cooling water year-round.

The plant and instrument air systems provide compressed air for plant uses (pneumatic tools and clean up), the Pneumapress units (prehydrolysis conditioning and post-distillation dewatering), and instrument operation.

The process water system mixes fresh well water with treated wastewater and provides water at a constant pressure to the facility. Water is provided to the stover washer system, seed production, boiler feed water, cooling tower make-up, the CIP system, and the scrubber. It is also mixed with recycle water for dilution before saccharification. Process water is also used throughout the facility for cleaning on an as-needed basis.

The CIP system provides a solution that can be heated and includes cleaning and sterilization chemicals to saccharification and co-fermentation, seed vessels, and the distillation system.

II.9.2 Design Basis

The primary cooling water consumers in this process are pretreatment, saccharification, fermentation, distillation, wastewater treatment, and steam condensation after the turbogenerator. The cooling water system is designed at 28°C with a 9°C temperature rise in coolers throughout the facility. We chose 28°C because the average summer wet bulb temperature in the southeastern part of the United States is 25°C and a 3°C approach is a reasonable design⁶⁰.

Overliming, saccharification, fermentation, distillation, wastewater treatment, and steam condensation in the boiler utilize cooling water year round. The initial cooling source for fermentation, which is operated at 41°C, is well water, which enters the facility at 13°C and is heated to 26°C by the fermentation cooling load before entering the process water system. The remaining heat is removed by cooling water.

Using ASPEN, we calculated the amount of cooling tower evaporation and assumed that windage would be 0.1% of the total flow to the tower. The tower blowdown is assumed to be 10% of the sum of the evaporative loss plus windage.

The plant and instrument air systems provide compressed air for plant uses (pneumatic tools and clean-up, Pneumapress filters) and instrument operation. Delta-T recommended 1,530 m³/hr (900 SCFM) compressed air for plant operation. The plant air compressor also provides air at 9.5 atm (140 psia) to the Pneumapress filters via air receivers at a combined usage of 8,892 m³/hr (5,230 ACFM). Three 5,228 m³/hr (3,075 CFM) screw compressors were specified—two on-line with one spare. An instrument air dryer and a surge tank were designed to provide clean dry air at a consistent pressure to the instrument air system. The surge tank was sized at 3.8 m³ (1,000 gal) to provide about 2.5 L/m³/hr (1 gal per SCFM) of compressor capacity.

Fresh well water is used to cool the fermentation broth and is then split three ways, to provide clean water to the boiler feed water make-up system and the scrubber. The process water tank (T-914) mixes and holds the treated wastewater and the remaining fresh water before it is pumped throughout the facility. It is designed for an 8 hr. residence time. The process water pump (P-914) pumps water from the tank into the facility. It is designed to handle 1.5-times the process water flow requirement. The scrubber and the boiler feedwater system require fresh water. Fresh process water is mixed with recycle water for dilution prior to entering seed production, cooling tower make-up, and the CIP system.

The CIP system is designed to provide cleaning solution to all the seed, saccharification and fermentation tanks, to the beer column, to all the beer column heat exchangers, and to the evaporators.

Process water flows into the CIP system tanks and is heated by low-pressure steam. Two CIP tanks are needed in order to maintain the ability to clean a tank at the same time as a beer column component.

The washing sequence follows:

- 1) Process water is pumped at 454 m³/hr (2,000 gpm) (or at the equipment design flow) to the equipment being cleaned in order to flush the solids out of the equipment.
- 2) a. CIP solution is then pumped at 454 m³/hr (2,000 gpm) (or at the equipment design flow) through the equipment and returned to the CIP tank via the cyclone separator.
b. For tanks with spray balls, CIP solution is pumped at 136 m³/hr (600 gpm) through the spray balls in the tank. The solution is then pumped back to the CIP tanks by the 136 m³/hr (600 gpm) CIP return pump, via the cyclone separator.
- 3) The cyclone separator continuously discharges the sludge stream to the wastewater treatment area while the centrate is returned to the CIP tank for reuse.
- 4) The CIP cycle continues until the equipment has been cleaned.

II.9.3 Cost Estimation

We based the cooling system cost estimate on a verbal quote by Marley. It was quoted for a heat load of 148 MM Kcal/hr (587 MMBtu/hr) and fiberglass construction for cost effectiveness and corrosion resistance. The quoted cooling tower is a five cell counterflow tower with a 82.3 m x 16.8 m (270 ft x 55 ft) frame, a 82.6 m x 18.6 m (271 ft x 61 ft) basin, a 181 kW (243 hp) fan in each cell, and a total flow capacity of 16,125 m³/hr (71,000 gpm). The cooling tower circulation pumps were estimated using ICARUS²³. Their material of construction is carbon steel, chosen because of Delta T's experience with these towers.

We used ICARUS to estimate the plant and instrument air compressor and dryer costs. The estimates are based on 125-psig rotary screw compressors and a dew point requirement of -40°C. We used ICARUS to estimate the plant air receiver tank costs as a horizontal vessel with a design pressure of 14.6 atm (200 psig). The Pneumapress air receivers were costed by Harris¹⁹.

The process water tank and pump costs were estimated using ICARUS. We estimated the tank cost using the atmospheric pressure carbon steel vertical vessel data and the pump cost using the carbon steel centrifugal pump data.

The CIP system was designed by Delta-T and the cost was estimated to be similar to the costs previously used by NREL for this system. The cost of the previous units totaled \$95,000 (1995). Scaling and installation factors were estimated.

II.10 Water and Carbon Balances and Energy Analysis

II.10.1 Water Balance

Large amounts of water are circulated throughout the biomass-to-ethanol process. Detailed water balances around the major processes and the entire plant were derived from the ASPEN simulations. Improving water usage to reduce makeup demand continues to be an area of study.

The process is designed for zero discharge to a municipal treatment plant in a steady state mode. Table 20 shows the major water inputs and outputs to the overall ethanol plant. Well water is used to make up for water losses to the atmosphere due to evaporation, water in streams vented to the atmosphere, and water entrained in the waste solids. Water is consumed in hydrolysis reactions that convert the long chain polymers to monomeric sugars (prehydrolysis and saccharification) and generated in the combustion and digestion reactions. The difference in the water and overall mass balance is discussed in the next section with the carbon balance.

Table 20. Ethanol Plant Overall Water Balance

| | Total Flow (kg/hr) | Water Flow (kg/hr) |
|--|--------------------|--------------------|
| <i>Process Inlets</i> | | |
| Stover Feedstock | 98,039 | 14,706 |
| Enzymes | 6,824 | 6,255 |
| Chemicals & Nutrients | 7,239 | 0 |
| Air | 310,255 | 3,382 |
| Well Water | 186,649 | 186,649 |
| Inlet Total | 609,006 | 210,992 |
| <i>Water Consumption/Generation</i> | | |
| Prehydrolysis | | -2,788 |
| Saccharification | | -2,736 |
| Combustion | | 20,035 |
| Wastewater Treatment | | 371 |
| Consumption/Generation Total | | 14,882 |
| <i>Process Outlets</i> | | |
| Ethanol Product | 24,686 | 122 |
| Evaporative Losses | 195,993 | 156,291 |
| Vents to Atmosphere | 375,443 | 68,051 |
| Solids to Landfill | 12,718 | 2,194 |
| Outlet Total | 608,840 | 226,658 |
| Water Difference (inputs + consumption + generation - outputs) | | -784 |

II.10.2 Carbon Balance

Overall mass balances are performed on the ethanol production process using ASPEN. As a check of our assumed biomass composition, stream flow definitions and reaction stoichiometry throughout the process, a carbon balance was performed⁶¹.

The overall carbon balance is 99% closed. The methods used in modeling two subsystems, wastewater treatment (T-606) and the treated water mix (T-914), contribute to the small error.

- T-606 was designed using the COD (chemical oxygen demand) method of wastewater treatment, which only ensures that the mass balance closes and not the component molar balance. This section accounts for 15 kmol/hr of the discrepancy.
- T-914 assumes that pure water is being recycled to the plant; therefore the trace carbon compounds exiting from the block are not taken into account. Since the total concentration of these trace compounds are very low (less than 0.5%) in the recycle stream, they are not modeled. This section accounts for the other 25 kmol/hr of the discrepancy.

Table 21 shows the flow of carbon as a percentage of the biomass feed. As shown in the table, 99% of the carbon enters in the biomass feed. The major exits for carbon (accounting for 99%) are in the combustion exhaust (47%), ethanol product (34%), and the scrubber vent (17%). These results are depicted in Figure 14.

Table 21. Ethanol Plant Overall Carbon Balance

| | Carbon Flow (C kmol/hr) | Ratio to Feedstock Carbon Content (C kmol basis) |
|-----------------------|----------------------------|---|
| <i>Carbon Inlets</i> | | |
| Stover Feedstock | 3,144 | 1.000 |
| Enzymes | 25 | 0.008 |
| Total | 3,169 | 1.008 |
| <i>Carbon Outlets</i> | | |
| Combustion Exhaust | 1,497 | 0.476 |
| Ethanol Product | 1,066 | 0.339 |
| Scrubber Vent | 532 | 0.169 |
| Ash | 16 | 0.005 |
| Gypsum | 10 | 0.003 |
| Aerobic Vent | 3 | 0.001 |
| Loss to Atmosphere | 4 | 0.001 |
| Total | 3,129 | 0.995 |

We expect the amount of carbon exiting in the combustion exhaust to be rather large because most byproducts (lignin etc.) of this process are burned; thus liberating CO₂. Over 99% of this stream consists of carbon dioxide. The majority of the carbon exiting the scrubber vent is in the form of CO₂ with some minor amounts of carbon exiting in the form of ethanol (0.05%). The scrubber processes the fermentation gas, which contains CO₂.

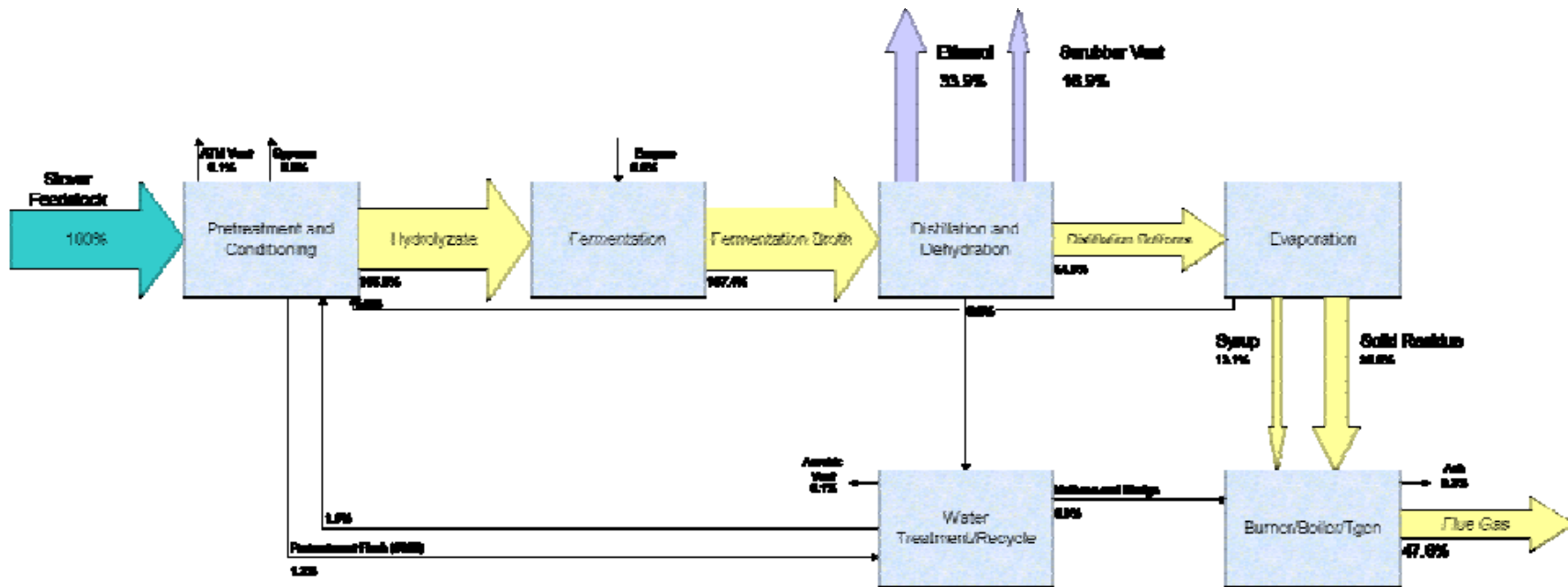

Figure 14. Process Carbon Balance

Table 22. Feed Stream Carbon Composition

| Component | Carbon Flow (C kmol/hr) | % Carbon Flow (C kmol basis) |
|--|-------------------------|------------------------------|
| <i>Ethanol Producing Reactants</i> | | |
| Cellulose | 1,154 | 36.7% |
| Xylan | 665 | 21.1% |
| Arabinan | 92 | 2.9% |
| Galactan | 60 | 1.9% |
| Mannan | 48 | 1.5% |
| Total | 2,019 | 64.2% |
| <i>Non-Ethanol Producing Reactants</i> | | |
| Lignin | 968 | 30.8% |
| Soluble Solids | 13 | 0.3% |
| Acetate | 81 | 2.6% |
| Protein | 40 | 0.8% |
| Extractives | 26 | 1.3% |
| Total | 1,125 | 35.8% |

The comparison of the ethanol product's carbon content to that of the total biomass feed is a little misleading since the non-carbohydrate components of the biomass cannot be converted to ethanol via fermentation. Accordingly, the biomass feed stream can be broken into the various ethanol and non-ethanol producing components. Table 22 shows the distribution; 64% (C mole basis) of the carbon in the feed stream is present as ethanol producing sugars. Converting all of this carbon represents the theoretical yield. According to Table 21, 51% of the feed stream carbon is actually converted by the ethanol pathway (ethanol in the product and CO₂ in the scrubber vent), so the actual yield is 80% of the theoretical yield.

II.10.3 Energy Analysis

The process has been analyzed to compare the energy available in its products (ethanol and electricity) to the maximum energy available from the biomass feed⁶². This analysis includes other energy inputs to the process (e.g., sensible heat effects of all feed streams and effluent streams).

The potential energy of the material streams is considered to have three contributions:

1. A chemical potential energy defined as its higher heating value (HHV) at a reference temperature of 25°C.
2. A sensible heat effect to account for the process temperature being different from this reference temperature.
3. A latent heat effect to account for a volatile component being in a phase condition different from its phase condition at the reference temperature. (For example, water being discharged as a vapor instead of its normal liquid state at 25°C.)

The potential energies of the material streams are referenced to the potential energy of the biomass feed. This is a convenient basis to analyze the energy contents of the streams since the energy of the ethanol product will ultimately be recovered by its combustion. One outcome of this basis is that combustion products have a zero energy contribution (other than any sensible and latent heat effects). Also, the carbon dioxide produced by fermentation essentially has a zero energy content compared to the other material and energy streams.

The HHV is a convenient reference for the combustion energy since there is a lot of liquid water flowing throughout the process. The HHV has its basis water produced by combustion in the liquid state, not the vapor state (as with the lower heating value, or the LHV). So, the liquid water in the process has a zero contribution to the chemical potential energy of any stream.

A comparison of the major energy streams produced by the process to the combustion energy of the biomass feed is made in Table 23 and depicted in Figure 15. The combined energy available from the ethanol product and the exported electricity is over half of the energy content of the biomass feed. The energy losses from the cooling tower and combustion exhausts are fairly large. There is a potential for increased energy recovery as exported electricity if more elaborate low level waste heat recovery systems were to be included in the process.

Table 23. Ethanol Plant Overall Energy Analysis

| | Energy Flow (MMkcal/hr) | Ratio to Feedstock Energy Flow |
|------------------------------|----------------------------|-----------------------------------|
| <i>Energy Inlets</i> | | |
| Stover Feedstock | 358 | 1.000 |
| Enzymes | 3 | 0.009 |
| Air | 2 | 0.005 |
| Sulfuric Acid | -2 | -0.005 |
| Well Water | -2 | -0.006 |
| Other | -1 | -0.004 |
| Total | 358 | 1.000 |
| <i>Energy Outlets</i> | | |
| Ethanol | 174 | 0.487 |
| Cooling Tower | 79 | 0.220 |
| Combustion Exhaust | 54 | 0.151 |
| Ambient Heat and Work Losses | 22 | 0.060 |
| Byproduct Electricity | 16 | 0.045 |
| Loss to Atmosphere | 1 | 0.004 |
| Ash | 1 | 0.003 |
| Other | -2 | -0.004 |
| Total | 346 | 0.966 |

Some of the energy flow values in this table are negative. This may be due to the stream's temperature being less than the reference temperature (e.g., the well water enters the process at 20°C and, as an inlet, represents a sensible heat penalty to the process). The negative value for sulfuric acid represents its negative heat of combustion (i.e., heat is required to convert sulfuric acid to its combustion products).

There is a small discrepancy in the overall energy balance for the process. The outlet energy flow is 12 MMkcal/hr less than the inlet energy flow. This is due to approximations made in three major areas: Pretreatment, Distillation, and Wastewater Treatment. This discrepancy is only 3% of the total inlet energy flow.

There is a small discrepancy in the overall energy balance for the process. The outlet energy flow is 12 MMkcal/hr less than the inlet energy flow. This is due to approximations made in three major areas: Pretreatment, Distillation, and Wastewater Treatment. This discrepancy is only 3% of the total inlet energy flow.

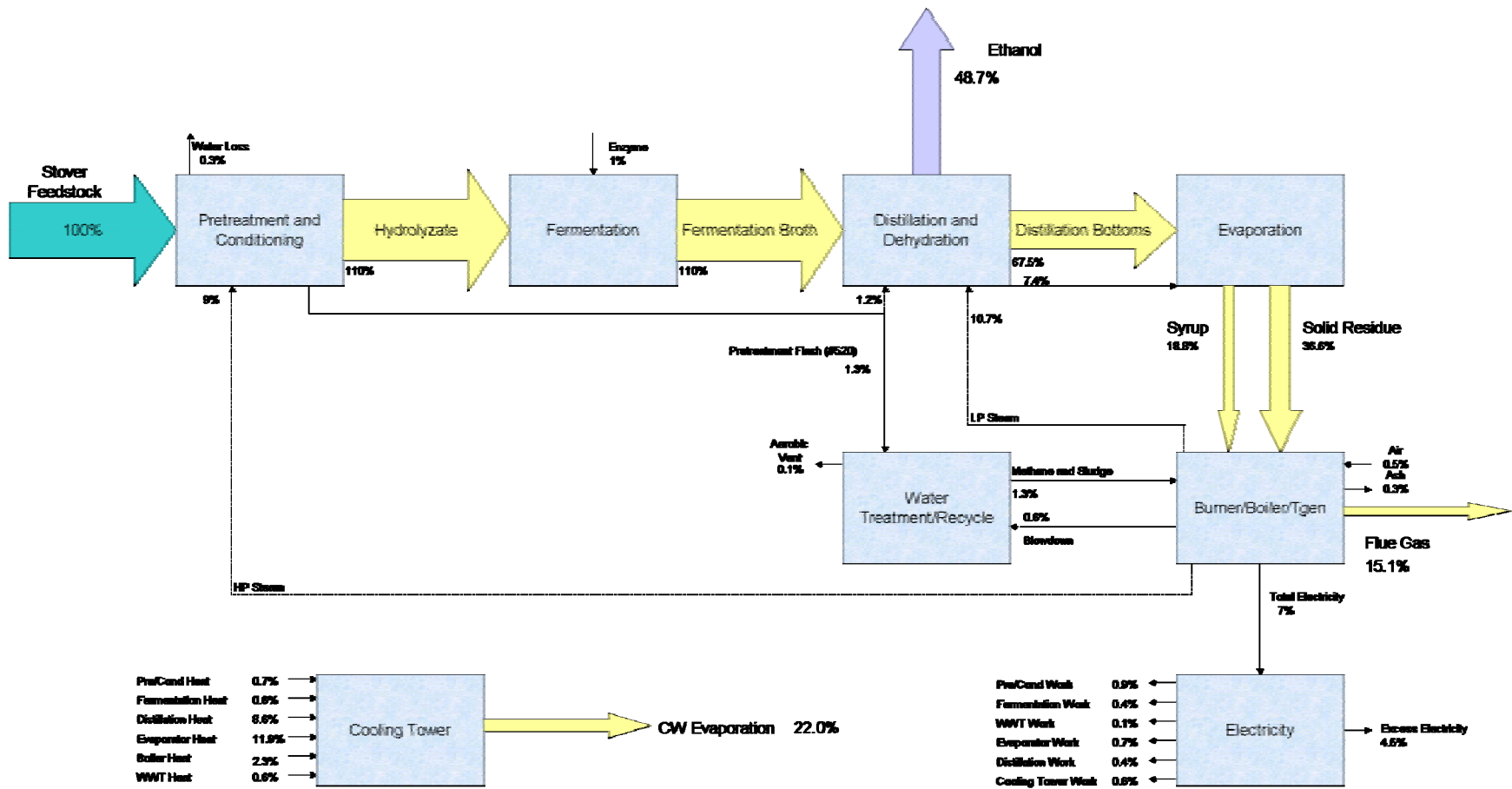

Figure 15. Process Energy Analysis Based on Higher Heating Value of Biomass Feed

As with the carbon balance, a comparison of the ethanol product's combustion energy content to that of the total biomass feed can be misleading. Because the conversion is done by fermentation of sugars, the process cannot convert non-carbohydrate components of the biomass (such as the lignin and the proteins). The energy content of the various feed components (carbohydrates that can be converted to ethanol and the non-carbohydrates that cannot) is shown in Table 24. Only 63% of the original combustion value of the biomass is due to carbohydrates that can produce ethanol. Taking this into account the energy content of the carbohydrates in the feed recovered as ethanol is much greater, over 77%.

Table 24. Feed Stream Energy Analysis

| Component | Energy Flow (MMkcal/hr) | % Total Feedstock Energy Flow |
|--|-------------------------|-------------------------------|
| <i>Ethanol Producing Reactants</i> | | |
| Cellulose | 129 | 36.1% |
| Xylan | 75 | 20.8% |
| Arabinan | 10 | 2.9% |
| Galactan | 7 | 1.9% |
| Mannan | 5.4 | 1.5% |
| Total | 226 | 63.2% |
| <i>Non-Ethanol Producing Reactants</i> | | |
| Lignin | 92 | 25.6% |
| Soluble Solids | 4 | 1.1% |
| Protein | 11 | 3.1% |
| Extractives | 17 | 4.6% |
| Acetate | 9 | 2.4% |
| Total | 132 | 36.8% |

Similar energy analyses can be performed around any section of the process. An energy analysis around the boiler section can identify the relative amount of the energy from the various feed streams to the combustor that will ultimately create the steam and electricity to run the process. See Figure 16 for a simplified flow diagram for this section of the process. The combined feeds to the combustor have an energy content of 178 MMkcal/hr (706 MMBtu/hr). The lignin residue provides the majority (59%) of this energy to the combustor. Combined, the electricity and steam produced is 66% of the energy to the combustor. The energy lost to the flue gas is due to its high temperature and fairly large amount of volatile material in the vapor phase. Though it would seem desirable to reduce this loss by further cooling the flue gas, operational problems could arise, such as condensation of acidic liquids or low gas velocities through the stack.

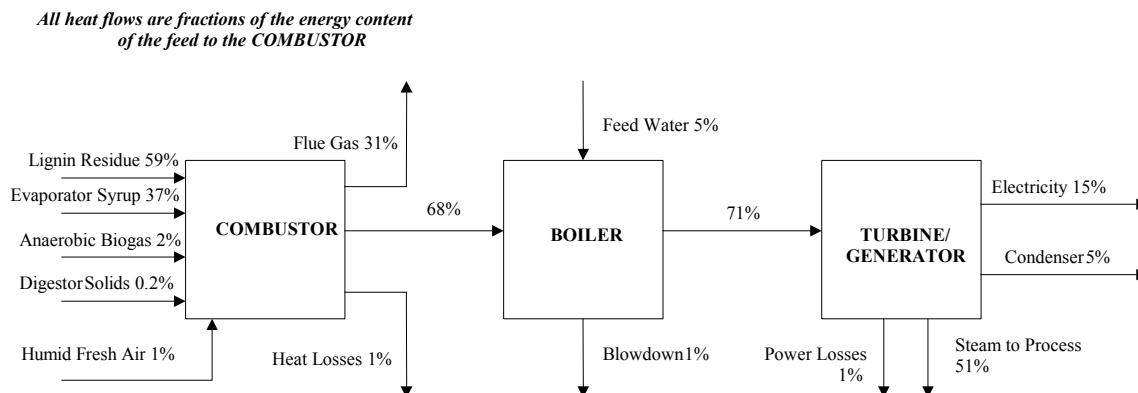

Figure 16. CFBC/Turbogenerator Energy Balance

III. Process Economics

As mentioned earlier, one of the primary purposes for developing a detailed process design, simulation model, and cost estimate is to determine the economics of ethanol production. The cost of ethanol production is used either to assess its potential in the marketplace with an absolute cost of production or to evaluate research proposals by looking at the relative cost of production of process modifications that could be developed through research.

III.1 Analysis Procedure

The total project investment (based on total equipment cost) as well as variable and fixed operating costs, are developed first. With these costs, we use a discounted cash flow analysis to determine the production cost of ethanol when the net present value of the project is zero. This section describes these three cost areas and the assumptions made to complete the discounted cash flow analysis.

III.1.1 Total Project Investment

Section II of this report describes the details of the conceptual process design and how the purchase cost of all equipment was determined. The next step is to determine the installed cost of that equipment. The installation cost can be determined by a detailed study of everything required to install the necessary equipment and make it operational. This type of detail is not warranted for the current level of the estimate. When the process is much closer to construction and an estimate of +/- 5% accuracy is required for financing, more details will be necessary. This study is more of a +25%/-10% accuracy, making a “factored” approach satisfactory. Many engineering texts such as Garrett⁶ or Peters and Timmerhaus⁶³ list installation factors that can be applied to purchased equipment costs to determine the installed cost. The ICARUS Process Evaluator²³ develops a detailed installation cost estimate using its estimate of the piping and instrumentation required for each type of equipment. Although the ICARUS estimate is more detailed than a simple factored method, it, as well as the standard textbook factored methods, was developed for the chemical and petroleum industry, not an aqueous-based biotechnology process. Standards for industries handling concentrated chemicals and fuels are based (to a significant degree) on the safety aspects of the process. Many of these standards (such as API for refineries and ANSI for chemical plants) are unnecessary for an aqueous-based process. A better

methodology is to use the expertise and engineering practices that Delta-T has developed in the design and construction of starch-based ethanol plants.

Delta-T reviewed the factors for direct installation costs suggested by Chem Systems⁶⁴ in its 1994 study of this process (Chem Systems in turn took these installation factors from Walas⁶⁵). These installation factors, given in Table 25, were applied to the equipment purchase costs. In addition to the Chem Systems installation factors, a more recent evaluation performed by Harris⁶⁶ provided equipment specific installation and scaling factors for corn stover feed handling, continuous pretreatment reactors, and solid-liquid separation equipment. In general, the Harris factors were higher than those from Chem Systems, particularly for smaller equipment like pumps. The overall installation “factor” was then calculated as the quotient of the sum of all purchased costs and the sum of all installed costs, excluding sections A600 and A800. Delta-T compared this ratio (1.42) to several existing corn ethanol projects, where the actual ratio was 1.46. Therefore, these installation factors were accepted for most equipment except where other information, such as installation factors from vendors, was available. Harris obtained installation factors for the stover handling and solid-liquid separation equipment; as a result this overall installation factor (excluding A600 and A800) is 1.61 for this design case. See Appendix B for a complete listing of the equipment, along with its purchased and installed costs.

Once the installed equipment cost has been determined from the purchased cost and the installation factor, it can be indexed to the project year being considered. In this case, we selected 2000 so as to align with petroleum costs projected by the Energy Information Administration (EIA),⁶⁷ which is in 2000 dollars. The purchase cost of each piece of equipment has a year associated with it. It might be 1998, if a vendor quote was obtained in that year, or it might be 1997 if ICARUS was used as its basis. The purchased cost year will be indexed to the year of interest using the Chemical Engineering Index.⁶⁸ Existing values for the index ranging from 1990 to 1999 were regressed to a simple equation. The resulting equation is used to extrapolate to future years (referred to as “out years”) when such an analysis is desired. Table 26 gives the index as a function of date.

Table 25. Installation Factors⁶⁹

| Equipment | Multiplier* |
|---|--------------------|
| Agitators – Carbon Steel (CS) | 1.3-1.4 |
| Agitators – Stainless Steel (SS) | 1.2-1.3 |
| Boilers | 1.3 |
| Compressors (motor driven) | 1.3 |
| Cooling Towers | 1.2 |
| Distillation columns – Carbon Steel | 3.0 |
| Distillation columns – Stainless Steel | 2.1 |
| Filters | 1.4 |
| Heat Exchangers (S&T) – Carbon Steel/Stainless Steel | 2.1 |
| Pumps – Lobe | 1.2-1.4 |
| Pumps – Centrifugal, Carbon Steel | 2.8 |
| Pumps – Centrifugal, Stainless Steel | 2.0 |
| Pressure Vessels – Carbon Steel | 2.8 |
| Pressure Vessels – Stainless Steel | 1.7 |
| Tanks – Field Erected, Carbon Steel | 1.4 |
| Tanks – Field Erected, Carbon Steel with Lining | 1.6 |
| Tanks – Field Erected, Stainless Steel | 1.2 |
| Solids Handling Equipment | 1.2-1.4 |
| Turbogenerator | 1.5 |
| *Installed cost = (purchased equipment cost) x (multiplier) | |

Table 26. Chemical Engineering Purchased Equipment Index⁶⁸

| Year | Index | Year | Index |
|-------------|--------------|-------------|--------------|
| 1990 | 357.6 | 1997 | 386.5 |
| 1991 | 361.3 | 1998 | 389.5 |
| 1992 | 358.2 | 1999 | 390.6 |
| 1993 | 359.2 | 2000 | 394.1 |
| 1994 | 368.1 | | |
| 1995 | 381.1 | | |
| 1996 | 381.7 | | |

The total equipment cost in the year of interest has now been determined. To obtain the total project investment, we must add several other items. Table 27 summarizes the categories and additional factors proposed by Chem Systems⁶⁹ based on industry standards. Delta-T reviewed the items and factors and determined that they were consistent with other projects the company has completed.

Table 27. Additional Costs for Determining Total Project Investment ⁶⁹

| Item | Description | Amount |
|------------------------|--|--|
| Warehouse | | 1.5% of Total Installed Equipment Cost |
| Site Development | Site Development: Includes fencing, curbing, parking, lot, roads, well drainage, rail system, soil borings, and general paving. This factor allows for minimum site development assuming a clear site, with no unusual problems such as right-of-way, difficult land clearing, or unusual environmental problems. | 9% of the installed cost of process equip. (areas A100, A200, A300, and A500). |
| Prorateable Costs | This includes fringe benefits, burdens, and insurance of the construction contractor. | 10% of Total Installed Cost |
| Field Expenses | Consumables, small tool equip. rental, field services, temporary construction facilities, and field construction supervision. | 10% of Total Installed Cost |
| Home Office and Const. | Engineering plus incidentals, purchasing, and construction. | 25% of Total Installed Cost |
| Project Contingency | Small because of the detail included in the process design. | 3% of Total Installed Cost |
| Other Costs | Start-up and commissioning costs. Land, rights-of-way, permits, surveys, and fees. Piling, soil compaction/dewatering, unusual foundations. Sales, use, and other taxes. Freight, insurance in transit and import duties on equipment, piping, steel, instrumentation, etc. Overtime pay during construction. Field insurance. Project team. Transportation equipment, bulk shipping containers, plant vehicles, etc. Escalation or inflation of costs over time. Interest on construction loan. | 10% of Total Capital Investment |

Table 28 summarizes the Total Installed Equipment Cost. Table 29 illustrates the application of factors in Table 27 to obtain the Total Project Investment (TPI).

Table 28. Total Installed Equipment Costs

| Process Area | Capital Cost |
|---------------------------------------|---------------|
| A100 Feed Handling | \$7,500,000 |
| A200 Pretreatment | \$19,000,000 |
| Neutralization/Conditioning | \$7,800,000 |
| A300 Saccharification/Fermentation | \$9,400,000 |
| A500 Distillation and Solids Recovery | \$21,800,000 |
| A600 Wastewater Treatment | \$3,300,000 |
| A700 Storage | \$2,000,000 |
| A800 Boiler/Turbogenerator | \$38,300,000 |
| A900 Utilities | \$4,700,000 |
| Total Installed Equipment Cost | \$113,700,000 |
| Model I0203I, 2000 \$ | |

Table 29. Total Project Investment (TPI)

| | |
|---|---------------|
| Total Installed Equipment Cost (Table 28) | \$113,700,000 |
| Warehouse | \$1,700,000 |
| Site Development | \$5,900,000 |
| Total Installed Cost | \$121,200,000 |
| Indirect Costs | |
| Field Expenses + Prorateable Expenses | \$24,300,000 |
| Home Office & Construction Fee | \$30,300,000 |
| Project Contingency | \$3,600,000 |
| Total Capital Investment | \$179,400,000 |
| Other Costs (Startup, Permits, etc.) | \$17,900,000 |
| Total Project Investment | \$197,400,000 |
| Model: I0203I, 2000 \$ | |

III.1.2 Variable Operating Costs

Variable operating costs, which include raw materials, waste handling charges, and by-product credits, are incurred only when the process is operating. All raw material quantities used and wastes produced were determined using the ASPEN mass and energy balance model. Appendix C documents the sources of the costs of these items. Table 30 summarizes these costs, both on a per-year and per-gallon of ethanol basis.

Table 30. Variable Operating Costs (Based on 69.3 MM annual gallons ethanol)

| Raw Material | kg/hr | Cost (\$/lb) | MMS/yr | Cents/gal Ethanol |
|---|--------------|--------------|--------|-------------------|
| Biomass Feedstock* | 98,039 | 0.0128 | 23.17 | 33.45 |
| Clarifier Polymer | 28 | 1.2500 | 0.66 | 0.95 |
| Sulfuric Acid | 3,288 | 0.0124 | 0.76 | 1.09 |
| Lime | 2,395 | 0.0348 | 1.54 | 2.23 |
| Corn Steep Liquor | 1,306 | 0.0804 | 1.95 | 2.81 |
| Purchased Cellulase | 6,824 | 0.0552 | 6.98 | 10.08 |
| Diammonium Phosphate | 163 | 0.0706 | 0.21 | 0.31 |
| Propane | 20 | 0.0022 | 0.0022 | 0.001 |
| Make-up Water | 186,649 | 0.0001 | 0.40 | 0.58 |
| BFW Chemicals | 1.0 | 1.3497 | 0.03 | 0.04 |
| Cooling Water Chemicals | 1.9 | 1.0204 | 0.04 | 0.05 |
| WWT Chemicals | 57.9 | 0.1579 | 0.17 | 0.24 |
| WWT Polymer | 0.2 | 2.551 | 0.01 | 0.01 |
| Ash Disposal | 4,492 | 0.0094 | 0.78 | 1.13 |
| Gypsum Disposal | 7,217 | 0.0094 | 1.25 | 1.81 |
| Electricity Credit | -18,747 (kW) | 0.041/kWh | -6.43 | -9.29 |
| *Cost of as-received corn stover, 15% moisture, \$30/dry U.S. ton | | | | |
| Model: I0203I, 2000 \$ | | | | |
| See Appendix C for cost sources | | | | |

As with capital equipment, the costs for chemicals are associated with a particular year. To index the costs from the year in which they were obtained to the year the analysis is being performed, we use the Industrial Inorganic Chemical Index⁷⁰ from SRI Consulting. Data for this index were available for years 1980 through 1999. These data were regressed to a simple equation and used to extrapolate to other years, as shown in Table 31.

Table 31. Inorganic Chemical Index⁷⁰

| Year | Index | Year | Index |
|--|--------------|-------------|--------------|
| 1982 | 91.1 | 1993 | 96.0 |
| 1983 | 86.6 | 1994 | 91.3 |
| 1984 | 85.9 | 1995 | 93.3 |
| 1985 | 88.1 | 1996 | 94.7 |
| 1986 | 86.8 | 1997 | 98.8 |
| 1987 | 86.1 | 1998 | 92.1 |
| 1988 | 91.9 | 1999 | 96.8 |
| 1989 | 99.2 | 2000 | 98.8 |
| 1990 | 101.7 | | |
| 1991 | 102.5 | | |
| 1992 | 100.0 | | |
| Note: 1990 to 1999 represents actual data. 2000 was extrapolated from the data. | | | |

III.1.3 Fixed Operating Costs

Fixed operating costs are generally incurred fully whether or not the plant is producing at full capacity. These costs include labor and various overhead items. Delta-T recommended information on fixed operating costs using data from similar ethanol plant projects the company has been involved with (ranging up to 230 million L [60 million gal] annual production), as well as the standard reference of Peters and Timmerhaus⁶³. Table 32 contains the Delta-T recommendation, except for the number of yard employees. Harris determined the number of yard employees for the corn stover feed handling system¹⁶.

Salaries do not include benefits; they are covered in the general overhead category. General overhead is a factor of 60% applied to the total salaries and covers items such as safety, general engineering, general plant maintenance, payroll overhead (including benefits), plant security, janitorial and similar services, phone, light, heat, and plant communications.

Annual maintenance materials, based on the experience of Delta-T and Peters & Timmerhaus, were estimated as 2% of the total installed equipment cost (shown in Table 28). Additionally, insurance and taxes were estimated at 1.5% of the total installed cost (shown in Table 29) using both Delta-T's in-house information and published information.

It is important to note that the estimates provided for this section are based on a representative Midwest U. S. location. The estimates can vary significantly depending on specific location.

Table 32. Fixed Operating Costs

| | Annual Salary | Number of Personnel | Total Annual Cost |
|--------------------------|----------------------|-----------------------------|--------------------------|
| Plant Manager | \$80,000 | 1 | \$80,000 |
| Plant Engineer | \$65,000 | 1 | \$65,000 |
| Maintenance Supervisor | \$60,000 | 1 | \$60,000 |
| Lab Manager | \$50,000 | 1 | \$50,000 |
| Shift Supervisor | \$37,000 | 5 | \$185,000 |
| Lab Technician | \$25,000 | 2 | \$50,000 |
| Maintenance Technician | \$28,000 | 8 | \$224,000 |
| Shift Operators | \$25,000 | 20 | \$500,000 |
| Yard Employees | \$20,000 | 32 | \$640,000 |
| General Manager | \$100,000 | 1 | \$100,000 |
| Clerks & Secretaries | \$20,000 | 5 | \$100,000 |
| Total Salaries (1998 \$) | | | \$2,054,000 |
| Total Salaries (2000 \$) | | | \$2,150,000 |
| | Factor | | |
| General Overhead | 60% | Of Total Salaries | \$1,293,000 |
| Maintenance | 2% | Of Installed Equipment Cost | \$2,273,000 |
| Insurance & Taxes | 1.5% | Of Total Installed Cost | \$1,819,000 |
| Model: I0203I, 2000 \$ | | | |

The salaries are on a 1998 basis and will need to be indexed to other cost years when appropriate. The index to adjust these costs is taken from the Bureau of Labor Statistics⁷¹ and is given in Table 33. The available data were regressed to a simple equation. The resulting regression equation can be used to extrapolate to out years.

Table 33. Labor Index⁷¹

| Year | Index | Year | Index |
|-------------|--------------|-------------|--------------|
| 1980 | 8.3 | 1992 | 14.51 |
| 1981 | 9.12 | 1993 | 14.82 |
| 1982 | 9.96 | 1994 | 15.13 |
| 1983 | 10.58 | 1995 | 15.62 |
| 1984 | 11.07 | 1996 | 16.17 |
| 1985 | 11.56 | 1997 | 16.57 |
| 1986 | 11.98 | 1998 | 17.09 |
| 1987 | 12.37 | 1999 | 17.38 |
| 1988 | 12.71 | 2000 | 17.93 |
| 1989 | 13.09 | | |
| 1990 | 13.54 | | |
| 1991 | 14.04 | | |

III.1.4 Discounted Cash Flow Analysis and the Selling Cost of Ethanol

Once the major three cost areas have been determined—(1) total project investment, (2) variable operating costs, and (3) fixed operating costs—a discounted cash flow analysis can be used to determine the minimum selling price per gallon of ethanol produced. The discounted cash flow analysis program iterates on the selling cost of ethanol until the net present value of the project is zero. This analysis requires that the discount rate, depreciation method, income tax rates, plant life, and construction start-up duration be specified. The minimum ethanol selling price is the

selling price of ethanol that makes the net present value of the biomass to ethanol process equal to zero with a 10% discounted cash flow rate of return over a 20 year plant life.

The discount rate for this analysis was set at 10%. This rate was selected based on the recommendation by Short et al.⁷² in his description of how to perform economic evaluations of renewable energy technologies for DOE. His view is that “In the absence of statistical data on discount rates used by industrial, transportation and commercial investors for investments with risks similar to those of conservation and renewable energy investments, it is recommended that an after tax discount rate of 10%... be used.”

For this analysis, we assumed that the plant would be 100% equity financed. This, along with our other financial assumptions, is of course subject to change for a specific project. For this analysis these parameters were chosen to provide a standard method that was not clouded by the infinite possibilities of financing, but are certainly not the final word in project financing. Figure 17 illustrates the dependence of minimum ethanol selling price on both the percentage of equity financing and the after tax discount rate (IRR), based on 7.5% interest on a 10-year loan.

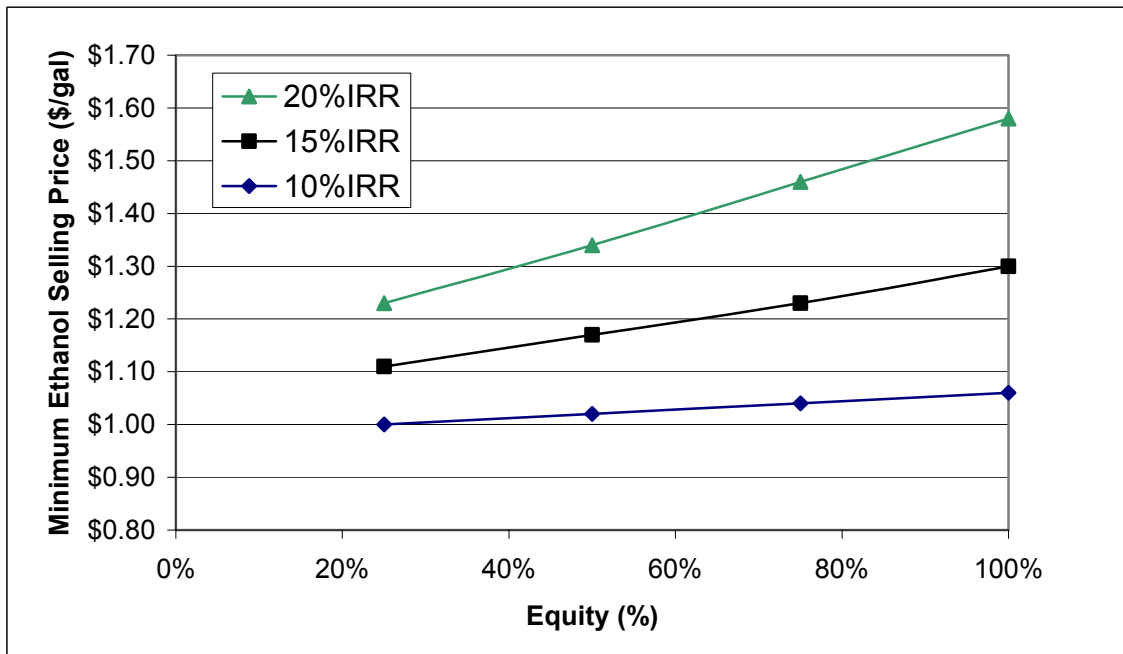

Figure 17. Effect of Varying IRR and Equity on Minimum Ethanol Selling Price (Loan Rate=7.5%, Loan Term=10 years)

To determine the depreciation amount for the calculation of federal taxes to be paid, Short et al.⁷³ recommends the use of the IRS Modified Accelerated Cost Recovery System (MARCS). Within the MARCS system is the General Depreciation System (GDS), which allows both the 200% and 150% declining balance (DB) methods of depreciation. This offers the shortest recovery period and the largest tax deductions. IRS publication 534 (IRS 1993) indicates that steam production plants should use a 20-year recovery period. The IRS indicates that other property not specifically described in the publication should be depreciated using a 7-year recovery period. Short et al.⁷⁴ indicates that property listed with a recovery period less than 10 years should use the 200% DB depreciation method and that a 20-year recovery period property should use the 150% DB depreciation.

State taxes are not considered, primarily because the location of the plant has not been determined and tax rates vary quite drastically (from 0% to 12%). Short et al⁷² suggested using the highest federal tax bracket, which is 39% for large corporations.

Return on investment is calculated on a per gallon basis. Income tax is averaged over the plant life and that average is calculated on a per gallon basis. The amount of income tax to be paid by a potential ethanol producer varies annually due to changes in the volume of product produced and the allowable depreciation deduction. In fact, no income tax is paid in the first three years of operation because the depreciation deduction is greater than the net income.

The construction time is important to the cash flow analysis because there is generally no income during construction but huge sums of money are being expended. Perry and Green⁷⁵ indicate that small projects (less than \$10 million investment) can be constructed in fewer than 18 months and that larger projects can take up to 42 months. An overview⁷⁶ of petroleum refining economics indicates that large refineries (of the order of \$1.5 billion investment) can be constructed in 24 months. Certainly this ethanol process is much smaller than the petroleum refinery, so using a construction time of more than 24 months is conservative and fits within these references. Delta-T's experience with grain-to-ethanol plants indicates that it will require a little more than 2 years to complete a project of this size. An important difference between this type of facility and a refinery are the large number of field-erected vessels in this process. Their on-site construction and proximity will cause the construction time to be a little longer. Table 34 summarizes the schedule for construction and the cash flow during that time.

Table 34. Construction Activities and Cash Flow

| Project Start Month | Project End Month | Activity Description | % of Project Cost |
|----------------------------|--------------------------|---|--------------------------|
| 0 | 6 | Project plan and schedule established, conceptual and basic design engineering, permitting completed. Major equipment bid packages issued, engineering started on selected sub-packages, P&IDs complete, preliminary plant and equipment arrangements complete. | 8.00% |
| 6 | 18 | All detailed engineering including foundations, structure, piping, electrical, site, etc. complete; all equipment and instrument components purchased and delivered; all site grading, drainage, sewers, rail, fire pond, foundation, and major structural installation complete; 80% of all major process equipment set (all except longest lead items), all field fabricated tanks built, and the majority of piping and electrical materials procured. | 60.62% |
| 18 | 30 | Complete process equipment setting, piping, and instrumentation installation complete; all electrical wiring complete; all building finishing and plumbing complete; all landscaping complete; pre-commissioning complete; and commissioning, start-up, and initial performance test complete. | 31.38% |
| | | TOTAL | 100.00% |

Notes:

1. The above presumes no utility or process equipment orders placed prior to month seven.
2. Expenditures based on typical 60 MM gal/yr grain-to-ethanol facility.

Perry and Green⁷⁵ indicate that for a moderately complex plant start-up should be about 25% of the construction time - or 6 months, in this case. Delta-T's experience with start-up demonstrates that a large grain-to-ethanol plant could be started in less time, but a biomass ethanol plant is more complex than a grain ethanol plant. Considering that this design is for the "nth" operating plant, we assumed a start-up time of 6 months. The start-up period is not completely wasted, however. We expect that an average of 50% production could be achieved during that period with about 75% expenditure of variable expenses and 100% of fixed expenses.

Peters and Timmerhaus⁶³ define working capital as money available to cover (1) raw materials and supplies in inventory 2) finished product in storage, (3) accounts receivable, (4) cash on hand for monthly payments such as wages and maintenance supplies, (5) accounts payable, and (6) taxes payable. They indicate that working capital is usually 10%-20% of the total capital investment. This flow of money is required over the life of the plant, beginning in the start-up phase to make product that generates revenue to use in purchasing more materials and supplies. For this project, 10% would be about \$18 million. On-site ethanol storage capacity is seven days; assuming the product can be made, shipped and payment received in 30 days is conservative. One month's raw materials, labor, maintenance, taxes and overhead is \$4 million. Therefore, a lower number seems reasonable. Garrett⁶ suggests that using a fraction of the yearly operating cost, typically 10-35% is more relevant. Using these percentages results in a working capital range of \$5 to \$16 million. We chose to use \$10 million, or 5% of the total capital investment.

Table 35 summarizes the parameters used in the discounted cash flow analysis.

Table 35. Discounted Cash Flow Parameters

| | |
|---------------------------------------|--------------------------------|
| Plant Life | 20 years |
| Discount Rate | 10% |
| General Plant Depreciation | 200% DB |
| General Plant Recovery Period | 7 years |
| Steam Plant Depreciation | 150% DB |
| Steam Plant Recovery Period | 20 years |
| Federal Tax Rate | 39% |
| Financing | 100% equity |
| Construction Period | 2.5 years |
| 1 st 6 Months Expenditures | 8% |
| Next 12 Months Expenditures | 61% |
| Last 12 Months Expenditures | 31% |
| Working Capital | 5% of Total Capital Investment |
| Start-Up Time | 6 months |
| Revenues | 50% |
| Variable Costs | 75% |
| Fixed Costs | 100% |

Using the discounted cash flow parameters in Table 35, plus the cost information in Table 29, 30 and 32, the resulting minimum ethanol selling price of pure ethanol is \$1.07/gal (see Table 36). Using the total project investment estimate margin of +25%/-10%, the impact on the cost of ethanol would be a low of \$1.02/gal and a high of \$1.19/gal. Samples of the discounted cash flow, operating costs, and summary worksheets are in Appendix D.

Table 36. Summary of Yields, Rates, and Conversion Costs

| | |
|--|--------------------------------|
| Feedstock Rate (dry metric tons/day) | 2,000 |
| Ethanol Yield (gal/dry US ton feedstock) | 89.7 |
| Ethanol Production (MM gal/yr) | 69.3 |
| Total Equipment Cost (MM \$) | 113.7 |
| Total Project Investment (capital) (MM \$) | 197.4 |
| Non-feedstock Raw Materials (MM \$/yr) | 12.7 |
| Waste Disposal (MM \$/yr) | 2.0 |
| Fixed Costs (MM \$/yr) | 7.5 |
| Excess Electricity Generated (kWh/gal ethanol) | 2.28 |
| On-Line Time (hr/yr) | 8,406 |
| Minimum Ethanol Selling Price | \$1.07 /gal (+\$0.12/- \$0.05) |
| Model: I0203I, 2000 \$ | |

The \$1.07/gal can be further broken down into the cost of each process area. Figure 18 illustrates the contribution to the overall cost by process area and capital, operations, and fixed costs.

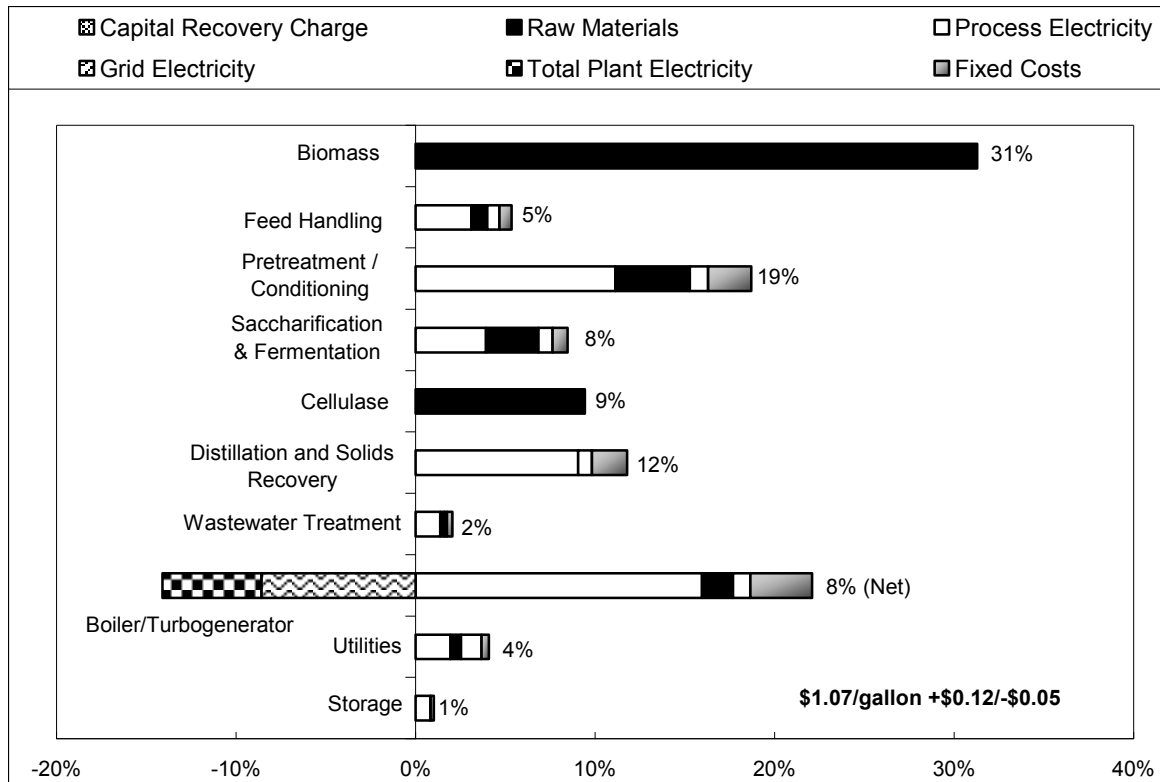

Figure 18. Cost Contribution Details from Each Process Area (% of Ethanol Selling Price)

These costs are probably still too high for a company to start constructing a grass-roots plant based on undemonstrated technology. Plants that are being engineered today have some niche that allows them a special advantage in the short term for a small market segment. This could be feedstock costs (very low or negative for environmental wastes), used equipment (making use of related equipment that has been shut down), co-location with existing facilities (biomass combustors and waste treatment facilities), or a combination of these. It is not expected that grass roots, large-scale cellulosic biomass-to-ethanol plants will be built until after these first pioneer plants.

III.1.5 The Cost of Sugar

Sugars are an intermediate product in the formation of ethanol. Hemicellulose is hydrolyzed to form xylose, arabinose, galactose, and mannose in the pretreatment area. Cellulase enzyme saccharifies the cellulose into glucose. For this analysis enzymatic hydrolysis is assumed to be operated in a near sterile way and nearly to completion so that a transferable sugar stream is produced as product.

To analyze the cost of the intermediate sugar stream the following areas were removed from the biomass-to-ethanol process model and economics: wastewater treatment (a cost was kept for treatment of the pretreatment flash vapor), fermentation, distillation and stillage treatment, and storage. Also, a counter-current washer was added after the saccharification area to separate lignin for combustion from the dilute mixed sugar stream. Mass balances and capital and operating costs were determined for the sugar process and the minimum sugar transfer price was calculated to be 6.4¢/lb. Table 37 shows the sugar stream composition. As in the design case for

ethanol, all of the hydrolysis (90% of theoretical) is assumed to occur in the saccharification tanks. In reality, glucose levels in the saccharification step may limit the extent of hydrolysis.

Table 37. Mixed Sugar Stream Concentration From Saccharification

| Sugar | Concentration (g/L) |
|---------------|---------------------|
| Glucose | 65 |
| Xylose | 38 |
| Arabinose | 5.2 |
| Mannose | 2.7 |
| Galactose | 3.4 |
| Total | 114.3 |
| Model: R0204E | |

In some cases the lignin stream can be sold either to a nearby plant that converts lignin into higher value byproducts or a larger more cost-efficient biomass power facility. Selling the lignin at the same price as the feedstock (on a lower heating value basis) reduces the sugar price to 5.6¢/lb.

IV. Sensitivity Analysis

The cost of ethanol as determined in the previous section was derived using technology that has been developed or is currently being developed. The process targets in the design represent what must be achieved to obtain the \$1.07 per gallon reported. When any target is not met, the cost is affected to varying degrees. In addition, uncertainty about equipment design and installation and construction costs will impact the economics. Some process targets can be met through research of the core technologies: feedstock collection, pretreatment, saccharification (enzyme development) and fermentation (ethanologen development). Others, like feedstock composition variability are not as controllable. The key is to understand the impact of those types of parameters that are likely to vary, and how they might be controlled to a definable range. For example, corn stover may need to be stored covered, or be used within a certain window after harvesting to avoid carbohydrate degradation. Equipment and operating costs are another area that research is less able to affect, since demand will affect the price of the ingredient or equipment. Discussed here are process targets that have been identified as key ones to understand and achieve. In most cases, values used for the sensitivities are picked from current experimental data, to demonstrate the effect of technology advancement (or lack of) on the economic viability of the process.

IV.1 Stover Composition, Cost, and Handling

Different parts of the corn have different compositions. The relative proportions of the various anatomical parts present in a given lot of feedstock will be affected by the genetics of the corn, environmental factors, harvest, and storage practices. These variations can have a significant effect on cost through yield alone, and preliminary observations suggest that variation in the solids composition of anatomical fractions of a plant can have an effect on pretreatment efficiency¹³.

Improved harvesting methods, weather, and demand are some of the factors that will affect the stover cost. The results of a small stover collection program in 1997-1998 by Iron Horse Custom Farming of Harlan, Iowa, reported stover collection costs between \$31-\$36 per dry U.S. ton⁹. Studies by contractors for DOE have reported a range of \$35-\$46 per dry U.S. ton with current

collection methods⁷⁷. ORNL has reported that almost all of the collectable stover becomes available for \$55 per dry U.S. ton¹¹. If these prices remain the norm due to any of the factors mentioned above, then the production cost of ethanol could be as high as \$1.35/gal using stover purchased at \$55 per dry U.S. ton.

Bale handling in the plant is currently envisioned to require a large complement of yard workers to move the bales from the trucks to storage or the feedstock handling area. Harris estimated 4 laborers per shift. If the number can be reduced from 32 to 8 (2 per shift) the resulting cost savings is \$0.02/gal. Such a reduction might occur from improved handling equipment or practices.

IV.2 Pretreatment Yields and Cost

Conversion of the hemicellulosic portion of the stover is important when it contains almost half (44%) of the available sugars. Xylan makes up 72% of the hemicellulosic sugars. Table 38 shows the effect of pretreatment yield on overall yield and ethanol selling price. If no more improvement is made in yields than the current data²⁵ shows, then there is a \$0.11/gal increase in the ethanol selling price.

Table 38. Effect of Pretreatment Yields on Minimum Ethanol Selling Price

| Pretreatment Hemicellulose to Monomer Yield | Overall Ethanol Yield (gal/dry U.S. ton) | Change in Overall Yield (%) | Ethanol Selling Price (\$/gal) | Change in price from design case (\$/gal) |
|--|---|------------------------------------|---------------------------------------|--|
| 67.5% | 80.4 | -10 | \$1.18 | +\$0.11 |
| 80% | 85.5 | -5 | \$1.12 | +\$0.05 |
| 90% | 89.7 | ----- | \$1.07 | ----- |
| 95% | 91.6 | +2 | \$1.05 | -\$0.02 |

While the equipment designed for continuous dilute acid pretreatment of the stover is similar to hydrolyzers used in the pulp and paper and rendering industries, the solids handling for stover may be significantly different, causing a more expensive reactor. Conditions in the reactor may require more exotic metallurgy than Inconel. These are not first of a kind costs, but a more expensive reactor design overall. If the costs are 50% higher (or lower) than currently envisioned (about \$17MM installed equipment cost), the ethanol selling price will change by \$0.04/gal.

IV.3 Gypsum

Solid-liquid separation prior to overliming and neutralization allows gypsum to be removed from the process and prevents deposits in the high temperature product recovery equipment. If this step is removed, there is a savings of \$0.03/gal due primarily to capital reduction (-\$7.2MM in conditioning/neutralization, +2.1MM in saccharification/fermentation and distillation) and a slight yield increase (0.4 gal/ton) from sugars that exited with the gypsum waste stream. These effects are easy to quantify. The impact of having the gypsum in the process is more difficult to translate to cost. Without the separation, gypsum in the saccharification feed stream (306) goes from 28 kg/hr (0.1%) to 5,100 kg/hr (1%). It is 0.06% of the solids with the separation and becomes 10% of the solids if the separation is removed. About this same concentration goes to the stripper column and the first evaporator effect; high solids recovery in the solids recovery separation step keeps most of the gypsum out of the second and third effects. The gypsum ends

up in the combustor, lowering the feed's lower heating value 15% (4,179 to 3,552 Btu/lb). The gypsum will affect the SO_x production in the combustor, but whether positively due to the calcium, negatively due to the sulfur, or some combination of both is unknown at this time. The unreacted portion will go with the ash to waste disposal.

IV.4 Saccharification and Fermentation Yields and Costs

If the enzyme cost is higher or lower than estimated in this analysis, it will have a direct effect on the ethanol selling price. Since the cellulase subcontracts are in the second year, it is early to have a preparation to test for efficacy and determine loading. There are several possible trade-offs to minimize the overall effect of a higher than expected enzyme cost per ethanol gallon. One of them is residence time. Doubling the residence time in the saccharification tanks (from 1.5 days) will increase the TPI by \$4.4MM and the ethanol selling price by \$0.01/gal. For every 5 FPU/ g cellulose increase in loading, the ethanol selling price increases \$0.04/gal, so for the cost of doubling the residence time, only a minimal increase in loading can be achieved.

If increasing the residence time can minimize the enzyme loading, the overall MESP can be minimized using a sensitivity analysis with empirical data. An example of that sensitivity analysis was run on an unoptimized corn stover pretreatment (P010129CS). That pretreatment was run at 165°C for 8 min. with an acid concentration of 1.37% and is described in a paper by Schell⁷⁸. The enzymatic digestibilities of the resulting hydrolyzed solids were measured in an SSF using Iogen (Ottawa, Canada) cellulase enzyme (lot no. BRC 191095) and a *Saccharomyces cerevisiae* D₅A in shake flasks. The flasks were loaded with 5.65% cellulose (equivalent to approximately 17% total solids). Since the enzyme is not representative of what will be produced by the DOE/enzyme manufacturer partnerships, the pretreatment conditions were not optimized, and the enzymatic digestibility measurements do not match process conditions (e.g., saccharification without fermentation vs. SSF with only glucose fermented) this study is only an example. It is not intended to show the ideal enzyme loading/residence time combination but rather to show how that optimization could be determined.

Yields from the SSF were calculated by dividing the final ethanol concentration by the theoretical ethanol concentration from cellulose after subtracting out ethanol added with the inoculum. The resulting yield is probably a conservative estimate of cellulose conversion because it does not include other fermentation products; however, it is close to what can be achieved in the process. Figure 19 shows ethanol yields for five enzyme loadings (5, 10, 15, 20, and 25 FPU/g cellulose) at multiple SSF times (ranging from 7 hours to 168 hours). Since only SSF data are available, for modeling purposes we assumed that the saccharification and fermentation times are each half of the SSF time. In the design case, the enzyme loading is 12 FPU/g cellulose, the saccharification time is 36 hours, the fermentation time is 36 hours (the equivalent SSF time is 72 hours), and the cellulose hydrolysis yield is 90%. Those parameters are discussed in section II.3.4 and were achieved using a more optimum pretreatment than was used for this study; therefore, the design case has better results than those shown in Figure 19.

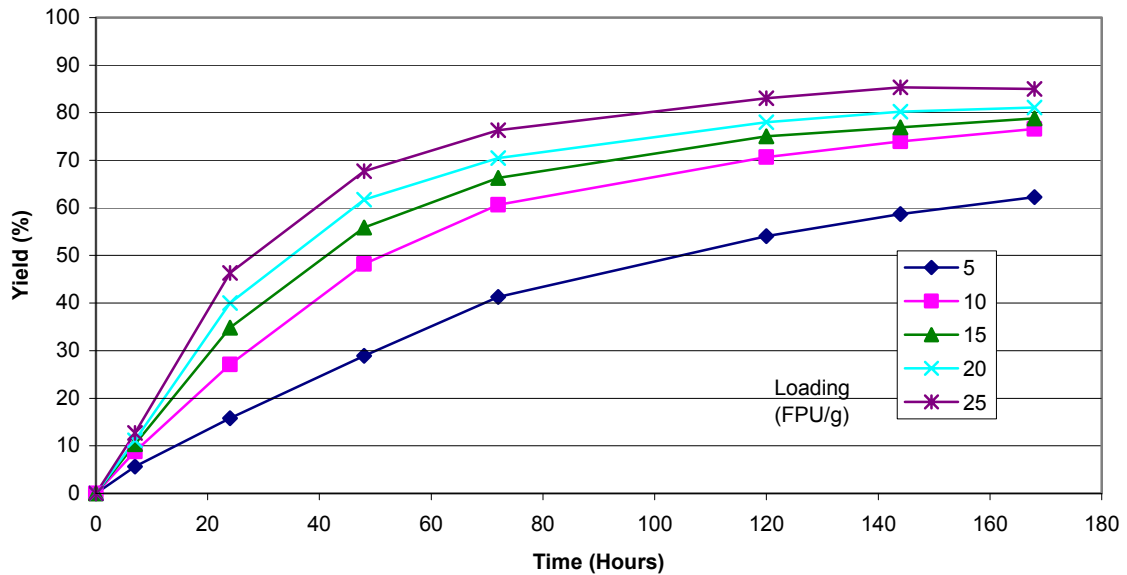

Figure 19. SSF Yields for Multiple Enzyme Loadings

Each of the enzyme loading, residence time, and yield combinations shown in Figure 19 were entered into the process model, and the model was run to calculate the corresponding MESP. Those MESP are shown in Figures 20 and 21. Figure 20 portrays the MESP at each time point with each of the enzyme loadings. It shows that the residence time should be at or above 144 hours and that the effect of increasing residence time is large until it reaches about 120 hours. Figure 21 portrays the MESP at each enzyme loading with each time point. It shows that the optimum enzyme loading is about 10 FPU/g cellulose. Both figures show the decreasing effect additional fermentation time (as additional fermentation capacity) has on the ethanol selling price. These results are highly dependent upon the corn stover, pretreatment conditions, enzyme cocktail, saccharification/fermentation design, and enzyme cost so the optimums will probably change if any of those process options are different.

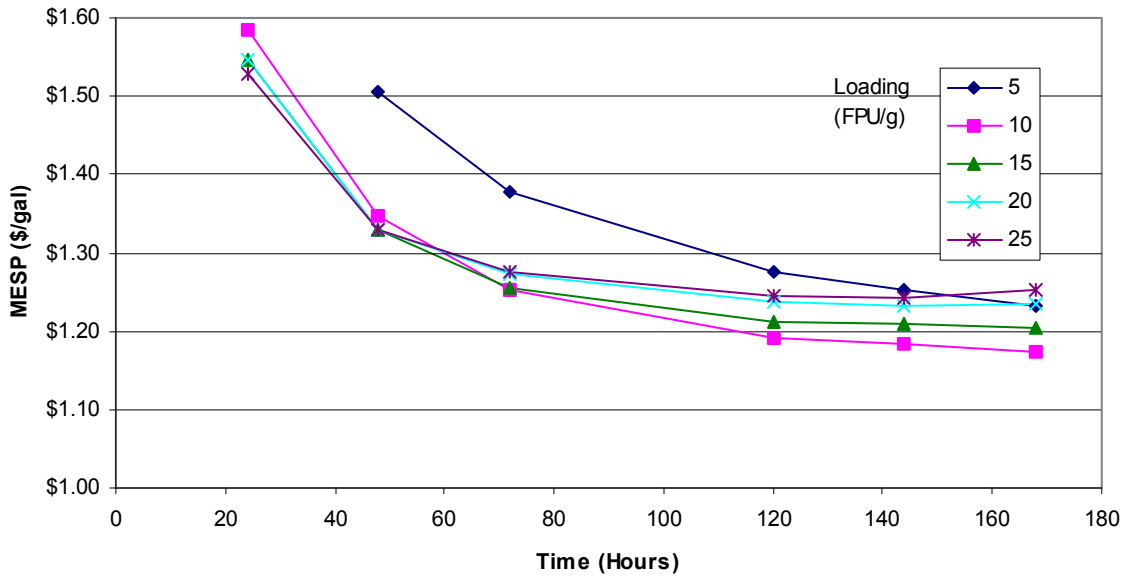

Figure 20. MESP for Multiple Enzyme Loadings

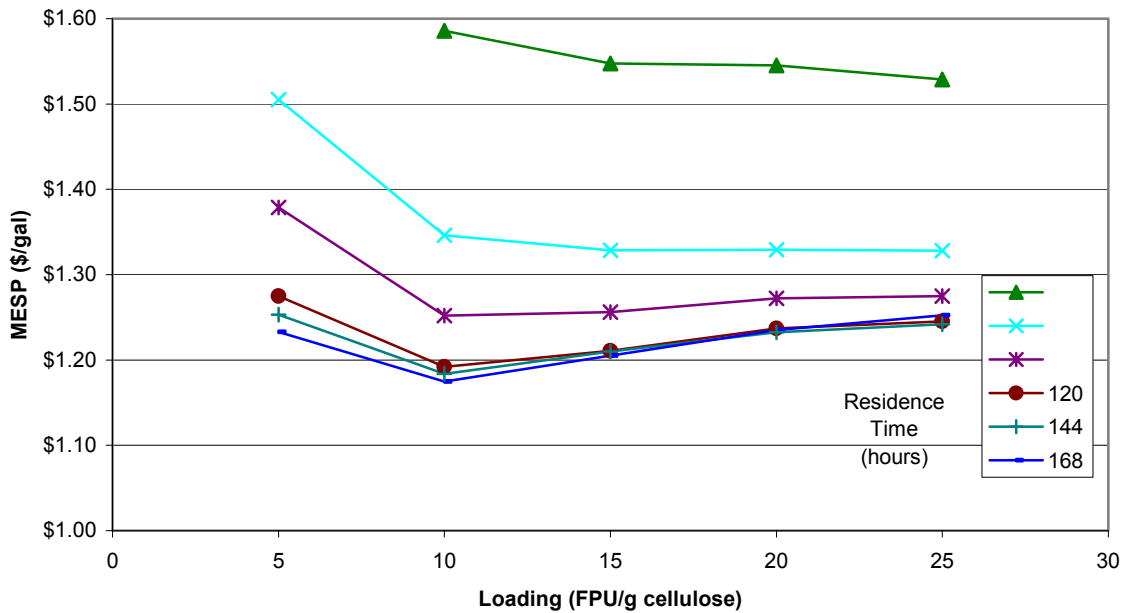

Figure 21. MESP for Multiple Residence Times

Hemicellulase activity in the enzyme preparation may also reduce costs by allowing for a milder pretreatment. Again, the work is at an early stage, but some of the commercial preparations show

hemicellulase activity. NREL is investigating opportunities in hemicellulase and other “accessory” enzymes.

Finding or engineering an organism to ferment hemicellulosic sugars is key to economic yields from stover. If an organism is developed, it may metabolize xylose and the minor sugars slower than, or after, glucose. If the minor sugars (arabinose, mannose, galactose) are not converted, there is a \$0.09/gal increase (\$0.04, \$0.03, \$0.02/gal, respectively) in the ethanol selling price. Table 39 shows other yield effects from a less than robust multi-fermentation organism(s). Increasing the residence time to 3 days has the same minimal effect on the ethanol selling price as increasing saccharification time, \$0.01/gal, so using it to increase ethanol yield can offset organism efficiency.

IV.5 Energy Production

Solids combustion (coal) is well known. Biomass co-firing has become industry practice among power generators to reduce emissions, and biomass power generation has been in California for several years. Aside from biomass, pulverized coal and coal slurries are the fuels most similar to the lignin residue from the ethanol process. A circulating fluidized bed combustor has been identified as the most likely combustor for this feed without drying it. If a CFBC requires additional drying or feed handling equipment for the residue, the cost may increase. Conversely, a cheaper type of combustor, like a modified pile or grate burner may be adequate. If the combustor costs (currently \$20.6MM installed equipment cost) change by 50%, the ethanol price is affected by \$0.05/gal. A 30% change translates to a \$0.03/gal effect.

A \$0.041/kWh credit is assumed for excess electricity produced by the plant and sold “to the grid”, which is usually an avoided use credit. If the value of the electricity were only \$0.02/kWh⁷⁹, the ethanol selling price would be \$1.12/gallon; if the value were \$0.06/kWh, the ethanol selling price would be \$1.02/gallon. The value of power is highly regional and fluctuates almost by the hour. There is the uncertainty of the plant’s ability to meet contracts or get a good price by supplying more at peak demand. A worst case scenario would be no revenue for the excess power, implying that the excess steam would be vented or used for some other non-revenue producing work. There may be some cost benefit in using the excess steam to heat the plant buildings. No net revenue for electricity means \$0.09/gal increase. Assuming the plant could purchase electricity for \$0.04/kW makes the ethanol selling price \$1.16/gal (with the turbogenerator removed from the design), which again hinges on the electricity cost variations. Given these two choices, in-house electricity production makes sense as a way to keep the costs controlled unless capital costs are controlling the decision.

If there were a value for the lignin residue outside of the plant, purchasing electricity and producing steam with a gas boiler would also reduce the capital costs.

Table 39 summarizes the sensitivity results by their cost impact.

Table 39. Summary of Sensitivity Results by Cost Impact

| Design Parameter | Values | | Overall Yield (gal/dry U.S. ton) | Change in Overall Yield (%) | Ethanol Selling Price (\$/gal) | Change in price from design case (\$/gal) |
|---|--------------------|--------------------|----------------------------------|-----------------------------|--------------------------------|---|
| | Design Case | Sensitivity | | | | |
| Xylose/minor sugar fermentation yields | 85%/85% | 50%/0% | 72.0 | -20 | \$1.31 | +\$0.24 |
| Stover cost | \$30/dry U.S. ton | \$50/dry U.S. ton | 89.7 | ----- | \$1.29 | +\$0.22 |
| Hemicellulose sugar fermentation yields | 85% | 50% | 77.4 | -14 | \$1.22 | +\$0.15 |
| Minor sugar (arabinose, mannose, galactose) fermentation yields | 85% | 0% | 81.1 | -10 | \$1.17 | +\$0.10 |
| Pretreatment yield | 90% | 67.5% | 80.4 | -10 | \$1.18 | +\$0.11 |
| Electricity credit | \$0.041 kWh | 0 | ----- | ----- | \$1.16 | +\$0.09 |
| | | \$0.02/kWh | 89.7 | | \$1.12 | +\$0.05 |
| | | \$0.06/kWh | 89.7 | | \$1.02 | -\$0.05 |
| Electricity source | Produced | Purchased | ----- | ----- | \$1.16 | +\$0.09 |
| Pretreatment yield | 90% | 80% | 85.7 | -4 | \$1.12 | +\$0.05 |
| Enzyme loading | 12 FPU/g cellulose | 17 FPU/g cellulose | 89.7 | ----- | \$1.12 | +\$0.05 |
| Glucose yield | 95% | 85% | 84.4 | -6 | \$1.12 | +\$0.05 |
| Combustor cost | \$20.6MM | +50% | ----- | ----- | \$1.12 | +\$0.05 |
| Pretreatment reactor cost | \$17MM | +50% | ----- | ----- | \$1.11 | +\$0.04 |
| Glucose yield | 95% | 90% | 87.0 | -3 | \$1.10 | +\$0.03 |
| Saccharification or fermentation residence time | 1.5 days | 3 days | 89.7 | ----- | \$1.08 | +\$0.01 |
| Pretreatment yield | 90% | 95% | 91.6 | +2 | \$1.05 | -\$0.02 |
| Stover handling labor | 8/shift | 2/shift | 89.7 | ----- | \$1.05 | -\$0.02 |
| Combustor cost | \$20.6MM | -30% | ----- | ----- | \$1.04 | -\$0.03 |
| Solid-liquid separation before overliming | Yes | No | 90.1 | +0.5 | \$1.04 | -\$0.03 |
| Pretreatment reactor cost | \$17MM | -50% | ----- | ----- | \$1.03 | -\$0.04 |

IV.6 Monte Carlo Analysis

IV.6.1 Overview

Monte Carlo analysis is a probabilistic analysis method that couples results with the uncertainty of values entered into a model. The basic uncertainty of parameter values can be represented with random distribution functions and the results can be shown as probability curves.

Since all parameter values have some uncertainty, reporting a single result set is an oversimplification of the potential results. The single result set is valid for the input set of data if

all values are absolutely accurate; however, a probability curve better represents real results based on uncertainty of the input parameters. The Monte Carlo analytical method allows the user to select one or more input parameters and define the probability curve of values for those parameters. It then utilizes random selection (according to the probability assigned) to set a value for each parameter, calculates the result, records the results, and repeats the process of selection, calculation, and recording numerous times. The final results can be reported in several different types of curves; the most common are histograms and probability curves.

The primary use of Monte Carlo simulation has been for financial decisions, although a few groups have begun to use it in the scientific arena. As early as 1986, NREL staff proposed utilization of Monte Carlo analysis as a management technique for biomass-to-ethanol research⁸⁰. They used cumulative probability curves to compare potential processes and focused on their overlaps and MESP with 50% probability. Akerberg and Zacchi show a probability curve of the production cost of lactic acid from starch⁸¹ to emphasize that a single production cost is insufficient.

As a preliminary Monte Carlo analysis for this process model, we selected several economic parameters, defined their probability curves, and calculated the resulting probability curves for ethanol selling price and total project investment. Utilizing Crystal Ball⁸² as an add-in to Excel⁸³ simplified the task of curve definition and recording and reporting of results. Process performance parameters were not varied during this analysis because of the difficulty of running an ASPEN simulation for each iteration. We plan to develop a method for Monte Carlo analysis of process parameters so that we can link economic results to research uncertainty as well as economic uncertainty.

IV.6.2 Parameter Estimates

Probability curves were defined for the following 5 parameters: stover cost, value of excess electricity, enzyme price, pretreatment reactor purchase price, and project contingency. Three of the parameters (stover cost, value of excess electricity, and enzyme price) affect operating costs directly. The other two (pretreatment reactor purchase price and project contingency) affect the capital investment and fixed operating costs that are scaled off of capital investment. Table 40 shows the distributions of the five parameters.

Table 40. Input Parameter Distribution for Monte Carlo Analysis

| | Stover cost | Value of Excess Electricity | Enzyme Price | Pretreatment Reactor Purchase Price | Project Contingency |
|-----------------------|--------------------|------------------------------------|---------------------|--|----------------------------|
| Distribution Function | Triangular | Normal | Triangular | Lognormal | Triangular |
| Most Probable* | \$30/dry US ton | \$0.04/kWh | \$0.10/gal ethanol | \$2,457,000 | 3% |
| Standard Deviation | ----- | \$0.008/kWh | ----- | \$500,000 | ----- |
| Minimum | \$25/dry US ton | \$0.02/kWh | \$0.07/gal ethanol | \$0 | 2% |
| Maximum | \$50/dry US ton | Infinite | \$0.20/gal ethanol | Infinite | 25% |

* Mean for normal and lognormal distributions

In all cases, the most probable input is the value in the standard model and has been reported in previous sections.

Two thousand iterations were run using the above probability distributions. For each iteration, all 5 parameters were randomly varied according to the defined distribution for each value and results were calculated and recorded.

IV.6.3 Results

The minimum ethanol selling price, total project investment, and Lang factor results were recorded. All results are based only upon the minimal number of varied values shown above. Obviously, a better analysis can be done once process performance parameters can be investigated in addition to the economic parameters that are currently being reported.

Figure 22 is a histogram of the minimum ethanol selling price and shows that the 90% confidence interval of the MESP is \$1.06/gal to \$1.29/gal. Figure 23 is the probability curve of the MESP and shows that the MESP has a 7% probability of being \$1.07/gal or less and that it has a 50% probability of being \$1.17/gal or less.

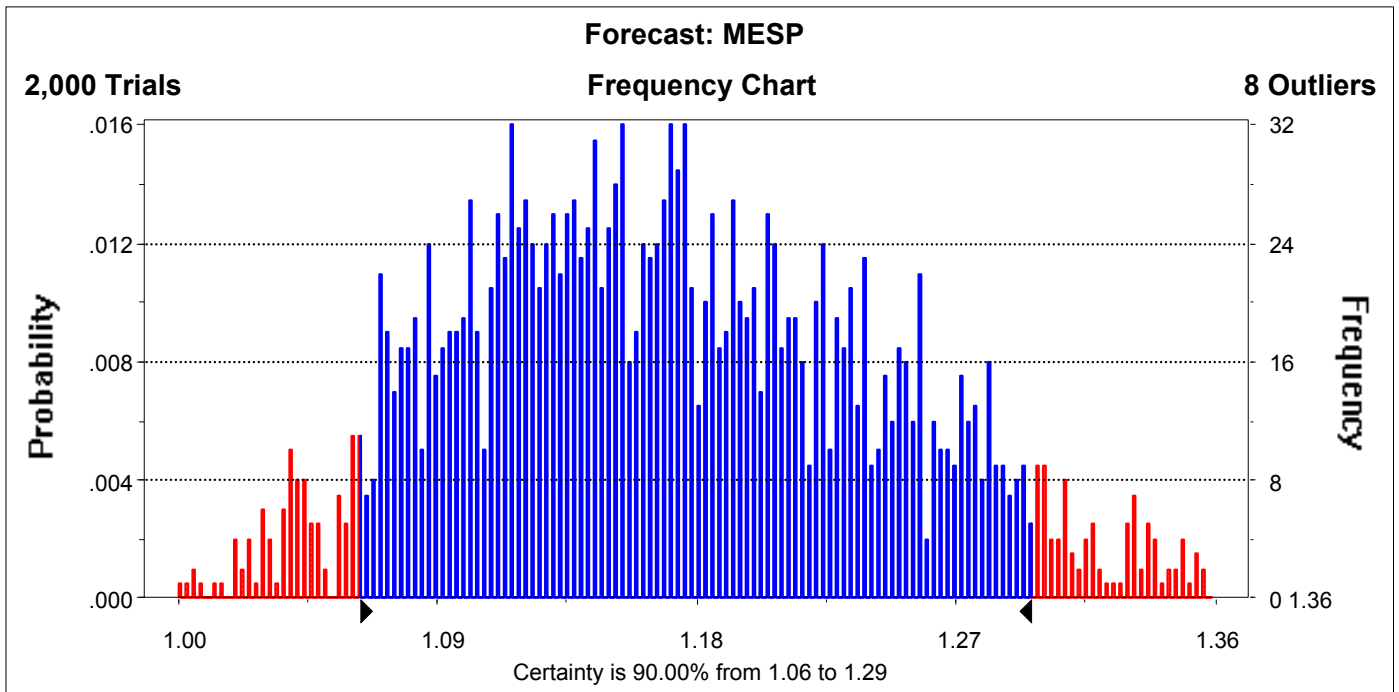

Figure 22. Histogram of the Minimum Ethanol Selling Price

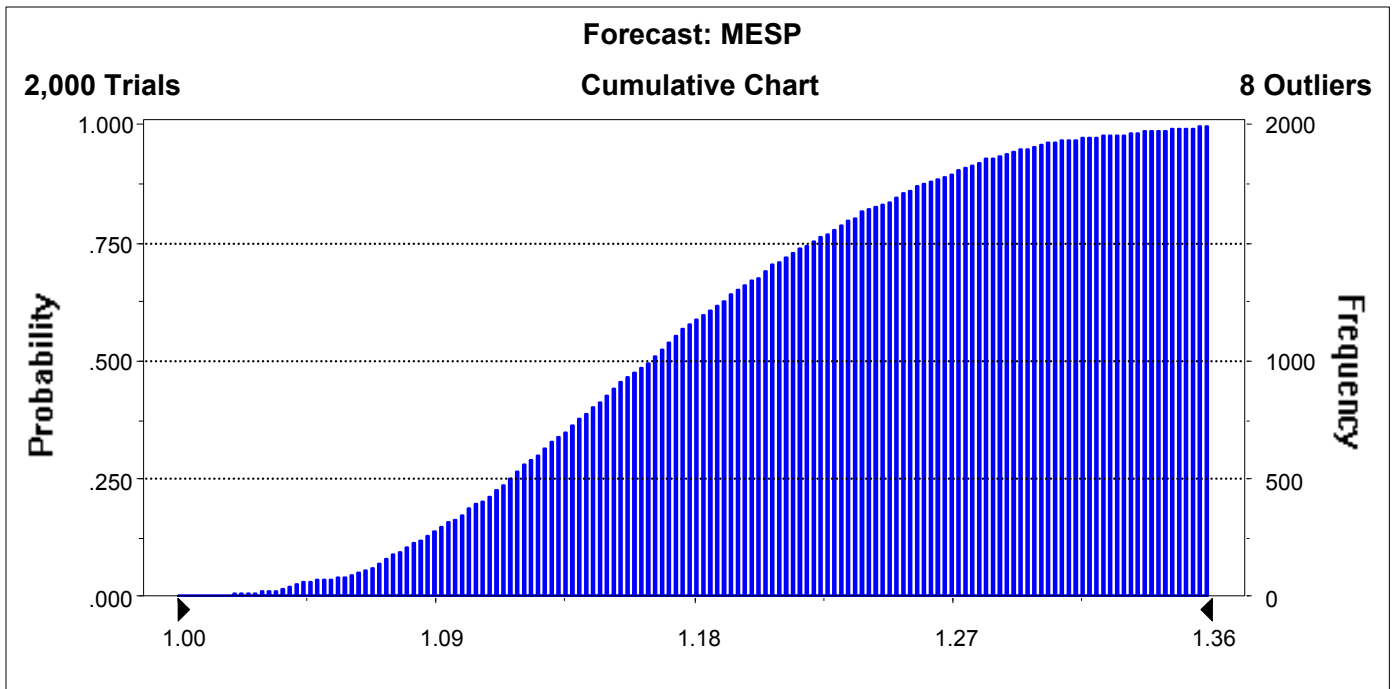

Figure 23. Probability Curve of the Minimum Ethanol Selling Price

Figure 24 is a histogram for the total project investment and shows that the 90% confidence interval for the TPI is \$192,000,000 to \$223,000,000.

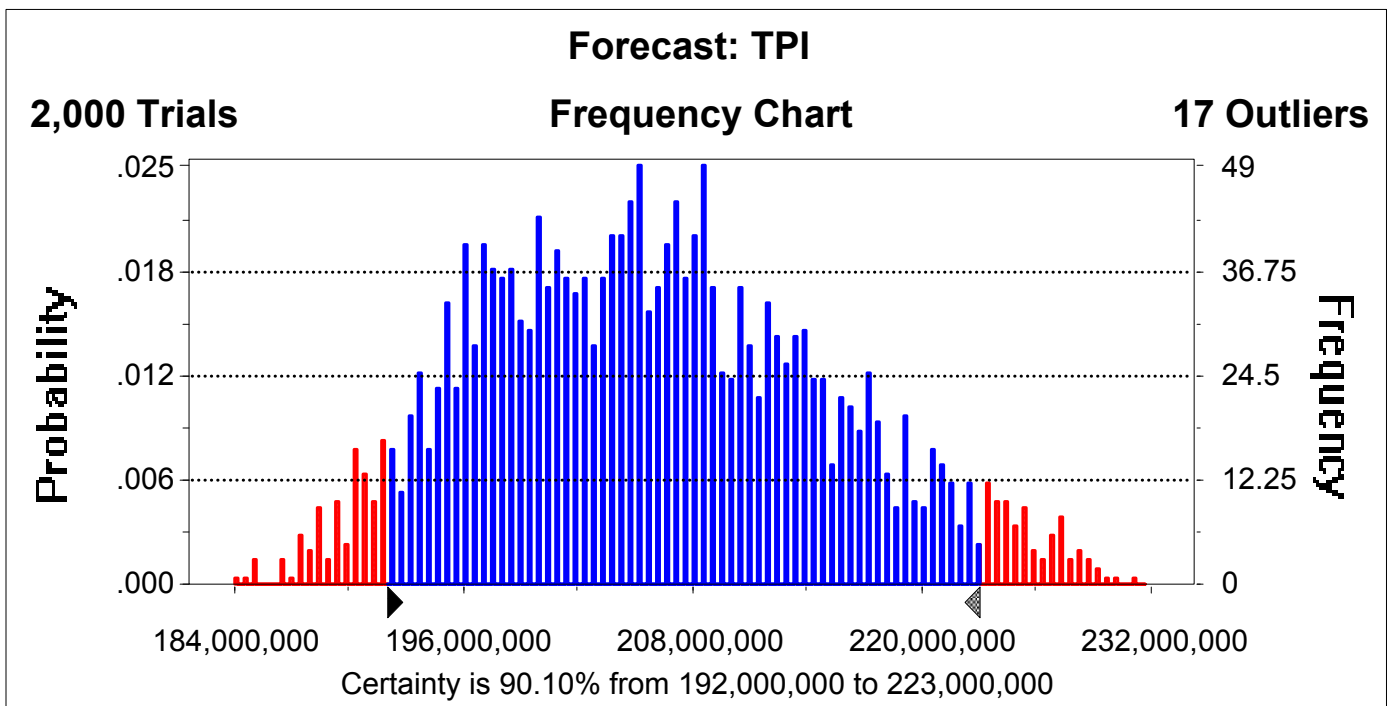

Figure 24. Histogram of the Total Project Investment

V. Planned Improvements and Extensions to the Model

The process design and economic model that we have described here is not a static tool. Not only will the information contained in the model will be continually improved, but the scope of technologies and the capabilities for calculation will also be expanded. The following gives a brief overview of the work currently underway or planned.

V.1 Water Balance and Optimization

Efficient water usage in a process can reduce the overall costs significantly. Alternate treatment schemes can reduce wastewater treatment costs, such as a fractionated approach where waste streams are treated differently by type. These may prove more efficient than the current system. Water recycle to the process will also be evaluated to determine the optimal approach to using the varying degrees of treated water available.

V.2 Fermentation pH Control

Biologically catalyzed processes can have a very narrow band of optimum operating conditions. The metabolic pathways of an organism are dependent on temperature, pH, inhibitors, and many other parameters. Two of the by-products of ethanol fermentation, acetic acid and lactic acid, cause a lowering of pH. In addition, some contaminant microorganisms may produce additional organic acids. Current process models do not address neutralizing the acids made during fermentation to ensure the optimum pH is maintained.

V.3 Air Emissions

There are several areas where air emissions are a concern. VOCs, and ethanol are produced during fermentation. Adequate treatment of these gases in the existing scrubber and by other means needs to be assured. Combustion of lignin residue generates SO_x , NO_x , and particulates. The mechanisms and amounts of these gases generated should dictate whether alternative or improved treatment is necessary. For example, emissions that exceed EPA limits for a biomass-to-ethanol plant will require further attention.

V.4 Greenhouse Gas Emissions

Carbon dioxide is a by-product of fermentation. Combustion of the lignin residue produces N_2O , CO and CO_2 that are considered greenhouse gases. Greenhouse gas emissions from the bioethanol facility are comprised of carbon dioxide (CO_2), nitrous oxide (N_2O) and methane (CH_4). There are many other compounds that have some potential for causing global warming, but these three are the most potent. CO_2 is the dominant greenhouse gas in emitted by the plant. It is generated as a result of lignin residue combustion in the boiler and as a byproduct of the fermentation of glucose to ethanol in the fermentors. Because CO_2 is by far the largest contributor to climate change effects, it is used as the standard for rating the relative global warming potential of other greenhouse gases. In other words, CO_2 is assumed to have a global warming potential (GWP) of 1. While N_2O emissions are much lower globally (and in this plant), they have a very high GWP. One gram of N_2O is equivalent to 360 grams of CO_2 . Methane is also a potent greenhouse gas. One gram of methane is equivalent to 24 grams of CO_2 . NO_x and other air pollutants can effect climate change, but their impacts are small relative to the GWP of CO_2 .

V.5 Lignin Gasification and Gas Turbine Power Generation

Another alternative to simply burning the lignin to generate steam and power is to gasify the lignin and use a gas turbine to generate power in combination with a steam turbine. This technology, termed integrated gasification combined cycle (IGCC) power generation, is currently being pursued by the DOE Biomass Power Program for use on biomass feedstocks. The current base case will be modified to incorporate this technology so that a comparison can be made between it and conventional lignin combustion.

V.6 Physical Properties of Corn Stover

As NREL works more with corn stover, we expect our knowledge base of its composition and properties to expand. This information will be incorporated into the mass and energy balance models to improve its predictive capabilities and provide a better picture of the energy balance of the process.

References and Notes

- ¹ Wooley, R., M. Ruth, J. Sheehan, K. Ibsen, "Lignocellulosic Biomass to Ethanol Process Design and Economics Utilizing Co-Current Dilute Acid Prehydrolysis and Enzymatic Hydrolysis Current and Futuristic Scenarios," NREL report TP-580-26157, July 1999. http://www.ott.doe.gov/biofuels/process_engineering.html
- ² "Wastewater Treatment Options for the Biomass-To-Ethanol Process," NREL Subcontract AXE-8-18020-01, Merrick & Company, Aurora, CO, February 24, 1998. http://www.ott.doe.gov/biofuels/process_engineering.html
- ³ "Steam and Electricity Generation Options For the Biomass-To-Ethanol Process," NREL Subcontract ACO-8-18019-01, Reaction Engineering International, Salt Lake City, UT, March 16, 1998. http://www.ott.doe.gov/biofuels/process_engineering.html
- ⁴ *ASPEN PlusTM, Release 10.2*, Aspen Technology, Inc., Cambridge, MA, February 2000.
- ⁵ Wooley, R.J. and V. Putsche, "Development of an ASPEN PLUS Physical Property Database for Biofuels Components," NREL, Golden, CO, Report MP-425-20685, April 1996. <http://www.afdc.doe.gov/pdfs/3955.pdf>
- ⁶ Garrett, D.E., *Chemical Engineering Economics*, Van Nostrand Reinhold, New York, 1989.
- ⁷ Riley, C. and D. Schell. *Technical and Economic Analysis of an Enzymatic Hydrolysis Based Ethanol Plant*. Solar Energy Research Institute Internal Report. Golden, CO, 1991.
- ⁸ Sheehan, J. et al. *Is ethanol from corn stover a sustainable fuel? A Case Study in Cyber Farming*. National Renewable Energy Laboratory, Golden, CO. In Press.
- ⁹ Glassner, D., J. Hettenhaus, T. Schechinger, "Corn Stover Collection Project," in *BioEnergy '98—Expanding Bioenergy Partnerships: Proceedings, Volume 2*, Madison, WI, pp 1100-1110, 1998. <http://www.afdc.doe.gov/pdfs/5149.pdf>.
- ¹⁰ Ruth, M., "Large Scale Ethanol Facilities and Short Cut for Changing Facility Size," Internal Report, National Renewable Energy Laboratory Technical Memo, October 1999.
- ¹¹ Walsh, M.E., et al, "Biomass Feedstock Availability in the United States: 1999 State Level Analysis", Bioenergy Information Network, Bioenergy Feedstock Development Program, Oak Ridge National Laboratory, January 2000. <http://bioenergy.ornl.gov/resourcedata/>

-
- ¹² Two separate batches of corn stover were received from B/MAP in May and November 2001. Sample analysis from totes 10,7,11 and 6 were used from the May batch. Sample analysis for Sunds runs P011211CS and B/MAP sample 112901CS were used from the November batch.
- ¹³ Thomas, S. et al, "Estimating the Effects of Compositional Variation on Biomass Conversion Process economics," Internal Report, National Renewable Energy Laboratory C milestone report to DOE, October 2001.
- ¹⁴ Templeton, D.; Hames, B.; Ruth, M.; Wiseloge, A.; McMillan, J. "Determine Compositional Stability of Corn Stover during Outdoor Storage: Year One Results," NREL milestone report to DOE, April 2000.
- ¹⁵ Templeton, D., B. Hames, J. McMillan, "Compositional and Storage Stability Study: Year 2 Results," Internal Report, National Renewable Energy Laboratory P milestone report to DOE, July 2001.
- ¹⁶ "Baled Feedstock Handling System," report no. 99-10600/13, NREL Subcontract ACO-9-29067-01, Harris Group Inc., Seattle, WA, October 11, 2001. http://www.ott.doe.gov/biofuels/process_engineering.html
- ¹⁷ "Continuous Acid Hydrolysis Reactor," report no. 99-10600/17, NREL Subcontract ACO-9-29067-01, Harris Group Inc., Seattle, WA, January 22, 2001. http://www.ott.doe.gov/biofuels/process_engineering.html
- ¹⁸ Hayden, J.G., and J.P. O'Connell, "A Generalized Method for Predicting Second Virial Coefficients," *IEC Process. Des. Dev.*, 14(3), 209, 1975.
- ¹⁹ "Liquid/Solid Separation" report no. 99-10600/14, NREL Subcontract ACO-9-29067-01, Harris Group Inc., Seattle, WA, March 6, 2001.
- ²⁰ Ranatunga, T.D., J. Jervis, R.F. Helm, J.D. McMillan, and C. Hatzis. "Identification of Inhibitory Components Toxic Toward *Zymomonas mobilis* CP4(pZB5) Xylose Fermentation," *Appl. Biochem. Biotechnol.* 67: 185-198, 1997 defines the hold time to be 30 minutes. The time is increased to 1 hr in the model to allow for reduced heating rates and different reaction kinetics in a large continuous stirred-tank reactor (CSTR).
- ²¹ H. Majdeski, Delta-T, Williamsburg, VA, personal experience in the flue gas desulfurization industry, 1998.
- ²² Letter to B. Bunner, Delta-T Corporation, Williamsburg, VA, from A. Bowser, Komline-Sanderson Limited, Peapack, NJ, August 1998.
- ²³ ICARUS Process Evaluator, Version 4.0, ICARUS Corporation, Rockville, MD, June 30, 1997.
- ²⁴ Jechura, J. "Correlation of Metal Corrosion Data," Internal Report, National Renewable Energy Laboratory Technical Memo, March 2001.
- ²⁵ Near-term Ethanol prehydrolysis run in NREL's Sunds reactor. Run #P001207CS Carbon Balance Point 2. Limited discussion of this run in "Preliminary Investigation of Corn Stover Pretreatment Using Dilute Sulfuric Acid" by D. Schell, Internal Report, National Renewable Energy Laboratory, July 2001.
- ²⁶ Nguyen, Q., "Summary of Corn Stover Pretreatment using the 4-L Steam Gun," run number CS000914-02, Internal Report, National Renewable Energy Laboratory Technical Memo, March 2002.
- ²⁷ The Sunds reactor in the PDU has been run at approximately 30% solids in several recent runs, most recently in March 2002, run number P020311CS #5. Compositional analysis of pretreated

material from these runs suggests that some of the lignin is being solublized; although rigorous mass balances to determine the lignin fate have not been completed to date.

- ²⁸ Leonard, R.H. and G.J. Hainy, *Industrial and Engineering Chemistry*, vol. 37 no. 4, pp. 390-395, 1945.
- ²⁹ Ranatunga, T.D., J. Jervis, R.F. Helm, J.D. McMillan, and R.J. Wooley, "The overliming of dilute acid pretreated lignocellulosics, Part 1. The fate of inorganics, uronic acids and ether soluble organics," submitted to *Enzyme and Microbial Technology*, 1999.
- ³⁰ Walker, L.P. and D.B. Wilson, "Enzymatic Hydrolysis of Cellulose: An Overview," *Bioresource Technology* 36:3-14, 1991.
- ³¹ Zhang, M., C. Eddy, K. Deanda, M. Finkelstein, and S. Picataggio, "Metabolic Engineering of a Pentose Metabolism Pathway in *Zymomonas mobilis*," *Science*, 267:240-243, 1995.
- ³² Kadam, K., "Evaluation of Potential Strains for Corn stover to Ethanol Conversion," Internal Report, National Renewable Energy Laboratory Technical Memo, December 2001. Several research groups' papers are listed in the bibliography that discuss different strain work.
- ³³ McMillan, J.; Tucker, M.; Hayward, T.; Newman, M.; Ruth, M.; Farmer, J. "Demonstrate process technology meeting or exceeding process qualifier performance in the mini-pilot biochemical conversion system and assess continuous SSCF performance to recommend future work," Internal Report, National Renewable Energy Laboratory C milestone to DOE, October 1997. Duplicate SSCF runs were demonstrated in the mini pilot fermentation system using an initial total solids loading of almost 20%.
- ³⁴ This is the titer of the enzyme used in the NREL pilot facility, purchased from Iogen in 1995.
- ³⁵ McMillan, J.D., M.P. Tucker, T.K. Hayward, C. Hatzis, and D. Glassner. "Process Qualifier Milestone," Internal Report, National Renewable Energy Laboratory, Golden, CO, 31 August 1996, Experiment PD 23 #3.
- ³⁶ McMillan, J.D., M.P. Tucker, T.K. Hayward, C. Hatzis, and D. Glassner. "Process Qualifier Milestone," Internal Report, National Renewable Energy Laboratory, Golden, CO, 31 August 1996, Experiment PD 23 #3. PD 23 #3 utilized a 24-hr residence time for seed production.
- ³⁷ Kern, D.Q., *Process Heat Transfer*, McGraw-Hill, New York, 1950, pp. 720-723.
- ³⁸ The seed reaction yields were assumed to be the same as fermentation yields in the ethanol production fermentors with increased cell mass production. Therefore the cell mass production was increased to 4% from both glucose and xylose and the xylose to products yield was reduced to allow more xylose to be converted to cell mass.
- ³⁹ The CSL loading used in McMillan, J.D., M.P. Tucker, T.K. Hayward, C. Hatzis, and D. Glassner, Process Qualifier Milestone, August 31, 1996, experiment PD 23 #3 was 1% clarified CSL. The experiment titled Nutrient Screen #2 for recombinant Zymo 39676pZB4L conducted by the Enzymatic Process Development (EPD) team during fiscal year 1998 showed that 0.25% CSL was as effective as 1% CSL, so 0.25% CSL is used in the model.
- ⁴⁰ Diammonium phosphate (DAP) is an inorganic nutrient typically added to SSCF experiments for nitrogen augmentation. It is typically provided at a concentration of 0.33 g/L as evident by Newman, M. "Three dry nutrient supplements obtained from the Marcor Corporation were tested and growth curves compared to media containing liquid CSL using the adapted strain *rZymomonas39676 (pZB 4L)*", Internal Report, National Renewable Energy Laboratory, Golden, CO, 20 September 2000. Notebook #2301, pp. 80-84. EPD experiment #EPD0007.

-
- ⁴¹ A loss of 3% of the fermentable sugars to non-ethanol products, such as lactic acid, is estimated based on conversations with corn ethanol producers who indicate they can tolerate a contamination loss less than 3%.
- ⁴² G. Brodl, P. Tetarenko, Vogelbusch, USA, personal communications with M. Ruth, 1998.
- ⁴³ Combs, N., McMillan, J. "LAP Procedures #8 - SSF Experimental Protocols: Lignocellulosic Biomass Hydrolysis and Fermentation," Published Procedure, 30 October 2001. <http://www.afdc.doe.gov/pdfs/4691.pdf>. The LAP analysis resulted in 87.2% measured conversion of insoluble glucan to ethanol. Assuming 3% loss of converted sugars to non-ethanol pathway products (e.g., cell mass and glycerol), the insoluble glucan to glucose conversion is 90%. The other yields were measured in a full mass-balanced experiment on yellow poplar that is listed in the reference.
- ⁴⁴ Dowe, N., "EPD0005: A Material Balance of the SSCF Using Whole In-house Cellulase Broth and Partially Washed Pretreated Yellow Poplar," Internal Report, National Renewable Energy Laboratory Experimental Report, March 2002.
- ⁴⁵ Aersten, F., and G. Street, *Applied Chemical Process Design*, Plenum Press, New York, 1978.
- ⁴⁶ "Wastewater Treatment Options for the Biomass-To-Ethanol Process," NREL Subcontract AXE-8-18020-01, Merrick & Company, Aurora, CO, February 24, 1998. http://www.ott.doe.gov/biofuels/process_engineering.html pp. 9-10. Three samples were analyzed for components and tested (in triplicate) for COD. The COD calculated from composition was 28,398 mg/L and the average measured COD was 27,199 mg/L.
- ⁴⁷ <http://my.ohio.voyager.net/~combs/arr/fp/tankcars.html>
- ⁴⁸ "Baled Feedstock Handling System," report no. 99-10600/13, NREL Subcontract ACO-9-29067-01, Harris Group Inc., Seattle, WA, October 11, 2001. Found in Appendix G, vendor is Northwest Handling Systems, Inc. http://www.ott.doe.gov/biofuels/process_engineering.html
- ⁴⁹ "Biomass-To-Ethanol Total Energy Cycle Analysis," NREL Subcontract RCN 213-185-01-00 Final Report, Radian Corporation, Austin, TX, November 22, 1991. http://www.ott.doe.gov/biofuels/process_engineering.html
- ⁵⁰ *Fluidized Bed Combustion and Gasification: A Guide for Biomass Waste Users*, Southeastern Regional Biomass Energy Program, FBT, Inc and Tennessee Valley Authority, Muscle Shoals, AL, July 1994. http://www.ott.doe.gov/biofuels/process_engineering.html
- ⁵¹ K. Ibsen, personal experience based on literature survey focused toward biomass residue combustion, 1998.
- ⁵² "Economic Feasibility Study of an Acid Hydrolysis-Based Ethanol Plant," NREL subcontract ZX-3-03096-2 Final Report, Badger Engineers, Inc., Cambridge, MA, April 1987. http://www.ott.doe.gov/biofuels/process_engineering.html
- ⁵³ "ASPEN Modeling of the NREL Boiler/Turbogenerator Systems," NREL Consultant Agreement CXL-8-18051-01, Final Report, V. Putsche, February 1998.
- ⁵⁴ Babcock & Wilcox, 1978, *Steam: Its Generation and Use* Thirty-ninth Edition. Babcock & Wilcox Company, New York, NY, p. 34/10-16.
- ⁵⁵ Phillippek, C. et al, 1997. "NO_x Formation and Reduction During Combustion of Wet Sewage Sludge in the Circulating Fluidized Bed," 1997 Fluidized Bed Combustion vol. 2, ASME 1997.

-
- ⁵⁶ *Process Plant Construction Estimating Standards*, electronic version section 100-374, Richardson Engineering Services, Inc., Mesa, AZ, 1999.
- ⁵⁷ “Biomass to Ethanol Process Evaluation,” NREL Final Subcontract Report, Chem Systems, Tarrytown, NY, Appendix V, December 1994.
http://www.ott.doe.gov/biofuels/process_engineering.html
- ⁵⁸ W. Campbell, Foster Wheeler Corporation, Cost Quotation, Proposal 0-02-43731, to V. Putsche, NREL, September 30, 1994.
- ⁵⁹ “Technical and Economic Evaluation: Wood to Ethanol Process,” SERI Subcontract Report, Chem Systems, Tarrytown, NY, August 1990.
http://www.ott.doe.gov/biofuels/process_engineering.html
- ⁶⁰ Sheehan, J., “Analysis of Regional Conditions for Cooling Water Used in Ethanol Production Technology,” Internal Report, National Renewable Energy Laboratory, Golden, CO, January 1998.
- ⁶¹ MacFarlane, B., “Calculation of an Overall Carbon Balance for the Ethanol Production Process,” Internal Report, National Renewable Energy Laboratory Technical Memo, June 2001.
- ⁶² MacFarlane, B., “Calculation of the Overall Energy Balance for the Ethanol Production Process,” Internal Report, National Renewable Energy Laboratory Technical Memo, December 2001.
- ⁶³ Peters, M.S. and K.D. Timmerhaus, *Plant Design and Economics for Chemical Engineers*, 4th Edition, McGraw-Hill, Inc., New York, 1991.
- ⁶⁴ “Biomass to Ethanol Process Evaluation,” NREL Final Subcontract Report, Chem Systems, Tarrytown, NY, December 1994. http://www.ott.doe.gov/biofuels/process_engineering.html
- ⁶⁵ Walas, S. M., *Chemical Process Equipment Selection and Design*, Butterworth Publishing, 1988.
- ⁶⁶ “Process Design and Cost Estimate of Critical Equipment in the Biomass to Ethanol Process,” NREL Final Subcontract Report, Harris Group Inc., Seattle, WA, March 2001.
- ⁶⁷ Energy Information Administration, *Annual Energy Outlook 2001 with Projections to 2020*. U.S. Department of Energy, Washington, DC, 2000. <http://www.eia.doe.gov/oiaf/aeo/>
- ⁶⁸ “Chemical Engineering Plant Cost Index,” *Chemical Engineering*, January 2001.
- ⁶⁹ “Biomass to Ethanol Process Evaluation,” NREL Final Subcontract Report, Chem Systems, Tarrytown, NY, p. VI-3, December 1994.
- ⁷⁰ “U.S. Producer Price Indexes – Chemicals and Allied Products/Industrial Inorganic Chemicals Index,” from the *Chemical Economics Handbook*, published by SRI Consulting, a division of SRI International, Menlo Park, CA, October 1997.
- ⁷¹ Bureau of Labor Statistics Data Web site (www.stats.bls.gov), National Employment, Hours, and Earnings Catalog, Industry: Chemicals and Allied Products. Series ID: EEU32280006, Years: 1980 - 2000, annual average. Data extracted on March 1, 2001.
- ⁷² Short, W., D.J. Packey, and T. Holt, “A Manual for the Economic Evaluation and Energy Efficiency and Renewable Energy Technologies,” National Renewable Energy Laboratory, Golden, CO, Report TP-462-5173, p.7, March 1995.

-
- ⁷³ Short, W., D.J. Packey, and T. Holt, "A Manual for the Economic Evaluation and Energy Efficiency and Renewable Energy Technologies," National Renewable Energy Laboratory, Golden, CO, Report TP-462-5173, p. 19, March 1995.
- ⁷⁴ Short, W., D.J. Packey, and T. Holt, "A Manual for the Economic Evaluation and Energy Efficiency and Renewable Energy Technologies," National Renewable Energy Laboratory, Golden, CO, Report TP-462-5173, pp. 20-21, March 1995.
- ⁷⁵ Perry, R. H., and D. W. Green, *Perry's Chemical Engineers' Handbook*, 7th Edition, McGraw-Hill, New York, pp. 9-76, 1997.
- ⁷⁶ Gary, J. H., and G. E. Handwerk, *Petroleum Refining, Technology and Economics*, 3rd Edition, Marcel Dekker, Inc., New York, 1994.
- ⁷⁷ Ibsen, K. "Publish results of Bridge to Corn Ethanol Subcontracts," Internal Report, National Renewable Energy Laboratory P milestone, February 2001.
- ⁷⁸ Reported as runs #1 and #2 in Schell, D.J., J. Farmer, M. Newman, and J.D. McMillan. "Dilute Sulfuric Acid Pretreatment of Corn Stover in a Pilot-Scale Reactor: Investigation of Yields, Kinetics, and Solids Enzymatic Digestibilities" presented at the Twenty-Fourth Symposium on Biotechnology for Fuels and Chemicals (Gatlinburg, TN, April-May 2002) and submitted to the conference proceedings which will be published in the Spring 2003 edition of Applied Biochemistry and Biotechnology.
- ⁷⁹ Comments from ethanol producers to J. Ashworth at the Enzyme Sugar Platform gate review meeting held in 2002 suggest that \$0.02/kWh is in the range for long term power purchase and sales contracts in key states (Nebraska, Kansas). \$0.06/kWh is below the industrial rate of many East coast utilities currently, so it represents a reasonable high-end value.
- ⁸⁰ Douglas, Larry J. "Monte Carlo Simulation as a Research Management Tool." TAPPI Proceedings of the 1986 Research and Development Conference. pp. 65-71.
- ⁸¹ Akerberg, Christina; and Zacchi, G. "An economic evaluation of the fermentation production of lactic acid from wheat flour." Bioresource Technology 75 (2000) 119-126.
- ⁸² *Crystal BallTM, Release 2000.1 Professional Edition*, Decisioneering, Inc., Denver, CO, September 2000.
- ⁸³ ExcelTM, *Release 2000*, Microsoft Corporation, Seattle, WA, 2000.

Appendix A

NREL Biofuels Process Design Database Description and Summary

Appendix A NREL Process Design Database Description and Summary

NREL's Process Engineering Team has developed a database of primary information on all of the equipment in the benchmark model. This database contains information about the cost, reference year, scaling factor, scaling characteristic, design information and back-up cost referencing. The information is stored in a secure database in the Biotechnology Center for Fuels and Chemicals and can be directly linked to the economic portion of the model. In addition to having all of the cost information used by the model, it has the ability to store documents pertaining to the piece of equipment. These include sizing and costing calculations and vendor information when available.

The following summarizes the important fields of information contained in the database. A partial listing of the information is attached for each piece of equipment. Additional information from the database is contained in the equipment cost listing in Appendix B.

| | |
|--|--|
| Equipment Number: ^{AB} | Unique identifier, the first letter indicates the equipment type and the first number represents the process area, e.g., P-301 is a pump in Area 300 |
| Equipment Name: ^{AB} | Descriptive name of the piece of equipment |
| Associated PFD: | PFD number on which the piece of equipment appears, e.g., PFD-P110-A101 |
| Equipment Category: ^A | Code indicating the general type of equipment, e.g., PUMP |
| Equipment Type: ^A | Code indicating the specific type of equipment, e.g., CENTRIFUGAL for a pump |
| Equipment Description: ^A | Short description of the size or characteristics of the piece of equipment, e.g., 20 gpm, 82 ft head for a pump |
| Number Required: ^B | Number of duplicate pieces of equipment needed |
| Number Spares: ^B | Number of on-line spares |
| Scaling Stream: ^B | Stream number or other characteristic variable from the ASPEN model by which the equipment cost will be scaled |
| Base Cost: ^B | Equipment cost |
| Cost Basis: ^A | Source of the equipment cost, e.g., ICARUS or VENDOR |
| Cost Year: ^B | Year for which the cost estimate is based |
| Base for Scaling: ^B | Value of the scaling stream or variable used to obtain the base cost of the equipment |
| Base Type: | Type of variable used for scaling, e.g., FLOW, DUTY, etc. |
| Base Units: | Units of the scaling stream or variable, e.g., KG/HR, CAL/S |
| Installation Factor: ^B | Value of the installation factor. Installed Cost = Base Cost x Installation Factor |
| Installation Factor Basis: | Source of the installation factor value, e.g., ICARUS, VENDOR |
| Scale Factor Exponent: ^B | Value of the exponential scaling equation |
| Scale Factor Basis: | Source of the scaling exponent value, e.g., GARRETT, VENDOR |
| Material of Construction: ^A | Material of Construction |
| Notes: | Any other important information about the design or cost |
| Document: | Complete, multi-page document containing design calculations, vendor literature and quotations and any other important information. This is stored as an electronic document and can be pages from a spreadsheet other electronic sources or scanned information from vendors. |
| Design Date: | Original date for the design of this piece of equipment |
| Modified Date: | The system automatically marks the date in this field whenever any field is changed |

^A These fields are listed for all pieces of equipment in this Appendix.

^B These fields are part of the equipment cost listing in Appendix B.

NREL Biofuels Process Design Database Summary

| Equipment Number | Equipment Name | Equipment Category | Equipment Type | Equipment Description | Cost Basis | Install. Factor Basis | Scale Factor Basis | Material of Construction |
|-------------------------|--|--------------------|------------------|---|------------|-----------------------|--------------------|--------------------------|
| PF-D-P110-A101 | | | | | | | | |
| C-101 | Bale Transport Conveyor | CONVEYOR | BELT | Bale Transport Conveyor, 400 ft long, 8' wide, 50 HP motor | HARRIS00 | HARRIS00 | DEFAULT | CS |
| C-102 | Bale Unwrapping Conveyor | CONVEYOR | BELT | Bale Unwrapping Conveyor, 90 bale / hr | HARRIS00 | HARRIS00 | DEFAULT | CS |
| C-103 | Belt Press Discharge Conveyor | CONVEYOR | BELT | Belt Press Discharge Conveyor, 3' wide X 50' long, | HARRIS00 | HARRIS00 | DEFAULT | CS |
| C-104 | Shredder Feed Conveyor | CONVEYOR | BELT | Shredder Feed Conveyor, 8' wide X 30' long, 6001 lbs 31 fpm | HARRIS00 | HARRIS00 | DEFAULT | CS |
| M-101 | Truck Scales | SCALE | TRUCK-SCALE | Truck Scales; 10' X 50' 50tn | HARRIS00 | HARRIS00 | DEFAULT | CONCRETE |
| M-102 | Truck Unloading Forklift | VEHICLE | LOADER | Truck Unloading Propane Gas Forklift | HARRIS00 | HARRIS00 | ASSUMED | |
| M-103 | Bale Moving Forklift | VEHICLE | LOADER | Bale Moving Propane Gas Forklift | HARRIS00 | HARRIS00 | ASSUMED | |
| M-104 | Corn Stover Wash Table | SIZE-REDUCTION | | Corn Stover Wash Table (55 ton/hr) | HARRIS00 | HARRIS00 | DEFAULT | A283 |
| M-105 | Shredder | SIZE-REDUCTION | | Shredder (28 ton/hr) | HARRIS00 | HARRIS00 | DEFAULT | ALLOY STEEL |
| M-106 | Concrete Feedstock-Storage Slab | MISCELLANEOUS | CONCRETE-SLAB | Concrete Feedstock-Storage Slab 350' X 538' | HARRIS00 | HARRIS00 | HARRIS00 | CONCRETE |
| M-107 | Polymer Feed System | MISCELLANEOUS | MISCELLANEOUS | Polymer Feed System | HARRIS00 | HARRIS00 | DEFAULT | CS |
| P-101 | Wash Table Pump | PUMP | CENTRIFUGAL | 2500 gpm, 50 ft head. | HARRIS00 | HARRIS00 | GARRETT | CS; RUBBER |
| P-102 | Wash Water Pump | PUMP | CENTRIFUGAL | 5000 gpm, 50 ft head. | HARRIS00 | HARRIS00 | GARRETT | CS; SS316 |
| P-103 | Clarifier Underflow Pump | PUMP | RECIPROCATING | Clarifier Underflow Pump MOD SRL 2X3-10 100 GPM -- 50 TDH | HARRIS00 | HARRIS00 | GARRETT | CS; RUBBER |
| P-104 | Clarified Water Pump | PUMP | CENTRIFUGAL | 5000 gpm, 50 ft head. | HARRIS00 | HARRIS00 | GARRETT | CS; SS316 |
| P-105 | Belt Press Sump Pump | PUMP | SLURRY | Belt Press Sump Pump VJC 1.5X2.11 100 GPM -- 40 TDH | HARRIS00 | HARRIS00 | GARRETT | CS |
| S-101 | Clarifier Thickener | SEPARATOR | | Clarifier Thickener 5000 GPM mechanism | HARRIS00 | HARRIS00 | DEFAULT | CS |
| S-102 | Belt Press | S/L SEPARATION | FILTER-PRESS | Belt Press 1.5 meter | HARRIS00 | HARRIS00 | DEFAULT | 304SS; FILTER |
| S-103 | Magnetic Separator | SEPARATOR | MAGNET | Tramp iron magnet separator. | VENDOR | DELTA-T98 | DEFAULT | |
| T-101 | Wash Water Tank | TANK | VERTICAL-VESSEL | Wash Water Tank (20' Diameter X 22' Tall, 50,000 gal) | HARRIS00 | HARRIS00 | GARRETT | CS |
| T-102 | Clarifier Thickener Tank | TANK | CLARIFIER | Clarifier Thickener Tank (80' diameter) | HARRIS00 | HARRIS00 | GARRETT | CEMENT |
| PF-D-P110-A201-3 | | | | | | | | |
| A-201 | In-line Sulfuric Acid Mixer | MIXER | STATIC | Static Mixer, 248 gpm total flow. | ICARUS | DELTA-T98 | ICARUS | SS304 |
| A-205 | Hydrolysate Mix Tank Agitator | AGITATOR | FIXED-PROP | Top-Mounted, 1800 rpm, 50 hp | ICARUS | DELTA-T98 | GARRETT | SS |
| A-209 | Overliming Tank Agitator | AGITATOR | FIXED-PROP | Top Mounted, 1800 rpm, 25 hp | ICARUS | DELTA-T98 | GARRETT | SS |
| A-224 | Reacidification Tank Agitator | AGITATOR | FIXED-PROP | Top-Mounted, 1800 rpm, 93 hp | ICARUS | DELTA-T98 | GARRETT | SS |
| A-232 | Reslurrying Tank Agitator | AGITATOR | FIXED-PROP | Top-Mounted, 1800 rpm, 50 hp | ICARUS | DELTA-T98 | GARRETT | SS |
| C-201 | Hydrolysate Screw Conveyor | CONVEYOR | SCREW | 18" dia. X 33' long, 7600 cfm max flow | ICARUS | DELTA-T98 | GARRETT | SS316 |
| C-202 | Hydrolysate Washed Solids Belt Conveyor | CONVEYOR | BELT | 4' X 60' belt conveyor | HARRIS00 | HARRIS00 | GARRETT | |
| C-225 | Lime Solids Feeder | CONVEYOR | ROTARY-VALVE | 8" dia., 140 cfm, 7000 lb/hr max flow | ICARUS | DELTA-T98 | | A285C |
| H-200 | Hydrolysate Cooler | HEATX | SHELL-TUBE | Fixed Tube Sheet, 1990 sf, 27" dia. X 20' long | ICARUS | DELTA-T98 | GARRETT | 304SS,CS |
| H-201 | Beer Column Feed Economizer | HEATX | SHELL-TUBE | Floating Head, 6266 sf, 48" dia x 23' long | ICARUS | DELTA-T98 | GARRETT | 304SS |
| H-205 | Pneumapress Vent Condensor | HEATX | SHELL-TUBE | Fixed Tube Sheet, 120 sf, CS construction | ICARUS | DELTA-T98 | GARRETT | CS |
| H-244 | Waste Vapor Condensor | HEATX | SHELL-TUBE | Floating Head, 6266 sf, 48" dia x 23' long | ICARUS | DELTA-T98 | GARRETT | 304SS |
| M-202 | Prehydrolysis/Screw Feeder/Impregnator Reactor | REACTOR | SCREW | Vertical Screw, 10 min residence time | VENDOR | CHEMSYST94 | GARRETT | HASTELLOY-C 200;SS316L |
| P-201 | Sulfuric Acid Pump | PUMP | CENTRIFUGAL | 4 gpm, 245 ft. head | ICARUS | DELTA-T98 | GARRETT | SS304 |
| P-205 | Pneumapress Feed Pump | PUMP | CENTRIFUGAL | Goulds Mod 3196 X8-13 1000 gpm 60 ft TDH 25 hp 1200 RPM | HARRIS00 | HARRIS00 | GARRETT | SS316 |
| P-209 | Overlimed Hydrolysate Pump | PUMP | CENTRIFUGAL | 687 gpm, 150 ft. head | ICARUS | DELTA-T98 | GARRETT | 304SS |
| P-211 | Primary Filtrate Pump | PUMP | CENTRIFUGAL | Goulds Mod 3410 10X12-17 1000 GPM 60 ft TDH | HARRIS00 | HARRIS00 | GARRETT | SS316 |
| P-213 | Wash Filtrate Pump | PUMP | CENTRIFUGAL | Goulds Mod 3410 10X12-17 6000 GPM 200 ft TDH | HARRIS00 | HARRIS00 | GARRETT | SS316 |
| P-222 | Filtered Hydrolysate Pump | PUMP | CENTRIFUGAL | 721 gpm, 150 ft head | ICARUS | DELTA-T98 | GARRETT | 304SS |
| P-223 | Lime Unloading Blower | FAN | CENTRIFUGAL | 7425 cfm, 6 psi, 22275 lb/hr | DELTA-T98 | DELTA-T98 | GARRETT | C.S. |
| P-224 | Fermentation Feed Pump | PUMP | ROTARY-LOBE | 737 gpm, 200 ft head | VENDOR | ICARUS | GARRETT | 304SS |
| P-239 | Reacidified Liquor Pump | PUMP | CENTRIFUGAL | 720 gpm, 100 ft head | ICARUS | DELTA-T98 | GARRETT | SS304 |
| S-205 | Pneumapress Filter | SEPARATOR | PNEUMAPRESS | MOD 30-12-316 285 GPM 360 SQ FT AREA | HARRIS00 | HARRIS00 | DEFAULT | SS316 |
| S-222 | Hydroclone & Rotary Drum Filter | S/L SEPARATOR | ROTARY-DRUM | Hydrocyclone and Vacuum Filter | VENDOR | DELTA-T98 | GARRETT | EPOXY LINED |
| S-227 | LimeDust Vent Baghouse | SEPARATOR | FABRIC-FILTER | 8333 cfm, 1389 sf, 6 cfm/sf | ICARUS | DELTA-T98 | ICARUS | A285C,POLYESTER |
| T-201 | Sulfuric Acid Storage | TANK | VERTICAL-VESSEL | 6444 gal., 24 hr. residence time, 90% wv | DELTA-T98 | DELTA-T98 | GARRETT | PLASTIC |
| T-203 | Blowdown Tank | TANK | VERTICAL-VESSEL | 14500 gal., 11' dia x 30' high, 10 min. res. time, 75% wv, 15 psig | ICARUS | ICARUS | GARRETT | SS316 |
| T-205 | Hydrolysate Mixing Tank | TANK | FLAT-BTM-STORAGE | Modeled after Tank T-232 in Enzyme Process. 15 min. res. Time | ICARUS | DELTA-T98 | GARRETT | SS304 |
| T-209 | Overliming Tank | TANK | VERTICAL-VESSEL | 46200 gal., 16' dia. X 32' high, 1 hr. res. time, 90% wv, 15 psig | ICARUS | DELTA-T98 | GARRETT | SS304 |
| T-211 | Primary Filtrate Tank | TANK | VERTICAL-VESSEL | 126" D X 13' high, 12,000 gal | HARRIS00 | HARRIS00 | GARRETT | SS316 |
| T-213 | Wash Filtrate Tank | TANK | VERTICAL-VESSEL | 10' D X 11' high 6000 gal | HARRIS00 | HARRIS00 | GARRETT | SS316 |
| T-220 | Lime Storage Bin | TANK | LIVE-BTM-BIN | 4465 cf, 14' dia x 25' high, 1.5x rail car vol., atmospheric | ICARUS | DELTA-T98 | ICARUS | CS |
| T-224 | Reacidification Tank | TANK | FLAT-BTM-STORAGE | 185200 gal., 32' dia x 32' high, 4 hr. res. time, 90% wv, atmospheric | ICARUS | DELTA-T98 | GARRETT | SS304 |
| T-232 | Slurrying Tank | TANK | FLAT-BTM-STORAGE | 24770 gal., 13' dia. X 25' high, 15 min. res. time, 90% wv, atmospheric | ICARUS | DELTA-T98 | GARRETT | SS304 |

Note: Equipment sizes listed are for a base case and may have been scaled up or down in the final cost estimation.

NREL Biofuels Process Design Database Summary

| Equipment Number | Equipment Name | Equipment Category | Equipment Type | Equipment Description | Cost Basis | Install. Factor Basis | Scale Factor Basis | Material of Construction |
|------------------------|--|--------------------|-------------------|---|------------|-----------------------|--------------------|--------------------------|
| PFDP-110-A301-2 | | | | | | | | |
| A-300 | Ethanol Fermentor Agitator | AGITATOR | FIXED-PROP | Side Mounted, 2 per vessel, 75 hp each, 0.15 hp/1000 gal | DELTA-T98 | DELTA-T98 | | SS304 |
| A-301 | Seed Hold Tank Agitator | AGITATOR | FIXED-PROP | Top Mounted, 1800 rpm, 23 hp, 0.1 hp/1000 gal | DELTA-T98 | DELTA-T98 | GARRETT | SS304 |
| A-304 | 4th Seed Vessel Agitator | AGITATOR | FIXED-PROP | Top Mounted, 1800 rpm, 6 hp, 0.3 hp/1000 gal | ICARUS | DELTA-T98 | GARRETT | SS |
| A-305 | 5th Seed Vessel Agitator | AGITATOR | FIXED-PROP | Top Mounted, 1800 rpm, 19 hp, 0.1 hp/1000 gal | DELTA-T98 | DELTA-T98 | GARRETT | SS |
| A-306 | Beer Surge Tank Agitator | AGITATOR | FIXED-PROP | Top Mounted, 1800 rpm, 4 hp, 0.3 hp/1000 gal | ICARUS | DELTA-T98 | GARRETT | SS304 |
| A-310 | Saccharification Tank Agitator | AGITATOR | FIXED-PROP | Side Mounted, 2 per vessel, 75 hp each, 0.15 hp/1000 gal | DELTA-T98 | DELTA-T98 | | SS304 |
| F-300 | Ethanol Fermentor | TANK | FLAT-BTM-STORAGE | 962,651 gal. each, 7 day residence total, 90% ww, API, atmospheric | VENDOR | DELTA-T98 | MULTI-UNIT | SS304 |
| F-301 | 1st Seed Fermentor | REACTOR | VERTICAL-VESSEL | 20 gal, jacketed, agitated, 1.3' dia., 2' high, 15 psig | ICARUS | DELTA-T98 | | SS304 |
| F-302 | 2nd Seed Fermentor | REACTOR | VERTICAL-VESSEL | 194 gal., jacketed, agitated, 3' dia., 4' high, 2.5 psig | ICARUS | ICARUS | | SS304 |
| F-303 | 3rd Seed Fermentor | REACTOR | VERTICAL-VESSEL | 1950 gal., jacketed, agitated, 6.5' dia, 8' high, 2.5 psig | ICARUS | DELTA-T98 | | SS304 |
| F-304 | 4th Seed Fermentor | REACTOR | FLAT-BTM-STORAGE | 19444 gal., 12' dia x 23' high, atmospheric | ICARUS | DELTA-T98 | GARRETT | SS304 |
| F-305 | 5th Seed Fermentor | REACTOR | FLAT-BTM-STORAGE | 194500 gal., API, atmospheric | VENDOR | DELTA-T98 | GARRETT | SS304 |
| H-300 | Fermentation Cooler | HEATX | PLATE-FRAME | 2393 sf, 300 BTU/hr sf F | ICARUS | DELTA-T98 | GARRETT | SS304 |
| H-301 | Hydrolyzate Heater | HEATX | PLATE-FRAME | 773 sf, 300 BTU/hr sf F | DELTA-T98 | DELTA-T98 | GARRETT | SS304 |
| H-302 | Saccharified Slurry Cooler | HEATX | PLATE-FRAME | 3765 sf total, 1255 sf each, 300 BTU/hr sf F | DELTA-T98 | DELTA-T98 | GARRETT | SS304 |
| H-304 | 4th Seed Fermentor Coils | HEATX | IMMERSED-COIL | 27 sf, 1" sch 40 pipe, 105 BTU/hr sf F | ICARUS | DELTA-T98 | ICARUS | SS |
| H-305 | 5th Seed Fermentor Coils | HEATX | IMMERSED-COIL | 307 sf, 3" sch 40 pipe, 92 BTU/hr sf F | ICARUS | DELTA-T98 | ICARUS | SS |
| H-310 | Fermentation Cooler | HEATX | PLATE-FRAME | 2393 sf, 300 BTU/hr sf F | ICARUS | DELTA-T98 | GARRETT | SS304 |
| P-300 | Fermentation Recirculation and Transfer Pump | PUMP | CENTRIFUGAL | 1060 gpm, 150 ft head | ICARUS | DELTA-T98 | GARRETT | SS304 |
| P-301 | Seed Hold Transfer Pump | PUMP | ROTARY-LOBE | 172 gpm, 150 ft head | VENDOR | CHEMSYST94 | VENDOR | SS304 |
| P-302 | Seed Transfer Pump | PUMP | ROTARY-LOBE | 1231 gpm total, 615 gpm each, 100 ft head | VENDOR | CHEMSYST94 | VENDOR | SS304 |
| P-306 | Beer Transfer Pump | PUMP | CENTRIFUGAL | 1632 gpm each, 171 ft head | ICARUS | DELTA-T98 | GARRETT | SS304 |
| P-310 | Saccharification Recirculation and Transfer Pump | PUMP | CENTRIFUGAL | 1060 gpm, 150 ft head | ICARUS | DELTA-T98 | GARRETT | SS304 |
| T-301 | Seed Hold Tank | TANK | FLAT-BTM-STORAGE | 233,333 gal., API atmospheric | VENDOR | DELTA-T98 | GARRETT | SS304 |
| T-306 | Beer Storage Tank | TANK | FLAT-BTM-STORAGE | 456617 gal., 45' dia x 40' high, 4 hr res. Time, 90% ww, atmospheric | ICARUS | DELTA-T98 | GARRETT | SS304 |
| T-310 | Saccharification Tank | TANK | FLAT-BTM-STORAGE | 962,651 gal. each, 7 day residence total, 90% ww, API, atmospheric | VENDOR | DELTA-T98 | MULTI-UNIT | SS304 |
| PFDP-110-A501-5 | | | | | | | | |
| A-530 | Recycled Water Tank Agitator | AGITATOR | FIXED-PROP | 5 hp, 50 rpm, | VENDOR | DELTA-T98 | GARRETT | CS |
| C-501 | Lignin Wet Cake Screw | CONVEYOR | SCREW | 14' Dia X 100' Long | ICARUS | DELTA-T98 | GARRETT | CS |
| D-501 | Beer Column | COLUMN | DISTILLATION | 13.5' dia, 32 Actual Trays, Nutter V-Grid Trays | ICARUS | DELTA-T98 | ICARUS | SS304 |
| D-502 | Rectification Column | COLUMN | DISTILLATION | 11.5' dia.(rect.), 4' dia. (strip) x 18' T.S., 60 act. Trays, 60% eff., Nutter V-Grid trays | DELTA-T98 | DELTA-T98 | ICARUS | SS |
| E-501 | 1st Effect Evaporation | HEATX | SHELL-TUBE | 22280 sf each., 135 BTU/hr sf F | DELTA-T98 | DELTA-T98 | GARRETT | SS316 |
| E-502 | 2nd Effect Evaporation | HEATX | SHELL-TUBE | 22278 sf, 170 BTU/hr sf F | DELTA-T98 | DELTA-T98 | GARRETT | SS316 |
| E-503 | 3rd Effect Evaporation | HEATX | SHELL-TUBE | 22278 sf each., 170 BTU/hr sf F | DELTA-T98 | DELTA-T98 | GARRETT | SS316 |
| H-501 | Beer Column Reboiler | HEATX | SHELL-TUBE | Fixed TS, 13899 sf, 41' dia., 20' long, 178 BTU/hr sf F | DELTA-T98 | DELTA-T98 | GARRETT | SS304;CS |
| H-502 | Rectification Column Reboiler | HEATX | SHELL-TUBE | Thermosyphon, 1089 sf, 20' dia., 20' long, 130 BTU/hr sf F | ICARUS | DELTA-T98 | GARRETT | SS304;CS |
| H-504 | Beer Column Condenser | HEATX | SHELL-TUBE | Floating Head, 880 sf, 20' dia., 22' long, 92 BTU/hr sf F | DELTA-T98 | DELTA-T98 | GARRETT | SS304;CS |
| H-505 | Rectification Column Condenser | HEATX | SHELL-TUBE | Fixed TS, 4146 sf, 39' dia, 20' long, 157 BTU/hr sf F | DELTA-T98 | DELTA-T98 | GARRETT | SS304;CS |
| H-512 | Beer Column Feed Interchange | HEATX | PLATE-FRAME | 909 sf, 200 BTU/hr sf F | DELTA-T98 | DELTA-T98 | GARRETT | SS |
| H-517 | Evaporator Condenser | HEATX | SHELL-TUBE | Fixed TS, 8223 sf, 39' dia., 20' long, 220 BTU/hr sf F | DELTA-T98 | DELTA-T98 | GARRETT | SS304;CS |
| M-503 | Molecular Sieve (9 pieces) | MISCELLANEOUS | PACKAGE | Superheater, twin mole sieve columns, product cooler, condenser, pumps, vacuum | VENDOR | DELTA-T98 | | SS |
| P-501 | Beer Column Bottoms Pump | PUMP | CENTRIFUGAL | 5053 gpm, 150 ft head | ICARUS | ICARUS | GARRETT | SS |
| P-503 | Beer Column Reflux Pump | PUMP | CENTRIFUGAL | 12 gpm, 140 ft head | DELTA-T98 | DELTA-T98 | GARRETT | SS |
| P-504 | Rectification Column Bottoms Pump | PUMP | CENTRIFUGAL | 154 gpm, 158 ft head | DELTA-T98 | DELTA-T98 | GARRETT | SS |
| P-505 | Rectification Column Reflux Pump | PUMP | CENTRIFUGAL | 437 gpm, 110 ft head | DELTA-T98 | DELTA-T98 | GARRETT | SS |
| P-511 | 1st Effect Pump | PUMP | CENTRIFUGAL | 2393 gpm each, 110 ft head | ICARUS | DELTA-T98 | GARRETT | SS |
| P-512 | 2nd Effect Pump | PUMP | CENTRIFUGAL | 1261 gpm, 110 ft head | ICARUS | DELTA-T98 | GARRETT | SS |
| P-513 | 3rd Effect Pump | PUMP | CENTRIFUGAL | 412 gpm each, 110 ft head | ICARUS | DELTA-T98 | GARRETT | SS |
| P-514 | Evaporator Condensate Pump | PUMP | CENTRIFUGAL | 617 gpm, 125 ft head | ICARUS | DELTA-T98 | GARRETT | SS304 |
| P-515 | Scrubber Bottoms Pump | PUMP | CENTRIFUGAL | 69 gpm, 104 ft head | DELTA-T98 | DELTA-T98 | GARRETT | SS |
| P-530 | Recycled Water Pump | PUMP | CENTRIFUGAL | 790 gpm, 150 ft head | ICARUS | DELTA-T98 | GARRETT | CS |
| S-505 | Pneumapress Filter | SEPARATOR | PNEUMAPRESS | 3 @MOD 30-10-316 285 GPM 300 SQ FT AREA & 1 @MOD 30-11-316 314 GPM 300 SQ FT AREA | HARRIS00 | HARRIS00 | DEFAULT | SS316 |
| T-503 | Beer Column Reflux Drum | TANK | HORIZONTAL-VESSEL | 346 gal, 15 min res. Time, 50% ww, 3' dia., 6.5' long, 25 psig | ICARUS | DELTA-T98 | GARRETT | SS304 |
| T-505 | Rectification Column Reflux Drum | TANK | HORIZONTAL-VESSEL | 13106 gal, 15 min res time, 50% ww, 9' dia, 27.5' long, 25 psig | ICARUS | DELTA-T98 | GARRETT | SS304 |
| T-512 | Vent Scrubber | COLUMN | ABSORBER | 7' dia x 25' high, 4 stages, plastic Jaeger Tri-Packing | DELTA-T98 | DELTA-T98 | GARRETT | SS304;PLASTIC |
| T-514 | Evaporator Condensate Drum | TANK | HORIZONTAL-VESSEL | 10233 gal, 10 min res. Time, 75% ww, 9' dia., 21.5' long, 1 psig | ICARUS | DELTA-T98 | GARRETT | SS304 |
| T-530 | Recycled Water Tank | TANK | FLAT-BTM-STORAGE | 13218 gal, Residence time 20 min, 2.5 psig | VENDOR | DELTA-T98 | VENDOR | CS |

Note: Equipment sizes listed are for a base case and may have been scaled up or down in the final cost estimation.

NREL Biofuels Process Design Database Summary

| Equipment Number | Equipment Name | Equipment Category | Equipment Type | Equipment Description | Cost Basis | Install. Factor Basis | Scale Factor Basis | Material of Construction |
|------------------------|-----------------------------------|--------------------|--------------------|---|------------|-----------------------|--------------------|--------------------------|
| PFD-P110-A601-2 | | | | | | | | |
| A-602 | Equalization Basin Agitator | AGITATOR | FIXED-PROP | 38 hp each, Fixed Prop, 0.1 hp/1000 gal | ICARUS | DELTA-T98 | GARRETT | SS |
| A-606 | Anaerobic Agitator | AGITATOR | FIXED-PROP | Fixed Prop, 41 hp, 0.05 hp/1000 gal | ICARUS | DELTA-T98 | GARRETT | SS |
| A-608 | Aerobic Lagoon Agitators | AGITATOR | SURFACE-AERATOR | Twister Surface Aerators, 50 HP ea | VENDOR | MERRICK98 | GARRETT | CS |
| C-614 | Aerobic Sludge Screw | CONVEYOR | SCREW | 9" Dia X 25' Long | ICARUS | DELTA-T98 | GARRETT | CS |
| H-602 | Anaerobic Digester Feed Cooler | HEATX | SHELL-TUBE | TEMA BES Type, Floating Head | ICARUS | DELTA-T98 | VENDOR | SS316/CS |
| M-604 | Nutrient Feed System | MISCELLANEOUS | PACKAGE | 5 Tanks and Pumps | VENDOR | VENDOR | | CS |
| M-606 | Biogas Emergency Flare | MISCELLANEOUS | MISCELLANEOUS | Flare and Pilot | VENDOR | VENDOR | DEFAULT | SS |
| M-612 | Filter Precoat System | MISCELLANEOUS | MISCELLANEOUS | Tank, Agitator, Pump | MERRICK98 | | | CS |
| P-602 | Anaerobic Reactor Feed Pump | PUMP | CENTRIFUGAL | 876 gpm, 150 ft head | ICARUS | DELTA-T98 | GARRETT | CS |
| P-606 | Aerobic Digester Feed Pump | PUMP | CENTRIFUGAL | 830 gpm, 150 ft head | ICARUS | DELTA-T98 | GARRETT | CS |
| P-608 | Aerobic Sludge Recycle Pump | PUMP | SLURRY | 2.5 gpm, 150 ft head | ICARUS | DELTA-T98 | GARRETT | SS316 |
| P-610 | Aerobic Sludge Pump | PUMP | SLURRY | 25.3 gpm, 150 ft head | ICARUS | DELTA-T98 | GARRETT | SS316 |
| P-611 | Aerobic Digestion Outlet Pump | PUMP | CENTRIFUGAL | 828 gpm, 150' head | ICARUS | DELTA-T98 | GARRETT | CS |
| P-614 | Sludge Filtrate Recycle Pump | PUMP | CENTRIFUGAL | 22 gpm, 150' head | ICARUS | DELTA-T98 | GARRETT | CS |
| P-616 | Treated Water Pump | PUMP | CENTRIFUGAL | 803 gpm, 100 ft head | ICARUS | DELTA-T98 | GARRETT | CS |
| S-600 | Bar Screen | SEPARATOR | SCREEN | 0.5" Mech. cleaned Screen | CH2MHL91 | DELTA-T98 | ASSUMED | CS |
| S-614 | Belt Filter Press | S/L SEPARATOR | FILTER-PRESS | BELT THICKNESS | VENDOR | VENDOR | VENDOR | 304SS,BUNA N |
| T-602 | Equalization Basin | TANK | FLAT-BTM-STORAGE | 377516 gal, Residence time 7.2 hr, | VENDOR | VENDOR | GARRETT | CONCRETE |
| T-606 | Anaerobic Digester | TANK | FLAT-BTM-STORAGE | 810250 gal each, space velocity 12g COD/L/DAY | VENDOR | VENDOR | GARRETT | EPOXY-LINED |
| T-608 | Aerobic Digester | REACTOR | LINED-PIT | 1950000 gal, 16.3 day residence time | MERRICK98 | MERRICK98 | | POLYMER LINED |
| T-610 | Clarifier | SEPARATOR | CLARIFIER | 195289 gal, Residence time 3.9 hr. | VENDOR | VENDOR | GARRETT | CONCRETE |
| PFD-P110-A701 | | | | | | | | |
| A-701 | Denaturant In-line Mixer | MIXER | STATIC | Static Mixer, total flow 341 gpm | ICARUS | DELTA-T98 | ICARUS | SS304 |
| A-720 | CSL Storage Tank Agitator | AGITATOR | FIXED-PROP | Top Mounted, 1800 rpm, 23 hp, 0.1 hp/1000 gal | DELTA-T98 | DELTA-T98 | GARRETT | SS304 |
| A-760 | CSL/DAP Day Tank Agitator | AGITATOR | FIXED-PROP | Top Mounted, 1800 rpm, 5 hp, 0.5 hp/1000 gal | ICARUS | DELTA-T98 | GARRETT | SS304 |
| C-755 | DAP Solids Feeder | CONVEYOR | ROTARY-VALVE | 8" dia., 140 cfm, 7000 lb/hr max flow | ICARUS | DELTA-T98 | | A285C |
| P-701 | Ethanol Product Pump | PUMP | CENTRIFUGAL | 324 gpm, 112 ft head | ICARUS | DELTA-T98 | GARRETT | CS |
| P-703 | Sulfuric Acid Pump | PUMP | CENTRIFUGAL | 215 gpm, 150 ft head | ICARUS | DELTA-T98 | GARRETT | SS316 |
| P-704 | Firewater Pump | PUMP | CENTRIFUGAL | 2500 gpm, 50 ft head | ICARUS | DELTA-T98 | GARRETT | CS |
| P-710 | Gasoline Pump | PUMP | CENTRIFUGAL | 17 gpm, 200 ft head | ICARUS | DELTA-T98 | GARRETT | CS |
| P-720 | CSL Pump | PUMP | CENTRIFUGAL | 431 gpm, 150 ft head | ICARUS | DELTA-T98 | GARRETT | CS |
| P-750 | Cellulase Pump | PUMP | CENTRIFUGAL | 2500 gpm, 50 ft head | ICARUS | DELTA-T98 | GARRETT | CS |
| P-755 | DAP Unloading Blower | FAN | CENTRIFUGAL | 7425 cfm, 6 psi, 22275 lb/hr | DELTA-T98 | DELTA-T98 | GARRETT | CS |
| P-760 | CSL/DAP Pump | PUMP | CENTRIFUGAL | 431 gpm, 150 ft head | ICARUS | DELTA-T98 | GARRETT | CS |
| S-755 | DAP Vent Baghouse | SEPARATOR | FABRIC-FILTER | 8333 cfm, 1389 sf, 6 cfm/sf | ICARUS | DELTA-T98 | ICARUS | A285C/POLYESTER |
| T-701 | Ethanol Product Storage Tank | TANK | FLAT-BTM-STORAGE | 604,133 gal, 7 day res time total, 90% wv, 51' dia x 40' high, atmospheric | ICARUS | DELTA-T98 | GARRETT | A285C |
| T-703 | Sulfuric Acid Storage Tank | TANK | FLAT-BTM-STORAGE | 18697 gal, 120 hr res time, 90% wv, 12' dia x 22' high, atmospheric | ICARUS | ICARUS | GARRETT | SS316 |
| T-704 | Firewater Storage Tank | TANK | FLAT-BTM-STORAGE | 600,000 gal, 4 hr res time, 51' dia x 40' high, atmospheric | ICARUS | DELTA-T98 | GARRETT | A285C |
| T-709 | Propane Storage Tank | TANK | HORIZONTAL STORAGE | 6000 gal, 10 day res time, 90% wv, 4 dia x 23.6' length, 250 psig | ICARUS | DELTA-T98 | GARRETT | A515 |
| T-710 | Gasoline Storage Tank | TANK | FLAT-BTM-STORAGE | 63,593 gal, 168 hr res time, 90% wv, 19' dia x 32' high, atmospheric | ICARUS | DELTA-T98 | GARRETT | A285C |
| T-720 | CSL Storage Tank | TANK | FLAT-BTM-STORAGE | 71,918 gal, 120 hr res time, 90% wv, 20' dia x 32' high, atmospheric | ICARUS | ICARUS | GARRETT | SS304 |
| T-750 | Cellulase Storage Tank | TANK | FLAT-BTM-STORAGE | 130,115 gal, 48 hr res time, 90% wv, 27' dia x 37' high, atmospheric | ICARUS | ICARUS | GARRETT | SS304 |
| T-755 | DAP Storage Bin | TANK | LIVE-BTM-BIN | 1425 cf, 9 dia x 19.5' high, 1.5x vessel vol. Req. for 7-day res time, atmospheric | ICARUS | DELTA-T98 | ICARUS | CS |
| T-760 | CSL/DAP Day Tank | TANK | FLAT-BTM-STORAGE | 10,000 gal, 24 hr res time, 90% wv, 9.5' dia x 18.9' high, atmospheric | ICARUS | ICARUS | GARRETT | SS304 |
| PFD-P110-A801-4 | | | | | | | | |
| H-801 | Burner Combustion Air Preheater | MISCELLANEOUS | MISCELLANEOUS | 37000 sf combustion air/exhaust interchanger | ICARUS | NREL-ESTM | DEFAULT | |
| H-811 | BFW Preheater | HEATX | SHELL-TUBE | Floating Head, 500 SF | ICARUS | DELTA-T98 | GARRETT | SS304 |
| M-803 | Fluidized Bed Combustion Reactor | MISCELLANEOUS | MISCELLANEOUS | 900 to 1250 psig/950F Circ. Fluid Bed | VENDOR | DELTA-T98 | VENDOR | CS |
| M-804 | Combustion Gas Baghouse | SEPARATOR | FABRIC-FILTER | Pulse Shaker, 545000 cfm, 135,135 SF | VENDOR | VENDOR | MULTI-UNIT | A285C/FABRIC |
| M-811 | Turbine/Generator | GENERATOR | STEAM-TURBINE | 52-61 MW; 281000 KG/HR STEAM | VENDOR | DELTA-T98 | VENDOR | |
| M-820 | Hot Process Water Softener System | MISCELLANEOUS | PACKAGE | 1000 gpm flow, 24' dia softener. Includes filters, chemical feeders, piping, valves | RICHARDSON | NREL-ESTM | MULTI-UNIT | |
| M-830 | Hydrazine Addition Pkg. | MISCELLANEOUS | PACKAGE | 150 gal tank, agitator, 2 metering pumps | CHEMSYST94 | CHEMSYST94 | DEFAULT | |
| M-832 | Ammonia Addition Pkg | MISCELLANEOUS | PACKAGE | 150 gal tank, agitator, 2 metering pumps | CHEMSYST94 | CHEMSYST94 | DEFAULT | |
| M-834 | Phosphate Addition Pkg. | MISCELLANEOUS | PACKAGE | 150 gal tank, agitator, 2 metering pumps | CHEMSYST94 | CHEMSYST94 | DEFAULT | |
| P-804 | Condensate Pump | PUMP | CENTRIFUGAL | 272 gpm 150' head | ICARUS | DELTA-T98 | GARRETT | SS316 |
| P-811 | Turbine Condensate Pump | PUMP | CENTRIFUGAL | 175 gpm, 150 ft head. | ICARUS | DELTA-T98 | GARRETT | SS304 |
| P-824 | Deaerator Feed Pump | PUMP | CENTRIFUGAL | 650 gpm, 115 ft head. | ICARUS | DELTA-T98 | GARRETT | SS304 |
| P-826 | BFW Pump | PUMP | CENTRIFUGAL | 500 gpm, 2740 ft head. | VENDOR | DELTA-T98 | GARRETT | SS316 |
| P-828 | Blowdown Pump | PUMP | CENTRIFUGAL | 29 gpm, 150' head | ICARUS | DELTA-T98 | GARRETT | CS |
| P-830 | Hydrazine Transfer Pump | PUMP | CENTRIFUGAL | 5 gpm, 75 ft head | DELTA-T98 | DELTA-T98 | GARRETT | CS |
| T-804 | Condensate Collection Tank | TANK | VERTICAL-VESSEL | 1600 gal, Residence time 1.5 minutes, atmospheric | ICARUS | DELTA-T98 | GARRETT | A285C |
| T-824 | Condensate Surge Drum | TANK | HORIZONTAL-VESSEL | 11,400 gal, 24' x 9'dia, 15psig, Residence time 11 min. | ICARUS | DELTA-T98 | GARRETT | SS304 |
| T-826 | Deaerator | TANK | HORIZONTAL-VESSEL | 18,170 gal hold tank, 150 psig design pressure, 10 min residence time | VENDOR | CHEMSYST94 | GARRETT | CS,SS316 |
| T-828 | Blowdown Flash Drum | TANK | HORIZONTAL-VESSEL | 424 gal, 4.5' x 4'dia, 15 psig | ICARUS | DELTA-T98 | GARRETT | CS |
| T-830 | Hydrazine Drum | TANK | VERTICAL-VESSEL | 260 gal, 4.9' x 3'dia., 10psig | ICARUS | DELTA-T98 | GARRETT | SS316 |

Note: Equipment sizes listed are for a base case and may have been scaled up or down in the final cost estimation.

NREL Biofuels Process Design Database Summary

| Equipment Number | Equipment Name | Equipment Category | Equipment Type | Equipment Description | Cost Basis | Install. Factor Basis | Scale Factor Basis | Material of Construction |
|------------------------|---|--------------------|---------------------|--|------------|-----------------------|--------------------|--------------------------|
| PFD-P110-A901-3 | | | | | | | | |
| M-902 | Cooling Tower System | COOLING-TOWER | INDUCED-DRAFT | 71000 gpm, 147.8 x E6 kcal/hr, 5 cell | DELTA-T98 | DELTA-T98 | GARRETT | FIBERGLASS |
| M-904 | Plant Air Compressor | COMPRESSOR | RECIPROCATING | 450 cfm, 125 psig outlet | ICARUS | DELTA-T98 | GARRETT | CS |
| M-910 | CIP System | MISCELLANEOUS | MISCELLANEOUS | Designed by Delta-T. Same cost as sum of previous units. | DELTA-T98 | DELTA-T98 | NREL-ESTM | CS |
| P-902 | Cooling Water Pumps | PUMP | CENTRIFUGAL | 41000 gpm, 70 ft head. | ICARUS | DELTA-T98 | GARRETT | CS |
| P-912 | Make-up Water Pump | PUMP | CENTRIFUGAL | 1083 gpm, 75 ft head | ICARUS | DELTA-T98 | GARRETT | CS |
| P-914 | Process Water Circulating Pump | PUMP | CENTRIFUGAL | 1199 gpm ea, 75 ft. head | ICARUS | DELTA-T98 | GARRETT | CS |
| S-904 | Instrument Air Dryer | DRYER | PACKAGE | 400 SCFM Air Dryer, -40F Dewpoint | RICHARDSON | DELTA-T98 | DEFAULT | CS |
| T-902 | Pretreatment Pressure Filter Press Air Receiver | TANK | HORIZONTAL-PRESSURE | 1000 gal | HARRIS00 | HARRIS00 | GARRETT | CS |
| T-904 | Plant Air Receiver | TANK | HORIZONTAL-VESSEL | 900 gal., 200 psig | ICARUS | DELTA-T98 | GARRETT | CS |
| T-905 | Product Recovery Pressure Filter Press Air Receiver | TANK | HORIZONTAL-PRESSURE | 1000 gal | HARRIS00 | HARRIS00 | GARRETT | CS |
| T-914 | Process Water Tank | TANK | FLAT-BTM-STORAGE | 1756000 gal. 8 hr res time | ICARUS | DELTA-T98 | GARRETT | CS |

Note: Equipment sizes listed are for a base case and may have been scaled up or down in the final cost estimation.

Appendix B

Individual Equipment Costs Summary

Individual Equipment Cost Summary

| Equipment Number | Number Required | Number Spares | Equipment Name | Scaled On | Size Ratio (Base/Current) | Original Equip Cost (per unit) | Base Year | Total Original Equip Cost (Req'd & Spare) in Base Year | Scaling Exponent | Scaled Cost in Base Year | Installation Factor | Installed Cost in Base Year | Installed Cost in 2000\$ |
|------------------|-----------------|---------------|---------------------------------|-----------|---------------------------|--------------------------------|------------------|--|------------------|--------------------------|---------------------|-----------------------------|--------------------------|
| C-101 | 2 | | Bale Transport Conveyor | Flow | 1.00 | \$400,000 | 2000 | \$800,000 | 0.6 | \$799,996 | 1.62 | \$1,295,994 | \$1,295,994 |
| C-102 | 2 | | Bale Unwrapping Conveyor | Flow | 1.00 | \$150,000 | 2000 | \$300,000 | 0.6 | \$299,999 | 1.19 | \$356,998 | \$356,998 |
| C-103 | 1 | | Belt Press Discharge Conveyor | Flow | 1.00 | \$50,000 | 2000 | \$50,000 | 0.6 | \$50,000 | 1.89 | \$94,500 | \$94,500 |
| C-104 | 4 | | Shredder Feed Conveyor | Flow | 1.00 | \$60,000 | 2000 | \$240,000 | 0.6 | \$239,999 | 1.38 | \$331,198 | \$331,198 |
| M-101 | 2 | | Truck Scales | Flow | 1.00 | \$34,000 | 2000 | \$68,000 | 0.6 | \$68,000 | 2.47 | \$167,959 | \$167,959 |
| M-102 | 4 | 1 | Truck Unloading Forklift | Flow | 1.00 | \$18,000 | 2000 | \$90,000 | 1 | \$89,999 | 1 | \$89,999 | \$89,999 |
| M-103 | 4 | | Bale Moving Forklift | Flow | 1.00 | \$18,000 | 2000 | \$72,000 | 1 | \$71,999 | 1 | \$71,999 | \$71,999 |
| M-104 | 2 | | Corn Stover Wash Table | Flow | 1.00 | \$104,000 | 2000 | \$208,000 | 0.6 | \$207,999 | 2.39 | \$497,118 | \$497,118 |
| M-105 | 4 | | Shredder | Flow | 1.00 | \$302,000 | 2000 | \$1,208,000 | 0.6 | \$1,207,994 | 1.38 | \$1,667,032 | \$1,667,032 |
| M-106 | 1 | | Concrete Feedstock-Storage Slab | Flow | 1.00 | \$450,655 | 2000 | \$450,655 | 1 | \$450,651 | 2.2 | \$991,433 | \$991,433 |
| M-107 | 1 | | Polymer Feed System | Flow | 1.00 | \$30,000 | 2000 | \$30,000 | 0.6 | \$30,000 | 2.28 | \$68,400 | \$68,400 |
| P-101 | 2 | 1 | Wash Table Pump | Flow | 1.00 | \$20,000 | 2000 | \$60,000 | 0.79 | \$60,000 | 3.87 | \$232,199 | \$232,199 |
| P-102 | 2 | 1 | Wash Water Pump | Flow | 1.00 | \$15,000 | 2000 | \$45,000 | 0.79 | \$45,000 | 5.19 | \$233,549 | \$233,549 |
| P-103 | 1 | 1 | Clarifier Underflow Pump | Flow | 1.00 | \$6,000 | 2000 | \$12,000 | 0.79 | \$12,000 | 13.41 | \$160,919 | \$160,919 |
| P-104 | 1 | 1 | Clarified Water Pump | Flow | 1.00 | \$15,000 | 2000 | \$30,000 | 0.79 | \$30,000 | 7.07 | \$212,099 | \$212,099 |
| P-105 | 1 | 1 | Belt Press Sump Pump | Flow | 1.00 | \$19,000 | 2000 | \$38,000 | 0.79 | \$38,000 | 2.92 | \$110,959 | \$110,959 |
| S-101 | 1 | | Clarifier Thickener | Flow | 1.00 | \$135,000 | 2000 | \$135,000 | 0.6 | \$134,999 | 1.51 | \$203,849 | \$203,849 |
| S-102 | 1 | | Belt Press | Flow | 1.00 | \$100,000 | 2000 | \$100,000 | 0.6 | \$100,000 | 1.25 | \$124,999 | \$124,999 |
| S-103 | 1 | | Magnetic Separator | Flow | 0.61 | \$13,863 | 1998 | \$13,863 | 0.6 | \$10,335 | 1.3 | \$13,435 | \$13,594 |
| T-101 | 1 | | Wash Water Tank | Flow | 1.00 | \$50,000 | 2000 | \$50,000 | 0.51 | \$50,000 | 2.8 | \$139,999 | \$139,999 |
| T-102 | 1 | | Clarifier Thickener Tank | Flow | 1.00 | \$135,000 | 2000 | \$135,000 | 0.51 | \$134,999 | 3.04 | \$410,398 | \$410,398 |
| A100 | | | | | | | Subtotal* | \$4,135,518 | | \$4,131,968 | 1.81 | \$7,475,036 | \$7,475,195 |

*Sections are subtotaled and an average "Installation Factor" is back-calculated for the section.

Individual Equipment Cost Summary

| Equipment Number | Number Required | Number Spares | Equipment Name | Scaled On | Size Ratio (Base/Current) | Original Equip Cost (per unit) | Base Year | Total Original Equip Cost (Req'd & Spare) in Base Year | Scaling Exponent | Scaled Cost in Base Year | Installation Factor | Installed Cost in Base Year | Installed Cost in 2000\$ |
|------------------|-----------------|---------------|---|-------------|---------------------------|--------------------------------|------------------|--|------------------|--------------------------|---------------------|-----------------------------|--------------------------|
| A-201 | 1 | | In-line Sulfuric Acid Mixer | Flow | 1.83 | \$1,900 | 1997 | \$1,900 | 0.48 | \$2,542 | 1 | \$2,542 | \$2,592 |
| A-205 | 1 | | Hydrolyzate Mix Tank Agitator | Flow | 0.63 | \$36,000 | 1997 | \$36,000 | 0.51 | \$28,421 | 1.2 | \$34,105 | \$34,775 |
| A-209 | 1 | | Overliming Tank Agitator | Flow | 1.62 | \$19,800 | 1997 | \$19,800 | 0.51 | \$25,349 | 1.3 | \$32,953 | \$33,601 |
| A-224 | 1 | | Reacidification Tank Agitator | Flow | 1.63 | \$65,200 | 1997 | \$65,200 | 0.51 | \$83,599 | 1.2 | \$100,318 | \$102,291 |
| A-232 | 1 | | Reslurrying Tank Agitator | Flow | 1.19 | \$36,000 | 1997 | \$36,000 | 0.51 | \$39,423 | 1.2 | \$47,308 | \$48,238 |
| C-201 | 1 | | Hydrolyzate Screw Conveyor | Flow | 1.00 | \$59,400 | 1997 | \$59,400 | 0.78 | \$59,518 | 1.3 | \$77,373 | \$78,895 |
| C-202 | 1 | | Hydrolysate Washed Solids Belt Conveyor | Flow | 0.95 | \$80,000 | 2000 | \$80,000 | 0.76 | \$77,213 | 1.45 | \$111,959 | \$111,959 |
| C-225 | 1 | | Lime Solids Feeder | None | | \$3,900 | 1997 | \$3,900 | | \$3,900 | 1.3 | \$5,070 | \$5,170 |
| H-200 | 1 | | Hydrolyzate Cooler | Area | 0.27 | \$45,000 | 1997 | \$45,000 | 0.51 | \$23,266 | 2.1 | \$48,859 | \$49,820 |
| H-201 | 2 | 1 | Beer Column Feed Economizer | Area | 1.16 | \$132,800 | 1997 | \$398,400 | 0.68 | \$441,162 | 2.1 | \$926,441 | \$944,658 |
| H-205 | 1 | | Pneumapress Vent Condensor | Area | 0.84 | \$15,385 | 2000 | \$15,385 | 0.68 | \$13,620 | 2.1 | \$28,603 | \$28,603 |
| H-244 | 2 | 1 | Waste Vapor Condensor | Area | 0.24 | \$132,800 | 1997 | \$398,400 | 0.68 | \$152,180 | 2.1 | \$319,578 | \$325,863 |
| M-202 | 3 | | Prehydrolysis/Screw Feeder/Reactor | Flow | 1.03 | \$2,457,487 | 2000 | \$7,372,462 | 0.6 | \$7,494,911 | 2.29 | \$17,163,347 | \$17,163,347 |
| P-201 | 1 | 1 | Sulfuric Acid Pump | Flow | 2.00 | \$4,800 | 1997 | \$9,600 | 0.79 | \$16,577 | 2.8 | \$46,416 | \$47,328 |
| P-205 | 2 | 1 | Pneumapress Feed Pump | Solids Flow | 0.95 | \$15,416 | 2000 | \$46,248 | 0.79 | \$44,579 | 3.34 | \$148,893 | \$148,893 |
| P-209 | 1 | 1 | Overlimed Hydrolyzate Pump | Flow | 1.62 | \$10,700 | 1997 | \$21,400 | 0.79 | \$31,377 | 2.8 | \$87,855 | \$89,583 |
| P-211 | 1 | 1 | Primary Filtrate Pump | Flow | 1.02 | \$32,549 | 2000 | \$65,098 | 0.79 | \$65,931 | 3.56 | \$234,716 | \$234,716 |
| P-213 | 1 | 1 | Wash Filtrate Pump | Flow | 0.99 | \$49,803 | 2000 | \$99,606 | 0.79 | \$98,809 | 2.71 | \$267,772 | \$267,772 |
| P-222 | 1 | 1 | Filtered Hydrolyzate Pump | Flow | 1.64 | \$10,800 | 1997 | \$21,600 | 0.79 | \$31,862 | 2.8 | \$89,214 | \$90,968 |
| P-223 | 1 | | Lime Unloading Blower | Flow | 4.38 | \$47,600 | 1998 | \$47,600 | 0.5 | \$99,594 | 1.4 | \$139,432 | \$141,078 |
| P-224 | 2 | 1 | Saccharification Feed Pump | Flow | 1.19 | \$61,368 | 1998 | \$184,104 | 0.7 | \$208,550 | 2.8 | \$583,941 | \$590,837 |
| P-239 | 1 | 1 | Reacidified Liquor Pump | Flow | 1.63 | \$10,800 | 1997 | \$21,600 | 0.79 | \$31,745 | 2.8 | \$88,886 | \$90,633 |
| S-205 | 3 | | Pneumapress Filter | Solids Flow | 0.95 | \$1,575,000 | 2000 | \$4,725,000 | 0.6 | \$4,594,911 | 1.05 | \$4,824,657 | \$4,824,657 |
| S-222 | 1 | | Hydroclone & Rotary Drum Filter | Flow | 1.39 | \$165,000 | 1998 | \$165,000 | 0.39 | \$187,567 | 1.4 | \$262,594 | \$265,695 |
| S-227 | 1 | | LimeDust Vent Baghouse | Flow | 4.37 | \$32,200 | 1997 | \$32,200 | 1 | \$140,707 | 1.5 | \$211,061 | \$215,211 |
| T-201 | 1 | | Sulfuric Acid Tank | Flow | 2.00 | \$5,760 | 1996 | \$5,760 | 0.71 | \$9,411 | 1.4 | \$13,175 | \$13,603 |
| T-203 | 1 | | Blowdown Tank | Flow | 1.03 | \$64,100 | 1997 | \$64,100 | 0.93 | \$65,987 | 1.2 | \$79,184 | \$80,741 |
| T-205 | 1 | | Hydrolyzate Mixing Tank | Flow | 0.63 | \$44,800 | 1997 | \$44,800 | 0.71 | \$32,237 | 1.2 | \$38,684 | \$39,445 |
| T-209 | 1 | | Overliming Tank | Flow | 1.62 | \$71,000 | 1997 | \$71,000 | 0.71 | \$100,144 | 1.4 | \$140,201 | \$142,958 |
| T-211 | 1 | | Primary Filtrate Tank | Flow | 1.02 | \$36,000 | 2000 | \$36,000 | 0.71 | \$36,414 | 2.45 | \$89,214 | \$89,214 |
| T-213 | 1 | | Wash Filtrate Tank | Flow | 0.99 | \$18,000 | 2000 | \$18,000 | 0.71 | \$17,870 | 3.68 | \$65,763 | \$65,763 |
| T-220 | 1 | | Lime Storage Bin | Flow | 4.37 | \$69,200 | 1997 | \$69,200 | 0.46 | \$136,370 | 1.3 | \$177,281 | \$180,767 |
| T-224 | 1 | | Reacidification Tank | Flow | 1.63 | \$147,800 | 1997 | \$147,800 | 0.51 | \$189,507 | 1.2 | \$227,409 | \$231,881 |
| T-232 | 1 | | Slurrying Tank | Flow | 1.19 | \$44,800 | 1997 | \$44,800 | 0.71 | \$50,839 | 1.2 | \$61,007 | \$62,207 |
| | | | | | | | | | | | | | |
| A200 | | | | | | | Subtotal* | \$14,472,363 | | \$14,636,094 | 1.83 | \$26,775,812 | \$26,843,763 |

*Sections are subtotaled and an average "Installation Factor" is back-calculated for the section.

Individual Equipment Cost Summary

| Equipment Number | Number Required | Number Spares | Equipment Name | Scaled On | Size Ratio (Base/Current) | Original Equip Cost (per unit) | Base Year | Total Original Equip Cost (Req'd & Spare) in Base Year | Scaling Exponent | Scaled Cost in Base Year | Installation Factor | Installed Cost in Base Year | Installed Cost in 2000\$ |
|------------------|-----------------|---------------|---------------------------------------|-----------|---------------------------|--------------------------------|------------------|--|------------------|--------------------------|---------------------|-----------------------------|--------------------------|
| A-300 | 10 | | Ethanol Fermentor Agitator | None | | \$19,676 | 1996 | \$196,760 | | \$196,760 | 1.2 | \$236,112 | \$243,782 |
| A-301 | 1 | | Seed Hold Tank Agitator | Flow | 0.99 | \$12,551 | 1996 | \$12,551 | 0.51 | \$12,492 | 1.2 | \$14,990 | \$15,477 |
| A-304 | 2 | | 4th Seed Vessel Agitator | Flow | 0.99 | \$11,700 | 1997 | \$23,400 | 0.51 | \$23,289 | 1.2 | \$27,947 | \$28,497 |
| A-305 | 2 | | 5th Seed Vessel Agitator | Flow | 0.99 | \$10,340 | 1996 | \$20,680 | 0.51 | \$20,582 | 1.2 | \$24,699 | \$25,501 |
| A-306 | 2 | | Beer Surge Tank Agitator | Flow | 1.18 | \$48,700 | 1998 | \$97,400 | 0.51 | \$105,852 | 1.2 | \$127,023 | \$128,523 |
| A-310 | 10 | | Saccharification Tank Agitator | None | | \$19,676 | 1996 | \$196,760 | | \$196,760 | 1.2 | \$236,112 | \$243,782 |
| F-300 | 5 | | Ethanol Fermentor | None | | \$493,391 | 1998 | \$2,466,955 | | \$2,466,955 | 1.2 | \$2,960,346 | \$2,995,308 |
| F-301 | 2 | | 1st Seed Fermentor | None | | \$14,700 | 1997 | \$29,400 | | \$29,400 | 2.8 | \$82,320 | \$83,939 |
| F-302 | 2 | | 2nd Seed Fermentor | None | | \$32,600 | 1997 | \$65,200 | | \$65,200 | 2.8 | \$182,560 | \$186,150 |
| F-303 | 2 | | 3rd Seed Fermentor | None | | \$81,100 | 1997 | \$162,200 | | \$162,200 | 2.8 | \$454,160 | \$463,090 |
| F-304 | 2 | | 4th Seed Fermentor | Flow | 0.99 | \$39,500 | 1997 | \$79,000 | 0.93 | \$78,320 | 1.2 | \$93,984 | \$95,832 |
| F-305 | 2 | | 5th Seed Fermentor | Flow | 0.99 | \$147,245 | 1998 | \$294,490 | 0.51 | \$293,097 | 1.2 | \$351,717 | \$355,871 |
| H-300 | 5 | 1 | Fermentation Cooler | Heat Duty | 1.97 | \$4,000 | 1997 | \$24,000 | 0.78 | \$40,684 | 2.1 | \$85,437 | \$87,117 |
| H-301 | 1 | 1 | Hydrolyzate Heater | Area | 2.49 | \$19,040 | 1996 | \$38,080 | 0.68 | \$70,858 | 2.1 | \$148,802 | \$153,636 |
| H-302 | 3 | | Saccharified Slurry Cooler | Area | 0.85 | \$25,409 | 1998 | \$76,227 | 0.78 | \$67,038 | 2.1 | \$140,779 | \$142,441 |
| H-304 | 1 | | 4th Seed Fermentor Coil | Heat Duty | 1.51 | \$3,300 | 1997 | \$3,300 | 0.83 | \$4,658 | 1.2 | \$5,589 | \$5,699 |
| H-305 | 1 | | 5th Seed Fermentor Coil | Heat Duty | 1.51 | \$18,800 | 1997 | \$18,800 | 0.98 | \$28,238 | 1.2 | \$33,886 | \$34,552 |
| H-310 | 5 | 1 | Fermentation Cooler | Heat Duty | 0.07 | \$4,000 | 1997 | \$24,000 | 0.78 | \$3,054 | 2.1 | \$6,413 | \$6,539 |
| P-300 | 5 | 1 | Fermentation Recirc/Transfer Pump | Heat Duty | 1.97 | \$8,000 | 1997 | \$48,000 | 0.79 | \$82,000 | 2.8 | \$229,600 | \$234,115 |
| P-301 | 1 | 1 | Seed Hold Transfer Pump | Flow | 0.99 | \$22,194 | 1998 | \$44,388 | 0.7 | \$44,100 | 1.4 | \$61,740 | \$62,469 |
| P-302 | 2 | | Seed Transfer Pump | Flow | 0.99 | \$54,088 | 1998 | \$108,176 | 0.7 | \$107,474 | 1.4 | \$150,464 | \$152,241 |
| P-306 | 1 | 1 | Beer Transfer Pump | Flow | 1.18 | \$17,300 | 1997 | \$34,600 | 0.79 | \$39,360 | 2.8 | \$110,209 | \$112,376 |
| P-310 | 5 | 1 | Saccharification Recirc/Transfer Pump | Heat Duty | 0.07 | \$8,000 | 1997 | \$48,000 | 0.79 | \$5,954 | 2.8 | \$16,671 | \$16,998 |
| T-301 | 1 | | Seed Hold Tank | Flow | 0.99 | \$161,593 | 1998 | \$161,593 | 0.51 | \$160,829 | 1.2 | \$192,995 | \$195,274 |
| T-306 | 1 | | Beer Storage Tank | Flow | 1.18 | \$237,700 | 1998 | \$237,700 | 0.71 | \$266,897 | 1.2 | \$320,276 | \$324,059 |
| T-310 | 5 | | Saccharification Tank | None | | \$493,391 | 1998 | \$2,466,955 | | \$2,466,955 | 1.2 | \$2,960,346 | \$2,995,308 |
| | | | | | | | | | | | | | |
| A300 | | | | | | | Subtotal* | \$6,978,615 | | \$7,039,007 | 1.3 | \$9,255,176 | \$9,388,577 |

*Sections are subtotaled and an average "Installation Factor" is back-calculated for the section.

Individual Equipment Cost Summary

| Equipment Number | Number Required | Number Spares | Equipment Name | Scaled On | Size Ratio (Base/Current) | Original Equip Cost (per unit) | Base Year | Total Original Equip Cost (Req'd & Spare) in Base Year | Scaling Exponent | Scaled Cost in Base Year | Installation Factor | Installed Cost in Base Year | Installed Cost in 2000\$ |
|------------------|-----------------|---------------|-----------------------------------|---------------|---------------------------|--------------------------------|------------------|--|------------------|--------------------------|---------------------|-----------------------------|--------------------------|
| A-530 | 1 | | Recycled Water Tank Agitator | Flow | 1.45 | \$5,963 | 1998 | \$5,963 | 0.51 | \$7,197 | 1.3 | \$9,356 | \$9,467 |
| C-501 | 1 | | Lignin Wet Cake Screw | Flow Diameter | 0.44 | \$31,700 | 1997 | \$31,700 | 0.78 | \$16,837 | 1.4 | \$23,571 | \$24,035 |
| D-501 | 1 | | Beer Column | Squared | 1.13 | \$478,100 | 1998 | \$478,100 | 0.68 | \$520,236 | 2.1 | \$1,092,496 | \$1,105,399 |
| D-502 | 1 | | Rectification Column | Flow | 1.25 | \$525,800 | 1996 | \$525,800 | 0.68 | \$613,596 | 2.1 | \$1,288,553 | \$1,330,413 |
| E-501 | 2 | | 1st Effect Evaporation | Area | 1.70 | \$544,595 | 1996 | \$1,089,190 | 0.68 | \$1,560,371 | 2.1 | \$3,276,779 | \$3,383,230 |
| E-502 | 1 | | 2nd Effect Evaporation | Area | 1.70 | \$435,650 | 1996 | \$435,650 | 0.68 | \$624,111 | 2.1 | \$1,310,634 | \$1,353,211 |
| E-503 | 2 | | 3rd Effect Evaporation | Area | 1.70 | \$435,650 | 1996 | \$871,300 | 0.68 | \$1,248,222 | 2.1 | \$2,621,267 | \$2,706,422 |
| H-501 | 1 | 1 | Beer Column Reboiler | Heat Duty | 1.19 | \$158,374 | 1996 | \$316,748 | 0.68 | \$357,008 | 2.1 | \$749,716 | \$774,072 |
| H-502 | 1 | | Rectification Column Reboiler | Heat Duty | 1.18 | \$29,600 | 1997 | \$29,600 | 0.68 | \$33,192 | 2.1 | \$69,703 | \$71,074 |
| H-504 | 1 | | Beer Column Condenser | Heat Duty | 0.37 | \$29,544 | 1996 | \$29,544 | 0.68 | \$15,042 | 2.1 | \$31,588 | \$32,614 |
| H-505 | 1 | | Start-up Rect. Column Condenser | Heat Duty | 1.39 | \$86,174 | 1996 | \$86,174 | 0.68 | \$107,911 | 2.1 | \$226,613 | \$233,975 |
| H-512 | 1 | 1 | Beer Column Feed Interchanger | Area | 1.18 | \$19,040 | 1996 | \$38,080 | 0.68 | \$42,690 | 2.1 | \$89,650 | \$92,562 |
| H-517 | 1 | 1 | Evaporator Condenser | Heat Duty | 1.75 | \$121,576 | 1996 | \$243,152 | 0.68 | \$355,539 | 2.1 | \$746,633 | \$770,888 |
| M-503 | 1 | | Molecular Sieve (9 pieces) | Flow | 1.20 | \$2,700,000 | 1998 | \$2,700,000 | 0.7 | \$3,075,992 | 1 | \$3,075,992 | \$3,112,319 |
| P-501 | 1 | 1 | Beer Column Bottoms Pump | Flow | 1.20 | \$42,300 | 1997 | \$84,600 | 0.79 | \$97,723 | 2.8 | \$273,623 | \$279,004 |
| P-503 | 1 | 1 | Beer Column Reflux Pump | Heat Duty | 0.37 | \$1,357 | 1998 | \$2,714 | 0.79 | \$1,239 | 2.8 | \$3,469 | \$3,510 |
| P-504 | 1 | 1 | Rectification Column Bottoms Pump | Flow | 1.19 | \$4,916 | 1998 | \$9,832 | 0.79 | \$11,316 | 2.8 | \$31,685 | \$32,059 |
| P-505 | 1 | 1 | Rectification Column Reflux Pump | Heat Duty | 1.39 | \$4,782 | 1998 | \$9,564 | 0.79 | \$12,418 | 2.8 | \$34,772 | \$35,182 |
| P-511 | 2 | 1 | 1st Effect Pump | Flow | 1.09 | \$19,700 | 1997 | \$59,100 | 0.79 | \$63,251 | 2.8 | \$177,103 | \$180,585 |
| P-512 | 1 | 1 | 2nd Effect Pump | Flow | 1.28 | \$13,900 | 1997 | \$27,800 | 0.79 | \$33,843 | 2.8 | \$94,759 | \$96,622 |
| P-513 | 2 | 1 | 3rd Effect Pump | Flow | 0.83 | \$8,000 | 1997 | \$24,000 | 0.79 | \$20,748 | 2.8 | \$58,095 | \$59,237 |
| P-514 | 1 | 1 | Evaporator Condensate Pump | Flow | 1.69 | \$12,300 | 1997 | \$24,600 | 0.79 | \$37,312 | 2.8 | \$104,475 | \$106,529 |
| P-515 | 1 | | Scrubber Bottoms Pump | Flow | 2.41 | \$2,793 | 1998 | \$2,793 | 0.79 | \$5,604 | 2.8 | \$15,692 | \$15,878 |
| P-530 | 1 | 1 | Recycled Water Pump | Flow | 1.45 | \$10,600 | 1997 | \$21,200 | 0.79 | \$28,372 | 2.8 | \$79,441 | \$81,003 |
| S-505 | 4 | | Pneumapress Filter | Solids Flow | 0.85 | \$1,418,750 | 2000 | \$5,675,000 | 0.6 | \$5,142,942 | 1.04 | \$5,348,660 | \$5,348,660 |
| T-503 | 1 | | Beer Column Reflux Drum | Heat Duty | 0.37 | \$11,900 | 1997 | \$11,900 | 0.93 | \$4,727 | 2.1 | \$9,927 | \$10,122 |
| T-505 | 1 | | Rectification Column Reflux Drum | Heat Duty | 1.39 | \$45,600 | 1997 | \$45,600 | 0.72 | \$57,855 | 2.1 | \$121,496 | \$123,885 |
| T-512 | 1 | | Vent Scrubber | Flow | 1.37 | \$99,000 | 1998 | \$99,000 | 0.78 | \$126,355 | 2.1 | \$265,346 | \$268,480 |
| T-514 | 1 | | Evaporator Condensate Drum | Flow | 1.44 | \$37,200 | 1998 | \$37,200 | 0.93 | \$52,286 | 2.1 | \$109,800 | \$111,097 |
| T-530 | 1 | | Recycled Water Tank | Flow | 1.45 | \$14,515 | 1998 | \$14,515 | 0.745 | \$19,106 | 1.4 | \$26,748 | \$27,064 |
| | | | | | | | | | | | | | |
| A500 | | | | | | | Subtotal* | \$13,030,419 | | \$14,293,042 | 1.49 | \$21,367,640 | \$21,778,596 |

*Sections are subtotaled and an average "Installation Factor" is back-calculated for the section.

Individual Equipment Cost Summary

| Equipment Number | Number Required | Number Spares | Equipment Name | Scaled On | Size Ratio (Base/Current) | Original Equip Cost (per unit) | Base Year | Total Original Equip Cost (Req'd & Spare) in Base Year | Scaling Exponent | Scaled Cost in Base Year | Installation Factor | Installed Cost in Base Year | Installed Cost in 2000\$ |
|------------------|-----------------|---------------|--------------------------------|-----------|---------------------------|--------------------------------|------------------|--|------------------|--------------------------|---------------------|-----------------------------|--------------------------|
| A-602 | 1 | | Equalization Basin Agitator | Flow | 0.52 | \$28,400 | 1997 | \$28,400 | 0.51 | \$20,286 | 1.2 | \$24,343 | \$24,822 |
| A-606 | 1 | | Anaerobic Agitator | Volume | 1.03 | \$30,300 | 1997 | \$30,300 | 0.51 | \$30,730 | 1.2 | \$36,875 | \$37,601 |
| A-608 | 16 | | Aerobic Lagoon Agitator | Power | 0.26 | \$31,250 | 1998 | \$500,000 | 0.51 | \$253,438 | 1.4 | \$354,813 | \$359,004 |
| C-614 | 1 | | Aerobic Sludge Screw | Flow | 0.22 | \$5,700 | 1997 | \$5,700 | 0.78 | \$1,768 | 1.4 | \$2,475 | \$2,524 |
| H-602 | 1 | | Anaerobic Digester Feed Cooler | Area | 0.43 | \$128,600 | 1997 | \$128,600 | 0.74 | \$68,759 | 2.1 | \$144,393 | \$147,232 |
| M-604 | 1 | | Nutrient Feed System | None | | \$31,400 | 1998 | \$31,400 | | \$31,400 | 2.58 | \$81,012 | \$81,969 |
| M-606 | 1 | | Biogas Emergency Flare | Flow | 0.24 | \$20,739 | 1998 | \$20,739 | 0.6 | \$8,877 | 1.68 | \$14,914 | \$15,090 |
| M-612 | 1 | | Filter Precoat System | None | | \$3,000 | 1998 | \$3,000 | | \$3,000 | 1.4 | \$4,200 | \$4,250 |
| P-602 | 1 | 1 | Anaerobic Reactor Feed Pump | Flow | 0.52 | \$11,400 | 1997 | \$22,800 | 0.79 | \$13,539 | 2.8 | \$37,910 | \$38,656 |
| P-606 | 1 | 1 | Aerobic Digester Feed Pump | Flow | 0.52 | \$10,700 | 1997 | \$21,400 | 0.79 | \$12,775 | 2.8 | \$35,771 | \$36,475 |
| P-608 | 1 | | Aerobic Sludge Recycle Pump | Flow | 0.22 | \$11,100 | 1997 | \$11,100 | 0.79 | \$3,356 | 1.4 | \$4,699 | \$4,791 |
| P-610 | 1 | | Aerobic Sludge Pump | Flow | 0.22 | \$11,100 | 1997 | \$11,100 | 0.79 | \$3,356 | 1.4 | \$4,699 | \$4,791 |
| P-611 | 1 | 1 | Aerobic Digestion Outlet Pump | Flow | 0.52 | \$10,700 | 1997 | \$21,400 | 0.79 | \$12,707 | 2.8 | \$35,579 | \$36,278 |
| P-614 | 1 | 1 | Sludge Filtrate Recycle Pump | Flow | 0.22 | \$6,100 | 1997 | \$12,200 | 0.79 | \$3,681 | 2.8 | \$10,306 | \$10,509 |
| P-616 | 1 | 1 | Treated Water Pump | Flow | 0.53 | \$10,600 | 1997 | \$21,200 | 0.79 | \$12,772 | 2.8 | \$35,760 | \$36,463 |
| S-600 | 1 | | Bar Screen | Flow | 0.52 | \$117,818 | 1991 | \$117,818 | 0.3 | \$96,663 | 1.2 | \$115,996 | \$126,526 |
| S-614 | 1 | | Belt Filter Press | COD | 0.26 | \$650,223 | 1998 | \$650,223 | 0.72 | \$248,935 | 1.8 | \$448,083 | \$453,375 |
| T-602 | 1 | | Equalization Basin | Flow | 0.52 | \$350,800 | 1998 | \$350,800 | 0.51 | \$250,578 | 1.42 | \$355,821 | \$360,023 |
| T-606 | 1 | | Anaerobic Digester | Volume | 1.03 | \$881,081 | 1998 | \$881,081 | 0.51 | \$893,571 | 1.04 | \$929,314 | \$940,289 |
| T-608 | 1 | | Aerobic Digester | Volume | 0.52 | \$635,173 | 1998 | \$635,173 | 1 | \$330,629 | 1 | \$330,629 | \$334,534 |
| T-610 | 1 | | Clarifier | Flow | 0.52 | \$174,385 | 1998 | \$174,385 | 0.51 | \$124,991 | 1.96 | \$244,981 | \$247,875 |
| A600 | | | | | | | Subtotal* | \$3,678,819 | | \$2,425,810 | 1.34 | \$3,252,573 | \$3,303,075 |

*Sections are subtotaled and an average "Installation Factor" is back-calculated for the section.

Individual Equipment Cost Summary

| Equipment Number | Number Required | Number Spares | Equipment Name | Scaled On | Size Ratio (Base/Current) | Original Equip Cost (per unit) | Base Year | Total Original Equip Cost (Req'd & Spare) in Base Year | Scaling Exponent | Scaled Cost in Base Year | Installation Factor | Installed Cost in Base Year | Installed Cost in 2000\$ |
|------------------|-----------------|---------------|------------------------------|-----------|---------------------------|--------------------------------|------------------|--|------------------|--------------------------|---------------------|-----------------------------|--------------------------|
| A-701 | 1 | | Denaturant In-line Mixer | Flow | 1.32 | \$1,900 | 1997 | \$1,900 | 0.48 | \$2,173 | 1 | \$2,173 | \$2,216 |
| A-720 | 1 | | CSL Storage Tank Agitator | Flow | 0.03 | \$12,551 | 1996 | \$12,551 | 0.51 | \$2,143 | 1.2 | \$2,572 | \$2,655 |
| A-760 | 1 | | CSL/DAP Day Tank Agitator | Flow | 0.93 | \$12,795 | 2001 | \$12,795 | 0.51 | \$12,348 | 1.2 | \$14,817 | \$14,582 |
| C-755 | 1 | | DAP Solids Feeder | None | | \$3,900 | 1997 | \$3,900 | | \$3,900 | 1.3 | \$5,070 | \$5,170 |
| P-701 | 2 | 1 | Ethanol Product Pump | Flow | 1.33 | \$7,500 | 1997 | \$22,500 | 0.79 | \$28,200 | 2.8 | \$78,959 | \$80,512 |
| P-703 | 1 | 1 | Sulfuric Acid Pump | Flow | 2.00 | \$8,000 | 1997 | \$16,000 | 0.79 | \$27,628 | 2.8 | \$77,359 | \$78,881 |
| P-704 | 1 | 1 | Firewater Pump | Flow | 1.33 | \$18,400 | 1997 | \$36,800 | 0.79 | \$46,120 | 2.8 | \$129,137 | \$131,676 |
| P-710 | 1 | 1 | Gasoline Pump | Flow | 1.15 | \$4,500 | 1997 | \$9,000 | 0.79 | \$10,041 | 2.8 | \$28,114 | \$28,667 |
| P-720 | 1 | 1 | CSL Pump | Flow | 0.64 | \$8,800 | 1997 | \$17,600 | 0.79 | \$12,376 | 2.8 | \$34,652 | \$35,333 |
| P-750 | 1 | 1 | Cellulase Pump | Flow | 1.00 | \$18,400 | 1997 | \$36,800 | 0.79 | \$36,803 | 2.8 | \$103,049 | \$105,075 |
| P-755 | 1 | | DAP Unloading Blower | Flow | 1.06 | \$47,600 | 1998 | \$47,600 | 0.5 | \$49,014 | 1.4 | \$68,620 | \$69,431 |
| P-760 | 1 | 1 | CSL/DAP Pump | Flow | 0.64 | \$8,800 | 1997 | \$17,600 | 0.79 | \$12,376 | 2.8 | \$34,652 | \$35,333 |
| S-755 | 1 | | DAP Vent Baghouse | Flow | 0.30 | \$32,200 | 1997 | \$32,200 | 1 | \$9,595 | 1.5 | \$14,392 | \$14,675 |
| T-701 | 2 | | Ethanol Product Storage Tank | Flow | 1.33 | \$165,800 | 1997 | \$331,600 | 0.51 | \$383,637 | 1.4 | \$537,092 | \$547,654 |
| T-703 | 1 | | Sulfuric Acid Storage Tank | Flow | 2.00 | \$42,500 | 1997 | \$42,500 | 0.51 | \$60,470 | 1.2 | \$72,564 | \$73,991 |
| T-704 | 1 | | Firewater Storage Tank | Flow | 1.33 | \$166,100 | 1997 | \$166,100 | 0.51 | \$192,175 | 1.4 | \$269,045 | \$274,335 |
| T-709 | 1 | | Propane Storage Tank | Flow | 1.35 | \$24,834 | 2001 | \$24,834 | 0.72 | \$30,825 | 1.4 | \$43,155 | \$42,470 |
| T-710 | 1 | | Gasoline Storage Tank | Flow | 1.15 | \$43,500 | 1997 | \$43,500 | 0.51 | \$46,684 | 1.4 | \$65,358 | \$66,643 |
| T-720 | 1 | | CSL Storage Tank | Flow | 0.64 | \$88,100 | 1997 | \$88,100 | 0.79 | \$61,949 | 1.4 | \$86,729 | \$88,434 |
| T-750 | 1 | | Cellulase Storage Tank | Flow | 0.74 | \$125,900 | 2001 | \$251,800 | 0.79 | \$198,278 | 1.4 | \$277,589 | \$273,186 |
| T-755 | 1 | | DAP Storage Bin | Flow | 1.06 | \$33,384 | 2001 | \$33,384 | 0.44 | \$34,255 | 1.3 | \$44,532 | \$43,826 |
| T-760 | 1 | | CSL/DAP Day Tank | Flow | 0.93 | \$30,084 | 2001 | \$30,084 | 0.79 | \$28,470 | 1.4 | \$39,858 | \$39,226 |
| A700 | | | | | | | Subtotal* | \$1,216,864 | | \$1,251,396 | 1.6 | \$1,975,238 | \$1,956,244 |

*Sections are subtotaled and an average "Installation Factor" is back-calculated for the section.

Individual Equipment Cost Summary

| Equipment Number | Number Required | Number Spares | Equipment Name | Scaled On | Size Ratio (Base/Current) | Original Equip Cost (per unit) | Base Year | Total Original Equip Cost (Req'd & Spare) in Base Year | Scaling Exponent | Scaled Cost in Base Year | Installation Factor | Installed Cost in Base Year | Installed Cost in 2000\$ |
|------------------|-----------------|---------------|-----------------------------------|-----------|---------------------------|--------------------------------|------------------|--|------------------|--------------------------|---------------------|-----------------------------|--------------------------|
| H-801 | 1 | | Burner Combustion Air Preheater | Heat Duty | 0.49 | \$1,049,900 | 1997 | \$1,049,900 | 0.6 | \$687,152 | 1.5 | \$1,030,728 | \$1,050,995 |
| H-811 | 1 | | BFW Preheater | Area | 0.48 | \$58,400 | 1997 | \$58,400 | 0.68 | \$35,477 | 2.1 | \$74,502 | \$75,967 |
| M-803 | 1 | | Fluidized Bed Combustion Reactor | Flow | 0.54 | \$24,900,000 | 1998 | \$24,900,000 | 0.75 | \$15,716,316 | 1.3 | \$20,431,211 | \$20,672,504 |
| M-804 | 1 | | Combustion Gas Baghouse | Flow | 0.55 | \$2,536,300 | 1998 | \$2,536,300 | 0.58 | \$1,784,255 | 1.5 | \$2,676,383 | \$2,707,991 |
| M-811 | 1 | | Turbine/Generator | Flow | 0.66 | \$10,000,000 | 1998 | \$10,000,000 | 0.71 | \$7,422,186 | 1.5 | \$11,133,279 | \$11,264,763 |
| M-820 | 1 | | Hot Process Water Softener System | Flow | 0.77 | \$1,381,300 | 1999 | \$1,381,300 | 0.82 | \$1,114,233 | 1.3 | \$1,448,503 | \$1,461,483 |
| M-830 | 1 | | Hydrazine Addition Pkg. | Flow | 0.83 | \$19,000 | 1994 | \$19,000 | 0.6 | \$16,995 | 1 | \$16,995 | \$18,196 |
| M-832 | 1 | | Ammonia Addition Pkg | Flow | 0.83 | \$19,000 | 1994 | \$19,000 | 0.6 | \$16,995 | 1 | \$16,995 | \$18,196 |
| M-834 | 1 | | Phosphate Addition Pkg. | Flow | 0.83 | \$19,000 | 1994 | \$19,000 | 0.6 | \$16,995 | 1 | \$16,995 | \$18,196 |
| P-804 | 2 | | Condensate Pump | Flow | 1.94 | \$7,100 | 1997 | \$14,200 | 0.79 | \$23,987 | 2.8 | \$67,162 | \$68,483 |
| P-811 | 2 | | Turbine Condensate Pump | Flow | 0.42 | \$7,800 | 1997 | \$15,600 | 0.79 | \$7,819 | 2.8 | \$21,892 | \$22,322 |
| P-824 | 2 | | Deaerator Feed Pump | Flow | 0.59 | \$9,500 | 1997 | \$19,000 | 0.79 | \$12,557 | 2.8 | \$35,161 | \$35,852 |
| P-826 | 5 | | BFW Pump | Flow | 0.34 | \$52,501 | 1998 | \$262,505 | 0.79 | \$111,259 | 2.8 | \$311,526 | \$315,205 |
| P-828 | 2 | | Blowdown Pump | Flow | 0.86 | \$5,100 | 1997 | \$10,200 | 0.79 | \$9,089 | 2.8 | \$25,448 | \$25,949 |
| P-830 | 1 | | Hydrazine Transfer Pump | Flow | 0.83 | \$5,500 | 1997 | \$5,500 | 0.79 | \$4,749 | 2.8 | \$13,297 | \$13,559 |
| T-804 | 1 | | Condensate Collection Tank | Flow | 0.52 | \$7,100 | 1997 | \$7,100 | 0.71 | \$4,472 | 1.4 | \$6,261 | \$6,384 |
| T-824 | 1 | | Condensate Surge Drum | Flow | 0.78 | \$49,600 | 1997 | \$49,600 | 0.72 | \$41,541 | 1.7 | \$70,619 | \$72,008 |
| T-826 | 1 | | Deaerator | Flow | 0.72 | \$165,000 | 1998 | \$165,000 | 0.72 | \$129,664 | 2.8 | \$363,059 | \$367,346 |
| T-828 | 1 | | Blowdown Flash Drum | Flow | 0.87 | \$9,200 | 1997 | \$9,200 | 0.72 | \$8,327 | 2.8 | \$23,316 | \$23,775 |
| T-830 | 1 | | Hydrazine Drum | Flow | 0.83 | \$12,400 | 1997 | \$12,400 | 0.93 | \$10,432 | 1.7 | \$17,734 | \$18,083 |
| A800 | | | | | | | Subtotal* | \$40,553,205 | | \$27,174,501 | 1.4 | \$37,801,069 | \$38,257,258 |

*Sections are subtotaled and an average "Installation Factor" is back-calculated for the section.

Individual Equipment Cost Summary

| Equipment Number | Number Required | Number Spares | Equipment Name | Scaled On | Size Ratio (Base/Current) | Original Equip Cost (per unit) | Base Year | Total Original Equip Cost (Req'd & Spare) in Base Year | Scaling Exponent | Scaled Cost in Base Year | Installation Factor | Installed Cost in Base Year | Installed Cost in 2000\$ |
|------------------|-----------------|---------------|--------------------------------------|-----------|---------------------------|--------------------------------|-----------------------------|--|------------------|--------------------------|---------------------|-----------------------------|--------------------------|
| M-902 | 1 | | Cooling Tower System | Heat Duty | 0.70 | \$1,659,000 | 1998 | \$1,659,000 | 0.78 | \$1,250,136 | 1.2 | \$1,500,163 | \$1,517,880 |
| M-904 | 2 | 1 | Plant Air Compressor | Flow | 1.00 | \$278,200 | 2000 | \$834,600 | 0.34 | \$834,598 | 1.3 | \$1,084,977 | \$1,084,977 |
| M-910 | 1 | | CIP System | Flow | 1.00 | \$95,000 | 1995 | \$95,000 | 0.6 | \$95,036 | 1.2 | \$114,043 | \$117,934 |
| P-902 | 1 | 1 | Cooling Water Pump | Flow | 0.67 | \$332,300 | 1997 | \$664,600 | 0.79 | \$484,432 | 2.8 | \$1,356,409 | \$1,383,080 |
| P-912 | 1 | 1 | Make-up Water Pump | Flow | 0.76 | \$10,800 | 1997 | \$21,600 | 0.79 | \$17,470 | 2.8 | \$48,917 | \$49,879 |
| P-914 | 2 | 1 | Process Water Circulating Pump | Flow | 0.75 | \$11,100 | 1997 | \$33,300 | 0.79 | \$26,453 | 2.8 | \$74,067 | \$75,524 |
| S-904 | 1 | 1 | Instrument Air Dryer | Flow | 0.61 | \$15,498 | 1999 | \$30,996 | 0.6 | \$23,108 | 1.3 | \$30,040 | \$30,309 |
| T-902 | 3 | | Prehydrolysis Filter Air Receiver | Flow | 0.89 | \$17,000 | 2000 | \$51,000 | 0.72 | \$46,942 | 1.2 | \$56,331 | \$56,331 |
| T-904 | 1 | | Plant Air Receiver | Flow | 0.61 | \$13,000 | 1997 | \$13,000 | 0.72 | \$9,139 | 1.3 | \$11,880 | \$12,114 |
| T-905 | 4 | | Product Recovery Filter Air Receiver | Flow | 1.04 | \$17,000 | 2000 | \$68,000 | 0.72 | \$69,887 | 1.2 | \$83,865 | \$83,865 |
| T-914 | 1 | | Process Water Tank | Flow | 0.75 | \$195,500 | 1997 | \$195,500 | 0.51 | \$168,502 | 1.4 | \$235,903 | \$240,542 |
| | | | | | | | | | | | | | |
| A900 | | | | | | | Subtotal* | \$3,666,596 | | \$3,025,703 | 1.5 | \$4,596,596 | \$4,652,435 |
| | | | | | | | | | | | | | |
| | | | | | | | Total Equipment Cost | \$87,764,599 | | \$73,987,116 | 1.52 | \$112,513,533 | \$113,669,816 |

*Sections are subtotaled and an average "Installation Factor" is back-calculated for the section.

Appendix C

Chemical Costs and Sources

Chemical Cost and Sources

| Raw Material | Cost (\$/lb) in 2000 | Reference |
|----------------------------|----------------------|--|
| Clarifier Polymer | 1.2500 | Harris Group, 2000 |
| Sulfuric Acid | 0.0124 | \$25/ton, Chemical Marketing Reporter, 2001 |
| Hydrated Lime | 0.0348 | \$70/ton, Chemical Marketing Reporter, 2001 |
| Corn Steep Liquor | 0.0804 | Analysis of CSL market, Ruth, M. Report to Process Engineering Team, 5 June 1998 |
| Purchased Cellulase Enzyme | 0.0552 | Set to \$0.10/gal ethanol, based on purchased, delivered enzyme |
| Diammonium Phosphate | 0.0706 | \$142/ton, Chemical Marketing Reporter, 2001 |
| Propane | 0.0022 | \$0.734/gal, 1999 average from DOE Energy Information Administration |
| Makeup Water | 0.0001 | \$1/1000 gal, Middle of range \$0.35-\$1.50/1000 gal in Peters/Timmerhaus, pg. 815 |
| Boiler Chemicals | 1.3497 | Radian Report, Cases |
| Cooling Tower Chems | 1.0204 | Unknown |
| WasteWater Chems | 0.1579 | Merrick Report Appendix G |
| WasteWater Polymer | 2.5510 | Merrick Report Appendix G |
| Gasoline Denaturant | 0.0967 | \$0.555/gal, Analysis of Corn ethanol producers' cost, 1999 average |
| | | |
| Utility | | |
| Solid Disposal | 0.0094 | \$20/ton, Chem Systems Report 1993 |
| | | |
| Co-product credit | | |
| Electricity | \$0.041/kWh | Chem Systems Report, 1994 |

Appendix D

Discounted Cash Flow Rate of Return Summary

Discounted Cash Flow Rate of Return

| Year | -2 | -1 | 0 | 1 | 2 | 3 | 4 | 5 | 6 | 7 | 8 | 9 | 10 |
|-------------------------------------|---------------|---------------|----------------|----------------|----------------|---------------|--------------|--------------|--------------|--------------|--------------|--------------|--------------|
| Fixed Capital Investment | \$15,794,024 | \$118,455,184 | \$63,176,098 | | | | | | | | | | |
| Working Capital | | | \$9,871,265 | | | | | | | | | | |
| Ethanol Sales | | | \$55,407,468 | \$73,876,624 | \$73,876,624 | \$73,876,624 | \$73,876,624 | \$73,876,624 | \$73,876,624 | \$73,876,624 | \$73,876,624 | \$73,876,624 | \$73,876,624 |
| By-Product Credit | | | \$4,824,203 | \$6,432,270 | \$6,432,270 | \$6,432,270 | \$6,432,270 | \$6,432,270 | \$6,432,270 | \$6,432,270 | \$6,432,270 | \$6,432,270 | \$6,432,270 |
| Total Annual Sales | | | \$60,231,670 | \$80,308,894 | \$80,308,894 | \$80,308,894 | \$80,308,894 | \$80,308,894 | \$80,308,894 | \$80,308,894 | \$80,308,894 | \$80,308,894 | \$80,308,894 |
| Annual Manufacturing Cost | | | | | | | | | | | | | |
| Raw Materials | | | \$20,272,908 | \$23,169,038 | \$23,169,038 | \$23,169,038 | \$23,169,038 | \$23,169,038 | \$23,169,038 | \$23,169,038 | \$23,169,038 | \$23,169,038 | \$23,169,038 |
| Ion Exchange Resin | | | \$0 | | | | | | \$0 | | | | |
| Baghouse Bags | | | \$349,682 | | | | | | \$349,682 | | | | |
| Other Variable Costs | | | \$12,932,287 | \$14,779,757 | \$14,779,757 | \$14,779,757 | \$14,779,757 | \$14,779,757 | \$14,779,757 | \$14,779,757 | \$14,779,757 | \$14,779,757 | \$14,779,757 |
| Fixed Operating Costs | | | \$7,540,360 | \$7,540,360 | \$7,540,360 | \$7,540,360 | \$7,540,360 | \$7,540,360 | \$7,540,360 | \$7,540,360 | \$7,540,360 | \$7,540,360 | \$7,540,360 |
| Total Product Cost | | | \$41,095,237 | \$45,489,155 | \$45,489,155 | \$45,489,155 | \$45,489,155 | \$45,838,837 | \$45,489,155 | \$45,489,155 | \$45,489,155 | \$45,489,155 | \$45,489,155 |
| Annual Depreciation | | | | | | | | | | | | | |
| General Plant | | | | | | | | | | | | | |
| DDB | | | \$37,422,543 | \$26,730,388 | \$19,093,134 | \$13,637,953 | \$9,741,395 | \$6,958,139 | \$4,970,099 | | | | |
| SL | | | \$18,711,271 | \$15,592,726 | \$13,365,194 | \$11,933,209 | \$11,364,961 | \$11,364,961 | \$11,364,961 | | | | |
| Remaining Value | | | \$93,556,357 | \$66,825,969 | \$47,732,835 | \$34,094,882 | \$24,353,487 | \$17,395,348 | \$12,425,249 | | | | |
| Actual | | | \$37,422,543 | \$26,730,388 | \$19,093,134 | \$13,637,953 | \$11,364,961 | \$11,364,961 | \$11,364,961 | | | | |
| Steam Plant | | | | | | | | | | | | | |
| DDB | | | \$4,983,480 | \$4,609,719 | \$4,263,990 | \$3,944,191 | \$3,648,377 | \$3,374,749 | \$3,121,642 | \$2,887,519 | \$2,670,955 | \$2,470,634 | |
| SL | | | \$3,322,320 | \$3,234,891 | \$3,158,511 | \$3,093,483 | \$3,040,314 | \$2,999,777 | \$2,972,993 | \$2,961,558 | \$2,961,558 | \$2,961,558 | |
| Remaining Value | | | \$61,462,926 | \$56,853,206 | \$52,589,216 | \$48,645,025 | \$44,996,648 | \$41,621,899 | \$38,500,257 | \$35,612,738 | \$32,941,782 | \$30,471,149 | |
| Actual | | | \$4,983,480 | \$4,609,719 | \$4,263,990 | \$3,944,191 | \$3,648,377 | \$3,374,749 | \$3,121,642 | \$2,961,558 | \$2,961,558 | \$2,961,558 | |
| Net Revenue | | | (\$23,269,590) | \$3,479,632 | \$11,462,614 | \$17,237,595 | \$19,806,401 | \$19,730,348 | \$20,333,136 | \$31,858,181 | \$31,858,181 | \$31,858,181 | |
| Losses Forward | | | | (\$23,269,590) | (\$19,789,958) | (\$8,327,344) | \$0 | \$0 | \$0 | \$0 | \$0 | \$0 | |
| Taxable Income | | | (\$23,269,590) | (\$19,789,958) | (\$8,327,344) | \$8,910,250 | \$19,806,401 | \$19,730,348 | \$20,333,136 | \$31,858,181 | \$31,858,181 | \$31,858,181 | |
| Income Tax | | | \$0 | \$0 | \$0 | \$3,474,998 | \$7,724,496 | \$7,694,836 | \$7,929,923 | \$12,424,690 | \$12,424,690 | \$12,424,690 | |
| Annual Cash Income | | | \$19,136,433 | \$34,819,739 | \$34,819,739 | \$31,344,741 | \$27,095,242 | \$26,775,222 | \$26,889,816 | \$22,395,048 | \$22,395,048 | \$22,395,048 | |
| Discount Factor | | 1.21 | 1.1 | 1 | 0.909090909 | 0.826446281 | 0.751314801 | 0.683013455 | 0.620921323 | 0.56447393 | 0.513158118 | 0.46650738 | 0.424097618 |
| Annual Present Value | \$220,991,534 | | \$17,396,757 | \$28,776,644 | \$26,160,585 | \$21,408,880 | \$16,824,014 | \$15,113,915 | \$13,798,727 | \$10,447,455 | \$9,497,687 | \$8,634,261 | |
| Total Capital Investment + Interest | \$19,110,770 | \$130,300,702 | \$73,047,363 | | | | | | | | | | |
| Net Present Worth | | | \$0 | | | | | | | | | | |

If income taxable income < 0, tax = \$0

Loan Interest subtracted from taxable income.

Loan payment subtracted from annual cash income

Interest on construction loan added to investment

| | | | | | | | | | | | | | |
|-----------------------|---------------|--|--------------|--------------|--------------|--------------|--------------|--------------|--------------|--------------|--------------|--------------|--|
| NPV of Income Tax | \$60,794,932 | | \$0 | \$0 | \$0 | \$2,373,470 | \$4,796,305 | \$4,343,534 | \$4,069,304 | \$5,796,210 | \$5,269,282 | \$4,790,256 | |
| NPV of Ethanol Income | \$612,163,202 | | \$50,370,425 | \$61,055,061 | \$55,504,601 | \$50,458,728 | \$45,871,571 | \$41,701,428 | \$37,910,389 | \$34,463,990 | \$31,330,900 | \$28,482,637 | |

Discounter Cash Flow Rate of Return

| Year | 11 | 12 | 13 | 14 | 15 | 16 | 17 | 18 | 19 | 20 |
|-------------------------------------|--------------|--------------|--------------|--------------|--------------|--------------|--------------|--------------|--------------|---------------|
| Fixed Capital Investment | | | | | | | | | | |
| Working Capital | | | | | | | | | | (\$9,871,265) |
| Ethanol Sales | \$73,876,624 | \$73,876,624 | \$73,876,624 | \$73,876,624 | \$73,876,624 | \$73,876,624 | \$73,876,624 | \$73,876,624 | \$73,876,624 | \$73,876,624 |
| By-Product Credit | \$6,432,270 | \$6,432,270 | \$6,432,270 | \$6,432,270 | \$6,432,270 | \$6,432,270 | \$6,432,270 | \$6,432,270 | \$6,432,270 | \$6,432,270 |
| Total Annual Sales | \$80,308,894 | \$80,308,894 | \$80,308,894 | \$80,308,894 | \$80,308,894 | \$80,308,894 | \$80,308,894 | \$80,308,894 | \$80,308,894 | \$80,308,894 |
| Annual Manufacturing Cost | | | | | | | | | | |
| Raw Materials | \$23,169,038 | \$23,169,038 | \$23,169,038 | \$23,169,038 | \$23,169,038 | \$23,169,038 | \$23,169,038 | \$23,169,038 | \$23,169,038 | \$23,169,038 |
| Ion Exchange Resin | \$0 | \$0 | \$0 | \$0 | \$0 | \$0 | \$0 | \$0 | \$0 | \$0 |
| Baghouse Bags | \$349,682 | | | | | \$349,682 | | | | |
| Other Variable Costs | \$14,779,757 | \$14,779,757 | \$14,779,757 | \$14,779,757 | \$14,779,757 | \$14,779,757 | \$14,779,757 | \$14,779,757 | \$14,779,757 | \$14,779,757 |
| Fixed Operating Costs | \$7,540,360 | \$7,540,360 | \$7,540,360 | \$7,540,360 | \$7,540,360 | \$7,540,360 | \$7,540,360 | \$7,540,360 | \$7,540,360 | \$7,540,360 |
| Total Product Cost | \$45,838,837 | \$45,489,155 | \$45,489,155 | \$45,489,155 | \$45,489,155 | \$45,838,837 | \$45,489,155 | \$45,489,155 | \$45,489,155 | \$45,489,155 |
| Annual Depreciation | | | | | | | | | | |
| General Plant | | | | | | | | | | |
| DDB | | | | | | | | | | |
| SL | | | | | | | | | | |
| Remaining Value | | | | | | | | | | |
| Actual | | | | | | | | | | |
| Steam Plant | | | | | | | | | | |
| DDB | \$2,285,336 | \$2,113,936 | \$1,955,391 | \$1,808,736 | \$1,673,081 | \$1,547,600 | \$1,431,530 | \$1,324,165 | \$1,224,853 | \$1,132,989 |
| SL | \$2,961,558 | \$2,961,558 | \$2,961,558 | \$2,961,558 | \$2,961,558 | \$2,961,558 | \$2,961,558 | \$2,961,558 | \$2,961,558 | \$2,961,558 |
| Remaining Value | \$28,185,812 | \$26,071,877 | \$24,116,486 | \$22,307,749 | \$20,634,668 | \$19,087,068 | \$17,655,538 | \$16,331,373 | \$15,106,520 | \$13,973,531 |
| Actual | \$2,961,558 | \$2,961,558 | \$2,961,558 | \$2,961,558 | \$2,961,558 | \$2,961,558 | \$2,961,558 | \$2,961,558 | \$2,961,558 | \$2,961,558 |
| Net Revenue | \$31,508,499 | \$31,858,181 | \$31,858,181 | \$31,858,181 | \$31,858,181 | \$31,508,499 | \$31,858,181 | \$31,858,181 | \$31,858,181 | \$31,858,181 |
| Losses Forward | \$0 | \$0 | \$0 | \$0 | \$0 | \$0 | \$0 | \$0 | \$0 | \$0 |
| Taxable Income | \$31,508,499 | \$31,858,181 | \$31,858,181 | \$31,858,181 | \$31,858,181 | \$31,508,499 | \$31,858,181 | \$31,858,181 | \$31,858,181 | \$31,858,181 |
| Income Tax | \$12,288,315 | \$12,424,690 | \$12,424,690 | \$12,424,690 | \$12,424,690 | \$12,288,315 | \$12,424,690 | \$12,424,690 | \$12,424,690 | \$12,424,690 |
| Annual Cash Income | \$22,181,743 | \$22,395,048 | \$22,395,048 | \$22,395,048 | \$22,395,048 | \$22,181,743 | \$22,395,048 | \$22,395,048 | \$22,395,048 | \$22,395,048 |
| Discount Factor | 0.350493899 | 0.318630818 | 0.28966438 | 0.263331254 | 0.239392049 | 0.217629136 | 0.197844669 | 0.17985879 | 0.163507991 | 0.148643628 |
| Annual Present Value | \$7,774,565 | \$7,135,753 | \$6,487,048 | \$5,897,316 | \$5,361,197 | \$4,827,393 | \$4,430,741 | \$4,027,946 | \$3,661,769 | \$3,328,881 |
| Total Capital Investment + Interest | | | | | | | | | | (\$1,467,301) |
| Net Present Worth | | | | | | | | | | |
| NPV of Income Tax | \$4,306,979 | \$3,958,889 | \$3,598,990 | \$3,271,809 | \$2,974,372 | \$2,674,295 | \$2,458,159 | \$2,234,690 | \$2,031,536 | \$1,846,851 |
| NPV of Ethanol Income | \$25,893,306 | \$23,539,369 | \$21,399,426 | \$19,454,024 | \$17,685,476 | \$16,077,706 | \$14,616,096 | \$13,287,360 | \$12,079,418 | \$10,981,289 |

Ethanol Production Process Engineering Analysis

Corn Stover Design Report Case, process P110: 2010 plant start-up
 Dilute Acid Prehydrolysis with Saccharification and Co-Fermentation
 All Values in 2000\$

Minimum Ethanol Selling Price **\$1.07**

Ethanol Production (MM Gal. / Year) 69.3 Ethanol at 68°F
 Ethanol Yield (Gal / Dry US Ton Feedstock) 89.7
 Feedstock Cost \$/Dry US Ton \$30
 Internal Rate of Return (After-Tax) 10%
 Equity Percent of Total Investment 100%

| Capital Costs | | Operating Costs (cents/gal ethanol) | |
|--------------------------------------|---------------|-------------------------------------|--------------|
| Feed Handling | \$7,500,000 | Feedstock | 33.4 |
| Pretreatment | \$19,000,000 | Biomass to Boiler | 0.0 |
| Neutralization/Conditioning | \$7,800,000 | CSL | 2.8 |
| Saccharification & Fermentation | \$9,400,000 | Cellulase | 10.1 |
| Distillation and Solids Recovery | \$21,800,000 | Other Raw Materials | 5.5 |
| Wastewater Treatment | \$3,300,000 | Waste Disposal | 2.9 |
| Storage | \$2,000,000 | Electricity | -9.3 |
| Boiler/Turbogenerator | \$38,300,000 | Fixed Costs | 10.9 |
| Utilities | \$4,700,000 | Capital Depreciation | 14.3 |
| Total Installed Equipment Cost | \$113,700,000 | Average Income Tax | 10.6 |
| | | Average Return on Investment | 25.4 |
| Added Costs | \$83,700,000 | | 106.8 |
| (% of TPI) | 42% | | |
| | | Operating Costs (\$/yr) | |
| Total Project Investment | \$197,400,000 | Feedstock | \$23,200,000 |
| | | Biomass to Boiler | \$0 |
| Loan Rate | N/A | CSL | \$1,900,000 |
| Term (years) | N/A | Cellulase | \$7,000,000 |
| Capital Charge Factor | 0.176 | Other Raw Matl. Costs | \$3,800,000 |
| | | Waste Disposal | \$2,000,000 |
| Denatured Fuel Prod. (MMgal / yr) | 72.5 | Electricity | -\$6,400,000 |
| Denatured Fuel Min. Sales Price | \$1.04 | Fixed Costs | \$7,500,000 |
| Denaturant Cost (\$/gal denaturant) | \$0.555 | Capital Depreciation | \$9,900,000 |
| | | Average Income Tax | \$7,300,000 |
| | | Average Return on Investment | \$17,600,000 |
| Maximum Yields (100% of Theoretical) | | | \$73,800,000 |
| Ethanol Production (MM Gal/yr) | 87.0 | Excess Electricity (KWH/gal) | 2.28 |
| Theoretical Yield (Gal/ton) | 112.7 | Plant Electricity Use (KWH/gal) | 1.42 |
| Current Yield (Actual/Theoretical) | 80% | | |
| | | Plant Steam Use (kg steam/gal) | 16.7 |
| | | Boiler Feed -- LHV (Btu/lb) | 2,870 |
| | | Boiler Feed -- Water Fraction | 0.518 |

Variable and Fixed Operating Costs

| Production Rate (MM gal/yr) | 69.27 | 24,686 | Feedstock Dry Tons/yr | 772168 | | | | | | | | |
|---------------------------------|---------------------------------------|------------|-------------------------|-----------|----------------------------|---------------------|-------------------------|-------------------|-----------------|----------------|-----------------------------|--|
| | | | gal/ton | 90 | | | | | | | | |
| Hours per Year | 8,406 | | | | | | | | | | | |
| Variable Operating Costs | | | | | | | | | | | | |
| Costing Code | Raw Material | Stream No. | kg/hr | lb/hr | Quoted Price (cents / ton) | Year of Price Quote | 2000 Cost (cents / ton) | 2000 Cost (\$/lb) | \$/hour | MM\$/yr (2000) | Cents/Gallon Ethanol (2000) | |
| F-1 | Feedstock | STRM010 | 98,039 | 216,176 | 2550 | 2000 | 2550.00 | 0.0128 | 2756.25 | 23.17 | 33.45 | |
| F-1 | Feedstock | STRM084 | 0 | 0 | 2550 | 2000 | 2550.00 | 0.0128 | 0.00 | 0.00 | 0.00 | |
| S-11 | Clarifier Polymer | STRM010 | 28 | 63 | 250000 | 2000 | 250000.00 | 1.2500 | 78.24 | 0.66 | 0.95 | |
| R-5 | Sulfuric Acid | STRM071 | 3,288 | 7,251 | 2500 | 2001 | 2485.99 | 0.0124 | 90.13 | 0.76 | 1.09 | |
| R-4 | Hydrated Lime | STRM074 | 2,395 | 5,280 | 7000 | 2001 | 6960.77 | 0.0348 | 183.77 | 1.54 | 2.23 | |
| R-3 | Corn Steep Liquor | STRM073 | 1,306 | 2,879 | 15000 | 1998 | 16087.17 | 0.0804 | 231.57 | 1.95 | 2.81 | |
| R-7 | Purchased Cellulase | STRM075 | 6,824 | 15,046 | 10823 | 1999 | 11044.07 | 0.0552 | 830.86 | 6.98 | 10.08 | |
| R-8 | Ammonium Phosphate | STRM075 | 163 | 360 | 14200 | 2001 | 14120.42 | 0.0706 | 25.42 | 0.21 | 0.31 | |
| S-12 | Propane | 3 | 20 | 45 | 436 | 1999 | 444.90 | 0.0022 | 0.10 | 0.00 | 0.001 | |
| S-8 | Makeup Water | STRM090 | 189,649 | 411,562 | 24 | 1990 | 23.30 | 0.0001 | 48.67 | 0.40 | 0.58 | |
| S-1 | Boiler Chemicals | STRM092 | 1.0 | 2 | 280000 | 1991 | 269932.90 | 1.3497 | 2.98 | 0.03 | 0.04 | |
| S-2 | Cooling Tower Chems | STRM092 | 1.9 | 4 | 200000 | 1999 | 204081.02 | 1.0204 | 4.28 | 0.04 | 0.05 | |
| S-4 | WasteWater Chems | STRM063 | 57.9 | 128 | 30956 | 1999 | 31587.66 | 0.1579 | 20.18 | 0.17 | 0.24 | |
| S-5 | WasteWater Polymer | STRM063 | 0.2 | 0.43 | 500000 | 1999 | 510202.54 | 2.5510 | 1.10 | 0.01 | 0.01 | |
| | Subtotal | | | | | | | | 4272.73 | 35.92 | 51.85 | |
| Waste Streams | | | | | | | | | | | | |
| W-2 | Disposal of Steam 809 | STRM080 | 4,492 | 9,906 | 1820 | 1993 | 1872.61 | 0.0094 | 92.75 | 0.78 | 1.13 | |
| W-3 | Disposal of Steam 229 | STRM022 | 7,217 | 15,913 | 1820 | 1993 | 1872.61 | 0.0094 | 148.99 | 1.25 | 1.81 | |
| | Subtotal | | | | | | | | 241.74 | 2.03 | 2.93 | |
| By-Product Credits | | | | | | | | | | | | |
| P-1 | Electricity | WKNET | 18,747 | na | 0.040 | 1999 | | 0.041 | 765.20 | 6.43 | 9.29 | |
| | Subtotal | | | | | | | | 765.20 | 6.43 | 9.29 | |
| | Total Variable Operating Costs | | | | | | | | 3,749.29 | 31.52 | 45.50 | |
| Fixed Operating Costs | | | | | | | | | | | | |
| | Plant Manager | 80000 | 1 | 80,000 | | | | | | | | |
| | Plant Engineer | 65000 | 1 | 65,000 | | | | | | | | |
| | Maintenance Supr | 60000 | 1 | 60,000 | | | | | | | | |
| | Lab Manager | 50000 | 1 | 50,000 | | | | | | | | |
| | Shift Supervisor | 37000 | 5 | 185,000 | | | | | | | | |
| | Lab Technician | 25000 | 2 | 50,000 | | | | | | | | |
| | Maintenance Tech | 28000 | 8 | 224,000 | | | | | | | | |
| | Shift Operators | 25000 | 20 | 500,001 | | | | | | | | |
| | Yard Employees | 20000 | 32 | 640,001 | | | | | | | | |
| | General Manager | 100000 | 1 | 100,000 | | | | | | | | |
| | Clerks & Secretaries | 20000 | 5 | 100,000 | | | | | | | | |
| | Total Salaries | | | 2,054,002 | | | | | | 2.15 | 3.11 | |
| | Overhead/Maint | 60% | of Labor & Supervision | 1,292,976 | | | | | | 1.29 | 1.87 | |
| | Maintenance | 2% | Equipment Cost | 2,273,396 | | | | | | 2.27 | 3.28 | |
| | Insurance & Taxes | 1.5% | of Total Installed Cost | 1,819,029 | | | | | | 1.82 | 2.63 | |
| | Total Fixed Operating Costs | | | | | | | | | 7.54 | 10.89 | |
| | Total Cash Cost | | | | | | | | | 39.06 | 56.38 | |

Appendix E

Process Parameters

| Process Area | Process Parameter | Model Value |
|---------------------|---|--------------------|
| | Minimum Ethanol Selling Price (\$/gal) | \$1.07 |
| Feedstock | Feedstock Flow (dry metric ton/day) | 2000 |
| | Feedstock Cost (\$/dry US ton) | \$30 |
| | Cellulose Fraction | 37.4% |
| | Xylan Fraction | 21.1% |
| | Arabinan Fraction | 2.9% |
| | Mannan Fraction | 1.6% |
| | Galactan Fraction | 2.0% |
| | Lignin Fraction | 18.0% |
| Pretreatment | Reactor Residence Time | 2 min |
| | Acid Concentration | 1.1% |
| | Temperature | 190°C |
| | Xylan to Xylose Yield | 90% |
| | Mannan to Mannose Yield | 90% |
| | Galactan to Galactose Yield | 90% |
| | Arabinan to Arabinose Yield | 90% |
| | Type of Conditioning | Overliming |
| Saccharification | Cellulase Purchase Price (\$/gal total ethanol) | \$0.10 |
| | Cellulase Purchase Price (\$/gal cellulose-derived ethanol) | \$0.17 |
| | Residence Time | 1.5 days |
| | Temperature | 65°C |
| | Cellulose to Glucose Yield | 90% |
| Co-Fermentation | Residence Time | 1.5 days |
| | Temperature | 41°C |
| | Glucose to Ethanol Yield | 95% |
| | Xylose to Ethanol Yield | 85% |
| | Arabinose to Ethanol Yield | 85% |
| | Mannose to Ethanol Yield | 85% |
| | Galactose to Ethanol Yield | 85% |
| | Contamination Loss | 3% |
| | Overall Cellulose to Ethanol Yield | 85.5% |
| Utilities | Electricity Credit (\$/kWh) | \$0.041 |
| | On-line Time (hr/yr) | 8406 |
| Model: I0203I | | |

Appendix F

Process Flow Diagrams

Note: Larger format (11" x 17") versions of these Process Flow Diagrams are available upon request from Kelly_Ibsen@nrel.gov

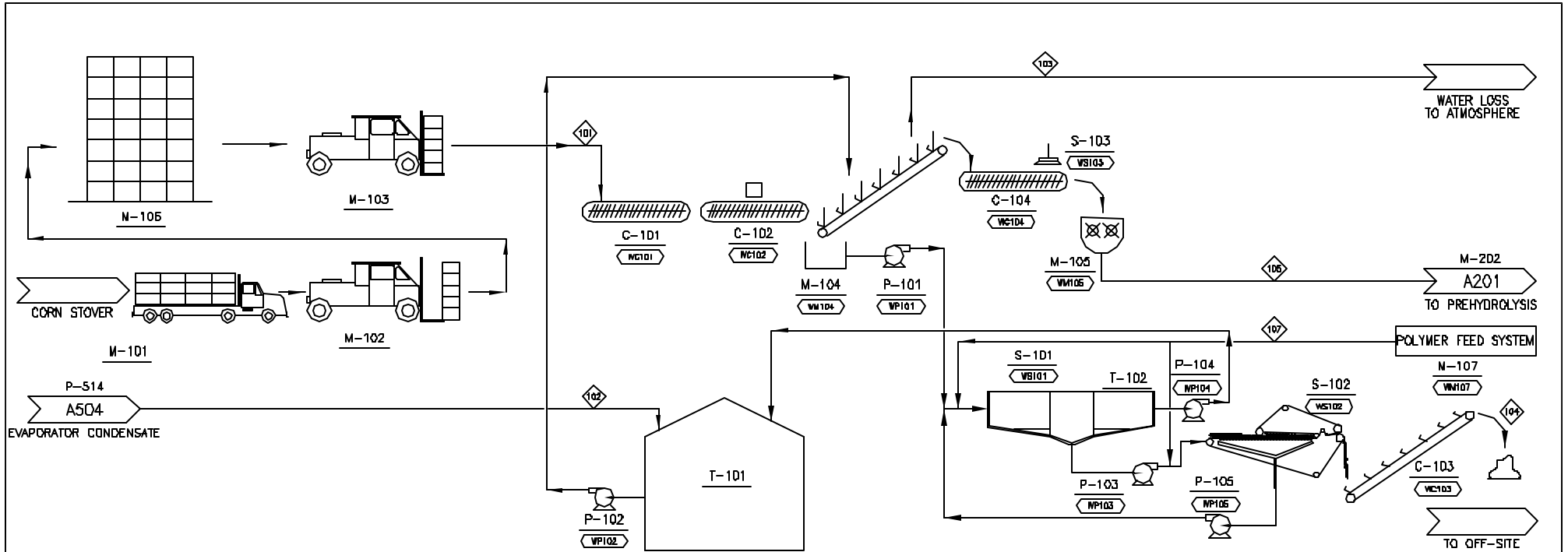

| COMPONENT | UNITS | 101 | 102 | 103 | 104 | 105 | 107 |
|---------------------------|---------|--------|--------|--------|--------|---------|--------|
| Total Flow | kg/hr | 98,039 | 43,017 | 11,400 | 1,006 | 128,676 | 28 |
| Insoluble Solids | % | 77.4% | 0.0% | 0.0% | 0.0% | 59.0% | 0.0% |
| Soluble Solids | % | 7.6% | 0.1% | 0.1% | 0.1% | 5.8% | 0.0% |
| Temperature | C | 20 | 74 | 74 | 74 | 45 | 20 |
| Pressure | atm | 1.00 | 3.00 | 1.00 | 1.00 | 1.00 | 1.00 |
| Vapor Fraction | | 0.00 | 0.00 | 0.00 | 0.00 | 0.00 | 0.00 |
| Ethano | kg/hr | 31 | 8 | 1 | 22 | | |
| Water | kg/hr | 14,706 | 42,546 | 11,275 | 970 | 45,007 | |
| Glucose (SS) | kg/hr | | | | | | |
| Xylose (SS) | kg/hr | 0 | 0 | 0 | 0 | 0 | |
| Arabinose (SS) | kg/hr | 0 | | | | | |
| Other Sugars (SS) | kg/hr | | | | | | |
| Cellulose (SS) | kg/hr | | | | | | |
| Glucose Oligomers (SS) | kg/hr | | | | | | |
| Xylose Oligomers (SS) | kg/hr | 0 | 0 | 0 | 0 | | |
| Other Oligomers (SS) | kg/hr | | | | | | |
| Corn Steep Liquor (SS) | kg/hr | | 58 | 15 | 1 | 41 | |
| Others (Soluble Solids) | kg/hr | 7,417 | | | | 7,417 | |
| Acetic Acid | kg/hr | | 325 | 86 | 7 | 232 | |
| Sulfuric Acid | kg/hr | | 0 | 0 | 0 | 0 | |
| Furfural | kg/hr | | 48 | 13 | 1 | 34 | |
| H ₂ O | kg/hr | | 7 | 2 | 0 | 5 | |
| Carbon Dioxide | kg/hr | | | | | | |
| Methane | kg/hr | | | | | | |
| Oxygen | kg/hr | | | | | | |
| Nitrogen | kg/hr | | 2 | 0 | 28 | 1 | 28 |
| Others | kg/hr | | | | | | |
| Cellulose (IS) | kg/hr | 31,187 | | | | 31,187 | |
| Biomass (IS) | kg/hr | | | | | | |
| Xylan (IS) | kg/hr | 17,570 | | | | 17,570 | |
| Arabinan (IS) | kg/hr | 2,435 | | | | 2,435 | |
| Other Sugar Polymers (IS) | kg/hr | 2,919 | | | | 2,919 | |
| Cellulose (IS) | kg/hr | | | | | | |
| Biomass (IS) | kg/hr | | | | | | |
| Ethano (IS) | kg/hr | | | | | | |
| Lignin (IS) | kg/hr | 15,002 | | | | 15,002 | |
| Gypsum (IS) | kg/hr | | | | | | |
| Ca(OH) ₂ (IS) | kg/hr | | | | | | |
| Others (Insoluble Solids) | kg/hr | 6,804 | | | | 6,804 | |
| Enthalpy Flow (millions) | Kcal/hr | -170.1 | -160.0 | -42.4 | -3.8 | -284.0 | -0.1 |
| Average Density | g/ml | 1.4709 | 0.9442 | 0.9443 | 0.9443 | 1.3433 | 0.9883 |

| Work Stream No. | kW | Work Stream No. | kW |
|-----------------|---------|-----------------|-------|
| WC101 | 55.93 | WP102 | 74.09 |
| WC102 | 11.18 | WP103 | 2.94 |
| WC103 | 2.80 | WP104 | 37.05 |
| WC104 | 11.18 | WP105 | 1.18 |
| WM104 | 83.90 | WS101 | 5.59 |
| WM105 | 1118.56 | WS102 | 4.19 |
| WM107 | 25.00 | WS103 | 0.00 |
| WP101 | 37.06 | | |

| Eq. No. | Equipment Name | Req | Spare | Equipment Type | Mat Const. |
|---------|---------------------------------|-----|-------|-----------------|---------------|
| C-101 | Bale Transport Conveyor | 2 | | BELT | CS |
| C-102 | Bale Unwrapping Conveyor | 2 | | BELT | CS |
| C-103 | Belt Press Discharge Conveyor | 1 | | BELT | CS |
| C-104 | Shredder Feed Conveyor | 4 | | BELT | CS |
| M-101 | Truck Scales | 2 | | TRUCK-SCALE | CONCRETE |
| M-102 | Truck Unloading Forklift | 4 | 1 | LOADER | |
| M-103 | Bale Moving Forklift | 4 | | LOADER | |
| M-104 | Corn Stover Wash Table | 2 | | | A283 |
| M-105 | Shredder | 4 | | | ALLOY STEEL |
| M-106 | Concrete Feedstock-Storage Slab | 1 | | CONCRETE-SLAB | CONCRETE |
| M-107 | Polymer Feed System | 1 | | MISCELLANEOUS | CS |
| P-101 | Wash Table Pump | 2 | 1 | CENTRIFUGAL | CS, RUBBER |
| P-102 | Wash Water Pump | 2 | 1 | CENTRIFUGAL | CS, SS316 |
| P-103 | Clarifier Underflow Pump | 1 | 1 | RECIPROCATING | CS, RUBBER |
| P-104 | Clarified Water Pump | 1 | 1 | CENTRIFUGAL | CS, SS316 |
| P-105 | Belt Press Sump Pump | 1 | 1 | SLURRY | CS |
| S-101 | Clarifier Thickener | 1 | | | |
| S-102 | Belt Press | 1 | | FILTER-PRESS | 304SS; FILTER |
| S-103 | Magnetic Separator | 1 | | MAGNET | |
| T-101 | Wash Water Tank | 1 | | VERTICAL-VESSEL | CS |
| T-102 | Clarifier Thickener Tank | 1 | | CLARIFIER | CEMENT |

| | | | |
|--|--|-------------------------|---|
| NREL NATIONAL RENEWABLE ENERGY LABORATORY Biotechnology Center For Fuels And Chemicals | SECTION A10D CORN STOVER FEED HANDLING PFD-P110-A101 | 102031.xis M 9/23/02 | B |
|--|--|-------------------------|---|

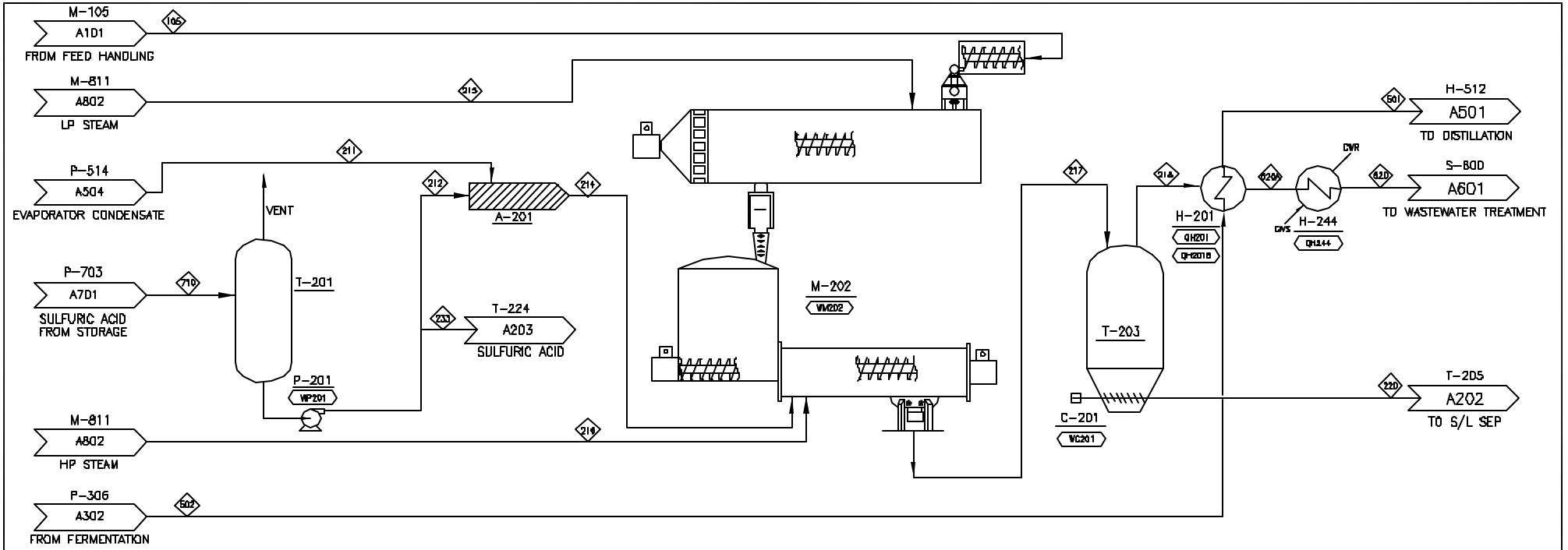

| COMPONENT | UNITS | 105 | 211 | 212 | 214 | 215 | 216 | 217 | 218 | 220 | 233 | 501 | 502 | 520 | 520A | 710 | | |
|---------------------------|---------|---------|--------|--------|---------|--------|--------|---------|--------|---------|--------|---------|---------|--------|--------|--------|--|--|
| Total Flow | kg/hr | 128,676 | 99,344 | 2,104 | 101,447 | 11,507 | 37,234 | 278,865 | 53,152 | 225,713 | 1,185 | 449,353 | 449,353 | 53,152 | 53,152 | 3,288 | | |
| Insoluble Solids | % | 59.0% | 0.0% | 0.0% | 0.0% | 0.0% | 0.0% | 17.2% | 0.0% | 21.3% | 0.0% | 5.0% | 5.0% | 0.0% | 0.0% | 0.0% | | |
| Soluble Solids | % | 5.8% | 0.1% | 0.0% | 0.1% | 0.0% | 0.0% | 12.6% | 0.1% | 15.6% | 0.0% | 3.6% | 3.6% | 0.1% | 0.1% | 0.0% | | |
| Temperature | C | 45 | 74 | 20 | 74 | 164 | 268 | 190 | 101 | 101 | 20 | 95 | 41 | 30 | 100 | 20 | | |
| Pressure | atm | 1.00 | 3.00 | 3.40 | 4.00 | 4.42 | 13.00 | 12.05 | 1.00 | 1.00 | 3.40 | 4.00 | 0.90 | 1.00 | 1.00 | 1.00 | | |
| Vapor Fraction | | 0.00 | 0.00 | 0.00 | 0.00 | 1.00 | 1.00 | 0.00 | 1.00 | 0.00 | 0.00 | 0.00 | 0.00 | 0.00 | 0.00 | 0.00 | | |
| Ethanol | kg/hr | 22 | 71 | | 71 | | | 93 | 73 | 20 | | 24,825 | 24,825 | 73 | 73 | | | |
| Water | kg/hr | 45,007 | 98,256 | | 98,256 | 11,507 | 37,234 | 189,218 | 52,244 | 136,974 | | 374,828 | 374,828 | 52,244 | 52,244 | | | |
| Glucose (SS) | kg/hr | | | | | | | 2,426 | | 2,426 | | 82 | 82 | | | | | |
| Xylose (SS) | kg/hr | 0 | 0 | | 0 | | | 17,969 | 0 | 17,969 | | 909 | 909 | 0 | 0 | | | |
| Arabinose (SS) | kg/hr | | 0 | | 0 | | | 2,490 | 0 | 2,490 | | 217 | 217 | 0 | 0 | | | |
| Other Sugars (SS) | kg/hr | | | | | | | 2,919 | | 2,919 | | 254 | 254 | | | | | |
| Cellulose (SS) | kg/hr | | | | | | | 230 | | 230 | | 360 | 360 | | | | | |
| Glucose Oligomers (SS) | kg/hr | | | | | | | 291 | | 291 | | 1,853 | 1,853 | | | | | |
| Xylose Oligomers (SS) | kg/hr | 0 | 0 | | 0 | | | 500 | 0 | 500 | | 646 | 646 | 0 | 0 | | | |
| Other Oligomers (SS) | kg/hr | | | | | | | 750 | | 750 | | 969 | 969 | | | | | |
| Corn Steep Liquor (SS) | kg/hr | 41 | 133 | | 133 | | | 174 | 48 | 126 | | 1,459 | 1,459 | 48 | 48 | | | |
| Others (Soluble Solids) | kg/hr | 7,417 | | | | | | 7,417 | | 7,417 | | 9,581 | 9,581 | | | | | |
| Acetic Acid | kg/hr | 232 | 751 | | 751 | | | 3,426 | 268 | 3,158 | | 5,258 | 5,258 | 268 | 268 | | | |
| Sulfuric Acid | kg/hr | 0 | 0 | 2,104 | 2,104 | | | 2,104 | 0 | 2,104 | 1,185 | 154 | 154 | 0 | 0 | 3,288 | | |
| Furfural | kg/hr | 34 | 111 | | 111 | | | 727 | 449 | 278 | | 576 | 576 | 449 | 449 | | | |
| HMF | kg/hr | 5 | 17 | | 17 | | | 114 | 70 | 43 | | 90 | 90 | 70 | 70 | | | |
| Carbon Dioxide | kg/hr | | | | | | | | | | | 440 | 440 | | | | | |
| Methane | kg/hr | | | | | | | | | | | 0 | 0 | | | | | |
| Oxygen | kg/hr | | | | | | | | | | | 0 | 0 | | | | | |
| Nitrogen | kg/hr | | | | | | | | | | | 0 | 0 | | | | | |
| Others | kg/hr | 1 | 4 | | 4 | | | 5 | 0 | 5 | | 4,276 | 4,276 | 0 | 0 | | | |
| Cellulose (LS) | kg/hr | 31,187 | | | | | | 28,567 | | 28,567 | | 1,365 | 1,365 | | | | | |
| Xylan (LS) | kg/hr | 17,570 | | | | | | 439 | | 439 | | 439 | 439 | | | | | |
| Arabinan (LS) | kg/hr | 2,435 | | | | | | 61 | | 61 | | 61 | 61 | | | | | |
| Other Sugar Polymers (LS) | kg/hr | 2,919 | | | | | | 73 | | 73 | | 73 | 73 | | | | | |
| Cellulose (IS) | kg/hr | | | | | | | | | | | 650 | 650 | | | | | |
| Biomass (IS) | kg/hr | | | | | | | | | | | 0 | 0 | | | | | |
| Zymo (IS) | kg/hr | | | | | | | | | | | 1,088 | 1,088 | | | | | |
| Lignin (IS) | kg/hr | 15,002 | | | | | | 14,251 | | 14,251 | | 14,252 | 14,252 | | | | | |
| Gypsum (IS) | kg/hr | | | | | | | | | | | 28 | 28 | | | | | |
| Ca(OH)2 (IS) | kg/hr | | | | | | | | | | | 4,620 | 4,620 | | | | | |
| Others (Insoluble Solids) | kg/hr | 6,804 | | | | | | 4,620 | | 4,620 | | 4,620 | 4,620 | | | | | |
| Enthalpy Flow (millions) | Kcal/hr | -284.0 | -369.5 | -4.1 | -373.6 | -36.2 | -115.2 | -809.0 | -166.8 | -642.2 | -2.3 | -1488.8 | -1510.5 | -198.6 | -195.0 | -6.4 | | |
| Average Density | g/ml | 1.3433 | 0.9442 | 1.8166 | 0.9489 | 0.0022 | 0.0053 | 0.9973 | 0.0006 | 1.1246 | 1.8166 | 0.9585 | 0.9520 | 0.9903 | 0.9195 | 1.8166 | | |

| Heat Stream No. | MM kcal/hr | Work Stream No. | kW |
|-----------------|------------|-----------------|--------|
| QH201 | -0.19 | WC201 | 37.08 |
| QH201B | -22.31 | WM202 | 699.80 |
| QH244 | 3.64 | WP201 | 1.16 |

| Eq. No. | Equipment Name | Req | Spare | Equipment Type | Mat Const. |
|---------|----------------------------------|-----|-------|------------------|--------------|
| A-201 | In-line Sulfuric Acid Mixer | 1 | | SS304 | SS304 |
| C-201 | Hydrolyzate Screw Conveyor | 1 | | SCREW | SS316 |
| H-201 | Beer Column Feed Economizer | 2 | 1 | SHELL-TUBE | 304SS |
| H-244 | Waste Vapor Condenser | 2 | 1 | SHELL-TUBE | 304SS |
| M-202 | Prehydrolysis/Screw Feeder/React | 3 | 1 | VESSEL W/ PADDLE | ALLOY 825-CL |
| P-201 | Sulfuric Acid Pump | 1 | 1 | CENTRIFUGAL | SS304 |
| T-201 | Sulfuric Acid Tank | 1 | 1 | VERTICAL-VESSEL | PLASTIC |
| T-203 | Blowdown Tank | 1 | 1 | VERTICAL-VESSEL | SS316 |

| | | |
|--|----------------------------|--|
| VED REVISION A. LIP INVOICE DATE B. 2002 DESIGN REVIEW | DATE 1/12/02 3/22/02 | NATIONAL RENEWABLE ENERGY LABORATORY Biotechnology Center For Fuels And Chemicals |
| SECTION A200 PREHYDROLYSIS | | |
| 102031.xls | | PFD-P110-A201 |

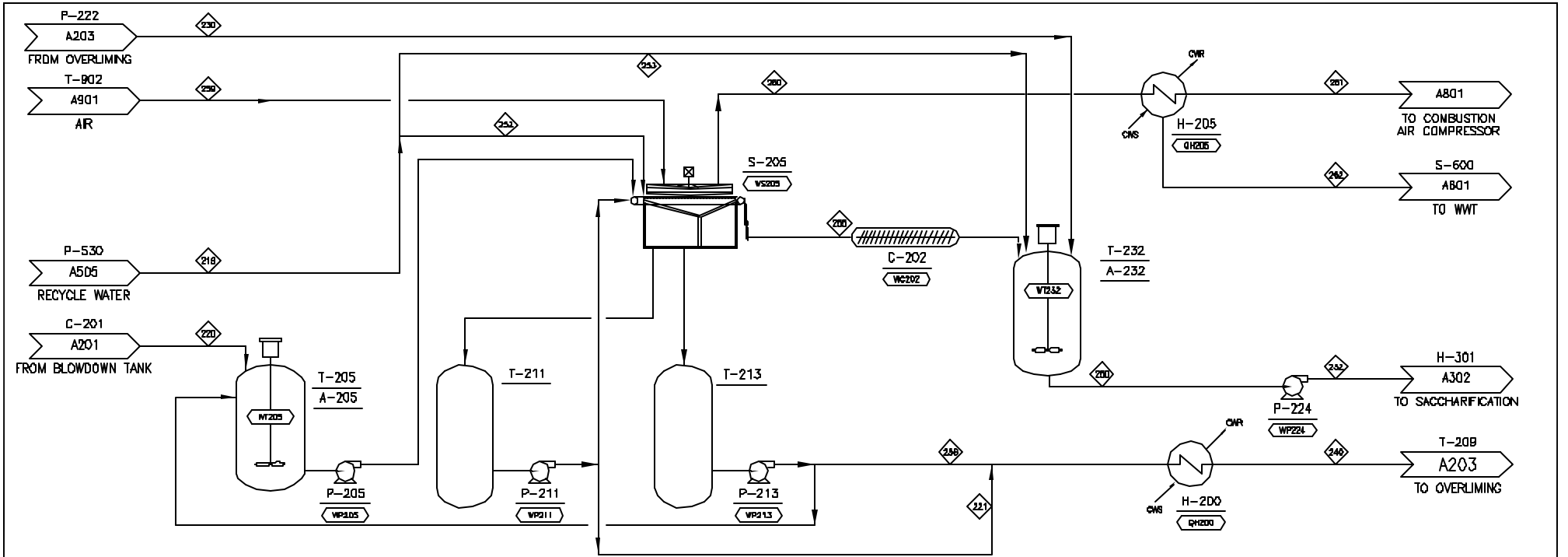

| COMPONENT | UNITS | 219 | 220 | 221 | 230 | 232 | 240 | 250 | 252 | 253 | 255 | 256 | 259 | 260 | 261 | 262 | | |
|---------------------------|---------|---------|---------|---------|---------|----------|---------|----------|---------|--------|--------|---------|--------|--------|--------|--------|--|--|
| Total Flow | kg/hr | 207,096 | 225,713 | 138,563 | 265,125 | 428,764 | 268,762 | 428,764 | 130,913 | 76,182 | 87,456 | 130,199 | 4,687 | 5,094 | 4,894 | 200 | | |
| Insoluble Solids | % | 0.2% | 21.3% | 0.2% | 0.0% | 11.2% | 0.1% | 11.2% | 0.2% | 0.2% | 54.9% | 0.0% | 0.0% | 0.0% | 0.0% | 0.0% | | |
| Soluble Solids | % | 1.7% | 15.6% | 19.7% | 13.1% | 9.0% | 13.0% | 9.0% | 1.7% | 1.7% | 2.7% | 5.9% | 0.0% | 0.0% | 0.0% | 0.0% | | |
| Temperature | C | 46 | 101 | 101 | 53 | 51 | 50 | 51 | 46 | 46 | 50 | 55 | 40 | 50 | 38 | 38 | | |
| Pressure | atm | 1.00 | 1.00 | 1.00 | 1.00 | 1.00 | 1.00 | 1.00 | 1.00 | 1.00 | 1.00 | 1.00 | 9.51 | 1.00 | 1.00 | 1.00 | | |
| Vapor Fraction | | 0.00 | 0.00 | 0.00 | 0.00 | 0.00 | 0.00 | 0.00 | 0.00 | 0.00 | 0.00 | 0.00 | 1.00 | 1.00 | 1.00 | 0.00 | | |
| Ethanol | kg/hr | 28 | 20 | 15 | 36 | 47 | 36 | 47 | 18 | 10 | 1 | 21 | | | | | | |
| Water | kg/hr | 200,466 | 136,974 | 106,622 | 225,312 | 335,811 | 226,537 | 335,811 | 126,722 | 73,744 | 36,755 | 119,915 | | 404 | 205 | 198 | | |
| Glucose (SS) | kg/hr | 19 | 2,426 | 1,888 | 2,283 | 2,432 | 2,275 | 2,432 | 12 | 7 | 163 | 387 | | | | | | |
| Xylose (SS) | kg/hr | 210 | 17,969 | 13,987 | 16,806 | 18,087 | 16,898 | 18,087 | 132 | 77 | 1,204 | 2,910 | | | | | | |
| Arabinose (SS) | kg/hr | 50 | 2,490 | 1,938 | 2,342 | 2,528 | 2,355 | 2,528 | 32 | 18 | 167 | 417 | | | | | | |
| Other Sugars (SS) | kg/hr | 59 | 2,919 | 2,272 | 2,745 | 2,962 | 2,760 | 2,962 | 37 | 22 | 196 | 488 | | | | | | |
| Cellulose (SS) | kg/hr | 83 | 230 | 179 | 266 | 312 | 267 | 312 | 52 | 31 | 15 | 88 | | | | | | |
| Glucose Oligomers (SS) | kg/hr | 427 | 291 | 227 | 338 | 716 | 542 | 716 | 270 | 157 | 20 | 315 | | | | | | |
| Xylose Oligomers (SS) | kg/hr | 149 | 500 | 389 | 558 | 646 | 561 | 646 | 94 | 55 | 34 | 171 | | | | | | |
| Other Oligomers (SS) | kg/hr | 223 | 750 | 584 | 837 | 969 | 841 | 969 | 141 | 82 | 50 | 257 | | | | | | |
| Corn Steep Liquor (SS) | kg/hr | 145 | 126 | 98 | 208 | 270 | 209 | 270 | 91 | 53 | 8 | 111 | | 0 | 0 | 0 | | |
| Others (Soluble Solids) | kg/hr | 2,209 | 7,417 | 5,773 | 8,271 | 9,581 | 8,316 | 9,581 | 1,397 | 813 | 497 | 2,543 | | | | | | |
| Acetic Acid | kg/hr | 1,341 | 3,158 | 2,458 | 3,773 | 4,477 | 3,794 | 4,477 | 848 | 493 | 210 | 1,336 | | 1 | 1 | 1 | | |
| Sulfuric Acid | kg/hr | 36 | 2,104 | 1,637 | | 154 | 1,985 | 154 | 22 | 13 | 141 | 348 | | 0 | 0 | 0 | | |
| Furfural | kg/hr | 301 | 278 | 217 | 448 | 576 | 450 | 576 | 190 | 111 | 17 | 233 | | 2 | 1 | 0 | | |
| HMF | kg/hr | 47 | 43 | 34 | 70 | 90 | 70 | 90 | 30 | 17 | 3 | 36 | | 0 | 0 | 0 | | |
| Carbon Dioxide | kg/hr | 29 | | | 18 | 29 | 19 | 29 | 19 | 11 | | 19 | | | | | | |
| Methane | kg/hr | 0 | | | 0 | 0 | 0 | 0 | 0 | 0 | 0 | 0 | | 984 | 984 | 984 | | |
| Oxygen | kg/hr | 0 | | | 0 | 0 | 0 | 0 | 0 | 0 | 0 | 0 | | 3,703 | 3,702 | 3,702 | | |
| Nitrogen | kg/hr | 0 | | | 0 | 0 | 0 | 0 | 0 | 0 | 0 | 0 | | | | | | |
| Others | kg/hr | 952 | 5 | 4 | 603 | 954 | 607 | 954 | 602 | 350 | 0 | 603 | | | | | | |
| Cellulose (IS) | kg/hr | 7 | 28,567 | 143 | 1 | 28,432 | 143 | 28,432 | 4 | 3 | 28,429 | | | | | | | |
| Xylan (IS) | kg/hr | 2 | 439 | 2 | 0 | 439 | 2 | 439 | 1 | 1 | 438 | | | | | | | |
| Arabinan (IS) | kg/hr | 0 | 61 | 0 | 0 | 61 | 0 | 61 | 0 | 0 | 61 | | | | | | | |
| Other Sugar Polymers (IS) | kg/hr | 0 | 73 | 0 | 0 | 73 | 0 | 73 | 0 | 0 | 73 | | | | | | | |
| Cellulase (IS) | kg/hr | 81 | | | | 81 | | 81 | 51 | 30 | 51 | | | | | | | |
| Biomass (IS) | kg/hr | 0 | | | | 0 | | 0 | 0 | 0 | 0 | | | | | | | |
| Zymo (IS) | kg/hr | 136 | | | | 136 | | 136 | 88 | 50 | 88 | | | | | | | |
| Lignin (IS) | kg/hr | 71 | 14,251 | 71 | 0 | 14,252 | 45 | 26 | 14,225 | | | | | | | | | |
| Gypsum (IS) | kg/hr | 0 | | | 28 | 28 | | 28 | 0 | 0 | 0 | | | | | | | |
| Ca(OH)2 (IS) | kg/hr | | | | | | | | | | | | | | | | | |
| Others (Insoluble Solids) | kg/hr | 23 | 4,620 | 23 | 0 | 4,620 | 23 | 4,620 | 15 | 8 | 4,612 | | | | | | | |
| Enthalpy Flow (millions) | kcal/hr | -755.7 | -642.2 | -425.6 | -874.2 | -1,389.4 | -883.9 | -1,389.4 | -477.7 | -278.0 | -237.2 | -455.8 | 0.0 | -1.3 | -0.6 | -0.8 | | |
| Average Density | g/ml | 0.9793 | 1.1246 | 0.9974 | 1.0158 | 1.0720 | 1.0207 | 1.0720 | 0.9793 | 0.9793 | 1.3246 | 0.9855 | 0.0106 | 0.0010 | 0.0011 | 0.9808 | | |

| Heat Stream No. | MM kcal/hr | Work Stream No. | kW |
|-----------------|------------|-----------------|--------|
| QH200 | 2.44 | WC202 | 26.76 |
| QH205 | 0.13 | WP205 | 159.88 |
| | | WP211 | 14.27 |
| | | WP213 | 221.34 |
| | | WP224 | 83.85 |
| | | WS205 | 96.02 |
| | | WT205 | 15.42 |
| | | WT232 | 30.24 |

| Eq. No. | Equipment Name | Req | Spare | Equipment Type | Mat Const. |
|---------|-----------------------------------|-----|-------|-----------------|------------|
| A-205 | Hydrolyzate Mix Tank Agitator | 1 | | FIXED-PROP | SS |
| A-232 | Reslurrying Tank Agitator | 1 | | FIXED-PROP | SS |
| C-202 | Hydrolyzate Washed Solids Belt Co | 1 | | BELT | CS |
| H-200 | Hydrolyzate Cooler | 1 | | SHELL-TUBE | 304SS/CS |
| H-205 | Pneumapress Vent Condensor | 1 | | SHELL-TUBE | CS |
| P-205 | Pneumapress Feed Pump | 2 | 1 | CENTRIFUGAL | SS316 |
| P-211 | Primary Filtrate Pump | 1 | 1 | CENTRIFUGAL | SS316 |
| P-213 | Wash Filtrate Pump | 1 | 1 | CENTRIFUGAL | SS316 |
| P-224 | Saccharification Feed Pump | 2 | 1 | ROTARY LOBE | 304SS |
| S-205 | Pneumapress Filter | 3 | | PNEUMAPRESS | SS316 |
| T-205 | Hydrolyzate Mixing Tank | 1 | | FLAT-BTM-STORAG | SS304 |
| T-211 | Primary Filtrate Tank | 1 | | VERTICAL-VESSEL | SS316 |
| T-213 | Wash Filtrate Tank | 1 | | VERTICAL-VESSEL | SS316 |
| T-232 | Slurrying Tank | 1 | | FLAT-BTM-STORAG | SS304 |

| | | |
|--|-------------------------|---|
| VEN RECORDING A. REV. PROJECT DATE B. 2022 DESIGN REVIEW | DATE 3/17 5/22/21 | NATIONAL RENEWABLE ENERGY LABORATORY Biomathematics Center For Fuels And Chemicals |
| SECTION A200 SOLID-LIQUID SEPARATION | | |
| 102031.xls | | PFD-P110-A202 B |

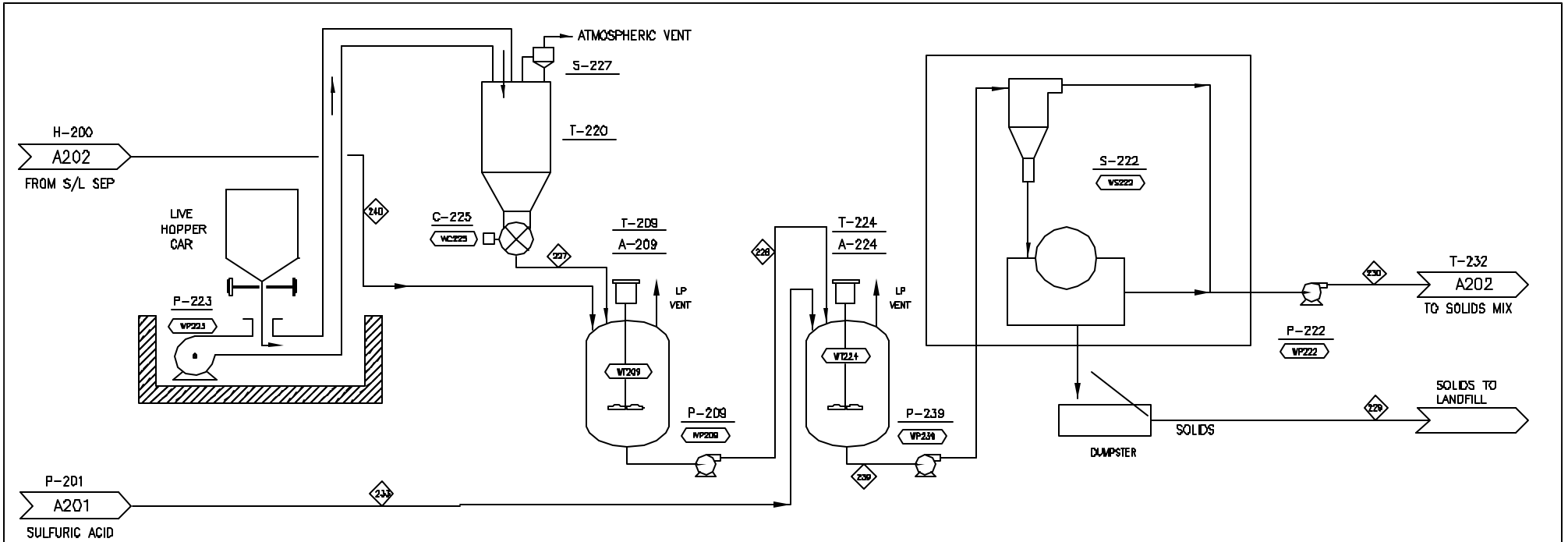

| COMPONENT | UNITS | 227 | 228 | 229 | 230 | 233 | 239 | 240 |
|---------------------------|---------|---------|---------|---------|---------|---------|---------|---------|
| Total Flow | kg/hr | 2,395 | 271,157 | 7,217 | 265,125 | 1,185 | 272,342 | 268,762 |
| Insoluble Solids | % | 100.0% | 1.7% | 80.0% | 0.0% | 0.0% | 2.1% | 0.1% |
| Soluble Solids | % | 0.0% | 12.9% | 2.6% | 13.1% | 0.0% | 12.9% | 13.0% |
| Temperature | C | 50 | 53 | 53 | 20 | 53 | 50 | |
| Pressure | atm | 1.00 | 1.00 | 1.00 | 3.40 | 1.00 | 1.00 | |
| Vapor Fraction | | 0.00 | 0.00 | 0.00 | 0.00 | 0.00 | 0.00 | |
| Ethanol | kg/hr | 36 | 0 | 36 | | 36 | 36 | |
| Water | kg/hr | 226,537 | 1,225 | 225,312 | | 226,537 | 226,537 | |
| Glucose (SS) | kg/hr | 2,275 | 12 | 2,263 | | 2,275 | 2,275 | |
| Xylose (SS) | kg/hr | 16,898 | 91 | 16,806 | | 16,898 | 16,898 | |
| Arabinose (SS) | kg/hr | 2,355 | 13 | 2,342 | | 2,355 | 2,355 | |
| Other Sugars (SS) | kg/hr | 2,760 | 15 | 2,745 | | 2,760 | 2,760 | |
| Cellobiose (SS) | kg/hr | 267 | 1 | 266 | | 267 | 267 | |
| Glucose Oligomers (SS) | kg/hr | 542 | 3 | 539 | | 542 | 542 | |
| Xylose Oligomers (SS) | kg/hr | 561 | 3 | 558 | | 561 | 561 | |
| Other Oligomers (SS) | kg/hr | 841 | 5 | 837 | | 841 | 841 | |
| Corn Steep Liquor (SS) | kg/hr | 209 | 1 | 208 | | 209 | 209 | |
| Others (Soluble Solids) | kg/hr | 8,316 | 45 | 8,271 | | 8,316 | 8,316 | |
| Acetic Acid | kg/hr | 3,794 | 21 | 3,773 | | 3,794 | 3,794 | |
| Sulfuric Acid | kg/hr | | | | 1,185 | | 1,985 | |
| Furfural | kg/hr | 450 | 2 | 448 | | 450 | 450 | |
| HMF | kg/hr | 70 | 0 | 70 | | 70 | 70 | |
| Carbon Dioxide | kg/hr | 19 | 0 | 19 | | 19 | 19 | |
| Methane | kg/hr | | | | | | | |
| Oxygen | kg/hr | 0 | 0 | 0 | | 0 | 0 | |
| Nitrogen | kg/hr | 0 | 0 | 0 | | 0 | 0 | |
| Others | kg/hr | 607 | 3 | 603 | | 607 | 607 | |
| Cellulose (IS) | kg/hr | 143 | 142 | 1 | | 143 | 143 | |
| Xylan (IS) | kg/hr | 2 | 2 | 0 | | 2 | 2 | |
| Arabinan (IS) | kg/hr | 0 | 0 | 0 | | 0 | 0 | |
| Other Sugar Polymers (IS) | kg/hr | 0 | 0 | 0 | | 0 | 0 | |
| Cellulase (IS) | kg/hr | | | | | | | |
| Biomass (IS) | kg/hr | | | | | | | |
| Zymo (IS) | kg/hr | | | | | | | |
| Lignin (IS) | kg/hr | | 71 | 71 | 0 | | 71 | 71 |
| Gypsum (IS) | kg/hr | | 3,485 | 5,537 | 28 | | 5,565 | |
| Ca(OH)2 (IS) | kg/hr | 2,395 | 895 | | | | | |
| Others (Insoluble Solids) | kg/hr | 23 | 23 | 0 | | 23 | 23 | |
| Enthalpy Flow (millions) | Kcal/hr | -7.6 | -892.6 | -20.7 | -874.2 | -2.3 | -894.9 | -883.9 |
| Average Density | g/ml | 2,3430 | 1,0397 | 2,0146 | 1,0158 | 1,8166 | 1,0422 | 1,0207 |

| Heat Stream No. | MM kcal/hr | Work Stream No. | RW |
|-----------------|------------|-----------------|--------|
| | | WC225 | 0.84 |
| | | WP209 | 57.53 |
| | | WP222 | 57.01 |
| | | WP223 | 28.74 |
| | | WP239 | 38.64 |
| | | WS222 | 30.34 |
| | | WT209 | 25.97 |
| | | WT224 | 104.41 |

| Eq. No. | Equipment Name | Req. | Spare | Equipment Type | Mat Const. |
|---------|---------------------------------|------|-------|-----------------|---------------|
| A-209 | Overliming Tank Agitator | 1 | | FIXED-PROP | SS |
| A-224 | Reacidification Tank Agitator | 1 | | FIXED-PROP | SS |
| C-225 | Lime Solids Feeder | 1 | | ROTARY-VALVE | A285C |
| P-209 | Overlimed Hydrolyzate Pump | 1 | 1 | CENTRIFUGAL | 304SS |
| P-222 | Filtered Hydrolyzate Pump | 1 | 1 | CENTRIFUGAL | 304SS |
| P-223 | Lime Unloading Blower | 1 | 1 | CENTRIFUGAL | C.S. |
| P-239 | Reacidified Liquor Pump | 1 | 1 | CENTRIFUGAL | SS304 |
| S-222 | Hydroclone & Rotary Drum Filter | 1 | | ROTARY-DRUM | EPOXY LINED |
| S-227 | LimeDust Vent Baghouse | 1 | | FABRIC-FILTER | A285C-POLYEST |
| T-209 | Overliming Tank | 1 | | VERTICAL-VESSEL | SS304 |
| T-220 | Lime Storage Bin | 1 | | LIVE-BTM-BIN | CS |
| T-224 | Reacidification Tank | 1 | | FLAT-BTM-STORAG | SS304 |

| | | |
|---|----------------------------------|---|
| REV A LIME PROCESS DIAG B 2002 DESIGN REPORT | DATE 1/2/05 8/22/01 |  NATIONAL RENEWABLE ENERGY LABORATORY Biotechnology Center For Fuels And Chemicals |
| SECTION A200 LIME ADDITION | | |
| | 102031.xls | PFD-P110-A203 |

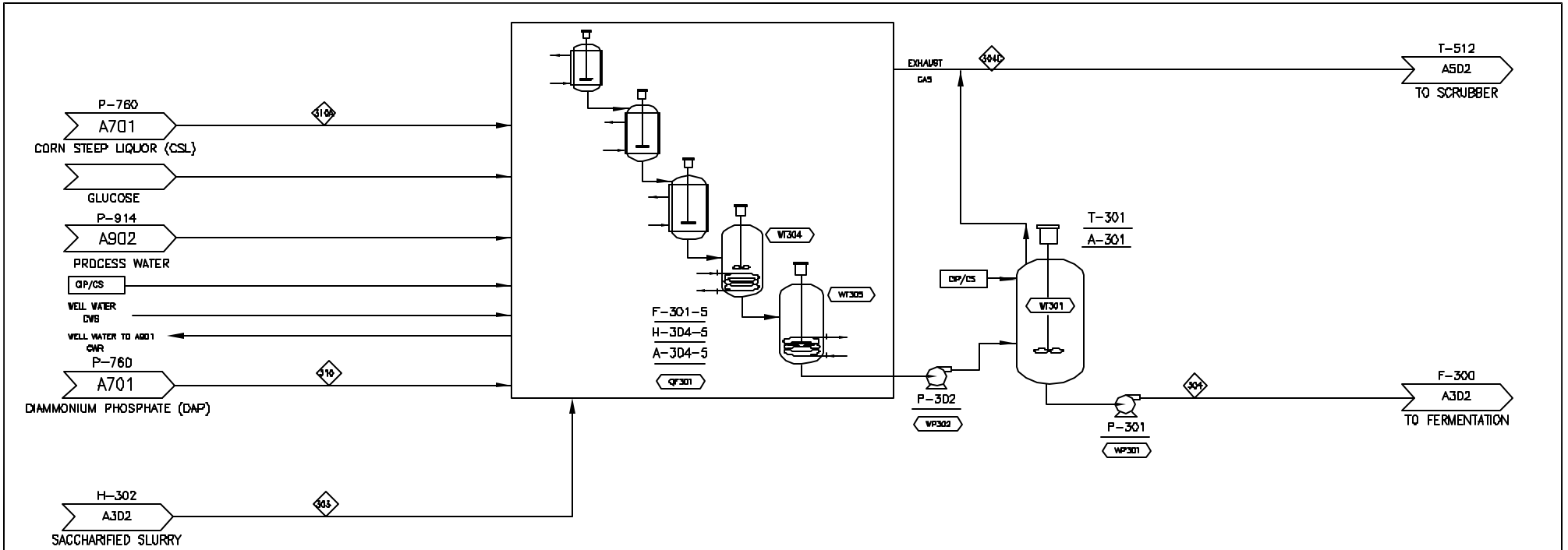

| COMPONENT | UNITS | 303 | 304 | 304C | 310 | 310A |
|---------------------------|---------|--------|--------|--------|--------|--------|
| Total Flow | kg/hr | 43,569 | 41,391 | 2,415 | 28 | 219 |
| Insoluble Solids | % | 5.0% | 5.7% | 0.0% | 0.0% | 0.0% |
| Soluble Solids | % | 15.7% | 4.6% | 0.0% | 0.0% | 100.0% |
| Temperature | C | 41 | 41 | 41 | 20 | 20 |
| Pressure | atm | 1.00 | 1.00 | 1.00 | 1.00 | 1.00 |
| Vapor Fraction | | 0.00 | 0.00 | 1.00 | 0.00 | 0.00 |
| Ethanol | kg/hr | 5 | 2,335 | 70 | | |
| Water | kg/hr | 33,919 | 33,881 | 76 | | |
| Glucose (SS) | kg/hr | 3,119 | 103 | | | |
| Xylose (SS) | kg/hr | 1,809 | 156 | | | |
| Arabinose (SS) | kg/hr | 253 | 32 | | | |
| Other Sugars (SS) | kg/hr | 296 | 37 | | | |
| Cellobiose (SS) | kg/hr | 36 | 36 | | | |
| Glucose Oligomers (SS) | kg/hr | 185 | 185 | | | |
| Xylose Oligomers (SS) | kg/hr | 65 | 65 | | | |
| Other Oligomers (SS) | kg/hr | 97 | 97 | | | |
| Corn Steep Liquor (SS) | kg/hr | 27 | 224 | 0 | | 219 |
| Others (Soluble Solids) | kg/hr | 958 | 958 | | | |
| Acetic Acid | kg/hr | 448 | 527 | 1 | | |
| Sulfuric Acid | kg/hr | 15 | 15 | 0 | | |
| Furfural | kg/hr | 58 | 57 | 1 | | |
| HMF | kg/hr | 9 | 9 | 0 | | |
| Carbon Dioxide | kg/hr | 3 | 40 | 2,235 | | |
| Methane | kg/hr | 0 | 0 | 32 | | |
| Oxygen | kg/hr | 0 | 0 | 0 | | |
| Nitrogen | kg/hr | 0 | 0 | 0 | 28 | |
| Others | kg/hr | 95 | 292 | 0 | | |
| Cellulose (IS) | kg/hr | 136 | 136 | | | |
| Xylan (IS) | kg/hr | 44 | 44 | | | |
| Arabinan (IS) | kg/hr | 6 | 6 | | | |
| Other Sugar Polymers (IS) | kg/hr | 7 | 7 | | | |
| Cellulose (IS) | kg/hr | 65 | 65 | | | |
| Biomass (IS) | kg/hr | 0 | 0 | | | |
| Zimo (IS) | kg/hr | 14 | 193 | | | |
| Lignin (IS) | kg/hr | 1,425 | 1,425 | | | |
| Gypsum (IS) | kg/hr | 3 | 3 | | | |
| Ca(OH)2 (IS) | kg/hr | | | | | |
| Others (Insoluble Solids) | kg/hr | 462 | 462 | | | |
| Enthalpy Flow (millions) | Kcal/hr | -141.7 | -137.7 | -5.1 | -0.1 | -0.8 |
| Average Density | g/ml | 1.0754 | 1.0176 | 0.0016 | 1.0096 | 0.9983 |

| Heat Stream No. | MM kcal/hr | Work Stream No. | RW |
|-----------------|------------|-----------------|-------|
| GF301 | 0.21 | WP301 | 16.95 |
| | | WP302 | 18.95 |
| | | WT301 | 23.40 |
| | | WT304 | 11.70 |
| | | WT305 | 39.00 |

| Eq. No. | Equipment Name | Req | Spare | Equipment Type | Mat Const. |
|---------|--------------------------|-----|-------|------------------|------------|
| A-301 | Seed Hold Tank Agitator | 1 | | FIXED-PROP | SS304 |
| A-304 | 4th Seed Vessel Agitator | 2 | | FIXED-PROP | SS |
| A-305 | 5th Seed Vessel Agitator | 2 | | FIXED-PROP | SS |
| F-301 | 1st Seed Fermentor | 2 | | VERTICAL-VESSEL | SS304 |
| F-302 | 2nd Seed Fermentor | 2 | | VERTICAL-VESSEL | SS304 |
| F-303 | 3rd Seed Fermentor | 2 | | VERTICAL-VESSEL | SS304 |
| F-304 | 4th Seed Fermentor | 2 | | FLAT-BTM-STORAGE | SS304 |
| F-305 | 5th Seed Fermentor | 2 | | FLAT-BTM-STORAGE | SS304 |
| H-304 | 4th Seed Fermentor Coil | 1 | | IMMERSED-COIL | SS |
| H-305 | 5th Seed Fermentor Coil | 1 | | IMMERSED-COIL | SS |
| P-301 | Seed Hold Transfer Pump | 1 | 1 | ROTARY-LOBE | SS304 |
| P-302 | Seed Transfer Pump | 2 | | ROTARY-LOBE | SS304 |
| T-301 | Seed Hold Tank | 1 | | FLAT-BTM-STORAGE | SS304 |

| | | |
|-----|---------------------|---------|
| REV | DESCRIPTION | DATE |
| A | 1st Process Change | 1/7/02 |
| B | 2002 Process Update | 9/27/02 |

NATIONAL RENEWABLE ENERGY LABORATORY

Biotechnology Center For Fuels And Chemicals

SECTION A301 SEED PRODUCTION

| | | |
|------------|---------------|---|
| 102031.xls | PFD-P110-A301 | B |
|------------|---------------|---|

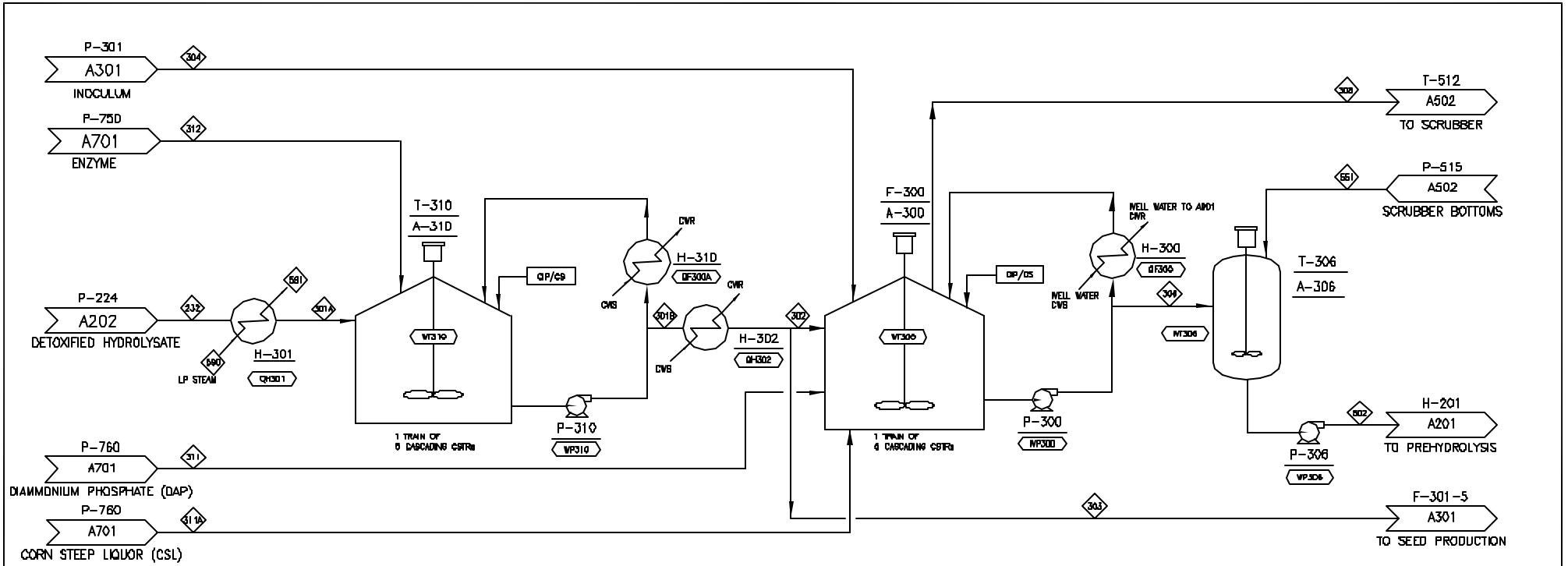

| COMPONENT | UNITS | 232 | 301A | 301B | 302 | 303 | 304 | 306 | 308 | 311 | 311A | 312 | 502 | 551 | 590 | 591 |
|---------------------------|---------|----------|----------|----------|----------|--------|--------|---------|--------|--------|-------|-------|---------|--------|-------|-------|
| Total Flow | kg/hr | 428,764 | 428,764 | 435,588 | 392,029 | 43,559 | 41,391 | 412,222 | 22,420 | 136 | 1,087 | 6,824 | 449,353 | 37,130 | 9,490 | 9,490 |
| Insoluble Solids | % | 11.2% | 11.2% | 5.0% | 5.0% | 5.0% | 5.7% | 5.5% | 0.0% | 0.0% | 0.0% | 8.3% | 5.0% | 0.0% | 0.0% | 0.0% |
| Soluble Solids | % | 9.0% | 9.0% | 15.7% | 15.7% | 15.7% | 4.6% | 4.0% | 0.0% | 100.0% | 0.0% | 0.0% | 3.6% | 0.0% | 0.0% | 0.0% |
| Temperature | C | 51 | 65 | 65 | 41 | 41 | 41 | 41 | 41 | 20 | 20 | 20 | 41 | 39 | 164 | 148 |
| Pressure | atm | 1.00 | 1.00 | 1.00 | 1.00 | 1.00 | 1.00 | 1.00 | 1.00 | 1.00 | 1.00 | 1.00 | 0.90 | 0.90 | 4.42 | 4.42 |
| Vapor Fraction | | 0.00 | 0.00 | 0.00 | 0.00 | 0.00 | 0.00 | 0.00 | 0.00 | 0.00 | 0.00 | 0.00 | 0.00 | 0.00 | 1.00 | 0.00 |
| Ethanol | kg/hr | 47 | 47 | 47 | 43 | 5 | 2,335 | 24,032 | 668 | | | | 24,825 | 793 | | |
| Water | kg/hr | 335,811 | 335,811 | 339,188 | 305,269 | 33,919 | 33,881 | 336,544 | 710 | | | 6,255 | 374,828 | 36,284 | 9,490 | 9,490 |
| Glucose (SS) | kg/hr | 2,432 | 2,432 | 31,193 | 28,074 | 3,119 | 103 | 82 | | | | | 82 | | | |
| Xylose (SS) | kg/hr | 18,067 | 18,067 | 18,067 | 16,279 | 1,809 | 156 | 909 | | | | | 909 | | | |
| Arabinose (SS) | kg/hr | 2,528 | 2,528 | 2,528 | 2,275 | 253 | 32 | 217 | | | | | 217 | | | |
| Other Sugars (SS) | kg/hr | 2,962 | 2,962 | 2,962 | 2,666 | 296 | 37 | 254 | | | | | 254 | | | |
| Cellulose (SS) | kg/hr | 312 | 312 | 360 | 324 | 36 | 36 | 360 | | | | | 360 | | | |
| Glucose Oligomers (SS) | kg/hr | 716 | 716 | 1,853 | 1,668 | 185 | 185 | 1,853 | | | | | 1,853 | | | |
| Xylose Oligomers (SS) | kg/hr | 646 | 646 | 646 | 581 | 65 | 65 | 646 | | | | | 646 | | | |
| Other Oligomers (SS) | kg/hr | 969 | 969 | 969 | 872 | 97 | 97 | 969 | | | | | 969 | | | |
| Corn Steep Liquor (SS) | kg/hr | 270 | 270 | 270 | 243 | 27 | 224 | 1,456 | 3 | | 1,087 | | 1,459 | 4 | | |
| Others (Soluble Solids) | kg/hr | 9,581 | 9,581 | 9,581 | 8,623 | 958 | 958 | 9,581 | | | | | 9,581 | | | |
| Acetic Acid | kg/hr | 4,477 | 4,477 | 4,477 | 4,029 | 448 | 527 | 5,251 | 6 | | | | 5,253 | 7 | | |
| Sulfuric Acid | kg/hr | 154 | 154 | 154 | 139 | 15 | 15 | 154 | 0 | | | | 154 | 0 | | |
| Formal | kg/hr | 576 | 576 | 576 | 518 | 58 | 57 | 568 | 7 | | | | 576 | 8 | | |
| FHF | kg/hr | 90 | 90 | 90 | 81 | 9 | 9 | 89 | 1 | | | | 90 | 1 | | |
| Carbon Dioxide | kg/hr | 29 | 29 | 29 | 26 | 3 | 40 | 406 | 20,799 | | | | 440 | 34 | | |
| Methane | kg/hr | 0 | 0 | 0 | 0 | 0 | 0 | 0 | 226 | | | | 0 | 0 | | |
| Oxygen | kg/hr | 0 | 0 | 0 | 0 | 0 | 0 | 0 | 0 | | | | 0 | 0 | | |
| Nitrogen | kg/hr | 0 | 0 | 0 | 0 | 0 | 0 | 0 | 0 | | | | 0 | 0 | | |
| Others | kg/hr | 154 | 154 | 154 | 139 | 15 | 15 | 154 | 0 | 136 | | | 4,276 | 0 | | |
| Cellulose (IS) | kg/hr | 28,432 | 28,432 | 1,365 | 1,228 | 136 | 136 | 1,365 | | | | | 1,365 | | | |
| Xylan (IS) | kg/hr | 439 | 439 | 439 | 395 | 44 | 44 | 439 | | | | | 439 | | | |
| Arabinan (IS) | kg/hr | 61 | 61 | 61 | 55 | 6 | 6 | 61 | | | | | 61 | | | |
| Other Sugar Polymers (IS) | kg/hr | 73 | 73 | 73 | 66 | 7 | 7 | 73 | | | | | 73 | | | |
| Cellulase (IS) | kg/hr | 81 | 81 | 650 | 585 | 65 | 65 | 650 | | | | 568 | 650 | | | |
| Biomass (IS) | kg/hr | 0 | 0 | 0 | 0 | 0 | 0 | 0 | | | | | 0 | | | |
| Zymo (IS) | kg/hr | 136 | 136 | 136 | 122 | 14 | 193 | 1,088 | | | | | 1,088 | | | |
| Lipin (IS) | kg/hr | 14,252 | 14,252 | 14,252 | 12,827 | 1,425 | 1,425 | 14,252 | | | | | 14,252 | | | |
| Gypsum (IS) | kg/hr | 28 | 28 | 28 | 25 | 3 | 3 | 28 | | | | | 28 | | | |
| Ca(OH)2 (IS) | kg/hr | 0 | 0 | 0 | 0 | 0 | 0 | 0 | | | | | 0 | | | |
| Others (Insoluble Solids) | kg/hr | 4,620 | 4,620 | 4,620 | 4,158 | 462 | 462 | 4,620 | | | | | 4,620 | | | |
| Enthalpy Flow (millions) | kcal/hr | -1,989.4 | -1,984.5 | -1,408.7 | -1,275.5 | -141.7 | -137.7 | -1372.7 | -47.5 | -0.4 | -4.1 | -24.2 | -1510.9 | -138.2 | -29.8 | -34.7 |
| Average Density | g/ml | 1.072 | 1.059 | 1.052 | 1.075 | 1.075 | 1.018 | 1.015 | 0.002 | 1.010 | 0.998 | 1.040 | 0.952 | 0.975 | 0.002 | 0.865 |

| Heat Stream No. | MM kcal/hr | Work Stream No. | kW |
|-----------------|------------|-----------------|--------|
| QF300A | 0.09 | WP300 | 345.20 |
| QF300 | 2.40 | WP306 | 119.04 |
| QH301 | -4.89 | WP310 | 122.90 |
| QH302 | 8.49 | WT300 | 438.73 |
| | | WT306 | 113.64 |
| | | WT310 | 445.89 |

| Eq. No. | Equipment Name | Req | Spare | Equipment Type | Mat Const. |
|---------|--------------------------------------|-----|-------|-----------------|------------|
| A-300 | Ethanol Fermentor Agitator | 10 | | FIXED-PROP | SS304 |
| A-306 | Beer Surge Tank Agitator | 2 | | FIXED-PROP | SS304 |
| A-310 | Saccharification Tank Agitator | 10 | | FIXED-PROP | SS304 |
| F-300 | Ethanol Fermentor | 5 | | FLAT-BTM-STORAG | SS304 |
| H-300 | Fermentation Cooler | 5 | 1 | PLATE-FRAME | SS304 |
| H-301 | Hydrolyzate Heater | 1 | 1 | PLATE-FRAME | SS |
| H-302 | Saccharified Slurry Cooler | 3 | | PLATE-FRAME | SS304 |
| H-310 | Fermentation Cooler | 5 | 1 | PLATE-FRAME | SS304 |
| P-300 | Fermentation Recirc/Transfer Pump | 5 | 1 | CENTRIFUGAL | SS304 |
| P-306 | Beer Transfer Pump | 1 | 1 | CENTRIFUGAL | SS304 |
| P-310 | Saccharification Recirc/Transfer Pur | 5 | 1 | CENTRIFUGAL | SS304 |
| T-306 | Beer Storage Tank | 1 | | FLAT-BTM-STORAG | SS304 |
| T-310 | Saccharification Tank | 5 | | FLAT-BTM-STORAG | SS304 |

| REV | DESCRIPTION | DATE |
|-----|------------------|---------|
| A | LP PROPOSED CASE | 1/17/08 |
| B | 2002 RCNM REPORT | 4/29/08 |



NATIONAL RENEWABLE ENERGY LABORATORY
 Biotechnology Center For Fuels And Chemicals

SECTION A300
SACCHARIFICATION & FERMENTATION

102031.xls | PFD-P110-A302 | B

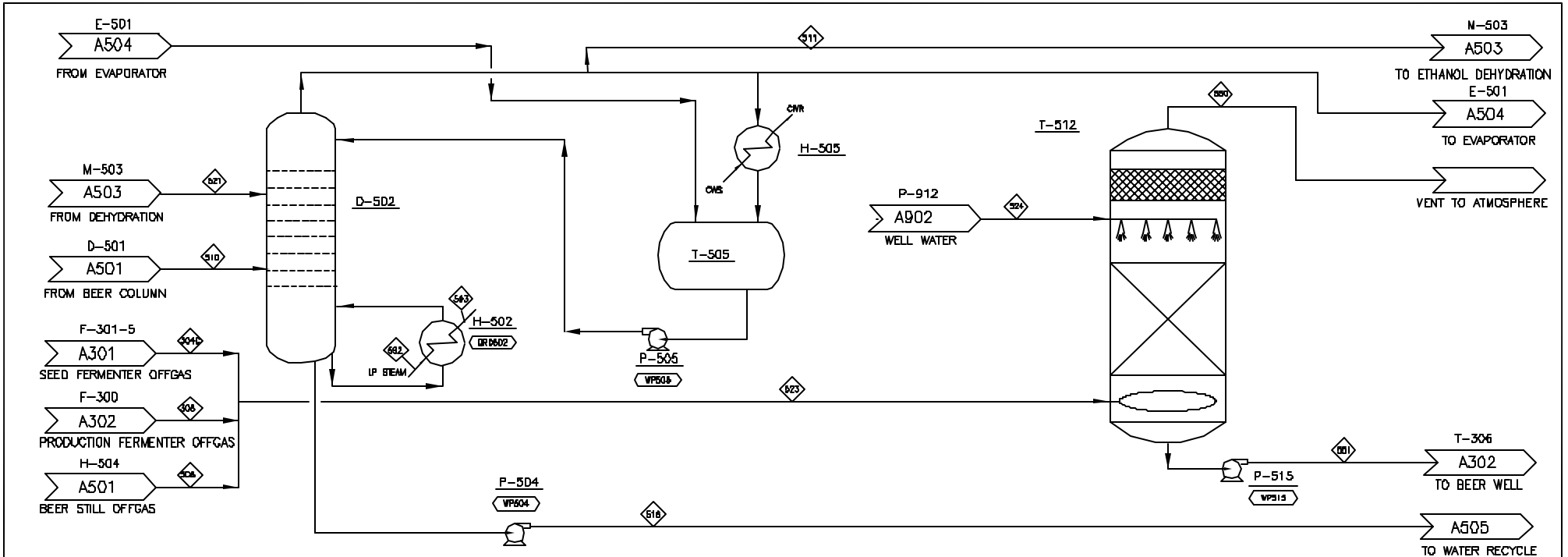

| COMPONENT | UNITS | 304C | 308 | 508 | 510 | 511 | 516 | 521 | 523 | 524 | 550 | 551 | 592 | 593 | | | | |
|---------------------------|---------|--------|--------|--------|--------|--------|--------|--------|--------|--------|--------|--------|--------|-------|--|--|--|--|
| Total Flow | kg/hr | 2,415 | 22,420 | 491 | 62,329 | 33,232 | 37,643 | 8,546 | 25,325 | 35,912 | 24,107 | 37,130 | 8,164 | 8,164 | | | | |
| Insoluble Solids | % | 0.0% | 0.0% | 0.0% | 0.0% | 0.0% | 0.0% | 0.0% | 0.0% | 0.0% | 0.0% | 0.0% | 0.0% | 0.0% | | | | |
| Soluble Solids | % | 0.0% | 0.0% | 0.0% | 0.2% | 0.0% | 0.4% | 0.0% | 0.0% | 0.0% | 0.0% | 0.0% | 0.0% | 0.0% | | | | |
| Temperature | C | 41 | 41 | 60 | 113 | 92 | 121 | 70 | 41 | 26 | 29 | 39 | 164 | 148 | | | | |
| Pressure | atm | 1.00 | 1.00 | 1.86 | 1.91 | 1.70 | 4.29 | 1.53 | 1.00 | 1.00 | 0.90 | 0.90 | 4.42 | 4.42 | | | | |
| Vapor Fraction | | 1.00 | 1.00 | 1.00 | 1.00 | 1.00 | 0.00 | 0.00 | 1.00 | 0.00 | 1.00 | 0.00 | 1.00 | 0.00 | | | | |
| Ethanol | kg/hr | 70 | 668 | 60 | 24,583 | 30,740 | 19 | 6,176 | 797 | 4 | 733 | | | | | | | |
| Water | kg/hr | 76 | 710 | 20 | 36,990 | 2,482 | 36,868 | 2,370 | 806 | 35,912 | 434 | 36,284 | 8,164 | 8,164 | | | | |
| Glucose (SS) | kg/hr | | | 0 | 0 | | | | 0 | | | | | | | | | |
| Xylose (SS) | kg/hr | | | 0 | 0 | | | | 0 | | | | | | | | | |
| Arabinose (SS) | kg/hr | | | 0 | 0 | | | | 0 | | | | | | | | | |
| Other Sugars (SS) | kg/hr | | | 0 | 0 | | | | 0 | | | | | | | | | |
| Cellobiose (SS) | kg/hr | | | 0 | 0 | | | | 0 | | | | | | | | | |
| Glucose Oligomers (SS) | kg/hr | | | 0 | 0 | | | | 0 | | | | | | | | | |
| Xylose Oligomers (SS) | kg/hr | | | 0 | 0 | | | | 0 | | | | | | | | | |
| Other Oligomers (SS) | kg/hr | | | 0 | 0 | | | | 0 | | | | | | | | | |
| Corn Steep Liquor (SS) | kg/hr | 0 | 3 | 0 | 145 | | 145 | | 4 | | 0 | 4 | | | | | | |
| Others (Soluble Solids) | kg/hr | | | 0 | 0 | | | | 7 | | | | | | | | | |
| Acetic Acid | kg/hr | 1 | 6 | 0 | 259 | | 259 | | 7 | | 0 | 7 | | | | | | |
| Sulfuric Acid | kg/hr | 0 | 0 | 0 | 0 | | 0 | | 0 | | 0 | 0 | | | | | | |
| Furfural | kg/hr | 1 | 7 | 0 | 278 | | 278 | | 8 | | 0 | 8 | | | | | | |
| H ₂ O | kg/hr | 0 | 1 | 0 | 43 | | 43 | | 1 | | 0 | 1 | | | | | | |
| Carbon Dioxide | kg/hr | 2,235 | 20,799 | 411 | 29 | | 29 | | 23,444 | | 23,410 | 34 | | | | | | |
| Methane | kg/hr | | | | | | | | | | | | | | | | | |
| Oxygen | kg/hr | 32 | 226 | 0 | 0 | | 0 | | 258 | | 258 | 0 | | | | | | |
| Nitrogen | kg/hr | 0 | 0 | 0 | 0 | | 0 | | 0 | | 0 | 0 | | | | | | |
| Others | kg/hr | 0 | 0 | 0 | 1 | | 1 | | 0 | | 0 | 0 | | | | | | |
| Cellulose (IS) | kg/hr | | | | | | | | | | | | | | | | | |
| Xylan (IS) | kg/hr | | | | | | | | | | | | | | | | | |
| Arabinan (IS) | kg/hr | | | | | | | | | | | | | | | | | |
| Other Sugar Polymers (IS) | kg/hr | | | | | | | | | | | | | | | | | |
| Cellulose (IS) | kg/hr | | | | | | | | | | | | | | | | | |
| Biomass (IS) | kg/hr | | | | | | | | | | | | | | | | | |
| Zymo (IS) | kg/hr | | | | | | | | | | | | | | | | | |
| Lignin (IS) | kg/hr | | | | | | | | | | | | | | | | | |
| Gypsum (IS) | kg/hr | | | | | | | | | | | | | | | | | |
| Ca(OH) ₂ (IS) | kg/hr | | | | | | | | | | | | | | | | | |
| Others (Insoluble Solids) | kg/hr | | | | | | | | | | | | | | | | | |
| Enthalpy Flow (millions) | Kcal/hr | -5.1 | -47.5 | -1.0 | -147.3 | -44.6 | -137.3 | -17.5 | -53.6 | -136.0 | -51.4 | -138.2 | -25.7 | -29.9 | | | | |
| Average Density | g/ml | 0.0016 | 0.0016 | 0.0029 | 0.0014 | 0.0023 | 0.8964 | 0.7943 | 0.0016 | 0.9925 | 0.9750 | 0.0022 | 0.8653 | | | | | |

| Heat Stream No. | MM kcal/hr | Work Stream No. | KW |
|-----------------|------------|-----------------|-------|
| ORD502 | -4.21 | WP504 | 9.31 |
| | | WP505 | 12.77 |
| | | WP515 | 6.10 |

| Eq. No. | Equipment Name | Req/Spare | Equipment Type | Mat Const. |
|---------|-----------------------------------|-----------|-------------------|---------------|
| D-502 | Rectification Column | 1 | DISTILLATION | SS |
| H-502 | Rectification Column Reboiler | 1 | SHELL-TUBE | SS304:CS |
| H-505 | Start-up Rect. Column Condenser | 1 | SHELL-TUBE | SS304:CS |
| P-504 | Rectification Column Bottoms Pump | 1 | CENTRIFUGAL | SS |
| P-505 | Rectification Column Reflux Pump | 1 | CENTRIFUGAL | SS |
| P-515 | Scrubber Bottoms Pump | 1 | CENTRIFUGAL | SS |
| T-505 | Rectification Column Reflux Drum | 1 | HORIZONTAL-VESSEL | SS304 |
| T-512 | Vent Scrubber | 1 | ABSORBER | SS304:PLASTIC |

| | | |
|--|---|---|
| NREL NATIONAL RENEWABLE ENERGY LABORATORY Biotechnology Center For Fuels And Chemicals | SECTION A500 RECTIFICATION DISTILLATION 102031.xls PFD-P110-A502 | B |
|--|---|---|

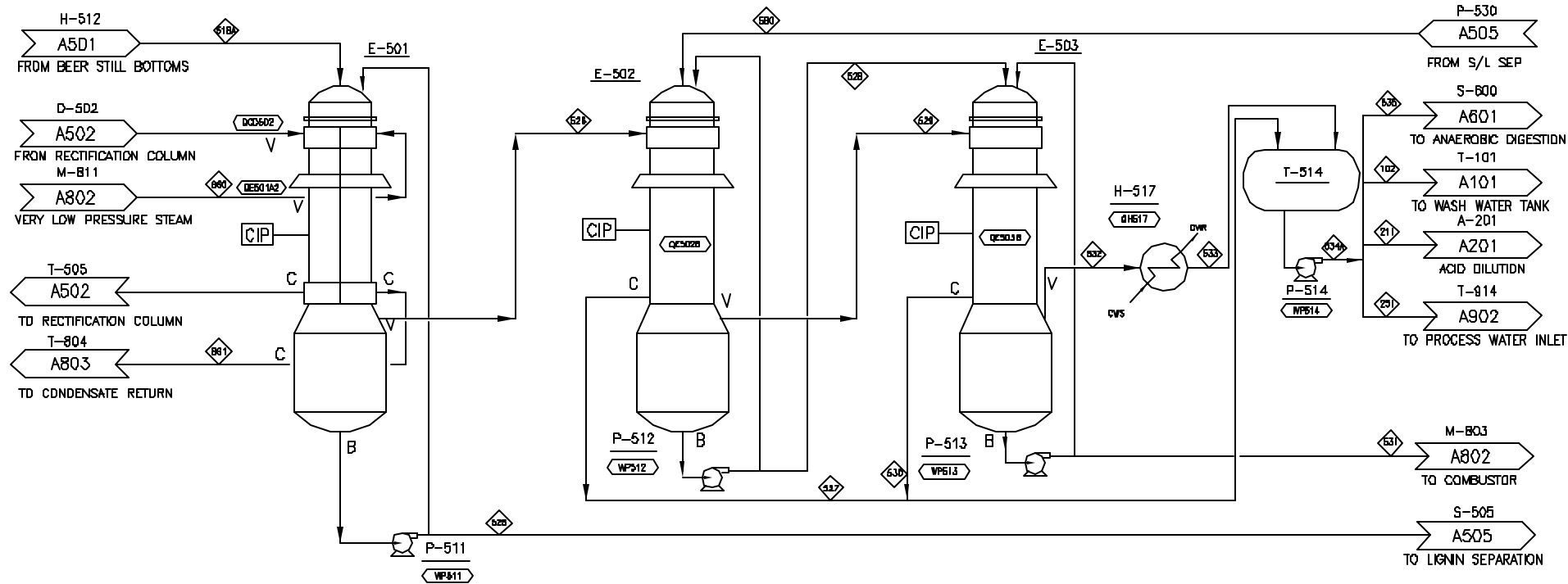

| COMPONENT | UNITS | 102 | 211 | 251 | 518A | 525 | 526 | 527 | 538 | 539 | 530 | 531 | 532 | 533 | 534A | 535 | 580 | 860 | 861 |
|---------------------------|---------|--------|--------|--------|---------|---------|--------|--------|--------|--------|--------|-------|--------|--------|--------|-------|--------|-------|-------|
| Total Flow | kg/hr | 43077 | 99344 | 71468 | 386533 | 303646 | 82887 | 82887 | 116868 | 77752 | 77752 | 39322 | 76946 | 76946 | 237585 | 23759 | 194620 | 4858 | 4858 |
| Insoluble Solids | % | 0.0% | 0.0% | 0.0% | 5.8% | 7.4% | 0.0% | 0.0% | 0.8% | 0.0% | 0.0% | 2.4% | 0.0% | 0.0% | 0.0% | 0.5% | 0.0% | 0.0% | 0.0% |
| Soluble Solids | % | 0.1% | 0.1% | 0.1% | 4.2% | 5.2% | 0.3% | 0.3% | 8.8% | 0.0% | 0.0% | 25.8% | 0.0% | 0.0% | 0.1% | 0.1% | 5.3% | 0.0% | 0.0% |
| Temperature | C | 74 | 74 | 74 | 117 | 87 | 87 | 87 | 71 | 71 | 71 | 64 | 64 | 64 | 74 | 74 | 40 | 115 | 115 |
| Pressure | am | 3.00 | 3.00 | 3.00 | 2.10 | 0.60 | 0.60 | 0.61 | 0.31 | 0.31 | 0.32 | 0.21 | 0.21 | 0.23 | 2.00 | 1.00 | 3.20 | 1.68 | 1.68 |
| Vapor Fraction | | 0.00 | 0.00 | 0.00 | 0.00 | 1.00 | 0.00 | 0.00 | 1.00 | 0.00 | 0.00 | 0.00 | 0.00 | 0.00 | 0.00 | 0.00 | 0.00 | 0.97 | 0.00 |
| Ethanol | kg/hr | 31 | 71 | 51 | 182 | 39 | 143 | 143 | 3 | 24 | 24 | 0 | 2 | 2 | 170 | 17 | 27 | | |
| Water | kg/hr | 42546 | 98256 | 70784 | 337819 | 253332 | 81387 | 81387 | 99313 | 77243 | 77243 | 23357 | 75356 | 75356 | 234395 | 23439 | 177056 | 4858 | 4858 |
| Glucose (SS) | kg/hr | | | | 82 | | | | 57 | | | | | | | | 57 | | |
| Xylose (SS) | kg/hr | 0 | 0 | 0 | 909 | 909 | 0 | 0 | 629 | 0 | 0 | 0 | 0 | 0 | 0 | 0 | 629 | | |
| Arabinose (SS) | kg/hr | 0 | 0 | 0 | 217 | 217 | 0 | 0 | 150 | 0 | 0 | 0 | 0 | 0 | 0 | 0 | 150 | | |
| Other Sugars (SS) | kg/hr | | | | 254 | 254 | | | 176 | | | | | | | | 176 | | |
| Cellulose (SS) | kg/hr | | | | 360 | 360 | | | 249 | | | | | | | | 249 | | |
| Glucose Oligomers (SS) | kg/hr | | | | 1,853 | 1,853 | | | 1,282 | | | | | | | | 1,282 | | |
| Xylose Oligomers (SS) | kg/hr | 0 | 0 | 0 | 646 | 646 | 0 | 0 | 447 | 0 | 0 | 0 | 0 | 0 | 0 | 0 | 447 | | |
| Other Oligomers (SS) | kg/hr | | | | 969 | 969 | | | 670 | | | | | | | | 670 | | |
| Corn Steep Liquor (SS) | kg/hr | 58 | 133 | 96 | 1,314 | 996 | 319 | 319 | | | | | | | 319 | 32 | | | |
| Others (Soluble Solids) | kg/hr | | | | 9,581 | 9,581 | | | 6,628 | | | | | | | | 6,628 | | |
| Acetic Acid | kg/hr | 325 | 751 | 540 | 4,998 | 4,689 | 309 | 309 | 2,827 | 418 | 418 | 1,757 | 1,070 | 1,070 | 1,796 | 180 | 3,244 | | |
| Sulfuric Acid | kg/hr | 0 | 0 | 0 | 154 | 154 | 0 | 0 | 107 | 0 | 0 | 107 | 0 | 0 | 0 | 0 | 107 | | |
| Furfural | kg/hr | 48 | 111 | 80 | 236 | 100 | 197 | 197 | 13 | 56 | 56 | 2 | 12 | 12 | 265 | 27 | 69 | | |
| PHF | kg/hr | 7 | 17 | 12 | 46 | 16 | 31 | 31 | 2 | 9 | 9 | 0 | 2 | 2 | 41 | 4 | 11 | | |
| Carbon Dioxide | kg/hr | | | | | | | | | | | | | | | | | | |
| Methane | kg/hr | | | | 0 | | | | | | | | | | | | | | |
| Oxygen | kg/hr | | | | 0 | | | | | | | | | | | | | | |
| Nitrogen | kg/hr | | | | 0 | | | | | | | | | | | | | | |
| Others | kg/hr | 2 | 4 | 3 | 4,275 | 4,273 | 2 | 2 | 2,852 | 2 | 2 | 2,847 | 5 | 5 | 9 | 1 | 2,854 | | |
| Cellulose (IS) | kg/hr | | | | 1,365 | 1,365 | | | 20 | | | 20 | | | | | 20 | | |
| Xylan (IS) | kg/hr | | | | 439 | 439 | | | 7 | | | 7 | | | | | 7 | | |
| Arabinan (IS) | kg/hr | | | | 61 | 61 | | | 1 | | | 1 | | | | | 1 | | |
| Other Sugar Polymers (IS) | kg/hr | | | | 73 | 73 | | | 1 | | | 1 | | | | | 1 | | |
| Cellulase (IS) | kg/hr | | | | 650 | 650 | | | 244 | | | 244 | | | | | 244 | | |
| Biomass (IS) | kg/hr | | | | 0 | 0 | | | 0 | | | 0 | | | | | 0 | | |
| Zymo (IS) | kg/hr | | | | 1,088 | 1,088 | | | 408 | | | 408 | | | | | 408 | | |
| Lignin (IS) | kg/hr | | | | 14,252 | 14,252 | | | 214 | | | 214 | | | | | 214 | | |
| Starchum (IS) | kg/hr | | | | 26 | 26 | | | 0 | | | 0 | | | | | 0 | | |
| Ca(OH)2 (IS) | kg/hr | | | | | | | | 69 | | | 69 | | | | | 69 | | |
| Others (Insoluble Solids) | kg/hr | | | | 4,620 | 4,620 | | | 69 | | | 69 | | | | | 69 | | |
| Enthalpy Flow (millions) | Kcal/hr | -160.0 | -369.5 | -265.8 | -1307.1 | -1018.2 | -262.3 | -307.3 | -374.4 | -247.0 | -290.0 | -88.4 | -243.9 | -286.5 | -883.7 | -88.4 | -666.5 | -15.5 | -18.0 |
| Average Density | g/ml | 0.944 | 0.944 | 0.944 | 0.957 | 1.003 | 0.000 | 0.932 | 0.983 | 0.000 | 0.948 | 1.085 | 0.000 | 0.954 | 0.944 | 0.944 | 0.999 | 0.001 | 0.947 |

| Stream No. | MM kcal/hr | Stream No. | KW |
|------------|------------|------------|--------|
| QC502A | 24.58 | WP511 | 198.53 |
| QC501A2 | 2.49 | WP512 | 55.37 |
| QC502B | 44.05 | WP513 | 23.68 |
| QC503B | 42.11 | WP514 | 40.33 |
| QH517 | 42.58 | | |

| Eq. No. | Equipment Name | Req | Spare | Equipment Type | Mat Const. |
|---------|----------------------------|-----|-------|------------------|------------|
| E-501 | 1st Effect Evaporation | 2 | | SHELL-TUBE | SS316 |
| E-502 | 2nd Effect Evaporation | 1 | | SHELL-TUBE | SS316 |
| E-503 | 3rd Effect Evaporation | 2 | | SHELL-TUBE | SS316 |
| H-517 | Evaporator Condenser | 1 | | SHELL-TUBE | SS304,CS |
| P-511 | 1st Effect Pump | 2 | 1 | CENTRIFUGAL | SS |
| P-512 | 2nd Effect Pump | 1 | 1 | CENTRIFUGAL | SS |
| P-513 | 3rd Effect Pump | 2 | 1 | CENTRIFUGAL | SS |
| P-514 | Evaporator Condensate Pump | 1 | 1 | CENTRIFUGAL | SS304 |
| T-514 | Evaporator Condensate Drum | 1 | 1 | HORIZONTAL-VESSE | SS304 |

PREPARED BY: JAY
 DATE: 1/2/02
 1. 3002 DESIGN REPORT
 DATE: 6/27/02

NATIONAL RENEWABLE ENERGY LABORATORY
 Biotechnology Center For Fuels And Chemicals

SECTION A500
 EVAPORATION

102031.xls | PFD-P110-A504 | B

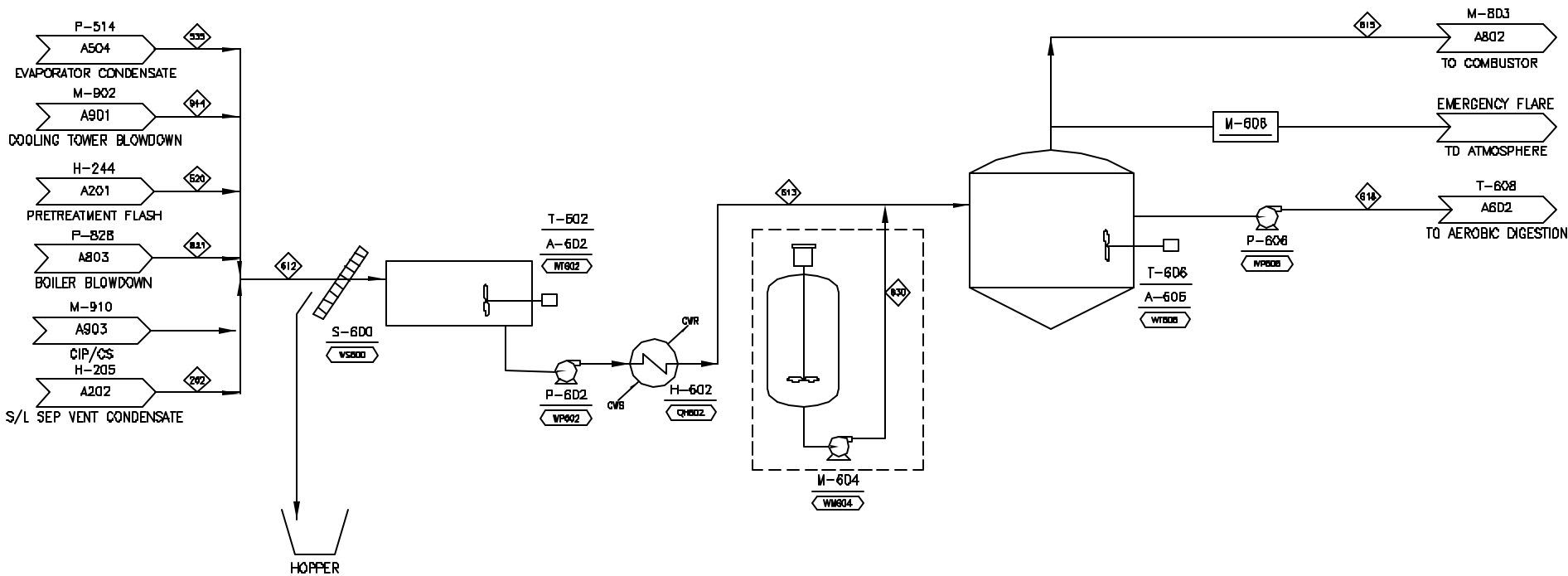

| COMPONENT | UNITS | 262 | 520 | 535 | 612 | 613 | 615 | 618 | 630 | 821 | 944 | | | | | | | | | |
|---------------------------|---------|--------|--------|--------|--------|--------|--------|--------|--------|--------|--------|--|--|--|--|--|--|--|--|--|
| Total Flow | kg/hr | 200 | 53,152 | 23,759 | 97,264 | 97,264 | 625 | 96,697 | 58 | 5,715 | 14,439 | | | | | | | | | |
| Insoluble Solids | % | 0.0% | 0.0% | 0.0% | 0.0% | 0.0% | 0.0% | 0.0% | 0.0% | 0.0% | 0.0% | | | | | | | | | |
| Soluble Solids | % | 0.0% | 0.1% | 0.1% | 0.1% | 0.1% | 0.0% | 0.1% | 0.0% | 0.0% | 0.0% | | | | | | | | | |
| Temperature | C | 38 | 30 | 74 | 59 | 35 | 35 | 35 | 20 | 309 | 28 | | | | | | | | | |
| Pressure | atm | 1.00 | 1.00 | 1.00 | 2.00 | 2.00 | 1.00 | 1.00 | 1.00 | 96.26 | 1.00 | | | | | | | | | |
| Vapor Fraction | | 0.00 | 0.00 | 0.00 | 0.00 | 0.00 | 1.00 | 0.00 | 0.00 | 0.00 | 0.00 | | | | | | | | | |
| Ethanol | kg/hr | 0 | 73 | 17 | 90 | 90 | 0 | 6 | | | | | | | | | | | | |
| Water | kg/hr | 199 | 52,244 | 23,499 | 96,094 | 96,094 | 28 | 96,414 | | 5,715 | 14,439 | | | | | | | | | |
| Glucose (SS) | kg/hr | | | | | | | | | | | | | | | | | | | |
| Xylose (SS) | kg/hr | | 0 | 0 | 0 | 0 | | 0 | | | | | | | | | | | | |
| Arabinose (SS) | kg/hr | | 0 | 0 | 0 | 0 | | 0 | | | | | | | | | | | | |
| Other Sugars (SS) | kg/hr | | | | | | | | | | | | | | | | | | | |
| Cellobiose (SS) | kg/hr | | | | | | | | | | | | | | | | | | | |
| Glucose Oligomers (SS) | kg/hr | | | | | | | | | | | | | | | | | | | |
| Xylose Oligomers (SS) | kg/hr | | 0 | 0 | 0 | 0 | | | | | | | | | | | | | | |
| Other Oligomers (SS) | kg/hr | | | | | | | | | | | | | | | | | | | |
| Corn Steep Liquor (SS) | kg/hr | 0 | 48 | 32 | 80 | 80 | 0 | 80 | | | | | | | | | | | | |
| Others (Soluble Solids) | kg/hr | | | | | | | | | | | | | | | | | | | |
| Acetic Acid | kg/hr | 1 | 268 | 180 | 449 | 449 | 0 | 31 | | | | | | | | | | | | |
| Sulfuric Acid | kg/hr | 0 | 0 | 0 | 0 | 0 | | | | | | | | | | | | | | |
| Furfural | kg/hr | 0 | 449 | 27 | 476 | 476 | 0 | 33 | | | | | | | | | | | | |
| HMF | kg/hr | 0 | 70 | 4 | 74 | 74 | 0 | 5 | | | | | | | | | | | | |
| Carbon Dioxide | kg/hr | | | | | | 273 | 25 | | | | | | | | | | | | |
| Methane | kg/hr | | | | | | 324 | 1 | | | | | | | | | | | | |
| Oxygen | kg/hr | 0 | | | 0 | 0 | 0 | 0 | | | | | | | | | | | | |
| Nitrogen | kg/hr | 0 | | | 0 | 0 | 0 | 0 | | | | | | | | | | | | |
| Others | kg/hr | 0 | 0 | 1 | 1 | 1 | 0 | 58 | 58 | | | | | | | | | | | |
| Cellulose (IS) | kg/hr | | | | | | | | | | | | | | | | | | | |
| Xylan (IS) | kg/hr | | | | | | | | | | | | | | | | | | | |
| Arabinan (IS) | kg/hr | | | | | | | | | | | | | | | | | | | |
| Other Sugar Polymers (IS) | kg/hr | | | | | | | | | | | | | | | | | | | |
| Cellulase (IS) | kg/hr | | | | | | | | | | | | | | | | | | | |
| Biomass (IS) | kg/hr | | | | | | | 43 | | | | | | | | | | | | |
| Zymo (IS) | kg/hr | | | | | | | | | | | | | | | | | | | |
| Lignin (IS) | kg/hr | | | | | | | | | | | | | | | | | | | |
| Gypsum (IS) | kg/hr | | | | | | | | | | | | | | | | | | | |
| Ca(OH)2 (IS) | kg/hr | | | | | | | | | | | | | | | | | | | |
| Others (Insoluble Solids) | kg/hr | | | | | | | | | | | | | | | | | | | |
| Enthalpy Flow (millions) | Kcal/hr | -0.8 | -198.6 | -88.4 | -362.3 | -364.6 | -1.0 | -365.0 | -0.2 | -19.9 | -54.6 | | | | | | | | | |
| Average Density | gm | 0.9808 | 0.9903 | 0.9442 | 0.9604 | 0.9846 | 0.0009 | 0.9841 | 0.9983 | 0.6925 | 0.9906 | | | | | | | | | |

| Heat Stream No. | MM kcal/hr | Work Stream No. | kW |
|-----------------|------------|-----------------|-------|
| QH602 | 2.26 | WM604 | 4.14 |
| | | WP602 | 22.57 |
| | | WP606 | 22.45 |
| | | WS600 | 0.42 |
| | | WT602 | 14.37 |
| | | WT606 | 31.06 |

| Eq. No. | Equipment Name | Req | Spare | Equipment Type | Mat Const. |
|---------|--------------------------------|-----|-------|------------------|-------------|
| A-602 | Equalization Basin Agitator | 1 | | FIXED-PROP | SS |
| A-606 | Anaerobic Agitator | 1 | | FIXED-PROP | SS |
| H-602 | Anaerobic Digester Feed Cooler | 1 | | SHELL-TUBE | SS316/CS |
| M-604 | Nutrient Feed System | 1 | | PACKAGE | CS |
| M-606 | Biogas Emergency Flare | 1 | | MISCELLANEOUS | SS |
| P-602 | Anaerobic Reactor Feed Pump | 1 | 1 | CENTRIFUGAL | CS |
| P-606 | Aerobic Digester Feed Pump | 1 | 1 | CENTRIFUGAL | CS |
| S-600 | Bar Screen | 1 | | SCREEN | CS |
| T-602 | Equalization Basin | 1 | | FLAT-BTM-STORAGE | CONCRETE |
| T-606 | Anaerobic Digester | 1 | | FLAT-BTM-STORAGE | EPOXY-LINED |

| | | | |
|-------------------------------------|---------------------|---------------|--|
| REV | DESCRIPTION | DATE | |
| A | PRELIMINARY DESIGN | 11/17/04 | |
| P | FINAL DESIGN REVIEW | 8/22/05 | |
| | | | NATIONAL RENEWABLE ENERGY LABORATORY Biotechnology Center For Fuels And Chemicals |
| SECTION AB00 ANAEROBIC DIGESTION | | | |
| | 102031.xls | PFD-P110-AB01 | B |

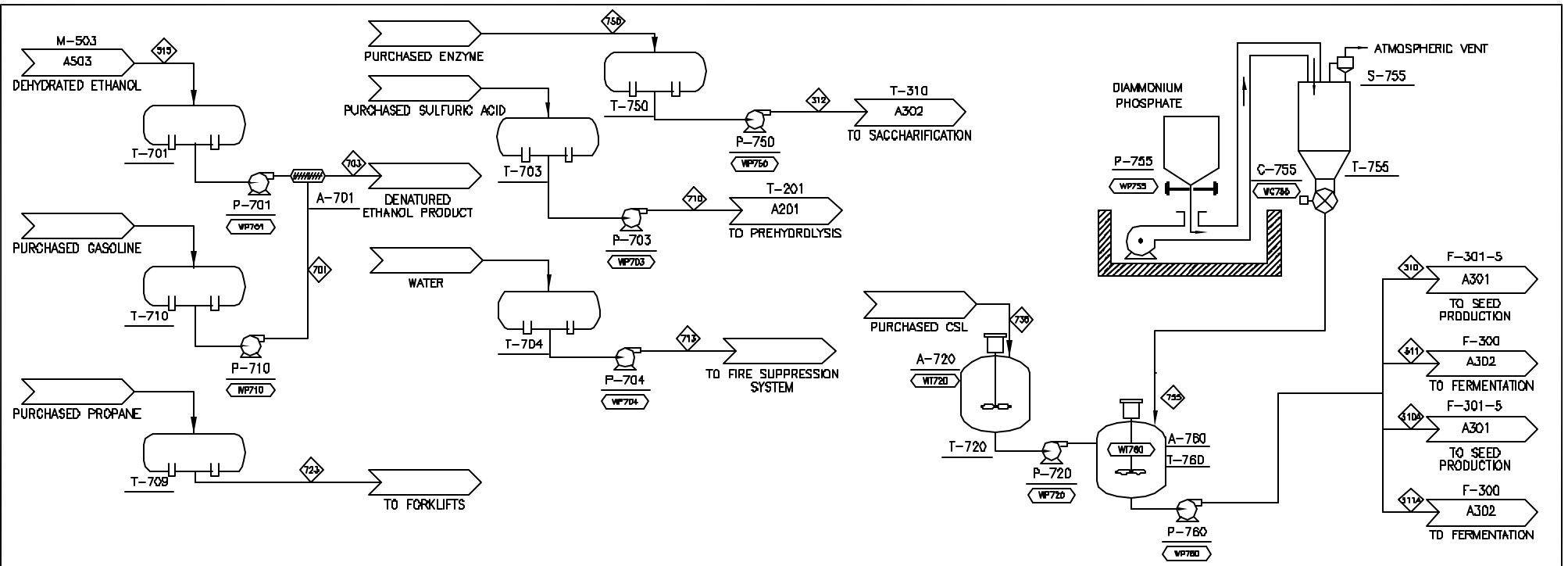

| COMPONENT | UNITS | 310 | 310A | 311 | 311A | 312 | 515 | 701 | 703 | 710 | 713 | 723 | 735 | 750 | 755 | Work Stream No. | kW | Work Stream No. | kW |
|---------------------------|---------|--------|--------|--------|--------|--------|--------|--------|--------|--------|--------|--------|--------|--------|--------|-----------------|------|-----------------|------|
| Total Flow | kg/hr | 28 | 219 | 136 | 1,087 | 6,824 | 24,686 | 1,019 | 25,705 | 3,288 | 9,080 | 20 | 1,306 | 6,824 | 163 | WC755 | 0.06 | WP750 | 0.48 |
| Insoluble Solids | % | 0.0% | 0.0% | 0.0% | 0.0% | 8.3% | 0.0% | 0.0% | 0.0% | 0.0% | 0.0% | 0.0% | 0.0% | 8.3% | 0.0% | WP701 | 5.24 | WP765 | 1.96 |
| Soluble Solids | % | 0.0% | 100.0% | 0.0% | 100.0% | 0.0% | 0.0% | 0.0% | 0.0% | 0.0% | 0.0% | 0.0% | 100.0% | 0.0% | 0.0% | WP703 | 0.40 | WP760 | 0.29 |
| Temperature | C | 20 | 20 | 20 | 20 | 20 | 38 | 20 | 20 | 20 | 20 | 20 | 20 | 20 | 20 | WP704 | 0.00 | WT720 | 3.09 |
| Pressure | atm | 1.00 | 1.00 | 1.00 | 1.00 | 1.00 | 1.00 | 1.00 | 1.00 | 1.00 | 1.00 | 1.00 | 1.00 | 1.00 | 1.00 | WP710 | 0.43 | WT760 | 3.61 |
| Vapor Fraction | | 0.00 | 0.00 | 0.00 | 0.00 | 0.00 | 0.00 | 0.00 | 0.00 | 0.00 | 0.00 | 1.00 | 0.00 | 0.00 | 0.00 | WP720 | 0.29 | | |
| Ethanol | kg/hr | | | | | | 24,564 | | 24,564 | | | | | | | | | | |
| Water | kg/hr | | | | | 6,255 | 122 | | 122 | | 9,080 | | | 6,255 | | | | | |
| Glucose (SS) | kg/hr | | | | | | | | | | | | | | | | | | |
| Xylose (SS) | kg/hr | | | | | | | | | | | | | | | | | | |
| Arabinose (SS) | kg/hr | | | | | | | | | | | | | | | | | | |
| Other Sugars (SS) | kg/hr | | | | | | | | | | | | | | | | | | |
| Cellulose (SS) | kg/hr | | | | | | | | | | | | | | | | | | |
| Glucose Oligomers (SS) | kg/hr | | | | | | | | | | | | | | | | | | |
| Xylose Oligomers (SS) | kg/hr | | | | | | | | | | | | | | | | | | |
| Other Oligomers (SS) | kg/hr | | | | | | | | | | | | | | | | | | |
| Corn Steep Liquor (SS) | kg/hr | | 219 | | 1,087 | | | | | | | | 1,306 | | | | | | |
| Others (Soluble Solids) | kg/hr | | | | | | | | | | | | | | | | | | |
| Acetic Acid | kg/hr | | | | | | | | | | | | | | | | | | |
| Sulfuric Acid | kg/hr | | | | | | | | | | 3,288 | | | | | | | | |
| Furfural | kg/hr | | | | | | | | | | | | | | | | | | |
| HMF | kg/hr | | | | | | | | | | | | | | | | | | |
| Carbon Dioxide | kg/hr | | | | | | | | | | | | | | | | | | |
| Methane | kg/hr | | | | | | | | | | | | | | | | | | |
| Oxygen | kg/hr | | | | | | | | | | | | | | | | | | |
| Nitrogen | kg/hr | | | | | | | | | | | | | | | | | | |
| Others | kg/hr | 28 | | 136 | | | | 1,019 | 1,019 | | | | | | 163 | | | | |
| Cellulose (IS) | kg/hr | | | | | | | | | | | | | | | | | | |
| Xylan (IS) | kg/hr | | | | | | | | | | | | | | | | | | |
| Arabinan (IS) | kg/hr | | | | | | | | | | | | | | | | | | |
| Other Sugar Polymers (IS) | kg/hr | | | | | | | | | | | | | | | | | | |
| Cellulase (IS) | kg/hr | | | | | | 568 | | | | | | | 568 | | | | | |
| Biomass (IS) | kg/hr | | | | | | | | | | | | | | | | | | |
| Zymo (IS) | kg/hr | | | | | | | | | | | | | | | | | | |
| Lignin (IS) | kg/hr | | | | | | | | | | | | | | | | | | |
| Gypsum (IS) | kg/hr | | | | | | | | | | | | | | | | | | |
| Ca(OH)2 (IS) | kg/hr | | | | | | | | | | | | | | | | | | |
| Others (Insoluble Solids) | kg/hr | | | | | | | | | | | | | | | | | | |
| Enthalpy Flow (millions) | kcal/hr | -0.1 | -0.8 | -0.4 | -4.1 | -24.2 | -35.6 | -0.5 | -36.4 | -6.4 | -34.4 | 0.0 | -5.0 | -24.2 | -0.5 | | | | |
| Average Density | g/ml | 1.0096 | 0.9983 | 1.0096 | 0.9983 | 1.0403 | 0.7753 | 0.6876 | 0.7872 | 1.8166 | 0.9983 | 0.0018 | 0.9983 | 1.0403 | 1.0096 | | | | |

| Eq. No. | Equipment Name | Req | Spare | Equipment Type | Mat Const. |
|---------|------------------------------|-----|-------|------------------|---------------|
| A-701 | Denaturant In-line Mixer | 1 | | STATIC | SS304 |
| A-720 | CSL Storage Tank Agitator | 1 | | FIXED-PROP | SS304 |
| A-760 | CSL/DAP Day Tank Agitator | 1 | | FIXED-PROP | SS304 |
| C-755 | DAP Solids Feeder | 1 | | ROTARY-VALVE | A285C |
| P-701 | Ethanol Product Pump | 2 | 1 | CENTRIFUGAL | CS |
| P-703 | Sulfuric Acid Pump | 1 | 1 | CENTRIFUGAL | SS316 |
| P-704 | Firewater Pump | 1 | 1 | CENTRIFUGAL | CS |
| P-710 | Gasoline Pump | 1 | 1 | CENTRIFUGAL | CS |
| P-720 | CSL Pump | 1 | 1 | CENTRIFUGAL | CS |
| P-750 | Cellulase Pump | 1 | 1 | CENTRIFUGAL | CS |
| P-755 | DAP Unloading Blower | 1 | 1 | CENTRIFUGAL | CS |
| P-760 | CSL/DAP Pump | 1 | 1 | CENTRIFUGAL | CS |
| S-755 | DAP Vent Baghouse | 1 | | FABRIC-FILTER | A285C-POLYEST |
| T-701 | Ethanol Product Storage Tank | 2 | | FLAT-BTM-STORAGE | A285C |
| T-703 | Sulfuric Acid Storage Tank | 1 | | FLAT-BTM-STORAGE | SS316 |
| T-704 | Firewater Storage Tank | 1 | | FLAT-BTM-STORAGE | A285C |
| T-709 | Propane Storage Tank | 1 | | HORIZONTAL STOR | A515 |
| T-710 | Gasoline Storage Tank | 1 | | FLAT-BTM-STORAGE | A285C |
| T-720 | CSL Storage Tank | 1 | | FLAT-BTM-STORAGE | SS304 |
| T-750 | Cellulase Storage Tank | 2 | | FLAT-BTM-STORAGE | SS304 |
| T-755 | DAP Storage Bin | 1 | | LIVE-BTM-BIN | CS |
| T-760 | CSL/DAP Day Tank | 1 | | FLAT-BTM-STORAGE | SS304 |

| | | |
|---|----------------------------|--|
| NOT REVISIONED A. A. FOR PROCESS CHG B. HERE DESIGN REVISION | DATE 1/17/02 9/17/02 | NATIONAL RENEWABLE ENERGY LABORATORY Biotechnology Center For Fuels And Chemicals |
| SECTION A700 STORAGE I0203L.xls PFD-P110-A701 B | | |

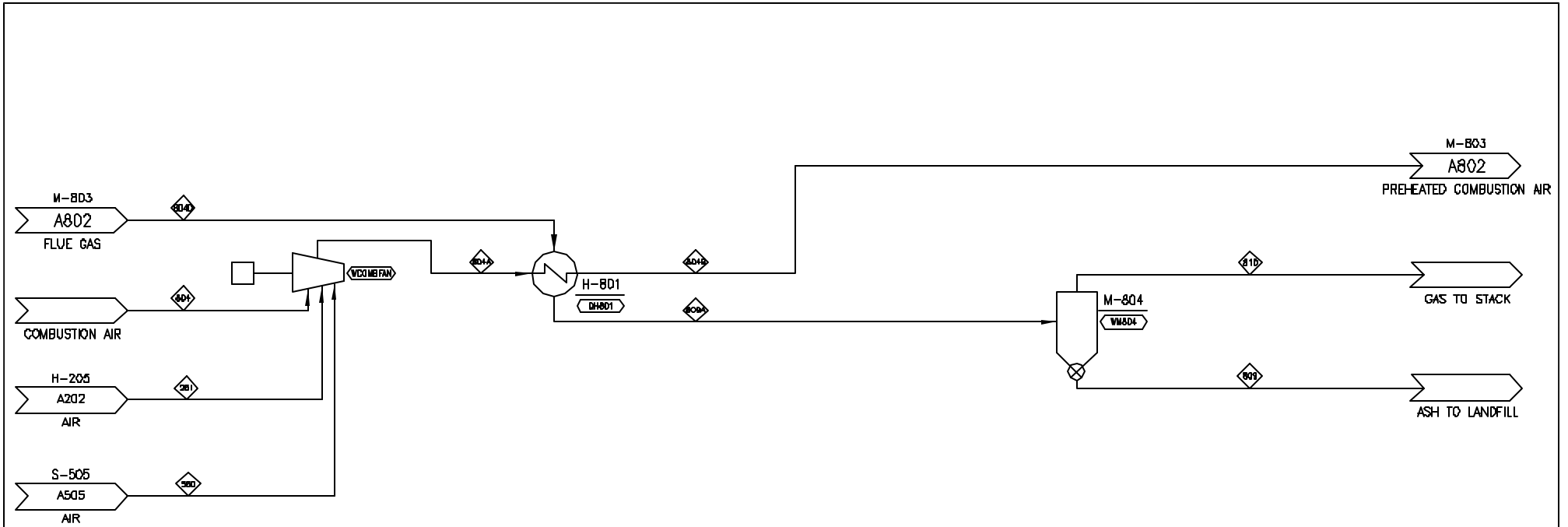

| COMPONENT | UNITS | 261 | 560 | 804 | 804A | 804B | 804D | 809 | 809A | 810 |
|---------------------------|---------|--------|--------|---------|---------|---------|---------|--------|---------|---------|
| Total Flow | kg/hr | 4,894 | 5,999 | 260,116 | 271,009 | 271,009 | 355,828 | 4,492 | 355,828 | 351,336 |
| Insoluble Solids | % | 0.0% | 0.0% | 0.0% | 0.0% | 0.0% | 0.0% | 1.3% | 1.3% | 0.0% |
| Soluble Solids | % | 0.0% | 0.1% | 0.0% | 0.0% | 0.0% | 0.3% | 100.0% | 0.3% | 0.3% |
| Temperature | C | 38 | 24 | 26 | 204 | 278 | | 164 | 164 | |
| Pressure | atm | 1.00 | 3.20 | 1.00 | 1.01 | 1.01 | 0.97 | | 0.97 | 0.97 |
| Vapor Fraction | | 1.00 | 1.00 | 1.00 | 1.00 | 0.99 | 0.00 | | 0.99 | 1.00 |
| Ethanol | kg/hr | 0 | 0 | 0 | 0 | 0 | 0 | | 0 | 0 |
| Water | kg/hr | 205 | 74 | 3,382 | 3,661 | 3,661 | 67,617 | | 67,617 | 67,617 |
| Glucose (SS) | kg/hr | | | | | | 1 | | 1 | 1 |
| Xylose (SS) | kg/hr | | | | | | 7 | | 7 | 7 |
| Arabinose (SS) | kg/hr | | | | | | 2 | | 2 | 2 |
| Other Sugars (SS) | kg/hr | | | | | | 2 | | 2 | 2 |
| Cellobiose (SS) | kg/hr | | | | | | 3 | | 3 | 3 |
| Glucose Oligomers (SS) | kg/hr | | | | | | 14 | | 14 | 14 |
| Xylose Oligomers (SS) | kg/hr | | | | | | 5 | | 5 | 5 |
| Other Oligomers (SS) | kg/hr | | | | | | 7 | | 7 | 7 |
| Corn Steep Liquor (SS) | kg/hr | 0 | 4 | | 4 | 4 | 996 | | 996 | 996 |
| Others (Soluble Solids) | kg/hr | | | | | | 74 | | 74 | 74 |
| Acetic Acid | kg/hr | 1 | 1 | | 1 | 1 | 21 | | 21 | 21 |
| Sulfuric Acid | kg/hr | 0 | 0 | | 0 | 0 | 2 | | 2 | 2 |
| Furfural | kg/hr | 1 | 0 | | 2 | 2 | 0 | | 0 | 0 |
| HMF | kg/hr | 0 | 0 | | 0 | 0 | 0 | | 0 | 0 |
| Carbon Dioxide | kg/hr | | | | | | 65,570 | | 65,570 | 65,570 |
| Methane | kg/hr | | | | | | 3 | | 3 | 3 |
| Oxygen | kg/hr | 984 | 1,243 | 59,411 | 61,638 | 61,638 | 10,273 | | 10,273 | 10,273 |
| Nitrogen | kg/hr | 3,702 | 4,677 | 197,324 | 205,703 | 205,703 | 206,283 | | 206,283 | 206,283 |
| Others | kg/hr | 0 | 0 | | 0 | 0 | 402 | | 402 | 402 |
| Cellulose (IS) | kg/hr | | | | | | 14 | 13 | 14 | 0 |
| Xylan (IS) | kg/hr | | | | | | 4 | 4 | 4 | 0 |
| Arabinan (IS) | kg/hr | | | | | | 1 | 1 | 1 | 0 |
| Other Sugar Polymers (IS) | kg/hr | | | | | | 1 | 1 | 1 | 0 |
| Cellulase (IS) | kg/hr | | | | | | 6 | 6 | 6 | 0 |
| Biomass (IS) | kg/hr | | | | | | 1 | 1 | 1 | 0 |
| Zymo (IS) | kg/hr | | | | | | 10 | 9 | 10 | 0 |
| Lysim (IS) | kg/hr | | | | | | 142 | 140 | 142 | 2 |
| Cyosum (IS) | kg/hr | | | | | | 28 | 27 | 28 | 0 |
| Ca(OH)2 (IS) | kg/hr | | | | | | | | | |
| Others (Insoluble Solids) | kg/hr | | | | | | 4,342 | 4,290 | 4,342 | 52 |
| Enthalpy Flow (millions) | Kcal/hr | -0.6 | -0.2 | -10.9 | -11.7 | 0.2 | -347.1 | -12.0 | -359.0 | -347.0 |
| Average Density | g/ml | 0.0011 | 0.0036 | 0.0012 | 0.0012 | 0.0007 | 0.0407 | 3.1415 | 0.0409 | 0.0012 |

| Heat Stream No. | MM kcal/hr | Work Stream No. | kW |
|-----------------|------------|-----------------|--------|
| QH801 | 11.86 | WCCMBFAN | 119.95 |
| | | WM804 | 176.00 |

| Eq. No. | Equipment Name | Req/Spare | Equipment Type | Mat Const. |
|---------|---------------------------------|-----------|----------------|--------------|
| H-801 | Burner Combustion Air Preheater | 1 | MISCELLANEOUS | |
| M-804 | Combustion Gas Baghouse | 1 | FABRIC-FILTER | A285C:FABRIC |

| REV | DESCRIPTION | DATE |  NATIONAL RENEWABLE ENERGY LABORATORY Biotechnology Center For Fuels And Chemicals | |
|-----|------------------|---------|---|---------------|
| 1 | ASAP PROCESS PFD | 1/2/02 | SECTION A800 BOILER FEED DRYING | |
| 1 | PROCESSED REPORT | 4/23/02 | | |
| | | | 102031.xls | PFD-P110-A801 |
| | | | | B |

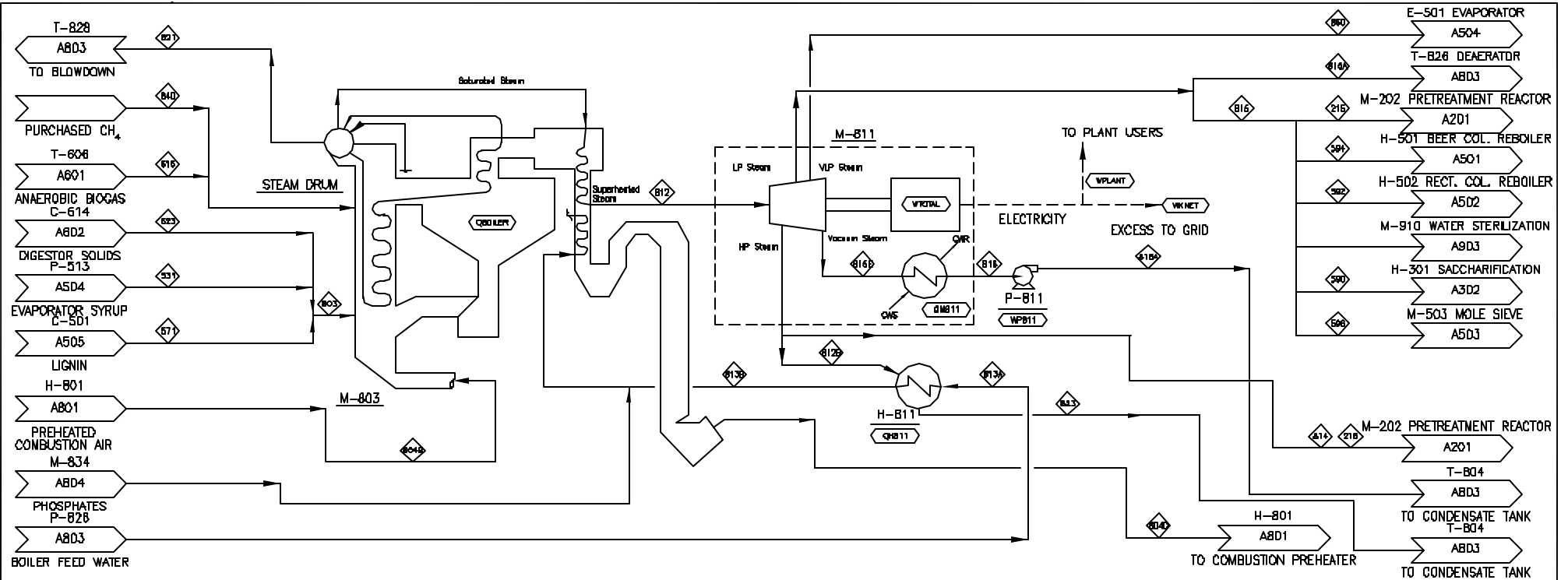

| COMPONENT | UNITS | 531 | 571 | 615 | 623 | 803 | 804B | 804D | 812 | 812B | 813A | 813B | 814 | 815 | 815A | 815E | 816 | 816A | 821 | 823 | 840 | 860 |
|---------------------------|---------|--------|--------|--------|--------|--------|---------|---------|---------|--------|---------|---------|--------|--------|--------|--------|--------|--------|--------|--------|--------|--------|
| Total Flow | kg/hr | 39,922 | 44,075 | 625 | 218 | 84,215 | 271,009 | 355,828 | 184,771 | 14,240 | 190,485 | 190,485 | 37,234 | 95,287 | 16,665 | 16,486 | 16,486 | 16,486 | 5,715 | 14,240 | 0 | 4,858 |
| Insoluble Solids | % | 2.4% | 48.3% | 0.0% | 30.0% | 26.5% | 0.0% | 1.3% | 0.0% | 0.0% | 0.0% | 0.0% | 0.0% | 0.0% | 0.0% | 0.0% | 0.0% | 0.0% | 0.0% | 0.0% | 0.0% | 0.0% |
| Soluble Solids | % | 25.8% | 4.9% | 0.0% | 0.1% | 14.8% | 0.0% | 0.3% | 0.0% | 0.0% | 0.0% | 0.0% | 0.0% | 0.0% | 0.0% | 0.0% | 0.0% | 0.0% | 0.0% | 0.0% | 0.0% | 0.0% |
| Temperature | C | 64 | 38 | 35 | 21 | 55 | 204 | 278 | 510 | 268 | 139 | 177 | 288 | 164 | 164 | 46 | 46 | 46 | 309 | 190 | 25 | 115 |
| Pressure | atm | 0.21 | 3.20 | 1.00 | 1.00 | 1.00 | 1.01 | 0.97 | 86.06 | 13.00 | 98.31 | 97.63 | 13.00 | 4.42 | 4.42 | 0.10 | 0.10 | 4.20 | 96.28 | 12.32 | 1.00 | 1.68 |
| Vapor Fraction | | 0.00 | 0.00 | 1.00 | 0.00 | 0.00 | 1.00 | 0.99 | 1.00 | 0.00 | 1.00 | 0.00 | 1.00 | 1.00 | 0.00 | 0.87 | 0.00 | 0.00 | 0.00 | 0.00 | 1.00 | 0.97 |
| Ethanol | kg/hr | 0 | 3 | 0 | 0 | 3 | 0 | 0 | 0 | 0 | 0 | 0 | 0 | 0 | 0 | 0 | 0 | 0 | 0 | 0 | 0 | 0 |
| Water | kg/hr | 23,957 | 19,783 | 28 | 152 | 43,893 | 3,661 | 67,617 | 184,771 | 14,240 | 190,485 | 190,485 | 37,234 | 95,287 | 16,665 | 16,486 | 16,486 | 16,486 | 5,715 | 14,240 | 0 | 4,858 |
| Glucose (SS) | kg/hr | 57 | 6 | | | 63 | | 1 | | | | | | | | | | | | | | |
| Xylose (SS) | kg/hr | 629 | 70 | | 0 | 699 | | 7 | | | | | | | | | | | | | | |
| Arabinose (SS) | kg/hr | 150 | 17 | | | 167 | | 2 | | | | | | | | | | | | | | |
| Other Sugars (SS) | kg/hr | 176 | 20 | | | 196 | | 2 | | | | | | | | | | | | | | |
| Cellulose (SS) | kg/hr | 249 | 28 | | | 277 | | 3 | | | | | | | | | | | | | | |
| Glucose Oligomers (SS) | kg/hr | 1,282 | 144 | | | 1,426 | | 14 | | | | | | | | | | | | | | |
| Xylose Oligomers (SS) | kg/hr | 447 | 50 | | | 497 | | 5 | | | | | | | | | | | | | | |
| Other Oligomers (SS) | kg/hr | 670 | 75 | | | 746 | | 7 | | | | | | | | | | | | | | |
| Corn Steep Liquor (SS) | kg/hr | 992 | 0 | 0 | 0 | 992 | 4 | 996 | | | | | | | | | | | | | | |
| Others (Soluble Solids) | kg/hr | 6,628 | 743 | | | 7,372 | | 74 | | | | | | | | | | | | | | |
| Acetic Acid | kg/hr | 1,757 | 383 | 0 | 0 | 2,120 | 1 | 21 | | | | | | | | | | | | | | |
| Sulfuric Acid | kg/hr | 107 | 12 | | | 118 | 0 | 2 | | | | | | | | | | | | | | |
| Furfural | kg/hr | 2 | 8 | 0 | 0 | 9 | 2 | 0 | | | | | | | | | | | | | | |
| HMF | kg/hr | 0 | 1 | 0 | 0 | 1 | 0 | 0 | | | | | | | | | | | | | | |
| Carbon Dioxide | kg/hr | | | 273 | 0 | 0 | | 85,570 | | | | | | | | | | | | | | |
| Methane | kg/hr | | | 324 | 0 | 0 | | 3 | | | | | | | | | | | | | 0 | |
| Oxygen | kg/hr | | 0 | 0 | 0 | 0 | | 10,273 | | | | | | | | | | | | | | |
| Nitrogen | kg/hr | | 0 | 0 | 0 | 0 | 205,703 | 206,283 | | | | | | | | | | | | | | |
| Others | kg/hr | 2,847 | 468 | 0 | 0 | 3,315 | 0 | 402 | | | | | | | | | | | | | | |
| Cellulose (IS) | kg/hr | 20 | 1,337 | | | 1,358 | | 14 | | | | | | | | | | | | | | |
| Xylan (IS) | kg/hr | 7 | 430 | | | 437 | | 4 | | | | | | | | | | | | | | |
| Arabinan (IS) | kg/hr | 1 | 60 | | | 61 | | 1 | | | | | | | | | | | | | | |
| Other Sugar Polymers (IS) | kg/hr | 1 | 72 | | | 73 | | 1 | | | | | | | | | | | | | | |
| Cellulase (IS) | kg/hr | 244 | 325 | | | 568 | | 6 | | | | | | | | | | | | | | |
| Biomass (IS) | kg/hr | 0 | 0 | | 65 | 65 | | 1 | | | | | | | | | | | | | | |
| Zymo (IS) | kg/hr | 408 | 544 | | | 952 | | 10 | | | | | | | | | | | | | | |
| Lignin (IS) | kg/hr | 214 | 13,967 | | | 14,181 | | 142 | | | | | | | | | | | | | | |
| Gypsum (IS) | kg/hr | 0 | 27 | | | 28 | | 28 | | | | | | | | | | | | | | |
| Ca(OH)2 (IS) | kg/hr | | | | | | | | | | | | | | | | | | | | | |
| Others (Insoluble Solids) | kg/hr | 69 | 4,528 | | | 4,597 | | 4,342 | | | | | | | | | | | | | | |
| Enthalpy Flow (millions) | Kcal/hr | -88.4 | -136.2 | -1.0 | -0.6 | -225.2 | 0.2 | -347.1 | -554.1 | -44.2 | -699.8 | -692.4 | -115.6 | -300.3 | -52.5 | -53.9 | -62.1 | -62.1 | -19.9 | -51.6 | 0.0 | -15.5 |
| Average Density | g/ml | 1.0845 | 1.3326 | 0.0009 | 1.1481 | 1.2092 | 0.0007 | 0.0407 | 0.0259 | 0.9320 | 0.8963 | 0.8963 | 0.0055 | 0.0023 | 0.0023 | 0.0001 | 0.9898 | 0.9899 | 0.6925 | 0.8763 | 0.0007 | 0.0010 |

| Heat Stream No. | MM kcal/hr | Work Stream No. | KW |
|-----------------|------------|-----------------|-----------|
| QB0ILER | 118.35 | WKNET | -18747.45 |
| QH811 | -0.64 | WP811 | 3.89 |
| QM811 | 8.22 | WPLANT | 11717.68 |
| | | WTOTAL | -30465.14 |

| Eq. No. | Equipment Name | Req./Spare | Equipment Type | Mat Const. |
|---------|----------------------------------|------------|----------------|------------|
| H-811 | BRW Preheater | 1 | SHELL-TUBE | SS304 |
| M-803 | Fluidized Bed Combustion Reactor | 1 | MISCELLANEOUS | CS |
| M-811 | Turbine/Generator | 1 | STEAM-TURBINE | |
| P-811 | Turbine Condensate Pump | 2 | CENTRIFUGAL | SS304 |

| | | |
|--|-----------------------------|--|
| M3 REVISIONS A. ICF PROCESS QMS B. BDO TECH REVISE | DATE 11/22/21 8/22/22 | NATIONAL RENEWABLE ENERGY LABORATORY Biotechnology Center For Fuels And Chemicals |
| SECTION A800 COMBUSTOR AND TURBOGENERATOR | | |
| 10203L.xls | | PFD-P110-AB02 B |

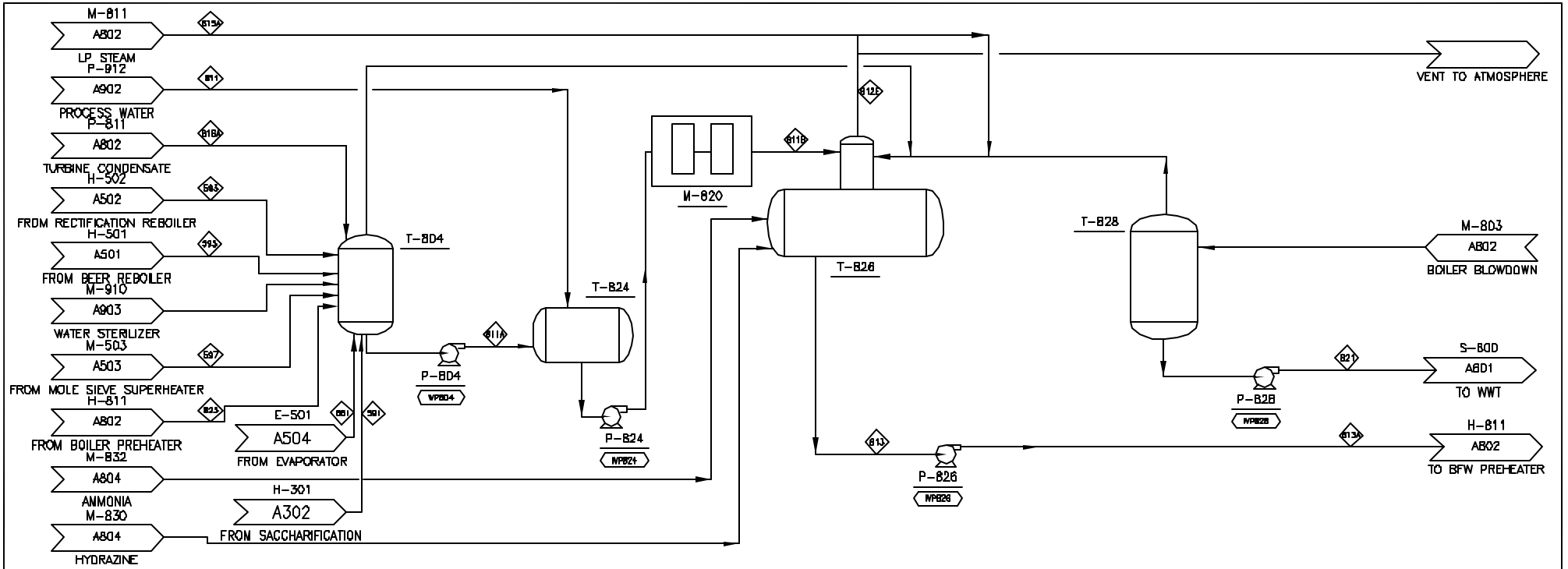

| COMPONENT | UNITS | 591 | 593 | 595 | 597 | 811 | 811A | 811B | 812E | 813 | 813A | 815A | 816A | 821 | 823 | 861 |
|---------------------------|---------|--------|--------|--------|--------|--------|---------|---------|------|---------|---------|--------|--------|--------|--------|--------|
| Total Flow | kg/hr | 9,490 | 8,164 | 65,505 | 621 | 54,456 | 119,364 | 173,820 | 0 | 190,485 | 190,485 | 16,665 | 16,486 | 5,715 | 14,240 | 4,858 |
| Insoluble Solids | % | 0.0% | 0.0% | 0.0% | 0.0% | 0.0% | 0.0% | 0.0% | 0.0% | 0.0% | 0.0% | 0.0% | 0.0% | 0.0% | 0.0% | 0.0% |
| Soluble Solids | % | 0.0% | 0.0% | 0.0% | 0.0% | 0.0% | 0.0% | 0.0% | 0.0% | 0.0% | 0.0% | 0.0% | 0.0% | 0.0% | 0.0% | 0.0% |
| Temperature | C | 148 | 148 | 148 | 148 | 26 | 115 | 87 | 137 | 139 | 164 | 46 | 309 | 190 | 115 | |
| Pressure | atm | 4.42 | 4.42 | 4.42 | 4.42 | 3.40 | 1.70 | 3.40 | 3.30 | 98.31 | 4.42 | 4.20 | 96.26 | 12.32 | 1.68 | |
| Vapor Fraction | | 0.00 | 0.00 | 0.00 | 0.00 | 0.00 | 0.00 | 0.00 | 0.00 | 0.00 | 1.00 | 0.00 | 0.00 | 0.00 | 0.00 | |
| Ethanol | kg/hr | | | | | | | | | | | | | | | |
| Water | kg/hr | 9,490 | 8,164 | 65,505 | 621 | 54,456 | 119,364 | 173,820 | | 190,485 | 190,485 | 16,665 | 16,486 | 5,715 | 14,240 | 4,858 |
| Glucose (SS) | kg/hr | | | | | | | | | | | | | | | |
| Xylose (SS) | kg/hr | | | | | | | | | | | | | | | |
| Arabinose (SS) | kg/hr | | | | | | | | | | | | | | | |
| Other Sugars (SS) | kg/hr | | | | | | | | | | | | | | | |
| Cellobiose (SS) | kg/hr | | | | | | | | | | | | | | | |
| Glucose Oligomers (SS) | kg/hr | | | | | | | | | | | | | | | |
| Xylose Oligomers (SS) | kg/hr | | | | | | | | | | | | | | | |
| Other Oligomers (SS) | kg/hr | | | | | | | | | | | | | | | |
| Corn Steep Liquor (SS) | kg/hr | | | | | | | | | | | | | | | |
| Others (Soluble Solids) | kg/hr | | | | | | | | | | | | | | | |
| Acetic Acid | kg/hr | | | | | | | | | | | | | | | |
| Sulfuric Acid | kg/hr | | | | | | | | | | | | | | | |
| Furfural | kg/hr | | | | | | | | | | | | | | | |
| HMF | kg/hr | | | | | | | | | | | | | | | |
| Carbon Dioxide | kg/hr | | | | | | | | | | | | | | | |
| Methane | kg/hr | | | | | | | | | | | | | | | |
| Oxygen | kg/hr | | | | | | | | | | | | | | | |
| Nitrogen | kg/hr | | | | | | | | | | | | | | | |
| Others | kg/hr | | | | | | | | | | | | | | | |
| Cellulose (IS) | kg/hr | | | | | | | | | | | | | | | |
| Xylan (IS) | kg/hr | | | | | | | | | | | | | | | |
| Arabinan (IS) | kg/hr | | | | | | | | | | | | | | | |
| Other Sugar Polymers (IS) | kg/hr | | | | | | | | | | | | | | | |
| Cellulase (IS) | kg/hr | | | | | | | | | | | | | | | |
| Biomass (IS) | kg/hr | | | | | | | | | | | | | | | |
| Zymo (IS) | kg/hr | | | | | | | | | | | | | | | |
| Lignin (IS) | kg/hr | | | | | | | | | | | | | | | |
| Gypsum (IS) | kg/hr | | | | | | | | | | | | | | | |
| Ca(OH)2 (IS) | kg/hr | | | | | | | | | | | | | | | |
| Others (Insoluble Solids) | kg/hr | | | | | | | | | | | | | | | |
| Enthalpy Flow (millions) | Kcal/hr | -34.7 | -29.9 | -239.7 | -2.3 | -206.3 | -441.8 | -647.9 | | -700.4 | -699.8 | -52.5 | -62.1 | -19.9 | -51.8 | -18.0 |
| Average Density | g/ml | 0.8653 | 0.8653 | 0.8653 | 0.8653 | 0.9970 | 0.9467 | 0.9670 | | 0.9283 | 0.9320 | 0.0023 | 0.9899 | 0.6925 | 0.8763 | 0.9466 |

| Heat Stream No. | MM kcal/hr | Work Stream No. | kW |
|-----------------|------------|-----------------|--------|
| | | WP804 | 20.46 |
| | | WP824 | 11.44 |
| | | WP826 | 719.27 |
| | | WP828 | 1.80 |

| Eq. No. | Equipment Name | Req. | Spare | Equipment Type | Mat Const. |
|---------|-----------------------------------|------|-------|-------------------|------------|
| M-820 | Hot Process Water Softener System | 1 | | PACKAGE | |
| P-804 | Condensate Pump | 2 | | CENTRIFUGAL | SS316 |
| P-824 | Deaerator Feed Pump | 2 | | CENTRIFUGAL | SS304 |
| P-826 | BFW Pump | 5 | | CENTRIFUGAL | SS316 |
| P-828 | Blowdown Pump | 2 | | CENTRIFUGAL | CS |
| T-804 | Condensate Collection Tank | 1 | | VERTICAL-VESSEL | A285C |
| T-824 | Condensate Surge Drum | 1 | | HORIZONTAL-VESSEL | SS304 |
| T-826 | Deaerator | 1 | | HORIZONTAL-VESSEL | CS,SS316 |
| T-828 | Blowdown Flash Drum | 1 | | HORIZONTAL-VESSEL | CS |

| | | |
|--|-----------------------------|--|
| 101 10/20/2014 A. LIP. PROCESS ENG B. BOE2 DESIGN REVIEW | DATE 11/27/20 1/22/20 | NATIONAL RENEWABLE ENERGY LABORATORY Biotechnology Center for Fuels and Chemicals |
| SECTION A800 BOILER FEED WATER PREPARATION | | |
| 102031.xls | PFD-P110-A803 | B |

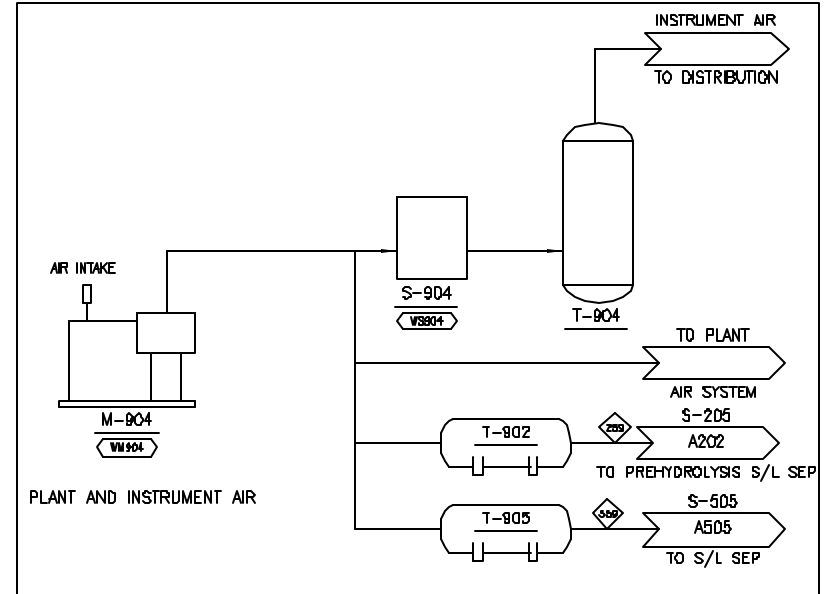
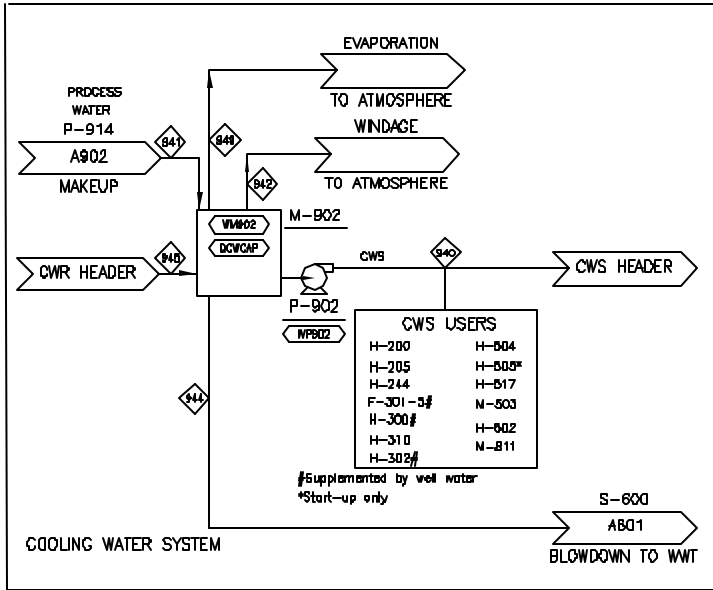

| COMPONENT | UNITS | 259 | 559 | 940 | 941 | 942 | 944 | 945 | 949 | | | | | | | | | | | |
|---------------------------|---------|--------|--------|------------|---------|--------|--------|------------|---------|--|--|--|--|--|--|--|--|--|--|--|
| Total Flow | kg/hr | 4,687 | 5,921 | 12,256,909 | 158,828 | 9,330 | 14,439 | 12,256,909 | 135,059 | | | | | | | | | | | |
| Insoluble Solids | % | 0.0% | 0.0% | 0.0% | 0.0% | 0.0% | 0.0% | 0.0% | 0.0% | | | | | | | | | | | |
| Soluble Solids | % | 0.0% | 0.0% | 0.0% | 0.0% | 0.0% | 0.0% | 0.0% | 0.0% | | | | | | | | | | | |
| Temperature | C | 40 | 40 | 37 | 28 | 28 | 28 | 28 | 28 | | | | | | | | | | | |
| Pressure | atm | 9.51 | 9.51 | 4.08 | 1.00 | 1.00 | 1.00 | 4.08 | 0.04 | | | | | | | | | | | |
| Vapor Fraction | | 1.00 | 1.00 | 0.00 | 0.00 | 0.00 | 0.00 | 0.00 | 1.00 | | | | | | | | | | | |
| Ethanol | kg/hr | | | | | | | | | | | | | | | | | | | |
| Water | kg/hr | | | 12,256,909 | 158,828 | 9,330 | 14,439 | 12,256,909 | 135,059 | | | | | | | | | | | |
| Glucose (SS) | kg/hr | | | | | | | | | | | | | | | | | | | |
| Xylose (SS) | kg/hr | | | | | | | | | | | | | | | | | | | |
| Arabinose (SS) | kg/hr | | | | | | | | | | | | | | | | | | | |
| Other Sugars (SS) | kg/hr | | | | | | | | | | | | | | | | | | | |
| Cellobiose (SS) | kg/hr | | | | | | | | | | | | | | | | | | | |
| Glucose Oligomers (SS) | kg/hr | | | | | | | | | | | | | | | | | | | |
| Xylose Oligomers (SS) | kg/hr | | | | | | | | | | | | | | | | | | | |
| Other Oligomers (SS) | kg/hr | | | | | | | | | | | | | | | | | | | |
| Corn Steep Liquor (SS) | kg/hr | | | | | | | | | | | | | | | | | | | |
| Others (Soluble Solids) | kg/hr | | | | | | | | | | | | | | | | | | | |
| Acetic Acid | kg/hr | | | | | | | | | | | | | | | | | | | |
| Sulfuric Acid | kg/hr | | | | | | | | | | | | | | | | | | | |
| Formic Acid | kg/hr | | | | | | | | | | | | | | | | | | | |
| H ₂ F | kg/hr | | | | | | | | | | | | | | | | | | | |
| Carbon Dioxide | kg/hr | | | | | | | | | | | | | | | | | | | |
| Methane | kg/hr | | | | | | | | | | | | | | | | | | | |
| Oxygen | kg/hr | 984 | 1,243 | | | | | | | | | | | | | | | | | |
| Nitrogen | kg/hr | 3,703 | 4,678 | | | | | | | | | | | | | | | | | |
| Others | kg/hr | | | | | | | | | | | | | | | | | | | |
| Cellulose (IS) | kg/hr | | | | | | | | | | | | | | | | | | | |
| Xylan (IS) | kg/hr | | | | | | | | | | | | | | | | | | | |
| Arabinan (IS) | kg/hr | | | | | | | | | | | | | | | | | | | |
| Other Sugar Polymers (IS) | kg/hr | | | | | | | | | | | | | | | | | | | |
| Cellulase (IS) | kg/hr | | | | | | | | | | | | | | | | | | | |
| Biomass (IS) | kg/hr | | | | | | | | | | | | | | | | | | | |
| Zymo (IS) | kg/hr | | | | | | | | | | | | | | | | | | | |
| Lignin (IS) | kg/hr | | | | | | | | | | | | | | | | | | | |
| Gypsum (IS) | kg/hr | | | | | | | | | | | | | | | | | | | |
| Ca(OH) ₂ (IS) | kg/hr | | | | | | | | | | | | | | | | | | | |
| Others (Insoluble Solids) | kg/hr | | | | | | | | | | | | | | | | | | | |
| Enthalpy Flow (millions) | Kcal/hr | 0.0 | 0.0 | -46287.8 | -601.1 | -35.3 | -54.6 | -46390.7 | -432.8 | | | | | | | | | | | |
| Average Density | g/ml | 0.0106 | 0.0106 | 0.9819 | 0.9906 | 0.9906 | 0.9906 | 0.9906 | 0.0000 | | | | | | | | | | | |

| Heat Stream No. | MM kcal/hr | Work Stream No. | kW |
|-----------------|------------|-----------------|---------|
| QCWCAP | 102.94 | WM902 | 657.67 |
| | | WM904 | 1110.89 |
| | | WP902 | 1258.33 |
| | | WS904 | 7.36 |

| Eq. No. | Equipment Name | Req | Spare | Equipment Type | Mat Const. |
|---------|--------------------------------------|-----|-------|-------------------|------------|
| M-902 | Cooling Tower System | 1 | | INDUCED-DRAFT | FIBERGLASS |
| M-904 | Plant Air Compressor | 2 | 1 | CENTRIFUGAL | |
| P-902 | Cooling Water Pump | 1 | 1 | CENTRIFUGAL | CS |
| S-904 | Instrument Air Dryer | 1 | 1 | PACKAGE | CS |
| T-902 | Prehydrolysis Filter Air Receiver | 3 | | HORIZONTAL-PRESS | CS |
| T-904 | Plant Air Receiver | 1 | | HORIZONTAL-VESSEL | CS |
| T-905 | Product Recovery Filter Air Receiver | 4 | | HORIZONTAL-PRESS | CS |

| NO. | DESCRIPTION | DATE | BY |
|-----|--------------------|---------|----|
| 1 | PRELIMINARY DESIGN | 1/27/04 | |
| 2 | REVISED DESIGN | 5/22/04 | |



NATIONAL RENEWABLE ENERGY LABORATORY
 Biotechnology Center For Fuels And Chemicals

SECTION A900
COOLING WTR PLNT & INST AIR SYS

102031.xls | PFD-P110-A901 | B

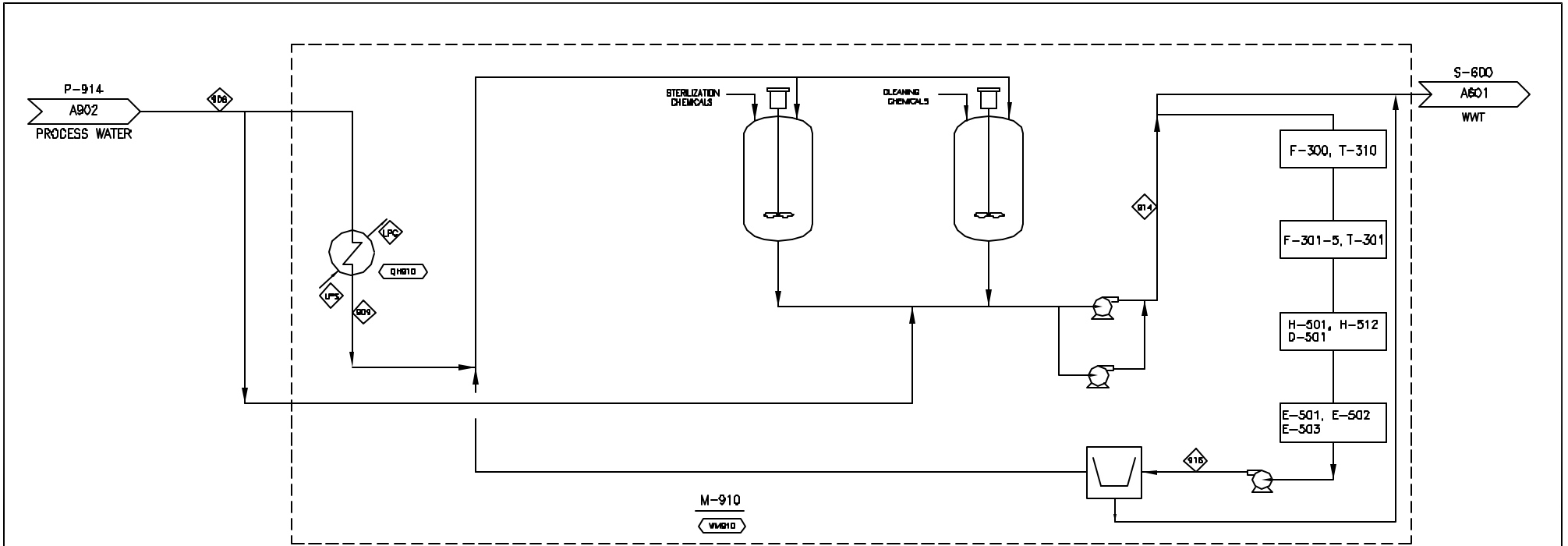

| COMPONENT | UNITS | 906 | 909 | 914 | 916 |
|---------------------------|---------|-------|-------|-------|-------|
| Total Flow | kg/hr | 145 | 145 | 63 | 63 |
| Insoluble Solids | % | 0.0% | 0.0% | 0.0% | 0.0% |
| Soluble Solids | % | 0.0% | 0.0% | 0.0% | 0.0% |
| Temperature | C | 20 | 121 | 20 | 20 |
| Pressure | atm | 1.00 | 1.00 | 1.00 | 1.00 |
| Vapor Fraction | | 0.00 | 1.00 | 0.00 | 0.00 |
| Ethanol | kg/hr | | | | |
| Water | kg/hr | 145 | 145 | 63 | 63 |
| Glucose (SS) | kg/hr | | | | |
| Xylose (SS) | kg/hr | | | | |
| Arabinose (SS) | kg/hr | | | | |
| Other Sugars (SS) | kg/hr | | | | |
| Cellobiose (SS) | kg/hr | | | | |
| Glucose Oligomers (SS) | kg/hr | | | | |
| Xylose Oligomers (SS) | kg/hr | | | | |
| Other Oligomers (SS) | kg/hr | | | | |
| Corn Steep Liquor (SS) | kg/hr | | | | |
| Others (Soluble Solids) | kg/hr | | | | |
| Acetic Acid | kg/hr | | | | |
| Sulfuric Acid | kg/hr | | | | |
| Furfural | kg/hr | | | | |
| HMF | kg/hr | | | | |
| Carbon Dioxide | kg/hr | | | | |
| Methane | kg/hr | | | | |
| Oxygen | kg/hr | | | | |
| Nitrogen | kg/hr | | | | |
| Others | kg/hr | | | | |
| Cellulose (IS) | kg/hr | | | | |
| Xylan (IS) | kg/hr | | | | |
| Arabinan (IS) | kg/hr | | | | |
| Other Sugar Polymers (IS) | kg/hr | | | | |
| Cellulase (IS) | kg/hr | | | | |
| Biomass (IS) | kg/hr | | | | |
| Zymo (IS) | kg/hr | | | | |
| Lignin (IS) | kg/hr | | | | |
| Gypsum (IS) | kg/hr | | | | |
| Ca(OH)2 (IS) | kg/hr | | | | |
| Others (Insoluble Solids) | kg/hr | | | | |
| Enthalpy Flow (millions) | Kcal/hr | -0.5 | -0.5 | -0.2 | -0.2 |
| Average Density | g/ml | 0.998 | 0.001 | 0.998 | 0.998 |

| Heat Stream | Mmkkal/hr | Work Stream No. | KW |
|-------------|-----------|-----------------|--------|
| QH910 | -0.09 | WM910 | 257.36 |

| Eq. No. | Equipment Name | Req. Spare | Equipment Type | Mat Const. |
|---------|----------------|------------|----------------|------------|
| M-910 | CIP System | 1 | MISCELLANEOUS | CS |

| REV | DESCRIPTION | DATE |
|-----|----------------------|----------|
| A | 102031 DESIGN CASE | 11/27/08 |
| B | 102031 DESIGN REPORT | 5/29/09 |

| | | | |
|---|--|--|---------------|
| NATIONAL RENEWABLE ENERGY LABORATORY Biotechnology Center For Fuels And Chemicals | | SECTION A900 STERILE WATER & CIP/CS SYSTEMS | |
| | | 102031.xls | PFD-P110-A903 |

Appendix G

Changes from the 1999 Design Report

The following section describes the major changes that have been made since the 1999 design report. In general, the process changes came from a new feedstock, better design and cost information, the need to portray the current state of research in enzyme production, and the change to target yields for pretreatment and co-fermentation that can be achieved in the next several years. Other minor changes (to the mass and energy balance model) had a small combined cost effect.

Corn Stover Feedstock

The change in feedstock from yellow poplar hardwood chips to corn stover is a major one. There are fewer carbohydrates in corn stover than hardwood, so the theoretical of ethanol yield per ton of feedstock is lower. The feedstock cost of \$30 per dry short ton is an increase from wood chips at \$25 per dry short ton. The cost represents our current understanding of the expected harvesting capabilities, transportation and farmer costs required to obtain stover in 2010. ORNL has been instrumental in providing us with information on feedstock costs to use in the process model, and continues to work towards a better understanding of the availability and cost of stover.

It is assumed that the bales would be stored in several locations until needed. The cost of offsite storage for the once-per-year harvest of stover was not included in this design.

The change from a loose, piled feedstock like wood chips to baled stover presented several changes in the feedstock receiving and handling area, including moving the bales, breaking them up, and making the stalks and other long pieces small enough to feed to the pretreatment reactors. Corn stover also contains a higher percentage of dirt and less moisture than wood chips, so dust and debris were issues. The Harris group looked at several designs for moving, unbaling, washing, and shredding baled corn stover, and picked one based on its performance in existing similar applications. The total installed cost of \$7.5MM for stover handling equipment was \$2.6MM higher than that for wood chips. The stover handling equipment was also sized on a dry feed rate unlike the wood chip handling equipment, which was sized on a total feed rate basis. It is conceivable that this system is overdone, and the washing and size reduction could be reduced as we learn to handle or minimize the dirt picked up in harvesting and gain a better understanding of the effect of particle size.

Labor for the baled feedstock was a significant change - eight forklift operators per shift for corn stover versus two bulldozer drivers for chips. Because the bales are trucked in and must be unloaded, a substantial amount of bale moving is anticipated.

Pretreatment Reactor and Yields

The Harris Group contacted several vendors for design and cost information to augment the information we obtained from Sunds through Delta-T. Anco-Eaglin and Andritz provided detailed estimates. Both companies specified lower cost metallurgy for the wetted parts (Incoloy 825 clad steel and Incoloy 825, respectively) than Sunds originally did (Hastelloy C-2000) for the pretreatment conditions. Harris contracted with a corrosion lab and corrosion consultant to conduct testing on these materials. The lower cost of the Anco-Eaglin system provided a savings of about \$5.5MM in purchased and \$2.5MM in installed equipment cost over the Sunds unit. The reason for this decrease in savings as the installation factor is applied is that the Anco-Eaglin system has a larger installation factor of 2.29 versus a factor of 1.5 for the Sunds unit. Yield targets were increased from 75 to 90% for hemicellulose to monomer conversion.

Solid-Liquid Separation Equipment

A significant portion of the Harris Group's work was with solid-liquid separation vendors in an attempt to optimize the design of equipment for both separation of prehydrolyzate slurry and post-distillate slurry. As a result of vendor testing over a wide range of separator types, a Pneumapress pressure filter was chosen for the prehydrolyzate slurry application based on its performance in solid recovery, cake dryness, and washing ability. When compared against the other quotes (for horizontal belt filters), the Pneumapress filter's estimated installed cost was \$2.2MM more than the closest cost quote, but \$18.5MM less than the highest quote. However, its separation and washing efficiencies were superior to the horizontal belt filters. The installed cost of the Pneumapress system was about \$4MM higher than our current estimate for a belt filter press (\$6.3MM installed cost for the Pneumapress and peripherals compared to \$2.1MM for the belt filter press), however, it allows for washing with a minimal amount of liquid, and has been verified through vendor testing.

For the post-distillate solids, the Pneumapress system used here is again about \$4MM more expensive than the prior centrifuge cost (\$6.4MM versus \$2.4MM), but also allows the removal of the solids dryer (\$2.2MM). The flue gas, previously used for drying, can now be used in a combustion air preheater (\$1.1MM). Also, Harris' estimated installed cost for a centrifuge system in this application (including all extraneous equipment such as pumps, conveyors, etc.) was \$0.7MM more expensive than that of the Pneumapress system. Because this data was based on vendor tests, we consider it more reliable than the previous separation equipment costs used

Enzymatic Hydrolysis (Saccharification) and Co-Fermentation

Based on our current understanding of what production of the first commercially available enzyme preparation for lignocellulosic biomass will entail, a cost of \$0.10 per gallon of ethanol was used for enzyme delivered to the plant from a local enzyme facility. This is a major change from the previous design, which assumed on-site fermentation of the enzyme using *T. Reesei* fungi (previously Area 400 in the design). The installed capital (\$15.5MM) and operating costs associated with that production were about \$0.30 per gallon ethanol. The electrical demand of the plant is roughly halved without the enzyme production fermenters. Chilled water demand is also greatly reduced by removing cellulase production.

In preparation for an improved thermal tolerant enzyme, the SSCF process was separated into separate saccharification and co-fermentation. The saccharification yield target was increased and the fermentation yield target for glucose was also increased.

Other Changes

1. Distillation column costing

Both the beer column and rectification distillation column capital costs are now scaled by the square of the diameter (previously just the diameter), to better represent the size (and hence cost) by a variable that is proportional to cross-sectional flow.

2. Solids Dryer Testing

In the current design, the solids fed to the boiler are not being dried, due to the high efficiency of the Pneumapress unit. The previous design used a centrifuge, and required a dryer to get the total boiler feed moisture content low enough to support combustion. A rotary drum dryer, similar to those used to dry the Distiller's Dried Grains (DDG) in the corn ethanol industry was used with

the hot flue gas as the heat source. The cost of the dryer was about \$2.2MM, and was incorporated into the design (replacing the rotary drum dryer) until the Pneumapress unit replaced it and the centrifuge in this new design.

Summary of Significant Changes

| | 1999 Design Report | 2002 Design Report | Ethanol Selling Price (\$/gal) |
|--|---|---|--------------------------------|
| 1999 Reported Cost (Model: R9906A, 1997 \$) | | | \$1.44 |
| Feedstock | Hardwood Chips | Corn Stover | +\$0.06 |
| Feedstock Cost | \$25 per dry ton | \$30 per dry ton | +\$0.07 |
| Feedstock Handling Installed Cost | \$4.9MM | \$7.5MM | +\$0.02 |
| Feedstock Handling Labor | 2 per shift | 8 per shift | +0.02 |
| Pretreatment Reactor | Hastelloy C-2000 | Incoloy 825 clad steel | -\$0.01 |
| Pretreatment Targets and Conditions | 75% Hemicellulose to Monomer Yield 190°C 0.5% acid, 10 minutes | 90% Hemicellulose to Monomer Yield 190°C, 1.1% acid, 2 minutes | -\$0.06 |
| Conditioning | Ion exchange and overliming | Overliming only | -\$0.08 |
| Solid-Liquid Separation Equipment | Belt Filter Press/Centrifuge | Pneumapress Pressure Filters | +\$0.01 |
| Enzyme | Produced on-site for \$0.30 per gallon ethanol | Purchased for \$0.10 per gallon ethanol | -\$0.20 |
| Enzymatic Hydrolysis and Fermentation Configuration | SSCF | Saccharification and Co- Fermentation | -\$0.01 |
| Fermentation Targets | 73.6% Cellulose to Ethanol Yield | 85.5% Cellulose to Ethanol Yield | -\$0.15 |
| | 85% Xylose to Ethanol Yield | 85% all Hemicellulosic Sugars to Ethanol Yield | -\$0.10 |
| Cost Year Change | 1997 | 2000 | +\$0.04 |
| Other Minor Model Fixes | | | +\$0.02 |
| 2002 Reported Cost (Model: I0203I, 2000 \$) | | | \$1.07 |

Appendix H

Chemical Formulas for Biomass Compounds

Chemical Formulas for Biomass Compounds

| Compound Name | Chemical Formula | Notes |
|-----------------------------|--------------------------|---|
| Acetate | $C_2H_4O_2$ | |
| Arabinan | $C_5H_8O_4$ | Use Xylan Properties |
| Arabinose | $C_5H_{10}O_5$ | Use Xylose properties |
| Cellobiose | $C_{12}H_{22}O_{11}$ | Use Glucose properties |
| Cellulose | $C_5H_{10}O_5$ | |
| Corn Steep Liquor (CSL) | Unknown | Modeled as water |
| Furfural | $C_5H_4O_2$ | |
| Galactan | $C_6H_{10}O_5$ | Use Cellulose properties |
| Galactose | $C_6H_{12}O_6$ | Use Glucose properties |
| Glucose | $C_6H_{12}O_6$ | |
| HydroxyMethylFurfural (HMF) | $C_5H_4O_2$ | Use Furfural properties |
| Lignin | $C_{10}H_{13.9}O_{1.3}$ | |
| Mannan | $C_6H_{10}O_5$ | Use Cellulose properties |
| Mannose | $C_6H_{12}O_6$ | Use Glucose properties |
| Soluble Lignin | $C_{10}H_{13.9}O_{1.3}$ | Use Glucose properties for liquid-liquid interactions |
| Tar | $C_5H_8O_4$ | Use Xylan Properties |
| Xylan | $C_5H_8O_4$ | |
| Xylose | $C_5H_{10}O_5$ | |
| <i>Z. mobilis</i> | $CH_{1.8}O_{0.5}N_{0.2}$ | |

Appendix I

Physical Property Model and Parameters for Distillation

Physical property models and parameters are important throughout a rigorous mass and energy balance model such as the one used here. This is even truer for distillation calculations involving azeotropes such as the separation of ethanol from water. The physical property option¹ selected for this ASPEN model uses the NRTLⁱⁱ activity coefficient (g_i) model for the liquid phase fugacity, f_i , calculation. The vapor phase is modeled using the ideal gas law, which makes the vapor fugacity coefficient equal to one. The vapor phase fugacity coefficient is not nearly as important as the liquid phase fugacity because of the low-pressure operation.

The liquid phase equation for liquid fugacity is:

$$f_i = x_i g_i f_i^*$$

The pure component liquid fugacity, f_i^* , reduces to the pure component vapor pressure, p_i^* , at low pressures (the Poynting correction is unity). The NRTL activity coefficient model and vapor pressure models used by ASPEN are given below. Tables 11 and 12 give the ethanol and water parameters for those equations.

$$\ln g_i = \frac{x_j t_{ji} G_{ji}}{x_k G_{ki}} + \frac{x_j G_{ij}}{x_k G_{kj}} t_{ij} - \frac{x_m t_{mj} G_{mj}}{x_k G_{kj}} \div$$

Where:

$$G_{ij} = \exp(\mathbf{a}_{ij} t_{ij})$$

$$t_{ij} = a_{ij} + \frac{b_{ij}}{T} + e_{ij} \ln T + f_{ij} T$$

$$a_{ij} = c_{ij} + d_{ij}(T - 273.15)$$

$$t_{ii} = 0$$

$$G_{ii} = 1$$

$$a_{ij} = a_{ji}$$

$$b_{ij} = b_{ji}$$

$$c_{ij} = c_{ji}$$

$$d_{ij} = d_{ji}$$

Vapor Pressure Correlation

$$\ln p_i^* = C_{1i} + \frac{C_{2i}}{T + C_{3i}} + C_{4i} T + C_{5i} \ln T + C_{6i} T^{C_{7i}}$$

NRTL Activity Coefficient Model Parametersⁱⁱⁱ

| | |
|------------------------------|----------|
| aij | 0 |
| aji | 0 |
| bij | -55.1698 |
| bji | 670.4442 |
| cij | 0.3031 |
| dij | 0 |
| eij | 0 |
| eji | 0 |
| fij | 0 |
| fji | 0 |
| Lower Temperature Limit | 348.15 |
| Upper Temperature Limit | 373.15 |
| Note: i – ethanol, j – water | |

Vapor Pressure Model Parametersⁱⁱⁱ

| Eq. Parameters | Ethanol | Water |
|----------------------------|----------------|--------------|
| C1 | 74.475 | 73.649 |
| C2 | -7164.3 | -7258.2 |
| C3 | 0 | 0 |
| C4 | 0 | 0 |
| C5 | -7.3270 | -7.3037 |
| C6 | 3.1340E-06 | 4.1653E-06 |
| C7 | 2 | 2 |
| Lower Temperature Limit | 159.05 | 273.16 |
| Upper Temperature Limit | 513.92 | 647.13 |
| Temperature Units, Kelvins | | |
| Pressure Units, Pascals | | |

ⁱ “ASPEN Plus™, Reference Manual–Volume 2, Physical Property Methods and Models,” Release 9.3, Aspen Technology, Inc., Cambridge, MA, 1996.

ⁱⁱ Renon, H., and J.M. Praustniz, “Local Composition in Thermodynamic Excess Functions for Liquid Mixtures,” *AIChE J.*, 14(1), 135, 1968.

ⁱⁱⁱ “ASPEN Plus™, Reference Manual–Volume 3, Physical Property Data,” Release 9.3, Aspen Technology, Inc., Cambridge, MA, 1996.

REPORT DOCUMENTATION PAGE

Form Approved
OMB NO. 0704-0188

Public reporting burden for this collection of information is estimated to average 1 hour per response, including the time for reviewing instructions, searching existing data sources, gathering and maintaining the data needed, and completing and reviewing the collection of information. Send comments regarding this burden estimate or any other aspect of this collection of information, including suggestions for reducing this burden, to Washington Headquarters Services, Directorate for Information Operations and Reports, 1215 Jefferson Davis Highway, Suite 1204, Arlington, VA 22202-4302, and to the Office of Management and Budget, Paperwork Reduction Project (0704-0188), Washington, DC 20503.

| | | | | |
|---|---|--|--|--|
| 1. AGENCY USE ONLY (Leave blank) | | 2. REPORT DATE June 2002 | 3. REPORT TYPE AND DATES COVERED Technical Report | |
| 4. TITLE AND SUBTITLE Lignocellulosic Biomass to Ethanol Process Design and Economics Utilizing Co-Current Dilute Acid Prehydrolysis and Enzymatic Hydrolysis for Corn Stover | | | 5. FUNDING NUMBERS TA: BFP2.A410 | |
| 6. AUTHOR(S) A. Aden, M.Ruth, K. Ibsen, J. Jechura, K. Neeves, J. Sheehan, B. Wallace L. Montague, A. Slayton, J. Lukas | | | | |
| 7. PERFORMING ORGANIZATION NAME(S) AND ADDRESS(ES) Biotechnology Center for Fuels and Chemicals National Renewable Energy Laboratory Golden, CO 80401 Harris Group Seattle, WA 98109 | | | 8. PERFORMING ORGANIZATION REPORT NUMBER | |
| 9. SPONSORING/MONITORING AGENCY NAME(S) AND ADDRESS(ES) National Renewable Energy Laboratory 1617 Cole Blvd. Golden, CO 80401-3393 | | | 10. SPONSORING/MONITORING AGENCY REPORT NUMBER NREL/TP-510-32438 | |
| 11. SUPPLEMENTARY NOTES | | | | |
| 12a. DISTRIBUTION/AVAILABILITY STATEMENT National Technical Information Service U.S. Department of Commerce 5285 Port Royal Road Springfield, VA 22161 | | | 12b. DISTRIBUTION CODE | |
| 13. ABSTRACT (Maximum 200 words) This report is an update of NREL's ongoing process design and economic analyses of processes related to developing ethanol from lignocellulosic feedstocks. | | | | |
| 14. SUBJECT TERMS process design; economic analyses; acid prehydrolysis; enzymatic hydrolysis | | | 15. NUMBER OF PAGES | |
| | | | 16. PRICE CODE | |
| 17. SECURITY CLASSIFICATION OF REPORT Unclassified | 18. SECURITY CLASSIFICATION OF THIS PAGE Unclassified | 19. SECURITY CLASSIFICATION OF ABSTRACT Unclassified | 20. LIMITATION OF ABSTRACT UL | |