



Welcome to Currents



When used in association with water, the term "current" describes the motion of the water. Some currents you may be familiar with are the motion of rainwater as it flows down the street, or the motion of the water in a creek, stream, or river flowing from higher elevation to lower elevation. This motion is caused by gravity. The speed and direction (velocity) of currents can be measured and recorded.



Oceanic currents are driven by tides, winds, and differences in water density. Currents are essential for maintaining the existing balance of life on Earth, but they can be deadly as well.

Oceanic currents are driven by several factors. One is the rise and fall of the tides, which is driven by the gravitational attraction of the sun and moon on Earth's oceans. Tides create a current in the oceans, near the shore, and in bays and estuaries along the coast. These are called "tidal currents." Tidal currents are the only type of currents that change in a very regular pattern and can be predicted for future dates.

A second factor that drives oceanic currents is wind. Winds drive currents that are at or near the ocean's surface. These currents are generally measured in meters per second or in knots (1 knot = 1.15 miles per hour or 1.85 kilometers per hour). Winds drive currents near coastal areas on a localized scale, and also in the open ocean on a global scale.

A third factor that drives currents is thermohaline circulation—a process driven by density differences in water due to temperature (thermo) and salinity (haline) in different parts of the ocean. Currents driven by thermohaline circulation occur at both deep and shallow ocean levels and move much slower than tidal or surface currents.

The Currents Tutorial is an overview of the types of currents, what causes them, how they are measured, and how they affect people's lives. The tutorial is composed of six primary "chapters," and includes many illustrations and animations.

The Roadmap to Resources directs you to online data and education offerings from NOAA and other reliable resources.

The lesson plans integrate information from the tutorial with offerings from the roadmap. These lesson plans have been developed for students in grades 9-12, but are easily adaptable for middle school and undergraduate students.

[\(top\)](#)



This site NOAA

Tutorial

[Roadmap](#)

[Lesson Plans](#)

Welcome

[Tidal Currents](#)

[Coastal Currents](#)

[Surface Ocean Currents](#)

[The Global Conveyor Belt](#)

[How Are Currents Measured](#)

[How Currents Affect Our Lives](#)

[References](#)



Currents

Tidal Currents 1 [2](#)



Tidal currents occur in conjunction with the rise and fall of the tide. The vertical motion of the tides near the shore causes the water to move horizontally, creating currents. When a tidal current moves toward the land and away from the sea, it "floods." When it moves toward the sea away from the land, it "ebbs." These tidal currents that ebb and flood in opposite directions are called "rectilinear" or "reversing" currents.

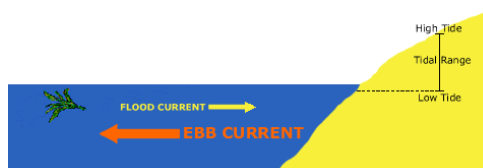

As the tides rise and fall, they create flood and ebb currents. *Click the image for a larger view.*

Rectilinear tidal currents, which typically are found in coastal rivers and estuaries, experience a "slack water" period of no velocity as they move from the ebbing to flooding stage, and vice versa. After a brief slack period, which can range from seconds to several minutes and generally coincides with high or low tide, the current switches direction and increases in velocity.

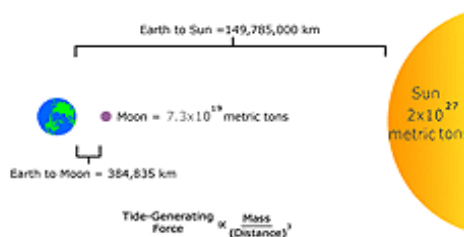

The relationship between the masses of the Earth, moon, and sun and their distances to each other play critical roles in affecting tides and the currents they produce. *Click the image for a larger view.*

Tidal currents are the only type of current affected by the interactions of the Earth, sun, and moon. The moon's force is much greater than that of the sun because it is 389 times closer to the Earth than the sun is. Tidal currents, just like tides, are affected by the different phases of the moon. When the moon is at full or new phases, tidal current velocities are strong and are called "spring currents." When the moon is at first or third quarter phases, tidal current velocities are weak and are called "neap currents."

[Continue \[2\]\(#\)](#)



This site NOAA

Tutorial

[Roadmap](#)

[Lesson Plans](#)

[Welcome](#)

[Tidal Currents](#)

[Coastal Currents](#)

[Surface Ocean Currents](#)

[The Global Conveyor Belt](#)

[How Are Currents Measured](#)

[How Currents Affect Our Lives](#)

[References](#)

[Return to Currents: Tidal Currents](#)

This animation shows the relationship between tides and currents. As the tide rises, water moves toward the shore. This is called a flood current. As the tide recedes, the water moves away from the shore. This is called an ebb current. The movement of water toward and away from the shore is illustrated by the movement of the green seaweed. Tidal currents that ebb and flood in opposite directions are called "rectilinear" or "reversing" currents.

[\(top\)](#)

[Return to Currents: Tidal Currents](#)

The relationship between the masses of the Earth, moon and sun and their distances to each other play a critical role in affecting the Earth's tides. Although the sun is 27 million times more massive than the moon, it is 390 times further away from the Earth than the moon. Tidal generating forces vary inversely as the cube of the distance from the tide-generating object. This means that the sun's tidal generating force is reduced by 390³ (about 59 million times) compared to the tide-generating force of the moon. Therefore, the sun's tide-generating force is about half that of the moon, and the moon is the dominant force affecting the Earth's tides and the currents they produce.

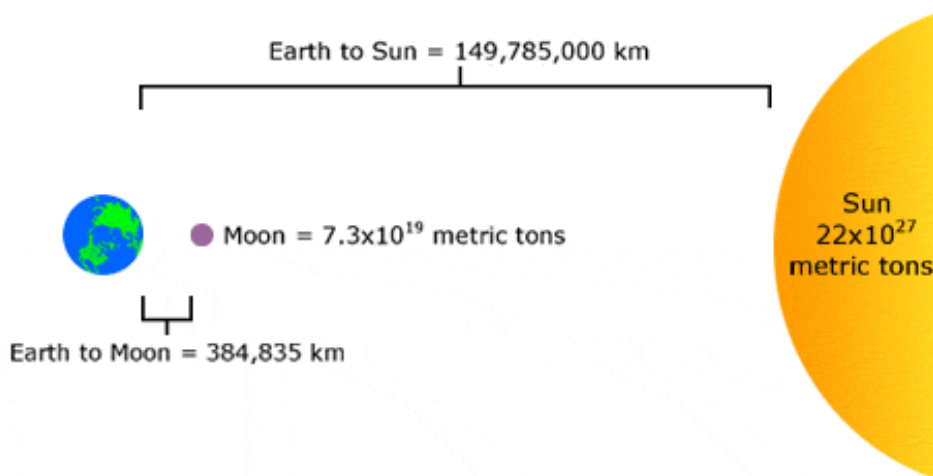

$$\text{Tide-Generating Force} = \propto \frac{\text{Mass}}{(\text{Distance})^3}$$

$$\text{Tide-Generating Force of the Sun} = \propto \frac{\text{Sun's Mass}}{(\text{Sun's Distance to Earth})^3}$$

***NOTE:** The sun has 27 million times more mass than the moon and is 390 times farther away from the earth than the moon.

$$(390)^3 = 59,000,000 \quad \text{So...} \quad \frac{27 \text{ million}}{59 \text{ million}} = 0.46 \text{ or } 46\%$$

Therefore the Sun has 46% of the tide-generating force of the Moon.

[\(top\)](#)



Currents

Tidal Currents 1 2



Also similar to tides, tidal currents are affected by the relative positions of the moon and Earth. When the moon and Earth are positioned nearest to each other (perigee), the currents are stronger than average and are called "perigean currents." When the moon and Earth are at their farthest distance from each other (apogee), the currents are weaker and are called "apogean currents."

The shape of bays and estuaries also can magnify the intensity of tides and the currents they produce. Funnel-shaped bays in particular can dramatically alter tidal current magnitude. The Bay of Fundy in Nova Scotia is a classic example of this effect, and has the highest tides in the world - over 15 meters (Thurman, H.V., 1994).

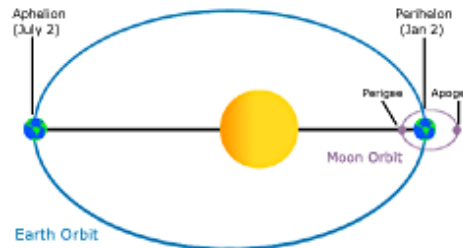

The elliptical orbits of the moon around the Earth and the Earth around the sun have substantial effects on the Earth's tides and the currents they produce. *Click the image for a larger view.*



Move your computer mouse over the image above to see the differences between high and low tides in the Bay of Fundy. *Photos © Scott Walking Adventures.*

The daily tidal currents experienced by coastal areas can also have a dramatic effect on estuarine ecosystems. View a slide show of the remarkable daily rise of waters at the Elkhorn Slough National Estuarine Research Reserve in California:

http://oceanservice.noaa.gov/education/kits/estuaries/media/supp_estuar01a_tide.html

[Back to 1](#)



This site NOAA

Tutorial

[Roadmap](#)

[Lesson Plans](#)

[Welcome](#)

[Tidal Currents](#)

[Coastal Currents](#)

[Surface Ocean Currents](#)

[The Global Conveyor Belt](#)

[How Are Currents Measured](#)

[How Currents Affect Our Lives](#)

[References](#)



[Return to Currents: Tidal Currents](#)

The elliptical orbits of the moon around the Earth and the Earth around the sun have substantial effects on the Earth's tides and the currents they produce. When the moon and Earth are positioned nearest to each other (perigee), the currents are stronger than average and are called "perigean currents." When the moon and Earth are at their farthest distance from each other (apogee), the currents are weaker and are called "apogean currents."

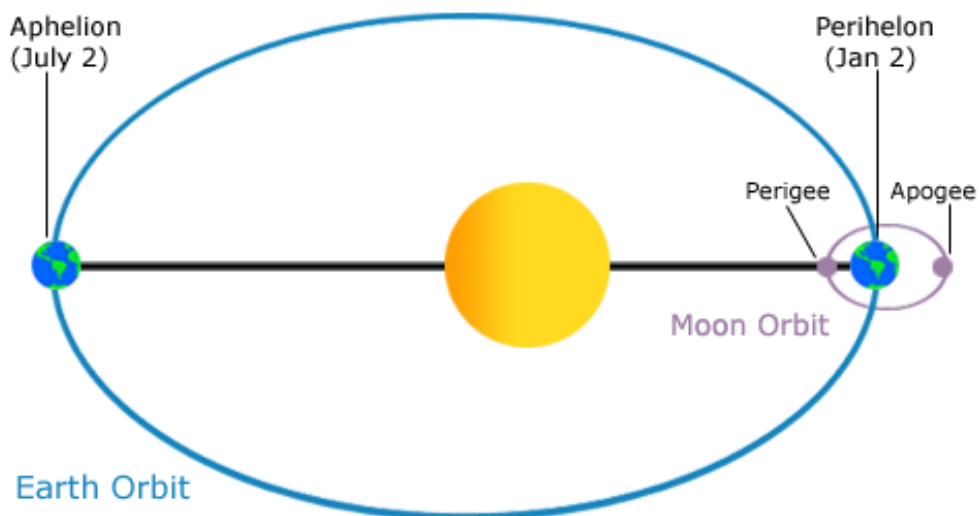

[\(top\)](#)

n o a a o c e a n s a n d c o a s t s

Revised May 02, 2007 | [Questions, Comments? Contact Us](#) | [Report Error On This Page](#) | [Disclaimer](#) | [User Survey](#)

[NOAA's National Ocean Service](#) | [National Oceanic and Atmospheric Administration](#) | [U.S. Department of Commerce](#)

http://oceanservice.noaa.gov/education/kits/currents/media/supp_cur02c.html

Best viewed in Internet Explorer 5+ or Netscape 6+.





Currents

Coastal Currents [1](#) [2](#) [3](#) [4](#)



Waves

Coastal currents are intricately tied to winds, waves, and land formations. Winds that blow along the shoreline—longshore winds—affect waves and, therefore, currents.

Before one can understand any type of surface current, one must understand how wind and waves operate. Wave height is affected by wind speed, wind duration (or how long the wind blows), and fetch, which is the distance over water that the wind blows in a single direction. If wind speed is slow, only small waves result, regardless of wind duration or fetch. If the wind speed is great but it only blows for a few minutes, no large waves will result even if the wind speed is strong and fetch is unlimited. Also, if strong winds blow for a long period of time but over a short fetch, no large waves form. Large waves occur only when all three factors combine (Duxbury, et al, 2002.)

As wind-driven waves approach the shore, friction between the sea floor and the water causes the water to form increasingly steep angles. Waves that become too steep and unstable are termed "breakers" or "breaking waves."

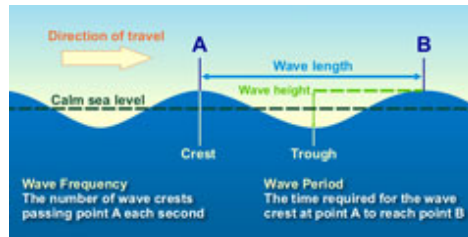

Anatomy of a wave. *Click the image for larger view.*

Continue to [2](#) [3](#) [4](#)



This site [NOAA](#)

Tutorial

[Roadmap](#)

[Lesson Plans](#)

[Welcome](#)

[Tidal Currents](#)

[Coastal Currents](#)

[Surface Ocean Currents](#)

[The Global Conveyor Belt](#)

[How Are Currents Measured](#)

[How Currents Affect Our Lives](#)

[References](#)



[Return to Coastal Currents: Waves](#)

The highest surface part of a wave is called the crest, and the lowest part is the trough. The vertical distance between the crest and the trough is the wave height. The horizontal distance between two adjacent crests or troughs is known as the wavelength.

Wave height is affected by wind speed, wind duration, or how long the wind blows, and fetch, which is the distance over water that the wind blows in a single direction. If wind speed is slow, only small waves result. If the wind speed is great but it only blows for a few minutes, no large waves will occur. Also, if strong winds blow for a long period of time but over a short fetch, no large waves form. Large waves occur only when all three factors combine (Duxbury, et al, 2002.)

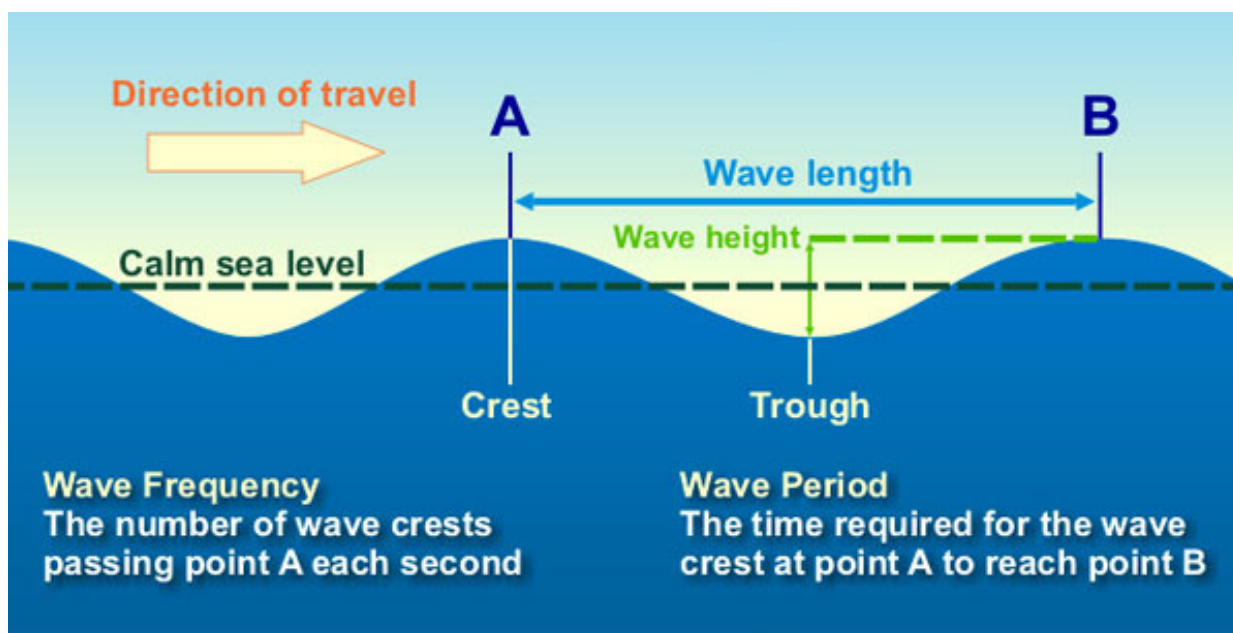

[\(top\)](#)





Currents

Coastal Currents [1](#) [2](#) [3](#) [4](#)



Longshore Currents

The speed at which waves approach the shore depends on sea floor and shoreline features and the depth of the water. As a wave moves toward the beach, different segments of the wave encounter the beach before others, which slows these segments down. As a result, the wave tends to bend and conform to the general shape of the coastline. Also, waves do not typically reach the beach perfectly parallel to the shoreline. Rather, they arrive at a slight angle, called the "angle of wave approach."

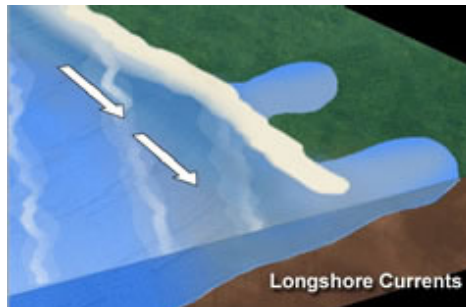

Longshore currents are generated when a "train" of waves reach the coastline and release bursts of energy.

When a wave reaches a beach or coastline, it releases a burst of energy that generates a current, which runs parallel to the shoreline. This type of current is called a "longshore current."

Discover: [How does an island disappear?](#)

Longshore currents are affected by the velocity and angle of a wave. When a wave breaks at a more acute (steep) angle on a beach, encounters a steeper beach slope, or is very high, longshore currents increase in velocity. Conversely, a wider breaking angle, gentler beach slope, and lower wave height slows a longshore current's velocity. In either case, the water in a longshore current flows up onto the beach, and back into the ocean, as it moves in a "sheet" formation.

As this sheet of water moves on and off the beach, it can "capture" and transport beach sediment back out to sea. This process, known as "longshore drift," can cause significant beach erosion.



Longshore drift can be very destructive to manmade structures. [Click the image to view a slideshow and learn more.](#)

This site NOAA

Tutorial

[Roadmap](#)

[Lesson Plans](#)

[Welcome](#)

[Tidal Currents](#)

[Coastal Currents](#)

[Surface Ocean Currents](#)

[The Global Conveyor Belt](#)

[How Are Currents Measured](#)

[How Currents Affect Our Lives](#)

[References](#)



[Return to Coastal Currents: Longshore Currents Page](#)

Barrier Islands

Longshore drift has a very powerful influence on the shape and composition of the coastline. It changes the slopes of beaches and creates long, narrow shoals of land called spits, that extend out from shore. Longshore drift may also create or destroy entire "barrier islands" along a shoreline. A barrier island is a long offshore deposit of sand situated parallel to the coast. As longshore drifts deposit, remove, and redeposit sand, barrier islands constantly change.

Tucker's Island, New Jersey, is a barrier island that clearly illustrates how longshore drift and strong weather affect these transient sand deposits. The island was first settled in 1735. Since its settlement, residents have had to move the island's lighthouse several times because the channels shifted constantly as a result of longshore drift. Eventually, they placed the lighthouse on high ground at the island's northern end.

Meanwhile, the inlet north of Tucker's Island—Beach Haven inlet—was also effected by longshore drift. At times, the inlet was narrow or nonexistent and Tucker's Island was attached to the nearby Long Beach Island. At other times, the inlet was wide, and Tucker's Island was separated from Long Beach Island.



In 1927, the lighthouse on Tucker's Island, NJ was destroyed when powerful longshore currents washed over 300 yards of the surrounding land out to sea.

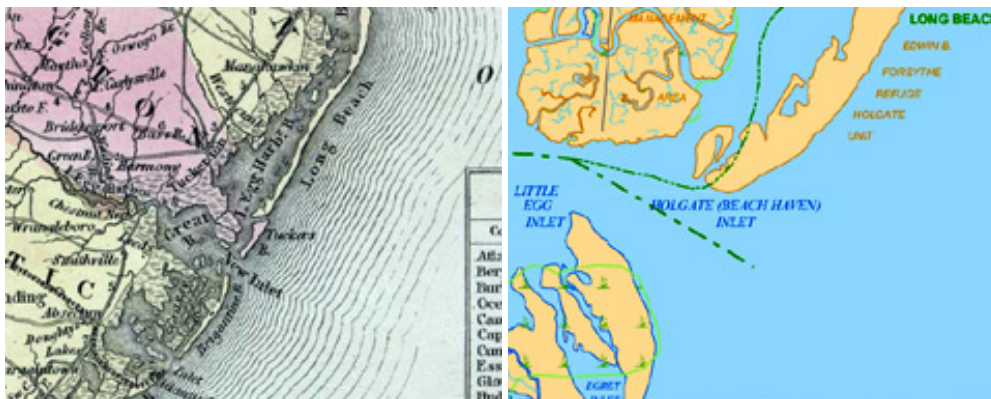

Powerful longshore currents causing longshore drift washed Tucker's Island away. Click the images to view a series of maps from 1856-2005 that show how Tucker's Island changed shape and eventually disappeared.

In 1924, in an effort to stop the beach erosion that was occurring on Tucker's Island, experts

installed jetties. They were initially successful in halting the erosion, but the jetties worked so well that the currents of Beach Haven inlet began to wash in the other direction—toward Tucker's Island. As the inlet began to widen, the island then began to erode very quickly. By 1927, just three years after the jetties were installed, waves and longshore drift washed away most of the beach. Later that year, the remaining 300 yards of beach were washed away in a series of storms. Then, in a final dramatic display, the lighthouse fell into the sea!

[\(top\)](#)

n o a a o c e a n s a n d c o a s t s

Revised May 02, 2007 | Questions, Comments? [Contact Us](#) | [Report Error On This Page](#) | [Disclaimer](#) | [User Survey](#)
[NOAA's National Ocean Service](#) | [National Oceanic and Atmospheric Administration](#) | [U.S. Department of Commerce](#)
http://oceanservice.noaa.gov/education/kits/currents/media/supp_cur03c.html
[Best viewed in Internet Explorer 5+ or Netscape 6+.](#)





Currents

Coastal Currents [1](#) [2](#) [3](#) [4](#)



Rip Currents

As longshore currents move on and off the beach, "rip currents" may form around low spots or breaks in sandbars, and also near structures such as jetties and piers. A rip current, sometimes incorrectly called a rip tide, is a localized current that flows away from the shoreline toward the ocean, perpendicular or at an acute angle to the shoreline. It usually breaks up not far from shore and is generally not more than 25 meters (80 feet) wide.

Rip currents typically reach speeds of 1 to 2 feet per second. However, some rip currents have been measured at 8 feet per second—faster than any Olympic swimmer ever recorded (NOAA, 2005b). If wave activity is slight, several low rip currents can form, in various sizes and velocities. But in heavier wave action, fewer, more concentrated rip currents can form.



These images of dangerous rip currents were taken at public swimming beaches. [Click the image to view a slideshow and learn more.](#)

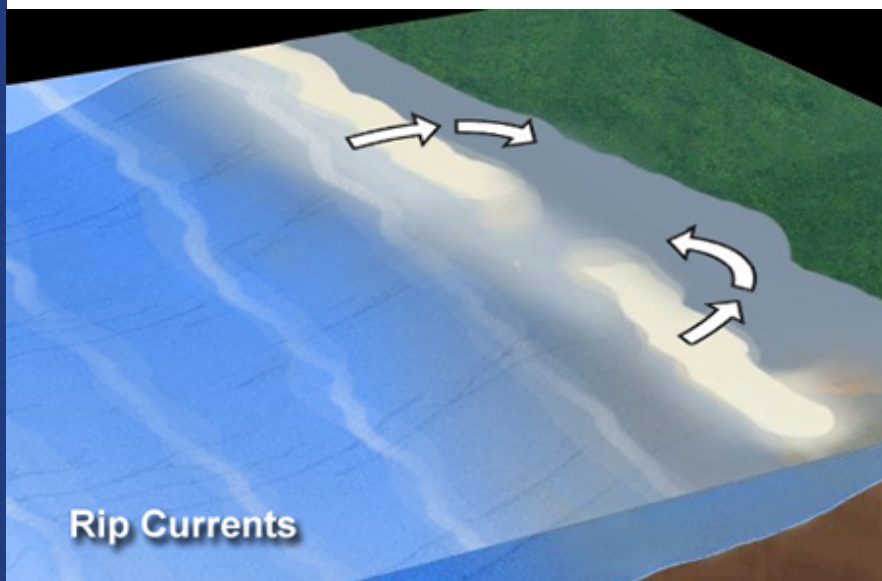

When waves travel from deep to shallow water, they break near the shoreline and generate currents. A rip current forms when a narrow, fast-moving section of water travels in an offshore direction. Rip current speeds as high as 8 feet per second have been measured—faster than an Olympic swimmer can sprint! This makes rip currents especially dangerous to beachgoers as these currents can sweep even the strongest swimmer out to sea.

[This site](#) [NOAA](#)

Tutorial

[Roadmap](#)

[Lesson Plans](#)

[Welcome](#)

[Tidal Currents](#)

[Coastal Currents](#)

[Surface Ocean Currents](#)

[The Global Conveyor Belt](#)

[How Are Currents Measured](#)

[How Currents Affect Our Lives](#)

[References](#)

Because rip currents move perpendicular to shore and can be very strong, beach swimmers need to be careful. A person caught in a rip can be swept away from shore very quickly. The best way to escape a rip current is by swimming parallel to the shore instead of towards it, since most rip currents are less than 80 feet wide. A swimmer can also let the current carry him or her out to sea until the force weakens, because rip currents stay close to shore and usually dissipate just beyond the line of breaking waves. Occasionally, however, a rip current can push someone hundreds of yards offshore. The most important thing to remember if you are ever caught in a rip current is not to panic. Continue to breathe, try to keep your head above water, and don't exhaust yourself fighting against the force of the current.

Back to 1 2 Continue 4



n o a a o c e a n s a n d c o a s t s

Revised May 02, 2007 | Questions, Comments? [Contact Us](#) | [Report Error On This Page](#) | [Disclaimer](#) | [User Survey](#)

[NOAA's National Ocean Service](#) | [National Oceanic and Atmospheric Administration](#) | [U.S. Department of Commerce](#)

<http://oceanservice.noaa.gov/education/kits/currents/03coastal3.html>

Best viewed in [Internet Explorer 5+](#) or [Netscape 6+](#).



[Return to Coastal Currents: Rip Currents](#)

These images of rip currents were taken at public swimming beaches. Rip currents are powerful, channeled currents that flow away from shore and can occur at any beach with breaking waves. Rip currents can be killers and account for over 80% of rescues performed by surf beach lifeguards.

The greatest precaution that you can take is to recognize the danger of rip currents and only swim at beaches with lifeguards on duty. If you get caught in a rip current, never fight against it. Remain calm to conserve your energy. Think of the rip current like a treadmill that can't be turned off, and which you need to step to the side of the treadmill to get off. To escape a rip current, swim in a direction parallel to the shoreline. When out of the current, swim at an angle--away from the current--towards shore. If you can't swim out of the rip current, float or calmly tread water. When out of the current, swim towards shore. For more information go to the NOAA Rip Current Safety Web site:

<http://www.ripcurrents.noaa.gov>.



[\(top\)](#)



Currents

Coastal Currents [1](#) [2](#) [3](#) [4](#)



Upwelling

Winds blowing across the ocean surface often push water away from an area. When this occurs, water rises up from beneath the surface to replace the diverging surface water. This process is known as "upwelling."

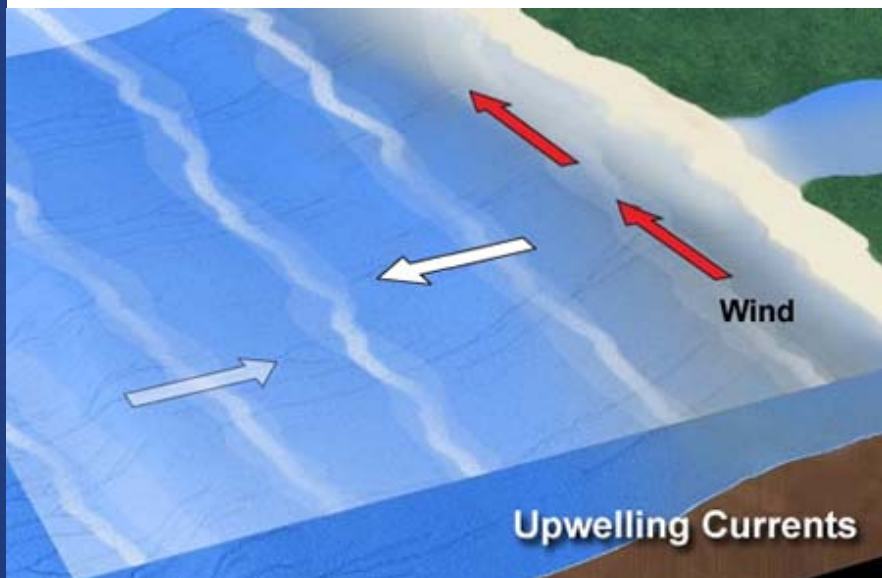

Upwelling occurs when winds blowing across the ocean surface push water away from an area and subsurface water rises up to replace the diverging surface water.

Upwelling occurs in the open ocean and along coastlines. The reverse process, called downwelling, also occurs when wind causes surface water to build up along a coastline. The surface water eventually sinks toward the bottom.

Subsurface water that rises to the surface as a result of upwelling is typically colder, rich in nutrients, and biologically productive. Therefore, good fishing grounds typically are found where upwelling is common. For example, the rich fishing grounds along the west coasts of Africa and South America are supported by year-round coastal upwelling.

Seasonal upwelling and downwelling also occur along the West Coast of the United States. In winter, winds blow from the south to the north, resulting in downwelling. During the summer, winds blow from the north to the south, and water moves offshore, resulting in upwelling along the coast. This summer upwelling produces cold coastal waters in

This site [NOAA](#)

Tutorial

[Roadmap](#)

[Lesson Plans](#)

[Welcome](#)

[Tidal Currents](#)

[Coastal Currents](#)

[Surface Ocean Currents](#)

[The Global Conveyor Belt](#)

[How Are Currents Measured](#)

[How Currents Affect Our Lives](#)

[References](#)

the San Francisco area, contributing to the frequent summer fogs. (Duxbury, et al, 2002.)

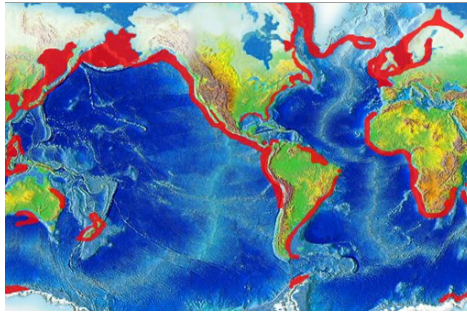

Major upwelling areas along the world's coasts are highlighted in red. *Click the image for a larger view.*

Back to [1](#) [2](#) [3](#)

◀ (top) ▶

n o a a o c e a n s a n d c o a s t s

Revised May 02, 2007 | [Questions, Comments? Contact Us](#) | [Report Error On This Page](#) | [Disclaimer](#) | [User Survey](#)

[NOAA's National Ocean Service](#) | [National Oceanic and Atmospheric Administration](#) | [U.S. Department of Commerce](#)

<http://oceanservice.noaa.gov/education/kits/currents/03coastal4.html>

Best viewed in [Internet Explorer 5+](#) or [Netscape 6+](#).



[Return to Coastal Currents: Rip Currents: Upwelling](#)

This image highlights major upwelling areas along the world's coasts in red. Upwelling occurs when winds blowing across the ocean surface push water away from an area and subsurface water rises up from beneath the surface to replace the diverging surface water. These subsurface waters are typically colder, rich in nutrients, and biologically productive. Therefore, good fishing grounds typically are found where upwelling is common. For example, the rich fishing grounds along the west coasts of Africa and South America are supported by year-round coastal upwelling.

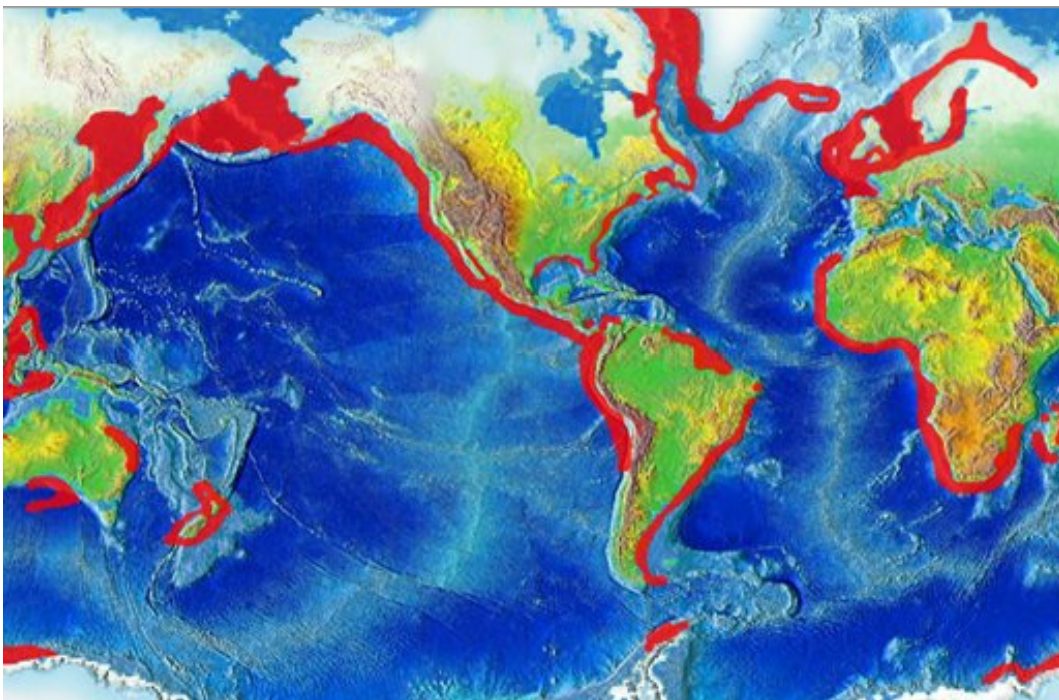
[\(top\)](#)*n o a a o c e a n s a n d c o a s t s*

Revised May 02, 2007 | Questions, Comments? [Contact Us](#) | [Report Error On This Page](#) | [Disclaimer](#) | [User Survey](#)
[NOAA's National Ocean Service](#) | [National Oceanic and Atmospheric Administration](#) | [U.S. Department of Commerce](#)
http://oceanservice.noaa.gov/education/kits/currents/media/supp_cur04a.html
Best viewed in Internet Explorer 5+ or Netscape 6+.





Currents

Surface Ocean Currents 1 2 3 4

Coastal currents are affected by local winds. Surface ocean currents, which occur on the open ocean, are driven by a complex global wind system. To understand the effects of winds on ocean currents, one first needs to understand the Coriolis force and the Ekman spiral.

Coriolis Effect

If the Earth did not rotate and remained stationary, the atmosphere would circulate between the poles (high pressure areas) and the equator (a low pressure area) in a simple back-and-forth pattern. But because the Earth rotates, circulating air is deflected. Instead of circulating in a straight pattern, the air deflects toward the right in the Northern Hemisphere and toward the left in the Southern Hemisphere, resulting in curved paths. This deflection is called the Coriolis effect. It is named after the French mathematician Gaspard Gustave de Coriolis (1792-1843), who studied the transfer of energy in rotating systems like waterwheels. (Ross, 1995).

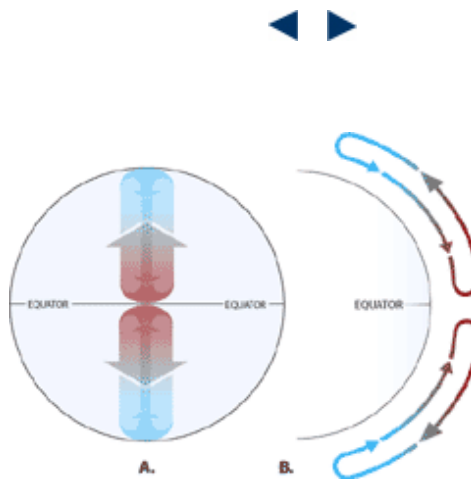

If the Earth did not rotate on its axis, the atmosphere would only circulate between the poles and the equator in a simple back-and-forth pattern. *Click the image for a larger view.*

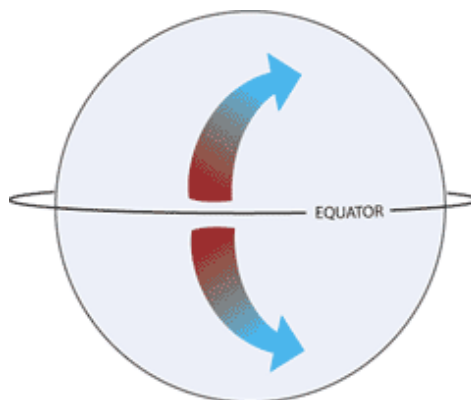

Because the Earth rotates on its axis, circulating air is deflected toward the right in the Northern Hemisphere and toward the left in the Southern Hemisphere. This deflection is called the Coriolis effect. *Click the image for a larger view.*

Continue to 2 3 4



This site NOAA

Tutorial

[Roadmap](#)

[Lesson Plans](#)

[Welcome](#)

[Tidal Currents](#)

[Coastal Currents](#)

[Surface Ocean Currents](#)

[The Global Conveyor Belt](#)

[How Are Currents Measured](#)

[How Currents Affect Our Lives](#)

[References](#)



[Return to Currents: Surface Ocean Currents: Coriolis Effect](#)

If the Earth did not rotate on its axis and remained stationary, the atmosphere would only circulate between the Earth's polar regions (areas of high pressure) and the equator (a low pressure area) in a simple back-and-forth pattern. Image B shows a "cutaway" view of this hypothetical circulation pattern.

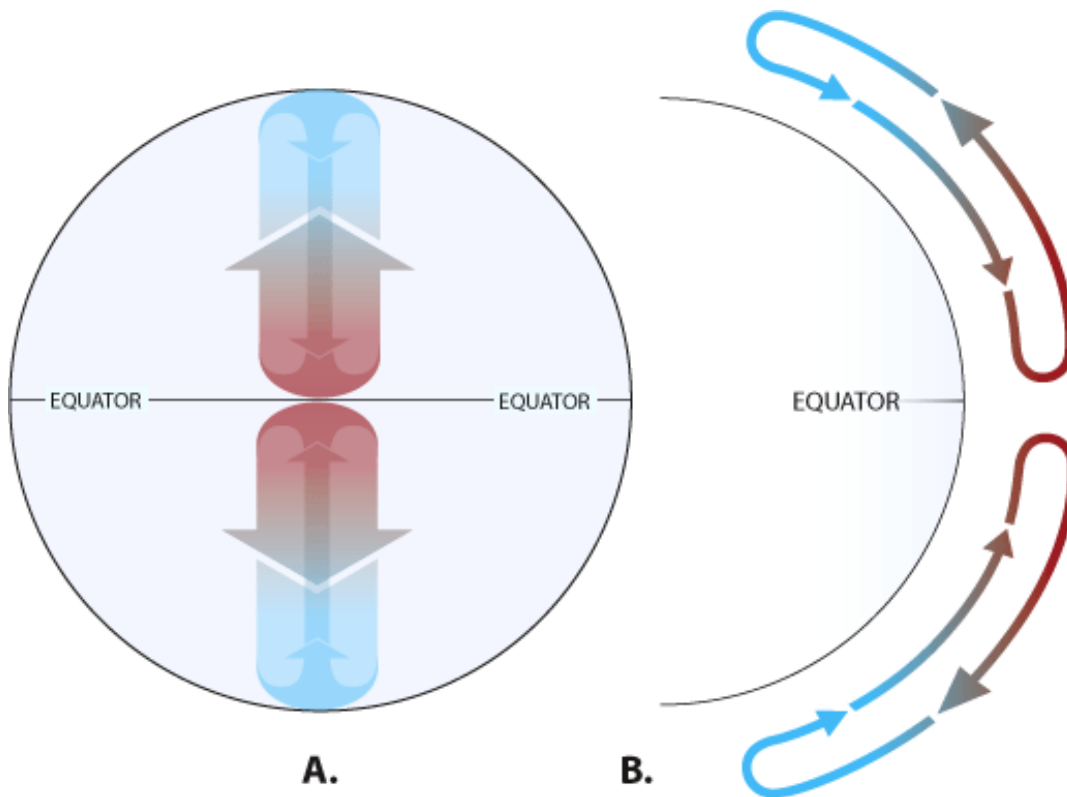

[\(top\)](#)





[Return to Currents: Surface Ocean Currents: Coriolis Effect](#)

Coriolis Effect

The rotation of the Earth on its axis deflects the atmosphere toward the right in the Northern Hemisphere and toward the left in the Southern Hemisphere, resulting in curved paths. The deflection of the atmosphere sets up the complex global wind patterns which drive surface ocean currents. This deflection is called the Coriolis effect. It is named after the French mathematician Gaspard Gustave de Coriolis (1792-1843), who studied the transfer of energy in rotating systems like waterwheels. (Ross, 1995).

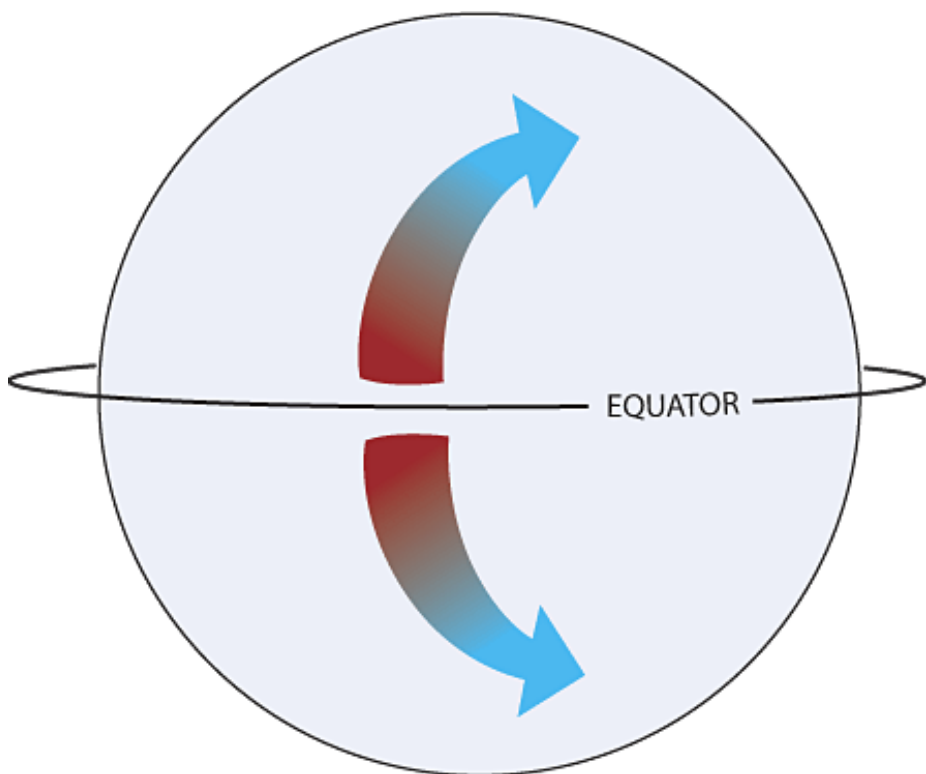

[\(top\)](#)





Currents

Surface Ocean Currents [1](#) [2](#) [3](#) [4](#)

Trade Winds

In the Northern Hemisphere, warm air around the equator rises and flows north toward the pole. As the air moves away from the equator, the Coriolis effect deflects it toward the right. It cools and descends near 30 degrees North latitude. The descending air blows from the northeast to the southwest, back toward the equator (Ross, 1995). A similar wind pattern occurs in the Southern Hemisphere; these winds blow from the southeast toward the northwest and descend near 30 degrees South latitude.

These prevailing winds, known as the trade winds, meet at the Intertropical Convergence Zone (also called the doldrums) between 5 degrees North and 5 degrees South latitude, where the winds are calm. The remaining air (air that does not descend at 30 degrees North or South latitude) continues toward the poles and is known as the westerly winds, or westerlies. The trade winds are so named because ships have historically taken advantage of them to aid their journeys between Europe and the Americas (Bowditch, 1995).

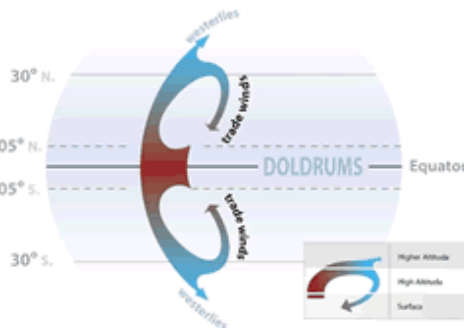

Atmospheric circulation and the Coriolis effect create global wind patterns including the trade winds and westerlies. *Click the image for a larger view.*

[Back to 1](#) [Continue to 3](#) [4](#)

[\(top\)](#)

This site NOAA

Tutorial

[Roadmap](#)

[Lesson Plans](#)

[Welcome](#)

[Tidal Currents](#)

[Coastal Currents](#)

[Surface Ocean Currents](#)

[The Global Conveyor Belt](#)

[How Are Currents Measured](#)

[How Currents Affect Our Lives](#)

[References](#)



[Return to Currents: Surface Ocean Currents: Trade Winds](#)

Trade Winds

Atmospheric circulation and the Coriolis effect create global wind patterns including the trade winds and westerlies.

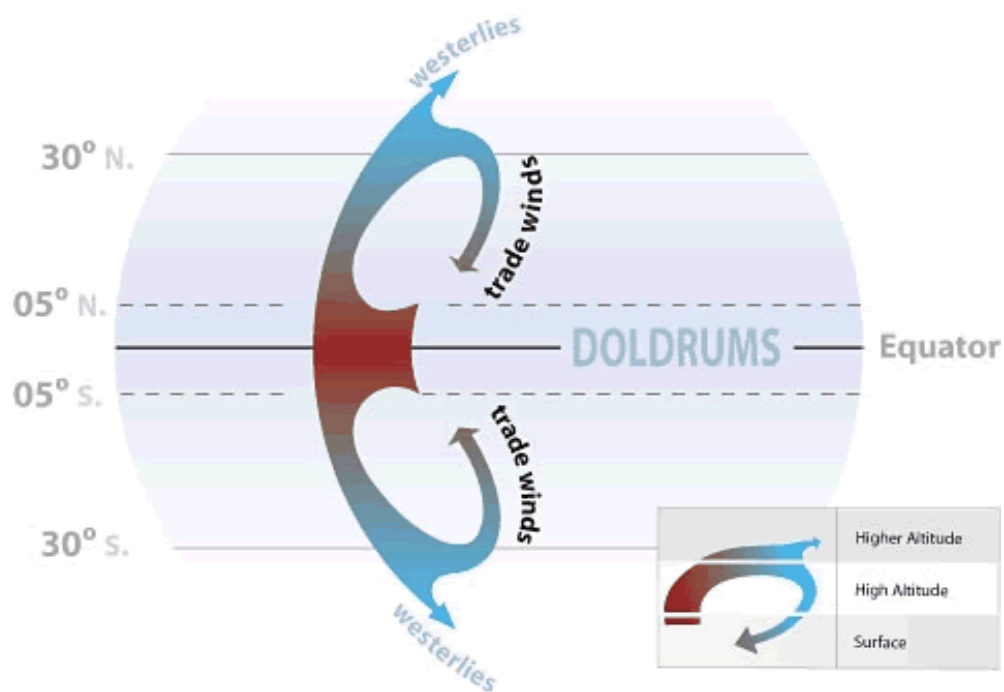

[\(top\)](#)





Currents

Surface Ocean Currents [1](#) [2](#) [3](#) [4](#)



Winds Drive Surface Ocean Currents

Global winds drag on the water's surface, causing it to move and build up in the direction that the wind is blowing. And just as the Coriolis effect deflects winds to the right in the Northern Hemisphere and to the left in the Southern Hemisphere, it also results in the deflection of major surface ocean currents to the right in the Northern Hemisphere (in a clockwise spiral) and to the left in the Southern Hemisphere (in a counter-clockwise spiral). These major spirals of ocean-circling currents are called "gyres" and occur north and south of the equator. They do not occur at the equator, where the Coriolis effect is not present (Ross, 1995).

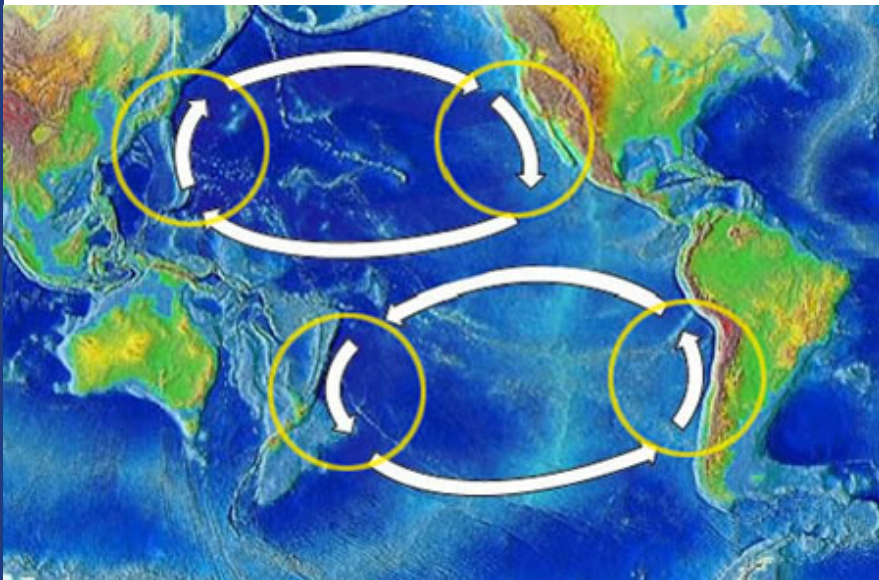

There are five major ocean-wide gyres—the North Atlantic, South Atlantic, North Pacific, South Pacific, and Indian Ocean gyres. Each is flanked by a strong and narrow "western boundary current," and a weak and broad "eastern boundary current" (Ross, 1995).

One particularly powerful western boundary current is the Gulf Stream. The Gulf Stream, paired with the eastern boundary Canary Current, flanks the North Atlantic gyre. The Gulf Stream, also called the North Atlantic Drift, originates in the Gulf of Mexico, exits through the Strait of Florida, and follows the eastern coastline of the United States and Newfoundland. It travels at speeds of 25 to 75 miles per day at about one to three knots (1.15-3.45 miles per hour or 1.85-5.55 kilometers per hour). It influences the climate of the east coast of Florida, keeping temperatures warmer in the winter and cooler than the other southeastern states in the summer.

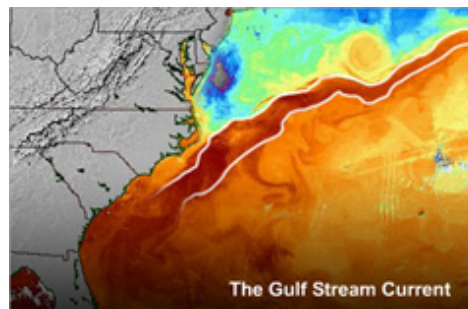

This site NOAA

Tutorial

[Roadmap](#)

[Lesson Plans](#)

[Welcome](#)

[Tidal Currents](#)

Coastal Currents

[Surface Ocean Currents](#)

[The Global Conveyor Belt](#)

[How Are Currents Measured](#)

[How Currents Affect Our Lives](#)

[References](#)

Since it also extends toward Europe, it warms western European countries as well.

The Gulf Stream is a powerful western boundary current in the North Atlantic Ocean that strongly influences the climate of the East Coast of the United States and many Western European countries. *Click the image for a larger view.*

Back to 1 2 Continue to 4

◀ (top) ▶

n o a a o c e a n s a n d c o a s t s

Revised May 02, 2007 | [Questions, Comments? Contact Us](#) | [Report Error On This Page](#) | [Disclaimer](#) | [User Survey](#)

[NOAA's National Ocean Service](#) | [National Oceanic and Atmospheric Administration](#) | [U.S. Department of Commerce](#)

<http://oceanservice.noaa.gov/education/kits/currents/05currents3.html>

Best viewed in [Internet Explorer 5+](#) or [Netscape 6+](#).





[Return to Currents: Surface Ocean Currents: Winds Drive Surface Ocean Currents](#)

The Gulf Stream Current

The Gulf Stream is a powerful western boundary current in the North Atlantic. Originating in the Gulf of Mexico, waters in the Gulf Stream travel at speeds of about one to three knots (1.15-3.45 miles per hour or 1.85-5.55 kilometers per hour). The Gulf Stream influences the climate of the east coast of Florida, keeping temperatures warmer in the winter and cooler than the other southeastern states in the summer. Since it also extends toward Europe, it warms western European countries as well.

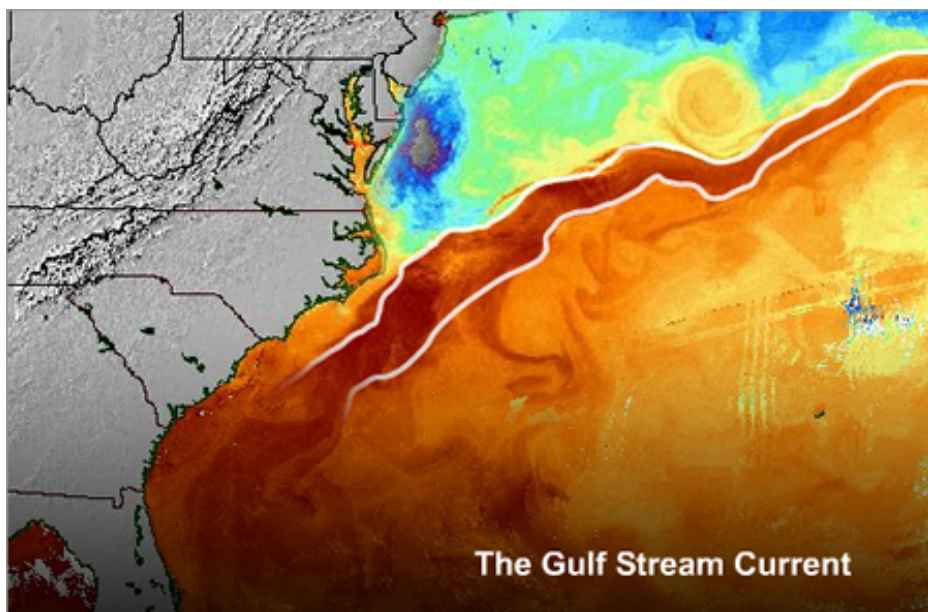

[\(top\)](#)





Currents

Surface Ocean Currents [1](#) [2](#) [3](#) [4](#)



Ekman spiral

The Ekman spiral, named after Swedish scientist Vagn Walfrid Ekman (1874-1954) who first theorized it in 1902, is a consequence of the Coriolis effect. When surface water molecules move by the force of the wind, they, in turn, drag deeper layers of water molecules below them. Each layer of water molecules is moved by friction from the shallower layer, and each deeper layer moves more slowly than the layer above it, until the movement ceases at a depth of about 100 meters (330 feet). Like the surface water, however, the deeper water is deflected by the Coriolis effect—to the right in the Northern Hemisphere and to the left in the Southern Hemisphere. As a result, each successively deeper layer of water moves more slowly to the right or left, creating a spiral effect. Because the deeper layers of water move more slowly than the shallower layers, they tend to “twist around” and flow opposite to the surface current.

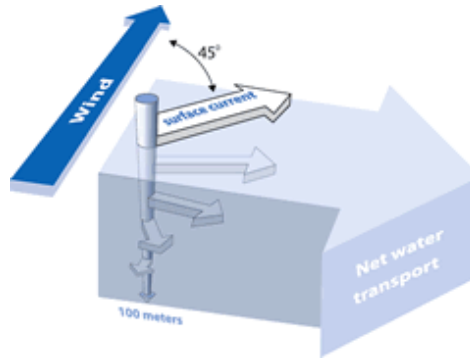

The Ekman spiral occurs as a consequence of the Coriolis effect. *Click the image for a larger view.*

[Back to \[1\]\(#\) \[2\]\(#\) \[3\]\(#\) \[4\]\(#\)](#)



This site NOAA

Tutorial

[Roadmap](#)

[Lesson Plans](#)

[Welcome](#)

[Tidal Currents](#)

[Coastal Currents](#)

[Surface Ocean Currents](#)

[The Global Conveyor Belt](#)

[How Are Currents Measured](#)

[How Currents Affect Our Lives](#)

[References](#)



[Return to Currents: Surface Ocean Currents: Ekman spiral](#)

Ekman spiral

The Ekman spiral occurs as a consequence of the Coriolis effect. When surface water molecules are moved by the wind, they drag deeper layers of water molecules below them. Like surface water, the deeper water is deflected by the Coriolis effect—to the right in the Northern Hemisphere and to the left in the Southern Hemisphere. As a result, each successively deeper layer of water moves more slowly to the right or left, creating a spiral effect.

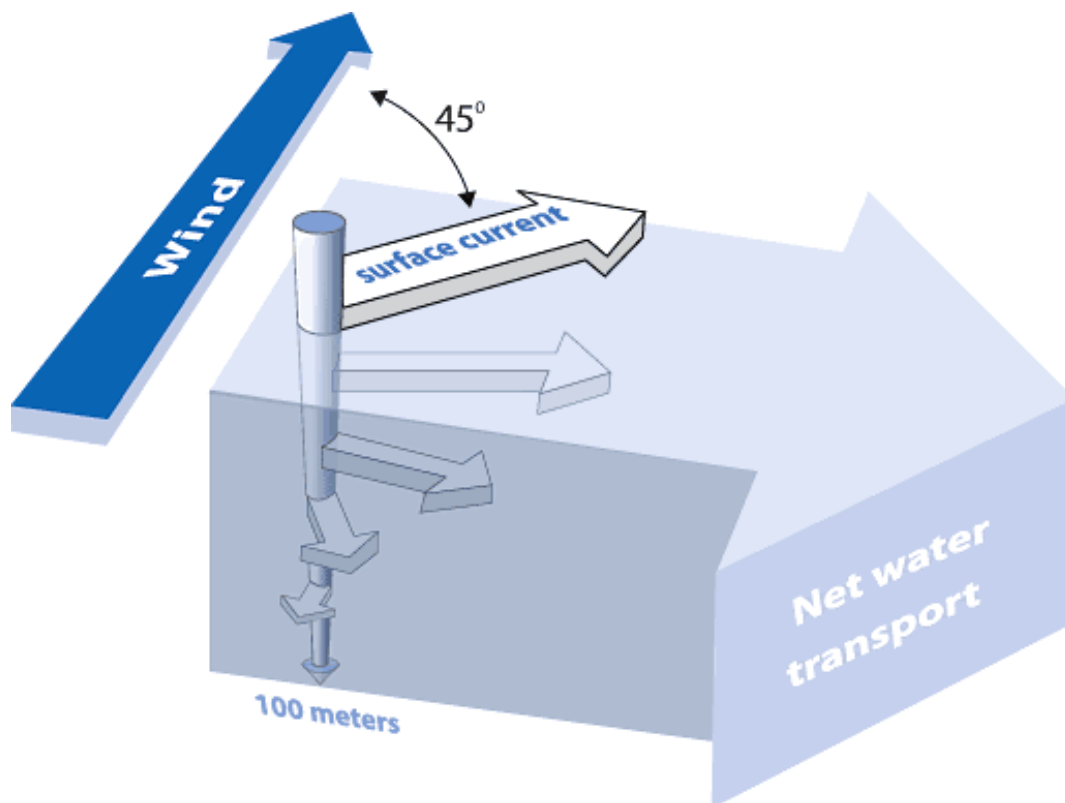

[\(top\)](#)





Currents

The Global Conveyor Belt 1 [2](#) [3](#)



Winds drive ocean currents in the upper 100 meters of the ocean's surface. However, ocean currents also flow thousands of meters below the surface. These deep-ocean currents are driven by differences in the water's density, which is controlled by temperature (*thermo*) and salinity (*haline*). This process is known as thermohaline circulation.

In the Earth's polar regions ocean water gets very cold, forming sea ice. As a consequence the surrounding seawater gets saltier, because when sea ice forms, the salt is left behind. As the seawater gets saltier, its density increases, and it starts to sink. Surface water is pulled in to replace the sinking water, which in turn eventually becomes cold and salty enough to sink. This initiates the deep-ocean currents driving the global conveyor belt.

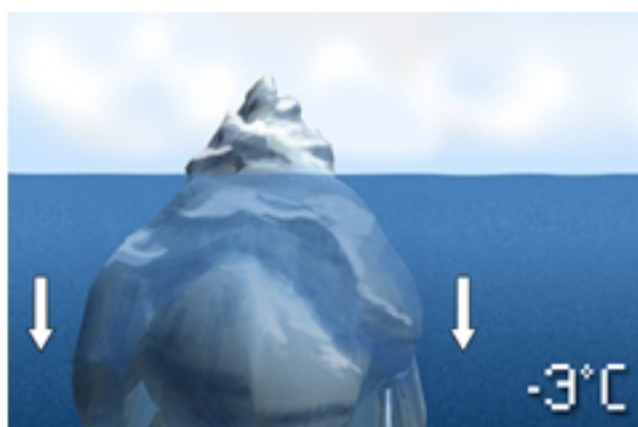

Thermohaline circulation begins in the Earth's polar regions. When ocean water in these areas gets very cold, sea ice forms. The surrounding seawater gets saltier, increases in density and sinks.

Continue to [2](#) [3](#)

 search

 This site NOAA

Tutorial

[Roadmap](#)[Lesson Plans](#)[Welcome](#)[Tidal Currents](#)[Coastal Currents](#)[Surface Ocean Currents](#)[The Global Conveyor Belt](#)[How Are Currents Measured](#)[How Currents Affect Our Lives](#)[References](#)



Currents

The Global Conveyor Belt [1](#) [2](#) [3](#)

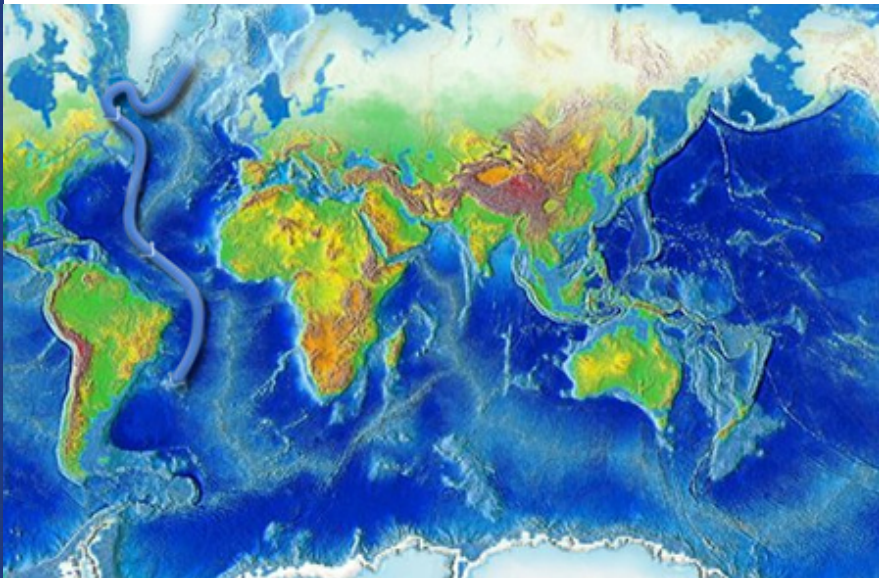

This animation shows the path of the global conveyor belt. The blue arrows indicate the path of deep, cold, dense water currents. The red arrows indicate the path of warmer, less dense surface waters. It is estimated that it can take 1,000 years for a "parcel" of water to complete the journey along the global conveyor belt.

Thermohaline circulation drives a global-scale system of currents called the "global conveyor belt." The conveyor belt begins on the surface of the ocean near the pole in the North Atlantic. Here, the water is chilled by arctic temperatures. It also gets saltier because when sea ice forms, the salt does not freeze and is left behind in the surrounding water. The cold water is now more dense, due to the added salts, and sinks toward the ocean bottom. Surface water moves in to replace the sinking water, thus creating a current.

This deep water moves south, between the continents, past the equator, and down to the ends of Africa and South America. The current travels around the edge of Antarctica, where the water cools and sinks again, as it does in the North Atlantic. Thus, the conveyor belt gets "recharged." As it moves around Antarctica, two sections split off the conveyor and turn northward. One section moves into the Indian Ocean, the other into the Pacific Ocean.

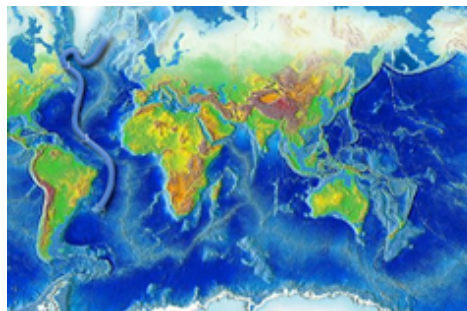

Cold, salty, dense water sinks at the Earth's northern polar region and heads south along the western Atlantic basin.

[This site](#) [NOAA](#)

Tutorial

[Roadmap](#)

[Lesson Plans](#)

[Welcome](#)

[Tidal Currents](#)

[Coastal Currents](#)

[Surface Ocean Currents](#)

[The Global Conveyor Belt](#)

[How Are Currents Measured](#)

[How Currents Affect Our Lives](#)

[References](#)

These two sections that split off warm up and become less dense as they travel northward toward the equator, so that they rise to the surface (upwelling). They then loop back southward and westward to the South Atlantic, eventually returning to the North Atlantic, where the cycle begins again.

The conveyor belt moves at much slower speeds (a few centimeters per second) than wind-driven or tidal currents (tens to hundreds of centimeters per second). It is estimated that any given cubic meter of water takes about 1,000 years to complete the journey along the global conveyor belt. In addition, the conveyor moves an immense volume of water—more than 100 times the flow of the Amazon River (Ross, 1995).

The conveyor belt is also a vital component of the global ocean nutrient and carbon dioxide cycles. Warm surface waters are depleted of nutrients and carbon dioxide, but they are enriched again as they travel through the conveyor belt as deep or bottom layers. The base of the world's food chain depends on the cool, nutrient-rich waters that support the growth of algae and seaweed.

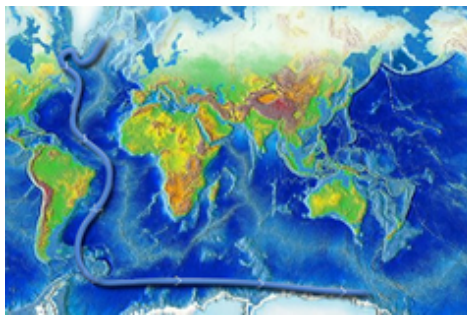

The current is "recharged" as it travels along the coast of Antarctica and picks up more cold, salty, dense water.

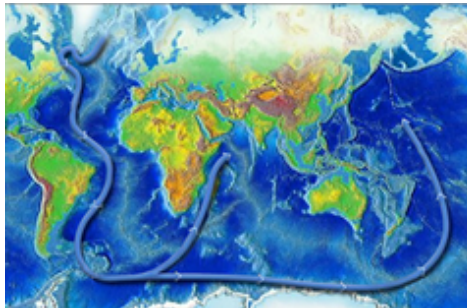

The main current splits into two sections, one traveling northward into the Indian Ocean, while the other heads up into the western Pacific.

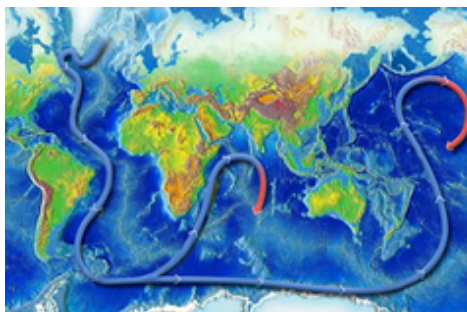

The two branches of the current warm and rise as they travel northward, then loop back around southward and westward.



The now-warmed surface waters continue circulating around the globe. They eventually return to the North Atlantic where the cycle begins again.



Currents

The Global Conveyor Belt [1](#) [2](#) [3](#)



The global conveyor belt is a strong, but easily disrupted process. Research suggests that the conveyor belt may be affected by climate change. If global warming results in increased rainfall in the North Atlantic, and the melting of glaciers and sea ice, the influx of warm freshwater onto the sea surface could block the formation of sea ice, disrupting the sinking of cold, salty water. This sequence of events could slow or even stop the conveyor belt, which could result in potentially drastic temperature changes in Europe.



Global climate change could disrupt the global conveyor belt, causing potentially drastic temperature changes in Europe and even worldwide.

[Back to \[1\]\(#\) \[2\]\(#\)](#)

[\(top\)](#)

This site NOAA

Tutorial

[Roadmap](#)

[Lesson Plans](#)

[Welcome](#)

[Tidal Currents](#)

[Coastal Currents](#)

[Surface Ocean Currents](#)

[The Global Conveyor Belt](#)

[How Are Currents Measured](#)

[How Currents Affect Our Lives](#)

[References](#)



Currents

How Are Currents Measured? 1 2 3 4 5 6



Since the age of exploration, mariners have needed to know the speed and direction (velocity) of ocean currents to steer their ships within harbors and along trade and exploration routes. A mariner needs to be able to measure the velocity of currents by observing distance, time, and direction.

The simplest method of determining the velocity of a current involves an observer, a floating object or drifter, and a timing device. The observer stands on an anchored ship with a timer. He or she then places the drifter (such as a piece of wood) into the water and measures the amount of time the drifter takes to move along the length of the ship. He or she then stops the timer after the object has traveled some distance, and measures that distance, noting the direction in which the object moved.

The observer then divides the distance the object traveled by the time it took the object to travel that distance, which equals the speed of the current. By combining the speed of the object with the direction in which it moved, the observer can then determine the current's velocity. Ocean currents typically are measured in knots.

Although they still follow the same essential concept to measure ocean currents, mariners today use more accurate and sophisticated instruments. Today, drifters are often elaborate buoys equipped with multiple oceanographic instruments. Some are equipped with global positioning system technology and satellite communications to relay their position in the ocean back to observers on land. Other drifters submerge for long periods of time to measure the ocean currents at depth. The drifter occasionally rises to the surface to send a signal that relays its position.

All drifter measurements are termed "Lagrangian measurements," named after mathematician Joseph Louis Lagrange (1736-1813), who first described the path followed by fluids. But current velocities



An oceanographer deploys a current meter in the 1920s while working in Alaska.



Joseph Louis Lagrange (1736-1813) was the first mathematician to describe the path followed by fluids. To this day, all drifter buoy measurements are referred to as "Lagrangian measurements."

This site NOAA

Tutorial

[Roadmap](#)

[Lesson Plans](#)

[Welcome](#)

[Tidal Currents](#)

[Coastal Currents](#)

[Surface Ocean Currents](#)

[The Global Conveyor Belt](#)

[How Are Currents Measured](#)

[How Currents Affect Our Lives](#)

[References](#)

can be measured another way as well—using “Eulerian measurements.” Named after Swiss mathematician Leonhard Euler (1707-1783), Eulerian measurements involve describing fluid flow by measuring the speed and direction of the fluid at one point only. In this method, an instrument is anchored in the ocean at a given location, and the water movement is measured as it flows past the instrument.

Measuring currents by Eulerian methods is becoming increasingly more common. One reason is that it is easier to retrieve these expensive but stationary instruments than it is to locate floating drifters.

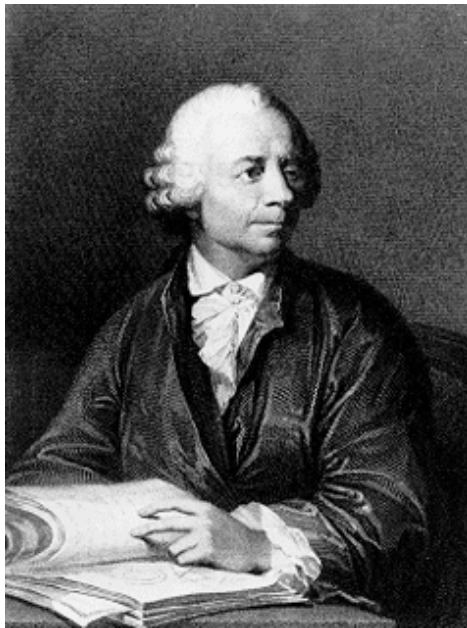

Leonhard Euler (1707-1783) was the first mathematician to describe the speed and direction of a liquid's flow as it passes a single point in space.

Continue to [2](#) [3](#) [4](#) [5](#) [6](#)



n o a a o c e a n s a n d c o a s t s

Revised May 02, 2007 | [Questions, Comments? Contact Us](#) | [Report Error On This Page](#) | [Disclaimer](#) | [User Survey](#)

[NOAA's National Ocean Service](#) | [National Oceanic and Atmospheric Administration](#) | [U.S. Department of Commerce](#)

<http://oceanservice.noaa.gov/education/kits/currents/07measure1.html>

Best viewed in [Internet Explorer 5+](#) or [Netscape 6+](#).





Currents

How Are Currents Measured? [1](#) [2](#) [3](#) [4](#) [5](#) [6](#)



What is a "knot"?

The term "knot", in reference to currents, is defined as one nautical mile per hour and is used to measure speed. A nautical mile is slightly more than a standard mile.

1 nautical mile = 1.15 miles = 1.85 kilometers
 1 knot = 1.15 miles per hour = 1.85 kilometers per hour
 1 knot = 20.251969 feet per second = 51.44 centimeters per second

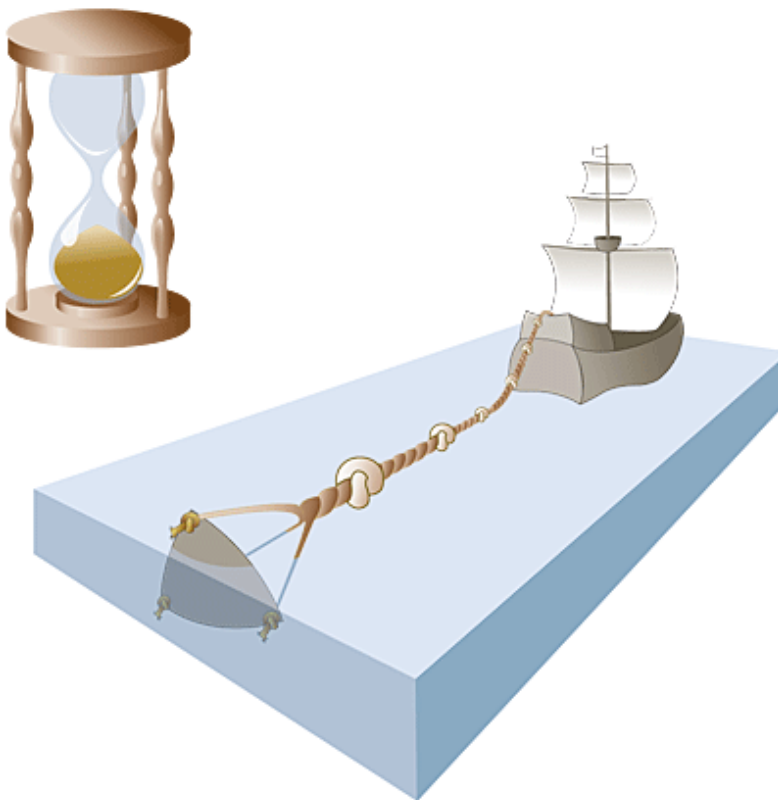

The term knot dates from the 17th Century, when sailors measured the speed of their ship by the use of a device called a "common log." This device was a coil of rope with uniformly spaced knots tied in it, attached to a piece of wood shaped like a slice of pie. The piece of wood was lowered from the back of the ship and allowed to float behind it. The line was allowed to pay out freely from the coil as the piece of wood fell behind the ship for a specific amount of time. When the specified time had passed, the line was pulled in and the number of knots on the rope between the ship and the wood were counted. The speed of the ship was said to be the number of knots counted (Bowditch, 1984).

This site NOAA

Tutorial

[Roadmap](#)

[Lesson Plans](#)

[Welcome](#)

[Tidal Currents](#)

[Coastal Currents](#)

[Surface Ocean Currents](#)

[The Global Conveyor Belt](#)

[How Are Currents Measured](#)

[How Currents Affect Our Lives](#)

[References](#)



Currents

Tidal Currents 1 [2](#)



Tidal currents occur in conjunction with the rise and fall of the tide. The vertical motion of the tides near the shore causes the water to move horizontally, creating currents. When a tidal current moves toward the land and away from the sea, it "floods." When it moves toward the sea away from the land, it "ebbs." These tidal currents that ebb and flood in opposite directions are called "rectilinear" or "reversing" currents.

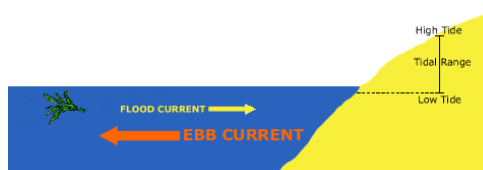

As the tides rise and fall, they create flood and ebb currents. *Click the image for a larger view.*

Rectilinear tidal currents, which typically are found in coastal rivers and estuaries, experience a "slack water" period of no velocity as they move from the ebbing to flooding stage, and vice versa. After a brief slack period, which can range from seconds to several minutes and generally coincides with high or low tide, the current switches direction and increases in velocity.

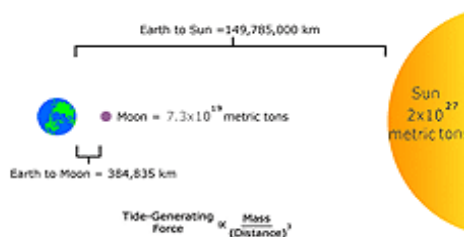

The relationship between the masses of the Earth, moon, and sun and their distances to each other play critical roles in affecting tides and the currents they produce. *Click the image for a larger view.*

Tidal currents are the only type of current affected by the interactions of the Earth, sun, and moon. The moon's force is much greater than that of the sun because it is 389 times closer to the Earth than the sun is. Tidal currents, just like tides, are affected by the different phases of the moon. When the moon is at full or new phases, tidal current velocities are strong and are called "spring currents." When the moon is at first or third quarter phases, tidal current velocities are weak and are called "neap currents."

[Continue \[2\]\(#\)](#)



This site NOAA

Tutorial

[Roadmap](#)

[Lesson Plans](#)

[Welcome](#)

[Tidal Currents](#)

[Coastal Currents](#)

[Surface Ocean Currents](#)

[The Global Conveyor Belt](#)

[How Are Currents Measured](#)

[How Currents Affect Our Lives](#)

[References](#)



Currents

How Are Currents Measured? [1](#) [2](#) [3](#) [4](#) [5](#) [6](#)



This site NOAA

Shallow Water Drifter

A Davis drifter is an instrument designed to measure wind-driven surface currents. It has four major components: (1) body, (2) sails, (3) floats, and (4) a data collection/transmitter package. The body, which is a waterproof tube about 3 feet long and 10 inches wide, holds the collection/transmitter package. The sails extend out from the body as four pairs of cloth or vinyl "arms" with about 3 square feet of total sail area. The sails move the drifter along with the prevailing currents. The four floats are attached by ropes to the body of the drifter, keeping it suspended a few feet beneath the surface so that the drifter is not directly affected by the wind or waves.

The drifter's transmitter sends signals to a polar orbiting satellite that calculates its position and relays this information to a receiving station. A typical drifter will transmit data for about one year before its power supply expires.

Tutorial

[Roadmap](#)

[Lesson Plans](#)

[Welcome](#)

[Tidal Currents](#)

[Coastal Currents](#)

[Surface Ocean Currents](#)

[The Global Conveyor Belt](#)

[How Are Currents Measured](#)

[How Currents Affect Our Lives](#)

[References](#)

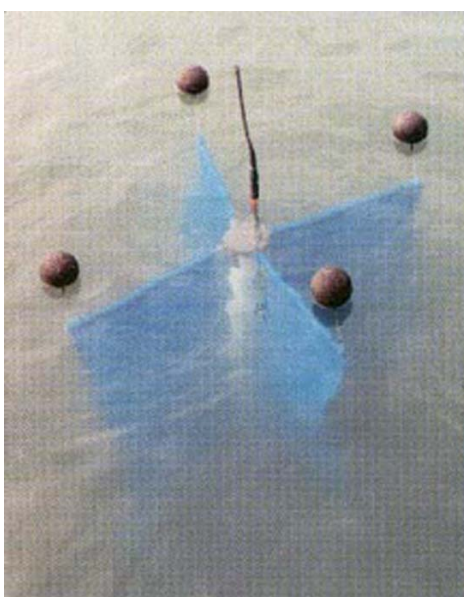
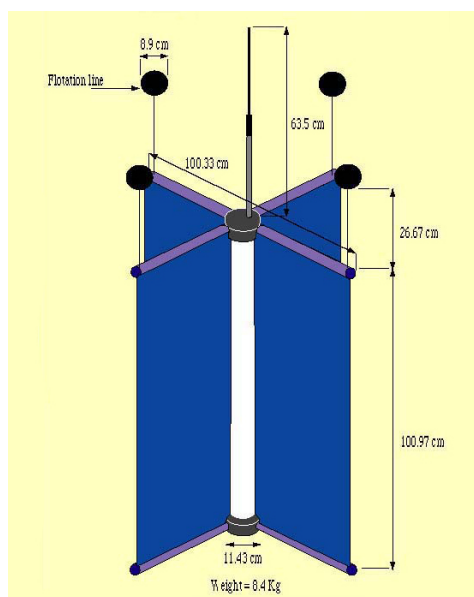

The image on the left is a schematic diagram of a shallow water Davis drifter. The image on the right shows an actual Davis drifter after it is deployed in the water. *Click on the images for a larger view.*

Back to [1](#) [2](#) Continue to [4](#) [5](#) [6](#)





[Return to Currents: How Are Currents Measured?](#)

Shallow Water or Davis Drifter

These are larger images of a shallow water Davis Drifter. The image on the top shows an actual Davis drifter after it is deployed in the water. Scroll down to see a detailed schematic diagram of the same drifter.



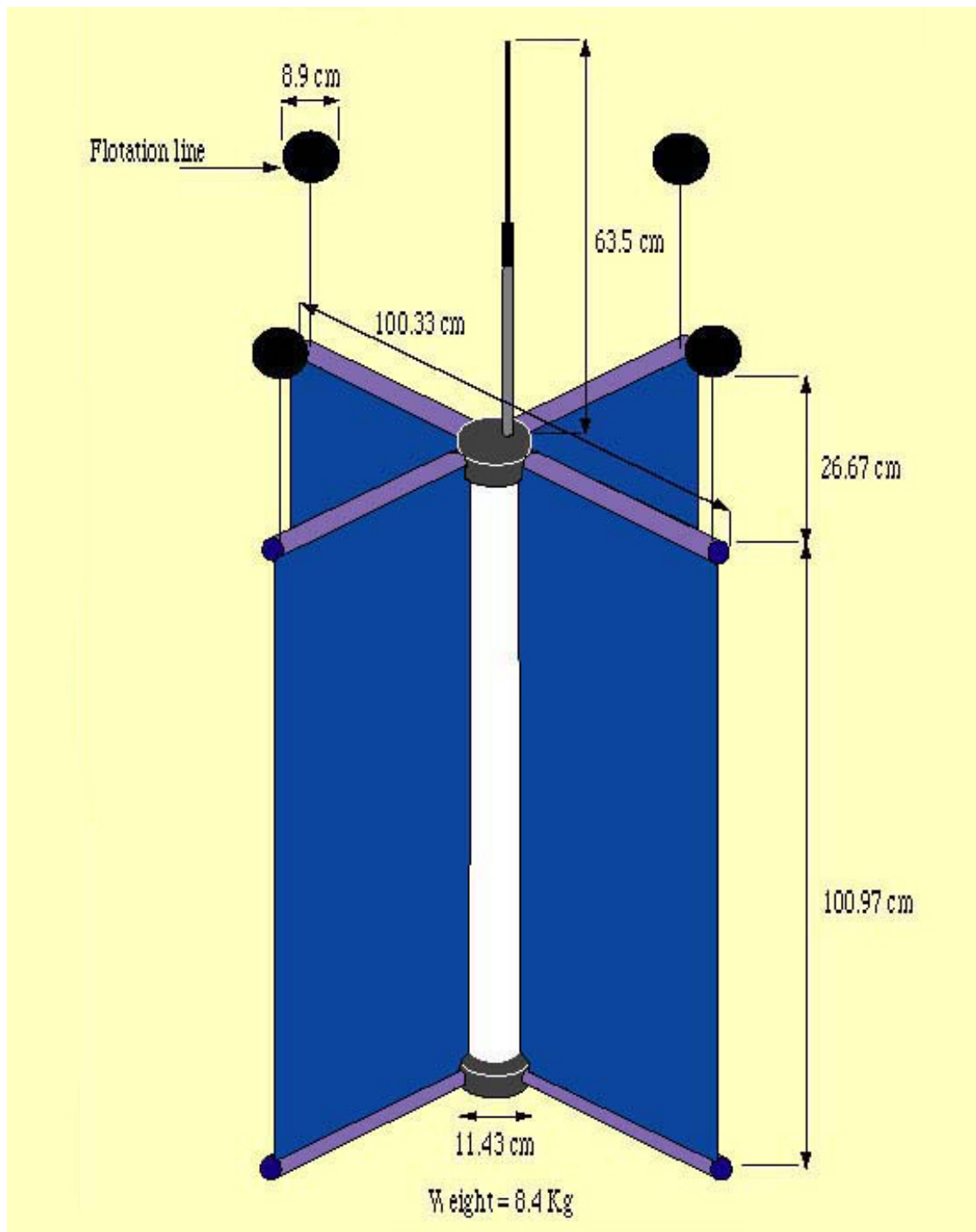

(top)

n o a a o c e a n s a n d c o a s t s

Revised May 02, 2007 | Questions, Comments? [Contact Us](#) | [Report Error On This Page](#) | [Disclaimer](#) | [User Survey](#)
NOAA's National Ocean Service | National Oceanic and Atmospheric Administration | U.S. Department of Commerce
http://oceanservice.noaa.gov/education/kits/currents/media/supp_cur07b.html
Best viewed in Internet Explorer 5+ or Netscape 6+.





Currents

How Are Currents Measured? 1 2 3 4 5 6



Deep Ocean Drifter

To monitor ocean currents and ocean water characteristics far beneath the ocean surface, scientists use devices called profiling floats. While Davis drifters remain at the ocean surface during their deployment, profiling floats are programmed to sink to a particular depth and remain there for a specific period of time. At that depth, which scientists call a "parking depth", the profiling float drifts with the prevailing current. After the pre-programmed time period, the profiling float begins to rise to the ocean surface. As the profiling float ascends, it can be programmed to take a series of measurements from the surrounding water, which may include the water's temperature, salinity, and pressure. When the profiling float reaches the surface, it transmits its data to an orbiting satellite to determine the profiling float's position, and begin to receive the profiling floats data. The satellite also receives information about the path the float has taken while it was drifting. When all of the float's data has been transmitted, the float sinks again to drift and the cycle is repeated. Floats are designed to make about 150 such cycles. Some floats, such as the one depicted in the image below, can sink and drift up to 2,000 meters (approximately 6,500 feet) beneath the surface of the ocean.

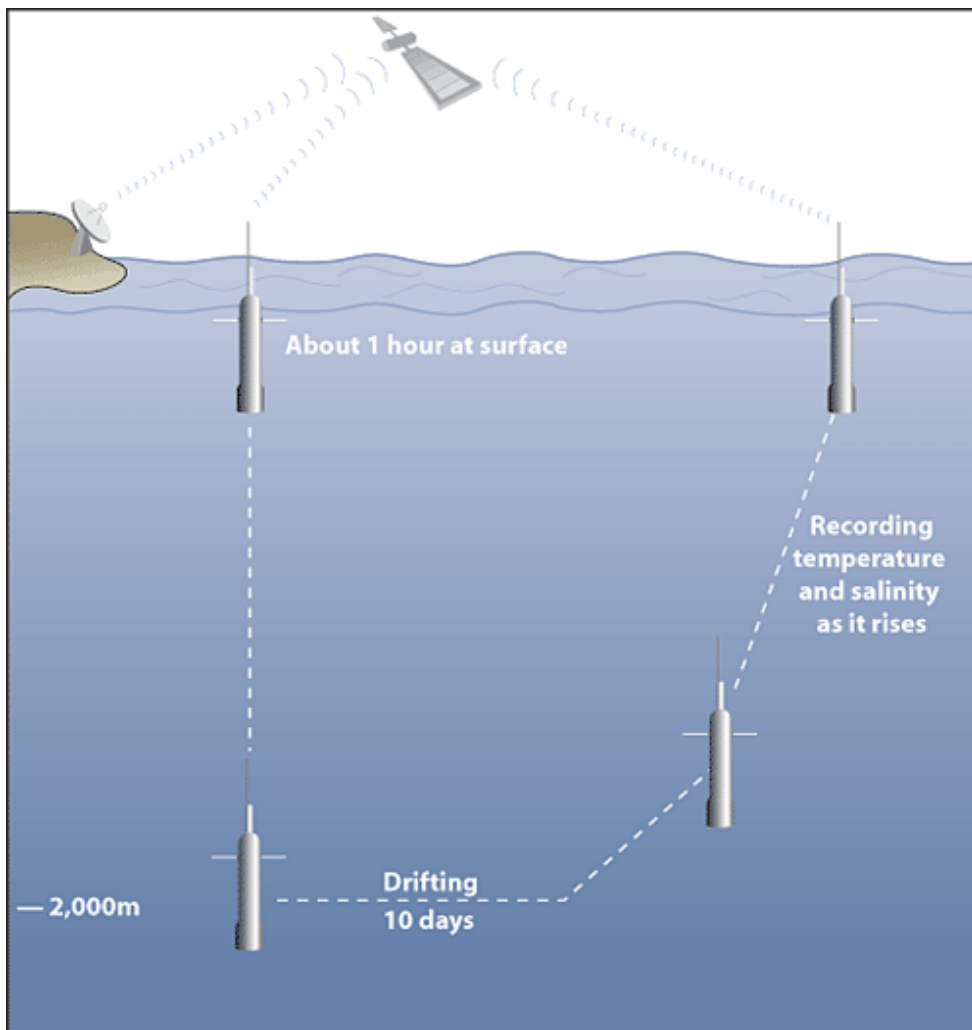

This site NOAA

Tutorial

[Roadmap](#)

[Lesson Plans](#)

[Welcome](#)

[Tidal Currents](#)

[Coastal Currents](#)

[Surface Ocean Currents](#)

[The Global Conveyor Belt](#)

[How Are Currents Measured](#)

[How Currents Affect Our Lives](#)

[References](#)



Currents

How Are Currents Measured? [1](#) [2](#) [3](#) [4](#) [5](#) [6](#)



ADCP, Acoustic Doppler Current Profiler

An Acoustic Doppler Current Profiler (ADCP) measures ocean currents using the principle of "Doppler shift." If you have heard a train whistle in the distance, you are familiar with Doppler effect. As the train gets closer, the whistle pitch gets higher. As the train moves away, the whistle pitch gets lower. The change in pitch is proportional to the speed of the train.

An ADCP follows the premise of the Doppler effect. It emits a series of high-frequency pulses of sound that bounce off of moving particles in the water. If the particle is moving away from the instrument, the return signal is at a lower frequency. If the particle is moving toward the instrument, the return signal is at a higher frequency. Because the particles move at the same speed as the water that carries them, the speed of the water's current can be determined.

An ADCP is usually equipped with four acoustic transducers that emit and receive signals from four different directions. This allows the instrument to measure currents at different depths simultaneously. On large research vessels, the ADCP is often permanently mounted on the ship's outer hull and operates continuously. (Source: NOAA Ocean Explorer Web Site)

NOAA's Center for Operational Oceanographic Products and Services (CO-OPS) uses Doppler profilers to collect ocean current information in various ports and harbors throughout United States territorial waters. Instruments, such as ADCPs, are anchored on the ocean floor for more than 30 days so that the tidal currents can be measured accurately. These measurements are used to update predictions in Tidal Current Tables that mariners are required to carry on board their vessels.



An Acoustic Doppler Current Profiler (ADCP) waiting to be deployed on the deck of a NOAA vessel. *Click on the image for a larger view.*

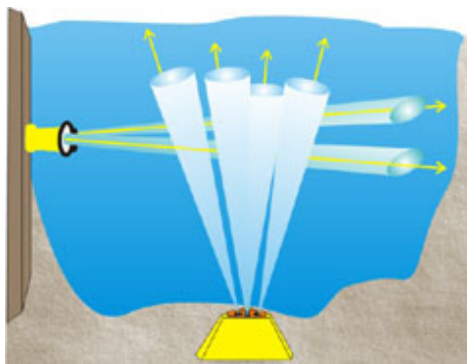

Two ADCPs deployed in a waterway. Together, they provide very accurate measurements of currents for vessels traveling through that waterway. *Click on the image for a larger view.*

[Back to 1](#) [2](#) [3](#) [4](#) [Continue to 6](#)



This site NOAA

Tutorial

[Roadmap](#)

[Lesson Plans](#)

[Welcome](#)

[Tidal Currents](#)

[Coastal Currents](#)

[Surface Ocean Currents](#)

[The Global Conveyor Belt](#)

[How Are Currents Measured](#)

[How Currents Affect Our Lives](#)

[References](#)



[Return to Currents: How Are Currents Measured?](#)

ADCP, Acoustic Doppler Current Profiler

An Acoustic Doppler Current Profiler (ADCP) waiting to be deployed on the deck of a NOAA vessel.



[\(top\)](#)





[Return to Currents: How Are Currents Measured?](#)

ADCP, Acoustic Doppler Current Profiler

This illustration shows two ADCPs deployed in a waterway. One device rests on the ocean bottom and provides information about the horizontal component of the current. The other device is mounted on its side, perhaps on a pier, and provides information about the vertical component of the current. Together they provide very accurate measurements of currents to vessels traveling through that waterway.

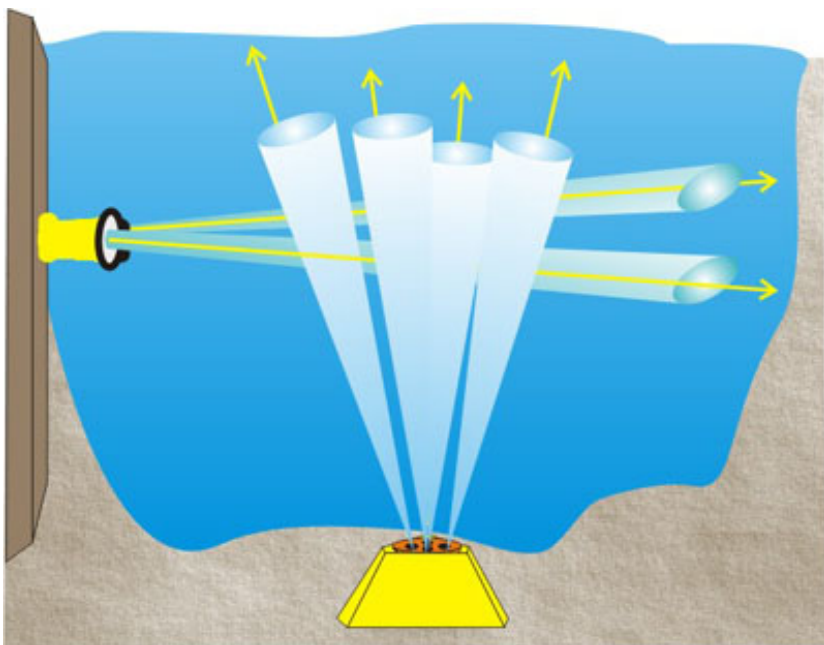

[\(top\)](#)





Currents

How Are Currents Measured? [1](#) [2](#) [3](#) [4](#) [5](#) [6](#)



Shore-based Current Meters

Shore-based current meters employ radio antennas and high frequency (HF) Radio Detecting and Ranging systems (radar) to measure surface ocean currents. Following the same premise of the ADCP, these shore-based instruments use the Doppler effect to determine when currents are moving toward or away from the shore. If a wind-driven current is moving toward the shore, the return signal is at a high frequency. If the wind-driven current is moving away from shore, the return signal is at a low frequency. Scientists also use these measurements to determine the velocity of the current. When two or more radar antennas are used, a scientist can calculate an entire field of surface current velocities for thousands of points. Using this data, the scientist can produce a "map" of surface currents for a large coastal area.



This antenna uses high frequency radar to measure the direction and speed of ocean surface currents. *Click on the image for a larger view.*

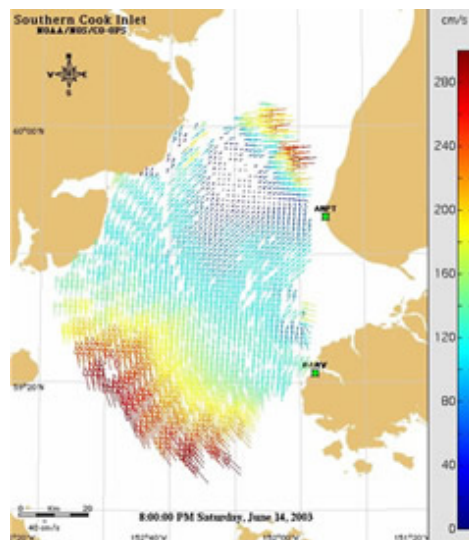

This plot of ocean surface currents was created using shore-based high frequency Radar. *Click on the image for a larger view.*

[Back to](#) [1](#) [2](#) [3](#) [4](#) [5](#)

[\(top\)](#)

This site NOAA

Tutorial

[Roadmap](#)

[Lesson Plans](#)

[Welcome](#)

[Tidal Currents](#)

[Coastal Currents](#)

[Surface Ocean Currents](#)

[The Global Conveyor Belt](#)

[How Are Currents Measured](#)

[How Currents Affect Our Lives](#)

[References](#)



[Return to Currents: How Are Currents Measured?](#)

Shore-based Current Meters

This antenna uses high frequency (HF) Radar to measure the direction and speed of ocean surface currents. When two or more Radar antennas are used, a scientist can calculate an entire field of wind driven surface current velocities.

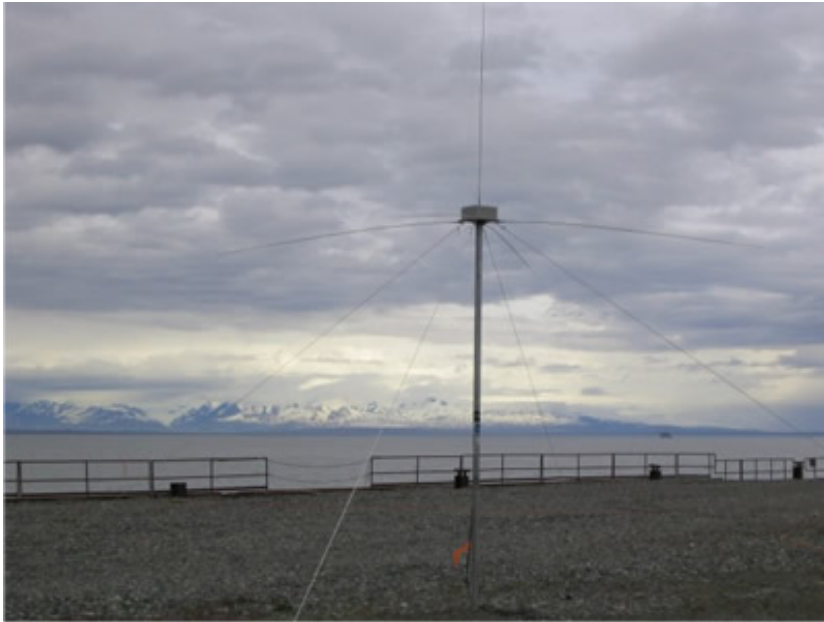

[\(top\)](#)





[Return to Currents: How Are Currents Measured?](#)

Shore-based Current Meters

This plot of wind driven ocean surface currents was created using shore-based high frequency radar. When two or more radar antennas are used, a scientist can calculate an entire field of surface current velocities. Using this data, the scientist can produce a map of surface currents for a large coastal area. The map consists of a series of different colored arrows. The direction of each arrow represents the direction that the current is moving, and the color of each arrow represents the current's speed at that particular location (red=fast, blue=slow.)

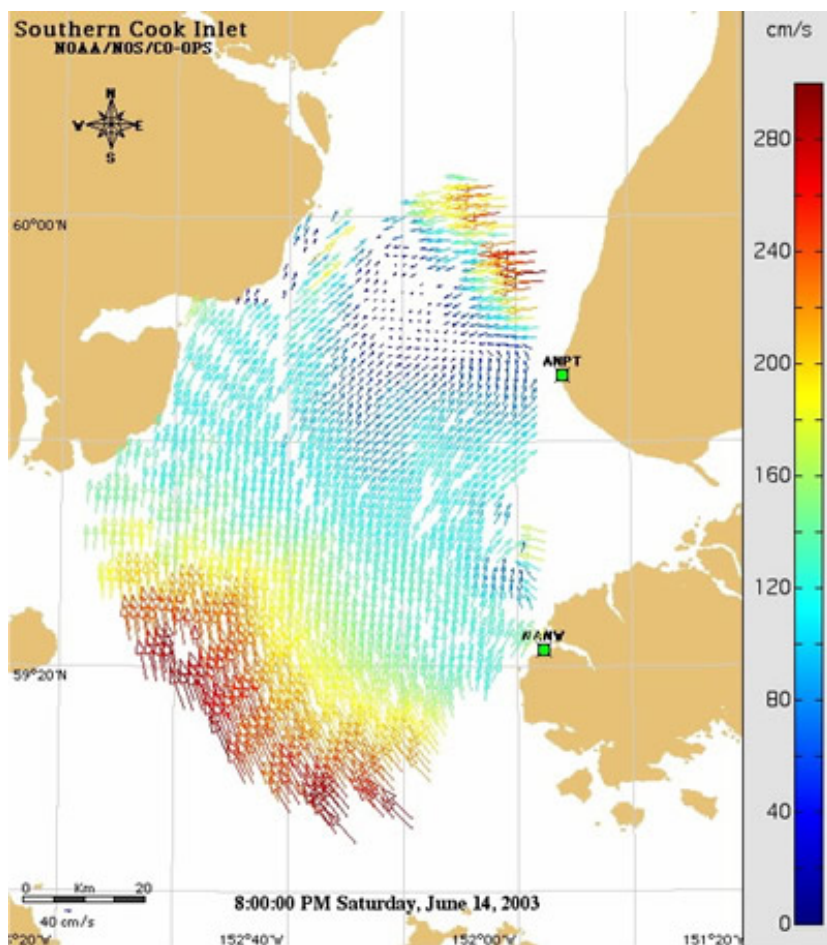

[\(top\)](#)



Currents

How Currents Affect Our Lives



Current measurements are important to shipping, commercial fishing, recreational boating, and safety. By using predicted, real-time and short-term forecasted currents, people can safely dock and undock ships, maneuver them in confined waterways and safely navigate through coastal waters. With this information, merchandise and people can arrive on schedule. Lack of this knowledge can lead to collisions and delayed arrivals.

Search-and-rescue personnel can use real-time and predicted current patterns to determine where the water may carry a missing person or floating object(s). Geographic Information Systems (GIS) programs are used to assist in search-and-rescue efforts as well. These programs use the last-known position of the lost person or item(s), predicted and real-time current and weather data, and drift patterns to estimate the location of the person or item (s).

Hazardous material (HAZMAT) cleanup operations also use real-time and predicted current information. Hazardous materials such as oil and fuel from tankers, typically remain on or near the water's surface, and travel with surface currents and winds. Models created from high-frequency radar, satellite, and wind data help predict where the hazardous material will go.

NOAA's Center for Operational Oceanographic Products and Services (CO-OPS) is working with a prototype of a quick-response buoy that can be deployed when a HAZMAT spill occurs. The buoy collects real-time current speed and direction, wind speed direction and gusts, barometric pressure, and water and air temperature. The buoy can be deployed for up to 30 days.

In addition, scientists study nutrient, sediment, and the concentration of chemicals which travel in the water column, to understand how currents transport these materials locally and globally.



Hundreds of massive container ships rely daily on accurate real-time tide and current information to navigate safely to and from U. S. ports.

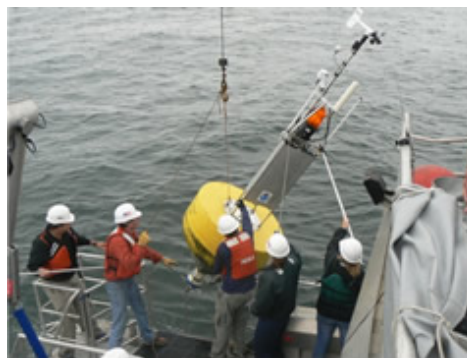

Deploying and regular maintenance of data buoys assures scientists, fishers, mariners, rescue personnel and others, of accurate and timely oceanographic and meteorological information.

This site NOAA

Tutorial

[Roadmap](#)

[Lesson Plans](#)

[Welcome](#)

[Tidal Currents](#)

[Coastal Currents](#)

[Surface Ocean Currents](#)

[The Global Conveyor Belt](#)

[How Are Currents Measured](#)

[How Currents Affect Our Lives](#)

[References](#)

Finally, currents affect swimmers and fishers. Localized currents can be observed in the form of rip currents at the beach, or a piece of floating wood meandering in different patterns in a tidal bay or river. Swimming at the beach near rip currents can be very dangerous. Before going to the beach, learn how to recognize rip currents and strong shore currents, and pay attention to the warning signs. Recreational and commercial fishers pay close attention to the timing and strength of currents to maximize their chances of catching fish.



Knowing when and where upwelling currents occur, and therefore where fish stocks may be located, is an enormous benefit to fishers.

[◀ \(top\) ▶](#)

n o a a o c e a n s a n d c o a s t s

Revised May 02, 2007 | Questions, Comments? [Contact Us](#) | [Report Error On This Page](#) | [Disclaimer](#) | [User Survey](#)
[NOAA's National Ocean Service](#) | [National Oceanic and Atmospheric Administration](#) | [U.S. Department of Commerce](#)
<http://oceanservice.noaa.gov/education/kits/currents/08affect.html>
Best viewed in [Internet Explorer 5+](#) or [Netscape 6+](#).



[Return to Currents: Tidal Currents](#)

This animation shows the relationship between tides and currents. As the tide rises, water moves toward the shore. This is called a flood current. As the tide recedes, the water moves away from the shore. This is called an ebb current. The movement of water toward and away from the shore is illustrated by the movement of the green seaweed. Tidal currents that ebb and flood in opposite directions are called "rectilinear" or "reversing" currents.

[\(top\)](#)



Currents

References



Bowditch, N. 1995. American Practical Navigator. Bethesda, MD: Defense Mapping Agency Hydrographic/Topographic Center. pp. 873.

Duxbury, et al. 2002. Fundamentals of Oceanography, 4th edition. New York: McGraw Hill. pp. 344.

Lloyd, J.B. 1986. Eighteen Miles of History on Long Beach Island. Harvey Cedars, New Jersey. Down The Shore Publishing and the SandPaper, Inc. pp. 204.

National Oceanic and Atmospheric Administration (NOAA). 2005a. Ocean Explorer: Technology. Online at <http://oceanexplorer.noaa.gov/technology/technology.html>.

National Oceanic and Atmospheric Administration (NOAA). 2005b. Rip Current Safety. Online at <http://www.ripcurrents.noaa.gov>.

New Jersey Department of Transportation Geographic Information Systems. 2006. State and County Maps. Online at <http://www.state.nj.us/transportation/gis/map.shtm>.

Pinet, P.R. 1998. Invitation to Oceanography. Sudbury, MA.: Jones and Bartlett Publishers. 596 pp. Sudbury, MA.

Ross, D. 1995 Introduction to Oceanography. New York: HarperCollins College Publishers. pp. 199-226, 339-343.

Rutgers University. Geography Department. Cartography homepage. Historical Maps of New Jersey Online at: <http://mapmaker.rutgers.edu/MAPS.html>.

Thurman, H. 1994. Introductory Oceanography, 7th edition. New York: Macmillan Publishing Company. pp. 172-222.



This site NOAA

Tutorial

[Roadmap](#)

[Lesson Plans](#)

[Welcome](#)

[Tidal Currents](#)

[Coastal Currents](#)

[Surface Ocean Currents](#)

[The Global Conveyor Belt](#)

[How Are Currents Measured](#)

[How Currents Affect Our Lives](#)

References

