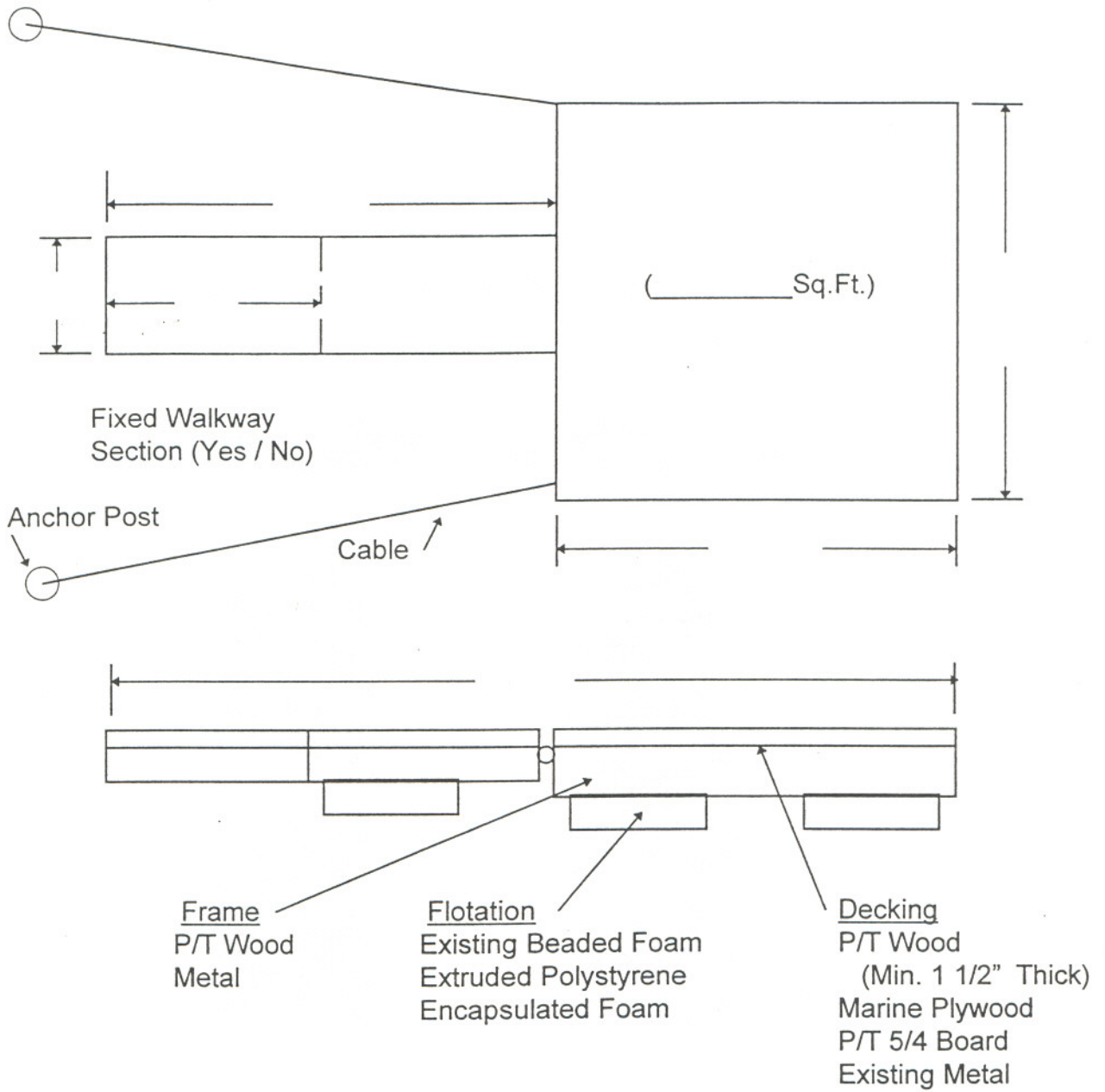

EXHIBIT 5

Standard Dock Plans



Name _____

Permit # _____

<p style="text-align: center;">CONCEPTUALLY APPROVED for US Army Corps of Engineers, Mobile District BY: _____ DATE: _____</p> <p>NOTICE: This approval stamp DOES NOT certify an engineering review. The builder should rely on professional engineering services to certify that the design is suitable for intended purposes and meets minimum standards including those related to the safety of the users.</p>
--

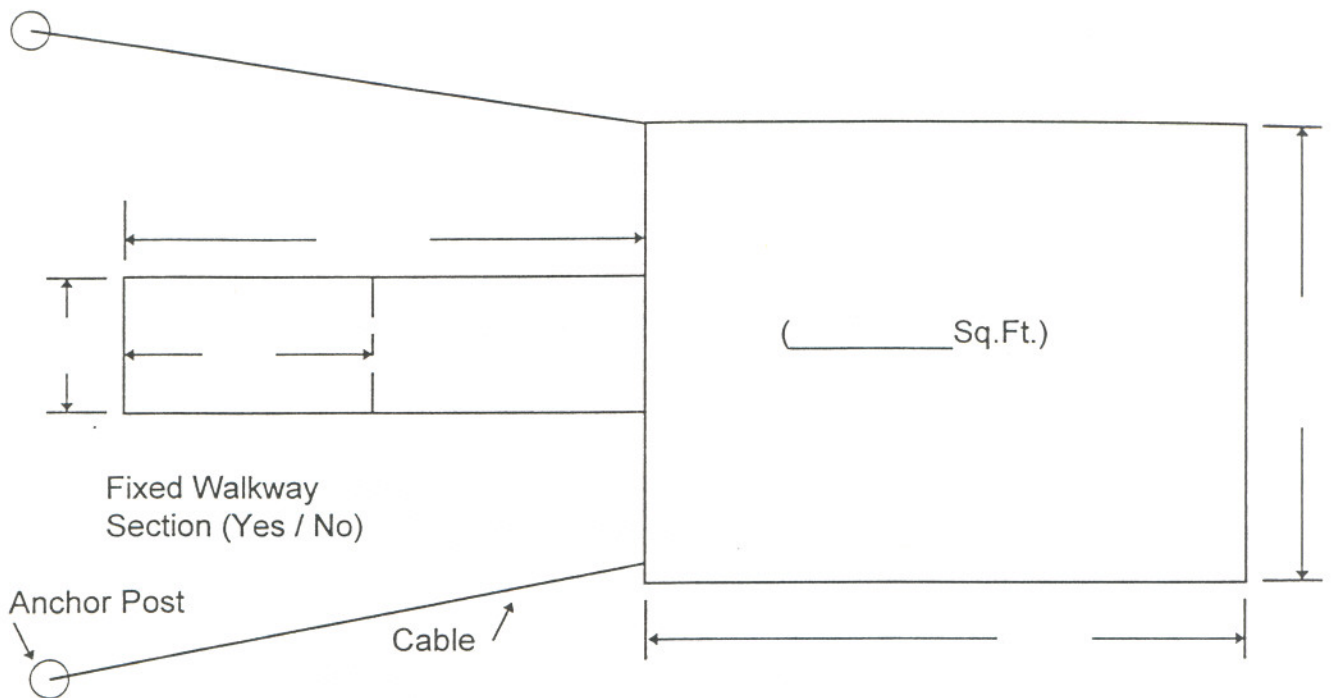

Fixed Walkway
Section (Yes / No)

Anchor Post

Cable

(_____ Sq.Ft.)

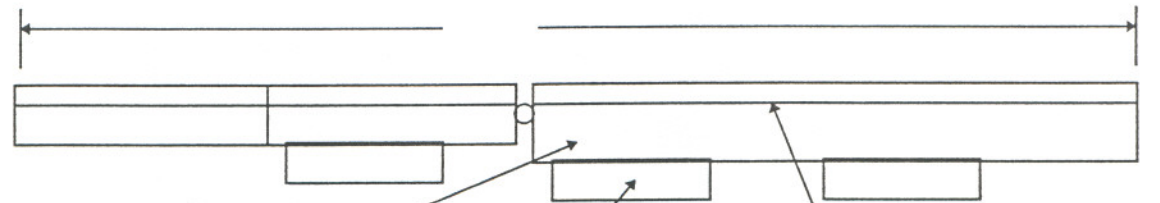

Frame
P/T Wood
Metal

Flotation
Existing Beaded Foam
Extruded Polystyrene
Encapsulated Foam

Decking
P/T Wood
(Min. 1 1/2" Thick)
Marine Plywood
P/T 5/4 Board
Existing Metal

Name _____

Permit # _____

CONCEPTUALLY APPROVED
for
US Army Corps of Engineers, Mobile District
BY: _____
DATE: _____

NOTICE: This approval stamp DOES NOT certify an engineering review. The builder should rely on professional engineering services to certify that the design is suitable for intended purposes and meets minimum standards including those related to the safety of the users.

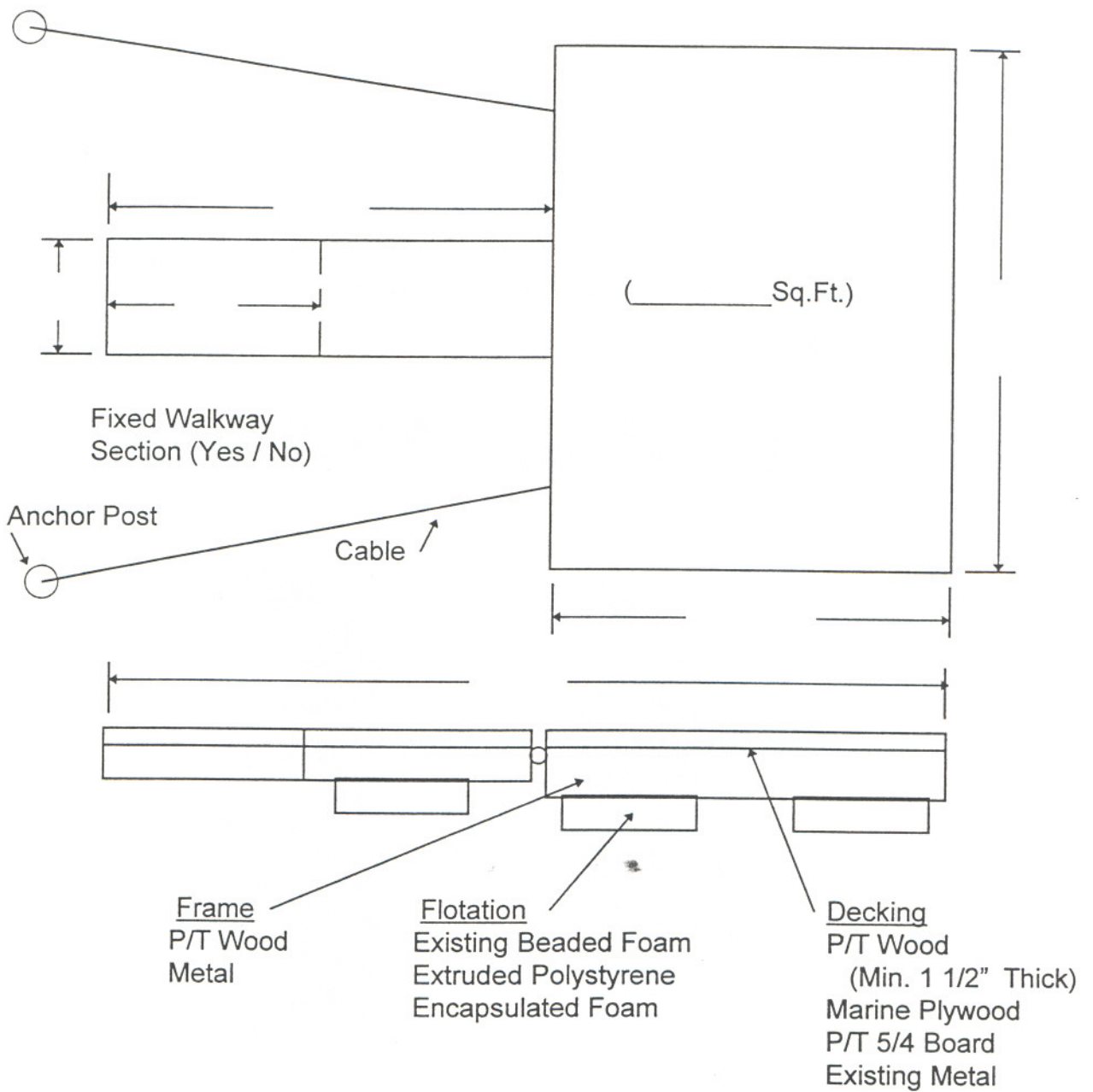

Name _____

Permit # _____

CONCEPTUALLY APPROVED
for
US Army Corps of Engineers, Mobile District
BY: _____
DATE: _____

NOTICE: This approval stamp DOES NOT certify an engineering review. The builder should rely on professional engineering services to certify that the design is suitable for intended purposes and meets minimum standards including those related to the safety of the users.

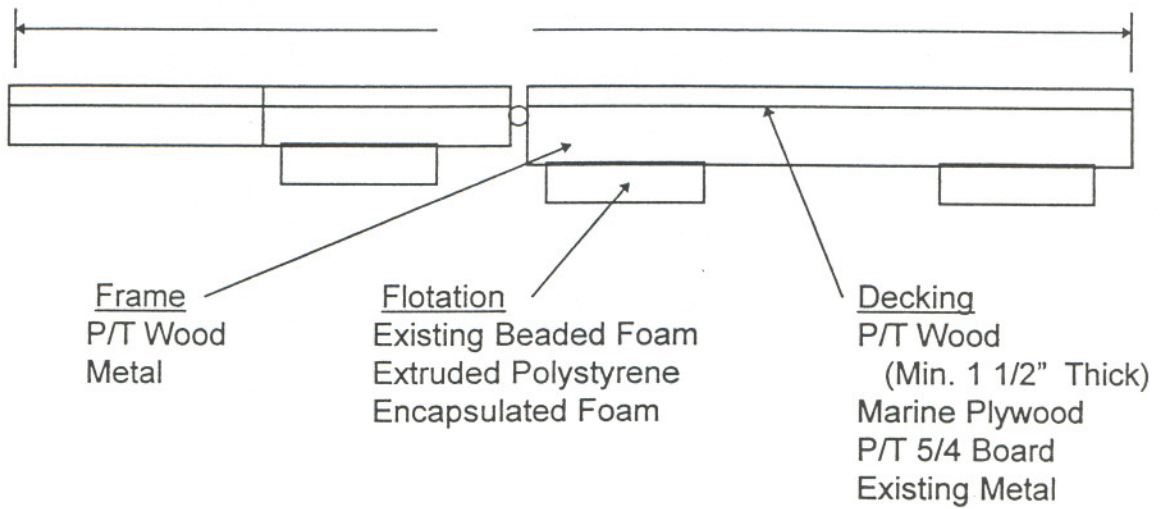
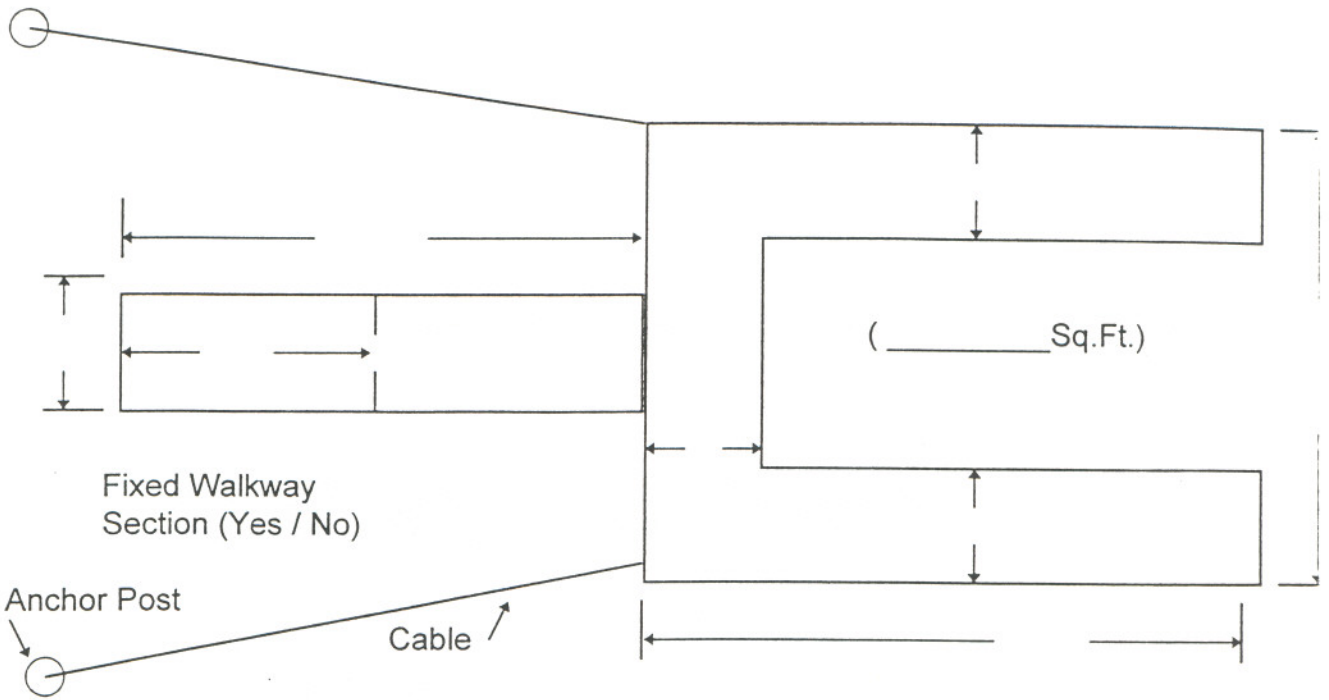

Name _____

Permit # _____

CONCEPTUALLY APPROVED
for
US Army Corps of Engineers, Mobile District
BY: _____
DATE: _____

NOTICE: This approval stamp DOES NOT certify an engineering review. The builder should rely on professional engineering services to certify that the design is suitable for intended purposes and meets minimum standards including those related to the safety of the users.

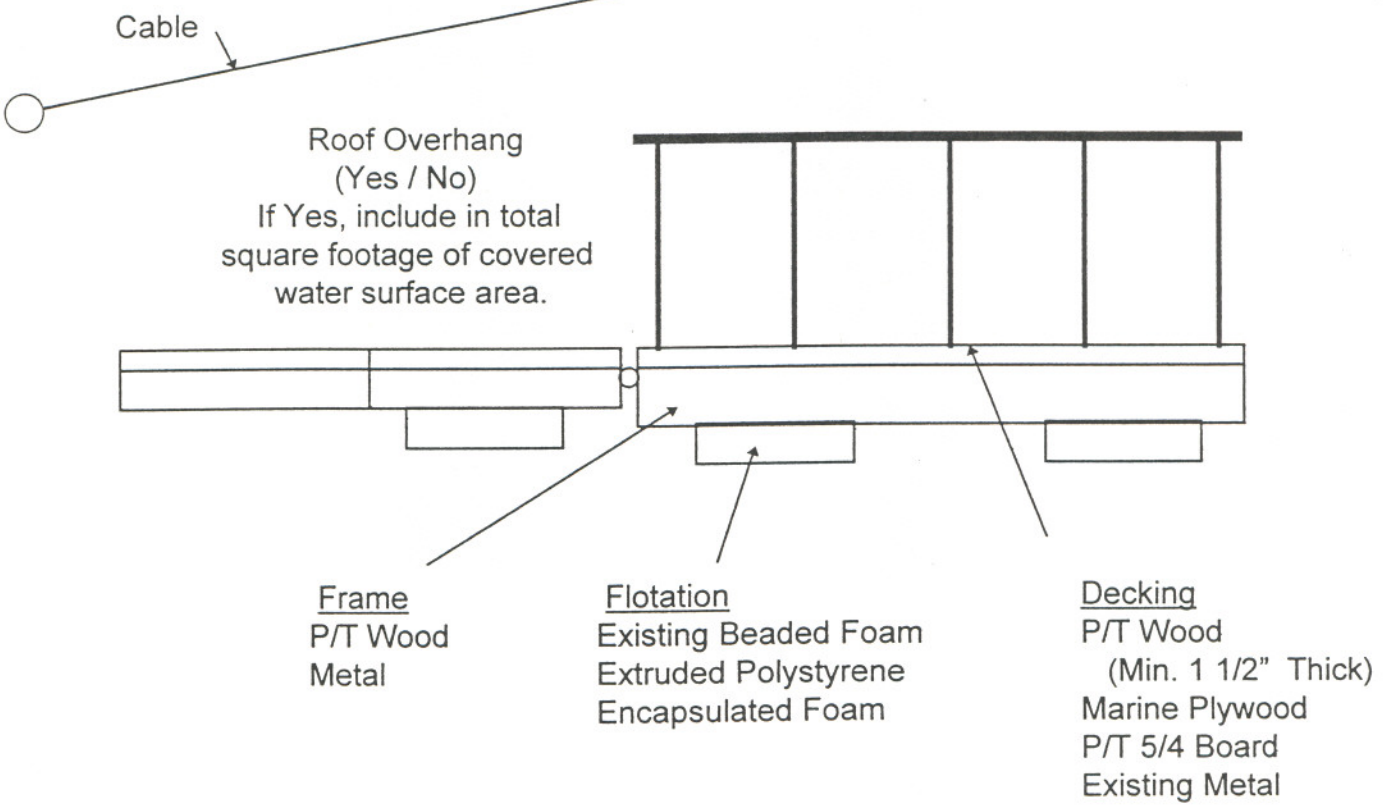
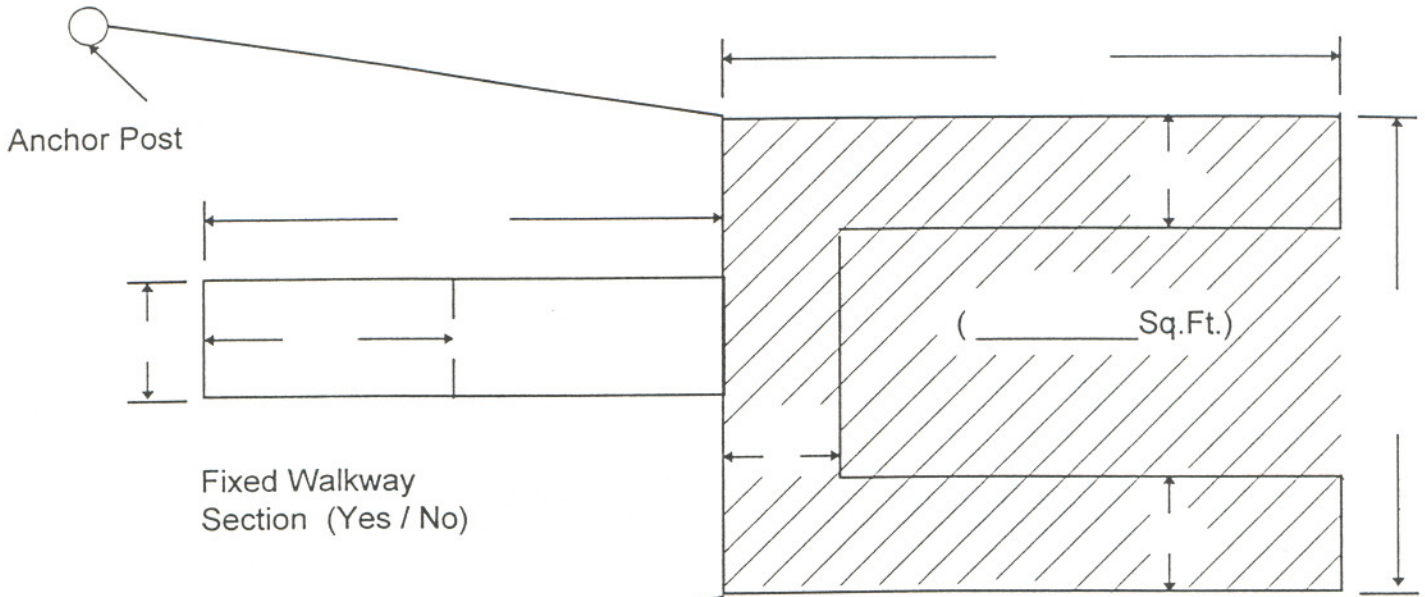

Name _____

Permit # _____

CONCEPTUALLY APPROVED
for
US Army Corps of Engineers, Mobile District
BY: _____
DATE: _____

NOTICE: This approval stamp DOES NOT certify an engineering review. The builder should rely on professional engineering services to certify that the design is suitable for intended purposes and meets minimum standards including those related to the safety of the users.

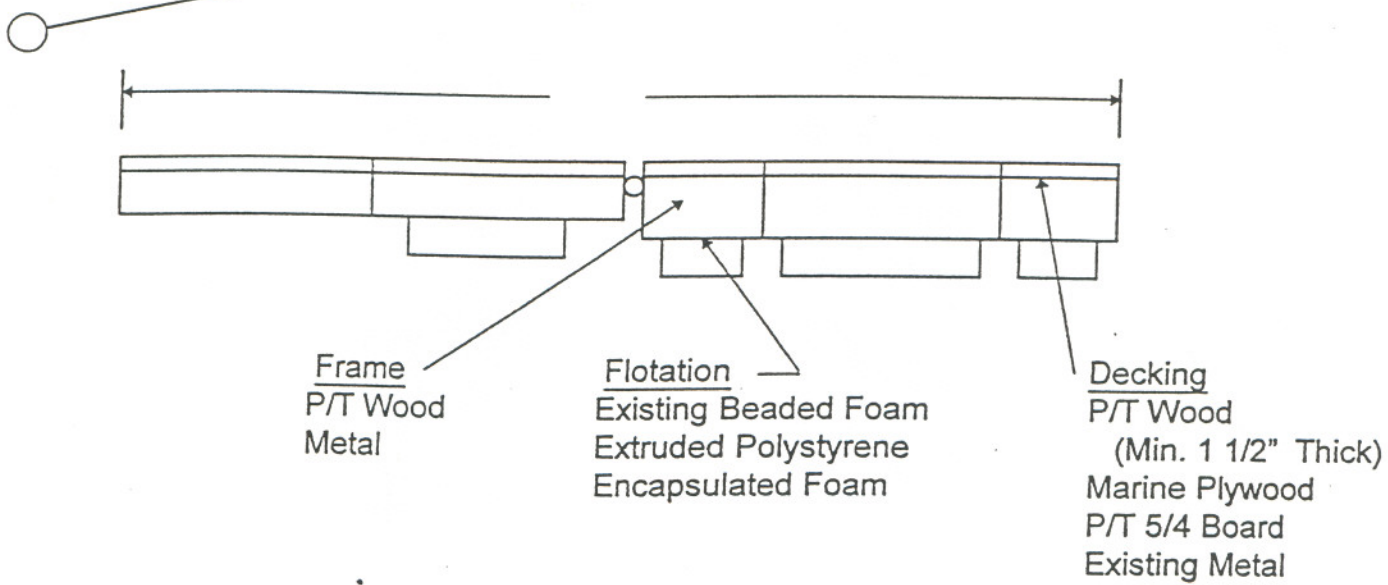
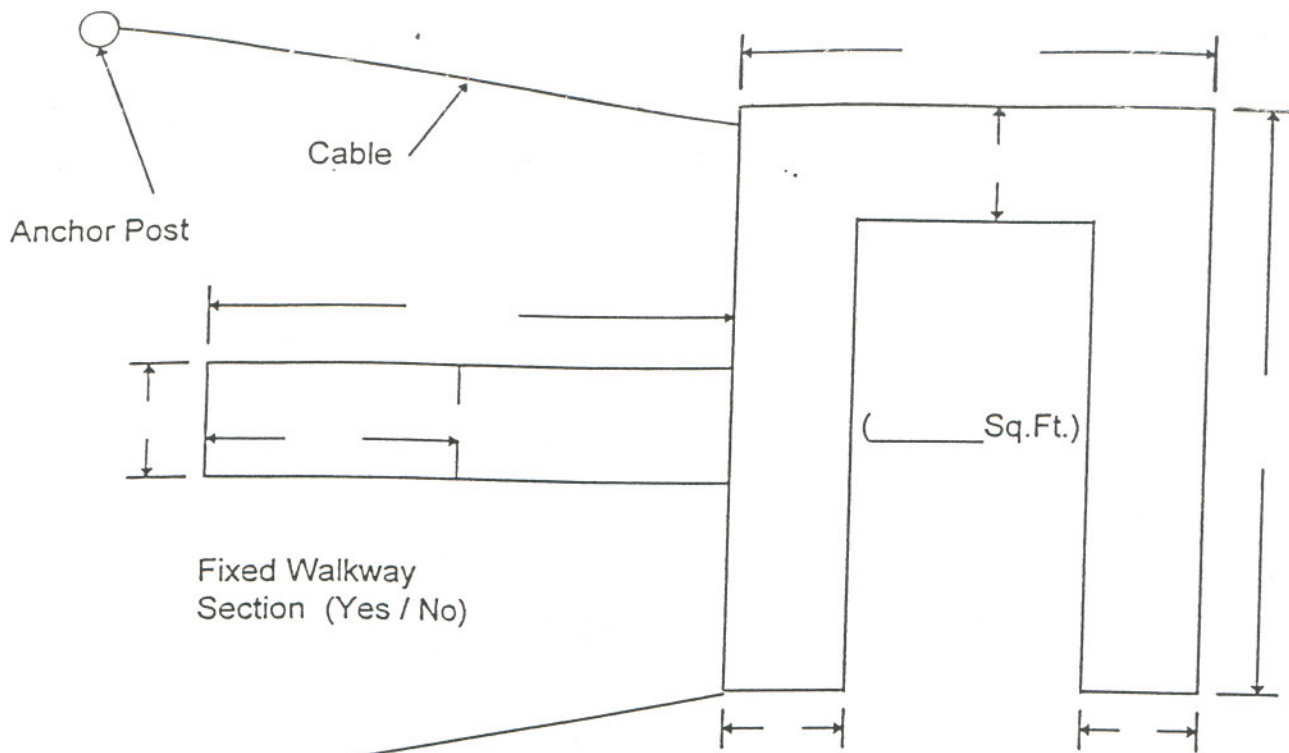

Name _____

Permit # _____

CONCEPTUALLY APPROVED
for
US Army Corps of Engineers, Mobile District
BY: _____
DATE: _____

NOTICE: This approval stamp DOES NOT certify an engineering review. The builder should rely on professional engineering services to certify that the design is suitable for intended purposes and meets minimum standards including those related to the safety of the users.

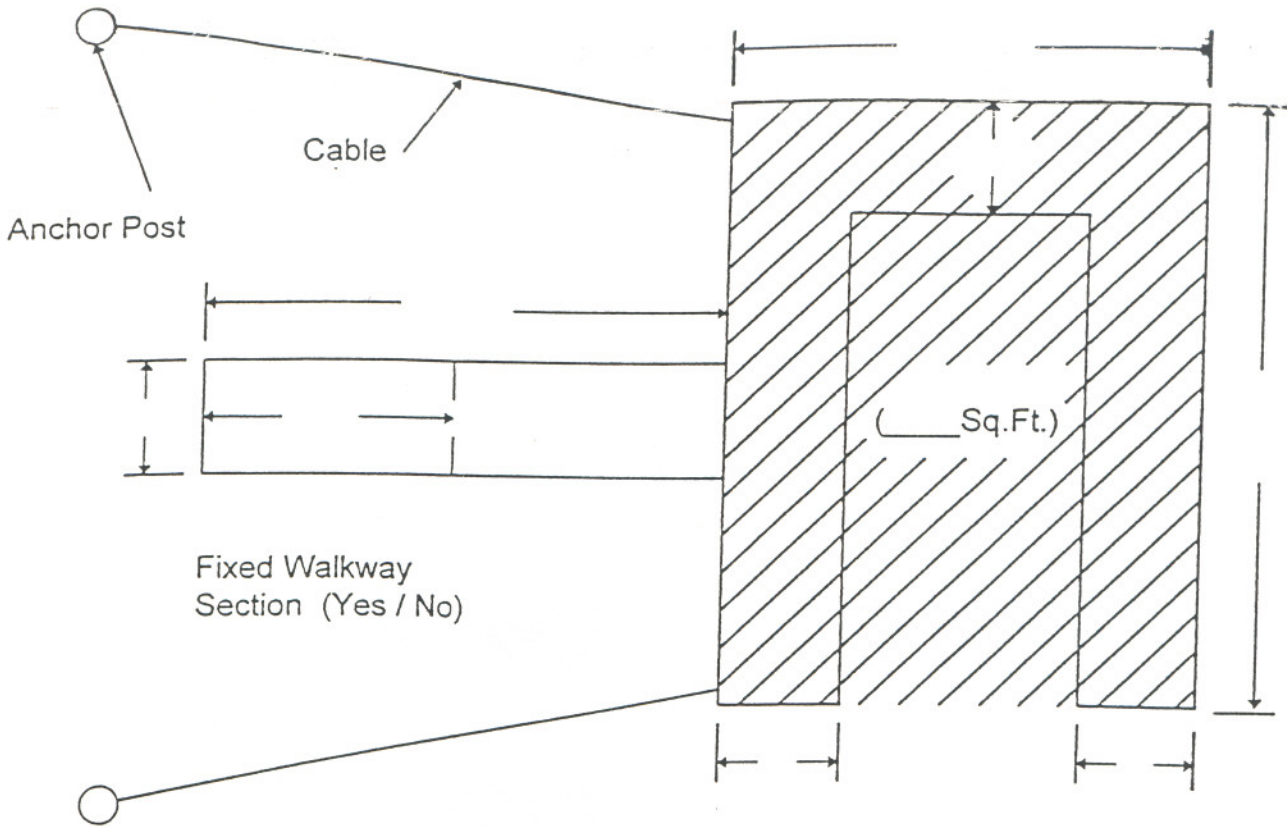

Roof Overhang
(Yes / No)
If Yes, include in total
square footage of covered
water surface area.

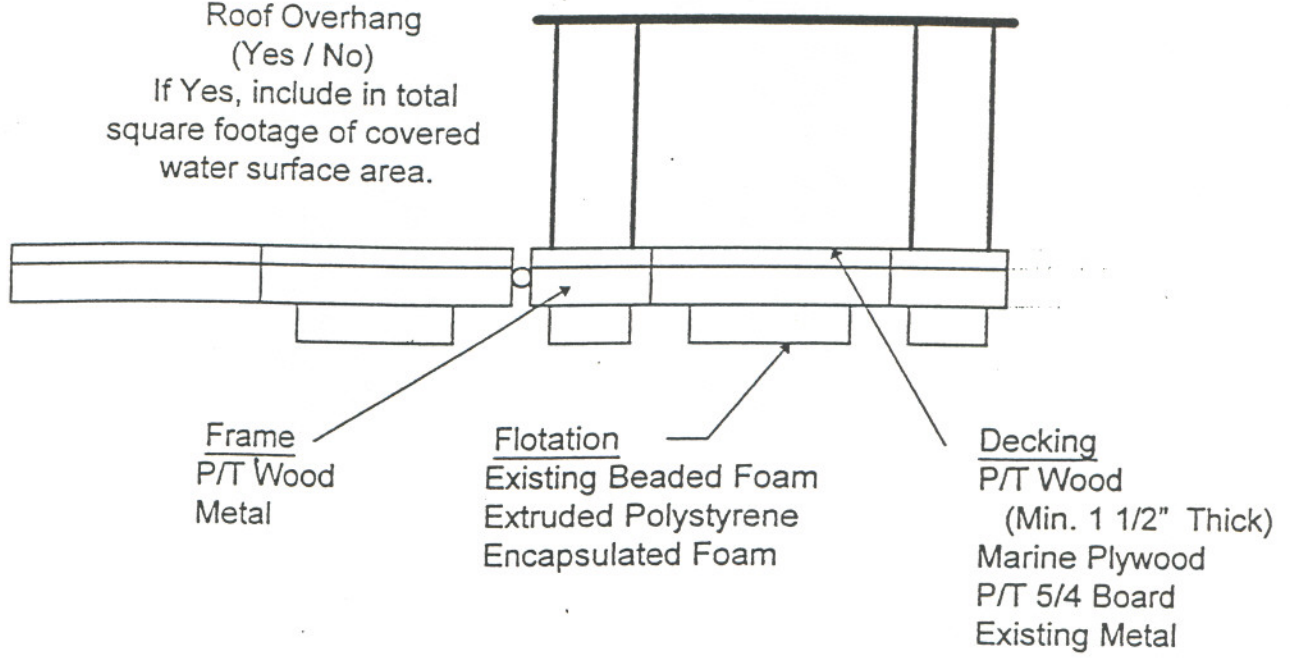

Name _____

Permit # _____

CONCEPTUALLY APPROVED
for
US Army Corps of Engineers, Mobile District
BY: _____
DATE: _____

NOTICE: This approval stamp DOES NOT certify an engineering review. The builder should rely on professional engineering services to certify that the design is suitable for intended purposes and meets minimum standards including those related to the safety of the users.

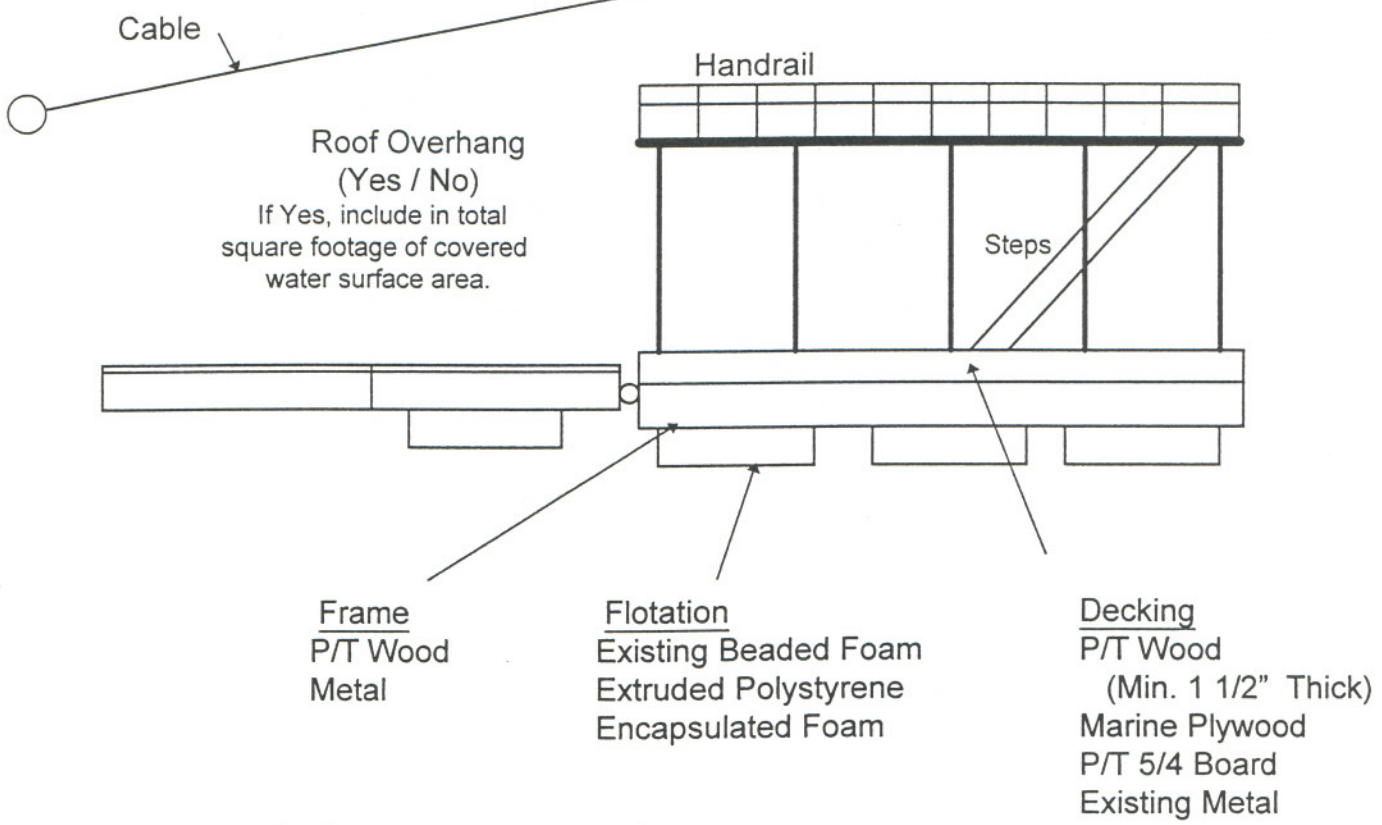
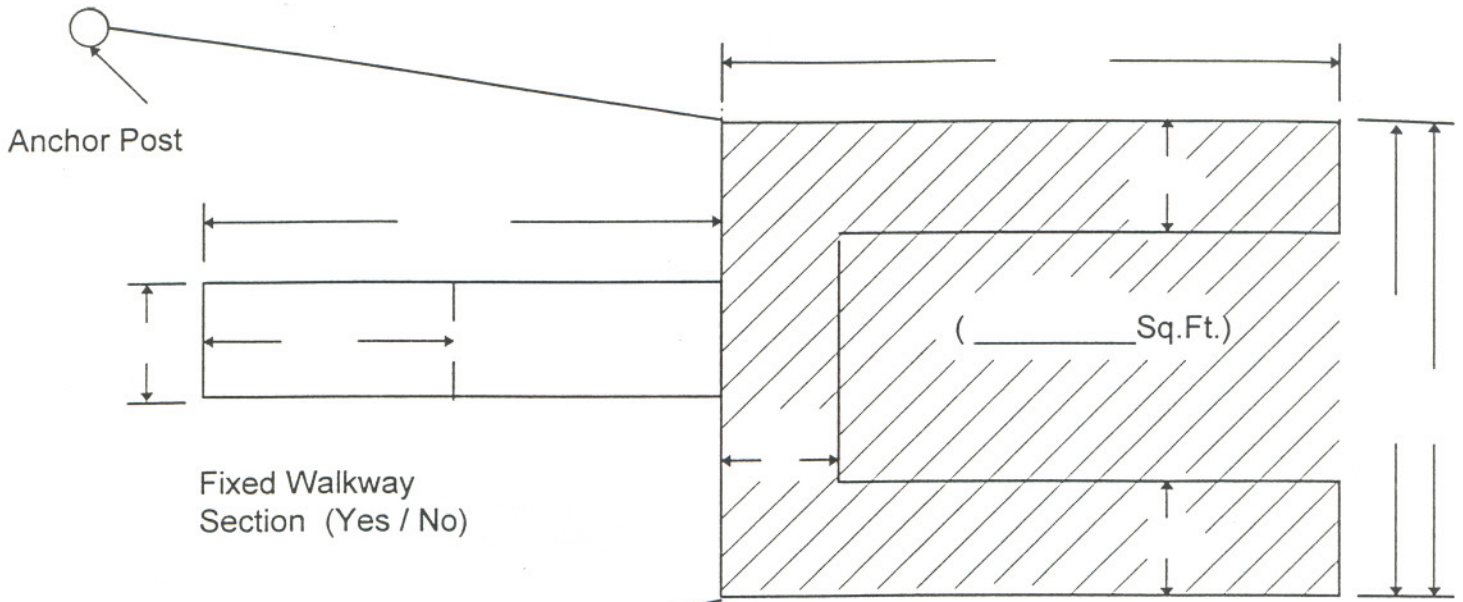

Live Load Rating for Top: _____ lbs/sq.ft.

Name _____

Permit # _____

CONCEPTUALLY APPROVED
for
US Army Corps of Engineers, Mobile District
BY: _____
DATE: _____

NOTICE: This approval stamp DOES NOT certify an engineering review. The builder should rely on professional engineering services to certify that the design is suitable for intended purposes and meets minimum standards including those related to the safety of the users.

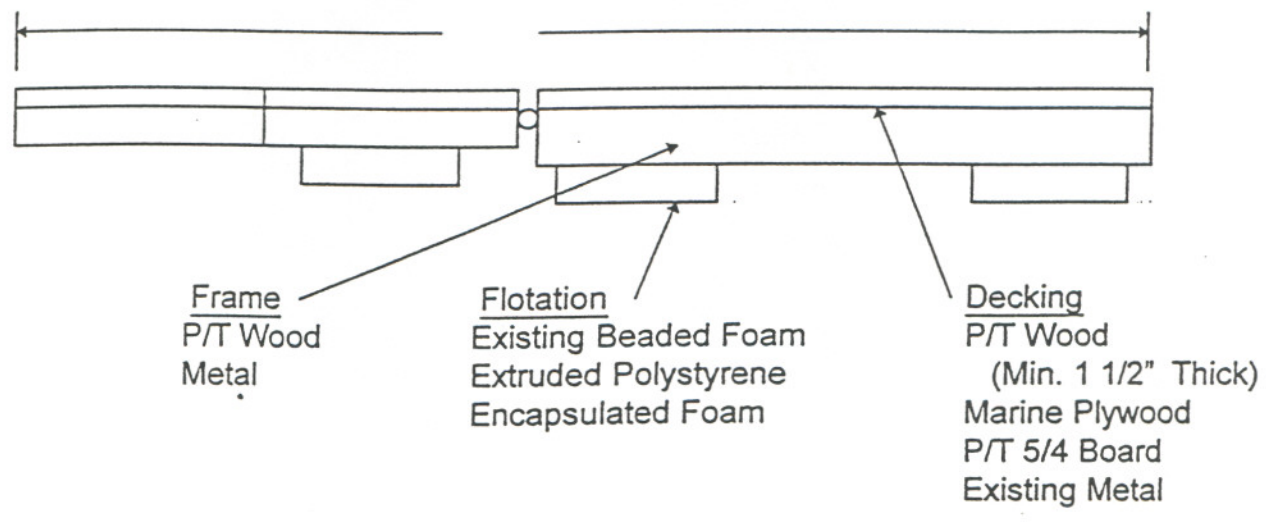
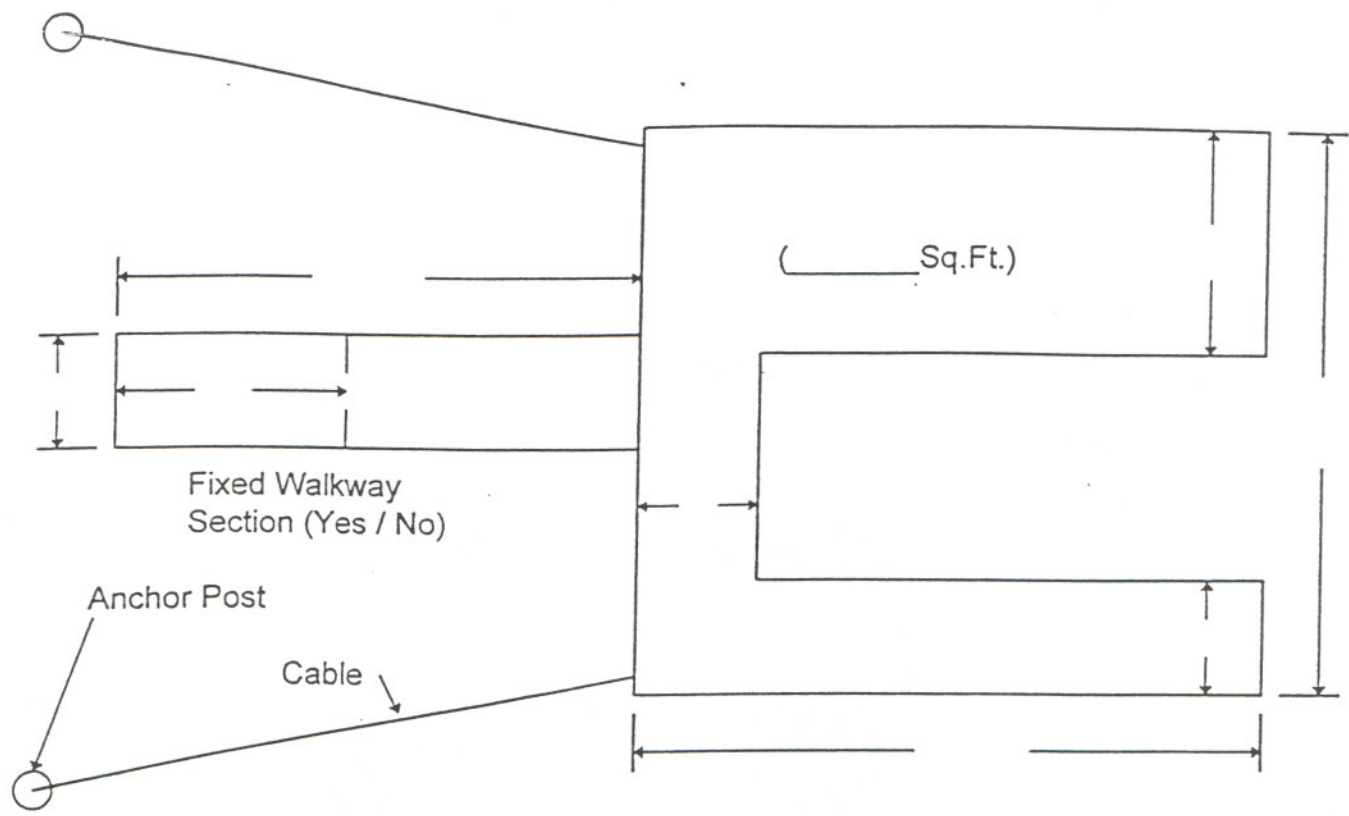

Name _____

Permit # _____

CONCEPTUALLY APPROVED
for
US Army Corps of Engineers, Mobile District
BY: _____
DATE: _____

NOTICE: This approval stamp DOES NOT certify an engineering review. The builder should rely on professional engineering services to certify that the design is suitable for intended purposes and meets minimum standards including those related to the safety of the users.