

SEATRAIN OHIO

(Ohio)

(Mission San Jose)

Beaumont Reserve Fleet, Neches River

Beaumont vicinity

Jefferson County

Texas

HAER TX-111

HAER TX-111

PHOTOGRAPHS

PAPER COPIES OF COLOR TRANSPARENCIES

WRITTEN HISTORICAL AND DESCRIPTIVE DATA

REDUCED COPIES OF MEASURED DRAWINGS

HISTORIC AMERICAN ENGINEERING RECORD

National Park Service

U.S. Department of the Interior

1849 C Street NW

Washington, DC 20240-0001

HISTORIC AMERICAN ENGINEERING RECORD

Seatrain Ohio
(Ohio)
(Mission San Jose)

HAER No. TX-111

Location: Beaumont Reserve Fleet, Neches River, Beaumont vicinity,
Jefferson County, Texas

Type of Craft: Container, railcar, and vehicle carrier

Trade: Military cargo transportation

MARAD Design No.: Converted T2-SE-A2

Builder's Hull No.: various

Official Registry No.: 244610

IMO No.: 6621234

Principal Measurements: Length (bp): 539'-6"
Length (oa): 559'-11"
Beam (molded): 68'
Depth (molded): 39'-3"
Draft: 27'
Displacement: 21,240 long tons
Deadweight: 12,293 long tons
Gross registered tonnage: 8,047
Net registered tonnage: 4,811
Normal continuous
shaft horsepower: 10,000
Service speed: 16 knots

(The listed dimensions are as-built, but it should be noted that draft, displacement, and tonnages are subject to alteration over time as well as variations in measurement.)

Propulsion: Single-screw turbo-electric drive

Dates of Construction: 1966-67 (conversion)

Designer: Maryland Shipbuilding and Drydock Company, Baltimore,
Maryland

Builder: Marinship Corporation, Sausalito, California (original
components); Maryland Shipbuilding and Drydock Company
(conversion)

Original Owner: Hudson Waterways Corporation

Present Owner: Maritime Administration
U.S. Department of Transportation

Names: *Mission San Jose* (stern only; 1944 to June 1966)
Ohio (June 1966 to August 1967 and 1978 to present)
Seatrain Ohio (August 1967 to 1978)

Disposition: National Defense Reserve Fleet; scheduled for disposal

Significance: The *Seatrain Ohio* is a welded, steel-hulled cargo ship designed with large, barrier-free holds for the flexible carriage of railcars, vehicles, containers, and general cargo. Its design was an attempt to adapt the "Seatrain"-type railcar carrier, first developed in the 1920s and 1930s, to carry more than just railroad freight cars. The ship is a textbook example of "jumboizing," the shipping-industry practice of enlarging and renewing obsolescent tonnage through the addition of new midsections and other alteration work. *Seatrain Ohio* was created in 1966-67 using sections from three obsolete World War II-era T2-SE-A2 tankers: the bow and forward cargo tanks of *Mission San Diego*; selected cargo tanks from the *Maine* (ex *Tomahawk*); and the stern, propulsion plant, and deckhouses of the *Ohio* (ex *Mission San Jose*). The ship was employed almost exclusively by the U.S. Navy's Military Sea Transportation Service (later the Military Sealift Command) to move military cargoes. Numerous supply missions to Vietnam form the ship's most notable service.

Author: Michael R. Harrison, 2010

Project Information: This project was undertaken by the Historic American Engineering Record (HAER), a long-range program to document historically significant engineering and industrial works in the United States. The HAER program is part of the Heritage Documentation Programs of the National Park Service, U.S. Department of the Interior. The documentation, which includes large-format photography by HAER photographer Jet Lowe and a historical report by historian Michael Harrison, was prepared under the direction of Todd Croteau, HAER Maritime Program coordinator.

PART I. HISTORICAL INFORMATION

A. Physical History

1. Dates of construction: August 1966 to August 1967. The *Seatrain Ohio* was assembled in 1966–67 from sections of multiple T2 “Mission”-type oil tankers originally built in 1943–44.¹

2. Designer: It is unclear who designed Hudson Waterways Corporation’s 1966 *Seatrain* conversions. The Maryland Shipbuilding and Drydock Company, contractor for three of the ships, and the Newport News Shipbuilding and Dry Dock Company, contractor for four, were both leading conversion and “jumboizing” firms and both had the capability to design the necessary work. It is also possible that each yard created its own final construction drawings based on a standard set of specifications stipulated by Hudson Waterways, although this would not have been a cost-effective approach.

3. Builder: The original ships that were cut apart, modified, and reassembled to form the *Seatrain Ohio* were constructed during World War II by the Marinship Corporation, Sausalito, California. The conversion work itself was carried out by Maryland Shipbuilding and Drydock Company, a Baltimore firm specializing in ship repair and overhaul. In the late 1950s, this company was one of the originators of the postwar American practice of “jumboizing,” where old tankers were enlarged and renewed through the addition of new midsections and other alteration work.²

4. Original plans and construction: The *Seatrain Ohio* is a steel-hulled cargo ship designed with large, barrier-free holds for the flexible carriage of railcars, vehicles, containers, and general cargo. The ship is distinguished by its high and narrow aft deckhouse, which is mounted over the machinery spaces at the stern, and its long superstructure deck (the Spar Deck), which surmounts the hull for much of the ship’s length and supports two 45-ton cargo cranes.

The *Seatrain Ohio* contains hull sections from three World War II-built T2-SE-A2, “Mission”-type tankers, the *Mission San Diego* (Marinship hull no. 38), the *Maine* (ex *Tomahawk*, no. 24), and the *Ohio* (ex *Mission San Jose*, no. 28). The *Mission San Diego* provided the bow, the *Maine* the midbody, and the *Ohio* the stern, deckhouses, and complete propulsion plant. Two sister ships, the *Seatrain Washington* and *Seatrain Maine*, were constructed at the same time using the remaining sections of these and other T2 tankers.³

¹ Richard Basoco, “\$9,000,000 conversion job slated,” *Baltimore Sun*, Aug. 31, 1966, C9; “MSTS signs charter for \$106,000,000,” *Baltimore Sun*, Nov. 11, 1966, C11.

² Robert C. Keith, *Baltimore Harbor: A Pictorial History*, 3rd ed. (Baltimore: Johns Hopkins University Press, 2005), 71.

³ L.A. Sawyer and W. H. Mitchell, *Victory Ships and Tankers* (Cambridge, Md.: Cornell Maritime Press, Inc., 1974), 175–76; *Record of the American Bureau of Shipping 1972* (New York: American Bureau of Shipping, 1972), 2:2172. The specific lengths for the sections that formed the *Seatrain Ohio* were: 300’-9” for the bow from *Mission San Diego*, 120’-4 1/2” for the midsection from *Maine* ex *Tomahawk*, and 118’-4 1/2” for the stern from *Ohio* (ex *Mission San Jose*). These dimensions seem plausible, but it has not been possible to verify them through primary documentation.

The ship is about 40' longer than any of the tankers from which it originated. The *Mission San Jose's* original midships deckhouse, which contained the bridge and certain crew quarters, was moved aft during the conversion and placed atop the balance of the original crew accommodations at the stern, creating a new, high single-island superstructure. A new wheelhouse was built atop this stack of decks to mitigate the visual obstruction created by the new cargo cranes. A tall conical funnel also had to be fitted to carry combustion gases clear. The bulkheads that separated the original center cargo tanks from each other were removed and a 'tween deck inserted to create two levels of barrier-free cargo space measuring 328'-6" long, 36' wide, and about 15' high. The original port and starboard wing cargo tanks were altered to serve as seawater ballast and anti-rolling tanks. The propulsion machinery spaces were not rearranged. The extent to which the crew accommodations may have been upgraded is unknown.⁴

5. Original cost: Approximately \$4 million. Although Hudson Waterways' contract with Maryland Shipbuilding was for \$9 million to convert three ships, change orders increased the final cost to about \$12 million.⁵

6. Modifications: Documentation of changes to the *Seatrain Ohio's* configuration and equipment during its service career is not known.

B. Historical Context

The emergency shipbuilding program in the United States during World War II created 669 tankers between 1939 and 1945. Of these, 481 were of a standard commercial design designated T2-SE-A1 by the U.S. Maritime Commission. An additional forty-three were of the similar T2-SE-A2 type, the primary difference being one of increased engine power in the later design. The Marinship Corporation of Sausalito, California, built all the type T2-SE-A2 tankers constructed during the war, including the three ships that contributed components to make the *Seatrain Ohio* in 1966.⁶

⁴ David Hendrickson, "From Boxcars to Boxships: The Ships of Seatrain Lines," *Steamboat Bill* 62, no. 2 (Summer 2005): 95; C. W. Walje, "Ninety House Trailers Sealifted to Vietnam in Former Tanker," *Sealift Magazine*, Feb. 1967, 15-16; Maryland Shipbuilding and Drydock Co., Baltimore Md., "S.S. *Seatrain Maine* capacity plan," Hull Technical Department drawing no. 94150-65-31, May 29, 1967, copy provided by Maritime Administration.

⁵ Basoco, "\$9,000,000 conversion job slated," C9; idem, "\$36 million sales seen at ship firm," *Baltimore Sun*, Nov. 20, 1966, 115.

⁶ The T2-SE-A1 tankers had these specifications: length overall, 523'-6"; beam, 68'; loaded draft, 30'-1.25"; designed gross tonnage, 10,448; displacement, 21,880 long tons; deadweight, 16,613 long tons; normal power, 6,000 shp; maximum power, 7,240 shp; speed, 14.5-15 knots; range, 12,600 miles. The A2 type was nearly identical but had increased engine power of 10,000 shp for a speed of 16 knots and a cruising range of 8,300 miles. Steven Spar, "Tankers," in *A Half Century of Maritime Technology, 1943-1993*, ed. Harry Benford (Jersey City: Society of Naval Architects and Marine Engineers, 1993), 262; Sawyer and Mitchell, *Victory Ships and Tankers*, 97-98.

After war's end, most of the surviving A1 tankers entered commercial service while the A2 tankers served the navy. As these ships aged, an increasing number were rehabilitated through lengthening or converting to alternative uses. The process of welding a new midsection between a ship's existing bow and stern did not originate in postwar America, but owners and shipbuilders embraced it anew in the late 1950s and 1960s as a way to extend a ship's service life and increase its carrying capacity by renewing much of the ship's structure. "Jumboizing," as the process was dubbed at the time, quickly came to encompass all manner of renovation and alteration projects where war-surplus tankers were converted into container ships, trailer ships, chemical carriers, bulk carriers, and even NASA tracking craft.⁷

In 1960, Congress authorized the Maritime Administration (MARAD) to start a ship exchange program helping U.S. carriers that were otherwise ineligible receive operating and construction subsidies (mostly those in coastal trades) to upgrade their fleets. The program allowed unsubsidized operators to exchange war-built cargo ships for more modern or efficient war-built tonnage held by the government in the National Defense Reserve Fleet. Tankers could not be acquired from MARAD under this program at first, but a 1965 amendment expanded the program to allow the trade-out of T2 tankers for use on the Great Lakes or for conversion to non-petroleum-carrying uses on the high seas. The amendment also permitted the trade-in of pre-war tonnage and extended the program from its original 1965 limit into 1970.⁸

Hudson Waterways Corporation, a subsidiary of the holding company Transeastern Associates, Inc., was one of a handful of companies that applied for T2 tankers soon after the liberalization of the trade-in rules. In 1965, Transeastern purchased Seatrain Lines, Inc., a company founded in 1928 to carry railcars by sea between the United States and Cuba. While Hudson Waterways was negotiating its trade-ins in 1966, corporate restructuring led Seatrain Lines to absorb its new parent, and Hudson Waterways thus became a subsidiary of Seatrain.⁹

Hudson Waterways was able to acquire nine tankers in 1966, which the company planned to convert to container and railcar carriers for charter to Seatrain for domestic service. Among other ships, the company traded in the 1896 Great Lakes bulk carrier *Wolverine*, valued at \$30,750, for the *Mission San Jose*, valued at \$274,600. The 1901 laker *Pillsbury* (value: \$59,250)

⁷ Sawyer and Mitchell, *Victory Ships and Tankers*, 100-04, 109-11; Dave Jones, "'Jumboizing' process adds size and life to scarce oil ships," *Wall Street Journal*, Mar. 12, 1957, 1.

⁸ *Ship Exchange Act*, Public Law 86-575 (July 5, 1960), *U.S. Statutes at Large* 74 (1960): 312; *Merchant Marine Act, 1936, amendment*, Public Law 89-254 (Oct. 10, 1965), *U.S. Statutes at Large* 79 (1965): 980; U.S. Department of Commerce, *Annual Report of the Maritime Administration*, 1965, 9, 37-38; *Annual Report of the Maritime Administration*, 1966, 7, 52-53.

⁹ Rene De La Pedraja, *A Historical Dictionary of the U.S. Merchant Marine and Shipping Industry Since the Introduction of Steam* (Westport, Conn.: Greenwood Press, 1994), 547-50; "The Railway-Car Ferry Seatrain," *Marine Engineering* 34 (Jan. 1929): 30; "While ICC weighs bid of one firm for line, rival snaps up prize," *Wall Street Journal*, May 28, 1965, 6; "Seatrain plans to buy all Transeastern stock in reorganization move," *Wall Street Journal*, July 13, 1966, 6; Werner Bamberger, "Sea carrier lines in consolidation," *New York Times*, Sept. 9, 1966, 88.

was exchanged for the *Tomahawk* (value: \$212,400), and the 1900 laker *Princeton* netted the *Mission San Diego*.¹⁰

The *Mission San Jose* and *Tomahawk* sales went through in June 1966; the *Mission San Diego* sale followed in the fall. Hudson Waterways immediately renamed the first two ships *Ohio* and *Maine*, but did not rename the third before all three were delivered to the Maryland Shipbuilding and Drydock Company in Baltimore for conversion. Hudson Waterways sent another seven tankers to the Newport News Shipbuilding and Dry Dock Company for alteration and two more to the Savannah Machine and Foundry Company.¹¹

Workers at Maryland Shipbuilding cut the three tankers into sections and recombined them, with heavy modifications and additions, into three new ships, the *Seatrain Maryland*, the *Seatrain Washington*, and the *Seatrain Ohio*, each adapted to carry 177 to 180 40' containers or thirty-five to forty railcars.¹²

As these alterations began, seven of the nine ships were included in a massive \$106 million U.S. government charter signed in November 1966. The build up of U.S. forces in Vietnam during 1965 and 1966 created an exceptional demand for ships to carry military cargoes across the Pacific. Among many actions taken to secure sufficient tonnage, the Military Sea Transportation Service (MSTS), the navy agency responsible for all military seaborne cargo operations, signed an initial charter with Seatrain for three ships in May 1966. This first agreement was incorporated into a second, vastly enlarged charter six months later, which secured for the government world-wide use of twelve ships for three years, with options for renewal for as long as eleven years. The contract set the rate for the *Seatrain Ohio* and its sisters at \$8,500 a day for the first three years, decreasing to \$7,500 during the fourth and fifth years and \$6,500 from the sixth year forward.¹³

"The vessels to be made available by Seatrain . . . are self-sustaining ships of exceptional flexibility," Werner Bamberger reported in the *New York Times*.¹⁴ A writer for the MSTS called the Seatrain conversions "an entirely new concept in cargo ships." Describing the *Seatrain Puerto Rico*, one of the Newport News conversions, he wrote:

¹⁰ "American steamship companies get navy tankers in exchange," *New York Times*, Mar. 6, 1966, S18; "Ship exchange gets approval," *Baltimore Sun*, June 28, 1966, C13; Sawyer and Mitchell, *Victory Ships and Tankers*, 176. MARAD custody cards for *Tomahawk*, *Mission San Jose*, *Mission San Diego*, *Wolverine*, *Pillsbury*, and *Princeton*, all at <https://pmars.marad.dot.gov/>.

¹¹ Sawyer and Mitchell, *Victory Ships and Tankers*, 175-76; Basoco, "\$9,000,000 conversion job slated," C9; MARAD custody cards for *Tomahawk*, *Mission San Jose*, *Mission San Diego*, and *Ohio* (ex-*Seatrain Ohio*).

¹² "Ship exchange gets approval," C13; Basoco, "\$9,000,000 conversion job slated," C9.

¹³ The November 1966 charter covered five existing Seatrain vessels (*Seatrain Texas*, *S. New Jersey*, *S. Savannah*, *S. Georgia*, *S. Louisiana*); the four T2s converted at Newport News (*Seatrain Puerto Rico*, *S. Carolina*, *S. Florida*, *S. Maryland*), and the three T2s converted at Maryland Shipbuilding (*Seatrain Ohio*, *S. Maine*, *S. Washington*). The two vessels converted at Savannah (*Seatrain San Juan* and *S. Delaware*) were not part of this charter agreement. "MSTS signs charter for \$106,000,000," C11; Sawyer and Mitchell, *Victory Ships and Tankers*, 176; Lane C. Kendall, "U.S. Merchant Shipping and Vietnam," *Naval Review* 1968: 144.

¹⁴ Werner Bamberger, "M.S.T.S. charters 12 Seatrain ships," *New York Times*, Nov. 12, 1966, 58.

Cargowise, the vessel is unique in that there are no obstructions whatsoever in the lower hold and 'tween deck spaces. She resembles a giant floating warehouse. Rails are installed in the 2 below-deck holds and the upper deck permitting the ship to carry nearly 40 railroad cars or locomotives.¹⁵

The *Seatrain Puerto Rico's* first cargo, as it turned out, was ninety house trailers recently used as displaced persons' housing after Hurricane Betsy in 1965, which the ship delivered to Vietnam from New Orleans in early 1967.¹⁶

C. Operational History

The conversion of three oil tankers into the *Seatrain Ohio* began in August 1966. The work was scheduled for completion in March 1967 but was actually finished in August.¹⁷ Upon delivery, the ship was turned over to MSTS and began carrying military cargoes between the United States and Vietnam. On most voyages the ship carried vehicles of all kinds, helicopters, and supplies, although it was also partly adapted at one point to carry troops. In April 1968, the ship took aboard damaged aircraft for return to the U.S. These were loaded by helicopter, a maneuver a *Seatrain* official said saved "a great deal of expense in time and effort." Later in the year, it loaded two replacement 16" gun barrels for the battleship USS *New Jersey*—each 67' long and weighing 125 tons—for transport from Long Beach, California, to the Naval Supply Depot at Subic Bay in the Philippines. Toward the end of the war, the ship carried a complete helicopter reconnaissance squadron from Vietnam to Hawaii.¹⁸

After its Vietnam service ended, the *Seatrain Ohio* was repositioned to the U.S. Atlantic coast. On January 6, 1973, the ship experienced a serious fire while en route from New York to Baltimore with a cargo of scrap metal and salvage equipment. The ship was about 40 miles north of Norfolk in the York Spit channel and nearly 6 miles off the western coast of Virginia's Eastern Shore when fire broke out in the boiler room around 7 p.m. The ship's carbon-dioxide system extinguished the blaze within a short time, but the crew did not leave the affected compartment sealed long enough, so oxygen readmitted before the room had sufficiently cooled reignited the fire. Water, foam, and more carbon dioxide were used over the next few hours to control the blaze. Three Coast Guard cutters, two Coast Guard

¹⁵ Walje, "Ninety House Trailers Sealifted," 15-16.

¹⁶ *ibid.*

¹⁷ Basoco, "\$9,000,000 conversion job slated," C9; "MSTS signs charter for \$106,000,000," C11; Maryland Shipbuilding and Drydock Company, *Annual Report* (1967), 2, copy in Special Collections, University of Maryland Libraries, College Park, Md.; *Record of the American Bureau of Shipping* 1972, 2:2172.

¹⁸ "Helicopters speed salvage of planes damaged in battle," *New York Times*, Nov. 10, 1968, S17; "Damaged Aircraft Lifted to Seatrain Ship by 'Copter," *Sealift Magazine* 18, no. 9 (Sept. 1968): 18; "Gun Barrels for Mighty Battleship Lifted to Subic Bay by MSTs," *Sealift Magazine* 18, no. 11 (Nov. 1968): 5; "Military cargo loading at port," *Lodi* (Calif.) *News Sentinel*, May 22, 1973, 9.

helicopters, and two navy tugs assisted at the scene. The tugs towed the crippled ship to Norfolk for inspection and repairs, which took only a few weeks.¹⁹

The following May, the ship loaded eight million pounds of military cargo, including pre-fabricated shelters and bunks, at Port Stockton, California, for shipment to England, Belgium, and Germany.²⁰ Then, in June, Hudson Waterways traded the ship in to the Maritime Administration, and it entered the James River Reserve Fleet in Virginia on November 30, 1973. It remained there until late 1986, except for two periods – September 1978 to July 1979 and February to July 1982 – when it was activated for Ready Reserve Fleet exercises. Before the first exercise, MARAD removed “Seatrain” from the ship’s name so the ship would no longer appear associated with its former owners. The second activation led to the ship’s participation in Exercise Reforger 82, an annual NATO training exercise.²¹ Mechanical difficulties made the ship late to the exercise, a fact that came up in House defense-appropriation hearings the next year. George A. Sawyer, the navy’s assistant secretary for shipbuilding and logistics, defended the fitness of the Ready Reserve Fleet by noting that the *Ohio*’s problems were not typical. “In other words, the common denominator is that if she was a well-maintained, well-operated ship when she went into inactivation, she will come out quickly and easily,” he argued. “If she was in poor condition or not well maintained, that will determine her condition when she comes out. I believe the latter was more representative of the *Seatrain Ohio* situation.”²²

The ship was moved to the Beaumont Reserve Fleet in Texas in November 1986. It was downgraded from reserve status to warehouse use in February 1990 and has been used as a maintenance station in the fleet since. The ship was downgraded again to disposal status in February 2009 and awaits sale for scrapping as of the end of 2010.²³

PART II. STRUCTURAL / DESIGN INFORMATION

A. General Description

1. Overall: The *Seatrain Ohio* is a welded, steel-hulled, single-screw, turbo-electric cargo ship fitted with long barrier-free holds for shipping railroad freight cars, vehicles, containers, and general cargo. The ship is distinguished by its single aft deckhouse; its long external cargo deck, the Spar Deck, mounted on beams above the hull; and its two 45-ton cargo cranes. Converted into its present form from sections of three T2 oil tankers, the ship retains the raked stem and modified cruiser stern typical of those ships.

¹⁹ “Ship blaze quelled in Chesapeake Bay,” *New York Times*, Jan. 7, 1973, 66; “Coast Guard fights fire on city-bound ship,” *Baltimore Sun*, Jan. 7, 1973, A20; “Ship disabled by fire is towed to Norfolk,” *Baltimore Sun*, Jan. 8, 1973, C16.

²⁰ “Military cargo loading at port,” 9.

²¹ Maritime Administration custody cards for *Ohio* (ex-*Seatrain Ohio*); *Merchant Vessels of the United States*, 1978 and 1979.

²² House Committee on Appropriations, *Department of Defense Appropriations for 1984*, 98th Cong., 1st sess., Apr. 21, 1983, pt. 6: 520–21.

²³ Maritime Administration custody cards for *Ohio* (ex-*Seatrain Ohio*).

2. Decks: The hull contains the Hold and the Second Deck. The largely exposed Upper Deck supports a raised forecastle at the bow and seven levels of crew accommodations at the stern. A long Spar Deck surmounts the hull above the Upper Deck.

The aft superstructure contains cold storage lockers and crew's quarters on the Upper Deck. The Poop Deck, next above, contains the galley, crew and officers' mess rooms, and engineers' quarters. The Boat Deck houses the emergency generator room, the carbon-dioxide room, fan and air-conditioning room, and cadets' quarters. The Bridge Deck holds rooms for deck officers; the Upper Bridge Deck, the captain's stateroom and office, the radio room, and the gyro room. The Navigating Bridge Deck, which formerly held the ship's wheelhouse and chartroom, now houses a lounge. The Upper Navigating Bridge Deck contains the wheelhouse and chart room.

3. Cargo holds: The ship has four cargo decks. The uppermost cargo deck, the Spar Deck, provides about 21,000 sq. ft. of space for containers or vehicles. The remaining three decks are laid with rails for the transport of standard American-gage railroad freight cars, six pairs on the Upper Deck, three on the Second Deck, and three in the Hold. To allow the loading of non-rail cargoes on these decks, the Upper Deck is laid with asphalt flush with the tops of the rails, and the Second Deck and Hold are similarly laid with concrete. These three decks together provide 775,000 cu. ft. of stowage space.²⁴

A hatch opening about 60' x 36' runs through the Spar, Upper, and Second decks and provides cargo-loading access to the holds.

4. Crew accommodations: The ship contains berths for about forty-five crewmen.

5. Safety: The ship is equipped with two lifeboats launched from gravity davits as well as canister rafts. The ship also has an extensive carbon-dioxide system for the suppression of cargo fires.

B. Mechanical Features

1. Engine plant: The *Seatrain Ohio* retains the 10,000-shp turbo-electric propulsion system built in 1944 for the tanker *Mission San Jose*. In brief, the ship is propelled by an electric motor driving a single shaft. The motor receives current from a 7,500 kW, 2,300 V generator driven by a turbine supplied with steam from two water-tube boilers. Two auxiliary 400 kW turbo generators provide current for ship's service. The engine system was manufactured by the General Electric Company; the boilers were made by the Babcock and Wilcox Company.²⁵

²⁴ Walje, "Ninety House Trailers Sealifted," 16.

²⁵ Sawyer and Mitchell, *Victory Ships and Tankers, 97-98; Register of Ships, 1977-78* (London: Lloyd's Register of Shipping, 1977), 1251.

2. Cargo handling arrangements: The ship is fitted with two 45-ton cranes for loading and unloading cargo.

PART III. SOURCES OF INFORMATION

A. Primary Sources

U.S. Congress. House. Committee on Appropriations. *Department of Defense Appropriations for 1984: Hearings before a subcommittee*. 98th Cong., 1st sess., 1983.

Maritime Administration custody cards for ships currently and formerly held in the National Defense Reserve Fleet. <https://pmars.marad.dot.gov/>.

Merchant Marine Act, 1936, amendment. Public Law 89-254 (Oct. 10, 1965). *U.S. Statutes at Large* 79 (1965): 980.

Ship Exchange Act. Public Law 86-575 (July 5, 1960). *U.S. Statutes at Large* 74 (1960): 312.

Maryland Shipbuilding and Drydock Co., Baltimore Md. "S.S. *Seatrain Maine* capacity plan." Hull Technical Department drawing no. 94150-65-31, May 29, 1967. Copy at Maritime Administration.

B. Secondary Sources

American Bureau of Shipping. *Record of the American Bureau of Shipping*. New York: American Bureau of Shipping, 1972-1979.

De La Pedraja, Rene. *A Historical Dictionary of the U.S. Merchant Marine and Shipping Industry Since the Introduction of Steam*. Westport, Conn.: Greenwood Press, 1994.

Hendrickson, David. "From Boxcars to Boxships: The Ships of Seatrains Lines." *Steamboat Bill* 62, no. 2 (Summer 2005): 89-102.

Keith, Robert C. *Baltimore Harbor: A Pictorial History*. 3rd ed. Baltimore: Johns Hopkins University Press, 2005.

Kendall, Lane C.. "U.S. Merchant Shipping and Vietnam." *Naval Review* 1968: 129-144.

Maryland Shipbuilding & Drydock Company. *Annual Report*. 1967. Copy in Special Collections, University of Maryland Libraries, College Park, Md.

"The Railway-Car Ferry Seatrains." *Marine Engineering* 34 (Jan. 1929): 30.

Register of Ships, 1977-78. London: Lloyd's Register of Shipping, 1977.

Sawyer, L.A. and W. H. Mitchell. *Victory Ships and Tankers*. Cambridge, Md.: Cornell Maritime Press, Inc., 1974.

Spar, Steven. "Tankers." In *A Half Century of Maritime Technology, 1943-1993*, edited by Harry Benford, 262-80. Jersey City: Society of Naval Architects and Marine Engineers, 1993.

U.S. Department of Commerce. Annual Reports of the Maritime Administration, 1965, 1966.

C. Newspaper and Magazine Articles

"'Jumboizing' process adds size and life to scarce oil ships." *Wall Street Journal*, Mar. 12, 1957, 1.

"While ICC weighs bid of one firm for line, rival snaps up prize." *Wall Street Journal*, May 28, 1965, 6.

"American steamship companies get navy tankers in exchange." *New York Times*, Mar. 6, 1966, S18.

"Ship exchange gets approval." *Baltimore Sun*, June 28, 1966, C13.

"Seatrains plans to buy all Transeastern stock in reorganization move." *Wall Street Journal*, July 13, 1966, 6.

Basoco, Richard. "\$9,000,000 conversion job slated." *Baltimore Sun*, Aug. 31, 1966, C9.

Bamberger, Werner. "Sea carrier lines in consolidation." *New York Times*, Sept. 9, 1966, 88.

"MSTS signs charter for \$106,000,000." *Baltimore Sun*, Nov. 11, 1966, C11.

Bamberger, Werner. "M.S.T.S. charters 12 Seatrain ships." *New York Times*, Nov. 12, 1966, 58.

Basoco, Richard. "\$36 million sales seen at ship firm." *Baltimore Sun*, Nov. 20, 1966, 115.

Walje, C. W. "Ninety House Trailers Sealifted to Vietnam in Former Tanker." *Sealift Magazine*, Feb. 1967, 15-16.

"Damaged Aircraft Lifted to Seatrain Ship by 'Copter." *Sealift Magazine* 18, no. 9 (Sept. 1968): 18.

"Gun Barrels for Mighty Battleship Lifted to Subic Bay by MSTS." *Sealift Magazine* 18, no. 11 (Nov. 1968): 5.

"Helicopters speed salvage of planes damaged in battle." *New York Times*, Nov. 10, 1968, S17.

"Coast Guard fights fire on city-bound ship." *Baltimore Sun*, Jan. 7, 1973, A20.

"Ship blaze quelled in Chesapeake Bay." *New York Times*, Jan. 7, 1973, 66.

"Ship disabled by fire is towed to Norfolk." *Baltimore Sun*, Jan. 8, 1973, C16.

"Military cargo loading at port." *Lodi (Calif.) News Sentinel*, May 22, 1973, 9.

APPENDIX I:
T2 tanker / Seatrain conversions

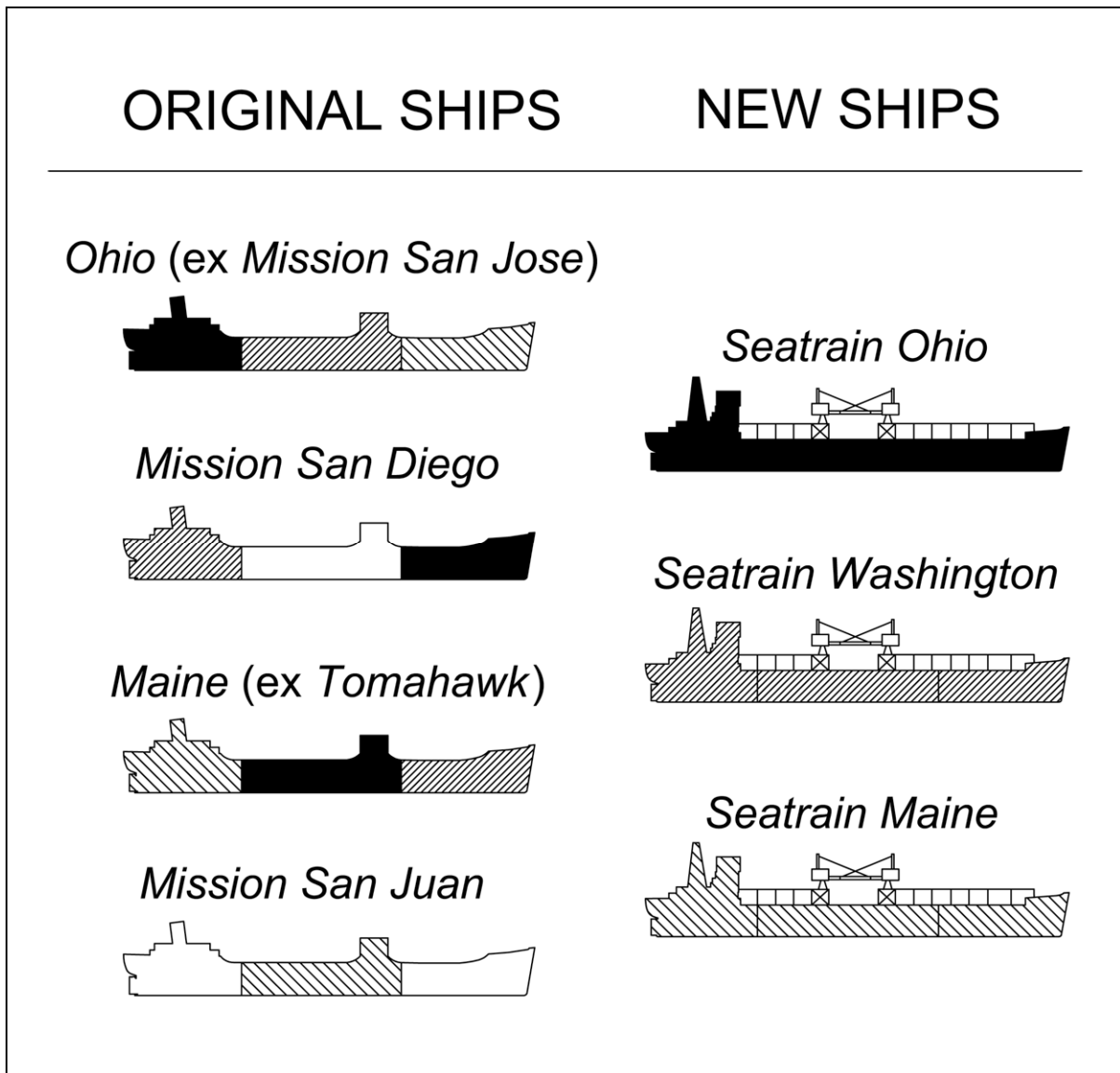

Fig. 1. This diagram demonstrates how four T2-SE-A2-type tankers built in 1943-44 were cut apart and reassembled into three new cargo ships for Hudson Waterways Corporation by the Maryland Shipbuilding and Drydock Company in 1966-67. Short additional hull sections inserted into each ship's midbody to create additional length are not shown. Six more tankers were "jumboized" in similar fashion for Hudson Waterways at two other shipyards around the same time. Illustration by Todd Croteau, HAER Maritime Program coordinator.

HISTORIC AMERICAN ENGINEERING RECORD

INDEX TO PHOTOGRAPHS

SEATRAN OHIO

HAER TX-111

(Ohio)

(Mission San Jose)

Beaumont Reserve Fleet, Neches River

Beaumont vicinity

Jefferson County

Texas

INDEX TO BLACK AND WHITE PHOTOGRAPHS

Jet Lowe, photographer, April 2009

- | | |
|-----------|--|
| TX-111-1 | Starboard profile view. |
| TX-111-2 | 3/4 view off the starboard bow. |
| TX-111-3 | 3/4 view off the port bow. |
| TX-111-4 | 3/4 view off the port quarter. |
| TX-111-5 | Poop deck, view looking to port. |
| TX-111-6 | View looking aft toward funnel from starboard bridge wing. |
| TX-111-7 | Poop deck, view looking forward. |
| TX-111-8 | View looking aft from the spar deck toward superstructure. |
| TX-111-9 | View of spar deck looking forward from the port bridge wing. |
| TX-111-10 | Upper deck, view looking forward across the gap in the spar deck. |
| TX-111-11 | View from forward spar deck of aft cargo crane. Note six pairs of rails for securing loaded rolling stock on the upper deck below. |
| TX-111-12 | View of upper deck looking aft with crane on upper deck above. |
| TX-111-13 | View from aft spar deck of cargo cranes and upper deck below. |
| TX-111-14 | Forward cargo crane looking aft toward port side. |

SEATRAN OHIO
HAER TX-111
INDEX TO PHOTOGRAPHS

TX-111-15	Detail view of cargo tackle at head of forward cargo crane.
TX-111-16	View looking aft along spar deck.
TX-111-17	Forecastle, looking aft.
TX-111-18	Forecastle, looking toward anchor windlass from starboard side.
TX-111-19	Boat deck, starboard side, view looking forward with life boat and davits in foreground.
TX-111-20	Wheelhouse, looking aft with chart room in background.
TX-111-21	Wheelhouse, looking forward.
TX-111-22	Gyro compass room on starboard side of upper bridge deck.
TX-111-23	Captain's office on starboard side of upper bridge deck.
TX-111-24	Captain's stateroom on port side of upper bridge deck.
TX-111-25	Captain's head on port side of upper bridge deck.
TX-111-26	Bathroom on port side of bridge deck connecting to hospital.
TX-111-27	View of galley, looking aft.
TX-111-28	Upper deck cargo space, looking forward.
TX-111-29	Bosun's and maintenance man's quarters, upper deck aft, port side.
TX-111-30	Detail view of space between hull and longitudinal bulkhead under the second deck, looking aft on starboard side.
TX-111-31	View of the hold, looking aft.
TX-111-32	View of the hold, looking forward.
TX-111-33	View of the second deck, looking forward from amidships.
TX-111-34	View of the second deck, looking aft from amidships.
TX-111-35	View of engine room looking aft from starboard side showing high and low pressure turbines.
TX-111-36	View of steering gear from port side.
TX-111-37	Steering room looking aft from starboard side showing hydraulic steering gear manufactured by the Stetson Ross Machine Co., Seattle.

SEATRAN OHIO
HAER TX-111
INDEX TO PHOTOGRAPHS

TX-111-38 Detail view of instruction board for changing the steering gear.

INDEX TO COLOR TRANSPARENCIES

Jet Lowe, photographer, April 2009

TX-111-39 (CT) 3/4 view off the starboard quarter.
TX-111-40 (CT) Bosun's and maintenance man's quarters, upper deck aft, port side.
TX-111-41 (CT) Captain's stateroom on port side of upper bridge deck.
TX-111-42 (CT) View looking aft along spar deck.
TX-111-43 (CT) View looking aft from the spar deck toward superstructure.
TX-111-44 (CT) Detail view of cargo tackle at head of forward cargo crane.
TX-111-45 (CT) Forecastle, looking aft.

HISTORIC AMERICAN ENGINEERING RECORD
SEE INDEX TO PHOTOGRAPHS FOR CAPTION

HAER No. TX-111-001



HISTORIC AMERICAN ENGINEERING RECORD
SEE INDEX TO PHOTOGRAPHS FOR CAPTION

HAER No. TX-111-002



HISTORIC AMERICAN ENGINEERING RECORD
SEE INDEX TO PHOTOGRAPHS FOR CAPTION

HAER No. TX-111-003



HISTORIC AMERICAN ENGINEERING RECORD
SEE INDEX TO PHOTOGRAPHS FOR CAPTION

HAER No. TX-111-004



HISTORIC AMERICAN ENGINEERING RECORD
SEE INDEX TO PHOTOGRAPHS FOR CAPTION

HAER No. TX-111-005



HISTORIC AMERICAN ENGINEERING RECORD
SEE INDEX TO PHOTOGRAPHS FOR CAPTION

HAER No. TX-111-006



HISTORIC AMERICAN ENGINEERING RECORD
SEE INDEX TO PHOTOGRAPHS FOR CAPTION

HAER No. TX-111-007



HISTORIC AMERICAN ENGINEERING RECORD
SEE INDEX TO PHOTOGRAPHS FOR CAPTION

HAER No. TX-111-008



HISTORIC AMERICAN ENGINEERING RECORD
SEE INDEX TO PHOTOGRAPHS FOR CAPTION

HAER No. TX-111-009



HISTORIC AMERICAN ENGINEERING RECORD
SEE INDEX TO PHOTOGRAPHS FOR CAPTION

HAER No. TX-111-010



HISTORIC AMERICAN ENGINEERING RECORD
SEE INDEX TO PHOTOGRAPHS FOR CAPTION

HAER No. TX-111-011



HISTORIC AMERICAN ENGINEERING RECORD
SEE INDEX TO PHOTOGRAPHS FOR CAPTION

HAER No. TX-111-012



HISTORIC AMERICAN ENGINEERING RECORD
SEE INDEX TO PHOTOGRAPHS FOR CAPTION

HAER No. TX-111-013



HISTORIC AMERICAN ENGINEERING RECORD
SEE INDEX TO PHOTOGRAPHS FOR CAPTION

HAER No. TX-111-014



HISTORIC AMERICAN ENGINEERING RECORD
SEE INDEX TO PHOTOGRAPHS FOR CAPTION

HAER No. TX-111-015



HISTORIC AMERICAN ENGINEERING RECORD
SEE INDEX TO PHOTOGRAPHS FOR CAPTION

HAER No. TX-111-016

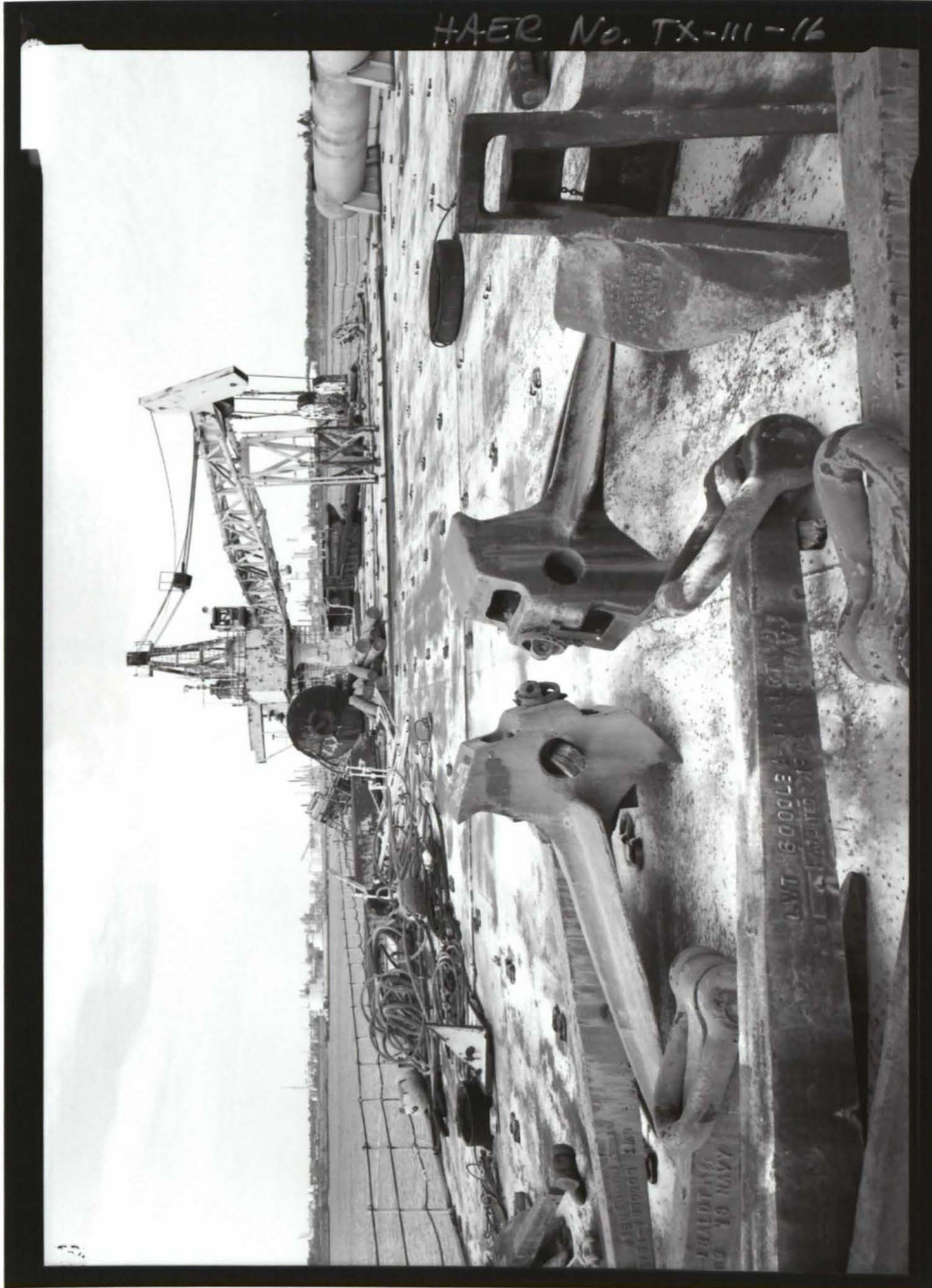

HISTORIC AMERICAN ENGINEERING RECORD
SEE INDEX TO PHOTOGRAPHS FOR CAPTION

HAER No. TX-111-017



HISTORIC AMERICAN ENGINEERING RECORD
SEE INDEX TO PHOTOGRAPHS FOR CAPTION

HAER No. TX-111-018

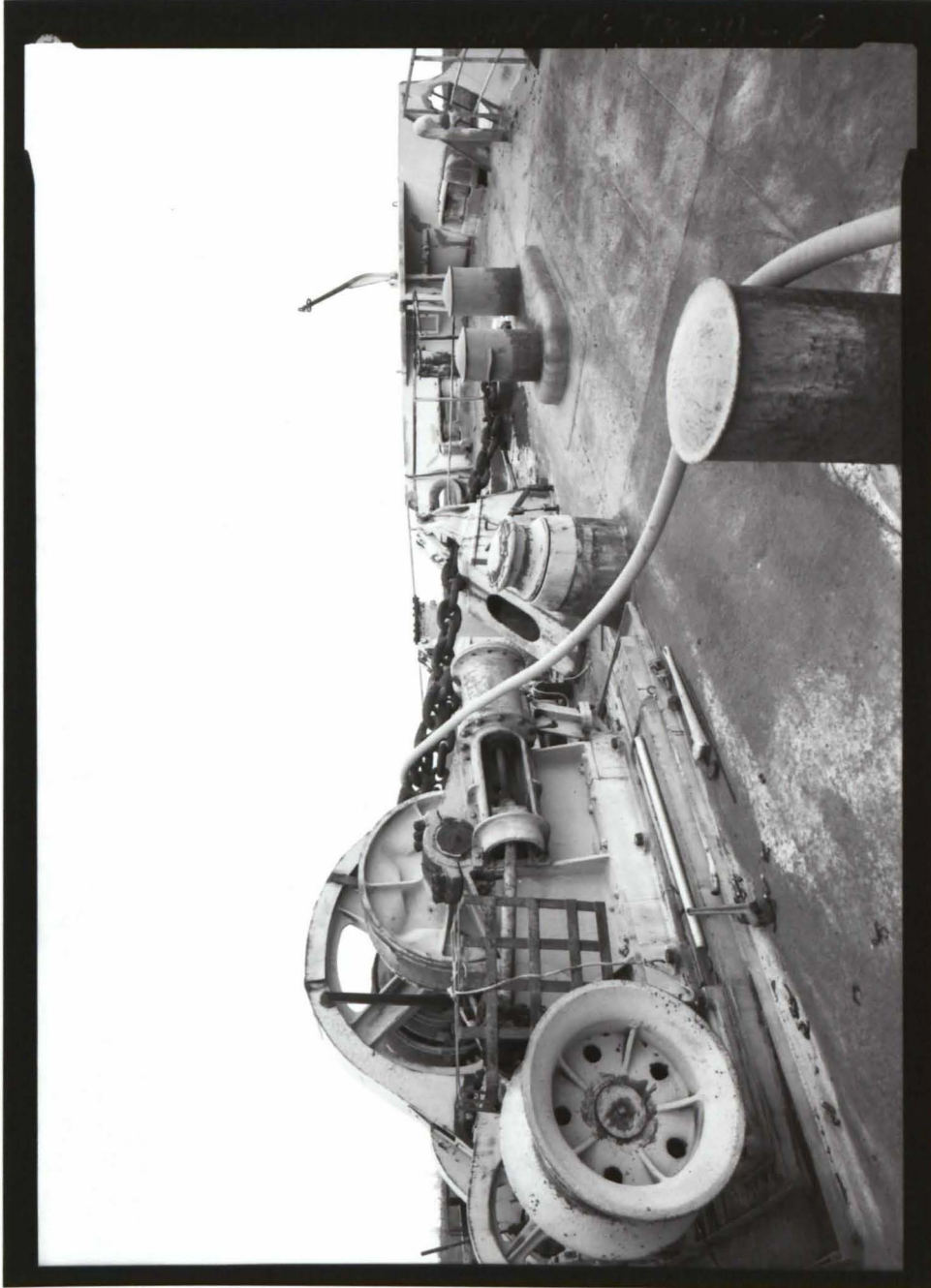

HISTORIC AMERICAN ENGINEERING RECORD
SEE INDEX TO PHOTOGRAPHS FOR CAPTION

HAER No. TX-111-019



HISTORIC AMERICAN ENGINEERING RECORD
SEE INDEX TO PHOTOGRAPHS FOR CAPTION

HAER No. TX-111-020



HISTORIC AMERICAN ENGINEERING RECORD
SEE INDEX TO PHOTOGRAPHS FOR CAPTION

HAER No. TX-111-021



HISTORIC AMERICAN ENGINEERING RECORD
SEE INDEX TO PHOTOGRAPHS FOR CAPTION

HAER No. TX-111-022

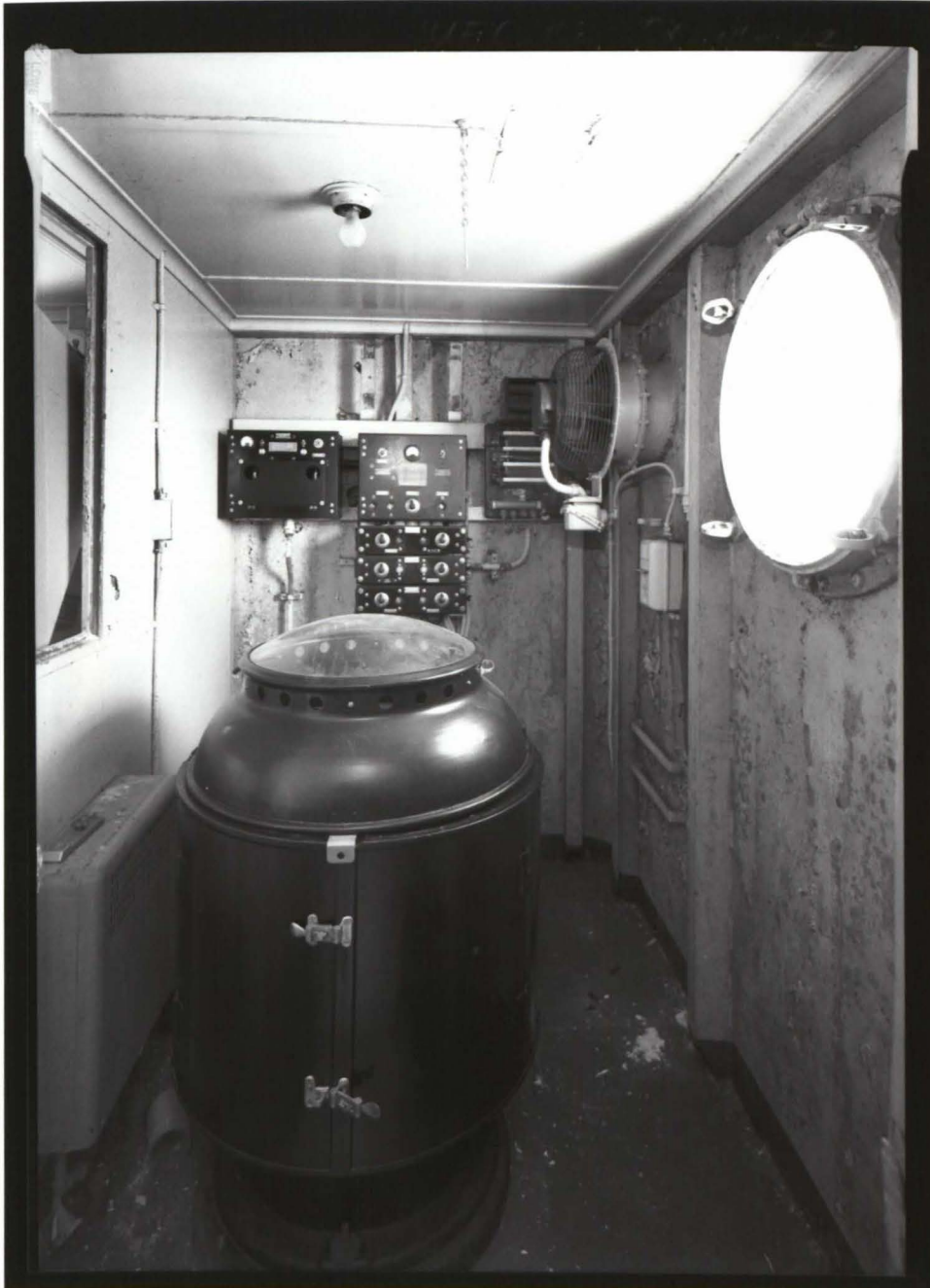

HISTORIC AMERICAN ENGINEERING RECORD
SEE INDEX TO PHOTOGRAPHS FOR CAPTION

HAER No. TX-111-023

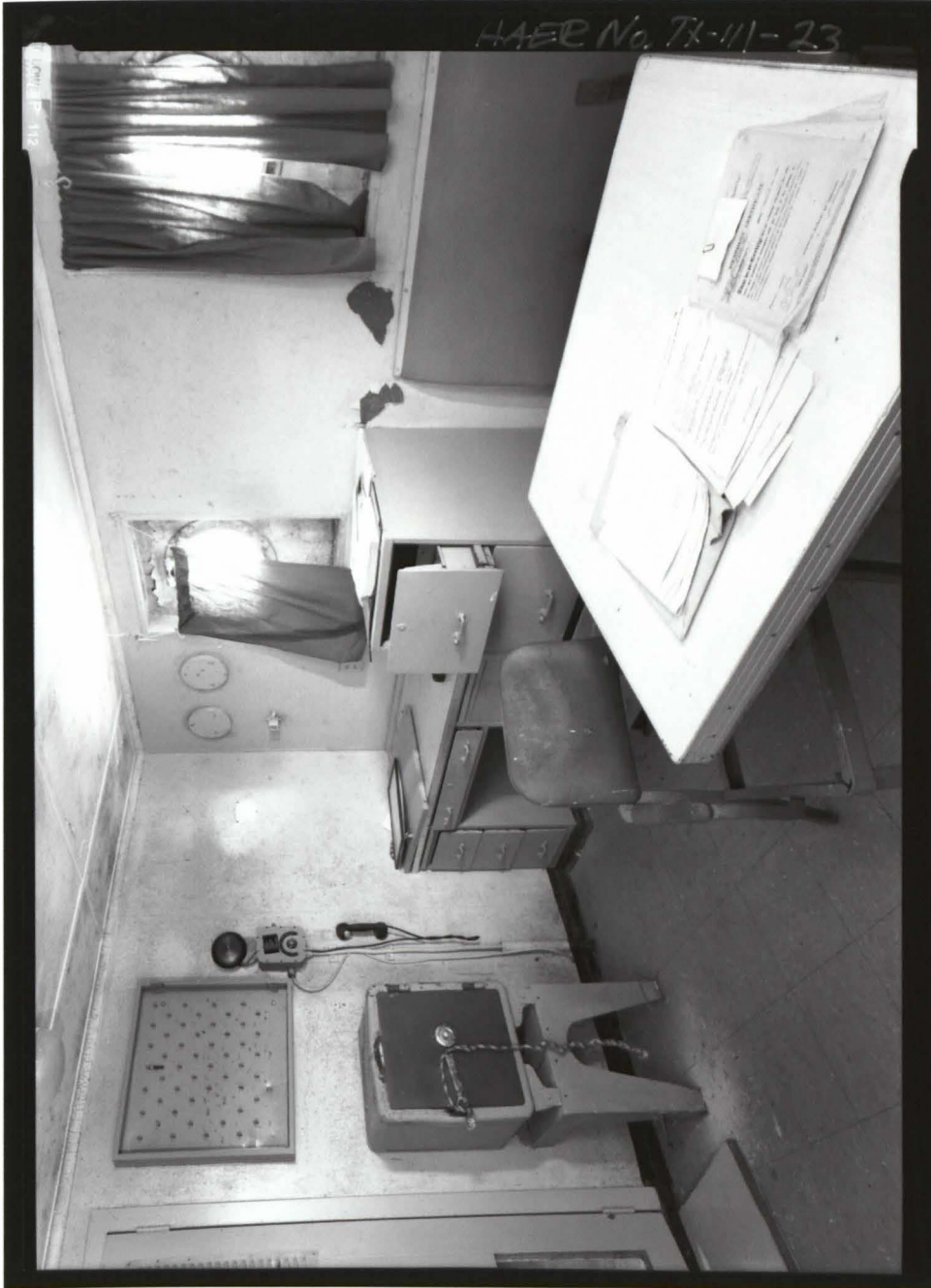

HISTORIC AMERICAN ENGINEERING RECORD
SEE INDEX TO PHOTOGRAPHS FOR CAPTION

HAER No. TX-111-024



HISTORIC AMERICAN ENGINEERING RECORD
SEE INDEX TO PHOTOGRAPHS FOR CAPTION

HAER No. TX-111-025



HISTORIC AMERICAN ENGINEERING RECORD
SEE INDEX TO PHOTOGRAPHS FOR CAPTION

HAER No. TX-111-026

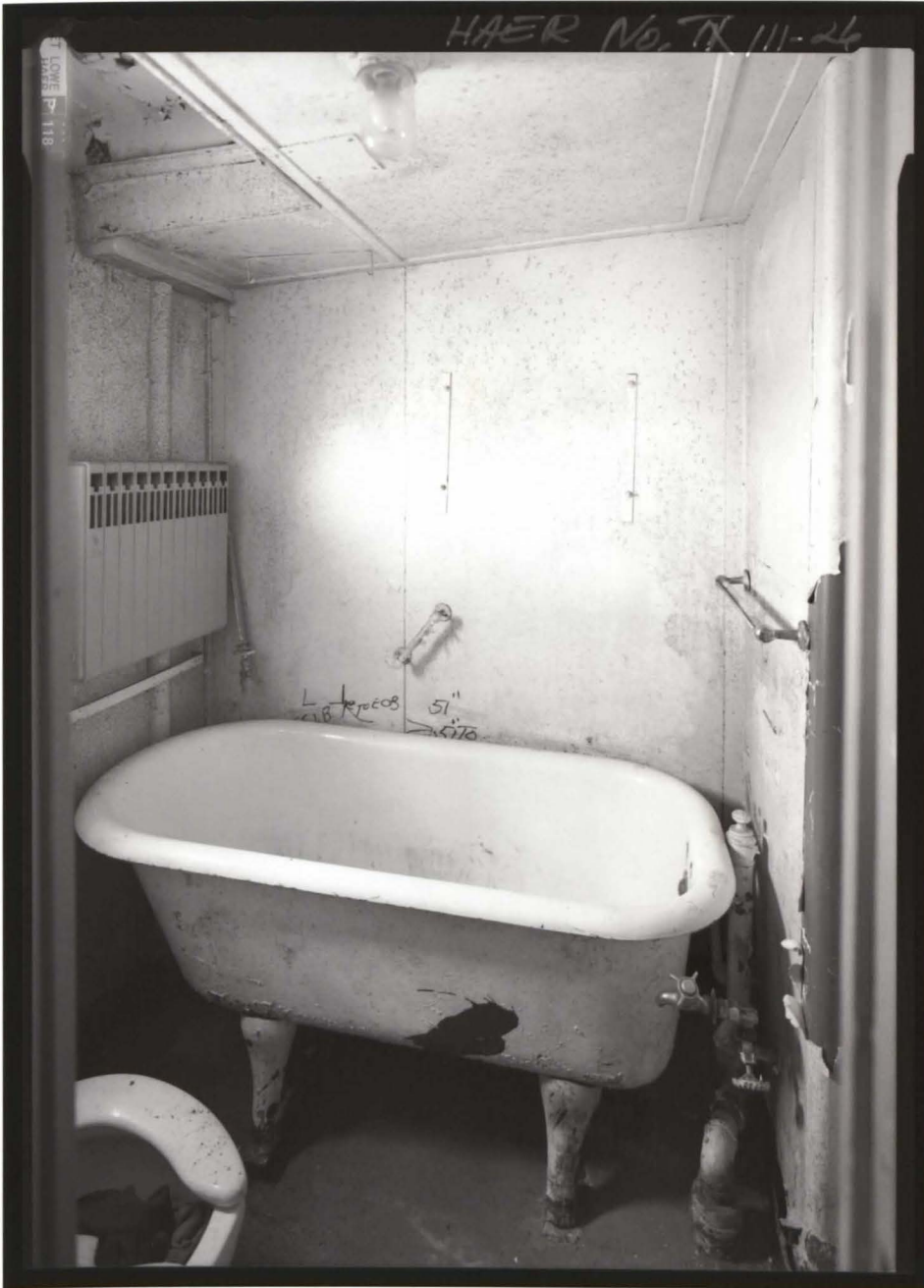

HISTORIC AMERICAN ENGINEERING RECORD
SEE INDEX TO PHOTOGRAPHS FOR CAPTION

HAER No. TX-111-027



HISTORIC AMERICAN ENGINEERING RECORD
SEE INDEX TO PHOTOGRAPHS FOR CAPTION

HAER No. TX-111-028



HISTORIC AMERICAN ENGINEERING RECORD
SEE INDEX TO PHOTOGRAPHS FOR CAPTION

HAER No. TX-111-029



HISTORIC AMERICAN ENGINEERING RECORD
SEE INDEX TO PHOTOGRAPHS FOR CAPTION

HAER No. TX-111-030



HISTORIC AMERICAN ENGINEERING RECORD
SEE INDEX TO PHOTOGRAPHS FOR CAPTION

HAER No. TX-111-031

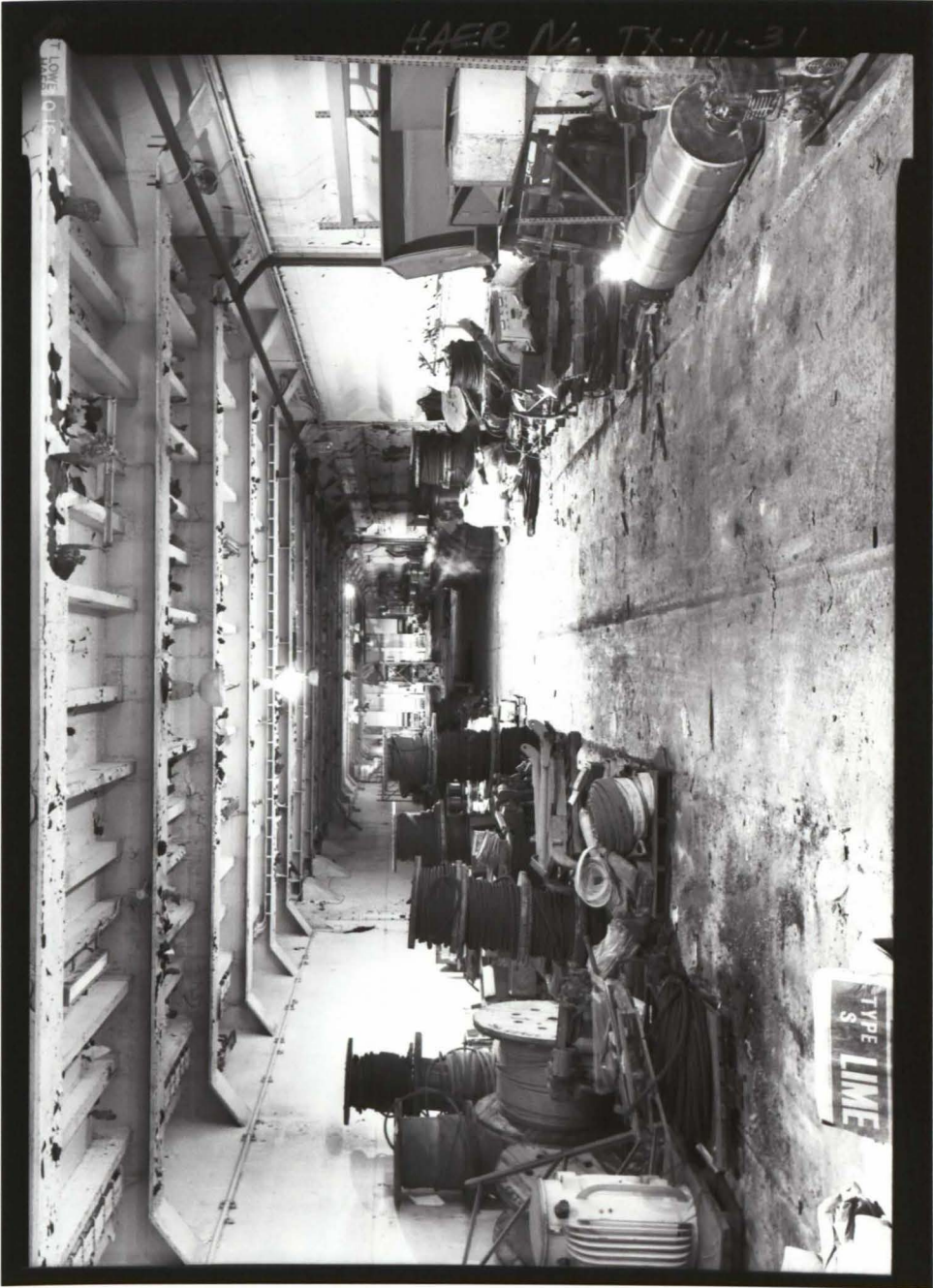

HISTORIC AMERICAN ENGINEERING RECORD
SEE INDEX TO PHOTOGRAPHS FOR CAPTION

HAER No. TX-111-032



HISTORIC AMERICAN ENGINEERING RECORD
SEE INDEX TO PHOTOGRAPHS FOR CAPTION

HAER No. TX-111-033



HISTORIC AMERICAN ENGINEERING RECORD
SEE INDEX TO PHOTOGRAPHS FOR CAPTION

HAER No. TX-111-034



HISTORIC AMERICAN ENGINEERING RECORD
SEE INDEX TO PHOTOGRAPHS FOR CAPTION

HAER No. TX-111-035

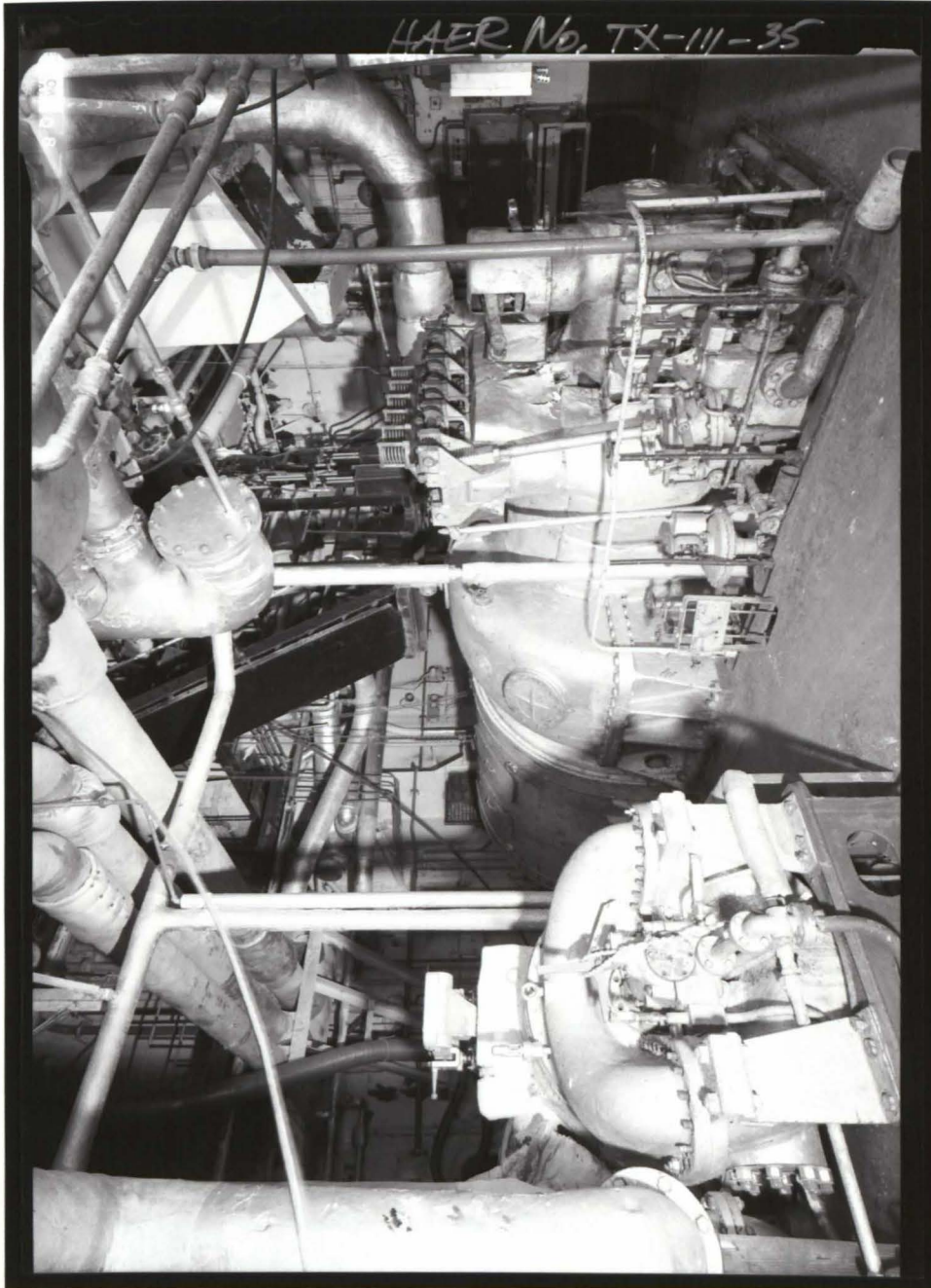

HISTORIC AMERICAN ENGINEERING RECORD
SEE INDEX TO PHOTOGRAPHS FOR CAPTION

HAER No. TX-111-036

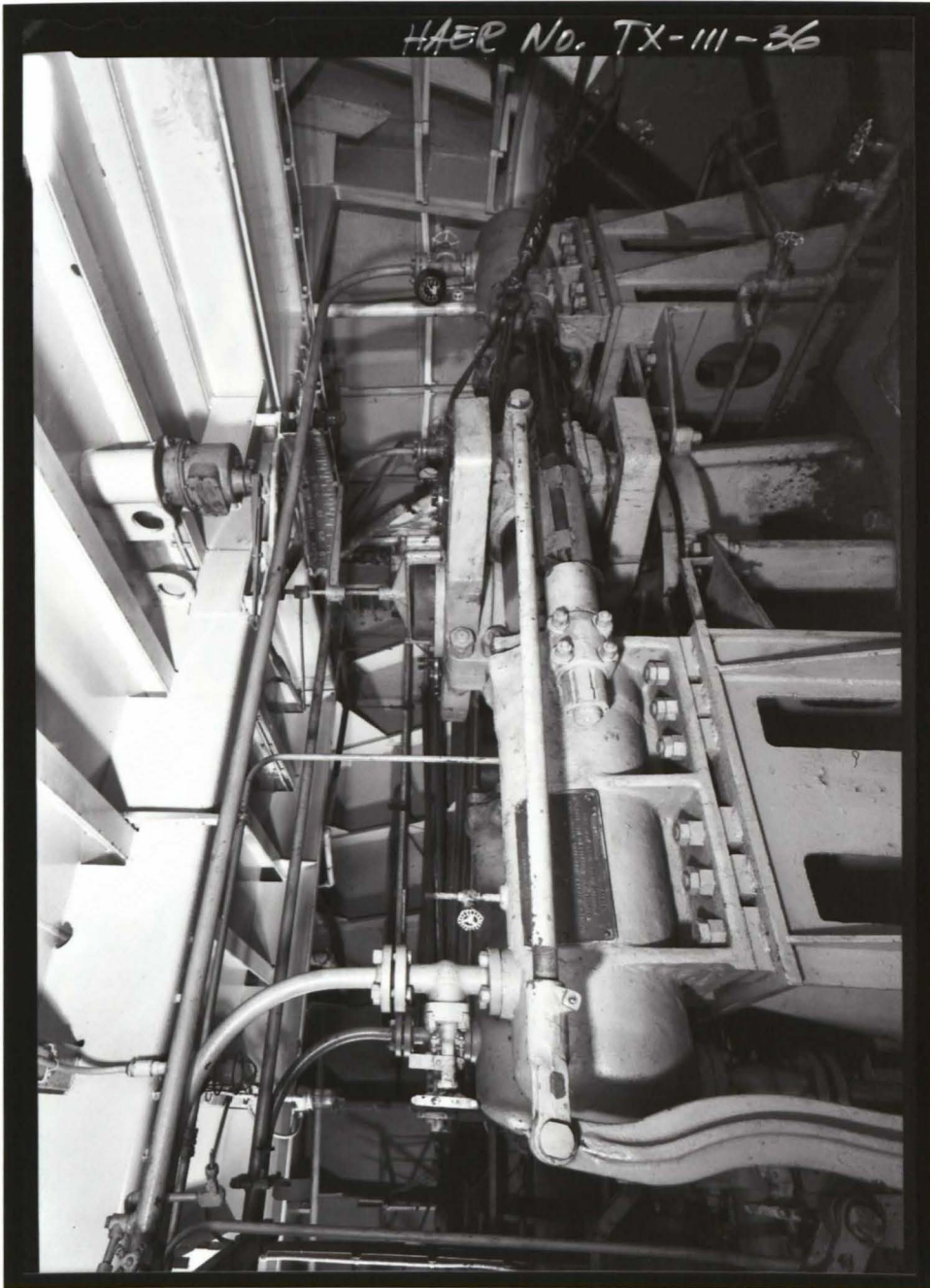

HISTORIC AMERICAN ENGINEERING RECORD
SEE INDEX TO PHOTOGRAPHS FOR CAPTION

HAER No. TX-111-037

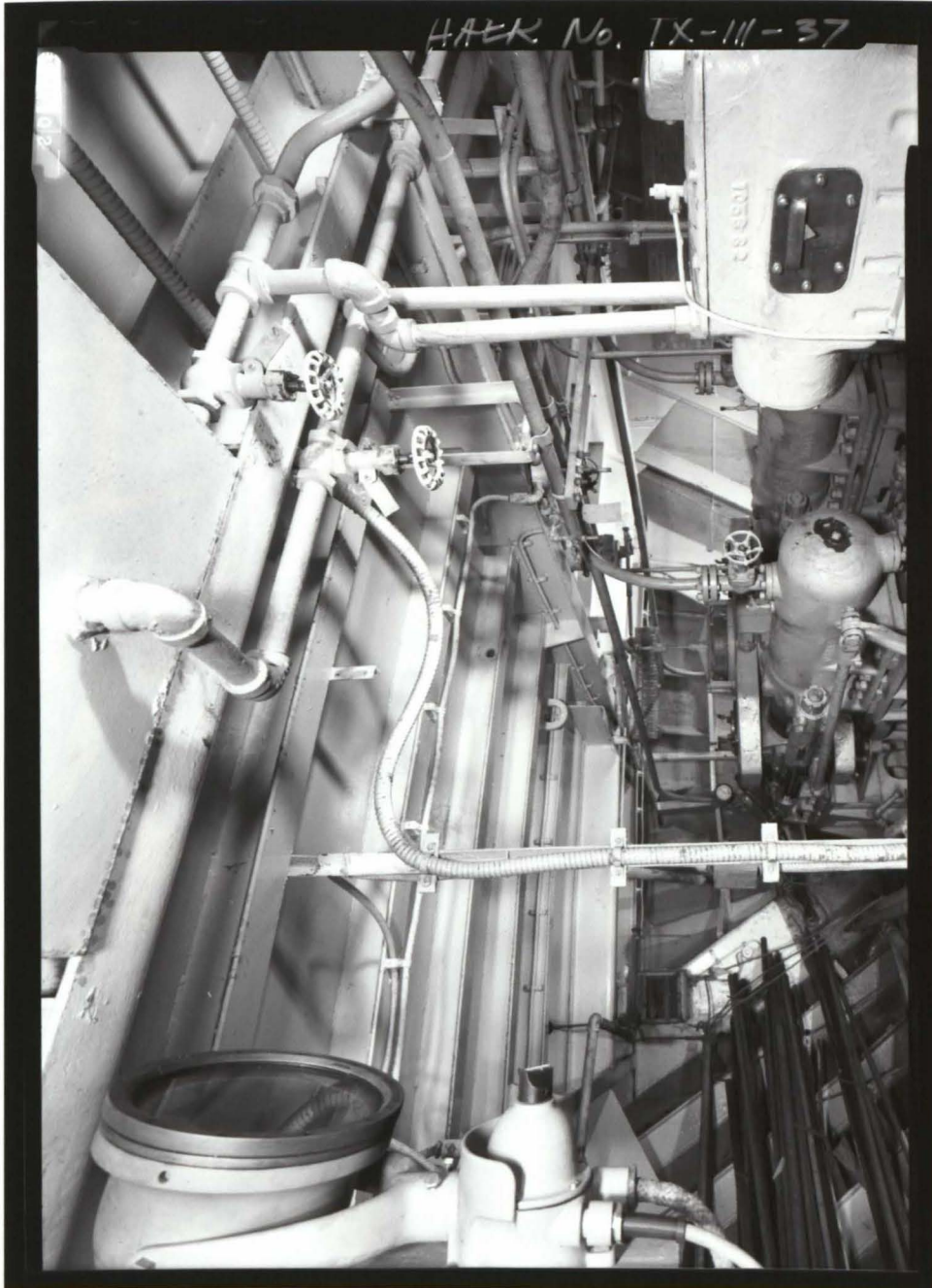

HISTORIC AMERICAN ENGINEERING RECORD
SEE INDEX TO PHOTOGRAPHS FOR CAPTION

HAER No. TX-111-039-CT



HISTORIC AMERICAN ENGINEERING RECORD
SEE INDEX TO PHOTOGRAPHS FOR CAPTION

HAER No. TX-111-040-CT



HISTORIC AMERICAN ENGINEERING RECORD
SEE INDEX TO PHOTOGRAPHS FOR CAPTION

HAER No. TX-111-041-CT



HISTORIC AMERICAN ENGINEERING RECORD
SEE INDEX TO PHOTOGRAPHS FOR CAPTION

HAER No. TX-111-042-CT



HISTORIC AMERICAN ENGINEERING RECORD
SEE INDEX TO PHOTOGRAPHS FOR CAPTION

HAER No. TX-111-043-CT



HISTORIC AMERICAN ENGINEERING RECORD
SEE INDEX TO PHOTOGRAPHS FOR CAPTION

HAER No. TX-111-044-CT



HISTORIC AMERICAN ENGINEERING RECORD
SEE INDEX TO PHOTOGRAPHS FOR CAPTION

HAER No. TX-111-045-CT



Seatrain Ohio

Profiles

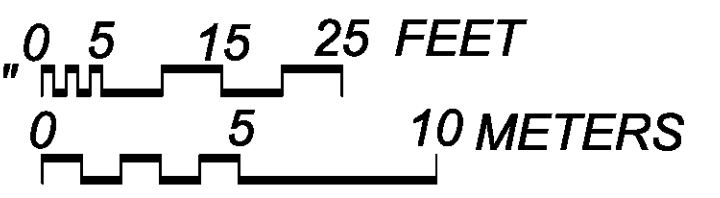
SCALE: 1/16" = 1'-0"  0 5 15 25 FEET
0 5 10 METERS

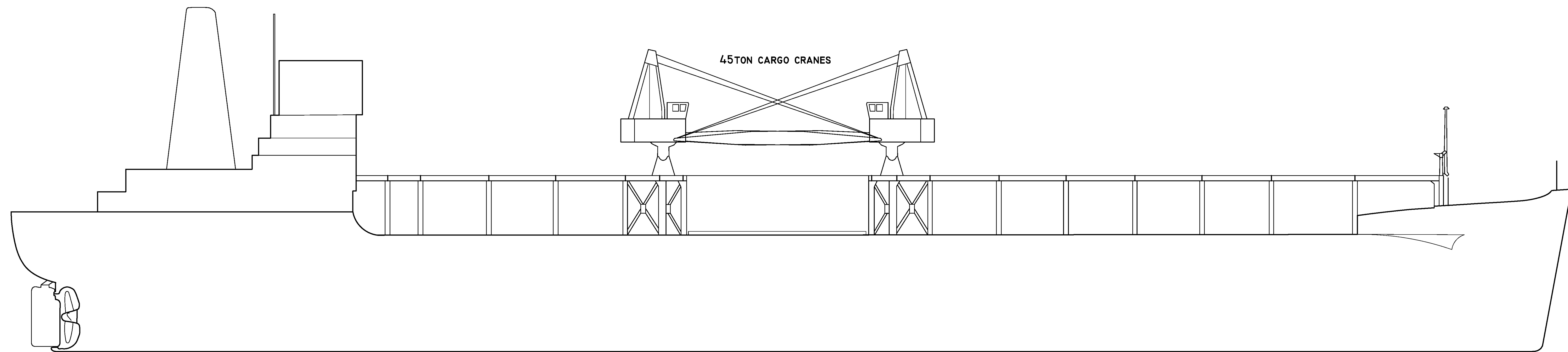

539'-6"

PROFILE

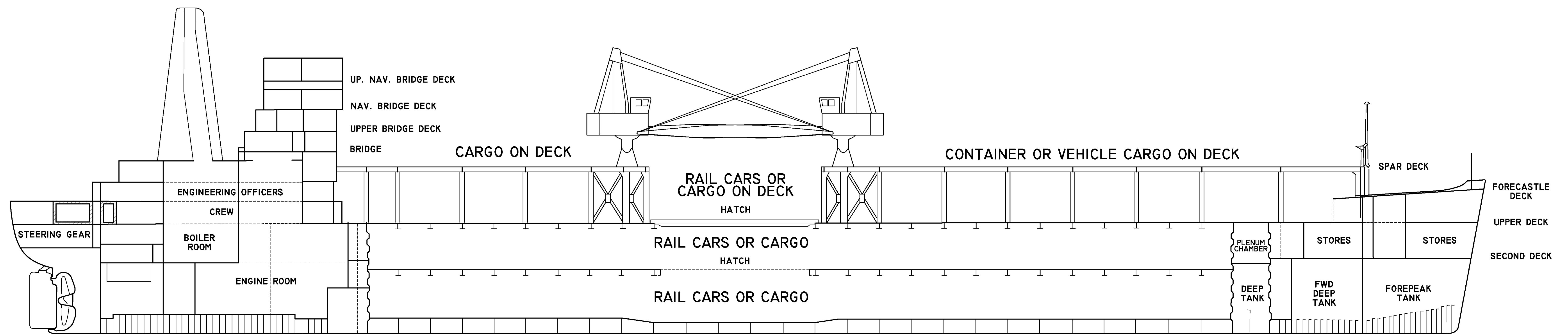

539'-6"
560'-0"
A.P.  F.P.

INBOARD PROFILE

NOTE: THIS DRAWING WAS TRACED FROM A SCAN OF AN ORIGINAL DRAWING LOCATED IN THE NATIONAL ARCHIVES AND RECORDS ADMINISTRATION. DRAWING NO. 94150-65-31, 1967. THE DIMENSIONS AND ARRANGEMENTS WERE NOT VERIFIED IN THE FIELD.

HISTORIC AMERICAN ENGINEERING RECORD
 SHEET 1 OF 2
 TEXAS
 SEATRAN OHIO
 READY RESERVE FLEET
 JEFFERSON COUNTY
 BEAUMONT VICINITY
 DELINEATED BY: TRACED FROM SCANS OF ORIGINAL DRAWINGS BY TODD A. GROTEAU, 2011
 HAER MARITIME RECORDING PROGRAM
 NATIONAL ARCHIVES
 UNITED STATES DEPARTMENT OF THE INTERIOR

Seatrain Ohio

Plans

SCALE: 1/16" = 1'-0"
 0 5 15 25 FEET
 0 5 10 METERS

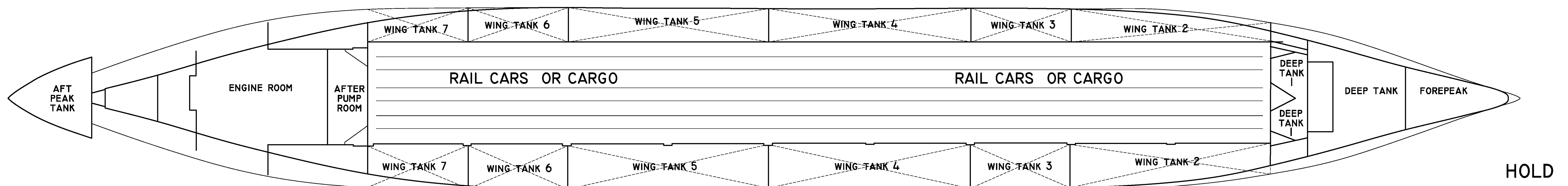
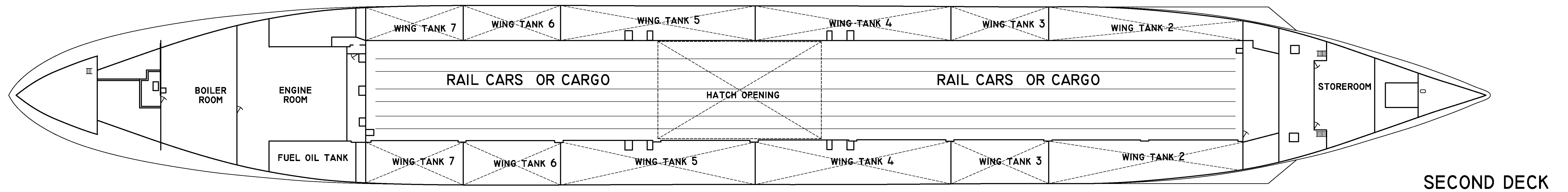
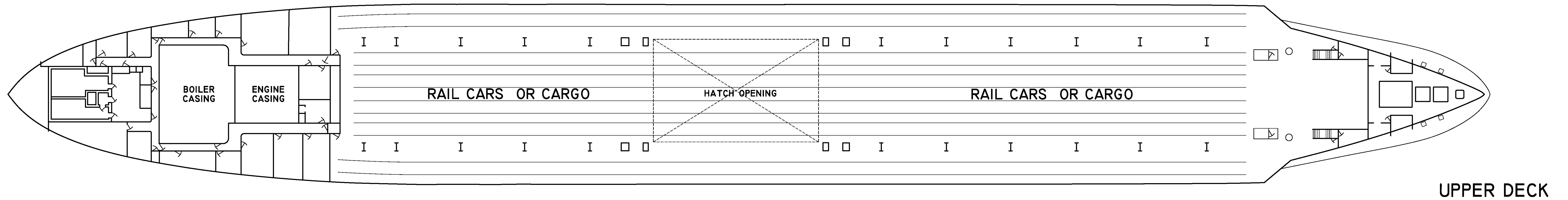
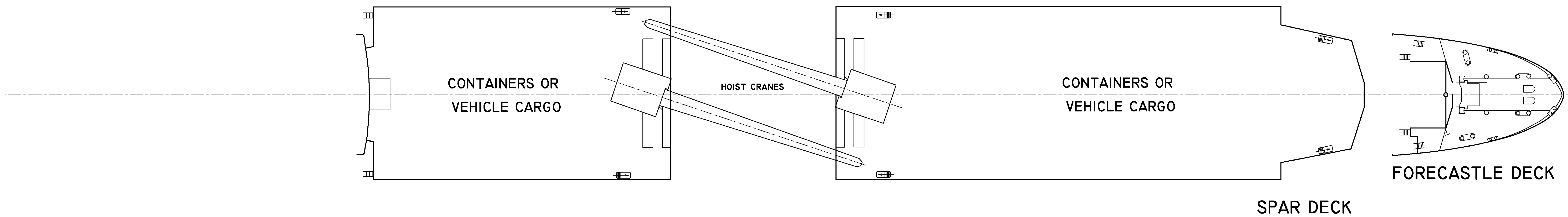

NOTE: THIS DRAWING WAS TRACED FROM A SCAN OF AN ORIGINAL DRAWING LOCATED IN THE NATIONAL ARCHIVES AND RECORDS ADMINISTRATION. DRAWING NO. 94150-65-31, 1967. THE DIMENSIONS AND ARRANGEMENTS WERE NOT VERIFIED IN THE FIELD.