

CONSOLIDATION TEST DATA

Client: TVA
Project: TVA Kingston - Proposed Gypsum Stack
Project Number: 3043051021

Sample Data

Source:
Sample No.: UD-1
Elev. or Depth: 9'-11'
Location: NB-44 (9'-11')
Description:
Liquid Limit:
USCS:
Testing Remarks:
Sample Length(in./cm.):
Plasticity Index:
AASHTO:
Figure No.:

Test Specimen Data

TOTAL SAMPLE
Wet w+t = 252.55 g.
Dry w+t = 217.09 g.
Tare Wt. = 110.78 g.
Height = 1.00 in.
Diameter = 2.37 in.
Weight = 141.77 g.
Moisture = 33.4 %
Wet Den. = 122.3 pcf
Dry Den. = 91.7 pcf
BEFORE TEST
Consolidometer # = 2
Spec. Gravity = 2.71
Height = 1.00 in.
Diameter = 2.37 in.
Defl. Table = Reference Set (inches/ksf)
Ht. Solids = 0.5423 in.
Dry Wt. = 106.31 g.
Void Ratio = 0.844
Saturation = 107.0 %
AFTER TEST
Wet w+t = 146.10 g.
Dry w+t = 114.43 g.
Tare Wt. = 8.12 g.
Moisture = 29.8 %
Dry Wt. = 106.31 g.*
Void Ratio = 0.598

* Final dry weight used in calculations

End-of-Load Summary

Table with 7 columns: Pressure (ksf), Final Dial (in.), Machine Defl. (in.), Cv (in.2/sec.), Ca, Void Ratio, % Compression/Swell. Rows show data points from 0.20 to 64.00 ksf.

Cc = 0.26 Pc = 11.16 ksf Cr = 0.00

Pressure: 0.20 ksf

TEST READINGS

Load No. 1

No.	Elapsed Time	Dial Reading	No.	Elapsed Time	Dial Reading
1	0.00	0.25000	11	60.00	0.24960
2	0.10	0.24980			
3	0.25	0.24975			
4	0.50	0.24970			
5	1.00	0.24965			
6	2.00	0.24960			
7	4.00	0.24960			
8	8.00	0.24960			
9	16.00	0.24960			
10	30.00	0.24960			

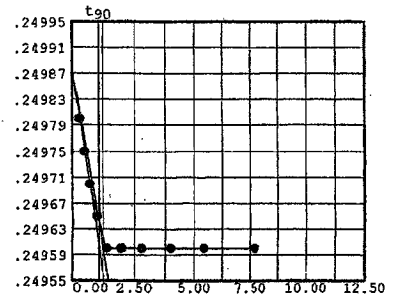

Void Ratio = 0.844 Compression = 0.0 %
 $D_0 = 0.24988$ $D_{90} = 0.24964$ $D_{100} = 0.24961$
 C_v at 1.2 min. = 0.0031 in.²/sec.

Pressure: 0.50 ksf

TEST READINGS

Load No. 2

No.	Elapsed Time	Dial Reading	No.	Elapsed Time	Dial Reading
1	0.00	0.24960	11	60.00	0.24880
2	0.10	0.24910			
3	0.25	0.24905			
4	0.50	0.24900			
5	1.00	0.24900			
6	2.00	0.24900			
7	4.00	0.24895			
8	8.00	0.24890			
9	16.00	0.24885			
10	30.00	0.24880			

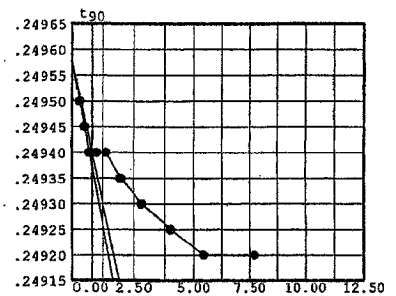

Void Ratio = 0.843* Compression = 0.1 %
 $D_0 = 0.24958$ $D_{90} = 0.24940$ $D_{100} = 0.24938$
 C_v at 0.7 min. = 0.0054 in.²/sec.

Pressure: 1.00 ksf

TEST READINGS

Load No. 3

No.	Elapsed Time	Dial Reading	No.	Elapsed Time	Dial Reading
1	0.00	0.24880	11	60.00	0.24625
2	0.10	0.24760			
3	0.25	0.24740			
4	0.50	0.24720			
5	1.00	0.24700			
6	2.00	0.24680			
7	4.00	0.24670			
8	8.00	0.24655			
9	16.00	0.24645			
10	30.00	0.24635			

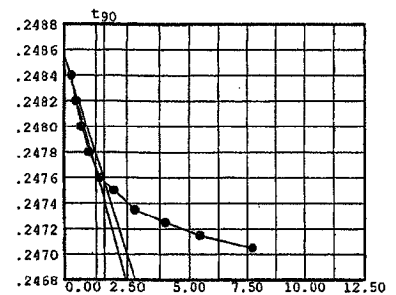

Void Ratio = 0.839 Compression = 0.3 %
 $D_0 = 0.24857$ $D_{90} = 0.24757$ $D_{100} = 0.24746$
 C_v at 2.5 min. = 0.0014 in.²/sec.

Pressure: 2.00 ksf

TEST READINGS

Load No. 4

No.	Elapsed Time	Dial Reading	No.	Elapsed Time	Dial Reading
1	0.00	0.24625	11	60.00	0.24050
2	0.10	0.24340	12	120.00	0.24040
3	0.25	0.24280			
4	0.50	0.24240			
5	1.00	0.24190			
6	2.00	0.24160			
7	4.00	0.24120			
8	8.00	0.24100			
9	16.00	0.24080			
10	30.00	0.24060			

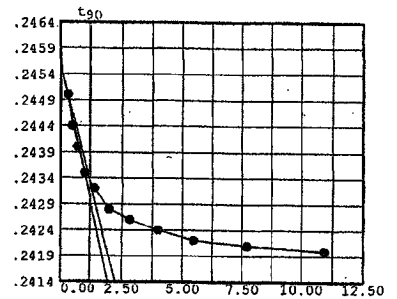

Void Ratio = 0.830 Compression = 0.8 %
 $D_0 = 0.24557$ $D_{90} = 0.24336$ $D_{100} = 0.24312$
 C_v at 1.4 min. = 0.0025 in.²/sec.

Pressure: 4.00 ksf

TEST READINGS

Load No. 5

No.	Elapsed Time	Dial Reading	No.	Elapsed Time	Dial Reading
1	0.00	0.24040	11	60.00	0.23050
2	0.10	0.23500	12	120.00	0.23030
3	0.25	0.23420	13	240.00	0.23020
4	0.50	0.23340	14	1527.00	0.22980
5	1.00	0.23270			
6	2.00	0.23200			
7	4.00	0.23150			
8	8.00	0.23110			
9	16.00	0.23080			
10	30.00	0.23070			

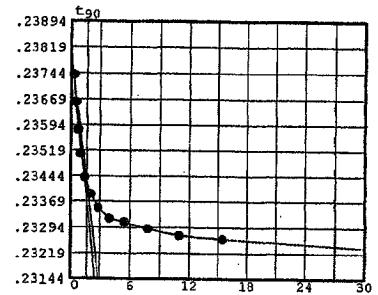

Void Ratio = 0.812 Compression = 1.8 %
 $D_0 = 0.23797$ $D_{90} = 0.23424$ $D_{100} = 0.23383$
 C_v at 2.6 min. = 0.0013 in.²/sec.

Pressure: 2.00 ksf

TEST READINGS

Load No. 6

No.	Elapsed Time	Dial Reading	No.	Elapsed Time	Dial Reading
1	0.00	0.22980	11	92.00	0.23085
2	0.10	0.23050	12	927.00	0.23085
3	0.25	0.23055			
4	0.50	0.23060			
5	1.00	0.23065			
6	2.00	0.23070			
7	4.00	0.23075			
8	8.00	0.23080			
9	16.00	0.23080			
10	30.00	0.23080			

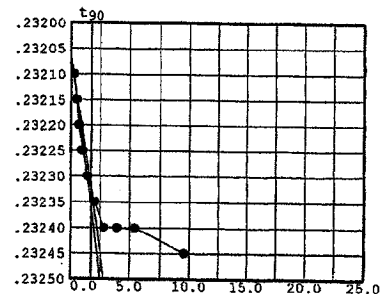

Void Ratio = 0.812 Compression = 1.8 %
 $D_0 = 0.23206$ $D_{90} = 0.23232$ $D_{100} = 0.23235$
 C_v at 2.9 min. = 0.0012 in.²/sec.

Pressure: 1.00 ksf

TEST READINGS

Load No. 7

Pressu

No.
1
2
3
4
5
6
7
8
9
10

Time
0

No.	Elapsed Time	Dial Reading
1	0.00	0.23085
2	0.10	0.23150
3	0.25	0.23160
4	0.50	0.23170
5	1.00	0.23180
6	2.00	0.23185
7	4.00	0.23190
8	8.00	0.23195
9	16.00	0.23200
10	30.00	0.23205

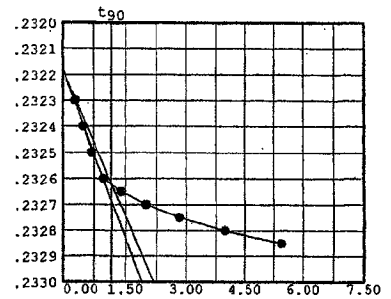

Void Ratio = 0.813 Compression = 1.7 %
 $D_0 = 0.23217$ $D_{90} = 0.23262$ $D_{100} = 0.23267$
 C_v at 1.4 min. = 0.0025 in.²/sec.

Pressure: 2.00 ksf

TEST READINGS

Load No. 8

Pre

No.	Elapsed Time	Dial Reading
1	0.00	0.23205
2	0.10	0.23170
3	0.25	0.23165
4	0.50	0.23160
5	1.00	0.23155
6	2.00	0.23155
7	4.00	0.23150
8	8.00	0.23150
9	16.00	0.23150

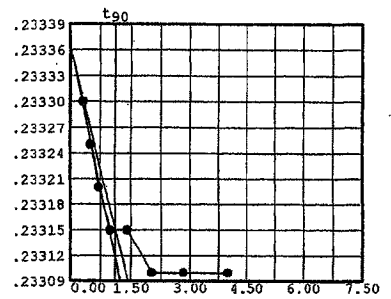

Void Ratio = 0.813 Compression = 1.7 %
 $D_0 = 0.23336$ $D_{90} = 0.23315$ $D_{100} = 0.23313$
 C_v at 1.3 min. = 0.0027 in.²/sec.

Pressure: 4.00 ksf

TEST READINGS

Load No. 9

No.	Elapsed Time	Dial Reading
1	0.00	0.23150
2	0.10	0.23020
3	0.25	0.23010
4	0.50	0.23000
5	1.00	0.22990
6	2.00	0.22980
7	4.00	0.22975
8	8.00	0.22970
9	16.00	0.22970
10	30.00	0.22970

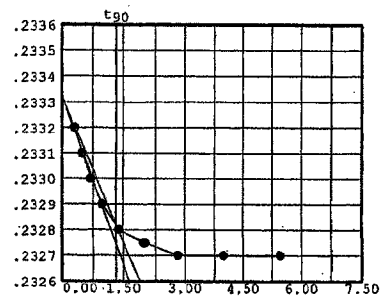

Void Ratio = 0.813 Compression = 1.7 %
 $D_0 = 0.23333$ $D_{90} = 0.23282$ $D_{100} = 0.23276$
 C_v at 1.8 min. = 0.0019 in.²/sec.

MACTEC, INC.

Pressure: 64.00 ksf

TEST READINGS

Load No. 13

No.	Elapsed Time	Dial Reading	No.	Elapsed Time	Dial Reading
1	0.00	0.15790	11	60.00	0.11815
2	0.10	0.14610	12	120.00	0.11770
3	0.25	0.14140	13	1152.00	0.11650
4	0.50	0.13770			
5	1.00	0.13330			
6	2.00	0.12830			
7	4.00	0.12360			
8	8.00	0.12080			
9	16.00	0.11940			
10	30.00	0.11865			

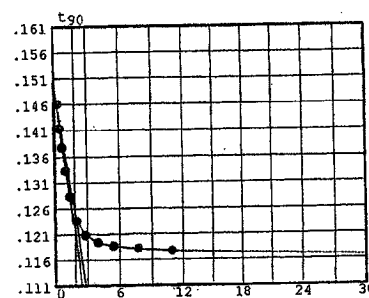

Void Ratio = 0.598 Compression = 13.3 %
D₀ = 0.14982 D₉₀ = 0.12541 D₁₀₀ = 0.12270
C_v at 3.1 min. = 0.0009 in.²/sec.

MACTEC, INC.

CONSOLIDATION TEST REPORT

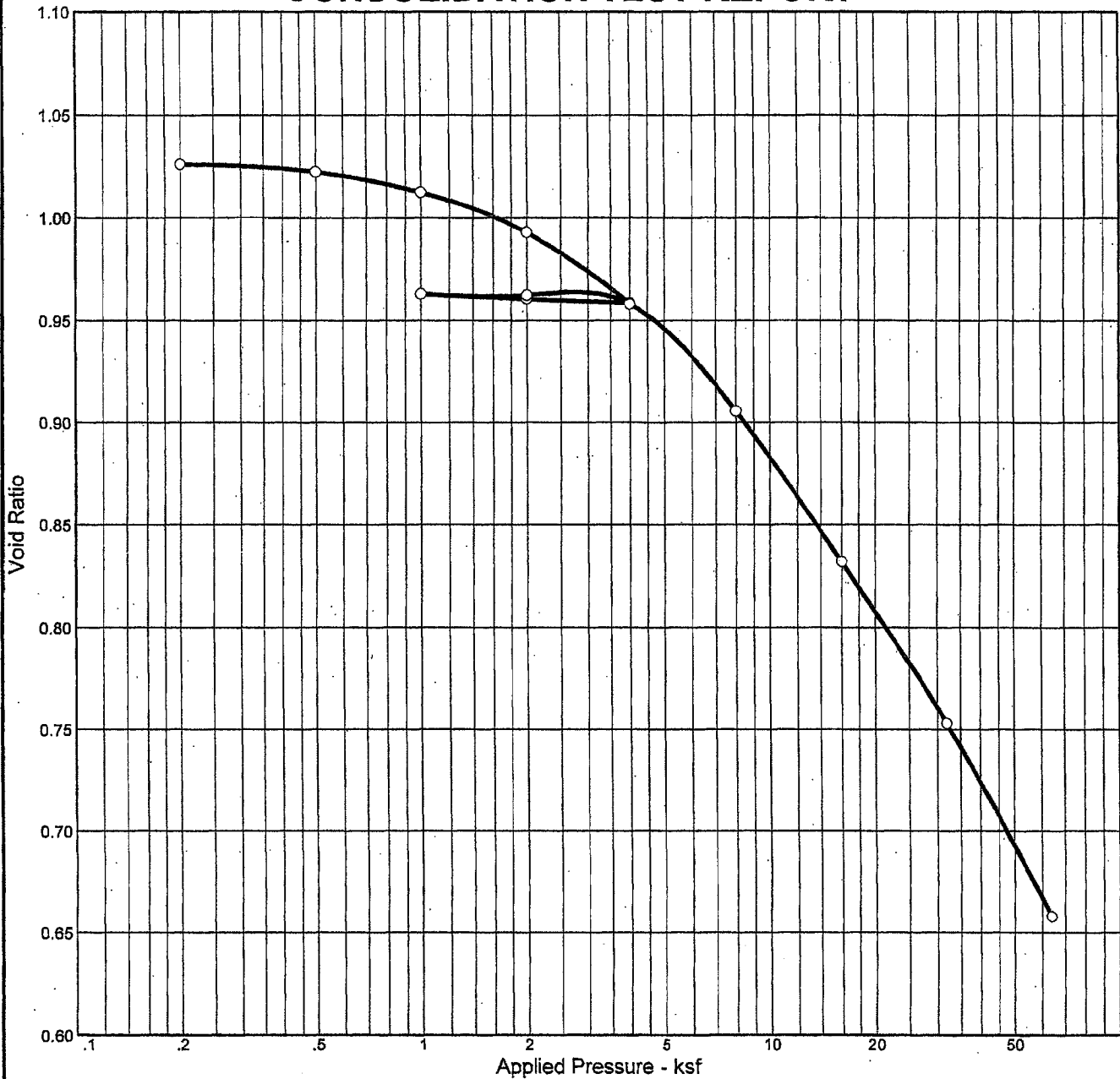

Natural		Dry Dens. (pcf)	LL	PI	Sp. Gr.	Overburden (ksf)	P _c (ksf)	C _c	C _r	Initial Void Ratio
Saturation	Moisture									
95.3 %	36.1 %	83.4	45	23	2.71	—	12.56	0.32	0.01	1.028

MATERIAL DESCRIPTION								USCS	AASHTO
Yellowish brown sandy silty clay								CL	-

<p>Project No. 3043051021 Client: TVA</p> <p>Project: TVA Kingston - Proposed Gypsum Stack</p> <p>Location: NB-44 (16.5'-18.5')</p> <p style="text-align: center;">CONSOLIDATION TEST REPORT</p> <p style="text-align: center;">MACTEC, INC.</p>	<p>Remarks:</p> <p style="text-align: right; margin-top: 100px;">Figure</p>
-----------------------------------------------------------------------------------------------------------------------------------------------------------------------------------------------------------------------------------------------------------------------------------------------	------------------------------------------------------------------------------------

Dial Reading vs. Time

Project No.: 3043051021

Project: TVA Kingston - Proposed Gypsum Stack

Location: NB-44 (16.5'-18.5')

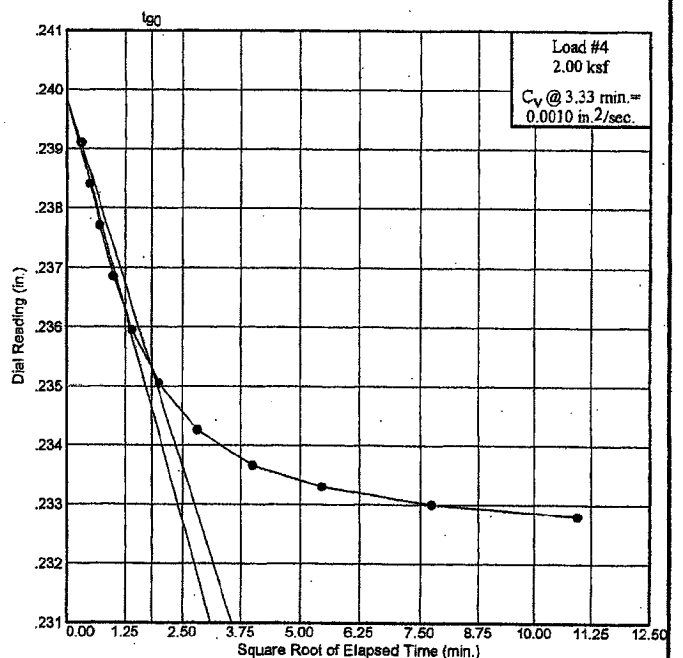
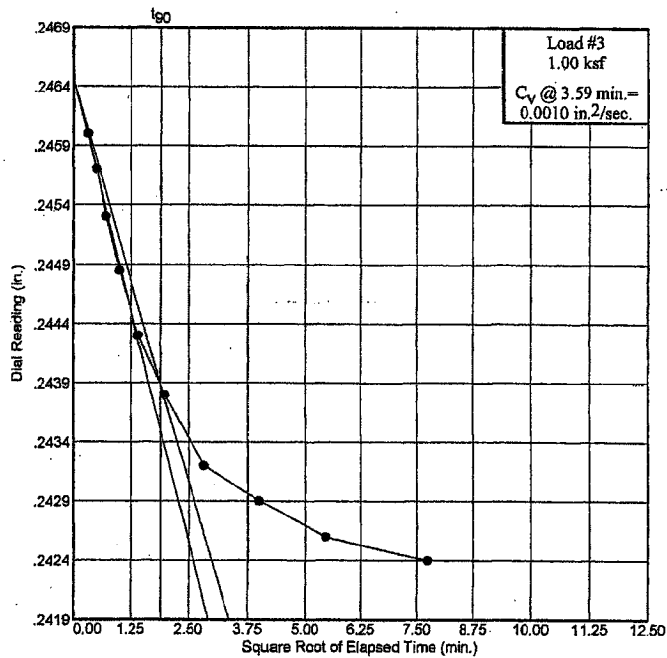
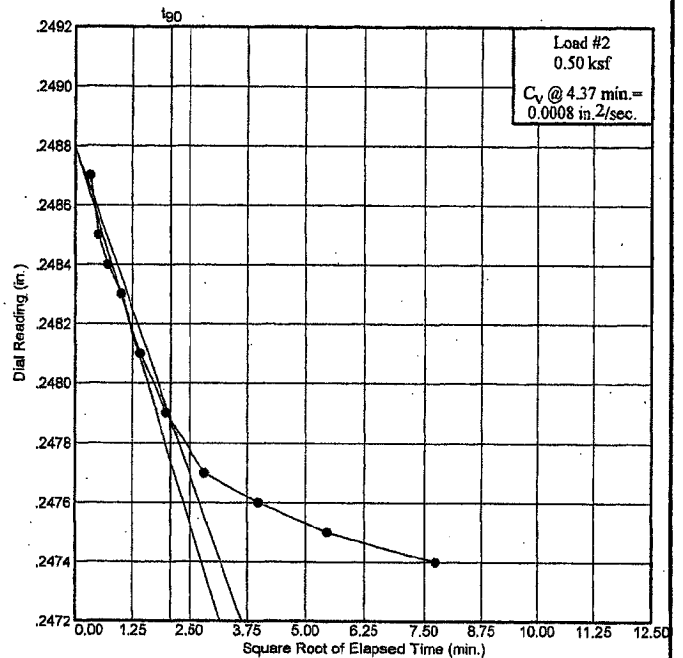
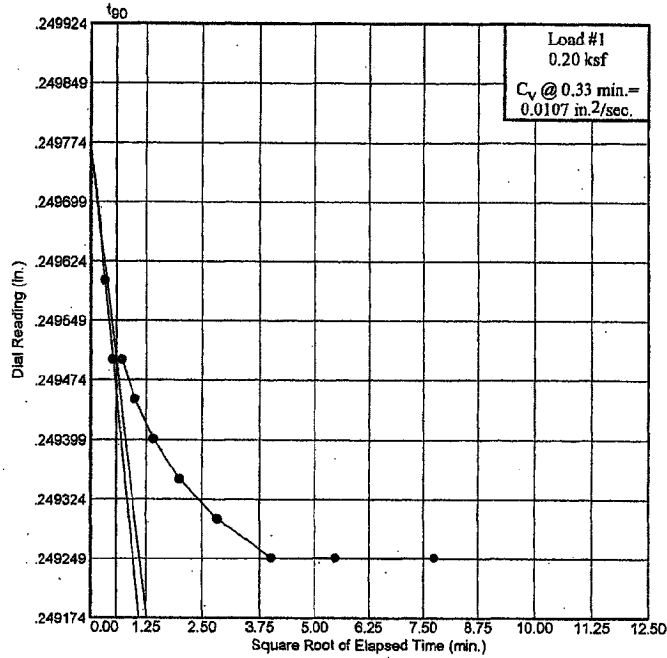

Dial Reading vs. Time
MACTEC, INC.

Figure

Dial Reading vs. Time

Project No.: 3043051021

Project: TVA Kingston - Proposed Gypsum Stack

Location: NB-44 (16.5'-18.5')

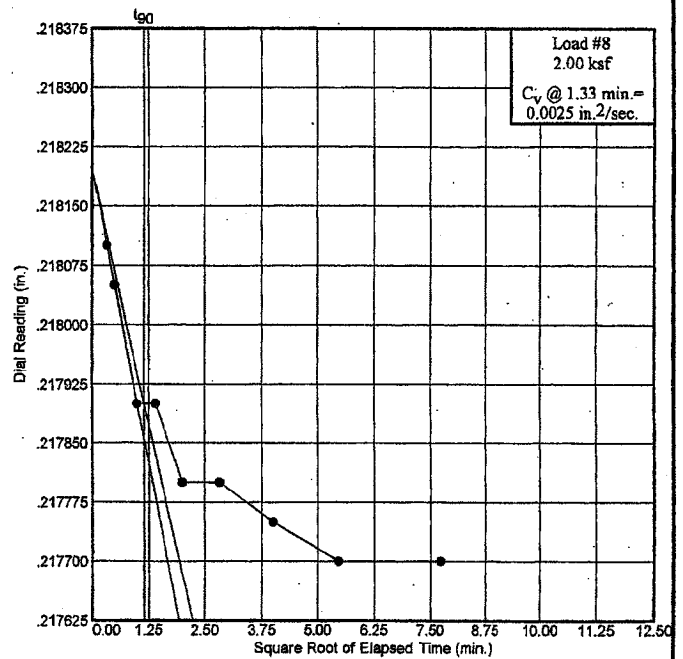
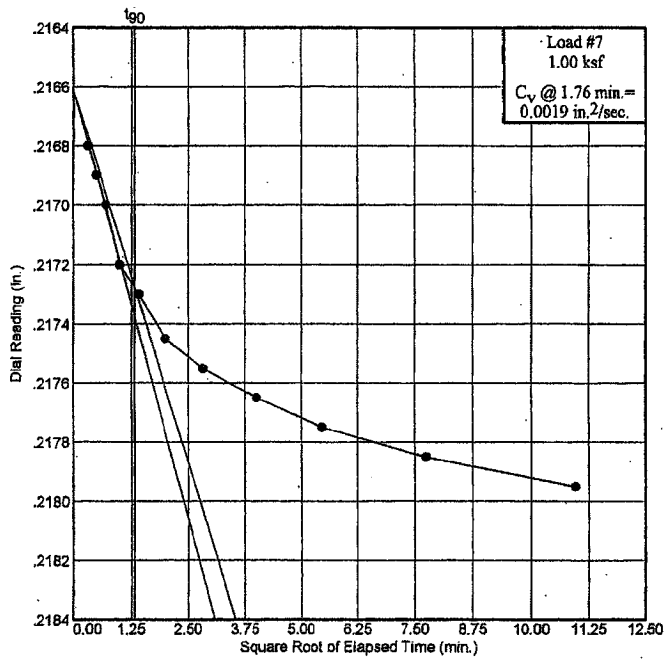
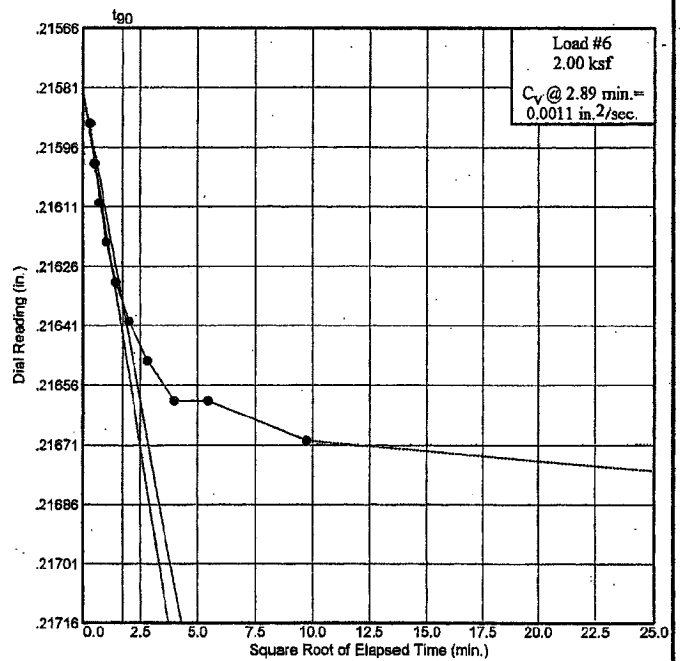
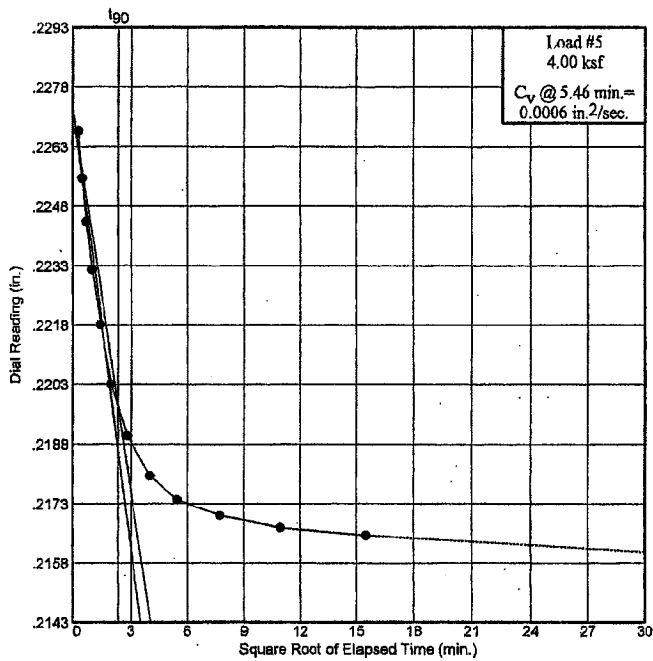

Dial Reading vs. Time
MACTEC, INC.

Figure

Dial Reading vs. Time

Project No.: 3043051021

Project: TVA Kingston - Proposed Gypsum Stack

Location: NB-44 (16.5'-18.5')

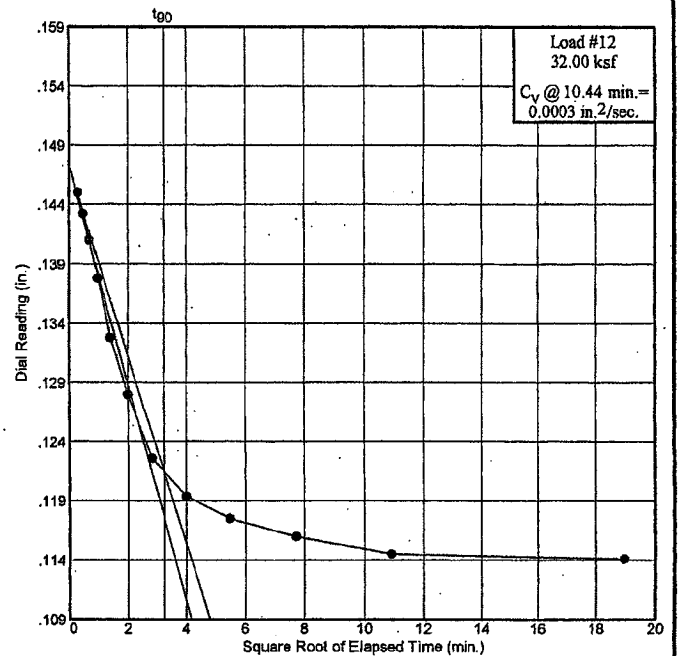
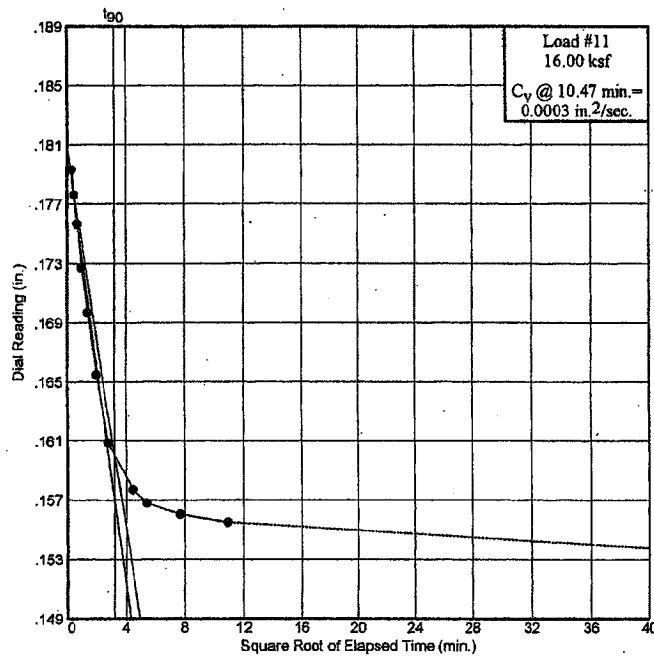
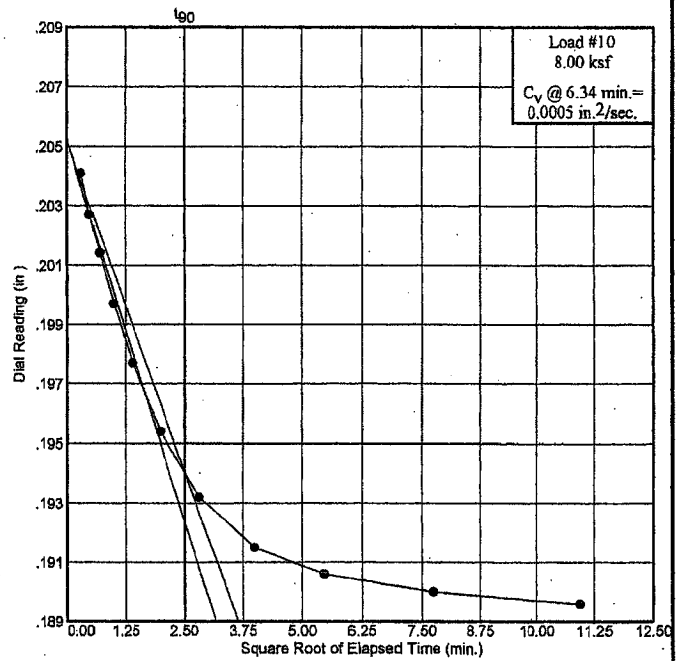
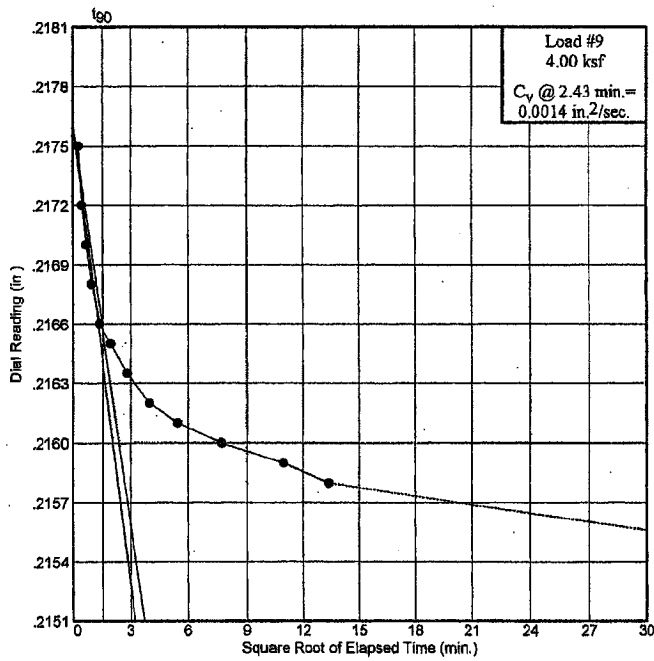

Dial Reading vs. Time
MACTEC, INC.

Figure

Dial Reading vs. Time

Project No.: 3043051021

Project: TVA Kingston - Proposed Gypsum Stack

Location: NB-44 (16.5'-18.5')

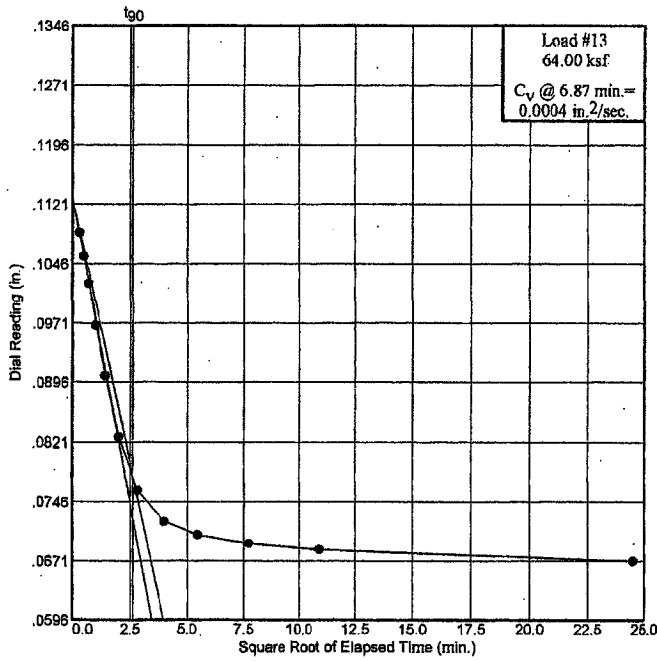

Dial Reading vs. Time

MACTEC, INC.

Figure

CONSOLIDATION TEST DATA

Client: TVA
 Project: TVA Kingston - Proposed Gypsum Stack
 Project Number: 3043051021

Sample Data

Source:
 Sample No.: UD-2
 Elev. or Depth: 16.5'-18.5' Sample Length(in./cm.):
 Location: NB-44 (16.5'-18.5')
 Description:
 Liquid Limit: 45 Plasticity Index: 23
 USCS: AASHTO: Figure No.:
 Testing Remarks:

Test Specimen Data

TOTAL SAMPLE	BEFORE TEST	AFTER TEST
Wet w+t = 243.88 g.	Consolidometer # = 3	Wet w+t = 123.73 g.
Dry w+t = 208.60 g.		Dry w+t = 97.65 g.
Tare Wt. = 110.95 g.	Spec. Gravity = 2.71	Tare Wt. = .00 g.
Height = 1.00 in.	Height = 1.00 in.	
Diameter = 2.38 in.	Diameter = 2.38 in.	
Weight = 132.93 g.	Defl. Table = Reference Set (inches/ksf)	
Moisture = 36.1 %	Ht. Solids = 0.4946 in.	Moisture = 26.7 %
Wet Den. = 113.6 pcf	Dry Wt. = 97.65 g.	Dry Wt. = 97.65 g.*
Dry Den. = 83.4 pcf	Void Ratio = 1.028	Void Ratio = 0.658
	Saturation = 95.3 %	

* Final dry weight used in calculations

End-of-Load Summary

Pressure (ksf)	Final Dial (in.)	Machine Defl. (in.)	C _v (in. ² /sec.)	C _α	Void Ratio	% Compression / Swell
start	0.25000				1.028	
0.20	0.24925	0.00000	0.0107		1.026	0.1 Compr.
0.50	0.24700	0.00040	0.0008		1.022	0.3 Compr.
1.00	0.24160	0.00080	0.0010		1.012	0.8 Compr.
2.00	0.23120	0.00160	0.0010		0.993	1.7 Compr.
4.00	0.21340	0.00240	0.0006		0.959	3.4 Compr.
2.00	0.21520	0.00160	0.0011		0.961	3.3 Compr.
1.00	0.21715	0.00080	0.0019		0.963	3.2 Compr.
2.00	0.21610	0.00160	0.0025		0.962	3.2 Compr.
4.00	0.21250	0.00300	0.0014		0.958	3.4 Compr.
8.00	0.18960	0.00000	0.0005		0.906	6.0 Compr.
16.00	0.15330	0.00000	0.0003		0.832	9.6 Compr.
32.00	0.11410	0.00000	0.0003		0.753	13.6 Compr.
64.00	0.06710	0.00000	0.0004		0.658	18.2 Compr.

C_c = 0.32 P_c = 12.56 ksf C_r = 0.01

Pressure: 0.20 ksf

TEST READINGS

Load No. 1

No.	Elapsed Time	Dial Reading	No.	Elapsed Time	Dial Reading
1	0.00	0.25000	11	60.00	0.24925
2	0.10	0.24960			
3	0.25	0.24950			
4	0.50	0.24950			
5	1.00	0.24945			
6	2.00	0.24940			
7	4.00	0.24935			
8	8.00	0.24930			
9	16.00	0.24925			
10	30.00	0.24925			

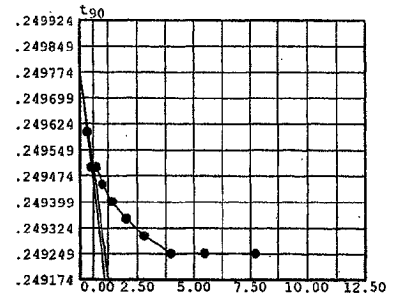

Void Ratio = 1.026 Compression = 0.1 %
 $D_0 = 0.24977$ $D_{90} = 0.24950$ $D_{100} = 0.24947$
 C_v at 0.3 min. = 0.0107 in.²/sec.

Pressure: 0.50 ksf

TEST READINGS

Load No. 2

No.	Elapsed Time	Dial Reading	No.	Elapsed Time	Dial Reading
1	0.00	0.24925	11	60.00	0.24700
2	0.10	0.24830			
3	0.25	0.24810			
4	0.50	0.24800			
5	1.00	0.24790			
6	2.00	0.24770			
7	4.00	0.24750			
8	8.00	0.24730			
9	16.00	0.24720			
10	30.00	0.24710			

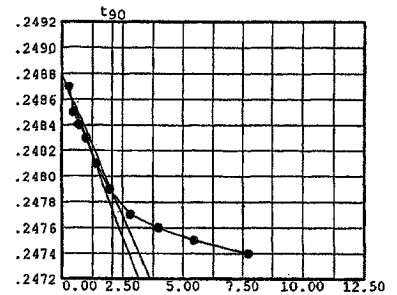

Void Ratio = 1.022 Compression = 0.3 %
 $D_0 = 0.24880$ $D_{90} = 0.24788$ $D_{100} = 0.24778$
 C_v at 4.4 min. = 0.0008 in.²/sec.

Pressure: 1.00 ksf

TEST READINGS

Load No. 3

No.	Elapsed Time	Dial Reading	No.	Elapsed Time	Dial Reading
1	0.00	0.24700	11	60.00	0.24160
2	0.10	0.24520			
3	0.25	0.24490			
4	0.50	0.24450			
5	1.00	0.24405			
6	2.00	0.24350			
7	4.00	0.24300			
8	8.00	0.24240			
9	16.00	0.24210			
10	30.00	0.24180			

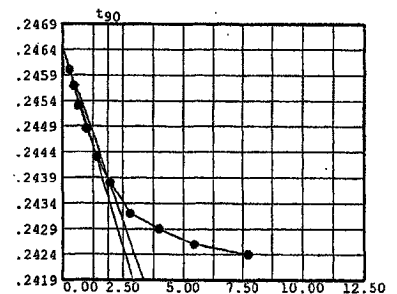

Void Ratio = 1.012 Compression = 0.8 %
 $D_0 = 0.24646$ $D_{90} = 0.24389$ $D_{100} = 0.24360$
 C_v at 3.6 min. = 0.0010 in.²/sec.

Pressure: 2.00 ksf

TEST READINGS

Load No. 4

No.	Elapsed Time	Dial Reading	No.	Elapsed Time	Dial Reading
1	0.00	0.24160	11	60.00	0.23140
2	0.10	0.23750	12	120.00	0.23120
3	0.25	0.23680			
4	0.50	0.23610			
5	1.00	0.23525			
6	2.00	0.23435			
7	4.00	0.23345			
8	8.00	0.23265			
9	16.00	0.23205			
10	30.00	0.23170			

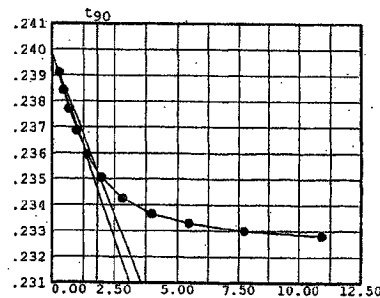

Void Ratio = 0.993 Compression = 1.7 %
 $D_0 = 0.23985$ $D_{90} = 0.23532$ $D_{100} = 0.23482$
 C_v at 3.3 min. = 0.0010 in.²/sec.

Pressure: 4.00 ksf

TEST READINGS

Load No. 5

No.	Elapsed Time	Dial Reading	No.	Elapsed Time	Dial Reading
1	0.00	0.23120	11	60.00	0.21460
2	0.10	0.22430	12	120.00	0.21430
3	0.25	0.22310	13	240.00	0.21410
4	0.50	0.22200	14	1530.00	0.21340
5	1.00	0.22080			
6	2.00	0.21940			
7	4.00	0.21790			
8	8.00	0.21660			
9	16.00	0.21560			
10	30.00	0.21500			

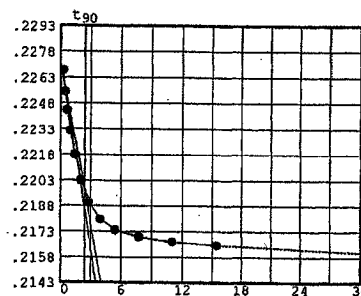

Void Ratio = 0.959 Compression = 3.4 %
 $D_0 = 0.22733$ $D_{90} = 0.21977$ $D_{100} = 0.21893$
 C_v at 5.5 min. = 0.0006 in.²/sec.

Pressure: 2.00 ksf

TEST READINGS

Load No. 6

No.	Elapsed Time	Dial Reading	No.	Elapsed Time	Dial Reading
1	0.00	0.21340	11	95.00	0.21510
2	0.10	0.21430	12	930.00	0.21520
3	0.25	0.21440			
4	0.50	0.21450			
5	1.00	0.21460			
6	2.00	0.21470			
7	4.00	0.21480			
8	8.00	0.21490			
9	16.00	0.21500			
10	30.00	0.21500			

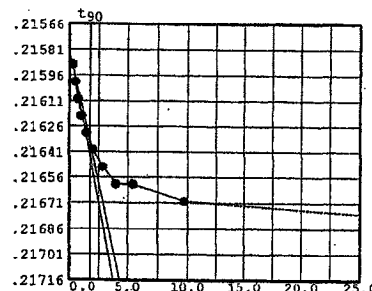

Void Ratio = 0.961 Compression = 3.3 %
 $D_0 = 0.21582$ $D_{90} = 0.21635$ $D_{100} = 0.21641$
 C_v at 2.9 min. = 0.0011 in.²/sec.

Pressure: 1.00 ksf

TEST READINGS

Load No. 7

No.	Elapsed Time	Dial Reading	No.	Elapsed Time	Dial Reading
1	0.00	0.21520	11	60.00	0.21705
2	0.10	0.21600	12	120.00	0.21715
3	0.25	0.21610			
4	0.50	0.21620			
5	1.00	0.21640			
6	2.00	0.21650			
7	4.00	0.21665			
8	8.00	0.21675			
9	16.00	0.21685			
10	30.00	0.21695			

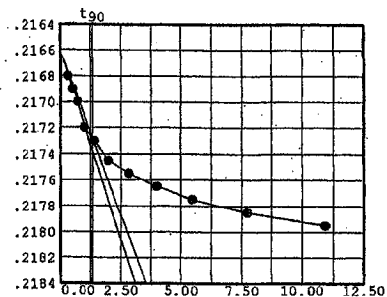

Void Ratio = 0.963 Compression = 3.2 %
 D₀ = 0.21661 D₉₀ = 0.21728 D₁₀₀ = 0.21735
 C_v at 1.8 min. = 0.0019 in.²/sec.

Pressure: 2.00 ksf

TEST READINGS

Load No. 8

No.	Elapsed Time	Dial Reading
1	0.00	0.21715
2	0.10	0.21650
3	0.25	0.21645
4	1.00	0.21630
5	2.00	0.21630
6	4.00	0.21620
7	8.00	0.21620
8	16.00	0.21615
9	30.00	0.21610
10	60.00	0.21610

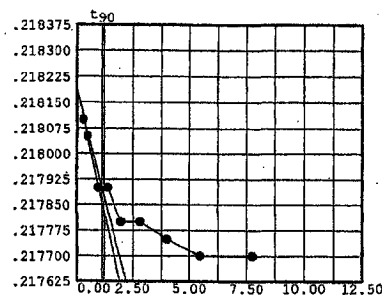

Void Ratio = 0.962 Compression = 3.2 %
 D₀ = 0.21819 D₉₀ = 0.21790 D₁₀₀ = 0.21787
 C_v at 1.3 min. = 0.0025 in.²/sec.

Pressure: 4.00 ksf

TEST READINGS

Load No. 9

No.	Elapsed Time	Dial Reading	No.	Elapsed Time	Dial Reading
1	0.00	0.21610	11	60.00	0.21300
2	0.10	0.21450	12	120.00	0.21290
3	0.25	0.21420	13	180.00	0.21280
4	0.50	0.21400	14	1170.00	0.21250
5	1.00	0.21380			
6	2.00	0.21360			
7	4.00	0.21350			
8	8.00	0.21335			
9	16.00	0.21320			
10	30.00	0.21310			

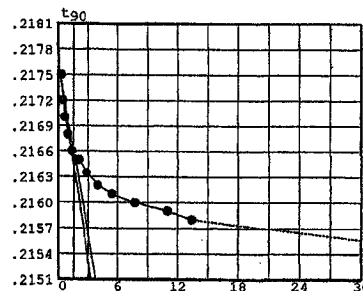

Void Ratio = 0.958 Compression = 3.4 %
 D₀ = 0.21764 D₉₀ = 0.21658 D₁₀₀ = 0.21646
 C_v at 2.4 min. = 0.0014 in.²/sec.

Pressure: 8.00 ksf

TEST READINGS

Load No. 10

No.	Elapsed Time	Dial Reading	No.	Elapsed Time	Dial Reading
1	0.00	0.21250	11	60.00	0.19000
2	0.10	0.20410	12	120.00	0.18960
3	0.25	0.20270			
4	0.50	0.20140			
5	1.00	0.19970			
6	2.00	0.19770			
7	4.00	0.19540			
8	8.00	0.19320			
9	16.00	0.19150			
10	30.00	0.19060			

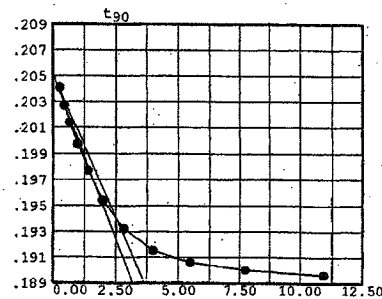

Void Ratio = 0.906 Compression = 6.0 %
 $D_0 = 0.20523$ $D_{90} = 0.19402$ $D_{100} = 0.19278$
 C_v at 6.3 min. = 0.0005 in.²/sec.

Pressure: 16.00 ksf

TEST READINGS

Load No. 11

No.	Elapsed Time	Dial Reading	No.	Elapsed Time	Dial Reading
1	0.00	0.18960	11	60.00	0.15605
2	0.10	0.17930	12	120.00	0.15550
3	0.25	0.17760	13	2273.00	0.15330
4	0.50	0.17565			
5	1.00	0.17270			
6	2.00	0.16970			
7	4.00	0.16550			
8	8.00	0.16085			
9	20.00	0.15770			
10	30.00	0.15680			

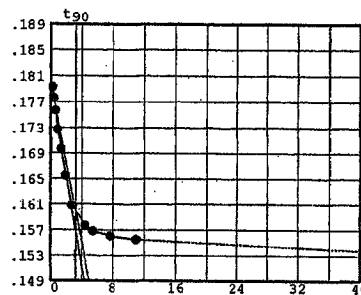

Void Ratio = 0.832 Compression = 9.6 %
 $D_0 = 0.18087$ $D_{90} = 0.16007$ $D_{100} = 0.15776$
 C_v at 10.5 min. = 0.0003 in.²/sec.

Pressure: 32.00 ksf

TEST READINGS

Load No. 12

No.	Elapsed Time	Dial Reading	No.	Elapsed Time	Dial Reading
1	0.00	0.15330	11	60.00	0.11600
2	0.10	0.14500	12	120.00	0.11450
3	0.25	0.14320	13	360.00	0.11410
4	0.50	0.14100			
5	1.00	0.13780			
6	2.00	0.13280			
7	4.00	0.12800			
8	8.00	0.12260			
9	16.00	0.11940			
10	30.00	0.11750			

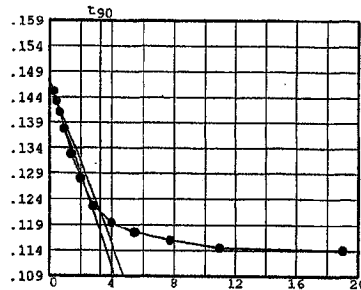

Void Ratio = 0.753 Compression = 13.6 %
 $D_0 = 0.14724$ $D_{90} = 0.12150$ $D_{100} = 0.11864$
 C_v at 10.4 min. = 0.0003 in.²/sec.

Pressure: 64.00 ksf

TEST READINGS

Load No. 13

No.	Elapsed Time	Dial Reading	No.	Elapsed Time	Dial Reading
1	0.00	0.11410	11	60.00	0.06930
2	0.10	0.10850	12	120.00	0.06850
3	0.25	0.10550	13	600.00	0.06710
4	0.50	0.10200			
5	1.00	0.09680			
6	2.00	0.09040			
7	4.00	0.08270			
8	8.00	0.07600			
9	16.00	0.07210			
10	30.00	0.07040			

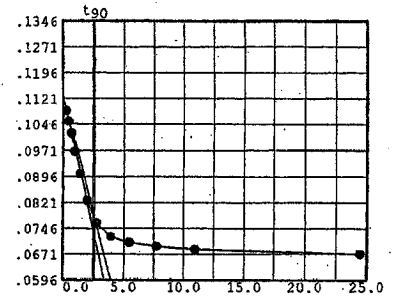

Void Ratio = 0.658 Compression = 18.2 %
D₀ = 0.11297 D₉₀ = 0.07767 D₁₀₀ = 0.07375
C_v at 6.9 min. = 0.0004 in.²/sec.

CONSOLIDATION TEST REPORT

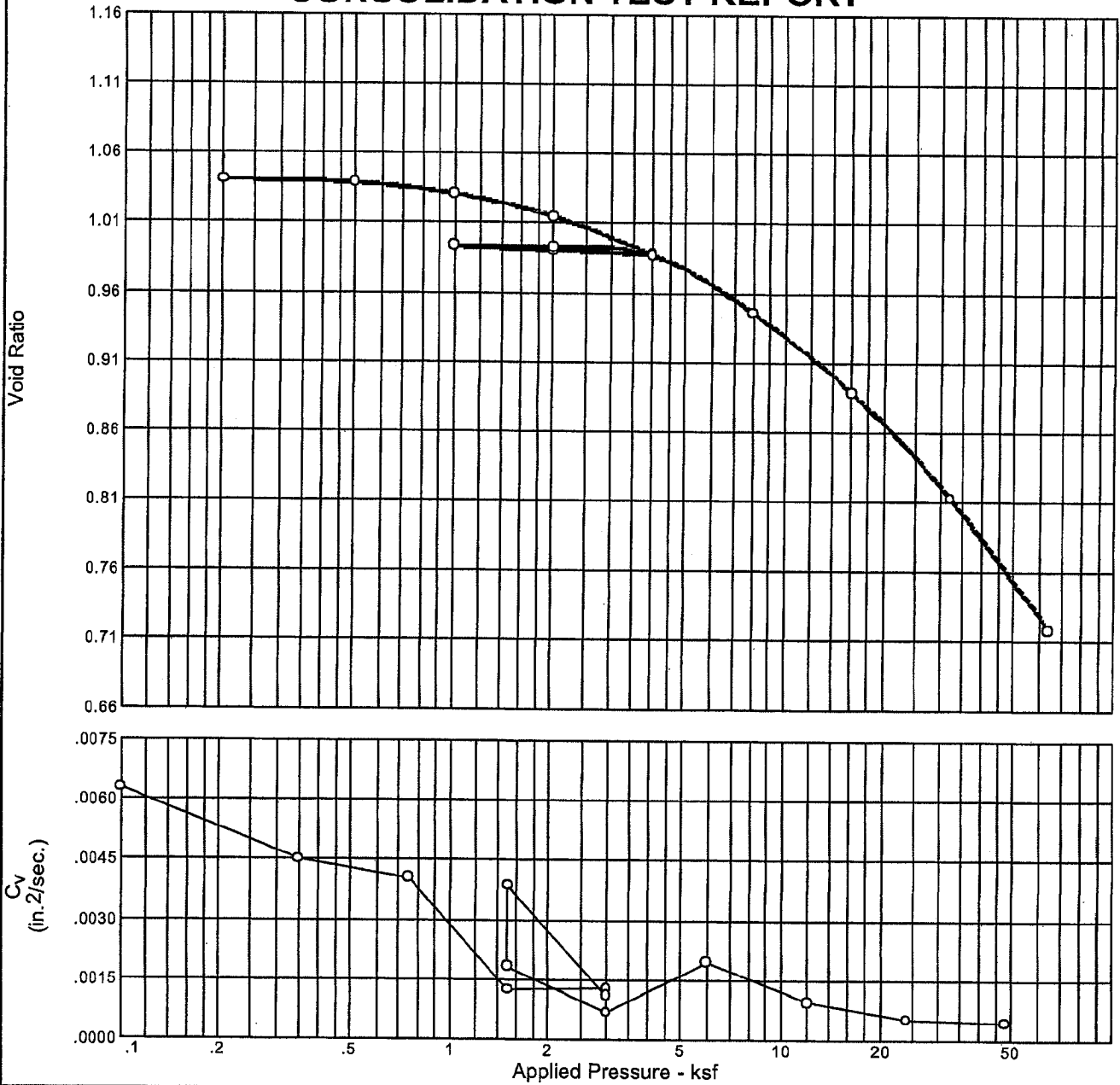

Natural		Dry Dens. (pcf)	LL	PI	Sp. Gr. (assumed)	Overburden (ksf)	P _c (ksf)	C _c	C _r	Initial Void Ratio
Saturation	Moisture									
96.8 %	36.9 %	83.5	54	30	2.73	—	10.79	0.32	0.01	1.041

MATERIAL DESCRIPTION								USCS	AASHTO
Dark yellowish brown fat clay with sand								CH	-

Project No. 3043051021 **Client:** TVA
Project: TVA Kingston - Proposed Gypsum Stack
Location: NB-44 (21'-23.5')

CONSOLIDATION TEST REPORT
MACTEC, INC.

Remarks:
 Material description and classification determined from combined Triaxial CU specimen sample test results

Figure

Dial Reading vs. Time

Project No.: 3043051021

Project: TVA Kingston - Proposed Gypsum Stack

Location: NB-44 (21'-23.5')

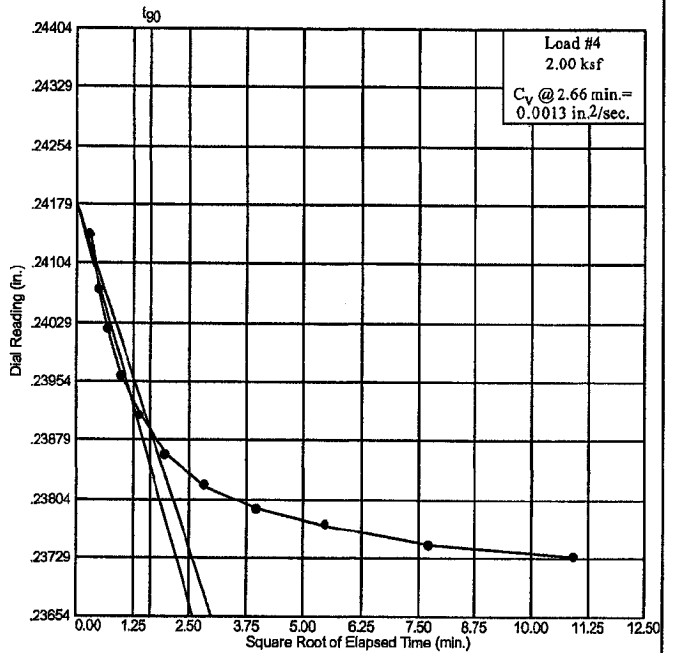
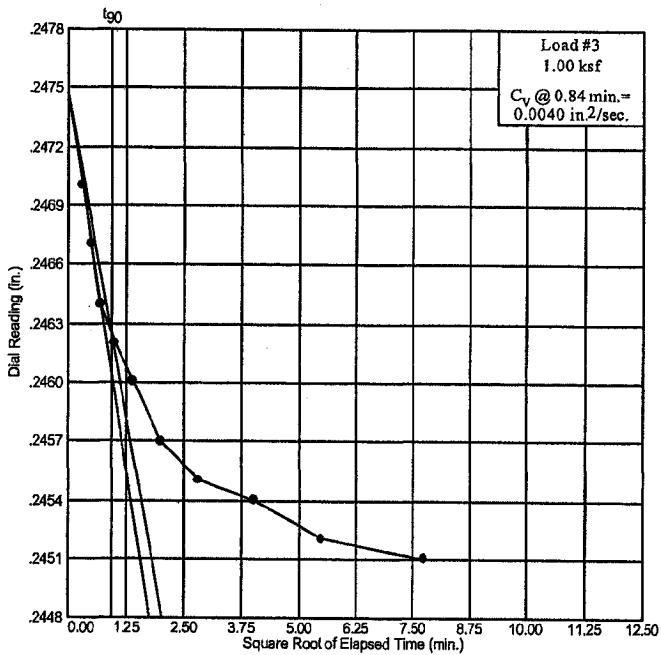
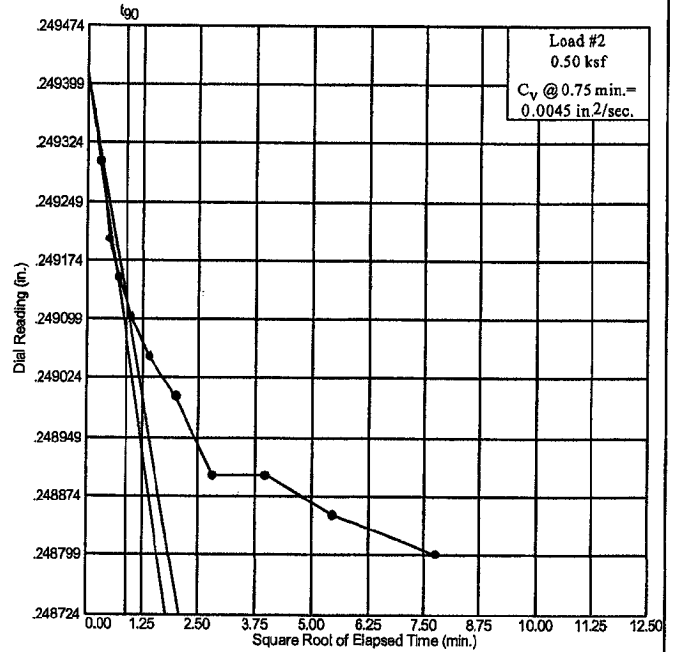
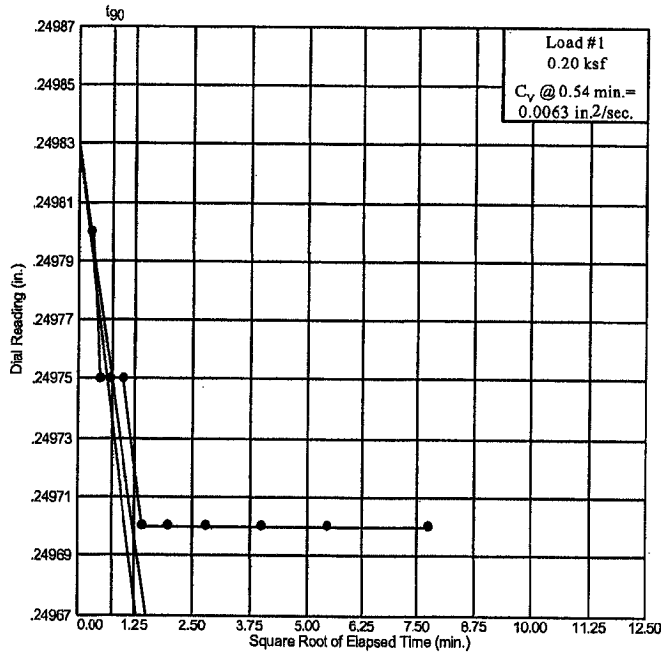

Dial Reading vs. Time
MACTEC, INC.

Figure

CONSOLIDATION TEST DATA

Client: TVA
 Project: TVA Kingston - Proposed Gypsum Stack
 Project Number: 3043051021

Sample Data

Source:
 Sample No.:
 Elev. or Depth: 21'-23.5' Sample Length (in./cm.):
 Location: NB-44 (21'-23.5')
 Description:
 Liquid Limit: 54 Plasticity Index: 30
 USCS: AASHTO: Figure No.:
 Testing Remarks:

Test Specimen Data

TOTAL SAMPLE	BEFORE TEST	AFTER TEST
Wet w+t = 238.55 g.	Consolidometer # = 4	Wet w+t = 121.34 g.
Dry w+t = 203.26 g.		Dry w+t = 95.56 g.
Tare Wt. = 107.70 g.	Spec. Gravity = 2.73	Tare Wt. = .00 g.
Height = .98 in.	Height = .98 in.	
Diameter = 2.38 in.	Diameter = 2.38 in.	
Weight = 130.85 g.	Defl. Table = Reference Set (inches/ksf)	
Moisture = 36.9 %	Ht. Solids = 0.4815 in.	Moisture = 27.0 %
Wet Den. = 114.3 pcf	Dry Wt. = 95.56 g.	Dry Wt. = 95.56 g.*
Den. = 83.5 pcf	Void Ratio = 1.041	Void Ratio = 0.718
	Saturation = 96.8 %	

* Final dry weight used in calculations

End-of-Load Summary

Pressure (ksf)	Final Dial (in.)	Machine Defl. (in.)	C_v (in. ² /sec.)	C_α	Void Ratio	% Compression / Swell
start	0.25000				1.041	
0.20	0.24970	0.00000	0.0063		1.040	0.0 Compr.
0.50	0.24840	0.00040	0.0045		1.039	0.1 Compr.
1.00	0.24430	0.00080	0.0040		1.031	0.5 Compr.
2.00	0.23570	0.00160	0.0013		1.015	1.3 Compr.
4.00	0.22190	0.00240	0.0013		0.988	2.6 Compr.
2.00	0.22390	0.00160	0.0011		0.990	2.5 Compr.
1.00	0.22620	0.00080	0.0039		0.993	2.3 Compr.
2.00	0.22490	0.00160	0.0018		0.992	2.4 Compr.
4.00	0.22100	0.00300	0.0007		0.987	2.6 Compr.
8.00	0.20400	0.00000	0.0020		0.945	4.7 Compr.
16.00	0.17660	0.00000	0.0010		0.889	7.5 Compr.
32.00	0.13990	0.00000	0.0005		0.812	11.2 Compr.
64.00	0.09460	0.00000	0.0005		0.718	15.8 Compr.

$C_c = 0.32$ $P_c = 10.79$ ksf $C_r = 0.01$

Pressure: 0.20 ksf

TEST READINGS

Load No. 1

No.	Elapsed Time	Dial Reading	No.	Elapsed Time	Dial Reading
1	0.00	0.25000	11	60.00	0.24970
2	0.10	0.24980			
3	0.25	0.24975			
4	0.50	0.24975			
5	1.00	0.24975			
6	2.00	0.24970			
7	4.00	0.24970			
8	8.00	0.24970			
9	16.00	0.24970			
10	30.00	0.24970			

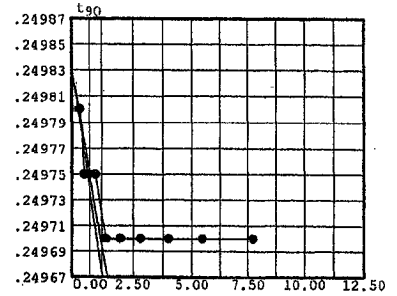

Void Ratio = 1.040 Compression = 0.0 %
 $D_0 = 0.24983$ $D_{90} = 0.24975$ $D_{100} = 0.24974$
 C_v at 0.5 min. = 0.0063 in.²/sec.

Pressure: 0.50 ksf

TEST READINGS

Load No. 2

No.	Elapsed Time	Dial Reading	No.	Elapsed Time	Dial Reading
1	0.00	0.24970	11	60.00	0.24840
2	0.10	0.24890			
3	0.25	0.24880			
4	0.50	0.24875			
5	1.00	0.24870			
6	2.00	0.24865			
7	4.00	0.24860			
8	8.00	0.24850			
9	16.00	0.24850			
10	30.00	0.24845			

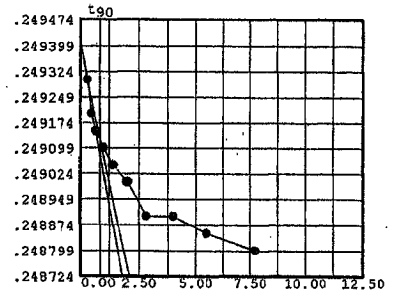

Void Ratio = 1.039 Compression = 0.1 %
 $D_0 = 0.24941$ $D_{90} = 0.24912$ $D_{100} = 0.24909$
 C_v at 0.8 min. = 0.0045 in.²/sec.

Pressure: 1.00 ksf

TEST READINGS

Load No. 3

No.	Elapsed Time	Dial Reading	No.	Elapsed Time	Dial Reading
1	0.00	0.24840	11	60.00	0.24430
2	0.10	0.24620			
3	0.25	0.24590			
4	0.50	0.24560			
5	1.00	0.24540			
6	2.00	0.24520			
7	4.00	0.24490			
8	8.00	0.24470			
9	16.00	0.24460			
10	30.00	0.24440			

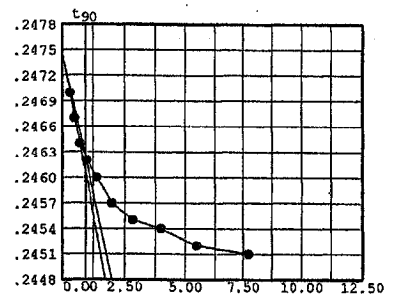

Void Ratio = 1.031 Compression = 0.5 %
 $D_0 = 0.24748$ $D_{90} = 0.24626$ $D_{100} = 0.24612$
 C_v at 0.8 min. = 0.0040 in.²/sec.

Pressure: 2.00 ksf

TEST READINGS

Load No. 4

No.	Elapsed Time	Dial Reading	No.	Elapsed Time	Dial Reading
1	0.00	0.24430	11	60.00	0.23585
2	0.10	0.23980	12	120.00	0.23570
3	0.25	0.23910			
4	0.50	0.23860			
5	1.00	0.23800			
6	2.00	0.23750			
7	4.00	0.23700			
8	8.00	0.23660			
9	16.00	0.23630			
10	30.00	0.23610			

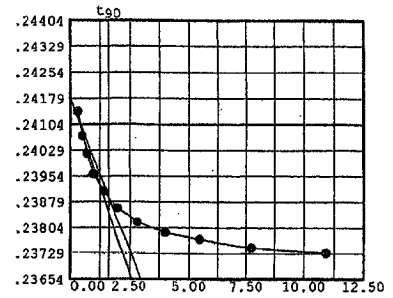

Void Ratio = 1.015 Compression = 1.3 %
 $D_0 = 0.24180$ $D_{90} = 0.23891$ $D_{100} = 0.23859$
 C_v at 2.7 min. = 0.0013 in.²/sec.

Pressure: 4.00 ksf

TEST READINGS

Load No. 5

No.	Elapsed Time	Dial Reading	No.	Elapsed Time	Dial Reading
1	0.00	0.23570	11	60.00	0.22290
2	0.10	0.22870	12	120.00	0.22270
3	0.25	0.22770	13	240.00	0.22250
4	0.50	0.22680	14	1533.00	0.22190
5	1.00	0.22590			
6	2.00	0.22510			
7	4.00	0.22450			
8	8.00	0.22390			
9	16.00	0.22340			
10	30.00	0.22310			

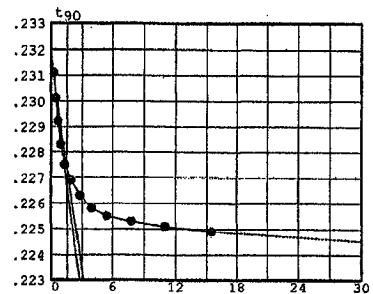

Void Ratio = 0.988 Compression = 2.6 %
 $D_0 = 0.23177$ $D_{90} = 0.22732$ $D_{100} = 0.22682$
 C_v at 2.5 min. = 0.0013 in.²/sec.

Pressure: 2.00 ksf

TEST READINGS

Load No. 6

No.	Elapsed Time	Dial Reading	No.	Elapsed Time	Dial Reading
1	0.00	0.22190	11	97.00	0.22380
2	0.10	0.22310	12	933.00	0.22390
3	0.25	0.22320			
4	0.50	0.22330			
5	1.00	0.22340			
6	2.00	0.22350			
7	4.00	0.22360			
8	8.00	0.22365			
9	16.00	0.22370			
10	30.00	0.22370			

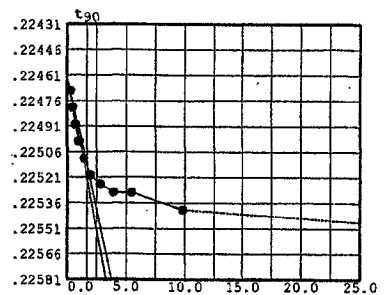

Void Ratio = 0.990 Compression = 2.5 %
 $D_0 = 0.22462$ $D_{90} = 0.22515$ $D_{100} = 0.22521$
 C_v at 2.9 min. = 0.0011 in.²/sec.

Pressure: 1.00 ksf

TEST READINGS

Load No. 7

No.	Elapsed Time	Dial Reading	No.	Elapsed Time	Dial Reading
1	0.00	0.22390	11	60.00	0.22610
2	0.10	0.22500	12	120.00	0.22620
3	0.25	0.22515			
4	0.50	0.22530			
5	1.00	0.22540			
6	2.00	0.22550			
7	4.00	0.22570			
8	8.00	0.22580			
9	16.00	0.22590			
10	30.00	0.22600			

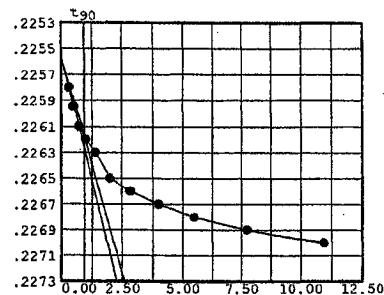

Void Ratio = 0.993 Compression = 2.3 %
 $D_0 = 0.22556$ $D_{90} = 0.22617$ $D_{100} = 0.22624$
 C_v at 0.8 min. = 0.0039 in.²/sec.

Pressure: 2.00 ksf

TEST READINGS

Load No. 8

No.	Elapsed Time	Dial Reading	No.	Elapsed Time	Dial Reading
1	0.00	0.22620	11	60.00	0.22490
2	0.10	0.22535			
3	0.25	0.22530			
4	0.50	0.22525			
5	1.00	0.22515			
6	2.00	0.22510			
7	4.00	0.22505			
8	8.00	0.22500			
9	16.00	0.22500			
10	30.00	0.22495			

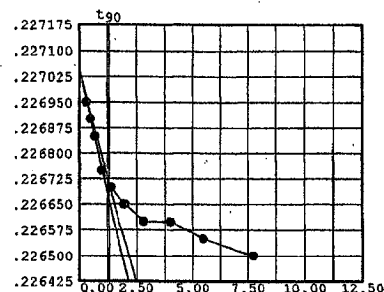

Void Ratio = 0.992 Compression = 2.4 %
 $D_0 = 0.22705$ $D_{90} = 0.22671$ $D_{100} = 0.22667$
 C_v at 1.8 min. = 0.0018 in.²/sec.

Pressure: 4.00 ksf

TEST READINGS

Load No. 9

No.	Elapsed Time	Dial Reading	No.	Elapsed Time	Dial Reading
1	0.00	0.22490	11	60.00	0.22140
2	0.10	0.22280	12	145.00	0.22125
3	0.25	0.22255	13	1238.00	0.22100
4	0.50	0.22230			
5	1.00	0.22215			
6	2.00	0.22200			
7	4.00	0.22180			
8	8.00	0.22170			
9	16.00	0.22160			
10	30.00	0.22150			

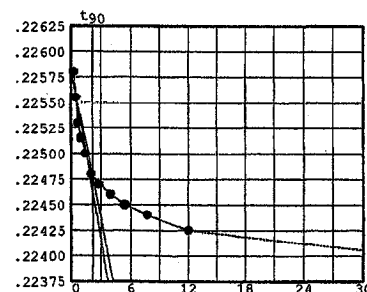

Void Ratio = 0.987 Compression = 2.6 %
 $D_0 = 0.22581$ $D_{90} = 0.22478$ $D_{100} = 0.22467$
 C_v at 4.6 min. = 0.0007 in.²/sec.

Pressure: 8.00 ksf

TEST READINGS

Load No. 10

No.	Elapsed Time	Dial Reading	No.	Elapsed Time	Dial Reading
1	0.00	0.22100	11	116.00	0.20420
2	0.10	0.21250	12	129.00	0.20400
3	0.25	0.21120			
4	0.50	0.21000			
5	1.00	0.20870			
6	2.00	0.20760			
7	5.00	0.20625			
8	8.00	0.20570			
9	16.00	0.20510			
10	30.00	0.20470			

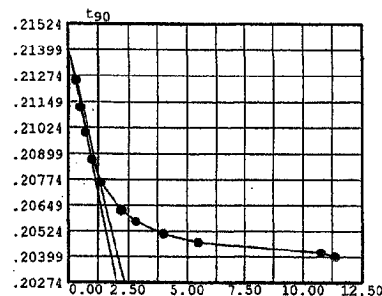

Void Ratio = 0.945 Compression = 4.7 %
 $D_0 = 0.21408$ $D_{90} = 0.20797$ $D_{100} = 0.20730$
 C_v at 1.6 min. = 0.0020 in.²/sec.

Pressure: 16.00 ksf

TEST READINGS

Load No. 11

No.	Elapsed Time	Dial Reading	No.	Elapsed Time	Dial Reading
1	0.00	0.20400	11	60.00	0.17890
2	0.10	0.19330	12	120.00	0.17850
3	0.25	0.19130	13	2242.00	0.17660
4	0.50	0.18945			
5	1.00	0.18730			
6	2.00	0.18500			
7	4.00	0.18280			
8	8.00	0.18115			
9	16.00	0.18005			
10	30.00	0.17940			

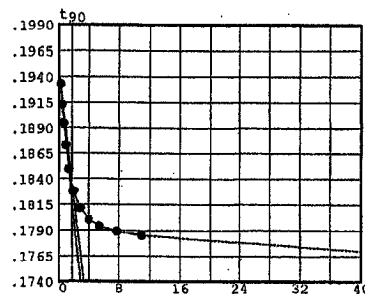

Void Ratio = 0.889 Compression = 7.5 %
 $D_0 = 0.19515$ $D_{90} = 0.18367$ $D_{100} = 0.18239$
 C_v at 3.1 min. = 0.0010 in.²/sec.

Pressure: 32.00 ksf

TEST READINGS

Load No. 12

No.	Elapsed Time	Dial Reading	No.	Elapsed Time	Dial Reading
1	0.00	0.17660	11	60.00	0.14150
2	0.10	0.16450	12	120.00	0.14050
3	0.25	0.16190	13	360.00	0.13990
4	0.50	0.15920			
5	1.00	0.15600			
6	2.00	0.15240			
7	4.00	0.14880			
8	8.00	0.14620			
9	16.00	0.14440			
10	30.00	0.14250			

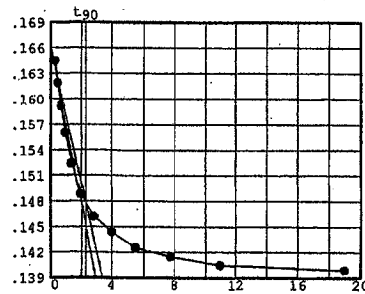

Void Ratio = 0.812 Compression = 11.2 %
 $D_0 = 0.16632$ $D_{90} = 0.14792$ $D_{100} = 0.14588$
 C_v at 5.2 min. = 0.0005 in.²/sec.

Pressure: 64.00 ksf

TEST READINGS

Load No. 13

No.	Elapsed Time	Dial Reading	No.	Elapsed Time	Dial Reading
1	0.00	0.13990	11	60.00	0.09700
2	0.10	0.12400	12	120.00	0.09610
3	0.25	0.12160	13	1320.00	0.09460
4	0.50	0.11850			
5	1.00	0.11460			
6	2.00	0.10980			
7	4.00	0.10480			
8	8.00	0.10150			
9	16.00	0.09930			
10	30.00	0.09800			

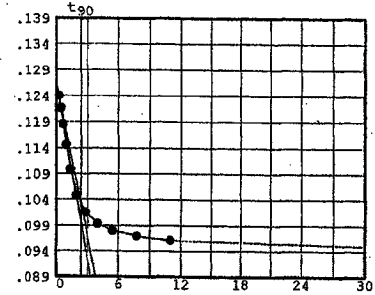

Void Ratio = 0.718 Compression = 15.8 %
D₀ = 0.12698 D₉₀ = 0.10342 D₁₀₀ = 0.10081
C_v at 5.5 min. = 0.0005 in.²/sec.

CONSOLIDATION TEST REPORT

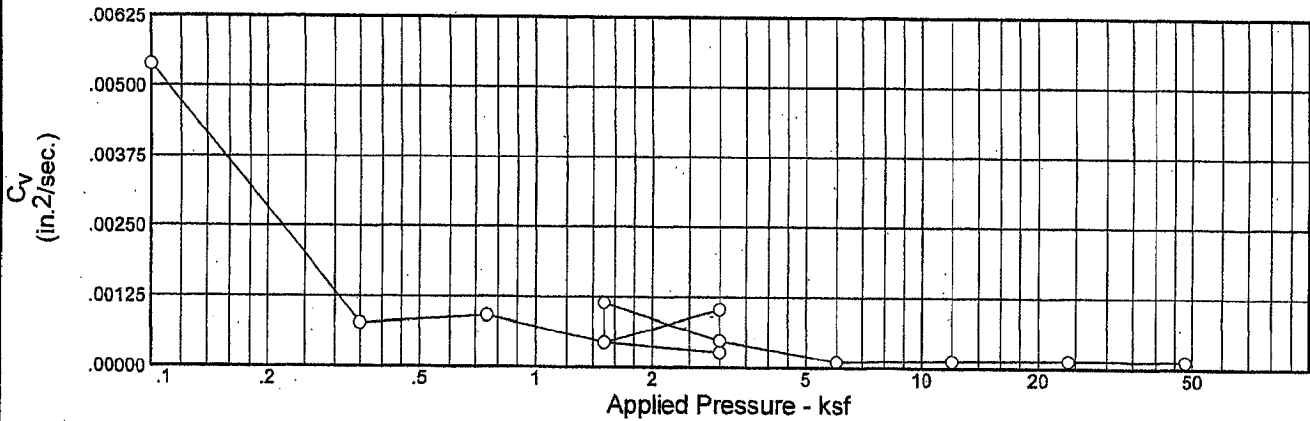
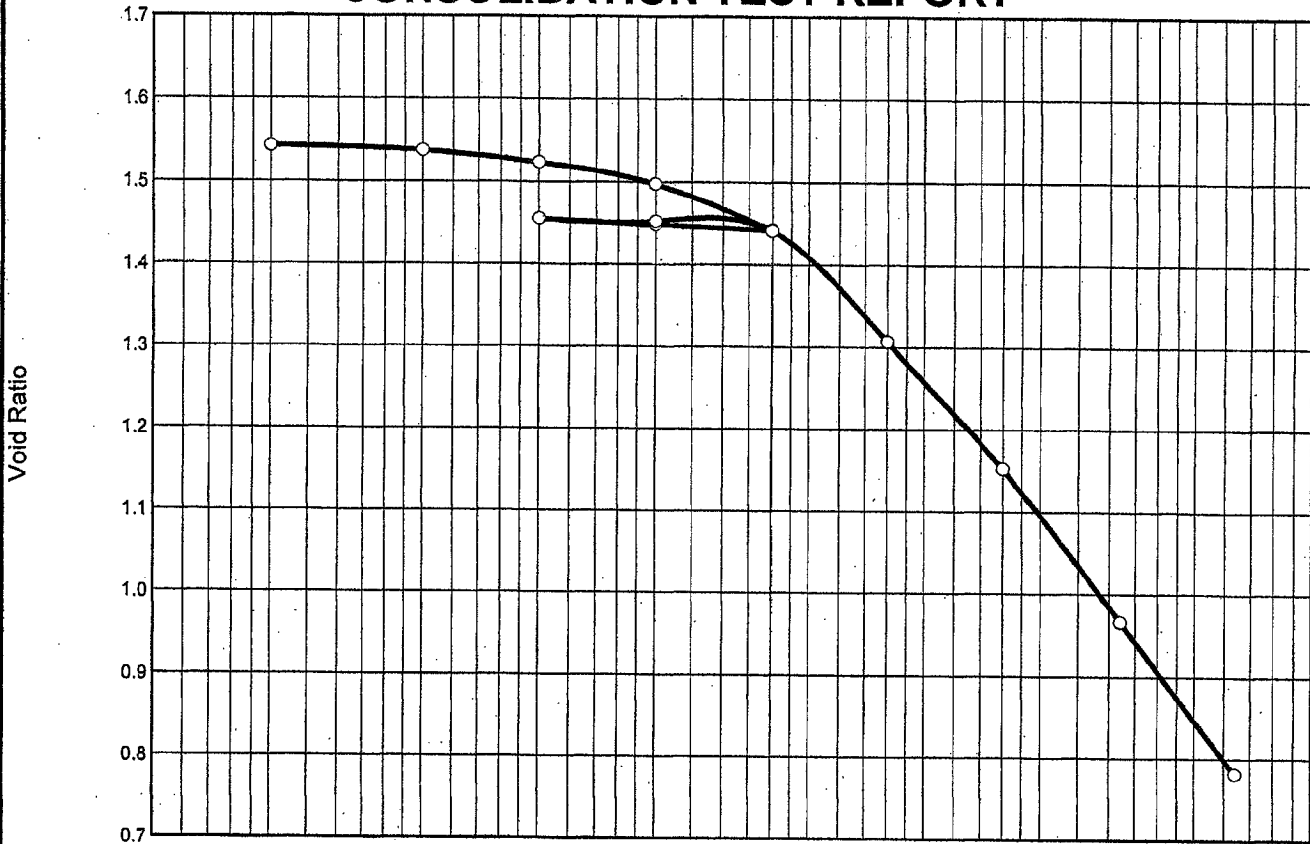

Natural		Dry Dens. (pcf)	LL	PI	Sp. Gr.	Overburden (ksf)	P _c (ksf)	C _c	C _r	Initial Void Ratio
Saturation	Moisture									
96.1 %	54.2 %	67.2	74	42	2.74	—	5.84	0.61	0.02	1.545

MATERIAL DESCRIPTION	USCS	AASHTO
Brown fat clay with sand	CH	-

<p>Project No. 3043051021 Client: TVA</p> <p>Project: TVA Kingston - Proposed Gypsum Stack</p> <p>Location: NB-44 (31'-33')</p> <p style="text-align: center;">CONSOLIDATION TEST REPORT</p> <p style="text-align: center;">MACTEC, INC.</p>	<p>Remarks:</p> <p style="text-align: right;">Figure</p>
-------------------------------------------------------------------------------------------------------------------------------------------------------------------------------------------------------------------------------------------------------------------------------------------	------------------------------------------------------------------------------------

Dial Reading vs. Time

Project No.: 3043051021

Project: TVA Kingston - Proposed Gypsum Stack

Location: NB-44 (31'-33')

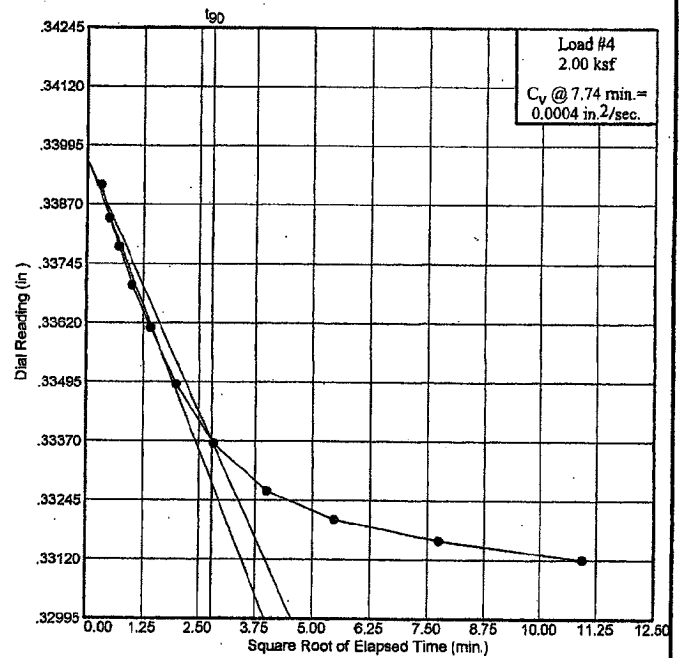
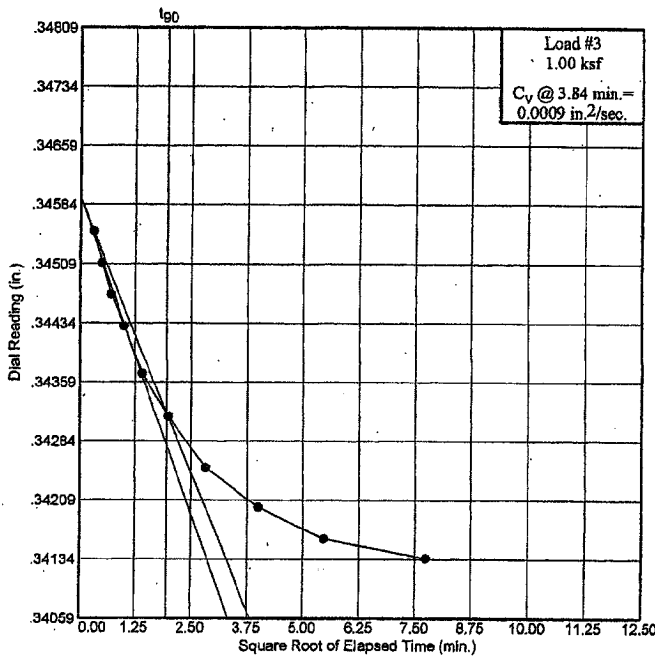
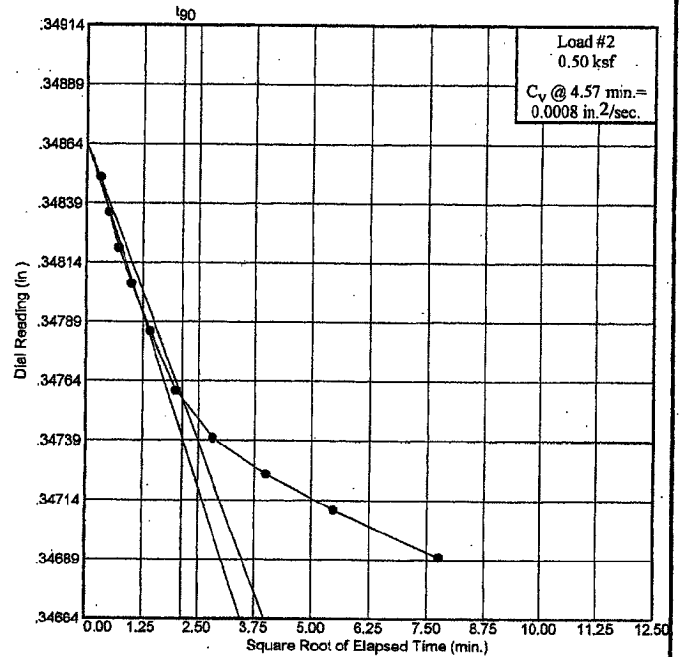
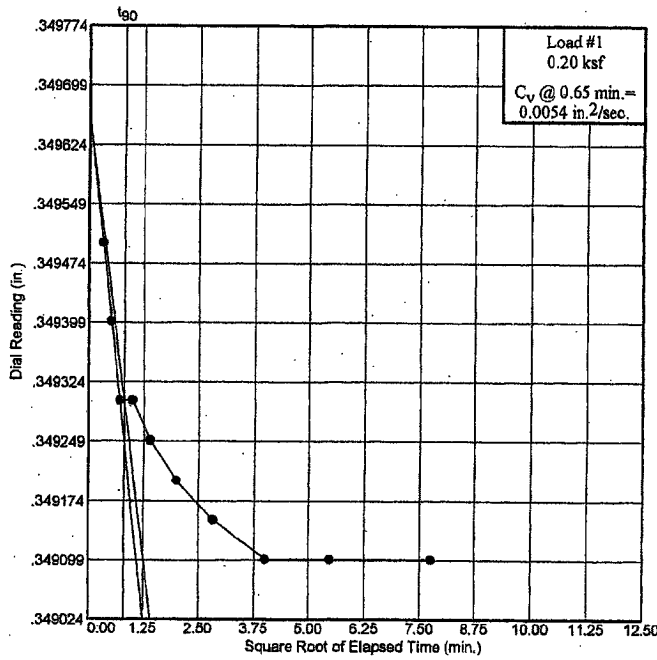

Dial Reading vs. Time
MACTEC, INC.

Figure

Dial Reading vs. Time

Project No.: 3043051021

Project: TVA Kingston - Proposed Gypsum Stack

Location: NB-44 (31'-33')

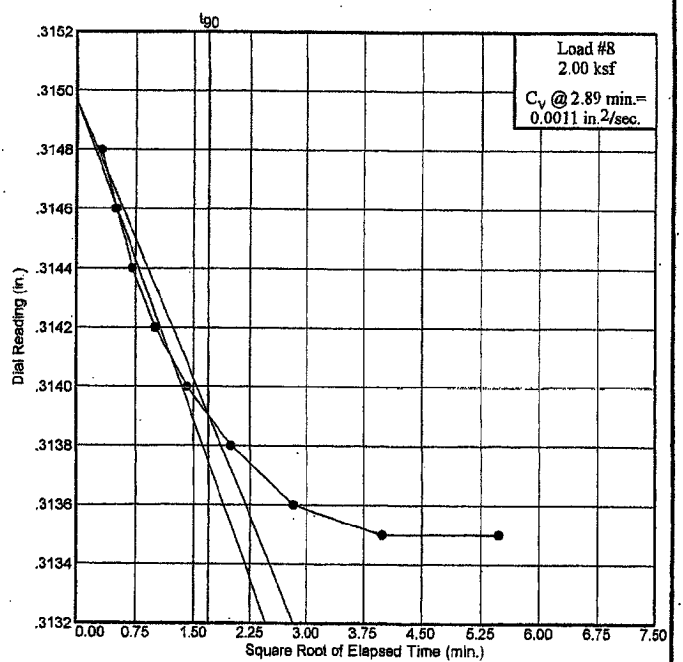
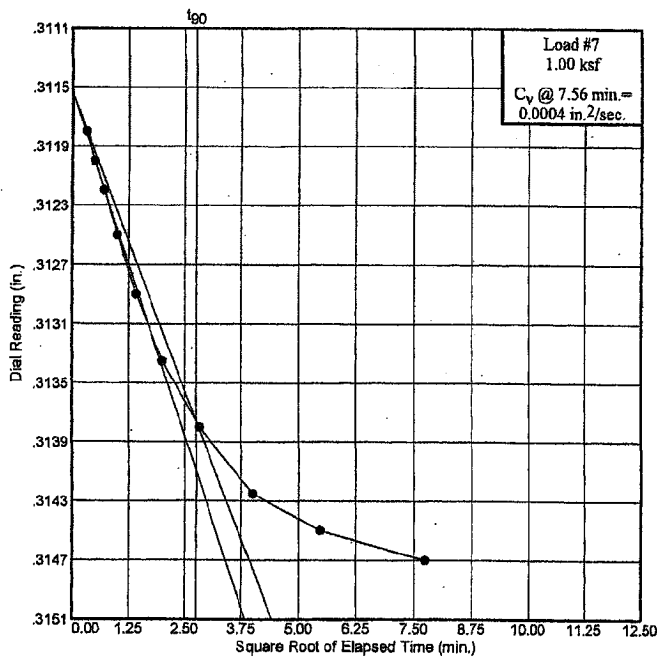
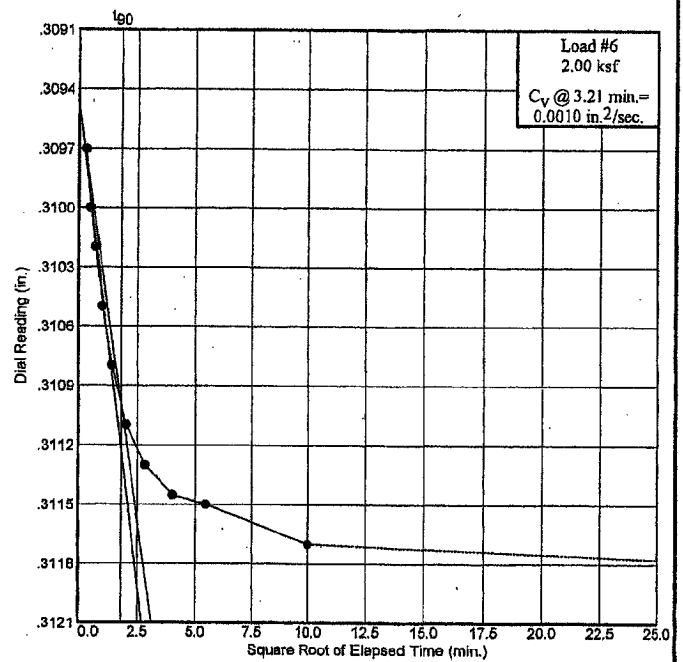
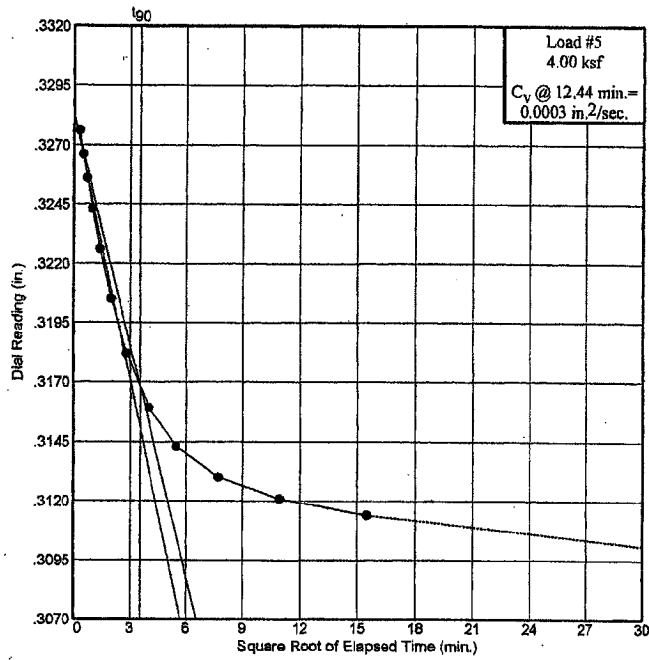

Dial Reading vs. Time
MACTEC, INC.

Figure

Dial Reading vs. Time

Project No.: 3043051021

Project: TVA Kingston - Proposed Gypsum Stack

Location: NB-44 (31'-33')

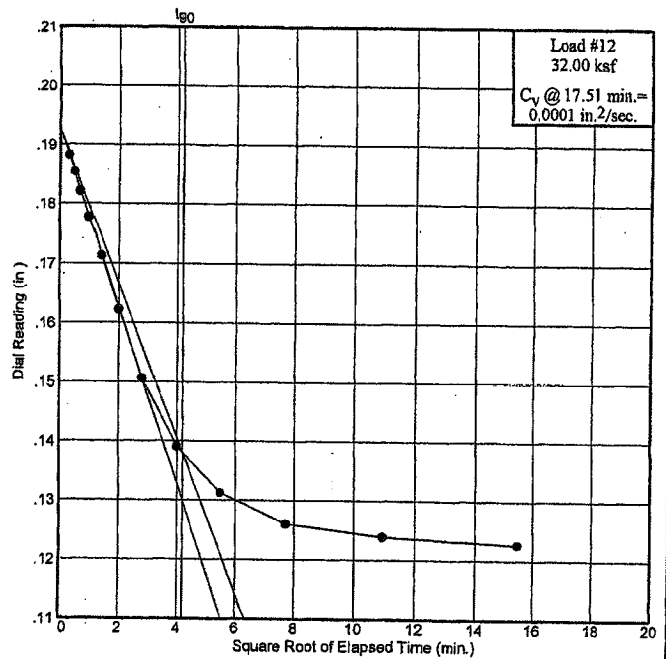
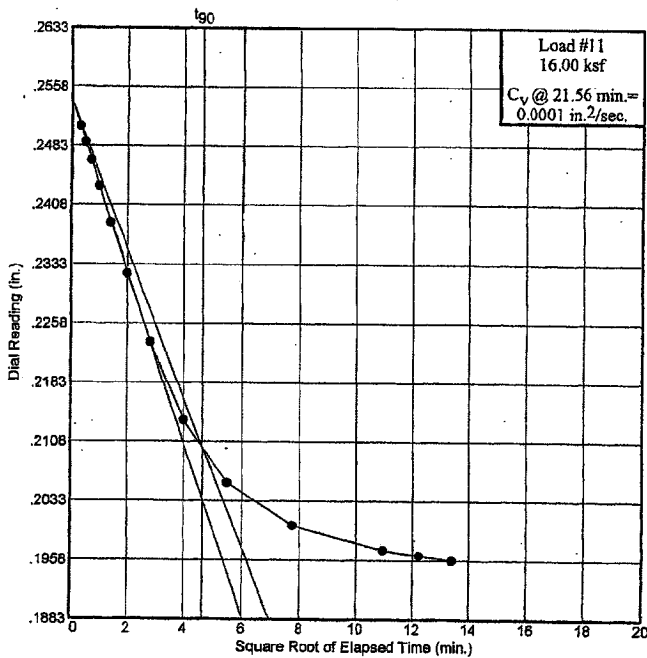
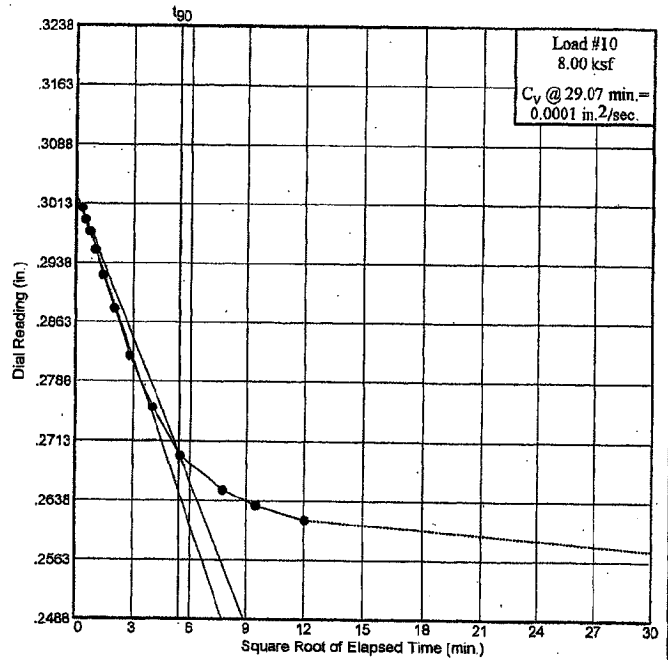
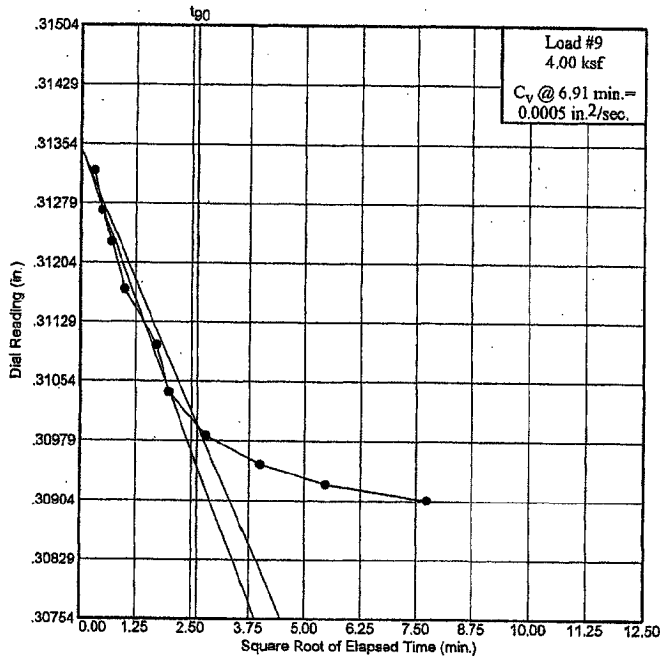

Dial Reading vs. Time
MACTEC, INC.

Figure

Dial Reading vs. Time

Project No.: 3043051021

Project: TVA Kingston - Proposed Gypsum Stack

Location: NB-44 (31'-33')

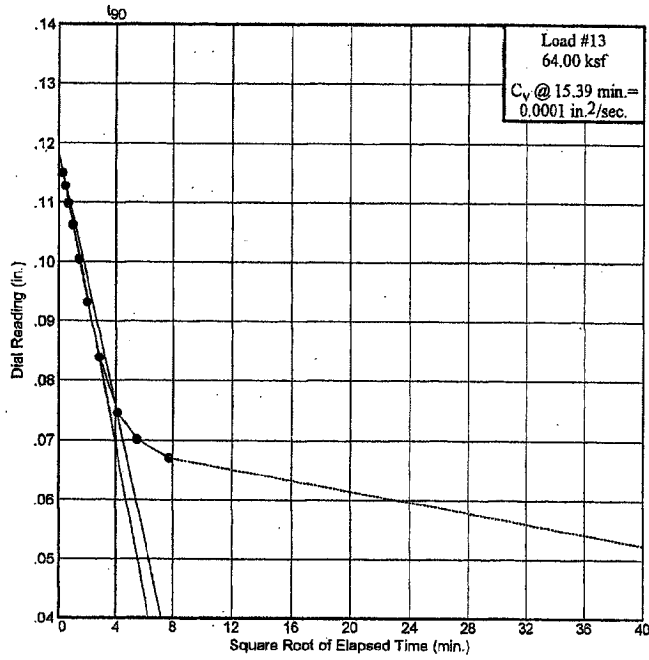

Dial Reading vs. Time

MACTEC, INC.

Figure

CONSOLIDATION TEST DATA

Client: TVA
 Project: TVA Kingston - Proposed Gypsum Stack
 Project Number: 3043051021

Sample Data

Source:
 Sample No.: UD-6
 Elev. or Depth: 31'-33' Sample Length(in./cm.):
 Location: NB-44 (31'-33')
 Description:
 Liquid Limit: 74 Plasticity Index: 42
 USCS: AASHTO: Figure No.:
 Testing Remarks:

Test Specimen Data

TOTAL SAMPLE	BEFORE TEST	AFTER TEST
Wet w+t = 231.55 g.	Consolidometer # = 5	Wet w+t = 103.21 g.
Dry w+t = 189.14 g.		Dry w+t = 78.28 g.
Tare Wt. = 110.86 g.	Spec. Gravity = 2.74	Tare Wt. = .00 g.
Height = 1.00 in.	Height = 1.00 in.	
Diameter = 2.38 in.	Diameter = 2.38 in.	
Weight = 120.69 g.	Defl. Table = Reference Set (inches/ksf)	
Moisture = 54.2 %	Ht. Solids = 0.3927 in.	Moisture = 31.8 %
Wet Den. = 103.6 pcf	Dry Wt. = 78.28 g.	Dry Wt. = 78.28 g.*
Dry Den. = 67.2 pcf	Void Ratio = 1.545	Void Ratio = 0.782
	Saturation = 96.1 %	

* Final dry weight used in calculations

End-of-Load Summary

Pressure (ksf)	Final Dial (in.)	Machine Defl. (in.)	C _v (in. ² /sec.)	C _α	Void Ratio	% Compression /Swell
start	0.35000				1.545	
0.20	0.34910	0.00000	0.0054		1.543	0.1 Compr.
0.50	0.34650	0.00040	0.0008		1.537	0.3 Compr.
1.00	0.34055	0.00080	0.0009		1.523	0.9 Compr.
2.00	0.32960	0.00160	0.0004		1.497	1.9 Compr.
4.00	0.30710	0.00240	0.0003		1.442	4.1 Compr.
2.00	0.31020	0.00160	0.0010		1.448	3.8 Compr.
1.00	0.31390	0.00080	0.0004		1.455	3.5 Compr.
2.00	0.31190	0.00160	0.0011		1.452	3.7 Compr.
4.00	0.30605	0.00300	0.0005		1.441	4.1 Compr.
8.00	0.25640	0.00000	0.0001		1.307	9.4 Compr.
16.00	0.19580	0.00000	0.0001		1.152	15.4 Compr.
32.00	0.12270	0.00000	0.0001		0.966	22.7 Compr.
64.00	0.05030	0.00000	0.0001		0.782	30.0 Compr.

C_c = 0.61 P_c = 5.84 ksf C_r = 0.02

Pressure: 0.20 ksf

TEST READINGS

Load No. 1

No.	Elapsed Time	Dial Reading	No.	Elapsed Time	Dial Reading
1	0.00	0.35000	11	60.00	0.34910
2	0.10	0.34950			
3	0.25	0.34940			
4	0.50	0.34930			
5	1.00	0.34930			
6	2.00	0.34925			
7	4.00	0.34920			
8	8.00	0.34915			
9	16.00	0.34910			
10	30.00	0.34910			

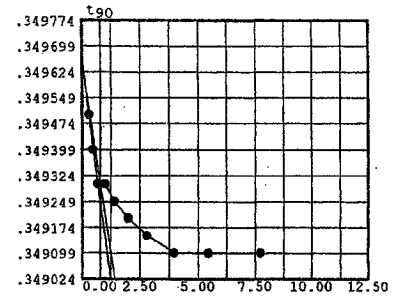

Void Ratio = 1.543 Compression = 0.1 %
 $D_0 = 0.34966$ $D_{90} = 0.34930$ $D_{100} = 0.34926$
 C_v at 0.7 min. = 0.0054 in.²/sec.

Pressure: 0.50 ksf

TEST READINGS

Load No. 2

No.	Elapsed Time	Dial Reading	No.	Elapsed Time	Dial Reading
1	0.00	0.34910	11	60.00	0.34650
2	0.10	0.34810			
3	0.25	0.34795			
4	0.50	0.34780			
5	1.00	0.34765			
6	2.00	0.34745			
7	4.00	0.34720			
8	8.00	0.34700			
9	16.00	0.34685			
10	30.00	0.34670			

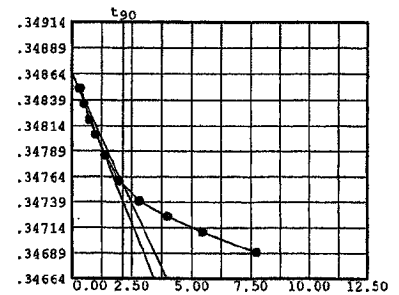

Void Ratio = 1.537 Compression = 0.3 %
 $D_0 = 0.34865$ $D_{90} = 0.34757$ $D_{100} = 0.34745$
 C_v at 4.6 min. = 0.0008 in.²/sec.

Pressure: 1.00 ksf

TEST READINGS

Load No. 3

No.	Elapsed Time	Dial Reading	No.	Elapsed Time	Dial Reading
1	0.00	0.34650	11	60.00	0.34055
2	0.10	0.34470			
3	0.25	0.34430			
4	0.50	0.34390			
5	1.00	0.34350			
6	2.00	0.34290			
7	4.00	0.34235			
8	8.00	0.34170			
9	16.00	0.34120			
10	30.00	0.34080			

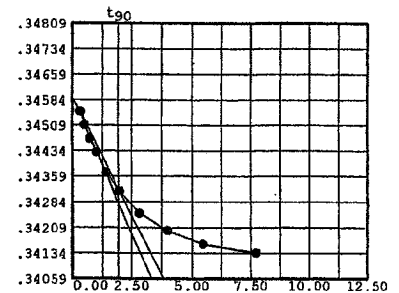

Void Ratio = 1.523 Compression = 0.9 %
 $D_0 = 0.34593$ $D_{90} = 0.34319$ $D_{100} = 0.34288$
 C_v at 3.8 min. = 0.0009 in.²/sec.

Pressure: 2.00 ksf

TEST READINGS

Load No. 4

No.	Elapsed Time	Dial Reading	No.	Elapsed Time	Dial Reading
1	0.00	0.34055	11	60.00	0.33000
2	0.10	0.33750	12	120.00	0.32960
3	0.25	0.33680			
4	0.50	0.33620			
5	1.00	0.33540			
6	2.00	0.33450			
7	4.00	0.33330			
8	8.00	0.33205			
9	16.00	0.33105			
10	30.00	0.33045			

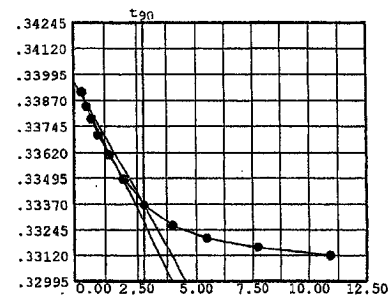

Void Ratio = 1.497 Compression = 1.9 %
 $D_0 = 0.33964$ $D_{90} = 0.33372$ $D_{100} = 0.33306$
 C_v at 7.7 min. = 0.0004 in.²/sec.

Pressure: 4.00 ksf

TEST READINGS

Load No. 5

No.	Elapsed Time	Dial Reading	No.	Elapsed Time	Dial Reading
1	0.00	0.32960	11	60.00	0.31060
2	0.10	0.32520	12	120.00	0.30970
3	0.25	0.32420	13	240.00	0.30900
4	0.50	0.32320	14	1344.00	0.30710
5	1.00	0.32190			
6	2.00	0.32020			
7	4.00	0.31810			
8	8.00	0.31580			
9	16.00	0.31350			
10	30.00	0.31190			

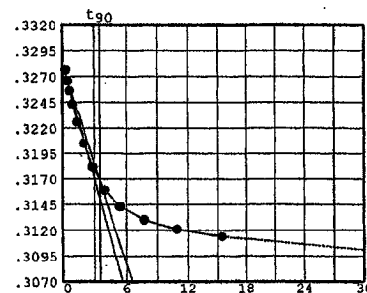

Void Ratio = 1.442 Compression = 4.1 %
 $D_0 = 0.32832$ $D_{90} = 0.31683$ $D_{100} = 0.31555$
 C_v at 12.4 min. = 0.0003 in.²/sec.

Pressure: 2.00 ksf

TEST READINGS

Load No. 6

No.	Elapsed Time	Dial Reading	No.	Elapsed Time	Dial Reading
1	0.00	0.30710	11	100.00	0.31010
2	0.10	0.30810	12	936.00	0.31020
3	0.25	0.30840			
4	0.50	0.30860			
5	1.00	0.30890			
6	2.00	0.30920			
7	4.00	0.30950			
8	8.00	0.30970			
9	16.00	0.30985			
10	30.00	0.30990			

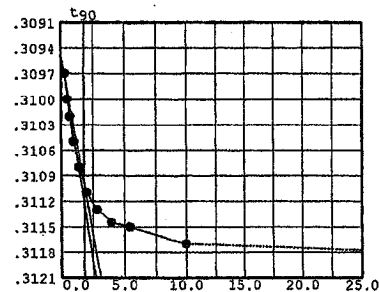

Void Ratio = 1.448 Compression = 3.8 %
 $D_0 = 0.30947$ $D_{90} = 0.31099$ $D_{100} = 0.31116$
 C_v at 3.2 min. = 0.0010 in.²/sec.

Pressure: 1.00 ksf

TEST READINGS

Load No. 7

No.	Elapsed Time	Dial Reading	No.	Elapsed Time	Dial Reading
1	0.00	0.31020	11	60.00	0.31390
2	0.10	0.31100			
3	0.25	0.31120			
4	0.50	0.31140			
5	1.00	0.31170			
6	2.00	0.31210			
7	4.00	0.31255			
8	8.00	0.31300			
9	16.00	0.31345			
10	30.00	0.31370			

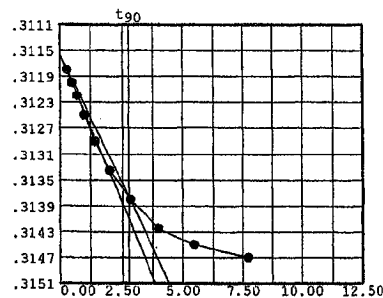

Void Ratio = 1.455 Compression = 3.5 %
 $D_0 = 0.31154$ $D_{90} = 0.31376$ $D_{100} = 0.31400$
 C_v at 7.6 min. = 0.0004 in.²/sec.

Pressure: 2.00 ksf

TEST READINGS

Load No. 8

No.	Elapsed Time	Dial Reading
1	0.00	0.31390
2	0.10	0.31320
3	0.25	0.31300
4	0.50	0.31280
5	1.00	0.31260
6	2.00	0.31240
7	4.00	0.31220
8	8.00	0.31200
9	16.00	0.31190
10	30.00	0.31190

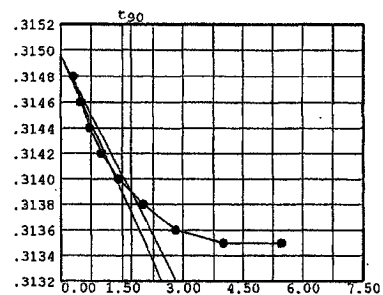

Void Ratio = 1.452 Compression = 3.7 %
 $D_0 = 0.31497$ $D_{90} = 0.31390$ $D_{100} = 0.31378$
 C_v at 2.9 min. = 0.0011 in.²/sec.

Pressure: 4.00 ksf

TEST READINGS

Load No. 9

No.	Elapsed Time	Dial Reading	No.	Elapsed Time	Dial Reading
1	0.00	0.31190	11	60.00	0.30605
2	0.10	0.31020			
3	0.25	0.30970			
4	0.50	0.30930			
5	1.00	0.30870			
6	3.00	0.30800			
7	4.00	0.30740			
8	8.00	0.30685			
9	16.00	0.30650			
10	30.00	0.30625			

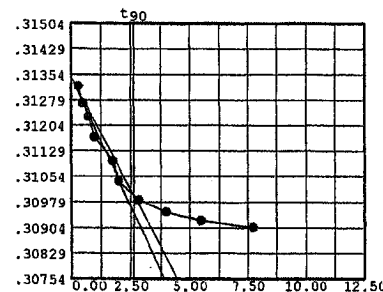

Void Ratio = 1.441 Compression = 4.1 %
 $D_0 = 0.31348$ $D_{90} = 0.30998$ $D_{100} = 0.30959$
 C_v at 6.9 min. = 0.0005 in.²/sec.

Pressure: 8.00 ksf

TEST READINGS

Load No. 10

No.	Elapsed Time	Dial Reading	No.	Elapsed Time	Dial Reading
1	0.00	0.30605	11	60.00	0.26520
2	0.10	0.30070	12	90.00	0.26320
3	0.25	0.29920	13	145.00	0.26140
4	0.50	0.29770	14	1313.00	0.25640
5	1.00	0.29540			
6	2.00	0.29220			
7	4.00	0.28800			
8	8.00	0.28200			
9	16.00	0.27550			
10	30.00	0.26950			

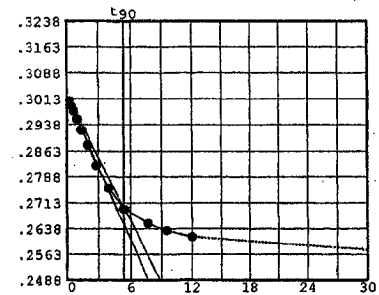

Void Ratio = 1.307 Compression = 9.4 %
 $D_0 = 0.30243$ $D_{90} = 0.26985$ $D_{100} = 0.26623$
 C_v at 29.1 min. = 0.0001 in.²/sec.

Pressure: 16.00 ksf

TEST READINGS

Load No. 11

No.	Elapsed Time	Dial Reading	No.	Elapsed Time	Dial Reading
1	0.00	0.25640	11	60.00	0.20020
2	0.10	0.25070	12	120.00	0.19710
3	0.25	0.24870	13	150.00	0.19640
4	0.50	0.24640	14	180.00	0.19580
5	1.00	0.24310			
6	2.00	0.23850			
7	4.00	0.23210			
8	8.00	0.22345			
9	16.00	0.21355			
10	30.00	0.20560			

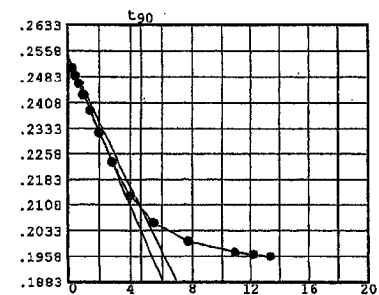

Void Ratio = 1.152 Compression = 15.4 %
 $D_0 = 0.25406$ $D_{90} = 0.21009$ $D_{100} = 0.20521$
 C_v at 21.6 min. = 0.0001 in.²/sec.

Pressure: 32.00 ksf

TEST READINGS

Load No. 12

No.	Elapsed Time	Dial Reading	No.	Elapsed Time	Dial Reading
1	0.00	0.19580	11	60.00	0.12610
2	0.10	0.18820	12	120.00	0.12400
3	0.25	0.18545	13	240.00	0.12270
4	0.50	0.18215			
5	1.00	0.17770			
6	2.00	0.17130			
7	4.00	0.16230			
8	8.00	0.15065			
9	16.00	0.13905			
10	30.00	0.13130			

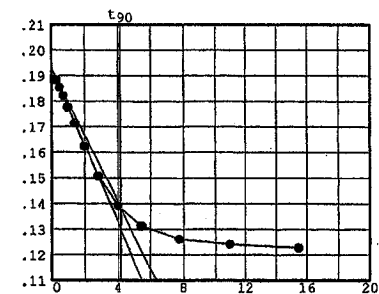

Void Ratio = 0.966 Compression = 22.7 %
 $D_0 = 0.19280$ $D_{90} = 0.13808$ $D_{100} = 0.13201$
 C_v at 17.5 min. = 0.0001 in.²/sec.

Pressure: 64.00 ksf

TEST READINGS

Load No. 13

No.	Elapsed Time	Dial Reading	No.	Elapsed Time	Dial Reading
1	0.00	0.12270	11	60.00	0.06700
2	0.10	0.11490	12	1980.00	0.05030
3	0.25	0.11270			
4	0.50	0.10980			
5	1.00	0.10610			
6	2.00	0.10040			
7	4.00	0.09310			
8	8.00	0.08380			
9	17.00	0.07450			
10	30.00	0.07010			

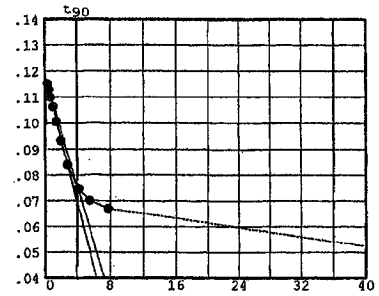

Void Ratio = 0.782 Compression = 30.0 %
D₀ = 0.11865 D₉₀ = 0.07594 D₁₀₀ = 0.07119
C_v at 15.4 min. = 0.0001 in.²/sec.

PINHOLE TEST RESULTS



Job Record Number: 00346
Lab ID Number: 004247

Identification and Classification of Dispersive Clay Soils by Pinhole Test
(ASTM D4647-93)

Project Name: TVA Kingston-Proposed Gypsum Disposal Area
Project Number: 3043-05-1021

Tested By: JM
Test Date: 8/8/2005
Reviewed By: TJ
Review Date: 9/13/05

Sample Identification: NB-44 UD1
Moisture Content: _____
Sample Weight, (grams): _____
Sample Volume, (Ft³): 0.0012
Dry Density, (pcf): 0.0
Test Method: A

Hydraulic Head (mm)	Rate of Flow (ml/sec)	Cloudiness	Length of Test (minutes)	Hole Diameter, (mm)		Classification
				Before Test	After Test	
51	0.20	CC	5	1.0	1.0	ND1
178	0.30	CC	5	1.0	1.0	ND1
381	0.32	CC	5	1.0	1.0	ND1
1016	0.32	CC	5	1.0	1.0	ND1

ASTM D 4647-93

Job Record Number: 00346

Lab ID Number: 004247

PINHOLE TEST DATA

Project Name: TVA Kingston-Disposal Area
 Project No. 3043-05-1021
 Sample No. NB-44 UD1
 Compaction Characteristics _____
 Water Content _____
 Distilled Water Added: Yes No _____
 Curing Time 1 Week
 State GA

Specimen after test

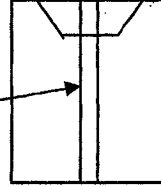

Final Hole
Dia (mm)
1.0

Date: 8/3/05

Page 1 of 2

Tested By: JM

Flow started on 1st trial

Head	Time (secs)	Flow (ml)	Flow Rate, (ml/sec.)	Turbidity from Side						Remarks
				Very Dark	Dark	Moderately dark	Slightly dark	Barely Visible	Completely Clear	

2"	120	24.00	0.20							x	
2"	120	24.00	0.20							x	
2"	120	24.00	0.20							x	
2"	120	24.00	0.20							x	
2"	120	24.00	0.20							x	
2"	AVERAGE		0.20								
2"											
2"											
2"											
2"											

Soil is Classified as: D1 D2 ND4 ND3 ND2 ND1

(Circle One)

Head	Time (secs)	Flow (ml)	Flow Rate, (ml/sec.)	Turbidity from Side							Remarks	
				Very Dark	Dark	Moderately dark	Slightly dark	Barely Visible	Completely Clear	Completely clear from top		
7"	120	38.00	0.32								x	
7"	120	36.00	0.30								x	
7"	120	36.00	0.30								x	
7"	120	36.00	0.30								x	
7"	120	36.00	0.30								x	
7"	AVERAGE		0.30									
7"												
7"												
7"												

15"	120	38.00	0.32								x	
15"	120	38.00	0.32								x	
15"	120	38.00	0.32								x	
15"	120	38.00	0.32								x	
15"	120	38.00	0.32								x	
15"	AVERAGE		0.32									
15"												
15"												
15"												

40"	120	38.00	0.32								x	
40"	120	38.00	0.32								x	
40"	120	38.00	0.32								x	
40"	120	38.00	0.32								x	
40"	120	38.00	0.32								x	
40"	AVERAGE		0.32									No change in hole diameter (1 mm).
40"												No observable crumbling.
40"												
40"												

Job Record Number: 00346
Lab ID Number: 004248

Identification and Classification of Dispersive Clay Soils by Pinhole Test
(ASTM D4647-93)

Project Name: TVA Kingston-Proposed Gypsum Disposal Area
Project Number: 3043-05-1021

Tested By: JM
Test Date: 8/8/2005
Reviewed By: TJ
Review Date: 9/13/05

Sample Identification: NB-44 UD4
Moisture Content: _____
Sample Weight, (grams): _____
Sample Volume, (Ft³): 0.0012
Dry Density, (pcf): 0.0
Test Method: A

Hydraulic Head (mm)	Rate of Flow (ml/sec)	Cloudiness	Length of Test (minutes)	Hole Diameter, (mm)		Classification
				Before Test	After Test	
51	1.76	CC	5	1.0	1.0	ND1
178	5.04	CC	5	1.0	1.0	ND1
381	6.60	CC	5	1.0	1.0	ND1
1016	10.16	CC	5	1.0	1.0	ND1

ASTM D 4647-93

Job Record Number: 00346

Lab ID Number: 004248

PINHOLE TEST DATA

Project Name: TVA Kingston-Disposal Area
 Project No. 3043-05-1021
 Sample No. NB-44 UD4
 Compaction Characteristics _____
 Water Content _____
 Distilled Water Added: Yes No _____
 Curing Time 1 week
 State GA

Final Hole
 Dia (mm)
1.0

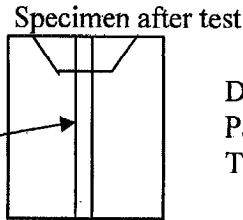

Date: 03/21/05
 Page 1 of 2
 Tested By: JM

Flow started on 1st trial

Head	Time (secs)	Flow (ml)	Flow Rate, (ml/sec.)	Turbidity from Side						Remarks
				Very Dark	Dark	Moderately dark	Slightly dark	Barely Visible	Completely Clear	

2"	60	105.00	1.75							x	
2"	60	106.00	1.77							x	
2"	60	106.00	1.77							x	
2"	60	105.00	1.75							x	
2"	60	106.00	1.77							x	
2"	AVERAGE		1.76								
2"											
2"											
2"											
2"											

Soil is Classified as: D1 D2 ND4 ND3 ND2 **ND1**
 (Circle One)

Head	Time (secs)	Flow (ml)	Flow Rate, (ml/sec.)	Turbidity from Side						Remarks	
				Very Dark	Dark	Moderately dark	Slightly dark	Barely Visible	Completely Clear		Completely clear from top
7"	50	259.00	5.18							x	
7"	40	200.00	5.00							x	
7"	40	200.00	5.00							x	
7"	40	200.00	5.00							x	
7"	40	200.00	5.00							x	
7"	AVERAGE		5.04								
7"											
7"											
7"											

15"	20	132.00	6.60								x
15"	20	132.00	6.60								x
15"	20	132.00	6.60								x
15"	20	132.00	6.60								x
15"	20	132.00	6.60								x
15"	AVERAGE		6.60								
15"											
15"											
15"											

40"	10	102.00	10.20								x
40"	10	100.00	10.00								x
40"	10	102.00	10.20								x
40"	10	102.00	10.20								x
40"	10	102.00	10.20								x
40"	AVERAGE		10.16								
40"											No change in hole diameter. No
40"											observable crumbling.
40"											(broke in layers upon
40"											removal)



REPORT OF GEOTECHNICAL EXPLORATION

**PROPOSED GYPSUM DISPOSAL AREA
KINGSTON FOSSIL PLANT
KINGSTON, TENNESSEE**

Prepared For:

TENNESSEE VALLEY AUTHORITY

Chattanooga, Tennessee

Prepared By:

MACTEC ENGINEERING AND CONSULTING, INC.

Knoxville, Tennessee

MACTEC Project 3043051021.01

October 10, 2005





engineering and constructing a better tomorrow

October 10, 2005

Mr. Ron Purkey
Tennessee Valley Authority
1101 Market Street, LP-2G
Chattanooga, TN 37402

**Subject: Report of Geotechnical Exploration
Proposed Gypsum Disposal Area
TVA Kingston Fossil Plant
Kingston, Tennessee
MACTEC Project 3043051021.01**

Dear Mr. Purkey:

We at MACTEC Engineering and Consulting, Inc., (MACTEC) are pleased to submit this Report of Geotechnical Exploration for your project. Our services, as authorized through TAO No. MAC-0717-00075 were provided in general accordance with our proposal number Prop05Knox/132 dated April 25, 2005.

This report reviews the information provided to us, discusses the site and subsurface conditions, and presents the results of our field and laboratory testing for the materials at the proposed gypsum disposal area. The Appendices contain a brief description of the Field Exploratory Procedures, a Key Sheet and Test Boring Records, Monitoring Well Installation Logs, Cone Penetrometer Test Results, the Laboratory Test Procedures, and the Laboratory Test Results. At the time of report finalization the results of the laboratory triaxial strength testing were not completed. MACTEC will issue the results of the triaxial testing in a separate letter report upon completion.

We anticipate further dialog and interaction with the designers as the design proceeds and will be happy to provide any additional information or interpretation of the data presented here in which may be necessary.

We will be pleased to discuss our data with you and would welcome the opportunity to provide the engineering and material testing services needed to successfully complete your project.

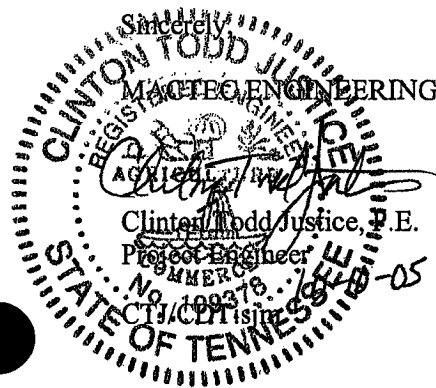

MACTEC ENGINEERING AND CONSULTING, INC.

Clinton Todd Justice, P.E.
Project Engineer

Carl D. Tockstein
Carl D. Tockstein, P.E.
Chief Engineer - Tennessee Operations

REPORT OF GEOTECHNICAL EXPLORATION

**PROPOSED GYPSUM DISPOSAL AREA
KINGSTON FOSSIL PLANT
KINGSTON, TENNESSEE**

Prepared For:

TENNESSEE VALLEY AUTHORITY

Chattanooga, Tennessee

Prepared By:

MACTEC ENGINEERING AND CONSULTING, INC.

Knoxville, Tennessee

MACTEC Project 3043051021.01

October 10, 2005

TABLE OF CONTENTS

	<u>Page</u>
LIST OF TABLES	IV
LIST OF FIGURES	V
EXECUTIVE SUMMARY	VI
1.0 INTRODUCTION.....	1
2.0 OBJECTIVES OF EXPLORATION	1
3.0 SCOPE OF EXPLORATION	1
4.0 PROJECT INFORMATION AND SITE CONDITIONS.....	3
5.0 AREA AND SITE GEOLOGY.....	3
6.0 SUBSURFACE CONDITIONS.....	4
6.1 FILL	6
6.2 ALLUVIUM	7
6.3 RESIDUUM.....	7
6.4 BEDROCK.....	7
7.0 MONITORING WELL INSTALLATION	8
8.0 CONE PENETROMETER TESTING.....	9
9.0 LABORATORY TESTING AND DISCUSSION OF TEST RESULTS	9
9.1 INDEX PROPERTIES, SPECIFIC GRAVITY AND UNIT WEIGHTS.....	9
9.2 MOISTURE-DENSITY RELATIONSHIP	10
9.3 HYDRAULIC CONDUCTIVITY	10
9.4 ONE-DIMENSIONAL CONSOLIDATION.....	10
9.5 PINHOLE TESTING.....	11
10.0 GROUND-WATER CONDITIONS.....	11
11.0 BASIS OF RESULTS	12
TABLES	
FIGURES	
APPENDIX A: FIELD EXPLORATORY PROCEDURES	
APPENDIX B: KEY TO SYMBOLS AND DESCRIPTIONS SOIL TEST BORING RECORDS	
APPENDIX C: MONITORING WELL INSTALLATION LOGS	
APPENDIX D: CONE PENETROMETER TEST PROCEDURES AND RESULTS	
APPENDIX E: LABORATORY TEST PROCEDURES GRAIN SIZE ANALYSIS TEST RESULTS MOISTURE-DENSITY RELATIONSHIP TEST RESULTS	

TABLE OF CONTENTS — Continued

APPENDIX E: PERMEABILITY TEST RESULTS
(Continued) ONE-DIMENSIONAL CONSOLIDATION TEST RESULTS
PINHOLE TEST RESULTS

LIST OF TABLES

Table

	<u>Page</u>
1 Boring Summary	5
2 Monitoring Well Summary	8
3 Ground-Water Data	11
E-1 Index Property and Moisture-Density Test Results	Appendix D
E-2 Hydraulic Conductivity Test Results	Appendix D
E-3 Consolidation Test Results	Appendix D

LIST OF FIGURES

Figure

- 1 Site Location Map
- 2 Boring Location Plan

EXECUTIVE SUMMARY

MACTEC was selected by the Tennessee Valley Authority (TVA) to perform a geotechnical exploration for the proposed Gypsum Disposal Area at the Kingston Fossil Plant in Kingston, Tennessee. The objectives of our exploration were to determine general subsurface conditions, to obtain data to evaluate the engineering characteristics of the on-site soils, and to install monitoring wells.

The exploration consisted of drilling 26 soil test borings, 7 offset geotechnical borings, installing 13 monitoring wells, and performing cone penetrometer testing (CPT) at 10 locations. Bedrock was cored in 14 of the test borings. The major findings of our geotechnical exploration are as follows:

- The test borings drilled in the proposed Gypsum Disposal Area typically encountered fill, alluvium, and residuum soils. The bedrock encountered in the test borings typically was composed of light brownish gray to medium gray dolomite. A summary of the subsurface conditions are presented in Section 6.0.
- Ground-water measurements were performed in all test borings at the time of drilling. Ground-water measurements were also conducted in the test borings at least 24 hours after completion of drilling. Long-term measurements for the presence or absence of ground water were not obtained during this exploration. Table 3 presents the ground-water data obtained during the exploration.
- Thirteen monitoring wells were installed to total depths ranging from about 35.4 feet (MW-77A) to 104.2 feet (MW-44B). Four monitoring wells were installed in bedrock (i.e. bedrock wells or "B" wells) and nine monitoring wells were installed within the overburden soils and upper 1.5 to 5 feet of bedrock (i.e. overburden / epikarst wells or "A" wells). Each well consisted of a 2-inch diameter, schedule 40 PVC pipe with double-density, 0.010-inch, slotted screen. A summary of the monitoring well installation is given in Section 7.0. The Monitoring Well Installation Logs are presented in Appendix C.
- Cone penetrometer test soundings were performed at 10 selected locations. The results of the cone penetrometer testing are presented in Appendix D.
- Laboratory tests were performed on selected bulk and undisturbed samples. A summary of the tests performed and the test results is presented in Section 9. The test results are presented in Appendix E.

This summary is only an overview and should not be used as a separate document or in place of reading the entire report, including the appendices.

1.0 INTRODUCTION

This report presents the findings of our subsurface exploration and laboratory testing recently performed for the Proposed Gypsum Disposal Area at the TVA Kingston Fossil Plant. Our services were authorized by Mr. Ron Purkey of TVA.

2.0 OBJECTIVES OF EXPLORATION

The objectives of our exploration were to determine general subsurface conditions, to obtain data for use by others to evaluate the engineering characteristics of the on-site soils, and to install monitoring wells. An assessment of site environmental conditions, or an assessment for the presence or absence of pollutants in the soil, bedrock, surface water, or ground water of the site was beyond the proposed objectives of our exploration.

3.0 SCOPE OF EXPLORATION

The scope of our exploration was based on our proposal number Prop05Knox/132 dated April 25, 2005, and the geotechnical scope of work outlined in the project's scope of work prepared by Parsons E&C. It includes the following:

- Reconnaissance of the immediate site.
- Drilling 26 soil test borings which ranged in depth from about 12.5 feet (NB-24) to 104.2 feet (NB-44). Bedrock was cored about 2 feet (NB-73W) to 60 feet (NB-44) in 14 of the borings.
- Drilling 7 offset geotechnical borings to obtain additional undisturbed samples
- Installing 13 monitoring wells (4 bedrock wells designated as "B" wells and 9 overburden / epikarst wells designated as "A" wells) to total depths ranging from about 35.4 feet (MW-77A) to 104.2 feet (MW-44B).
- Performing cone penetrometer testing (CPT) at 10 locations
- Conducting laboratory testing on bulk and undisturbed samples from the on-site soils.
- Preparing a geotechnical report summarizing the field and laboratory test results

The drilling and sampling were performed in general accordance with ASTM procedures included in Appendix A. The drilling was performed during the period from April 29 to June 6, 2005. The equipment used consisted of a CME Model 550 ATV (all-terrain-vehicle) mounted drill rig equipped with a manual hammer, a CME Model 55 ATV mounted drill rig equipped with a manual hammer, and a CME Model 75 truck-mounted drill rig equipped with an automatic hammer.

Continuous standard penetration tests (SPTs) were performed in five of the test borings. In the remaining test borings, the SPT sampling was performed at 5-foot vertical intervals. In addition to the SPT samples, bulk and relatively undisturbed samples were obtained from selected test borings for laboratory testing.

Ground-water levels were measured during drilling in each boring. Ground-water measurements were also made in the borings at approximately 24 hours or later after the completion of the borings. Thirteen monitoring wells were installed at selected boring locations. Four bedrock wells designated as "B" wells, and nine overburden/epikarst wells designated as "A" wells were installed. The monitoring well installation program was completed on June 14, 2005.

Upon completion of drilling, the test borings were plugged and abandoned by backfilling the full depth with cement grout.

The CPT soundings were performed on May 16 and 17, 2005. The CPT testing procedures are presented in Appendix D. A track-mounted CPT rig with a 20-ton capacity electronic cone was utilized to perform the testing. During the CPT testing, the cone is continuously pushed into the ground and measurements are taken of the cone tip resistance, sleeve friction, and dynamic pore pressure. Pore pressure dissipation testing was performed only once at some of the CPT locations to estimate the depth to ground-water level. Upon completion of the CPT testing, each hole was plugged and abandoned by backfilling the full depth with grout.

All samples were transported to our laboratories in Knoxville, Tennessee and Charlotte, North Carolina. Parsons (PEC) selected the soil samples for laboratory testing. MACTEC received the laboratory assignment from PEC on July 05, 2005. The testing program for this project consisted of the following:

- 25 Plasticity Index (Atterberg Limits) Tests
- 25 Grain Size Distribution Tests

- 29 Natural Moisture Content Tests
- 10 Standard Proctor Compaction Tests
- 16 Specific Gravity Tests
- 19 Unit Weight and Natural Moisture Content Tests for Undisturbed Samples
- 10 Permeability Tests
- 4 One-Dimensional Consolidation Tests
- 2 Pinhole Tests

Subsurface conditions encountered in the borings are presented on the Test Boring Records in Appendix B. The Monitoring Well Installation Logs are presented in Appendix C. The results of the CPT testing are presented in Appendix D. The laboratory testing results are presented in Appendix E.

4.0 PROJECT INFORMATION AND SITE CONDITIONS

Project information was provided to us by Mr. Daniel Smith with Parsons E&C in the form of a Geotechnical Investigation Scope of Work and a proposed boring/CPT location plan. The site of the proposed gypsum disposal area is located east of the Kingston Fossil Plant site. The ground surface elevations varied by as much as 110 feet (NB-24 to NB-22) in the areas explored. The northern portion of the site is located within a wooded hillside. The remainder of the site is covered with grass and some tree lines.

5.0 AREA AND SITE GEOLOGY

Kingston, Tennessee, is located in the Appalachian Valley and Ridge Physiographic Province. This province extends as a continuous belt from central Alabama, through Georgia and Tennessee, northward into Pennsylvania. The formations that underlie this province consist primarily of limestone, dolostone, shale, and sandstone, which have been folded and faulted in the geologic past. These formations range in age from Cambrian to Pennsylvanian and have been subject to at least one extensive period of erosion since their structural deformation. The erosion has produced a series of subparallel, alternating ridges and valleys. The valleys are formed over more soluble bedrock (interbedded limestone and limestone), whereas bedrock more resistant to solution weathering forms ridges (sandstone, shale, and cherty dolostone).

In particular, the site is geologically mapped to be underlain by the Knox Group. The Knox Group is mainly composed of light gray to dark gray and olive-gray, siliceous dolomite with a few limestone layers in the upper part. The rock usually weathers to reddish orange residuum containing chert fragments.

Dolostone and limestone, such as the strata underlying this site, are of great geologic age and have been subject to solution weathering for many years. Rainwater falling onto the surface and percolating downward through the soil and into cracks and fissures gradually dissolves the rock, producing insoluble impurities such as chert and clay. Since limestone and dolostone vary greatly in their resistance to weathering, the soil/bedrock contact may be extremely irregular. More soluble bedrock develops a thicker soil cover and a more irregular bedrock surface, with pinnacles and slots and less soluble bedrock usually develops a thinner soil cover and a less irregular soil-bedrock surface. Because of the geologic history of the area and the difference in weathering, it is not uncommon to encounter rock at depths varying by as much as 50 feet in borings as close as 10 feet apart in some areas.

These large variations in bedrock depth are greatly enhanced by the presence of fractures, bedding planes, and faults, which provide an increased opportunity for a greater influx of percolating water. The weaknesses may form clay-filled cavities or enlarge into caves and may be connected by a network of passageways. If a cave forms close to the bedrock surface, its roof may collapse and the overlying soils may erode into the cave. Once the weight of the overlying soil exceeds the soil's arching strength, the soil collapses and an open hole or depression may appear at the ground surface. Such a feature is termed a sinkhole.

6.0 SUBSURFACE CONDITIONS

Subsurface conditions at the site of the proposed gypsum disposal area were explored with 26 soil test borings and 10 CPT soundings. Seven offset geotechnical borings were drilled in conjunction with the soil test borings in order to obtain additional undisturbed Shelby tube samples for laboratory testing purposes. The locations for all the borings and CPT soundings were proposed by Parsons E&C. The locations were established in the field by others. After drilling was completed, the boring locations were surveyed by others and we were provided with the surveyed locations and elevations of all borings. Because of access restrictions, some of the borings were offset from

the originally proposed location. Offset distances with bearing information were recorded in the field and noted on the field logs.

Subsurface conditions encountered at each boring location are shown on the Soil Test Boring Records in Appendix B. The Test Boring Records represent our interpretation of the subsurface conditions, based on the field logs and visual examination of the samples by one of our geotechnical engineers. The lines designating the interfaces between various strata on the Test Boring Records represent the approximate interface locations.

The test borings performed at this site typically encountered fill, alluvial, and residual materials. Fill soils are soils which have been transported to their current location by man. Alluvial soils are soils that have been transported to their present location by running water. Residual soils are soils that have developed from the in-place weathering of the underlying parent bedrock. Bedrock was cored in 14 of the test borings. A summary of the soil test boring depths is presented in Table 1.

Boring Number	Ground Elevation msl (Feet)	Auger Refusal Depth (Feet)	Refusal Elevation msl (Feet)	Boring Termination Depth (Feet)	Boring Termination Elevation msl (Feet)
NB-2	762.6	20.2	742.4	20.2	742.4
NB-10	768.1	42.5	725.6	72.9	695.2
NB-18	813.5	23.0	790.5	23.0	790.5
NB-21	757.0	49.9 **	707.1	61.2	695.8
NB-21A*	757.0	NE	NE	41.0	716.0
NB-22	742.1	38.5	703.6	48.5	693.6
NB-22A*	742.1	NE	NE	21.0	721.1
NB-24	852.2	12.5	839.7	12.5	839.7
NB-25	822.7	55.5	767.2	55.5	767.2
NB-35	744.8	20.4	724.4	31.5	713.3
NB-39	787.5	23.2	764.3	23.2	764.3
NB-41	809.2	31.0	778.2	31.0	778.2
NB-44	742.7	44.2	698.5	104.2	638.5
NB-47	762.8	40.0	722.8	69.4	693.4
NB-47A*	762.9	NE	NE	36.5	726.4

Table 1					
Soil Test Boring Summary					
Boring Number	Ground Elevation msl (Feet)	Auger Refusal Depth (Feet)	Refusal Elevation msl (Feet)	Boring Termination Depth (Feet)	Boring Termination Elevation msl (Feet)
NB-59	758.3	34.0	724.3	34.0	724.3
NB-63	781.0	43.2	737.8	75.1	705.9
NB-63(A)	781.0	52.3	728.7	82.3	698.7
NB-65	768.5	38.4	730.1	38.5	730.0
NB-66	752.7	36.4	716.3	66.4	686.3
NB-73	747.5	40.0	707.5	40.0	707.5
NB-73(A)	747.5	NE	NE	80.5	667.0
NB-73W	749.7	47.5	702.2	49.8	699.9
NB-74	752.1	44.0	708.1	75.8	676.3
NB-74A*	752.3	NE	NE	27.0	725.3
NB-76	769.4	38.0	731.4	38.0	731.4
NB-77	749.3	32.3	717.0	64.5	684.8
NB-77A*	749.3	NE	NE	26.0	723.3
NB-81	762.6	30.5	732.1	61.1	701.5
NB-84	761.2	49.2	712.0	59.2	702.0
NB-85	760.2	32.0	728.2	32.0	728.2
NB-85A*	760.6	NE	NE	23.0	737.6
NB-85B*	761.1	31.0	730.1	31.0	730.1
NE - Not Encountered					
* offset geotechnical borings drilled to obtain additional undisturbed Shelby tube samples					
** Original location of NB-21 encountered auger refusal at 47.8 ft. Boring was offset and re-drilled due to coring difficulties and encountered auger refusal at 49.9 ft.					

Prepared/Date: CTJ 6/23/05
 Checked/Date: CDT 10/7/05

6.1 FILL

Fill soils were encountered underlying a thin veneer of topsoil in test boring NB-63. The fill extended to a depth of about 3.0 feet. The fill soils consisted primarily of brown silty clay with a few chert fragments and black manganese nodules. The SPT resistance value in the fill interval varied from 18 to 22 bpf, indicating very stiff consistency.

6.2 ALLUVIUM

Alluvial soils were encountered in test borings NB-21, NB-22, NB-35, and NB-44. The alluvial soils were encountered at ground surface or underlying topsoil near the ground surface and extended to depths ranging from about 2.5 (NB-22 and NB-44) to 47.8 feet (NB-21). The alluvial soils consisted primarily of red, yellow, brown, and gray clayey silt, silty clay, and sandy silt with sand, gravel, chert fragments, and roots. The SPT resistance values in the alluvium ranged from 2 (NB-22 and NB-44) to 19 (NB-35) blows per foot (bpf), indicating very soft to very stiff consistencies.

6.3 RESIDUUM

Residual materials were encountered in all test borings except NB-21. The residual soils were encountered below the fill, alluvium, or topsoil and extended to refusal. The residuum encountered in the borings consisted of red, orange, yellow, and brown clays and silts with sand and chert fragments. The SPT resistance values in the residuum ranged from 2 (NB-44 and NB-76) to over 50 bpf, indicating very soft to very hard consistencies.

6.4 BEDROCK

Bedrock was cored approximately 2 to 60 feet in 14 of the test borings. The bedrock encountered in the test borings typically was composed of light brownish gray to medium gray dolomite. The recovered bedrock was observed to be hard. The core recovery ratio for the various core runs ranged from about 0 (NB-77) to 100 percent (NB-47, NB-63A, NB-77, and NB-81) with an average of about 67 percent. The rock quality designation (RQD) values for the various rock core runs ranged from 0 (NB-22, NB-44, NB-66, NB-73W, NB-77, and NB-84) to 99 percent (NB-47) with an average of about 39 percent. The core recovery ratios and RQD values for each individual core run are shown on the Test Boring Records in Appendix B. Detailed descriptions including structural and mineralogical features for the recovered rock core are also presented on the Test Boring Records in Appendix B.

7.0 MONITORING WELL INSTALLATION

Thirteen monitoring wells were installed at the site as part of our field exploration. Four of the monitoring wells were installed into bedrock, (i.e. bedrock wells) (MW-10B, MW-44B, MW-63B, and MW-81B). The remaining monitoring wells were installed within the overburden soils and upper 1.5 to 5 feet of bedrock, (i.e. overburden/epikarst wells) (MW-10A, MW-21A, MW-44A, MW-47A, MW-63A, MW-66A, MW-74A, MW-77A, and MW-81A). Each monitoring well consisted of a 2-inch I.D., schedule 40 PVC pipe with double-density, 0.010-inch slotted screens. The screened intervals within the overburden/epikarst wells spanned from approximately groundwater depth to top of bedrock. The screened intervals within the bedrock monitoring wells spanned the entire depth in bedrock which ranged from about 30 to 60 feet. A summary of the well installation is presented in Table 2. The Monitoring Well Installation Logs are included in Appendix C.

**Table 2
 Monitoring Well Summary**

Well Number	Ground Surface Elevation (feet msl)	Total Depth (feet)	Screen Depth		Screen Elevation	
			Top (feet)	Bottom (feet)	Top(feet msl)	Bottom (feet msl)
MW-10A	768.2	56.2	20.7	55.1	747.5	713.1
MW-10B	768.2	72.4	45.6	70.2	722.6	698.0
MW-21A	757.7	50.4	18.5	48.1	739.2	709.6
MW-44A	742.4	40.5	3.0	37.5	739.4	704.9
MW-44B	742.7	104.2	49.1	98.6	693.6	644.1
MW-47A	762.9	44.4	22.5	42.1	740.4	720.8
MW-63A	780.2	48.8	17.1	46.5	763.1	733.7
MW-63B	780.9	82.3	52.4	80.9	728.5	700.0
MW-66A	752.9	38.8	12.5	37.0	740.4	715.9
MW-74A	752.0	59.3	12.1	56.5	739.9	695.5
MW-77A	749.9	35.4	11.8	31.4	738.1	718.5
MW-81A	763.4	39.8	21.0	35.4	742.4	728.0
MW-81B	762.9	61.1	33.5	57.9	729.4	705.0

Prepared/Date: CTJ 6/2405
 Checked/Date: CDT 10/7/05

8.0 CONE PENETROMETER TESTING

Ten CPT soundings (NB-11, NB-26, NB-54, NB-56, NB-57, NB-58, NB-62, NB-71, NB-79, and NB-82) were performed in general accordance with ASTM Standard D5778-95 and the procedures in Appendix D. The CPT sounding locations were proposed by Parsons E&C. The results are presented in Appendix D.

During the CPT testing, the cone is pushed into the ground at a constant rate. Measurement of tip resistance (q_c), sleeve friction (f_s), and dynamic pore pressure (U) are obtained at small intervals (approximately 2-inch intervals). Using published correlations, the collected data is used to estimate several soil parameters such as unit weight, strength parameters, standard penetration test (SPT) value, relative density, and others. Graphs in Appendix D show plots of recorded field data versus depth. The recorded field data and estimated parameters are presented in table format in Appendix D, in addition to the correlations used to develop them.

In addition to the above, pore pressure dissipation tests were performed at some CPT locations to estimate the depth to ground water. The results of the pore pressure tests are also presented in Appendix D.

9.0 LABORATORY TESTING AND DISCUSSION OF TEST RESULTS

This section describes the geotechnical laboratory testing program and summarizes the test results. The laboratory testing procedures and laboratory test results are included in Appendix E. The laboratory tests were performed on undisturbed and bulk soil samples obtained during drilling. The following paragraphs provide a short discussion of the general types of testing conducted and the test results.

9.1 INDEX PROPERTIES, SPECIFIC GRAVITY AND UNIT WEIGHTS

Natural moisture content tests were performed on many of the undisturbed soil samples. Liquid limit, plastic limit, and plasticity index tests (collectively referred to herein as Atterberg limits); specific gravity tests; grain size distributions with hydrometer analyses; and unit weight tests were performed on selected undisturbed and/or bulk samples. These tests were used to confirm our visual-manual classifications. Table E-1 summarizes the index property and moisture-density test results.

Liquid limits for the soil samples tested ranged from 35 to 81; plastic limits ranged from 18 to 42; and plasticity indices ranged from 12 to 47. The tested soils were classified as MH, CH, ML, CL, and SC soils in accordance with the Unified Soil Classification System (USCS).

The natural moisture content of the tested alluvial and residual soils ranged from 17.7 percent (boring NB-41) to 54.2 percent (boring NB-44). The majority of the alluvium and residuum samples tested had a natural moisture content ranging from about 22 to 35 percent.

Specific gravities of the soils tested ranged from 2.62 to 2.78.

The unit weights of the tested soils ranged from 103.6 to 125.1 pcf.

9.2 MOISTURE-DENSITY RELATIONSHIP

Standard Proctor compaction tests were performed on ten bulk soil samples obtained from auger cuttings. The results of the compaction tests performed indicated that the maximum dry densities ranged from 94.7 to 107.6 pcf, and the optimum moisture contents ranged from 17.7 to 26.8 percent.

9.3 HYDRAULIC CONDUCTIVITY

A total of ten constant head permeability tests were performed on undisturbed and remolded bulk samples obtained from the borings. The bulk samples were remolded to approximately 95 % their respective Proctor maximum dry densities and about 2 percent over optimum moisture content. The effective confining pressures applied to the various specimens were varied according to the laboratory assignment. The permeability tests results indicated that the permeabilities ranged from 1.5×10^{-8} cm/sec to 1.6×10^{-4} cm/sec for the soil samples tested. Table E-2 shows the hydraulic conductivity laboratory test results.

9.4 ONE-DIMENSIONAL CONSOLIDATION

Four one-dimensional consolidation tests were performed on undisturbed samples from boring NB-44. The test results indicated that the samples tested had a "laboratory" compression index ranging from 0.26 to 0.61. The recompression indices ranged from 0.0 to 0.02, while the preconsolidation

pressures for all samples tested varied from 5.84 to 12.56 ksf. Table E-3 shows the results of the consolidation laboratory testing.

9.5 PINHOLE TESTING

Two pinhole tests were performed on samples obtained from boring NB-44. The results of the pinhole testing are found in Appendix E.

10.0 GROUND-WATER CONDITIONS

Ground-water levels were measured in all test borings at the time of drilling. Further, ground-water measurements were performed approximately 24 hours or later after the completion of drilling in the test borings. The recorded ground-water levels are presented in Table 3. For safety reasons, the borings were backfilled promptly; consequently, long-term measurements for the presence or absence of ground water were not obtained.

Fluctuations in the ground-water level occur because of variation in rainfall, evaporation, construction activity, surface run-off, and other site-specific factors such as fluctuation of water levels in the adjacent Watts Bar Lake.

Boring Number	Ground Elevation (Feet msl)	Depth to Ground Water at Time of Drilling (Feet)	Ground-Water Elevation at Time of Drilling (Feet msl)	Depth to Ground Water 24 Hours After Drilling (Feet)	Ground-Water Elevation 24 Hours After Drilling (Feet msl)
NB-2	762.6	NE	NE	NE	NE
NB-10	768.1	NE	NE	20.7	747.4
NB-18	813.5	NE	NE	NE	NE
NB-21	757.0	34.0	723.0	16.2	740.8
NB-22	742.1	11.5	730.6	2.0	740.1
NB-24	852.2	NE	NE	NE	NE
NB-25	822.7	53.8	768.9	53.8	768.9
NB-35	744.8	14.0	730.8	4.0	740.8
NB-39	787.5	NE	NE	NE	NE

Boring Number	Ground Elevation (Feet msl)	Depth to Ground Water at Time of Drilling (Feet)	Ground-Water Elevation at Time of Drilling (Feet msl)	Depth to Ground Water 24 Hours After Drilling (Feet)	Ground-Water Elevation 24 Hours After Drilling (Feet msl)
NB-41	809.2	NE	NE	NE	NE
NB-44	742.7	9.0	733.7	2.9	739.8
NB-47	762.8	NE	NE	22.0	740.8
NB-59	758.3	20.0	738.3	17.0	741.3
NB-63	781.0	42.5	738.5	16.6	764.4
NB-63A	781.0	NE	NE	NM	NM
NB-65	768.5	23.7*	744.8	24.1	744.4
NB-66	752.7	16.5**	736.2	12.4	740.3
NB-73	747.5	9.8**	737.7	7.5	740.0
NB-73W	749.7	15.0	734.7	9.5	740.2
NB-74	752.1	19.0	733.1	11.5	740.6
NB-76	769.4	28.2*	741.2	27.6	741.8
NB-77	749.3	15.0	734.3	9.0	740.3
NB-81	762.6	21.3**	741.3	20.9	741.7
NB-84	761.2	34.5**	726.7	18.6	742.6
NB-85	760.2	19.0*	741.2	19.9	740.3

NE - Not Encountered
 NM - Not Measured
 * recorded at the time of boring termination
 ** recorded at the time of auger refusal

Prepared/Date: CTJ 6/24/05
 Checked/Date: CDT 10/7/05

11.0 BASIS OF RESULTS

The results provided herein are based on the encountered subsurface conditions related to the specific project and site discussed in this report.

Regardless of the thoroughness of a field exploration, there is always a possibility that conditions between test locations will differ from those at specific test locations, and that conditions may not be anticipated. In addition, interpretation of the data is critical to the intended design and/or analysis. Therefore, experienced geotechnical engineers should interpret the field data and review any site-specific analysis or design that incorporates the field data. We recommend that TVA retain MACTEC to provide this service, based upon our familiarity with the subsurface conditions, the field and laboratory data, and our geotechnical experience.

Our exploration services include storing the collected samples and making them available for inspection for a period of 30 days. The samples are then discarded unless you request otherwise.

TABLES

TABLE E-1
 Index Property and Moisture-Density Test Results
 TVA Kingston Gypsum Disposal Area
 MACTEC Project 3043051021/01

Boring Number	Sample Depth (Feet)	Sample Type	Natural Moisture Content, %	Unit Weight, pcf	Atterberg Limits			Percent Finer Than No. 200 Sieve	USCS Classification	Specific Gravity	Compaction Tests	
					Liquid Limit	Plastic Limit	Plasticity Index				Std. Proctor Max. Dry Density, pcf	Opt. Moisture Content, %
NB-2	2 - 10	Bulk	30.9	-	63	35	28	78.2	MH	2.75	100.7	23.1
NB-18	5 - 15	Bulk	33.3	-	62	33	29	86.4	MH	2.76	94.7	26.8
NB-18	6.5 - 18.5	UD	-	-	81	42	39	95.5	MH	2.62	-	-
NB-18	6.5 - 8.5	UD	29.2	115.0	-	-	-	-	-	-	-	-
NB-18	11.5 - 13.5	UD	26.7	114.2	-	-	-	-	-	-	-	-
NB-18	16.5 - 18.5	UD	32.3	110.7	-	-	-	-	-	-	-	-
NB-21A	15 - 23	UD	-	-	53	28	25	83.8	CH	2.65	-	-
NB-21A	18 - 20	UD	29.6	116.4	-	-	-	-	-	-	-	-
NB-21A	30 - 32	UD	24.5	121.1	-	-	-	-	-	-	-	-
NB-21A	30 - 38	UD	-	-	36	21	15	84.8	CL	2.66	-	-
NB-21A	33 - 35	UD	29.9	117.9	-	-	-	-	-	-	-	-
NB-21A	33 - 35	UD	26.6**	124.1**	-	-	-	-	-	-	-	-
NB-21A	36 - 38	UD	26.5	113.9	-	-	-	-	-	-	-	-
NB-21A	39 - 41	UD	28.3	-	-	-	-	-	-	-	-	-
NB-22	2 - 10	Bulk	30.7	-	40	22	18	81.1	CL	2.63	107.6	17.7
NB-22A	9 - 11	UD	28.4	112.3	-	-	-	-	-	-	-	-
NB-25	2 - 10	Bulk	33.1	-	72	25	47	85.2	CH	2.74	95.1	26.0
NB-39	5 - 10	Bulk	18.3	-	47	20	27	79.7	CL	2.75	103.8	20.8
NB-41	2 - 10	Bulk	17.7	-	35	18	17	74.9	CL	2.73	106.1	18.8
NB-44	9 - 11	UD	33.4*	122.3*	-	-	-	-	-	-	-	-
NB-44	16.5 - 18.5	UD	36.1*	113.5*	45	22	23	67.4	CL	2.71	-	-
NB-44	16.5 - 18.5	UD	28.2**	121.3**	-	-	-	-	-	-	-	-
NB-44	21.5 - 23.5	UD	36.9*	114.3*	-	-	-	-	-	-	-	-
NB-44	21.5 - 23.5	UD	25.7**	123.4**	54	24	30	71.0	CH	2.73	-	-
NB-44	31 - 33	UD	54.2*	103.6*	74	32	42	74.5	CH	2.74	-	-
NB-47A	9 - 17	UD	-	-	51	30	21	79.2	MH	2.72	-	-
NB-47A	12 - 14	UD	27.6	122.6	-	-	-	-	-	-	-	-

TABLE E-1
 Index Property and Moisture-Density Test Results
 TVA Kingston Gypsum Disposal Area
 MACTEC Project 3043051021/01

Boring Number	Sample Depth (Feet)	Sample Type	Natural Moisture Content, %	Unit Weight, pcf	Atterberg Limits			Percent Finer Than No. 200 Sieve	USCS Classification	Specific Gravity	Compaction Tests	
					Liquid Limit	Plastic Limit	Plasticity Index				Std. Proctor Max. Dry Density, pcf	Opt. Moisture Content, %
NB-47A	18 - 27	UD	-	-	58	34	24	62.8	MH	2.72	-	-
NB-47A	23 - 25	UD	30.5	114.3	-	-	-	-	-	-	-	-
NB-47A	30 - 32	UD	32.8**	117.4**	59	27	32	83.3	CH	2.68	-	-
NB-59	5 - 15	Bulk	25.5	-	40	28	12	77.3	ML	2.75	103.6	20.1
NB-65	2 - 10	Bulk	30.9	-	60	28	32	72.3	CH	2.78	100.2	23.1
NB-76	5 - 15	Bulk	25.3	-	48	28	20	70.0	ML	2.65	100.7	21.7
NB-76	19 - 20.5	UD	23.9**	122.1**	37	24	13	76.3	CL	2.69	-	-
NB-77A	4 - 14	UD	-	-	41	25	16	55.3	CL	2.66	-	-
NB-77A	12 - 14	UD	30.2	113.5	-	-	-	-	-	-	-	-
NB-77A	15 - 26	UD	-	-	53	29	24	57.5	MH	2.64	-	-
NB-77A	21 - 23	UD	21.1	-	-	-	-	-	-	-	-	-
NB-77A	24 - 26	UD	26.5	118.9	-	-	-	-	-	-	-	-
NB-84	2 - 10	Bulk	24.2	-	47	25	22	81.6	CL	2.76	102.2	21.6
NB-84	32.5 - 34.5	UD	27.1**	124.6**	46	30	16	60.8	ML	2.70	-	-
NB-85A	15 - 17	UD	19.5	125.1	-	-	-	-	-	-	-	-
NB-85A/B	13 - 19	UD	-	-	59	30	29	45.4	SC	2.66	-	-
NB-85B	17 - 19	UD	23.0	125.1	-	-	-	-	-	-	-	-
NB-85B	19 - 20.65	UD	18.7	117.4	-	-	-	-	-	-	-	-
NB-85B	23 - 29	UD	-	-	50	24	26	68.7	CH	2.64	-	-
NB-85B	25 - 27	UD	30.7	118.9	-	-	-	-	-	-	-	-
NB-85B	29 - 31	UD	23.8	113.0	-	-	-	-	-	-	-	-

UD - Undisturbed Shelby Tube Sample

* - Test results obtained from consolidation testing

** - Test results obtained from Hydraulic conductivity testing

Prepared/Date: CTJ 08/05/05
 Checked/Date: SDS 08/05/05

TABLE E-2
Hydraulic Conductivity Laboratory Test Results
TVA Kingston Gypsum Disposal Area
MACTEC Project 3043051021/01

Boring Number	Sample Depth (Feet)	Sample Type	Moisture Content (%)	Dry Density (pcf)	Effective Confining Pressure (psi)	Hydraulic Conductivity (cm/sec)
NB-21A	33 - 35	UD	26.6	98.0	24.0	1.5×10^{-8}
NB-22	2 - 10	BULK	19.2	102.3	10.0	1.3×10^{-6}
NB-44	16.5 - 18.5	UD	28.2	94.6	14.0	4.6×10^{-8}
NB-44	21.5 - 23.5	UD	25.7	98.2	55.6	1.6×10^{-4}
NB-47A	30 - 32	UD	32.8	88.4	24.0	5.5×10^{-8}
NB-59	5 - 15	BULK	22.4	98.2	10.0	1.1×10^{-7}
NB-76	5 - 15	BULK	23.0	94.3	10.0	2.5×10^{-6}
NB-76	19 - 20.5	UD	23.9	98.6	20.0	2.0×10^{-7}
NB-84	2 - 10	BULK	23.8	96.9	10.0	1.4×10^{-7}
NB-84	32.5 - 34.5	UD	27.1	98.0	40.0	5.9×10^{-8}

UD = Undisturbed Shelby Tube Sample

Note: Bulk soil samples were remolded to approximately 95% of their respective Proctor maximum dry densities and 2% over optimum moisture content.

Prepared/Date: CTJ 07/13/05
Checked/Date: SDS 07/19/05

TABLE E-3
Consolidation Laboratory Test Results
TVA Kingston Gypsum Disposal Area
MACTEC Project 3043051021/01

Boring Number	Sample Depth (Feet)	Sample Type	USCS Classification	Initial Moisture Content (%)	Initial Dry Density (pcf)	Initial Void Ratio e_0	"Laboratory" Compression Index C_c	"Laboratory" Recompression Index C_R	"Laboratory" Preconsolidation Pressure P_c (ksf)
NB-44	9 - 11	UD	-	33.4	91.7	0.844	0.26	0.00	11.16
NB-44	16.5 - 18.5	UD	CL	36.1	83.4	1.028	0.32	0.01	12.56
NB-44	21 - 23.5	UD	CH	36.9	83.5	1.041	0.32	0.01	10.79
NB-44	31 - 33	UD	CH	54.2	67.2	1.545	0.61	0.02	5.84

UD = Undisturbed Shelby Tube Sample

Prepared/Date: CTJ 07/13/05
 Checked/Date: SDS 07/19/05



FIGURES

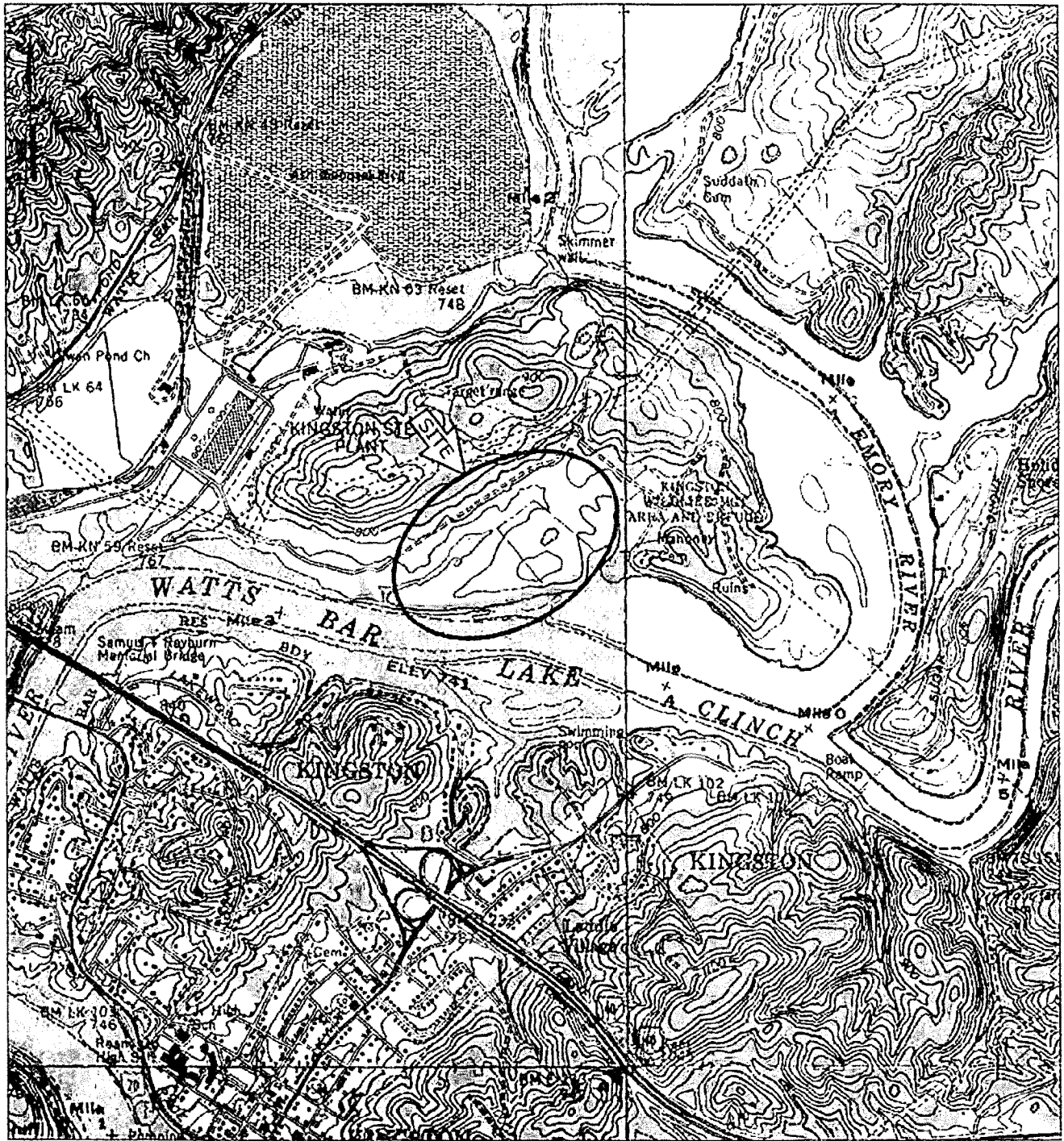

SOURCE: USGS TOPOGRAPHIC MAPS OF HARRIMAN AND ELVERTON, TN QUADRANGLES



MACTEC Engineering and Consulting, Inc.
 1725 Louisville Drive
 Knoxville, Tennessee 37921-5904
 865-588-6544 • Fax: 865-588-8026

**FIGURE 1: SITE LOCATION MAP
 PROPOSED GYPSUM DISPOSAL AREA
 KINGSTON, TENNESSEE**

DRAFTING BY:	PREPARED BY: <i>CTJ</i>	CHECKED BY: <i>CDT</i>
JOB NUMBER: 3043051021/0001	DATE: MAY 5, 2005	SCALE: 0 2000'

COORDINATES: N 35°53'39" W 84°31'13"

3043051021.ctb Thu 05 May 2005 - 2:13pm REV:PREN

APPENDIX A

FIELD EXPLORATORY PROCEDURES

FIELD EXPLORATORY PROCEDURES

Soil Test Boring (Hollow Stem)

All boring and sampling operations were conducted in general accordance with ASTM D 1586. The borings were advanced by mechanically twisting continuous steel hollow-stem auger flights into the ground. At regular intervals, soil samples were obtained with a standard 1.4-inch I.D., 2-inch O.D., split-tube sampler. The sampler was first seated six inches to penetrate any loose cuttings and then driven an additional foot with blows of a 140-pound hammer falling 30 inches. The number of hammer blows required to drive the sampler the final foot of penetration was recorded and is designated the "standard penetration resistance (SPT)". Proper evaluation of the penetration resistance provides an index to the soil's strength, density, and ability to support foundations.

Representative portions of the soil samples obtained from the split-tube sampler were sealed in glass jars and transported to our laboratory, where they were examined by our engineer to verify the driller's field classifications. Test Boring Records are attached, graphically showing the soil descriptions and penetration resistances.

Undisturbed Sampling

The relatively undisturbed samples were obtained by pushing a section of 3-inch O.D., 16-gauge steel tubing into the soil at the desired sampling level. The sampling was performed in general accordance with ASTM D-1587. The tube, together with the encased soils, was carefully removed from the ground, made airtight, and transported to our laboratory.

Boring Backfill

The borings were backfilled to the ground surface with cement grout. The owner is advised that, even with this backfill technique, there is the possibility of future borehole subsidence depending on actual subsurface conditions, surface drainage, etc. The property owner should monitor the boring locations over time to discover subsidence and make the necessary repairs.

Rock Coring

Prior to coring, casing is set in the hole drilled through the overburden soils, if necessary, to keep the hole from caving. Refusal materials are then cored according to ASTM D 2113, using a diamond-studded bit fastened to the end of a hollow, double-tube core barrel. This device is rotated at high speeds, and the cuttings are brought to the surface by circulating water. Core samples of the material penetrated are protected and retained in the swivel-mounted inner tube. Upon completion of each core run, the core barrel is brought to the surface, the core recovery is measured, the samples are removed, and the core is placed in boxes for transportation and storage.

The core samples are returned to the laboratory where the refusal material is identified, and the percent core recovery and rock quality designation are determined by a soils engineer or geologist. The percent core recovery is the ratio of the sample length obtained to the depth drilled, expressed as a percent. The rock quality designation (RQD) is obtained by summing up the length of core recovered, including only the pieces of core that are 4 inches or longer, and divided by the total length drilled. The percent core recovery and RQD are related to the soundness and continuity of the refusal material. Refusal material descriptions, recoveries, and the bit size used are shown on the "Test Boring Records."

The NQ and HQ sizes designate bits that obtain rock cores 1-7/8 and 2-1/2 inches in diameter, respectively.

APPENDIX B

KEY TO SYMBOLS AND DESCRIPTIONS

SOIL TEST BORING RECORDS

GROUP SYMBOLS	TYPICAL NAMES	GROUP SYMBOLS	TYPICAL NAMES	Undisturbed Sample 1.5-2.0 = Recovered (ft) / Pushed (ft)
	TOPSOIL		CONCRETE	Split Spoon Sample
				Auger Cuttings
				Rock Core 60-100 = RQD / Recovery
	ASPHALT		DOLOMITE	No Sample
				Crandall Sampler
				Rotary Drill
	GRAVEL		LIMESTONE	Water Table at time of drilling
				No Recovery
				Water Table after 24 hours
	FILL		SHALE	
	SUBSOIL		LIMESTONE/SHALE - Limestone with shale interbeds	
	ALLUVIUM		SANDSTONE	
	COLLUVIUM		SILTSTONE	
	RESIDIUM - Soft to firm		AUGER BORING	
	RESIDIUM - Stiff to very hard		UNDISTURBED SAMPLE ATTEMPT	

Correlation of Penetration Resistance
with Relative Density and Consistency

SAND & GRAVEL		SILT & CLAY	
No. of Blows	Relative Density	No. of Blows	Consistency
0 - 4	Very Loose	0 - 2	Very Soft
5 - 10	Loose	3 - 4	Soft
11 - 20	Firm	5 - 8	Firm
21 - 30	Very Firm	9 - 15	Stiff
31 - 50	Dense	16 - 30	Very Stiff
Over 50	Very Dense	31 - 50	Hard
		Over 50	Very Hard

BOUNDARY CLASSIFICATIONS: Soils possessing characteristics of two groups are designated by combinations of group symbols.

KEY TO SYMBOLS AND DESCRIPTIONS

SILT OR CLAY	SAND			GRAVEL		Cobbles	Boulders
	Fine	Medium	Coarse	Fine	Coarse		
	No.200	No.40	No.10 No.4	3/4"	3"	12"	

U.S. STANDARD SIEVE SIZE



MACTEC Engineering and Consulting of Georgia, Inc.
1725 Louisville Drive
Knoxville, Tennessee 37921-5904
865-588-8544 • Fax: 865-588-8026

Reference: The Unified Soil Classification System, Corps of Engineers, U.S. Army Technical Memorandum No. 3-357, Vol. 1, March, 1953 (Revised April, 1960)

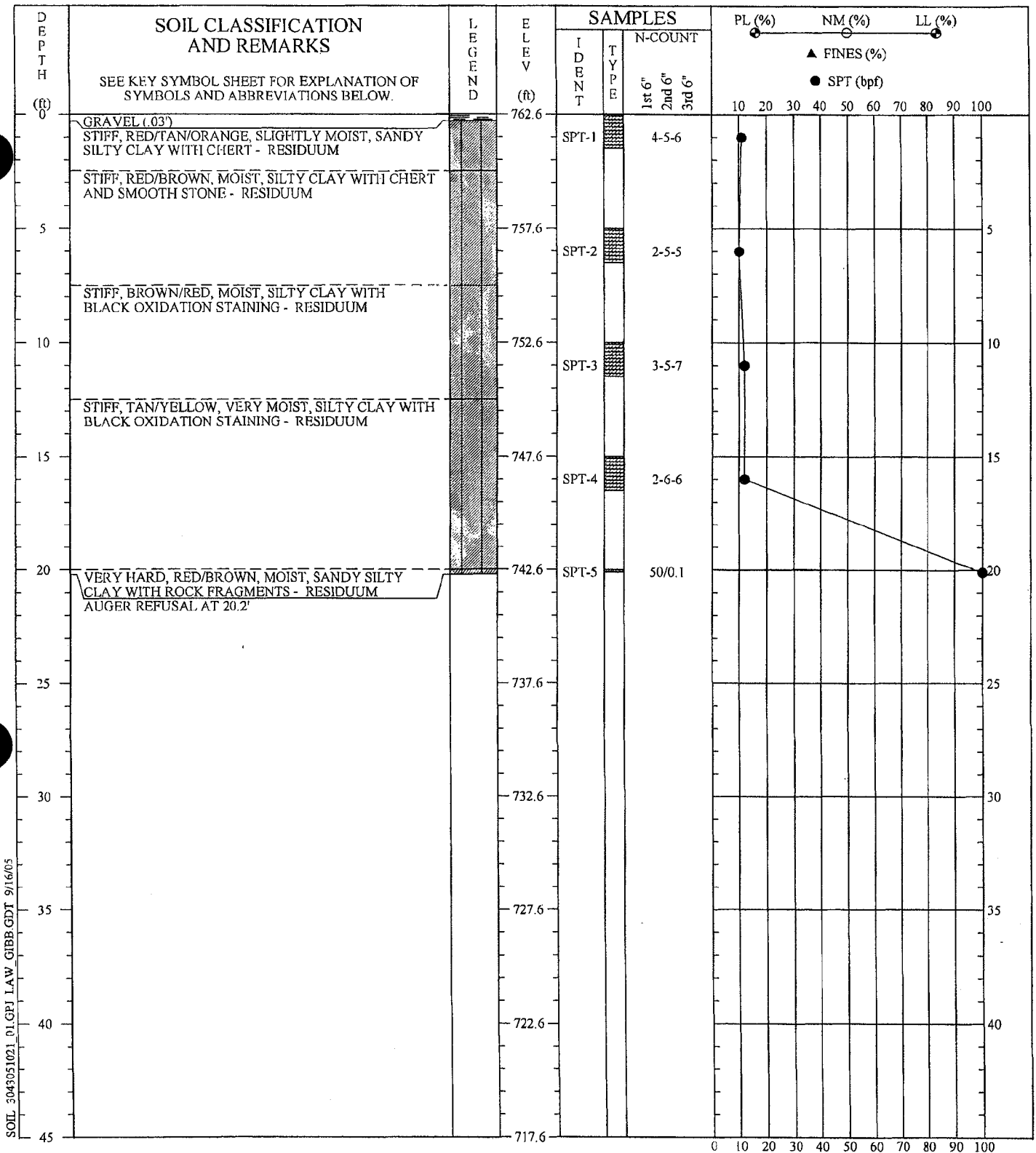

SOIL 3043051021 01.GPJ LAW GIBB GDT 9/16/03

REMARKS: STANDARD PENETRATION RESISTANCE TESTING PERFORMED USING AN AUTOMATIC HAMMER. NO GROUND WATER ENCOUNTERED AT TIME OF EXPLORATION.

SOIL TEST BORING RECORD

PROJECT: Proposed Gypsum Disposal Area
DRILLED: May 24, 2005 **BORING NO.:** NB-2
PROJ. NO.: 3043051021/0001 **PAGE 1 OF 1**

THIS RECORD IS A REASONABLE INTERPRETATION OF SUBSURFACE CONDITIONS AT THE EXPLORATION LOCATION. SUBSURFACE CONDITIONS AT OTHER LOCATIONS AND AT OTHER TIMES MAY DIFFER. INTERFACES BETWEEN STRATA ARE APPROXIMATE. TRANSITIONS BETWEEN STRATA MAY BE GRADUAL.

Driller : Bailey
 Prepared By: Lawson
 Checked By: Justice



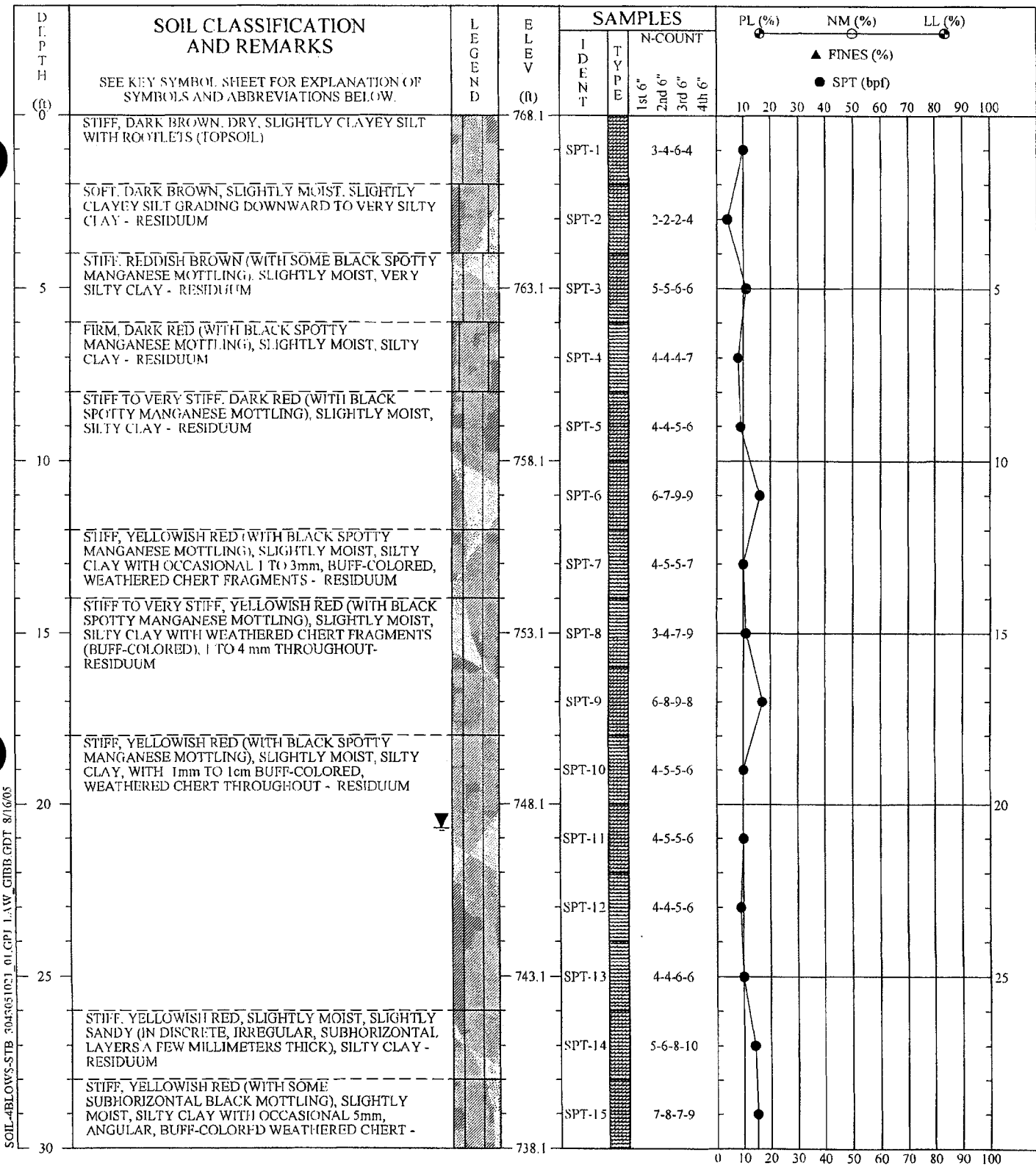

SOIL-BLOWS-STB 3043051021_01.CPJ LAW, GIBB, GDT 8/16/05

REMARKS: STANDARD PENETRATION RESISTANCE TESTING PERFORMED USING AN AUTOMATIC HAMMER.

SOIL TEST BORING RECORD	
PROJECT: Proposed Gypsum Disposal Area	
DRILLED: May 19, 2005	BORING NO.: NB-10
PROJ. NO.: 3043051021/0001	PAGE 1 OF 3
MACTEC	

THIS RECORD IS A REASONABLE INTERPRETATION OF SUBSURFACE CONDITIONS AT THE EXPLORATION LOCATION. SUBSURFACE CONDITIONS AT OTHER LOCATIONS AND AT OTHER TIMES MAY DIFFER. INTERFACES BETWEEN STRATA ARE APPROXIMATE. TRANSITIONS BETWEEN STRATA MAY BE GRADUAL.

Driller : Burnett
 Prepared By: Mason
 Checked By: Haston

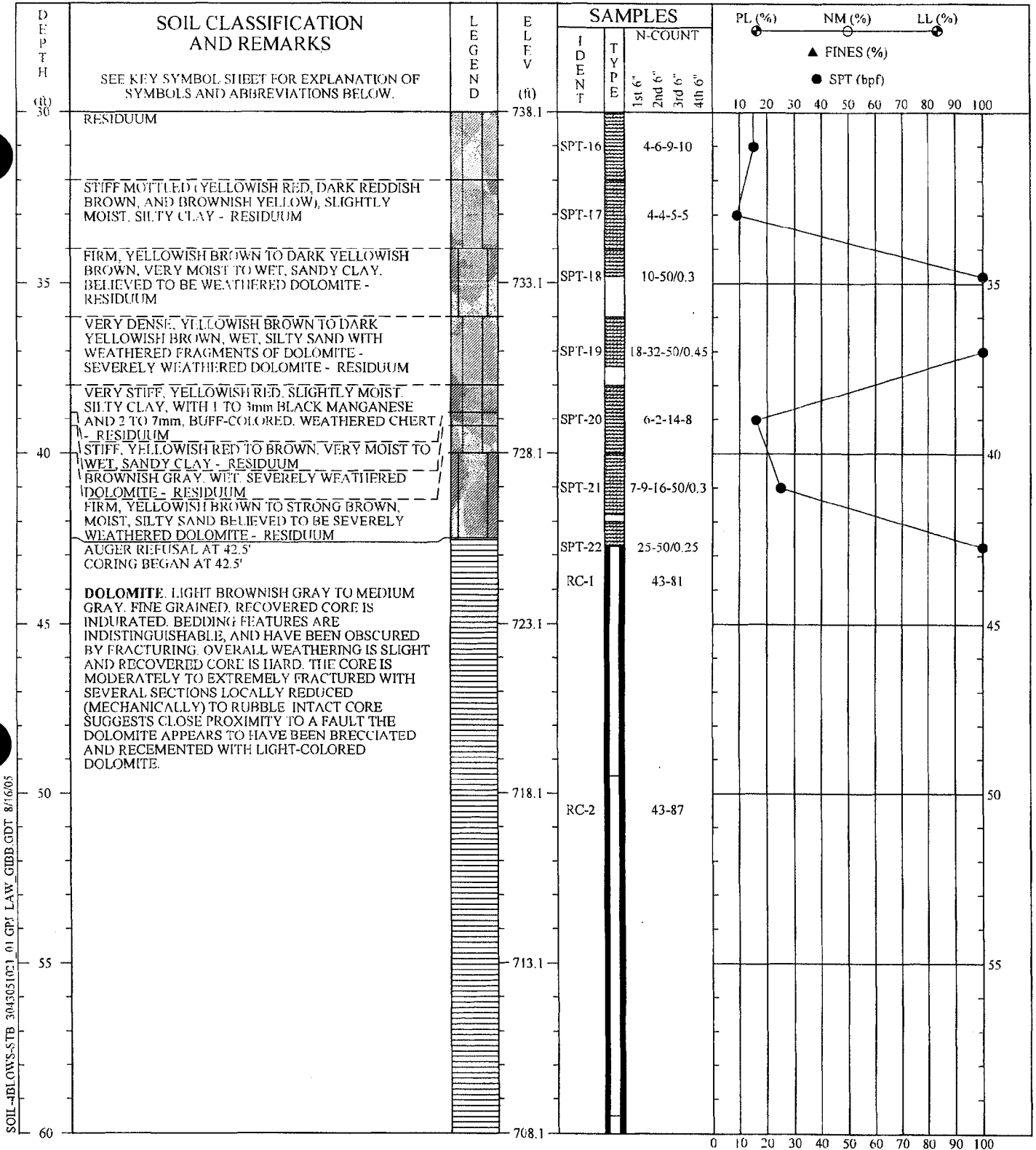

SOIL-DBL QWS-S TB 3043051021 01 GFI LAW GIBB GDT 8/16/05

REMARKS: STANDARD PENETRATION RESISTANCE TESTING PERFORMED USING AN AUTOMATIC HAMMER.

THIS RECORD IS A REASONABLE INTERPRETATION OF SUBSURFACE CONDITIONS AT THE EXPLORATION LOCATION. SUBSURFACE CONDITIONS AT OTHER LOCATIONS AND AT OTHER TIMES MAY DIFFER. INTERFACES BETWEEN STRATA ARE APPROXIMATE. TRANSITIONS BETWEEN STRATA MAY BE GRADUAL.

Driller : Burnett
 Prepared By: Mason
 Checked By: Haston

SOIL TEST BORING RECORD	
PROJECT: Proposed Gypsum Disposal Area	
DRILLED: May 19, 2005	BORING NO.: NB-10
PROJ. NO.: 3043051021/0001	
PAGE 2 OF 3	
MACTEC	

DEPTH (ft)	SOIL CLASSIFICATION AND REMARKS SEE KEY SYMBOL SHEET FOR EXPLANATION OF SYMBOLS AND ABBREVIATIONS BELOW.	LEGEND	ELEV (ft)	SAMPLES				PL (%)	NM (%)	LL (%)	
				IDENT	TYPE	N-COUNT				▲ FINES (%)	● SPT (bpf)
						1st 6"	2nd 6"	3rd 6"	4th 6"		
80	DOLOMITE. LIGHT BROWNISH GRAY TO MEDIUM GRAY FINE GRAINED. RECOVERED CORE IS INDURATED. BEDDING FEATURES ARE INDISTINGUISHABLE AND HAVE BEEN OBSCURED BY FRACTURING. OVERALL WEATHERING IS SLIGHT AND RECOVERED CORE IS HARD. THE CORE IS MODERATELY TO EXTREMELY FRACTURED WITH SEVERAL SECTIONS LOCALLY REDUCED (MECHANICALLY) TO RUBBLE. INTACT CORE SUGGESTS CLOSE PROXIMITY TO A FAULT THE DOLOMITE APPEARS TO HAVE BEEN BRECCIATED AND RECEMENTED WITH LIGHT-COLORED DOLOMITE.		708.1	RC-3		6-73					
65			703.1								
70			698.1								
75			693.1								
80			688.1								
85	CORING TERMINATED AT 72.89'		683.1								
90			678.1								

SOIL-BLOWS-STB 3043051021 01 GPJ LAW GIBB.GDT 8/16/05

REMARKS: STANDARD PENETRATION RESISTANCE TESTING PERFORMED USING AN AUTOMATIC HAMMER.

SOIL TEST BORING RECORD	
PROJECT: Proposed Gypsum Disposal Area	
DRILLED: May 19, 2005	BORING NO.: NB-10
PROJ. NO.: 3043051021/0001	
PAGE 3 OF 3	
MACTEC	

THIS RECORD IS A REASONABLE INTERPRETATION OF SUBSURFACE CONDITIONS AT THE EXPLORATION LOCATION. SUBSURFACE CONDITIONS AT OTHER LOCATIONS AND AT OTHER TIMES MAY DIFFER. INTERFACES BETWEEN STRATA ARE APPROXIMATE. TRANSITIONS BETWEEN STRATA MAY BE GRADUAL.

Driller : Burnett
 Prepared By: Mason
 Checked By: Haston

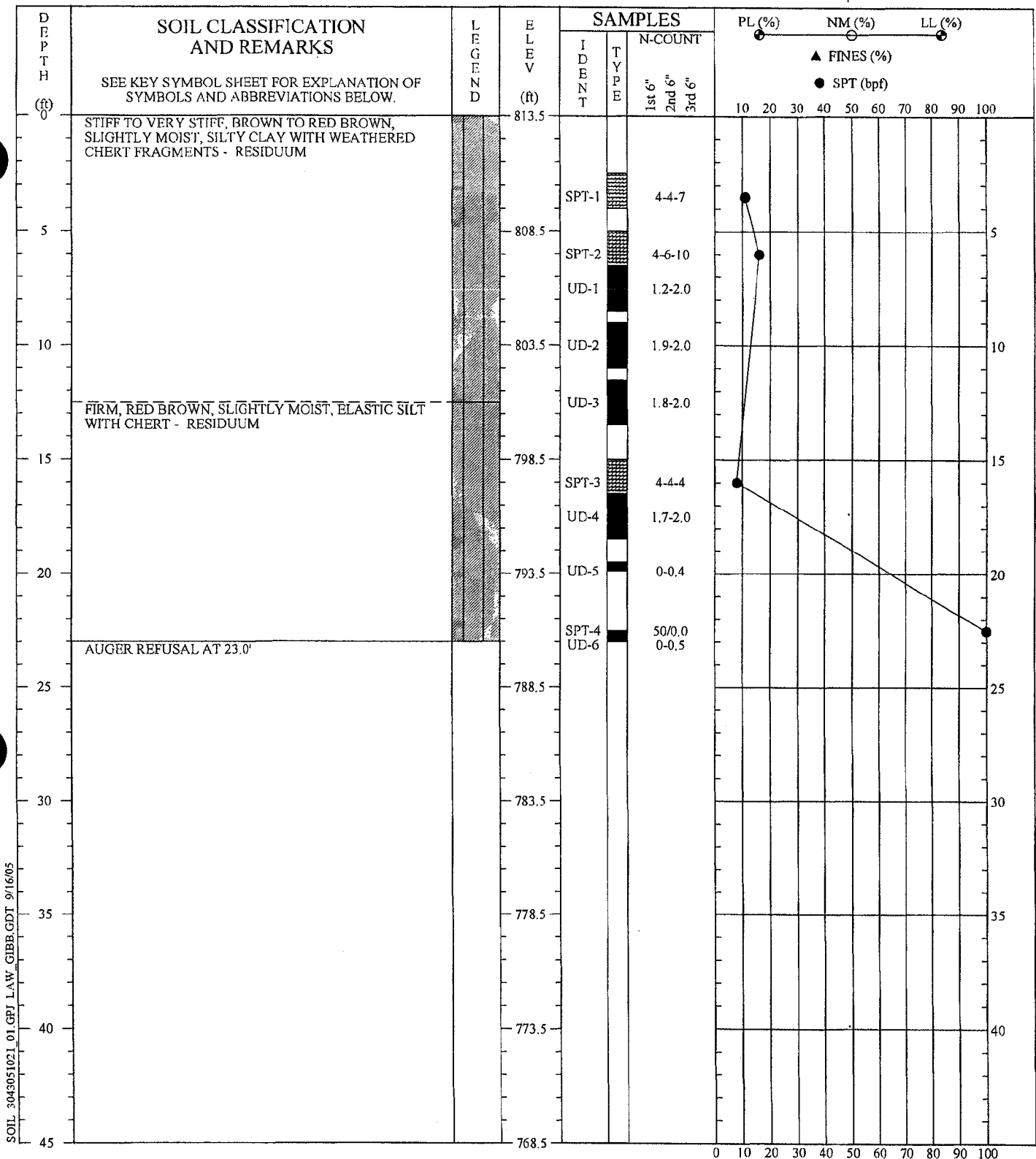

SOIL 3043051021_01.GPJ LAW_CIBB.GDT 9/16/05

REMARKS: STANDARD PENETRATION RESISTANCE TESTING PERFORMED USING AN AUTOMATIC HAMMER. NO GROUND WATER ENCOUNTERED AT TIME OF EXPLORATION. NB-18 OFFSET APPROXIMATELY 6.5' S82°W OF ORIGINAL STAKED LOCATION.

THIS RECORD IS A REASONABLE INTERPRETATION OF SUBSURFACE CONDITIONS AT THE EXPLORATION LOCATION. SUBSURFACE CONDITIONS AT OTHER LOCATIONS AND AT OTHER TIMES MAY DIFFER. INTERFACES BETWEEN STRATA ARE APPROXIMATE. TRANSITIONS BETWEEN STRATA MAY BE GRADUAL.

Driller : Akins
Prepared By: Justice
Checked By: Lawson

SOIL TEST BORING RECORD	
PROJECT: Proposed Gypsum Disposal Area	
DRILLED: May 18, 2005	BORING NO.: NB-18
PROJ. NO.: 3043051021/0001	PAGE 1 OF 1
	

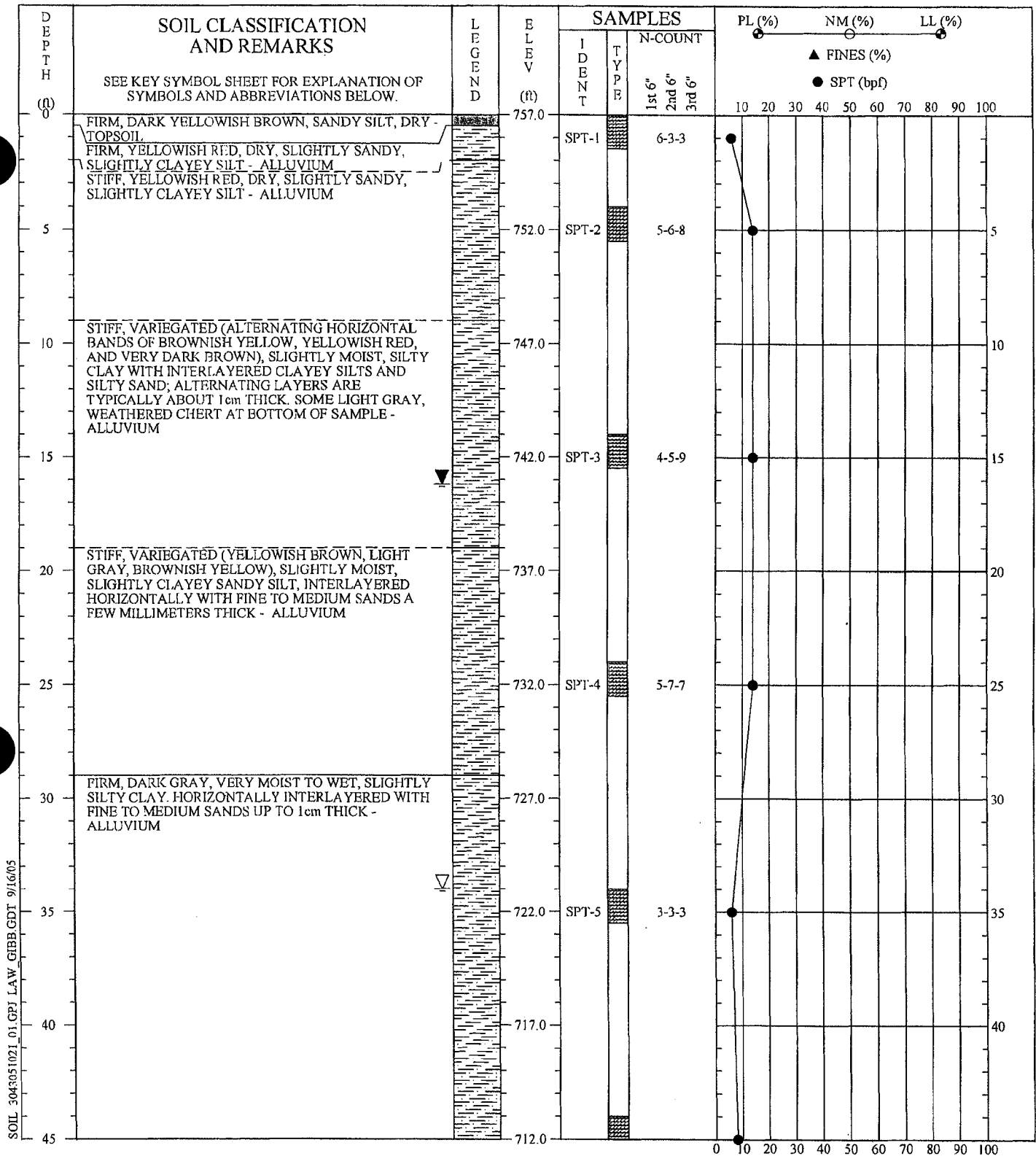

REMARKS: STANDARD PENETRATION RESISTANCE TESTING PERFORMED USING AN AUTOMATIC HAMMER.

SOIL TEST BORING RECORD

PROJECT: Proposed Gypsum Disposal Area

DRILLED: May 17, 2005

BORING NO.: NB-21

PROJ. NO.: 3043051021/0001

PAGE 1 OF 2

THIS RECORD IS A REASONABLE INTERPRETATION OF SUBSURFACE CONDITIONS AT THE EXPLORATION LOCATION. SUBSURFACE CONDITIONS AT OTHER LOCATIONS AND AT OTHER TIMES MAY DIFFER. INTERFACES BETWEEN STRATA ARE APPROXIMATE. TRANSITIONS BETWEEN STRATA MAY BE GRADUAL.

Driller: Burnett
Prepared By: Mason
Checked By: Justice



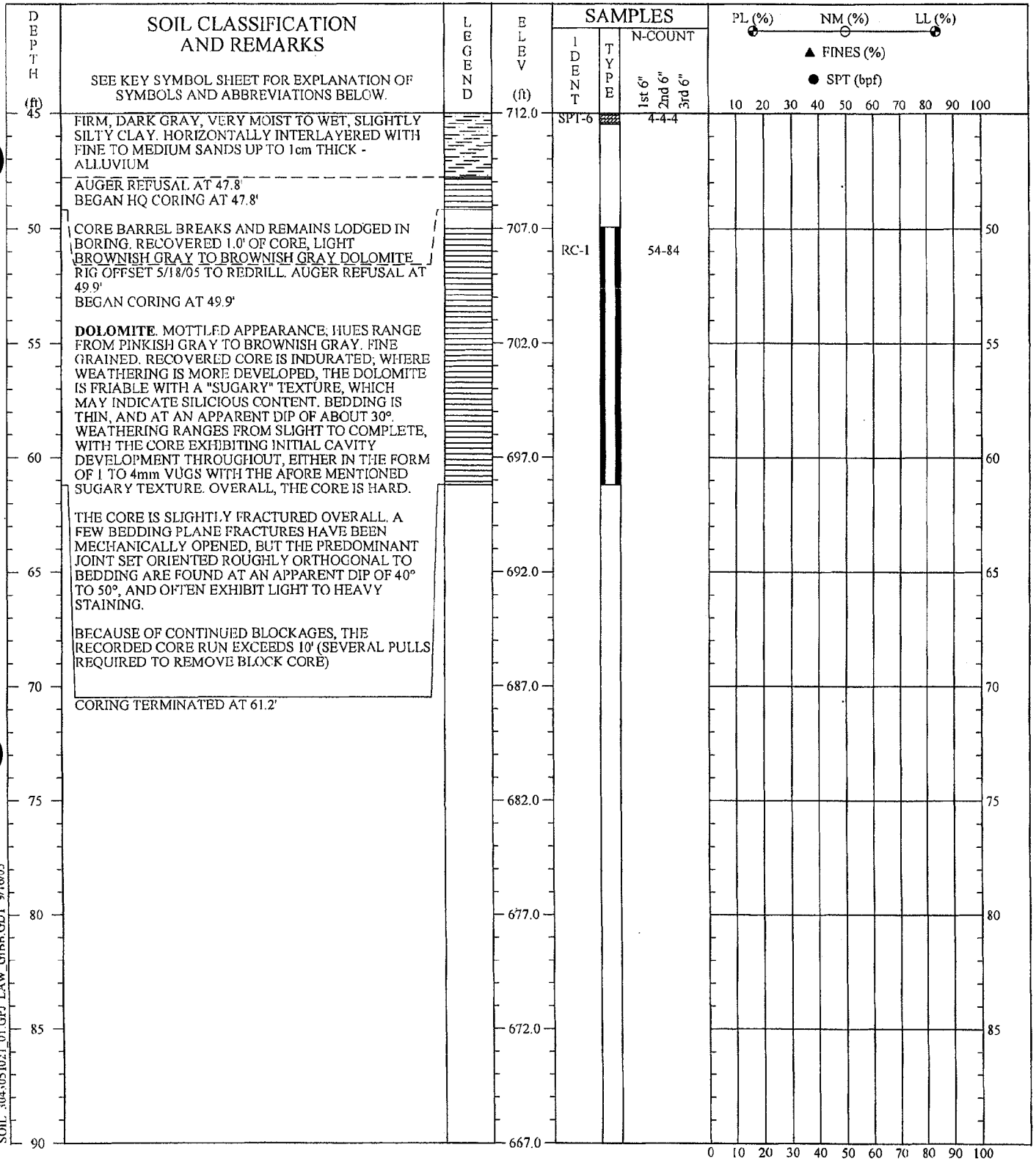

SOIL 3043051021_01.CPJ LAW GTRB.CDT 9/16/05

REMARKS: STANDARD PENETRATION RESISTANCE TESTING PERFORMED USING AN AUTOMATIC HAMMER.

THIS RECORD IS A REASONABLE INTERPRETATION OF SUBSURFACE CONDITIONS AT THE EXPLORATION LOCATION. SUBSURFACE CONDITIONS AT OTHER LOCATIONS AND AT OTHER TIMES MAY DIFFER. INTERFACES BETWEEN STRATA ARE APPROXIMATE. TRANSITIONS BETWEEN STRATA MAY BE GRADUAL.

Driller : Burnett
Prepared By: Mason
Checked By: Justice

SOIL TEST BORING RECORD	
PROJECT: Proposed Gypsum Disposal Area	
DRILLED: May 17, 2005	BORING NO.: NB-21
PROJ. NO.: 3043051021/0001	PAGE 2 OF 2
MACTEC	

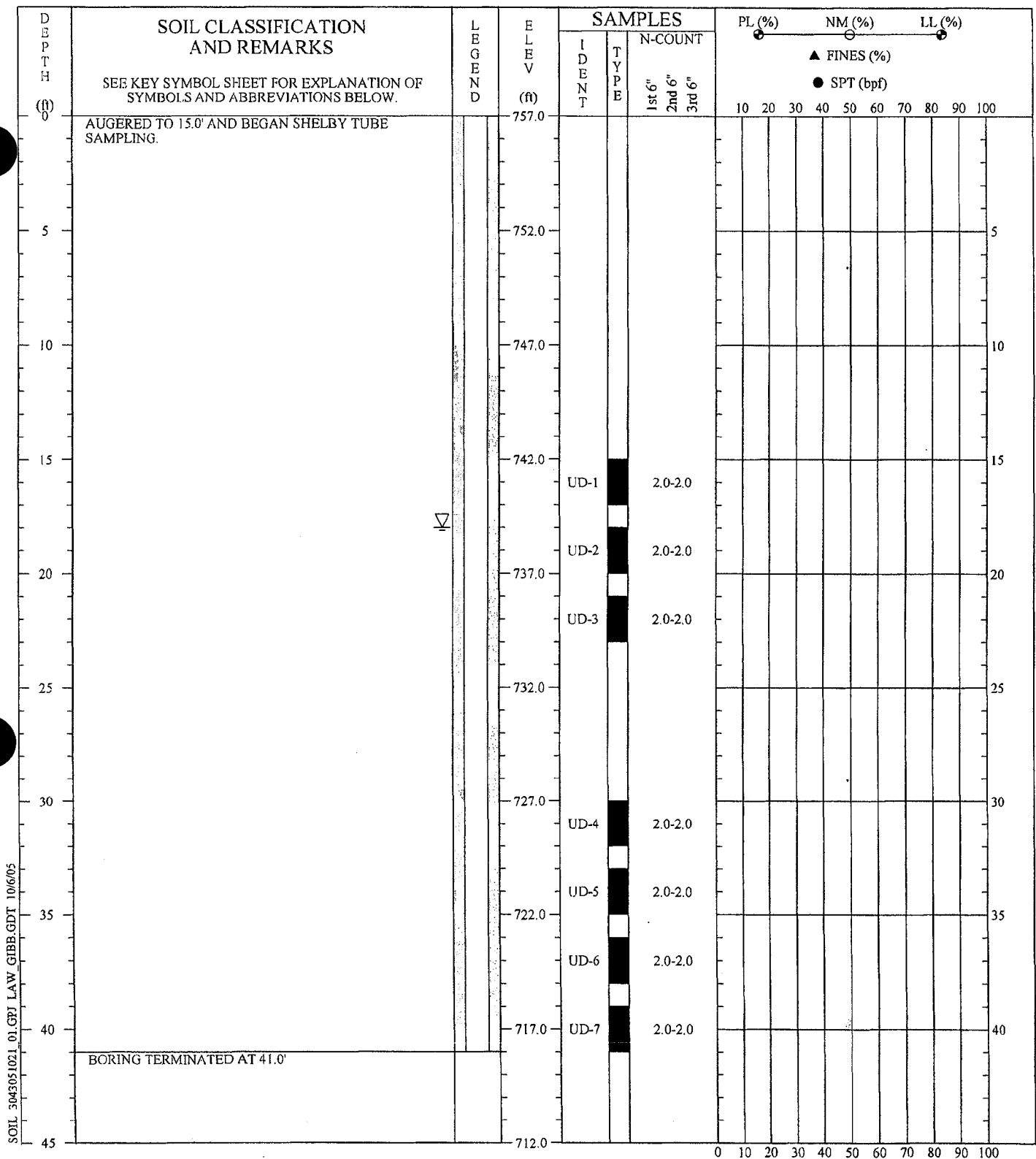

SOIL 3043051021 01.GPJ LAW GIBB.GDT 10/6/05

REMARKS: NB-21A WAS OFFSET APPROXIMATELY 13.3' NW OF NB-21

SOIL TEST BORING RECORD

PROJECT: Proposed Gypsum Disposal Area
DRILLED: May 25, 2005 **BORING NO.:** NB-21A
PROJ. NO.: 3043051021/0001 **PAGE 1 OF 1**

THIS RECORD IS A REASONABLE INTERPRETATION OF SUBSURFACE CONDITIONS AT THE EXPLORATION LOCATION. SUBSURFACE CONDITIONS AT OTHER LOCATIONS AND AT OTHER TIMES MAY DIFFER. INTERFACES BETWEEN STRATA ARE APPROXIMATE. TRANSITIONS BETWEEN STRATA MAY BE GRADUAL.

Driller : Bailey
 Prepared By: Lawson
 Checked By: Justice



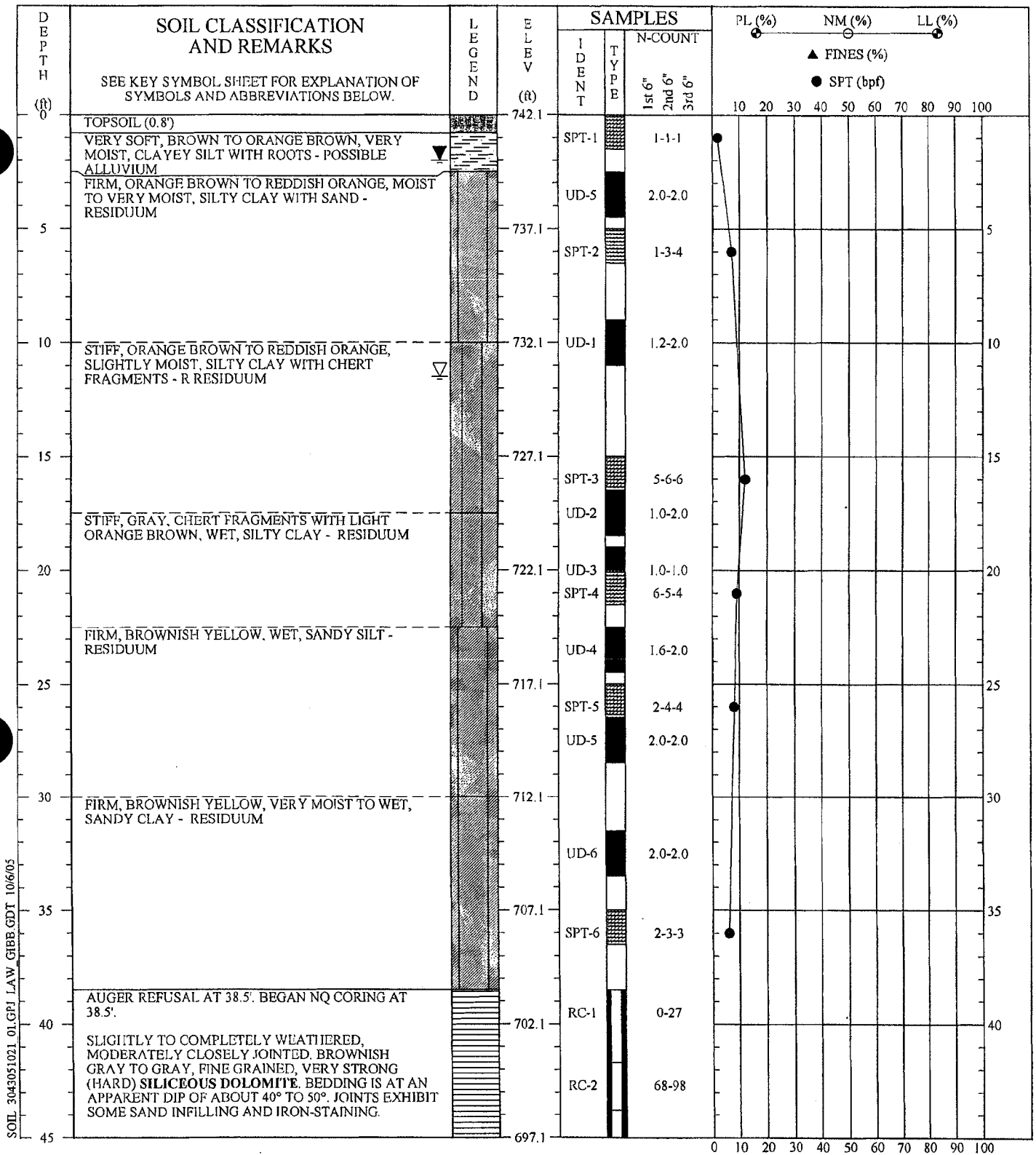

SOIL 3043051021 01.GPJ LAW GIBB.GDT 10/6/05

REMARKS: STANDARD PENETRATION RESISTANCE TESTING PERFORMED USING AN AUTOMATIC HAMMER. NB-22 OFFSET APPROXIMATELY 50.0' S14°W OF ORIGINAL STAKED LOCATION.

THIS RECORD IS A REASONABLE INTERPRETATION OF SUBSURFACE CONDITIONS AT THE EXPLORATION LOCATION. SUBSURFACE CONDITIONS AT OTHER LOCATIONS AND AT OTHER TIMES MAY DIFFER. INTERFACES BETWEEN STRATA ARE APPROXIMATE. TRANSITIONS BETWEEN STRATA MAY BE GRADUAL.

Driller : Akins
Prepared By: Justice
Checked By: Lawson

SOIL TEST BORING RECORD	
PROJECT: Proposed Gypsum Disposal Area	
DRILLED: June 3, 2005	BORING NO.: NB-22
PROJ. NO.: 3043051021/0001	PAGE 1 OF 2
	

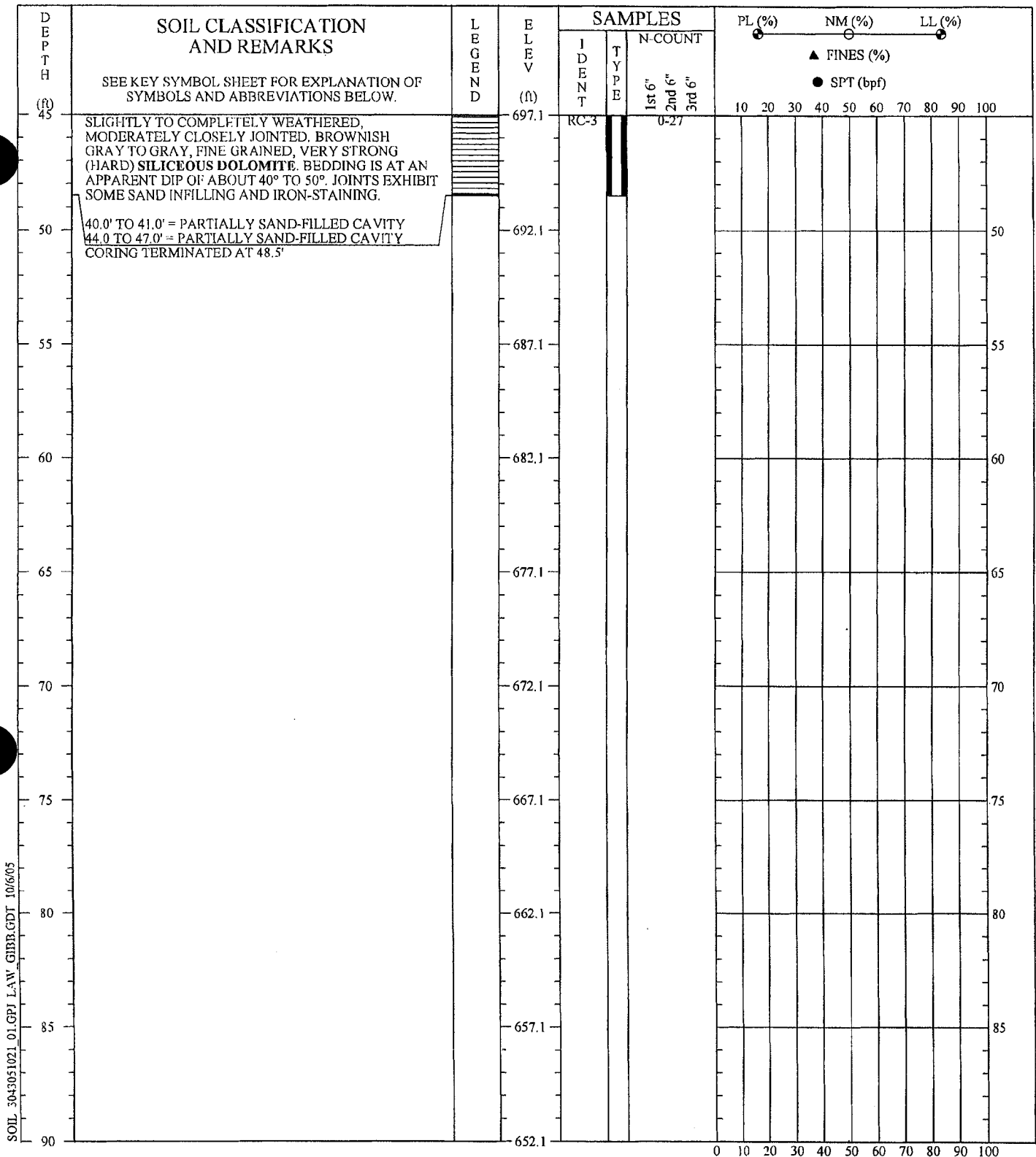

SOIL 3043051021 01.GPJ L.A.W. GIBB.GDT 10/6/05

REMARKS: STANDARD PENETRATION RESISTANCE TESTING PERFORMED USING AN AUTOMATIC HAMMER. NB-22 OFFSET APPROXIMATELY 50.0' S14°W OF ORIGINAL STAKED LOCATION.

THIS RECORD IS A REASONABLE INTERPRETATION OF SUBSURFACE CONDITIONS AT THE EXPLORATION LOCATION. SUBSURFACE CONDITIONS AT OTHER LOCATIONS AND AT OTHER TIMES MAY DIFFER. INTERFACES BETWEEN STRATA ARE APPROXIMATE. TRANSITIONS BETWEEN STRATA MAY BE GRADUAL.

Driller : Akins
 Prepared By: Justice
 Checked By: Lawson

SOIL TEST BORING RECORD	
PROJECT: Proposed Gypsum Disposal Area	
DRILLED: June 3, 2005	BORING NO.: NB-22
PROJ. NO.: 3043051021/0001	PAGE 2 OF 2
	

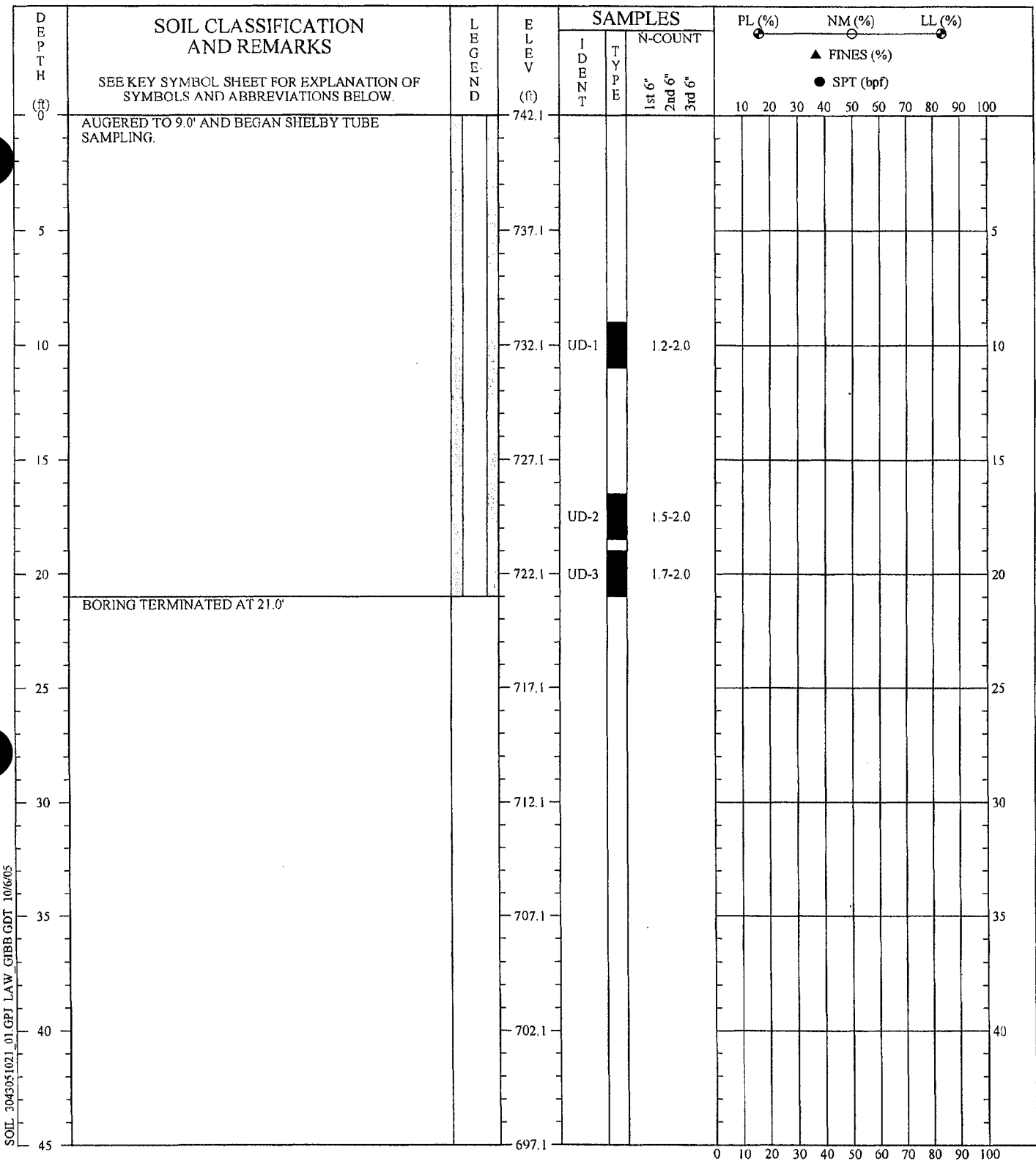

SOIL 3043051021 01.GPJ LAW_GIBB.GDT 10/6/05

REMARKS: NB-22A OFFSET APPROXIMATELY 3.4' AND S55°W OF NB-22.

SOIL TEST BORING RECORD

PROJECT: Proposed Gypsum Disposal Area
DRILLED: June 6, 2005 **BORING NO.:** NB-22A
PROJ. NO.: 3043051021/0001 **PAGE 1 OF 1**

THIS RECORD IS A REASONABLE INTERPRETATION OF SUBSURFACE CONDITIONS AT THE EXPLORATION LOCATION. SUBSURFACE CONDITIONS AT OTHER LOCATIONS AND AT OTHER TIMES MAY DIFFER. INTERFACES BETWEEN STRATA ARE APPROXIMATE. TRANSITIONS BETWEEN STRATA MAY BE GRADUAL.

Driller: Akins
 Prepared By: Justice
 Checked By: Lawson



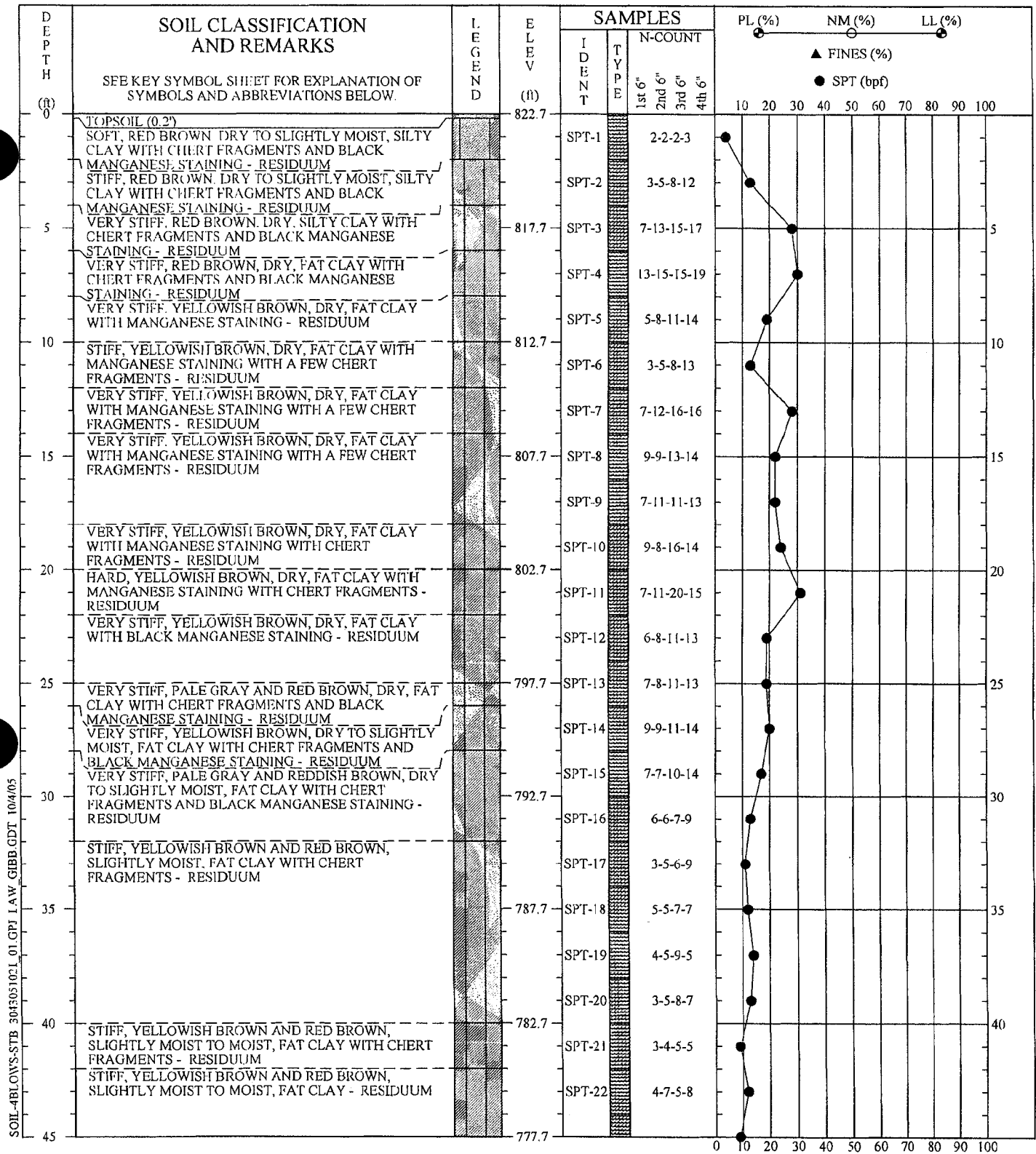

SOIL-4BLOVYS-STB 3043051021_01.GPJ I.A.W. GIBB.GDT 10/4/05

REMARKS: STANDARD PENETRATION RESISTANCE TESTING PERFORMED USING AN AUTOMATIC HAMMER.

SOIL TEST BORING RECORD

PROJECT: Proposed Gypsum Disposal Area
DRILLED: May 19, 2005 **BORING NO.:** NB-25
PROJ. NO.: 3043051021/0001 **PAGE 1 OF 2**

THIS RECORD IS A REASONABLE INTERPRETATION OF SUBSURFACE CONDITIONS AT THE EXPLORATION LOCATION. SUBSURFACE CONDITIONS AT OTHER LOCATIONS AND AT OTHER TIMES MAY DIFFER. INTERFACES BETWEEN STRATA ARE APPROXIMATE. TRANSITIONS BETWEEN STRATA MAY BE GRADUAL.

Driller : Akins
 Prepared By: Justice
 Checked By: Lawson



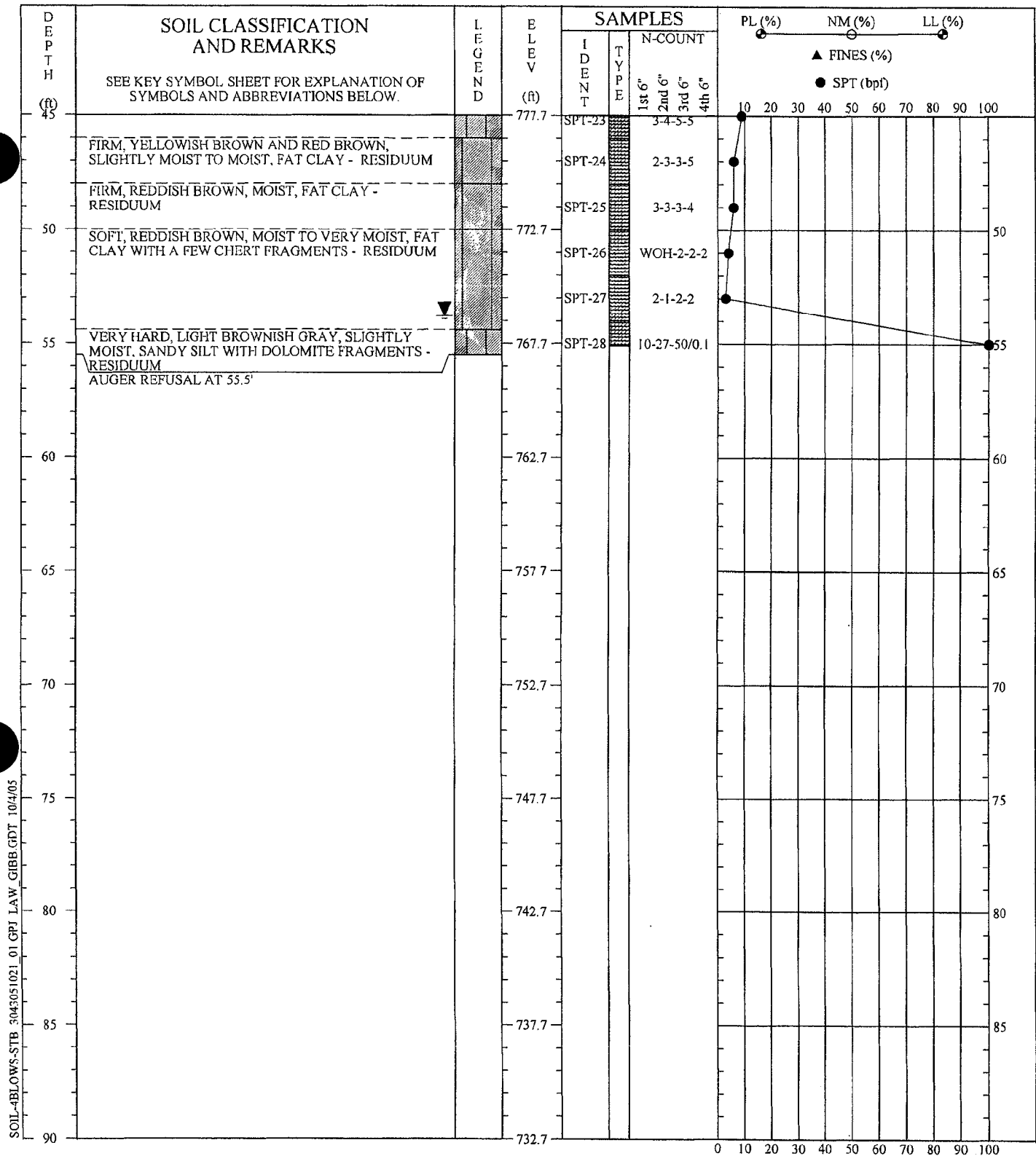

SOIL-BLOWS-STB 3043051021 01 GPJ LAW GIBB GDT 10/4/05

REMARKS: STANDARD PENETRATION RESISTANCE TESTING PERFORMED USING AN AUTOMATIC HAMMER.

SOIL TEST BORING RECORD

PROJECT: Proposed Gypsum Disposal Area
DRILLED: May 19, 2005 **BORING NO.:** NB-25
PROJ. NO.: 3043051021/0001 **PAGE 2 OF 2**

THIS RECORD IS A REASONABLE INTERPRETATION OF SUBSURFACE CONDITIONS AT THE EXPLORATION LOCATION. SUBSURFACE CONDITIONS AT OTHER LOCATIONS AND AT OTHER TIMES MAY DIFFER. INTERFACES BETWEEN STRATA ARE APPROXIMATE. TRANSITIONS BETWEEN STRATA MAY BE GRADUAL.

Driller: Akins
 Prepared By: Justice
 Checked By: Lawson



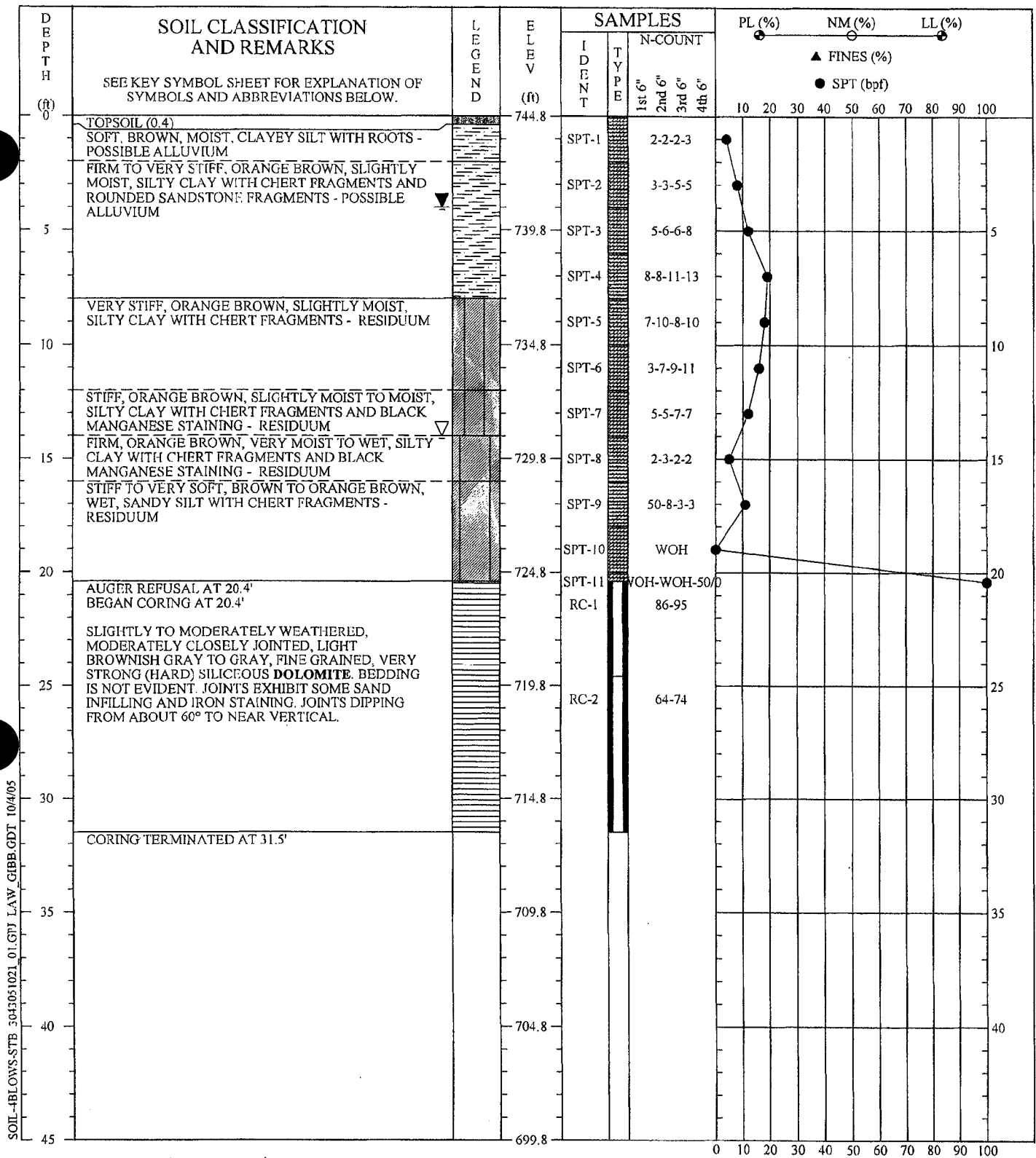

SOIL-BLOWNS-STB 3043051021_01.GPJ LAW GIBB GDT 10/4/05

REMARKS: STANDARD PENETRATION RESISTANCE TESTING PERFORMED USING AN AUTOMATIC HAMMER. NB-35 OFFSET APPROXIMATELY 200.0' N45°E OF NB-36 AND ABOUT 20.0' SE FROM EDGE OF POND.

THIS RECORD IS A REASONABLE INTERPRETATION OF SUBSURFACE CONDITIONS AT THE EXPLORATION LOCATION. SUBSURFACE CONDITIONS AT OTHER LOCATIONS AND AT OTHER TIMES MAY DIFFER. INTERFACES BETWEEN STRATA ARE APPROXIMATE. TRANSITIONS BETWEEN STRATA MAY BE GRADUAL.

Driller : Akins
Prepared By: Justice
Checked By: Lawson

SOIL TEST BORING RECORD	
PROJECT: Proposed Gypsum Disposal Area	
DRILLED: June 3, 2005	BORING NO.: NB-35
PROJ. NO.: 3043051021/0001	PAGE 1 OF 1

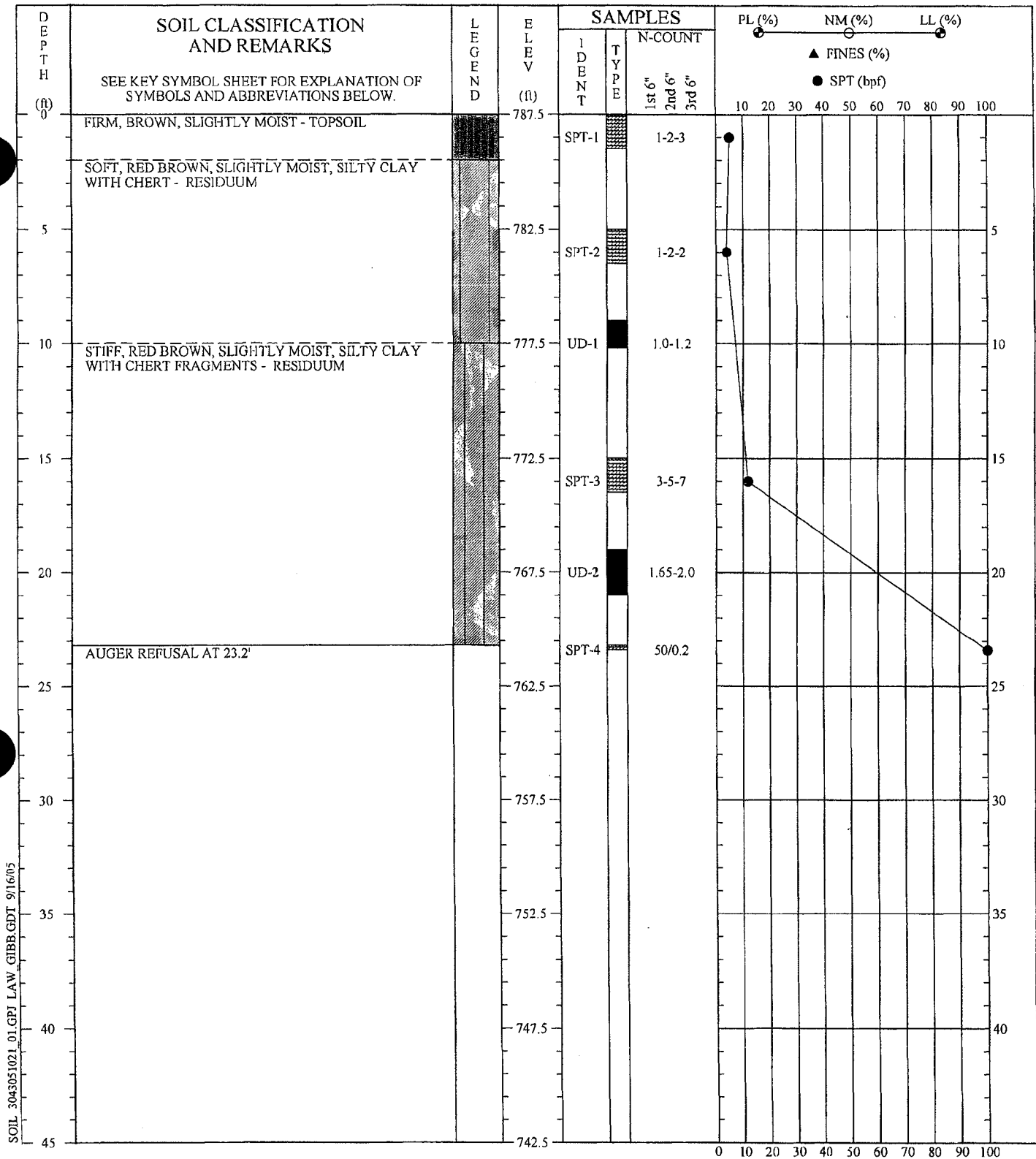

SOIL 3043051021_01.GPJ LAW_GIBB.GDT 9/16/05

REMARKS: STANDARD PENETRATION RESISTANCE TESTING PERFORMED USING AN AUTOMATIC HAMMER. NO GROUND WATER ENCOUNTERED AT TIME OF EXPLORATION

SOIL TEST BORING RECORD

PROJECT: Proposed Gypsum Disposal Area
DRILLED: May 23, 2005 **BORING NO.:** NB-39
PROJ. NO.: 3043051021/0001 **PAGE 1 OF 1**

THIS RECORD IS A REASONABLE INTERPRETATION OF SUBSURFACE CONDITIONS AT THE EXPLORATION LOCATION. SUBSURFACE CONDITIONS AT OTHER LOCATIONS AND AT OTHER TIMES MAY DIFFER. INTERFACES BETWEEN STRATA ARE APPROXIMATE. TRANSITIONS BETWEEN STRATA MAY BE GRADUAL.

Driller : Bailey
 Prepared By: Lawson
 Checked By: Justice



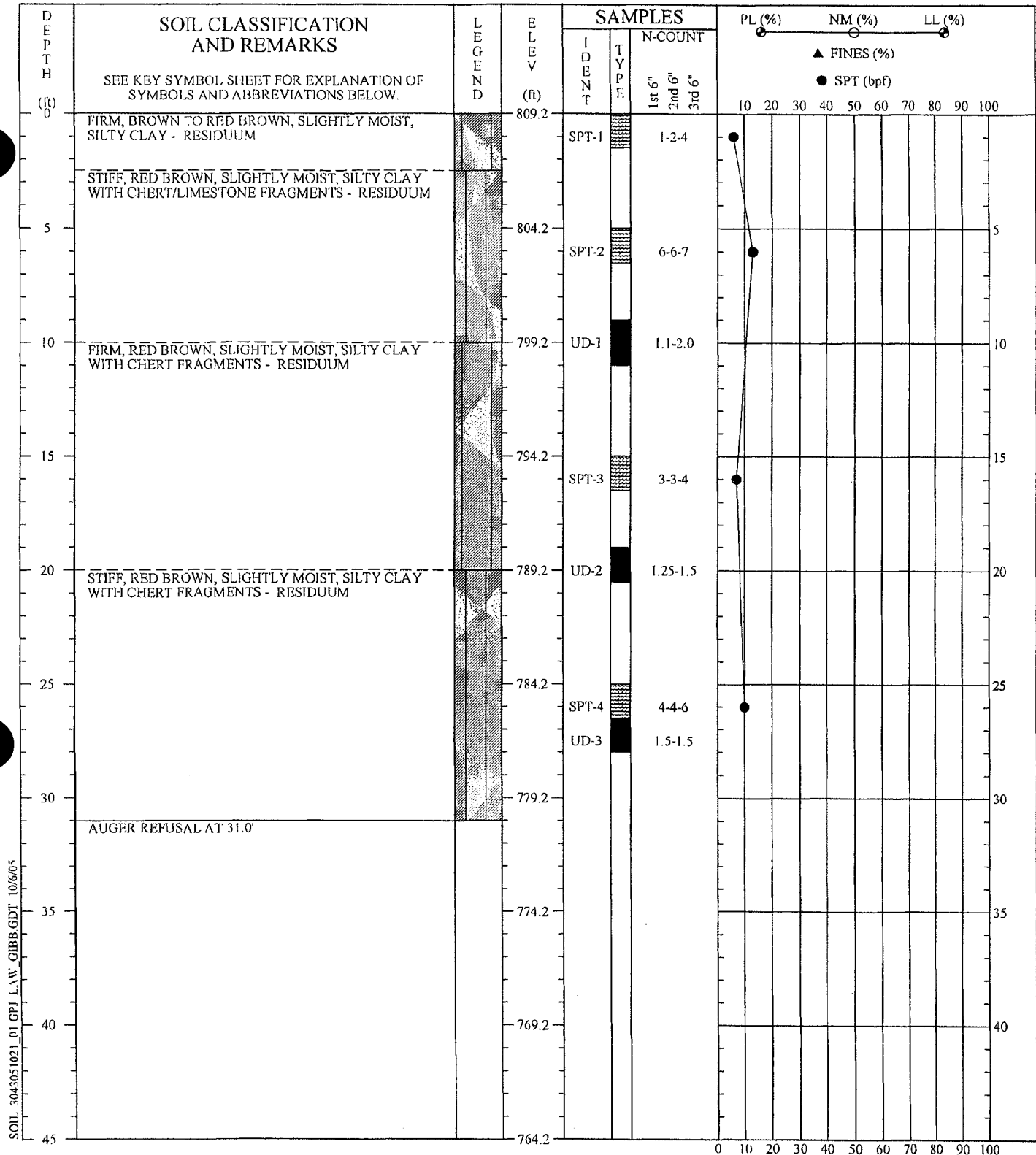

SOIL 3043051021_01.GPJ LAW GIBB GDT 10/6/05

REMARKS: STANDARD PENETRATION RESISTANCE TESTING PERFORMED USING AN AUTOMATIC HAMMER. NO GROUND WATER ENCOUNTERED AT TIME OF EXPLORATION.

SOIL TEST BORING RECORD	
PROJECT: Proposed Gypsum Disposal Area	
DRILLED: May 23, 2005	BORING NO.: NB-41
PROJ. NO.: 3043051021/0001	PAGE 1 OF 1
MACTEC	

THIS RECORD IS A REASONABLE INTERPRETATION OF SUBSURFACE CONDITIONS AT THE EXPLORATION LOCATION. SUBSURFACE CONDITIONS AT OTHER LOCATIONS AND AT OTHER TIMES MAY DIFFER. INTERFACES BETWEEN STRATA ARE APPROXIMATE. TRANSITIONS BETWEEN STRATA MAY BE GRADUAL.

Driller : Bailey
 Prepared By: Lawson
 Checked By: Justice

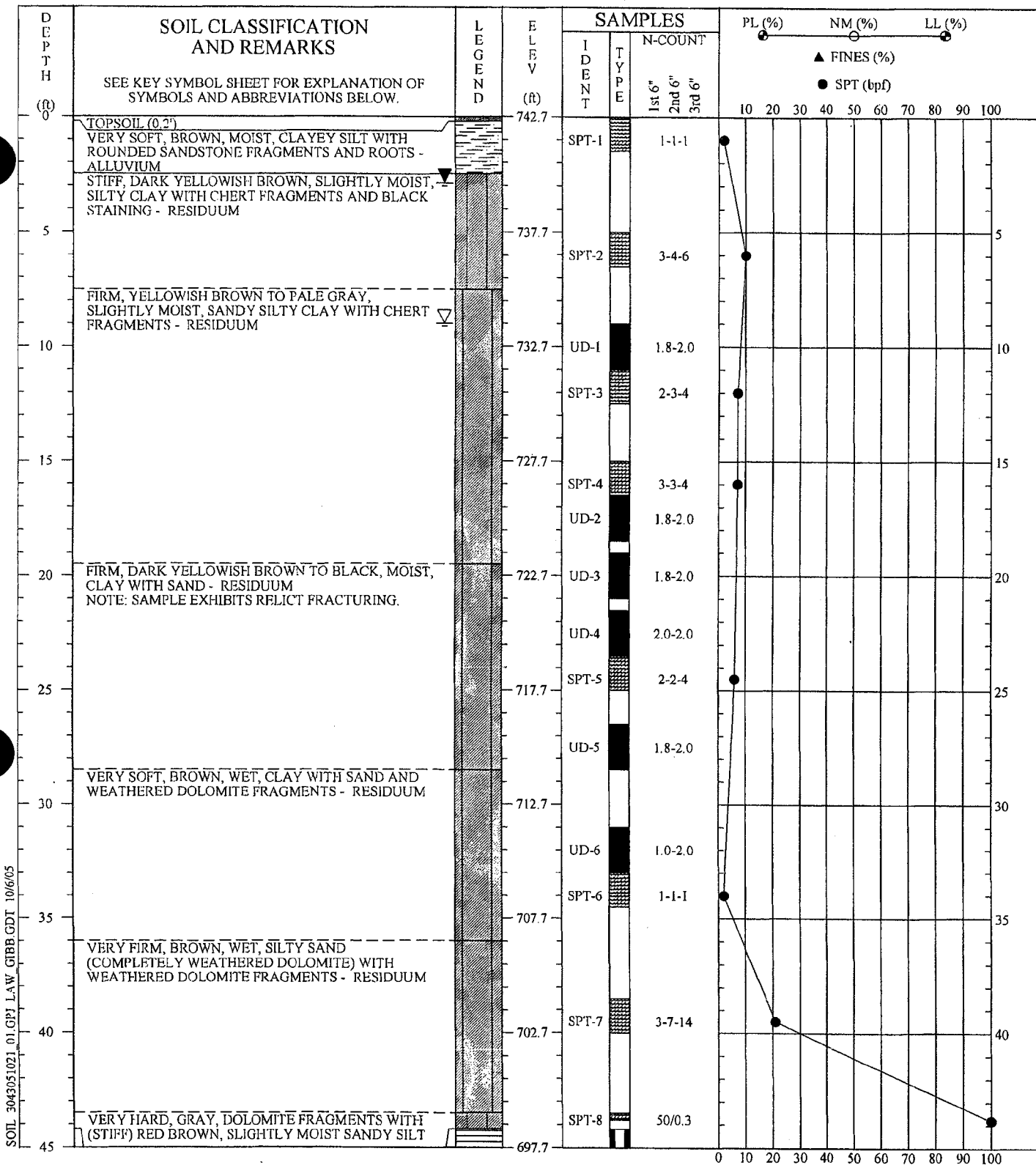

SOIL 3043051021 01.GPJ LAW GIBB.GDT 10/6/05

REMARKS: STANDARD PENETRATION RESISTANCE TESTING PERFORMED USING AN AUTOMATIC HAMMER. NB-44 OFFSET APPROXIMATELY 9.0' S85°E OF ORIGINAL STAKED LOCATION.

THIS RECORD IS A REASONABLE INTERPRETATION OF SUBSURFACE CONDITIONS AT THE EXPLORATION LOCATION. SUBSURFACE CONDITIONS AT OTHER LOCATIONS AND AT OTHER TIMES MAY DIFFER. INTERFACES BETWEEN STRATA ARE APPROXIMATE. TRANSITIONS BETWEEN STRATA MAY BE GRADUAL.

Driller : Akins
 Prepared By: Justice
 Checked By: Lawson

SOIL TEST BORING RECORD	
PROJECT: Proposed Gypsum Disposal Area	BORING NO.: NB-44
DRILLED: May 31, 2005	PAGE 1 OF 3
PROJ. NO.: 3043051021/0001	

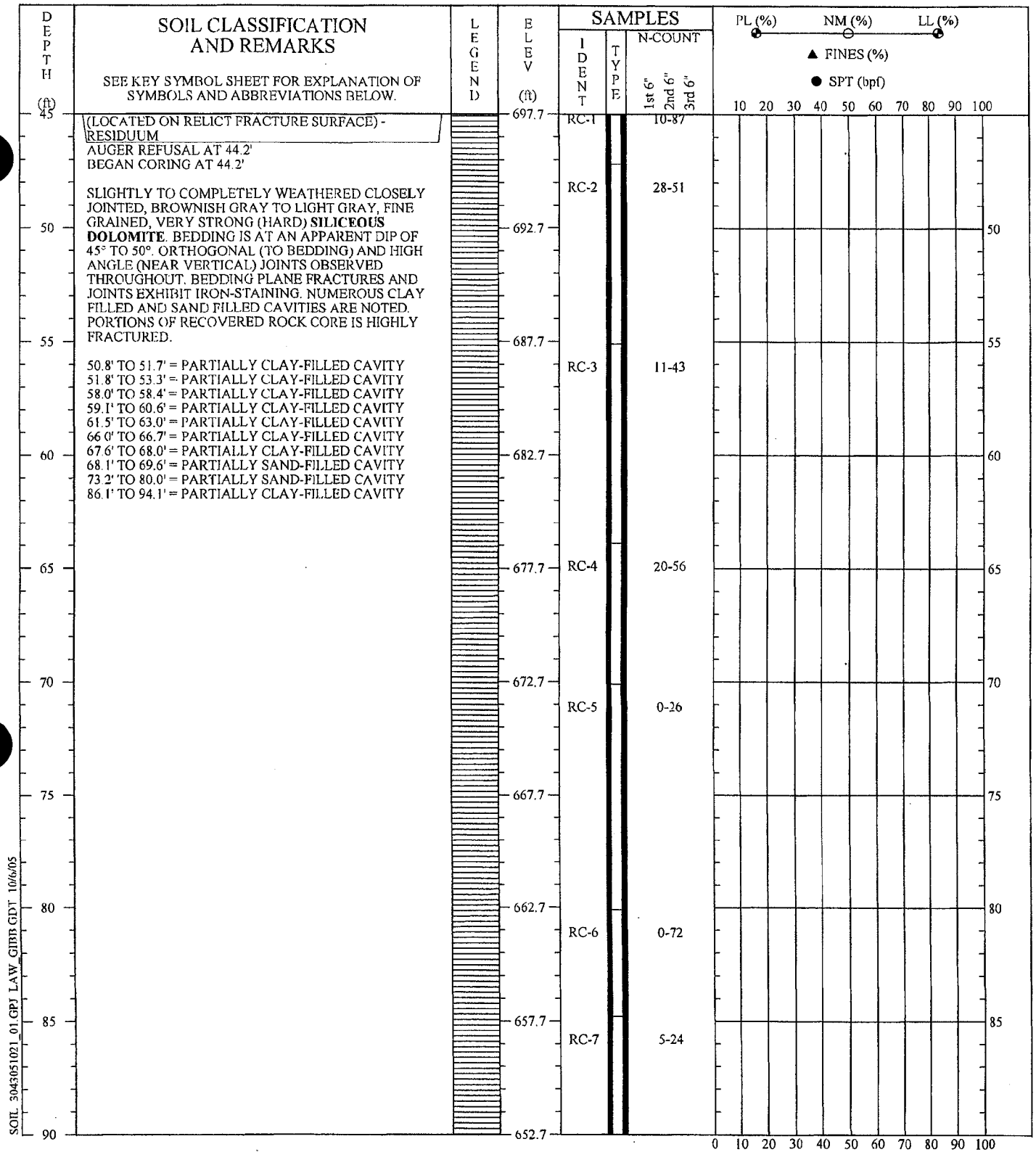

SOIL_3043051021_01.GPJ LAW_GIBB.GDT 10/6/05

REMARKS: STANDARD PENETRATION RESISTANCE TESTING PERFORMED USING AN AUTOMATIC HAMMER. NB-44 OFFSET APPROXIMATELY 9.0' S85°E OF ORIGINAL STAKED LOCATION.

SOIL TEST BORING RECORD

PROJECT: Proposed Gypsum Disposal Area
DRILLED: May 31, 2005 **BORING NO.:** NB-44
PROJ. NO.: 3043051021/0001 **PAGE 2 OF 3**

THIS RECORD IS A REASONABLE INTERPRETATION OF SUBSURFACE CONDITIONS AT THE EXPLORATION LOCATION. SUBSURFACE CONDITIONS AT OTHER LOCATIONS AND AT OTHER TIMES MAY DIFFER. INTERFACES BETWEEN STRATA ARE APPROXIMATE. TRANSITIONS BETWEEN STRATA MAY BE GRADUAL.

Driller : Akins
 Prepared By: Justice
 Checked By: Lawson



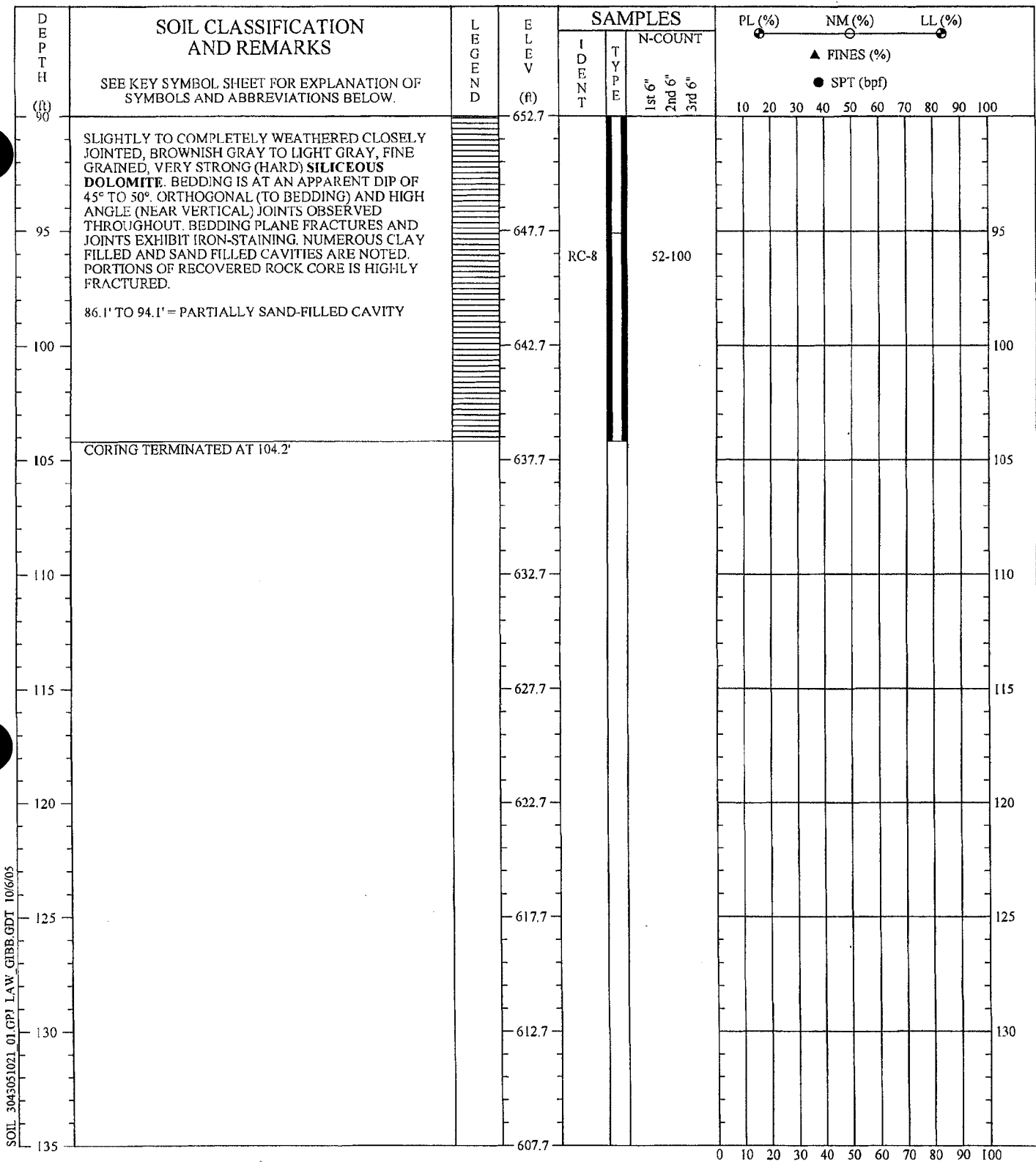

SOIL 3043051021.01.GPJ LAW GIBB.GDT 10/6/05

REMARKS: STANDARD PENETRATION RESISTANCE TESTING PERFORMED USING AN AUTOMATIC HAMMER. NB-44 OFFSET APPROXIMATELY 9.0' S85°E OF ORIGINAL STAKED LOCATION.

SOIL TEST BORING RECORD

PROJECT: Proposed Gypsum Disposal Area
DRILLED: May 31, 2005 **BORING NO.:** NB-44
PROJ. NO.: 3043051021/0001 **PAGE 3 OF 3**

THIS RECORD IS A REASONABLE INTERPRETATION OF SUBSURFACE CONDITIONS AT THE EXPLORATION LOCATION. SUBSURFACE CONDITIONS AT OTHER LOCATIONS AND AT OTHER TIMES MAY DIFFER. INTERFACES BETWEEN STRATA ARE APPROXIMATE. TRANSITIONS BETWEEN STRATA MAY BE GRADUAL.

Driller : Akins
 Prepared By: Justice
 Checked By: Lawson



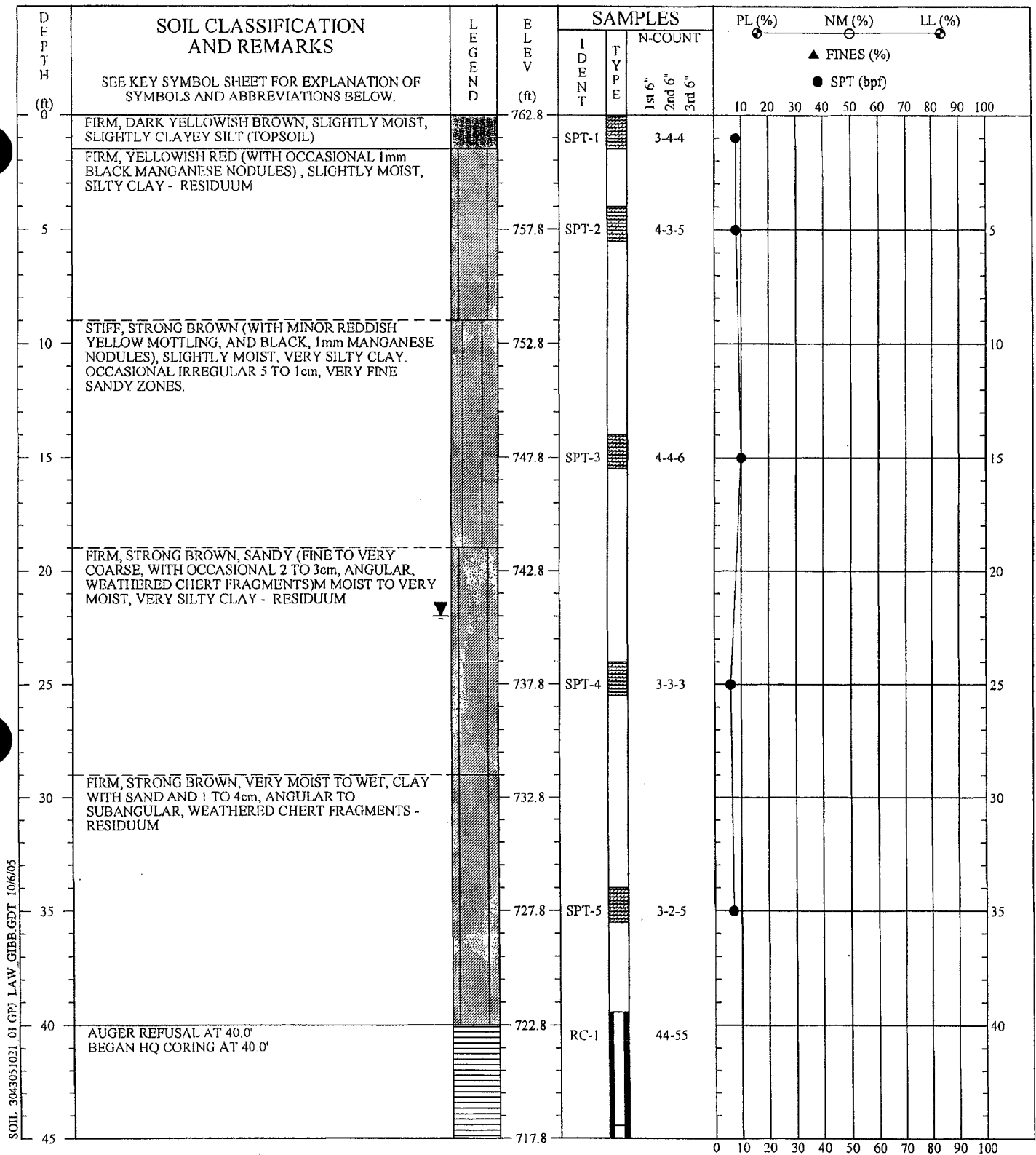

SOIL 3043051021 01 GFI LAW GIBB.GDT 10/6/05

REMARKS: STANDARD PENETRATION RESISTANCE TESTING PERFORMED USING AN AUTOMATIC HAMMER.

SOIL TEST BORING RECORD	
PROJECT: Proposed Gypsum Disposal Area	BORING NO.: NB-47
DRILLED: May 16, 2005	PAGE 1 OF 2
PROJ. NO.: 3043051021/0001	
	

THIS RECORD IS A REASONABLE INTERPRETATION OF SUBSURFACE CONDITIONS AT THE EXPLORATION LOCATION. SUBSURFACE CONDITIONS AT OTHER LOCATIONS AND AT OTHER TIMES MAY DIFFER. INTERFACES BETWEEN STRATA ARE APPROXIMATE. TRANSITIONS BETWEEN STRATA MAY BE GRADUAL.

Driller : Burnett
Prepared By: Mason
Checked By: Justice

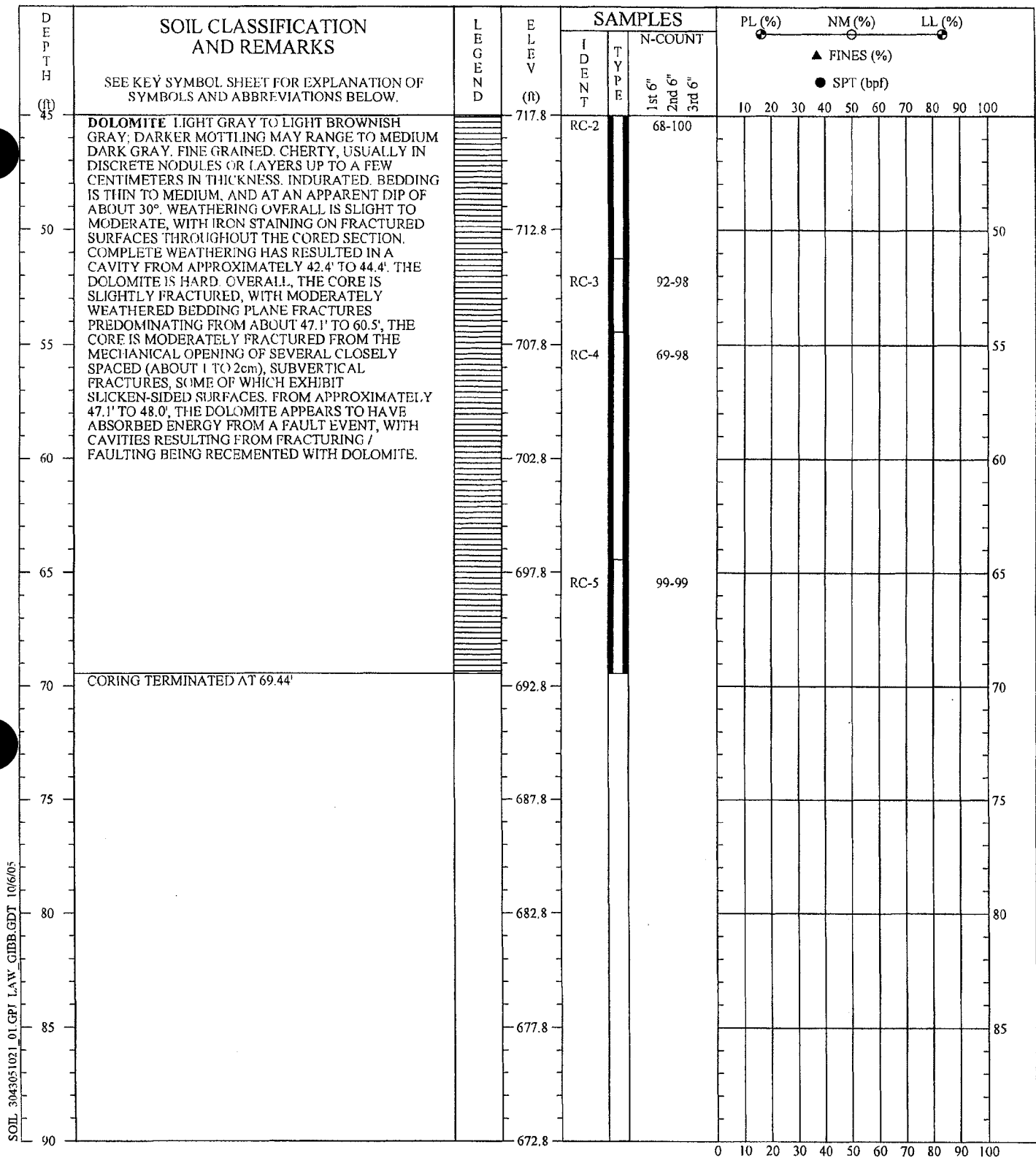

SOIL 3043051021_01.GPJ LAW GIBB.GDT 10/6/05

REMARKS: STANDARD PENETRATION RESISTANCE TESTING PERFORMED USING AN AUTOMATIC HAMMER.

THIS RECORD IS A REASONABLE INTERPRETATION OF SUBSURFACE CONDITIONS AT THE EXPLORATION LOCATION. SUBSURFACE CONDITIONS AT OTHER LOCATIONS AND AT OTHER TIMES MAY DIFFER. INTERFACES BETWEEN STRATA ARE APPROXIMATE. TRANSITIONS BETWEEN STRATA MAY BE GRADUAL.

Driller : Burnett
Prepared By: Mason
Checked By: Justice

SOIL TEST BORING RECORD	
PROJECT: Proposed Gypsum Disposal Area	BORING NO.: NB-47
DRILLED: May 16, 2005	PROJ. NO.: 3043051021/0001
PAGE 2 OF 2	
	

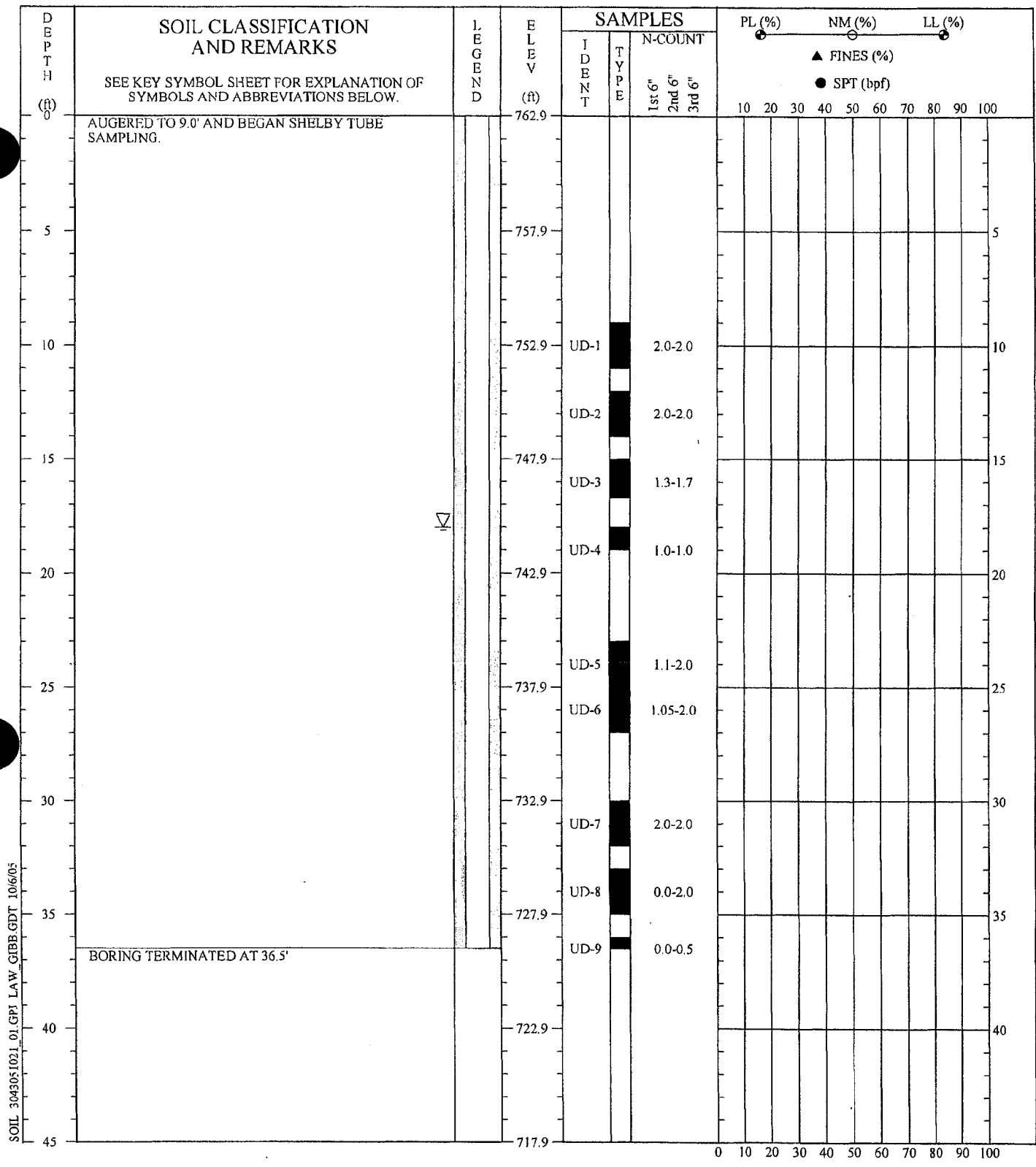

SOIL 3043051021.01.GPJ LAW GIBB.GDT 10/6/05

REMARKS: STANDARD PENETRATION RESISTANCE TESTING PERFORMED USING AN AUTOMATIC HAMMER. NB-47A WAS OFFSET APPROXIMATELY 9.0' N48°E OF NB-47.

THIS RECORD IS A REASONABLE INTERPRETATION OF SUBSURFACE CONDITIONS AT THE EXPLORATION LOCATION. SUBSURFACE CONDITIONS AT OTHER LOCATIONS AND AT OTHER TIMES MAY DIFFER. INTERFACES BETWEEN STRATA ARE APPROXIMATE. TRANSITIONS BETWEEN STRATA MAY BE GRADUAL.

Driller: Bailey
Prepared By: Lawson
Checked By: Haston

SOIL TEST BORING RECORD	
PROJECT: Proposed Gypsum Disposal Area	BORING NO.: NB-47A
DRILLED: May 26, 2005	PROJ. NO.: 3043051021/0001
PAGE 1 OF 1	
	

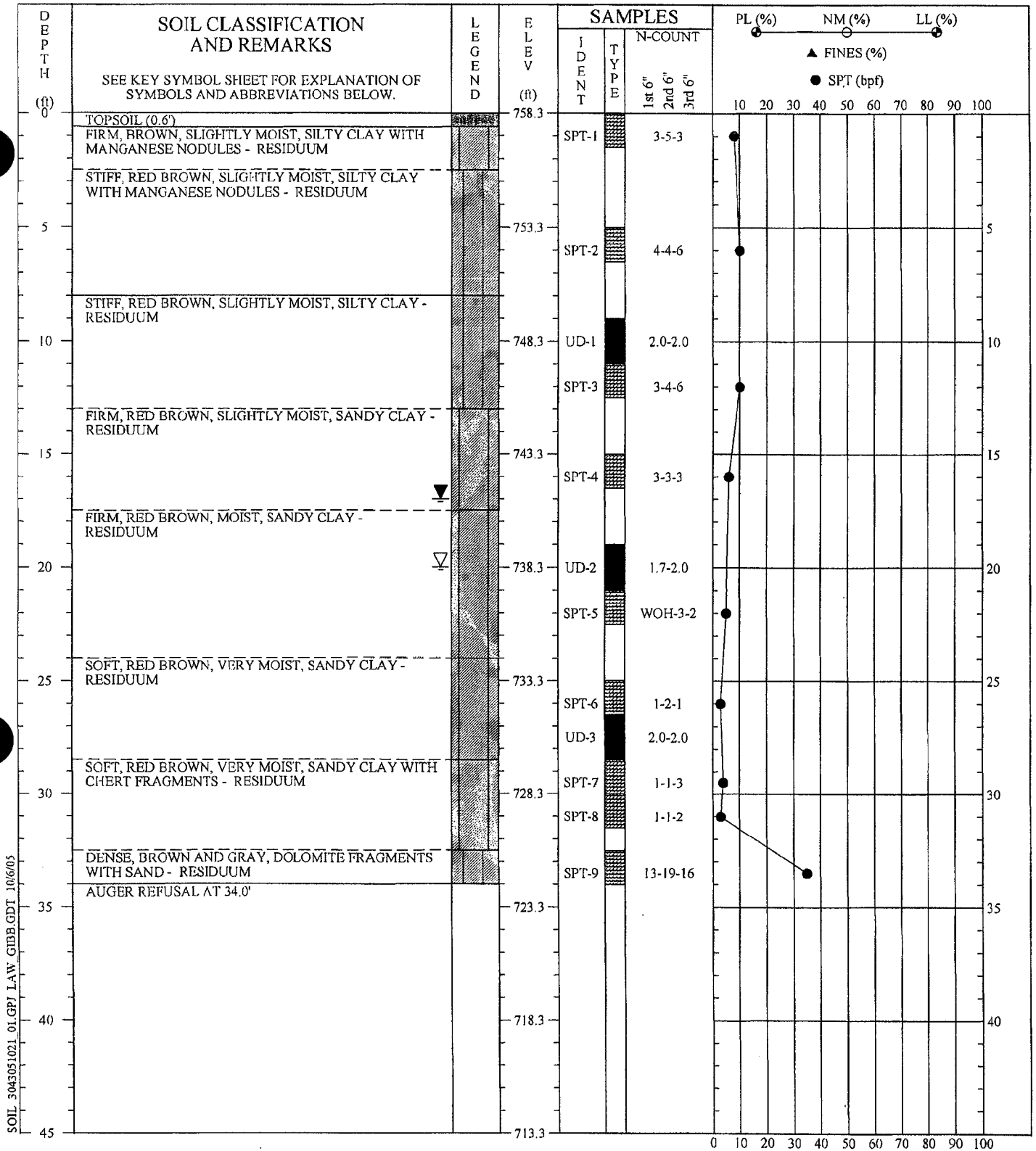

SOIL 3043051021.01.GPJ LAW GIBB.GDT 10/6/05

REMARKS: STANDARD PENETRATION RESISTANCE TESTING PERFORMED USING AN AUTOMATIC HAMMER.

SOIL TEST BORING RECORD

PROJECT: Proposed Gypsum Disposal Area
DRILLED: May 12, 2005 **BORING NO.:** NB-59
PROJ. NO.: 3043051021/0001 **PAGE 1 OF 1**

THIS RECORD IS A REASONABLE INTERPRETATION OF SUBSURFACE CONDITIONS AT THE EXPLORATION LOCATION. SUBSURFACE CONDITIONS AT OTHER LOCATIONS AND AT OTHER TIMES MAY DIFFER. INTERFACES BETWEEN STRATA ARE APPROXIMATE. TRANSITIONS BETWEEN STRATA MAY BE GRADUAL.

Driller : Akins
 Prepared By: Justice
 Checked By: Lawson



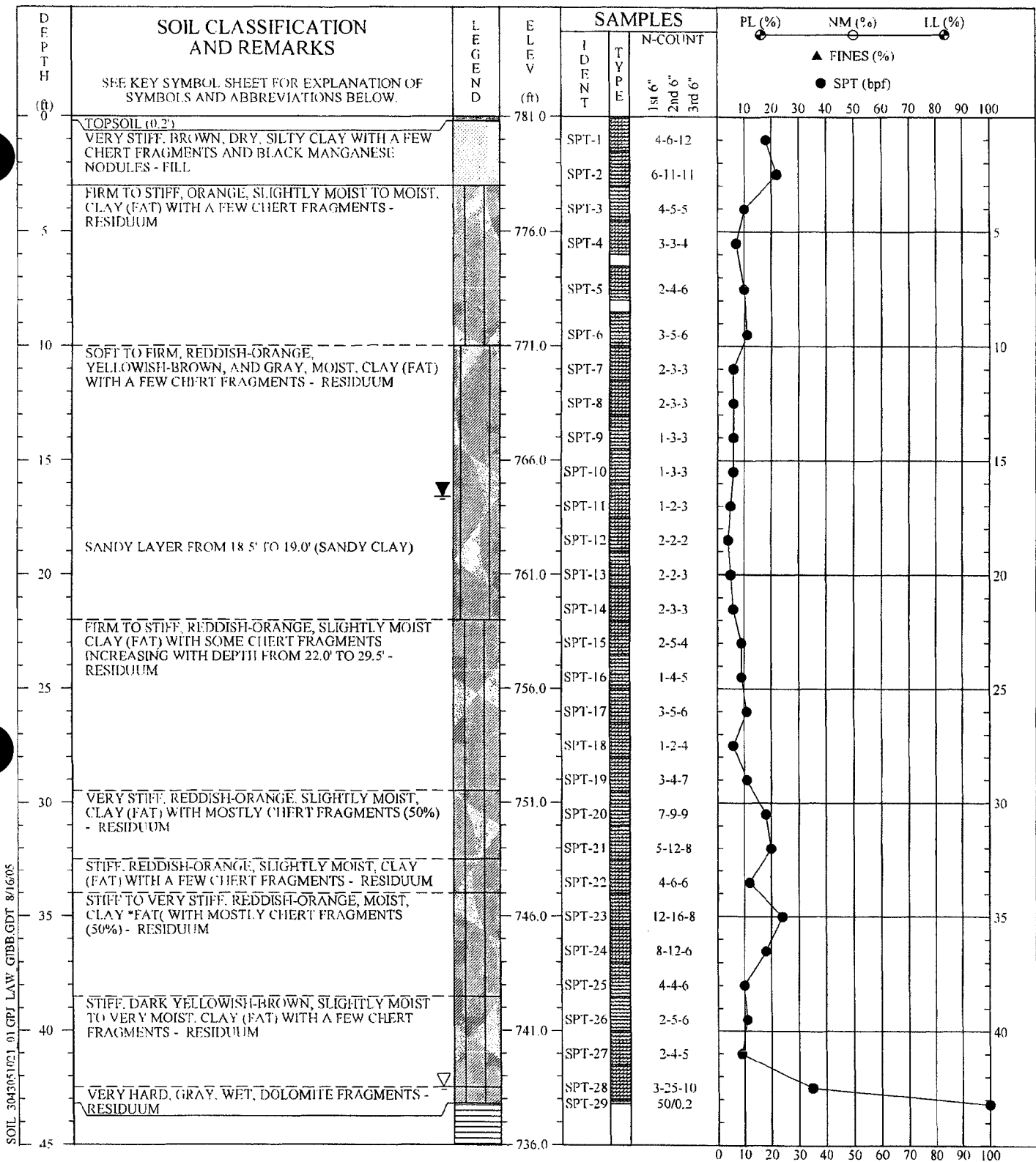

SOIL 3043051021 01 GPT LAW GIBB.GDT 8/16/05

REMARKS: STANDARD PENETRATION RESISTANCE TESTING PERFORMED USING AN AUTOMATIC HAMMER, NB-63 OFFSET APPROXIMATELY 39.0' S45°E OF THE ORIGINAL, STAKED LOCATION.

SOIL TEST BORING RECORD

PROJECT: Proposed Gypsum Disposal Area
DRILLED: April 29, 2005 **BORING NO.:** NB-63
PROJ. NO.: 3043051021/0001 **PAGE 1 OF 2**

THIS RECORD IS A REASONABLE INTERPRETATION OF SUBSURFACE CONDITIONS AT THE EXPLORATION LOCATION. SUBSURFACE CONDITIONS AT OTHER LOCATIONS AND AT OTHER TIMES MAY DIFFER. INTERFACES BETWEEN STRATA ARE APPROXIMATE. TRANSITIONS BETWEEN STRATA MAY BE GRADUAL.

Driller : Warren
 Prepared By: Justice
 Checked By: Lawson



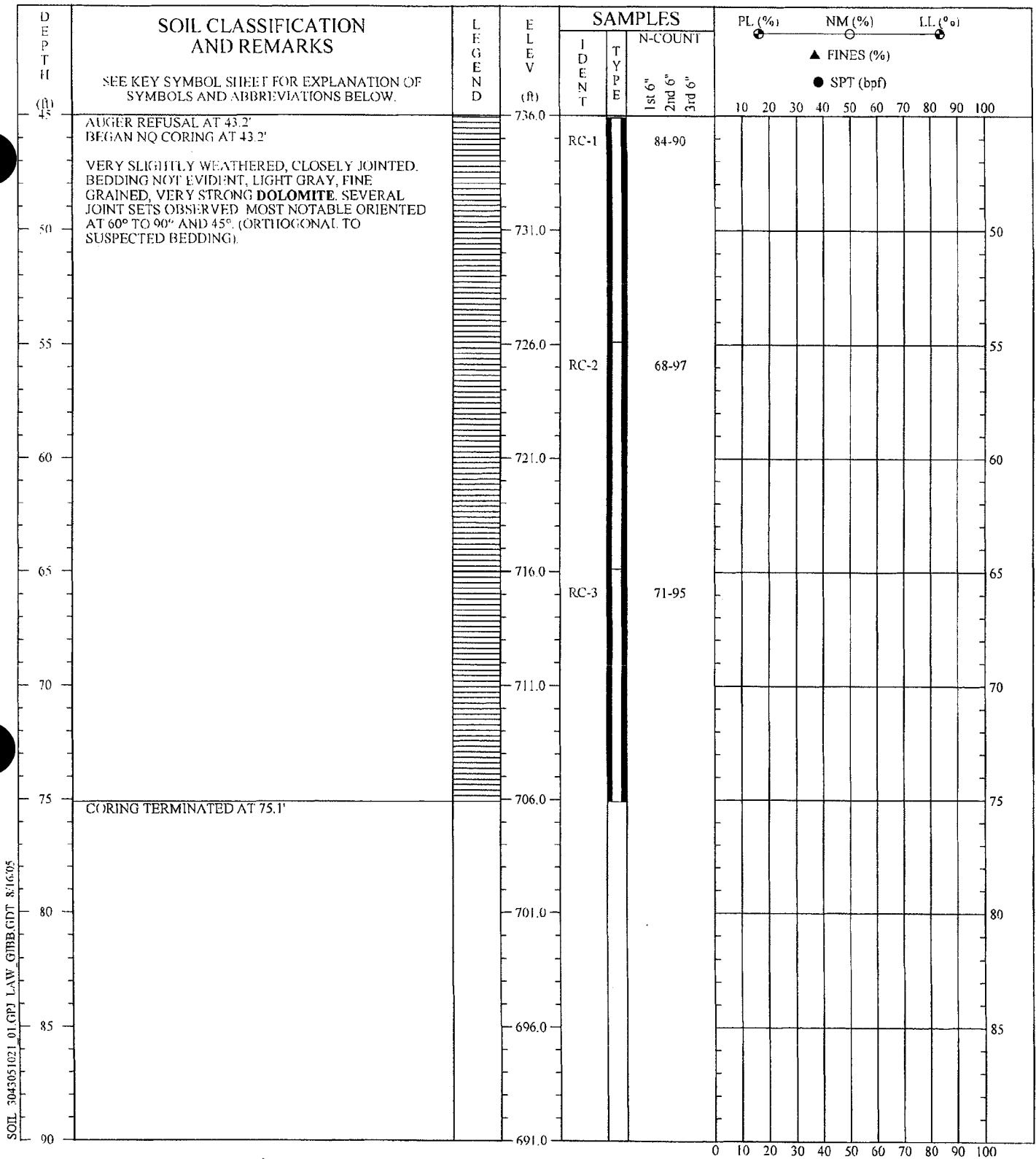

SOIL 3043051021 01 GFI LAW GIBB.GDT 8/16/05

REMARKS: STANDARD PENETRATION RESISTANCE TESTING PERFORMED USING AN AUTOMATIC HAMMER. NB-63 OFFSET APPROXIMATELY 39.0' S45°E OF THE ORIGINAL STAKED LOCATION.

THIS RECORD IS A REASONABLE INTERPRETATION OF SUBSURFACE CONDITIONS AT THE EXPLORATION LOCATION. SUBSURFACE CONDITIONS AT OTHER LOCATIONS AND AT OTHER TIMES MAY DIFFER. INTERFACES BETWEEN STRATA ARE APPROXIMATE. TRANSITIONS BETWEEN STRATA MAY BE GRADUAL.

Driller Warren
Prepared By: Justice
Checked By: Lawson

SOIL TEST BORING RECORD	
PROJECT: Proposed Gypsum Disposal Area	
DRILLED: April 29, 2005	BORING NO.: NB-63
PROJ. NO.: 3043051021/0001	PAGE 2 OF 2

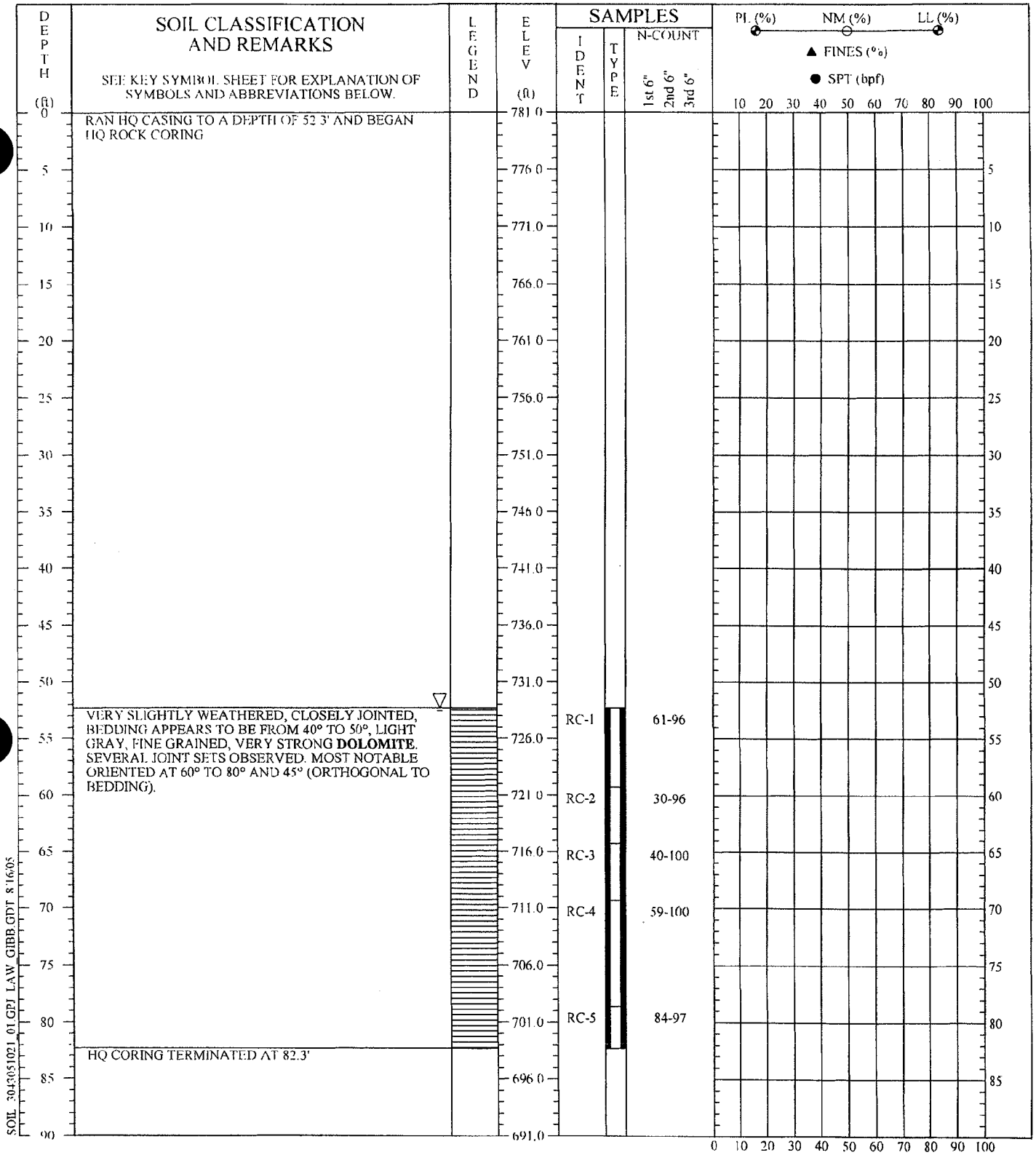

SOIL 3043051021.01.GPJ LAW GIBB.GDT 8/16/05

REMARKS: STANDARD PENETRATION RESISTANCE TESTING PERFORMED USING AN AUTOMATIC HAMMER.

SOIL TEST BORING RECORD

PROJECT: Proposed Gypsum Disposal Area
DRILLED: May 6, 2005 **BORING NO.:** NB-63A
PROJ. NO.: 3043051021/0001 **PAGE 1 OF 1**

THIS RECORD IS A REASONABLE INTERPRETATION OF SUBSURFACE CONDITIONS AT THE EXPLORATION LOCATION. SUBSURFACE CONDITIONS AT OTHER LOCATIONS AND AT OTHER TIMES MAY DIFFER. INTERFACES BETWEEN STRATA ARE APPROXIMATE. TRANSITIONS BETWEEN STRATA MAY BE GRADUAL.

Driller : Warren
 Prepared By: Justice
 Checked By: Lawson



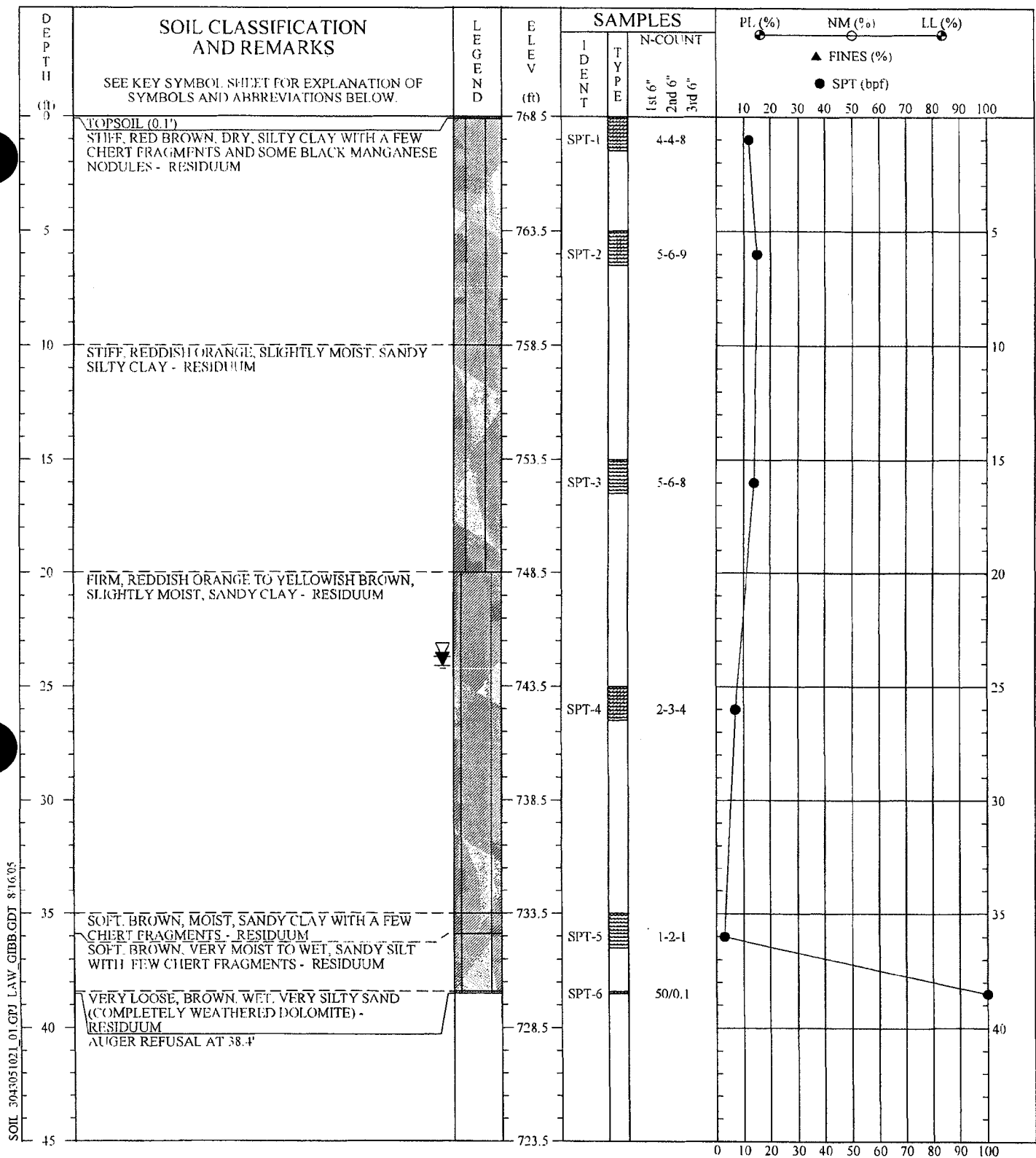

SOIL 3043051021_01.GPJ LAW_GIBB.GDT 8/16/05

REMARKS: STANDARD PENETRATION RESISTANCE TESTING PERFORMED USING AN AUTOMATIC HAMMER.

SOIL TEST BORING RECORD

PROJECT: Proposed Gypsum Disposal Area
DRILLED: May 12, 2005 **BORING NO.:** NB-65
PROJ. NO.: 3043051021/0001 **PAGE 1 OF 1**

THIS RECORD IS A REASONABLE INTERPRETATION OF SUBSURFACE CONDITIONS AT THE EXPLORATION LOCATION. SUBSURFACE CONDITIONS AT OTHER LOCATIONS AND AT OTHER TIMES MAY DIFFER. INTERFACES BETWEEN STRATA ARE APPROXIMATE. TRANSITIONS BETWEEN STRATA MAY BE GRADUAL.

Driller: Akins
 Prepared By: Justice
 Checked By: Lawson



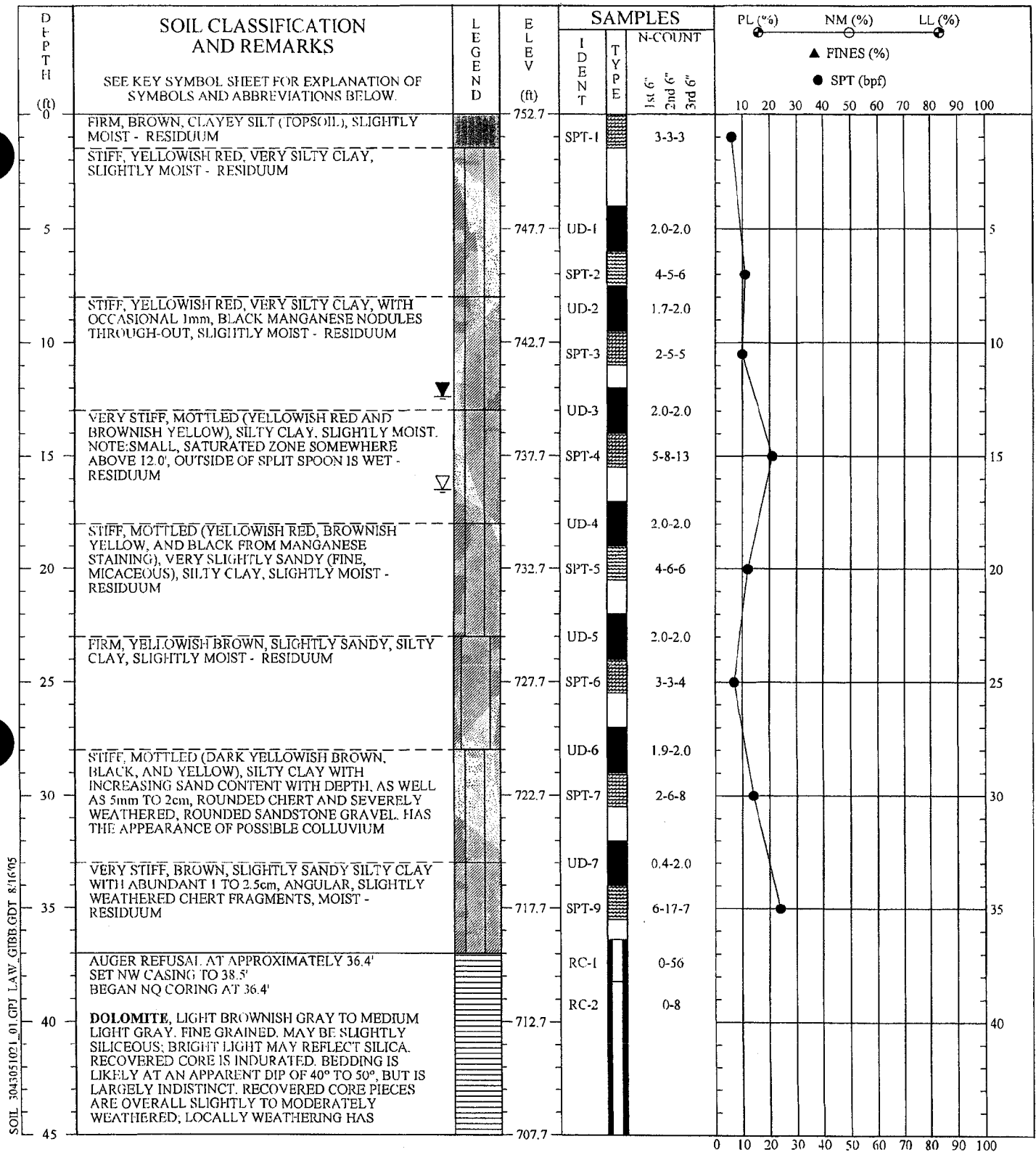

SOIL 3043051021_01.CPT LAW, GIBB.GDT 8/16/05

REMARKS: STANDARD PENETRATION RESISTANCE TESTING PERFORMED USING AN AUTOMATIC HAMMER.

THIS RECORD IS A REASONABLE INTERPRETATION OF SUBSURFACE CONDITIONS AT THE EXPLORATION LOCATION. SUBSURFACE CONDITIONS AT OTHER LOCATIONS AND AT OTHER TIMES MAY DIFFER. INTERFACES BETWEEN STRATA ARE APPROXIMATE. TRANSITIONS BETWEEN STRATA MAY BE GRADUAL.

Driller : Burnett
Prepared By: Mason
Checked By: Justice

SOIL TEST BORING RECORD	
PROJECT: Proposed Gypsum Disposal Area	BORING NO.: NB-66
DRILLED: May 2, 2005	PROJ. NO.: 3043051021/0001
PAGE 1 OF 2	
	

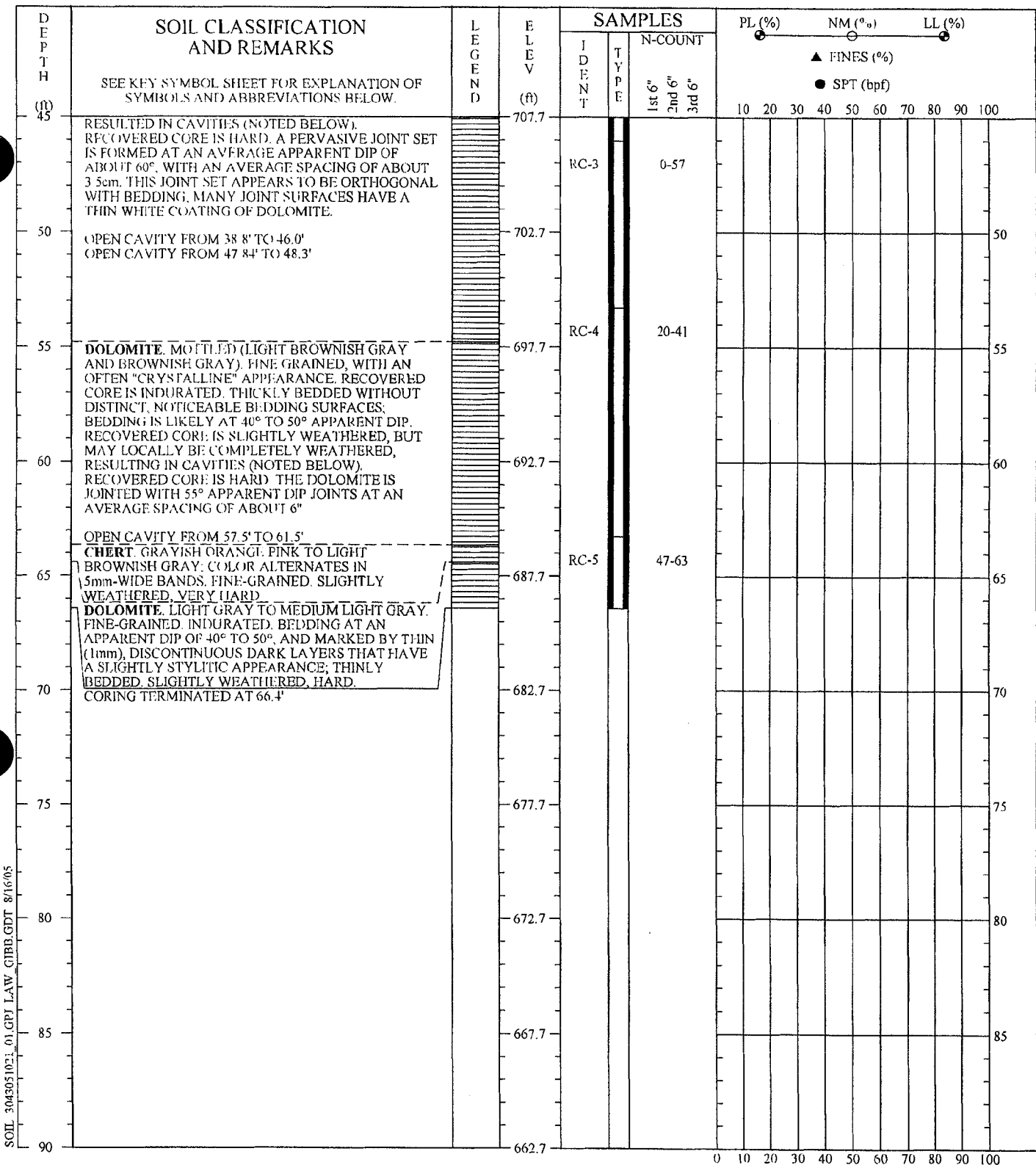

SOIL 3043051021.01.GPJ LAW QIBB.GDT 8/16/05

REMARKS: STANDARD PENETRATION RESISTANCE TESTING PERFORMED USING AN AUTOMATIC HAMMER.

SOIL TEST BORING RECORD

PROJECT: Proposed Gypsum Disposal Area
DRILLED: May 2, 2005 **BORING NO.:** NB-66
PROJ. NO.: 3043051021/0001 **PAGE 2 OF 2**

THIS RECORD IS A REASONABLE INTERPRETATION OF SUBSURFACE CONDITIONS AT THE EXPLORATION LOCATION. SUBSURFACE CONDITIONS AT OTHER LOCATIONS AND AT OTHER TIMES MAY DIFFER. INTERRACHES BETWEEN STRATA ARE APPROXIMATE. TRANSITIONS BETWEEN STRATA MAY BE GRADUAL.

Driller : Burnett
 Prepared By: Mason
 Checked By: Justice



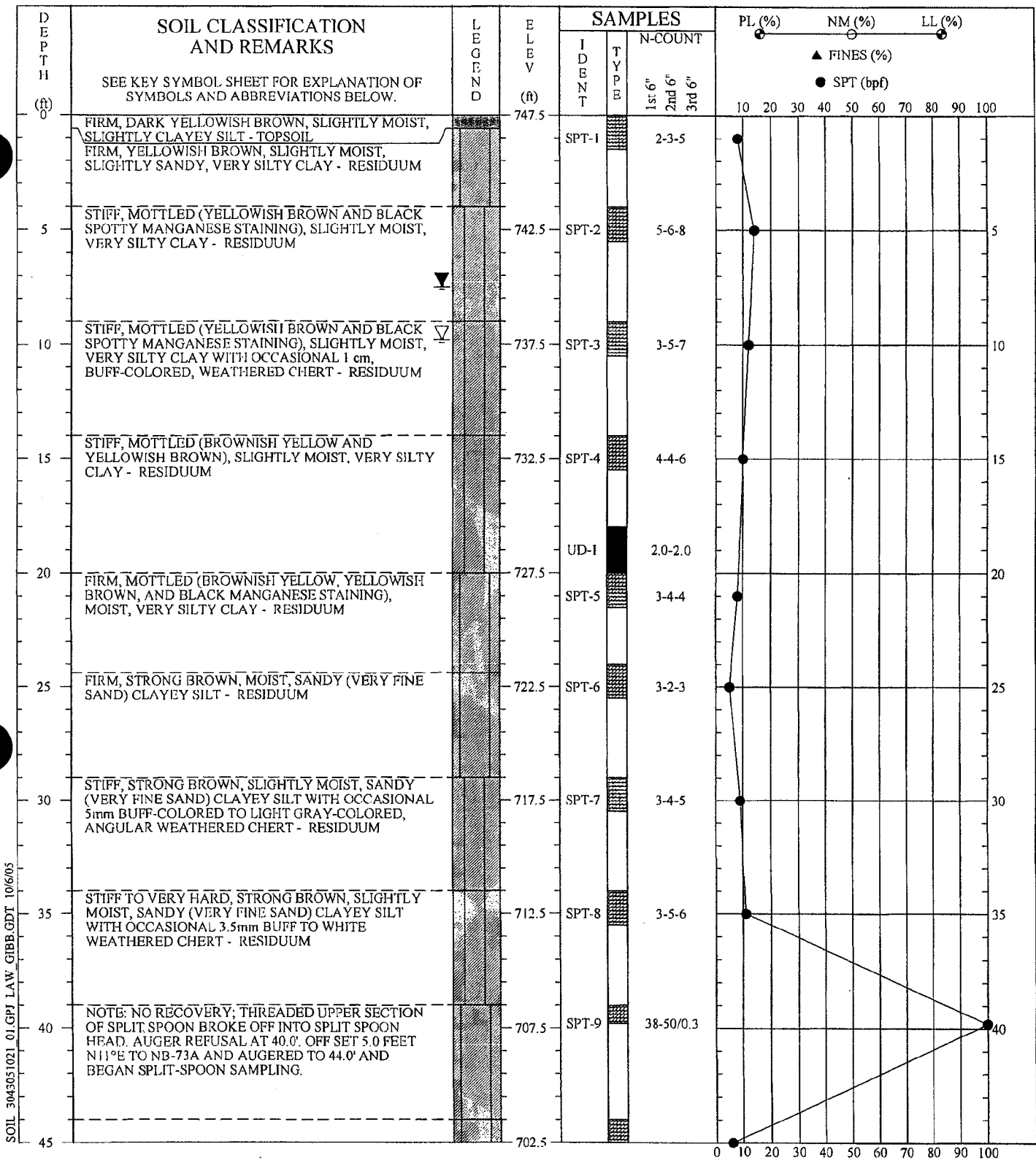

SOIL 3043051021_01.GPJ LAW_GIBB.GDT 10/6/05

REMARKS: STANDARD PENETRATION RESISTANCE TESTING PERFORMED USING AN AUTOMATIC HAMMER. NB-73A WAS OFFSET APPROXIMATELY 5.0' N11°E OF NB-73.

SOIL TEST BORING RECORD

PROJECT: Proposed Gypsum Disposal Area
DRILLED: May 4, 2005 **BORING NO.:** NB-73/73A
PROJ. NO.: 3043051021/0001 **PAGE 1 OF 2**

THIS RECORD IS A REASONABLE INTERPRETATION OF SUBSURFACE CONDITIONS AT THIS EXPLORATION LOCATION. SUBSURFACE CONDITIONS AT OTHER LOCATIONS AND AT OTHER TIMES MAY DIFFER. INTERFACES BETWEEN STRATA ARE APPROXIMATE. TRANSITIONS BETWEEN STRATA MAY BE GRADUAL.

Driller : Burnett
 Prepared By: Mason
 Checked By: Haston



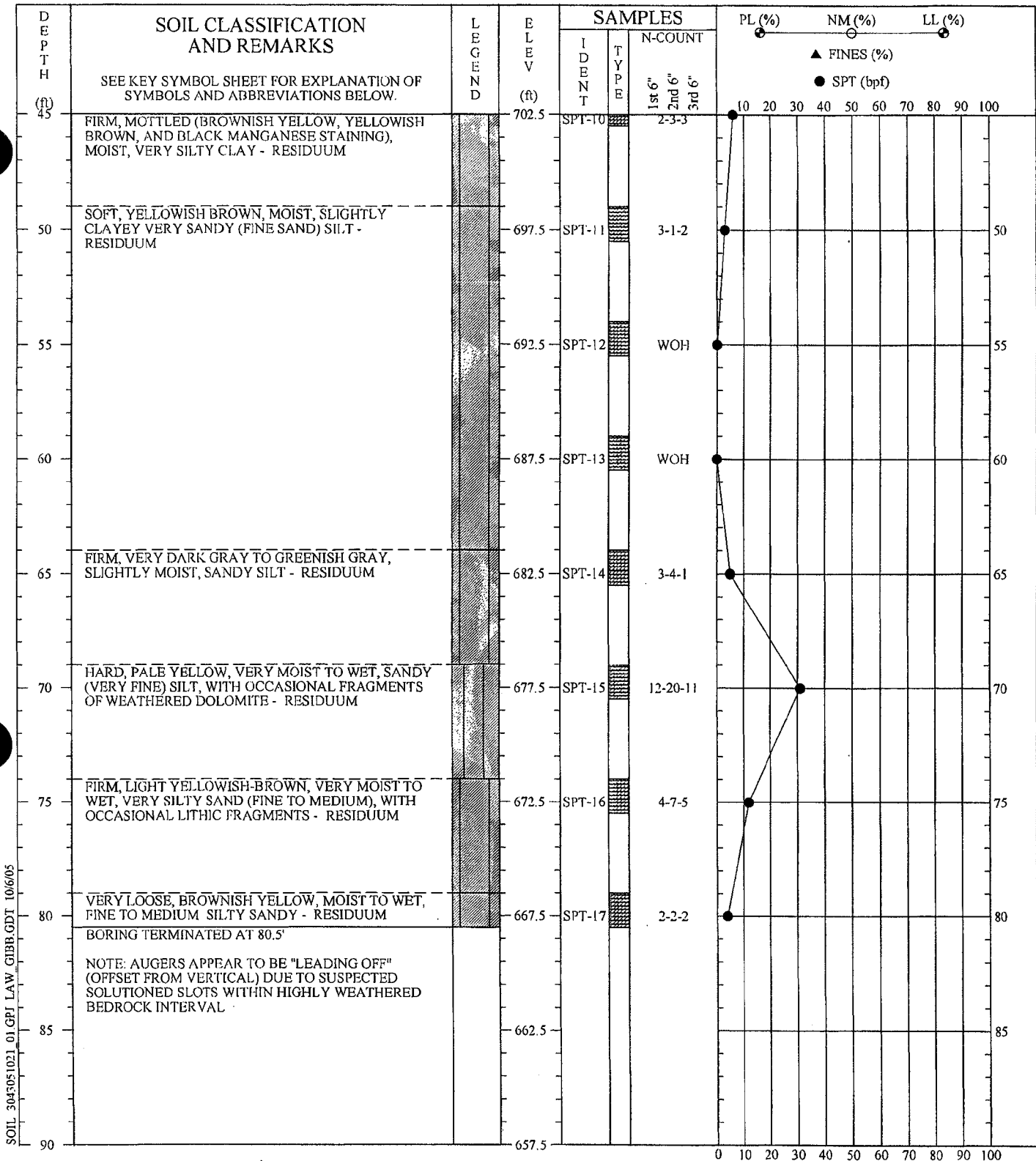

SOIL 3043051021 01.GPJ LAW GIBB.GDT 10/6/05

REMARKS: STANDARD PENETRATION RESISTANCE TESTING PERFORMED USING AN AUTOMATIC HAMMER. NB-73A WAS OFFSET APPROXIMATELY 5.0' N11°E OF NB-73.

SOIL TEST BORING RECORD

PROJECT: Proposed Gypsum Disposal Area
DRILLED: May 4, 2005 **BORING NO.:** NB-73/73A
PROJ. NO.: 3043051021/0001 **PAGE 2 OF 2**

THIS RECORD IS A REASONABLE INTERPRETATION OF SUBSURFACE CONDITIONS AT THE EXPLORATION LOCATION. SUBSURFACE CONDITIONS AT OTHER LOCATIONS AND AT OTHER TIMES MAY DIFFER. INTERFACES BETWEEN STRATA ARE APPROXIMATE. TRANSITIONS BETWEEN STRATA MAY BE GRADUAL.

Driller : Burnett
 Prepared By: Mason
 Checked By: Haston



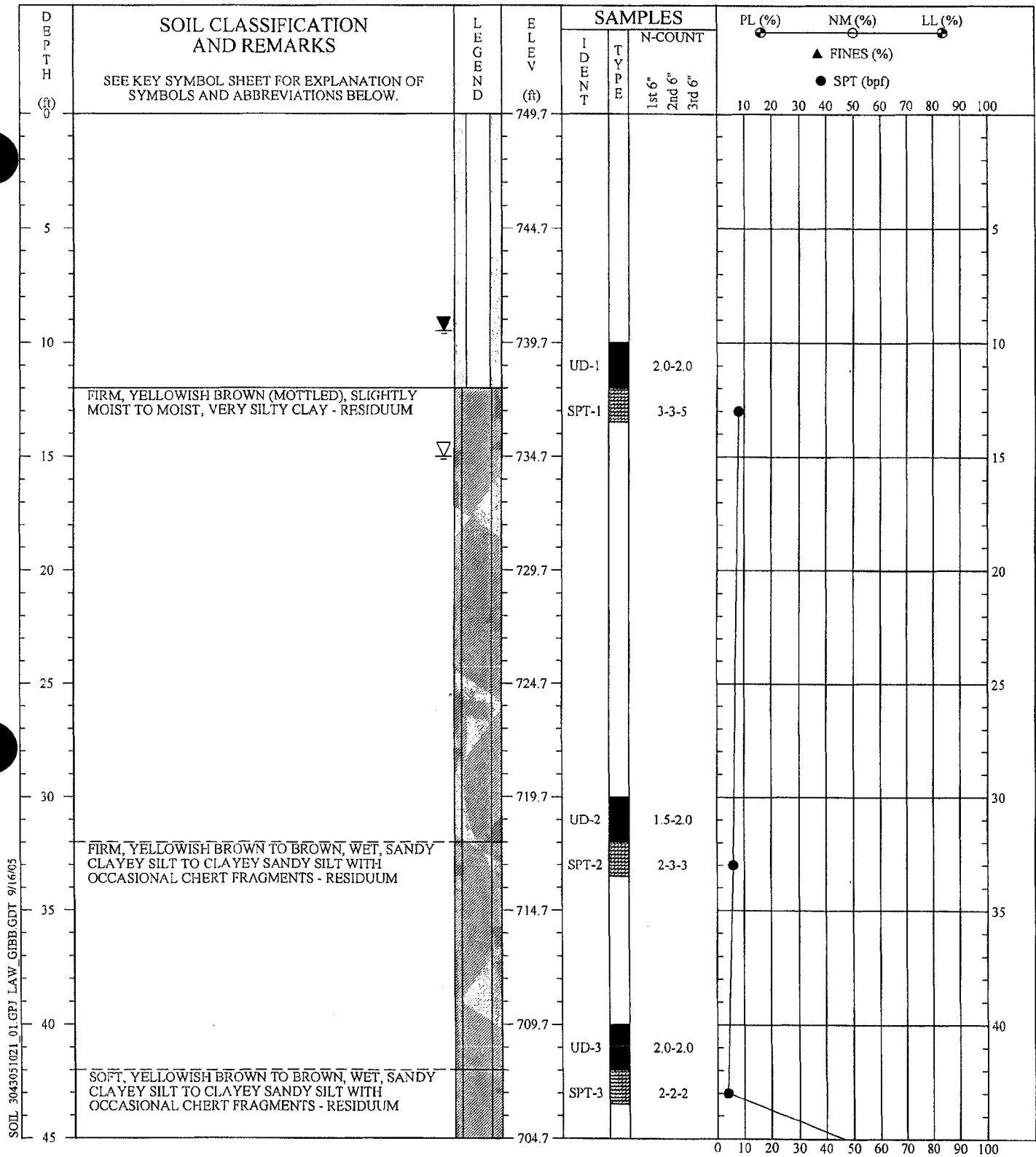

SOIL 3043051021 01.GPJ LAW GIBB GDT 9/16/05

REMARKS: STANDARD PENETRATION RESISTANCE TESTING PERFORMED USING AN AUTOMATIC HAMMER. NB-73W WAS OFFSET APPROXIMATELY 48.9' W OF NB-73.

SOIL TEST BORING RECORD

PROJECT: Proposed Gypsum Disposal Area
DRILLED: May 18, 2005 **BORING NO.:** NB-73W
PROJ. NO.: 3043051021/0001 **PAGE 1 OF 2**

THIS RECORD IS A REASONABLE INTERPRETATION OF SUBSURFACE CONDITIONS AT THE EXPLORATION LOCATION. SUBSURFACE CONDITIONS AT OTHER LOCATIONS AND AT OTHER TIMES MAY DIFFER. INTERFACES BETWEEN STRATA ARE APPROXIMATE. TRANSITIONS BETWEEN STRATA MAY BE GRADUAL.

Driller : Akins
 Prepared By: Justice
 Checked By: Lawson



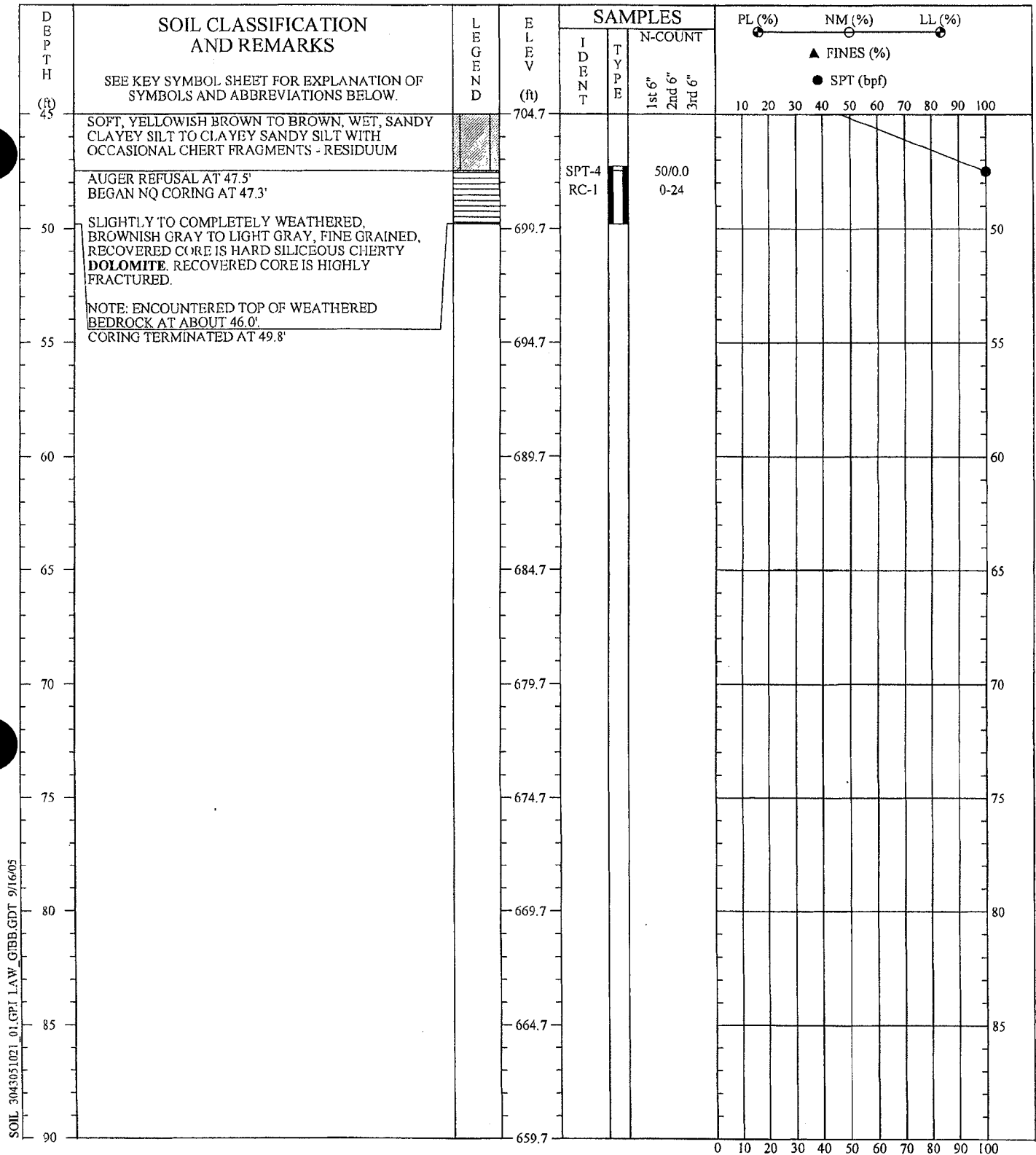

SOIL 3043051021 01.CPI.LAW.GEBB.GDT 9/16/05

REMARKS: STANDARD PENETRATION RESISTANCE TESTING PERFORMED USING AN AUTOMATIC HAMMER. NB-73W WAS OFFSET APPROXIMATELY 48.9' W OF NB-73.

SOIL TEST BORING RECORD

PROJECT: Proposed Gypsum Disposal Area
DRILLED: May 18, 2005 **BORING NO.:** NB-73W
PROJ. NO.: 3043051021/0001 **PAGE 2 OF 2**

THIS RECORD IS A REASONABLE INTERPRETATION OF SUBSURFACE CONDITIONS AT THE EXPLORATION LOCATION. SUBSURFACE CONDITIONS AT OTHER LOCATIONS AND AT OTHER TIMES MAY DIFFER. INTERFACES BETWEEN STRATA ARE APPROXIMATE. TRANSITIONS BETWEEN STRATA MAY BE GRADUAL.

Driller : Akins
 Prepared By: Justice
 Checked By: Lawson



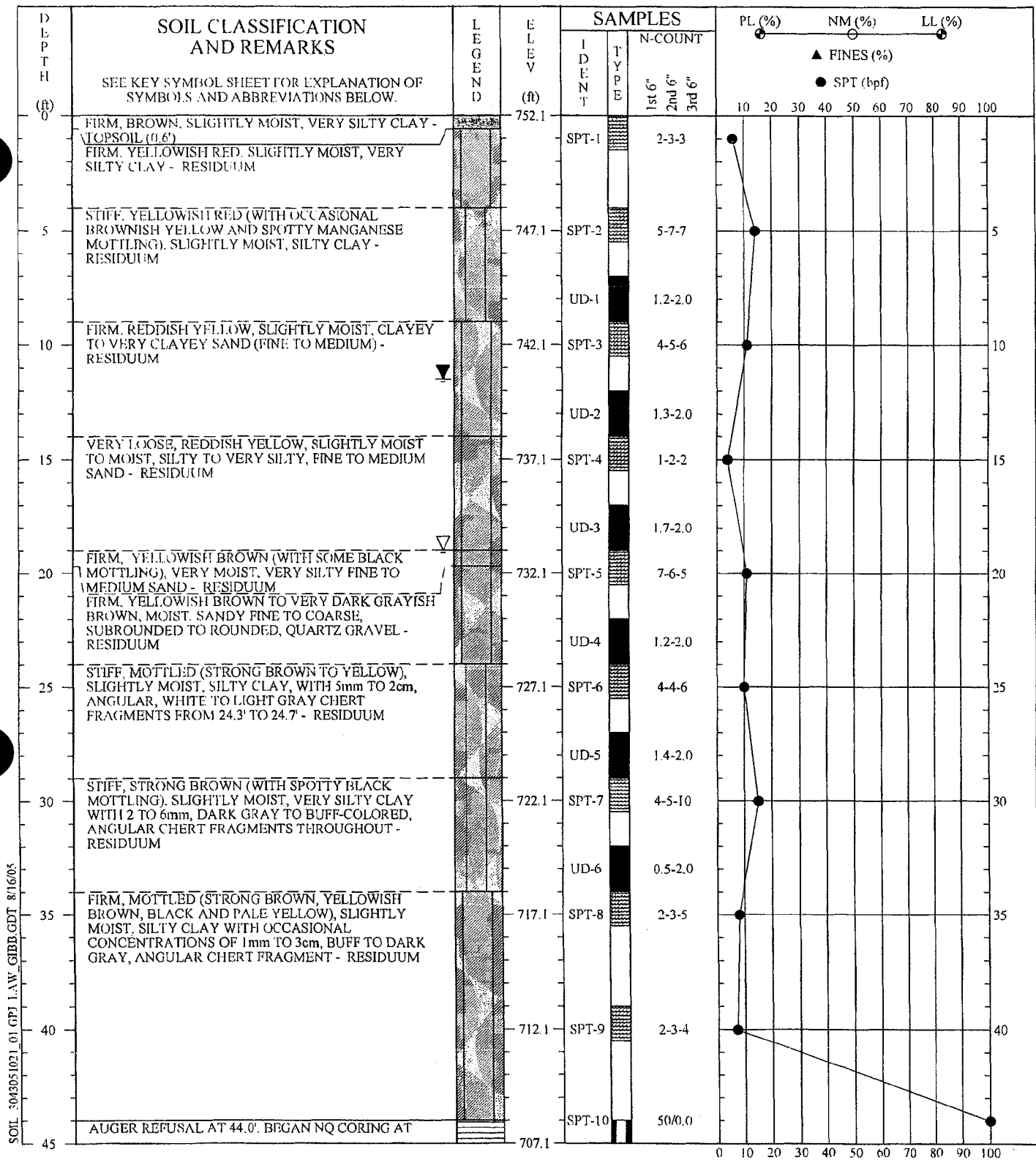

SOIL 3043051021_01.GPJ I.A.W. GIBB.GDT 8/16/05

REMARKS: STANDARD PENETRATION RESISTANCE TESTING PERFORMED USING AN AUTOMATIC HAMMER.

THIS RECORD IS A REASONABLE INTERPRETATION OF SUBSURFACE CONDITIONS AT THE EXPLORATION LOCATION. SUBSURFACE CONDITIONS AT OTHER LOCATIONS AND AT OTHER TIMES MAY DIFFER. INTERFACES BETWEEN STRATA ARE APPROXIMATE. TRANSITIONS BETWEEN STRATA MAY BE GRADUAL.

Driller : Burnett
 Prepared By: Mason
 Checked By: Lawson

SOIL TEST BORING RECORD	
PROJECT: Proposed Gypsum Disposal Area	BORING NO.: NB-74
DRILLED: May 5, 2005	
PROJ. NO.: 3043051021/0001	PAGE 1 OF 2

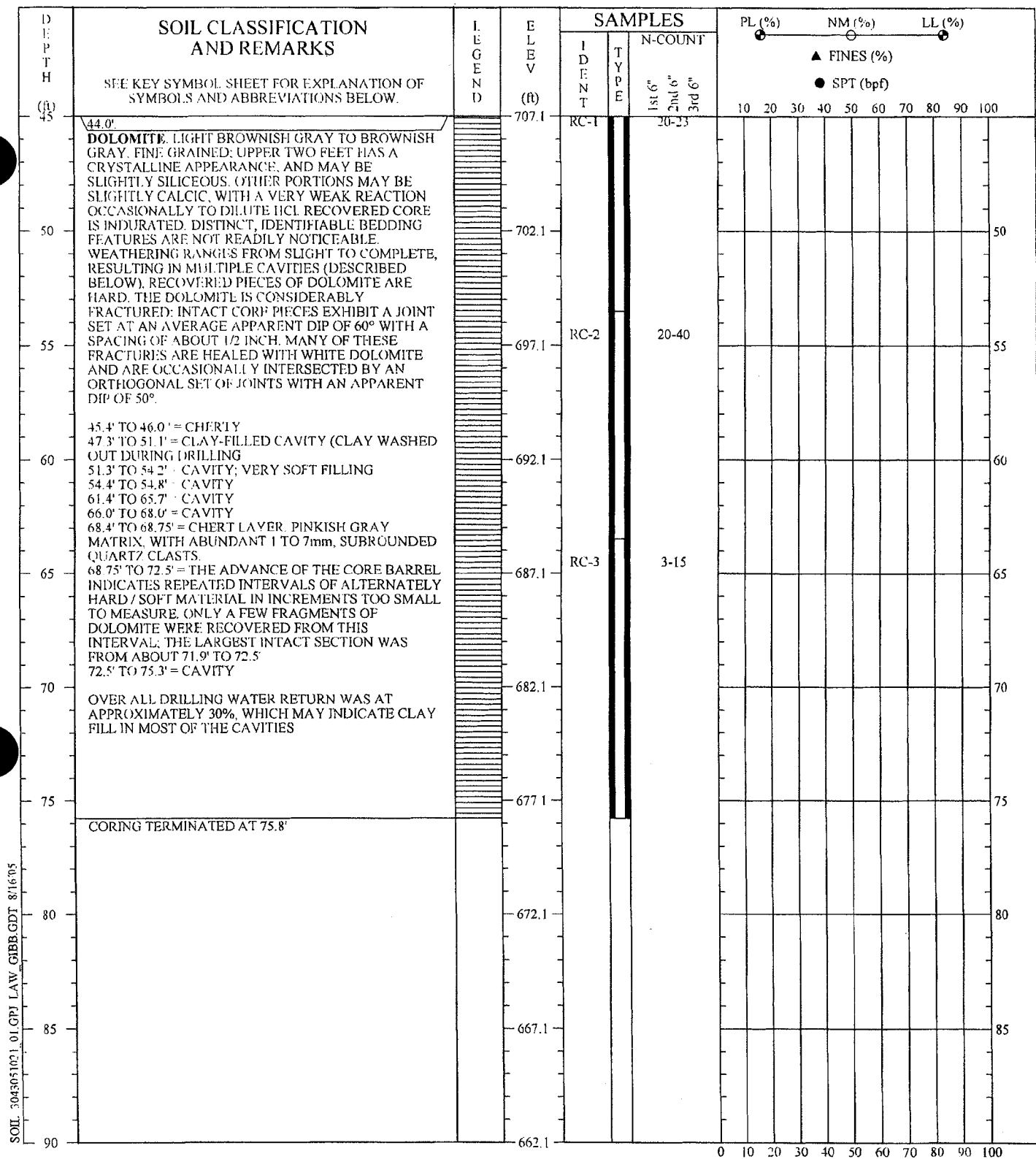

SOIL 3043051021 01.GPJ LAW_GIBB.GDT 8/16/05

REMARKS: STANDARD PENETRATION RESISTANCE TESTING PERFORMED USING AN AUTOMATIC HAMMER.

SOIL TEST BORING RECORD

PROJECT: Proposed Gypsum Disposal Area
DRILLED: May 5, 2005 **BORING NO.:** NB-74
PROJ. NO.: 3043051021/0001 **PAGE 2 OF 2**

THIS RECORD IS A REASONABLE INTERPRETATION OF SUBSURFACE CONDITIONS AT THE EXPLORATION LOCATION. SUBSURFACE CONDITIONS AT OTHER LOCATIONS AND AT OTHER TIMES MAY DIFFER. INTERFACES BETWEEN STRATA ARE APPROXIMATE. TRANSITIONS BETWEEN STRATA MAY BE GRADUAL.

Driller: Burnett
 Prepared By: Mason
 Checked By: Lawson



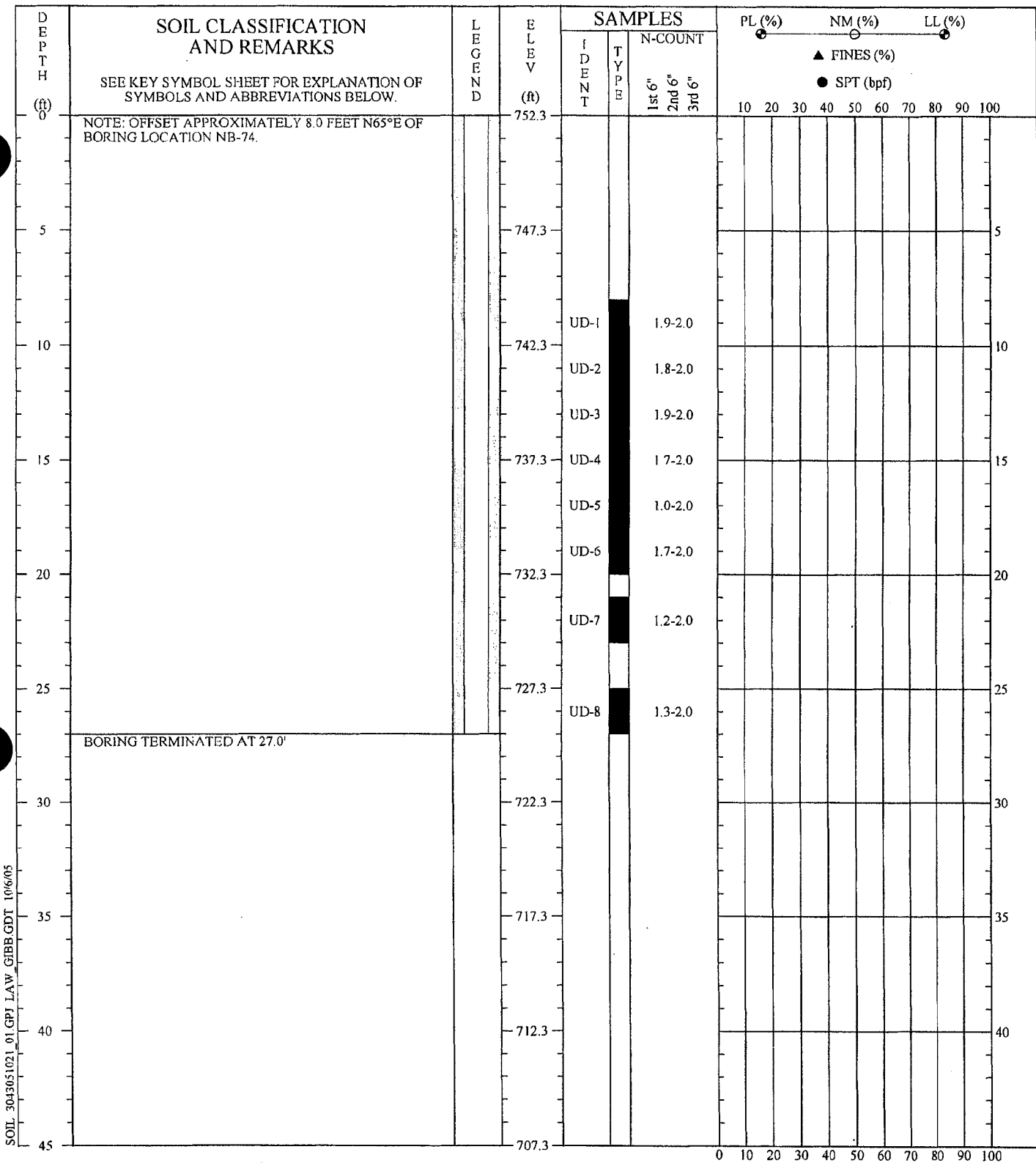

SOIL 3043051021 01.GPJ LAW GIBB.GDT 10/6/05

REMARKS: STANDARD PENETRATION RESISTANCE TESTING PERFORMED USING AN AUTOMATIC HAMMER. NO GROUND WATER ENCOUNTERED AT TIME OF EXPLORATION. NB-74A WAS OFFSET APPROXIMATELY 8.0° N65°E OF NB-74.

THIS RECORD IS A REASONABLE INTERPRETATION OF SUBSURFACE CONDITIONS AT THE EXPLORATION LOCATION. SUBSURFACE CONDITIONS AT OTHER LOCATIONS AND AT OTHER TIMES MAY DIFFER. INTERFACES BETWEEN STRATA ARE APPROXIMATE. TRANSITIONS BETWEEN STRATA MAY BE GRADUAL.

Driller : Burnett
Prepared By: Justice
Checked By: Lawson

SOIL TEST BORING RECORD	
PROJECT: Proposed Gypsum Disposal Area	
DRILLED: May 11, 2005	BORING NO.: NB-74A
PROJ. NO.: 3043051021/0001	PAGE 1 OF 1
 MACTEC	

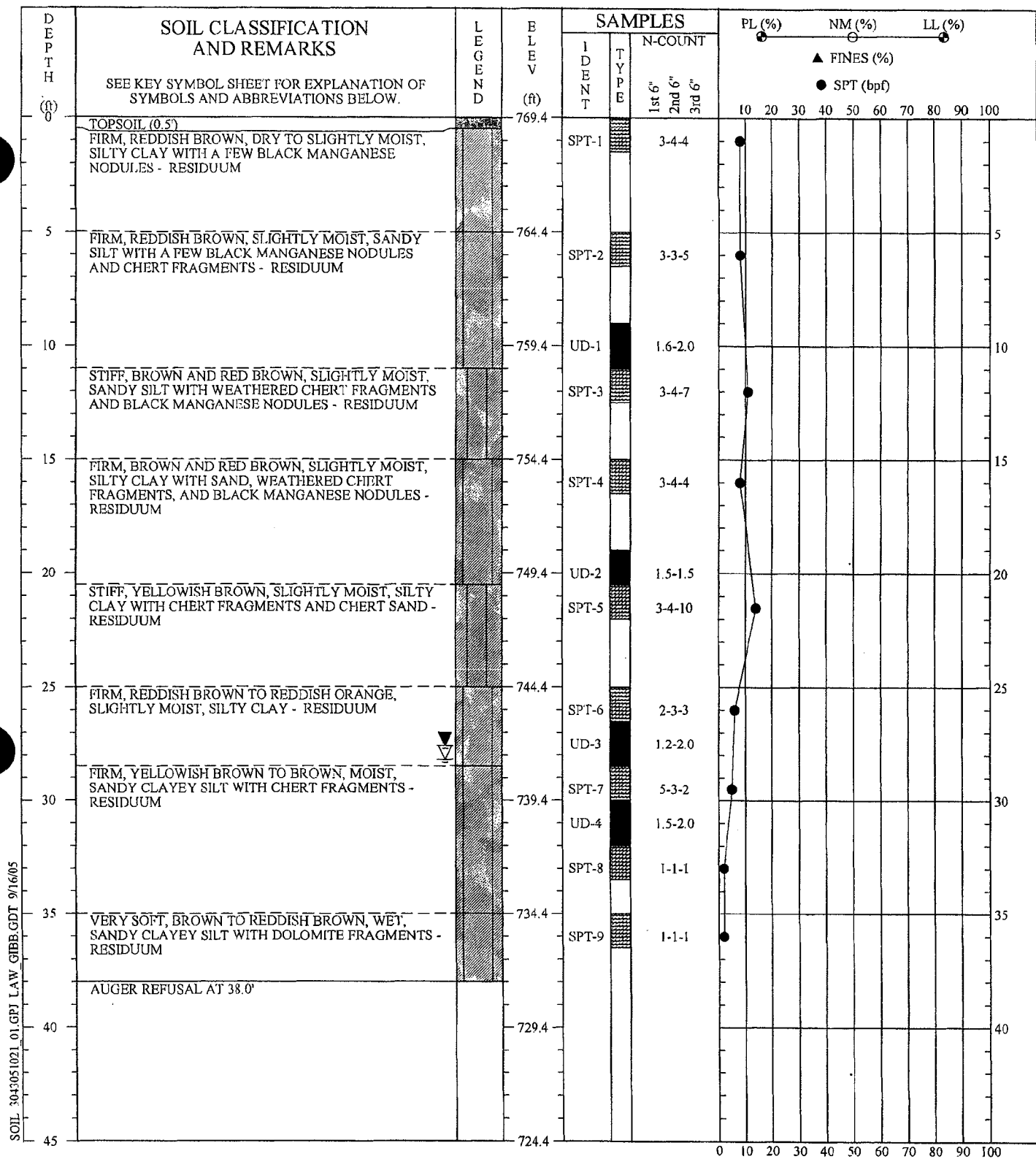

SOIL 3043051021 01.GPJ LAW GIBB.GDT 9/16/05

REMARKS: STANDARD PENETRATION RESISTANCE TESTING PERFORMED USING AN AUTOMATIC HAMMER.

SOIL TEST BORING RECORD	
PROJECT: Proposed Gypsum Disposal Area	
DRILLED: May 12, 2005	BORING NO.: NB-76
PROJ. NO.: 3043051021/0001	PAGE 1 OF 1

THIS RECORD IS A REASONABLE INTERPRETATION OF SUBSURFACE CONDITIONS AT THE EXPLORATION LOCATION. SUBSURFACE CONDITIONS AT OTHER LOCATIONS AND AT OTHER TIMES MAY DIFFER. INTERFACES BETWEEN STRATA ARE APPROXIMATE. TRANSITIONS BETWEEN STRATA MAY BE GRADUAL.

Driller : Akins
Prepared By: Justice
Checked By: Lawson

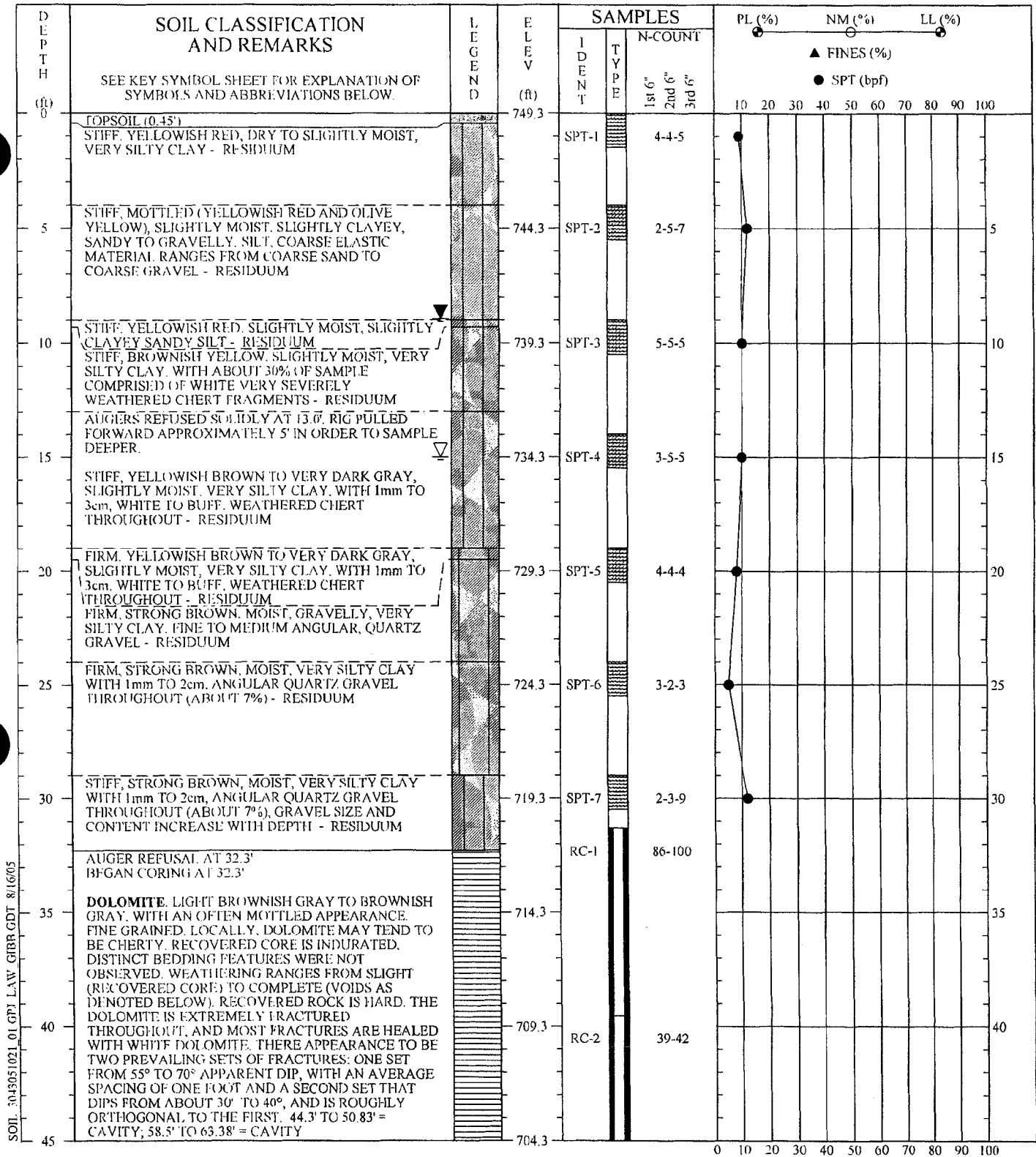

SOIL: 3043051021 01 GPI LAW GIBR GDT 8/16/05

REMARKS: STANDARD PENETRATION RESISTANCE TESTING PERFORMED USING AN AUTOMATIC HAMMER.

THIS RECORD IS A REASONABLE INTERPRETATION OF SUBSURFACE CONDITIONS AT THE EXPLORATION LOCATION. SUBSURFACE CONDITIONS AT OTHER LOCATIONS AND AT OTHER TIMES MAY DIFFER. INTERFACES BETWEEN STRATA ARE APPROXIMATE. TRANSITIONS BETWEEN STRATA MAY BE GRADUAL.

Driller: Burnett
Prepared By: Mason
Checked By: Lawson

SOIL TEST BORING RECORD	
PROJECT: Proposed Gypsum Disposal Area	
DRILLED: May 10, 2005	BORING NO.: NB-77
PROJ. NO.: 3043051021/0001	PAGE 1 OF 2
MACTEC	

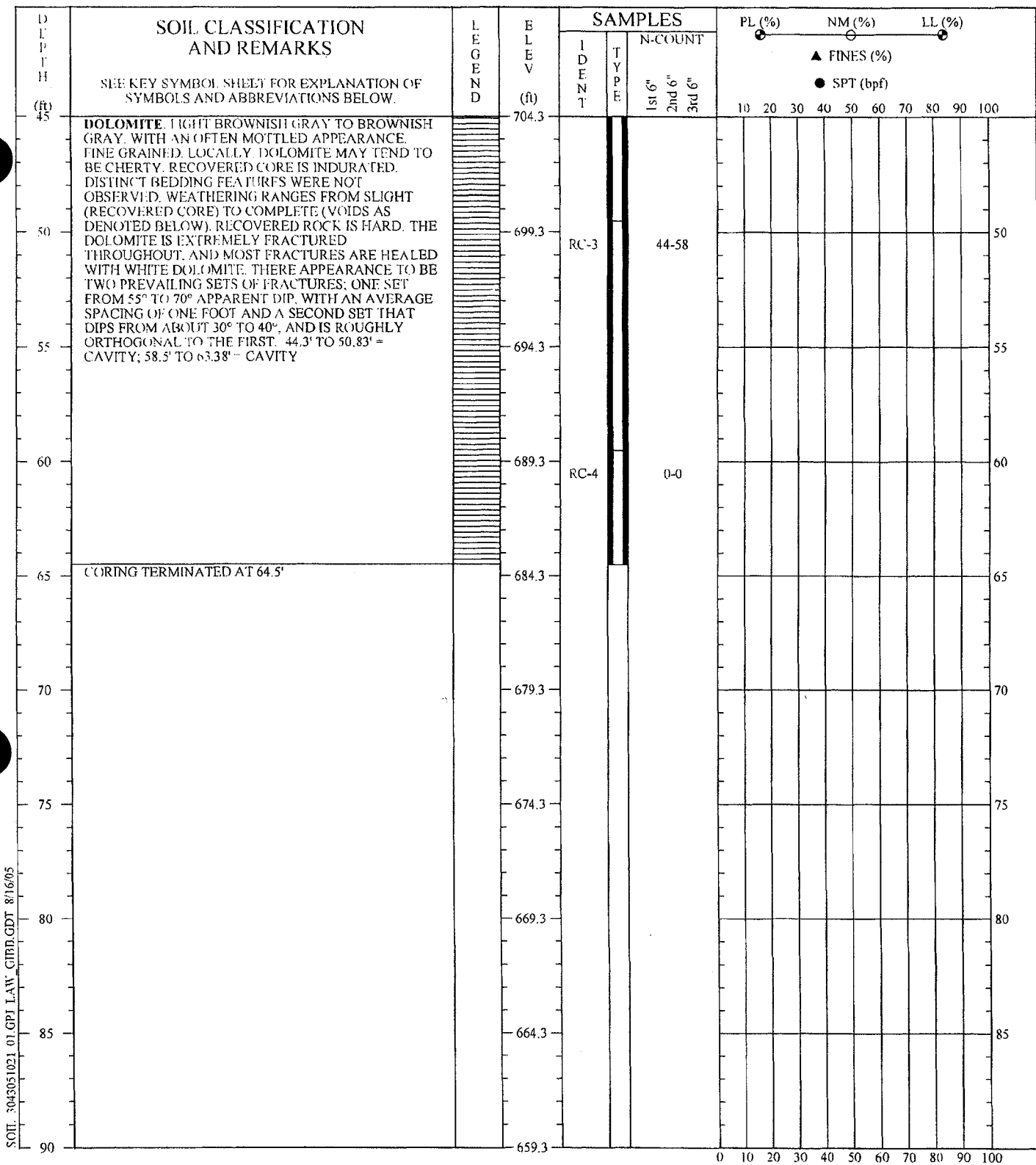

SOIL: 3043051021 01 GPI LAW: CIMB.GDT 8/16/05

REMARKS: STANDARD PENETRATION RESISTANCE TESTING PERFORMED USING AN AUTOMATIC HAMMER.

SOIL TEST BORING RECORD

PROJECT: Proposed Gypsum Disposal Area
DRILLED: May 10, 2005 **BORING NO.:** NB-77
PROJ. NO.: 3043051021/0001 **PAGE 2 OF 2**

THIS RECORD IS A REASONABLE INTERPRETATION OF SUBSURFACE CONDITIONS AT THE EXPLORATION LOCATION. SUBSURFACE CONDITIONS AT OTHER LOCATIONS AND AT OTHER TIMES MAY DIFFER. INTERFACES BETWEEN STRATA ARE APPROXIMATE. TRANSITIONS BETWEEN STRATA MAY BE GRADUAL.

Driller: Burnett
 Prepared By: Mason
 Checked By: Lawson



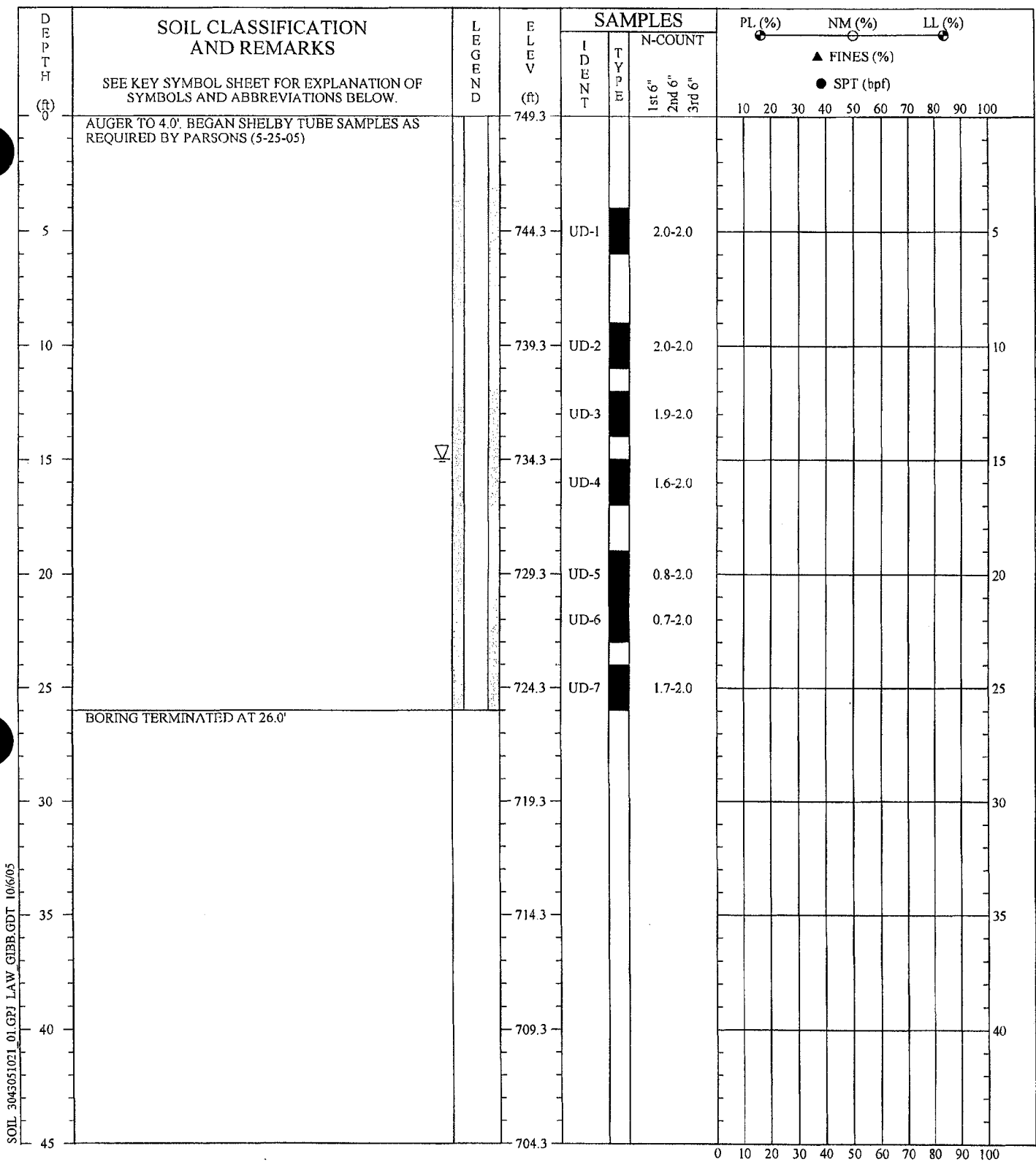

SOIL 3043051021_01.GPJ LAW GIBB.GDT 10/6/05

REMARKS: STANDARD PENETRATION RESISTANCE TESTING PERFORMED USING AN AUTOMATIC HAMMER. NB-77A WAS OFFSET APPROXIMATELY 11.0 N75°E OF NB-77.

SOIL TEST BORING RECORD	
PROJECT: Proposed Gypsum Disposal Area	BORING NO.: NB-77A
DRILLED: May 27, 2005	PAGE 1 OF 1
PROJ. NO.: 3043051021/0001	
	

THIS RECORD IS A REASONABLE INTERPRETATION OF SUBSURFACE CONDITIONS AT THE EXPLORATION LOCATION. SUBSURFACE CONDITIONS AT OTHER LOCATIONS AND AT OTHER TIMES MAY DIFFER. INTERFACES BETWEEN STRATA ARE APPROXIMATE. TRANSITIONS BETWEEN STRATA MAY BE GRADUAL.

Driller : Bailey
 Prepared By: Lawson
 Checked By: Haston

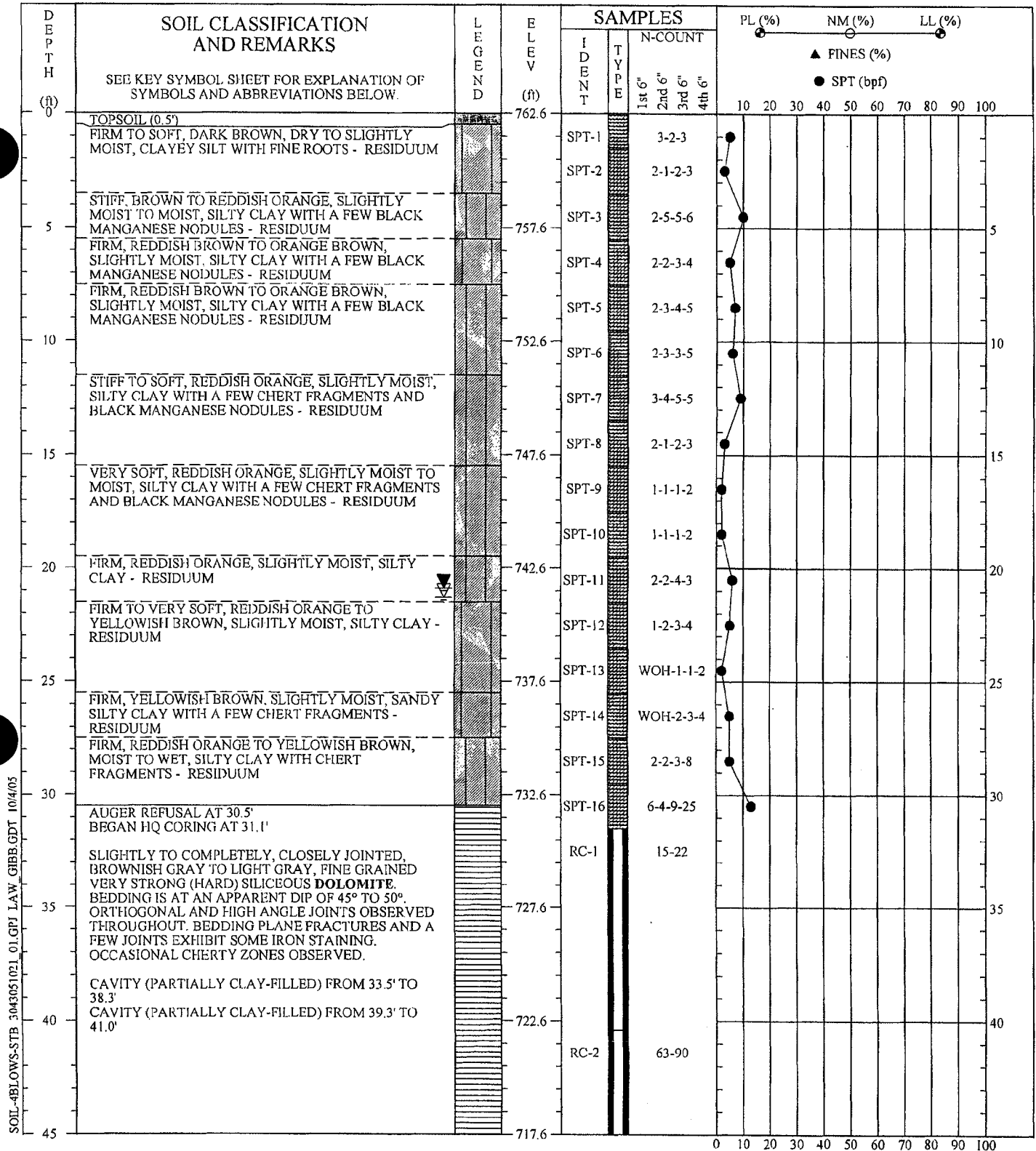

SOIL-BLOWS-STB 3043051021_01.GPJ LAW_GIBB.GDT 10/4/05

REMARKS: STANDARD PENETRATION RESISTANCE TESTING PERFORMED USING AN AUTOMATIC HAMMER.

SOIL TEST BORING RECORD	
PROJECT: Proposed Gypsum Disposal Area	
DRILLED: May 13, 2005	BORING NO.: NB-81
PROJ. NO.: 3043051021/0001	
PAGE 1 OF 2	
MACTEC	

THIS RECORD IS A REASONABLE INTERPRETATION OF SUBSURFACE CONDITIONS AT THE EXPLORATION LOCATION. SUBSURFACE CONDITIONS AT OTHER LOCATIONS AND AT OTHER TIMES MAY DIFFER. INTERFACES BETWEEN STRATA ARE APPROXIMATE. TRANSITIONS BETWEEN STRATA MAY BE GRADUAL.

Driller : Akins
 Prepared By: Justice
 Checked By: Lawson

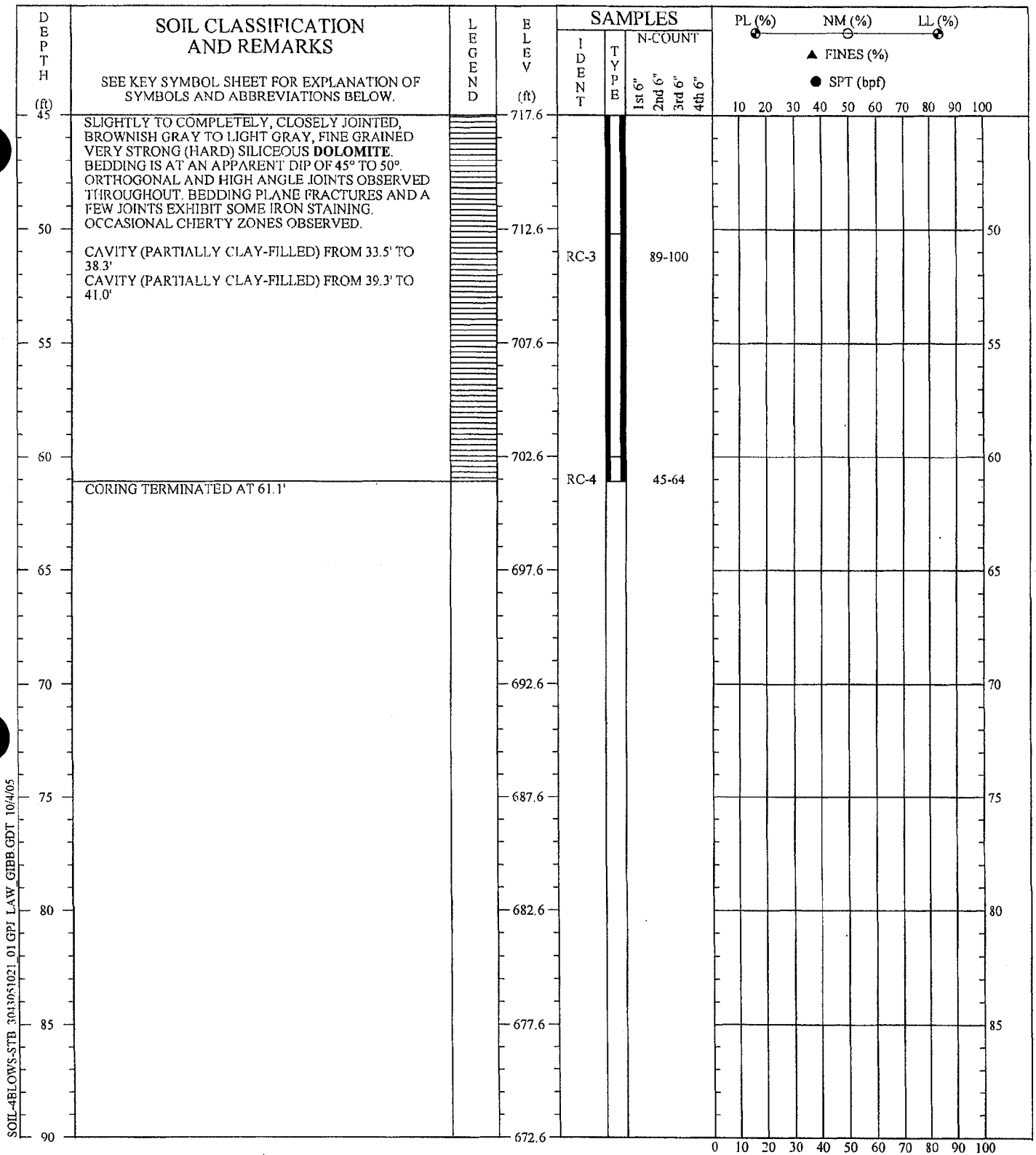

SOIL-BLOWS-STB 3043051021 01 GPJ LAW GIBB GDT 10/4/05

REMARKS: STANDARD PENETRATION RESISTANCE TESTING PERFORMED USING AN AUTOMATIC HAMMER.

SOIL TEST BORING RECORD

PROJECT: Proposed Gypsum Disposal Area
DRILLED: May 13, 2005 **BORING NO.:** NB-81
PROJ. NO.: 3043051021/0001 **PAGE 2 OF 2**

THIS RECORD IS A REASONABLE INTERPRETATION OF SUBSURFACE CONDITIONS AT THE EXPLORATION LOCATION. SUBSURFACE CONDITIONS AT OTHER LOCATIONS AND AT OTHER TIMES MAY DIFFER. INTERFACES BETWEEN STRATA ARE APPROXIMATE. TRANSITIONS BETWEEN STRATA MAY BE GRADUAL.

Driller : Akins
 Prepared By: Justice
 Checked By: Lawson



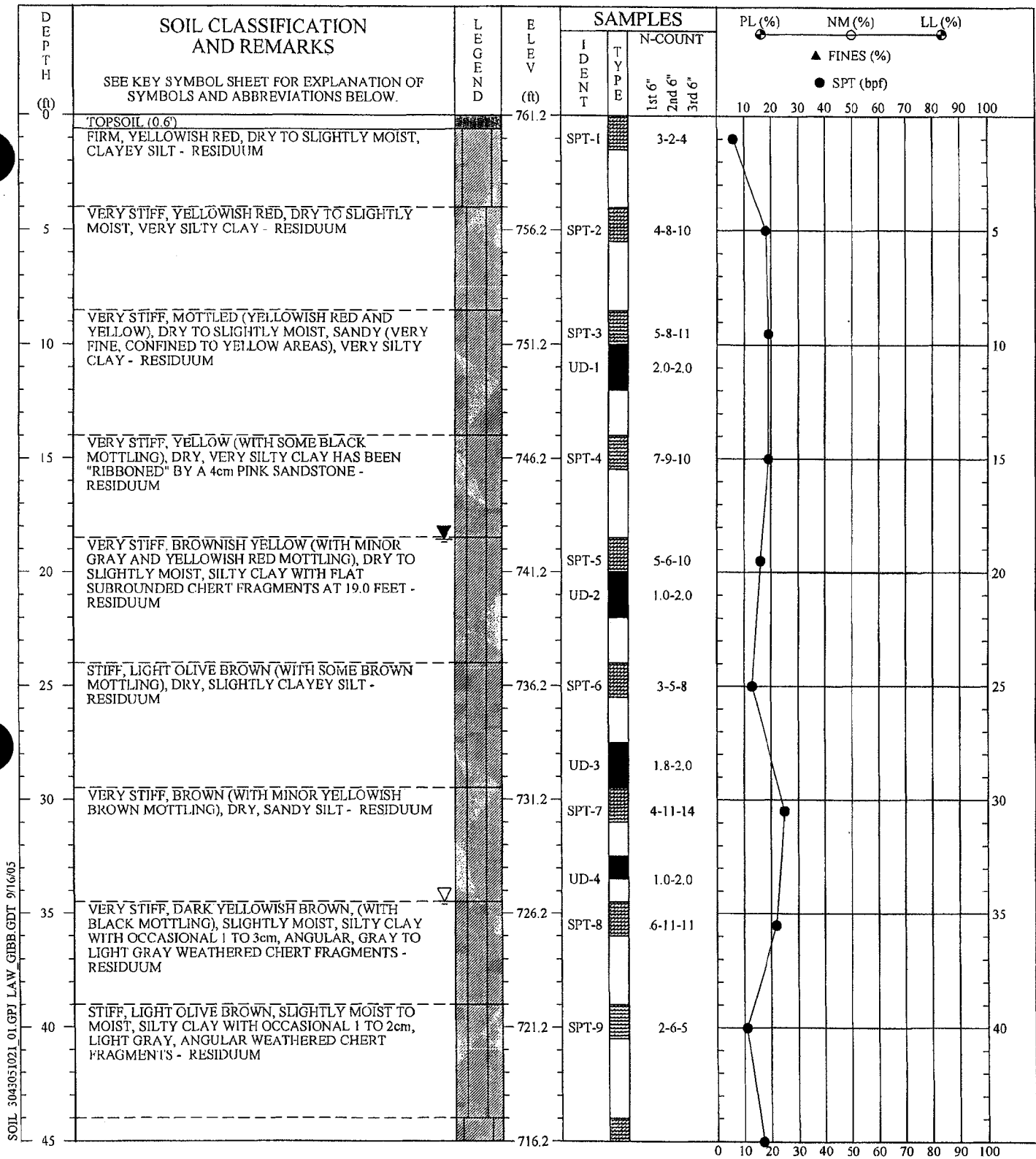

SOIL 3043051021 01.GPI LAW_GIBB.GDT 9/16/05

REMARKS: STANDARD PENETRATION RESISTANCE TESTING PERFORMED USING AN AUTOMATIC HAMMER.

SOIL TEST BORING RECORD

PROJECT: Proposed Gypsum Disposal Area
DRILLED: May 13, 2005 **BORING NO.:** NB-84
PROJ. NO.: 3043051021/0001 **PAGE 1 OF 2**

THIS RECORD IS A REASONABLE INTERPRETATION OF SUBSURFACE CONDITIONS AT THE EXPLORATION LOCATION. SUBSURFACE CONDITIONS AT OTHER LOCATIONS AND AT OTHER TIMES MAY DIFFER. INTERFACES BETWEEN STRATA ARE APPROXIMATE. TRANSITIONS BETWEEN STRATA MAY BE GRADUAL.

Driller : Burnett
 Prepared By: Mason
 Checked By: Lawson



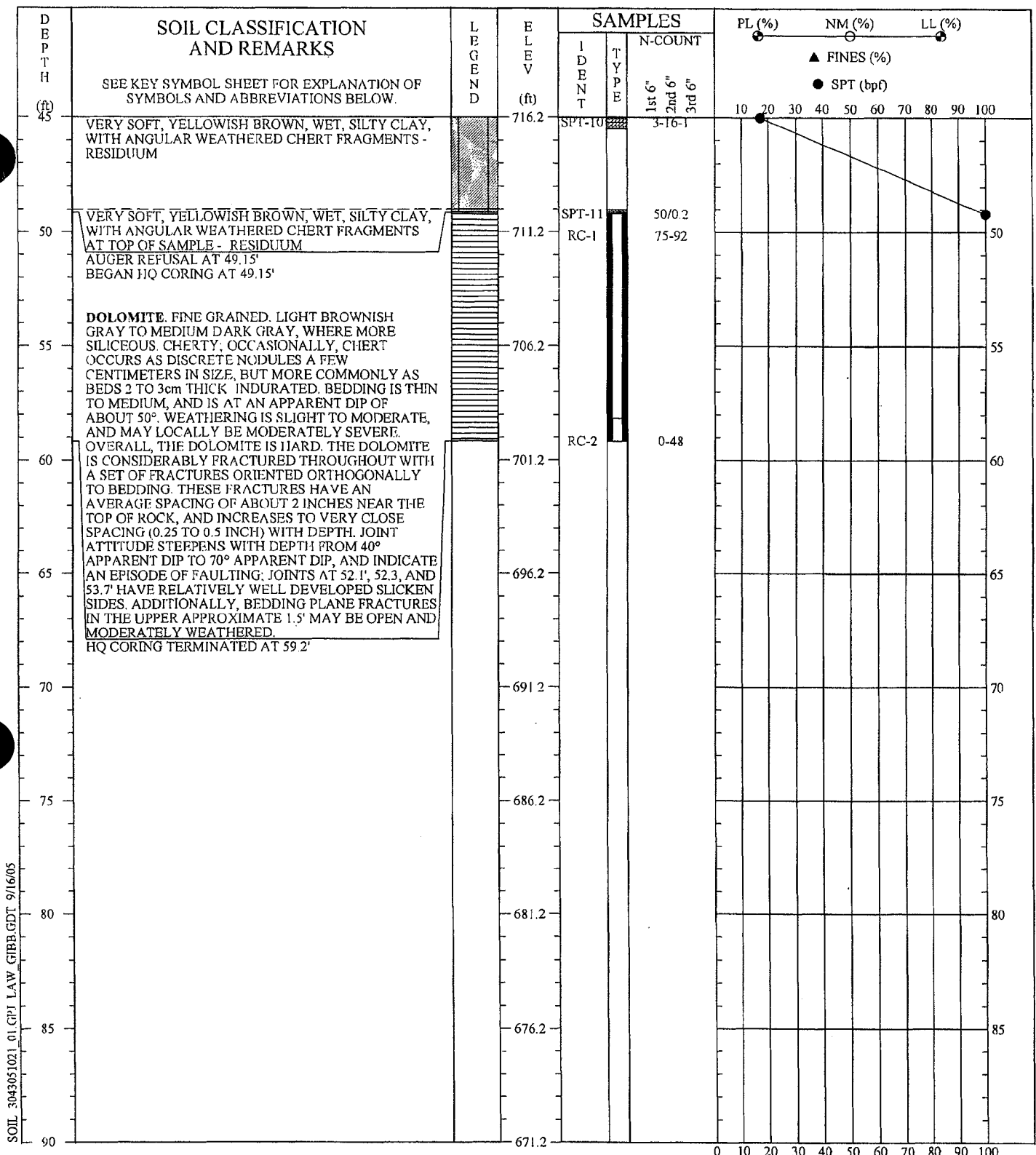

SOIL 3043051021_01.CPJ LAW, GIBB, GDT 9/16/05

REMARKS: STANDARD PENETRATION RESISTANCE TESTING PERFORMED USING AN AUTOMATIC HAMMER.

SOIL TEST BORING RECORD	
PROJECT: Proposed Gypsum Disposal Area	
DRILLED: May 13, 2005	BORING NO.: NB-84
PROJ. NO.: 3043051021/0001	PAGE 2 OF 2
MACTEC	

THIS RECORD IS A REASONABLE INTERPRETATION OF SUBSURFACE CONDITIONS AT THE EXPLORATION LOCATION. SUBSURFACE CONDITIONS AT OTHER LOCATIONS AND AT OTHER TIMES MAY DIFFER. INTERFACES BETWEEN STRATA ARE APPROXIMATE. TRANSITIONS BETWEEN STRATA MAY BE GRADUAL.

Driller : Burnett
 Prepared By: Mason
 Checked By: Lawson

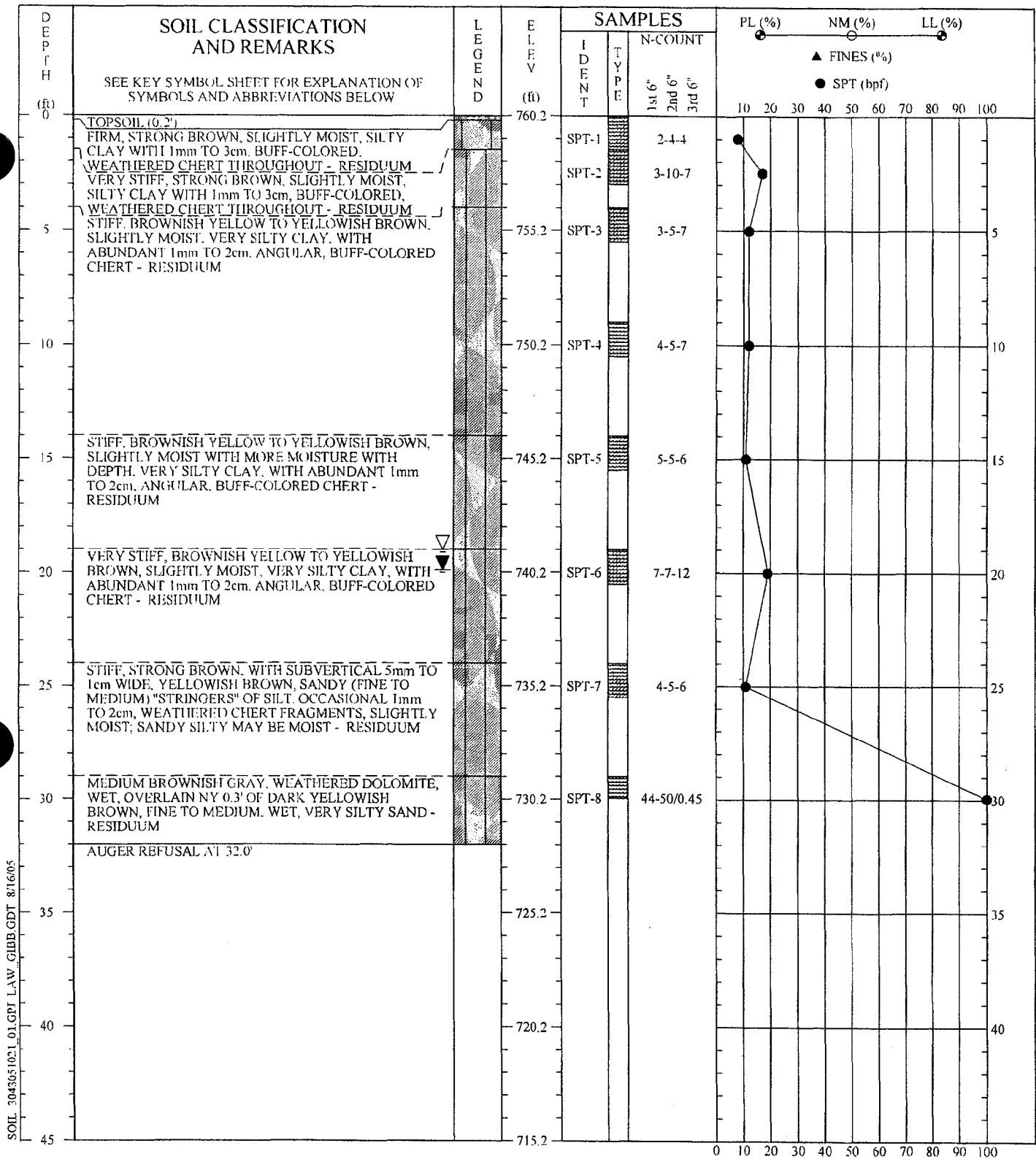

SOIL 3043051021 01.GPJ LAW_GIBB.GDT 8/16/05

REMARKS: STANDARD PENETRATION RESISTANCE TESTING PERFORMED USING AN AUTOMATIC HAMMER.

SOIL TEST BORING RECORD	
PROJECT: Proposed Gypsum Disposal Area	BORING NO.: NB-85
DRILLED: May 10, 2005	
PROJ. NO.: 3043051021/0001	PAGE 1 OF 1

THIS RECORD IS A REASONABLE INTERPRETATION OF SUBSURFACE CONDITIONS AT THE EXPLORATION LOCATION. SUBSURFACE CONDITIONS AT OTHER LOCATIONS AND AT OTHER TIMES MAY DIFFER. INTERFACES BETWEEN STRATA ARE APPROXIMATE. TRANSITIONS BETWEEN STRATA MAY BE GRADUAL.

Driller: Burnett
 Prepared By: Mason
 Checked By: Lawson

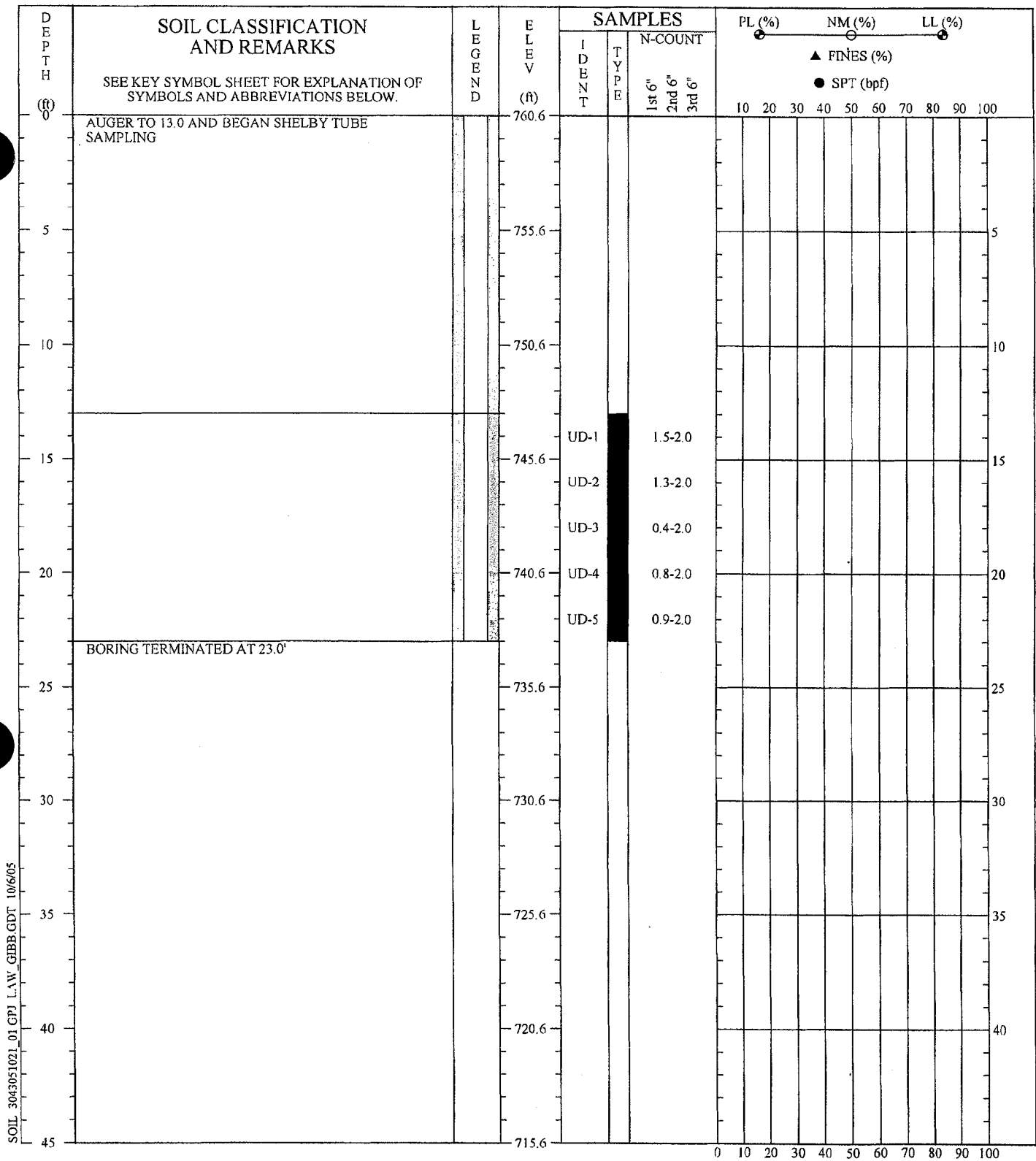

SOIL 3043051021 01 GPJ L.1W. GIBB GDT 10/6/05

REMARKS: STANDARD PENETRATION RESISTANCE TESTING PERFORMED USING AN AUTOMATIC HAMMER. NO GROUND WATER ENCOUNTERED AT TIME OF EXPLORATION. NB-85A WAS OFFSET APPROXIMATELY 4.3' N25°W OF NB-85.

THIS RECORD IS A REASONABLE INTERPRETATION OF SUBSURFACE CONDITIONS AT THE EXPLORATION LOCATION. SUBSURFACE CONDITIONS AT OTHER LOCATIONS AND AT OTHER TIMES MAY DIFFER. INTERFACES BETWEEN STRATA ARE APPROXIMATE. TRANSITIONS BETWEEN STRATA MAY BE GRADUAL.

Driller : Burnett
Prepared By: Mason
Checked By: Lawson

SOIL TEST BORING RECORD	
PROJECT: Proposed Gypsum Disposal Area	
DRILLED: May 12, 2005	BORING NO.: NB-85A
PROJ. NO.: 3043051021/0001	PAGE 1 OF 1
	

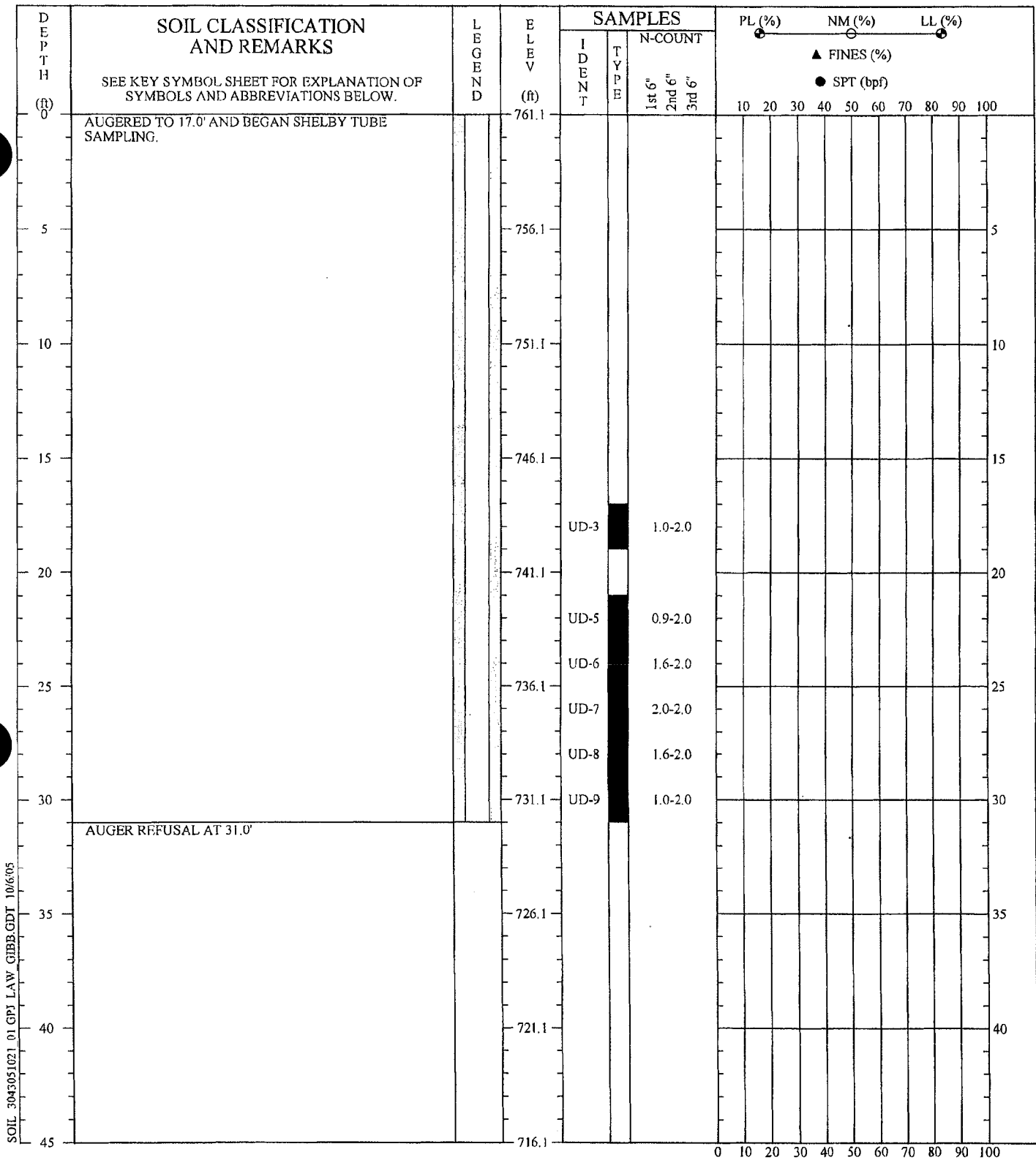

SOIL 3043051021 01.GPJ LAW GIBB.GDT 10/6/05

REMARKS: STANDARD PENETRATION RESISTANCE TESTING PERFORMED USING AN AUTOMATIC HAMMER. NO GROUND WATER ENCOUNTERED AT TIME OF EXPLORATION. NB-85B WAS OFFSET APPROXIMATELY 7.9' N25°W OF NB-85.

SOIL TEST BORING RECORD

PROJECT: Proposed Gypsum Disposal Area
DRILLED: May 12, 2005 **BORING NO.:** NB-85B
PROJ. NO.: 3043051021/0001 **PAGE 1 OF 1**

THIS RECORD IS A REASONABLE INTERPRETATION OF SUBSURFACE CONDITIONS AT THE EXPLORATION LOCATION. SUBSURFACE CONDITIONS AT OTHER LOCATIONS AND AT OTHER TIMES MAY DIFFER. INTERFACES BETWEEN STRATA ARE APPROXIMATE. TRANSITIONS BETWEEN STRATA MAY BE GRADUAL.

Driller : Burnett
 Prepared By: Mason
 Checked By: Lawson



APPENDIX C

MONITORING WELL INSTALLATION LOGS

OVERBURDEN MONITORING WELL INSTALLATION RECORD

JOB NAME TVA KINGSTON GYPSUM DISPOSAL AREA

JOB NUMBER 3043051021

TVA WELL NUMBER MW-10A

INSTALLATION DATE 06/01/2005

BOREHOLE DIAMETER 8.25" (SOIL); 3.78" (BEDROCK)

DRILLED BY M.BURNETT

TOTAL DEPTH 56.2'

RISER/SCREEN MATERIAL SCHEDULE 40 PVC

FIELD REPRESENTATIVE JOHN MASON

DIAMETER 2.0"

CTJ

SLOT SIZE 0.010"

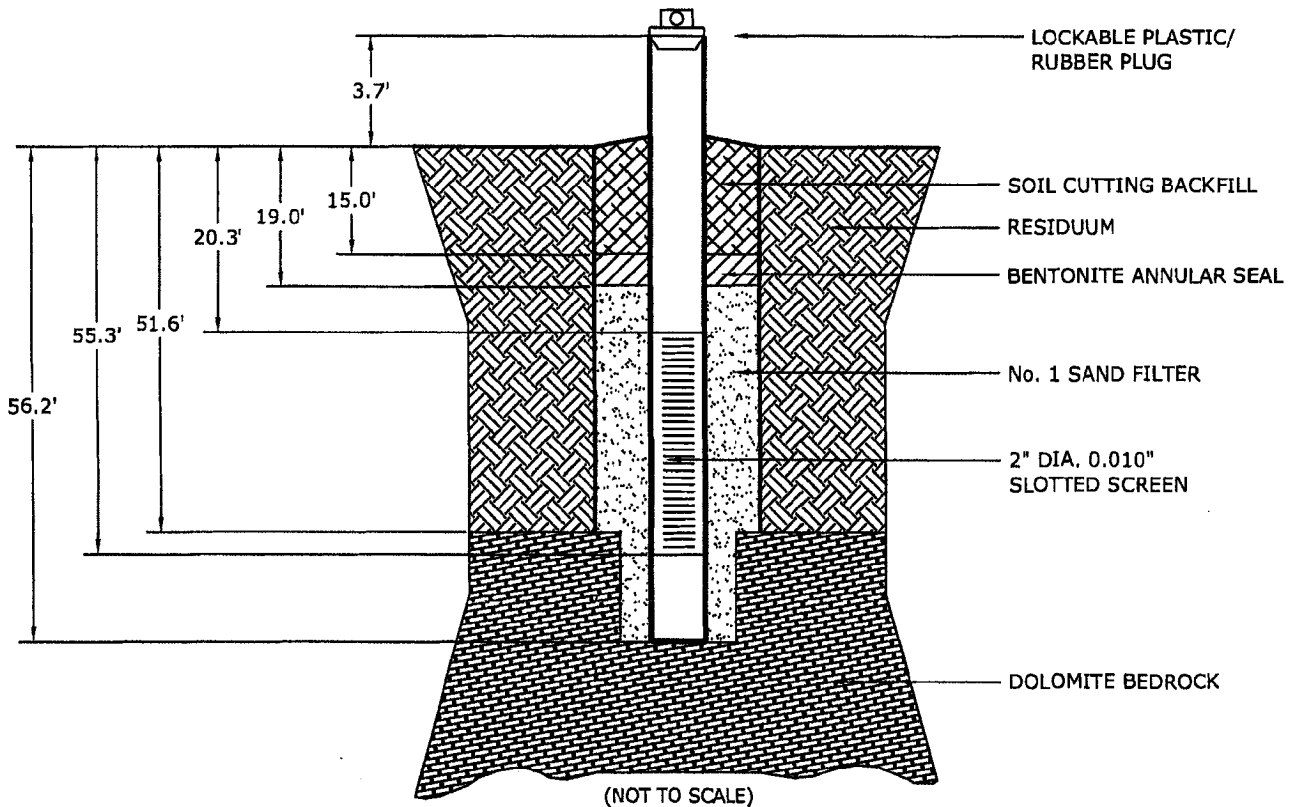

 **MACTEC**

BEDROCK MONITORING WELL INSTALLATION RECORD

JOB NAME TVA KINGSTON GYPSUM DISPOSAL AREA

JOB NUMBER 3043051021

TVA WELL NUMBER MW-10B

INSTALLATION DATE 05/31/2005

BOREHOLE DIAMETER 8.25" (SOIL); 3.78" (BEDROCK)

DRILLED BY M. BURNETT

TOTAL DEPTH 72.4'

RISER/SCREEN

FIELD REPRESENTATIVE JOHN MASON

MATERIAL SCHEDULE 40 PVC

DIAMETER 2.0"

SLOT SIZE 0.010"

CMJ

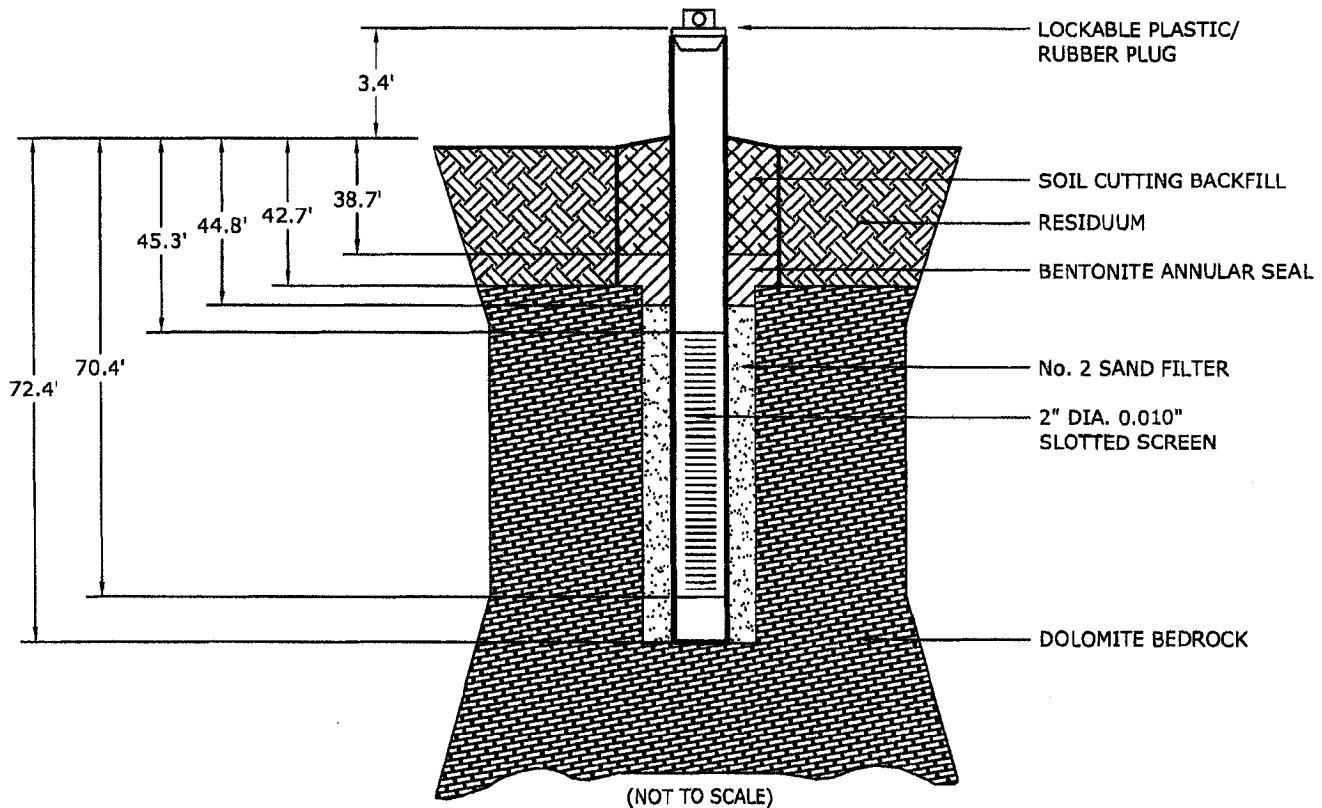

MACTEC

OVERBURDEN MONITORING WELL INSTALLATION RECORD

JOB NAME TVA KINGSTON GYPSUM DISPOSAL AREA

JOB NUMBER 3043051021

TVA WELL NUMBER MW-21A

INSTALLATION DATE 06/02/2005

BOREHOLE DIAMETER 8.25" (SOIL); 3.78" (BEDROCK)

DRILLED BY M.BURNETT

TOTAL DEPTH 50.4'

RISER/SCREEN

FIELD REPRESENTATIVE JOHN MASON

MATERIAL SCHEDULE 40 PVC

DIAMETER 2.0"

SLOT SIZE 0.010"

CTA

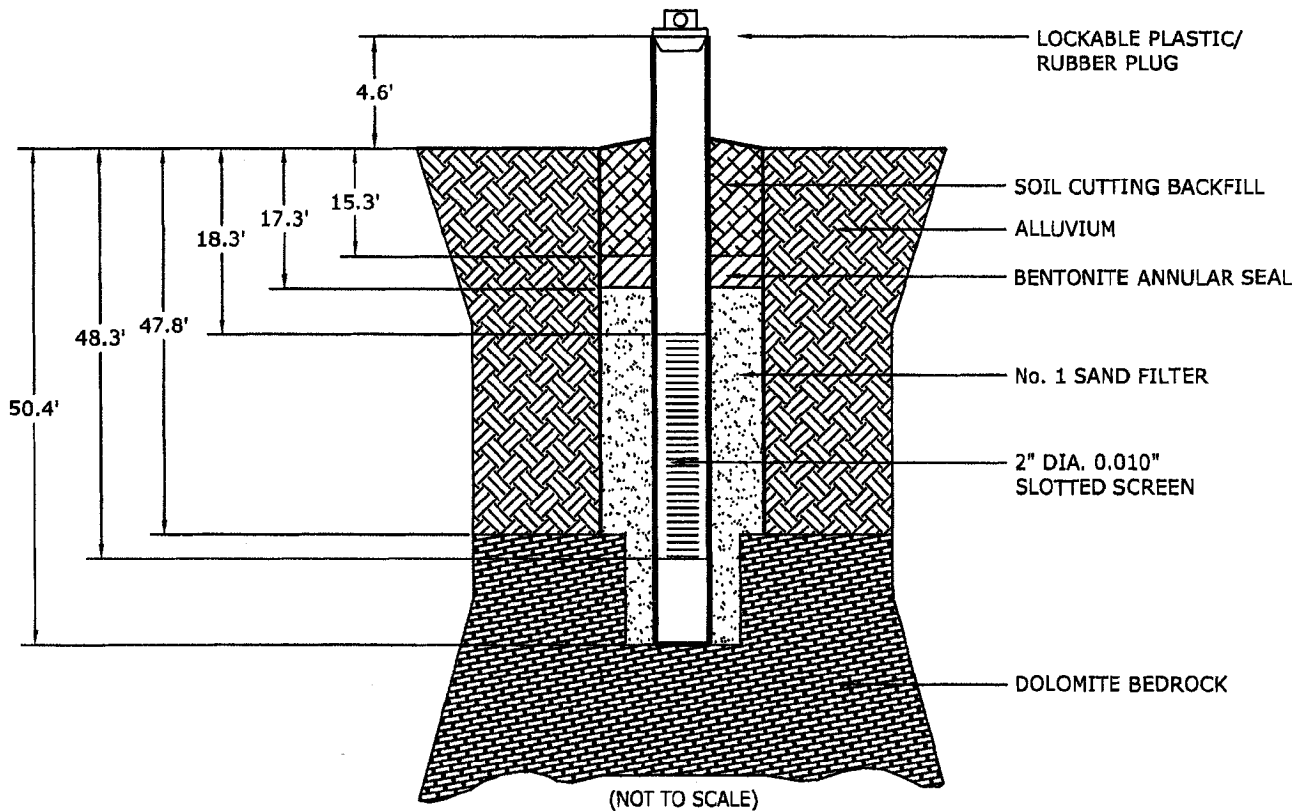

 MACTEC

OVERBURDEN MONITORING WELL INSTALLATION RECORD

JOB NAME TVA KINGSTON GYPSUM DISPOSAL AREA

JOB NUMBER 3043051021

TVA WELL NUMBER MW-44A

INSTALLATION DATE 06/07/2005

BOREHOLE DIAMETER 8.25" (SOIL); 3.78" (BEDROCK)

DRILLED BY G. AKINS

TOTAL DEPTH 40.5'

RISER/SCREEN

FIELD REPRESENTATIVE TODD JUSTICE

MATERIAL SCHEDULE 40 PVC

DIAMETER 2.0"

SLOT SIZE 0.010"

CTJ

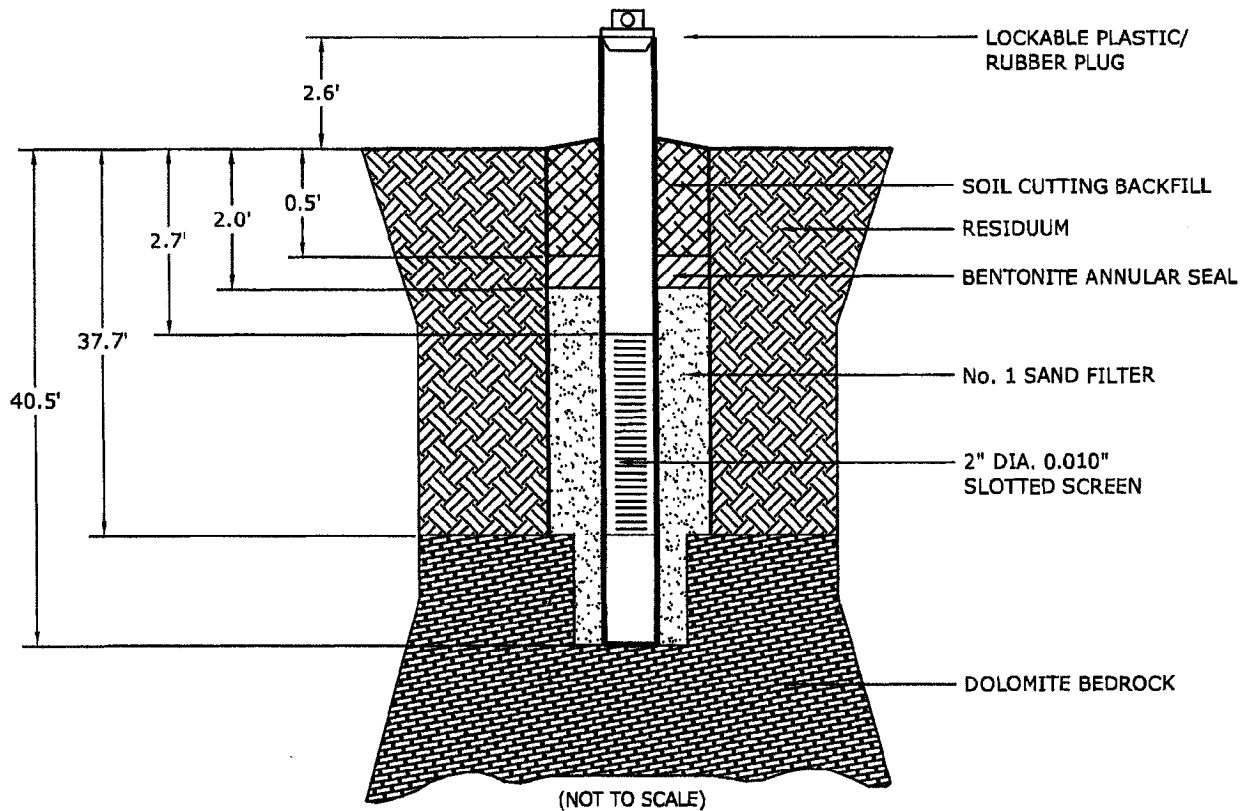

 MACTEC

BEDROCK MONITORING WELL INSTALLATION RECORD

JOB NAME TVA KINGSTON GYPSUM DISPOSAL AREA

JOB NUMBER 3043051021

TVA WELL NUMBER MW-44B

INSTALLATION DATE 06/02/2005

BOREHOLE DIAMETER 8.25" (SOIL); 3.78" (BEDROCK)

DRILLED BY G.AKINS

TOTAL DEPTH 104.2'

RISER/SCREEN SCHEDULE 40 PVC

FIELD REPRESENTATIVE TODD JUSTICE

MATERIAL SCHEDULE 40 PVC

DIAMETER 2.0"

SLOT SIZE 0.010"

CJT

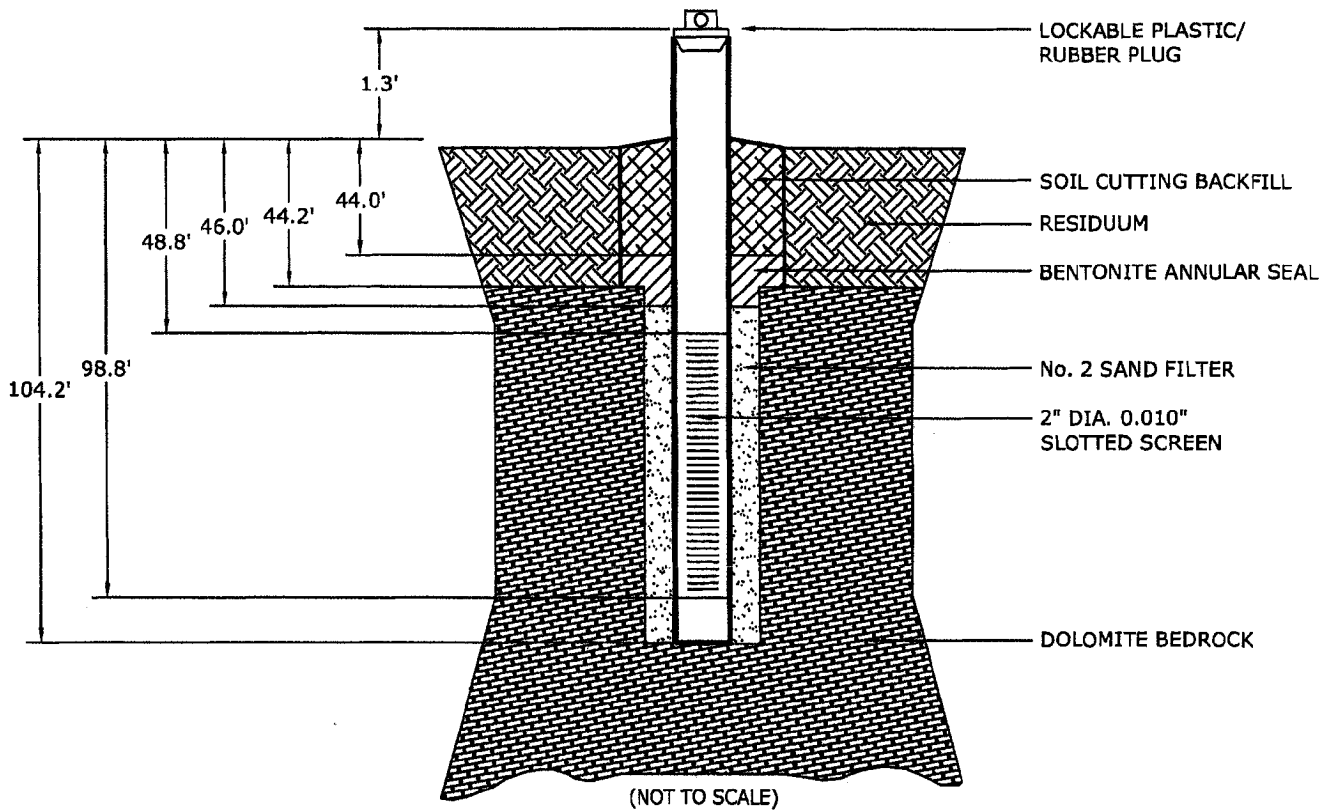

OVERBURDEN MONITORING WELL INSTALLATION RECORD

JOB NAME TVA KINGSTON GYPSUM DISPOSAL AREA

JOB NUMBER 3043051021

TVA WELL NUMBER MW-47A

INSTALLATION DATE 06/08/2005

BOREHOLE DIAMETER 8.25" (SOIL); 3.78" (BEDROCK)

DRILLED BY M. BURNETT

TOTAL DEPTH 44.4'

RISER/SCREEN SCHEDULE 40 PVC

FIELD REPRESENTATIVE JOHN MASON

MATERIAL SCHEDULE 40 PVC

DIAMETER 2.0"

SLOT SIZE 0.010"

CTJ

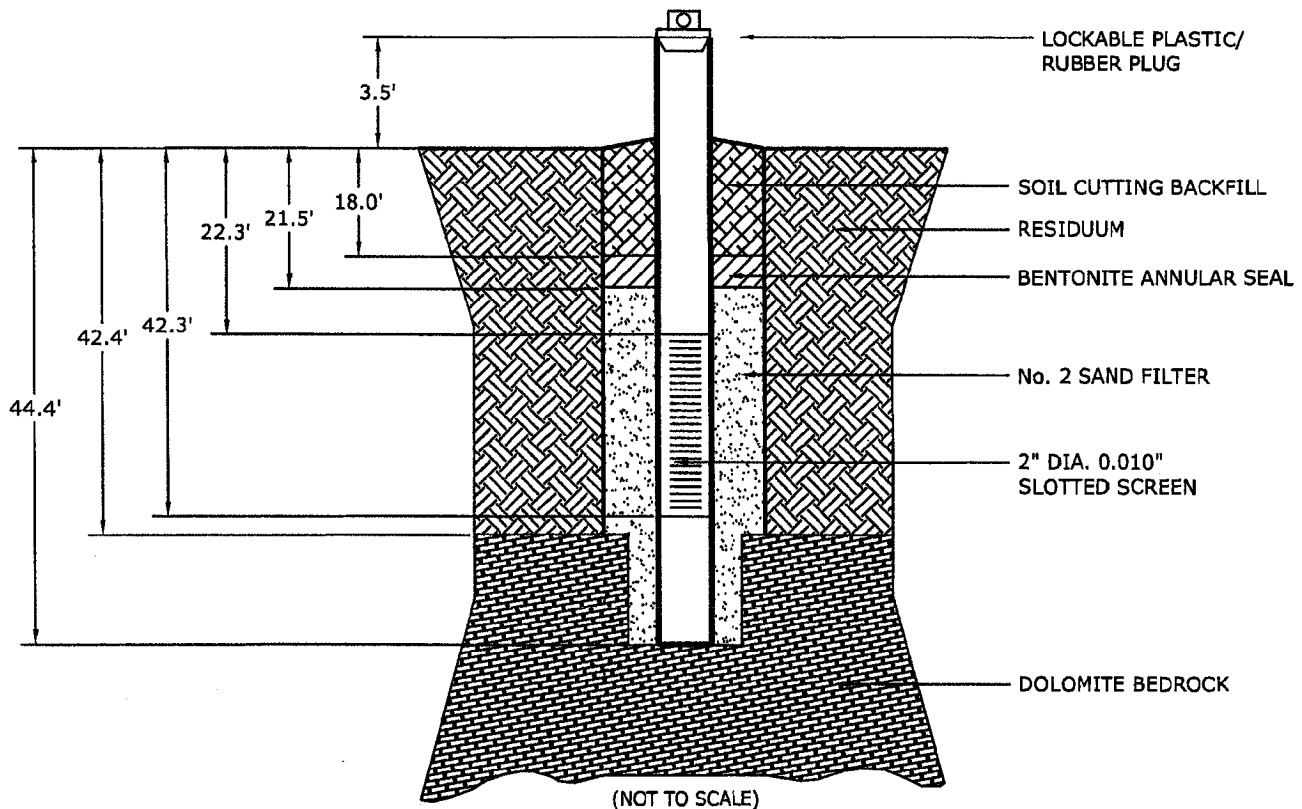

OVERBURDEN MONITORING WELL INSTALLATION RECORD

JOB NAME TVA KINGSTON GYPSUM DISPOSAL AREA

JOB NUMBER 3043051021

TVA WELL NUMBER MW-63A

INSTALLATION DATE 06/06/2005

BOREHOLE DIAMETER 8.25" (SOIL); 3.78" (BEDROCK)

DRILLED BY M.BURNETT

TOTAL DEPTH 48.8'

RISER/SCREEN SCHEDULE 40 PVC

FIELD REPRESENTATIVE JOHN MASON

MATERIAL SCHEDULE 40 PVC

DIAMETER 2.0"

SLOT SIZE 0.010"

CMJ

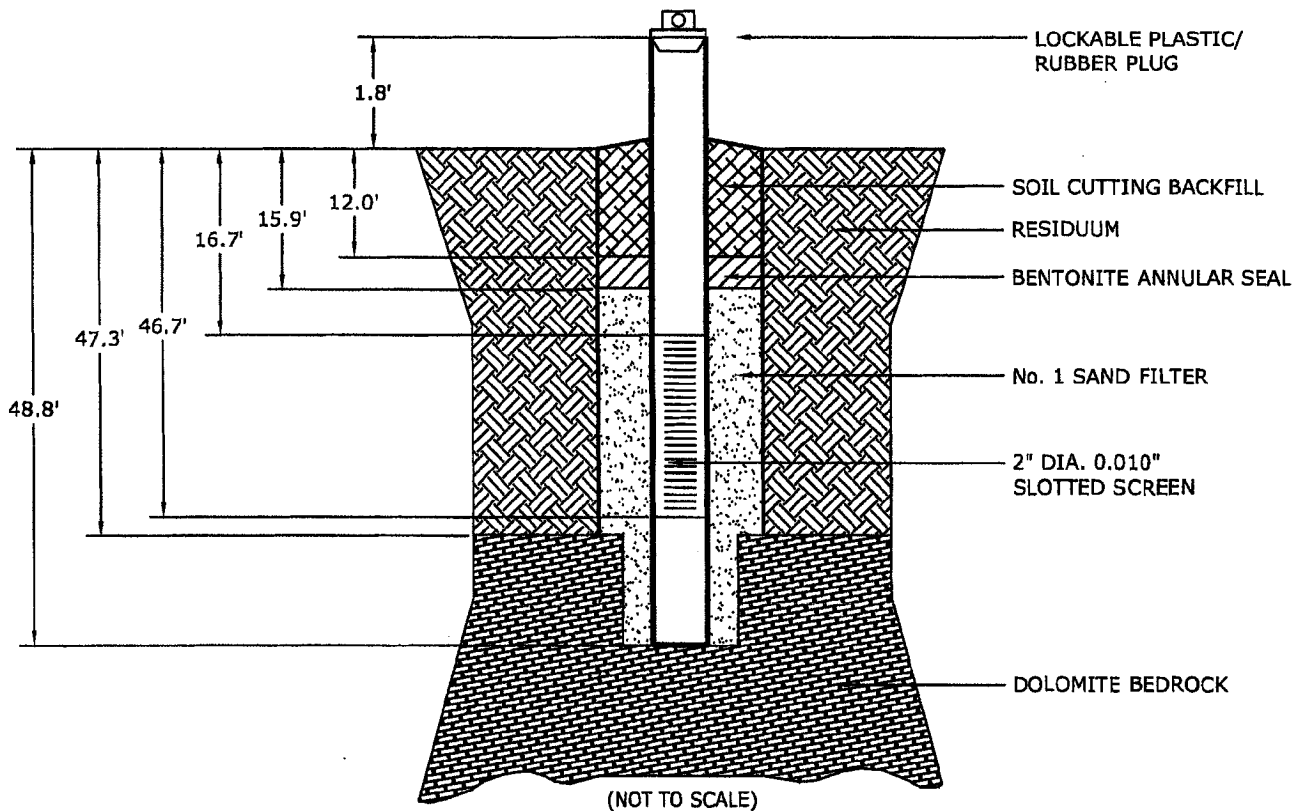

 **MACTEC**

BEDROCK MONITORING WELL INSTALLATION RECORD

JOB NAME <u>TVA KINGSTON GYPSUM DISPOSAL AREA</u>	JOB NUMBER <u>3043051021</u>
TVA WELL NUMBER <u>MW-63B</u>	INSTALLATION DATE <u>05/09/2005</u>
BOREHOLE DIAMETER <u>8.25" (SOIL); 3.78" (BEDROCK)</u>	DRILLED BY <u>J. WARREN</u>
TOTAL DEPTH <u>82.3'</u>	RISER/SCREEN
FIELD REPRESENTATIVE <u>TODD JUSTICE</u>	MATERIAL <u>SCHEDULE 40 PVC</u>
<i>CJA</i>	DIAMETER <u>2.0"</u>
	SLOT SIZE <u>0.010"</u>

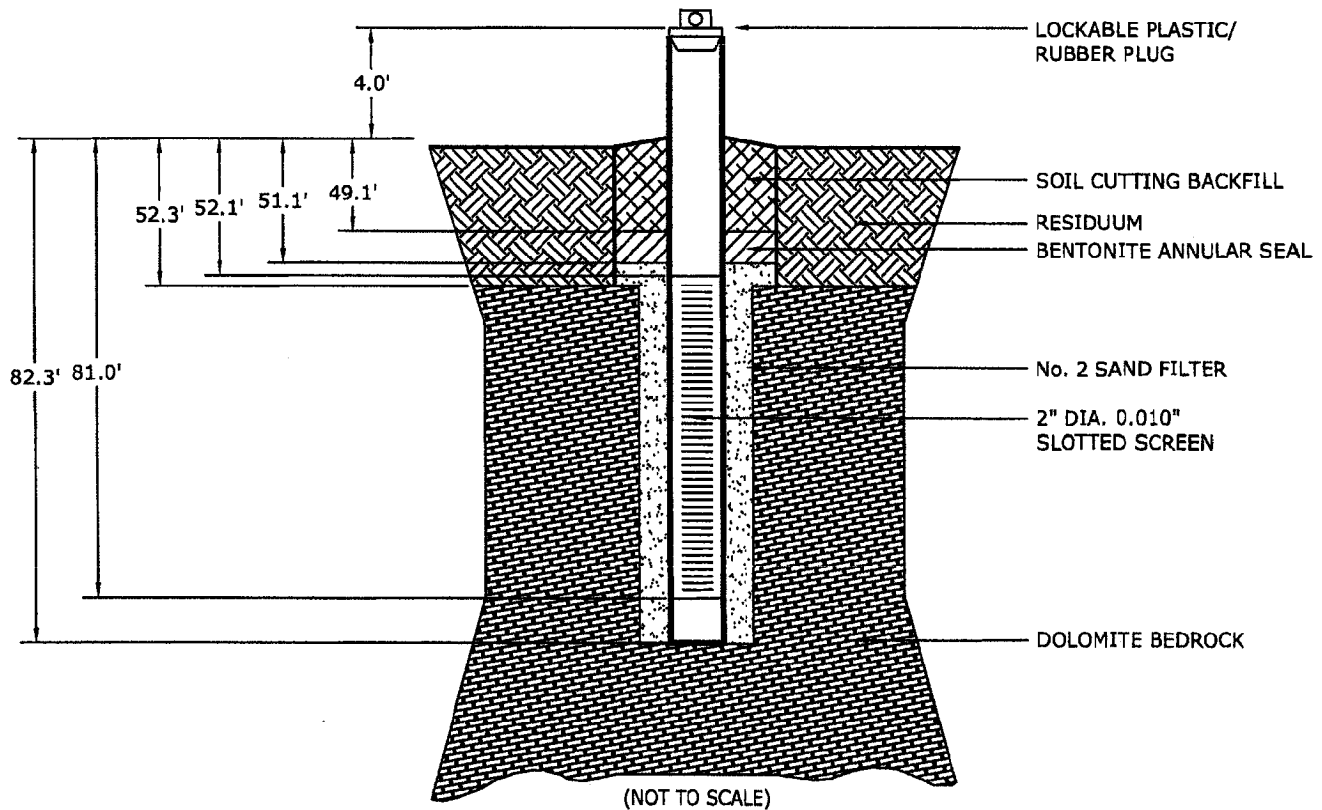

MACTEC

OVERBURDEN MONITORING WELL INSTALLATION RECORD

JOB NAME TVA KINGSTON GYPSUM DISPOSAL AREA

JOB NUMBER 3043051021

TVA WELL NUMBER MW-66A

INSTALLATION DATE 05/04/2005

BOREHOLE DIAMETER 8.25" (SOIL); 3.78" (BEDROCK)

DRILLED BY M.BURNETT

TOTAL DEPTH 38.8'

RISER/SCREEN MATERIAL SCHEDULE 40 PVC

FIELD REPRESENTATIVE JOHN MASON

DIAMETER 2.0"

SLOT SIZE 0.010"

CTA

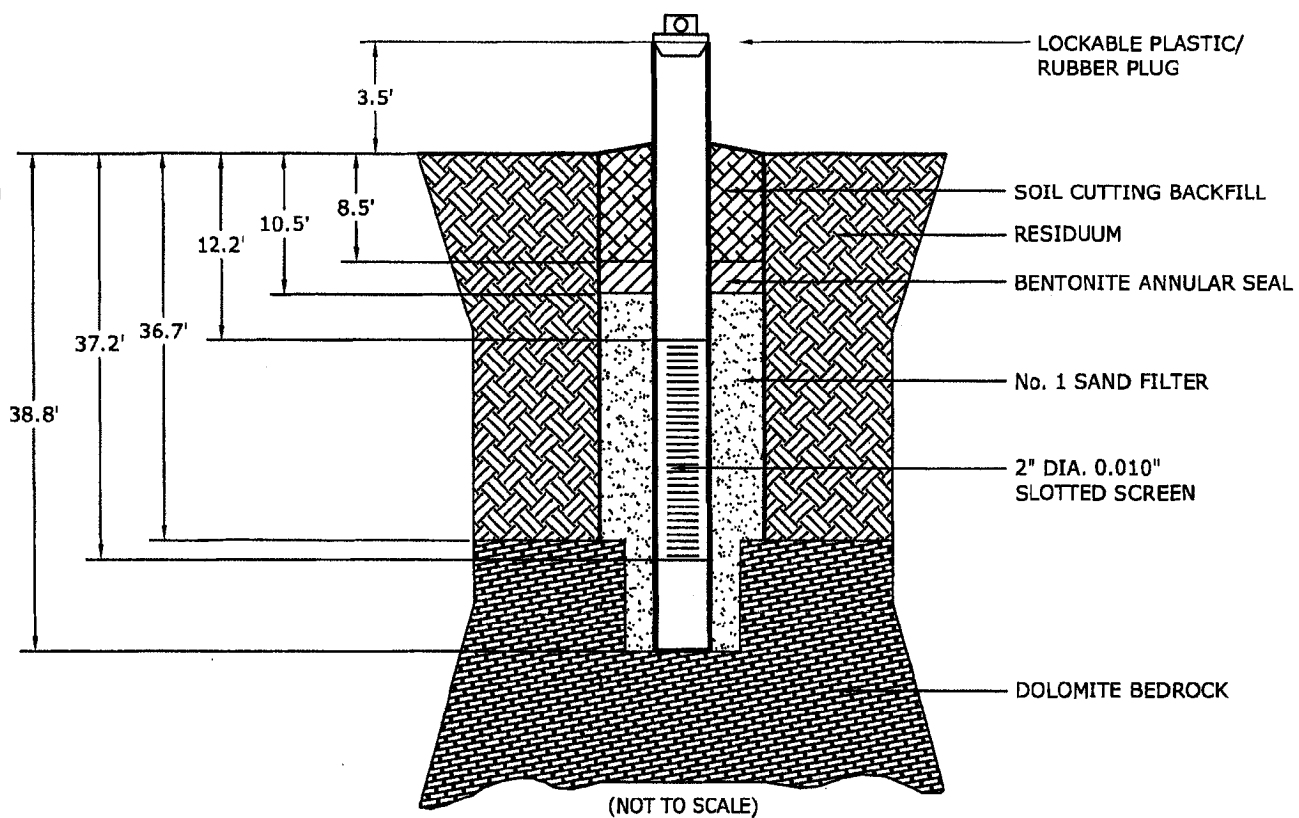

 MACTEC

OVERBURDEN MONITORING WELL INSTALLATION RECORD

JOB NAME TVA KINGSTON GYPSUM DISPOSAL AREA

JOB NUMBER 3043051021

TVA WELL NUMBER MW-74A

INSTALLATION DATE 05/12/2005

BOREHOLE DIAMETER 8.25" (SOIL); 3.78" (BEDROCK)

DRILLED BY M.BURNETT

TOTAL DEPTH 59.3'

RISER/SCREEN SCHEDULE 40 PVC

FIELD REPRESENTATIVE JOHN MASON

MATERIAL SCHEDULE 40 PVC

DIAMETER 2.0"

SLOT SIZE 0.010"

John Mason

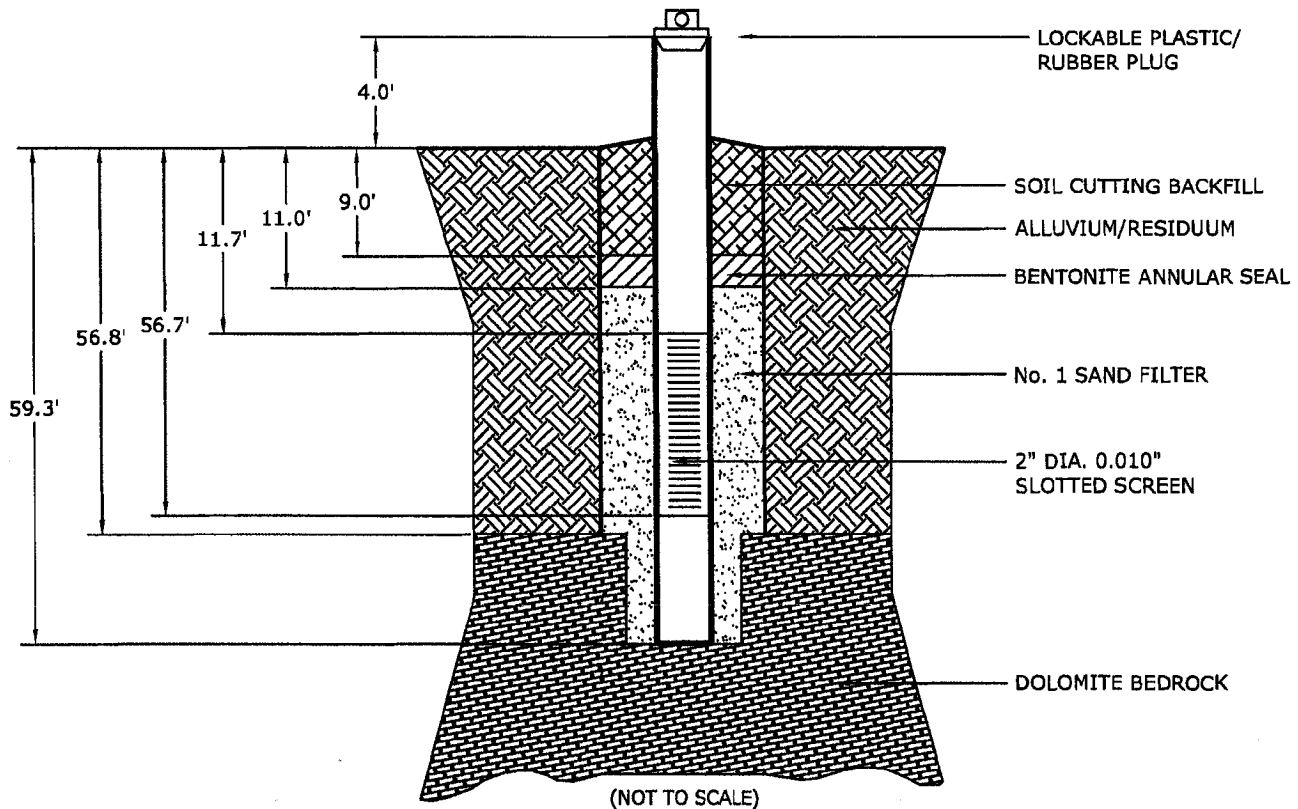

MACTEC

OVERBURDEN MONITORING WELL INSTALLATION RECORD

JOB NAME TVA KINGSTON GYPSUM DISPOSAL AREA

JOB NUMBER 3043051021

TVA WELL NUMBER MW-77A

INSTALLATION DATE 06/14/2005

BOREHOLE DIAMETER 8.25" (SOIL); 3.78" (BEDROCK)

DRILLED BY J. WARREN

TOTAL DEPTH 35.4'

RISER/SCREEN MATERIAL SCHEDULE 40 PVC

FIELD REPRESENTATIVE TODD JUSTICE

DIAMETER 2.0"

SLOT SIZE 0.010"

CTJ

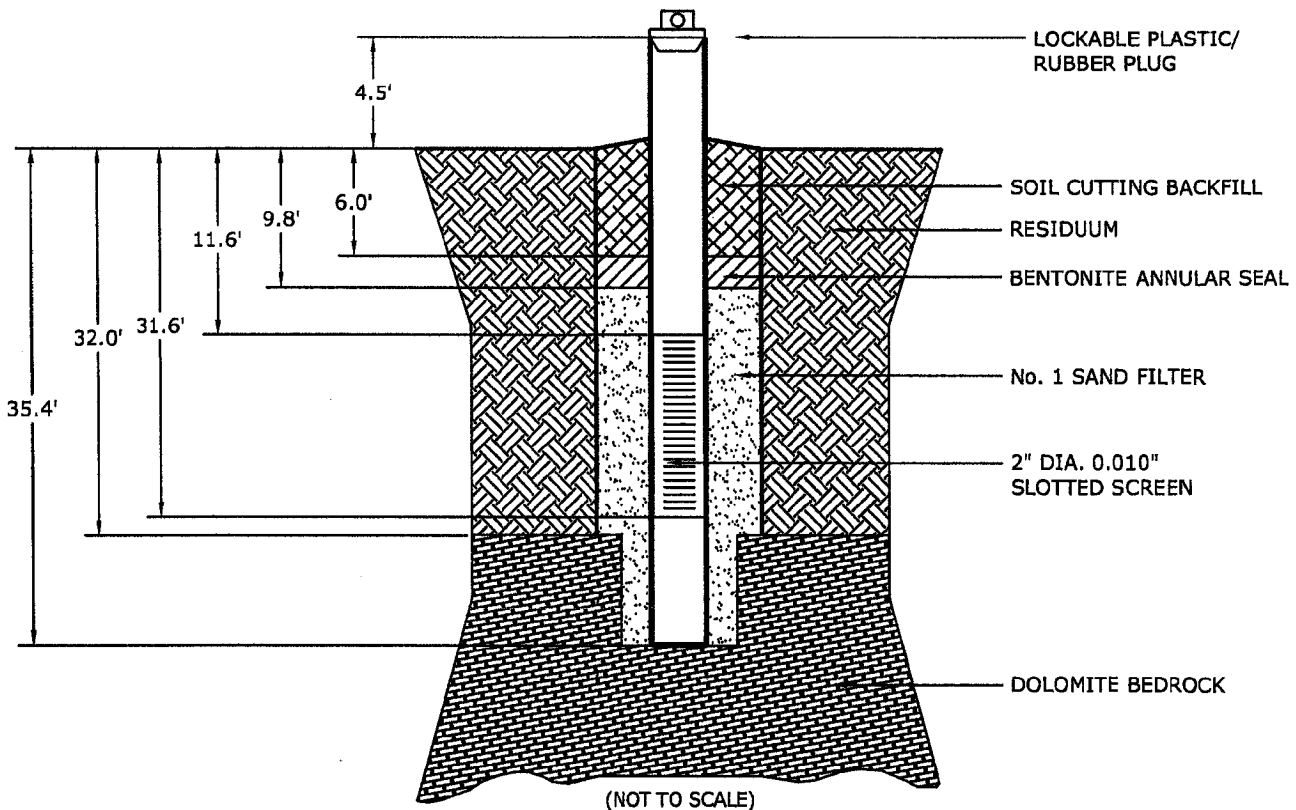

MACTEC

OVERBURDEN MONITORING WELL INSTALLATION RECORD

JOB NAME TVA KINGSTON GYPSUM DISPOSAL AREA

JOB NUMBER 3043051021

TVA WELL NUMBER MW-81A

INSTALLATION DATE 06/08/2005

BOREHOLE DIAMETER 8.25" (SOIL); 3.78" (BEDROCK)

DRILLED BY G.AKINS

TOTAL DEPTH 39.8'

RISER/SCREEN

FIELD REPRESENTATIVE TODD JUSTICE

MATERIAL SCHEDULE 40 PVC

DIAMETER 2.0"

SLOT SIZE 0.010"

TJ

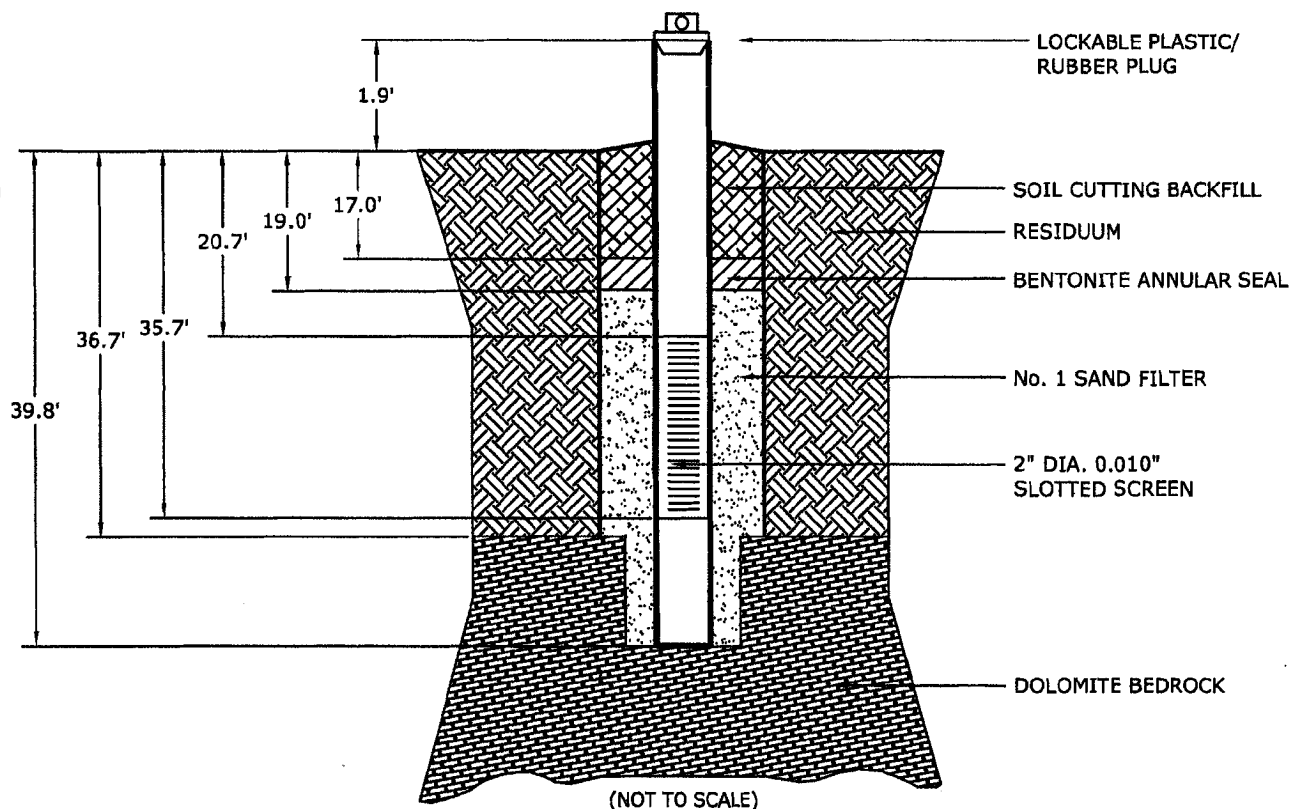

 **MACTEC**

BEDROCK MONITORING WELL INSTALLATION RECORD

JOB NAME TVA KINGSTON GYPSUM DISPOSAL AREA

JOB NUMBER 3043051021

TVA WELL NUMBER MW-81B

INSTALLATION DATE 05/17/2005

BOREHOLE DIAMETER 8.25" (SOIL); 3.78" (BEDROCK)

DRILLED BY G.AKINS

TOTAL DEPTH 61.1'

RISER/SCREEN

FIELD REPRESENTATIVE TODD JUSTICE

MATERIAL SCHEDULE 40 PVC

DIAMETER 2.0"

SLOT SIZE 0.010"

CJT

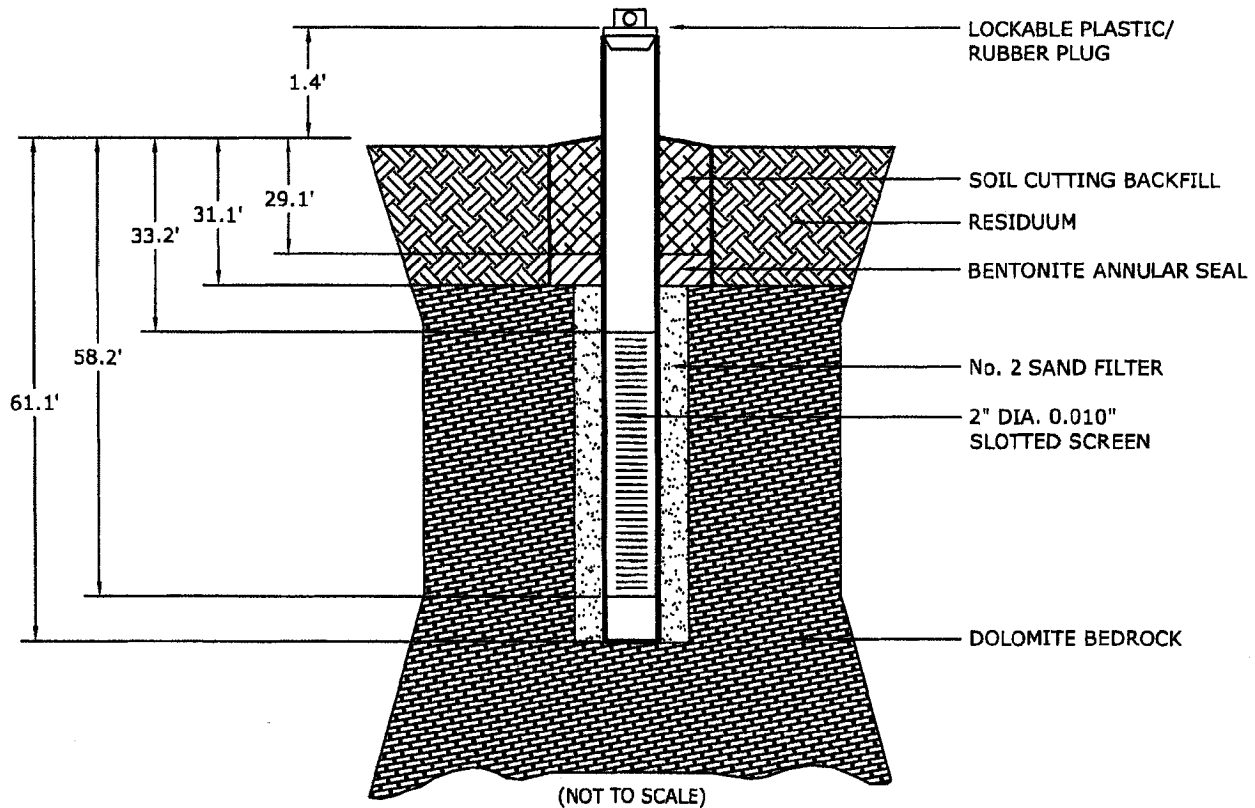

MACTEC

APPENDIX D

CONE PENETROMETER TEST PROCEDURES AND RESULTS



GREGG DRILLING AND TESTING, INC.
 GREGG IN SITU, INC.
 ENVIRONMENTAL AND GEOTECHNICAL INVESTIGATION SERVICES

May 20, 2005

Mactec
 Attn: Hussein Benkhayal
 1725 Louisville Drive
 Knoxville, TN 37921

Subject: CPT Site Investigation
 Kingston TVA
 Kingston, TN
 GREGG Project Number: 05-062SC

Dear Mr. Benkhayal:

The following report presents the results of GREGG IN SITU's Cone Penetration Test investigation for the above referenced site. The following testing services were performed:

1	Cone Penetration Tests	(CPTU)	<input checked="" type="checkbox"/>
2	Pore Pressure Dissipation Tests	(PPD)	<input checked="" type="checkbox"/>
3	Seismic Cone Penetration Tests	(SCPTU)	<input type="checkbox"/>
4	Resistivity Cone Penetration Tests	(RCPTU)	<input type="checkbox"/>
5	UVIF Cone Penetration Tests	(UVIFCPTU)	<input type="checkbox"/>
6	Groundwater Sampling	(GWS)	<input type="checkbox"/>
7	Soil Sampling	(SS)	<input type="checkbox"/>
8	Vapor Sampling	(VS)	<input type="checkbox"/>
9	Vane Shear Testing	(VST)	<input type="checkbox"/>
10	SPT Energy Calibration	(SPTC)	<input type="checkbox"/>

A list of reference papers providing additional background on the specific tests conducted is provided in the bibliography following the text of the report. If you would like a copy of any of these publications or should you have any questions or comments regarding the contents of this report, please do not hesitate to contact our office at (843) 832-4918.

Sincerely,
 GREGG IN SITU, Inc.

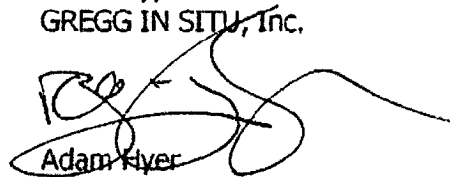
 Adam Hyer
 Operations Manager



Cone Penetration Testing Procedure (CPT)

Gregg In Situ, Inc. carries out all Cone Penetration Tests (CPT) using an integrated electronic cone system, *Figure CPT*. The soundings were conducted using a 20 ton capacity cone with a tip area of 15 cm^2 and a friction sleeve area of 225 cm^2 . The cone is designed with an equal end area friction sleeve and a tip end area ratio of 0.85.

The cone takes measurements of cone bearing (q_c), sleeve friction (f_s) and dynamic pore water pressure (u_2) at 5-cm intervals during penetration to provide a nearly continuous hydrogeologic log. CPT data reduction and interpretation is performed in real time facilitating on-site decision making. The above mentioned parameters are stored on disk for further analysis and reference. All CPT soundings are performed in accordance with revised (2002) ASTM standards (D 5778-95).

The cone also contains a porous filter element located directly behind the cone tip (u_2), *Figure CPT*. It consists of porous plastic and is 5.0mm thick. The filter element is used to obtain dynamic pore pressure as the cone is advanced as well as Pore Pressure Dissipation Tests (PPDT's) during appropriate pauses in penetration. It should be noted that prior to penetration, the element is fully saturated with silicon oil under vacuum pressure to ensure accurate and fast dissipation.

When the soundings are complete, the test holes are grouted using a Gregg In Situ support rig. The grouting procedure consists of pushing a hollow CPT rod with a "knock out" plug to the termination depth of the test hole. Grout is then pumped under pressure as the tremie pipe is pulled from the hole. Disruption or further contamination to the site is therefore minimized.

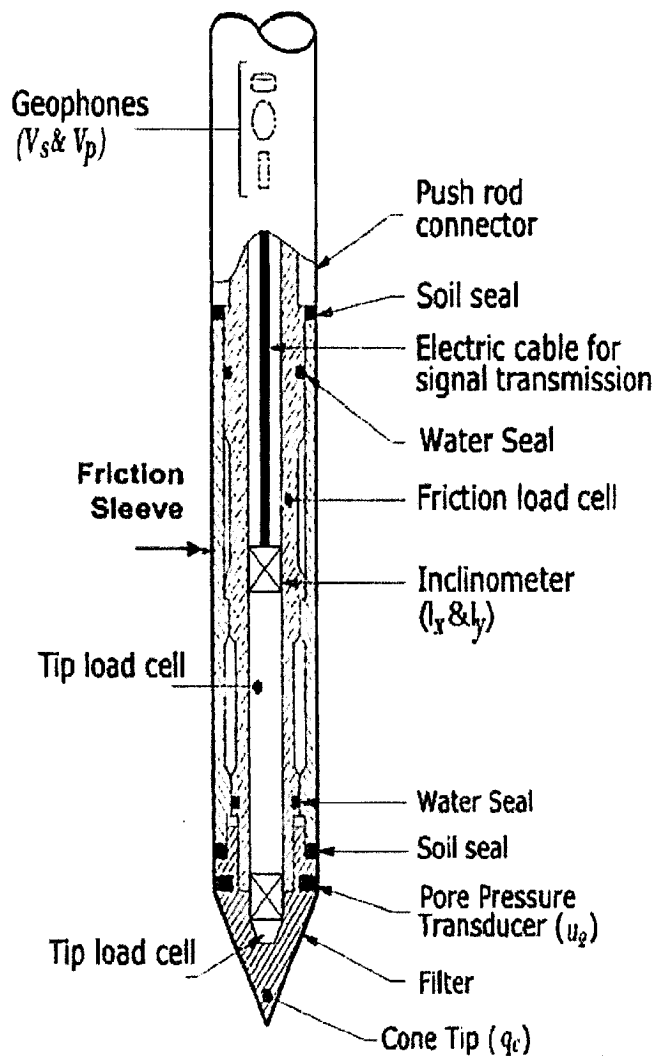

Figure CPT



GREGG DRILLING AND TESTING, INC.
 GREGG IN SITU, INC.
 ENVIRONMENTAL AND GEOTECHNICAL INVESTIGATION SERVICES

Cone Penetration Test Sounding Summary

-Table 1-

CPT Sounding Identification	Client Identification	Date	Termination Depth (Feet)	Depth of Soil Samples (ft)	Depth of Pore Pressure Dissipation Tests (ft)
CPT-01	NB-79	5/16/05	24.4	-	24.4
CPT-02	NB-82	5/16/05	22.3	-	-
CPT-03	NB-71	5/16/05	33.0	-	-
CPT-04	NB-62	5/16/05	58.7	-	56.7
CPT-05	NB-57	5/17/05	41.7	-	-
CPT-06	NB-54	5/17/05	28.8	-	-
CPT-07	NB-58	5/17/05	36.7	-	36.8
CPT-08	NB-56	5/17/05	33.9	-	-
CPT-09	NB-11	5/17/05	30.9	-	30.9
CPT-10	NB-26	5/17/05	35.6	-	35.6

106 Butternut Rd • Summerville, South Carolina 29483 • (843) 832-1918 • FAX (843) 832-1919
 OTHER OFFICES: LOS ANGELES • SAN FRANCISCO • SALT LAKE CITY • HOLSTON • VANDERWER • WEST BERTHOUD • ALBANY
 www.greggdrilling.com



Cone Penetration Test Data & Interpretation

Soil behavior type and stratigraphic interpretation is based on relationships between cone bearing (q_c), sleeve friction (f_s), and pore water pressure (u_2). The friction ratio (R_f) is a calculated parameter defined by $100f_s/q_c$, and is used to infer soil behavior type. Generally:

Cohesive soils (clays)

- High friction ratio (R_f) due to small cone bearing (q_c)
- Generate large excess pore water pressures (u_2)

Cohesionless soils (sands)

- Low friction ratio (R_f) due to large cone bearing (q_c)
- Generate very little excess pore water pressures (u_2)

A complete set of baseline readings are taken prior to and at the completion of each sounding to determine temperature shifts and any zero load offsets. Corrections for temperature shifts and zero load offsets can be extremely important, especially when the recorded loads are relatively small. In sandy soils, however, these corrections are generally negligible.

The cone penetration test data collected from your site is presented in graphical form in Appendix CPT. The data includes CPT logs of measured soil parameters, computer calculations of interpreted soil behavior types (SBT), and additional geotechnical parameters. A summary of locations and depths is available in Table 1. Note that all penetration depths referenced in the data are with respect to the existing ground surface.

Soil interpretation for this project was conducted using recent correlations developed by Robertson et al, 1990, *Figure SBT*. Note that it is not always possible to clearly identify a soil type based solely on q_c , f_s , and u_2 . In these situations, experience, judgment, and an assessment of the pore pressure dissipation data should be used to infer the soil behavior type.

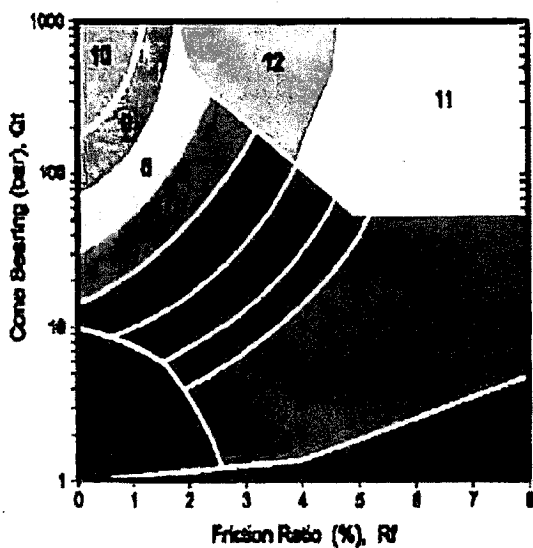

ZONE	Q _i /N	SBT
1	2	Sensitive, fine grained
2	1	Organic materials
3	1	Clay
4	1.5	Silty clay to clay
5	2	Clayey silt to silty clay
6	2.5	Sandy silt to clayey silt
7	3	Silty sand to sandy silt
8	4	Sand to silty sand
9	5	Sand
10	6	Gravelly sand to sand
11	1	Very stiff fine grained*
12	2	Sand to clayey sand*

*over consolidated or cemented

Figure SBT



Pore Pressure Dissipation Tests (PPDT)

Pore Pressure Dissipation Tests (PPDT's) conducted at various intervals measured hydrostatic water pressures and determined the approximate depth of the ground water table. A PPDT is conducted when the cone is halted at specific intervals determined by the field representative. The variation of the penetration pore pressure (u) with time is measured behind the tip of the cone and recorded by a computer system.

Pore pressure dissipation data can be interpreted to provide estimates of:

- Equilibrium piezometric pressure
- Phreatic Surface
- In situ horizontal coefficient of consolidation (c_H)
- In situ horizontal coefficient of permeability (k_H)

In order to correctly interpret the equilibrium piezometric pressure and/or the phreatic surface, the pore pressure must be monitored until such time as there is no variation in pore pressure with time, *Figure PPDT*. This time is commonly referred to as t_{100} , the point at which 100% of the excess pore pressure has dissipated.

A complete reference on pore pressure dissipation tests is presented by Robertson et al. 1991.

A summary of the pore pressure dissipation tests is summarized in Table 1. Pore pressure dissipation data is presented in graphical form in Appendix PPDT.

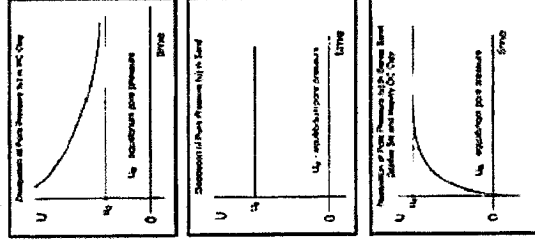
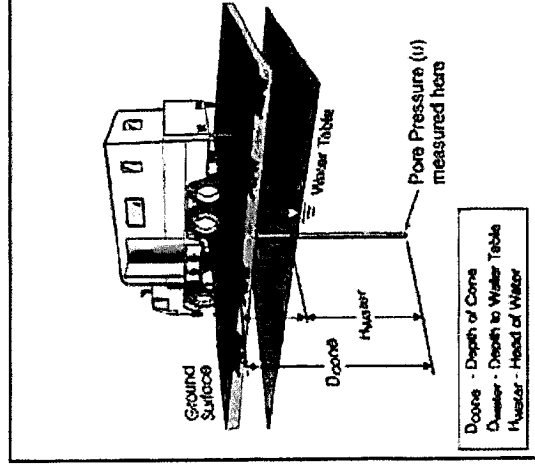

Water Table Calculation

$$D_{water} = D_{cone} - H_{water}$$

where $H_{water} = U_0$ (depth units)

Useful Conversion Factors: 1 psf = 0.704m = 2.31 feet (water)
1 tsf = 0.958 bar = 13.9 psi
1m = 3.28 feet

Figure PPDT



Bibliography

Campanella, R.G. and I. Weemees, "Development and Use of An Electrical Resistivity Cone for Groundwater Contamination Studies", Canadian Geotechnical Journal, Vol. 27 No. 5, 1990 pp. 557-567.

Daniel, C.R., J.A. Howie and A. Sy, "A Method for Correlating Large Penetration Test (LPT) to Standard Penetration Test (SPT) Blow Counts", 55th Canadian Geotechnical Conference, Niagara Falls, Ontario, Proceedings, 2002.

DeGroot, D.J. and A.J. Lutenegeger, "Reliability of Soil Gas Sampling and Characterization Techniques", International Site Characterization Conference - Atlanta, 1998.

Greig, J.w., R.G. Campanella and P.K. Robertson, "Comparison of Field Vane Results With Other In-Situ Test Results", International Symposium, on Laboratory and Field Vane Shear Strength Testing, ASTM, Tampa, FL, Proceedings, 1987.

Kurfurst, P.J. and D.J. Woeller, "Electric cone Penetrometer - Development and Field Results From the Canadian Arctic", Penetration Testing 1988 ISOPT, Orlando, Volume 2 pp 823-830.

Marchetti S., P. Monaco, G. Totani, M. Calabrese, "The Flat Dilatometer Test (DMT) in Soil Investigations", Report of the ISSMGE Technical Committee, IN SITU 2001 Intl. Conf. On in Situ Measurement of soil Properties, Bali, Indonesia.

Mayne, P.W., "NHI (2002) Manual on Subsurface Investigations: Geotechnical Site Characterization", available through www.ce.gatech.edu/~geosys/Faculty/Mayne/papers/index.html, Section 5.3, pp. 107-112.

Robertson, P.K., R.G. Campanella, D. Gillespie and A. Rice, "Seismic CPT to Measure In-Situ Shear Wave Velocity", Journal of Geotechnical Engineering ASCE, Vol. 112, No. 8, 1986 pp. 791-803.

Robertson, P.K., T. Lunne and J.J.M. Powell, "Geo-Environmental Application of Penetration Testing", Geotechnical Site Characterization, Robertson & Mayne (editors), 1998 Balkema, Rotterdam, ISBN 90 5410 939 4 pp 35-47.

Roberston, P.K., "Soil Classification using the Cone Penetration Test", Canadian Geotechnical Journal, Vol. 27, 1990 pp. 151-158.

Woeller, D.J., P.K. Robertson, T.J. Boyd and Dave Thomas, "Detection of Polyaromatic Hydrocarbon Contaminants Using the UVIF-CPT", 53rd Canadian Geotechnical Conference Montreal, QC October pp. 733-739, 2000.

Zemo, D.A., T.A. Delfino, J.D. Gallinatti, V.A. Baker and L.R. Hilpert, "Field Comparison of Analytical Results from Discrete-Depth Groundwater Samplers" BAT EnviroProbe and QED HydroPunch, Sixth national Outdoor Action Conference, Las Vegas, Nevada Proceedings, 1992, pp 299-312.

Copies of ASTM Standards are available through www.astm.org



MACTEC

Site: KINGSTON TUA
Location: NR-79

Engineer: H. BENKIYAH
Date: 05/16/05 02:26

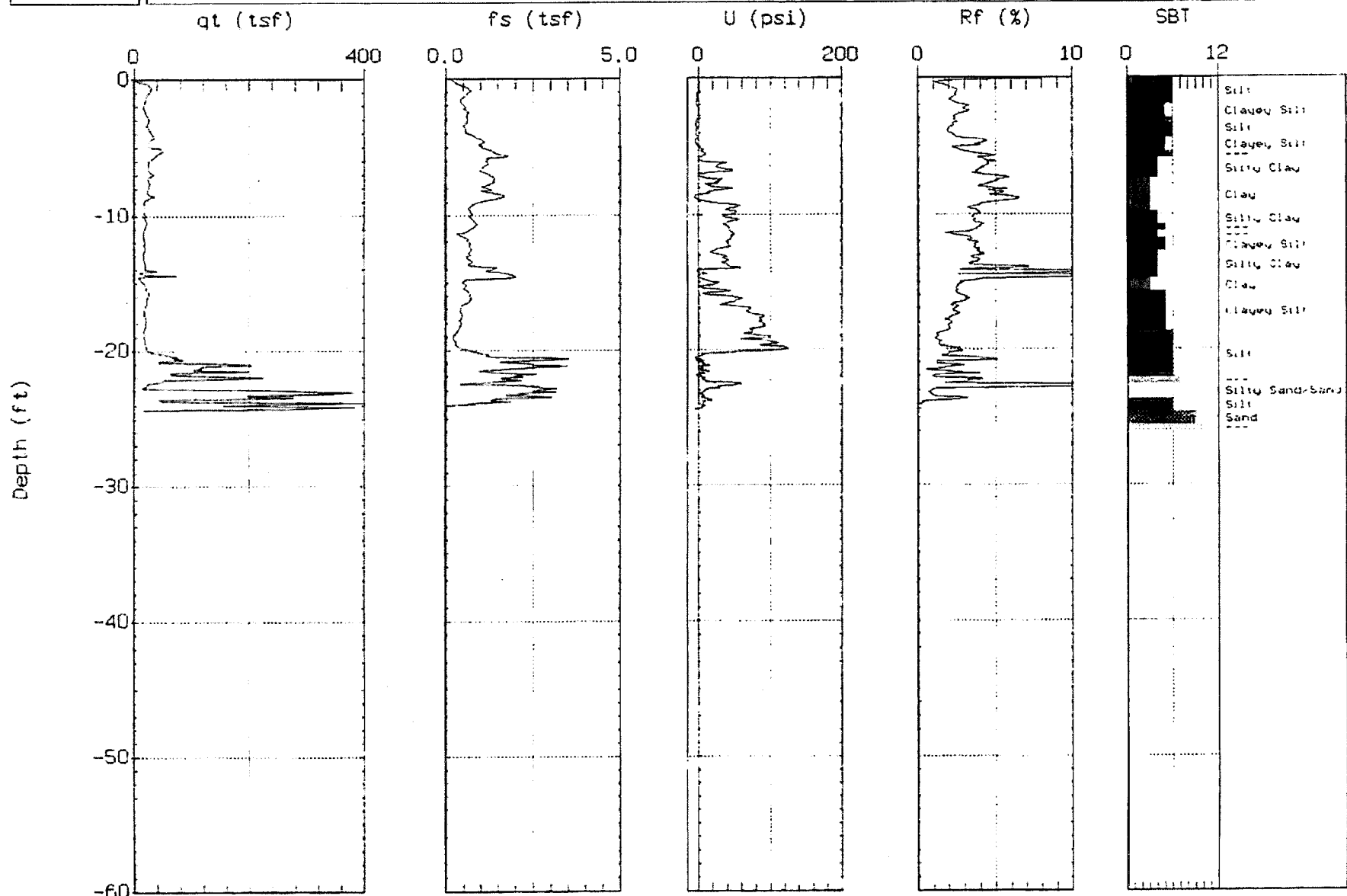

Max. Depth: 24.41 (ft)
Depth Inc.: 0.066 (ft)

SBT: Soil Behavior Type (Robertson, 1990)



MACTEC

Site: KINGSTON TWA
Location: NB-82

Engineer: H. BENKHYAL
Date: 05/16/05 06:46

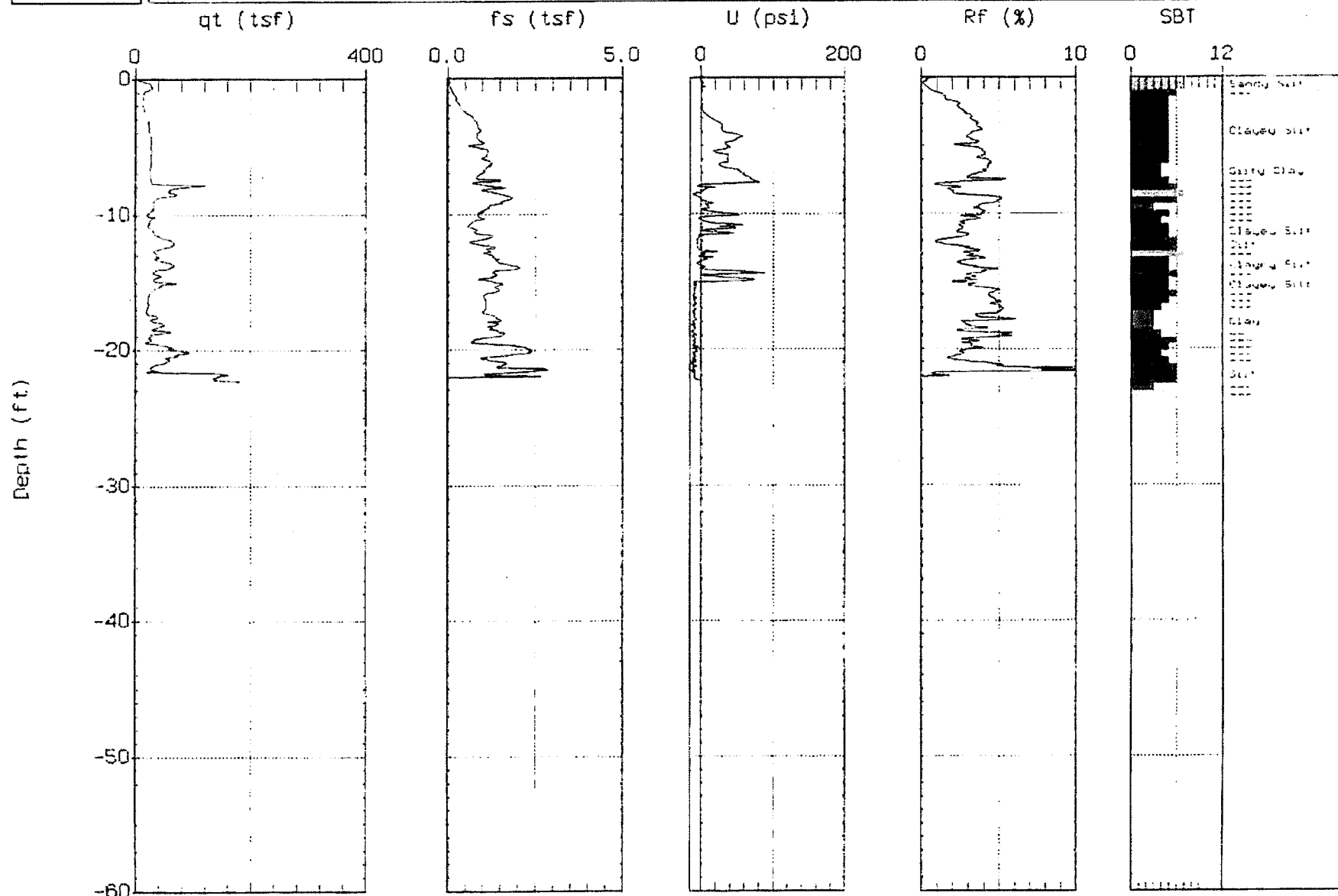

Max. Depth: 22.91 (ft)
Depth Inc.: 0.066 (ft)

SBT: Soil Behavior Type (Robertson, 1990)



MACTEC

STEVENSON TWA
LABOR 01-13-21

Engineer: H. BENKHAOU
Date: 05-16-05 10:51

Depth (ft)

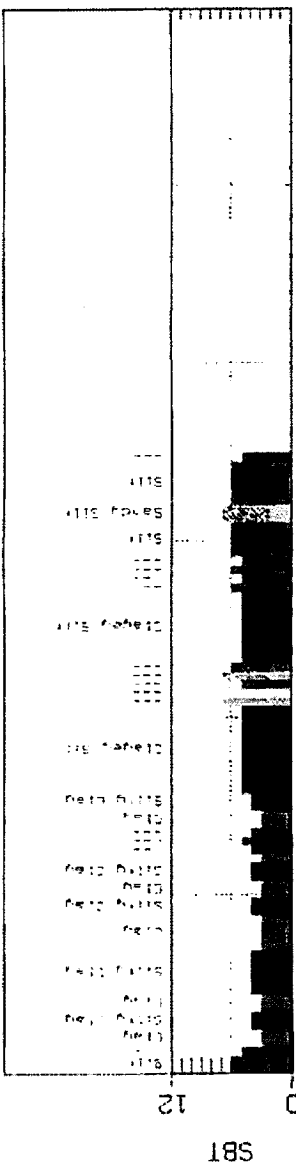
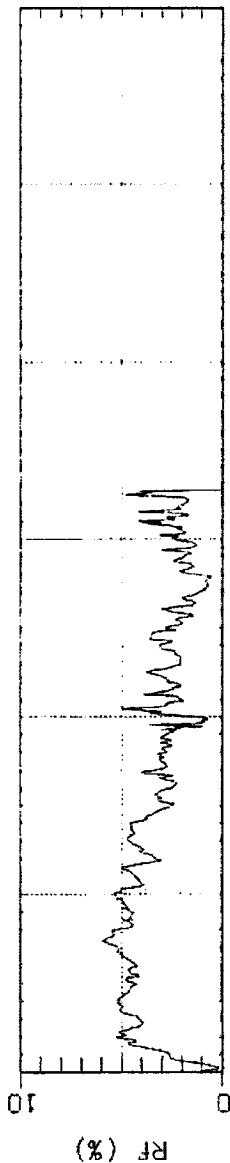
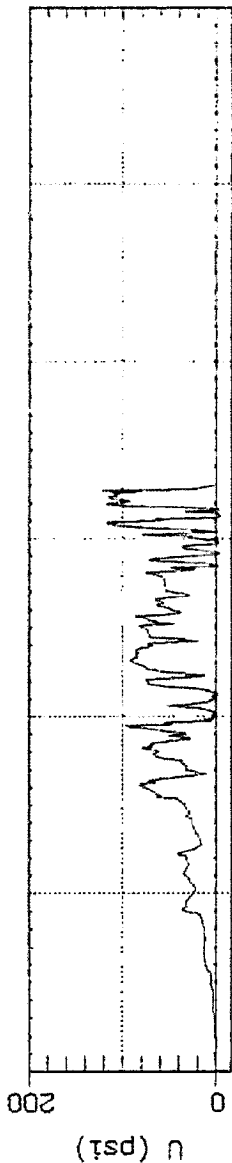
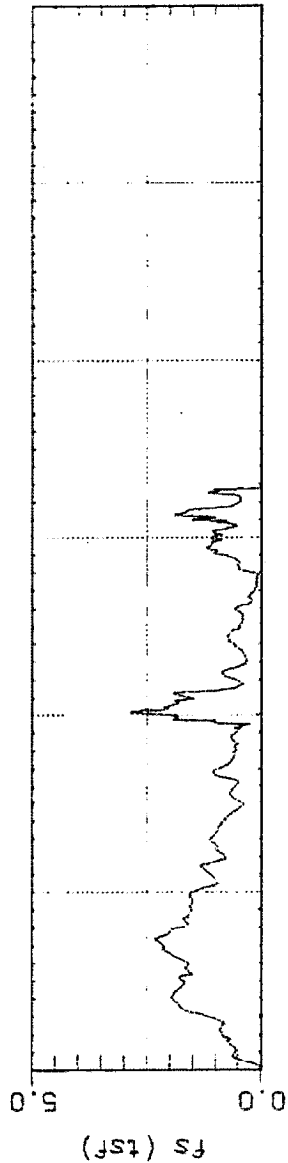
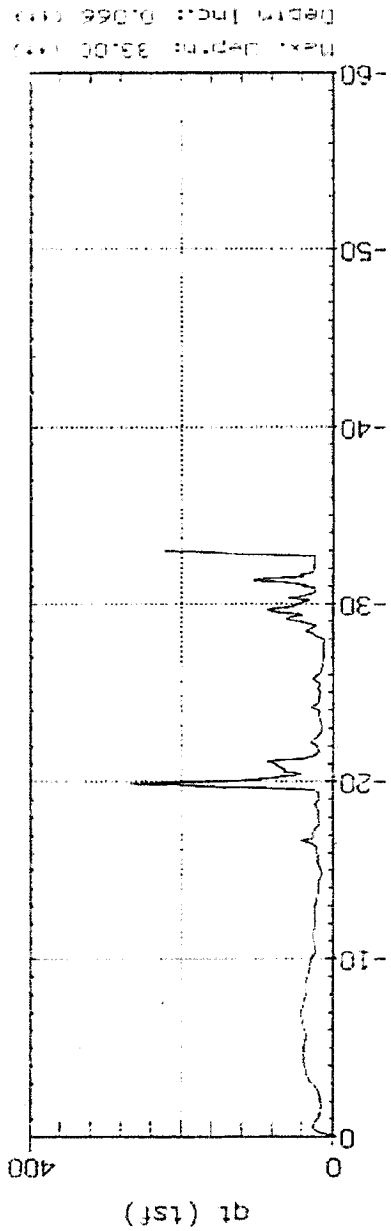

Next Depth: 33.00 (ft)
Depth Inct: 0.066 (ft)



MACTEC

STATION: TWA

LOCATION: NB-62

ENGINEER: H. BENKHAJRA

DATE: 05/16/08 08:35

Depth (ft)

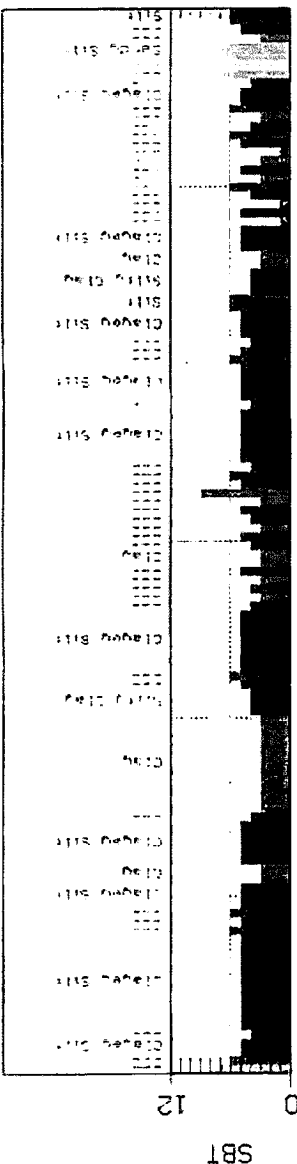
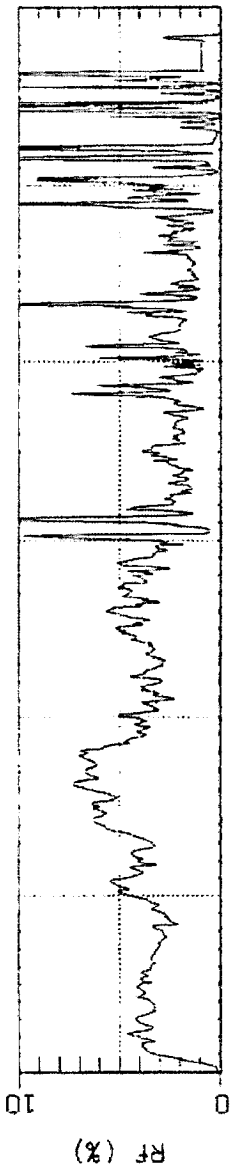
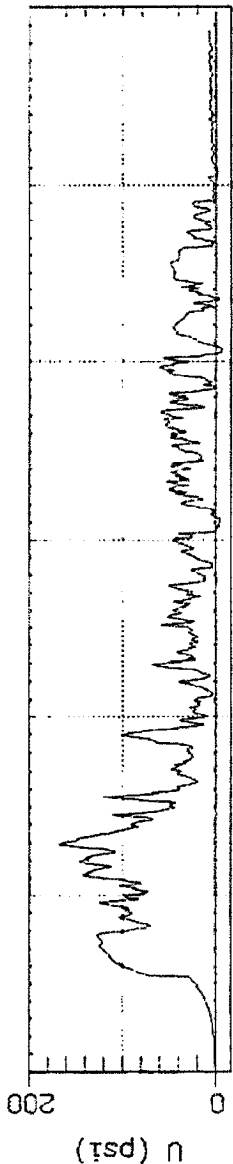
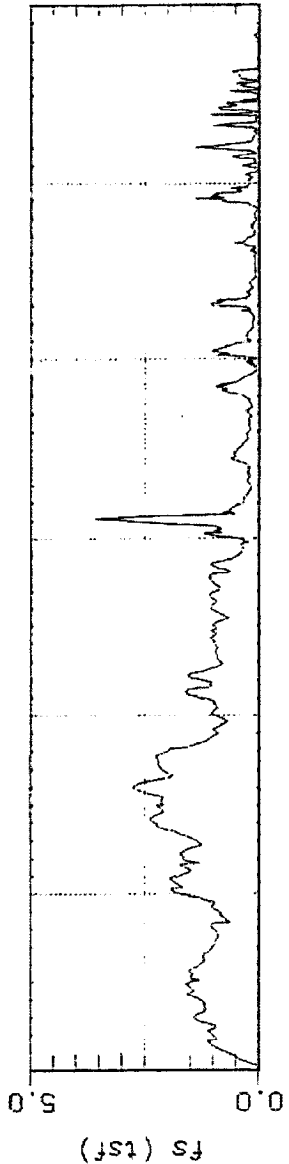
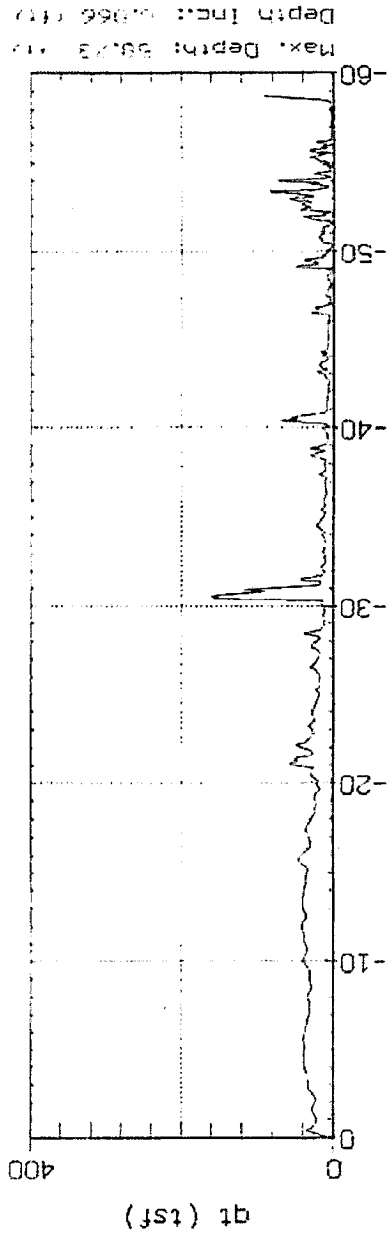

Max. Depth: 59.3 ft
Depth Incr: 0.066 ft

SBT: Soil Behavior Type Robertson (1990)



MACTEC

Station: KINGSTON T04

Location: NB-52

Engineer: H. BENKHAJOU

Date: 05/17/05 01:25

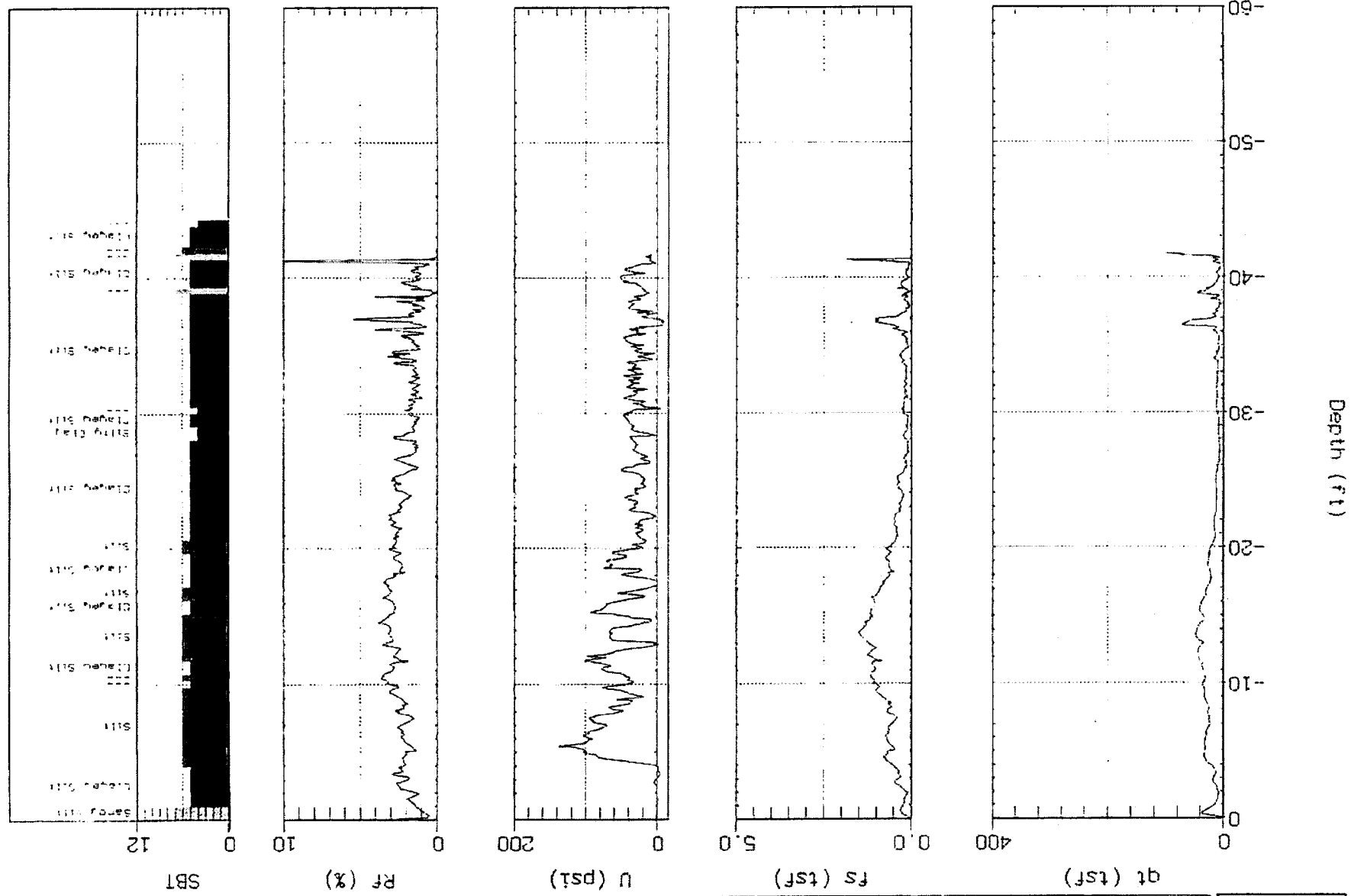

Test Depth: 41.73 ft
Depth Index: 0.066 ft

Soil Behavior Type: 1990

Depth (ft)

Max Depth: 29.81 (ft)
Depth Incl: 21.066 (ft)



MACTEC

Site: KINGSTON T04

Location: NB-04

Engineer: H. BENKHAHL

Date: 03/13 12:05

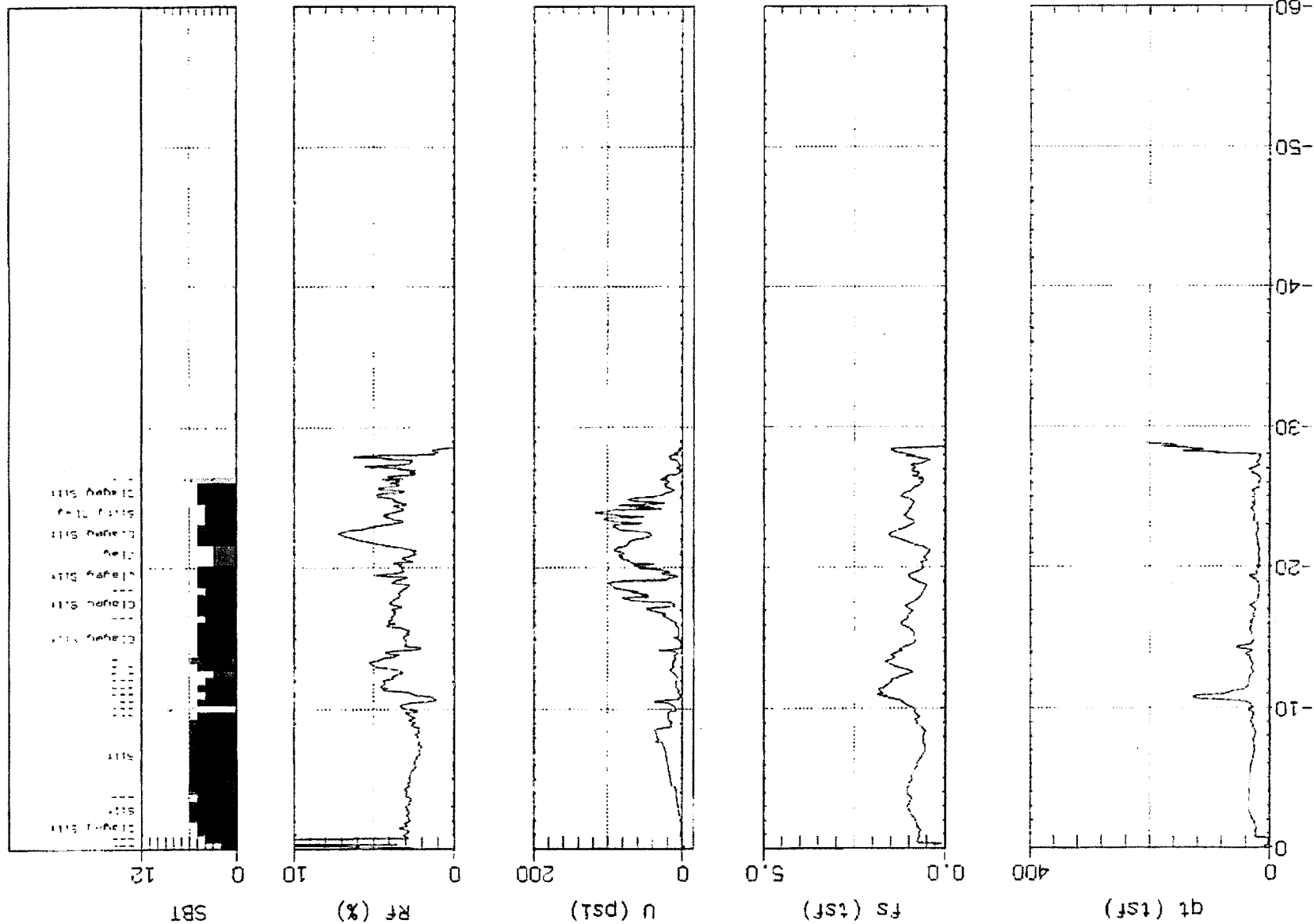

SBT: SOIL BEHAVIOR TYPE (ASTM D1586, 1990)



MACTEC

Site: KINGSTON TDA
Location: NB-58

Engineer: H. BENKHEVER
Date: 05/14/05 04:04

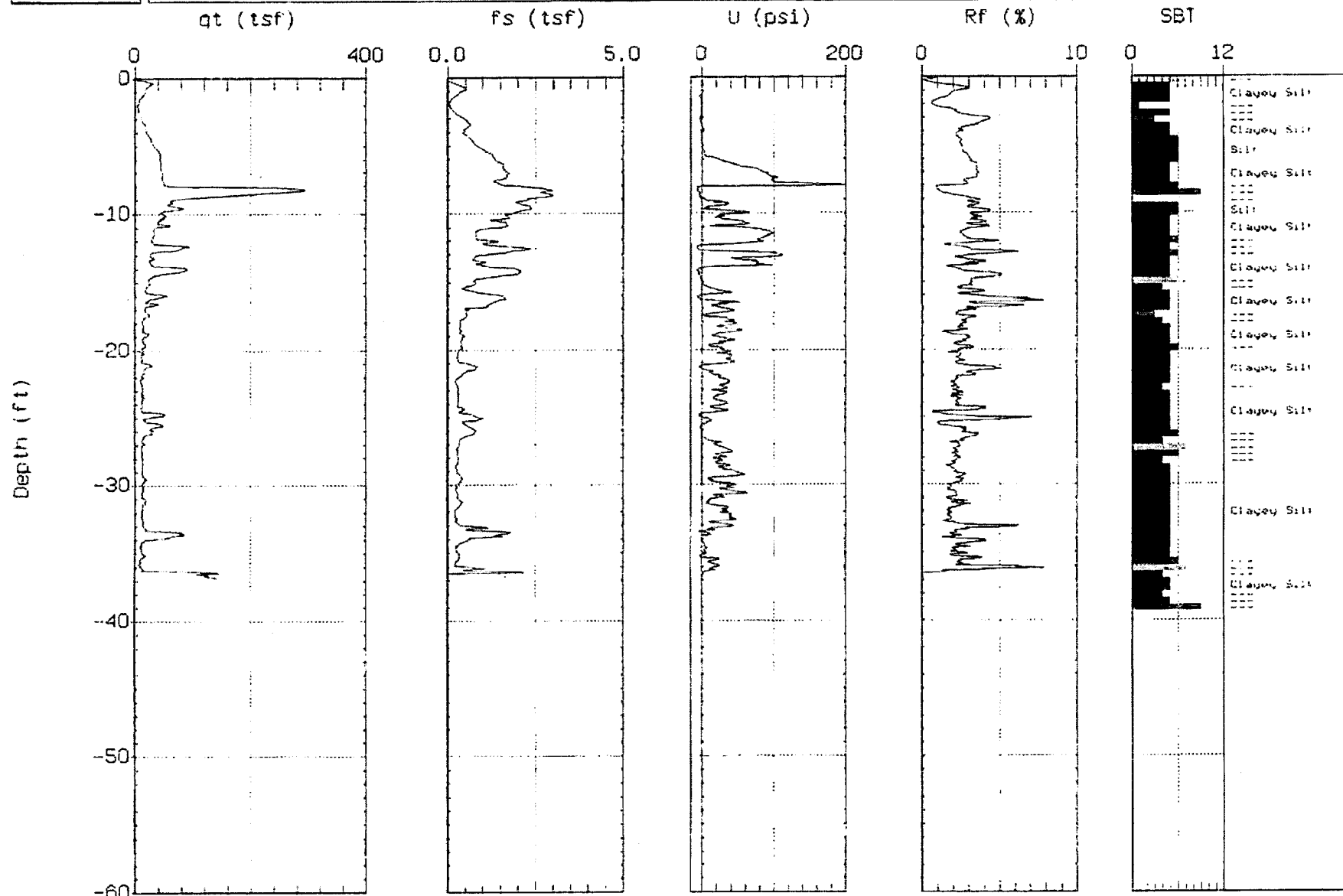

Max. Depth: 36.74 (ft)
Depth Int.: 0.066 (ft)

SBT: Soil Behavior Type (Robertson, 1990)

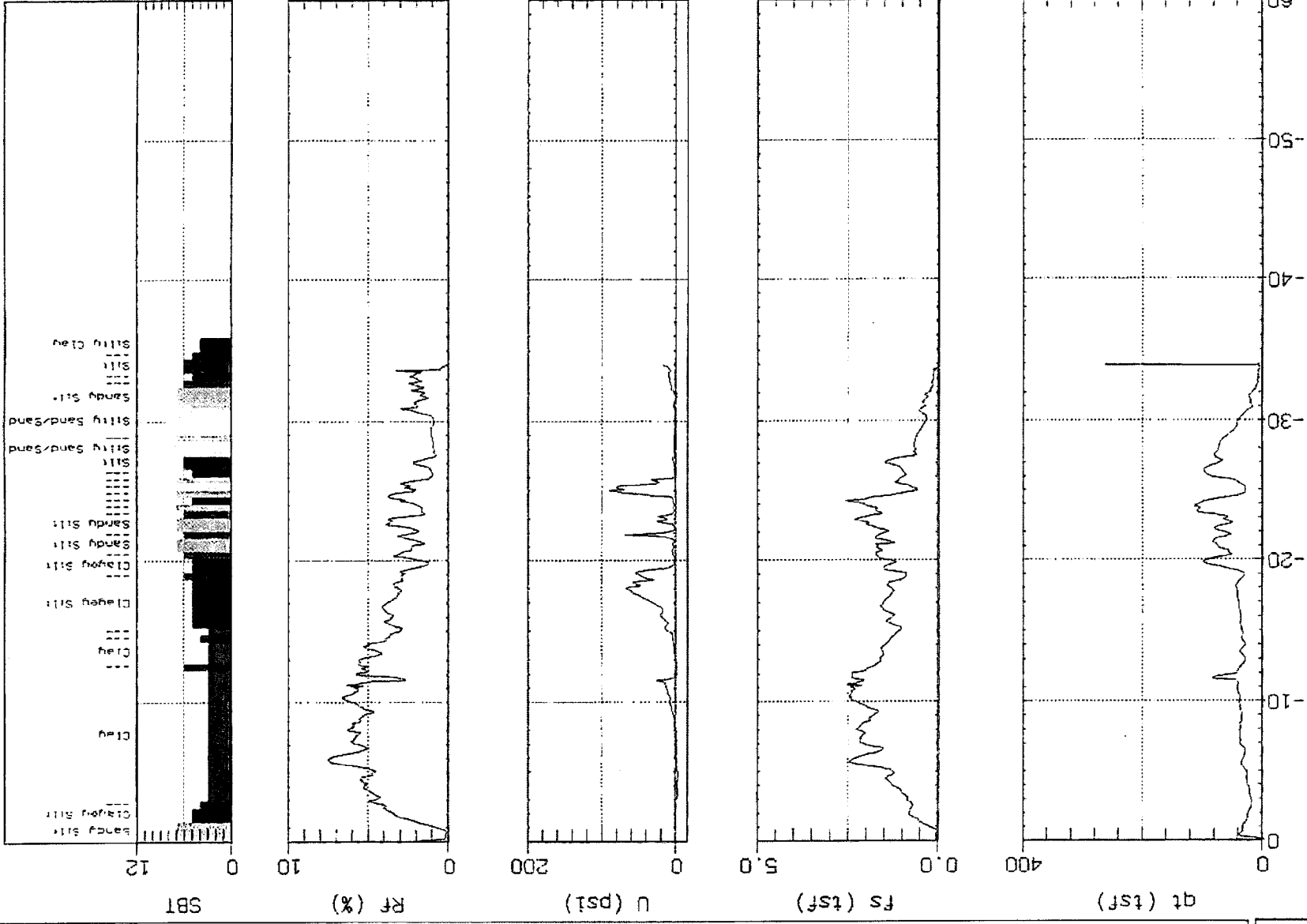

Max. Depth: 33.92 (ft)
 Depth Inc.: 0.066 (ft)

SBT: Soil Behavior Type (Robertson: 1990)



MACTEC

Site: KINGSTON TWP
Location: NH-11

Engineer: H. BENKIAYAH
Date: 05/17/05 06:07

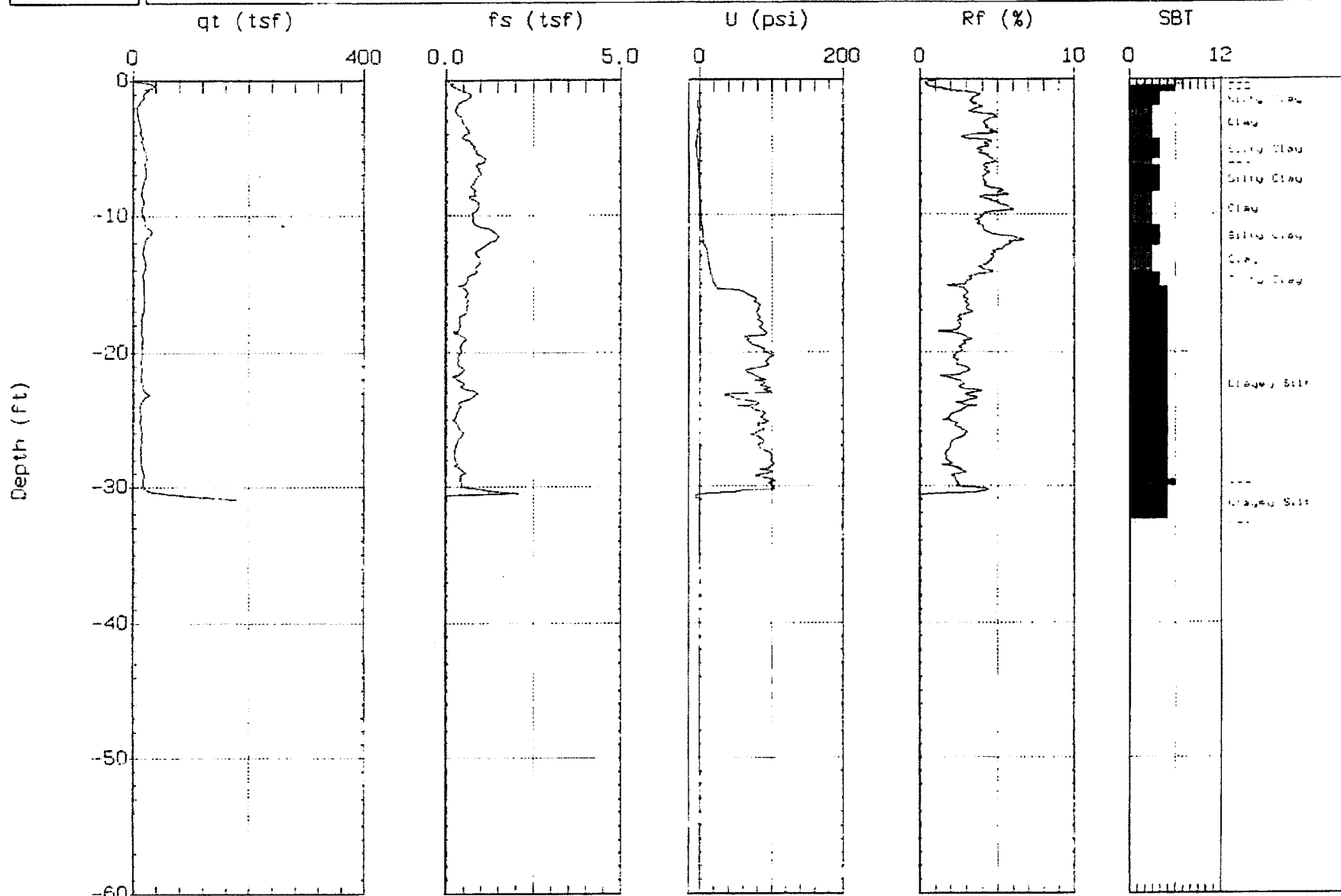



Max. Depth: 30.91 ft
Depth Inc.: 0.066 ft

SBT: Soil Behavior Type (D.Bertoni, 1990)

SBT: Soil Behavior Type (Refer to SPT Chart)

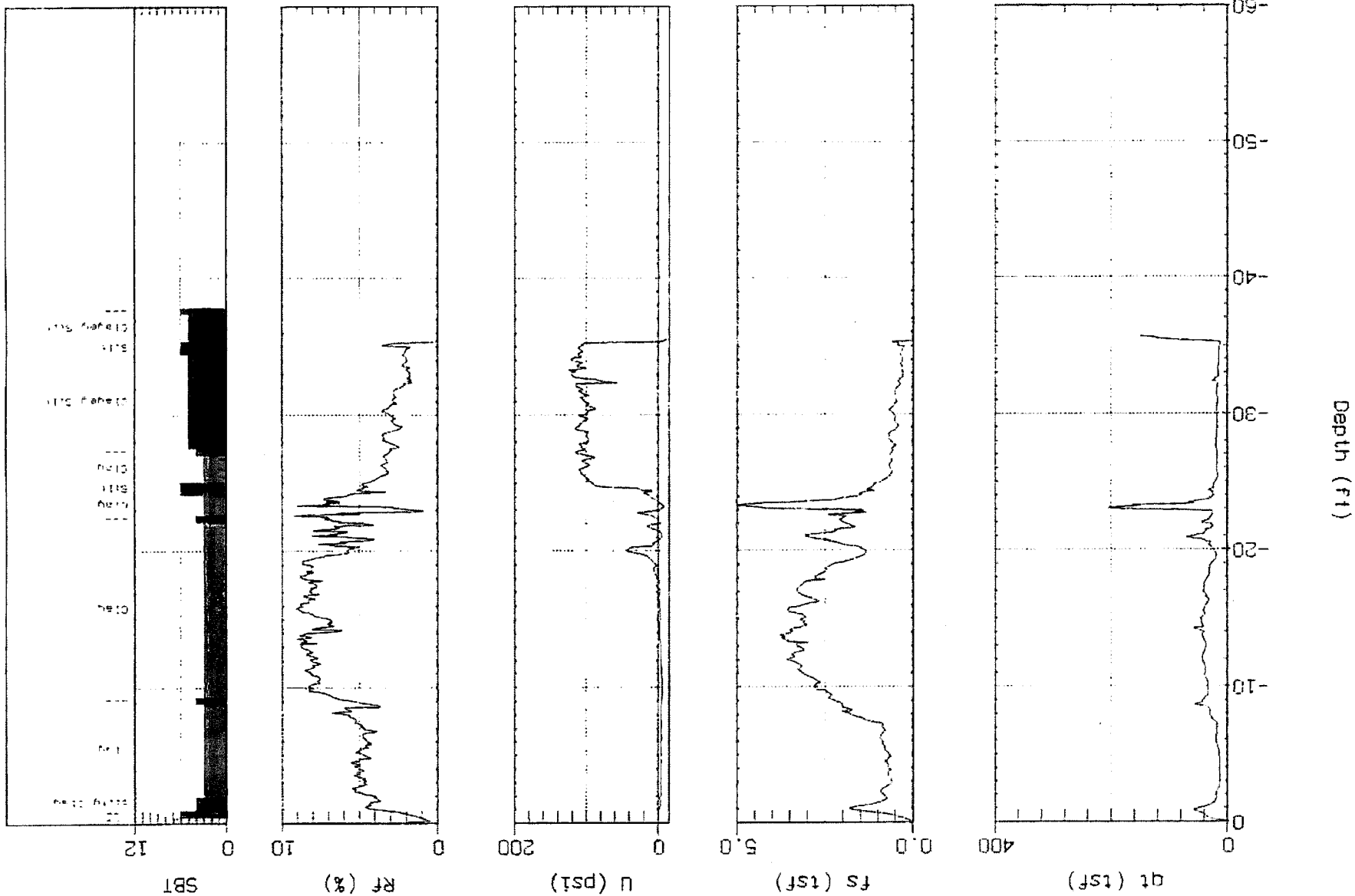
Max. Depth: 35.03 ft
Depth: 0.00 ft



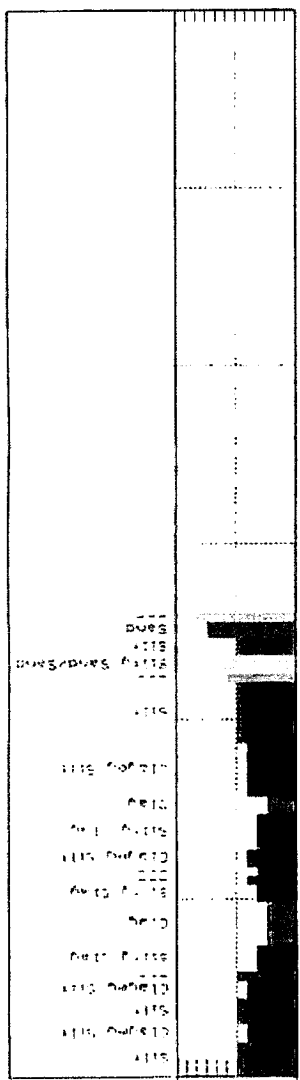

MACTEC
 Site: KINGSTON TUA
 Location: NE Z6
 Date: 05/12/05 07:22
 Engineer: R. BENJAMIN

SPT: Soil Behavior Type (Robertson, 1990)

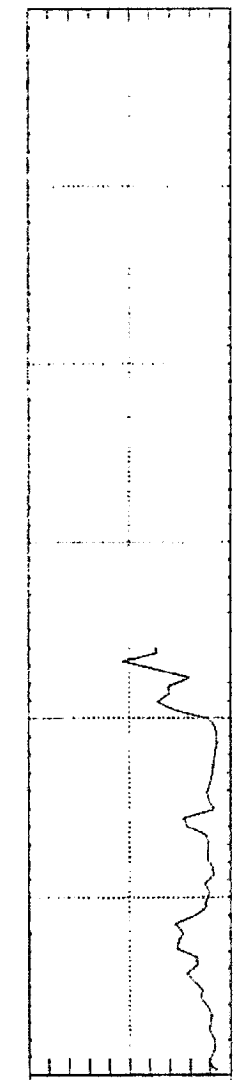

SBT



SPT N(60)

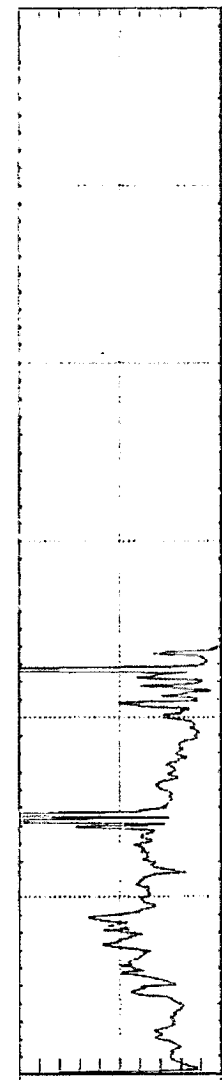

Rf (%)

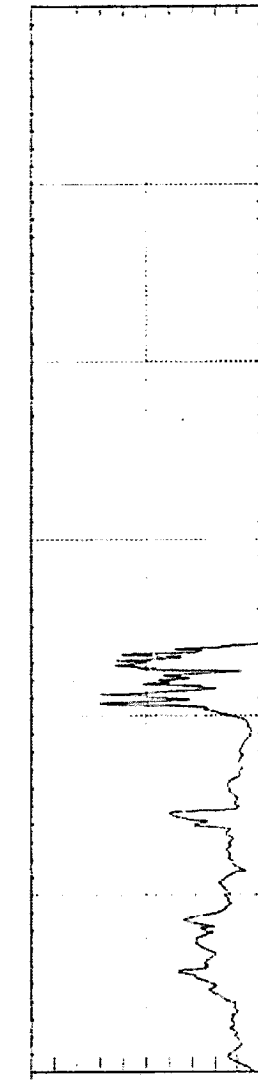

fs (tsf)

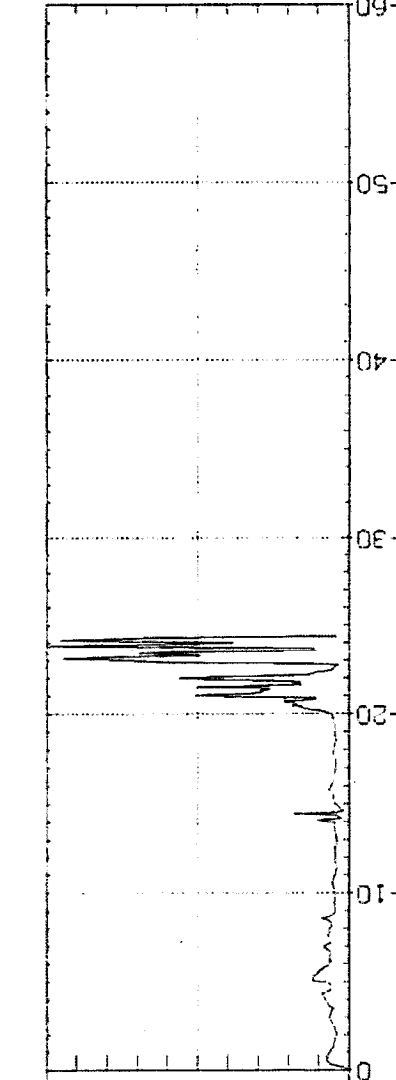

qt (tsf)

Depth (ft)

Max Depth: 24.41 (ft)
Depth (Inch): 0.056 (ft)

MACTEC
 Station: KINGSTON JOB
 Location: NB-29
 Engineer: H. BENTLEY
 Date: 05/16/05 04:29

SPT BEHAVIOR TYPE MODIFIED (1995)

MAX. DEPTH 23.31 FT
 DEPTH INCH 0.066 (1.7)

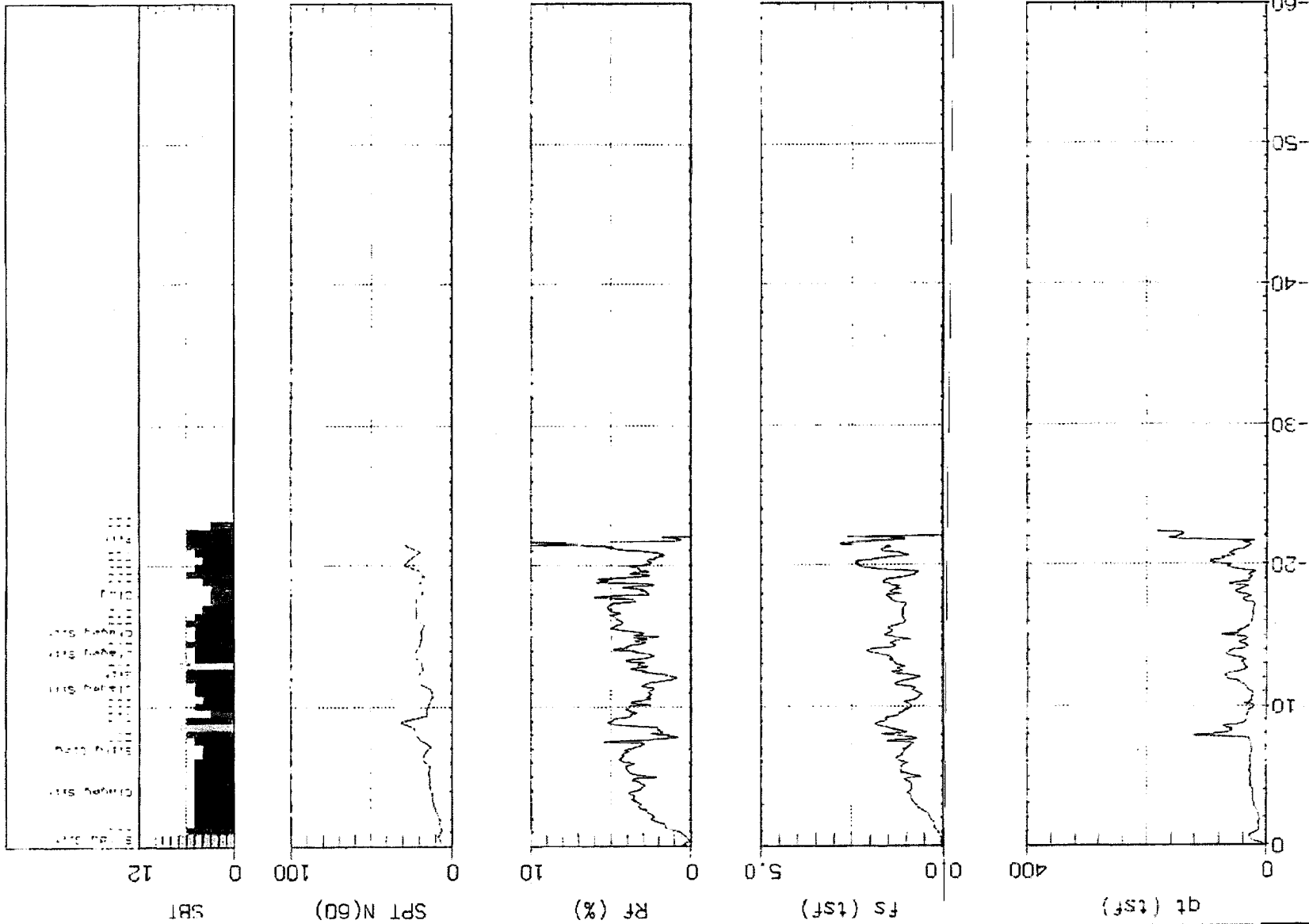

Site: KINGSTON TWP
 Location: NB-82
 Engineer: H.B. KHAYAL
 Date: 05/16/07 06:46
 MACTEC



Depth (ft)

Max Depth: 33.00 (ft)
 Depth Incr: 0.066 (ft)

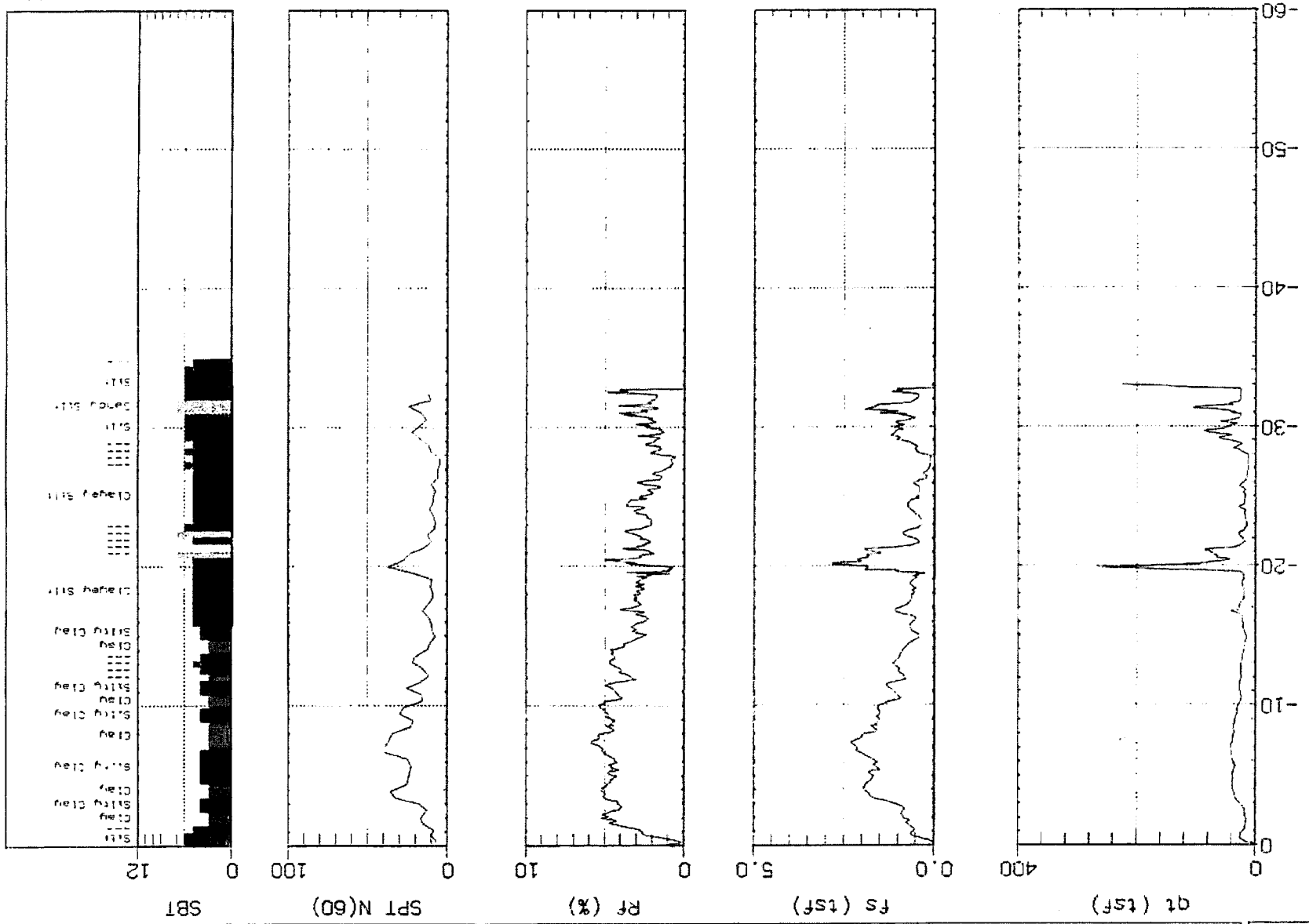

SBT: Soil Behavior Type (Based on 1990)



MACTEC

Site: KINGSTON TUA

Location: NB-62

Engineer: H. STINEBAUGH

Date: 05/16/05 08:25

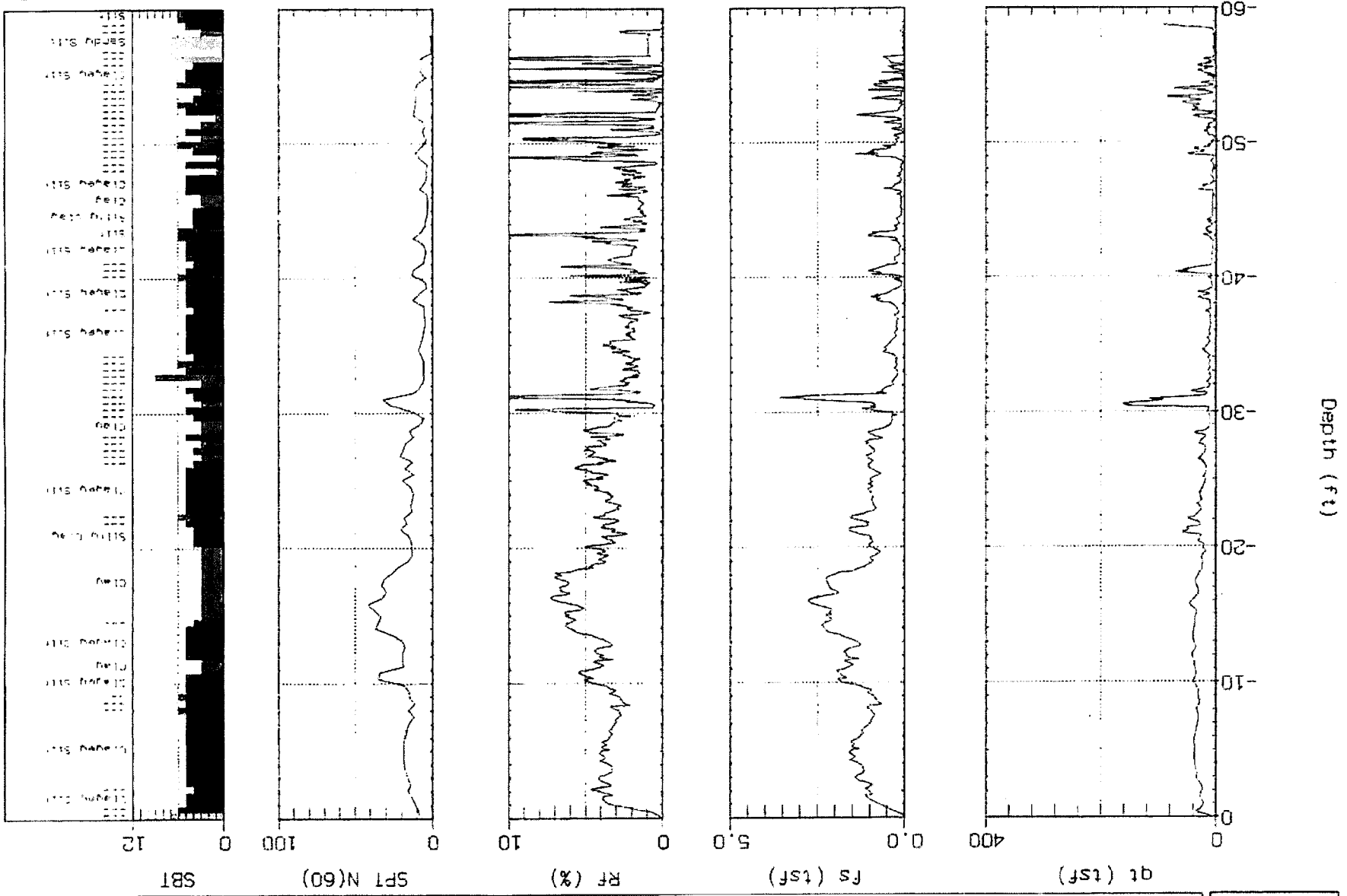

Max Depth: 58.23 (ft)
 Depth Unit: 0.066 (ft)

SPT Soil Behavior Type (After Schn 1990)



MACTEC

Site: KINGSTON TUN

Location: NB-57

Engineer: P. BERNI (PH)

Date: 05/17/05 08:28

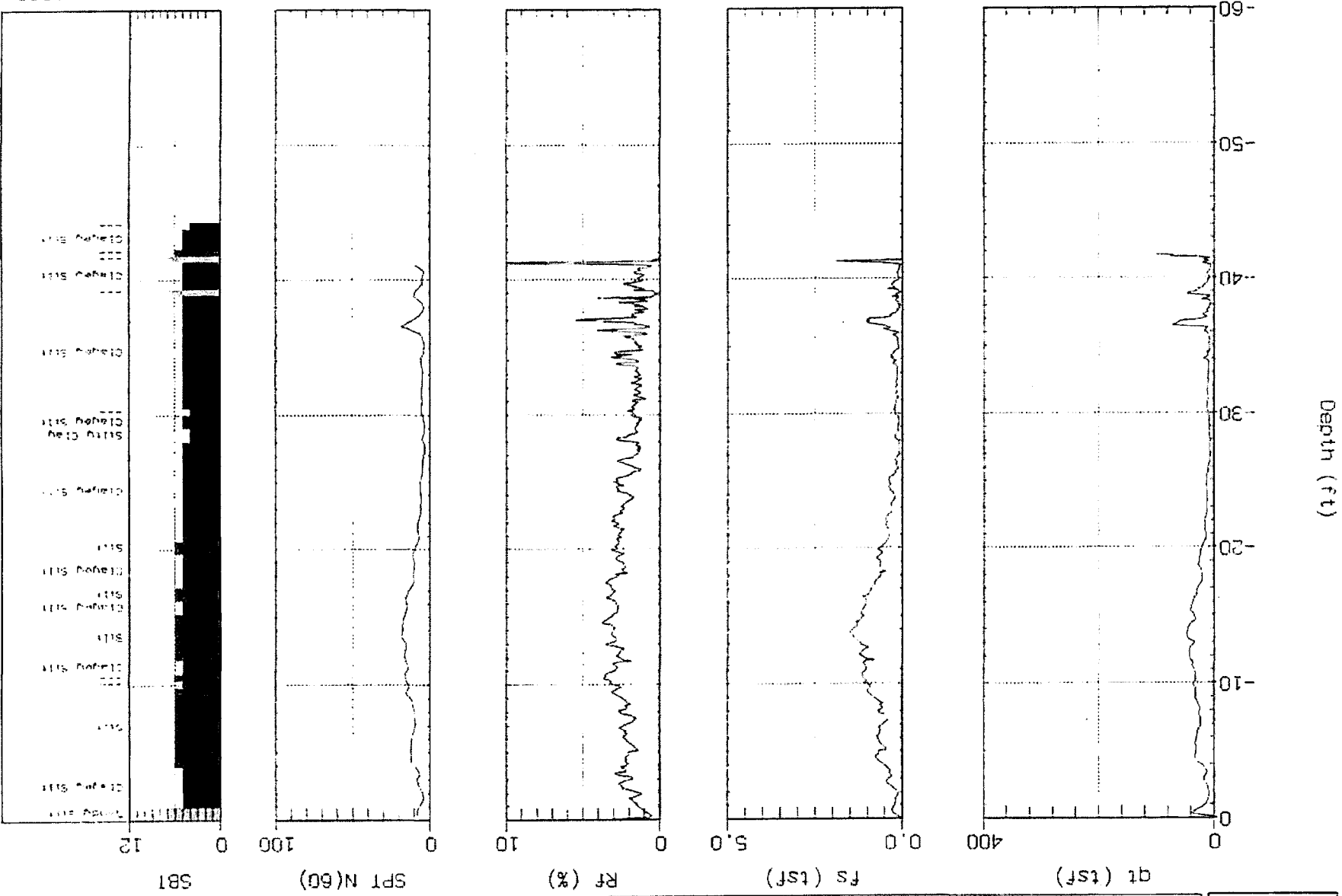

Depth (ft)



MACTEC

Site: KINGSTON TUP

Location: NB-94

Engineer: J. BENHAYEL

Date: 03/13/05

Depth (ft)

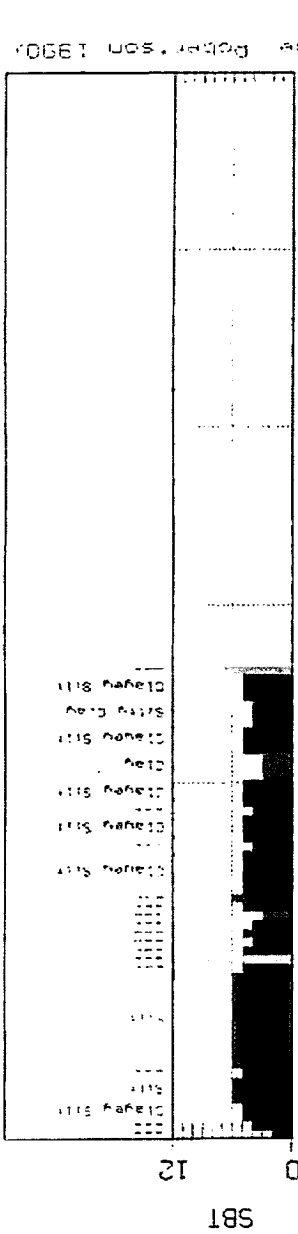
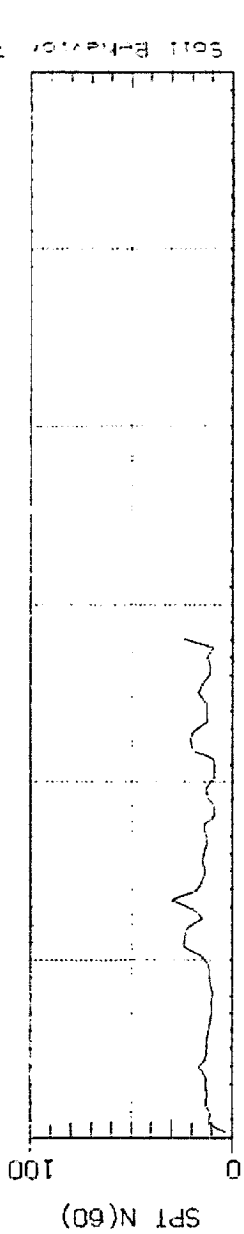
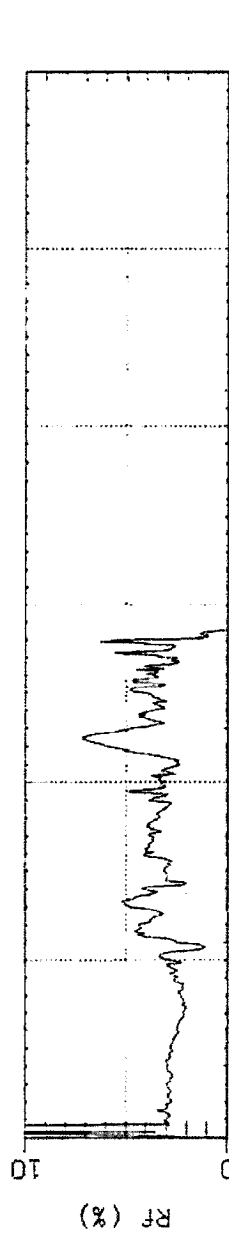
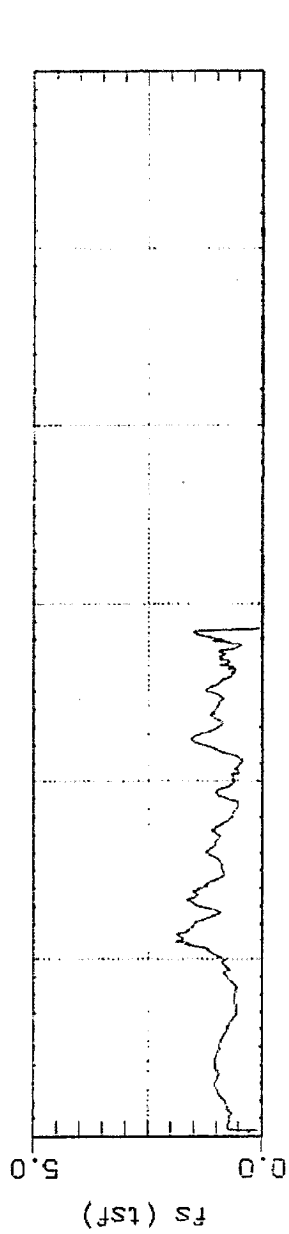
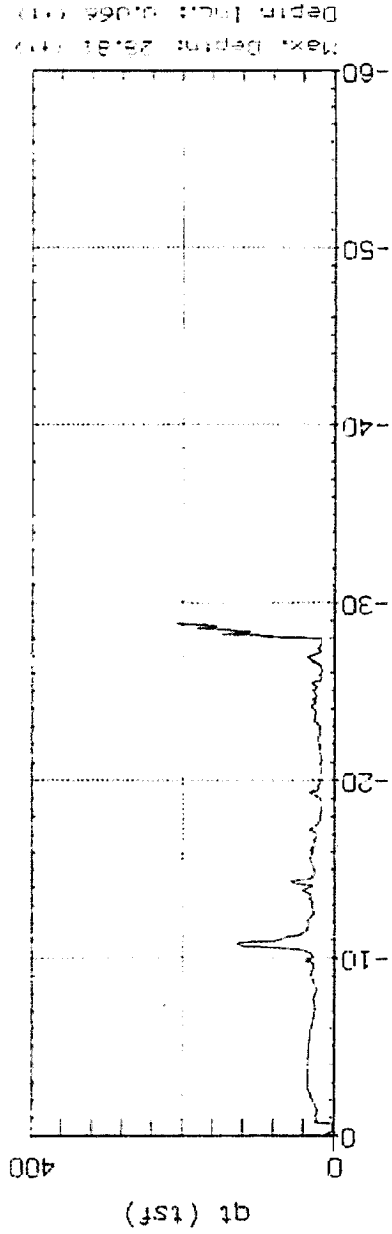

Max. Depth: 25.81 m
Depth Limit: 60.61 m

SBT Soil Behavior Type Report, 1900



MACTEC

Site: KINGSTON, TVA
Location: NB-5A

Engineer: M. BENKHYA
Date: 05/17/05 04:01

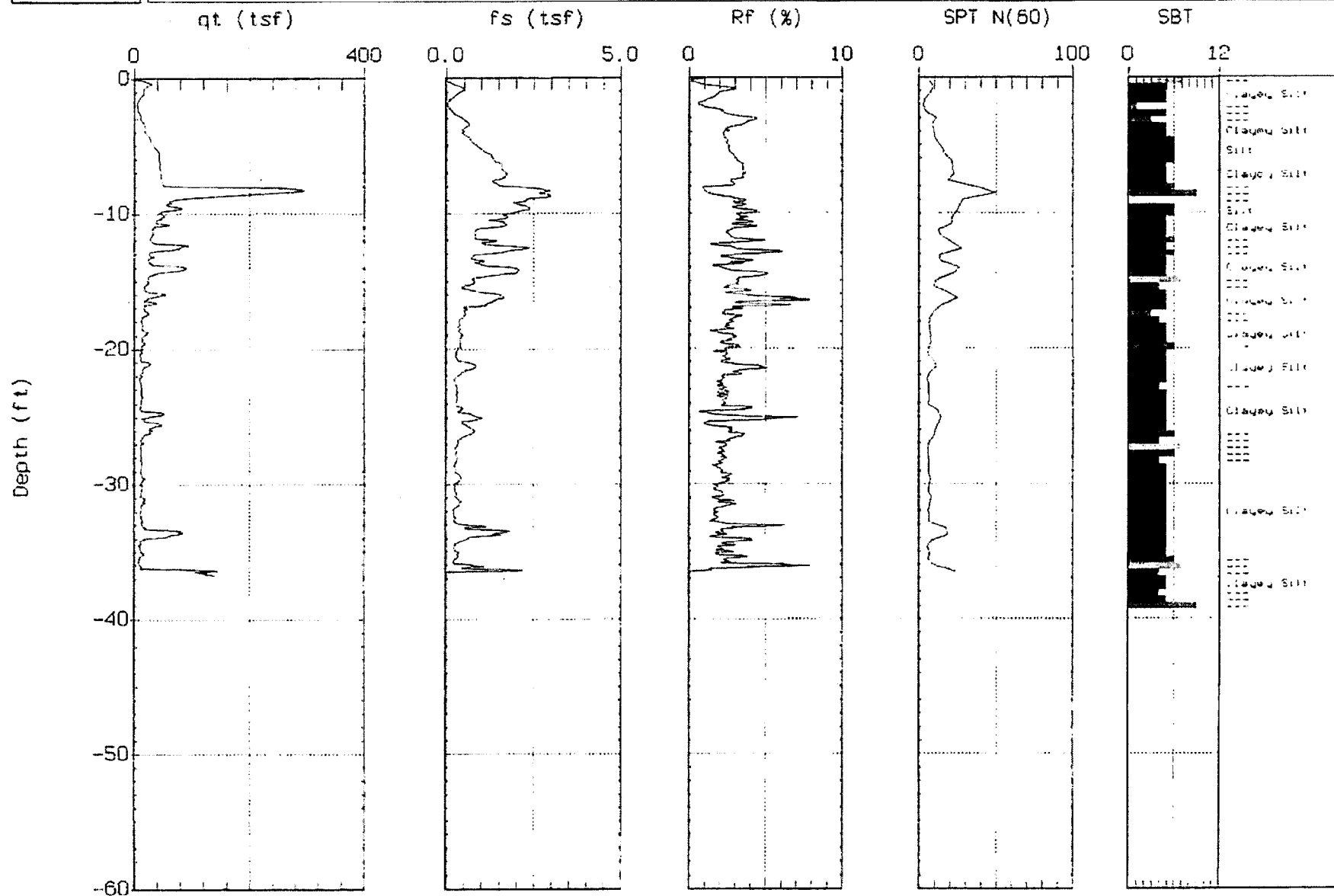

Max. Depth: 36.74 (ft)
Depth Inc.: 0.036 (ft)

SBT: Soil Behavior Type (Robertson 1990)



MACTEC

Site: KINGSTON TPA
Location: NE-56

Engineer: H. BENKHYAL
Date: 05:12:05 05:04

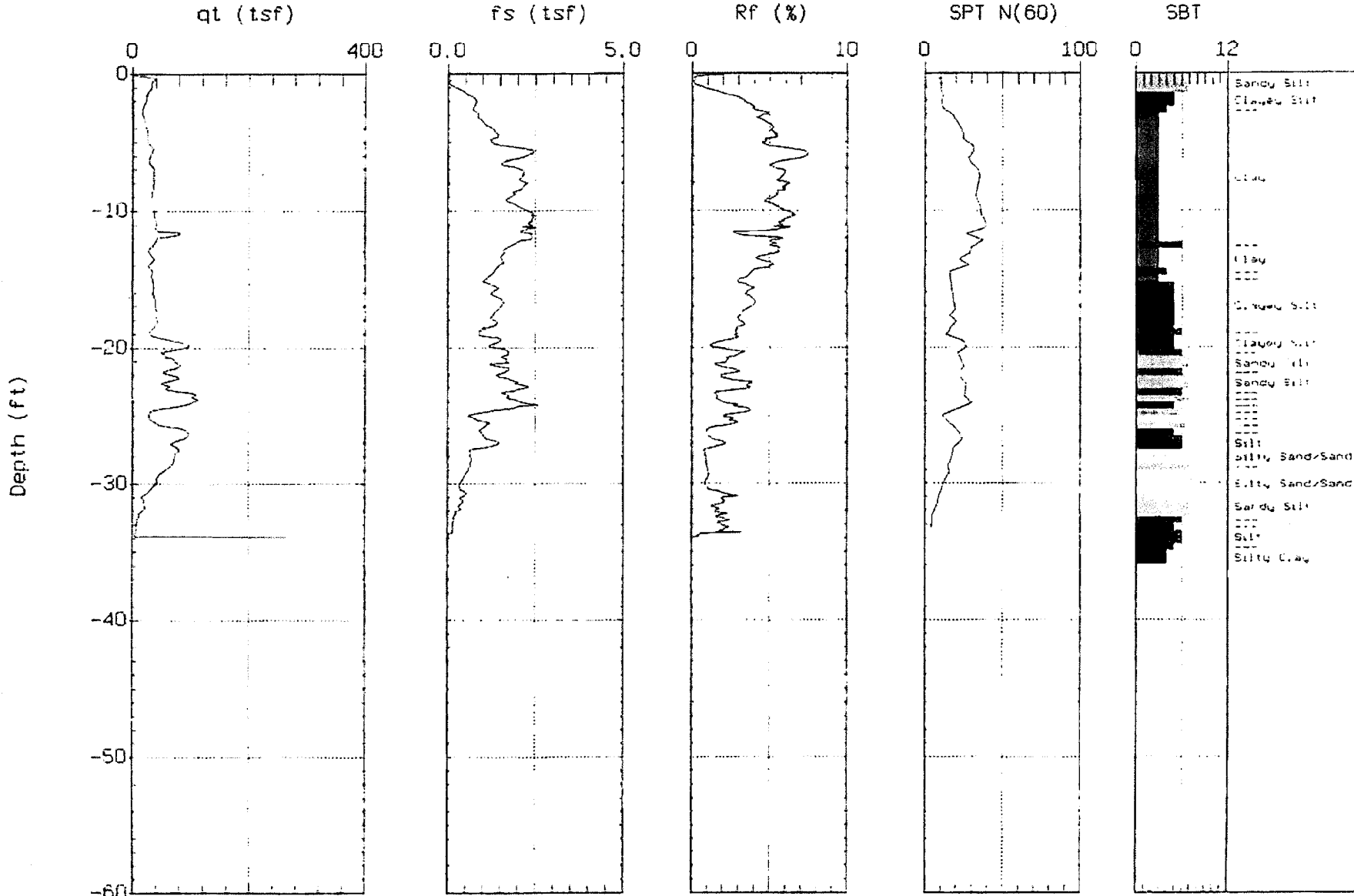

Max. Depth: 33.92 (ft)
Depth Inc.: 0.066 (ft)

SBT: Soil Behavior Type - Robertson 1990

Depth (ft)

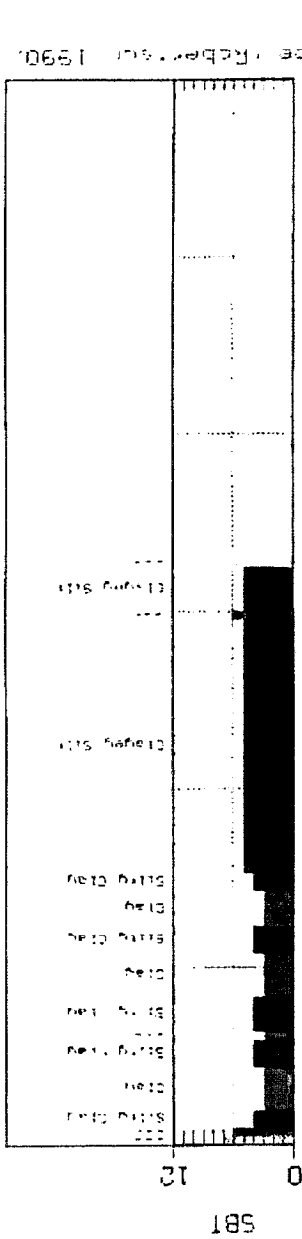
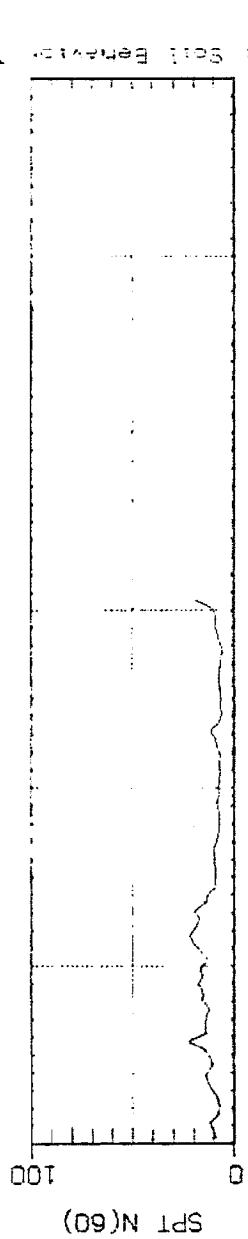
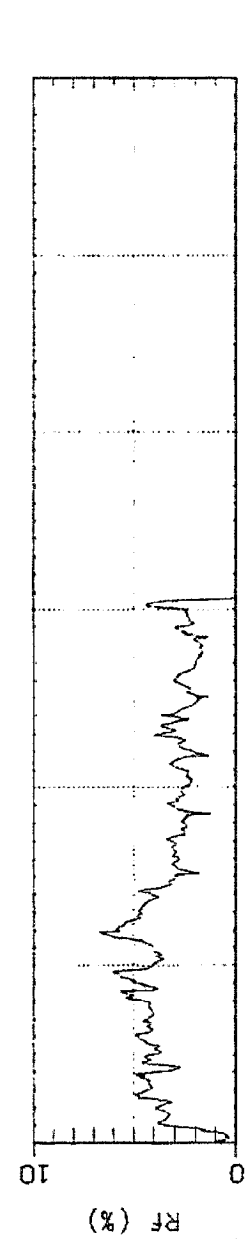
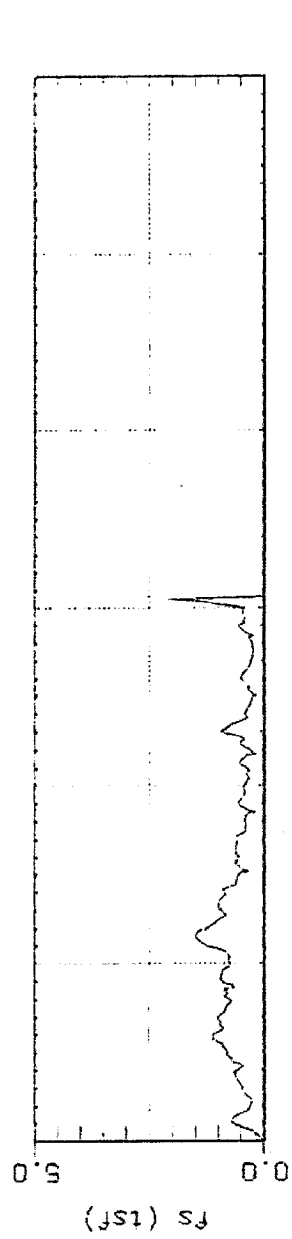
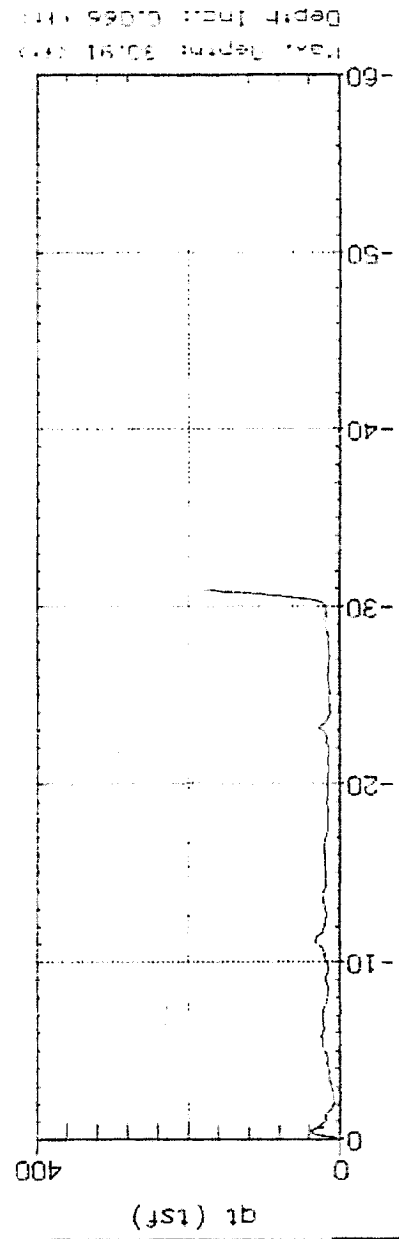

Total Depth: 30.91 m
Depth Incl: 0.065 m

SBT: Soil Behavior Type (Robertson, 1990)



MACTEC

ST. KINGSTON, TN
Location: NB-11

Engineer: H. BENKIN/RYAL
Date: 05/12/08 08:07



MACTEC

Site: KINOSTON TUN

Location: NB-26

Engineer: H. BENKHEVAL

Date: 05/12/05 07:52

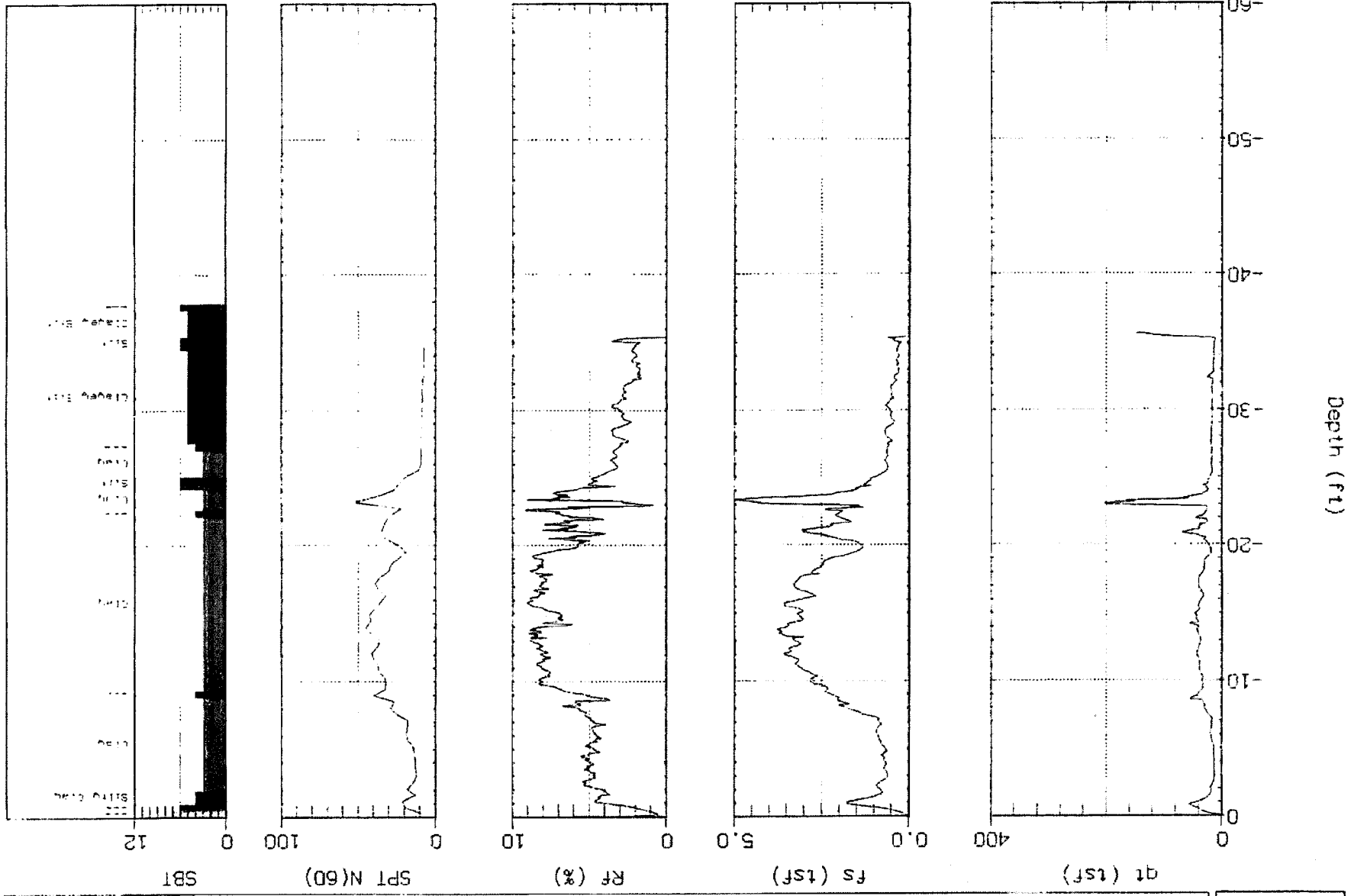

Max. Depth: 35.63 m
Depth Incr: 0.066 m

SPT Soil Behavior Type (Robertson 1992)

MACTEC

Site:KINGSTON TVA
Location:NB-79

Engineer:H.BENKHAYAL
Date:05:16:05 02:28

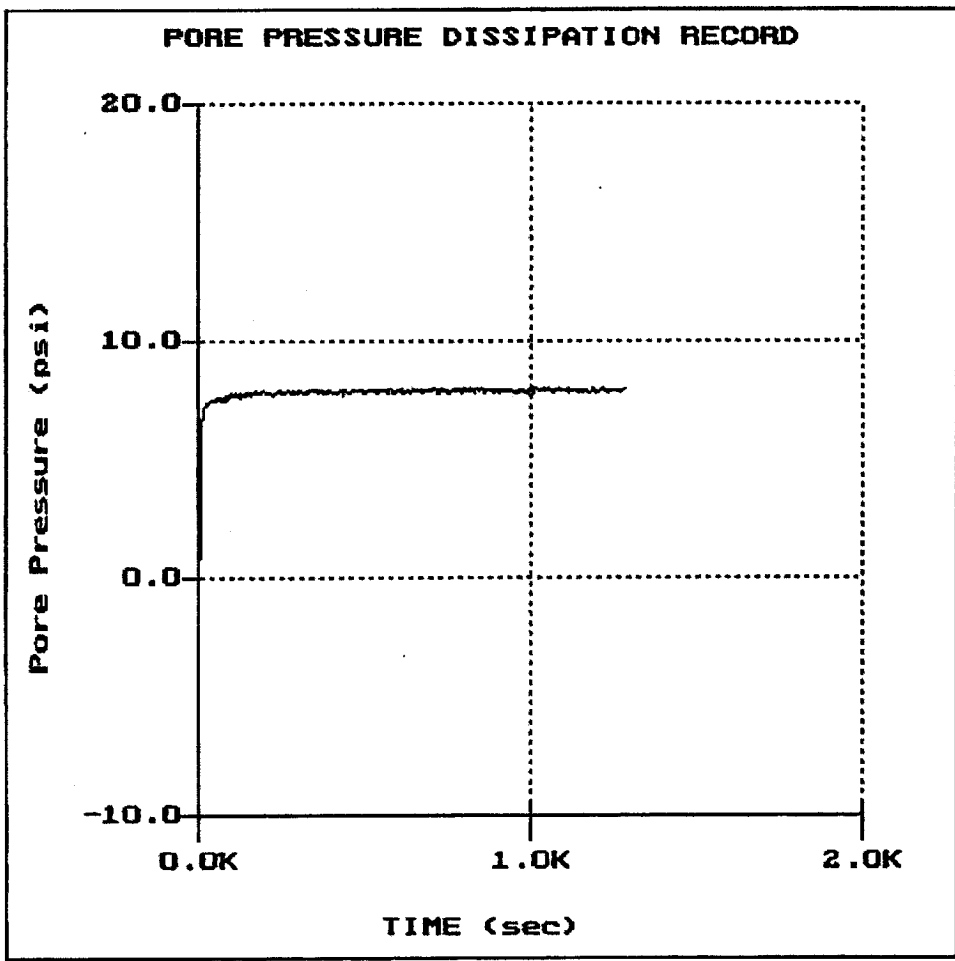

File: 062CP01.PPC
Depth (m): 7.44
(ft): 24.41
Duration : 1285.0s
U-min: -3.21 0.0s
U-max: 8.06 770.0s

MACTEC

Site:KINGSTON TVA
Location:NB-62

Engineer:H.BENKHAYAL
Date:05:16:05 08:35

PORE PRESSURE DISSIPATION RECORD

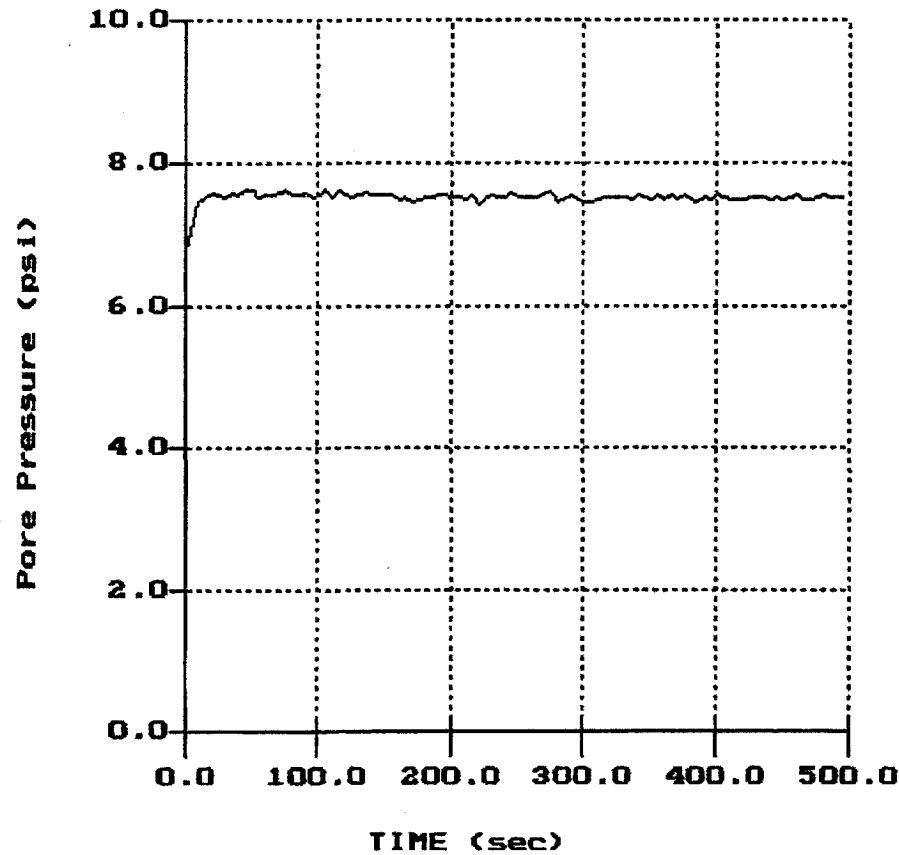

File: 062CP04.PPC
Depth (m): 17.28
(ft): 56.69
Duration : 495.0s
U-min: 6.73 0.0s
U-max: 7.59 115.0s

MACTEC

Site: KINGSTON TUA
Location: NB-58

Engineer: H. BENKHAVAL
Date: 05:17:05 04:04

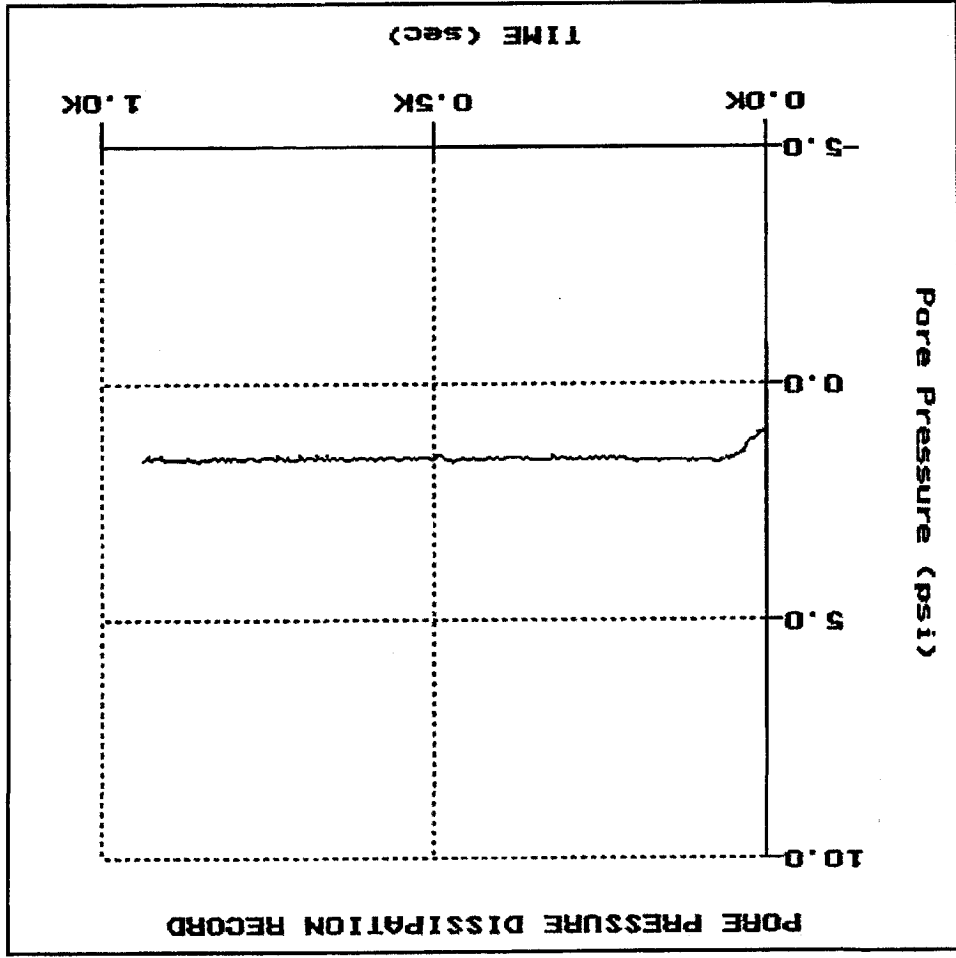

File: 062CP07.PPC
Depth (m): 11.20
(ft): 36.75
Duration: 935.05
U-min: 0.81 0.05
U-max: 1.67 855.05

MACTEC

Site: KINGSTON TVA
Location: NB-11

Engineer: H. BENKHAHAL
Date: 05:17:05 06:07

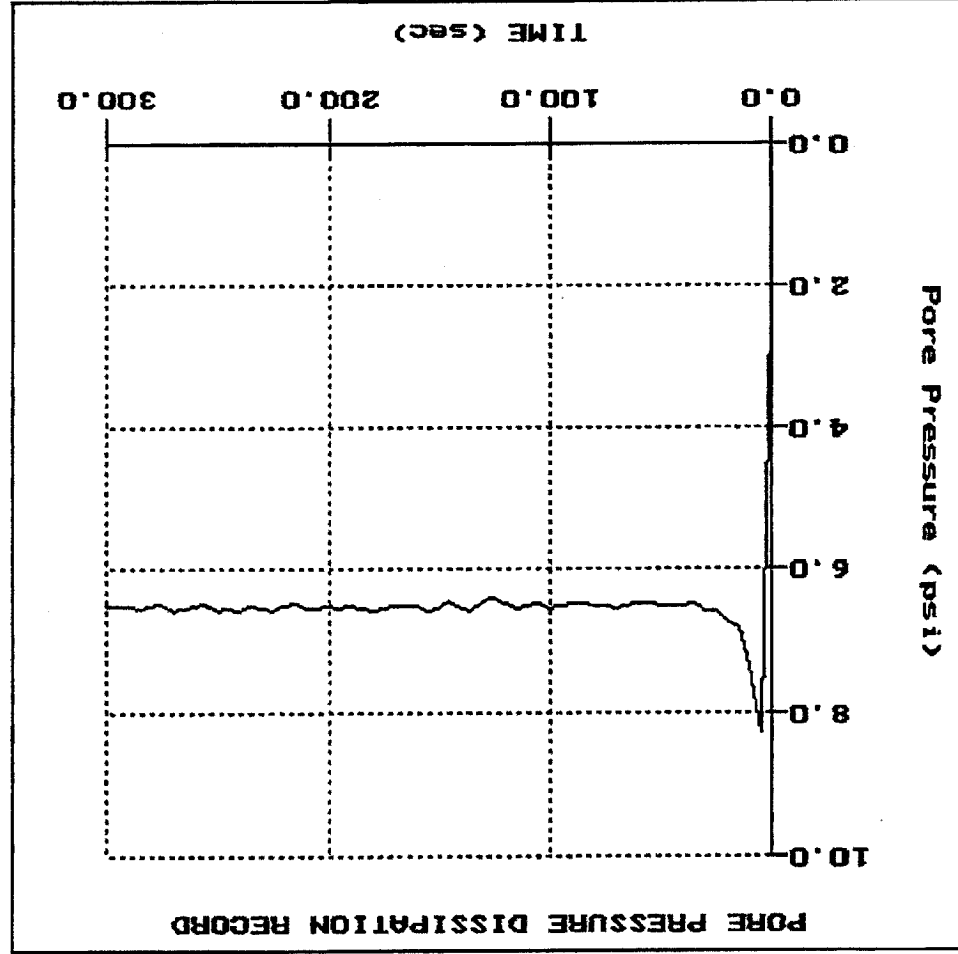

File: 062CP09.PPC
Depth (m): 9.42
(ft): 30.91
Duration: 300.0s
U-min: 2.22 0.0s
U-max: 8.26 5.0s

MACTEC

Site: KINGSTON TUA
Location: NB-26

Engineer: H. BENKHAYAL
Date: 05:17:05 07:02

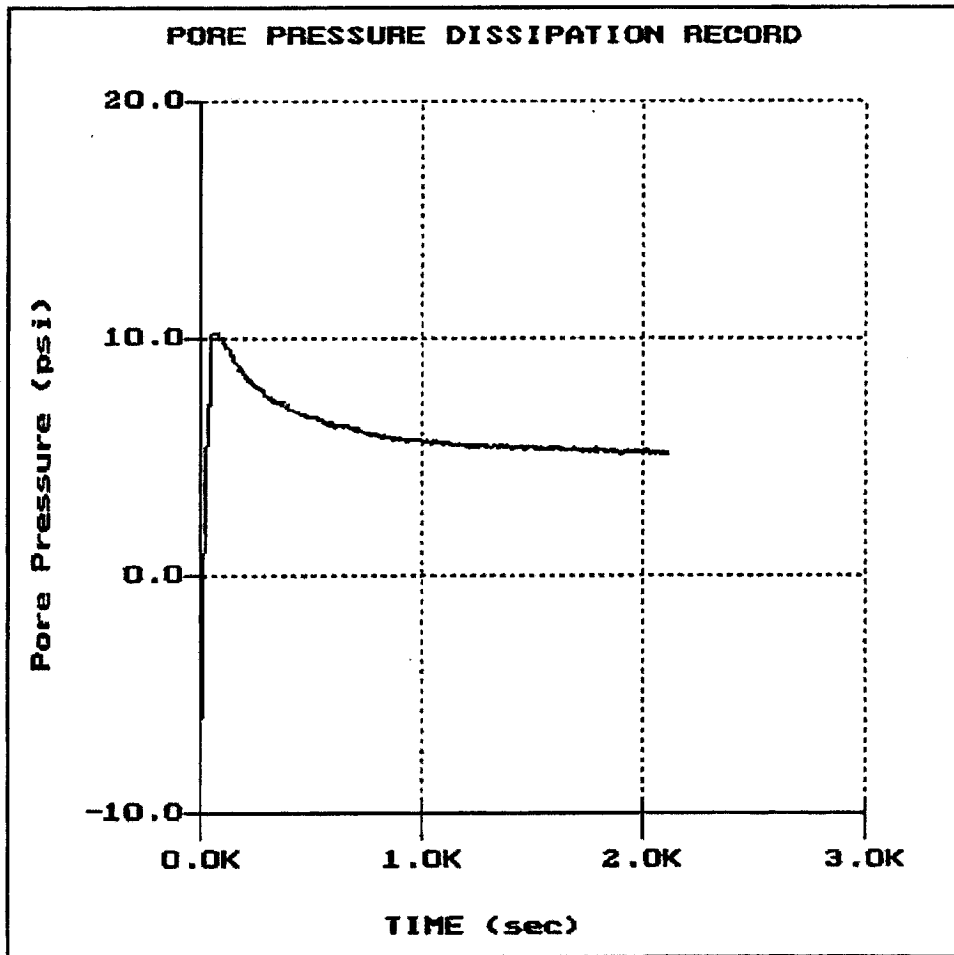

File: 062CP10.PPC
Depth (m): 10.86
(ft): 35.63
Duration : 2105.0s
U-min: -9.03 0.0s
U-max: 10.23 75.0s

APPENDIX E

LABORATORY TEST PROCEDURES

LABORATORY TEST RESULTS

LABORATORY TEST PROCEDURES

Moisture Content

The moisture content in a given mass of soil is the ratio, expressed as a percentage, of the weight of the water to the weight of the solid particles. This test was conducted in accordance with ASTM D-2216.

Atterberg Limits (Plasticity Index)

Originally, the Atterberg Limits consisted of seven "limits of consistency" of fine-grained soils. In current engineering usage, the term usually refers only to the liquid limit (LL) and plastic limit (PL). The LL (between the liquid and plastic states) is the water content at which a trapezoidal groove of specified shape, cut in moist soil held in a special cup, is closed after 25 taps on a hard rubber plate. The PL (between plastic and semi-solid states) is the water content at which the soil crumbles when rolled into threads of 1/8-inch in diameter.

The LL has been found to be proportional to the compressibility of the normally consolidated soil. The Plasticity Index (PI) is the calculated difference in water contents between the LL and PL. Together the LL and PI are used to classify silts and clays according to the Unified Soils Classification System (ASTM D 2487). The PI is used to predict the potential for volume changes in confined soils beneath foundations or grade slabs. The LL, PL, and PI are determined in accordance with ASTM D 4318.

Grain Size Distribution

Grain size tests are performed to aid in determining the soil classification and the grain size distribution. The soil samples are prepared for testing according to ASTM D 421 (dry preparation) or ASTM D 2217 (wet preparation). If only the grain size distribution of soils coarser than a number 200 sieve (0.074-mm opening) is desired, the grain size distribution is determined by washing the sample over a number 200 sieve and, after drying, passing the samples through a standard set of nested sieves. If the grain size distribution of the soils finer than the number 200 sieve is also desired, the grain size distribution of the soils coarser than the number 10 sieve is determined by passing the sample through a set of nested sieves. Materials passing the number 10 sieve are dispersed with a dispersing agent and suspended in water, and the grain size distribution calculated from the measured settlement rate of the

particles. These tests are conducted in accordance with ASTM D 422. The percentage of clay, silt, sand, and gravel which are given on the individual particle size analysis sheets presented later in this appendix, were obtained on particle size boundaries in accordance with AASHTO M145-94 (1995).

Specific Gravity

The specific gravity of soil solids is the ratio of the mass of a unit volume of a soil solids to the mass of the same volume of gas-free distilled water at 20C. The test method for determining the specific gravity of soil solids that passes the 4.75-mm (No. 4) sieve using a water pycnometer is described in ASTM D 854, Method B, "Test Methods for Specific Gravity of Soil Solids by Water Pycnometer".

Compaction Tests (Moisture-Density Relationship)

Compaction tests are performed on representative soil samples to determine the maximum dry density and optimum moisture content. The results of the tests are used in conjunction with other tests to determine engineering properties relating to settlement, bearing capacity, shear strength, and permeability. The results may also be used as a standard to determine the percent compaction of any soil embankment.

The two most commonly used compaction tests are the standard Proctor test and the modified Proctor test. They are performed in accordance with ASTM D 698 and D 1557, respectively. Generally, the standard Proctor compaction test is run on samples from building areas and areas where moderate loads are anticipated. The modified Proctor compaction test is generally used for analyses of highways and other areas where large building loads are expected. Both tests have three procedures, depending upon soil particle size:

Test	Procedure	Hammer Weight (Pounds)	Hammer Fall (Inches)	Mold Diameter (Inches)	Screen Size (Material Finer Than)	Number of Layers	Number of Blows per Layer
Standard (D 698)	A	5.5	12	4	No. 4 sieve	3	25
	B	5.5	12	4	No. 3/8" sieve	3	25
	C	5.5	12	6	3/4" sieve	3	56
Modified (D 1557)	A	10	18	4	No. 4 sieve	5	25
	B	10	18	4	No. 3/8" sieve	5	25
	C	10	18	6	3/4" sieve	5	56

Test results are presented as a curve depicting dry unit weight versus moisture content. The compaction method used and any deviations from the recommended procedures are noted in the report.

Constant Head Permeability Test

The test was performed on undisturbed and remolded samples. The physical dimensions and weight were obtained and the sample was encased in a rubber membrane and placed in a triaxial chamber. The sample was then back-pressure saturated until a B value of 0.95 or greater was reached. After saturation was obtained, the sample was consolidated under various confining stresses depending upon the laboratory assignment requirements. Upon completion of consolidation, a constant head permeability test was performed.

Pinhole Testing

The pinhole test presents a direct, qualitative measurement of the dispersibility or deflocculation and consequent erodibility of clay soils by causing water to flow through a small hole punched in a specimen. The test and criteria for evaluating the test data are based upon results of several hundred tests on samples collected from embankments, channels, and other areas where clay soils have eroded or resisted erosion in nature. The pinhole testing was conducted in accordance to ASTM D 4647.

Consolidation Test

Consolidation tests are conducted on representative soil samples to determine the change in height of the sample with increasing load. The results of these tests are used to estimate the amount and rate of settlement of structures constructed on similar soils.

A consolidation test is conducted according to ASTM D-2435 on a single section of an undisturbed sample extruded from a sample tube. The sample is trimmed into a disc 2.0 or 2.5 inches in diameter and 1 inch thick. The disc is confined in a steel ring and sandwiched between porous plates. Depending on the conditions in the field, the test may be conducted with a sample either at its natural moisture content or saturated. It is then subjected to incrementally increasing vertical loads, and the resulting deformations are measured with a micrometer dial gauge. Void ratios are

then calculated from these deformation readings. The test results are presented in the form of pressure-versus-void-ratio curves on the accompanying Consolidation Test Sheet.



GRAIN SIZE ANALYSIS TEST RESULTS

PARTICLE SIZE DISTRIBUTION TEST REPORT

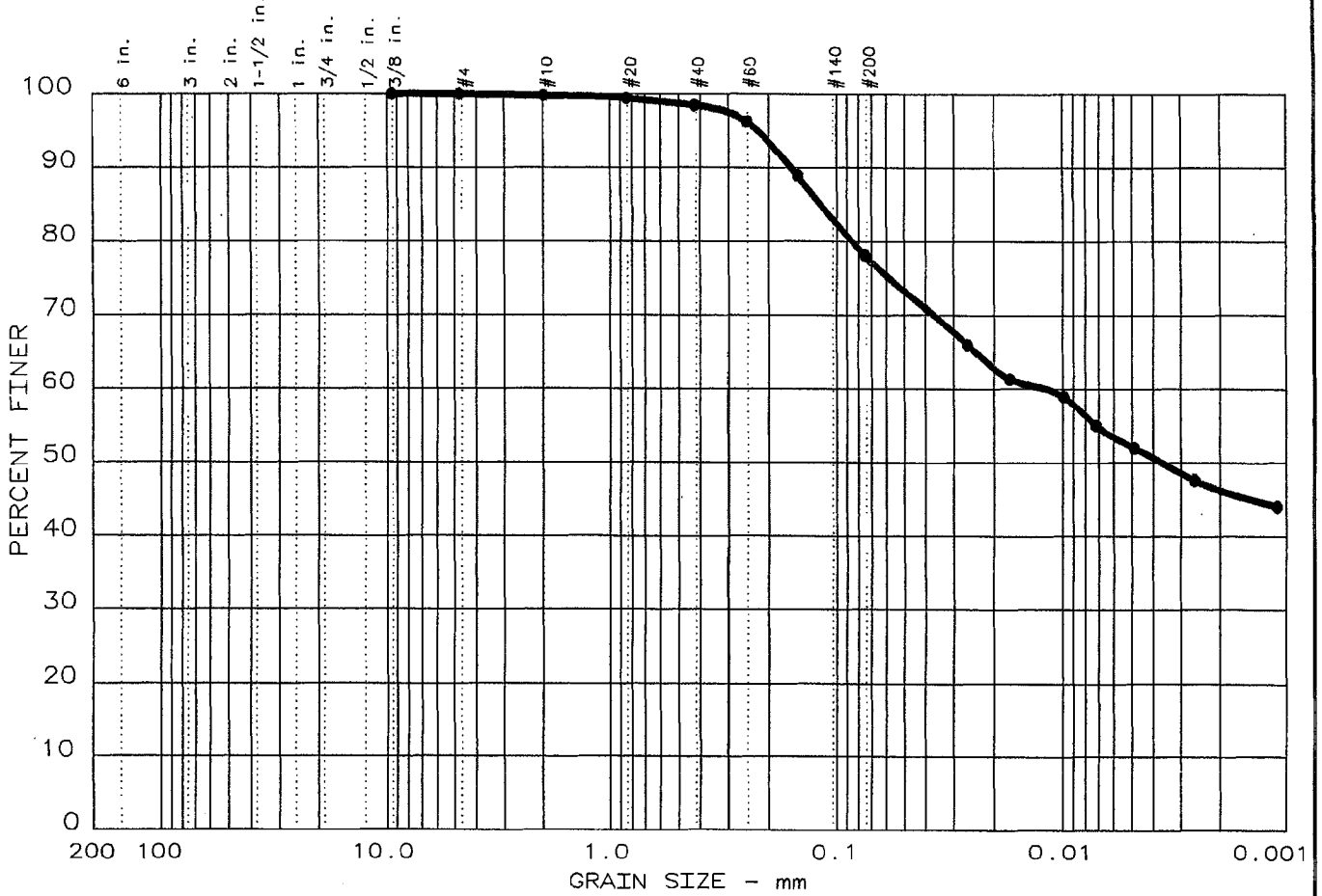

Test	% +3"	% GRAVEL	% SAND	% SILT	% CLAY	USCS	LL	PI
2	0.0	0.0	21.8	26.0	52.2	MH	63	28

SIEVE inches size	PERCENT FINER	
	●	
0.375	100.0	
GRAIN SIZE		
D ₆₀	0.0116	
D ₃₀		
D ₁₀		
COEFFICIENTS		
C _c		
C _u		

SIEVE number size	PERCENT FINER	
	●	
4	100.0	
10	99.8	
20	99.4	
40	98.4	
60	96.2	
100	89.0	
200	78.2	

Sample information:
 ● Boring NB-2, 2-10' Bulk
 Light orange brown
 elastic silt with sand

Remarks:
 Sample Number 3203
 Methods: Particle Size:
 ASTM D 422-63; Sieve
 Analysis: AASHTO T 27-99

Project No.: 3043051021.0001
 Project: TVA Kingston - Proposed Gypsum Stack
 Date: June 23, 2005

=====

GRAIN SIZE DISTRIBUTION TEST DATA

Test No.: 2

Date: June 23, 2005
 Project No.: 3043051021.0001
 Project: TVA Kingston - Proposed Gypsum Stack

=====

Sample Data

Location of Sample: Boring NB-2, 2-10' Bulk
 Sample Description 1: Light orange brown
 Sample Description 2: elastic silt with sand
 USCS Class: MH Liquid limit: 63 Plasticity index: 28

Notes

Remarks: Sample Number 3203 Methods: Particle Size:
 ASTM D 422-63; Sieve Analysis: AASHTO T 27-99
 Fig. No.: 203

Mechanical Analysis Data

	Initial	After wash
Dry sample and tare=	686.56	159.81
Tare =	0.00	0.00
Dry sample weight =	686.56	159.81
Minus #200 from wash=	76.7 %	
Tare for cumulative weight retained=	0	

Sieve	Cumul. Wt. retained	Percent finer
0.375 inches	0.00	100.0
# 4	0.14	100.0
# 10	1.59	99.8
# 20	4.37	99.4
# 40	10.77	98.4
# 60	26.19	96.2
# 100	75.76	89.0
# 200	149.82	78.2

Hydrometer Analysis Data

Separation sieve is number 40
 Percent -# 40 based on complete sample= 98.4
 Weight of hydrometer sample: 63
 Hygroscopic moisture correction:
 Moist weight & tare = 55.28
 Dry weight & tare = 54.50
 Tare = 22.40
 Hygroscopic moisture= 2.4 %
 Calculated biased weight= 62.49
 Table of composite correction values:
 Temp, deg C: 20.0 21.0 22.0 22.5 23.0

Comp. corr: - 6.7 - 6.4 - 6.1 - 5.9 - 5.8
 Meniscus correction only= 0
 Specific gravity of solids= 2.75
 Specific gravity correction factor= 0.978
 Hydrometer type: 152H Effective depth L= 16.294964 - 0.164 x Rm

Elapsed time, min	Temp, deg C	Actual reading	Corrected reading	K	Rm	Eff. depth	Diameter mm	Percent finer
2.0	23.0	48.0	42.2	0.0128	48.0	8.4	0.0262	66.1
5.0	23.0	45.0	39.2	0.0128	45.0	8.9	0.0171	61.4
15.0	23.0	43.5	37.7	0.0128	43.5	9.2	0.0100	59.0
30.0	23.0	41.0	35.2	0.0128	41.0	9.6	0.0072	55.1
68.0	23.0	39.0	33.2	0.0128	39.0	9.9	0.0049	52.0
251.0	22.0	36.5	30.4	0.0129	36.5	10.3	0.0026	47.6
1445.0	22.5	34.0	28.1	0.0128	34.0	10.7	0.0011	44.0

 Fractional Components

Gravel/Sand based on #4 sieve
 Sand/Fines based on #200 sieve
 % + 3 in. = 0.0 % GRAVEL = 0.0 % SAND = 21.8
 % SILT = 26.0 % CLAY = 52.2

D85= 0.12 D60= 0.012 D50= 0.004

PARTICLE SIZE DISTRIBUTION TEST REPORT

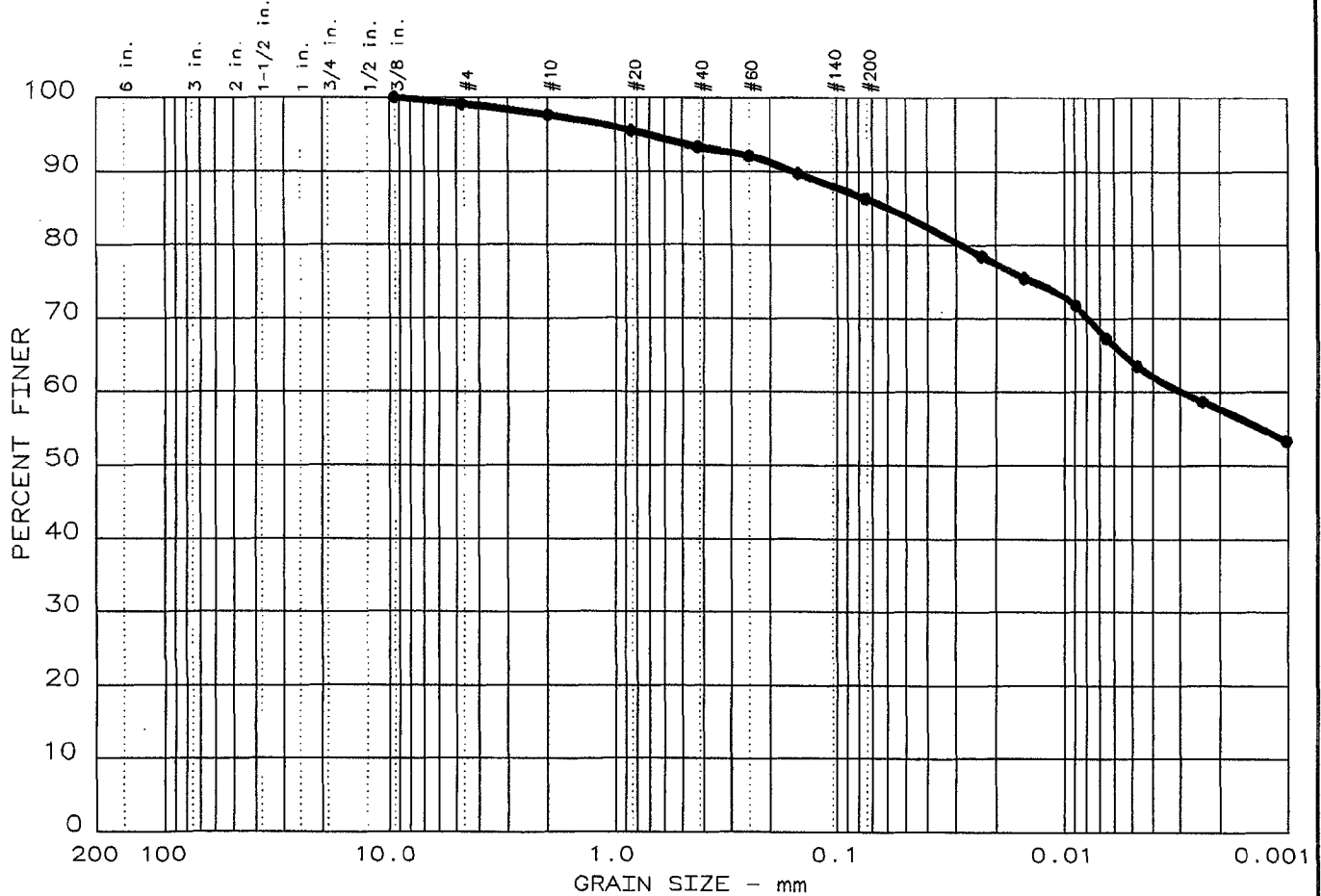

Test	% +3"	% GRAVEL	% SAND	% SILT	% CLAY	USCS	LL	PI
17	0.0	0.9	12.7	22.3	64.1	MH	62	29

SIEVE inches size	PERCENT FINER	
	●	
0.375	100.0	
GRAIN SIZE		
D ₆₀	0.0030	
D ₃₀		
D ₁₀		
COEFFICIENTS		
C _c		
C _u		

SIEVE number size	PERCENT FINER	
	●	
4	99.1	
10	97.6	
20	95.5	
40	93.4	
60	92.1	
100	89.8	
200	86.4	

Sample information:
 ● Boring NB-18, 5-15' Bulk
 Tan elastic silt with sand

Remarks:
 Sample Number 3198
 Methods: Particle Size:
 ASTM D 422-63; Sieve
 Analysis: AASHTO T 27-99

	Project No.: 3043051021.0001
	Project: TVA Kingston - Proposed Gypsum Stack
	Date: June 29, 2005

=====

GRAIN SIZE DISTRIBUTION TEST DATA

Test No.: 17

Date: June 23, 2005
 Project No.: 3043051021.0001
 Project: TVA Kingston - Proposed Gypsum Stack

=====

Sample Data

Location of Sample: Boring NB-18, ~~1~~⁵-15' Bulk
 Sample Description 1: Tan elastic silt with
 Sample Description 2: sand
 USCS Class: MH Liquid limit: 62 Plasticity index: 29

Notes

Remarks: Sample Number 3198 Methods: Particle Size:
 ASTM D 422-63; Sieve Analysis: AASHTO T 27-99
 Fig. No.: 198

Mechanical Analysis Data

	Initial	After wash
Dry sample and tare=	568.96	79.24
Tare =	0.00	0.00
Dry sample weight =	568.96	79.24
Minus #200 from wash=	86.1 %	

Tare for cumulative weight retained= 0

Sieve	Cumul. Wt. retained	Percent finer
0.375 inches	0.00	100.0
# 4	5.33	99.1
# 10	13.60	97.6
# 20	25.62	95.5
# 40	37.82	93.4
# 60	44.98	92.1
# 100	58.22	89.8
# 200	77.60	86.4

Hydrometer Analysis Data

Separation sieve is number 40
 Percent -# 40 based on complete sample= 93.4
 Weight of hydrometer sample: 62.28
 Hygroscopic moisture correction:
 Moist weight & tare = 52.49
 Dry weight & tare = 51.78
 Tare = 22.04
 Hygroscopic moisture= 2.4 %
 Calculated biased weight= 65.16
 Table of composite correction values:
 Temp, deg C: 21.0 22.0 23.0 23.5 24.0

Comp. corr: - 6.4 - 6.1 - 5.8 - 5.6 - 5.4
 Meniscus correction only= 0
 Specific gravity of solids= 2.76
 Specific gravity correction factor= 0.976
 Hydrometer type: 152H Effective depth L= 16.294964 - 0.164 x Rm

Elapsed time, min	Temp, deg C	Actual reading	Corrected reading	K	Rm	Eff. depth	Diameter mm	Percent finer
2.0	23.5	58.0	52.4	0.0127	58.0	6.8	0.0233	78.5
5.0	23.5	56.0	50.4	0.0127	56.0	7.1	0.0151	75.5
15.0	23.5	53.5	47.9	0.0127	53.5	7.5	0.0090	71.8
30.0	23.5	50.5	44.9	0.0127	50.5	8.0	0.0065	67.3
60.0	23.5	48.0	42.4	0.0127	48.0	8.4	0.0047	63.5
250.0	23.0	45.0	39.2	0.0127	45.0	8.9	0.0024	58.7
1441.0	24.0	41.0	35.6	0.0126	41.0	9.6	0.0010	53.3

 Fractional Components

Gravel/Sand based on #4 sieve
 Sand/Fines based on #200 sieve
 % + 3 in. = 0.0 % GRAVEL = 0.9 % SAND = 12.7
 % SILT = 22.3 % CLAY = 64.1

D85= 0.06 D60= 0.003

Particle Size Distribution Report

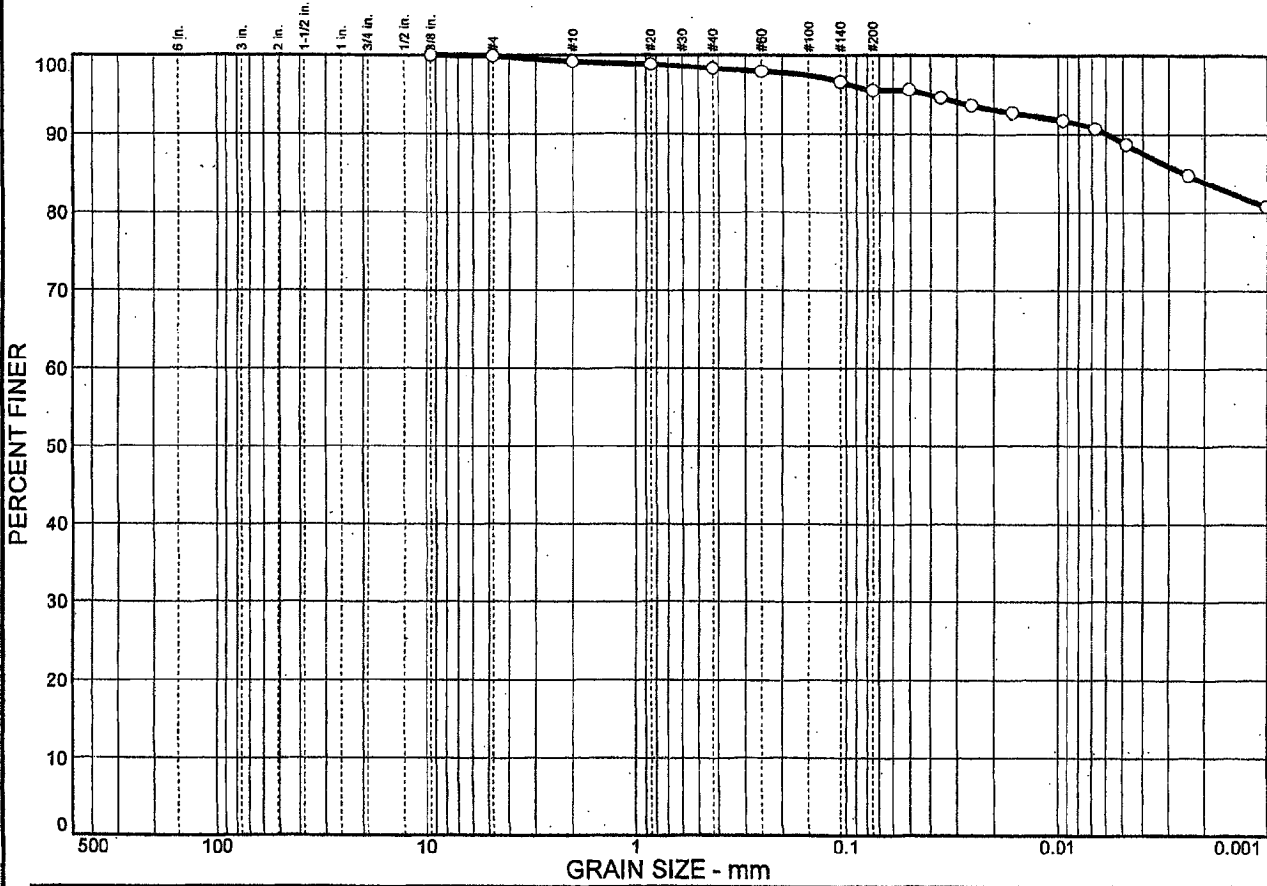

% COBBLES	% GRAVEL	% SAND	% SILT	% CLAY
0.0	0.1	4.4	6.5	89.0

SIEVE SIZE	PERCENT FINER	SPEC.* PERCENT	PASS? (X=NO)
.375 in.	100.0		
#4	99.9		
#10	99.2		
#20	98.8		
#40	98.3		
#60	97.9		
#140	96.6		
#200	95.5		

Soil Description
Brown to red brown elastic silt

Atterberg Limits
 PL = 42 LL = 81 PI = 39

Coefficients
 D₈₅ = 0.0025 D₆₀ = D₅₀ =
 D₃₀ = D₁₅ = D₁₀ =
 C_u = C_c =

Classification
 USCS = MH AASHTO =

Remarks

* (no specification provided)

Sample No.: UD-1, 3 & 4 (CU) Source of Sample:
 Location: NB-18

Date:
 Elev./Depth: 6.5'-18.5'

MACTEC, INC.

Client: TVA
 Project: TVA Kingston - Proposed Gypsum Stack

Project No: 3043051021

Figure

GRAIN SIZE DISTRIBUTION TEST DATA

Client: TVA
Project: TVA Kingston - Proposed Gypsum Stack
Project Number: 3043051021

Sample Data

Source:
Sample No.: UD-1, 3 & 4 (CU)
Elev. or Depth: 6.5'-18.5' Sample Length (in./cm.):
Location: NB-18
Description: Brown to red brown elastic silt
Date: PL: 42 LL: 81 PI: 39
USCS Classification: MH AASHTO Classification:
Testing Remarks:

Mechanical Analysis Data

Initial

Dry sample and tare= 224.16
Tare = 0.00
Dry sample weight = 224.16
Sample split on number 10 sieve
Split sample data:
Sample and tare = 50.53 Tare = .00 Sample weight = 50.53
Cumulative weight retained tare= .00
Tare for cumulative weight retained= .00

Sieve	Cumul. Wt. retained	Percent finer
# 75 inch	0.00	100.0
# 4	0.32	99.9
# 10	1.85	99.2
# 20	0.22	98.8
# 40	0.46	98.3
# 60	0.67	97.9
# 140	1.32	96.6
# 200	1.86	95.5

Hydrometer Analysis Data

Separation sieve is #10
Percent -#10 based upon complete sample= 99.2
Weight of hydrometer sample: 53.51
Hygroscopic moisture correction:
Moist weight & tare = 40.29
Dry weight & tare = 38.67
Tare = 11.02
Hygroscopic moisture= 5.9 %
Calculated biased weight= 50.96
Table of composite correction values:
Temp, deg C: 13.7 24.7 29.1
Comp. corr: -6.0 -5.0 -3.5

Discus correction only= 1.0
Specific gravity of solids= 2.62
Specific gravity correction factor= 1.007
Hydrometer type: 152H

MACTEC, INC.

Effective depth $L = 16.294964 - 0.164 \times R_m$

Elapsed time, min	Temp, deg C	Actual reading	Corrected reading	K	Rm	Eff. depth	Diameter mm	Percent finer
0.50	23.5	53.5	48.4	0.0132	54.5	7.4	0.0506	95.6
1.00	23.5	53.0	47.9	0.0132	54.0	7.4	0.0360	94.6
2.00	23.5	52.5	47.4	0.0132	53.5	7.5	0.0256	93.6
5.00	23.5	52.0	46.9	0.0132	53.0	7.6	0.0163	92.7
15.00	23.5	51.5	46.4	0.0132	52.5	7.7	0.0094	91.7
30.00	23.5	51.0	45.9	0.0132	52.0	7.8	0.0067	90.7
60.00	23.5	50.0	44.9	0.0132	51.0	7.9	0.0048	88.7
250.00	23.5	48.0	42.9	0.0132	49.0	8.3	0.0024	84.8
1440.00	23.3	46.0	40.9	0.0132	47.0	8.6	0.0010	80.8

Fractional Components

Gravel/Sand based on #4

Sand/Fines based on #200

% COBBLES = % GRAVEL = 0.1 % SAND = 4.4

% SILT = 6.5 % CLAY = 89.0

D₈₅ = 0.00

Particle Size Distribution Report

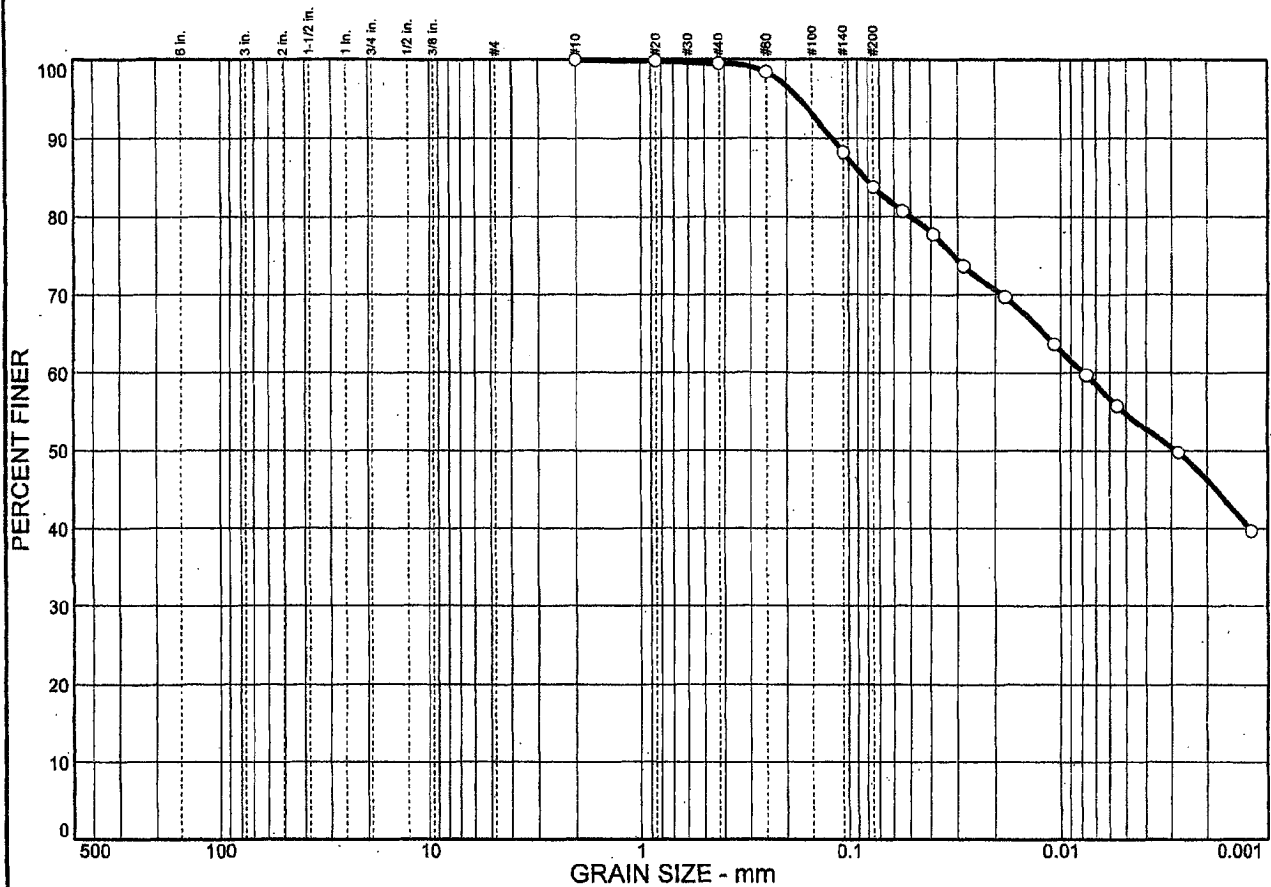

% COBBLES	% GRAVEL	% SAND	% SILT	% CLAY
0.0	0.0	16.2	29.1	54.7

SIEVE SIZE	PERCENT FINER	SPEC.* PERCENT	PASS? (X=NO)
#10	100.0		
#20	99.8		
#40	99.5		
#60	98.4		
#140	88.2		
#200	83.8		

Soil Description

Brown fat clay with sand

Atterberg Limits

PL= 28 LL= 53 PI= 25

Coefficients

D₈₅= 0.0831 D₆₀= 0.0079 D₅₀= 0.0029
 D₃₀= D₁₅= D₁₀=
 C_u= C_c=

Classification

USCS= CH AASHTO=

Remarks

* (no specification provided)

Sample No.: UD-1, 2 & 3 (CU) Source of Sample:
 Location: NB-21A

Date:
 Elev./Depth: 15'-23'

MACTEC, INC.

Client: TVA
 Project: TVA Kingston - Proposed Gypsum Stack
 Project No: 3043051021

Figure

GRAIN SIZE DISTRIBUTION TEST DATA

Client: TVA
Project: TVA Kingston - Proposed Gypsum Stack
Project Number: 3043051021

Sample Data

Source:
Sample No.: UD-1, 2 & 3 (CU)
Elev. or Depth: 15'-23' Sample Length(in./cm.):
Location: NB-21A
Description: Brown fat clay with sand
Date: PL: 28 LL: 53 PI: 25
USCS Classification: CH AASHTO Classification:
Testing Remarks:

Mechanical Analysis Data

Initial
Dry sample and tare= 243.64
Tare = 0.00
Dry sample weight = 243.64
Sample split on number 10 sieve
Split sample data:
Sample and tare = 50.04 Tare = .00 Sample weight = 50.04
Cumulative weight retained tare= .00
Tare for cumulative weight retained= .00

Sieve	Cumul. Wt. retained	Percent finer
10	0.00	100.0
# 20	0.11	99.8
# 40	0.25	99.5
# 60	0.80	98.4
# 140	5.89	88.2
# 200	8.10	83.8

Hydrometer Analysis Data

Separation sieve is #10
Percent -#10 based upon complete sample= 100.0
Weight of hydrometer sample: 51.29
Hygroscopic moisture correction:
Moist weight & tare = 41.04
Dry weight & tare = 40.31
Tare = 11.09
Hygroscopic moisture= 2.5 %
Calculated biased weight= 50.04
Table of composite correction values:
Temp, deg C: 13.7 24.7 29.1
Comp. corr: -6.0 -5.0 -3.5

Meniscus correction only= 1.0
Specific gravity of solids= 2.65
Specific gravity correction factor= 1.000
Hydrometer type: 152H
Effective depth L= 16.294964 - 0.164 x Rm

Elapsed time, min	Temp, deg C	Actual reading	Corrected reading	K	Rm	Eff. depth	Diameter mm	Percent finer
0.50	23.5	45.5	40.4	0.0131	46.5	8.7	0.0544	80.7
1.00	23.5	44.0	38.9	0.0131	45.0	8.9	0.0390	77.7
2.00	23.5	42.0	36.9	0.0131	43.0	9.2	0.0281	73.7
5.00	23.5	40.0	34.9	0.0131	41.0	9.6	0.0181	69.7
15.00	23.5	37.0	31.9	0.0131	38.0	10.1	0.0107	63.7
30.00	23.5	35.0	29.9	0.0131	36.0	10.4	0.0077	59.7
60.00	23.5	33.0	27.9	0.0131	34.0	10.7	0.0055	55.7
250.00	23.5	30.0	24.9	0.0131	31.0	11.2	0.0028	49.7
1440.00	23.3	25.0	19.9	0.0131	26.0	12.0	0.0012	39.7

Fractional Components

Gravel/Sand based on #4

Sand/Fines based on #200

% COBBLES =

% GRAVEL =

% SAND = 16.2

% SILT = 29.1

% CLAY = 54.7

D₈₅= 0.08 D₆₀= 0.01 D₅₀= 0.00

Particle Size Distribution Report

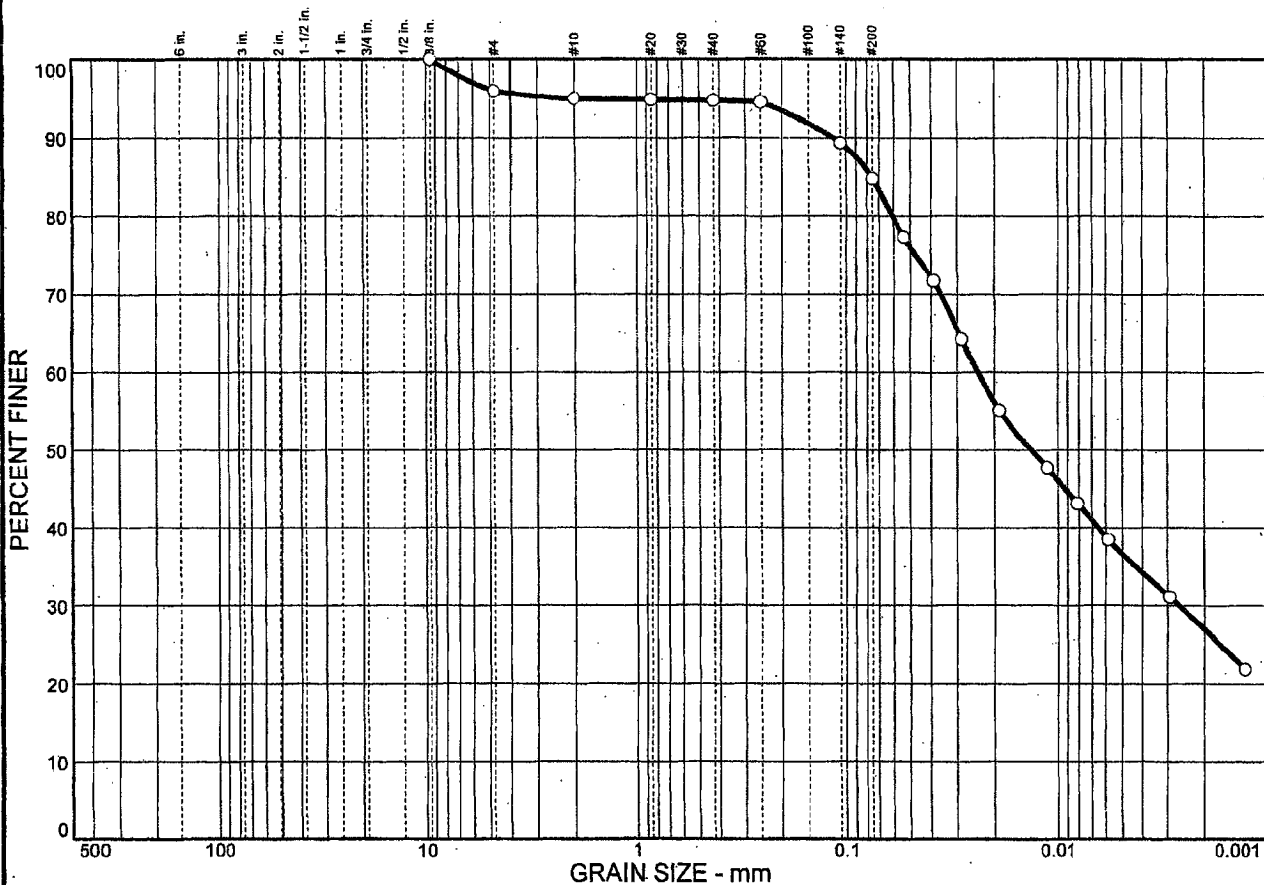

% COBBLES	% GRAVEL	% SAND	% SILT	% CLAY
0.0	4.1	11.1	48.2	36.6

SIEVE SIZE	PERCENT FINER	SPEC.* PERCENT	PASS? (X=NO)
.375 in.	100.0		
#4	95.9		
#10	94.9		
#20	94.8		
#40	94.7		
#60	94.5		
#140	89.3		
#200	84.8		

Soil Description

Dark gray lean clay with sand

Atterberg Limits

PL= 21 LL= 36 PI= 15

Coefficients

D₈₅= 0.0758 D₆₀= 0.0240 D₅₀= 0.0134
 D₃₀= 0.0026 C_c= D₁₅=
 C_u=

Classification

USCS= CL AASHTO=

Remarks

* (no specification provided)

Sample No.: UD-4, 5 & 6 (CU) Source of Sample:
 Location: NB-21A

Date:
 Elev./Depth: 30'-38'

MACTEC, INC.

Client: TVA
 Project: TVA Kingston - Proposed Gypsum Stack

Project No: 3043051021

Figure

GRAIN SIZE DISTRIBUTION TEST DATA

Client: TVA
Project: TVA Kingston - Proposed Gypsum Stack
Project Number: 3043051021

Sample Data

Source:
Sample No.: UD-4, 5 & 6 (CU)
Elev. or Depth: 30'-38' Sample Length (in./cm.):
Location: NB-21A
Description: Dark gray lean clay with sand
Date: PL: 21 LL: 36 PI: 15
USCS Classification: CL AASHTO Classification:
Testing Remarks:

Mechanical Analysis Data

 Initial
Dry sample and tare= 202.53
Tare = 0.00
Dry sample weight = 202.53
Sample split on number 10 sieve
Split sample data:
Sample and tare = 51.29 Tare = .00 Sample weight = 51.29
Cumulative weight retained tare= .00
Tare for cumulative weight retained= .00

Sieve	Cumul. Wt. retained	Percent finer
# 75 inch	0.00	100.0
# 4	8.36	95.9
# 10	10.36	94.9
# 20	0.03	94.8
# 40	0.11	94.7
# 60	0.20	94.5
# 140	3.05	89.3
# 200	5.45	84.8

Hydrometer Analysis Data

Separation sieve is #10
Percent -#10 based upon complete sample= 94.9
Weight of hydrometer sample: 52.28
Hygroscopic moisture correction:
Moist weight & tare = 48.58
Dry weight & tare = 47.88
Tare = 11.01
Hygroscopic moisture= 1.9 %
Calculated biased weight= 54.06
Table of composite correction values:
Temp, deg C: 13.7 24.7 29.1
Comp. corr: -6.0 -5.0 -3.5

Discus correction only= 1.0
Specific gravity of solids= 2.66
Specific gravity correction factor= 0.998
Hydrometer type: 152H

MACTEC, INC.

TVA-00024580

Effective depth $L = 16.294964 - 0.164 \times R_m$

Elapsed time, min	Temp, deg C	Actual reading	Corrected reading	K	Rm	Eff. depth	Diameter mm	Percent finer
0.50	23.1	47.0	41.9	0.0131	48.0	8.4	0.0538	77.3
1.00	23.1	44.0	38.9	0.0131	45.0	8.9	0.0391	71.7
2.00	23.1	40.0	34.9	0.0131	41.0	9.6	0.0287	64.3
5.00	23.1	35.0	29.9	0.0131	36.0	10.4	0.0189	55.1
15.00	23.1	31.0	25.9	0.0131	32.0	11.0	0.0112	47.7
30.00	23.1	28.5	23.4	0.0131	29.5	11.5	0.0081	43.1
60.00	23.1	26.0	20.9	0.0131	27.0	11.9	0.0058	38.5
250.00	23.1	22.0	16.9	0.0131	23.0	12.5	0.0029	31.1
1440.00	23.1	17.0	11.9	0.0131	18.0	13.3	0.0013	21.9

Fractional Components

Gravel/Sand based on #4

Sand/Fines based on #200

% COBBLES = % GRAVEL = 4.1 % SAND = 11.1

% SILT = 48.2 % CLAY = 36.6

D85= 0.08 D60= 0.02 D50= 0.01

D30= 0.00

Particle Size Distribution Report

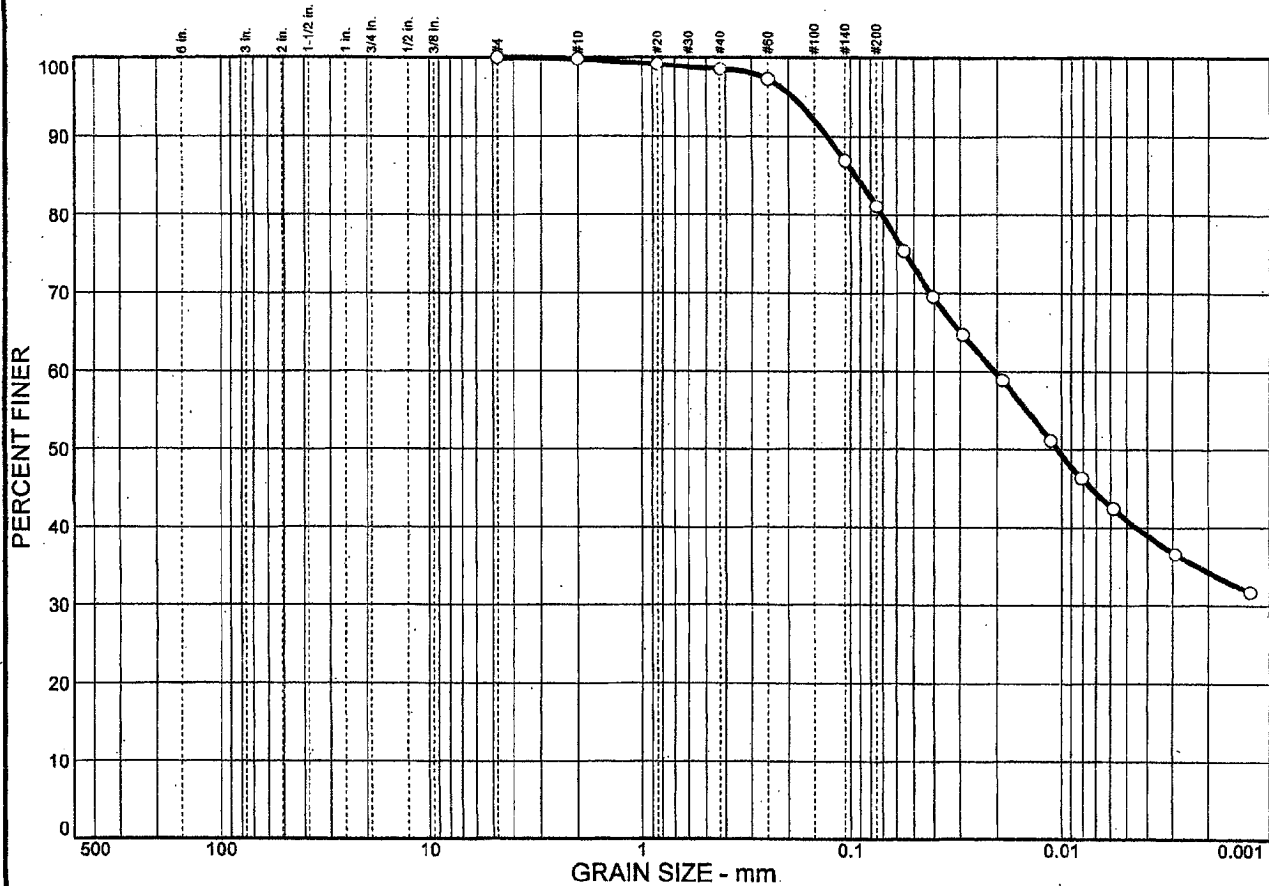

% COBBLES	% GRAVEL	% SAND	% SILT	% CLAY
0.0	0.0	18.9	40.2	40.9

SIEVE SIZE	PERCENT FINER	SPEC.* PERCENT	PASS? (X=NO)
#4	100.0		
#10	99.8		
#20	99.1		
#40	98.5		
#60	97.2		
#140	86.9		
#200	81.1		

Soil Description

Reddish orange lean clay with sand

Atterberg Limits

PL= 22 LL= 40 PI= 18

Coefficients

D₈₅= 0.0942 D₆₀= 0.0205 D₅₀= 0.0105
D₃₀= D₁₅= D₁₀=
C_u= C_c=

Classification

USCS= CL AASHTO=

Remarks

* (no specification provided)

Sample No.: Bulk
Location: NB-22

Source of Sample:

Date:
Elev./Depth: 2'-10'

MACTEC, INC.

Client: TVA
Project: TVA Kingston - Proposed Gypsum Stack

Project No: 3043051021

Figure

GRAIN SIZE DISTRIBUTION TEST DATA

Client: TVA
Project: TVA Kingston - Proposed Gypsum Stack
Project Number: 3043051021

Sample Data

Source:
Sample No.: Bulk
Elev. or Depth: 2'-10' Sample Length(in./cm.):
Location: NB-22, 2.0'-10.0'
Description: Reddish orange lean clay with sand
Date: PL: 22 LL: 40 PI: 18
USCS Classification: CL AASHTO Classification:
Testing Remarks:

Mechanical Analysis Data

Initial

Dry sample and tare= 247.01
Tare = 0.00
Dry sample weight = 247.01
Sample split on number 10 sieve
Split sample data:
Sample and tare = 51.79 Tare = .00 Sample weight = 51.79
Cumulative weight retained tare= .00
Tare for cumulative weight retained= .00

Sieve	Cumul. Wt. retained	Percent finer
4	0.00	100.0
# 10	0.38	99.8
# 20	0.34	99.1
# 40	0.69	98.5
# 60	1.34	97.2
# 140	6.69	86.9
# 200	9.69	81.1

Hydrometer Analysis Data

Separation sieve is #10
Percent -#10 based upon complete sample= 99.8
Weight of hydrometer sample: 52.88
Hygroscopic moisture correction:
Moist weight & tare = 44.40
Dry weight & tare = 43.71
Tare = 11.59
Hygroscopic moisture= 2.1 %
Calculated biased weight= 51.87
Table of composite correction values:
Temp, deg C: 13.7 24.7 29.1
Comp. corr: -6.0 -5.0 -3.5

Meniscus correction only= 1.0
Specific gravity of solids= 2.63
Specific gravity correction factor= 1.005
Hydrometer type: 152H
Effective depth L= 16.294964 - 0.164 x Rm

MACTEC, INC.

Elapsed time, min	Temp, deg C	Actual reading	Corrected reading	K	Rm	Eff. depth	Diameter mm	Percent finer
0.50	23.5	44.0	38.9	0.0132	45.0	8.9	0.0555	75.4
1.00	23.5	41.0	35.9	0.0132	42.0	9.4	0.0403	69.5
2.00	23.5	38.5	33.4	0.0132	39.5	9.8	0.0291	64.7
5.00	23.5	35.5	30.4	0.0132	36.5	10.3	0.0189	58.9
15.00	23.5	31.5	26.4	0.0132	32.5	11.0	0.0112	51.1
30.00	23.5	29.0	23.9	0.0132	30.0	11.4	0.0081	46.3
60.00	23.5	27.0	21.9	0.0132	28.0	11.7	0.0058	42.4
250.00	23.5	24.0	18.9	0.0132	25.0	12.2	0.0029	36.6
1440.00	23.3	21.5	16.4	0.0132	22.5	12.6	0.0012	31.7

Fractional Components

Gravel/Sand based on #4

Sand/Fines based on #200

% COBBLES = % GRAVEL = % SAND = 18.9

% SILT = 40.2 % CLAY = 40.9

D₈₅= 0.09 D₆₀= 0.02 D₅₀= 0.01

PARTICLE SIZE DISTRIBUTION TEST REPORT

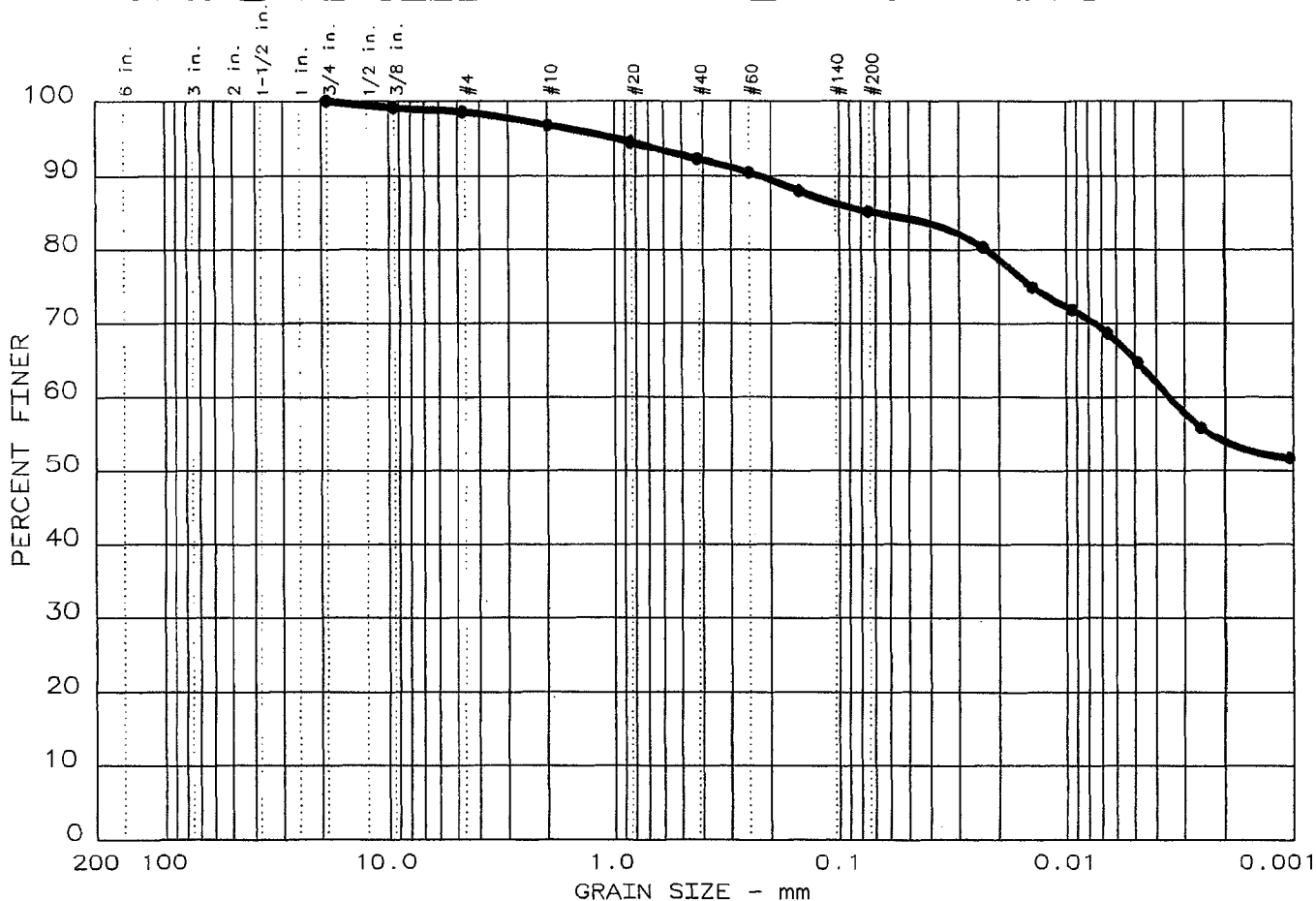

Test	% +3"	% GRAVEL	% SAND	% SILT	% CLAY	USCS	LL	PI
18	0.0	1.5	13.3	19.9	65.3	CH	72	47

SIEVE inches size	PERCENT FINER		
	●		
0.75	100.0		
0.375	99.1		
GRAIN SIZE			
D ₆₀	0.0035		
D ₃₀			
D ₁₀			
COEFFICIENTS			
C _c			
C _u			

SIEVE number size	PERCENT FINER		
	●		
4	98.5		
10	96.7		
20	94.5		
40	92.2		
60	90.5		
100	88.0		
200	85.2		

Sample information:
 ● Boring NB-25,2-10' Bulk
 Orange brown fat clay
 with sand

Remarks:
 Sample Number 3199
 Methods: Particle Size:
 ASTM D 422-63; Sieve
 Analysis: AASHTO T 27-99

	Project No.: 3043051021.0001 Project: TVA Kingston - Proposed Gypsum Stack Date: June 23, 2005
--	------------------------------------------------------------------------------------------------------

GRAIN SIZE DISTRIBUTION TEST DATA

Test No.: 18

Date: June 23, 2005
 Project No.: 3043051021.0001
 Project: TVA Kingston - Proposed Gypsum Stack

Sample Data

Location of Sample: Boring NB-25,2-10' Bulk
 Sample Description 1: Orange brown fat clay
 Sample Description 2: with sand
 USCS Class: CH Liquid limit: 72 Plasticity index: 47

Notes

Remarks: Sample Number 3199 Methods: Particle Size:
 ASTM D 422-63; Sieve Analysis: AASHTO T 27-99
 Fig. No.: 199

Mechanical Analysis Data

	Initial	After wash
Dry sample and tare=	505.06	77.56
Tare =	0.00	0.00
Dry sample weight =	505.06	77.56
Minus #200 from wash=	84.6 %	

Tare for cumulative weight retained= 0

Sieve	Cumul. Wt. retained	Percent finer
0.75 inches	0.00	100.0
0.375 inches	4.49	99.1
# 4	7.37	98.5
# 10	16.42	96.7
# 20	27.54	94.5
# 40	39.15	92.2
# 60	48.09	90.5
# 100	60.84	88.0
# 200	74.88	85.2

Hydrometer Analysis Data

Separation sieve is number 40
 Percent -# 40 based on complete sample= 92.2
 Weight of hydrometer sample: 60.45
 Hygroscopic moisture correction:
 Moist weight & tare = 51.93
 Dry weight & tare = 51.11
 Tare = 22.22
 Hygroscopic moisture= 2.8 %
 Calculated biased weight= 63.72
 Table of composite correction values:

Temp, deg C: 20.0 21.0 22.0 22.5 23.0
 Comp. corr: - 6.7 - 6.4 - 6.1 - 5.9 - 5.8
 Meniscus correction only= 0
 Specific gravity of solids= 2.74
 Specific gravity correction factor= 0.980
 Hydrometer type: 152H Effective depth L= 16.294964 - 0.164 x Rm

Elapsed time, min	Temp, deg C	Actual reading	Corrected reading	K	Rm	Eff. depth	Diameter mm	Percent finer
2.0	23.0	58.0	52.2	0.0128	58.0	6.8	0.0236	80.3
6.0	23.0	54.5	48.7	0.0128	54.5	7.4	0.0142	74.9
14.0	23.0	52.5	46.7	0.0128	52.5	7.7	0.0095	71.9
30.0	23.0	50.5	44.7	0.0128	50.5	8.0	0.0066	68.8
60.0	22.5	48.0	42.1	0.0129	48.0	8.4	0.0048	64.8
252.0	20.0	43.0	36.3	0.0133	43.0	9.2	0.0025	55.9
1492.0	22.5	39.5	33.6	0.0129	39.5	9.8	0.0010	51.7

 Fractional Components

Gravel/Sand based on #4 sieve
 Sand/Fines based on #200 sieve
 % + 3 in. = 0.0 % GRAVEL = 1.5 % SAND = 13.3
 % SILT = 19.9 % CLAY = 65.3

D85= 0.07 D60= 0.003

PARTICLE SIZE DISTRIBUTION TEST REPORT

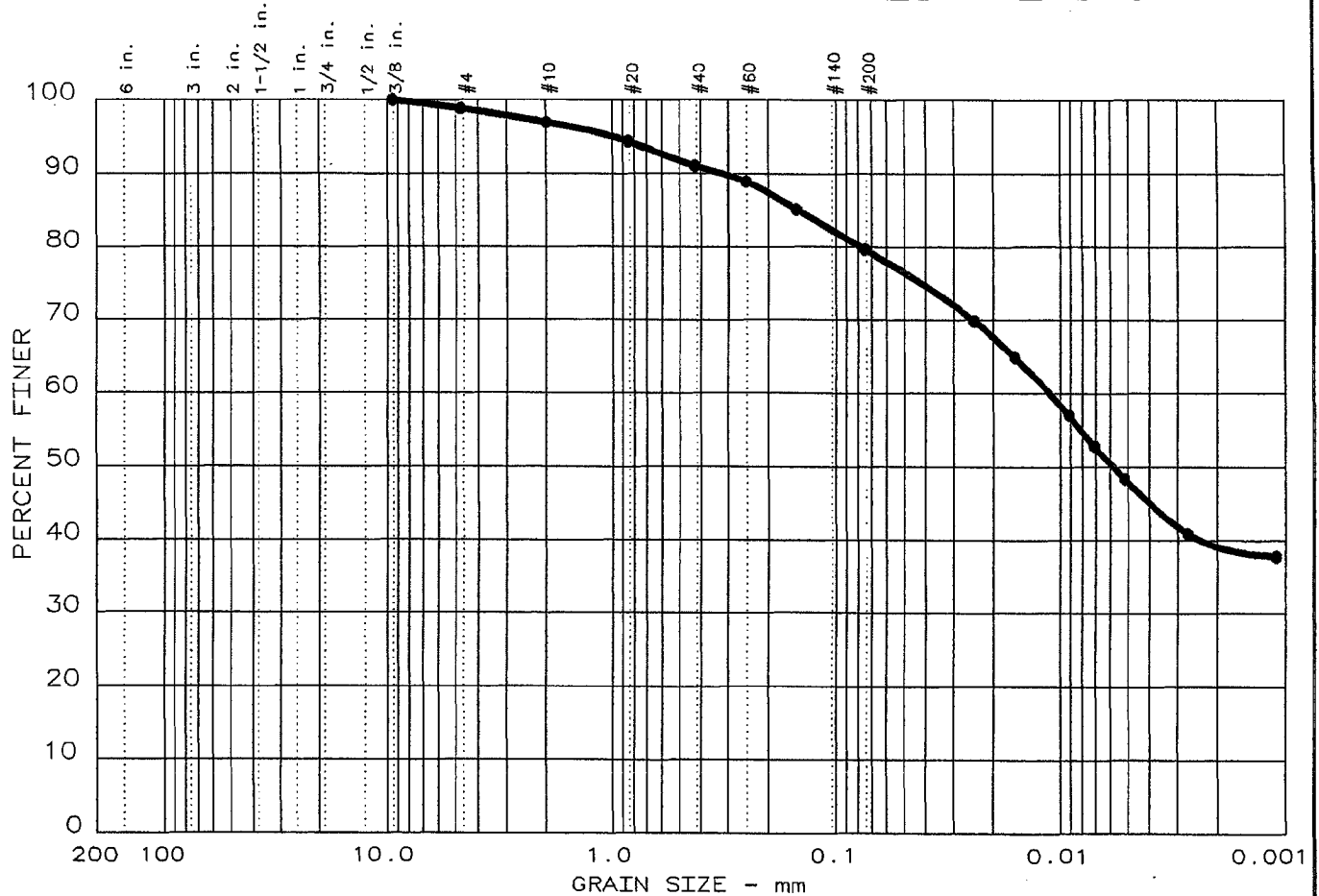

Test	% +3"	% GRAVEL	% SAND	% SILT	% CLAY	USCS	LL	PI
20	0.0	1.2	19.1	31.7	48.0	CL	47	27

SIEVE inches size	PERCENT FINER	
	●	
0.375	100.0	
 GRAIN SIZE 		
D ₆₀	0.0111	
D ₃₀		
D ₁₀		
 COEFFICIENTS 		
C _c		
C _u		

SIEVE number size	PERCENT FINER	
	●	
4	98.8	
10	96.9	
20	94.4	
40	91.0	
60	88.9	
100	85.2	
200	79.7	

Sample information:
 ● Boring NB-39, 5-10' Bulk
 Brown lean clay with
 sand

Remarks:
 Sample Number 3201
 Methods: Particle Size:
 ASTM D 422-63; Sieve
 Analysis: AASHTO T 27-99

Project No.: 3043051021.0001
 Project: TVA Kingston - Proposed Gypsum Stack
 Date: June 23, 2005

GRAIN SIZE DISTRIBUTION TEST DATA

Test No.: 20

Date: June 23, 2005
 Project No.: 3043051021.0001
 Project: TVA Kingston - Proposed Gypsum Stack

Sample Data

Location of Sample: Boring NB-39,5-10' Bulk
 Sample Description 1: Brown lean clay with
 Sample Description 2: sand
 USCS Class: CL Liquid limit: 47 Plasticity index: 27

Notes

Remarks: Sample Number 3201 Methods: Particle Size:
 ASTM D 422-63; Sieve Analysis: AASHTO T 27-99
 Fig. No.: 201

Mechanical Analysis Data

	Initial	After wash
Dry sample and tare=	799.81	164.79
Tare =	0.00	0.00
Dry sample weight =	799.81	164.79
Minus #200 from wash=	79.4 %	

Tare for cumulative weight retained= 0

Sieve	Cumul. Wt. retained	Percent finer
0.375 inches	0.00	100.0
# 4	9.59	98.8
# 10	24.70	96.9
# 20	44.97	94.4
# 40	71.71	91.0
# 60	88.72	88.9
# 100	118.72	85.2
# 200	162.61	79.7

Hydrometer Analysis Data

Separation sieve is number 40
 Percent -# 40 based on complete sample= 91.0
 Weight of hydrometer sample: 64.07

Hygroscopic moisture correction:

Moist weight & tare = 52.78
 Dry weight & tare = 52.15
 Tare = 22.40
 Hygroscopic moisture= 2.1 %

Calculated biased weight= 68.92

Table of composite correction values:

Temp, deg C: 20.0 21.0 22.0 22.5 23.0

Comp. corr: - 6.7 - 6.4 - 6.1 - 5.9 - 5.8
 Meniscus correction only= 0
 Specific gravity of solids= 2.75
 Specific gravity correction factor= 0.978
 Hydrometer type: 152H Effective depth L= 16.294964 - 0.164 x Rm

Elapsed time, min	Temp, deg C	Actual reading	Corrected reading	K	Rm	Eff. depth	Diameter mm	Percent finer
2.0	23.0	55.0	49.2	0.0128	55.0	7.3	0.0244	69.8
5.0	23.0	51.5	45.7	0.0128	51.5	7.8	0.0160	64.9
17.0	23.0	46.0	40.2	0.0128	46.0	8.8	0.0092	57.1
30.0	23.0	43.0	37.2	0.0128	43.0	9.2	0.0071	52.8
60.0	22.5	40.0	34.1	0.0128	40.0	9.7	0.0052	48.4
250.0	20.0	35.5	28.8	0.0132	35.5	10.5	0.0027	40.9
1483.0	22.5	32.5	26.6	0.0128	32.5	11.0	0.0011	37.8

 Fractional Components

Gravel/Sand based on #4 sieve
 Sand/Fines based on #200 sieve
 % + 3 in. = 0.0 % GRAVEL = 1.2 % SAND = 19.1
 % SILT = 31.7 % CLAY = 48.0

D85= 0.15 D60= 0.011 D50= 0.006

PARTICLE SIZE DISTRIBUTION TEST REPORT

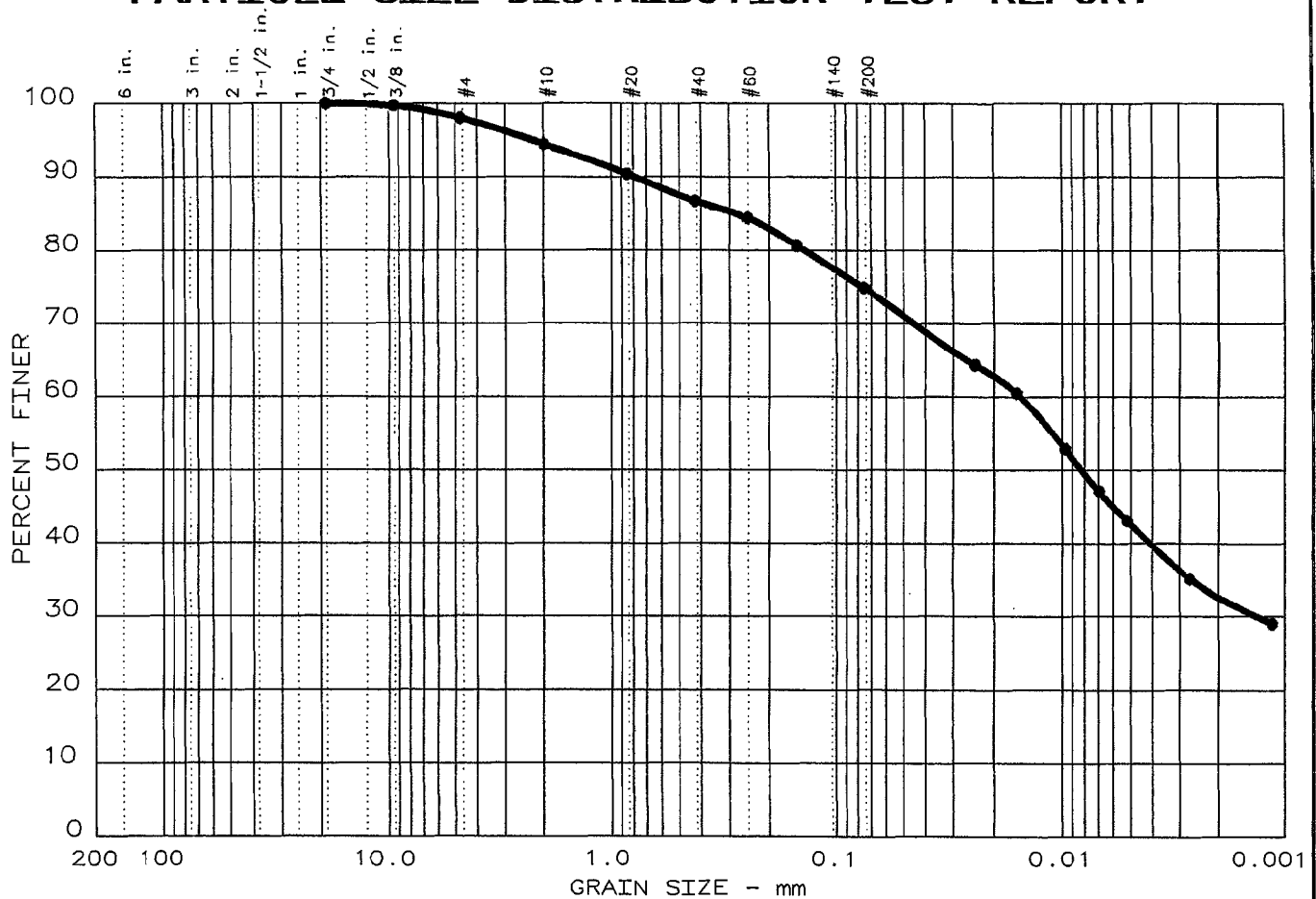

Test	% +3"	% GRAVEL	% SAND	% SILT	% CLAY	USCS	LL	PI
1	0.0	2.0	23.1	32.4	42.5	CL	35	17

SIEVE inches size	PERCENT FINER		
	●		
0.75	100.0		
0.375	99.7		
GRAIN SIZE			
D ₆₀	0.0151		
D ₃₀	0.0013		
D ₁₀			
COEFFICIENTS			
C _c			
C _u			

SIEVE number size	PERCENT FINER		
	●		
4	98.0		
10	94.4		
20	90.4		
40	86.7		
60	84.4		
100	80.6		
200	74.9		

Sample information:
 ● Boring NB-41,2-10' Bulk
 Brown lean clay with
 sand

Remarks:
 Sample Number 3202
 Methods: Particle Size:
 ASTM D 422-63; Sieve
 Analysis: AASHTO T 27-99

	Project No.: 3043051021.0001 Project: TVA Kingston - Proposed Gypsum Stack Date: June 23, 2005
--	------------------------------------------------------------------------------------------------------

=====

GRAIN SIZE DISTRIBUTION TEST DATA

Test No.: 1

Date: June 23, 2005
 Project No.: 3043051021.0001
 Project: TVA Kingston - Proposed Gypsum Stack

=====

Sample Data

Location of Sample: Boring NB-41,2-10' Bulk
 Sample Description 1: Brown lean clay with
 Sample Description 2: sand
 USCS Class: CL Liquid limit: 35 Plasticity index: 17

Notes

Remarks: Sample Number 3202 Methods: Particle Size:
 ASTM D 422-63; Sieve Analysis: AASHTO T 27-99
 Fig. No.: 202

Mechanical Analysis Data

	Initial	After wash
Dry sample and tare=	742.20	189.68
Tare =	0.00	0.00
Dry sample weight =	742.20	189.68
Minus #200 from wash=	74.4 %	
Tare for cumulative weight retained=	0	

Sieve	Cumul. Wt. retained	Percent finer
0.75 inches	0.00	100.0
0.375 inches	2.30	99.7
# 4	14.60	98.0
# 10	41.29	94.4
# 20	71.55	90.4
# 40	98.62	86.7
# 60	115.68	84.4
# 100	143.76	80.6
# 200	186.56	74.9

Hydrometer Analysis Data

Separation sieve is number 40
 Percent -# 40 based on complete sample= 86.7
 Weight of hydrometer sample: 67.67
 Hygroscopic moisture correction:
 Moist weight & tare = 53.32
 Dry weight & tare = 52.74
 Tare = 22.19
 Hygroscopic moisture= 1.9 %
 Calculated biased weight= 76.59
 Table of composite correction values:

Temp, deg C: 20.0 21.0 22.0 22.5 23.0

Comp. corr: - 6.7 - 6.4 - 6.1 - 5.9 - 5.8

Meniscus correction only= 0

Specific gravity of solids= 2.73

Specific gravity correction factor= 0.983

Hydrometer type: 152H Effective depth L= 16.294964 - 0.164 x Rm

Elapsed time, min	Temp, deg C	Actual reading	Corrected reading	K	Rm	Eff. depth	Diameter mm	Percent finer
2.0	23.0	56.0	50.2	0.0128	56.0	7.1	0.0242	64.4
5.0	23.0	53.0	47.2	0.0128	53.0	7.6	0.0158	60.6
15.0	23.0	47.0	41.2	0.0128	47.0	8.6	0.0097	52.9
32.0	23.0	42.5	36.7	0.0128	42.5	9.3	0.0069	47.1
60.0	22.5	39.5	33.6	0.0129	39.5	9.8	0.0052	43.1
250.0	22.0	33.5	27.4	0.0130	33.5	10.8	0.0027	35.2
1471.0	22.5	28.5	22.6	0.0129	28.5	11.6	0.0011	29.0

Fractional Components

Gravel/Sand based on #4 sieve

Sand/Fines based on #200 sieve

% + 3 in. = 0.0 % GRAVEL = 2.0 % SAND = 23.1

% SILT = 32.4 % CLAY = 42.5

D85= 0.28 D60= 0.015 D50= 0.008

D30= 0.0013

Particle Size Distribution Report

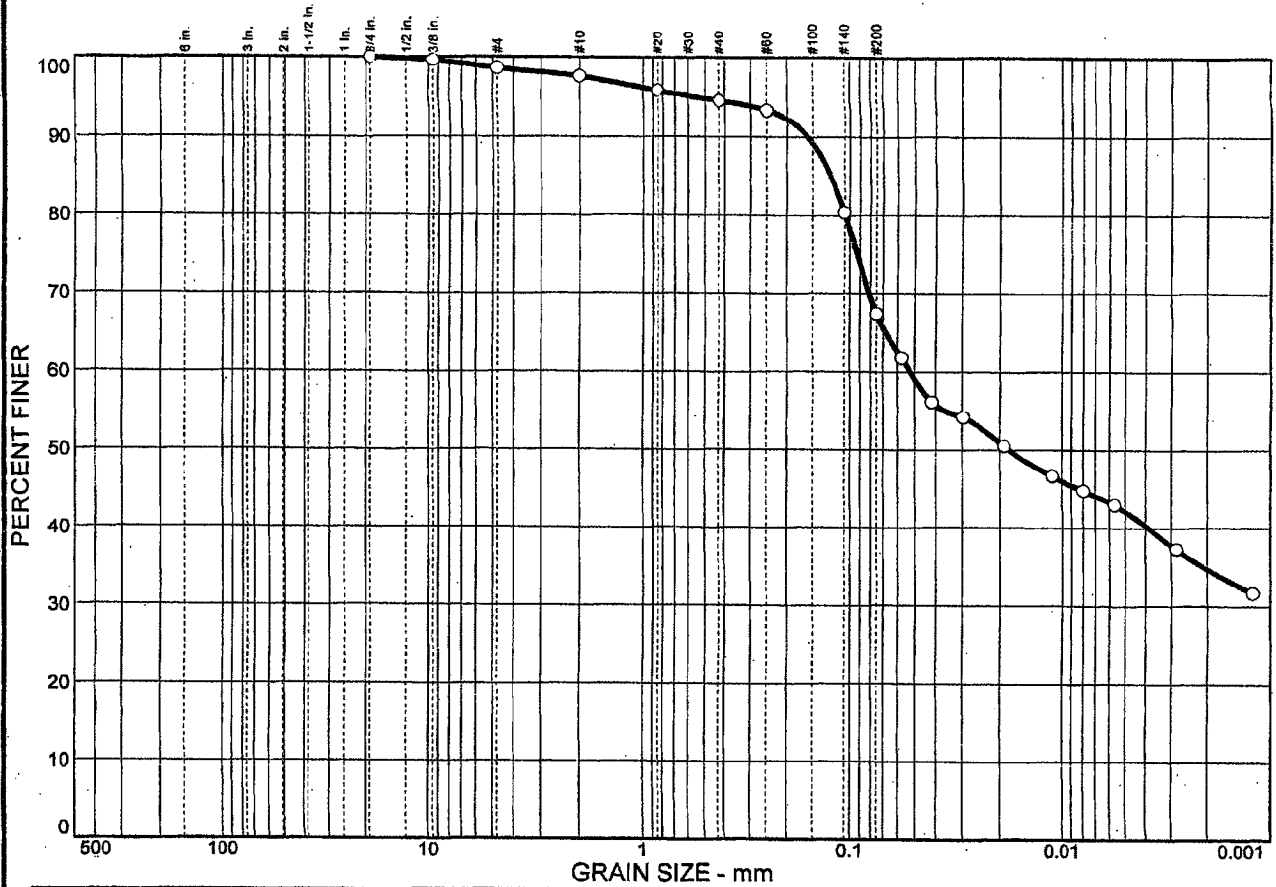

% COBBLES	% GRAVEL	% SAND	% SILT	% CLAY
0.0	1.4	31.2	25.3	42.1

SIEVE SIZE	PERCENT FINER	SPEC.* PERCENT	PASS? (X=NO)
75 in.	100.0		
37.5 in.	99.6		
#4	98.6		
#10	97.6		
#20	95.8		
#40	94.5		
#60	93.3		
#140	80.4		
#200	67.4		

Soil Description

Yellowish brown sandy silty clay

Atterberg Limits

PL= 22 LL= 45 PI= 23

Coefficients

D₈₅= 0.123 D₆₀= 0.0523 D₅₀=
D₃₀= D₁₅= D₁₀=
C_u= C_c=

Classification

USCS= CL AASHTO=

Remarks

* (no specification provided)

Sample No.: UD-2 Source of Sample: Date:
Location: NB-44 Elev./Depth: 16.5'-18.5'

MACTEC, INC.

Client: TVA
Project: TVA Kingston - Proposed Gypsum Stack
Project No: 3043051021 Figure

GRAIN SIZE DISTRIBUTION TEST DATA

Client: TVA
Project: TVA Kingston - Proposed Gypsum Stack
Project Number: 3043051021

Sample Data

Source:
Sample No.: UD-2
Elev. or Depth: 16.5'-18.5' Sample Length(in./cm.):
Location: NB-44 (16.5'-18.5')
Description: Yellowish brown sandy silty clay
Date: PL: 22 LL: 45 PI: 23
USCS Classification: CL AASHTO Classification: -
Testing Remarks:

Mechanical Analysis Data

	Initial	After wash
Dry sample and tare=	366.18	0.00
Tare =	0.00	0.00
Dry sample weight =	366.18	0.00
Minus #200 from wash=	100.0 %	
Sample split on number 10 sieve		
Split sample data:		
Sample and tare =	51.24	Tare = .00
Sample weight =	51.24	
Cumulative weight retained tare=	.00	
Tare for cumulative weight retained=	.00	
Sieve	Cumul. Wt. retained	Percent finer
.75 inch	0.00	100.0
.375 inch	1.30	99.6
# 4	5.07	98.6
# 10	8.66	97.6
# 20	0.94	95.8
# 40	1.65	94.5
# 60	2.28	93.3
# 140	9.01	80.4
# 200	15.83	67.4

Hydrometer Analysis Data

Separation sieve is #10
Percent -#10 based upon complete sample= 97.6
Weight of hydrometer sample: 52.32
Hygroscopic moisture correction:
Moist weight & tare = 49.42
Dry weight & tare = 48.65
Tare = 11.66
Hygroscopic moisture= 2.1 %
Calculated biased weight= 52.51
Table of composite correction values:
Temp, deg C: 13.7 24.7 29.1
Comp. corr: -6.0 -5.0 -3.5
Meniscus correction only= 1.0
Specific gravity of solids= 2.71

Specific gravity correction factor= 0.987

Hydrometer type: 152H

Effective depth $L = 16.294964 - 0.164 \times R_m$

Elapsed Time, min	Temp, Actual deg C	Actual reading	Corrected reading	K	Rm	Eff. depth	Diameter mm	Percent finer
0.50	23.1	38.0	32.9	0.0129	39.0	9.9	0.0574	61.8
1.00	23.1	35.0	29.9	0.0129	36.0	10.4	0.0416	56.1
2.00	23.1	34.0	28.9	0.0129	35.0	10.6	0.0296	54.2
5.00	23.1	32.0	26.9	0.0129	33.0	10.9	0.0190	50.5
15.00	23.1	30.0	24.9	0.0129	31.0	11.2	0.0112	46.7
30.00	23.1	29.0	23.9	0.0129	30.0	11.4	0.0079	44.8
60.00	23.1	28.0	22.9	0.0129	29.0	11.5	0.0057	43.0
250.00	23.1	25.0	19.9	0.0129	26.0	12.0	0.0028	37.3
1440.00	23.2	22.0	16.9	0.0129	23.0	12.5	0.0012	31.7

Fractional Components

Gravel/Sand based on #4

Sand/Fines based on #200

% COBBLES = % GRAVEL = 1.4 % SAND = 31.2

% SILT = 25.3 % CLAY = 42.1

D₈₅= 0.12 D₆₀= 0.05 D₅₀= 0.02

Particle Size Distribution Report

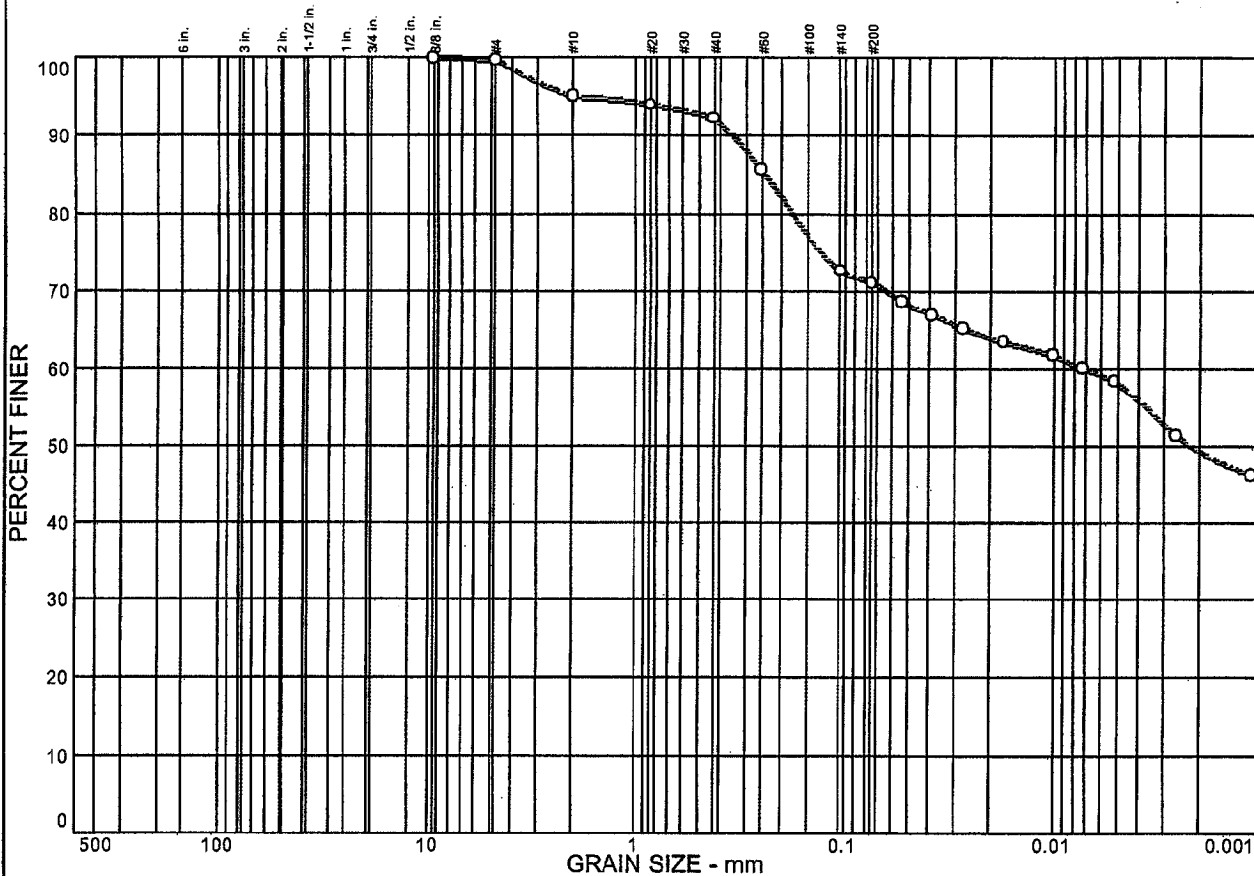

% COBBLES	% GRAVEL	% SAND	% SILT	% CLAY
0.0	0.3	28.7	12.9	58.1

SIEVE SIZE	PERCENT FINER	SPEC.* PERCENT	PASS? (X=NO)
.375 in.	100.0		
#4	99.7		
#10	95.0		
#20	94.0		
#40	92.3		
#60	85.6		
#140	72.6		
#200	71.0		

Soil Description
Dark yellowish brown fat clay with sand

Atterberg Limits
PL = 24 LL = 54 PI = 30

Coefficients
 D₈₅ = 0.241 D₆₀ = 0.0072 D₅₀ = 0.0022
 D₃₀ = D₁₅ = D₁₀ =
 C_u = C_c =

Classification
USCS = CH AASHTO = -

Remarks

* (no specification provided)

Sample No.: UD-4 Source of Sample: Date: Elev./Depth: 21.5'-23.5'

Location: NB-44 (21.5'-23.5')

MACTEC, INC.

Client: TVA
Project: TVA Kingston - Proposed Gypsum Stack

Project No: 3043051021

Figure

GRAIN SIZE DISTRIBUTION TEST DATA

Client: TVA
Project: TVA Kingston - Proposed Gypsum Stack
Project Number: 3043051021

Sample Data

Source:
Sample No.: UD-4
Elev. or Depth: 21.5'-23.5' Sample Length (in./cm.):
Location: NB-44 (21.5'-23.5')
Description: Dark yellowish brown fat clay with sand
Date: PL: 24 LL: 54 PI: 30
USCS Classification: CH AASHTO Classification: -
Testing Remarks:

Mechanical Analysis Data

	Initial	After wash
Dry sample and tare=	465.57	0.00
Tare =	0.00	0.00
Dry sample weight =	465.57	0.00
Minus #200 from wash=	100.0 %	
Sample split on number 10 sieve		
Split sample data:		
Sample and tare =	54.20	Tare = .00 Sample weight = 54.20
Cumulative weight retained tare=	.00	
Tare for cumulative weight retained=	.00	
Sieve	Cumul. Wt. retained	Percent finer
.375 inch	0.00	100.0
# 4	1.61	99.7
# 10	23.08	95.0
# 20	0.57	94.0
# 40	1.55	92.3
# 60	5.35	85.6
# 140	12.79	72.6
# 200	13.68	71.0

Hydrometer Analysis Data

Separation sieve is #10
Percent -#10 based upon complete sample= 95.0
Weight of hydrometer sample: 55.70
Hygroscopic moisture correction:
Moist weight & tare = 45.71
Dry weight & tare = 44.82
Tare = 11.59
Hygroscopic moisture= 2.7 %
Calculated biased weight= 57.10
Table of composite correction values:
Temp, deg C: 13.7 24.7 29.1
Comp. corr: -6.0 -5.0 -3.5
Pycnometer correction only= 1.0
Specific gravity of solids= 2.73
Specific gravity correction factor= 0.983

MACTEC, INC.

Hydrometer type: 152H

Effective depth $L = 16.294964 - 0.164 \times R_m$

Elapsed Time, min	Temp, deg C	Actual reading	Corrected reading	K	R _m	Eff. depth	Diameter mm	Percent finer
0.50	23.1	45.0	39.9	0.0128	46.0	8.8	0.0537	68.6
1.00	23.1	44.0	38.9	0.0128	45.0	8.9	0.0383	66.9
2.00	23.1	43.0	37.9	0.0128	44.0	9.1	0.0273	65.2
5.00	23.1	42.0	36.9	0.0128	43.0	9.2	0.0174	63.4
15.00	23.1	41.0	35.9	0.0128	42.0	9.4	0.0102	61.7
30.00	23.1	40.0	34.9	0.0128	41.0	9.6	0.0072	60.0
60.00	23.1	39.0	33.9	0.0128	40.0	9.7	0.0052	58.3
250.00	23.1	35.0	29.9	0.0128	36.0	10.4	0.0026	51.4
1440.00	23.2	32.0	26.9	0.0128	33.0	10.9	0.0011	46.2

Fractional Components

Gravel/Sand based on #4

Sand/Fines based on #200

% COBBLES =

% GRAVEL = 0.3

% SAND = 28.7

% SILT = 12.9

% CLAY = 58.1

D₈₅ = 0.24 D₆₀ = 0.01 D₅₀ = 0.00

Effective depth $L = 16.294964 - 0.164 \times R_m$

Elapsed time, min	Temp, Actual deg C	Actual reading	Corrected reading	K	Rm	Eff. depth	Diameter mm	Percent finer
0.50	23.2	53.0	47.9	0.0128	54.0	7.4	0.0493	74.2
1.00	23.2	52.0	46.9	0.0128	53.0	7.6	0.0352	72.7
2.00	23.2	51.0	45.9	0.0128	52.0	7.8	0.0252	71.1
5.00	23.2	49.0	43.9	0.0128	50.0	8.1	0.0163	68.0
15.00	23.2	48.0	42.9	0.0128	49.0	8.3	0.0095	66.5
30.00	23.2	46.5	41.4	0.0128	47.5	8.5	0.0068	64.1
60.00	23.2	45.0	39.9	0.0128	46.0	8.8	0.0049	61.8
250.00	23.2	40.0	34.9	0.0128	41.0	9.6	0.0025	54.1
1440.00	23.2	35.0	29.9	0.0128	36.0	10.4	0.0011	46.3

Fractional Components

Gravel/Sand based on #4

Sand/Fines based on #200

% COBBLES = % GRAVEL = 4.1 % SAND = 21.4

% SILT = 12.5 % CLAY = 62.0

D₈₅ = 2.67 D₆₀ = 0.00 D₅₀ = 0.00

Particle Size Distribution Report

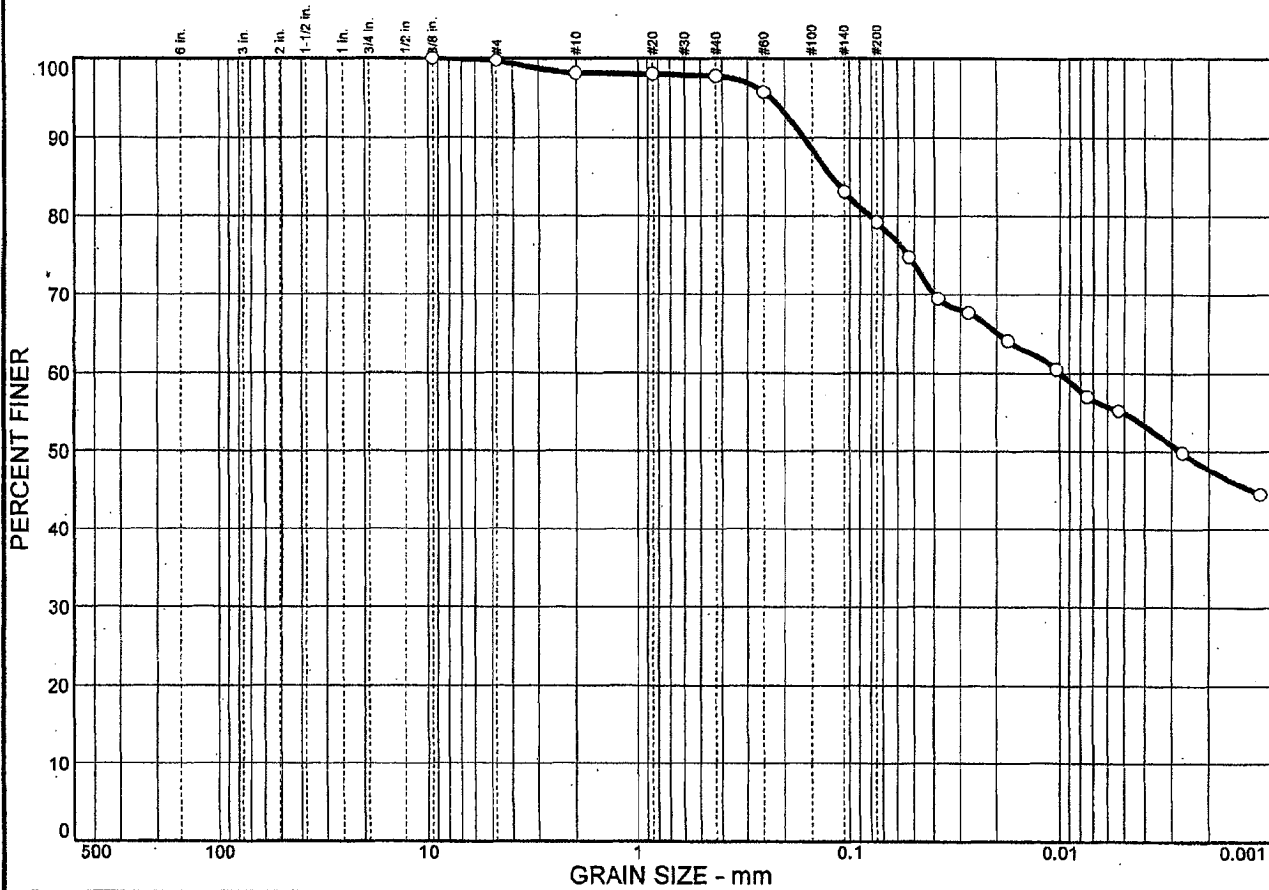

% COBBLES	% GRAVEL	% SAND	% SILT	% CLAY
0.0	0.3	20.5	24.3	54.9

SIEVE SIZE	PERCENT FINER	SPEC.* PERCENT	PASS? (X=NO)
.375 in.	100.0		
#4	99.7		
#10	98.1		
#20	98.0		
#40	97.7		
#60	95.7		
#140	83.1		
#200	79.2		

Soil Description

Brown elastic silt with sand

Atterberg Limits

PL= 30 LL= 51 PI= 21

Coefficients

D₈₅= 0.121 D₆₀= 0.0099 D₅₀= 0.0027
D₃₀= D₁₅= D₁₀=
C_u= C_c=

Classification

USCS= MH AASHTO=

Remarks

(no specification provided)

Sample No.: UD-1, 2 & 3 (CU) Source of Sample:
 Location: NB-47A

Date:
 Elev./Depth: 9'-17'

MACTEC, INC.

Client: TVA
 Project: TVA Kingston - Proposed Gypsum Stack

Project No: 3043051021

Figure

GRAIN SIZE DISTRIBUTION TEST DATA

Client: TVA
Project: TVA Kingston - Proposed Gypsum Stack
Project Number: 3043051021

Sample Data

Source:
Sample No.: UD-1, 2 & 3 (CU)
Elev. or Depth: 9'-17' Sample Length(in./cm.):
Location: NB-47A
Description: Brown elastic silt with sand
Date: PL: 30 LL: 51 PI: 21
USCS Classification: MH AASHTO Classification:
Testing Remarks:

Mechanical Analysis Data

Initial
Dry sample and tare= 335.39
Tare = 0.00
Dry sample weight = 335.39
Sample split on number 10 sieve
Split sample data:
Sample and tare = 53.95 Tare = .00 Sample weight = 53.95
Cumulative weight retained tare= .00
Tare for cumulative weight retained= .00

Sieve	Cumul. Wt. retained	Percent finer
# 75 inch	0.00	100.0
# 4	1.04	99.7
# 10	6.49	98.1
# 20	0.04	98.0
# 40	0.21	97.7
# 60	1.34	95.7
# 140	8.25	83.1
# 200	10.42	79.2

Hydrometer Analysis Data

Separation sieve is #10
Percent -#10 based upon complete sample= 98.1
Weight of hydrometer sample: 55.96
Hygroscopic moisture correction:
Moist weight & tare = 44.87
Dry weight & tare = 43.70
Tare = 10.80
Hygroscopic moisture= 3.6 %
Calculated biased weight= 55.08
Table of composite correction values:
Temp, deg C: 13.7 24.7 29.1
Comp. corr: -6.0 -5.0 -3.5

Discus correction only= 1.0
Specific gravity of solids= 2.72
Specific gravity correction factor= 0.985
Hydrometer type: 152H

Effective depth $L = 16.294964 - 0.164 \times R_m$

Elapsed time, min	Temp, deg C	Actual reading	Corrected reading	K	Rm	Eff. depth	Diameter mm	Percent finer
0.50	23.1	47.0	41.9	0.0129	48.0	8.4	0.0528	74.8
1.00	23.1	44.0	38.9	0.0129	45.0	8.9	0.0384	69.5
2.00	23.1	43.0	37.9	0.0129	44.0	9.1	0.0274	67.7
5.00	23.1	41.0	35.9	0.0129	42.0	9.4	0.0177	64.1
15.00	23.1	39.0	33.9	0.0129	40.0	9.7	0.0104	60.5
30.00	23.1	37.0	31.9	0.0129	38.0	10.1	0.0075	57.0
60.00	23.1	36.0	30.9	0.0129	37.0	10.2	0.0053	55.2
250.00	23.1	33.0	27.9	0.0129	34.0	10.7	0.0027	49.8
1440.00	23.2	30.0	24.9	0.0129	31.0	11.2	0.0011	44.5

Fractional Components

Gravel/Sand based on #4

Sand/Fines based on #200

% COBBLES = % GRAVEL = 0.3 % SAND = 20.5
% SILT = 24.3 % CLAY = 54.9

D₈₅ = 0.12 D₆₀ = 0.01 D₅₀ = 0.00



Particle Size Distribution Report

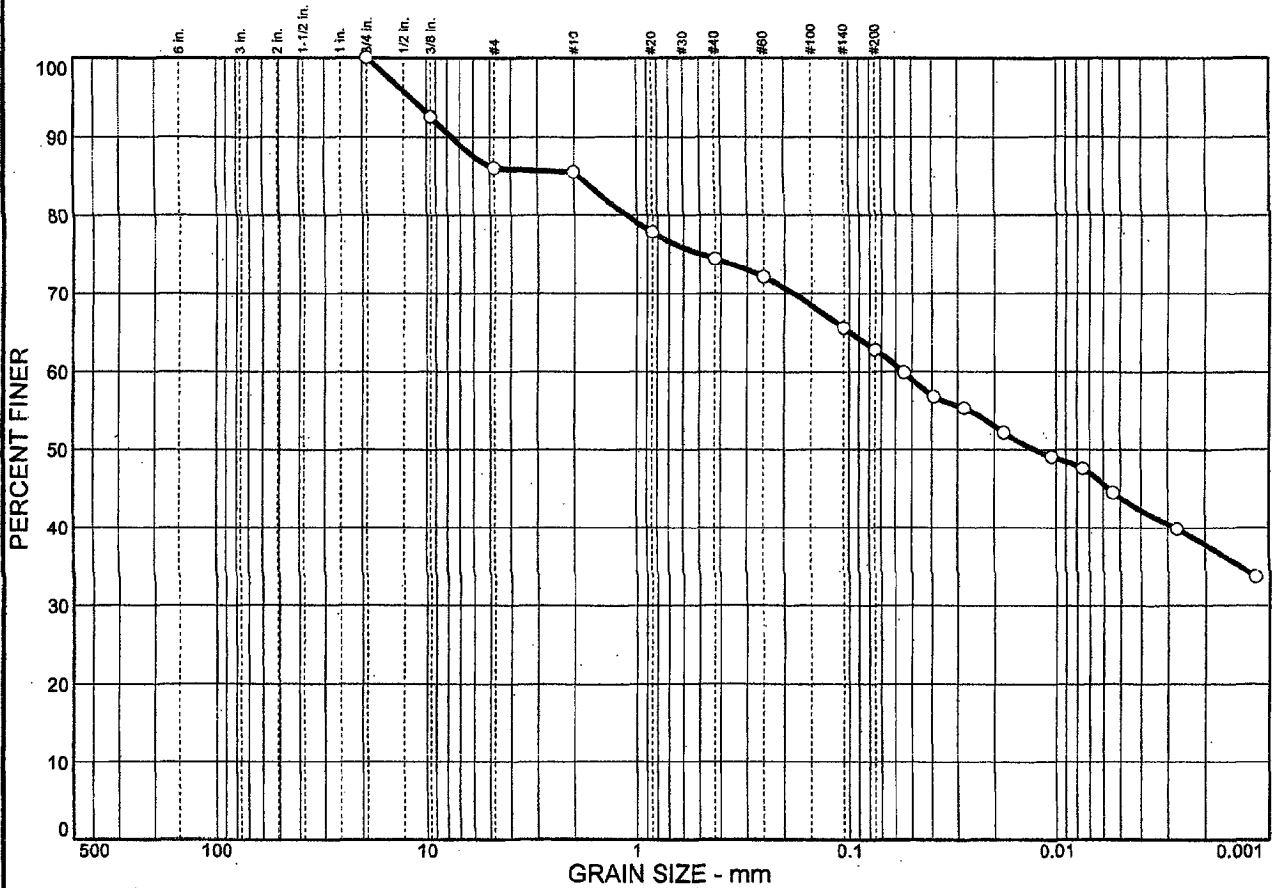

% COBBLES	% GRAVEL	% SAND	% SILT	% CLAY
0.0	14.0	23.2	19.0	43.8

SIEVE SIZE	PERCENT FINER	SPEC.* PERCENT	PASS? (X=NO)
.75 in.	100.0		
.375 in.	92.5		
#4	86.0		
#10	85.5		
#20	77.8		
#40	74.4		
#60	72.1		
#140	65.6		
#200	62.8		

Soil Description

Brown sandy elastic silt

Atterberg Limits

PL= 34 LL= 58 PI= 24

Coefficients

D₈₅= 1.90 D₆₀= 0.0549 D₅₀= 0.0128
 D₃₀= D₁₅= D₁₀=
 C_u= C_c=

Classification

USCS= MH AASHTO=

Remarks

* (no specification provided)

Sample No.: UD-4, 5 & 6 (UU) Source of Sample:
 Location: NB-47A

Date:
 Elev./Depth: 18'-27"

MACTEC, INC.

Client: TVA
 Project: TVA Kingston - Proposed Gypsum Stack

Project No: 3043051021

Figure

Hydrometer type: 152H

Effective depth $L = 16.294964 - 0.164 \times R_m$

Elapsed Time, min	Temp, deg C	Actual reading	Corrected reading	K	Rm	Eff. depth	Diameter mm	Percent finer
0.50	23.1	44.0	38.9	0.0129	45.0	8.9	0.0543	59.9
1.00	23.1	42.0	36.9	0.0129	43.0	9.2	0.0391	56.8
2.00	23.1	41.0	35.9	0.0129	42.0	9.4	0.0279	55.3
5.00	23.1	39.0	33.9	0.0129	40.0	9.7	0.0180	52.2
15.00	23.1	37.0	31.9	0.0129	38.0	10.1	0.0105	49.1
30.00	23.1	36.0	30.9	0.0129	37.0	10.2	0.0075	47.6
60.00	23.1	34.0	28.9	0.0129	35.0	10.6	0.0054	44.5
250.00	23.1	31.0	25.9	0.0129	32.0	11.0	0.0027	39.9
1440.00	23.2	27.0	21.9	0.0129	28.0	11.7	0.0012	33.7

Fractional Components

Gravel/Sand based on #4

Sand/Fines based on #200

% COBBLES = % GRAVEL = 14.0 % SAND = 23.2

% SILT = 19.0 % CLAY = 43.8

D₈₅ = 1.90 D₆₀ = 0.05 D₅₀ = 0.01

Particle Size Distribution Report

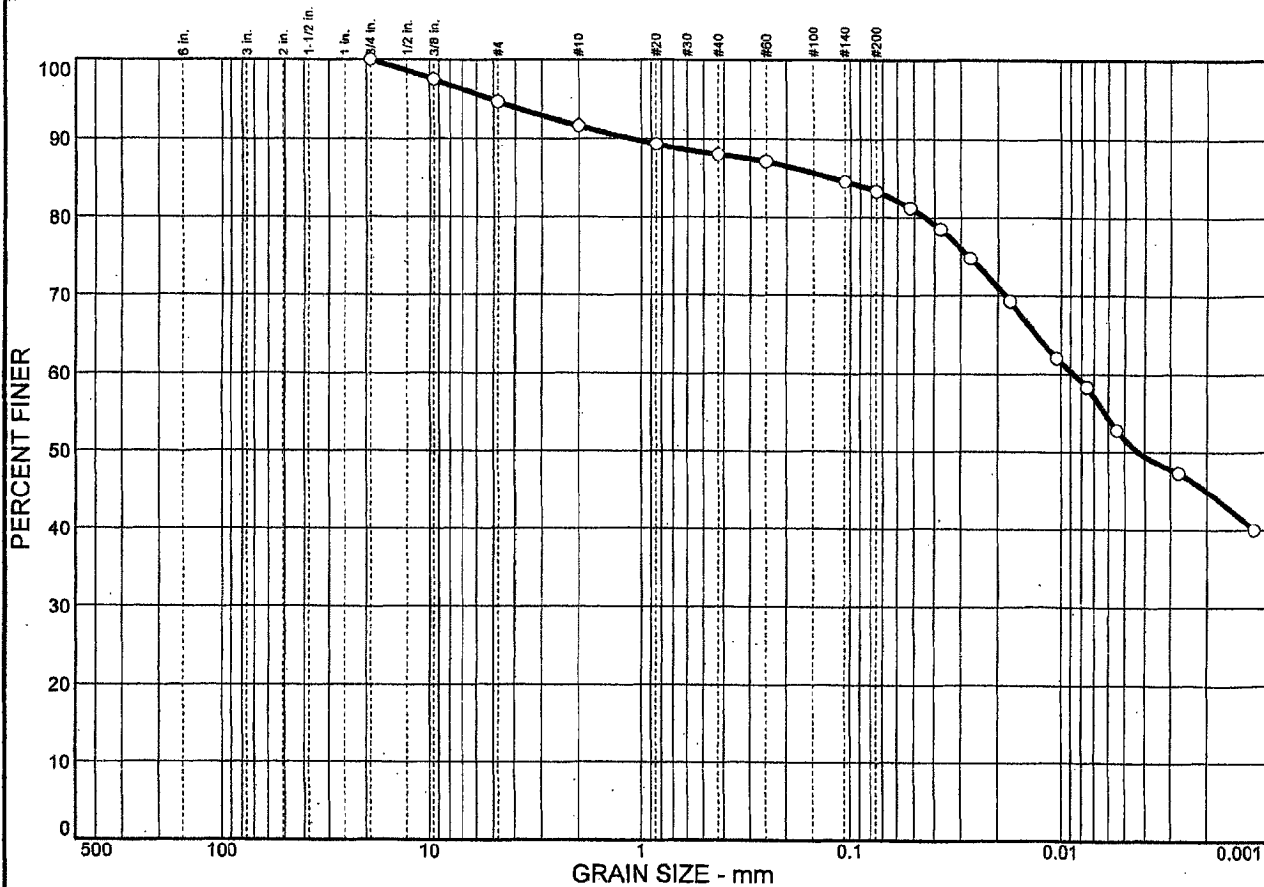

% COBBLES	% GRAVEL	% SAND	% SILT	% CLAY
0.0	5.4	11.3	31.7	51.6

SIEVE SIZE	PERCENT FINER	SPEC.* PERCENT	PASS? (X=NO)
.75 in.	100.0		
.375 in.	97.5		
#4	94.6		
#10	91.6		
#20	89.3		
#40	88.0		
#60	87.1		
#140	84.6		
#200	83.3		

Soil Description

Brown fat clay with sand

Atterberg Limits

PL= 27 LL= 59 PI= 32

Coefficients

D₈₅= 0.120 D₆₀= 0.0087 D₅₀= 0.0043
D₃₀= D₁₅= D₁₀=
C_u= C_c=

Classification

USCS= CH AASHTO=

Remarks

* (no specification provided)

Sample No.: UD-7
Location: NB-47A

Source of Sample:

Date:
Elev./Depth: 30'-32'

MACTEC, INC.

Client: TVA
Project: TVA Kingston - Proposed Gypsum Stack

Project No: 3043051021

Figure

Hydrometer type: 152H

Effective depth $L = 16.294964 - 0.164 \times R_m$

Elapsed time, min	Temp, deg C	Actual reading	Corrected reading	K	Rm	Eff. depth	Diameter mm	Percent finer
0.50	23.1	49.5	44.4	0.0130	50.5	8.0	0.0521	81.2
1.00	23.1	48.0	42.9	0.0130	49.0	8.3	0.0374	78.5
2.00	23.1	46.0	40.9	0.0130	47.0	8.6	0.0270	74.8
5.00	23.1	43.0	37.9	0.0130	44.0	9.1	0.0175	69.3
15.00	23.1	39.0	33.9	0.0130	40.0	9.7	0.0105	62.0
30.00	23.1	37.0	31.9	0.0130	38.0	10.1	0.0075	58.3
60.00	23.1	34.0	28.9	0.0130	35.0	10.6	0.0055	52.8
250.00	23.1	31.0	25.9	0.0130	32.0	11.0	0.0027	47.3
1440.00	23.1	27.0	21.9	0.0130	28.0	11.7	0.0012	40.0

Fractional Components

Gravel/Sand based on #4

Sand/Fines based on #200

% COBBLES = % GRAVEL = 5.4 % SAND = 11.3

% SILT = 31.7 % CLAY = 51.6

D₈₅ = 0.12 D₆₀ = 0.01 D₅₀ = 0.00

PARTICLE SIZE DISTRIBUTION TEST REPORT

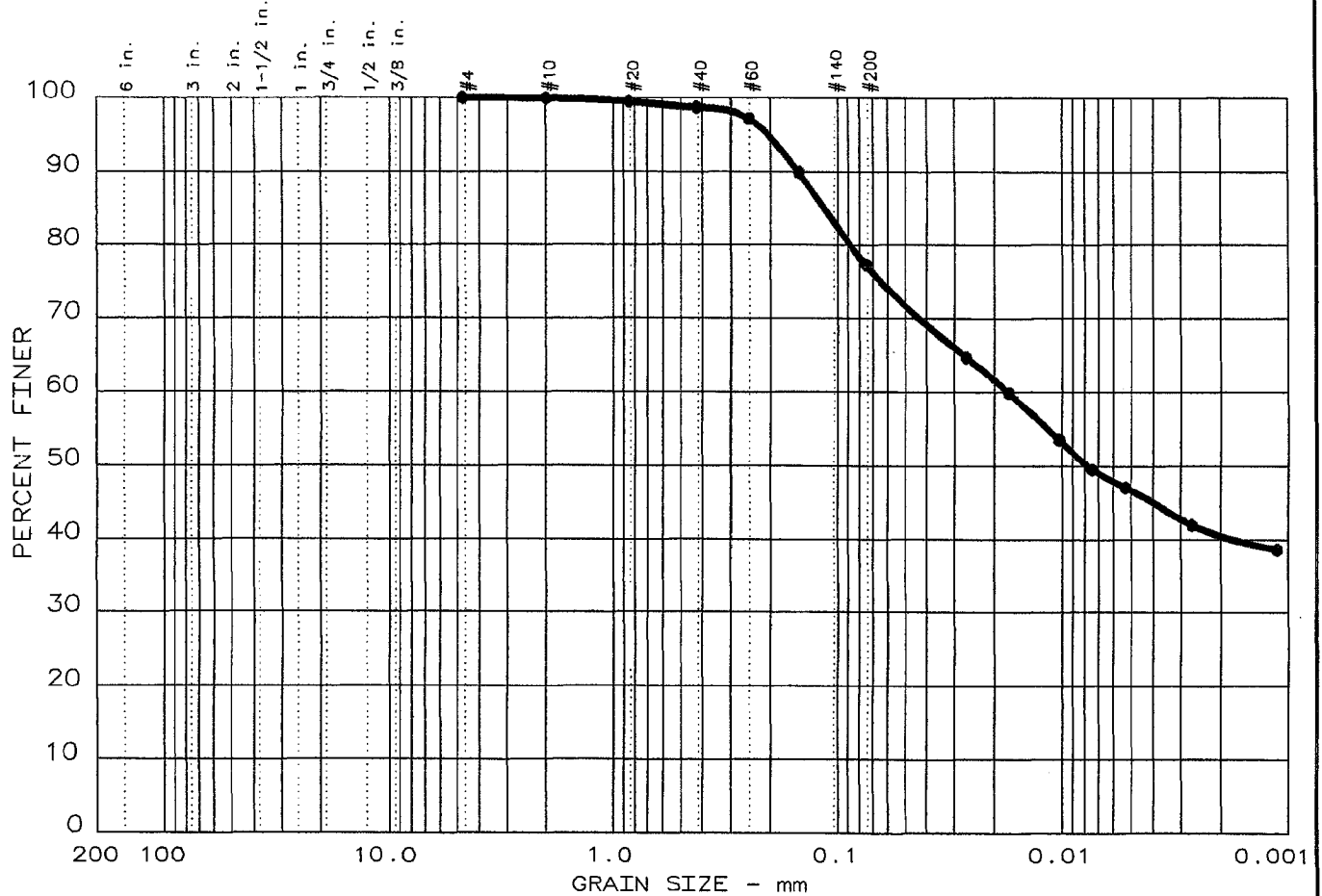

Test	% +3"	% GRAVEL	% SAND	% SILT	% CLAY	USCS	LL	PI
15	0.0	0.0	22.7	30.6	46.7	ML	40	12

SIEVE inches size	PERCENT FINER		
	●		
 	GRAIN SIZE		
D ₆₀	0.0174		
D ₃₀			
D ₁₀			
 	COEFFICIENTS		
C _c			
C _u			

SIEVE number size	PERCENT FINER		
	●		
4	100.0		
10	99.9		
20	99.5		
40	98.7		
60	97.2		
100	89.9		
200	77.3		

Sample information:
 ● Boring NB-59, 5-15' Bulk
 Light red brown silt
 with sand

Remarks:
 Sample Number 3196
 Methods: Particle Size:
 ASTM D 422-63; Sieve
 Analysis: AASHTO T 27-99

Project No.: 3043051021.0001
 Project: TVA Kingston - Proposed Gypsum Stack
 Date: June 13, 2005

=====

GRAIN SIZE DISTRIBUTION TEST DATA

Test No.: 15

Date: June 13, 2005
 Project No.: 3043051021.0001
 Project: TVA Kingston - Proposed Gypsum Stack

=====

Sample Data

Location of Sample: Boring NB-59, 5-15' Bulk
 Sample Description 1: Light red brown silt
 Sample Description 2: with sand
 USCS Class: ML Liquid limit: 40 Plasticity index: 12

Notes

Remarks: Sample Number 3196 Methods: Particle Size:
 ASTM D 422-63; Sieve Analysis: AASHTO T 27-99
 Fig. No.: 196

Mechanical Analysis Data

	Initial	After wash
Dry sample and tare=	602.60	147.20
Tare =	0.00	0.00
Dry sample weight =	602.60	147.20
Minus #200 from wash=	75.6 %	

Tare for cumulative weight retained= 0

Sieve	Cumul. Wt. retained	Percent finer
# 4	0.00	100.0
# 10	0.68	99.9
# 20	3.18	99.5
# 40	7.88	98.7
# 60	17.13	97.2
# 100	60.60	89.9
# 200	136.81	77.3

Hydrometer Analysis Data

Separation sieve is number 40
 Percent -# 40 based on complete sample= 98.7

Weight of hydrometer sample: 61.46

Hygroscopic moisture correction:

Moist weight & tare = 51.99

Dry weight & tare = 51.42

Tare = 22.18

Hygroscopic moisture= 1.9 %

Calculated biased weight= 61.09

Table of composite correction values:

Temp, deg C:	21.0	22.0	23.0	23.5	24.0
--------------	------	------	------	------	------

Comp. corr:	- 6.4	- 6.1	- 5.8	- 5.6	- 5.4
-------------	-------	-------	-------	-------	-------

Meniscus correction only= 0

Specific gravity of solids= 2.75

Specific gravity correction factor= 0.978

Hydrometer type: 152H Effective depth L= 16.294964 - 0.164 x Rm

Elapsed Time, min	Temp, deg C	Actual reading	Corrected reading	K	Rm	Eff. depth	Diameter mm	Percent finer
2.0	23.5	46.0	40.4	0.0127	46.0	8.8	0.0266	64.7
5.0	23.5	43.0	37.4	0.0127	43.0	9.2	0.0173	59.9
15.0	23.5	39.0	33.4	0.0127	39.0	9.9	0.0103	53.5
30.0	23.5	36.5	30.9	0.0127	36.5	10.3	0.0074	49.5
60.0	23.5	35.0	29.4	0.0127	35.0	10.6	0.0053	47.1
250.0	23.0	32.0	26.2	0.0128	32.0	11.0	0.0027	42.0
1440.0	24.0	29.5	24.1	0.0126	29.5	11.5	0.0011	38.6

Fractional Components

Gravel/Sand based on #4 sieve

Sand/Fines based on #200 sieve

% + 3 in. = 0.0 % GRAVEL = 0.0 % SAND = 22.7

% SILT = 30.6 % CLAY = 46.7

D85= 0.11 D60= 0.017 D50= 0.008

PARTICLE SIZE DISTRIBUTION TEST REPORT

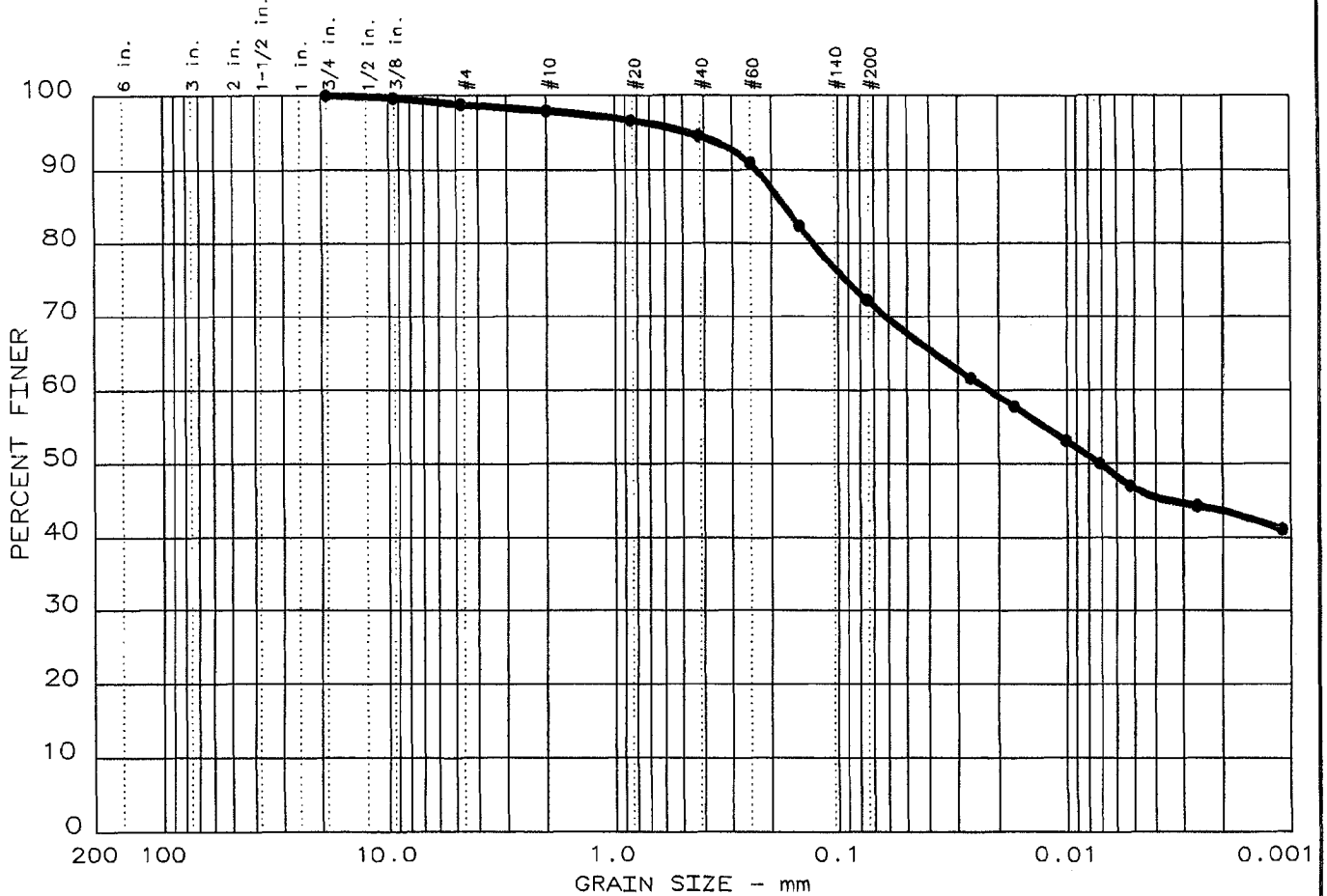

Test	% +3"	% GRAVEL	% SAND	% SILT	% CLAY	USCS	LL	PI
16	0.0	1.2	26.5	25.7	46.6	CH	60	32

SIEVE inches size	PERCENT FINER		
	●		
0.75	100.0		
0.375	99.6		
GRAIN SIZE			
D ₆₀	0.0219		
D ₃₀			
D ₁₀			
COEFFICIENTS			
C _c			
C _u			

SIEVE number size	PERCENT FINER		
	●		
4	98.8		
10	97.9		
20	96.6		
40	94.6		
60	90.9		
100	82.4		
200	72.3		

Sample information:
 ● Boring NB-65, 2-10' Bulk Red brown fat clay with sand

Remarks:
 Sample Number 3197
 Methods: Particle Size: ASTM D 422-63; Sieve Analysis: AASHTO T 27-99

	Project No.: 3043051021.0001
	Project: TVA Kingston - Proposed Gypsum Stack
	Date: June 29, 2005

GRAIN SIZE DISTRIBUTION TEST DATA

Test No.: 16

Date: June 13, 2005
 Product No.: 3043051021.0001
 Project: TVA Kingston - Proposed Gypsum Stack

65 Sample Data
~~CS-1/5/5~~

Location of Sample: Boring NB-85, 2-10' Bulk
 Sample Description 1: Red brown fat clay with
 Sample Description 2: sand
 USCS Class: CH Liquid limit: 60 Plasticity index: 32

Notes

Remarks: Sample Number 3197 Methods: Particle Size:
 ASTM D 422-63; Sieve Analysis: AASHTO T 27-99
 Fig. No.: 197

Mechanical Analysis Data

	Initial	After wash
Dry sample and tare=	567.15	173.55
Tare =	0.00	0.00
Dry sample weight =	567.15	173.55
Minus #200 from wash=	69.4 %	
Tare for cumulative weight retained=	0	

Sieve	Cumul. Wt. retained	Percent finer
0.75 inches	0.00	100.0
0.375 inches	2.41	99.6
# 4	6.80	98.8
# 10	12.01	97.9
# 20	19.22	96.6
# 40	30.72	94.6
# 60	51.46	90.9
# 100	99.63	82.4
# 200	157.24	72.3

Hydrometer Analysis Data

Separation sieve is number 40
 Percent -# 40 based on complete sample= 94.6
 Weight of hydrometer sample: 60.13
 Hygroscopic moisture correction:
 Moist weight & tare = 53.87
 Dry weight & tare = 53.55
 Tare = 21.88
 Hygroscopic moisture= 1.0 %
 Calculated biased weight= 62.94
 Table of composite correction values:

Temp, deg C: 21.0 22.0 23.0 23.5 24.0
 Comp. corr: - 6.4 - 6.1 - 5.8 - 5.6 - 5.4
 Meniscus correction only= 0
 Specific gravity of solids= 2.78
 Specific gravity correction factor= 0.972
 Hydrometer type: 152H Effective depth L= 16.294964 - 0.164 x Rm

Elapsed time, min	Temp, deg C	Actual reading	Corrected reading	K	Rm	Eff. depth	Diameter mm	Percent finer
2.0	23.5	45.5	39.9	0.0126	45.5	8.8	0.0265	61.6
5.0	23.5	43.0	37.4	0.0126	43.0	9.2	0.0171	57.8
15.0	23.5	40.0	34.4	0.0126	40.0	9.7	0.0101	53.2
31.0	23.5	38.0	32.4	0.0126	38.0	10.1	0.0072	50.1
60.0	23.5	36.0	30.4	0.0126	36.0	10.4	0.0052	47.0
252.0	23.0	34.5	28.7	0.0127	34.5	10.6	0.0026	44.3
1440.0	24.0	32.0	26.6	0.0125	32.0	11.0	0.0011	41.1

 Fractional Components

Gravel/Sand based on #4 sieve
 Sand/Fines based on #200 sieve
 % + 3 in. = 0.0 % GRAVEL = 1.2 % SAND = 26.5
 % SILT = 25.7 % CLAY = 46.6

D85= 0.17 D60= 0.022 D50= 0.007

Particle Size Distribution Report

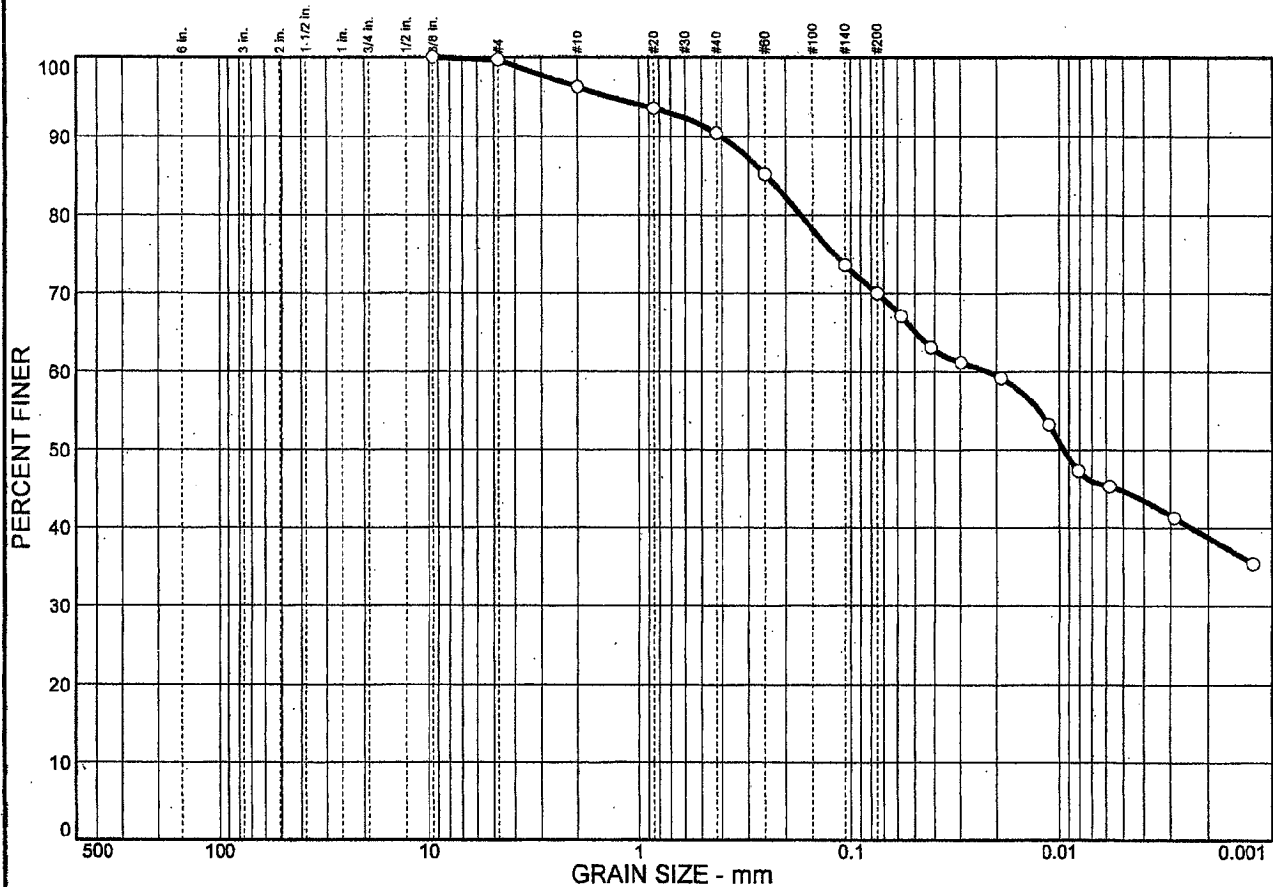

% COBBLES	% GRAVEL	% SAND	% SILT	% CLAY
0.0	0.3	29.7	25.3	44.7

SIEVE SIZE	PERCENT FINER	SPEC.* PERCENT	PASS? (X=NO)
.375 in.	100.0		
#4	99.7		
#10	96.2		
#20	93.5		
#40	90.4		
#60	85.2		
#140	73.6		
#200	70.0		

Soil Description

Reddish brown sandy silt

Atterberg Limits

PL= 28 LL= 48 PI= 20

Coefficients

D₈₅= 0.246 D₆₀= 0.0219 D₅₀= 0.0095
D₃₀= D₁₅= D₁₀=
C_u= C_c=

Classification

USCS= ML AASHTO=

Remarks

* (no specification provided)

Sample No.: Bulk
Location: NB-76

Source of Sample:

Date:
Elev./Depth: 5'-15'

MACTEC, INC.

Client: TVA
Project: TVA Kingston - Proposed Gypsum Stack

Project No: 3043051021

Figure

GRAIN SIZE DISTRIBUTION TEST DATA

Client: TVA

Project: TVA Kingston - Proposed Gypsum Stack

Project Number: 3043051021

Sample Data

Source:

Sample No.: Bulk

Elev. or Depth: 5'-15'

Sample Length(in./cm.):

Location: NB-76, 5.0'-15.0'

Description: Reddish brown sandy silt

Date: PL: 28

LL: 47

PI: 19

USCS Classification: ML

AASHTO Classification:

Testing Remarks:

Mechanical Analysis Data

Initial

Dry sample and tare= 305.41

Tare = 0.00

Dry sample weight = 305.41

Sample split on number 10 sieve

Split sample data:

Sample and tare = 48.47 Tare = .00 Sample weight = 48.47

Cumulative weight retained tare= .00

Tare for cumulative weight retained= .00

Sieve	Cumul. Wt. retained	Percent finer
# 375 inch	0.00	100.0
# 4	0.86	99.7
# 10	11.66	96.2
# 20	1.34	93.5
# 40	2.90	90.4
# 60	5.52	85.2
# 140	11.40	73.6
# 200	13.22	70.0

Hydrometer Analysis Data

Separation sieve is #10

Percent -#10 based upon complete sample= 96.2

Weight of hydrometer sample: 50.02

Hygroscopic moisture correction:

Moist weight & tare = 51.54

Dry weight & tare = 50.33

Tare = 10.83

Hygroscopic moisture= 3.1 %

Calculated biased weight= 50.45

Table of composite correction values:

Temp, deg C: 13.7 24.7 29.1

Comp. corr: -6.0 -5.0 -3.5

Discus correction only= 1.0

Specific gravity of solids= 2.65

Specific gravity correction factor= 1.000

Hydrometer type: 152H

MACTEC, INC.

TVA-00024620

Effective depth $L = 16.294964 - 0.164 \times R_m$

Elapsed time, min	Temp, deg C	Actual reading	Corrected reading	K	Rm	Eff. depth	Diameter mm	Percent finer
0.50	23.1	39.0	33.9	0.0131	40.0	9.7	0.0580	67.1
1.00	23.1	37.0	31.9	0.0131	38.0	10.1	0.0417	63.1
2.00	23.1	36.0	30.9	0.0131	37.0	10.2	0.0297	61.2
5.00	23.1	35.0	29.9	0.0131	36.0	10.4	0.0189	59.2
15.00	23.1	32.0	26.9	0.0131	33.0	10.9	0.0112	53.2
30.00	23.1	29.0	23.9	0.0131	30.0	11.4	0.0081	47.3
60.00	23.1	28.0	22.9	0.0131	29.0	11.5	0.0058	45.3
250.00	23.1	26.0	20.9	0.0131	27.0	11.9	0.0029	41.3
1440.00	23.1	23.0	17.9	0.0131	24.0	12.4	0.0012	35.4

Fractional Components

Gravel/Sand based on #4

Sand/Fines based on #200

% COBBLES = % GRAVEL = 0.3 % SAND = 29.7

% SILT = 25.3 % CLAY = 44.7

D₈₅ = 0.25 D₆₀ = 0.02 D₅₀ = 0.01

Particle Size Distribution Report

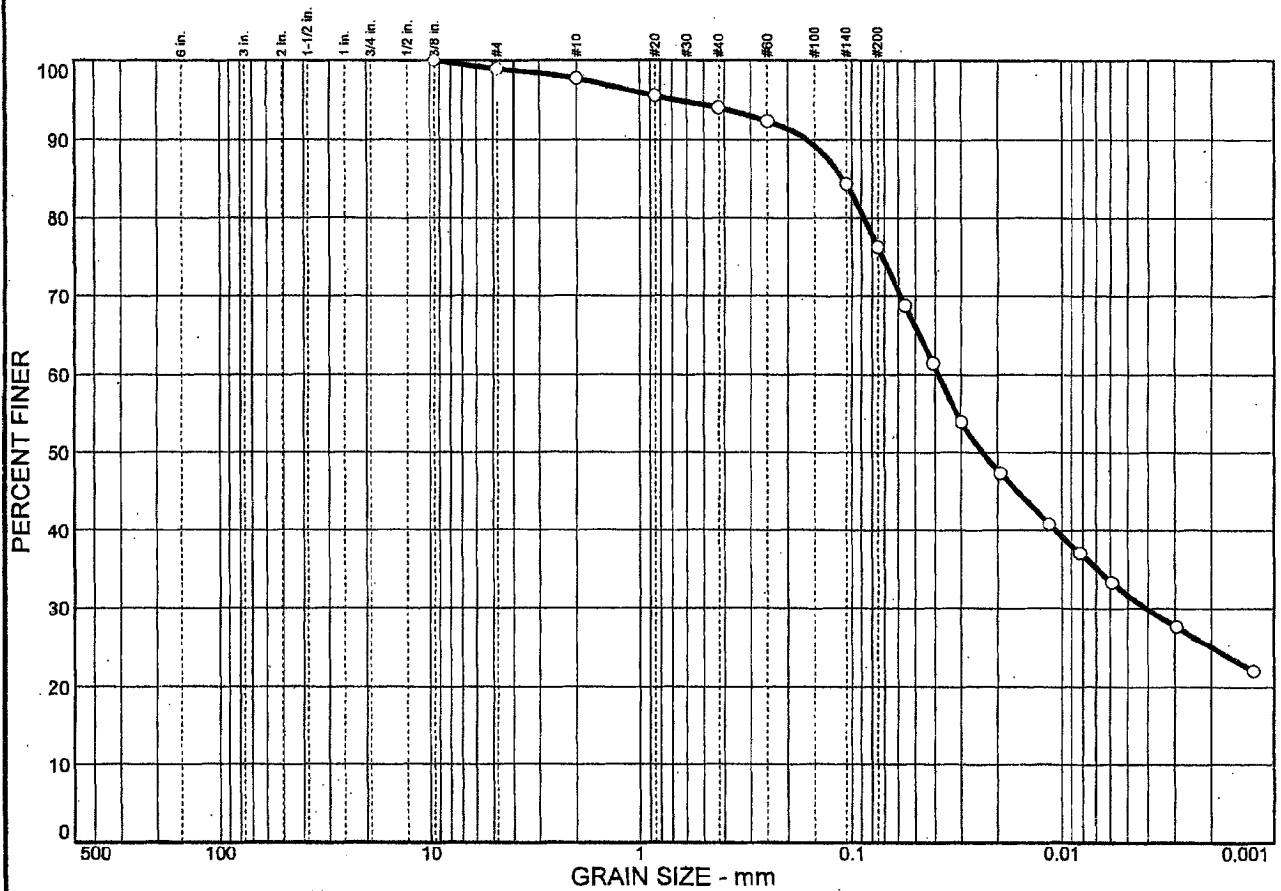

% COBBLES	% GRAVEL	% SAND	% SILT	% CLAY
0.0	1.1	22.6	44.6	31.7

SIEVE SIZE	PERCENT FINER	SPEC.* PERCENT	PASS? (X=NO)
.375 in.	100.0		
#4	98.9		
#10	97.7		
#20	95.5		
#40	94.0		
#60	92.3		
#140	84.3		
#200	76.3		

Soil Description

Brown and red brown lean clay with sand

Atterberg Limits
 PL= 24 LL= 37 PI= 13

Coefficients
 D₈₅= 0.110 D₆₀= 0.0386 D₅₀= 0.0236
 D₃₀= 0.0041 D₁₅= D₁₀=
 C_u= C_c=

Classification
 USCS= CL AASHTO=

Remarks

* (no specification provided)

Sample No.: UD-2
 Location: NB-76

Source of Sample:

Date:
 Elev./Depth: 19'-20.5'

MACTEC, INC.

Client: TVA
 Project: TVA Kingston - Proposed Gypsum Stack

Project No: 3043051021

Figure

GRAIN SIZE DISTRIBUTION TEST DATA

Client: TVA
Project: TVA Kingston - Proposed Gypsum Stack
Project Number: 3043051021

Sample Data

Source:
Sample No.: UD-2
Elev. or Depth: 19'-20.5' Sample Length(in./cm.):
Location: NB-76
Description: Brown and red brown lean clay with sand
Date: PL: 24 LL: 37 PI: 13
USCS Classification: CL AASHTO Classification:
Testing Remarks:

Mechanical Analysis Data

Initial

Dry sample and tare= 331.04
Tare = 0.00
Dry sample weight = 331.04
Sample split on number 10 sieve
Split sample data:
Sample and tare = 51.85 Tare = .00 Sample weight = 51.85
Cumulative weight retained tare= .00
Tare for cumulative weight retained= .00

Sieve	Cumul. Wt. retained	Percent finer
# 75 inch	0.00	100.0
# 4	3.73	98.9
# 10	7.70	97.7
# 20	1.16	95.5
# 40	1.98	94.0
# 60	2.84	92.3
# 140	7.12	84.3
# 200	11.36	76.3

Hydrometer Analysis Data

Separation sieve is #10
Percent -#10 based upon complete sample= 97.7
Weight of hydrometer sample: 52.78
Hygroscopic moisture correction:
Moist weight & tare = 46.17
Dry weight & tare = 45.54
Tare = 10.83
Hygroscopic moisture= 1.8 %
Calculated biased weight= 53.06
Table of composite correction values:
Temp, deg C: 13.7 24.7 29.1
Comp. corr: -6.0 -5.0 -3.5

Discus correction only= 1.0
Specific gravity of solids= 2.69
Specific gravity correction factor= 0.991
Hydrometer type: 152H

Effective depth $L = 16.294964 - 0.164 \times R_m$

Elapsed time, min	Temp, deg C	Actual reading	Corrected reading	K	Rm	Eff. depth	Diameter mm	Percent finer
0.50	23.1	42.0	36.9	0.0130	43.0	9.2	0.0558	68.8
1.00	23.1	38.0	32.9	0.0130	39.0	9.9	0.0408	61.4
2.00	23.1	34.0	28.9	0.0130	35.0	10.6	0.0298	53.9
5.00	23.1	30.5	25.4	0.0130	31.5	11.1	0.0194	47.4
15.00	23.1	27.0	21.9	0.0130	28.0	11.7	0.0115	40.8
30.00	23.1	25.0	19.9	0.0130	26.0	12.0	0.0082	37.1
60.00	23.1	23.0	17.9	0.0130	24.0	12.4	0.0059	33.3
250.00	23.1	20.0	14.9	0.0130	21.0	12.9	0.0029	27.7
1440.00	23.1	17.0	11.9	0.0130	18.0	13.3	0.0012	22.1

Fractional Components

Gravel/Sand based on #4

Sand/Fines based on #200

% COBBLES = % GRAVEL = 1.1 % SAND = 22.6

% SILT = 44.6 % CLAY = 31.7

D85= 0.11 D60= 0.04 D50= 0.02

D30= 0.00

Particle Size Distribution Report

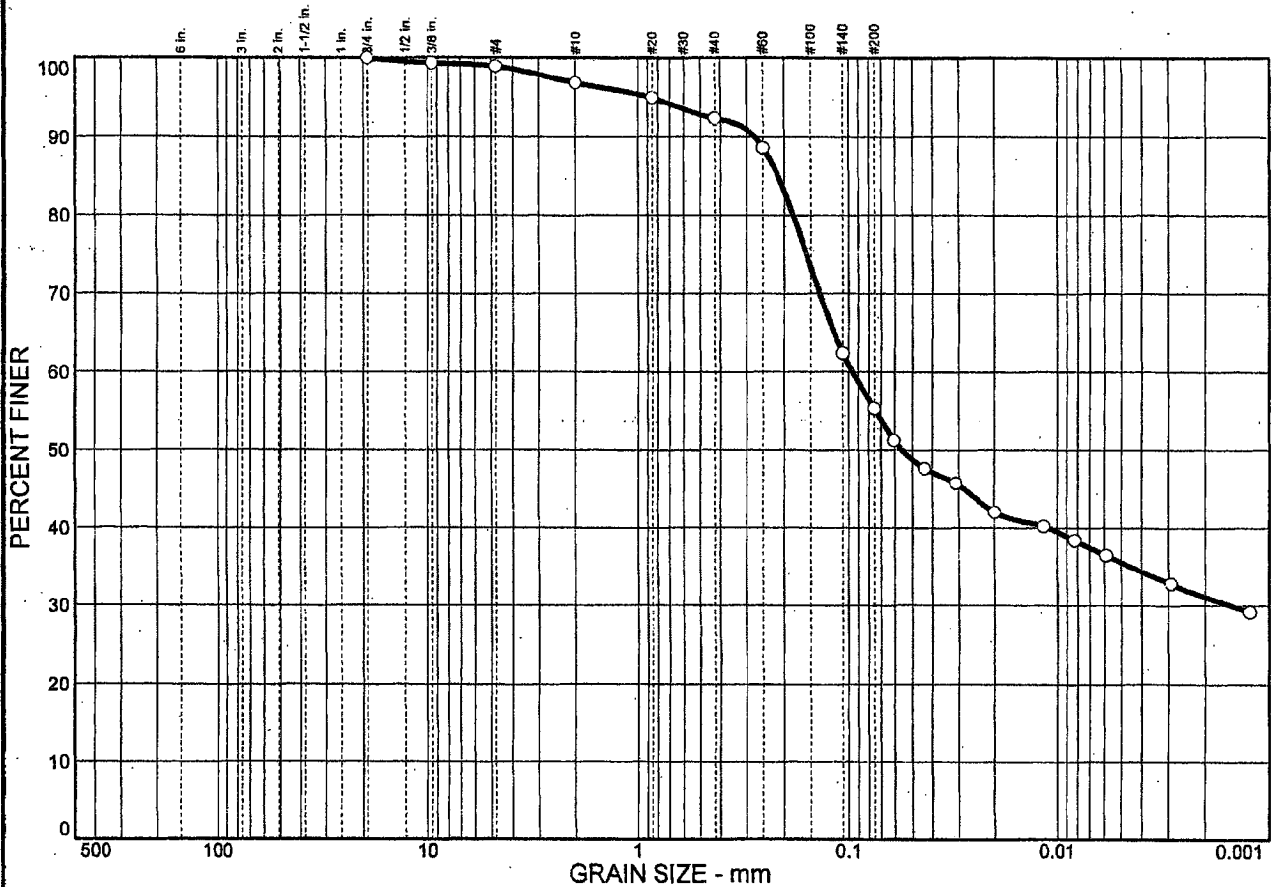

% COBBLES	% GRAVEL	% SAND	% SILT	% CLAY
0.0	1.1	43.6	19.7	35.6

SIEVE SIZE	PERCENT FINER	SPEC.* PERCENT	PASS? (X=NO)
.75 in.	100.0		
.375 in.	99.3		
#4	98.9		
#10	96.8		
#20	94.9		
#40	92.3		
#60	88.6		
#140	62.4		
#200	55.3		

Soil Description
Brownish yellow sandy lean clay

Atterberg Limits
PL= 25 LL= 41 PI= 16

Coefficients
D₈₅= 0.214 D₆₀= 0.0956 D₅₀= 0.0560
D₃₀= 0.0015 D₁₅= D₁₀=
C_u= C_c=

Classification
USCS= CL AASHTO=

Remarks

* (no specification provided)

Sample No.: UD-1, 2 & 3 (UU) Source of Sample:
Location: NB-77A

Date:
Elev./Depth: 4'-14'

MACTEC, INC.

Client: TVA
Project: TVA Kingston - Proposed Gypsum Stack

Project No: 3043051021

Figure

GRAIN SIZE DISTRIBUTION TEST DATA

Client: TVA
Project: TVA Kingston - Proposed Gypsum Stack
Project Number: 3043051021

Sample Data

Source:

Sample No.: UD-1, 2 & 3 (UU)

Elev. or Depth: 4'-14'

Sample Length(in./cm.):

Location: NB-77A

Description:

Date: PL: 25

LL: PI:

USCS Classification: CL

AASHTO Classification:

Testing Remarks:

Mechanical Analysis Data

Initial
Dry sample and tare= 408.59
Tare = 0.00
Dry sample weight = 408.59
Sample split on number 10 sieve
Split sample data:
Sample and tare = 52.47 Tare = .00 Sample weight = 52.47
Cumulative weight retained tare= .00
Tare for cumulative weight retained= .00

Sieve	Cumul. Wt. retained	Percent finer
75 inch	0.00	100.0
.375 inch	2.87	99.3
# 4	4.32	98.9
# 10	12.97	96.8
# 20	1.04	94.9
# 40	2.45	92.3
# 60	4.42	88.6
# 140	18.63	62.4
# 200	22.50	55.3

Hydrometer Analysis Data

Separation sieve is #10
Percent -#10 based upon complete sample= 96.8
Weight of hydrometer sample: 53.60
Hygroscopic moisture correction:
Moist weight & tare = 55.37
Dry weight & tare = 54.48
Tare = 11.31
Hygroscopic moisture= 2.1 %
Calculated biased weight= 54.25
Table of composite correction values:
Temp, deg C: 13.7 24.7 29.1
Comp. corr: -6.0 -5.0 -3.5

Specific gravity correction only= 1.0
Specific gravity of solids= 2.66
Specific gravity correction factor= 0.998

Hydrometer type: 152H

Effective depth $L = 16.294964 - 0.164 \times R_m$

Elapsed Time, min	Temp, deg C	Actual reading	Corrected reading	K	R _m	Eff. depth	Diameter mm	Percent finer
0.50	23.1	33.0	27.9	0.0131	34.0	10.7	0.0606	51.2
1.00	23.1	31.0	25.9	0.0131	32.0	11.0	0.0435	47.6
2.00	23.1	30.0	24.9	0.0131	31.0	11.2	0.0310	45.7
5.00	23.1	28.0	22.9	0.0131	29.0	11.5	0.0199	42.0
15.00	23.1	27.0	21.9	0.0131	28.0	11.7	0.0116	40.2
30.00	23.1	26.0	20.9	0.0131	27.0	11.9	0.0082	38.4
60.00	23.1	25.0	19.9	0.0131	26.0	12.0	0.0059	36.5
250.00	23.1	23.0	17.9	0.0131	24.0	12.4	0.0029	32.8
1440.00	23.2	21.0	15.9	0.0131	22.0	12.7	0.0012	29.2

Fractional Components

Gravel/Sand based on #4

Sand/Fines based on #200

% COBBLES = % GRAVEL = 1.1 % SAND = 43.6

% SILT = 19.7 % CLAY = 35.6

D₈₅ = 0.21 D₆₀ = 0.10 D₅₀ = 0.06

D₃₀ = 0.00

Particle Size Distribution Report

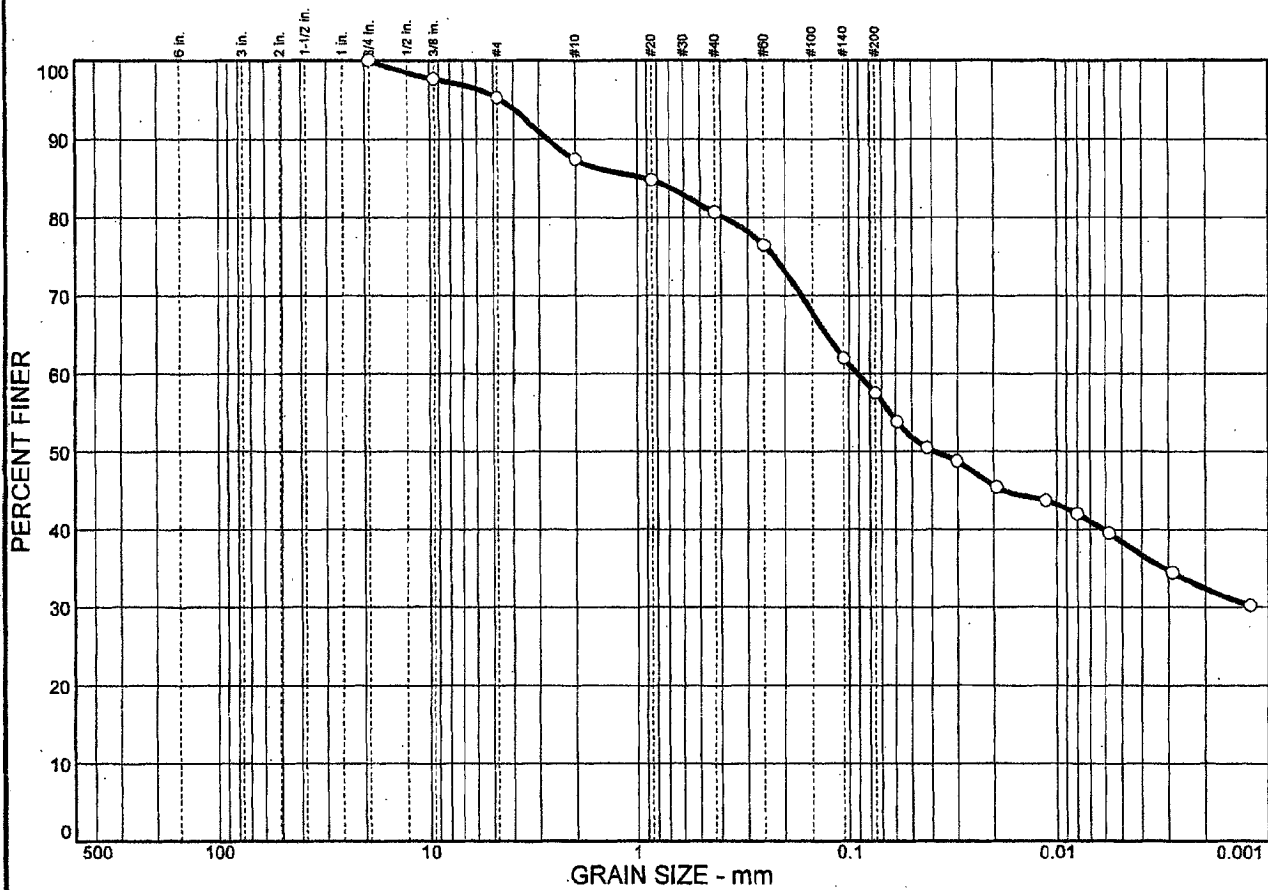

% COBBLES	% GRAVEL	% SAND	% SILT	% CLAY
0.0	4.8	37.7	19.1	38.4

SIEVE SIZE	PERCENT FINER	SPEC.* PERCENT	PASS? (X=NO)
.75 in.	100.0		
.375 in.	97.6		
#4	95.2		
#10	87.4		
#20	84.8		
#40	80.6		
#60	76.4		
#140	62.0		
#200	57.5		

Soil Description

Brown sandy elastic silt

Atterberg Limits

PL= 29 LL= 53 PI= 24

Coefficients

D₈₅= 0.899 D₆₀= 0.0909 D₅₀= 0.0385
 D₃₀= D₁₅= D₁₀=
 C_u= C_c=

Classification

USCS= MH AASHTO=

Remarks

* (no specification provided)

Sample No.: UD-4, 5 & 7 (CU) Source of Sample:
 Location: NB-77A

Date:
 Elev./Depth: 15'-26'

MACTEC, INC.	Client: TVA Project: TVA Kingston - Proposed Gypsum Stack Project No: 3043051021 Figure
---------------------	----------------------------------------------------------------------------------------------------------------------------------

Hydrometer type: 152H

Effective depth $L = 16.294964 - 0.164 \times R_m$

Elapsed Time, min	Temp, deg C	Actual reading	Corrected reading	K	R _m	Eff. depth	Diameter mm	Percent finer
0.50	23.5	37.0	31.9	0.0131	38.0	10.1	0.0588	53.8
1.00	23.5	35.0	29.9	0.0131	36.0	10.4	0.0423	50.5
2.00	23.5	34.0	28.9	0.0131	35.0	10.6	0.0301	48.8
5.00	23.5	32.0	26.9	0.0131	33.0	10.9	0.0193	45.4
15.00	23.5	31.0	25.9	0.0131	32.0	11.0	0.0113	43.7
30.00	23.5	30.0	24.9	0.0131	31.0	11.2	0.0080	42.0
60.00	23.5	28.5	23.4	0.0131	29.5	11.5	0.0057	39.5
250.00	23.5	25.5	20.4	0.0131	26.5	11.9	0.0029	34.4
1440.00	23.3	23.0	17.9	0.0131	24.0	12.4	0.0012	30.2

Fractional Components

Gravel/Sand based on #4

Sand/Fines based on #200

% COBBLES = % GRAVEL = 4.8 % SAND = 37.7

% SILT = 19.1 % CLAY = 38.4

D₈₅ = 0.90 D₆₀ = 0.09 D₅₀ = 0.04

PARTICLE SIZE DISTRIBUTION TEST REPORT

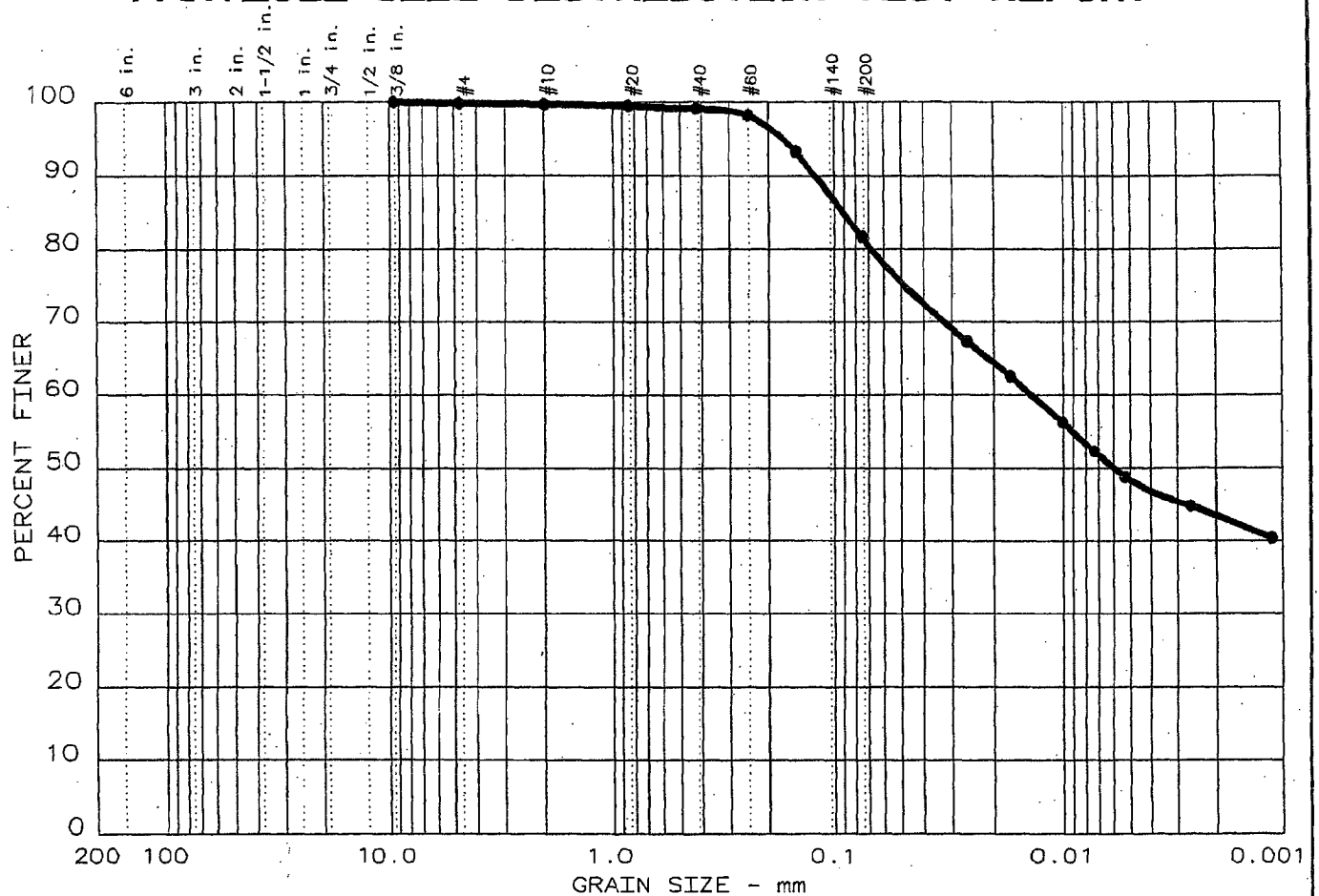

Test	% +3"	% GRAVEL	% SAND	% SILT	% CLAY	USCS	LL	PI
19	0.0	0.2	18.2	33.3	48.3	CL	47	22

SIEVE inches size	PERCENT FINER
0.375	100.0
GRAIN SIZE	
D ₆₀	0.0135
D ₃₀	
D ₁₀	
COEFFICIENTS	
C _c	
C _u	

SIEVE number size	PERCENT FINER
4	99.8
10	99.7
20	99.5
40	99.1
60	98.2
100	93.2
200	81.6

Sample information:
 • Boring NB-84, 2-10' Bulk
 Light orange brown fat
 clay with sand

Remarks:
 Sample Number 3200
 Methods: Particle Size:
 ASTM D 422-63; Sieve
 Analysis: AASHTO T 27-99

Project No.: 3043051021.0001
 Project: TVA Kingston - Proposed Gypsum Stack
 Date: June 23, 2005

GRAIN SIZE DISTRIBUTION TEST DATA

Test No.: 19

Date: June 23, 2005
 Project No.: 3043051021.0001
 Project: TVA Kingston - Proposed Gypsum Stack

Sample Data

Location of Sample: Boring NB-84, 2-10' Bulk
 Sample Description 1: Light orange brown fat
 Sample Description 2: clay with sand
 USCS Class: CL Liquid limit: 47 Plasticity index: 22

Notes

Remarks: Sample Number 3200 Methods: Particle Size:
 ASTM D 422-63; Sieve Analysis: AASHTO T 27-99
 Fig. No.: 200

Mechanical Analysis Data

	Initial	After wash
Dry sample and tare=	479.21	106.31
Tare =	0.00	0.00
Dry sample weight =	479.21	106.31
Minus #200 from wash=	77.8 %	
Tare for cumulative weight retained=	0	
Sieve	Cumul. Wt. retained	Percent finer
0.375 inches	0.00	100.0
# 4	0.93	99.8
# 10	1.57	99.7
# 20	2.57	99.5
# 40	4.44	99.1
# 60	8.84	98.2
# 100	32.41	93.2
# 200	88.09	81.6

Hydrometer Analysis Data

Separation sieve is number 40
 Percent -# 40 based on complete sample= 99.1
 Weight of hydrometer sample: 62.39
 Hygroscopic moisture correction:
 Moist weight & tare = 52.68
 Dry weight & tare = 51.95
 Tare = 22.35
 Hygroscopic moisture= 2.5 %
 Calculated biased weight= 61.46
 Table of composite correction values:
 Temp, deg C: 21.0 22.0 23.0 23.5 24.0

Comp. corr: - 6.4 - 6.1 - 5.8 - 5.6 - 5.4
 Meniscus correction only= 0
 Specific gravity of solids= 2.76
 Specific gravity correction factor= 0.976
 Hydrometer type: 152H Effective depth L= 16.294964 - 0.164 x Rm

Elapsed time, min	Temp, deg C	Actual reading	Corrected reading	K	Rm	Eff. depth	Diameter mm	Percent finer
2.0	23.5	48.0	42.4	0.0127	48.0	8.4	0.0260	67.4
5.0	23.5	45.0	39.4	0.0127	45.0	8.9	0.0169	62.6
15.0	23.5	41.0	35.4	0.0127	41.0	9.6	0.0101	56.2
30.0	23.5	38.5	32.9	0.0127	38.5	10.0	0.0073	52.3
60.0	23.0	36.5	30.7	0.0127	36.5	10.3	0.0053	48.8
250.0	23.0	34.0	28.2	0.0127	34.0	10.7	0.0026	44.8
1443.0	23.5	31.0	25.4	0.0127	31.0	11.2	0.0011	40.4

 Fractional Components

Gravel/Sand based on #4 sieve
 Sand/Fines based on #200 sieve
 % + 3 in. = 0.0 % GRAVEL = 0.2 % SAND = 18.2
 % SILT = 33.3 % CLAY = 48.3

D85= 0.09 D60= 0.013 D50= 0.006

Particle Size Distribution Report

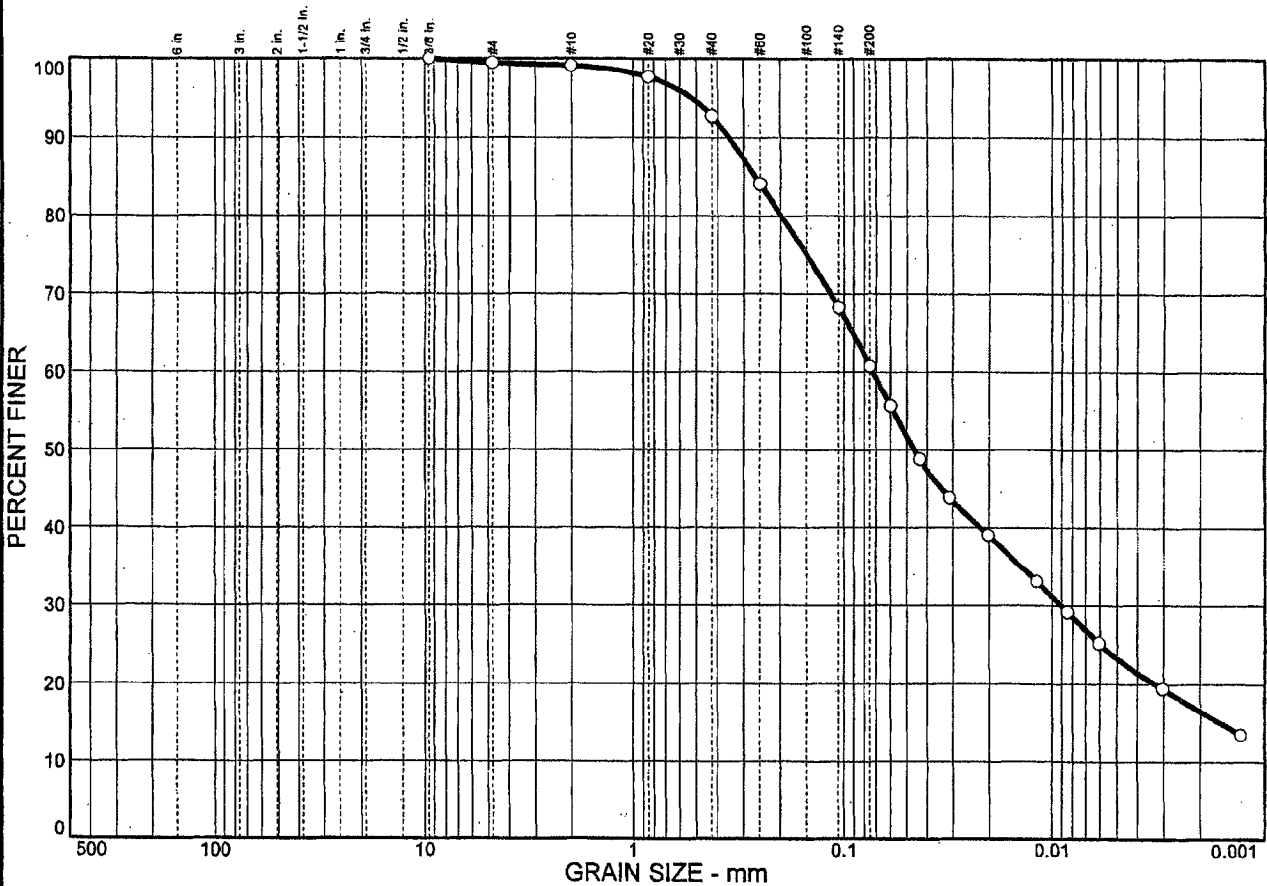

% COBBLES	% GRAVEL	% SAND	% SILT	% CLAY
0.0	0.5	38.7	37.5	23.3

SIEVE SIZE	PERCENT FINER	SPEC.* PERCENT	PASS? (X=NO)
.375 in.	100.0		
#4	99.5		
#10	99.1		
#20	97.7		
#40	92.7		
#60	84.1		
#140	68.3		
#200	60.8		

Soil Description

Brown sandy silt

Atterberg Limits

PL= 30 LL= 46 PI= 16

Coefficients

D₈₅= 0.263 D₆₀= 0.0723 D₅₀= 0.0461
D₃₀= 0.0091 D₁₅= 0.0016 D₁₀=
C_u=

Classification

USCS= ML AASHTO=

Remarks

* (no specification provided)

Sample No.: UD-4 Source of Sample: Date: Elev./Depth: 32.5'-34.5'
Location: NB-84

MACTEC, INC.

Client: TVA
Project: TVA Kingston - Proposed Gypsum Stack
Project No: 3043051021 Figure

GRAIN SIZE DISTRIBUTION TEST DATA

Client: TVA
Project: TVA Kingston - Proposed Gypsum Stack
Project Number: 3043051021

Sample Data

Source:
Sample No.: UD-4
Elev. or Depth: 32.5'-34.5' Sample Length(in./cm.):
Location: NB-84
Description: Brown sandy silt
Date: PL: 30 LL: 46 PI: 16
USCS Classification: ML AASHTO Classification:
Testing Remarks:

Mechanical Analysis Data

Initial

Dry sample and tare= 190.97
Tare = 0.00
Dry sample weight = 190.97
Sample split on number 10 sieve
Split sample data:
Sample and tare = 52.06 Tare = .00 Sample weight = 52.06
Cumulative weight retained tare= .00
Tare for cumulative weight retained= .00

Sieve	Cumul. Wt. retained	Percent finer
375 inch	0.00	100.0
# 4	1.04	99.5
# 10	1.76	99.1
# 20	0.73	97.7
# 40	3.36	92.7
# 60	7.89	84.1
# 140	16.17	68.3
# 200	20.11	60.8

Hydrometer Analysis Data

Separation sieve is #10
Percent -#10 based upon complete sample= 99.1
Weight of hydrometer sample: 52.06
Hygroscopic moisture correction:
Moist weight & tare = 45.54
Dry weight & tare = 44.10
Tare = 10.89
Hygroscopic moisture= 4.3 %
Calculated biased weight= 50.35
Table of composite correction values:
Temp, deg C: 13.7 24.7 29.1
Comp. corr: -6.0 -5.0 -3.5

Discus correction only= 1.0
Specific gravity of solids= 2.70
Specific gravity correction factor= 0.989
Hydrometer type: 152H

Effective depth $L = 16.294964 - 0.164 \times R_m$

Elapsed time, min	Temp, deg C	Actual reading	Corrected reading	K	Rm	Eff. depth	Diameter mm	Percent finer
0.50	23.1	33.5	28.4	0.0129	34.5	10.6	0.0597	55.7
1.00	23.1	30.0	24.9	0.0129	31.0	11.2	0.0433	48.8
2.00	23.1	27.5	22.4	0.0129	28.5	11.6	0.0312	43.9
5.00	23.1	25.0	19.9	0.0129	26.0	12.0	0.0201	39.0
15.00	23.1	22.0	16.9	0.0129	23.0	12.5	0.0118	33.1
30.00	23.1	20.0	14.9	0.0129	21.0	12.9	0.0085	29.2
60.00	23.1	18.0	12.9	0.0129	19.0	13.2	0.0061	25.2
250.00	23.1	15.0	9.9	0.0129	16.0	13.7	0.0030	19.4
1440.00	23.2	12.0	6.9	0.0129	13.0	14.2	0.0013	13.5

Fractional Components

Gravel/Sand based on #4

Sand/Fines based on #200

% COBBLES = % GRAVEL = 0.5 % SAND = 38.7

% SILT = 37.5 % CLAY = 23.3

D85= 0.26 D60= 0.07 D50= 0.05

D30= 0.01 D15= 0.00

Particle Size Distribution Report

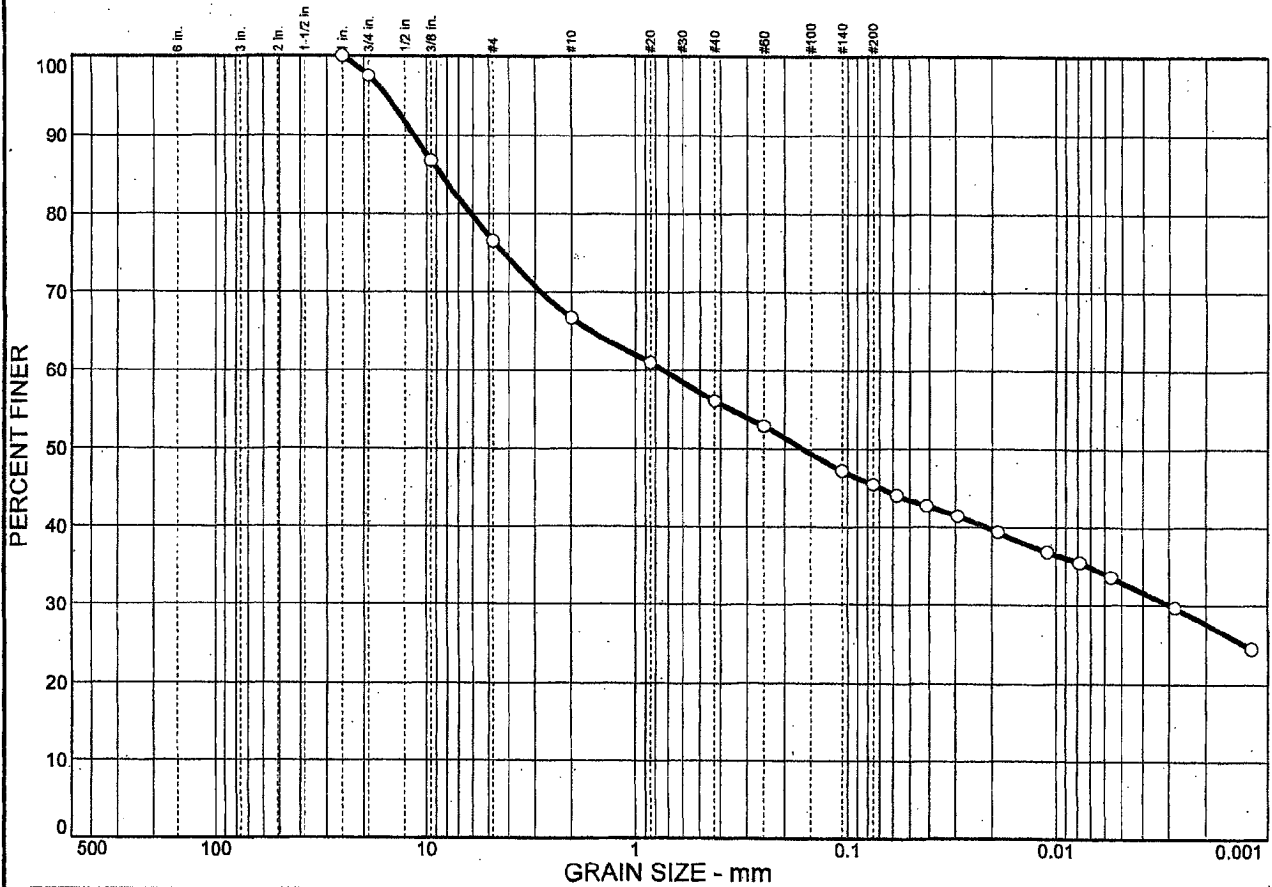

% COBBLES	% GRAVEL	% SAND	% SILT	% CLAY
0.0	23.5	31.1	12.5	32.9

SIEVE SIZE	PERCENT FINER	SPEC.* PERCENT	PASS? (X=NO)
1 in.	100.0		
.75 in.	97.5		
.375 in.	86.8		
#4	76.5		
#10	66.7		
#20	61.0		
#40	56.1		
#60	52.9		
#140	47.2		
#200	45.4		

Soil Description

Brownish yellow clayey sand with gravel

Atterberg Limits

PL= 30 LL= 59 PI= 29

Coefficients

D₈₅= 8.53 D₆₀= 0.735 D₅₀= 0.163
D₃₀= 0.0030 D₁₅= D₁₀=
C_u= C_c=

Classification

USCS= SC AASHTO=

Remarks

* (no specification provided)

Sample No.: UD-1, 2 & 3 (CU) Source of Sample: Date: Elev./Depth: 13'-19'

Location: NB-85A and NB-85B

MACTEC, INC.	Client: TVA Project: TVA Kingston - Proposed Gypsum Stack Project No: 3043051021
	Figure

GRAIN SIZE DISTRIBUTION TEST DATA

Client: TVA
Project: TVA Kingston - Proposed Gypsum Stack
Project Number: 3043051021

Sample Data

Source:
Sample No.: UD-1, 2 & 3 (CU)
Elev. or Depth: 13'-19' **Sample Length(in./cm.):**
Location: NB-85A and NB-85B
Description: Brownish yellow clayey sand with gravel
Date: PL: 30 LL: 59 PI: 29
USCS Classification: SC **AASHTO Classification:**
Testing Remarks:

Mechanical Analysis Data

Initial

Dry sample and tare= 732.52
Tare = 0.00
Dry sample weight = 732.52
Sample split on number 10 sieve
Split sample data:
Sample and tare = 51.33 Tare = .00 Sample weight = 51.33
Cumulative weight retained tare= .00
Tare for cumulative weight retained= .00

Sieve	Cumul. Wt. retained	Percent finer
1/2 inch	0.00	100.0
.75 inch	18.41	97.5
.375 inch	96.86	86.8
# 4	172.34	76.5
# 10	244.12	66.7
# 20	4.39	61.0
# 40	8.14	56.1
# 60	10.63	52.9
# 140	15.01	47.2
# 200	16.37	45.4

Hydrometer Analysis Data

Separation sieve is #10
Percent -#10 based upon complete sample= 66.7
Weight of hydrometer sample: 52.25
Hygroscopic moisture correction:
Moist weight & tare = 40.44
Dry weight & tare = 39.91
Tare = 11.02
Hygroscopic moisture= 1.8 %
Calculated biased weight= 76.92
Table of composite correction values:
Temp, deg C: 13.7 24.7 29.1
Temp. corr: -6.0 -5.0 -3.5
Meniscus correction only= 1.0
Specific gravity of solids= 2.66

MACTEC, INC.

Specific gravity correction factor= 0.998

Hydrometer type: 152H

Effective depth L= 16.294964 - 0.164 x Rm

Elapsed Time, min	Temp, Actual deg C	Actual reading	Corrected reading	K	Rm	Eff. depth	Diameter mm	Percent finer
0.50	23.5	39.0	33.9	0.0130	40.0	9.7	0.0575	44.0
1.00	23.5	38.0	32.9	0.0130	39.0	9.9	0.0410	42.7
2.00	23.5	37.0	31.9	0.0130	38.0	10.1	0.0292	41.4
5.00	23.5	35.5	30.4	0.0130	36.5	10.3	0.0187	39.4
15.00	23.5	33.5	28.4	0.0130	34.5	10.6	0.0110	36.8
30.00	23.5	32.5	27.4	0.0130	33.5	10.8	0.0078	35.5
60.00	23.5	31.0	25.9	0.0130	32.0	11.0	0.0056	33.6
250.00	23.5	28.0	22.9	0.0130	29.0	11.5	0.0028	29.7
1440.00	23.3	24.0	18.9	0.0131	25.0	12.2	0.0012	24.5

Fractional Components

Gravel/Sand based on #4

Sand/Fines based on #200

% COBBLES = % GRAVEL = 23.5 % SAND = 31.1

% SILT = 12.5 % CLAY = 32.9

D₈₅= 8.53 D₆₀= 0.74 D₅₀= 0.16

D₃₀= 0.00

Particle Size Distribution Report

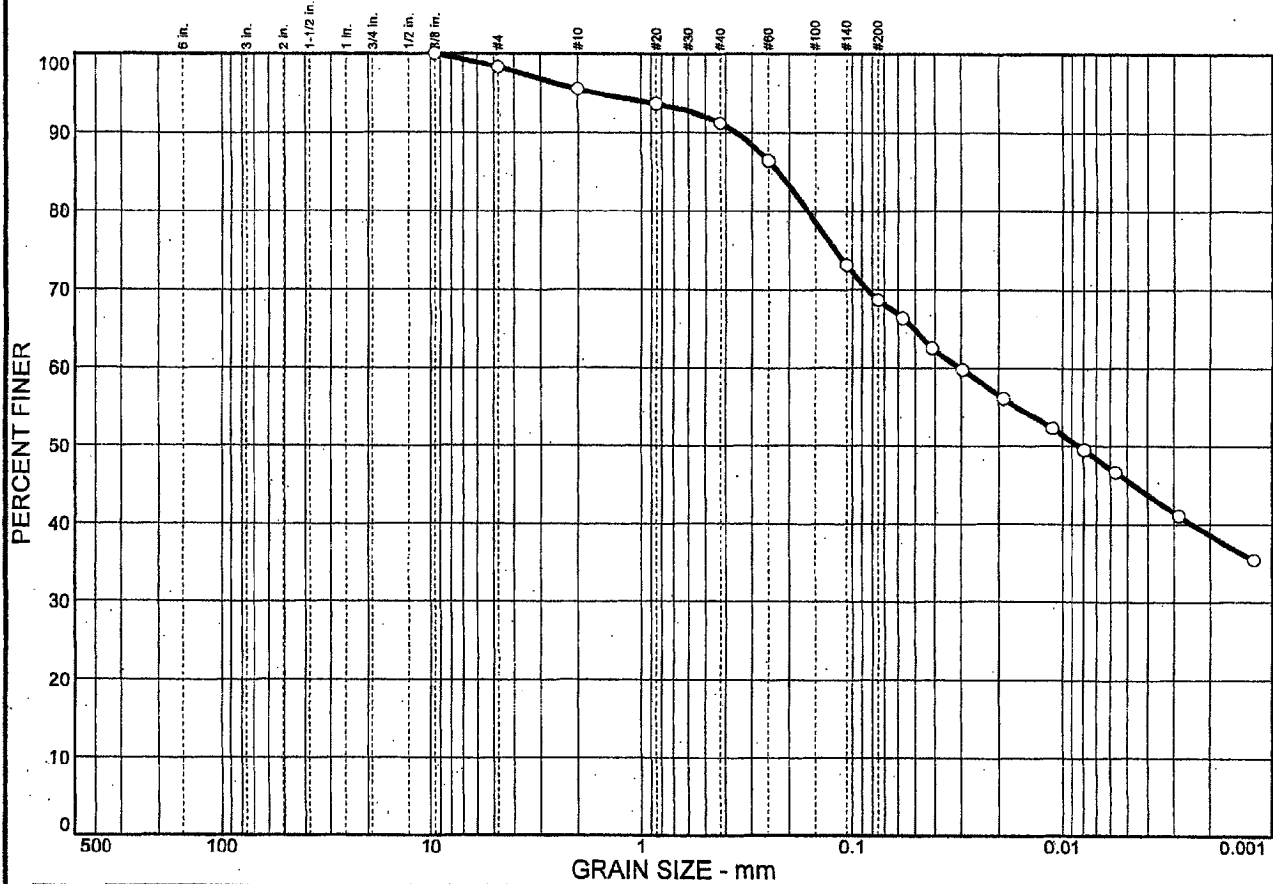

% COBBLES	% GRAVEL	% SAND	% SILT	% CLAY
0.0	1.7	29.6	23.0	45.7

SIEVE SIZE	PERCENT FINER	SPEC.* PERCENT	PASS? (X=NO)
.375 in.	100.0		
#4	98.3		
#10	95.5		
#20	93.6		
#40	91.2		
#60	86.4		
#140	73.1		
#200	68.7		

Soil Description

Brown sandy fat clay

Atterberg Limits

PL= 24 LL= 50 PI= 26

Coefficients

D₈₅= 0.225 D₆₀= 0.0302 D₅₀= 0.0084
D₃₀= D₁₅= D₁₀=
C_u= C_c=

Classification

USCS= CH AASHTO=

Remarks

* (no specification provided)

Sample No.: UD-6, 7 & 8 (CU) Source of Sample:
Location: NB-85B

Date:
Elev./Depth: 23'-29'

MACTEC, INC.

Client: TVA
Project: TVA Kingston - Proposed Gypsum Stack

Project No: 3043051021

Figure

GRAIN SIZE DISTRIBUTION TEST DATA

Client: TVA
 Project: TVA Kingston - Proposed Gypsum Stack
 Project Number: 3043051021

Sample Data

Source:
 Sample No.: UD-6, 7 & 8 (CU)
 Elev. or Depth: 23'-29' Sample Length(in./cm.):
 Location: NB-85B
 Description: Brown sandy fat clay
 Date: PL: 24 LL: 50 PI: 26
 USCS Classification: CH AASHTO Classification:
 Testing Remarks:

Mechanical Analysis Data

Initial

Dry sample and tare= 365.89
 Tare = 0.00
 Dry sample weight = 365.89
 Sample split on number 10 sieve
 Split sample data:
 Sample and tare = 51.01 Tare = .00 Sample weight = 51.01
 Cumulative weight retained tare= .00
 Tare for cumulative weight retained= .00

Sieve	Cumul. Wt. retained	Percent finer
# 75 inch	0.00	100.0
# 4	6.28	98.3
# 10	16.56	95.5
# 20	1.04	93.6
# 40	2.32	91.2
# 60	4.85	86.4
# 140	11.99	73.1
# 200	14.29	68.7

Hydrometer Analysis Data

Separation sieve is #10
 Percent -#10 based upon complete sample= 95.5
 Weight of hydrometer sample: 51.93
 Hygroscopic moisture correction:
 Moist weight & tare = 40.16
 Dry weight & tare = 39.64
 Tare = 10.94
 Hygroscopic moisture= 1.8 %
 Calculated biased weight= 53.41
 Table of composite correction values:
 Temp, deg C: 13.7 24.7 29.1
 Comp. corr: -6.0 -5.0 -3.5

Meniscus correction only= 1.0
 Specific gravity of solids= 2.64
 Specific gravity correction factor= 1.002
 Hydrometer type: 152H

MACTEC, INC.

Effective depth $L = 16.294964 - 0.164 \times R_m$

Elapsed time, min	Temp, Actual deg C	Actual reading	Corrected reading	K	Rm	Eff. depth	Diameter mm	Percent finer
0.50	23.5	40.5	35.4	0.0131	41.5	9.5	0.0571	66.4
1.00	23.5	38.5	33.4	0.0131	39.5	9.8	0.0411	62.6
2.00	23.5	37.0	31.9	0.0131	38.0	10.1	0.0294	59.8
5.00	23.5	35.0	29.9	0.0131	36.0	10.4	0.0189	56.1
15.00	23.5	33.0	27.9	0.0131	34.0	10.7	0.0111	52.3
30.00	23.5	31.5	26.4	0.0131	32.5	11.0	0.0079	49.5
60.00	23.5	30.0	24.9	0.0131	31.0	11.2	0.0057	46.7
250.00	23.5	27.0	21.9	0.0131	28.0	11.7	0.0028	41.1
1440.00	23.3	24.0	18.9	0.0131	25.0	12.2	0.0012	35.4

Fractional Components

Gravel/Sand based on #4

Sand/Fines based on #200

% COBBLES =

% GRAVEL = 1.7

% SAND = 29.6

% SILT = 23.0

% CLAY = 45.7

D₈₅ = 0.22 D₆₀ = 0.03 D₅₀ = 0.01

MOISTURE-DENSITY RELATIONSHIP TEST RESULTS

MOISTURE-DENSITY RELATIONSHIP TEST

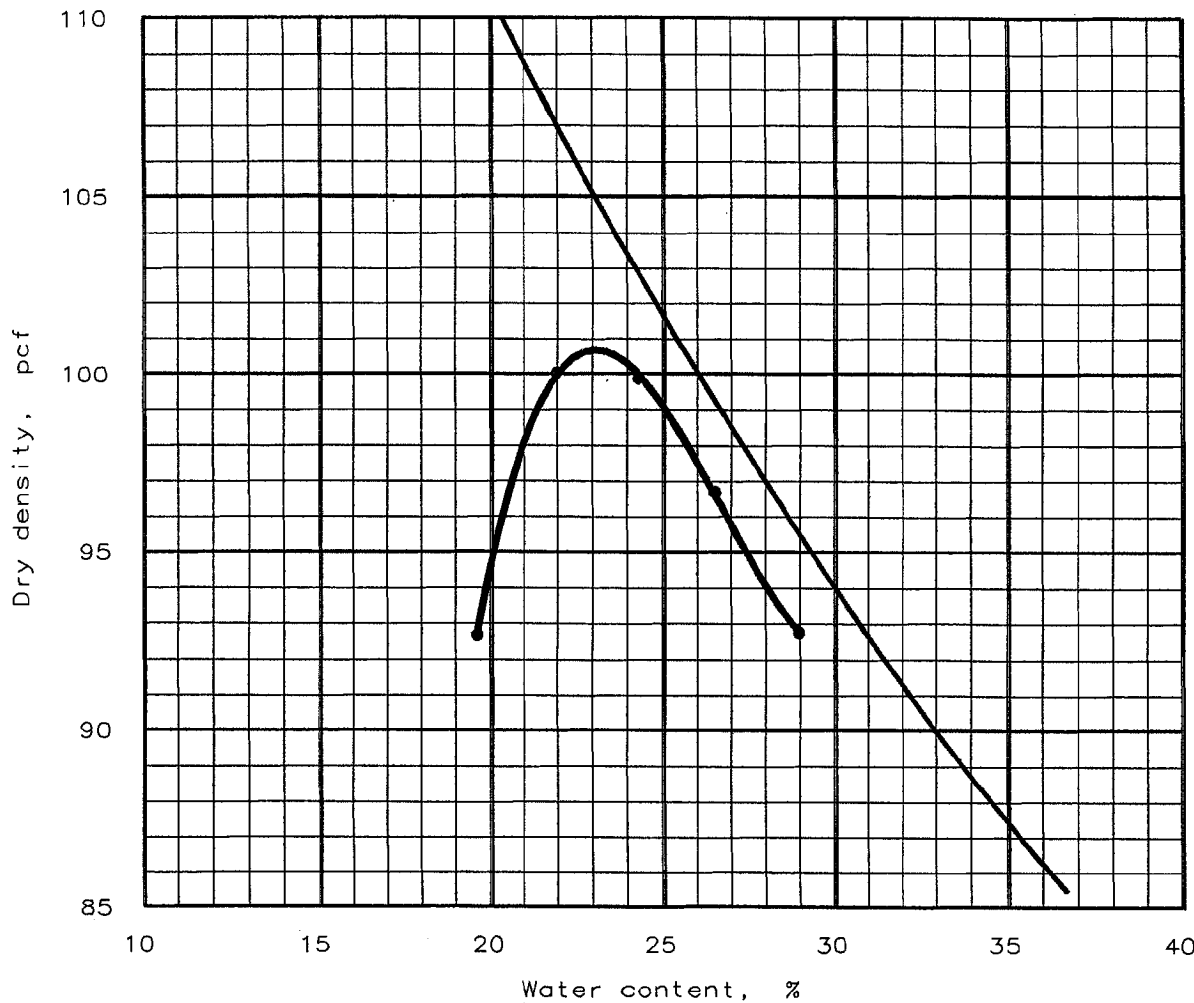

Test specification: ASTM D 698-00ae1 Procedure B, Standard

Elev/ Depth	Classification		Nat. Moist.	Sp.G.	LL	PI	% > 3/8 in	% < No.200
	USCS	AASHTO						
2-10'	MH	A-7-5(25)	30.9 %	2.75	63	28	0 %	78.2 %

TEST RESULTS	MATERIAL DESCRIPTION
Maximum dry density = 100.7 pcf Optimum moisture = 23.1 %	Light orange brown elastic silt with sand
Project No.: 3043051021.0001 Project: TVA Kingston - Proposed Gypsum Stack Location: Boring NB-2, 2-10' auger cuttings bulk sample Date: June 23, 2005	Remarks: Sample Number 3203 NT - No Test DNS - Data Not Submitted
MOISTURE-DENSITY RELATIONSHIP TEST	

MOISTURE-DENSITY RELATIONSHIP TEST

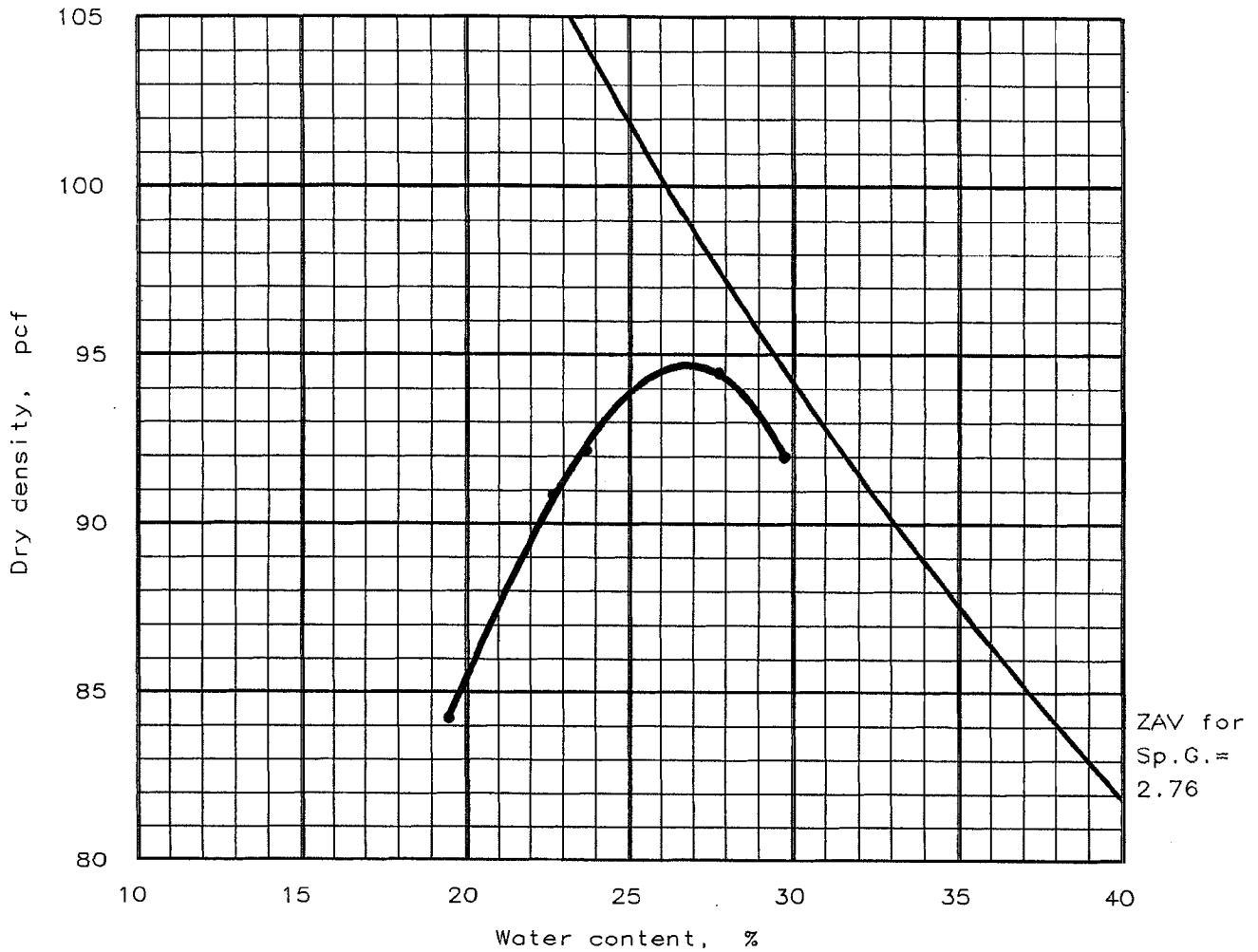

Test specification: ASTM D 698-00ae1 Procedure B, Standard

Elev/ Depth	Classification		Nat. Moist.	Sp.G.	LL	PI	% > 3/8 in	% < No.200
	USCS	AASHTO						
5-15'	MH	A-7-5(29)	33.3 %	2.76	62	29	0 %	86.4 %

TEST RESULTS	MATERIAL DESCRIPTION
Maximum dry density = 94.7 pcf Optimum moisture = 26.8 %	Tan elastic silt
Project No.: 3043051021.0001 Project: TVA Kingston - Proposed Gypsum Stack Location: Boring NB-18, 5-15' auger cuttings bulk sample Date: June 23, 2005	Remarks: Sample Number 3198 NT - No Test DNS - Data Not Submitted
MOISTURE-DENSITY RELATIONSHIP TEST	

COMPACTION TEST REPORT

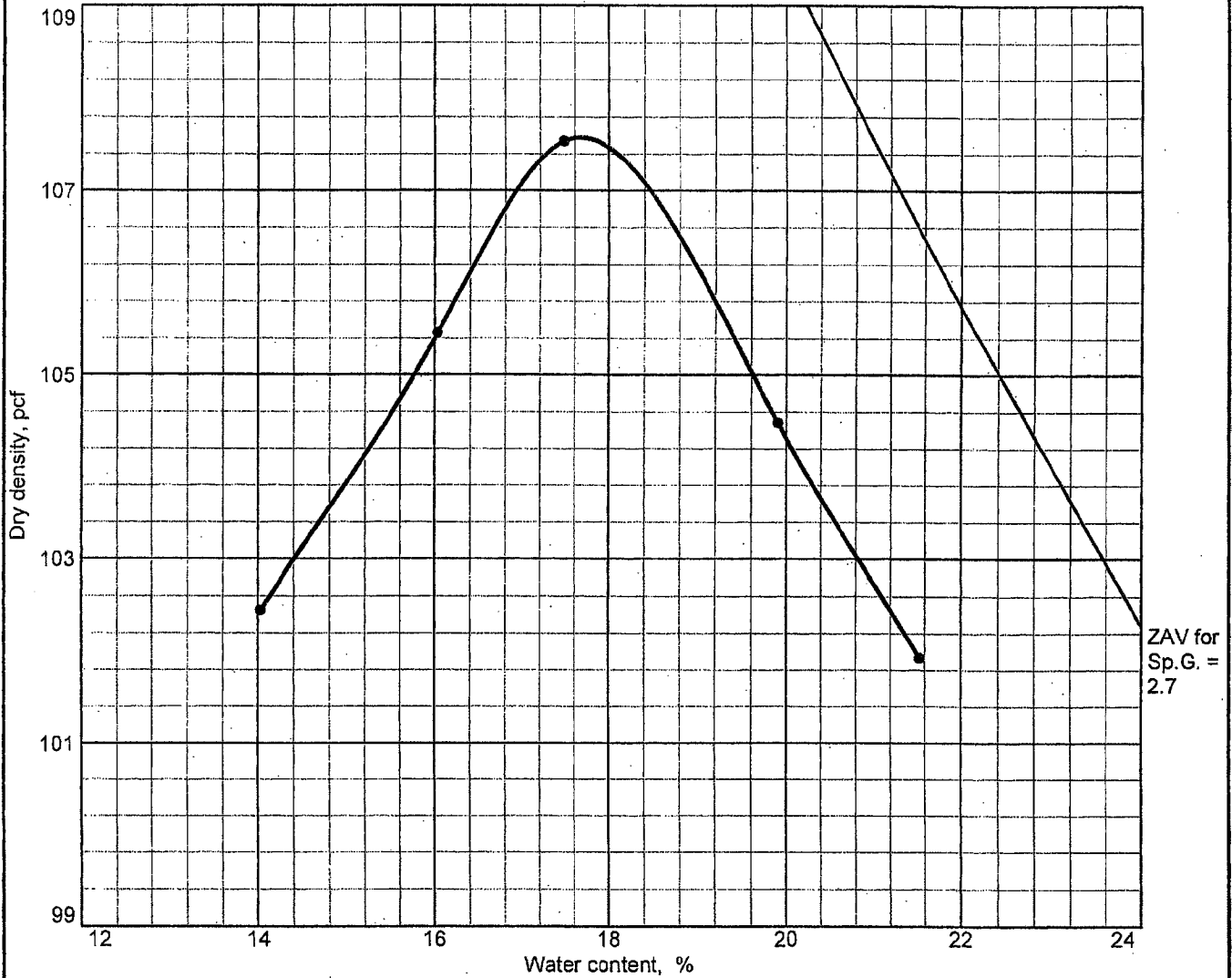

Test specification: ASTM D 698-91 Procedure A Standard

Elev/ Depth	Classification		Nat. Moist.	Sp.G.	LL	PI	% > No.4	% < No.200
	USCS	AASHTO						
2'-10'	CL	—	30.7	2.63	40	18	0.0	81.1

TEST RESULTS	MATERIAL DESCRIPTION
Maximum dry density = 107.6 pcf Optimum moisture = 17.7 %	Reddish orange lean clay with sand
Project No. 3043051021 Client: TVA Project: TVA Kingston - Proposed Gypsum Stack • Location: NB-22, 2.0'-10.0'	Remarks:
COMPACTION TEST REPORT MACTEC, INC.	Figure

MOISTURE-DENSITY RELATIONSHIP TEST

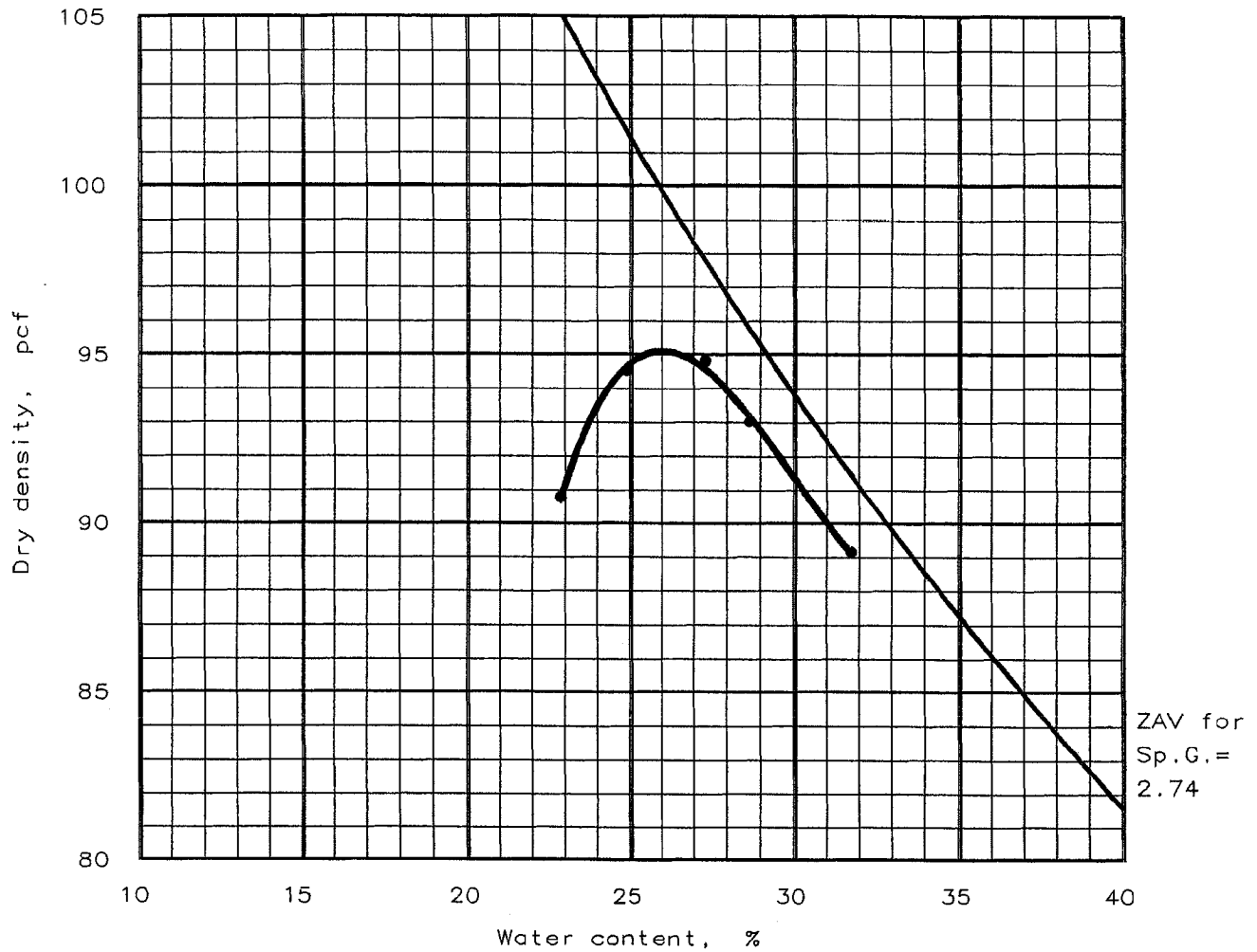

Test specification: ASTM D 698-00ae1 Procedure B, Standard

Elev/ Depth	Classification		Nat. Moist.	Sp.G.	LL	PI	% > 3/8 in	% < No.200
	USCS	AASHTO						
2-10'	CH	A-7-6(44)	33.1 %	2.74	72	47	0.9 %	85.2 %

TEST RESULTS	MATERIAL DESCRIPTION
Maximum dry density = 95.1 pcf Optimum moisture = 26.0 %	Orange brown fat clay
Project No.: 3043051021.0001 Project: TVA Kingston - Proposed Gypsum Stack Location: Boring NB-25, 2-10' auger cuttings bulk sample Date: June 23, 2005	Remarks: Sample Number 3199 NT - No Test DNS - Data Not Submitted
MOISTURE-DENSITY RELATIONSHIP TEST	

MOISTURE-DENSITY RELATIONSHIP TEST

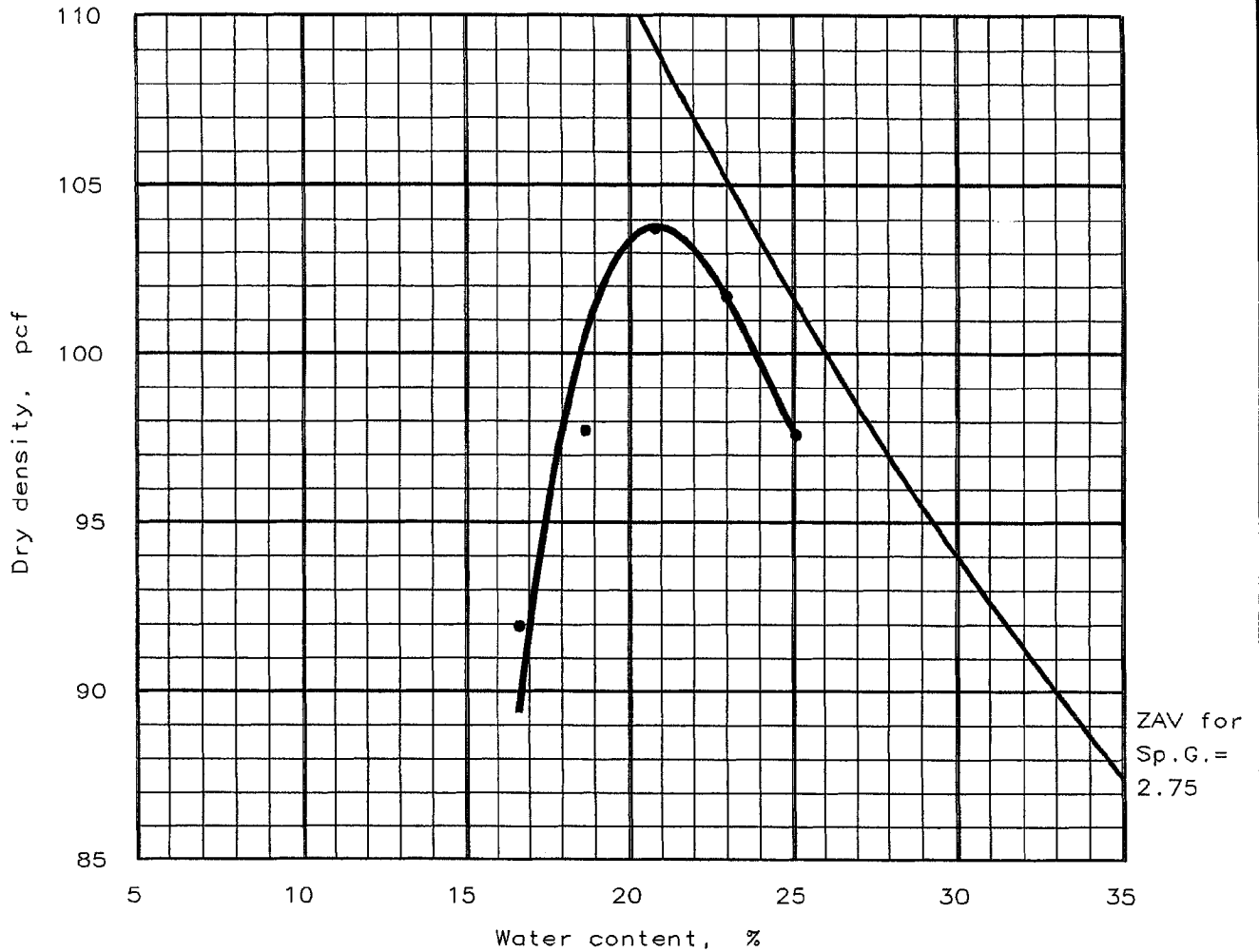

Test specification: ASTM D 698-00ae1 Procedure B, Standard

Elev/ Depth	Classification		Nat. Moist.	Sp.G.	LL	PI	% > 3/8 in	% < No.200
	USCS	AASHTO						
5-10'	CL	A-7-6(22)	18.3 %	2.75	47	27	0 %	79.7 %

TEST RESULTS	MATERIAL DESCRIPTION
Maximum dry density = 103.8 pcf Optimum moisture = 20.8 %	Brown lean clay with sand
Project No.: 3043051021.0001 Project: TVA Kingston - Proposed Gypsum Stack Location: Boring NB-39, 5-10' auger cuttings bulk sample Date: June 23, 2005	Remarks: Sample Number 3201 NT - No Test DNS - Data Not Submitted
MOISTURE-DENSITY RELATIONSHIP TEST	

MOISTURE-DENSITY RELATIONSHIP TEST

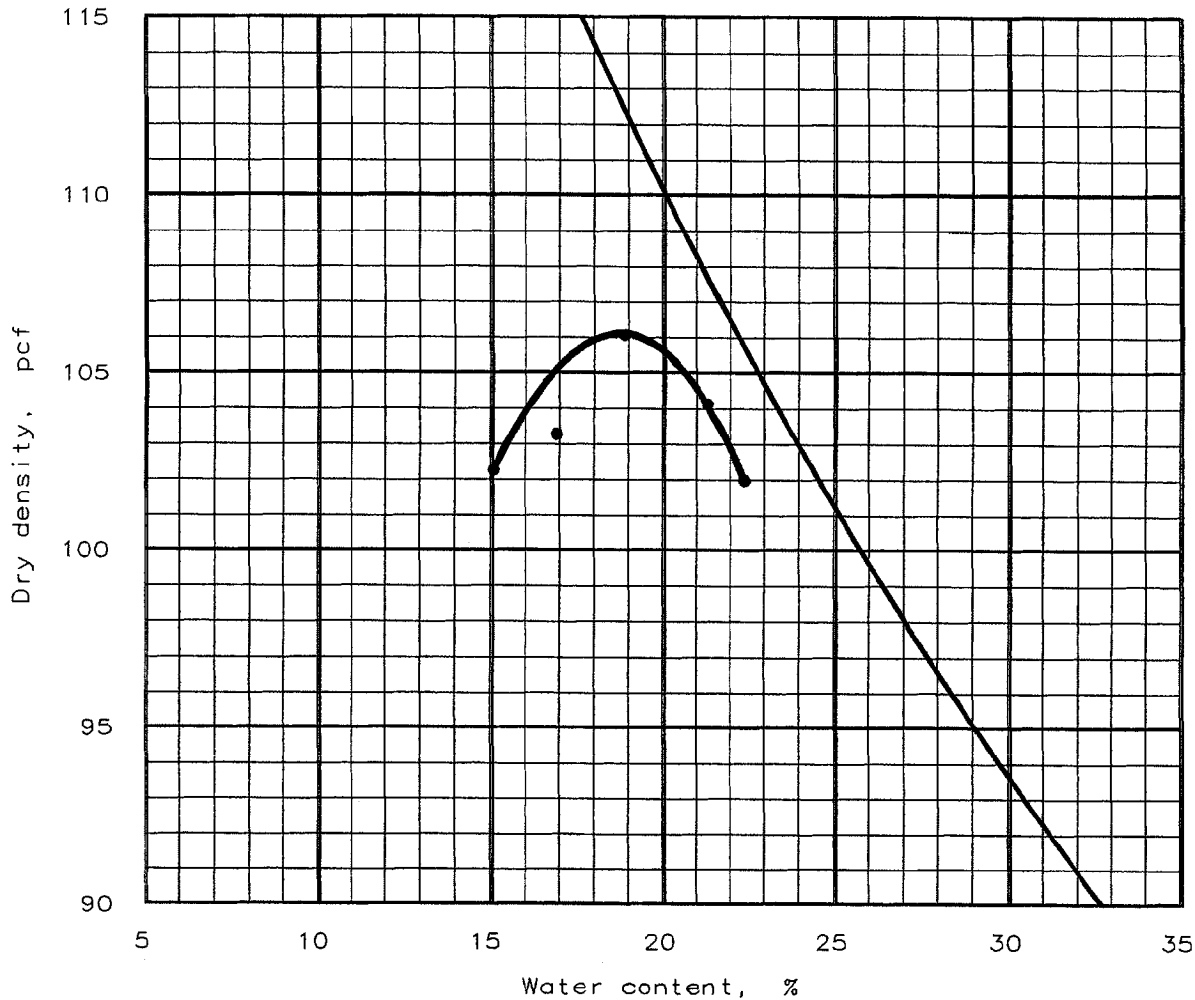

ZAV for
Sp.G. =
2.73

Test specification: ASTM D 698-00ae1 Procedure B, Standard

Elev/ Depth	Classification		Nat. Moist.	Sp.G.	LL	PI	% > 3/8 in	% < No.200
	USCS	AASHTO						
2-10'	CL	A-6(11)	17.7 %	2.73	35	17	0.3 %	74.9 %

TEST RESULTS	MATERIAL DESCRIPTION
Maximum dry density = 106.1 pcf Optimum moisture = 18.8 %	Brown lean clay with sand
Project No.: 3043051021.0001 Project: TVA Kingston - Proposed Gypsum Stack Location: Boring NB-41, 2-10' auger cuttings bulk sample Date: June 23, 2005	Remarks: Sample Number 3202 NT - No Test DNS - Data Not Submitted
MOISTURE-DENSITY RELATIONSHIP TEST	

MOISTURE-DENSITY RELATIONSHIP TEST

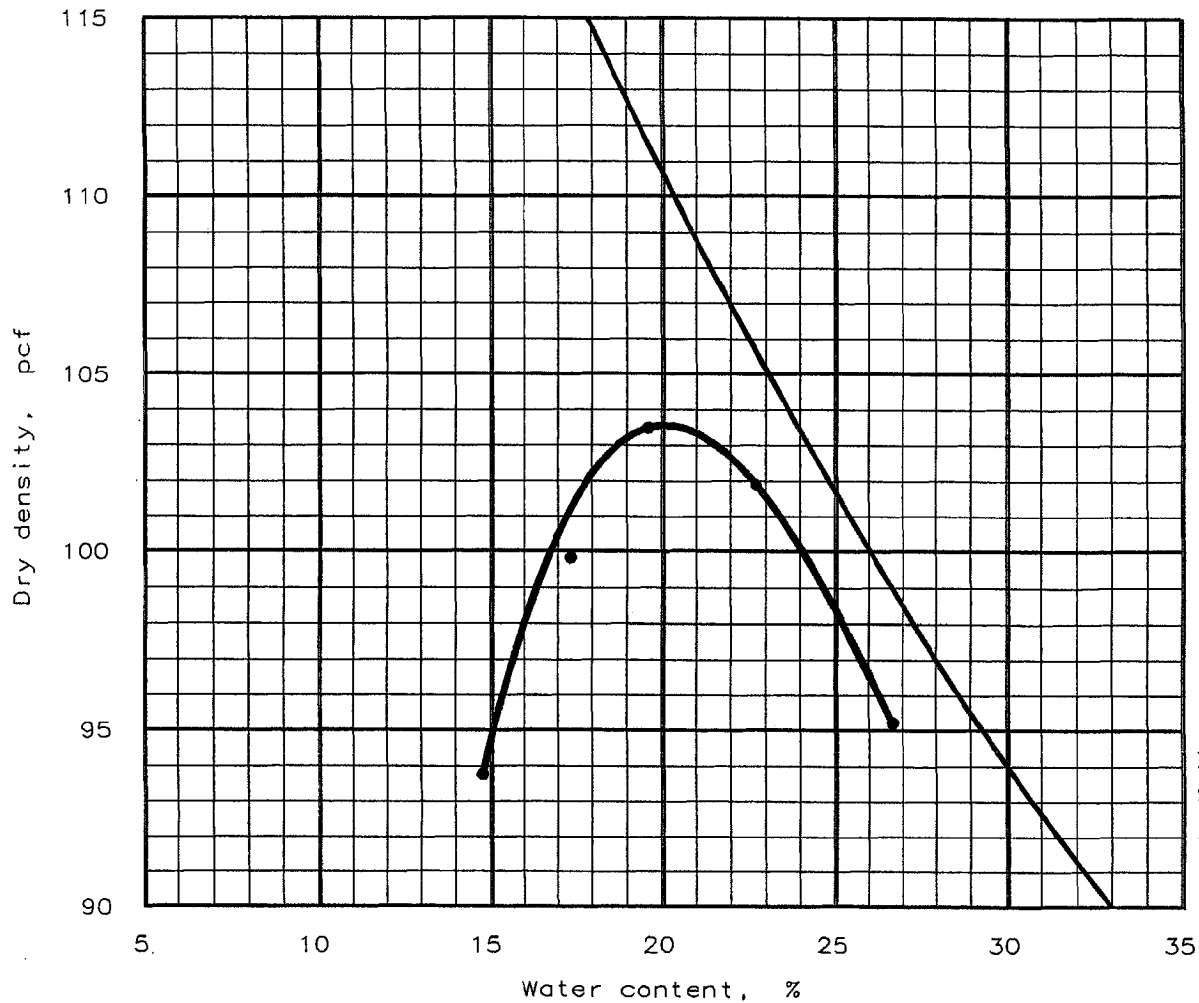

Test specification: ASTM D 698-00ae1 Procedure B, Standard

Elev/ Depth	Classification		Nat. Moist.	Sp.G.	LL	PI	% > 3/8 in	% < No.200
	USCS	AASHTO						
5-15'	ML	A-6(10)	25.5 %	2.75	40	12	0 %	77.3 %

TEST RESULTS	MATERIAL DESCRIPTION
Maximum dry density = 103.6 pcf Optimum moisture = 20.1 %	Light red brown silt with sand
Project No.: 3043051021.0001 Project: TVA Kingston - Proposed Gypsum Stack Location: Boring NB-59, 5-15' auger cuttings bulk sample Date: 6-13-2005	Remarks: Sample Number 3196 NT - No Test DNS - Data Not Submitted
MOISTURE-DENSITY RELATIONSHIP TEST	

MOISTURE-DENSITY RELATIONSHIP TEST

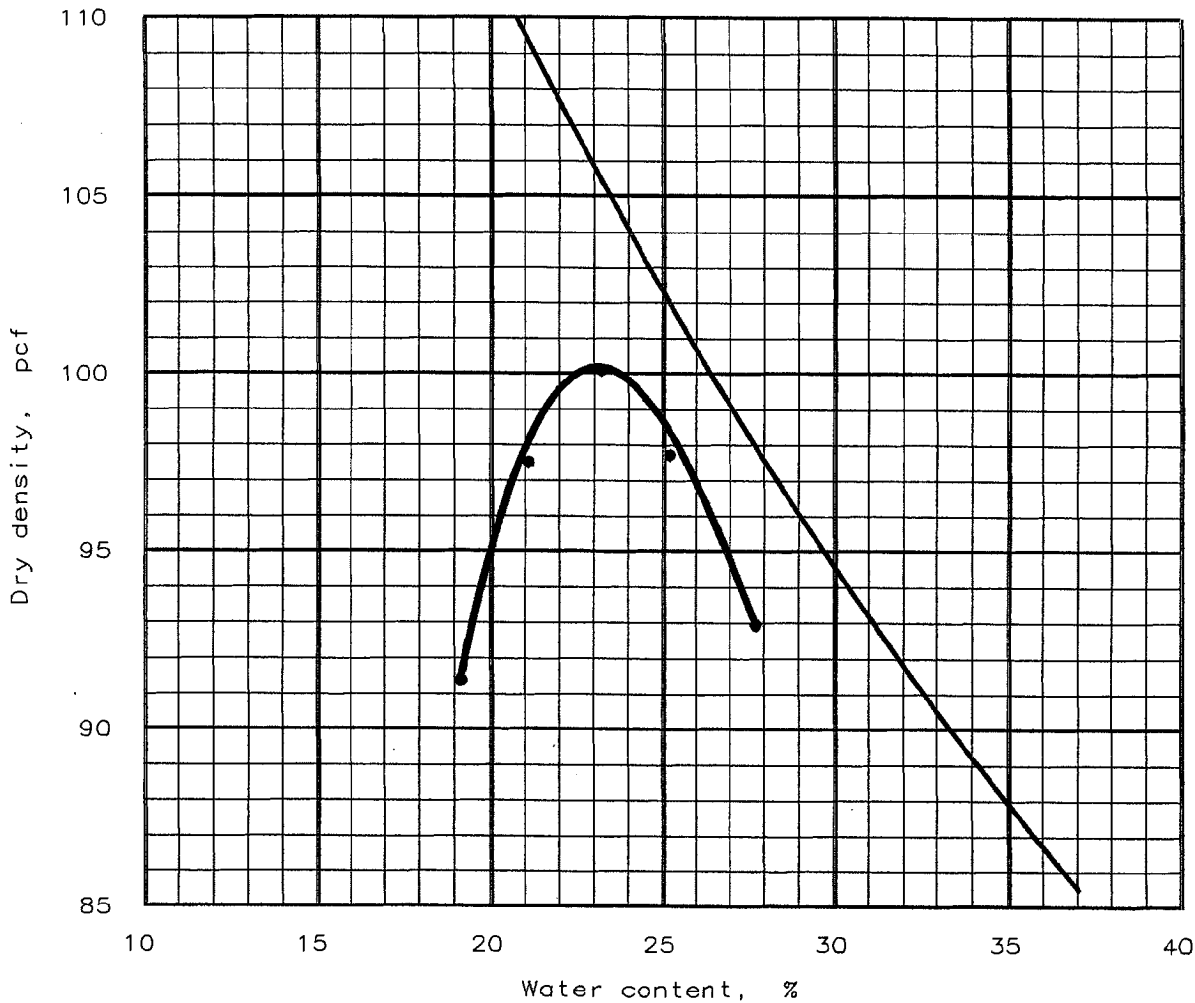

ZAV for
Sp.G. =
2.78

Test specification: ASTM D 698-00ae1 Procedure B, Standard

Elev/ Depth	Classification		Nat. Moist.	Sp.G.	LL	PI	% > 3/8 in	% < No.200
	USCS	AASHTO						
2-10'	CH	A-7-6(24)	30.9 %	2.78	60	32	0.4 %	72.3 %

TEST RESULTS	MATERIAL DESCRIPTION
Maximum dry density = 100.2 pcf Optimum moisture = 23.1 %	Red brown fat clay with sand
Project No.: 3043051021.0001 Project: TVA Kingston - Proposed Gypsum Stack Location: Boring NB-65, 2-10' auger cuttings bulk sample Date: 6-13-2005	Remarks: Sample Number 3197 NT - No Test DNS - Data Not Submitted
MOISTURE-DENSITY RELATIONSHIP TEST	

COMPACTION TEST REPORT

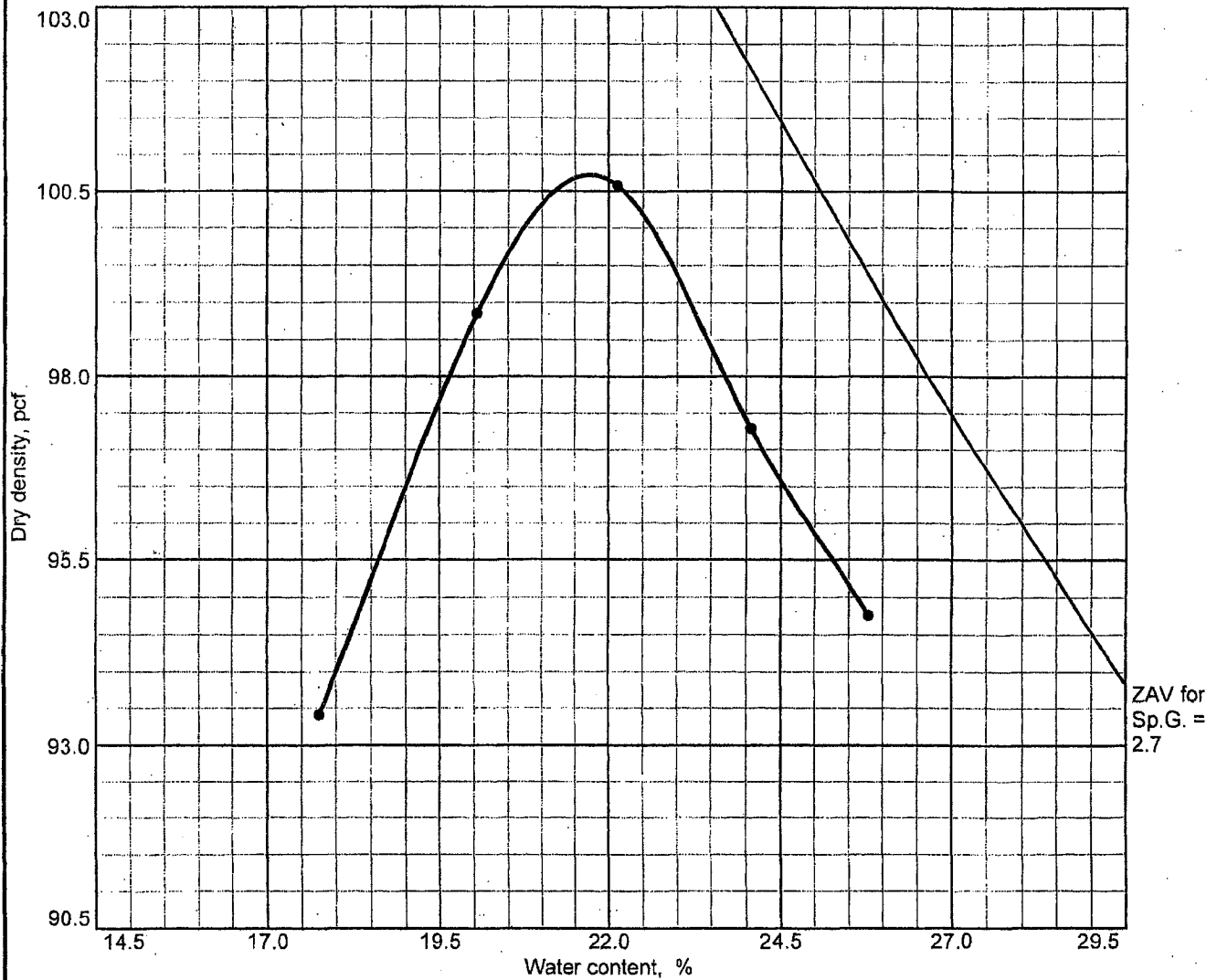

Test specification: ASTM D 698-91 Procedure A Standard

Elev/ Depth	Classification		Nat. Moist.	Sp.G.	LL	PI	% > No.4	% < No.200
	USCS	AASHTO						
5'-15'	ML	—	25.3	2.65	40	20	0.3	70.0

TEST RESULTS	MATERIAL DESCRIPTION
Maximum dry density = 100.7 pcf Optimum moisture = 21.7 %	Reddish brown sandy silt
Project No. 3043051021 Client: TVA Project: TVA Kingston - Proposed Gypsum Stack • Location: NB-76, 5.0'-15.0'	Remarks:
COMPACTION TEST REPORT MACTEC, INC.	Figure

MOISTURE-DENSITY RELATIONSHIP TEST

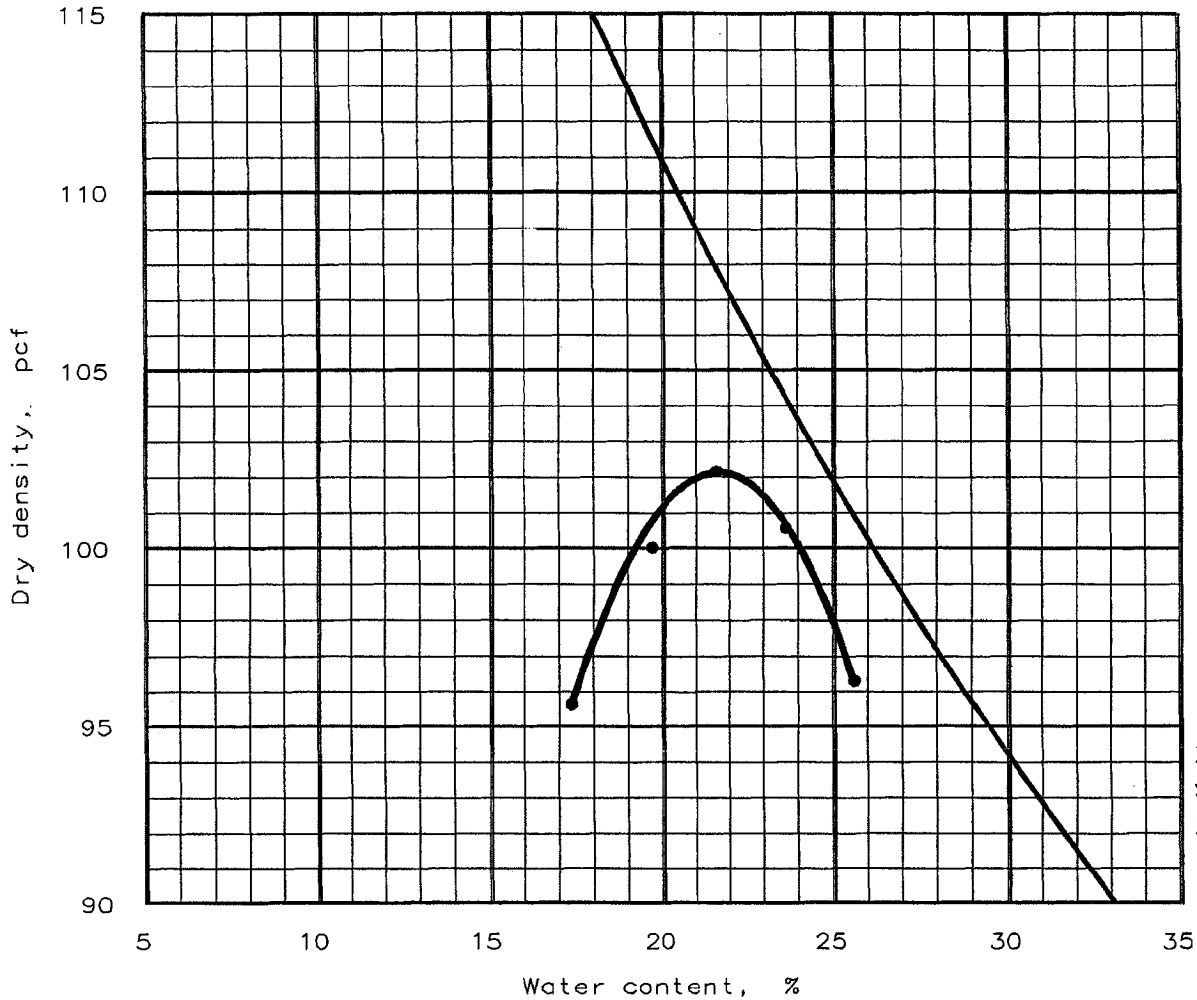

ZAV for
Sp.G. =
2.76

Test specification: ASTM D 698-00ae1 Procedure B, Standard

Elev/ Depth	Classification		Nat. Moist.	Sp.G.	LL	PI	% > 3/8 in	% < No.200
	USCS	AASHTO						
2-10'	CL	A-7-6(19)	24.2 %	2.76	47	22	0 %	81.6 %

TEST RESULTS	MATERIAL DESCRIPTION
Maximum dry density = 102.2 pcf Optimum moisture = 21.6 %	Light orange brown lean clay with sand
Project No.: 3043051021.0001 Project: TVA Kingston - Proposed Gypsum Stack Location: Boring NB-84, 2-10' auger cuttings bulk sample Date: June 23, 2005	Remarks: Sample Number 3200 NT - No Test DNS - Data Not Submitted
MOISTURE-DENSITY RELATIONSHIP TEST	

PERMEABILITY TEST RESULTS



MACTEC

CONSTANT HEAD PERMEABILITY TEST

(ASTM D5084)

JOB NAME: TVA KINGSTON - PROP. GYP. STACK
 JOB NO.: 3043-05-1021
 BORING NO.: NB-21A
 DEPTH: 33'-35'
 SAMPLE: UD-5
 DESCRIPTION: 24PST

TECHNICIAN: JA.
 DATE: 8-9-5
 CHECKED BY: HVC
 CELL NO.: Trax A
 SYSTEM NO.: 2

SAMPLE INFORMATION

WEIGHT TUBE & SOIL (g): _____
 WEIGHT TUBE (g): _____
 WEIGHT SOIL (g): _____
 VOLUME SOIL (cu ft): _____
 DRY UNIT WEIGHT (pcf): _____
 WET UNIT WEIGHT (pcf): _____

TUBE LENGTH: _____ (in) _____ (cm)
 TUBE DIAMETER: 2.8135 (in) _____ (cm)
 SOIL LENGTH(L): 1.9750 (in) 50.16 (cm)
 SOIL DIAMETER: 2.8435 (in) 7.222 (cm)
 AREA(A): _____ (in²) 40.97 (cm²)

MOISTURE CONTENT

INITIAL WET WEIGHT (g): 408.45g
 FINAL WET WEIGHT (g): 409.45
 FINAL DRY WEIGHT (g): 322.67
 INITIAL MOISTURE (%): 26.6
 FINAL MOISTURE (%): 27.0
 PAN NAME: NICOLE

PERM INFORMATION

CELL PRESSURE (psi): 64
 FORE PRESSURE (psi): 42
 BACK PRESSURE (psi): 40
 HEAD, h (psi) x 70.34: 140.62
 TEMPERATURE (°F): 73°F
 VISCOSITY CORRECTION (R_T): 2.931
 PERMEANT LIQUID USED: H₂O
 BURET CORRECTION FACTOR (C): 1.0

$$Y_{moist} = Y_d(1 + m.c.)$$

TABLE OF HYDRAULIC CONDUCTIVITY

DATE		TIME		ELAPSED TIME (+)		READING			FLOW (CC)		
START	END	START	END	MINUTES	SECONDS	(L) START	(L) END	(L) CC	K		
8-17	8-17	11:50 AM	5:04 PM	314	18840	22.0	18.0	20.3	17.2	1.7	7.5 x 10⁻⁸
8-17	8-18	5:04 AM	9:04 AM	960	1452600	20.3	17.2	19.2	18.9	1.1	1.5 x 10 ⁻⁸
8-18	8-18	9:04 AM	3:39 PM	395	23700	19.2	18.9	18.8	19.6	0.4	1.7 x 10 ⁻⁸
8-18	8-18	3:40 PM	6:05 PM	145	2700	18.8	19.6	18.6	14.8	0.2	1.9 x 10 ⁻⁸
8-18	8-19	6:05 PM	10:05 AM	960	57600	18.6	19.8	17.5	21.5	1.1	1.5 x 10 ⁻⁸
TOTALS				= 147600					Q = 2.8		

$$\text{COEFFICIENT OF PERMEABILITY, } k = \frac{Q \times L \times R_T \times C}{h \times A \times t}$$

$$= 1.5 \times 10^{-8}$$



MACTEC

CONSTANT HEAD PERMEABILITY TEST

(ASTM D5084)

JOB NAME: TVA - KINGSTON
 JOB NO.: 3043-05-1021
 BORING NO.: ND-22 (BULK)
 DEPTH: 2'-10"
 SAMPLE: RED BRN F-MSA CLS1
 DESCRIPTION: _____

TECHNICIAN: J. HEE
 DATE: 8-25-5
 CHECKED BY: HLC
 CELL NO.: A
 SYSTEM NO.: #2

SAMPLE INFORMATION

WEIGHT TUBE & SOIL (g): _____
 WEIGHT TUBE (g): _____
 WEIGHT SOIL (g): _____
 VOLUME SOIL (cu ft): 0.00752422
 DRY UNIT WEIGHT (pcf): 102.4
 WET UNIT WEIGHT (pcf): 122.1 @ 19.2%

TUBE LENGTH: _____ (in) _____ (cm)
 TUBE DIAMETER: _____ (in) _____ (cm)
 SOIL LENGTH(L): 2.014 (in) 5.116 (cm)
 SOIL DIAMETER: 2.867 (in) 7.282 (cm)
 AREA(A): _____ (in²) 41.65 (cm²)

MOISTURE CONTENT

INITIAL WET WEIGHT (g): 416.70
 FINAL WET WEIGHT (g): 420.29
 FINAL DRY WEIGHT (g): 348.29
 INITIAL MOISTURE (%): _____
 FINAL MOISTURE (%): _____
 PAN NAME: BOND

PERM INFORMATION

CELL PRESSURE(psi): 60.0
 FORE PRESSURE(psi): 52
 BACK PRESSURE (psi): 59
 HEAD, h (psi) x 70.34: 140.68
 TEMPERATURE (°F): 73°F
 VISCOSITY CORRECTION(R_v): 0.931
 PERMEANT LIQUID USED: H₂O
 BURET CORRECTION FACTOR(C): 1.0

TABLE OF HYDRAULIC CONDUCTIVITY

DATE		TIME		ELAPSED TIME (+)		READING			FLOW (CC)		
START	END	START	END	MINUTES	SECONDS	START	END		Q	K	
8-25	8-25	4:46 PM	5:11 PM	25	1500	19.2	11.1	15.9	14.7	3.3	1.8 x 10 ⁻⁶
8-25	8-25	5:11 PM	7:58 PM	167	10920	15.9	14.7	0.6	30.8	19.3	1.2 x 10 ⁻⁶
8-26	8-26	8:17 AM	8:49 AM	32	1920	22.0	18.6	19.2	21.5	2.8	1.2 x 10 ⁻⁶
8-26	8-26	8:49 AM	12:05 PM	196	11760	19.2	21.5	0.0	40.7	19.3	1.3 x 10 ⁻⁶
8-26		14:10				18.3	21.9				
8-29	8-29	9:20 AM	10:20 AM	60	3600	26.7	14.4	20.9	20.2	5.8	1.3 x 10 ⁻⁶
TOTALS					t = 27300					Q = 43.1	

COEFFICIENT OF PERMEABILITY, $k = \frac{Q \times L \times R_T \times C}{h \times A \times t}$

$$\frac{Q}{t} = \frac{5.116(0.931)}{140.68(41.65)} = 1.3 \times 10^{-6}$$

MACTEC

CONSTANT HEAD PERMEABILITY TEST

(ASTM D5084)

JOB NAME: TVA-KINGSTON
 JOB NO.: 3043-5-1021
 BORING NO.: NB-44 UD-2
 DEPTH: 16.5-18.5
 SAMPLE: _____
 DESCRIPTION: FIRM CLAYEY SILT

TECHNICIAN: JALEX
 DATE: 8-18-5
 CHECKED BY: HIC
 CELL NO.: #1
 SYSTEM NO.: 13

SAMPLE INFORMATION

WEIGHT TUBE & SOIL (g): _____
 WEIGHT TUBE (g): _____
 WEIGHT SOIL (g): _____
 VOLUME SOIL (cu ft): _____
 DRY UNIT WEIGHT (pcf): _____
 WET UNIT WEIGHT (pcf): _____

TUBE LENGTH: _____ (in) _____ (cm)
 TUBE DIAMETER: _____ (in) _____ (cm)
 SOIL LENGTH(L): 2.006 (in) 5.095 (cm)
 SOIL DIAMETER: 2.843 (in) 7.221 (cm)
 AREA(A): _____ (in²) 40.96 (cm²)

MOISTURE CONTENT

INITIAL WET WEIGHT (g): 405.34
 FINAL WET WEIGHT (g): 405.15
 FINAL DRY WEIGHT (g): ~~108.87~~ 316.12
 INITIAL MOISTURE (%): 28.2
 FINAL MOISTURE (%): 28.2
 PAN NAME: B-6

PERM INFORMATION

CELL PRESSURE (psi): 57 64 14 8.5
 FORE PRESSURE (psi): 52
 BACK PRESSURE (psi): 50
 HEAD, h (psi) x 70.34: 140.68
 TEMPERATURE (°F): 73°F
 VISCOSITY CORRECTION (R_v): 0.98
 PERMEANT LIQUID USED: H₂O
 BURET CORRECTION FACTOR (C): 1.0

TABLE OF HYDRAULIC CONDUCTIVITY

DATE		TIME		ELAPSED TIME (+)		READING		FLOW (CC)	
START	END	START	END	MINUTES	SECONDS	START	END	CC	K
8-19		8:11				12.0	8.0		
8-19	8-19	9:59 AM	1:25 PM	Consolidating		13.6	6.5	12.5	7.0
8-19	8-19	1:25 PM	2:08 PM	43	2580	12.5	7.0	12.4	7.2
8-19	8-20	2:08 PM	5:30 PM	1642	98520	12.4	7.2	7.0	13.0
8-20	8-20	5:30 PM	9:10 PM	220	13200	15.3	4.7	14.5	5.5
8-20	8-22	9:10 PM	9:58 AM	2208	132400	14.5	5.5	7.1	13.5
8-22	8-22	9:58 AM	10:58 AM	60	3600	7.1	13.5	6.9	13.7
8-22		11:07 AM				6.9	13.7		
TOTALS					c = 247800				Q = 13.8

COEFFICIENT OF PERMEABILITY, $k = \frac{Q \times L \times R_T \times C}{h \times A \times t} = \frac{Q (5.095)(0.98)}{E (140.68)(40.96)} = 4.6 \times 10^{-8}$



MACTEC

CONSTANT HEAD PERMEABILITY TEST

(ASTM D5084)

JOB NAME: TVA KINGSTON
 JOB NO.: 3043-S-192
 BORING NO.: NB 44 UD-4
 DEPTH: 21.5' - 23.5'
 SAMPLE: _____
 DESCRIPTION: PARTIALLY SANDY

TECHNICIAN: JALEX
 DATE: 8-18-05
 CHECKED BY: HLC
 CELL NO.: #2
 SYSTEM NO.: #14

SAMPLE INFORMATION

WEIGHT TUBE & SOIL (g): _____
 WEIGHT TUBE (g): _____
 WEIGHT SOIL (g): _____
 VOLUME SOIL (cu ft): _____
 DRY UNIT WEIGHT (pcf): _____
 WET UNIT WEIGHT (pcf): _____

TUBE LENGTH: _____ (in) _____ (cm)
 TUBE DIAMETER: _____ (in) _____ (cm)
 SOIL LENGTH(L): 2.931 (in) 5.159 (cm)
 SOIL DIAMETER: 2.778 (in) 7.056 (cm)
 AREA(A): _____ (in²) 39.10 (cm²)

MOISTURE CONTENT

INITIAL WET WEIGHT (g): 399.03
 FINAL WET WEIGHT (g): 399.33
 FINAL DRY WEIGHT (g): 317.42
 INITIAL MOISTURE (%): 25.7 ✓
 FINAL MOISTURE (%): 25.8 ✓
 PAN NAME: 20

PERM INFORMATION

CELL PRESSURE (psi): 95.6 ^{95.6} 55.6
PSI
 FORE PRESSURE (psi): 42
 BACK PRESSURE (psi): 40
 HEAD, h (psi) x 70.34: 140.68
 TEMPERATURE (°F): 73
 VISCOSITY CORRECTION (R_v): 0.931
 PERMEANT LIQUID USED: H₂O
 BURET CORRECTION FACTOR (C): 1.0

TABLE OF HYDRAULIC CONDUCTIVITY

DATE		TIME		ELAPSED TIME (+)		READING		FLOW (CC)	
START	END	START	END	MINUTES	SECONDS	START	END	C _e	K
8-19	8-19	8:08 AM	8:09 AM	1	60	19.3	1.0	4.2	16.0
8-19	8-19	8:15 AM	8:16 AM	1	60	14.3	6.0	3.0	17.3
8-19	8-19	10:00	10:01	1	60	15.1	5.4	9.3	(16.7) (1.8) 1.7 x 10 ⁻⁴
8-19	8-19	10:02	10:03	1	60	16.5	3.8	5.8	14.5 (10.7) 1.6 x 10 ⁻⁴
8-19	8-19	10:04	10:05	1	60	15.2	4.9	4.6	15.5 (10.6) 1.5 x 10 ⁻⁴
8-19	8-19	10:06	10:06	1	60	15.2	4.8	4.6	15.4 (10.6) 1.5 x 10 ⁻⁴
TOTALS				t = 240 ✓				Q = 43.7 ✓	

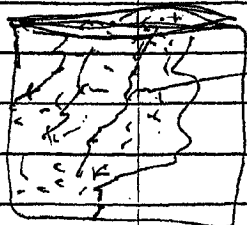

SANDY
 POCKETS
 WITH
 SILTY CLAYERS

COEFFICIENT OF PERMEABILITY, $k = \frac{Q \times L \times R_v \times C}{h \times A \times t}$

$\frac{Q}{t} = \frac{(5.159)(0.931)}{(140.68)(39.10)} = 1.6 \times 10^{-4}$

MACTEC

CONSTANT HEAD PERMEABILITY TEST

(ASTM D5084)

JOB NAME: TVA KINGSTON
 JOB NO.: 3043-5-1a2
 BORING NO.: NB 47A 1D-7
 DEPTH: 30'-3 21
 SAMPLE: _____
 DESCRIPTION: VERY SOFT AND WET

TECHNICIAN: ALEX
 DATE: 8-18-5
 CHECKED BY: HL
 CELL NO.: #3
 SYSTEM NO.: #4 #12/22 SYS: 18

SAMPLE INFORMATION

WEIGHT TUBE & SOIL (g): _____
 WEIGHT TUBE (g): _____
 WEIGHT SOIL (g): _____
 VOLUME SOIL (cu ft): _____
 DRY UNIT WEIGHT (pcf): _____
 WET UNIT WEIGHT (pcf): _____

TUBE LENGTH: _____ (in) (cm)
 TUBE DIAMETER: JA (in) (cm)
 SOIL LENGTH(L): 1.997 (in) 5.072 (cm)
 SOIL DIAMETER: 2.829 (in) 7.186 (cm)
 AREA(A): _____ (in²) 40.55 (cm²)

MOISTURE CONTENT

INITIAL WET WEIGHT (g): 386.66
 FINAL WET WEIGHT (g): 378.28
 FINAL DRY WEIGHT (g): 291.15
 INITIAL MOISTURE (%): 32.8
 FINAL MOISTURE (%): 29.9
 PAN NAME: BC-14

PERM INFORMATION

CELL PRESSURE (psi): 74.0
 FORE PRESSURE (psi): 32
 BACK PRESSURE (psi): 50
 HEAD, h (psi) x 70.34: 140.68
 TEMPERATURE (°F): 73.9F
 VISCOSITY CORRECTION (R_v): 0.931
 PERMEANT LIQUID USED: H₂O
 BURET CORRECTION FACTOR (C): 1.0

TABLE OF HYDRAULIC CONDUCTIVITY

DATE		TIME		ELAPSED TIME (+)		READING		FLOW (CC)	
START	END	START	END	MINUTES	SECONDS	START	END	α	k
8-19	8-19	8:10 AM	8:10 AM	0	0	12.0	8.1		
8-19	8-19	9:58 AM	1:27 PM	0	50	31.9	16.2	17.8	15.9
8-19	8-19	1:27 PM	2:09 PM	42	2520	19.8	15.9	14.5	16.2
8-19	8-20	2:09 PM	5:29 PM	164	9840	19.5	16.2	12.4	23.8
8-20	8-20	5:30 PM	9:13 PM	223	13380	25.2	15.9	24.4	15.8
8-20	8-22	9:13 PM	10:05 AM	222	13270	34.4	15.8	16.3	24.2
8-22	8-22	10:05 AM	11:10 AM	65	3900	16.3	24.2	16.1	24.4
8-22	8-22	11:10 AM	12:57 PM	67	4020	16.1	24.4	15.8	24.7
TOTALS				i = 248400				Q = 16.5	

COEFFICIENT OF PERMEABILITY, $k = \frac{Q \times L \times R_T \times C}{h \times A \times t}$

$$k = \frac{5.072 (0.931)}{140.68 (40.55)} = 5.5 \times 10^{-8}$$



MACTEC

CONSTANT HEAD PERMEABILITY TEST

(ASTM D5084)

JOB NAME: TVA-KINGSTON-PROP. EYP. STACK
 JOB NO.: 3043-95-1021
 BORING NO.: NB-59
 DEPTH: S-15
 SAMPLE: BULK (REVALUED)
 DESCRIPTION: _____

TECHNICIAN: JA
 DATE: 8-9-5
 CHECKED BY: HIC
 CELL NO.: A
 SYSTEM NO.: #2

SAMPLE INFORMATION

MDD = 103.6 pcf OMC = 20.1%

WEIGHT TUBE & SOIL (g): _____
 WEIGHT TUBE (g): _____
 WEIGHT SOIL (g): _____
 VOLUME SOIL (cu ft): _____
 DRY UNIT WEIGHT (pcf): _____
 WET UNIT WEIGHT (pcf): _____

TUBE LENGTH: _____ (in) _____ (cm)
 TUBE DIAMETER: _____ (in) _____ (cm)
 SOIL LENGTH(L): 2.021 (in) 5.133 (cm) ✓
 SOIL DIAMETER: 2.856 (in) 7.254 (cm) ✓
 AREA(A): _____ (in²) 41.33 (cm²) ✓

MOISTURE CONTENT

INITIAL WET WEIGHT (g): 408.96
 FINAL WET WEIGHT (g): 421.02
 FINAL DRY WEIGHT (g): ~~333.81~~ 333.81
 INITIAL MOISTURE (%): 22.5 ✓
 FINAL MOISTURE (%): 26.1 ✓
 PAN NAME: Wallace

PERM INFORMATION

CELL PRESSURE (psi): 60
 FORE PRESSURE (psi): 52
 BACK PRESSURE (psi): 59
 HEAD, h (psi) x 70.34: 140.68
 TEMPERATURE (°F): 73°F
 VISCOSITY CORRECTION (R_v): 0.931
 PERMEANT LIQUID USED: H₂O
 BURET CORRECTION FACTOR (C): 1.0

OPSI

TABLE OF HYDRAULIC CONDUCTIVITY

DATE		TIME		ELAPSED TIME (+)		READING		FLOW (CC)		
START	END	START	END	MINUTES	SECONDS	START	END	cc	k	
8-22	8-22	9:08 ^{pm}	9:08 ^{am}	60	<u>3600</u>	132	7.3	12.7	7.8	<u>0.5</u> 1.1×10^{-7}
8-22	8-22	10:04 ^{am}	10:10 ^{am}	6	<u>360</u>	11.8	8.5	11.7	8.6	<u>0.17</u> 2.3×10^{-7}
8-22	8-22	10:10 ^{am}	11:05 ^{am}	55	<u>3300</u>	11.7	8.6	11.3	9.0	<u>0.45</u> 1.0×10^{-7}
8-22	8-22	11:05 ^{am}	2:05 ^{pm}	180	<u>10800</u>	11.3	9.0	9.9	10.4	<u>1.4</u> 1.1×10^{-7}
TOTALS					<u>18060</u>					<u>Q = 2.4</u> 1.1×10^{-7}

COEFFICIENT OF PERMEABILITY, $k = \frac{Q \times L \times R_T \times C}{h \times A \times t}$

$Q = \frac{5.133 (0.931)}{140.68 (41.33)}$

~~1.1 x 10^-7~~ 1.1 x 10^-7



CONSTANT HEAD PERMEABILITY TEST

(ASTM D5084)

JOB NAME: TVA-KINGSTON-PROP. GYP. STACK
 JOB NO.: 3043-05-1021
 BORING NO.: NB-76
 DEPTH: 5-15
 SAMPLE: BULK (REMOVED)
 DESCRIPTION: RED BROWN SILT CLS

TECHNICIAN: JA
 DATE: 8-9-5
 CHECKED BY: HIC
 CELL NO.: #13
 SYSTEM NO.: #3

SAMPLE INFORMATION

MPD = 99.3 pcf OMC = 21.0%

WEIGHT TUBE & SOIL (g): _____
 WEIGHT TUBE (g): _____
 WEIGHT SOIL (g): _____
 VOLUME SOIL (cu ft): _____
 DRY UNIT WEIGHT (pcf): _____
 WET UNIT WEIGHT (pcf): _____

TUBE LENGTH: _____ (in) _____ (cm)
 TUBE DIAMETER: _____ (in) _____ (cm)
 SOIL LENGTH(L): 2.041 (in) 5.184 (cm)
 SOIL DIAMETER: 2.873 (in) 7.297 (cm)
 AREA(A): _____ (in²) 41.82 (cm²)

MOISTURE CONTENT

INITIAL WET WEIGHT (g): 395.55
 FINAL WET WEIGHT (g): 403.09
 FINAL DRY WEIGHT (g): 317.89
 INITIAL MOISTURE (%): 24.4
 FINAL MOISTURE (%): 26.8
 PAN NAME: B-9

PERM INFORMATION

CELL PRESSURE (psi): 60
 FORE PRESSURE (psi): 52
 BACK PRESSURE (psi): 50
 HEAD, h (psi) x 70.34: 140.68
 TEMPERATURE (°F): 73°F
 VISCOSITY CORRECTION (R_v): 0.931
 PERMEANT LIQUID USED: H₂O
 BURET CORRECTION FACTOR (C): 1.0

TABLE OF HYDRAULIC CONDUCTIVITY

DATE		TIME		ELAPSED TIME (+)		READING				FLOW (CC)	
START	END	START	END	MINUTES	SECONDS	START	END	α	κ	α	κ
8-20	8-22	9:13 AM	9:59 PM	46		44.1	8.2				
8-22	8-22	10:02 AM	10:06 AM	4	240	11.1	8.9	10.3	9.7	0.8	3.7 x 10 ⁻⁶
8-22	8-22	10:06 AM	10:09 AM	3	180	10.3	9.7	9.6	10.4	0.7	3.2 x 10 ⁻⁶
8-22	8-22	10:09 AM	10:12 AM	3	180	9.6	10.4	8.9	11.1	0.7	3.2 x 10 ⁻⁶
8-22	8-22	10:06 AM	12:48	102	6120	30.1	10.9	4.5	29.9	18.6	2.5 x 10 ⁻⁶
TOTALS					i = 6720					Q = 20.8	

COEFFICIENT OF PERMEABILITY, $k = \frac{Q \times L \times R_T \times C}{h \times A \times t} = \frac{Q}{t} \times \frac{5.164 (0.931)}{140.68 (41.82)} = 2.5 \times 10^{-6}$



CONSTANT HEAD PERMEABILITY TEST

(ASTM D5084)

JOB NAME: TVA KINGSTON
 JOB NO.: 3043-S-021
 BORING NO.: KB-76 (H)-2
 DEPTH: 19'-29.5'
 SAMPLE: _____
 DESCRIPTION: SILTY - FIRM

TECHNICIAN: ALEX
 DATE: 8-8-5
 CHECKED BY: HVC
 CELL NO.: #5
 SYSTEM NO.: #15

SAMPLE INFORMATION

WEIGHT TUBE & SOIL (g): _____
 WEIGHT TUBE (g): _____
 WEIGHT SOIL (g): _____
 VOLUME SOIL (cu ft): _____
 DRY UNIT WEIGHT (pcf): _____
 WET UNIT WEIGHT (pcf): _____

TUBE LENGTH: _____ (in) _____ (cm)
 TUBE DIAMETER: _____ (in) _____ (cm)
 SOIL LENGTH(L): 2.089 (in) 5.346 (cm)
 SOIL DIAMETER: 2.833 (in) 7.196 (cm)
 AREA(A): _____ (in²) 40.67 (cm²)

MOISTURE CONTENT

INITIAL WET WEIGHT (g): 422.17
 FINAL WET WEIGHT (g): 423.20
 FINAL DRY WEIGHT (g): ~~340.53~~ 340.78
 INITIAL MOISTURE (%): 23.9 ✓
 FINAL MOISTURE (%): 24.2 ✓
 PAN NAME: CMS

PERM INFORMATION

CELL PRESSURE (psi): 70 PSI (20 PSI)
 FORE PRESSURE (psi): 52
 BACK PRESSURE (psi): 50
 HEAD, h (psi) x 70.34: 140.68
 TEMPERATURE (°F): 73°F
 VISCOSITY CORRECTION (R_v): 0.931
 PERMEANT LIQUID USED: H₂O
 BURET CORRECTION FACTOR (C): 1.0

TABLE OF HYDRAULIC CONDUCTIVITY

DATE		TIME		ELAPSED TIME (+)		READING		FLOW (CC)			
START	END	START	END	MINUTES	SECONDS	START	END	cc	K		
8-19	8-19	8:07 AM				12.0	8.1				
8-19	8-19	10:00 AM	1:26 PM	206	12360	13.2	6.4	9.5	10.0	3.7	2.6 x 10 ⁻⁷
8-19	8-19	1:26 PM	2:08 PM	42	(2520)	9.5	10.0	8.8	10.7	(9.7)	2.4 x 10 ⁻⁷
8-19	8-19	2:08 PM				8.8	10.7				
8-20	8-20	5:34 PM	8:24 PM	170	(10200)	11.1	9.1	8.4	11.9	(2.7)	2.3 x 10 ⁻⁷
8-22	8-22	9:58	11:08 AM	70	(4200)	13.2	6.7	12.5	2.4	(0.7)	1.4 x 10 ⁻⁷
8-22	8-22	11:08 AM	1:58 PM	170	(10200)	12.5	7.4	10.4	9.4	(2.1)	1.8 x 10 ⁻⁷
TOTALS				Σ = 27120						Q = 6.2	

COEFFICIENT OF PERMEABILITY, $k = \frac{Q \times L \times R_v \times C}{h \times A \times t} = \frac{Q}{t} \cdot \frac{5.346 (0.931) (1.0)}{140.68 (40.67)}$

2.0 x 10⁻⁷ ✓



MACTEC

CONSTANT HEAD PERMEABILITY TEST

(ASTM D5084)

JOB NAME: TVA KINGSTON - PROP. SYP. STACK
 JOB NO.: 3043-05-1021
 BORING NO.: NB-24
 DEPTH: 2'-10"
 SAMPLE: BULK (REMOVED)
 DESCRIPTION: _____

TECHNICIAN: J.A.
 DATE: 8-7-5
 CHECKED BY: H.C.
 CELL NO.: #2
 SYSTEM NO.: #14

SAMPLE INFORMATION

MDD = 102.2 PCF OMC = 21.6 %

WEIGHT TUBE & SOIL (g): _____
 WEIGHT TUBE (g): _____
 WEIGHT SOIL (g): _____
 VOLUME SOIL (cu ft): _____
 DRY UNIT WEIGHT (pcf): _____
 WET UNIT WEIGHT (pcf): _____

TUBE LENGTH: _____ (in) _____ (cm)
 TUBE DIAMETER: _____ (in) _____ (cm)
 SOIL LENGTH(L): 2.030 (in) 5.156 (cm)
 SOIL DIAMETER: 2.862 (in) 7.269 (cm)
 AREA(A): _____ (in²) 41.50 (cm²)

MOISTURE CONTENT

INITIAL WET WEIGHT (g): 408.74
 FINAL WET WEIGHT (g): 417.20
 FINAL DRY WEIGHT (g): 329.71
 INITIAL MOISTURE (%): 24.0 ✓
 FINAL MOISTURE (%): 26.5 ✓
 PAN NAME: BOT

PERM INFORMATION

CELL PRESSURE (psi): 60
 FORE PRESSURE (psi): 52
 BACK PRESSURE (psi): 50
 HEAD, h (psi) x 70.34: 140.68
 TEMPERATURE (°F): 73°F
 VISCOSITY CORRECTION (R_T): 0.931
 PERMEANT LIQUID USED: H₂O
 BURET CORRECTION FACTOR (C): 1.0

TABLE OF HYDRAULIC CONDUCTIVITY

DATE		TIME		ELAPSED TIME (+)		READING				FLOW (CC)	
START	END	START	END	MINUTES	SECONDS	START	END	START	END	Q	k
8-20	8-20	9:11 ^{AM}	10:11 ^{AM}	60	3600	15.9	4.6	15.2	5.3	0.7	1.6 x 10 ⁻⁷
8-22	8-22	9:56 ^{AM}	10:07 ^{AM}	11	660	11.0	8.9	10.9	9.0	0.1	1.2 x 10 ⁻⁷
8-22	8-22	10:07 ^{AM}	11:07 ^{AM}	60	3600	10.9	9.0	10.3	9.6	0.6	1.4 x 10 ⁻⁷
8-22	8-22	11:07 ^{AM}	12:27 ^{PM}	80	4800	10.7	9.6	9.5	10.5	0.8	1.4 x 10 ⁻⁷
TOTALS					= 12660						Q = 2.2

COEFFICIENT OF PERMEABILITY, $k = \frac{Q \times L \times R_T \times C}{h \times A \times t} = \frac{0.5156 \times (0.931)}{140.68 \times (41.50)} = 1.4 \times 10^{-7}$ ✓



ONE-DIMENSIONAL CONSOLIDATION TEST RESULTS

CONSOLIDATION TEST REPORT

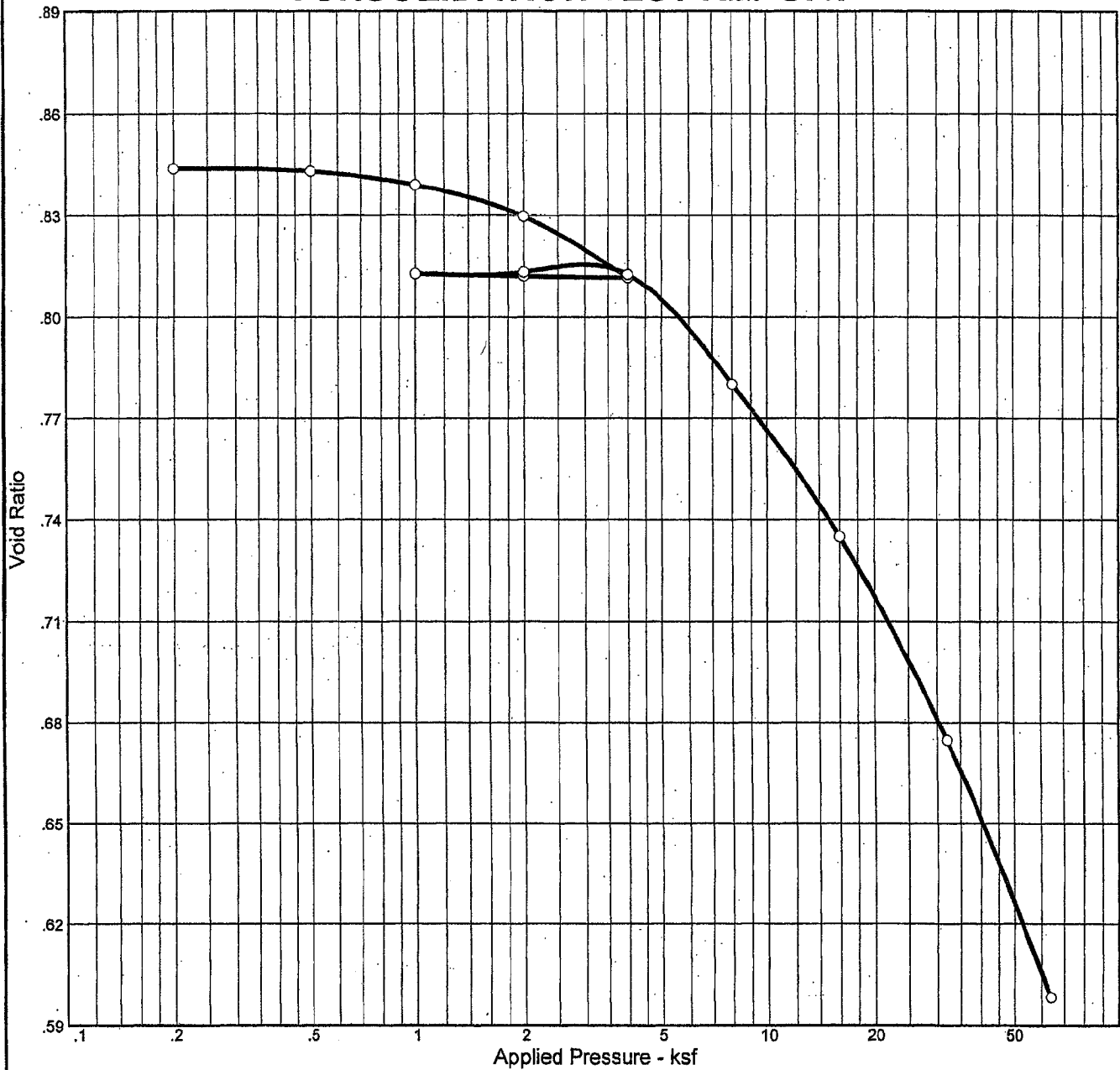

Natural		Dry Dens. (pcf)	LL	PI	Sp. Gr. (assumed)	Overburden (ksf)	P _c (ksf)	C _c	C _r	Initial Void Ratio
Saturation	Moisture									
107.0 %	33.4 %	91.7	-	-	2.71	—	11.16	0.26	0.00	0.844

MATERIAL DESCRIPTION	USCS	AASHTO
Yellowish Brown to pale gray sandy silty clay with chert fragments	-	-

<p>Project No. 3043051021 Client: TVA</p> <p>Project: TVA Kingston - Proposed Gypsum Stack</p> <p>Location: NB-44 (9'-11')</p>	<p>Remarks:</p> <p>Material description obtained from the field boring log.</p>
<p>CONSOLIDATION TEST REPORT</p> <p>MACTEC, INC.</p>	
<p>Figure</p>	

Dial Reading vs. Time

Project No.: 3043051021

Project: TVA Kingston - Proposed Gypsum Stack

Location: NB-44 (9'-11')

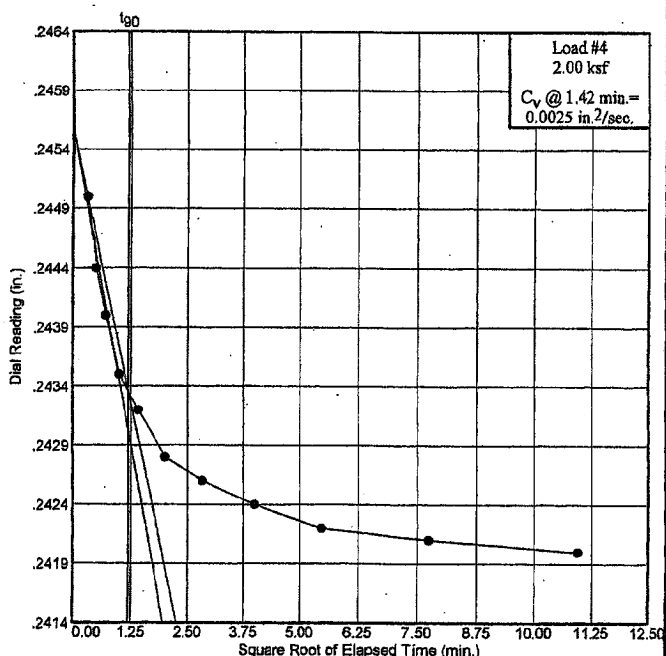
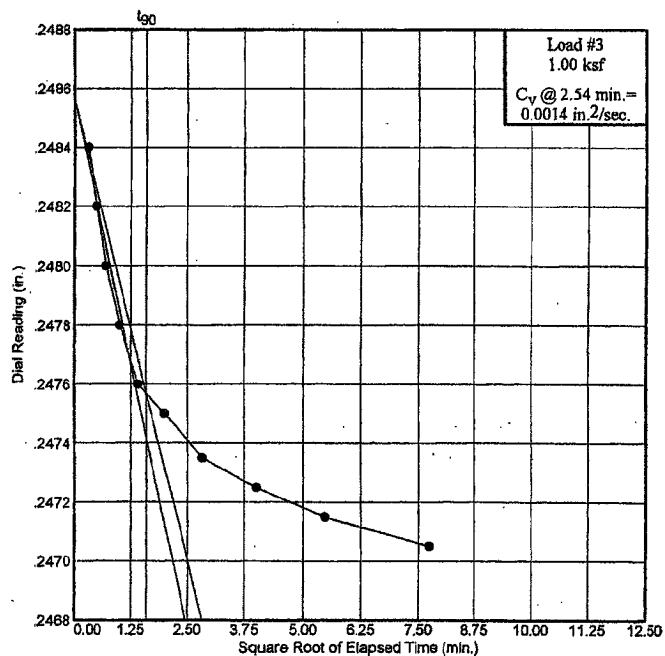
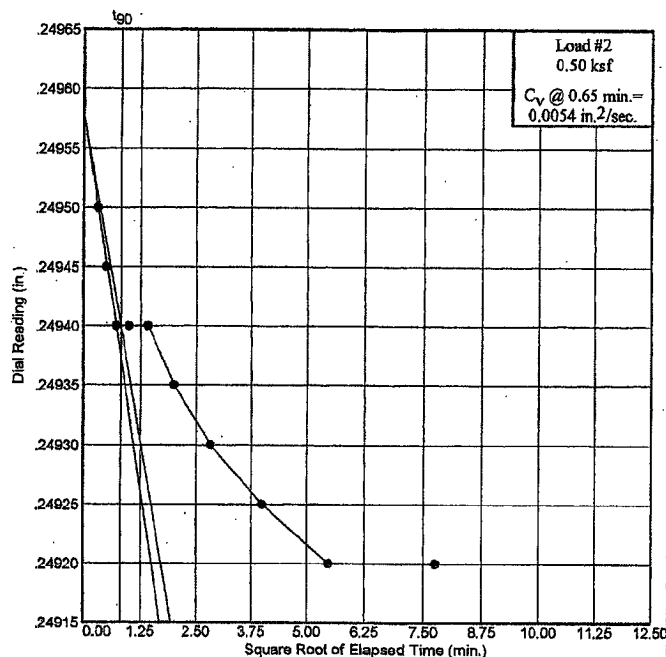
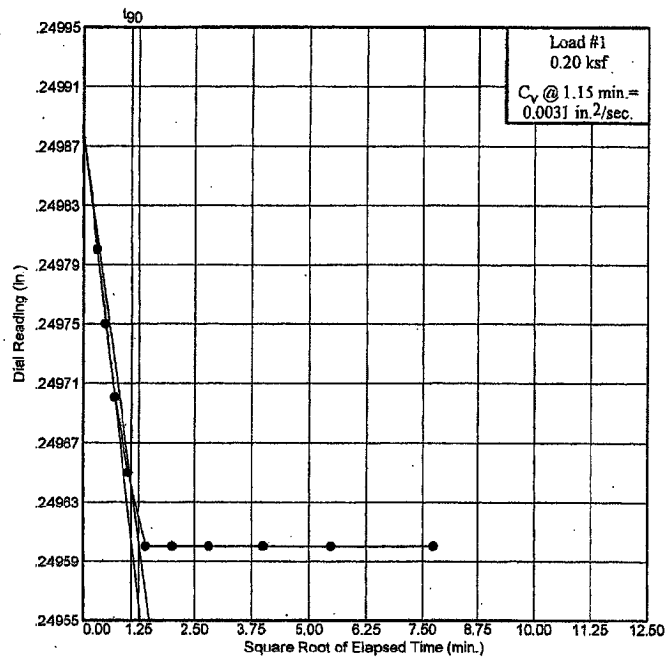

Dial Reading vs. Time
MACTEC, INC.

Figure

Dial Reading vs. Time

Project No.: 3043051021

Project: TVA Kingston - Proposed Gypsum Stack

Location: NB-44 (9'-11')

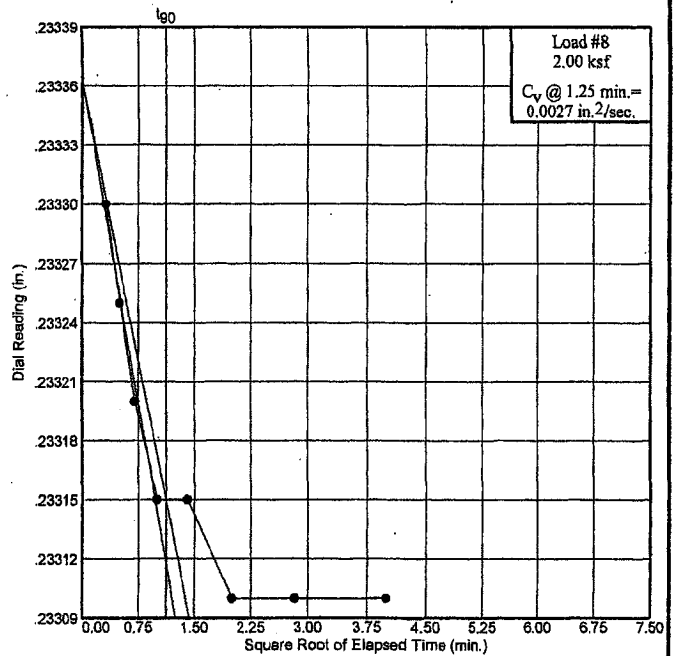
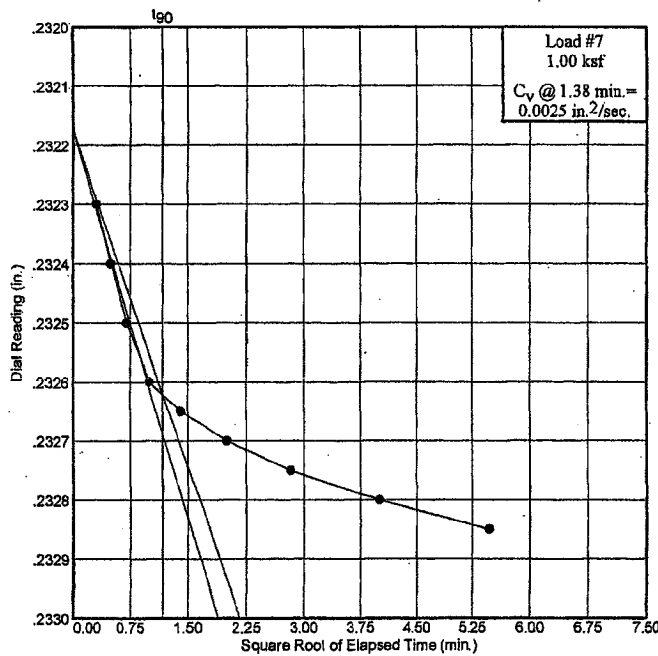
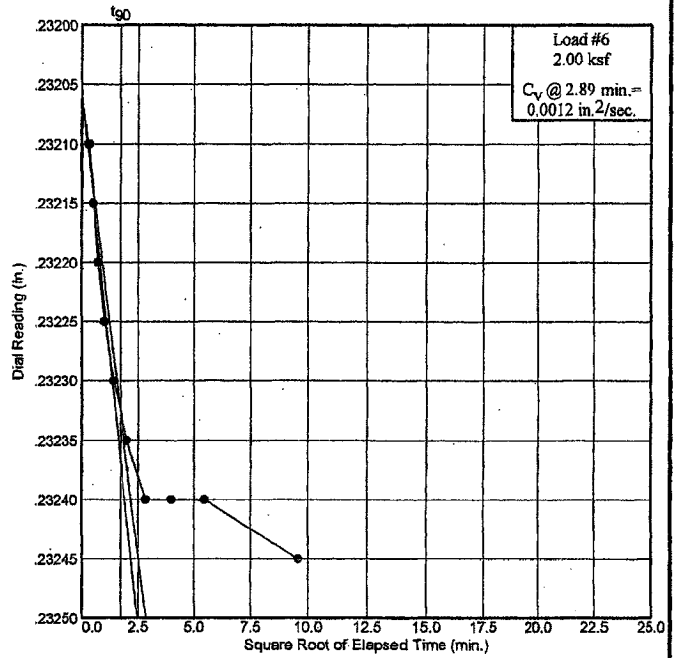
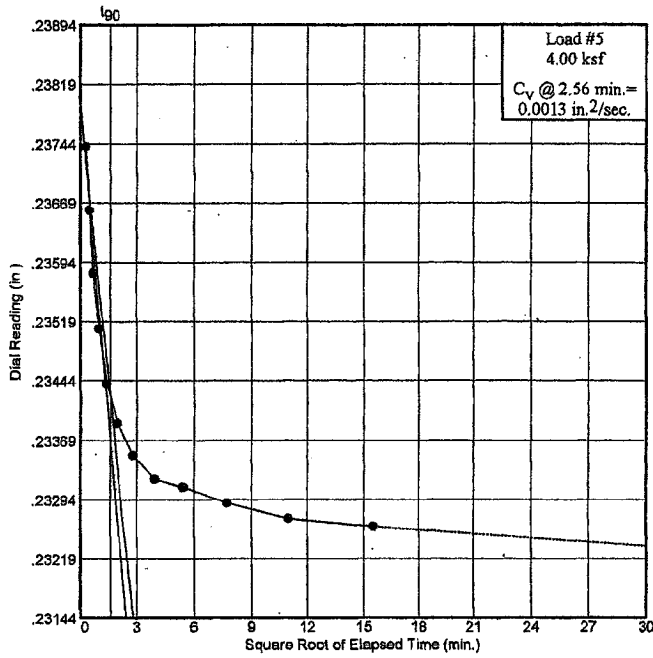

Dial Reading vs. Time
MACTEC, INC.

Figure

Dial Reading vs. Time

Project No.: 3043051021

Project: TVA Kingston - Proposed Gypsum Stack

Location: NB-44 (9'-11')

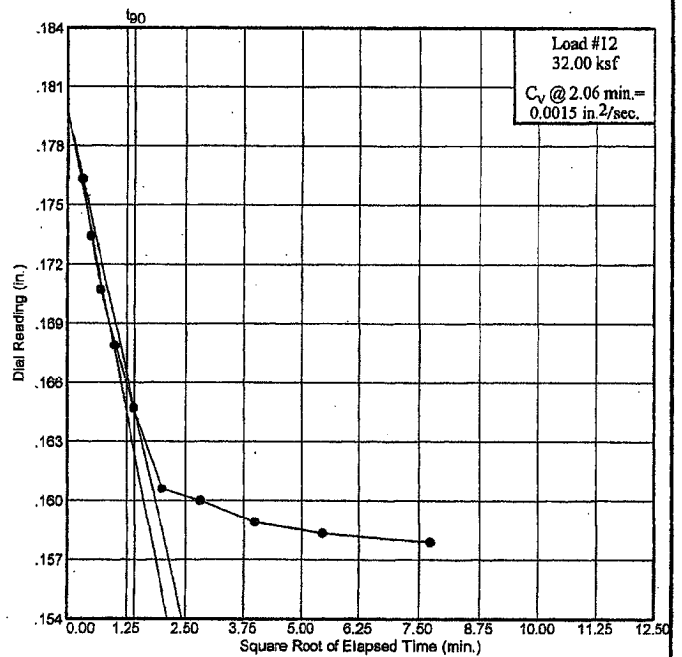
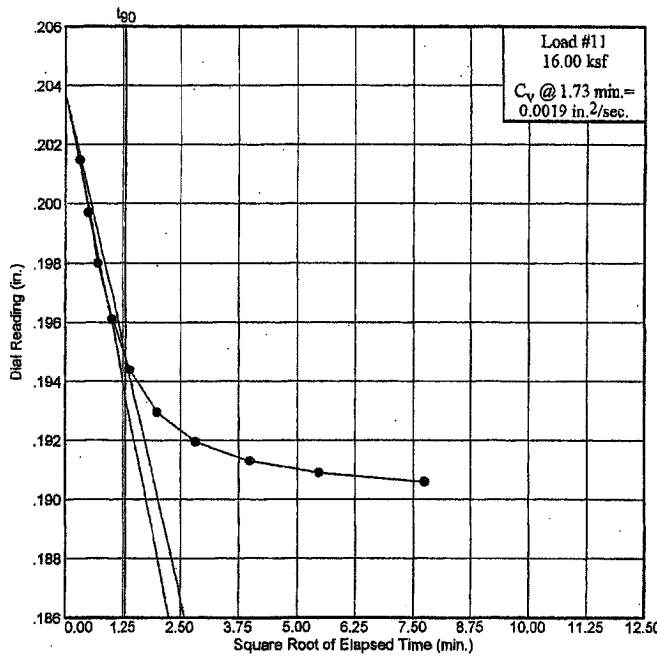
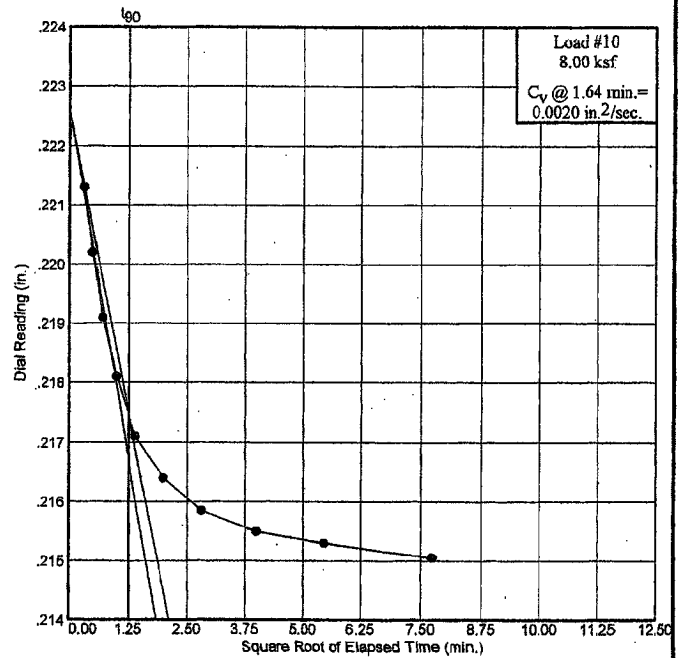
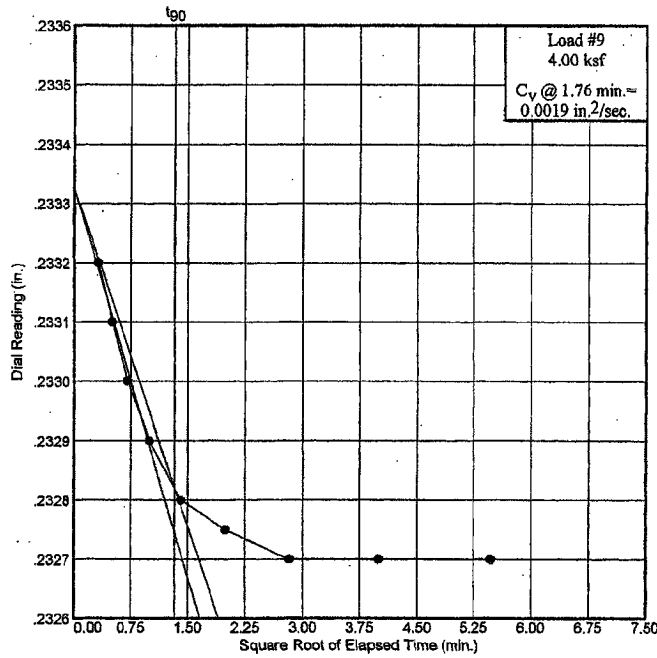

Dial Reading vs. Time
MACTEC, INC.

Figure

Dial Reading vs. Time

Project No.: 3043051021

Project: TVA Kingston - Proposed Gypsum Stack

Location: NB-44 (9'-11')

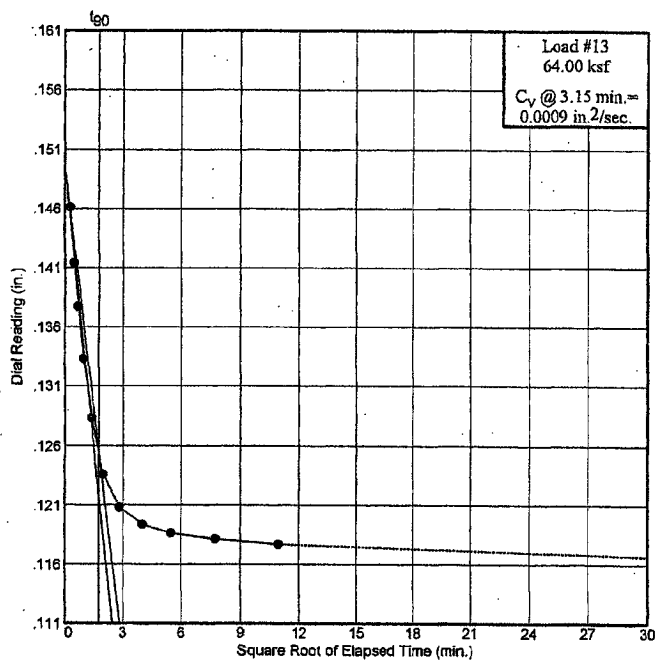

Dial Reading vs. Time

MACTEC, INC.

Figure

Pressure: 0.20 ksf

TEST READINGS

Load No. 1

No.	Elapsed Time	Dial Reading	No.	Elapsed Time	Dial Reading
1	0.00	0.25000	11	60.00	0.24960
2	0.10	0.24980			
3	0.25	0.24975			
4	0.50	0.24970			
5	1.00	0.24965			
6	2.00	0.24960			
7	4.00	0.24960			
8	8.00	0.24960			
9	16.00	0.24960			
10	30.00	0.24960			

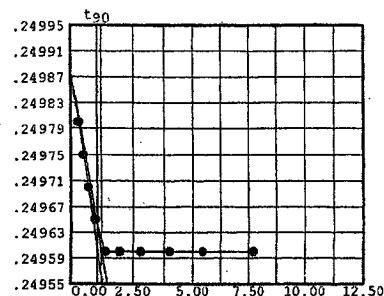

Void Ratio = 0.844 Compression = 0.0 %
 $D_0 = 0.24988$ $D_{90} = 0.24964$ $D_{100} = 0.24961$
 C_v at 1.2 min. = 0.0031 in.²/sec.

Pressure: 0.50 ksf

TEST READINGS

Load No. 2

No.	Elapsed Time	Dial Reading	No.	Elapsed Time	Dial Reading
1	0.00	0.24960	11	60.00	0.24880
2	0.10	0.24910			
3	0.25	0.24905			
4	0.50	0.24900			
5	1.00	0.24900			
6	2.00	0.24900			
7	4.00	0.24895			
8	8.00	0.24890			
9	16.00	0.24885			
10	30.00	0.24880			

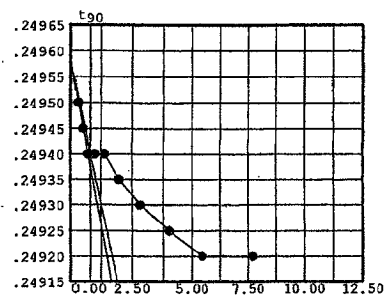

Void Ratio = 0.843* Compression = 0.1 %
 $D_0 = 0.24958$ $D_{90} = 0.24940$ $D_{100} = 0.24938$
 C_v at 0.7 min. = 0.0054 in.²/sec.

Pressure: 1.00 ksf

TEST READINGS

Load No. 3

No.	Elapsed Time	Dial Reading	No.	Elapsed Time	Dial Reading
1	0.00	0.24880	11	60.00	0.24625
2	0.10	0.24760			
3	0.25	0.24740			
4	0.50	0.24720			
5	1.00	0.24700			
6	2.00	0.24680			
7	4.00	0.24670			
8	8.00	0.24655			
9	16.00	0.24645			
10	30.00	0.24635			

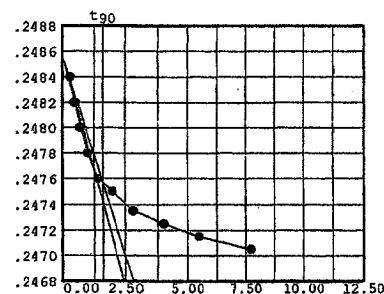

Void Ratio = 0.839 Compression = 0.3 %
 $D_0 = 0.24857$ $D_{90} = 0.24757$ $D_{100} = 0.24746$
 C_v at 2.5 min. = 0.0014 in.²/sec.

Pressure: 2.00 ksf

TEST READINGS

Load No. 4

No.	Elapsed Time	Dial Reading	No.	Elapsed Time	Dial Reading
1	0.00	0.24625	11	60.00	0.24050
2	0.10	0.24340	12	120.00	0.24040
3	0.25	0.24280			
4	0.50	0.24240			
5	1.00	0.24190			
6	2.00	0.24160			
7	4.00	0.24120			
8	8.00	0.24100			
9	16.00	0.24080			
10	30.00	0.24060			

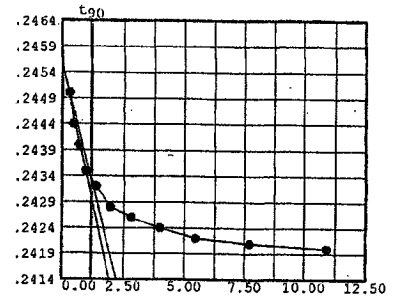

Void Ratio = 0.830 Compression = 0.8 %
 $D_0 = 0.24557$ $D_{90} = 0.24336$ $D_{100} = 0.24312$
 C_v at 1.4 min. = 0.0025 in.²/sec.

Pressure: 4.00 ksf

TEST READINGS

Load No. 5

No.	Elapsed Time	Dial Reading	No.	Elapsed Time	Dial Reading
1	0.00	0.24040	11	60.00	0.23050
2	0.10	0.23500	12	120.00	0.23030
3	0.25	0.23420	13	240.00	0.23020
4	0.50	0.23340	14	1527.00	0.22980
5	1.00	0.23270			
6	2.00	0.23200			
7	4.00	0.23150			
8	8.00	0.23110			
9	16.00	0.23080			
10	30.00	0.23070			

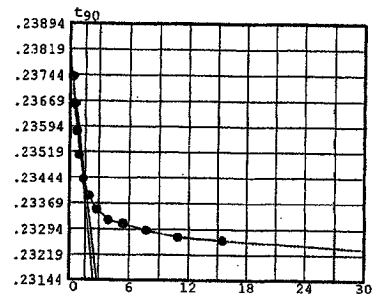

Void Ratio = 0.812 Compression = 1.8 %
 $D_0 = 0.23797$ $D_{90} = 0.23424$ $D_{100} = 0.23383$
 C_v at 2.6 min. = 0.0013 in.²/sec.

Pressure: 2.00 ksf

TEST READINGS

Load No. 6

No.	Elapsed Time	Dial Reading	No.	Elapsed Time	Dial Reading
1	0.00	0.22980	11	92.00	0.23085
2	0.10	0.23050	12	927.00	0.23085
3	0.25	0.23055			
4	0.50	0.23060			
5	1.00	0.23065			
6	2.00	0.23070			
7	4.00	0.23075			
8	8.00	0.23080			
9	16.00	0.23080			
10	30.00	0.23080			

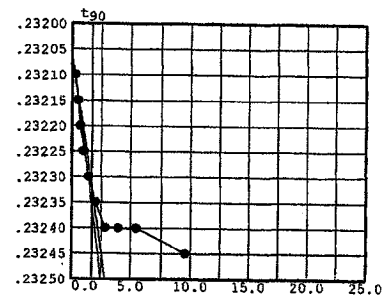

Void Ratio = 0.812 Compression = 1.8 %
 $D_0 = 0.23206$ $D_{90} = 0.23232$ $D_{100} = 0.23235$
 C_v at 2.9 min. = 0.0012 in.²/sec.

Pressure: 1.00 ksf

TEST READINGS

Load No. 7

No.	Elapsed Time	Dial Reading
1	0.00	0.23085
2	0.10	0.23150
3	0.25	0.23160
4	0.50	0.23170
5	1.00	0.23180
6	2.00	0.23185
7	4.00	0.23190
8	8.00	0.23195
9	16.00	0.23200
10	30.00	0.23205

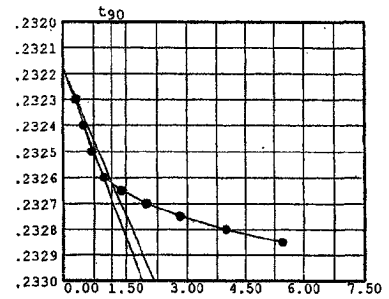

Void Ratio = 0.813 Compression = 1.7 %
 $D_0 = 0.23217$ $D_{90} = 0.23262$ $D_{100} = 0.23267$
 C_v at 1.4 min. = 0.0025 in.²/sec.

Pressure: 2.00 ksf

TEST READINGS

Load No. 8

No.	Elapsed Time	Dial Reading
1	0.00	0.23205
2	0.10	0.23170
3	0.25	0.23165
4	0.50	0.23160
5	1.00	0.23155
6	2.00	0.23155
7	4.00	0.23150
8	8.00	0.23150
9	16.00	0.23150

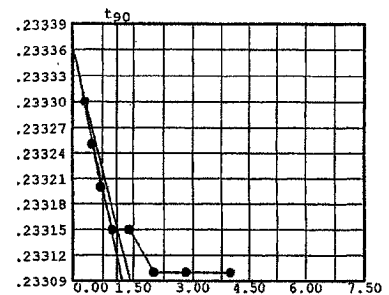

Void Ratio = 0.813 Compression = 1.7 %
 $D_0 = 0.23336$ $D_{90} = 0.23315$ $D_{100} = 0.23313$
 C_v at 1.3 min. = 0.0027 in.²/sec.

Pressure: 4.00 ksf

TEST READINGS

Load No. 9

No.	Elapsed Time	Dial Reading
1	0.00	0.23150
2	0.10	0.23020
3	0.25	0.23010
4	0.50	0.23000
5	1.00	0.22990
6	2.00	0.22980
7	4.00	0.22975
8	8.00	0.22970
9	16.00	0.22970
10	30.00	0.22970

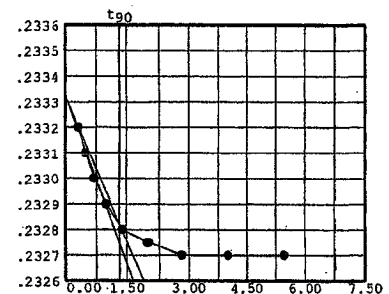

Void Ratio = 0.813 Compression = 1.7 %
 $D_0 = 0.23333$ $D_{90} = 0.23282$ $D_{100} = 0.23276$
 C_v at 1.8 min. = 0.0019 in.²/sec.

Pressure: 8.00 ksf

TEST READINGS

Load No. 10

No.	Elapsed Time	Dial Reading	No.	Elapsed Time	Dial Reading
1	0.00	0.22970	11	60.00	0.21505
2	0.10	0.22130			
3	0.25	0.22020			
4	0.50	0.21910			
5	1.00	0.21810			
6	2.00	0.21710			
7	4.00	0.21640			
8	8.00	0.21585			
9	16.00	0.21550			
10	30.00	0.21530			

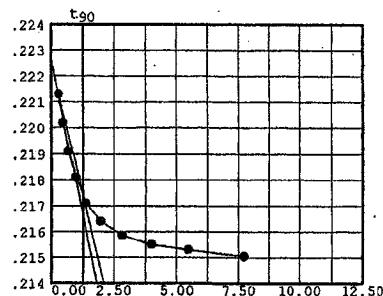

Void Ratio = 0.780 Compression = 3.5 %
 $D_0 = 0.22262$ $D_{90} = 0.21742$ $D_{100} = 0.21685$
 C_v at 1.6 min. = 0.0020 in.²/sec.

Pressure: 16.00 ksf

TEST READINGS

Load No. 11

No.	Elapsed Time	Dial Reading	No.	Elapsed Time	Dial Reading
1	0.00	0.21505	11	60.00	0.19060
2	0.10	0.20150			
3	0.25	0.19970			
4	0.50	0.19800			
5	1.00	0.19610			
6	2.00	0.19440			
7	4.00	0.19295			
8	8.00	0.19195			
9	16.00	0.19130			
10	30.00	0.19090			

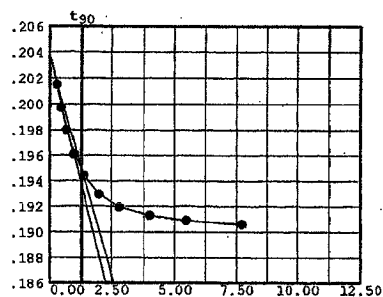

Void Ratio = 0.735 Compression = 5.9 %
 $D_0 = 0.20377$ $D_{90} = 0.19481$ $D_{100} = 0.19382$
 C_v at 1.7 min. = 0.0019 in.²/sec.

Pressure: 32.00 ksf

TEST READINGS

Load No. 12

No.	Elapsed Time	Dial Reading	No.	Elapsed Time	Dial Reading
1	0.00	0.19060	11	60.00	0.15790
2	0.10	0.17630			
3	0.25	0.17340			
4	0.50	0.17070			
5	1.00	0.16790			
6	2.00	0.16470			
7	4.00	0.16060			
8	8.00	0.16000			
9	16.00	0.15890			
10	30.00	0.15835			

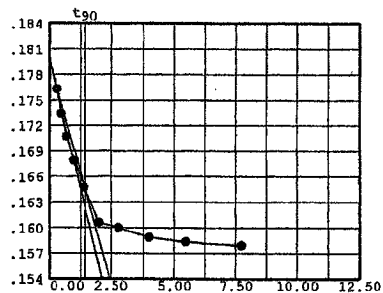

Void Ratio = 0.675 Compression = 9.2 %
 $D_0 = 0.17977$ $D_{90} = 0.16456$ $D_{100} = 0.16287$
 C_v at 2.1 min. = 0.0015 in.²/sec.

Pressure: 64.00 ksf

TEST READINGS

Load No. 13

No.	Elapsed Time	Dial Reading	No.	Elapsed Time	Dial Reading
1	0.00	0.15790	11	60.00	0.11815
2	0.10	0.14610	12	120.00	0.11770
3	0.25	0.14140	13	1152.00	0.11650
4	0.50	0.13770			
5	1.00	0.13330			
6	2.00	0.12830			
7	4.00	0.12360			
8	8.00	0.12080			
9	16.00	0.11940			
10	30.00	0.11865			

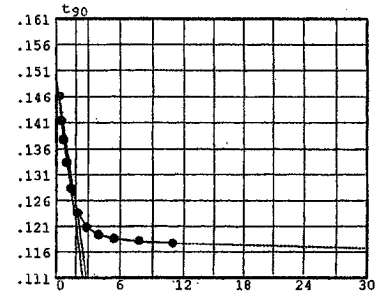

Void Ratio = 0.598 Compression = 13.3 %
D₀ = 0.14982 D₉₀ = 0.12541 D₁₀₀ = 0.12270
C_v at 3.1 min. = 0.0009 in.²/sec.

CONSOLIDATION TEST REPORT

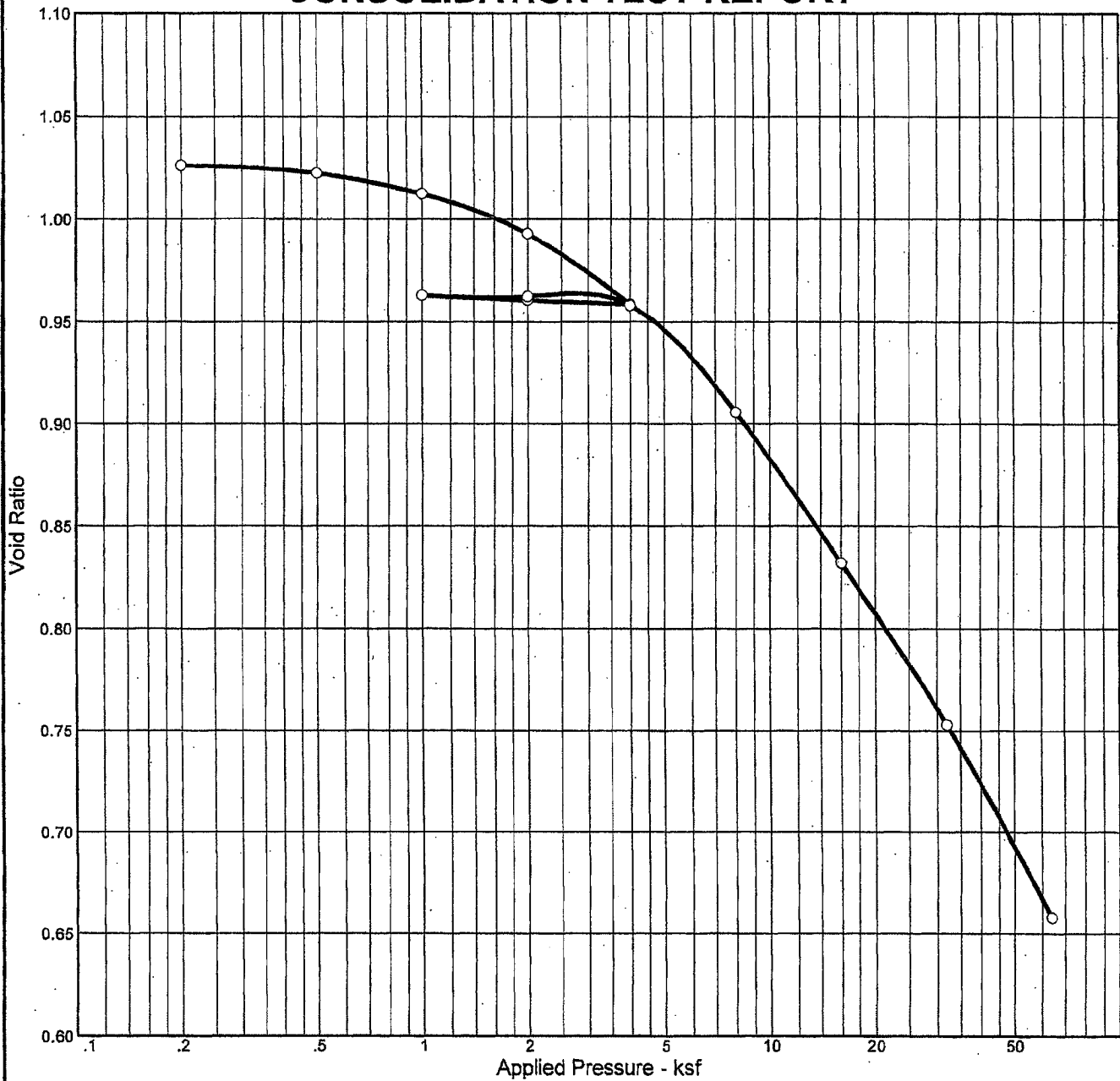

Natural		Dry Dens. (pcf)	LL	PI	Sp. Gr.	Overburden (ksf)	P _c (ksf)	C _c	C _r	Initial Void Ratio
Saturation	Moisture									
95.3 %	36.1 %	83.4	45	23	2.71	—	12.56	0.32	0.01	1.028

MATERIAL DESCRIPTION								USCS	AASHTO
Yellowish brown sandy silty clay								CL	-

<p>Project No. 3043051021 Client: TVA</p> <p>Project: TVA Kingston - Proposed Gypsum Stack</p> <p>Location: NB-44 (16.5'-18.5')</p> <p style="text-align: center;">CONSOLIDATION TEST REPORT</p> <p style="text-align: center;">MACTEC, INC.</p>	<p>Remarks:</p> <p style="text-align: right;">Figure</p>
-----------------------------------------------------------------------------------------------------------------------------------------------------------------------------------------------------------------------------------------------------------------------------------------------	--------------------------------------------------------------------------------------------------------

Dial Reading vs. Time

Project No.: 3043051021

Project: TVA Kingston - Proposed Gypsum Stack

Location: NB-44 (16.5'-18.5')

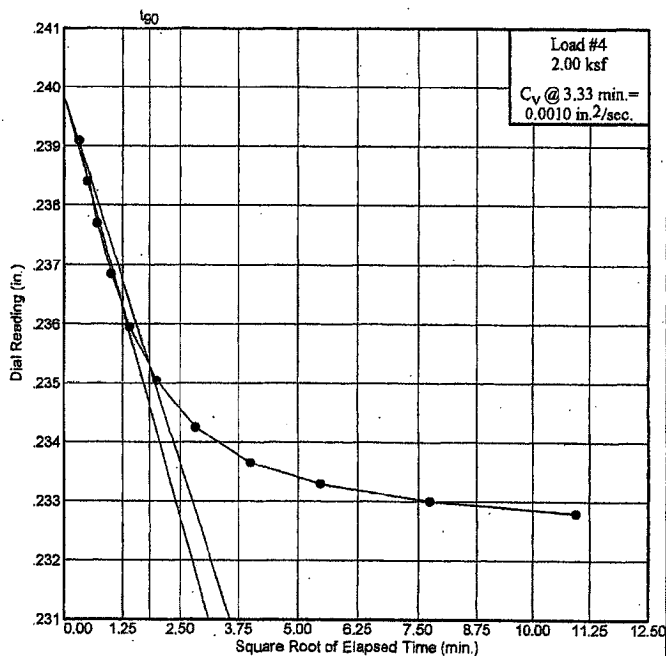
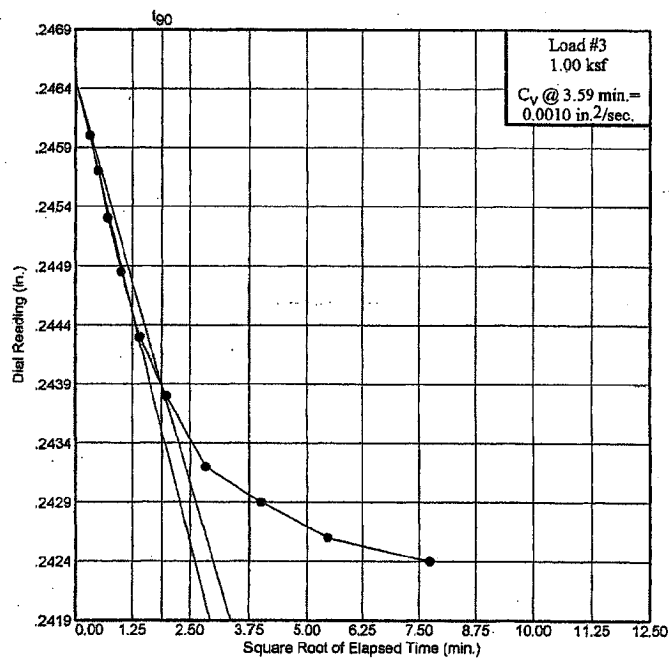
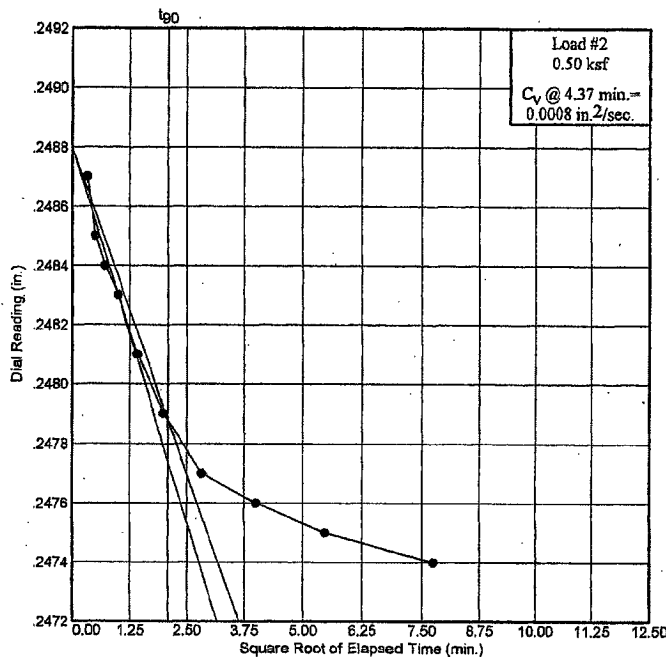
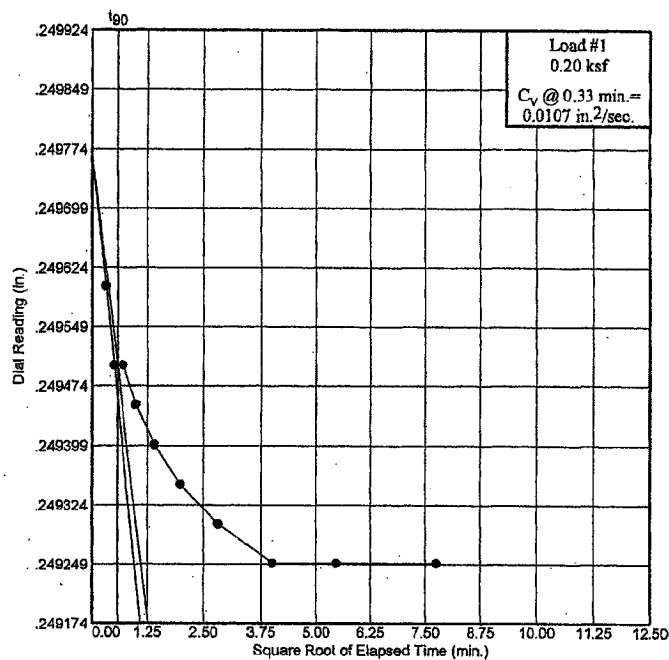

Dial Reading vs. Time
MACTEC, INC.

Figure

Dial Reading vs. Time

Project No.: 3043051021

Project: TVA Kingston - Proposed Gypsum Stack

Location: NB-44 (16.5'-18.5')

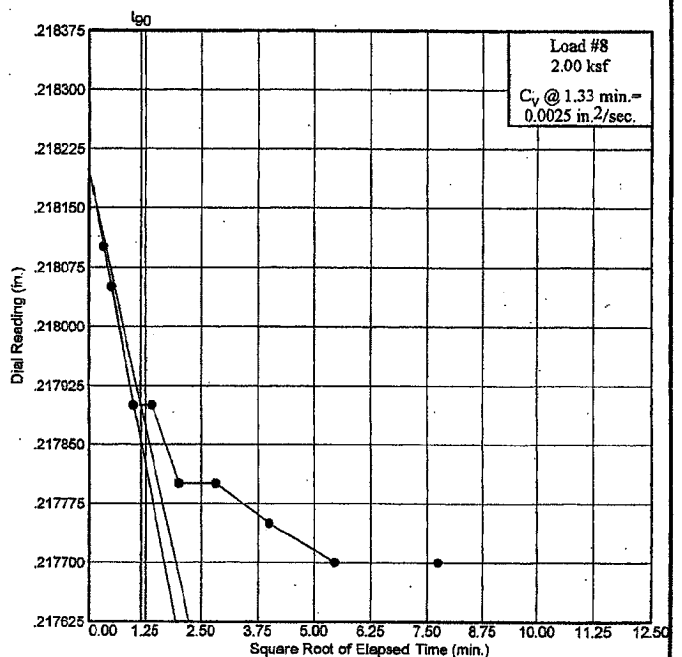
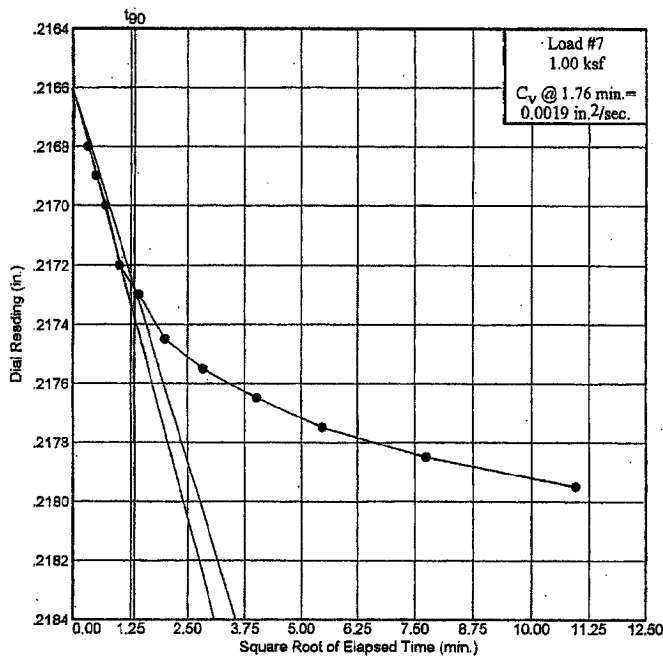
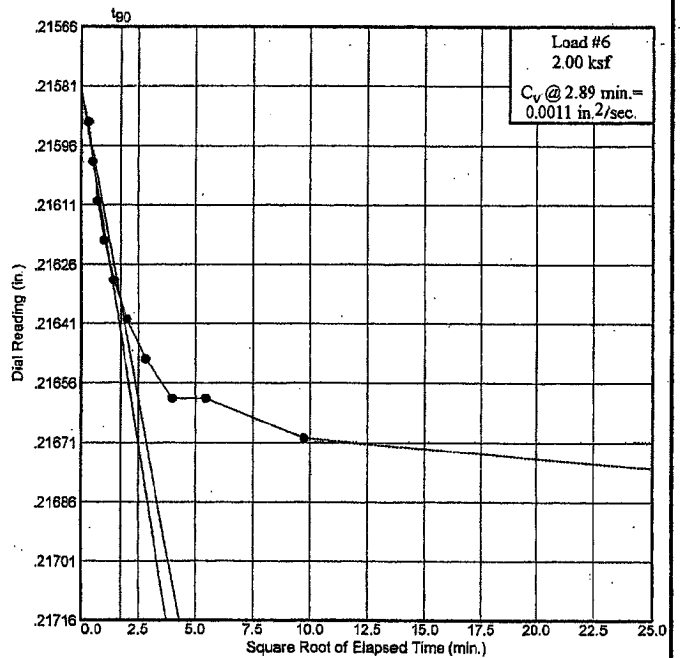
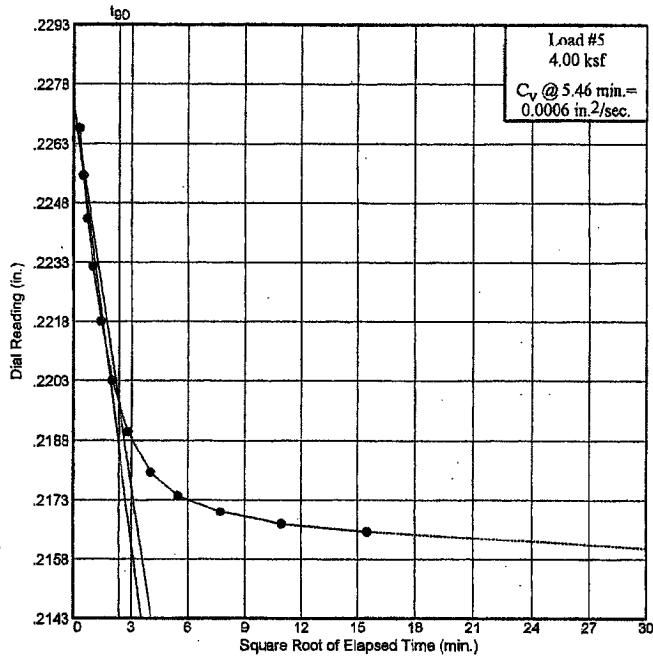

Dial Reading vs. Time
MACTEC, INC.

Figure

Dial Reading vs. Time

Project No.: 3043051021

Project: TVA Kingston - Proposed Gypsum Stack

Location: NB-44 (16.5'-18.5')

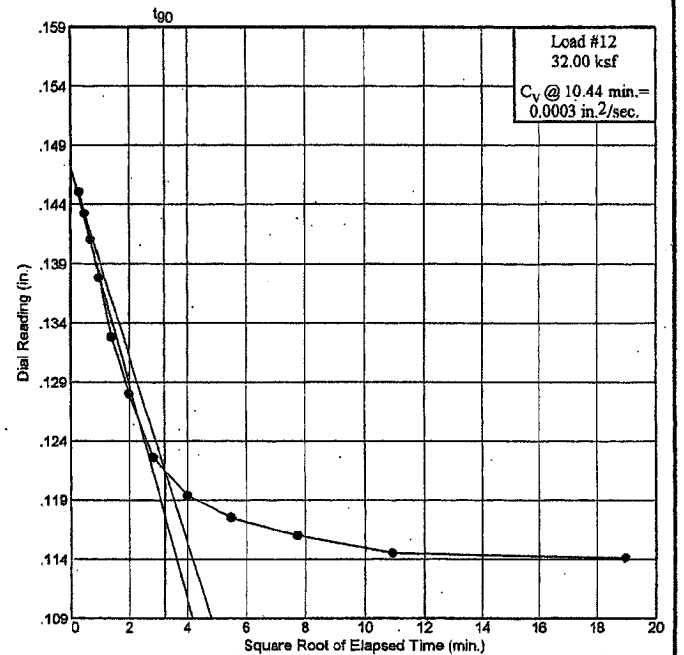
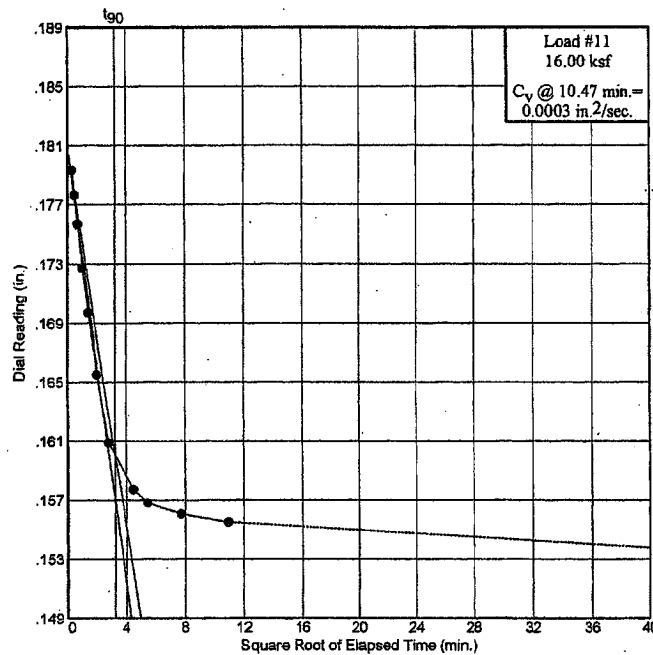
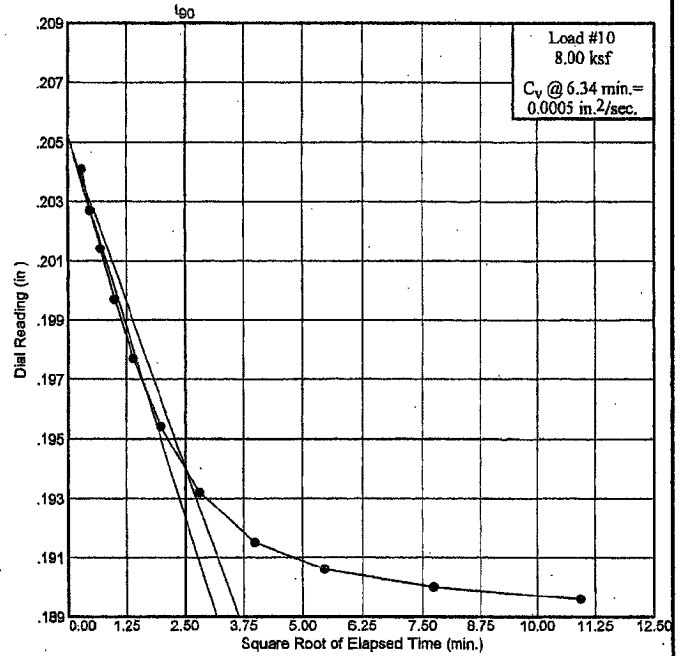
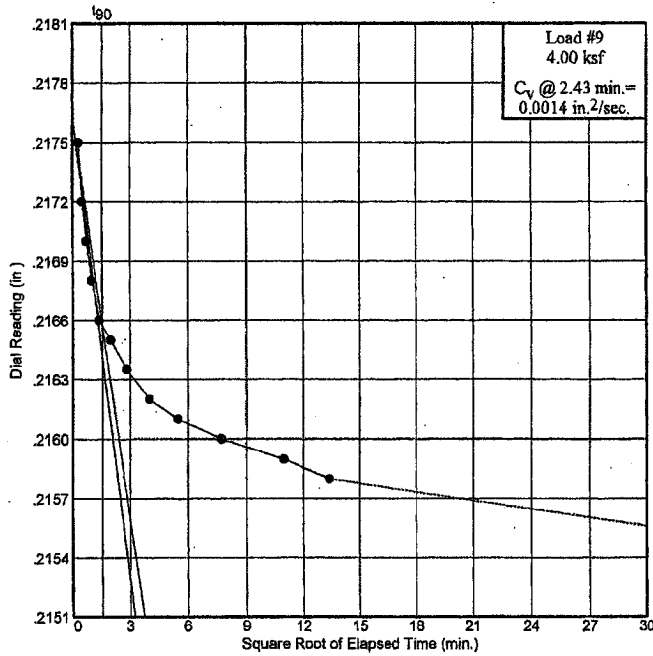

Dial Reading vs. Time
MACTEC, INC.

Figure

Dial Reading vs. Time

Project No.: 3043051021

Project: TVA Kingston - Proposed Gypsum Stack

Location: NB-44 (16.5'-18.5')

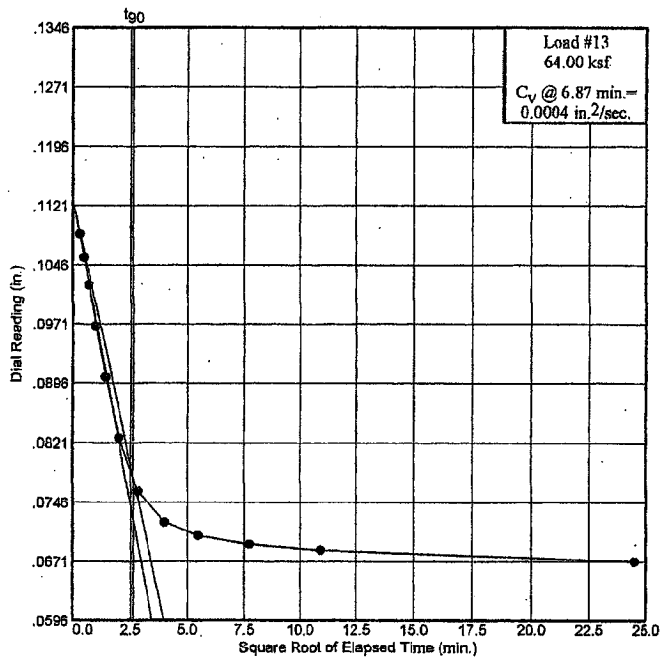

Dial Reading vs. Time

MACTEC, INC.

Figure

CONSOLIDATION TEST DATA

Client: TVA
 Project: TVA Kingston - Proposed Gypsum Stack
 Project Number: 3043051021

Sample Data

Source:
 Sample No.: UD-2
 Elev. or Depth: 16.5'-18.5' Sample Length(in./cm.):
 Location: NB-44 (16.5'-18.5')
 Description:
 Liquid Limit: 45 Plasticity Index: 23
 USCS: AASHTO: Figure No.:
 Testing Remarks:

Test Specimen Data

TOTAL SAMPLE	BEFORE TEST	AFTER TEST
Wet w+t = 243.88 g.	Consolidometer # = 3	Wet w+t = 123.73 g.
Dry w+t = 208.60 g.		Dry w+t = 97.65 g.
Tare Wt. = 110.95 g.	Spec. Gravity = 2.71	Tare Wt. = .00 g.
Height = 1.00 in.	Height = 1.00 in.	
Diameter = 2.38 in.	Diameter = 2.38 in.	
Weight = 132.93 g.	Defl. Table = Reference Set (inches/ksf)	
Moisture = 36.1 %	Ht. Solids = 0.4946 in.	Moisture = 26.7 %
Wet Den. = 113.6 pcf	Dry Wt. = 97.65 g.	Dry Wt. = 97.65 g.*
Dry Den. = 83.4 pcf	Void Ratio = 1.028	Void Ratio = 0.658
	Saturation = 95.3 %	

* Final dry weight used in calculations

End-of-Load Summary

Pressure (ksf)	Final Dial (in.)	Machine Defl. (in.)	C_v (in. ² /sec.)	C_α	Void Ratio	% Compression / Swell
start	0.25000				1.028	
0.20	0.24925	0.00000	0.0107		1.026	0.1 Compr.
0.50	0.24700	0.00040	0.0008		1.022	0.3 Compr.
1.00	0.24160	0.00080	0.0010		1.012	0.8 Compr.
2.00	0.23120	0.00160	0.0010		0.993	1.7 Compr.
4.00	0.21340	0.00240	0.0006		0.959	3.4 Compr.
2.00	0.21520	0.00160	0.0011		0.961	3.3 Compr.
1.00	0.21715	0.00080	0.0019		0.963	3.2 Compr.
2.00	0.21610	0.00160	0.0025		0.962	3.2 Compr.
4.00	0.21250	0.00300	0.0014		0.958	3.4 Compr.
8.00	0.18960	0.00000	0.0005		0.906	6.0 Compr.
16.00	0.15330	0.00000	0.0003		0.832	9.6 Compr.
32.00	0.11410	0.00000	0.0003		0.753	13.6 Compr.
64.00	0.06710	0.00000	0.0004		0.658	18.2 Compr.

$C_c = 0.32$ $P_c = 12.56$ ksf $C_r = 0.01$

Pressure: 0.20 ksf

TEST READINGS

Load No. 1

No.	Elapsed Time	Dial Reading	No.	Elapsed Time	Dial Reading
1	0.00	0.25000	11	60.00	0.24925
2	0.10	0.24960			
3	0.25	0.24950			
4	0.50	0.24950			
5	1.00	0.24945			
6	2.00	0.24940			
7	4.00	0.24935			
8	8.00	0.24930			
9	16.00	0.24925			
10	30.00	0.24925			

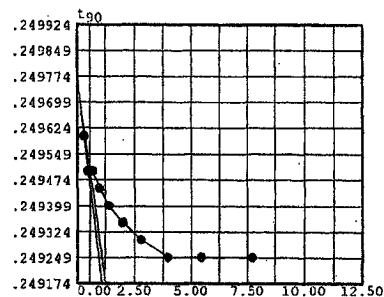

Void Ratio = 1.026 Compression = 0.1 %
 $D_0 = 0.24977$ $D_{90} = 0.24950$ $D_{100} = 0.24947$
 C_v at 0.3 min. = 0.0107 in.²/sec.

Pressure: 0.50 ksf

TEST READINGS

Load No. 2

No.	Elapsed Time	Dial Reading	No.	Elapsed Time	Dial Reading
1	0.00	0.24925	11	60.00	0.24700
2	0.10	0.24830			
3	0.25	0.24810			
4	0.50	0.24800			
5	1.00	0.24790			
6	2.00	0.24770			
7	4.00	0.24750			
8	8.00	0.24730			
9	16.00	0.24720			
10	30.00	0.24710			

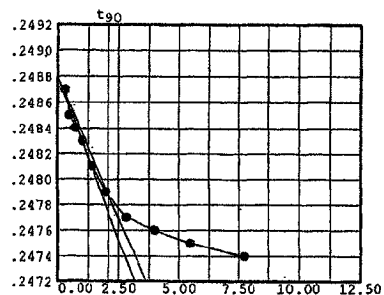

Void Ratio = 1.022 Compression = 0.3 %
 $D_0 = 0.24880$ $D_{90} = 0.24788$ $D_{100} = 0.24778$
 C_v at 4.4 min. = 0.0008 in.²/sec.

Pressure: 1.00 ksf

TEST READINGS

Load No. 3

No.	Elapsed Time	Dial Reading	No.	Elapsed Time	Dial Reading
1	0.00	0.24700	11	60.00	0.24160
2	0.10	0.24520			
3	0.25	0.24490			
4	0.50	0.24450			
5	1.00	0.24405			
6	2.00	0.24350			
7	4.00	0.24300			
8	8.00	0.24240			
9	16.00	0.24210			
10	30.00	0.24180			

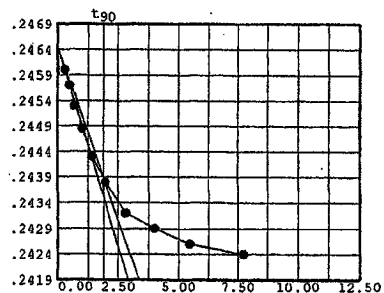

Void Ratio = 1.012 Compression = 0.8 %
 $D_0 = 0.24646$ $D_{90} = 0.24389$ $D_{100} = 0.24360$
 C_v at 3.6 min. = 0.0010 in.²/sec.

Pressure: 2.00 ksf

TEST READINGS

Load No. 4

No.	Elapsed Time	Dial Reading	No.	Elapsed Time	Dial Reading
1	0.00	0.24160	11	60.00	0.23140
2	0.10	0.23750	12	120.00	0.23120
3	0.25	0.23680			
4	0.50	0.23610			
5	1.00	0.23525			
6	2.00	0.23435			
7	4.00	0.23345			
8	8.00	0.23265			
9	16.00	0.23205			
10	30.00	0.23170			

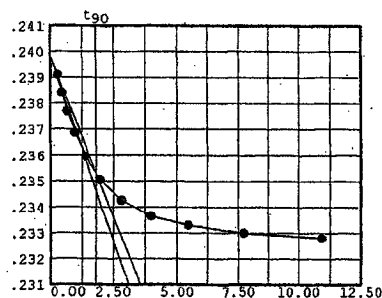

Void Ratio = 0.993 Compression = 1.7 %
 $D_0 = 0.23985$ $D_{90} = 0.23532$ $D_{100} = 0.23482$
 C_v at 3.3 min. = 0.0010 in.²/sec.

Pressure: 4.00 ksf

TEST READINGS

Load No. 5

No.	Elapsed Time	Dial Reading	No.	Elapsed Time	Dial Reading
1	0.00	0.23120	11	60.00	0.21460
2	0.10	0.22430	12	120.00	0.21430
3	0.25	0.22310	13	240.00	0.21410
4	0.50	0.22200	14	1530.00	0.21340
5	1.00	0.22080			
6	2.00	0.21940			
7	4.00	0.21790			
8	8.00	0.21660			
9	16.00	0.21560			
10	30.00	0.21500			

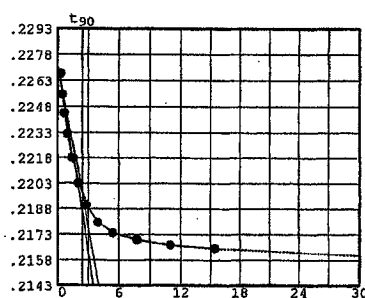

Void Ratio = 0.959 Compression = 3.4 %
 $D_0 = 0.22733$ $D_{90} = 0.21977$ $D_{100} = 0.21893$
 C_v at 5.5 min. = 0.0006 in.²/sec.

Pressure: 2.00 ksf

TEST READINGS

Load No. 6

No.	Elapsed Time	Dial Reading	No.	Elapsed Time	Dial Reading
1	0.00	0.21340	11	95.00	0.21510
2	0.10	0.21430	12	930.00	0.21520
3	0.25	0.21440			
4	0.50	0.21450			
5	1.00	0.21460			
6	2.00	0.21470			
7	4.00	0.21480			
8	8.00	0.21490			
9	16.00	0.21500			
10	30.00	0.21500			

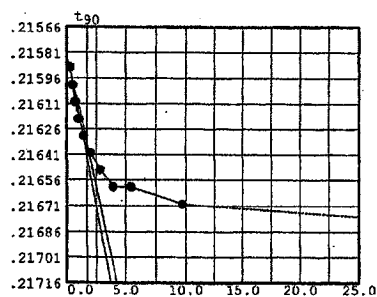

Void Ratio = 0.961 Compression = 3.3 %
 $D_0 = 0.21582$ $D_{90} = 0.21635$ $D_{100} = 0.21641$
 C_v at 2.9 min. = 0.0011 in.²/sec.

Pressure: 1.00 ksf

TEST READINGS

Load No. 7

No.	Elapsed Time	Dial Reading	No.	Elapsed Time	Dial Reading
1	0.00	0.21520	11	60.00	0.21705
2	0.10	0.21600	12	120.00	0.21715
3	0.25	0.21610			
4	0.50	0.21620			
5	1.00	0.21640			
6	2.00	0.21650			
7	4.00	0.21665			
8	8.00	0.21675			
9	16.00	0.21685			
10	30.00	0.21695			

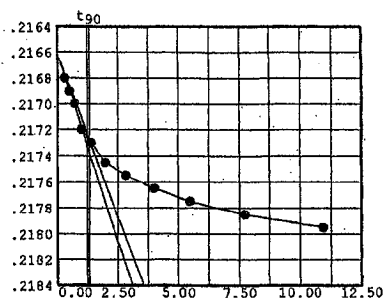

Void Ratio = 0.963 Compression = 3.2 %
 $D_0 = 0.21661$ $D_{90} = 0.21728$ $D_{100} = 0.21735$
 C_v at 1.8 min. = 0.0019 in.²/sec.

Pressure: 2.00 ksf

TEST READINGS

Load No. 8

No.	Elapsed Time	Dial Reading
1	0.00	0.21715
2	0.10	0.21650
3	0.25	0.21645
4	1.00	0.21630
5	2.00	0.21630
6	4.00	0.21620
7	8.00	0.21620
8	16.00	0.21615
9	30.00	0.21610
10	60.00	0.21610

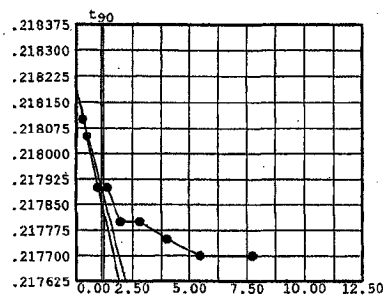

Void Ratio = 0.962 Compression = 3.2 %
 $D_0 = 0.21819$ $D_{90} = 0.21790$ $D_{100} = 0.21787$
 C_v at 1.3 min. = 0.0025 in.²/sec.

Pressure: 4.00 ksf

TEST READINGS

Load No. 9

No.	Elapsed Time	Dial Reading	No.	Elapsed Time	Dial Reading
1	0.00	0.21610	11	60.00	0.21300
2	0.10	0.21450	12	120.00	0.21290
3	0.25	0.21420	13	180.00	0.21280
4	0.50	0.21400	14	1170.00	0.21250
5	1.00	0.21380			
6	2.00	0.21360			
7	4.00	0.21350			
8	8.00	0.21335			
9	16.00	0.21320			
10	30.00	0.21310			

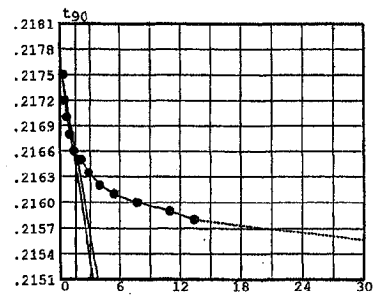

Void Ratio = 0.958 Compression = 3.4 %
 $D_0 = 0.21764$ $D_{90} = 0.21658$ $D_{100} = 0.21646$
 C_v at 2.4 min. = 0.0014 in.²/sec.

Pressure: 8.00 ksf

TEST READINGS

Load No. 10

No.	Elapsed Time	Dial Reading	No.	Elapsed Time	Dial Reading
1	0.00	0.21250	11	60.00	0.19000
2	0.10	0.20410	12	120.00	0.18960
3	0.25	0.20270			
4	0.50	0.20140			
5	1.00	0.19970			
6	2.00	0.19770			
7	4.00	0.19540			
8	8.00	0.19320			
9	16.00	0.19150			
10	30.00	0.19060			

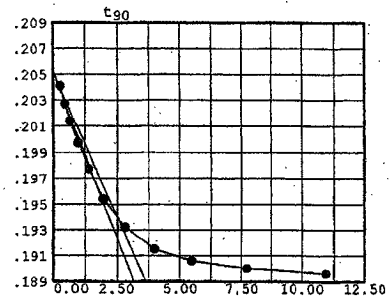

Void Ratio = 0.906 Compression = 6.0 %
 $D_0 = 0.20523$ $D_{90} = 0.19402$ $D_{100} = 0.19278$
 C_v at 6.3 min. = 0.0005 in.²/sec.

Pressure: 16.00 ksf

TEST READINGS

Load No. 11

No.	Elapsed Time	Dial Reading	No.	Elapsed Time	Dial Reading
1	0.00	0.18960	11	60.00	0.15605
2	0.10	0.17930	12	120.00	0.15550
3	0.25	0.17760	13	2273.00	0.15330
4	0.50	0.17565			
5	1.00	0.17270			
6	2.00	0.16970			
7	4.00	0.16550			
8	8.00	0.16085			
9	20.00	0.15770			
10	30.00	0.15680			

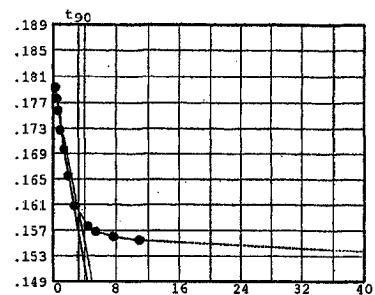

Void Ratio = 0.832 Compression = 9.6 %
 $D_0 = 0.18087$ $D_{90} = 0.16007$ $D_{100} = 0.15776$
 C_v at 10.5 min. = 0.0003 in.²/sec.

Pressure: 32.00 ksf

TEST READINGS

Load No. 12

No.	Elapsed Time	Dial Reading	No.	Elapsed Time	Dial Reading
1	0.00	0.15330	11	60.00	0.11600
2	0.10	0.14500	12	120.00	0.11450
3	0.25	0.14320	13	360.00	0.11410
4	0.50	0.14100			
5	1.00	0.13780			
6	2.00	0.13280			
7	4.00	0.12800			
8	8.00	0.12260			
9	16.00	0.11940			
10	30.00	0.11750			

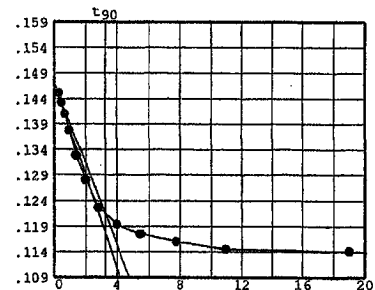

Void Ratio = 0.753 Compression = 13.6 %
 $D_0 = 0.14724$ $D_{90} = 0.12150$ $D_{100} = 0.11864$
 C_v at 10.4 min. = 0.0003 in.²/sec.

Pressure: 64.00 ksf

TEST READINGS

Load No. 13

No.	Elapsed Time	Dial Reading	No.	Elapsed Time	Dial Reading
1	0.00	0.11410	11	60.00	0.06930
2	0.10	0.10850	12	120.00	0.06850
3	0.25	0.10550	13	600.00	0.06710
4	0.50	0.10200			
5	1.00	0.09680			
6	2.00	0.09040			
7	4.00	0.08270			
8	8.00	0.07600			
9	16.00	0.07210			
10	30.00	0.07040			

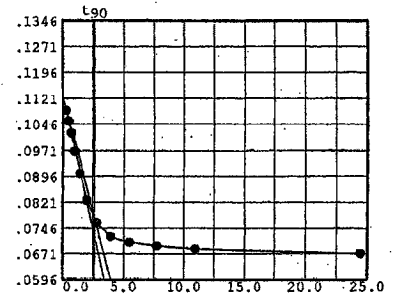

Void Ratio = 0.658 Compression = 18.2 %
D₀ = 0.11297 D₉₀ = 0.07767 D₁₀₀ = 0.07375
C_v at 6.9 min. = 0.0004 in.²/sec.

CONSOLIDATION TEST REPORT

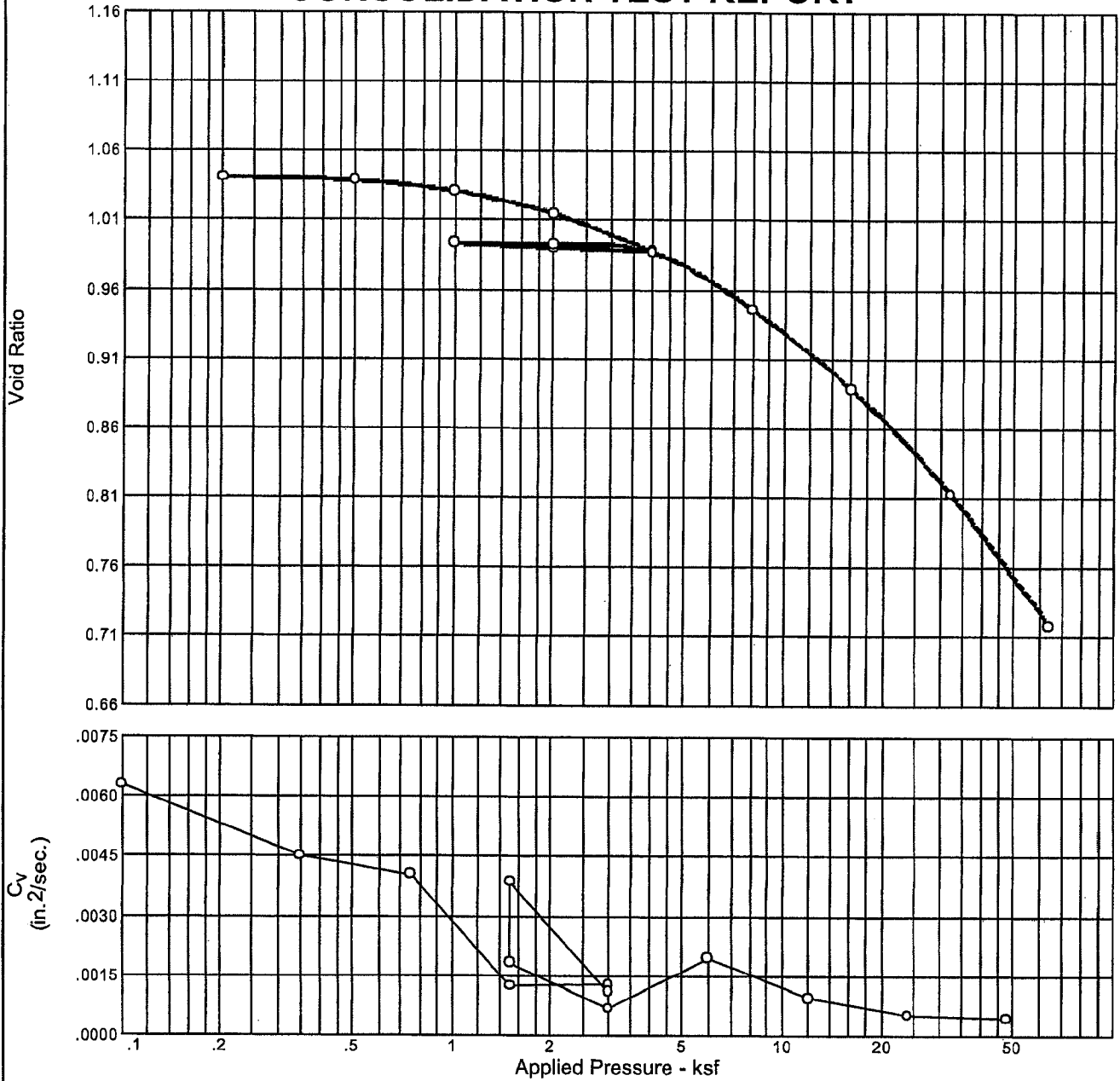

Natural		Dry Dens. (pcf)	LL	PI	Sp. Gr. (assumed)	Overburden (ksf)	P _c (ksf)	C _c	C _r	Initial Void Ratio
Saturation	Moisture									
96.8 %	36.9 %	83.5	54	30	2.73	—	10.79	0.32	0.01	1.041

MATERIAL DESCRIPTION								USCS	AASHTO
Dark yellowish brown fat clay with sand								CH	-

Project No. 3043051021 **Client:** TVA
Project: TVA Kingston - Proposed Gypsum Stack
Location: NB-44 (21'-23.5')

CONSOLIDATION TEST REPORT
MACTEC, INC.

Remarks:
 Material description and classification determined from combined Triaxial CU specimen sample test results

Figure

Dial Reading vs. Time

Project No.: 3043051021

Project: TVA Kingston - Proposed Gypsum Stack

Location: NB-44 (21'-23.5')

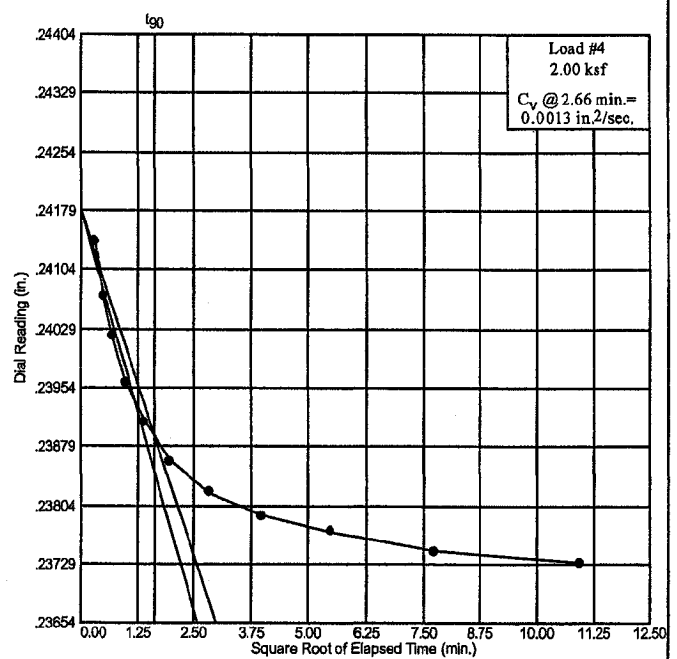
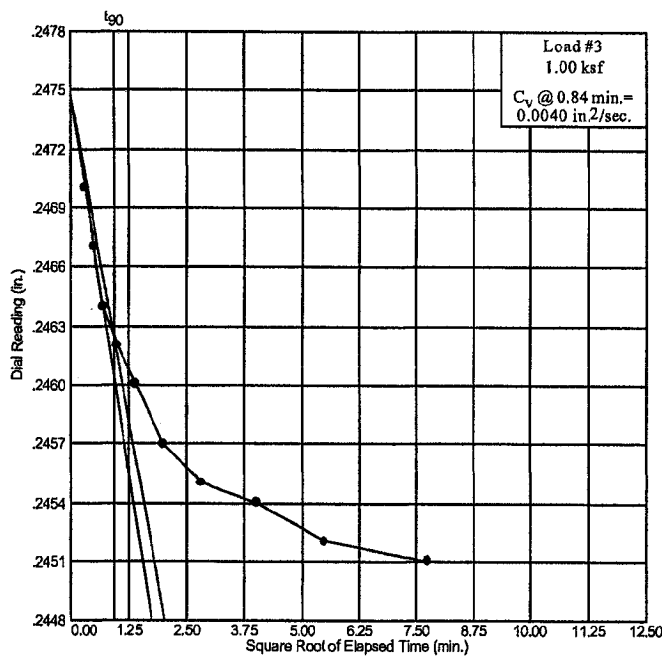
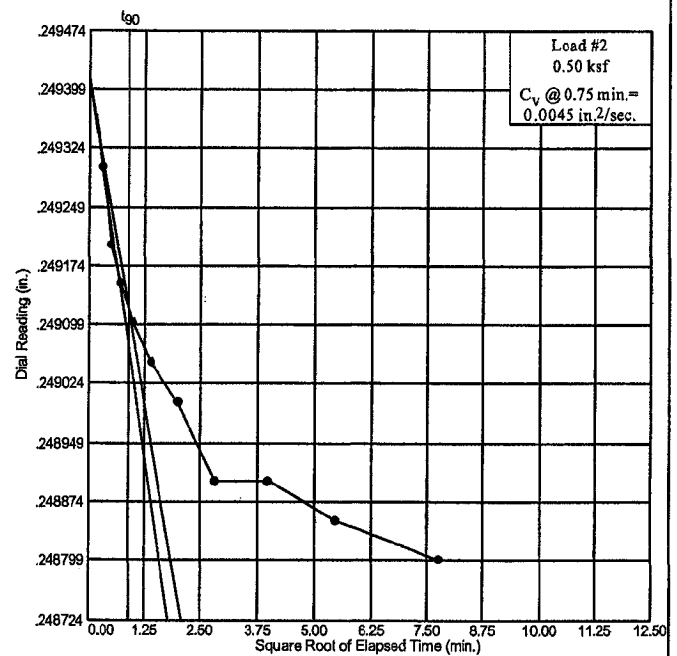
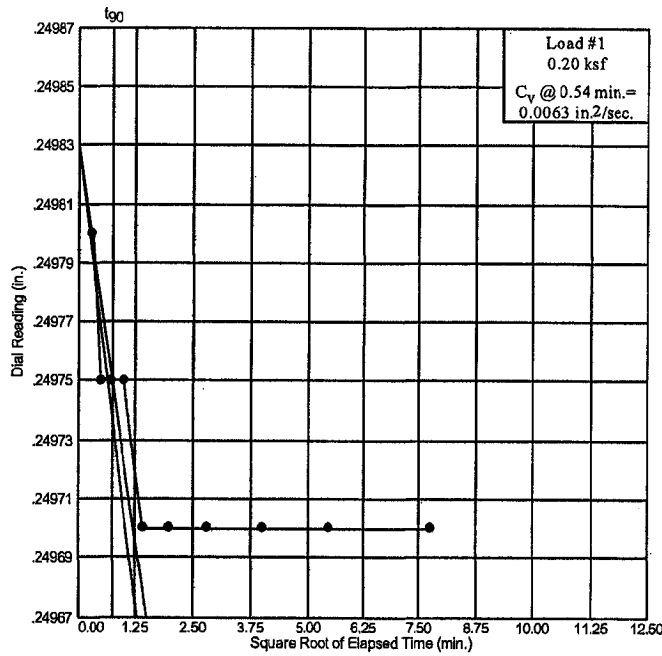

Dial Reading vs. Time
MACTEC, INC.

Figure

CONSOLIDATION TEST DATA

Client: TVA
 Project: TVA Kingston - Proposed Gypsum Stack
 Project Number: 3043051021

Sample Data

Source:
 Sample No.:
 Elev. or Depth: 21'-23.5' Sample Length(in./cm.):
 Location: NB-44 (21'-23.5')
 Description:
 Liquid Limit: 54 Plasticity Index: 30
 USCS: AASHTO: Figure No.:
 Testing Remarks:

Test Specimen Data

TOTAL SAMPLE	BEFORE TEST	AFTER TEST
Wet w+t = 238.55 g.	Consolidometer # = 4	Wet w+t = 121.34 g.
Dry w+t = 203.26 g.		Dry w+t = 95.56 g.
Tare Wt. = 107.70 g.	Spec. Gravity = 2.73	Tare Wt. = .00 g.
Height = .98 in.	Height = .98 in.	
Diameter = 2.38 in.	Diameter = 2.38 in.	
Weight = 130.85 g.	Defl. Table = Reference Set (inches/ksf)	
Moisture = 36.9 %	Ht. Solids = 0.4815 in.	Moisture = 27.0 %
Wet Den. = 114.3 pcf	Dry Wt. = 95.56 g.	Dry Wt. = 95.56 g.*
Den. = 83.5 pcf	Void Ratio = 1.041	Void Ratio = 0.718
	Saturation = 96.8 %	

* Final dry weight used in calculations

End-of-Load Summary

Pressure (ksf)	Final Dial (in.)	Machine Defl. (in.)	C_v (in. ² /sec.)	C_α	Void Ratio	% Compression /Swell
start	0.25000				1.041	
0.20	0.24970	0.00000	0.0063		1.040	0.0 Compr.
0.50	0.24840	0.00040	0.0045		1.039	0.1 Compr.
1.00	0.24430	0.00080	0.0040		1.031	0.5 Compr.
2.00	0.23570	0.00160	0.0013		1.015	1.3 Compr.
4.00	0.22190	0.00240	0.0013		0.988	2.6 Compr.
2.00	0.22390	0.00160	0.0011		0.990	2.5 Compr.
1.00	0.22620	0.00080	0.0039		0.993	2.3 Compr.
2.00	0.22490	0.00160	0.0018		0.992	2.4 Compr.
4.00	0.22100	0.00300	0.0007		0.987	2.6 Compr.
8.00	0.20400	0.00000	0.0020		0.945	4.7 Compr.
16.00	0.17660	0.00000	0.0010		0.889	7.5 Compr.
32.00	0.13990	0.00000	0.0005		0.812	11.2 Compr.
64.00	0.09460	0.00000	0.0005		0.718	15.8 Compr.

$C_c = 0.32$ $P_c = 10.79$ ksf $C_r = 0.01$

Pressure: 0.20 ksf

TEST READINGS

Load No. 1

No.	Elapsed Time	Dial Reading	No.	Elapsed Time	Dial Reading
1	0.00	0.25000	11	60.00	0.24970
2	0.10	0.24980			
3	0.25	0.24975			
4	0.50	0.24975			
5	1.00	0.24975			
6	2.00	0.24970			
7	4.00	0.24970			
8	8.00	0.24970			
9	16.00	0.24970			
10	30.00	0.24970			

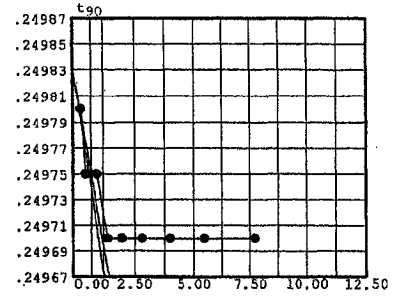

Void Ratio = 1.040 Compression = 0.0 %
 $D_0 = 0.24983$ $D_{90} = 0.24975$ $D_{100} = 0.24974$
 C_v at 0.5 min. = 0.0063 in.²/sec.

Pressure: 0.50 ksf

TEST READINGS

Load No. 2

No.	Elapsed Time	Dial Reading	No.	Elapsed Time	Dial Reading
1	0.00	0.24970	11	60.00	0.24840
2	0.10	0.24890			
3	0.25	0.24880			
4	0.50	0.24875			
5	1.00	0.24870			
6	2.00	0.24865			
7	4.00	0.24860			
8	8.00	0.24850			
9	16.00	0.24850			
10	30.00	0.24845			

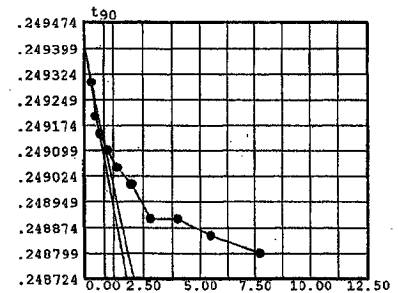

Void Ratio = 1.039 Compression = 0.1 %
 $D_0 = 0.24941$ $D_{90} = 0.24912$ $D_{100} = 0.24909$
 C_v at 0.8 min. = 0.0045 in.²/sec.

Pressure: 1.00 ksf

TEST READINGS

Load No. 3

No.	Elapsed Time	Dial Reading	No.	Elapsed Time	Dial Reading
1	0.00	0.24840	11	60.00	0.24430
2	0.10	0.24620			
3	0.25	0.24590			
4	0.50	0.24560			
5	1.00	0.24540			
6	2.00	0.24520			
7	4.00	0.24490			
8	8.00	0.24470			
9	16.00	0.24460			
10	30.00	0.24440			

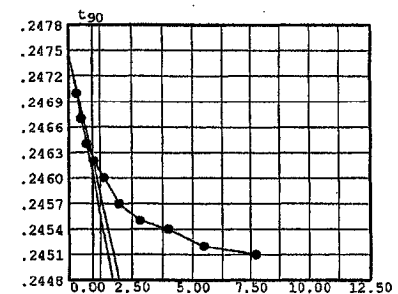

Void Ratio = 1.031 Compression = 0.5 %
 $D_0 = 0.24748$ $D_{90} = 0.24626$ $D_{100} = 0.24612$
 C_v at 0.8 min. = 0.0040 in.²/sec.

Pressure: 2.00 ksf

TEST READINGS

Load No. 4

No.	Elapsed Time	Dial Reading	No.	Elapsed Time	Dial Reading
1	0.00	0.24430	11	60.00	0.23585
2	0.10	0.23980	12	120.00	0.23570
3	0.25	0.23910			
4	0.50	0.23860			
5	1.00	0.23800			
6	2.00	0.23750			
7	4.00	0.23700			
8	8.00	0.23660			
9	16.00	0.23630			
10	30.00	0.23610			

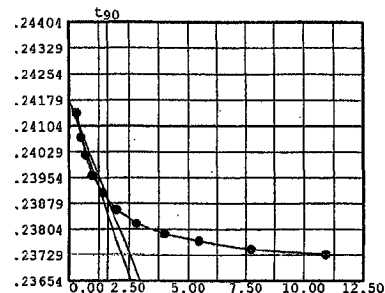

Void Ratio = 1.015 Compression = 1.3 %
 $D_0 = 0.24180$ $D_{90} = 0.23891$ $D_{100} = 0.23859$
 C_v at 2.7 min. = 0.0013 in.²/sec.

Pressure: 4.00 ksf

TEST READINGS

Load No. 5

No.	Elapsed Time	Dial Reading	No.	Elapsed Time	Dial Reading
1	0.00	0.23570	11	60.00	0.22290
2	0.10	0.22870	12	120.00	0.22270
3	0.25	0.22770	13	240.00	0.22250
4	0.50	0.22680	14	1533.00	0.22190
5	1.00	0.22590			
6	2.00	0.22510			
7	4.00	0.22450			
8	8.00	0.22390			
9	16.00	0.22340			
10	30.00	0.22310			

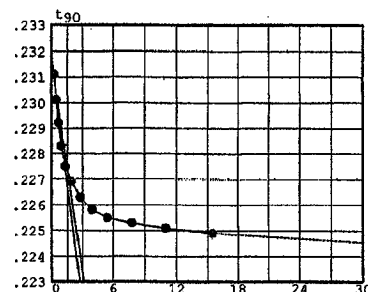

Void Ratio = 0.988 Compression = 2.6 %
 $D_0 = 0.23177$ $D_{90} = 0.22732$ $D_{100} = 0.22682$
 C_v at 2.5 min. = 0.0013 in.²/sec.

Pressure: 2.00 ksf

TEST READINGS

Load No. 6

No.	Elapsed Time	Dial Reading	No.	Elapsed Time	Dial Reading
1	0.00	0.22190	11	97.00	0.22380
2	0.10	0.22310	12	933.00	0.22390
3	0.25	0.22320			
4	0.50	0.22330			
5	1.00	0.22340			
6	2.00	0.22350			
7	4.00	0.22360			
8	8.00	0.22365			
9	16.00	0.22370			
10	30.00	0.22370			

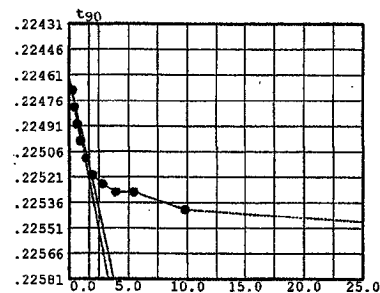

Void Ratio = 0.990 Compression = 2.5 %
 $D_0 = 0.22462$ $D_{90} = 0.22515$ $D_{100} = 0.22521$
 C_v at 2.9 min. = 0.0011 in.²/sec.

Pressure: 1.00 ksf

TEST READINGS

Load No. 7

No.	Elapsed Time	Dial Reading	No.	Elapsed Time	Dial Reading
1	0.00	0.22390	11	60.00	0.22610
2	0.10	0.22500	12	120.00	0.22620
3	0.25	0.22515			
4	0.50	0.22530			
5	1.00	0.22540			
6	2.00	0.22550			
7	4.00	0.22570			
8	8.00	0.22580			
9	16.00	0.22590			
10	30.00	0.22600			

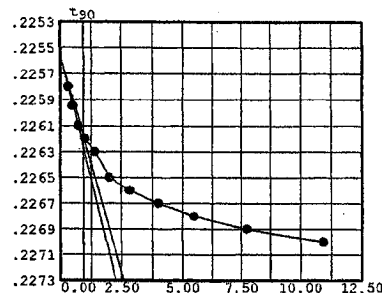

Void Ratio = 0.993 Compression = 2.3 %
 $D_0 = 0.22556$ $D_{90} = 0.22617$ $D_{100} = 0.22624$
 C_v at 0.8 min. = 0.0039 in.²/sec.

Pressure: 2.00 ksf

TEST READINGS

Load No. 8

No.	Elapsed Time	Dial Reading	No.	Elapsed Time	Dial Reading
1	0.00	0.22620	11	60.00	0.22490
2	0.10	0.22535			
3	0.25	0.22530			
4	0.50	0.22525			
5	1.00	0.22515			
6	2.00	0.22510			
7	4.00	0.22505			
8	8.00	0.22500			
9	16.00	0.22500			
10	30.00	0.22495			

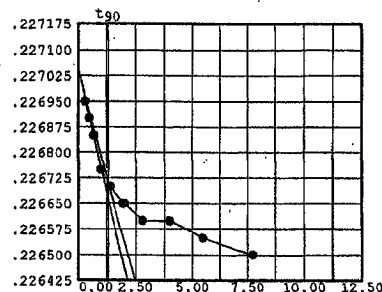

Void Ratio = 0.992 Compression = 2.4 %
 $D_0 = 0.22705$ $D_{90} = 0.22671$ $D_{100} = 0.22667$
 C_v at 1.8 min. = 0.0018 in.²/sec.

Pressure: 4.00 ksf

TEST READINGS

Load No. 9

No.	Elapsed Time	Dial Reading	No.	Elapsed Time	Dial Reading
1	0.00	0.22490	11	60.00	0.22140
2	0.10	0.22280	12	145.00	0.22125
3	0.25	0.22255	13	1238.00	0.22100
4	0.50	0.22230			
5	1.00	0.22215			
6	2.00	0.22200			
7	4.00	0.22180			
8	8.00	0.22170			
9	16.00	0.22160			
10	30.00	0.22150			

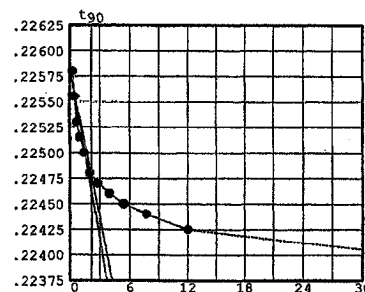

Void Ratio = 0.987 Compression = 2.6 %
 $D_0 = 0.22581$ $D_{90} = 0.22478$ $D_{100} = 0.22467$
 C_v at 4.6 min. = 0.0007 in.²/sec.

Pressure: 8.00 ksf

TEST READINGS

Load No. 10

No.	Elapsed Time	Dial Reading	No.	Elapsed Time	Dial Reading
1	0.00	0.22100	11	116.00	0.20420
2	0.10	0.21250	12	129.00	0.20400
3	0.25	0.21120			
4	0.50	0.21000			
5	1.00	0.20870			
6	2.00	0.20760			
7	5.00	0.20625			
8	8.00	0.20570			
9	16.00	0.20510			
10	30.00	0.20470			

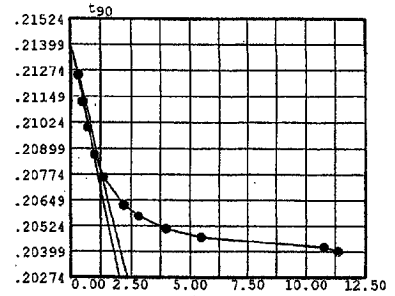

Void Ratio = 0.945 Compression = 4.7 %
 $D_0 = 0.21408$ $D_{90} = 0.20797$ $D_{100} = 0.20730$
 C_v at 1.6 min. = 0.0020 in.²/sec.

Pressure: 16.00 ksf

TEST READINGS

Load No. 11

No.	Elapsed Time	Dial Reading	No.	Elapsed Time	Dial Reading
1	0.00	0.20400	11	60.00	0.17890
2	0.10	0.19330	12	120.00	0.17850
3	0.25	0.19130	13	2242.00	0.17660
4	0.50	0.18945			
5	1.00	0.18730			
6	2.00	0.18500			
7	4.00	0.18280			
8	8.00	0.18115			
9	16.00	0.18005			
10	30.00	0.17940			

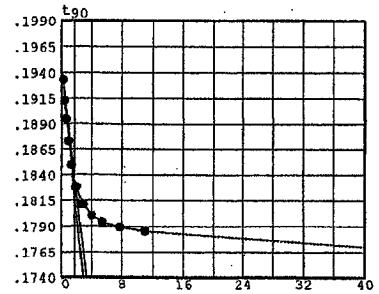

Void Ratio = 0.889 Compression = 7.5 %
 $D_0 = 0.19515$ $D_{90} = 0.18367$ $D_{100} = 0.18239$
 C_v at 3.1 min. = 0.0010 in.²/sec.

Pressure: 32.00 ksf

TEST READINGS

Load No. 12

No.	Elapsed Time	Dial Reading	No.	Elapsed Time	Dial Reading
1	0.00	0.17660	11	60.00	0.14150
2	0.10	0.16450	12	120.00	0.14050
3	0.25	0.16190	13	360.00	0.13990
4	0.50	0.15920			
5	1.00	0.15600			
6	2.00	0.15240			
7	4.00	0.14880			
8	8.00	0.14620			
9	16.00	0.14440			
10	30.00	0.14250			

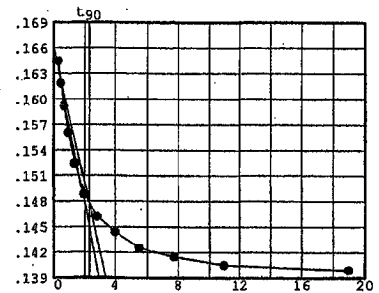

Void Ratio = 0.812 Compression = 11.2 %
 $D_0 = 0.16632$ $D_{90} = 0.14792$ $D_{100} = 0.14588$
 C_v at 5.2 min. = 0.0005 in.²/sec.

Pressure: 64.00 ksf

TEST READINGS

Load No. 13

No.	Elapsed Time	Dial Reading	No.	Elapsed Time	Dial Reading
1	0.00	0.13990	11	60.00	0.09700
2	0.10	0.12400	12	120.00	0.09610
3	0.25	0.12160	13	1320.00	0.09460
4	0.50	0.11850			
5	1.00	0.11460			
6	2.00	0.10980			
7	4.00	0.10480			
8	8.00	0.10150			
9	16.00	0.09930			
10	30.00	0.09800			

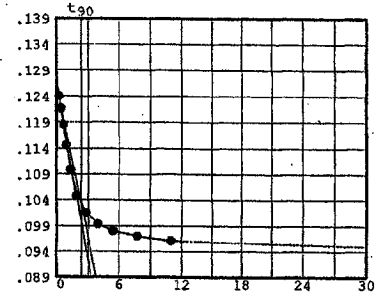

Void Ratio = 0.718 Compression = 15.8 %
D₀ = 0.12698 D₉₀ = 0.10342 D₁₀₀ = 0.10081
C_v at 5.5 min. = 0.0005 in.²/sec.

CONSOLIDATION TEST REPORT

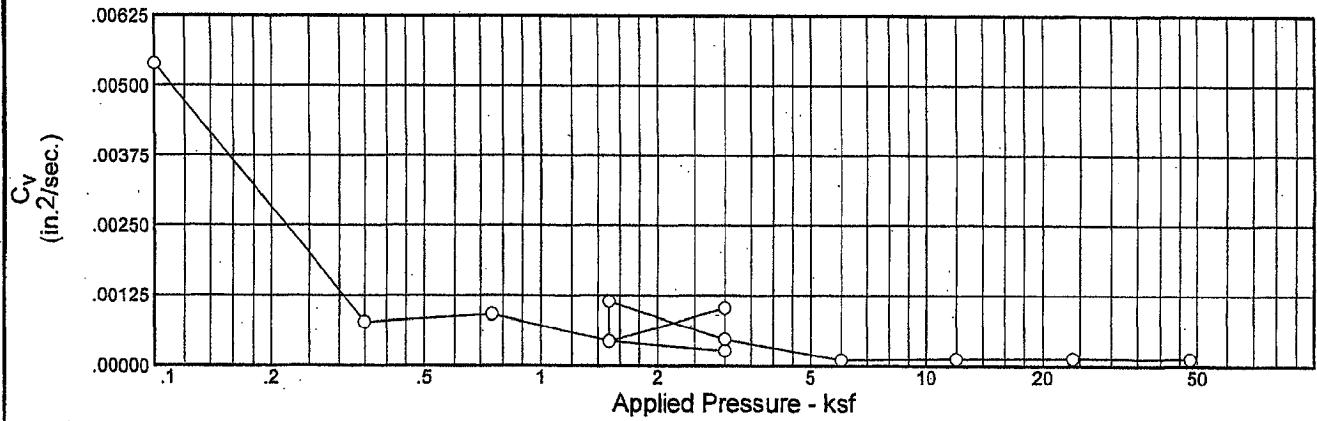

Natural		Dry Dens. (pcf)	LL	PI	Sp. Gr.	Overburden (ksf)	P _c (ksf)	C _c	C _r	Initial Void Ratio
Saturation	Moisture									
96.1 %	54.2 %	67.2	74	42	2.74	—	5.84	0.61	0.02	1.545

MATERIAL DESCRIPTION								USCS	AASHTO
Brown fat clay with sand								CH	-

Project No. 3043051021 Client: TVA Project: TVA Kingston - Proposed Gypsum Stack Location: NB-44 (31'-33')	Remarks:
CONSOLIDATION TEST REPORT MACTEC, INC.	
Figure	

Dial Reading vs. Time

Project No.: 3043051021

Project: TVA Kingston - Proposed Gypsum Stack

Location: NB-44 (31'-33')

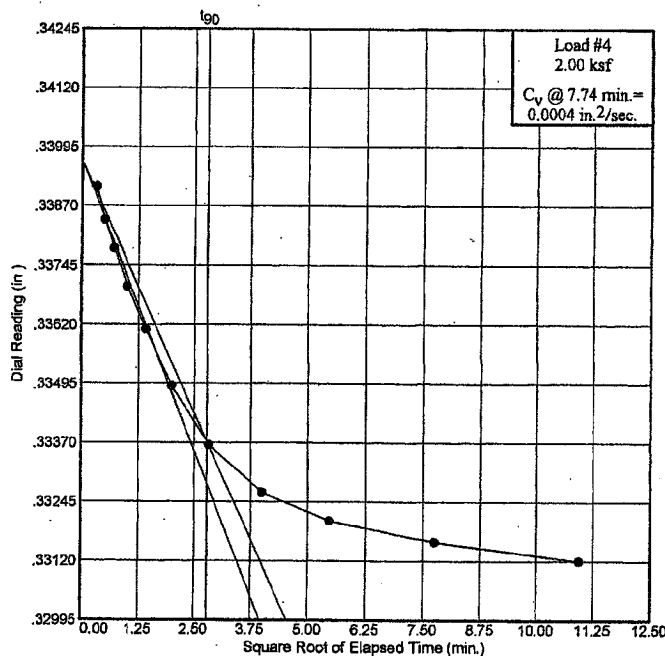
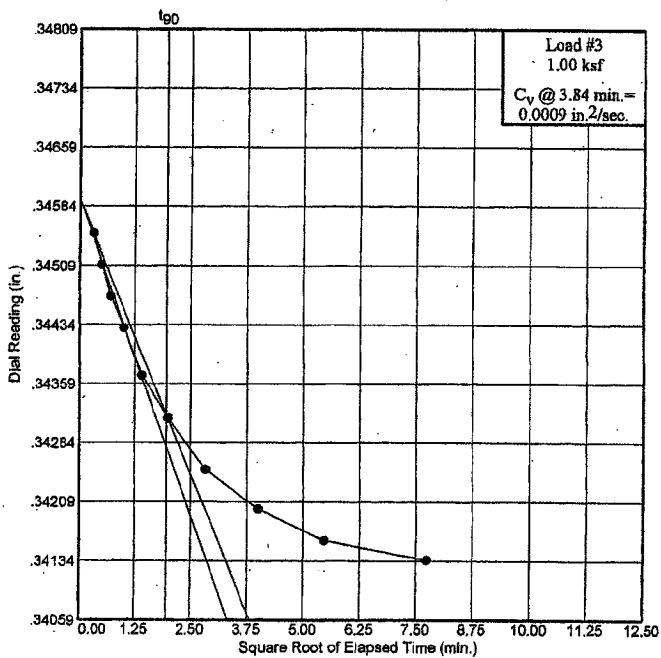
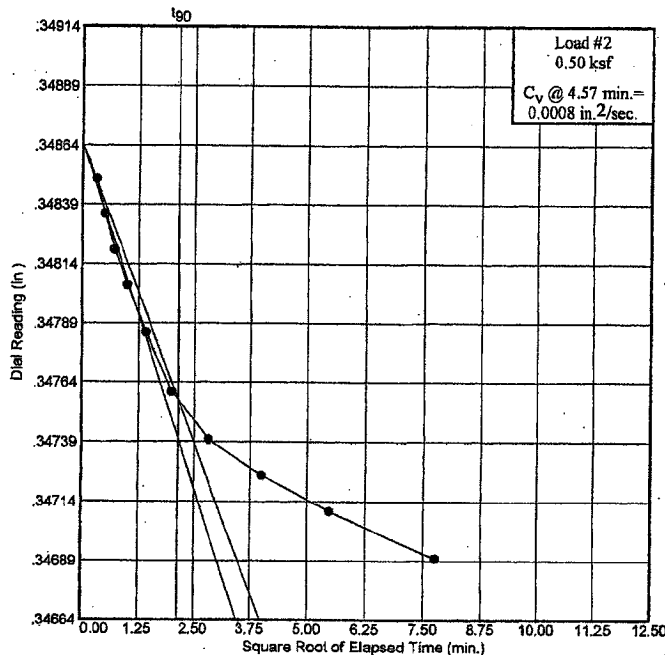
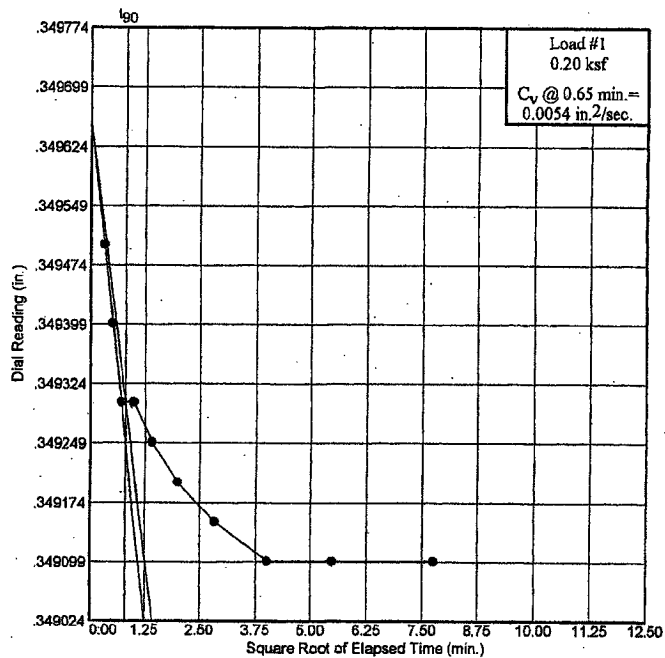

Dial Reading vs. Time
MACTEC, INC.

Figure

Dial Reading vs. Time

Project No.: 3043051021

Project: TVA Kingston - Proposed Gypsum Stack

Location: NB-44 (31'-33')

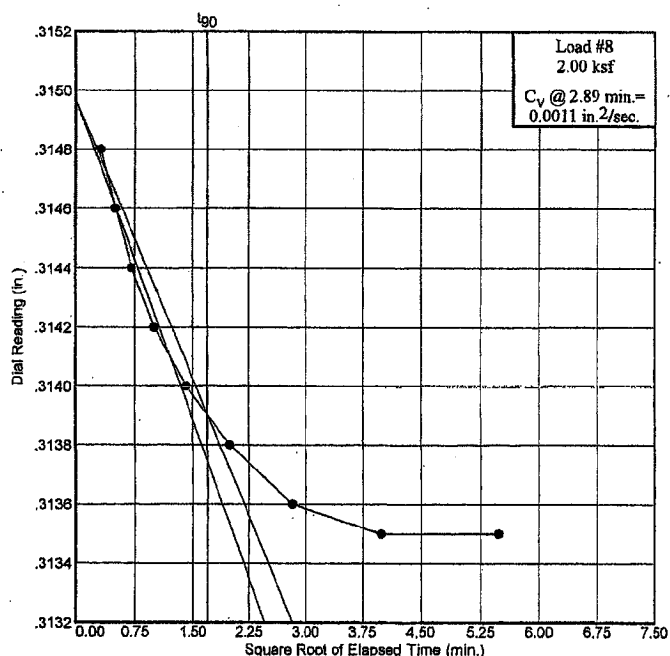
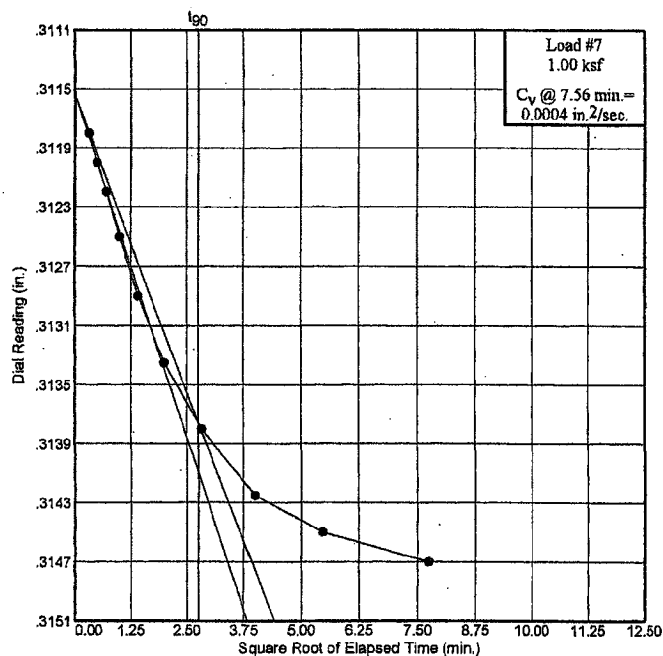
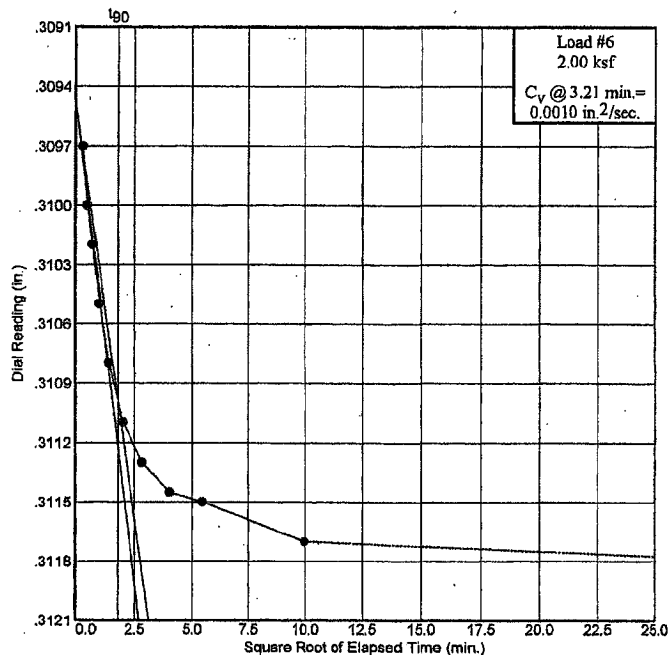
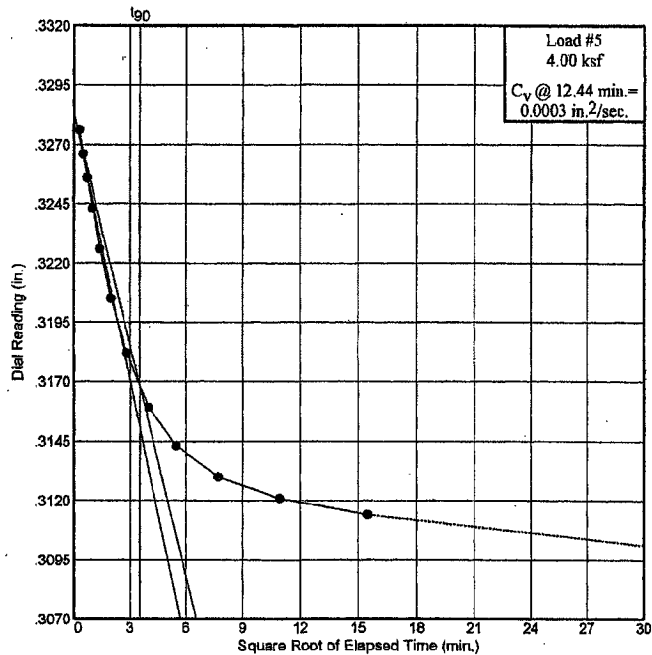

Dial Reading vs. Time
MACTEC, INC.

Figure

Dial Reading vs. Time

Project No.: 3043051021

Project: TVA Kingston - Proposed Gypsum Stack

Location: NB-44 (31'-33')

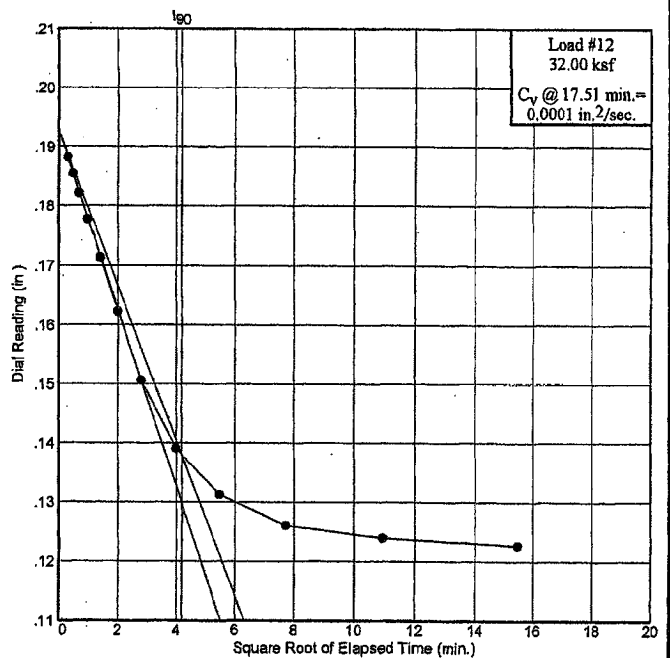
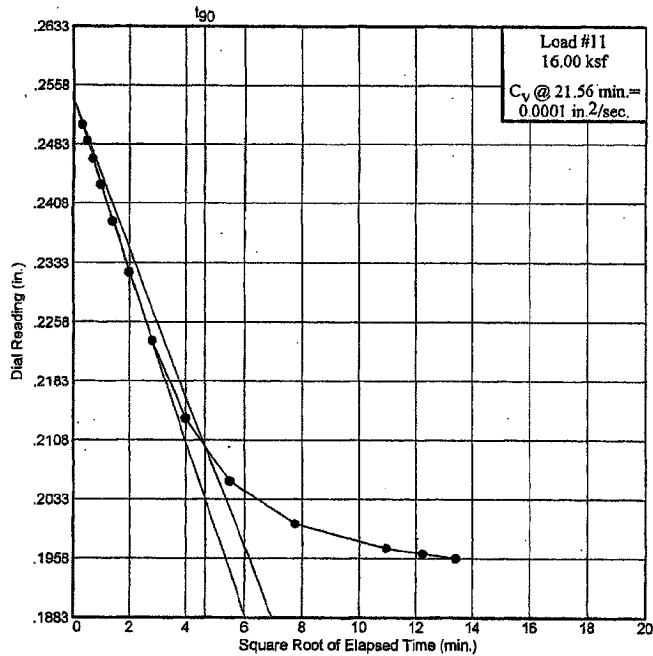
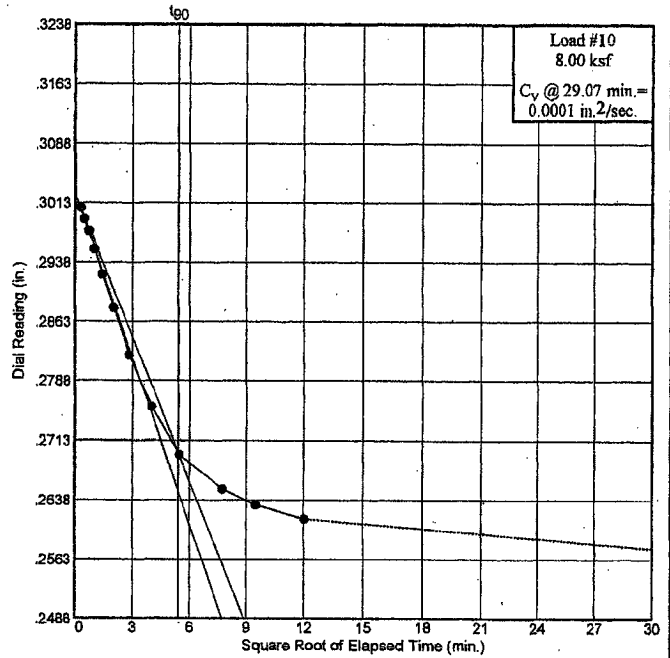
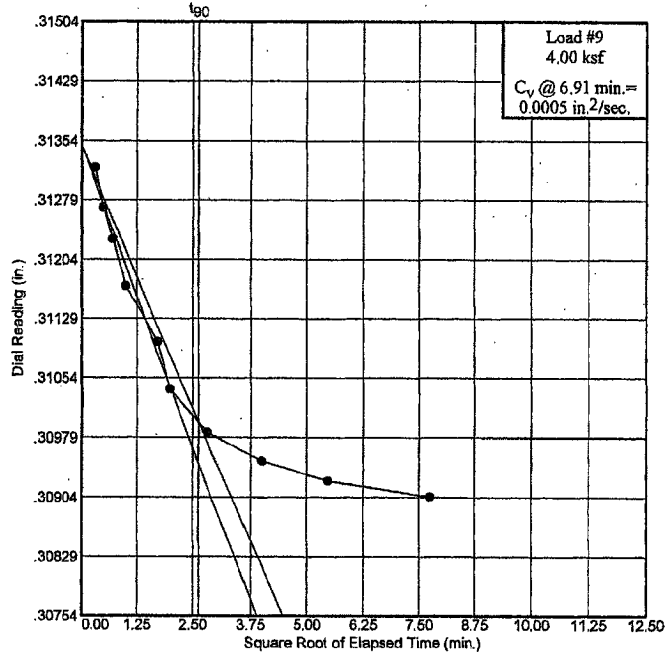

Dial Reading vs. Time
MACTEC, INC.

Figure

Dial Reading vs. Time

Project No.: 3043051021

Project: TVA Kingston - Proposed Gypsum Stack

Location: NB-44 (31'-33')

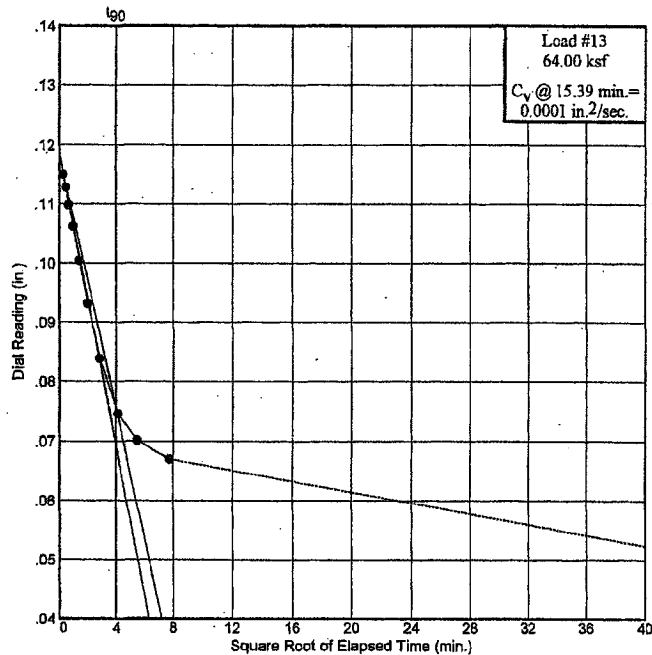

Dial Reading vs. Time

MACTEC, INC.

Figure

CONSOLIDATION TEST DATA

Client: TVA
 Project: TVA Kingston - Proposed Gypsum Stack
 Project Number: 3043051021

Sample Data

Source:
 Sample No.: UD-6
 Elev. or Depth: 31'-33' Sample Length(in./cm.):
 Location: NB-44 (31'-33')
 Description:
 Liquid Limit: 74 Plasticity Index: 42
 USCS: AASHTO: Figure No.:
 Testing Remarks:

Test Specimen Data

TOTAL SAMPLE	BEFORE TEST	AFTER TEST
Wet w+t = 231.55 g.	Consolidometer # = 5	Wet w+t = 103.21 g.
Dry w+t = 189.14 g.		Dry w+t = 78.28 g.
Tare Wt. = 110.86 g.	Spec. Gravity = 2.74	Tare Wt. = .00 g.
Height = 1.00 in.	Height = 1.00 in.	
Diameter = 2.38 in.	Diameter = 2.38 in.	
Weight = 120.69 g.	Defl. Table = Reference Set (inches/ksf)	
Moisture = 54.2 %	Ht. Solids = 0.3927 in.	Moisture = 31.8 %
Wet Den. = 103.6 pcf	Dry Wt. = 78.28 g.	Dry Wt. = 78.28 g.*
Dry Den. = 67.2 pcf	Void Ratio = 1.545	Void Ratio = 0.782
	Saturation = 96.1 %	

* Final dry weight used in calculations

End-of-Load Summary

Pressure (ksf)	Final Dial (in.)	Machine Defl. (in.)	C _v (in. ² /sec.)	C _α	Void Ratio	% Compression /Swell
start	0.35000				1.545	
0.20	0.34910	0.00000	0.0054		1.543	0.1 Compr.
0.50	0.34650	0.00040	0.0008		1.537	0.3 Compr.
1.00	0.34055	0.00080	0.0009		1.523	0.9 Compr.
2.00	0.32960	0.00160	0.0004		1.497	1.9 Compr.
4.00	0.30710	0.00240	0.0003		1.442	4.1 Compr.
2.00	0.31020	0.00160	0.0010		1.448	3.8 Compr.
1.00	0.31390	0.00080	0.0004		1.455	3.5 Compr.
2.00	0.31190	0.00160	0.0011		1.452	3.7 Compr.
4.00	0.30605	0.00300	0.0005		1.441	4.1 Compr.
8.00	0.25640	0.00000	0.0001		1.307	9.4 Compr.
16.00	0.19580	0.00000	0.0001		1.152	15.4 Compr.
32.00	0.12270	0.00000	0.0001		0.966	22.7 Compr.
64.00	0.05030	0.00000	0.0001		0.782	30.0 Compr.

C_c = 0.61 P_c = 5.84 ksf C_r = 0.02

MACTEC, INC.

Pressure: 0.20 ksf

TEST READINGS

Load No. 1

No.	Elapsed Time	Dial Reading	No.	Elapsed Time	Dial Reading
1	0.00	0.35000	11	60.00	0.34910
2	0.10	0.34950			
3	0.25	0.34940			
4	0.50	0.34930			
5	1.00	0.34930			
6	2.00	0.34925			
7	4.00	0.34920			
8	8.00	0.34915			
9	16.00	0.34910			
10	30.00	0.34910			

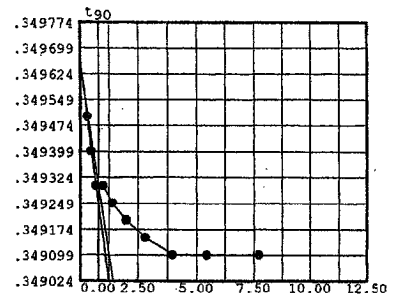

Void Ratio = 1.543 Compression = 0.1 %
 $D_0 = 0.34966$ $D_{90} = 0.34930$ $D_{100} = 0.34926$
 C_v at 0.7 min. = 0.0054 in.²/sec.

Pressure: 0.50 ksf

TEST READINGS

Load No. 2

No.	Elapsed Time	Dial Reading	No.	Elapsed Time	Dial Reading
1	0.00	0.34910	11	60.00	0.34650
2	0.10	0.34810			
3	0.25	0.34795			
4	0.50	0.34780			
5	1.00	0.34765			
6	2.00	0.34745			
7	4.00	0.34720			
8	8.00	0.34700			
9	16.00	0.34685			
10	30.00	0.34670			

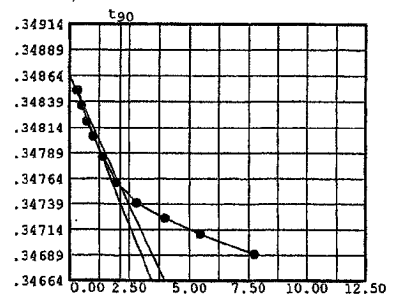

Void Ratio = 1.537 Compression = 0.3 %
 $D_0 = 0.34865$ $D_{90} = 0.34757$ $D_{100} = 0.34745$
 C_v at 4.6 min. = 0.0008 in.²/sec.

Pressure: 1.00 ksf

TEST READINGS

Load No. 3

No.	Elapsed Time	Dial Reading	No.	Elapsed Time	Dial Reading
1	0.00	0.34650	11	60.00	0.34055
2	0.10	0.34470			
3	0.25	0.34430			
4	0.50	0.34390			
5	1.00	0.34350			
6	2.00	0.34290			
7	4.00	0.34235			
8	8.00	0.34170			
9	16.00	0.34120			
10	30.00	0.34080			

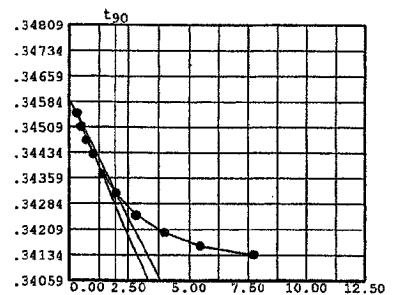

Void Ratio = 1.523 Compression = 0.9 %
 $D_0 = 0.34593$ $D_{90} = 0.34319$ $D_{100} = 0.34288$
 C_v at 3.8 min. = 0.0009 in.²/sec.

Pressure: 2.00 ksf

TEST READINGS

Load No. 4

No.	Elapsed Time	Dial Reading	No.	Elapsed Time	Dial Reading
1	0.00	0.34055	11	60.00	0.33000
2	0.10	0.33750	12	120.00	0.32960
3	0.25	0.33680			
4	0.50	0.33620			
5	1.00	0.33540			
6	2.00	0.33450			
7	4.00	0.33330			
8	8.00	0.33205			
9	16.00	0.33105			
10	30.00	0.33045			

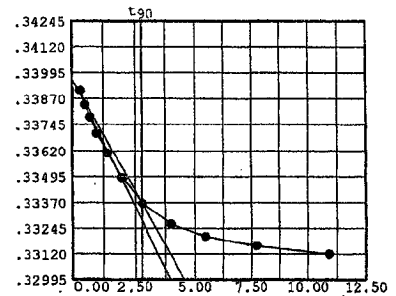

Void Ratio = 1.497 Compression = 1.9 %
 $D_0 = 0.33964$ $D_{90} = 0.33372$ $D_{100} = 0.33306$
 C_v at 7.7 min. = 0.0004 in.²/sec.

Pressure: 4.00 ksf

TEST READINGS

Load No. 5

No.	Elapsed Time	Dial Reading	No.	Elapsed Time	Dial Reading
1	0.00	0.32960	11	60.00	0.31060
2	0.10	0.32520	12	120.00	0.30970
3	0.25	0.32420	13	240.00	0.30900
4	0.50	0.32320	14	1344.00	0.30710
5	1.00	0.32190			
6	2.00	0.32020			
7	4.00	0.31810			
8	8.00	0.31580			
9	16.00	0.31350			
10	30.00	0.31190			

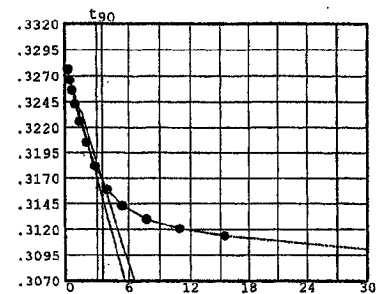

Void Ratio = 1.442 Compression = 4.1 %
 $D_0 = 0.32832$ $D_{90} = 0.31683$ $D_{100} = 0.31555$
 C_v at 12.4 min. = 0.0003 in.²/sec.

Pressure: 2.00 ksf

TEST READINGS

Load No. 6

No.	Elapsed Time	Dial Reading	No.	Elapsed Time	Dial Reading
1	0.00	0.30710	11	100.00	0.31010
2	0.10	0.30810	12	936.00	0.31020
3	0.25	0.30840			
4	0.50	0.30860			
5	1.00	0.30890			
6	2.00	0.30920			
7	4.00	0.30950			
8	8.00	0.30970			
9	16.00	0.30985			
10	30.00	0.30990			

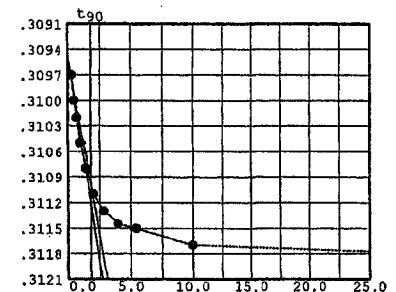

Void Ratio = 1.448 Compression = 3.8 %
 $D_0 = 0.30947$ $D_{90} = 0.31099$ $D_{100} = 0.31116$
 C_v at 3.2 min. = 0.0010 in.²/sec.

Pressure: 1.00 ksf

TEST READINGS

Load No. 7

No.	Elapsed Time	Dial Reading	No.	Elapsed Time	Dial Reading
1	0.00	0.31020	11	60.00	0.31390
2	0.10	0.31100			
3	0.25	0.31120			
4	0.50	0.31140			
5	1.00	0.31170			
6	2.00	0.31210			
7	4.00	0.31255			
8	8.00	0.31300			
9	16.00	0.31345			
10	30.00	0.31370			

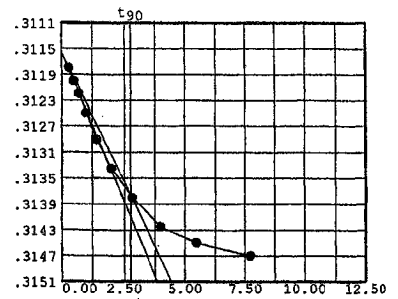

Void Ratio = 1.455 Compression = 3.5 %
 $D_0 = 0.31154$ $D_{90} = 0.31376$ $D_{100} = 0.31400$
 C_v at 7.6 min. = 0.0004 in.²/sec.

Pressure: 2.00 ksf

TEST READINGS

Load No. 8

No.	Elapsed Time	Dial Reading
1	0.00	0.31390
2	0.10	0.31320
3	0.25	0.31300
4	0.50	0.31280
5	1.00	0.31260
6	2.00	0.31240
7	4.00	0.31220
8	8.00	0.31200
9	16.00	0.31190
10	30.00	0.31190

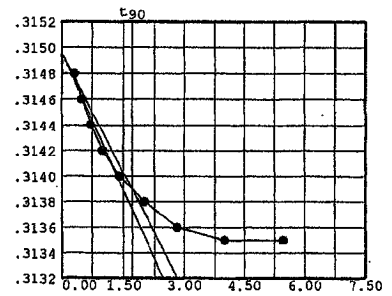

Void Ratio = 1.452 Compression = 3.7 %
 $D_0 = 0.31497$ $D_{90} = 0.31390$ $D_{100} = 0.31378$
 C_v at 2.9 min. = 0.0011 in.²/sec.

Pressure: 4.00 ksf

TEST READINGS

Load No. 9

No.	Elapsed Time	Dial Reading	No.	Elapsed Time	Dial Reading
1	0.00	0.31190	11	60.00	0.30605
2	0.10	0.31020			
3	0.25	0.30970			
4	0.50	0.30930			
5	1.00	0.30870			
6	3.00	0.30800			
7	4.00	0.30740			
8	8.00	0.30685			
9	16.00	0.30650			
10	30.00	0.30625			

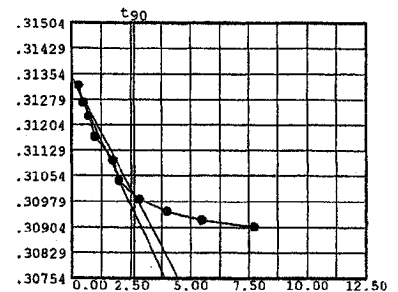

Void Ratio = 1.441 Compression = 4.1 %
 $D_0 = 0.31348$ $D_{90} = 0.30998$ $D_{100} = 0.30959$
 C_v at 6.9 min. = 0.0005 in.²/sec.

Pressure: 8.00 ksf

TEST READINGS

Load No. 10

No.	Elapsed Time	Dial Reading	No.	Elapsed Time	Dial Reading
1	0.00	0.30605	11	60.00	0.26520
2	0.10	0.30070	12	90.00	0.26320
3	0.25	0.29920	13	145.00	0.26140
4	0.50	0.29770	14	1313.00	0.25640
5	1.00	0.29540			
6	2.00	0.29220			
7	4.00	0.28800			
8	8.00	0.28200			
9	16.00	0.27550			
10	30.00	0.26950			

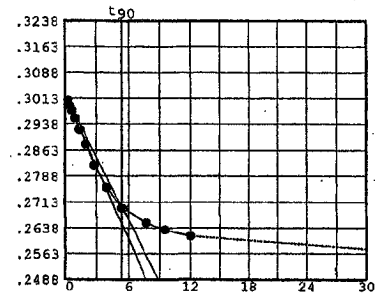

Void Ratio = 1.307 Compression = 9.4 %
 $D_0 = 0.30243$ $D_{90} = 0.26985$ $D_{100} = 0.26623$
 C_v at 29.1 min. = 0.0001 in.²/sec.

Pressure: 16.00 ksf

TEST READINGS

Load No. 11

No.	Elapsed Time	Dial Reading	No.	Elapsed Time	Dial Reading
1	0.00	0.25640	11	60.00	0.20020
2	0.10	0.25070	12	120.00	0.19710
3	0.25	0.24870	13	150.00	0.19640
4	0.50	0.24640	14	180.00	0.19580
5	1.00	0.24310			
6	2.00	0.23850			
7	4.00	0.23210			
8	8.00	0.22345			
9	16.00	0.21355			
10	30.00	0.20560			

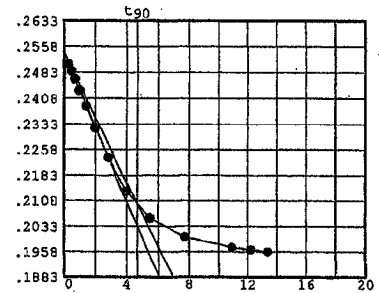

Void Ratio = 1.152 Compression = 15.4 %
 $D_0 = 0.25406$ $D_{90} = 0.21009$ $D_{100} = 0.20521$
 C_v at 21.6 min. = 0.0001 in.²/sec.

Pressure: 32.00 ksf

TEST READINGS

Load No. 12

No.	Elapsed Time	Dial Reading	No.	Elapsed Time	Dial Reading
1	0.00	0.19580	11	60.00	0.12610
2	0.10	0.18820	12	120.00	0.12400
3	0.25	0.18545	13	240.00	0.12270
4	0.50	0.18215			
5	1.00	0.17770			
6	2.00	0.17130			
7	4.00	0.16230			
8	8.00	0.15065			
9	16.00	0.13905			
10	30.00	0.13130			

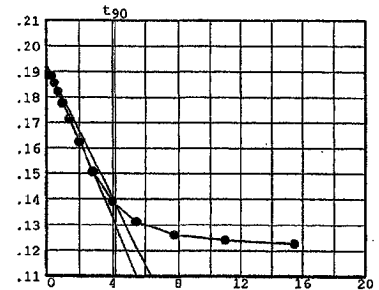

Void Ratio = 0.966 Compression = 22.7 %
 $D_0 = 0.19280$ $D_{90} = 0.13808$ $D_{100} = 0.13201$
 C_v at 17.5 min. = 0.0001 in.²/sec.

Pressure: 64.00 ksf

TEST READINGS

Load No. 13

No.	Elapsed Time	Dial Reading	No.	Elapsed Time	Dial Reading
1	0.00	0.12270	11	60.00	0.06700
2	0.10	0.11490	12	1980.00	0.05030
3	0.25	0.11270			
4	0.50	0.10980			
5	1.00	0.10610			
6	2.00	0.10040			
7	4.00	0.09310			
8	8.00	0.08380			
9	17.00	0.07450			
10	30.00	0.07010			

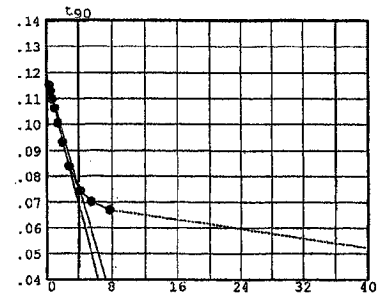

Void Ratio = 0.782 Compression = 30.0 %
D₀ = 0.11865 D₉₀ = 0.07594 D₁₀₀ = 0.07119
C_v at 15.4 min. = 0.0001 in.²/sec.

PINHOLE TEST RESULTS

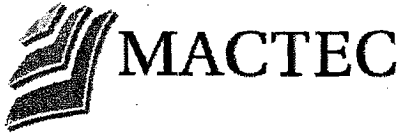

Job Record Number: 00346
Lab ID Number: 004247

Identification and Classification of Dispersive Clay Soils by Pinhole Test
(ASTM D4647-93)

Project Name: TVA Kingston-Proposed Gypsum Disposal Area
Project Number: 3043-05-1021

Tested By: JM
Test Date: 8/8/2005
Reviewed By: TJ
Review Date: 9/13/05

Sample Identification: NB-44 UD1
Moisture Content: _____
Sample Weight, (grams): _____
Sample Volume, (Ft³): 0.0012
Dry Density, (pcf): 0.0
Test Method: A

Hydraulic Head (mm)	Rate of Flow (ml/sec)	Cloudiness	Length of Test (minutes)	Hole Diameter, (mm)		Classification
				Before Test	After Test	
51	0.20	CC	5	1.0	1.0	ND1
178	0.30	CC	5	1.0	1.0	ND1
381	0.32	CC	5	1.0	1.0	ND1
1016	0.32	CC	5	1.0	1.0	ND1

ASTM D 4647-93

Job Record Number: 00346

Lab ID Number: 004247

PINHOLE TEST DATA

Project Name: TVA Kingston-Disposal Area
 Project No. 3043-05-1021
 Sample No. NB-44 UD1
 Compaction Characteristics _____
 Water Content _____
 Distilled Water Added: Yes No _____
 Curing Time 1 Week
 State GA

Final Hole
 Dia (mm)
1.0

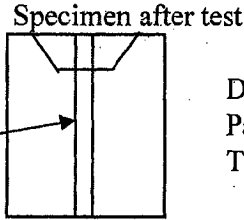

Date: 8/3/05
 Page 1 of 2
 Tested By: JM

Flow started on 1st trial

Head	Time (secs)	Flow (ml)	Flow Rate, (ml/sec.)	Turbidity from Side							Remarks
				Very Dark	Dark	Moderately dark	Slightly dark	Barely Visible	Completely Clear	Completely clear from top	

2"	120	24.00	0.20								x	
2"	120	24.00	0.20								x	
2"	120	24.00	0.20								x	
2"	120	24.00	0.20								x	
2"	120	24.00	0.20								x	
2"	AVERAGE		0.20									
2"												
2"												
2"												
2"												

Soil is Classified as: D1 D2 ND4 ND3 ND2 **ND1**
 (Circle One)

Head	Time (secs)	Flow (ml)	Flow Rate, (ml/sec.)	Turbidity from Side						Remarks	
				Very Dark	Dark	Moderately dark	Slightly dark	Barely Visible	Completely Clear		Completely clear from top
7"	120	38.00	0.32							x	
7"	120	36.00	0.30							x	
7"	120	36.00	0.30							x	
7"	120	36.00	0.30							x	
7"	120	36.00	0.30							x	
7"	AVERAGE		0.30								
7"											
7"											
7"											

15"	120	38.00	0.32								x
15"	120	38.00	0.32								x
15"	120	38.00	0.32								x
15"	120	38.00	0.32								x
15"	120	38.00	0.32								x
15"	AVERAGE		0.32								
15"											
15"											
15"											

40"	120	38.00	0.32								x
40"	120	38.00	0.32								x
40"	120	38.00	0.32								x
40"	120	38.00	0.32								x
40"	120	38.00	0.32								x
40"	AVERAGE		0.32								
40"											No change in hole diameter (1 mm).
40"											No observable crumbling.
40"											
40"											

Job Record Number: 00346
Lab ID Number: 004248

Identification and Classification of Dispersive Clay Soils by Pinhole Test
(ASTM D4647-93)

Project Name: TVA Kingston-Proposed Gypsum Disposal Area
Project Number: 3043-05-1021

Tested By: JM
Test Date: 8/8/2005
Reviewed By: TJ
Review Date: 9/13/05

Sample Identification: NB-44 UD4
Moisture Content: _____
Sample Weight, (grams): _____
Sample Volume, (Ft³): 0.0012
Dry Density, (pcf): 0.0
Test Method: A

Hydraulic Head (mm)	Rate of Flow (ml/sec)	Cloudiness	Length of Test (minutes)	Hole Diameter, (mm)		Classification
				Before Test	After Test	
51	1.76	CC	5	1.0	1.0	ND1
178	5.04	CC	5	1.0	1.0	ND1
381	6.60	CC	5	1.0	1.0	ND1
1016	10.16	CC	5	1.0	1.0	ND1

ASTM D 4647-93

Job Record Number: 00346

Lab ID Number: 004248

PINHOLE TEST DATA

Project Name: TVA Kingston-Disposal Area
 Project No. 3043-05-1021
 Sample No. NB-44 UD4
 Compaction Characteristics _____
 Water Content _____
 Distilled Water Added: Yes No _____
 Curing Time 1 week
 State GA

Final Hole
 Dia (mm)
1.0

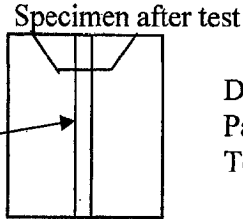

Date: 03/21/05
 Page 1 of 2
 Tested By: JM

Flow started on 1st trial

Head	Time (secs)	Flow (ml)	Flow Rate, (ml/sec.)	Turbidity from Side						Remarks
				Very Dark	Dark	Moderately dark	Slightly dark	Barely Visible	Completely Clear	

2"	60	105.00	1.75							x	
2"	60	106.00	1.77							x	
2"	60	106.00	1.77							x	
2"	60	105.00	1.75							x	
2"	60	106.00	1.77							x	
2"	AVERAGE		1.76								
2"											
2"											
2"											
2"											

Soil is Classified as: D1 D2 ND4 ND3 ND2 ND1
 (Circle One)

Head	Time (secs)	Flow (ml)	Flow Rate, (ml/sec.)	Turbidity from Side						Remarks	
				Very Dark	Dark	Moderately dark	Slightly dark	Barely Visible	Completely Clear		
7"	50	259.00	5.18							x	Completely clear from top
7"	40	200.00	5.00							x	
7"	40	200.00	5.00							x	
7"	40	200.00	5.00							x	
7"	40	200.00	5.00							x	
7"	AVERAGE		5.04								
7"											
7"											
7"											

15"	20	132.00	6.60								x
15"	20	132.00	6.60								x
15"	20	132.00	6.60								x
15"	20	132.00	6.60								x
15"	20	132.00	6.60								x
15"	AVERAGE		6.60								
15"											
15"											
15"											

40"	10	102.00	10.20								x
40"	10	100.00	10.00								x
40"	10	102.00	10.20								x
40"	10	102.00	10.20								x
40"	10	102.00	10.20								x
40"	AVERAGE		10.16								
40"											
40"											
40"											
40"											



REPORT OF GEOTECHNICAL INVESTIGATION

**GYPSUM STACK BORROW AREA
KINGSTON FOSSIL PLANT
KINGSTON, TENNESSEE**

Prepared For:

TENNESSEE VALLEY AUTHORITY

Chattanooga, Tennessee

Prepared By:

MACTEC ENGINEERING AND CONSULTING, INC.

Knoxville, Tennessee

MACTEC Project 3043051030.01

October 4, 2005





engineering and constructing a better tomorrow

October 4, 2005

Mr. Ron Purkey
Tennessee Valley Authority
1101 Market Street, LP-2G
Chattanooga, TN 37402

Subject: **Report of Geotechnical Investigation
Gypsum Stack Borrow Area
TVA Kingston Fossil Plant
Kingston, Tennessee
MACTEC Project 3043051030.01**

Dear Mr. Purkey:

We at MACTEC Engineering and Consulting, Inc., (MACTEC) are pleased to submit this Report of Geotechnical Investigation for your project. Our services, as authorized through TAO No. MAC-0724-00082, were provided in general accordance with our proposal number Prop05Knox/182, dated June 9, 2005.

This report reviews the information provided to us, discusses the site and subsurface conditions, and presents the results of our laboratory testing for the materials at the Gypsum Stack Borrow Area. The Appendices contain a brief description of the Field Exploratory Procedures, Observation Trench Logs, the Laboratory Test Procedures, and the Laboratory Test Results. At the time of report finalization, samples of the composite geonet fabric were not available for laboratory testing purposes as required in this scope of work. MACTEC will provide the results of the geonet fabric testing within a separate letter report upon completion of the laboratory testing.

We anticipate further dialog and interaction with the designers as the design proceeds and will be happy to provide any additional information or interpretation of the data presented here in which may be necessary.

We will be pleased to discuss our data with you and would welcome the opportunity to provide the engineering and material testing services needed to successfully complete your project.

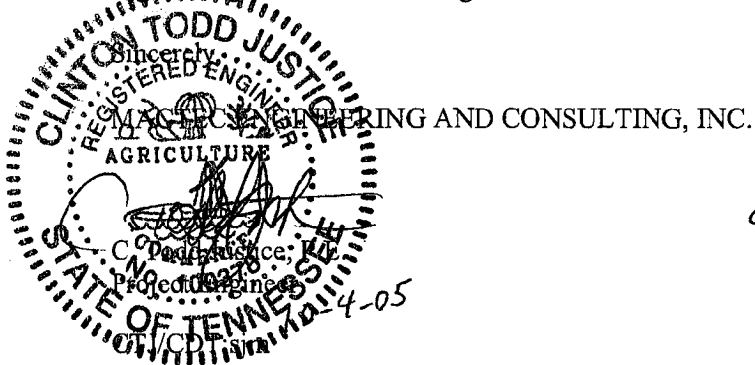

Carl D. Tockstein
Carl D. Tockstein, P.E.
Chief Engineer - Tennessee Operations

MACTEC Engineering and Consulting, Inc.
1725 Louisville Drive • Knoxville, TN 37921-5904 • Phone: 865.588.8544 • Fax: 865.588.8026

www.mactec.com

REPORT OF GEOTECHNICAL INVESTIGATION

**GYPSUM STACK BORROW AREA
KINGSTON FOSSIL PLANT
KINGSTON, TENNESSEE**

Prepared For:

TENNESSEE VALLEY AUTHORITY

Chattanooga, Tennessee

Prepared By:

MACTEC ENGINEERING AND CONSULTING, INC.

Knoxville, Tennessee

MACTEC Project 3043051030.01

October 4, 2005

TABLE OF CONTENTS

	<u>Page</u>
LIST OF TABLES	III
LIST OF FIGURES.....	IV
EXECUTIVE SUMMARY	V
1.0 INTRODUCTION.....	1
2.0 OBJECTIVES OF EXPLORATION	1
3.0 SCOPE OF EXPLORATION	1
4.0 PROJECT INFORMATION AND SITE CONDITIONS.....	2
5.0 AREA AND SITE GEOLOGY.....	2
6.0 SUBSURFACE CONDITIONS.....	3
7.0 LABORATORY TESTING METHODOLOGY AND DISCUSSION OF TEST RESULTS ...	4
7.1 INDEX PROPERTIES.....	5
7.2 MOISTURE-DENSITY RELATIONSHIP	5
7.3 HYDRAULIC CONDUCTIVITY	5
8.0 RECOMMENDATIONS	6
9.0 BASIS OF RESULTS	7
TABLES	
FIGURES	
APPENDIX A: FIELD EXPLORATORY PROCEDURES	
APPENDIX B: OBSERVATION TRENCH LOGS	
APPENDIX C: LABORATORY TEST PROCEDURES	
LABORATORY TEST RESULTS	
GRAIN SIZE ANALYSIS TEST RESULTS	
MOISTURE-DENSITY RELATIONSHIP TEST RESULTS	
HYDRAULIC CONDUCTIVITY TEST RESULTS	

LIST OF TABLES

Table

- C-1 Index Property and Moisture-Density Test Results
- C-2 Hydraulic Conductivity Test Results Soil Type A
- C-3 Hydraulic Conductivity Test Results Soil Type B
- C-4 Hydraulic Conductivity Test Results Soil Type C

LIST OF FIGURES

Figure

- 1 Site Location Map
- 2 Observation Trench Location Plan
- 3A Hydraulic Conductivity versus Molding Moisture Content for Soil Type A
- 3B Hydraulic Conductivity versus Molding Moisture Content for Soil Type B
- 3C Hydraulic Conductivity versus Molding Moisture Content for Soil Type C
- 4 Compaction Data Points Showing Acceptable Zone of Hydraulic Conductivity –
Soil Type A
- 5 Compaction Data Points Showing Acceptable Zone of Hydraulic Conductivity –
Soil Type B
- 6 Compaction Data Points Showing Acceptable Zone of Hydraulic Conductivity –
Soil Type C

EXECUTIVE SUMMARY

MACTEC was selected by the Tennessee Valley Authority (TVA) to perform a geotechnical investigation for the Gypsum Stack Borrow Area at the Kingston Fossil Plant in Kingston, Tennessee. The objectives of our exploration were to determine general subsurface conditions in the borrow area and to perform geotechnical laboratory testing in order to evaluate the engineering characteristics of the potential borrow soils.

The exploration consisted of excavating 5 observation trenches (OT-1 through OT-5) to maximum depths of 10 feet or refusal, whichever occurred first. The major findings of our geotechnical exploration are as follows:

- The observation trenches excavated in the Gypsum Stack Borrow Area typically encountered residual soils underlying minor amounts of topsoil. The residuum typically consisted of fat clay and lean clays with varying amounts of roots, sand, chert fragments, and manganese nodules. The observation trenches were terminated at depths of about 10 feet.
- Ground water was not encountered in the observation trenches during the time of our investigation. Long-term measurements for the presence or absence of ground water were not obtained during this exploration.
- Laboratory tests were performed on bulk soil samples from the potential borrow area. A summary of the tests performed and the test results is presented in Section 3.0 and Section 7.0, respectively. The test results are presented in Appendix C and are summarized in Tables C-1 through C-4.
- Figures 4, 5, and 6 show graphical plots that can be used to assist the constructors in field control and quality assurance during the placement of the compacted engineered fill. MACTEC recommends that additional hydraulic conductivity testing be performed in order to more accurately develop and verify the initially constructed Acceptable Zone boundaries. Section 8.0 describes the procedures to implement the use of the graphical plots in the field.

This summary is only an overview and should not be used as a separate document or in place of reading the entire report, including the appendices.

1.0 INTRODUCTION

This report presents the findings of our subsurface exploration and laboratory testing recently performed for the Gypsum Stack Borrow Area at the TVA Kingston Fossil Plant. Our services were authorized by Mr. Ron Purkey of TVA.

2.0 OBJECTIVES OF EXPLORATION

The objectives of our exploration were to determine general subsurface conditions in the borrow area and to perform geotechnical laboratory testing in order to evaluate the engineering characteristics of the potential borrow soils. An assessment of site environmental conditions, or an assessment for the presence or absence of pollutants in the soil, bedrock, surface water, or ground water of the site was beyond the proposed objectives of our exploration.

3.0 SCOPE OF EXPLORATION

The scope of our exploration was based on our proposal number Prop05Knox/182, dated June 9, 2005 and the geotechnical scope of work outlined in the project's scope of work. It includes the following:

- Excavate 5 observation trenches including logging the soil strata and collecting samples within the Gypsum Stack Borrow Area
- Locate each observation trench using GPS
- Conduct laboratory testing on the potential borrow soils
- Develop moisture-density / hydraulic conductivity relationships for each soil type encountered
- Prepare a geotechnical report summarizing the field and laboratory test results with applicable recommendations

The field work was performed in accordance to the procedures included in Appendix A. The field work was performed on June 28, 2005. TVA provided the backhoe equipment used to excavate the observation trenches. A MACTEC geotechnical engineer was present to identify and log the various soil types encountered. Bulk soil samples of each soil type were obtained from the excavated soils

within the observation trenches. Photographs of the observation trenches and soils excavated from the trenches were made upon completion of sampling.

Upon completing the excavation of an observation trench, the trenches were backfilled with the excavated soils.

The samples were transported to our laboratories in Knoxville, Tennessee and Charlotte, North Carolina where the soil samples were tested. The testing program for this project consisted of the following:

- 9 Plasticity Index (Atterberg Limits) Tests
- 9 Grain Size Distribution Tests
- 3 Natural Moisture Content Tests
- 9 Standard Proctor Compaction Tests
- 9 Specific Gravity Tests
- 18 Hydraulic Conductivity Tests

Subsurface conditions encountered in the observation trenches are presented on the Observation Trench Logs in Appendix B. The laboratory testing results are presented in Appendix C.

4.0 PROJECT INFORMATION AND SITE CONDITIONS

Project information was provided to us by Mr. Lynn Petty with TVA in the form of a Geotechnical Investigation Scope of Work and a proposed Observation Trench location plan. The investigation was performed in the Gypsum Stack Borrow Area. The Gypsum Stack Borrow Area is located northwest of the proposed Gypsum Disposal Area and is shown in Figure 1- Site Location Map.

5.0 AREA AND SITE GEOLOGY

Kingston, Tennessee, is located in the Appalachian Valley and Ridge Physiographic Province. This province extends as a continuous belt from central Alabama, through Georgia and Tennessee, northward into Pennsylvania. The formations that underlie this province consist primarily of limestone, dolostone, shale, and sandstone, which have been folded and faulted in the geologic past. These formations range in age from Cambrian to Pennsylvanian and have been subject to at least one extensive period of erosion since their structural deformation. The erosion has produced a series of subparallel, alternating ridges and valleys. The valleys are formed over more soluble

bedrock (interbedded limestone and limestone), whereas bedrock more resistant to solution weathering forms ridges (sandstone, shale, and cherty dolostone).

In particular, the site is geologically mapped to be underlain by the Knox Group. The Knox Group is mainly composed of light gray to dark gray and olive-gray, siliceous dolomite with a few limestone layers in the upper part. The rock usually weathers to reddish orange residuum containing chert fragments.

6.0 SUBSURFACE CONDITIONS

Subsurface conditions were explored with 5 observation trenches excavated in general accordance with the procedures presented in Appendix A. The trench locations and depths were selected by TVA. The trench locations were located by GPS by the MACTEC geotechnical engineer. The GPS coordinates are shown on the Observation Trench Logs. The trench locations are shown on Figure 2 - Observation Trench Location Plan.

Subsurface conditions encountered at the boring locations are shown on the Observation Trench Logs. These logs represent our interpretation of the subsurface conditions, based on observations of the materials exposed in the trenches by our geotechnical engineer. The depth intervals designating the interfaces between various strata on the logs represent the approximate interface locations.

The observation trenches excavated at this site encountered topsoil and residual soils. Topsoil is the dark-colored organic soil that forms naturally at the ground surface. Residual soils are soils that have developed from the in-place weathering of the underlying parent bedrock. The observation trenches were terminated at depths of about 10 feet.

A brief summary of subsurface conditions encountered in the trenches is discussed in the following portions of this section. For detailed conditions at each trench location, refer to the Observation Trench Logs in Appendix B.

Topsoil was encountered in observation trenches OT-1 through OT-4 to depths of about 0.5 feet. About 1 foot of topsoil was encountered in OT-5. Lean clay and fat clay residuum was typically encountered underlying the topsoil to termination depths. Large diameter roots (up to 1-inch) were encountered within the residuum to depths varying from about 2 to 4 feet below the existing ground

surface. The percentage of chert observed within the encountered soils was visually estimated and noted on the observation trench logs.

7.0 LABORATORY TESTING METHODOLOGY AND DISCUSSION OF TEST RESULTS

A detailed visual examination of the soils obtained from the observation trenches led to the identification of three distinct soil types based on color and chert content. The soil types have been designated as types "A", "B", and "C". Soil type A consists of reddish orange fat clay with varying amounts of chert fragments (observed in OT-1, OT-2 and OT-5). Soil type B consists of reddish brown lean clay / fat clay with varying amounts of sand and chert fragments (observed in OT-3). Soil type C consists of dark reddish brown lean clay with varying amounts of sand and black manganese nodules (observed in OT-4).

Laboratory tests were performed on bulk soil samples obtained from observation trenches OT-1 (soil type A), OT-3 (soil type B), and OT-4 (soil type C). The laboratory testing for each soil type included the following:

- 1 Natural Moisture Content Test
- 3 Plasticity Index (Atterberg Limits) Tests
- 3 Grain Size Distribution Tests
- 3 Specific Gravity Tests
- 3 Standard Proctor Compaction Tests
- 6 to 7 Hydraulic Conductivity Tests

Representative samples of each soil type were obtained from the bulk samples in preparation for laboratory testing. The results of the Proctor compaction tests were used to prepare remolded specimens at relative compactions of 90 and 95 percent maximum dry density, at moisture contents of -2, +1, and +4 percent of optimum. The remolded specimens were subjected to laboratory hydraulic conductivity testing. The data obtained from the laboratory test results was used to develop graphical plots showing relationships between molding moisture content and hydraulic conductivity for soils types A, B, and C at relative compactions of 90 and 95 percent standard Proctor density (Figures 3A, 3B, and 3C). Final graphical plots (Figures 4, 5, and 6), showing the compaction data points, were constructed in order to create an "acceptable zone" which includes data points for specimens with hydraulic conductivity values less than or equal to 1×10^{-6} cm/s.

The tests and test results are summarized below in the following paragraphs. Table C-1 summarizes the natural moisture content, compaction characteristics, specific gravity, Atterberg Limits, percent fines and Unified Soil Classification results for the soils tested. Tables C-2, C-3, and C-4 summarize the results of the hydraulic conductivity testing performed on the tested soils.

7.1 INDEX PROPERTIES

Natural moisture content, Atterberg limits, and grain size analysis tests were performed on bulk samples obtained from the potential borrow soils at trench locations OT-1, OT-3, and OT-4.

Natural moisture contents of the tested samples ranged from 22.5 percent (OT-4) to 24.6 percent boring (OT-1).

The Atterberg limits test results indicated that liquid limits for the on-site borrow soils tested ranged from 36 to 60, plastic limits ranged from 19 to 29, and plasticity indices ranged from 17 to 33. The tested on-site borrow soils were classified as CL and CH in accordance with the USCS.

The specific gravity of the tested samples ranged from 2.72 to 2.75.

7.2 MOISTURE-DENSITY RELATIONSHIP

Nine Standard Proctor compaction tests were performed on bulk samples obtained from trench locations OT-1, OT-3, and OT-4. The test results indicated that the maximum dry density for the soils tested ranged from 90.7 to 107.3 pcf, and the corresponding optimum moisture contents were 28.3 and 17.6, respectively.

7.3 HYDRAULIC CONDUCTIVITY

Constant head permeability tests were performed on remolded samples from bulk soil samples obtained at locations OT-1, OT-3, and OT-4. The samples were remolded to or near 90 and 95 percent of the standard Proctor maximum dry density and at or near -2, +1, and +4 percent of optimum moisture content for a total of 18 tests. Two additional permeability tests were performed on bulk soil samples from locations OT-1 and OT-4 remolded to or near 95 percent of standard Proctor maximum dry density and at or near +1.7 and +1.8 percent of optimum moisture content.

The permeability test results indicated that the permeability's ranged from 1.2×10^{-5} cm/s to 8.1×10^{-8} cm/s.

8.0 RECOMMENDATIONS

The laboratory testing program just described was used to develop the graphical plots shown in Figures 4, 5, and 6. These graphical plots show compaction data points with respect to an "Acceptable Zone" which includes data points for specimens with hydraulic conductivity values approximately less than or equal to 1×10^{-6} cm/s. The lower limit of the Acceptable Zone is typically parallel to the zero air voids curve. Figures 4, 5, and 6 utilize a specified degree of saturation as the lower boundary of the Acceptable Zone. It is observed that only a limited number of compaction data points were used to construct the Acceptable Zones which utilize a degree of saturation as the lower boundary for each of the soil types. MACTEC recommends that additional hydraulic conductivity testing be performed in order to more accurately develop and verify the initially constructed Acceptable Zone boundaries. Specifically, additional hydraulic conductivity testing should be performed on specimens of each soil type remolded to or near 98 to 100 percent standard Proctor maximum dry density at or near their respective optimum moisture contents and at -1 percent of optimum. An additional 12 hydraulic conductivity tests are recommended.

Once the additional testing has been performed to verify and/or modify the Acceptable Zones, the graphical plots can be used to assist the constructors in field control and quality assurance during the placement of the compacted engineered fill. In order to implement the use of the graphical plots in the field, the soil technicians will have to first classify the soils as types A, B, or C. One-point standard Proctor compaction tests can be occasionally performed in the field to aid in identification of questionable materials. After the materials have been placed and compacted in lifts, the technicians then measure the dry density and moisture content in the field. The field dry density-moisture content point is then plotted on the appropriate graphical plot (Figures 4, 5, or 6). If the field measured dry density value exceeds the minimum required dry density (falls within the acceptable zone) then no further action is needed. If the field measured dry density was less than the minimum required dry density, then additional compaction is performed until the field measured dry density exceeds the minimum required value.

9.0 BASIS OF RESULTS

The results and recommendations provided herein are based on the encountered subsurface conditions and laboratory testing related to the specific project and site discussed in this report.

Regardless of the thoroughness of a field exploration, there is always a possibility that conditions between test locations will differ from those at specific test locations, and that conditions may not be anticipated. In addition, interpretation of the data is critical to the intended design and/or analysis. Therefore, experienced geotechnical engineer should interpret the field data and review any site-specific analysis or design that incorporates the field data. We recommend that TVA retain MACTEC to provide this service, based upon our familiarity with the subsurface conditions, the field and laboratory data, and our geotechnical experience.

Our exploration services include storing the collected samples and making them available for inspection for a period of 30 days. The samples are then discarded unless you request otherwise.

TABLES

TABLE C-1

Index Property and Moisture-Density Test Results
 TVA Kingston Gypsum Stack Borrow Area
 MACTEC Project 3043051030/01

Test Location Number	Sample Depth (Feet)	Soil Type	Natural Moisture Content, %	Atterberg Limits			Percent Finer Than No. 200 Sieve	USCS Classification	Specific Gravity	Compaction Tests	
				Liquid Limit	Plastic Limit	Plasticity Index				Std. Proctor Max. Dry Density, pcf	Opt. Moisture Content, %
OT-1	2.5 - 10	A	24.6	58	29	29	87.8	CH	2.75	90.7	28.3
OT-1	2.5 - 10	A	24.6	59	26	33	87.5	CH	2.75	91.6	28.3
OT-1	2.5 - 10	A	24.6	60	28	32	87.7	CH	2.75	91.4	28.8
OT-3	3 - 10	B	23.3	47	23	24	74.0	CL	2.74	101.0	22.4
OT-3	3 - 10	B	23.3	50	23	27	74.6	CH	2.75	101.3	20.3
OT-3	3 - 10	B	23.3	45	22	23	74.1	CL	2.73	100.6	22.1
OT-4	4 - 10	C	22.5	36	19	17	82.4	CL	2.72	107.3	17.6
OT-4	4 - 10	C	22.5	38	20	18	83.8	CL	2.73	105.9	18.8
OT-4	4 - 10	C	22.5	39	19	20	83.5	CL	2.73	104.9	18.4

Prepared/Date: CTJ 07/29/05
 Checked/Date: SDS 08/05/05

Table C-2
Hydraulic Conductivity
Soil Type A
TVA Kingston Gypsum Stack Borrow Area
MACTEC Project 3043051030/01

Trench Location	Bulk Sample Depth (ft)	Target Remolded Proctor Dry Density %	Remolded Moisture (%)	Wet Unit wt (pcf)	Dry Unit wt (pcf)	Hydraulic Conductivity (cm/sec)
OT-1	2.5 - 10	90	26.4	103.1	81.6	6.0×10^{-6}
OT-1	2.5 - 10	90	29.3	105.5	81.6	3.9×10^{-6}
OT-1	2.5 - 10	90	32.5	108.0	81.5	4.3×10^{-7}
OT-1	2.5 - 10	95	26.4	109.0	86.2	1.1×10^{-6}
OT-1	2.5 - 10	95	29.3	111.5	86.2	1.8×10^{-6}
OT-1	2.5 - 10	95	30.0	112.1	86.2	1.4×10^{-7}
OT-1	2.5 - 10	95	32.5	114.0	86.0	2.2×10^{-7}

Note: Maximum dry density is 90.7 pcf and optimum moisture content is 28.3 % for soil type A

Table C-3
Hydraulic Conductivity
Soil Type B
TVA Kingston Gypsum Stack Borrow Area
MACTEC Project 3043051030/01

Trench Location	Bulk Sample Depth (ft)	Target Remolded Proctor Dry Density %	Remolded Moisture (%)	Wet Unit wt (pcf)	Dry Unit wt (pcf)	Hydraulic Conductivity (cm/sec)
OT-3	3 - 10	90	19.9	108.7	90.7	2.1×10^{-6}
OT-3	3 - 10	90	22.5	111.4	90.9	2.4×10^{-6}
OT-3	3 - 10	90	25.6	114.0	90.8	2.1×10^{-7}
OT-3	3 - 10	95	19.9	114.7	95.7	1.2×10^{-5}
OT-3	3 - 10	95	22.5	117.6	96.0	2.6×10^{-7}
OT-3	3 - 10	95	25.6	120.6	96.0	3.5×10^{-7}

Note: Maximum dry density is 100.6 pcf and optimum moisture is 22.1% for soil type B

Table C-4
Hydraulic Conductivity
Soil Type C
TVA Kingston Gypsum Stack Borrow Area
MACTEC Project 3043051030/01

Trench Location	Bulk Sample Depth (ft)	Target Remolded Proctor Dry Density %	Remolded Moisture (%)	Wet Unit wt (pcf)	Dry Unit wt (pcf)	Hydraulic Conductivity (cm/sec)
OT-4	4 - 10	90	17.1	111.2	95.0	1.1×10^{-5}
OT-4	4 - 10	90	19.8	114.2	95.3	3.5×10^{-6}
OT-4	4 - 10	90	22.7	117.1	95.4	4.0×10^{-7}
OT-4	4 - 10	95	17.1	117.5	100.3	4.8×10^{-6}
OT-4	4 - 10	95	19.8	120.5	100.6	1.6×10^{-6}
OT-4	4 - 10	95	20.6	121.3	100.6	1.1×10^{-6}
OT-4	4 - 10	95	22.7	123.6	100.7	8.1×10^{-8}

Note: Maximum dry density is 105.9 pcf and optimum moisture is 18.8 % for soil type C

FIGURES

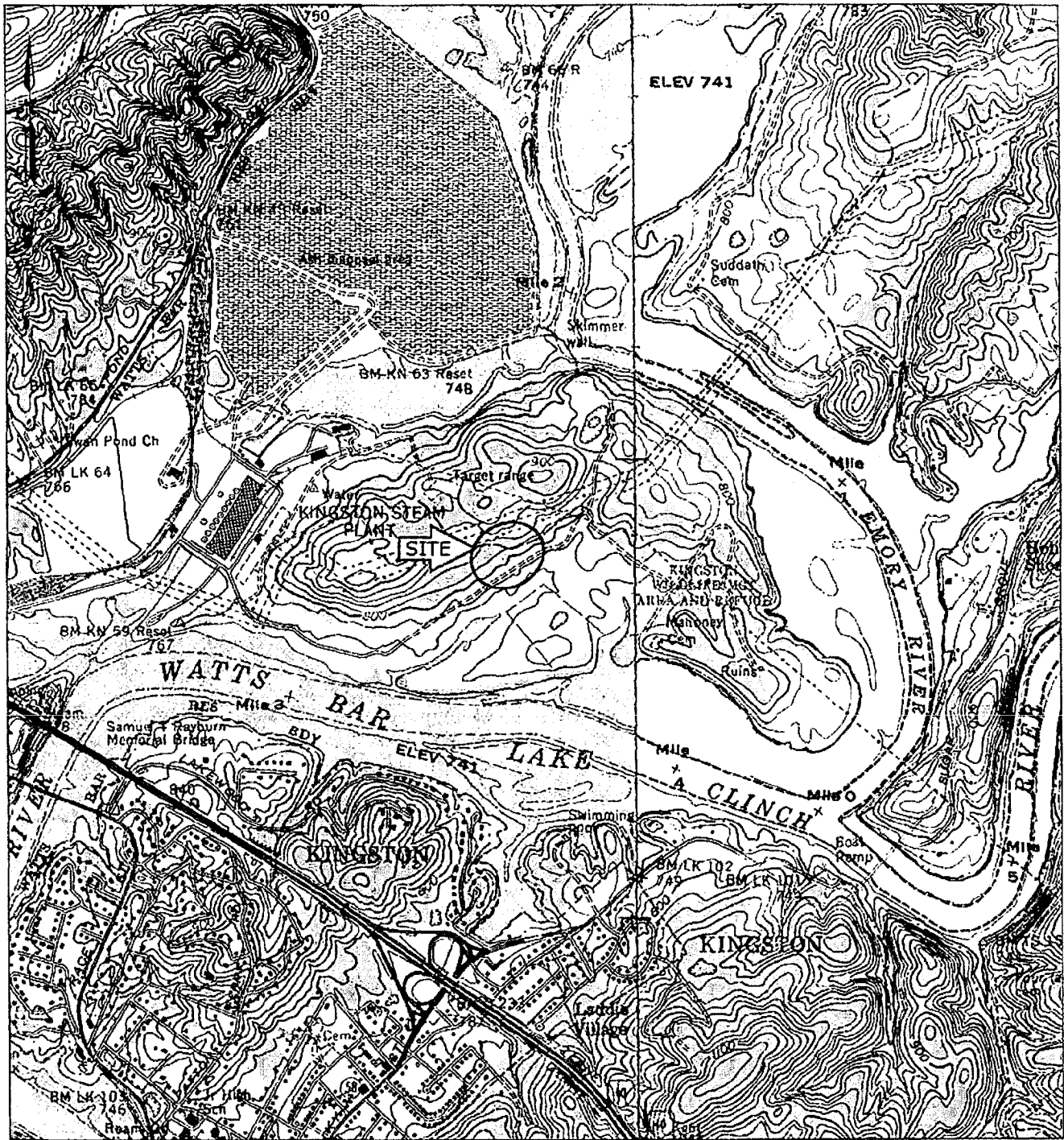

SOURCE: USGS TOPOGRAPHIC MAPS OF HARRIMAN AND ELVERTON, TN QUADRANGLES



MACTEC Engineering and Consulting, Inc.
 1725 Louisville Drive
 Knoxville, Tennessee 37921-5904
 865-588-8544 • Fax: 865-588-8026

**FIGURE 1: SITE LOCATION MAP
 TVA KINGSTON
 PROPOSED GYPSUM STACK BORROW AREA
 KINGSTON, TENNESSEE**

DRAFTING BY: <i>WSS</i>	PREPARED BY: <i>CTJ</i>	CHECKED BY: <i>CDT</i>
JOB NUMBER: 3043051030/0001	DATE: JULY 22, 2005	SCALE: 0 2000'

COORDINATES: N 35°53'39" W 84°31'13"

3043051030 Fri, 22 Jul 2005 - 10:30am REV:RENC

04/18/05 04:44pm No. 13 of 2005 - 11:53am

07-1 OBSERVATION TRENCH
 TEST LOCATION AND IDENTIFICATION
 LEGEND



FIGURE 2: OBSERVATION TRENCH TEST
 LOCATION PLAN AND IDENTIFICATION
 TVA KINGSTON-PROPOSED GYPSUM STACK
 BORROW AREA - KINGSTON, TENNESSEE
 DRAFTER BY: GAH
 PREPARED BY: [Signature]
 CHECKED BY: [Signature]
 JOB NUMBER: 30N951030/0901
 DATE: 7/11/05
 SCALE: 0 200'

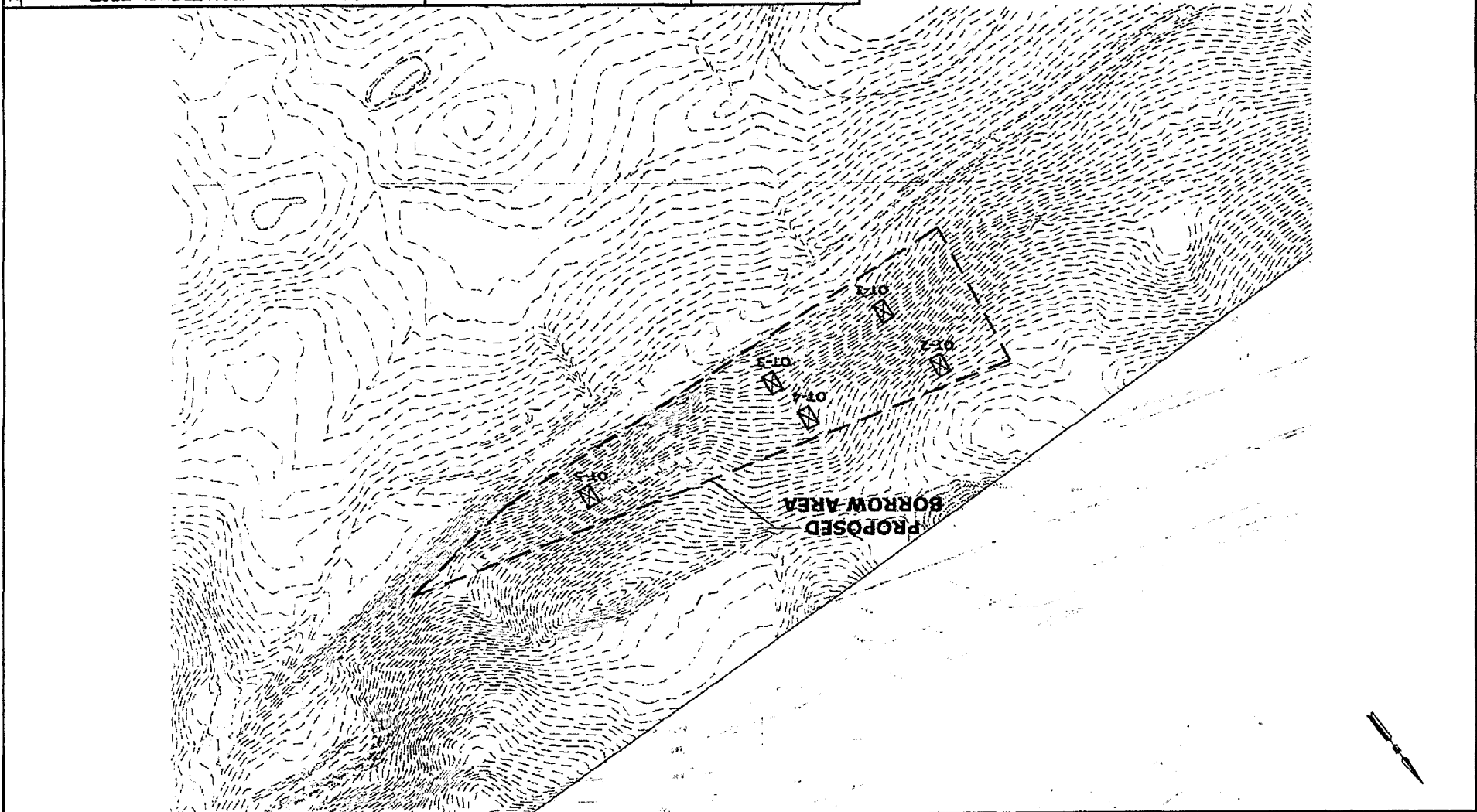

Soil Type "A" - Reddish Orange Fat Clay with Chert Fragments (CH)
Standard Proctor Maximum Dry Density = 90.7 pcf, Optimum Moisture Content = 28.3%

HYDRAULIC CONDUCTIVITY DATA - SOIL TYPE "A"

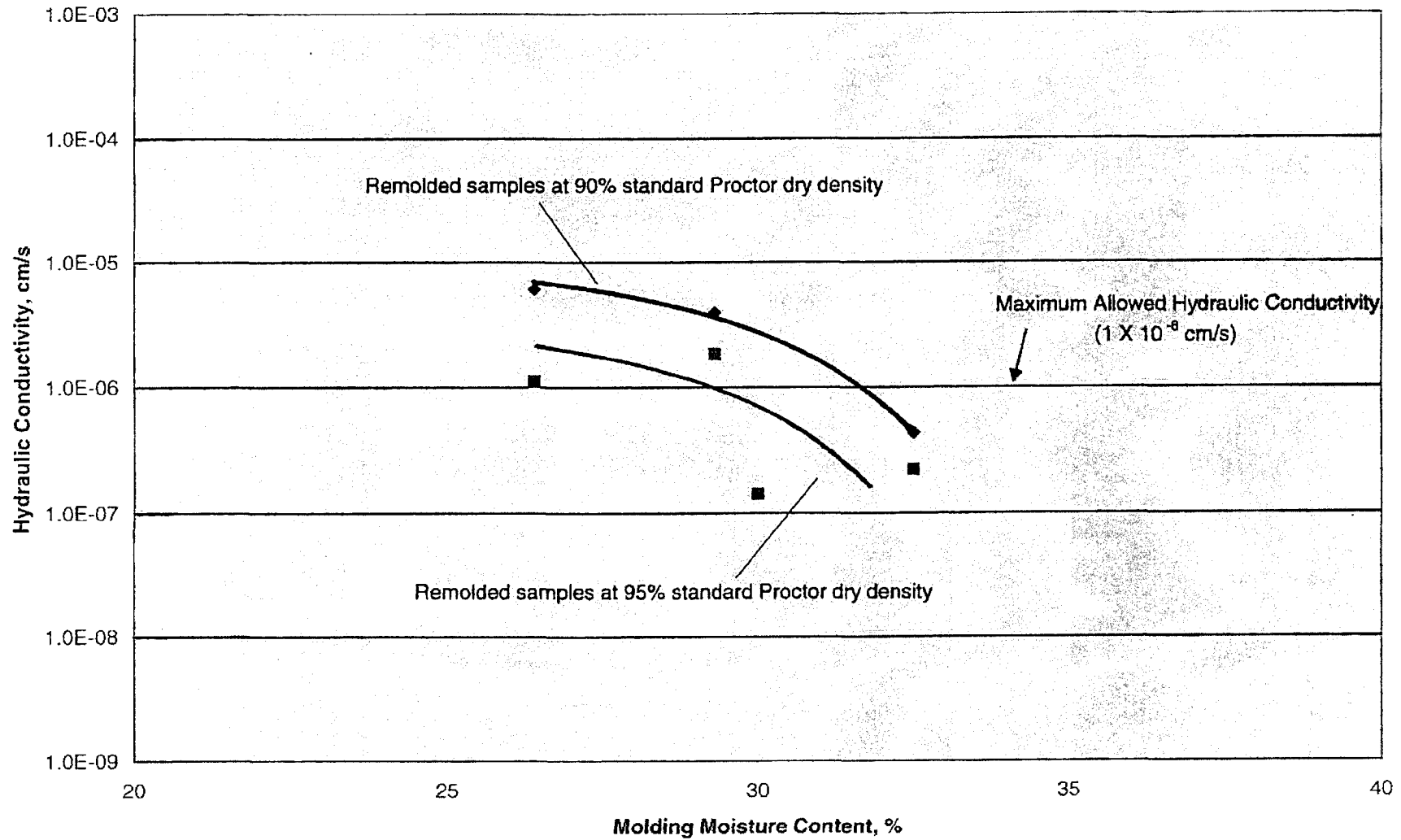

Figure 3A- Hydraulic Conductivity versus Molding Moisture Content for Type "A" Soil

Soil Type "B" - Reddish Brown Lean Clay / Fat Clay with Sand and Chert Fragments (CL/CH)
Standard Proctor Maximum Dry Density = 100.6 pcf, Optimum Moisture Content = 22.1%

HYDRAULIC CONDUCTIVITY DATA - SOIL TYPE "B"

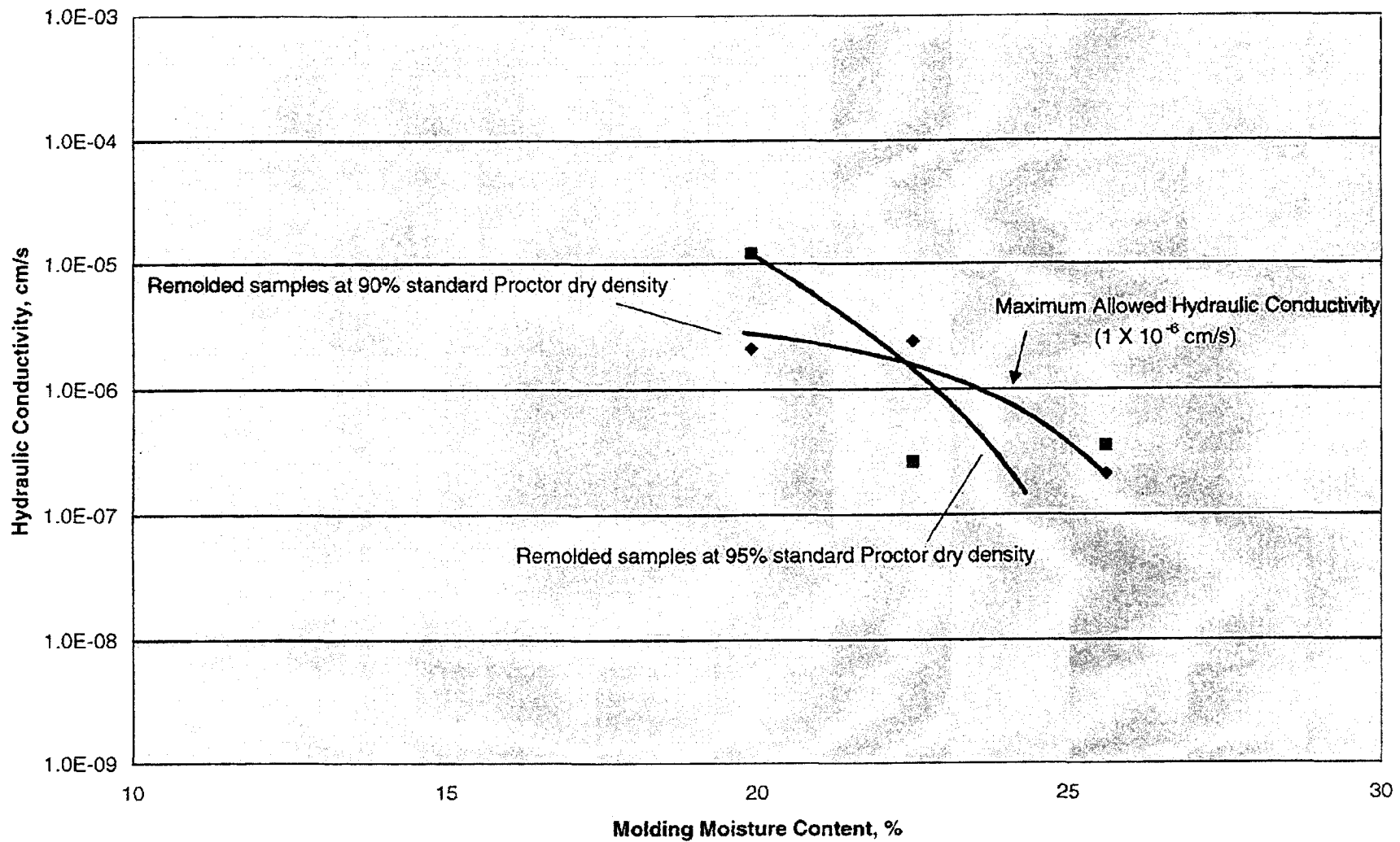

Figure 3B- Hydraulic Conductivity versus Molding Moisture Content for Type "B" Soil

Soil Type "C" - Dark Reddish Brown Lean Clay with Sand and Black Manganese Nodules (CL)
Standard Proctor Maximum Dry Density = 105.9 pcf, Optimum Moisture Content = 18.8%

HYDRAULIC CONDUCTIVITY DATA - SOIL TYPE "C"

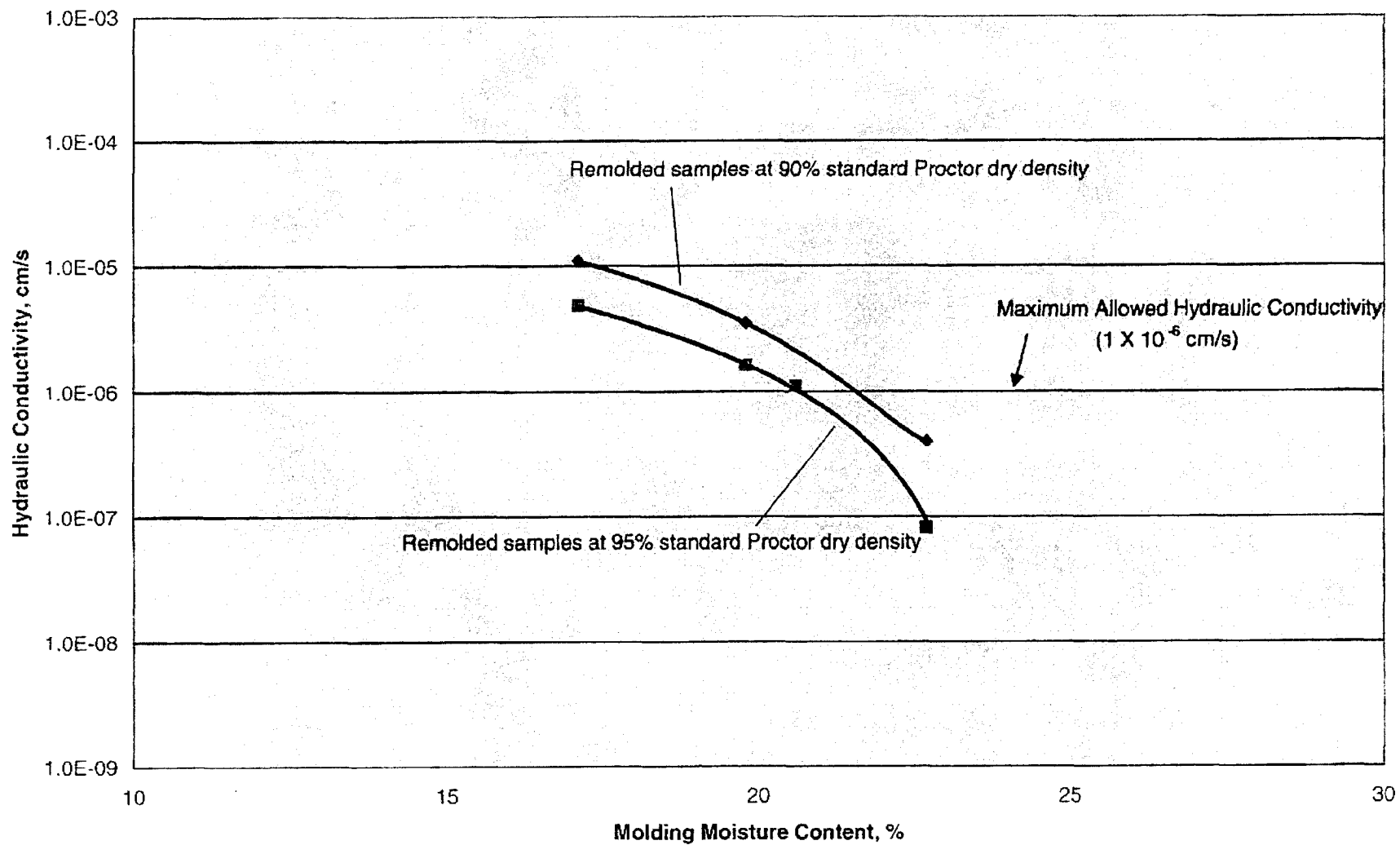

Figure 3C- Hydraulic Conductivity versus Molding Moisture Content for Type "C" Soil

Soil Type "A" - Reddish Orange Silt Clay with Chert Fragments (CH)
Standard Proctor Maximum Dry Density = 90.7 pcf, Optimum Moisture Content = 28.3%

COMPACTION DATA FOR SOIL TYPE "A"

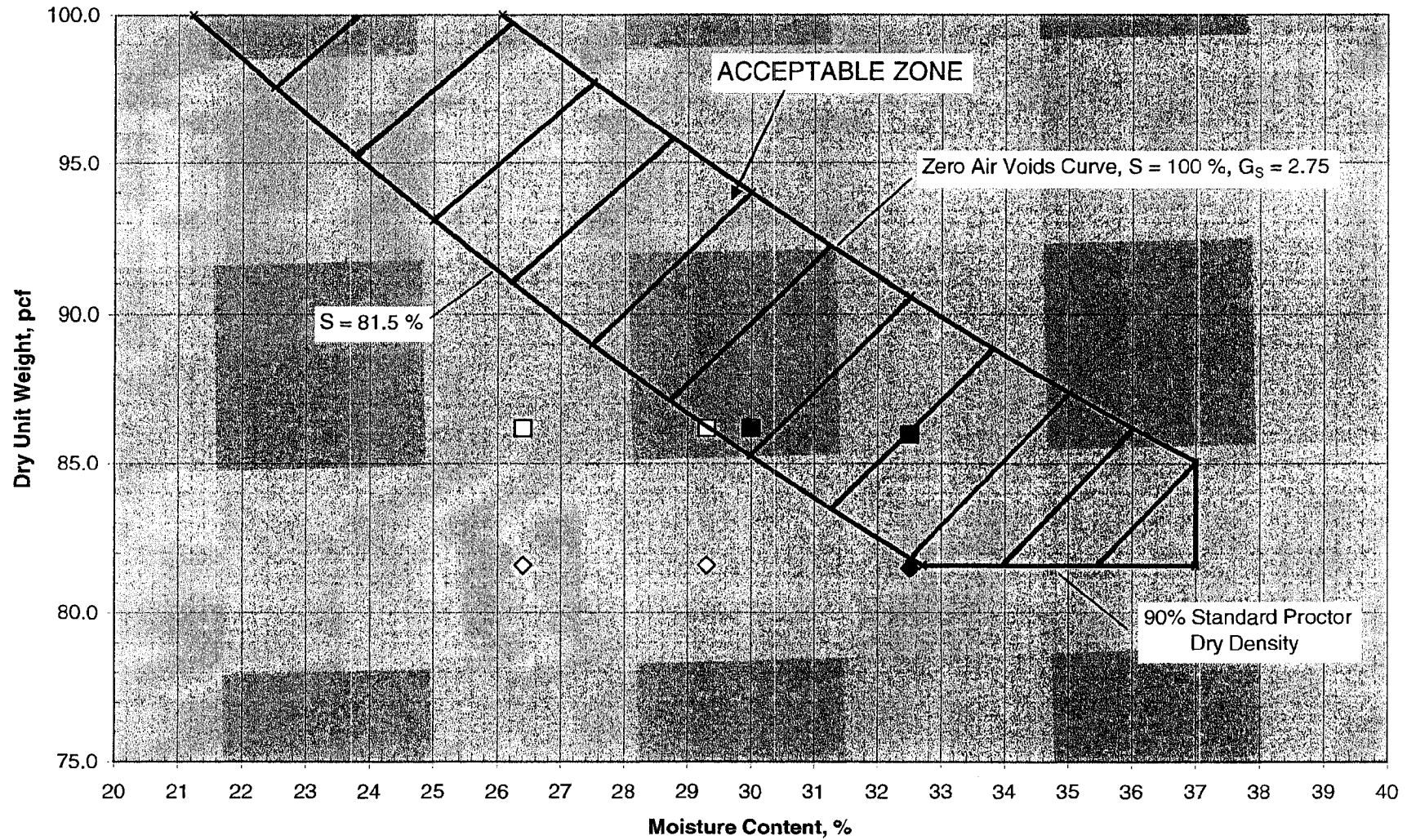

Figure 4- Solid symbols are for compacted specimens with a hydraulic conductivity <math>< 1 \times 10^{-6}</math> cm/s and open symbols for specimens with a hydraulic conductivity >math>> 1 \times 10^{-6}</math> cm/s. Squares and Diamonds represent 95 and 90% compaction, respectively.

Soil Type "B" - Reddish Brown Lean Clay / Clay with Sand and Chert Fragments (CL/CH)
Standard Proctor Maximum Dry Density = 100.6 pcf, Optimum Moisture Content = 22.1%

COMPACTION DATA FOR SOIL TYPE "B"

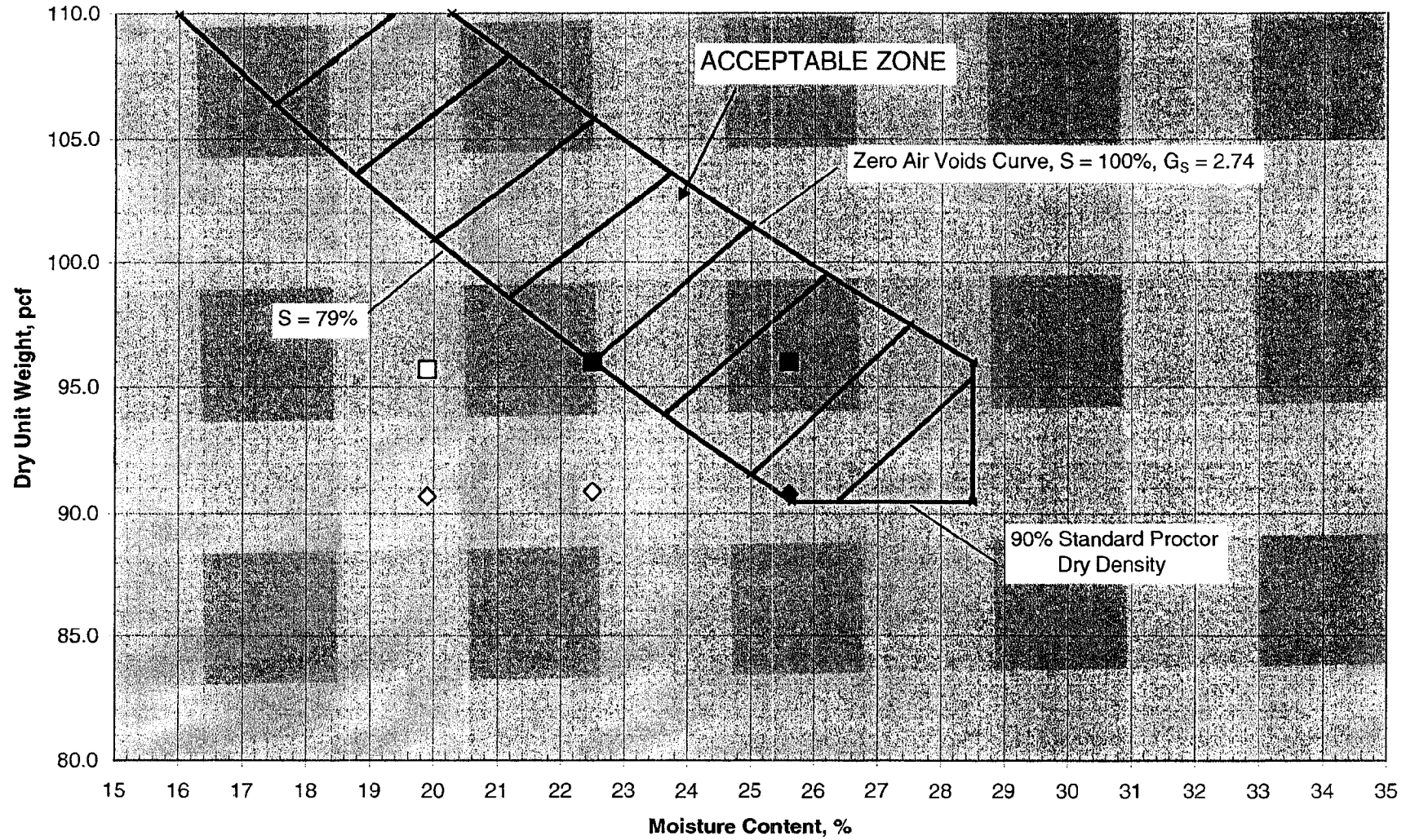

Figure 5- Solid symbols are for compacted specimens with a hydraulic conductivity $< 1 \times 10^{-6}$ cm/s and open symbols for specimens with a hydraulic conductivity $> 1 \times 10^{-6}$ cm/s. Squares and Diamonds represent 95 and 90% compaction, respectively.

Soil Type "C" - Dark Reddish Brown Lean with Sand and Black Manganese Nodules (CL)
Standard Proctor Maximum Dry Density = 105.9 pcf, Optimum Moisture Content = 18.8%

COMPACTION DATA FOR SOIL TYPE "C"

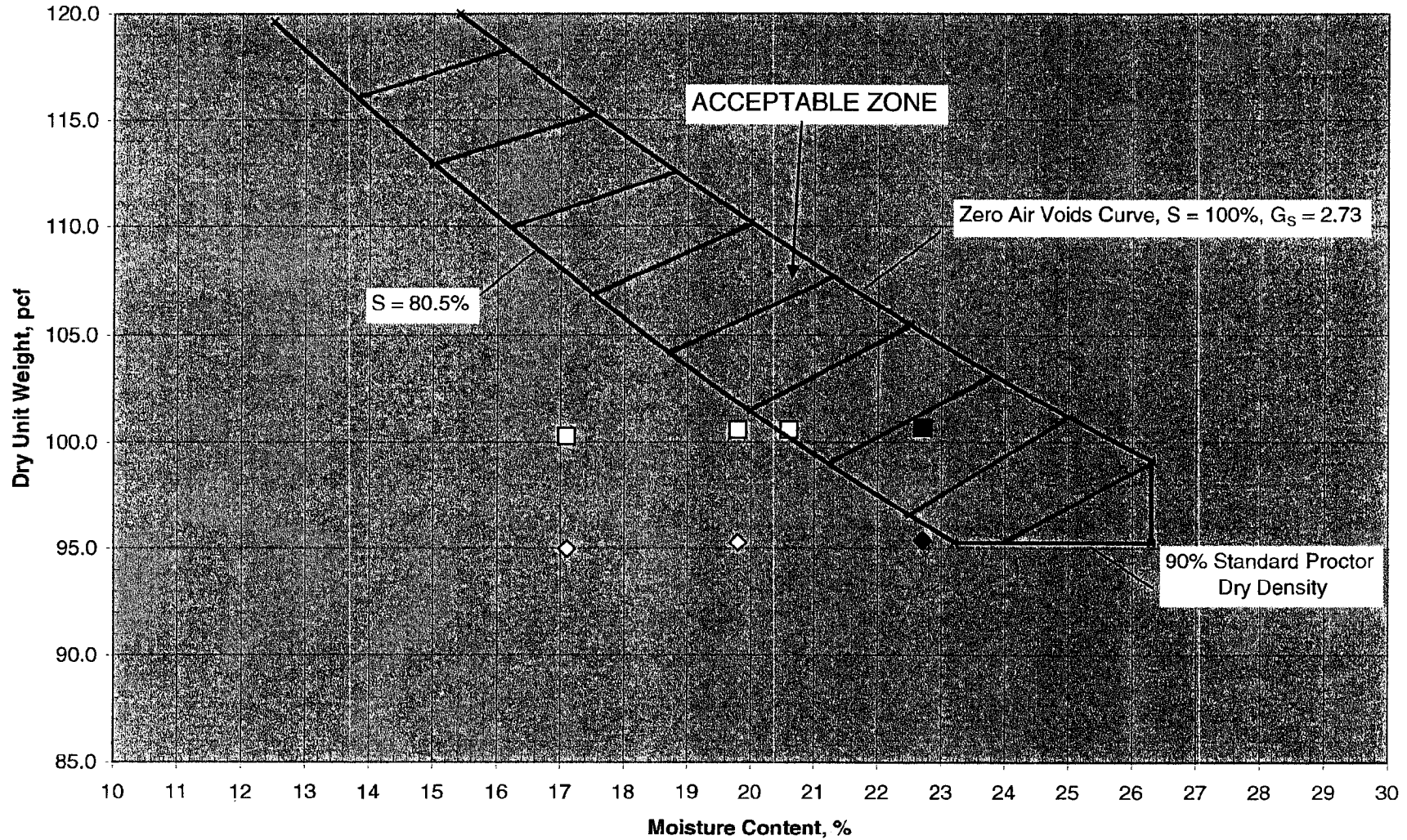

Figure 6- Solid symbols are for compacted specimens with a hydraulic conductivity <math>< 1 \times 10^{-6}</math> cm/s and open symbols for specimens with a hydraulic conductivity >math>> 1 \times 10^{-6}</math> cm/s. Squares and Diamonds represent 95 and 90% compaction, respectively.

APPENDIX A

FIELD EXPLORATORY PROCEDURES

FIELD EXPLORATORY PROCEDURES

Observation Trenches

The observation trenches were excavated by TVA using a Ford backhoe excavator. One of our geotechnical engineers observed the excavation and documented the materials exposed. The observation trenches were backfilled immediately after excavation for safety purposes. The operator tamped the materials in place with the excavator bucket. You are advised there is the probability of future backfill subsidence depending on actual subsurface conditions, surface drainage, etc.

APPENDIX B

OBSERVATION TRENCH LOGS

OBSERVATION TRENCH LOG			
Project Name: TVA Kingston Proposed Gypsum Stack Borrow Area		Logged By: Todd Justice	
Project Number: 3043051030/01		Date Logged: 6/28/05	
Observation Trench Number: OT-1		Degrees/Minutes (GPS): N35° 53.754' W84° 30.410'	
Depth (Feet)		Stratum Description	Chert %
From	To		
0.0	0.5	Topsoil with roots (up to 1-inch diameter)	0
0.5	2.5	Brown, clayey silt / silty clay with sand and roots (up to 1-inch diameter)	0
2.5	10.0	Reddish orange, fat clay with chert fragments	5 to 10
Remarks and Notes: Observation Trench OT-1 was terminated at approximately 10 feet. Bulk sample was obtained from 2.5 to 10.0 feet.			



Photograph 1 - Observation Trench OT-1.



Photograph 2 - Materials excavated from Observation Trench OT-1.

OBSERVATION TRENCH LOG			
Project Name: TVA Kingston Proposed Gypsum Stack Borrow Area		Logged By: Todd Justice	
Project Number: 3043051030/01		Date Logged: 6/28/05	
Observation Trench Number: OT-2		Degrees/Minutes (GPS): N35° 53.775' W84° 30.421'	
Depth (Feet)		Stratum Description	Chert %
From	To		
0	0.5	Topsoil with roots (up to 1-inch diameter)	0
0.5	2.0	Light brown, clayey silt with sand and roots (up to 1-inch diameter)	0
2.0	10.0	Reddish orange, fat clay with chert fragments	<5
Remarks and Notes: Majority of chert encountered was severely weathered. Observation Trench OT-2 was terminated at approximately 10.0 feet. Bulk sample was obtained from 2.0 to 10.0 feet.			



Photograph 3 - Observation Trench OT-2.



Photograph 4 - Materials excavated from Observation Trench OT-2.

OBSERVATION TRENCH LOG			
Project Name: TVA Kingston Proposed Gypsum Stack Borrow Area		Logged By: Todd Justice	
Project Number: 3043051030/01		Date Logged: 6/28/05	
Observation Trench Number: OT-3		Degrees/Minutes (GPS): N35° 53.783' W84° 30.372'	
Depth (Feet)		Stratum Description	Chert %
From	To		
0	0.5	Topsoil with roots (up to 1-inch diameter)	0
0.5	3.0	Brown, clayey silt / silty clay with sand and roots (up to 1-inch diameter)	0
3.0	10.0	Reddish brown, lean clay/ fat clay with sand and chert fragments	10 to 15
Remarks and Notes: Observation Trench OT-3 was terminated at approximately 10 feet. Bulk sample was obtained from 3.0 to 10.0 feet.			



Photograph 5 - Observation Trench OT-3.



Photograph 6 - Materials excavated from Observation Trench OT-3.

OBSERVATION TRENCH LOG			
Project Name: TVA Kingston Proposed Gypsum Stack Borrow Area		Logged By: Todd Justice	
Project Number: 3043051030/01		Date Logged: 6/28/05	
Observation Trench Number: OT-4		Degrees/Minutes (GPS): N35° 53.792' W84° 30.381'	
Depth (Feet)		Stratum Description	Chert %
From	To		
0	0.5	Topsoil with roots (up to 1-inch diameter)	0
0.5	4.0	Brown, clayey silt with sand and roots (up to 1-inch diameter)	0
4.0	10.0	Dark reddish brown, lean clay with sand and black manganese nodules	0
Remarks and Notes: Observation Trench OT-4 was terminated at approximately 10.0 feet. Bulk sample was obtained from 4.0 to 10.0 feet.			



Photograph 7 - Observation Trench OT-4.



Photograph 8 - Materials excavated from Observation Trench OT-4.

OBSERVATION TRENCH LOG			
Project Name: TVA Kingston Proposed Gypsum Stack Borrow Area		Logged By: Todd Justice	
Project Number: 3043051030/01		Date Logged: 6/28/05	
Observation Trench Number: OT-5		Degrees/Minutes (GPS): N35° 53.826' W84° 30.272'	
Depth (Feet)		Stratum Description	Chert %
From	To		
0	1.0	Topsoil with roots (up to 1-inch diameter)	0
1.0	2.0	Light brown, clayey silt with roots (up to 1-inch diameter)	0
2.0	10.0	Reddish orange, fat clay with chert fragments	5
Remarks and Notes: Majority of chert encountered was severely weathered. Observation Trench OT-5 was terminated at approximately 10.0 feet. Bulk sample was obtained from 2.0 to 10.0 feet.			



Photograph 9 - Observation Trench OT-5.



Photograph 10 - Materials excavated from Observation Trench OT-5.

APPENDIX C

LABORATORY TEST PROCEDURES

LABORATORY TEST RESULTS

LABORATORY TEST PROCEDURES

Moisture Content

The moisture content in a given mass of soil is the ratio, expressed as a percentage, of the weight of the water to the weight of the solid particles. This test was conducted in accordance with ASTM D-2216.

Atterberg Limits (Plasticity Index)

Originally, the Atterberg Limits consisted of seven "limits of consistency" of fine-grained soils. In current engineering usage, the term usually refers only to the liquid limit (LL) and plastic limit (PL). The LL (between the liquid and plastic states) is the water content at which a trapezoidal groove of specified shape, cut in moist soil held in a special cup, is closed after 25 taps on a hard rubber plate. The PL (between plastic and semi-solid states) is the water content at which the soil crumbles when rolled into threads of 1/8-inch in diameter.

The LL has been found to be proportional to the compressibility of the normally consolidated soil. The Plasticity Index (PI) is the calculated difference in water contents between the LL and PL. Together the LL and PI are used to classify silts and clays according to the Unified Soils Classification System (ASTM D 2487). The PI is used to predict the potential for volume changes in confined soils beneath foundations or grade slabs. The LL, PL, and PI are determined in accordance with ASTM D 4318.

Grain Size Distribution

Grain size tests are performed to aid in determining the soil classification and the grain size distribution. The soil samples are prepared for testing according to ASTM D 421 (dry preparation) or ASTM D 2217 (wet preparation). If only the grain size distribution of soils coarser than a number 200 sieve (0.074-mm opening) is desired, the grain size distribution is determined by washing the sample over a number 200 sieve and, after drying, passing the samples through a standard set of nested sieves. If the grain size distribution of the soils finer than the number 200 sieve is also desired, the grain size distribution of the soils coarser than the number 10 sieve is determined by passing the sample through a set of nested sieves. Materials passing the number 10 sieve are dispersed with a dispersing agent and suspended in water, and the grain size distribution calculated from the measured settlement rate of the

particles. These tests are conducted in accordance with ASTM D 422. The percentage of clay, silt, sand, and gravel which are given on the individual particle size analysis sheets presented later in this appendix, were obtained on particle size boundaries in accordance with AASHTO M145-94 (1995).

Specific Gravity

The specific gravity of soil solids is the ratio of the mass of a unit volume of a soil solids to the mass of the same volume of gas-free distilled water at 20C. The test method for determining the specific gravity of soil solids that passes the 4.75-mm (No. 4) sieve using a water pycnometer is described in ASTM D 854, Method B, "Test Methods for Specific Gravity of Soil Solids by Water Pycnometer".

Compaction Tests (Moisture-Density Relationship)

Compaction tests are performed on representative soil samples to determine the maximum dry density and optimum moisture content. The results of the tests are used in conjunction with other tests to determine engineering properties relating to settlement, bearing capacity, shear strength, and permeability. The results may also be used as a standard to determine the percent compaction of any soil embankment.

The two most commonly used compaction tests are the standard Proctor test and the modified Proctor test. They are performed in accordance with ASTM D 698 and D 1557, respectively. Generally, the standard Proctor compaction test is run on samples from building areas and areas where moderate loads are anticipated. The modified Proctor compaction test is generally used for analyses of highways and other areas where large building loads are expected. Both tests have three procedures, depending upon soil particle size:

Test	Procedure	Hammer Weight (Pounds)	Hammer Fall (Inches)	Mold Diameter (Inches)	Screen Size (Material Finer Than)	Number of Layers	Number of Blows per Layer
Standard (D 698)	A	5.5	12	4	No. 4 sieve	3	25
	B	5.5	12	4	No. 3/8" sieve	3	25
	C	5.5	12	6	3/4" sieve	3	56
Modified (D 1557)	A	10	18	4	No. 4 sieve	5	25
	B	10	18	4	No. 3/8" sieve	5	25
	C	10	18	6	3/4" sieve	5	56

Test results are presented as a curve depicting dry unit weight versus moisture content. The compaction method used and any deviations from the recommended procedures are noted in the report.

Constant Head Permeability Test

The test was performed on undisturbed and remolded samples. The physical dimensions and weight were obtained and the sample was encased in a rubber membrane and placed in a triaxial chamber. The sample was then back-pressure saturated until a B value of 0.95 or greater was reached. After saturation was obtained, the sample was consolidated under 10-psi confining stress. Upon completion of consolidation, a constant head permeability test was performed.

*Gypsum Stack Borrow Area, TVA Kingston Fossil Plant
MACTEC Project 3043051030.01*

October 4, 2005

GRAIN SIZE ANALYSIS TEST RESULTS

PARTICLE SIZE DISTRIBUTION TEST REPORT

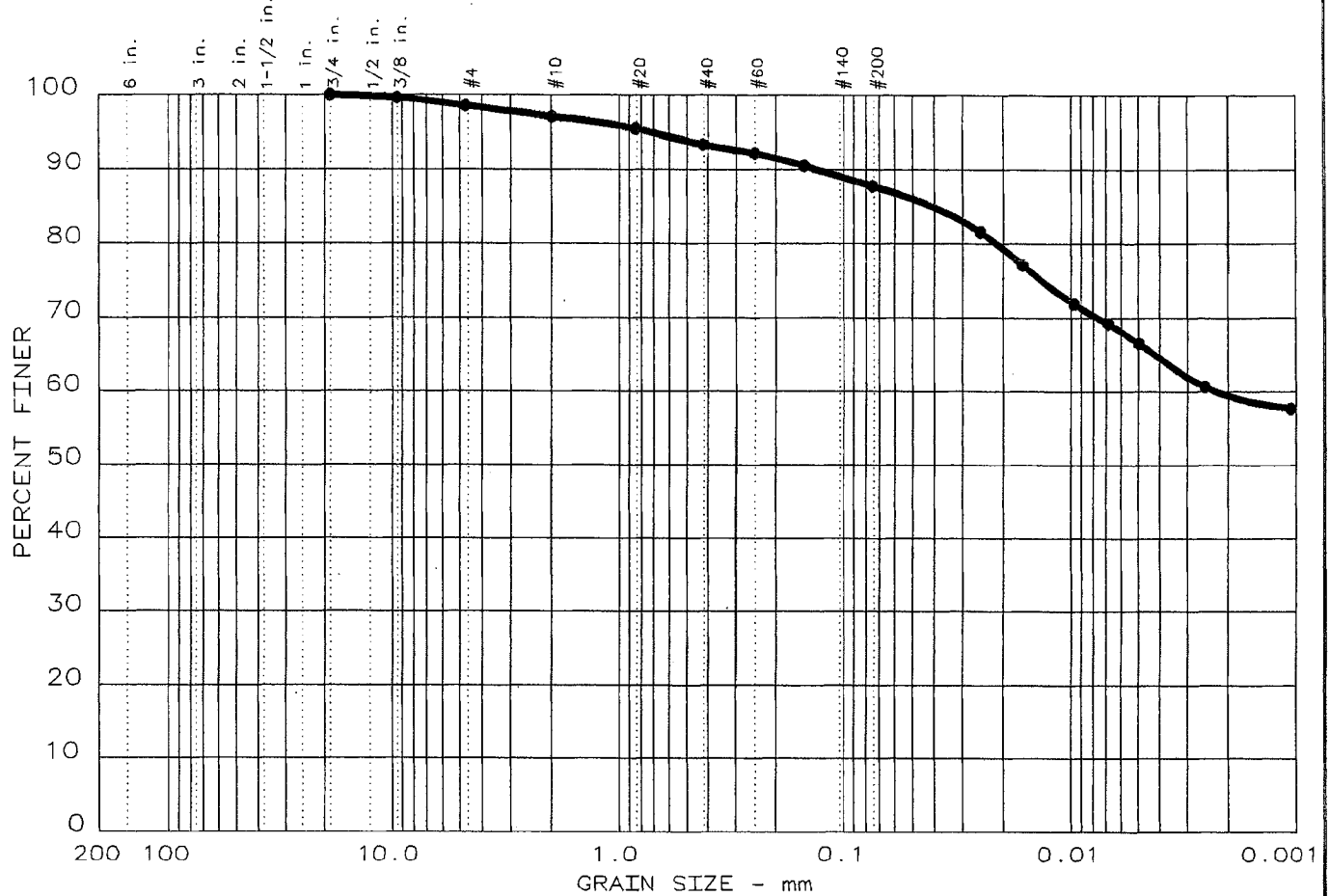

Test	% +3"	% GRAVEL	% SAND	% SILT	% CLAY	USCS	LL	PI
11	0.0	1.5	10.7	21.2	66.6	CH	58	29

SIEVE inches size	PERCENT FINER		
	●		
0.75	100.0		
0.375	99.6		
GRAIN SIZE			
D ₆₀	0.0022		
D ₃₀			
D ₁₀			
COEFFICIENTS			
C _c			
C _u			

SIEVE number size	PERCENT FINER		
	●		
4	98.5		
10	97.1		
20	95.4		
40	93.3		
60	92.2		
100	90.5		
200	87.8		

Sample information:
 ● Borrow area OT-1, 2.5-10
 Reddish orange fat clay
 , Sample No. 3221

Remarks:
 Methods: Particle Size:
 ASTM D 422-63; Sieve
 Analysis: AASHTO T27-99;
 Specific Gravity: 2.75

	Project No.: 3043051030.0001
	Project: TVA Kingston - Proposed Gypsum Stack
	Date: July 28, 2005
	Fig. No.: 221

GRAIN SIZE DISTRIBUTION TEST DATA

Test No.: 11

Date: July 21, 2005
 Project No.: 3043051030.0001
 Project: TVA Kingston - Proposed Gypsum Stack

Sample Data

Location of Sample: Borrow area OT-1,2.5-10
 Sample Description 1: **Reddish Orange** fat
 Sample Description 2: **clay**, Sample No. 3221
 USCS Class: CH Liquid limit: 58 Plasticity index: 29

Notes

Remarks: Methods: Particle Size: ASTM D 422-63; Sieve
 Analysis: AASHTO T27-99; Specific Gravity: 2.75
 Fig. No.: 221

Mechanical Analysis Data

Initial
 Dry sample and tare= 801.29
 Tare = 0.00
 Dry sample weight = 801.29
 Sample split on number 40 sieve
 Split sample data:
 Sample and tare = 51.73 Tare = 0 Sample weight = 51.73
 Cumulative weight retained tare= 0
 for cumulative weight retained= 0

Sieve	Cumul. Wt. retained	Percent finer
0.75 inches	0.00	100.0
0.375 inches	3.44	99.6
# 4	11.78	98.5
# 10	23.63	97.1
# 20	36.62	95.4
# 40	53.40	93.3
# 60	0.64	92.2
# 100	1.58	90.5
# 200	3.08	87.8

Hydrometer Analysis Data

Separation sieve is number 40
 Percent -# 40 based on complete sample= 93.3
 Weight of hydrometer sample: 54.47
 Hygroscopic moisture correction:
 Moist weight & tare = 53.50
 Dry weight & tare = 51.92
 Tare = 22.22

Hygroscopic moisture= 5.3 %
 Calculated biased weight= 55.41
 Table of composite correction values:
 Temp, deg C: 21.0 22.0 22.5 23.0 23.5
 Comp. corr: - 6.4 - 6.1 - 5.9 - 5.8 - 5.6
 Mucous correction only= 0
 Specific gravity of solids= 2.75
 Specific gravity correction factor= 0.978
 Hydrometer type: 152H Effective depth L= 16.294964 - 0.164 x Rm

Elapsed time, min	Temp, deg C	Actual reading	Corrected reading	K	Rm	Eff. depth	Diameter mm	Percent finer
2.0	23.0	52.0	46.2	0.0128	52.0	7.8	0.0252	81.6
5.0	23.0	49.5	43.7	0.0128	49.5	8.2	0.0163	77.2
15.0	23.0	46.5	40.7	0.0128	46.5	8.7	0.0097	71.9
31.0	23.0	45.0	39.2	0.0128	45.0	8.9	0.0068	69.2
60.0	23.0	43.5	37.7	0.0128	43.5	9.2	0.0050	66.6
250.0	22.0	40.5	34.4	0.0129	40.5	9.7	0.0025	60.7
1441.0	23.0	38.5	32.7	0.0128	38.5	10.0	0.0011	57.7

 Fractional Components

Gravel/Sand based on #4 sieve
 Sand/Fines based on #200 sieve
 % + 3 in. = 0.0 % GRAVEL = 1.5 % SAND = 10.7
 % SILT = 21.2 % CLAY = 66.6

D85= 0.04 D60= 0.002

PARTICLE SIZE DISTRIBUTION TEST REPORT

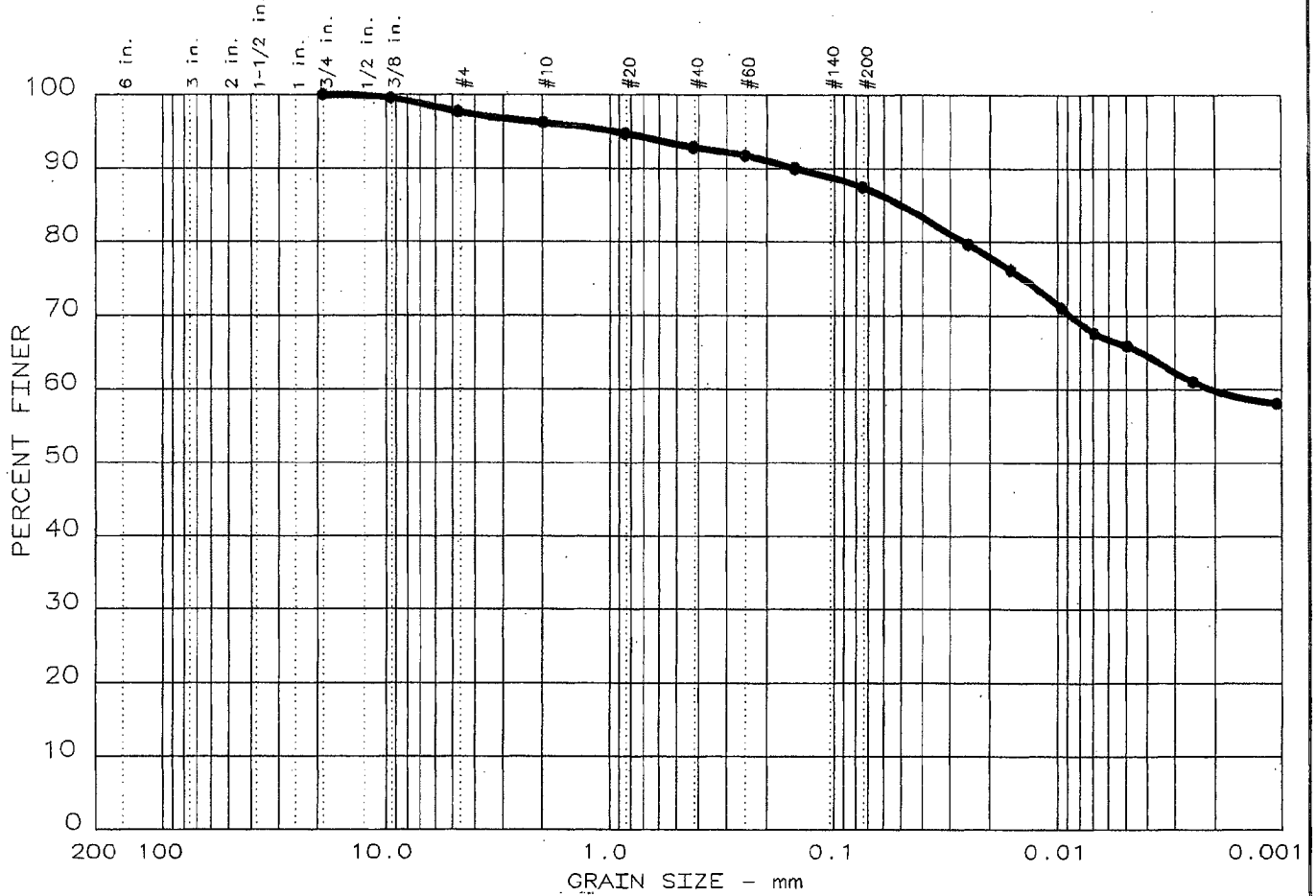

Test	% +3"	% GRAVEL	% SAND	% SILT	% CLAY	USCS	LL	PI
• 12	0.0	2.3	10.2	21.6	65.9	CH	59	33

SIEVE inches size	PERCENT FINER		
	●		
0.75	100.0		
0.375	99.5		
X GRAIN SIZE			
D ₆₀	0.0020		
D ₃₀			
D ₁₀			
X COEFFICIENTS			
C _c			
C _u			

SIEVE number size	PERCENT FINER		
	●		
4	97.7		
10	96.2		
20	94.6		
40	92.8		
60	91.7		
100	90.0		
200	87.5		

Sample information:
 • Borrow area OT-1, 2.5-10
 Reddish orange fat clay
 , Sample No. 3222

Remarks:
 Methods: Particle Size:
 ASTM D 422-63; Sieve
 Analysis: AASHTO T27-99;
 Specific Gravity: 2.75

Project No.: 3043051030.0001
 Project: TVA Kingston - Proposed Gypsum Stack
 Date: July 28, 2005
 Fig. No.: 222

=====

GRAIN SIZE DISTRIBUTION TEST DATA

Test No.: 12

Date: July 20, 2005
 Project No.: 3043051030.0001
 Project: TVA Kingston - Proposed Gypsum Stack

=====

Sample Data

Location of Sample: Borrow area OT-1,2.5-10
 Sample Description 1: **Reddish Orange** fat
 Sample Description 2: clay, Sample No. 3222
 USCS Class: CH Liquid limit: 59 Plasticity index: 33

Notes

Remarks: Methods: Particle Size: ASTM D 422-63; Sieve
 Analysis: AASHTO T27-99; Specific Gravity: 2.75
 Fig. No.: 222

Mechanical Analysis Data

Initial
 Dry sample and tare = 849.43
 Tare = 0.00
 Dry sample weight = 849.43
 Sample split on number 40 sieve
 Split sample data:
 Sample and tare = 52.65 Tare = 0 Sample weight = 52.65
 Cumulative weight retained tare = 0
 Tare for cumulative weight retained = 0

Sieve	Cumul. Wt. retained	Percent finer
0.75 inches	0.00	100.0
0.375 inches	4.13	99.5
# 4	19.88	97.7
# 10	32.60	96.2
# 20	45.53	94.6
# 40	61.10	92.8
# 60	0.62	91.7
# 100	1.58	90.0
# 200	3.02	87.5

Hydrometer Analysis Data

Separation sieve is number 40
 Percent -# 40 based on complete sample = 92.8
 Weight of hydrometer sample: 56.02
 Hygroscopic moisture correction:
 Moist weight & tare = 54.00
 Dry weight & tare = 52.09
 Tare = 22.27

Hygroscopic moisture= 6.4 %
 Calculated biased weight= 56.73
 Table of composite correction values:
 Temp, deg C: 21.0 22.0 22.5 23.0 23.5
 Comp. corr: - 6.4 - 6.1 - 5.9 - 5.8 - 5.6
 Meniscus correction only= 0
 Specific gravity of solids= 2.75
 Specific gravity correction factor= 0.978
 Hydrometer type: 152H Effective depth L= 16.294964 - 0.164 x Rm

Elapsed time, min	Temp, deg C	Actual reading	Corrected reading	K	Rm	Eff. depth	Diameter mm	Percent finer
2.0	23.0	52.0	46.2	0.0128	52.0	7.8	0.0252	79.7
5.0	23.0	50.0	44.2	0.0128	50.0	8.1	0.0163	76.2
15.0	23.0	47.0	41.2	0.0128	47.0	8.6	0.0097	71.1
30.0	23.0	45.0	39.2	0.0128	45.0	8.9	0.0070	67.6
60.0	23.0	44.0	38.2	0.0128	44.0	9.1	0.0050	65.9
250.0	22.0	41.5	35.4	0.0129	41.5	9.5	0.0025	61.1
1440.0	23.0	39.5	33.7	0.0128	39.5	9.8	0.0011	58.1

 Fractional Components

Gravel/Sand based on #4 sieve
 Sand/Fines based on #200 sieve
 % + 3 in. = 0.0 % GRAVEL = 2.3 % SAND = 10.2
 % SILT = 21.6 % CLAY = 65.9

D85= 0.05 D60= 0.002

PARTICLE SIZE DISTRIBUTION TEST REPORT

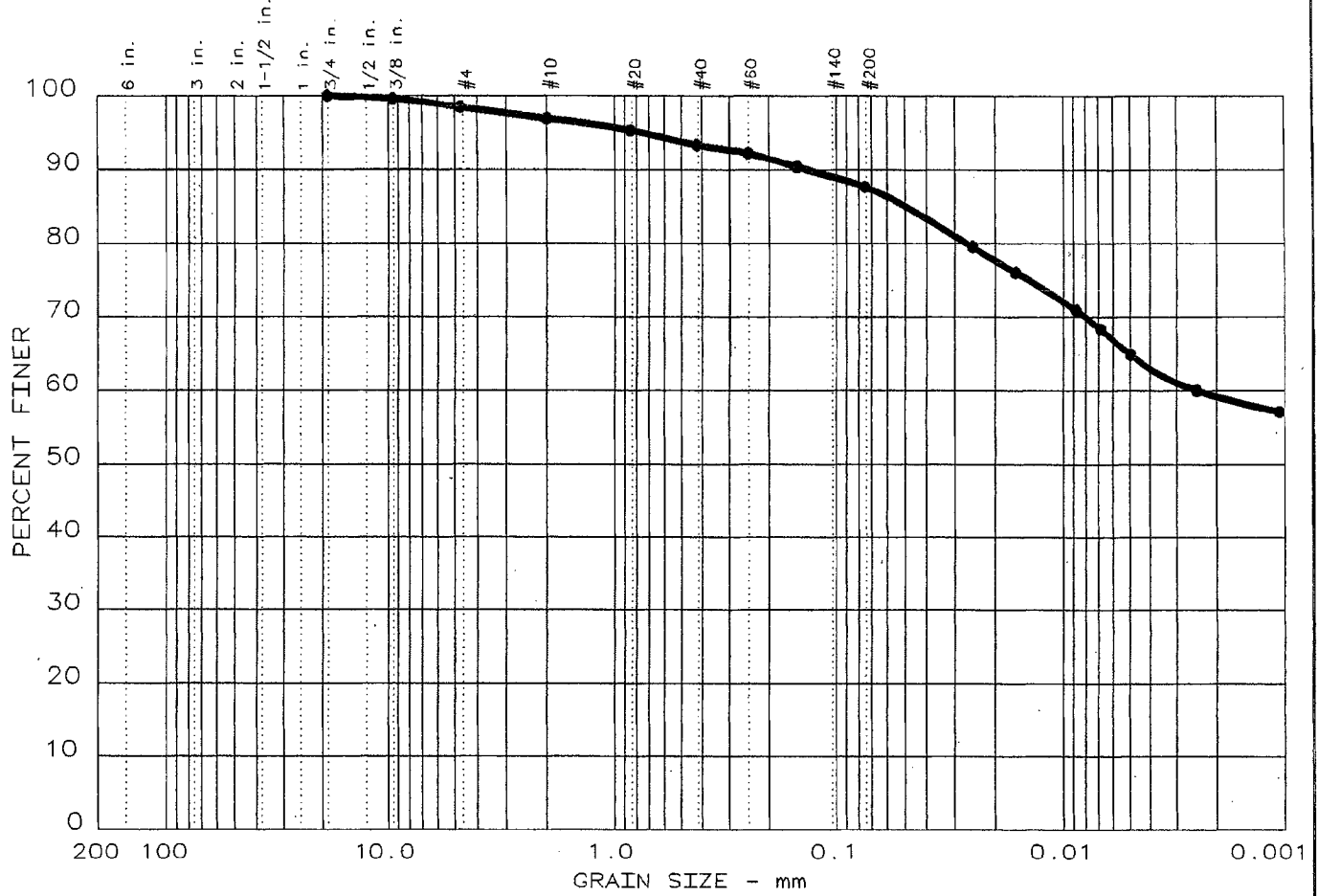

Test	% +3"	% GRAVEL	% SAND	% SILT	% CLAY	USCS	LL	PI
13	0.0	1.6	10.7	22.8	64.9	CH	60	32

SIEVE inches size	PERCENT FINER	
	●	
0.75	100.0	
0.375	99.6	
GRAIN SIZE		
D ₆₀	0.0024	
D ₃₀		
D ₁₀		
COEFFICIENTS		
C _c		
C _u		

SIEVE number size	PERCENT FINER	
	●	
4	98.4	
10	96.9	
20	95.3	
40	93.3	
60	92.2	
100	90.4	
200	87.7	

Sample information:
 ● Borrow area OT-1, 2.5-10
 Reddish orange fat clay
 , Sample No. 3223

Remarks:
 Methods: Particle Size:
 ASTM D 422-63; Sieve
 Analysis: AASHTO T27-99;
 Specific Gravity: 2.75

	Project No.: 3043051030.0001 Project: TVA Kingston - Proposed Gypsum Stack Date: July 28, 2005
	Fig. No.: 223

GRAIN SIZE DISTRIBUTION TEST DATA

Test No.: 13

Date: July 21, 2005
 Project No.: 3043051030.0001
 Project: TVA Kingston - Proposed Gypsum Stack

Sample Data

Location of Sample: Borrow area OT-1, 2.5-10
 Sample Description 1: **Reddish Orange** fat
 Sample Description 2: clay, Sample No. 3223
 USCS Class: CH Liquid limit: 60 Plasticity index: 32

Notes

Remarks: Methods: Particle Size: ASTM D 422-63; Sieve
 Analysis: AASHTO T27-99; Specific Gravity: 2.75
 Fig. No.: 223

Mechanical Analysis Data

Initial
 Dry sample and tare= 821.53
 Tare = 0.00
 Dry sample weight = 821.53
 Sample split on number 40 sieve
 Split sample data:
 Sample and tare = 53.02 Tare = 0 Sample weight = 53.02
 Cumulative weight retained tare= 0
 for cumulative weight retained= 0

Sieve	Cumul. Wt. retained	Percent finer
0.75 inches	0.00	100.0
0.375 inches	3.35	99.6
# 4	12.86	98.4
# 10	25.56	96.9
# 20	38.86	95.3
# 40	55.24	93.3
# 60	0.62	92.2
# 100	1.66	90.4
# 200	3.17	87.7

Hydrometer Analysis Data

Separation sieve is number 40
 Percent -# 40 based on complete sample= 93.3
 Weight of hydrometer sample: 54.24
 Hygroscopic moisture correction:
 Moist weight & tare = 56.01
 Dry weight & tare = 55.25
 Tare = 22.22

Hygroscopic moisture= 2.3 %
 Calculated biased weight= 56.84
 Table of composite correction values:
 Temp, deg C: 21.0 22.0 22.5 23.0 23.5
 Comp. corr: - 6.4 - 6.1 - 5.9 - 5.8 - 5.6
 Meniscus correction only= 0
 Specific gravity of solids= 2.75
 Specific gravity correction factor= 0.978
 Hydrometer type: 152H Effective depth L= 16.294964 - 0.164 x Rm

Elapsed time, min	Temp, deg C	Actual reading	Corrected reading	K	Rm	Eff. depth	Diameter mm	Percent finer
2.0	23.0	52.0	46.2	0.0128	52.0	7.8	0.0252	79.5
5.0	23.0	50.0	44.2	0.0128	50.0	8.1	0.0163	76.1
18.0	23.0	47.0	41.2	0.0128	47.0	8.6	0.0088	70.9
31.0	23.0	45.5	39.7	0.0128	45.5	8.8	0.0068	68.3
60.0	23.0	43.5	37.7	0.0128	43.5	9.2	0.0050	64.9
266.0	22.0	41.0	34.9	0.0129	41.0	9.6	0.0025	60.1
1440.0	23.0	39.0	33.2	0.0128	39.0	9.9	0.0011	57.1

 Fractional Components

Gravel/Sand based on #4 sieve
 Sand/Fines based on #200 sieve
 % + 3 in. = 0.0 % GRAVEL = 1.6 % SAND = 10.7
 % SILT = 22.8 % CLAY = 64.9

D85= 0.05 D60= 0.002

PARTICLE SIZE DISTRIBUTION TEST REPORT

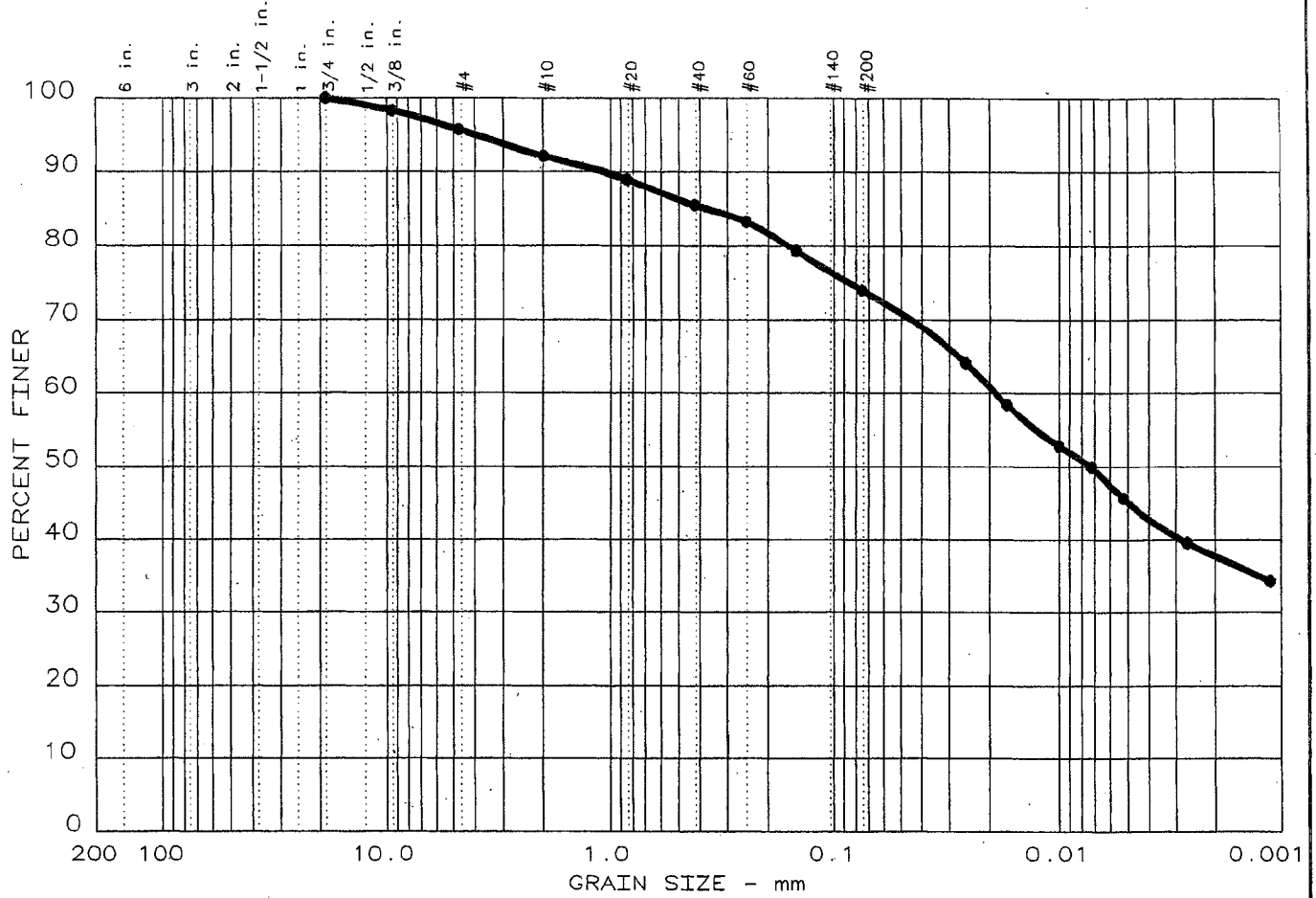

Test	% +3"	% GRAVEL	% SAND	% SILT	% CLAY	USCS	LL	PI
● 14	0.0	4.3	21.7	28.9	45.1	CL	47	24

SIEVE inches size	PERCENT FINER	
	●	
0.75	100.0	
0.375	98.3	
 GRAIN SIZE 		
D ₆₀	0.0186	
D ₃₀		
D ₁₀		
 COEFFICIENTS 		
C _c		
C _u		

SIEVE number size	PERCENT FINER	
	●	
4	95.7	
10	92.1	
20	89.0	
40	85.5	
60	83.3	
100	79.4	
200	74.0	

Sample information:
 ● Borrow area OT-3, 3-10'
 Reddish brown lean clay
 with sand, Sample # 3224

Remarks:
 Methods: Particle Size:
 ASTM D 422-63; Sieve
 Analysis: AASHTO T27-99;
 Specific Gravity: 2.74

	Project No.: 3043051030.0001 Project: TVA Kingston - Proposed Gypsum Stack Date: July 28, 2005
	Fig. No.: 224

=====

GRAIN SIZE DISTRIBUTION TEST DATA

Test No.: 14

Date: July 21, 2005
 Project No.: 3043051030.0001
 Project: TVA Kingston - Proposed Gypsum Stack

=====

Sample Data

Location of Sample: Borrow area OT-3, 3-10'
 Sample Description 1: **Reddish** brown lean
 Sample Description 2: clay w/sand, Sample 3224
 USCS Class: CL Liquid limit: 47 Plasticity index: 24

Notes

Remarks: Methods: Particle Size: ASTM D 422-63; Sieve
 Analysis: AASHTO T27-99; Specific Gravity: 2.74
 Fig. No.: 224

Mechanical Analysis Data

Initial
 Dry sample and tare= 980.29
 Tare = 0.00
 Dry sample weight = 980.29
 Sample split on number 40 sieve
 Split sample data:

Sample and tare = 59.13 Tare = 0 Sample weight = 59.13
 Cumulative weight retained tare= 0
 Sample for cumulative weight retained= 0

Sieve	Cumul. Wt. retained	Percent finer
0.75 inches	0.00	100.0
0.375 inches	17.15	98.3
# 4	42.37	95.7
# 10	77.60	92.1
# 20	107.68	89.0
# 40	141.66	85.5
# 60	1.55	83.3
# 100	4.26	79.4
# 200	7.96	74.0

Hydrometer Analysis Data

Separation sieve is number 40
 Percent -# 40 based on complete sample= 85.5
 Weight of hydrometer sample: 59.72
 Hygroscopic moisture correction:
 Moist weight & tare = 54.87
 Dry weight & tare = 54.53
 Tare = 22.14

Hygroscopic moisture= 1.0 %
 Calculated biased weight= 69.08
 Table of composite correction values:
 Temp, deg C: 21.0 22.0 22.5 23.0 23.5
 Comp. corr: - 6.4 - 6.1 - 5.9 - 5.8 - 5.6

Meniscus correction only= 0

Specific gravity of solids= 2.74

Specific gravity correction factor= 0.980

Hydrometer type: 152H Effective depth L= 16.294964 - 0.164 x Rm

Elapsed time, min	Temp, deg C	Actual reading	Corrected reading	K	Rm	Eff. depth	Diameter mm	Percent finer
2.0	23.0	51.0	45.2	0.0128	51.0	7.9	0.0255	64.2
5.0	23.0	47.0	41.2	0.0128	47.0	8.6	0.0168	58.5
15.0	23.0	43.0	37.2	0.0128	43.0	9.2	0.0101	52.8
30.0	23.0	41.0	35.2	0.0128	41.0	9.6	0.0072	50.0
60.0	23.0	38.0	32.2	0.0128	38.0	10.1	0.0052	45.7
250.0	22.0	34.0	27.9	0.0130	34.0	10.7	0.0027	39.6
1449.0	23.0	30.0	24.2	0.0128	30.0	11.4	0.0011	34.3

 Fractional Components

Gravel/Sand based on #4 sieve

Sand/Fines based on #200 sieve

% + 3 in. = 0.0 % GRAVEL = 4.3 % SAND = 21.7

% SILT = 28.9 % CLAY = 45.1

D85= 0.37 D60= 0.019 D50= 0.007

PARTICLE SIZE DISTRIBUTION TEST REPORT

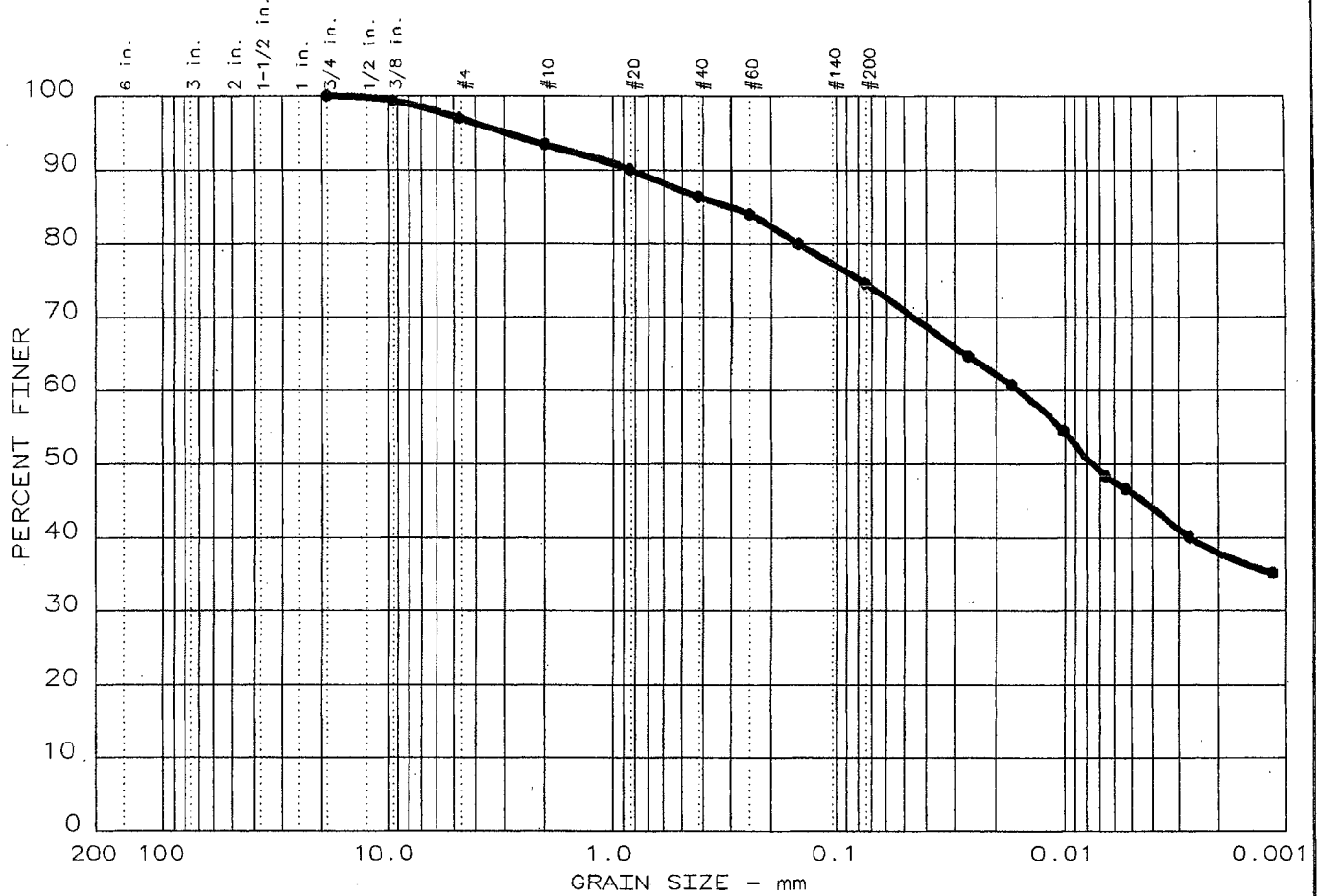

Test	% +3"	% GRAVEL	% SAND	% SILT	% CLAY	USCS	LL	PI
● 15	0.0	3.0	22.4	28.5	46.1	CH	50	27

SIEVE inches size	PERCENT FINER		
	●		
0.75	100.0		
0.375	99.3		
X	GRAIN SIZE		
D ₆₀	0.0157		
D ₃₀			
D ₁₀			
X	COEFFICIENTS		
C _c			
C _u			

SIEVE number size	PERCENT FINER		
	●		
4	97.0		
10	93.4		
20	90.1		
40	86.4		
60	84.0		
100	80.0		
200	74.6		

Sample information:
 ● Borrow area OT-3, 3-10'
 Reddish brown fat clay
 with sand, Sample # 3225

Remarks:
 Methods: Particle Size:
 ASTM D 422-63; Sieve
 Analysis: AASHTO T27-99;
 Specific Gravity: 2.75

	Project No.: 3043051030.0001
	Project: TVA Kingston - Proposed Gypsum Stack
	Date: July 28, 2005
	Fig. No.: 225

GRAIN SIZE DISTRIBUTION TEST DATA

Test No.: 15

Date: July 21, 2005
 Project No.: 3043051030.0001
 Project: TVA Kingston - Proposed Gypsum Stack

Sample Data

Location of Sample: Borrow area OT-3, 3-10'
 Sample Description 1: **Reddish** brown fat
 Sample Description 2: clay w/sand, Sample 3225
 USCS Class: CH Liquid limit: 50 Plasticity index: 27

Notes

Remarks: Methods: Particle Size: ASTM D 422-63; Sieve
 Analysis: AASHTO T27-99; Specific Gravity: 2.75
 Fig. No.: 225

Mechanical Analysis Data

Initial
 Dry sample and tare = 836.50
 Tare = 0.00
 Dry sample weight = 836.50
 Sample split on number 40 sieve
 Split sample data:
 Sample and tare = 54.49 Tare = 0 Sample weight = 54.49
 Cumulative weight retained tare = 0
 Weight for cumulative weight retained = 0

Sieve	Cumul. Wt. retained	Percent finer
0.75 inches	0.00	100.0
0.375 inches	5.70	99.3
# 4	25.34	97.0
# 10	55.35	93.4
# 20	82.95	90.1
# 40	114.15	86.4
# 60	1.51	84.0
# 100	4.01	80.0
# 200	7.41	74.6

Hydrometer Analysis Data

Separation sieve is number 40
 Percent -# 40 based on complete sample = 86.4
 Weight of hydrometer sample: 56.02
 Hygroscopic moisture correction:
 Moist weight & tare = 53.51
 Dry weight & tare = 52.66
 Tare = 22.10

Hygroscopic moisture= 2.8 %
 Calculated biased weight= 63.12
 Table of composite correction values:
 Temp, deg C: 21.0 22.0 22.5 23.0 23.5
 Comp. corr: - 6.4 - 6.1 - 5.9 - 5.8 - 5.6

Mucous correction only= 0
 Specific gravity of solids= 2.75
 Specific gravity correction factor= 0.978
 Hydrometer type: 152H Effective depth L= 16.294964 - 0.164 x Rm

Elapsed time, min	Temp, deg C	Actual reading	Corrected reading	K	Rm	Eff. depth	Diameter mm	Percent finer
2.0	23.0	47.5	41.7	0.0128	47.5	8.5	0.0263	64.6
5.0	23.0	45.0	39.2	0.0128	45.0	8.9	0.0171	60.8
15.0	23.0	41.0	35.2	0.0128	41.0	9.6	0.0102	54.6
38.0	23.0	37.0	31.2	0.0128	37.0	10.2	0.0066	48.4
60.0	22.5	36.0	30.1	0.0128	36.0	10.4	0.0053	46.7
250.0	22.0	32.0	25.9	0.0129	32.0	11.0	0.0027	40.2
1442.0	23.0	28.5	22.7	0.0128	28.5	11.6	0.0011	35.2

 Fractional Components

Gravel/Sand based on #4 sieve
 Sand/Fines based on #200 sieve
 % + 3 in. = 0.0 % GRAVEL = 3.0 % SAND = 22.4
 % SILT = 28.5 % CLAY = 46.1

D85= 0.30 D60= 0.016 D50= 0.007

PARTICLE SIZE DISTRIBUTION TEST REPORT

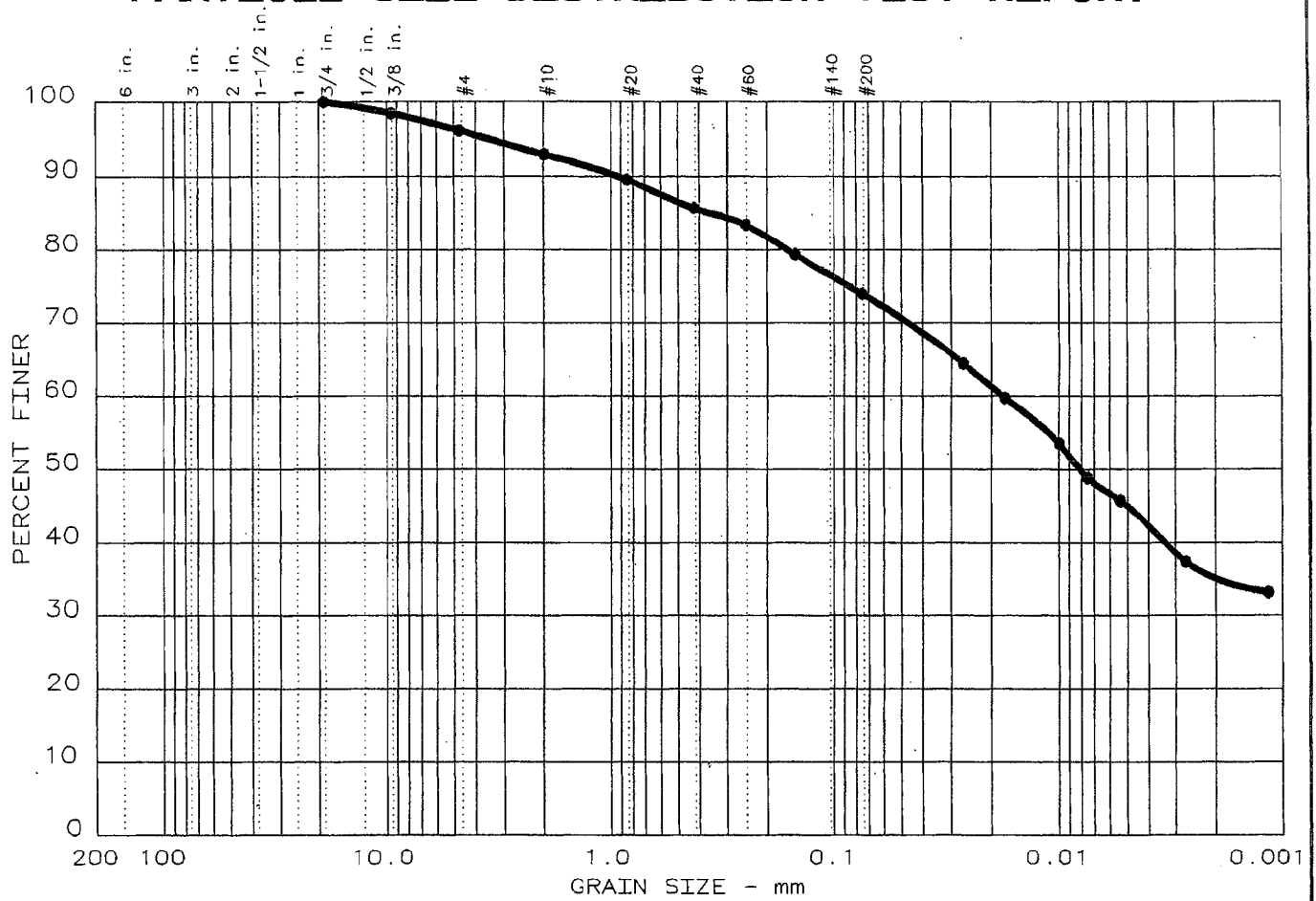

Test	% +3"	% GRAVEL	% SAND	% SILT	% CLAY	USCS	LL	PI
16	0.0	3.9	22.0	29.2	44.9	CL	45	23

SIEVE inches size	PERCENT FINER	
	●	
0.75	100.0	
0.375	98.4	
GRAIN SIZE		
D ₆₀	0.0176	
D ₃₀		
D ₁₀		
COEFFICIENTS		
C _c		
C _u		

SIEVE number size	PERCENT FINER	
	●	
4	96.1	
10	92.9	
20	89.5	
40	85.7	
60	83.4	
100	79.4	
200	74.1	

Sample information:
 ● Borrow area OT-3, 3-10'
 Reddish brown lean clay
 with sand, Sample # 3226

Remarks:
 Methods: Particle Size:
 ASTM D 422-63; Sieve
 Analysis: AASHTO T27-99;
 Specific Gravity: 2.73

	Project No.: 3043051030.0001
	Project: TVA Kingston - Proposed Gypsum Stack
	Date: July 21, 2005 Fig. No.: 226

=====

GRAIN SIZE DISTRIBUTION TEST DATA

Test No.: 16

Date: July 21, 2005
 Project No.: 3043051030.0001
 Project: TVA Kingston - Proposed Gypsum Stack

=====

Sample Data

Location of Sample: Borrow area OT-3, 3-10'
 Sample Description 1: ~~Reddish~~ brown lean
 Sample Description 2: clay w/sand, Sample 3226
 USCS Class: CL Liquid limit: 45 Plasticity index: 23

Notes

Remarks: Methods: Particle Size: ASTM D 422-63; Sieve
 Analysis: AASHTO T27-99; Specific Gravity: 2.73
 Fig. No.: 226

Mechanical Analysis Data

Initial
 Dry sample and tare= 902.40
 Tare = 0.00
 Dry sample weight = 902.40
 Sample split on number 40 sieve
 Split sample data:
 Sample and tare = 53.77 Tare = 0 Sample weight = 53.77
 Cumulative weight retained tare= 0
 Tare for cumulative weight retained= 0

Sieve	Cumul. Wt. retained	Percent finer
0.75 inches	0.00	100.0
0.375 inches	14.25	98.4
# 4	35.33	96.1
# 10	64.17	92.9
# 20	94.51	89.5
# 40	129.34	85.7
# 60	1.45	83.4
# 100	3.95	79.4
# 200	7.29	74.1

Hydrometer Analysis Data

Separation sieve is number 40
 Percent -# 40 based on complete sample= 85.7
 Weight of hydrometer sample: 56.14
 Hygroscopic moisture correction:
 Moist weight & tare = 53.13
 Dry weight & tare = 51.84
 Tare = 22.50

Hygroscopic moisture= 4.4 %
 Calculated biased weight= 62.77
 Table of composite correction values:
 Temp, deg C: 21.0 22.0 22.5 23.0 24.0
 Comp. corr: - 6.4 - 6.1 - 5.9 - 5.8 - 5.4

Miscus correction only= 0

Specific gravity of solids= 2.73

Specific gravity correction factor= 0.983

Hydrometer type: 152H Effective depth L= 16.294964 - 0.164 x Rm

Elapsed time, min	Temp, deg C	Actual reading	Corrected reading	K	Rm	Eff. depth	Diameter mm	Percent finer
2.0	23.0	47.0	41.2	0.0128	47.0	8.6	0.0266	64.5
5.0	23.0	44.0	38.2	0.0128	44.0	9.1	0.0173	59.8
16.0	23.0	40.0	34.2	0.0128	40.0	9.7	0.0100	53.5
30.0	23.0	37.0	31.2	0.0128	37.0	10.2	0.0075	48.8
60.0	23.0	35.0	29.2	0.0128	35.0	10.6	0.0054	45.7
260.0	22.0	30.0	23.9	0.0130	30.0	11.4	0.0027	37.4
1441.0	23.0	27.0	21.2	0.0128	27.0	11.9	0.0012	33.2

 Fractional Components

Gravel/Sand based on #4 sieve

Sand/Fines based on #200 sieve

% + 3 in. = 0.0 % GRAVEL = 3.9 % SAND = 22.0

% SILT = 29.2 % CLAY = 44.9

D85= 0.36 D60= 0.018 D50= 0.008

PARTICLE SIZE DISTRIBUTION TEST REPORT

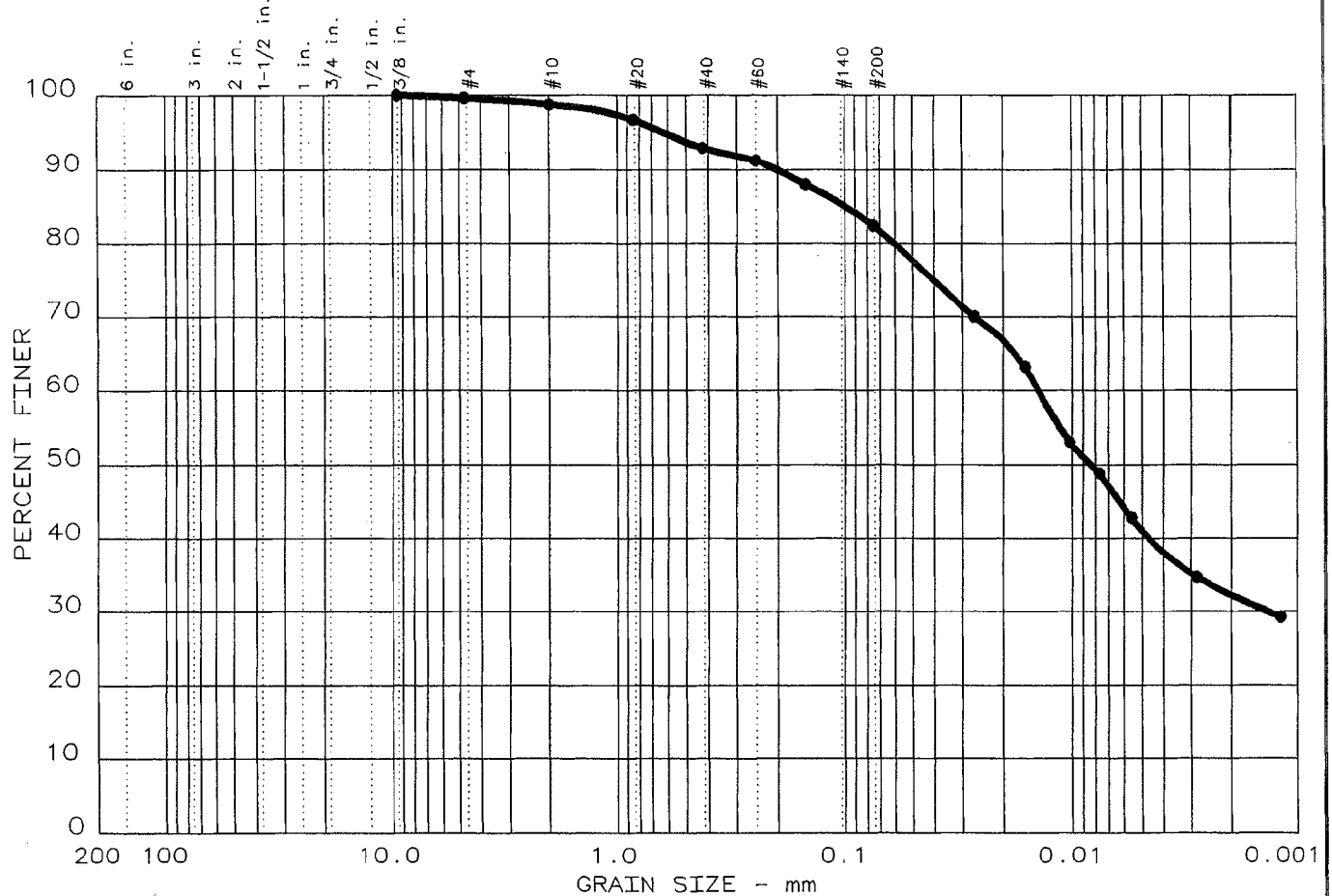

Test	% +3"	% GRAVEL	% SAND	% SILT	% CLAY	USCS	LL	PI
17	0.0	0.4	17.2	41.4	41.0	CL	36	17

SIEVE inches size	PERCENT FINER
0.375	100.0
GRAIN SIZE	
D ₆₀	0.0138
D ₃₀	0.0014
D ₁₀	
COEFFICIENTS	
C _c	
C _u	

SIEVE number size	PERCENT FINER
4	99.6
10	98.8
20	96.7
40	92.9
60	91.2
100	88.0
200	82.4

Sample information:
 • Borrow area OT-4, 4-10'
 Dark red brown lean clay w/sand, Sample 3227

Remarks:
 Methods: Particle Size: ASTM D 422-63; Sieve Analysis: AASHTO T27-99; Specific Gravity: 2.72

	Project No.: 3043051030.0001	
	Project: TVA Kingston - Proposed Gypsum Stack	
	Date: July 21, 2005	Fig. No.: 227

=====

GRAIN SIZE DISTRIBUTION TEST DATA

Test No.: 17

Date: July 21, 2005

Project No.: 3043051030.0001

Project: TVA Kingston - Proposed Gypsum Stack

=====

Sample Data

Location of Sample: Borrow area OT-4, 4-10'

Sample Description 1: Dark red brown lean

Sample Description 2: clay with sand, # 3227

USCS Class: CL Liquid limit: 36 Plasticity index: 17

Notes

Remarks: Methods: Particle Size: ASTM D 422-63; Sieve

Analysis: AASHTO T27-99; Specific Gravity: 2.72

Fig. No.: 227

Mechanical Analysis Data

Initial

Dry sample and tare= 766.97

Tare = 0.00

Dry sample weight = 766.97

Sample split on number 40 sieve

Split sample data:

Sample and tare = 53.78 Tare = 0 Sample weight = 53.78

Cumulative weight retained tare= 0

Tare for cumulative weight retained= 0

Sieve	Cumul. Wt. retained	Percent finer
0.375 inches	0.00	100.0
# 4	2.93	99.6
# 10	9.58	98.8
# 20	25.58	96.7
# 40	54.33	92.9
# 60	0.99	91.2
# 100	2.84	88.0
# 200	6.09	82.4

Hydrometer Analysis Data

Separation sieve is number 40

Percent -# 40 based on complete sample= 92.9

Weight of hydrometer sample: 54.91

Hygroscopic moisture correction:

Moist weight & tare = 53.25

Dry weight & tare = 52.62

Tare = 21.93

Hygroscopic moisture= 2.1 %

Calculated biased weight= 57.91

Table of composite correction values:

Temp, deg C: 21.0 22.0 22.5 23.0 24.0

Comp. corr: - 6.4 - 6.1 - 5.9 - 5.8 - 5.4

Meniscus correction only= 0

Specific gravity of solids= 2.72

Specific gravity correction factor= 0.985

Hydrometer type: 152H Effective depth L= 16.294964 - 0.164 x Rm

Elapsed time, min	Temp, deg C	Actual reading	Corrected reading	K	Rm	Eff. depth	Diameter mm	Percent finer
2.0	23.0	47.0	41.2	0.0129	47.0	8.6	0.0267	70.1
6.0	23.0	43.0	37.2	0.0129	43.0	9.2	0.0160	63.3
16.0	23.0	37.0	31.2	0.0129	37.0	10.2	0.0103	53.1
30.0	23.0	34.5	28.7	0.0129	34.5	10.6	0.0077	48.8
60.0	23.0	31.0	25.2	0.0129	31.0	11.2	0.0056	42.8
250.0	22.0	26.5	20.4	0.0130	26.5	11.9	0.0029	34.7
1440.0	23.0	23.0	17.2	0.0129	23.0	12.5	0.0012	29.2

Fractional Components

Gravel/Sand based on #4 sieve

Sand/Fines based on #200 sieve

% + 3 in. = 0.0 % GRAVEL = 0.4 % SAND = 17.2

% SILT = 41.4 % CLAY = 41.0

D85= 0.10 D60= 0.014 D50= 0.008

D30= 0.0014

PARTICLE SIZE DISTRIBUTION TEST REPORT

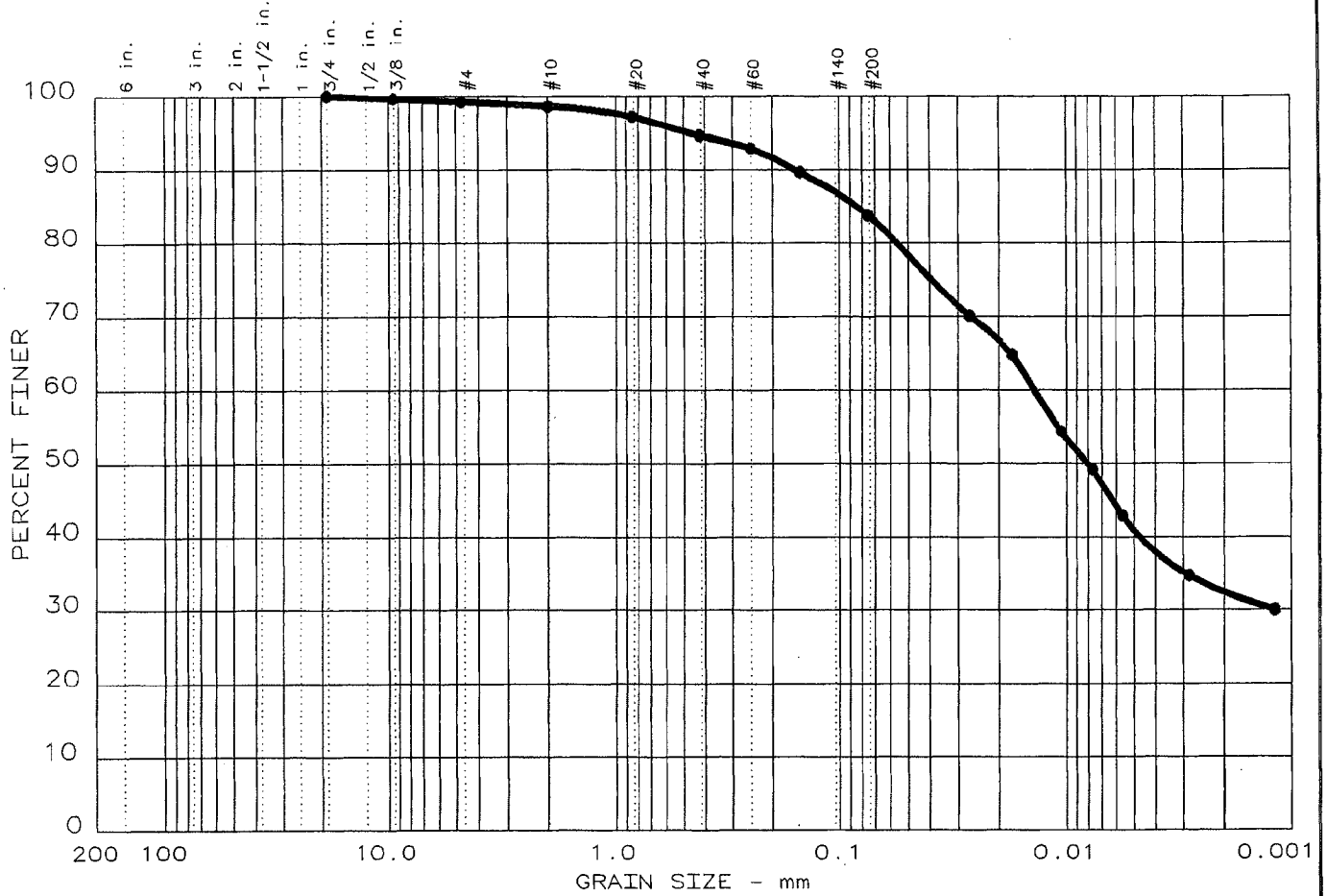

Test	% +3"	% GRAVEL	% SAND	% SILT	% CLAY	USCS	LL	PI
18	0.0	0.8	15.4	42.9	40.9	CL	38	18

SIEVE inches size	PERCENT FINER		
	●		
0.75	100.0		
0.375	99.6		
GRAIN SIZE			
D ₆₀	0.0138		
D ₃₀			
D ₁₀			
COEFFICIENTS			
C _c			
C _u			

SIEVE number size	PERCENT FINER		
	●		
4	99.2		
10	98.6		
20	97.2		
40	94.6		
60	92.9		
100	89.7		
200	83.8		

Sample information:
 ● Borrow area OT-4, 4-10'
 Dark red brown lean
 clay w/sand, Sample 3228

Remarks:
 Methods: Particle Size:
 ASTM D 422-63; Sieve
 Analysis: AASHTO T27-99;
 Specific Gravity: 2.73

	Project No.: 3043051030.0001 Project: TVA Kingston - Proposed Gypsum Stack Date: July 21, 2005
	Fig. No.: 228

=====

GRAIN SIZE DISTRIBUTION TEST DATA

Test No.: 18

Date: July 21, 2005
 Project No.: 3043051030.0001
 Project: TVA Kingston - Proposed Gypsum Stack

=====

Sample Data

Location of Sample: Borrow area OT-4, 4-10'
 Sample Description 1: Dark red brown lean
 Sample Description 2: clay with sand, # 3228
 USCS Class: CL Liquid limit: 38 Plasticity index: 18

Notes

Remarks: Methods: Particle Size: ASTM D 422-63; Sieve
 Analysis: AASHTO T27-99; Specific Gravity: 2.73
 Fig. No.: 228

Mechanical Analysis Data

Initial
 Dry sample and tare= 736.29
 Tare = 0.00
 Dry sample weight = 736.29
 Sample split on number 40 sieve
 Split sample data:
 Sample and tare = 53.35 Tare = 0 Sample weight = 53.35
 Cumulative weight retained tare= 0
 Tare for cumulative weight retained= 0

Sieve	Cumul. Wt. retained	Percent finer
0.75 inches	0.00	100.0
0.375 inches	3.01	99.6
# 4	5.77	99.2
# 10	10.49	98.6
# 20	20.88	97.2
# 40	39.58	94.6
# 60	0.97	92.9
# 100	2.79	89.7
# 200	6.11	83.8

Hydrometer Analysis Data

Separation sieve is number 40
 Percent -# 40 based on complete sample= 94.6
 Weight of hydrometer sample: 53.99
 Hygroscopic moisture correction:
 Moist weight & tare = 53.35
 Dry weight & tare = 52.97
 Tare = 22.26

Hygroscopic moisture= 1.2 %
 Calculated biased weight= 56.36
 Table of composite correction values:
 Temp, deg C: 21.0 22.0 22.5 23.0 24.0
 mp. corr: - 6.4 - 6.1 - 5.9 - 5.8 - 5.4
 viscosity correction only= 0
 Specific gravity of solids= 2.73
 Specific gravity correction factor= 0.983
 Hydrometer type: 152H Effective depth L= 16.294964 - 0.164 x Rm

Elapsed time, min	Temp, deg C	Actual reading	Corrected reading	K	Rm	Eff. depth	Diameter mm	Percent finer
2.0	23.0	46.0	40.2	0.0128	46.0	8.8	0.0269	70.1
5.0	23.0	43.0	37.2	0.0128	43.0	9.2	0.0175	64.9
15.0	23.0	37.0	31.2	0.0128	37.0	10.2	0.0106	54.4
30.0	23.0	34.0	28.2	0.0128	34.0	10.7	0.0077	49.2
60.0	22.5	30.5	24.6	0.0129	30.5	11.3	0.0056	42.9
250.0	22.0	26.0	19.9	0.0130	26.0	12.0	0.0029	34.7
1444.0	23.0	23.0	17.2	0.0128	23.0	12.5	0.0012	30.0

 Fractional Components

Gravel/Sand based on #4 sieve
 Sand/Fines based on #200 sieve
 % + 3 in. = 0.0 % GRAVEL = 0.8 % SAND = 15.4
 % SILT = 42.9 % CLAY = 40.9

D85= 0.08 D60= 0.014 D50= 0.008

PARTICLE SIZE DISTRIBUTION TEST REPORT

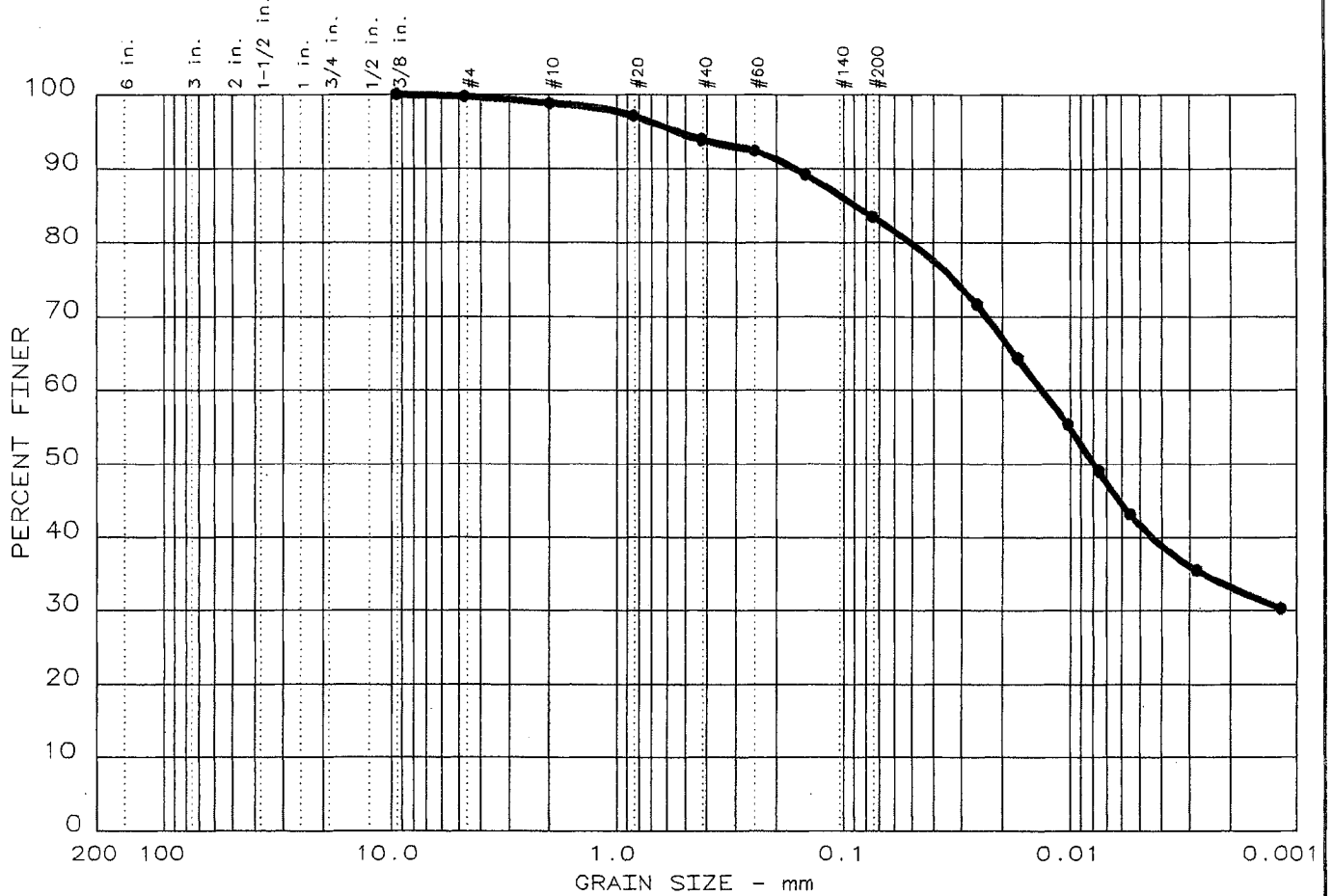

Test	% +3"	% GRAVEL	% SAND	% SILT	% CLAY	USCS	LL	PI
19	0.0	0.3	16.2	41.9	41.6	CL	39	20

SIEVE inches size	PERCENT FINER	
	●	
0.375	100.0	
GRAIN SIZE		
D ₆₀	0.0132	
D ₃₀		
D ₁₀		
COEFFICIENTS		
C _c		
C _u		

SIEVE number size	PERCENT FINER	
	●	
4	99.7	
10	98.8	
20	97.1	
40	93.9	
60	92.4	
100	89.3	
200	83.5	

Sample information:
 ● Borrow area OT-4, 4-10'
 Dark red brown lean
 clay w/sand, Sample 3229

Remarks:
 Methods: Particle Size:
 ASTM D 422-63; Sieve
 Analysis: AASHTO T27-99;
 Specific Gravity: 2.73

	Project No.: 3043051030.0001
	Project: TVA Kingston - Proposed Gypsum Stack
	Date: July 21, 2005
	Fig. No.: 229

GRAIN SIZE DISTRIBUTION TEST DATA

Test No.: 19

Date: July 21, 2005

Project No.: 3043051030.0001

Project: TVA Kingston - Proposed Gypsum Stack

Sample Data

Location of Sample: Borrow area OT-4, 4-10'

Sample Description 1: Dark red brown lean

Sample Description 2: clay with sand, # 3229

USCS Class: CL Liquid limit: 39 Plasticity index: 20

Notes

Remarks: Methods: Particle Size: ASTM D 422-63; Sieve

Analysis: AASHTO T27-99; Specific Gravity: 2.73

Fig. No.: 229

Mechanical Analysis Data

Initial

Dry sample and tare= 662.70

Tare = 0.00

Dry sample weight = 662.70

Sample split on number 40 sieve

Split sample data:

Sample and tare = 56.92 Tare = 0 Sample weight = 56.92

Cumulative weight retained tare= 0

Tare for cumulative weight retained= 0

Sieve	Cumul. Wt. retained	Percent finer
0.375 inches	0.00	100.0
# 4	1.90	99.7
# 10	7.78	98.8
# 20	19.16	97.1
# 40	40.45	93.9
# 60	0.89	92.4
# 100	2.81	89.3
# 200	6.30	83.5

Hydrometer Analysis Data

Separation sieve is number 40

Percent -# 40 based on complete sample= 93.9

Weight of hydrometer sample: 58.34

Hygroscopic moisture correction:

Moist weight & tare = 53.55

Dry weight & tare = 52.77

Tare = 21.97

Hygroscopic moisture= 2.5 %

Calculated biased weight= 60.60

Table of composite correction values:

Temp, deg C: 21.0 22.0 22.5 23.0 24.0

Comp. corr: - 6.4 - 6.1 - 5.9 - 5.8 - 5.4

Misc correction only= 0

Specific gravity of solids= 2.73

Specific gravity correction factor= 0.983

Hydrometer type: 152H Effective depth L= 16.294964 - 0.164 x Rm

Elapsed time, min	Temp, deg C	Actual reading	Corrected reading	K	Rm	Eff. depth	Diameter mm	Percent finer
2.0	23.0	50.0	44.2	0.0128	50.0	8.1	0.0258	71.7
5.0	23.0	45.5	39.7	0.0128	45.5	8.8	0.0171	64.4
15.0	23.0	40.0	34.2	0.0128	40.0	9.7	0.0103	55.5
30.0	23.0	36.0	30.2	0.0128	36.0	10.4	0.0076	49.0
60.0	22.5	32.5	26.6	0.0129	32.5	11.0	0.0055	43.1
250.0	22.0	28.0	21.9	0.0130	28.0	11.7	0.0028	35.5
1440.0	23.0	24.5	18.7	0.0128	24.5	12.3	0.0012	30.3

Fractional Components

Gravel/Sand based on #4 sieve

Sand/Fines based on #200 sieve

% + 3 in. = 0.0 % GRAVEL = 0.3 % SAND = 16.2

% SILT = 41.9 % CLAY = 41.6

D85= 0.09 D60= 0.013 D50= 0.008

Gypsum Stack Borrow Area, TVA Kingston Fossil Plant
MACTEC Project 3043051030.01

October 4, 2005

MOISTURE-DENSITY RELATIONSHIP TEST RESULTS

MOISTURE-DENSITY RELATIONSHIP TEST

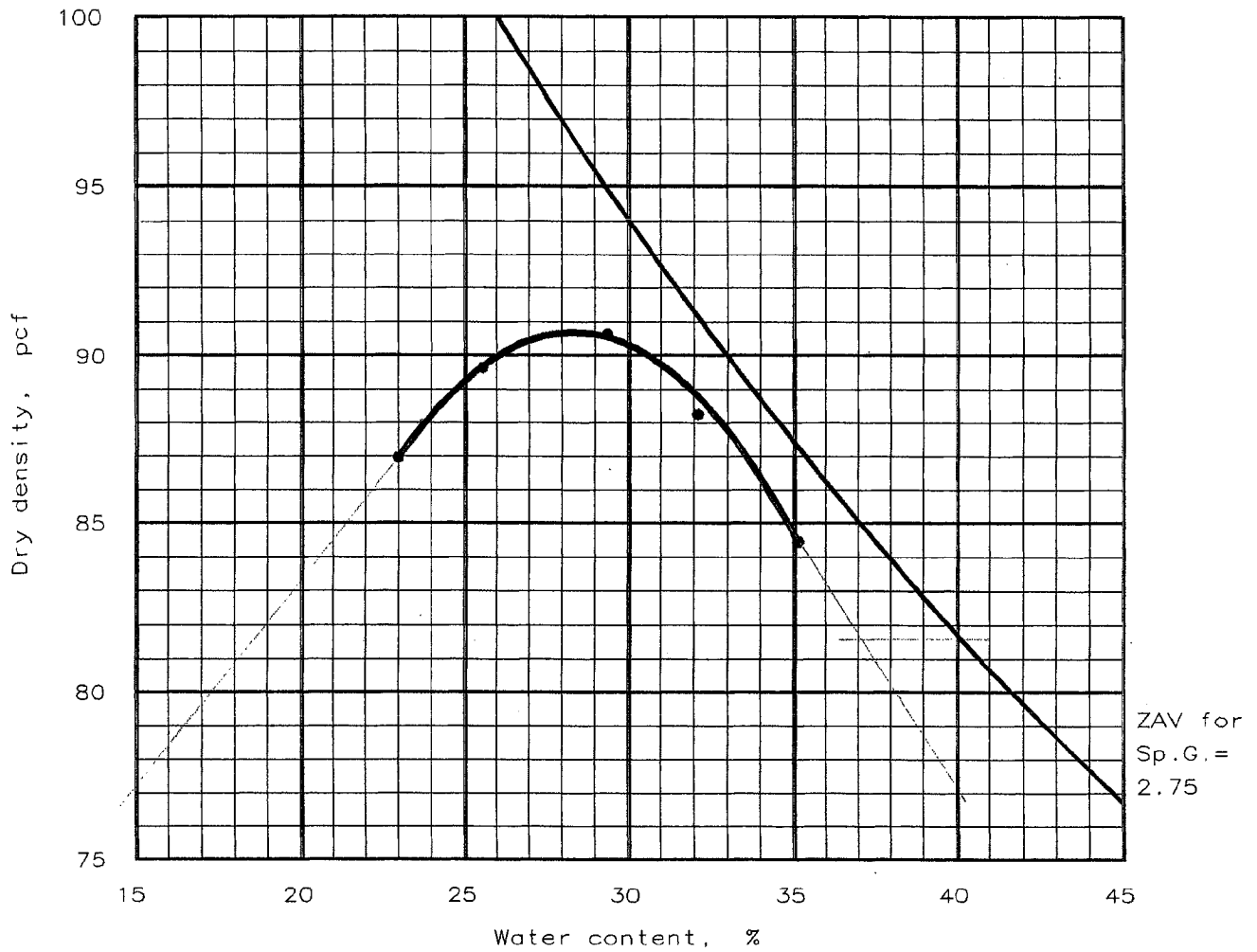

Test specification: ASTM D 698-00ae1 Procedure B, Standard

Elev/ Depth	Classification		Nat. Moist.	Sp.G.	LL	PI	% > 3/8 in	% < No.200
	USCS	AASHTO						
2.5-10	CH	A-7-6(16)	24.6 %	2.75	58	29	0.4 %	87.8 %

TEST RESULTS	MATERIAL DESCRIPTION
Maximum dry density = 90.7 pcf Optimum moisture = 28.3 %	Reddish orange fat clay
Project No.: 3043051030.0001 Project: TVA Kingston - Proposed Gypsum Stack Location: Borrow Area Observation Trench OT-1 Date: 7-28-2005	Remarks: Sample Number 3221 TIP - Test In Progress NT - No Test
MOISTURE-DENSITY RELATIONSHIP TEST	

MOISTURE-DENSITY RELATIONSHIP TEST

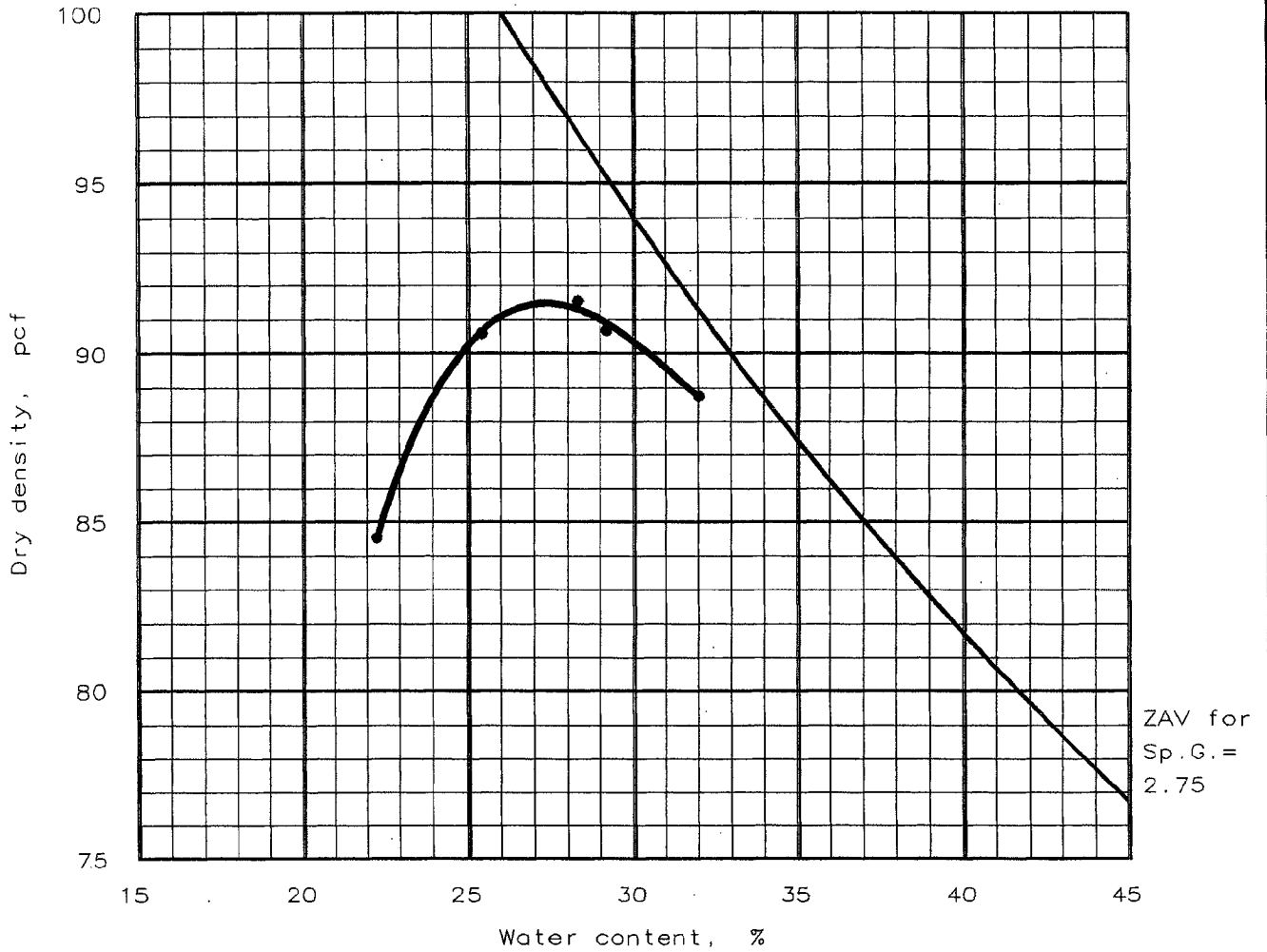

Test specification: ASTM D 698-00ae1 Procedure B, Standard

Elev/ Depth	Classification		Nat. Moist.	Sp.G.	LL	PI	% > 3/8 in	% < No.200
	USCS	AASHTO						
2.5-10	CH	A-7-6(32)	24.6 %	2.75	59	33	0.5 %	87.5 %

TEST RESULTS	MATERIAL DESCRIPTION
Maximum dry density = 91.6 pcf Optimum moisture = 28.3 %	Reddish orange fat clay
Project No.: 3043051030.0001 Project: TVA Kingston - Proposed Gypsum Stack Location: Borrow Area Observation Trench OT-1 Date: 7-28-2005	Remarks: Sample Number 3222 TIP - Test In Progress NT - No Test
MOISTURE-DENSITY RELATIONSHIP TEST	

MOISTURE-DENSITY RELATIONSHIP TEST

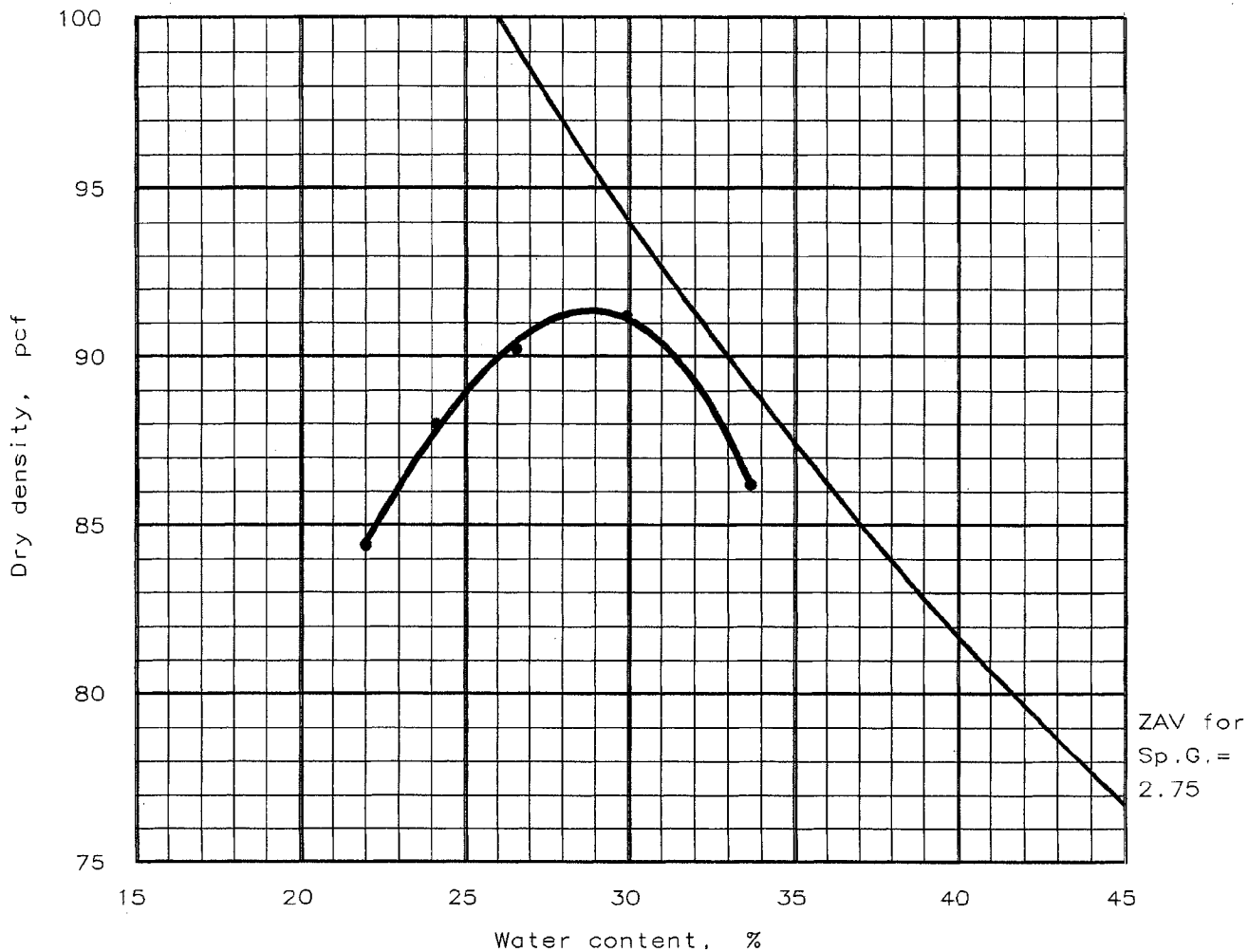

Test specification: ASTM D 698-00ae1 Procedure B, Standard

Elev/ Depth	Classification		Nat. Moist.	Sp.G.	LL	PI	% > 3/8 in	% < No.200
	USCS	AASHTO						
2.5-10	CH	A-7-6(32)	24.6 %	2.75	60	32	0.4 %	87.7 %

TEST RESULTS	MATERIAL DESCRIPTION
Maximum dry density = 91.4 pcf Optimum moisture = 28.8 %	Reddish orange fat clay
Project No.: 3043051030.0001 Project: TVA Kingston - Proposed Gypsum Stack Location: Borrow Area Observation Trench OT-1 Date: 7-28-2005	Remarks: Sample Number 3223 TIP - Test In Progress NT - No Test
MOISTURE-DENSITY RELATIONSHIP TEST	

MOISTURE-DENSITY RELATIONSHIP TEST

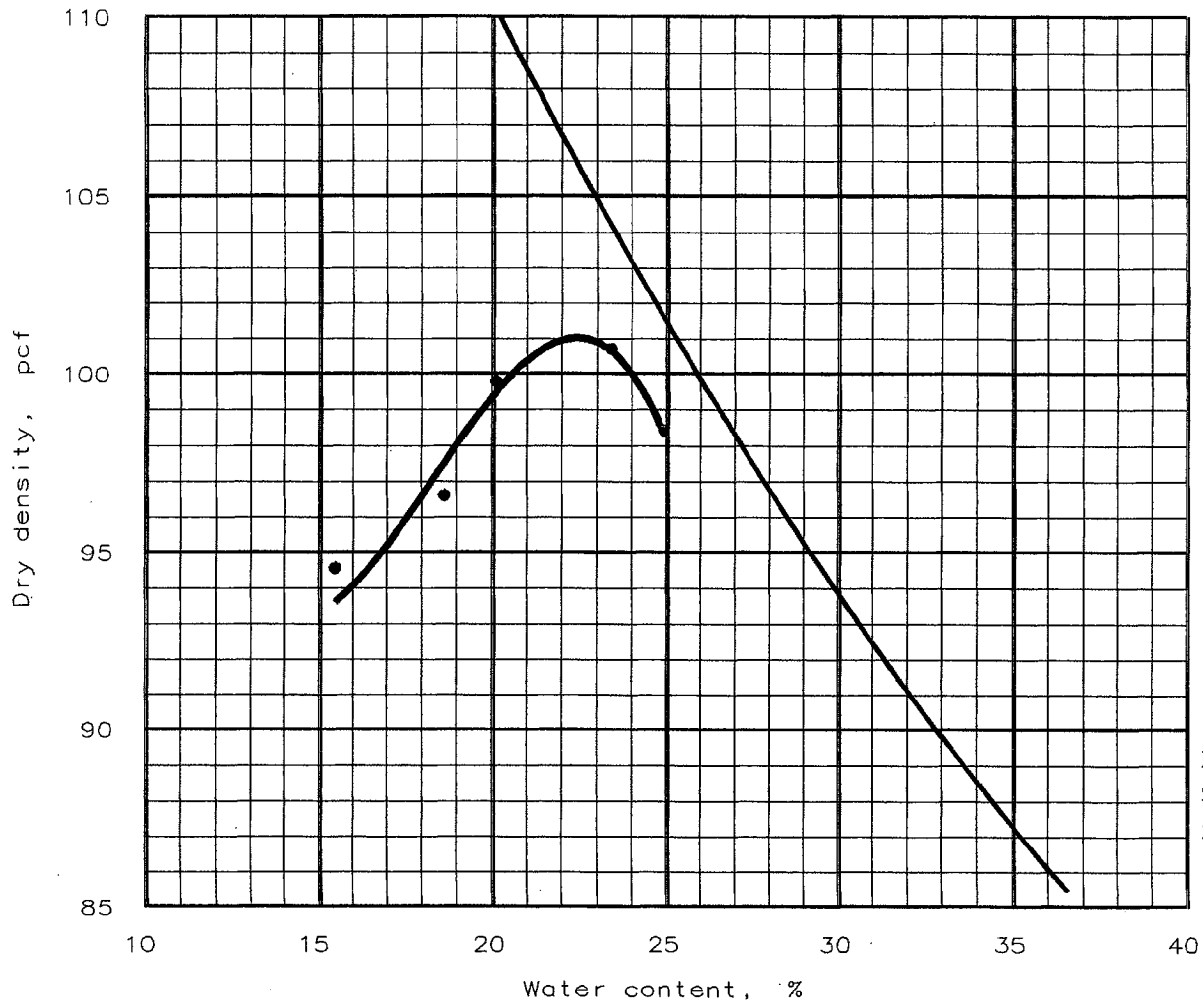

Test specification: ASTM D 698-00ae1 Procedure B, Standard

Elev/ Depth	Classification		Nat. Moist.	Sp.G.	LL	PI	% > 3/8 in	% < No.200
	USCS	AASHTO						
3-10'	CL	A-7-6(17)	23.3 %	2.74	47	24	1.7 %	74.0 %

TEST RESULTS	MATERIAL DESCRIPTION
Maximum dry density = 101.0 pcf Optimum moisture = 22.4 %	Reddish brown lean clay with sand
Project No.: 3043051030.0001 Project: TVA Kingston - Proposed Gypsum Stack Location: Borrow Area Observation Trench OT-3 Date: 7-28-2005	Remarks: Sample Number 3224 TIP - Test In Progress NT - No Test
MOISTURE-DENSITY RELATIONSHIP TEST	

MOISTURE-DENSITY RELATIONSHIP TEST

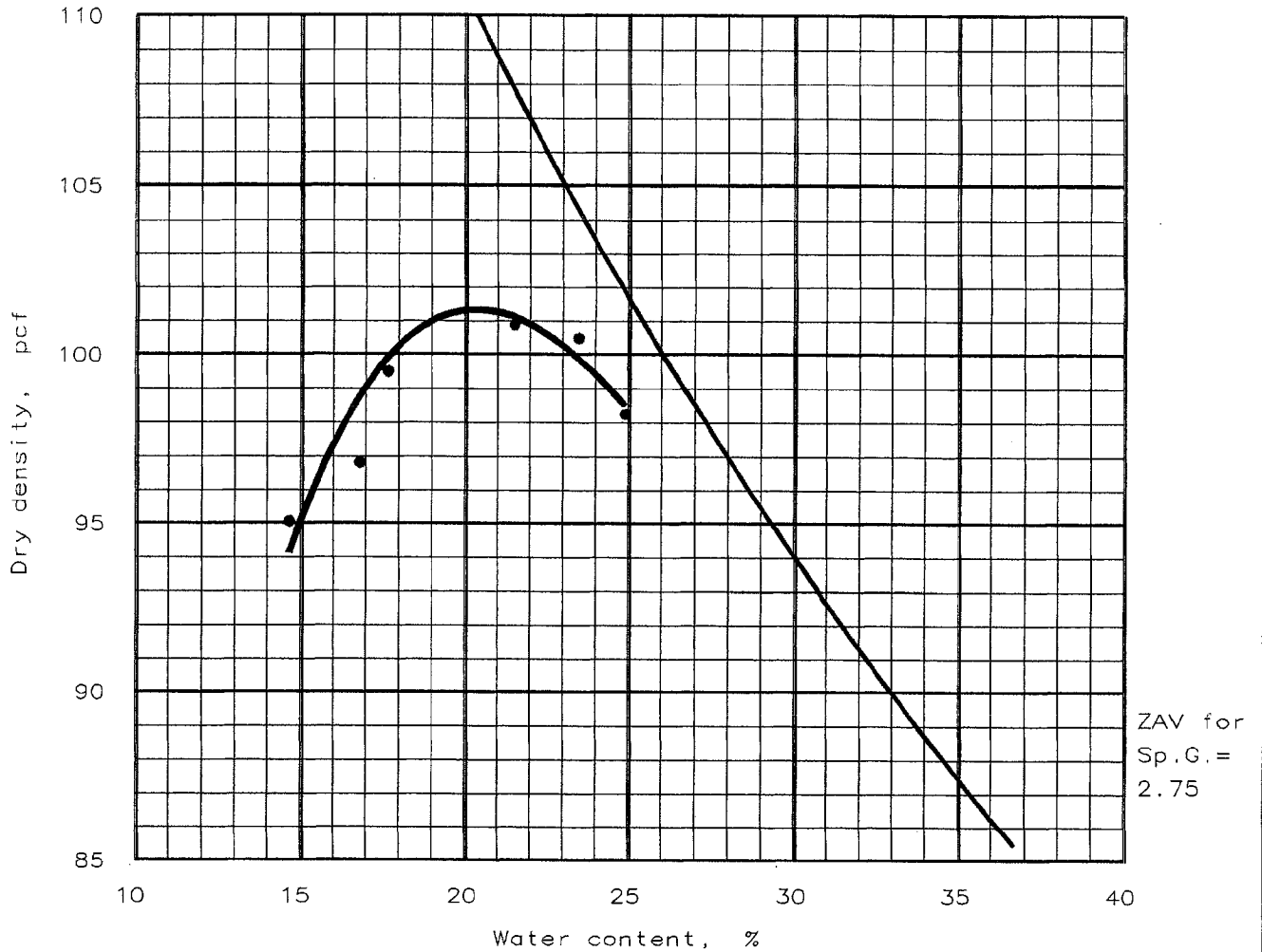

Test specification: ASTM D 698-00ae1 Procedure B, Standard

Elev/ Depth	Classification		Nat. Moist.	Sp.G.	LL	PI	% > 3/8 in	% < No.200
	USCS	AASHTO						
3-10'	CH	A-7-6(20)	23.3 %	2.75	50	27	0.7 %	74.6 %

TEST RESULTS	MATERIAL DESCRIPTION
Maximum dry density = 101.3 pcf Optimum moisture = 20.3 %	Reddish brown fat clay with sand
Project No.: 3043051030.0001 Project: TVA Kingston - Proposed Gypsum Stack Location: Borrow Area Observation Trench OT-3 Date: 7-28-2005	Remarks: Sample Number 3225 TIP - Test In Progress NT - No Test
MOISTURE-DENSITY RELATIONSHIP TEST	

MOISTURE-DENSITY RELATIONSHIP TEST

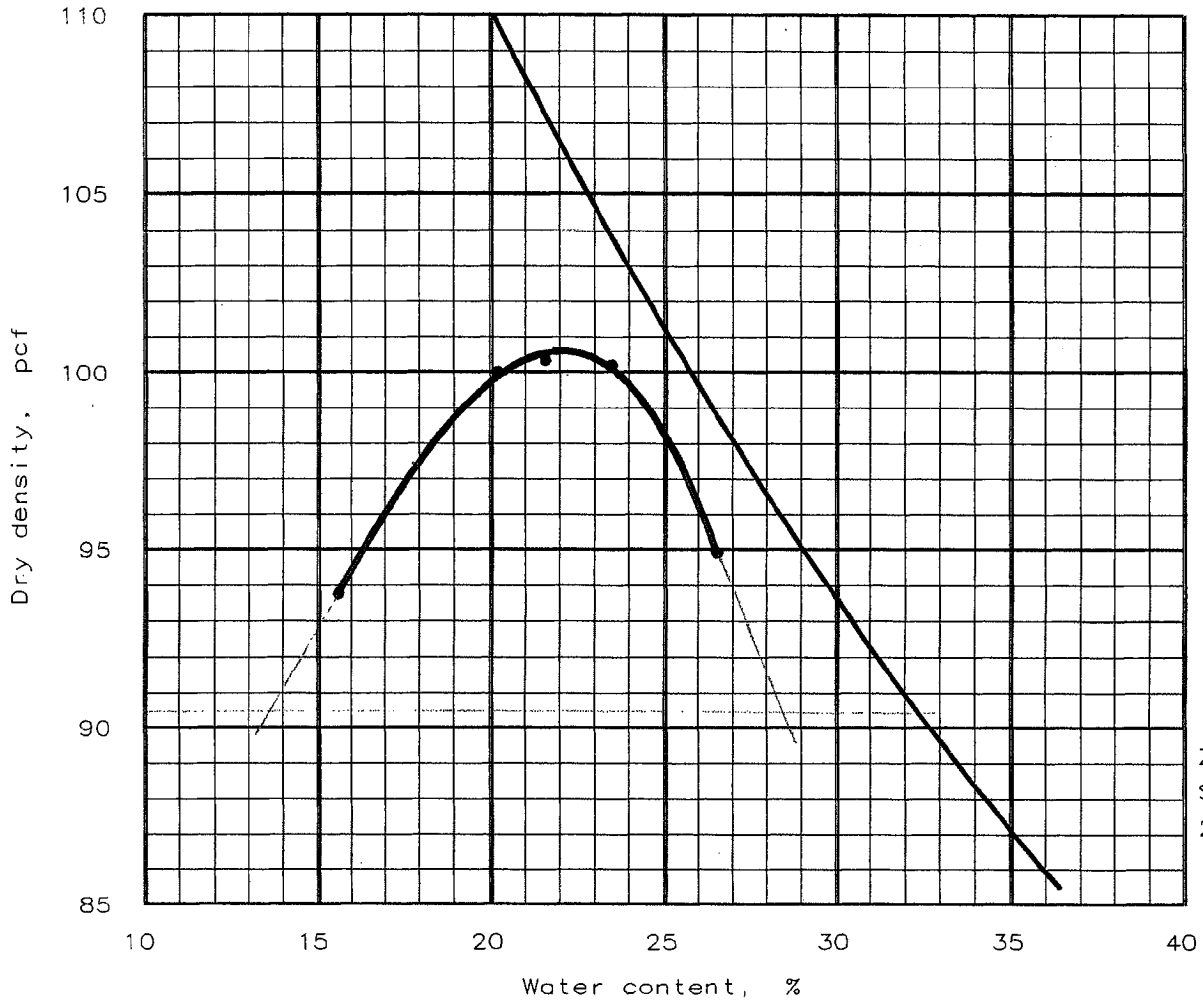

Test specification: ASTM D 698-00ae1 Procedure B, Standard

Elev/ Depth	Classification		Nat. Moist.	Sp.G.	LL	PI	% > 3/8 in	% < No.200
	USCS	AASHTO						
3-10'	CL	A-7-6(16)	23.3 %	2.73	45	23	1.6 %	74.1 %

TEST RESULTS	MATERIAL DESCRIPTION
Maximum dry density = 100.6 pcf Optimum moisture = 22.1 %	Reddish brown lean clay with sand
Project No.: 3043051030.0001 Project: TVA Kingston - Proposed Gypsum Stack Location: Borrow Area Observation Trench OT-3 Date: 7-21-2005	Remarks: Sample Number 3226 TIP - Test In Progress NT - No Test
MOISTURE-DENSITY RELATIONSHIP TEST	

MOISTURE-DENSITY RELATIONSHIP TEST

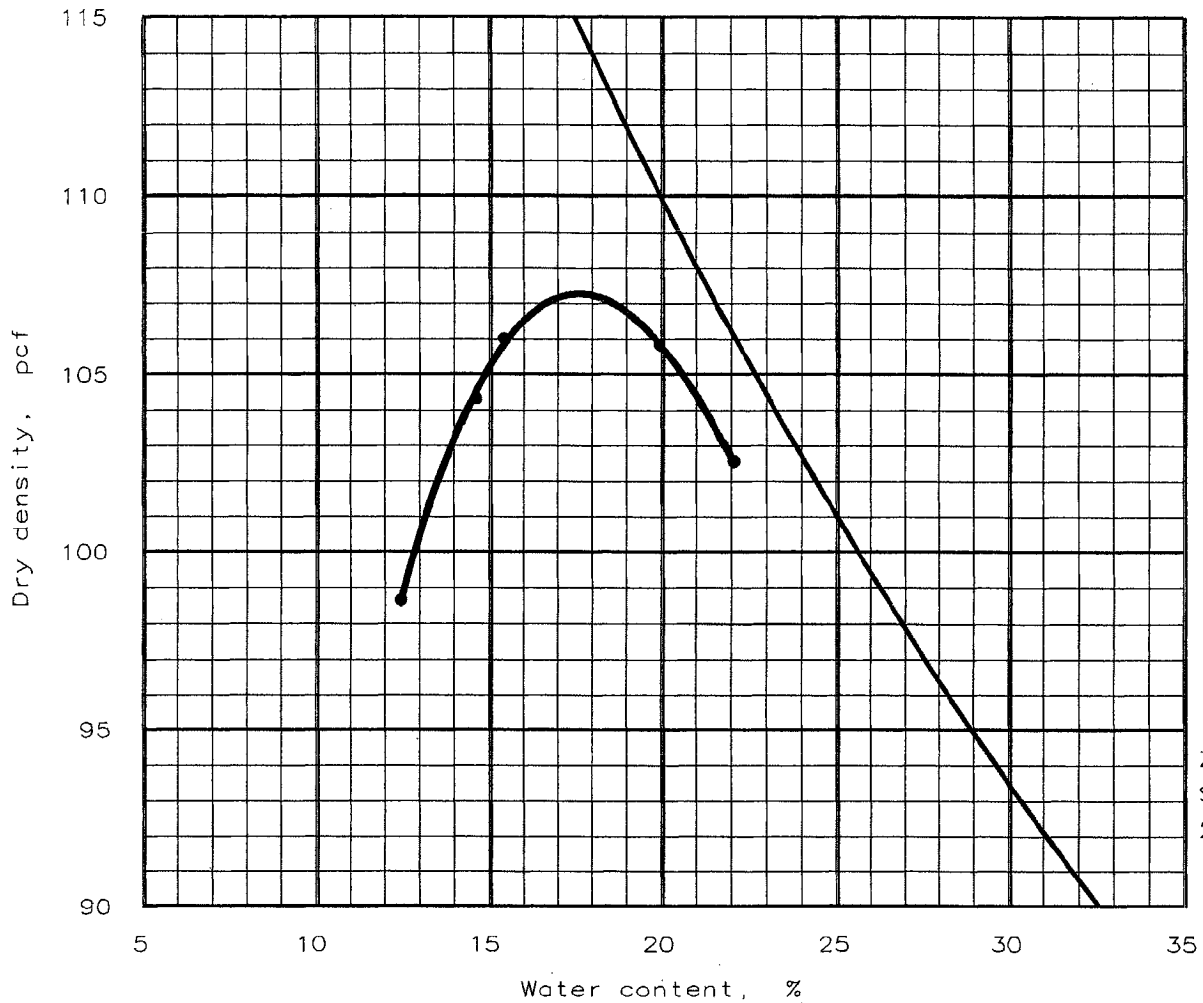

Test specification: ASTM D 698-00ae1 Procedure B, Standard

Elev/ Depth	Classification		Nat. Moist.	Sp.G.	LL	PI	% > 3/8 in	% < No.200
	USCS	AASHTO						
4-10'	CL	A-6(13)	22.5 %	2.72	36	17	0.0 %	82.4 %

TEST RESULTS	MATERIAL DESCRIPTION
Maximum dry density = 107.3 pcf Optimum moisture = 17.6 %	Dark red brown lean clay with sand
Project No.: 3043051030.0001 Project: TVA Kingston - Proposed Gypsum Stack Location: Borrow Area Observation Trench OT-4 Date: 7-21-2005	Remarks: Sample Number 3227 TIP - Test In Progress NT - No Test
MOISTURE-DENSITY RELATIONSHIP TEST	

MOISTURE-DENSITY RELATIONSHIP TEST

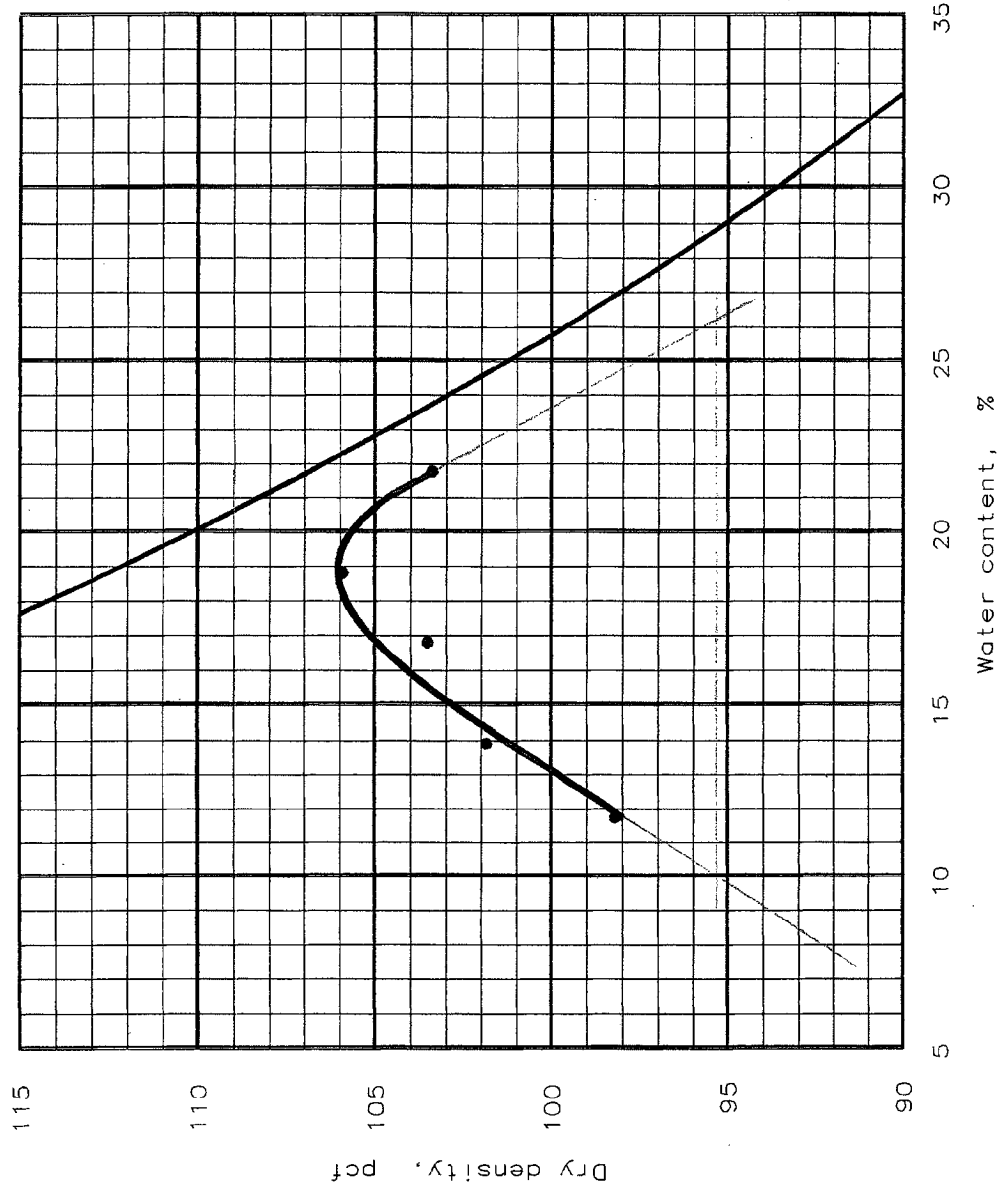

Test specification: ASTM D 698-00ae1 Procedure B, Standard

Elev/ Depth	Classification		Nat. Moist.	Sp.G.	LL	PI	% > 3/8 in	% < No.200
	USCS	AASHTO						
4-10'	CL	A-6(15)	22.5 %	2.73	38	18	0.4 %	83.8 %

TEST RESULTS

Maximum dry density = 105.9 pcf
Optimum moisture = 18.8 %

MATERIAL DESCRIPTION

Dark red brown lean clay
with sand

Project No.: 3043051030.0001

Project: TVA Kingston - Proposed Gypsum Stack

Location: Borrow Area Observation Trench OT-4

Date: 7-21-2005

Remarks:

Sample Number 3228

TIP - Test In Progress

NT - No Test

MOISTURE-DENSITY RELATIONSHIP TEST

MOISTURE-DENSITY RELATIONSHIP TEST

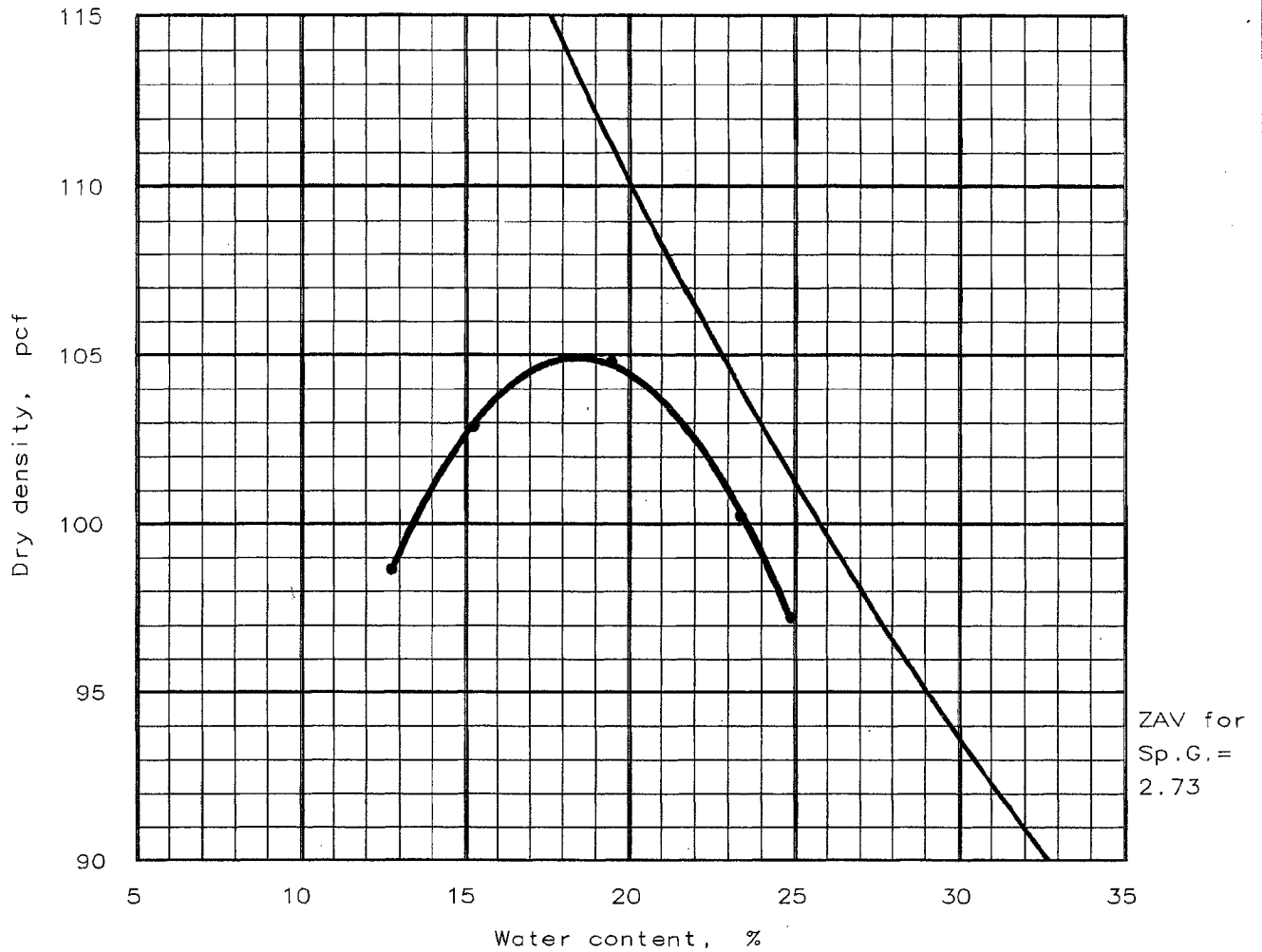

Test specification: ASTM D 698-00ae1 Procedure B, Standard

Elev/ Depth	Classification		Nat. Moist.	Sp.G.	LL	PI	% > 3/8 in	% < No.200
	USCS	AASHTO						
4-10'	CL	A-6(16)	22.5 %	2.73	39	20	0.0 %	83.5 %

TEST RESULTS	MATERIAL DESCRIPTION
Maximum dry density = 104.9 pcf Optimum moisture = 18.4 %	Dark red brown lean clay with sand
Project No.: 3043051030.0001 Project: TVA Kingston - Proposed Gypsum Stack Location: Borrow Area Observation Trench OT-4 Date: 7-21-2005	Remarks: Sample Number 3229 TIP - Test In Progress NT - No Test
MOISTURE-DENSITY RELATIONSHIP TEST	

HYDRAULIC CONDUCTIVITY TEST RESULTS



MACTEC

CONSTANT HEAD PERMEABILITY TEST

(ASTM D5084)

JOB NAME: TVA Kingston - Proposed Gypsum Stack
 JOB NO.: 3043-05-1030 Borrow Area
 BORING NO.: OT-1
 DEPTH: 2.5-10'
 SAMPLE: BULK
 DESCRIPTION: RMS-90 @ 26.3 (89.9%)

TECHNICIAN: J.C.
 DATE: 8/30/05
 CHECKED BY: [Signature]
 CELL NO.: #3
 SYSTEM NO.: 14

(Actual Compaction)

SAMPLE INFORMATION

WEIGHT TUBE & SOIL (g): _____
 WEIGHT TUBE (g): _____
 WEIGHT SOIL (g): _____
 VOLUME SOIL (cu. ft): _____
 DRY UNIT WEIGHT (pcf): _____
 WET UNIT WEIGHT (pcf): _____

TUBE LENGTH: _____ (in) _____ (cm)
 TUBE DIAMETER: _____ (in) _____ (cm)
 SOIL LENGTH(L): 2.1435 (in) 5.444 (cm)
 SOIL DIAMETER: 2.8910 (in) 7.348 (cm)
 AREA(A): _____ (in²) 42.35 (cm²)

MOISTURE CONTENT

INITIAL WET WEIGHT (g): 351.45
 FINAL WET WEIGHT (g): 373.64
 FINAL DRY WEIGHT (g): 276.68
 INITIAL MOISTURE (%): _____ → 26.4%
 FINAL MOISTURE (%): _____
 PAN NAME: UN

PERM INFORMATION

CELL PRESSURE (psi): _____
 FORE PRESSURE (psi): _____
 BACK PRESSURE (psi): _____
 HEAD, h (psi) x 70.34: 140.68
 TEMPERATURE (°F): _____
 VISCOSITY CORRECTION (R_T): _____
 PERMEANT LIQUID USED: _____
 BURET CORRECTION FACTOR (C): _____

TABLE OF HYDRAULIC CONDUCTIVITY

DATE		TIME		ELAPSED TIME (+)		READING				FLOW (CC)	
START	END	START	END	MINUTES	SECONDS	START	END	START	END	Q	K
8-31	8-31	8:19 AM	8:24 AM	5	<u>300</u>	14.4	5.9	11.8	8.3	<u>26</u>	7.3×10^{-6}
8-31	8-31	8:24 AM	8:28 AM	4	<u>240</u>	11.8	8.3	10.0	10.0	<u>18</u>	6.4×10^{-6}
8-31	8-31	8:28 AM	8:32 AM	4	<u>240</u>	10.0	10.0	8.5	11.5	<u>15</u>	5.3×10^{-6}
8-31	8-31	8:32 AM	8:39 AM	7	<u>420</u>	8.5	11.5	6.0	14.1	<u>25</u>	5.1×10^{-6}
8-31	8-31	8:39									
8-31	8-31										
										6.0×10^{-6}	
TOTALS				i = 1200						Q = 8.4	

COEFFICIENT OF PERMEABILITY, $k = \frac{Q \times L \times R_T \times C}{h \times A \times t}$

$$\frac{Q}{t} = \frac{(5.474)(0.971)}{(140.68)(42.35)} = \frac{Q}{t} = 8.507 \times 10^{-4}$$



MACTEC

CONSTANT HEAD PERMEABILITY TEST

(ASTM D5084)

JOB NAME: TVA Kingston - Proposed Gypsum Stack
 JOB NO.: 3043-05-1030 Bormw Area
 BORING NO.: OT-1
 DEPTH: 2.5 - 10'
 SAMPLE: Bulk
 DESCRIPTION: RMS - 95 @ 26.3 95.0%

TECHNICIAN: J.C
 DATE: 8/30/05
 CHECKED BY: JQ
 CELL NO.: 45
 SYSTEM NO.: 15

SAMPLE INFORMATION

WEIGHT TUBE & SOIL (g): _____
 WEIGHT TUBE (g): _____
 WEIGHT SOIL (g): _____
 VOLUME SOIL (cu ft): _____
 DRY UNIT WEIGHT (pcf): _____
 WET UNIT WEIGHT (pcf): _____

TUBE LENGTH: _____ (in) _____ (cm)
 TUBE DIAMETER: _____ (in) _____ (cm)
 SOIL LENGTH(L): 19.53 (in) 4.961 (cm)
 SOIL DIAMETER: 2.8750 (in) 7.303 (cm)
 AREA(A): _____ (in²) 41.88 (cm²)

(ACTUAL COMPACTION)

MOISTURE CONTENT

INITIAL WET WEIGHT (g): 371.92
 FINAL WET WEIGHT (g): 391.94
 FINAL DRY WEIGHT (g): 293.16
 INITIAL MOISTURE (%): _____ 26.4%
 FINAL MOISTURE (%): _____
 PAN NAME: TF

PERM INFORMATION

CELL PRESSURE (psi): 57
 FORE PRESSURE (psi): 52
 BACK PRESSURE (psi): 50
 HEAD, h (psi) x 70.34: 140.68
 TEMPERATURE (°F): 73°F
 VISCOSITY CORRECTION (R_v): 0.931
 PERMEANT LIQUID USED: H₂O
 BURET CORRECTION FACTOR (C): 1.0

TABLE OF HYDRAULIC CONDUCTIVITY

DATE		TIME		ELAPSED TIME (+)		READING				FLOW (CC)	
START	END	START	END	MINUTES	SECONDS	START	END	START	END	cc	k
8-31	8-31	8:18 ^{am}	8:47 ^{am}	29	1740	15.4	4.6	12.7	7.1	(2.7)	1.2 x 10 ⁻⁶
8-31	8-31	8:47 ^{am}	9:13 ^{am}	26	1560	12.7	7.1	10.4	9.3	(2.3)	1.2 x 10 ⁻⁶
8-31	8-31	9:13 ^{am}	10:08 ^{am}	55	3300	10.4	9.3	5.8	13.8	(4.6)	1.14 x 10 ⁻⁶
8-31	8-31	10:08 ^{am}	10:16 ^{am}	8	480	5.8	13.8	5.1	14.4	(0.7)	1.14 x 10 ⁻⁶
TOTALS				= 7080						Q = 10.3	

COEFFICIENT OF PERMEABILITY, $k = \frac{Q \times L \times R_v \times C}{h \times A \times t} = \frac{Q}{t} \cdot \frac{4.961 (0.931)}{140.68 (41.88)} = 1.1 \times 10^{-6}$



MACTEC

CONSTANT HEAD PERMEABILITY TEST

(ASTM D5084)

JOB NAME: TVA Kingston - Proposed Gypsum Stack
 JOB NO.: 3043-05-1030 Borrow Area
 BORING NO.: OT-1
 DEPTH: 2.5-10'
 SAMPLE: BULK
 DESCRIPTION: RMS-90 @ 29.3 90.0%

TECHNICIAN: JC
 DATE: 8/13/05
 CHECKED BY: JO
 CELL NO.: #1
 SYSTEM NO.: _____

SAMPLE INFORMATION

WEIGHT TUBE & SOIL (g): _____
 WEIGHT TUBE (g): _____
 WEIGHT SOIL (g): _____
 VOLUME SOIL (cu ft): _____
 DRY UNIT WEIGHT (pcf): _____
 WET UNIT WEIGHT (pcf): _____

TUBE LENGTH: _____ (in) _____ (cm)
 TUBE DIAMETER: _____ (in) _____ (cm)
 SOIL LENGTH(L): 2.090 (in) 5.331 (cm)
 SOIL DIAMETER: 2.865 (in) 7.332 (cm)
 AREA(A): _____ (in²) 42.22 (cm²)

(Actual Compaction)

MOISTURE CONTENT

INITIAL WET WEIGHT (g): 358.68
 FINAL WET WEIGHT (g): 374.57
 FINAL DRY WEIGHT (g): 278.08
 INITIAL MOISTURE (%): _____ 29.3%
 FINAL MOISTURE (%): _____
 PAN NAME: Bot

PERM INFORMATION

CELL PRESSURE (psi): _____
 FORE PRESSURE (psi): _____
 BACK PRESSURE (psi): _____
 HEAD, h (psi) x 70.34: 140.68
 TEMPERATURE (°F): _____
 VISCOSITY CORRECTION (R_v): _____
 PERMEANT LIQUID USED: _____
 BURET CORRECTION FACTOR (C): _____

TABLE OF HYDRAULIC CONDUCTIVITY

DATE		TIME		ELAPSED TIME (+)		READING				FLOW (CC)	
START	END	START	END	MINUTES	SECONDS	START	END	START	END	cc	k
8-31	8-31	8:21 AM	8:33 AM	12	720	15.6	4.7	11.8	8.3	3.8	4.4 x 10 ⁻⁶
8-31	8-31	8:33 AM	8:40 AM	7	420	11.8	8.3	9.8	10.4	2.1	4.2 x 10 ⁻⁶
8-31	8-31	8:40 AM	8:46 AM	6	360	9.8	10.4	8.1	12.0	1.7	3.9 x 10 ⁻⁶
8-31	8-31	8:46 AM	9:10	24	1440	8.1	12.0	2.0	18.1	6.1	3.5 x 10 ⁻⁶
TOTALS					i = 2940					Q = 13.7	

COEFFICIENT OF PERMEABILITY, $k = \frac{Q \times L \times R_T \times C}{h \times A \times t}$

$\frac{Q}{t} = 8.356 \times 10^{-4} = 3.9 \times 10^{-6}$



MACTEC

CONSTANT HEAD PERMEABILITY TEST

(ASTM D5084)

JOB NAME: TVA Kingston - Proposed Gypsum Stack
 JOB NO.: 3043-05-1030 Borman Area
 BORING NO.: OT-1
 DEPTH: 2.5 - 10'
 SAMPLE: BULK
 DESCRIPTION: RMS-95 @ 29.3 95.1%

TECHNICIAN: J.C.
 DATE: 8/30/05
 CHECKED BY: J.A.
 CELL NO.: #2
 SYSTEM NO.: 13/14

SAMPLE INFORMATION

WEIGHT TUBE & SOIL (g): _____
 WEIGHT TUBE (g): _____
 WEIGHT SOIL (g): _____
 VOLUME SOIL (cu ft): _____
 DRY UNIT WEIGHT (pcf): _____
 WET UNIT WEIGHT (pcf): _____

TUBE LENGTH: _____ (in) _____ (cm)
 TUBE DIAMETER: _____ (in) _____ (cm)
 SOIL LENGTH(L): 2.0690 (in) 5.2553 (cm)
 SOIL DIAMETER: 2.8765 (in) 7.3063 (cm)
 AREA(A): _____ (in²) 41.93 (cm²)

(ACTUAL COMPACTION)

MOISTURE CONTENT

INITIAL WET WEIGHT (g): 379.82
 FINAL WET WEIGHT (g): 395.00
 FINAL DRY WEIGHT (g): 294.71
 INITIAL MOISTURE (%): _____
 FINAL MOISTURE (%): _____
 PAN NAME: FF

PERM INFORMATION

CELL PRESSURE (psi): 57
 FORE PRESSURE (psi): 52
 BACK PRESSURE (psi): 59
 HEAD, h (psi) x 70.34: 140.68
 TEMPERATURE (°F): 73°F
 VISCOSITY CORRECTION (R_v): 0.971
 PERMEANT LIQUID USED: H₂O
 BURET CORRECTION FACTOR (C): 1.0

TABLE OF HYDRAULIC CONDUCTIVITY

DATE		TIME		ELAPSED TIME (+)		READING				FLOW (CC)	
START	END	START	END	MINUTES	SECONDS	START	END	START	END	C	K
8-31	8-31	8:20 ^{AM}	8:34 ^{AM}	14	<u>840</u>	15.0	5.3	12.8	7.5	<u>2.2</u>	2.24 × 10 ⁻⁶
8-31	8-31	8:34 ^{AM}	9:11 ^{AM}	37	<u>2220</u>	12.8	7.5	7.5	12.9	<u>5.3</u>	2.0 × 10 ⁻⁶
8-31	8-31	9:11 ^{AM}	10:05 ^{AM}	54	<u>3240</u>	7.5	12.9	0.8	19.7	<u>6.7</u>	1.7 × 10 ⁻⁶
8-31	8-31	10:07 ^{AM}	10:21 ^{AM}	14	<u>840</u>	12.4	7.8	11.0	9.6	<u>1.4</u>	1.4 × 10 ⁻⁶
TOTALS											
						c = 7140					Q = 15.6

COEFFICIENT OF PERMEABILITY, $k = \frac{Q \times L \times R_T \times C}{h \times A \times t}$ $\frac{0}{t} \cdot \frac{(5.255)(0.971)}{(140.66)(41.93)} = 1.8 \times 10^{-6}$



MACTEC

CONSTANT HEAD PERMEABILITY TEST

(ASTM D5084)

JOB NAME: TVA Kingston - Proposed Gypsum Stack
 JOB NO.: 3043-05-1030 Borrow Area
 BORING NO.: OT-1
 DEPTH: 2.5 - 10'
 SAMPLE: BULK
 DESCRIPTION: RMS-90 @ 32.3 89.9%

TECHNICIAN: J.C.
 DATE: 8/30/05
 CHECKED BY: SO.
 CELL NO.: A
 SYSTEM NO.: 2

SAMPLE INFORMATION

WEIGHT TUBE & SOIL (g): _____
 WEIGHT TUBE (g): _____
 WEIGHT SOIL (g): _____
 VOLUME SOIL (cu ft): _____
 DRY UNIT WEIGHT (pcf): _____
 WET UNIT WEIGHT (pcf): _____

TUBE LENGTH: _____ (in) _____ (cm)
 TUBE DIAMETER: _____ (in) _____ (cm)
 SOIL LENGTH(L): 1.9945 (in) 5.066 (cm)
 SOIL DIAMETER: 2.8910 (in) 7.343 (cm)
 AREA(A): _____ (in²) 42.35 (cm²)

(ACTUAL COMPACTION)

MOISTURE CONTENT

INITIAL WET WEIGHT (g): 374.52
 FINAL WET WEIGHT (g): 368.99
 FINAL DRY WEIGHT (g): 274.18
 INITIAL MOISTURE (%): _____
 FINAL MOISTURE (%): 32.5%
 PAN NAME: RR

PERM INFORMATION

CELL PRESSURE(psi): 57
 FORE PRESSURE(psi): 52
 BACK PRESSURE (psi): 59
 HEAD, h (psi) x 70.34: 140.68
 TEMPERATURE (°F): 73°F
 VISCOSITY CORRECTION(R_v): 0.931
 PERMEANT LIQUID USED: H₂O
 BURET CORRECTION FACTOR(C): 1.9

TABLE OF HYDRAULIC CONDUCTIVITY

DATE		TIME		ELASPED TIME (+)		READING				FLOW (CC)	
START	END	START	END	MINUTES	SECONDS	START	END	START	END	CC	K
8-31	8-31	8:23 AM	9:13 AM	50	3000	23.4	19.5	23.4	17.7	20	5.3 x 10 ⁻⁷
8-31	8-31	9:13 AM	10:09 AM	56	3360	23.4	17.7	21.4	19.8	2.9	4.7 x 10 ⁻⁷
8-31	8-31	10:09 AM	10:21 AM	12	720	21.4	19.8	21.0	20.2	0.4	4.4 x 10 ⁻⁷
8-31	8-31	10:21 AM	11:25 AM	64	3840	21.0	20.2	18.9	22.4	2.1	4.3 x 10 ⁻⁷
8-31	8-31	11:25 AM	1:15 PM	110	6600	18.9	22.4	15.6	25.8	3.3	4.0 x 10 ⁻⁷
TOTALS					c = 14520						Q = 7.8

COEFFICIENT OF PERMEABILITY, $k = \frac{Q \times L \times R_v \times C}{h \times A \times t}$

$$\frac{(5.066)(0.931)}{(140.68)(42.35)} = 4.3 \times 10^{-7}$$



MACTEC

CONSTANT HEAD PERMEABILITY TEST

(ASTM D5084)

JOB NAME: TVA Kingston - Proposed Gypsum Stack
 JOB NO.: 3043-05-1030 Borrow Area
 BORING NO.: OT-1
 DEPTH: 2.5-10'
 SAMPLE: Bulk
 DESCRIPTION: RMS-95 @ 32.3 94.9%

TECHNICIAN: J.P.
 DATE: 8/30/05
 CHECKED BY: S.O.
 CELL NO.: #13
 SYSTEM NO.: _____

SAMPLE INFORMATION

(ACTUAL COMPACTION)

WEIGHT TUBE & SOIL (g): _____
 WEIGHT TUBE (g): _____
 WEIGHT SOIL (g): _____
 VOLUME SOIL (cu ft): _____
 DRY UNIT WEIGHT (pcf): _____
 WET UNIT WEIGHT (pcf): _____

TUBE LENGTH: _____ (in) _____ (cm)
 TUBE DIAMETER: _____ (in) _____ (cm)
 SOIL LENGTH(L): 2.0435 (in) 5.190 (cm)
 SOIL DIAMETER: 2.8890 (in) 7.338 (cm)
 AREA(A): _____ (in²) 42.29 (cm²)

MOISTURE CONTENT

INITIAL WET WEIGHT (g): 299.92
 FINAL WET WEIGHT (g): 391.39
 FINAL DRY WEIGHT (g): 292.95
 INITIAL MOISTURE (%): _____
 FINAL MOISTURE (%): 32.5%
 PAN NAME: SS

PERM INFORMATION

CELL PRESSURE (psi): 57
 FORE PRESSURE (psi): 52
 BACK PRESSURE (psi): 50
 HEAD, h (psi) x 70.34: 140.68
 TEMPERATURE (°F): 78°F
 VISCOSITY CORRECTION (R_T): 0.971
 PERMEANT LIQUID USED: H₂O
 BURET CORRECTION FACTOR (C): 1.0

TABLE OF HYDRAULIC CONDUCTIVITY

DATE		TIME		ELAPSED TIME (+)		READING				FLOW (CC)	
START	END	START	END	MINUTES	SECONDS	START	END	CC	K		
8-31	8-31	8:22 AM	9:28 AM	66	<u>3960</u>	26.5	15.1	25.3	16.2	<u>1.2</u>	2.5 x 10 ⁻⁷
8-31	8-31	9:28 AM	11:38 AM	130	<u>7800</u>	25.3	16.2	23.3	18.5	<u>2.9</u>	2.1 x 10 ⁻⁷
8-31	8-31	11:38 AM	1:15 PM	97	<u>5820</u>	23.3	18.5	21.8	20.1	<u>1.9</u>	2.1 x 10 ⁻⁷
8-31	8-31	1:15 PM	1:50	35	<u>2100</u>	21.8	20.1	21.2	20.7	<u>0.6</u>	2.3 x 10 ⁻⁷
TOTALS					<u>19680</u>					<u>0 = 5.3</u>	

COEFFICIENT OF PERMEABILITY, $k = \frac{Q \times L \times R_T \times C}{h \times A \times t} = \frac{Q}{L} \times \frac{5.190 (0.971)}{(140.68)(42.29)} = 2.24 \times 10^{-7}$

MACTEC

CONSTANT HEAD PERMEABILITY TEST

(ASTM D5084)

JOB NAME: TVA KINGSTON - B.A.
 JOB NO.: 3043-05-1030
 BORING NO.: QT-1
 DEPTH: 2.5-10'
 SAMPLE: Bulk
 DESCRIPTION: RMS @ 95% @ 30.0% CT

TECHNICIAN: JAHX / J.C.
 DATE: 9-13-5
 CHECKED BY: JAH
 CELL NO.: #5
 SYSTEM NO.: #15

SAMPLE INFORMATION

WEIGHT TUBE & SOIL (g): _____
 WEIGHT TUBE (g): _____
 WEIGHT SOIL (g): _____
 VOLUME SOIL (cu ft): _____
 DRY UNIT WEIGHT (pcf): _____
 WET UNIT WEIGHT (pcf): _____

TUBE LENGTH: _____ (in) _____ (cm)
 TUBE DIAMETER: _____ (in) _____ (cm)
 SOIL LENGTH(L): 1.990 (in) 5.055 (cm)
 SOIL DIAMETER: 2.881 (in) 7.318 (cm)
 AREA(A): _____ (in²) 42.06 (cm²)

MOISTURE CONTENT

INITIAL WET WEIGHT (g): 381.76
 FINAL WET WEIGHT (g): 389.79
 FINAL DRY WEIGHT (g): 294.32
 INITIAL MOISTURE (%): 29.7
 FINAL MOISTURE (%): 32.4
 PAN NAME: SS

PERM INFORMATION

CELL PRESSURE (psi): _____
 FORE PRESSURE (psi): _____
 BACK PRESSURE (psi): _____
 HEAD, h (psi) x 70.34: 140.68
 TEMPERATURE (°F): 73
 VISCOSITY CORRECTION (R_v): .931
 PERMEANT LIQUID USED: H₂O
 BURET CORRECTION FACTOR (C): 1.0

TABLE OF HYDRAULIC CONDUCTIVITY

DATE		TIME		ELAPSED TIME (+)		READING				FLOW (CC)	
START	END	START	END	MINUTES	SECONDS	START	END	START	END	Q	K
9-15	9-15	9:14	9:14	120	7200	13.1	6.8	11.8	8.2	1.3	1.4 x 10 ⁻⁷
9-15	9-15	11:14	11:49	35	2100	11.8	8.2	11.4	8.6	.4	1.5 x 10 ⁻⁷
9-15	9-15	11:49	1:00	71	4260	11.4	8.6	10.7	9.3	.7	1.3 x 10 ⁻⁷
9-15	9-15	1:00	2:07	67	4020	10.7	9.3	10.0	10.0	.7	1.4 x 10 ⁻⁷
TOTALS					17580					Q = 3.1	

COEFFICIENT OF PERMEABILITY, $k = \frac{Q \times L \times R_T \times C}{h \times A \times t}$

$$k = \frac{Q \cdot 5.055 \cdot (.931) \cdot (1.0)}{h \cdot A \cdot t} = \frac{3.1 \cdot 5.055 \cdot (.931) \cdot (1.0)}{(140.68) \cdot (42.06)} = 1.4 \times 10^{-7}$$



MACTEC

CONSTANT HEAD PERMEABILITY TEST

(ASTM D5084)

JOB NAME: TVA Kingston - Proposed Gypsum Stack
 JOB NO.: 3043-05-1030 Bornw Area
 BORING NO.: OT-3
 DEPTH: 3'-10'
 SAMPLE: Bulk
 DESCRIPTION: RMS-90@ 20.1 90.1%

TECHNICIAN: J.C.
 DATE: 8/31/05
 CHECKED BY: JA
 CELL NO.: 13
 SYSTEM NO.: 4

SAMPLE INFORMATION

WEIGHT TUBE & SOIL (g): _____
 WEIGHT TUBE (g): _____
 WEIGHT SOIL (g): _____
 VOLUME SOIL (cu ft): _____
 DRY UNIT WEIGHT (pcf): _____
 WET UNIT WEIGHT (pcf): _____

TUBE LENGTH: _____ (in) _____ (cm)
 TUBE DIAMETER: _____ (in) _____ (cm)
 SOIL LENGTH(L): 1.9730 (in) 5.011 (cm)
 SOIL DIAMETER: 2.8820 (in) 7.320 (cm)
 AREA(A): _____ (in²) 42.09 (cm²)

MOISTURE CONTENT

INITIAL WET WEIGHT (g): 357.15
 FINAL WET WEIGHT (g): 393.66
 FINAL DRY WEIGHT (g): 308.70
 INITIAL MOISTURE (%): _____
 FINAL MOISTURE (%): 19.9%
 PAN NAME: 4011

PERM INFORMATION

CELL PRESSURE (psi): _____
 FORE PRESSURE (psi): _____
 BACK PRESSURE (psi): _____
 HEAD, h (psi) x 70.34: 140.68
 TEMPERATURE (°F): _____
 VISCOSITY CORRECTION (R_v): _____
 PERMEANT LIQUID USED: _____
 BURET CORRECTION FACTOR (C): _____

TABLE OF HYDRAULIC CONDUCTIVITY

DATE		TIME		ELAPSED TIME (+)		READING				FLOW (CC)	
START	END	START	END	MINUTES	SECONDS	START	END	A ₁	A ₂	Q	
9-1		10:02	10:13	11	660	28.8	49.2	33.2	41.8	4.4	5.3 x 10 ⁻⁶
		10:13	10:58	45	2700	33.2	44.8	46.6	31.1	13.7	4.0 x 10 ⁻⁶
		10:58	11:11	13	(780)	46.6	31.1	41.3	28.4	(2.7)	2.7 x 10 ⁻⁶
		11:11	11:45	34	(1040)	49.3	28.4	55.0	22.6	(5.7)	2.2 x 10 ⁻⁶
		11:45	12:03	18	(1090)	55.0	22.6	57.9	20.2	(2.4)	1.8 x 10 ⁻⁶
		12:03	12:21	18	(1080)	57.9	20.2	59.8	17.8	(2.4)	1.8 x 10 ⁻⁶
TOTALS					i = 4980 ✓					Q = 13.2 ✓	

COEFFICIENT OF PERMEABILITY, $k = \frac{Q \times L \times R_v \times C}{h \times A \times t}$ $\frac{Q \cdot (5.011) \cdot (93) \cdot (10)}{t \cdot (140.68) \cdot (42.09)} = 2.1 \times 10^{-6}$



CONSTANT HEAD PERMEABILITY TEST

(ASTM D5084)

JOB NAME: TVA Kingston - Proposed Gypsum Stack
 JOB NO.: 3043-05-1030 Borrow Area
 BORING NO.: OT-3
 DEPTH: 3' - 10'
 SAMPLE: BULK
 DESCRIPTION: RMS-95 @ 20.1 95.2%

TECHNICIAN: J.C
 DATE: 8/31/05
 CHECKED BY: A
 CELL NO.: 1-0
 SYSTEM NO.: 5

SAMPLE INFORMATION

(Actual Compaction)

WEIGHT TUBE & SOIL (g): _____
 WEIGHT TUBE (g): _____
 WEIGHT SOIL (g): _____
 VOLUME SOIL (cu ft): _____
 DRY UNIT WEIGHT (pcf): _____
 WET UNIT WEIGHT (pcf): _____

TUBE LENGTH: _____ (in) _____ (cm)
 TUBE DIAMETER: _____ (in) _____ (cm)
 SOIL LENGTH(L): 1.9945 (in) 5.066 (cm)
 SOIL DIAMETER: 2.8840 (in) 7.325 (cm)
 AREA(A): _____ (in²) 42.15 (cm²)

MOISTURE CONTENT

INITIAL WET WEIGHT (g): 378.18
 FINAL WET WEIGHT (g): 415.16
 FINAL DRY WEIGHT (g): 326.86
 INITIAL MOISTURE (%): _____ 19.9%
 FINAL MOISTURE (%): _____
 PAN NAME: BOT

PERM INFORMATION

CELL PRESSURE (psi): _____
 FORE PRESSURE (psi): _____
 BACK PRESSURE (psi): _____
 HEAD, h (psi) x 70.34: 140.68
 TEMPERATURE (°F): _____
 VISCOSITY CORRECTION (R_v): _____
 PERMEANT LIQUID USED: _____
 BURET CORRECTION FACTOR (C): _____

TABLE OF HYDRAULIC CONDUCTIVITY

DATE		TIME		ELAPSED TIME (+)		READING		FLOW (CC)	
START	END	START	END	MINUTES	SECONDS	START	END		
8/1		10:05				27.2	49.3		
		12:26	12:29	3	180	27.4	11.1	30.4	38.3
		12:29	12:30	1	(60)	30.4	38.3	31.3	37.4 (9) 1.2x10 ⁻⁵
		12:30	12:31	1	(60)	31.3	37.4	32.3	31.3 (10) 1.3x10 ⁻⁵
		12:31	12:32	1	(60)	32.3	36.3	33.2	35.5 (9) 1.2x10 ⁻⁵
		12:32	12:33	1	(60)	33.2	35.5	34.0	34.7 (8) 1.1x10 ⁻⁵
TOTALS					i = 240 ✓				Q = 3.6 ✓

COEFFICIENT OF PERMEABILITY, $k = \frac{Q \times L \times R_v \times C}{h \times A \times t}$

$$\frac{Q}{t} = \frac{(5.066)(9.9)(1.0)}{(140.68)(42.15)} = 1.2 \times 10^{-5}$$



MACTEC

CONSTANT HEAD PERMEABILITY TEST

(ASTM D5084)

JOB NAME: TVA Kingston - Proposed Gypsum Stack
 JOB NO.: 3043-05-1030 Borrow Area
 BORING NO.: OT-3
 DEPTH: 3'-10'
 SAMPLE: BULK
 DESCRIPTION: RMS-95 @ 23.1 95.4%

TECHNICIAN: J.C
 DATE: 9/1/05
 CHECKED BY: JA
 CELL NO.: 2-N
 SYSTEM NO.: 6

SAMPLE INFORMATION

WEIGHT TUBE & SOIL (g): _____
 WEIGHT TUBE (g): _____
 WEIGHT SOIL (g): _____
 VOLUME SOIL (cu. ft): _____
 DRY UNIT WEIGHT (pcf): _____
 WET UNIT WEIGHT (pcf): _____

TUBE LENGTH: _____ (in) _____ (cm)
 TUBE DIAMETER: _____ (in) _____ (cm)
 SOIL LENGTH(L): 2.1085 (in) 5.102 (cm)
 SOIL DIAMETER: 2.8805 (in) 7.316 (cm)
 AREA(A): _____ (in²) 42.04 (cm²)

MOISTURE CONTENT

INITIAL WET WEIGHT (g): 401.57
 FINAL WET WEIGHT (g): 412.71
 FINAL DRY WEIGHT (g): 320.50
 INITIAL MOISTURE (%): _____
 FINAL MOISTURE (%): 22.59%
 PAN NAME: RR

PERM INFORMATION

CELL PRESSURE(psi): _____
 FORE PRESSURE(psi): _____
 BACK PRESSURE (psi): _____
 HEAD, h (psi) x 70.34: 140.68
 TEMPERATURE (°F): _____
 VISCOSITY CORRECTION(R_v): _____
 PERMEANT LIQUID USED: _____
 BURET CORRECTION FACTOR(C): _____

TABLE OF HYDRAULIC CONDUCTIVITY

DATE		TIME		ELAPSED TIME (+)		READING		FLOW (CC)
START	END	START	END	MINUTES	SECONDS	START	END	
9-1		10:14						
		11:02	12:04	62	(3720)	29.8	35.3	26.1 34.1 (1.2) 2.6x10 ⁻⁷
		12:04	12:34	30	(1800)	26.1	34.1	26.6 33.6 (5) 2.2x10 ⁻⁷
		12:34	1:09	35	(2100)	26.6	33.6	27.2 33.0 (7) 2.7x10 ⁻⁷
		1:09	1:34	25	(1500)	27.2	33.0	27.7 32.5 (5) 2.7x10 ⁻⁷
TOTALS				t = 9120 ^v				Q = 2.9 ^v

COEFFICIENT OF PERMEABILITY, $k = \frac{Q \times L \times R_T \times C}{h \times A \times t}$ $\frac{Q}{t} \frac{(5.102)(.931)(1.0)}{(140.68)(42.04)} = 2.6 \times 10^{-7}$



CONSTANT HEAD PERMEABILITY TEST

(ASTM D5084)

JOB NAME: TVA Kingston - Proposed Gypsum Stack
 JOB NO.: 3043-05-1030 Borrow Area
 BORING NO.: OT-3
 DEPTH: 3'-10"
 SAMPLE: Bulk
 DESCRIPTION: RMS-95@26.1 95.4%

TECHNICIAN: J.C
 DATE: 8/13/05
 CHECKED BY: JA
 CELL NO.: B
 SYSTEM NO.: 2

SAMPLE INFORMATION

WEIGHT TUBE & SOIL (g): _____
 WEIGHT TUBE (g): _____
 WEIGHT SOIL (g): _____
 VOLUME SOIL (cu ft): _____
 DRY UNIT WEIGHT (pcf): _____
 WET UNIT WEIGHT (pcf): _____

TUBE LENGTH: _____ (in) _____ (cm)
 TUBE DIAMETER: _____ (in) _____ (cm)
 SOIL LENGTH(L): 2.0905 (in) 5.284 (cm)
 SOIL DIAMETER: 2.8805 (in) 7.316 (cm)
 AREA(A): _____ (in²) 42.64 (cm²)

MOISTURE CONTENT

INITIAL WET WEIGHT (g): 411.37
 FINAL WET WEIGHT (g): 477.73
 FINAL DRY WEIGHT (g): 326.41
 INITIAL MOISTURE (%): _____ 25.6%
 FINAL MOISTURE (%): _____
 PAN NAME: WALLACE

PERM INFORMATION

CELL PRESSURE (psi): _____
 FORE PRESSURE (psi): _____
 BACK PRESSURE (psi): _____
 HEAD, h (psi) x 70.34: 140.68
 TEMPERATURE (°F): 73°F
 VISCOSITY CORRECTION (R_v): 0.931
 PERMEANT LIQUID USED: H₂O
 BURET CORRECTION FACTOR (C): 1.0

TABLE OF HYDRAULIC CONDUCTIVITY

DATE		TIME		ELAPSED TIME (+)		READING				FLOW (CC)	
START	END	START	END	MINUTES	SECONDS	START	END	START	END		
9-1		9:09	9:48	39	2340	25.2	16.0	24.1	16.1	1.1	3.9x10 ⁻⁷
		9:48	10:04	16	960	24.1	16.1	23.6	16.6	.5	4.3x10 ⁻⁷
		10:04	10:19	15	900	23.6	16.6	23.2	16.9	.3	2.8x10 ⁻⁷
		10:19	10:51	32	1920	23.2	16.9	22.9	17.7	.8	3.5x10 ⁻⁷
		10:51	11:08	17	(1020)	22.4	17.7	21.9	18.2	(.5)	4.1x10 ⁻⁷
		11:39	12:09	30	(1800)	21.8	18.4	21.0	19.2	(.8)	3.7x10 ⁻⁷
		12:09	12:36	27	(1620)	21.0	19.2	20.4	19.8	(.6)	3.1x10 ⁻⁷
		12:36	1:12	36	(2160)	20.4	19.8	19.5	20.7	(.9)	3.5x10 ⁻⁷

$\frac{Q}{L} = \frac{5.284}{2.0905} (0.931)$
 $\frac{Q}{L} = \frac{140.68}{7.316} (42.04)$

$n = 6600$

$Q = 2.8$

TOTALS

COEFFICIENT OF PERMEABILITY, $k = \frac{Q \times L \times R_v \times C}{A \times h \times t} = \frac{5.284 (0.931) (1.0)}{1140.68 (2.0905)} = 3.5 \times 10^{-7}$



MACTEC

CONSTANT HEAD PERMEABILITY TEST

(ASTM D5084)

JOB NAME: TVA Kingston - Proposed Gypsum Stack
 JOB NO.: 3043-05-1030 Bormn Area
 BORING NO.: OT-4
 DEPTH: 4'-10'
 SAMPLE: Bulk
 DESCRIPTION: RMS-90 @ 16.8 (89.8%)

TECHNICIAN: J.C
 DATE: 8/31/05
 CHECKED BY: [Signature]
 CELL NO.: #3
 SYSTEM NO.: 13/14

SAMPLE INFORMATION

WEIGHT TUBE & SOIL (g): _____
 WEIGHT TUBE (g): _____
 WEIGHT SOIL (g): _____
 VOLUME SOIL (cu ft): _____
 DRY UNIT WEIGHT (pcf): _____
 WET UNIT WEIGHT (pcf): _____

TUBE LENGTH: _____ (in) _____ (cm)
 TUBE DIAMETER: _____ (in) _____ (cm)
 SOIL LENGTH(L): 2.0615 (in) 5.236 (cm)
 SOIL DIAMETER: 2.9875 (in) 7.533 (cm)
 AREA(A): _____ (in²) 42.23 (cm²)

MOISTURE CONTENT

INITIAL WET WEIGHT (g): 379.35
 FINAL WET WEIGHT (g): 412.34
 FINAL DRY WEIGHT (g): 323.33
 INITIAL MOISTURE (%): _____
 FINAL MOISTURE (%): _____
 PAN NAME: B-9

PERM INFORMATION

CELL PRESSURE (psi): _____
 FORE PRESSURE (psi): _____
 BACK PRESSURE (psi): _____
 HEAD, h (psi) x 70.34: 140.68
 TEMPERATURE (°F): _____
 VISCOSITY CORRECTION (R_v): _____
 PERMEANT LIQUID USED: _____
 BURET CORRECTION FACTOR (C): _____

TABLE OF HYDRAULIC CONDUCTIVITY

DATE		TIME		ELAPSED TIME (+)		READING		FLOW (CC)		
START	END	START	END	MINUTES	SECONDS	START	END			
9-1		9:24	9:37			14.3	5.5	4.0	16.0	
		9:40	9:52			18.7	2.2	10.0	10.9	
		9:52	10:01			10.0	10.9	3.6	17.4	
		10:49				10.1	9.7			
		12:15	12:17	2	(120)	15.5	5.0	13.8	6.7	(1.7) 1.2x10 ⁻⁵
		12:17	12:19	2	(120)	13.8	6.7	12.3	7.9	(1.3) 1.0x10 ⁻⁵
		12:19	12:21	2	(120)	12.3	7.9	11.0	9.9	(1.5) 1.0x10 ⁻⁵
		12:21	12:23	2	(120)	11	9.9	9.3	10.8	(1.5) 1.0x10 ⁻⁵
TOTALS					$t = 480$					$Q = 6.2$

COEFFICIENT OF PERMEABILITY, $k = \frac{Q \times L \times R_v \times C}{h \times A \times t}$

$$\frac{Q}{t} = \frac{(5.236)(9.3)(1.0)}{(140.68)(42.23)} = 1.1 \times 10^{-5}$$



MACTEC

CONSTANT HEAD PERMEABILITY TEST

(ASTM D5084)

JOB NAME: TVA Kingston - Proposed Gypsum Stack
 JOB NO.: 3043-OS-1030 Borrow Area
 BORING NO.: OT-A
 DEPTH: 4'-10"
 SAMPLE: BULK
 DESCRIPTION: PMS-95A 16.8 94.8%

TECHNICIAN: J.C
 DATE: 8/31/05
 CHECKED BY: JA
 CELL NO.: #1
 SYSTEM NO.: 13

(ACTUAL % Compaction)

SAMPLE INFORMATION

WEIGHT TUBE & SOIL (g): _____
 WEIGHT TUBE (g): _____
 WEIGHT SOIL (g): _____
 VOLUME SOIL (cu ft): _____
 DRY UNIT WEIGHT (pcf): _____
 WET UNIT WEIGHT (pcf): _____

TUBE LENGTH: _____ (in) _____ (cm)
 TUBE DIAMETER: _____ (in) _____ (cm)
 SOIL LENGTH(L): 2.175 (in) 5.378 (cm)
 SOIL DIAMETER: 2.883 (in) 7.323 (cm)
 AREA(A): _____ (in²) 42.12 (cm²)

MOISTURE CONTENT

INITIAL WET WEIGHT (g): 400.50
 FINAL WET WEIGHT (g): 432.17
 FINAL DRY WEIGHT (g): 341.20
 INITIAL MOISTURE (%): _____ 17.1%
 FINAL MOISTURE (%): _____
 PAN NAME: CM6

PERM INFORMATION

CELL PRESSURE (psi): _____
 FORE PRESSURE (psi): _____
 BACK PRESSURE (psi): _____
 HEAD, h (psi) x 70.34: 140.68
 TEMPERATURE (°F): _____
 VISCOSITY CORRECTION (R_v): _____
 PERMEANT LIQUID USED: _____
 BURET CORRECTION FACTOR (C): _____

TABLE OF HYDRAULIC CONDUCTIVITY

DATE		TIME		ELAPSED TIME (+)		READING				FLOW (CC)	
START	END	START	END	MINUTES	SECONDS	START	END				
9-1		9:18	9:36	18	1080	12.7	6.1	4.6	14.2	8.1	6.3 x 10 ⁻⁶
9-1		9:39	9:51	12	720	17.2	2.3	11.9	7.4	5.1	6.0 x 10 ⁻⁶
		9:51	10:02	11	660	11.9	7.4	8.0	11.4	5.9	5.0 x 10 ⁻⁶
		10:02	10:09	7	420	8.0	11.4	5.6	13.8	2.4	4.8 x 10 ⁻⁶
		10:09	10:17	8	480	5.6	13.8	3.0	16.4	2.6	4.6 x 10 ⁻⁶
		10:55	11:07	12	720	11.1	9.6	7.1	13.0	4.0	4.7 x 10 ⁻⁶
TOTALS					i = 2280						12.9

COEFFICIENT OF PERMEABILITY, $k = \frac{Q \times L \times R_v \times C}{h \times A \times t}$

$\frac{Q}{t} = 8.45 \times 10^{-4} = 4.8 \times 10^{-6}$

MACTEC

CONSTANT HEAD PERMEABILITY TEST

(ASTM D5084)

JOB NAME: TVA - KINGSTON - PROCPYP STA. TECHNICIAN: J.C.
 JOB NO.: 3043-05-1030 Soil Lab Area DATE: 8/31/05
 BORING NO.: OT-4
 DEPTH: 4' - 10' CHECKED BY: JA
 SAMPLE: BULK CELL NO.: #2
 DESCRIPTION: RMS - 900 19.8 90.0% SYSTEM NO.: #14

(ACTUAL COMPRESSION)

SAMPLE INFORMATION

WEIGHT TUBE & SOIL (g): _____
 WEIGHT TUBE (g): _____
 WEIGHT SOIL (g): _____
 VOLUME SOIL (cu ft): _____
 DRY UNIT WEIGHT (pcf): _____
 WET UNIT WEIGHT (pcf): _____

TUBE LENGTH: _____ (in) _____ (cm)
 TUBE DIAMETER: _____ (in) _____ (cm)
 SOIL LENGTH(L): 2.0755 (in) 5.272 (cm)
 SOIL DIAMETER: 2.8735 (in) 7.3472 (cm)
 AREA(A): _____ (in²) 4.98 (cm²)
41.87

MOISTURE CONTENT

INITIAL WET WEIGHT (g): 384.65
 FINAL WET WEIGHT (g): 406.14
 FINAL DRY WEIGHT (g): 320.86
 INITIAL MOISTURE (%): _____
 FINAL MOISTURE (%): 19.8%
 PAN NAME: WARR AOE

PERM INFORMATION

CELL PRESSURE (psi): 57
 FORE PRESSURE (psi): 52
 BACK PRESSURE (psi): 59
 HEAD, h (psi) x 70.34: 140.68
 TEMPERATURE (°F): 73°F
 VISCOSITY CORRECTION (R_v): 0.931
 PERMEANT LIQUID USED: H₂O
 BURET CORRECTION FACTOR (C): 1.0

TABLE OF HYDRAULIC CONDUCTIVITY

DATE		TIME		ELAPSED TIME (+)		READING				FLOW (CC)	
START	END	START	END	MINUTES	SECONDS	START	END	cc	Ki		
9-5	9-5	4:08 PM	4:14 PM	6	360	10.9	9.4 9.1 11.1	1.8		4.2 × 10 ⁻⁶	
9-5	9-5	4:15 PM	4:21 PM	6	360	10.9	9.3 9.3 10.8	1.6		3.7 × 10 ⁻⁶	
9-5	9-5	4:22 PM	4:35 PM	13	780	11.2	9.1 8.7 11.6	2.5		2.7 × 10 ⁻⁶	
9-5	9-5	4:36 PM	4:42	6	360	11.2	9.0 9.3 10.9	1.9		4.4 × 10 ⁻⁶	
TOTALS					i = 1860					Q = 7.8	

COEFFICIENT OF PERMEABILITY, $k = \frac{Q \times L \times R_T \times C_a}{h \times A \times t} = \frac{5.272 (0.931)}{140.68 (41.87)} = 3.5 \times 10^{-6}$

MACTEC

CONSTANT HEAD PERMEABILITY TEST

(ASTM D5084)

JOB NAME: TVA Kingston - Proposed Gypsum Stack
 JOB NO.: 3043-05-1030 Borrow Area
 BORING NO.: OT-4
 DEPTH: 4' - 10'
 SAMPLE: Bulk
 DESCRIPTION: RMS-95 @ 19.8 95.0%
 (Actual Compaction)

TECHNICIAN: J.C
 DATE: 8/17/05
 CHECKED BY: MA
 CELL NO.: 5
 SYSTEM NO.: 15

SAMPLE INFORMATION

WEIGHT TUBE & SOIL (g): _____
 WEIGHT TUBE (g): _____
 WEIGHT SOIL (g): _____
 VOLUME SOIL (cu ft): _____
 DRY UNIT WEIGHT (pcf): _____
 WET UNIT WEIGHT (pcf): _____

TUBE LENGTH: _____ (in) _____ (cm)
 TUBE DIAMETER: _____ (in) _____ (cm)
 SOIL LENGTH(L): 1.9900 (in) 5.055 (cm)
 SOIL DIAMETER: 2.8665 (in) 7.281 (cm)
 AREA(A): _____ (in²) 41.64 (cm²)

MOISTURE CONTENT

INITIAL WET WEIGHT (g): 404.15
 FINAL WET WEIGHT (g): 419.91
 FINAL DRY WEIGHT (g): 336.51
 INITIAL MOISTURE (%): _____ 19.8%
 FINAL MOISTURE (%): _____
 PAN NAME: B-3

PERM INFORMATION

CELL PRESSURE (psi): _____
 FORE PRESSURE (psi): _____
 BACK PRESSURE (psi): _____
 HEAD, h (psi) x 70.34: 140.68
 TEMPERATURE (°F): _____
 VISCOSITY CORRECTION (R_v): _____
 PERMEANT LIQUID USED: _____
 BURET CORRECTION FACTOR (C): _____

TABLE OF HYDRAULIC CONDUCTIVITY

DATE		TIME		ELAPSED TIME (+)		READING				FLOW (CC)		
START	END	START	END	MINUTES	SECONDS	START	END	START	END			
9-1		9:30	9:54	24	1440	15.2	5.1	12.2	8.0	3.0	1.7 x 10 ⁻⁶	
		9:54	10:00	6	(360)	12.2	8.0	11.6	8.7	(.7)	1.6 x 10 ⁻⁶	
		10:00	10:07	7	(420)	11.6	8.7	10.8	9.5	(.8)	1.5 x 10 ⁻⁶	
		10:07	10:15	8	(480)	10.8	9.5	9.8	10.5	(1.0)	1.7 x 10 ⁻⁶	
		10:51	11:04	13	(780)	11.6	3.8	15.0	5.3	(1.6)	1.6 x 10 ⁻⁶	
										4.1	✓	
TOTALS					i = 2040						Q =	✓

COEFFICIENT OF PERMEABILITY, $k = \frac{Q \times L \times R_T \times C}{h \times A \times t}$

$\frac{4.1}{2040} \cdot \frac{(5.055 \cdot (9.81) \cdot (1.0))}{(140.68 / (41.64))} = 1.6 \times 10^{-6}$



CONSTANT HEAD PERMEABILITY TEST

(ASTM D5084)

JOB NAME: TVA Kingston - Proposed Gypsum Stack
 JOB NO.: 3043-05-1030 Borrow Area
 BORING NO.: OT-9
 DEPTH: 4' - 10'
 SAMPLE: BULK
 DESCRIPTION: RMS-90 @ 22.8 90.9%

TECHNICIAN: J.C
 DATE: 8/31/05
 CHECKED BY: J.A
 CELL NO.: 4
 SYSTEM NO.: 9

SAMPLE INFORMATION

(Actual Compaction)

WEIGHT TUBE & SOIL (g): _____
 WEIGHT TUBE (g): _____
 WEIGHT SOIL (g): _____
 VOLUME SOIL (cu ft): _____
 DRY UNIT WEIGHT (pcf): _____
 WET UNIT WEIGHT (pcf): _____

TUBE LENGTH: _____ (in) _____ (cm)
 TUBE DIAMETER: _____ (in) _____ (cm)
 SOIL LENGTH(L): 1.9840 (in) 5.039 (cm)
 SOIL DIAMETER: 2.8905 (in) 7.342 (cm)
 AREA(A): _____ (in²) 42.34 (cm²)

MOISTURE CONTENT

INITIAL WET WEIGHT (g): 399.44
 FINAL WET WEIGHT (g): 405.29
 FINAL DRY WEIGHT (g): 324.43
 INITIAL MOISTURE (%): _____
 FINAL MOISTURE (%): 22.7%
 PAN NAME: FF

PERM INFORMATION

CELL PRESSURE (psi): _____
 FORE PRESSURE (psi): _____
 BACK PRESSURE (psi): _____
 HEAD, h (psi) x 70.34: 140.68
 TEMPERATURE (°F): _____
 VISCOSITY CORRECTION (R_T): _____
 PERMEANT LIQUID USED: _____
 BURET CORRECTION FACTOR (C): _____

TABLE OF HYDRAULIC CONDUCTIVITY

DATE		TIME		ELAPSED TIME (+)		READING				FLOW (CC)	
START	END	START	END	MINUTES	SECONDS	START	END				
9/1		10:01	10:57	56	3360	19.3	39.4	21.1	37.5	1.8	4.2 x 10 ⁻⁷
		10:57	11:44	47	2820	21.1	37.5	22.7	36.1	1.5	4.2 x 10 ⁻⁷
		11:44	12:28	44	2640	22.7	36.1	24.0	34.5	1.3	3.9 x 10 ⁻⁷
		12:28	1:03	35	2100	24.0	34.5	25.0	33.3	1.0	3.8 x 10 ⁻⁷
TOTALS											

$i = 109204$ $Q = 5.6$

COEFFICIENT OF PERMEABILITY, $k = \frac{Q \times L \times R_T \times C}{h \times A \times t}$

$$\frac{Q \cdot 5.039 \cdot (93) \cdot (1.0)}{E \cdot (140.68) \cdot (42.34)} = 4.0 \times 10^{-7}$$



MACTEC

CONSTANT HEAD PERMEABILITY TEST

(ASTM D5084)

JOB NAME: TVA Kingston - Proposed Gypsum Stack
 JOB NO.: 3043-05-1030 Borrow Area
 BORING NO.: OT-4
 DEPTH: 4'-10'
 SAMPLE: Bulk
 DESCRIPTION: RMS-950 22.8 95.0%
 (ACTUAL Compaction)

TECHNICIAN: J.C
 DATE: 8/31/05
 CHECKED BY: JL
 CELL NO.: #1
 SYSTEM NO.: 8

SAMPLE INFORMATION

WEIGHT TUBE & SOIL (g): _____
 WEIGHT TUBE (g): _____
 WEIGHT SOIL (g): _____
 VOLUME SOIL (cu ft): _____
 DRY UNIT WEIGHT (pcf): _____
 WET UNIT WEIGHT (pcf): _____

TUBE LENGTH: _____ (in) _____ (cm)
 TUBE DIAMETER: _____ (in) _____ (cm)
 SOIL LENGTH(L): 2.0760 (in) 5.273 (cm)
 SOIL DIAMETER: 2.8835 (in) 7.324 (cm)
 AREA(A): _____ (in²) 42.13 (cm²)

MOISTURE CONTENT

INITIAL WET WEIGHT (g): 421.08
 FINAL WET WEIGHT (g): 427.70
 FINAL DRY WEIGHT (g): 342.09
 INITIAL MOISTURE (%): _____
 FINAL MOISTURE (%): 22.7%
 PAN NAME: II

PERM INFORMATION

CELL PRESSURE (psi): _____
 FORE PRESSURE (psi): _____
 BACK PRESSURE (psi): _____
 HEAD, h (psi) x 70.34: 140.68
 TEMPERATURE (°F): _____
 VISCOSITY CORRECTION (R_T): _____
 PERMEANT LIQUID USED: _____
 BURET CORRECTION FACTOR (C): _____

TABLE OF HYDRAULIC CONDUCTIVITY

DATE		TIME		ELAPSED TIME (+)		READING				FLOW (CC)	
START	END	START	END	MINUTES	SECONDS	START	END	START	END	Q	k
9/1		9:52	10:56	64	3840	27.6	38.6	28.0	38.2	.4	8.6 x 10 ⁻⁸
		10:56	11:43	47	2820	28.0	38.2	28.3	37.9	.3	8.8 x 10 ⁻⁸
		11:43	1:02	79	4740	28.3	37.9	28.7	37.4	.4	7.0 x 10 ⁻⁸
		1:02	1:33	31	1860	28.7	37.4	28.9	37.2	.2	8.9 x 10 ⁻⁸
TOTALS						13260					Q = 1.3

COEFFICIENT OF PERMEABILITY, $k = \frac{Q \times L \times R_T \times C}{h \times A \times t} = \frac{Q}{E} \times \frac{(5.273)(.931)(1.0)}{(140.68)(42.13)} = 8.1 \times 10^{-8}$



MACTEC

CONSTANT HEAD PERMEABILITY TEST

(ASTM D5084)

JOB NAME: TVA KINGSTON - B.A.
 JOB NO.: 3043-05-1930
 BORING NO.: QT-4
 DEPTH: 41-10'
 SAMPLE: Bulk
 DESCRIPTION: Rms \approx 95% @ 20.6% CF

TECHNICIAN: J. Alex / J.C.
 DATE: 9-12-5
 CHECKED BY: JA
 CELL NO.: #2
 SYSTEM NO.: #14

SAMPLE INFORMATION

WEIGHT TUBE & SOIL (g): _____
 WEIGHT TUBE (g): _____
 WEIGHT SOIL (g): _____
 VOLUME SOIL (cu ft): _____
 DRY UNIT WEIGHT (pcf): _____
 WET UNIT WEIGHT (pcf): _____

TUBE LENGTH: _____ (in) _____ (cm)
 TUBE DIAMETER: _____ (in) _____ (cm)
 SOIL LENGTH(L): 2.006 (in) 5.095 (cm)
 SOIL DIAMETER: 2.888 (in) 7.336 (cm)
 AREA(A): _____ (in²) 42.26 (cm²)

MOISTURE CONTENT

INITIAL WET WEIGHT (g): 416.04
 FINAL WET WEIGHT (g): 429.77
 FINAL DRY WEIGHT (g): 345.82
 INITIAL MOISTURE (%): 20.3
 FINAL MOISTURE (%): 24.3
 PAN NAME: FF

PERM INFORMATION

CELL PRESSURE (psi): _____
 FORE PRESSURE (psi): _____
 BACK PRESSURE (psi): _____
 HEAD, h (psi) x 70.34: 140.68
 TEMPERATURE (°F): 73°F
 VISCOSITY CORRECTION (R_v): .931
 PERMEANT LIQUID USED: H₂O distilled
 BURET CORRECTION FACTOR (C): 1.0

TABLE OF HYDRAULIC CONDUCTIVITY

DATE		TIME		ELAPSED TIME (+)		READING				FLOW (CC)	
START	END	START	END	MINUTES	SECONDS	START	END	START	END	Q	K
9-15	9-15	9:13	11:14	121	7260	13.0	7.3	2.6	18.2	10.4	1.1x10 ⁻⁶
9-15	9-15	11:14	11:45	31	1860	2.6	18.2	.2	20.6	2.4	1.0x10 ⁻⁶
9-15	9-15	11:48	12:59	71	4260	13.8	2.9	7.3	9.4	6.5	1.2x10 ⁻⁶
9-15	9-15	12:59	2:06	67	4020	7.3	9.4	2.0	14.9	5.3	1.1x10 ⁻⁶
TOTALS						17400					24.6

COEFFICIENT OF PERMEABILITY, $k = \frac{Q \times L \times R_v \times C}{h \times A \times t}$

$\frac{Q}{E} \cdot (.00079787) = 1.1 \times 10^{-6}$

