



# Application of the Electromagnetic Borehole Flowmeter

# **Application of the Electromagnetic Borehole Flowmeter**

by

Steven C. Young, Hank E. Julian, and Hubert S. Pearson  
Tennessee Valley Authority  
Engineering Laboratory  
Norris, TN 37828

and

Fred J. Molz and Gerald K. Boman  
Auburn University  
Auburn, AL 36849

Interagency Agreement  
DW64934812

Project Officer

Steven D. Acree  
Subsurface Protection and Remediation Division  
National Risk Management Research Laboratory  
Ada, OK 74820

National Risk Management Research Laboratory  
Office of Research and Development  
U.S. Environmental Protection Agency  
Cincinnati, OH 45268

---

## Notice

The U.S. Environmental Protection Agency, through its Office of Research and Development, partially funded and collaborated in the research described here under Interagency Agreement DW64934812 to the Tennessee Valley Authority. It has been subjected to the Agency's peer and administrative review and has been approved for publication as an EPA document. Mention of trade names or commercial products does not constitute endorsement or recommendation for use.

All research projects funded by the U.S. Environmental Protection Agency that make conclusions or recommendations based on environmentally related measurements are required to participate in the Agency Quality Assurance Program. This project was conducted under an approved Quality Assurance Project Plan and the procedures therein specified were used. Information on the plan and documentation of the quality assurance activities and results are available from the Principal Investigator.

---

## Foreword

The U.S. Environmental Protection Agency is charged by Congress with protecting the Nation's land, air, and water resources. Under a mandate of national environmental laws, the Agency strives to formulate and implement actions leading to a compatible balance between human activities and the ability of natural systems to support and nurture life. To meet these mandates, EPA's research program is providing data and technical support for solving environmental problems today and building a science knowledge base necessary to manage our ecological resources wisely, understand how pollutants affect our health, and prevent or reduce environmental risks in the future.

The National Risk Management Research Laboratory is the Agency's center for investigation of technological and management approaches for reducing risks from threats to human health and the environment. The focus of the Laboratory's research program is on methods for the prevention and control of pollution to air, land, water, and subsurface resources; protection of water quality in public water systems; remediation of contaminated sites and ground water; and prevention and control of indoor air pollution. The goal of this research effort is to catalyze development and implementation of innovative, cost-effective environmental technologies; develop scientific and engineering information needed by EPA to support regulatory and policy decisions; and provide technical support and information transfer to ensure effective implementation of environmental regulations and strategies.

This report presents a discussion of the applications of vertical-component borehole flowmeters to site characterization with an emphasis on the design and use of a sensitive electromagnetic flowmeter partially developed under this project. The methodologies discussed in this document provide cost-effective means for obtaining detailed definitions of hydrogeologic controls on ground-water flow and contaminant transport. Such information is often essential for evaluation of contaminant fate in the environment and design of effective monitoring and remediation systems. It is published and made available by EPA's Office of Research and Development to assist the user community.

Clinton W. Hall, Director  
Subsurface Protection and Remediation Division  
National Risk Management Research Laboratory

---

## Abstract

A prerequisite for useful monitoring, modeling, and remedial design strategies is knowledge of the network of hydraulically active fractures in bedrock aquifers and three-dimensional hydraulic conductivity fields in granular aquifers. Due to a relative lack of practicable characterization technologies, many ground-water remediation strategies have been designed based on very little, if any, detailed information regarding fracture or hydraulic conductivity distribution. As a result, the underestimation of aquifer heterogeneity may contribute to inadequate conceptual models of contaminant transport/fate and inadequate design/performance of many remediation systems.

Borehole flowmeters are effective tools for measuring vertical variations in the flow field of an aquifer. Although borehole flowmeters have been used in the petroleum industry for decades, they are not common in ground-water studies due, in part, to the lack of suitable meters. A vertical component electromagnetic (EM) borehole flowmeter with the versatility and sensitivity required for application at most sites has been developed by the Tennessee Valley Authority (TVA). The prototype TVA EM flowmeters have outer diameters of less than 5.25 cm, and inner diameters of either 2.54 cm or 1.27 cm. The detection limits for the 1.27-cm and 2.54-cm flowmeters are near 0.005 L/min and 0.03 L/min, respectively. In addition to a low detection limit, attractive features of the prototype and commercial versions of this EM flowmeter include a wide measurement range, durable construction, no moving parts, and a design that facilitates use with packer assemblies.

This report describes the operation and application of the TVA prototype EM borehole flowmeters, including theory, design, calibration, basic field applications, data analysis, and potential effects of various well construction and development procedures on data. The majority of these results are also applicable to the commercial version of this meter and other vertical component borehole flowmeters, including heat pulse and impeller tools. Several case studies illustrating specific uses of these tools are also discussed.

# Contents

<u>Section</u>	<u>Page</u>
Notice .....	ii
Foreword .....	iii
Abstract .....	iv
List of Figures .....	vii
List of Tables .....	ix
<b>I. Theory and Application of the Electromagnetic Borehole Flowmeter .....</b>	<b>1</b>
I-1. Overview .....	1
I-2. Principles of Operation .....	2
I-3. Collection of Flowmeter Logs .....	2
I-4. Analysis of Flowmeter Logs .....	2
a. Flow Distribution Logs .....	2
b. Hydraulic Conductivity Logs in Granular Aquifers .....	6
c. Data Analysis .....	7
I-5. Conclusions .....	8
<b>II. Electromagnetic Borehole Flowmeter System .....</b>	<b>9</b>
II-1. Design and Construction .....	9
II-2. Laboratory Calibration .....	10
<b>III. Hydrogeologic Characterization Test Design .....</b>	<b>13</b>
III-1. Overview .....	13
III-2. Measurement Interval Selection .....	13
III-3. Flowmeter Measurements .....	13
III-4. Pumping Rate and Drawdown Measurements .....	14
III-5. Selection of Pumps .....	14
III-6. Packer Selection .....	14
III-7. Method of Inflation .....	15
III-8. Issues Regarding Flowmeter Measurements in the Field .....	15
a. Well or Borehole Storage .....	15
b. Selection of Pumping Rate .....	15
c. Background Electromagnetic Currents .....	16
d. Reproducibility of Flowmeter Data .....	16
III-9. Flowmeter Investigations in Consolidated Materials .....	16
a. Introduction .....	16
b. Fractured Rock Applications .....	17
c. Conclusions .....	18
<b>IV. Well Construction and Development .....</b>	<b>19</b>
IV-1. Background .....	19
a. In-Situ Hydraulic Conductivity Estimates Using Wells .....	19
b. Formation Damages and Skin Effects .....	19
IV-2. Well Design .....	19
IV-3. Well Installation Methods .....	20
a. Overview .....	20
b. Drilling Techniques and Hydraulic Conductivity Estimates .....	20

**Contents**  
(continued)

<u>Section</u>	<u>Page</u>
IV-4. Well Development Methods .....	21
a. Overview .....	21
b. Development Methods and Hydraulic Conductivity Estimates .....	21
V. Field Studies of Well Construction and Development at Columbus, Mississippi .....	23
V-1. Description of Test Site .....	23
a. Site Location .....	23
b. Aquifer Characteristics .....	23
c. Previous Pumping Tests .....	23
d. Monitoring Well Installation .....	24
V-2. Test Descriptions .....	25
V-3. Test Analyses and Results .....	26
a. Ambient Flow Distributions .....	26
b. Induced Flow Distributions .....	28
c. Specific Capacity Values .....	28
d. Transmissivity Values .....	28
V-4. Summary .....	31
VI. Field Studies of Well Construction and Development at Mobile, Alabama .....	33
VI-1. Description of Test Site .....	33
a. Site Location .....	33
b. Aquifer Characteristics .....	33
c. Well Installation .....	33
VI-2. Test Description .....	34
VI-3. Test Results .....	35
a. Shallow Well A .....	35
b. Shallow Well B .....	36
c. Deep Well C .....	38
VI-4. Summary and Discussion .....	40
VII. Case Studies .....	43
VII-1. Field Applications .....	43
VII-2. Columbus AFB, Mississippi .....	43
VII-3. Oak Ridge National Laboratory, Tennessee .....	45
VII-4. The Oklahoma Refining Company Superfund Site, Oklahoma .....	46
VII-5. Gilson Road Superfund Site, New Hampshire .....	46
VII-6. Mirror Lake, New Hampshire .....	46
VII-7. Logan Martin Dam, Alabama .....	48
VII-8. Cape Cod, Massachusetts .....	50
VII-9. Summary .....	51
VIII. References .....	53
APPENDIX A. Field Data Sheets for Borehole Flowmeter Tests .....	57
APPENDIX B. Equipment Checklist .....	59

## Figures

<u>Number</u>	<u>Page</u>
I-1	Schematic diagram of the TVA electromagnetic borehole flowmeter ..... 3
I-2	Apparatus and geometry associated with a borehole flowmeter test ..... 3
I-3	Graphical illustration of the hypothetical case presented in Table I-1 ..... 4
I-4	Assumed layered geometry within which flowmeter data are collected and analyzed ..... 5
II-1	Mechanical packer (a) assembled on probe and (b) in schematic view ..... 9
II-2	Inflatable packer assembled on probe ..... 10
II-3	Conceptual system for flowmeter calibration ..... 10
II-4	Calibration data for the 1.27-cm ID flowmeter in 5.1-cm PVC pipe ..... 11
II-5	Frictional losses associated with the 1.27-cm and 2.54-cm ID flowmeters ..... 12
III-1	Acoustic-televiwer, caliper, single-point resistance, and flowmeter logs for borehole DH-14 in northeastern Illinois (Paillet and Keys, 1984; Molz et al., 1990) ..... 17
V-1	Ox bow meander at the Columbus AFB site drawn from a 1956 aerial photograph ..... 23
V-2	Well network at the 1-Ha test site ..... 24
V-3	Design of wells used to evaluate the effect of well development on flowmeter tests ..... 25
V-4	Ambient flow profiles after successive well development ..... 27
V-5	Induced flow profiles after successive well development ..... 29
V-6	Effect of well development on the drawdown values for pumping tests at the 38-39-40 well cluster ..... 30
V-7	Comparison of specific capacities at different wells ..... 31
V-8	Calculated transmissivities using early time data ..... 32
VI-1	Vertical cross-sectional illustration of the subsurface hydrologic system at the Mobile site ..... 33
VI-2	Schematic diagram providing the details of the shallow and deep wells constructed at the Mobile site. Well casing and well screen are the same dimension and schedule. The only difference is the depth dimensions of the casing and screen ..... 34
VI-3	(Well A) (a) Ambient flow as measured by the EM flowmeter and (b) net flow (total flow - ambient flow). Data were obtained after the 2nd and 3rd developments ..... 36
VI-4	(Well A) Differential net flow obtained (a) after 2nd development, (b) after 2nd development and an overnight waiting period, and (c) after 3rd development ..... 37



**Figures**  
(continued)

<u>Number</u>	<u>Page</u>
VI-5 (Well B) (a) Ambient flow as measured by the EM flowmeter and (b) net flow (total flow - ambient flow). Data sets were obtained prior to development and after 1st, 2nd, and 3rd developments .....	38
VI-6 (Well B) Differential net flow obtained (a) prior to development, (b) after 1st development, (c) after 2nd development, and (d) after 3rd development .....	39
VI-7 (Well B) Ambient flow after the first development and repeated after an overnight period.....	40
VI-8 (Well C) (a) Ambient flow as measured by the EM flowmeter and (b) net flow (total flow - ambient flow). Data were obtained prior to development and after 1st, 2nd, and 3rd developments for the ambient flow and after 1st, 2nd, and 3rd developments for net flow .....	40
VI-9 (Well C) Differential net flow obtained (a) after 1st development, (b) after 1st development and overnight waiting period, (c) after 2nd development, and (d) after 3rd development .....	41
VII-1 Vertical profile of hydraulic conductivity values along the longitudinal axis of the MADE tracer plume .....	44
VII-2 Depth-averaged hydraulic conductivity values for the lowermost 2 m (left) and the uppermost 2 m (right) of the unconfined aquifer below the 1-Ha test site at Columbus AFB .....	44
VII-3 (a) Ambient flow distribution in a well and (b) the flow distribution caused by constant-rate pumping .....	45
VII-4 Ambient and induced flow distributions for wells NE-2, SBB-36, and IBB-4 at the ORC Superfund Site .....	47
VII-5 Ambient and induced flow distributions for wells I, J, and K at the Gilson Road site .....	47
VII-6 Ambient and induced flow distributions for wells FSE-06, FSE-09, and FSE-10 at Mirror Lake, New Hampshire .....	49
VII-7 Substantial ambient flow moving from one stratum to another as detected by an impeller flowmeter. The flow is moving under a dam, the base of which is at an elevation of about 140 m AMSL. Flowmeter data were used to help select a geologic model for explaining the large amount of leakage of water low in dissolved oxygen that was observed below the dam .....	50

---

## Tables

<u>Number</u>		<u>Page</u>
I-1	Hypothetical data and data analysis related to the application of a borehole flowmeter. ....	6
I-2	Results of the analysis of data from a borehole flowmeter test to estimate hydraulic conductivity distributions .....	8
II-1	Sample calibration factors (liter/min/volt) from a linear regression of discharge versus voltage for electromagnetic flowmeter data .....	12
III-1	Generalized borehole flowmeter field test procedures .....	13
III-2	Problems that produce errors in EM flowmeter measurements .....	14
V-1	Testing sequence .....	26
V-2	Early-time CJSJL transmissivity values .....	32
VI-1	Pump-induced flow and ambient flow tests performed on wells A, B, and C .....	35
VII-1	Characterization objectives for borehole flowmeter studies .....	43
VII-2	Summary statistics of hydraulic conductivity data obtained using a borehole flowmeter method and a permeameter analysis method (Hess et al. (1992)).....	51

x

---

# Chapter 1

## Theory and Application of the Electromagnetic Borehole Flowmeter

### I-1 Overview

The underestimation of aquifer heterogeneity has significantly contributed to the inefficient design and, consequently, inadequate performance of many types of remediation systems (Mercer et al., 1990; Haley et al., 1991). This is especially true of pump-and-treat remediation systems. In many cases, interpretation of hydraulic properties is limited by field measurement capability. Characterization of a hydrogeologic system requires an effective method for measuring vertical variations in hydraulic properties. At least three research teams (Boggs et al., 1989; Rehfeldt et al., 1989b; Molz et al., 1989, 1990) have evaluated alternative methods for measuring the vertical variation of hydraulic conductivity (K). These methods included: small-scale tracer tests, multilevel slug tests, laboratory permeameter tests, empirical equations based on grain-size distributions, and borehole flowmeter tests.

These comparisons indicated that the borehole flowmeter test is one of the most promising methods for measuring the spatial variability of the hydraulic conductivity fields.

Various types of flowmeters based on impeller, thermal-pulse, tracer-release or electromagnetic technologies have been devised for measuring flow distribution along a borehole or well screen. Impeller meters (also known as spinners) have been used for several decades in the petroleum industry, and such instruments suitable for some ground-water applications are now available. A meter of this type was applied in the field by Hufschmied (1983), Molz et al. (1990), and others. Most impeller meters cannot operate at the lower flow ranges often required for ground-water applications. Based on the need to measure low flow velocities, the United States Geological Survey (USGS) developed a thermal-pulse flowmeter (Hess, 1982, 1986; Morin et al., 1988a; Paillet et al., 1987). Such tools are quite sensitive to low flow velocities. Electromagnetic flowmeters can also operate within a relatively large range of flow rates suitable for most ground-water investigations. Although this document focuses on the design and application of the electromagnetic flowmeter developed under this project for the measurement of the vertical component of flow within a well, the data collection and methods of analysis apply to other types of vertical component flowmeters.

A sensitive, vertical-component borehole flowmeter enables one to accomplish two basic tasks:

1. It allows one to measure the natural (ambient) vertical flow that exists in many wells; and

2. If the well is pumped at a steady rate, it enables one to determine the flow distribution that is entering the well from the surrounding medium.

Ambient flow distributions provide information on the direction of the vertical component of the hydraulic gradient, and on the location of hydraulically active fractures in the case of a fractured formation. If certain conditions are met, flow distributions during pumping provide information on the relative differences in the permeability of selected aquifer zones or additional information on fracture hydraulic characteristics.

Flowmeter measurements depend on factors such as skin effects due to well construction and development and ambient hydrologic conditions. Such factors may be variable within a well and some may change with time. Also, it cannot be overemphasized that a borehole flowmeter should be viewed only as another tool available to ground-water hydrologists. As expected, the best hydrogeologic characterizations are achieved when this tool is used in combination with other methods (e.g., geophysical measurements and traditional aquifer tests). Application of several technologies that are suitable for characterization of various aspects of site hydrology on different scales are necessary for definition of hydrogeologic controls on ground-water flow.

A sensitive borehole flowmeter, such as tools based on thermal-pulse technology or the electromagnetic system discussed in this report, is most applicable for characterization objectives that require few assumptions regarding aquifer properties or other complex variables. These tools are directly applicable for such objectives as identifying transmissive intervals in wells, evaluation of the effects and state of well development, and identification of natural flow patterns within conventional monitoring wells. Information regarding zones where ground water enters and, in the case of ambient flow, exits a well is often essential for detailed evaluation of ground-water monitoring efforts. Studies (e.g., Church and Granato, 1996; Collar and Mock, 1997; Martin-Hayden and Robbins, 1997) have demonstrated the potential effects of the mixing of waters with different chemistries within a conventional monitoring well on contaminant transport evaluations. Borehole flowmeters provide direct information concerning the mix of water that enters a well under either ambient or pumping conditions. In fractured rock settings, where water may enter the well from only a few discrete intervals, the flowmeter allows identification of those intervals. Such intervals may then be individually targeted for

characterization of water chemistry. Direction of natural flow within a well under ambient conditions is a direct means of assessing vertical components of the hydraulic gradient at the time of the study. This information is useful in conceptualization of the hydrologic setting in various parts of a site. Such direct uses of these tools are readily apparent and not discussed in detail in this report.

These tools may also provide data used in the estimation of detailed profiles of the differences in hydraulic conductivity of granular aquifer materials. However, many simplifying assumptions are required in such analyses increasing uncertainty in the results as is true for more traditional aquifer tests. This indirect use of data obtained using these tools is not readily apparent and is discussed in detail in this document. As with any site characterization tool, study objectives and site conditions must be critically evaluated during test selection and design. Results obtained from borehole flowmeter studies, such as investigations described in this document, should be viewed as only one piece of information used in the overall characterization of site conditions.

## I-2 Principles of Operation

An electromagnetic (EM) prototype flowmeter (Figure I-1) was developed at the Tennessee Valley Authority (TVA) Engineering Laboratory in Norris, Tennessee. It consists of an electromagnet and two electrodes that are cast in a durable epoxy. The epoxy is molded in a cylindrical shape to minimize turbulence associated with channeling water past the electrodes and electromagnet. Having no moving parts, the flowmeter operates according to Faraday's Law of Induction, which states that the voltage induced across a conductor moving at right angles through a magnetic field is directly proportional to the translational velocity of the conductor. Flowing water is the conductor, the electromagnet generates a magnetic field, and the electrodes are used to measure the induced voltage. Electronics connected to the electrodes transmit a voltage that is directly proportional to the velocity of the water.

## I-3 Collection of Flowmeter Logs

The concept of borehole flowmeter measurements using the simplest test design is illustrated in Figure I-2. A flowmeter log is recorded before pumping to measure any ambient flow in the well. This step is very important, particularly in the case of highly sensitive flowmeters and low permeability formations, where the ambient flow may be a significant fraction of the flow induced by pumping. Following the ambient test, a pump is placed in the well and operated at a constant flow rate,  $QP$ . After a steady flow field toward the well is obtained, the flowmeter is positioned near the bottom of the well and a measurement of discharge rate is obtained. The meter is then raised a distance  $\Delta z$  and another reading is taken. As illustrated in Figure I-2, the result is a series of measurements of cumulative vertical discharge,  $Q$ , within the well screen as a function of vertical position,  $z$ . Just above the

top of the screen the meter reading should be equal to  $QP$ , the steady pumping rate that is measured independently at the surface. This procedure may be repeated several times to ascertain that the readings are stable and flow to the well has reached a steady-state condition. EM flowmeters are capable of measuring upward or downward flow. Therefore, if the selected pumping rate,  $QP$ , causes excessive drawdown or there are concerns associated with disposal of contaminated ground water, one can employ an injection procedure as an alternative.

## I-4 Analysis of Flowmeter Logs

### a. Flow Distribution Logs

The basic data obtained in the field (Table I-1) are:

- Column (a) - the elevations where readings are taken,
- Column (b) - the ambient flow log, and
- Column (d) - the total flow log, which is measured flow under pumping conditions.

The following data are then calculated:

- Column (c) - differential ambient flow,
- Column (e) - the net flow log, and
- Column (f) - the differential net flow.

The data in Table I-1 are shown graphically in Figure I-3. The aquifer base is located at  $z = 0$ , and the water table or upper confining layer is located at  $z = 20$  m.

Measurements and calculations are made based on the assumed layered geometry illustrated in Figure I-4. Flow to the well is assumed to be horizontal. The basic flow logs, Columns (b) and (d) represent upward (positive) or downward (negative) vertical flow within the well itself; while the differential flow logs represent horizontal flow in the assumed layers to the well (positive) or from the well (negative). The sign convention introduced herein is not universal. However, the same sign convention should be followed for any particular application.

For the example of Table I-1 and Figure I-3, the ambient flow is upward. The differential ambient flow log, obtained by taking differences between adjacent values of ambient flow in the well, indicates that water enters the well at varying rates from the bottom half of the aquifer and exits the well at varying rates in the top half of the aquifer.

At this stage in the data analysis, a distinction must be made. The drawdown that is measured while recording the total flow log is due only to pumping. However, the measured flow log is due to a superposition of the ambient flow and the pumping flow. Therefore, to be consistent one must subtract the ambient flow log from the total flow log to obtain the net flow log, which is that portion of the total flow due to the measured drawdown. If this subtraction is not made, the results could be ambiguous.

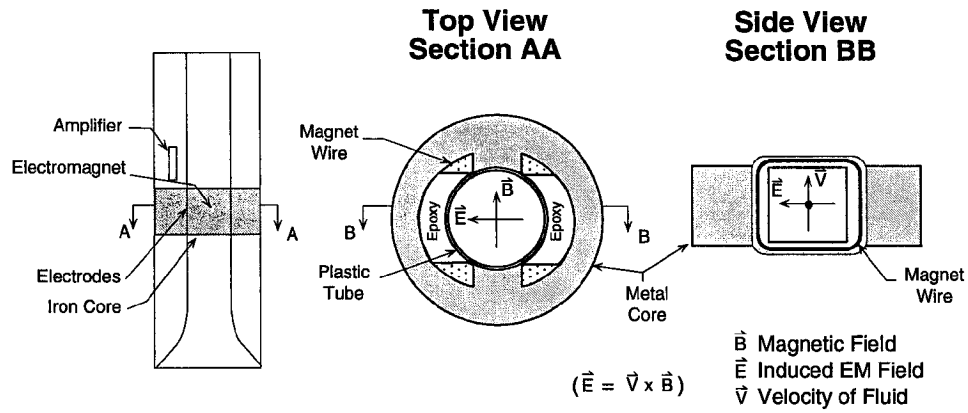

Figure I-1. Schematic diagram of the TVA electromagnetic borehole flowmeter.

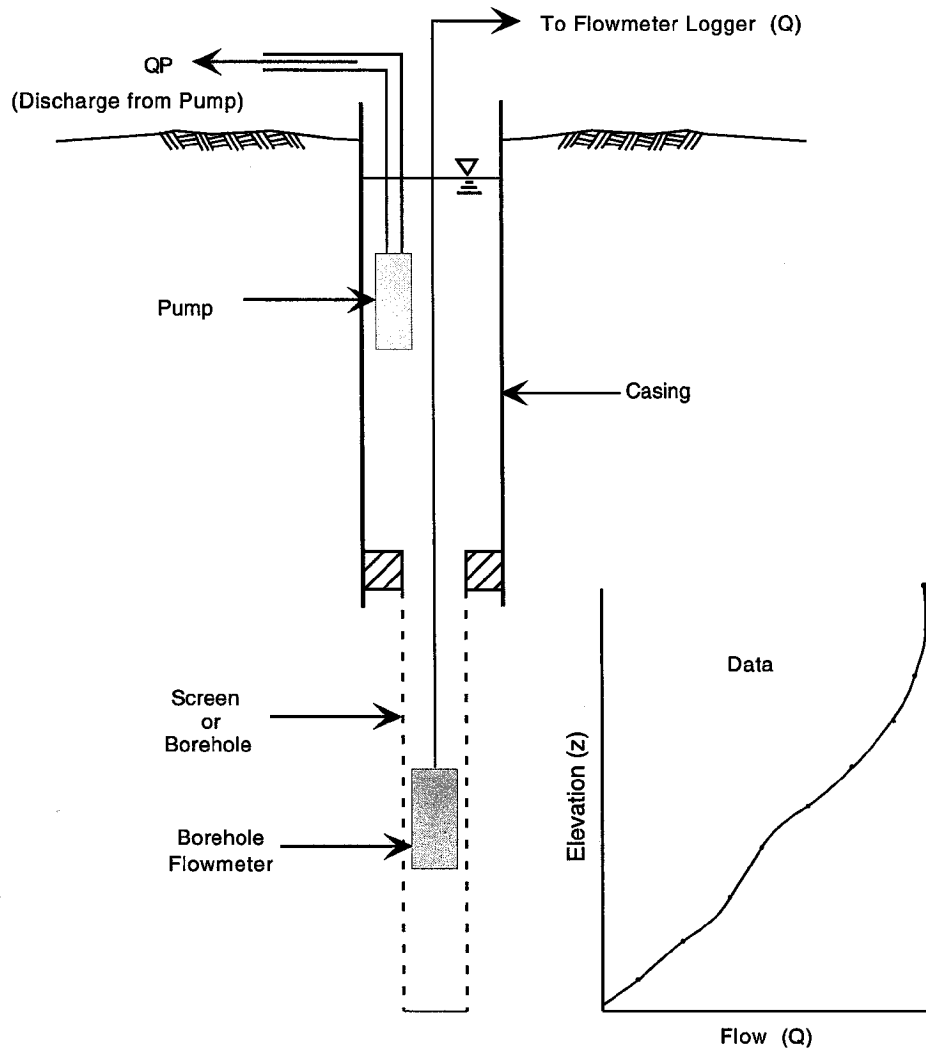

Figure I-2. Apparatus and geometry associated with a borehole flowmeter test.

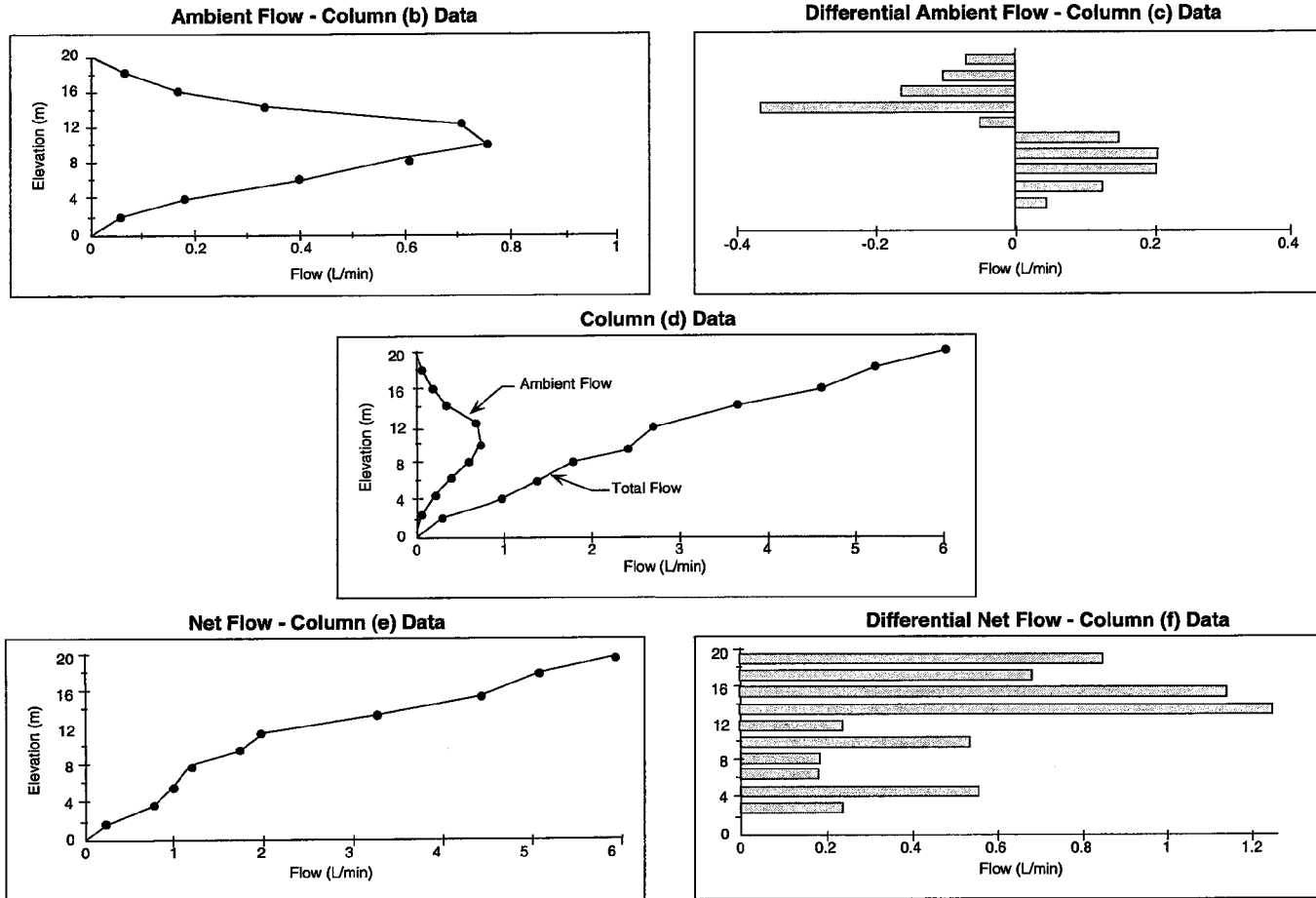

Figure I-3. Graphical illustration of the hypothetical case presented in Table I-1.

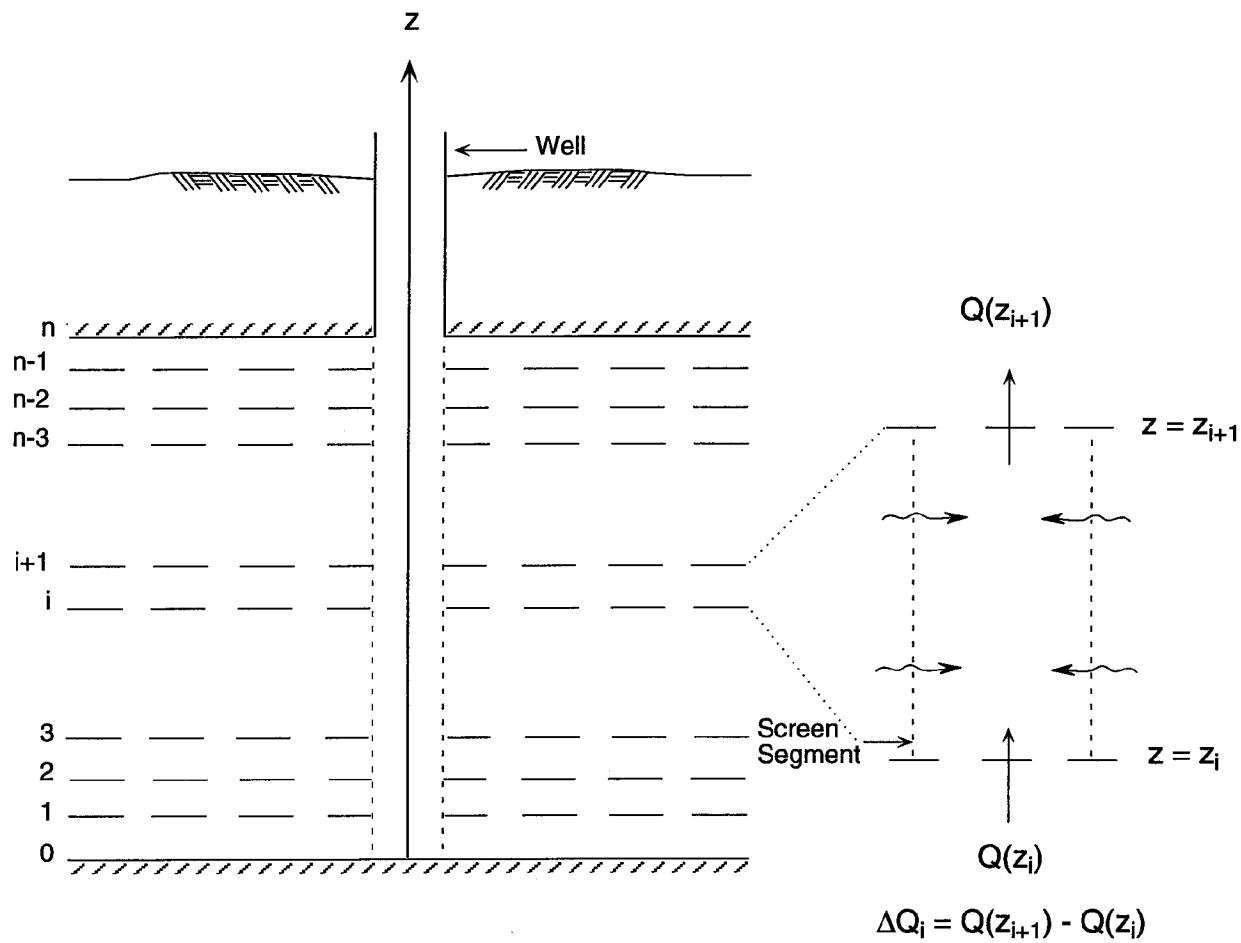

Figure I-4. Assumed layered geometry within which flowmeter data are collected and analyzed.



Table I-1. Hypothetical Data and Data Analysis Related to the Application of a Borehole Flowmeter

Elevation (m)	Ambient Flow (L/min)	Δ Ambient Flow (L/min)	Total Flow (L/min)	Net Flow (L/min)	ΔNet Flow (L/min)
(a)	(b)	(c)	(d)	(e)	(f)
20	0.0	-0.07	6.0	6.0	0.87
18	0.07	-0.10	5.2	5.13	0.70
16	0.17	-0.16	4.6	4.43	1.16
14	0.33	-0.37	3.6	3.27	1.27
12	0.70	-0.05	2.7	2.00	0.25
10	0.75	+0.15	2.5	1.75	0.55
8	0.60	+0.21	1.8	1.20	0.19
6	0.39	+0.21	1.4	1.01	0.19
4	0.18	+0.13	1.0	0.82	0.57
2	0.05	+0.05	0.3	0.25	0.25
0	0.00	--	0.0	0.00	--

The final column in Table I-1, the differential net flow, is obtained by calculating the difference between adjacent values in the net flow log. This yields the horizontal flow that is entering the well from each interval due to pumping. Under conditions of steady, horizontal flow into the well, this flow is proportional to the vertical distribution of horizontal hydraulic conductivity in the vicinity of the test well (Molz et al., 1988; 1989).

### Hydraulic Conductivity Logs in Granular Aquifers

For purposes of these analyses, the aquifer is assumed to be composed of a series of n horizontal layers (Figure I-4). In practice, hydrogeologic information, such as data available from cores and geophysical logs, may be used to conceptualize potential geologic layers and choose appropriate intervals for measurements during the flowmeter study. The difference between two successive flowmeter readings obtained under pumping conditions yields the flow, ΔQ<sub>i</sub>, entering a well screen between the elevations where the readings are taken, which are assumed to bound layer i (i = 1,2,...,n). The Δq<sub>i</sub> from the ambient flow log are computed in an identical manner. Most, aquifers are not composed of horizontal, homogeneous layers. However, the n-layer case at this scale is more realistic than the single-layer case of classical pumping test analyses.

To calculate a hydraulic conductivity profile, three methods have been detailed in the literature. The first is based on the Cooper-Jacob equation relating drawdown to a constant pumping rate in a fully penetrating well (Cooper and Jacob, 1946). The second is based on the numerical results by Javandel and Witherspoon (1969). Molz and Young (1993) provided an overview of these methods. A third method is the two-step procedure described by Kabala (1994), which yields S<sub>i</sub> as well as a K distribution. Drawdown data collected at different times and flowmeter data are used to estimate the

vertical distribution of hydraulic parameters. Such a procedure does not require knowledge or estimation of specific storage (S<sub>s</sub>) and may have advantages in certain situations where S<sub>s</sub> is expected to vary greatly. Only the first two methods are discussed herein. Xiang (1995), Hanson and Nishikawa (1996), and Ruud and Kabala (1996) provide additional discussion on numerical evaluation of flowmeter tests.

In the Cooper-Jacob method, the assumed horizontal flow in each layer is treated as if it was from an aquifer of infinite horizontal extent and thickness, Δz<sub>i</sub>. Then for each layer, i, one can write

$$\Delta H_i(r_w, t) = \frac{(\Delta Q_i - \Delta q_i)}{2\pi K_i \Delta z_i} \ln \left[ \frac{1.5}{r_w} \sqrt{\frac{K_i \Delta z_i t}{S_i}} \right] \quad (I-1)$$

where:

- ΔH<sub>i</sub> = drawdown in ith layer
- ΔQ<sub>i</sub> = induced flow from ith layer
- Δq<sub>i</sub> = ambient flow from ith layer
- K<sub>i</sub> = horizontal hydraulic conductivity of the ith layer
- Δz<sub>i</sub> = ith layer thickness
- r<sub>w</sub> = effective well radius
- t = time since pumping started
- S<sub>i</sub> = storage coefficient for the ith layer.

If one assumes that head losses associated with flow within the well are negligible, then all the ΔH<sub>i</sub> are equal to ΔH, the measured drawdown in the test well. If such an assumption cannot be made, then one must measure the head loss opposite each layer associated with pumping the test well. Rehfeldt et al. (1989b) provide further discussion of various possible head losses.

Often, a value for the storativity of the aquifer being studied will be estimated, and the question becomes how to use this information to obtain  $S_i$  for each layer. In previous studies, two assumptions have been made. The most basic assumption is to assume that  $S_s$ , the specific storage, is constant, in which case  $S_i = S_s \Delta z_i$  (Morin et al., 1988a; Molz et al., 1989). An alternate assumption used by Rehfeldt et al. (1989b) is that  $S_s$  varies in such a way that the hydraulic diffusivity of each layer,  $K_i \Delta z_i / S_i$ , remains constant and equal to the hydraulic diffusivity ( $T/S$ ) for the aquifer, where  $T$  is transmissivity and  $S$  is the storage coefficient. If the latter assumption is made, Equation (I-1) may be solved for  $K_i$  yielding

$$K_i = \frac{(\Delta Q_i - \Delta q)}{2\pi \Delta H_i \Delta z_i} \ln \left[ \frac{1.5}{r_w} \sqrt{\frac{Tt}{S}} \right]. \quad (I-2)$$

If the constant  $S_s$  assumption is made, one can solve Equation (I-1) for  $K_i$  outside the logarithmic term to yield

$$K_i = \frac{(\Delta Q_i - \Delta q)}{2\pi \Delta H_i \Delta z_i} \ln \left[ \frac{1.5}{r_w} \sqrt{\frac{K_i \Delta z_i t}{S_i}} \right] \quad (I-3)$$

which can be solved iteratively to obtain a value for  $K_i$ . Further details may be found in Morin et al. (1988a), Molz et al. (1989), or Rehfeldt et al. (1989b).

Javandel and Witherspoon (1969) showed that, in idealized layered aquifers, flow at the well-bore radius,  $r_w$ , rapidly becomes horizontal even for relatively large permeability contrasts between layers. Under such conditions the radial gradients along the wellbore are constant and uniform, and flow into the well from a given layer, due to pumping, is proportional to the transmissivity of that layer, that is:

$$(\Delta Q_i - \Delta q) = \alpha \Delta z_i K_i \quad (I-4)$$

where  $\alpha$  is a constant of proportionality. This condition occurs when the dimensionless variable  $t_D = \bar{K} t / (S_s r_w^2)$  is  $\geq 100$ . In this expression,  $\bar{K}$  is the average or bulk horizontal hydraulic conductivity defined as  $\sum K_i \Delta z_i / b$ , where  $b$  is the aquifer thickness,  $S_s$  is the aquifer specific storage,  $t$  is time since pumping started, and  $r_w$  is the wellbore radius.

To solve for  $\alpha$ , sum the  $(\Delta Q_i - \Delta q_i)$  over the aquifer thickness, to obtain

$$\sum_{i=1}^n (\Delta Q_i - \Delta q) = QP = \alpha \sum_{i=1}^n \Delta z_i K_i \quad (I-5)$$

Multiplying the right-hand side of Equation (I-5) by  $b/b$  and solving for  $\alpha$  yields

$$\alpha = \frac{QP}{b \bar{K}} \quad (I-6)$$

Finally, substituting for  $\alpha$  in Equation (I-4) and solving for  $K_i / \bar{K}$  gives

$$\frac{K_i}{\bar{K}} = \frac{(\Delta Q_i - \Delta q) / \Delta z_i}{QP / b}; \quad i = 1, 2, \dots, n \quad (I-7)$$

To obtain Equation (I-7), it was assumed that  $\Delta Q_i$  and  $QP$  do not change with time and pseudo-steady-state conditions were reached. Thus, a plot of  $K_i / \bar{K}$  versus elevation may be obtained from the basic data. If one then has an estimate of  $\bar{K}$  from a conventional aquifer test (e.g., fully-penetrating pumping test), dimensional values for  $K_i$  can easily be calculated by taking the product of  $\bar{K}$  and the flowmeter test result.

In situations where the inherent assumptions are valid, the  $K_i / \bar{K}$  approach has practical appeal because the values for  $r_w$  and  $S_s$ , which are difficult to estimate, are not required. Also, errors in flowmeter readings involving constant multipliers are canceled out, and the meter calibration is not critical as long as its response is linear. However, a reliable aquifer test must be performed to estimate  $\bar{K}$ . A detailed example of data analysis, including head loss measurements for each layer, is presented in the following section.

### c. Data Analysis

The data presented in this section were obtained from a borehole flowmeter test conducted in a fully-penetrating well in a confined aquifer located 40 m to 61 m below ground. The well screen was 10.2-cm diameter slotted PVC pipe (0.025-cm slots). Testing began with mild redevelopment and cleaning of the test well screen using injected air.

Prior to the flowmeter survey, caliper and ambient pressure logs were run. Data obtained from the caliper logs were used to verify and compute the cross-sectional area of the well, and the hydraulic head distribution derived from the pressure logs served as calibration references for evaluating  $\Delta H_i$  produced by pumping. No ambient flow was detected. Subsequently, a pressure transducer and a flowmeter with centralizer were lowered into the well, followed by a submersible pump. The pump was started and allowed to run for about 50 minutes prior to taking pressure and impeller meter readings.

Listed in the first three columns of Table I-2 are corresponding values of depth, head change, and discharge associated with pumping. This constitutes the basic data resulting from the flowmeter test. The discharge measured at the 40-m depth (0.24 m<sup>3</sup>/min) was taken as the pumping rate  $QP$ .

Additional hydraulic information about the aquifer in the vicinity of the test well was obtained from small-scale pumping tests. A standard Cooper-Jacob (1946) analysis resulted in a transmissivity of 0.83 m<sup>2</sup>/min, a  $\bar{K}$  of 0.039 m/min, a storage coefficient of  $4.5 \times 10^{-3}$ , and a specific storage of  $2.1 \times 10^{-4}$ . Data analysis proceeds by subtracting

Table I-2. Results of the Analysis of Data from a Borehole Flowmeter Test to Estimate Hydraulic Conductivity Distributions

z(m)	$\Delta H_i$ (m)	Q(m <sup>3</sup> /min)	$\Delta Q_i$ (m <sup>3</sup> /min)	K <sub>2i</sub> (m/min)*	K <sub>3i</sub> (m/min)*	K <sub>7i</sub> (m/min)*	Interval (i)
39.6	0.371	0.240	0.0062	0.014	0.013	0.014	13
41.1	0.366	0.234	0.0057	0.013	0.012	0.012	12
42.7	0.362	0.229	0.0147	0.034	0.033	0.033	11
44.2	0.359	0.214	0.0071	0.016	0.015	0.016	10
45.7	0.355	0.207	0.0119	0.027	0.027	0.027	9
47.2	0.353	0.195	0.0057	0.013	0.012	0.013	8
48.8	0.350	0.189	0.0113	0.027	0.026	0.026	7
50.3	0.348	0.178	0.0422	0.099	0.105	0.098	6
51.8	0.347	0.136	0.0153	0.036	0.036	0.035	5
53.3	0.347	0.120	0.0099	0.023	0.023	0.023	4
54.9	0.347	0.110	0.0331	0.078	0.082	0.077	3
56.4	0.347	0.077	0.0436	0.103	0.109	0.101	2
57.9	0.347	0.034	0.0337	0.040	0.042	0.039	1
61.0	0.347	0					

\*Based on Equations I-2, I-3, and I-7, respectively.

neighboring Q values to get the  $\Delta Q_i$  for each of the 13 layers (Column 4, Table I-2), noting that layer 1 is 3.05-m thick and succeeding layers are 1.52-m thick. Listed in the last three columns of Table I-2 are K distributions denoted by K<sub>2</sub>, K<sub>3</sub>, and K<sub>7</sub>. These were calculated based on Equations (I-2), (I-3), and (I-7), respectively. In order to account for the small change in pressure head between the bottom and top of the screen, Equation (I-7) was modified to read

$$\frac{K_i}{\bar{K}} = \frac{\Delta H(\Delta Q_i - \Delta q)/\Delta z_i}{\Delta H_i Q P/b} ; i = 1, 2, \dots, n. \quad (I-8)$$

Equation (I-8) is a good approximation when the  $\Delta H_i$  are close to  $\Delta H$ , the average change in pressure head. When the aquifer/well hydraulic data, including  $r_w = 0.0634$  m and  $t = 60$  min, are substituted in Equations (I-2), (I-3), and (I-8), one arrives at (meter, minute units)

$$K_{2i} = \frac{0.8176 \Delta Q_i}{\Delta H_i};$$

$$K_{3i} = \frac{0.1044 \Delta Q_i \ln(12,677 \sqrt{K_{3i}})}{\Delta H_i}; \text{ and}$$

$$K_{7i} = \frac{0.8031 \Delta Q_i}{\Delta H_i} \quad (I-9)$$

with the exception of the bottom layer where  $\Delta z_1 = 3.05$  m rather than 1.52 m. The results show that there are no significant differences between the three alternate hydraulic conductivity calculations using data from this flowmeter test.

## I.5 Conclusions

Presented in this chapter is an overview of vertical-component flowmeter operation, application, and data analysis. While the EM flowmeter was emphasized, the data collection and analysis procedures apply to many types of flowmeters. A flowmeter of this design measures only one thing directly: upward or downward water velocity in a borehole, screen, or casing due to natural head differences (ambient flow) or to artificial head differences (pumping-induced flow). By calibrating the meter for volumetric flowrate and taking differences between two vertical flow measurements at known elevations, assuming that no undetected flow is leaking past the meter, it is possible to calculate the incremental horizontal flow in the aquifer to or from the well. It is the horizontal flow distribution over the vertical extent of the well that enables one to calculate a horizontal hydraulic conductivity distribution as a function of position in the vertical,  $K(z)$ . The calculated K distribution may be absolute,  $K(z)$ , or relative,  $K(z)/\bar{K}$ . Alternate formulas are given for both quantities. The advantage of the  $K(z)/\bar{K}$  calculation [Equation (I-7)] is that well radius and storativity do not have to be known or estimated.

## Chapter II Electromagnetic Borehole Flowmeter System

### II-1 Design and Construction

The electromagnetic borehole flowmeter system discussed in this report can measure vertical flow in various types of wells and boreholes. The flowmeter system has three main components: downhole flowmeter, packer assembly, and above-ground electronics. The flowmeter provides accurate flow measurements across a four order-of-magnitude range and fits snugly in wells with casing diameters as small as 5.1 cm (standard 2-inch schedule-40 PVC pipe). A packer assembly may be attached to the flowmeter to direct flow through the meter in larger diameter wells. The above-ground electronics package provides the magnetic drive and converts the flowmeter signal to a discharge reading.

Two of the major components of the meter are an electromagnet and a pair of silver chloride electrodes mounted at right angles to the pole pieces of the electromagnet (Figure I-1). During operation, the electromagnet creates a strong magnetic field across the flow passage. As water (the conductor) flows through the magnetic field, a voltage gradient is generated. The voltage is proportional to the average velocity of the water across the magnetic field and is detected by the electrodes. The magnitude of the voltage is unaffected by the electrical conductivity of ground water under normal conditions. The polarity of the generated

voltage is dependent on the direction of flow. Upward flow is generally designated as a positive voltage and downward flow as a negative voltage.

Flowmeters of this design can be built to any outer diameter greater than 4.8 cm. As flow is channeled through this meter, the applicable flow range is a function of the inner diameter of the open probe core. Flowmeters with inner diameters (IDs) of 1.27 cm or 2.54 cm have been produced. The length of the current prototype flowmeter is 30 cm, but flowmeters as short as 10 cm have been used successfully. The 1.27-cm and 2.54-cm ID flowmeters are typically used to measure low and high flow rates, respectively. In wells or boreholes with relatively large diameters, the effectiveness of the flowmeter diminishes unless a packer assembly is used to direct flow through the flowmeter. Both mechanical (Figure II-1) and inflatable (Figure II-2) packers have been developed.

The mechanical packer assembly used with prototype meters was a collar consisting of a rubber gasket sandwiched between two plexiglass or stainless steel rings that slipped over the flowmeter and was held in place with set screws. The rubber gasket was sized to insure a tight seal between the probe and the inner surface of the well. The mechanical packer was easily used, but its application was tedious because the friction between the collar and well made lowering of the flowmeter

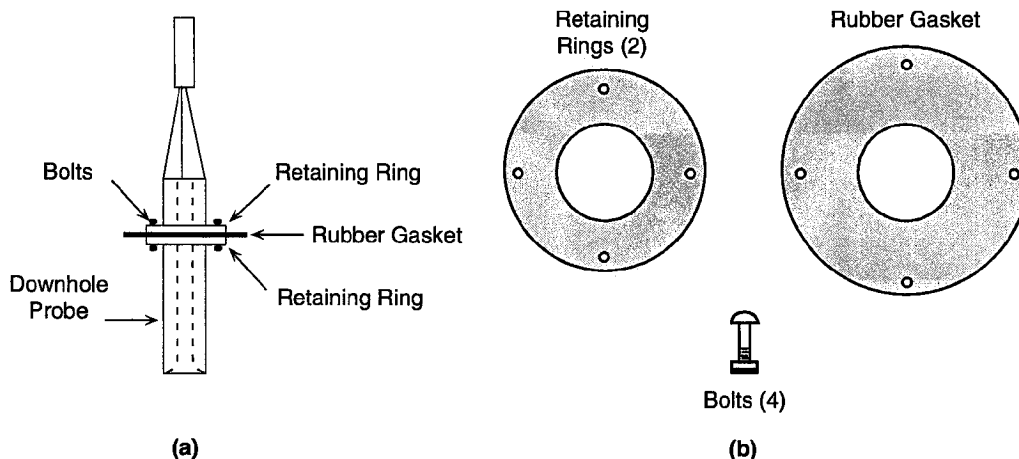

Figure II-1. Mechanical packer (a) assembled on probe and (b) in schematic view.

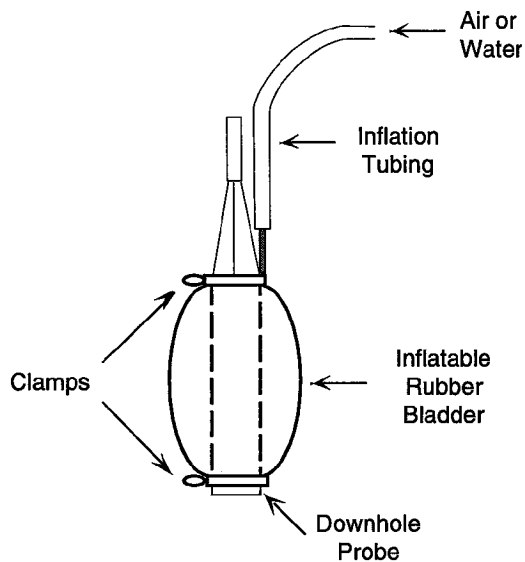

Figure II-2. Inflatable packer assembled on probe.

more difficult. In situations where the screen or borehole was uneven, the collar design may not have provided an adequate seal and was not used.

The inflatable packer for the prototype system consisted of a rubber sleeve attached to a stainless steel assembly. The packer assembly easily slipped onto the flowmeter and sealed with "O" rings. This assembled unit had a diameter of 8.9 cm. If the rubber sleeve was slipped directly onto the flowmeter, the flowmeter and sleeve had a combined diameter of 8.7 cm. Approximately 103 kPa (15 psi) and 172 kPa (25 psi) of pressure was needed to inflate the rubber sleeve to diameters of 10 cm and 20 cm, respectively. Inflation was achieved by injecting water into the rubber sleeve through a tube in the packer assembly. Both a pressurized chamber at the ground surface and a submersible pump have been used to inject water into the sleeve. For most applications, the submersible pump was the method of choice. However, at shallow depths (<20 meters) where only a few flowmeter measurements were desired, the pressurized chamber had an advantage in its simplicity and relatively short set-up time. The seal provided by a properly inflated packer was such that the flowmeter could not be moved by pulling the cable and rope.

The above-ground electronics includes an electromagnet drive, power supplies, amplifiers, and synchronous demodulator for converting the voltage from the probe's electrodes to flow rate. The probe's signal is in the microvolt range and is typically several orders-of-magnitude less than background noise. Synchronous demodulation is used to extract the signal and has the effect of canceling noise out of phase with the electromagnetic drive. With additional amplification and filtering, a DC signal proportional to water velocity through the flowmeter is generated. The electronics package collects and processes signals from the flowmeter every second. At

the end of a pre-set time interval or upon keyboard command, the signals are averaged and the standard deviation is calculated. This average and standard deviation are displayed, stored on disk, and printed to a hardcopy device.

## II-2 Laboratory Calibration

Calibration of the prototype flowmeter was performed in a facility located at the TVA Engineering Laboratory, Norris, Tennessee. The apparatus included standard 5.1-cm, 10.2-cm, and 15.2-cm schedule-40 flush-joint PVC pipes. Before and after any field measurements, calibration checks were performed at a range of flow rates using the same flowmeter system (above-ground electronics, cable, and flowmeter) used in the field. Calibrations were simple and consisted primarily of establishing a constant uniform flow through a vertical PVC pipe and comparing the flowmeter measurements to other flow measurements at the intake and/or the outlet of the PVC pipe (Figure II-3). Flow rates were maintained by throttling a pressure valve on the public waterline and measuring the generated flow rate near the PVC pipe intake with an in-line commercial flowmeter. For all flows, the baseline rate was determined by measuring the time required for the discharge to fill a calibrated container. At lower flow rates (< 30 ml/min), the discharge volume was determined by dividing the weight of water by the temperature corrected density of water.

Electromagnetic flowmeter calibrations are similar to those for other flowmeter types and require: (1) the use of proper and certified measuring devices for volume, time, length, weight, and temperature; and (2) the documentation of calibration conditions including personnel, date and time, and equipment set-up. Instructions and guidelines for performing flow

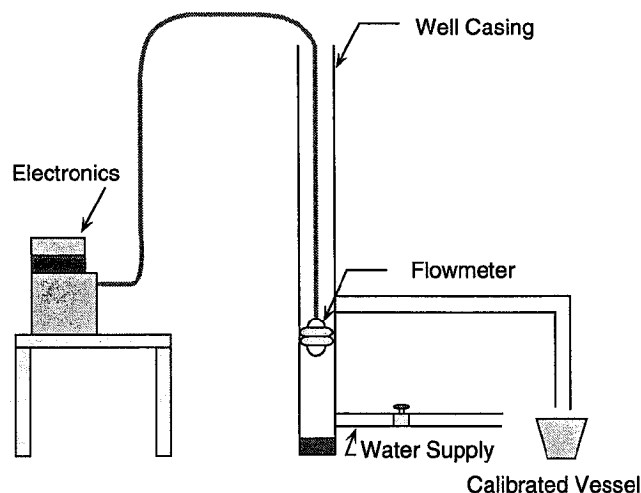

Figure II-3. Conceptual system for flowmeter calibration.

calibrations can be found in standard texts such as Ferson (1983) and Liptak and Venczel (1982). Besides standard flowmeter calibrations, similar equipment has been used to investigate phenomena such as turbulence, frictional losses, and flow around the probe. The three main PVC pipes used in the calibration facility are transparent to permit visual monitoring of dye releases so that turbulence and flow around the probe can be evaluated. One of the PVC pipes is fitted with manometers to measure head losses within the pipe and flowmeter. All of the PVC pipes possess side ports to permit the introduction of flow. This allows monitoring of the flowmeter response as it approaches and passes a horizontal inlet source. Horizontal inflows may be large enough to produce turbulence effects, and gauging the sensitivity of the

flowmeter to these inflows was important. Testing indicates that the electromagnetic flowmeter is insensitive to the proximity of horizontal inflows.

Figure II-4 provides a sample calibration data set associated with field testing of the EM flowmeter. The figure shows the calibration data on both linear and logarithmic scales. The linear scale illustrates the linear response between volts (flowmeter signal) and flow. The logarithmic scale shows the sensitivity of the meter at lower flow ranges. The 2.54-cm ID flowmeter exhibits good repeatability and linearity from about 100 ml/min to 40 L/min. The 1.27-cm ID flowmeter exhibits good repeatability and linearity from 30 ml/min to 10 L/min. Below 30 ml/min, the repeatability and linearity of the

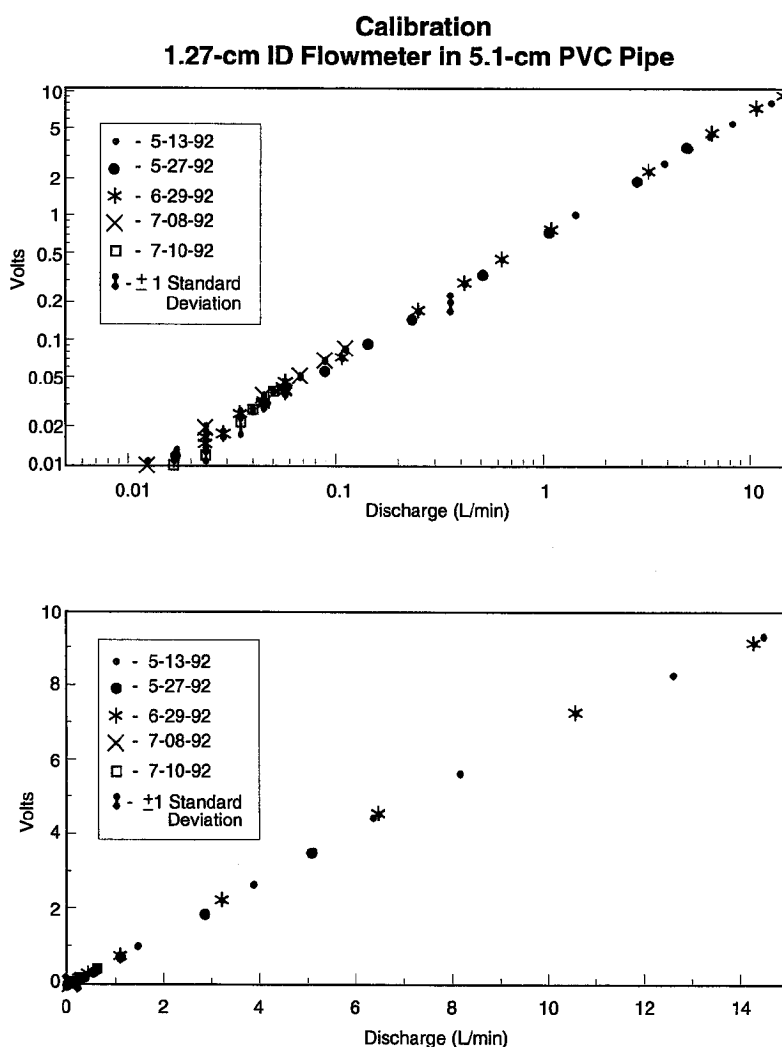

Figure II-4. Calibration data for the 1.27-cm ID flowmeter in 5.1-cm PVC pipe.

1.27-cm ID flowmeter drops significantly. Deviation from linearity at these low flows may be a result of shifts in the flowmeter response over time, or problems/uncertainties associated with maintaining and measuring low flows during calibration.

In Figure II-4, each calibration point is the mean of sixty readings taken over a one minute period. For the majority of the flow measurements, the relative standard deviation is less than 2 percent of the average flow rate. Significantly lower percentages occur at the higher flow rates and slightly higher percentages occur at the lower flow rates. Calibration data show that the sensitivity and low end accuracy (below 50 ml/min) of the 1.27-cm ID flowmeter is less in a 5.1-cm pipe without a packer assembly, than in larger diameter pipes with a packer assembly. For the 5.1-cm pipe, the calibration plot is essentially linear up to 6 L/min. Above 6 L/min, the flowmeter signal becomes slightly nonlinear. As no packer assembly was used in the 5.1-cm application, the nonlinearity is probably the result of water flow around the probe.

Flowmeter sensitivity can be expressed in a calibration factor. Calibration factors are used to convert voltage from the probe electrodes to flow and have the units of volume per time per volt (e.g., liter/minute/volt). Table II-1 provides example calibration factors calculated for different combinations of

**Table II-1. Sample Calibration Factors (Liter/Min/Volt) from a Linear Regression of Discharge Versus Voltage for Electromagnetic Flowmeter Data**

	1.27-cm ID EM Flowmeter	2.54-cm ID EM Flowmeter
Flowmeter in a 5.1-cm pipe*	1.46	3.99
Flowmeter with a mechanical collar in a 10.2-cm pipe*	1.38	3.95
Flowmeter with an inflatable packer in a 15.4-cm pipe*	1.32	3.94

\* pipe is schedule-40 PVC

flowmeter sizes, packer types, and well diameters. Greater sensitivity is achieved with a packer because less water flows around the exterior of the flowmeter. The flowmeter should be calibrated using the same equipment and in the same type of casing as the wells to be surveyed prior to use.

At flow rates above 10 L/min, two concerns exist with use of the 1.27-cm ID flowmeter: high frictional losses through the orifice, and an electrode voltage that will exceed the capacity of the above-ground electronics. High frictional losses (Figure II-5) affect the hydraulic head distribution and, consequently, the distribution of flow in the well and through the meter. In selecting between electromagnetic flowmeters with different orifice diameters, the trade-offs associated with decreases in the detection limit and increases in frictional losses should be considered. As a general rule, the frictional losses should be a concern if they exceed 10 percent of the total drawdown in a well or borehole for cases where the data will be used to calculate a hydraulic conductivity profile.

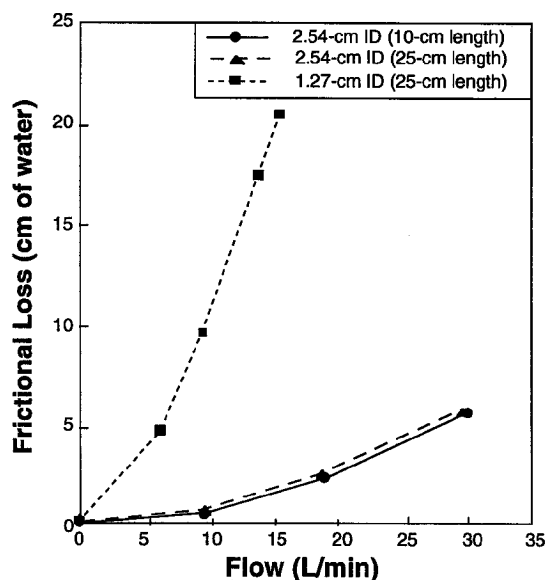

**Figure II-5. Frictional losses associated with the 1.27-cm and 2.54-cm ID flowmeters.**

---

## Chapter III

### Hydrogeologic Characterization Test Design

#### III-1 Overview

The primary objective of an electromagnetic borehole flowmeter test is to measure the profile of horizontal flow into or out of designated aquifer intervals during ambient and/or pumping conditions. These profiles are used to identify the zones of relatively high and low permeability. Combined with a transmissivity measurement or the proper drawdown data at the tested well, the flowmeter data may be used to calculate a vertical profile of horizontal hydraulic conductivity. In many situations, the pumping tests performed concurrently with such flowmeter tests will provide the drawdown data necessary to calculate a transmissivity value.

Table III-1 lists the general procedures which were used in these studies to perform borehole flowmeter tests. Detailed descriptions of these procedures and associated equipment are contained in the following sections. Appendix A provides the forms used to record the field data and Appendix B provides an equipment checklist.

#### III-2 Measurement Interval Selection

Selection of appropriate intervals for obtaining flowmeter measurements in porous media involves consideration of site stratigraphy interpreted from geologic and geophysical logs. However, such logs generally provide only enough information to determine the basic hydrogeologic framework and not the detailed variability within geologic units. Although, these logs may provide constraints for specifying measurement intervals, the scale on which measurements are

ultimately obtained will usually be based on other factors. Such factors include the pumping rate to be used during the test. Constraints on pumping rate, such as limitations related to water storage, treatment, and disposal, may necessitate increased interval size to provide meaningful data. The thickness of the disturbed zone surrounding the well screen is also a factor that affects interval selection. Results of studies by Ruud and Kabala (1997) indicate that skin effects bias the distribution of flow to a well. As the ratio of the flowmeter measurement interval thickness to the thickness of the disturbed zone decreases, the bias in the test results increases. In general, local deviations from horizontal flow will occur during most tests. Errors associated with these deviations will increase as the size of the measurement interval decreases.

#### III-3 Flowmeter Measurements

Prior to testing, the flowmeter is connected to the electronics and permitted to warm up. This warm-up period was approximately 30 min for the prototype electromagnetic system. Well construction logs, including a caliper log of the test well, are reviewed if there is any doubt about the screen or borehole diameter. Field testing has shown that the calibration of the prototype electromagnetic flowmeter may drift up to 10 millivolts (0.1 percent full scale) over several hours if large temperature changes ( $> 10^{\circ}\text{C}$ ) occur. In many instances, this temperature sensitivity is not a concern because of the relatively short time needed to obtain a flow log. However, flowmeter calibration at zero flow is checked prior to initiation of the test and at the end of each test. This is accomplished by positioning the flowmeter at a location in the well where no

**Table III-1. Generalized Borehole Flowmeter Field Test Procedures**

- 
1. Measure ground-water elevation in the well relative to a fixed datum (such as top of well casing) and total well depth. Examine well construction, geologic, and geophysical logs to determine measurement intervals.
  2. Zero flowmeter under no-flow conditions. Measure the ambient vertical flow profile. In these studies, this profile typically consisted of a minimum of ten measurements. Obtain flowmeter reading under no-flow conditions to evaluate baseline drift.
  3. Install equipment as for a single-well pumping test, including pressure transducer, data logger, and pump. Place intake hose or pump above the pressure transducer and within the well casing above the screen, if possible. Measure ground-water elevation to insure static conditions are attained.
  4. Start constant-rate pumping test. Accurately measure pump discharge rate on a routine basis. Record drawdown. Verify that wellbore storage effects have dissipated and estimate transmissivity based on drawdown data.
  5. After pseudo-steady-state conditions have been achieved, obtain flowmeter measurements at the same elevations as the ambient measurements. Repeat flowmeter measurements to demonstrate a stable flow profile has been achieved. Shut system down and obtain flowmeter reading under no-flow conditions.
-



ambient flow exists. In a well, no ambient flow should exist above or below the screened interval. In a borehole, no ambient flow should occur in the cased interval. If there is doubt about the location of a no-flow zone, the problem is resolved by manually plugging the flowmeter and lowering it into the well. Plugging may be accomplished by securely fastening a cork in the lower orifice of the flowmeter.

Lowering or raising the flowmeter induces water movement in a wellbore and it may require several minutes to regain quiescent conditions in low permeability aquifers. After moving the flowmeter, measurements should not begin until the flowmeter signals have stabilized. If the readings do not stabilize, and/or if the standard deviation is approximately ten times greater than observed in the calibration data for the measured flow, then reject the reading and attempt to diagnose the problem. Table III-2 lists problems that have been encountered in the field. Problems 3 and 4 can often be remedied by rapidly moving the flowmeter up and down the well or borehole several times.

**Table III-2. Problems that Produce Errors in EM Flowmeter Measurements**

- |    |  |
|----|--|
| 1. | Insufficient time to regain quiescent conditions in well after flowmeter movement.                           |
| 2. | High ground currents (above- or below-ground power lines or power sources in vicinity of well or boreholes.) |
| 3. | Coating on the electrodes such as mud or oil.  |
| 4. | Blockage of signal path to electrodes by gas bubbles.  |
| 5. | High flow rate entering well near location of flowmeter.   |

### III-4 Pumping Rate and Drawdown Measurements

One of the most important aspects of the pumping test is the pumping rate, which should be high enough to achieve a measurable drawdown, if analyses of time/drawdown data are desired. The rate should also be low enough to support the assumption of negligible head loss within the well, if head loss across each interval is not measured. Additional considerations include methods for maintaining a constant flow rate throughout the test and constraints due to containment, treatment, and disposal requirements for contaminated water. In practice, it is often necessary to set the pumping rate by trial and error. After each trial start, sufficient time should be allowed for the well to recover before beginning a subsequent pumping test.

Constant flow rates are important for two reasons. First, a constant flow rate permits calculation of horizontal inflow from aquifer intervals by subtracting the cumulative flow rates at different elevations. Second, a constant flow rate permits the use of conventional pumping test analytical solutions to calculate a transmissivity value at a well location.

Problems associated with maintaining a constant flow rate are greatest where large drawdowns occur and the lift requirements of a pump are affected. If no adjustments are made to the pump as the drawdown increases, the pumping rate will decrease until the drawdown stabilizes. In regions of low transmissivity, the problems associated with a constant flow rate can be severe because of large drawdowns. Although data analysis methods can be adjusted to compensate for changes in the pumping rate, these changes are not desirable. Injection tests may be considered instead of pumping tests if large drawdowns are expected.

Accurate measurement of drawdown response during the pumping test generally requires a pressure transducer and data logger to record data at frequent intervals. As any movement in the well has the potential to alter the water level or the position of the transducer, sufficient drawdown data for calculating transmissivity should be collected before flowmeter testing begins.

### III-5 Selection of Pumps

The type of pump used for the test depends on site conditions, well construction, and available power. If the depth of the water from the top of casing will not exceed approximately 7 m, then a surface pump may be used. For flows greater than 4 L/min, centrifugal surface pumps have proven to be reliable. This type of pump is tolerant of suspended solids and high or blocked discharge pressures, has good lift, and can provide an order-of-magnitude flow range by manually adjusting the back pressure. A disadvantage of this pump is the difficulty of presetting the pump to a known rate. A peristaltic pump is often a good choice for flows less than 4 L/min. It is easy to use, there is no contamination of the pump itself, and it may be preset within reasonable tolerances.

Dissolved gases may be a problem with surface pumps when air bubbles accumulate in the intake line. The intake line pressure will be lowest near the surface pump. In some cases, the pressure may be sufficiently low to cause the water to degas. If sufficient gas accumulates in the intake line, then flow will be restricted to the pump and the pumping rate will decrease. In situations where degassing is a concern, the pump should be located above the well head to allow gas movement upward and through the pump.

If the depth to water exceeds approximately 7 m, then submersible pumps are required. In general, submersible pumps present less operational problems than surface pumps. However, their use is often limited to wells with an ID greater than 5.1 cm due to the size of most pumps and the induced flow test design. If a submersible pump is used, it should be small enough to fit into the well and allow passage of flowmeter and pressure transducer cables.

### III-6 Packer Selection

For wells greater than 5.1 cm in diameter, a packer may be needed to channel water through the flowmeter. If the velocities are sufficiently high, and the well has a constant

diameter, the flowmeter may be operated as a velocity meter without a packer. When used as a velocity meter, flow occurs around, as well as through, the EM flowmeter. Hence, a different set of calibration data is required in lieu of that obtained under conditions where packer assemblies are used. Where low flows are of concern and/or the well or borehole is not of constant diameter, a packer generally is required. Packer systems of different designs may be appropriate for these investigations.

### III-7 Method of Inflation

Two methods generally were used for inflating/deflating the prototype inflatable packer assembly. One method incorporated an above-ground pressure chamber and the other used a submersible pump positioned above the flowmeter. Inflation using the pressure chamber was relatively slow and use was limited to sites where the water table was relatively shallow. The submersible pump has the advantage of rapid inflation and operates at wide ranges of depth to water and pressure heads. At Oak Ridge National Laboratory, Oak Ridge, Tennessee, submersible pump inflation has been successful at depths below 300 m, and depths-to-water of greater than 15 m.

Installation using the above-ground pressure chamber was relatively simple. The pressure chamber has a fill port, a vent port, a pressure gauge, and a discharge port attached to a tube that inflates the packer. The most common setup involved filling the chamber 75 % full with water. The pressure chamber was charged to the required pressure with an air compressor or air tank. When the discharge valve was opened, the packer assembly inflated. Packer inflation was monitored by observing the decline in water level in the chamber. Adequate inflation was checked by tugging on a rope connected to the flowmeter. Packer deflation was usually accomplished by venting only the connection hose.

In situations where the packer was inflated at large depths, or inflated and deflated relatively quickly, a submersible pump was used with the packer assembly. Several alternative and equally viable submersible pump configurations exist. A small ground-water sampling pump located approximately 0.3 m above the packer was used in these studies. The pump discharge was connected to the packer via a tube and integral solenoid valve. The assembly was wired such that the valve could not be closed when the pump was operating. In operation, the pump was turned on and the valve was opened to inflate the packer. Once the packer was inflated, the pump was stopped and the valve closed simultaneously. For deflation, the valve was opened, allowing the relatively high-pressure water inside the packer to flow back through the pump. Operation was reasonably fail safe as the pump could not operate against a closed valve, and the valve would open and deflate the packer upon power failure.

Inflation times ranged from approximately 10 s to 15 s for a 10.2-cm well to greater than 3 min for a 17.8-cm well. At shallow depths, packer inflation was checked by pulling the

cable to determine if the flowmeter was firmly in place. However, at depths of 500 ft and greater the weight of the cable makes it difficult to check for inflation. At these depths, rapid increase in the electrical current drawn by the pump was monitored as an indicator of inflation.

### III-8 Issues Regarding Flowmeter Measurements in the Field

Successful performance of investigations using the procedures described in this document requires knowledge of the mechanics of single-well pumping tests. This understanding provides the framework necessary to designate appropriate pumping rates, ascertain that flow conditions have stabilized, and select elevations for flowmeter measurements. In addition, familiarity with local geology, analytical solutions for pumping tests, and issues such as those listed below is necessary.

#### a. Well or Borehole Storage

During a pumping test, a common assumption is that the pumping rate equals the discharge from the aquifer. This assumption is acceptable only as long as a small percentage of discharge originates from within the well or borehole. In any large diameter well, borehole storage is a potential concern. If borehole storage dominates the response of a single-well pumping test, the time/drawdown data will appear as a straight line on a log-log plot with a slope of one. During a pumping test, the effects of borehole storage diminish with time and may be ignored at late times. Until storage effects dissipate, the drawdown will be less than if storage effects were not present.

Two problems exist if flowmeter measurements are made before borehole storage dissipates. One problem is that the total flow into the well from the aquifer is increasing with time. Hence, the flow distribution to the well will be changing with time. Another problem is that calculated transmissivity values will be too high unless the drawdown values are corrected for wellbore storage. When performing a flowmeter test of this design, borehole storage should be considered in the analyses, especially in low permeability aquifers or in boreholes of large diameters.

#### b. Selection of Pumping Rate

Factors affected by the pumping rate include the magnitude of the total discharge, the drawdown response, and friction losses. In situations where ground-water contamination is of concern and discharged water may require treatment, a lower pumping rate is beneficial. Minimizing the drawdown also reduces the importance of vertical flow in unconfined aquifers. As discussed in Chapter I, horizontal flow is an assumption in the data analysis. For large drawdowns, horizontal ground-water flow is not a valid assumption for unconfined aquifers.

During any flowmeter test, frictional losses occur through the well screen, well casing, and flowmeter. Because they are

difficult to measure in the field and can complicate the analysis of flowmeter data, these losses should be minimized. Conditions for which frictional losses may be of concern include heterogeneous highly transmissive aquifers and deep boreholes. In the former case, frictional losses associated with high flows entering the well through a narrow interval may be a problem if the total drawdown is small (e.g., < 25 cm) as the well loss becomes a significant fraction of the drawdown. In deep boreholes, cumulative friction losses associated with flow through a well pipe or borehole may be significant.

Concerns associated with low pumping rates include: possible reduced sensitivity of the electromagnetic flowmeter, difficulty in monitoring the drawdown response, and adequately stressing the aquifer. Hence, although low pumping rates might be desirable, they should be high enough to ensure that the aquifer and well responses can be accurately measured with the available equipment.

### *c. Background Electromagnetic Currents*

The flowmeter shell and telemetry cables are shielded against ground currents, but the inlet and outlet of the prototype flowmeter are not shielded. As a result, large background voltage gradients may influence the circuitry. Although the flowmeter is designed to reject such noise, its signal is in the micro-volt range and large voltage gradients may produce masking effects. Several wells where instabilities occurred in the flowmeter readings have been observed during development and use of the flowmeter. In such cases, the problems were believed to be caused by background currents. One of these wells, located near a building with large machinery, was surveyed twice. The first survey occurred with the machinery operating. During this survey, unstable flowmeter readings were recorded. The second survey occurred when the machinery was turned off. Stable, reproducible flowmeter readings were recorded.

Due to the uncertainties associated with field testing, some simple laboratory tests were performed to better identify the problem. The tests involved inducing a voltage gradient across a pipe in the calibration facility and recording flowmeter responses. As long as the induced gradient was a sine wave synchronized with the power line, no instabilities were observed. However, once the voltage gradient varied in both amplitude and frequency, instabilities occurred. To shield the flowmeter from the voltage gradient, a metal screen was placed across the flowmeter's outlet and inlet. This modification reduced the sensitivity of the flowmeter's response, but appeared to eliminate the instabilities induced by background currents. In situations where electromagnetic background currents are large, problems may occur with the performance of the electromagnetic flowmeter. Preliminary investigations indicate these problems may be overcome by providing additional shielding for the flowmeter. However, additional testing is required before appropriate shielding can be developed.

### *d. Reproducibility of Flowmeter Data*

A concern with any test is the reproducibility of the data. During a borehole flowmeter test, it is a good practice to repeat several flowmeter measurements without changing flowmeter position. If two measurements produce similar means and standard deviations, then the flowmeter system is assumed to be functioning properly. As standard practice, the flowmeter was considered to be performing adequately if two successive measurements produced mean values that overlapped in the range of their standard deviations.

In developing a quality assurance plan for field testing, two types of duplicate measurements should be taken. The first type involves two successive measurements without moving the flowmeter. An assumption in comparing these values is that flow conditions in the aquifer have remained constant between measurements so that any differences reflect the uncertainties associated with the measurement technique. The second type involves measurements at the same location but at different times. Over periods of minutes and/or hours, the flow conditions in the aquifer may change. Differences in flow measurements would be primarily produced by variations in the saturated thickness of an unconfined aquifer in response to a pumping test, variations in the pumping rate caused by fluctuations in the performance of the pump, and inability to exactly reoccupy the same elevation in the well. The second type of duplicate measurement reflects the error associated with assuming that the flow conditions are at steady-state.

## **III-9 Flowmeter Investigations in Consolidated Materials**

### *a. Introduction*

Many of the most intractable ground-water contamination problems occur in consolidated rocks and sediments where transport is dominated by flow through fractures or solution features. In systems where flow is dominated by secondary porosity (fractures, conduits, etc.), the identification of fractures that are hydraulically active and how they are interconnected is often important. This task may be complicated by the general observation that many fractures are inactive. Therefore, identifying fracture distributions using only a caliper log or a televiwer log provides limited information on the actual flow distribution that exists (Paillet et al., 1987; Paillet and Hess, 1987; Molz et al., 1990).

Characterization of ground-water flow in fractured media will often involve measurements of flow to or from individual fractures or fracture zones. Over the past decade, researchers at the U.S. Geological Survey (USGS) have been refining procedures developed using a sensitive heat-pulse flowmeter (Hess, 1982, 1986; Paillet et al., 1987; Paillet and Hess, 1987; Hess and Paillet, 1990; Paillet and Kapucu, 1989; Paillet, 1991a, 1991b, 1991c; Paillet et al., 1992). It is mainly their contributions that will be reviewed in the remainder of this section. The applications described below illustrate the need to incorporate a variety of geological, hydrogeological, and

geophysical tools in the investigation of site hydrology. Information from only one tool, such as a borehole flowmeter, will generally be insufficient to evaluate ground-water flow and contaminant transport and fate issues. This integrated characterization approach is necessary for investigations in porous media as well as fractured rock settings.

### b. Fractured Rock Applications

Some of the most direct uses of a sensitive borehole flowmeter are in fractured rock investigations. These applications demonstrate the advantages in combining flowmeter information with other types of geophysical data. Perhaps the best way to describe this process is to present an example application in fractured dolomite in northeastern Illinois. This study was performed by the USGS (Molz et al., 1990).

Acoustic-televiwer, caliper, single-point-resistance, and flowmeter logs were obtained in a 64-m deep borehole (DH-

14) in the northeastern Illinois area as part of a study of ground-water flow and transport in fractured dolomite (Figure III-1). The acoustic-televiwer log is a magnetically orientated, television-like image of the borehole wall which is produced with a short-range sonar probe (Zemanek et al., 1970). Irregularities in the borehole wall, such as fractures and vugular openings, absorb or scatter the incident acoustic energy, and result in dark features on the recorded image. Such televiwer logs may be used to determine the strike and dip of observed features. The acoustic-televiwer and caliper logs for borehole DH-14 (Figure III-1) indicate a number of nearly horizontal fractures that seem to be associated with bedding planes. The larger of these fractures are designated A, B, C, and D, respectively. The caliper log indicates that the major planar features on the televiwer log are large fractures or solution openings associated with substantial borehole diameter enlargements. The large but irregular features on the televiwer log between fractures B and C also are associated with borehole enlargements, but these are interpreted as vugular cavities within the dolomite rather than fractures. The

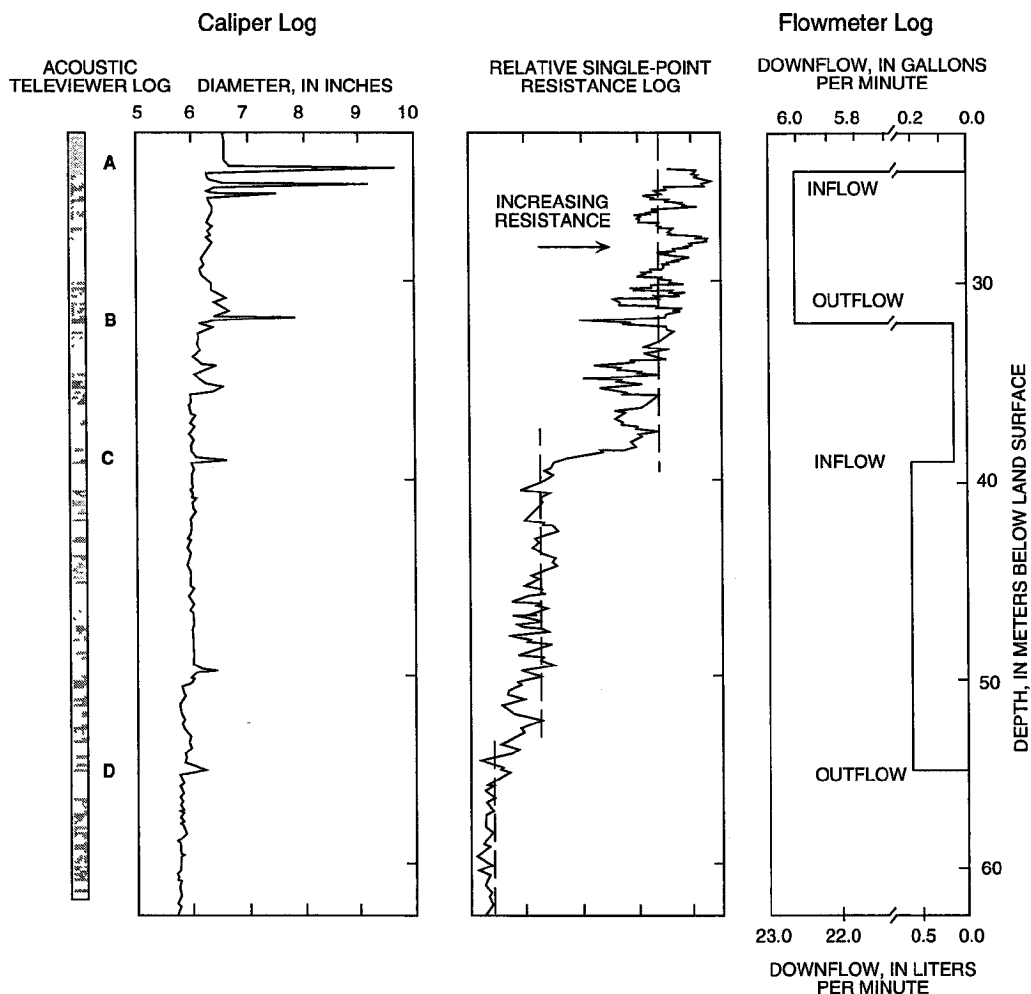

Figure III-1. Acoustic-televiwer, caliper, single-point resistance, and flowmeter logs for borehole DH-14 in northeastern Illinois (Paillet and Keys, 1984; Molz et al., 1990).

single-point-resistance log indicates abrupt shifts in resistance, at depths of about 40 m and 56 m. These shifts may reflect differences in the dissolved-solids concentration of the water in the borehole.

The pattern of vertical flow determined by the flowmeter measurements indicates the probable origin for the inferred water quality contrasts in the borehole (Figure III-1). The flowmeter log indicated downflow, which probably was associated with naturally occurring hydraulic-head differences, causing water to enter at the uppermost fracture, A, and exit at fracture B. A much smaller flow of water with the same electrical conductivity and dissolved-solids concentration continued down the borehole to fracture C. At this fracture, the downflow increased and the water inflow apparently contained a greater concentration of dissolved solids, which accounts for the shift to greater electrical conductivity. This increased downflow exited the borehole at fracture D, where there was another, somewhat smaller, shift in single-point-resistance. Although not rigorously proven from the geophysical logs, the second shift in resistance appears to be associated with the dissolved-solids concentration of the water entering at fracture C.

Subsequent water sampling confirmed that there were differences in the dissolved-solids concentration of the water at the different depths. Sample analysis indicated that the water entering at fracture A had a dissolved-solids concentration of about 750 mg/L; and the water entering at fracture C had a dissolved-solids concentration of about 1,800 mg/L. In this instance, the geophysical data, especially the thermal-pulse flowmeter data, were useful in planning subsequent packer testing of the aquifer and in interpreting water quality measurements. Identification of substantial natural differences in background water quality was useful in conceptualization prior to modeling of conservative solute transport. At the same time, measurements of vertical velocity distributions in the borehole provided useful indications of hydraulic head differences between different depth intervals.

This information could not be obtained from conventional water level measurements without the time-consuming installation of packers at multiple levels in all of the boreholes at the site.

Paillet et al. (1992) consider the application of borehole flowmeters to measure flow transients in pumped boreholes and in adjacent observation boreholes. Their approach is based on the theoretical observation by Long et al. (1982) that fracture connections are more important than local fracture aperture in controlling the rate of flow through random distributions of finite fractures. Thus, their technique is designed to identify fracture connections. Paillet et al. (1992) also consider approaches to the problem at different scales of measurement which begins to attack the question of how individual fractures and fracture sets are integrated into larger-scale flow systems.

### *c. Conclusions*

The previous study illustrates potential applications and integration of borehole flowmeters with other geophysical tools in the interpretation of flow in fractured aquifers. The relative ease and simplicity of flowmeter measurements permits reconnaissance of naturally occurring flows prior to hydraulic testing and identification of transient pumping effects. Flowmeter surveys may provide a valuable means by which to identify fracture interconnections and solute transport pathways during planning for much more time-consuming packer and solute studies. The borehole flowmeter is especially useful at sites where boreholes are intersected by permeable horizontal fractures or bedding planes. The simple and direct measurements of vertical flows provided information pertaining to the relative magnitude and vertical extent of naturally occurring hydraulic-head differences in a few hours of measurement. While the studies described in this section did not involve contaminated ground water, the potential application to contaminant migration problems and monitoring well screen location is obvious.

## Chapter IV Well Construction and Development

### IV-1 Background

#### *a. In-Situ Hydraulic Conductivity Estimates Using Wells*

Well installation results in disturbance of aquifer materials. This immediately raises the question of what effects, if any, well construction and development techniques have on hydraulic conductivity measurements? There are many considerations that contribute to the answer of this question. Such considerations include the following.

1. Is the subsurface material consolidated or unconsolidated?
2. What is the relative importance of primary versus secondary porosity?
3. What drilling technique is selected?
4. Is the well constructed with an artificial filter pack?
5. What drilling fluid, if any, is used?
6. How is the finished well developed?
7. What scale does the hydraulic conductivity measurement represent?

It is beyond the scope of this report to provide a comprehensive answer to the question of how well construction and development affects hydraulic conductivity measurements. Especially for small-scale measurements, this potential problem is neither well-documented nor understood. The approach herein will be to discuss the various drilling and development methodologies, review previous studies, discuss problems, and present test results concerning the sensitivity of borehole flowmeter measurements to well development and construction from two test sites.

#### *b. Formation Damages and Skin Effects*

All drilling methods alter the hydraulic characteristics of an aquifer near the wellbore. The impairment may be caused by the physical rearrangement of the matrix of aquifer material, by the smearing of silt and/or clay particles across the borehole face, or by invasion of drilling fluids or solids into aquifer formations. The amount of damage that occurs is related to the drilling method used for well construction and subsurface geology. The changes in hydraulic conductivity resulting from formation damage can produce skin effects in the near-well aquifer formations.

The term "skin effect" was introduced by van Everdingen and Hurst (1949) when they discovered mismatches between

analytical solutions and field data from well tests. The skin effect was caused by mud particle invasion into aquifer formations during well installation producing a decrease in hydraulic conductivity. Skin effects can be either negative or positive and represent increases or decreases, respectively, of hydraulic conductivity near the wellbore. Negative skin effects can be created at wellbores where drilling causes fractures in the aquifer and/or development causes excessive removal of fines from aquifer sediments. Negative skin effects may also result from well construction using an artificial filter pack that is significantly coarser than aquifer material. Positive skin effects can result from compaction, invasion of drilling fluids, smearing of clays, etc.

Skin effects influence the flow distribution along the well. In single-well pressure transient tests, wellbore damage has been recognized (Dudgeon and Huyakorn, 1976; Chu et al., 1980; Moench and Hsieh, 1985) as adversely affecting the tests. Analysis of the test data can result in large errors in estimates of storativity and transmissivity if skin effects and wellbore storage are not properly delineated. There are solutions available that account for both wellbore storage and infinitesimally thin skin in the pumping well (Sandall et al., 1978; Chu et al., 1980) and both the pumping and observation wells (Tongpenyai and Raghaven, 1981; Ogbe, 1984; Ogbe and Brigham, 1984). The mathematical treatment used in these models to account for the skin region, however, is only an approximation and the hydraulic head drop across the skin is presumed to occur under steady flow conditions.

Well development can reduce positive skin effects by repairing damage to the aquifer formations so that natural hydraulic properties are partially restored. For production wells, development comprises the systematic procedures followed to ensure the maximum discharge rate at the highest specific capacity with minimum production of particulate matter (Moss and Moss, 1990). More specific construction and development considerations are necessary for wells that are to be used to obtain geohydrologic data for aquifer characterization.

### IV-2 Well Design

Ideally, wells designed for characterization using techniques described in this document should be fully screened across the interval of interest, such as the contaminant plume, be constructed without an artificial filter pack, and be screened such that the top of the screen is far enough below the water table to allow placement of the pump intake in the well casing

during the test. Boman et al. (1997) discuss the potential influence of an artificial filter pack on flowmeter results. A coarse-grained gravel or sand pack may result in significant vertical flow through the pack prior to entering the screen. This phenomena is enhanced by use of high flow rates that result in resistance to flow through the downhole probe of the electromagnetic flowmeter. In this situation, the measured flow distribution is skewed with a high influx of water near the top of the screen. For this reason, use of a borehole flowmeter in wells constructed with a filter pack of gravel-sized material may not provide meaningful data and generally should be avoided. It is also possible to observe some effects in wells with filter packs constructed of coarse-grained sand if the hydraulic conductivity of the pack material is significantly greater than aquifer materials. However, use of a natural collapse well construction is not always feasible. For example, formations with a significant fraction of fine-grained materials or units may not be appropriate for natural collapse construction and may result in void space within the annulus that affects test results. Results of field applications of the borehole flowmeter indicate that it is possible to obtain representative flowmeter measurements in many wells constructed using an artificial pack. In general, wells specifically constructed for these tests should avoid use of artificial filter packs, where possible. If an artificial pack is used, the data should be carefully examined for evidence of bias in the flow distribution.

Wells that are screened across the water table may be subject to increased head loss near the pump intake. This is particularly true for wells constructed with an artificial filter pack that is significantly more conductive than surrounding aquifer materials (Boman et al., 1997). This situation may result in a nonuniform head distribution in the well and an increased influx of water near the pump intake. Such a situation would also bias flowmeter test results.

Presence of a low permeability skin (i.e., positive skin effect) adjacent to the well may also significantly bias flowmeter results by affecting the distribution of flow to the well. Studies by Ruud and Kabala (1997) indicate that the presence of a low permeability skin adjacent to the well may have a much greater effect than the presence of a zone of increased permeability. As previously noted, the bias in the flowmeter measurements increases with increasing thickness of the disturbed zone and increasing difference between the permeability of the disturbed zone and the formation materials.

These studies imply that wells should be designed and constructed to minimize the size of disturbed zones and the degree of disturbance. In general, formation of a higher permeability disturbed zone would be preferable to the presence of a lower permeability zone. The results also imply that the minimum size of measurement intervals deserves careful consideration in test design. Potential effects of well design and construction on the representativeness of the data obtained from these investigations should be carefully considered prior to well installation. Many of these questions are still areas for continuing research.

## IV-3 Well Installation Methods

### a. Overview

Drilling methods chosen for construction of test wells should be those techniques that result in the least possible disturbance to the formation surrounding the well and result in a minimum annular space between the well screen and the borehole wall. The most appropriate method will depend on site-specific conditions. A number of references have appeared during the past decade regarding well drilling techniques, technologies, and related subject matter (e.g., Driscoll, 1986; Aller et al., 1989; Harlan et al., 1989; and Moss and Moss, 1990).

### b. Drilling Techniques and Hydraulic Conductivity Estimates

There are many possible interactions between the various drilling methods and the types of subsurface media at a particular site. Optimum methods depend on site conditions. In addition, the various studies that have dealt with the interaction of well drilling and hydrogeologic measurements have focused more on chemical measurements than on hydraulic measurements. Prominent studies during the past decade include Minning (1982), Barcelona and Helfrich (1986), Hackett (1987, 1988), Keely and Boateng (1987a,b), Paul et al. (1988), and Strauss et al. (1989).

Keely and Boateng (1987a,b) present an illuminating discussion of various options and trade-offs when constructing monitoring wells. Much of the following discussion is based on those two references. Mud rotary has been a relatively common drilling technique for water supply wells because it is rapid, economical, and essential to the performance of certain geophysical logs. However, the technique has the disadvantage that the potential exists for large volumes of drilling fluids to enter the formation resulting in formation of a low permeability skin. Subsequent development sufficient to remove this skin effect is usually difficult or impossible.

Improvements to this technology include driving a temporary casing while drilling or use of dual-wall reverse circulation drilling. In the dual-wall method, mud travels down a cylindrical annulus that is bounded by the outer drill pipe and an internal, rotating drill stem connected to the bit. Mud is ejected just above the bit, picks up cuttings, and is pumped up the inner drill stem to the surface. This technique limits exposure of the borehole wall to drilling fluids and decreases mud invasion into the formation.

Many of the problems associated with introduction of drilling fluids using mud rotary techniques are also common to air rotary methods. These problems can be minimized by driving a temporary casing flush with the borehole wall. In fact, this is often necessary to prevent caving of the borehole walls when drilling in unconsolidated materials. However, compressed air can still enter the formation, and "air binding" is a well-known phenomenon that decreases the apparent hydraulic conductivity of porous materials. Just as with mud

invasion, air invasion would be expected to be particle-size dependent.

According to Keely and Boateng (1987a), the cable tool method appears to have several advantages when used to construct monitoring wells, although it is rarely used for this purpose. In cable tool drilling, no drilling fluids are necessary. A temporary casing is driven as the drilling proceeds. Water may be added to the hole to aid bailing, but it is not under pressure. Driving and removing the temporary casing may not disturb the borehole wall significantly because there is a sharp drive shoe at the bottom, the casing is smooth, the annular spacing between the casing and the borehole wall is sufficiently small that material is not dragged along with the moving casing, and the casing is slowly moved up and down. This method may produce a well that is exceptionally well-suited for hydraulic conductivity and other measurements.

The hollow-stem augering method is relatively fast, does not involve addition of drilling fluid, and formation samples may be obtained easily during the course of drilling. A major disadvantage, however, especially from the viewpoint of estimating hydraulic conductivity, is that the augering process causes wet clay and silt material to be smeared along the borehole wall. In certain types of soils such as clayey saprolites, the smearing and destruction of the open pore structure of the soil can be so severe that the resulting well is not suitable for hydraulic conductivity tests. Another potential disadvantage is that the annular space between a well screen installed through the hollow-stem auger and the borehole wall can be relatively large. Thus, if one does not wish to install a sand pack, there would be a relatively large volume into which the surrounding formation would collapse, further disrupting the structure of the natural formation. If collapse of cohesive soils was not complete, channels for vertical water movement would be formed.

Much of the available literature contains information concerning well construction and measurements of various types in a variety of subsurface environments. This information is usually in the form of case histories, descriptions of problems that arose on particular projects, and the manner in which these problems were addressed. There have been relatively few investigations performed to study the effects of well construction on hydraulic conductivity and other measurements in a systematic fashion. One exception to this is the work of Morin et al. (1988b). In this study, epithermal neutron and natural gamma logs were used to measure the formation disturbance caused by three different well drilling techniques: hollow-stem augering; mud rotary; and hammer-driven, flush-jointed, temporary casing within which a permanent casing and screen were installed. Each type of construction was utilized for a number of wells so that a statistically significant set of logs could be obtained for each method.

The study was conducted in a glacial outwash plane deposited in a braided stream environment. The study aquifer was composed of coarse sand and gravel in horizontal lenses and layers with silt and clay comprising less than five percent of

the formation. This resulted in significant vertically-distributed heterogeneity that was reflected in the geophysical logs. The basic concept of the study was to associate an increase in formation disturbance due to well construction with a decrease in the degree of heterogeneity (more homogeneous appearance) observed in the well logs. Using this criterion, the order of increasing disturbance was: driven casing, mud rotary, and augering.

## IV-4 Well Development Methods

### a. Overview

Well development includes a broad spectrum of techniques, procedures, and tools for applying some form of energy to the well screen and adjacent formation. Historically, several development methods that have been used following well installation include: overpumping, backwashing, mechanical surging, air development, and high-velocity jetting. Well development methods such as chemical treatment, hydraulic fracturing, and use of explosives to maximize the water yield in production wells are not applicable to these studies. Discussion in this text is restricted to aquifer characterization wells and development methods that assist in restoring the undisturbed hydraulic characteristics of aquifer formations.

Determining which development methods are most appropriate for any given well requires an understanding of available methods, a knowledge of the aquifer formations present at the well location, and particulars of the well design. In some cases, a single method might be effective for development. However, in many instances, the use of more than one development method will yield much better results. Driscoll (1986), Moss and Moss (1990), and Harlan et al. (1989) explain the mechanics of the different well development methods.

### b. Development Methods and Hydraulic Conductivity Estimates

The literature offers little guidance on the selection of an optimum method of well development for any particular site. Much of the former work related to well development has concentrated on maximizing water yield in production wells. In general, these types of studies (National Ground Water Association, 1989) provide evaluations of different well drilling and development techniques based upon specific capacity measurements. This is a measure of the reduction in positive skin effects produced by well development.

Although the influence of skin effects on pumping tests has long been recognized in the petroleum industry (e.g., van Everdingen and Hurst, 1949; Hawkins, 1956) and by ground-water scientists (e.g., Moench and Hsieh, 1985), very few studies provide comparisons of different development methods using explicit hydrogeologic measurement techniques. Rehfeldt et al. (1989b) provide results from experiments that were undertaken using an impeller flowmeter to investigate well installation and development methods on flowmeter



discharge profiles. The test site was a heterogeneous sand and gravel aquifer located at the MacroDispersion Experiment (MADE) site on the Columbus Air Force Base, Columbus, Mississippi. One of the major objectives of the study was to determine the most appropriate well installation and development method that would minimally disturb the aquifer and allow accurate estimates of hydraulic conductivity at the test site. Wells evaluated in the experiment included a driven steel well screen, drive-and-wash wells using compressed air, and hollow-stem auger wells, constructed with both natural and artificial filter packs. The wells were developed in three stages; first by cyclic overpumping and backwashing, then with a surge block attached to the drill rig, and finally using a hand-drawn swab. Hydraulic conductivity profiles were determined from impeller flowmeter measurements after each stage of development. When hydraulic conductivity estimates were reproducible, well development was considered complete.

The study indicated that a large diameter (30 cm) hollow-stem auger method of well installation was the least satisfactory of the test methods because of the degree of disturbance associated with auger drilling and the fact that more annular space exists between the wellbore and screen. Although the driven steel well screen was installed to represent a well with no open annular space, it was substantially more expensive than other methods because of material costs. The internal vertical rods that support the steel screen also presented problems with well development since the surge block and

swabbing tool could not develop a good seal along the inside of the screen. Rehfeldt et al. (1989b) provide the following observations based on their testing.

1. Well development caused changes in the aquifer material adjacent to the wellbore and altered the hydraulic conductivity profiles.
2. Overpumping and backwashing development produced changes in the profiles of both the augered well and the well installed using drive-and-wash methods. Order-of-magnitude increases in hydraulic conductivity were observed at a minimum of five locations for the augered well, but were never that large for the drive-and-wash well. Additionally, the trends in the profiles after overpumping and backwashing development were generally similar in the drive-and-wash well but not in the augered well.
3. After swabbing, the augered well again showed significant differences in the profiles, although less than for the first two development cycles. The profile for the drive-and-wash well after swabbing was relatively consistent.
4. The profile for the driven steel screen generally had lower values than the profile for both the augered and drive-and-wash wells. The lower hydraulic conductivity values may have been partly caused by compressed aquifer material near the well, the adherence of fine-grained material to the well screen, or incomplete development of the well.

## Chapter V

### Field Studies of Well Construction and Development at Columbus, Mississippi

#### V-1 Description of Test Site

##### a. Site Location

The test site occupies one of twenty-five hectares (Ha) in the northeastern corner of Columbus Air Force Base (CAFB), Columbus, Mississippi, leased from the U.S. Air Force for the MacroDispersion Experiment (MADE). The site is approximately 6 km east of the Tombigbee River and 2.5 km south of the Buttahatchee River, and lies above the 100-yr floodplain of both rivers. The site is situated on the youngest terrace deposits associated with the Buttahatchee River.

##### b. Aquifer Characteristics

Young (1991b) describes the Columbus Aquifer as being composed of approximately 10 m of Pleistocene and Holocene fluvial deposits. The aquifer overlies the Eutaw formation that consists primarily of marine clay and serves as an aquitard. In addition to numerous samples from boreholes, a geological investigation of the aquifer included mapped geological facies at a gravel pit and an aerial photography survey that indicated an abandoned river meander crossing the northern region of the 1-Ha test site and passing through the middle of the MADE test site (Figure V-1).

The aquifer at the site is composed of poorly-sorted to well-sorted sandy gravel and gravelly sand with minor amounts of silt and clay. Sediments are generally unconsolidated and cohesionless below the water table. The upper portion of the aquifer is generally composed of coarse-grained sediments and bar deposits from a meandering river system (Kaye, 1955; Rehfeldt et al., 1989b). The abrupt changes in vertical sequences and coarse texture suggest that the pointbar sediments were deposited during catastrophic flooding events. Chute bars and channels with clay drapes were also deposited during flood stage. Such events result in an uneven sand distribution and a seemingly chaotic occurrence of gravel lenses and clay drapes (Collinson and Thompson, 1989).

The lower portion of the aquifer is composed of sediments from a braided river system. This model implies an irregular pattern of coarse gravelly lenses deposited as longitudinal and transverse bars at high flow stage, alternating laterally and vertically with finer sand and silt deposited in channels at low flow stage. As these depositional bodies were formed by short-lived branching and rejoining shallow channels, and subsequent partial truncation by secondary stream channels,

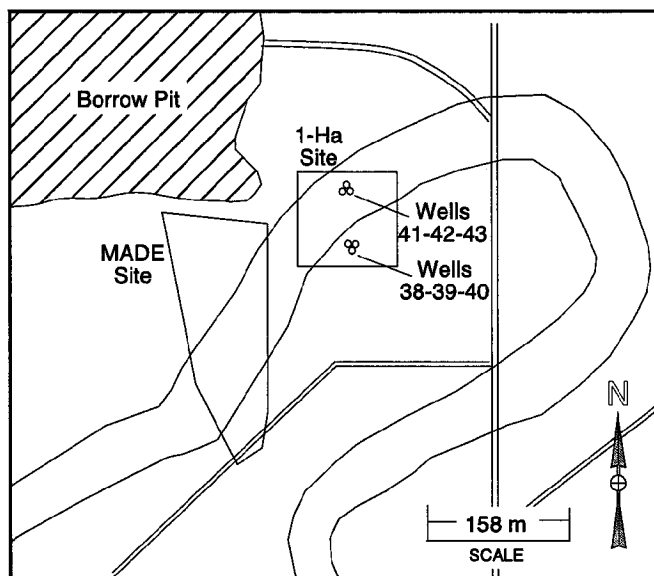

Figure V-1. Ox bow meander at the Columbus AFB site drawn from a 1956 aerial photograph.

a large range of shapes and sizes exist for the depositional bodies. The shapes might best be described as irregular tongues, shoestrings, wedges, and pods.

##### c. Previous Pumping Tests

A series of single-well pumping tests, slug tests, and electromagnetic borehole flowmeter tests were conducted at the original thirty-seven wells located across the 1-Ha test site. The results of these tests indicate that a zone of interconnected high-K deposits exists at elevations of 59 m to 62 m above mean sea level (AMSL) within boundaries mapped by the former meander shown in Figure V-1. These results also indicated that positive (low-K) skin effects exist at most, if not all, of the wells. Young (1991a,b) provides an analysis of the pumping test data using the Cooper-Jacob equation and the Cooper-Jacob Straight-Line (CJSL) method (Cooper and Jacob, 1946). The analysis indicates that the two approaches provide significantly different transmissivity values.

Considering that poorly-sorted coarse-grain sediments often lie adjacent to well-sorted fine-grain sediments, and that highly permeable lenses can dominate ground-water flow at Columbus, significant skin effects were considered probable. The following are potential causes of positive skin effects:

(1) smearing of silt and clay particles into and across high-permeability zones; (2) compaction of aquifer material by methods that include advancement of a protective casing; and (3) alignment of blank (i.e., nonslotted) sections of well casing with aquifer zones of high permeability.

#### d. Monitoring Well Installation

For the purposes of this study, two clusters of three wells each were added to an existing network of thirty-seven wells at the 1-Ha test site (Figure V-2). The drilling and development methods used to install the first thirty-seven wells at the 1-Ha test site are described by Young (1991a). The six new wells are numbered 38 through 43. The well clusters were configured as equilateral triangles with individual wells being separated by distances of two meters so that aquifer conditions near each well would be similar. The two well clusters are separated by a distance of about 60 m. Well cluster 38-39-40 resides on the southern side of the 1-Ha test site within possible pointbar deposits in the upper aquifer and possible braided river deposits in the lower aquifer. Well cluster 41-42-43 is located in the northern portion of the test site, within possible channel sediments from a meandering river system and with possible channel sediments at depth from a braided river system.

Each well is approximately 11 m deep and consists of 5.1-cm (inside diameter), schedule-40 PVC casing and screen (Figure V-3). The screen for each well is 9.14 m in length and machine-slotted with 0.25-mm slots spaced at 3.18-mm

intervals. The following three drilling methods were used for wells at each well cluster:

1. 19.4-cm hollow-stem auger - natural filter pack
2. 27.0-cm hollow-stem auger - artificial filter pack
3. 11.4-cm drive-and-wash - natural filter pack

Wells 39 and 43 were installed using a 19.4-cm (outside diameter) hollow-stem auger. The aquifer material was allowed to collapse around the screen and casing, and auger cuttings were used to backfill approximately the top two meters of borehole. Wells 38 and 41 were installed using a 27-cm (outside diameter) hollow-stem auger with artificial filter packs. The filter pack was comprised of 1.6 mm to 3.2 mm, subangular to angular, quartz sand. A disadvantage of the larger auger is the size of the annulus created.

Wells 40 and 42 were installed using a modified rotary wash method. The method involved driving an 11.4-cm steel outer-casing ahead of the rotary bit and then washing the cuttings out of the casing with water. The well screen and casing were lowered into place, and the outer steel casing was removed allowing formation material to collapse around the well. The modification minimizes both the wash into undisturbed aquifer sediments and the amount of formation material removed.

In unconsolidated aquifer materials, the driving of casing generally creates a region of compacted aquifer material around the casing. Pulling the outside casing and allowing aquifer material to collapse on the inner well screen and casing may relieve this compression. Based upon studies by

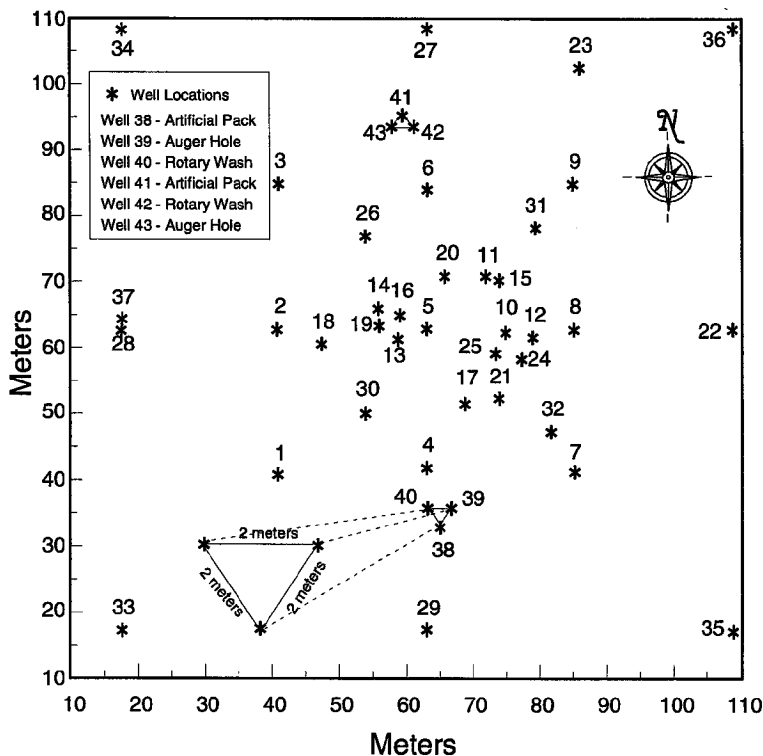

Figure V-2. Well network at the 1-Ha test site.

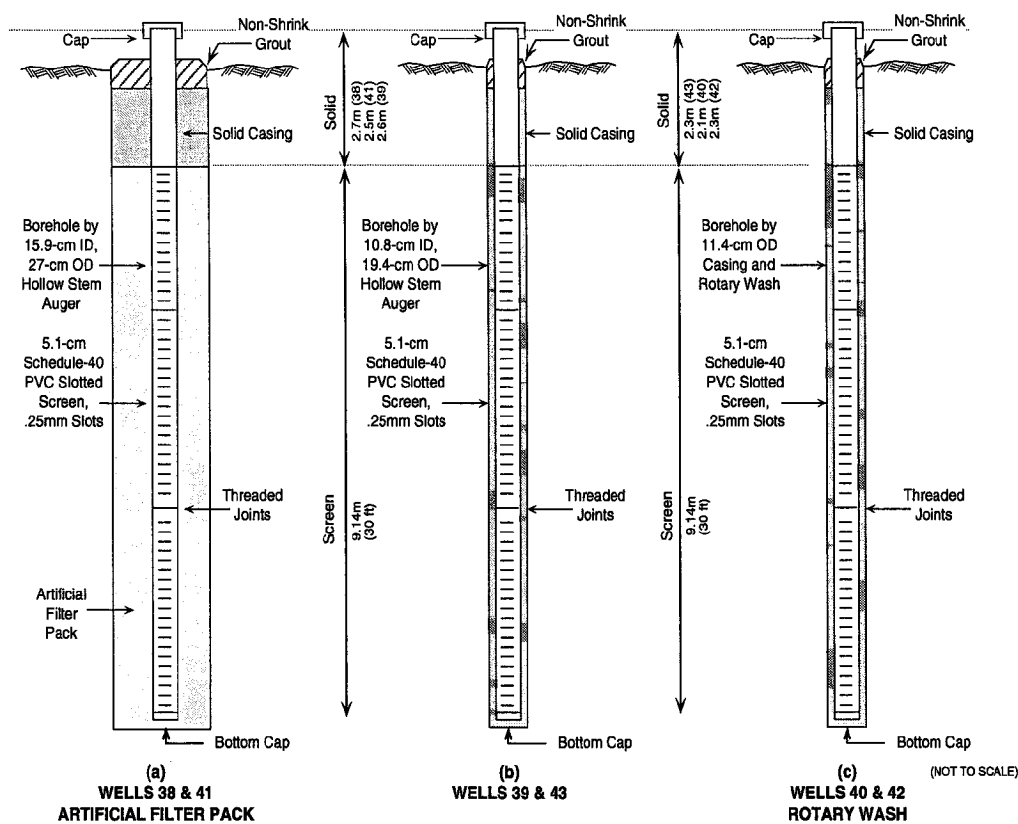

Figure V-3. Design of wells used to evaluate the effect of well development on flowmeter tests.

Rehfeldt et al. (1989a) at CAFB, this was expected to be the preferred method of installation as the extent of aquifer disturbance is much less than in auger drilling. The annular space surrounding the well into which the aquifer material must collapse is also effectively reduced from about 6.7 cm for small (19.4-cm) diameter auger wells to 2.7 cm for the driven wells. Hence, the in-situ hydraulic conductivity estimated from a well installed by drive-and-wash methods is more likely to be representative of the true aquifer hydraulic conductivity.

## V-2 Test Descriptions

This study consisted of a series of single-well pumping tests conducted at six wells. Between pumping tests, additional well development was performed. During each pumping test, drawdown and electromagnetic flowmeter data were collected. Testing at each of the two well clusters was conducted concurrently using two teams outfitted with flowmeters, pressure transducers, data loggers, lap-top computers, and other equipment required for monitoring and testing. The flowmeters were calibrated against known flows prior to, and after, their use in the field. Both 1.27-cm and 2.54-cm (orifice diameters) electromagnetic flowmeters were used during testing.

The procedure for sequential development and testing of the monitoring wells consisted of the following steps:

1. Ambient flowmeter tests were conducted at each well.
2. Pumping tests and flowmeter tests were performed.
3. Wells were developed according to prescribed methods.
4. Retesting and development sequence was completed for three development cycles.
5. Injection tests and high-rate pumping tests were performed.

Ambient flowmeter tests were conducted to measure natural (background) ground-water flow within each well. The type of well installed, the aquifer formations present, and the degree of formation damage from drilling have differing effects on ambient flows. Ambient measurements were taken at 30.5-cm increments beginning at the bottom of the well and advancing upwards until the water table was reached. The ambient measurements were taken after the test wells had sufficient time to return to a quiescent state from development activities and pumping tests, which was usually overnight.

Single-well pumping tests and borehole flowmeter tests were completed at each well following ambient flowmeter testing. Discharge measurements were made several times during each test. The flowmeters were used to obtain a profile of the flow distribution after a steady flow field was achieved in the vicinity of the well, which generally occurred after 20 min to

30 min of pumping. Flowmeter readings were obtained at 30.5-cm increments as in ambient testing. Flow distribution profiles were compared in the field after progressive well development. Test wells were allowed to fully recover before proceeding with each stage of development, usually overnight.

A total of six pumping and flowmeter tests were completed for each well (Table V-1). The first four tests were conducted prior to and after each development cycle. The last two tests were injection and high-rate pumping tests. The first method used for well development was overpumping and backwashing. Initially, the well was pumped until the water began to clear. Development was then completed by pumping water through a discharge hose several feet above the top of the well, and then allowing it to flow back through the pump and out through the well screen. Water was occasionally discharged to remove the fine-grained materials. Several pumping cycles were completed until the discharge was clear.

The second development consisted of a modified swabbing method that was alternated with overpumping and backwashing. This method is similar to the procedure used by Rehfeldt et al. (1989b). A section of galvanized pipe was added to weight the swab and increase its rate of fall. The swab and galvanized pipe had a combined weight of over 2.9 kg. Beginning at the bottom of the well, the swab was manually raised with force over a 1-meter increment of the well screen and then allowed to fall back to its original position to provide a surging action. This swabbing movement was repeated for a total of four repetitions, until the water table was reached. Water was then pumped to remove fines liberated during development and overpumping/backwashing was conducted. The entire cycle was repeated

using three swabbing repetitions. The third and final development was a reiteration of the alternating modified swabbing and overpump/backwash method that was identical to that used in the second development.

### V-3 Test Analyses and Results

#### a. Ambient Flow Distributions

Ambient flow measurements collected after each successive phase of well development (Figure V-4) varied from -0.34 L/min to 0.04 L/min for well cluster 38-39-40, and from -0.06 L/min to 0.29 L/min for well cluster 41-42-43. The sign convention is positive for upward flow and negative for downward flow. The initial development, if properly conducted, should displace extraneous fines from the wellbore. From observation of the flowmeter plots, it is apparent that the initial development (overpumping and backwashing in this case) is important. A relatively large change in ambient flow is displayed after the first development by all wells except wells 42 and 43. The magnitude of the changes in ambient flows decrease with ensuing stages of development. Following the first stage of development, the changes that occur in the ambient flows also vary according to well type and differences in aquifer materials. The modified rotary wash wells (40 and 42) exhibit ambient flow profiles that were essentially reproducible after the first stage of development.

The ambient flow profiles for the wells constructed with an artificial filter pack (38 and 41) show differing responses after the second and third development (Figure V-4). The ambient

Table V-1. Testing Sequence

Test No.	Test Type	Development Cycle	Development Method
1	Ambient Borehole Flowmeter (BHFM) Tests Constant Discharge Pumping Tests BHFM Tests During Pumping	Pre-development	None
2	Ambient BHFM Tests Constant Discharge Pumping Tests BHFM Tests During Pumping	After 1st development	Overpump/Backwash (15 minutes)
3	Ambient BHFM Tests Constant Discharge Pumping Tests BHFM Tests During Pumping	After 2nd development	Alternating Modified Swabbing and Overpump/Backwash (60 minutes)
4	Ambient BHFM Tests Constant Discharge Pumping Tests BHFM Tests During Pumping	After 3rd development	Alternating Modified Swabbing and Overpump/Backwash (60 minutes)
5	Ambient BHFM Tests Constant-Rate Injection Tests BHFM Tests During Injection	Development complete	None
6	Ambient BHFM Tests Constant Discharge Pumping Tests BHFM Tests During High-Rate Pumping	Development complete	None

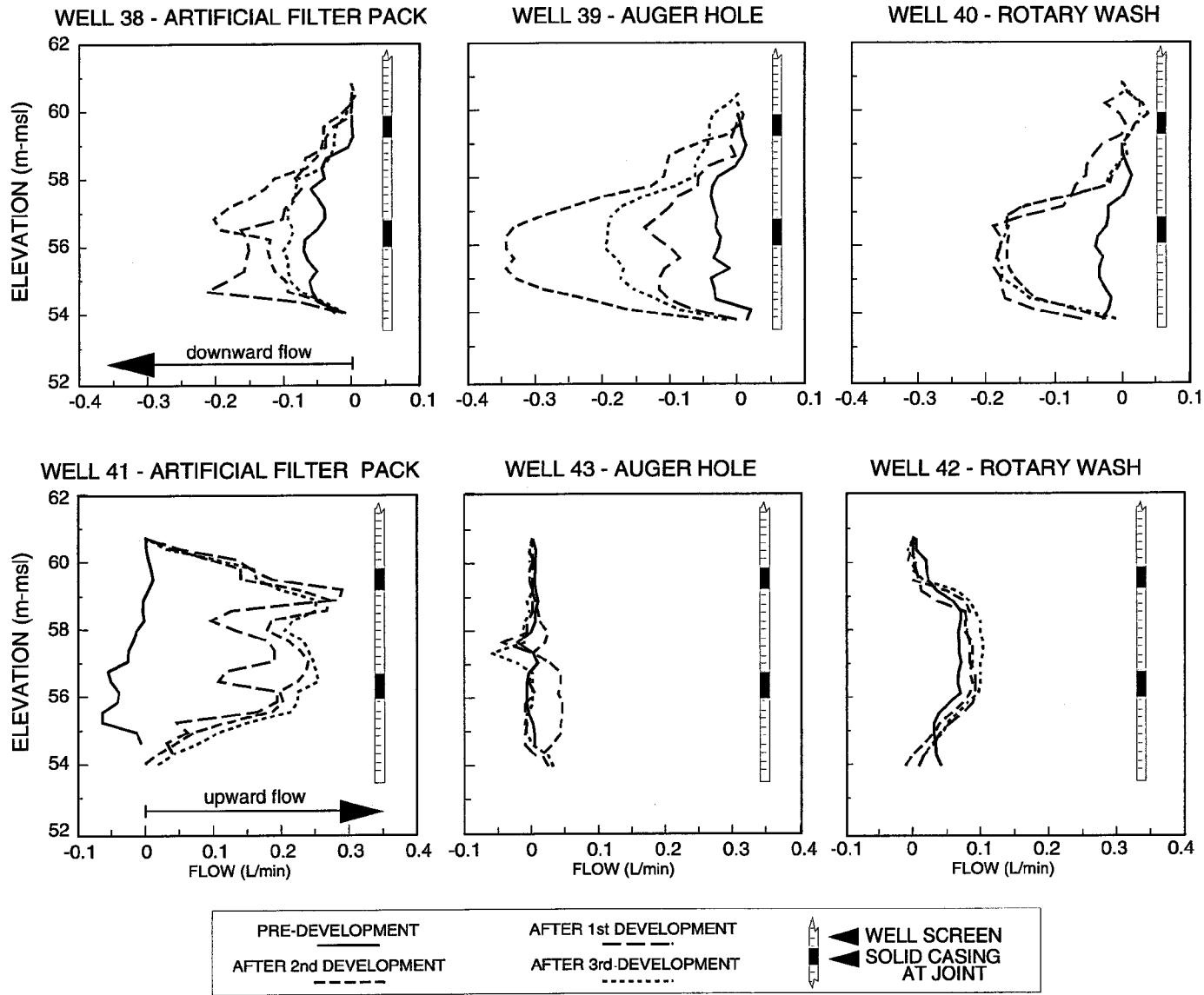

Figure V-4. Ambient flow profiles after successive well development.

flows at well 41 increase incrementally with diminishing differences between development cycles. Well 38, on the other hand, exhibits some irregularities in ambient flow profiles. Below about 56 m, the first development of well 38 produces the highest ambient flows with succeeding development resulting in reductions of ambient flow. Above about 56 m, the second development of well 38 produces the highest ambient flows with ambient flows being reduced following the third development. These responses may simply be due to stabilization of the filter pack or to effects of minor temporal changes in local hydrology.

The augered wells with natural filter packs (39 and 43) display ambient flow profiles that are quite variable (Figure V-4). For both wells, the ambient flows measured following the second stage of development are greater than those of the third stage of development. The two wells also show the largest differences in their ambient profiles between the second and third development cycles. These results suggest that the material around the augered wells was the most sensitive to well development.

Several shifts and peaks in the ambient flow profiles were observed through the first two stages of well development for both well clusters. These phenomena are attributed to inadequate collapse and stabilization of aquifer material around the screens for the auger hole wells, and to incomplete grading and stabilization of aquifer and filter pack materials for the wells with artificial filter packs. Very little deviation in the ambient flow profiles are shown by the modified rotary wash wells after initial development. By the third stage of development, the shifts and peaks in all the ambient flow profiles had decreased to the point that wellbore material was stabilized and development was deemed complete.

Well cluster 38-39-40 shows good correlation between wells for the final profiles of ambient flow. The profiles indicate that most of the water is entering between about 57 m and 58 m AMSL and leaving between 54 m and 55 m AMSL, with little ambient flow above 58 m AMSL. These two high ambient flow zones suggest that sequences of high hydraulic conductivity sediments may intersect the wells at these horizons. For well cluster 41-42-43, there is less similarity among the ambient flow plots. All three wells have upward ambient flow but there is considerable variability in the source and magnitude of the flow.

### ***b. Induced Flow Distributions***

The flow distributions measured under pumping conditions (Figure V-5) represent the results from flowmeter testing during steady-state flow conditions. The mean flow rates used for pumping tests were 8.0 L/min and 13.4 L/min for well clusters 38-39-40 and 41-42-43, respectively. The pumping rates used for the tests were fairly constant and had variances of only 0.015 L/min and 0.076 L/min for well clusters 38-39-40 and 41-42-43, respectively. The cumulative flows were adjusted by taking the net difference between the measured flows under pumping and ambient conditions, and then normalizing the result to the pumping rate.

The induced flow distributions for wells 41 and 43 show changes after the initial development that are relatively large in comparison to succeeding development cycles. The magnitude of the changes in flow decreases incrementally with ensuing stages of development for the well with the artificial filter pack (well 41). Observation of the induced flow distributions for well cluster 38-39-40 does not indicate a large change in the profiles of wells 38 and 40 between pre- and initial development. The greatest change in the flow profiles for these two wells occurs after the second development, indicating that the modified swabbing method was necessary to effectively develop the wells. The induced flow profiles for well 39 indicate that it is experiencing a moderate degree of formation stabilization during later stages of development.

### ***c. Specific Capacity Values***

Drawdown data (Figure V-6) were used to calculate specific capacity (Figure V-7) for each well based on the drawdown responses at 1500 s after initiation of extraction. In general, the greatest increases in specific capacity occur after the initial development. Except for well 41, specific capacity values stabilized after the second development. Well 41 has an artificial filter pack and is located in a region where highly transmissive aquifer zones exist near the top of the well screen. The different response at well 41 may be caused by spatial variability within the aquifer and the possible intersection of a highly permeable lens that is not interconnected with the neighboring wells.

### ***d. Transmissivity Values***

The single-well test drawdown curves (Figure V-6) were analyzed using the Cooper-Jacob straight line (CJSL) method (Cooper and Jacob, 1946) to calculate transmissivity. The semilog plots of drawdown data are characterized by an early slope that is about five to twenty-five times steeper than the late slope (after 100 s). For comparison purposes, transmissivities were calculated for both early and late times. Typically, the late-time portion of the curve used for the CJSL analysis began between 100 s and 300 s and ended between 900 s and 1,000 s. Late-time average transmissivities were calculated using the data from all four pumping tests at each cluster. The average transmissivities for well clusters 38-39-40 and 41-42-43 are 19.8 cm<sup>2</sup>/s and 34.0 cm<sup>2</sup>/s, respectively. At every well, the ratio of the transmissivity after each well development to the average transmissivity were within a factor of two. The results indicate increases and decreases in transmissivity with additional well development. However, no consistent trends are evident in the data. It is possible that the changes in the calculated transmissivity values were caused more by the differences in the testing and analyses procedures than the aquifer conditions. In order to minimize recovery time between pumping tests, low pumping rates were used. As a result, trends in the drawdown curves are difficult to define because the aquifer was not adequately stressed.

The CJSL analysis for the early-time portion of the semilog drawdown curves typically began near 20 s and ended at about

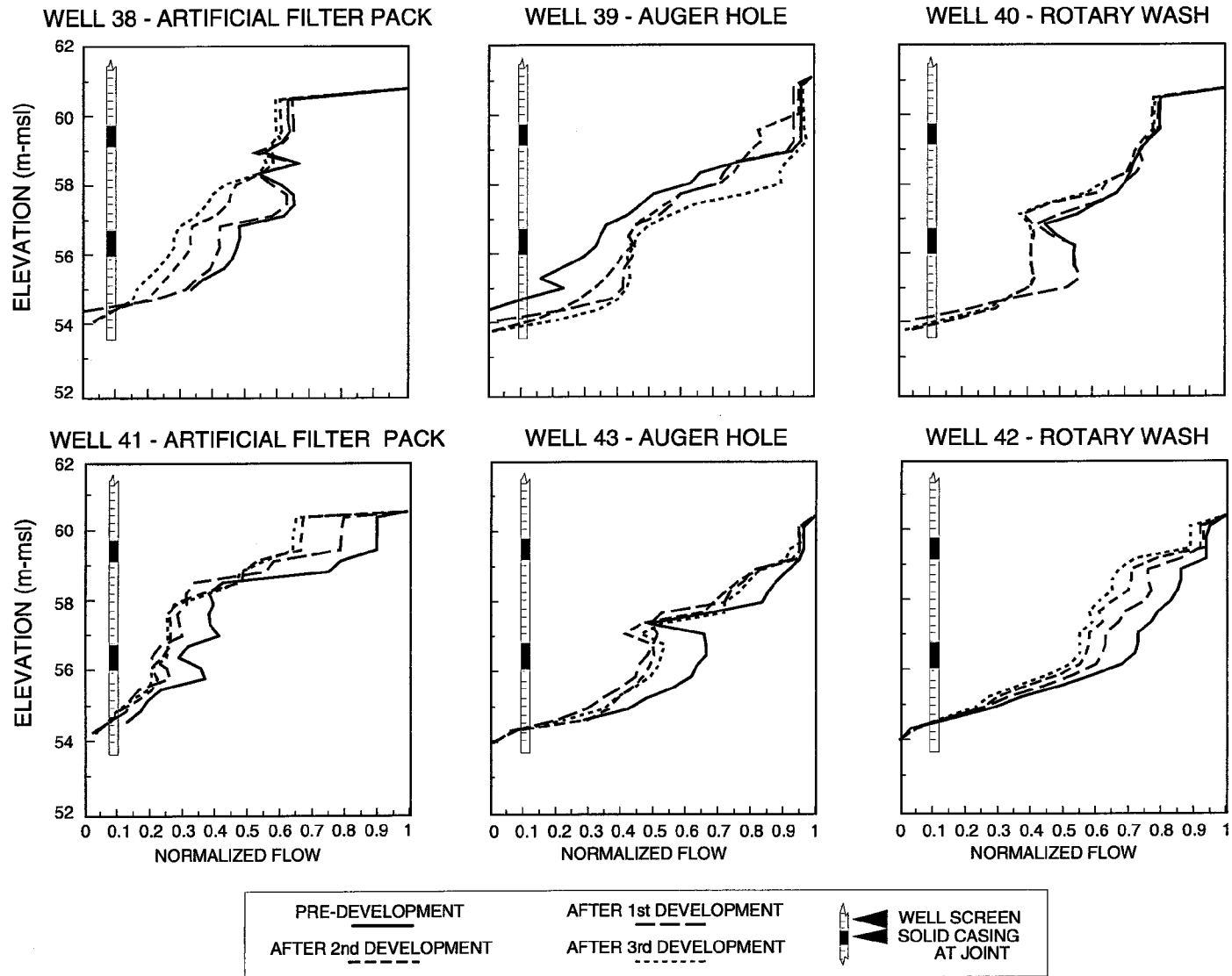
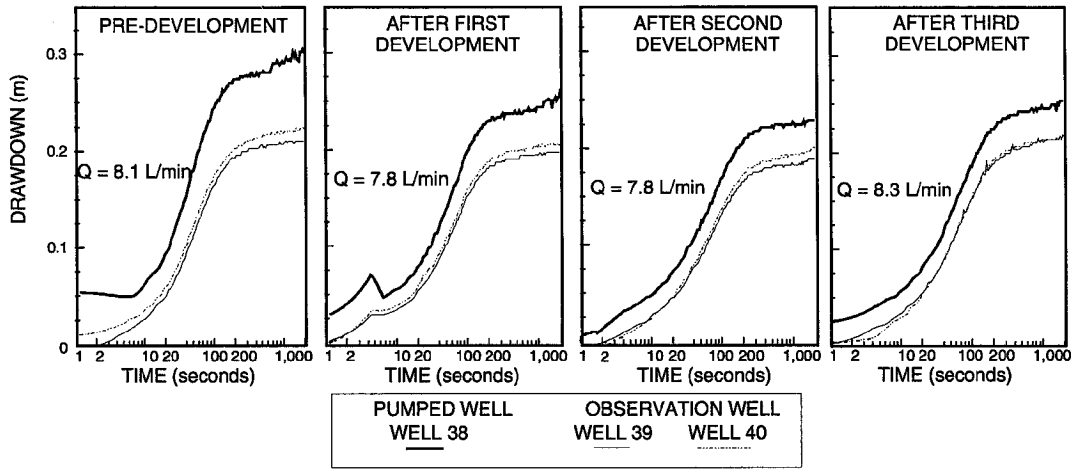

Figure V-5. Induced flow profiles after successive well development.



### WELL 38 - ARTIFICIAL FILTER PACK



### WELL 39 - AUGER HOLE

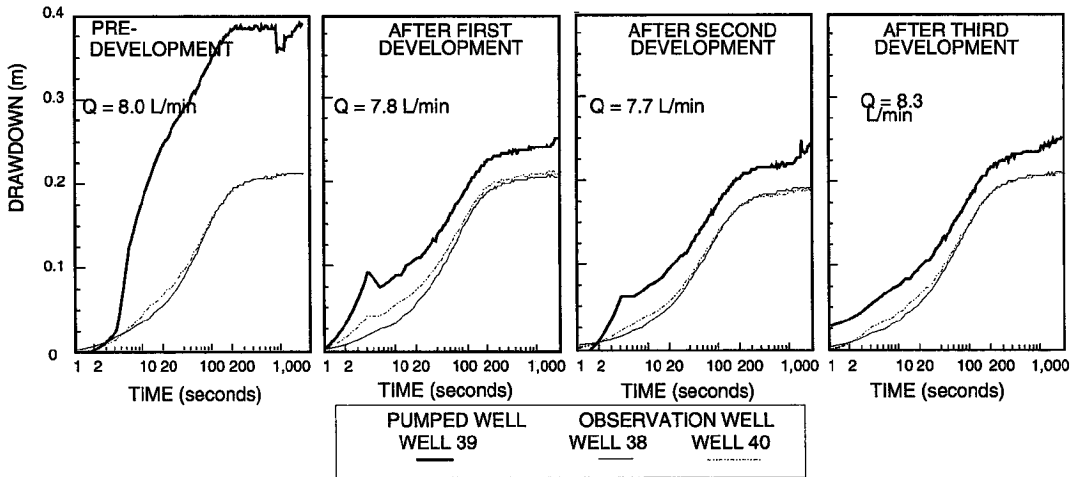

### WELL 40 - ROTARY WASH

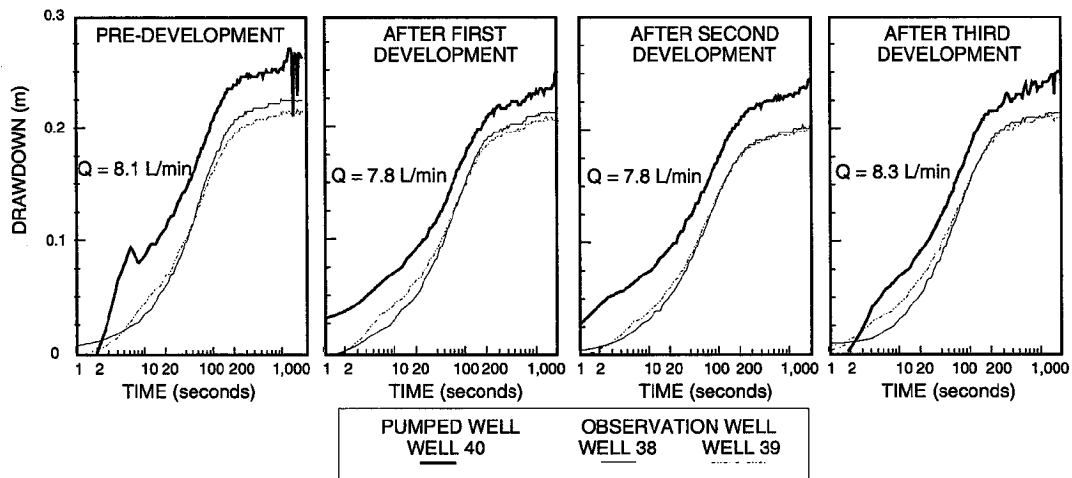

Figure V-6. Effect of well development on the drawdown values for pumping tests at the 38-39-40 well cluster.

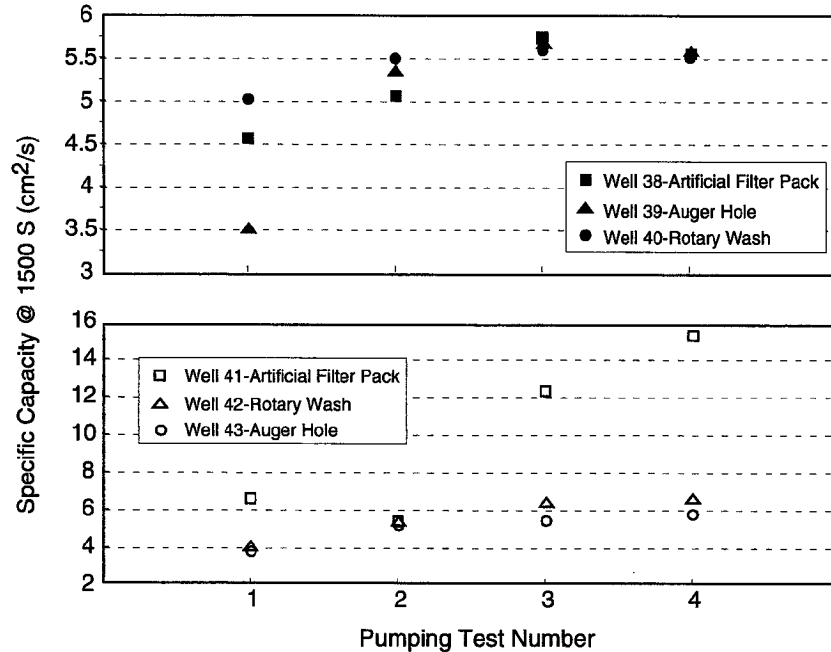

Figure V-7. Comparison of specific capacities at different wells.

30 s. Values of early-time transmissivity (Figure V-8, Table V-2) only increased with successive well development. These increases are interpreted as reductions in positive skin effects. There are no similarities evident for early-time transmissivity increases among wells of a particular construction type. However, well cluster 38-39-40 exhibits increases in early-time transmissivity values that are up to an order-of-magnitude less than estimates for well cluster 41-42-43. This appears to be a reflection of the low transmissivity region in which cluster 38-39-40 resides. The geometric means for early-time transmissivity values were 1.6 cm<sup>2</sup>/s and 3.2 cm<sup>2</sup>/s for well clusters 38-39-40 and 41-42-43, respectively. These averages are approximately ten times lower than the transmissivity values measured at late times, and are in good agreement with that of 3.6 cm<sup>2</sup>/s calculated by Young (1991a,b) for early-time slopes from fifty-seven single-well pumping tests and thirty-one slug tests at the 1-Ha test site.

#### V-4. Summary

A series of flowmeter tests were conducted at Columbus Air Force Base to investigate the effects of well construction and development methods on flow distributions and drawdown responses in a highly heterogeneous aquifer. Two well clusters were installed 60 m apart. Each well cluster included three 5.1-cm diameter PVC wells installed using different drilling techniques. The three installation techniques included modified rotary wash method, a 19.4-cm hollow-stem auger method, and a 27.0-cm hollow-stem auger method using an

artificial filter pack in well construction. Differences in local-scale geohydrology are immediately apparent from observation of the ambient flow profiles. At one well cluster, all three wells exhibit only downward ambient flow. At the other well cluster, upward ambient flow was measured.

The test results show that well development has a significant impact on increasing the magnitude of ambient flows. At several vertical zones, the directions of ambient flow changed because of well development. The artificial filter packed and rotary wash wells displayed the greatest changes in ambient flow profiles following initial well development by overpumping and backwashing. The largest changes for the augered wells with a natural filter pack occurred after the second well development, which included swabbing with a surge block accompanied by overpumping and backwashing.

Among the ambient flow profiles, those from the rotary wash wells had the least sensitivity to well development beyond the initial development. At the two rotary wash wells, the ambient flow profiles stabilized after the initial well development. At the "19.4-cm augered" wells and one of the augered wells with an artificial filter pack, the ambient profile patterns remained similar after the initial well development, but the magnitude of the flow rates differed. The data clearly indicate that some type of well development is necessary to obtain useful flowmeter data for ambient conditions, and suggests that the amount and method of well development depends on the well type and aquifer properties.

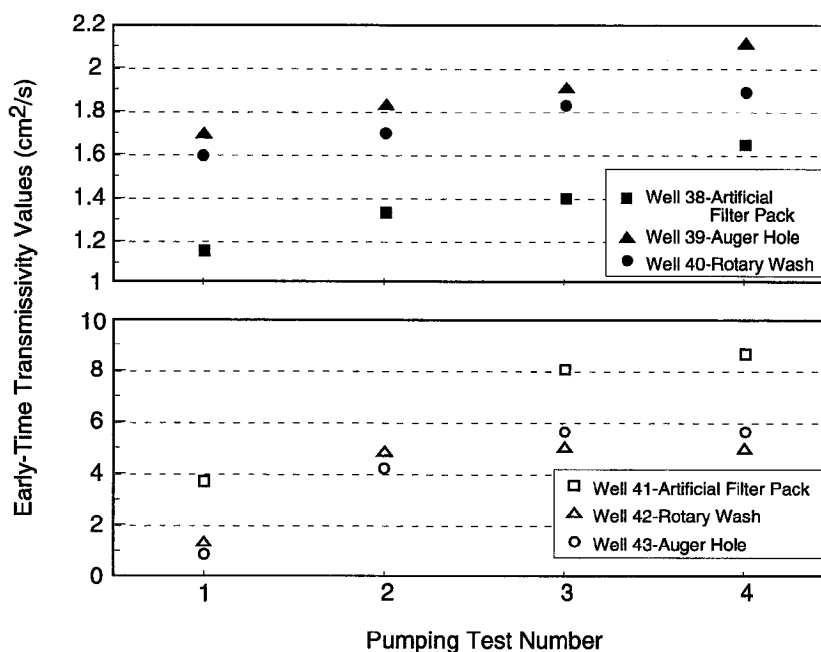

Figure V-8. Calculated transmissivities using early time data.

Table V-2. Early-Time CJS� Transmissivity Values

Well No.	Initial T (cm²/s)	Final T (cm²/s)	Percent Increase
38	1.2	1.7	42
39	1.7	2.1	25
40	1.6	1.9	18
41	3.8	8.8	129
42	1.4	4.9	242
43	0.9	5.6	494

The flowmeter results for pumping conditions produced conclusions similar to those obtained for the ambient flow conditions. However, two differences were observed. The first difference was a convergence to a stabilized flow profile for all of the well types. The second was the effect of the well cluster locations on the relative differences among the flow profiles. One well cluster displayed the greatest flow profile changes between the “pre-development” and “1st development.” The other well cluster showed the greatest differences between profiles for “1st development” and the “2nd development.”

At several elevations in the “pre-development” profiles, a decrease in net differential flow occurred with increasing elevation. For this decrease to occur, vertical flow established

within the well must temporarily exit the well. This might occur near regions where voids existed in the well annulus and/or the flowmeter caused significant blockage of incoming flow. The flow bypass problem can be lessened by creating a more uniform packing in the well annulus. In subsequent tests after well development, the frequency and magnitude of the flow bypass problems were greatly reduced.

For each flowmeter test, the drawdown data in the pumped well were analyzed using the CJS� method to estimate transmissivity. Typically, the drawdown response was characterized by a linear slope at early times (<50 s) that was about five to twenty-five times steeper than the late slope (after 100 s). The early slope values are reflective of the disturbed aquifer material near the well. The late-time values better represent undisturbed aquifer material at radial distances further away from the well. The CJS� analysis shows that the transmissivity values calculated at early times only increased with additional well development. Although positive skin effects were not eliminated, these results indicate that the effects were significantly reduced.

## Chapter VI Field Studies of Well Construction and Development at Mobile, Alabama

### VI-1 Description of Test Site

#### a. Site Location

The well field is located at the Barry Steam Plant, which is owned and operated by the Alabama Power Company. Geographically, it is approximately 32 km north of Mobile, Alabama.

#### b. Aquifer Characteristics

The surface is composed of a low terrace deposit of Quaternary age consisting of interbedded sands and clays that have, in geologic time, been recently deposited along the western edge of the Mobile River. The sand and clay deposits (Figure VI-1) extend to a depth of 61 m where the contact between the Quaternary and Tertiary formations is located. Below the contact are deposits of the Miocene series that consist of undifferentiated sands, silty clays, and thin-bedded limestones extending to an approximate depth of 305 m.

The shallow subsurface consists of fluvial sediments with a confined aquifer in the bottom 20 m of the Quaternary sediments. The aquifer is confined above and below by clay bearing strata that extend laterally for several thousands of meters or more. The upper confining layer is located about 40 m deep, and the thickness of the aquifer is relatively constant at about 20 m. The piezometric surface for the confined aquifer ranges from land surface elevation to two or three meters below land surface depending on seasonal and climatic conditions. In general, the confined aquifer matrix may be described as a medium sand with silt and clay fractions ranging from one percent to fifteen percent by weight.

#### c. Well Installation

Four observation wells at the Mobile test site were designed to provide two distinct environments for construction and development studies. Two of the wells (Figure VI-2) were deep wells and were installed to depths of 60 m, with fully-penetrating screens in the confined zone between 40 m and 60 m. The other two wells were shallow wells drilled in the

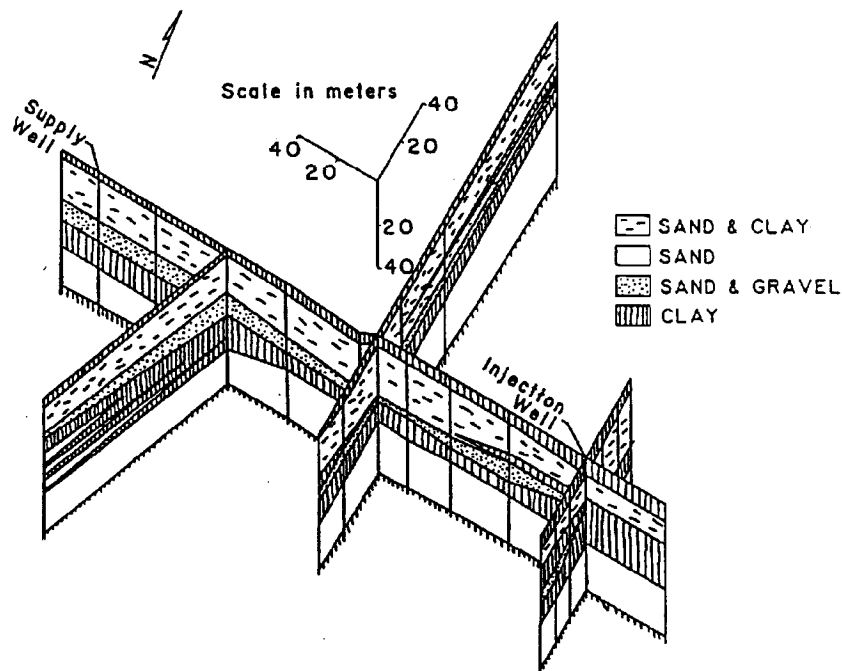

Figure VI-1. Vertical cross-sectional illustration of the subsurface hydrologic system at the Mobile site.

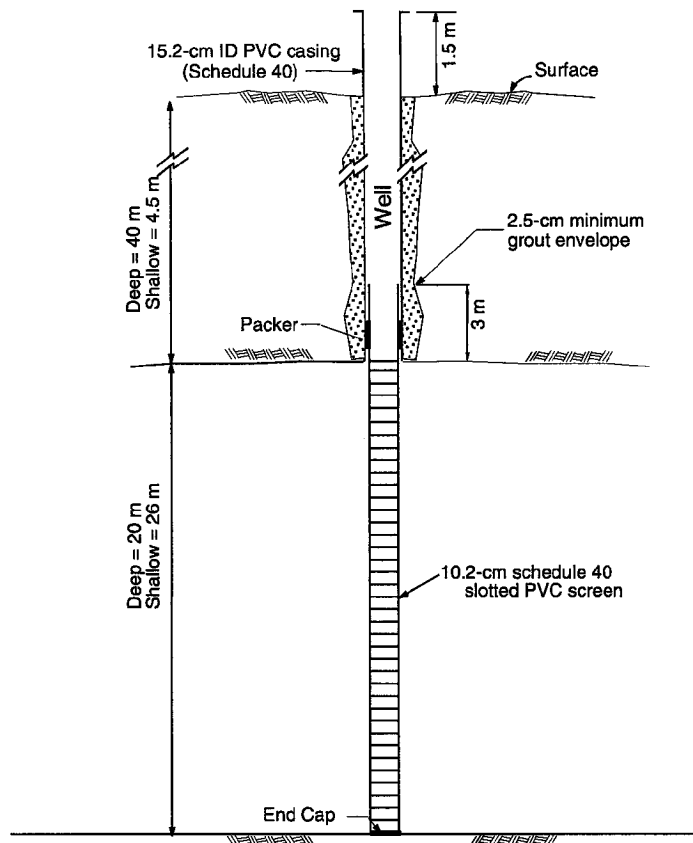

Figure VI-2. Schematic diagram providing the details of the shallow and deep wells constructed at the Mobile site. Well casing and well screen are the same dimension and schedule. The only difference is the depth dimensions of the casing and screen.

sand, gravel, and clay strata (Figure VI-1) to a depth of 30 m and screened between 4.5 m and 30 m. The layout of the wells is in a 10 m x 10 m square arrangement with a well positioned at each corner. The designations for the wells are A and B for the shallow wells, and C and D for the deep wells. During construction, a portion of the installed casing of well D was fractured allowing sediment to enter the well. Thus, well D was then considered non-functional and removed from the study. All wells were installed using the direct circulation rotary drilling method. The shallow wells were drilled to accommodate a 15.2-cm schedule-40 PVC casing from ground surface to an approximate depth of 4.5 meters. The casing was sealed in place by cement grout and left undisturbed for 12 hours. Following the 12-hour period, the well was drilled to its final depth (30 m) to receive a 10.2-cm slotted schedule-40 PVC screen. No artificial filter pack material was used in the construction of these wells. A 3-m section of 10.2-cm PVC pipe was attached to the screen and extended upward approximately 3 m from the bottom of the casing. The annular space between the pipe and the 15.2-cm casing was closed by a packer. The deep well was constructed in the same manner using the same size casing and screen. After completion, each well was developed by forcing air into the casing to agitate, surge, and lift the water; mildly cleaning the well of drilling fluid, cuttings, and fines.

## VI-2 Test Description

The direct rotary drilling method used a mud slurry as a drilling fluid during the construction operation. Site conditions necessitated use of this method. However, the mud cake has a deleterious effect on the production capacity of the well due to its very low hydraulic conductivity. Development was necessary to remove the mud cake to the extent practical. In this study, air development was used to surge compressed air into the casing of each well for approximately fifteen minutes. The key question, of course, was how much development was necessary to remove the mud without affecting the hydraulic properties of the aquifer materials outside the well? This was the main question studied in the field tests reported below.

The series of testing performed on wells A, B, and C were identical with a few exceptions and consisted of four sets of tests (Table VI-1). The first set consisted of an ambient flow test and a pump-induced flow test which occurred before any well development. The second, third, and fourth sets were identical in procedure; air development, followed by an ambient flow test, followed by a pump-induced flow test. Some pump-induced flow tests were repeated following an overnight rest period (without a repeat of the air development)

Table VI-1. Pump-Induced Flow and Ambient Flow Tests Performed on Wells A, B, and C

Ambient Flow Tests	Well A	Well B	Well C
Pre-development	—	X	X
1st Development	—	X	X
2nd Development	X	X	X
3rd Development	X	X	X
<b>Pump-Induced Flow Tests</b>			
Pre-development	X	X	—
1st Development	X	X	X
2nd Development	X	X	X
3rd Development	X	X	X
<b>Repeat Tests (Overnight)</b>			
<b>Ambient Flow Test</b>			
1st Development	—	X	—
<b>Pump-Induced Flow Tests</b>			
1st Development	—	—	X
2nd Development	X	—	—

to determine if the results were repeatable. The ambient and pump-induced flow tests were conducted in the same manner as far as flowmeter position was concerned. The electromagnetic flowmeter was lowered to the bottom of the borehole where the first measurement (zero reference) was taken. Subsequent flow measurements were recorded as the flowmeter was raised at 1.52-m increments until reaching the top of the screen. The pump-induced flow was maintained at a constant rate and averaged about 34 L/min for all tests.

### VI-3 Test Results

#### a. Shallow Well A

Well A served as the standard for measurement procedures at the remaining wells. Due to the experimental function of this well, ambient testing was not performed until after the second development. Pumping tests were completed from the pre-developed stage through the three stages of development. Net flow and ambient flow plots (Figure VI-3), as well as differential net flow charts (Figure VI-4) of the flow distribution following the second and third developments, are presented to illustrate the effects of a third air-development.

The ambient flow curve shown (Figure VI-3a) indicates that either the natural vertical flow has been altered somewhat by applying a third development, or the hydraulic conditions causing the ambient flow have changed. The natural flow has decreased by varying amounts at every measurement point except the uppermost point, and the greater shifts occur between depths of 15 m and 27 m. For example, at a depth of 18.3 m the ambient flow after the second development was 3.6 L/min, and at the same depth, after the third development it was 2.9 L/min, an eighteen percent drop. It is possible that variable hydraulic stresses on the aquifer resulted in the shifts rather than changes in well development. Several chemical processing plants and an electrical power plant, some of which place huge water withdrawal demands on the aquifer, are located within a 5-km radius of the testing site.

The net flow plot (Figure VI-3b) shows the pump-induced flow data that have been corrected for the ambient flow measurements. Both data plots begin at 27.4 m with nearly the same nominal flow, and increase in tandem to about 15 m. At this point, the plots indicate that at least some variable development has occurred between depths of 6 m and 14 m. The 4.2 L/min flow variation at 9.1 m is a seventeen percent increase, but there is no clear evidence of its cause. This shift

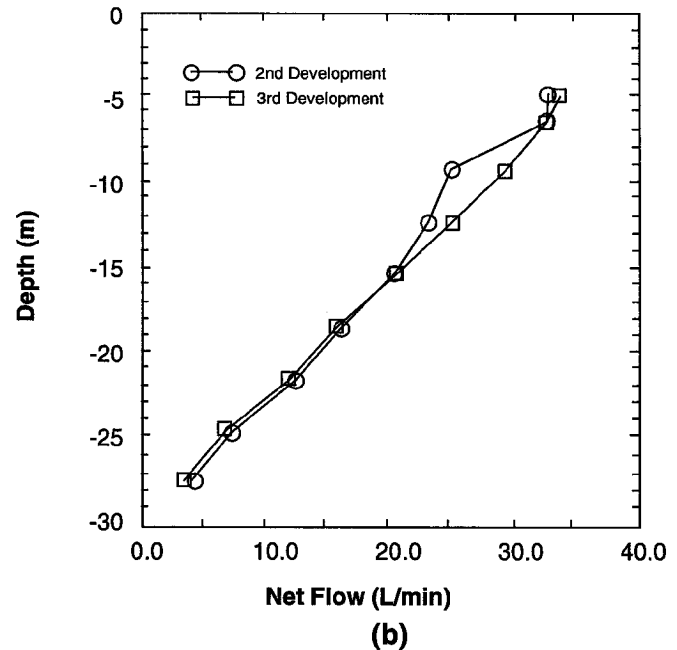
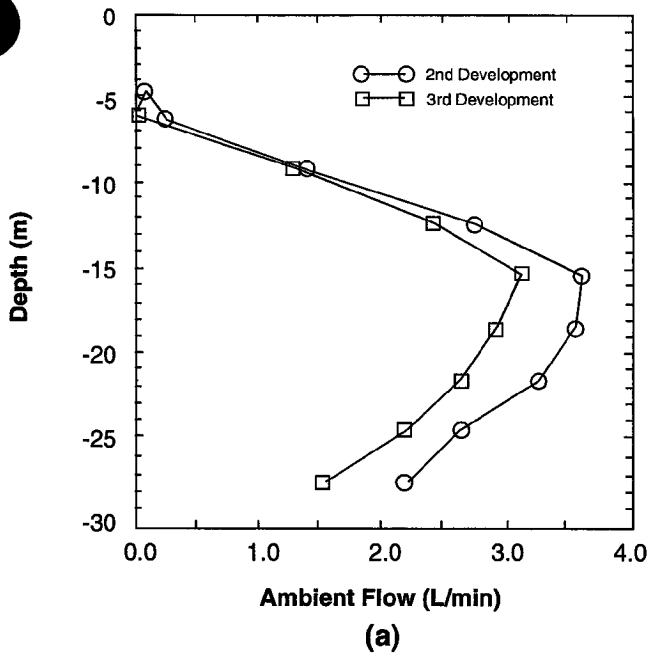

Figure VI-3. (Well A) (a) Ambient flow as measured by the EM flowmeter and (b) net flow (total flow - ambient flow). Data sets were obtained after the 2nd and 3rd developments.

again may be attributable to external stresses placed on the quifer.

The differential net flow (DNF) logs (Figures VI-4) provide a picture of successive development effects. Each bar represents the amount of water released from the aquifer and entering a segment of the screen. Adding the flow of each segment should equal the net flow at the uppermost measurement station. The screened segment in this case is the length of the measurement interval. It is important to note that a comparison of DNF charts at different stages of development can be made only when the induced pumping rate  $Q_p$  is common among the tests.

Presumably, one would like to see a "shift and hold" pattern occurring after the first or second development. Shown in Figures VI-4a and 4b are the DNF measurements taken after the second development for two time periods. There is not a great deal of similarity in the two charts which indicates that the well needs further development to stabilize, or there is interference caused by stresses other than those produced by the pumping test. In comparing the results of the second development with the results obtained after the third development, there appears to be significant correlation. The upper and lower segments have relatively low DNF with the bulk of the DNF between 6.1 m and 21 m.

### b. Shallow Well B

Well B is a shallow well having the same dimensions and construction as well A and is located approximately 10 m

away. Each of the test series (pre-development through third development) was performed on this well for ambient and pump-induced flow. In addition, an ambient flow test after the first development was repeated after an overnight waiting period. The ambient flow data (Figure VI-5a) shows shifts in the flow profile after successive developments. In measurements obtained prior to development, the ambient flows are downward in the extreme upper and extreme lower sections of the screen, and upward elsewhere. After the first development, the downward flows disappear except for the extreme upward measurement point after the third development. Noteworthy at this point are the relatively high ambient flows in the mid-range of the screen when compared to the pump-induced flow rate of 34 L/min. For example, after the third development a measurement taken at a depth of 20 m recorded a 7 L/min ambient flow; this is about twenty percent of the pumping rate during the pump-induced flow test. The "shift and hold" pattern is quite evident in the measurements taken after the first and second development. Although a further increase in ambient flow is observed after the third development, this finding is not unusual considering the aquifer character and the sensitivity of ambient flow to external stresses. However, the cause of the large shift after the third development is not certain.

The net flow curves (Figure VI-5b) indicate that successive developments had a measurable effect on the well. Each successive development showed slight decreases in net flows while maintaining the profile. The net flow curves correlate well with the ambient flow curves in that there were little changes in the upper and lower segments of the screen, and much larger

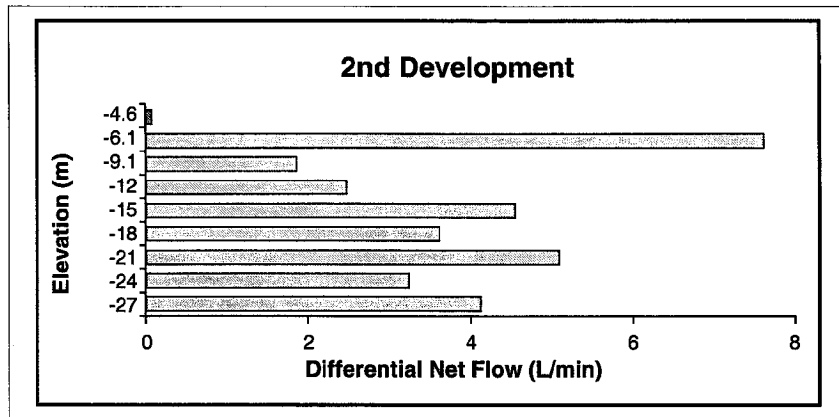

(a)

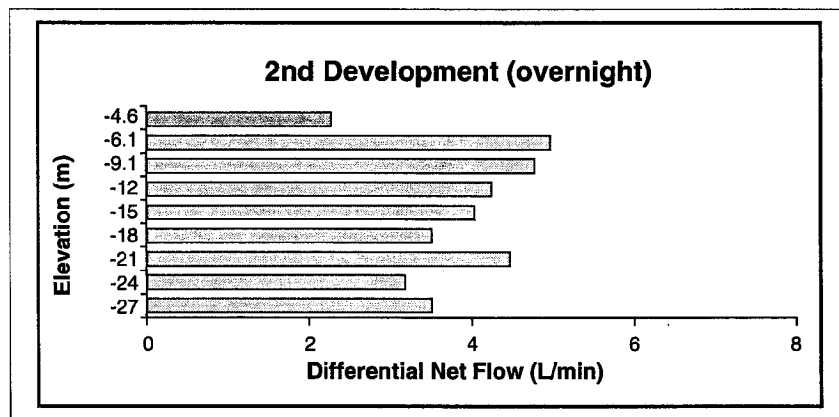

(b)

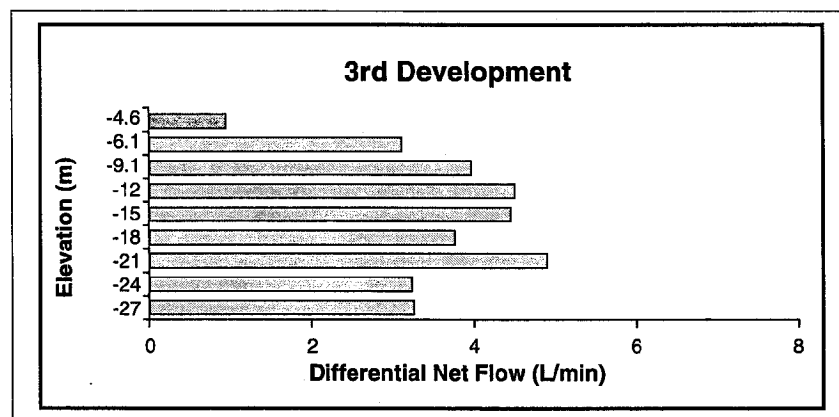

(c)

Figure VI-4. (Well A) Differential net flow (a) obtained after 2nd development, (b) obtained after 2nd development and an overnight waiting period, and (c) obtained after 3rd development.



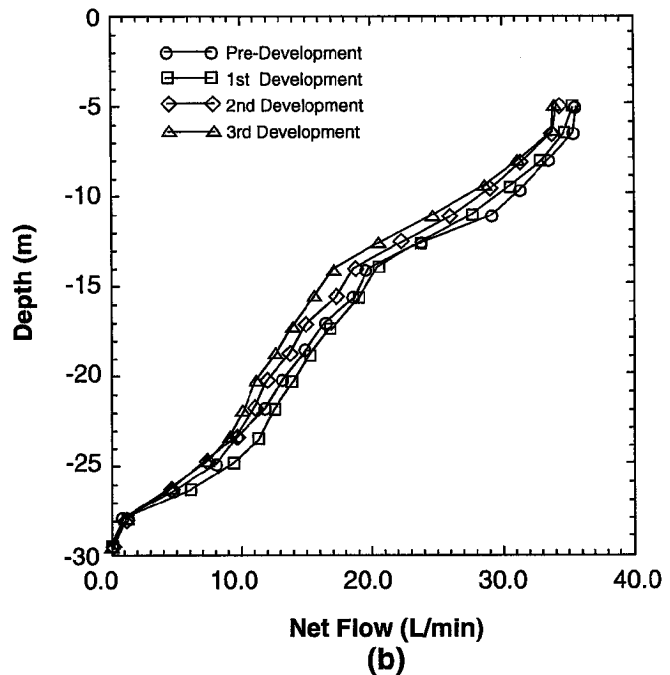
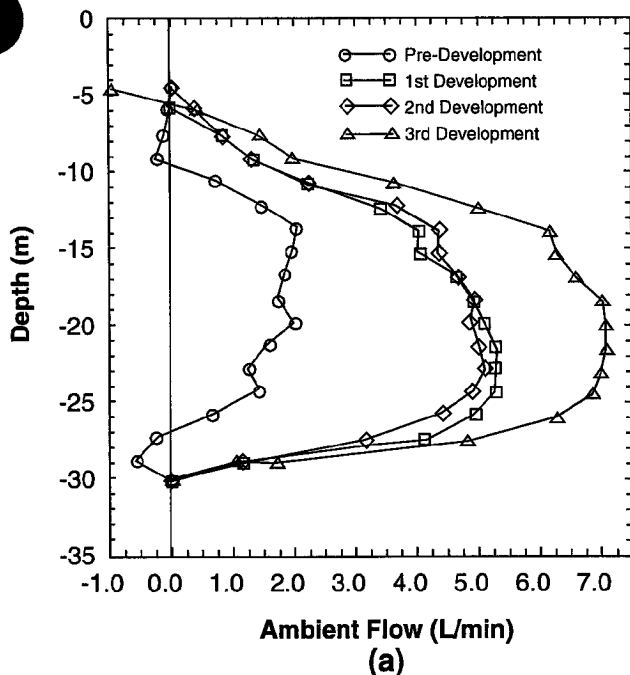

Figure VI-5. (Well B) (a) Ambient flow as measured by the EM flowmeter and (b) net flow (total flow - ambient flow). Data sets were obtained prior to development and after 1st, 2nd, and 3rd developments.

changes at the mid-screen level. It appears that for well B, ambient flow varied more than net flow, as seen between pre-development, first development, and third development.

The largest differences in the distribution of DNF (Figure VI-6) occur between pre-development and first development, while only minor differences occur after subsequent developments. In addition, the large shift in ambient flow occurring after the third development is not obvious in the corresponding DNF chart. This result supports the conclusion that the ambient flow variations must be removed from the total flows to obtain consistent results. Since DNF reflects the flow entering a screen segment due to pumping, it is logical that pump-induced flow would be less responsive to development than ambient flow.

For well B, an additional test was performed after the first development to determine the effects of an overnight time period on the ambient flows. No additional development was performed between these tests. The results (Figure VI-7) are quite similar to those obtained the previous day.

### c. Deep Well C

The ambient flow in the confined aquifer screened by well C would be expected to be much smaller than those in the unconfined or semi-confined sediments above. It is known also that local industries placed less external demand on this

aquifer than the shallow aquifers. The maximum ambient flow (Figure VI-8a) was about 1.75 L/min and was recorded prior to the first development. This flow is in contrast to 7 L/min recorded as maximum ambient flow in shallow well B. Development of well C resulted in irregular shifts of the ambient flows, and the tendency was toward the aquifer having no natural vertical flows. This result is clearly seen in the measurement taken after the third development where the majority of ambient flows are less than approximately 0.5 L/min.

Variability in the net flow curves following the first, second, and third developments is generally small throughout the range of measurements (Figure VI-8b). It appears that most development took place in the upper three measurement stations, which corresponds to the same area where the larger shifts in the ambient flow occur.

The DNF profiles for well C are shown in Figure VI-9. Although the pumping test data before the first development were not available, the relevant sequential test data following that stage are presented. A moderate change in the profile is observed through the progression of developments. Some of the flow in the upper half of the confined aquifer has shifted to the bottom half, though most of the flow still remains in the upper portion. The DNF chart displaying the pump-induced flow test after an overnight period has the same general distribution as the first development pump-induced flow test performed the previous day.

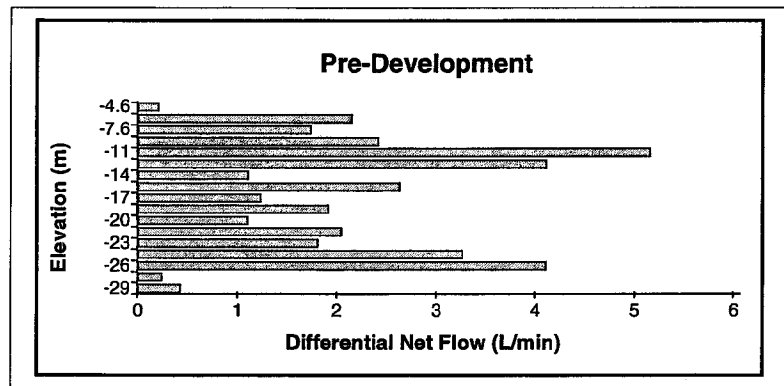

(a)

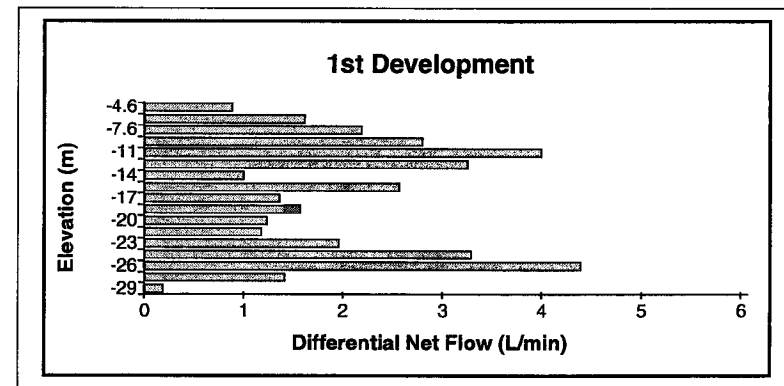

(b)

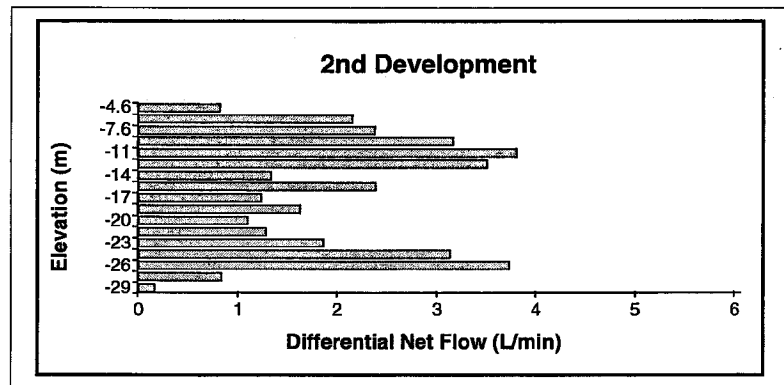

(c)

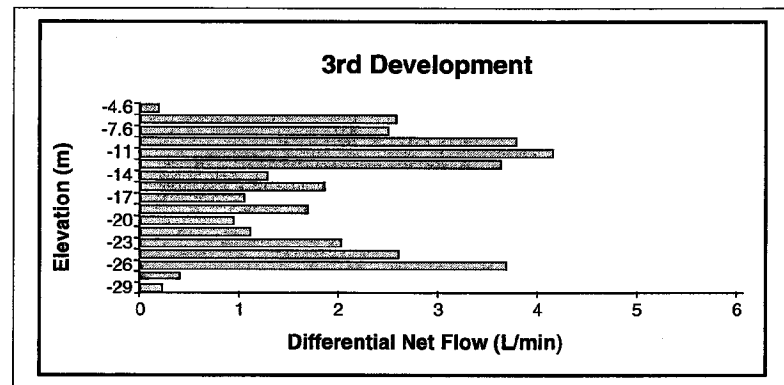

(d)

Figure VI-6. (Well B) Differential net flow obtained (a) prior to development, (b) after 1st development, (c) after 2nd development, and (d) after 3rd development.

## VI-4 Summary and Discussion

As noted earlier, the key question is how much development is necessary to return disturbed porous media surrounding a well to a near-natural state. This study has presented some initial observations of the effects of successive developments on three wells. Two wells were shallow and screened in phreatic or semi-confined aquifers, and the third was a deeper, fully-penetrating well, screened through a confined aquifer.

The results of tests on well A were inconclusive, in part because of a lack of ambient flow data from pre-development and first development stages. In addition to the lack of data, a good correlation between the flow distributions after second and third development did not exist as shown by the differential net flow charts. This was probably due, in part, to the experimental technique used at this well. There was, however, a similarity between a test repeated after the second development and the test performed after the third development. This similarity indicates that the first test may have been influenced by factors other than those imposed by the pump-induced flow.

The differential net flow charts for well B show that the first development made a significant difference in the vertical distribution of flow to the well. Tests after the first, second, and third developments resulted in quite similar DNF profiles.

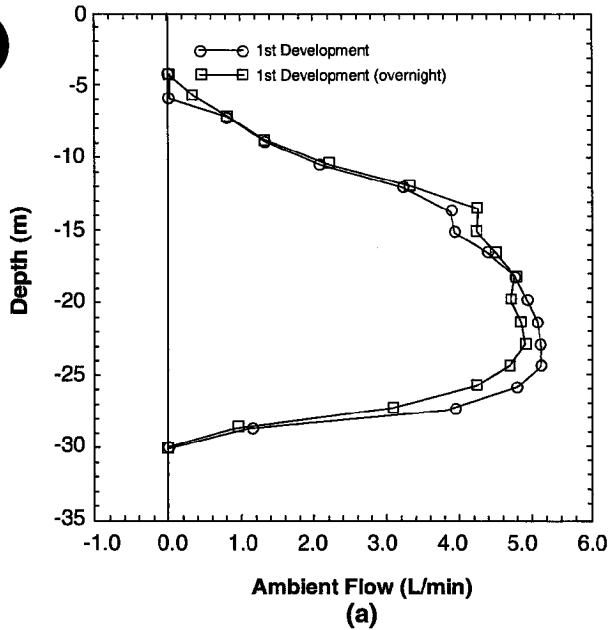

Figure VI-7. (Well B) Ambient flow obtained after the first development and repeated after an overnight period.

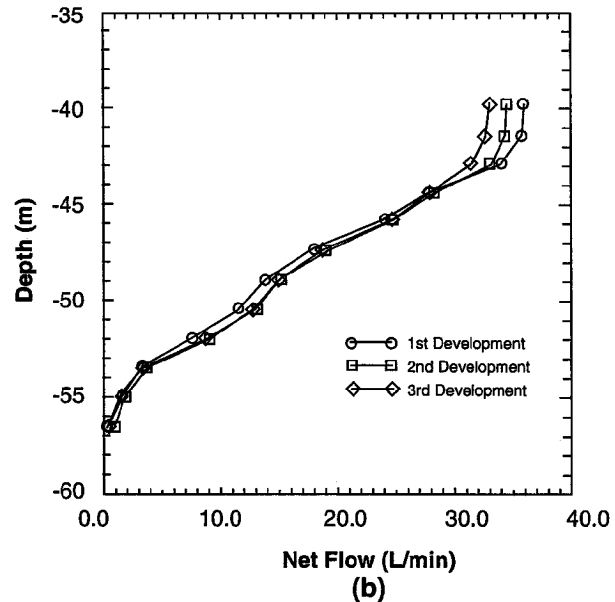
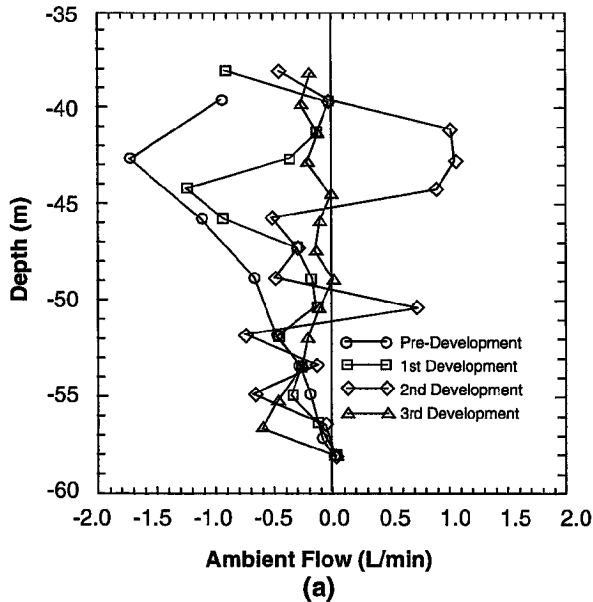
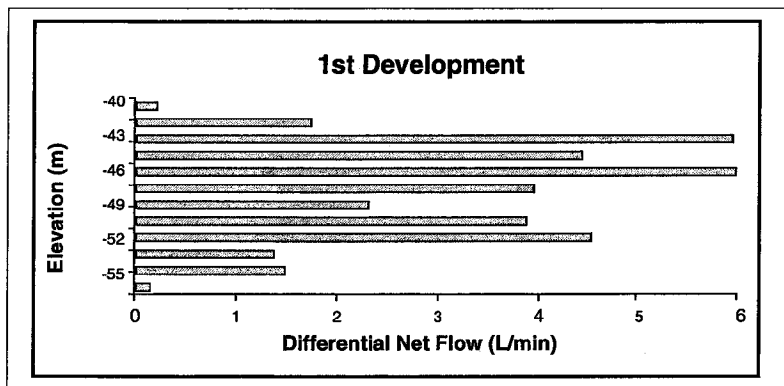
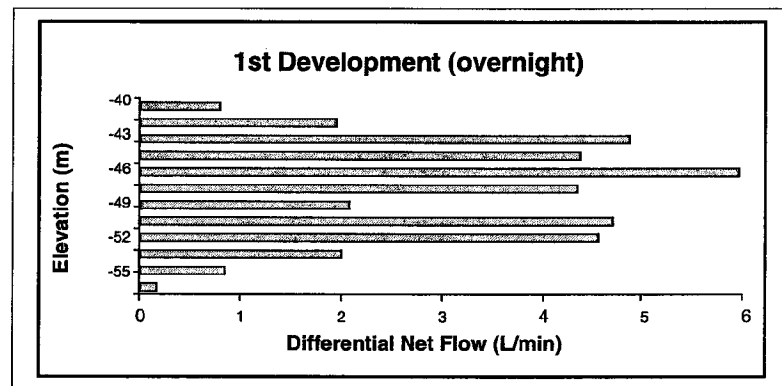

Figure VI-8. (Well C) (a) Ambient flow as measured by the EM flowmeter and (b) net flow (total flow - ambient flow). Data sets are obtained prior to development and after the 1st, 2nd, and 3rd developments for the ambient flow and after the 1st, 2nd, and 3rd developments for net flow.



(a)



(b)

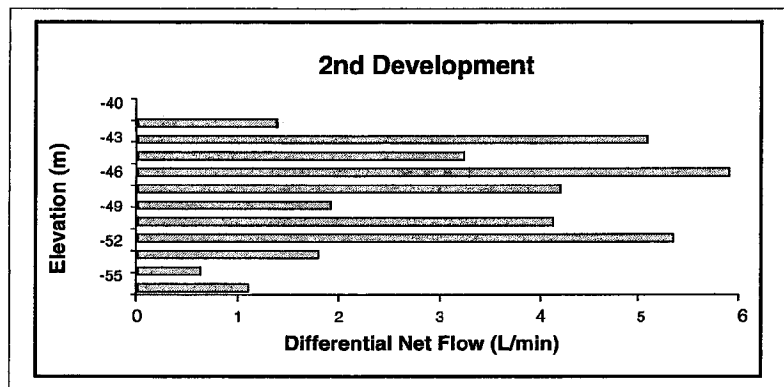

(c)

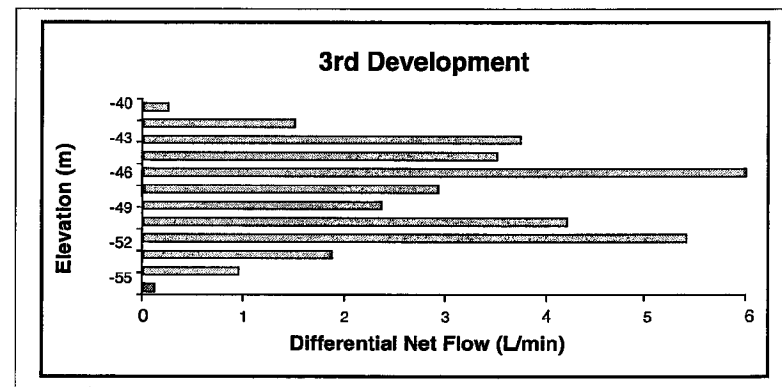

(d)

Figure VI-9. (Well C) Differential net flow obtained after (a) 1st development, (b) 1st development and an overnight period, (c) 2nd development, and (d) 3rd development.

---

However, as would be expected, the ambient flow data were less stable. Part of the irregularity may be attributable to the varying withdrawal demands placed on the aquifer by the local industry.

The third well was screened in the confined aquifer, presumably more shielded from the hydraulic stresses beyond experimental control. The ambient flow in well C was small compared to the other wells, although measurable shifts were observed after each development. The irregularity of ambient flows may be due more to experimental "noise" than to any significant change in the natural flow. The differential net flow charts were moderately dissimilar after each development, indicating that slight adjustments were still being made to the media even after the third development.

The results of the tests at the Mobile site were generally similar to those obtained at the Columbus site. Ambient flow profiles at both sites were more sensitive to effects such as the state of well development and minor changes in hydraulic stresses than induced flow profiles. In addition, the state of well development appeared to vary with differences in aquifer materials, as is expected.

## Chapter VII Case Studies

### VII-1 Field Applications

Issues related to aquifer heterogeneity are particularly important at sites where contaminant transport and fate will be characterized or subsurface remediation will be performed. A vertical-component borehole flowmeter may be used to investigate several aspects of ground-water flow relevant to monitoring and remedial design (Table VII-1). In order to demonstrate the utility of flowmeter investigations for gaining quantitative insight into aquifer characterization, results from several borehole flowmeter applications are described.

**Table VII-1. Characterization Objectives for Borehole Flowmeter Studies**

Measured Flow Log	Phenomena That Can Be Investigated
<i>Ambient Conditions</i>	<ul style="list-style-type: none"> <li>• Direction of the vertical hydraulic gradient</li> <li>• Cross-connection among geological units intersected by a well</li> <li>• Active fracture locations/zones in bedrock</li> </ul>
<i>Pumping Conditions</i>	<ul style="list-style-type: none"> <li>• Active fracture locations in bedrock</li> <li>• Horizontal hydraulic conductivity distribution</li> <li>• Identify zones of preferential flow and, potentially, contaminant transport for design of monitoring and remediation networks</li> </ul>

### VII-2 Columbus AFB, Mississippi

As discussed in Chapter V, borehole flowmeter tests were performed at two sites on the Columbus Air Force Base (CAFB). The two sites overlie a highly heterogeneous, unconsolidated and unconfined fluvial aquifer, are about 60 m apart, and are located approximately 6 km east of the Tombigbee River and 2.5 km south of the Buttahatchee River. Seasonal water table fluctuations range from 2 m to 3 m. The aquifer is composed of approximately 10 m of terrace deposits consisting primarily of poorly- to well-sorted, sandy gravel and gravelly sand that often occur in irregular lenses and

layers. Visual inspection of the facies exposed at a quarry located a few kilometers from the site shows a complex series of lenses with significantly different physical and hydrological properties. The terrace aquifer is unconformably underlain by the Cretaceous-age Eutaw Formation, an aquitard consisting primarily of marine clay and silt.

The Electric Power Research Institute performed the MADE study (Betson et al., 1985) at the first test site, which covers about 8 Ha. The MADE experiment included a network of 258 multilevel sampling wells designed to monitor a 20-month, rapid injection, natural gradient tracer study. Boggs et al. (1992) provide a review of the tracer experiment. The dominant feature of the tracer plume is a highly asymmetric concentration distribution in the longitudinal direction. At the conclusion of the experiment, the more concentrated region of the plume remained within approximately 20 m of the injection point, while a more dilute portion extended downgradient a distance of more than 260 m. In certain respects, the plume configuration would appear to be the result of a continuous tracer injection rather than the rapid injection that actually occurred.

One explanation for the skewed plume is that the tracer was slowly bleeding from a zone of relatively low hydraulic conductivity into relatively conductive zones, and thereafter moved rapidly downgradient. This explanation is supported by the hydraulic conductivity values from borehole flowmeter tests performed by Boggs et al. (1989) and Rehfeldt et al. (1989b). These particular flowmeter tests were performed primarily with an impeller flowmeter. The electromagnetic flowmeter was used only to supplement the basic data. Figure VII-1 shows a vertical cross section of the spatially correlated hydraulic conductivity profile along the longitudinal axis of the plume. The profile shows that the tracer was injected into a region of relatively low transmissivity and 25 m upgradient of a large region of relatively high transmissivity that contained several conductive lenses. Thus, the flowmeter measurements provide the basis for understanding the major characteristics of the tracer experiment.

The first major application of the electromagnetic flowmeter in a granular aquifer was at the second CAFB site, which covers about 1 Ha. This is the location of the tests described in Chapter V. Numerous pumping, flowmeter, and recirculating tracer tests were conducted using thirty-seven fully-screened wells. Shown in Figure VII-2 are areal distributions for the depth-averaged hydraulic conductivity values for the uppermost and lowermost two meters of the

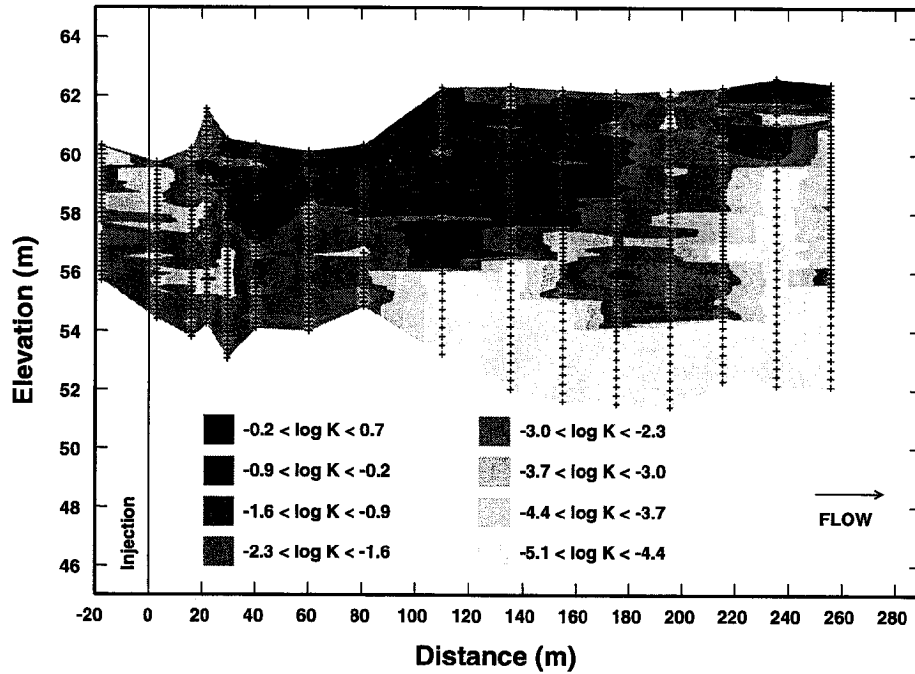

Figure VII-1. Vertical profile of hydraulic conductivity values along the longitudinal axis of the MADE tracer plume.

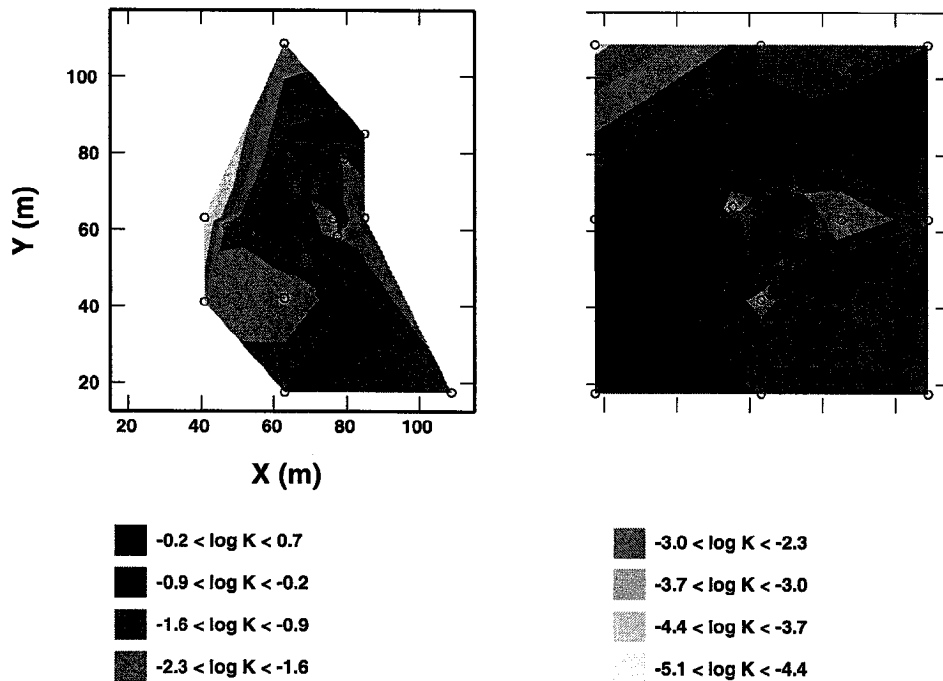

Figure VII-2. Depth-averaged hydraulic conductivity values for the lowermost 2 m (left) and the uppermost 2 m (right) of the unconfined aquifer below the 1-Ha test site at Columbus AFB.

saturated aquifer. In the upper portion of the aquifer, a band of high hydraulic conductivity crosses the test site. The location of this band matches the location of a former river meander shown in a 1956 aerial photograph of the site (Figure V-1). In the lower portion of the aquifer, the only non-clay material occurs in a depression of the lower aquitard near the center of the site. The S-shaped band of material with a relatively high hydraulic conductivity in the central portion of the figure is most likely sands and gravel deposited by an earlier river system. Thus, flowmeter data at the 1-Ha test site provided sufficient detail to delineate the sand and gravel beds of two former river channels. Being able to observe correlations between the hydraulic conductivity field and the geological/depositional history of a study site provides the type of detailed data required to understand flow and transport in heterogeneous aquifers.

### VII-3 Oak Ridge National Laboratory, Tennessee

The electromagnetic borehole flowmeter has been used to characterize the ground-water flow patterns in fractured bedrock at the Oak Ridge National Laboratory (ORNL) (Moore and Young, 1992; Young et al., 1991). The laboratory is located in the Valley and Ridge physiographic province of the Appalachian thrust belt of eastern Tennessee. The geological units consist of fractured sequences of calcareous shale, siltstone, shaly limestone, and limestone, which typically dip at angles between 45° to 60° from horizontal.

Measurements at outcrops and on cores of the Conasauga Group show a density of 10-15 joints per meter in shale and 6-40 joints per meter in siltstone (Sledz and Huff, 1981). The joints and fractures are oriented parallel to the bedding planes, strikes, and dips of the lithologic units.

At ORNL, the electromagnetic flowmeter has been used in open boreholes and in boreholes with sand-packed PVC screens. In most of the deep boreholes, the measured ambient flow profiles in the wells indicate that cross-communication was occurring between different fracture zones. Figure VII-3 shows a profile of ambient flow where ground-water enters the well at a depth of about 100 m and exits at a depth of 41 m. The ambient flow is produced by natural upward hydraulic gradients, along with hydraulically active fractures at depths of 100 m and 41 m.

At most of the wells, the permeable vertical zones are typically greater than 30 cm, which is the minimum vertical distance required for a steeply dipping fracture (>60°) to cross through a 17-cm OD borehole, the size of most of the boreholes at ORNL. Analysis of flowmeter logs indicate that the orthogonal spacing between fractures is about 0.15 m to 0.44 m in the shallow bedrock, and about 0.44 m to 0.73 m in the deeper bedrock. Specific information regarding the location of fractures assists in correlating lithologic structure and hydraulically-significant fractures. Differences were observed in the flow profiles between different strata and regions. In some areas, a permeable flow zone is located near the top of bedrock. This zone was likely produced by

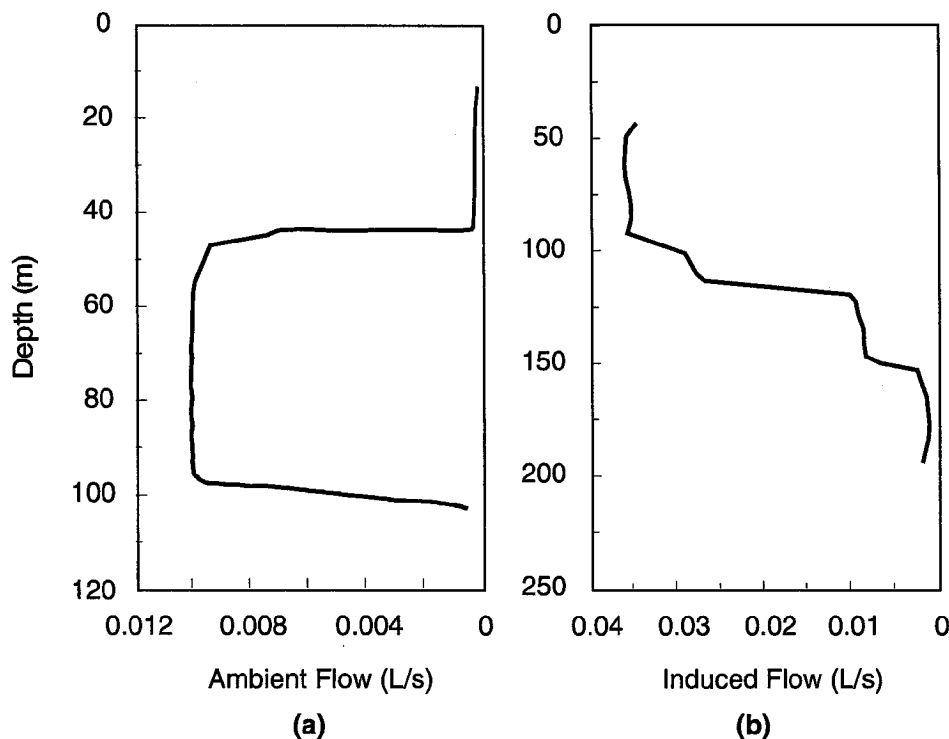

Figure VII-3. (a) Ambient flow distribution in a well and (b) the flow distribution induced by constant-rate pumping.



weathering and serves as a pathway for significant shallow ground-water flow toward valley streams.

At ORNL, newly drilled boreholes with depths near 500 m penetrate several fracture zones. In some cases, the different fracture zones contain ground waters of significantly different chemistry and from different recharge zones. Among the applications of the flowmeter data at ORNL is a refinement of the monitoring program based on the location of hydraulically active fractures. Once the hydraulically active fractures are located, specific borehole zones may be isolated so that selective monitoring can include fluids from fractures or fracture zones and matrix fluids with long residence times. These data may be used to identify changes in water chemistry with depth and water chemistry signatures associated with a particular rock type.

#### **VII-4 The Oklahoma Refining Company Superfund Site, Oklahoma**

The Oklahoma Refining Company (ORC) Superfund Site is located in Caddo County on the eastern edge of Cyril, Oklahoma. Site topography consists of low, rolling hills with a deeply incised drainage system. Soils are characteristically red silty clay loams with low to very low permeability. Alluvium and terrace deposits are present in and around old stream channel sediments. Soils are underlain by the Weatherford Member of the Cloud Chief Formation (gypsum) in the northwestern part of the ORC site, and the Rush Springs sandstone elsewhere. Ground water in the Weatherford commingles with that of the Rush Springs Sandstone, which is believed to act as an unconfined aquifer. The Rush Springs Sandstone consists of even-bedded to highly cross-bedded, very fine-grained, silty sandstone and outcrops on the eastern side of the ORC site (Bechtel, 1991).

Electromagnetic flowmeter field demonstrations were conducted at three pairs of ORC wells. One well pair consisted of wells NE-2 and NE-3, which lies in a region where gypsum overlies sandstone. Figure VII-4 shows the flow distributions for ambient and induced-flow conditions at well NE-2. The flow distributions for well NE-3 were very similar. The profile of induced flow indicates that about eighty percent of the total flow to the well originates from the upper thirty percent of the well screen. This result suggests that materials in the upper portion of the screened interval are more permeable than those in the lower portion.

The downward ambient flows indicate downward vertical hydraulic gradients and possible cross connection between different hydrostratigraphic units. At wells NE-2 and NE-3, about 0.2 L/min enters the well near the water table and migrates down the well, where it flows into the aquifer. Of the 0.2 L/min, about half of it enters the sandstone at a depth 18 m below the top of well casing (TOC). If the recharging ground water was contaminated, ambient flows in the well would accelerate the downward migration of ground-water contamination. If the recharging ground water was clean but the deeper ground water was contaminated, ambient flows in

the well could dilute ground-water contamination in the vicinity of well and in samples, hindering characterization of the ground-water contamination.

In the southeast quadrant of the site, flowmeter tests were performed on a well pair consisting of wells IBB-4 and SBB-36. The ambient flows at these wells (Figures VII-4) are upward. Well IBB-4 was a flowing artesian well at the time of the test. The flow profiles at well IBB-4 indicate that the source of the artesian ground water is a narrow zone near a depth of 36 m. Boring logs indicate that a 0.8-m thick siltstone layer exists at the 36-m depth, which appears to be the source of the artesian ground-water flow. Well SBB-36 shows two narrow zones of relatively high flow near depths of 13.5 m and 15.5 m. The limited flowmeter testing at the ORC test site provided valuable information related to aquifer heterogeneity and potential contaminant transport.

#### **VII-5 Gilson Road Superfund Site, New Hampshire**

The Gilson Road site at Nashua, New Hampshire, was originally a 2.4-Ha landfill for refuse and demolition material. In 1979, it became a site for disposal of other wastes. Ground-water contamination formed a plume over 450 m wide and 33 m deep, which was estimated to be moving at a rate of 0.6 m/day (Morrison, 1983). A bentonite slurry wall was constructed to contain the plume and the surface was capped with a synthetic membrane to prevent infiltration of rainfall. A ground-water pump-and-treat system was in operation for several years.

The Gilson Road site is underlain primarily by stratified, unconsolidated sand and gravel deposits of glacial origin. The permeable sand and gravel deposits are underlain by a thin, discontinuous, low-permeability glacial till unit, that is up to 3-m thick. Bedrock underlying the till is biotite schist of the Merrimack Group, which is differentially weathered and fractured across the site (Morrison, 1983).

Electromagnetic flowmeter tests were conducted at four monitoring wells and three recovery wells of the pump-and-treat remediation system. The recovery wells were designed to fully penetrate the drift and till overburden. None of the available well logs indicated intersection of the upper bedrock. In all three recovery wells, the measured flow (Figure VII-5) was significantly greater near the top of the well screen. These results may be due to use of a coarse-grained filter pack in well construction and may not be representative of actual site conditions. However, if the results are representative of the shallow hydraulic structure in this aquifer, they would indicate potential inefficiencies in the recovery of ground water from the lower portions of the overburden using these wells.

#### **VII-6 Mirror Lake, New Hampshire**

The Mirror Lake drainage basin is located in the Hubbard Brook Experimental Forest in the White Mountains of central New Hampshire. The drainage basin is a small, well-defined

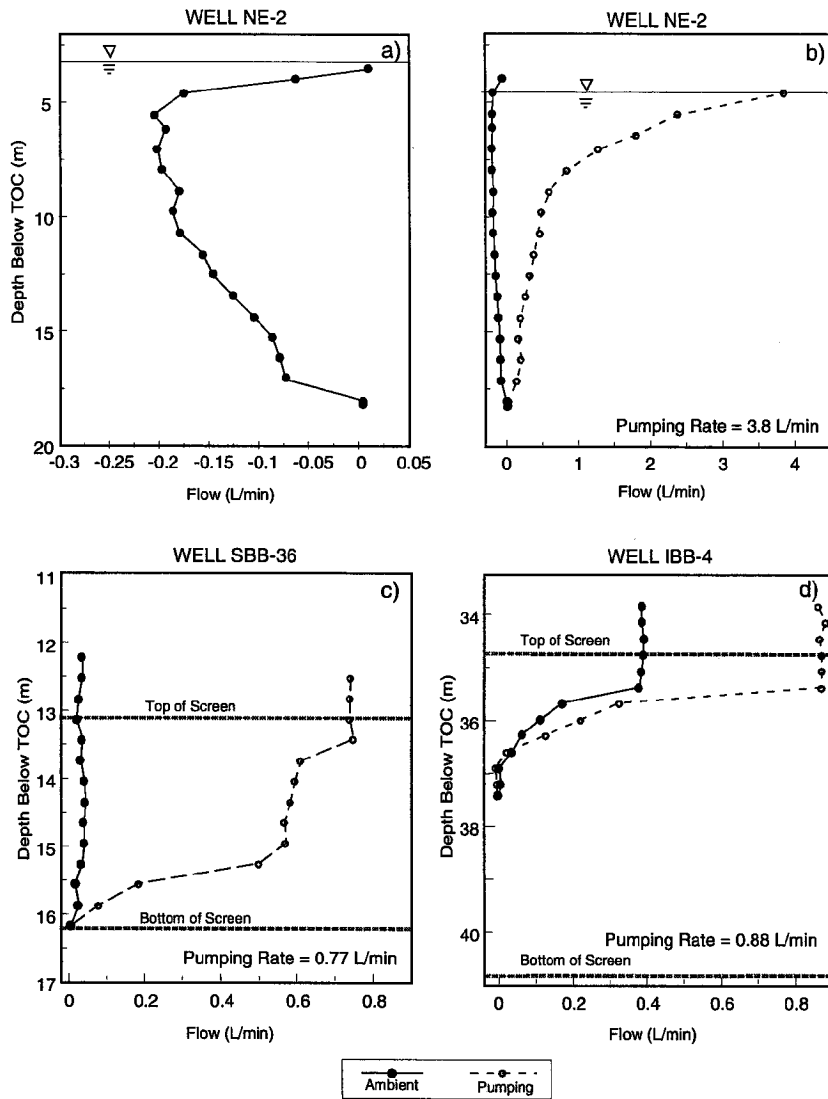

Figure VII-4. Ambient and induced flow distributions for wells NE-2, SBB-36, and IBB-4 at the ORC Superfund Site.

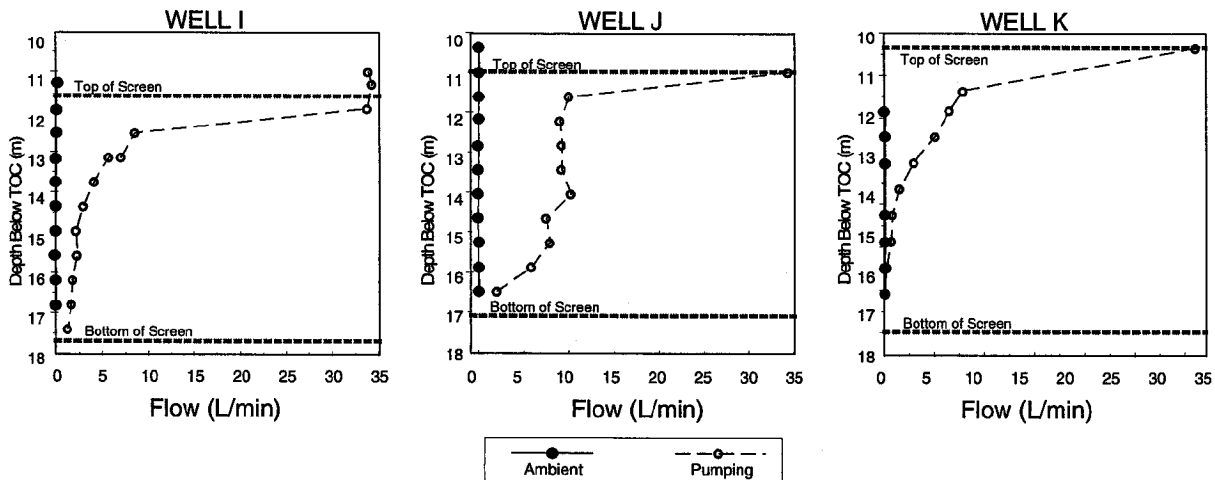

Figure VII-5. Ambient and induced flow distributions for wells I, J, and K at the Gilson Road site.

hydrologic environment covering 85 Ha. A test site was established in the southwest corner of the basin by the U.S. Geological Survey for three primary purposes: long-term monitoring of bedrock environments; maintenance of a controlled field-scale laboratory to test new equipment, methods, and interpretive models; and characterization of fluid movement and solute transport in fractured rock (Winter, 1984).

Bedrock underlying the Mirror Lake drainage basin is primarily composed of Silurian-age schist (Shapiro and Hsieh, 1991). The schist is intruded by granite, and less commonly pegmatites and basalts. The rocks are extensively fractured from folding and faulting during successive orogenies. Overlying the bedrock is a layer of glacial drift, predominantly till, which varies in thickness from zero to 49 m. At the test site, bedrock is a granite dike, which is overlain by 12 m to 15 m of glacial drift.

Three existing wells, each drilled to a depth of 75 m, were chosen for demonstration of the electromagnetic borehole flowmeter. Well FSE-06 (Figure VII-6a) exhibited the largest ambient flow at 0.3 L/min. The results indicate two zones of significant transmissivity; an upper zone between 30 m and 35 m below TOC and a lower zone around 57 m to 64 m. The two zones are probably related to major rock fractures. Further evidence of transmissive fractures can be seen in the flowmeter profile obtained during pumping (Figure VII-6b). Ground water predominantly enters the well from these two intervals.

Well FSE-09 exhibited much lower ambient flow (Figure VII-6c) than that detected in FSE-06, but the flows are high enough to indicate a hydraulically active fracture zone near a depth of 42 m to 46 m. The presence of this fracture zone is supported by the induced flow profile (Figure VII-6d). Very low magnitude ambient flows (Figure VII-6e) were detected in Well FSE-10. However, a large change in the ambient flow around a depth of 30 m to 38 m suggests that a transmissive fracture zone is present. Good correlation with the pumping induced flow data (Figure VII-6f) verifies the fracture zone. For comparison, results from acoustic televiewer surveys of wells FSE-09 and FSE-10 were made available by the U.S. Geological Survey. The televiewer images many linear features in the walls of both holes, including a relatively large feature at a depth of about 44 m in Well FSE-09. Similar general correlations between televiewer features and the flow profiles were observed in well FSE-10.

Collective interpretation of the flowmeter logs indicates that there may be a network of hydraulically-active fractures at approximately 40 m below the ground surface in this area of the site. Data from these different logging methods are highly complimentary. The acoustic televiewer may be used to estimate the density and orientation of linear features, including fractures. The borehole flowmeter provides information to identify which features or zones are hydraulically active.

## VII-7 Logan Martin Dam, Alabama

Logan Martin Dam is located in east-central Alabama in a complex geologic terrain. Situated on the lower Knox Group

of the Pell City Thrust Sheet, the dam rests on a bed comprised of eighty percent to ninety percent dolomite which ranges from fine- to coarse-grained. The remaining rock is made up of a collection of cherts, shaley limestones, and fine-grained silica. The rock is highly fractured and creates a situation that is extremely conducive to diffuse ground-water flow. The hydrogeology is complicated further by the fact that certain layers of the underlying material are preferentially solutioned. This solutioning has created areas of conduit flow within the rock.

Logan Martin Dam has experienced extensive problems with seepage and poor water quality downstream of the dam since its completion in 1964. The rate of leakage under the dam has increased from 168 m<sup>3</sup>/min in 1964 to approximately 1104 m<sup>3</sup>/min, with the flow rate increasing only 84 m<sup>3</sup>/min since 1974. In 1968, it was observed that the flow rate at a monitoring weir increased sharply from 0.6 m<sup>3</sup>/min to 10.2 m<sup>3</sup>/min. A steep-walled sinkhole then developed on the downstream side of the earthworks. Subsequent investigations revealed multiple sinkholes in the reservoir upstream of the dam. Grouting the earthworks and filling the sinkholes reduced the flow from the monitoring weir to the original 0.6 m<sup>3</sup>/min.

Geologic mapping based on outcrops, lineaments, and core analyses suggested that a zone of rocks within the Knox Group, called Target Zone #1, was a major source of leakage (Redwine et al., 1990). The geophysical/hydraulic procedure to test this hypothesis was to use various existing wells and coreholes to run a suite of caliper, temperature, and flowmeter logs in an attempt to detect the vertical movement of water within the target zone, thereby documenting the qualitative information resulting from the earlier geologic study. Of the wells that were tested, most were clogged with mud at various depths, thus no substantive data were obtained from these tests. However, two of the wells (Well 332 and Well 301) were clear for logging.

At Well 332, upward flows of about 130 L/min were encountered between 78 m and 110 m above mean sea level (AMSL) (Figure VII-7). The natural flow entered the borehole at 78 m to 80 m AMSL and flowed up the borehole until reaching an exit point at about 110 m to 112 m AMSL. These data were interpreted as indicative of large fractures or conduits at these elevations.

Well 301 provided different results. At 1.5 m AMSL, a flow of 51 L/min was measured entering the borehole. This flow steadily decreased to 43.3 L/min at 29.5 m AMSL where the flow then disappeared completely over a short section of the borehole. The flow then resumed at 30.5 m AMSL and rose to a maximum at about 33.5 m AMSL, then decreased, first slowly and then rapidly, until 48 m AMSL, where flow was no longer detected. The decrease of flow occurring between 29.5 m and 30.5 m AMSL was due to a large solution opening where the cross-sectional area for flow was enlarged dramatically, leading to a substantial decrease in flow velocity in the wellbore. This expansion in the wellbore was shown on a caliper log.

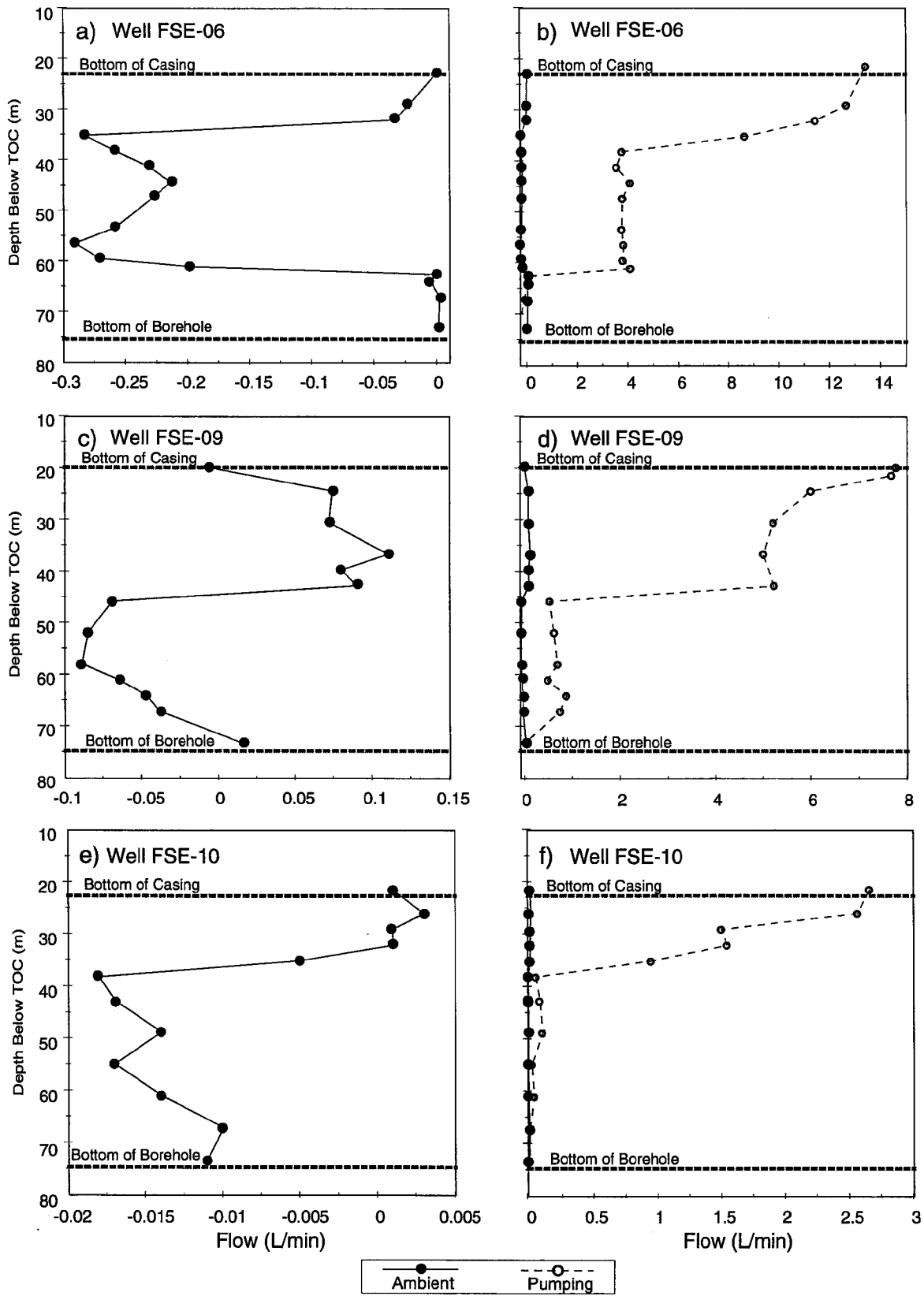

Figure VII-6. Ambient and induced flow distributions for wells FSE-06, FSE-09, and FSE-10 at Mirror Lake, New Hampshire.

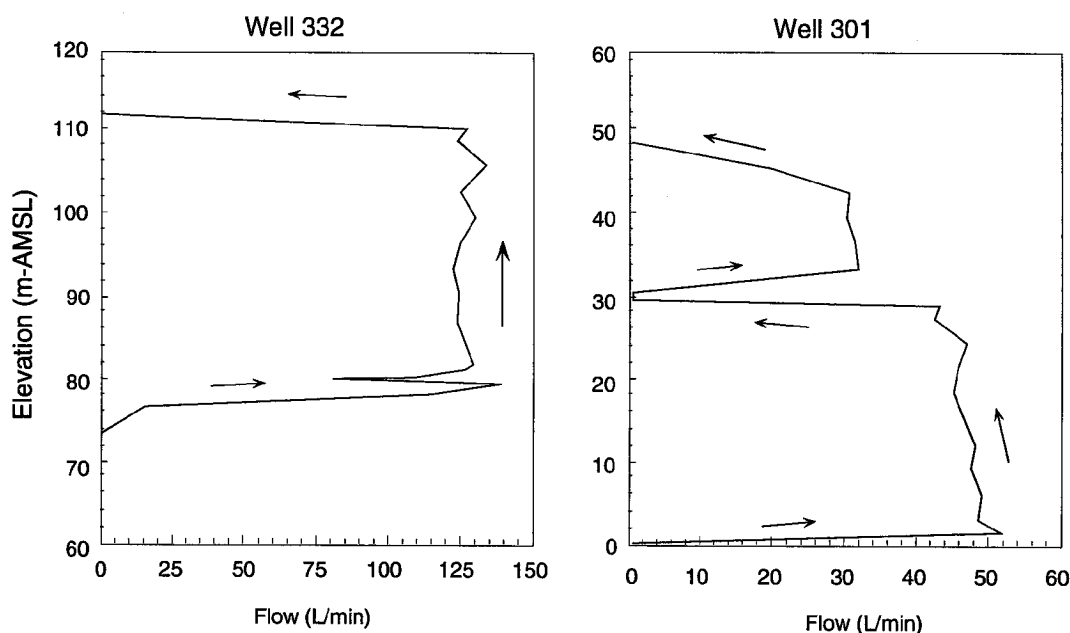

Figure VII-7. Substantial ambient flow moving from one stratum to another as detected by an impeller flowmeter. The flow is moving under a dam, the base of which is at an elevation of about 140 m AMSL. Flowmeter data were used to help select a geologic model for explaining the large leakage of water low in dissolved oxygen that was observed below the dam.

All detected flows were upward, indicating that water leakage was from around and/or under the reservoir. It was concluded that the borehole flowmeter was a valuable device for locating transmissive features and directly measuring flows of ground water in fractured rock systems.

### VII-8 Cape Cod, Massachusetts

In a study by Hess et al. (1992), a comparison of the variability of hydraulic conductivity was presented for in situ borehole flowmeter measurements and lab permeameter measurements. The theory and application pertaining to the flowmeter data are those techniques given by Hufschmied (1983, 1986) and Rehfeldt et al. (1989a, b). Much of what follows comes directly from Hess et al. (1992).

Field studies into the characterization of aquifer heterogeneity were conducted in an abandoned gravel pit south of Otis Air Force Base at Cape Cod, Massachusetts. The unconfined aquifer is located in a glacial outwash plain and is composed of clean, medium-to-coarse sand and gravel, containing typically less than one percent silt and clay. The aquifer is about 30 m thick and is underlain by less permeable silty sand and till deposits. The water table is about 14 m AMSL and about 6 m below land surface. The hydraulic gradient is approximately 0.0015 m/m and indicates a southward flow direction. Ground-water seepage velocity averages 0.42 m/d as calculated from average properties of the aquifer (LeBlanc et al., 1991). Surface exposures of the outwash reveal interbedded sand and gravel deposits. Crossbedded troughs up to 1 m wide, but typically less than 0.5 m high, are observed in

exposures perpendicular to the hypothesized paleocurrent direction, which is north to south. Parallel to this direction, troughs exhibit a tubular form and are several meters long (Hess and Wolf, 1991).

Sixteen wells were installed for flowmeter tests. Fifteen of the wells were installed by a drive-and-wash technique to minimize the disturbance of the aquifer region surrounding the well. One well was installed using a hollow-stem auger so that core material could be obtained for permeameter analysis, which could then be directly compared to the flowmeter analysis. In addition, core samples were taken from the upper 6 m of each of the boreholes. Each 5.1-cm diameter flowmeter well was screened over the upper 12 m of the saturated zone. Only the top 6 m to 7 m of the profiles were used for comparisons. These intervals correspond to the core sample zones, and also to the horizon of the aquifer through which the tracers moved during an earlier tracer test.

Multiport, constant-head permeameter analysis of the core samples was the second method used in this study to obtain a measure of hydraulic conductivity. Measurements were taken from each section of the core between adjacent manometer probes inserted at 5-cm to 10-cm intervals along the core sample length. Summary statistics, mean, variance, and range for the hydraulic conductivity data sets from the two methods are presented in Table VII-2. The flowmeter data have significantly higher mean and variance values than do the permeameter data. The flowmeter geometric mean of 0.11 cm/s lies within the range of values previously estimated for this aquifer and is only slightly lower than the value

**Table VII-2. Summary Statistics of Hydraulic Conductivity Data Obtained Using a Borehole Flowmeter Method and a Permeameter Analysis Method (from Hess et al. (1992))**

	Flowmeter	Permeameter
Number of wells or coring locations	16	16
Number of hydraulic conductivity values (K)	668	825
Mean vertical spacing (cm)	15	7.3
Geometric mean of K (cm/s)	0.11	0.035
Variance of ln K ( $\sigma_l^2$ )	0.24	0.14
Range		
Minimum K (cm/s)	0.013	0.006
Maximum K (cm/s)	0.37	0.14
Range in horizontal spacing (m)	0.9-24	0.9-24

estimated from the aquifer and tracer tests (0.13 cm/s). The permeameter mean of 0.035 cm/s is significantly lower than previously reported values. Several potential reasons for the low permeameter calculations include: local-scale anisotropy, nonrepresentative sampling techniques, and the influence of compaction during the coring process. In comparison, the flowmeter appears to supply more representative data, and is an easier and cost-effective alternative to core sampling and permeameter measurements.

## VII-9 Summary

Sensitive borehole flowmeters, including the electromagnetic flowmeter described in this report, are valuable tools for detailed characterization of hydrogeology. In many cases, these tools may be used in existing wells to obtain such information as natural ground-water flow patterns within the well, identification of hydraulically active fracture zones in rock, and, potentially, estimates of the relative hydraulic conductivities of materials adjacent to the well screen. In conjunction with other data, including information from geologic and geophysical logs, these results may be used to define the hydrostratigraphy of aquifer formations and evaluate such issues as contaminant transport and fate, efficient design of extraction and injection systems for subsurface remediation, and monitoring network design.



## Chapter VIII References

- Aller, L., T. W. Bennett, G. Hackett, R. J. Petty, J. H. Lehr, H. Sedoris, D. M. Nielsen, and J. E. Denne, 1989. *Handbook of Suggested Practices for the Design and Installation of Ground-Water Monitoring Wells*, National Ground Water Association, Dublin, Ohio.
- Barcelona, M. J., and J. A. Helfrich, 1986. Well construction and purging effects on ground-water samples, *Environmental Science and Technology*, 20:1179-1184.
- Bechtel Environmental, Inc., 1991. Remedial investigation report: Oklahoma Refining Company (ORC) Superfund Site, Cyril, Oklahoma, Contract No. BP02358, Houston, Texas.
- Betson, R. P., J. M. Boggs, S. C. Young, and L. W. Gelhar, 1985. Macrodispersion Experiment (MADE): Design of a field experiment to investigate transport processes in a saturated groundwater zone, EPRI Interim Report, EA-4082, Electric Power Research Institute, Palo Alto, California.
- Boggs, J. M., S. C. Young, D. J. Benton, and Y. C. Chung, 1989. Hydrogeologic characterization of the MADE site, EPRI Interim Report, EN-6915, Electric Power Research Institute, Palo Alto, California.
- Boggs, J. M., S. C. Young, L. M. Beard, L. W. Gelhar, K. R. Rehfeldt, and E. E. Adams, 1992. Field study of dispersion in a heterogeneous aquifer, 1. Overview and site description, *Water Resources Research*, 28:3281-3292.
- Boman, G.K., F.J. Molz, and K.D. Boone, 1997. Borehole flowmeter application in fluvial sediments: Methodology, results, and assessment, *Ground Water*, 35:443-450.
- Chu, W. C., J. Garcia-Rivera, and R. Raghavan, 1980. Analysis of interference test data influenced by wellbore storage and skin at the flowing well, *Journal of Petroleum Technology*, 32(1):171.
- Church, P.E., and G.E. Granato, 1996. Bias in ground-water data caused by well-bore flow in long-screen wells, *Ground Water*, 34:262-273.
- Collar, R.J., and P.A. Mock, 1997. Using water-supply wells to investigate vertical ground-water quality, *Ground Water*, 35:743-750.
- Collinson, J. D., and D. B. Thompson, 1989. *Sedimentary Structures*, Routledge, Chapman & Hall, Inc., New York, New York.
- Cooper, Jr., H. H., and C. E. Jacob, 1946. A generalized graphical method for evaluations of formation constants and summarizing well-field history, *Transactions of the American Geophysical Union*, 27:526-534.
- Driscoll, F. G., 1986. *Groundwater and Wells*, Johnson Filtration Systems, St. Paul, Minnesota.
- Dudgeon, C. R., and P. S. Huyakorn, 1976. Effects of near-well permeability variation on well performance, Australian Water Resource Council Technical Paper No. 18, Canberra, Australia.
- Ferson, L. M., ed., 1983. *Standards and Practices for Instrumentation*, Instrument Society of America, Research Triangle Park, North Carolina.
- Hackett, G., 1987. Drilling and constructing monitoring wells with hollow/stem augers. Part 1: Drilling considerations, *Ground Water Monitoring Review*, 7:51-62.
- Hackett, G., 1988. Drilling and constructing monitoring wells with hollow/stem augers. Part 2: Monitoring well installation, *Ground Water Monitoring Review*, 8:60-68.
- Haley, J. L., B. Hanson, C. Enfield, and J. Glass, 1991. Evaluating the effectiveness of ground-water extraction systems, *Ground Water Monitoring Review*, 11:119-124.
- Hanson, R.T., and T. Nishikawa, 1996. Combined use of flowmeter and time-drawdown data to estimate hydraulic conductivities in layered aquifer systems, *Ground Water*, 34:84-94.
- Harlan, R. L., K. E. Kolm, and E. D. Gutentag, 1989. *Water/Well Design and Construction*, Elsevier, New York, New York.
- Hawkins, M. F., Jr., 1956. A note on the skin effect, *Trans. Am. Inst. Min. Metall. Pet. Eng.*, 207:356-367.
- Hess, A. E., 1982. A heat-pulse flowmeter for measuring low velocities in boreholes, U.S. Geological Survey Open-File Report 82-699, U.S. Geological Survey, Reston, Virginia.
- Hess, A. E., 1986. Identifying hydraulically conductive fractures with a slow-velocity borehole flowmeter, *Canadian Geotechnical Journal*, 23:69-78.



- Hess, A. E., and F. L. Paillet, 1990. Applications of the thermal-pulse flowmeter in the hydraulic characterization of fractured rocks, in *Geophysical Applications for Geotechnical Investigations*, Paillet and Saunders, ed., ASTM STP 1101, ASTM, Philadelphia, Pennsylvania, 99-112.
- Hess, K. M., and S. H. Wolf, 1991. Techniques to determine spatial variations in hydraulic conductivity of sand and gravel, EPA/600/2-91/006, U.S. Environmental Protection Agency, Ada, Oklahoma.
- Hess, K. M., S. H. Wolf, and M. A. Celia, 1992. Large-scale natural gradient tracer test in sand and gravel, Cape Cod, Massachusetts, 3. Hydraulic conductivity variability and calculated macrodispersivities, *Water Resources Research*, 8:2011-2027.
- Hufschmied, P., 1983. Ermittlung der durchlässigkeit von lockergesteins-grundwasserleitern, eine vergleichende untersuchung verschiedener feldmethoden, Ph.D. Dissertation 7397, Eidgenössische Technische Hochschule, Zurich, Switzerland.
- Hufschmied, P., 1986. Estimation of three-dimensional statistically anisotropic hydraulic conductivity field by means of a single well pumping test combined with flowmeter measurements, *Hydrogeologie*, 2:163-174.
- Javandel, I., and P.A. Witherspoon, 1969. A method of analyzing transient fluid flow in multilayered aquifers, *Water Resources Research*, 5:856-869.
- Kabala, Z.J., 1994. Measuring distributions of hydraulic conductivity and specific storage by the double flowmeter test, *Water Resources Research*, 30:685-690.
- Kaye, J. M., 1955. Certain aspects of the geology of Lowndes County, Mississippi, M. S. Thesis, Mississippi State University.
- Keely, J. F., and K. Boateng, 1987a. Monitoring well installation, purging and sampling techniques - Part 1: Conceptualizations, *Ground Water*, 25:300-314.
- Keely, J. F., and K. Boateng, 1987b. Monitoring well installation, purging and sampling techniques - Part 2: Case histories, *Ground Water*, 25:427-439.
- LeBlanc, D. R., S. R. Garabedian, K. M. Hess, L. W. Gelhar, R. D. Quadri, K. G. Stollenwerk, and W. W. Wood, 1991. Large-scale natural gradient tracer test in sand and gravel, Cape Cod, Massachusetts, 1. Experimental design and observed tracer movement, *Water Resources Research*, 27:895-910.
- Leptak, B. G., and L. Venczel, 1982. *Instrument Engineers' Handbook*, Chilton Book Company, Radnor, Pennsylvania.
- Long, J.C.S., J. S. Remer, C. R. Wilson, and P. A. Witherspoon, 1982. Porous media equivalents for networks of discontinuous fractures, *Water Resources Research*, 18:645-658.
- Martin-Hayden, J.M., and G.A. Robbins, 1997. Plume distortion and apparent attenuation due to concentration averaging in monitoring wells, *Ground Water*, 35:339-346.
- Mercer, J.W., D.C. Skipp, and D. Griffin, 1990. Basics of pump-and-treat remediation technology, EPA/600/8-90/003, U.S. Environmental Protection Agency, Ada, Oklahoma.
- Minning, R. C., 1982. Monitoring well design and installation, Proceedings of the Second National Symposium on Aquifer Restoration and Ground Water Monitoring, Columbus, Ohio, National Ground Water Association, Dublin, Ohio, 194-197.
- Moench, A. F., and P. A. Hsieh, 1985. Analysis of slug test data in a well with finite thickness skin, in *Memoirs of the 17th International Congress on the Hydrogeology of Rocks of Low Permeability*, 17(1):1729, Int. Assoc. Hydrogeol., Tucson, Arizona.
- Molz, F. J., and S. C. Young, 1993. Development and application of borehole flow meters for environmental assessment, *The Log Analyst*, 34:13-23.
- Molz, F. J., O. Güven, J. G. Melville, J. S. Nohrstedt, and J. K. Overholtzer, 1988. Forced-gradient tracer tests and inferred hydraulic conductivity distributions at the Mobile site, *Ground Water*, 26:570-579.
- Molz, F. J., R. H. Morin, A. E. Hess, J. G. Melville, and O. Güven, 1989. The impeller meter for measuring aquifer permeability variations: Evaluations and comparison with other tests, *Water Resources Research*, 25:1677-1683.
- Molz, F. J., O. Güven, J. G. Melville, (with contributions by I. Javandel, A. E. Hess, and F. L. Paillet), 1990. A new approach and methodologies for characterizing the hydrogeologic properties of aquifers, EPA/600/2-90/002, U.S. Environmental Protection Agency, Ada, Oklahoma.
- Moore, G. K., and S. C. Young, 1992. Borehole flowmeter data and interpretation, Report ORNL/ER-91, Oak Ridge National Laboratory, Oak Ridge, Tennessee.
- Morin, R. H., A. E. Hess, and F. L. Paillet, 1988a. Determining the distribution of hydraulic conductivity in fractured limestone aquifers by simultaneous injection and geophysical logging, *Ground Water*, 26:587-595.
- Morin, R. H., D. R. LeBlanc, and W. E. Teasdale, 1988b. A statistical evaluation of formation disturbance produced by well/casing installation method, *Ground Water*, 26:207-217.

- Morrison, A., 1983. Arresting a toxic plume, *Civil Engineering*, ASCE, 53(8):35-37.
- Moss, R., Jr., and G. E. Moss, 1990. *Handbook for Groundwater Development*, John Wiley & Sons, New York, New York.
- National Ground Water Association, 1989. Development methods for water wells - an anthology, National Ground Water Association, Dublin, Ohio.
- Ogbe, D.O., 1984. Pulse testing in the presence of wellbore storage and skin effect, Ph.D. Dissertation, Stanford University, Stanford, California.
- Ogbe, D.O., and W. E. Brigham, 1984. A model for interference testing with wellbore storage and skin effects at both wells, Society of Petroleum Engineers 59th Annual Technical Conference, Houston, Texas.
- Paillet, F. L., 1991a. Use of geophysical well-logs in evaluating crystalline rocks for siting of radioactive waste repositories, *The Log Analyst*, 33:85-107.
- Paillet, F. L., 1991b. High-resolution flow logging in observation boreholes during hydraulic testing of fractured-rock aquifers, Society of Professional Well Log Analysts 32nd Annual Logging Symposium Transactions, Midland, Texas, L1-L23.
- Paillet, F. L., 1991c. The 1st core hole at Mirror Lake, New Hampshire—Comparing geophysical logs to core and cross-hole flow logging, U.S. Geological Survey Toxic Substance Hydrology Conference, Monterey, California, Proceedings, Water Resources Investigations Report 91-4034, U.S. Geological Survey, Reston, Virginia, 162-171.
- Paillet, F. L., and A. E. Hess, 1987. Geophysical well log analysis of fractured granitic rocks at Atikokan, Ontario, Canada, U.S. Geological Survey Water Resources Investigations Report 87-4154, U.S. Geological Survey, Reston, Virginia.
- Paillet, F. L., and K. Kapucu, 1989. Characterization of fracture permeability and fracture flow modeling at Mirror Lake, New Hampshire, U.S. Geological Survey Water Resources Investigations Report 89-4058, U.S. Geological Survey, Reston, Virginia.
- Paillet, F. L., and W.S. Keys, 1984. Applications of borehole geophysics in characterizing the hydrology of fractured rocks, Proc. of NWWA/EPA Conference on Surface and Borehole Geophysical Methods in Ground-Water Investigations, San Antonio, TX, 743-761.
- Paillet, F. L., A. E. Hess, C. H. Cheng, and E. L. Hardin, 1987. Characterization of fracture permeability with high-resolution vertical flow measurements during borehole pumping, *Ground Water*, 25:28-40.
- Paillet, F. L., K. Novakowski, and P. Lapcevic, 1992. Analysis of transient flows in boreholes during pumping in fractured formations, Society of Professional Well Log Analysts 33rd Annual Logging Symposium Transactions, S1-S22.
- Paul, D. G., C. D. Palmer, and D. S. Cherkauer, 1988. The effect of construction, installation and development on the turbidity of water in monitoring wells in fine-grained glacial till, *Ground Water Monitoring Review*, 8:73-82.
- Redwine, J. C., R. R. Parizek, and F. J. Molz, 1990. Controls on porosity and permeability in fracture-flow/conduit-flow rocks of the Knox Group, Southern Appalachian Fold-and-Thrust Belt, U.S.A., Southern Company Services, Birmingham, Alabama.
- Rehfeldt, K. R., L. W. Gelhar, J. B. Southard, and A. M. Dasinger, 1989a. Estimates of macrodispersivity based on analysis of hydraulic conductivity variability at the MADE site, EPRI Interim Report EN-6405, Electric Power Research Institute, Palo Alto, California.
- Rehfeldt, K. R., P. Hufschmied, L. W. Gelhar, and M. E. Schaefer, 1989b. Measuring hydraulic conductivity with the borehole flowmeter, EPRI Topical Report EN-6511, Electric Power Research Institute, Palo Alto, California.
- Ruud, N.C., and Z.J. Kabala, 1996. Numerical evaluation of flowmeter test interpretation methodologies, *Water Resources Research*, 32:845-852.
- Ruud, N.C., and Z.J. Kabala, 1997. Numerical evaluation of the flowmeter test in a layered aquifer with a skin zone, *Journal of Hydrology*, 203:101-108.
- Sandal, H. M., R. N. Horne, and H. J. Ramey, Jr., and J. W. Williamson, 1978. Interference testing with wellbore storage and skin effects at the produced well, Society of Petroleum Engineers, 53rd Annual Technical Conference, Houston, Texas.
- Shapiro, A.M., and P.A. Hsieh, 1991. Research in fractured rock hydrogeology: Characterizing fluid movement and chemical transport in fractured rock at the Mirror Lake Drainage Basin, New Hampshire, in U.S. Geological Survey Open File Report, Proc. of USGS Toxic Substances Hydrology Program Technical Meeting, Monterey, California, March 1991, U.S. Geological Survey, Reston, Virginia.
- Sledz, J. J., and D. D. Huff, 1981. Computer model for determining fracture porosity and permeability in the Conasauga Group, Report ORNL/TM-7695, Oak Ridge National Laboratory, Oak Ridge, Tennessee.
- Strauss, M. F., S. L. Story, and N. E. Mehlhorn, 1989. Applications of dual-wall reverse-circulation drilling in ground-water exploration and monitoring, *Ground Water Monitoring Review*, 9:63-71.

---

Tongpenyai, Y., and R. Raghaven, 1981. The effect of storage and skin on interference test data, *Journal of Petroleum Technology*, 33:151-160.

van Everdingen, A. F., and W. Hurst, 1949. The application of Laplace transforms to flow problems in reservoirs, *Transactions of the American Institute for Min. Metall. Pet. Eng.*, 186:305-320.

Winter, T. C., 1984. Geohydrologic setting of Mirror Lake, West Thorton, New Hampshire, U.S. Geological Survey Water Resources Investigations Report 84-4266, U.S. Geological Survey, Reston, Virginia.

Xiang, J., 1995. The evaluation of the flowmeter test in three-layer aquifers and the influence of disturbed zones, *Journal of Hydrology*, 166:127-145.

Young, S. C., 1991a. A site characterization methodology for aquifers in support of bioreclamation activities, Vol. I: Well network design, well equation, and aquifer multi-well and single-well tests, U.S. Air Force Engineering and Services Center, Tyndall AFB, Florida.

Young, S. C., 1991b. A site characterization methodology for aquifers in support of bioreclamation activities, Vol. II: Borehole flowmeter technique, tracer tests, geostatistics, and geology, U.S. Air Force Engineering and Services Center, Tyndall AFB, Florida.

Young S. C., H. S. Pearson, G. K. Moore, and R. B. Clapp, 1991. Application of the electromagnetic borehole flowmeter technique at the Oak Ridge National Laboratory, Report WR28-1-900-247, Tennessee Valley Authority, Norris, Tennessee.

Zemanek, J., E. E. Glenn, L. J. Norton, and R. L. Caldwell, 1970. Formation evaluation by inspection with the borehole televiewer, *Geophysics*, 35:254-269.

## Appendix A Field Data Sheets for Borehole Flowmeter Tests

TVA ENGINEERING LABORATORY EM FLOWMETER FIELD DATA SHEET																	
Project Name / Project Abbr. (xxx)			QA Number (xxx....)														
			Survey By														
Date	Start Time	End Time															
Pre-Calibration Ref No.			Flowmeter Cal	Flowmeter Zero													
			LPM / Volt	Volts													
Gain Switch		Integration Switch		Excitation Voltage													
<input type="checkbox"/> HI <input type="checkbox"/> LOW		<input type="checkbox"/> 1s <input type="checkbox"/> 10s <input type="checkbox"/> 20s		VRMS													
Packer		Collar (Serial #)															
<input type="checkbox"/> Yes <input type="checkbox"/> No		<input type="checkbox"/> Yes <input type="checkbox"/> No															
Flowmeter Serial #		Electronic Serial #		Cable Serial #													
<input type="checkbox"/> Pump <input type="checkbox"/> Injection <input type="checkbox"/> Ambient			Pump Intake Depth		GW Temperature												
Rate																	
<table style="width: 100%; border: none;"> <tr> <td style="width: 50%;">Well Number: _____</td> <td style="width: 50%;">Depth to Water: _____</td> </tr> <tr> <td>Top of Reference Elevation: _____</td> <td>Depth to Top of Screen: _____</td> </tr> <tr> <td>Construction Type: _____</td> <td>Depth of Bottom of Screen: _____</td> </tr> <tr> <td>Pipe Size: _____</td> <td>Depth to Bottom of Well: _____</td> </tr> <tr> <td>Screen Type: _____</td> <td></td> </tr> <tr> <td colspan="2">Blank Sections in Screened Interval: _____</td> </tr> </table>						Well Number: _____	Depth to Water: _____	Top of Reference Elevation: _____	Depth to Top of Screen: _____	Construction Type: _____	Depth of Bottom of Screen: _____	Pipe Size: _____	Depth to Bottom of Well: _____	Screen Type: _____		Blank Sections in Screened Interval: _____	
Well Number: _____	Depth to Water: _____																
Top of Reference Elevation: _____	Depth to Top of Screen: _____																
Construction Type: _____	Depth of Bottom of Screen: _____																
Pipe Size: _____	Depth to Bottom of Well: _____																
Screen Type: _____																	
Blank Sections in Screened Interval: _____																	
Comments:																	

## Appendix A

### Field Data Sheets for Borehole Flowmeter Tests (continued)

TVA ENGINEERING LABORATORY SINGLE-WELL FIELD DATA SHEET							
Project Name / Project Abbr. (xxx)				QA Number (xxx....)			
Well Number		Survey By			Date		
Pump Type:		Pump Serial #		Transducer Type:		Transducer Serial #	
Flow Check							
<b>Time</b>	<b>Volume</b>	<b>Time to Fill</b>	<b>Flow Rate</b>	Depth of Transducer:			
				Initial Transducer Reading:			
				Datalogger File Name:			
				Pumping Schedule			
				Time (hr, min)		Rate (LPM)	
				1. _____			
				2. _____			
				3. _____			
				Drawdown Check			
				<b>Time</b>	<b>Electric Tape Depth</b>	<b>Datalogger Reading</b>	<b>Depth</b>
Comments:							

## Appendix B Equipment Checklist

- |   |   |
|---|---|
| <ul style="list-style-type: none"> <li><input type="checkbox"/> Address &amp; phone number of contact</li> <li><input type="checkbox"/> Site maps</li> <li><input type="checkbox"/> Well specifications</li> <li><input type="checkbox"/> Calibration sheets</li> <li><input type="checkbox"/> Test forms</li> <li><input type="checkbox"/> Equipment manuals</li> <li><input type="checkbox"/> 1/2-inch flowmeter</li> <li><input type="checkbox"/> 1-inch flowmeter</li> <li><input type="checkbox"/> Flowmeter electronic system</li> <li><input type="checkbox"/> Computer interface (6B12, HPIB)</li> <li><input type="checkbox"/> Flowmeter spare parts</li> <li><input type="checkbox"/> Flowmeter collar</li> <li><input type="checkbox"/> Collar weight</li> <li><input type="checkbox"/> Packer assembly</li> <li><input type="checkbox"/> Packer inflator</li> <li><input type="checkbox"/> Air compressor</li> <li><input type="checkbox"/> Air tank</li> <li><input type="checkbox"/> Pressure inflator tank</li> <li><input type="checkbox"/> Inflation tubing, fittings, and valves</li> <li><input type="checkbox"/> Flowmeter cables</li> <li><input type="checkbox"/> 5 psi pressure transducer</li> <li><input type="checkbox"/> 10 psi pressure transducer</li> <li><input type="checkbox"/> 20 psi pressure transducer</li> <li><input type="checkbox"/> 30 psi pressure transducer</li> <li><input type="checkbox"/> Flowmeter computer</li> <li><input type="checkbox"/> Electronic data logger</li> <li><input type="checkbox"/> Printer</li> <li><input type="checkbox"/> Computer, printer, transducer, &amp; electronics cables</li> <li><input type="checkbox"/> Cable for downloading data logger</li> <li><input type="checkbox"/> Floppy disks</li> <li><input type="checkbox"/> Application and operating software</li> <li><input type="checkbox"/> Flowmeter software</li> <li><input type="checkbox"/> Datalogger software</li> <li><input type="checkbox"/> Other software</li> <li><input type="checkbox"/> Peristaltic pump</li> <li><input type="checkbox"/> Submersible pump</li> <li><input type="checkbox"/> Centrifugal pump</li> <li><input type="checkbox"/> Other pumps</li> <li><input type="checkbox"/> Valves</li> <li><input type="checkbox"/> Inlet hoses</li> <li><input type="checkbox"/> Discharge hoses</li> <li><input type="checkbox"/> Checkvalve</li> <li><input type="checkbox"/> Hose clamps and fittings</li> <li><input type="checkbox"/> Pump calibration containers</li> <li><input type="checkbox"/> Flowmeter calibration cylinder</li> <li><input type="checkbox"/> Water containers</li> </ul> | <ul style="list-style-type: none"> <li><input type="checkbox"/> OSHA Training Card</li> <li><input type="checkbox"/> Stop Watch</li> <li><input type="checkbox"/> 120 ACV generator</li> <li><input type="checkbox"/> 220 ACV generator</li> <li><input type="checkbox"/> 50 ft 120 ACV extension cord</li> <li><input type="checkbox"/> 50 ft 220 ACV extension cord</li> <li><input type="checkbox"/> 25 ft 120 ACV extension cord</li> <li><input type="checkbox"/> Special extension cords</li> <li><input type="checkbox"/> Ground fault box</li> <li><input type="checkbox"/> Power strip</li> <li><input type="checkbox"/> Gas can</li> <li><input type="checkbox"/> Weight for steel tape</li> <li><input type="checkbox"/> Engineering rule</li> <li><input type="checkbox"/> Steel tape</li> <li><input type="checkbox"/> Tools (electrical and mechanical)</li> <li><input type="checkbox"/> Hack saw</li> <li><input type="checkbox"/> Drill and bits</li> <li><input type="checkbox"/> Tie wraps</li> <li><input type="checkbox"/> Electrical tape</li> <li><input type="checkbox"/> Flashlight</li> <li><input type="checkbox"/> Electrical supplies (splicing kit, solder, wire, etc.)</li> <li><input type="checkbox"/> Misc hardware (screws, bolts, etc.)</li> <li><input type="checkbox"/> Marking tape</li> <li><input type="checkbox"/> Indelible pen</li> <li><input type="checkbox"/> Rope</li> <li><input type="checkbox"/> Tarpaulins</li> <li><input type="checkbox"/> Canopy</li> <li><input type="checkbox"/> Tent</li> <li><input type="checkbox"/> Spring clamps</li> <li><input type="checkbox"/> Parachute cord</li> <li><input type="checkbox"/> Multimeter</li> <li><input type="checkbox"/> Oscilloscope</li> <li><input type="checkbox"/> Rain suit</li> <li><input type="checkbox"/> Boots</li> <li><input type="checkbox"/> Cold weather gear</li> <li><input type="checkbox"/> Sun screen</li> <li><input type="checkbox"/> Insect repellent</li> <li><input type="checkbox"/> Cooler and drinking water</li> <li><input type="checkbox"/> Stools, chairs</li> <li><input type="checkbox"/> Portable table</li> <li><input type="checkbox"/> Cart</li> <li><input type="checkbox"/> Decontamination supplies (buckets, water, soap, brushes)</li> <li><input type="checkbox"/> Rubber gloves</li> <li><input type="checkbox"/> Work gloves</li> <li><input type="checkbox"/> Rags, paper towels</li> <li><input type="checkbox"/> First aid kit</li> </ul> |
|---|---|

