

APPENDIX B:
**CARBON DIOXIDE CAPTURE
TECHNOLOGY SHEETS**

PRE-COMBUSTION SOLVENTS
PRE-COMBUSTION SORBENTS
PRE-COMBUSTION MEMBRANES
POST-COMBUSTION SOLVENTS
POST-COMBUSTION SORBENTS
POST-COMBUSTION MEMBRANES
OXY-COMBUSTION
OXYGEN PRODUCTION
CHEMICAL LOOPING
ADVANCED COMPRESSION
R&D COLLABORATIONS

TABLE OF CONTENTS

B-2

PRE-COMBUSTION SOLVENTS

SRI International — Ammonium Carbonate

B-5

B-4

PRE-COMBUSTION SORBENTS

URS Group — Sorbent-Enhanced Water Gas Shift

B-11

TDA Research, Inc. — High Capacity Regenerable Sorbent

B-18

UNDEERC — Evaluation of Sorbents

B-22

UNDEERC — High-Density Activated Carbon

B-25

RTI International — Warm Gas Cleanup with Sorbents

B-28

Lehigh University — Sorbent-Enhanced Water Gas Shift

B-32

UNDEERC — Sorbent-Enhanced Water Gas Shift

B-37

B-10

PRE-COMBUSTION MEMBRANES

Western Research Institute — Integrated WGS Membrane

B-41

Praxair, Inc. — Membrane for H₂ Separation

B-44

Worcester Polytechnic Institute — Pd-Pd Alloy Composite Membrane for H₂ Separation

B-47

University of North Dakota — Composite Polymer Membrane

B-54

University Of Minnesota — Hydrogen Selective Zeolite Membranes

B-57

Arizona State University — Dual-Phase Ceramic-Carbonate Membrane Reactor

B-60

Pall Corporation — Ternary Palladium-Alloy Hydrogen Separation Membranes

B-63

New Jersey Institute of Technology — Pressure Swing Absorption with Membrane Contactor

B-66

Los Alamos National Laboratory — High-Temperature Polymer-Based Membrane

B-70

Ceramatec — Ceramic Membrane for H₂ Separation

B-74

Gas Technology Institute — Nanoporous, Superhydrophobic Membranes

B-76

University of Texas at Dallas — Integrated WGS Non-Precious Membrane

B-79

United Technologies Research Center — Membrane for H₂ Separation

B-83

Worcester Polytechnic Institute — Supported Molten Metal Membrane for H₂ Separation

B-86

Colorado School of Mines — Nanoporous Metal Carbide Membrane for H₂ Separation

B-89

Southwest Research Institute — Amorphous Alloy Membrane for H₂ Separation

B-93

University of Nevada — Amorphous Alloy Membrane for H₂ Separation

B-96

Membrane Technology and Research, Inc. — Polymer Membranes

B-100

United Technologies Research Center — Palladium-Copper Trimetallic Alloy Membranes

B-105

Praxair, Inc. — Palladium Alloy Membranes

B-108

Worcester Polytechnic Institute — Palladium-Based Membranes

B-111

Media and Process Technology, Inc. — Carbon Molecular Sieve Membranes

B-118

Southwest Research Institute — Ternary Palladium Alloy Membranes

B-122

SRI International — High-Temperature Polymeric Membranes

B-125

Grambling State University — Catalysts for Use in Membrane Reactors

B-129

REB Research and Consulting — High-Flux Metallic Membranes and Reactors

B-134

North Carolina A&T State University — Palladium/Silver Composite Membranes

B-137

Eltron Research, Inc. — Hydrogen Transport Membranes

B-140

Western Research Institute — Water Gas Shift Catalyst with Vanadium Alloy Membrane

B-143

Worcester Polytechnic Institute — Sulfur-Tolerant Palladium Alloy Membranes

B-146

University of Texas at Dallas — Mixed Matrix Membranes for H₂/CO₂ Separations

B-149

Los Alamos National Laboratory — Palladium-Based Membrane Reactor

B-151

Argonne National Laboratory — Dense High-Temperature Ceramic Membranes

B-154

UNDEERC — H₂/CO₂ Separation Membranes

B-157

B-40

POST-COMBUSTION SOLVENTS

University of Illinois at Urbana-Champaign — Hot Carbonate Absorption Process

B-161

URS Group — Piperazine Solvent with Flash Regeneration

B-164

Siemens Energy, Inc. — Amino Acid Salt

B-166

3H Company, LLC — Non-Aqueous, Amine-Based Solvent

B-169

Akermin, Inc. — Carbonic Anhydrase-Potassium Carbonate Mixture

B-172

ION Engineering — Ionic Liquid-Amine Mixture

B-175

GE Global Research — High-Capacity Oligomers

B-178

Illinois State Geological Survey — Integrated Vacuum Carbonate Absorption

B-183

B-160

Georgia Tech Research Corporation — Ionic Liquids	B-188
Lawrence Berkeley National Laboratory — Mixed Solvent	B-192
University of Notre Dame — Ionic Liquids	B-195
Hampton University — Phase Transitional Absorption	B-200

POST-COMBUSTION SORBENTS**B-204**

Penn State University — Solid Molecular Baskets	B-205
TDA Research, Inc. — Alkalized Alumina	B-209
SRI International — Carbon-Based Sorbents	B-212
ADA-ES, Inc. — Evaluation of Solid Sorbents	B-217
UOP, LLC — Metal Organic Frameworks	B-223
Research Triangle Institute — Dry Sodium Carbonate	B-228
University of Akron — Metal Monolithic Amine-Grafted Zeolites	B-231

POST-COMBUSTION MEMBRANES**B-236**

American Air Liquide — Sub-Ambient Temperature, Hollow-Fiber Membrane	B-237
Gas Technology Institute — Hybrid with Solvent and Hollow-Fiber Membrane	B-241
RTI International — Hollow-Fiber, Polymeric Membranes	B-245
Membrane Technology and Research, Inc. — Spiral-Wound, Polymeric Membranes	B-250
Carbozyme, Inc. — Biomimetic Membrane	B-256
University of New Mexico — Dual-Functional, Silica-Based Membrane	B-259

OXY-COMBUSTION**B-264**

Alstom Power — Tangential-Fired Oxy-Combustion Retrofits	B-265
Foster Wheeler Corporation — Evaluation of Boiler Materials for Oxy-Combustion	B-270
Reaction Engineering International — Characterization of Oxy-Combustion Impacts	B-273
Praxair, Inc. — Flue Gas Purification Options	B-278
Air Products and Chemicals, Inc. — Flue Gas Purification via Compression	B-282
Jupiter Oxygen Corporation — Oxy-Combustion and Integrated Pollutant Removal	B-286
Babcock & Wilcox — Oxy-Combustion for Cyclone and Wall-Fired Boilers	B-290
Clean Energy Systems, Inc. — Oxy-Syngas Combustor	B-294
Southern Research Institute — Evaluation of Gas Recycle for Oxy-Combustion	B-299
Washington University — Multi-Pollutant Control	B-303
Brigham Young University — NO _x Behavior in Oxy-Combustion	B-306
CanmetENERGY — Engineering Assessment of Oxy-Combustion	B-309
Argonne National Laboratory — Engineering Assessment of Oxy-Combustion	B-313

OXYGEN PRODUCTION**B-316**

Eltron Research, Inc. — Materials for Temperature Swing Adsorption Oxygen Separation	B-317
Praxair, Inc. — Oxygen Transport Membrane-Based Oxy-Combustion	B-320
TDA Research, Inc. — Sorbents for Air Separation	B-325
Linde, LLC (formerly The BOC Group, Inc.) — Ceramic Auto-Thermal Recovery	B-327
North Carolina A&T State University — Nanofiller-Modulated Polymeric Membranes	B-330
Air Products and Chemicals, Inc. — Ion Transport Membrane	B-333

CHEMICAL LOOPING**B-338**

University of Florida — Chemical Looping for Fluidized Bed Reactor	B-339
Ohio State University — Coal Direct Chemical Looping for Retrofits	B-343
Alstom Power — Chemical Looping Simulation and Control	B-346
Ohio State University — Calcium Looping Process for Hydrogen Production	B-350
Alstom Power — Chemical Looping Combustion Prototype	B-354

ADVANCED COMPRESSION**B-358**

Lehigh University — Thermal Integration of CO ₂ Compression Processes	B-359
Ramgen Power Systems, LLC — Shock Wave Compression	B-362
Southwest Research Institute — Evaluation of Compression Efficiency Improvements	B-367

R&D COLLABORATIONS**B-374**

UNDEERC — Partnership for CO ₂ Capture	B-375
---	-------

APPENDIX B: CARBON DIOXIDE CAPTURE TECHNOLOGY SHEETS

PRE-COMBUSTION SOLVENTS

CO₂ CAPTURE FROM IGCC GAS STREAMS USING AC-ABC PROCESS

Primary Project Goals

SRI International is developing, for integrated gasification combined cycle (IGCC)-based power plants, a carbon dioxide (CO₂) capture technology based on the use of a high-capacity and low-cost aqueous ammoniated solution containing ammonium carbonate (AC), which reacts with CO₂ to form ammonium bicarbonate (ABC).

Technical Goals

- Test the technology on a bench-scale batch reactor to validate the concept.
- Determine the optimum operating conditions for a small pilot-scale reactor.
- Design and build a small pilot-scale reactor capable of continuous integrated operation.
- Perform pilot-scale tests to evaluate the process in a coal gasifier environment.
- Perform a technical and economic evaluation on the technology.

Technical Content

The technology is based on the use of an aqueous ammoniated solution containing AC, which reacts with CO₂ to form ABC.

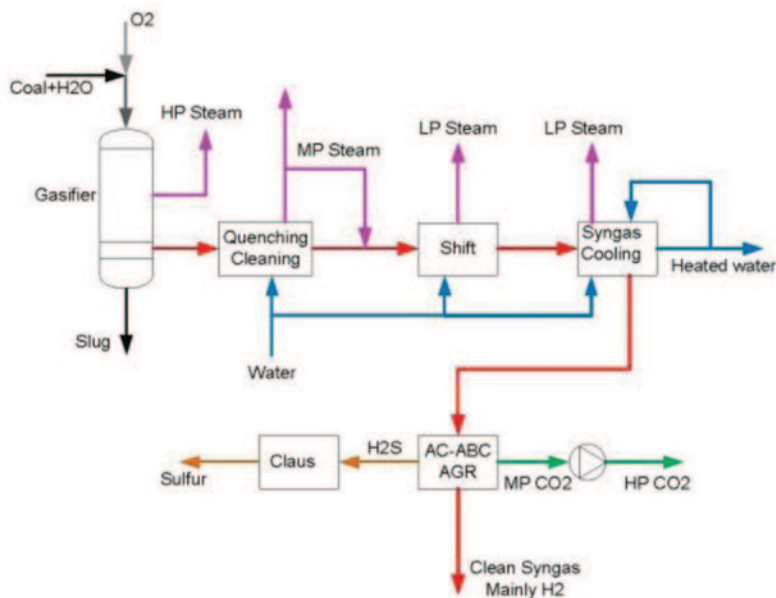

Figure 1: Acid Gas Removal in Gasification System

The concentrated ammoniated solution is used to capture CO₂ and hydrogen sulfide (H₂S) from synthesis gas (syngas) at high pressure. This technique reduces the size of the CO₂ stripper and operates at high pressure, reducing CO₂ compression needs. Both reduce electric power consump-

Technology Maturity:

Pilot-scale using actual syngas

Project Focus:

Ammonium Carbonate

Participant:

SRI International

Project Number:

FE0000896

NETL Project Manager:

Meghan Napoli

Meghan.Napoli@netl.doe.gov

Principal Investigator:

Gopala Krishnan

SRI International

Gopala.Krishnan@sri.com

Partners:

Great Point Energy

Performance Period:

9/30/09 – 3/31/12

tion. AC has high net CO₂ loading, is a low-cost and readily available reagent, and requires little solvent makeup; the solubility of hydrogen (H₂), carbon monoxide (CO), and methane (CH₄) in absorber solution is extremely low.

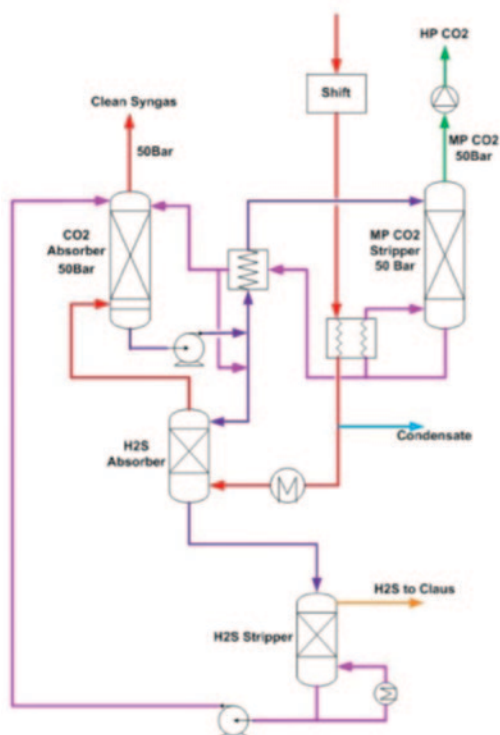

Figure 2: Schematic of the CO₂ and H₂S Capture System

The project, in its first phase, has constructed a bench-scale batch reactor unit to test the technology at SRI's facility in California. Testing is being done to validate the concept and to determine the optimum operating conditions.

Absorber testing is being done to first determine the solubility of shifted-gas components [H₂, CO, nitrogen (N₂), argon (Ar)], then determine the reactivity of CO₂, H₂S, and carbonyl sulfide (COS); mixed-gas testing will determine the relative reaction kinetics.

Regenerator testing is being done to determine CO₂ and H₂S release characteristics, as well as the relative kinetics of CO₂ and H₂S release. Optimal operating conditions derived in bench-scale testing will be carried over into a pilot-scale test.

Pilot-scale testing will be performed on a slip stream of Great Point Energy's 1 ton/day pilot gasifier located at Brayton Point, MA. SRI will design and construct a pilot-scale continuous, integrated test system. The pilot-scale test will emphasize stability of integrated operation. The tests will be of longer duration, about six to eight times longer total test time than with the simulated tests at SRI. The effects of trace contaminants will be observed, as the pilot tests will use a gas stream from an operating gasifier that has undergone minimum cleanup and will contain trace contaminants.

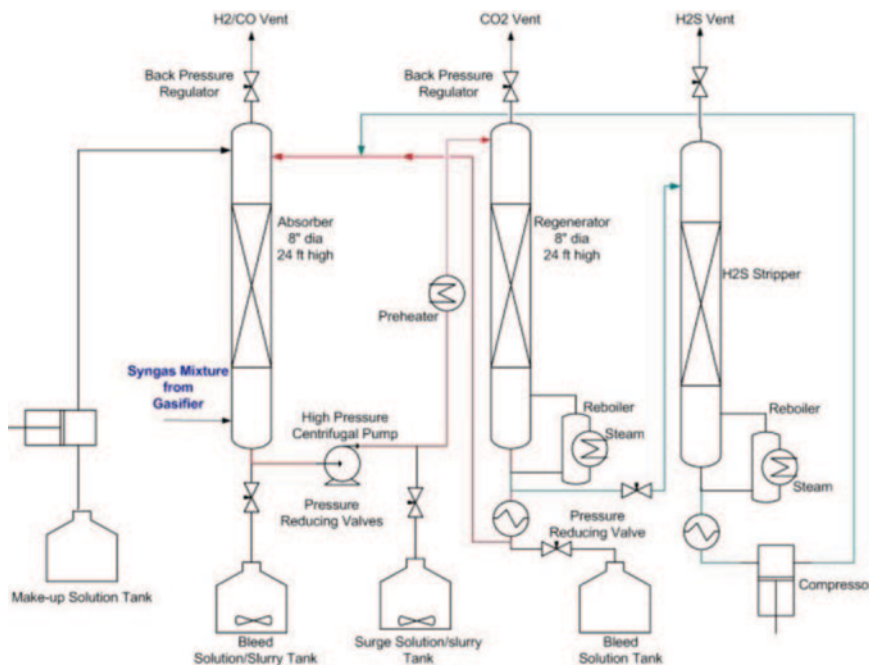

Figure 3: Pilot-Scale Integrated Testing (Preliminary)

A technical and economic analysis is underway using Aspen modeling to generate the equipment sizing and heat and material flows; DOE cost models; and a base case, 750-MW nominal IGCC plant without CO₂ capture to compare the AC-ABC process with a similar-size plant using CO₂ capture with a Selexol subsystem.

Table 1: Solvent Parameters

	Parameter	Current R&D Value	Target R&D Value
Solvent Properties	Type of solvent	Aqueous ammoniated solution	Aqueous ammoniated solution
	Molecular weight	Nominal 18	Nominal 18
	Boiling point (°C)	Varies with pressure; 100 °C at 1 atm	Varies with pressure; 100 °C at 1 atm
	Heat of reaction (kJ/mole CO ₂)	40–60 depending on the NH ₃ /CO ₂ ratio	40–60
	CO ₂ loading/working capacity ¹ , wt%	10	20
	Solvent concentration to stripper (mol/liter)	6 M NH ₃	8 M NH ₃
	Heat capacity of solution (kJ/K/kg)	3.5	3.5
	Viscosity, cP	1	1
Operating Conditions	Absorption temperature, °C	25	25–40
	Absorption pressure, atm	20	50
	CO ₂ capture efficiency, %	>90	>90
	Regeneration method	Heating with steam	Heating with steam
	Regeneration temperature, °C	N/A	150
	Regeneration pressure, atm	N/A	50
Heat Integration	Required regeneration steam temperature, °C	120	170
Miscellaneous	Solvent make-up rate, kg/kg CO ₂	N/A	N/A
Product Quality	CO ₂ purity, %	>98	98.1
	N ₂ concentration, %	N/A	1.9
	Other contaminants, %	N/A	0.01
Process Performance	Electricity requirement, kJ/kg CO ₂	N/A	17.7
	Heat requirement, kJ/kg CO ₂	N/A	620.6
	Total energy (electricity equivalent), kJ/kg CO ₂	N/A	638.3

Note:

1. Working capacity is the loading difference CO₂-rich solution before and after it is regenerated.

Equations Describing Chemical Reaction:

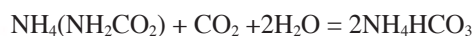
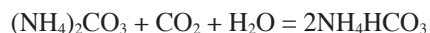

Solvent Reaction Kinetics: The absorption of CO₂ by the ammoniated solution is proportional (1st order) to the CO₂ partial pressure. Preliminary experiments confirm this behavior. The kinetics of CO₂ absorption is expected to be rapid at the elevated pressures and high CO₂ concentrations expected in the IGCC gas stream downstream of the water gas shift (WGS) reactors.

Solvent Heating/Cooling Method: During regeneration, the liquid is heated by steam using a reboiler. In the absorber, the liquid is cooled using a heat exchanger and a coolant from a direct contact cooler.

Solvent Contaminant Resistance: The solvent is expected to be resistant to several contaminants nominally present in an IGCC gas stream. Hydrogen sulfide reacts with the solvent, but it can be removed during the regeneration. The ammonia (NH₃) in the IGCC may negate any NH₃ loss from the solvent. The resistance of the solvent to trace metals is not known yet.

Flue Gas Pretreatment Requirements: The IGCC gas stream needs to undergo WGS reaction to convert CO to CO₂ and to be cooled to a temperature of 25 °C to 50 °C.

Waste Streams Generated: Ammonium sulfate solution from the capture of trace residual NH_3 in the gas.

Technology Advantages

- Low-cost and stable reactive solution.
- Reactive solution has a high CO_2 loading capacity due, in part, to the formation of ABC solids during absorption.
- Optimum operating pressure, including CO_2 output stream, is expected to be between 200 and 700 pounds per square inch (psi), resulting in lower compression costs than conventional technologies.

R&D Challenges

- Precipitation of solids could potentially foul packing and heat exchanger surfaces.
- Absorber operation at an elevated temperature could create excessive residual ammonia in the fuel gas stream leaving the absorber.
- Adequate separation of H_2S and CO_2 in the regenerator gas.

Results To Date/Accomplishments

- Bench-scale mixed gas batch tests, in various gas compositions, were conducted. Carbon dioxide and H_2S capture rates were experimentally determined as a function of temperature, pressure, and solution and gas compositions. Data from regenerator experiments were used to determine the optimum regenerator conditions for the release of CO_2 and H_2S exclusively.
- Bench-scale simple gas mixture batch test runs were conducted. It was observed that:
 - CO_2 and H_2S are absorbed in the system at pressures between 200 and 300 psi and temperatures between 20 and 60 °C.
 - The absorption of CO_2 in the ammoniated solution was found to be efficient, capable of capturing >95% of the feed CO_2 at a temperature above ambient.
 - Absorption tests with H_2S also showed that the ammoniated solutions were highly effective in absorbing H_2S and efficiencies as high as 95% were achieved.
 - The ratio of CO_2/NH_3 (R' value) in solution has a major influence on the rate of both H_2S and CO_2 absorption; the rate increased with decreasing value of the parameter.
 - The total pressure had a positive effect on the rate, as expected. The NH_3 concentration of the solution had only a minor effect, indicating that high CO_2 loading of the solution can be achieved without a significant effect on the absorption efficiency.
- Bench-scale regenerator tests were conducted with 10–20 wt% CO_2 loaded ammoniated solutions. Regeneration tests showed that:
 - CO_2 can be released from the solution under conditions of 450 psi and 125 °C.
 - The regeneration tests showed that ammoniated solutions suitable for absorption with high NH_3/CO_2 ratios can be generated at moderate temperatures and at elevated pressures.

In summary, the bench-scale tests demonstrated an efficient absorption of CO_2 and H_2S at elevated pressures without the need for sub-ambient operation. High-pressure CO_2 and concentrated H_2S streams can be released during the regeneration of loaded solution.

- Preliminary economic analysis using simulations was performed and indicates that the AB-ABC capture process requires less parasitic electric power consumption and has a lower capital cost than the Selexol process. The cost of CO₂ capture by the AC-ABC process was estimated for a 750-MWe IGCC plant.

Next Steps

- Perform preliminary process modeling.
- Prepare for pilot scale.

Available Reports/Technical Papers/Presentations

CO₂ Capture from IGCC Gas Streams Using AC-ABC Process; Presentation at the 2010 NETL CO₂ Capture Technology Meeting, Pittsburgh, PA, September 13–17, 2010. [http://www.netl.doe.gov/publications/proceedings/10/co2capture/presentations/thursday/Gopala Krishnan - FE0000896.pdf](http://www.netl.doe.gov/publications/proceedings/10/co2capture/presentations/thursday/Gopala%20Krishnan%20-%20FE0000896.pdf)

CO₂ Capture from IGCC Gas Streams Using the AC-ABC Process; Presentation at the Pre-Combustion CO₂ Capture Kick-off Meetings, Pittsburgh, PA, November 12–13, 2009; Available at the NETL website.

APPENDIX B: CARBON DIOXIDE CAPTURE TECHNOLOGY SHEETS

PRE-COMBUSTION SORBENTS

EVALUATION OF DRY SORBENT TECHNOLOGY FOR PRE-COMBUSTION CO₂ CAPTURE

Primary Project Goals

URS Group is developing dry carbon dioxide (CO₂) sorbent materials, through the coupling of thermodynamic, molecular simulation, and process simulation modeling with novel synthesis methods, that possess superior adsorption and regeneration properties at conditions applicable to water gas shift (WGS) systems. If successful, this project will demonstrate that one or more sorbent materials are able to remove greater than 90% of the CO₂ from a simulated synthesis gas (syngas) at conditions applicable to a WGS reactor, thus meeting a key DOE program objective. Furthermore, a successful project will demonstrate through a detailed techno-economic analysis that DOE COE cost objectives can be met with sorption-enhanced WGS (SEWGS) technology through the development of effective sorbents with superior adsorption-regeneration properties, appropriate reactor design and integration, resulting process enhancements to the WGS reaction (associated with lower steam requirements), and expected future process improvements to integrated gasification combined capture (IGCC) technology. Successful demonstration of DOE performance and cost objectives will validate the feasibility of subsequent scale-up prototype testing of the SEWGS technology.

Technical Goals

This program meets the programmatic objectives established by DOE by targeting novel sorbents that will achieve greater than 90% CO₂ removal from simulated syngas at conditions applicable to WGS reactors. A novel approach will integrate the use of multiple computational models with sorbent synthesis and characterization activities to develop sorbents with optimal CO₂ removal properties at high temperatures and pressures applicable to WGS applications. Tests will be performed in alignment with DOE experimental objectives, where sorbent performance is evaluated in simulated WGS gas mixtures at commercially relevant conditions. Appropriate data reduction and analysis will be conducted in order to provide suitable data that will provide the basis for a techno-economic analysis to evaluate the feasibility and scale-up potential of the SEWGS technology.

Specific technical objectives of this project include:

- Determination of optimal CO₂ sorbent properties and operating conditions for CO₂ removal and regeneration and carbon monoxide (CO) conversion in simulated syngas using a combination of computational and experimental methods.
- Development of one or more sorbents that recover high-quality heat during CO₂ adsorption, regenerate at elevated pressure, have minimal deactivation over multiple cycles, have high selectivity at high temperatures, have high adsorption capacity, and have acceptable thermal stability and mechanical integrity. This will result in sorbents capable of 90% CO₂ removal with high loading capacities and able to operate at the high temperatures and pressures typically encountered upstream of a WGS reactor. If successful, the sorbents developed in this program will augment or replace the CO conversion catalysts currently used in WGS reactors and improve overall WGS thermal efficiency.
- Determine the techno-economic feasibility of the SEWGS process for removing CO₂.

Project objectives will be achieved through the execution of five primary tasks: Project Management and Planning; Sorbent Engineering Analysis and Selection; Sorbent Preparation; Sorbent Evaluation Testing; and Engineering Feasibility Study.

Technology Maturity:

Bench-scale using simulated syngas

Project Focus:

Sorbent-Enhanced Water Gas Shift

Participant:

URS Group

Project Number:

FE0000465

NETL Project Manager:

Meghan Napoli
Meghan.Napoli@netl.doe.gov

Principal Investigator:

Carl Richardson
 URS Group, Inc.
Carl_Richardson@urscorp.com

Partners:

Illinois Clean Coal Institute
 University of Illinois at Urbana-Champaign (UIUC)

Performance Period:

1/1/10 – 3/31/13

Technical Content

URS Group, Inc. is leading an investigative effort for the development of a dry sorbent process configured to combine the WGS reaction with CO₂ removal for coal gasification systems. The result will be a SEWGS technology.

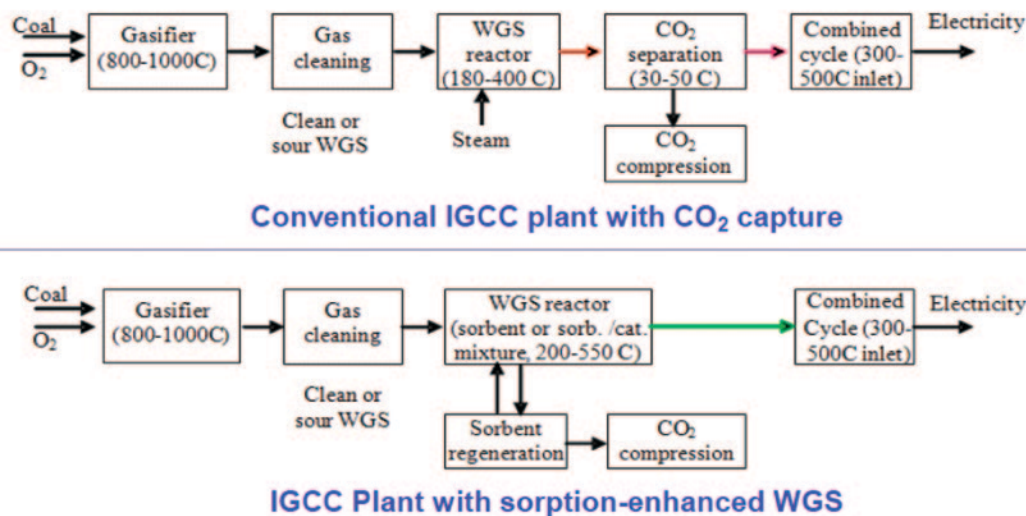

Figure 1: IGCC with SEWGS vs. Conventional IGCC

The University of Illinois at Urbana-Champaign (UIUC) will perform process simulation modeling and sorbent molecular and thermodynamic analyses. These analyses will allow prediction of optimal sorbent properties and identification of optimal operating temperature and pressure windows to maximize the energy efficiency of the combined WGS and CO₂ capture processes. The thermodynamic study will include developing phase equilibrium diagrams for potential sorbents, identifying optimum operating conditions for CO₂ capture, understanding impacts of syngas impurities, and identifying promising sorbents. Molecular simulation will predict isotherms and properties, predict kinetics and dynamics, and identify sorbents with desired properties using quantum chemistry/mechanics, force field-based Monte Carlo (MC), Kinetic Monte Carlo (KMC), Molecular Dynamics (MD), and reactive dynamics (RD) simulations. Process simulation analysis will analyze various process scenarios for heat integration between SEWGS and IGCC and process energy performance for individual sorbents.

Concurrently, UIUC will perform sorbent development. Sorbents will be synthesized with desired pore structure, surface functionality, and composition guided by the first phase testing and modeling effort. Sorbents will be synthesized using various precursors including calcium, magnesium, and other metal oxides, zirconates, titanates, silicates, aluminates, and adsorbent-shift catalyst hybrid. Sorbent down-selection will proceed according to the decision tree shown in Figure 2.

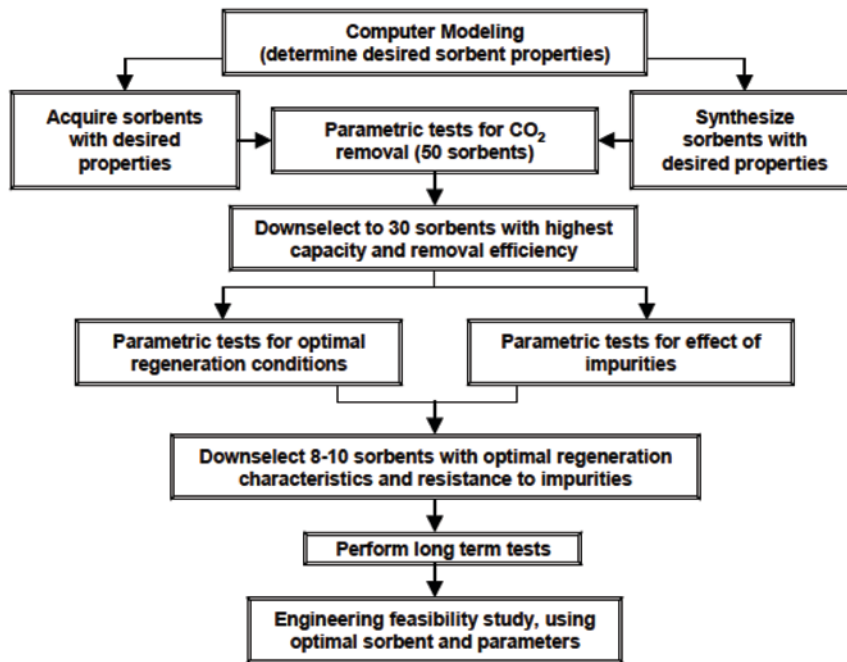

Figure 2: Sorbent Development and Analysis Decision Tree

UIUC will use a high-pressure thermogravimetric analyzer (PTGA) and a high temperature and pressure reactor (HTPR) system capable of 300 pounds per square inch gauge (psig) and 950 °C for screening sorbents for CO₂ removal. Also, URS will construct an HTPR to evaluate sorbent adsorption performance in presence of syngas impurities and regeneration performance. Thirty down-selected sorbents will also be tested for sorbent resistance to syngas impurities and determine optimal regeneration parameters. Eight to 10 sorbents will be further down-selected and will be tested on a longer-term basis.

Lab results will be used in a preliminary engineering study of process feasibility for adsorbing and removing CO₂ as part of the WGS process with the comparison made to base WGS operation and other CO₂ removal strategies. Parameters include cost of >90% removal [cost of electricity (COE), operation and maintenance (O&M)], sorbent costs, anticipated lifetime (i.e., replacement rate), estimated future market costs of precursor materials, handling equipment, sorbent regeneration costs, heat/energy integration, compression costs with SEWGS, unit footprint, and capital costs and scalability.

Table 1: Solid Sorbent Parameters

	Parameter	Current R&D Value	Target R&D Value
Sorbent Properties	Type of sorbent	(1) Calcium based smart sorbents; (2) calcium and magnesium oxide mixture sorbents; (3) zirconate, titanate, silicate, aluminate sorbents; (4) WGS/sorbent hybrid; (5) others	Program is designed to determine optimal sorbent type(s)
	Heat of adsorption, kJ/mole CO ₂	100–200	TBD
	CO ₂ loading/working capacity, wt%	N/A	Optimal loading properties will be impacted by regeneration properties (TBD in program)
	Surface area, m ² /g	40–75	>40
	Particle density, cm ³ /g	N/A	TBD
	Particle size, nm	Nano (20–50 nm) or micro meter (0.5–10 μm) level; particles can be pelletized if needed	TBD
	Heat capacity, kJ/K/kg	N/A	TBD
	Thermal stability, °C	N/A	TBD
	Hydrothermal stability, °C	Inert to water vapor at operating temperatures	TBD
Process Configuration	Attrition rate (fluidized bed), %/year	N/A	Values will be impacted by costs of optimal sorbent type(s)
	Cycle time (fixed bed), minutes	Not applicable to fluidized bed or moving bed configuration	N/A
	Pressure drop (fixed bed), psia	Depending on sorbent properties, to be determined during the project	TBD
Operating Conditions	Adsorption temperature, °C	200–550	550
	Adsorption pressure, atm	30–40	40
	CO ₂ capture efficiency, %	90%	>90%
	Regeneration method	Temperature swing	Temperature swing.
	Regeneration temperature, °C	Depends on individual sorbent and highest regeneration pressure achievable	TBD; optimization based on minimal energy input
	Regeneration pressure, atm	Up to 30 atm	Highest possible pressure up to 30 atm
Heat Integration	Required regeneration steam temperature, °C	Steam may not be used; if a steam is used, steam temperature <1,000 °F	TBD
Miscellaneous	Sorbent make-up rate, kg/kg CO ₂	N/A	TBD
Product Quality	CO ₂ purity, %	>99%	>99%
	N ₂ concentration, %	0	0
	Other contaminants, %	Moisture <600 ppm	N/A
Process Performance	Electricity requirement, kJ/kg CO ₂	N/A	TBD
	Heat requirement, kJ/kg CO ₂	N/A	TBD
	Total energy (electricity equivalent), kJ/kg CO ₂	N/A	0.1 kWh/kg CO ₂ (360 kJ/kg)

This is a research and development (R&D) program involving fairly immature technology. As such, many target R&D values will be determined during execution of the test program and will be impacted by a number of key process parameters including sorb-

ent type and cost, sorbent performance and loading capacity, sorbent lifetime, regeneration conditions and cycling parameters, and complexity of integration of optimal adsorption and regeneration processing steps.

Sorbent Heating/Cooling Method: For sorbent regeneration, the sorbent is heated in a fluidized bed or moving bed configuration with heat supplied by either hydrogen (H_2) (or syngas) oxy-combustion or steam extracted from the gasification plant steam cycle. Before entering the adsorption bed, the regenerated sorbent is cooled by exchanging heat with inlet regeneration H_2 /oxygen (O_2) or syngas. In the adsorption bed, a heat exchanger (such as a boiler tube bundle used in the fluidized bed boiler) is used for recovering heat generated from CO_2 adsorption.

Heat of Adsorption Handling: Adsorption heat is recovered during CO_2 adsorption by using a heat exchanger to generate steam, which is combined into the gasification plant's steam cycle for electricity generation.

Heat Supply Method for Regeneration: Two methods will be considered. One is to burn a small amount of the H_2 or syngas using O_2 to supply heat directly. Another approach is to use the steam from the gasification plant's steam cycle if the regeneration temperature is far below 1,000 °F.

Contamination Resistance: This program will evaluate the impact of various syngas impurities on the adsorption and regeneration performance of promising CO_2 sorbents. Sorbents may not be resistant to sulfur species [hydrogen sulfide (H_2S), carbon disulfide (CS_2), etc].

Flue Gas Pretreatment Requirements: The pretreatment of H_2S/CS_2 is needed for sorbents with no sulfur resistance. If it is determined that the performance of identified sorbents is inhibited by sulfur species present in the syngas, additional work will focus on the development of sorbents materials that are resistant to sulfur; the objective will be to avoid the need for syngas pretreatment associated with this technology.

Waste Streams Generated: Desulfurization byproducts.

Successful completion of this project will demonstrate the feasibility of the SEWGS concept for removing CO_2 from syngas. The separation of CO_2 across a WGS reactor with dry sorbents would reduce or eliminate the need for WGS catalysts and would eliminate the need for a separate downstream CO_2 control process. It would result in a purified CO_2 stream at an appreciably higher temperature and pressure than obtained with existing capture processes, thus reducing the energy requirement for CO_2 compression for subsequent pipeline transport. Specific benefits of a successful SEWGS process would include:

- 50–80% decrease in compression costs relative to existing CO_2 capture processes (such as Selexol).
- Decreased steam requirements associated with syngas cooling/reheating (for downstream CO_2 capture).
- Elimination of capital and operation and maintenance costs associated with downstream CO_2 capture.

It is acknowledged that capital costs associated with the WGS process will increase as a result of this technology due to the additional vessels and mechanical equipment associated with the dry sorbents. The extent of this increase will be impacted by the properties and performance of the developed sorbents and is expected to be considerably lower than the potential cost reductions described above. Sorbent optimization is an objective of this program and subsequent impacts on WGS capital and O&M costs will be a focus of the techno-economic evaluation.

R&D Challenges

- Sorbent pores may be plugged during adsorption causing capacity and activity loss.
- Long-term capacity and activity stability after multiple cycles.
- Selectivity at high temperature.

Results To Date/Accomplishments

Activities conducted to date have included computational modeling (thermodynamic, process, and molecular modeling) to identify key physical and chemical properties for optimal sorbent performance at operating conditions applicable to a WGS process.

The model-derived information has been used to identify a number of promising sorbent materials for subsequent evaluation. Sorbent synthesis methods have been developed or refined and a number of sorbent samples have been prepared and characterized. Preliminary laboratory screening tests have been conducted to compare the CO₂ adsorption ability of the prepared sorbents. Additional activities have included mobilization of an HTPR and design of the integrated reactor for adsorption-regeneration testing. A summary of key project findings is provided below.

The project has achieved milestones associated with thermodynamic and process simulation modeling, as well as sorbent preparation. Thermodynamic modeling activities included screening analyses of a number of different metal oxides and zirconates, silicates, and titanates under various operating conditions. A group of 18 sorbents were further modeled and subsequently down-selected to seven candidates [magnesium oxide (MgO), calcium oxide (CaO), lithium zirconate (Li₂ZrO₃), calcium zirconium oxide (CaZrO₃), barium zirconate (BaZrO₃), barium titanate (BaTiO₃), and barium silicate (BaSiO₃)] for further development. Process simulations were performed for a baseline IGCC plant with WGS and a Selexol process and compared to an IGCC with SEWGS. These showed a 0.5–2.4% increase in net thermal efficiency for the simulated plant with SEWGS. The exact value depended on the nature of each of the seven sorbents. It should be noted, however, that these simulations were performed at common operating conditions and the efficiency increase is expected to increase as process conditions are optimized for each of the individual sorbents. Initial molecular simulation efforts have involved simulation of a single CO₂ molecule and how its interaction varied based on the solid sorbent material, crystallographic surface, and local environment.

A series of CaO spheres were synthesized using an ultrasonic spray pyrolysis (USP) procedure that is applicable to the synthesis of other materials of interest. Efforts were made to create hollow spheres with high BET surface areas ranging between 40 and 75 m²/g, comparing very favorably to commercially available lime products (1–3 m²/g) and other products reported in the literature (9–36 m²/g). Water was initially used as the solvent but was replaced with ethanol, resulting in better hollow sphere particles yield; the addition of water to ethanol resulted in further yield improvement. The hollow structure made the materials more robust to extreme volume changes associated with carbonation and calcination, but USP-derived CaO sorbents showed morphological deterioration as well as loss of capacity (19% capacity reduction over 10 cycles) when undergoing multiple CO₂ adsorption/desorption cycles. The sorbent showed a strong affinity for CO₂ in air, adsorbing 31% of its maximum CO₂ capacity in 60 minutes under ambient conditions.

A highly energetic ball mill was used to synthesize new sorbents from commercially available materials using a molecular alloying (MA) process. X-ray diffraction (XRD) of produced particles revealed a decrease in crystallite size from 61 to 20 nm after milling CaO for 1.5 hours and TGA tests showed a 3% increase in capacity over the virgin material. An MgO/CaO alloy was synthesized and displayed a 6% improvement in CO₂ adsorption over a physically mixed sample. The results indicate that fundamental phase and/or structural changes occur to a material, at the nanometer scale, during ball milling. A series of sorbents with varying CaO:MgO ratios were synthesized and it was found that the CaO utilization actually increased over pure CaO when the MgO content was between 30 and 80%.

Shakedown and preliminary tests of the PTGA were performed so that sorbents can be screened at conditions more closely reflected those that will be experienced during an SEWGS. The effect on weight change due to CO₂ adsorption of both sample buoyancy and drag force were quantified and data sets generated with this unit will be adjusted accordingly.

Next Steps

- Complete molecular simulation analysis.
- Continue to refine sorbent preparation activities to achieve high activity and multi-cycle stability.
- Sorbent evaluation testing.
 - PTGA and high temperature and pressure reactor sorbent screening testing.
 - Syngas simulation tests.
 - Regeneration tests.
- Engineering feasibility study.

Available Reports/Technical Papers/Presentations

Evaluation of Dry Sorbent Technology; Presentation at the 2010 NETL CO₂ Capture Technology Meeting, Pittsburgh, PA, September 13–17, 2010.

“Evaluation of Dry Sorbent Technology for Pre-Combustion CO₂ Capture,” **Pre-Combustion CO₂ Capture Kick-off Meetings**, Pittsburgh, PA, November 12–13, 2009. [http://www.netl.doe.gov/publications/proceedings/09/CO₂capture/7-URS Dry Sorbent Kickoff Presentatin-111309.pdf](http://www.netl.doe.gov/publications/proceedings/09/CO2capture/7-URS%20Dry%20Sorbent%20Kickoff%20Presentatin-111309.pdf)

A LOW-COST, HIGH-CAPACITY REGENERABLE SORBENT FOR PRE-COMBUSTION CO₂ CAPTURE

Primary Project Goals

TDA Research is further developing a low-cost, high-capacity regenerable carbon dioxide (CO₂) sorbent technology, demonstrating its technical and economic viability for pre-combustion CO₂ capture from coal-derived synthesis gas (syngas) fueling integrated gasification combined cycle (IGCC) power plants.

Technical Goals

- Optimize chemical and physical properties of an existing sorbent.
- Modify the sorbent to improve capacity and stability.
- Scale up sorbent production using commercially adoptable equipment.
- Demonstrate long-term sorbent performance at bench-scale in the presence of contaminants.
- Design and build a prototype unit to support slipstream demonstration tests using actual syngas.
- Detailed process design and cost analysis to evaluate sorbent's ability to remove CO₂ at a lower cost than current technologies.

Technical Content

TDA is developing a new pre-combustion CO₂ capture technology that uses a TDA proprietary sorbent modified to remove CO₂ from shifted syngas. The CO₂ capture system uses two (or more) beds that switch positions between adsorption and regeneration. In addition to the conventional pressure and temperature swing operation, the sorbent can be regenerated under near isothermal and isobaric conditions while the driving force for separation is provided by a swing in CO₂ concentration. The sorbent consists of a carbon support modified with surface functional groups that remove CO₂ via strong physical adsorption. The CO₂ surface interaction is strong enough to allow operation at elevated temperatures. Because the CO₂ is not bonded via a covalent bond, the energy input to the regeneration is low—only 4.9 kcal/mole of CO₂ removed (comparable to Selexol). This energy requirement is much lower than that of the chemical absorbents [e.g., sodium carbonate (Na₂CO₃) requires 29.9 kcal/mol] and amine solvents (~14 kcal/mol). The energy output loss of the IGCC plant is expected to be similar to that of Selexol's; however, a higher overall IGCC efficiency can be achieved due to higher temperature CO₂ capture.

Initially, the researchers will be optimizing the chemical, mechanical, and physical properties of the sorbent to optimize the active material content; assess the impact of key synthesis parameters on surface area, pore volume, and pore size distribution; and determine crush strength and attrition resistance. Cost will be kept to a minimum by evaluating low-cost raw materials and optimizing the production process. Sorbents will be evaluated under simulated syngas, water gas shift (WGS), and simulated contaminant conditions using two TGAs and a 1-, 3-, and 6-inch bench-scale flow reactor. TDA and the University of California Irvine (UCI) will carry out process design and modeling. Based on that information, UCI will carry out multiple design options and the best option will be selected for detailed simulation.

Technology Maturity:

Pilot-scale slipstream using actual syngas

Project Focus:

High Capacity Regenerable Sorbent

Participant:

TDA Research, Inc.

Project Number:

FE0000469

NETL Project Manager:

Arun Bose

Arun.Bose@netl.doe.gov

Principal Investigator:

Dr. Gokhan Alptekin

TDA Research, Inc.

galptekin@tda.com

Partners:

ConocoPhillips

KBR

MeadWestvaco

Southern Company

University of California Irvine

Performance Period:

10/1/09 – 9/30/11

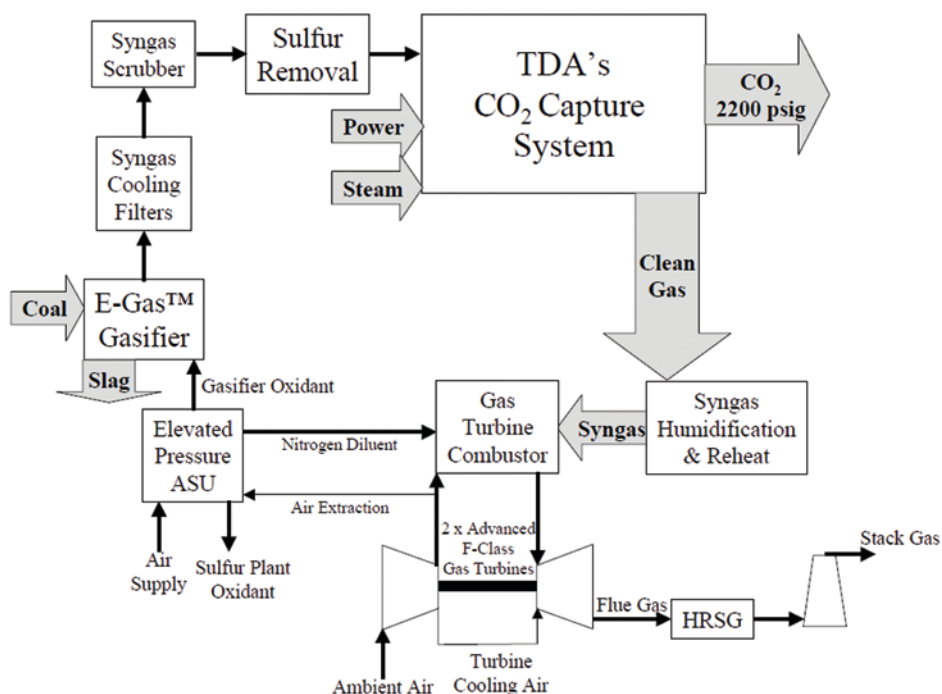
Figure 1: IGCC Integrated CO₂ Removal System

The next objective is to scale up sorbent production by a factor of 10 at the end of Year 1 using commercially adoptable equipment. Scale up will explore the use of continuous or semi-continuous preparation approaches, and reduce or optimize the number of processing steps via intensification (co-synthesis, co-firing, etc.). A preparation recipe will be developed in cooperation with MeadWestvaco, who will carry out a detailed analysis to estimate the cost of the sorbent. Long-term tests will be performed to ensure that the sorbent does maintain its CO₂ capacity over many cycles. A minimum of 2,000 cycles are planned in Year 1.

Year 2 of the project focuses on designing, building, and testing a prototype unit using slipstream syngas and analyzing the results. TDA will work with KBR to carry out a detailed design and sizing of sorbent reactors for each of the two gasifier types that will be used for pilot testing.

TDA and UCI will continue to optimize the process design and modeling. The focus of system analysis in Year 2 will be on the integration of the CO₂ capture system with the IGCC plant. TDA will fabricate the test module, which will have a control rack using Labview programming to control, monitor, and log key process parameters. The test module will also have an analyzer rack for continuous analysis of carbon monoxide (CO), CO₂, methane (CH₄), hydrogen (H₂), and water (H₂O) on the adsorption and regeneration sides, and hydrogen sulfide (H₂S) analysis on the adsorption side. TDA will perform all shakedown and troubleshooting before shipping the test system. Field tests will be performed at ConocoPhillips' Wabash River IGCC Plant with the oxygen (O₂)-blown E-Gas gasifier in Terre Haute and in collaboration with the Southern Company at the National Carbon Capture Center (NCCC) using the syngas generated by an air-blown gasifier at Wilsonville, AL. Two, three-week long (500 hours) test campaigns are scheduled with 24 hr/day continuous operation. A majority of testing will be performed under optimum conditions and limited scope testing to assess the impact of operating parameters.

Table 1: Solid Sorbent Parameters

	Parameter	Current R&D Value	Target R&D Value
Sorbent Properties	Type of sorbent	Physical adsorbent	Physical adsorbent
	Heat of adsorption (kJ/mole CO ₂)	20.5	Less than 30
	CO ₂ loading/working capacity, wt%	7	TBD
	Surface area, m ² /g	350–450	TBD
	Particle density, cm ³ /g	0.6–0.7	TBD
	Packing density, cm ³ /g	0.40–0.45	TBD
	Particle size (mm)	3.2	TBD
	Heat capacity (kJ/K/kg)	TBD	TBD
	Thermal stability, °C	1,100	Greater than 400
	Hydrothermal stability, °C	600	Greater than 400
Process Configuration	Attrition rate (fluidized bed), %/year	TBD	Less than 1%
	Cycle time (fixed bed), minutes	TBD	TBD
	Pressure drop (fixed bed), psia	TBD	TBD
Operating Conditions	Adsorption temperature, °C	20–320	200–300
	Adsorption pressure, atm	1–60	50
	CO ₂ capture efficiency, %	98+	90+
	Regeneration method	TBD	TBD
	Regeneration temperature, °C	TBD	TBD
	Regeneration pressure, atm	TBD	TBD
Heat Integration	Required regeneration steam temperature, °C	TBD	TBD
Miscellaneous	Sorbent make-up rate, kg/kg CO ₂	TBD	TBD
Product Quality	CO ₂ purity, %	TBD	Pipeline spec
	N ₂ concentration, %	TBD	Pipeline spec
	Other contaminants, %	TBD	Pipeline spec
Process Performance	Electricity requirement, kJ/kg CO ₂	TBD	TBD
	Heat requirement, kJ/kg CO ₂	TBD	TBD
	Total energy (electricity equivalent), kJ/kg CO ₂	TBD	TBD

Sorbent Heating/Cooling Method: Isothermal operation is planned.

Heat of Adsorption Handing: The small heat of adsorption will be removed by convective losses (i.e., warming the syngas) and by increasing the sensible heat of the sorbent pellets.

Heat Supply Method for Regeneration: The stored heat in the sorbent pellets and the convective heat input.

Contaminant Resistance: The sorbent will be resistant to syngas contaminants.

Fuel Gas Pretreatment Requirements: Particulate removal, bulk desulfurization, and WGS.

Waste Streams Generated: The spent sorbent will be replaced periodically.

Technology Advantages

- Carbon dioxide recovered at pressure reduces compression costs for sequestration.
- A weak CO₂ surface interaction allows fast regenerations at low temperature with the minimal or no heat input.
- Short adsorption/regeneration cycles reduce bed size and weight.

R&D Challenges

- Demonstration to the resistance of syngas contaminants.
- Reducing the use of purge gas during regeneration.

Results To Date/Accomplishments

- Completed sorbent optimization.
 - Identified an optimum chemical composition.
 - Production scale-up.
- Demonstrated high CO₂ capacity in bench-scale experiments.
 - Saturation capacity approaching 20 wt% CO₂.
 - 6–8 wt% working capacity.
- Long-term durability was demonstrated through 6,000 cycles.
- System simulation indicates that TDA's CO₂ technology will provide higher net plant efficiency than that of IGCC-Selexol.

Next Steps

- Complete 10,000 cycles to demonstrate sorbent life.
- Complete the process design and optimization.
 - Estimate the cost of capital equipment.
 - Economic analysis.
- Complete the fabrication of a skid-mounted unit for field evaluations.
- Carry out field demonstrations.

Available Reports/Technical Papers/Presentations

Low Cost, High Capacity Regenerable Sorbent; Presentation at the 2010 NETL CO₂ Capture Technology Meeting, Pittsburgh, PA, September 13–17, 2010. http://www.netl.doe.gov/publications/proceedings/10/co2capture/presentations/friday/Gokhan_Alptekin - FE0000469.pdf

“A New Sorbent-Based Pre-Combustion CO₂ Capture System,” presented at the International Conference of Energy and Power Generation Systems, Costa Mesa, CA, 2010.

HYDROGEN PRODUCTION AND PURIFICATION FROM COAL AND OTHER HEAVY FEEDSTOCKS

Primary Project Goals

The University of North Dakota Energy and Environmental Research Center (UNDEERC) is evaluating the ability of various conventional and high-temperature carbon dioxide (CO₂) sorbents to resist the deleterious effects of hydrogen sulfide (H₂S)-containing (sour) synthesis gas (syngas).

Technical Goals

- Assess the performance of high-temperature and conventional CO₂ sorbents in simulated and real syngas.
- Evaluate the effect of H₂S on solid sorbents when operating in a fixed bed under simulated and real syngas conditions.
- Analyze CO₂ sorbents after exposure to real and simulated syngas.

Technical Content

Gasification of coal and other heavy feedstocks is becoming an attractive approach for power and chemical production. The solid fuels are transformed into a sour syngas which must be further processed to yield the desired final products [e.g., high-purity hydrogen (H₂) or H₂-rich fuel and a CO₂-rich byproduct]. Air Products is interested in two types of syngas treatment processes: a high-temperature process (400 °C) and an ambient-temperature process. Both require information on the impact of sour gas species on the solid adsorbents and the ability of these adsorbents to reversibly adsorb H₂S and CO₂.

UNDEERC has conducted two major sets of experiments in this program. In Phase 1 of the program, a 10-bed exposure unit was built and operated, and the impact of a synthetic sour syngas on various high- and low-temperature CO₂ adsorbents was determined. Most of the adsorbents showed an increase in sulfur content and subsequent decrease in surface area and CO₂ adsorption capacity with exposure. Two materials were able to maintain their CO₂ capacity at ambient temperature.



Figure 1: Fixed-Bed Reactor Skid

In the next phase of work, these two materials were tested in a fixed-bed skid (Figure 1). The unit consisted of two packed beds, with the necessary valves and heating equipment to permit regeneration by pressure swing adsorption (PSA) or temperature swing adsorption (TSA) cycles.

Breakthrough experiments were conducted with 2% H₂S in H₂ feed gas to determine the H₂S adsorption capacity and mass transfer coefficients for the two materials. Hydrogen sulfide adsorption was shown to be reversible and rapid.

Technology Maturity:
Laboratory- and pilot-scale

Project Focus:
Evaluation of Sorbents

Participant:
UNDEERC

Project Number:
NT42465-1.4

NETL Project Manager:
Arun Bose
Arun.Bose@netl.doe.gov

Principal Investigator:
Grant Dunham
UNDEERC
gdunham@undeerc.org

Partners:
Air Products and Chemicals, Inc.

Performance Period:
6/23/05 – 5/31/11

The fixed-bed unit was then connected to UNDEERC's existing lab-scale circulating fluidized-bed gasifier. The gasifier processed Powder River Basin (PRB) sub-bituminous coal spiked with elemental sulfur (S) to generate a syngas with an elevated H₂S concentration. The syngas was continuously fed to the fixed-bed unit (operating in PSA mode) for more than 1,000 cycles. The adsorbent beds were capable of reducing H₂S in the product stream to less than 50 parts per million (ppm). The H₂S capacity of the adsorbent decreased with initial syngas exposure (first couple of hundred cycles), but then remained stable. Post-mortem analysis of the adsorbent showed some deposition of S and chlorine (Cl) species at the front of the bed and capture of organic tar species.

UNDEERC operated the entrained-flow gasifier under oxygen-blown conditions with petcoke feed to generate a second sour syngas feed to the fixed-bed unit. The system was operated under various conditions (temperature and process flow rates) to determine the impact on separation performance. At the end of the testing, the adsorbent was systematically removed and analyzed to monitor changes in capacity/integrity. UNDEERC also modified the exposure unit to allow injection of low levels of iron carbonyl, carbonyl sulfide, and hydrogen fluoride. Impact of exposure was determined for the most promising adsorbent to date.

Technology Advantages

High-temperature acid gas (H₂S and CO₂) removal from integrated gasification combined cycle (IGCC) syngas streams has the potential to increase the net power system efficiency by maintaining a high-temperature, high-moisture feed stream to the combustion turbine power cycle. These advantages also hold for applications that utilize the syngas for coproducing hydrogen, fuels, or chemicals. Energy losses through syngas cooling and re-heating resulting from cool acid gas removal (such as Rectisol® or Selexol™) are prevented with high-temperature separation.

An ambient-temperature acid gas separation process based on adsorption would also be attractive relative to typical liquid absorption-based processes because of reductions in steam consumption and capital cost.

R&D Challenges

The physical/chemical stability of the adsorbents in a sour syngas environment remains a concern, as does the ultimate fate of trace components (mercury, Cl, particulate matter) and the reversibility of heavy component (tars) adsorption.

Results To Date/Accomplishments

- Identified two promising ambient-temperature adsorbents that exhibited very little CO₂ capacity loss after sour syngas exposure.
- Conducted H₂S breakthrough experiments, both with and without CO₂, which showed that the most promising adsorbent is selective for H₂S over CO₂, the mass transfer rate of H₂S is described by macropore diffusion, and H₂S adsorption is reversible.
- Operated the fixed-bed test unit in PSA mode with coal-based syngas produced in a circulating fluidized-bed gasifier. Demonstrated that H₂S and CO₂ can be effectively rejected from the sour syngas. Completed roughly 1,500 adsorption/regeneration cycles. Showed that the H₂S capacity initially dropped but then leveled off at about 80% of the fresh capacity.
- Conducted postmortem analysis of adsorbent to determine progression of Cl, S, and organics into bed. Chlorine and sulfur were limited to the first few inches of the bed. Organics were found to penetrate deeper, and are thought to be responsible for the initial drop in H₂S capacity.
- Operated a second batch of adsorbent in the fixed-bed unit with syngas generated from petroleum coke in an entrained-flow gasifier. Observed negligible levels of organics in the syngas. Completed more than 1,000 adsorption/regeneration cycles with no indication of H₂S capacity loss.

Next Steps

Experimental work is complete. Final test results will be included in the project report scheduled to be available by May 31, 2011. This task is being continued under a new cooperative agreement, DE-FE0003466— Activity 1.4, Add-On Task.

Available Reports/Technical Papers/Presentations

“Hydrogen Production and Purification from Coal and Other Heavy Feedstocks—Final Topical Report” will be available May 31, 2011.

An abstract will be submitted for presentation of results at the 28th Annual International Pittsburgh Coal Conference (September 2011).

HIGH-DENSITY ACTIVATED CARBON FOR HIGH-PRESSURE HYDROGEN PURIFICATION

Primary Project Goals

The University of North Dakota Energy and Environmental Research Center (UNDEERC) is developing high-density, electrically conductive monolithic-activated carbon for use in a high-pressure swing adsorber to produce hydrogen (H₂) and sequestration-ready carbon dioxide (CO₂) from gasification synthesis gas (syngas).

Technical Goals

- Prepare a high-density, electrically conductive monolithic-activated carbon sorbent for H₂/CO₂ separation.
- Measure adsorptivity, pressure drop, and electrical conductivity (for regeneration) of monolith.
- Determine the feasibility of using activated carbons as CO₂ sorbents in gasification syngas.

Technical Content

UNDEERC worked with SGL Carbon to produce a monolithic, high-density activated carbon sorbent for use in high-pressure swing adsorbers to separate H₂ and CO₂ in a high-pressure syngas stream, while maintaining the pressure of the H₂ near that of the incoming syngas. By producing and purifying the H₂ from liquid feedstocks at high pressure, the associated cost of compressing the H₂ is reduced. This process, if employed at an integrated gasification combined cycle (IGCC) power plant, could potentially be used to produce high-purity CO₂ for storage.

As syngas passes through the activated carbon adsorbers, CO₂ is adsorbed onto the surface of the material, leaving relatively pure H₂ to pass through. Once saturated, the adsorbers can possibly be regenerated by passing an electrical current through it at constant pressure. Oak Ridge National Laboratory (ORNL) has been developing such a process and has produced a continuous, low-density, porous, fiber-reinforced activated carbon. By being continuous, it can conduct electricity at low voltage and can be sealed in a horizontal container that will not allow gas bypass. However, when used at high pressures, the high pore volume requires significant H₂ for backflushing. UNDEERC is attempting to significantly increase the density of the carbon monolith in order to reduce the amount of clean H₂ required for backflushing at high pressures and decrease the regeneration interval.

During this project, UNDEERC attempted to activate four different formulations of high-density carbon fiber/carbon matrix composites. Activation methods included heating to 450 °C in static, high-pressure steam or oxygen and the use of chemical activation. However, only butane adsorptivities of 2–3% were able to be obtained for the activated carbon produced from the monolithic carbon fiber composite, whereas commercial granulated activated carbons have butane adsorptivities of up to 18%. In follow-on work, the focus was on pressing mixtures of granular and powdered activated carbon and binder. These results were successful in making conductive monoliths with twice the density of granular beds, or approximately 40% of the theoretical skeletal carbon density. In addition, a method of treatment of the activated carbon granules were developed to

Technology Maturity:

Laboratory-scale

Project Focus:

High-Density Activated Carbon

Participant:

UNDEERC

Project Number:

NT42465-3.1

NETL Project Manager

Edgar Klunder

Edgar.Klunder@netl.doe.gov

Principal Investigator:

John Hurley

University of North Dakota
Energy and Environmental
Research Center

jhurley@undeerc.org

Partners:

SGL Carbon

Performance Period:

6/23/05 – 6/22/07

reduce the resistivity of the monoliths by a factor of 10 relative to those made from the commercially available granular activated carbon.

Figure 1 shows how well the monolith separates different components from a simulated reformer gas stream. The figure is a plot of gas breakthrough curves for a monolith tested at 200 pounds per square inch gauge (psig) with a simulated reformer gas stream. The horizontal dashed lines show the concentrations of the different gases in the incoming gas stream. The light blue curve on the lower left is oxygen coming out of the monolith that was originally saturated with air. The difference between the sums of the curves and 100% is due to nitrogen, which was not directly detected. The monoliths are being tested at higher pressures in a follow-on U.S. Department of Defense (DoD) project and will be tested for their ability to be regenerated by passing an electric current through the monolith, possibly to disrupt the Vander Waals forces holding the gas molecules to the activated carbon surface or to resistively heat the monolith in a thermal swing adsorption process.

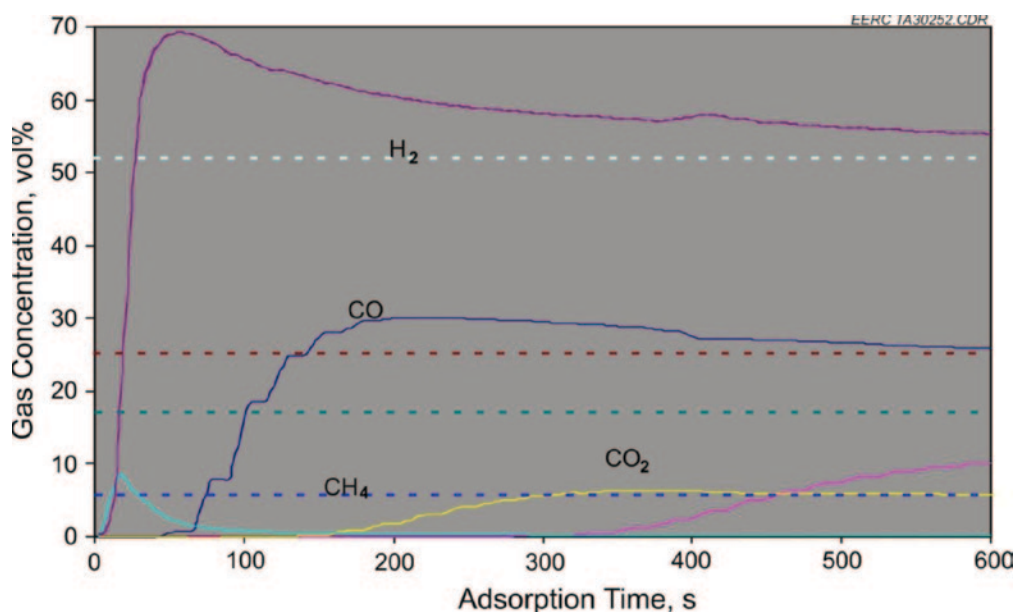

Figure 1: Gas Breakthrough Curves for a Monolith Tested at 200 psig

The following solid sorbent parameter table (Table 1) was completed by the Principal Investigator (PI) with best available data. “N/A” has been used for data that are not available. Data entered in the “Current R&D Value” column are based on test results achieved to date. As this project has ended, there are no further test results to enter in the “Target R&D Value” column.

Table 1: Solid Sorbent Parameters

	Parameter	Current R&D Value	Target R&D Value
Sorbent Properties	Type of sorbent	Activated carbon	—
	Heat of adsorption (kJ/mole CO ₂)	N/A	—
	CO ₂ loading/working capacity, wt%	9	—
	Surface area, m ² /g	1,200	—
	Particle density, g/cm ³	N/A	—
	Packing density, g/cm ³	0.85	—
	Particle size (mm)	Monolith	—
	Heat capacity (kJ/K/kg)	N/A	—
	Thermal stability, °C	75 °C	—
	Hydrothermal stability, °C	N/A	—
Process Configuration	Attrition rate (fluidized bed), %/year	Near 0	—
	Cycle time (fixed bed), minutes	N/A	—
	Pressure drop (fixed bed), psia	N/A	—

Table 1: Solid Sorbent Parameters

	Parameter	Current R&D Value	Target R&D Value
Operating Conditions	Adsorption temperature, °C	N/A	—
	Adsorption pressure, atm	N/A	—
	CO ₂ capture efficiency, %	N/A	—
	Regeneration method	Electrical/thermal	—
	Regeneration temperature, °C	N/A	—
	Regeneration pressure, atm	N/A	—
Heat Integration	Required regeneration steam temperature, °C	N/A	—
Miscellaneous	Sorbent make-up rate, kg/kg CO ₂	N/A	—
Product Quality	CO ₂ purity, %	N/A	—
	N ₂ concentration, %	N/A	—
	Other contaminants, %	N/A	—
Process Performance	Electricity requirement, kJ/kg CO ₂	N/A	—
	Heat requirement, kJ/kg CO ₂	N/A	—
	Total energy (electricity equivalent), kJ/kg CO ₂	N/A	—

Technology Advantages

High-pressure H₂/CO₂ separation, coupled with isobaric sorbent regeneration using an electrical current, will increase plant efficiency by reducing the parasitic load associated with gas compression. Also, because of the high density of the monolith, the gas adsorption per unit volume is nearly doubled, and the amount of H₂ necessary to flush the intergranular spaces is cut by 25%.

R&D Challenges

The project team discovered that the carbon sorbents require a long adsorption/desorption cycle time and no activation occurred during exposure to steam for 24 hours, while attempts to activate the material by reaction with an oxidizing gas showed limited results. Further, the introduction of reactive metals had a nominal effect on surface area creation.

Results To Date/Accomplishments

- Prepared high-density, monolithic-activated carbons for high-pressure H₂/CO₂ separation.
- Measured the surface area, pressure drop, and electrical conductivity of the activated carbon sorbents.

Next Steps

Development activities for this technology are no longer part of the DOE/NETL portfolio, but work is continuing under a DoD program.

Available Reports/Technical Papers/Presentations

Hurley, J.P. *High-Density Activated Carbon for High-Pressure Hydrogen Purification*; Final Report; U.S. DOE, April 2008.

INTEGRATED WARM GAS MULTI-CONTAMINANT CLEANUP TECHNOLOGIES FOR COAL-DERIVED SYNGAS

Primary Project Goals

Research Triangle Institute (RTI) is developing a modular warm, multi-contaminant synthesis gas (syngas) cleaning system that can be adapted to meet the specifications for both power and chemical/fuels production.

Technical Goals

- Develop a modular high-temperature (150–370 °C or 300–700 °F) and high-pressure [up to 83 atm or 1,200 pounds per square inch gauge (psig)] cleanup process that produces an effluent syngas suitable for chemical/fuels production by controlling trace contaminants to the levels shown in Table 1.

Table 1: Targeted Control Levels for Syngas Contaminants

Contaminant	Control Level
Sulfur (S)	<50 ppbw
Ammonia (NH ₃)	10 ppm
Chlorine (Cl)	10 ppb
Mercury (Hg)	5 ppbw
Selenium (Se)	0.2 ppm
Arsenic (As)	5 ppb
Phosphorus (P)	<20 ppbw

- Utilize a transport reactor and regenerable sorbents to control bulk syngas contaminants, such as hydrogen sulfide (H₂S), carbonyl sulfide (COS), ammonia (NH₃), and hydrogen chloride (HCl).
- Evaluate the performance of high-temperature carbon dioxide (CO₂) sorbents and promoters.

Technical Content

In this project, RTI is developing a sequential process where high-temperature syngas is cleaned using a transport reactor and a multi-functional fixed-bed system. The system is designed to operate at syngas feed conditions [150–370 °C (300–700 °F)] and 28–83 atm (400–1,200 psig), which will improve plant efficiency by eliminating the need for syngas cooling and re-heating. RTI's novel warm syngas cleaning technology could represent a significant improvement for chemical/fuels production applications due to reduced capital and operating costs; however, development and optimization for trace contaminant removal and warm CO₂ capture is needed to achieve the target syngas specifications for both power [integrated gasification combined cycle (IGCC) applications] and chemical/fuels production.

The bulk contaminant removal system consists of a transport reactor containing regenerable sorbents that target H₂S, COS, NH₃, and HCl. RTI investigated three sorbents: (1) RTI-3 for sulfur; (2) CBV-712 for NH₃; and (3) a sodium carbonate-based sorbent for chlorine. Syngas

Technology Maturity:

Bench-scale

Project Focus:

Warm Gas Cleanup with Sorbents

Participant:

RTI International

Project Number:

NT42459

NETL Project Manager:

K. David Lyons

K.David.Lyons@netl.doe.gov

Principal Investigator:

Brian S. Turk

Research Triangle Institute

bst@rti.org

Partners:

Nexant

Performance Period:

6/1/05 – 9/30/10

leaving the transport reactor is routed to a multi-functional, fixed sorbent bed that reduces contaminants to parts per billion by volume (ppbv) levels.



Figure 1: Modified TGA for CO₂ Sorbent Testing

RTI employed the modified, high-pressure thermal gravimetric analyzer (TGA) shown in Figure 1 and a microreactor system to evaluate the performance of high-temperature CO₂ sorbents. The bench-scale CO₂ sorbent testing campaign included experiments with lithium orthosilicate (Li₄SiO₄) and magnesium oxide (MgO) sorbents, as well as several promoters and support structures. RTI's Li₄SiO₄ sorbent exhibited a CO₂ adsorption capacity of about 35 wt% at high temperatures, but a technical-economic analysis concluded that the regeneration stage is prohibitively expensive.

Meanwhile, a promoted MgO sorbent has demonstrated a CO₂ capacity of nearly 60 wt% and the ability to be regenerated at a CO₂ partial pressure of about 150 psig. RTI developed a knowledge base for the promoted MgO sorbent and focused research on fundamental issues, including sorbent preparation procedures, sorbent support structures and binders, and syngas pretreatment requirements.

Table 2: CO₂ Solid Sorbent Parameters

	Parameter	Current R&D Value	Target R&D Value
Sorbent Properties	Type of sorbent	Promoted MgO	—
	Heat of adsorption (kJ/mole CO ₂)	95–100	~98
	CO ₂ loading/working capacity, wt%	10–60	30–40
	Surface area, m ² /g	N/A	—
	Particle density, cm ³ /g	N/A	—
	Packing density, cm ³ /g	N/A	—
	Particle size (mm)	N/A	—
	Heat capacity (kJ/K/kg)	N/A	—
	Thermal stability, °C	N/A	—
	Hydrothermal stability, °C	N/A	—
Process Configuration	Attrition rate (fluidized bed), %/year	N/A	—
	Cycle time (fixed bed), minutes	N/A	—
	Pressure drop (fixed bed), psia	N/A	—
Operating Conditions	Adsorption temperature, °C	350–450	350–450
	Adsorption pressure, atm	~24	40
	CO ₂ capture efficiency, %	>85	90
	Regeneration method	Thermal	Investigating
	Regeneration temperature, °C	500–550	Investigating
	Regeneration pressure, atm	~24	Investigating
Heat Integration	Required regeneration steam temperature, °C	N/A	Investigating
Miscellaneous	Sorbent make-up rate, kg/kg CO ₂	N/A	—
Product Quality	CO ₂ purity, %	N/A	—
	N ₂ concentration, %	N/A	—
	Other contaminants, %	N/A	—
Process Performance	Electricity requirement, kJ/kg CO ₂	N/A	Investigating
	Heat requirement, kJ/kg CO ₂	N/A	Investigating
	Total energy (electricity equivalent), kJ/kg CO ₂	N/A	Investigating

In parallel with this experimental program, RTI investigated potential process configurations and operating conditions to exploit the attributes of the promoted MgO sorbent. Research was geared toward developing a suitable fluidized version of the sorbent to facilitate sorbent transport between the adsorption and stripping columns, while also improving the heat transfer coefficient of the sorbent bed. RTI also worked to identify the temperature window between adsorption and regeneration that maximizes the sorbent's CO₂ working capacity, while minimizing the sensible heating requirement. In addition, RTI explored techniques to reuse the high-quality heat generated during the high-temperature CO₂ adsorption process, (e.g., transferring the high-quality heat to the steam cycle to generate additional power, or replacing a portion of the steam generated in the radiant syngas cooler).

Technology Advantages

Warm syngas cleanup will increase IGCC net power plant efficiency by eliminating the need for syngas cooling and re-heating, while also producing an effluent syngas suitable for chemical/fuels production and high-purity CO₂ for storage.

R&D Challenges

Integration and scale up of the bench-scale transport reactor and multi-functional fixed-bed system, as well as startup and standby options for the warm syngas cleanup technologies.

Results To Date/Accomplishments

- Technical support provided to DOE/NETL researchers has resulted in a computational fluid dynamics (CFD) model that predicts temperature and differential pressure profiles similar to actual pilot plant results.
- Demonstrated that combustion products [CO₂, steam, and carbon monoxide (CO)] do not adversely affect the desulfurization performance of RTI-3.
- Adapted existing bench-scale testing system to support phosphine (in addition to arsine and hydrogen selenide) testing.
- Developing a coconut-based charcoal as a quality control cartridge for supporting mass balance determination during phosphine testing.
- Identified a family of promoters that increased the CO₂ capacity of the MgO sorbent from <2 wt% to 40–60 wt%.
- Completed a technical-economic analysis of warm CO₂ capture using RTI's Li₄SiO₄ sorbent, which concluded that the regeneration stage is prohibitively expensive.
- Independent system analysis by both Nexant and Noblis indicate that RTI's warm syngas cleaning system can yield a three to four point increase in the net HHV thermal efficiency and a 10–15% reduction in capital costs, compared to an IGCC plant equipped with Selexol™ for acid gas removal.
- Identified a new process configuration/operating cycle that demonstrates technical and economic promise and achieves 82–87% CO₂ capture with warm MgO-based sorbent CO₂ capture.
- Demonstrated that the operational cycle (higher adsorption temperature than regeneration temperature) is valid.
- Demonstrated the potential to achieve low effluent CO₂ concentrations (~100 ppmv) with MgO-based sorbents at pressures from 150 to 325 psig.
- Completion of preliminary techno-economic evaluations by RTI and Noblis for multiple warm CO₂ capture processes with RTI's promoted MgO sorbents demonstrating a slight thermal efficiency advantage.

Next Steps

Development activities for this CO₂ capture technology are no longer part of the DOE/NETL portfolio.

In a follow-on DOE/NETL project (DE-FE0000489), RTI is designing, building, and testing a pre-commercial scale [30–50 megawatt electric equivalent (MWe)] warm gas cleanup system, integrated with CCS at Tampa Electric Company's Polk Power Station.

Available Reports/Technical Papers/Presentations

Final report not yet available.

“Integrated Warm Gas Multicontaminant Cleanup Technologies for Coal-Derived Syngas” fact sheet, <http://www.netl.doe.gov/publications/factsheets/project/Proj395.pdf>

Scaleup and Commercialization of Warm Syngas Cleanup Technology with Carbon Capture and Storage, presented at the 2010 Gasification Technologies Conference, Washington, DC, October 31 to November 3, 2010. <http://www.gasification.org/uploads/downloads/Conferences/2010/38GUPTA.pdf>

RTI/Eastman Warm Syngas Clean-up Technology: Integration with Carbon Capture, presented at the 2009 Gasification Technologies Conference, Colorado Springs, CO, October 4–7, 2009. <http://www.gasification.org/uploads/downloads/Conferences/2009/37GUPTA.pdf>

“Warm Syngas Cleanup for Chemical Applications using Regenerable CO₂ Sorbents,” presented at the 26th International Pittsburgh Coal Conference, Pittsburgh, PA, September 20–23, 2009.

“High Temperature CO₂ Capture from Syngas for Gasification Applications,” Eighth Annual Carbon Capture and Sequestration Conference, (May 2009).

“Development of a Warm Gas Cleanup Technology Platform for Power and Chemicals Production,” Pittsburgh Coal Conference, (September 2008).

NOVEL SORPTION ENHANCED REACTION PROCESS FOR SIMULTANEOUS PRODUCTION OF CO₂ AND H₂ FROM SYNTHESIS GAS PRODUCED BY COAL GASIFICATION

Primary Project Goals

Lehigh University has evaluated the feasibility of the novel thermal swing sorption enhanced reaction (TSSER) process to simultaneously separate carbon dioxide (CO₂) and carry out the water gas shift (WGS) reaction as a single-unit operation in a fixed bed reactor.

Technical Goals

While evaluating the feasibility of the TSSER process through experiments and process modeling, develop a sorbent that exhibits:

- High selectivity of CO₂ in the presence of steam at 200–500 °C.
- Adequate CO₂ working capacity at the reaction temperature.
- Low heat of adsorption for reversible CO₂ sorption and desorption.
- Adequately fast kinetics of CO₂ sorption and desorption.
- Thermal stability.

Technical Content

The WGS reaction, which converts most of the synthesis gas (syngas) carbon monoxide (CO) to hydrogen (H₂) and CO₂ by reacting the CO with water over a bed of catalyst, can be utilized to enhance H₂ production at an integrated gasification combined cycle (IGCC) plant. The excess steam serves to drive the shift equilibrium toward the products. The reaction is exothermic and, due to equilibrium constraints, typically consists of two stages: (1) high-temperature shift that benefits from high reaction rates at elevated temperatures; and (2) low-temperature shift that yields more favorable reaction equilibrium.

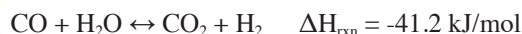

The TSSER process (Figure 1), under development by Lehigh University, simultaneously carries out the WGS reaction and the separation of CO₂ as a single-unit operation in a sorber-reactor (Step A). According to this process, the syngas from the coal gasifier (after removal of sulfur impurities) is introduced to a sorber-reactor, which is packed with an admixture of a WGS catalyst and a CO₂ sorbent that can selectively sorb CO₂ in the presence of excess steam. Removal of CO₂ (for geological storage) from the reaction zone drives the reversible reaction to the product side (circumventing equilibrium limits) and enhances the forward reaction rate.

An essentially pure (fuel cell grade) stream of H₂ (dry basis) is produced at feed gas pressure. The sorbed CO₂ is periodically removed (regeneration) by counter-currently purging the reactor with

Technology Maturity:

Laboratory-scale

Project Focus:

Sorbent-Enhanced Water Gas Shift

Participant:

Lehigh University

Project Number:

NT42455

NETL Project Manager:

Paula B. Flenory

Paula.Flenory@netl.doe.gov

Principal Investigator:

Shivaji Sircar

Lehigh University

shs3@lehigh.edu

Partners:

None

Performance Period:

5/25/05 – 6/4/10

superheated steam at feed gas and near-ambient pressures, as well as at a temperature higher than that of the feed step. An intermediate step of co-current CO₂ rinse at feed gas pressure prior to the regeneration step produces an essentially pure CO₂ stream at high pressure. This significantly reduces CO₂ compression costs.

Two novel CO₂ sorbents have been identified as candidates for the TSSER concept, and key parameters for the optimal CO₂ sorbent are provided in Table 1.

- Potassium carbonate (K₂CO₃) promoted hydrotalcite (400–550 °C).
- Sodium oxide (Na₂O) promoted alumina (200–550 °C).

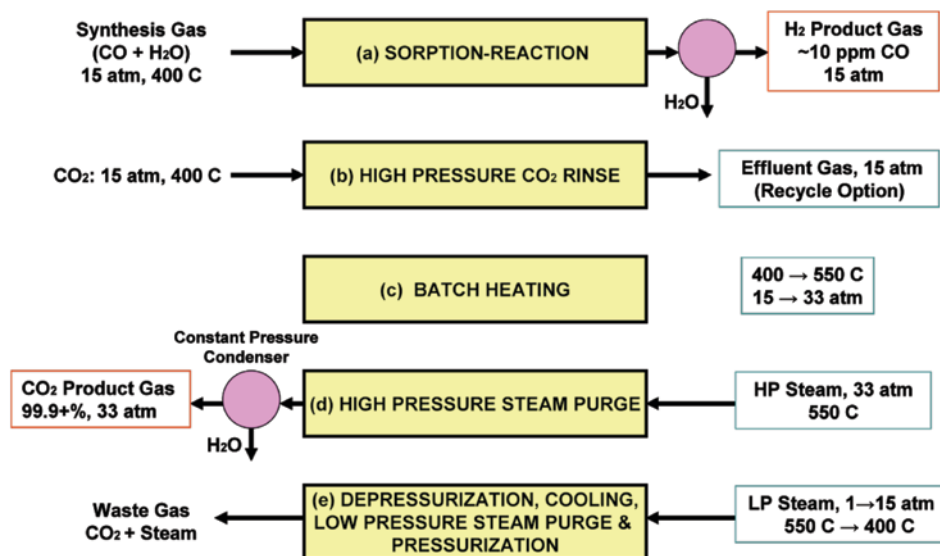

Figure 1: Components of the TSSER Process

This research project includes retrofitting an existing single-column sorption apparatus for measurement of high-pressure CO₂ adsorption characteristics; measurement of high-pressure CO₂ adsorption equilibria, kinetics, and sorption/desorption column dynamic characteristics under the conditions of thermal swing operation of the TSSER process; experimental evaluation of the individual steps of the TSSER process; development of a detailed mathematical model for simulating the performance of the individual steps of the TSSER process for optimization, process scale up, and for guiding future work; simulation and testing of the TSSER concept using a realistic syngas composition; demonstration of the thermal stability of sorbents using a thermogravimetric analysis (TGA) apparatus; and evaluating the effects of sulfur compounds [hydrogen sulfide (H₂S)] present in coal-derived syngas on the CO₂ sorbents.

Table 1: Solid Sorbent Parameters

	Parameter	Current R&D Value	Target R&D Value
Sorbent Properties	Type of sorbent	Na ₂ O promoted Al ₂ O ₃	New material
	Heat of adsorption (kJ/mole CO ₂)	64.9 kJ/mol	Same
	CO ₂ loading/working capacity, wt%	0.65 mol/kg	0.5 mol/kg
	Surface area, m ² /g	N/A	N/A
	Particle density, cm ³ /g	2.22 g/cm ³	Same
	Packing density, cm ³ /g	0.694 g/cm ³	Same
	Particle size (mm)	1.5 mm	Same
	Heat capacity (kJ/K/kg)	1.05	Same
	Thermal stability, °C	Stable to 600 °C	Acceptable
	Hydrothermal stability, °C	Yes to 550 °C	—

Table 1: Solid Sorbent Parameters

	Parameter	Current R&D Value	Target R&D Value
Process Configuration	Attrition rate (fluidized bed), %/year	N/A	Fixed-bed operation
	Cycle time (fixed bed), minutes	20 min	Acceptable
	Pressure drop (fixed bed), psia	<1 psia	<1 psia
Operating Conditions	Adsorption temperature, °C	200–400 °C	Same
	Adsorption pressure, atm	Up to ~25 atm	Same
	CO ₂ capture efficiency, %	71%	>50%
	Regeneration method	Thermal Swing	Novel
	Regeneration temperature, °C	550 °C	Same
	Regeneration pressure, atm	Up to 40 atm	N/A
Heat Integration	Required regeneration steam temperature, °C	550 °C	Acceptable
Miscellaneous	Sorbent make-up rate, kg/kg CO ₂	N/A	—
Product Quality	CO ₂ purity, %	99.9+%	95+%
	N ₂ concentration, %	<0.5%	—
	Other contaminants, %	<0.5%	—
Process Performance	Electricity requirement, kJ/kg CO ₂	45.2 kJ/kg CO ₂ (for CO ₂ compression to 140 atm)	<180 KJ/kg
	Heat requirement, kJ/kg CO ₂	6,014 kJ/kg CO ₂	—
	Total energy (electricity equivalent), kJ/kg CO ₂	6,059 kJ/kg CO ₂	—

Technology Advantages

The simultaneous removal of CO₂ drives the WGS reaction to completion, which along with operation at feed conditions (high temperature and pressure), will increase plant efficiency. Regeneration via thermal swing with steam maximizes the CO₂ working capacity of the sorbent, while eliminating H₂ losses that occur during system purging with pressure swing adsorption processes. The TSSER process also produces high-purity H₂ and CO₂ streams.

R&D Challenges

- Qualitative results suggest that the chemisorbents cannot be exposed to trace sulfur dioxide (SO₂) or H₂S impurities in the TSSER feed gas, and they must be removed by a conventional method such as selective sorption on zinc oxide (ZnO) employing a pretreatment system.
- A considerable amount of time is required to regenerate the sorbents via thermal swing cycling.

Results To Date/Accomplishments

- Retrofitted and debugged an existing test apparatus for high-pressure operation.
- Characterized the CO₂ sorbents at high pressures, including measurement of isotherms, kinetics, and sorption/desorption column dynamics for CO₂ adsorption from nitrogen (N₂).
- Ascertained the thermal stability of the sorbents.
- Evaluated isothermal and isobaric high-pressure desorption of CO₂ by N₂ purge.
- Developed a CO₂ adsorption isotherm model for use in data analysis and process simulation.

- Developed a process model for data correlation and process simulation.
- Evaluated the performance of each step of the TSSER process.
- Identified Na₂O promoted alumina as the best available CO₂ sorbent for the TSSER process.

Next Steps

Development activities for this technology are no longer part of the DOE/NETL portfolio.

Available Reports/Technical Papers/Presentations

Novel Sorption Enhanced Reaction Process for Simultaneous Production of CO₂ and H₂ from Synthesis Gas Produced by Coal Gasification, (June 2010) Final Report.

Lee, K. B., A. Verdooren, H. S. Caram, and S. Sircar, "Chemisorption of CO₂ on Potassium Carbonate Promoted Hydrotalcite," *J. Colloid Interface Sci.*, **308**, 30 (2007).

Lee, K. B., M. G. Beaver, H. S. Caram, and S. Sircar, "Chemisorption of CO₂ on Sodium Oxide promoted Alumina," *AIChE J.*, **53**, 2824 (2007).

Lee, K. B., M. G. Beaver, H. S. Caram, and S. Sircar, "Effect of Reaction Temperature on the Performance of Thermal Swing Sorption Enhanced Process for Simultaneous Production of Fuel-Cell Grade H₂ and Compressed CO₂ from Synthesis Gas," *Ind. Eng. Chem. Res.*, In Press (2008).

Lee, K. B., M. G. Beaver, H. S. Caram, and S. Sircar, "Novel Thermal Swing Sorption Enhanced Reaction Process Concept for H₂ Production by Low Temperature Steam-Methane Reforming," *Ind. Eng. Chem. Res.*, **46**, 5003 (2007).

Lee, K. B., M. G. Beaver, H. S. Caram, and S. Sircar, "Performance of Na₂O Promoted Alumina as CO₂ Chemisorbent in Sorption Enhanced Reaction Process for Simultaneous Production of Fuel-Cell Grade H₂ and Compressed CO₂ from Synthesis Gas," *J. Power Sources*, **176**, 312 (2008).

Lee, K. B., M. G. Beaver, H. S. Caram, and S. Sircar, "Production of Fuel-Cell Grade H₂ by Thermal Swing Sorption Enhanced Reaction Concept," *Int. J. Hydrogen Energy*, **33**, 781 (2008).

Lee, K. B., M. G. Beaver, H. S. Caram, and S. Sircar, "Reversible Chemisorption of Carbon Dioxide: Simultaneous Production of Fuel-Cell Grade H₂ and Compressed CO₂ from Synthesis Gas," *Adsorption*, **13**, 385 (2007).

Lee, K.B., Beaver, M.G., Caram, H.S., Sircar, S., "Reversible Chemisorbents for Carbon Dioxide and Their Potential Applications," *Ind. Eng. Chem. Res.*, **47**, 8048 (2008).

Beaver, M. G., Caram, H. S., Sircar, S., Lee, K.B., "Rapid thermal swing sorption enhanced (RTSSER) concepts for production of fuel cell grade H₂" Chapter 4 in *Sorption Enhanced Reaction Concepts for Hydrogen Production: Materials and Processes*, S. Sircar and K. B. Lee (eds), Research Signpost, Kerala, India (2009), in press.

Beaver, M.G., Caram, H.S., Sircar, S., "Selection of CO₂ chemisorbent for fuel-cell grade H₂ production by sorption-enhanced water gas shift reaction," *Int. J. Hydrogen Energy*, **34**, 2972 (2009).

Beaver, M. G., Caram, H. S., Sircar, S., " Sorption Enhanced Reaction Process for Direct Production of Fuel Cell Grade Hydrogen by Low Temperature Catalytic Steam- Methane Reforming," *J. Power Sources*, **195**, 1998–2002, (2009).

"Effect of Reaction Temperature on Performance of Thermal Swing Sorption Enhanced Reaction Process for Simultaneous Production of Fuel-Cell Grade H₂ and Compressed CO₂ from Synthesis Gas," Presented at 25th International Pittsburgh Coal Conference, Pittsburgh, PA, September 2008 and at AIChE Annual Meeting, Philadelphia, November 2008.

"Utilization of High Temperature CO₂ Chemisorbents in Sorption Enhanced Reaction Concepts for Production of Fuel Cell Grade H₂ from Fossil Fuel Feedstocks," Presented at 26th International Pittsburgh Coal Conference on September 22, 2009.

B-36 “Experimental Demonstration of Sorption Enhanced Reaction (SER) Concepts for Direct Production of Fuel Grade H₂ by SE-Water Gas Shift (WGS) and SE-Steam Methane Reforming (SMR) Reactions”, Presented at the Hydrogen Production and Storage 2009 Meeting held in Washington, DC, September 30 to October 2, 2009.

“Selection of CO₂ Chemisorbent for Fuel-Cell Grade H₂ Production by Sorption Enhanced Water-Gas-Shift and Steam-Methane-Reforming Reaction,” Presented at American Institute of Chemical Engineering Annual Meeting, Nashville, TN, November 12, 2009.

HYDROGEN PRODUCTION USING WATER GAS SHIFT CATALYST WITH CO₂ SORBENTS

Primary Project Goals

The University of North Dakota Energy and Environmental Research Center (UNDEERC) is developing a high-temperature carbon dioxide (CO₂) sorbent to enhance the water gas shift (WGS) reaction and produce a synthesis gas (syngas) stream that is at least 90% hydrogen (H₂) on a nitrogen-free basis.

Technical Goals

- Develop hydrotalcite sorbent briquettes and determine the required chemical composition for optimal WGS and CO₂ capture conditions.
- Test a pressure swing absorber on a continuous fluidized-bed reactor (CFBR) gasification system.
- Test lithium silicate and hydrotalcite sorbents in a bench-scale, heated fixed-bed reactor using a slipstream from the CFBR gasification system.
- Determine the optimum high-temperature CO₂ sorbent.

Technical Content

The WGS reaction, which converts most of the syngas carbon monoxide (CO) to H₂ and CO₂ by reacting the CO with steam over a bed of catalyst, can be utilized to enhance H₂ production at an integrated gasification combined cycle (IGCC) plant. The excess steam serves to drive the shift equilibrium toward the products. The reaction is exothermic and, due to equilibrium constraints, typically consists of two stages: high-temperature shift that benefits from high reaction rates at elevated temperatures; and low-temperature shift that yields more favorable reaction equilibrium.

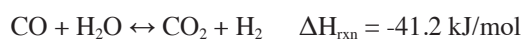

The sorption-enhanced WGS (SEWGS) process, which combines a high-temperature CO₂ sorbent and a WGS catalyst in a packed-bed reactor that can operate at high temperature and pressure, represents one approach to further promote H₂ production. The SEWGS reactor consists of an initial adsorbent bed to remove inherent CO₂ from the syngas, followed by a second bed wherein the WGS reaction occurs as the CO₂ produced during the reaction is simultaneously captured by the adsorbent bed. Regeneration of the saturated adsorbent bed is accomplished by pressure swing absorption. By incorporating sorbent-based CO₂ removal, not only is a near capture-ready stream of CO₂ produced, but the efficiency of the plant is increased by driving the WGS reaction further to completion.

By routing a slipstream from the CFBR gasification system to the bench-scale, heated fixed-bed reactors shown in Figure 1, UNDEERC evaluated the performance of high-temperature lithium orthosilicate (Li₄SiO₄) and hydrotalcite CO₂ sorbents in the SEWGS process. Hydrotalcites are anionic clays with positively charged brucitelike [Mg(OH)₂] layers and inter layers of anions such as carbonates. Although the hydrotalcite sorbent did exhibit some enhanced WGS properties during bench-scale testing, the sorbent is unlikely to be a cost-effective option for IGCC power plants due to the observed low CO₂ adsorption capacity and the long purge cycles required for regeneration.

Technology Maturity:

Bench-scale

Project Focus:

Sorbent-Enhanced Water Gas Shift

Participant:

UNDEERC

Project Number:

FT40320

NETL Project Manager:

Edgar Klunder
Edgar.Klunder@netl.doe.gov

Principal Investigator:

Michael L. Swanson
 University of North Dakota
 Energy and Environmental
 Research Center
MSwanson@undeerc.org

Partners:

Nexant

Performance Period:

4/1/05 – 3/31/09

UNDEERC also compared the performance of two Li_4SiO_4 sorbents provided by Toshiba and Research Triangle Institute (RTI). Lithium orthosilicate, which reacts with CO_2 via the following reversible reaction, has exhibited a CO_2 adsorption capacity of about 35% (based on sorbent weight) at high temperatures.



As shown in Table 1, the Toshiba sorbent demonstrated superior adsorption at elevated temperatures, whereas the sorbent supplied by RTI showed higher adsorption capacity at relatively lower temperatures. One notable pattern is the sorbent provided by Toshiba demonstrated a reduction in adsorption capacity with decreasing CO_2 concentrations, eventually leading to inferior adsorption at higher temperatures as compared to RTI's sorbent.

Additionally, it was found that RTI's sorbent had slightly better desorption properties with complete desorption taking place at 700°C , whereas Toshiba's sorbent required temperatures as high as 800°C to attain complete desorption in a 100% nitrogen atmosphere.



Figure 1: Heated Fixed-Bed Reactors

Table 1: Comparison of Adsorption Properties of Sorbents Provided by Toshiba and RTI

Temperature (°C)	100% CO_2		40% CO_2		20% CO_2	
	Adsorption (wt%)		Adsorption (wt%)		Adsorption (wt%)	
	Toshiba	RTI	Toshiba	RTI	Toshiba	RTI
400	1.32	4.33	0.89	2.48	0.69	1.43
500	19.32	14.10	18.04	12.48	15.89	14.10
600	23.26	15.22	19.87	14.04	18.61	14.39
700	33.32	15.88	31.68	—	2.41	8.97
800	3.46	—	1.45	—	1.31	—

Technology Advantages

The simultaneous removal of CO_2 drives the WGS reaction to completion, which along with operation at feed conditions (high temperature and pressure), will increase IGCC power plant efficiency by maintaining a high-temperature, high-pressure feed gas to the combustion turbine. The Li_4SiO_4 sorbents exhibit high CO_2 adsorption capacity at elevated temperatures and effectiveness across a wide range of CO_2 concentrations.

R&D Challenges

A considerable amount of time is required to regenerate a Li_4SiO_4 sorbent which, when coupled with the large quantity of sorbent required, imposes significant limitations for industrial use.

Results To Date/Accomplishments

- Completed testing of a pressure swing absorber on a continuous fluid-bed gasification system.
- Produced 20 wt% potassium carbonate/80 wt% hydrotalcite briquettes.
- Completed testing of Li_4SiO_4 sorbents in heated fixed-bed reactors using a slipstream from the CFBR gasification system, and determined the physical strength in high-moisture atmospheres and the CO_2 adsorption capacity of the sorbents at various operating conditions.

Next Steps

Project completed March 2009.

Available Reports/Technical Papers/Presentations

Base Research Program—Final Report, August, 2009. http://www.osti.gov/bridge/product.biblio.jsp?query_id=0&page=0&osti_id=984507&Row=1

APPENDIX B: CARBON DIOXIDE CAPTURE TECHNOLOGY SHEETS
PRE-COMBUSTION MEMBRANES

PILOT-SCALE WATER GAS SHIFT— MEMBRANE DEVICE FOR HYDROGEN FROM COAL

Primary Project Goals

Western Research Institute is building and testing several pilot-scale hydrogen separation devices for use in a gasification product stream. The outcome of the project will be a demonstration of manufacturing practices in addition to the delivery of the engineering for a hydrogen production system ready for testing at large scale.

Technical Goals

- Design a modular water gas shift (WGS)-membrane reactor at 2 lbs hydrogen/day.
- Adapt suitable composite anodized alumina/palladium (Pd) copper (Cu) membranes to fit the reactor design.
- Test the reactor under NETL protocol and coal-derived synthesis gas (syngas) conditions.

Technical Content

Composite ceramic and alloy membranes have physical and chemical characteristics that allow them to be assembled with standard structural steels in easily fabricated constructions. The test data for the composite membranes shows that they eliminate some of the problems seen with metallic foil membranes of Pd or vanadium. By joining the composite membranes to off-the-shelf stainless steel components, complex devices can be designed that remain cost-effective to fabricate. The membrane modules are then inserted into systems that operate similar to heat exchange reactors, the well-established manufacturing capability of an engineering team member. The inclusion of structural monolithic catalysts into the assembly combines a WGS step with the hydrogen separation step to maximize hydrogen production from syngas. This project uses the developments that have been produced over the past five years and builds systems large enough to identify economic and technical issues with potential commercial units for hydrogen production.

Technology Maturity:

Pilot-scale, hydrogen separation in gasification product stream, 2 lbs/day

Project Focus:

Integrated WGS Membrane

Participant:

Western Research Institute

Project Number:

FE0004992

NETL Project Manager:

Darryl Shockley
Darryl.Shockley@netl.doe.gov

Principal Investigator:

Tom Barton
Western Research Institute
tbarton@uwyo.edu

Partners:

Chart Energy & Chemicals, Inc.
Synkera Technologies, Inc.

Performance Period:

9/24/10 – 12/31/11

Table 1: Membrane Process Parameters

	Parameter	Current R&D Value	Target R&D Value
Membrane Properties	Materials of fabrication for selective layer	Pd	PdCu
	Materials of fabrication for support layer (if applicable)	AAO	AAO
	Selectivity of key gas components: H ₂ /CO ₂ for pre-combustion technology	H ₂ /CO ₂	H ₂ /CO ₂
	Type of selectivity measurement (ideal or mixed gas)	Mixed gas	Mixed gas
	Pressure normalized flux (permeance for linear materials) for more selective gas component, GPU or equivalent units	$1.0 \times 10^{-3} \text{ mol/m}^2\text{sPa}^{0.5}$	$1.5 \times 10^{-3} \text{ mol/m}^2\text{sPa}^{0.5}$
	Temperature, °C	400 °C	400 °C
	Bench-scale testing, hours without significant performance degradation	300	1,000
	Pilot-scale testing (if applicable), hours without significant performance degradation	0	300
	Maximum pressure differential achieved without significant performance degradation or failure, bar	400 psi	600 psi
Module Properties	Module configuration: hollow-fiber, spiral-wound sheet, shell-and-tube, plate-and-frame, other	Supported sheet	Supported sheet
	Packing density, m ² /m ³	5	25
	Pressure drop, bar	0.5	0.5
	Estimated cost of manufacturing and installation, \$/m ² -GPU or equivalent	\$2,800/ft ²	\$743/ft ²
Product Quality	CO ₂ purity, %	90%	97%
	H ₂ purity, %	99%	100%

Technology Advantages

- The Pd alloy plugs in the membrane are discontinuous, which greatly reduces embrittlement issues.
- The natural aluminum rim to the composite membrane allows multiple joining technologies, such as brazing and laser welding.
- The volume around the membranes is suited for structural WGS catalyst, which improves hydrogen separation performance.

R&D Challenges

- Electrochemically depositing Pd Cu alloys in the anodized alumina.
- Joining aluminum-rimmed membranes to stainless steel structure.
- Accounting for thermal expansion mismatch during heating and cooling.
- Hydrogen sulfide and other contaminants in coal-derived syngas.

Results To Date/Accomplishments

- Two furnaces were fabricated for testing of components and the 2-lb/day hydrogen unit.
- The slipstream system for the small coal gasifier was refurbished and readied for operation.

- Design of the membrane reactor is completed.
- Laser welding was confirmed by testing to be the best joining technology for the aluminum-rimmed membranes.
- Donut-shaped membranes have been produced in the format suitable for the reactor design.

Next Steps

- Complete fabrication of the 2-lb/day device.
- Development and testing 1-inch Pd-alloys membranes for S-resistance.
- Complete scale-up of fabrication processes and perform trials with 6-inch membranes.
- Preparation for production and delivery of sufficient quantities of scaled membranes to accommodate at least two devices with 2 lb/day of hydrogen output.

Available Reports/Technical Papers/Presentations

The first presentation from this project will be made at the 2011 DOE Annual Hydrogen Review Meeting in Washington, DC, on May 13, 2011.

ADVANCED HYDROGEN TRANSPORT MEMBRANES FOR COAL GASIFICATION

Primary Project Goals

Praxair, Inc is conducting research and development (R&D) on hydrogen transport membranes resulting in the design, fabrication, and testing of a hydrogen separator capable of separating 2-lb/day hydrogen from a coal gasification fuel gas stream.

Technical Goals

- Identify and evaluate a suitable high-temperature, contaminant-resistant, hydrogen transport membrane.
- Fabricate and install hydrogen membrane in a proof-of-concept reactor connected to an operating coal gasifier.
- Test the membrane reactor for separating at least 2 lb/day [approximately 15 standard cubic feet per hour (scfh)] of hydrogen from the coal-derived synthesis gas (syngas).

Technical Content

The membranes must be incorporated into a membrane unit that separates hydrogen from syngas derived from gasification and produces a high-pressure carbon dioxide (CO₂)-rich retentate stream. The project will examine different membrane reactor designs, including use of catalysts and sweep streams, to select the optimum membrane reactor configuration. Reactor modeling will evaluate different configurations and estimate the impact of reactor design on performance. In Phase I, a small proof-of-concept reactor will be built to separate at least 2 lbs/day (about 15 scfh) of hydrogen from coal-derived syngas. In Phase II, a pilot-scale reactor will be built and integrated with an operating gasifier to produce at least 100 lbs/day (about 800 scfh) of hydrogen.

Technology Maturity:

Bench- to pilot-scale, hydrogen separation

Project Focus:

Membrane for H₂ Separation

Participant:

Praxair, Inc.

Project Number:

FE0004908

NETL Project Manager:

Elaine Everitt

Elaine.Everitt@netl.doe.gov

Principal Investigator:

Joseph Schwartz

Praxair, Inc.

Joseph_Schwartz@praxair.com

Partners:

Colorado School of Mines

T3 Scientific, LLC

Performance Period:

9/29/10 – 12/31/11

Table 1: Membrane Process Parameters

	Parameter	Current R&D Value	Target R&D Value
Membrane Properties	Materials of fabrication for selective layer	Pd alloy	Pd alloy
	Materials of fabrication for support layer (if applicable)	Ceramic	Ceramic
	Selectivity of key gas components: H ₂ /CO ₂ for pre-combustion technology	>500 at 100 psi	>500 at 300 psi
	Type of selectivity measurement (ideal or mixed gas)	Mixed	Mixed
	Pressure normalized flux (permeance for linear materials) for more selective gas component, GPU or equivalent units	300 scfh/ft ² at 100 psi	300 scfh/ft ² at 100 psi
	Temperature, °C	300–400	300–400
	Bench-scale testing, hours without significant performance degradation	250	500
	Pilot-scale testing (if applicable), hours without significant performance degradation	N/A	N/A
	Maximum pressure differential achieved without significant performance degradation or failure, bar	13.79	17.24
Module Properties	Module configuration: hollow-fiber, spiral-wound sheet, shell-and-tube, plate-and-frame, other	Shell-and-tube	Shell-and-tube
	Packing density, m ² /m ³	N/A	25
	Pressure drop, bar	N/A	0.5
	Estimated cost of manufacturing and installation, \$/m ² -GPU or equivalent	N/A	5,000
Product Quality	CO ₂ purity, %	N/A	N/A
	H ₂ purity, %	99	99

Technology Advantages

- Thin supported membrane has high flux at low precious metal cost.
- Alloys under development that have shown excellent performance in mixed gas streams including sulfur.

R&D Challenges

- Develop a membrane that matches or exceeds current flux performance in an environment with sulfur and other contaminants from coal or biomass gasification.
- Incorporate membrane treatments to improve contaminant resistance.
- Scale up membrane size and reactor design.

Results To Date/Accomplishments

- A mixed gas test was completed without sulfur. The flux was significantly lower than pure hydrogen at the same feed hydrogen partial pressure, but high hydrogen recovery (86%) was achieved.
- Reactor sizing and design has begun.

Next Steps

- Prepare palladium (Pd) binary alloy membranes with platinum (Pt), as there are indications that Pt may have similar carbon and sulfur inhibition properties as gold (Au).
- The systematic study of ethylenediaminetetraacetic acid (EDTA) will continue with pure gas testing of the Pd membranes prepared using 20 and 40 g/L EDTA in the plating bath.
- Begin testing in sulfur.
- Begin synthesis and testing of Pd/Pt membranes.

Available Reports/Technical Papers/Presentations

No reports, technical papers, or presentations are yet available.

ENGINEERING DESIGN OF ADVANCED H₂-CO₂ PD AND PD/ALLOY COMPOSITE MEMBRANE SEPARATIONS AND PROCESS INTENSIFICATION

Primary Project Goals

Worcester Polytechnic Institute (WPI) is reducing the production of pure hydrogen from the synthesis gas (syngas) to a single unit operation consisting of a composite palladium (Pd) or Pd/alloy water gas shift (WGS) membrane shifter in order to lower the cost of separation.

Technical Goals

- Synthesize thin layer Pd and Pd/gold (Au) membranes with long-term thermal and chemical stability with a special emphasis on long-term stability of hydrogen flux and selectivity.
- Synthesize thin layer Pd, Pd/copper (Cu), and Pd/Au membranes with sulfur poisoning resistance by the use of MembraGuard coating or any other novel techniques.
- Fabricate and testing at the National Carbon Capture Center (NCCC) a membrane module skid consisting of a WGS membrane reactor capable of producing 2 lb of hydrogen (H₂)/day at the competition of Phase I.
- Fabrication and successful operation of a 100-lb-of-H₂/day WGS membrane reactor at the completion of Phase II.
- Full engineering design of a unit capable of producing a minimum for 4 tons/day of H₂ and integration into commercial integrated gasification combined cycle (IGCC) will be complete at the end of Phase III.

Technology Maturity:

Bench-scale (½" OD, 2.5" L),
231 scf H₂/day at ~450 °C,
ΔP = 100 psi (P_{low} = 15 psia)

Pilot-scale (1" OD, 6" L),
201 scf H₂/day at ~450 °C,
ΔP = 15 psi (P_{low} = 15 psia)

Bench and pilot-scale Pd and Pd/alloy membrane,
4 tons H₂ per day

Project Focus:

Pd-Pd Alloy Composite Membrane for H₂ Separation

Participant:

Worcester Polytechnic Institute

Project Number:

FE0004895

NETL Project Manager:

Jason Hissam
Jason.Hissam@netl.doe.gov

Principal Investigator:

Yi Hua Ma
Worcester Polytechnic Institute
yhma@wpi.edu

Partners:

Membrane Technology and Research, Inc.
Siemens Energy, Inc.
T3 Scientific, LLC

Performance Period:

9/20/10 – 12/31/11

Technical Content

B-48

Table 1: Membrane Process Parameters

	Parameter	Current R&D Value	Target R&D Value
Membrane Properties	Materials of fabrication for selective layer	Pd, Pd/Au, Pd/Cu,	Pd, Pd/Au, Pd coated with S-resistant layer
	Materials of fabrication for support layer (if applicable)	PSS-316L, Inconel-625	PSS-316L, Inconel-625
	Selectivity of key gas components: H ₂ /CO ₂ for pre-combustion technology	≈ ∞	≈ ∞
	Type of selectivity measurement (ideal or mixed gas)	Ideal, mixed	Mixed
	Pressure normalized flux (permeance for linear materials) for more selective gas component, GPU or equivalent units	Bench Scale: 3.59 at 450 °C Pilot Scale: 2.91 at 450 °C	DOE 2015 Target: Pilot scale 100 lb H ₂ per day Complete design of a 4 ton H ₂ per day plant
	Temperature, °C	300–450	250–500
	Bench-scale testing, hours without significant performance degradation	3,550	N/A
	Pilot-scale testing (if applicable), hours without significant performance degradation	850	N/A
	Maximum pressure differential achieved without significant performance degradation or failure, bar	14	N/A
Module Properties	Module configuration: hollow-fiber, spiral-wound sheet, shell-and-tube, plate-and-frame, other	Shell-and-tube	Shell-and-tube
	Packing density, m ² /m ³	N/A	N/A
	Pressure drop, bar	N/A	N/A
	Estimated cost of manufacturing and installation, \$/m ² -GPU or equivalent	\$1,254 per square foot 744 tonne/day (calculated based on simulation)	\$1,000 per square foot
Product Quality	CO ₂ purity, %	80.3% (at feed mixed-gas: 37.1% CO ₂ , 1.2% CO and 61.7% H ₂ at 450 °C, 212 psia, GHSV of 1,069 h ⁻¹ and 92.6% H ₂ recovery); 83.5% (at feed mixed-gas: 10% CO ₂ , 23% CO, 22% H ₂ and 45% H ₂ O at 450 °C, 212 psia, GHSV of 4,497 h ⁻¹ , 83.2% H ₂ recovery and 95% CO conversion)	N/A
	H ₂ purity, %	>≈99%	—

Other Membrane Parameters

Contaminant Resistance: Pd/Au and Pd/Cu alloy membranes provide some resistance to hydrogen sulfide (H₂S) and are also regenerable.

Technology Advantages

- High-pressure carbon dioxide (CO₂) for carbon capture (low compression costs).
- Low steam requirements compared with traditional WGS reactor.
- High purity hydrogen at the permeate side for fuel cell applications.
- Lower cost operation by combining WGS reaction and separation in the same module.
- Higher energy efficiency.

R&D Challenges

- Inconsistent quality from suppliers of porous metal supports.
- Development of a procedure with fewer steps for industrial production.
- Development of reliable, well reproducible, compatible with support materials, and environmentally friendly to modify support surface in order to overcome support irregularities and surface characteristics inconsistencies.
- Long-term stability selectivity at 450 °C for membranes thinner than 6–8 microns.
- The formulation of defect free membranes material with resistant to sulfur.

Results To Date/Accomplishments

- Completed a new testing rig, fully automatic and remotely controllable, for the study and characterization of pilot-scale (1" OD) membrane under WGS reaction.
- Several composite Pd membranes have been prepared on porous metal supports from Chand Eisenmann Metallurgical. Thicknesses varied from 4 to 28 μm and hydrogen permeances at 450 °C varied for helium (He) leak stable membranes between 13 and 42 scfh/ft²-psi^{0.5} (with ΔP = 14.7 psi, and P_{tube} = 14.7 psi).
- Stable membranes were obtained on 0.2 μm PSS 316L supports.
- Pure Pd membranes showed good stability less than 200 parts per million by volume (ppmv) of H₂S for more than 250 hours at 400 °C with MembraGuard coating.
- A prototype for the Phase II membrane reactor module has been designed.
- A complete setup for a WGS reactor capable of producing 2 lb/day of hydrogen at temperature ranging between 350 and 450 °C has been projected.

Next Steps

- Prepare thin and stable composite pure Pd membranes on 1" OD PSS 316L and Hastelloy supports.
- Characterize such membranes in pure hydrogen atmospheres and in WGS reaction conditions.
- The most stable membranes will be sent to MTR for their integration in the skid module.
- Continue equipment preparation for coating deposition on tubular membrane anticipated for next performing period at T3 facilities.
- In the next project performing period, conduct DOE Test 2A (simulated effluent of WGS reactor) on MembraGuard coated Pd membrane to further confirm the stability of MembraGuard coated membrane under WGS reaction conditions.

- Membranes will be sent to T3 so that the H₂S protective coating will be deposited. Such membranes will be tested in sulfur conditions at WPI and then at NCCC under syngas atmospheres.
- The Phase I membrane module skid will be assembled and shipped to NCCC.
- A Phase II membrane reactor module will be fabricated.
- Mounting and leaks testing of the WGS reactor at WPI.
- Pure nitrogen and pure hydrogen tests will be performed in the WGS reactor at WPI in order to reproduce the experimental data obtained with the same membranes in other devices already present in the WPI laboratories.
- Nitrogen-hydrogen mixture experiments at different operative conditions (i.e., different temperatures, hydrogen compositions, and feed flow rates) in the presence of the catalytic bed to perform fluid dynamic analysis and to esteem the mass transport coefficients and the relationship between the dimensionless number characteristic of the system. This analysis can be used in the future to model in a more accurate way the behavior of the system in the presence of the WGS reaction.

Available Reports/Technical Papers/Presentations

Journal Articles:

Pomerantz, N. and Ma, Y. H., “Isothermal Solid-State Transformation Kinetics Applied to Pd/Cu Alloy Membrane Fabrication,” *AIChE J*, 56, 3062–3073 (2010).

Chen, Chao-Huang and Ma, Yi Hua, “The Effect of H₂S on the Performance of Pd and Pd/Au Composite Membrane,” 362(1-2), 535–544(2010).

Pomerrantz, N., Ma, Y. H., “Novel Method for Producing High H₂ Permeability Pd Membranes with a Thin Layer of the Sulfur Tolerant Pd/Cu fcc Phase,” *J Memb Sci.*, 370, 97–108 (2011).

Koc, Reyyan, Kazantzis, Nikolaos K and Ma, Yi Hua, “A Process Dynamic Modeling and Control Framework for Performance Characterization and Enhancement of Pd-Based Membrane Reactors Used in Hydrogen Production,” *International J of Hydrogen Energy*, Accepted for publication.

Augustine; Alexander Sullivan, Kazantzis, Nikolaos K., Ma, Yi Hua, “High pressure palladium-membrane reactor for the high-temperature water-gas shift reaction *International Journal of Hydrogen Energy*,” *International J of Hydrogen Energy*, Accepted for publication.

Ayturk, M. E. and Ma, Y. H., “*Defect-Free Composite Pd Membranes with High Temperature Long-Term Stability*,” In preparation.

Chen, C. H. and Ma, Y. H., “The Effect of H₂S on the performance of Pd and Pd/Au composite membrane,” Submitted to the **Journal of Membrane Science**.

Pomerantz, N.; Payzant, E.A. and Ma, Y.H. “*Isothermal Solid-State Transformation Kinetics Applied to Pd/Cu Alloy Membrane Fabrication*,” **AIChE Journal**, In press.

Ma, Y. H., Ayturk, M.E., Augustine, A.S. and Kazantzis, N., “*Palladium Membrane Reactor for Water Gas Shift Reaction*,” Submitted to **Catalysis Today**, In press.

Pomerantz, N. and Ma, Y.H. “*Effect of H₂S on the performance and long-term stability of Pd/Cu membranes*,” **Industrial and Engineering Chemistry Research**, 48(8) (2009) 4030–4039.

Ayturk, M. E., Kazantzis, N.K. and Ma, Y. H., “*Modeling and Performance Assessment of Pd- and Pd/Au-based Catalytic Membrane Reactors for Hydrogen Production*,” **Energy and Environmental Science**, 2 (2009) 430–438.

Conference Proceedings:

Ayturk, M. E. and Ma, Y.H. “Hydrogen Production via Composite Palladium Membranes with Long-Term Selectivity Stability.” **Prepr. Pap. - Am. Chem. Soc., Div. Fuel Chem.**, 55(1) (2010).

Chen, C. H. and Ma, Y. H., “Effect of H₂S concentration on hydrogen permeance of a composite Pd/Au hydrogen separation membrane prepared by galvanic displacement,” **Preprint in the Proceedings of 239th ACS Annual Meeting**, March 21–25, 2010, San Francisco, CA, USA.

Pomerantz, N. and Ma, Y.H. “Effect of mass transfer on Cu plating rate and deposition morphology for Pd/Cu alloy membranes for hydrogen separation,” Extended abstract in the **Proceedings of the ACS 239th National Meeting and Exposition**, March 21–25, 2010, San Francisco, CA, USA.

Ma, Y. H., Ayturk, M.E., Augustine, A.S. and Kazantzis, N., “Palladium Membrane Reactor for Water Gas Shift Reaction,” Proceedings of the 9th **International Conference on Catalysis in Membrane Reactors (ICCMR9)**, June 28–July 2, 2009, Lyon, France.

Chen, C. H. and Ma, Y. H., “Characterization of sulfur resistance of Pd/Au hydrogen separation membranes,” Extended abstract in the **Proceedings of the 2008 AIChE Annual Meeting**, November 16–21, 2008, Philadelphia, PA, USA.

Pomerantz, N.; Shaw, E. and Ma, Y.H. “The effect of H₂S on the long-term stability of Pd/Cu membranes and the characteristics of H₂S poisoning of electroless deposited Pd,” Extended abstract in the **Proceedings of the AIChE Annual Meeting 2008**, November 16–21, 2008, Philadelphia, PA, USA.

Ma, Y. H., Kazantzis, N., Ayturk, M. E., Pomerantz, N. and Chen, C.-H. Synthesis and Long-Term Characterization of Sulfur Tolerant Pd/Cu and Pd/Au Alloy Membranes for Hydrogen Production via Catalytic Membrane Reactor Applications. Extended abstract in the **Proceedings of the 10th Intl. Conf. on Inorganic Membranes (ICIM10)**, (2008) Tokyo, Japan.

Chen, C. H. and Ma, Y. H., “Permeation of composite Pd/Au hydrogen separation membrane prepared by galvanic displacement,” Preprint in the **Proceedings of 234th ACS Annual Meeting**, August 19–23, 2007, Boston, MA, USA.

Pomerantz, N. and Ma, Y.H. “Effect of H₂S poisoning of Pd/Cu membranes on H₂ permeance and membrane morphology,” Extended abstract in the **Proceedings of the ACS 234th National Meeting and Exposition**, August 19–23, 2007, Boston, MA, USA.

Presentations:

Ma, Yi Hua, “Composite Pd and Pd Alloy Porous Stainless Steel Membranes for Hydrogen Production and Process Intensification,” U.S. DOE FY11 Advanced Fuels Peer Review, October 18–22, 2010, Morgantown, WV, USA.

Koc, Reyyan, Kazantzis, Nikolaos K. and Ma, Yi H., “A Process Dynamic Modeling Framework for Performance Assessment of Pd-Based Membrane Reactors,” Oral presentation, Session: Process Modeling, NAMS/ICIM, July 17–22, 2010, Washington DC, USA.

Koc, Reyyan, Kazantzis, Nikolaos K. and Ma, Yi H., “Theoretical study for the integration of the Pd-based water gas shift membrane reactors into the IGCC plants,” Poster presentation, 240th ACS National Meeting, Division of Environmental Chemistry, August 22–26, 2010, Boston, MA, USA.

Koc, Reyyan, Kazantzis, Nikolaos K. and Ma, Yi H., “Process Safety Aspects in Water-Gas-Shift (WGS) Catalytic Membrane Reactors Used for Pure Hydrogen Production,” Mary Kay O’Connor Process Safety Center International Symposium, October 26–28, 2010, College Station, TX, USA.

Koc, Reyyan, Kazantzis, Nikolaos and Ma, Yi Hua, “A Process Dynamic Modeling and Control Framework for Performance Characterization and Enhancement of Pd-Based Membrane Reactors,” Session: on Membranes for Hydrogen Purification, 10th AIChE Annual Meeting, November 7–12, 2010, Salt Lake City, UT, USA.

Koc, Reyyan, Kazantz, Nikolaos and Ma, Yi Hua, “A Process Modeling Framework for Performance Assessment of Pd-Based Water-Gas Shift Membrane Reactors,” Oral presentation, Session: on Membrane Reactors, AIChE 2010 Annual Meeting, November 7–12, 2010, Salt Lake City, UT, USA.

Augustine, Alexander S., Ayturk, M. Engin and Ma, Yi Hua, “Composite Palladium Membrane Reactor for Hydrogen Production with Syngas Feed,” Session on Membranes for Energy Applications, Joint Meeting of North American Membrane Society Annual Meeting and 11th International Conference on Inorganic Membranes, July 17–22, 2010, Washington, DC, USA.

Chen, Chao-Huang and Ma, Y. H., “The Effect of Au Content in Composite Pd/Au Membranes Prepared by Galvanic Displacement On Hydrogen Permeance and H₂S Resistance,” Session on Membranes for Hydrogen Purification, AIChE 2010 Annual Meeting, November 17–22, 2010, Salt Lake City, UT, USA.

Ayturk, M. E. and Ma, Y.H. “*Hydrogen Production via Composite Palladium Membranes with Long-Term Selectivity Stability*,” To be presented at the **ACS Spring National Meeting and Exposition**, March 21–25, 2010, San Francisco, CA, USA.

Chen, C. H. and Ma, Y. H., “Effect of H₂S concentration on hydrogen permeance of a composite Pd/Au hydrogen separation membrane prepared by galvanic displacement.” To be presented at the **ACS Spring National Meeting and Exposition**, March 21–25, 2010, San Francisco, CA, USA.

Pomerantz, N. and Ma, Y.H. “*Effect of mass transfer on Cu plating rate and deposition morphology for Pd/Cu alloy membranes for hydrogen separation*,” To be presented at the **ACS 239th National Meeting and Exposition**, March 21–25, 2010, San Francisco, CA, USA.

Ayturk, M. E. and Ma, Y.H. “*Long-Term Selectivity Stability and High-Pressure Mixed Gas Hydrogen Permeation Testing of Composite Pd/Inconel Membranes*.” Presented at the **AIChE Annual Meeting**, November 8–13, 2009, Nashville, TN, USA.

Augustine, A. S.; Ayturk, M.E.; Kazantzis, N. and Ma, Y. H. “*Palladium Membrane Reactor for Water Gas Shift Reaction*.” Presented at the **AIChE Annual Meeting**, November 8–13, 2009, Nashville, TN, USA.

Ma, Y. H., Ayturk, M.E., Augustine, A.S. and Kazantzis, N., “*Palladium Membrane Reactor for Water Gas Shift Reaction*,” Presented at the **9th International Conference on Catalysis in Membrane Reactors (ICCMR9)**, June 28-July 2, 2009, Lyon, France.

Ayturk, M. E. and Ma, Y. H., “*Defect-Free Composite Pd Membranes with High Temperature Long-Term Stability*,” Presented at the **2008 AIChE Annual Meeting**, November 16–21, 2008 Philadelphia, PA, USA.

Chen, C. H. and Ma, Y. H., “Characterization of sulfur resistance of Pd/Au hydrogen separation membranes,” Presented at the **2008 AIChE Annual Meeting**, November 16–21, 2008, Philadelphia, PA, USA.

Pomerantz, N.; Payzant, E.A. and Ma, Y.H. “*Isothermal Solid-State Transformation Kinetics Applied to Pd/Cu Alloy Membrane Fabrication*,” Presented at the **AIChE Annual Meeting 2009**, Nashville, TN, USA, November 8–13, 2009.

Pomerantz, N.; Shaw, E. and Ma, Y.H. “*The effect of H₂S on the long-term stability of Pd/Cu membranes and the characteristics of H₂S poisoning of electroless deposited Pd*,” Presented at the **AIChE Annual Meeting 2008**, November 16–21, 2008, Philadelphia, PA, USA.

Ma, Y. H., Kazantzis, N., Ayturk, M. E., Pomerantz, N. and Chen, C.-H., “*Synthesis and Long-Term Characterization of Sulfur Tolerant Pd/Cu and Pd/Au Alloy Membranes for Hydrogen Production via Catalytic Membrane Reactor Applications*,” Presented at the **10th International Conference on Inorganic Membranes (ICIM10)**, August 18–22, 2008, Tokyo, Japan.

Ayturk, M. E., Kazantzis, N.K. and Ma, Y. H., “*Modeling and Performance Assessment of Pd- and Pd/Alloy-based Catalytic Membrane Reactors for Hydrogen Production*,” Presented at the **International Congress on Membranes and Membrane Processes (ICOM 2008)**, July 12–18, 2008, Honolulu, HI, USA.

Pomerantz, N.; Shaw, E. and Ma, Y.H. “XPS studies of H₂S poisoned Pd deposits and the implications on Pd membrane performance.” Presented at the **International Congress on Membranes and Membrane Processes (ICOM 2008)**, July 12–18, 2008, Honolulu, HI, USA.

Ma, Y. H., Kazantzis, N., Ayturk, M. E., Pomerantz, N. and Chen, C.-H., “*Composite Pd and Pd/alloy Porous Stainless Steel Membranes for Hydrogen Production, Process Intensification and CO₂ Sequestration*,” Presented at the **2008 NHA Annual Hydrogen Conference and Expo: “Ramping up Commercialization,”** March 30-April 03, 2008 Sacramento, CA, USA.

Chen, C. H. and Ma, Y. H., “Permeation of composite Pd/Au hydrogen separation membrane prepared by galvanic displacement,”

Presented at the **2007 ACS Annual Meeting**, August 19–23, 2007 Boston, MA, USA.

Pomerantz, N. and Ma, Y.H. “Effect of H₂S poisoning of Pd/Cu membranes on H₂ permeance and membrane morphology.”
Presented at the **ACS 234th National Meeting and Exposition**, August 19–23, 2007, Boston, MA, USA.

Chen, C. H. and Ma, Y. H., “Preparation of Pd/Au hydrogen separation membrane by galvanic displacement,” Presented at the
2007 North American Membrane Society Annual Meeting, May 13–16, 2007, Orlando, FL, USA.

EFFICIENT REGENERATION OF PHYSICAL AND CHEMICAL SOLVENTS FOR CO₂ CAPTURE

Primary Project Goals

The University of North Dakota is evaluating the use of composite polymer membranes and porous membrane contactors for the recovery of carbon dioxide (CO₂) from CO₂-rich solvent streams from flue gas and coal gasification synthesis gas (syngas). The development of materials and processes is necessary to reduce the capital and operating costs of the solvent regeneration process, particularly the energy expended in regeneration.

Technical Goals

- Assess the capability of a range of composite polymer membranes and porous membrane contactors to regenerate physical and chemical solvents for CO₂ capture.
- Fabricate a continuous bench-scale test system to measure membrane performance and the effect of several key process parameters: gas flow rate, liquid flow rate, temperature, etc.

Technical Content

This project will investigate the use of two membrane technologies for the recovery of CO₂ from solvents: porous membrane contactors and composite membranes (Figure 1). In both cases a liquid solvent, saturated with CO₂, will flow over the membrane, while either a vacuum or sweep gas will be used to maintain a low partial pressure of CO₂ on the permeate side of the membrane. Porous membranes will rely on surface tension of the solvent to prevent bulk flow of solvent through its pores. Composite membranes will utilize a thin (<50 micron) selective layer to prevent loss of solvent.

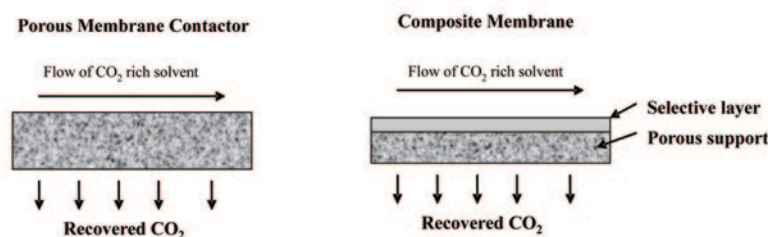

Figure 1: Two Types of Membranes Investigated in this Project

An experimental system has been built to evaluate membrane materials for this application (Figure 2). This system contains an absorber to saturate the solvent at a specified temperature, a pump to circulate the solvent, a heater to heat the solvent to a specified temperature, and a membrane unit. The permeate is analyzed using a gas chromatograph, while samples can be taken from the absorber and after the membrane unit in order to measure the rate of CO₂ recovery.

Technology Maturity:

Bench-scale, CO₂ recovery from flue gas, syngas

Project Focus:

Composite Polymer Membrane

Participant:

University of North Dakota

Project Number:

FE0002196

NETL Project Manager:

Robert Noll

Robert.Noll@netl.doe.gov

Principal Investigator:

Brian Tande

University of North Dakota

briantande@mail.und.edu

Partners:

None

Performance Period:

12/1/09 – 11/30/12

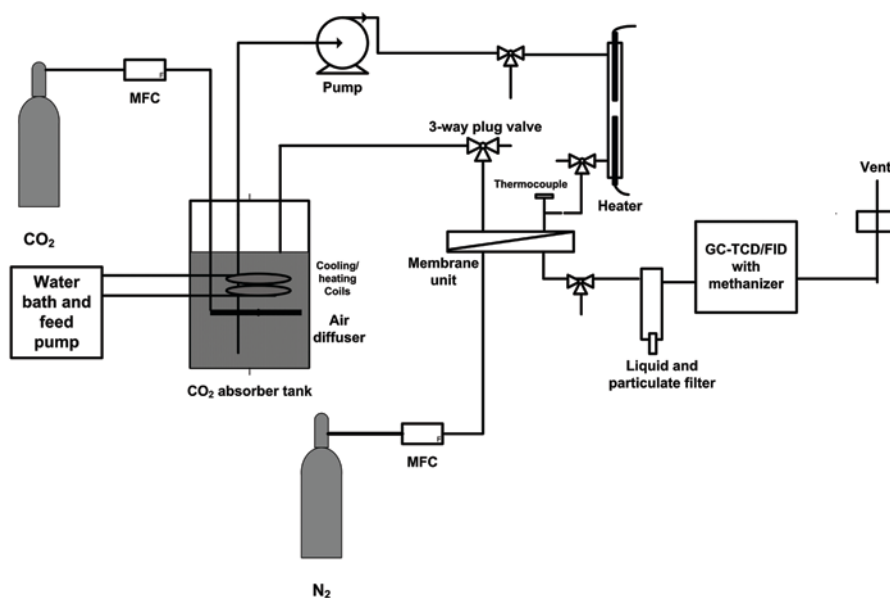

Figure 2: Experimental Apparatus

Technology Advantages

- More mass transfer area per volume than traditional packed or trayed columns.
- Lower operating temperatures than current technology, reducing energy costs, and minimizing amine degradation.
- Potentially wider operating ranges than packed or trayed columns.

R&D Challenges

- Identification of materials with the necessary set of properties.
- Accurate control of temperature and flow rates.
- Measurement of low permeability materials. The gas chromatograph has been calibrated to 100 parts per million (ppm), but a flame ionization detector (FID) with a methanizer may be needed to quantify lower levels of CO₂ in the carrier gas.

Results To Date/Accomplishments

- Recent progress on this project includes the fabrication and commissioning of the test system, as well as the calibration of the gas chromatograph, which is being used to analyze the CO₂ content of the carrier gas so that the CO₂ permeation rate through each membrane material can be determined. Existing methods of determining CO₂ loading of the solvent have also been implemented.
- Porous membrane testing is underway. Early results indicate that polytetrafluoroethylene (PTFE) porous membranes are able to recover as much as 40% of the CO₂ from a saturated monoethanolamine (MEA) solution at a temperature of 95 °C.

Next Steps

- Continue porous membrane testing, which should be complete by end of summer 2011.
- Parametric study for top membrane candidates.
- Commercial feasibility analysis for one of the most promising solvent-membrane candidate systems.

Available Reports/Technical Papers/Presentations

No reports, technical papers, or presentations are yet available.

HYDROGEN SELECTIVE EXFOLIATED ZEOLITE MEMBRANES

Primary Project Goals

The University of Minnesota researchers are further developing exfoliated zeolite coating technology for hydrogen (H_2) separation membranes, including membrane production methodology, and determining the feasibility of integration of the membrane into a water gas shift (WGS) reactor model.

Technical Goals

- Develop and optimize a membrane production method for the exfoliated zeolite coating.
- The membrane must demonstrate high flux, high selectivity, and stable performance.
- Determine the feasibility of integrating these membranes in WGS reactors and integrated gasification combined cycle (IGCC) flow sheets.
- Performing a techno-economic analysis.

Technical Content

This project will further develop a novel silica molecular sieve membrane using exfoliated zeolite coatings with the potential to contribute to carbon capture by high temperature separation of H_2 from carbon dioxide (CO_2) and other gases present in shifted synthesis gas (syngas). The project will establish procedures for the production of the required supply of these layered silicates, first optimizing the synthesis process of the exfoliated zeolite, then the layer-by-layer coating process.

The pore structure of the zeolite that is currently studied (MCM-22) includes ultra-small (potentially H_2 -selective) sized pores defined by six SiO_4 tetrahedra (6-Member Ring pores: 6MR) along the c-axis. Therefore, c-out-of-plane oriented films are promising for H_2 -separation membranes. MCM-22 has highly anisotropic plate or disk-like crystal shape, thin along the c-crystallographic axis and appropriate for achieving c-oriented films. Among available compositions, an all-silica and potentially hydrothermally stable composition has been reported, which could enable H_2 -separations in applications like WGS reactors.

Membrane Microstructures Achieved Currently: MCM-22/silica composite films were fabricated using layer-by-layer deposition towards a nanoscale realization of the selective flake concept. The repetition of appropriate deposition cycles (i.e., particle deposition and subsequent silica coating) led to the gradual increase of separation performance achieving H_2 /nitrogen (N_2) ideal selectivity as high as 120. The SEM cross-section image of a five-layer membrane along with its schematic is shown in Figure 1. The aim of the ongoing work is to improve performance using thinner flakes (exfoliated zeolite layers).

The H_2 permeance and selectivity to CO_2 and other gases, as well as hydrothermal stability, will be determined for the developed membrane. A series of tests will determine membrane separation performance. Performance testing configurations will include

Technology Maturity:

Laboratory evaluation using synthetic gases

Project Focus:

Hydrogen Selective Zeolite Membranes

Participant:

University of Minnesota

Project Number:

FE0001322

NETL Project Manager:

Richard Dunst
Richard.Dunst@netl.doe.gov

Principal Investigator:

Michael Tsapatsis
University of Minnesota
tsapatsis@umn.edu

Partners:

None

Performance Period:

10/1/09 – 9/30/13

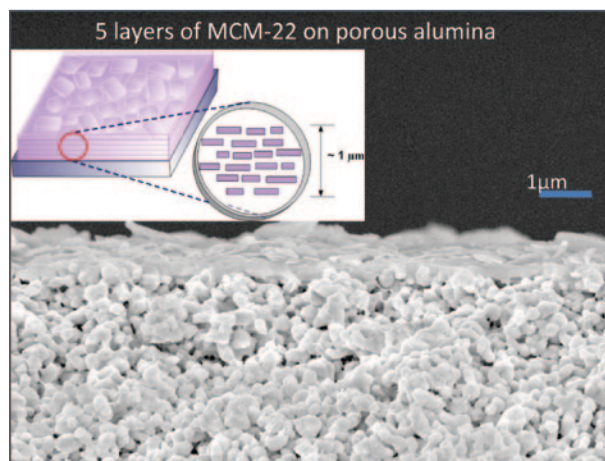

Figure 1: SEM Cross-Section Image of a Five-Layer Membrane Along with its Schematic

flat alumina supports up to 220 °C; tubular membrane testing using single gases up to 600 °C; tubular membrane testing using simulated feeds up to 600 °C; and high-temperature, high-pressure testing of tubular supports. The membrane stability will be determined in a WGS environment. The three stability test configurations are in steam containing simulated feeds for exfoliated powders; in steam containing simulated feeds for alumina supported films; and in steam containing simulated feeds for stainless steel supported films.

The project will also integrate the membrane into a WGS membrane reactor model, integrate the model in an IGCC flow sheet, and perform techno-economic analysis and operability evaluation and analysis.

Table 1: Membrane-Based CO₂ Separations

	Parameter	Current R&D Value	Target R&D Value
Membrane Properties	Materials of fabrication for selective layer	MCM-22 plate-like crystals	Exfoliated MCM-22 layers
	Materials of fabrication for support layer (if applicable)	Porous alumina discs (homemade)	Porous stainless steel tubes (commercial)
	Selectivity of key gas components: H ₂ /CO ₂ for pre-combustion technology	20	80–800
	Type of selectivity measurement (ideal or mixed gas)	Ideal	Mixed gas
	Pressure normalized flux (permeance for linear materials) for more selective gas component, GPU or equivalent units	0.01 mol/m ² -s-bar	0.1–1 mol/m ² -s-bar
	Temperature, °C	200	500
	Bench-scale testing, hours without significant performance degradation	48	250
	Pilot-scale testing (if applicable), hours without significant performance degradation	N/A	N/A
	Maximum pressure differential achieved without significant performance degradation or failure, bar	3	10
Module Properties	Module configuration: hollow-fiber, spiral-wound sheet, shell-and-tube, plate-and-frame, other	N/A	TBD
	Packing density, m ² /m ³	N/A	TBD
	Pressure drop, bar	1–2 atm	10 atm
	Estimated cost of manufacturing and installation, \$/m ² -GPU or equivalent	N/A	\$3,000/m ²
Product Quality	CO ₂ purity, %	N/A	TBD
	H ₂ purity, %	N/A	TBD
Process Performance	Electricity requirement, kJ/kg CO ₂	N/A	TBD
	Heat requirement, kJ/kg CO ₂	N/A	TBD
	Total energy (electricity equivalent), kJ/kg CO ₂	N/A	TBD

Other Membrane Parameters

Contaminant Resistance: These materials are crystalline silicates and the main issue is stability to steam. Other contaminants are not expected to create problems.

Flue Gas Pretreatment Requirements: To be determined as project progresses.

Waste Streams Generated: To be determined as project progresses.

Technology Advantages

This membrane technology will form the selective film using a coating process and pre-made components, and will have high selectivity, flux, and stability.

R&D Challenges

- Dispersible exfoliated layers.
- Simple and efficient coatings process.

Results To Date/Accomplishments

Results from the project are not yet available.

Next Steps

Final test results will not be available until the September 2013 project completion date.

Available Reports/Technical Papers/Presentations

Maheshwari S., Kumar S., Bates F.S., Penn R.L., Shantz D.F., Tsapatsis M. **Journal of the American Chemical Society** **130**, 1507–1516 (2008) *Layer Structure Preservation during Swelling, Pillaring and Exfoliation of a Zeolite Precursor*.

Choi J., Tsapatsis M. **Journal of the American Chemical Society** **132(2)**, 448–449 (2010) *MCM-22/Silica Selective Flake Nano-composite Membranes for Hydrogen Separations*.

PRE-COMBUSTION CARBON DIOXIDE CAPTURE BY A NEW DUAL-PHASE CERAMIC-CARBONATE MEMBRANE REACTOR

B-60

PRE-COMBUSTION MEMBRANES

Primary Project Goals

Arizona State University is developing a dual-phase, membrane-based separation device which will separate carbon dioxide (CO₂) from typical water gas shift (WGS) mixture feeds and produce hydrogen, which can be introduced into the combustion turbines of integrated gasification combined cycle (IGCC) plants.

Technical Goals

- Synthesize chemically and thermally stable dual-phase, ceramic-carbonate membranes with CO₂ permeance and CO₂ selectivity [with respect to hydrogen (H₂), carbon monoxide (CO), or water (H₂O)] larger than $5 \times 10^{-7} \text{ mol/m}^2 \cdot \text{s} \cdot \text{Pa}$ and 500.
- Fabricate tubular dual-phase membranes and membrane reactor modules suitable for WGS membrane reactor applications.
- Identify experimental conditions for WGS in the dual-phase membrane reactor that will produce the hydrogen stream with at least 93% purity and CO₂ stream with at least 95% purity.

Technical Content

A membrane separation device consisting of a porous metal phase and a molten carbonate phase can conduct carbonate ion (CO₃²⁻) at a high rate. The metal-carbonate membranes only conduct electrons, and oxygen (O₂) should be mixed with CO₂ in the feed in order to convert CO₂ to CO₃⁻ ions. However, the presence of O₂ can also oxidize the metallic support and reduce its electronic conductivity, and thus CO₂ permeability. The problem can be solved by the proposed dual-phase, ceramic-carbonate membrane configuration consisting of a porous ionic conducting ceramic phase and a molten carbonate phase.

At the upstream surface, CO₂ reacts with oxygen ions supplied from the ceramic phase to form CO₃⁻, which transports through the molten carbonate phase towards the downstream surface of the membrane. On the downstream surface, the reverse surface reaction takes place, converting CO₃⁻ to CO₂, with O⁻ released and transported back through the ceramic phase towards the upstream surface of the membrane. The net effect is permeation of neutral CO₂ through the membrane driven by the CO₂ pressure gradient. The dual-phase membrane will be made of continuous thin mesoporous oxygen ionic conducting ceramic layer filled with a molten carbonate, supported on porous stainless steel or other metal, with an intermediate layer of sub-micron, pore-sized oxygen ionic conducting material.

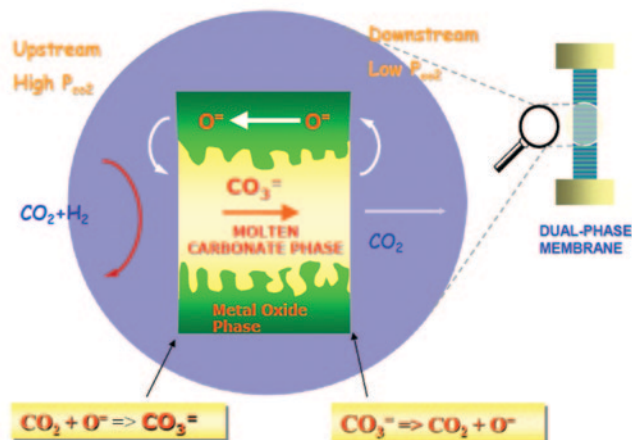

Figure 1: Concept of Dual-Phase Membrane

Technology Maturity:

Bench-scale using simulated syngas

Project Focus:

Dual-Phase Ceramic-Carbonate Membrane Reactor

Participant:

Arizona State University

Project Number:

FE0000470

NETL Project Manager:

Arun Bose

Arun.Bose@netl.doe.gov

Principal Investigator:

Jerry Y.S. Lin

Arizona State University

Jerry.Lin@asu.edu

Partners:

None

Performance Period:

10/1/09 – 9/30/13

Development of this dual-phase membrane will be divided into two phases. Phase I work will include identifying optimum conditions for synthesis of adequate membrane supports and the dual-phase membranes in disk geometry and studying gas permeation properties of the membranes. The second part of the Phase I work will be focused on fabrication of the dual-phase membranes in tubular geometries and the study of permeation, chemical, and mechanical stability of the tubular membranes relevant to their uses in membrane reactors for WGS reaction.

Phase II work will be directed towards studying the dual-phase membrane reactor performance for WGS reaction for hydrogen production and CO₂ capture. The work includes synthesis and kinetic study of a high-temperature WGS catalyst and experimental and modeling study of WGS reaction on the dual-phase membrane reactors. The experimental data will be compared with modeling results to identify optimum operating conditions for WGS reaction. The project will perform an economic analysis using the dual-phase membrane as a WGS reactor for hydrogen production and CO₂ capture for an IGGC plant.

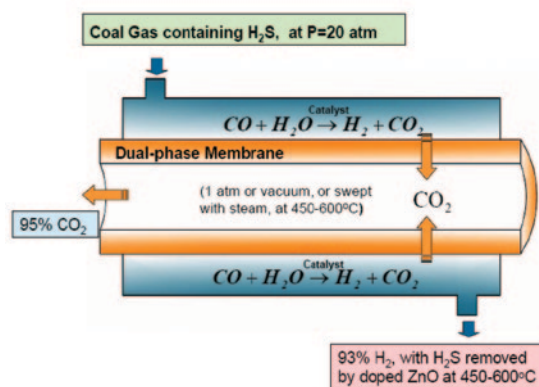

Figure 2: Proposed Membrane Reactor for WGS Reaction

Table 1: Membrane-Based CO₂ Separations

	Parameter	Current R&D Value	Target R&D Value
Membrane Properties	Materials of fabrication for selective layer	Li ₂ /K ₂ CO ₃	Doped Li ₂ /K ₂ CO ₃
	Materials of fabrication for support layer (if applicable)	Porous stainless steel	Fast-ionic conductors (doped ZrO ₂)
	Selectivity of key gas components: H ₂ /CO ₂ for pre-combustion technology	20	>300
	Type of selectivity measurement (ideal or mixed gas)	Mixed gas	Mixed gas
	Pressure normalized flux (permeance for linear materials) for more selective gas component, GPU or equivalent units	200 GPU	1,500 GPU
	Temperature, °C	800	500
	Bench-scale testing, hours without significant performance degradation	N/A	1,000
	Pilot-scale testing (if applicable), hours without significant performance degradation	N/A	N/A
	Maximum pressure differential achieved without significant performance degradation or failure, bar	N/A	20
Module Properties	Module configuration: hollow-fiber, spiral-wound sheet, shell-and-tube, plate-and-frame, other	Disk	Shell-and-tube
	Packing density, m ² /m ³	10	60
	Pressure drop, bar	0.2	10
	Estimated cost of manufacturing and installation, \$/m ² -GPU or equivalent	N/A	\$1,500–\$3,000/m ²
Product Quality	CO ₂ purity, %	N/A	95
	N ₂ purity, %	N/A	N/A
	Other contaminants, %	N/A	N/A
Process Performance	Electricity requirement, kJ/kg CO ₂	N/A	N/A
	Heat requirement, kJ/kg CO ₂	N/A	N/A
	Total energy (electricity equivalent), kJ/kg CO ₂	N/A	N/A

Other Membrane Parameters

Contaminant Resistance: The membrane to be stable in 0.1–1% atmosphere containing hydrogen sulfide (H₂S).

Flue Gas Pretreatment Requirements: N/A.

Waste Streams Generated: N/A.

Technology Advantages

- WGS reaction at one temperature (about 400 °C).
- Separation of CO₂ and H₂ mixture in one step.
- Production of high-pressure hydrogen stream.

R&D Challenges

- Failure to obtain sufficiently high CO₂ permeance due to a rate-limiting surface reaction.
- Undesired surface properties of ceramic supports resulting in instability of the carbonate in the support pores.

Results To Date/Accomplishments

Results from the project are not yet available.

Next Steps

Final test results will not be available until the September 2013 project completion date.

Available Reports/Technical Papers/Presentations

No reports, technical papers, or presentations are yet available.

DESIGNING AND VALIDATING TERNARY PD ALLOYS FOR OPTIMUM SULFUR/CARBON RESISTANCE

Primary Project Goals

Pall Corporation is developing an economic, high temperature and pressure, hydrogen (H₂) separation membrane system for carbon dioxide (CO₂) capture, while resisting moderate levels of contaminants using a ternary palladium (Pd)-alloy. A membrane module prototype will be fabricated and will undergo long-term testing in actual coal gasification conditions. The final objective is a pilot-scale membrane system with a product plan for commercialization of the technology.

Technical Goals

- Create an advanced Pd-alloy for optimum H₂ separation performance using combinatorial material methods for high-throughput screening, testing, and characterization.
- Demonstrate durability under long-term testing of a pilot membrane module at a commercial coal gasification facility.
- Understand long-term effects of the coal gasifier environment on the metallurgy of the membrane components by comparing controlled diffusion studies with in-service membranes.

Technical Content



Figure 1: A Co-Sputtering Chamber

The project will develop an advanced Pd-alloy for optimum H₂ separation performance and to demonstrate long-term durability under coal synthesis gas (syngas) conditions. Ternary Pd-alloys with potential for favorable performance will be selected based on a literature search. This large set of ternary Pd-alloys will undergo combinatorial alloy spreads on thin film support disks. These disks will be tested in a syngas environment using in-situ Raman spectroscopy to measure H₂ separation factor and permeability, as well as characterize sulfur and carbon resistance of best candidate alloys. These alloys will be compared to baseline tests of traditional Pd-gold (Au) alloy membranes.

The best alloys will be fabricated into 15-cm² tubular membranes and tested. As with the combinatorial disks, the 15-cm² active area tubes will be exposed to conditions representative of a coal gasifier environment: high temperature and high pressure in the presence of contaminating species. Emphasis will be placed on identification and characterization of membrane defects, surface analysis of the regions affected by the contaminants, and assessment of the surface quality of the ceramic substrate.

The project will develop an advanced Pd-alloy for optimum H₂ separation performance and to demonstrate long-term durability under coal synthesis gas (syngas) conditions. Ternary Pd-alloys with potential for favorable performance will be selected based on a literature search. This large set of ternary Pd-alloys will undergo combinatorial alloy spreads on thin film support disks. These disks will be tested in a syngas environment using in-situ Raman spectroscopy to measure H₂

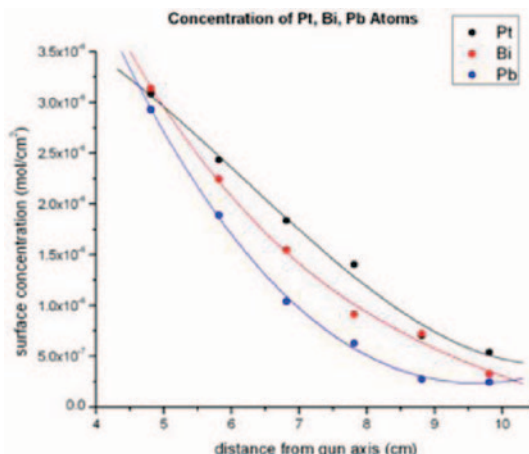

Figure 2: Graph of Atom Concentration as a Function of Distance from the Gun Axis for Pt, Bi, and Pb Targets

Technology Maturity:

Pilot-scale using actual syngas

Project Focus:

Ternary Palladium-Alloy Hydrogen Separation Membranes

Participant:

Pall Corporation

Project Number:

FE0001181

NETL Project Manager:

Patricia Rawls
Patricia.Rawls@netl.doe.gov

Principal Investigator:

Daniel Henkel
 Pall Corporation
Daniel_Henkel@pall.com

Partners:

Cornell University
 Georgia Institute of Technology
 Oak Ridge National Laboratory
 Southern Company

Performance Period:

10/1/09 – 9/30/12

Using the best candidate alloys, the 15-cm² membranes will be scaled up by a factor of 5–75 cm². After a series of performance tests and membrane characterization, a module of 75-cm² tubes, made with the best performing alloy, will be assembled. The module will be subjected to 500-hour service tests at a commercial coal gasification facility.

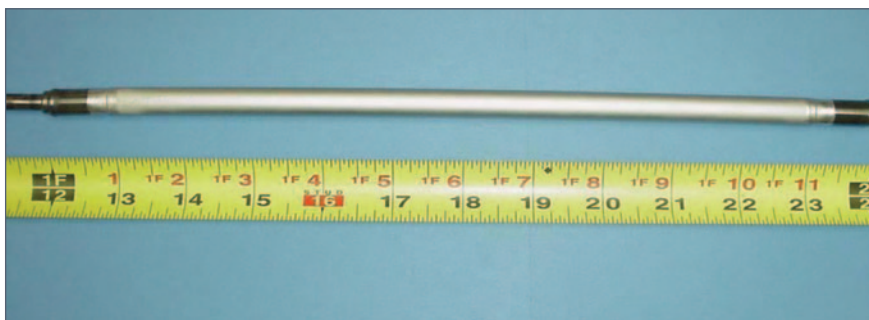

Figure 3: A 75-cm² Membrane

Technical Targets:

- Membrane would be tolerant of up to 20 parts per million (ppm) hydrogen sulfide (H₂S).
- Hydrogen flux of 200 ft³/hr/ft² at 400 °C and 20 pounds per square inch (psi) H₂ partial pressure differential.
- Total pressure differential operating capability 400 psi.
- The membrane cost must be in the range of \$500/ft².
- Permeate H₂ purity should be at a level of 99.5%.
- The membrane must be resistant to coking with relatively low steam-to-carbon ratio.
- The system should be stable for a minimum of three years in service.

Table 1: Membrane-Based CO₂ Separations

	Parameter	Current R&D Value	Target R&D Value
Membrane Properties	Materials of fabrication for selective layer	Palladium-gold alloys	N/A
	Materials of fabrication for support layer (if applicable)	Zirconia coated porous stainless steel tubes	N/A
	Selectivity of key gas components: H ₂ /CO ₂ for pre-combustion technology	>5,000 of H ₂ /CO ₂	>10,000
	Type of selectivity measurement (ideal or mixed gas)	Ideal	Ideal
	Pressure normalized flux (permeance for linear materials) for more selective gas component, GPU or equivalent units	72 scfh/ft ² psi ^{0.5}	N/A
	Temperature, °C	400	N/A
	Bench-scale testing, hours without significant performance degradation	500 hours with syngas	5,000 hours with syngas
	Pilot-scale testing (if applicable), hours without significant performance degradation	N/A	N/A
	Maximum pressure differential achieved without significant performance degradation or failure, bar	N/A	300 psi
Module Properties	Module configuration: hollow-fiber, spiral-wound sheet, shell-and-tube, plate-and-frame, other	Shell-and-tube	Shell-and-tube
	Packing density, m ² /m ³	N/A	N/A
	Pressure drop, bar	N/A	N/A
	Estimated cost of manufacturing and installation, \$/m ² -GPU or equivalent	N/A	N/A
Product Quality	CO ₂ purity, %	N/A	N/A
	H ₂ purity, %	N/A	N/A

Other Membrane Parameters

Contaminant Resistance: Pd-based alloy membranes should tolerate moderate levels of coal gas contaminants after advanced hot syngas cleanup. Primary contaminants include H₂S and carbon monoxide (CO). A typical hot gas cleanup process can bring residual level of sulfur into the range of 0.5–20 parts per million volume (ppmv). After a single-stage water gas shift (WGS) reactor, CO can be as low as a few percent.

Flue Gas Pretreatment Requirements: No flue gas pretreatment is required since it is pre-combustion CO₂ capture technology (i.e., coal is converted to syngas by partial combustion/gasification process).

Waste Streams Generated: No waste streams are generated since H₂ is extracted by a Pd-alloy membrane system with primarily CO₂ and water (H₂O) left at high pressure. After steam is condensed, CO₂ is sent for sequestration.

Technology Advantages

- Researchers will use a proprietary process to create ultrathin, economical, Pd-alloy membranes in virtually any alloy system.
- The project will apply combinatorial methods to continuous ternary alloy spreads and use a novel characterization method to rapidly scan the alloys after syngas exposure to identify the most resistant compositions.
- A customized composite substrate from Pall will be used to deposit ultrathin Pd-alloy membranes. The substrate is porous stainless steel tubes with ceramic coating on the outside surface as a diffusion barrier. Thus membrane elements can be assembled into the module by a conventional welding technique.

R&D Challenges

- Hydrogen separation performance may not achieve target performance by membrane design alone. Supplements such as additional gas reforming capabilities may be required either upstream or downstream of the membrane module.
- Scaleup of the Pd-alloy surface area from 15 to 75 cm²; although the membrane fabrication process has been designed for 75 cm² on tubular substrates, the actual scaleup has not been attempted.
- Membrane durability during thermal cycling and its effect on stability; the stability of the ceramic coated support has been demonstrated but not the long-term stability with a Pd-alloy membrane in place.

Results To Date/Accomplishments

A dozen binary and ternary alloy spreads were fabricated. Six have been exposed to high-temperature syngas, representative of actual coal gas conditions. Four of the ternary spreads had shiny areas after exposure that indicate exceptional carbon and sulfur tolerance (170 ppm H₂S). Raman spectroscopy of shiny areas show little or no sulfides or carbon compounds present on Pd-alloy surface. DFT modeling of binding energies of sulfur/carbon compounds are in agreement with observations. Hydrogen permeance through high-potential alloys has not yet been quantified.

Next Steps

Final test results will not be available until the September 2012 project completion date.

Available Reports/Technical Papers/Presentations

Five quarterly reports and two milestone reports have been submitted to NETL. A presentation was made at the NETL Technology Conference in Pittsburgh on September 16, 2010.

PRESSURE SWING ABSORPTION DEVICE AND PROCESS FOR SEPARATING CO₂ FROM SHIFTED SYNGAS AND ITS CAPTURE FOR SUBSEQUENT STORAGE

Primary Project Goals

The New Jersey Institute of Technology (NJIT) is developing, via laboratory-scale experiments, a pressure swing absorption-based (PSAB) device using a non-dispersive membrane-based gas-liquid contactor which produces hydrogen at high pressure for integrated gasification combined cycle (IGCC) and a carbon dioxide (CO₂) stream between 1 and 5 atm containing at least 90% of the CO₂ from a feed gas at ~200 °C and 300 pounds per square inch gauge (psig).

Technical Goals

- Develop, via laboratory experiments, an advanced PSAB device and a cyclic process to produce helium (He) (a surrogate for hydrogen) at high pressure from low-temperature post-shift reactor synthesis gas (syngas) and a CO₂ stream containing at least 90% of the CO₂ and suitable for sequestration.
- Provide data and analysis of the cyclic process and device to facilitate subsequent scale up.
- Develop a detailed analysis for the process and device to allow economic evaluation for potential larger-scale use.

Technical Content

In the first phase of research, an experimental set up will be developed for studying the PSAB process. NJIT will work with Media and Process Technology, Inc. and Applied Membrane Technologies (AMT), Inc. to develop ceramic tubule-based and Polytetrafluoroethylene (PTFE) hollow fiber-based absorption devices. The absorption device will be explored on a preliminary basis for performance of PSAB separation of a moist CO₂-He gas mixture at 150–200 °C and 200–300 psig, simulating a low-temperature post-shift reactor syngas stream.

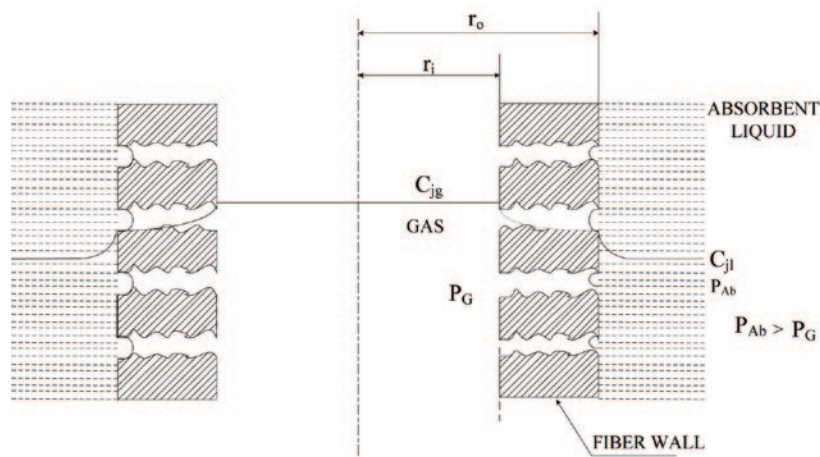

Figure 1: Concentration Profile of Absorbed Species in Gas and Liquid Phases

Technology Maturity:

Laboratory-scale using simulated syngas

Project Focus:

Pressure Swing Absorption with Membrane Contactor

Participant:

New Jersey Institute of Technology

Project Number:

FE0001323

NETL Project Manager:

Norman Popkie
Norman.Popkie@netl.doe.gov

Principal Investigator:

Dr. Kamallesh Sirkar
 New Jersey Institute of Technology
sirkar@njit.edu

Partners:

Applied Membrane Technologies
 Media and Process Technology, Inc.
 Techverse

Performance Period:

10/1/09 – 9/30/12

In phase two, NJIT will explore in detail the purification and separation performance of the PSAB process for selected absorbents vis-à-vis purification of the feed gas stream to obtain a high-pressure purified He stream and a low-pressure purified CO₂ stream. Experimental setups will be developed to measure the solubility and diffusion coefficients of CO₂ and He at the appropriate ranges of temperature and pressure for selected absorbents. Researchers will develop a mathematical model of the PSAB device and process.

In phase three, NJIT will generate experimental data on the solubility and diffusion coefficient for CO₂ and He for the selected absorbents. This will allow comparison of the results of simulation of the mathematical model with the observed purification and separation in the PSAB process and device for selected absorbents. Simulations of the model will be performed to explore scale up of the process and facilitate process evaluation. The extent of loss/deterioration of the absorbents over extended periods of operation will be determined.

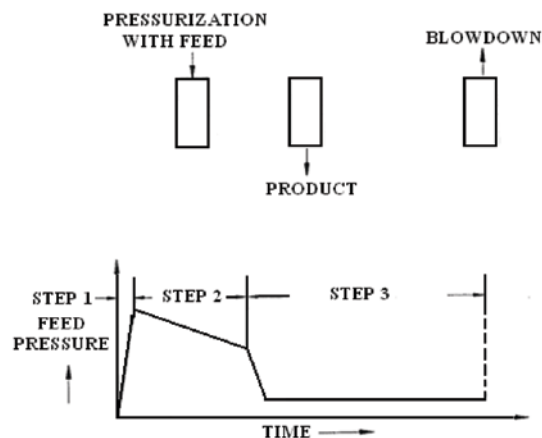

Figure 2: Pressure vs. Time Profile in Bore of Tubule or Hollow Fiber

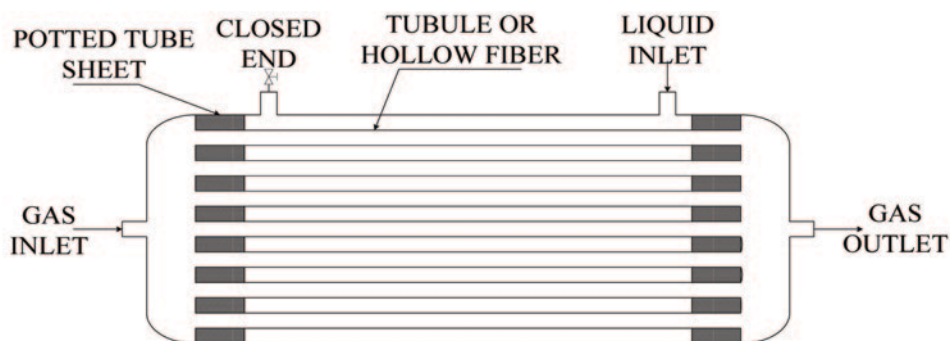

Figure 3: Schematic of Absorber Containing Ceramic Tubules or Hollow Fibers

Table 1: Liquid-Sorbent Bed Parameters

	Parameter	Current R&D Value		Target R&D Value
Liquid Sorbent Properties	Type of sorbent			Ionic liquid
	Molecular weight			200–300
	Boiling point (°C)			>500
	Viscosity, cP			~33
	Heat of absorption (kJ/mole CO ₂)			N/A
	CO ₂ loading/working capacity, wt%	—		N/A
	Cycle time (fixed bed), minutes	—		0.4–2 min
	Pressure drop (fixed bed), psia	—		1–2
Operating Conditions	Absorption temperature, °C	—		150–200
	Absorption pressure, atm	—		13–20
	CO ₂ capture efficiency, %	—		>90
	H ₂ recovery, %	—		N/A
	Regeneration method	—		Pressure swing
	Regeneration temperature, °C	—		150–200
	Regeneration pressure, atm	—		1–5

Table 1: Liquid-Sorbent Bed Parameters

	Parameter	Current R&D Value	Target R&D Value
Miscellaneous	Sorbent replacement rate, kg/kg CO ₂	—	N/A
Product Quality	CO ₂ purity, %	—	>90
	H ₂ purity, %	—	N/A
Process Performance	Electricity requirement, kJ/kg CO ₂	—	N/A
	Heat requirement, kJ/kg CO ₂	—	N/A
	Total energy (electricity equivalent), kJ/kg CO ₂	—	N/A

Table 2: Membrane-Contactor Parameters

	Parameter	Current R&D Value	Target R&D Value
Membrane Properties	Materials of fabrication for selective layer	—	Fluoropolymer
	Materials of fabrication for support layer (if applicable)	—	Ceramic, teflon, PEEK
	Selectivity of key gas components: H ₂ /CO ₂ for pre-combustion technology	—	30–100+
	Type of selectivity measurement (ideal or mixed gas)	—	Mixed gas
	Pressure normalized flux (permeance for linear materials) for more selective gas component, GPU or equivalent units	—	N/A
	Bench-scale testing, hours without significant performance degradation	—	100–200
	Pilot-scale testing (if applicable), hours without significant performance degradation	—	N/A
	Maximum pressure differential achieved without significant performance degradation or failure, bar	—	13–20
Module Properties	Module configuration: hollow-fiber, spiral-wound sheet, shell-and-tube, plate-and-frame, other	—	Hollow-fiber Shell-and-tube
	Packing density, m ² /m ³	—	Ceramic: 900 Teflon: 2,000 PEEK: 5,000
	Pressure drop, bar	—	N/A
	Estimated cost of manufacturing and installation, \$/m ² -GPU or equivalent	—	100–500 \$/m ²

Other Membrane Parameters

Contaminant Resistance: Hydrogen Sulfide (H₂S) will not affect the ceramic substrate; it will not affect the fluoropolymer coating on ceramic and PEEK materials; the Teflon hollow fibers will remain unaffected also. PEEK material is also unlikely to be affected.

Flue Gas Pretreatment Requirements: N/A.

Waste Streams Generated: Degraded absorption solvent.

Technology Advantages

- High solubility selectivity of novel selected liquid absorbents, high purification ability of the PSA process, and high gas-liquid contacting surface area per unit device volume.
- Compact, membrane-like device.
- Will deliver highly purified hydrogen (H₂) at nearly its partial pressure and temperature in the post-shifted reactor syngas feed.
- Purified CO₂ stream (>90% CO₂) will be available at 1–5 atm.

R&D Challenges

- Leakage of absorbent through microporous PTFE hollow fibers having a plasma polymerized microporous fluorosilicone coating.
- Capability of the hydrophobic coatings on ceramic tubules to hydrophobize them sufficiently (avoid defects) to eliminate leakage of absorbent into the tube side.
- Effect of module diameter and length on He purification ability.
- Achieve a steady state in the cyclic process by preventing a drift in the composition and amount of two purified product streams obtained.

Results To Date/Accomplishments

Results from the project are not yet available

Next Steps

Final test results will not be available until the September 2012 project completion date.

Available Reports/Technical Papers/Presentations

No reports, technical papers, or presentations are yet available.

HIGH TEMPERATURE POLYMER-BASED MEMBRANE SYSTEMS FOR PRE-COMBUSTION CARBON DIOXIDE CAPTURE

Primary Project Goals

Los Alamos National Laboratory is developing and demonstrating polymer-based membrane structures, deployment platforms, and sealing technologies that achieve the critical combination of high selectivity, high permeability, chemical stability, and mechanical stability all at elevated temperatures (>150 °C) and packaged in a scalable, economically viable, high area density system amenable to incorporation into an integrated gasification combined cycle (IGCC) plant for pre-combustion carbon dioxide (CO₂) capture. The project is focused on the optimization of a technology that could be positioned upstream or downstream of one or more of the water gas shift reactors (WGSRs), or integrated with a WGSR.

Technical Goals

- Development and demonstration of high temperature m-polybenzimidazole (PBI)-based membrane chemistries and morphologies for carbon capture and hydrogen purification from a coal-derived shifted synthesis gas (syngas) IGCC process stream.
 - Operation at/near water gas shift (WGS) conditions.
 - Stability in the presence of anticipated concentrations of primary coal-derived syngas components and impurities.
- Development of the capability to deposit/fabricate in situ thin membrane selective layers on microporous substrates with the goal of hollow fiber membrane fabrication where the membrane selective layer is comprised of the PBI-based polymers of interest.
- Development of the materials and techniques required to successfully mount (pot) the produced fibers into a cartridge/module. A barrier/potting material, along with a sealing technique that is compatible with the target process' thermal, chemical, and mechanical environments, must be developed or the fibers produced will not be useful.
- All of the aforementioned developments must be utilized together to ultimately achieve a module package that can be tested for permselectivity character in simulated and ultimately real process environments.

Technical Content

Los Alamos National Laboratory (LANL) work to-date has demonstrated that PBI and other benzimidazole-based materials show promise as membranes for pre-combustion-based capture of CO₂. The ultimate achievement in the area of CO₂ capture is the production of a CO₂-rich stream at pressure using methods compatible with the overall DOE NETL Carbon Sequestration Program goals of 90% CO₂ capture at less than 10% increase in the cost of energy services. The work that this project team is pursuing is aligned directly with these capture goals and utilizes a pre-combustion capture approach focused on the continued development of high-temperature polymer-based membranes that will ultimately be integrated into an advanced IGCC process.

Technology Maturity:

Pre-pilot testing, prototype development, manufacturing methodology development/optimization

Project Focus:

High-Temperature Polymer-Based Membrane

Participant:

Los Alamos National Laboratory

Project Number:

FE13-AC24

NETL Project Manager:

Robie Lewis

Robie.Lewis@netl.doe.gov

Principal Investigator:

Kathryn A. Berchtold

Los Alamos National Laboratory

berchtold@lanl.gov

Partners:

None

Performance Period:

10/1/09 – 9/30/12

PBI, the membrane selective layer, is a high-temperature polymer that is stable to temperatures approaching 500 °C. PBI possesses excellent chemical resistance, a very high glass transition temperature (~460–500 °C), good mechanical properties, and an appropriate level of processability. The PBI-based membranes developed by this project team have demonstrated operating temperatures significantly higher than 150 °C (up to 400–450 °C) with excellent chemical, mechanical, and hydrothermal stability.

The commercial viability of a membrane separation process is ultimately driven by selectivity, permeability (throughput), and stability in the process environments of interest (Figure 1). The goal is to utilize materials that exhibit the important and often elusive combination of high selectivity, high permeability, and chemical and mechanical stability all at temperatures significantly above 25 °C. Stability goals are focused on tolerance to the primary syngas components and impurities at various locations in the process. As process stream compositions and conditions (temperature and pressure) vary throughout the IGCC process, it is essential to incorporate all aspects of system integration into any plan. To that end, the work is aimed at evaluation of the PBI-based membrane over a broad temperature range (ambient: 400 °C), trans-membrane pressure range (10–450 psid), and in the presence of the primary syngas components [hydrogen (H₂), CO₂, nitrogen (N₂), methane (CH₄), carbon monoxide (CO), hydrogen sulfide (H₂S), and water (H₂O)].

A previous programmatic effort was focused on the utilization of the PBI formulations as a selective layer deposited on and supported by a unique porous metal substrate (fabricated by Pall Corporation). Systems, economic, and commercialization analyses conducted by NETL, LANL, and others, combined with in- and out-of-laboratory testing, established the technical viability of the technology and indicated the strong potential for the membrane-based capture technology to meet and exceed the DOE Sequestration Program goals. However, these analyses also made clear the need to cut the costs of the support material and increase the area density realized by the ultimate module design in order to realize the desired step-change in both performance and cost of CO₂ capture associated with the use of this membrane-based capture technology. One promising option for achieving a substantial increase in active membrane area density and mitigating the cost of a metal or inorganic material-based support is the use of a hollow fiber membrane platform. A hollow fiber module is the membrane configuration with the highest achievable packing density (i.e., the highest membrane selective area density). Hollow fiber modules have been fabricated to obtain a density as high as 30,000 m²/m³. This affords the opportunity to achieve several orders of magnitude improvement over the density achievable with the previous polymeric-metallic membrane platform (ca. 250 m²/m³). Realization of such a step change in area density with the materials previously developed by this team would lead to substantial economic and technical benefits.

Current and future work is aimed at continued development and demonstration of the membrane based pre-combustion hydrogen purification/carbon capture technology developed by LANL. A major aspect of that work involves developing the capability, materials, and methods to realize a high area density membrane platform with a selective layer comprised of the PBI-based polymers of interest. Furthermore, development of the materials and techniques required to successfully mount (pot) the produced fibers into a cartridge/module is essential. Finally, all of the aforementioned developments must be utilized together to ultimately achieve a module package that can be tested for permselectivity character in simulated and ultimately real process environments.

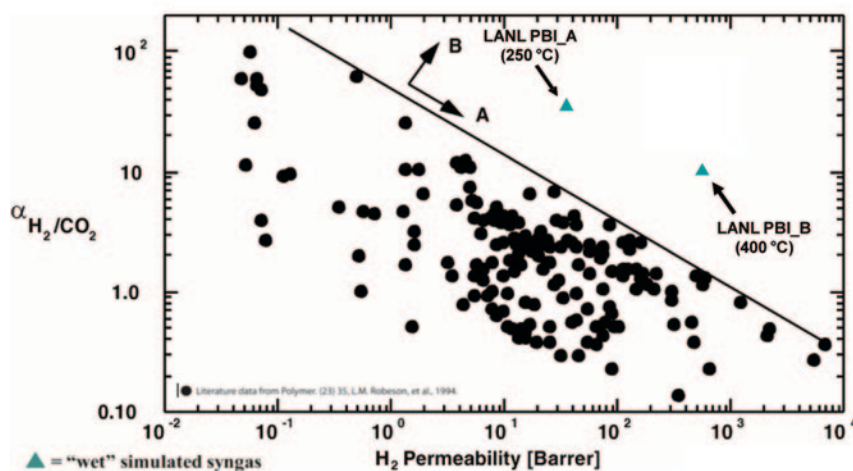

Figure 1: Trade-Off Plot Between H₂ Permeability and H₂/CO₂ Selectivity

Literature data are for polymeric membranes at ambient temperature and are represented by the filled circles below the upper bound. The data points for PBI reflect measurements made at elevated temperature in a “wet” simulated syngas environment. Most of the literature materials would be degraded by the process relevant test temperatures presented for PBI.

Table 1: Membrane Process Parameters

	Parameter	Current R&D Value	Target R&D Value
Membrane Properties	Materials of fabrication for selective layer	High T _g polymer	High T _g polymer
	Materials of fabrication for support layer (if applicable)	Metallic composite	High T _g polymer
	Selectivity of key gas components: H ₂ /CO ₂ for pre-combustion technology	43	≥25
	Type of selectivity measurement (ideal or mixed gas)	Mixed	Mixed
	Pressure normalized flux (permeance for linear materials) for more selective gas component, GPU or equivalent units	150	>100
	Temperature, °C	100–400 ¹	250
	Bench-scale testing, hours without significant performance degradation	8,400 (at 250 °C)	—
	Pilot-scale testing (if applicable), hours without significant performance degradation	—	—
	Maximum pressure differential achieved without significant performance degradation or failure, bar	31	>20
Module Properties	Module configuration: hollow-fiber, spiral-wound sheet, shell-and-tube, plate-and-frame, other	Shell-and-tube	Hollow-fiber
	Packing density, m ² /m ³	250	2,000–30,000
	Pressure drop, bar	2.3	— ²
	Estimated cost of manufacturing and installation, \$/m ² -GPU or equivalent	—	<\$200/m ²
Product Quality	CO ₂ purity, %	90% capture ³	90% capture ³
	H ₂ purity, %	— ²	— ²

Notes:

1. Presented data at 250 °C.
2. Highly dependent on system configuration, including: utilized sweep gas flows, staging, and turbine inlet specs.
3. Highly dependent requirements including: syngas composition treated, pipeline/transportation specs, system configuration.

Technology Advantages

- Broad accessible membrane operating temperature range (150–300 °C) facilitating increased opportunity for process integration/optimization.
- Demonstrated long-term hydrothermal stability, sulfur tolerance, and overall durability of selective layer materials.
- Membrane-based technology competitive advantages: modularity, low-maintenance operations, small footprint, low/no waste process, and flexible design opportunities.

R&D Challenges

- Design, control, prediction, and synthesis of tailored material morphologies.
- Realizing defect-free gas separation viable hollow fibers of optimized material chemistries and morphologies.
- Realizing barrier/potting materials and processes and defect sealing methods compatible with the target materials' and process' thermal, chemical, and mechanical characteristics/environments.

Results To Date/Accomplishments

- Successful demonstration of hollow fiber potting materials and methods that allow for testing of hollow fibers up to 250 °C at laboratory scale in simulated syngas environments.
- Successful demonstration of a hollow fiber membrane with permselectivity characteristics matching that of the shell and tube composite membranes.
- Successful testing of the high T_g polymer-based membrane in simulated syngas environments containing H_2 , CO_2 , CH_4 , N_2 , CO , H_2O , and H_2S from 25 to 400 °C. Demonstration of the membrane's thermal stability via 300+ days in operation at 250 °C.

Next Steps

Continued Materials, Methods, and Process Development.

Available Reports/Technical Papers/Presentations

K.A. Berchtold, et al., "High Temperature Polymer-Based Membranes for Hydrogen Purification and Carbon Capture," North American Membrane Society Annual Meeting, Charleston, SC (2009).

HIGH-TEMPERATURE, HIGH-PRESSURE MEMBRANES FOR HYDROGEN SEPARATION

Primary Project Goals

Ceramatec is producing a prototype membrane that will separate hydrogen from coal-derived synthesis gas (syngas) at operating conditions found at a typical coal gas facility without the use of precious metals. This research will enhance performance and efficiency as well as reduce the cost of hydrogen separation membrane technology.

Technical Goals

- Hydrogen flux of greater than 200 standard cubic feet per hour per square foot (scfh/ft²).
- Hydrogen purity >99.5%.
- Manufacturing cost of less than \$100/ft².
- Efficient operation at relevant conditions.

Technical Content

Modern gasifier and water gas shift (WGS) reactor technology produce syngas, a mixture primarily of hydrogen (H₂), carbon monoxide (CO), and carbon dioxide (CO₂). By using a pressure-driven hydrogen separation membrane, the high-pressure CO₂ is retained and thus amenable for capture and sequestration. Ceramic perovskite membranes show very high hydrogen separation efficiency. Because of their low electronic conductivity, ceramic-metal composites have been investigated as a potential pressure-driven membrane. Thermochemical instability of the perovskite in syngas and processing incompatibilities between ceramic and metal components has hampered effective use of ceramic-metal composites. Ceramatec has demonstrated a ceramic-ceramic composite material that shows excellent stability in syngas at the desired membrane operating temperature range. The use of an all ceramic membrane allows employing conventional ceramic processing for the manufacture of low-cost membrane devices.

The membrane consists of barium cerate as the proton conducting composition with ceria as the electron conducting composition. The technical bench mark criteria that are set for Year 1 of the project are:

1. Demonstration of effective membrane proton conductivity of 0.02 S/cm, corresponding to >150 scfh/ft² wafer hydrogen separation.
2. Preliminary membrane design (layer thickness, channel dimensions) showing <\$200/ft² fabrication feasibility.

Technology Maturity:

Bench-scale, hydrogen separation

Project Focus:

Ceramic Membrane for H₂ Separation

Participant:

Ceramatec

Project Number:

FE0001045

NETL Project Manager:

Arthur Baldwin
Arthur.Baldwin@netl.doe.gov

Principal Investigator:

S. Elangovan
 Ceramatec
elango@ceramatec.com

Partners:

CoorsTek
 Sandia National Laboratories

Performance Period:

10/1/09 – 9/30/12

Table 1: Membrane Process Parameters

	Parameter	Current R&D Value	Target R&D Value
Membrane Properties	Materials of fabrication for selective layer	Barium cerate + ceria	Barium cerate + ceria
	Materials of fabrication for support layer (if applicable)	Barium cerate + ceria	Barium cerate + ceria
	Selectivity of key gas components: H ₂ /CO ₂ for pre-combustion technology	100% for H ₂	100% for H ₂
	Type of selectivity measurement (ideal or mixed gas)	Mixed gas	Mixed gas
	Pressure normalized flux (permeance for linear materials) for more selective gas component, GPU or equivalent units	N/A	—
	Temperature, °C	800 °C	600–700 °C
	Bench-scale testing, hours without significant performance degradation	N/A	—
	Pilot-scale testing (if applicable), hours without significant performance degradation	N/A	—
	Maximum pressure differential achieved without significant performance degradation or failure, bar	N/A	—
Module Properties	Module configuration: hollow-fiber, spiral-wound sheet, shell-and-tube, plate-and-frame, other	Flat plate stack	Flat plate stack
	Packing density, m ² /m ³	N/A	—
	Pressure drop, bar	N/A	—
	Estimated cost of manufacturing and installation, \$/m ² -GPU or equivalent	~\$150/ft ²	\$100/ft ²
Product Quality	CO ₂ purity, %	—	—
	H ₂ purity, %	N/A	>99.5

Technology Advantages

- All ceramic composite is amenable to low-cost ceramic fabrication technology.
- Membrane has 100% selectivity to hydrogen.

R&D Challenges

- Fabrication technology development for thin supported membrane.
- Optimizing membrane composition for high hydrogen conductivity.
- Stability of contaminants, especially sulfur.

Results To Date/Accomplishments

- Composition showing proton conductivity of 0.02 S/cm at ~600 °C demonstrated.
- Cost model shows a pathway for achieving target cost.

Next Steps

- Demonstration of hydrogen flux corresponding to measure proton conductivity.
- Fabrication development for thin membrane.

Available Reports/Technical Papers/Presentations

No reports, technical papers, or presentations are yet available.

PRE-COMBUSTION CARBON CAPTURE BY A NANOPOROUS, SUPERHYDROPHOBIC MEMBRANE CONTACTOR PROCESS

Primary Project Goals

The Gas Technology Institute (GTI) is developing cost-effective separation technology for carbon dioxide (CO₂) capture from synthesis gas (syngas) based on a hollow-fiber membrane contactor.

Technical Goals

- Design an energy-efficient CO₂ recovery process which minimizes hydrogen loss.
- Tailor highly chemical inert and temperature stable, superhydrophobic, hollow-fiber poly (ether ether ketone) (PEEK) membrane for pre-combustion CO₂ capture.
- Manufacture a low-cost integrated membrane module.

Technical Content

The membrane contactor is a novel gas separation technology based on a gas/liquid membrane concept. The membrane contactor is an advanced mass transfer device that operates with a liquid on one side of the membrane and gas on the other. Unlike gas separation membranes where a differential pressure across the membrane provides the driving force for separation, the membrane contactor can operate with pressures that are almost the same on both sides of the membrane. The driving force is the chemical potential of CO₂ absorption into the liquid. This process is thus easily tailored to suit the needs for pre-combustion CO₂ capture.

The hollow fiber membrane is manufactured from an engineered material called PEEK by PoroGen Corporation using a patented process. Some key characteristics which make PEEK attractive for this process are: high heat resistance, high rigidity, high dimensional stability, good strength, excellent chemical resistance, excellent hydrolytic stability, an average pore size of 1–50 nm, an average porosity of 40–70%, and an 800 pound per square inch (psi) water breakthrough pressure.

The PEEK hollow-fiber membrane is nanoporous and can be surface modified to achieve super-hydrophobicity, fiber OD can range from 200 μm to 1 mm, and fibers can be made with very thin wall (<25 μ) due to the strength of PEEK. The PEEK membrane pore size can be controlled from 1 to 50 nm, and asymmetric membrane structures can be utilized for high performance. The hollow fiber has a high burst pressure of greater than 500 pounds per square inch gauge (psig), and a high collapse pressure of greater than 1,000 psig.

The advanced hollow-fiber module is constructed by computer-controlled helical winding. The modules exhibit favorable flow dynamics with minimal pressure drop, high uniform packing density, and thermodynamically efficient counter-current flow configuration.

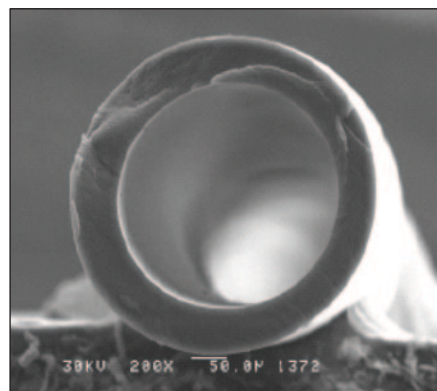

Figure 1: PEEK Hollow Fiber

Technology Maturity:

Bench-scale using simulated syngas

Project Focus:

Nanoporous, Superhydrophobic Membranes

Participant:

Gas Technology Institute

Project Number:

FE0000646

NETL Project Manager:

Arun Bose

Arun.Bose@netl.doe.gov

Principal Investigator:

Howard Meyer

Gas Technology Institute

Howard.Meyer@gastechnology.org

Partners:

PoroGen Corporation

Performance Period:

10/1/09 – 9/30/11

The project is divided into two phases. The activities of the first phase will be the development of hollow-fiber membranes suitable for the membrane contactor application with improved mass transfer, establishing feasibility of the proposed technology for syngas CO₂ separation, and performing initial process design and economic analysis based on test data.

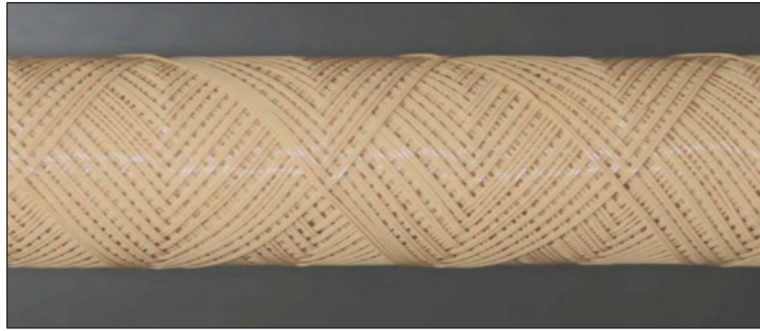

Figure 2: Advanced Hollow-Fiber Module Design

The focus of the phase two activity is to scale up the process from lab to bench scale. This includes scale up of the membrane module fabrication process so that membrane modules of the size suitable for large-scale application can be manufactured; bench-scale testing of the membrane contactor process stability and sensitivity to process variations; and refinement of the process economics based on bench-test data.

Table 1: GTI Membrane Parameters

	Parameter	Current R&D Value	Target R&D Value
Membrane Properties	Materials of fabrication for selective layer	Perfluoro-oligomer	Perfluoro-oligomer/polymer
	Materials of fabrication for support layer (if applicable)	PEEK	PEEK
	Selectivity of key gas components: H ₂ /CO ₂ for pre-combustion technology	Solvent dependent	Solvent dependent
	Type of selectivity measurement (ideal or mixed gas)	Mixed	Mixed
	Pressure normalized flux (permeance for linear materials) for more selective gas component, GPU or equivalent units	300	700
	Temperature, °C	50	Maximize
	Bench-scale testing, hours without significant performance degradation	TBD	TBD
	Pilot-scale testing (if applicable), hours without significant performance degradation	N/A	N/A
	Maximum pressure differential achieved without significant performance degradation or failure, bar	3.4	Maximize
Module Properties	Module configuration: hollow-fiber, spiral-wound sheet, shell-and-tube, plate-and-frame, other	Hollow-fiber	Hollow-fiber
	Packing density, m ² /m ³	500–1,000	500–1,000
	Pressure drop, bar	0.4	Minimize
	Estimated cost of manufacturing and installation, \$/m ² -GPU or equivalent	\$100	\$40
Product Quality	CO ₂ purity, %	—	—
	H ₂ purity, %	—	—

Other Membrane Parameters

Contaminant Resistance: Membrane is resistant to all contaminants. Absorbents will be affected by contaminants to a lesser extent than a conventional packed or tray column.

Flue Gas Pretreatment Requirements: N/A.

Waste Streams Generated: None.

Technology Advantages

- Counter-current flow allows for the most efficient mass transfer, thermodynamically.
- Computer-controlled winding provides structured packing to enable enhanced turbulence flow at fiber surface.
- High temperature stability for the desorption step.
- High liquid breakthrough pressure (no liquid wet out), high membrane integrity.
- High membrane productivity.

R&D Challenges

- Membrane hydrophobic properties change with solvent contact causing leakage.
- Mass transfer coefficient not sufficiently high for gas absorption in the membrane contactor.

Results To Date/Accomplishments

Results from the project are not yet available.

Next Steps

Final test results will not be available until the September 2011 project completion date.

Available Reports/Technical Papers/Presentations

S. James Zhou, Howard Meyer, Ben Bikson and Yong Ding, "Hybrid Membrane Absorption Process for Post Combustion CO₂ Capture." AIChE Spring Meeting, San Antonio, TX, March 21–25, 2010.

INTEGRATED WATER GAS SHIFT MEMBRANE REACTORS UTILIZING NOVEL, NON-PRECIOUS METAL MIXED-MATRIX MEMBRANES

Primary Project Goals

The University of Texas at Dallas (UTD) is preparing novel, non-precious metal mixed-matrix membranes (MMMs) in flat, tubular, and hollow fiber geometries based on polymer composites with nanoparticles of zeolitic imidazolate frameworks (ZIFs). Membrane performance to separate hydrogen from synthesis gas (syngas) [e.g., hydrogen (H₂), carbon monoxide (CO), carbon dioxide (CO₂), water (H₂O)] generated during coal gasification will be evaluated in an integrated water gas shift (WGS) membrane reactor. The goal is to exploit the high surface areas, adsorption capacities, and sieving capabilities of the nanoporous ZIF additives to achieve unprecedented, selective transport of hydrogen.

Technical Goals

- To prepare novel, non-precious metal MMMs in flat, tubular, and hollow fiber geometries based on polymer composites with nanoparticles of ZIFs in an integrated WGS membrane reactor.
- To prepare a high-performance membrane to separate hydrogen from syngas (e.g., H₂, CO, CO₂, H₂O) generated during coal gasification that will be evaluated in an integrated WGS membrane reactor using NETL test protocols.

Technical Content

The utilization of coal as a clean source of energy relies on the successful development and implementation of carbon capture and sequestration (CCS) technologies with a minimal impact on energy generation costs. The efficient conversion of coal into H₂ and CO₂ requires membranes that are stable at high temperatures and pressures (300–500 °C, 15–30 bar, Table 1) with an H₂/CO₂ separation selectivity that provides H₂ with >99% purity. A minimum temperature of 250–300 °C is required to maintain catalyst activity for the efficient conversion of syngas (>95% with commercial low temperature CuO-ZnO-Al₂O₃ catalyst), while a high H₂ flux across the membrane (>300 ft³_{stp}/ft²•h) drives the reaction.

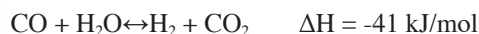

MMMs combine the polymers' processability with the ZIFs' superior permselective properties for H₂/CO₂ separations. Selected polymer membranes (Figure 1) displayed increased H₂ and CO₂ permeabilities (up to a 45-fold increase) at 300 °C and up to 30 bar (Figure 2). Hydrogen sorption isotherms of selected ZIFs showed H₂ adsorption up to 350 °C and 100 bar, while the integrity of the framework was maintained.

The UTD Membranes Team has fabricated robust, defect-free MMMs with good metal organic framework (MOF)/polymer interfaces with MOF loadings up to 80% (w/w). Hydrogen-selective ZIFs (an MOF subfamily) and thermally stable polymers, such as polyimides (synthesized 6FDA-based polymers and commercial VTEC PI-1388), polybenzimidazole (PBI), and Polymers

Technology Maturity:

Bench- to pilot-scale, non-precious metal membranes for hydrogen separation

Project Focus:

Integrated WGS Non-Precious Membrane

Participant:

University of Texas at Dallas

Project Number:

FE0001293

NETL Project Manager:

Jason Hissam
Jason.Hissam@netl.doe.gov

Principal Investigator:

John P. Ferraris
University of Texas at Dallas
Ferraris@utdallas.edu

Partners:

Santa Fe Science & Technology, Inc.

Performance Period:

9/30/09 – 9/29/12

of Intrinsic Microporosity-1 (PIM-1) were fabricated into MMMs. These MMMs demonstrated increased H₂ permeability, and crosslinking polyimides further increased the H₂/CO₂ selectivity (Figure 3). These membranes will be tested under WGS reaction conditions (300 °C, 15–30 bar) in a membrane reactor.

B-80

PRE-COMBUSTION MEMBRANES

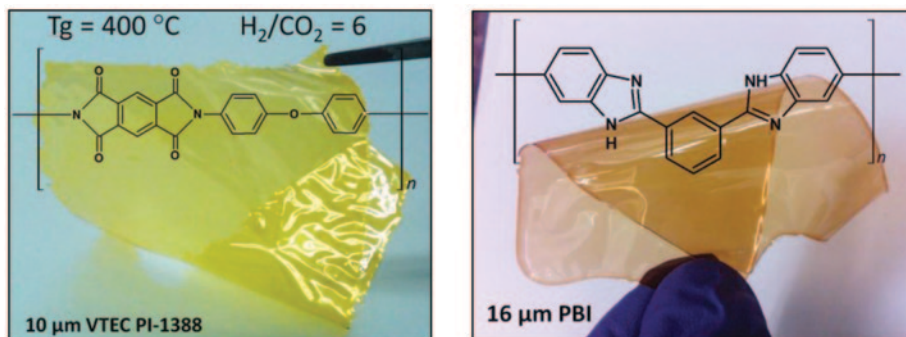

Figure 1: Polymer Membranes Annealed at 250 °C (Left: VTEC PI-1388; Right: Polybenzimidazole, PBI)

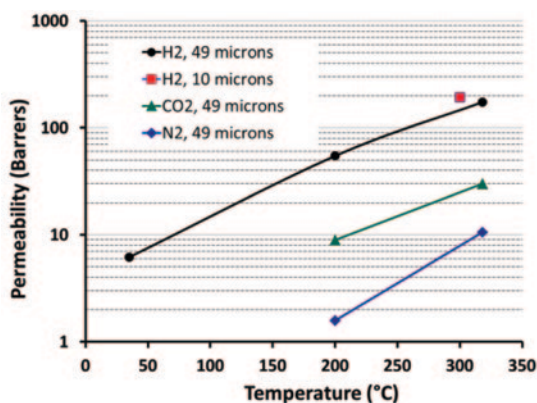

Figure 2: VTEC Polymer Gas Permeability at High Temperatures and up to 30 atm

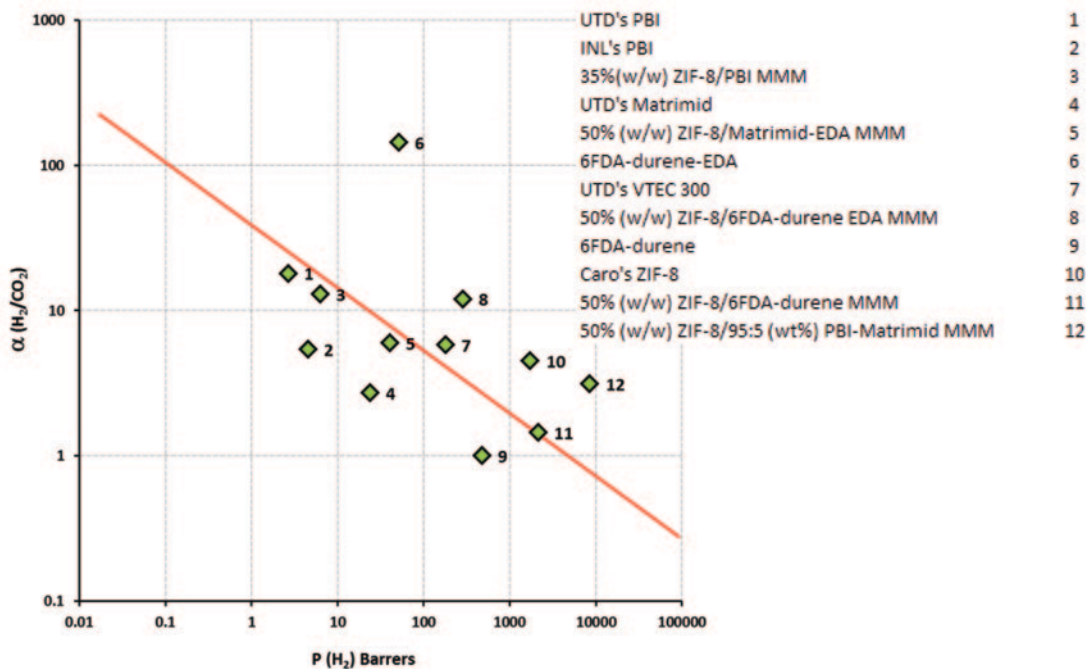

Figure 3: Robeson Upper Bound for H₂/CO₂ Separations

Table 1: Membrane Process Parameters

	Parameter	Current R&D Value	Target R&D Value
Membrane Properties	Materials of fabrication for selective layer	ZIF/polymer	ZIF/polymer
	Materials of fabrication for support layer (if applicable)	Polymer, ZIF/polymer	Polymer, alumina
	Selectivity of key gas components: H ₂ /CO ₂ for pre-combustion technology	6–102	99
	Type of selectivity measurement (ideal or mixed gas)	Ideal selectivity	Mixed gas
	Pressure normalized flux (permeance for linear materials) for more selective gas component, GPU or equivalent units	20 GPU	120 GPU
	Temperature, °C	300	300
	Bench-scale testing, hours without significant performance degradation	>120	120
	Pilot-scale testing (if applicable), hours without significant performance degradation	N/A	—
	Maximum pressure differential achieved without significant performance degradation or failure, bar	>15	15
Module Properties	Module configuration: hollow-fiber, spiral-wound sheet, shell-and-tube, plate-and-frame, other	N/A	—
	Packing density, m ² /m ³	N/A	—
	Pressure drop, bar	N/A	—
	Estimated cost of manufacturing and installation, \$/m ² -GPU or equivalent	N/A	—
Product Quality	CO ₂ purity, %	N/A	—
	H ₂ purity, %	85%	99.5%

Other Membrane Parameters

- Membranes did not fail up to 33 bar.
- The thicknesses of the flat membranes tested were 10 and 49 μm, with an exposed area of 0.5 cm².
- In a hollow fiber configuration, a <1-μm thick layer is expected to provide the target flux (300 ft³_{stp}/ft²•h).

Technology Advantages

- Low cost, low carbon footprint, readily available materials for ZIF, polymer, and membrane preparation: Non-precious metals (i.e., zinc, copper, and aluminum) can be easily obtained or, for organic compounds, synthesized from commercially available materials.
- Membrane fabrication follows simple procedures: mix and cast. Dispersions of ZIFs and polymer solutions are easily prepared without the use of expensive equipment. Casting solvents can be re-utilized.
- Membrane geometry can be adapted to different module types: flat, spiral wound, hollow fiber, or tubular.

R&D Challenges

- Obtaining defect-free polymer/ZIF interfaces remains a challenge for MMMs.
- Obtaining required gas fluxes in MMMs.

Results To Date/Accomplishments

- Thermally and chemically stable nanosized ZIFs with high affinity and selectivity for H₂ and CO₂ were synthesized based on reported procedures and used in MMMs. Robust polyimides (Matrimid®, VTEC PI-1388, and 6FDA-based PIs), PBI, and PIM-1 were employed.
- High-performance polymers (VTEC polyimide and polybenzimidazole, PBI) were tested for gas permeation [H₂, CO₂, and nitrogen (N₂)]. VTEC was tested up to 30 bar and 300 °C.
- Measurement of hydrogen sorption in thermally stable molecular sieve ZIFs showed H₂ adsorption up to 350 °C and 100 bar, while retaining the ZIF's integrity.
- ZIF/PBI MMMs exhibited a 130% increase in H₂ permeability with a 28% reduction in H₂/CO₂ selectivity at 35 °C and 3 bar.
- The measured H₂/CO₂ selectivity ($\alpha = 144$) for 6FDA-durene treated with ethylenediamine (EDA) results from a reduction in polymer chain mobility, which is accompanied by a dramatic decrease in permeability compared to the pure polymer. Incorporation of ZIFs into MMMs is known to increase permeability. ZIF-8/polymer (Matrimid® and 6FDA-durene) MMMs were crosslinked in an attempt to retain selectivity while increasing permeability (Figure 3).
- A membrane reactor was designed to meet DOE target conditions for the H₂/CO₂ separation at 300 °C and 15 atm, considering a gas flux across the membrane of 300 ft³_{stp}/ft²•h and currently under construction.

Next Steps

- Testing of select ZIF/polymer MMMs at 300 °C and up to 30 bar.
- Preparation of tubular ZIF/polymer mixed-matrix membranes for testing under WGS reaction conditions.
- Testing of the WGS membrane reactor.

Available Reports/Technical Papers/Presentations

Molecular sieving realized with ZIF-8/Matrimid® mixed-matrix membranes, Ordoñez, M. J. C.; Balkus Jr, K. J.; Ferraris, J. P.; Musselman, I. H., *J. Membr. Sci.* **2010**, *361*, 28–37.

The PIs presented for the U.S. Department of Energy National Energy Technology Laboratory Strategic Center for Coal's Advanced Fuels Peer Review October 18–22, 2010, in Morgantown, WV.

Perfluorocyclobutyl (PFCB) Polymers for Gas Separation Applications, **G. D. Kalaw**, K. J. Balkus, Jr., I. H. Musselman, J. P. Ferraris (Poster), 2010 NAMS annual meeting, Washington, D.C.

ZIF-8/6FDA-Durene Mixed-Matrix Membranes for Gas Separations, **S. N. Wijenayake**, K. J. Balkus, Jr., I. H. Musselman, J. P. Ferraris (Poster), 2010 NAMS annual meeting, Washington, D.C.

ZIF-7/Matrimid® Mixed-Matrix Membranes for Gas Separations, **Zhang, Z.**, K. J. Balkus, Jr., J. P. Ferraris, I. H. Musselman (Poster), 2010 NAMS annual meeting, Washington, D.C.

Metal-Organic Framework Mixed-Matrix Membranes for Gas Separations, **K. J. Balkus, Jr.**, J. P. Ferraris, I. H. Musselman (Talk), 16th International Zeolite Conference, Sorrento, Italy, 2010.

Perfluorocyclobutyl (PFCB) Polymer/Basolite® Z1200 Mixed-Matrix Membranes (MMM) for Gas Separation Applications (Poster and talk), **G. D. Kalaw**, K. J. Balkus, Jr., I. H. Musselman, J. P. Ferraris, 240th ACS National Meeting, Boston, MA, 2010.

Mixed-matrix membranes (MMM) comprising metal organic frameworks and novel perfluorocyclobutyl-based polymers or high temperature polyimides for gas separations, J. P. Ferraris; **K. J. Balkus**; I. H. Musselman; G. J. Kalaw; M. C. Ordoñez; S. N. Wijenayake, PacifiChem 2010. Honolulu, HI.

Polymer-based mixed-matrix membranes containing zeolitic imidazolate frameworks for gas separations, **I. H. Musselman**; M. C. Ordoñez; Z. Zhang; K. J. Balkus; J. P. Ferraris, PacifiChem 2010. Honolulu, HI.

ADVANCED PALLADIUM MEMBRANE SCALE-UP FOR HYDROGEN SEPARATION

Primary Project Goals

United Technologies Research Center (UTRC), in collaboration with Power+Energy, Inc. (P+E) and the Energy and Environmental Research Center at the University of North Dakota (UN-DEERC), is demonstrating the membrane-based separation of H₂ from coal-derived synthesis gas (syngas) at the pre-engineering/pilot scale using an improved palladium (Pd) -based membrane technology.

Technical Goals

- Construct, test, and demonstrate a Pd copper (Cu) metallic tubular membrane micro-channel separator capable of producing 2 lb/day of H₂ at $\geq 95\%$ recovery when operating downstream of an actual coal gasifier.
- Quantify the impact of simulated gas composition and temperature on separator performance.
- Compare the performance and durability of a surface-modified higher H₂ flux PdCu membrane with the baseline PdCu tubular membrane.
- Evaluate various materials of construction for the separator structural parts to ensure durability under harsh gasifier conditions.

Technology Maturity:

Bench- to pilot-scale, hydrogen separation

Project Focus:

Membrane for H₂ Separation

Participant:

United Technologies Research Center

Project Number:

FE0004967

NETL Project Manager:

Jason Hissam
Jason.Hissam@netl.doe.gov

Principal Investigator:

Sean Emerson
 United Technologies Research Center
emersosc@utrc.utc.com

Partners:

Power+Energy, Inc.
 University of North Dakota
 EERC

Performance Period:

9/24/10 – 12/31/11

Technical Content

B-84

Table 1: Membrane Process Parameters

	Parameter	Current R&D Value	Target R&D Value
Membrane Properties	Materials of fabrication for selective layer	Pd, Cu	Pd, Cu
	Materials of fabrication for support layer (if applicable)	N/A	N/A
	Selectivity of key gas components: H ₂ /CO ₂ for pre-combustion technology	999,999	999,999
	Type of selectivity measurement (ideal or mixed gas)	Mixed gas	Mixed gas
	Pressure normalized flux (permeance for linear materials) for more selective gas component, GPU or equivalent units	50 ft ³ ft ⁻² h ⁻¹ for 200 psia H ₂	300 ft ³ ft ⁻² h ⁻¹
	Temperature, °C	250–600	250–500
	Bench-scale testing, hours without significant performance degradation	1,031 h	43,829 h
	Pilot-scale testing (if applicable), hours without significant performance degradation	—	—
	Maximum pressure differential achieved without significant performance degradation or failure, bar	13.8 bar	—
Module Properties	Module configuration: hollow-fiber, spiral-wound sheet, shell-and-tube, plate-and-frame, other	Shell-and-tube	—
	Packing density, m ² /m ³	157	—
	Pressure drop, bar	—	—
	Estimated cost of manufacturing and installation, \$/m ² -GPU or equivalent	—	—
Product Quality	CO ₂ purity, %	—	—
	H ₂ purity, %	99.9999	99.99

Technology Advantages

- The PdCu alloy has stronger resistance to sulfur compared to traditional membranes, resulting in improved CO₂ capture efficiency.
- A PdCu alloy-based CO₂ capture membrane is able to better withstand the corrosion and wear associated with membranes constructed of other materials.
- Less corrosion means the membrane does not need to be replaced as often, resulting in a lower overall operating cost for the power plant.

R&D Challenges

- Membrane resistance to coal gasifier exhaust such as carbon monoxide, sulfur, arsenic, and mercury.
- Corrosion and metal dusting resistance of non-membrane materials of construction.
- Separation of 2 lb/day of H₂ operating downstream of an actual coal gasifier.

Results To Date/Accomplishments

- Delivery of first two 0.1 ft² separators.
- Prepared samples of eight alloys for corrosion testing (SS-316, SS-309, C-22, C-276, SS-310, HR-120, and Oak Ridge National Laboratory OC-10 and OC-11 alloys).
- Evaluated the gas impurity resistance of the first 0.1-ft² separator.

Next Steps

- Corrosion testing of metal alloy coupons at 500 °C.
- Evaluate the performance of PdCu separators with improved surface coating.
- Conduct durability studies under DOE protocol test conditions of 2-lb/day H₂ separators.
- Conduct pilot-scale testing of a 2-lb/day H₂ separator at UNDEERC's coal gasifier.

Available Reports/Technical Papers/Presentations

Emerson, S.C., et al. *Experimental Demonstration of Advanced Palladium Membrane Separators for Central High Purity Hydrogen Production*, DOE Award Number DE-FC26-07NT43055. East Hartford, CT: United Technologies Research Center, 2010. Final Report.

Advanced Palladium Membrane Scale-up for Hydrogen Separation, invited presentation at *Advancing the Hydrogen Economy Action Summit III*. Emerson, S.C. Grand Forks, ND: University of North Dakota EERC's National Center for Hydrogen Technology, 2010.

Opalka, S.M., Løvvik, O.M., Emerson, S.C., Vanderspurt, T.H. Electronic Origins for Sulfur Interactions with Palladium Alloys for Hydrogen-Selective Membranes, submitted to *J. Membrane Sci.* 2010.

SUPPORTED MOLTEN METAL MEMBRANE FOR HYDROGEN SEPARATION

Primary Project Goals

Worcester Polytechnic Institute (WPI) is developing and testing novel supported molten metal membranes (SMMMs) for hydrogen separation that meet DOE's targets in terms of cost, operating conditions, permeability, selectivity, robustness, and longevity. These membranes would be based on low-melting, non-precious group metals [e.g., tin (Sn), indium (In), gallium (Ga), bismuth (Bi)] and their alloys, supported as thin films on an inert porous ceramic or a porous metal support with or without an intermetallic diffusion barrier.

Technical Goals

- Selection of molten metals and their supports and develop membrane fabrication protocols, and establish feasibility to the SMMM technique.
- Select and optimize final SMMM candidates and investigate in term of permeability, selectivity, and susceptibility to poisons, as well as microstructural, solubility, and diffusion characteristics.
- Investigate best SMMM candidate under increasingly realistic conditions.

Technical Content

Experiments were continued in an effort to fabricate dense and stable SMMMs on oxidized porous metal and/or ceramic supports. Ceramic disk membranes were found to lack wettability as well as the strength needed for effective sealing at higher temperatures.

Coupon studies indicated that porous stainless steel (PSS) oxidized at the usual temperature (700 °C) does not provide an effective diffusion barrier that holds up to the liquid metals tested (In, Ga, Sn). PSS membranes oxidized at a higher temperature seem to provide a firmer barrier and may work. A porous Ni disk when oxidized provides a diffusion barrier that is effective. Therefore, oxidized porous Ni and porous Inconel supports should be effective as membrane supports.

Technology Maturity:

Bench-scale, SMMM hydrogen membranes

Project Focus:

Supported Molten Metal Membrane for H₂ Separation

Participant:

Worcester Polytechnic Institute

Project Number:

FE0001050

NETL Project Manager:

Jason Hissam
Jason.Hissam@netl.doe.gov

Principal Investigator:

Ravinda Datta
 Worcester Polytechnic Institute
rdatta@wpi.edu

Partners:

None

Performance Period:

9/23/09 – 9/29/11

Table 1: Membrane Process Parameters

	Parameter	Current R&D Value	Target R&D Value
Membrane Properties	Materials of fabrication for selective layer	In, Ga, Sn	Non-PGM
	Materials of fabrication for support layer (if applicable)	NiO, ZrO ₂ , TiO ₂	Durable
	Selectivity of key gas components: H ₂ /CO ₂ for pre-combustion technology	N/A	10,000
	Type of selectivity measurement (ideal or mixed gas)	—	Mixed
	Pressure normalized flux (permeance for linear materials) for more selective gas component, GPU or equivalent units	N/A	1 sccm/psi.cm ²
	Temperature, °C	300–400	300–600
	Bench-scale testing, hours without significant performance degradation	—	—
	Pilot-scale testing (if applicable), hours without significant performance degradation	—	—
	Maximum pressure differential achieved without significant performance degradation or failure, bar	—	100 psi
Module Properties	Module configuration: hollow-fiber, spiral-wound sheet, shell-and-tube, plate-and-frame, other	—	Shell-and-tube, Plate-and-frame
	Packing density, m ² /m ³	—	—
	Pressure drop, bar	—	—
	Estimated cost of manufacturing and installation, \$/m ² -GPU or equivalent	N/A	\$5,400/m ²
Product Quality	CO ₂ purity, %	—	—
	H ₂ purity, %	N/A	99.99

Technology Advantages

- The SMMM comprises non precious-group metal membranes and, thus, has a cost advantage.
- Its range of operating temperatures is potentially wider than conventional palladium (Pd)-based membranes.
- Thermal mismatch issues between metal and support are absent and is potentially self-repairing of pinholes.
- It potentially has better tolerance to other synthesis gas (syngas) components.

R&D Challenges

- The SMMM is conceptually a novel idea and there is a lack of prior work/recipe in the literature, thereby leading to a lack in guidance.
- Molten metals are highly reactive and are likely to infiltrate the support, making the naked porous metal supports unsuitable.
- Most ceramics are too fragile to allow compressive sealing at higher temperatures.
- Thinning of the tubular liquid metal membrane upon heating.

Results To Date/Accomplishments

- It was found that wettability and chemical inertness are competing requirements. Thus, ceramic supports (e.g., zirconia) possess good inertness but poor wettability, while naked metal supports (e.g., PSS), while readily wetted, react with molten metals at elevated temperatures to form impermeable solid alloys and intermetallic compounds.
- Ceramic supports are fragile and crack at sealing pressures necessary for effective sealing at higher temperatures. Thus, efforts were focused on developing interfacial layers on porous metal substrates that provide an appropriate combination of wettability and inertness and experiments were performed using disks and tubular supports.
- Coupon studies indicated that PSS oxidized at the usual temperature (700°C) that works for Pd membranes does not provide an effective diffusion barrier that holds up to the liquid metals tested (In, Ga, Sn).
- It appears that porous nickel (Ni) (and Inconel) supports when oxidized appropriately may provide an adequate diffusion barrier needed for the stability of the molten metal membrane.
- Despite persistent sealing leaks in the disk permeator, it was found that the hydrogen (H₂)/helium (He) selectivity of several tested membranes is higher than ideal selectivity of Knudson diffusion.
- Two alternate procedures have been developed for depositing a second metal (Pd for now) to alloy with the base liquid metal deposited on a tubular support in order to obtain membranes with melting point in the range of 300–400 °C.

Next Steps

- Fabricate dense and stable SMMMs with porous Ni, porous Inconel, and porous Itanium supports.
- Investigating if the wettability can also be improved by sputtering a nanoscale layer of these elements at the interface.
- Resolving sealing issues of disk permeator setup, to get accurate idea of hydrogen flux and selectivity through SMMMs.
- Improve the wettability of the membrane so that there is a stronger bond between membrane and support.
- Utilize liquid membranes with melting points not significantly below the operating temperature of 400 °C or above, so that liquid thinning at high temperatures is less of an issue.

Available Reports/Technical Papers/Presentations

No reports, technical papers, or presentations are yet available.

NANOPOROUS, METAL CARBIDE, SURFACE DIFFUSION MEMBRANE FOR HIGH TEMPERATURE HYDROGEN SEPARATIONS

Primary Project Goals

The Colorado School of Mines (CSM) is fabricating, characterizing, and optimizing transition metal carbide, composite membranes to separate hydrogen (H₂) from gas mixtures at high temperatures and pressures representative of gasification of carbon feedstocks such as coal or biomass. Supports will be either dense BCC metals [vanadium (V), niobium (Nb), tantalum (Ta), etc.] or porous stainless steel filters from Pall Corporation.

Technical Goals

- Pore size, carbide formation conditions, and the thickness of the carbide layer will be varied to study the effects on the performance of the metal carbide composite membranes.
- Investigate the effect of synthetic water-gas shift product mixtures on permeance and selectivity of nanoporous, metal carbide/sulfide, composite membranes.
- Determine if metal carbide layers can catalyze the dissociation of hydrogen on dense, Group V, BCC metal membranes (V, Nb, Ta, or their alloys).

Technical Content

CSM will fabricate, characterize, and optimize novel, high-temperature membranes for hydrogen separation based on metal [molybdenum (Mo) or tungsten (W)] carbides and sulfides. These membranes could be used in water gas-shift environments for the simultaneous generation of pure H₂ and a stream enriched in carbon dioxide (CO₂) at high pressure for subsequent capture. These membranes contain no platinum group metals (PGMs) such as ruthenium (Ru), rhodium (Rh), palladium (Pd), osmium (Os), iridium (Ir), or platinum (Pt). The membrane selective layer will be either a mesoporous carbide layer on a porous support (see Figure 1) or a thin carbide layer on a dense BCC metal (V, Nb, Ta, or their alloys) as shown in Figure 2.

The CSM synthesis strategy consists of the use of a low-temperature, plasma-enhanced chemical vapor deposition (PECVD) process to form a dense metal oxide layer on tubular, stainless steel filtration membrane from Pall Corporation. The dense metal oxide layer will then be converted to a carbide phase containing small nanopores (2–3 nm) via a reduction process in a hydrocarbon/hydrogen environment. Tests will be used to identify membranes with larger pores that will subsequently be repaired to eliminate non-selective transport by viscous flow. Robust, porous stainless steel substrates will be used which will facilitate high-temperature sealing and can be scaled up as they have been modularized for industrial-scale filtration by Pall Corporation.

In addition to the experiments with porous molybdenum carbide (Mo₂C) to obtain a surface diffusion membrane, its use as a catalyst on crystalline, dense Group V metal membranes (e.g., V, Nb, Ta) was also examined. In these experiments, an Mo₂C target was used to apply catalytic layers by sputtering on both sides of dense vanadium foils. This approach is shown schematically in Figure 2.

Technology Maturity:

Bench-scale composite membranes H₂ separation

Project Focus:

Nanoporous Metal Carbide Membrane for H₂ Separation

Participant:

Colorado School of Mines

Project Number:

FE0001009

NETL Project Manager:

Robie Lewis
Robie.Lewis@netl.doe.gov

Principal Investigator:

J. Douglas Way
 Colorado School of Mines
dway@mines.edu

Colin A. Wolden
 Colorado School of Mines
cwolden@mines.edu

Partners:

Pall Corporation

Performance Period:

9/23/09 – 9/30/12

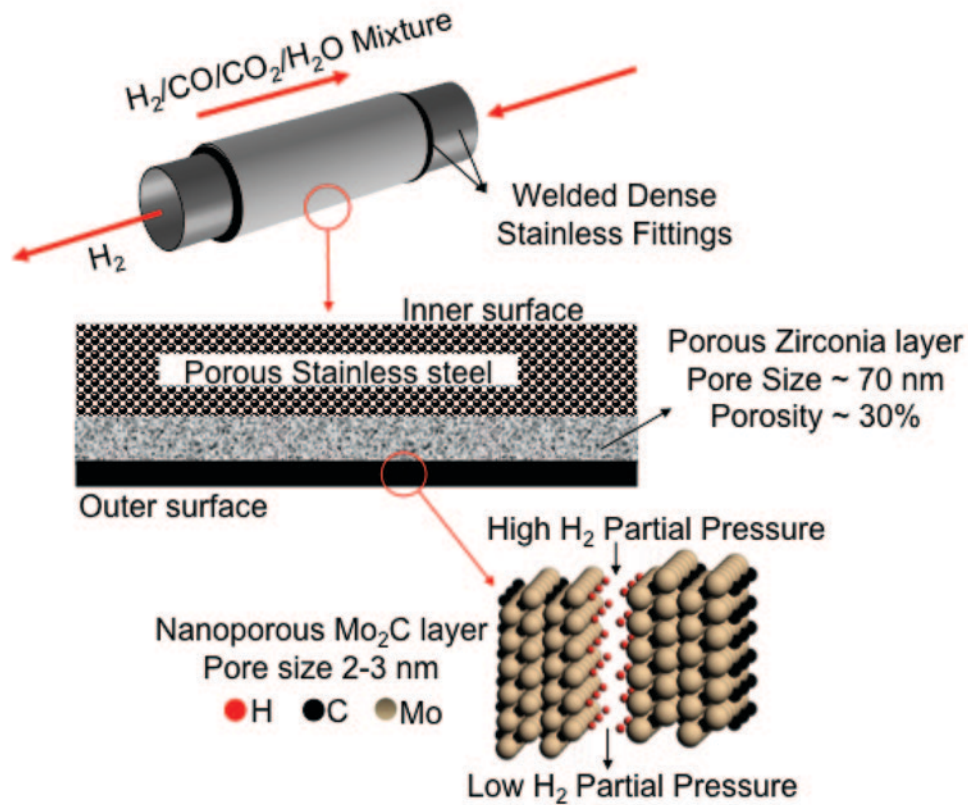

Figure 1: Schematic Diagram of Metal Carbide, Surface Diffusion Membrane Concept

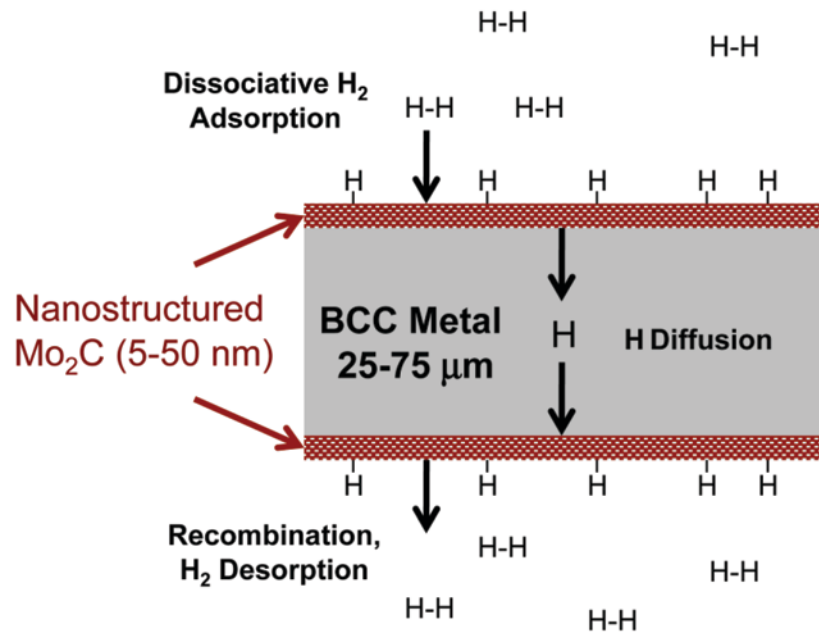

Figure 2: Schematic Diagram of Mo₂C Coated, Group V (Nb, V, Ta), BCC Metal Composite Membrane

Table 1: Membrane Process Parameters

	Parameter	Current R&D Value	Target R&D Value
Membrane Properties	Materials of fabrication for selective layer	65 nm thick Mo ₂ C on 50 micron thick V	—
	Materials of fabrication for support layer (if applicable)	—	—
	Selectivity of key gas components: H ₂ /CO ₂ for pre-combustion technology	H ₂ /N ₂ ideal selectivity is infinite	—
	Type of selectivity measurement (ideal or mixed gas)	Ideal	—
	Pressure normalized flux (permeance for linear materials) for more selective gas component, GPU or equivalent units	Pure H ₂ permeance = 5.97×10^{-4} mole/m ² •s•Pa ^{0.5}	Pure H ₂ permeance = 2.63×10^{-3} mole/m ² •s•Pa ^{0.5}
	Temperature, °C	700 °C	250–500 °C
	Bench-scale testing, hours without significant performance degradation	168 hours	>5 years
	Pilot-scale testing (if applicable), hours without significant performance degradation	N/A	—
Module Properties	Maximum pressure differential achieved without significant performance degradation or failure, bar	100 psia = 6.8 bar	800–1,000 psi
	Module configuration: hollow-fiber, spiral-wound sheet, shell-and-tube, plate-and-frame, other	N/A	—
	Packing density, m ² /m ³	—	—
	Pressure drop, bar	—	—
Product Quality	Estimated cost of manufacturing and installation, \$/m ² -GPU or equivalent	—	—
	CO ₂ purity, %	—	—
	H ₂ purity, %	100%	99.99%

Technology Advantages

No Platinum Group Metals needed, materials costs of Mo₂C/BCC metal membranes are a fraction of an equivalent Pd or Pd alloy membrane. For example, Mo costs more than 300 times less than Pd, while V is more than 800 times cheaper than Pd.

R&D Challenges

- Stability of Mo₂C/BCC metal membrane in mixed gases representative of a water-gas shift equilibrium product mixture.
- Determination of rate limiting step(s) in hydrogen permeation through carbide/BCC composite membranes.
- Improve selectivity of metal carbide surface diffusion membranes.
- Increase hydrogen flux of Mo₂C/BCC metal membranes to meet 2015 DOE NETL target value of 300 standard cubic feet per hour (SCFH)/ft² for a hydrogen differential pressure of 100 pounds per square inch (psi).

Results To Date/Accomplishments

- After carburization, the best Mo₂C surface diffusion membrane, GTC 5, achieved a pure hydrogen flux of 367 SCFH/ft² at a feed pressure of only 20 pounds per square inch gauge (psig). The corresponding H₂/nitrogen (N₂) separation factor was 4.1.
- The new PECVD reactor system was used to deposit molybdenum oxide (MoO₃) coatings on three porous alumina tubes and multiple Mott porous stainless steel disks. The N₂ leak rate for a typical alumina tube was reduced from approximately 1 liter/minute to essentially zero.

- TEM images after permeation testing confirm that a dense, 65-nm thick layer of Mo₂C was deposited on the V foil, and that there was no evidence of reduction of the Mo₂C layer or diffusion into the V foil after extended testing at 700 °C.
- Experiments on Mo₂C/V composite membranes produced a pure H₂ flux as high as 93.7 SCFH/ft² at 700 °C and 100 psig, with no detectable inert gas permeance during the testing period. The pure H₂ flux was stable for 168 hours equals one week. This flux is approximately the same as pure Pd at the same membrane thickness and test conditions.

Next Steps

- Coat Pall AccuSep and GTC substrate tubes with MoO₃ using pulsed PECVD.
- Perform in-situ carburization followed by permeation tests with H₂ and UHP N₂ to investigate the causes of the observed H₂ flux decline.
- Vary the thickness of the V foil to determine the effect on the H₂ flux (25–75 microns). If bulk diffusion controls, then the flux should vary with the reciprocal of the membrane thickness.
- Reduce the thickness of the Mo₂C catalyst layer on the V foil membranes and vary its morphology through control of sputter parameters.
- Perform further analysis of the TEM sample using in-situ selected area diffraction.
- Develop techniques for in-situ reduction of pore size in substrates prior to deposition, and likewise to repair defects that may develop during carburization.
- Continue to optimize parameters associated with conversion of oxides to carbides with a focus on the use of higher flow rates to mitigate mass transfer limitations.

Available Reports/Technical Papers/Presentations

Wolden, C. A., Pickerell, A., Gawai, T., Parks, S., Hensley, J. and J. D. Way, "Synthesis of β -Mo₂C Thin Films," *ACS Applied Materials and Interfaces*, 2011, 3, 517–521.

AMORPHOUS ALLOY MEMBRANE FOR HIGH-TEMPERATURE HYDROGEN SEPARATION

Primary Project Goals

Southwest Research Institute (SwRI) is modeling, fabricating, and testing thin film amorphous alloy membranes which separate hydrogen (H_2) from a coal-based system with performance meeting the DOE 2015 targets of flux, selectivity, cost, and chemical and mechanical robustness, without the use of platinum group metals (PGMs). This project will use a combination of theoretical modeling, advanced physical vapor deposition fabricating, and laboratory and gasifier testing to develop amorphous alloy membranes.

Technical Goals

- Use density functional theory (DFT) methods to predict H_2 flux through amorphous zirconium (Zr)-based alloys as functions of operating temperature, H_2 feed pressure, membrane thickness, and trans-membrane pressure drop to advance testing of heuristics for alloy selection.
- Fabricate amorphous alloy membranes using magnetron sputtering with compositions consistent with those identified by H_2 flux modelling that are mechanically robust for application in a hydrogen separation unit.
- Test and establish thermal stability, pure gas [H_2 and nitrogen (N_2)] and mixture [H_2 /carbon monoxide (CO) and H_2 /hydrogen sulphide (H_2S)] permeation performance, and gasifier testing on optimized amorphous alloy membrane materials.

Technical Content

Thin film amorphous alloy membranes are a nascent but promising new technology for industrial-scale hydrogen gas separations from coal-derived syngas. This project uses a combination of theoretical modeling, advanced physical vapor deposition fabricating, and laboratory and gasifier testing to develop amorphous alloy membranes that have the potential to meet DOE targets in the testing strategies outlined in the NETL Membrane Test Protocol. The project is on schedule with SwRI, Georgia Institute of Technology (GT), and Western Research Institute (WRI) all operating independently and concurrently. GT has applied the computational methodology to investigate a series of candidates with relatively high crystallization temperatures ($>700K$). GT performed extensive calculations for ternary element additions to zirconium copper (ZrCu), specifically for $Zr_{30}Cu_{60}Ti_{10}$ [T = scandium (Sc), yttrium (Y), niobium (Nb), molybdenum (Mo), technetium (Tc), ruthenium (Ru), rhodium (Rh), silver (Ag), tantalum (Ta), tungsten (W), rhenium (Re), osmium (Os), iridium (Ir), platinum (Pt), gold (Au)]. The selection of 30:60:10 composition is because $Zr_{30}Cu_{60}Ti_{10}$ showed good results in previous calculations. Among these materials, Sc, Ta, and Y have been identified as good ternary elements for $Zr_{30}Cu_{60}Ti_{10}$. To achieve fast surface H_2 dissociation process, a thin layer of palladium (Pd) is normally added on the amorphous film's surface as a catalytic layer. It is thus interesting to see the hydrogen properties in $Zr_{30}Cu_{60}Pd_{10}$ due to Pd diffusion into the host lattice. Hydrogen permeability through $Zr_{30}Cu_{60}Pd_{10}$ is not favorable compared to either Pd, $Zr_{54}Cu_{46}$, or $Zr_{30}Cu_{60}Ti_{10}$. Ni_xZr_{1-x} coatings with x ranging from 0.71 to 0.93 were deposited by magnetron co-sputtering process. It was found that as-deposited films are more amorphous with an increase of Zr content starting from $x = 0.9$ and reaching an X-ray diffraction (XRD)-amorphous state at $x > 0.88$.

Technology Maturity:

Bench-scale

Project Focus:

Amorphous Alloy Membrane for H_2 Separation

Participant:

Southwest Research Institute

Project Number:

FE0001057

NETL Project Manager:

Steven Markovich

Steven.Markovich@netl.doe.gov

Principal Investigator:

Kent Coulter

Southwest Research Institute

kent.coulter@swri.org

Partners:

The Georgia Institute of Technology

Western Research Institute

Performance Period:

9/23/09 – 9/29/11

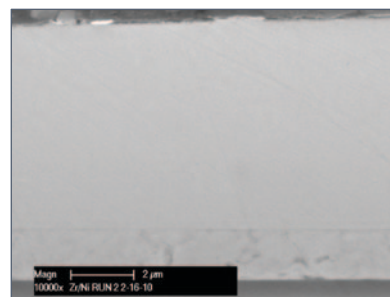

Figure 1: A Cross Section of a Ni93Zr7 Deposited Alloy

Mechanical properties of these coatings are strongly correlated with their composition. Amorphous films with higher Zr content have retained their XRD measured amorphous state after one hour of annealing in an argon/2% hydrogen atmosphere at 300 °C. The partial re-crystallization in films with the highest Zr content occurs after 24 hours of annealing. The precise deposition of metal coatings by magnetron sources was demonstrated for deposition of CuZr and CuZrTi coatings. In these coatings, the Cu:Zr ratio was varied to line up with the previously calculated permeability data. The CuZr and CuZrTi all are amorphous as deposited, but none have survived 24 hours at 350 °C. The species that form are not consistent with standard XRD spectra for CuZr species.

Table 1: Membrane Process Parameters

	Parameter	Current R&D Value	Target R&D Value
Membrane Properties	Materials of fabrication for selective layer	Amorphous Zr-based alloys	Amorphous Zr-based alloys
	Materials of fabrication for support layer (if applicable)	Stainless steel	Stainless Steel
	Selectivity of key gas components: H ₂ /CO ₂ for pre-combustion technology	TBD	99.99
	Type of selectivity measurement (ideal or mixed gas)	Mixed	Mixed
	Pressure normalized flux (permeance for linear materials) for more selective gas component, GPU or equivalent units	TBD	H ₂ -200 SCFH/ft ²
	Temperature, °C	300	300–600
	Bench-scale testing, hours without significant performance degradation	1	120
	Pilot-scale testing (if applicable), hours without significant performance degradation	TBD	120
	Maximum pressure differential achieved without significant performance degradation or failure, bar	TBD	6.9
Module Properties	Module configuration: hollow-fiber, spiral-wound sheet, shell-and-tube, plate-and-frame, other	Plate-and-frame	Plate-and-frame
	Packing density, m ² /m ³	N/A	N/A
	Pressure drop, bar	TBD	4.8
	Estimated cost of manufacturing and installation, \$/m ² -GPU or equivalent	TBD	\$10,764/m ²
Product Quality	CO ₂ purity, %	N/A	N/A
	H ₂ purity, %	N/A	N/A

Technology Advantages

- GT has developed a detailed DFT and a heuristic lattice model that is appropriate for rapidly characterizing hydrogen solubility and diffusion in the search for new promising alloys for membranes. This approach can be used as an initial tool for screening materials prior to using more expensive experimental investigations.
- The advanced vapor deposition methods used to construct the amorphous alloy membranes provide unique advantages compared to other membrane fabrication techniques. The high-power, pulsed magnetron sputtering and plasma-enhanced magnetron deposition methods are able to rapidly produce membranes of almost any alloy composition, providing excellent flexibility in terms of the materials and properties used in a membrane.

R&D Challenges

Since they are thermodynamically metastable, amorphous alloys have the distinct disadvantage that they have a tendency to crystallize when heated to sufficiently high temperatures. This property places limits on the operating conditions at which amorphous membranes can be used.

Results To Date/Accomplishments

- To achieve fast surface H₂ dissociation process, a thin layer of Pd is normally added on the amorphous film's surface as a catalytic layer. It is thus interesting to see the hydrogen properties in Zr₃₀Cu₆₀Pd₁₀ due to Pd diffusion into host lattice. Hydrogen permeability through Zr₃₀Cu₆₀Pd₁₀ is not favorable compared to either Pd, Zr₅₄Cu₄₆, or Zr₃₀Cu₆₀Ti₁₀.
- SwRI has demonstrated the precise deposition of metal coatings by magnetron sputtering for deposition of CuZr and CuZrTi coatings.
- GT performed extensive calculations for ternary element additions to ZrCu, specifically for Zr₃₀Cu₆₀T₁₀ (T = Sc, Y, Nb, Mo, Tc, Ru, Rh, Ag, Ta, W, Re, Os, Ir, Pt, Au). The selection of a 30:60:10 composition is because Zr₃₀Cu₆₀Ti₁₀ showed good results in previous calculations.
- WRI has conducted all X-ray powder crystallography, elemental composition tests, and thermal annealing tests. The ternary NiZrNb coatings have demonstrated superior thermal stability during 24 hours of annealing at 300 °C in Ar/2%H₂ as compared to the binary NiZr coatings having similar Zr concentration.

Next Steps

- GT will perform both solubility and diffusion calculations on selected membranes.
- SwRI will fabricate amorphous alloys for testing.
- WRI will continue thermal stability testing in air and reducing environments and begin permeability testing.

Available Reports/Technical Papers/Presentations

No reports, technical papers, or presentations are yet available.

AMORPHOUS ALLOY MEMBRANES PREPARED BY MELT-SPIN METHODS FOR LONG-TERM USE IN HYDROGEN SEPARATION APPLICATIONS

Primary Project Goals

University of Nevada's main objective is to produce amorphous ribbons from non-precious metal alloys. These amorphous membranes are expected to work towards meeting all 2015 separation targets, such as of flux (300 ft³/hr/ft²), temperature (200–500 Å°C), sulfur tolerance [>100 parts per million by volume (ppmv)], and cost (<\$100/ft²). The project consists of developing multiple metal-alloy ribbon membranes for evaluation and down selection.

Technical Goals

- Screening of amorphous alloys and selection of potential alloys, which gives comparable performance in terms of hydrogen flux, thermal stability, etc.
- Determine hydrogen solubility, permeation, and recrystallization temperatures.

Technology Maturity:

Bench-scale, hydrogen separation

Project Focus:

Amorphous Alloy Membrane for H₂ Separation

Participant:

University of Nevada

Project Number:

FE0000998

NETL Project Manager:

Steven Seachman
Steven.Seachman@netl.doe.gov

Principal Investigator:

Dhanesh Chandra
University of Nevada, Reno
dchandra@unr.edu

Partners:

CSIRO, Division of Energy
Technology
TDA Research, Inc.

Performance Period:

9/22/09 – 9/30/12

Technical Content

B-97

Table 1: Membrane Process Parameters

	Parameter	Current R&D Value	Target R&D Value
Membrane Properties	Materials of fabrication for selective layer	Pd	Ni-Nb-Zr Ni-Nb-Zr-Ta
	Materials of fabrication for support layer (if applicable)	—	—
	Selectivity of key gas components: H ₂ /CO ₂ for pre-combustion technology	H ₂	H ₂
	Type of selectivity measurement (ideal or mixed gas)	Ideal	Mixed gas
	Pressure normalized flux (permeance for linear materials) for more selective gas component, GPU or equivalent units		300 ft ³ /hr/ft ²
	Temperature, °C	400	250–500
	Bench-scale testing, hours without significant performance degradation	100	500
	Pilot-scale testing (if applicable), hours without significant performance degradation	N/A	N/A
	Maximum pressure differential achieved without significant performance degradation or failure, bar	—	55–69
Module Properties	Module configuration: hollow-fiber, spiral-wound sheet, shell-and-tube, plate-and-frame, other	Plate-and-frame	Plate-and-frame
	Packing density, m ² /m ³	—	150 ¹
	Pressure drop, bar	—	—
	Estimated cost of manufacturing and installation, \$/m ² -GPU or equivalent	Ni-Nb-Zr foil only: <\$50/m ² Pd-coated foil: <\$300/m ² Module containing membrane: <\$500/m ² (2)	<929
Product Quality	CO ₂ purity, %	Depends on H ₂ yield through membrane: 85% H ₂ yield gives CO ₂ purity of ~90%	—
	H ₂ purity, %	100	100

Notes:

1. Based on 2,000 mm × 100 mm × 10 mm planar, dual-sided membrane modules with compressive seals inside cylindrical containment vessel with diameter 2,000 mm and packing density of 0.80.
2. Costs based on module of above dimensions, taking into account containment vessels, materials, machining, membrane manufacture, etc.

Technology Advantages

- Drastic reduction in overall cost compared to conventional palladium (Pd) alloy membranes system.
- Tolerant to carbon monoxide (CO) poisoning.
- High-volume, reliable, and inexpensive manufacturing process.

R&D Challenges

- Defects during fabrication of robust amorphous alloy membranes.
- Thermal cycling.
- Membrane stability/embrittlement.

- Loss of membrane structural integrity/performance.
- Wide operating temperature range.

Results To Date/Accomplishments

Permeability

- Completed permeability testing of the $(\text{Ni}_{0.6}\text{Nb}_{0.4})_{100-x}\text{Zr}_x$ and $(\text{Ni}_{0.6}\text{Nb}_{0.3}\text{Ta}_{0.1})_{100-x}\text{Zr}_x$ (where $x = 0, 10, 20$ or 30) series of amorphous alloy membranes.
- The partial substitution of niobium (Nb) with tantalum (Ta) resulted in slightly lower permeability. Alloys with ≤ 10 wt% zirconium (Zr) content had very low permeabilities; $< 2 \times 10^{-9}$ mol m^{-1} s^{-1} Pa $^{-0.5}$.
- Thermal stability results showed a rapid decrease in hydrogen flux with time at 400 or 450 °C for alloys containing higher Zr contents; details included in this report.
- The addition of Ta showed modest increase in the thermal stability of the amorphous nickel (Ni)-Nb-Zr alloy with only a slight impact on hydrogen permeability.
- Alloys containing little or no Zr displayed very stable, but low, hydrogen permeabilities throughout 100-hour tests.
- Fracture due to embrittlement decreased with increasing Zr content.
- Ta substitution in the $(\text{Ni}_{0.6}\text{Nb}_{0.4})_{70}\text{Zr}_{30}$ alloy embrittled significantly, but $(\text{Ni}_{0.6}\text{Nb}_{0.3}\text{Ta}_{0.1})_{70}\text{Zr}_{30}$ clearly decreased the susceptibility to hydrogen embrittlement at 400 °C.

Solubility

- Completed solubility testing of $(\text{Ni}_{0.6}\text{Nb}_{0.3}\text{Ta}_{0.1})_{90}\text{Zr}_{10}$ and $(\text{Ni}_{0.6}\text{Nb}_{0.4})_{100-x}\text{Zr}_x$ (where $x = 0, 10, 20$ or 30) series of amorphous alloy membranes.
- Results show that higher Zr content gives higher hydrogen solubility at all the temperatures in the 200–400 °C range.
- All the membranes showed higher solubility at lower temperatures.
- In case of $(\text{Ni}_{0.6}\text{Nb}_{0.3}\text{Ta}_{0.1})_{90}\text{Zr}_{10}$, Ta addition resulted in lowering the solubility at all the temperatures.
- In all the cases, Sievert's Law is being violated (positively), which is being understood to be a general trend in case of amorphous alloys.
- We observed a hook effect in case of lower Zr content alloy membranes ($x = 10, 20$), which we are trying to analyze.

Crystallization Kinetics

- Completed crystallization temperature and kinetics of a series of $(\text{Ni}_{0.6}\text{Nb}_{0.4})_{100-x}\text{Zr}_x$ and $(\text{Ni}_{0.6}\text{Nb}_{0.3}\text{Ta}_{0.1})_{100-x}\text{Zr}_x$ (where $x = 0, 10, 20$ or 30) amorphous alloy membranes.
- The crystallization temperature increases with decreasing Zr content or increasing Ta content.
- The Jonson-Mehl-Avrami (JMA) equation was applied to the isothermal analysis: the main crystallization process of the Ni-Nb-Zr alloy is governed by diffusion-controlled three-dimension growth.
- The activation energies of the crystallization of amorphous alloy membranes were determined by Kissinger and Ozawa analyses: (i) the activation energy of crystallization increases with decreasing Zr content, and (ii) the addition of Ta increase the activation energy of the amorphous Ni-Nb-Zr alloy.

Next Steps

- Complete ongoing solubility testing of rest of $(\text{Ni}_{0.6}\text{Nb}_{0.3}\text{Ta}_{0.1})_{100-x}\text{Zr}_x$ (where $x = 20$ or 30) series of amorphous alloys membranes, and also the amorphous alloy membranes of both the series without Pd coating to get more information to analyze the hump effect.
- Continue crystallization kinetics studies for amorphous alloy membranes with various transition metal substitutions.
- Begin testing a new series of Ni-Nb-Zr amorphous alloy membrane materials with various transition metal substitutions.
- Continue testing various surface catalytic coatings to replace Pd and increase chemical and thermal stability.
- Continue micro-structural analysis studies for membrane and coating optimization using SEM, XRD, and XPS/AES.

Available Reports/Technical Papers/Presentations

Presentations at the Meetings:

“Effect of tantalum substitution on the crystallization kinetics and hydrogen permeability of Ni-Nb-Zr amorphous alloys,” *S.-M. Kim, N. K. Pal, D. Chandra, M. D. Dolan, W.-M. Chien, J. Lamb, A. Talekar, S. N. Paglieri, and T. B. Flanagan*. Presented at the TMS 2011 Meeting, Feb 27-March 3, San Diego, CA, USA.

“Hydrogen permeability and crystallization kinetics in amorphous Ni-Nb-Zr alloys,” *S.-M. Kim, N. K. Pal, W.-M. Chien, J. Lamb, M. D. Dolan, A. Talekar, D. Chandra, S. N. Paglieri, T. B. Flanagan and Jim Reilly*, Presented at the “International Conference on Renewable Energy (ICRE 2011), Jan. 17–21, 2011, Jaipur, India.

“Crystallization Kinetics and Hydrogen Solubility in Ni-based Amorphous Alloys for Hydrogen Permeability,” Sang-Mun Kim, Narendra K. Pal, Wen-Ming Chien, Joshua H. Lamb, Anjali Talekar, Dhanesh Chandra, Michael D. Dolan and Stephen N. Paglieri, **NAMS/ICIM 2010 Conferences**, July 17–22, 2010, Washington, D.C., USA.

“Ni-Nb-Zr Amorphous Alloy Membranes for Hydrogen Separation,” Stephen N. Paglieri, Michael D. Dolan, David P. Moore, Kevin M. Hubbard, Sang-Mun Kim, Narendra K. Pal, Wen-Ming Chien, Joshua H. Lamb, Anjali Talekar, Dhanesh Chandra, Sarah J. DeVoss and Gokhan O. Alptekin, **2010 AIChE Annual Meeting**, November 7–12, 2010, Salt Lake City, UT, USA.

“Ni-Nb-Zr and Ni-Nb-Zr-Ta Amorphous Alloy Membranes for Hydrogen Separation,” Stephen N. Paglieri, Sarah J. DeVoss, Gökhan O. Alptekin, Tyler B. Gleditsch, Michael D. Dolan, Kevin M. Hubbard, David P. Moore, Sang-Mun Kim, Narendra K. Pal, Joshua H. Lamb, Wen-Ming Chien, and Dhanesh Chandra, **NAMS/ICIM 2010 Conference**, July 17–22, 2010, Washington, D.C., USA.

Manuscripts: Submitted and Prepared:

“Hydrogen permeability, thermal stability and hydrogen embrittlement of Ni-Nb-Zr and Ni-Nb-Ta-Zr amorphous alloy membranes,” *S. N. Paglieri, N. K. Pal, M. D. Dolan, S-M Kim, W-M Chien, J. Lamb, and D. Chandra*. **Journal of Membrane Science**, 2011. In review.

“Hydrogen permeability and crystallization kinetics in amorphous Ni-Nb-Zr alloys,” **S.-M. Kim, W.-M. Chien, M. D. Dolan, N. K. Pal, A. Talekar, J. Lamb, D. Chandra, S. N. Paglieri, and T. B. Flanagan**, **International Journal of Hydrogen Energy**, 2011. In review.

“Glass transition and crystallization kinetics of melt-spun $\text{Ni}_{60}\text{Nb}_{20}\text{Zr}_{20}$ amorphous alloy,” *Sang-Mun Kim, Wen-Ming Chien, Michael D. Dolan, Narendra Kumar Pal, Joshua Lamb, Anjali Talekar, Dhanesh Chandra, Stephen N. Paglieri, Ted B. Flanagan*. (Prepared the manuscript for **Journal Publication**).

“Effect of tantalum substitution on the crystallization kinetics and hydrogen permeability of Ni-Nb-Zr amorphous alloys,” *S.-M. Kim, D. Chandra, M. D. Dolan, W.-M. Chien, N. K. Pal, J. Lamb, A. Talekar, S. N. Paglieri, and T. B. Flanagan*. (Prepared the manuscript for submission to the **Met. Trans A**. 2011).

NOVEL POLYMER MEMBRANE PROCESS FOR PRE-COMBUSTION CO₂ CAPTURE FROM COAL-FIRED SYNGAS

Primary Project Goals

Membrane Technology and Research, Inc. (MTR) is developing a new polymer membrane and membrane separation process to capture carbon dioxide (CO₂) from shifted synthesis gas (syngas) generated by a coal-fired integrated gasification combined cycle (IGCC) power plant.

Technical Goals

- Investigate novel high-temperature-stable polymers identified by Tetramer for use in hydrogen (H₂)/CO₂ selective membranes.
- Prepare composite polymer membranes and bench-scale modules that have H₂/CO₂ selectivities of 10 or higher and hydrogen permeances of greater than 200 gas permeation units (GPU) at syngas cleanup temperatures of 100–200 °C.
- Optimize membrane process designs, investigate the sensitivity of different proposed processes to membrane performance, and assess the optimal integration of a membrane system into the syngas cleanup train.
- Conduct bench-scale testing of optimized membranes and membrane modules at Membrane Technology and Research, Inc.'s (MTR) laboratories with simulated syngas mixtures to evaluate membrane performance and lifetime under expected operating conditions.
- Prepare a comparative evaluation of the cost of the polymer membrane-based separation process versus current cleanup technologies (Rectisol®, Selexol®, and PSA) and proposed future membrane reactors.

Technical Content

The thrust of this project is development of polymer membranes that currently show mixture H₂ permeances up to 200 GPU and H₂/CO₂ selectivities of 10 at 100–200 °C. These membranes can be fabricated into robust, inexpensive modules of the type currently used commercially in the refinery and natural gas industries to separate gas mixtures at high pressures. Experience from these industries shows that membrane selectivity requirements often depend on the process design. Calculations utilizing new polymer membranes and innovative process schemes indicate that membranes with current properties can approach DOE CO₂ capture goals. Further improvements in performance and reductions in energy penalty are possible with membrane optimization.

This program will consist of two 12-month phases. The first phase will focus on materials development with an emphasis on identifying high-temperature polymers with desirable H₂/CO₂ separation properties. Promising polymers will be fabricated into industrial flat-sheet composite membranes and tested with simulated WGS mixtures. Parametric data from these tests will be used in a systems analysis to identify the optimal membrane design for syngas cleanup. Researchers will confirm that composite membranes made from novel membrane selective layers give hydrogen permeances of at least 200 GPU and H₂/CO₂ selectivities of greater than 10 in bench-scale tests using model syngas mixtures. These actual membrane performance data will be used to demonstrate that a membrane process shows progress toward meeting DOE pre-combustion CO₂ capture program targets.

Technology Maturity:

Bench-scale using simulated syngas and membrane stamp field tests using actual syngas slipstream

Project Focus:

Polymer Membranes

Participant:

Membrane Technology and Research, Inc.

Project Number:

FE0001124

NETL Project Manager:

Richard Dunst
Richard.Dunst@netl.doe.gov

Principal Investigator:

Tim Merkel
 Membrane Technology and Research, Inc.
tcmerkel@mtrinc.com

Partners:

Southern Company
 Tetramer Technologies, LLC

Performance Period:

9/14/09 – 9/10/10

In the second phase of the project, optimized membrane materials will be down-selected and fabricated into composite membranes on commercial-scale equipment. These membranes will be formed into laboratory-scale, spiral-wound modules, each containing about 1 m² of membrane. The modules will be tested with simulated syngas mixtures to provide performance and lifetime data and demonstrate module performance and lifetime consistent with small-scale membrane stamp studies. This information will allow cost estimates of the membrane CO₂ capture process to be prepared to determine the overall technical and economic competitiveness of the proposed process as compared to alternative technologies and the DOE program targets.

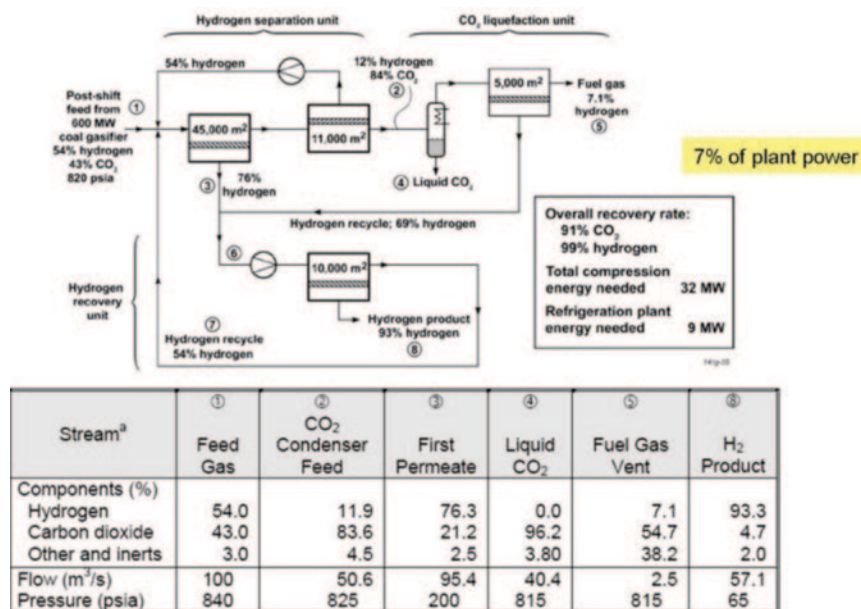

Figure 1: A Possible Membrane Process Design to Capture 90% CO₂ from Shifted Syngas that Recovers >99% of the Hydrogen in Syngas at >93% Purity

An H₂/CO₂ selectivity versus H₂ permeance trade-off curve is presented in Figure 2. All data points below the upper bound are for polymeric membranes from literature and have been translated from pure-gas permeability at 25 °C assuming a selective layer thickness of 1 micron. Polymeric composite hydrogen-selective membranes are being developed in this project. The pure- and mixed-gas performance of the membranes is shown in Figure 2. For the mixed-gas measurement, the feed gas is an H₂/CO₂ (50:50 vol%) mixture at 50 pounds per square inch gauge (psig) and 150 °C. The mixed-gas performance target set in the proposal (hydrogen permeance = 200 GPU, H₂/CO₂ selectivity = 10 at 150 °C) is also included for comparison.

Figure 3 shows a test skid installed by MTR at the National Carbon Capture Center (NCCC) managed by the Southern Company. The skid will be used to test membrane and module candidates with coal-derived syngas throughout this project. Initial tests of both hydrogen-selective and CO₂-selective membranes during November and December of 2009 showed stable performance that exceeded project targets.

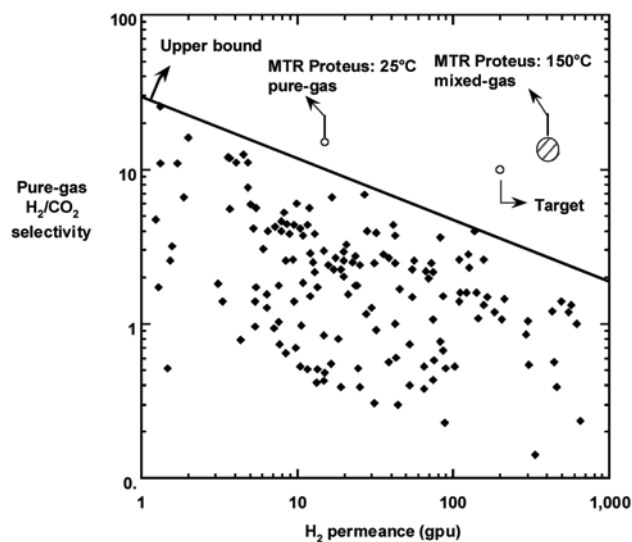

Figure 2: Tradeoff Plot of H₂/CO₂ Selectivity versus H₂ Permeance



Figure 3: MTR Membrane Test Skid at the National Carbon Capture Center

Table 1: Membrane-Based CO₂ Separations

	Parameter	Current R&D Value	Target R&D Value
Membrane Properties	Materials of fabrication for selective layer	Polymer	Polymer
	Materials of fabrication for support layer (if applicable)	Polymer	Polymer
	Selectivity of key gas components: H ₂ /CO ₂ for pre-combustion technology	15–25	>10
	Type of selectivity measurement (ideal or mixed gas)	Mixed	Mixed
	Pressure normalized flux (permeance for linear materials) for more selective gas component, GPU or equivalent units	200–400 GPU	>200 GPU
	Temperature, °C	120–150	150
	Bench-scale testing, hours without significant performance degradation	20 hours	>100
	Pilot-scale testing (if applicable), hours without significant performance degradation	500 hours	500
	Maximum pressure differential achieved without significant performance degradation or failure, bar	50 bar	50 bar
Module Properties	Module configuration: hollow-fiber, spiral-wound sheet, shell-and-tube, plate-and-frame, other	Spiral-wound	Spiral-wound
	Packing density, m ² /m ³	700	700
	Pressure drop, bar	0.5	0.5
	Estimated cost of manufacturing and installation, \$/m ² -GPU or equivalent	2.0	0.5
Product Quality	CO ₂ purity, %	N/A	97+
	H ₂ purity, %	N/A	93+ or 40–45% in fuel
	Other contaminants (H ₂ S if it is not removed upstream of the membrane process), %	N/A	<25 ppm in H ₂ fuel
Process Performance	Electricity requirement, kJ/kg CO ₂	N/A	<100
	Cooling requirement (electricity equivalent), kJ/kg CO ₂	N/A	<150
	Total energy (electricity equivalent), kJ/kg CO ₂	N/A	<250

Other Membrane Parameters

Contaminant Resistance: The greatest concern would be fouling of the membrane surface due to residual particulate matter or heavy hydrocarbons/tars. Preliminary results from tests at NCCC suggest that existing syngas filters upstream of the membranes will be sufficient to protect the membranes from such surface fouling.

Syngas Pretreatment Requirements: As described above, existing syngas filters should be adequate protection for the membranes. Current temperature limitations on the polymeric membranes require the syngas to be cooled to ~ 150 °C prior to treatment.

Waste Streams Generated: The membrane process will not generate any waste streams. Periodic module replacement (expected lifetime of three years) will produce a small amount of solid waste. Typically, for the large membrane applications like sea water desalination by reverse osmosis, these membrane modules are sent to a landfill.

Technology Advantages

- Membranes developed in this project are based on polymer materials that show higher hydrogen permeance and higher H₂/CO₂ selectivity than conventional polymer materials. These membranes can be fabricated into robust, stable, and inexpensive modules of the type currently used commercially in the refinery and natural gas industries to separate gas mixtures at high pressures.
- The process design using hydrogen permeable membranes will create a high-pressure CO₂ stream capturing >90% of CO₂ in post-shift syngas and a 93 mol% purity hydrogen stream, and could use as little as about 7% of the plant's power output.
- Membranes offer the advantages of simple, passive operation; no use of hazardous chemicals and the subsequent waste handling and disposal issues; no stream use; and a small footprint.

R&D Challenges

- Polymer materials that are used in the selective layer and the support layer need to be thermally stable at high operating temperatures.
- Membrane modules to be developed for this application have to endure the extended long-term operations at high temperatures (~ 150 °C). All the module components, including feed and permeate spacers, support papers, and glues, require new development for this application.
- There is little membrane operational experience with real coal-derived syngas.

Results To Date/Accomplishments

- The first project milestone (membrane permeance and selectivity targets) was met ahead of schedule.
- The second and third project milestones (process design study and module fabrication, respectively) were accomplished on schedule.
- Three 500-hour slipstream tests of membrane stamps with coal-derived syngas have been completed at NCCC. The membranes show stable performance treating syngas containing up to 780 parts per million (ppm) hydrogen sulfide (H₂S). The average membrane performance (H₂/CO₂ selectivity of 15–25 and H₂ permeance of 200–300 GPU) exceeds project targets.

Next Steps

- A module test with a coal syngas slipstream is scheduled at NCCC in May 2011.
- Final test results and a report will be available by the September 2011 project completion date.

Available Reports/Technical Papers/Presentations

T. C. Merkel, S. Thomas, M. Zhou, H. Lin, A. Serbanescu, *Novel Polymer Membrane Process For Pre-Combustion CO₂ Capture From Coal-Fired Syngas*, DOE 2010 Carbon Dioxide Capture Technology Meeting.

M. Zhou, S. Thomas, H. Lin, A. Serbanescu, T. Merkel, *Polymer Membranes For Pre-Combustion CO₂ Capture*, 2010 NAMS Annual Meeting and International Conference on Inorganic Membranes.

M. Zhou, S. Thomas, H. Lin, A. Serbanescu, T. Merkel, *Polymer Membranes For Pre-Combustion CO₂ Capture*, 2010 AIChE Spring Meeting and 6th Global Congress on Process Safety.

T. C. Merkel, M. Zhou, and R. W. Baker; *Carbon Dioxide Capture with Membranes at an IGCC Power Plant*; manuscript in preparation.

EXPERIMENTAL DEMONSTRATION OF ADVANCED PALLADIUM MEMBRANE SEPARATORS FOR CENTRAL HIGH-PURITY HYDROGEN PRODUCTION

Primary Project Goals

United Technologies Research Center (UTRC) is developing a palladium copper (PdCu) trimetallic alloy hydrogen (H₂) separator for central H₂ production from coal gasification-derived synthesis gas (syngas).

Technical Goals

- Test the high stability and resistance of a PdCu trimetallic alloy to carbon and carbide formation, sulfur, halides, and ammonia (NH₃).
- Develop a sulfur-, halide-, and NH₃-resistant alloy membrane with a projected H₂ permeance of 25 m³m⁻²atm^{-0.5}h⁻¹ at 400 °C and capable of operating at pressures of 120 atm (12.1 MPa).
- Construct and experimentally validate the performance of PdCu trimetallic alloy membranes operating at an H₂ separation rate of 0.1 kg/day at feed pressures of 20 atm (2 MPa) in the presence of hydrogen sulfide (H₂S), NH₃, and hydrogen chloride (HCl). The performance of the best separator candidate will be demonstrated for a minimum of 2,000 hours of operation.

Technical Content

Figure 1 depicts one of the membrane separators developed for this project. The purpose of the separators is to house the membrane and receive the flue gas stream from combustion. The membrane allows the H₂ to pass through it, following the H₂ permeate path in the diagram. The remaining gas stream then exits the membrane system for further processing.

Figure 2 illustrates the path of the gas stream through the separation mechanism's structure. The gas stream enters through the PdCu alloy pipes, which allow the H₂ present in the gas stream to permeate through the alloy walls into the secondary level of the structure (shown as the white area within the blue outer-shell), while containing the remaining gases [carbon monoxide (CO), carbon dioxide (CO₂), water (H₂O), and nitrogen (N₂)]. The H₂ and other gases can then be separately processed once they exit the separator mechanism.

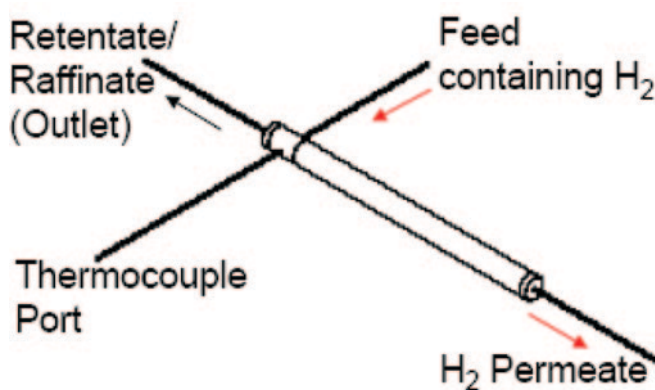

Figure 1: Tubular Membrane Separator

Technology Maturity:

Bench-scale, 0.1 kg/day of H₂

Project Focus:

Palladium-Copper Trimetallic Alloy Membranes

Participant:

United Technologies Research Center

Project Number:

NT43055

NETL Project Manager:

Jason Hissam
Jason.Hissam@netl.doe.gov

Principal Investigator:

Sean Emerson
 United Technologies Research Center
emersonsc@utrc.utc.com

Partners:

Metal Hydride Technologies, Inc.
 Pall Corporation
 Power+Energy, Inc.

Performance Period:

6/15/07 – 6/14/09

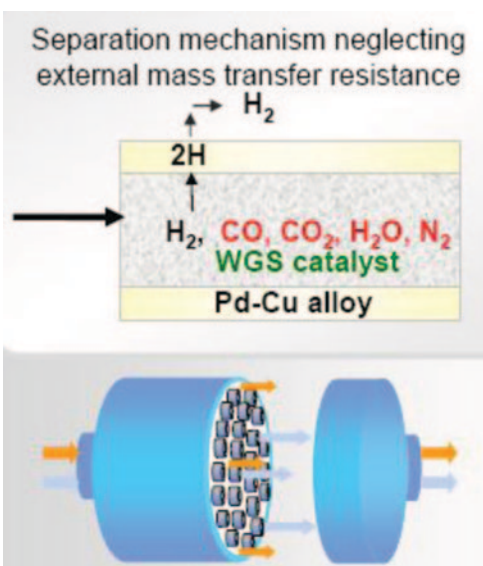

Figure 2: Configuration of Larger Assembly

Table 1: UTRC Membrane Parameters

	Parameter	Current R&D Value	Target R&D Value
Membrane Properties	Materials of fabrication for selective layer	Pd,Cu	Pd,Cu
	Materials of fabrication for support layer (if applicable)	N/A	N/A
	Selectivity of key gas components: H_2/CO_2 for pre-combustion technology	999,999	999,999
	Type of selectivity measurement (ideal or mixed gas)	Mixed gas	Mixed gas
	Pressure normalized flux (permeance for linear materials) for more selective gas component, GPU or equivalent units	61 $ft^3ft^{-2}h^{-1}$ for a feed containing 100 psig H_2 and 100 psig N_2	200 $ft^3ft^{-2}h^{-1}$
	Temperature, °C	350–600 °C	350–600 °C
	Bench-scale testing, hours without significant performance degradation	527 h	527 h
	Pilot-scale testing (if applicable), hours without significant performance degradation	—	—
	Maximum pressure differential achieved without significant performance degradation or failure, bar	13.8 bar	13.8 bar
Module Properties	Module configuration: hollow-fiber, spiral-wound sheet, shell-and-tube, plate-and-frame, other	Shell-and-tube	Shell-and-tube
	Packing density, m^2/m^3	157	157
	Pressure drop, bar	N/A	N/A
	Estimated cost of manufacturing and installation, $\$/m^2$ -GPU or equivalent	N/A	N/A

Technology Advantages

A PdCu alloy-based CO₂ capture membrane is able to better withstand the corrosion and wear associated with membranes constructed of other materials. Less corrosion means the membrane does not need to be replaced as often, resulting in a lower overall operating cost for the power plant. The PdCu alloy also has a stronger resistance to sulfur compared to traditional membranes, resulting in an improved CO₂ capture efficiency.

R&D Challenges

Tests have shown that the fcc PdCu alloy produced by Power+Energy is capable of meeting all of the program goals, except the H₂ flux target. The UTRC ternary alloy tubes tested to date have not been able to exceed the fcc PdCu alloy flux, primarily due to surface compositional variations. Work is in progress to identify ways to change the surface properties of the tubes.

Results To Date/Accomplishments

The PdCu alloy separators were tested for their H₂ separation performance and the membranes have not yet met all of the DOE 2010 targets. The highest H₂ flux obtained in these experiments was $61.03 \pm 0.01 \text{ ft}^3\text{h}^{-1}\text{ft}^{-2}$ at a feed pressure of 7.8 atm [100 pounds per square inch gauge (psig)]. The alloy has not yet met the H₂ flux goal of $200 \text{ ft}^3\text{h}^{-1}\text{ft}^{-2}$. Tests also showed that the alloy's sulfur resistance exceeded the project's designated target of 20 parts per million by volume (ppmv). The membranes themselves are still costly to make compared to the desired cost of use on the commercial scale, and they still do not meet the required average lifespan of three years. Overall, the PdCu alloy testing has successfully met performance requirements for operating temperature (350–600 °C), sulfur tolerance (20 ppmv), operating pressure [27 atm (400 psi) max], CO tolerance, and the production of at least 99.5% pure H₂.

In addition:

- Initial technical and economic models are complete.
- Advanced membrane property simulations by atomistic and thermodynamic modeling calculations are complete.
- Hydrogen solubility tests using various alloys for 6–12 separators and H₂ permeability performance tests are complete.

Next Steps

- Conduct a durability study on the Pd alloy membrane separators in a high-pressure reformer test rig.
- Continue to work with Power+Energy to develop and test better ternary alloy tubes for use in the new hydrogen separator units.
- Complete revisions to the technical and economic models to better define the feasibility of using these membranes on an industrial scale.

Available Reports/Technical Papers/Presentations

No reports, technical papers, or presentations are yet available.

NOVEL HYDROGEN PURIFICATION DEVICE INTEGRATED WITH PEM FUEL CELLS

Primary Project Goals

Praxair is developing a palladium (Pd) alloy membrane capable of concentrating carbon dioxide (CO₂) effluent from technologies, such as coal gasification plants, by efficiently removing high purity hydrogen (H₂) for subsequent use as a fuel.

Technical Goals

- Develop simulation models to predict H₂ flux based on membrane composition.
- Design a Pd membrane capable of operating at lower than typical temperatures.
- Develop the necessary membranes, seals, and other required components for a cost-effective H₂ purification device.
- Research and select a suitable substrate material that compliments the membrane's thermal expansion properties.
- Develop production practices capable of producing consistently high-quality membrane substrates at low cost.

Technical Content

Development of a Pd alloy membrane capable of operating at lower temperatures to efficiently separate H₂ at low cost from various sources, including synthesis gas (syngas) from coal gasification units. The removal of H₂ from syngas would result in a stream of concentrated CO₂ ready for further purification and sequestration.

A porous ceramic substrate that has graded porosity has been produced. This grading permits the coating of the microporous surface without significant defects while the rest of the tube has open porosity that poses minimal resistance to flow. The Pd alloy coating is achieved by use of the electroless plating method.

Preliminary results have shown that the Pd alloy membranes tested maintain structural integrity after several periods of thermal cycling, which is an important attribute for use in processes where process temperatures are not constant, such as coal gasification.

Several tests have been completed in order to determine H₂ flux through the membrane at various pressures and temperatures. It was found that at 225 °C and 0.7 atm [10 pounds per square inch (psi)], the flux is approximately 40 scfh/ft², increasing with both temperature and pressure up to 400 °C and 4.8 atm (70 psi) where the flux was approximately 300 scfh/ft². This demonstrates the membrane's stability at both low and high temperatures, making it a versatile product.

In order to maximize efficiency, a model of H₂ transport through the membrane has been developed. All steps of the entire process are considered in the model, which is used to determine the rate determining step for different membrane compositions and thicknesses. This model will be used to provide guidance for alloy selection and for optimizing membrane properties.

Technology Maturity:
Bench-scale, 80 kg H₂/day

Project Focus:
Palladium Alloy Membranes

Participant:
Praxair, Inc.

Project Number:
NT43054

NETL Project Manager:
Arthur L. Baldwin
Arthur.Baldwin@netl.doe.gov

Principal Investigator:
Joseph Schwartz
Praxair, Inc.
Joseph_Schwartz@praxair.com

Partners:
Boothroyd-Dewhurst
Colorado School of Mines

Performance Period:
6/1/07 – 5/31/10

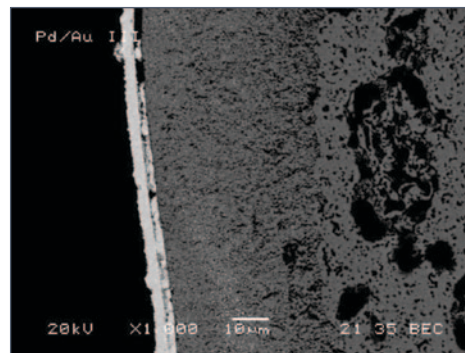

Figure 1: Image of Pd-Au Structure

Table 1: Praxair Membrane Parameters

	Parameter	Current R&D Value	Target R&D Value
Membrane Properties	Materials of fabrication for selective layer	Pd, Pd-Au, Pd-Ru, Pd-Au-Ru, Pd-Ag, Pd-Cu	Pd, Pd-Au, Pd-Ru, Pd-Au-Ru, Pd-Ag, Pd-Cu
	Materials of fabrication for support layer (if applicable)	Modified ZrO ₂	Modified ZrO ₂
	Selectivity of key gas components: H ₂ /CO ₂ for pre-combustion technology	>100	>1,000
	Type of selectivity measurement (ideal or mixed gas)	Ideal	Mixed
	Pressure normalized flux (permeance for linear materials) for more selective gas component, GPU or equivalent units	965 scfh/ft ² at 400 °C and 200 psi 134 scfh/ft ² at 400 °C and 20 psi	1,000 150
	Temperature, °C	225	200
	Bench-scale testing, hours without significant performance degradation	264 with planned shutdown	250
	Pilot-scale testing (if applicable), hours without significant performance degradation	N/A	168
	Maximum pressure differential achieved without significant performance degradation or failure, bar	14	14
Module Properties	Module configuration: hollow-fiber, spiral-wound sheet, shell-and-tube, plate-and-frame, other	Shell-and-tube	Shell-and-tube
	Packing density, m ² /m ³	N/A	3.07
	Pressure drop, bar	N/A	14
	Estimated cost of manufacturing and installation, \$/m ² -GPU or equivalent	N/A	N/A
Product Quality	H ₂ purity, %	N/A	N/A

Technology Advantages

Palladium alloy membranes have:

- High structural stability at both high and low temperatures and through thermal cycling.
- High flux and selectivity.
- Low production costs.

R&D Challenges

- Structural failure occurs for Pd-gold (Au) membranes at 200 °C.
- Ethylenediaminetetraacetic acid (EDTA) has been found to remain in the membrane after completing the plating bath, producing carbon contamination and compromising performance.
- Production of the substrate by protrusion produces defects that are difficult to repair.

Results To Date/Accomplishments

- Economic analysis based on technical work done in Phase I and Phase II indicates the expected cost for the membrane purifier will be lower than the cost of alternative purification methods.
- A Pd-ruthenium (Ru) membrane had a flux of 965 scfh/ft² at 200 psi and 400 °C.
- A method to produce substrate tubes by extrusion was developed. Extrusion allows for larger substrates to be produced and for larger quantities of substrates to be produced.
- A model was developed to determine alloy structures using cluster expansion and a model has been developed to calculate flux based on all steps of the overall process; when combined, the models will assist in finding potential candidate alloys to synthesize and test.
- A multi-tube prototype reactor has been designed and is currently being built with testing scheduled for later this year.

Next Steps

Perform mixed gas permeation tests with H₂, carbon monoxide (CO), CO₂, steam (H₂O), methane (CH₄), and nitrogen (N₂).

Available Reports/Technical Papers/Presentations

“Novel Hydrogen Purification Device Integrated with PEM Fuel Cells.” http://www.netl.doe.gov/technologies/hydrogen_clean_fuels/refshelf/presentations/2008Reviews/Praxair-NETL%20Review%20080429.pdf

COMPOSITE Pd AND Pd ALLOY POROUS STAINLESS STEEL MEMBRANES FOR HYDROGEN PRODUCTION AND PROCESS INTENSIFICATION

Primary Project Goals

Worcester Polytechnic Institute (WPI) is developing an advanced synthesis gas (syngas) cleanup system and an integrated, cost-effective, hydrogen (H₂) production and separation process using a unique H₂ separation composite palladium (Pd) and alloy membrane for water gas shift (WGS) reactors. WPI is also developing advanced technologies that offer the potential to consolidate two or more unit processes/units, such as gas separation processes in one module for process intensification, which would be integrated downstream of a coal gasification system designed to produce a pure stream of H₂ with high-pressure carbon dioxide (CO₂) for sequestration.

Technical Goals

- Synthesis of composite Pd and Pd/alloy porous Inconel membranes for WGS shift reactors with long-term thermal, chemical, and mechanical stability with special emphasis on the stability of H₂ flux and selectivity.
- Demonstration of the effectiveness and long-term stability of the WGS membrane shift reactor for the production of fuel-cell quality H₂.
- Research and development (R&D) of advanced gas clean-up technologies for sulfur removal to reduce the sulfur compounds to <2 parts per million (ppm) (Sub, ARI).
- Development of a systematic framework towards process intensification to achieve higher efficiencies and enhanced performance at a lower cost.
- Rigorous analysis and characterization of the behavior of the resulting overall process system, as well as the design of reliable control and supervision/monitoring systems.
- Assessment of the economic viability of the proposed intensification strategy through a comprehensive calculation of the cost of energy output and its determinants (capital cost, operation cost, fuel cost, etc.), followed by comparative studies against other existing pertinent energy technologies.

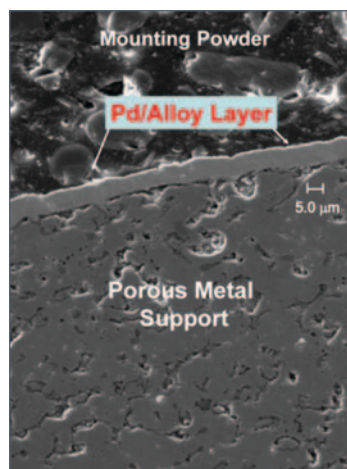

Figure 1: Illustration of WPI's Pd/Alloy Layer

Technical Content

WPI's unique, patented technology to synthesize robust composite thin Pd and Pd/alloy membranes on porous sintered metal substrates uses an electroless plating process to produce membranes that are stable in the range of 300–450 °C. In addition, the novel aspects of WPI's membrane technology can be summarized as follows:

Technology Maturity:

Bench-scale (½" OD, 2.5"L), 231 scf H₂/day at ~450 °C, ΔP = 100 psi (P_{low} = 15 psia)

Pilot-scale (1" OD, 6"L), 201 scf H₂/day at ~450 °C, ΔP = 15 psi (P_{low} = 15 psia)

Project Focus:

Palladium-Based Membranes

Participant:

Worcester Polytechnic Institute

Project Number:

NT43058

NETL Project Manager:

Daniel Driscoll
Daniel.Driscoll@netl.doe.gov

Principal Investigator:

Yi Hua Ma
 Worcester Polytechnic Institute
yhma@wpi.edu

Partners:

Adsorption Research, Inc.

Performance Period:

5/7/07 – 5/6/10

- It is made with a patented novel intermetallic diffusion barrier to prevent loss of permeance at high temperatures.
- It is plated on a porous metal support for mechanical strength at high pressures, low Pd/alloy layer thickness, and good chemical resistance to the feed gases.
- It is made of Pd/alloys that avoid H₂ embrittlement and crack formation during cycling.
- It is scalable and modular to accommodate small to large diameter and length tubular dimensions by connecting sections with commercial welding techniques.
- It can be easily integrated into a WGS reactor to effect one-step H₂ production from coal gas at small to large scales.

Further refinement and/or advancement of the aforementioned fabrication approaches and synthesis techniques were successfully reported in the quarterly progress reports submitted to DOE.

Table 1: WPI Membrane Parameters

	Parameter	Current R&D Value	Target R&D Value
Membrane Properties	Materials of fabrication for selective layer	Pd	Pd/Au
	Materials of fabrication for support layer (if applicable)	PSS-316L, PSS-310, Inconel-625	PSS-316L, PSS-310, Inconel-625
	Selectivity of key gas components: H ₂ /CO ₂ for pre-combustion technology	∞	∞
	Type of selectivity measurement (ideal or mixed gas)	Ideal	Mixed
	Pressure normalized flux (permeance for linear materials) for more selective gas component, GPU or equivalent units (scfh/ft ² -psi at ΔP = 100 psi H ₂ partial pressure with P _{low} = 15 psia)	Bench scale: 3.59 at 450 °C Pilot scale ¹ : 2.91 at 450 °C	DOE 2015 Target: 3
	Temperature, °C	300–450	250–500
	Bench-scale testing, hours without significant performance degradation	3,550	N/A
	Pilot-scale testing (if applicable), hours without significant performance degradation	850	N/A
	Maximum pressure differential achieved without significant performance degradation or failure, bar	14	N/A
Module Properties	Module configuration: hollow-fiber, spiral-wound sheet, shell-and-tube, plate-and-frame, other	Shell-and-tube	Shell-and-tube
	Packing density, m ² /m ³ (for ½" OD, 2.5" L or 1" OD, 6" L assemblies)	N/A	N/A
	Pressure drop, bar	N/A	N/A
	Estimated cost of manufacturing and installation, \$/m ² -GPU or equivalent	N/A	N/A
Product Quality	CO ₂ purity, %, of the retentate stream (>99.9% hydrogen purity at the permeate side)	80.3% (at feed mixed-gas: 37.1% CO ₂ , 1.2% CO and 61.7% H ₂ at 450 °C, 212 psia, GHSV of 1,069 h ⁻¹ and 92.6% H ₂ recovery); 83.5% (at feed mixed-gas: 10% CO ₂ , 23% CO, 22% H ₂ and 45% H ₂ O at 450 °C, 212 psia, GHSV of 4,497 h ⁻¹ , 83.2% H ₂ recovery and 95% CO conversion)	
	Other contaminants, % CO (feed gas: 10% CO ₂ , 23% CO, 22% H ₂ and 45% H ₂ O at 450 °C, 212 psia, GHSV of 4,497 h ⁻¹ , 83.2% H ₂ recovery and 95% CO conversion)	2.9% at the retentate (dry basis) 0% at the permeate	N/A

Note:

1. Computed pressure normalized flux. Experiments were conducted at a ΔP = 15 psi H₂ partial pressure (P_{low} = 15 psia) due to the large membrane surface area and feed hydrogen demand.

Other Membrane Parameters

Contaminant Resistance: Pd/gold (Au) and Pd/copper (Cu) alloy membranes provide some resistance to hydrogen sulfide (H_2S) and also regenerable.

Flue Gas Pretreatment Requirements: Pressure Swing Adsorption (PSA) for removal of sulfur compounds (Sub, ARI).

Waste Streams Generated: None.

Technology Advantages

The H_2 separation membrane can deliver CO_2 at high-pressure, significantly reducing compression costs associated with transporting the CO_2 and recompression for sequestration. The membrane also reduces the steam requirement associated with a traditional WGS reactor, thus improving overall plant efficiency. WPI's unique Pd alloy membranes provide high fluxes, proved high selectivity of separation, provide the ability to operate at temperatures around 300–450 °C, and allow high-purity H_2 production from the WGS membrane reactor. In addition, by combining reaction, separation, and purification in a single-unit operation, the Pd/alloy-based membrane reactor is markedly more efficient than the conventional technology and also economical by combining the high- and low-temperature shift reactors and preferential oxidation reactor, as well as the H_2 separator (i.e., PSA), into a single-unit operation, allowing for process intensification.

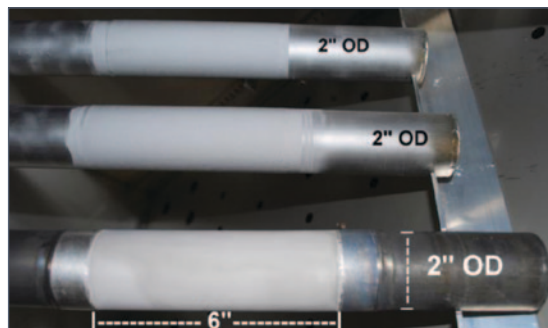

Figure 2: WPI Pd/Inconel H_2 Separation Membranes

R&D Challenges

- The formulation and synthesis of defect-free membrane materials, which are resistant to sulfur.
- Long-term selectivity stability.
- Support metals with uniform pore size distribution and minimum mass transfer resistance.

Results To Date/Accomplishments

- Achieved excellent long-term H_2 /helium (He) selectivity stability of essentially infinite over a total testing period of ~3,550 hours (>147 days) at 300–450 °C and at a DP of 15–100 pounds per square inch (psi) [$P_{\text{low}} = 15$ pounds per square inch absolute (psia)].
- At 450 °C, achieved re-producible, long-term H_2 /He selectivity stability with several membranes with H_2 purity $\geq 99.99\%$ over a testing period of 30–90 days.
- Flux of ~359 scfh/ft², which exceeded DOE's 2010 and 2015 H_2 flux targets [$T = 442$ °C and DP of 100 psi (with $P_{\text{low}} = 15$ psia)].
- Conducted an additional ~3,000 hours of mixed gas permeation experiments [61.7% H_2 , 37.1% CO_2 and 1.2% carbon monoxide (CO) with and without 19% steam].
- Reduced the number of synthesis steps for the large-scale preparation for potential commercialization of WPI's composite Pd-based membrane production technologies.
- Achieved 99% total CO conversion and 89.9% H_2 recovery in a 12.5 μm -thick Pd-based catalytic membrane reactor (CMR) operated at ~350 °C, $\Delta P = 200$ psi ($P_{\text{low}} = 15$ psia) $\text{H}_2\text{O}/\text{CO} = 1.44$ and $\text{GHSV}_{\text{stp}} = 150$ h⁻¹, exceeding equilibrium conversion of 93.4% and traditional packed bed conversion of 92.7%.

- Successfully completed steady-state MSR and WGS reaction modeling studies and initiated process intensification analysis.
- Successfully completed unsteady-state WGS reaction modeling studies and implemented process control strategies.
- Successfully completed a two-dimensional model for WGS tube and shell membrane reactors.
- Successfully used the two-dimensional model to calculate CO conversion and H₂ recovery for different configurations of MR integration into integrated gasification combined cycle (IGCC) plants.
- Completed capital and operation and maintenance costs of an IGCC-MR plant.
- Completed net present value (NPV) analysis of IGCC, IGCC-PBR, IGCC-MR, and SC-PC plants.
- Completed property and isotherm measurements for the selected adsorbents (Sub, ARI).
- Completed the PSA system construction and initiated PSA testing at 200 °C and a feed pressure of 200 psia (with P_{low} = 1 atm) (Sub, ARI).

Next Steps

Since the grant will be completed on May 6, 2011, the planned activities will be in conjunction with the grant, which are listed in the following:

- Prepare thin and stable composite pure Pd membranes on 1" OD PSS 316L and Hastelloy supports.
- Characterize such membranes in pure hydrogen atmospheres and in WGS reaction conditions.
- The most stable membranes will be sent to MTR for their integration in the skid module.
- Continue equipment preparation for coating deposition on tubular membrane anticipated for next performing period at T3 facilities.
- In the next project performing period, conduct DOE Test 2A (simulated effluent of WGS reactor) on MembraGuard-coated Pd membrane to further confirm stability under WGS reaction conditions.
- Membranes will be sent to T3 so that the H₂S protective coating will be deposited. Such membranes will be tested in sulfur conditions at WPI and then at National Carbon Capture Center (NCCC) under syngas atmospheres.
- The Phase I membrane module skid will be assembled and shipped to NCCC.
- A Phase II membrane reactor module will be fabricated.
- Mounting and leaks testing of the WGS reactor at WPI.
- Pure nitrogen and pure hydrogen tests will be performed in the WGS reactor at WPI in order to reproduce the experimental data obtained with the same membranes in other devices already present in the WPI laboratories.
- Nitrogen-hydrogen mixtures experiments at different operative conditions (i.e., different temperatures, hydrogen compositions, and feed flow rates) in the presence of the catalytic bed to perform fluid dynamic analysis and to esteem the mass transport coefficients and the relationship between the dimensionless number characteristic of the system. This analysis can be used in the future to model, in a more accurate way, the behavior of the system in the presence of the WGS reaction.

*Available Reports/Technical Papers/Presentations**Journal Articles:*

Pomerantz, N. and Ma, Y. H., “Isothermal Solid-State Transformation Kinetics Applied to Pd/Cu Alloy Membrane Fabrication,” *AIChE J*, 56, 3062–3073 (2010).

Chen, Chao-Huang and Ma, Yi Hua, “The Effect of H₂S on the Performance of Pd and Pd/Au Composite Membrane,” 362(1-2), 535–544 (2010).

Pomerrantz, N., Ma, Y. H., “Novel Method for Producing High H₂ Permeability Pd Membranes with a Thin Layer of the Sulfur Tolerant Pd/Cu fcc Phase,” *J Memb Sci.*, 370, 97–108 (2011).

Koc, Reyyan, Kazantzis, Nikolaos K. and Ma, Yi Hua, “A Process Dynamic Modeling and Control Framework for Performance Characterization and Enhancement of Pd-Based Membrane Reactors Used in Hydrogen Production”, *International J of Hydrogen Energy*,” Accepted for Publication.

Augustine; Alexander Sullivan, Kazantzis, Nikolaos K., Ma, Yi Hua, “High pressure palladium-membrane reactor for the high-temperature water-gas shift reaction *International Journal of Hydrogen Energy*,” *International J of Hydrogen Energy*, Accepted for publication.

Ayturk, M. E. and Ma, Y. H., “*Defect-Free Composite Pd Membranes with High Temperature Long-Term Stability*,” In preparation.

Chen, C. H. and Ma, Y. H., “The Effect of H₂S on the performance of Pd and Pd/Au composite membrane,” Submitted to the **Journal of Membrane Science**.

Pomerantz, N.; Payzant, E.A.; and Ma, Y.H. “*Isothermal Solid-State Transformation Kinetics Applied to Pd/Cu Alloy Membrane Fabrication*,” **AIChE Journal**, In press.

Ma, Y. H., Ayturk, M.E., Augustine, A.S. and Kazantzis, N., “*Palladium Membrane Reactor for Water Gas Shift Reaction*,” Submitted to **Catalysis Today**, In press.

Pomerantz, N. and Ma, Y.H. “*Effect of H₂S on the performance and long-term stability of Pd/Cu membranes*,” **Industrial and Engineering Chemistry Research**, 48(8) (2009) 4030–4039.

Ayturk, M. E., Kazantzis, N.K. and Ma, Y. H., “*Modeling and Performance Assessment of Pd- and Pd/Au-based Catalytic Membrane Reactors for Hydrogen Production*,” **Energy and Environmental Science**, 2 (2009) 430–438.

Conference Proceedings:

Ayturk, M. E. and Ma, Y.H. “*Hydrogen Production via Composite Palladium Membranes with Long-Term Selectivity Stability*.” **Prepr. Pap. - Am. Chem. Soc., Div. Fuel Chem.**, 55(1) (2010).

Chen, C. H. and Ma, Y. H., “*Effect of H₂S concentration on hydrogen permeance of a composite Pd/Au hydrogen separation membrane prepared by galvanic displacement*,” **Preprint in the Proceedings of 239th ACS Annual Meeting**, March 21–25, 2010, San Francisco, CA, USA.

Pomerantz, N. and Ma, Y.H. “*Effect of mass transfer on Cu plating rate and deposition morphology for Pd/Cu alloy membranes for hydrogen separation*,” Extended abstract in the **Proceedings of the ACS 239th National Meeting and Exposition**, March 21–25, 2010, San Francisco, CA, USA.

Ma, Y. H., Ayturk, M.E., Augustine, A.S. and Kazantzis, N., “*Palladium Membrane Reactor for Water Gas Shift Reaction*,” Proceedings of the 9th **International Conference on Catalysis in Membrane Reactors (ICCMR9)**, June 28–July 2, 2009, Lyon, France.

Chen, C. H. and Ma, Y. H., “*Characterization of sulfur resistance of Pd/Au hydrogen separation membranes*,” Extended abstract in the **Proceedings of the 2008 AIChE Annual Meeting**, November 16–21, 2008, Philadelphia, PA, USA.

Pomerantz, N.; Shaw, E. and Ma, Y.H. “*The effect of H₂S on the long-term stability of Pd/Cu membranes and the characteristics of H₂S poisoning of electroless deposited Pd.*” Extended abstract in the **Proceedings of the AIChE Annual Meeting 2008**, November 16–21, 2008, Philadelphia, PA, USA.

Ma, Y. H., Kazantzis, N., Ayturk, M. E., Pomerantz, N. and Chen, C.-H. Synthesis and Long-Term Characterization of Sulfur Tolerant Pd/Cu and Pd/Au Alloy Membranes for Hydrogen Production via Catalytic Membrane Reactor Applications. Extended abstract in the **Proceedings of the 10th Intl. Conf. on Inorganic Membranes (ICIM10)**, (2008) Tokyo, Japan.

Chen, C. H. and Ma, Y. H., “Permeation of composite Pd/Au hydrogen separation membrane prepared by galvanic displacement,” Preprint in the **Proceedings of 234th ACS Annual Meeting**, August 19–23, 2007, Boston, MA, USA.

Pomerantz, N. and Ma, Y.H. “*Effect of H₂S poisoning of Pd/Cu membranes on H₂ permeance and membrane morphology.*” Extended abstract in the **Proceedings of the ACS 234th National Meeting and Exposition**, August 19–23, 2007, Boston, MA, USA.

Presentations:

Ma, Yi Hua, “Composite Pd and Pd Alloy Porous Stainless Steel Membranes for Hydrogen Production and Process Intensification,” U.S. DOE FY11 Advanced Fuels Peer Review, October 18–22, 2010, Morgantown, WV, USA.

Koc, Reyyan, Kazantzis, Nikolaos K. and Ma, Yi H., “A Process Dynamic Modeling Framework for Performance Assessment of Pd-Based Membrane Reactors,” Oral presentation, Session: Process Modeling, NAMS/ICIM, July 17–22, 2010, Washington DC, USA.

Koc, Reyyan, Kazantzis, Nikolaos K, and Ma, Yi H., “Theoretical study for the integration of the Pd-based water gas shift membrane reactors into the IGCC plants”, Poster presentation, 240th ACS National Meeting, Division of Environmental Chemistry, August 22–26, 2010, Boston, MA, USA.

Koc, Reyyan, Kazantzis, Nikolaos K. and Ma, Yi H., “Process Safety Aspects in Water-Gas-Shift (WGS) Catalytic Membrane Reactors Used for Pure Hydrogen Production,” Mary Kay O’Connor Process Safety Center International Symposium, October 26–28, 2010, College Station, TX, USA.

Koc, Reyyan, Kazantzis, Nikolaos and Ma, Yi Hua, “A Process Dynamic Modeling and Control Framework for Performance Characterization and Enhancement of Pd-Based Membrane Reactors,” Session: on Membranes for Hydrogen Purification, 10th AIChE Annual Meeting, November 7–12, 2010, Salt Lake City, UT, USA.

Koc, Reyyan, Kazantzis, Nikolaos and Ma, Yi Hua, “A Process Modeling Framework for Performance Assessment of Pd-Based Water-Gas Shift Membrane Reactors,” Oral presentation, Session: on Membrane Reactors, AIChE 2010 Annual Meeting, November 7–12, 2010, Salt Lake City, UT, USA.

Augustine, Alexander S., Ayturk, M. Engin and Ma, Yi Hua, “Composite Palladium Membrane Reactor for Hydrogen Production with Syngas Feed,” Session on Membranes for Energy Applications, Joint Meeting of North American Membrane Society Annual Meeting and 11th International Conference on Inorganic Membranes, July 17–22, 2010, Washington, DC, USA.

Chen, Chao-Huang and Ma, Y. H., “The Effect of Au Content in Composite Pd/Au Membranes Prepared by Galvanic Displacement On Hydrogen Permeance and H₂S Resistance,” Session on Membranes for Hydrogen Purification, AIChE 2010 Annual Meeting, November 17–22, 2010, Salt Lake City, UT, USA.

Ayturk, M. E. and Ma, Y.H. “*Hydrogen Production via Composite Palladium Membranes with Long-Term Selectivity Stability.*” To be presented at the **ACS Spring National Meeting and Exposition**, March 21–25, 2010, San Francisco, CA, USA.

Chen, C. H. and Ma, Y. H., “Effect of H₂S concentration on hydrogen permeance of a composite Pd/Au hydrogen separation membrane prepared by galvanic displacement.” To be presented at the **ACS Spring National Meeting and Exposition**, March 21–25, 2010, San Francisco, CA, USA.

Pomerantz, N. and Ma, Y.H. “*Effect of mass transfer on Cu plating rate and deposition morphology for Pd/Cu alloy membranes for hydrogen separation.*” To be presented at the **ACS 239th National Meeting and Exposition**, March 21–25, 2010, San Francisco, CA, USA.

- Ayturk, M. E. and Ma, Y.H. “*Long-Term Selectivity Stability and High-Pressure Mixed Gas Hydrogen Permeation Testing of Composite Pd/Inconel Membranes.*” Presented at the **AICHE Annual Meeting**, November 8–13, 2009, Nashville, TN, USA.
- Augustine, A. S.; Ayturk, M.E.; Kazantzis, N. and Ma, Y. H. “*Palladium Membrane Reactor for Water Gas Shift Reaction.*” Presented at the **AICHE Annual Meeting**, November 8–13, 2009, Nashville, TN, USA.
- Ma, Y. H., Ayturk, M.E., Augustine, A.S. and Kazantzis, N., “*Palladium Membrane Reactor for Water Gas Shift Reaction,*” Presented at the 9th **International Conference on Catalysis in Membrane Reactors (ICCMR9)**, June 28–July 2, 2009, Lyon, France.
- Ayturk, M. E. and Ma, Y. H., “*Defect-Free Composite Pd Membranes with High Temperature Long-Term Stability,*” Presented at the **2008 AIChE Annual Meeting**, November 16–21, 2008 Philadelphia, PA, USA.
- Chen, C. H. and Ma, Y. H., “*Characterization of sulfur resistance of Pd/Au hydrogen separation membranes,*” Presented at the **2008 AIChE Annual Meeting**, November 16–21, 2008, Philadelphia, PA, USA.
- Pomerantz, N.; Payzant, E.A. and Ma, Y.H. “*Isothermal Solid-State Transformation Kinetics Applied to Pd/Cu Alloy Membrane Fabrication,*” Presented at the **AICHE Annual Meeting 2009**, Nashville, TN, USA, November 8–13, 2009.
- Pomerantz, N.; Shaw, E. and Ma, Y.H. “*The effect of H₂S on the long-term stability of Pd/Cu membranes and the characteristics of H₂S poisoning of electroless deposited Pd,*” Presented at the **AICHE Annual Meeting 2008**, November 16–21, 2008, Philadelphia, PA, USA.
- Ma, Y. H., Kazantzis, N., Ayturk, M. E., Pomerantz, N. and Chen, C.-H., “*Synthesis and Long-Term Characterization of Sulfur Tolerant Pd/Cu and Pd/Au Alloy Membranes for Hydrogen Production via Catalytic Membrane Reactor Applications,*” Presented at the **10th International Conference on Inorganic Membranes (ICIM10)**, August 18–22, 2008, Tokyo, Japan.
- Ayturk, M. E., Kazantzis, N.K. and Ma, Y. H., “*Modeling and Performance Assessment of Pd- and Pd/Alloy-based Catalytic Membrane Reactors for Hydrogen Production,*” Presented at the **International Congress on Membranes and Membrane Processes (ICOM 2008)**, July 12–18, 2008, Honolulu, HI, USA.
- Pomerantz, N.; Shaw, E. and Ma, Y.H. “*XPS studies of H₂S poisoned Pd deposits and the implications on Pd membrane performance.*” Presented at the **International Congress on Membranes and Membrane Processes (ICOM 2008)**, July 12–18, 2008, Honolulu, HI, USA.
- Ma, Y. H., Kazantzis, N., Ayturk, M. E., Pomerantz, N. and Chen, C.-H., “*Composite Pd and Pd/alloy Porous Stainless Steel Membranes for Hydrogen Production, Process Intensification and CO₂ Sequestration,*” Presented at the **2008 NHA Annual Hydrogen Conference and Expo: “Ramping up Commercialization,”** March 30–April 03, 2008 Sacramento, CA, USA.
- Chen, C. H. and Ma, Y. H., “*Permeation of composite Pd/Au hydrogen separation membrane prepared by galvanic displacement,*” Presented at the **2007 ACS Annual Meeting**, August 19–23, 2007 Boston, MA, USA.
- Pomerantz, N. and Ma, Y.H. “*Effect of H₂S poisoning of Pd/Cu membranes on H₂ permeance and membrane morphology.*” Presented at the **ACS 234th National Meeting and Exposition**, August 19–23, 2007, Boston, MA, USA.
- Chen, C. H. and Ma, Y. H., “*Preparation of Pd/Au hydrogen separation membrane by galvanic displacement,*” Presented at the **2007 North American Membrane Society Annual Meeting**, May 13–16, 2007, Orlando, FL, USA.

CARBON MOLECULAR SIEVE MEMBRANE AS A TRUE ONE-BOX UNIT FOR LARGE-SCALE HYDROGEN PRODUCTION

Primary Project Goals

Media and Process Technology, Inc. is developing a one-box process for hydrogen (H_2) production based on carbon molecular-sieve (CMS) membranes. Gas cleanup will be combined with a water gas shift membrane reactor (WGS-MR) in a single processing unit.

Technical Goals

- Develop and test a one-box (gas cleanup and the WGS-MR), H_2 production process that integrates the four major technology components for synthesis gas (syngas) cleanup and conditioning into a single unit.
- Demonstrate the one-box process at bench-scale at the University of Southern California (USC); followed by a single-tube slipstream test at the Power Systems Development Facility (PSDF). Upon successful completion of this testing, a pilot-scale unit will be developed and tested with a stream from a gasifier.
- A mathematical model will be verified with the bench- and pilot-scale test results, and then used to conduct a techno-economic analysis.
- Evaluate the CMS membrane deposited on a ceramic substrate for candidate selection in future full-scale demonstrations.

Technical Content

The one-box process under investigation combines the gas cleanup and WGS-MR for H_2 production. Figure 1 displays how the one-box process will be incorporated following the gasification of a coal-based feedstock. Syngas cleaning will consist of a water quench, particulate removal, WGS, and CMS membrane to produce an H_2 gas stream and a carbon dioxide (CO_2) stream ready for sequestration. The one-box process will remove the sulfur and other contaminants from the H_2 product stream via the molecular sieving mechanism of the H_2 -selective CMS membrane. If a high-purity H_2 product is necessary, an optional palladium (Pd) membrane can be installed for post-treatment of this sulfur-removed H_2 product stream. Table 1 compares the one-box process to a conventional H_2 purification processes.

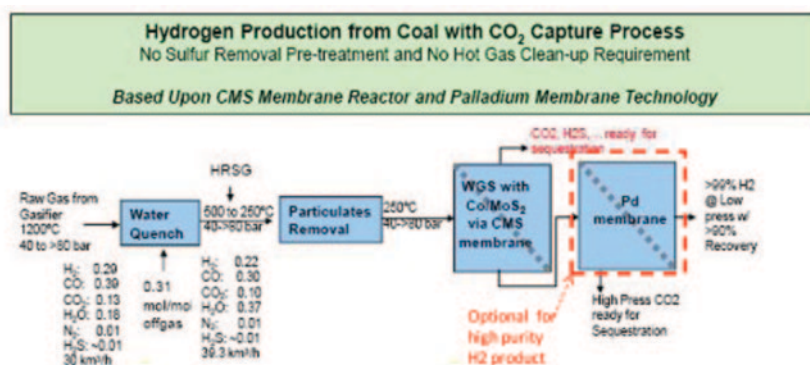

Figure 1: Incorporation of One-Box Process Following the Gasification of a Coal-Based Feedstock

Technology Maturity:

Bench-scale

Project Focus:

Carbon Molecular Sieve Membranes

Participant:

Media and Process Technology, Inc.

Project Number:

NT43057

NETL Project Manager:

John Stipanovich
John.Stipanovich@netl.doe.gov

Principal Investigator:

Paul K.T. Liu
Media and Process Technology, Inc.
pliu@mediaandprocess.com

Partners:

Power Systems Development Facility
University of Southern California

Performance Period:

5/2/07 – 5/1/12

Media and Process Technology, Inc. — Carbon Molecular Sieve Membranes

Table 1: One-Box Process Versus a Conventional Hydrogen Purification Processes

Performance Criteria	Conventional WGS with PSA	One-Box Process
H ₂ product pressure, psig	High pressure, 200–400	Low pressure, e.g., 5 to >100 psig
H ₂ product purity, %	>99.9	>99.9
H ₂ product yield, %	60 to 80	>90
CO conversion, %	90 to 97	>97
H ₂ O/CO ratio for WGS	3–4	~1.5
CO ₂ Stream Pressure, psig	Low pressure, 5–10	High pressure, i.e., gasifier pressure

Within the one-box unit, a cobalt sulfide (CoS₂)/molybdenum disulfide (MoS₂) catalyst will be used to perform the WGS reaction. As shown in Figure 2, the CMS membrane will incorporate a candle filter configuration that has a high resistance to hydrogen sulfide (H₂S), which allows the H₂ to permeate through the membrane and create an H₂-rich stream. After the H₂ permeates through the CMS membrane, a CO₂-rich stream will remain outside the membrane at a high pressure ready for transportation.



Figure 2: Candle Filter Configuration for CMS Membrane and Module (pilot scale)

Figure 3 shows the permeance of the membrane under investigation for separation of H₂ and CO₂.

Figure 3: Permeances of Membranes for Separation of H₂ and CO₂ from Coal Gasifier Off-Gas Generated at PSDF

Table 2: Media and Process Technology Membrane Parameters

	Parameter	Current R&D Value	Target R&D Value
Membrane Properties	Materials of fabrication for selective layer	Carbon	Carbon
	Materials of fabrication for support layer (if applicable)	Ceramic	Ceramic
	Selectivity of key gas components: H ₂ /CO ₂ for pre-combustion technology	25–30 (50 to >100 for H ₂ /CO)	25–30 (50 to >100 for H ₂ /CO)
	Type of selectivity measurement (ideal or mixed gas)	Mixed	Mixed
	Pressure normalized flux (permeance for linear materials) for more selective gas component, GPU or equivalent units	925 GPU	1,295 FPU
	Temperature, °C	250	>600
	Bench-scale testing, hours without significant performance degradation	>500	>1,000
	Pilot-scale testing (if applicable), hours without significant performance degradation	100	>250
	Maximum pressure differential achieved without significant performance degradation or failure, bar	>50	>50
Module Properties	Module configuration: hollow-fiber, spiral-wound sheet, shell-and-tube, plate-and-frame, other	Shell-and-tube in candle filter configuration	Shell-and-tube in candle filter configuration
	Packing density, m ² /m ³	250	500
	Pressure drop, bar	<0.1	<0.1
	Estimated cost of manufacturing and installation, \$/m ² -GPU or equivalent	\$1,000/m ²	<\$500/m ²
Product Quality	CO ₂ purity, %	80	85
	N ₂ purity, %	2	2
	Other contaminants, %	18	13
Process Performance	Electricity requirement, kJ/kg CO ₂	Minimal (theoretical 0)	Minimal (theoretical 0)
	Heat requirement, kJ/kg CO ₂	Minimal (theoretical 0)	Minimal (theoretical 0)
	Total energy (electricity equivalent), kJ/kg CO ₂	Minimal (theoretical 0)	Minimal (theoretical 0)

Technology Advantages

- Produces a high-pressure CO₂ stream for sequestration.
- Achieves nearly complete carbon monoxide (CO) conversion, increases H₂ recovery from the gasification stream.
- Reduces the steam required for the WGS reaction, improving plant efficiency.
- Removes sulfur contaminants and uses an existing Pd membrane to filter >99.9% H₂.

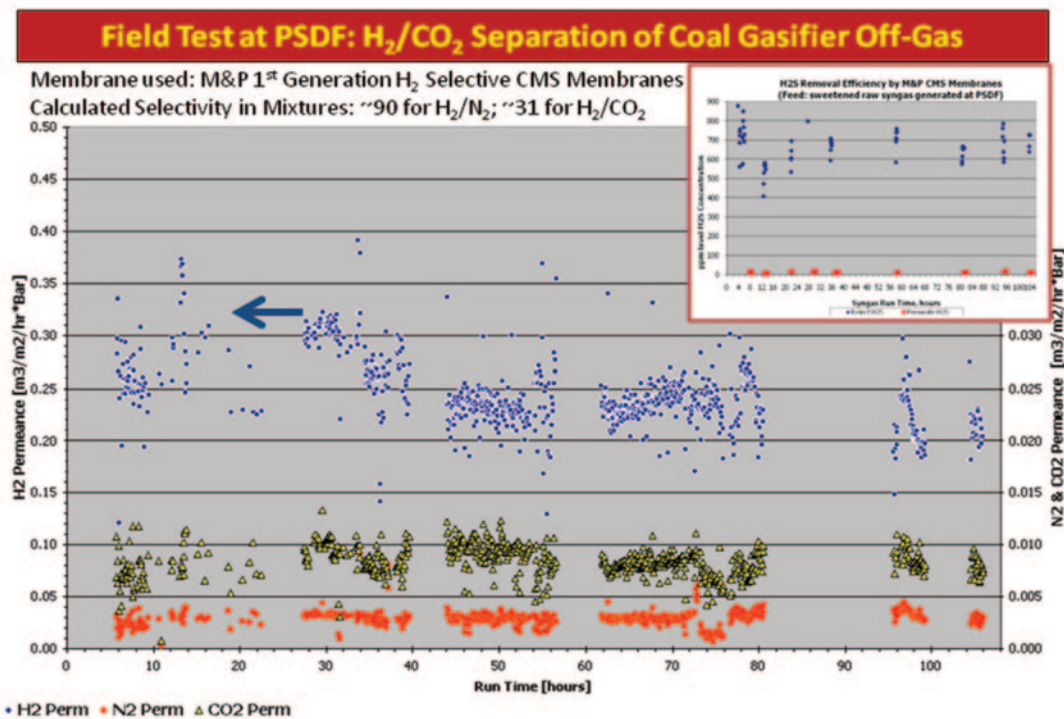
R&D Challenges

- Scaling the one-box process from laboratory scale to larger scales.
- The one-box process produces a H₂ stream product at a high pressure.
- Increase H₂ recovery rate at a high purity hydrogen.

Results To Date/Accomplishments

- Performed a membrane performance field test for >100 hours using a slipstream test at the PSDF facility.
- Completed an evaluation of the CoS₂/MoS₂ catalyst for WGS of simulated coal gasifier off-gas.
- Established the separation efficiency of key contaminants in a simulated stream.
- Experimentally determined the performance of the one-box process in a bench-scale unit.
- Evaluated the outside coated CMS membrane and compared its performance with the existing membrane.

Next Steps

- Fabricate the ceramic membrane/module for the pilot testing unit and conduct an examination analysis of the ceramic membrane.
- Refine the mathematical model of the one-box H₂ production process from the bench-scale unit.
- Assemble a slipstream testing unit and perform slipstream tests at PSDF.
- Evaluate the performance of the pilot-scale testing unit.
- Complete the simulation, optimization, and economic analysis of the one-box process.
- Assess the ceramic-based, one-box H₂ production unit.

Available Reports/Technical Papers/Presentations

Hydrogen Production from Syngas, Using a Catalytic Membrane Reactor, Mitra Abdollahi, Hyun Hwang, Jiang Yu, Paul K.T. Liu, Muhammad Sahimi, Theodore T. Tsotsis, NAMS 2009.

Integrated One Box Process for Hydrogen Production From Syngas, Mitra Abdollahi, Jiang Yu, Paul K.T. Liu, Muhammad Sahimi, Theodore T. Tsotsis, AIChE 2009.

Process Intensification in Hydrogen Production From Syngas, Mitra Abdollahi, Jiang Yu, Paul K.T. Liu, Muhammad Sahimi, Theodore T. Tsotsis, ISCRE 2010.

Hydrogen Production from Coal-Derived Syngas Using a Catalytic Membrane Reactor-Based Process, Mitra Abdollahi, Jiang Yu, Paul K.T. Liu, Rich Ciora, Muhammad Sahimi, Theodore T. Tsotsis, Journal of Membrane Science, submitted.

HIGH PERMEABILITY TERNARY PALLADIUM ALLOY MEMBRANES WITH IMPROVED SULFIDE AND HALIDE TOLERANCE

Primary Project Goals

Southwest Research Institute (SwRI) is employing an iterative modeling, rapid fabrication, and testing approach to develop and demonstrate an ultra-thin (<5 micron), durable ternary palladium (Pd)-alloy membrane with excellent resistance to sulfur and halogen attacks while meeting or exceeding the hydrogen (H₂) permeability performance established by DOE. A secondary benefit is to support the process of carbon dioxide (CO₂) gas sequestration.

Technical Goals

- Investigate the performance of a variety of ternary Pd-copper (Cu)-M alloys to identify which experimental alloys show improved H₂ permeance compared to a baseline Pd alloy.
- Develop the necessary methods for the fabrication of high-performance, thin Pd-alloy membranes using advanced physical vapor deposition methods.
- Experimentally determine the H₂ and nitrogen (N₂) permeation rates of the alloys under a range of pressures from 1.3 to 11 atm [5–150 pounds per square inch gauge (psig) feed pressure] and temperatures (200–500 °C).
- Characterize the alloy membranes using binary mixture permeation tests, electron microscopy (to observe structure and morphology), X-ray diffraction (for purity of the film and crystal structure), atomic force microscopy (for surface structure), and energy-dispersive X-ray spectroscopy (for alloy composition).
- Test the performance of the alloy membranes in the presence of a single- and multi-contaminant synthesis gas (syngas).

Technical Content

The project team consisting of SwRI, Georgia Institute of Technology (GT), the Colorado School of Mines (CSM), TDA Research, and IdaTech, LLC was focused on developing a robust, poison-tolerant, hydrogen-selective free standing membrane to produce clean hydrogen. The project completed on schedule and on budget with SwRI, GT, CSM, TDA, and IdaTech all operating independently and concurrently. GT has developed a robust platform for performing extensive Density Functional Theory (DFT) calculations for H in the bulk of Pd, binary alloys, and ternary alloys of Pd. In GT's work, the idea of describing the binding sites with a series of well-defined geometric configurations via a cluster expansion (CE) method was introduced. In order to select the best CE model, the Leave One Out (LOO) analysis was introduced. With the CE-LOO analysis, the DFT data sets were taken and models developed that could accurately define the binding sites, these models were then used in subsequent analysis of the solubility and diffusion of H in the bulk of the ternary alloys. SwRI deposited and released more than 160 foils of binary and ternary Pd alloys. There was considerable work on characterizing and improving the durability of the deposited foils using new alloy compositions, post annealing, and ion bombardment. The 10- and 25- μ m thick films were sent to CSM, TDA, and IdaTech for characterization and permeation testing. CSM conducted more than 60 pure gas permeation tests with binary and ternary alloy

Technology Maturity:

Bench-scale

Project Focus:

Ternary Palladium Alloy Membranes

Participant:

Southwest Research Institute

Project Number:

NT43056

NETL Project Manager:

Richard Dunst

Richard.Dunst@netl.doe.gov

Principal Investigator:

Kent Coulter

Southwest Research Institute

kent.coulter@swri.org

Partners:

Colorado School of Mines

The Georgia Institute of

Technology

IdaTech

TDA Research, Inc.

Performance Period:

5/2/07 – 5/1/10

membranes. The Pd-gold (Au) and PdAu-platinum (Pt) membranes exhibited the best performance at temperatures in the range of 423–773 °C, and their performance correlates well with the predictions from GT. TDA completed testing under the DOE testing guidelines on more than 16 membranes; of particular interest is the PdAuPt alloys that exhibited only a 20% drop in flux when sulfur was added to the gas mixture and the flux was completely recovered when the sulfur flow was stopped. IdaTech tested binary and ternary membranes on simulated flue gas streams and experienced significant difficulty in mounting and testing the sputter deposited membranes. IdaTech was able to successfully test PdAu and PdAuPt membranes and saw similar sulfur tolerance to what TDA found.

Table 1: SwRI Membrane Parameters

	Parameter	Current R&D Value	Target R&D Value
Membrane Properties	Materials of fabrication for selective layer	Pd ternary alloys	Pd ternary alloys
	Materials of fabrication for support layer (if applicable)	N/A	N/A
	Selectivity of key gas components: H ₂ /CO ₂ for pre-combustion technology	99.99	99.99
	Type of selectivity measurement (ideal or mixed gas)	Mixed	Mixed
	Pressure normalized flux (permeance for linear materials) for more selective gas component, GPU or equivalent units	H ₂ -242 scfh/ft ²	H ₂ -200 scfh/ft ²
	Temperature, °C	400	300–600
	Bench-scale testing, hours without significant performance degradation	250	120
	Pilot-scale testing (if applicable), hours without significant performance degradation	24	120
	Maximum pressure differential achieved without significant performance degradation or failure, bar	6.9	6.9
Module Properties	Module configuration: hollow-fiber, spiral-wound sheet, shell-and-tube, plate-and-frame, other	Plate-and-frame	Plate-and-frame
	Packing density, m ² /m ³	N/A	N/A
	Pressure drop, bar	4.8	4.8
	Estimated cost of manufacturing and installation, \$/m ² -GPU or equivalent	\$16,146/m ²	\$10,764/m ²
Product Quality	CO ₂ purity, %	N/A	N/A
	H ₂ purity, %	N/A	N/A

Technology Advantages

GT developed a detailed DFT and a heuristic lattice model that is appropriate for rapidly characterizing H solubility and diffusion in the search for new promising alloys for membranes. This approach can be used as an initial tool for screening materials prior to using more expensive experimental investigations. The advanced vapor deposition methods used to construct the Pd-alloy membranes provide unique advantages compared to other membrane fabrication techniques. The high-power, pulsed magnetron sputtering and plasma-enhanced magnetron deposition methods are able to rapidly produce membranes of almost any alloy composition, providing excellent flexibility in terms of the materials and properties used in a membrane. These methods also generate alloy compositions with good uniformity over areas up to 645 cm² (100 in²).

R&D Challenges

The mechanical durability of membranes fabricated using magnetron sputtering are inferior compared to cold rolled membranes, and is it currently not ready for industrial environments.

Results To Date/Accomplishments

- Developed a rigorous strategy for predicting H₂ permeability through ternary alloys using complex calculations.
- Coated more than 160 thin (5–25 micron) membranes of PdCu, PdAg, Pd-ruthenium (Ru), PdAu, Pd-thulium (Tm), PdCu-silver (Ag), PdCuAu, PdCuPt, PdCu-nickel (Ni), PdCuRu, PdCuAu, PdAuAg, and PdAuPt for structural and composition measurements and permeation testing.
- Determined pure gas H₂ and N₂ permeation rates for a range of pressure differentials [1.3–11 atm feed pressure (5–150 psig)] and temperatures ranging from 200 to 500 °C for more than 60 membranes.
- Under DOE specified test conditions, evaluated 16 membranes.
- More than 10 presentations at national and international conferences were made, four papers were published (two additional papers in progress) in technical journals, and three students completed their Ph.D. using results generated during the course of the program.
- The three major findings of program were: (1) the DFT modeling was verified as a predictive tool for the permeability of Pd-based ternary alloys; (2) while magnetron sputtering is useful in precisely fabricating binary and ternary alloys, the mechanical durability of membranes fabricated using this technique are inferior compared to cold rolled membranes and sputtered membranes are not currently ready for industrial environments; and (3) based on both modeling and experimental verification in pure gas and mixed gas environments, PdAu and PdAuPt alloys were found to have the combination of the highest permeability and tolerance to sulfur.
- The program met all the deliverables on schedule and on budget.

Next Steps

- Program completed on December 31, 2010.

Available Reports/Technical Papers/Presentations

No reports, technical papers, or presentations are yet available.

FABRICATION AND SCALE-UP OF POLYBENZIMIDAZOLE MEMBRANE-BASED SYSTEM FOR PRE-COMBUSTION BASED CAPTURE OF CARBON DIOXIDE

Primary Project Goals

SRI International is developing a high-temperature polymer membrane and designing a membrane module for pre-combustion capture of carbon dioxide (CO₂) from integrated gasification combined cycle (IGCC)-derived synthesis gas (syngas).

Technical Goals

- Design, construct, and test a pre-combustion-based CO₂ capture system (50 kWth) skid using polybenzimidazole (PBI) membranes developed by Los Alamos National Laboratory (LANL).
- Evaluate the effectiveness of the membrane elements for CO₂ separation in relation to permeability and selectivity.
- Perform a techno-economic analysis of an IGCC system employing PBI membranes for carbon capture and sequestration (CCS).

Technical Content

The membrane under development consists of hollow-fiber PBI, which is chemically and thermally stable at temperatures up to 450 °C and pressures up to 55 atm [800 pounds per square inch gauge (psig)]. This characteristic permits the use of a PBI membrane without requiring additional cooling after the water gas shift (WGS) section of an IGCC system including carbon capture. Further gas cooling is not required before the PBI membrane, increasing plant efficiency. In addition, the CO₂ is recovered at high pressure, decreasing CO₂ compression requirements.

PBI-based hollow fibers, as seen in Figure 1 and Figure 2, offer a considerable advantage over stainless steel-coated tubes. They require as much as 24 times less membrane surface area and 305 times less membrane volume when using a 0.1–0.5 micrometer separation layer.

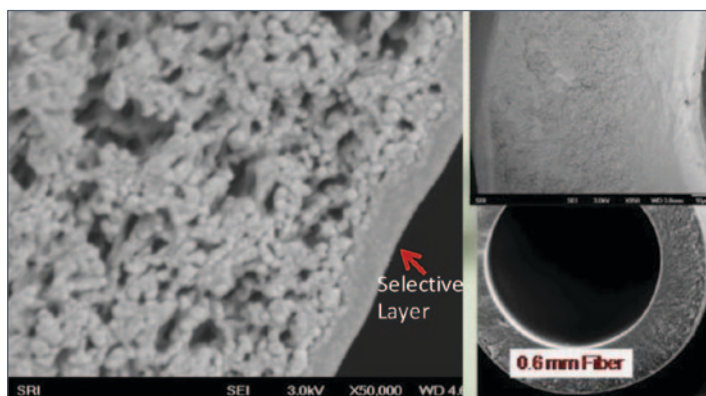

Figure 1: Image of PBI-Based Hollow Fibe Produced at SRI

Technology Maturity:

Prototype, 0.4 tonnes CO₂/day

Project Focus:

High-Temperature Polymeric Membranes

Participant:

SRI International

Project Number:

NT43090

NETL Project Manager:

Robie Lewis

Robie.Lewis@netl.doe.gov

Principal Investigator:

Gopala Krishnan

SRI International

Gopala.Krishnan@sri.com

Partners:

BP

Enerfex

LANL

Visage Energy

Whitefox

Performance Period:

3/30/07 – 3/31/12

The durability of narrow, single-bore, PBI-based hollow fibers has been shown to be considerable, with near constant levels of permeability and selectivity over the course of 330 days while in the presence of hydrogen (H₂), carbon monoxide (CO), methane (CH₄), nitrogen (N₂), CO₂, and hydrogen sulfide (H₂S) at 250 °C.



Figure 2: Image of a Bundle of PBI-Based, Asymmetric Hollow Fibers

Table 1: LANL PBI Membrane Parameters

	Parameter	Current R&D Value	Target R&D Value
Membrane Properties	Materials of fabrication for selective layer	—	—
	Materials of fabrication for support layer (if applicable)	PBI	PBI
	Selectivity of key gas components: H ₂ /CO ₂ for pre-combustion technology	40	>40
	Type of selectivity measurement (ideal or mixed gas)	Mixed gas	Mixed gas
	Pressure normalized flux (permeance for linear materials) for more selective gas component, GPU or equivalent units	130	130
	Temperature, °C	250	250
	Bench-scale testing, hours without significant performance degradation	1,000	1,000
	Pilot-scale testing (if applicable), hours without significant performance degradation	N/A	N/A
	Maximum pressure differential achieved without significant performance degradation or failure, bar	10	20
Module Properties	Module configuration: hollow-fiber, spiral-wound sheet, shell-and-tube, plate-and-frame, other	Hollow-fiber	Hollow-fiber
	Packing density, m ² /m ³	N/A	2,292
	Pressure drop, bar	N/A	N/A
	Estimated cost of manufacturing and installation, \$/m ² -GPU or equivalent	N/A	161
Product Quality	CO ₂ purity, %	90	90
	N ₂ purity, %	N/A	<1
	Other contaminants, %	N/A	<0.01
Process Performance	Electricity requirement, kJ/kg CO ₂	N/A	281
	Heat requirement, kJ/kg CO ₂	N/A	0
	Total energy (electricity equivalent), kJ/kg CO ₂	N/A	281

Other Membrane Parameters

Contaminant Resistance: Sulfur tolerance.

Gas Pretreatment Requirements: No pretreatment of the gas stream from WGS is required.

Waste Streams Generated: No waste stream.

Technology Advantages

- The use of PBI offers several advantages over Selexol and conventional polymeric membranes, including reduced CO₂ compression costs due to the ability to deliver the concentrated CO₂ stream at pressures up to 55 atm (800 psig).
- PBI is thermally stable up to 450 °C and sulfur tolerant.
- Highest demonstrated operating temperature (400 °C) of a polymer-based membrane with permeabilities and selectivities of interest.

R&D Challenges

- Designing and synthesizing materials structure and configuration.
- Obtaining desired selectivity, productivity, chemical resistance, and durability at elevated temperatures and pressures by overcoming the limitations of current state-of-the-art technology.
- Understanding and optimizing mass transfer and the interaction with heat transfer.
- Scale up of the technology from laboratory to larger scales.
- Integration and optimization of systems.

Results To Date/Accomplishments

- Developed an IGCC process simulation model.
- Performed and analyzed several membrane separation scenarios under various temperatures, pressures, and gases, which showed:
 - PBI membrane-based, high-temperature CO₂ separation is competitive with the Selexol system.
 - COE for CO₂ capture may approach the DOE goal under optimized membrane performance.
- Fabricated both single- and multi-bore, hollow-fiber PBI membrane configurations.
- Determined that multi-bore configuration offers increased selective layer area density while single bore provides higher mechanical stability.
- Completed characterization using scanning electron microscope (SEM) and X-ray tomography.
- Identified a sealant for short-term testing.
- Completed permeability measurements with both single- and mixed-gas environments.
- Achieved an H₂ permeability of >100 GPU with an H₂/CO₂ selectivity of 40 at 250 °C. Long-term performance evaluation data-selectivity and H₂ permeance are given in Figure 3.

- Determined that the PBI membrane has a high permeability for steam.
- Determined that PBI hollow-fiber configuration provides the most compact membrane module.
- Established the fabrication of PBI substrate with interconnected pores.
- Performed risk management analysis to identify several system-level questions pertaining to the PBI technology.
- Developed and refined mitigation strategies that considered all stakeholder needs and requirements.
- Completed successful testing of the polymeric-metallic composite membrane in dry gas environments containing H₂, CO₂, CH₄, N₂, CO, and H₂S from 25 to 400 °C.
- Completed successful testing of the polymer-based membrane on fully hydrated natural gas reformat up to 300 °C.

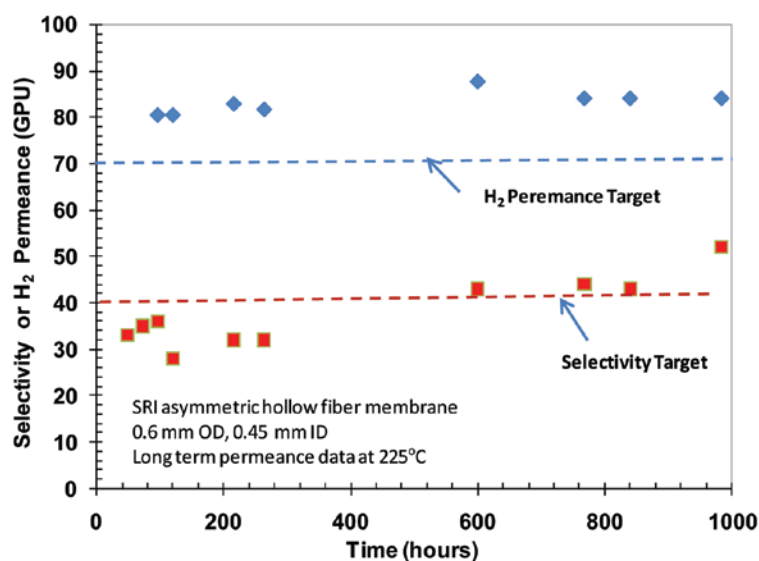

Figure 3: PBI-Based Hollow-Fiber Performance Data

Next Steps

- Complete subcomponent design and evaluation.
- Construct membrane modules using the selected asymmetric hollow fibers fabricated at SRI.
- Integrate the membrane module with commercially available skids, control systems, and connectors.
- Evaluate the complete system.
- Develop feasible approaches for commercializing the technology in the designated markets and sectors, along with possible routes for technology transfer.

Available Reports/Technical Papers/Presentations

Krishnan, Gopala et al., "Fabrication and Scale-up of Polybenzimidazole (PBI) Membrane Based Capture of CO₂," 2010 NETL CO₂ Capture Technology Conference, September 16, 2010, Pittsburgh, PA.

Krishnan, Gopala et al., "Simulation of a Process to Capture CO₂ From IGCC Syngas Using a High Temperature PBI Membrane," <http://www.sciencedirect.com/science/article/B984K-4W0SFYG-MR/2/a10e288aa794a1a71db6123e6ddde6c8>

DEVELOPMENT OF LOW-COST MEMBRANES FOR H₂/CO₂/CO SEPARATION FOR WGS REACTORS

Primary Project Goals

Grambling State University is developing low temperature bimetallic nanocatalysts for use in the water gas shift (WGS) reaction for hydrogen (H₂) production from a carbon monoxide (CO) and steam mixture, along with development of low-cost metal/ceramic membranes for H₂/carbon dioxide (CO₂) separation.

Technical Goals

- Develop micro/mesoporous ceramic membrane disks, composed of tantalum (Ta)/niobium (Nb) alloys, for optimum H₂ separation.
- Examine the effect of alloying the Ta/Nb ceramic membranes with other metals to reduce H₂ embrittlement and promote cathodic protection.
- Develop cellulose acetate interlayers between two micro/mesoporous ceramic disks for optimum H₂ and CO₂ separation.
- Examine the effects of plasticizers on CO₂ permeability.
- Prepare and optimize nano-bimetallic nickel (Ni)/molybdenum (Mo), cobalt (Co)/cerium (Ce), copper (Cu)/Ni, and iron (Fe)/Mo catalysts supported on mesoporous γ -Al₂O₃ and Al₂O₃/SiO₂ granules for the WGS reaction.
- Develop and demonstrate a prototype reactor based on novel low-cost metal (Ta/Nb)/ceramic and cellulose acetate membranes to separate H₂ and CO₂.
- Examine the performance of Ta/Nb and cellulose acetate/ceramic membranes under WGS conditions.

Technical Content

The WGS will utilize Cu-Ni-Ce/alumina granular nanocatalysts that react CO and steam to produce H₂ and CO₂. Figure 1 represents the chemical reaction inside the WGS as the gas stream is exposed to the catalyst and converts the CO to CO₂. The Cu-Ce catalyst converts approximately 69% of the CO, while Cu-Ce-Ni converts approximately 83% during a 10-hour reaction period.

Table 1 displays different compositions of metal catalysts investigated for promoting the WGS reaction. Four catalyst compositions (rows 3, 4, 9, and 10 in Table 1) are evaluated for high-temperature shift (HTS) reactions with optimum temperature between 350 and 400 °C and six compositions (1, 2, 5, 6, 7, and 8 in Table 1) for low-temperature shift (LTS) reactions with optimum temperatures between 150 and 300 °C obtained using a Gas Phase Dynamic Flow Reactor Study.

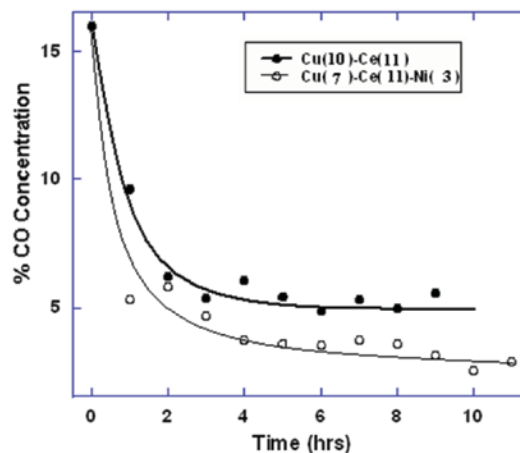

Figure 1: Catalytic Conversion of CO to CO₂

Technology Maturity:

Laboratory-scale

Project Focus:

Catalysts for Use in Membrane Reactors

Participant:

Grambling State University

Project Number:

NT43064

NETL Project Manager:

Daniel Driscoll

Daniel.Driscoll@netl.doe.gov

Principal Investigator:

Seetala V. Naidu

Grambling State University

naidusv@gram.edu

Partners:

Louisiana Tech University

Performance Period:

12/20/06 – 1/1/10

Table 1: Compositions of Metal Catalysts Under Investigation for Promoting WGS Reaction

Catalyst Composition											
Cu (%)	Ni (%)	Ce (%)	% Metal	Ni(NO ₃) ₂ •6H ₂ O (g)	Wt. (g)	Wt. CuO (g)	Wt. Cu (g)	Wt. CeO ₂ (g)	Wt. Ce (g)	Wt. Fe ₂ O ₃ (g)	Wt Fe (g)
10		11	20.96	0.00	0.00	0.46	0.37	0.52	0.42	0.00	0.00
7	3	11	20.70	0.54	0.11	0.33	0.26	0.48	0.39	0.00	0.00
5	5	11	21.31	0.93	0.19	0.24	0.19	0.49	0.40	0.00	0.00
3	7	11	21.29	1.31	0.26	0.14	0.11	0.48	0.39	0.00	0.00
	10	11	21.32	1.86	0.38	0.00	0.00	0.46	0.38	0.00	0.00
	10	9	19.15	1.80	0.36	0.00	0.00	0.37	0.30	0.00	0.00
	10	6	16.09	1.75	0.35	0.00	0.00	0.24	0.19	0.00	0.00
	10	3	13.04	1.69	0.34	0.00	0.00	0.11	0.09	0.00	0.00
	10		10.00	1.64	0.33	0.00	0.00	0.00	0.00	0.00	0.00
7	9	13	28.39	1.93	0.39	0.35	0.28	0.54	0.45	0.00	0.00
		Fe(10%) Ce(11%)	21.05	0.00	0.00	0.00	0.00	0.51	0.41	0.54	0.38

The optimum reaction temperatures obtained from gas-phase flow reactor, and the CO conversion and CO₂ production obtained from a gas-phase batch reactor at optimum temperatures for Ni-Cu-Ce/alumina LTS and HTS catalysts, are summarized in Table 2.

Table 2: Optimum Reaction Temperature, CO Conversion, and CO₂ Production after 13 Hours of Reaction for LTS and HTS Ni-Cu-Ce/Alumina Catalysts

Catalyst	Optimum Temp. (°C)	CO conversion (% moles)	CO ₂ production (% moles)
Low Temperature Shift (LTS) catalysts			
Ni(10%)Ce(3%)	300	92.72	29.09
Ni(10%)Ce(9%)	250	77.2	61.81
Ni(10%)Ce(11%)	250	73.63	71.81
Ni(10%)Ce(6%)	300	72.72	43.63
Cu(10%)Ce(11%)	200	48.18	62.72
Ni(3%)Cu(7%)Ce(11%)	200	47.09	17.27
High Temperature Shift (HTS) catalysts			
Ni(10%)	400	98.18	17.2
Ni(5%)Cu(5%)Ce(11%)	350	80.09	100.0
Ni(7%)Cu(3%)Ce(11%)	350	59.09	90.9
Fe(10%)Ce(11%)	350	7.27	17.2

After the WGS reaction takes place, the H₂ will be separated from the CO₂ using an outer shell ceramic membrane of Ta/Nb metal that will be used to separate H₂ from the rest of the constituents. A membrane consisting of cellulose acetate (CA) with 75% triethyl citrate plasticizer is used to separate the CO₂. The CA will be located between two mesoporous ceramic disks. Figure 2 shows a blank ceramic disk on the left (a) and the ceramic disk on the right (b) sputter coated with Nb. The metal film coating the disk is approximately 400 nanometers thick and the coatings will be applied through sputtering (physical) techniques or aluminothermic (chemical) methods. The parameters for Ta/Nb membranes are given in Table 3 and those for CA membranes are given in Table 4.

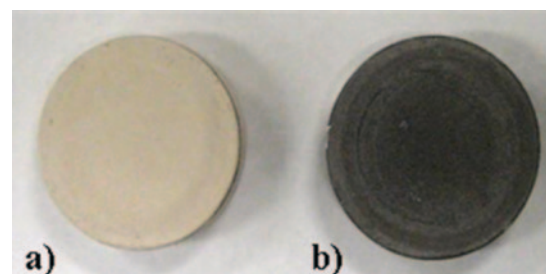

Figure 2: Uncoated and Coated Ceramic Disks

Table 3: Grambling Parameters for Ta/Nb Membranes

	Parameter	Current R&D Value	Target R&D Value
Membrane Properties	Materials of fabrication for selective layer	Ta/Nb 400 μm thin films	Ta/Nb 400 μm thin films
	Materials of fabrication for support layer (if applicable)	Ceramic or asbestos	Ceramic or asbestos
	Selectivity of key gas components: H ₂ /CO ₂ for pre-combustion technology	70%	90%
	Type of selectivity measurement (ideal or mixed gas)	Permeability (indirect)	Permeability (direct)
	Pressure normalized flux (permeance for linear materials) for more selective gas component, GPU or equivalent units	N/A	N/A
	Temperature, °C	350 °C	400 °C
	Pilot-scale testing (if applicable), hours without significant performance degradation	1 week	1 month.
	Maximum pressure differential achieved without significant performance degradation or failure, bar	5 bar	15 bar
Module Properties	Module configuration: hollow-fiber, spiral-wound sheet, shell-and-tube, plate-and-frame, other	Film	Film
	Packing density, m ² /m ³	N/A	N/A
	Pressure drop, bar	<1 bar	<1 bar
	Estimated cost of manufacturing and installation, \$/m ² -GPU or equivalent	~\$10,000	\$4,000
Product Quality	CO ₂ purity, %	N/A	N/A
	H ₂ purity, %	70% indirect	90% direct

Table 4: Grambling Parameters CA Membrane

	Parameter	Current R&D Value	Target R&D Value
Membrane Properties	Materials of fabrication for selective layer	500 nm	500 nm
	Materials of fabrication for support layer (if applicable)	Cellulose/filter paper	Cellulose/filter paper
	Selectivity of key gas components: H ₂ /CO ₂ for pre-combustion technology	60%	90%
	Type of selectivity measurement (ideal or mixed gas)	Permeability	Permeability
	Pressure normalized flux (permeance for linear materials) for more selective gas component, GPU or equivalent units	N/A	N/A
	Temperature, °C	25 °C	25 °C
	Pilot-scale testing (if applicable), hours without significant performance degradation	4 days	1 month.
	Maximum pressure differential achieved without significant performance degradation or failure, bar	x bar	x bar
Module Properties	Module configuration: hollow-fiber, spiral-wound sheet, shell-and-tube, plate-and-frame, other	Film	Film
	Packing density, m ² /m ³	N/A	N/A
	Pressure drop, bar	<1 bar	<1 bar
	Estimated cost of manufacturing and installation, \$/m ² -GPU or equivalent	~\$500	<\$500
Product Quality	CO ₂ purity, %	60%	90%
	H ₂ purity, %	N/A	N/A

Technology Advantages

Ceramic/asbestos membranes incorporating low-cost metals (Ta/Nb) could lower H₂ production costs.

R&D Challenges

- Lower Ta/Nb H₂ separation efficiencies.
- The WGS reaction time is longer than desired.

Results To Date/Accomplishments

- Prepared the bimetallic Ni/Cu nanoparticles/sol-gel supported Ce promoted catalysts.
- Fabricated Ta/Nb-ceramic and asbestos membranes and studied for H₂ separation.
- Fabricated cellulose acetate-ceramic membranes and studied CO₂ separation.
- Ni(10%)Ce(11%) catalyst was found to be the best WGS catalyst among the LTS catalysts, while Ni(5%)Cu(5%)Ce(11%) was found to be the best among HTS catalysts.

Next Steps

- Design a WGS reactor and complete the catalytic studies.
- Integrate system evaluation using the prototype WGS reactor with H₂/CO₂ separation membranes.

Available Reports/Technical Papers/Presentations

“Water gas shift reaction nano-catalysts for hydrogen production; and metal/ceramic and polymer membranes for H₂/CO/CO₂ gas separation,” N. Seetala, U. Siriwardane, and T. Kudale, Invited talk at the International Conference on Green Chemistry and Sustainable Environment, 7–8, July 2010, Tiruchirappalli, India. To be published in the Proceedings.

“Nanoparticle metal oxide (MgO, CaO, and ZnO) heterogeneous catalysts for biodiesel production,” N. Seetala, U. Siriwardane, R. Forester, and R. Talathi, International Conference on Green Chemistry and Sustainable Environment, 7–8, July 2010, Tiruchirappalli, India.

“Positron lifetime/free volume and gas diffusion studies of cellulose acetate membranes with triethyl citrate as plasticizer for drug delivery systems,” N. Seetala, R. Bhandaria, T. Kudale, and U. Siriwardane, International Conference - Bangalore India Bio 2010, June 2–4, 2010.

“Nb/Ta Thin Film Coated Micro-Porous Alumina Membranes for Hydrogen Separation from WGS Reaction Products,” N. Seetala, U. Siriwardane, R. Jayasingha, and J. Bass, World Journal of Engineering, Vol. 7 (No. 3), pp. 62–66, 2010.

“Development of Metal (Ta, Nb)/Ceramic and Cellulose Acetate Membranes for Cu-Ni-Ce/Alumina WGS Catalytic Reactor,” N. Seetala, U. Siriwardane, T. Kudal, R. Foreste, and A. Pokhare, ACS Fuel Chemistry Division Preprints 2010.

“Fabrication of cellulose acetate membranes (CA) and their CO/CO₂/H₂ permeabilities”, T. V. Kudale, N. V. Seetala, and U. Siriwardane, LAS Meeting, Alexandria, Feb. 2010.

“Preparation and characterization of nanoparticle metal oxide (MgO, CaO, and ZnO) heterogeneous catalysts for biodiesel production,” R. Forester, S. Brown, U. Siriwardane and N. V. Seetala, LAS Meeting, Alexandria, Feb. 2010.

“Development of Low Cost Membranes for H₂/CO₂ Separation for WGS Reactors,” University Coal Research/Contractors Review Conference, Morgan Town, June 2009.

“Sol-gel Synthesis, Characterization and Activities of Alumina Supported Nanoparticle CuO-NiO-CeO₂ Catalysts for Water-Gas-Shift (WGS) Reaction,” N. Seetala, U. Siriwardane, R. Garudadri, and J. Bass, Invited Talk presented at the International Conference on Nano-Composites Engineering (ICCE-17), Honolulu, HI, July 26-Aug. 1, 2009; World Journal of Engineering, Vol. 6, Supplement 2009, pp. 903–906.

“Bimetallic Nanocatalysts for Water-Gas-Shift Reaction,” Naidu V. Seetala, Invited talk at the Inorganic Chemistry Seminar, LSU-Baton Rouge, LA, Feb. 10, 2009.

“Sol-gel Prepared Cu-Ce-Ni Nanoparticle Alumina Catalysts for WGS Hydrogen Production,” N. V. Seetala, J. Bass, A. M. R. Jayasingha, R. Garudadri, and U. Siriwardane, Microscopy and Microanalysis, Vol. 14, Suppl. 2, (2008) 308.

“Microreactors for Syngas Conversion to Higher Alkanes: Effect of Ruthenium on Silica-Supported Iron-Cobalt Nanocatalysts,” S. Zhao, V. S. Nagineni, N. V. Seetala, and D. Kuila, Ind. Eng. Chem. Res., 47 (2008) 1684.

“Development of Low Cost Membranes for H₂/CO₂ Separation for WGS Reactors,” University Coal Research/Contractors Review Conference, Pittsburgh June 10–11, 2008.

“Sol-gel synthesis and characterization of alumina supported Cu-Ni-Ce catalysts for water-gas-shift (WGS) reaction,” R. S. Garudadri, R. A.M. Jayasingha, N. V. Seethala and U. Siriwardane, 235th ACS National Meeting, New Orleans, LA, April 6–10, 2008.

“Preparation and characterization of alumina porous membranes coated with Nb/Ta thin films for the separation of H₂/CO₂/CO,” R. A. M. Jayasingha, R. S. Garudadri, N. V. Seethala and U. Siriwardane, 235th ACS National Meeting, New Orleans, LA, April 6–10, 2008.

“Microreactors for Syngas Conversion to Higher Alkanes: Effect of Ruthenium on Silica-Supported Iron-Cobalt Nanocatalysts,” Ind. Eng. Chem. Res., 47 (2008) 1684.

“Preparation and characterization of sol-gel alumina supported bimetallic nanocatalysts for WGS reaction,” J. Bass, N.V. Seetala, A.M.R. Jayasingha, R.K. Garudadri, and U. Siriwardane, Louisiana Academy of Sciences Meeting, Northwestern State University, Natchitoches, LA, March 14, 2008.

“Development of Low Cost Membranes for H₂/CO₂ Separation for WGS Reactors,” University Coal Research/HBCU-MI Contractors Review Conference, Pittsburgh June 5–7, 2007.

HIGH FLUX METALLIC MEMBRANES FOR HYDROGEN RECOVERY AND MEMBRANE REACTORS

Primary Project Goals

REB Research and Consulting is developing a carbon dioxide (CO₂)/hydrogen (H₂) separation membrane that utilizes a base metal in place of more expensive palladium (Pd).

Technical Goals

- Fabricate metallic alloys for coupon testing to determine permeation and inter-diffusion properties along with material embrittlement.
- Conduct more thorough evaluation of the most promising membranes in harsher conditions, and evaluate drawability, cladability, and brazability.
- Fabricate an H₂ purifier and membrane reactor units, and perform H₂ permeation, shock resistance, and longevity tests on modules under simulated operating conditions.

Technical Content

The project is investigating a more economic metal to replace Pd for use in an H₂ membrane. The current focus is on B2 alloys. These are similar to the B1 alloys (also known as BCC) metals of the 4B and 5B element region (columns) on the periodic table—metals like vanadium (V), niobium (Nb), and tantalum (Ta) that are reasonably good at H₂ purification. These metals have a high H₂ sorption, high H₂ diffusivity, and are flexible enough for membrane fabrication; however, even when alloyed with a moderator, they tend to embrittle. Further, in the B1 form, stress creep and Pd-substrate interdiffusion are a problem. B2 (CP2) metals have similar structure and properties to the B1 metals, but should be much more resistant to creep and interdiffusion. Several membranes of the B2 structure have been developed and tested, and so far as predicted, they have passed H₂ and have been durable. Figure 1 depicts the membrane structure. The B2 intermetallic alloy substrate is coated with a thin layer of Pd alloy for catalytic activity and oxidation protection. These improved membranes so far have been hard to fabricate as tubes.

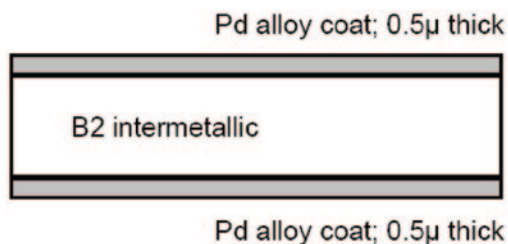

Figure 1: Typical B2 Alloy Coated with Pd-Alloy



Figure 2: Hydrogen Permeation Disk

Figure 2 displays the disc configuration that has been developed for use with B2 membrane materials and Figure 3 displays how the B2 alloy discs (H₂ permeation discs) will be assembled into a purifier or membrane reactor.

Technology Maturity:
Pilot-scale, 8 tonnes CO₂/day

Project Focus:
High-Flux Metallic Membranes and Reactors

Participant:
REB Research and Consulting

Project Number:
NT42400

NETL Project Manager:
Richard Dunst
Richard.Dunst@netl.doe.gov

Principal Investigator:
Robert Buxbaum
REB Research and Consulting
buxbaum@rebresearch.com

Partners:
G&S Titanium Co.
Iowa State University, Ames Laboratory
Los Alamos National Laboratory
Western Research Institute

Performance Period:
10/1/05 – 3/31/09

A version of this reactor/separator has been tested using a coal gasifier slipstream at the Western Research Institute at Laramie, WY. A device with one catalytic doughnut and two membrane discs produced 2.28 standard cubic feet per hour (scfh) of pure H₂ from a 90 pound per square inch (psi) slip-stream at 400 °C. The total membrane surface area was 0.947 ft² and the coal gas had a dry composition of 37% H₂, 27% carbon monoxide (CO), 30% CO₂, 3% methane (CH₄), and 100 parts per million (ppm) hydrogen sulfide (H₂S) (2.41 scfh/ft²). There was excess steam in the gas. Calculations suggest that a scaled up version of this purifier should allow economical H₂ from coal-gas, where the H₂ permeates through the metal and leaves behind a high-pressure CO₂-rich stream. The high-pressure, CO₂-rich gas stream is sequestration ready.

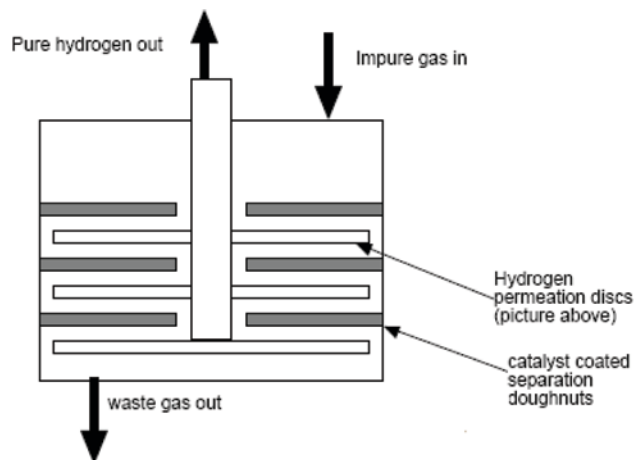

Figure 3: Membrane Reactor Design

Table 1: REB Research Membrane Parameters

	Parameter	Current R&D Value	Target R&D Value
Membrane Properties	Materials of fabrication for selective layer	B2 alloys	B2 alloys
	Materials of fabrication for support layer (if applicable)	N/A	N/A
	Selectivity of key gas components: H ₂ /CO ₂ for pre-combustion technology	100%	100%
	Type of selectivity measurement (ideal or mixed gas)	Helium leak	Helium leak, CO/CO ₂ in H ₂ stream for larger units
	Pressure normalized flux (permeance for linear materials) for more selective gas component, GPU or equivalent units	0.2 mol /m ² s (51 scfh/ft ²) at ΔP = 44 psi	Same, but for gas mixtures
	Temperature, °C	350–400 °C	350–400 °C
	Bench-scale testing, hours without significant performance degradation	1,500	1,500
	Pilot-scale testing (if applicable), hours without significant performance degradation	75	200
	Maximum pressure differential achieved without significant performance degradation or failure, bar	6 bar	20 bar
Module Properties	Module configuration: hollow-fiber, spiral-wound sheet, shell-and-tube, plate-and-frame, other	Disc and doughnut	Disc and doughnut
	Packing density, m ² /m ³	135 m ² /m ³	135 m ² /m ³
	Pressure drop, bar	N/A	<1bar
	Estimated cost of manufacturing and installation, \$/m ² -GPU or equivalent	\$1,200/m ²	\$1,200/m ²
Product Quality	CO ₂ purity, %	80%	80%
	H ₂ purity, %	>99%	>99%

Membranes, when copper (Cu)-Pd coated, resisted poisoning from 50 hours with 100 ppm H₂S; better resistance is expected with gold (Au)-Pd coated membranes. Dust from the coal-gas built up at the seals; scaled up operation will require dust filtering. Waste gas was a high-pressure, CO₂-rich stream suitable for sequestration (or perhaps, for sale).

Technology Advantages

- B2 alloys should extend the life of the separator, effectively making it cost-competitive.
- Membranes have similar selectivity and flux to Pd.
- Projected life of the material to be 15+ years.
- Low embrittlement.
- Base metal costs \$1,080/m² (\$100/ft²), while Pd costs \$32,300/m² (\$3,000/ft²).

R&D Challenges

There can be difficulty in fabricating membranes to the shapes and tolerances needed. More potential problems can arise, fabricating durable purifiers and membrane reactors with the new alloys (seals). Some alloys are much cheaper than Pd, but exhibit higher embrittlement.

Results To Date/Accomplishments

- Demonstrated suitable lifespan and flux in accelerated tests at target costs.
- Demonstrated acceptable brazing behavior.
- Lowered the cost/flux of H₂ permeation membranes, thus lowering the cost of H₂.
- Identified several new B2 alloys with potential use in other applications, such as nuclear reactor fabrication.

Next Steps

- Fabricate and test B2 metal-metal matrix membranes in hopes that these membranes will work as well but will be easier to fabricate.
- Conduct disc membrane reactor tests with coal-gas for the new alloy membranes at a higher pressure with revised seals and flow path.

Available Reports/Technical Papers/Presentations

S. N. Paglieri (AET-3), Y. Wang (MST-8), T. J. Venhaus (AET-3), H. Oona (AET-3), R. E. Buxbaum, K. S. Rothenberger, B. H. Howard, R. P. Killmeyer, "Characterization of V-6Ni-5Co Membranes for Hydrogen Separation." International Symposium on Metal-Hydrogen Systems (MH-2006) held October 1–6, 2006, in Maui, HI.

Low-cost Coal to Hydrogen for Electricity with CO₂ Sequestration, Dr. Robert E. Buxbaum, MI Catalysis Soc. Talk, April 2009.

Development of membranes for hydrogen separation: Pd coated V-10Pd, Paglieri, S.N.; Wermer, J.R.; Buxbaum, R.E.; Ciocco, M.V.; Howard, B.H.; Morreale, B.D., Volume 3, Number 3, September 2008, pp. 169–176(8).

Development of Group V Based Metal Membranes for Hydrogen Separation, **Stephen N. Paglieri**, Micheal V. Ciocco, Robert E. Buxbaum, Bryan D. Morreale. AIChE meeting, November 20, 2008, Paper 701f.

DEVELOPMENT OF PALLADIUM-SILVER COMPOSITE MEMBRANE FOR SEPARATION OF HYDROGEN AT ELEVATED TEMPERATURE

Primary Project Goals

North Carolina A&T State University is developing hydrogen (H_2)-selective, palladium (Pd)-silver (Ag) composite membranes in microporous substrates for use in the production and separation of H_2 and carbon dioxide (CO_2) at elevated temperature.

Technical Goals

- Fabricate thin film, Pd-Ag alloy composite membranes.
- Evaluate the long-term integrity and stability of the fabricated membranes under thermal cycling.
- Optimize the electroless plating process for co-deposition of Pd-Ag in microporous stainless steel (MPSS) substrate.
- Conduct H_2 permeation studies for disc membranes.
- Fabricate a tubular diffusion cell reactor.
- Conduct H_2 permeation studies for tubular membranes.
- Conduct methanol steam-reforming experiments.

Technical Content

A reactor-separator is a device that utilizes a catalyst and a membrane. Incorporating a membrane in the reactor permits the removal of H_2 from the reaction zone, which increases the efficiency by allowing a greater conversion rate. Additionally, the removal of H_2 produces a waste stream with high concentrations of CO_2 for subsequent filtration and containment.

North Carolina A&T State University has been developing a Pd-Ag alloy thin film composite membrane capable of withstanding high temperatures for use in a reactor-separator; specifically, the reforming of liquid hydrocarbons and methanol by equilibrium shift to produce H_2 for subsequent use as fuel.

Figure 1 is a diagram of a reactor-separator used to convert methanol to H_2 . The methanol was fed into the reactor with steam to prevent catalyst degradation and promote additional H_2 production via a water gas shift (WGS) reaction.

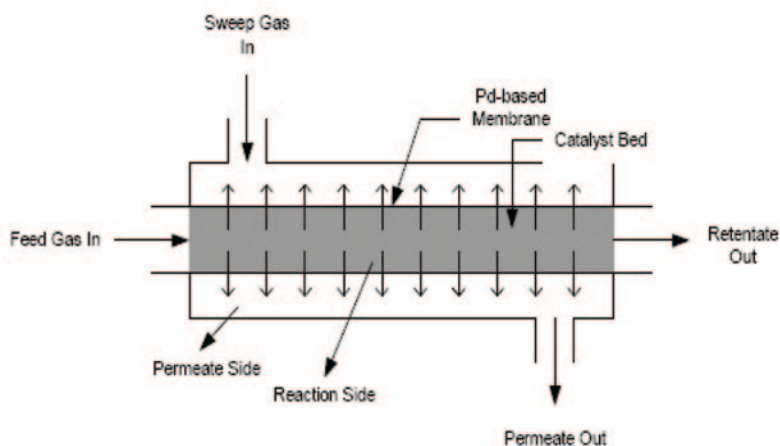

Figure 1: Schematic of Reactor Separator

Technology Maturity:

Laboratory-scale

Project Focus:

Palladium/Silver Composite Membranes

Participant:

North Carolina A&T State University

Project Number:

NT42492

NETL Project Manager:

Arun Bose
Arun.Bose@netl.doe.gov

Principal Investigator:

Shamsuddin Ilias
 North Carolina A&T State University
ilias@garfield.ncat.edu

Partners:

None

Performance Period:

9/1/05 – 2/28/09

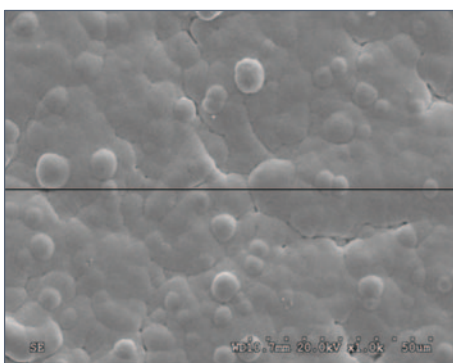

Figure 2: Image of Membrane

Technology Advantages

Inorganic membrane reactors:

- Have significantly higher H₂ flux [1.791×10^{-6} mol/(m²•s•Pa^{0.56})] with high selectivity (~75%) compared to other commercially available membranes.
- Are capable of operating at high temperatures, which allows for the combining of the reaction and separation into a single step.
 - Eliminates the need for additional equipment, which reduces capital costs and lowers energy requirements.
 - Allows for the immediate removal of H₂, which shifts the equilibrium in favor of the desired conversion and consequently increases efficiency.

R&D Challenges

- Developing an H₂ selective thin solid film that is thermally, chemically, and mechanically stable at high temperatures.
- Designing and fabricating effective seals at high temperature and high pressure.

Results To Date/Accomplishments

- Installed an electroless plating bath with digital continuous monitoring of temperature.
- Fabricated Pd membranes.
- Conducted permeability measurements of H₂ through Pd membranes.
- Developed a 2-D steady state membrane reactor-separator model to describe the reactive reforming process with effective radial concentration gradients due to H₂ permeation across the membrane cylindrical surface.
- Simultaneous production and separation of H₂ in a Pd-MPSS membrane reactor has been demonstrated using steam methanol reforming (SMR) reactions as an example.

Next Steps

This project is complete.

Available Reports/Technical Papers/Presentations

“Development of Pd-Ag Composite Membrane for Separation of Hydrogen at Elevated Temperature.”
<http://www.netl.doe.gov/publications/proceedings/06/ucr/abstracts/ILIAS.pdf> (Accessed 06/04/2009).

Ilias, Shamsuddin. “Development of Pd-Ag Composite Membrane for Separation of Hydrogen at Elevated Temperatures.”
http://www.netl.doe.gov/publications/proceedings/08/ucr/abstracts/ILIAS2_Abstract.pdf (Accessed June 4, 2009).

SCALE-UP OF HYDROGEN TRANSPORT MEMBRANES FOR IGCC AND FUTURE GEN PLANTS

Primary Project Goals

Eltron is developing an advanced membrane technology for separating and purifying hydrogen (H_2) from carbon dioxide (CO_2).

Technical Goals

Develop and H_2/CO_2 separation system that:

- Delivers pure H_2 for use in fuel cells, gas turbines, or hydrocarbon processing.
- Retains CO_2 at coal gasifier pressures.
- Operates near water gas shift (WGS) conditions.
- Tolerates coal-derived impurities (e.g., sulfur).

Technical Content

Hydrogen separation membranes are being developed that will be compatible with high-temperature WGS reactors employed in coal gasification-based H_2 production and combined-cycle power plants. The membranes will operate in the range of approximately 320–440 °C. A typical feed gas composition is 41 mol% H_2 , 37% steam (H_2O), 17.8% CO_2 , and 3.3% carbon monoxide (CO), and will also contain residual impurities from coal gasification that have not been removed upstream of the WGS reactors. The membranes function at pressures set by coal gasifier operations of 30 atm [450 pounds per square inch (psi)] to 70 atm (1,000 psi).

The membranes under investigation will use a dense metal or metal alloy. Metallic membranes have been developed that exhibit high mechanical strength, little distortion in the presence of high temperatures and pressures, and resistance to fracture. The membrane unit may be operated solely as an H_2/CO_2 separation device, or be integrated within the WGS reactor and perform the dual function of separation and conversion of CO and H_2O to additional H_2 and CO_2 using surface exchange catalysis.

Figure 1 illustrates Eltron's H_2 membrane. Hydrogen is separated by a multilayer dense membrane, leaving a CO_2 -rich stream at high pressure ready for geological storage. The membrane can be operated without a sweep gas for pure H_2 production, or with a nitrogen sweep gas for H_2 turbine power production.

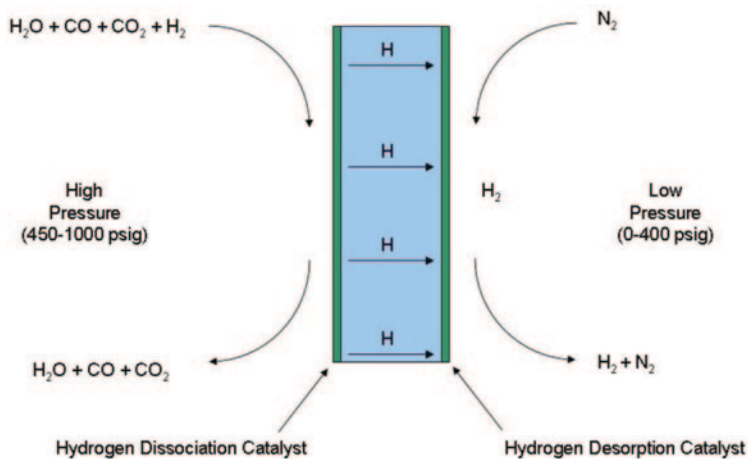

Figure 1: Eltron Hydrogen Membrane

Technology Maturity:
Pilot-scale, 100 kg/day H_2 production

Project Focus:
Hydrogen Transport Membranes

Participant:
Eltron Research, Inc.

Project Number:
NT42469

NETL Project Manager:
Arun Bose
Arun.Bose@netl.doe.gov

Principal Investigator:
Carl Evenson
Eltron Research, Inc.
cevenson@eltronresearch.com

Partners:
Eastman Chemical Co

Performance Period:
8/16/05 – 9/30/08

Table 1: Eltron Membrane Parameters

	Parameter	Current R&D Value	Target R&D Value
Membrane Properties	Materials of fabrication for selective layer	Metal alloy	Metal alloy
	Materials of fabrication for support layer (if applicable)	N/A	N/A
	Selectivity of key gas components: H ₂ /CO ₂ for pre-combustion technology	100% selective	100% selective
	Type of selectivity measurement (ideal or mixed gas)	Mixed gas	Mixed gas
	Pressure normalized flux (permeance for linear materials) for more selective gas component, GPU or equivalent units	4×10^{-4} mol/m ² /s/Pa ^{1/2}	8×10^{-4} mol/m ² /s/Pa ^{1/2}
	Temperature, °C	320–440 °C	320–440 °C
	Bench-scale testing, hours without significant performance degradation	1,000	3,000
	Pilot-scale testing (if applicable), hours without significant performance degradation	N/A	N/A
	Maximum pressure differential achieved without significant performance degradation or failure, bar	69 bar	69 bar
Module Properties	Module configuration: hollow-fiber, spiral-wound sheet, shell-and-tube, plate-and-frame, other	Shell-and-tube	Shell-and-tube
	Packing density, m ² /m ³	85.2	85.2
	Pressure drop, bar	0.06	0.06
	Estimated cost of manufacturing and installation, \$/m ² -GPU or equivalent	6,140	6,140
CO₂ Quality	CO ₂ purity, %	95.9	95.9
	N ₂ purity, %	3.2	3.2
	Other contaminants, %	0.9	0.9
H₂ Purity	H ₂ purity	99.99%	99.99%
	H ₂ delivery pressure (psig)	400	400
	H ₂ recovery	65%	95%

The membrane is expected to be contaminant resistant; it also produces H₂ product and CO₂ at high pressures for efficient carbon capture.

Technology Advantages

Dense metallic membranes have a high flux and produce essentially pure H₂. They can be operated at the desired application pressures and temperatures, producing a residual CO₂ stream at higher pressures than competing technologies and minimizing CO₂ compression requirements for sequestration.

R&D Challenges

Major challenges include low membrane tolerance of feed gas impurities, such as hydrogen sulfide (H₂S), and high costs for materials and fabrication of the membrane modules.

Results To Date/Accomplishments

- Improved composition and properties of the membrane leading to better understanding of fabrication and improved separation performance.
- Demonstrated more stable membrane performance at lower temperatures.
- Developed modeling tools to characterize and design membranes modules and systems.
- Improved membrane-based integrated gasification combined cycle (IGCC) flow sheets, achieving carbon capture greater than 95%, plant efficiencies greater than 6%, and a cost of electricity 10% lower than for conventional technology.

Next Steps

- Evaluate membrane materials from seven different manufacturers for: H₂ flux, lifetime stability, mechanical strength, scalability, and cost.
- Develop design basis for scale up to 100 kg H₂/day process development unit (PDU).
- Continue to work with commercial suppliers on developing techniques to manufacture full-size alloy membranes.
- Conduct durability tests.
- Conduct further experiments to understand and improve tolerance of contaminants.
- Continue techno-economic analyses relating to process optimization and scale up.

Available Reports/Technical Papers/Presentations

Advanced Power Systems Peer Review Presentation, July 2007.

Eltron Presentation, June 13, 2008.

Hydrogen Separation Using Dense Composite Membranes, In *Inorganic Membranes for Energy and Fuel Applications*; Arun Bose, Editor; Springer: New York, 2009; 125–172.

INTEGRATION OF A STRUCTURAL WATER GAS SHIFT CATALYST WITH A VANADIUM ALLOY HYDROGEN TRANSPORT DEVICE

Primary Project Goals

Western Research Institute (WRI) is developing and designing a membrane reactor for processing coal gasification-derived synthesis gas (syngas) that integrates water gas shift (WGS) and hydrogen (H_2) separation functions.

Technical Goals

- Develop a structural WGS catalyst capable of withstanding high-pressure differentials.
- Develop vanadium alloy H_2 separation membrane.
- Integrate the WGS catalyst and metallic membranes into a device and test under simulated gasifier conditions.
- Fabricate a modular WGS/membrane integrated device capable of producing 10,000 L H_2 /day from coal-derived syngas.

Technical Content

The membrane reactor under development promotes the reaction of carbon monoxide (CO) with water, by use of a WGS catalyst, to produce carbon dioxide (CO_2) and H_2 , and then separates the H_2 , by use of a metallic membrane. Hydrogen produced can be used for electricity generation. The concentrated stream of CO_2 produced can be further purified and sequestered.

Figure 1 shows a schematic of a possible configuration for the membrane reactor. In this configuration, there are alternating stages of membrane disks and catalyst doughnuts.

By integrating the WGS and the gas separation into one unit, the WGS conversion is increased due to the continuous removal of H_2 .

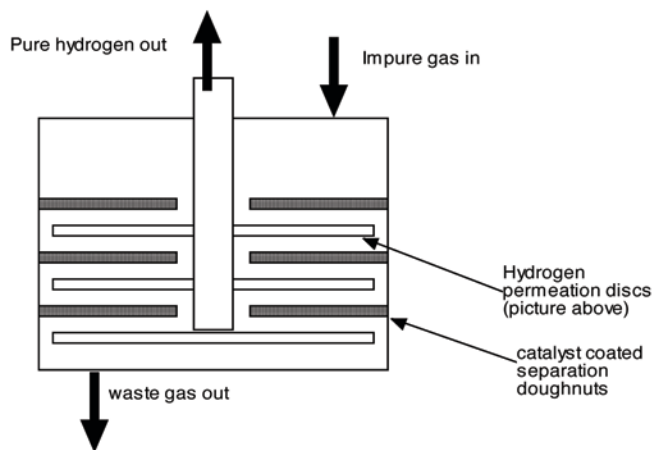

Figure 1: Schematic of Disk and Donut Integrated Device Design

Technology Maturity:

Prototype, 10,000 L H_2 /day

Project Focus:

Water Gas Shift Catalyst with Vanadium Alloy Membrane

Participant:

Western Research Institute

Project Number:

NT42454

NETL Project Manager:

Paula B. Flenory
Paula.Flenory@netl.doe.gov

Principal Investigator:

Tom Barton
 Western Research Institute
tbarton@uwyo.edu

Partners:

Chart Energy and Chemicals
 REB Research and Consulting
 University of Wyoming
 U.S. DOE Ames Laboratory

Performance Period:

7/1/05 – 12/30/08

Table 1: WRI Membrane Parameters

	Parameter	Current R&D Value	Target R&D Value
Membrane Properties	Materials of fabrication for selective layer	V-Pd	V-Pd
	Materials of fabrication for support layer (if applicable)	304 SS	304SS
	Selectivity of key gas components: H ₂ /CO ₂ for pre-combustion technology	100% H ₂	100% H ₂
	Type of selectivity measurement (ideal or mixed gas)	Mixed	Mixed
	Pressure normalized flux (permeance for linear materials) for more selective gas component, GPU or equivalent units	52 scfh/ft ²	52 scfh/ft ²
	Temperature, °C	400 °C	400 °C
	Bench-scale testing, hours without significant performance degradation	100	100
	Pilot-scale testing (if applicable), hours without significant performance degradation	40	40
	Maximum pressure differential achieved without significant performance degradation or failure, bar	200 psig	200 psig
Module Properties	Module configuration: hollow-fiber, spiral-wound sheet, shell-and-tube, plate-and-frame, other	Plate	Plate
	Packing density, m ² /m ³	10	10
	Pressure drop, bar	N/A	N/A
	Estimated cost of manufacturing and installation, \$/m ² -GPU or equivalent	\$2,100/m ²	\$2,100/m ²

The project is completed so current and target values are identical. The membrane reactor ran at baseline flux levels for 40 hours in a coal-derived syngas mixture with 125 parts per million (ppm) hydrogen sulfide (H₂S) and 30% CO. Other low-level contaminants were not quantified but were also not removed from the gas mixture.

Technology Advantages

Combining the WGS catalyst with H₂ separating membrane increases production of H₂ by removing it from the reaction zone and reduces capital cost of the plant by eliminating the need for additional gas separation.

R&D Challenges

Consistent production of vanadium 9 wt% palladium (Pd) alloy is difficult due to persistent cracking of the alloy during rolling.

Results To Date/Accomplishments

The focus of the chemistry of the WGS catalyst has been on iron (Fe), aluminum (Al), chromium (Cr), copper (Cu), and cerium (Ce) -based systems, including:

- Tested catalysts by impregnation into porous mullite substrates and cordierite monoliths.
- Determined highest activity and stability for 75Fe-15Al-8Cr-2Cu.
- Identified among the Fe-Cr-Cu-Ce-oxygen (O) catalysts, those with 4 wt% ceria are the most active and stable for WGS.
- Determined that producing high surface area monoliths of this catalyst series may be problematic due to sintering at higher operational temperatures.

- Obtained and tested multiple vanadium alloys for brazing performance with Cu.
- Developed guidelines based on the brazing tests and analysis of the literature to anticipate the performance of vanadium alloys with respect to H₂ transport and fabricability based on alloying elements.
- Determined elements that are potentially positive to both H₂ transport performance and brazing performance include Ce, Cu, Fe, manganese (Mn), molybdenum (Mo), nickel (Ni), and zinc (Zn).
- Identified alloying elements that can be sufficiently used to overcome their detrimental effect on brazing.
- Determined that brazing with vanadium and structural alloys, including mild steel, 304 stainless steel, and 9Cr 1Mo steel, were generally excellent.
- Produced an integrated WGS membrane device which produced 10,000 liters per day of H₂ under coal-derived syngas.

Next Steps

Project work was recently completed.

Available Reports/Technical Papers/Presentations

Barton Tom, Morris Argyle. "Integration of a Structural Water Gas Shift Catalyst with a Vanadium Alloy Hydrogen Transport Device." http://www.hydrogen.energy.gov/pdfs/review07/pd_18_barton.pdf (Accessed June 2009).

Barton Tom, Morris Argyle. "The Integration of a Structural Water Gas Shift Catalyst with a Vanadium Alloy Hydrogen Transport Device." http://www.hydrogen.energy.gov/pdfs/progress08/ii_g_4_barton.pdf (Accessed June 2009).

SULFUR-TOLERANT Pd/Cu AND Pd/Au ALLOY MEMBRANES FOR H₂ SEPARATION WITH HIGH-PRESSURE CO₂ FOR SEQUESTRATION

Primary Project Goals

Worcester Polytechnic Institute (WPI) is designing and developing sulfur-tolerant composite palladium (Pd)/copper (Cu) and Pd/gold (Au) alloy membranes on porous stainless steel substrates for separating hydrogen (H₂) from coal gases and producing high-pressure, sequestration-ready carbon dioxide (CO₂) streams.

Technical Goals

- Synthesize a sulfur-tolerant composite Pd/Cu and Pd/Au alloy porous stainless steel membrane with a thin intermediate oxide layer.
- Develop an understanding of the kinetics of Pd/Cu and Pd/Au alloy formations.
- Conduct permeation studies in order to characterize the membrane performance and its relation to the changes in nanostructure properties of the alloy.
- Test the membrane at lab scale using simulated coal gases to develop low-cost, high-flux, ultra-thin, sulfur-tolerant Pd/Cu and Pd/Au membranes for simultaneous H₂ separation from coal gases and production of sequestration-ready CO₂.

Technical Content

Coal gasification processes with shift reactions, such as integrated gasification combined cycle (IGCC), produce synthesis gas (syngas), a mixture of H₂ and CO₂. WPI is developing a Pd membrane to separate H₂ from syngas at practical rates to produce high-purity H₂ for later use as a combustible, while simultaneously leaving high-pressure, sequestration-ready CO₂ in the waste stream.

However, Pd alone is not sufficient for a membrane intended for use in coal-related processes due to the sulfur composition of coal. Hydrogen sulfide (H₂S), formed during the burning of coal, reacts with Pd to form palladium sulfide (Pd₄S), which drastically reduces the membranes permeability and creates small holes, reducing its selectivity. The plating of Pd with Cu or Au has been shown to reduce the reaction with H₂S, therefore increasing the membranes chemical stability.

Palladium/copper membranes were tested for H₂ permeability under 45–55 parts per million (ppm) H₂S. It was found that approximately 80% of the H₂ permeance was lost due to the formation of H₂S. However, exposing the membrane to a stream of pure H₂ recovered some of the H₂ permeance, showing that the reaction is partially reversible. Conversely, the amount of irreversible poisoning increased with the increasing time of H₂S exposure.

Palladium/gold membranes offered even greater permeance than that of Pd/Cu membranes. However, as with Pd/Cu membranes, they exhibited a sharp decline in H₂ permeance when exposed to H₂S. Unlike Pd/Cu membranes, the permeance was nearly fully recovered in pure H₂, indicating that the poisoning was reversible. Also, a longer H₂S exposure time did not increase the permeance decline, as it only slowed the permeance recovery rate.

Technology Maturity:

Laboratory-scale

Project Focus:

Sulfur-Tolerant Palladium Alloy Membranes

Participant:

Worcester Polytechnic Institute

Project Number:

NT42194

NETL Project Manager:

Arun Bose

Arun.Bose@netl.doe.gov

Principal Investigator:

Yi Hua Ma

Worcester Polytechnic Institute

yhma@wpi.edu

Partners:

None

Performance Period:

9/28/04 – 9/30/08

In both Pd/Cu and Pd/Au membranes, the permeation and chemical resistance to sulfur increased with increasing temperatures, and decreased with decreasing temperatures. Experiments were run at temperatures up to 600 °C, demonstrating the thermal stabilities of these membranes.

The damaging effects of H₂S on Pd membranes can be observed by comparing Figure 1 (no exposure) to Figure 2 (exposed to 54.8 ppm H₂S/H₂ gas mixture for 24 hours at 350 °C).

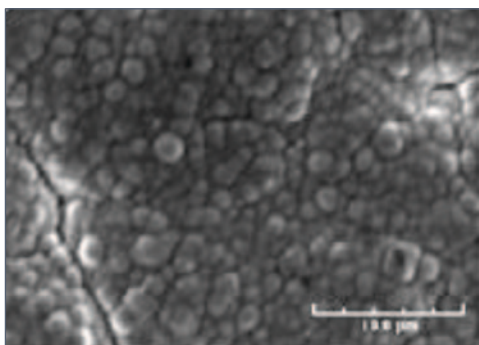

Figure 1: Micrograph of Pd as Deposited
(No Exposure to H₂S)

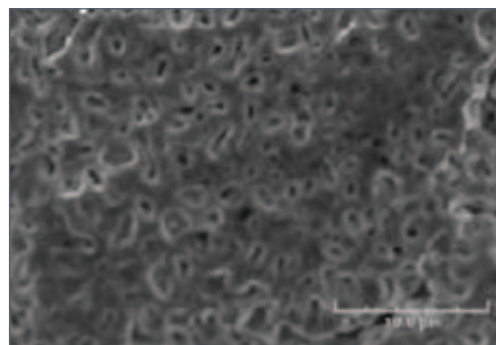

Figure 2: Micrograph of Pd Exposed to a 54.8 ppm
H₂S/H₂ Gas Mixture for 24 Hours at 350 °C

Technology Advantages

- Permeation lost to the formation of H₂S is recoverable by exposing the Pd/Cu or Pd/Au membrane to a stream of pure H₂.
- Selective properties of Pd/Cu and Pd/Au membranes are retained despite the formation of H₂S.
- Membranes with an oxide and additional Pd/Ag inter-metallic diffusion barrier display additional stability in H₂ permeance.
- Palladium/gold and Pd/Cu membranes show significant gains in chemical stability and sulfur resistance compared to Pd membranes.

R&D Challenges

- Palladium/gold membranes showed an almost instantaneous sharp decline of the H₂ permeance when exposed to H₂S.
- Palladium/copper membranes showed a permeance decline of approximately 80% when exposed to H₂S.
- With extended exposure to H₂S, the amount of Pd/Cu that was regenerable with pure H₂ decreased.

Results To Date/Accomplishments

- Synthesized Pd/Cu and Pd/Au alloy porous stainless steel membranes with a thin intermediate oxide layer.
- Conducted permeation studies and observed the membrane performance and its relation to the changes in nanostructure properties of the alloy.
- Conducted studies to determine the effects of H₂S on Pd/Cu and Pd/Au membranes.

Next Steps

This project is complete.

Available Reports/Technical Papers/Presentations

“Sulfur-Tolerant Pd/Cu and Pd/Au Alloy Membranes for Hydrogen Separation with High Pressure CO₂ for Sequestration.”
http://www.netl.doe.gov/publications/proceedings/07/ucr/Poster-Abstract/Ma_Poster_Abstract.pdf

“Effect of H₂S on the Performance and Long-Term Stability of Pd/Cu Membranes.”
<http://pubs.acs.org/doi/abs/10.1021/ie801947a>

B-148

PRE-COMBUSTION MEMBRANES

MIXED MATRIX MEMBRANES FOR CO₂ AND H₂ GAS SEPARATIONS USING METAL-ORGANIC FRAMEWORKS AND MESOPOROUS HYBRID SILICAS

Primary Project Goals

The University of Texas at Dallas is applying metal organic frameworks (MOFs) and mesoporous hybrid silicas in polymer-based mixed-matrix membranes (MMMs) for the separation of hydrogen (H₂) and carbon dioxide (CO₂).

Technical Goals

The technical goal of this project is to exploit the high surface areas, adsorption capacities, and selectivities of microporous additives for membrane-based separations.

Technical Content

Matrimid is a widely used polyimide (a polymer) that has both attractive thermal and gas transport properties. When combined with microporous organic-inorganic hybrid nanocrystals for the preparation of polymer-based MMMs, the time and steps required for membrane preparation is reduced compared to inorganic additives.

The following materials have been synthesized and combined with Matrimid to form MMMs: MOF-5, Copper(II) biphenyldiacetate triethylenediamine metal organic framework (Cu-MOF), metal organic polyhedral 18 (MOP-18), zeolitic imidazolate framework 8 (ZIF-8), zeolite socony mobil 5 (ZSM-5), carbon aerogel, carbon aerogel-zeolite composites, single-walled carbon nanotube (SWNT), Copper(II) bipyridine hexafluorosilicate metal organic framework (Cu-BPY-HFS), and periodic mesoporous organosilicas (PMOs). Experiments have also been conducted to determine the selectivity and permeability of microporous additives with Matrimid MMMs. MOF-5, Cu-MOF, MOP-18, and ZIF-8 were found to be stable up to 350 °C, 300 °C, 300 °C, and 400 °C, respectively. Carbon aerogels, carbon aerogel-zeolites, and PMOs showed similar mechanical resistance.

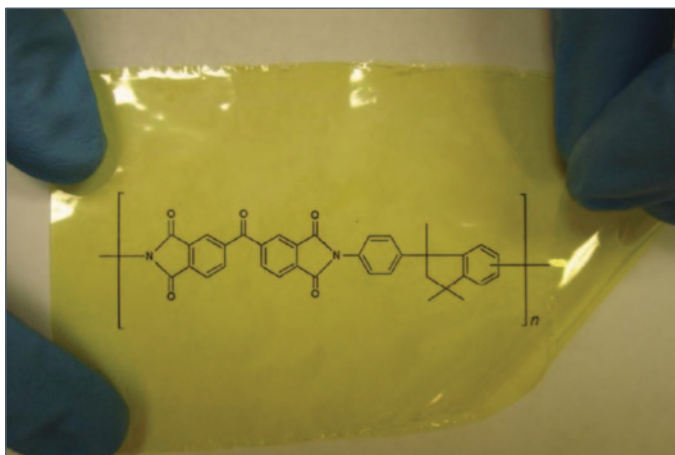

Figure 1: Flat Matrimid Membrane Cast From Chloroform

Technology Maturity:

Bench-scale

Project Focus:

Mixed Matrix Membranes for H₂/CO₂ Separations

Participant:

University of Texas at Dallas

Project Number:

NT42173

NETL Project Manager:

Edgar Klunder
Edgar.Klunder@netl.doe.gov

Principal Investigator:

Inga Holl Musselman
 University of Texas at Dallas
imusselm@utdallas.edu

Partners:

None

Performance Period:

8/26/04 – 8/31/08

Technology Advantages

- Addition of substances, such as MOF-5, Cu-MOF, MOP-18, ZIF-8, ZSM-5, carbon aerogel, carbon aerogel-zeolite, functional SWNT and SWNT-short, Cu-BPY-HFS, and PMOs, may provide benefits, such as increased selectivity, permeability, and increased mechanical and thermal stability.
- Incorporation of organic functionalities in frameworks improves dispersion in a polymer matrix.
- Inclusion of these substances reduces time and steps required for membrane preparation. Organic character of the crystals facilitates the dispersion and improves the interfacial contact with the polymer matrix.

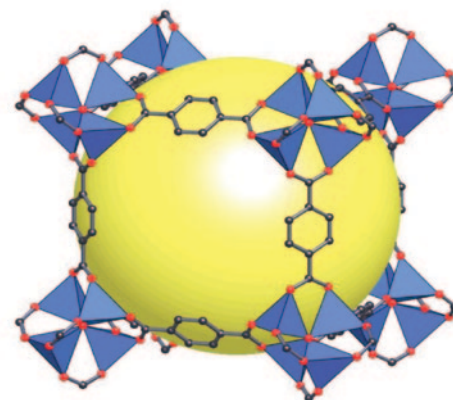

Figure 2: Model of MOF-5

R&D Challenges

- Obtaining selectivities high enough to achieve effective separation.
- Obtaining permeabilities high enough to achieve efficient separation.
- Developing membrane pores resistant to contamination.

Results To Date/Accomplishments

- Synthesized MOF-5, Cu-MOF, MOP-18, ZIF-8, ZSM-5, carbon aerogel, carbon aerogel-zeolite, functional SWNT and SWNT-short, Cu-BPY-HFS, and PMOs.
- Fabricated all synthesized materials with Matrimid MMMs.
- Completed permeability studies.

Next Steps

This project is complete.

Available Reports/Technical Papers/Presentations

Musselman, Inga H. et al., "Mixed-Matrix Membranes for CO₂ and H₂ Separations Using Metal-Organic Frameworks and Mesoporous Hybrid Silicas." http://www.netl.doe.gov/publications/proceedings/05/UCR_HBCU/pdf/papers/Musselman.pdf

MEMBRANES FOR USE IN PALLADIUM MEMBRANE REACTOR TECHNOLOGY FOR PRODUCTION OF HYDROGEN FROM COAL GAS

Primary Project Goals

Los Alamos National Laboratory (LANL) is designing and developing a composite palladium (Pd) membrane reactor (PMR) capable of extracting hydrogen (H_2) from fossil fuels, resulting in near capture-ready concentrations of carbon dioxide (CO_2) in the effluent stream.

Technical Goals

- Identify and develop sulfur-tolerant water gas shift (WGS) catalysts and membranes.
- Develop methods of fabricating PMRs with thin, active Pd-alloy surfaces on porous substrates.
- Determine the performance of the PMRs at elevated pressures.
- Determine the influence impurities impose on the functionality of PMRs.
- Develop Pd alloys resistant to effects of impurities.
- Determine optimal PMR operating pressure and temperature.

Technical Content

Current methods of extracting H_2 from hydrocarbons have low efficiency due to limitations imposed by reaction equilibrium. A PMR has been developed that combines the WGS reaction with H_2 separation. By doing so, the H_2 product of the reaction is removed from the reaction zone, driving the reaction towards completion and significantly increasing the efficiency of the process. Additionally, the extraction of H_2 leaves behind a near capture-ready concentration of CO_2 in the effluent stream.

The removal of H_2 from the reaction zone increases the reaction rate by freeing up active reaction sites on the catalyst. This results in reaction rates equal to conventional reforming technology at lower temperatures. For instance, conventional methane reforming is carried out at temperatures ranging from 800 to 1,000 °C, whereas equivalent results are obtained in a PMR at temperatures near 450 °C.

Additionally, the pressure required to carry out the reaction is reduced by the removal of H_2 from the reaction zone. It is estimated that approximately 60–80% of the feed hydrogen (in the form of water and fuel) will be recovered at an inlet pressure of 10 atm. At 20 atm, the anticipated recovery increases to 80–95%. However, while higher pressures are not required, the permeation rate decreases significantly with decreasing pressures. Therefore, operating at the optimal pressure is important.

Technology Maturity:

Bench-scale employing simulated syngas

Project Focus:

Palladium-Based Membrane Reactor

Participant:

Los Alamos National Laboratory

Project Number:

FWP-FE99002-4A24A

NETL Project Manager:

Richard Dunst
Richard.Dunst@netl.doe.gov

Principal Investigator:

Stephen Birdsell
 Las Alamos National Laboratory
Steve.Birdsell@lanl.gov

Partners:

Ames Laboratory

Performance Period:

10/1/05 – 6/22/07



Figure 1: Unheated, Broken Pd-Cu/-Alumina Composite Membrane

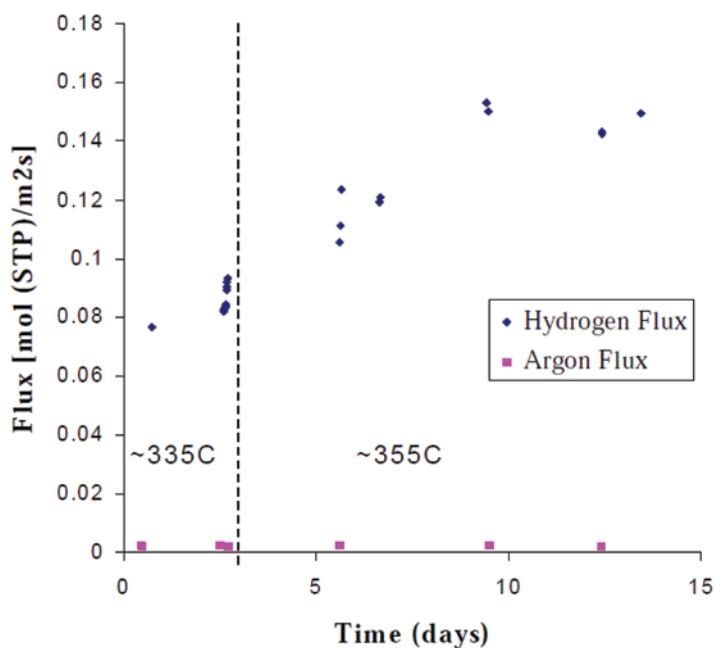

Figure 2: Flux Data for Pd-Cu/-Alumina Composite Membrane

Coal gas contains impurities, such as hydrogen sulfate (H_2S), which de-activate and degrade Pd membranes. It is expected that the level of degradation will be proportional to the concentration of H_2S present. However, much of the damage should be reversible and simple to alleviate by methods like exposure to steam or air. Also, by combining Pd with copper (Cu) or gold (Au), the amount of sulfur poisoning is reduced significantly.

In order to reduce the cost of membranes and increase the flux of H_2 through the membranes, ultra-thin (<10 microns), Pd-alloy films are applied to H_2 -permeable supports to form composite metal membranes. One such membrane has been developed—a vanadium (V) or tantalum (Ta) metal foil coated on both sides with Pd. This membrane has demonstrated fluxes more than 10 times greater than other Pd composite membranes.

Technology Advantages

In comparison to existing methods of H_2 extraction, PMRs have:

- Nearly 10 times greater flux.
- Reduced capital costs.
- Lower temperatures (450 °C), pressures (<20 atm), and amounts of excess water.
- Resistance to hydrogen embrittlement.
- Prolonged physical and chemical stability.

R&D Challenges

- Thick membranes have fluxes lower than desired that result in higher capital costs and greater space requirements.
- Impurities, such as H_2S , degrade the functionality of Pd consisting apparatus.

Results To Date/Accomplishments

- Characterized the performance of PMRs with respect to inlet conditions, temperature, geometry, and catalyst type.
- Developed mechanistic model of PMR incorporating information gathered through experimentation.
- Investigated WGS reaction, as well as the reforming of methane, methanol, ethanol, octane, and gasoline with the PMR.
- Fabricated membranes consisting of modified porous supports deposited with thin layers of composite Pd alloys.

Next Steps

This project has been completed.

Available Reports/Technical Papers/Presentations

S. N. Paglieri, D. R. Pesiri, R. C. Dye, and R. C. Snow. Palladium-Coated Vanadium Alloy Membranes for Hydrogen Separation. *Proceedings of the 19th Annual Conf. on Fossil Energy Mater.* Knoxville, TN; May 9–11, 2005.

S. N. Paglieri, I. E. Anderson, R. L. Terpstra, R. E. Buxbaum, M. V. Ciocco, and B. H. Howard. A Pd₆₀Cu₄₀/Porous Iron Aluminide Membrane for Hydrogen Separation. *Proceedings of the 21st Annual Conf. on Fossil Energy Mater.*, Knoxville, TN; Apr. 30-May 2, 2007.

S. N. Paglieri, I. E. Anderson, R. L. Terpstra, T. J. Venhaus, Y. Wang, R. E. Buxbaum, K. S. Rothenberger, and B. H. Howard. Metal Membranes for Hydrogen Separation. *Proceedings of the 20th Annual Conf. on Fossil Energy Mater.* Knoxville, TN, June 12–14, 2006.

S. N. Paglieri. "Palladium Membranes" in *Nonporous Inorganic Membranes*. Edited by A.F. Sammells and M. V. Mundschau, Miley-VCH, pp. 77–106 (2006).

S. N. Paglieri, Y. Wang, T. J. Venhaus, H. Oona, R. C. Snow, B. P. Nolen, R. E. Buxbaum, K. S. Rothenberger, B. H. Howard, and R. P. Killmeyer. Characterization of V-6Ni-5Co Membranes for Hydrogen Separation. *Proceedings of the 9th Int. Conf. on Inorganic Membranes*, Lillehammer, Norway, June 25–29, 2006.

DEVELOPMENT OF DENSE CERAMIC MEMBRANES FOR HYDROGEN SEPARATION

Technology Maturity:
Laboratory- and bench-scale

Primary Project Goals

Argonne National Laboratory is developing a dense ceramic or cermet (ceramic/metallic composite) membrane for separating hydrogen (H_2) from synthesis gas (syngas) generated during coal gasification, resulting in a high concentration carbon dioxide (CO_2) stream.

Project Focus:
Dense High-Temperature Ceramic Membranes

Participant:
Argonne National Laboratory

Project Number:
FWP-49601

NETL Project Manager:
Richard Dunst
Richard.Dunst@netl.doe.gov

Principal Investigator:
U. (Balu) Balachandran
Argonne National Laboratory
balu@anl.gov

Partners:
None

Performance Period:
3/31/98 – 9/30/13

Technical Goals

Develop a membrane that is:

- Chemically stable in the presence of steam, carbon monoxide (CO), CO_2 , methane (CH_4), hydrogen sulfide (H_2S), ammonia (NH_3), mercury (Hg), and halides.
- Mechanically stable under high pressures, high temperatures, and temperature cycles.
- Capable of providing industrially significant fluxes at desired levels of H_2 selectivity.

Technical Content

During coal gasification, large volumes of H_2 and CO_2 are produced. Dense ceramic and cermet membranes are being developed for use with coal gasification process to separate H_2 from CO_2 . These membranes must be capable of achieving a high flux and selectivity in order to reduce the surface area required to process the high volumes of gas produced. Reducing a membrane thickness can increase H_2 flux; however, to maintain selectivity, the membrane must remain defect free. Dense ceramic and cermet membranes are capable of providing reduced thickness while avoiding the formation of defects.

High density membranes are achieved by sintering the cermet at high temperatures. Sintering aids have been developed that prevent delamination of the cermet from the porous ceramic substrate. Figure 1 shows a cermet membrane with cobalt nitrate as the sintering aid on a TZ-3Y [zirconium dioxide (ZrO_2) partially stabilized with yttrium oxide (Y_2O_3)] substrate.

The chemical stability of the membranes is also important for their use in the corrosive syngas stream produced from coal gasification. Hydrogen sulfide is a particularly corrosive contaminant to membranes containing palladium (Pd). When H_2S reacts with Pd, palladium sulfide (Pd_4S) forms on the surface of the membrane, which greatly reduces H_2 permeation through the membrane. Therefore, it is important to identify the temperatures and pressures at which the membrane is stable. The Pd-containing cermets being developed are stable between about 430 and 680 °C (700 K and 950 K) in stable a gas containing 73% H_2 with between approximately 60 and 400 parts per million (ppm) H_2S . When the gas contains only 10% H_2 , the membrane is stable for H_2S concentrations between approximately 8 and 50 ppm.

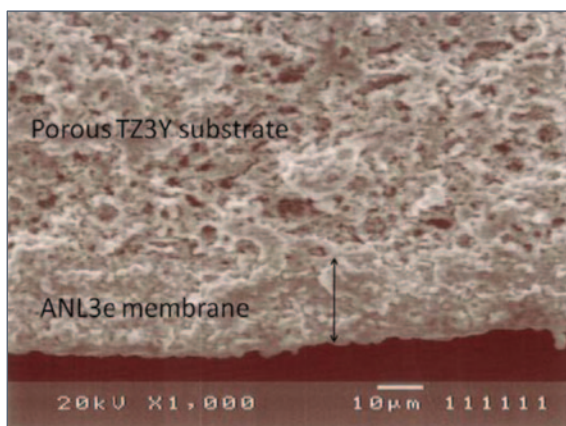

Figure 1: Cross-Sectional View of ANL-3e Thin Film Membrane Sintered at 1,160 °C on Porous TZ-3Y Substrate

Table 1: ANL Membrane Parameter

	Parameter	Current R&D Value	Target R&D Value
Membrane Properties	Materials of fabrication for selective layer	Pd/TZ-3Y cermet	Pd/TZ-3Y cermet and/or non-precious metal
	Materials of fabrication for support layer (if applicable)	Alumina/zirconia	Metal/alloy
	Selectivity of key gas components: H ₂ /CO ₂ for pre-combustion technology	150	10,000
	Type of selectivity measurement (ideal or mixed gas)	Mixed gas	Mixed gas
	Pressure normalized flux (permeance for linear materials) for more selective gas component, GPU or equivalent units	5.0 scc/min/cm ² at 400 °C with hydrogen feed pressure of 7.4×10^5 Pa (7.3 atm) and hydrogen sweep pressure of 3.0×10^3 Pa (0.03 atm)	75
	Temperature, °C	400–600	250–500
	Bench-scale testing, hours without significant performance degradation	1,200 hr	1,200 hr
	Pilot-scale testing (if applicable), hours without significant performance degradation	N/A	N/A
	Maximum pressure differential achieved without significant performance degradation or failure, bar	12.2	20.4
Module Properties	Module configuration: hollow-fiber, spiral-wound sheet, shell-and-tube, plate-and-frame, other	Disk/short tube (≈ 3 in)	Long tubes (≈ 12 in)
	Packing density, m ² /m ³	N/A	N/A
	Pressure drop, bar	N/A	N/A
	Estimated cost of manufacturing and installation, \$/m ² -GPU or equivalent	N/A	N/A
Product Quality	H ₂ purity, %	99.8	99.99

Other Membrane Parameters

Contaminant Resistance: The membrane is tolerant to H₂S between 430 and 680 °C in gas containing 73% H₂ and approximately 60–400 ppm H₂S.

The membrane is tolerant to ≈ 15 mol% CO and ≈ 20 mol% steam in the temperature range of 400–700 °C.

Technology Advantages

- Ceramic phase of the cermet membrane provides 3-D mechanical support that can blunt or deflect crack propagation through the metallic phase.
- Dense ceramic membranes operate at high pressures and temperatures.
- Dense ceramic membranes have no interconnected porosity; therefore, selectivity for H₂ is high.
- Dense ceramic membranes remove H₂ from H₂ and CO₂ mixtures, resulting in a concentrated stream of CO₂ that is near sequestration-ready.

R&D Challenges

- Reducing membrane thickness increases flux, but can lead to pin-holes in the membrane, which reduces H₂ selectivity. Therefore, reducing defects in thinner membrane is desired.
- Developing low-temperature sintering methods to avoid loss of Pd to evaporation during sintering at high temperatures.
- Determining stability restrictions in order to limit the reaction of Pd with H₂S, which forms Pd₄S and reduces H₂ flux.
- Understanding chemical stability in the presence of NH₃, Hg, and halides.
- Increasing the resistance to the effects of particulates impacting the membrane surface.
- Developing leak-proof metal/ceramic seals at high pressures under thermal cycling.
- Reducing the cost of the membrane by employing non-precious metals/alloys to form the cermet membrane.

Results To Date/Accomplishments

- Developed dense, cermet membranes that non-galvanically separate H₂ from mixed-gas streams.
- Achieved an H₂ flux of 52 cm³/min-cm² measured on an 18- μ m thick membrane composed of Pd and TZ-3Y using a feed of 1 atm H₂.
- Achieved H₂ permeation exceeding 150 cm³/min (0.32 scfh) measured in short, 8-cm long tubular membranes at 600 °C and ambient pressures.
- Demonstrated durability of membrane during cycling in temperature and H₂ concentration.
- Maintained flux stability for 1,200 hours in feed stream with 400 ppm H₂S at 900 °C.
- Achieved regeneration of sulfur-poisoned, cermet membrane.
- Long-term (\approx 4 months) flux measurements showed that cermet membranes are stable in NETL Test Protocol test 1 gas mixtures.

Next Steps

- Develop methods for eliminating pin-holes in thinner membranes for high purity and high selectivity for H₂.
- Fabricate and test tubular membranes at high flow rates and changing flow directions to overcome the external transport phenomena that are limiting the H₂ flux at the boundary layer.
- Continue testing of membranes as per test protocols established by NETL.
- Fabricate/test membrane performance in a gasifier syngas slip stream.
- Perform experiments integrating H₂ separation and shift reaction.
- Make long-term flux measurements and demonstrate reliability and durability of membranes under high-pressure conditions.

Available Reports/Technical Papers/Presentations

Balachandran, u., et al., "Hydrogen Separation Membranes Annual Report for FY2010," publication date January 30, 2011, <http://www.osti.gov/bridge>

GASIFICATION OF LIGNITES TO PRODUCE LIQUID FUELS, HYDROGEN, AND POWER

Primary Project Goals

The University of North Dakota Energy and Environment Research Center (UNDEERC) is conducting research to determine the effects of lignite coal on gas cleanup processes used for coal gasification; including hydrogen (H_2)/carbon dioxide (CO_2) separation membranes, as well as the removal of condensed vapors, particulates, mercury, and sulfur.

Technical Goals

- Construct an entrained-flow gasifier (EFG), and perform shakedown on the EFG.
- Demonstrate the gasification lignite, and monitor the composition and concentration of synthesis gas (syngas) produced.
- Perform testing of membranes and other gas cleanup processes.

Technical Content

Lignite coal is an attractive fuel for gasification because of its calcium and sodium concentrations, which are known to catalyze the gasification reactions. This permits lower operating temperatures with increased carbon conversion efficiency. However, the composition of lignite, mainly sodium and chlorine, causes damaging effects to H_2/CO_2 membrane separators. Research is ongoing on the effectiveness of H_2/CO_2 membrane separators, specifically palladium (Pd)/copper (Cu) membranes, for use in lignite coal-fueled gasification processes.

The gas cleanup configuration can be found in Figure 1, where the syngas is delivered from a transport reactor development unit (TRDU). The waste gas from the separation membrane contains high concentrations of CO_2 that can be further purified and sequestered.

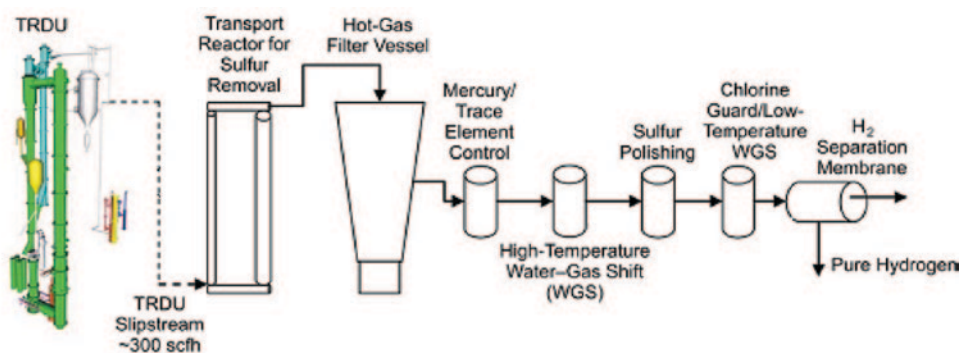

Figure 1: Gas Cleanup Configuration Schematic

Figure 2 is a plot of H_2 flux through the tested membrane over time. The oxygen (O_2)-blown run contained H_2 at higher partial pressures as a result of reduced nitrogen levels, which resulted in higher H_2 flux. This demonstrates that higher-pressure differentials will yield greater quantities of H_2 .

Technology Maturity:

Bench, 2 lb/day H_2 ; 45 lb/day CO_2

Project Focus:

H_2/CO_2 Separation Membranes

Participant:

UNDEERC

Project Number:

NT42465-1.2

NETL Project Manager:

Edgar Klunder
Edgar.Klunder@netl.doe.gov

Principal Investigator:

Joshua J. Stanislawski
 University of North Dakota
 Energy and Environmental
 Research Center
jstanislawski@undeerc.org

Partners:

EPRI
 Great River Energy
 Luminant
 North American Coal
 Corporation
 North Dakota Industrial
 Commission
 Porviar Filtration Group
 Rio Tinto

Performance Period:

6/23/05 – 5/31/11

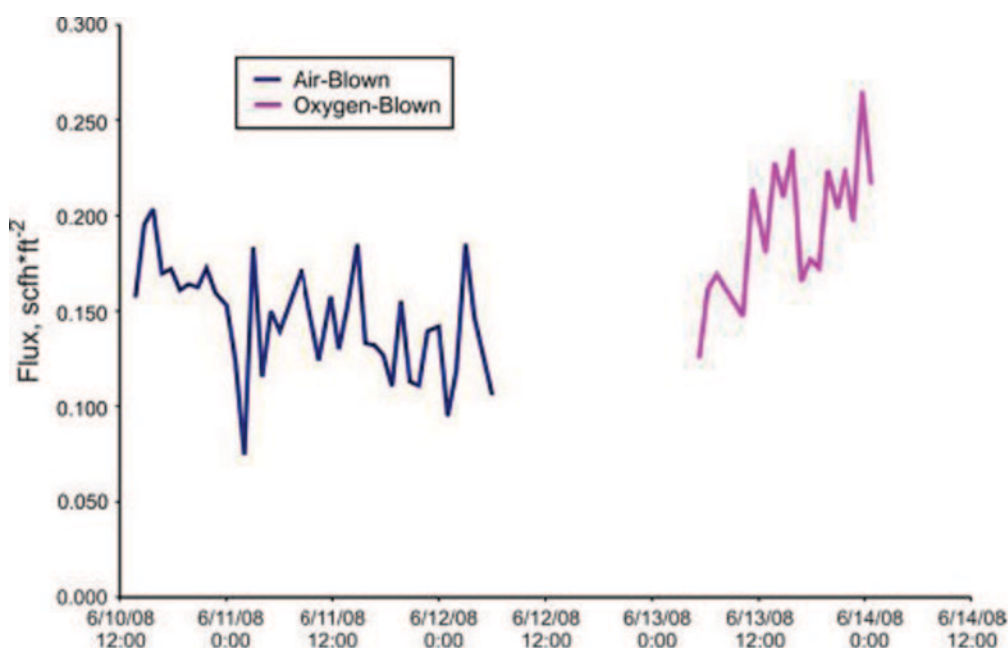

Figure 2: Hydrogen Flux of Air- and Oxygen-Blown Syngas

The permeate stream contained greater than 99.9% H₂, demonstrating the selectivity of the membrane and its ability to be utilized in gasification processes fueled by lignite coal.

To date, Pd-Cu-based membranes developed by Wah-Chang and TDA Research have been tested in the UNDEERC's gasification facilities. Both membranes have shown high hydrogen purities, but flux measurements were low because of low partial pressure across the membrane. Additional testing with these and other membranes is planned to occur in 2010. Gasifiers capable of producing syngas at pressures up to 1,000 pounds per square inch (psi) will be used in conjunction with the membranes, resulting in high dP and improved hydrogen flux.

Technology Advantages

- The calcium and sodium concentrations of lignite coal catalyze the gasification reaction, which permits lower operating temperatures with increased carbon conversion efficiency.
- Pd/Cu membranes produce high purity hydrogen and a separate stream of CO₂ that remains at high pressure and is ready for sequestration.

R&D Challenges

- Lignite's high calcium, sodium, mercury, and chlorine composition cause operation issues, such as bed agglomeration and ash deposition, as well as damage to water gas shift (WGS) catalysts.
- Pd/Cu membranes have a low tolerance for sulfur, so gas cleanup systems must remove the hydrogen sulfide (H₂S) and carbonyl sulfide (COS) to subparts per million levels.

Results To Date/Accomplishments

- Completed feedstock characterization.
- Completed bench-scale testing of gas desulfurization and H₂ and CO₂ purification concepts.
- Completed construction of the EFG, as well as gasification test runs on the EFG.
- Conducted testing to determine optimum warm- or hot-gas cleanup to remove impurities, such as condensed vapors and particulates, as well as control trace elements like mercury.
- Conducted testing of high-efficiency sulfur removal techniques.
- Performed testing of H₂/CO₂ separation membranes.

Next Steps

- Perform advance characterization analysis of lignites and ash materials.
- Issue final report to project sponsors.
- Continue membrane development work through additional test programs at UNDEERC.

Available Reports/Technical Papers/Presentations

No reports, technical papers, or presentations are yet available.

APPENDIX B: CARBON DIOXIDE CAPTURE TECHNOLOGY SHEETS

POST-COMBUSTION SOLVENTS

BENCH-SCALE DEVELOPMENT OF A HOT CARBONATE ABSORPTION PROCESS WITH CRYSTALLIZATION-ENABLED HIGH PRESSURE STRIPPING FOR POST-COMBUSTION CO₂ CAPTURE

Primary Project Goals

The University of Illinois at Urbana-Champaign (UIUC) is performing a proof-of-concept study that will generate process engineering and scale-up data to optimize the Hot Carbonate Absorption Process with Crystallization-Enabled High Pressure Stripping (Hot-CAP) technology and demonstrate its capability to achieve the DOE goals of at least 90% carbon dioxide (CO₂) removal from coal-fired power plant flue gas with less than a 35% increase in the cost of electricity (COE), and that will help to advance the process to pilot-scale level within three years.

Technical Goals

- Perform laboratory- and bench-scale tests to measure thermodynamic and reaction engineering data that will be used to evaluate technical feasibility and cost-effectiveness, performance and scale-up, and commercial competitiveness of the Hot-CAP process with Monoethanolamine (MEA)-based processes and other emerging post-combustion CO₂ capture technologies.
- A combination of experimental, modeling, process simulation, and technical and economic analysis studies will be performed.

Technical Content

For this three-year project, UIUC and Energy Commercialization, LLC will investigate a Hot-CAP to overcome the energy use disadvantage of the MEA-based processes. A preliminary technical-economic evaluation shows that the energy use of the Hot-CAP is about 50% less than that of its MEA counterpart, and the process has the potential to meet or exceed DOE's technical and cost goals of $\geq 90\%$ CO₂ removal and $\leq 35\%$ increase in the COE.

The Hot-CAP is an absorption-based, post-combustion CO₂ technology that uses a carbonate salt (K₂CO₃ or Na₂CO₃) as a solvent. The process integrates a high-temperature (70–80 °C) CO₂ absorption column, a slurry-based high-pressure (up to 40 atm) CO₂ stripping column, a crystallization unit to separate bicarbonate and recover the carbonate solvent, and a declaimer to recover CaSO₄ as the byproduct of the sulfur dioxide (SO₂) removal.

Project objectives include performing a proof-of-concept study aimed at generating process engineering and scale-up data to help advance the Hot-CAP technology to pilot-scale demonstration level within three years. The project tasks employ lab- and bench-scale test facilities to measure thermodynamics and reaction engineering data that can help evaluate technical feasibility and cost-effectiveness, performance and scale-up, and commercial competitiveness of the Hot-CAP compared to the MEA-based processes and other emerging post-combustion CO₂ capture technologies.

Technology Maturity:

Laboratory-scale, simulated flue gas

Project Focus:

Hot Carbonate Absorption Process

Participant:

University of Illinois at Urbana-Champaign

Project Number:

FE0004360

NETL Project Manager:

Andrew Jones
Andrew.Jones@netl.doe.gov

Principal Investigator:

Yongqi Lu
Illinois State Geological Survey
lu@isgs.illinois.edu

Partners:

Energy Commercialization, LLC

Performance Period:

1/1/11 – 12/31/13

To meet project objectives, lab- and bench-scale tests will be performed by UIUC to measure the kinetics and phase equilibrium data associated with the major reactions and unit operations in the Hot-CAP including CO₂ absorption, bicarbonate crystallization, sulfate recovery, and CO₂ stripping. Energy Commercialization, LLC will use the results from the lab- and bench-scale studies to help create a process flow diagram, perform equipment and process simulations, and conduct a techno-economic study for a conceptual 500-MWe high-sulfur coal-fired power plant retrofitted with the Hot-CAP.

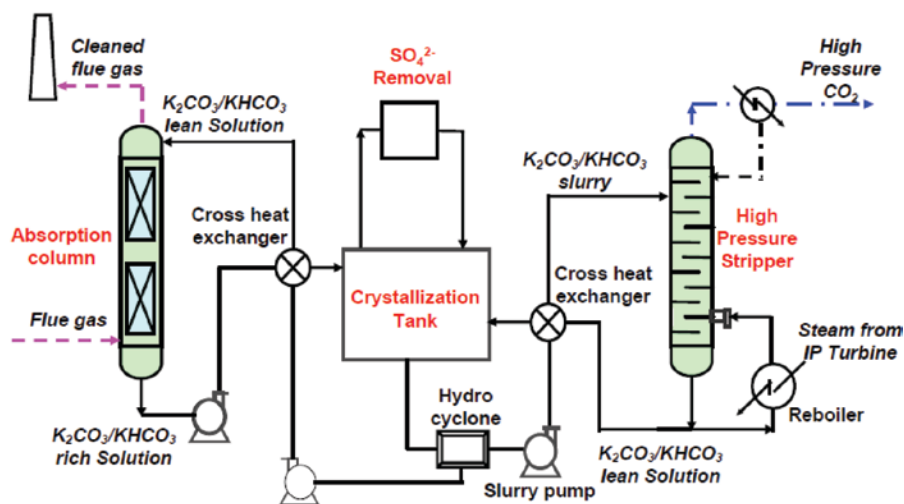

Figure 1: Hot Carbonate Absorption Process with High Pressure Stripping Enabled by Crystallization (Hot-CAP): Process Flow Diagram

Table 1: Process Parameters for Carbonate Salt Solvent

	Parameter	Current R&D Value	Target R&D Value
Solvent Properties	Type of solvent	Carbonate salt (potassium or sodium carbonate)	
	Molecular weight	—	—
	Boiling point (°C)	—	—
	Heat of reaction (kJ/mole CO ₂)	7–17	—
	CO ₂ loading/working capacity, wt%	—	—
	Solvent concentration to stripper (mol/liter)	—	—
	Heat capacity of solution (kJ/K/kg)	—	—
	Viscosity, cP (glycol concentration)	—	—
Operating Conditions	Absorption temperature, °C	70–80	—
	Absorption pressure (CO ₂ partial pressure), atm	—	—
	CO ₂ capture efficiency, %	90	—
	Regeneration method	—	—
	Regeneration temperature, °C	130–200	—
	Regeneration pressure, atm	8–40	—
Heat Integration	Required regeneration steam temperature, °C	—	—
Miscellaneous	Solvent make-up rate, kg/kg CO ₂	N/A	—
Product Quality	CO ₂ purity, %	N/A	—
	N ₂ concentration, %	N/A	—
	Other contaminants, %	N/A	—
Process Performance	Electricity requirement, kJ/kg CO ₂	N/A	—
	Heat requirement, kJ/kg CO ₂	N/A	—
	Total energy (electricity equivalent), kJ/kg CO ₂	N/A	—

Technology Advantages

- High stripping pressure which equates to low compression work and low stripping heat (high CO₂/H₂O ratio).
- Low sensible heat results in comparable working capacity to MEA and low C_p (½).
- Low heat of absorption, 7–17 kcal/mol CO₂ (crystallization heat included) versus 21 kcal/mol for MEA.
- Increased absorption rate by employing high concentration PC and high absorption temperature.
- Flue gas desulfurization (FGD) may be eliminated.
- No solvent degradation.
- Low-cost solvent.
- Less corrosiveness.

R&D Challenges

- Identifying favorable process conditions for absorption kinetics in carbonate solution.
- Identifying process conditions and solution properties for achieving the crystallization rate and desirable crystal size for solid separation.
- Identifying process conditions for potassium bicarbonate slurry to achieve stripping pressure ≥10 bar.
- Identifying process conditions for >95% SO₂ removal and continuous reclamation of the sulfate.

Results To Date/Accomplishments

Results from the project are not yet available.

Next Steps

Final test results will not be available until the December 2013 project completion date.

Available Reports/Technical Papers/Presentations

General project information is available on DOE/NETL website at: <http://www.netl.doe.gov/technologies/coalpower/ewr/co2/post-combustion/bench-scale-dev.html>

EVALUATION OF CONCENTRATED PIPERAZINE FOR CO₂ CAPTURE FROM COAL-FIRED FLUE GAS

Primary Project Goals

URS Group (URS) is gaining operational experience with the concentrated piperazine (PZ) solvent in coal-fired flue gas while employing the high-temperature, two-stage flash regeneration design. Results will be used to evaluate the technical and economic feasibility of a full-scale implementation of this process.

Technical Goals

Project objectives are to:

- Quantify and demonstrate the robustness of concentrated PZ with coal-fired flue gas in an integrated absorption/stripping system with solvent regeneration at 150 °C.
- Optimize equipment design and energy performance of the innovative, two-stage flash system.
- Identify and resolve other potential operational and design issues including process control, corrosion, foaming, and solids precipitation.

Technical Content

URS, in collaboration with the University of Texas (UT) and Trimeric Corporation, will investigate the use of concentrated PZ as a solvent for absorbing carbon dioxide (CO₂) from coal-fired power plant flue gas. Evaluations were previously performed on concentrated PZ for CO₂ removal through laboratory investigations, process modeling, and synthetic flue gas testing in a 0.1-megawatt (MW) unit. Results have indicated greater than 90% CO₂ capture with significant progress toward DOE's goal of less than 35% cost of electricity (COE) increase, as well as opportunities for further improvement. This project continues the development of the PZ-based CO₂ absorption process through a series of three field tests to gain operational experience with the solvent in coal-fired flue gas, while employing a novel, high-temperature, two-stage flash regeneration design. The tests will be conducted at Commonwealth Scientific and Industrial Research Organization's (CSIRO) Post-Combustion Capture (PCC) facility, UT's Separations Research Program (SRP) plant, and DOE's National Carbon Capture Center (NCCC). Results will be used to evaluate the technical and economic feasibility of full-scale implementation of the integrated absorber-flash regeneration system.

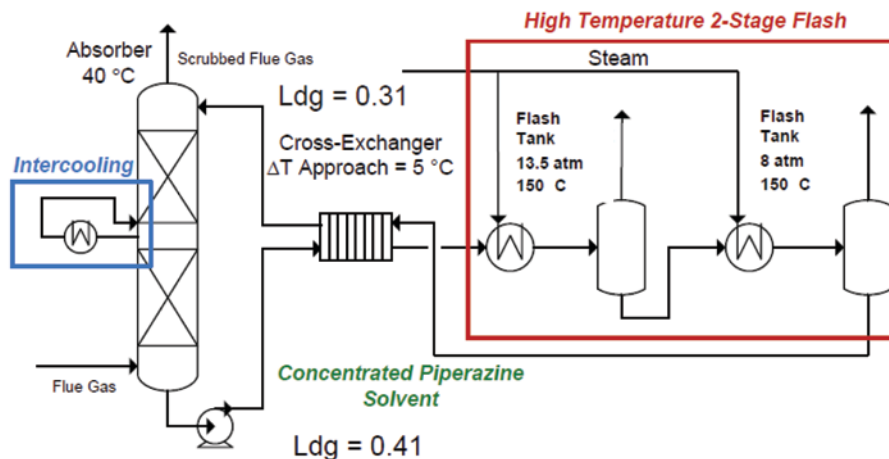

Figure 1: Diagram of Piperazine CO₂ Absorption Process

Technology Maturity:

Laboratory-scale, simulated flue gas and actual flue gas slipstream

Project Focus:

Piperazine Solvent with Flash Regeneration

Participant:

URS Group

Project Number:

FE0005654

NETL Project Manager:

Bruce Lani
Bruce.Lani@netl.doe.gov

Principal Investigator:

Katherine Dombrowski
 URS Group
Katherine.Dombrowski@URScorp.com

Partners:

Trimeric Corporation
 University of Texas at Austin

Performance Period:

9/27/10 – 3/31/14

This 42-month project will consist of a series of three field tests designed for continuous process improvement and scale-up of the PZ-based process. The first program will be a three-month test in coal-fired flue gas using CSIRO's 0.1-MW absorption column installed at a power station, coupled with the project team's 0.1-MW high-temperature, two-stage, flash solvent regeneration system. The second field test will entail refining the regenerator design based on the CSIRO test results in a three-week test in synthetic flue gas at UT's 0.1-MW pilot facility. The third field test will be a three-month test on coal-fired flue gas conducted with the 0.5-MW absorption column at NCCC in conjunction with a 0.5-MW regeneration skid built by the project team. The larger regeneration system design will be based on the operational experiences gained in the two prior testing programs. An engineering feasibility study will be performed on data obtained during the three testing programs to assess the feasibility of using concentrated PZ solvent for post-combustion CO₂ control. This analysis will include estimated capital and operating costs for installing and operating a full-scale system capable of achieving more than 90% CO₂ removal. Additionally, the next steps for research and development will be defined.

Technology Advantages

As compared to conventional amine solvents, the advantages of piperazine are:

- Greater CO₂ absorption rate, greater working capacity, greater thermal stability, and less oxidative degradation—all of which point toward 10–20% less energy use.
- Lower capital costs.
- Additional savings in COE may be achieved by optimization of absorber packing, flue gas pre-treating, compressors, heat exchangers, and design improvements realized as part of this project.

R&D Challenges

- Robustness of concentrated PZ in flue gas must be demonstrated—PZ is more expensive to replace than monoethanolamine (MEA).
- Robustness of process to excursions in CO₂ loading, temperature, and water balance must be demonstrated, which will require quantification of the effect on solids precipitation and plant operation.

Results To Date/Accomplishments

Results from the project are not yet available.

Next Steps

Final test results will not be available until the March 2014 project completion date.

Available Reports/Technical Papers/Presentations

General project information is available on DOE/NETL website at: <http://www.netl.doe.gov/technologies/coalpower/ewr/co2/post-combustion/evaluation-concentrated-piperazine.html>

RECOVERY ACT: SLIPSTREAM DEVELOPMENT AND TESTING OF SIEMENS POSTCAP CAPTURE AND SEPARATION TECHNOLOGY

Primary Project Goals

Siemens Energy is designing, installing, and operating a pilot plant to treat a 2.5-MW flue gas slipstream from an operating coal-fired power plant to demonstrate the aqueous amino acid salt solvent-based, post-combustion carbon dioxide (CO₂) gas capture technology.

Technical Goals

- Demonstrate the ability of Siemens Energy's POSTCAP technology to achieve 90% CO₂ removal while approaching a 35% increase in the cost of electricity (COE).
- Demonstrate the scalability and feasibility of developing the technology to a full-scale, commercial, post-combustion CO₂ capture (550 MW) application for coal-fired power plants and to full-scale commercial application for industrial sources of CO₂ emissions.

Technical Content

Siemens Energy is designing, installing, and operating an advanced CO₂ capture, solvent-based pilot plant. The Siemens POSTCAP CO₂ capture process utilizes an aqueous amino acid salt (AAS) solution as the solvent that offers cost and performance advantages when compared to state-of-the-art amine-based solvents. The POSTCAP pilot plant will be installed at Tampa Electric Company's (TECO) Big Bend Station and will treat a flue gas slipstream equivalent to approximately 2.5 MWe. Although the CO₂ source for this slipstream pilot-scale testing is from a coal-fired power plant flue gas, it will provide an appropriate design and performance baseline for direct scale-up to many industrial applications.

The project encompasses the complete design, engineering, procurement, installation, operation, data analysis, and decommissioning of the CO₂ capture system and will be completed in four phases. In Phase I, the engineering design and permitting for the project will be completed. POSTCAP system mass and energy balances and pilot plant process flow diagrams will be generated, and the host site will be analyzed for integration of the pilot plant. Phase II will encompass the equipment procurement, fabrication, delivery, and installation of the components at the host site with required tie-ins to plant interfaces. In Phase III, the pilot plant will be commissioned and started up, the pilot program test campaigns will be conducted, and the resulting data will be analyzed. Phase IV will cover the pilot plant decommissioning and disassembly.



Figure 1: Siemens Lab Plant for CO₂ Capture Tests at Frankfurt Hoechst Industrial Park

Technology Maturity:

Pilot-scale, actual flue gas slipstream

Project Focus:

Amino Acid Salt

Participant:

Siemens Energy, Inc.

Project Number:

FE0003714

NETL Project Manager:

David Lang

David.Lang@netl.doe.gov

Principal Investigator:

John Winkler

Siemens Energy, Inc.

John.Winkler@siemens.com

Partners:

Siemens AG

Performance Period:

10/1/10 – 10/31/13

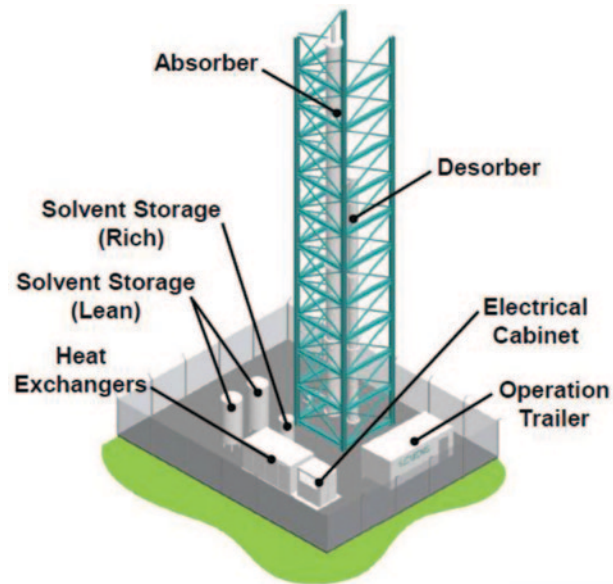

Figure 2: Basic POSTCAP Pilot Layout

Technology Advantages

- Lower energy consumption.
- Negligible solvent emission and degradation.
- High absorption capacity.
- Low environmental impact.

R&D Challenges

- Developing solvent suppliers on a large, commercial scale.
- Minimize energy consumption.
- Available footprint for large-scale carbon capture retrofits.
- Combined cycle challenges to be overcome:
 - Low CO₂ concentration in flue gas.
 - High oxygen content in flue gas.
 - Operation with frequent load changes.
 - Fewer integration options for low-temperature heat from the capture plant.

Results To Date/Accomplishments

Results from the project are not yet available.

Next Steps

Final test results will not be available until the October 2013 project completion date.

Available Reports/Technical Papers/Presentations

General project information is available on DOE/NETL website at: <http://www.netl.doe.gov/technologies/coalpower/ewr/co2/post-combustion/self-concentrating-amine.html>

POST-COMBUSTION CO₂ CAPTURE FOR EXISTING PC BOILERS BY SELF-CONCENTRATING AMINE ABSORBENT

Primary Project Goals

In this project, 3H Company is experimentally and analytically confirming the feasibility of the proposed Self-Concentrating Absorbent CO₂ Capture Process, with the goal of developing a sound engineering design, supported by laboratory data and economic justification, for a flue gas slip stream testing unit.

Technical Goals

- Perform laboratory screening experiments to identify different absorbent/solvent combinations that can exhibit the “self-concentrating” carbon dioxide (CO₂) absorption effect, and conduct fundamental absorption/regeneration rates and physical and chemical property measurements to allow its process design and techno-economic feasibility to be evaluated.
- Conduct experiments to demonstrate the process under dynamic column testing conditions and to develop a process design package for a slipstream testing facility.

Technical Content

This project will examine an innovative and proprietary CO₂ capture technology developed by 3H Company. The process is based on amine and/or other chemical absorbents in a non-aqueous solvent that can phase separate into a distinct CO₂-rich liquid phase upon reaction with CO₂. The process is demonstrated using commercially available amines and solvents. The technology has the potential of not only greatly reducing the energy penalty associated with regeneration, compared to conventional monoethanolamine (MEA)-based processes, but it can also increase the amine CO₂ absorption rate. Preliminary experimental data shows that the proposed Self-Concentrating Amine Absorbent process has the potential of reducing the total regeneration energy by as much as 70%.

The technology removes CO₂ from power plant flue gas, using an absorbent (e.g., amine or special designed chemical species) and a matched solvent, which rapidly forms two immiscible liquid phases upon absorbing CO₂ (Figure 1). The process has been demonstrated in the laboratory for a number of specific amine/solvent pairs. The solvents employed are non-aqueous. The novelty of the concept rests on the dual hydrophobic/hydrophilic functionality of the CO₂ absorbents (e.g., amine), the stability of the “CO₂-rich” reaction product, and its solubility behavior

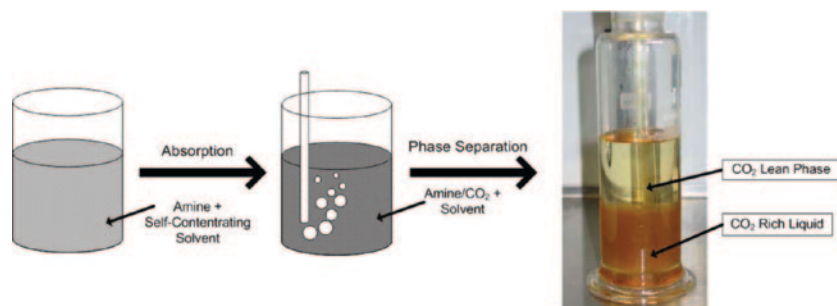

Figure 1: Concept of the Proposed Self-Concentrating Amine Absorbent Process

Technology Maturity:

Laboratory-scale, simulated flue gas

Project Focus:

Non-Aqueous, Amine-Based Solvent

Participant:

3H Company, LLC

Project Number:

FE0004274

NETL Project Manager:

Morgan Mosser

Morgan.Mosser@netl.doe.gov

Principal Investigator:

Liang Hu

3H Company, LLC

lianghu59@yahoo.com

Partners:

Nexant, Inc.

Performance Period:

10/1/10 – 9/30/13

within the non-aqueous solvent system employed. When an amine is used as the CO₂ absorbent, it is reasonable to assume that the chemistry follows that for an aqueous-based system. However, in the presence of a Self-Concentrating Solvent, the CO₂: amine reaction forms a stable product that can be solvated in higher concentration within the solvent system. The chemistry and mechanism of the process requires additional research and development.

Conventional 30 wt% MEA-based CO₂ capture is considered to be the benchmark for performance. A typical heat of regeneration for a 30% MEA CO₂ capture process is about 1,934 Btu/lb CO₂ as cited in the literature. To better understand the inherent benefits of the 3H technology, it is important to examine the components that influence the heat of regeneration, heat of reaction, sensible heat, and latent heat. For a typical 30% MEA system, only about 1/3 of the regeneration energy is used to break the amine:CO₂ bonds. Minimizing the overall heat of regeneration by using a unique absorbent/solvent system is the key to the Self-Concentrating Absorbent process. Figure 2 shows a flow scheme for the concept, using amine as the CO₂ absorbent. The flow scheme is similar to a conventional MEA process, with the exception that a decanter is incorporated downstream of the absorber to allow the “rich CO₂ liquid” to be fully phase separated before sending it onto the stripper. Only the “rich CO₂ liquid” is subjected to regeneration, at a significant reduced volume as compared to a conventional MEA process. Overall, a 70% reduction in heat of regeneration can be achieved with the Self-Concentrating Absorbent process, taking into consideration that (1) only the “rich CO₂/solvent liquid” will be sent onto regeneration with minimum excess solvent, and (2) the solvent has a lower heat capacity and heat of vaporization than water. Because the process uses a non-aqueous system, many of the problems associated with MEA, including degradation due to corrosion, oxygen degradation, and the formation of stable salts, are expected to be mitigated. These types of effects, along with the potential environmental emissions and health problems associated with the use of non-aqueous process, will need to be investigated in more detail.

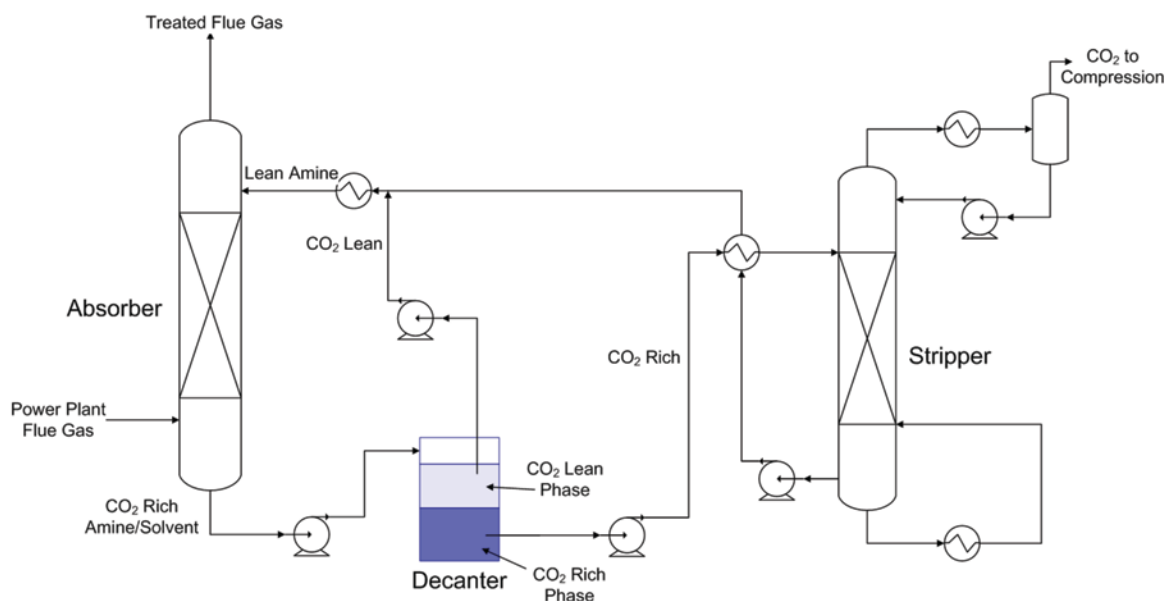

Figure 2: Simplified Flow Scheme of the Proposal Self-Concentrating Amine Absorbent Concept

Technology Advantages

- Lower regeneration energy requirements.
- Minimal degradation due to corrosion, oxygen degradation, and the formation of stable salts.

R&D Challenges

Not identified.

Results To Date/Accomplishments

Results from the project are not yet available.

Next Steps

Final test results will not be available until the September 2013 project completion date.

Available Reports/Technical Papers/Presentations

General project information is available on DOE/NETL website at: <http://www.netl.doe.gov/technologies/coalpower/ewr/co2/post-combustion/self-concentrating-amine.html>

ADVANCED LOW-ENERGY ENZYME CATALYZED SOLVENT FOR CO₂ CAPTURE

Primary Project Goals

Akermin is developing a bench-scale level reactor with the ability to capture up to 90% of carbon dioxide (CO₂) from a simulated flue gas using a solvent with significantly lower regeneration energy and at high reaction rates achieved by the use of an immobilized enzyme, carbonic anhydrase (CA), to catalyze the hydration reaction of CO₂.

Technical Goals

- Evaluate potential enzyme isoforms for stability to anticipated operating conditions and down-select to preferred option.
- Optimize micellar polymer to achieve high enzyme immobilization and stabilization.
- Develop detailed Aspen model of enzyme-catalyzed carbonate system and extrapolate to a power plant equivalent to 550 MWe, including mass and energy balances, electric power requirements, and projected chemical and maintenance costs.
- Build and test a closed-loop bio-reactor capable of processing up to 500 standard liters per minute (SLPM) of gas, the approximate equivalent of a 5-kWe power plant, and demonstrate continuous operation over a six-month period.

Technical Content

An advanced enzyme catalyzed low-energy solvent system is being developed for post-combustion CO₂ capture in this project. The core technology involves the integration of a proprietary immobilized CA enzyme into a packed column absorber to promote the hydration of CO₂ in lower reaction energy solvents. Chemical solvents of interest include potassium carbonate (K₂CO₃) and methyl diethanolamine (MDEA), both of which are known to produce bicarbonate as a product of reaction and therefore demonstrate accelerated rates of CO₂ capture with carbonic anhydrase enzymes.

The principal project objective is to demonstrate 90% CO₂ capture from simulated flue gas in a bench-scale unit at rates comparable to monoethanolamine (MEA) using a solvent that has significantly lower regeneration energy. Other key project objectives include evaluating the potential impact of minor contaminants, such as sulfur oxides and nitrogen oxides, common to coal-fired flue gases using lab-scale tests, and to demonstrate immobilized enzyme life in excess of 200 days in a bench-scale unit.

The current work plan is focused on establishing kinetic and lab-scale closed-loop reactor data to support design and scale-up from lab-scale ~20 SLPM to the bench-unit scale ~500 SLPM flue gas. Akermin is working to identify a preferred strain of CA that will have a long lifetime under industrial conditions, to optimize a micellar polymer for immobilization of this preferred enzyme, to develop and scale-up the immobilized enzyme packing material to the lab-scale closed-loop reactor system, and then to scale-up to a bench-scale system.

Pacific Northwest National Laboratory (PNNL) and Battelle Memorial Institute (Battelle) are collaborating to perform necessary wetted wall kinetic and mass transfer studies, chemical process modeling, and relevant cost estimation to determine how such a system would scale and cost-ef-

Technology Maturity:

Laboratory-scale, simulated flue gas

Project Focus:

Carbonic Anhydrase-Potassium Carbonate Mixture

Participant:

Akermin, Inc.

Project Number:

FE0004228

NETL Project Manager:

Andrew Jones

Andrew.Jones@netl.doe.gov

Principal Investigator:

John Reardon

Akermin, Inc.

reardonj@akermin.com

Partners:

Battelle Memorial Institute
Pacific Northwest National
Laboratory

Performance Period:

9/30/10 – 9/30/12

ffectively integrate into an existing coal-fired power plant compared to DOE's goal of less than a 35% increase in cost of electricity with post-combustion CO₂ capture.

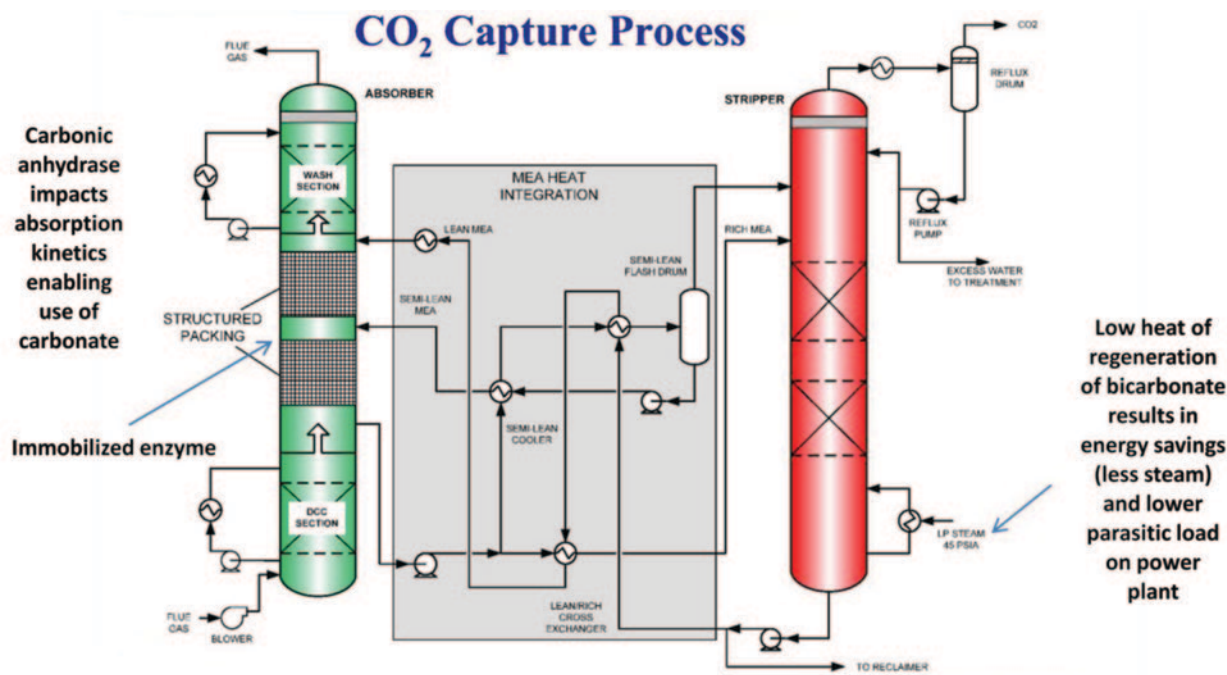

Figure 1: Akermin's CO₂ Capture Process

Akermin's activities are distributed in parallel as needed to address: proof-of-concept testing and thermodynamic analysis; laboratory-scale process development and testing; bench unit design; immobilized enzyme scale-up; and bench unit installation, commissioning, and operation.

The four main areas of development in this project include: identification of preferred enzyme; optimization of immobilization polymer/enzyme system in catalyst support systems suitable for the bench-scale unit; definition of operating limits through analysis of lab-scale reactor data and process modeling; and process design, detailed engineering, fabrication and commissioning of a bench-scale unit capable of processing simulated flue gas, or interfacing directly to a commercial slip-stream.

Table 1: Solvent Process Parameters

	Parameter	Current R&D Value	Target R&D Value
Solvent Properties	Type of solvent	Potassium carbonate	
	Molecular weight	138.2 g/mol	—
	Boiling point (°C)	105 °C	—
	Heat of reaction (kJ/mole CO ₂)	28.2	—
	CO ₂ loading/working capacity, wt%	N/A	—
	Solvent concentration to stripper (mol/liter)	N/A	—
	Heat capacity of solution (kJ/K/kg)	N/A	—
	Viscosity, cP	5.6	—
Operating Conditions	Absorption temperature, °C	60	—
	Absorption pressure (CO ₂ partial pressure), atm	N/A	—
	CO ₂ capture efficiency, %	N/A	—
	Regeneration method	N/A	—
	Regeneration temperature, °C	120	—
Regeneration pressure, atm	N/A	—	

Table 1: Solvent Process Parameters

	Parameter	Current R&D Value	Target R&D Value
Heat Integration	Required regeneration steam temperature, °C	N/A	—
Miscellaneous	Solvent make-up rate, kg/kg CO ₂	N/A	—
Product Quality	CO ₂ purity, %	N/A	—
	N ₂ concentration, %	N/A	—
	Other contaminants, %	N/A	—
Process Performance	Electricity requirement, kJ/kg CO ₂	N/A	—
	Heat requirement, kJ/kg CO ₂	N/A	—
	Total energy (electricity equivalent), kJ/kg CO ₂	N/A	—

Technology Advantages

Ability to capture CO₂ using a solvent with significantly lower regeneration energy and at rates comparable to the solvent MEA.

R&D Challenges

- Enzyme immobilization, greater than 80% physical retention in flow liquid.
- Enzyme stabilization under anticipated absorber conditions (40–60 °C, pH 9–10, high ionic strengths).
- Flexible immobilization technology needed, which can easily adapt to improved enzymes and is adaptable to varied carbonate chemistries (K₂CO₃/KHCO₃, ammonium carbonate, MDEA, etc.).
- Demonstrate tolerance to sulfur and nitrogen oxides in bench-scale flow system.

Results To Date/Accomplishments

Results from the project are not yet available.

Next Steps

Final test results will not be available until the September 2012 project completion date.

Available Reports/Technical Papers/Presentations

General project information is available on DOE/NETL website at: <http://www.netl.doe.gov/technologies/coalpower/ewr/co2/post-combustion/adv-low-energy-enzyme.html>

NOVEL SOLVENT SYSTEM FOR POST-COMBUSTION CO₂ CAPTURE

Primary Project Goals

The overall project goals are to demonstrate ION Engineering's ionic liquid (IL)-amine solvents and carbon dioxide (CO₂) capture process design at a bench-scale level using coal-fired power plant flue gas, to evaluate process improvements to reduce costs, and to further evaluate the ability to achieve DOE cost and performance targets at commercial scale.

Technical Goals

- Process design objectives are to evaluate key parameters for the design of a 1.0-gallon per minute (gpm) CO₂ capture unit through laboratory work, process modeling, and performance tests.
- Process operation and evaluation objectives are to fabricate, install, and operate the portable bench-scale unit with simulated flue gas at ION's laboratories
- Subsequently operate continuously the portable bench-scale unit using actual flue gas at Xcel Energy's Valmont Station for at least 72 hours and with greater than 90% CO₂ capture.

Technical Content

ION Engineering, in collaboration with its partners, will design, construct, operate, and evaluate a bench-scale CO₂ capture system using simulated flue gas at ION Engineering's laboratories and then using actual flue gas at Xcel Energy's Valmont Power Station. The project will demonstrate ION's solvent approach for amine-based CO₂ capture, using amines as chemical solvents with ILs as the physical solvent. ION's IL-amine solvent system is related to well-understood aqueous amine solvent-based processes in that it utilizes proven amines as chemical solvents for CO₂ capture; however, it differs significantly with the use of an IL rather than water as the physical solvent. As ILs do not incur the high energy penalties of an aqueous system, utilizing ILs in place of water can reduce energy requirements by approximately 45% compared to aqueous amine systems. By selectively balancing the amines and ILs, higher CO₂ loading capacities can be achieved as well.

The 18-month project will demonstrate the ability of the IL-amine solvent system to capture CO₂ using a 1.0-gpm bench-scale process unit, and will include simulation modeling to finalize process designs, laboratory evaluations, solvent selection, and scale-up from the existing laboratory units to the bench-scale process unit. Design, construction, installation, integration, operation, monitoring, and decommissioning of the bench-scale unit will be performed, as well as commercial and operational assessments of the technology's ability to perform at full-scale. The evaluation of the IL-amine system in an operating environment with actual flue gas will provide data to confirm performance levels and evaluate additional opportunities to improve performance at commercial scale.

Technology Maturity:

Laboratory-scale, simulated flue gas and actual flue gas slipstream

Project Focus:

Ionic Liquid-Amine Mixture

Participant:

ION Engineering

Project Number:

FE0005799

NETL Project Manager:

Isaac Aurelio
Isaac.Aurelio@netl.doe.gov

Principal Investigator:

Claude Corkadel
 ION Engineering, LLC
corky@ion-engineering.com

Partners:

Electric Power Research Institute
 Eltron Research
 Evonik Goldschmidt Corporation
 University of Alabama
 WorleyParsons Group, Inc.
 Xcel Energy

Performance Period:

10/1/10 – 4/30/12

The project is divided into two phases, as follows:

Phase I:

- Laboratory testing will be conducted on ION solvents to characterize vapor-liquid equilibrium and the requisite physical and chemical properties of the solvents for simulation modeling and process design.
- A process simulation model will be selected and customized to more effectively represent unique characteristics of IL and amine solvents versus current models.
- A laboratory-scale continuous process unit will be fabricated and used for tests with simulated flue gas to validate solvent performance, calibrate the simulation model, and develop the field test process design.
- Process design options will be evaluated considering system performance under varying flue gas conditions and requirements for corrosion, sulfur dioxide (SO₂), and thermal stability.
- A 5–15 liter-per-minute (1–3 gpm) system for CO₂ capture will be designed for field tests with actual flue gas.

Phase II:

- The final design, fabrication, installation, and shake-down of the field test unit will be completed.
- A series of test runs using the preferred ION solvent will be conducted in the field test unit at Xcel Energy's Valmont Station with data captured for monitoring and analysis.
- Aspen Plus® process modeling will be refined and expanded to evaluate potential commercial and operational performance. Capital expenditures and operating expenditures will be estimated.
- A final report will be completed that integrates the commercial and operational assessment, process modeling outcomes, and an assessment of potential savings in the use of waste steam, lower-cost materials, and other process improvement opportunities that were identified as the project proceeded.

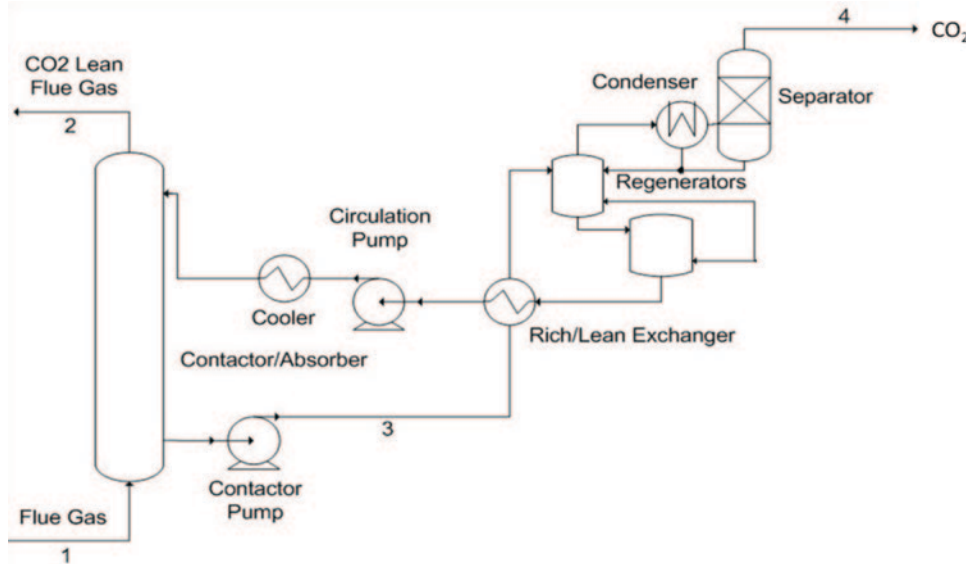

Figure 1: IL-Amine Solvent CO₂ Capture Process Diagram

Technology Advantages

Relative to state-of-the-art aqueous amine technology, IL-amine solvents offer:

- A 45% reduction in energy requirements.
- Higher CO₂ loading capacities.
- Reduced corrosion and solvent losses.
- Smaller units with reduced CAPEX.
- Ability to use lower-quality steam in regeneration.

R&D Challenges

- Solvent lifetime in actual flue gas conditions.
- Heat stable salt (HSS) formation, foaming, and corrosion.

Results To Date/Accomplishments

Results from the project are not yet available.

Next Steps

Final test results will not be available until the April 2012 project completion date.

Available Reports/Technical Papers/Presentations

General project information is available on DOE/NETL website at: <http://www.netl.doe.gov/technologies/coalpower/ewr/co2/post-combustion/novel-solvent-system.html>

NOVEL HIGH-CAPACITY OLIGOMERS FOR LOW-COST CO₂ CAPTURE

Primary Project Goals

GE Global Research is developing a novel oligomeric solvent and process for carbon dioxide (CO₂) capture from post-combustion flue gases.

Technical Goals

- Use molecular modeling to design new compounds with optimal heats of reaction (-8.5 to -10 kcal/mol).
- Design new oligomer solvents that have higher CO₂ solubility than current solvents.
- Achieve 25% greater CO₂ capacity than aqueous MEA.
- Achieve low solvent volatility.
- Achieve high reaction rate.

Technical Content

Silicone based solvents, which may be either oligomeric (defined as short-chain polymers containing 2–20 repeat units) or small molecule species, will be developed. Silicones are known in the literature to be CO₂-philic. These materials are advantageous compared to aqueous amine technology because they have low volatility, do not require a carrier fluid such as water, and can be synthesized with a number of CO₂ capture sites per molecule, increasing the overall CO₂ capacity. In addition, silicones have a high degree of thermal stability, allowing the system to operate at higher temperatures. Polymer-CO₂ interactions have been extensively studied in the literature and several CO₂-philic functional groups, such as acetates, carbonates, and ketones, have been identified.

The development of the capture solvent has taken the following approach:

- Identify solvent backbones and functional groups (Figure 1), using a literature review, that are potentially CO₂-philic (see Table 1 and Table 2).
- Use molecular modeling to predict favorable structures and heats of reaction.
- Synthesize Generation 1 solvents.
- Screen silicone solvents using high throughput screening (HTS) techniques.
- Confirm materials by:
 - Nuclear magnetic resonance (NMR).
 - Boiling point, vapor pressure, flash point, viscosity, thermal stability, and CO₂ release characteristics.
- Downselect candidate solvents and synthesize.

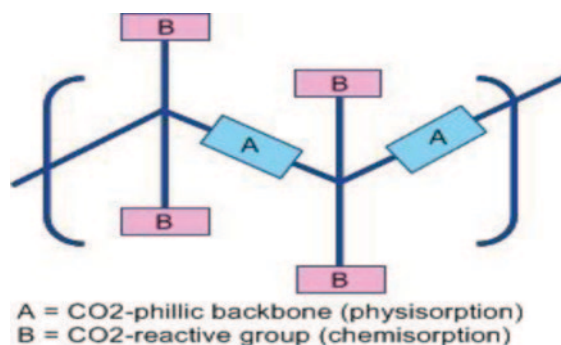

Figure 1: Solvent Concept

Technology Maturity:

Laboratory-scale, simulated flue gas

Project Focus:

High-Capacity Oligomers

Participant:

GE Global Research

Project Number:

NT0005310

NETL Project Manager:

David Lang

David.Lang@netl.doe.gov

Principal Investigator:

Teresa Grocela-Rocha

GE Global Research

grocela@ge.com

Partners:

GE Energy

University of Pittsburgh

Performance Period:

10/1/08 – 9/30/10

- Estimate physical, chemical, and thermodynamic properties using modeling to further select candidates.
- Physically measure solvent properties.
- Conduct degradation and stability tests in the presence of CO₂, water, sulfur dioxide (SO₂), etc.
- Determine minimized cost of energy (COE) and an optimized capture process using power plant models.

Table 1: Examples of Solvent Backbone Candidates

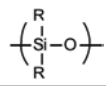
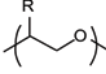
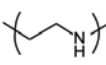
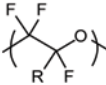
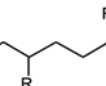
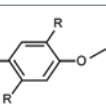
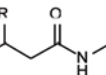
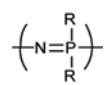
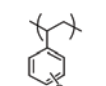
Backbone	Structure	Attribute						Total
		Physical State	Cost (inexpensive)	Synthetic Availability	Ease of Derivatization	CO ₂ -philic	Stability	
Siloxane		9	5	9	9	9	9	50
Alkyl Ether		9	9	9	5	5	9	46
Alkyl Amino		5	9	9	5	9	9	46
Perfluoroether		9	1	5	1	9	9	34
Alkyl		9	9	9	5	1	9	42
Aryl Ether		1	5	5	5	5	5	26
Alkylamido		5	5	9	5	5	5	34
Phosphazene		5	1	5	5	5	1	22
Polystyrene		1	9	9	9	1	9	38
Physical State Cost (inexpensive) Synthetic Availability Ease of Derivatization CO ₂ -philic		must be low viscosity liquid should be <\$10/lb able to be made on large scale must be easily functionalized physisorption	9=liquid, 5=viscous liquid, 1=solid 9=<\$10/lb, 5=\$10-20/lb, 1=>\$20/lb 9=commercial, 5=small scale, 1=laboratory 9=easy, 5=moderate, 1=difficult 9=high, 5=moderate, 1=low					

The solvent selection process splits the oligomers into backbones and functional groups so that physisorption and chemisorption are decoupled in the modeling of CO₂ solubility. Higher total scores indicate more promising candidates.

After HTS of various materials, one candidate solvent that showed much promise was 1,3-bis(3-aminopropyl)-1,2,3,3-tetramethyldisiloxane. The reaction of it and CO₂ is shown below:

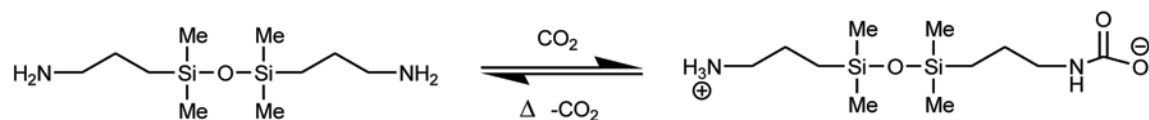

Currently, the absorption process involves contacting the aminosilicone/glycol solvent system with gas phase CO₂. The viscosity of the system increases as CO₂ reacts until maximum CO₂ absorption is achieved. The solvent system remains a liquid and is transferred to a pressurized desorption chamber where it is heated, the CO₂ is released, and the lean solvent system is regenerated.

Table 2: Examples of Solvent Functional Group Candidates







Backbone	Structure	Attribute					Total
		CO ₂ Capacity	Heat of Reaction	Kinetics	Ease of Attachment	Cost	
Aminoethyl		5	5	9	5	9	33
Aminopropyl		5	5	9	9	9	37
Aminoethylaminopropyl		9	9	9	9	9	45
Bis(aminoethyl)aminopropyl		9	9	9	9	9	45
Imidazole		1	1	1	9	5	17
Histamine		5	9	1	5	1	21
Isocytosine		5	5	5	5	1	21
5-Azacytosine		9	5	5	5	1	25
Piperazine		9	9	9	9	5	41
Urea		5	5	1	5	9	25
Acetamide		1	5	1	5	5	17
Guanidine		9	5	9	1	5	29
Amidine		9	5	9	9	5	37
Benzylamine		5	9	5	9	5	33
CO ₂ capacity Heat of Reaction Kinetics Ease of Attachment		9=high, 5=moderate, 1=low 9=moderate, 5=low, 1=high 9=fast, 5=moderate, 1=slow 9=easy, 5=doable, 1=difficult (Reaction with CO ₂)					

Table 3: Process Parameters for Aminosilicone/Glycol Solvents

	Parameter	Current R&D Value	Target R&D Value
Solvent Properties	Type of solvent	Amino silicone/glycol	
	Molecular weight	248/150	—
	Boiling point (°C)	132 °C at 11 mm Hg/125 °C at 0.1 mm Hg	—
	Heat of reaction (kJ/mole CO ₂)	45	—
	CO ₂ loading/working capacity, wt%	5.5–6%	—
	Solvent concentration to stripper (mol/liter)	—	—
	Heat capacity of solution (kJ/K/kg)	~2.1	—
	Viscosity, cP	At 40 °C <50 (0%) <4,500 (100%)	—
Operating Conditions	Absorption temperature, °C	—	—
	Absorption pressure (CO ₂ partial pressure), atm	0.1~0.15	—
	CO ₂ capture efficiency, %	>90	—
	Regeneration method	Thermal	—
	Regeneration temperature, °C	100~150	—
	Regeneration pressure, atm	5~20	—
Heat Integration	Required regeneration steam temperature, °C	120~170	—
Miscellaneous	Solvent make-up rate, kg/kg CO ₂	N/A	—
Product Quality	CO ₂ purity, %	N/A	—
	N ₂ concentration, %	N/A	—
	Other contaminants, %	N/A	—
Process Performance	Electricity requirement, kJ/kg CO ₂	N/A	—
	Heat requirement, kJ/kg CO ₂	N/A	—
	Total energy (electricity equivalent), kJ/kg CO ₂	N/A	—

Technology Advantages

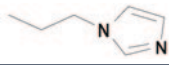
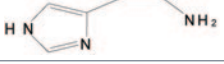
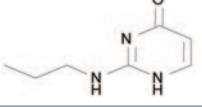
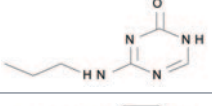
- Low volatility.
- Water not required as a carrier fluid, thus lowering heat capacity.
- Silicones have a high degree of thermal stability.

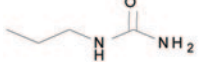
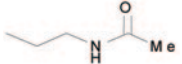
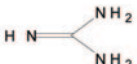
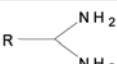
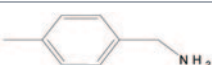
R&D Challenges

Flexible short chain silicones have not been previously demonstrated as CO₂ absorbing solvents, and thus a number of potential risks have been identified. The most significant technical risks include:

- Insufficient chemical and thermal stability of the solvents.
- Low CO₂ absorption and desorption rates.
- Excessively high heat of reaction.

Results To Date/Accomplishments

- Selected solvent classes.
- Calibrated plant model for absorption cycles, stripping cycles, and cost calculations.
- Downselected aminosilicones solvent classes.
- Found that a glycol co-solvent aids in physisorption of CO₂ and decreases viscosity.
- Shown thermal regeneration of solvent after CO₂ capture.
- Demonstrated continuous CO₂ absorption by aminosilicone solvent system.
- Discovered aminosilicone solvent systems that show a >25% increase in loading compared to 30% MEA.
- Determined thermal stability and tolerance to impurities of selected solvents.
- Constructed a continuous absorption/desorption unit which created ability to determine mass transfer coefficients, robustness of the solvent system, and special heating or cooling needs.
- Calculated 41% increase in COE vs. 74% for optimized MEA system.

Next Steps

Project is complete.

Available Reports/Technical Papers/Presentations

Xie, H-B, Johnson, J. K., Perry, R., Genovese, S., Wood, B., "A Computational Study of the Heats of Reaction of Substituted Monoethanolamine with CO₂," J. Phys. Chem. A, 2011, Vol 115, Issue 3, pp. 342–350.

Perry, R., Grocela-Rocha, T., O'Brien, M., Genovese, S., Wood, B., Lewis, L., Lam, H., Soloveichik, G., Rubinsztajn, M., Kniajanski, S., Draper, S., Enick, R., Johnson, J., Xie, H.-b. and Tapriyal, D., "Aminosilicone Solvents for CO₂ Capture." Chem-SusChem, 2010, 3: 919–930.

"Novel Aminosilicones for CO₂ Capture," Fuel Preprints, 2010, 55(1), 282.

ACS National Meeting, March 24, 2010 "Novel Aminosilicone Solvents for CO₂ Capture."

43rd Silicon Symposium, May 21, 2010 "Aminosilicone Solvents for Low Cost CO₂ Capture."

2010 NETL CO₂ Capture Technology Meeting, September 15, 2010 "Novel High Capacity Solvents for CO₂ Capture."

AIChE Meeting, November 8, 2010 "Characteristics of Aminosilicones for CO₂ Capture."

AIChE Meeting, November 12, 2010 "CO₂-Capture Process Using Aminosilicone-Based Absorbents."

PacifiChem 2010, December 17, 2010 "Aminosilicones as CO₂-Capture Solvents."

Annual NETL CO₂ Capture Technology for Existing Plants R&D Meeting, March 24–26, 2009, Pittsburgh, PA.

General project information is available on DOE/NETL website at: <http://www.netl.doe.gov/technologies/coalpower/ewr/co2/post-combustion/oligomers.html>

DEVELOPMENT AND EVALUATION OF A NOVEL INTEGRATED VACUUM CARBONATE ABSORPTION PROCESS

Primary Project Goals

The goal of this project is for the Illinois State Geological Survey to prove the novel Integrated Vacuum Carbonate Absorption Process (IVCAP) concept and further improve the energy efficiency of the process for post-combustion carbon dioxide (CO₂) capture.

Technical Goals

- Test the proof-of-concept of the IVCAP.
- Identify an effective catalyst for accelerating CO₂ absorption.
- Identify an effective additive for reducing the stripping heat.
- Evaluate a modified IVCAP as a multi-pollutant control process for combined sulfur dioxide (SO₂) and CO₂ capture.

Technical Content

The proposed IVCAP employs a potassium carbonate (K₂CO₃) aqueous solution for CO₂ absorption. While the absorption takes place at atmospheric pressure, the stripper is operated under a vacuum condition. As seen in Figure 1 and Table 1, the low heat of reaction between CO₂ and K₂CO₃ favors a stripping process operated at a low temperature and the low-quality steam (close to the exhaust end of low pressure turbine in the power plant) can be used as a heat source for the stripping process as a result.

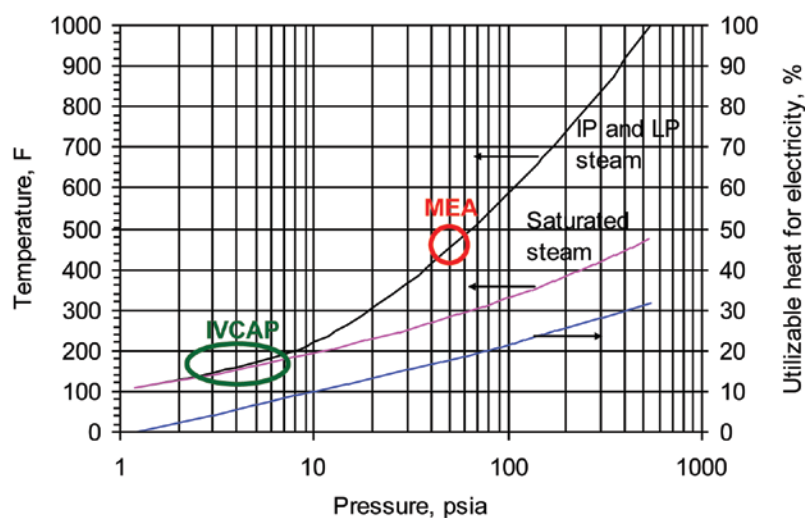

Figure 1: Steam Properties During Expansion in the Intermediate and Low-Pressure Turbines

Technology Maturity:

Laboratory-scale, simulated flue gas

Project Focus:

Integrated Vacuum Carbonate Absorption

Participant:

Illinois State Geological Survey

Project Number:

NT0005498

NETL Project Manager:

Andrew Jones

Andrew.Jones@netl.doe.gov

Principal Investigator:

Yongqi Lu

Illinois State Geological Survey

lu@isgs.illinois.edu

Partners:

Calgon Carbon Corporation
Illinois Clean Coal Institute
University of Illinois

Performance Period:

9/26/08 – 4/30/12

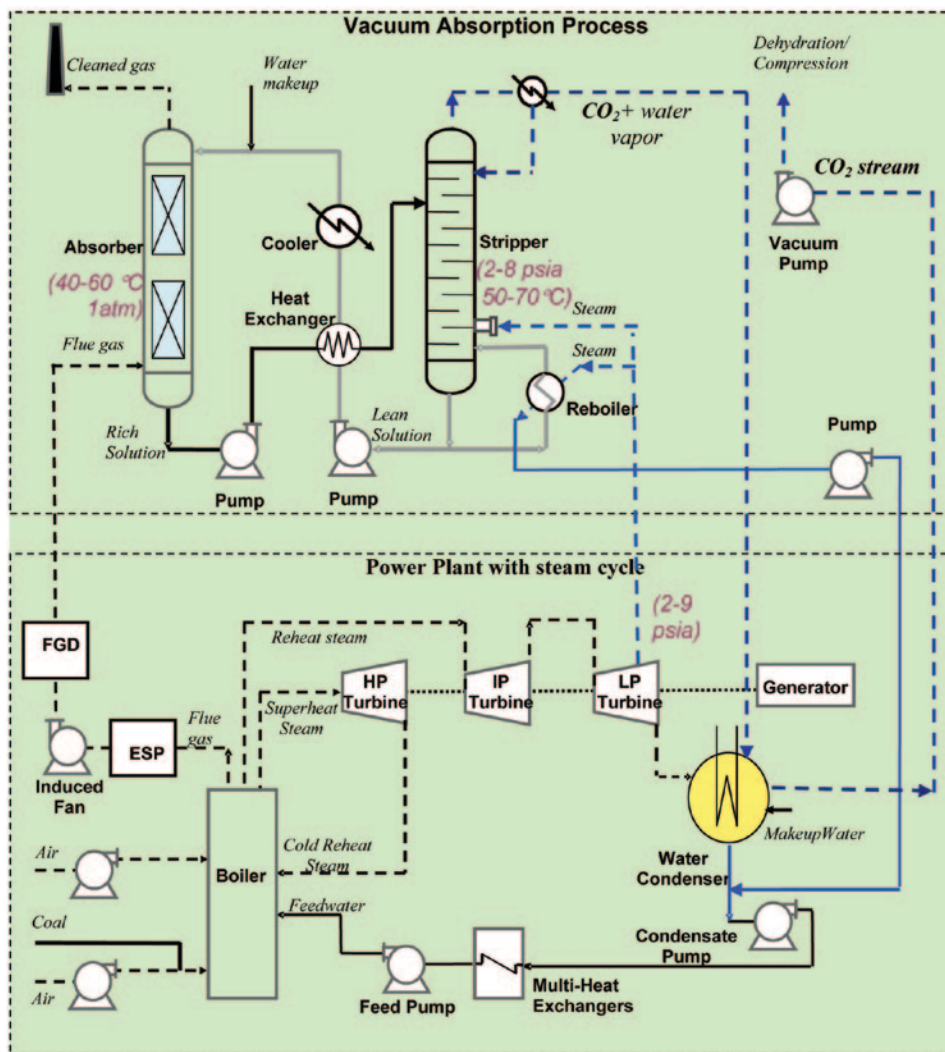

Figure 2: Vacuum Stripping in the IVCAP Allows for Use of Low-Quality Steam From the Power Plant

Table 1: A Comparison of Heats of Absorption for CO₂ Solvents

Solvent	Main Reaction	Heat of Absorption
Primary/Secondary Amines	$2RR'NH + CO_2 = RR'NCOO^- + RR'NH_2^+$	MEA: 1,900 kJ/kg
Tertiary Amine	$RR'R''N + CO_2 + H_2O = HCO_3^- + RR'R''NH^+$	MDEA: 1,200 kJ/kg
Carbonate	$CO_3^{2-} + CO_2 + H_2O = 2 HCO_3^-$	600 kJ/kg

The intrinsic rate of CO₂ absorption into the K₂CO₃ solution is much slower in an MEA solution; therefore, enzyme catalysts will be developed to promote the absorption rate. Unlike the mixing of another solvent into a primary solvent, a catalyst accelerates the absorption rate without increasing the heat of absorption of the solvent.

The enzyme catalysts will need to be immobilized in order to:

- Reduce enzyme leakage in a flow system.
- Improve chemical stability of enzymes.
- Improve thermal stability of enzymes.

Three supportive matrices (i.e., carbon-, ceramic-, and polymer-based materials) will be evaluated for enzyme immobilization.

Since more than 60% of the process heat in the IVCAP is the stripping heat, an additive able to suppress water vaporization of the CO₂-loaded solution can reduce the stripping heat in the stripper. Successful screening and development of an additive can further reduce the heat use in the IVCAP.

The IVCAP has the flexibility to integrate SO₂ removal in the CO₂ capture process. In the amine-based and amine-promoted absorption processes, the flue gas must be treated to reduce the concentration of SO₂ and other acid gases to below 20 parts per million (ppm) to prevent/minimize the formation of heat-stable salts that are difficult to reclaim. In the IVCAP, SO₂ can be removed by the reaction with the solvent to form a sulfate salt which can be further processed to reclaim the solvent.

Table 2: Process Parameters for IVCAP Process

	Parameter	Current R&D Value	Target R&D Value
Solvent Properties	Type of solvent	K ₂ CO ₃ /KHCO ₃	—
	Molecular weight	138	—
	Boiling point (°C)	103	—
	Heat of reaction (kJ/mole CO ₂)	26.4	—
	CO ₂ loading/working capacity ¹ , wt%	2.7–4.0 wt%	—
	Solvent concentration to stripper (mol/liter)	20–25 wt%	—
	Heat capacity of solution (kJ/K/kg)	3.35	—
	Viscosity, cP	0.95 (50 °C)	—
Operating Conditions	Absorption temperature, °C	40–60	—
	Absorption pressure, atm	1	—
	CO ₂ capture efficiency, %	90%	—
	Regeneration method	Pressure swing	—
	Regeneration temperature, °C	50–70	—
	Regeneration pressure, atm	0.14–0.54	—
Heat Integration	Required regeneration steam temperature, °C	60–100	—
Miscellaneous	Solvent make-up rate, kg/kg CO ₂	Negligible	—
Product Quality	CO ₂ purity, %	>99	—
	N ₂ concentration, %	Negligible	—
	Other contaminants, %	0.1%	—
Process Performance	Electricity requirement, kJ/kg CO ₂	460–580	—
	Heat requirement, kJ/kg CO ₂	240–550 (electricity equivalent)	—
	Total energy (electricity equivalent), kJ/kg CO ₂	800–1,130	~800

Note:

1. Working capacity is the loading difference CO₂-rich solution before and after it is regenerated.

Equations Describing Chemical Reaction:

The main reactions involving in the IVCAP include:

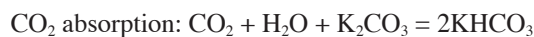

Solvent Reaction Kinetics: Based on the experimental results to date, the overall CO₂ absorption rate measured for a 20 wt% potassium carbonate (PC) solution mixed with 300 mg/l free carbonic anhydrase (CA) enzyme was about 1.5 to five times lower than that of the MEA, depending on the CO₂ loading in the solution. The CA enzyme promotes the absorption more significantly when the CO₂ loading in the solution is higher. The CO₂ absorption rate into the CA-promoted PC solution can be close to the MEA if a higher enzyme dosage level (>300 mg/l), an additive to increase CO₂ solubility in the solution, and an absorber configuration with large liquid holdup are further employed.

Solvent Heating/Cooling Method: There are two process configurations for heating and cooling the carbonate solvent in the IVCAP. If the stripper is operated at close to 70 °C, a heat exchanger is employed for exchanging heat between the CO₂-rich solution from the absorber and CO₂-lean solution from the stripper. If the stripping temperature is chosen at close to 50 °C, the heat exchange between the rich and lean solution can be eliminated, and only a cooler (using cooling water as medium) is used to cool down the lean solution before it enters the absorber.

Solvent Contaminant Resistance: Since the potassium carbonate solution is used as a solvent, no solvent degradation and little corrosion problems are expected. No SO₂ scrubbing is needed prior to the IVCAP, since SO₂ removal can be combined with CO₂ capture. Therefore, there is also no problem related to SO₂ contamination.

Flue Gas Pretreatment Requirements: Sulfur dioxide removal can be combined with CO₂ capture in the IVCAP. The carbonate solution absorbs SO₂ to form a sulfate salt, which is reclaimable using a reclamation approach developed in this project. Therefore, a separate flue gas desulfurization (FGD) unit currently required in the power plant can be eliminated in the IVCAP. No other flue gas pretreatments [such as for particulate matter (PM), nitrogen oxides (NO_x)] are required either.

Waste Streams Generated: Waste streams mainly include the process blowdown streams, such as the carbonate/bicarbonate aqueous solution from the absorber/stripper and water condensate saturated with CO₂.

Technology Advantages

- Uses lower quality steam than amines (MEA), consequently increasing net power output.
- Lower heat of absorption.
- Higher absorption capacity.
- Less energy required for stripping.
- Modified IVCAP may be able to remove SO₂ without a FGD unit.
- Approximately 25% lower electricity loss.

R&D Challenges

- Slow kinetics of CO₂ absorption into the K₂CO₃ solution and thus a high-activity catalyst is required.
- Potentially large capital and operating cost of the vacuum pump.
- Suppressing water vaporization in the stripper.
- Chemical and thermal stability of the absorption enzymes.
- Materials need to be developed to immobilize the enzymes.

Results To Date/Accomplishments

- Completed the reactivity test of CA enzyme from a leading enzyme manufacturer and the evaluation of existing inorganic catalysts. The results showed that the CA is a promising catalyst for accelerating CO₂ absorption into the K₂CO₃ solution.

- Results have shown that the CA enzyme:
 - Effective catalyst to promote CO₂ absorption into PC.
 - 300 mg/l CA promotes rate by 2–20 times.
 - Activity comparable at 25–50 °C.
 - Rates comparable at different CO₂ loadings.
 - Rate could further increase at higher CA dosage (>300 mg/l).
 - Stable at tested pH range (9–11.5).
- Rate into PC+CA (at 300 mg/l) 2–5 times less than MEA in a packed-bed column.
- Presence of flue gas impurities resulted in <11% loss of initial CA activity.
- CA immobilized onto silica/glass materials with high Immobilization Factor.

Next Steps

- Investigate catalytic methods to enhance the CO₂ absorption rate in the K₂CO₃ solution.
 - Evaluate and optimize activity of enzyme catalysts.
 - Investigate enzyme immobilization.
 - Evaluate other potential catalysts.
- Screen and develop additives for suppressing water vaporization in the stripper.
 - Measure vapor-liquid phase equilibrium for the CO₂-H₂O-K₂CO₃-KHCO₃ systems with and without additives at a temperature range of 25–70 °C.
 - Inorganic and organic additives to be examined.
- Combine SO₂ removal in the CO₂ capture process.
 - Evaluate reclamation reagents.
 - Conduct parametric tests in the batch and semi-continuous lab systems.
- Conduct techno-economic analysis of the IVCAP.

Available Reports/Technical Papers/Presentations

Presentation at the Annual NETL CO₂ Capture Technology R&D Meeting, September 2010.

Presentation at the Annual NETL CO₂ Capture Technology for Existing Plants R&D Meeting, March 2009.

Poster presentation at the Eighth Annual Conference on Carbon Capture and Sequestration, Pittsburgh, PA, May 2009.

Presentation at the 2009 AIChE Annual Meeting, Nashville, TN, November 2009.

General project information is available on DOE/NETL website at: <http://www.netl.doe.gov/technologies/coalpower/ewr/co2/post-combustion/vacuumcarbonate.html>

REVERSIBLE IONIC LIQUIDS AS DOUBLE-ACTION SOLVENTS FOR EFFICIENT CO₂ CAPTURE

Primary Project Goals

Georgia Tech Research Corporation is developing a novel class of solvents for the recovery of carbon dioxide (CO₂) from post-combustion flue gases that will achieve a substantial increase in CO₂ working capacity with a reduction in cost.

Technical Goals

- Synthesis of silyl amine-based ionic liquids (ILs) with minimal viscosity.
- Measure heat of absorption and desorption.
- Measure rates of CO₂ absorption and desorption.
- Identify solvents that will consume the minimal amount of energy.
- Use simulation tools, such as ASPEN, to design an economic absorption/desorption process.

Technical Content

Reversible ionic liquids (RevILs) are neutral molecules that react with CO₂ to form an IL, which then dissolves additional CO₂ by a physisorption mechanism. Subsequently, modest elevations in temperature reverse the reaction and yield pure CO₂ for disposal; because of this dual mode, capacity can be large.

In a two-component RevIL, CO₂ at 1 atmosphere acts as a “switch,” as shown in Figure 1.

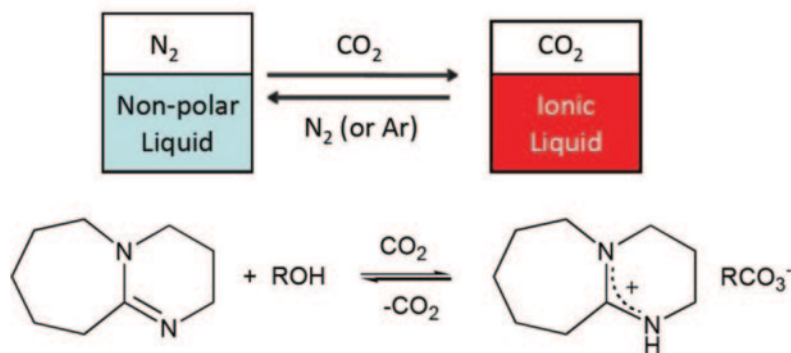

Figure 1: CO₂ Will Switch a Non-Polar Liquid to an Ionic Liquid

Two-component RevILs have the disadvantage of being too complex and requiring alcohol. Light alcohol would evaporate with the CO₂, while a heavy alcohol would have too much heat capacity. A single component RevIL would eliminate the need for alcohol.

Figure 2 shows an example based on silylated amine. The chemistry must work well in the presence of water, considering that water is a component of flue gas. The RevILs will be tested for

Technology Maturity:

Laboratory-scale, simulated flue gas

Project Focus:

Ionic Liquids

Participant:

Georgia Tech Research Corporation

Project Number:

NT0005287

NETL Project Manager:

David Lang

David.Lang@netl.doe.gov

Principal Investigator:

Charles A. Eckert

Georgia Tech Research Corporation

charles.eckert@chbe.gatech.edu

Partners:

None

Performance Period:

10/1/08 – 9/30/11

their chemical stability with 0% and 10% water present. Stability will also be tested at 4, 25, and 50 °C. High viscosity could also be an issue; however, viscosity in RevILs is highly nonlinear (as shown in Figure 3) and can be reduced with impurities, such as water or dissolved gases.

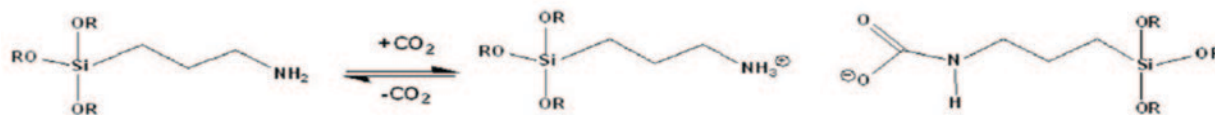

Figure 2: An Example of a Single Component RevIL

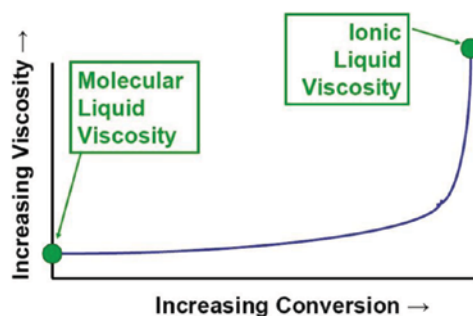

Figure 3: Ionic Liquids are More Viscous Than Their Respective Molecular Liquids

Table 1: : Process Parameters for RevIL Solvents

	Parameter	Current R&D Value	Target R&D Value
Solvent Properties	Type of solvent	Reversible ionic liquid	
	Molecular weight	170–220	150
	Boiling point (°C)	130	200
	Heat of reaction (kJ/mole CO ₂)	Unknown	50
	CO ₂ loading/working capacity ¹ , wt%	Unknown	100
	Solvent concentration to stripper (mol/liter)	4.5	7
	Heat capacity of solution (kJ/K/kg)	—	<4.2
	Viscosity, cP	>1,000	<80
Operating Conditions	Absorption temperature, °C	35	>50
	Absorption pressure, atm	1.2	1.2
	CO ₂ capture efficiency, %	—	90
	Regeneration method	Thermal	Thermal
	Regeneration temperature, °C	115	75
	Regeneration pressure, atm	2	2
Heat Integration	Required regeneration steam temperature, °C	135	100
Miscellaneous	Solvent make-up rate, kg/kg CO ₂	—	<0.003
Product Quality	CO ₂ purity, %	—	>99
	N ₂ concentration, %	—	<1
	Other contaminants, %	—	<1
Process Performance	Electricity requirement, kJ/kg CO ₂	—	500
	Heat requirement, kJ/kg CO ₂	—	1,500
	Total energy (electricity equivalent), kJ/kg CO ₂	—	950

Note:

1. Working capacity is the loading difference CO₂-rich solution before and after it is regenerated.

Equations Describing Chemical Reaction:

Chemical reaction for the CO₂ capture process is shown in Figure 2.

Solvent Contaminant Resistance: Since amine groups are involved in the reaction, sulfur oxides (SO_x) and nitrogen oxides (NO_x), as well as other acid gases, have to be removed. However, solvents have been shown to be stable in wet and oxygen-rich environments for a period of two months.

Flue Gas Pretreatment Requirements: Flue gas pretreatment should be similar to the amine-based absorption processes since the RevIL is resistant to moisture.

Technology Advantages

- Use both physical absorption (dissolution in RevILs) and chemical absorption (reaction with RevILs); amines utilize only chemical absorption.
- Structure can be modified to optimize properties.
- Silylation will decrease viscosity.
- Function in the presence of water.
- Greater capacity than current solvents.
- Smaller energy penalty than current solvents.

R&D Challenges

- New compounds must be designed, synthesized, and characterized.
- Optimum equilibria and heats must be achieved.
- Rapid reaction rates must be achieved.
- Favorable transport rates must be achieved.
- Results from new process must meet DOE goals.

Results To Date/Accomplishments

- Have demonstrated greater capacity than current solvents.
- Successful synthesis and chemical characterization of ten precursors for novel RevILs:
 - (3-aminopropyl) trimethoxysilane
 - (3-aminopropyl) triethoxysilane
 - (3-aminopropyl) triethylsilane
 - (3-aminopropyl) tripropylsilane
 - (3-aminopropyl) trihexylsilane
 - (3-aminopropyl) diisopropyl silane
 - (3-aminopropyl) cyclohexyldimethyl silane

- (3-aminopropyl) phenyldimethyl silane
- (E)-3-(triethylsilyl)prop-2-en-1-amine
- 4-(triethylsilyl)butan-2-amine
- Completed examination of the chemical and physical absorption of CO₂ in the 6 silyl-amine based RevILs at operating pressures of up to 1,000 pounds per square inch (psi) and temperatures of 35, 50, 75, and 100 °C.
- Established recyclability of silyl-amine based reversible ILs.

Next Steps

- Successfully synthesize and characterize silylated one-component RevILs.
 - Demonstrate function in presence of water.
- Measure candidate RevIL's thermodynamic properties.
- Measure candidate RevIL's absorption and desorption rates.
- Identify and produce optimum capture solvent.
- Show that energy penalty is smaller than with current solvents.
- Design of capture process.
- Conduct an economic analysis.

Available Reports/Technical Papers/Presentations

Presentation from Kickoff Meeting held on December 2, 2009.

Presentation: Annual NETL CO₂ Capture Technology for Existing Plants R&D Meeting, March 24–26, 2009, in Pittsburgh, PA.

Vittoria Blasucci, Cerag Dilek, Hillary Huttenhower, Ejae John, Veronica Llopis-Mestre, Pamela Pollet, Charles A. Eckert, and Charles L. Liotta, "One Component, Switchable, Neutral to Ionic Liquid Solvents Derived from Siloxylated Amines," *Chem Comm*, 116–119, 2009.

Vittoria Blasucci, Ryan Hart, Veronica Llopis-Mestre, D. Julia Hahne, Melissa Burlager, Hillary Huttenhower, Reginald Thio, Charles L. Liotta, and Charles A. Eckert, "Single Component, Reversible Ionic Liquids for Energy Applications," *Fuel*, **89**, 1315–1319, 2010.

Vittoria M. Blasucci, Ryan Hart, Pamela Pollet, Charles L. Liotta, and Charles A. Eckert, "Reversible Ionic Liquids Designed for Facile Separations," *Fluid Phase Equilibria*, **294**, 1–6, 2010.

Ryan Hart, Pamela Pollet, Dominique J. Hahne, Ejae John, Veronica Llopis-Mestre, Vittoria Blasucci, Hillary Huttenhower, Walter Leitner, Charles A. Eckert, and Charles L. Liotta, "Benign Coupling of Reactions and Separations with Reversible Ionic Liquids," *Tetrahedron*, **66**, 1082–1090, 2010.

Presentation: Annual NETL CO₂ Capture Technology Meeting, September 13–17, 2010, in Pittsburgh, PA.

General project information is available on DOE/NETL website at: <http://www.netl.doe.gov/technologies/coalpower/ewr/co2/post-combustion/double-action.html>

DEVELOPMENT OF CHEMICAL ADDITIVES FOR CO₂ CAPTURE COST REDUCTION

Primary Project Goals

Lawrence Berkeley National Laboratory (LBNL) is developing a novel solvent system that will integrate amine, potassium carbonate (K₂CO₃), and ammonium solvents to obtain as much carbon dioxide (CO₂) absorption and as little solvent regeneration energy demand as possible.

Technical Goals

- Develop additives to promote CO₂ absorption by K₂CO₃ solution.
- Develop methods to convert KHCO₃ to NH₄HCO₃.
- Develop additives to allow conversion of KHCO₃ to K₂CO₃ with low energy demand.
- Investigate chemistry involved, develop process configuration, determine energy demand, and prepare for scale-up demonstration.

Technical Content

LBNL is performing a bench-scale investigation of novel solvents for post-combustion CO₂ capture. The goal is to enhance CO₂ absorption by the solvent and reduce the cost of regenerating solvents. To date, a bench-scale CO₂ absorber has been set up and calibrated, and parametric tests to determine baseline kinetic performance for methylethanolamine (MEA), ammonia, and chilled ammonia have been conducted as a reference for tests with advanced solvents. LBNL will now investigate a new solvent with CO₂ absorption kinetics reportedly at least twice as fast as MEA. They believe that this should allow CO₂ absorber and packing sizes to be reduced by 50%. The new solvent will produce a CO₂-bearing salt, ammonium bicarbonate. LBNL expects that the energy required to decompose the ammonium bicarbonate for separation of CO₂ will be much less than that required for conventional MEA carbamate salt. During the decomposition process, LBNL will separate ammonia gas from CO₂ and investigate ways to reduce ammonia emissions from the CO₂ capture process.

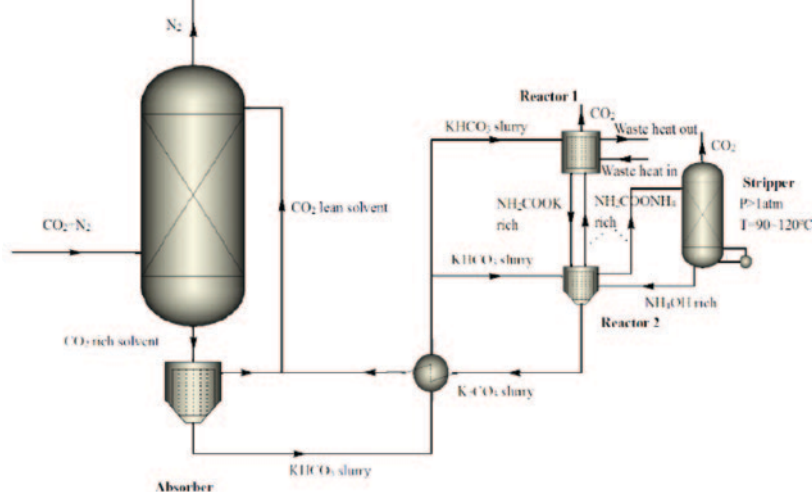

Figure 1: Conceptual Process Configuration #1

Technology Maturity:

Laboratory-scale, simulated flue gas

Project Focus:

Mixed Solvent

Participant:

Lawrence Berkeley National Laboratory

Project Number:

FWP-ED33EE

NETL Project Manager:

David Lang
David.Lang@netl.doe.gov

Principal Investigator:

Shih-Ger Chang
 Lawrence Berkeley National Laboratory
sgchang@lbl.gov

Partners:

None

Performance Period:

6/1/08 – 5/31/13

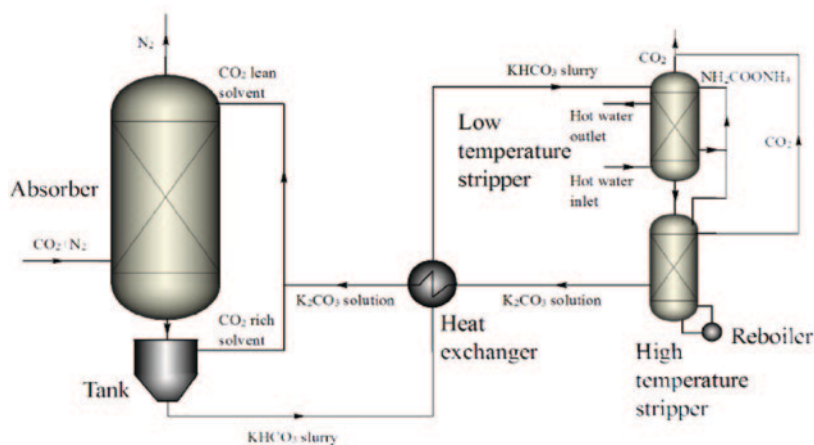

Figure 2: Conceptual Process Configuration #2

Table 1: Solvent Process Parameters

	Parameter	Current R&D Value	Target R&D Value
Solvent Properties	Type of solvent	Amine, potassium carbonate, and ammonium solvent	
	Molecular weight	N/A	—
	Boiling point (°C)	N/A	—
	Heat of reaction (kJ/mole CO ₂)	N/A	—
	CO ₂ loading/working capacity, wt%	N/A	—
	Solvent concentration to stripper (mol/liter)	N/A	—
	Heat capacity of solution (kJ/K/kg)	N/A	—
	Viscosity, cP	N/A	—
Operating Conditions	Absorption temperature, °C	55	—
	Absorption pressure (CO ₂ partial pressure), atm	N/A	—
	CO ₂ capture efficiency, %	N/A	—
	Regeneration method	Thermal	—
	Regeneration temperature, °C	120	—
	Regeneration pressure, atm	N/A	—
Heat Integration	Required regeneration steam temperature, °C	N/A	—
Miscellaneous	Solvent make-up rate, kg/kg CO ₂	N/A	—
Product Quality	CO ₂ purity, %	N/A	—
	N ₂ concentration, %	N/A	—
	Other contaminants, %	N/A	—
Process Performance	Electricity requirement, kJ/kg CO ₂	N/A	—
	Heat requirement, kJ/kg CO ₂	4,503	—
	Total energy (electricity equivalent), kJ/kg CO ₂	N/A	—

Technology Advantages

- Low energy demand.
 - Slurries, reduce sensible and latent heat.
 - NH_4HCO_3 , low solvent decomposition temperature.
 - Waste heat, CO_2 production.
- Reduced reagent loss and equipment corrosion.
 - Organic rate promoters not exposed to H.T. stripping.
- Avoid NH_3 emissions.

R&D Challenges

- CO_2 absorption rate promoters.
- Reaction mechanisms, kinetics, and thermodynamics involving many chemical species, three phases, high concentrations, elevated temperatures, and pressure.
- Most appropriate process configuration.

Results To Date/Accomplishments

- Bench-scale CO_2 absorber has been set up and calibrated.
- Parametric tests to determine baseline kinetic performance for MEA, ammonia, and chilled ammonia.
- Developed a conceptual process configuration.

Next Steps

Final test results will not be available until the May 2013 project completion date.

Available Reports/Technical Papers/Presentations

Annual NETL CO_2 Capture Technology Meeting, September 13–17, 2010, Pittsburgh, PA.

IONIC LIQUIDS: BREAKTHROUGH ABSORPTION TECHNOLOGY FOR POST-COMBUSTION CO₂ CAPTURE

Primary Project Goals

The University of Notre Dame is developing a new ionic liquid (IL) solvent and accompanying capture process that will incur a small increase in cost of electricity (COE) compared to currently available capture technologies.

Technical Goals

- ILs will have low water solubility and will be used in essentially an anhydrous state.
- The target selectivity of carbon dioxide (CO₂) over nitrogen (N₂) for the IL will be 50.
- The complexing ratio of CO₂: IL will be at least 1:1.
- Desired IL properties include:
 - Liquid at room temperature or slightly above.
 - Thermally stable to 300 °C.
 - Minimal viscosity increase upon complexation with CO₂.
 - Binding strength tuned to yield optimal capture and regeneration performance.

Technical Content

ILs are salts that are liquid at room temperature. They are known to have high intrinsic physical solubility for CO₂. Examples of ILs are illustrated in Figure 1.

Previous experiments have shown a potential for high CO₂ solubility and low oxygen (O₂), N₂ solubility (see Figure 2). ILs as CO₂ absorbents are promising for reducing costs by developing a process with higher CO₂ loading in the circulating liquid and lower heat requirements for regeneration. Both of these effects would lower process costs.

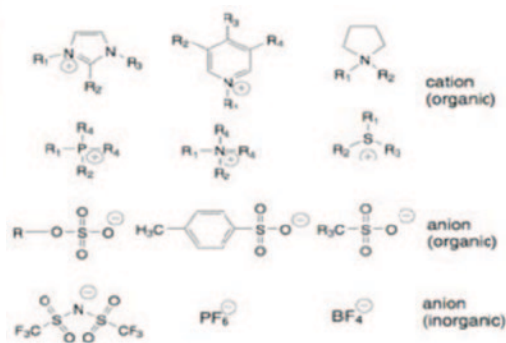

Figure 1: Examples of Ionic Liquids

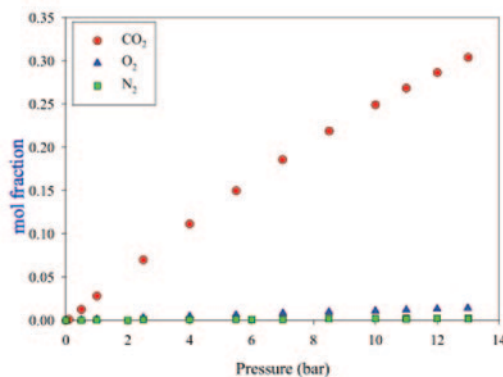

Figure 2: CO₂ Solubility in Ionic Liquids

Technology Maturity:

Laboratory-scale, simulated flue gas

Project Focus:

Ionic Liquids

Participant:

University of Notre Dame

Project Number:

NT43091

NETL Project Manager:

David Lang

David.Lang@netl.doe.gov

Principal Investigator:

Edward J. Maginn

University of Notre Dame

ed@nd.edu

Partners:

Babcock & Wilcox

DTE

EMD

Trimeric Corporation

Performance Period:

2/28/07 – 2/29/12

A suitable capture process cannot be identified until the best IL candidate is selected. However, the following is a base case absorber/stripper process.

Process simulation has been used to evaluate the sensitivity of a representative 500-MW, coal-fired power plant CO₂ capture process for the properties of ILs. The results will be used to guide the development of the next generation of ILs. Variables include:

- Stoichiometry: Notre Dame has developed both 1:1 and 2:1 (IL: CO₂) stoichiometries; to date, preliminary modeling assumed 1:1 since this should yield the best performance.
- Enthalpy of reaction: Notre Dame proposed a range of low to high based on molecular modeling.
- Loading (K_{eq}): Sensitivity includes a range of CO₂ loadings that result from the above enthalpies of reaction.
- Water miscibility: Both partially and fully miscible systems are included. Activities coefficients modeled with Nationally Recognized Testing Laboratory (NRTL) using experimental data.

Preliminary results show much lower parasitic energy compared with an MEA system.

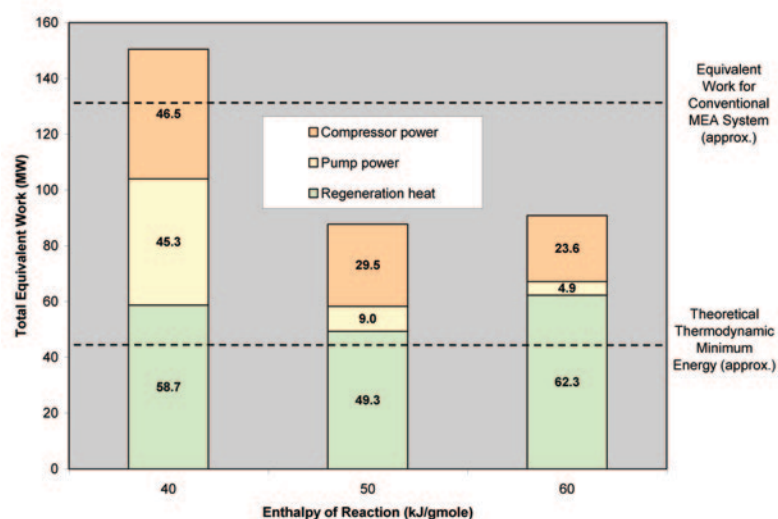

Figure 3: Preliminary Results on the Parasitic Power Requirement of Ionic Liquid Solvents

Table 1: Process Parameters for Ionic Liquid Solvents

	Parameter	Current R&D Value	Target R&D Value
Solvent Properties	Type of solvent	Ionic liquid	Ionic liquid
	Molecular weight	575 g/mol	<575 g/mol
	Boiling point (°C)	N/A, do not boil	N/A, do not boil
	Heat of reaction (kJ/mole CO ₂)	35–75	35–75
	CO ₂ loading/working capacity ¹ , wt%	1.6–2.6%	>2.6%
	Solvent concentration to stripper (mol/liter)	1.8	1–2
	Heat capacity of solution (kJ/K/kg)	2.1	<2
	Viscosity, cP	100 at 40 °C	<100 at 40 °C

Table 1: Process Parameters for Ionic Liquid Solvents

	Parameter	Current R&D Value	Target R&D Value
Operating Conditions	Absorption temperature, °C	40–50	40–50
	Absorption pressure, atm	0.15 of CO ₂	0.15
	CO ₂ capture efficiency, %	90	90
	Regeneration method	Thermal	Thermal
	Regeneration temperature, °C	120–160	120–204
	Regeneration pressure, atm	1–3	>2
Heat Integration	Required regeneration steam temperature, °C	126–218 °C	126–218 °C
Miscellaneous	Solvent make-up rate, kg/kg CO ₂	0.001	<0.001
Product Quality	CO ₂ purity, %	>95%	>95%
	N ₂ concentration, %	<3%	<3%
	Other contaminants, %	Unknown	<2%
Process Performance	Electricity requirement, kJ/kg CO ₂	390–560	Minimize
	Heat requirement, kJ/kg CO ₂	1,650–1,850	Minimize
	Total energy (electricity equivalent), kJ/kg CO ₂	890–950	Minimize

Note:

- Working capacity is the loading difference CO₂-rich solution before and after it is regenerated.

Technology Advantages

- Low volatility and good thermal stability.
- Wide liquidus range.
- Adjustable enthalpy of absorption (10–80 kJ/mol).

R&D Challenges

- Maintain high thermal stability with good reaction kinetics and capacity.
- Unknown corrosion behavior.
- Determine mass transfer characteristics.
- Gain operational experience in lab-scale units.
- Cost of solvent made on large-scale unknown.

Results To Date/Accomplishments

Phase I and Phase II of the project are complete; Phase III is in progress. Key accomplishments to date include:

- Synthesized and tested a total of 17 new “Generation 1” ILs during the first year of the project; synthesized a total of 7 “Generation 2” ILs during the second year of the project.
- Developed molecular modeling techniques that have enabled Notre Dame researchers to compute key properties of ILs from first principles.
- Developed a way to tune the binding strength of CO₂ to optimize the ILs using process modeling as a guide.

- Developed unique experimental techniques, including the ability to monitor the IR spectrum of the IL as it absorbs CO₂, and then use this information to determine reaction rates and mechanisms.
- Evaluated alternative process configurations; selected a viscosity modified absorber stripper process for continued study.
- Developed a detailed understanding of the mechanism responsible for the large viscosity increase observed upon complexing CO₂, and designed new molecules that do not show viscosity increase.
- Synthesized several “Generation 3” ILs that exhibit low viscosity and whose viscosity does not significantly increase upon reaction with CO₂, unlike the case with “Generation 2” ILs.
- Selected “optimal” IL(s) for lab-scale testing.
- Conducted bench-scale tests to evaluate process design.
- Designed and contrasted a laboratory-scale test system.

Next Steps

- Continued synthesis and testing of “Generation 3” ILs.
- Construct and operate lab-scale test system using conventional solvent and Phase III IL.
- Finalize economic, engineering, and systems analyses.

Available Reports/Technical Papers/Presentations

W. F. Schneider and E. Mindrup, “First-Principles Evaluation of CO₂ Complexation In Functionalized Ionic Liquids,” Symposium on Ionic Liquids: From Knowledge to Application, American Chemical Society National Meeting, Philadelphia, PA, August 17–21, 2008.

K. E. Gutowski and E. J. Maginn, “Amine-Functionalized Task Specific Ionic Liquids for CO₂ Capture,” Symposium on Ionic Liquids: From Knowledge to Application, American Chemical Society National Meeting, Philadelphia, PA, August 17–21, 2008.

Joan F. Brennecke, “CO₂ Capture – Challenges and Opportunities,” Energy, Citizens and Economic Transformation for Indiana and America, University of Notre Dame, July 7, 2008.

Joan F. Brennecke, Jessica L. Anderson, Alexandre Chapeaux, Devan E. Kestel, Zulema K. Lopez-Castillo, and Juan C. de la Fuente, “Carbon Dioxide Capture Using Ionic Liquids,” 236th ACS National Meeting, Philadelphia, PA, August 17, 2008.

E. M. Mindrup and W. F. Schneider, “Comparison of Functionalized Amine Energetics for CO₂ Capture,” poster presented at the AIChE Annual Meeting, Philadelphia, PA 2008.

Wei Shi and E. J. Maginn, “Molecular simulation of pure and mixture gases absorption in ionic liquids,” presented at the AIChE Annual Meeting, Philadelphia, PA 2008.

Wei Shi and E. J. Maginn, “Molecular simulation and regulation solution theory modeling of pure and mixed gas absorption in the ionic liquid 1-n-butyl-3-methylimidazolium Bis(Trifluoromethylsulfonyl)amide [(hmim)(Tf₂N)],” *Journal of Physical Chemistry B*, 112(51), 16710–16720.

Fisher, K.S., et al. *Advanced Amine Solvent Formulations and Process Integration for Near-Term CO₂ Capture Success*. Final Report to U.S. Department of Energy, National Energy Technology Laboratory (NETL). Grant No. DE-FG02-06ER84625, June 2007.

Christina Myers, Henry Pennline, David Luebke, Jeffery Ilconich, JaNeille Dixon, Edward J. Maginn, and Joan F. Brennecke, “High Temperature Separation of Carbon Dioxide/Hydrogen Mixtures Using Facilitated Supported Liquid Membranes,” *Journal of Membrane Science*, 2008, 322, 28–31.

Xiaochun Zhang, Feng Huo, Zhiping Liu, Wenchuan Wang, Edward Maginn and Wei Shi, "Absorption of CO₂ in the Ionic Liquid 1-n-hexyl-3-methylimidazolium tris(pentafluoroethyl)trifluorophosphate [(hmim)(FEP)]: A Molecular View by Computer Simulations," *Journal of Physical Chemistry B*, 2009, 113, 7591–7598.

Keith Gutowski and Edward J. Maginn, "Amine-Functionalized Task-Specific Ionic Liquids: A Mechanistic Explanation for the Dramatic Increase in Viscosity Upon Complexation with CO₂ from Molecular Simulation," *Journal of the American Chemical Society*, 2008, 130, 14690–14704.

E. J. Maginn, Developing New Ionic Liquids for CO₂ Capture: A Success Story for Thermodynamics and Computational Molecular Design, GE Global Research Symposium on Emissions and Aftertreatment, GE Global Research Center, Niskayuna, NY, Sept. 17, 2009.

Marcos Perez-Blanco and Edward J. Maginn, "Molecular Dynamics Simulations of CO₂ at an Ionic Liquid Interface: Adsorption, Ordering and Interfacial Crossing", *Journal of Physical Chemistry B* (cover article), 2010, 36, 11827.

W. F. Schneider, "Ionic Liquids for CO₂ Capture from First-Principles," CECAM workshop on Carbon Capture, Lausanne, Switzerland, July 26–28, 2010.

W. F. Schneider and E. Mindrup, "AHA! Computational design of aprotic heterocyclic anions for ionic-liquid-based CO₂ separations," Division of Fuel Chemistry, American Chemical Society National Meeting, Boston, MA, August 22–26, 2010.

Burcu E. Gurkan, Juan C. de la Fuente, Elaine M. Mindrup, Lindsay E. Ficke, Brett F. Goodrich, Erica A. Price, William F. Schneider, and Joan F. Brennecke, "Equimolar CO₂ absorption by anion-functionalized ionic liquids," *J. Am. Chem. Soc.*, 132, 2010, 2116–2117.

Burcu E. Gurkan, Juan de la Fuente, Elaine M. Mindrup, Lindsay E. Ficke, Brett F. Goodrich, Erica A. Price, William F. Schneider, Edward J. Maginn and Joan F. Brennecke, "Chemically Complexing Ionic Liquids for Post-Combustion CO₂ Capture," Clearwater Clean Coal Conference, Clearwater, FL, June 6–10, 2010.

Edward J. Maginn, "Molecular engineering of new ionic liquid sorbents for CO₂ capture" at the 9th Annual Carbon Capture and Sequestration Meeting, Pittsburgh, PA, May 2010.

Edward J. Maginn, Joan F. Brennecke, William F. Schneider, and Mark J. McCready, "Ionic Liquids: Breakthrough Absorption Technology for Post-Combustion CO₂ Capture", NETL CO₂ Capture Meeting, Pittsburgh, PA, Sept 13, 2010.

CO₂ CAPTURE FROM FLUE GAS BY PHASE TRANSITIONAL ABSORPTION

Primary Project Goals

Hampton University is demonstrating the techno-economic viability of the phase transitional absorption process, which is a novel, innovative, low-cost, and low-energy-consuming carbon dioxide (CO₂) capture technology relative to the mainstream amine-based technology.

Technical Goals

To understand the mechanisms of phase transitional absorption by measuring absorption kinetics, regeneration rate, loading capacity, absorbent losses, and regeneration energy losses; and further to compare with other methods, such as the state-of-art monoethanolamine absorption.

Technical Content

The phase transitional absorption process is radically different from the conventional absorption processes. It uses an activated agent, which, when mixed with a special solvent, forms a special phase transitional absorbent for CO₂ capture. The absorbent, after absorbing CO₂ from flue gas in an absorber, flows into a settler where it is separated into two phases: a CO₂-rich phase and a CO₂-lean phase. The CO₂-rich solvent is then sent to a regenerator for regeneration. After regeneration, the solvent is cooled and mixed with the CO₂-lean phase and sent to an absorber to complete the cycle. The absorbent is characterized as phase transitional absorbent due to its ability to separate the concentrated CO₂-rich phase from CO₂-lean phase. A schematic diagram of the process is shown in Figure 1. It may be noted that the process is similar to a conventional MEA process, except that a settler is added for separating the two phases.

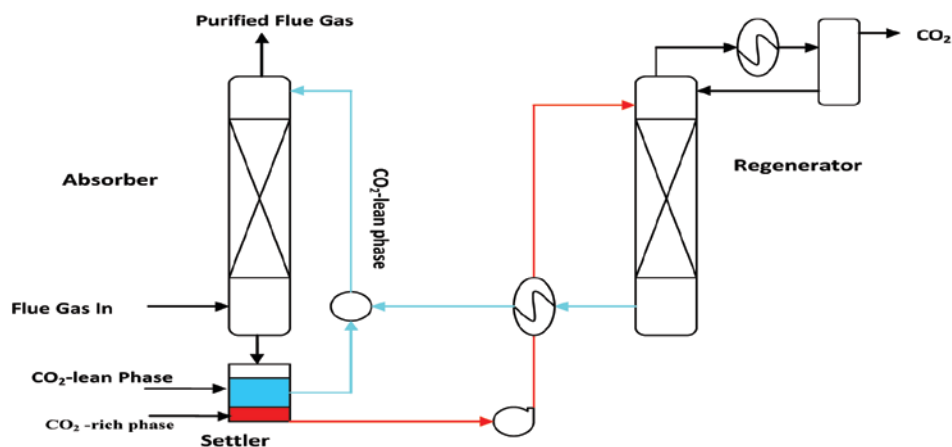

Figure 1: Concept Flow Diagram of Phase Transitional Absorption

In the conventional absorption process, such as an MEA process, the entire solvent is sent to the regenerator for regeneration, which necessitates a large circulation pump and a large amount of regeneration energy. In contrast, in the phase transitional absorption process, the absorbent separates into two phases, and only the CO₂-rich phase needs to be regenerated. The CO₂-rich phase is only approximately 20% of the total absorbent. Thus, the pumping and heating requirements are significantly less compared to the MEA process.

Technology Maturity:

Laboratory-scale, simulated flue gas

Project Focus:

Phase Transitional Absorption

Participant:

Hampton University

Project Number:

NT42488

NETL Project Manager:

Isaac Aurelio

Isaac.Aurelio@netl.doe.gov

Principal Investigator:

Liang Hu

Hampton University

lianghu59@yahoo.com

Partners:

None

Performance Period:

6/15/05 – 6/30/09

Another important feature of the phase transitional absorption is that the absorption rate of CO₂ will be enhanced by selecting the proper solvent, as shown in Figure 2.

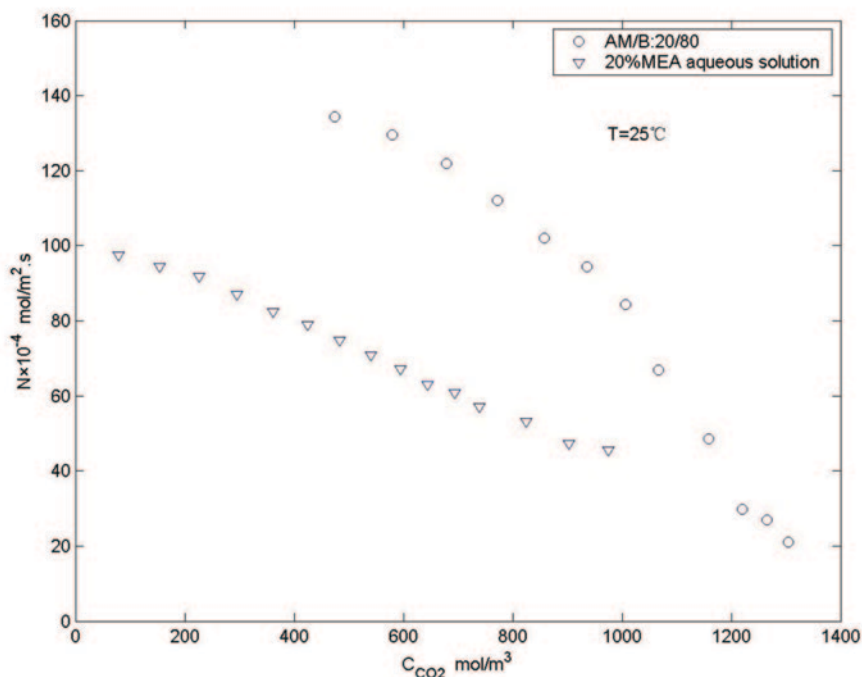

Figure 2: Absorption Rate Comparison (Phase Transitional Absorption vs. MEA Technology)

T = 25 °C; P_{CO₂} = 1 atm; N = 60 rpm; V_L = 900 ml.

Phase Transitional Absorption: activated agent: AM 20% by volume; solvent: B 80%.

MEA Technology: 20% (by volume) MEA aqueous solution.

Experimental results also showed that the temperature did not have strong impact on the absorption rate for the several absorbent studied. The small effect on the absorption rate by temperature could be attributed to the much smaller reaction heat.

The highest absorption rate is found when the activated agent was in the range between 30 and 40% by volume. The range may vary if the different activated agents and solvents are used. The range of activated agents with the highest absorption rate is highly related to the physical and chemical properties of the absorbent (i.e., activated agents and solvents), and also the combination.

It was determined from these results that the mechanism of the absorption is a fast chemical reaction controlled by the liquid side mass transfer. Therefore, an absorber with large gas-liquid interface and sufficient liquid turbulence is recommended in order to have a higher absorption rate, such as a packed column.

Table 1: Parameters for Phase Transitional Absorption Processes

Parameter	Current R&D Value	Target R&D Value
Type of solvent	Non-aqueous amine	
Molecular weight	Varies	—
Boiling point (°C)	Varies	—
Heat of reaction (kJ/mole CO ₂)	—	—
CO ₂ loading/working capacity ¹ , wt%	20%	—
Solvent concentration to stripper (mol/liter)	—	—
Heat capacity of solution (kJ/K/kg)	—	—
Viscosity, cP	—	—

Table 1: Parameters for Phase Transitional Absorption Processes

	Parameter	Current R&D Value	Target R&D Value
Operating Conditions	Absorption temperature, °C	25–50	—
	Absorption pressure, atm	Atmospheric	—
	CO ₂ capture efficiency, %	>90	—
	Regeneration method	Thermal	—
	Regeneration temperature, °C	90–120	—
	Regeneration pressure, atm	Vacuum, 2 or 3	—
Heat Integration	Required regeneration steam temperature, °C	120	—
Miscellaneous	Solvent make-up rate, kg/kg CO ₂	N/A	—
Product Quality	CO ₂ purity, %	99.9%	—
	N ₂ concentration, %	—	—
	Other contaminants, %	—	—
Process Performance	Electricity requirement, kJ/kg CO ₂	—	—
	Heat requirement, kJ/kg CO ₂	1,000 (heat)	—
	Total energy (electricity equivalent), kJ/kg CO ₂	—	—

Note:

1. Working capacity is the loading difference CO₂-rich solution before and after it is regenerated.

Technology Advantages

- Greatly reducing regeneration energy comparing with MEA process.
- Higher absorption rate, resulting in lower capital investment for absorption equipment.
- Higher CO₂ working capacity, which will reduce sensible heat and solvent volume in circulation.
- Low corrosion rate to carbon steel compared to MEA process.
- Potentially less solvent loss.
- Non-toxic, environmentally safe.

R&D Challenges

- Process exists only at the laboratory scale and needs to be scaled up.
- Moisture in flue gas may have impact on the process.

Results To Date/Accomplishments

- Measured the absorption rate at 15, 25, 35, 45, and 55 °C.
- Measured the effect of absorbent concentration in solution (from 10 to 50% by volume) on absorption rate and loading capacity.
- Measured the effect of solution agitation speed (30, 60, and 90 rpm) on absorption rate.
- Measured the absorption rate at 1 atm of CO₂ partial pressure.

- Conducted the regeneration tests; measured the regeneration rate at different temperature.
- Conducted the corrosion tests for carbon steel coupon.
- Conduct the initial process evaluation based on the lab results and made the comparison with MEA absorption.

Next Steps

The project is completed.

Available Reports/Technical Papers/Presentations

Hu, Liang, Monica Wood, Joseph Hoque. "CO₂ Capture from Flue Gas by Phase Transitional Absorption." <http://www.netl.doe.gov/publications/proceedings/07/ucr/abstracts/Hu.pdf> (Accessed 9/28/2009).

APPENDIX B: CARBON DIOXIDE CAPTURE TECHNOLOGY SHEETS

POST-COMBUSTION SORBENTS

CO₂ CAPTURE FROM FLUE GAS USING SOLID MOLECULAR BASKET SORBENTS

Primary Project Goals

Pennsylvania State University (PSU) is developing a new generation of solid and regenerable polymeric molecular basket sorbent (MBS) for more cost-efficient capture and separation of carbon dioxide (CO₂) from flue gas of coal-fired power plants.

Technical Goals

- A regenerable working sorption capacity higher than 70 mg-CO₂/g-S.
- A significantly lower cost for the sorbent preparation compared to the early generations of MBS.

Technical Content

The current state-of-the-art post-combustion capture technology—aqueous amine scrubbing—is a highly energy-intensive process estimated to increase the cost of electricity (COE) by about 75–85%, according to U.S. Department of Energy (DOE) reports. The goal of DOE's Existing Plants, Emissions, and Capture (EPEC) Research and Development (R&D) Program is to achieve 90% CO₂ capture with an increase in COE less than 35%. Therefore, it is important to develop inexpensive, effective, and robust materials and technologies that can reduce CO₂ emission and are suitable for installation in power plants to maintain the cost-effectiveness of U.S. coal-fired power plants. Recently, a new sorbent concept called MBS has been developed for CO₂ capture from flue gas. The idea of MBS development, as shown in Figure 1, is to load CO₂-philic polymers on to high surface area mesoporous materials. This process increases the number of approachable sites on/in the sorbent and enhances the sorption/desorption rate by increasing the gas-sorbent contacting interface and by improving the mass transfer in the sorption/desorption process. The expected result of this project will be a concentrated CO₂ stream that can be directed to CO₂ sequestration or CO₂ utilization.

The researchers are using the following approaches to accomplish the technical project goals:

- Using cheaper nanoporous materials to replace SBA-15 and MCM-41 to reduce the cost for the sorbent.
 - Silica-gel, fumed silica, carbon.
- Using cross-linkers to improve the thermal stability and regenerability of MBS via chemical bonding.

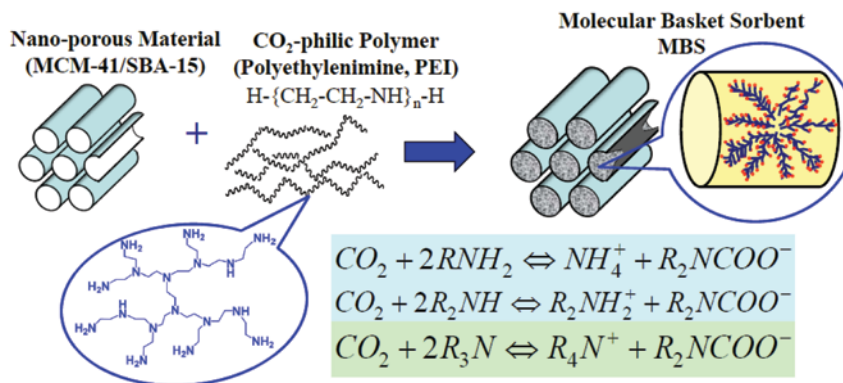

Figure 1: Molecular Basket Sorbent (MBS) Concept

Technology Maturity:
Bench-scale

Project Focus:
Solid Molecular Baskets

Participant:
Penn State University

Project Number:
FE0000458

NETL Project Manager:
Andrew O'Palko
Andrew.Opalko@netl.doe.gov

Principal Investigator:
Chunshan Song
Pennsylvania State University
csong@psu.edu

Partners:
None

Performance Period:
9/1/09 – 8/31/11

Table 1: Process Parameters for Sorbents

	Parameter	Current R&D Value	Target R&D Value
Sorbent Properties	Type of sorbent	Solid amine	Solid amine
	Heat of adsorption (kJ/mole CO ₂)	~69	—
	CO ₂ loading/working capacity, wt%	140/80	120/70
	Surface area, m ² /g	20–80	~60
	Particle density, g/cm ³	N/A	—
	Packing density, g/cm ³	0.4–0.8	~0.8
	Particle size (mm)	~0.05	~0.05
	Heat capacity (kJ/K/kg)	~1.6	—
	Thermal stability, °C	~100	120
	Hydrothermal stability, °C	<90	120
Process Configuration	Attrition rate (fluidized bed), %/year	N/A	N/A
	Cycle time (fixed bed), minutes	60	40
	Pressure drop (fixed bed), psia	<10	<5
Operating conditions	Adsorption temperature, °C	75	75
	Adsorption pressure, atm	1 (CO ₂ , 0.15%)	1
	CO ₂ capture efficiency, %	>90	>95
	Regeneration method	PSA+TSA	PSA/TSA
	Regeneration temperature, °C	100	100
	Regeneration pressure, atm	0.01	—
Heat Integration	Required regeneration steam temperature, °C	N/A	—
Miscellaneous	Sorbent make-up rate, kg/kg CO ₂	N/A	—
Product Quality	CO ₂ purity, %	~90%	>95%
	N ₂ concentration, %	N/A	—
	Other contaminants, %	N/A	—
Process Performance	Electricity requirement, kJ/kg CO ₂	N/A	—
	Heat requirement, kJ/kg CO ₂	N/A	—
	Total energy (electricity equivalent), kJ/kg CO ₂	N/A	—

Technology Advantages

- High capacity: 3.2 mol-CO₂/kg (or 14%) at CO₂ conc. of 15%.
- High selectivity: CO₂/N₂>1,000.
- No (or less of a) corrosion problem.
- Suitable operation conditions.
- High sorption/desorption rate.
- Positive effect of moisture.
- Regenerable at mild conditions.

R&D Challenges

- High cost of nanoporous materials (SBA-15 and MCM-41).
- Low packing density.
- Thermal and regenerable stability needs to be improved.

Results To Date/Accomplishments

- Four types of nanoporous supports, including silica-gel, Cab-O-Sil, carbon black, and mesoporous foam silica either purchased or synthesized in the lab, have been tested for polyethylenimine loading.
- More than 50 sorbent samples have been prepared and examined for CO₂ capture using thermogravimetric analysis, fixed-bed flow system, and temperature-programmed desorption methods.
- Several sorbents have showed comparable sorption capacity to SBA-15-based molecular basket sorbent, reaching about 140 mg-CO₂/g-sorbent, while the cost for the sorbent is much lower, being ~\$40/kg. It exceeds the project goals of higher than 70 mg-CO₂/g-sorbent with less than \$240/kg cost.
- A new approach, polymer cross-linking, has been proposed and tested to further improve the thermal and regenerable stability of molecular basket sorbents. More than 15 samples have been tested with thermal degradation at heating over 100 °C, CO₂ sorption at 75 °C, and desorption at 100 °C cycling.
- Primary computational calculations show that the addition of cross-linker can promote the stability of the cross-linked polymer and improve the sorption strength between CO₂ and amine sites; thus, both the thermal stability and regenerability may be enhanced.

Next Steps

- More experimental and computational work will be conducted to identify a proper way to prepare and obtain a highly thermal stable molecular basket sorbent, and it will be applied to the low-cost sorbents developed in this project.
- The best regeneration conditions and method (TAS and/or PSA) will be determined.
- Based on the developed MBS, scale-up of CO₂ sorption process using MBS will be carried out (about 200 ml sorber in the lab).
- Based on the selected materials and sorption performance, a primary analysis on the techno-economy of MBS technology will be conducted.

Available Reports/Technical Papers/Presentations

Peer-Reviewed Journal Papers:

DX Wang, C Sentorun-Shalaby, XL Ma, CS Song, High-capacity and low-cost carbon-based molecular basket sorbent for CO₂ capture from flue gas. *Energy Fuels* **2011**, 25, 456–458.

Presentations:

XX Wang, SQ Zhao, XL Ma, CS Song, CO₂ capture from gas streams with low CO₂ concentrations using solid molecular basket sorbent. 241st ACS National Meeting, Anaheim, CA, USA, March 27–31, **2011**.

XX Wang, SQ Zhao, XL Ma, CS Song, Carbon dioxide sorption over molecular basket sorbents: a detailed TPD study. 22th North American Catalysis Society meeting, Detroit, MI, June 2–10, **2011**.

XL Ma, ZH Zhang, J Zhu, XX Wang, CS Song, CO₂ capture from the atmosphere using nano-porous-material-supported polyethylenimine sorbents. 241st ACS National Meeting, Anaheim, CA, USA, March 27–31, **2011**.

XL Ma, XX Wang, CS Song, Advances and challenges in development of amine-functionalized and amine-immobilized solid sorbents for CO₂ capture. The International Chemical Congress of Pacific Basin Societies, Honolulu, HI, USA, December 15–20, **2010**.

XX Wang, DX Wang, EP Fillerup, E Peduzzi, ZH Zhang, XL Ma and Chunshan Song. CO₂ Capture from Flue Gas Using Solid Molecular Basket Sorbents. Oral Presentation. 2010 NETL CO₂ Capture Technology Meeting. Pittsburgh, September 13–17, **2010**. http://www.netl.doe.gov/publications/proceedings/10/co2capture/presentations/monday/Xiaoxing_Wang-FE0000458.pdf

EP Fillerup, XX Wang, XL Ma, and CS Song. Utilization of Polymer Cross-linkers to Improve the Thermal Stability of Molecular-Basket Sorbents. Oral Presentation. American Chemistry Society 240th National Meeting, Boston, MA, August 22–26, **2010**.

XL Ma, XX Wang, CS Song, “Molecular Basket” Sorbents for CO₂ Capture from Flue Gas. 26th International Pittsburgh Coal Conference, Pittsburgh, PA, September 21–24, **2009**.

Manuscript in Preparation:

XX Wang, SQ Zhao, XL Ma, ZH Zhang, DX Wang, CS Song, SBA-15-supported polyethylenimine sorbents for CO₂ capture from flue gas. **2011**, in preparation.

XX Wang, SQ Zhao, XL Ma, CS Song, CO₂ sorption over polyethylenimine loaded SBA-15 sorbents: a TPD study. **2011**, in preparation.

XX Wang, XL Ma, V Schwartz, JC Clark, SH Overbury, SQ Zhao, XC Xu, CS Song, Superior solid sorbent for CO₂ capture and separation from gas streams with low CO₂ concentration at ambient conditions. **2011**, in preparation.

LOW-COST SORBENT FOR CAPTURING CO₂ EMISSIONS GENERATED BY EXISTING COAL-FIRED POWER PLANTS

Primary Project Goals

TDA Research is designing and developing a low-cost solid sorbent that is capable of cost-effectively and efficiently capturing carbon dioxide (CO₂) from existing coal-fired power plants, as well as an adsorption/regeneration process designed around that material.

Technical Goals

- Use existing information to select candidates for a low-cost, highly efficient CO₂ sorbent.
- Perform thermogravimetric analysis (TGA), surface area (BET), and crush strength analyses to characterize the sorbent.
- To determine the effects of sulfur oxides (SO_x), nitrogen oxides (NO_x), and water (H₂O) on the working capacity of the optimum sorbent.
- Construct and demonstrate a novel CO₂ removal system for real flue gas stream.

Technical Content

TDA's CO₂ capture system uses a dry alkalized alumina sorbent. This regenerable sorbent acts as a physical adsorbent for CO₂. The CO₂ capture process runs near isothermally at around 150 °C in both adsorption and regeneration. No heating or cooling of the sorbent between absorption and regeneration steps is required. The sorbent is regenerated with low-pressure [15.5 pounds per square inch absolute (psia)] steam. This regeneration is done at near the same temperature as adsorption.

The sorbent has shown excellent tolerance to contaminants. Laboratory tests using simulated flue gas with sulfur dioxide (SO₂) were performed for more than 2,000 cycles. Testing with NO_x has been conducted for more than 180 cycles. No loss of CO₂ loading capacity was observed during these tests. For this process, additional flue gas pretreatment upstream of the CO₂ capture unit may not be required beyond what is already in place with existing flue gas desulfurization (FGD) units.

Figure 1 shows an overall schematic of TDA's system, which consists of three primary components: (1) the absorber/regenerator unit; (2) the low-pressure steam generator; and (3) the CO₂ compression and purification unit. The process is designed for the sorbent to pull the dilute CO₂ out of the flue gas at intermediate temperature and near ambient pressure, and then be regenerated with low-pressure superheated steam. TDA is developing both the sorbent and the process designed around that material.

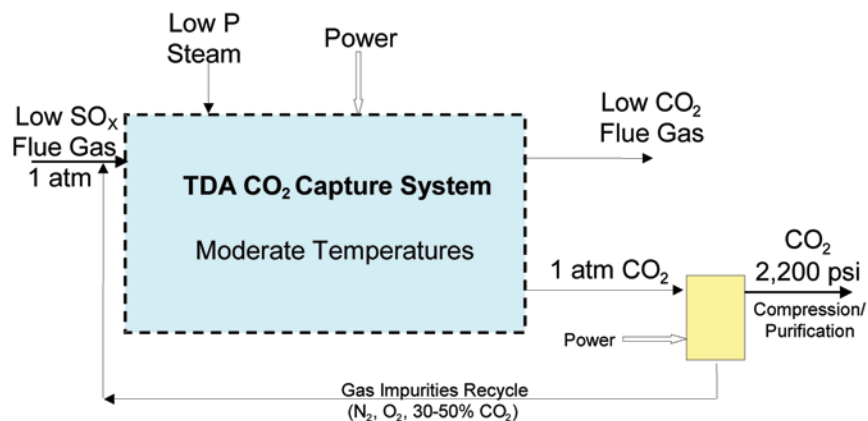

Figure 1: Schematic of TDA's CO₂ Emission Control System

Technology Maturity:

Bench-scale using simulated flue gas

Project Focus:

Alkalized Alumina

Participant:

TDA Research, Inc.

Project Number:

NT0005497

NETL Project Manager:

Andrew O'Palko
Andrew.Opalko@netl.doe.gov

Principal Investigator:

Jeannine E. Elliott
 TDA Research, Inc.
jelliott@tda.com

Partners:

Babcock & Wilcox
 Louisiana State University
 Western Research Institute

Performance Period:

11/1/08 – 10/31/11

Table 1: Process Parameters

	Parameter	Current R&D Value	Target R&D Value
Sorbent Properties	Type of sorbent	Adsorbent	Adsorbent
	Heat of adsorption (kJ/mole CO ₂)	12–25	10–20
	CO ₂ loading/working capacity, wt%	0.7	1–3
	Surface area, m ² /g	100	100–150
	Particle density, cm ³ /g	0.63	0.6
	Packing density, cm ³ /g	1.05	1
	Particle size (mm)	1.6	9.5
	Heat capacity (kJ/K/kg)	0.8	0.8
	Thermal stability, °C	650	>250
	Hydrothermal stability, °C	110 < T < 650	110 < T < 650
Process Configuration	Attrition rate (fluidized bed), %/year	TBD	TBD
	Cycle time (fixed bed), minutes	5–15	5–15
	Pressure drop (fixed bed), psia	2–5	0.5
Operating Conditions	Adsorption temperature, °C	110 < T < 200	110 < T < 250
	Adsorption pressure, atm	1	1.05
	CO ₂ capture efficiency, %	90	90
	Regeneration method	Steam	Steam
	Regeneration temperature, °C	110 < T < 200	110 < T < 200
	Regeneration pressure, atm	1	1.05
Heat Integration	Required regeneration steam temperature, °C	TBD	TBD
Miscellaneous	Sorbent make-up rate, kg/kg CO ₂	TBD	Annual
Product Quality	CO ₂ purity, %	TBD	99.99998
	N ₂ concentration, %	TBD	1.8e–8
	Other contaminants, %	TBD	1.98e–5
Process Performances	Electricity requirement, kJ/kg CO ₂	N/A	—
	Heat requirement, kJ/kg CO ₂	N/A	—
	Total energy (electricity equivalent), kJ/kg CO ₂	N/A	—

Technology Advantages

- Low regeneration energy.
- Rapid adsorption/regeneration kinetics due to surface-only adsorption.
- Isothermal operation.

R&D Challenges

- Effectively produce a sorbent from low-cost raw materials with extensive regenerative life of the sorbent.
- Minimizing the parasitic demands from the sorbent system.

Results To Date/Accomplishments

- Performed TGA, BET, and crush strength analyses on a variety of sorbent materials.
- Determined alkalized alumina to be the optimum sorbent with a loading capacity of 0.7 wt%.
- Performed extended period testing up to 1,800 cycles and found the sorbent maintained its loading capacity at near-constant levels throughout.
- Optimized the sorbent composition and production process.
- Performed sorbent testing and characterization.
- Initiated 1,500-hour sorbent cycling test to evaluate the SO_x contamination of the sorbent and to complete wear and service assessments of the sorbent.
- Evaluated the affect of NO_x in simulated flue gas. No loss of CO₂ loading capacity observed after 180 cycles with 820 parts per million (ppm) of NO_x.
- Created a CO₂ capture process design and ASPEN model that includes steam source, CO₂ compression, and heat sources, and calculates efficiency.
- Designed bench-scale testing apparatus to show continuous absorption of CO₂ in simulated flue gas feed.
- Construction of CO₂ capture bench-scale unit is nearly complete.

Next Steps

- Demonstrate sorbent in new apparatus with continuous absorption and regeneration functions.
- Update system analysis with experimental data and determine process economics.
- Demonstrate system on coal-derived flue gas at Western Research Institute.

Available Reports/Technical Papers/Presentations

General project information is available on DOE/NETL website at: <http://www.netl.doe.gov/technologies/coalpower/ewr/co2/post-combustion/lowcostsorbent.html>

Low-Cost Sorbent for Capturing CO₂ Emissions Generated by Existing Coal-Fired Power Plants; Presentation at the 2010 NETL CO₂ Capture Technology Meeting, Pittsburgh, PA, September 13–17, 2010. http://www.netl.doe.gov/publications/proceedings/10/co2capture/presentations/monday/Jeannine_Elliott-NT0005497.pdf

Low-cost Sorbent for Capturing CO₂ Emissions Generated by Existing Coal-fired Power Plants; Project Fact Sheet, January 2011. <http://www.netl.doe.gov/publications/factsheets/project/NT0005497.pdf>

Low Cost Solid Sorbent for CO₂ Capture on Existing Coal-Fired Power Plants; Presentation at the 26th Annual International Pittsburgh Coal Conference, September 20–23, 2009. http://www.tda.com/Library/docs/PCC_Sept_2009_v3.pdf

Low-Cost Sorbent for Capturing CO₂ Emissions Generated by Existing Coal-Fired Power Plants – Project Overview; Presentation at the Annual NETL CO₂ Capture Technology for Existing Plants R&D Meeting, Pittsburgh, PA, March 24–26, 2009. http://www.netl.doe.gov/publications/proceedings/09/CO2/pdfs/5497_TDA_sorbent_%28Elliott%29_mar09.pdf

DEVELOPMENT OF NOVEL CARBON SORBENTS FOR CO₂ CAPTURE

Primary Project Goals

SRI is developing an innovative, low-cost, low-energy, carbon dioxide (CO₂)-consuming capture technology based on adsorption with a high-capacity and low-cost carbon sorbent. The project is validating sorbent performance in a bench-scale system for post-combustion applications and performing parametric testing to determine optimum operating conditions.

Technical Goals

- Determine properties of the sorbent, such as surface area, heat of absorption and desorption, compressive strength and attrition resistance, and size and shape of sorbent particles.
- Validate the performance of the sorbent in a bench-scale, fixed-bed reactor.
- Perform parametric experiments to determine the optimum operating conditions for the system.
- Evaluate the technical and economic viability of the technology.

Technical Content

The novel sorbent developed for the project is composed of carbon pellets, as shown in Figure 1. The sorbent was manufactured by ATMI, Inc., and is designated as ACS-1. Initially, the characteristics of the sorbent were determined using the BET adsorption technique and thermogravimetric analysis (TGA) under various temperatures, pressures, and gas exposures. Bench-scale tests were performed in three stages: absorber parametric testing, regenerator parametric testing, and cyclic testing. An integrated absorber-regenerator system was designed and being operated for determining long-term durability of the sorbents.

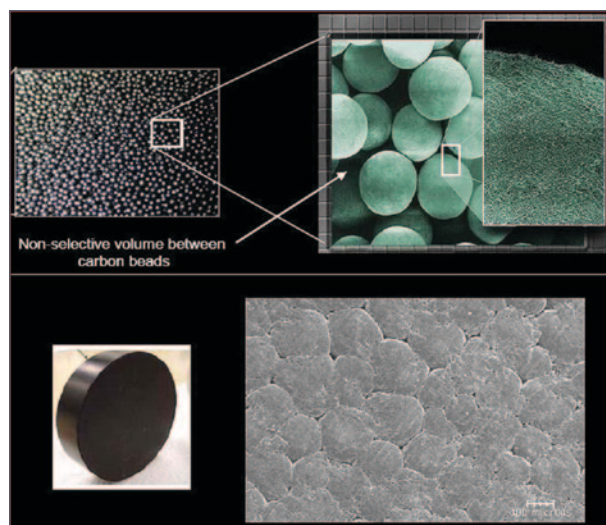

Figure 1: Graphic Displays of the Novel Carbon Pellets Sorbent

Technology Maturity:

Bench-scale using simulated flue gas

Project Focus:

Carbon-Based Sorbents

Participant:

SRI International

Project Number:

NT0005578
FE0000896

NETL Project Manager:

Andrew O'Palko
Andrew.Opalko@netl.doe.gov

Principal Investigator:

Gopala Krishnan
SRI International
gopala.krishnan@sri.com

Partners:

ATMI, Inc.

Performance Period:

10/1/08 – 9/30/11

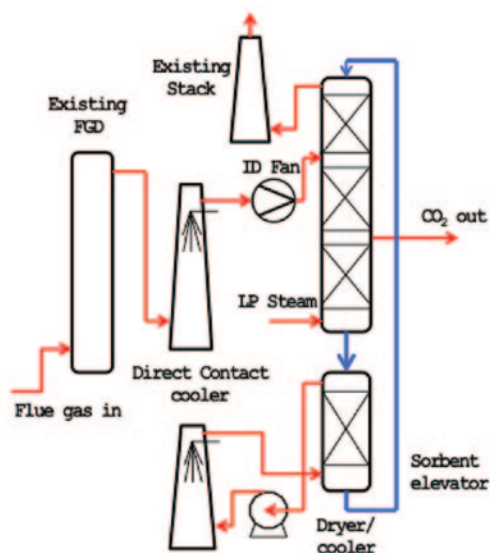

Figure 2: The Proposed Sorbent System

Figure 2 depicts the proposed sorbent system for an existing coal-fired power plant. Flue gas first enters an existing flue gas desulfurization (FGD) system where most of the sulfur content is removed. The gas is then cooled before entering the cascading-bed adsorption reactor, which utilizes a high-capacity carbon sorbent (0.1–0.2 kg of CO₂ per kg of sorbent). As the gas stream passes over the lean sorbent, CO₂ is removed from the gas and adsorbed by the sorbent. The loaded sorbent cascades down the separation column and is heated by low-pressure steam, causing the sorbent to release the adsorbed CO₂. The CO₂ is siphoned off to a compressor where it can be prepared for sequestration. The sorbent is then dried and cooled and sent back into the separation column for re-use and the cycle begins again.

The primary waste stream will be carbon fines generated by attrition of the carbon sorbent granules.

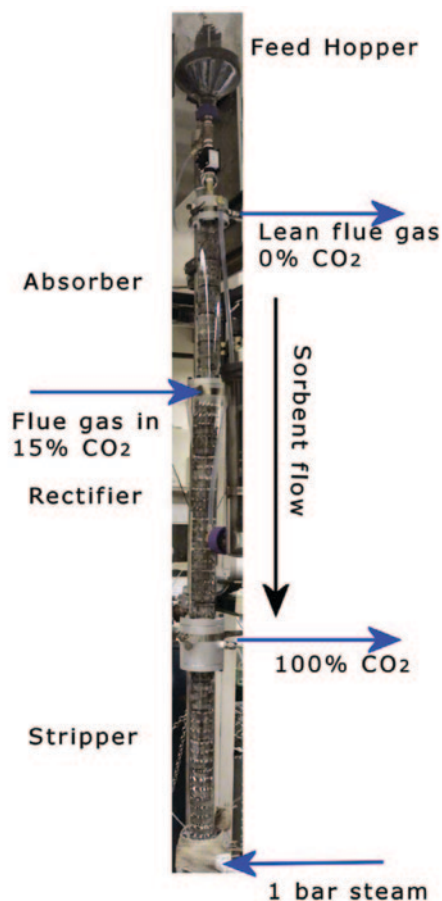

Figure 3: Photograph of 6-Inch ID x 24-Foot Tall Integrated System Column

Based on the results of parametric experiments using a two-inch bench-scale absorber and desorber, SRI designed and assembled the larger bench-scale, six-inch diameter integrated absorber-desorber system, shown in Figure 3. The system is being used to perform tests with varying gas and solid flow rates to determine the interaction between these variables. The amount of steam needed to strip the CO₂ and the water balance in the system will be determined. Later, the system will be setup for long-term tests.

Table 1: Process Parameters for Solid Carbon Sorbent

	Parameter	Current R&D Value	Target R&D Value
Sorbent Properties	Type of sorbent	Carbon	Carbon
	Heat of adsorption (kJ/mole CO ₂)	28	28
	CO ₂ loading/working capacity, wt%	5	8
	Surface area, m ² /g	1,600	1,600
	Particle density, cm ³ /g	1.1	1.1
	Packing density, cm ³ /g	0.7	0.7
	Particle size (mm)	0.2	0.2
	Heat capacity (kJ/K/kg)	1.0	1.0
	Thermal stability, °C	>400	>100
	Hydrothermal stability, °C	>100	>100
Process Configuration	Attrition rate (fluidized bed), %/year	<0.01 ¹	<0.05 ¹
	Cycle time (fixed bed), minutes	0.25 ²	N/A
	Pressure drop (fixed bed), psia	0.04 ³	N/A
Operating Conditions	Adsorption temperature, °C	15–25	25
	Adsorption pressure, atm	1	1
	CO ₂ capture efficiency, %	>95	>90
	Regeneration method	Direct steam	Indirect or direct
	Regeneration temperature, °C	80–100	100
	Regeneration pressure, atm	1	1
Heat Integration	Required regeneration steam temperature, °C	100	100
Miscellaneous	Sorbent make-up rate, kg/kg CO ₂	Not known	N/A
Product Quality	CO ₂ purity, %	>95	>95
	N ₂ concentration, %	<2	<10
	Other contaminants, %	N/A	SO ₂ , NO _x
Process Performance	Electricity requirement, kJ/kg CO ₂	N/A	450 ⁴
	Heat requirement, kJ/kg CO ₂	2,000	1,200 ⁵
	Total energy (electricity equivalent), kJ/kg CO ₂	N/A	720 ⁶

Notes:

1. Measured by ASTM D5757 accelerated attrition testing; long-term attrition rate has not been established.
2. 0.25 minutes estimated in a moving bed.
3. At a space velocity corresponding to 95% capture of air-15% CO₂ mixture.
4. Includes electricity for compression of released CO₂ to 150 atm.
5. No heat recovery savings is accounted.
6. Based on simulation of pulverized coal (PC)-fired boiler from coal to electricity enabling CO₂ capture and compression.

Technology Advantages

- The sorbent has a low cost and a stable operating range of 20–100 °C.
- The sorbent has a high capacity of CO₂ loading with 0.1–0.2 kg of CO₂ per kg of sorbent.
- The sorbent features a low heat of adsorption reaction of 25–28 kJ/mole of CO₂ and releases CO₂ at atmospheric pressure at a low temperature of 80–100 °C.

R&D Challenges

- Other elements of the flue gas, such as moisture, sulfur oxides (SO_x), and nitrogen oxides (NO_x) may compete with CO₂ in being adsorbed by the sorbent, reducing the amount of CO₂ that gets adsorbed as the gas passes through the reactor.
- A low temperature needs to be maintained for optimal adsorption conditions. Excess heat may have to be removed from the adsorption reactor in addition to the flue gas being cooled prior to treatment by the sorbent.
- The heat exchange between the cold, loaded sorbent and regenerated, hot sorbent will have to be kept to a minimum to maintain optimal temperatures for the adsorption process.

Results To Date/Accomplishments

- Determined the CO₂ adsorption and desorption characteristics and the heat of adsorption for the carbon sorbent.
- Determined the CO₂ loading on the sorbent as a function of CO₂ partial pressure and temperature.
- The desorption characteristics were tested in a temperature range of 40–100 °C using a TGA.
- Evaluated several physical, chemical, and mechanical properties of the sorbent in the context of the CO₂ capture system using a bench-scale, fixed-bed reactor.
- Demonstrated >95% CO₂ capture in a moving bed from air containing 15% CO₂ at ambient temperature.
- Demonstrated regeneration using direct contact steam producing relatively pure CO₂.
- Simulated CO₂ capture using novel carbon sorbent in a PC-fired boiler from coal to electricity and compressed CO₂.
- Determined several physical and chemical properties of the advanced carbon sorbent in the context of flue gas CO₂ capture.
- Demonstrated a unique sorbent for CO₂ capture.
 - Achieved ~98% CO₂ capture from air-CO₂ gas mixture.
 - Achieved >97% pure CO₂ during regeneration.
 - Capable of rapid adsorption and regeneration.
 - Low heat requirements for regeneration.
 - Fluid-like flow properties.
 - High attrition resistance.
- Developed an unique reactor system.
 - Integrated absorber-desorber geometry.
 - Minimize solids handling.
 - Minimize heat exchanger requirements.

Next Steps

- Conduct parametric testing on the absorber and regenerator, including gas velocity, temperature, CO₂ inlet level, sorbent pellet size and geometry, heating method, and the presence of SO_x or NO_x.
- Design and construct a bench-scale system for testing.
- Conduct 100 cycle tests on select sorbents.
- Conduct a long-term (1,000 cycle) test on the superior sorbent to determine durability.
- 1,000-cycle test under integrated adsorption-desorption conditions.
- Evaluation of the technical merits and increase in cost of electricity for CO₂ capture using the novel carbon sorbents.
- Field testing of the process using a flue gas from an operating PC-fired boiler.

Available Reports/Technical Papers/Presentations

Development of Novel Carbon Sorbents for CO₂ Capture; presented at the 2010 NETL CO₂ Capture Technology Meeting, Pittsburgh, PA, September 13–17, 2010. [http://www.netl.doe.gov/publications/proceedings/10/co2capture/presentations/monday/Gopala Krishnan-NT0005578.pdf](http://www.netl.doe.gov/publications/proceedings/10/co2capture/presentations/monday/Gopala%20Krishnan-NT0005578.pdf)

Development of Novel Carbon Sorbents for CO₂ Capture; presented at the 9th Annual Conference on Carbon Capture and Sequestration, Pittsburgh, PA, May 10–13, 2010. [http://www.netl.doe.gov/publications/proceedings/10/co2capture/presentations/monday/Gopala Krishnan-NT0005578.pdf](http://www.netl.doe.gov/publications/proceedings/10/co2capture/presentations/monday/Gopala%20Krishnan-NT0005578.pdf)

Development of Novel Carbon Sorbents for Carbon Dioxide Capture – Continuation application report submitted to U.S. Department of Energy, August 2009.

Development of Novel Carbon Sorbents for CO₂ Capture – Project Overview; presented at the Annual NETL CO₂ Capture Technology for Existing Plants R&D Meeting, Pittsburgh, PA, March 24–26, 2009. [http://www.netl.doe.gov/publications/proceedings/09/CO2/pdfs/5578 SRI carbon sorbent %28Hornbostel%29 mar09.pdf](http://www.netl.doe.gov/publications/proceedings/09/CO2/pdfs/5578%20SRI%20carbon%20sorbent%20Hornbostel%29%20mar09.pdf)

EVALUATION OF SOLID SORBENTS AS A RETROFIT TECHNOLOGY FOR CO₂ CAPTURE FROM COAL-FIRED POWER PLANTS

Primary Project Goals

ADA Environmental Solutions (ADA-ES) is designing and constructing a 1-megawatt (MW) pilot plant to demonstrate solid sorbent-based post-combustion carbon dioxide (CO₂) capture technology to reduce uncertainty of scale up and accelerate the path to commercialization.

Technical Goals

Validate and optimize a solid sorbent-based post-combustion CO₂ capture technology through 1-MW slipstream pilot testing and process modeling.

Technical Content

ADA-ES is utilizing progress it made on sorbent-based CO₂ capture as demonstrated in a viability assessment project. The viability assessment included laboratory-scale and 1-kW pilot-scale sorbent screening and a commercial-scale equipment study in a separate Department of Energy (DOE) project DE-NT0005649. The specific work completed under the viability assessment included:

Evaluated more than 100 potential CO₂ sorbents, which were procured from various CO₂ solid sorbent developers worldwide. Sorbents were evaluated on the basis of cyclic stability, CO₂ capacity, working CO₂ capacity, availability, cost of raw materials, production process, manageable disposal costs (low toxicity), interaction with flue gas constituents, adequate physical strength, and theoretical regeneration energy. The CO₂ sorbents were investigated in such a way to assess their respective performances in a temperature swing adsorption (TSA) process. Table 1 displays the key properties used to evaluate CO₂ sorbents.

Table 1: Key Properties Used to Evaluate CO₂ Sorbents

Physical Property	Current Range	Goal
Sorbent particle size (mm)	Highly varied and controllable	~0.1–5
Sorbent surface area (m ² /g)	0.5–3,000	0.5–1,500
Sorbent active component concentration (wt%)	5–60	10–100
Shape of sorbent	Varied	Spherical
Density of sorbent [g/cm ³ (lb/ft ³)]	0.2–0.6 (15–40)	Dependant on contractor design
Mechanical strength	Not reported	Dependant on contractor design
Attrition fines: form, processing, and fate	Not reported	To be determined

The lab-scale tests consisted of <3 grams of the adsorbents exposed to simulated flue gas and then regenerated by a temperature swing with a humid nitrogen (N₂) sweep gas. For the adsorption step, the simulated flue gas was 55 °C (130 °F) with oxygen (O₂) and CO₂ concentrations of 4% and 12%, respectively. The moisture level was varied (0%, 50%, or 90% relative humidity). The regeneration temperature was varied between 65 and 250 °C (150 and 480 °F).

Technology Maturity:

Pilot-scale using a 1-MW slip stream of actual flue gas

Project Focus:

Evaluation of Solid Sorbents

Participant:

ADA-ES, Inc.

Project Number:

FE0004343
NT0005649

NETL Project Manager:

Bruce Lani
Bruce.Lani@netl.doe.gov

Principal Investigator:

Sharon M. Sjostrom
ADA-ES, Inc.
sharons@adaes.com

Partners:

EPRI
Southern Company
Stantec Consulting, Ltd.

Performance Period:

9/30/08 – 12/31/14

A 1-kW pilot was constructed to more thoroughly investigate the most positively rated adsorbents tested at the laboratory scale. At the first field test site, more than 90% CO₂ removal was achieved repeatedly in batch mode with one supported amine sorbent. Testing is underway at the second field site. The 1-kW pilot tests are parametric in nature to characterize sorbent performance under a range of realistic conditions. Figure 1 is a schematic of the 1-kW pilot, which consists of a transport reactor for adsorption and a fluidized bed for regeneration. A photo of the 1-kW pilot test equipment is shown in Figure 2.

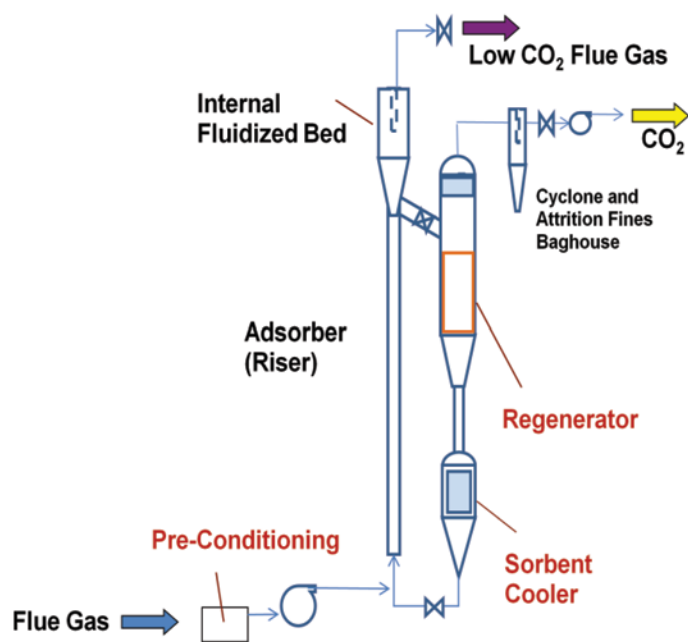

Figure 1: Diagram of Circulating Transport Reactor



Figure 2: 1-kW Pilot

In a concurrent effort to the sorbent evaluation, a technology survey was completed to identify potential commercial and conceptual processes and equipment options for use in retrofitting the existing fleet of coal-fired power plants for post-combustion CO₂ capture. Different equipment options were selected for the adsorption, regeneration, and cooling sections and pieced together to form the conceptual design of the commercial-scale process. The technologies selected were proven to be the most reliable, cost-effective, and versatile options available. This conceptual design was not intended to be a final commercial-scale design, but rather serve as an example of one option that could be used to calculate high level cost estimates and identify the technology cost drivers. A schematic of the final technology selection integrated into a power plant is shown in Figure 3.

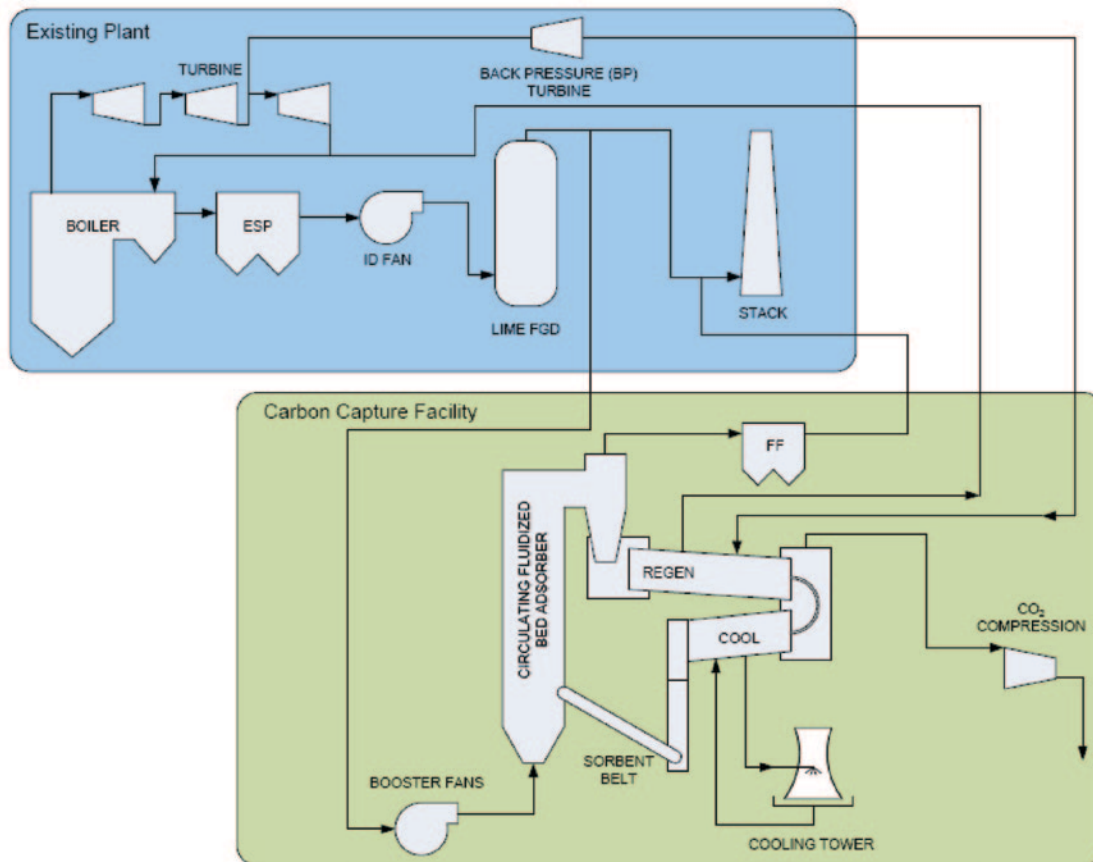

Figure 3: Conceptual Flow Sheet

Based on the viability assessment conducted under project DE-NT0005649, a follow on project, DE-FE0004343, will include design, construction, and operation of a 1-MW pilot plant on a slipstream of coal-fired flue gas. The information gained from the 1-MW pilot operation will be used to complete a technical and economic analysis of the process. The project objectives are being accomplished in three phases. In Phase 1, a 500-MW conceptual design will be developed, refined, and scaled to a 1-MW pilot plant. Phase 2 will include the 1-MW pilot construction, installation, and tie-in of the pilot plant at a coal-fired power plant site. Phase 3 will include field testing with the 1-MW pilot, system analysis, and conceptual engineering design of the full-scale system. In addition to parametric studies, up to two months of continuous pilot operation will be conducted to validate pilot plant performance. Based on the test results, process models will be refined, a full-scale conceptual engineering design will be prepared, and the cost of electricity (COE) for a commercialized process will be determined. Specific objectives for the proposed effort include:

- Demonstrate the technical, economic, and energy benefits of a promising CO₂ capture technology.
- Develop performance data through the operation of the system on flue gas, including thermal management of sorbent and optimized system heat recovery.
- Assess sorbent performance sensitivity to flue gas constituents [e.g., moisture and sulfur dioxide (SO₂)] and effectiveness of sorbent for capture of other regulated pollutants [i.e., SO₂, nitrogen oxide (NO_x), mercury (Hg), key HAPS that may be included in a MACT regulation].
- Operate continuously for at least 2 months to identify operating and maintenance issues along with system reliability.
- Remove at least 90% of the incoming CO₂ from the flue gas.
- Produce high-purity CO₂.
- Conduct a techno-economic analysis of the commercial design.

The sorbent and process properties identified to date are provided in Table 2.

Table 2: Process Parameters for Solid Sorbent

	Parameter	Current R&D Value	Target R&D Value
Sorbent Properties	Type of sorbent	Supported amine, activated carbon	N/A
	Heat of reaction (kJ/mole CO ₂)	~ -60	-60
	CO ₂ loading (55°C, 12% CO ₂) wt%	14	≥15 (stable)
	Working capacity (regenerating in pure CO ₂), wt%	<6	10
	Surface area, m ² /g	20–1,500	TBD
	Particle density, g/cm ³	Pending	TB
	Bulk density, g/cm ³	0.2–0.6	0.3–1.0
	Particle size (mm)	10–1000	Depends on contactor design
	Heat capacity (kJ/kg•K)	1.4	0.8–1.3
	Thermal stability, °C	100	150
	Hydrothermal stability, °C, relative humidity in %	120, 5	150, 50
Process Configuration	Attrition rate (fluidized bed), %/year	Not measured	≤50
	Cycle time, minutes	Depends on contactor	≤30
	Pressure drop, psia	0.1	0.5 (depends on contactor)
Operating Conditions	Adsorption temperature, °C	55	55
	Adsorption pressure, atm	1	1
	CO ₂ capture efficiency, %	100 (lab-scale)	90
	Regeneration method	Temperature swing with sweep gas	Temperature swing with >95% CO ₂ in regen. gas
	Regeneration temperature, °C	100–120	100–120
Heat Integration	Regeneration pressure, atm	1 (lab-scale total pressure)	1 (>95% CO ₂)
	Required regeneration steam temperature, °C	Not measured	120–150
Miscellaneous	Sorbent make-up rate, kg/kg CO ₂	Will be measured for 1 kW pilot	≤0.0005
Product Quality	CO ₂ purity, %	20% (lab-scale with N ₂ purge)	≥95
	N ₂ concentration, %	Not measured	≤5
	Other contaminants, %	Not measured	≤1
Process Performance	Parasitic Electricity requirement ¹ , kJ/kg CO ₂	Not measured	≤20
	Heat requirement, kJ/kg CO ₂	Not measured	≤1,500
	Total energy (electricity equivalent) ² , kJ/kg CO ₂	Not measured	≤1,800

Notes:

1. Does not include makeup power or CO₂ compression.
2. Includes compression (estimated at 0.1 MW/ton CO₂).

Technology Advantages

- Reduction in the regeneration energy requirements by minimizing heat input (no liquid solvent is involved).
- High sorbent CO₂ capacities have been demonstrated (lab-scale).
- Fundamental sorbent chemistry is well-know (e.g., amine).
- Components of process equipment are mature (e.g., circulating fluidized bed).

R&D Challenges

- Similar to aqueous amines, long-term stability of sorbents when exposed to flue gas is of concern. Can sorbents be reclaimed?
- Availability of sorbents including the number of suppliers.
- Ability to scale-up sorbent manufacturing without impacting performance.
- Ability to design a process that can control sorbent temperatures and counteract changes resulting from the heat of reaction, potential erosion, and/or corrosion of process equipment.

Results To Date/Accomplishments

- Detailed assessment of the current state of development of solid sorbents.
- Identified technology cost drivers in order to direct future technology development efforts.
- Selected supported amines as the sorbent family for the 1-MW pilot.

Next Steps

- Refine 500-MW concept with modeling and bench-testing.
- Design 1-MW pilot.
- Manufacture sorbents.
- Construct and install 1-MW pilot to validate 500-MW concept.
- Perform 1-MW testing.
- Develop 500-MW preliminary design.
- Conduct techno-economic analysis.

Available Reports/Technical Papers/Presentations

General project information is available on DOE/NETL website at: <http://www.netl.doe.gov/technologies/coalpower/ewr/co2/post-combustion/eval-solid-sorbent.html>

Evaluation of Solid Sorbents as a Retrofit Technology for CO₂ Capture from Coal-Fired Power Plants; Presentation at the 2010 NETL CO₂ Capture Technology Meeting, Pittsburgh, PA, September 13–17, 2010. [http://www.netl.doe.gov/publications/proceedings/10/co2capture/presentations/thursday/Sharon Sjoström - ADA Environmental Solutions.pdf](http://www.netl.doe.gov/publications/proceedings/10/co2capture/presentations/thursday/Sharon%20Sjostrom%20-%20ADA%20Environmental%20Solutions.pdf)

Solid Sorbents as a Retrofit CO₂ Capture Technology: Results from Field Testing; Presentation at the Power Plant Air Pollutant Control “MEGA” Symposium, Baltimore, MD, August 30–September 2, 2010. [http://www.netl.doe.gov/technologies/coalpower/ewr/co2/pubs/Sjostrom - ADA CO₂ Solid Sorbents - MEGA 2010.pdf](http://www.netl.doe.gov/technologies/coalpower/ewr/co2/pubs/Sjostrom%20-%20ADA%20CO2%20Solid%20Sorbents%20-%20MEGA%202010.pdf)

Solid Sorbents as a Retrofit CO₂ Capture Technology: Results from Field Testing; Paper #2010-A-131 submitted for presentation at the Power Plant Air Pollutant Control “MEGA” Symposium, Baltimore, MD, August 30–September 2, 2010. [http://www.netl.doe.gov/technologies/coalpower/ewr/co2/pubs/Sjostrom - ADA CO₂ Solid Sorbents - MEGA 2010 Paper.pdf](http://www.netl.doe.gov/technologies/coalpower/ewr/co2/pubs/Sjostrom%20-%20ADA%20CO2%20Solid%20Sorbents%20-%20MEGA%202010%20Paper.pdf)

Cameron Martin, Sjoström, S., Krutka, H., Richard, M., Cameron, D., *Topical Report 1, 2 and 3: Technology Survey, Screening, and Final Selection*, Reporting Period: October 1, 2008–January 31, 2010 for U.S. Department of Energy Contract No. DE-NT0005649, July 2010.

B-222 Sharon Sjostrom, Holly Krutka, Evaluation of solid sorbents as a retrofit technology for CO₂ capture, Fuel, Volume 89, Issue 6, Advanced Fossil Energy Utilization, June 2010, Pages 1298–1306. <http://www.sciencedirect.com/science/article/B6V3B-4XVH-HK9-1/2/71d79dcdd8ea282606d7e9c5c8f862cb>

Post-Combustion CO₂ Control Using Solid Sorbents: Results from 1 kW Pilot Tests, Presented at the Ninth Annual Conference on Carbon Capture and Sequestration, May 2010. <http://www.netl.doe.gov/technologies/coalpower/ewr/co2/pubs/5649 CCS Conference May 2010.pdf>

Sjostrom, S.; Campbell, T.; Krutka, H.; O’Palko, A. *Solid Sorbents as a Retrofit CO₂ Capture Technology: Results from Pre-Pilot Field Testing*, Air Quality VII Conference, Arlington, VA, October 27, 2009. (Presentation and paper).

Evaluation of Solid Sorbents as a Retrofit Technology for CO₂ Capture from Coal-Fired Power Plants – Project Overview; Presentation at the Annual NETL CO₂ Capture Technology for Existing Plants R&D Meeting, Pittsburgh, PA, March 24–26, 2009. <http://www.netl.doe.gov/publications/proceedings/09/CO2/pdfs/5649 ADA-ES sorbents %28Sjostrom%29 mar09.pdf>

Results from Lab and Field Testing of Novel CO₂ Sorbents for Existing Coal-Fired Power Plants - Power Plant Air Pollutant Control “Mega” Symposium in Baltimore, MD - August 2008. <http://www.netl.doe.gov/technologies/coalpower/ewr/co2/pubs/5649 ADA-ES sorbent evaluation 2008 MEGA paper.pdf>

Summary of Post-Combustion CO₂ Capture Technologies for Existing Coal-Fired Power Plants, Air and Waste Management Association Annual Conference, paper #808, Portland, OR, June 24–26, 2008.

CO₂ REMOVAL FROM FLUE GAS USING MICROPOROUS METAL ORGANIC FRAMEWORKS

Primary Project Goals

UOP is designing and developing a carbon dioxide (CO₂) removal system that employs metal organic framework (MOF) sorbents.

Technical Goals

- Use combinatorial chemistry to systematically synthesize and characterize a wide range of MOF and related materials.
- Screen materials for hydrothermal stability.
- Collect isotherm data for subsequent development and optimization.
- Determine the effects of water on CO₂ adsorption.
- Develop and validate material scale up and forming procedures.
- Select the best one or two materials for final optimization and scale up.
- Determine the effects of contaminants on the performance of scaled up materials.
- Understand detailed kinetic and equilibrium data for incorporation in a process design and an economic analysis.

Technical Content

MOFs are extremely high surface area, crystalline, microporous, and thermally-stable materials that have shown exceptional storage capacity for CO₂, methane, hydrogen, and other gases. MOFs typically consist of transition metal vertices, or hubs, attached three-dimensionally to other metal vertices by organic 'linker' molecules. After removal of reaction solvent, the resulting porosity can be adjusted by simply changing the length or composition of the molecules used to link the metal vertices. Well-ordered openings, channels, and pockets in the structures are from a few angstroms to tens of angstroms. Figure 1 represents the building blocks used to create prototypical MOF-5, in which the green ball represents the metal-containing hub, and the yellow cylinder represents the organic linker.

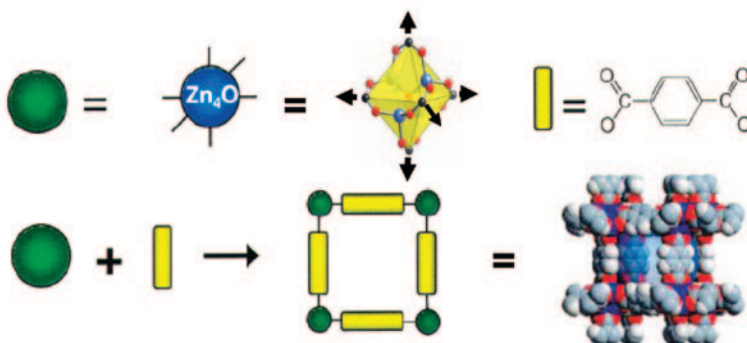

Figure 1: Building Blocks Used to Create Prototypical MOF-5

Technology Maturity:

Laboratory-scale using simulated flue gas

Project Focus:

Metal Organic Frameworks

Participant:

UOP, LLC

Project Number:

NT43092

NETL Project Manager:

David Lang
David.Lang@netl.doe.gov

Principal Investigator:

Richard Willis
 UOP, LLC
richard.willis@uop.com

Partners:

University of Edinburgh
 University of Michigan
 Vanderbilt University
 Northwestern University

Performance Period:

3/12/07 – 6/30/10

More than 50 MOFs for CO₂ adsorption were prepared from literature reports or designed by the experimenters. Table 1 displays the top MOFs for CO₂ capture.

Table 1: Top 10 MOFs for CO₂ Capture

Sample	Loading (mol/kg)	Loading (wt%)	Heat of Adsorption (kJ/mol)
Mg/DOBDC (2)	4.73	20.9	60.1
Ni/DOBDC	3.40	15.0	27.2
Co/DOBDC	1.84	8.1	19.9
Mg/DOBDC (1)	1.28	5.6	21.3
HKUST-1 (CuBTC)	0.42	1.8	23.3
Zn/DOBDC	.041	1.8	22.9
Al-MIL-110	0.24	1.1	21.7
Cr-MIL-101	0.18	.08	13.3
Tb-MOF-76	0.18	.08	21.7
Al-MIL-53	0.17	.07	26.0
Zn-IRMOF-1	0.13	.06	13.5

MOF-based adsorbents will be utilized in a vacuum pressure swing adsorption (VPSA) process for removal of CO₂ from flue gas. Figure 2 represents an example of MOF CO₂ adsorption capabilities as a function of pressure (for M/DOBDC, M represents the metal).

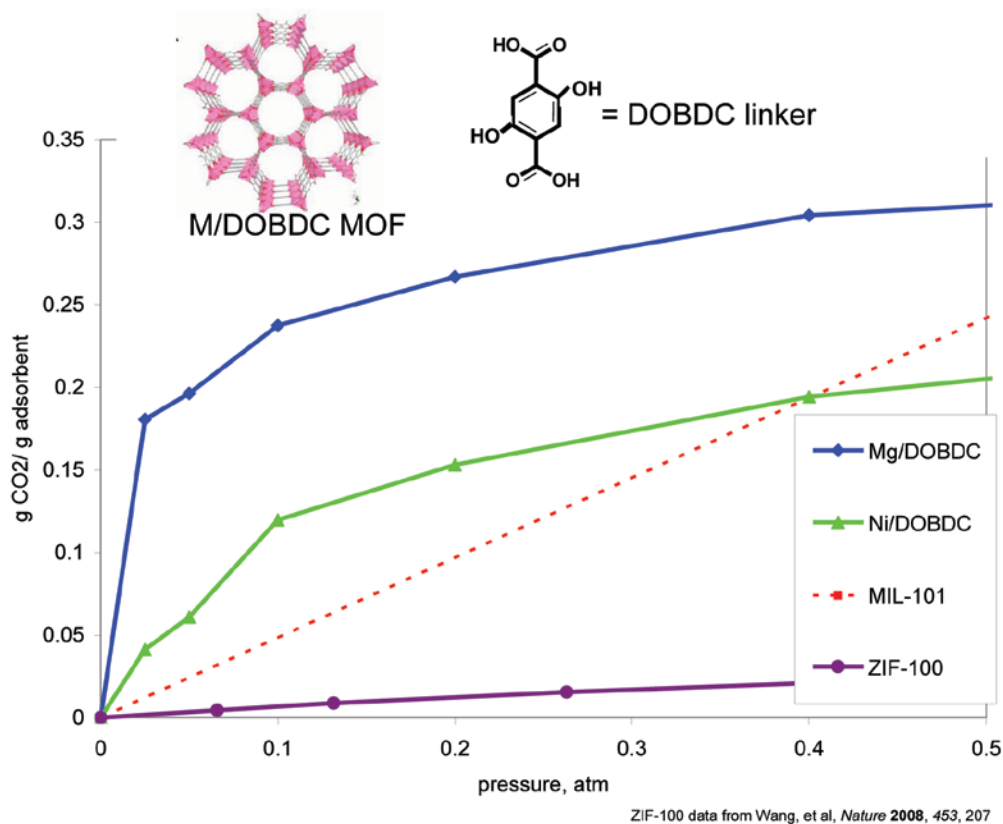

Figure 2: Example of MOF CO₂ Adsorption Capabilities as a Function of Pressure

The MOF-based VPSA CO₂ recovery system will be located after a contaminant removal section and before the final CO₂ compression and drying section. The nitrogen-rich waste stream (raffinate) will be sent to the stack. A process schematic is provided in Figure 3.

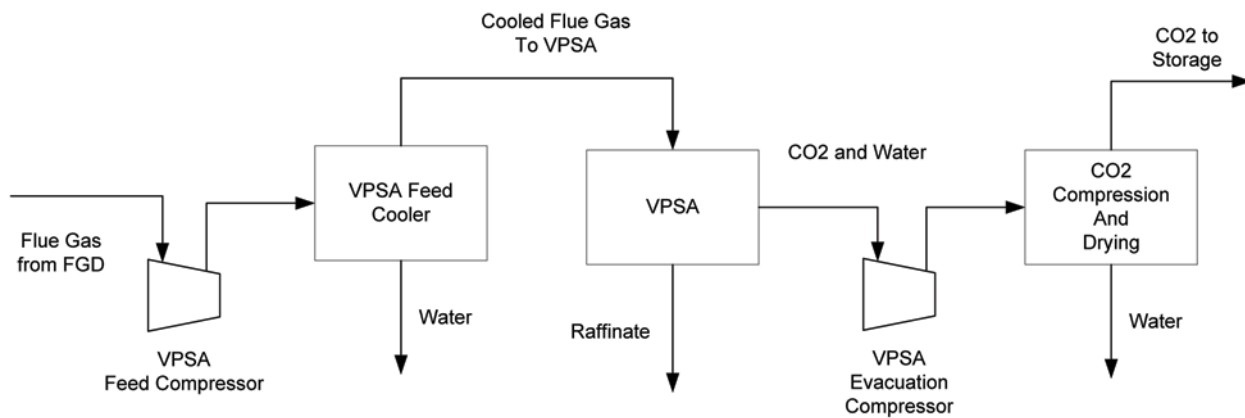

Figure 3: The MOF-Based CO₂ Capture System Process Schematic

Downstream from the flue gas desulfurization (FGD) and polishing scrubber, flue gas pressure is boosted in the VPSA Feed Compressor by approximately 4.8 pounds per square inch (psi) to make up for pressure drop in the contaminant removal section and to maximize the adsorption of CO₂ in the VPSA unit. The VPSA Feed Compressor will be followed by a VPSA Feed Cooler to lower the temperature of the flue gas to approximately 100 °F. It is likely that two parallel operating VPSA Feed Compressor and VPSA Feed Cooler trains will be required. Compressing and cooling the flue gas to 100 °F will reduce the flue gas volume flow rate [actual cubic feet per minute (ACFM)] by up to 35% and concurrently knock out at least 75% of the water vapor originally present in the flue gas. The combined lower volume, lower temperature, and lower water content will allow the VPSA unit to operate more efficiently and effectively on the resultant flue gas stream.

The cooled flue gas enters the VPSA unit and will flow in a radial fashion through a short bed of adsorbent in either a vertical or horizontal configuration, depending upon the particular power plant's requirements. The adsorbent beds will consist of alumina for moisture polishing, and MOF for CO₂ removal. In the VPSA conceptual design at the end of the adsorption step, the vessel first vents nitrogen (N₂) raffinate to the stack to reduce the bed pressure to atmospheric pressure; pressure then equalizes with another vessel that had just completed the vacuum regeneration step. This would reduce the bed pressure to 7–8 pounds per square inch absolute (psia). These steps also reduce the N₂ stored in the vessel voids and minimize the amount that would be co-produced with the CO₂. The adsorbent bed would then be evacuated to 0.5 psia to produce the CO₂. For the purposes of the calculations, it was assumed that there was negligible co-adsorption of N₂ on the CO₂ loaded adsorbent and that the N₂ was primarily stored in the voids of the adsorbent vessel. The target CO₂ delta loadings were based on producing a >90% CO₂ purity stream during the regeneration step. The parasitic load for regeneration of the adsorbent is the compression energy associated with evacuating the vessel to 0.5 psia and compressing the contents to at least 8.8 pounds per square inch gauge (psig). The contribution of the N₂ stored in the voids is quite small compared to the compression energy associated with desorbing the CO₂. A purge step was not used in this process since the primary concern is producing a high purity CO₂ stream.

The VPSA Evacuation Compressor will be used to remove CO₂ streams at 95–97% purity from the adsorbent beds. The water that comes along with the CO₂ will be removed during the CO₂ Compression and Drying stage of the process. In order to facilitate the Gas Compression and Drying section CAPEX estimate, the VPSA Evacuation Compressor discharge pressure is 8.8 psig. This is the same pressure that the Econamine process delivers captured CO₂ to the Gas Compression and Drying section. In the compression section, the CO₂ is compressed to 2,215 psia by a six-stage centrifugal compressor with inter-stage cooling to 100 °F. The discharge pressures of the stages were balanced to give reasonable power distribution and discharge temperatures across the various stages. During compression in the multiple-stage, intercooled compressor, the CO₂ stream is dehydrated to a dew point of -40 °F with triethylene glycol. The virtually moisture-free supercritical CO₂ stream is delivered to the plant battery limit as sequestration-ready.

There are no heating or cooling steps within the VPSA unit operation, which is typical of VPSA processes. Since this is still a conceptual design, however, there remain other types of processes to consider depending upon future pilot study and other experimental results. In a VPSA process, the heat of adsorption is released and is stored in the bed by a sensible temperature rise. The heat is removed during the desorption step as the adsorbent bed cools. Approximately 90% of the CO₂ in the feed gas is adsorbed onto the MOF adsorbent, and the rest leaves the VPSA section to the stack. Further, other than spent adsorbent, there is no waste generated in this process. The MOF-based VPSA process should generate very little waste because the adsorbent itself is not hazardous waste, nor is it expected that the MOF will generate any hazardous waste products via degradation.

Table 2: Process Parameters for MOF Sorbents

	Parameter	Current R&D Value	Target R&D Value
Sorbent Properties	Type of sorbent	MOF	MOF
	Heat of adsorption (kJ/mole CO ₂)	45	45–55
	CO ₂ loading/working capacity, wt%	15	>20
	Surface area, m ² /g	1,400	2,000
	Particle density, g/cm ³	0.8	1.0
	Packing density, g/cm ³	0.5	0.7
	Particle size (mm)	0.5–2.0	1.0
	Heat capacity (kJ/K/kg)	~1	<1
	Thermal stability, °C	250	400
	Hydrothermal stability, °C	200	200
Process Configuration	Attrition rate (fluidized bed), %/year	N/A	<5
	Cycle time (fixed bed), minutes	4–16	4
	Pressure drop (fixed bed), psia	1–2	<1
Operating Conditions	Adsorption temperature, °C	25–45	25–45
	Adsorption pressure, atm	0.1	0.1–0.15
	CO ₂ capture efficiency, %	95	95
	Regeneration method	VPSA	VPSA
	Regeneration temperature, °C	Ambient	Ambient
	Regeneration pressure, atm	0.01–0.05	0.05
Heat Integration	Required regeneration steam temperature, °C	N/A	N/A
Miscellaneous	Sorbent make-up rate, kg/kg CO ₂	N/A	< 0.1
Product Quality	CO ₂ purity, %	90–98	97–99
	N ₂ concentration, %	Balance	Balance
	Other contaminants, %	<1	<1
Process Performance	Electricity requirement, kJ/kg CO ₂	~1,000	800
	Heat requirement, kJ/kg CO ₂	N/A	N/A
	Total energy (electricity equivalent), kJ/kg CO ₂	~1,000	800

In commercial operation, the MOF-based PSA system will have a lower regeneration duty than the monoethanolamine (MEA) process because of higher relative CO₂ loading on a mass basis and because VPSA is a physical rather than chemical process. As such, no high quality steam from the coal-fired boilers will be required to regenerate the MOF adsorbent. By contrast, the MEA process will require high quality steam in order to get the amine to an elevated temperature to release the CO₂.

Technology Advantages

- High CO₂ adsorption capacity.
- Good adsorption/desorption rates.
- Good hydrothermal stability.
- Environmentally friendly.

R&D Challenges

- Effects of sulfur oxides (SO_x), and nitrogen oxides (NO_x) on the MOF material.
- Need for large vacuum pumps to compress the CO₂ from the outlet of the VPSA.

Results To Date/Accomplishments

- More than 50 MOF materials were evaluated; two were selected for further development and testing. The CO₂ capacity for these MOFs was determined in the presence of water and other contaminants and measured at several temperatures. Hydrothermal stability testing at accelerated conditions was also carried out for these MOFs.
- Mg/DOBDC outperformed all MOF and zeolite materials evaluated, with about 25 wt% CO₂ captured by this MOF at flue gas conditions (~0.13 atm CO₂ pressure, 311 K).
- UOP's techno-economic analysis indicated that an MOF-based VPSA process has potential to be a less expensive option than using amines to capture CO₂. Their analysis indicated a 65% increase in cost of electricity compared to a reference power plant without CO₂ capture.

Next Steps

Project completed June 2010. Final report issued October 2010.

Available Reports/Technical Papers/Presentations

General project information is available on DOE/NETL website at: <http://www.netl.doe.gov/technologies/coalpower/ewr/co2/post-combustion/mofs.html>

Carbon Dioxide Removal from Flue Gas Using Microporous Metal Organic Frameworks (Oct 2010) Final Technical Report. <http://www.netl.doe.gov/technologies/coalpower/ewr/co2/pubs/43092F1.pdf>

CO₂ Removal from Flue Gas Using Microporous Metal Organic Frameworks – Progress Update; presented at the Annual NETL CO₂ Capture Technology for Existing Plants R&D Meeting Pittsburgh, PA, March 24–26, 2009. [http://www.netl.doe.gov/publications/proceedings/09/CO2/pdfs/43092_UOP_MOF_sorbent %28Benin%29_public version mar09.pdf](http://www.netl.doe.gov/publications/proceedings/09/CO2/pdfs/43092_UOP_MOF_sorbent%28Benin%29_public_version_mar09.pdf)

DEVELOPMENT OF A DRY SORBENT-BASED POST-COMBUSTION CO₂ CAPTURE TECHNOLOGY FOR RETROFIT IN EXISTING POWER PLANTS

Technology Maturity:
Bench-scale/small pilot-scale

Project Focus:
Dry Sodium Carbonate

Participant:
Research Triangle Institute

Project Number:
NT43089

NETL Project Manager:
José Figueroa
Jose.Figueroa@netl.doe.gov

Principal Investigator:
Thomas Nelson
Research Triangle Institute
tnelson@rti.org

Partners:
Arcadis
ADA-ES, Inc.
BOC
EPA
EPRI
Nexant
Süd-Chemie, Inc.

Performance Period:
3/7/07 – 12/31/09

Primary Project Goals

Research Triangle Institute (RTI) is developing and testing a carbon dioxide (CO₂) capture process that utilizes a dry sodium carbonate (Na₂CO₃) sorbent and is based on the reaction of Na₂CO₃ with CO₂ and water vapor present in the flue gas from a coal-fired power plant.

Technical Goals

- Determine the optimal process configuration for the dry carbonate process.
- Construct and demonstrate a bench-scale CO₂ capture process using Na₂CO₃.
- Construct and demonstrate a pilot-scale, dry carbonate process that captures 0.9 tonnes of CO₂/day (1 ton of CO₂/day).
- Demonstrate the long-term chemical and mechanical stability of the sorbent.
- Update the economic analyses of the CO₂ sorbent capture process.
- Develop a commercialization plan for instituting the CO₂ capture process.

Technical Content

In an effort to develop a pre-pilot scale facility, RTI has been collecting data needed for designing, constructing, and operating the dry sorbent-based capture unit. RTI has designed and constructed a bench-scale heat transfer evaluation unit, shown in Figure 1, which is used to experimentally determine realistic gas and solid circulation rates and overall heat transfer coefficients for new reactor designs.

A schematic diagram of the process is shown in Figure 1.

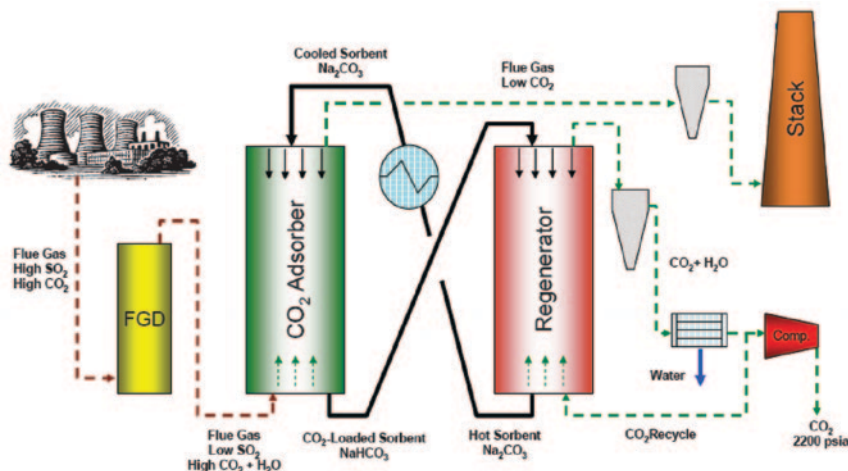

Figure 1: Schematic Diagram of CO₂ Capture Process

The CO₂ capture unit is located after the wet flue gas desulfurization (FGD) unit. The Na₂CO₃ sorbent reacts with the CO₂ and water (H₂O) located in the gas stream through a cyclic temperature swing cycle by adsorbing the CO₂ and H₂O at 60 °C and releasing the constituents at 120 °C during the sorbent regenerating stage. Considering the high exothermic heat of absorption (3.08 MJ/kg), significant cooling fluid is required to maintain the adsorption temperature at the desired value.

Utilizing the information gathered from the bench-scale unit, as well as the lab-scale unit shown in Figure 2, RTI has developed engineered sorbents that exhibit improved CO₂ capture rate and physical characteristics (e.g., attrition resistance, fluidizability, and density) over the supported (multi-layer) sorbents. These improvements will have a significant impact on a commercial, dry carbonate system by lowering the solids handling requirements and minimizing the heating and cooling duties in a commercial process. A long-term, multi-cycle testing of these sorbents to demonstrate chemical stability has been undertaken. Initial results indicate that the engineered sorbents are highly stable in the presence of contaminants such as hydrochloric acid (HCL), nitrous oxides (NO_x), H₂O, and oxygen (O₂). While sulfur dioxide (SO₂) forms irreversible chemical bonds to the sorbent, it is considered to be a minor issue, considering the rate of attrition is generally greater than the rate of deactivation due to SO₂.

The heat transfer experiments will be conducted in a fluidized bed contactor, as shown in Figure 2. The conveyors (one heated, the other cooled) will be used to move the Na₂CO₃ through the fluidized bed to introduce a simulated flue gas (from coal or natural gas) to the sorbent. The instrument is used to analyze the adsorption effectiveness and the attrition rate of the Na₂CO₃ sorbent. Data from the fluidized bed will be used to validate and develop the computational fluid dynamic (CFD) model called MFIx.

Some physical properties of the sorbent are provided in Table 1.

As seen in the aforementioned table, the theoretical maximum CO₂ loading for the sorbent is ~40 wt%. While RTI has achieved loading as high as 30 wt%, it requires a cycle time much greater than would be practical. Allowing only 30 minutes per cycle phase results in loading capacities of ~20–25%.

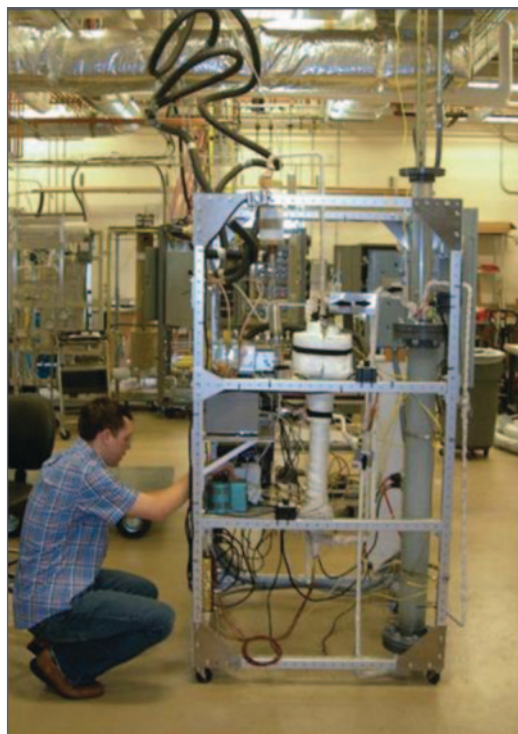

Figure 2: Lab-Scale CO₂ Absorption Reactor Skid

Table 1: Physical Properties of Sodium Carbonate Sorbents

Property	Value
Bulk density	1.0–1.1 g/mL
Average particle size	65–75 μm
Surface area	100–120 m ² /g
Physical strength (AR)	0.77
Na ₂ CO ₃ content	10–40 wt%
Heat of absorption	3.08 MJ/kg
Regeneration energy	3.08 MJ/kg

Technology Advantages

- Lower capital and operating costs for CO₂ removal.
- Sorbent is inexpensive and easy to acquire (~\$200/ton).
- Sorbent is non-hazardous, non-toxic, and does not produce hazardous waste.

R&D Challenges

- Circulation of solids may be problematic.
- The reaction of Na₂CO₃ with H₂O is highly exothermic and requires effective heat transfer.
- Removal of CO₂ requires equimolar amounts of H₂O.

- Irreversible reactions of Na_2CO_3 with SO_2 and HCl during process conditions.
- Raw Na_2CO_3 is not a physically strong material leading to high attrition rates.
- Raw Na_2CO_3 agglomerates upon contact with condensed H_2O .

Results To Date/Accomplishments

- Constructed a heat transfer evaluation system used to evaluate the hydrodynamics and heat transfer characteristics of the reactor designs.
- Constructed a packed-bed reactor system to demonstrate sorbent stability over many adsorption and regeneration cycles and provide insight into reaction kinetics.
- Validated the operation of a bench-scale, coupled cold-flow system and collected data on gas-solid contactor bed height control, range of operability, sorbent bed densities, bed void volumes, and fluidization characteristics.
- Measured the heat transfer limitations of the existing screw conveyor system and determined that the screw conveyors cannot be used for sorbent regeneration in a 1-ton/day CO_2 capture pre-pilot system.
- Developed updated process simulations for the new dry carbonate process design using ASPEN Plus.

Next Steps

Development activities for this technology are no longer part of the DOE/NETL portfolio.

Available Reports/Technical Papers/Presentations

General project information is available on DOE/NETL website at: <http://www.netl.doe.gov/technologies/coalpower/ewr/co2/post-combustion/dry-regen.html>

Development of a Dry Sorbent-Based Post Combustion CO_2 Capture Technology for Retrofit in Existing Power Plants – Final Report – April 2010.

Development of a Dry Sorbent-Based Post Combustion CO_2 Capture Technology for Retrofit in Existing Power Plants – Progress Update, presented at the Annual NETL CO_2 Capture Technology for Existing Plants R&D Meeting, Pittsburgh, PA, March 24-26, 2009. <http://www.netl.doe.gov/publications/proceedings/09/CO2/pdfs/43089 RTI sorbent %28Nelson%29 mar09.pdf>

The Dry Carbonate Process: Carbon Dioxide Recovery from Power Plant Flue Gas – 7th Annual Conference on Carbon Capture and Sequestration in Pittsburgh, PA – May 2008.

The Dry Carbonate Sorbent Technology for CO_2 Removal from Flue Gas of Existing Coal-Fired Power Plants – Power Plant Air Pollutant Control “Mega” Symposium in Baltimore, MD – August 2008.

Carbon Dioxide Capture from Flue Gas Using Dry Regenerable Sorbents Fact Sheet – April 2008.

Development of a Dry Sorbent-Based Post Combustion CO_2 Capture Technology for Retrofit in Existing Power Plants Fact Sheet – April 2008.

Carbon Dioxide Capture from Flue Gas Using Dry Regenerable Sorbents – Topical Report – November 2004.

METAL MONOLITHIC AMINE-GRAFTED SILICA FOR CO₂ CAPTURE

Primary Project Goals

The University of Akron is developing a low-cost carbon dioxide (CO₂) capture technology by integrating metal monoliths with a grafted amine sorbent.

Technical Goals

- 1.5 mmol-CO₂/g-sorbent.
- 1.0 mmol-sulfur dioxide (SO₂)/g-sorbent.
- 500 repeated thermal cycles of sorbent between CO₂ adsorption at 25 °C and desorption at 110 °C with less than 10% degradation in original CO₂ capture capacity.

Technical Content

The key innovation of this project is the utilization of metal foils with amine-grafted porous silica to fabricate a highly efficient and low-cost CO₂ adsorption system. Porous silica, alumina, zeolite, and carbon, which are used as commercial adsorbents for a wide range of applications, are impregnated with alkyl amine molecules such as monoethanolamine/tetraethylenepentamine. The adsorption capacity of this novel amine-grated silica was determined to be greater than 1.5 mmol-CO₂/g-sorbent because of the abundance of available amine functional groups on the amine-grafted silica. The adsorption and desorption can be further optimized by the sorbent preparation procedures with additives.

The metal monolithic structure allows the rapid removal of heat of CO₂ adsorption. The surface of the metal monolith is coated with a layer of silica, carbon fibers, and a binder. Calcination of the metal monolith with this coating produces the silica or zeolite layers structure with 10 μm diameter channels. The binder and carbon fiber concentration is fine-tuned to optimize the number of the micro channel pathways for CO₂ diffusion into the amine-grafted silica and zeolite.

The University of Akron, as part of this project, has also investigated using coal fly ash treated first with sodium hydroxide (NaOH) and/or hydrochloric acid (HCl) and then impregnated with the amine tetraethylenepentamine. Coal fly ash is being investigated as a support for amine due to its ready availability and low cost.

Technology Maturity:

Pilot-scale using simulated flue gas, 15 kW

Project Focus:

Metal Monolithic Amine-Grafted Zeolites

Participant:

University of Akron

Project Number:

NT43086

NETL Project Manager:

I. Andrew Aurelio
Isaac.Aurelio@netl.doe.gov

Principal Investigator:

Steven Chuang
University of Akron
chuang@uakron.edu

Partners:

FirstEnergy

Performance Period:

2/21/07 – 3/31/11

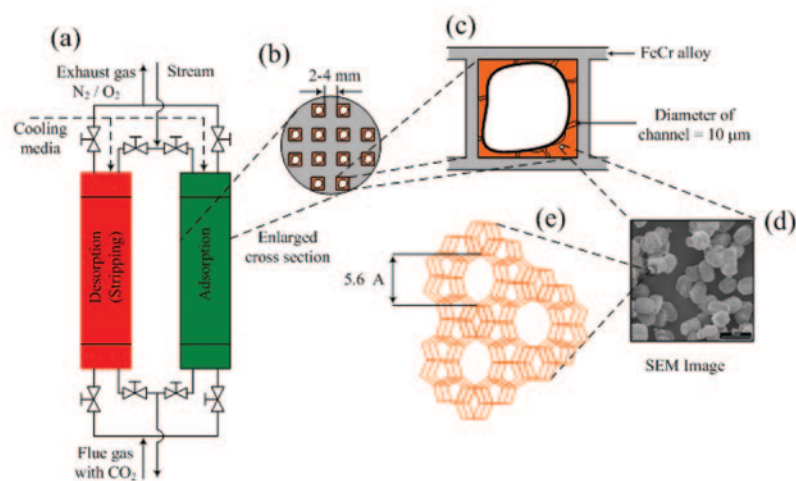

Figure 1: Metal Monolithic Amine-Grafted Silica Sorbents

Figure 1 displays the amine-grafted zeolite structure (5.6 Angstroms in length) inside an adsorption unit. The amine is located in the adsorption (a) chamber within holding tubes. The tubes housed in the adsorption unit holds the individual metal (b) tubes with the amine about 2–4 mm apart. The silica or zeolite is coated inside the square metal tube. Gas enters the tube and flows through the channels (d) of the amine grafted silica, which are 10 µm in diameter. Heating for CO₂ desorption (i.e., regeneration) and cooling for adsorption are achieved by 40 pounds per square inch gauge (psig) steam and cooling water flowing through the jacket side of the adsorber. Desorbed CO₂ is purged from the channels of metal monoliths by pulses of steam and hot air. The goal is that CO₂ and SO₂ adsorption capacity of the amine will be greater than 1.5 mmol-CO₂/g-sorbent and 1.0 mmol-CO₂/g-sorbent, respectively. The amine is capable of greater than 500 times regeneration with less than 10% degradation in CO₂ capacity. The amine grafted silica sorbent is expected to exhibit a heat capacity of 1.5 kJ/kg K. The CO₂ will be captured at an approximate temperature of 50 °C (140 °F) and then released at approximately 110 °C (230 °F).

Table 1: Process Parameters for Metal Monolithic Amine-Grafted Silica Sorbents

	Parameter	Current R&D Value	Target R&D Value
Sorbent Properties	Type of sorbent	PEG/TEPA/SiO ₂	N/A
	Heat of adsorption (kJ/mole CO ₂)	52	50–55
	CO ₂ loading/working capacity, wt%	8 (dry); >11 (wet)	10
	Surface area, m ² /g	30	40
	Particle density, cm ³ /g	0.5	<0.5
	Packing density, cm ³ /g	0.43	<0.5
	Particle size (mm)	0.05–1	<1
	Heat capacity (kJ/K/kg)	1.49	1.3–1.5
	Thermal stability, °C	130 °C	130 °C
	Hydrothermal stability, °C	110 °C	110 °C
Process Configuration	Attrition rate (fluidized bed), %/year	TBD	20
	Cycle time (fixed bed), minutes	12	10
	Pressure drop (fixed bed), psia	2	—
Operating Conditions	Adsorption temperature, °C	50	<55
	Adsorption pressure, atm	1	1
	CO ₂ capture efficiency, %	98	90
	Regeneration method	Thermal swing	Thermal swing
	Regeneration temperature, °C	100–110	100–110
	Regeneration pressure, atm	1–1.05	1–1.05

Table 1: Process Parameters for Metal Monolithic Amine-Grafted Silica Sorbents

	Parameter	Current R&D Value	Target R&D Value
Heat Integration	Required regeneration steam temperature, °C	100–110	100–110
Miscellaneous	Sorbent make-up rate, kg/kg CO ₂	0 not tested	TBD
Product Quality	CO ₂ purity, %	95%	99.9%
	N ₂ concentration, %	Balance	—
	Other contaminants, %	250 ppm SO ₂	<40 ppm SO ₂
Process Performance	Electricity requirement, kJ/kg CO ₂	N/A	—
	Heat requirement, kJ/kg CO ₂	TBD	1,500
	Total energy (electricity equivalent), kJ/kg CO ₂	N/A	—

Technology Advantages

- High stability for CO₂ adsorption and desorption.
- Accelerated removal of the heat of adsorption.
- Low regeneration heat duty due to the low heat capacity of the sorbent.
- Low-cost immobilized amine sorbent.

R&D Challenges

- The scale up transition from lab- to bench-scale tests.
- Temperature swing adsorption requires a long cycle time due to the heating and cooling of the sorbent.
- Contaminants, such as sulfur oxides (SO_x), will react with amine functional groups similar to the monoethanolamine process.
- Currently, the CO₂ capture capacity of the sorbent is too low.

Results To Date/Accomplishments

- Silica-supported amine sorbent with additives is able to capture more than 1.5 mmol CO₂/g-sorbent at 40 °C and desorb at 100 °C for more than 500 cycles with less 10% degradation. Degradation was due to overheating of those sorbents which were in contact with the tube wall. During heating for CO₂ desorption, the wall temperature is 5–15 °C higher than that of the center of packed bed. The presence of 4% water (H₂O) in the CO₂/air stream increases the CO₂ capture capacity by more than 1.6 times and decreases the rate of degradation.
- Zeolite was shown to not be an effective support because of its hydrophilicity and small pore sizes.
- Developed a pilot-scale sorbent manufacturing process at a rate of 1 kg/hr.
- Enhanced the sorbent resistance to SO₂ poisoning by adding a proprietary additive to the CO₂ sorbent.
- Identified the structure of adsorbed CO₂ and SO₂ on the amine sorbents.
- More than 500 of sorbents have been prepared and tested for CO₂ capture.
- Fabricated a metal monolith CO₂ absorber.
- Demonstrated the sorbent at pilot scale, a 5-kg fixed bed. Adsorption was carried out at 55 °C and desorption was with steam at 110 °C.

Next Steps

- Continue to improve CO₂ and SO₂ capture capacity and stability by fine-tuning sorbent compositions.
- Improve the heat transfer rate of the absorber.
- Conduct economic analysis.

Available Reports/Technical Papers/Presentations

General project information is available on DOE/NETL website at: <http://www.netl.doe.gov/technologies/coalpower/ewr/co2/post-combustion/zeolite.html>

Metal Monolithic Amine-Grafted Zeolites for CO₂ Capture Power Plants, presented at the 2010 NETL CO₂ Capture Technology Meeting, Pittsburgh, PA, September 13–17, 2010. [http://www.netl.doe.gov/publications/proceedings/10/co2capture/presentations/monday/Steven Chuang-NT43086.pdf](http://www.netl.doe.gov/publications/proceedings/10/co2capture/presentations/monday/Steven%20Chuang-NT43086.pdf)

Metal Monolithic Amine-Grafted Zeolites for CO₂ Capture Factsheet, U.S. DOE National Energy Technology Laboratory, May 2010. <http://www.netl.doe.gov/publications/factsheets/project/NT43086.pdf>

Metal Monolithic Amine-grafted Zeolites for CO₂ Capture, presented at the Annual NETL CO₂ Capture Technology for Existing Plants R&D Meeting, Pittsburgh, PA, March 24–26, 2009. [http://www.netl.doe.gov/publications/proceedings/09/CO2/pdfs/43086 Akron amine-zeolite sorbent %28Chuang%29 mar09.pdf](http://www.netl.doe.gov/publications/proceedings/09/CO2/pdfs/43086%20Akron%20amine-zeolite%20sorbent%20Chuang%20mar09.pdf)

“In Situ Infrared Study of the Role of PEG in Stabilizing Silica-Supported Amines for CO₂ Capture” J. Tanthana and S.S. C. Chuang, *Chemical and Sustainability Energy and Materials*, 3, 957–964, 2010. <http://onlinelibrary.wiley.com/doi/10.1002/cssc.201000090/abstract>

“Oxide-supported Tetraethylenepentamine for Carbon Dioxide Capture,” J. C. Fisher II, J. Tanthana, and S.S. C. Chuang, *Environmental Progress and Sust Energy*, 28 (4), 589–598, 2009. <http://onlinelibrary.wiley.com/doi/10.1002/ep.10363/abstract>

“Metal Monolithic Immobilized Amine Absorber for Carbon Dioxide Capture,” U.S. Patent Applications, Nov. 7, 2008, UA 685.

This page intentionally left blank

APPENDIX B: CARBON DIOXIDE CAPTURE TECHNOLOGY SHEETS
POST-COMBUSTION MEMBRANES

CO₂ CAPTURE BY SUB-AMBIENT MEMBRANE OPERATION

B-237

Primary Project Goals

American Air Liquide, Inc. (AL) is developing a post-combustion carbon dioxide (CO₂) capture process based on sub-ambient temperature operation (<-10 °C) of a hollow fiber membrane.

Technical Goals

- Demonstrate membrane performance (high selectivity and permeance) operating at sub-ambient temperature with a commercial-scale membrane module in a bench-scale test skid. The bench-scale test work will be conducted mainly at AL's Delaware Research and Technology Center.
- Verify mechanical integrity of commercial-scale membrane module structural components at sub-ambient temperatures.
- Demonstrate the long-term operability of the sub-ambient temperature membrane skid.
- Evaluate the effect of possible contaminants [e.g., sulfur dioxide (SO₂), nitrogen oxides (NO_x)] on membrane performance.
- Refine process simulation for integrated process with flue gas conditioning and CO₂ liquefier.
- Design slip-stream-scale unit for possible field test.

Technical Content

AL is developing a CO₂ capture process based on sub-ambient temperature operation of a hollow fiber membrane. For most membrane materials, permeability decreases and selectivity increases with a decrease in operating temperature. However, laboratory measurements of the AL membranes operated at temperatures below -20 °C show two to four times higher CO₂/nitrogen (N₂) selectivity with minimal loss of CO₂ permeance compared to ambient temperature values.

Figure 1 presents a simplified block diagram of the cold membrane process. A highly selective cold membrane provides pre-concentration of CO₂ prior to CO₂ partial condensation in a liquefaction unit. The cryogenic heat exchanger system provides energy integration between the membrane and CO₂ liquefaction system.

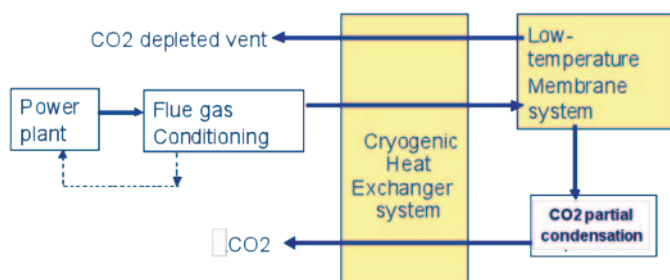

Figure 1: Block Diagram of Cold Membrane Process

Technology Maturity:
Laboratory/bench-scale

Project Focus:
Sub-Ambient Temperature,
Hollow-Fiber Membrane

Participant:
American Air Liquide

Project Number:
FE0004278

NETL Project Manager:
Andrew O'Palko
Andrew.OPalko@netl.doe.gov

Principal Investigator:
Sudhir Kulkarni
American Air Liquide, Inc.
sudhir.kulkarni@airliquide.com

Partners:
Air Liquide Advanced
Technologies U.S. – MEDAL
Air Liquide Process and
Construction

Performance Period:
10/1/10 – 9/30/12

Figure 2 shows a schematic diagram of the membrane-based CO₂ compression and purification unit (CPU) process. The process lines in Figure 2 are color coded: black for ambient temperature, dark blue for ~-30 °C, and light blue for ~-50 °C. The pre-treated flue gas is compressed to ~230 pounds per square inch (psi) (16 bar). The heat of compression is captured in boiler feed water raising its temperature to ~147 °C. The compressed flue gas is then dried in a dehydration unit to prevent water condensation when the stream is cooled in the economizing heat exchanger to -30 °C. The cooled, dried, compressed flue gas is then fed to the membrane to produce a residue stream with ~1.6% CO₂ at ~215 psi (15 bar) and a permeate stream with ~60 to 70% CO₂ at ~17 psi (1–2 bar). After the residue is sent through one pass of the heat exchanger, further cooling and energy recovery is done via a series of turbo-expanders with the resulting cold residue stream at -57 °C sent through the heat exchanger. Finally, the excess pressure energy remaining in the warmed residue is partly recovered in a warm turbo-expander before venting. A fraction of the vent gas is used to regenerate the drier. The permeate stream is re-compressed, cooled in the heat exchanger, and undergoes phase separation in the cryo-phase separator. Liquid CO₂ is pumped from the separator to provide a sequestration-ready product CO₂ at approximately 870 psi (60 bar), or greater, and 20 °C. The overhead from the cryo-phase separator is warmed through the heat exchanger and then undergoes energy recovery in a turbo-expander. This stream is mixed with the incoming dried flue gas, which raises the mixed feed concentration entering the membrane to 18% CO₂. The higher CO₂ content improves the membrane separation.

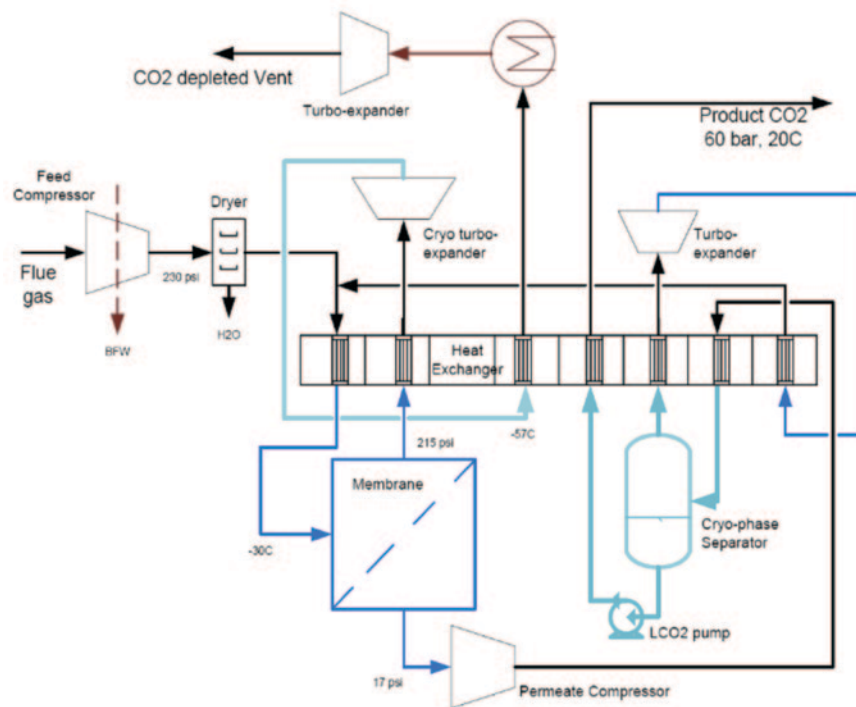

Figure 2: Schematic Diagram of Cold Membrane Process

Table 1: Membrane Process Parameters

	Parameter	Current R&D Value	Target R&D Value
Membrane Properties	Materials of fabrication for selective layer	—	—
	Materials of fabrication for support layer (if applicable)	—	—
	Selectivity of key gas components: CO ₂ /N ₂ for post-combustion technology	>90 at proposed conditions	—
	Type of selectivity measurement (ideal or mixed gas)	Mixed gas	—
	Pressure normalized flux (permeance for linear materials) for more selective gas component, GPU or equivalent units	>90	—
	Temperature, °C	-30 to -40	—
	Laboratory-scale testing, hours without significant performance degradation	2,000	—
	Pilot-scale testing (if applicable), hours without significant performance degradation	—	—
	Maximum pressure differential achieved without significant performance degradation or failure, bar	24	—
Module Properties	Module configuration: hollow-fiber, spiral-wound sheet, shell-and-tube, plate-and-frame, other	Hollow fiber	—
	Packing density, m ² /m ³	>1,000	—
	Pressure drop, bar (feed to residue)	~0.1 bar	—
	Estimated cost of manufacturing and installation, \$/m ² -GPU or equivalent	TBD	—
Product Quality	CO ₂ purity, %	97+%	—
	N ₂ concentration, %	—	—
	Other contaminants, %	—	—
Process Performance	Electricity requirement, kJ/kg CO ₂	~800	—
	Heat requirement, kJ/kg CO ₂	—	—
	Total energy (electricity equivalent), kJ/kg CO ₂	~800	—

Other Membrane Parameters

Contaminant Resistance: Expected to be resistant to acidic components based on experience to date.

Flue Gas Pretreatment Requirements: Particulate removal and acid component removal to meet compressor specifications, dehydration to meet cold box specifications, mercury (Hg) removal to meet heat exchanger specification.

Waste Streams Generated: Acidic water.

Technology Advantages

- Sub-ambient operation improves membrane performance.
- Process design provides partial recovery of the flue gas compression energy.
- Process design provides an economic method of cooling the flue gas feed to the required sub-ambient temperature for optimal membrane operation without external refrigeration.
- The process design can be combined with a novel scheme for contaminant (SO₂, NO_x) removal.

R&D Challenges

- Sub-ambient membrane operation requires development of suitable membrane module materials with adequate permeance and selectivity in a commercial membrane module.
- Long-term membrane module performance stability.
- Integration of sub-ambient membrane process including: energy integration with the CPU, and energy integration with the power plant such as compression and turbo-expansion schemes, heat economizers, and energy conservation.
- Flue gas contaminant-specific challenges, including: acid gas (NO_x, SO₂) separation, compressor materials of construction, particulate removal, Hg removal, and water management.

Results To Date/Accomplishments

- Initiated design and fabrication of a closed loop sub-ambient bench-scale test system for testing the membrane bundles at the proposed sub-ambient temperature conditions using synthetic flue gas (CO₂ and N₂).
- Modified an existing AL cold test facility in order to conduct laboratory testing of the membrane with feeds containing acidic components.

Next Steps

- Complete construction of the closed loop sub-ambient bench-scale test system.
- Initiate laboratory testing of the membrane using synthetic flue gas (CO₂ and N₂) that contains low concentrations of SO₂.

Final test results will not be available until after the September 2012 project completion date.

Available Reports/Technical Papers/Presentations

General project information is available on DOE/NETL website at: <http://www.netl.doe.gov/technologies/coalpower/ewr/co2/post-combustion/sub-ambient-membrane.html>

“CO₂ Capture By Sub-Ambient Membrane Operation,” Annual NETL CO₂ Capture Technology for Existing Plants R&D Meeting, Pittsburgh, PA, September 2010. <http://www.netl.doe.gov/publications/proceedings/10/co2capture/index.html>

HYBRID MEMBRANE/ABSORPTION PROCESS FOR POST-COMBUSTION CO₂ CAPTURE

Primary Project Goals

Gas Technology Institute (GTI) is developing a hybrid membrane/absorption process (known as Carbo-Lock™) for post-combustion carbon dioxide (CO₂) capture. The project includes bench-scale testing on a 25 kWe-equivalent slipstream at Midwest Generation's Joliet Power Station.

Technical Goals

- Develop hollow fiber membranes suitable for the membrane absorption application with improved mass transfer. Porous and composite membrane configurations are being evaluated.
- Demonstrate feasibility of the membrane contactor technology for flue gas CO₂ separation.
- Determine optimum solvent for use in process.
- Develop an energy efficient regeneration process that enables CO₂ separation at elevated pressures.
- Conduct bench-scale testing of the process using actual flue gas.
- Conduct process design and preliminary economic analysis.

Technical Content

GTI is partnering with PoroGen Corporation and Aker Process Systems in a three-year effort to develop a hybrid technology for CO₂ capture based on a combination of solvent absorption and hollow fiber membrane technologies. The membrane contactor is a novel gas separation technology based on a gas/liquid membrane concept. It operates with a solvent on one side of the membrane and gas on the other. The membrane contactor process combines the advantageous features of membrane and absorption technologies and enables economical utilization of advanced absorption solvents. The PoroGen hollow fiber membrane is based on a chemically and thermally resistant commercial engineered polymer (poly ether ether ketone or PEEK). The hybrid technology increases gas/liquid contact area by a factor of 10 over conventional packed or tray absorption columns, thus increasing mass transfer. The membrane CO₂/nitrogen (N₂) selectivity is controlled by the chemical affinity of CO₂ with the selected solvent. The process could lower steam regeneration energy requirement as compared to conventional amine-based solvent processes, and the CO₂ could be generated at pressure, reducing compression costs.

Figure 1 shows the basic mass transfer principle using the porous, hollow fiber PEEK membrane contactor. The membrane matrix is filled with gas and mass transfer occurs via a diffusion reaction mechanism. The driving force is the difference in chemical potential of the CO₂ in the gas side versus the liquid side of the membrane. The mass transfer is not pressure-driven and, therefore, the absolute pressure difference between the membrane shell and tube side is either low or close to zero.

Technology Maturity:

Laboratory/bench-scale testing using actual flue gas

Project Focus:

Hybrid with Solvent and Hollow-Fiber Membrane

Participant:

Gas Technology Institute

Project Number:

FE0004787

NETL Project Manager:

José Figueroa
Jose.Figueroa@netl.doe.gov

Principal Investigator:

Shaojun Zhou
Gas Technology Institute
shaojun.zhou@gastechnology.org

Partners:

Aker Process Systems
Midwest Generation EME, LLC
PoroGen Corporation

Contract Performance Period

10/1/10 – 9/30/13

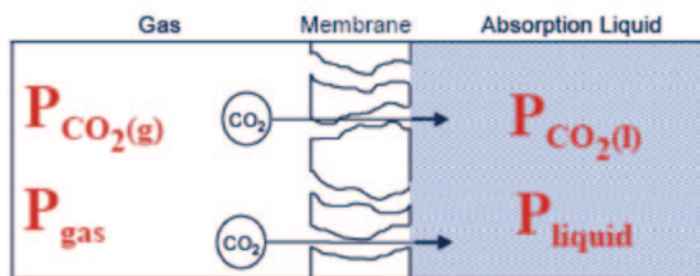

Figure 1: Mass Transfer Principle for Hybrid Membrane/Solvent Contactor

An advanced hindered amine and promoted carbonate solvents are being tested in combination with the membrane contactor system. The use of these solvents will decrease regeneration energy requirements as well as absorbent degradation. For the hindered amine solvent, the regeneration will be carried out in a membrane contactor at high temperature to generate CO_2 at elevated pressure. For the carbonate solvent, the regeneration will be carried out in a membrane contactor with low-pressure steam sweep to decrease regeneration energy. Both solvent systems are being evaluated initially and the most optimal system will be selected for the bench-scale field tests. Figure 2 shows a schematic diagram for the hybrid membrane/solvent process showing the absorber (membrane contactor) and regeneration columns.

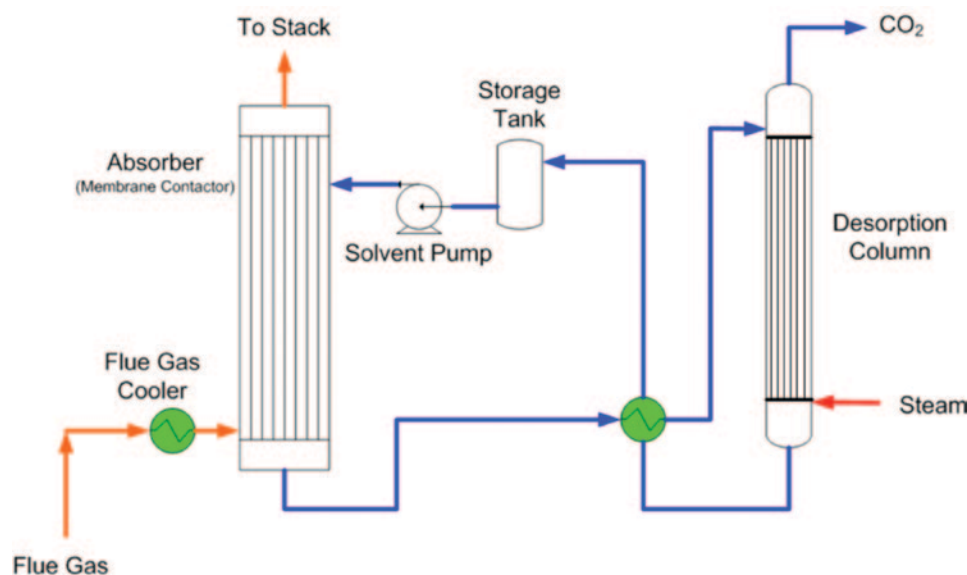

Figure 2: Process Schematic for Hybrid Membrane/Solvent Technology

The main process features of the hybrid membrane/solvent technology include: a higher CO_2 loading differential between rich and lean solvent is possible; increased mass transfer reduces system size; high specific surface area available for mass transfer; independent gas and liquid flow; linear scale up; and concentrated solvents or specialty absorbents can be used. Table 1 provides a summary of the membrane process parameters.

Table 1: Membrane Process Parameters

	Parameter	Current R&D Value	Target R&D Value
Membrane Properties	Materials of fabrication for selective layer	Perfluoro-oligomer	Perfluoro-oligomer
	Materials of fabrication for support layer (if applicable)	PEEK	PEEK
	Selectivity of key gas components: CO ₂ /N ₂ for post-combustion technology	Determined by solvent used	Determined by solvent used
	Type of selectivity measurement (ideal or mixed gas)	Mixed	Mixed
	Pressure normalized flux (permeance for linear materials) for more selective gas component, GPU or equivalent units	1,000–5,000	1,000–5,000
	Temperature, °C	20–50	20–50
	Bench-scale testing, hours without significant performance degradation	TBD	TBD
	Pilot-scale testing (if applicable), hours without significant performance degradation	N/A	N/A
	Maximum pressure differential achieved without significant performance degradation or failure, bar	N/A	N/A
Module Properties	Module configuration: hollow-fiber, spiral-wound sheet, shell-and-tube, plate-and-frame, other	Hollow-fiber	Hollow-fiber
	Packing density, m ² /m ³	500–1,000	500–1,000
	Pressure drop, bar	0.2	0.1
	Estimated cost of manufacturing and installation, \$/m ² -GPU or equivalent	100	40
Product Quality	CO ₂ purity, %	99%	99%
	N ₂ concentration, %	TBD	TBD
	Other contaminants, %	TBD	TBD
Process Performance	Electricity requirement, kJ/kg CO ₂	TBD	TBD
	Heat requirement, kJ/kg CO ₂	TBD	TBD
	Total energy (electricity equivalent), kJ/kg CO ₂	TBD	TBD

Other Membrane Parameters

Contaminant Resistance: Membrane is resistant to all contaminants. Absorbents will be affected by contaminants to a lesser extent than a conventional packed or tray column. Membrane will provide a measure of protection for the solvents from degradation by contaminants (a barrier).

Flue Gas Pretreatment Requirements: Particle removal.

Waste Streams Generated: None.

Technology Advantages

- The membrane contactor process combines the advantageous features of membrane and absorption technologies and enables economical utilization of advanced absorption solvents.
- The hybrid technology increases interfacial gas/liquid area by a factor of 10 over conventional packed or tray absorption columns, thus increasing mass transfer.
- The process requires lower steam regeneration energy compared to conventional amine-based solvent processes.

- The CO₂ is generated at pressure, reducing compression costs.
- Up to 70% reduction in system size and footprint compared to a conventional solvent-based process.

R&D Challenges

- Membrane hydrophobic properties may change with contact time in solvent causing solvent leakage. Long-term testing required.
- Mass transfer coefficient not sufficiently high for gas absorption and solvent regeneration in the membrane contactor.
- Develop solvent regeneration process in membrane module.
- Reduce process capital and operating costs.

Results To Date/Accomplishments

- Optimization of the super-hydrophobic PEEK membranes morphology for the preferred MDEA solvent system is close to completion. A membrane with “non-wetting” characteristics towards the MDEA solvent system was developed. The membrane morphology will be further optimized based on CO₂ separation and capture test results.
- Contactor module design was initiated, the prototype laboratory-scale module design was completed, and the laboratory test module was constructed and is ready for testing.

Next Steps

- PEEK membrane morphology will be further optimized for MDEA solvent system and tested for non-wetting characteristics in longer term tests and at elevated temperatures (50 and 120–130 °C).
- PEEK membrane morphology will be optimized for the carbonate solvent system. PEEK hollow fiber dimensions will be optimized for flue gas application to minimize pressure drop.
- PEEK membrane test modules (2-inch diameter and 10 ft² area) will be constructed for laboratory-scale tests. Manufacturing procedures and module design will be further optimized based on test results.
- Conduct CO₂ capture laboratory tests utilizing simulated flue gas.
- Liquid break through tests will be extended to elevated temperatures.

Final test results will not be available until after the September 2013 project completion date.

Available Reports/Technical Papers/Presentations

General project information is available on DOE/NETL website at: <http://www.netl.doe.gov/technologies/coalpower/ewr/co2/post-combustion/hybrid-membrane.html>

“Hybrid Membrane/Absorption Process for Post-Combustion CO₂ Capture (Membrane Contactor),” Annual NETL CO₂ Capture Technology for Existing Plants R&D Meeting, Pittsburgh, PA, September 2010. <http://www.netl.doe.gov/publications/proceedings/10/co2capture/index.html>

CO₂ CAPTURE MEMBRANE PROCESS FOR POWER PLANT FLUE GAS

B-245

Primary Project Goals

Research Triangle Institute (RTI) is developing an advanced hollow-fiber, polymeric membrane-based process that can be cost-effectively retrofitted into current pulverized coal (PC)-fired power plants to capture at least 90% of the carbon dioxide (CO₂) from the plant's flue gas.

Technical Goals

- Develop new fluorinated polymers as membrane materials that have superior CO₂ separation properties compared to conventional and competitive membrane platforms. A minimum selectivity of 30 for CO₂ over nitrogen (N₂) and CO₂ permeance in excess of 300 gas permeance unit (GPU) are targeted. Fluorinated polymers are a promising material platform because they exhibit excellent chemical stability to moisture, sulfur dioxide (SO₂), and nitrogen oxide (NO_x) contaminants present in flue gas.
- Develop next-generation polycarbonate hollow-fiber membranes and membrane modules with higher CO₂ permeance than current commercial polycarbonate membranes.
- Develop and fabricate improved membrane hollow fibers and module designs to handle large flue gas flow rates and high CO₂ permeate flow rates with minimal pressure drop.
- Identify and develop CO₂ capture membrane process design and integration strategies suitable for retrofit installation.
- Demonstrate CO₂ capture performance and durability of membrane modules using actual coal-fired flue gas.

Technical Content

Project research efforts include development of membrane materials and membrane hollow fibers, membrane module design and fabrication, and process design.

RTI is pursuing the development of two membrane material platforms. As a near-term membrane platform solution, RTI is working with Generon to develop next-generation, high-flux polycarbonate hollow-fiber membranes and membrane modules with higher CO₂ permeance than current-generation, commercial polycarbonate membranes. Hollow-fiber membranes made from the high-flux polycarbonate have been successfully developed, scaled up, and fabricated into module separation devices. Laboratory-scale membrane modules have been studied with simulated flue gas mixtures with and without flue gas contaminants. Two large prototype membrane modules of the high-flux polycarbonate membrane fibers have been produced and will be evaluated for field performance and durability with a real combustion flue gas slipstream at a coal-fired power plant in Chapel Hill, NC.

For a longer-term membrane platform solution, RTI is working with Arkema to develop improved CO₂ capture membrane materials based on the polymer chemistry of polyvinylidene fluoride (PVDF), the chemical structure of which is shown in Figure 1 and comprises the [CH₂-CF₂]_n repeat unit. PVDF is well suited for contact with flue gas, possessing high chemical resistance to

Technology Maturity:

Bench-scale using actual flue gas (120 scfm)

Project Focus:

Hollow-Fiber, Polymeric Membranes

Participant:

RTI International

Project Number:

NT0005313

NETL Project Manager:

Andrew O'Palko
Andrew.OPalko@netl.doe.gov

Principal Investigator:

Lora Toy
 Research Triangle Institute
ltoy@rti.org

Partners:

Arkema
 Generon IGS

Performance Period:

10/1/08 –3/31/11

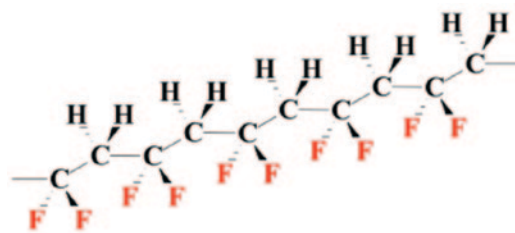

Figure 1: Chemical Structure of PVDF

acids and oxidants, specific affinity for CO₂ for high CO₂ solubility, and high thermal stability ($T_d \sim 340^\circ\text{C}$). PVDF also features excellent physical and mechanical properties, durability, and longevity suited to the fiber extrusion process used to fabricate membrane hollow fibers. However, conventional PVDF is a homopolymer that is semicrystalline and has CO₂/N₂ selectivity of ~ 23 and low CO₂ permeance of ~ 10 GPU. Arkema is thus synthesizing and developing advanced PVDF based copolymers possessing improved CO₂ permeance and selectivity.

In this project, the membrane is being developed in the form of hollow fibers that are packaged into compact, high surface area-to-volume module devices. Multiple modules will be utilized in a given CO₂ capture membrane system for power plant applications due to the large quantity of flue gas to be processed. The modularity of the membrane separation devices allows for easy adaptation to different levels of CO₂ removal desired by simply adding or subtracting the number of membrane modules used. Figure 2 shows a cross-section of a hollow-fiber membrane module. A single-membrane module consists of hundreds of thousands to more than a million micron-sized-diameter hollow fibers bundled together. A couple of individual membrane hollow fibers, a small bundle loop of fibers, and modules of different sizes are shown in Figure 3. As flue gas flows through the membrane fibers, the feed is split into two streams. A permeate stream enriched in CO₂ is produced by the preferential transport of CO₂ across the fiber walls. The remaining flue gas (non-permeate) flows out of the membrane module as a CO₂-depleted retentate stream that is sent to the plant stack for discharge to the atmosphere.

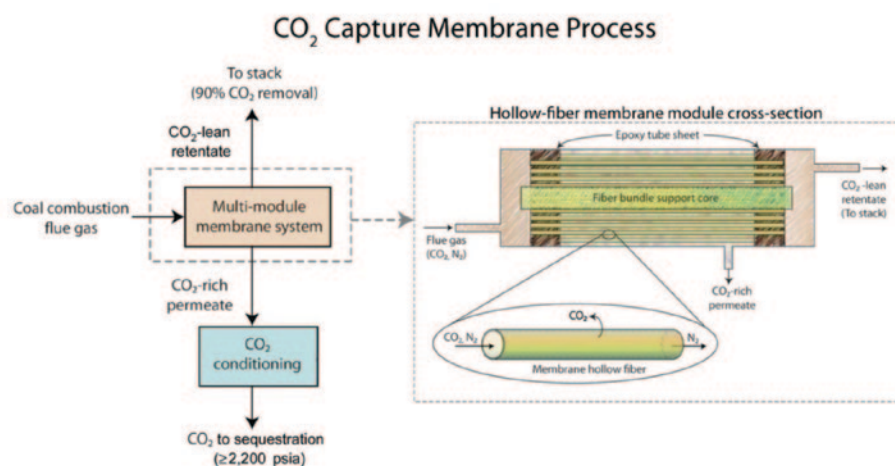

Figure 2: Cross-Section of a Hollow-Fiber Membrane Module



Figure 3: Membrane Hollow Fibers

Process simulations for a single-stage membrane process were conducted to determine the sensitivity of CO₂ removal performance and permeate CO₂ purity to different parameters, including membrane flux (permeance), membrane selectivity, membrane fiber dimensions, and membrane pressure driving force. An important outcome of this sensitivity analysis was the understanding that membrane property development should focus on improving both permeance and selectivity together rather than individually.

To achieve high levels of CO₂ capture and purity, RTI developed the three-stage membrane process shown in Figure 4, where the membrane stages are represented by M1, M2, and M3. The flue gas is compressed and fed to the first membrane stage M1. To obtain a net 90% removal of CO₂ from the stream ultimately sent to the stack, the CO₂-depleted retentate exiting M1 is fed to M3, which is operated with a permeate-side air sweep to enhance removal of more CO₂. Before being released into the stack, the pressurized M3 retentate is sent to an expander to recover the energy associated with high pressure. The resulting M3 permeate is a CO₂ enriched air stream that is sent back to the boiler. In the second membrane stage M2, the CO₂ captured in the M1 permeate is further concentrated. The resulting CO₂-rich M2 permeate is then compressed and dehydrated to produce the final, sequestration-

ready CO₂ capture stream. The M2 retentate is recycled and fed back to M1. The numbers shown in Figure 4 are for a 550-MW coal-fired power plant to achieve 90% CO₂ capture and 95% CO₂ purity in the capture stream using the high-flux polycarbonate membrane (400 GPU; CO₂/N₂ = 35).

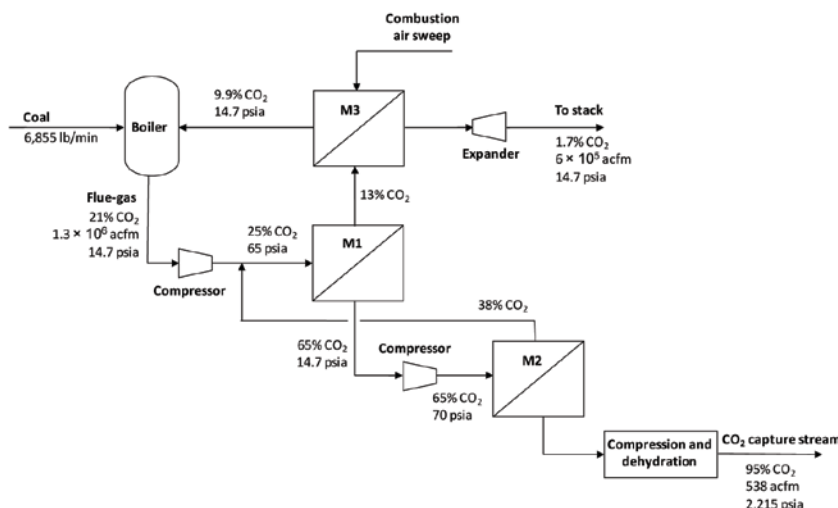

Figure 4: RTI's Three-Stage CO₂ Capture Membrane Process Design

Table 1: Membrane Process Parameters

	Parameter	Current R&D Value	Target R&D Value
Membrane Properties	Materials of fabrication for selective layer	Polycarbonate-based	Vinylidene fluoride-based
	Materials of fabrication for support layer (if applicable)	N/A	N/A
	Selectivity of key gas components: H ₂ /CO ₂ for pre-combustion technology	35	50
	Type of selectivity measurement (ideal or mixed gas)	Ideal and mixed	Ideal and mixed
	Pressure normalized flux (permeance for linear materials) for more selective gas component, GPU or equivalent units	400	1,000
	Temperature, °C	25–30	50
	Bench-scale testing, hours without significant performance degradation	165	300 (coal)
	Pilot-scale testing (if applicable), hours without significant performance degradation	N/A	N/A
Module Properties	Maximum pressure differential achieved without significant performance degradation or failure, bar	15 (not tested higher)	15
	Module configuration: hollow-fiber, spiral-wound sheet, shell-and-tube, plate-and-frame, other	Hollow-fiber	Hollow-fiber
	Packing density, m ² /m ³	9,000	9,000
	Pressure drop, bar	0.5	<0.1
Product Quality	Estimated cost of manufacturing and installation, \$/m ² -GPU or equivalent	0.08	0.02
	CO ₂ purity, %	95	95+
	N ₂ concentration, %	4%	<1%
Process Performance	Other contaminants, %	1%	<0.5%
	Electricity requirement, kJ/kg CO ₂	1,250	900
	Heat requirement, kJ/kg CO ₂	0	0
	Total energy (electricity equivalent), kJ/kg CO ₂	1,250	900

Other Membrane Parameters

Contaminant Resistance: Membrane resistance to contaminant species (NO_x , SO_2 , moisture) found in flue gas was investigated in continuous seven-day, bench-scale separation performance stability tests with contaminant-containing CO_2/N_2 mixtures. The permeance of the high-flux polycarbonate membrane showed some sensitivity to contaminants such as NO_x , but its selectivity was stable. The new PVDF-based membrane material platform, because of its intrinsically high chemical resistance, exhibited excellent permeability (permeance) and selectivity stability in the contaminant tests.

Flue Gas Pretreatment Requirements: Before being fed to the membrane system, the flue gas from the plant stack must be conditioned to remove solid particulates and any condensed/entrained liquids (essentially liquid water).

Waste Streams Generated: Because the membrane permeates and concentrates water into the CO_2 capture stream, a liquid water stream is recovered by the membrane process during compression of the capture stream to sequestration pressure. A water condensate stream is also produced upstream of membrane stages M1 and M2 because of compression of their feed gas streams, followed by cooling of this compressed gas with cooling water to the optimum membrane operating temperature. The quality of these liquid water streams is not known and will need to be determined.

Technology Advantages

Membrane-based processes have the potential to provide PC-fired power plants with a cost-effective technology option for CO_2 capture. They are inherently energy-efficient because the membrane enables passive separation of gases. Their compact footprint and modular nature allows for easy installation into an existing PC-fired plant, and, with no moving parts, they are simple to operate and maintain. In addition, the hollow fiber membrane approach taken in this project is particularly well-suited for high-volume applications such as the large flue gas volumes that must be handled in post-combustion carbon capture. Hollow-fiber modules have much higher membrane packing density and lower cost per membrane area than other module types. The hollow-fiber membrane tubes are economically produced on a commercial scale by using existing fiber manufacturing equipment technology.

R&D Challenges

Flue gas properties, such as low CO_2 concentration of 13–15%, low flue gas pressure of 1 atm, large flue gas volumes, and the presence of moisture and contaminants [sulfur oxides (SO_x), NO_x , and particulate matter], can pose certain challenges for a conventional membrane separation process. These technology challenges are being addressed in this project through the development of new membrane materials with improved CO_2 separation properties and chemical resistance, improved membrane module design and engineering, and novel process design and integration strategies.

Results To Date/Accomplishments

- Development and fabrication of next-generation, high-flux polycarbonate membrane hollow fibers with CO_2 permeance of 410 GPU, which is four times greater than the CO_2 flux of current commercial standard polycarbonate fibers, and CO_2/N_2 selectivity (25–35) comparable to that of the standard fibers. Eight laboratory-scale modules made from these fibers were investigated with pure N_2 , oxygen (O_2), and CO_2 at feed pressures up to 200 pounds per square inch gauge (psig) and with CO_2/N_2 mixtures with and without flue gas contaminants, including 290 parts per million (ppm) SO_2 , 255 ppm nitric oxide (NO), and 30 ppm nitrogen dioxide (NO_2), at 75 psig feed pressure.
- Development and fabrication of high-flux polycarbonate membrane hollow fibers with a 25% increase in fiber diameter to reduce the axial pressure drop by 50%.
- Successful fabrication scale-up of high-flux polycarbonate hollow fibers into 10 large prototype membrane modules (6 by 36 inches) with 6,000–12,000 times more membrane area than that of laboratory-scale modules. In quality control checks, the prototype modules showed CO_2 permeation properties consistent with those of the laboratory-scale modules.
- Development and synthesis of novel fluorinated VDF-based copolymers having excellent resistance to flue gas contaminants (SO_2 , NO_x , moisture) and improved CO_2 separation properties.

- Flue gas contaminants had no plasticization or detrimental effect on VDF-based copolymer platform as shown by stable (constant) CO₂ permeance and selectivity in continuous seven-day tests with CO₂/N₂ mixtures containing 30 ppm NO₂, 250 ppm NO, 290 ppm SO₂, or ~1% water vapor.
 - VDF-co-A copolymer series achieved up to 17–18 times higher CO₂ permeability (permeance) than the base PVDF homopolymer with no adverse impact on base CO₂/N₂ selectivity.
 - VDF-co-B copolymer series achieved up to 1.7–3.0 times higher CO₂/N₂ selectivity and up to six to eight times higher CO₂ permeability (permeance) than the base PVDF polymer.
 - Process temperature may be used to further enhance CO₂ permeance in the VDF-based material platform as a substantial 10-fold increase in permeance was measured over only a small 35 °C temperature rise.
- Successful preparation of fine hollow fibers from selected VDF-co-A copolymer candidate in trial fiber spin runs, thus demonstrating the feasibility of making fibers from the new VDF-based material platform.
 - Development of three-stage CO₂ capture membrane process design to achieve 90% CO₂ capture and 95% CO₂ purity.

Next Steps

- Continued development of VDF-based membrane polymer platform by exploring other synthetic strategies to further increase CO₂ permeability (permeance) and selectivity.
- Design and construction of a field CO₂ capture membrane test skid.
- Field performance and durability testing (300 hours cumulative) of two prototype high-flux polycarbonate membrane modules with 120 scfm slipstream of real coal-derived flue gas at a coal-fired power plant (32 MWe) in Chapel Hill, NC. Field-test plans also include testing of the VDF-based membrane platform.
- Techno-economic evaluation, using the field-test data collected, of the “best” integrated CO₂ capture membrane process design package.

Final test results will not be available until after the September 2011 project completion date.

Available Reports/Technical Papers/Presentations

General project information is available on the DOE/NETL website at: <http://www.netl.doe.gov/technologies/coalpower/ewr/co2/post-combustion/membrane-process.html>

“CO₂ Capture Membrane Process for Power Plant Flue Gas,” 2010 NETL CO₂ Capture Technology Meeting, Pittsburgh, PA, September 2010. <http://www.netl.doe.gov/publications/proceedings/10/co2capture/index.html>

“CO₂ Capture Membrane Process for Power Plant Flue Gas,” Annual NETL CO₂ Capture Technology for Existing Plants R&D Meeting, Pittsburgh, PA, March 2009.

MEMBRANE PROCESS TO CAPTURE CARBON DIOXIDE FROM COAL-FIRED POWER PLANT FLUE GAS

Primary Project Goals

Membrane Technology and Research, Inc. (MTR) is developing a polymeric membrane and associated process for carbon dioxide (CO₂) capture. The project includes conducting slipstream (0.05 MWe) and small pilot-scale (1 MWe) field tests using full-scale commercial membrane modules to treat combustion flue gas at a coal-fired power plant.

Technical Goals

- Develop a thin film, composite, polymer-based membrane to increase CO₂ permeance while maintaining CO₂/nitrogen (N₂) selectivity.
- Develop a countercurrent sweep membrane module design using incoming combustion air to generate separation driving force and reduce the need for vacuum pumps and the associated parasitic energy cost.
- Fabricate commercial-scale membrane modules that meet low pressure-drop and high packing-density performance targets.
- Continue slipstream field testing of a membrane system at a coal-fired power plant; the system will process 7,000 standard m³/day (0.25 MMscfd) of flue gas (equivalent to approximately 0.05 MWe), separating about one tonne of CO₂/day.
- Further scale up the process in order to conduct a six-month small pilot-scale field test of a membrane system at a coal-fired power plant (equivalent to approximately 1 MWe or about 20 tonne of CO₂/day).
- Analyze the performance of the membrane system, determine how it would be best integrated with a coal-fired power plant, and prepare a comparative economic analysis of the membrane-based CO₂ capture process versus other capture technologies.

Technical Content

MTR is developing composite membranes with high CO₂ permeance and high CO₂/N₂ selectivity for post-combustion flue gas applications. Tests indicate the membrane has 10 times the CO₂ permeance of conventional gas separation membranes. The combination of these membranes with a novel countercurrent module design that utilizes incoming combustion air to generate separation driving force greatly reduces the projected cost of CO₂ capture. MTR is developing a commercial-scale membrane module that can meet low pressure-drop and high packing-density performance targets. This thin-film membrane utilizes hydrophilic polymers and is known by the trade name “Polaris™.”

Polaris™ membranes will be used in a novel two-step membrane process design, as shown in Figure 1. The process includes two types of membrane arrangements—a conventional cross-flow module and a novel countercurrent sweep module. First, the combustion flue gas enters a cross-flow module, which removes most of the CO₂. The retentate from the cross-flow module is then fed into a countercurrent sweep module, from which the permeate is recycled back to the boiler

Technology Maturity:

Small pilot-scale on actual flue gas (equivalent to 1 MW)

Project Focus:

Spiral-Wound, Polymeric Membranes

Participant:

Membrane Technology and Research, Inc.

Project Number:

FE0005795
NT0005312
NT43085

NETL Project Manager:

José Figueroa
Jose.Figueroa@netl.doe.gov

Principal Investigator:

Tim Merkel
Membrane Technology and Research, Inc.
tcmerkel@mtrinc.com

Partners:

Arizona Public Service
Babcock & Wilcox
EPRI
Helios-NRG
Southern Company/NCCC
Worley Parsons

Performance Period:

4/1/07 – 9/30/15

via an air sweep, which increases the CO₂ concentration of the flue gas entering the initial cross-flow module. The CO₂-rich permeate from the cross-flow module is then dehydrated and compressed. A second stage cross-flow module is used after compression to further enrich the CO₂ stream by recycle of the permeate back to the inlet of the compressor.

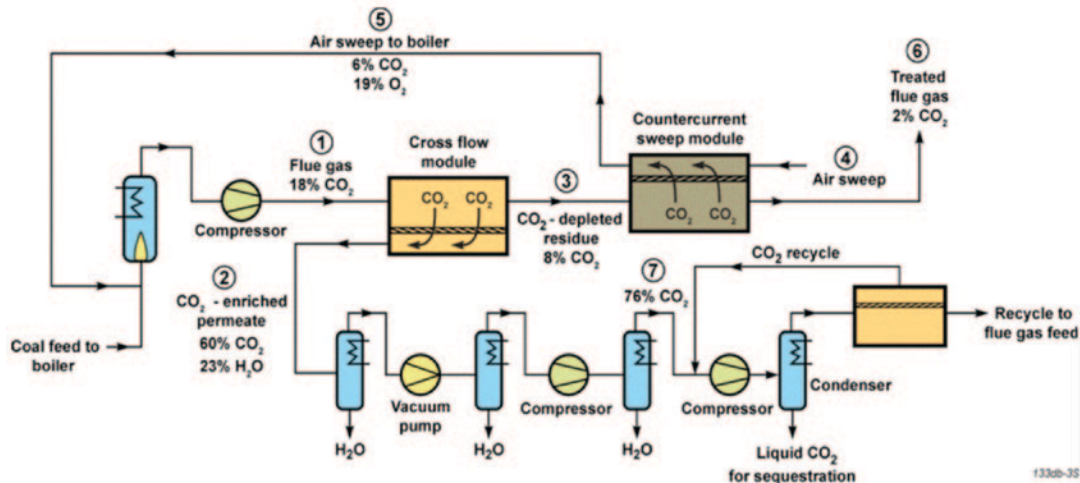

Figure 1: Process Design for the Membrane System

Polaris™ membranes will be packed into spiral-wound membrane modules, the most commonly used module design for commercial membrane installations today. Spiral-wound modules are robust, resistant to fouling, and economical; they are used in 95% of the reverse osmosis (RO) desalination industry and more than 60% of the membrane market for CO₂ removal from natural gas. Figure 2 shows the general design features of a spiral-wound membrane module. The module consists of a permeate collection tube with a spiral formation of permeate spacers and feed spacers, which allow the flue gas and separated CO₂ to flow through the device.

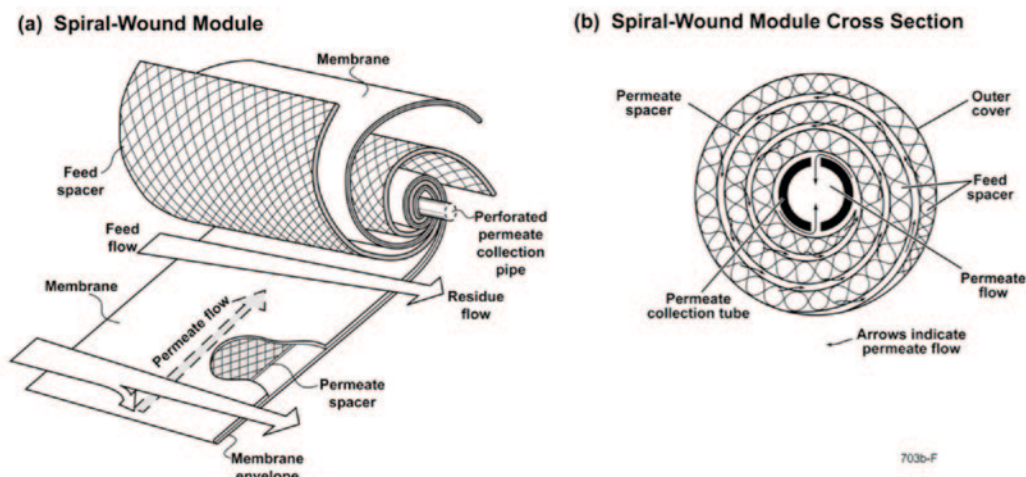

Figure 2: Schematic Diagram of a Spiral-Wound Membrane Module

MTR estimates that a total membrane area of about 0.5 million m² is required to achieve 90% CO₂ capture for a 550-MWe plant using this process design and would consume approximately 20–25% of the plant's gross power output. Figure 3 shows a proposed design for a full-scale membrane system. Each set of modules would be stacked on a skid and connected together to form a single "mega-module." About 130 mega-module skids would be required for a 550-MWe power plant (current RO plants already use similar numbers of modules and module skids).

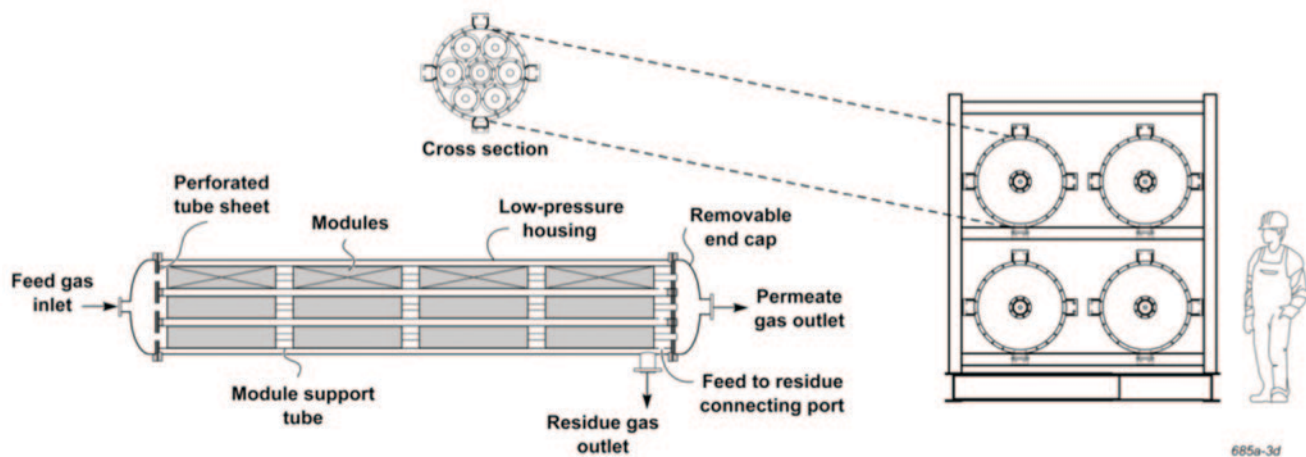

Figure 3: Proposed Design for Full-Scale Membrane System

Figure 4 shows the membrane skid used for the pilot-scale slipstream test at the coal-fired Cholla Power Plant operated by APS. The skid can hold up to eight (four cross-flow and four countercurrent sweep), 8-inch diameter Polaris™ membrane modules. The membrane skid is designed to capture one tonne of CO₂ per day from a 7,000 standard m³/day (250,000 scfd) flue gas slipstream. The test is demonstrating membrane operation in commercial-scale modules and will determine typical membrane lifetimes under coal combustion flue gas operating conditions.



Figure 4: Membrane Skid Used for Pilot-Scale Slipstream Testing at the APS Cholla Power Plant

Table 1: Membrane Process Parameters

	Parameter	Current R&D Value	Target R&D Value
Membrane Properties	Materials of fabrication for selective layer	Polymer	Polymer
	Materials of fabrication for support layer (if applicable)	Polymer	Polymer
	Selectivity of key gas components: CO ₂ /N ₂ for post-combustion technology	25	25
	Type of selectivity measurement (ideal or mixed gas)	Mixed	Mixed
	Pressure normalized flux (permeance for linear materials) for more selective gas component, GPU or equivalent units	1,500	2,500+
	Temperature, °C	50	50
	Bench-scale testing, hours without significant performance degradation	1,500	1,500
	Pilot-scale testing (if applicable), hours without significant performance degradation	1,000 (coal)	5,000 (coal)
	Maximum pressure differential achieved without significant performance degradation or failure, bar	70	70
Module Properties	Module configuration: hollow-fiber, spiral-wound sheet, shell-and-tube, plate-and-frame, other	Spiral	Spiral
	Packing density, m ² /m ³	700	1,000
	Pressure drop, bar	0.1	<0.05
	Estimated cost of manufacturing and installation, \$/m ² -GPU or equivalent	0.3	0.05
Product Quality	CO ₂ purity, %	No data	98+
	N ₂ concentration, %	No data	1
	Other contaminants, %	No data	<0.1
Process Performance	Electricity requirement, kJ/kg CO ₂	No data	750
	Cooling requirement, kJ/kg CO ₂	No data	150
	Total energy (electricity equivalent), kJ/kg CO ₂	No data	900

Other Membrane Parameters

Contaminant Resistance: The membranes are known to be unaffected by water (H₂O), oxygen (O₂), and sulfur dioxide (SO₂). The effect of trace contaminants (e.g., mercury, arsenic, etc.) is unknown and is being examined in the Cholla slipstream field testing.

Flue Gas Pretreatment Requirements: Currently, pretreatment requirements are unknown. The Cholla slipstream test is treating post-flue gas desulfurization (FGD) flue gas and will clarify the need for gas treatment prior to entering the membrane system. Of the species present in flue gas, the greatest concern is that particulate matter will foul the membranes, reducing module lifetimes. Particulate filters—which can achieve an order-of-magnitude better ash removal than a standard bag house, and are used today to treat refinery and gasification streams—may be needed.

Waste Streams Generated: The membrane process will recover >95% of the H₂O in flue gas as liquid. The quality of this H₂O, and its potential to be re-used in the plant, will be studied in future work.

Technology Advantages

- The membranes developed are 10 times more permeable to CO₂ than conventional membranes, which reduce the required membrane area and capital costs.
- A membrane system does not contain any chemical reactions or moving parts, making it simple to operate and maintain.

- The membrane material has a high tolerance of wet acid gases and is inert to O₂.
- The membrane system has a compact footprint and low energy cost.
- The membrane capture system can recover water from flue gas.
- The use of an existing air stream to generate a CO₂ partial pressure gradient in the countercurrent sweep membrane stage reduces the need for compressors or vacuum pumps, thus reducing the overall energy cost.
- The recycled CO₂ from the air sweep to the boiler increases the CO₂ partial pressure driving force for separation in the initial cross-flow membrane stage, reducing the required membrane area and total system cost.

R&D Challenges

- The membrane process requires a large membrane surface area to achieve separation due to the low partial pressure of CO₂ in flue gas.
- The countercurrent sweep module design could result in several potential inefficiencies including: sweep-side pressure drop, concentration polarization, poor utilization of the membrane area due to module geometry, and non-countercurrent flow patterns.
- Particulate matter needs to be controlled to reduce its potential impact on the membrane lifetime.
- Feed and permeate side pressure drops may lead to excessive energy losses.
- Cost reductions for the membrane module materials will be needed if the technology is to become economically viable.
- The membrane process depends on large rotating equipment (vacuum pumps, booster fans). The availability of cost-effective equipment that can operate on full-scale flue gas streams has yet to be demonstrated.
- Scale up and integration issues are a possibility given the large number of membranes needed to service a 550-MWe plant.

Results To Date/Accomplishments

- Scaled up and produced high permeance membrane formulations on commercial casting and coating equipment. Produced more than 1,000 m² of Polaris™ membrane material used to construct 203-mm (8-inch) diameter commercial-sized conventional cross-flow and novel countercurrent sweep modules.
- Field tested pilot- and commercial-scale membrane modules with various industrial gas streams [raw coal-fired flue gas, raw natural gas-fired flue gas, and synthesis gas (syngas) containing sulfur species] for up to three months of continuous operation. The modules showed stable performance throughout these tests.
- Field tests revealed the membrane permeance is 10 times higher than existing materials and the membranes possess good stability in acid gases.
- Provided a membrane system to APS to process 4,250 m³/day (0.15 MMscfd) of natural-gas fired flue gas to provide concentrated CO₂ for testing at an experimental algae farm.
- In mid-2010, MTR conducted a three-month field test of a small slipstream membrane system at the Cholla Unit 3 power plant. The membrane test skid can process 7,000 m³/day (0.25 MMscfd) of coal-fired flue gas and capture one tonne CO₂/day. The test skid is composed of four, 8-inch diameter Polaris™ membrane modules which demonstrate the cross-flow and sweep configurations. The membrane modules showed stable performance for 45 days during the field testing, consistent with laboratory test results. There was minimal membrane fouling by particulates in the gas stream, which was originally anticipated to be a concern. Most of the system downtime was related to mechanical and electrical problems with the rotating equipment (feed compressor and permeate vacuum pump) caused by the corrosive operating environment. Use of equipment with more appropriate materials of construction in future testing should solve these problems.

- MTR developed new sweep-side flow channel configurations for the membrane sweep modules. Bench-scale testing indicated the new designs lower the sweep-side pressure drop, while maintaining the sweep performance efficiency.
- MTR estimates the membrane-based CO₂ separation and liquefaction process can capture 90% CO₂ using 20–25% of the plant's energy and cost \$30 per tonne of CO₂ captured.

Next Steps

- Continue to operate the slipstream (0.05 MWe equivalent gas flow) membrane system at a coal-fired power plant. Use this system to evaluate new membrane formulations with a goal of doubling CO₂ permeance from that of the baseline Polaris™ membrane.
- Conduct field testing on the small slipstream membrane system of modules with new flow channel configurations with a goal of minimizing pressure drop through the membrane system.
- Understand sweep flow distribution and pressure drop in membrane modules by computational fluid dynamics (CFD) simulations.
- Design, construct, and operate a small pilot-scale (approximately 1 MWe equivalent gas flow) membrane system for a six-month field test at a coal-fired power plant beginning in 2013.
- Analyze the performance of the membrane system, determine how it would be best integrated with a coal-fired power plant, and prepare a comparative economic analysis of the membrane-based CO₂ capture process versus other capture technologies.
- With Babcock & Wilcox, analyze the impact of CO₂ recycle in sweep air on boiler performance.
- Lower the membrane module cost by incorporating low-cost components with a target of \$50/m².
- Integrate a CO₂ liquefaction section into the overall CO₂ capture system.
- Test options for recycling the air sweep from the countercurrent sweep module to the boiler.

Final test results will not be available until after the September 2015 project completion date.

Available Reports/Technical Papers/Presentations

General project information is available on DOE/NETL website at: <http://www.netl.doe.gov/technologies/coalpower/ewr/co2/post-combustion/slipstream-membrane-process.html>

“Membrane Process to Capture CO₂ from Coal-Fired Power Plant Flue Gas,” Annual NETL CO₂ Capture Technology for Existing Plants R&D Meeting, Pittsburgh, PA, September 2010.

<http://www.netl.doe.gov/publications/proceedings/10/co2capture/index.html>

Merkel et al., “Power plant post-combustion carbon dioxide capture: An opportunity for membranes,” *Journal of Membrane Science*, Volume 359, Issues 1–2, 1 September 2010, pages 126–139. Available electronically at doi:10.1016/j.memsci.2009.10.041.

Merkel et al., “Opportunities for Membranes in Power Generation Processes,” Gordon Research Conference Presentation, July 27, 2010.

“A Membrane Process to Capture CO₂ from Coal-Fired Power Plant Flue Gas,” Annual NETL CO₂ Capture Technology for Existing Plants R&D Meeting, Pittsburgh, PA, March 2009.

“The Membrane Solution to Global Warming,” 6th Annual Conference on Carbon Capture and Sequestration, Pittsburgh, PA, May 2007.

DEVELOPMENT OF BIOMIMETIC MEMBRANES FOR NEAR-ZERO PC POWER PLANT EMISSIONS

Primary Project Goals

Carbozyme is developing an enzyme-based, contained liquid membrane (CLM) to extract carbon dioxide (CO₂) from coal and natural gas combustion flue gas. Carbozyme is also evaluating a state-of-the-art electrolysytic (EDI) method for CO₂ capture and comparing its performance with that of the CLM.

Technical Goals

- Scale up the enzyme-catalyzed, CLM permeator design (4–400 m²) to include multiple units organized as a skid (3 × 40 m²) for testing with various coal ranks and natural gas.
- Implement a pretreatment conditioner to ensure that the flue gas constituents will not adversely impact the CLM permeator.
- Validate technology to cost-effectively produce carbonic anhydrase (CA) enzymes for the CLM.
- Test and analyze three different EDI test cells: a controlled pH resin wafer, a hollow fiber fed bipolar membrane (BPM), and an ion exchange membrane-resin wafer (IEM-RW).
- Conduct a commercialization study for both the CLM and EDI technologies.

Technical Content

The enzyme-based CA CLM membrane process mimics the natural process for removing CO₂ from an organism. An organism's blood stream is used to transport oxygen (O₂) and CO₂ to and from its cells, respectively. CA is an enzyme in the blood that captures the CO₂ from the cells and converts it to bicarbonate (HCO₃⁻). The enzyme reverses this reaction in the lungs, allowing the CO₂ to be exhaled. Figure 1 shows the configuration for the enzyme-based CA CLM membrane process being developed by Carbozyme. The CA CLM membrane is able to incorporate the absorption and stripping processes into a single unit. A membrane module consists of two groups of hollow fibers—one group contains the incoming CO₂ lean flue gas and the second group contains the CO₂ rich permeate stream. The CA enzyme is contained in a thin-film liquid between the two groups of fibers. The CA helps catalyze the CO₂ to HCO₃⁻ to promote permeation across the CO₂ lean membrane and reverses the process promoting permeation across the CO₂-rich membrane. CA is one of the fastest acting enzymes with a turnover rate of 600,000 katals (catalyzes the hydration of 600,000 molecules of CO₂ per second per molecule of CA).

Figure 2 shows a process schematic for the CA CLM. Pretreated combustion flue gas from the boiler enters the membrane. A vacuum system is used to provide the driving force across the membrane. After the CO₂ is separated from the flue gas it goes through a knockback condenser for water removal prior to compression. The resulting product is a 95% pure CO₂ stream. The remaining flue gas is sent to the plant stack.

Technology Maturity:
Laboratory/bench-scale

Project Focus:
Biomimetic Membrane

Participant:
Carbozyme, Inc.

Project Number:
NT43084
NT42824

NETL Project Manager:
José Figueroa
Jose.Figueroa@netl.doe.gov

Principal Investigator:
Michael Trachtenberg
Carbozyme, Inc.
mct@cz-na.com

Partners:
Argonne National Laboratory
EERC
Electrostep
Kansas State University
Siemens
SRI
Visage Energy

Performance Period:
3/28/07 – 7/31/09

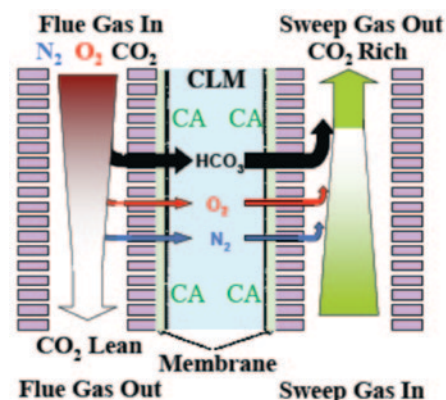

Figure 1: Configuration for Carbozyme-Developed, Enzyme-Based Carbonic Anhydrase Contained Liquid Membrane

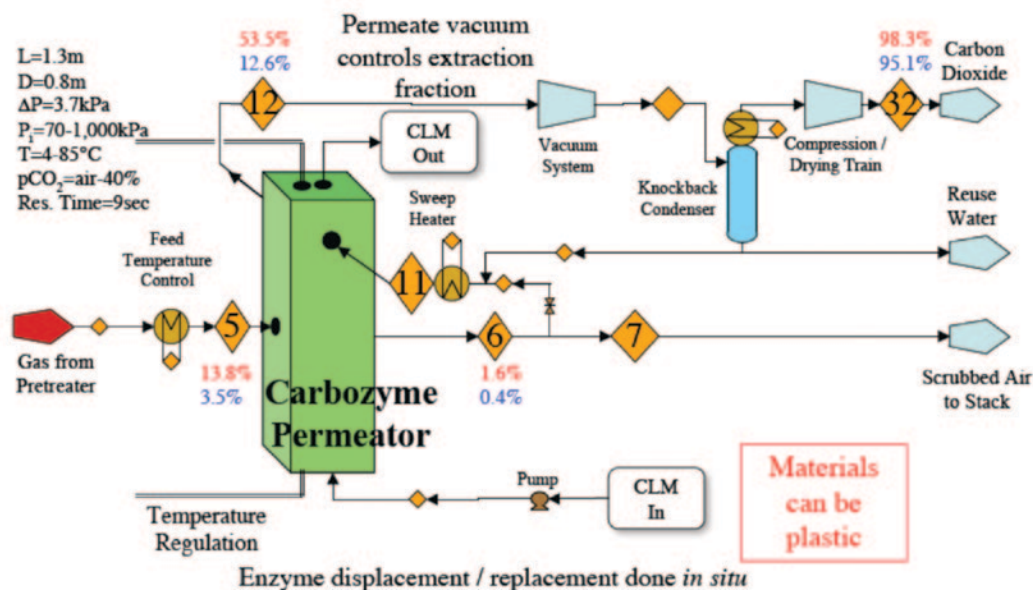

Figure 2: Process Schematic for the Carbonic Anhydrase Contained Liquid Membrane

Technology Advantages

- The CA enzyme catalyst does not contain any toxic chemicals or byproducts, making it more environmentally friendly than competing technologies.
- The CA enzyme catalyst has a fast CO₂ production rate with low energy requirements and boosts separation and purification due to its low nitrogen (N₂) and O₂ solubility.
- The enzyme catalyst is not vulnerable to oxidation or the formation of stable salts.
- The CA CLM system requires only minimal pumping and no heat exchangers, allowing it to consume 30–50% less energy compared to competing technologies.
- The CA CLM system recycles nearly all of its water and a portion of its waste heat.
- The modular design of the membrane makes it easy to manufacture, install, and scale up.

R&D Challenges

- The cost of the purified CA enzyme remains high and production costs will need to be reduced in order to be considered economically viable.
- Early immobilization of the CA enzyme needs to be addressed.
- Sulfur dioxide (SO₂) acidification of the carbonate carrier fluid needs to be addressed via flue gas pretreatment.
- Ionized mercury in the flue gas could reduce enzyme activity.

Results To Date/Accomplishments

Development progress for the CA CLM process was made in several categories, such as flue gas stream analysis and conditioning, enzyme selection, enzyme immobilization, membrane module construction, and economic analysis.

Specific accomplishments include:

- Developed an immobilized CA enzyme catalyst based on a thermophilic form of CA that can maintain a high activity at elevated temperature (~50 °C). The enzyme was immobilized using a proprietary surface activation method using an ultrathin polyamino acid (PAA) layer that can be removed and replaced, as needed. Enzyme testing indicated up to 80% of initial activity was retained over a 60-day period.
- Developed a 0.5 m² bench-scale CLM permeator that combines absorption and desorption in a single housing through use of dual hollow fiber, spiral wound, polymer membranes. In this configuration, CO₂ capture is driven by a combination of pressure, vacuum, and temperature. More than 90% CO₂ capture was achieved during testing.
- Developed an alternate process technology based on separate absorption/desorption modules using single hollow fiber, spiral wound, polymer membranes.
- Fabricated an 11 m² CLM module for scale-up testing.
- Developed and tested a flue gas pre-treatment system for the CLM process.
- Developed computer modeling for CLM process components and integrated systems.
- Developed and tested a second technology based on a resin-wafer EDI system that uses a pH shift to accomplish CO₂ absorption/desorption.

Next Steps

Project #43084 was completed July 2009. The draft final report is under review by NETL.

Available Reports/Technical Papers/Presentations

General project information is available on DOE/NETL website at: <http://www.netl.doe.gov/technologies/coalpower/ewr/co2/post-combustion/biomimetic.html>

“Capture of CO₂ by the Carbozyme Permeator,” 8th Annual Conference on Carbon Capture and Sequestration, Pittsburgh, PA, May 2009.

“Development of Biomimetic Membranes for Near-Zero Power Plant Emissions,” Annual NETL CO₂ Capture Technology for Existing Plants R&D meeting, Pittsburgh, PA, March 2009.

“Membrane-based, Enzyme Facilitated, Efficient, Carbon Dioxide Capture,” 9th International Conference on Greenhouse Gas Control Technologies, Washington, DC, November 2008.

“Progress on Carbozyme’s HFCLM Permeator Technology Scale-up Project,” 7th Annual Conference on Carbon Capture and Sequestration, Pittsburgh, PA, May 2008.

“Biomimetic Membrane for CO₂ Capture from Flue Gas,” Final Report for Project #42824, August 2007.

NOVEL DUAL-FUNCTIONAL MEMBRANE FOR CONTROLLING CARBON DIOXIDE EMISSIONS FROM FOSSIL-FUELED POWER PLANTS

Primary Project Goals

The University of New Mexico is developing a new, dual-functional, silica-based membrane for carbon dioxide (CO₂) emissions capture from coal-fired power plants.

Technical Goals

- Achieve a membrane CO₂/nitrogen (N₂) selectivity of 100 and a CO₂ permeance of 1,000 gas permeance units (GPU) or greater.
- Formulate a sol-gel composition to be used in the preparation of clear aminosilicate coatings for membrane deposition onto the siliceous support matrix.
- Setup multi-component gas separation tests for preliminary membrane performance analysis.
- Refine the sol-gel compositions for optimal membrane deposition.
- Study the influence of sulfur dioxide (SO₂), water vapor, and trace oxygen (O₂) on membrane performance.
- Optimize membrane deposition on alternative economical membrane supports.
- Conduct preliminary economic analysis of the membrane process for post-combustion CO₂ capture.
- Identify a processing window that allows reproducible preparation of an asymmetric microporous silica membrane.
- Stabilize membrane performance through a nickel (Ni)-doping approach.
- Prepare an ultra-thin silica membrane using a plasma-assisted, atomic layer deposition technique (PA-ALD).

Technical Content

The dual-functional, silica-based membrane is prepared by a unique sol-gel dip-coating process for depositing a microporous amino-silicate membrane on a porous tubular ceramic support. It consists of a microporous inorganic siliceous matrix, with amine functional groups physically immobilized or covalently bonded on the membrane pore walls. Strong interactions between the permeating CO₂ molecules and the amine functional membrane pores enhance surface diffusion of CO₂ on the pore wall of the membrane, subsequently blocking other gases. The membrane is composed of three distinct layers as shown in Figure 1: (1) a commercially available tubular or hollow fiber ceramic support; (2) a mesoporous surfactant-templated silica sub-layer with pore size 15–50 Å; and (3) a microporous aminosilicate gas separation membrane layer with pore size 4–10 Å.

Technology Maturity:

Laboratory-scale, with simulated flue gas

Project Focus:

Dual-Functional, Silica-Based Membrane

Participant:

University of New Mexico

Project Number:

NT42120

NETL Project Manager:

José Figueroa
Jose.Figueroa@netl.doe.gov

Principal Investigator:

C. Jeffrey Brinker
 University of New Mexico
cjbrink@sandia.gov

Partners:

T3 Scientific, LLC

Performance Period:

8/23/04 – 4/30/09

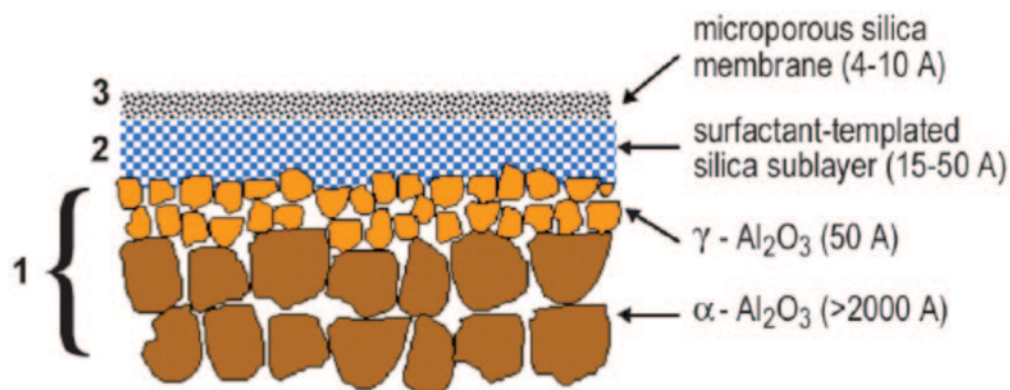

Figure 1: Cross-Section of Membrane

Table 1: Membrane Process Parameters

	Parameter	Current R&D Value	Target R&D Value
Membrane Properties	Materials of fabrication for selective layer	Aminosilicate/doped-silicate	Aminosilicate/doped silicate
	Materials of fabrication for support layer (if applicable)	Surfactant-templated silica on alumina	Surfactant-templated silica on alumina
	Selectivity of key gas components: CO ₂ /N ₂ for post-combustion technology	CO ₂ /N ₂ = 80–100 (dry feed); CO ₂ /N ₂ = 50–60 (humidified feed)	CO ₂ /N ₂ = 100
	Type of selectivity measurement (ideal or mixed gas)	Mixed gas	Mixed gas
	Pressure normalized flux (permeance for linear materials) for more selective gas component, GPU or equivalent units	CO ₂ : 400 GPU	CO ₂ : 1,000 GPU
	Temperature, °C	25–250 °C	25–80 °C
	Bench-scale testing, hours without significant performance degradation	168 hrs	100 hrs
	Pilot-scale testing (if applicable), hours without significant performance degradation	N/A	N/A
	Maximum pressure differential achieved without significant performance degradation or failure, bar	3 bar	N/A
Module Properties	Module configuration: hollow-fiber, spiral-wound sheet, shell-and-tube, plate-and-frame, other	Plate-and-frame	Hollow-fiber
	Packing density, m ² /m ³	500	980
	Pressure drop, bar	0.01–0.02	0.01–0.02
	Estimated cost of manufacturing and installation, \$/m ² -GPU or equivalent	\$0.33–\$0.39/m ² -GPU	N/A
Product Quality	CO ₂ purity, %	>90%	90%
	N ₂ concentration, %	<10%	10%
	Other contaminants, %	N/A	N/A
Process Performance	Electricity requirement, kJ/kg CO ₂	1,313 kJ/kg CO ₂ or 0.365 kWh/kg CO ₂	1,333 kJ/kg CO ₂ or 0.370 kWh/kg CO ₂
	Heat requirement, kJ/kg CO ₂	0	0
	Total energy (electricity equivalent), kJ/kg CO ₂	1,313 kJ/kg CO ₂ or 0.365 kWh/kg CO ₂	1,333 kJ/kg CO ₂ or 0.370 kWh/kg CO ₂

Note: Values for membrane properties are experimental. Other values are calculated based on membrane properties.

Other Membrane Parameters

Contaminant Resistance: SO₂ >10 parts per million (ppm).

Flue Gas Pretreatment Requirements: Particulate removal.

Waste Streams Generated: None.

Technology Advantages

The dual-functional, silica-based membrane will have a higher CO₂ selectivity and permeance compared to conventional membranes that separate gases based on differences in molecular size only.

R&D Challenges

- The permeance of the new membrane will need to be increased by a factor of five to meet the research and development (R&D) target.
- The selectivity for the new membrane must remain constant under temperatures of 50–70 °C and high humidity conditions.
- The presence of particulates in the flue gas could adversely affect membrane performance.
- Previous membrane designs suffered from a gradual reduction in permeance and selectivity under elevated temperature and humidity conditions due to pore shrinkage/blockage.

Results To Date/Accomplishments

- Three classes of microporous, sol-gel derived, silica-based membranes were developed for CO₂ removal under simulated flue gas conditions.
- A novel class of amine-functional, microporous silica membranes was prepared using an amine-derivatized alkoxy silane precursor, exhibiting enhanced CO₂:N₂ selectivity (>70) in the presence of water vapor, but its CO₂ permeance [$<1.25 \text{ cm}^3 \text{ (STP)/cm}^2\text{-min-atm}$ (~275 GPU)] was below the target.
- Pure siliceous membranes showed higher CO₂ permeance [$1.5\text{--}2.0 \text{ cm}^3 \text{ (STP)/cm}^2\text{-min-atm}$ (~330–440 GPU)], but subsequent densification occurred under prolonged simulated flue gas conditions.
- Nickel oxide (NiO) was incorporated into the membrane's microporous network to retard densification and achieved CO₂ permeance of $0.5 \text{ cm}^3 \text{ (STP)/cm}^2\text{-min-atm}$ (~110 GPU) and CO₂:N₂ selectivity of ~50 after 163 hours exposed to simulated flue gas conditions.
- The implementation of a novel ALD processing scheme shows evidence that a vapor-processed membrane can exhibit higher thermal/structural stability combined with higher flux and selectivity compared to the traditional liquid phase processing approach (sol-gel).

Next Steps

Project completed April 2009.

Available Reports/Technical Papers/Presentations

General project information is available on DOE/NETL website at: <http://www.netl.doe.gov/technologies/coalpower/ewr/co2/post-combustion/dual-function.html>

“Novel Dual-Functional Membrane for Controlling Carbon Dioxide Emissions from Fossil Fuel Power Plants,” Final Scientific/Technical Report, August 2009. <http://www.netl.doe.gov/technologies/coalpower/ewr/co2/pubs/2009Novel%20Dual-Functional%20Membrane%20for%20Controlling%20Carbon%20Di.pdf>

“Tubular Ceramic-Supported Sol-Gel Silica-Based Membranes for Flue Gas Carbon Dioxide Capture and Sequestration,” *J. Memb. Sci.*, **341** (2009) 30–36.

“Novel Dual-Functional Membrane for CO₂ Capture,” Seventh Annual Carbon Capture and Sequestration Conference, Pittsburgh, PA, May 2008.

“Anodic Alumina Supported Dual-Layer Microporous Silica Membranes,” *J. Memb. Sci.*, **287**, (2007) 157–161.

“Microporous Sol-Gel Derived Aminosilicate Membrane for Enhanced Carbon Dioxide Separation,” *Separation and Purification Technology*, **42**(3) (2005) 249–257.

This page intentionally left blank

APPENDIX B: CARBON DIOXIDE CAPTURE TECHNOLOGY SHEETS

OXY-COMBUSTION

OXY-COMBUSTION BOILER DEVELOPMENT FOR TANGENTIAL FIRING

Primary Project Goals

Alstom is developing and testing oxy-combustion technology for tangentially-fired (T-fired) boilers in retrofit and new power plant applications.

Technical Goals

- Design and develop an innovative oxy-combustion firing system for existing T-fired boilers that minimizes overall capital investment and operating costs.
- Evaluate the performance of oxy-combustion T-fired boilers in pilot-scale tests at Alstom's 15-MW_{th} Boiler Simulation Facility (BSF).
- Determine the boiler design and performance impacts for oxy-combustion.
- Evaluate and improve engineering and computational fluid dynamic (CFD) modeling tools for oxy-combustion.
- Develop the design, performance, and costs for a demonstration-scale oxy-combustion boiler and auxiliary systems.
- Develop the design and costs for both industrial and utility commercial-scale reference oxy-combustion boilers and auxiliary systems, which are optimized for overall plant performance and cost.

Technical Content

Initial screening studies were conducted to assess the impacts of a broad range of process variables and boiler design parameters on oxy-combustion boiler design, performance, and cost. This information was used to refine the test plan and establish design requirements for the 15-MW_{th} testing.

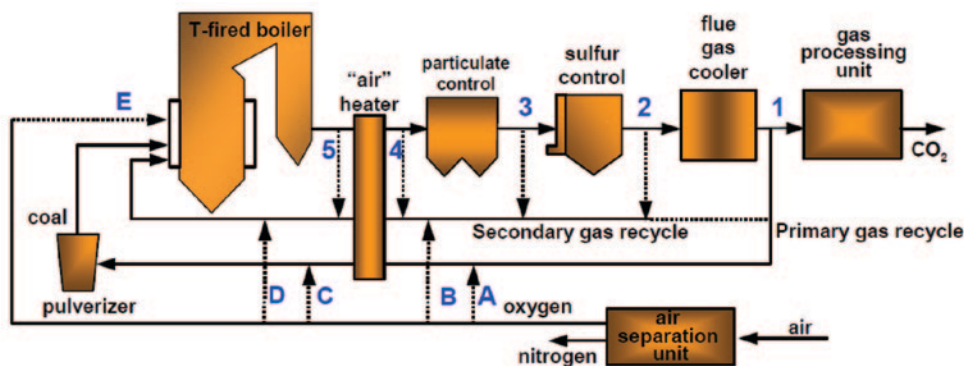

Figure 1: Simplified Oxy-Combustion Process Diagram

Technology Maturity:

Pilot-scale using actual flue gas, 120 tonnes CO₂/day

Project Focus:

Tangentially-Fired Oxy-Combustion Retrofits

Participant:

Alstom Power

Project Number:

NT0005290

NETL Project Manager:

Timothy Fout
Timothy.Fout@netl.doe.gov

Principal Investigator:

Armand A. Levasseur
 Alstom Power
armand.a.levasseur@power.alstom.com

Partners:

Illinois Clean Coal Institute
 North Dakota Industrial Commission
 Utility Advisory Group (10 utility companies)

Performance Period:

9/30/08 – 9/30/13

Figure 1 is a schematic representation of an oxy-combustion process showing the location of a T-fired boiler and several possible take-off locations for flue gas recirculation (1–5) and locations for oxygen injection (A–E). The different take-off locations will affect variables in the recirculation stream (i.e., water, particulate, and sulfur content) and impact the size of equipment.

The screening studies included evaluation of the following variables: gas recycle take-off location, gas recycle composition, gas recycle ratio, oxygen injection concentration and distribution, windbox design, and separate over-fire air design. Both process modeling and CFD analysis were applied.

CFD simulations of the BSF and an 850-MWe supercritical T-fired boiler were developed and used to evaluate various oxy-combustion design options. The BSF models are being updated using boundary conditions and data from the BSF test runs to be compared with test measurements and validate predictions.

Alstom Power is conducting the pilot tests in its 15-MW_{th} BSF facility, shown in Figure 2. The BSF replicates the T-firing conditions in utility boilers. The BSF was modified for oxy-combustion operation and to provide flexibility to test over a broad range of conditions. The primary combustion test parameters evaluated include:

- Gas recycle rate and recycle sulfur capture rate.
- Distribution of gas recycle into the furnace.
- Excess oxygen.
- Oxygen injection location, distribution, and concentration.

Key aspects of boiler operation that are being investigated under this project during the 15-MW_{th} pilot testing and during design studies are shown in Figure 3.

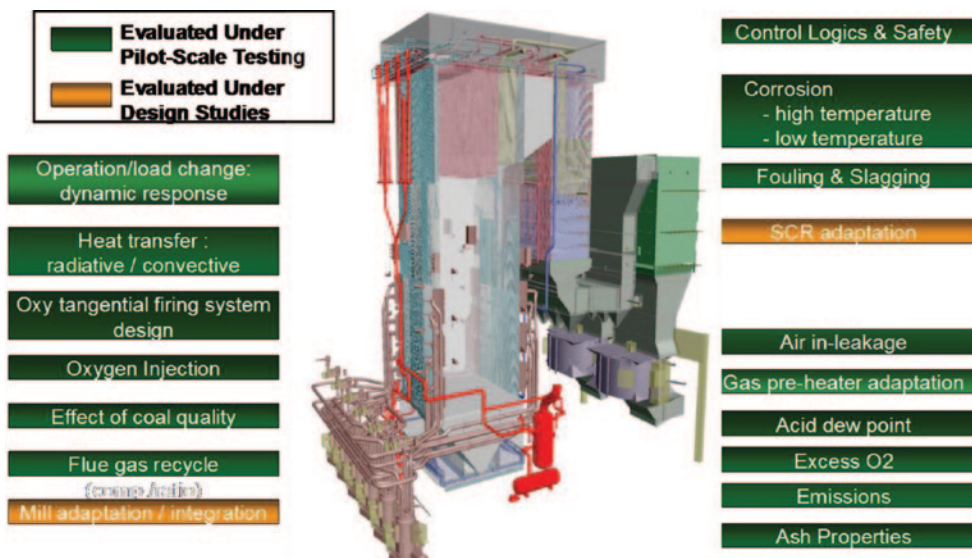

Figure 3: Aspects of Boiler Operation Requiring Assessment

The testing focuses on control of furnace heat release rates and heat transfer for boiler thermal performance during oxy-combustion, while obtaining good fuel burnout and control of emissions. Measurements are conducted to assess ash deposition and fireside corrosion, as well as sulfur trioxide (SO₃) formation and behavior of trace metals such as mercury.

Detailed furnace mapping measurements are also being performed to better understand behavior during oxy-combustion, as well as to provide comprehensive data sets for model refinement and validation. Furnace and convection pass temperatures are meas-



Figure 2: Alstom 15 MW_{th} Boiler Simulation Facility

ured using suction pyrometers. Heated gas extraction probes are used with a dedicated gas analyzer system to measure in-furnace gas compositions. Incident heat fluxes to the furnace walls are measured using total heat flux probes and radiant heat fluxes are measured by ellipsoidal radiometer probes. Typical measurement planes are shown in Figure 4.

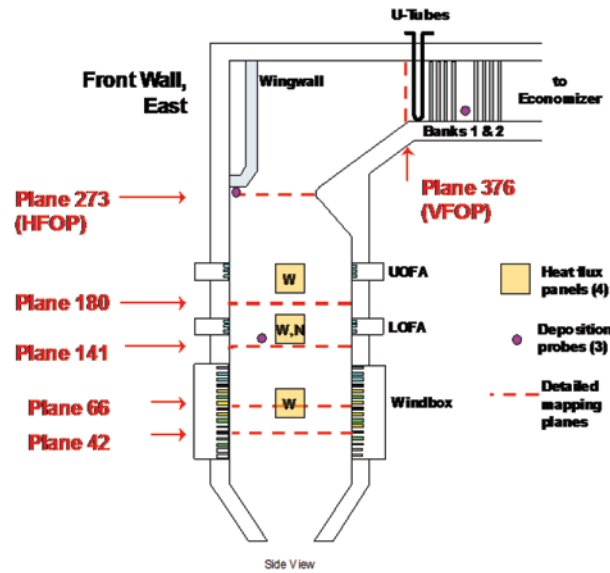

Figure 4: BSF Furnace Probe Measurement Planes

Results from the 15-MW_{th} testing, along with the refined modeling tools (CFD and dynamic simulations), are being applied to develop a basic design for a full-scale oxy boiler, which can be rapidly applied for demonstration. This will include the oxy-boiler design with advanced oxy-firing system and operational controls, as well performance and cost data. Additionally, large, commercial-scale oxy-boiler reference designs will be developed for industrial and utility applications, which are integrated and optimized for overall oxy-plant performance and costs, and to provide a vision for the final commercial product.

Technology Advantages

Oxy-combustion is a cost-competitive, near-term solution for carbon dioxide (CO₂) capture that offers a relatively low technical risk due to use of conventional components. It can be used in new and retrofit applications, and has the potential for greater than 90% CO₂ capture.

R&D Challenges

- Understanding difference from air-firing in pollutant formation, ash deposition, fireside corrosion, and heat transfer rates in an oxy-combustion boiler, as well as the control of air in-leakage.
- Application of this knowledge to reduce design risks and optimize designs for performance and costs.
- Overall integration to provide commercially attractive CO₂ reduction solutions.

Results To Date/Accomplishments

- Completed CFD screening evaluations.
- Completed modifications to the BSF for oxy-combustion operation to permit the firing under both air and oxygen, as well as with several flue gas recycle configurations and oxygen injection methods.
- Completed pilot-scale testing over a range of coal types, including sub-bituminous, low-sulfur bituminous, high-sulfur bituminous, and North Dakota lignite. Testing included both oxy- and air-firing tests, which examined the impacts of combustion

and oxy-process parameters on boiler design and operation for each of the coals. Test parameters included re-circulated flue gas ratio, effect of oxygen concentration and oxygen distribution into the furnace, re-circulated flue gas take-off location, total excess oxygen, furnace combustion staging, air in-leakage rates, and reduced load operation. A brief overview of results in some key areas examined is below.

- General oxy-fired operation – Stable operation over a broad range of test conditions. Able to produce flue gas with greater than 90% CO₂ concentration (dry basis).
- Combustion – Good performance during both air- and oxy-combustion testing for all coal types. Able to operate at low excess oxygen [less than 2% oxygen (O₂) at the economizer outlet]; low (near zero) carbon monoxide (CO) emissions; and low carbon in fly ash.
- Nitrogen oxide (NO_x) emissions – Lower NO_x emissions with oxy-combustion than air-firing. NO_x emissions were generally more than 50% lower for oxy-fired than air-firing under similar staged combustion conditions.
- Heat transfer – Able to control furnace heat flux and temperature profiles during oxy-firing to be similar to those for air-firing.
- SO₃ formation – Sulfur dioxide (SO₂) to SO₃ conversion appears to be similar to air-firing; however, SO₃ concentrations could be much higher for oxy-combustion depending on recycle scheme.
- Ash deposition – Appeared generally similar to air-firing in terms of deposits physical characteristics and in composition.
- Waterwall corrosion – Appeared generally similar to air-firing.

Next Steps

- Complete remaining two 15-MW_{th} test campaigns: (1) with Schwarze Pumpe test fuel to provide a link with the Vattenfall 30-MW_{th} oxy-combustion pilot plant, and (2) for evaluation of second generation oxy-combustion concepts.
- Perform bench-scale corrosion evaluation in order to provide supplemental data to support the pilot results and help define material requirements.
- Complete engineering tools and CFD modeling refinement and validation.
- Develop oxy-combustion boiler design package with performance and costs for full-scale demonstration application.
- Develop oxy-combustion boiler references designs for utility and industrial applications for future large-scale commercial products.

Final test results are scheduled to be issued in January 2012. The overall project is scheduled to be completed by September 2013.

Available Reports/Technical Papers/Presentations

General project information is available on DOE/NETL website at: <http://www.netl.doe.gov/technologies/coalpower/ewr/co2/oxy-combustion/tangential.html>

“Oxy-Combustion: A Sound CCS Solution Built From Pilot Operation.” Power Gen International – 2010, December 14, 2010, Orlando, FL.

“SO₃ Emissions From a Tangentially-Fired Pilot Scale Boiler Operating SO₃ Emissions From a Tangentially-Fired Pilot Scale Boiler Operating Under Oxy-Combustion Conditions.” 2010 AIChE Annual Meeting, November 10, 2010, Salt Lake City, UT.

“Oxy-Combustion Boiler Development for Tangential Firing,” Annual NETL CO₂ Capture Technology for Existing Plants R&D Meeting, Pittsburgh, PA, September 2010. <http://www.netl.doe.gov/publications/proceedings/10/co2capture/index.html>

“Alstom’s Oxy-Combustion Technology Development – Update on Pilot Plants Operation.” 35th International Technical Conference on Clean Coal and Fuel Systems, June 6–10, 2010, Clearwater, FL.

“Assessment of Oxy-Combustion Impacts on Boiler Design and Performance During 15 MW_{th} Pilot-scale Testing.” 9th Annual Carbon Capture and Sequestration Conference, May 10-13, 2010, Pittsburgh, PA.

“Update on Alstom’s Oxy-Combustion Technology Development.” 12th Annual ELECTRIC POWER Conference and Exhibition, May 18-20, 2010, Baltimore, MD.

“Alstom’s Oxy-Firing Technology Development and Demonstration – Near Term CO₂ Solutions.” 34th International Technical Conference on Coal Utilization and Fuel Systems. June 2009.

“Oxy-Combustion Boiler Development for Tangential Firing.” Presented at the annual NETL CO₂ capture technology for existing plants R&D meeting. March 2009.

“Oxy-Combustion PC and CFB Solutions – A Promising Option for CO₂ Capture.” Presented at 8th Annual Conference Carbon Capture and Sequestration, Pittsburgh, PA, May 2009.

“Oxy-Firing Technology – Pilot Testing Leading to Large-Scale Demonstration.” 11th Annual Electric Power Conference, Chicago, IL, May 2009.

OXY-COMBUSTION BOILER MATERIAL DEVELOPMENT

Primary Project Goals

Foster Wheeler is conducting a laboratory test program to assess the corrosion characteristics of oxy-combustion relative to air-fired combustion for pulverized coal (PC)-fired boilers; identify the corrosion mechanisms involved; and determine oxy-combustion's effects on conventional boiler tube materials, conventional protective coatings, and alternative materials and coatings when operating with high to low sulfur coals.

Technical Goals

- Conduct computational fluid dynamic (CFD) modeling of air- and oxy-fired PC boilers operating with high, medium, and low sulfur coals to determine the flue gas compositions that will exist throughout these units and especially along the furnace waterwalls where highly corrosive micro-climates can exist.
- Conduct corrosion tests using coupons of conventional and advanced boiler tube materials that are coated with deposits representative of low to high sulfur coals and exposed to the CFD-predicted oxy-combustion and air-fired flue gases for up to 1,000 hours in electric furnaces using synthesized gases from pressurized cylinders.
- Conduct post-test macroscopic and microscopic analyses of the material coupons to identify corrosion mechanisms, evaluate the corrosiveness of oxy-fired flue gas relative to air-fired flue gas, and identify materials suitable for oxy-combustion.

Technical Content

An oxy-combustion boiler retrofit will utilize flue gas recycle to maintain the heat absorption of the original air-fired boiler and limit the combustion temperature. With air nitrogen (N_2) eliminated, and with the recycle consisting of carbon dioxide (CO_2) and water vapor (H_2O), along with corrosive products of combustion, the level of reducing and corrosive gases in the boiler [e.g., carbon monoxide (CO), sulfur dioxide (SO_2), sulfur trioxide (SO_3), hydrogen sulfide (H_2S), and hydrogen chloride (HCl)] will increase and could cause increased corrosion. To assess the corrosiveness of oxy-combustion flue gas, coupons of conventional and advanced waterwall and superheater/reheater materials will be exposed to oxy- and air-fired flue gases in electric tube furnaces. Rectangular shaped coupons, typically 19 mm ($\frac{3}{4}$ inch) wide by 25 mm (1 inch) high by 3 mm ($\frac{1}{8}$ inch) thick, will be used to investigate tube materials, tube welds, and tube weld overlays; bullet shaped coupons, typically 19 mm ($\frac{3}{4}$ inch) in diameter by 38 mm ($1\frac{1}{2}$ inch) high, will investigate thermal spray coatings. The conventional and advanced materials to be tested are listed in Table 1 and Table 2.

Technology Maturity:

Laboratory evaluation using synthetic gases

Project Focus:

Evaluation of Boiler Materials for Oxy-Combustion

Participant:

Foster Wheeler Corporation

Project Number:

NT0005262

NETL Project Manager:

Timothy Fout
Timothy.Fout@netl.doe.gov

Principal Investigator:

Archie Robertson
 Foster Wheeler Corporation
archie_robertson@fwc.com

Partners:

None

Performance Period:

10/1/08 – 9/30/11

Table 1: Waterwall Materials

Material	Description	Boiler Use	Nominal Composition
1	Tube	SA210-A1	Conventional 0.27% Carbon
2	Tube	SA213-T2	Conventional 1/2 Cr-1/2 Mo
3	Tube	SA213-T11	Conventional 1-1/4 Cr-1/2 Mo
4	Weld	T11 to T11	Conventional 1-1/4 Cr-1/2 Mo
5	Weld Overlay	309L StnStl	Conventional 24 Cr
6	Weld Overlay	Inconel 622	Conventional 21 Cr-55 Ni
7	Weld Overlay	VDM Alloy 33	Conventional 33 Cr-31 Ni
8	Thermal Spray	IGS UTEx 5-450	Relatively New 40 Cr-55 Ni
9	Thermal Spray	IGS UTEx 5-480	Relatively New 25 Cr-60 Ni
10	Thermal Spray	IGS UTEx 5-500	Relatively New 15 Cr-80 Fe

Table 2: Superheater/Reheater Materials

Material	Description	Boiler Use	Nominal Composition
1	Tube	T22	Conventional 2-1/4 Cr-1 Mo
2	Tube	304H StnStl	Conventional 18 Cr-8 Ni
3	Tube	347H StnStl	Conventional 18 Cr-9 Ni
4	Tube	T91/T92	New Boilers 9 Cr
5	Tube	NF709	New Boilers 20 Cr-25 Ni
6	Tube	HR3C	New Boilers 25 Cr-20 Ni
7	Weld Overlay	Inconel 622	Conventional 21 Cr-55 Ni
8	Weld Overlay	VDM Alloy 33	Conventional 33 Cr-31 Ni
9	Weld Overlay	Inconel 72	Conventional 44 Cr-55 Ni
10	Welded Coupon	T22-304H	Conventional 1-1/4 Cr-18 Cr

The coupons, mounted in racks and inserted in electric tube test furnaces (see Figure 1), will be exposed for 1,000 hours to synthesized air- and oxy-fired flue gases. Foster Wheeler will conduct CFD analyses of nominal 500-megawatt electric (MWe) air- and oxy-fired boilers (see Figure 2) to determine the range of flue gas compositions that will exist throughout these boilers and especially along their furnace walls where highly corrosive micro-climates can exist; based on those ranges, gas compositions will be selected for the corrosion tests. The test gases will be synthesized/blended from gas cylinders and consist of varying concentrations of CO₂, H₂O, N₂, CO, SO₂, H₂S, and HCl.

The material coupons will be coated with three types of synthetic ash deposits representative of high, medium, and low sulfur coals. The deposits will be produced from reagent grade powders that are mixed and applied to the coupons as a paste. The waterwall materials will be tested at three temperatures: 399 °C, 468 °C, and 538 °C (750 °F, 875 °F, and 1,000 °F); the superheater/reheater materials will be tested at: 538 °C, 593 °C, and 649 °C (1,000 °F; 1,100 °F; and 1,200 °F)—temperatures that span the range of boilers operating at subcritical and supercritical pressure. Upon completion of exposure testing, the condition of the coupons will be evaluated macroscopically and microscopically and the materials will be assessed for their suitability for oxy-combustion.

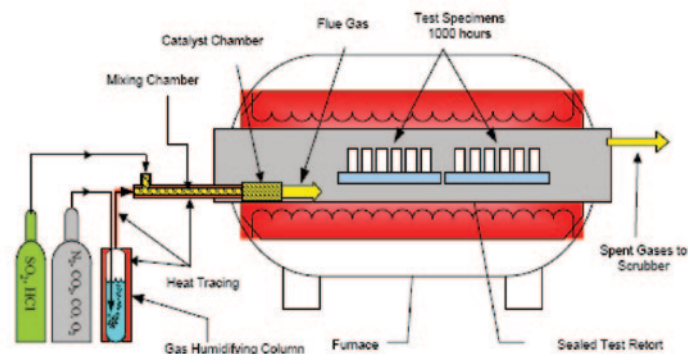

Figure 1: Coupons Mounted in Racks and Inserted in Electric Tube Test Furnaces

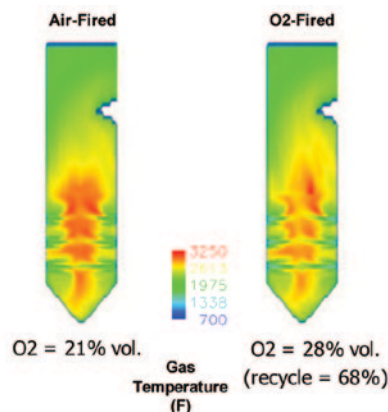

Figure 2: Example of Foster Wheeler CFD Analyses

Technology Advantages

This project will identify the corrosion mechanisms that occur under oxy-combustion and assess the suitability of conventional and advanced boiler materials for this new combustion environment.

R&D Challenges

Flue gas recycle used for the oxy-combustion process could increase corrosion of boiler materials.

Results To Date/Accomplishments

- CFD analyses of nominal 500-MWe PC boilers (wall- and tangential-fired) have identified the bulk flue gas compositions and waterwall micro climates that will exist in these units under air- and oxy-firing.
- The most corrosive gas compositions together with intermediate levels of corrosiveness for each combustion mode were selected for use in laboratory electric furnace corrosion studies.
- The boiler materials coupon testing is in progress and includes five 1,000-hour test series; four test series investigate furnace waterwall micro climates that range from highly reducing (20% CO) to mildly oxidizing (1% O₂) conditions, and one test series investigates the oxidizing (nominally 3% O₂) superheater/reheater condition. The superheater/reheater and three furnace wall test series have been completed and the fifth and final test series (waterwall with 5% CO) began in January 2011. An example of some preliminary corrosion test results are shown below in Figure 3 for waterwall materials exposed to 2% CO air- and oxy-fired micro-climates at 875 °F for 1,000 hours with three levels of iron sulfide (FeS) deposits.

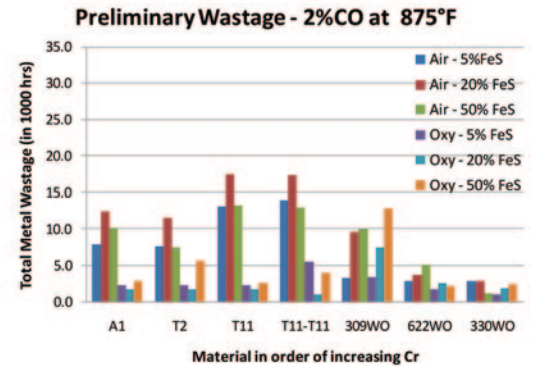

Figure 3: Example of Preliminary Corrosion Results for Waterwall Materials

- The preliminary 1,000-hour results show that under oxy-combustion:
 - The effect of oxy-combustion on test coupon corrosion varies with the type of material, deposit, and temperature.
 - Superheater/reheater and waterwall wastages are generally less than under air-firing.
 - Superheater/reheater and waterwall wastage increases with increasing temperature and tends to decrease with increasing chromium concentrations.
 - Waterwall wastages at 2% CO were higher than at 1% O₂.

Next Steps

- Complete the planned coupon test matrix.
- Complete macroscopic and microscopic examination of the material coupons to identify corrosion mechanisms and material suitability for oxy-combustion.

Final test results will not be available until after the September 2011 project completion date.

Available Reports/Technical Papers/Presentations

General project information is available on DOE/NETL website at: <http://www.netl.doe.gov/technologies/coalpower/ewr/co2/oxy-combustion/material.html>

“Oxy-Combustion Boiler Material Development,” Annual NETL CO₂ Capture Technology for Existing Plants R&D Meeting, Pittsburgh, PA, September 2010. <http://www.netl.doe.gov/publications/proceedings/10/co2capture/index.html>

“Oxy-Combustion Boiler Material Development,” Annual NETL CO₂ Capture Technology for Existing Plants R&D Meeting, March 2009, Pittsburgh, PA.

CHARACTERIZATION OF OXY-COMBUSTION IMPACTS IN EXISTING COAL-FIRED BOILERS

Primary Project Goals

Reaction Engineering International (REI) is developing analytical tools to characterize and predict impacts of carbon dioxide (CO₂) flue gas recycle (FGR) and burner feed design on flame characteristics, fouling, slagging, and corrosion, inherent in the retrofit of existing coal-fired boilers for oxy-combustion. Investigations include laboratory-, bench-, and pilot-scale tests, as well as computer simulations of pilot-scale and full-scale systems.

Technical Goals

- Utilize multi-scale testing and theory to develop:
 - Fundamental data that describe flame characteristics, corrosion rates, and ash properties during oxy-combustion coal firing.
 - Validated mechanisms that describe oxy-combustion processes.
 - Firing system principles that guide oxy-burner design and FGR properties.
- Incorporate validated mechanisms into a computational fluid dynamics (CFD) model to evaluate full-scale oxy-combustion retrofit designs:
 - Predict flame characteristics and surface impacts for different full-scale oxy-firing designs and FGR properties.

Technical Content

REI is characterizing and predicting the performance and operational impacts of oxy-combustion retrofit designs on existing coal-fired boilers. The project focus is to develop tools to characterize and predict impacts of FGR and burner feed design on flame characteristics [burnout, nitrogen oxide (NO_x), sulfur oxide (SO_x) and fine particle emissions, heat transfer], fouling, slagging, and corrosion. Testing includes production of multi-scale experimental data focused on burner design, char oxidation, soot evolution, ash characterization and deposition, and corrosion. Mechanisms capable of describing these phenomena under air- and oxy-combustion conditions are being developed and validated using the data generated during experimentation and from the literature. The mechanisms are being implemented into a CFD code and an existing coal-fired utility boiler is modeled under air- and oxy-combustion conditions to identify the likely impacts of retrofit.

This project is tailored to both identify potential impacts of the oxy-combustion retrofit of existing coal-fired utility boilers (through multi-scale experiments) and to develop tools that allow accurate prediction of these impacts (through mechanism development). Experiments are performed on three different scales: (1) a bench-scale optical entrained flow reactor is used to elucidate the impact of oxy-combustion flue gas composition on the rate of char oxidation; (2) a 100-kW lab-scale combustor is used to characterize the effects of FGR on ash characteristics; and (3) a 1.2-MW pilot-scale combustor is used to investigate burner and firing system principles, deposition, corrosion, and radiative heat transfer, including soot evolution. The data from these experiments is used to guide development of mechanisms that may be used to describe char oxidation, deposition (slagging and fouling), corrosion, and soot evolution. The data generated is used to produce an overview of firing system principles for oxy-combustion that should help guide design of full-scale firing systems.

Technology Maturity:

Laboratory-, bench-, and pilot-scale; simulated and actual flue gas; 0.3-8 tonnes of CO₂ per day

Project Focus:

Characterization of Oxy-Combustion Impacts

Participant:

Reaction Engineering International

Project Number:

NT0005288

NETL Project Manager:

Timothy Fout
Timothy.Fout@netl.doe.gov

Principal Investigator:

Bradley R. Adams
 Reaction Engineering International
adams@reaction-eng.com

Partners:

Brigham Young University
 Corrosion Management LTD
 PacifiCorp
 Praxair, Inc.
 Sandia National Laboratory
 Siemens Energy, Inc.
 Southern Company
 University of Utah
 Vattenfall AB

Performance Period:

10/1/08 – 9/30/11

Bench-Scale Optical Entrained Flow Reactor Experiments

Bench-scale experimentation is conducted at Sandia National Laboratories to further elucidate the behavior of char in an oxygen (O_2)-enriched FGR gas matrix. These experiments are conducted in Sandia's optical entrained flow reactor and associated particle-sizing pyrometry diagnostics.

100 kW Oxy-Fuel Combustor (OFC) Experiments

Data related to ash characterization and deposition is collected using experiments conducted in the University of Utah's 100-kW Oxy-Fuel Combustor (OFC), shown in Figure 1. The furnace consists of an OFC chamber and radiant zone in the vertical section, followed by a horizontal convective section where temperature profile is prescribed through adjustment of independently controlled cooling coils to simulate practical furnace temperature profiles.

These air- and oxy-fired experiments focus primarily on effects of FGR on ash chemistry, under practical time/temperature/particle composition conditions. Multiple modes of gas recycle are tested to investigate FGR conditions ranging from hot, moist, and particle-laden gases to clean CO_2 . This information provides insight into how slagging and fouling could be impacted under oxy-firing conditions. Measurements include sampling of ash aerosol using low-pressure impactors and isokinetic dilution probes. In addition, mobility particle sizers determine ultrafine (sub-micron) particle concentrations and particle size distributions, and energy-dispersive X-ray spectroscopy (EDS) and computer-controlled scanning electron microscopy (CCSEM) techniques are used to identify ash compositions.

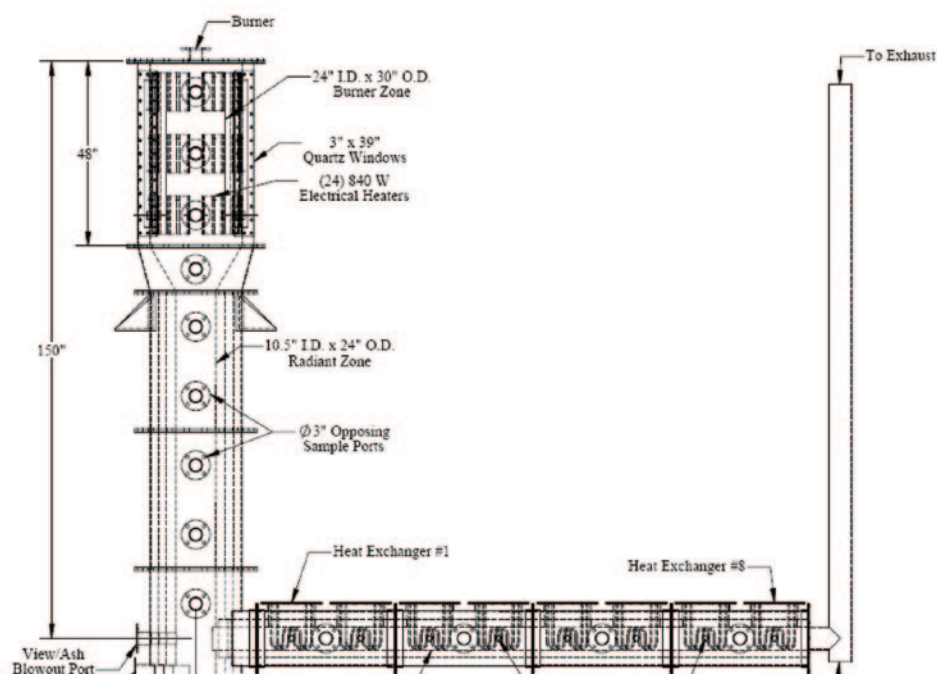

Figure 1: Diagram of 100-kW Oxy-Fuel Combustor (OFC)



Figure 2: Pilot-Scale Combustion Facility (L1500)

1.2 MW Pilot-Scale Furnace (L1500) Experiments

Pilot-scale experiments are performed in a 1.2-MW pulverized coal furnace (L1500). These experiments are designed to investigate firing system configuration impact on flame stability and heat transfer, soot evolution and water wall, and superheat material corrosion. A picture of the L1500 is shown in Figure 2. Four weeks of parametric testing were performed in the L1500 to develop practical guidelines that allow optimized operation of an actual burner under oxy-combustion conditions with FGR. Burner operating parameters of interest include:

- Variable O₂, FGR, and coal distribution in the burner.
- Variable FGR ratios that produce 27% and 32% O₂ in the O₂/FGR mixture.
- Variable burner stoichiometric ratio within the range of 0.8–1.2.
- Targeted O₂ injection.
- Furnace staging of FGR independent of burner conditions.

Six weeks of testing were performed in the L1500 to characterize corrosion under both air- and oxy-combustion conditions. Results from previous experiments were used to identify regions in the furnace for installation of the corrosion probes where deposition, heat flux, and flue gas compositions are favorable for corrosion and relevant for full-scale utility boilers. The parameters of interest in the corrosion test include:

- Air- and oxy-fired conditions.
- Powder River Basin (PRB) and bituminous coals.
- Optimized O₂, FGR, and coal distribution in the burner, from previous experiments.
- Variable flue gas recirculation ratio, within the limits from previous experiments.
- Variable burner stoichiometric ratio, within the limits from previous experiments.

Measurements performed in the pilot-scale furnace include:

- Flue gas composition [O₂, CO₂, carbon monoxide (CO), NO_x, mercury (Hg), and sulfur dioxide (SO₂)] using existing measurement equipment.
- Unburned carbon in ash, using loss on ignition analysis.
- Flame attachment, using ultraviolet sensors and cameras.
- Real-time corrosion measurements.
- Deposition rate and composition at the corrosion locations.
- Heat flux at the corrosion locations and other locations in the furnace.
- Local flue gas temperatures, using suction pyrometry.
- Soot volume fraction using the two-color extinction method.

Technology Advantages

- Enable the development of validated combustion mechanisms specifically designed for oxy-combustion with FGR for retrofitting existing coal-fired boilers.
- Identify firing system principles that guide oxy-burner design and potential retrofit strategies.
- Quantify impacts of FGR properties on ash deposition.

- Quantify impacts of oxy-combustion firing on corrosion of typical boiler waterwall and superheat materials.
- Develop the capability to assess the performance and optimize the retrofit of oxy-combustion to a full-scale existing boiler to

R&D Challenges

- Ability to control and quantify how much air-in leakage occurs inside the OFC and L1500 furnace during the experiments.
- Development and operation of a coal-fired research burner specifically designed to span a range of coal/O₂/FGR injection strategies and operating conditions.
- Correlation of experimental data with mechanisms and model predictions in order to provide adequate mechanism/model validation.

Results To Date/Accomplishments

- Burner primary retrofit results:
 - Matching burner primary gas/fuel ratio or momentum ratio with air-fired operation produced a stable attached flame (good retrofit strategies).
 - Matching primary velocity with air-fired operation did not provide a stable attached flame (may depend on burner flexibility).
 - There is a fundamental difference in devolatilization rates and ignition between air and oxygen/FGR firing.
 - A stable flame can be achieved with no oxygen enrichment in the primary.
- Oxygen injection results:
 - Targeted oxygen injection at the burner primary-inner secondary boundary produced the most effective flame stabilization and ignition. Axial injection produced a permanently detached flame and radial injection produced a wider flame, but did not improve flame attachment.
 - Axial injection in the primary produced a more intensely radiating flame downstream of burner; secondary injection produced a less intense flame near the burner.
 - For maximum pre-mixed primary O₂, adding small amounts of oxygen enrichment radially through the bluff body did not improve flame attachment.
- Soot volume fraction ~40% lower for oxy-combustion cases than air-fired cases for the Utah coal, and 10–20% lower for PRB coal.
- NO_x emissions were up to 75% lower with oxy-combustion depending on level of staging.
- Corrosion testing results:
 - Waterwall (SA210) corrosion rates decreased when converting from air- to oxy-firing for all coals.
 - Superheater (T22, P91, and 347H) rates generally increased when converting from air- to oxy-firing.
 - 347H corrosion rates increased dramatically for SO₂ >~3,000 parts per million (ppm) and T_{probe} <~1,150 °F.
 - Corrosion for lower alloyed materials (T22, SA210) increased when changing between oxidizing-reducing. Likely to contribute to in-plant corrosion in near-burner and near-overfire air (OFA) port regions. Transient effects cannot be resolved using coupon tests.

- Mercury testing results:
 - Native mercury removal was higher for both OFC and L1500 cases.
 - Similar speciation for air- and oxy-firing; slightly lower total gas mercury under oxy conditions.

Next Steps

- Continue ash characterization and soot tests in laboratory-scale furnace.
- Validate and refine mechanisms (char oxidation, soot, slagging, fouling, corrosion); implement in CFD code.
- Design conceptual commercial-scale retrofit firing system.
- Assess oxy-combustion retrofit impacts on existing boiler.

Final test results will not be available until after the September 2011 project completion date.

Available Reports/Technical Papers/Presentations

General project information is available on the DOE/NETL website at: <http://www.netl.doe.gov/technologies/coalpower/ewr/co2/oxy-combustion/impacts.html>

Andrew Fry, Bradley Adams, Dave Swensen and William Cox, "Potential Impacts of Oxy-Combustion Retrofit On Boiler Tube Corrosion Rate," AIChE Annual Meeting, Salt Lake City, UT, November 10, 2010.

Dunxi Yu, William Morris, Raphael Erickson, Jost O. L. Wendt, Andrew Fry and Constance Senior, "Ash Formation and Deposition During Oxy-Coal Combustion," AIChE Annual Meeting, Salt Lake City, UT, November 10, 2010.

M. Geier, C. R. Shaddix, and B. S. Haynes, "Oxy-Combustion of Pulverized Coal: Modeling of Char-Combustion Kinetics," 27th Annual International Pittsburgh Coal Conference, Istanbul, Turkey October 11–14, 2010.

Fry, A., Adams, B., Davis, K., Cremer, M., Swensen, D., Munson, S., Kazalski, P., Cox, W., Oryshchyn, D., Gerdemann, S., "Topics in Oxy-Coal Retrofit of Utility Boilers Burner Principles and Fire-Side Corrosion," The MEGA Symposium, August 30–September 2, 2010, Baltimore, MD.

"Characterization of Oxy-Combustion Impacts in Existing Coal-fired Boilers," Annual NETL CO₂ Capture Technology for Existing Plants R&D Meeting, Pittsburgh, PA, September 2010. <http://www.netl.doe.gov/publications/proceedings/10/co2capture/index.html>

Fry, A., Adams, B., Cremer, M., Shan, J., "Development of Oxy-Burner Retrofit Principles for Existing Coal-Fired Utility Boilers," IEA 1st International Oxy-Fuel Combustion Conference, Cottbus, Germany, September 2009.

Adams, B., Fry, A., Senior, C., Wang, D., "Oxy-Combustion Impacts on Coal Ash Slagging and Fouling," IEA 1st International Oxy-Fuel Combustion Conference, Cottbus, Germany, September 2009.

Fry, A. and Adams, B., "Characterization and Prediction of Oxy-Combustion Impacts in Existing Coal-fired Boilers," 34th International Technical Conference on Clean Coal and Fuel Systems, Clearwater, FL, June 2009.

"Characterization of Oxy-Combustion Impacts in Existing Coal-Fired Boilers," NETL CO₂ Capture Technology for Existing Plants R&D Meeting, Pittsburgh, PA, March 2009.

NEAR-ZERO EMISSIONS OXY-COMBUSTION FLUE GAS PURIFICATION

Primary Project Goals

Praxair is developing a near-zero emission flue gas purification technology for a retrofitted existing coal-fired power plant with oxy-combustion technology.

Technical Goals

- Design a contaminant removal system that will produce saleable sulfuric acid and nitric acid without the need for flue gas desulfurization (FGD) or selective catalytic reduction (SCR) units.
- Design a second contaminant removal system that will produce gypsum.
- Achieve greater than 95% carbon dioxide (CO₂) capture by incorporating a vacuum pressure swing adsorption (VPSA) unit in an existing plant with a high air ingress, and reduce sulfur oxide (SO_x) and mercury (Hg) emissions by more than 99% and nitrogen oxide (NO_x) emissions by more than 90% (high and low sulfur coal).
- Perform a techno-economic study and an operability and integration evaluation to assess the commercial viability of retrofitting an existing power plant with the proposed technology.

Technical Content

Two approaches for SO_x/NO_x/Hg removal are proposed depending on the SO_x levels in the flue gas. By carrying out these unit operations at high pressure, it is envisioned that capital costs would be reduced while achieving low levels of SO_x and NO_x in the CO₂ stream. For plants with existing FGD and SCR, operating cost savings could be realized by shutting down those units while operating the proposed SO_x/NO_x removal process. For plants burning low sulfur coal, there is no need for investment in separate FGD and SCR equipment for producing high purity CO₂.

High air ingress in existing plants limits the amount of CO₂ that can be recovered from oxy-combustion flue gas using a cold box alone to <65%. The CO₂ recovery limitation is overcome by using a hybrid process that combines a cold box and VPSA (Figure 1). In the proposed hybrid process, up to 90% of CO₂ in the cold box vent stream is recovered by CO₂ VPSA and then recycled and mixed with the flue gas stream upstream of the compressor. The recovery from the process will be >95%.

Pollutant Removal

The high sulfur coal tests will be bench-scale and will utilize a single gas/liquid contact column that operates at up to 17 atm [250 pounds per square inch absolute (psia)] and 150 °C (300 °F) for testing multiple reactions. Nitric oxide (NO) in the flue gas is converted to nitrogen dioxide (NO₂), which catalyzes sulfur dioxide (SO₂) oxidation to sulfur trioxide (SO₃). The hydrolysis of SO₃ and NO₂ forms sulfuric and nitric acids.

The low sulfur coal experiments will use a single column unit [2.5 cm (1 inch) diameter, 3.8 cm (1.5 inch) long], and operate up to 17 atm (250 psia) and 93 °C (200 °F). Activated carbon is used as an adsorbent/catalyst for the capture of SO_x and NO_x from the flue gas. The activated carbon oxidizes the SO₂ to SO₃, NO to NO₂, and a periodic water wash will be used to remove the acids formed.

Technology Maturity:

Bench-scale, 5 kg of CO₂/hr

Project Focus:

Flue Gas Purification Options

Participant:

Praxair, Inc.

Project Number:

NT0005341

NETL Project Manager:

Morgan Mosser

Morgan.Mosser@netl.doe.gov

Principal Investigator:

Minish Shah

Praxair, Inc.

minish_shah@praxair.com

Partners:

AES

Foster Wheeler

WorleyParsons Canada

Performance Period:

10/1/08 – 12/31/11

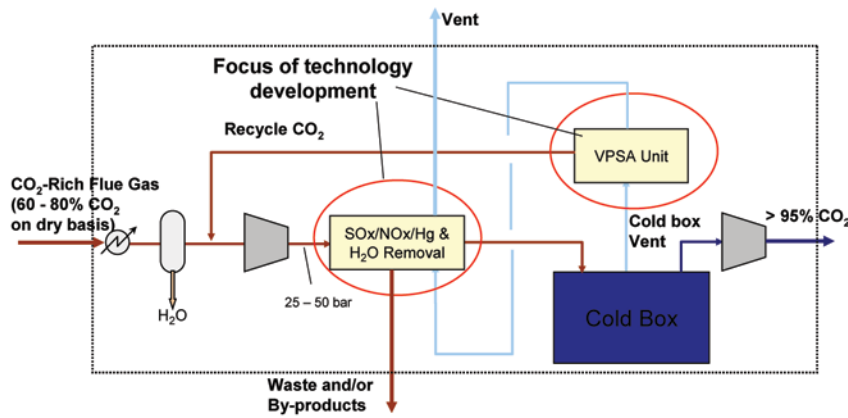

Figure 1: Technology Concept

The chemical reactions for the high and low sulfur coal pollutant removal system are summarized below.

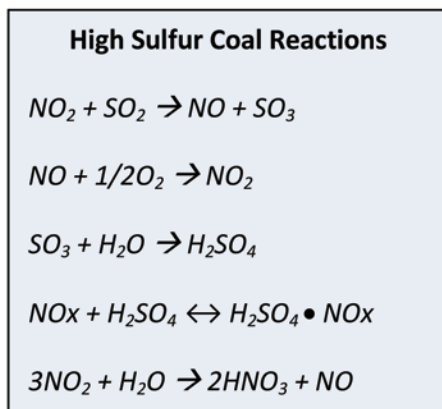

Figure 2: High Sulfur Coal Pollutant Removal System

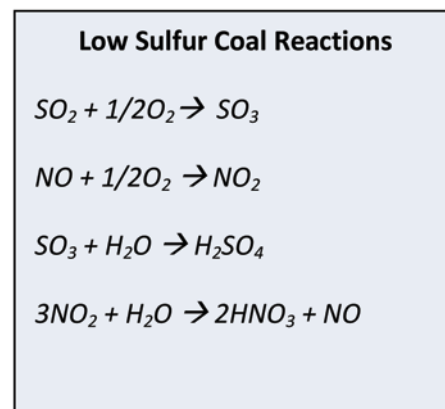

Figure 3: Low Sulfur Coal Pollutant Removal

High CO₂ Recovery Using VPSA

The VPSA unit is a multi-bed unit that performs multiple depressurization/re-pressurizations steps. Oxy-combustion flue gas will enter the CO₂ VPSA from the “cold box” (25–35 atm and ambient temperature) that will recover additional CO₂ (produce 80–95% CO₂ concentration) and recycle the CO₂ back into the CO₂-rich flue gas stream at ambient pressure. The flue gas stream not recycled from the VPSA contains mainly oxygen (O₂), nitrogen (N₂), and argon (Ar) that will be vented to the atmosphere.

Technology Advantages

Cold box-VPSA hybrid technology achieves >95% CO₂ recovery even for plants with high air ingress. The flue gas purification process for high sulfur coal has lower capital and operating costs than FGD and SCR and it allows for revenue from sale of acids. The flue gas purification process for low sulfur coal will not need investment in expensive FGD and SCR units.

R&D Challenges

- Sulfuric acid process for SO_x/NO_x/Hg removal from high sulfur coal:
 - Reactor materials must be able to withstand the operating conditions in the process.
 - Determine an effective NO_x catalyst for producing saleable sulfuric acid.

- Activated carbon process for SO_x/NO_x/Hg removal from low sulfur coal:
 - Find activated carbon materials that are effective for regeneration based on sorption capacity and ability to maintain performance.
- Identify adsorbents with a tolerance to residual SO_x/NO_x to be used in the VPSA process.
- Determine VPSA cost benefit for recovering additional CO₂.
- Establish proper modifications required for retrofitting existing plants.

Results To Date/Accomplishments

Bench-scale experimental test systems have been built and commissioned for all three experimental programs.

- Sulfuric Acid Process:
 - Gas phase NO oxidation kinetics confirmed.
 - Greater than 98% NO_x absorption in one stage.
 - SO_x removal tests completed.
 - Removal of NO_x from sulfuric acid was not successful.
 - Sulfuric acid produced is not of commercial grade.
- Activated Carbon Process:
 - Two carbon materials selected based on SO_x removal screening tests.
 - Simultaneous SO_x/NO_x removal – SO₂ >99%, NO_x >96%.
 - Performance enhanced by lower temperature, higher pressure, and presence of moisture.
- High CO₂ Recovery Using VPSA:
 - Three adsorbents selected based on cost, CO₂ recovery, CO₂ purity, and vacuum pump.
 - Pilot unit with 12 vessels commissioned.
 - First data set meets/exceeds performance targets – 99% capture rate with VSPA and cold box.

Next Steps

- Complete long-term regenerability tests for activated carbon process.
- Build and operate a dual-bed continuous activated carbon process unit with 0.125 ton-per-day (tpd) capacity.
- Conduct bench-scale tests for VSPA SO_x/NO_x tolerance.
- Complete pilot-scale VSPA tests to find optimum combination of adsorbents and process configuration.
- Develop a simulation tool to predict VSPA process performance.
- Conduct a techno-economic analysis and operability assessment.

Final test results will not be available until the December 2011 project completion date.

Available Reports/Technical Papers/Presentations

Project webpage: <http://www.netl.doe.gov/technologies/coalpower/ewr/co2/oxy-combustion/near-zero.html>

“Near-Zero Emissions Oxy-Combustion Flue Gas Purification” – Presentation given at the 2010 NETL CO₂ Capture Technology Meeting: <http://www.netl.doe.gov/publications/proceedings/10/co2capture/presentations/tuesday/Minish%20Shah%20-%20NT0005341.pdf>

“Near-Zero Emissions Oxy-Combustion Flue Gas Purification” – Fact Sheet: <http://www.netl.doe.gov/publications/factsheets/project/Proj611.pdf>

FLUE GAS PURIFICATION UTILIZING SO_x/NO_x REACTIONS DURING COMPRESSION OF CO₂ DERIVED FROM OXYFUEL COMBUSTION

Primary Project Goals

Air Products and Chemicals is designing and developing a system for purifying an oxy-combustion derived flue gas by utilizing the reactions of sulfur oxides (SO_x) and nitrogen oxides (NO_x) that occur during compression, leaving behind a pressurized, pure stream of carbon dioxide (CO₂).

Technical Goals

- Design and construct a 15-atm flue gas pilot development unit (PDU) for the removal of SO_x and NO_x from actual oxy-combustion derived CO₂-rich flue gas.
- Evaluate PDU performance based on effluents at different pressures and water recycle rates.
- Characterize the PDU effluents to assess any change in performance.
- Develop an engineering model to describe the 15-atm PDU performance.

Technical Content

Acidic gases must be removed from a CO₂ stream prior to pipeline transportation to avoid corrosion and to comply with purity requirements for applications such as enhanced oil recovery (EOR) and geological storage. In order to address this requirement, Air Products and Chemicals is developing a novel approach to remove SO_x and NO_x from the flue gas by converting them to sulfuric acid and nitric acid (HNO₃).

In order to determine the effect of pressure on sulfur dioxide (SO₂) and nitric oxide (NO) conversion, previous experiments were performed where one standard liter per minute (sl/min) of gas was supplied at both 8 and 15 atm. The results are shown in the Table 1.

Table 1: Pressure vs. Conversion

	15 atm			8 atm		
	Inlet	After Compressor and Receiver	Conversion	Inlet	After Compressor and Receiver	Conversion
ppm SO ₂	900	20	98%	950	150	84%
ppm NO _x	500	50	90%	390	120	68%

Clearly, the conversion rate increases significantly with pressure. Therefore, it is logical to assume that these contaminants can be removed during the compression of CO₂.

The PDU developed for this project includes three main units, as indicated below: the scrubber/condenser, the compressor, and the reactor. Fine particulate ash and acid mist in the flue gas are removed prior to compression to avoid damage to the compressor.

Technology Maturity:

Pilot, flue gas, 2.45 tonnes CO₂/day

Project Focus:

Flue Gas Purification via Compression

Participant:

Air Products and Chemicals, Inc.

Project Number:

NT0005309

NETL Project Manager:

Timothy Fout

Timothy.Fout@netl.doe.gov

Principal Investigator:

Kevin Fogash

Air Products and Chemicals, Inc.

fogashkb@airproducts.com

Partners:

None

Performance Period:

10/1/08 – 9/30/10

The compressor increases the pressure of the gas from near atmospheric to approximately 15 atm in a multistage adiabatic compressor unit. After the initial compression, the flue gas is cooled prior to entering the reactor. In the reactor, the flue gas is contacted with water to obtain complete conversion of SO_2 to sulfuric acid and high conversion of NO_x to HNO_3 .

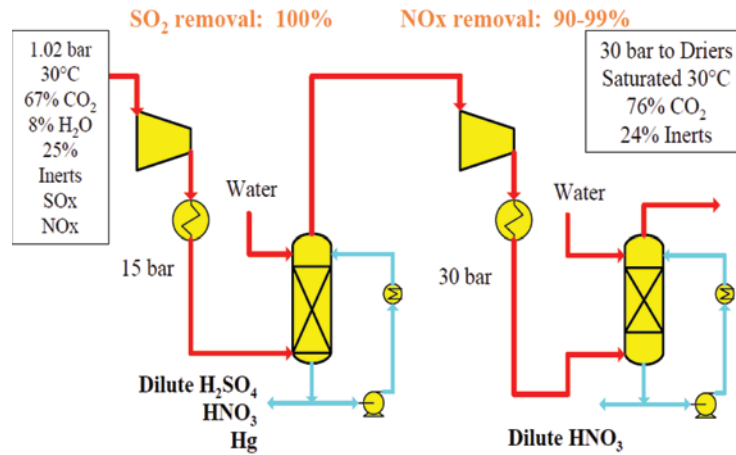

Figure 1: Flue Gas Pilot Development Unit (PDU)

Multiple tests were conducted within two campaigns of the project. The host site was Alstom Power's 15-MW_{th} oxy-combustion pilot unit. The 15-bar reactor system received a slip stream of 0.25–0.33 MW_{th} equivalent flow rate from the Alstom unit for several days. A variety of process conditions were tested, including changes in SO_x and NO_x feed levels, to enable a broad understanding of the technology. The flue gas PDU is shown in Figure 2. In the reactor, the flue gas was contacted with water to obtain up to complete conversion of SO_2 to sulfuric acid and high conversion of the NO_x to HNO_3 . Figure 3 shows an example of the results obtained.



Figure 2: PDU at the Host Site

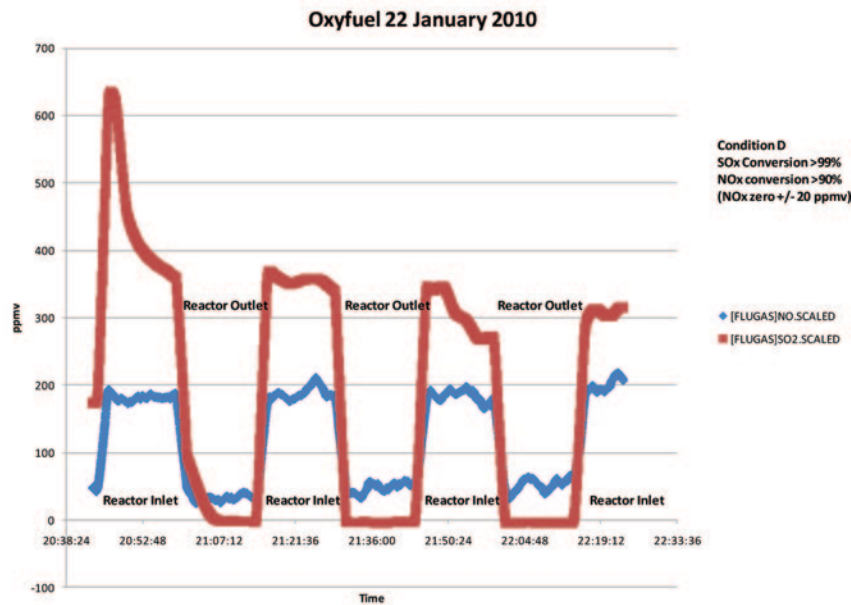

Figure 3: Example Results from the Oxyfuel Test

Technology Advantages

By incorporating an efficient NO_x and SO_x removal system with a compressor, the need for low NO_x burners, flue gas desulfurization (FGD), and post-combustion NO_x control systems are greatly reduced or eliminated for oxy-combustion plants. In particular, this system allows for a degree of freedom to optimize any upstream purification needs and target reduction in size or removal of upstream equipment for the retrofit of an existing plant or the construction of a new plant.

R&D Challenges

The main challenge is to obtain sufficient data for engineering design and to further develop the understanding of the effect of residence time, pressure, and temperature on the unit performance. The prolonged presence of acid gases in the system and the presence of such gases at high pressures in the compressor may lead to the requirement of more advanced materials of construction.

Results To Date/Accomplishments

- Developed a simulation of the flue gas PDU and modeled the reactions occurring within the reactor.
- Conducted simulations to understand the influence of liquid to vapor flow rates on SO_2 and NO_2 conversions as well as overall residence time in the reactor.
- Developed a design specification for the PDU and auxiliary equipment.
- Completed construction and installed the PDU at host site.
- For the overall process, total SO_2 removal was 40–100% (based on gas compositions).
- For the overall process, total NO_x removal was 60–90% (based on gas compositions).
- The effects of variations in the SO_2/NO_x feed ratio, column pressure, gas flow rate, and liquid recirculation on the reactor performance were elucidated. Process performance was most sensitive to SO_2/NO_x feed ratio, over the range of parameter values investigated.

- SO₂ was removed from the flue gas through both sulfite and sulfate mechanisms.
- No evidence of NO_x removal was observed prior to compression, confirming that elevated pressure was required to accelerate the oxidation reaction of NO to NO₂ to a rate at which appreciable NO_x removal (as HNO₃) could be achieved.

Next Steps

Project complete.

Available Reports/Technical Papers/Presentations

Project webpage: <http://www.netl.doe.gov/technologies/coalpower/ewr/co2/oxy-combustion/purification.html>

“Flue Gas Purification Utilizing SO_x/NO_x Reactions During Compression of CO₂ Derived from Oxyfuel Combustion.” Presentation given at the 2010 NETL CO₂ Capture Technology Meeting. <http://www.netl.doe.gov/publications/proceedings/10/co2capture/presentations/tuesday/Kevin%20Fogash%20-%20NT0005309.pdf>

Fact Sheet. “Flue Gas Purification Utilizing SO_x/NO_x Reactions During Compression of CO₂ Derived from Oxyfuel Combustion.” <http://www.netl.doe.gov/publications/factsheets/project/Proj595.pdf>

“Purification of Oxyfuel-Derived CO₂ for Sequestration or EOR,” Technical paper presented at the 8th International Conference on Greenhouse Gas Control Technologies in Trondheim, Norway. <http://www.netl.doe.gov/technologies/coalpower/ewr/co2/pubs/5309%20Air%20Products%20oxy-combustion%20GHGT-8%20paper.pdf>

JUPITER OXY-COMBUSTION AND INTEGRATED POLLUTANT REMOVAL RESEARCH AND DEVELOPMENT TEST FACILITY

Primary Project Goals

Jupiter Oxygen will design, construct, and operate a 5-MWe, high flame temperature, oxy-combustion test facility with a 20-kWe integrated pollutant removal (IPR) bench-scale system to demonstrate carbon dioxide (CO₂) capture from an oxy-combustion process.

Technical Goals

- Develop high flame temperature oxy-fuel burners.
- Retrofit an existing boiler with high flame temperature oxy-combustion and operate with coal and natural gas without altering interior boiler materials.
- Collect data on burner performance and boiler heat transfer.
- Conduct a study of the ash and slagging characteristics of the process and its impact on boiler materials.
- Capture CO₂ and collect data on impurity removal using the Jupiter Oxygen combustion process along with IPR technology developed by NETL.
- Evaluate the high flame temperature approach with respect to capital and operating costs.
- Design, build, and test a new 1-MW_{th} module boiler design for high flame temperature oxy-combustion.

Technical Content

There are two different approaches to oxy-combustion. Jupiter's approach is to use a high temperature flame that is minimally tempered with nitrogen, CO₂, or other inert gases (the only tempering occurs as a result of flue gas recycle that is used to motivate coal). High flame temperature oxy-combustion results in improved heat transfer in the boiler's radiant zone. Other oxy-combustion facilities use a low flame temperature approach which uses large amounts of CO₂ recycled through or at the burner to cool the flame to a temperature similar to air firing. The unique combination of the high-temperature approach coupled with the IPR system will allow the evaluation of the impact of using high- and low-temperature approaches and energy recovery on a variety of aspects of power plant operations.

Coal analyses, such as heating value, mineralogy, and trace element content; proximate; and ultimate analyses will be determined using ASTM procedures. This information will be used to determine the effect of the coal characteristics on oxy-combustion performance and the effectiveness of emissions capture. Other performance measurements for the test facility include water tube and web temperature, heat transfer rate, flue gas emissions [nitrogen oxides (NO_x), carbon monoxide (CO), CO₂, sulfur dioxide (SO₂), and trace metals], and loss on ignition (LOI) of the ash. The facility will incorporate the following approaches to conduct measurements:

Technology Maturity:

Pilot/bench

Project Focus:

Oxy-Combustion and Integrated Pollutant Removal

Participant:

Jupiter Oxygen Corporation

Project Number:

NT42811

NETL Project Manager:

Timothy Fout
Timothy.Fout@netl.doe.gov

Principal Investigator:

Mark Schoenfield
 Jupiter Oxygen Corporation
m_schoenfield@jupiteroxygen.com

Partners:

Coalteck, LLC
 Doosan Babcock, LLC
 EPRI
 Maxon Corporation
 Michigan State University
 Purdue University
 University of Wyoming

Performance Period:

9/28/06 – 9/30/11

- Flue gas species concentrations will be measured by Fourier Transform Infrared Spectroscopy (FTIR).
- Ash LOI will be measured by laboratory testing.
- Heat transfer in the radiant zone will be determined by spectral flame mapping, furnace gas temperature measurement (at the screen wall and boiler exit), temperature measurements of the flux through the boiler tubes, and optical measurements of the total radiant heat flux from the flame.
- Flame shape and transient behavior will be evaluated by high-speed video.
- Net heat output from the burner and heat absorbed by the boiler will be calculated based on combustion and steam side energy balances.
- Combustion side mass balances will be calculated by combining species measurements with mass flows.
- Corrosion monitoring probes will be used.
- Gas-phase and particulate-phase trace elements, including mercury (Hg), will be measured in samples from select runs.
- IPR contaminant removal will be measured by laboratory analyses and FTIR.

The IPR system was added to the pilot facility to remove pollutants from the oxy-combustion flue gas re-circulated stream. The current device is used to process 45 kg/hr (100 lb/hr) of flue gas from the facility. The IPR system will capture, separate, and produce a dry, supercritical stream of CO₂; a stream of captured pollutants; and a stream of condensed water from the flue gas. Figure 1 shows a representation of major components of a typical IPR system.

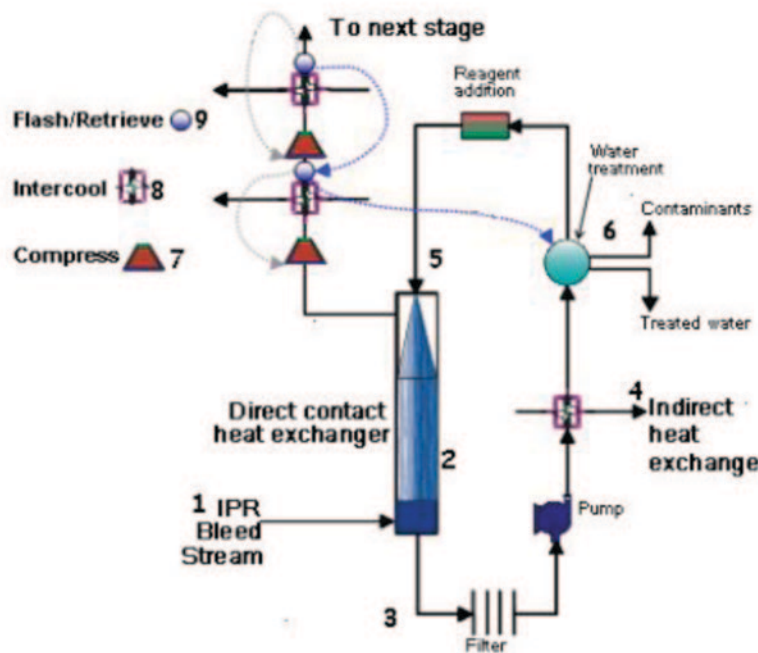

Figure 1: Representation of IPR System Integrated at a Pilot-Scale Facility

The generalized IPR process flow diagram is presented above: a flue gas bleed stream (1) enters the IPR system into a glass-pipe spray tower (2) in which sulfur oxide (SO_x) is removed by a spray stream (reagent addition) as the gas rises. The spray water and combustion condensed water (3) are cooled (4) and partially re-circulated back into the spray tower (5). The water that is not re-circulated back in to the spray tower is treated outside the IPR system (6). As the scrubbed gas leaves the tower, it enters a two-stage reciprocal compressor (7) and a water-cooled, counter flow heat exchanger (8). During the compression stage, separated water can be collected in the collection vessel (9).

Technology Advantages

The higher flame temperature improves heat transfer in the radiant zone, which increases boiler efficiency. Oxyfuel combustion lowers the quantity of flue gas, concentrates CO₂ in the flue gas, and significantly reduces NO_x emissions. For retrofit applications, this technology maintains actual water wall and steam temperatures without altering the boiler design or size. For new construction this technology can use a smaller boiler, which provides the same thermal output as larger, existing power plant boilers.

R&D Challenges

Design, build, and test a new, 1-MW_{th} module boiler design for high flame temperature oxy-combustion.

Results To Date/Accomplishments

- Retrofitted and operated a 5-MWe equivalent air-fired boiler as an oxy-coal combustion test facility without major boiler modifications. The test facility was operated along with ancillary systems including oxygen production and generated appropriate steam.
- Performed a series of oxy-coal burner development tests which resulted in a modified first generation burner.
- Performed parametric studies with the modified first generation oxy-coal burner.
- No increased fouling, slagging, or damage to boiler materials indicated.
- Developed a computational fluid dynamics (CFD) model of the modified first generation burner.
- Designed, constructed, and operated a 20-kWe equivalent IPR facility.
 - Demonstrated CO₂ capture at 95–100%.
 - 95% NO_x, SO_x, and particulate removal; 60–90% Hg removal.
 - FeCl₃/polymer pairing found to be effective flue gas condensate flocculent.
- Full-scale parametric model of a power plant retrofitted with high temperature oxy-combustion and an IPR system has been developed and is ready for economic evaluation.

Next Steps

- Develop second generation oxy-coal burner based on CFD modeling and first generation testing designed for improved coal/oxygen mixing, shorter flame length, and turndown capability.
- Improve flame characterization and heat transfer measurement.
- Develop an air-coal performance baseline for the test facility.
- Conduct IPR system performance tests and modeling to optimize heat recovery and gas reactions.
- Evaluate interactions between gas species that are expected to enhance the removal of SO_x, NO_x, and Hg.
- Complete slagging, fouling, and corrosion studies.
- Conduct analysis for technical and economic scale up of the technologies.

Final test results will not be available until the September 2011 project completion date.

Available Reports/Technical Papers/Presentations

Project webpage: <http://www.netl.doe.gov/technologies/coalpower/ewr/co2/oxy-combustion/jupiter.html>

Oxy-Fuel Burner and Integrated Pollutant Removal Research and Development Test Facility – Presentation given at the 2010 NETL CO₂ Capture Technology Meeting: <http://www.netl.doe.gov/publications/proceedings/10/co2capture/presentations/tuesday/Manny%20Menendez%20-%20NT42811.pdf>

Project update report (Aug 2010): http://www.netl.doe.gov/technologies/coalpower/ewr/co2/pubs/42811_ProjectUpdate_0810.pdf

Project topical report (Aug 2009): <http://www.netl.doe.gov/technologies/coalpower/ewr/co2/pubs/42811%20Jupiter%20topical%20August%202009.pdf>

Technical paper from the Proceedings of the 34th International Technical Conference on Coal Utilization and Fuel Systems (Jun 2009): <http://www.netl.doe.gov/technologies/coalpower/ewr/co2/pubs/42811%20Jupiter%20paper%20Clearwater%20jun09.pdf>

S. Gerdemann, C. Summers, D. Oryshchyn, B. Patrick, T. Ochs, “Developments in Integrated Pollutant Removal for Low-Emission Oxy-Fuel Combustion.”

Jupiter Oxycombustion and Integrated Pollutant Removal of the Existing Coal-Fired Power Generation Fleet – CO₂ Capture Technology for Existing Plants R&D Meeting – March 2009.

Results of initial operation of the Jupiter Oxygen Corporation oxyfuel 15 MW_{th} burner test facility – Paper presented at GHGT-9 Conference – November 2008. <http://www.netl.doe.gov/technologies/coalpower/ewr/co2/pubs/Nov%202008%20GHGT9%20JOC%20%26%20NETL%20Results%20of%20Initial%20Operation%20of%20th.pdf>

The Jupiter Oxygen Boiler Test Facility: 3rd Generation – Poster presented at GHGT-9 Conference – November 2008. <http://www.netl.doe.gov/technologies/coalpower/ewr/co2/pubs/2008%20JOC%20GHGT9%20poster.pdf>

Project Status Update. January 2009. [http://www.netl.doe.gov/technologies/coalpower/ewr/co2/pubs/42811 WEB UPDATE Jan 2009.pdf](http://www.netl.doe.gov/technologies/coalpower/ewr/co2/pubs/42811_WEB_UPDATE_Jan_2009.pdf)

DEVELOPMENT OF COST-EFFECTIVE OXY-COMBUSTION TECHNOLOGY FOR RETROFITTING COAL-FIRED BOILERS

Primary Project Goals

Babcock and Wilcox (B&W) is developing oxy-combustion technology for application to new and existing cyclone and wall-fired boilers. A two-phase research project is being conducted that includes pilot-scale testing and a full-scale engineering and economic analysis.

Technical Goals

- Conduct pilot-scale testing to evaluate the effect of coal rank (i.e., bituminous, subbituminous, and lignite) on oxy-combustion boiler operation.
- Determine the equipment requirements for the boiler island, flue gas purification, carbon dioxide (CO₂) compression, CO₂ transportation, and CO₂ sequestration for different coal ranks and boiler designs.
- Investigate the potential for multi-pollutant [nitrogen oxides (NO_x), sulfur dioxide (SO₂), and particulate] emissions control.
- Validate an existing three-dimensional computational flow, heat transfer, and combustion model for oxy-combustion scale up to a commercial-size boiler.
- Conduct an engineering and economic assessment of the technology for commercial-scale retrofit and green field application for cyclone and wall-fired boilers.
- Assess CO₂ capture cost reductions via energy integration of the air separation unit (ASU), flue gas purification, and CO₂ compression systems.
- Evaluate the impact of oxy-combustion implementation on net power production and cost of electricity (COE) for cyclone and wall-fired boilers.

Technical Content

B&W had previously conducted pilot-scale oxy-combustion testing for wall-firing at 1.8 and 30 MW_{th}. In this project, a pilot-scale evaluation—14 GJ/hr (6 million Btu/hr)—is conducted for three coals using a cyclone boiler configuration at its Barberton, OH, test facility. An illustration of the oxy-combustion pilot-scale test facility is shown below (Figure 1). The three types of coal tested are North Dakota lignite, Western sub-bituminous, and Eastern bituminous. Each of the oxy-combustion tests is run for 100 continuous hours to assess the slagging, fouling, heat transfer, and overall operability characteristics. Data from the pilot-scale testing is used to validate a computational fluid dynamic (CFD) model of the oxy-combustion process. From the test data, equipment required for flue gas purification, compression, transportation, and sequestration is determined for the engineering and economic assessment.

Technology Maturity:

Pilot-scale laboratory testing using actual flue gas; equivalent to 13 tons of CO₂/day

Project Focus:

Oxy-Combustion for Cyclone and Wall-Fired Boilers

Project Developer:

Babcock & Wilcox

Project Number:

NT42747

NETL Project Manager:

José Figueroa

Jose.Figueroa@netl.doe.gov

Principal Investigator:

Hamid Farzan

Babcock & Wilcox PGG

HFarzan@Babcock.com

Partners:

Air Liquide

Battelle

Performance Period:

4/1/06 – 12/31/10

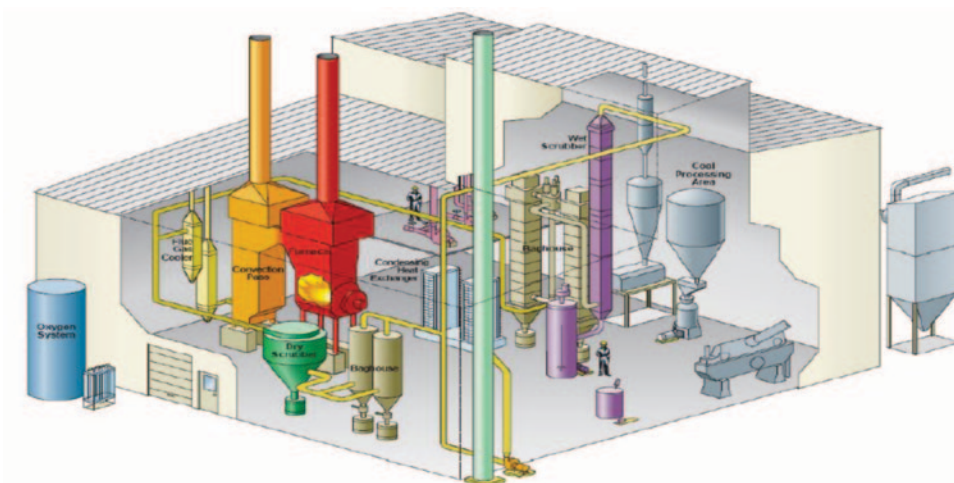

Figure 1: Illustration of B&W's Oxy-Combustion Pilot-Scale Test Facility in Barberton, Ohio

A modeling assessment is also being conducted to compare three CO₂ capture purification processes: (1) no purification—only drying to Kinder Morgan pipeline specifications with water (H₂O) at 600 parts per million volume (ppmv); (2) partial condensation at cryogenic conditions (cold box)—95% CO₂ purity target; and (3) cold box including distillation—1 ppm oxygen (O₂) target. The purification assessment includes investigation of operating costs, energy requirements, and effects of air infiltration. The following graph (Figure 2) represents a model analysis showing the effect of purification process on CO₂ recovery, purity, and specific energy.

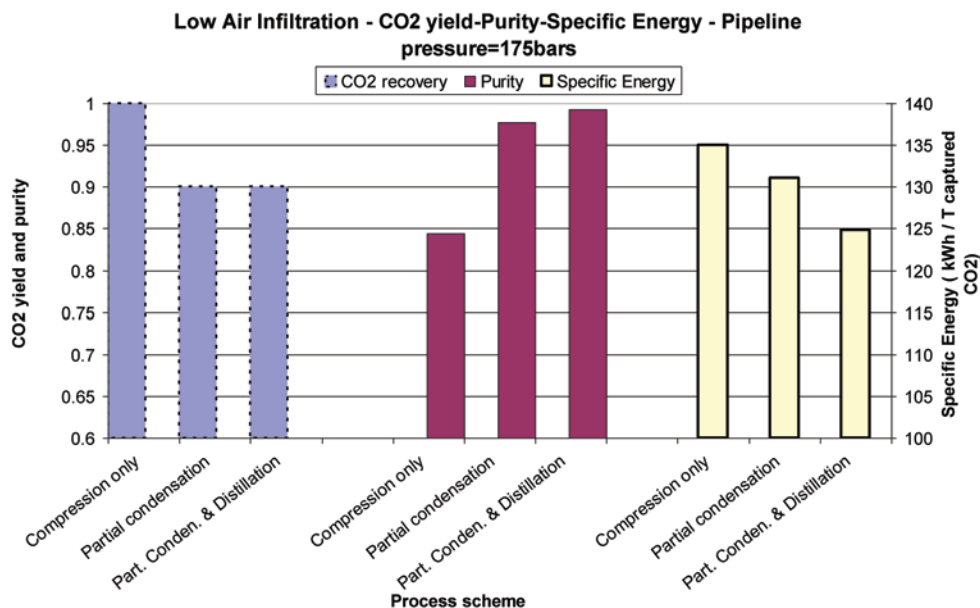

Figure 2: Model Analysis Showing Effect of Purification Process on CO₂ Recovery, Purity, and Specific Energy

Technology Advantages

Oxy-combustion has the potential to offer a lower cost solution for CO₂ capture compared to post-combustion CO₂ capture technologies.

R&D Challenges

The necessary level of flue gas purification remains an issue regarding potential adverse impacts on CO₂ transportation and storage:

- Potential precipitation problems with SO₂ forming sulfate minerals (e.g., anhydrite) if high-sulfur coal is used without scrubbing.
- Non-condensable gases, such as nitrogen (N₂) and O₂, could affect subsurface processes which might require more purification. For example, non-condensable gases could create multi-phase flow, which can reduce injectivity or the capacity of the storage site.

Results To Date/Accomplishments

- Completed oxy-combustion pilot-scale testing with the following general results:
 - Oxy-combustion is a technically feasible technology for wall-fired and cyclone boilers.
 - The flame stability and cyclone slagging characteristics was not negatively impacted by oxy-combustion.
 - Boiler emissions [NO_x, carbon monoxide (CO), and unburned combustibles] are lower for oxy-combustion than air-firing.
 - Radiant boiler and convection pass heat absorptions under optimum oxy-combustion conditions was similar to air-firing.
 - Higher CO₂ (up to 90%) levels were achieved when air leakage was minimized by reducing pressure drop in the boiler back-end equipment.
 - Sulfur dioxide must be scrubbed from recycle gas for high-sulfur coal applications to maintain acceptable boiler corrosion.
 - Higher sulfur trioxide (SO₃) concentrations occur with oxy-combustion than air-firing at the convection pass exit that could increase corrosion if the flue gas temperature goes below acid dew point.
- Completed engineering feasibility and economic analysis with the following general results:
 - Co-sequestration of CO₂ and SO₂ might be feasible in deep geological reservoirs. It was concluded that the pipeline transportation corrosion by acid gas can be minimized by removing the moisture from the flue gas.
 - Modeling of the compression and purification unit (CPU) demonstrated that the overall energy requirement is lower if flue gas inerts are removed in the CPU than compressing the entire flue gas for pipeline transport.
 - Oxy-combustion is an economically viable technology. The incremental cost of oxy-combustion for existing boilers varied between \$0.05 and \$0.07/kWh, which is competitive with other technologies.
 - COE for green-field boilers using oxy-combustion coupled with ultra-supercritical boilers was 25% higher than COE for a supercritical boiler under air-firing without CO₂ capture, which is below the DOE/NETL target of 35%.
 - Oxy-combustion can be applied to the majority of the existing wall-fired and cyclone boilers depending on space and existing equipment. The site requirements are similar to those for post-combustion capture.

Next Steps

Project completed December 2010. Final technical report under review.

Available Reports/Technical Papers/Presentations

General project information is available on the DOE/NETL website at: <http://www.netl.doe.gov/technologies/coalpower/ewr/co2/oxy-combustion/oxy-combustion.html>

“Development of Cost Effective Oxy-Combustion for Retrofitting Coal-Fired Boilers,” Annual NETL CO₂ Capture Technology for Existing Plants R&D Meeting, Pittsburgh, PA, September 2010. <http://www.netl.doe.gov/publications/proceedings/10/co2capture/index.html>

“Development of Cost Effective Oxy-Combustion for Retrofitting Coal-Fired Boilers,” NETL CO₂ Capture Technology for Existing Plants R&D meeting in Pittsburgh, PA, March 2009.

“Considerations for Treating Impurities in Oxy-Combustion Flue Gas Prior to Sequestration,” 9th International Conference on Greenhouse Gas Control Technologies in Washington, DC, Nov. 2008.

“Developing Oxy-combustion for Retrofitting Coal-fired Boilers,” 7th Annual Conference on Carbon Capture and Sequestration in Pittsburgh, PA, May 2008.

“Development of Cost Effective Oxy-Combustion Technology for Retrofitting Coal-Fired Boilers,” NETL Fact Sheet.

OXY-FUEL TURBOMACHINERY DEVELOPMENT FOR ENERGY-INTENSIVE INDUSTRIAL APPLICATIONS

Primary Project Goals

Clean Energy Systems (CES) is designing and developing a pre-commercial oxy-fuel (O-F) combustor, able to utilize synthesis gas (syngas), which will be used in a power generation cycle able to achieve high thermal efficiency with near-zero atmospheric emissions, including carbon dioxide (CO₂). The technology is a high-pressure O-F combustor that produces a steam/CO₂ working fluid for expansion in a turbine.

CES is also designing and developing a commercial-scale O-F turbine that can be deployed in industrial O-F plants that capture >99% of the produced CO₂, at competitive cycle efficiency and cost-of-electricity, using diverse fuels including gasified petcoke/coal, gasified or liquefied renewable fuels, and natural gas (NG).

Technical Goals

- Develop a detailed design of a 100 megawatt thermal (MW_{th}) O-F syngas combustor.
- Develop a detailed design and test an O-F reheat (RH) combustor. The RH combustor is a variant of the main O-F combustor and enables the exhaust from a high-pressure turbine to be reheated to the higher and more efficient inlet temperatures of an O-F intermediate pressure turbine (IPT).
- Develop a detailed design of a commercial-scale O-F turbine.
- Fabricate an O-F combustor with an attendant control system.
- Fabricate an O-F IPT with a control system integrated with an O-F combustor.
- Commission and test the O-F combustor using NG.
- Integrate, commission, and test O-F IPT with an O-F combustor using NG.
- Conduct pilot-scale testing of alternative fuels (syngases, petcoke, glycerol, etc.).

Technical Content

CES has designed a pre-commercial O-F combustor that can utilize syngas in an O-F power cycle to produce electricity from fossil fuel at high-thermal efficiency with near-zero emissions. The CES O-F combustor can produce high-pressure drive gases at temperatures between 315 and 1,760 °C (600–3,200 °F).

The CES cycle involves burning high purity oxygen (O₂) with a gaseous carbonaceous fuel (NG, coal syngas, gasified biomass, etc.) in the presence of water to generate a high-pressure, high-temperature drive gas comprised of approximately 90 vol% steam and 10 vol% CO₂ (when combusting NG), or 75 vol% steam and 25 vol% CO₂ (when combusting syngas). The drive gas powers steam or aero-derivative turbo-generators to produce electricity.

Technology Maturity:

100 MW thermal-scale oxy-fuel combustor and turbine

Project Focus:

Oxy-Syngas Combustor

Project Developer:

Clean Energy Systems, Inc.

Project Number:

NT42645

NETL Project Manager:

Travis Shultz
Travis.Shultz@netl.doe.gov

Principal Investigator:

Rebecca Hollis
Clean Energy Systems, Inc.
rhollis@cleanenergysystems.com

Partners:

Florida Turbine Technologies, Inc.
Siemens Energy, Inc.

Performance Period:

10/1/05 – 9/30/14

The heart of the O-F combustor is the main injector, which is used to inject precisely controlled quantities of O₂, fuel, and water into the combustion chamber. Figure 1 depicts the assembled syngas combustor with the main O₂/fuel/water injector assembly at the left end of the combustor.

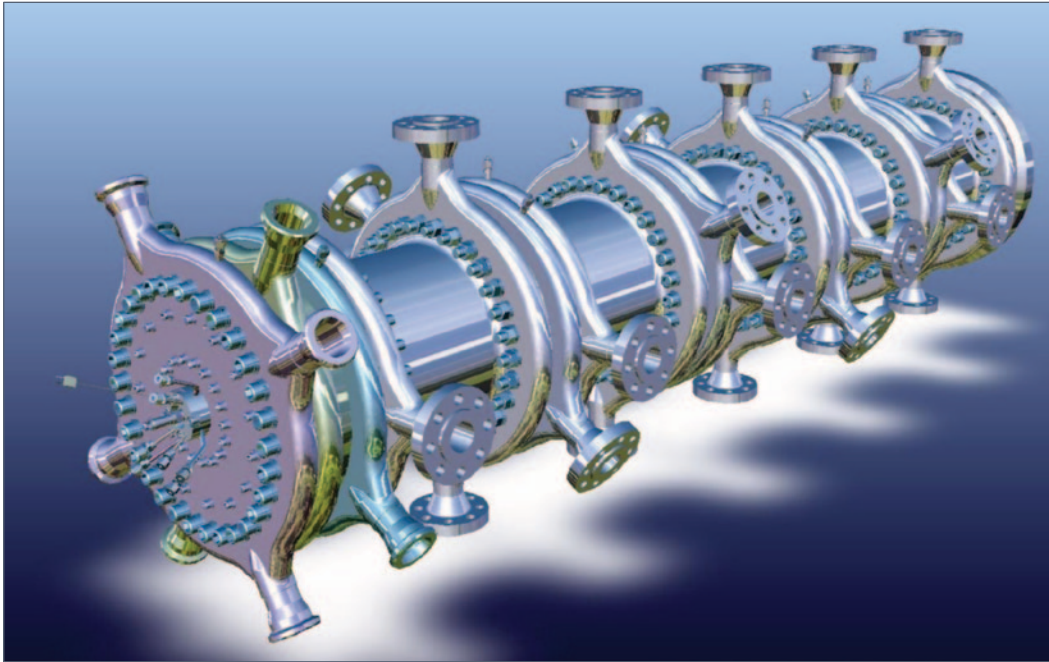

Figure 1: Syngas O-F Combustor Assembly

To utilize the high drive gas temperatures, and thereby achieve significantly higher plant efficiencies, CES is also working with turbine developers to accelerate deployment of advanced, high-temperature O-F IPTs. These commercial-scale IPTs are derived from existing high-temperature gas turbines. The gas turbines are being modified to utilize the steam-CO₂ drive gas from the CES O-F combustor and will incorporate unique O-F RH combustors to boost the inlet steam-CO₂ temperature, improving overall plant efficiency by up to 10%. This approach fields high-temperature steam turbines faster and less expensively by utilizing gas turbines already capable of high inlet temperatures. In a two-phased approach, CES first modified an aero-derivative aircraft turbine (J79) to accept the steam-CO₂ drive gas by removing its compressor, quadrupling its potential electrical power output. In a joint effort with Florida Turbine Technologies (FTT), an existing J79 turbine combustor “can” was modified to an O-F RH combustor configuration and hot-fired to confirm FTT modeling predictions of temperature and pressure profiles. Figure 2 is a cutaway view of a single-can J79 RH combustor.

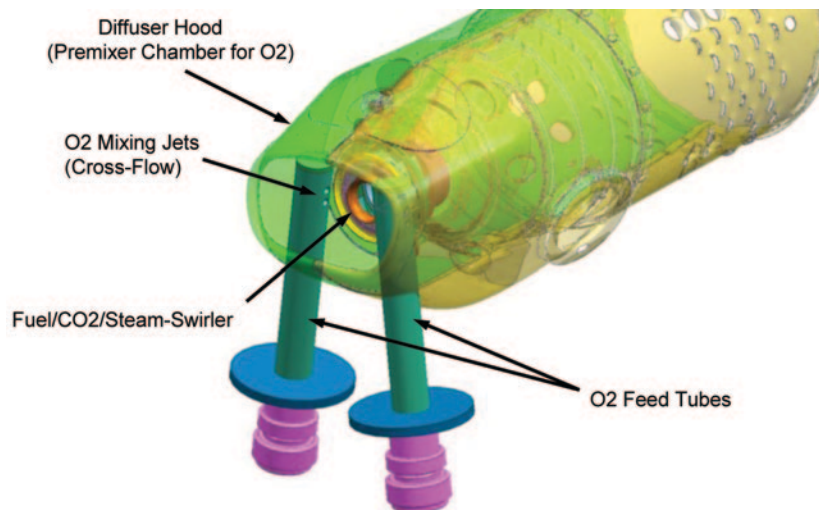

Figure 2: Cutaway Image of J79 Oxy-Fuel Combustor

The second phase of O-F turbine development is the re-engineering of a commercial-scale gas turbine, the 50-MWe Siemens SGT-900, to an O-F IPT (OFT-900) capable of tripling the original turbine's power output by up to 150 MWe. FTT, under contract to CES, is re-engineering the SGT-900 and will provide detailed manufacturing drawings for the conversion to an OFT-900. Siemens Energy will then manufacture and install the new O-F IPT components on a refurbished SGT-900. The converted IPT will then be tested at low power at CES's test facility. Figure 3 shows a conceptual drawing of the OFT-900; a section of the top casing removed to show interior detail.

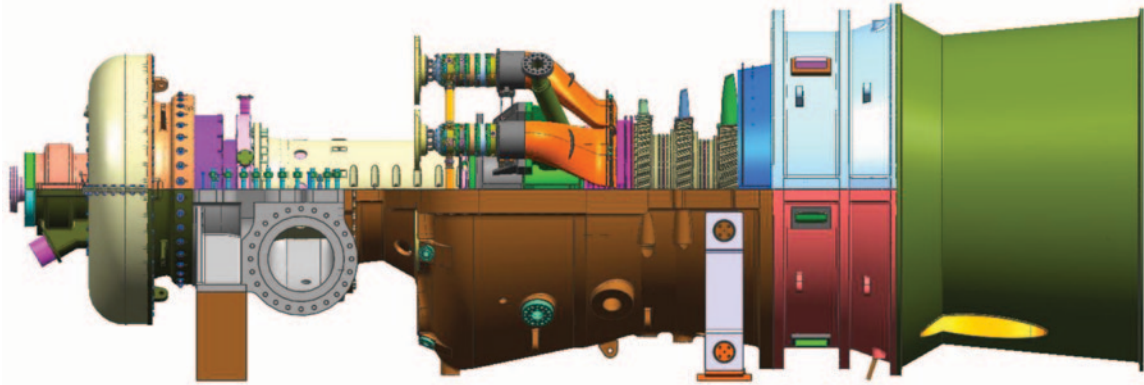

Figure 3: OFT-900 Concept Drawing (Top Casing Removed to Show Detail)

In support of the OFT IPT design, CES is conducting a parallel development of two O-F RH combustor designs, an aero-derivative approach led by the FTT development team, and a platelet-style design by CES engineers who developed the main O-F combustor. A half-annulus of the CES-style OFT-900 RH combustor is shown in Figure 4, with transitions to turbine inlet.

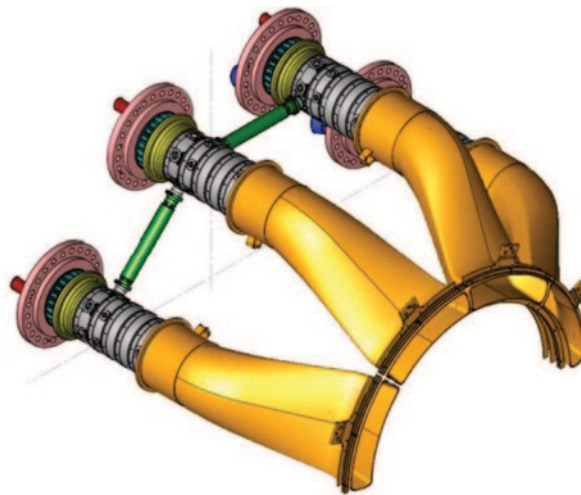

Figure 4: CES RH Combustor Concept with Cross-Fire Tubes and Transition Duct to O-F Turbine Inlet

CES will upgrade its test facility as necessary to support OFT-900 testing, while Siemens fabricates the OFT-900. The OFT will be installed at the test site and integrated with CES's main O-F combustor. After the turbine and its support systems are commissioned, approximately one year of integrated testing of the OFT-900 and O-F combustor will be conducted.

Technology Advantages

O-F Combustor:

An O-F combustor can burn a variety of fossil and renewable fuels to produce a drive gas consisting of steam and readily separable CO₂. This process (the CES cycle) yields a base-load power cycle that captures virtually 100% the CO₂ emissions through condensation of the steam from the effluent. In addition, the high-temperature drive gas produced by the O-F combustor enables higher-efficiency power cycles when coupled with high-temperature turbines.

High Temperature Turbine:

The capabilities of advanced, high-temperature turbines [up to 1,204 °C (2,200 °F)] permits plant heat rate improvements of 25% compared to conventional steam turbines. By utilizing modified gas turbines as O-F IPTs, development schedules and costs are significantly reduced, allowing accelerated deployment of high-temperature, O-F compatible steam turbo-generators to the market.

R&D Challenges

High Temperatures:

Equipment is subjected to increased stress, potentially increasing maintenance/ reducing life cycles.

Steam/CO₂ Drive Gas:

Condensate from steam/CO₂ drive gases is acidic (carbonic acid), requiring the use of costlier, corrosion-resistant materials. Also, steam/CO₂ transfers heat to metal surfaces more readily than the drive gases from air-fuel combustion, requiring provision for more effective cooling, including use of steam and/or CO₂ as a cooling medium instead of air.

Results To Date/Accomplishments

- Completed a detailed design of a 100 MW_{th} oxy-syngas combustor and its enclosure. In parallel, built mirror-image 170 MW_{th} NG-fired O-F combustor, commissioned unit, and began hot-fire testing. Ignition tests and low-power operations conducted to-date with good results. Lessons learned applied to syngas combustor enclosure design.
- Completed hot-fire testing of the J79 O-F RH combustor. FTT modeling showed excellent correlation with cold-flow testing, though discrepancies between predictions and results occurred during hot-fire tests. FTT has updated its combustor model to reflect test results—the revised combustor model will be used in designing the O-F reheaters for the OFT-900. J79 O-F RH combustor had ignition difficulties due to poor mixing of reactants, but combustor ran well after ignition, showing good turn-down capabilities and resistance to flame out.
- Completed design of CES's platelet O-F RH combustor. This design is the first of two OFT-900 RH combustor alternatives. CES design is undergoing computational fluid dynamics (CFD) analysis to verify uniform mixing and desired exhaust temperature profiles, and minimal pressure losses are achieved before being released for manufacture.
- Completed engineering design of the O-F IPT assemblies, excepting the O-F RH combustor. FTT engineering activities are now focused on completing FTT's O-F RH combustor design (second RH combustor design alternative), life modeling of the O-F turbine, and completion of individual assembly drawings.
- Purchased used SGT-900 for conversion to OFT-900.

Next Steps

- Submit CES drawing packages for 100 MW_{th} O-F syngas combustor, enclosure/piping drawings, and enclosure technical specification.
- Complete detailed manufacturing drawings for OFT-900 assemblies.
- Complete analyses and detailed engineering drawings for both FTT and CES OFT-900 O-F RH designs.
- Removal and shipment of SGT-900 to Siemens facility for refurbishment.
- Award contract(s) for subsystem modifications required to upgrade test facility to accommodate O-F combustor and OFT-900 operations.
- Determine fuels and develop test plan for pilot-scale alternative fuels testing with a CES O-F combustor.

Available Reports/Technical Papers/Presentations

Anderson, R., Viteri, F., Hollis, R., Keating, A., Shipper, J., Merrill, G., Schillig, C. Shinde, S., Downs, J., Davies, D., and Harris, M., 2010, "Oxy-Fuel Gas Turbine, Gas Generator and Reheat Combustor Technology Development and Demonstration," ASME Paper No. GT2010-23001.

Anderson, R., Viteri, F., Hollis, R., Hebbbar, M., Downs, J., Davies, D., and Harris, M., 2009, "Application of Existing Turbomachinery for Zero Emissions Oxy-Fuel Power Systems," ASME Paper No. GT2009-59995.

Anderson, R., MacAdam, S., Viteri, F., Davies, D., Downs, J., and Paliszewski, A., 2008, "Adapting Gas Turbines to Zero Emission Oxy-Fuel Power Plants," ASME Paper No. GT2008-51377.

Hustad, C., 2008, "Development of Low and Zero Emission Fossil Fuel Power Generation in Emerging Niche Markets," ASME Paper No. GT2008-50106.

Keating, A., "Alternative Synthetic Fuels Injector Tests," EISG Report on Project EISG 04-10, California Energy Commission Grant #54085A, July 2007.

Pronske, K., Trowsdale, L., MacAdam, S., Viteri, F., Bevc, F., and Horazak, D., 2006, "Overview of Turbine and Combustor Development for Coal-Based Oxy-Syngas Systems," ASME Paper No. GT2006-90816.

Anderson, R., Baxter, E. and Doyle, S., "Fabricate and Test an Advanced Non-Polluting Turbine Drive Gas Generator," Final Report under DE Cooperative Agreement No. DE-FC26-00NT 40804, 1 September 2000 to 1 June 2003.

Anderson, R., "Development of a Unique Gas Generator for a Non-Polluting Power Plant," EISG Report on Project EISG 99-20, California Energy Commission Grant #99-20, May 2001.

OXYGEN-FIRED CO₂ RECYCLE FOR APPLICATION TO DIRECT CO₂ CAPTURE FROM COAL-FIRED POWER PLANTS

Primary Project Goals

Southern Research Institute (SRI) is designing and developing carbon dioxide (CO₂) recycle technology for oxy-combustion retrofit applications.

Technical Goals

The technical goals of this project are to:

- Modify the 1-MW_{th} pilot-scale Combustion Research Facility (CRF) to allow oxy-combustion and CO₂-recycle operations.
- Design, manufacture, and install an oxy-combustion burner specifically for the CRF.
- Collect data on furnace temperatures, unburned carbon (UBC), gas composition, and flow rates into and out of the furnace.
- Evaluate the effect of various parameters, including firing configuration, oxygen (O₂) purity, CO₂ recycle rate, O₂ concentration, and coal type.

Technical Content

SRI is developing flue gas recycle for oxy-combustion retrofit application to coal-fired utility boilers in order to avoid the excessive flame temperatures that are associated with oxy-combustion and to maintain flow and heat-transfer requirements in the furnace and convective sections.

SRI is conducting the pilot-scale, oxy-combustion experiments using a modified CRF. Figure 1 contains a diagram that represents the CRF with the necessary modifications. These modifications include the addition of an O₂ storage tank and concrete pad; O₂ skid, control, and safety systems; a new burner by Maxon that is designed for O₂ combustion and CO₂ recycle; the additional ducting to allow flue gas recirculation to the burner; and the decrease in ducting size to account for smaller flue gas flow rate.

Technology Maturity:

Pilot-scale using actual flue gas, 25 tonnes of CO₂/day

Project Focus:

Evaluation of Gas Recycle for Oxy-Combustion

Participant:

Southern Research Institute

Project Number:

NT42430

NETL Project Manager:

Timothy Fout
Timothy.Fout@netl.doe.gov

Principal Investigator:

Thomas Gale
 Southern Research Institute
gale@sri.org

Partners:

CORR Systems
 Doosan Power Systems
 Linde Gas
 Maxon Corporation
 Reaction Engineering International
 Southern Company

Performance Period:

9/27/05 – 9/25/10

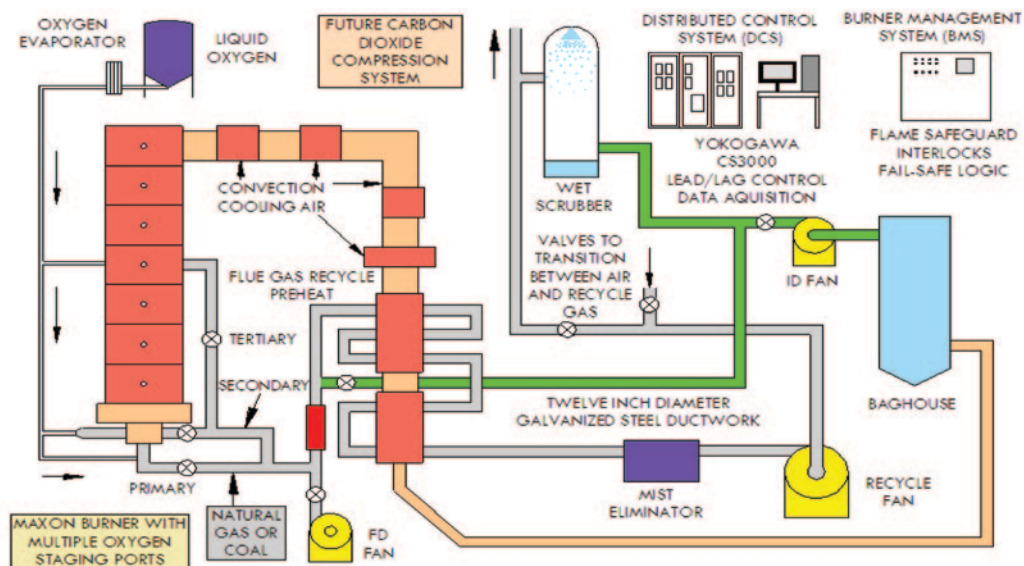

Figure 1: Diagram of the Modified CRF

The CRF is used to investigate the effects of coal type, firing staging, percentage of flue gas recycled, and O₂ purity on oxy-combustion.

In addition to flue gas recirculation, an advanced O₂ burner developed by Maxon is used to allow the flame shape and heat released to be controlled and to provide a stable attached flame. Figure 2 is an image of the flame produced by the oxy-combustion burner.

A preliminary test was performed on the Maxon burner using Illinois Bituminous coal. The test chamber was heated to 2,400 °F with 3% excess O₂. Performance of the burner under air-fired conditions resulted in a nitrogen oxides (NO_x) emission rate of 0.3–0.4 lbs/MMBtu. However, oxy-combustion testing resulted in a lower emission rate of 0.16–0.18 lbs NO_x/MMBtu.

Reaction Engineering International (REI) updated a computational fluid dynamics (CFD) model of the CRF facility to predict oxy-combustion burner performance. The model describes temperatures, reaction rates, char burnout, and NO_x formation and/or destruction as a function of O₂ purity, stoichiometry, coal type, staging, furnace exit O₂ (FEO), and fuel processing. The model was validated by the CRF oxy-combustion experiments and can be utilized for any follow on preliminary designs for project scale up.

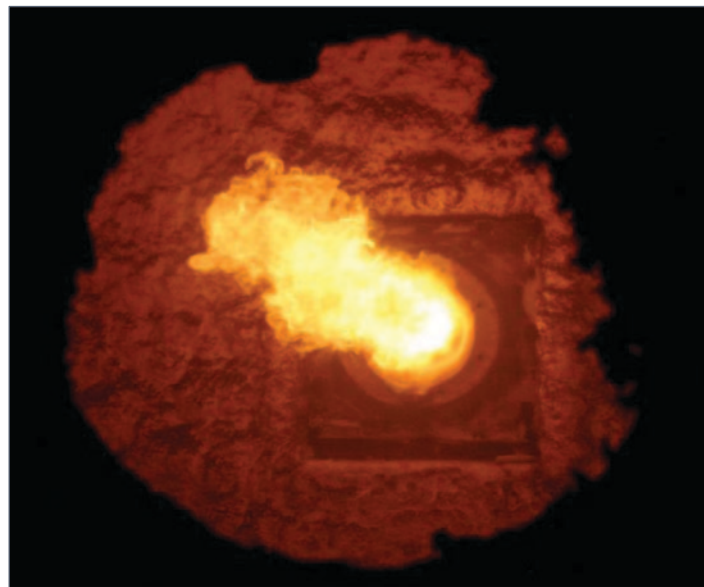

Figure 2: Image of Maxon Oxygen Burner Flame

Technology Advantages

- The oxy-combustion burner is able to maintain a stable attached flame and can light off without natural-gas assist.
- The reduced volume of flue gas produced under oxy-combustion conditions should be less expensive to purify and compress for CO₂ sequestration than flue gas of a conventional air-fired, pulverized coal (PC) plant.

- For plants burning Powder River Basin (PRB) coal, recycling dry flue gas through the coal pulverizers should minimize concern of pulverizer fires.
- Oxy-combustion burners and flue gas recycle rate can be tuned to achieve low-cost operation (i.e., minimize recycle) and maximum heat transfer for a given boiler type and plant configuration.
- Advanced thermodynamic cycles can recover some of the energy penalty associated with air separation for new power plant applications.

R&D Challenges

- Reduce cost of oxy-combustion retrofit for existing plants.
- Reduce energy penalty for O₂ production, which is approximately 25% for conventional cryogenic process.
- Address potential corrosion of low-temperature ductwork and equipment due to flue gas recycle.

Results To Date/Accomplishments

- Completed the oxy-combustion and flue gas recycle retrofit of the CRF.
- Completed the update of the CFD model for oxy-combustion and flue gas recycle.
 - The CFD model was used to predict the flame geometry and temperatures in the CRF and make a comparison with the air-fired case.
 - The CFD model predictions were consistent with the experimental data in showing that the O₂-fired Maxon burner produced lower flame temperatures than the air-fired burner.
- Conducted oxy-combustion and flue gas recycle testing using the CRF.
 - The Maxon staged oxy-combustion burner produced a stable flame over a significant range of firing turn-down, staging, and while firing five different U.S. coal types, including three eastern bituminous coals, a PRB sub-bituminous coal, and a western bituminous coal.
 - The parametric testing included extent of recycle and recycle turndown, FEO percentage, O₂ staging in the burner cup, burner quarl, secondary recycle, and overfire recycle. The load was also varied with and without changes in the amount of recycle flow.
 - The oxy-combustion burner produced lower flame temperatures than for air firing, which should enable safe operation, reduction of recycle flow without concern about furnace flame temperatures, and could be effective at reducing slagging and fouling in the boiler and super heater for full-scale applications.
 - The temperature/time profile was affected by four main factors: (1) the difference in load, (2) the difference in recycle flow back to the furnace and the absence of nitrogen (N₂) flow, (3) the difference in the Maxon oxy-burner design and an air-burner design, and (4) the difference in diffusivity of CO₂ and N₂.
 - Hydrochloric (HCl) acid concentration in the flue gas was consistent with the coal chlorine content and no buildup of HCl was observed via flue gas recirculation.
 - The sulfur dioxide (SO₂) concentration in the flue gas was consistent with the coal sulfur content and no build up was observed via flue gas recirculation.
 - The carbon monoxide (CO) levels were also consistent with that of air firing, and the CO concentration had a significant correlation with only one parameter, that of FEO. Above 1.5% FEO, the CO concentration was around 50 parts per million by volume (ppmv); below 0.5% FEO, the CO concentration could reach hundreds of ppmv.

- The relation of UBC in the ash with FEO was consistent with that of CO. The UBC in the ash increased with increased furnace staging similar to air firing.
- NO_x emissions were high under baseline oxy-combustion conditions. However, NO_x emissions were dramatically reduced with staging of the O₂ in the secondary recycle gas and overfire-recycle flue gas.
- The control system and retrofit concept allowed safe and controlled startup, changing of conditions, continuous operation without buildup of moisture, acid gases, pollutants, or other problems, and yielded efficient combustion of the coal and associated volatile gases.

Next Steps

Project completed September 2010. Final report is under review by NETL.

Available Reports/Technical Papers/Presentations

General project information is available on DOE/NETL website at: <http://www.netl.doe.gov/technologies/coalpower/ewr/co2/oxy-combustion/o2firedco2recycle.html>

“Oxy-Fired CO₂ Recycle for Application to Direct CO₂ Capture from Coal-Fired Power Plants,” 34th International Technical Conference on Coal Utilization and Fuel Systems, Clearwater, FL, June 2009.

“Oxy-Fired CO₂ Recycle for Application to Direct CO₂ Capture from Coal-Fired Power Plants,” Annual NETL CO₂ Capture Technology for Existing Plants R&D Meeting, Pittsburgh, PA, March 2009. <http://www.netl.doe.gov/publications/proceedings/09/CO2/index.html>

MULTI-POLLUTANT CONTROL THROUGH NOVEL APPROACHES TO OXYGEN ENHANCED COMBUSTION

Primary Project Goals

Washington University is developing best practices for implementing oxy-fuel combustion with flue gas recirculation and sorbent processes to minimize nitrogen oxides (NO_x), sulfur oxides (SO_x), particulate matter (PM_{2.5}), and mercury (Hg) emissions, and maximize combustion efficiency and the concentration of carbon dioxide (CO₂) in the flue gas through research and experimentation.

Technical Goals

- Measure NO_x emissions resulting from air- and oxy-combustion with CO₂ recirculation.
- Determine the effect of CO₂ recirculation on Hg capture, combustion temperature, flame geometry, etc.
- Experimentally determine the optimum approach to mixing coal, oxygen (O₂), CO₂, and sorbents.
- Determine the effect of the steam temperature to identify the optimum preheating conditions for minimized emissions.
- Develop nano-structured sorbent technologies to reduce Hg emissions.

Technical Content

Oxy-combustion offers several advantages over traditional air-combustion technologies, including higher temperatures and smaller flue gas volume. However, in order to maintain the combustion temperatures at a level that existing, cost-effective materials can handle, the O₂ must be diluted to approximate atmospheric levels. Washington University is researching oxy-combustion that utilizes recirculated flue gas, causing the CO₂ levels in the final flue gas stream to be increased to levels greater than 95%, and controls emissions of NO_x, PM_{2.5}, and Hg.

Washington University has also been performing flame types and stability studies for oxy-combustion facilities. The experiments used a 10-25 kW down-fired coal combustor consisting of a non-swirling primary oxidizer (PO) and a swirling secondary oxidizer (SO). The system is run under slight negative pressure and the primary oxidizer preheat temperature was maintained between 300 and 350 °C. Table 1 shows the mole fractions of each component in the PO and SO for all flame studies.

Results from these studies showed that 30 mole percent O₂ is required when using CO₂ as the inert gas to obtain stability results similar to conventional coal air-combustion. Also, inert exchange flames were shown to improve flame stability when compared with conventional coal air-combustion despite the O₂ concentration in the PO being substantially reduced.

Technology Maturity:

Laboratory/pilot scale, 1.2 tonnes CO₂/day

Project Focus:

Multi-Pollutant Control

Participant:

Washington University

Project Number:

NT42531

NETL Project Manager:

Sara Zenner
Sara.Zenner@netl.doe.gov

Principal Investigator:

Richard L. Axelbaum
 Washington University
rla@wustl.edu

Partners:

None

Performance Period:

8/29/05 – 2/28/09

Table 1: Flame Types for Oxy-Coal Flame Stability Study

Type	PO Mole Fraction			SO Mole Fraction			T _m * (K)	T _{NB} ** (K)	
	% O ₂ in PO/SO*	O ₂	N ₂	CO ₂	O ₂	N ₂	CO ₂	Fluent Simulation	
A	6% / 35%	6	94	0	35	65	0	2,420	1,860
B	15% / 25%	15	85	0	25	75	0	2,440	1,860
C	21% / 21%	21	79	0	21	79	0	2,480	1,860
D	21% / 25%	21	79	0	25	75	0	2,600	1,930
E	21% / 35%	21	79	0	35	65	0	2,850	1,950
F	25% / 25%	25	75	0	25	75	0	2,720	1,940
G	35% / 21%	35	65	0	21	79	0	—	—
H	35% / 35%	35	65	0	35	65	0	3,010	2,070
I	21% / 35% (N ₂ /CO ₂)	21	79	0	35	0	65	—	—
J	25% / 25% CO ₂ **	25	23	52	25	0	75	—	—
K	30% / 30% CO ₂ **	30	21	49	30	0	70	—	—
L	35% / 21% CO ₂ **	35	23	42	21	0	79	—	—
M	35% / 35% CO ₂ **	35	25	40	35	0	65	—	—

Notes: Values for component compositions are accurate +/-2%.

1. + Inert balance in both PO and SO is nitrogen (N₂), unless otherwise indicated.
2. ++ Due to eductor, inert balance in PO is not entirely CO₂.
3. * Maximum temperature in temperature profile, as determined from modeling.
4. ** Maximum flame temperature one inch from downstream from burner exit, as determined from modeling.

Technology Advantages

Oxy-combustion offers increased temperature, increased thermal efficiency, reduced pollutant emissions, reduced fuel consumption, and improved flame stability. Oxy-combustion alone, and coupled with unique burner designs, can reduce NO_x emissions beyond levels achieved by using overfire air and low-NO_x burners. Also, oxy-combustion with flue gas recirculation concentrates CO₂ levels, helping to reduce the cost of capture; concentrations up to 95% can be achieved.

R&D Challenges

It was found that the flame structure of non-premixed systems is changed dramatically when oxy-combustion is used.

Results To Date/Accomplishments

- Completed modifications to the oxy-coal combustor to minimize air leakage.
- Developed an understanding of flame geometry under oxy-fuel combustion.
- Developed a simple model that explains the presence of appreciable molecular O₂ at the location of peak temperature in high oxy-fuel combustion.
- Obtained NO_x measurements as a function of stoichiometric mixture fractions for a system that maintained a methane flame at both constant temperature and fuel flow rate.
- Examined the effect of replacing nitrogen (N₂) with CO₂ on the jet exit velocity at start-up for non-premixed jet flames of ethylene.
- The performance of titanium dioxide (TiO₂) with UV irradiation for Hg capture was tested in a bench- and pilot-scale system.

- Flame stability in a Type I laboratory-scale pulverized coal combustor was quantified as a function of inert gas type and O₂ concentration in both the primary and secondary oxidizer streams.
- Developed a model of soot inception limits under oxy-fuel combustion conditions and validated with gaseous fuels.
- Completed a study of blow-off limits in oxy-coal combustion.
- Demonstrated that the approach used to mixing the oxy-coal flame can lead to stronger flames even with reduced O₂ in the primary region.

Next Steps

Project completed February 2009.

Available Reports/Technical Papers/Presentations

Final Report: <http://www.osti.gov/bridge/purl.cover.jsp;jsessionid=1D534757947F8B04FBF869761C2461AD?purl=/981333-x4gI1M/>

C. E. Baukal, *Oxygen Enhanced Combustion*. CRC Press LLC: Boca Raton, 1998; p 490.

C. J. Sung; C. K. Law, *Proc. Combust. Inst.* 27 (1) (1998) 1411-1418.

F. Chatel-Pelage; R. Varagani; P. Pranda; N. Perrin; H. Farzan; S. J. Vecci; Y. Lu; S. Chen, *Thermal Science* 10 (3) (2006) 119-142.

L. Bool; H. Kobayashi; D. Thompson; E. Eddings; R. Okerlund; M. Cremer; D. Wang, 19th Annual International Pittsburgh Coal Conference, Pittsburgh, PA, September (2002).

A MECHANISTIC INVESTIGATION OF NITROGEN EVOLUTION AND CORROSION WITH OXY-COMBUSTION

Primary Project Goals

Brigham Young University (BYU) is investigating the evolution of nitrogen from its origin in coal to emissions in both air- and oxy-combustion. A model of detailed kinetics, devolatilization, and char oxidation in a simple plug flow is also being developed and used to interpret the data.

Technical Goals

- Modify the flat flame burner (FFB) to run using simulated oxy-fuel combustion.
- Modify the multi-fuel flow reactor (MFR) to run with simulated oxy-fuel combustion.
- Gather data through experimental measurements of gas species in air-fired and oxy-fuel pulverized coal flames.
- Develop a computational model of the combustion process, including fuel devolatilization, gas phase kinetic mechanisms, and char oxidation.

Technical Content

The experiments were performed at two facilities designed to investigate the evolution of coal nitrogen species, fuel nitrogen oxide (NO_x) formation, and emissions during combustion processes in air and oxygen (O_2)/carbon dioxide (CO_2) mixtures. A model of detailed kinetics, devolatilization, and char oxidation in a plug flow operation was developed and used to interpret the data collected.

In the experiments performed by BYU, the flue gas was not recycled. Rather, bottled CO_2 was used to simulate dry recycled flue gas. While the results are applicable to entrained-flow pulverized coal combustion in general, the absence of turbulence in the laminar flow experiment is a notable difference from any practical combustor.

Pulverized coal was burned in a refractory-lined, laminar flow reactor referred to as the MFR, shown in Figure 1.

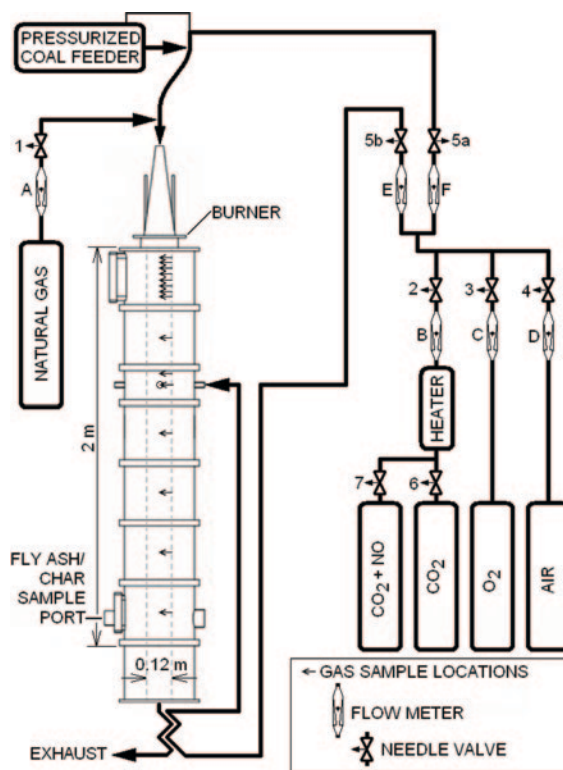

Figure 1: Schematic of the Multi-Fuel Flow Reactor

Technology Maturity:

Pilot-scale using simulated flue gas, 0/05 tonnes CO_2 /day

Project Focus:

NO_x Behavior in Oxy-Combustion

Participant:

Brigham Young University

Project Number:

NT42530

NETL Project Manager:

Arun Bose

Arun.Bose@netl.doe.gov

Principal Investigator:

Dale R. Tree

Brigham Young University

treed@byu.edu

Partners:

Air Liquide

Performance Period:

8/4/05 – 12/31/08

The unit at the first facility was a premixed, down-fired staged reactor where the first stage was fuel-rich followed by a burnout oxidizer stage. The oxidizer was varied from air [23% O₂ by mass in nitrogen (N₂)] to two different mixtures of O₂ and CO₂ (25% and 30% O₂ by mass). The coals used were Pittsburgh #8, Illinois #6, and Powder River Basin (PRB). Selected coal properties are shown in Table 1.

Table 1: Selected Properties of the Coals

	Sub-Bituminous	Illinois #6	Pittsburgh #8
Proximate Analysis	DAF wt%	DAF wt%	DAF wt%
Volatile Matter	49.72	44.17	41.96
Fixed Carbon	50.28	55.83	58.04
Ash (wt%, dry)	6.42	9.31	10.67
Higher Heating Value (Btu/lb, DAF)	11,981	14,226	14,785
ASTM Rank	Sub-bituminous A	High-volatile C bituminous	High-volatile A bituminous
Ultimate Analysis	DAF wt%	DAF wt%	DAF wt%
C	70.56	81.88	85.19
H	4.18	4.37	4.87
O	23.63	7.83	4.70
N	1.04	1.27	1.38
S	0.59	4.64	3.86
Total	100	100	100

Both the air and mixture cases produced a rapid initial formation of nitric oxide (NO), with a similar amount of total fuel nitrogen converted to NO. In air combustion, NO can be either formed or reduced by thermal equilibrium forces dependent on the local equivalence ratio. At an initial or primary zone stoichiometric ratio (SR) of 0.82, air combustion appeared to produce thermal NO; while at an SR of 0.65, no evidence of thermal NO is seen. In oxy-combustion, initial NO formation produced concentrations above equilibrium, creating a situation where NO was being destroyed by thermal processes at all measured SR.

There is competition between the NO destruction in the fuel-rich region and the NO formation at tertiary air injection, which creates an effluent out of NO minimum for each oxidizer. The magnitude of the minimum was similar for air- and oxy-fuel combustion; however, the SR at the minimum was higher for oxy-fuel combustion, suggesting that oxy-fuel combustion does not require as deep of a staging environment to achieve NO_x reduction and can therefore achieve higher burnout.

The second facility included an FFB with particle and gas sampling. Char particles were sampled after passing through either air- or oxy-flames. In oxy-flames, the normal diluents of N₂ were replaced with CO₂. The ratio of O₂/CO₂ was varied in order to produce different flame temperatures. There was little difference observed between air- and oxy-fuel pyrolysis of coals.

The probe, shown in Figure 2, was used to sample gas in the reactor.

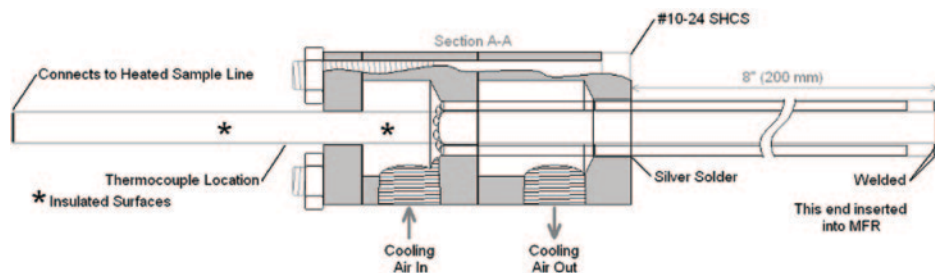

Figure 2: Diagram of the Air-Cooled Gas Sampling Probe

In unstaged, premixed combustion, air- and oxy-fuel combustion produced similar levels of fuel nitrogen conversion to NO_x. Low NO_x emissions from oxy-fuel combustion are therefore not achieved without staged mixing of the oxidizer and fuel as is the case for conventional air combustion.

Technology Advantages

The research will supply information that will significantly aid in the development of oxy-combustion technology.

R&D Challenges

Due to the use of bottled CO₂ to simulate dry recycled flue gas, there was an absence of turbulence in the laminar flow experiment, which creates a notable difference from any practical combustor. This could possibly lead to difficulties when scaling to a commercial plant.

Results To Date/Accomplishments

- Modified the FFB to run using simulated oxy-fuel combustion.
- Modified the MFR to run with simulated oxy-fuel combustion.
- Completed air- and oxy-combustion NO_x profiles with 500 parts per million (ppm) NO added to the reactants to determine the extent of reburning in oxy-combustion.
- Completed a staged combustion experiment of NO_x and major gas species profiles in the MFR.
- Produced a full kinetic mechanism model of oxy-fuel combustion.

Next Steps

Project completed December 2008.

Available Reports/Technical Papers/Presentations

Allam, R. J., R. S. Panesar, V. White, D. Dillon (2005) *Optimising the design of an Oxyfuel-Fired Supercritical PF Boiler*, The 30th International Technical Conference on Coal Utilization and Fuel Systems, April 17–21, 2005, Clearwater, FL.

Andersson, K. (2007) *Combustion Tests and Modeling of the Oxy-fuel Process, An Overview of Research Activities at Chalmers University*, 2nd IEAGHG International Oxy-Combustion Workshop, January 25–26, 2007, Windsor, CT.

Asay, B. W. (1982) *Effects of Coal Type and Moisture Content on Burnout and Nitrogenous Pollutant Formation*, Ph.D. Dissertation, Brigham Young University, Provo, UT.

Bose, A. C., K. M. Dannecker, J. O. L. Wendt (1988) *Coal Composition Effects on Mechanisms Governing the Destruction of NO and Other Nitrogenous Species during Fuel-Rich Combustion*, Energy and Fuels 2:301–308.

CANMETENERGY CO₂ R&D CONSORTIUM

Primary Project Goals

The CanmetENERGY CO₂ R&D Consortium (Consortium) is conducting oxy-fuel combustion research and development (R&D) using a 0.3 MW_{th} (1 million Btu/h) modular pilot-scale facility. The Consortium has completed nine successive phases of R&D that include oxy-fuel combustion, advanced power cycles, integrated multi-pollutant control, and carbon dioxide (CO₂) capture and compression technologies.

Technical Goals

The technical goal of the Consortium is to develop advanced energy conversion technologies with near-zero emissions for improved efficiency and commercial competitiveness for capture of CO₂ and air pollutants resulting from combustion of fossil fuels. One emphasis of the Consortium research program is the oxy-fuel combustion technology. Since combustion takes place in an oxygen (O₂)-enriched environment, the flue gas comprises mainly CO₂, water, and minor impurities. This CO₂-rich flue gas stream can then be purified, dried, and compressed for pipeline transport and use or permanent storage in geological formations. Oxy-fuel combustion also results in efficiency advances of high flame temperatures and reduced equipment sizes due to lower gas volume.

Technical Content

The Consortium activities in the past have included experimental investigations using coal; coal slurry; bitumen and natural gas to study the characteristics of oxy-fuel combustion; advanced near-zero emissions Brayton and Rankine cycles; solid oxide fuel cell modeling; multi-pollutant capture research for integrated removal of fine particulates, nitrogen oxide (NO_x), sulfur oxide (SO_x), and mercury (Hg); advanced oxy-fuel combustion processes and co-firing with opportunity fuels such as petroleum coke; system components and prototype design and pilot-scale testing; and modeling and development of new CO₂ capture and compression processes.

The latest completed Phase 9 of the Consortium's program included the development of a CO₂ capture and compression unit (CO₂CCU). This unit is capable of separating and compressing CO₂ from combustion flue gas streams for pipeline transport and storage. Part of this work involved the development of a CO₂ high-pressure test cell for studying CO₂ phase change, generating vapor-liquid equilibrium (VLE) data, and studying the impact of impurities in the flue gas stream on the capture processes. This has important practical applications relating to the CO₂ pipeline, material selection, and commercial design of these systems. Other ongoing R&D activities include the modeling of advanced supercritical oxy-coal plants with CO₂ capture; cost analysis; the development and testing of multi-pollutant control strategies, as well as testing in oxy-steam mode; and optimization of a novel multi-function oxy-fuel/steam burner.

Figure 1 shows the major process components comprising the 0.3 MW_{th} oxy-fuel Vertical Combustor Research Facility (VCRF) integrated with the CO₂CCU. The overall pilot-scale research facility is used to develop pollutant control technologies that incorporate a fabric filter or electrostatic precipitator (ESP) for particulate capture, condensing heat exchangers and/or SO_x scrubbing to remove acid gases and oxidized Hg from the flue gas combustion stream.

Technology Maturity:

Pilot-scale research

Project Focus:

Engineering Assessment of Oxy-Combustion

Participant:

CanmetENERGY

Project Number:

IEA-CANMET-CO2

NETL Project Manager:

Timothy Fout
Timothy.Fout@netl.doe.gov

Principal Investigator:

Dr. Kourosh Zanganeh
 Natural Resources Canada-
 CanmetENERGY
Kourosh.Zanganeh@nrcan.gc.ca

Partners:

Phase 9 Consortium Members:
 Ontario Power Generation,
 SaskPower, Governments of
 Canada and Alberta, Babcock
 & Wilcox, U.S. Department of
 Energy, and the CO₂ Capture
 Project (CCP2)

Performance Period:

9/30/99 – 12/31/09

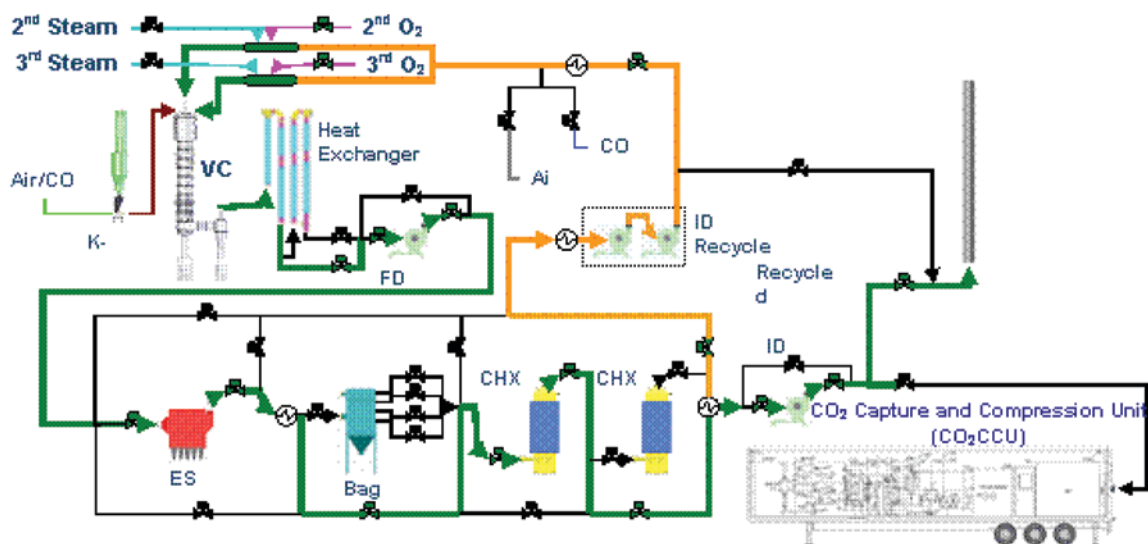

Figure 1: Schematic of the CanmetENERGY's Integrated Oxy-Fuel Vertical Combustor Research Facility

Figure 2 displays the pilot-scale CO₂CCU. The CO₂CCU is capable of processing CO₂ flue gas streams at a maximum rate of 160 Kg/hr with CO₂ concentrations of 50% or higher (in dry volume) to produce a CO₂ product stream with more than 95% purity.



Figure 2: CanmetENERGY's CO₂ Capture and Compression Unit

The high-pressure CO₂ test cell and its high-pressure viewing chamber (HPVC) shown in Figure 3 were used to create super-critical CO₂ and study the CO₂ phase change in a controlled environment. The chamber can handle a maximum pressure of 200 atm and a temperature range of -60 to 150 °C. There are two gas and liquid sample ports located at different heights and optical windows with a camera for observations inside the chamber to study the CO₂ liquid-gas interface.



Figure 3: CanmetENERGY's High-Pressure CO₂ Test Cell and Bench-Scale Facility

Technology Advantages

The program allows research to be carried out at a pilot scale small enough to reduce the overall R&D cost, while the experiments scale is sufficiently large enough to provide proof-of-concept before proceeding to a larger and more costly medium-scale pilot technology demonstration.

R&D Challenges

- Integration and cycle development for O₂/flue gas recirculation (FGR), O₂ combustion, and hydroxy-fuel combustion of fossil fuels in different advanced cycles.
- Improving the understanding of combustion, heat transfer, and emissions in oxy-fuel combustion.
- Development of environmental multi-pollutant controls for NO_x, SO_x, Hg, and particulates.
- Minimizing energy demand for O₂ production while keeping the O₂ purity high.
- Decreasing energy consumption for capture and compression of CO₂.

Results To Date/Accomplishments

- Developed new, ultra-low NO_x oxy-combustion burner and tested the prototype burners in VCRF with sub-bituminous and lignite coals.
- Determined that FE³⁺ salts were capable of oxidizing Hg and achieved a 75% Hg oxidation with an optimal pH between 1 and 3 on bench-scale tests.
- Increased the computational fluid dynamic (CFD) tools for model simulation of oxy-combustion flame characteristics.
- Created a CO₂ capture and compression process simulator and implemented a pilot-scale CO₂ capture research facility that has enhanced the program's CO₂ research capabilities.

- Developed new advanced gas turbine and high-efficiency fuel cell-based power generation cycles.
- Developed models of advanced supercritical oxy-coal plants with CO₂ capture and cost models for economic analysis.
- Developed and tested multi-pollutant control strategies and processes.
- Conducted testing in oxy-steam mode for pulverized coal and performed optimization of a novel multi-function oxy-fuel/steam burner.

Next Steps

DOE/NETL participation in this project ended December 2009. A final report is not available.

Available Reports/Technical Papers/Presentations

General project information is available on DOE/NETL website at: <http://www.netl.doe.gov/technologies/coalpower/ewr/co2/oxy-combustion/canmet.html>

“Novel Oxy-Steam Burner for Zero-Emission Power Plants,” 1st International Oxy-Fuel Combustion Conference, Cottbus, Germany, September 2009.

“Performance of an Advanced Pilot-Scale CO₂ Capture and Compression Unit,” 1st International Oxyfuel Combustion Conference, Cottbus, Germany, September 2009.

“An Integrated Approach for Oxy-fuel Combustion with CO₂ Capture and Compression,” 7th Annual Conference on CCS – May 5–8, 2008.

EVALUATION OF CO₂ CAPTURE/UTILIZATION/ DISPOSAL OPTIONS

B-313

OXY-COMBUSTION

Primary Project Goals

Argonne National Laboratory (ANL) is conducting comparative engineering assessments of carbon dioxide (CO₂) capture retrofit technologies with a focus on oxy-combustion and its possible use as a transitional strategy to integrated gasification combined cycle (IGCC) with carbon capture and storage (CCS).

Technical Goals

- Develop engineering evaluations for oxy-combustion CO₂ capture from existing pulverized coal (PC)-fired power plants retrofitted for flue gas recirculation.
- Identify existing power plants that may be retrofit candidates, considering the effects of coal characteristics and the accessibility of a sequestration site.
- Investigate the potential cost-effectiveness of oxy-combustion retrofits with the All-Modular Industry Growth Assessment (AMIGA) model, regarding least-cost investment and ranking, as well as dispatch order and energy use in the economy.

Technical Content

The project is conducting engineering assessments and economic evaluations on retrofitting PC boilers with oxy-combustion and then eventually repowering the site with IGCC. The engineering assessment for oxy-combustion is being conducted with the ASPEN process model and the economic evaluations with the AMIGA macroeconomic model (see Figure 1). The assessment is investigating the entire life cycle of the plant, which includes the mining of the coal, coal transportation, coal preparation, power generation, environmental controls, water use, pipeline CO₂ conditioning, and pipeline transport of CO₂ for sequestration.

ANL is conducting ASPEN modeling for 18 different oxy-combustion and air-fired cases. Three different power production ratings (150 MW, 300 MW, and 450 MW) are being investigated. The model includes a selective catalytic reduction (SCR) system and a flue gas desulfurization (FGD) system for flue gas clean-up.

ANL is also conducting a net present value (NPV) cost assessment for three alternative scenarios for existing PC plants in order to assess the economic feasibility of retrofitting CCS. The three scenarios are:

1. A base case in which an existing PC plant is operated until retirement in year N and then replaced with an IGCC plant with CCS.
2. An alternative case in which a PC plant with N years of remaining life is replaced in year zero with an IGCC plant with CCS.
3. An alternative case in which a PC plant is retrofit in year zero with oxy-combustion and CCS with subsequent replacement of the plant in year N with IGCC, such that the existing oxygen plant and CO₂ recovery system can be used by the IGCC plant.

Technology Maturity:

Systems analysis and macroeconomic modeling

Project Focus:

Engineering Assessment of Oxy-Combustion

Participant:

Argonne National Laboratory

Project Number:

FWP-49539

NETL Project Manager:

Timothy Fout
Timothy.Fout@netl.doe.gov

Principal Investigator:

Richard D. Doctor
Argonne National Laboratory
rdoctor@anl.gov

Partners:

None

Performance Period:

10/1/97 – 12/31/10

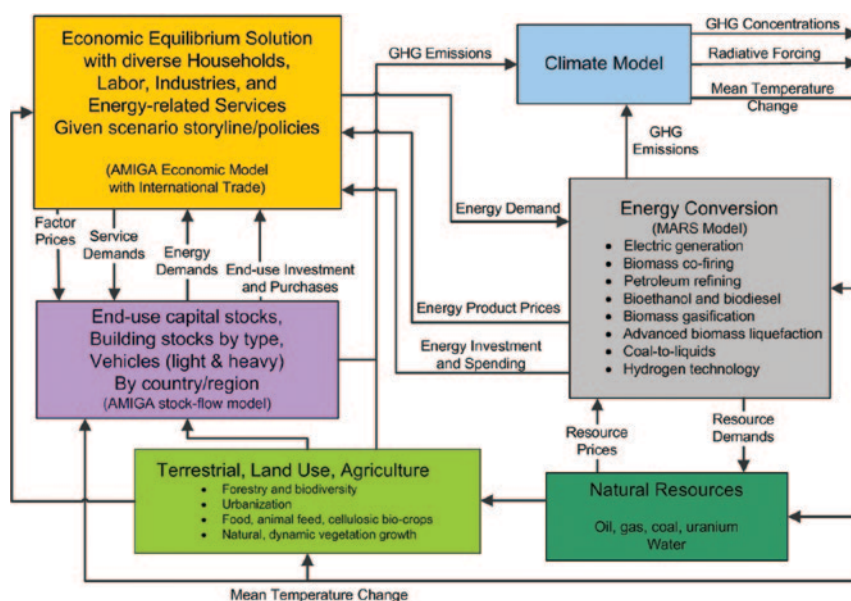

Figure 1: AMIGA Modeling System

Technology Advantages

- Post-combustion CO₂ capture systems that treat conventional flue gas are critically dependent upon deep levels of sulfur dioxide (SO₂) clean-up to protect solvents. Oxy-combustion does not require that level of SO₂ reduction.
- For plants envisioning repowering, there is an advantage to using oxy-combustion because the air separation unit (ASU) system can be transitioned to the new repowered system.

R&D Challenges

Lowering the cost of oxygen production and clean-up.

Results To Date/Accomplishments

- There is an Oxyfuel Power Plant Base Case operating using ASPEN 23.0 with the refinement of system pressure drop calculations and the incorporation of a hierarchy block for the FGD system reflecting the performance criteria as calculated in the separate detailed ASPEN 23.0 model with aqueous electrolytes.
- An ASPEN 20.0 model for the full steam cycle is available.
- In order to better understand the link between compression energy and oxygen impurity compositions, an ASPEN 23.0 model for the ASU was developed and compared against current system performance.
- An ASPEN 23.0 FGD model using Electrolyte Wizard was developed to address retrofit details.
- An ASPEN 23.0 model of the CO₂ conditioning section was developed so that a 50 parts per million (ppm) oxygen (O₂) specification of the pipeline product is met.
- A full energy-cycle was evaluated based on simulation of an oxy-combustion, PC boiler with flue gas recirculation, and CO₂ capture.
- Process design and economics for 300- to 900-MW PC-fired boilers with low-, medium-, and high-sulfur coals indicate that the oxy-combustion strategy is economic and could be an approach to lower the costs of eventually repowering a site with an IGCC system.

- AMIGA was compared to the Second Generation Model (SGM), which is a competing climate economical model from the U.S. Environmental Protection Agency (EPA).
- AMIGA projects a ramping-up of oxy-combustion retrofits with deployment peaking in 2035.
- AMIGA projects a different investment strategy than some competing macroeconomic models.

Next Steps

Project completed December 2010. Final report under development.

Available Reports/Technical Papers/Presentations

General project information is available on DOE/NETL website at: <http://www.netl.doe.gov/technologies/coalpower/ewr/co2/oxy-combustion/evaluation.html>

“Evaluation of CO₂ Capture/Utilization/Disposal Options,” NETL Fact Sheet.

“ANNUAL REPORT 2009: Evaluation of CO₂ Capture and Sequestration Using Oxyfuels with AMIGA Economic Modeling,” November 23, 2009.

“Economics of CCS Systems – Potential Investment into CCS Technologies Stimulated by a ‘Carbon’ Market,” 8th Annual Conference on Carbon Capture and Sequestration, Pittsburgh, PA, May 4–7, 2009.

“Representing technology in CGE models: a comparison of SGM and AMIGA for electricity sector CO₂ mitigation,” *Int. J. Energy Technology and Policy*, 6:4 (2008) p.323.

“CO₂ capture and sequestration: Technology options for new and retrofit applications,” 2nd U.S. – China CO₂ Emissions Control Science and Technology Symposium, Zhejiang University Hangzhou, People’s Republic of China, May 29–30, 2008.

“High-sulfur Coal Desulfurization for Oxyfuels,” 7th Annual Conference on Carbon Capture and Sequestration, Pittsburgh, PA, May 5–8, 2008.

APPENDIX B: CARBON DIOXIDE CAPTURE TECHNOLOGY SHEETS

OXYGEN PRODUCTION

NOVEL SUPPORTS AND MATERIALS FOR OXYGEN SEPARATION AND SUPPLY

B-317

OXYGEN PRODUCTION

Primary Project Goals

Eltron Research is designing and developing a temperature swing adsorption (TSA) system capable of producing high purity (>99%) oxygen (O₂) for use as an air substitute in power plants, reducing waste gas volume and simplifying carbon dioxide (CO₂) capture and containment.

Technical Goals

- Produce materials which provide more O₂/m³•hr than the zeolites currently used in small to mid-size TSA O₂ separation technologies (23 kg O₂/m³•hr).
- Develop materials capable of producing an O₂ with purity comparable to cryogenic O₂ separation (>99+%).

Technical Content

Eltron Research is developing a TSA system that is capable of producing O₂ at purities comparable to those produced by cryogenic methods but at reduced cost.

This program initially focused on the coating of sintered metal fiber filters (SMFFs) with cerium oxide (CeO₂), silicon oxide (SiO₂), and/or aluminum oxide (Al₂O₃). These base-coated fibers were then separately impregnated using a mixed metal oxide nitrate. The SMFFs used were chosen for their high porosity (80%) and permeability (1,500 L/dm²•min), which provided a near-negligible post-reactor pressure drop. Also, due to their high thermal conductivity, the chosen SMFFs had significantly reduced thermal irregularities compared to ceramic monoliths. This feature resulted in near isothermal reactor beds. Cerium- (Ce), silicon- (Si), and aluminum- (Al) based oxides were chosen as base-coating materials for their ability to increase surface area and provide a more ideal binding surface on the SMFFs. Additionally, they also prevent or dramatically decrease agglomeration and its impact on the overall O₂ storage and release capability of the materials. However, based upon an economic analysis, it was determined that the volume needed for the SMFFs was too large, and so the program was then re-focused strictly on fixed beds with no SMFF supports. In addition, the focus was changed from co-precipitated mixed metal oxide materials to perovskite materials produced using ceramic processing methods.

Twelve combinations of materials were selected and produced via ceramic processing methods and calcined at high temperatures (>900 °C). Upon testing, results showed that one of the selected materials (K-12), a perovskite, was capable of producing >132 kg O₂/m³•hr, far surpassing the original mixed metal oxide primary material produced via co-precipitation from nitrate solutions.

Figure 1 compares the O₂ production rates of several leading technologies, including Eltron's primary materials. Figure 2 compares the required reactor volume, based on a 5 ton-per-day (tpd) O₂ system. As indicated, the K-12 sorbent offers significantly improved O₂ production over existing pressure swing adsorption (PSA) zeolite-based sorbents. Utilizing a sorbent capable of such high production rates may significantly reduce the required reactor volume, leading to reduced capital and operational costs.

Technology Maturity:

Laboratory, 5–10 lb oxygen/day

Project Focus:

Materials for Temperature Swing Adsorption Oxygen Separation

Participant:

Eltron Research, Inc.

Project Number:

ER84600.002

NETL Project Manager:

Arun Bose
Arun.Bose@netl.doe.gov

Principal Investigator:

Erick Schutte
 Eltron Research, Inc.
eschutte@eltronresearch.com

Partners:

None

Performance Period:

8/8/07 – 8/7/10

Eltron Oxygen Separation Material Advances and Their Comparison to OGSi's Zeolite per Reactor Volume

* - Oxygen Generating Systems, Inc. PSA Zeolite

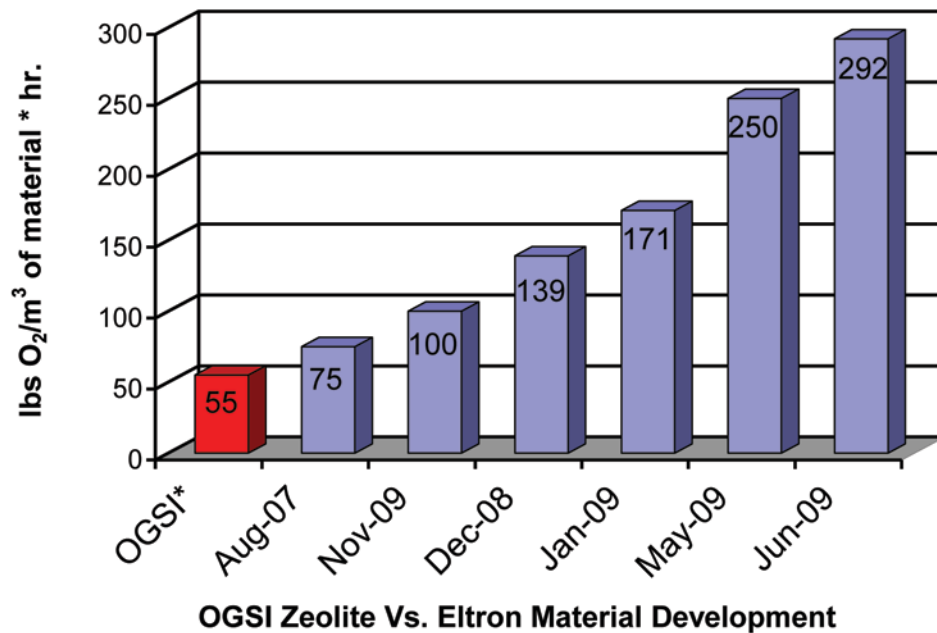

Figure 1: Oxygen Production Comparison

Reactor Volume Required for Five Ton/Day O₂ Plant

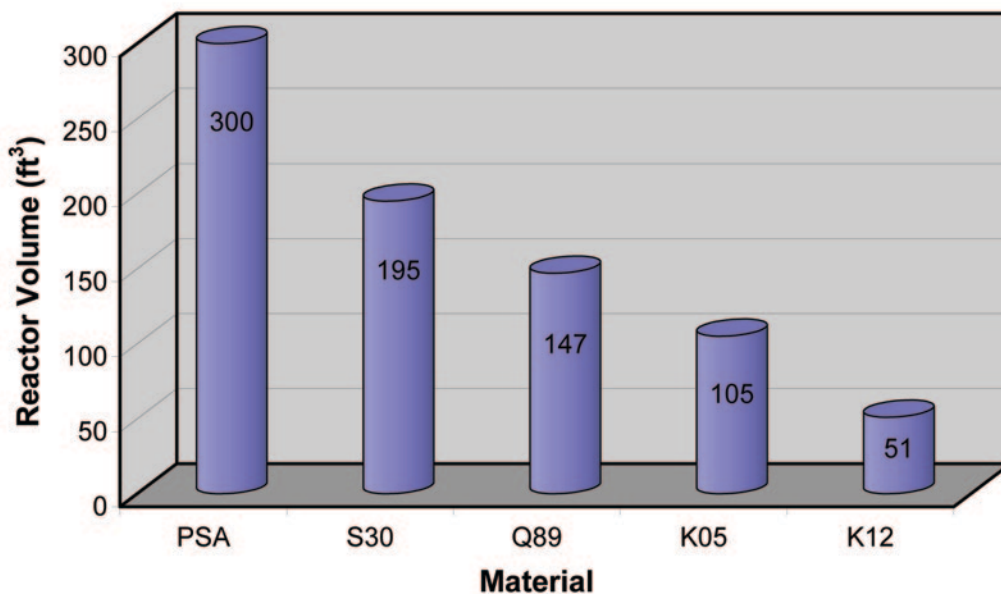

Figure 2: Required Reactor Volume Comparison

Technology Advantages

Materials being researched have superior mechanical strength, durability, and thermal resistance when compared to current TSA materials. They have the capability of producing O₂ at >99% purity, industrially relevant volumes, and at significantly reduced cost in comparison to cryogenic methods.

R&D Challenges

- Heating issues (i.e., how to most effectively heat large amounts of material; how to heat and cool a large amount of material fast; how to make sure heating is even; etc.).
- Scale-up: The central focus of the technology was to compete with cryogenic separation on large scale (>1,000 tpd); however, initial development leaned towards competing with current small-scale PSA systems (1 lb–1,000 tpd), which require additional processes to achieve high O₂ purity >95%.

Results To Date/Accomplishments

- Developed a new primary material (K-12) which yields >132 kg O₂/m³•hr.
- Observed that air flow during calcination is crucial to phase formation.
- Adding polyvinyl butyral (PVB) binder to calcined K-12, pelletizing, and re-firing at calcination temperatures yields a material which produced >130 kg O₂/m³•hr with no drop-off in performance (>16,000 cycles).

Next Steps

- Project complete.
- Engage industrial partner for scale-up and commercialization push.

Available Reports/Technical Papers/Presentations

A.R. Smith and J. Klosek, "A review of air separation technologies and their integration with energy conversion processes," Elsevier, 2001, http://www.airproducts.com/NR/rdonlyres/D29B6AF0-A218-415D-B692-20537B197E7D/0/2_ReviewOfAirSeparationTechnologiesAndTheirIntegrationWithEnergyConversionProcesses2001p.pdf

"Oxygen," Madehow.com, <http://www.madehow.com/Volume-4/Oxygen.html> (accessed September 18, 2007).

"Technology: SeprOx," Trans Ionics Corporation, http://www.transionics.com/tech_seprOx.html

"Vision Fossil Fuel Options for the Future," National Research Council, 2005.

OXYGEN TRANSPORT MEMBRANES FOR INDUSTRIAL APPLICATIONS

Primary Project Goals

Praxair is optimizing oxygen transport membrane (OTM) performance, materials, and process configurations leading to subsequent field testing of OTM technology for both synthesis gas (syngas) production and oxy-combustion applications, providing valuable experience needed to develop commercial OTM technology in industrial applications and, ultimately, future utility-scale power generation applications.

Technical Goals

Phase I:

- Develop more detailed OTM cost and performance estimates based on experiments.
- Develop a preliminary conceptual design and cost models for a pilot plant utilizing OTM technology.
- Identify the rate limiting steps for oxygen (O₂) separation through the OTM and address kinetic or mass transport limitations by appropriate materials selection and membrane architecture.
- Develop procedures to manufacture one-third pilot-size OTM tubes; test them for O₂ flux and durability in carbon monoxide (CO), hydrogen (H₂), carbon dioxide (CO₂), and water (H₂O) fuel streams with the presence of sulfur impurities.
- Test OTMs in a coal gas OTM reactor.

Phase II:

- Demonstrate ability to produce OTM tubes with the appropriate dimensions and manufacturing yield required to proceed with pilot demonstration.
- Deliver preliminary engineering cost estimate for OTM pilot plant system [OTM partial oxide reactor (POx) and Boiler].

Phase III:

- Demonstrate conversion of natural gas to 1 MM standard cubic feet per day (scfd) of syngas in a skidded OTM integrated pilot-scale system.
- Demonstrate OTM oxy-combustion and heat transfer at high rates of fuel utilization in a developmental-scale 1-MW_{th} system.

Technical Content

As oxy-combustion is currently practiced, a pure stream of O₂ is separated in an air separation unit (ASU) and then delivered to a boiler for combustion. OTM technology integrates O₂ separation and combustion in one unit. An OTM consists of an inert porous support coated with a dense gas separation layer, as illustrated in Figure 1. Air contacts the separation layer where molecular O₂ reacts with O₂ vacancies and electrons on the membrane surface to form O₂ ions, which are transported through O₂ vacancies in the separation layer using a chemical potential difference as

Technology Maturity:

Laboratory, 1–5 liters/minute oxygen

Project Focus:

Oxygen Transport Membrane-Based Oxy-Combustion

Participant:

Praxair, Inc.

Project Number:

NT43088

NETL Project Manager

Timothy Fout

Timothy.Fout@netl.doe.gov

Principal Investigator:

Sean Kelly

Praxair, Inc.

sean_kelly@praxair.com

Partners:

ENrG, Inc.

The Shaw Group

The University of Utah

Performance Period:

4/30/07 – 9/30/15

the driving force. Fuel species [CO, H₂, methane (CH₄), etc.] located on the porous support side diffuse through the support and react with O₂ ions at the membrane surface to form oxidation products (H₂O, CO₂) and release electrons which are transported back through the separation layer.

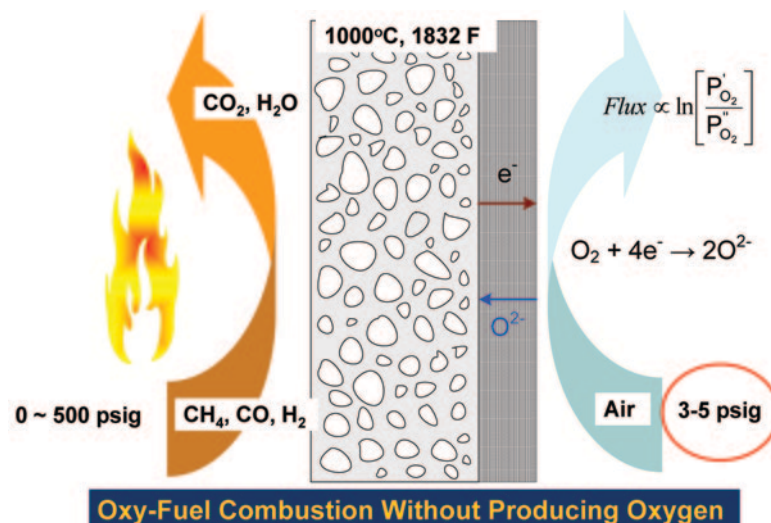

Figure 1: Schematic of Ceramic OTM

Several process concepts incorporating ceramic OTM are being explored to understand their impact on process economics. One process concept under development is shown in Figure 2. In this process, coal is first gasified in an O₂-blown gasifier to generate syngas. The syngas is optionally reacted in an OTM POx to raise its temperature. The hot syngas is expanded to recover power. After the syngas is expanded to ambient pressure, it is sent to the OTM boiler. Within the OTM boiler, syngas is first passed over an array of OTM tubes. Air is preheated by heat exchange with the O₂-depleted air and then passed on to the feed side of the OTM tubes. Oxygen from the air transports across the membrane and reacts with the syngas. Since the rate of O₂ transport is limited by the availability of the membrane area, the oxidation of syngas will take place over a large area (the OTM zone) within the boiler. As the syngas gets oxidized, the driving force for O₂ transport will decrease and the required membrane area will increase. For practical reasons, the OTM will be used to supply O₂ to the fuel side until 80–90% fuel utilization is achieved. The remainder of fuel will be combusted using O₂ supplied from the cryogenic ASU.

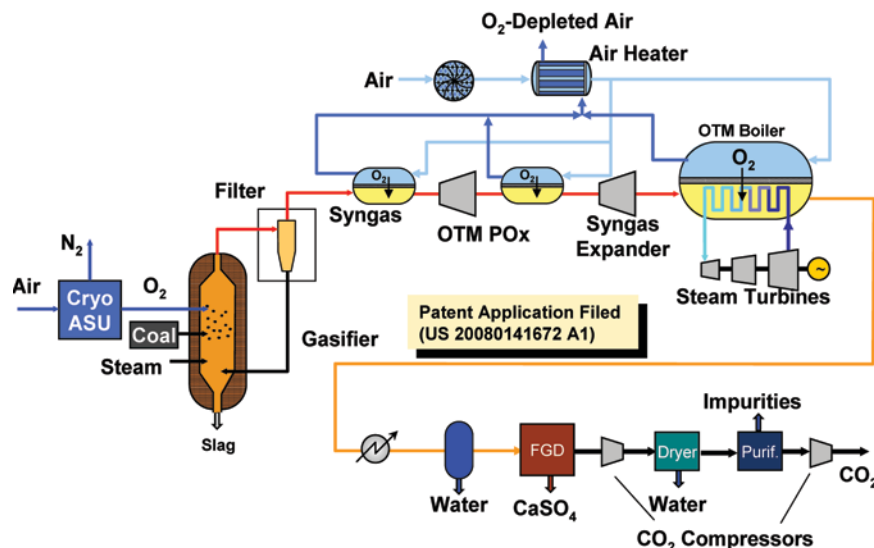

Figure 2: OTM-Based Process for Power Generation with CO₂ Capture

The thermal energy released within the boiler is used for steam generation. In the OTM zone, steam tubes will be interspersed with the OTM tubes such that the temperature is maintained at the optimum level for membrane performance. After the fuel is completely oxidized with externally supplied O₂, the flue gas will pass through a convective section of the boiler for further steam

generation and boiler feed water preheating. The flue gas exiting the boiler is processed according to a purification process proposed for a conventional oxy-fuel technology.

A number of OTM-based power cycles have been simulated for comparison against the DOE Cost of Electricity (COE) targets in 2008 dollars. Table 1 illustrates three OTM cases with different steam cycles (super critical, ultra-supercritical, and advanced ultra-supercritical) and a flue gas desulfurization (FGD) system. The base case for comparison is a DOE pulverized coal air-based combustion power cycle (without CO₂ capture) using a supercritical steam cycle. The table includes data regarding the net efficiency, plant cost, and COE for three different coal prices. The COE increase over the DOE base case is calculated and those cases meeting the DOE target of <35% increase in COE are highlighted in green. The high net efficiency, >36% higher heating value (HHV), seen in the OTM cases is a major contributing factor leading to achievement of the COE increase target.

Table 1: COE Comparison of a Standard DOE Air-Coal Power Cycle with OTM Power Cycles

Case	OTM FGD Process Cases			Air-PC Case
	1 SC	2 USC	3 AdUSC	Praxair/DOE No CCS SC
Net Efficiency (HHV)	36.3	37.2	39.7	39.7
Cost Basis (Year)	3/2008	3/2008	3/2008	3/2008
Plant Cost (\$/kW)	\$2,894	\$2,887	\$2,997	\$1,908
Increase in COE	Coal Price (\$/mMBtu)			
	1.8	39.4%	38.4%	39.7%
	3.0	34.9%	33.8%	33.8%
	4.0	32.1%	30.8%	30.0%

One part within Phase III of the project will focus on the design and construction of a skidded syngas system with O₂ supplied from OTM membranes capable of producing approximately 1 MM scfd of syngas at full capacity. It is anticipated that this system will incorporate a second-generation OTM module that improves on the performance and cost of the initial module. Another part within Phase III of the project will focus on demonstrating the oxy-combustion of a syngas using reactively driven OTM modules operating with high fuel utilization and transferring energy to a thermal load. The unit will be designed to demonstrate heat transfer from the OTM modules to a process stream (Figure 3).

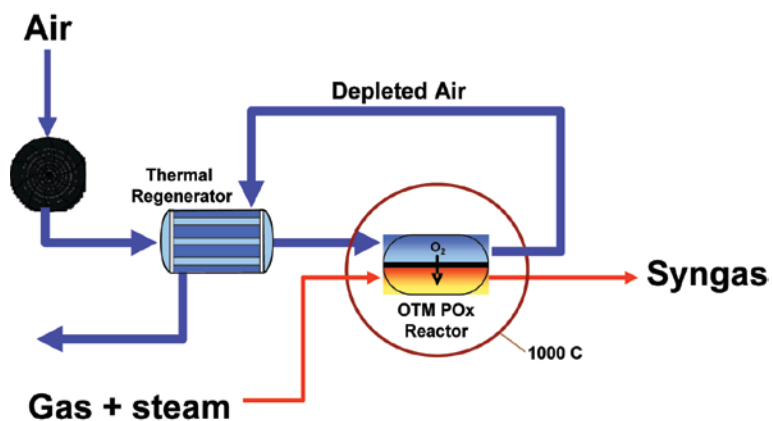

Figure 3: Phase III OTM Syngas System Concept

Technology Advantages

The OTM oxy-combustion system can provide a highly concentrated, sequestration-ready stream of CO₂ without costly cryogenic oxygen production or CO₂ separation processes. The use of reactively driven OTMs is expected to reduce the power associated with oxygen production by 70–80%. This represents a step change in the cost and related CO₂ emissions, and will enable a variety of oxy-combustion technologies, as well as other combustion applications, where CO₂ capture may be required. The development of OTMs will also benefit industrial processes used to produce syngas for subsequent processing into a variety of chemical and/or petrochemical end products by dramatically reducing the power requirements.

R&D Challenges

- Reliability of the OTM tubes at high pressure.
- Achieving membrane cost and performance targets.
- Engineering design of OTM equipment including OTM syngas reactor and boiler.

Results To Date/Accomplishments

- Demonstrated stable OTM performance with sulfur impurities in simulated coal-derived fuel gas.
- Developed pilot plant specifications for OTM oxygen flux and fuel utilization.
- Continued OTM performance improvement through characterization and manufacture of OTM tubes, and preparations for scale-up.
- Demonstrated achievement of flux and performance targets with advanced OTM materials.
- Developed manufacturing protocol for pilot-sized OTM tubes.
- Completed design and construction of the OTM multi-tube reactor at the University of Utah.
- Designed a hot oxygen burner (HOB) coal gasifier to achieve required testing parameters for the OTM system. The HOB was tested at Praxair's facilities and then sent to the OTM reactor at the University of Utah for integration. Testing on coal-derived syngas has been initiated.
- Developed conceptual design of prototype OTM module and methodology for reactor integration.

Next Steps

- Complete a Technology Evaluation Study of the potential uses/benefits of OTM technology. The study will contain projected cost savings, CO₂ reduction potential, CCS capabilities, and other environmental benefits.
- Develop detailed process models of an OTM syngas unit and an OTM combustion unit that, once validated, will be used for development of equipment specifications and to create a detailed process and instrumentation diagram (P&ID).
- Design, optimize, and test first generation OTM modules.
- Design the unit operation process equipment identified in the P&IDs, including the reactors housing the OTM modules, for both the syngas and oxy-combustion units.
- Perform testing on the development-scale syngas system (160,000 scfd), which will validate all required startup and shut-down processes, as well as the overall performance of a fully integrated system.
- Design, construct, and test a skidded pilot-scale syngas system (1 MM scfd) incorporating the second generation OTM module system.
- Develop a 1-MW_{th} oxy-combustion system.

Available Reports/Technical Papers/Presentations

Project webpage: <http://www.netl.doe.gov/technologies/coalpower/ewr/co2/oxy-combustion/otm-based.html>

Presentation given at the 2010 NETL CO₂ Capture Technology Meeting (Sep 2010): <http://www.netl.doe.gov/publications/proceedings/10/co2capture/presentations/tuesday/Maxwell%20Christie%20-%20NT43088.pdf>

Fact sheet: <http://www.netl.doe.gov/publications/factsheets/project/Proj470.pdf>

Presentation at the 2009 American Institute for Chemical Engineers Annual Meeting (Nov 2009): <http://www.netl.doe.gov/technologies/coalpower/ewr/co2/pubs/43088%20Praxair%20OTM%20AIChE%20mtg%20ov09.pdf>

Technical paper from the Proceedings of the 34th International Technical Conference on Coal Utilization and Fuel Systems (Jun 2009): <http://www.netl.doe.gov/technologies/coalpower/ewr/co2/pubs/43088%20Praxair%20OTM%20presentation%20Clearwater%20jun09.pdf>

Presentation at the CO₂ Capture Technology for Existing Plants Conference in Pittsburgh, PA (March 2009): <http://www.netl.doe.gov/publications/proceedings/09/CO2/pdfs/43088%20Praxair%20oxy-combustion%20OTM%20%28Christie%29%20mar09.pdf>

SORBENTS FOR AIR SEPARATION

Primary Project Goals

TDA Research is designing and developing a new regenerable chemical sorbent to selectively remove oxygen (O_2) from air.

Technical Goals

- Optimize and screen sorbent formulations.
- Scale up sorbent production.
- Perform long-term testing of the sorbent to demonstrate its durability through a minimum of 5,000 absorption/regeneration cycles.
- Design and size a conceptual air separation system based on experimental results.

Technical Content

Air separation units (ASUs) are one of the most expensive components of the integrated gasification combined cycle (IGCC) plant, accounting for approximately 18% of the overall plant cost and more than 14% of the cost of electricity (COE). TDA Research is developing a new, highly efficient, sorbent-based air separation technology that can produce high purity O_2 from air at high temperatures (approximately 800 °C).

By performing the air separation at high temperatures, much of the COE increase is avoided, because much of the energy penalty associated with separating air by cryogenic methods is in cooling the gas to temperatures as low as 80 K. Additionally, some of the capital cost is reduced due to the faster kinetics which permits the use of less material.

TDA's sorbent, a mixed metal oxide, has been found to achieve up to 4 wt% O_2 capacity and maintain its capacity for more than 300 cycles. This sorbent can be regenerated under near isothermal and isobaric conditions by changing O_2 partial pressure between the absorption and regeneration bed. This then demands the use of a minimum of two separate reactors, one for absorption and the other for regeneration. A solid circulation system is being developed to eliminate the use of high temperature valves. Figure 1 is a schematic depiction of this process.

It is estimated that the cost of O_2 could be as low as \$18.5/tonne (\$16.8/ton), which is a significant savings compared to cryogenic methods (\$31–\$35/tonne) and is below the U.S. Department of Energy's (DOE) target of \$22/tonne. Also, capital cost is estimated to be \$85–\$104/kWe, which again is well below cryogenic plants (\$360/tonne) and achieves DOE's target of \$82–\$110/ton.

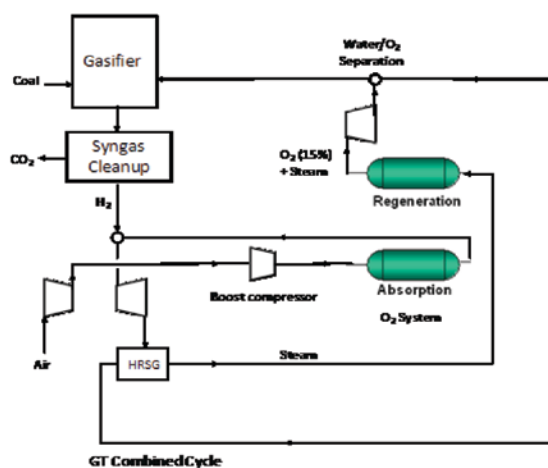

Figure 1: Schematic of Two Reactor Air Separation Unit

Technology Maturity:

Bench-scale

Project Focus:

Sorbents for Air Separation

Participant:

TDA Research, Inc.

Project Number:

ER84216

NETL Project Manager:

Steven Markovich

MarkoviS@netl.doe.gov

Principal Investigator:

Gokhan Alptekin

TDA Research, Inc.

galptekin@tda.com

Partners:

None

Performance Period:

8/7/06 – 8/6/09

Technology Advantages

The process temperature is maintained at 600–800 °C to increase the reaction kinetics. The sorbent is regenerated under an inert gas (e.g., steam) at the same temperature and pressure, eliminating time required for temperature and/or pressure transitions. The oxidized phase is meta-stable and a small change in chemical potential leads to its reduction.

R&D Challenges

Scale up from batch to prototype.

Results To Date/Accomplishments

- Optimized sorbent formulations and screened them under representative IGCC plant conditions.
- Scaled up sorbent production.

Next Steps

Project completed August 2009.

Available Reports/Technical Papers/Presentations

PCC Oxy-Combustion Alptekin, Presentation at the Pittsburgh Coal Conference, September 30, 2008.

Oxygen Sorbents for Oxy-fuel Combustion, Alptekin, Presentation at the 2008 AIChE Annual Meeting. http://www.tda.com/Library/docs/TDA_AIChE-Oxycombustion_111908_v3.pdf

PILOT-SCALE DEMONSTRATION OF A NOVEL, LOW-COST OXYGEN SUPPLY PROCESS AND ITS INTEGRATION WITH OXY-FUEL COAL-FIRED BOILERS

Primary Project Goals

The BOC Group, Inc. (now Linde, LLC) is conducting pilot-scale tests of its Ceramic Auto-Thermal Recovery (CAR) oxygen (O₂) generation process, integrated with a coal-fired combustor, to produce a carbon dioxide (CO₂)-rich flue gas.

Technical Goals

Phase I:

- Evaluate the performance of a 0.7-tonne/day, O₂ pilot-scale CAR system (long- and short-duration), when fully integrated with a pilot-scale coal combustor, and determine the optimum operating conditions of this unit.
- Perform a techno-economic evaluation of a commercial-scale, O₂-fired power plant that utilizes a CAR system to provide the O₂.

Phase II:

- Design and construct a nine-tonne/day, O₂ pilot-scale CAR unit.

Technical Content

In the CAR process, O₂ is separated from an air stream using a perovskite ceramic oxide adsorbent (composed of lanthanum, strontium, cobalt, and iron) at high temperature (800–900 °C). As shown in Figure 1, the process involves two separate beds that are cycled to deliver the O₂ flow (one bed is adsorbing the oxygen, while the other is desorbing). The O₂ is desorbed from the catalyst by a partial pressure swing using a purge gas containing low levels of O₂ in standard runs; CO₂ is used for this purpose. Half cycle times are varied for most efficient operational parameters, but fall in the range of 30 seconds to one minute. Multiple temperatures are monitored in the catalytic bed and are spatially placed to give an accurate representation of the bulk temperatures in the ceramic bed.

Technology Maturity:

Pilot-scale, 0.7 tonnes O₂/day

Project Focus:

Ceramic Auto-Thermal Recovery

Participant:

Linde, LLC (formerly The BOC Group, Inc.)

Project Number:

NT42748

NETL Project Manager:

Timothy Fout
Timothy.Fout@netl.doe.gov

Principal Investigator:

Krish R. Krishnamurthy
 The BOC Group, Inc. now Linde, LLC
Krish.Krishnamurthy@linde.com

Partners:

Alstom Power Plant
 Laboratories
 Western Research Institute

Performance Period:

4/1/06 – 9/30/08

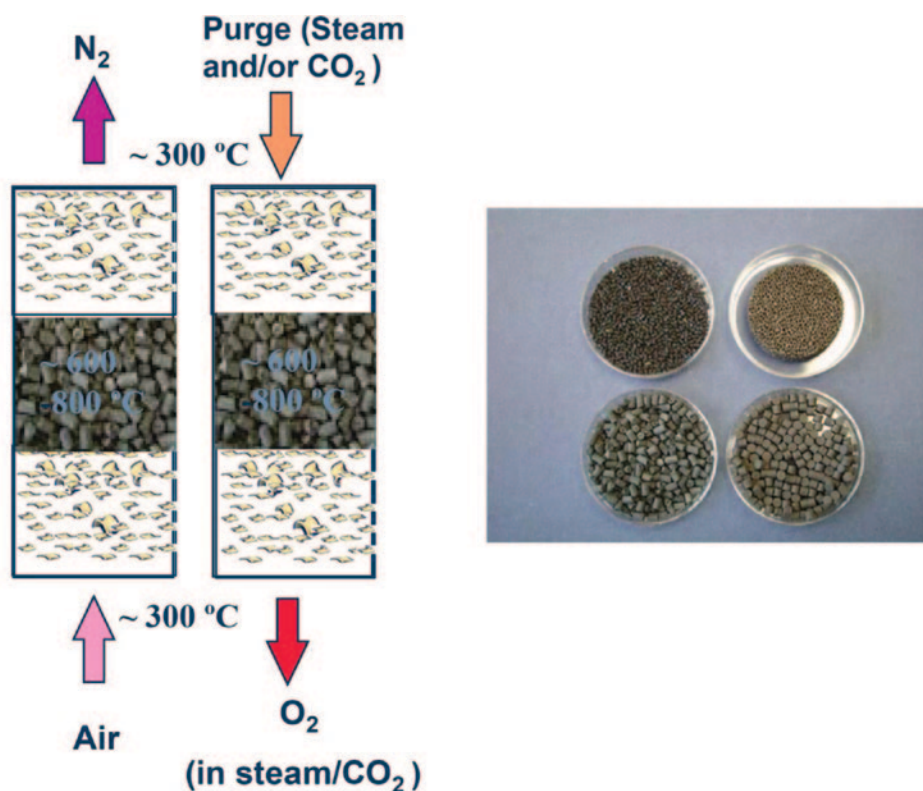

Figure 1: Ceramic Auto-Thermal Recovery (CAR) Two-Bed Oxygen Separation Process

Technology Advantages

The O₂ production process has shown a clear advantage in performance and cost compared to an air separation unit (ASU).

R&D Challenges

Although the CAR process alone compares favorably to an ASU, the techno-economic analysis has shown that overall capital costs, heat losses, and fuel consumption make the CAR process unfavorable compared to an ASU unless the working oxygen capacity of the CAR adsorbent can be increased from the current level of approximately 0.5–1.0 wt%. In addition, long duration tests have shown that the perovskite adsorbent experiences substantial mechanical breakdown and decline in performance when exposed to sulfur dioxide (SO₂).

Results To Date/Accomplishments

Completed Phase I activities include:

- Evaluated the performance of the 0.7-tonne/day, O₂ pilot-scale CAR system (long- and short-duration) and determined the optimum operating conditions of the unit.
- Performed a techno-economic evaluation of a commercial-scale, O₂-fired power plant that utilizes a CAR system to provide the O₂.

Next Steps

Phase I results led to cancellation of Phase II activities; project completed September 2008.

Available Reports/Technical Papers/Presentations

Project webpage: <http://www.netl.doe.gov/technologies/coalpower/ewr/co2/oxy-combustion/oxy-fuel.html>

Final Report: http://www.netl.doe.gov/technologies/coalpower/ewr/co2/pubs/42748%20BOC%20O2%20supply%20CAR%20Final%20Report_Dec%202008.pdf

Fact Sheet: <http://www.netl.doe.gov/publications/factsheets/project/Proj466.pdf>

May 2007 Presentation, 6th Annual Conference on Carbon Capture and Sequestration, Pittsburgh, PA.

DEVELOPMENT OF NANOFILLER-MODULATED POLYMERIC OXYGEN ENRICHMENT MEMBRANES FOR REDUCTION OF NITROGEN OXIDES IN COAL COMBUSTION

Primary Project Goals

North Carolina A&T State University (NCATSU) is designing and developing a nanofiller-modulated polymer membrane for the oxygen (O₂)-enrichment of coal combustion and gasification applications. This will reduce the volume of waste gas and increase the concentration of near-capture ready carbon dioxide (CO₂) within the waste gas to simplify capture and reduce related costs.

Technical Goals

- Research and select polymer candidates as well as functional nanofillers.
- Experiment with the selected nanofiller-modulated polymers and document the fundamental microstructure-property relationships.
- Develop models for selected membranes using Material Studio 4.0 and Groningen Machine for Chemical Simulation (GROMACS) 3.3.

Technical Content

NCATSU is researching membrane technology capable of separating O₂ from nitrogen (N₂). The selected membranes must be capable of producing a sufficient volume of high purity O₂ at reasonable operational and capital costs. The primary method of research used to develop a membrane with the required traits has been to vary the amount and type of filler, the type of polymer backbone, and the method of distribution and casting used. The results are used to develop computational models to further study and develop the technology. The membranes evaluated thus far include single-walled carbon nanotube, nanofumed silica polydimethylsiloxane (PDMS), and zeolite-modulated polyimide (a polymer) membranes.

The polyimide selected was Matrimid 5218—chosen for its high glass transition temperature, high structural and thermal stability, and low cost. For example, a mixed matrix membrane utilizing Matrimid 5218 as the polyimide backbone and a zeolite as the filler was fabricated on a porous stainless steel substrate. This membrane was exposed to pure N₂ and pure O₂ at 3.4 atm [50 pounds per square inch (psi)] for two hours. The resulting permeability was 0.114 Barrer and 0.380 Barrer, respectively, with a selectivity for O₂ of 3.33. After 12 hours, the results improved to a permeability of 0.093 for N₂ and 0.460 for O₂, with a selectivity for O₂ of 4.95. While the results are still below required values, they show considerable potential that a mixed matrix polyimide membrane with zeolite nanofiller could meet the requirements necessary for commercial application in the future.

As for nanofumed silica PDMS membranes, the fumed silica chosen was CAB-O-SIL TS-530. The hydrophobic silica was chosen because it had greater potential for proper mixing with the elastomer. However, the fumed silica did not produce good dispersion in the polymer, resulting in limited success. The O₂ selectivity observed for 1% and 2.5% fumed-silica at 4.1 atm (60 psi) was 2.72 and 2.81, respectively. When compared to an O₂ selectivity of 2.54 for pure PDMS, it is apparent that little improvement was achieved through the use of the fumed silica.

Technology Maturity:

Laboratory-scale

Project Focus:

Nanofiller-Modulated Polymeric Membranes

Participant:

North Carolina A&T State University

Project Number:

NT42742

NETL Project Manager:

Timothy Fout
Timothy.Fout@netl.doe.gov

Principal Investigator:

Jianzhong Lou
 North Carolina A&T State University
lou@ncat.edu

Partners:

American Air Liquide
 Babcock & Wilcox
 Battelle Memorial Institute

Performance Period:

2/17/06 – 12/31/10

Lastly, molecular dynamics simulations have been conducted to calculate the theoretical O_2 molecular diffusion coefficient and N_2 molecular coefficient inside single-walled carbon nanotube PDMS membranes, in order to predict the effect of the nanotubes on the gas-separation permeability. A simulated model of these membranes is shown in Figure 1.

The selectivity achieved from experimentation is 0.86 for PDMS filled with single-walled carbon nanotubes. When compared to pure PDMS, with a selectivity of 1.97, it is apparent that this filler is not appropriate for the purpose of this project.

Technology Advantages

The membranes being researched have several desirable properties, including high glass transition temperatures, high thermal and structural stability, high permeability (0.460 Barrers), and high selectivity (4.95). In addition, capital costs are low due to the absence of precious metals found in many other membrane technologies.

R&D Challenges

- The experiments performed thus far have shown that the nanofillers and polymers used have unstable properties over extended periods of time.
- It was found that fumed silica did not produce good dispersion in the polymers tested.
- Insufficient permeability and selectivity for O_2 .

Results To Date/Accomplishments

- Performed permeation and diffusion experiments using polymers with nanosilica particles, nanotubes, and zeolites as fillers.
- Studied the influence of nanofillers on the self diffusion, free volume, glass transition, O_2 diffusion and solubility, and permselectivity of O_2 in polymer membranes.
- Developed molecular models of single-walled carbon nanotube and nanofumed silica PDMS membranes, and zeolites-modulated polyimide membranes.

Next Steps

Project complete.

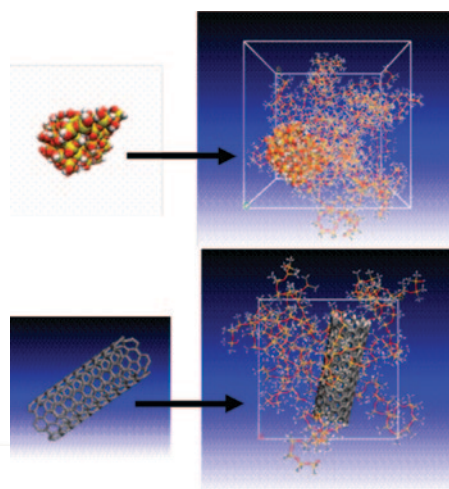

Figure 1: Model of Nanofumed Silica (above) and Single-Walled Carbon Nanotube PDMS Membrane

Available Reports/Technical Papers/Presentations

J. Zhang, J. Lou, S. Ilias, P. Krishnamachari, J. Yan. "Thermal properties of poly(lactic acid) fumed silica nanocomposites: Experiments and molecular dynamics simulations," *Polymer*, **2008**, 49, 2381–2386.

J. Zhang, Y. Liang, J. Yan, J. Lou, "Study of molecular weight dependence of glass transition temperature for amorphous poly(l-lactide) by molecular dynamics simulation," *Polymer*, **2007**, 48, 4900–4905.

Vu, D. Q.; Koros, W. J.; Miller, S. J., Mixed matrix membranes using carbon molecular sieves: I. Preparation and experimental results. *Journal of Membrane Science* **2003**, 211 (2), 311–334.

ITM OXYGEN TECHNOLOGY FOR INTEGRATION IN IGCC AND OTHER ADVANCED POWER GENERATION SYSTEMS

Primary Project Goals

Air Products and Chemicals is designing and developing an ion transport membrane (ITM) based on ceramics that selectively transport oxygen (O_2) ions when operated at high temperature. This high temperature process may be integrated with advanced power generation processes that require O_2 as a feedstock, such as integrated gasification combined cycle (IGCC) and other clean energy and industrial applications.

Technical Goals

- Design, construct, and operate a 0.1-ton/day (TPD) technology development unit (TDU) to validate the ITM technology concept, verify the technology prospects for stand-alone O_2 production plants, and integrate with IGCC and other advanced power generation systems.
- Design and construct a 5-TPD Sub-Scale Engineering Prototype (SEP) facility and produce greater than 95% O_2 purity.
- Increase the scale of the engineering test facility from 5 TPD of O_2 to 100 TPD of O_2 in an intermediate-scale test unit (ISTU).
- Develop the manufacturing capability needed to support ITM technology commercialization.
- Develop preliminary design concepts for a 2,000-TPD ITM O_2 production plant.

Technical Content

Air Products and Chemicals is designing a ceramic ITM that, under high temperatures, separates O_2 from nitrogen (N_2). These non-porous, multi-component metallic oxides have high O_2 flux and selectivity (100%), resulting in high capacity production of high purity O_2 at low cost. Figure 1 illustrates the concept of the ITM.

Technology Maturity:

Prototype, 5 tons oxygen produced/day

Project Focus:

Ion Transport Membrane

Participant:

Air Products and Chemicals, Inc.

Project Number:

FT40343

NETL Project Manager

Susan Maley
Susan.Maley@netl.doe.gov

Principal Investigator:

Douglas L. Bennett
 Air Products and Chemicals, Inc.
bennetdl@apci.com

Partners:

Becht Engineering
 Ceramatec
 Concept NREC
 Eltron Research
 EPRI
 GE-Chevron-Texaco
 NovelEdge Technologies
 Pennsylvania State University
 Siemens Power Group
 SofCo
 University of Pennsylvania
 Williams International

Performance Period:

10/1/98 – 9/30/15

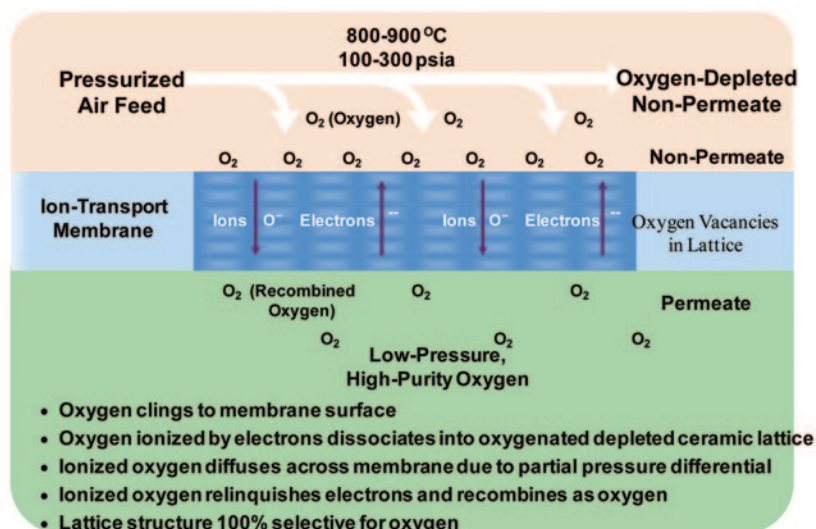
Figure 1: Conceptual Schematic of ITM O₂ Technology

The membrane employs a ceramic planar wafer architecture that incorporates a non-porous ITM on supporting porous and slotted layers that typically operate between 800 and 900 °C. The driving force for O₂ separation is determined by the relative O₂ partial pressure gradient across the membrane. Therefore, air is typically supplied at pressures of 7–20 atm, while the product O₂ pressure is typically below ambient (~1 atm). Figure 2 shows a cutaway view of part of a wafer. The wafer consists of two thin outer membrane layers through which the oxygen ions diffuse. The thin layers on the top and bottom of the wafer are supported by a porous layer which is itself supported by a slotted layer. High-temperature, high-pressure air flows over the membrane surface exterior to the wafer. Oxygen passes from the air outside each wafer through the thin outer membrane layer, through the pores of the porous layer and into the slots of the innermost layer, where it is collected. In a typical membrane module, stacks of wafers are joined together, separated by a spacer ring to form a gap for air flow between the wafers. The oxygen is collected in a central region of the module formed by the open center of each wafer and the spacer rings and passes out of the module through a ceramic tube sealed to a metal pipe. The high-pressure air on both sides of each wafer creates compressive stresses within the ceramic, which stabilize the wafer. The planar design also makes for a very compact separation device, while facilitating good gas phase mass transfer. All of the layers are made of the same ceramic material, and therefore expand and contract together during temperature changes.

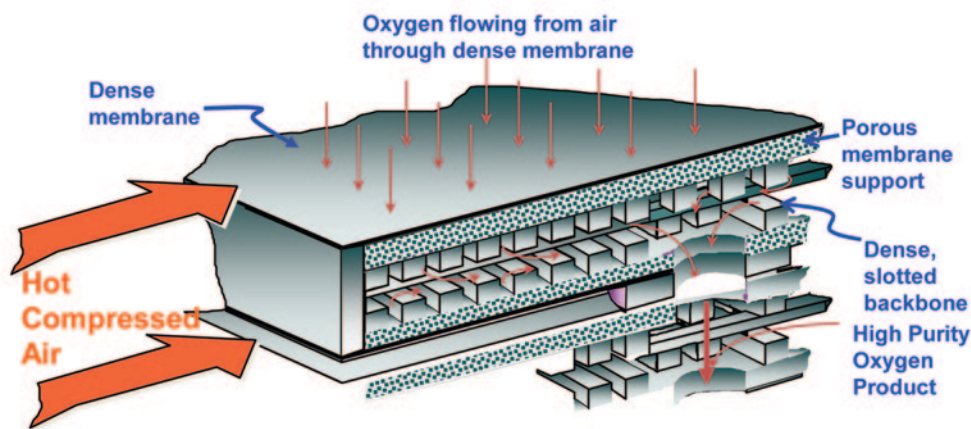
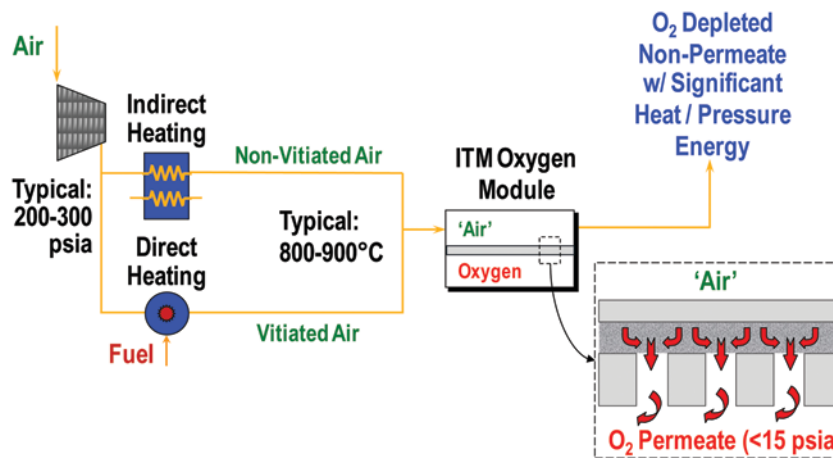

Figure 2: A Portion of an ITM Planar Membrane Wafer Shown in Cutaway View

Figure 3 shows a schematic diagram of an ITM O₂ production plant that includes both indirect and direct heating of the pressurized feed air, in order to satisfy the heating requirement of the thermally activated transport mechanism. While not shown in the schematic, the resulting hot, pressurized, non-permeate stream can be recovered if combined with a gas turbine power generation system.

Figure 3: Diagram of O₂ Production Plant

An ITM O₂ plant is projected to decrease the installed capital cost of air separation equipment by more than one-third and the installed capital cost of an IGCC facility by 7%, while improving efficiency and reducing the power requirement for air separation by approximately 35%. These increases in efficiency and reductions in cost, along with the near-capture ready concentrations of CO₂ in the waste stream, make ITM a technology that may be capable of making CO₂ capture more economically feasible.

Technology Advantages

This technology is capable of producing 95+% O₂ at high flux rates. It is resistant to structural damage and provides consistent performance during thermal and hydraulic cycling. It offers low capital and operating costs, improves efficiency and reduces the power requirement for air separation by approximately 35% relative to cryogenic separation, and reduces capital cost of an IGCC facility by 7%.

R&D Challenges

Scale up from 5 TPD to 100 TPD to 2,000 TPD and obtaining flux rates competitive to other available technologies.

Results To Date/Accomplishments

- Developed a stable, high-flux material; demonstrated stable operation in the 0.1-TPD TDU.
- Demonstrated the commercial flux target under anticipated commercial operating conditions.
- Devised a planar ITM architecture.
- Scaled-up and produced commercial-size wafers in large quantities.
- Built first commercial-scale ITM oxygen modules.
- Completed detailed design, construction, and testing of SEP vessel capable of housing full-size ITM oxygen modules to produce an estimated 5 TPD of 95% pure oxygen at full commercial conditions of 200–300 pounds per square inch gauge (psig) and 800–900 °C.
- Completed subscale wafer flux evaluation studies with feed air impurities and determined the effect of potential impurities on the cost and engineering performance of ITM systems.
- Implemented patented advanced process control techniques during heating and cooling to improve module reliability at the SEP.

- Completed the 100-TPD module conceptual design by including major elements of a commercial ITM oxygen facility.
- Completed economic assessment of carbon capture power plant cases with ITM oxygen that feature carbon capture and sequestration (CCS) technology options.
- The 5-TPD SEP was operated for over 18,000 hours, commercial flux targets were achieved or surpassed, and product purity exceeded 99%.
- Developed and selected a supported getter material that will remove gas phase chromium species upstream of the ITM modules.

Next Steps

- Select one of the proposed designs for a scale up plant and perform a detailed design.
- Construct an ISTU that co-produces electrical power and up to 100 TPD of O₂.
- Develop the manufacturing capability needed to support ITM technology commercialization and preliminary design concepts for a 2,000 TPD ITM oxygen production plant.

Final test results will not be available until the September 2015 project completion date.

Available Reports/Technical Papers/Presentations

B. C. H. Steele, *C. R. Acad. Sci. Paris*, t.1, Serie II, 533 (1998).

D. Wright and R. J. Copeland, Report No. TDA-GRI-90/0303 *prepared for the Gas Research Institute*, September 1990.

ITM Oxygen for Gasification. International Thermal Operations and Heavy Oil Symposium 1–3 November 2005, Calgary, Alberta. Canada SPE/PS-CIM/CHOA 97801: PS₂005-XXX. P.N. Dyer, R.E. Richards, S.L. Russek, and D.M.Taylor, "Ion Transport Membrane Technology for Oxygen Separation and Syngas Production," *Solid State Ionics*, 134 (2000) 21–33.

This page intentionally left blank

APPENDIX B: CARBON DIOXIDE CAPTURE TECHNOLOGY SHEETS

CHEMICAL LOOPING

MAGNETICALLY FLUIDIZED BED REACTOR DEVELOPMENT FOR THE LOOPING PROCESS: COAL TO HYDROGEN PRODUCTION R&D

Primary Project Goals

The University of Florida (UF) is developing novel fluidized bed and magnetically stabilized bed reactor systems that use a chemical looping process with metal oxide sorbents to separate hydrogen (H_2) and carbon dioxide (CO_2) from coal-derived synthesis gas (syngas).

Technical Goals

- Conduct laboratory-scale testing to investigate chemical, heat, and mass transfer in the fluidized and magnetically stabilized bed reactors, and develop modeling/simulation tools.
 - Determine optimal reaction pathways and operation conditions for iron (Fe)-, and alloyed Fe-metal oxide powders in both reducing and oxidizing environments.
 - Evaluate the chemical kinetics for reaction pathways.
 - Characterize chemical, thermal, and fluid transport properties of fluidized bed and magnetically stabilized bed reactors.
 - Investigate reactivity and durability of Fe, Fe/zirconia (Zr), and Fe/magnesium oxide (MgO).
 - Conduct a techno-economic analysis.
- Design, construct, and operate a bench-scale system to further evaluate the viability of the process upon successful completion of the laboratory-scale testing.

Technical Content

The metal oxide looping process is a two-step process, and in its simplest form steam is injected into a reactor containing a reduced metal oxide [e.g., iron oxide (FeO)]. The steam oxidizes the FeO to produce magnetite (Fe_3O_4) and high purity H_2 is liberated. The H_2 is captured by condensing the water vapor from the steam and H_2 mixture. In the second step, the Fe_3O_4 must be reduced so that water splitting can proceed in a cyclic manner. The looping process uses carbon monoxide (CO) produced from the gasification of coal to reduce the Fe_3O_4 . The advantages of the chemical looping process are that the H_2 produced via water splitting is highly pure, and the reduction step can be accomplished at sufficiently low temperature (400–850 K) to enable a commercially viable reactor.

Research efforts focus on: detailed thermal management throughout the process to enable efficient recuperation of heat; advanced reactor design that enables rapid kinetics; Fe or other metal powders which are stable and highly reactive over thousands of cycles; and operation in thermodynamically favorable regimes to maximize H_2 production and minimize the formation of Fe carbide compounds. The successful design of an efficient and cost-effective chemical reactor will ensure rapid kinetics, a homogenized thermal field, a high production rate, uniform solids distribution, completed reaction pathways, and low pressure drop with minimal energy consumption.

Technology Maturity:

Laboratory-scale

Project Focus:

Chemical Looping for Fluidized Bed Reactor

Participant:

University of Florida

Project Number:

FE0001321

NETL Project Manager:

Paula Flenory
Paula.Flenory@netl.doe.gov

Principal Investigator:

James F. Klausner
 University of Florida
klaus@ufl.edu

Partners:

None

Performance Period:

10/1/09 – 9/28/12

The fluidization of magnetic powders has received considerable attention in the literature. The majority of the fluidization approaches utilize magnetically assisted fluidization. In this process, a uniform steady magnetic field is applied to a conventional fluidized bed to stabilize it. The advantage of operating in this regime is that sintering, which occurs during the oxidation step, freezes the bed, and the reactor maintains its high porosity, surface area, favorable chemical kinetics, and low pressure drop. The application of the magnetic field serves to stabilize the fluidized bed to promote bed uniformity, which is favorable for chemical kinetics and eliminates bubbling. Magnetically stabilized fluidized beds provide enhanced uniformity of void fraction, enhanced heat transfer, and enhanced reactivity. In addition, a conventional fluidized bed reactor is being studied for comparison with the magnetically stabilized bed. A blend of Fe and silica (Si) powder is used to suppress particle sintering and sustain fluidization.

Figure 1 shows the process flow diagram for the chemical looping process. Coal is the input to the system, and the outputs consist of highly pure H_2 and highly concentrated CO_2 that is suitable for sequestration. The energy content of gasifier products and heat released during the oxidation step drives the complete chemical looping process. Steam at the desired temperature is obtained by using the high temperature syngas. Treated syngas is reheated to the required reduction temperature using the raw syngas. Two identical reactors are used in the process in order to maintain a continuous stream of products. While one reactor operates in the oxidation mode producing H_2 , the other reactor operates in the reduction mode regenerating the Fe bed.

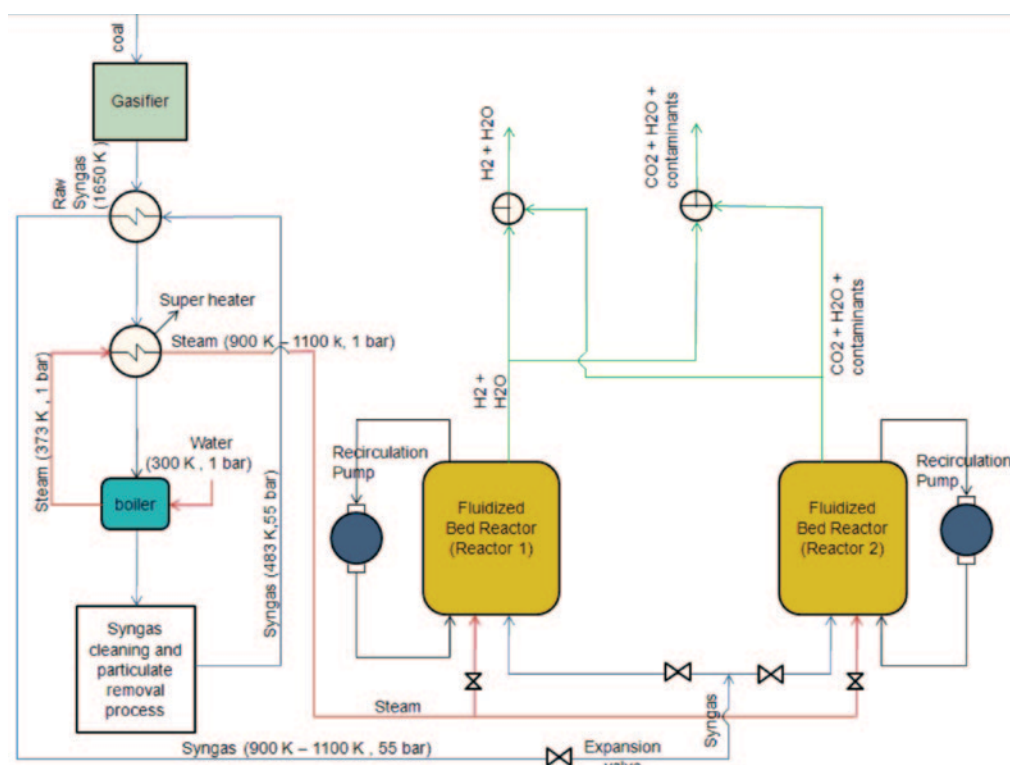

Figure 1: Process Flow Diagram of the Chemical Looping Process Using Cleansed Syngas for the Oxidation Step

A laboratory-scale magnetically stabilized reactor has been fabricated, and its performance is under investigation. The cylindrical reactor shown in Figure 2 is fabricated with a quartz wall and can accommodate the upper operating temperature limit of the reactor, 800 °C. A porous ceramic frit is positioned at the entrance of the reactor in order to evenly distribute the flow. Two magnetic poles produce a transverse magnetic field and create magnetic chains of Fe particles within the bed. The magnetic chains repel each other, because of their polarity, and form a naturally porous structure. The reactants enter the reactor from the bottom and exit through the top. The reactor is insulated with high temperature ceramic fiber insulation.

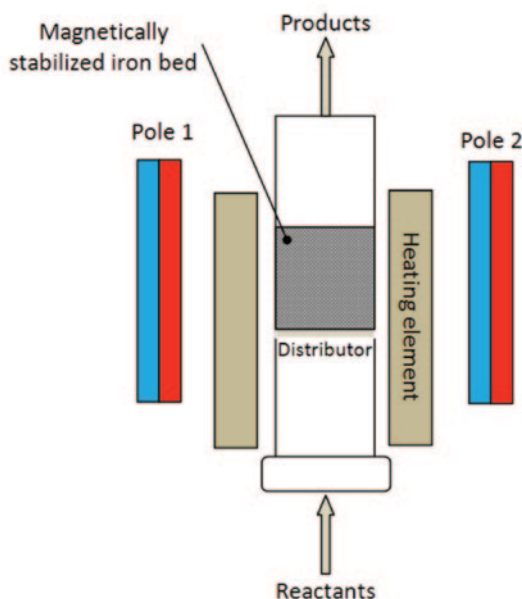

Figure 2: Magnetically Stabilized Bed Reactor

This reactor concept has inherent advantages and disadvantages. The high porosity and low pressure drop through the bed are advantageous. In addition, this reactor concept advantageously exploits the particle sintering during the oxidation step. Because the bed is frozen due to sintering, transverse thermal transport through the bed is reduced. The vertical flow configuration lends itself to mathematical modeling of the fluid, thermal, and species transport. Such modeling will prove useful to reliably predict the large-scale throughput in a scaled-up design. A major objective of this work is to utilize the experimental measurements to develop a mathematical framework to accurately model the magnetically stabilized bed reactor performance over a range of different operating conditions.

Technology Advantages

- Chemical looping enables extraction of high purity H_2 and sequestration-ready CO_2 from syngas near gasification operating conditions to obtain improved thermal efficiency over more traditional gas separation methods that operate at low temperatures and pressures.
- Metal oxide sorbents with magnetic properties have the potential to reduce pressure drop, provide more uniform solids distribution, and aid in solids transport within the magnetically stabilized bed reactors.
 - Large surface area available to enhance reaction rate per unit volume.
 - Enhanced mixing provides more uniform temperature field.
 - Reactive powder surface properties are easily modified (e.g., enhance reactivity and modify radiant properties).
 - A uniform stabilized bed with no large voids can be sustained, thus more uniform flow through the bed is established.
 - The bed stabilization characteristics are well controlled through the magnetic input field configuration and strength.
 - Low velocity vapor flow can be sustained in order to increase the residence time.
 - Stoichiometric flow can be sustained.

R&D Challenges

- Iron powders have a tendency to sinter at high temperature.
- Maintaining stability of powder reactivity over many cycles.
- Multi-scale, multi-physics modeling effort is required.

Results To Date/Accomplishments

- Completed a comprehensive parametric chemical equilibrium study for the chemical looping cycle based on Fe and Fe oxides. A thermodynamic investigation of the H₂ production step indicates that H₂ is favored at low temperatures with steam to H₂ conversion exceeding 90% at reaction temperatures below 700 K. The H₂ yield is independent of pressure.
- Reaction conditions were determined for obtaining energy and cost-effective operation of the chemical looping process.
- Constructed and tested a laboratory-scale experimental system to evaluate H₂ production performance in the magnetically stabilized bed reactor. Investigated the optimum conditions for providing the best reaction results using stationary matrix of Fe–Si.
- Devised three distinct plant layouts for reaction temperature ranges of 500–900 K; 900–1,100 K; and 1,100–1,200 K, respectively. Results from a thermal management study for the proposed chemical looping process indicate that no external energy is needed for looping cycle based H₂ production, but system configurations vary with temperature. Simulation of multiple cycles indicates that temperatures in the 900–1,000 K range will maximize H₂ yield.
- Demonstrated a high yield of H₂ production within the magnetically stabilized bed reactor over several looping cycles.

Next Steps

- Cycle reactors through repetitive oxidation and reduction cycles and characterize the stability of the bed reactivity over repeated cycles.
- Use the fundamental kinetic studies to construct a reaction rate law that is consistent with observations, and test the validity of the rate law applied to the reactor H₂ and CO₂ production.
- Continue with powder characterization studies before and after reactions.
- Test alloyed iron powders for chemical reactivity.
- Combine mass, momentum, energy, and species transport simulation modules, and test fidelity of the computational code against several test cases.
- Develop a reactor scale-up design strategy from laboratory to bench scale.

Final test results will not be available until after the September 2012 project completion date.

Available Reports/Technical Papers/Presentations

A. Mehdizadeh, R., Mei, J. F., Klausner and N., Rahmatian. "Interaction forces between soft magnetic particles in uniform and non-uniform magnetic fields." *Acta Mechanica Sinica*, 26: 921–929, 2010.

COAL DIRECT CHEMICAL LOOPING RETROFIT TO PULVERIZED COAL POWER PLANTS FOR IN-SITU CO₂ CAPTURE

Primary Project Goals

Ohio State University (OSU) is developing an iron oxide (Fe₂O₃)-based chemical looping process for retrofit on existing coal-fired power plants.

Technical Goals

- Select optimum iron-based oxygen carrier. Evaluate the reactivity, recyclability, and physical strength of different Fe₂O₃-based oxygen carrier particle compositions.
- Demonstrate bench-scale (2.5 kWth) coal direct chemical looping (CDCL) system including fuel reactor demonstration and coal char and volatile conversion. Determine optimum fuel reactor operating conditions to gasify coal char using oxygen carrier particle.
- Demonstrate sub-pilot scale (25 kWth) CDCL system including integration of fuel reactor and combustor with continuous solid circulation at reaction temperature. Operate integrated sub-pilot system for a minimum of 50 continuous hours with the optimal oxygen carrier. Determine the fate of nitrogen oxide (NO_x) and sulfur via integrated system testing.
- Conduct ASPEN simulation based on the CDCL test results.
- Conduct techno-economic study.

Technical Content

Researchers at OSU are developing a one-step CDCL process to produce electric power and high-purity carbon dioxide (CO₂) in retrofit power plant applications. While preliminary tests with the bench-scale reactor have shown 90–95% coal char conversion and >99% volatile conversion, the primary focus of this project is to identify the optimal oxygen carrier chemical composition and conduct integrated, continuous CDCL testing at the sub-pilot (25 kWth) scale.

As shown in Figure 1, the CDCL system consists of a fuel reactor and a combustor. The moving-bed fuel reactor utilizes a countercurrent gas-solid contacting pattern to maximize the conversion of the Fe₂O₃-based oxygen carrier, as it transfers oxygen to facilitate coal combustion. The combustor, an entrained-flow reactor, uses air to pneumatically transport the oxygen carrier back to the fuel reactor, while re-oxidizing the oxygen carrier and generating a significant amount of heat. A portion of the heat generated in the combustor is used for steam generation via the high-temperature exhaust gas, while the remainder is carried to the fuel reactor by the hot regenerated particles to supply the heat required for coal combustion.

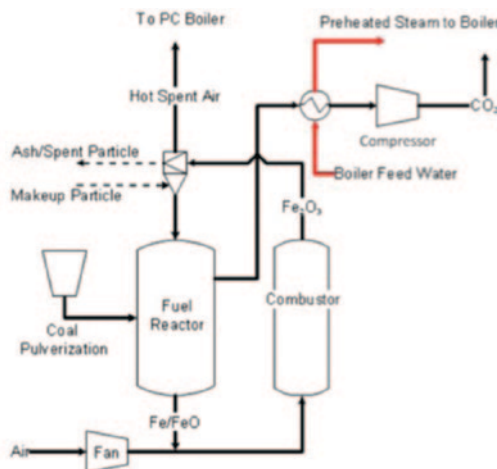

Figure 1: CDCL Process Flow Diagram

Technology Maturity:

Laboratory-scale

Project Focus:

Coal Direct Chemical Looping for Retrofits

Participant:

Ohio State University

Project Number:

NT0005289

NETL Project Manager:

Bruce Lani

Bruce.Lani@netl.doe.gov

Principal Investigator:

Liang Shih Fan

Ohio State University Research Foundation

fan.1@osu.edu

Partners:

Air Products and Chemicals, Inc.
Babcock & Wilcox Power Generation Group, Inc.
Clear Skies Consulting
CONSOL Energy, Inc.
Shell/CRI/Criterion, Inc.

Performance Period:

1/1/09 – 12/31/11

The oxygen carrier consists primarily of Fe_2O_3 based on earlier tests that showed an acceptable oxygen capacity and no loss of activity during more than 100 redox cycles in a thermogravimetric analyzer (TGA) test. To optimize the reactivity, recyclability, and physical strength of the Fe_2O_3 -based oxygen carrier for the CDCL process, OSU researchers evaluated the performance of different support materials and promoters using a TGA and a fixed-bed reactor. These initial screening experiments were used to select the 10 most reactive and recyclable particle compositions, which were subjected to additional reactivity and physical strength tests. These 10 particles were tested to measure their reactivity with coal char in an inert environment and their tolerance to carbon deposition using TGA. The particles were then pelletized for further evaluations, such as pellet strength and reactivity, using a fixed-bed. After eliminating pellets with unacceptable strength and reactivity, the five most promising Fe_2O_3 -based composite oxygen carrier particles were identified.

Bench-scale (2.5 kWth) testing of the five most promising oxygen carrier particle compositions in a moving-bed reactor will be used to determine the optimal oxygen carrier particle composition for the CDCL process. A series of bench-scale tests have been conducted for more than 50 hours.

Using the sub-pilot scale (25 kWth) testing unit shown in Figure 2, the integrated CDCL process will be evaluated during a minimum of 50 hours of continuous operation with the optimal oxygen carrier particle composition. During testing, OSU researchers will monitor the composition of outlet gases [including CO_2 , sulfur dioxide (SO_2), and (NO_x)], attrition of the oxygen carrier, and the ash separation effectiveness of the cyclone system.

To quantify the performance and potential benefits of the CDCL process, detailed modeling and a techno-economic analysis of the system will be conducted by CONSOL Energy.



Figure 2: Sub-Pilot Scale (25 kWth) CDCL Unit

Technology Advantages

- An air separation unit is not required for oxygen production.
- CO_2 separation simultaneously takes place with the coal conversion.
- The CDCL process is a versatile technology that can produce power, synthesis gas (syngas), or hydrogen (H_2), while offering fuel flexibility.

R&D Challenges

- Scale-up issues.
- Solids handling and transport.
- Oxygen carrier capacity, reactivity, and attrition.
- Slow reaction rates between the oxygen carrier and coal char.
- Ash management.

Results To Date/Accomplishments

- Completed analyses for selection of optimum oxygen carrier and support particle. Identified five Fe_2O_3 -based oxygen carrier particles. Testing of the oxygen carrier particles included evaluation of recyclability, carbon deposition tolerance, reaction with coal char, and pellet strength and reactivity.
- Demonstrated coal conversion by oxygen carrier using a TGA for solids analysis and a fixed-bed experiment for gas analysis.
- Conducted bench-scale testing (2.5 kWth) of coal char conversion. Studied the effects of H_2O (steam) and CO_2 as gasification enhancers on metallurgical coke char with the goal to determine the optimum oxygen carrier. Achieved 97% char conversion with H_2O (steam) as the gasification enhancer and 88% char conversion with CO_2 as the gasification enhancer.
 - The conditions that produce the highest conversion are the use of steam as an enhancer gas, higher temperatures, higher char residence times, and higher oxygen carrier to char ratios. However, all of these factors need to be optimized, since a high residence time will result in a larger, more capital-intensive setup, and a higher temperature will result in possible sintering of particles. Furthermore, the use of steam is a parasitic energy requirement, so conversion using steam needs to be controlled.
- Conducted solid handling study for sub-pilot scale demonstration using the cold model reactor.
- Initiated construction of sub-pilot scale (25 kWth) system.

Next Steps

- Complete construction of the sub-pilot scale system and integrated CDCL testing for at least 50 continuous hours.
- Conduct ASPEN simulation studies.
- Complete a techno-economic analysis.

Final test results will not be available until the December 2011 project completion date.

Available Reports/Technical Papers/Presentations

General project information is available on DOE/NETL website at: <http://www.netl.doe.gov/technologies/coalpower/ewr/co2/oxy-combustion/in-situ.html>

“Chemical Looping Systems for Fossil Energy Conversions,” John Wiley and Sons, Inc., Hoboken, NJ, USA, October 2010. <http://www.wiley.com/WileyCDA/WileyTitle/productCd-0470872527.html>

“Coal Direct Chemical Looping (CDCL) Retrofit to Pulverized Coal Power Plants for In-Situ CO_2 Capture,” Annual NETL CO_2 Capture Technology for Existing Plants R&D Meeting, Pittsburgh, PA, September 2010. <http://www.netl.doe.gov/publications/proceedings/10/co2capture/index.html>

“Coal Direct Chemical Looping Retrofit for Pulverized Coal-fired Power Plants with In-Situ CO_2 Capture,” Annual NETL CO_2 Capture Technology for Existing Plants R&D Meeting, Pittsburgh, PA, March 2009. <http://www.netl.doe.gov/publications/proceedings/09/CO2/index.html>

DEVELOPMENT OF COMPUTATIONAL APPROACHES FOR SIMULATION AND ADVANCED CONTROLS FOR HYBRID COMBUSTION-GASIFICATION CHEMICAL LOOPING

Primary Project Goals

Alstom is developing advanced computational models and optimizing control systems for chemical looping processes.

Technical Goals

- Identify sensor and control needs for chemical looping processes.
- Develop process simulation models with dynamic capability to evaluate control methods.
- Incorporate advanced process controls into the chemical looping plant design process.
- Investigate advanced process controls for complex solids flow and gas pressure control.
- Develop a control system design concept for the chemical looping prototype facility.

Technical Content

Alstom is developing advanced computational models and optimizing control systems for chemical looping processes, such as the hybrid combustion-gasification process shown in Figure 1. Chemical looping is a two-step process which first separates oxygen (O_2) from nitrogen (N_2) in an air stream in an air reactor. The O_2 is transferred to a solid oxygen carrier. The oxygen is carried by the solid oxide and is then used to gasify or combust solid fuel in a separate fuel reactor. As shown in Figure 1, a metal or calcium material (oxygen carrier) is burned in air forming a hot oxide (MeO_x or CaO_x) in the air reactor (Oxidizer). The oxygen in the hot metal oxide is used to gasify coal in the fuel reactor (Reducer), thereby reducing the oxide for continuous reuse in the chemical looping cycle.

Chemical looping is applicable to both new and retrofit plants and has the flexibility to be designed in a number of configurations. The reactor can be operated in a partial combustion mode, to generate a carbon monoxide (CO)-rich syngas, which in another variant, can be shifted to produce hydrogen (H_2). Alternately, it can operate in full combustion mode, resulting in exhaust of carbon dioxide (CO_2) and water. The three main configurations are: Option 1, chemical looping combustion with CO_2 capture; Option 2, chemical looping gasification with downstream CO_2 capture; and Option 3, chemical looping gasification to produce H_2 with inherent CO_2 capture.

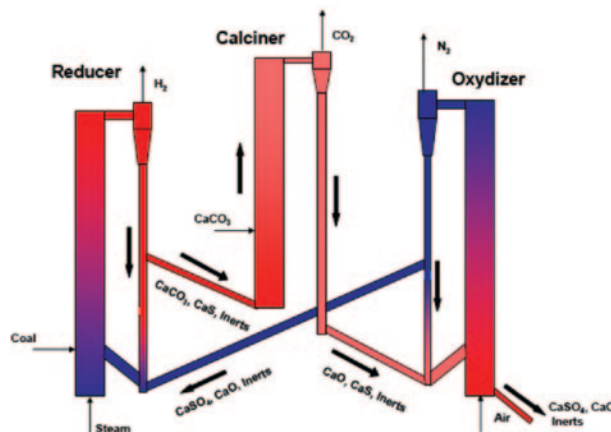

Figure 1: Alstom's Hybrid Combustion-Gasification Process

Technology Maturity:
Laboratory-scale

Project Focus:
Chemical Looping Simulation and Control

Participant:
Alstom Power

Project Number:
NT43095

NETL Project Manager
Susan Maley
Susan.Maley@netl.doe.gov

Principal Investigator:
Carl Neuschaefer
Alstom Power
Carl.h.neuschaefer@power.alstom.com

Partners:
Taft Engineering, Inc.
University of Illinois Urbana-Champaign (UIUC)

Performance Period:
7/12/07 – 3/31/11

Chemical looping is a process with multiple material and energy streams inter-connected between the multiple reactors. In order to obtain and maintain optimal conditions for operation with reduced waste stream volume and minimum required energy, advanced optimizing control systems are required. As such, process control development is needed to operate the system in a safe, integrated, and optimized fashion and is viewed as critical for enhancing the performance of the chemical looping system. This project is developing model-based controls that can be used to operate the system. Approaches to model development and control algorithms are being developed by researchers at Alstom and the University of Illinois Urbana-Champaign (UIUC).

Alstom is developing computational models to gain a better understanding of the chemical looping process behavior and to develop control strategies, including: a two-loop cold flow model, a dual-loop hot flow model (without reactions), and a real-time dual-loop simulator. The dual-loop simulation platforms are configured to test conceptual control designs. For example, it was used to investigate both linear and non-linear control concepts and evaluate control strategies with different sensors and actuators. In addition to developing process models and advanced controls applications, Alstom is developing advanced sensors, such as the ultrasonic-time of flight and the image-based laser-light spot and triangulation prototype level sensors.

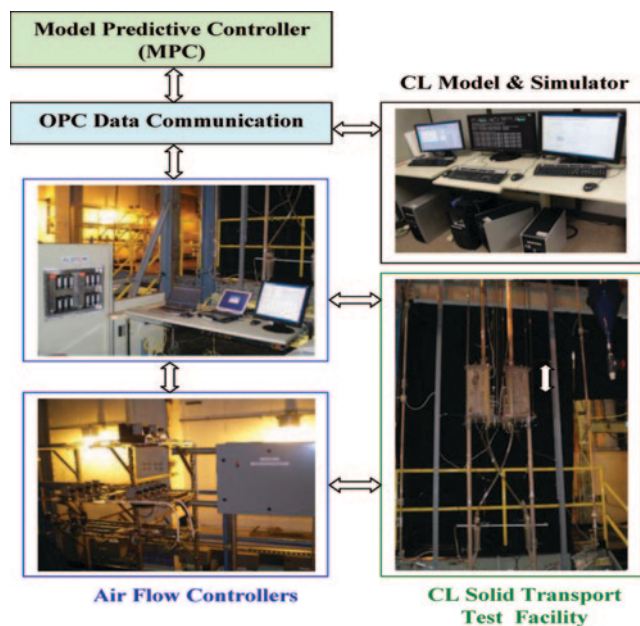

Figure 2: Experimental Facility Control Testing



Figure 3: Sensor Testing

Technology Advantages

Power plants using conventional circulating fluidized bed or transport reactor technology do not require very sophisticated control since there is only a single, uncontrolled recycle loop. However, it is anticipated that power plants using a chemical looping process that has more complex multi-loop controlled solids circulating and transfer loops will require more sophisticated and demanding process control systems. The overall advantage is to develop advanced multivariable optimizing controls integrated early into the process development cycle to ensure a plant level design that is more controllable and reliable.

Advanced control systems for chemical looping will provide for more stable and continuous operation of the process, thus enabling high efficiency, high reliability, low environmental impact, and reduced costs. Project investigations have shown that traditional controls are more subject to interactions and disturbances and hence less robust to maintaining stable loop control when compared to model-based control of the same system, suggesting that this approach may be essential for reliably operating multiple cross-flowing loops together in a continuous manner.

R&D Challenges

Challenges include the development of real-time, fast, and dynamically accurate response models for use in simulation and dynamic control of the chemical looping multi-loops, followed by the inclusion of new measured control variables and reliable instrumentation as input into the model-based control. Additional challenges will be to scale-up the computational models and simulation tools and integrate the advanced controls with the scale up of the chemical looping process from the current laboratory scale to a commercial demonstration size unit. This will include consideration of the appropriate process dynamics, chemical reactions, and externalities so the control can account for a large number of variables and the changes in process dynamics at the larger size units that will impact stable loop control.

Results To Date/Accomplishments

- Developed process and control performance benchmarks.
- Completed process characterization by developing an understanding of the dynamic operation and control issues at the cold flow and chemical looping test facilities.
- Completed process modeling and simulation.
- Validated chemical looping process models.
- A two-loop cold flow model has been validated with extensive test data.
- A real-time dual-loop cold flow simulator has been developed to test control designs.
- A hot-loop model (without reactions) has been developed and parameterized using data from the chemical looping process development unit (PDU) test facility.
- The dual-loop simulation platform is completed and was used to evaluate different control strategies with various sensors and actuators.
- Conceptual proportional-integral-derivative (PID) control and model predictive control (MPC) designs have been completed and tested with the simulator.
- A real-time linear MPC controller was revised and tested for the 15-foot dual-loop facility.
- Initiated scale-up modeling and simulation of a larger cold flow solids transport test facility.
- Completed further scale-up to develop models and multi-loop simulations for the 3-MW_{th} chemical looping prototype test facility being constructed by Alstom under DOE/NETL project No. DE-NT0005286.
- Evaluated a nonlinear model predictive control (NMPC) based on the development of an initial reduced order model (ROM) for dual-loop controls.
- Completed testing of advanced sensors. Both the solids level sensor and the two-phase mass flow sensor candidates were tested and confirmed that a direct measurement of both level and mass flow rate are feasible and significantly aid in the process control. Soft sensing based on the measurement of differential pressures has also been investigated.

Next Steps

Final results will not be available until after the March 2011 project completion date.

Available Reports/Technical Papers/Presentations

The 33rd International Technical Conference on Coal Utilization and Fuel Systems, Clearwater, FL, USA, June 1–5, 2008, “Simulation and Advanced Controls for Alstom’s Chemical Looping Process,” Xinsheng Lou, Carl Neuschaefer, and Hao Lei.

51st ISA Power Industry Division Symposium and 18th Annual Joint ISA POWID/EPRI, Controls and Instrumentation Conference, Scottsdale, AZ, USA, June 8–13, 2008, “Simulation and Advanced Controls for Hybrid Combustion-Gasification Chemical Looping Process,” Xinsheng Lou, Carl Neuschaefer, and Hao Lei.

International Pittsburgh Coal Conference, Pittsburgh, PA, USA, September 21–24, 2009 “Dynamic Simulation and Advanced Controls for Alstom’s Chemical Looping Process,” Xinsheng Lou, Carl Neuschaefer, Hao Lei and Abhinaya Joshi.

Modelling, Controller Design, and Computational Tools for the Closed-Loop Control of the Cold Flow Fluidized Bed Rise, submitted to the journal of Nonlinear Phenomena in Complex Systems by UIUC Dong Ye, Shu Zhang, Vivek Natarajan, Bryan Petrus, and Joseph Bentsman.

An invited presentation on this project was given by Mr. Carl Neuschaefer at the workshop on advanced controls organized by DOE/NETL aligned with 2008 ISA Power Conference in Scottsdale, AZ, USA.

2010 International Pittsburgh Coal Conference, Istanbul, Turkey, October 11–14, 2010, “Development of Real-time Dynamic Simulation of Chemical Looping Process for Advanced Controls,” Hao Lei, Xinsheng Lou, Abhinaya Joshi and Carl Neuschaefer.

HIGH PURITY HYDROGEN PRODUCTION WITH IN-SITU CARBON DIOXIDE AND SULFUR CAPTURE IN A SINGLE-STAGE REACTOR

Primary Project Goals

Ohio State University (OSU) is developing a Calcium Looping Process (CLP) to enhance hydrogen (H_2) production by integrating the water gas shift (WGS) reaction with high-temperature carbon dioxide (CO_2), sulfur, and halide removal from synthesis gas (syngas) in a single-stage reactor for integrated gasification combined cycle (IGCC) applications.

Technical Goals

- Reduce steam requirement and operate at near-stoichiometric steam consumption.
- Evaluate the regenerability of the calcium oxide (CaO) sorbent by repeated in-situ carbonation and regeneration for 10–100 cycles.
- Demonstrate simultaneous removal of CO_2 , sulfur, and halides using a CaO sorbent in the bench-scale, fixed-bed unit.
- Produce either a 90–95% H_2 stream without WGS catalyst, or a 99+% high-purity H_2 stream with WGS catalyst at high temperatures and pressures.
- Demonstrate H_2 production with the sub-pilot-scale testing unit.
- Perform a techno-economic feasibility study for different integrated process scenarios using Aspen modeling.

Technical Content

The WGS reaction, which converts most of the syngas carbon monoxide (CO) to H_2 and CO_2 by reacting the CO with steam over a bed of catalyst, can be utilized to enhance H_2 production. The excess steam serves to drive the WGS equilibrium toward the products. The reaction is exothermic and, due to equilibrium constraints, typically consists of two stages: (1) high-temperature shift that benefits from high reaction rates at elevated temperatures; and (2) low-temperature shift that yields more favorable reaction equilibrium.



OSU researchers are developing the CLP that combines the WGS reaction and high-temperature, sorbent-based acid gas removal in a single-stage reactor, as shown in Figure 1. By implementing the CLP near the high-temperature reaction zone, syngas cooling and re-heating is no longer required, and the process may eliminate the need for the WGS catalyst. A CaO sorbent is used as the circulating material for in-situ removal of CO_2 , sulfur, and halides. By incorporating sorbent-based CO_2 removal, not only is a near sequestration-ready stream of CO_2 produced, but plant efficiency and H_2 production are increased by driving the WGS reaction further to completion.

Technology Maturity:

Laboratory-scale

Project Focus:

Calcium Looping Process for Hydrogen Production

Participant:

Ohio State University

Project Number:

NT43059

NETL Project Manager

Don Krastman

Donald.Krastman@netl.doe.gov

Principal Investigator:

Liang Shih Fan

Ohio State University-
Department of Chemical
Engineering

fan.1@osu.edu

Partners:

Clear Skies Consulting
Consol Energy, Inc.

Performance Period:

7/5/07 – 4/30/11

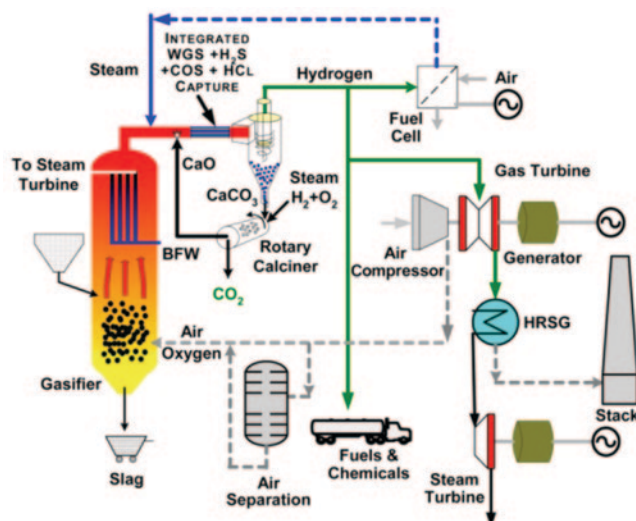

Figure 1: Calcium Looping Process for Enhanced Hydrogen Production with In-Site CO₂ and Sulfur Capture in a Single-Stage Reactor

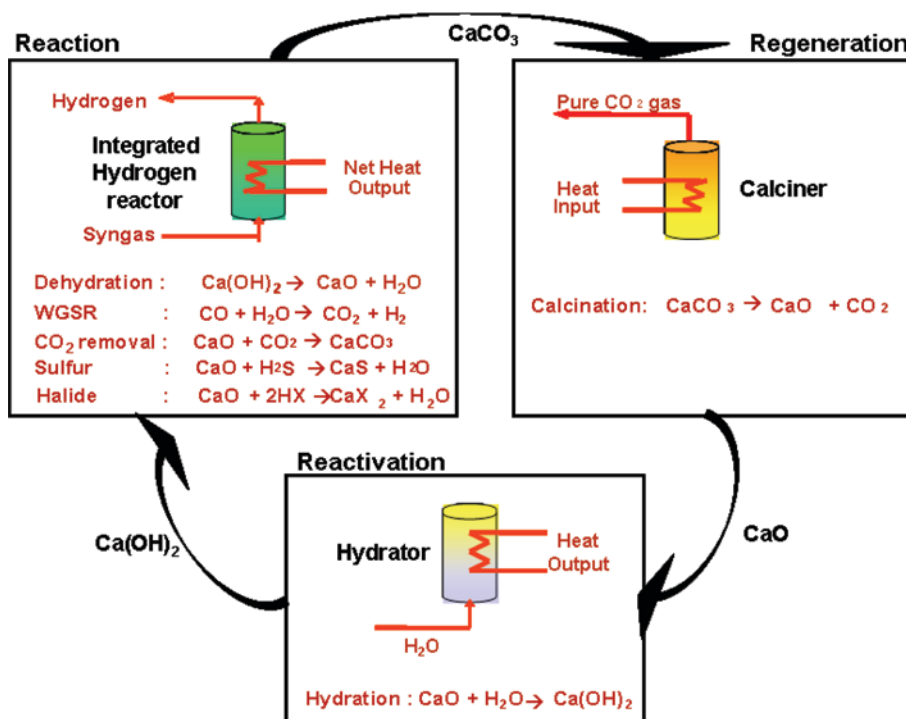

Figure 2: Illustration of the Reaction Schemes in the Calcium Looping Process

As shown in Figure 2, the CLP is comprised of three reactors: (1) the carbonator, where high-purity H₂ is produced and contaminant removal takes place; (2) the calciner, where the CaO sorbent is regenerated and a sequestration-ready CO₂ stream is produced; and (3) the hydrator, which reactivates the CaO sorbent. The carbonator (either a fixed, fluidized-bed, or an entrained flow reactor) operates at high pressures ranging from 20 to 30 atm and temperatures of 550–650 °C. The thermodynamic constraint of the WGS reaction is overcome in the carbonation reactor by the incessant removal of the CO₂ product from the reaction mixture, which enhances H₂ production. This is achieved by concurrent WGS reaction and carbonation reaction of CaO to form calcium carbonate (CaCO₃), thereby removing the CO₂ product from the reaction mixture and obviating the need for a WGS catalyst and excess steam addition. The CLP does not require syngas pretreatment, because the CaO sorbent also controls hydrogen sulfide (H₂S), hydrogen chloride (HCl), and carbonyl sulfide (COS) to parts-per-billion (ppb) levels. Key parameters for the CaO sorbent are provided in Table 1.

Table 1: Solid Sorbent Parameters

	Parameter	Current R&D Value	Target R&D Value
Sorbent Properties	Type of sorbent	CaO powder	CaO powder
	Heat of adsorption (kJ/mole CO ₂)	-178.3	-178.3
	CO ₂ loading/working capacity, wt%	45–55%	55%
	Surface area, m ² /g	14–32	14–32
	Particle density, cm ³ /g	1.150 g/cm ³	1.150 g/cm ³
	Packing density, cm ³ /g	1.289 g/cm ³	1.289 g/cm ³
	Particle size (mm)	0.01–0.05	0.01–0.05
	Heat capacity (kJ/K/kg)	0.96(CaO)–1.23(CaCO ₃)	0.96(CaO)–1.23(CaCO ₃)
	Thermal stability, °C	Much higher than the temperature of operation	Much higher than the temperature of operation
	Hydrothermal stability, °C	N/A	N/A
Process Configuration	Attrition rate (fluidized bed), %/year	N/A since micron sized particles are used	N/A since micron sized particles are used
	Cycle time (fixed bed), minutes	N/A	N/A
	Pressure drop (fixed bed), psia	N/A	N/A
Operating Conditions	Adsorption temperature, °C	600	600
	Adsorption pressure, atm	1–30 atms	1–30 atms
	CO ₂ capture efficiency, %	>99%	>99%
	Regeneration method	Calcination in N ₂ , or pure CO ₂	Calcination in CO ₂
	Regeneration temperature, °C	700–950	700–950
	Regeneration pressure, atm	1	1
Heat Integration	Required regeneration steam temperature, °C	External steam not required for regeneration	External steam not required for regeneration
Miscellaneous	Sorbent make-up rate, kg/kg CO ₂	N/A	—
Product Quality	CO ₂ purity, %	N/A	>99%
	N ₂ concentration, %	N/A	<1%
	Other contaminants, %	N/A	—
Process Performance	Electricity requirement, kJ/kg CO ₂	N/A	N/A
	Heat requirement, kJ/kg CO ₂	N/A	N/A
	Total energy (electricity equivalent), kJ/kg CO ₂	N/A	N/A

The spent sorbent, consisting mainly of CaCO₃, is regenerated back to CaO in the calciner, which operates at atmospheric pressure in a rotary, or a fluidized-bed system. Calcination occurs at temperatures above 900 °C in the presence of 1 atm CO₂, but CO₂ dilution via steam addition or syngas combustion in a direct-fired calciner permits calcination at lower temperatures. The regenerated CaO sorbent is then conveyed to the hydrator.

The hot solids from the calciner are then cooled to 500–600 °C and hydrated via contact with low-temperature steam in the hydrator. The calcination process causes sorbent sintering, which reduces the sorbent's reactivity; the hydration process reverses this effect by increasing the pore volume and surface area available for reaction with the gas mixture. The calcium hydroxide [Ca(OH)₂] decomposes in the carbonator to produce CaO and steam. The steam obtained from the dehydration reaction is used for the WGS reaction. Hence, no excess steam is required in the CLP as the WGS steam is supplied to the hydrator.

Technology Advantages

- The simultaneous removal of CO₂ drives the WGS reaction to completion, which due to operation at feed conditions (high temperature and pressure), will increase plant efficiency.

- The process also eliminates the need for a WGS catalyst.
- No separate steps necessary for removal of sulfur and halide impurities.
- High-quality exothermic heat available from all three reactors can be used to generate electricity.

R&D Challenges

- Waste disposal.
- Solids handling and transport.
- Design of a high-temperature steam hydrator.

Results To Date/Accomplishments

- Determined optimum temperature (600 °C) for H₂ production and impurity removal.
- Identified temperature range for CO₂ capture while reducing excess steam requirements.
- Identified process conditions for H₂S and halide capture.
- Combined WGS, carbonation, and sulfidation reactions conducted in the absence of a catalyst.
- Designed and fabricated a cold model for the carbonator.
- Developed the sorbent reactivation process by hydration and achieved sustained reactivity for multiple cycles.
- Conducted cold flow and hot flow tests using air to ensure proper functioning of the sub-pilot-scale unit.
- Successfully conducted high-temperature CO₂ capture tests using CaO in the sub-pilot-scale unit.

Next Steps

- Conduct sub-pilot-scale testing of combined WGS and CO₂ capture to evaluate process feasibility.
- Complete Aspen simulation studies.
- Complete techno-economic analysis.
- Design a 1–5 MWe pilot-scale CLP unit.

Final test results will not be available until after the April 2011 project completion date.

Available Reports/Technical Papers/Presentations

Ramkumar, S. and Fan, L.-S.; Calcium Looping Process for Clean Fossil Fuel Conversion. *Proc. 26th Intl Pittsburgh Coal Conf.*, Pittsburgh, PA, September 2009.

Ramkumar, S.; Connell, D. and Fan, L.-S.; Calcium Looping Process for Clean Fossil Fuel Conversion. *1st Meeting of the High Temperature Solid Looping Cycles Network*, Oviedo, Spain, September 2009.

Ramkumar, S. and Fan, L.-S.; Calcium Looping Process for Clean Fossil Fuel Conversion. *8th World Congress of Chemical Engineering*, Montreal, Canada, August 2009.

ALSTOM'S CHEMICAL LOOPING COMBUSTION PROTOTYPE FOR CO₂ CAPTURE FROM EXISTING PULVERIZED COAL-FIRED POWER PLANTS

Primary Project Goals

Alstom Power is to design, build, and test a 3-MW_{th} limestone-based chemical looping combustion (CLC) prototype facility.

Technical Goals

- Design a CLC prototype that consumes approximately 454 kg/hr (1,000 lb/hr) of coal and uses calcium sulfate (CaSO₄) as an oxygen carrier.
- Test cold flow solids transport.
- Characterize the environmental performance of the CLC prototype facility.
- Develop design information for a larger-scale CLC commercial demonstration plant.

Technical Content

Alstom is to scale up the limestone-based CLC process from a 65-kW_{th} pilot, which was successfully demonstrated in an earlier project, to a 3-MW_{th} prototype facility that is to be operational in 2010 and 2011. CLC utilizes a metal oxide or other compound, in this case limestone (CaSO₄), as an oxygen carrier to transfer oxygen from the combustion air to the fuel. Since direct contact between fuel and combustion air is avoided (Figure 1), the products of combustion [carbon dioxide (CO₂) and water] are kept separate from the rest of the flue gases (primarily nitrogen). CLC splits combustion into separate oxidation and reduction reactions. The carrier releases oxygen in a reducing atmosphere to react with the fuel. The carrier is then recycled back to the oxidation chamber to be regenerated by contact with air. Calcination of hot solids produced in the oxidation reactor produce a concentrated stream of CO₂ in lieu of the dilute CO₂ stream typically found in flue gas from coal-fired power plants.

Prior to DOE/NETL involvement, Alstom constructed a small-scale pilot facility [process development unit (PDU)] at its Power Plant Laboratories in Windsor, CT, that was completed in 2003. The PDU was subsequently used in the DOE/NETL project. In Phase I, Alstom developed the indirect combustion loop with CO₂ separation, and also synthesis gas (syngas) production from coal with the calcium sulfide (CaS)/CaSO₄ loop utilizing the PDU facility.

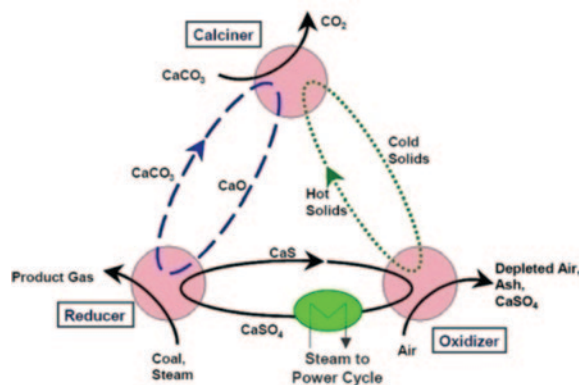

Figure 1: Limestone-Based CLC Process

Technology Maturity:

Prototype scale, 3-MW_{th}, 1,000 lb of coal/hr

Project Focus:

Chemical Looping Combustion Prototype

Participant:

Alstom Power

Project Number:

NT0005286
(continuation of NT41866)

NETL Project Manager

Bruce Lani
Bruce.Lani@netl.doe.gov

Principal Investigator:

Herbert E. Andrus
Alstom Power, Boiler R&D Execution
Herbert.e.andrus@power.alstom.com

Partners:

Dr. Fred Zenz, PEMM Corporation
Dr. John Grace and Dr. Jim Lim, University of British Columbia
Dr. Janos Beer, MIT

Performance Period:

9/30/03 – 9/30/11

In Phase II, Alstom developed the carbonate loop [lime (CaO)/calcium carbonate (CaCO_3)], integrated it with the gasification loop from Phase I, and demonstrated the feasibility of hydrogen production from the combined loops.

In Phase III, Alstom operated the small pilot plant to obtain engineering information to design a prototype of the commercial chemical looping concept. The activities included modifications to the Phase II chemical looping PDU, solids transportation studies, control and instrumentation studies, and additional cold flow modeling.

In the current Phase IV activities, Alstom is to design, construct, and operate a 3-MW_{th} CLC prototype that includes process loops to transfer solids and oxygen between the reducing and oxidation reactors. The facility has the ability to combust coal, gasify coal, or produce hydrogen; however, hydrogen is not expected to be produced during this particular project. Alstom plans to conduct seven weeks of cold flow and hot flow testing, with CO_2 vented to the atmosphere. Information gleaned from prototype testing will be used to develop a technical plan and cost estimate for a subsequent larger-scale commercial demonstration project at a full-scale power plant. Figure 2 is a photograph of the 40 foot-tall cold flow model and Figure 3 is a general arrangement drawing of the 3-MW_{th} prototype facility. The prototype includes a reducing reactor, an oxidation reactor, and process loops to transfer solids and oxygen between the two reactors using limestone as the oxygen carrier.



Figure 2: 40-Foot Cold Flow Model

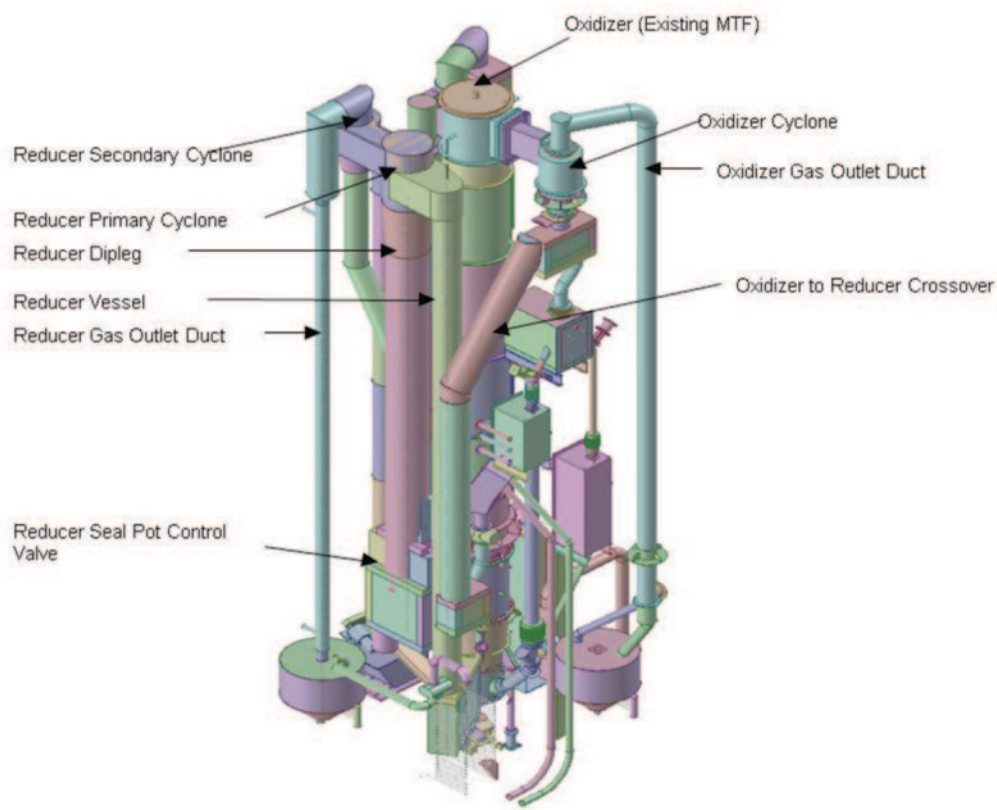

Figure 3: General Arrangement of 3-MW_{th} Prototype Test Facility

Technology Advantages

- An air separation unit (ASU) is not required for oxygen production.
- CO₂ separation takes place during combustion.
- The technology can produce power, syngas, or hydrogen, while offering fuel flexibility.

R&D Challenges

- Scale up issues.
- Solids handling and transport.
- Oxygen carrier capacity and reactivity.

Results To Date/Accomplishments

Phases I, II, and III were completed in the earlier project (NT41866) and Phase IV is being conducted under the current project (NT0005286).

Phase I:

- It is practical to build a chemical looping system using the CaS to CaSO₄ reaction without losing sulfur as either sulfur dioxide (SO₂) or hydrogen sulfide (H₂S).
- High gasification rates can be obtained in a chemical looping system even with low reactivity coals.
- It is possible to operate three interactive solids transport loops (oxidizer, reducer, and sorbent activation) at elevated temperatures (1,800 °F).
- It is possible to start up and heat up the solids transport loops interactively.
- The chemical looping PDU design concept was validated.
- Cold flow modeling provides a valuable tool for simulating the hot chemical looping system. The cold flow model is useful for determining fluidization and solids transport control settings for fluidizing and transport gases.

Phase II:

- The PDU demonstrated operation of five parallel loops cold and four parallel at operating temperatures.
- CaO and CaCO₃ kinetics were demonstrated in the PDU at operating temperatures.
- Water gas shift reactions occurred rapidly at PDU operating conditions.
- Cold flow bench test scale-up methods revealed what the hot PDU behavior will be like.
- Important control strategies were tested and validated.
- The sorbent activation vent system can accurately measure flow from the sorbent reactivation reactor.

Phase III:

- It is feasible to build an approximately 3-MW_{th} prototype chemical looping plant that is auto-thermal (requiring no external heaters).
- It is possible to design and operate an automatic control system for the chemical looping system.

- It is possible to design reactors for the chemical looping system using standard materials of construction and standard design methods.
- High efficiency cyclone performance can be achieved with the proper design. It is also possible to keep all solids greater than 7 microns in size in the loop.
- Controllable and smooth solids flow can be maintained.
- Scale-up to a 1,000 lb/hr coal flow prototype should be feasible.
- The performance of the cold flow models has shown a good correlation to the performance of the hot PDU.
- The chemical looping concept is ready for the prototype phase.

Phase IV:

- Design and construction of the 3-MW_{th} prototype facility is in progress.

Next Steps

- Complete construction and begin prototype operation/testing/modification/development.
- Update commercial economics analysis.

Final test results will not be available until after the September 2011 project completion date.

Available Reports/Technical Papers/Presentations

General project information is available on DOE/NETL website at: <http://www.netl.doe.gov/technologies/coalpower/ewr/co2/oxy-combustion/prototype.html>

“Alstom’s Calcium Oxide Chemical Looping Combustion Prototype Development,” Annual NETL CO₂ Capture Technology for Existing Plants R&D Meeting, Pittsburgh, PA, September 2010. <http://www.netl.doe.gov/publications/proceedings/10/co2capture/index.html>

“Chemical Looping Combustion Coal Power Technology Development Prototype,” Annual NETL CO₂ Capture Technology for Existing Plants R&D Meeting, Pittsburgh, PA, March 2009. <http://www.netl.doe.gov/publications/proceedings/09/CO2/index.html>

Nsakala, N. Y. and Liljedahl, G. N., Greenhouse Gas Emissions Control by Oxygen Firing in Circulating Fluidized Bed Boilers, Alstom Power – U.S. DOE Report, PPL Report No, PPL-03-CT-09, 15 May 2003.

Andrus, H. E., Jr., et. al., Hybrid Combustion-Gasification Chemical Looping Coal Power Technology Development – Phase I Final Report, U.S. DOE, December, 29, 2004.

Andrus, H. E., Jr., et. al., Hybrid Combustion-Gasification Chemical Looping Coal Power Technology Development – Phase II Final Report, U.S. DOE, June, 9, 2006.

APPENDIX B: CARBON DIOXIDE CAPTURE TECHNOLOGY SHEETS
ADVANCED COMPRESSION

THERMAL INTEGRATION OF CO₂ COMPRESSION PROCESSES WITH COAL-FIRED POWER PLANTS EQUIPPED WITH CARBON CAPTURE

Primary Project Goals

Lehigh University is developing systems analysis models to study the benefits of improved thermal integration for coal-fired power plants equipped with post- or oxy-combustion carbon dioxide (CO₂) capture systems.

Technical Goals

- Gather technical and performance information from compressor manufacturers and the technical literature in order to calculate compressor power requirements, performance of interstage heat transfer, and interstage pressure changes.
- Develop and validate ASPEN Plus models of coal-fired power plants with solvent-based post-combustion CO₂ capture to simulate the effects of different thermal integration options on power plant efficiency and net power output.
- Develop and validate ASPEN Plus models of oxy-combustion coal power plants to simulate the effects of different thermal integration options on power plant efficiency and net power output.

Technical Content

Coal-based power plants equipped for CO₂ capture require a compression system to increase the pressure of the CO₂ to the level needed for geological storage [approximately 2,200 pounds per square inch absolute (psia)]. In addition to its relatively high capital cost, the CO₂ compression system requires a significant amount of auxiliary power for operation. The technology options available for CO₂ compression include:

- A multistage in-line centrifugal compressor with interstage and post-compression cooling.
- A multistage integrally geared centrifugal compressor with interstage cooling.
- A multistage supersonic shockwave compressor with interstage and post-compression cooling.
- A compression process involving gas phase compression to approximately 200 psia, cryogenic cooling through the two-phase region, and increase in pressure of the liquid CO₂ to the final pressure using a liquid cryogenic pump.

For some of these technology options, there is the potential for utilization of waste heat from the CO₂ compressors within the power plant. This project uses first-principle engineering analyses and computer simulations to determine the increase in power output and improvement in net unit heat rate which could occur by thermal integration of the CO₂ compression process with the CO₂ capture system, boiler, and turbine cycle. The study includes gathering information on compressor internal geometry and compressor stage efficiencies. The aerodynamic conditions and flow

Technology Maturity:
Systems analysis models

Project Focus:
Thermal Integration of CO₂ Compression Processes

Participant:
Lehigh University

Project Number:
FE0002146

NETL Project Manager:
Darin Damiani
Darin.Damiani@netl.doe.gov

Principal Investigator:
Edward Levy
Lehigh University
ek10@lehigh.edu

Partners:
None

Performance Period:
10/1/09 – 6/29/12

geometry change from the low-pressure to high-pressure end of the compressor, very likely resulting in significant variations in isentropic stage efficiency from inlet to outlet. Correct values for isentropic stage efficiency are needed in order to obtain realistic values of compressor power and CO₂ exit temperature for each stage. In addition, fluid flow and heat transfer analyses will be performed to estimate CO₂ pressure drop in the intercoolers and the exit temperature of the cooling fluid as a function of coolant flow rate. While the literature suggests that most CO₂ compressors are air-cooled, analyses will be performed to determine the feasibility of using liquid-cooled heat exchangers for interstage cooling.

Once the analyses of the compressors are complete, the results will be linked to models of the power plant for analysis of various thermal integration options. The compressor and power plant simulations will be performed using the ASPEN Plus software. Each of the following cases will be analyzed using bituminous, Powder River Basin (PRB), and lignite coals:

- Pulverized coal-fired boiler with post-combustion solvent-based capture systems using both amine and ammonia scrubbers.
- Oxy-combustion pulverized coal boiler.

The thermal integration options which will be considered include pre-drying of low-rank coals, regeneration of CO₂ solvent, and boiler feedwater preheating. Table 1 presents the matrix of analyses which will be performed.

Table 1: Systems Analysis Matrix for CO₂ Compression Heat Integration

Use of Recovered Heat From CO ₂ Compressor			
Integration Method	Pre-Dry Low Rank Coal	Regenerate CO ₂ Solvent	Preheat Boiler Feedwater
Post-Combustion Solvent-Based CO₂ Capture			
Bituminous	No	Yes	Yes
PRB	Yes	Yes	Yes
Lignite	Yes	Yes	Yes
Oxy-Combustion			
Bituminous	No	No	Yes
PRB	Yes	No	Yes
Lignite	Yes	No	Yes

Technology Advantages

- Determine the best way to utilize waste heat from CO₂ compression.
- Improve power plant efficiency and increase the net power output.
- Reduce capital and operating cost for CO₂ capture and compression systems.

R&D Challenges

Implementation of the thermal integration opportunities as cost-effective technology options.

Results To Date/Accomplishments

- Obtained compressor design and performance information from CO₂ compressor vendors.
- Compared analysis algorithms to vendor data and verified analytical results.
- Initiated analysis of heat transfer and pressure drops for the pre-compression and interstage coolers.
- Developed ASPEN Plus models to analyze the effects of thermal integration on post-combustion capture and oxy-combustion systems.

Next Steps

- Complete analyses of thermal integration options for post-combustion capture system.
- Complete analyses of thermal integration options for oxy-combustion system.
- Complete analyses of pre-compression and interstage coolers.

Available Reports/Technical Papers/Presentations

No reports, technical papers, or presentations are yet available.

RAMGEN SUPERSONIC SHOCK WAVE COMPRESSION AND ENGINE TECHNOLOGY

Technology Maturity:
Pilot, 1,680 tonnes/day CO₂

Primary Project Goals

Ramgen Power Systems is designing and developing a unique compressor technology based upon aerospace shock wave compression theory for use as a carbon dioxide (CO₂) compressor. A shock wave-based gas turbine engine is also being developed.

Project Focus:
Shock Wave Compression

Participant:
Ramgen Power Systems, LLC

Technical Goals

Phase I:

- Complete testing of a high-pressure ratio (10:1) air compressor rotor for the Ram 2 program.
- Demonstrate the feasibility of high-pressure shock wave compression.
- Develop and detail a viable commercialization path.

Project Number:
FE0000493
NT42651

NETL Project Manager:
Timothy Fout
Timothy.Fout@netl.doe.gov

Phase II:

- Perform critical success factors risk reduction validation and test program to identify and reduce technical risk areas.
- Complete general assessment, preliminary, and final design of a demonstration CO₂ supersonic shock compressor approximately 13,000 hp in size.

Principal Investigator:
Aaron Koopman
Ramgen Power Systems, LLC
akoopman@ramgen.com

Technical Content

Shock Wave CO₂ Compressor

Ramgen Power Systems is developing a supersonic shock wave compression technology, similar in concept to an aircraft's ramjet engine, for use in a stationary compressor. Ramgen's compressor design, known as a Rampressor, features a rotating disk that operates at high peripheral speeds to generate shock waves that compress the CO₂. Compared to conventional compressor technologies, shock compression offers several potential advantages: high compression efficiency; high, single-stage compression ratios; opportunity for waste heat recovery; and low capital cost. For example, Ramgen's shock compression has the potential to develop compression ratios from 2.0 to 15.0 per stage with an associated adiabatic efficiency of 85–90%. For CO₂ applications, Ramgen anticipates using a nominal, two-stage 100:1 compression ratio, featuring a matched pair of 10:1 compression stages with an intercooler located between the stages. Prototype testing completed in 2007 achieved a 7.8:1 compression ratio.

When shock waves pass through a gas they cause a localized compression. Figure 1 shows that the rotating rotor rim has small, shallow angles which, when rotating at high speeds, will produce supersonic shock waves both prior to and post-peak. These shock waves, modeled in the 3-D Euler Computational Fluid Dynamics (CFD) image shown, are first oblique, then normal. Additionally, strakes (ridges) are incorporated into the design of the rotor to form sidewalls. The strakes are utilized as shock compression ducts, as well as to separate high-pressure discharge from low-pressure suction. The combination of shocks and strakes result in a compressed fluid delivered from a stationary discharge duct with compression efficiencies comparable to conventional industrial turbo-compressors, but with much higher single-stage pressure ratios and therefore higher quality heat of compression that combine to deliver significant installed and operational cost savings versus existing turbo-compressors.

Partners:
Dresser-Rand

Performance Period:
5/10/06 – 12/31/13

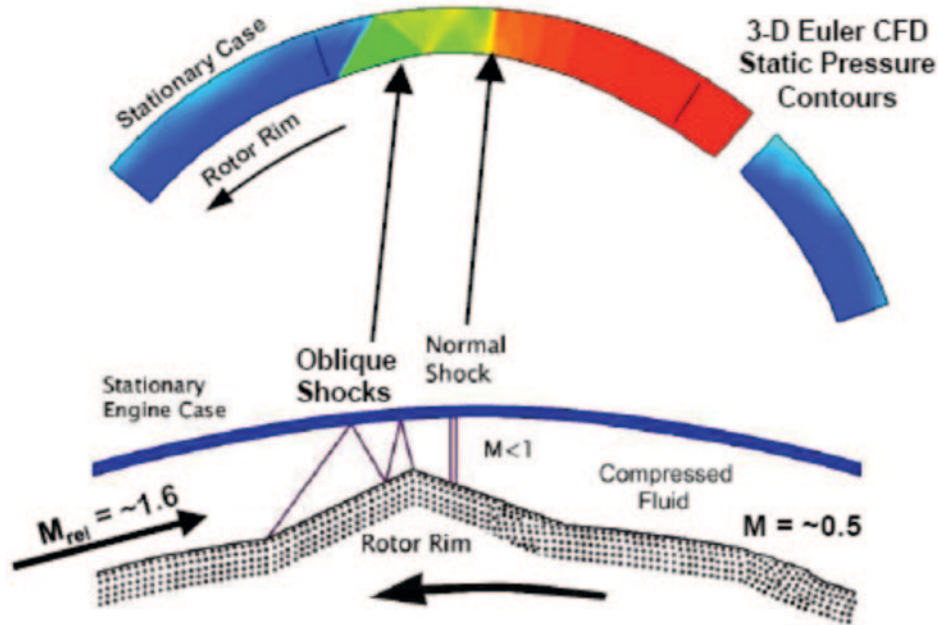

Figure 1: Schematic of Rotor Rim and Engine Case and 3-D Euler CFD Image Depicting Shock Wave Behavior

Two stages of compression are used with an intercooler located between the stages to optimize the efficiency of the compression process. Figure 2 shows the energy required as shaft work and the thermal energy lost to the cooling stream for a 200-MW coal plant with 90% CO₂ capture. The numbers found in the figure represent a stage in the process; each stage is driven independently through an external gearbox.

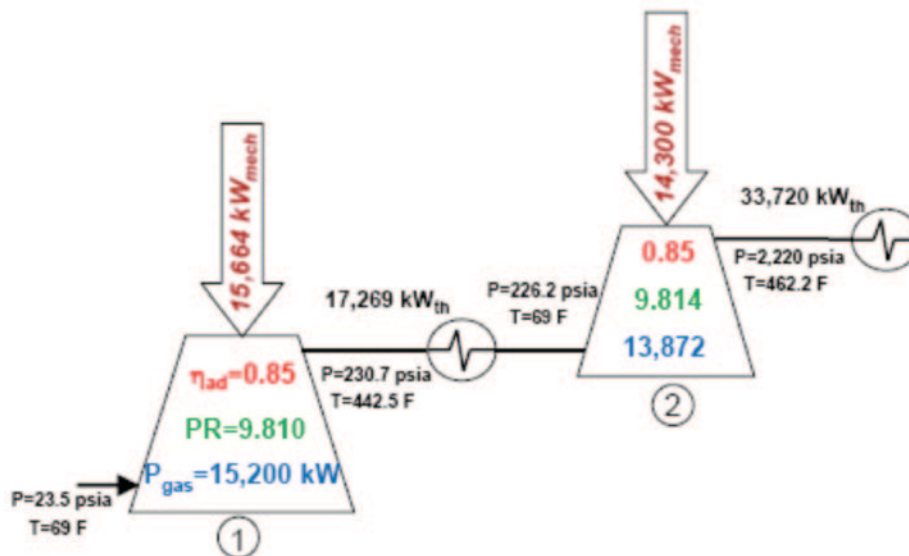

Figure 2: Series Process Schematic

As seen in Figure 2, the total shaft power is 29,964 kW_{mech}, which corresponds to a heat of compression of 50,989 kW_{th}. Approximately 28,986 kW_{th} of the heat of compression lost is recoverable down to 93 °C (200 °F).

Shock Wave Gas Turbine Engine

Ramgen is also developing a unique shock wave-based gas turbine engine that is expected to significantly improve energy efficiency. The Ramgen Integrated Supersonic Component Engine (ISCE) consolidates the compressor, combustor, and turbine of a conventional gas turbine into a single wheel that operates based on the same Brayton thermodynamic cycle as a conventional gas turbine; however, the mechanical implementation of the process is quite different. One important advantage is that because the compression, combustion, and expansion processes are all integrated into a single constant speed rotor, there is no physical acceleration of the rotating components required as the system transitions from idle to full power. The output torque and power are modulated from the full-speed, no load condition to the full-speed, full power condition by adjusting the fuel flow. As a result, the system can transition from idle to full power as quickly as the fuel flow can be adjusted. Testing has demonstrated a transition from combustor heat release levels consistent with a power variation from idle (pilot fuel only) to full power (full fuel/air premix) in periods as short as 150–200 milli-seconds (ms). The ISCE will have the ability to load follow from idle to full power in time scales as short as a few hundred ms compared with a response rate of 7–10 seconds for most intermediate sized gas turbine electric power generating systems.

The initial proof of concept Ramgen engine used an un-shrouded rotor configuration mounted on a single high-speed shaft driving a generator/starter motor through a speed reducing gearbox. The ISCE system will incorporate a fully shrouded flowpath power-wheel configuration. The power wheel now proposed will be directly supported by a magnetic bearing system and will incorporate permanent magnets into the inner diameter of the rotor. This rotor mounted magnet system will rotate around a central stator winding to form an integrated high-speed permanent magnet motor/starter system on the inner hub of the power wheel. This configuration will eliminate the need for a speed-reducing gearbox and the discrete separate motor/generator. This consolidation will result in a significantly more compact, lightweight, low-cost generation system compared to any other conventional turbo-generator system. This integrated power-wheel system is illustrated in Figure 4 and shows the engine feature of a propulsive flowpath that is fully shrouded and formed by a series of nested rim segments supported by a metal-matrix or polyimide composite outside diameter support ring.

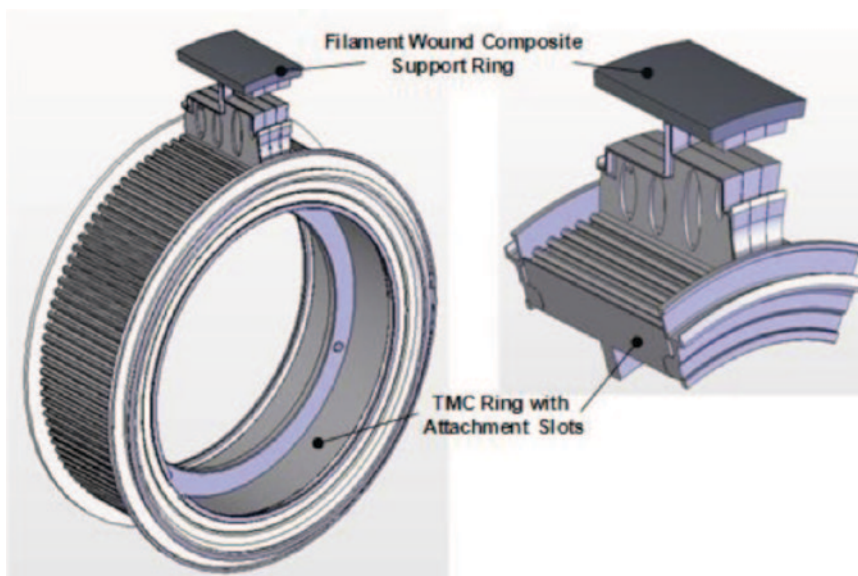

Figure 4: Integrated Power Wheel

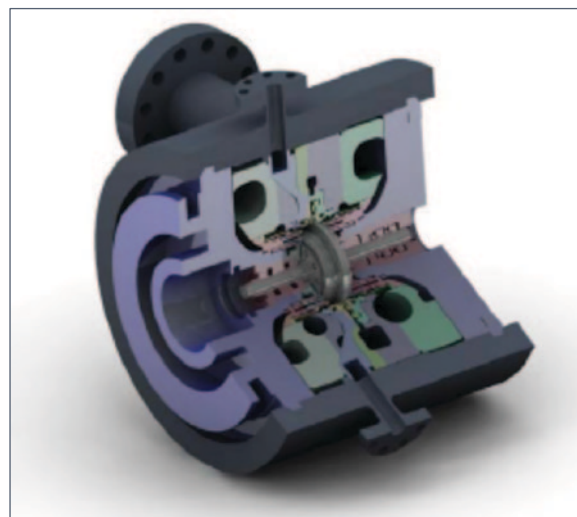

Figure 3: Cross Sectional Model of a 1/10th Scale Single Stage Supersonic Shock Wave Compressor

Technology Advantages

- Competitive operating efficiency and reduced installed capital cost (approximately 50%) over multi-stage bladed turbo compressors.
- High-stage discharge temperature enables cost-effective recovery of heat of compression.
 - Improves carbon capture and sequestration (CCS) efficiency.
 - Reduces power plant de-rate.

R&D Challenges

- Complicated shock wave aerodynamics on the flowpath requires intensive computing capabilities and model development.
- High rotational speeds and the resulting stresses can result in expensive rotor manufacturing techniques.
- High-pressure ratio compressors yield high rotor thrust loads on bearings and structure.

Results To Date/Accomplishments

- Finalized the CO₂ compressor rotor and static hardware geometry.
- Completed the preliminary conceptual design of the CO₂ compressor.
- Completed flowpath validation test conceptual design review.
- Completed CO₂ compressor demonstration unit feasibility study.
- Prepared a detailed systems analysis of the CO₂ compression technology.
- Prepared a rigorous comparative economic analysis based on the systems analysis of the CO₂ compressor.
- Achieved breakthrough rotor pressure ratio of approximately 7.9:1 in air.
- Demonstrated tip speeds up to ~2,200 ft/s and M_{rels} up to ~2.7.
- Successfully modeled full flowpath 3-D viscous CFD.
- Matched performance prediction/design tools to test.
- Obtained benign surge characteristics.
- Gathered data for preliminary compressor maps.
- Developed and demonstrated bearing designs suitable for product application.
- Completed CO₂ compressor stage configuration simulations.
- Completed CO₂ compressor preliminary design review.

Next Steps

- Improve understanding of the supersonic aerodynamics needed to achieve product performance levels in the CO₂ compressor.
- Continue to develop high-speed performance computing capability at Oak Ridge National Laboratory.
- Finalize design of the rotor and all other rig components and systems.
- Fabricate and retrofit the inlet guide vanes and diffuser.
- Install and test 13,000 hp CO₂ compressor.
- Complete ISCE preliminary design review.
- Test ISCE subcomponents.

Available Reports/Technical Papers/Presentations

General project information is available on DOE/NETL website at: <http://www.netl.doe.gov/technologies/coalpower/ewr/co2/co2compression/supersonic.html>

“CO₂ Compression Using Supersonic Shock Wave Technology,” Annual NETL CO₂ Capture Technology for Existing Plants R&D Meeting, Pittsburgh, PA, September 2010, <http://www.netl.doe.gov/publications/proceedings/10/co2capture/index.html>

“CO₂ Compression Using Supersonic Shock Wave Technology,” Annual NETL CO₂ Capture Technology for Existing Plants R&D Meeting, Pittsburgh, PA, May 2009, <http://www.netl.doe.gov/technologies/coalpower/ewr/co2/co2compression/supersonic.html>

“Ramgen Power Systems Low-Cost, High-Efficiency CO₂ Compressor,” Seventh Annual Conference on Carbon Capture and Sequestration, May 2008, <http://www.netl.doe.gov/technologies/coalpower/ewr/co2/co2compression/supersonic.html>

NOVEL CONCEPTS FOR THE COMPRESSION OF LARGE VOLUMES OF CO₂

Primary Project Goals

Southwest Research Institute (SwRI) is developing two novel compression technology concepts to reduce carbon dioxide (CO₂) compression power requirements by 35% compared to conventional compressor designs. The first concept is a semi-isothermal compression process where the CO₂ is continually cooled using an internal cooling jacket rather than using conventional inter-stage cooling. The second concept involves the use of refrigeration to liquefy the CO₂ so that its pressure can be increased using a pump rather than a compressor. The project includes prototype testing and a full-scale demonstration of each concept.

Technical Goals

- Conduct thermodynamic and economic analysis to determine the preferred CO₂ state for compression.
- Identify and evaluate intercooling concepts.
- Develop preliminary intercooling design.
- Calculate total potential energy savings.
- Complete a comprehensive thermodynamic and cost analysis of an integrated gasification combined cycle (IGCC) plant incorporating the new compression technology.
- Design a single-stage compressor test rig based on the analyses and design studies.
- Design, fabricate, and test a multi-stage pump test rig based on the analyses and design studies.

Technical Content

In the first concept, semi-isothermal compression, the gas is continually cooled after each stage in the path through the compressor. A cooling jacket insert is used in the diaphragm of each stage to provide continuous cooling. Figure 1 shows a design for an internally cooled compressor. The flow of the CO₂ is shown in red, while the cooling liquid is shown in blue.

In the second concept, compression is achieved by a combination of partial compression, liquefaction, and pumping. The liquefaction process utilizes a refrigeration system to condense CO₂ at 250 pounds per square inch gauge (psig) and -12 °F. The liquid CO₂ is then pumped from 250 to 2,200 psig. The primary power requirements are the initial compression required to boost the CO₂ to approximately 250 pounds per square inch absolute (psia) and the refrigeration power required to liquefy the gas. The pumping power to boost the pressure to pipeline supply pressure is minimal after the CO₂ is liquefied.

SwRI examined a number of different compression options to find the ones that would consume the least amount of power. Figure 2 shows how two hypothetical compression processes can achieve the same pressure, but still consume different quantities of power. The isothermal compression, even at 60% efficiency, is preferable to isentropic compression at 100% efficiency. Figure 3 shows the pressure/enthalpy curves for six of the options examined by SwRI. Table 1

Technology Maturity:

Pilot-scale, 90 tonnes/hr

Project Focus:

Evaluation of Compression Efficiency Improvements

Participant:

Southwest Research Institute

Project Number:

NT42650

NETL Project Manager:

Timothy Fout
Timothy.Fout@netl.doe.gov

Principal Investigator:

Jeffery Moore
 Southwest Research Institute
jeff.moore@swri.org

Partners:

Dresser-Rand

Performance Period:

9/28/05 – 12/31/13

presents a description of the compression and cooling technology options and the resultant power requirements for a 400-MW IGCC power plant (~700,000 lb/hr CO₂ stream). The optimal solution combines interstage cooling and a liquefaction approach (Option E.2).

B-368

ADVANCED COMPRESSION

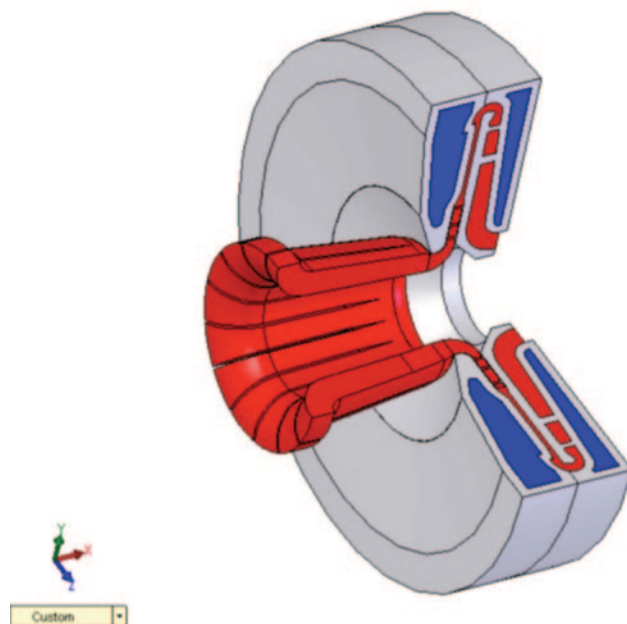

Figure 1: Design for an Internally Cooled Compressor

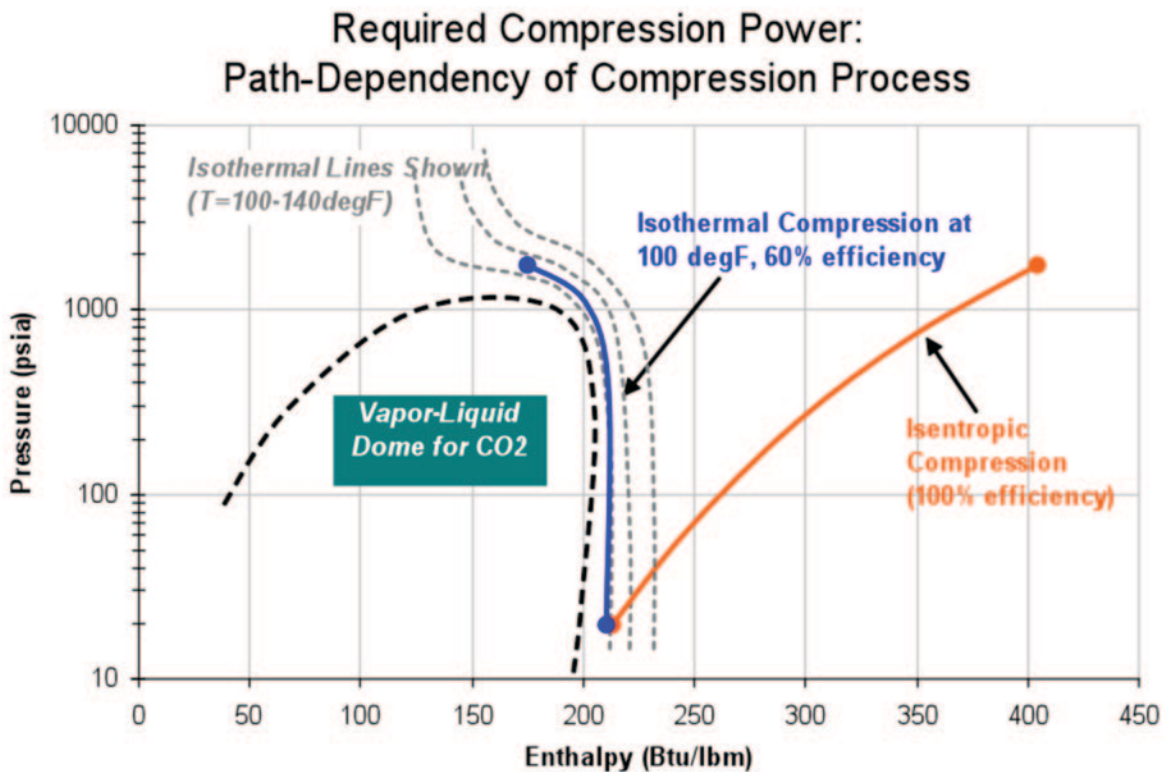

Figure 2: The Path Dependency of Compression Power

Compression Technology Options for IGCC Waste Carbon Dioxide Streams

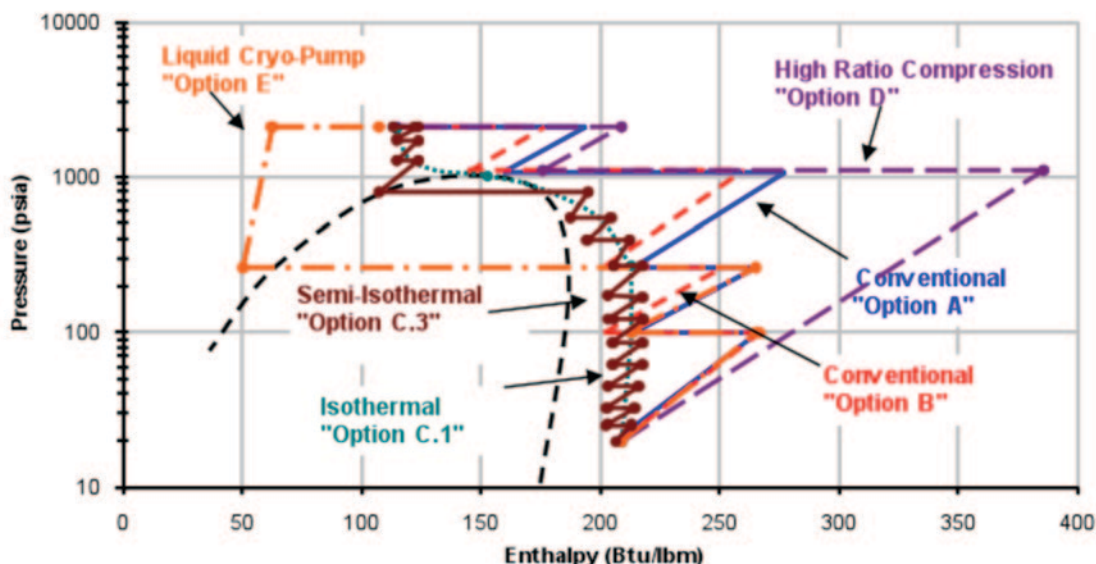

Figure 3: Required Compression Power for the Investigated Technology Options

Table 1: Comparison of Compression Technologies

Option	Compression Technology	Power Requirements	% Difference from Option A	Cooling Technology
A	Conventional Dresser-Rand Centrifugal 10-stage Compression	23,251 BHP	0.00%	Air-cool streams between separate stages
B	Conventional Dresser-Rand Centrifugal 10-stage Compression with additional cooling	21,522 BHP	-7.44%	Air-cool streams between separate stages using ASU cool N ₂ stream
C.1	Isothermal compression at 70 °F and 80% efficiency	14,840 BHP	-36.17%	T _c = 70 °F inlet temp throughout
C.4	Semi-isothermal compression at 70 °F, pressure ratio ~1.55	17,025 BHP (required cooling power TBD)	-26.78%	T _c = 70 °F in between each stage.
C.7	Semi-isothermal compression at 100 °F, pressure Ratio ~1.55	17,979 BHP (required cooling power TBD)	-22.67%	T _c = 100 °F in between each stage.
D.3	High ratio compression at 90% efficiency—no inter-stage cooling	34,192 BHP	47.06%	Air cool at 2,215 psia only
D.4	High ratio compression at 90% efficiency - intercooling on final compression stage	24,730 BHP	6.36%	Air cool at 220 and 2,215 psia
E.1	Centrifugal compression to 250 psia, Liquid cryo-pump from 250 to 2,215 psia	16,198 BHP (includes 7,814 BHP for refrigeration)	-30.33%	Air cool up to 250 psia, refrigeration to reduce CO ₂ to -25 °F to liquify
E.2	Centrifugal compression to 250 psia with semi-isothermal cooling at 100 degF, Liquid cryo-pump from 250 to 2,215 psia	15,145 BHP (includes 7,814 BHP for refrigeration)	-34.86%	Air cool up to 250 psia between centrifugal stages, refrigeration to reduce CO ₂ to -25 °F to liquify



Figure 4: Existing Liquid CO₂ Pump Loop Constructed at SwRI

The Option E.2 compression concepts were tested in Phase 2 of the project, which included construction of a dedicated liquid CO₂ flow loop to qualify an industrial turbo-pump. Also, a cooled diaphragm was tested in a compressor test rig that verified successful performance in a single-stage test. Figure 4 shows a photograph of the liquid CO₂ pump loop including the 12-stage vertical pump that was tested. Performance and mechanical testing was performed for a range of speeds, flows, and pressures. The pump met the design conditions with a discharge pressure in excess of 2,200 psig and showed good mechanical behavior. Figure 5 shows the performance map that was measured indicating good correlation to factory measurements using liquid nitrogen.

Figure 6 shows a photograph of the internally cooled compressor diaphragm, which routes cooling fluid through the diaphragm to remove the heat of compression. This prototype was installed into a closed-loop compressor test facility at SwRI and tested for a range of speeds, flows, pressures, and cooling fluid conditions. The testing agreed well with computational fluid dynamics (CFD) predictions for the heat transfer characteristics. Figure 7 shows a comparison between measured and predicted heat exchanger effectiveness for the diaphragm, which shows good agreement. Unlike external heat exchangers, no additional pressure drop occurs between stages. Implementation of the cooled diaphragm technology into a multi-stage application can reduce the power requirements of the compressor by 20% compared to adiabatic compression.

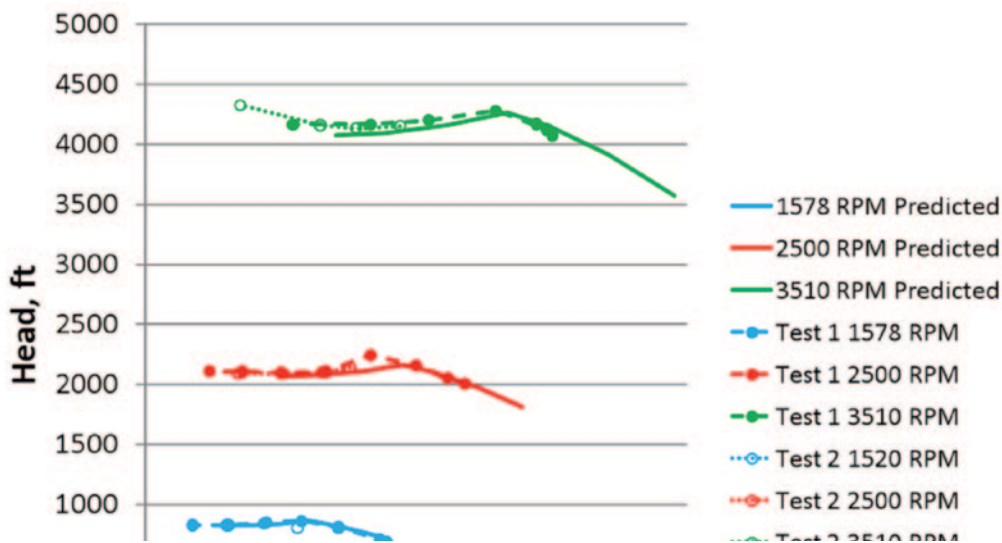

Figure 5: Pump Performance Plot (Head vs. Flow)



Figure 6: Internally Cooled Compressor Diaphragm

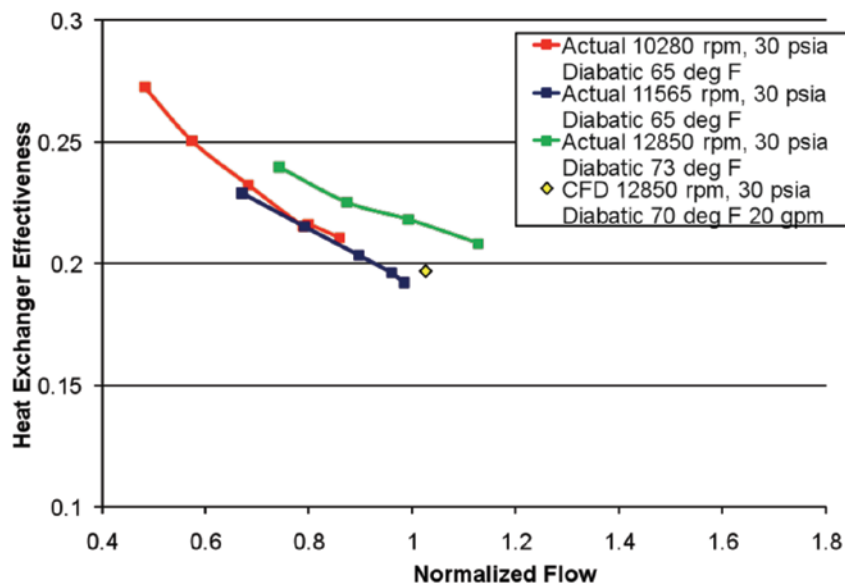

Figure 7: Heat Transfer Effectiveness of CFD and Test Results

Technology Advantages

- New compression process could use up to 35% less power combining semi-isothermal compression, liquefaction, and liquid pumping.
- Applicable to all types of power plants.
- Could result in significant capital savings compared to an integrally geared compressor.
- Pump operating costs will be lower than high-pressure compressor operating costs.

R&D Challenges

- There will be a wide range of CO₂ output from the power plant based on required electrical output.
- CO₂ compression technology must have high reliability.
- IGCC plants contain multiple CO₂ streams at different pressures.

Results To Date/Accomplishments

- Completed a thermodynamic and economic analysis to determine the preferred CO₂ state for compression. The optimal solution combines interstage cooling and a liquefaction approach (Option E.2).
- Designed, constructed, and tested pilot-scale prototype using a liquid CO₂ pumping loop.
 - Pump performed well matching the measured performance during factory testing on liquid nitrogen.
 - Achieved discharge pressure goals.
 - Liquid CO₂ introduced no mechanical issues for the pump.
 - Vibration levels were reasonable.
 - A sub-synchronous vibration occurred at minimum flow point, but only at very low flow rates.
- Designed, constructed, and tested pilot-scale prototype using a closed-loop CO₂ compressor with internal cooling.
 - Heat transfer effectiveness matched CFD predictions.
 - Up to 55% of the heat of compression was removed during testing with cooled diaphragm technology with no additional pressure drop.

Next Steps

In Phase 3 of this project, a full-scale CO₂ compression and pumping system will be engineered and installed at a power plant. This work will include:

- Detailed design and fabrication of the CO₂ compressor.
- Measurement of the CO₂ compressor performance.
- Testing to assess the actual field efficiency.
- Conduct long-term performance studies.

Final test results will not be available until the December 2013 project completion date.

Available Reports/Technical Papers/Presentations

General project information is available on DOE/NETL website at: <http://www.netl.doe.gov/technologies/coalpower/ewr/co2/co2compression/novelconcepts.html>

“Novel Concepts for the Compression of Large Volumes of CO₂,” Annual NETL CO₂ Capture Technology for Existing Plants R&D Meeting, Pittsburgh, PA, September 2010. <http://www.netl.doe.gov/publications/proceedings/10/co2capture/index.html>

“Novel Concepts for the Compression of Large Volumes of CO₂ - Phase II,” Annual NETL CO₂ Capture Technology for Existing Plants R&D Meeting, Pittsburgh, PA, March 2009.

This page intentionally left blank

APPENDIX B: CARBON DIOXIDE CAPTURE TECHNOLOGY SHEETS

R&D COLLABORATIONS

PARTNERSHIP FOR CO₂ CAPTURE

Primary Project Goals

The University of North Dakota Energy and Environmental Research Center (UNDEERC) is conducting pilot-scale testing to demonstrate and evaluate a range of carbon dioxide (CO₂) capture technologies to develop key technical and economic information that can be used to examine the feasibility of capture technologies as a function of fuel type and system configuration.

Technical Goals

- Integrate a high-efficiency flexible capture system with existing pilot-scale combustion and emission control systems to evaluate the performance of several capture techniques and technologies in flue gas streams derived from selected fossil fuels, biomass, and blends.
- Conduct testing of oxy-combustion for selected fuels and blends in one or more of UNDEERC's existing pilot-scale units.
- Evaluate the performance of emerging CO₂ capture technologies under development.
- Perform systems engineering modeling to examine efficient and cost-effective integration of CO₂ capture technologies in existing and new systems.

Technical Content

UNDEERC is constructing two pilot-scale systems with the intention of performing experiments on several advanced CO₂ capture technologies and comparing them to one another, as well as to monoethanolamine (MEA), which is considered to be the current state-of-the-art technology.

Baseline testing will be conducted using MEA to gather information to characterize each of the units. The results obtained by using MEA in the CO₂ absorption system will be used as a standard by which all other solvents will be compared. Data to be collected includes CO₂ removal, CO₂ purity, required regeneration heat, and effects of sulfur oxide (SO_x), nitrogen oxide (NO_x), particulate matter, and trace metals.



Figure 1: UNDEERC Post-Combustion CO₂ Capture Test Facility

Technology Maturity:

Pilot-scale

Project Focus:

Partnership for CO₂ Capture

Participant:

UNDEERC

Project Number:

NT43291-02.5

NETL Project Manager:

Arun Bose

Arun.Bose@netl.doe.gov

Principal Investigator:

Brandon M. Pavlish
University of North Dakota
Energy and Environmental
Research Center

bpavlish@undeerc.org

Partners:

None

Performance Period:

6/30/08 – 8/31/11

Baseline testing of the oxy-combustion system will follow similar procedures as the absorption system. The data collected will be used to identify potential challenges concerning this technology. These challenges include effects of mercury (Hg) capture, flame stability, fouling, slagging, and heat-transfer issues.

Once CO₂ capture technologies have been selected, testing will begin. Some of the technologies under consideration include other solvents [monodiethanolamine (MDEA), tailored amines, designer amines, ammonia, and potassium bicarbonate), membranes (metal membranes and carbozyme], and solid sorbents (zeolites, metal-organic frameworks, solid amines, and C-Quest). In addition to testing these technologies, different fuels will be used to evaluate their impact on the performance of the fabricated test units. Factors to be examined will include the effects of SO_x, NO_x, and other gas components; effects of ash deposition along with corrosion of refractory; and alloy components.

UNDEERC has completed the construction of the oxy-combustion system and has begun shakedown testing of the units. UNDEERC has also completed an Aspen model of the solvent absorption and stripping column (SASC) system.

Technology Advantages

UNDEERC will be capable of providing experimental data for a variety of advanced CO₂ capture technologies and oxy-combustion systems. This information will not only provide needed information for further advancement, but will provide a clear comparison of various approaches.

R&D Challenges

Retrieving enough information on existing technologies to make appropriate selections for testing.

Results To Date/Accomplishments

- Completed design and construction of the post-combustion test system.
- Evaluated four solvents in the post-combustion test system: three advanced solvents and MEA
- Completed the oxy-combustion retrofit.
- Conducted two phases of testing with the oxy-combustion system
- Modeled the combustion test facility (CTF) system in Aspen with and without the oxygen-fired retrofit modifications.

Next Steps

- Perform additional experiments on promising technologies.
- Conduct systems engineering analyses to evaluate technology integration opportunities for CO₂ capture systems.

Final test results will not be available until the August 2011 project completion date.

Available Reports/Technical Papers/Presentations

Chen, S.G.; Lu, Y.; Rostam-Abadi, M. *Carbon Dioxide Capture and Transportation Options in the Illinois Basin*; Topical Report Oct 1, 2003–Sept 30, 2004 for U.S. Department of Energy Contract No. DE-FC26-03NT41994.

Metz, B.; Davidson, O.; Coninik, H.; Loos, M.; Meyer, L. *IPCC Special Report Carbon Dioxide Capture and Storage Technical Summary*; ISBN 92-9169-119-4, Sept 2005. Narula, R.; Wen, H.; Himes, K. *Economics of Greenhouse Gas Reduction – The Power Generating Technology Options*. Presented at the World Energy Congress, Buenos Aires, Brazil, October 2001.

U.S. Environmental Protection Agency. *Greenhouse Gas Inventory Sector Analysis*. www.yosemite.epa.gov (accessed June 2006).