



# FEDERAL REGISTER

---

Vol. 76

Thursday,

No. 179

September 15, 2011

---

Part II

## Environmental Protection Agency

---

40 CFR Parts 85, 86, 600, *et al.*

## Department of Transportation

---

National Highway Traffic Safety Administration

49 CFR Parts 523, 534, and 535

Greenhouse Gas Emissions Standards and Fuel Efficiency Standards for Medium- and Heavy-Duty Engines and Vehicles; Final Rule

**ENVIRONMENTAL PROTECTION AGENCY**

**40 CFR Parts 85, 86, 600, 1033, 1036, 1037, 1039, 1065, 1066, and 1068**

**DEPARTMENT OF TRANSPORTATION**

**National Highway Traffic Safety Administration**

**49 CFR Parts 523, 534, and 535**

[EPA-HQ-OAR-2010-0162; NHTSA-2010-0079; FRL-9455-1]

RIN 2060-AP61; 2127-AK74

**Greenhouse Gas Emissions Standards and Fuel Efficiency Standards for Medium- and Heavy-Duty Engines and Vehicles**

**AGENCY:** Environmental Protection Agency (EPA) and National Highway Traffic Safety Administration (NHTSA), DOT.

**ACTION:** Final Rules.

**SUMMARY:** EPA and NHTSA, on behalf of the Department of Transportation, are each finalizing rules to establish a comprehensive Heavy-Duty National Program that will reduce greenhouse gas emissions and fuel consumption for on-road heavy-duty vehicles, responding to the President's directive on May 21, 2010, to take coordinated steps to produce a new generation of clean vehicles. NHTSA's final fuel consumption standards and EPA's final carbon dioxide (CO<sub>2</sub>) emissions standards are tailored to each of three regulatory categories of heavy-duty vehicles: Combination Tractors; Heavy-duty Pickup Trucks and Vans; and Vocational Vehicles. The rules include separate standards for the engines that power combination tractors and vocational vehicles. Certain rules are exclusive to the EPA program. These include EPA's final hydrofluorocarbon standards to control leakage from air conditioning systems in combination tractors, and pickup trucks and vans. These also include EPA's final nitrous oxide (N<sub>2</sub>O) and methane (CH<sub>4</sub>) emissions standards that apply to all heavy-duty engines, pickup trucks and vans.

EPA's final greenhouse gas emission standards under the Clean Air Act will begin with model year 2014. NHTSA's final fuel consumption standards under the Energy Independence and Security Act of 2007 will be voluntary in model years 2014 and 2015, becoming mandatory with model year 2016 for most regulatory categories. Commercial trailers are not regulated in this phase of the Heavy-Duty National Program.

The agencies estimate that the combined standards will reduce CO<sub>2</sub> emissions by approximately 270 million metric tons and save 530 million barrels of oil over the life of vehicles sold during the 2014 through 2018 model years, providing over \$7 billion in net societal benefits, and \$49 billion in net societal benefits when private fuel savings are considered.

EPA is also finalizing provisions allowing light-duty vehicle manufacturers to use CO<sub>2</sub> credits to meet the light-duty vehicle N<sub>2</sub>O and CH<sub>4</sub> standards, technical amendments to the fuel economy provisions for light-duty vehicles, and a technical amendment to the criteria pollutant emissions requirements for certain switch locomotives.

**DATES:** These final rules are effective on November 14, 2011. The incorporation by reference of certain publications listed in this regulation is approved by the Director of the Federal Register as of November 14, 2011.

**ADDRESSES:** EPA and NHTSA have established dockets for this action under Docket ID No. EPA-HQ-OAR-2010-0162 and NHTSA-2010-0079, respectively. All documents in the docket are listed on the <http://www.regulations.gov> Web site. Although listed in the index, some information is not publicly available, e.g., confidential business information or other information whose disclosure is restricted by statute. Certain other material, such as copyrighted material, is not placed on the Internet and will be publicly available only in hard copy form. Publicly available docket materials are available either electronically through <http://www.regulations.gov> or in hard copy at the following locations: EPA: EPA Docket Center, EPA/DC, EPA West

Building, 1301 Constitution Ave., NW., Room 3334, Washington, DC. The Public Reading Room is open from 8:30 a.m. to 4:30 p.m., Monday through Friday, excluding legal holidays. The telephone number for the Public Reading Room is (202) 566-1744, and the telephone number for the Air Docket is (202) 566-1742. NHTSA: Docket Management Facility, M-30, U.S. Department of Transportation, West Building, Ground Floor, Rm. W12-140, 1200 New Jersey Avenue, SE., Washington, DC 20590. The Docket Management Facility is open between 9 a.m. and 5 p.m. Eastern Time, Monday through Friday, except Federal holidays.

**FOR FURTHER INFORMATION CONTACT:** NHTSA: Lily Smith, Office of Chief Counsel, National Highway Traffic Safety Administration, 1200 New Jersey Avenue, SE., Washington, DC 20590. Telephone: (202) 366-2992. EPA: Lauren Steele, Office of Transportation and Air Quality, Assessment and Standards Division (ASD), Environmental Protection Agency, 2000 Traverwood Drive, Ann Arbor, MI 48105; telephone number: (734) 214-4788; fax number: (734) 214-4816; e-mail address: [steele.lauren@epa.gov](mailto:steele.lauren@epa.gov), or contact the Office of Transportation and Air Quality at [OTAQPUBLICWEB@epa.gov](mailto:OTAQPUBLICWEB@epa.gov).

**SUPPLEMENTARY INFORMATION:**

**A. Does this action apply to me?**

This action affects companies that manufacture, sell, or import into the United States new heavy-duty engines and new Class 2b through 8 trucks, including combination tractors, school and transit buses, vocational vehicles such as utility service trucks, as well as ¾-ton and 1-ton pickup trucks and vans. The heavy-duty category incorporates all motor vehicles with a gross vehicle weight rating of 8,500 pounds or greater, and the engines that power them, except for medium-duty passenger vehicles already covered by the greenhouse gas emissions standards and corporate average fuel economy standards issued for light-duty model year 2012-2016 vehicles. Regulated categories and entities include the following:

Category	NAICS Code <sup>a</sup>	Examples of potentially affected entities
Industry .....	336111 336112 336120	Motor Vehicle Manufacturers, Engine and Truck Manufacturers.
Industry .....	541514 811112 811198	Commercial Importers of Vehicles and Vehicle Components.
Industry .....	336111 336112	Alternative Fuel Vehicle Converters.

Category	NAICS Code <sup>a</sup>	Examples of potentially affected entities
Industry .....	422720 454312 541514 541690 811198 333618 336510	Manufacturers, remanufacturers and importers of locomotives and locomotive engines.

NOTE:  
<sup>a</sup> North American Industry Classification System (NAICS).

This table is not intended to be exhaustive, but rather provides a guide for readers regarding entities likely covered by these rules. This table lists the types of entities that the agencies are aware may be regulated by this action. Other types of entities not listed in the table could also be regulated. To determine whether your activities are regulated by this action, you should carefully examine the applicability criteria in the referenced regulations. You may direct questions regarding the applicability of this action to the persons listed in the preceding **FOR FURTHER INFORMATION CONTACT** section.

**Table of Contents**

- A. Does this action apply to me?
- I. Overview
  - A. Introduction
  - B. Building Blocks of the Heavy-Duty National Program
  - C. Summary of the Final EPA and NHTSA HD National Program
  - D. Summary of Costs and Benefits of the HD National Program
  - E. Program Flexibilities
  - F. EPA and NHTSA Statutory Authorities
  - G. Future HD GHG and Fuel Consumption Rulemakings
- II. Final GHG and Fuel Consumption Standards for Heavy-Duty Engines and Vehicles
  - A. What vehicles will be affected?
  - B. Class 7 and 8 Combination Tractors
  - C. Heavy-Duty Pickup Trucks and Vans
  - D. Class 2b–8 Vocational Vehicles
  - E. Other Standards
- III. Feasibility Assessments and Conclusions
  - A. Class 7–8 Combination Tractor
  - B. Heavy-Duty Pickup Trucks and Vans
  - C. Class 2b–8 Vocational Vehicles
- IV. Final Regulatory Flexibility Provisions
  - A. Averaging, Banking, and Trading Program
  - B. Additional Flexibility Provisions
- V. NHTSA and EPA Compliance, Certification, and Enforcement Provisions
  - A. Overview
  - B. Heavy-Duty Pickup Trucks and Vans
  - C. Heavy-Duty Engines
  - D. Class 7 and 8 Combination Tractors
  - E. Class 2b–8 Vocational Vehicles
  - F. General Regulatory Provisions
  - G. Penalties
- VI. How will this program impact fuel consumption, GHG emissions, and climate change?

- A. What methodologies did the agencies use to project GHG emissions and fuel consumption impacts?
- B. MOVES Analysis
- C. What are the projected reductions in fuel consumption and GHG emissions?
- D. Overview of Climate Change Impacts From GHG Emissions
- E. Changes in Atmospheric CO<sub>2</sub> Concentrations, Global Mean Temperature, Sea Level Rise, and Ocean pH Associated With the Program’s GHG Emissions Reductions
- VII. How will this final action impact non-ghg emissions and their associated effects?
  - A. Emissions Inventory Impacts
  - B. Health Effects of Non-GHG Pollutants
  - C. Environmental Effects of Non-GHG Pollutants
  - D. Air Quality Impacts of Non-GHG Pollutants
- VIII. What are the agencies’ estimated cost, economic, and other impacts of the final program?
  - A. Conceptual Framework for Evaluating Impacts
  - B. Costs Associated With the Final Program
  - C. Indirect Cost Multipliers
  - D. Cost per Ton of Emissions Reductions
  - E. Impacts of Reduction in Fuel Consumption
  - F. Class Shifting and Fleet Turnover Impacts
  - G. Benefits of Reducing CO<sub>2</sub> Emissions
  - H. Non-GHG Health and Environmental Impacts
  - I. Energy Security Impacts
  - J. Other Impacts
  - K. The Effect of Safety Standards and Voluntary Safety Improvements on Vehicle Weight
  - L. Summary of Costs and Benefits
  - M. Employment Impacts
- IX. Analysis of the Alternatives
  - A. What are the alternatives that the agencies considered?
  - B. How do these alternatives compare in overall GHG emissions reductions and fuel efficiency and cost?
  - C. What is the agencies’ decision regarding trailer standards?
- X. Public Participation
- XI. NHTSA’s Record of Decision
  - A. The Agency’s Decision
  - B. Alternatives Considered by NHTSA in Reaching Its Decision, Including the Environmentally Preferable Alternative
  - C. Factors Balanced by NHTSA in Making Its Decision
  - D. How the Factors and Considerations Balanced by NHTSA Entered Into Its Decision

- E. The Agency’s Preferences Among Alternatives Based on Relevant Factors, Including Economic and Technical Considerations and Agency Statutory Missions
- F. Mitigation
- XII. Statutory and Executive Order Reviews
- XIII. Statutory Provisions and Legal Authority
  - A. EPA
  - B. NHTSA

**I. Overview**

*A. Introduction*

EPA and NHTSA (“the agencies”) are announcing a first-ever program to reduce greenhouse gas (GHG) emissions and fuel consumption in the heavy-duty highway vehicle sector. This broad sector—ranging from large pickups to sleeper-cab tractors—together represent the second largest contributor to oil consumption and GHG emissions from the mobile source sector, after light-duty passenger cars and trucks. These are the second joint rules issued by the agencies, following on the April 1, 2010 standards to sharply reduce GHG emissions and fuel consumption from MY 2012–2016 passenger cars and light trucks (published on May 7, 2010 at 75 FR 25324).

In a May 21, 2010 memorandum to the Administrators of EPA and NHTSA (and the Secretaries of Transportation and Energy), the President stated that “America has the opportunity to lead the world in the development of a new generation of clean cars and trucks through innovative technologies and manufacturing that will spur economic growth and create high-quality domestic jobs, enhance our energy security, and improve our environment.”<sup>1 2</sup> In the

<sup>1</sup> Improving Energy Security, American Competitiveness and Job Creation, and Environmental Protection Through a Transformation of Our Nation’s Fleet of Cars And Trucks,” Issued May 21, 2010, published at 75 FR 29399, May 26, 2010.

<sup>2</sup> The May 2010 Presidential Memorandum also directed EPA and NHTSA, in close coordination with the California Air Resources Board, to build on the National Program for 2012–2016 MY light-duty vehicles by developing and proposing coordinated light-duty vehicle standards for MY 2017–2025. The agencies have taken an initial step in this process, releasing a Joint Notice of Intent and

Continued

May 2010 memorandum, the President specifically requested the Administrators of EPA and NHTSA to “immediately begin work on a joint rulemaking under the Clean Air Act (CAA) and the Energy Independence and Security Act of 2007 (EISA) to establish fuel efficiency and greenhouse gas emissions standards for commercial medium-and heavy-duty on-highway vehicles and work trucks beginning with the 2014 model year (MY).” In this final rulemaking, each agency is addressing this Memorandum by adopting rules under its respective authority that together comprise a coordinated and comprehensive HD National Program designed to address the urgent and closely intertwined challenges of reduction of dependence on oil, achievement of energy security, and amelioration of global climate change.

At the same time, the final program will enhance American competitiveness and job creation, benefit consumers and businesses by reducing costs for transporting goods, and spur growth in the clean energy sector.

The HD National Program the agencies are finalizing today reflects a collaborative effort between the agencies, a range of public interest nongovernmental organizations (NGOs), the state of California and the regulated industry. At the time of the President’s announcement, a number of major HD truck and engine manufacturers representing the vast majority of this industry, and the California Air Resources Board (California ARB), sent letters to EPA and NHTSA supporting the creation of a HD National Program based on a common set of principles. In the letters, the stakeholders committed to working with the agencies and with other stakeholders toward a program consistent with common principles, including:

Increased use of existing technologies to achieve significant GHG emissions and fuel consumption reductions;

A program that starts in 2014 and is fully phased in by 2018;

A program that works towards harmonization of methods for determining a vehicle’s GHG and fuel efficiency, recognizing the global nature of the issues and the industry;

Standards that recognize the commercial needs of the trucking industry; and

Initial Joint Technical Assessment Report in September 2010 (75 FR 62739), and a Supplemental Notice of Intent (75 FR 76337). The agencies plan to issue a full light-duty vehicle proposal to extend the National Program to MY 2017–2025 in September 2011.

Incentives leading to the early introduction of advanced technologies.

The final rules adopted today reflect these principles. The final HD National Program also builds on many years of heavy-duty engine and vehicle technology development to achieve what the agencies believe is the greatest degree of fuel consumption and GHG emission reduction appropriate, technologically and economically feasible, and cost-effective for model years 2014–2018. In addition to taking aggressive steps that are reasonably possible now, based on the technological opportunities and pathways that present themselves during these model years, the agencies and industry will also continue learning about emerging opportunities for this complex sector to further reduce fuel consumption and GHG emission through future regulatory steps.

Similarly, the agencies will participate in efforts to improve our ability to accurately characterize the actual in-use fuel consumption and emissions of this complex sector. As technologies progress in the coming years and as the agencies improve the regulatory tools to evaluate real world vehicle performance, we expect that we will develop a second phase of regulations to reinforce these initial rules and achieve further reductions in GHG emissions and fuel consumption reduction for the mid- and longer-term time frame (beyond 2018). The agencies are committed to working with all interested stakeholders in this effort and to the extent possible working towards alignment with similar programs being developed in Canada, Mexico, Europe, China, and Japan. In doing so, we will continue to evaluate many of the structural and technical decisions we are making in today’s final action in the context of new technologies and the new regulatory tools that we expect to realize in the future.

The regulatory program we are finalizing today is largely unchanged from the proposal the agencies made on November 30, 2010 (*See* 75 FR 741512). The structure of the program and the stringency of the standards are essentially the same as proposed. We have made a number of changes to the testing requirements and reporting requirements to provide greater regulatory certainty and better align the NHTSA and EPA portions of the program. In response to comments, we have also made some changes to the averaging, banking and trading (ABT) provisions of the program that will make implementation of this final program more flexible for manufacturers. We have added

provisions to further encourage the development of advanced technologies and to provide a more straightforward mechanism to certify engines and vehicles using innovative technologies. Finally in response to comments, we have made some technical changes to our emissions compliance model that results in different numeric standards for both combination tractors and vocational vehicles to more accurately characterize emissions while maintaining the same overall stringency and therefore expected costs and benefits of the program.

Heavy-duty vehicles move much of the nation’s freight and carry out numerous other tasks, including utility work, concrete delivery, fire response, refuse collection, and many more. Heavy-duty vehicles are primarily powered by diesel engines, although about 37 percent of these vehicles are powered by gasoline engines.<sup>3</sup> Heavy-duty trucks<sup>4</sup> have long been an important part of the goods movement infrastructure in this country and have experienced significant growth over the last decade related to increased imports and exports of finished goods and increased shipping of finished goods to homes through Internet purchases.

The heavy-duty sector is extremely diverse in several respects, including types of manufacturing companies involved, the range of sizes of trucks and engines they produce, the types of work the trucks are designed to perform, and the regulatory history of different subcategories of vehicles and engines. The current heavy-duty fleet encompasses vehicles from the “18-wheeler” combination tractors one sees on the highway to school and transit buses, to vocational vehicles such as utility service trucks, as well as the largest pickup trucks and vans.

For purposes of this preamble, the term “heavy-duty” or “HD” is used to apply to all highway vehicles and engines that are not within the range of light-duty vehicles, light-duty trucks, and medium-duty passenger vehicles (MDPV) covered by the GHG and Corporate Average Fuel Economy (CAFE) standards issued for MY 2012–2016.<sup>5</sup> It also does not include

<sup>3</sup>References in this preamble to “gasoline” engines (and the vehicles powered by them) generally include other Otto-cycle engines as well, such as those fueled by ethanol and natural gas, except in contexts that are clearly gasoline-specific.

<sup>4</sup>In this rulemaking, EPA and NHTSA use the term “truck” in a general way, referring to all categories of regulated heavy-duty highway vehicles (including buses). As such, the term is generally interchangeable with “heavy-duty vehicle.”

<sup>5</sup>Light-Duty Vehicle Greenhouse Gas Emission Standards and Corporate Average Fuel Economy Standards; Final Rule 75 FR 25323, May 7, 2010.

motorcycles. Thus, in this rulemaking, unless specified otherwise, the heavy-duty category incorporates all vehicles with a gross vehicle weight rating above 8,500 pounds, and the engines that power them, except for MDPVs.<sup>6</sup>

The agencies proposed to cover all segments of the heavy-duty category above, except with respect to recreational vehicles (RVs or motor homes). We note that the Energy Independence and Security Act of 2007 requires NHTSA to set standards for “commercial medium- and heavy-duty on-highway vehicles and work trucks.”<sup>7</sup> The standards that EPA is finalizing today cover recreational on-highway vehicles, while NHTSA proposed not to include recreational vehicles based on an interpretation of the term “commercial medium- and heavy-duty on-highway commercial” vehicles. NHTSA stated in the NPRM that recreational vehicles are non-commercial, and therefore outside of the term and the scope of its rule.

Oshkosh Corporation commented that this interpretation did not match the statutory definition of the term in EISA, which defines “commercial medium- and heavy-duty on-highway vehicle” by weight only,<sup>8</sup> and that therefore the agency’s interpretation of the term should be explicitly broadened to include all vehicles, and more than only vehicles that are not engaged in interstate commerce as defined by the Federal Motor Carrier Safety Administration in 49 CFR part 202. Alternatively, Oshkosh suggested that if NHTSA followed the definition provided in EISA, which makes no direct reference to the concept of “commercial,” there would be no logical reason to exclude RVs based on that definition.

NHTSA has considered Oshkosh’s comment and reconsidered its interpretation that effectively read words into the statutory definition. Given the very wide variety of vehicles contained in the HD fleet, reading those words into the definition and thereby excluding certain types of vehicles could create illogical results, *i.e.*, treating similar vehicles differently. Therefore, NHTSA will adhere to the

statutory definition contained in EISA for this rulemaking. However, as RVs were not included by NHTSA in the proposed regulation in the NPRM, they are not within the scope and must be excluded in NHTSA’s portion of the final program. Accordingly, NHTSA will address this issue in the next rulemaking. However, as noted, RVs are subject to the CO<sub>2</sub> standards for vocational vehicles.

Setting fuel consumption standards for the heavy-duty sector, pursuant to NHTSA’s EISA authority, will also improve our energy and national security by reducing our dependence on foreign oil, which has been a national objective since the first oil price shocks in the 1970s. Net petroleum imports now account for approximately 49–51 percent of U.S. petroleum consumption. World crude oil production is highly concentrated, exacerbating the risks of supply disruptions and price shocks as the recent unrest in North Africa and the Persian Gulf highlights. Recently, oil prices have been over \$100 per barrel, gasoline and diesel fuel prices in excess of \$4 per gallon, causing financial hardship for many families and businesses. The export of U.S. assets in exchange for oil imports continues to be an important component of the historically unprecedented U.S. trade deficits. Transportation accounts for about 72 percent of U.S. petroleum consumption. Heavy-duty vehicles account for about 17 percent of transportation oil use, which means that they alone account for about 12 percent of all U.S. oil consumption.<sup>9</sup>

Setting GHG emissions standards for the heavy-duty sector will help to ameliorate climate change. The EPA Administrator found after a thorough examination of the scientific evidence on the causes and impact of current and future climate change, and careful review of public comments, that the science compellingly supports a positive finding that atmospheric concentrations of six greenhouse gases taken in combination result in air pollution which may reasonably be anticipated to endanger both public health and welfare and that the combined emissions of these greenhouse gases from new motor vehicles and engines contributes to the greenhouse gas air pollution that endangers public health and welfare. In her finding, the Administrator carefully studied and relied heavily upon the major findings and conclusions from the recent assessments of the U.S. Climate Change Science Program and the U.N.

Intergovernmental Panel on Climate Change. 74 FR 66496, December 15, 2009. As summarized in the Technical Support Document for EPA’s Endangerment and Cause or Contribute Findings under section 202(a) of the Clean Air Act, anthropogenic emissions of GHGs are very likely (a 90 to 99 percent probability) the cause of most of the observed global warming over the last 50 years.<sup>10</sup> Primary GHGs of concern are carbon dioxide (CO<sub>2</sub>), methane (CH<sub>4</sub>), nitrous oxide (N<sub>2</sub>O), hydrofluorocarbons (HFCs), perfluorocarbons (PFCs), and sulfur hexafluoride (SF<sub>6</sub>). Mobile sources emitted 31 percent of all U.S. GHGs in 2007 (transportation sources, which do not include certain off-highway sources, account for 28 percent) and have been the fastest-growing source of U.S. GHGs since 1990.<sup>11</sup> Mobile sources addressed in EPA’s endangerment and contribution findings under CAA section 202(a)—light-duty vehicles, heavy-duty trucks, buses, and motorcycles—accounted for 23 percent of all U.S. GHG emissions in 2007.<sup>12</sup> Heavy-duty vehicles emit CO<sub>2</sub>, CH<sub>4</sub>, N<sub>2</sub>O, and HFCs and are responsible for nearly 19 percent of all mobile source GHGs (nearly 6 percent of all U.S. GHGs) and about 25 percent of section 202(a) mobile source GHGs. For heavy-duty vehicles in 2007, CO<sub>2</sub> emissions represented more than 99 percent of all GHG emissions (including HFCs).<sup>13</sup>

In developing this HD National program, the agencies have worked with a large and diverse group of stakeholders representing truck and engine manufacturers, trucking fleets, environmental organizations, and states including the State of California.<sup>14</sup> Further, it is our expectation based on our ongoing work with the State of California that the California ARB will

<sup>10</sup> U.S. EPA. (2009). “Technical Support Document for Endangerment and Cause or Contribute Findings for Greenhouse Gases Under Section 202(a) of the Clean Air Act” Washington, DC, available at Docket: EPA–HQ–OAR–2009–0171–11645, and at <http://epa.gov/climatechange/endangerment.html>.

<sup>11</sup> U.S. Environmental Protection Agency. 2009. Inventory of U.S. Greenhouse Gas Emissions and Sinks: 1990–2007. EPA 430–R–09–004. Available at [http://epa.gov/climatechange/emissions/downloads09/GHG2007entire\\_report-508.pdf](http://epa.gov/climatechange/emissions/downloads09/GHG2007entire_report-508.pdf).

<sup>12</sup> See Endangerment TSD, Note 10, above, at pp. 180–194.

<sup>13</sup> U.S. Environmental Protection Agency. 2009. Inventory of U.S. Greenhouse Gas Emissions and Sinks: See Note 11, above.

<sup>14</sup> Pursuant to DOT Order 2100.2, NHTSA has docketed a memorandum recording those meetings that it attended and documents submitted by stakeholders which formed a basis for this action and which can be made publicly available in its docket for this rulemaking. DOT Order 2100.2 is available at <http://www.reg-group.com/library/DOT2100-2.PDF>.

<sup>6</sup> The CAA defines heavy-duty as a truck, bus or other motor vehicles with a gross vehicle weight rating exceeding 6,000 pounds (CAA section 202(b)(3)). The term HD as used in this action refers to a subset of these vehicles and engines.

<sup>7</sup> 49 U.S.C. 32902(k)(2). “Commercial medium- and heavy-duty on-highway vehicles” are defined as on-highway vehicles with a gross vehicle weight rating of 10,000 pounds or more, while “work trucks” are defined as vehicles rated between 8,500 and 10,000 pounds gross vehicle weight that are not MDPVs. See 49 U.S.C. 32901(a)(7) and (a)(19).

<sup>8</sup> See 49 U.S.C. 32902(k)(2), Note 7 above.

<sup>9</sup> In 2009 Source: EIA Annual Energy Outlook 2010 released May 11, 2010.

be able to adopt regulations equivalent in practice to those of this HD National Program, just as it has done for past EPA regulation of heavy-duty trucks and engines. NHTSA and EPA have been working with California ARB to enable that outcome.

In light of the industry's diversity, and consistent with the recommendations of the National Academy of Sciences (NAS) as discussed further below, the agencies are adopting a HD National Program that recognizes the different sizes and work requirements of this wide range of heavy-duty vehicles and their engines. NHTSA's final fuel consumption standards and EPA's final GHG standards apply to manufacturers of the following types of heavy-duty vehicles and their engines; the final provisions for each of these are described in more detail below in this section:

- Heavy-duty Pickup Trucks and Vans.
- Combination Tractors.
- Vocational Vehicles.

As in the light-duty 2012–2016 MY vehicle rule, EPA's and NHTSA's final standards for the heavy-duty sector are largely harmonized with one another due to the close and direct relationship between improving the fuel efficiency of these vehicles and reducing their CO<sub>2</sub> tailpipe emissions. For all vehicles that consume carbon-based fuels, the amount of CO<sub>2</sub> exhaust emissions is essentially constant per gallon for a given type of fuel that is consumed. The more efficient a heavy-duty truck is in completing its work, the lower its environmental impact will be, because the less fuel consumed to move cargo a given distance, the less CO<sub>2</sub> that truck emits directly into the air. The technologies available for improving fuel efficiency, and therefore for reducing both CO<sub>2</sub> emissions and fuel consumption, are one and the same.<sup>15</sup> Because of this close technical relationship, NHTSA and EPA have been able to rely on jointly-developed assumptions, analyses, and analytical conclusions to support the standards and other provisions that NHTSA and EPA are adopting under our separate legal authorities.

This program is based on standards for direct exhaust emissions from engines and vehicles. In characterizing the overall emissions impacts, benefits and costs of the program, analyses of air pollutant emissions from upstream sources have been conducted. In this

<sup>15</sup> However, as discussed below, in addition to addressing CO<sub>2</sub>, the EPA's final standards also include provisions to address other GHGs (nitrous oxide, methane, and air conditioning refrigerant emissions). See Section II.

action, the agencies use the term upstream to include emissions from the production and distribution of fuel. A summary of the analysis of upstream emissions can be found in Section VI.C of this preamble, and further details are available in Chapter 5 of the RIA.

The timelines for the implementation of the final NHTSA and EPA standards are also closely coordinated. EPA's final GHG emission standards will begin in model year 2014. In order to provide for the four full model years of regulatory lead time required by EISA, as discussed in Section 0 below, NHTSA's final fuel consumption standards will be voluntary in model years 2014 and 2015, becoming mandatory in model year 2016, except for diesel engine standards which will be voluntary in model years 2014, 2015 and 2016, becoming mandatory in model year 2017. Both agencies are also allowing for early compliance in model year 2013. A detailed discussion of how the final standards are consistent with each agency's respective statutory requirements and authorities is found later in this preamble.

Allison Transmission stated that sufficient time must be taken before issuing the final rules in order to ensure that the standards are supportable. As explained in Sections II and III below, as well as in the RIA, the agencies believe there is sufficient lead time to meet all of the standards adopted in today's rules. For those areas for which the agencies have determined that insufficient time is available to develop appropriate standards, such as for trailers, the agencies are not including regulations as part of this initial program.

NHTSA received several comments related to the timing of the implementation of its fuel consumption standards. The Engine Manufacturers Association (EMA), the National Automobile Dealers Association (NADA), The Volvo Group (Volvo), and Navistar argued that the timing of NHTSA's standards violated the lead time requirement of 49 U.S.C. 32902(k)(3)(A), which states that standards under the new medium- and heavy-duty program shall have "not less than 4 full model years of regulatory lead-time." The commenters seemed to interpret the voluntary program as the imposition of regulation upon industry. NADA described NHTSA's standards during the voluntary period as "mandates."

NHTSA has reviewed this issue and believes that the regulatory schedule is consistent with the lead time requirement of Section 32902(k)(3). To clarify, NHTSA will not be imposing a

mandatory regulatory program until 2016, and none of the voluntary standards will be "mandates." As described in later sections, the voluntary standards would only apply to a manufacturer if it makes the voluntary and affirmative choice to opt-in to the program.<sup>16</sup> Mandatory NHTSA standards will first come into effect in 2016, giving industry four full years of lead time with the NHTSA fuel consumption standards.

EMA, NADA, and Navistar also argued that the proposed standards would violate the stability requirement of 49 U.S.C. 32902(k)(3)(B), which states that they shall have "not less than 3 full model years of regulatory stability." EMA stated that since there are HD emission standards taking effect in 2013, the 2014 implementation date for this rule would violate the stability requirements. NADA argued that the MY 2014–2017/2018 phase-in period was inadequate to fulfill the stability requirement.

Congress has not spoken directly to the meaning of the words "regulatory stability." NHTSA believes that the "regulatory stability" requirement exists to ensure that manufacturers will not be subject to new standards in repeated rulemakings too rapidly, given that Congress did not include a minimum duration period for the MD/HD standards.<sup>17</sup> NHTSA further believes that standards, which as set provide for increasing stringency during the period that the standards are applicable under this rule to be the maximum feasible during the regulatory period, are within the meaning of the statute. In this statutory context, NHTSA interprets the phrase "regulatory stability" in Section 32902(k)(3)(B) as requiring that the standards remain in effect for three years before they may be increased by amendment. It does not prohibit standards which contain pre-determined stringency increases.

As laid out in Section II below, NHTSA's final standards follow different phase-in schedules based on differences between the regulatory categories. Consistent with NHTSA's statutory obligation to implement a program designed to achieve the maximum feasible fuel efficiency improvement, the standards increase in stringency based upon increasing fleet penetration rates for the available technologies. The NPRM proposed phase-in schedules aligned with EPA's,

<sup>16</sup> Prior to or at the same time that a manufacturer submits its first application for a certificate of conformity; See Section V below.

<sup>17</sup> In contrast, light-duty standards must remain in place for "at least 1, but not more than 5, model years." 23902(b)(3)(B).

some of which followed pre-determined stringency increases. The NPRM also noted that NHTSA was considering alternate standards that would not change in stringency during the time frame when the regulations are effective for those standards that increased throughout the mandatory program. As described in Section II below, the final rule includes the proposed alternate standards for those standards that follow such a stringency phase-in path. Therefore, NHTSA believes that the final rule provides ample stability for each standard.

Each standard, associated phase-in schedule, and alternative standard implemented by this final rule was noticed in the NPRM. Those fuel consumption standards that become mandatory in 2017 will remain in effect through at least 2019. This further ensures that the fuel consumption standards in this rule will remain in effect for at least three years, providing the statutorily-mandated three full years of regulatory stability, and ensuring that manufacturers will not be subject to new or amended standards too rapidly. (The greenhouse gas emission standards remain in effect unless and until amended in all later model years in any case.) Therefore, NHTSA believes the commenters' concern about regulatory stability is addressed in the structure of the rule.

Neither EPA nor NHTSA is adopting standards at this time for GHG emissions or fuel consumption, respectively, for heavy-duty commercial trailers or for vehicles or engines manufactured by small businesses. The agencies recognize that aerodynamic and tire rolling resistance improvements to trailers represent a significant opportunity to reduce fuel consumption and GHGs as evidenced, among other things, by the work of the EPA SmartWay program. While we are deferring action today on setting trailer standards, the agencies are committed to moving forward to create a regulatory program for trailers that would complement the current vehicle program. See Section IX for more details on the agencies' decisions regarding trailers, and Sections II and XII for more details on the agencies' decisions regarding small businesses.

The agencies have analyzed in detail the projected costs, fuel savings, and benefits of the final GHG and fuel consumption standards. Table I-1 shows estimated lifetime discounted program costs (including technological outlays), fuel savings, and benefits for all heavy-duty vehicles projected to be sold in model years 2014-2018 over these vehicles' lives. Section I.D

includes additional information about this analysis.

TABLE I-1—ESTIMATED LIFETIME DISCOUNTED COSTS, FUEL SAVINGS, BENEFITS, AND NET BENEFITS FOR 2014-2018 MODEL YEAR HEAVY-DUTY VEHICLES<sup>a b</sup>

[Billions, 2009\$]

Lifetime Present Value <sup>c</sup> —3% Discount Rate	
Program Costs .....	\$8.1
Fuel Savings .....	50
Benefits .....	7.3
Net Benefits <sup>d</sup> .....	49
Annualized Value <sup>e</sup> —3% Discount Rate	
Annualized Costs .....	0.4
Fuel Savings .....	2.2
Annualized Benefits .....	0.4
Net Benefits <sup>d</sup> .....	2.2
Lifetime Present Value <sup>c</sup> —7% Discount Rate	
Program Costs .....	8.1
Fuel Savings .....	34
Benefits .....	6.7
Net Benefits <sup>d</sup> .....	33
Annualized Value <sup>e</sup> —7% Discount Rate	
Annualized Costs .....	0.6
Fuel Savings .....	2.6
Annualized Benefits .....	0.5
Net Benefits <sup>d</sup> .....	2.5

**Notes:**

<sup>a</sup> The agencies estimated the benefits associated with four different values of a one ton CO<sub>2</sub> reduction (model average at 2.5% discount rate, 3%, and 5%; 95th percentile at 3%), which each increase over time. For the purposes of this overview presentation of estimated costs and benefits, however, we are showing the benefits associated with the marginal value deemed to be central by the inter-agency working group on this topic: the model average at 3% discount rate, in 2009 dollars. Section VIII.F provides a complete list of values for the 4 estimates.

<sup>b</sup> Note that net present value of reduced GHG emissions is calculated differently than other benefits. The same discount rate used to discount the value of damages from future emissions (SCC at 5, 3, and 2.5 percent) is used to calculate net present value of SCC for internal consistency. Refer to Section VIII.F for more detail.

<sup>c</sup> Present value is the total, aggregated amount that a series of monetized costs or benefits that occur over time is worth now (in year 2009 dollar terms), discounting future values to the present.

<sup>d</sup> Net benefits reflect the fuel savings plus benefits minus costs.

<sup>e</sup> The annualized value is the constant annual value through a given time period (2012 through 2050 in this analysis) whose summed present value equals the present value from which it was derived.

*B. Building Blocks of the Heavy-Duty National Program*

The standards that are being adopted in this notice represent the first time that NHTSA and EPA are regulating the heavy-duty sector for fuel consumption and GHG emissions, respectively. The HD National Program is rooted in EPA's prior regulatory history, the SmartWay® Transport Partnership program, and extensive technical and engineering analyses done at the federal level. This section summarizes some of the most important of these precursors and foundations for this HD National Program.

(1) EPA's Traditional Heavy-Duty Regulatory Program

Since the 1980s, EPA has acted several times to address tailpipe emissions of criteria pollutants and air toxics from heavy-duty vehicles and engines. During the last 18 years, these programs have primarily addressed emissions of particulate matter (PM) and the primary ozone precursors, hydrocarbons (HC) and oxides of nitrogen (NO<sub>x</sub>). These programs have successfully achieved significant and cost-effective reductions in emissions and associated health and welfare benefits to the nation. They have been structured in ways that account for the varying circumstances of the engine and truck industries. As required by the CAA, the emission standards implemented by these programs include standards that apply at the time that the vehicle or engine is sold as well as standards that apply in actual use. As a result of these programs, new vehicles meeting current emission standards will emit 98 percent less NO<sub>x</sub> and 99 percent less PM than new trucks 20 years ago. The resulting emission reductions provide significant public health and welfare benefits. The most recent EPA regulations which were fully phased-in in 2010, the monetized health and welfare benefits alone are projected to be greater than \$70 billion in 2030—benefits far exceeding compliance costs and not including the unmonetized benefits resulting from reductions in air toxics and ozone precursors (66 FR 5002, January 18, 2001).

EPA's overall program goal has always been to achieve emissions reductions from the complete vehicles that operate on our roads. The agency has often accomplished this goal for many heavy-duty truck categories through the regulation of heavy-duty engine emissions. A key part of this success has been the development over many years of a well-established, representative, and robust set of engine

test procedures that industry and EPA now routinely use to measure emissions and determine compliance with emission standards. These test procedures in turn serve the overall compliance program that EPA implements to help ensure that emissions reductions are being achieved. By isolating the engine from the many variables involved when the engine is installed and operated in a HD vehicle, EPA has been able to accurately address the contribution of the engine alone to overall emissions. The agencies discuss below how the final program incorporates the existing engine-based approach used for criteria pollutant regulations, as well as new vehicle-based approaches.

#### (2) NHTSA's Responsibilities To Regulate Heavy-Duty Fuel Efficiency under EISA

With the passage of the EISA in December 2007, Congress laid out a framework developing the first fuel efficiency regulations for HD vehicles. As codified at 49 U.S.C. 32902(k), EISA requires NHTSA to develop a regulatory system for the fuel efficiency of commercial medium-duty and heavy-duty on-highway vehicles and work trucks in three steps: a study by NAS, a study by NHTSA,<sup>18</sup> and a rulemaking to develop the regulations themselves.

Specifically, section 102 of EISA, codified at 49 U.S.C. 32902(k)(2), states that not later than two years after completion of the NHTSA study, DOT (by delegation, NHTSA), in consultation with the Department of Energy (DOE) and EPA, shall develop a regulation to implement a "commercial medium-duty and heavy-duty on-highway vehicle and work truck fuel efficiency improvement program designed to achieve the maximum feasible improvement." NHTSA interprets the timing requirements as permitting a regulation to be developed earlier, rather than as requiring the agency to wait a specified period of time.

Congress specified that as part of the "HD fuel efficiency improvement program designed to achieve the maximum feasible improvement," NHTSA must adopt and implement:

- Appropriate test methods;
- Measurement metrics;
- Fuel economy standards;<sup>19</sup> and

<sup>18</sup> Factors and Considerations for Establishing a Fuel Efficiency Regulatory Program for Commercial Medium- and Heavy-Duty Vehicles, October 2010, available at [http://www.nhtsa.gov/staticfiles/rulemaking/pdf/cafe/NHTSA\\_Study\\_Trucks.pdf](http://www.nhtsa.gov/staticfiles/rulemaking/pdf/cafe/NHTSA_Study_Trucks.pdf).

<sup>19</sup> In the context of 49 U.S.C. 32902(k), NHTSA interprets "fuel economy standards" as referring not specifically to miles per gallon, as in the light-duty vehicle context, but instead more broadly to

Compliance and enforcement protocols.

Congress emphasized that the test methods, measurement metrics, standards, and compliance and enforcement protocols must all be appropriate, cost-effective, and technologically feasible for commercial medium-duty and heavy-duty on-highway vehicles and work trucks. NHTSA notes that these criteria are different from the "four factors" of 49 U.S.C. 32902(f)<sup>20</sup> that have long governed NHTSA's setting of fuel economy standards for passenger cars and light trucks, although many of the same issues are considered under each of these provisions.

Congress also stated that NHTSA may set separate standards for different classes of HD vehicles, which the agency interprets broadly to allow regulation of HD engines in addition to HD vehicles, and provided requirements new to 49 U.S.C. 32902 in terms of timing of regulations, stating that the standards adopted as a result of the agency's rulemaking shall provide not less than four full model years of regulatory lead time, and three full model years of regulatory stability.

#### (3) National Academy of Sciences Report on Heavy-Duty Technology

In April 2010 as mandated by Congress in EISA, the National Research Council (NRC) under NAS issued a report to NHTSA and to Congress evaluating medium-duty and heavy-duty truck fuel efficiency improvement opportunities, titled "Technologies and Approaches to Reducing the Fuel Consumption of Medium- and Heavy-duty Vehicles."<sup>21</sup> This study covers the same universe of heavy-duty vehicles that is the focus of this final

account as accurately as possible for MD/HD fuel efficiency. While it is a metric that NHTSA considered for setting MD/HD fuel efficiency standards, the agency recognizes that miles per gallon may not be an appropriate metric given the work that MD/HD vehicles are manufactured to do. NHTSA is thus finalizing alternative metrics as discussed further below.

<sup>20</sup> 49 U.S.C. 32902(f) states that "When deciding maximum feasible average fuel economy under this section, [NHTSA] shall consider technological feasibility, economic practicability, the effect of other motor vehicle standards of the Government on fuel economy, and the need of the United States to conserve energy."

<sup>21</sup> Committee to Assess Fuel Economy Technologies for Medium- and Heavy-Duty Vehicles; National Research Council; Transportation Research Board (2010). "Technologies and Approaches to Reducing the Fuel Consumption of Medium- and Heavy-Duty Vehicles," (hereafter, "NAS Report"). Washington, DC, The National Academies Press. Available electronically from the National Academies Press Website at [http://www.nap.edu/catalog.php?record\\_id=12845](http://www.nap.edu/catalog.php?record_id=12845) (last accessed September 10, 2010).

rulemaking—all highway vehicles that are not light-duty, MDPVs, or motorcycles. The agencies have carefully evaluated the research supporting this report and its recommendations and have incorporated them to the extent practicable in the development of this rulemaking.

The NAS report is far reaching in its review of the technologies that are available and which may become available in the future to reduce fuel consumption from medium and heavy-duty vehicles. In presenting the full range of technical opportunities the report includes technologies which may not be available until 2020 or even further into the future. As such, the report provides not only a valuable list of off the shelf technologies from which the agencies have drawn in developing this near-term 2014–2018 program consistent with statutory authorities and with the set of principles set forth by the President, but the report also provides a road map the agencies can use as we look to develop future regulations for this sector. A review of the technologies in the NAS report makes clear that there are not only many technologies readily available today to achieve important reductions in fuel consumption, like the ones we used in developing the 2014–2018 program, but there are also great opportunities for even larger reductions in the future through the development of advanced hybrid drive systems and sophisticated engine technologies such as Rankine waste heat recovery. The agencies will again make extensive use of this report when we move forward to develop the next phase of regulations for medium and heavy-duty vehicles.

Allison Transmission commented that NHTSA (implicitly, both agencies) had improperly relied on the NAS report and failed to do sufficient independent analysis, which Allison claimed did not meet the statutory obligation to provide an adequate basis for the rule. First, an agency does not improperly delegate its authority or judgment merely by using work performed by outside parties as the factual basis for its decision making. See *U.S. Telecom Ass'n v. FCC*, 359 F.3d 554, 568 (DC Cir. 2004); *United Steelworkers of Am. v. Marshall*, 647 F.2d 1189, 1216–17 (DC Cir. 1980). Here, although EPA and NHTSA carefully considered the NAS report, the agencies' consideration and use of the report was not uncritical and the agencies exercised reasonable independent judgment in developing the proposed and final rules. Consistent with EISA's direction, NAS submitted a report evaluating MD/HD fuel economy standards to NHTSA in March of 2010.



Indeed, many commenters argued that the agencies should have adopted more of the NAS report recommendations. The agencies reviewed the findings and recommendations of the NAS report when developing the proposed rules, as was clearly intended by Congress, but also conducted an independent study, as described throughout the record to the proposal and summarized in Section X of the NPRM, 75 FR at 74351–56. In conducting its analysis of the NAS report, the agencies found that several key recommendations, such as the use of fuel efficiency metrics, were the best approach to implementing the new program. However, the agencies rejected other recommendations of the NAS report, for example, by proposing separate regulation of engines and vehicles and the regulation of large manufacturers.

#### (4) The NHTSA and EPA Light-Duty National GHG and Fuel Economy Program

On May 7, 2010, EPA and NHTSA finalized the first-ever National Program for light-duty cars and trucks, which set GHG emissions and fuel economy standards for model years 2012–2016 (See 75 FR 25324). The agencies have used the light-duty National Program as a model for this final HD National Program in many respects. This is most apparent in the case of heavy-duty pickups and vans, which are very similar to the light-duty trucks addressed in the light-duty National Program both technologically as well as in terms of how they are manufactured (*i.e.*, the same company often makes both the vehicle and the engine). For these vehicles, there are close parallels to the light-duty program in how the agencies have developed our respective final standards and compliance structures, although, as discussed below, the technologies applied to light-duty trucks are not invariably applicable to heavy-duty pickups and vans at the same penetration rates in the lead time afforded in this heavy-duty action. Another difference is that each agency adopts standards based on attributes other than vehicle footprint, as discussed below.

Due to the diversity of the remaining HD vehicles, there are fewer parallels with the structure of the light-duty program. However, the agencies have maintained the same collaboration and coordination that characterized the development of the light-duty program. Most notably, as with the light-duty program, manufacturers will be able to design and build vehicles to meet a closely coordinated, harmonized national program, and avoid

unnecessarily duplicative testing and compliance burdens.

#### (5) EPA's SmartWay Program

EPA's voluntary SmartWay Transport Partnership program encourages shipping and trucking companies to take actions that reduce fuel consumption and CO<sub>2</sub> by working with the shipping community and the freight sector to identify low carbon strategies and technologies, and by providing technical information, financial incentives, and partner recognition to accelerate the adoption of these strategies. Through the SmartWay program, EPA has worked closely with truck manufacturers and truck fleets to develop test procedures to evaluate vehicle and component performance in reducing fuel consumption and has conducted testing and has established test programs to verify technologies that can achieve these reductions. Over the last six years, EPA has developed hands-on experience testing the largest heavy-duty trucks and evaluating improvements in tire and vehicle aerodynamic performance. In 2010, according to vehicle manufacturers, approximately five percent of new combination heavy-duty trucks will meet the SmartWay performance criteria demonstrating that they represent the pinnacle of current heavy-duty truck reductions in fuel consumption.

In developing this HD National Program, the agencies have drawn from the SmartWay experience, as discussed in detail both in Sections II and III below (*e.g.*, developing test procedures to evaluate trucks and truck components) but also in the RIA (estimating performance levels from the application of the best available technologies identified in the SmartWay program). These technologies provide part of the basis for the GHG emission and fuel consumption standards in this rulemaking for certain types of new heavy-duty Class 7 and 8 combination tractors.

In addition to identifying technologies, the SmartWay program includes operational approaches that truck fleet owners as well as individual drivers and their freight customers can incorporate, that the NHTSA and EPA believe will complement the final standards. These include such approaches as improved logistics and driver training, as discussed in the RIA. This approach is consistent with the one of the three alternative approaches that the NAS recommended be considered. The three approaches were raising fuel taxes, relaxing truck size and weight restrictions, and encouraging incentives to disseminate information to inform

truck drivers about the relationship between driving behavior and fuel savings. Taxes and truck size and weight limits are mandated by public law; as such, these options are outside EPA's and NHTSA's authority to implement. However, complementary operational measures like driver training, which SmartWay does promote, can complement the final standards and also provide benefits for the existing truck fleet, furthering the public policy objectives of addressing energy security and climate change.

#### (6) Environment Canada

The Government of Canada's Department of the Environment (Environment Canada) assisted EPA's development of this rulemaking by conducting emissions testing of heavy-duty vehicles at their test facilities to gather data on a range of possible test cycles, and to evaluate the impact of certain emissions reduction technologies. Environment Canada also facilitated the evaluation of heavy-duty vehicle aerodynamic properties at Canada's National Research Council wind tunnel, and during coastdown testing.

We expect the technical collaboration with Environment Canada to continue as we implement testing and compliance verification procedures for this rulemaking. We may also begin to develop a knowledge base enabling improvement upon this regulatory framework for model years beyond 2018 (for example, improvements to the means of demonstrating compliance). We also expect to continue our collaboration with Environment Canada on compliance issues.

Collaboration with Environment Canada is taking place under the Canada-U.S. Air Quality Committee.

#### C. Summary of the Final EPA and NHTSA HD National Program

When EPA first addressed emissions from heavy-duty trucks in the 1980s, it established standards for engines, based on the amount of work performed (grams of pollutant per unit of work, expressed as grams per brake horsepower-hour or g/bhp-hr).<sup>22</sup> This

<sup>22</sup> The term "brake power" refers to engine torque and power as measured at the interface between the engine's output shaft and the dynamometer. This contrasts with "indicated power", which is a calculated value based on the pressure dynamics in the combustion chamber, not including internal losses that occur due to friction and pumping work. Since the measurement procedure inherently measures brake torque and power, the final regulations refer simply to g/hp-hr. This is consistent with EPA's other emission control programs, which generally include standards in g/kW-hr.

approach recognized the fact that engine characteristics are the dominant determinant of the types of emissions generated, and engine-based technologies (including exhaust aftertreatment systems) need to be the focus for addressing those emissions. Vehicle-based technologies, in contrast, have less influence on overall truck emissions of the pollutants that EPA has regulated in the past. The engine testing approach also recognized the relatively small number of distinct heavy-duty engine designs, as compared to the extremely wide range of truck designs. EPA concluded at that time that any incremental gain in conventional emission control that could be achieved through regulation of the complete vehicle would be small in comparison to the cost of addressing the many variants of complete trucks that make up the heavy-duty sector—smaller and larger vocational vehicles for dozens of purposes, various designs of combination tractors, and many others.

Addressing GHG emissions and fuel consumption from heavy-duty trucks, however, requires a different approach. Reducing GHG emissions and fuel consumption requires increasing the inherent efficiency of the engine as well as making changes to the vehicles to reduce the amount of work demanded from the engine in order to move the truck down the road. A focus on the entire vehicle is thus required. For example, in addition to the basic emissions and fuel consumption levels of the engine, the aerodynamics of the vehicle can have a major impact on the amount of work that must be performed to transport freight at common highway speeds. For this first rulemaking, the agencies proposed a complementary engine and vehicle approach in order to achieve the maximum feasible near-term reductions.

NHTSA received comments on the proposal to create complementary engine and vehicle standards. Volvo and Daimler argued that EISA limited NHTSA’s authority to the regulation of completed vehicles and did not give NHTSA authority to regulate engines. 49 U.S.C. 32902(k)(2) grants NHTSA broad authority to regulate this sector, stating simply that the Secretary “shall determine in a rulemaking proceeding how to implement a commercial medium- and heavy-duty on-highway vehicle and work truck fuel efficiency improvement program designed to achieve the maximum feasible improvement,” considering appropriateness, cost-effectiveness, and technological feasibility. NHTSA does not believe that this language precludes the regulation of engines, but rather explicitly leaves the regulatory approach to the agency’s expertise and discretion. *See* 75 FR at 74173 n. 36. Considering the factors described in the NPRM and in Sections III and IV below, NHTSA continues to believe that the separate regulation of engines and vehicles is both consistent with the agency’s statutory mandate to determine how to implement a regulatory program designed to achieve the maximum feasible improvement and facilitates coordination with EPA’s efforts to reduce greenhouse gas emissions. The Clean Air act, of course, mandates standards for both “new motor vehicles” and “new motor vehicle engines”, so there is no issue of authority for separate engine standards under the EPA GHG program. CAA section 202(a)(1).

As described elsewhere in this preamble, the final standards under the HD National Program address the complete vehicle, to the extent practicable and appropriate under the agencies’ respective statutory

authorities, through complementary engine and vehicle standards. The agencies continue to believe that this complementary engine and vehicle approach is the best way to achieve near term reductions from the heavy-duty sector. However, we also recognize as did the NAS committee and a wide range of industry and environmental commenters, that in order to fully capture the multi-faceted synergistic aspects of engine and vehicle design a more comprehensive complete vehicle standard may be appropriate in the future. The agencies are committed to fully exploring such a possibility and to developing the testing and modeling tools necessary to enable such a regulatory approach. We intend to work with all interested stakeholders as we move forward.

(1) Brief Overview of the Heavy-Duty Truck Industry

The heavy-duty truck sector spans a wide range of vehicles with often unique form and function. A primary indicator of the extreme diversity among heavy-duty trucks is the range of load-carrying capability across the industry. The heavy-duty truck sector is often subdivided by vehicle weight classifications, as defined by the vehicle’s gross vehicle weight rating (GVWR), which is a measure of the combined curb (empty) weight and cargo carrying capacity of the truck.<sup>23</sup> Table I–2 below outlines the vehicle weight classifications commonly used for many years for a variety of purposes by businesses and by several federal agencies, including the Department of Transportation, the Environmental Protection Agency, the Department of Commerce, and the Internal Revenue Service.

TABLE I–2—VEHICLE WEIGHT CLASSIFICATION

Class	2b	3	4	5	6	7	8
GVWR (lb) .....	8,501–10,000	10,001–14,000	14,001–16,000	16,001–19,500	19,501–26,000	26,001–33,000	> 33,001

In the framework of these vehicle weight classifications, the heavy-duty truck sector refers to Class 2b through Class 8 vehicles and the engines that power those vehicles.<sup>24</sup> Unlike light-duty vehicles, which are primarily used for transporting passengers for personal

travel, heavy-duty vehicles fill much more diverse operator needs. Heavy-duty pickup trucks and vans (Classes 2b and 3) are used chiefly as work truck and vans, and as shuttle vans, as well as for personal transportation, with an average annual mileage in the range of

15,000 miles. The rest of the heavy-duty sector is used for carrying cargo and/or performing specialized tasks. “Vocational” vehicles, which may span Classes 2b through 8, vary widely in size, including smaller and larger van trucks, utility “bucket” trucks, tank

<sup>23</sup> GVWR describes the maximum load that can be carried by a vehicle, including the weight of the vehicle itself. Heavy-duty vehicles also have a gross combined weight rating (GCWR), which describes the maximum load that the vehicle can haul,

including the weight of a loaded trailer and the vehicle itself.

<sup>24</sup> Class 2b vehicles designed as passenger vehicles (Medium Duty Passenger Vehicles,

MDPVs) are covered by the light-duty GHG and fuel economy standards and not addressed in this rulemaking.

trucks, refuse trucks, urban and over-the-road buses, fire trucks, flat-bed trucks, and dump trucks, among others. The annual mileage of these trucks is as varied as their uses, but for the most part tends to fall in between heavy-duty pickups/vans and the large combination tractors, typically from 15,000 to 150,000 miles per year, although some travel more and some less. Class 7 and 8 combination tractor-trailers—some equipped with sleeper cabs and some not—are primarily used for freight transportation. They are sold as tractors and sometimes run without a trailer in between loads, but most of the time they run with one or more trailers that can carry up to 50,000 pounds or more of payload, consuming significant quantities of fuel and producing significant amounts of GHG emissions. The combination tractor-trailers used in combination applications can travel more than 150,000 miles per year.

EPA and NHTSA have designed our respective standards in careful consideration of the diversity and complexity of the heavy-duty truck industry, as discussed next.

## (2) Summary of Final EPA GHG Emission Standards and NHTSA Fuel Consumption Standards

As described above, NHTSA and EPA recognize the importance of addressing the entire vehicle in reducing fuel consumption and GHG emissions. At the same time, the agencies understand that the complexity of the industry means that we will need to use different approaches to achieve this goal, depending on the characteristics of each general type of truck. We are therefore dividing the industry into three discrete regulatory categories for purposes of setting our respective standards—combination tractors, heavy-duty pickups and vans, and vocational vehicles—based on the relative degree of homogeneity among trucks within each category. For each regulatory category, the agencies are adopting related but distinct program approaches reflecting the specific challenges that we see in these segments. In the following paragraphs, we discuss EPA's final GHG emission standards and NHTSA's final fuel consumption standards for the three regulatory categories of heavy-duty vehicles and their engines.

The agencies are adopting test metrics that express fuel consumption and GHG emissions relative to the most important measures of heavy-duty truck utility for each segment, consistent with the recommendation of the 2010 NAS Report that metrics should reflect and account for the work performed by various types of HD vehicles. This

approach differs from NHTSA's light-duty program that uses fuel economy as the basis. The NAS committee discussed the difference between fuel economy (a measure of how far a vehicle will go on a gallon of fuel) and fuel consumption (the inverse measure, of how much fuel is consumed in driving a given distance) as potential metrics for MD/HD regulations. The committee concluded that fuel economy would not be a good metric for judging the fuel efficiency of a heavy-duty vehicle, and stated that NHTSA should instead consider fuel consumption as the metric for its standards. As a result, for heavy-duty pickup trucks and vans, EPA and NHTSA are finalizing standards on a per-mile basis (g/mile for the EPA standards, gallons/100 miles for the NHTSA standards), as explained in Section 0 below. For heavy-duty trucks, both combination and vocational, the agencies are adopting standards expressed in terms of the key measure of freight movement, tons of payload miles or, more simply, ton-miles. Hence, for EPA the final standards are in the form of the mass of emissions from carrying a ton of cargo over a distance of one mile (g/ton-mi). Similarly, the final NHTSA standards are in terms of gallons of fuel consumed over a set distance (one thousand miles), or gal/1,000 ton-mile. Finally, for engines, EPA is adopting standards in the form of grams of emissions per unit of work (g/bhp-hr), the same metric used for the heavy-duty highway engine standards for criteria pollutants today. Similarly, NHTSA is finalizing standards for heavy-duty engines in the form of gallons of fuel consumption per 100 units of work (gal/100 bhp-hr).

Section II below discusses the final EPA and NHTSA standards in greater detail.

### (a) Class 7 and 8 Combination Tractors

Class 7 and 8 combination tractors and their engines contribute the largest portion of the total GHG emissions and fuel consumption of the heavy-duty sector, approximately 65 percent, due to their large payloads, their high annual miles traveled, and their major role in national freight transport.<sup>25</sup> These vehicles consist of a cab and engine (tractor or combination tractor) and a detachable trailer. In general, reducing GHG emissions and fuel consumption for these vehicles will involve

<sup>25</sup> The on-highway Class 7 and 8 combination tractors constitute the vast majority of this regulatory category, and form the backbone of this HD National Program. A small fraction of combination tractors are used in off-road applications and are regulated differently, as described in Section II.

improvements in aerodynamics and tires and reduction in idle operation, as well as engine-based efficiency improvements.

In general, the heavy-duty combination tractor industry consists of tractor manufacturers (which manufacture the tractor and purchase and install the engine) and trailer manufacturers. These manufacturers are usually not the same entity. We are not aware of any manufacturer that typically assembles both the finished truck and the trailer and introduces the combination into commerce for sale to a buyer. The owners of trucks and trailers are often distinct as well. A typical truck buyer will purchase only the tractor. The trailers are usually purchased and owned by fleets and shippers. This occurs in part because trucking fleets on average maintain 3 trailers per tractor and in some cases as many as 6 or more trailers per tractor. There are also large differences in the kinds of manufacturers involved with producing tractors and trailers. For HD highway tractors and their engines, a relatively limited number of manufacturers produce the vast majority of these products. The trailer manufacturing industry is quite different, and includes a large number of companies, many of which are relatively small in size and production volume. Setting standards for the products involved—tractors and trailers—requires recognition of the large differences between these manufacturing industries, which can then warrant consideration of different regulatory approaches.

Based on these industry characteristics, EPA and NHTSA believe that the most straightforward regulatory approach for combination tractors and trailers is to establish standards for tractors separately from trailers. As discussed below in Section IX, the agencies are adopting standards for the tractors and their engines in this rulemaking, but did not propose and are not adopting standards for trailers.

As with the other regulatory categories of heavy-duty vehicles, EPA and NHTSA have concluded that achieving reductions in GHG emissions and fuel consumption from combination tractors requires addressing both the cab and the engine, and EPA and NHTSA each are adopting standards that reflect this conclusion. The importance of the cab is that its design determines the amount of power that the engine must produce in moving the truck down the road. As illustrated in Figure I-1, the loads that require additional power from the engine include air resistance (aerodynamics), tire rolling resistance,

and parasitic losses (including accessory loads and friction in the drivetrain). The importance of the engine design is that it determines the basic GHG emissions and fuel consumption performance of

the engine for the variety of demands placed on the engine, regardless of the characteristics of the cab in which it is installed. The agencies intend for the final standards to result in the

application of improved technologies for lower GHG emissions and fuel consumption for both the cab and the engine.

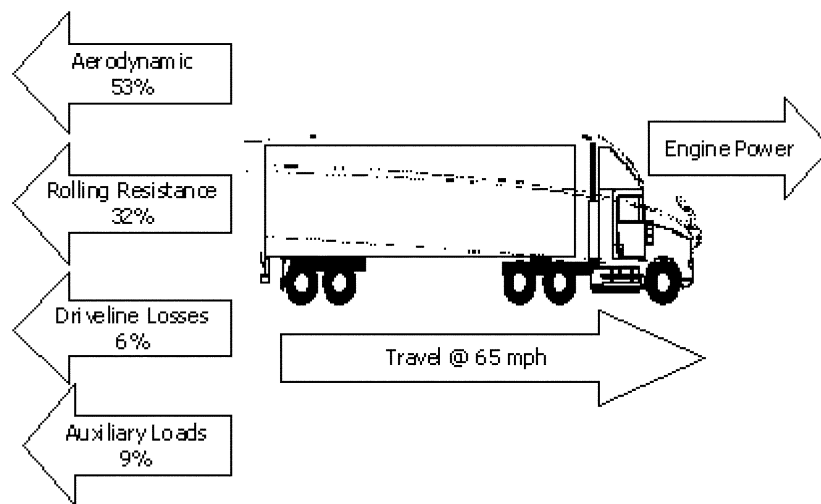

Figure I-1: Combination Tractor and Trailer Loads<sup>26</sup>

Accordingly, for Class 7 and 8 combination tractors, the agencies are each finalizing two sets of standards. For vehicle-related emissions and fuel consumption, tractor manufacturers are required to meet vehicle-based standards. Compliance with the vehicle standard will typically be determined based on a customized vehicle simulation model, called the Greenhouse gas Emissions Model (GEM), which is consistent with the NAS Report recommendations to require compliance testing for combination tractors using vehicle simulation rather than chassis dynamometer testing. This compliance model was developed by EPA specifically for this final action. It is an accurate and cost-effective alternative to measuring emissions and fuel consumption while operating the vehicle on a chassis dynamometer. Instead of using a chassis dynamometer as an indirect way to evaluate real-world operation and performance, various characteristics of the vehicle are measured and these measurements are used as inputs to the model. These characteristics relate to key technologies appropriate for this subcategory of truck—including aerodynamic features, weight reductions, tire rolling resistance, the presence of idle-reducing technology, and vehicle speed limiters. The model also assumes the use of a

representative typical engine, rather than a vehicle-specific engine, because engines are regulated separately. Using these inputs, the model will be used to quantify the overall performance of the vehicle in terms of CO<sub>2</sub> emissions and fuel consumption. The model's development and design, as well as the sources for inputs, are discussed in detail in Section II below and in Chapter 4 of the RIA.

(j) Final Standards for Class 7 and 8 Combination Tractors and Their Engines

The vehicle standards that EPA and NHTSA are adopting for Class 7 and 8 combination tractor manufacturers are based on several key attributes related to GHG emissions and fuel consumption that we believe reasonably represent the many differences in utility and performance among these vehicles. The final standards differ depending on GVWR (*i.e.*, whether the truck is Class 7 or Class 8), the height of the roof of the cab, and whether it is a "day cab" or a "sleeper cab." These later two attributes are important because the height of the roof, designed to correspond to the height of the trailer, significantly affects air resistance, and a sleeper cab generally corresponds to the opportunity for extended duration idle emission and fuel consumption improvements. We received a number of comments supporting this approach and

no comments that provided a compelling reason to change our approach in this final action.

Thus, the agencies have created nine subcategories within the Class 7 and 8 combination tractor category based on the differences in expected emissions and fuel consumption associated with the key attributes of GVWR, cab type, and roof height. The agencies are setting standards beginning in 2014 model year with more stringent standards following in 2017 model year. Table I-3 presents the agencies' respective standards for combination tractor manufacturers for the 2017 model year. The standards represent an overall fuel consumption and CO<sub>2</sub> emissions reduction up to 23 percent from the tractors and the engines installed in them when compared to a baseline 2010 model year tractor and engine without idle shutdown technology. The standard values shown below differ somewhat from the proposal, reflecting refinements made to the GEM in response to comments. These changes did not impact our estimates of the relative effectiveness of the various control technologies modeled in this final action nor the overall cost or benefits or cost effectiveness estimated for these final vehicle standards.

As proposed, the agencies are exempting certain types of tractors which operate off-road to be exempt

<sup>26</sup> Adapted from Figure 4.1. Class 8 Truck Energy Audit, Technology Roadmap for the 21st Century

Truck Program: A Government-Industry Research Partnership, 21CT-001, December 2000.

from the combination tractor vehicle standards (although standards would still apply to the engines installed in these vehicles). The criteria for tractors to be considered off-road have been amended slightly from those proposed,

in response to public comment. The agencies have also recognized, again in response to public comment, that some combination tractors operate in a manner essentially the same as vocational vehicles and have created a

subcategory of “vocational tractors” as a result. Vocational tractors will be subject to the standards for vocational vehicles rather than the combination tractor standards. See Section II.B of this preamble.

TABLE I-3—HEAVY-DUTY COMBINATION TRACTOR EPA EMISSIONS STANDARDS (G CO<sub>2</sub>/TON-MILE) AND NHTSA FUEL CONSUMPTION STANDARDS (GAL/1,000 TON-MILE)

	Day cab		Sleeper cab
	Class 7	Class 8	Class 8
<b>2017 Model Year CO<sub>2</sub> Grams per Ton-Mile</b>			
Low Roof .....	104	80	66
Mid Roof .....	115	86	73
High Roof .....	120	89	72
<b>2017 Model Year Gallons of Fuel per 1,000 Ton-Mile</b>			
Low Roof .....	10.2	7.8	6.5
Mid Roof .....	11.3	8.4	7.2
High Roof .....	11.8	8.7	7.1

In addition, the agencies are finalizing separate performance standards for the engines manufactured for use in these trucks. EPA’s engine-based CO<sub>2</sub> standards and NHTSA’s engine-based fuel consumption standards are implemented using EPA’s existing test procedures and regulatory structure for criteria pollutant emissions from medium- and heavy-duty engines. As at proposal, the final engine standards vary depending on engine size linked to intended vehicle service class. Consistent with our proposal, the agencies are finalizing an interim alternative compression ignition engine standard for model years 2014–2016. This alternative standard is designed to provide a glide path for legacy diesel engine products that may not be able to comply with the final engine standards for model years 2014–16 given the short (approximately 2-year) lead time of this program. We believe this alternative standard is appropriate for a first-ever program when the overall baseline performance of the industry is quite varied and where the short lead time means that not every product can be brought into compliance by 2014. The alternative standard only applies through and including model year 2016.

Separately, EPA is adopting standards for combination tractors that apply in use. EPA is also finalizing engine-based N<sub>2</sub>O and CH<sub>4</sub> standards for manufacturers of the engines used in these combination tractors. EPA is finalizing separate engine-based standards for N<sub>2</sub>O and CH<sub>4</sub> because the agency believes that emissions of these GHGs are technologically related solely to the engine, fuel, and emissions

aftertreatment systems, and the agency is not aware of any influence of vehicle-based technologies on these emissions. NHTSA is not incorporating standards for N<sub>2</sub>O and CH<sub>4</sub> because these emissions do not impact fuel consumption in a significant way. The standards that EPA is finalizing for N<sub>2</sub>O and CH<sub>4</sub> are less stringent than those we proposed, reflecting new data provided to EPA in comments on the proposal showing that the current baseline level of N<sub>2</sub>O and CH<sub>4</sub> emissions varies more than EPA had expected. EPA expects that manufacturers of current engine technologies will be able to comply with the final N<sub>2</sub>O and CH<sub>4</sub> “cap” standards with little or no technological improvements; the value of the standards will be to prevent significant increases in these emissions as alternative technologies are developed and introduced in the future. Compliance with the final EPA engine-based CO<sub>2</sub> standards and the final NHTSA engine-based fuel consumption standards, as well as the final EPA N<sub>2</sub>O and CH<sub>4</sub> standards, will be determined using the appropriate EPA engine test procedure, as discussed in Sections II.B, II.D, and II.E below.

As with the other categories of heavy-duty vehicles, EPA and NHTSA are finalizing respective standards that will apply to Class 7 and 8 tractors at the time of production (as in Table I-3, above). In addition, EPA is finalizing separate standards that will apply for a specified period of time in use. All of the standards for these vehicles, as well as details about the provisions for certification and implementation of these standards, are discussed in more

detail in Sections II, III, IV, and V below and in the RIA.

(ii) EPA’s Final Air Conditioning Leakage Standard for Class 7 and 8 Combination Tractors

In addition to the final EPA tractor- and engine-based standards for CO<sub>2</sub> and engine-based standards for N<sub>2</sub>O, and CH<sub>4</sub> emissions, EPA is finalizing a separate standard to reduce leakage of HFC refrigerant from cabin air conditioning (A/C) systems from combination tractors, to apply to the tractor manufacturer. This standard is independent of the CO<sub>2</sub> tractor standard, as discussed below in Section II.E.5. Because the current refrigerant used widely in all these systems has a very high global warming potential, EPA is concerned about leakage of refrigerant.<sup>27</sup>

Because the interior volume to be cooled for most tractor cabins is similar to that of light-duty vehicles, the size and design of current tractor A/C systems is also very similar. The compliance approach for Class 7 and 8 tractors is therefore similar to that in the light-duty rule in that these standards are design-based. Manufacturers will choose technologies from a menu of leak-reducing technologies sufficient to comply with the standard, as opposed to using a test to measure performance.

However, the final heavy-duty A/C provisions differ in two important ways from those established in the light-duty rule. First, the light-duty provisions were established as voluntary ways to

<sup>27</sup> The global warming potential for HFC-134a refrigerant of 1430 used in this program is consistent with the Intergovernmental Panel on Climate Change Fourth Assessment Report.

generate credits towards the CO<sub>2</sub> g/mi standard, and EPA took into account the expected use of such credits in determining the stringency of the CO<sub>2</sub> emissions standards. In the HD National Program, EPA is requiring that manufacturers actually meet a standard—as opposed to having the opportunity to earn a credit—for A/C refrigerant leakage. Thus, refrigerant leakage control is not separately accounted for in the final heavy-duty CO<sub>2</sub> standards. We are taking this approach here recognizing that while the benefits of leakage control are almost identical between light-duty and heavy-duty vehicles on a per vehicle basis, these benefits on a per mile basis expressed as a percentage of overall GHG emissions are much smaller for heavy-duty vehicles due to their much higher CO<sub>2</sub> emissions rates and higher annual mileage when compared to light-duty vehicles. Hence a credit-based approach as done for light-duty vehicles would provide less motivation for manufacturers to install low leakage systems even though such systems represent a highly cost effective means to control GHG emissions. The second difference relates to the expression of the leakage rate. The light-duty A/C leakage standard is expressed in terms of grams per year. For EPA's heavy-duty program, however, because of the wide variety of system designs and arrangements, a one-size-fits-all gram per year standard would not be appropriate, so EPA is adopting a standard in terms of annual mass leakage rate for A/C systems with refrigerant capacities less than or equal to 733 grams and percent of total refrigerant leakage per year for A/C systems with refrigerant capacities greater than 733 grams. The percent of total refrigerant leakage per year requires the total refrigerant capacity of the A/C system to be taken into account in determining compliance. EPA believes that this approach—a standard instead of a credit, and basing the standard on percent or mass of leakage over time—is more appropriate for heavy-duty tractors than the light-duty vehicle approach and that it will achieve the desired reductions in refrigerant leakage. Compliance with the standard will be determined through a showing by the tractor manufacturer that its A/C system incorporates a combination of low-leak technologies sufficient to meet the leakage rate of the applicable standard. The “menu” of technologies is very similar to that

established in the light-duty 2012–2016 MY vehicle rule.<sup>28</sup>

Finally, the agencies did not propose and are not adopting an A/C system efficiency standard in this heavy-duty rulemaking, although an efficiency credit was a part of the light-duty rule. The much larger emissions of CO<sub>2</sub> from a heavy-duty tractor as compared to those from a light-duty vehicle mean that the relative amount of CO<sub>2</sub> that could be reduced through A/C efficiency improvements is very small.

A more detailed discussion of A/C related issues is found in Section II.E.5 of this preamble.

(b) Heavy-Duty Pickup Trucks and Vans (Class 2b and 3)

Heavy-duty vehicles with GVWR between 8,501 and 10,000 lb are classified in the industry as Class 2b motor vehicles per the Federal Motor Carrier Safety Administration definition. As discussed above, Class 2b includes MDPVs that are regulated by the agencies under the light-duty vehicle rule, and the agencies are not adopting additional requirements for MDPVs in this rulemaking. Heavy-duty vehicles with GVWR between 10,001 and 14,000 lb are classified as Class 3 motor vehicles. Class 2b and Class 3 heavy-duty vehicles (referred to in these rules as “HD pickups and vans”) together emit about 15 percent of today's GHG emissions from the heavy-duty vehicle sector.

About 90 percent of HD pickups and vans are ¾-ton and 1-ton pickup trucks, 12- and 15-passenger vans, and large work vans that are sold by vehicle manufacturers as complete vehicles, with no secondary manufacturer making substantial modifications prior to registration and use. These vehicle manufacturers are companies with major light-duty markets in the United States, primarily Ford, General Motors, and Chrysler. Furthermore, the technologies available to reduce fuel consumption and GHG emissions from this segment are similar to the technologies used on light-duty pickup trucks, including both engine efficiency improvements (for gasoline and diesel engines) and vehicle efficiency improvements.

<sup>28</sup> EPA has approved an alternative refrigerant, HFO-1234yf, which has a very low GWP, for use in light-duty vehicle mobile A/C systems. The final heavy-duty vehicle A/C leakage standard is designed to account for use of an alternative, low-GWP refrigerant. If in the future this refrigerant is approved for heavy-duty applications and if it becomes widespread as a substitute for HFC-134a in heavy-duty vehicle mobile A/C systems, EPA may propose to revise or eliminate the leakage standard.

For these reasons, EPA believes it is appropriate to adopt GHG standards for HD pickups and vans based on the whole vehicle (including the engine), expressed as grams per mile, consistent with the way these vehicles are regulated by EPA today for criteria pollutants. NHTSA believes it is appropriate to adopt corresponding gallons per 100 mile fuel consumption standards that are likewise based on the whole vehicle. This complete vehicle approach being adopted by both agencies for HD pickups and vans is consistent with the recommendations of the NAS Committee in their 2010 Report. EPA and NHTSA also believe that the structure and many of the detailed provisions of the recently finalized light-duty GHG and fuel economy program, which also involves vehicle-based standards, are appropriate for the HD pickup and van GHG and fuel consumption standards as well, and this is reflected in the standards each agency is finalizing, as detailed in Section II.C. These commonalities include a new vehicle fleet average standard for each manufacturer in each model year and the determination of these fleet average standards based on production volume-weighted targets for each model, with the targets varying based on a defined vehicle attribute. Vehicle testing will be conducted on chassis dynamometers using the drive cycles from the EPA Federal Test Procedure (Light-duty FTP or “city” test) and Highway Fuel Economy Test (HFET or “highway” test).<sup>29</sup>

For the light-duty GHG and fuel economy standards, the agencies factored in vehicle size by basing the emissions and fuel economy targets on vehicle footprint (the wheelbase times the average track width).<sup>30</sup> For those standards, passenger cars and light trucks with larger footprints are assigned higher GHG and lower fuel economy target levels in acknowledgement of their inherent tendency to consume more fuel and emit more GHGs per mile. For HD pickups and vans, the agencies believe that setting standards based on vehicle attributes is appropriate, but feel that a work-based metric serves as a better attribute than the footprint attribute utilized in the light-duty vehicle

<sup>29</sup> The Light-duty FTP is a vehicle driving cycle that was originally developed for certifying light-duty vehicles and subsequently applied to HD chassis testing for criteria pollutants. This contrasts with the Heavy-duty FTP, which refers to the transient engine test cycles used for certifying heavy-duty engines (with separate cycles specified for diesel and spark-ignition engines).

<sup>30</sup> EISA requires CAFE standards for passenger cars and light trucks to be attribute-based; See 49 U.S.C. 32902(b)(3)(A).

rulemaking. Work-based measures such as payload and towing capability are key among the parameters that characterize differences in the design of these vehicles, as well as differences in how the vehicles will be utilized. Buyers consider these utility-based attributes when purchasing a heavy-duty pickup or van. EPA and NHTSA are therefore finalizing standards for HD pickups and vans based on a “work factor” attribute that combines their payload and towing capabilities, with an added adjustment for 4-wheel drive vehicles. The agencies received a number of comments supporting this approach arguing, as the agencies had, that this approach was an effective way to encourage technology development and to appropriately reflect the utility of work vehicles while setting a consistent metric measure of vehicle performance.

As proposed, the agencies are adopting provisions such that each manufacturer’s fleet average standard will be based on production volume-weighting of target standards for all vehicles that in turn are based on each vehicle’s work factor. These target standards are taken from a set of curves (mathematical functions), presented in Section II.C below and in § 1037.104. EPA is also phasing in the CO<sub>2</sub> standards gradually starting in the 2014 model year, at 15–20–40–60–100 percent of the model year 2018 standards stringency level in model years 2014–2015–2016–2017–2018, respectively. The phase-in takes the form of a set of target standard curves, with increasing stringency in each model year, as detailed in Section II.C. The final EPA standards for 2018 (including a separate standard to control air conditioning system leakage) represent an average per-vehicle reduction in GHGs of 17 percent for diesel vehicles and 12 percent for gasoline vehicles, compared to a common baseline, as described in Sections II.C and III.B of this preamble. The rule contains separate standards for diesel and gasoline heavy duty pickups and vans for reasons described in Section II.C below. EPA is also finalizing a compliance alternative whereby manufacturers can phase in different percentages: 15–20–67–67–67–100 percent of the model year 2019 standards stringency level in model years 2014–2015–2016–2017–2018–2019, respectively. This compliance alternative parallels and is equivalent to NHTSA’s first alternative described below.

NHTSA is allowing manufacturers to select one of two fuel consumption standard alternatives for model years 2016 and later. The first alternative

defines individual gasoline vehicle and diesel vehicle fuel consumption target curves that will not change for model years 2016–2018, and are equivalent to EPA’s 67–67–67–100 percent target curves in model years 2016–2017–2018–2019, respectively. The target curves for this alternative are presented in Section II.C. The second alternative uses target curves that are equivalent to the EPA’s 40–60–100 percent target curves in model years 2016–2017–2018, respectively. Stringency for the alternatives has been selected to allow a manufacturer, through the use of the credit and deficit carry-forward provisions that the agencies are also finalizing, to rely on the same product plans to satisfy either of these two alternatives, and also EPA requirements. If a manufacturer cannot meet an applicable standard in a given model year, it may make up its shortfall by overcomplying in a subsequent year, called reconciling a credit deficit. NHTSA is also allowing manufacturers to voluntarily opt into the NHTSA HD pickup and van program in model years 2014 or 2015. For these model years, NHTSA’s fuel consumption target curves are equivalent to EPA’s target curves.

The agencies received a number of comments including from the Senate authors and supporters of the Ten-in-Ten Fuel Economy Act suggesting that the standards for heavy-duty pickups and vans should be made more stringent for gasoline vehicles and that the phase-in timing of the standards should be accelerated to the 2016 model year (from 2018). We also received comments arguing that the proposed standards were aggressive and could only be met given the phase-in schedules proposed by the agencies. In response to these comments, we reviewed again the technology assessments from the 2010 NAS report, our own joint light-duty 2012–2016 rulemaking, and information provided by the commenters relevant to the stringency of these standards. After reviewing all of the information, we continue to conclude that the proposed standards and associated phase-in schedules represent technically stringent but reasonable standards considering the available lead time and costs to bring the necessary technologies to market and our own assessments of the efficacy of the technologies when applied to heavy-duty pickup trucks and vans. Further detail on the feasibility of the standards and the agencies’ choices among alternative standards is found in Section III.C below.

The Senate authors and supporters of the Ten-in-Ten Fuel Economy Act sent

a letter to the agencies encouraging the agencies to finalize a fuel economy labeling requirement for heavy-duty pickups and vans.<sup>31</sup> The agencies recognize that consumer information in the form of a fuel efficiency label can be a valuable tool to help achieve our goals, and we note that the agencies have just recently finalized a new fuel economy label for passenger cars and light trucks. See 76 FR at 39478. That rulemaking effort focused solely on modifying an existing label and was a multi-year process with significant public input. As we did not propose a consumer label for heavy-duty pickups and vans in this action and have not appropriately engaged the public in developing such a label, we are not prepared to finalize a consumer-based label in this action. However, we do intend to consider this issue as we begin work on the next phase of regulations, as we recognize that a consumer label can play an important role in reducing fuel consumption and GHG emissions.

The form and stringency of the EPA and NHTSA standards curves are based on a set of vehicle, engine, and transmission technologies expected to be used to meet the recently established GHG emissions and fuel economy standards for model year 2012–2016 light-duty vehicles, with full consideration of how these technologies are likely to perform in heavy-duty vehicle testing and use. All of these technologies are already in use or have been announced for upcoming model years in some light-duty vehicle models, and some are in use in a portion of HD pickups and vans as well. The technologies include:

- Advanced 8-speed automatic transmissions.
- Aerodynamic improvements.
- Electro-hydraulic power steering.
- Engine friction reductions.
- Improved accessories.
- Low friction lubricants in powertrain components.
- Lower rolling resistance tires.
- Lightweighting.
- Gasoline direct injection.
- Diesel aftertreatment optimization.
- Air conditioning system leakage reduction (for EPA program only).

See Section III.B for a detailed analysis of these and other potential technologies, including their feasibility, costs, and effectiveness when employed for reducing fuel consumption and CO<sub>2</sub> emissions in HD pickups and vans.

A relatively small number of HD pickups and vans are sold by vehicle manufacturers as incomplete vehicles, without the primary load-carrying

<sup>31</sup> See Docket EPA–HQ–OAR–2010–0162.

device or container attached. We are generally regulating these vehicles as Class 2b through 8 vocational vehicles but are also allowing manufacturers the option to choose to comply with heavy-duty pickup or van standards, as described in Section I.C.(2)(c).

Although, as with vocational vehicles generally, we have little information on baseline aerodynamic performance and opportunities for improvement, a sizeable subset of these incomplete vehicles, often called cab-chassis vehicles, are sold by the vehicle manufacturers in configurations with many of the components that affect GHG emissions and fuel consumption identical to those on complete pickup truck or van counterparts—including engines, cabs, frames, transmissions, axles, and wheels. We are including provisions that will allow manufacturers to include these vehicles, as well as some Class 4 and 5 vehicles, to be regulated under the chassis-based HD pickup and van program (*i.e.* subject to the standards for HD pickups and vans), rather than the vocational vehicle program. These provisions are described in Section V.B(1)(e).

In addition to the EPA CO<sub>2</sub> emission standards and the NHTSA fuel consumption standards for HD pickups and vans, EPA is also finalizing standards for two additional GHGs, N<sub>2</sub>O and CH<sub>4</sub>, as well as standards for air conditioning-related HFC emissions. These standards are discussed in more detail in Section II.E. Finally, EPA is finalizing standards that will apply to HD pickups and vans in use. All of the standards for these HD pickups and vans, as well as details about the provisions for certification and implementation of these standards, are discussed in Section II.C.

#### (c) Class 2b–8 Vocational Vehicles

Class 2b–8 vocational vehicles consist of a wide variety of vehicle types. Some of the primary applications for vehicles in this segment include delivery, refuse, utility, dump, and cement trucks; transit, shuttle, and school buses; emergency vehicles, motor homes,<sup>32</sup> tow trucks, among others. These vehicles and their engines contribute approximately 20 percent of today's heavy-duty truck sector GHG emissions.

Manufacturing of vehicles in this segment of the industry is organized in a more complex way than that of the other heavy-duty categories. Class 2b–8 vocational vehicles are often built as a chassis with an installed engine and an

installed transmission. Both the engine and transmissions are typically manufactured by other manufacturers and the chassis manufacturer purchases and installs them. Many of the same companies that build Class 7 and 8 tractors are also in the Class 2b–8 chassis manufacturing market. The chassis is typically then sent to a body manufacturer, which completes the vehicle by installing the appropriate feature—such as dump bed, delivery box, or utility bucket—onto the chassis. Vehicle body manufacturers tend to be small businesses that specialize in specific types of bodies or specialized features.

EPA and NHTSA proposed that in this vocational vehicle category the proposed GHG and fuel consumption standards apply to chassis manufacturers. Chassis manufacturers play a central role in the manufacturing process. The product they produce—the chassis with engine and transmission—includes the primary technologies that affect GHG emissions and fuel consumption. They also constitute a much more limited group of manufacturers for purposes of developing and implementing a regulatory program. The agencies believe that a focus on the body manufacturers would be much less practical, since they represent a much more diverse set of manufacturers, many of whom are small businesses. Further, the part of the vehicle that they add affords very few opportunities to reduce GHG emissions and fuel consumption (given the limited role that aerodynamics plays in many types of lower speed and stop-and-go operation typically found with vocational vehicles.) Therefore, the agencies proposed that the standards in this vocational vehicle category would apply to the chassis manufacturers of all heavy-duty vehicles not otherwise covered by the HD pickup and van standards or Class 7 and 8 combination tractor standards discussed above. The agencies requested comment on the proposed focus on chassis manufacturers.

Volvo and Daimler commented that the EISA does not speak to the regulation of subsystems, such as engines or incomplete vehicles, and argued that on the other hand, Section 32902(k)(2) prescribes the regulation of vehicles. Volvo further stated that precedent for the regulation of complete vehicles exists in the light-duty fuel economy rule. As noted above, NHTSA does not believe that EISA mandates a particular regulatory approach, but rather gives the agency wide latitude and explicitly leaves that determination

to the agency. NHTSA also notes that its heavy-duty rule creates a new fuel efficiency program for which the light-duty program does not necessarily serve as a useful precedent for considerations of its structure. Unlike the light-duty fuel economy program, MD/HD vehicles are produced in widely diverse stages. Further, given the MD/HD market structure, where the complete vehicle manufacturers are numerous, diverse, and often small businesses, the regulation of complete vehicles would create unique difficulties for the application of appropriate and feasible technologies. These same considerations justify EPA's determination, pursuant to CAA section 202 (a), to regulate only chassis manufacturers in this first stage of GHG rules for the heavy-duty sector. NHTSA also notes that this rule does not represent the first time that the agency has regulated incomplete vehicles. Rather, incomplete vehicles have a history of regulation under the Federal Motor Vehicle Safety Standards.<sup>33</sup> For this first phase of the HD National Program, NHTSA and EPA believe that given the complexity of the manufacturing process for vocational vehicles, and given the wide range of entities that participate in that process, vehicle fuel consumption standards would be most appropriately applied to chassis manufacturers and not to body builders.

The agencies continue to believe that regulation of the chassis manufacturers for this vocational vehicle category will achieve the maximum feasible improvement in fuel efficiency for purposes of EISA and appropriate emissions reductions for purposes of the CAA. Therefore, consistent with our proposal the final standards in this vocational vehicle category apply to the chassis manufacturers of all heavy-duty vehicles not otherwise covered by the HD pickup and van standards or Class 7 and 8 combination tractor standards discussed above. As discussed above, EPA and NHTSA have concluded that reductions in GHG emissions and fuel consumption require addressing both the vehicle and the engine. As discussed above for Class 7 and 8 combination tractors, the agencies are each finalizing two sets of standards for Class 2b–8 vocational vehicles. For vehicle-related emissions and fuel consumption, the agencies are adopting standards for chassis manufacturers: EPA CO<sub>2</sub> (g/ton-mile) standards and NHTSA fuel consumption (gal/1,000 ton-mile) standards). While the agencies believe that a freight-based metric is broadly appropriate for vocational vehicles

<sup>32</sup> NHTSA's final fuel consumption standards will not apply to recreational vehicles, as discussed in earlier in this preamble section.

<sup>33</sup> See 49 U.S.C. 567.5 and 568.4.



because the vocational vehicle population is dominated by freight trucks and maintain that it is appropriate for the first phase of the program, the agencies may consider other metrics for future phases of a HD program. Manufacturers will use GEM, the same customized vehicle simulation model used for Class 7 and 8 tractors, to determine compliance with the vocational vehicle standards finalized in this action. The primary manufacturer-generated input into the GEM for this category of trucks will be a measure of tire rolling resistance, as discussed further below, because tire improvements are the primary means of vehicle improvement available at this time for vocational vehicles. The model also assumes the use of a typical representative, compliant engine in the simulation, resulting in an overall value for CO<sub>2</sub> emissions and one for fuel consumption. This is done for the same reason as for combination tractors. As is the case for combination tractors, the manufacturers of the engines intended for vocational vehicles will be subject to separate engine-based standards.

(i) Final Standards for Class 2b–8 Vocational Vehicles and Their Engines

Based on our analysis and research, the agencies believe that the primary opportunity for reductions in vocational vehicle GHG emissions and fuel consumption will be through improved engine technologies and improved tire rolling resistance. For engines, EPA and NHTSA are adopting separate standards for the manufacturers of engines used in Class 2b–8 vocational vehicles (the same approach as for combination tractors and engines intended for use in those tractors). EPA’s final engine-based CO<sub>2</sub> standards and NHTSA’s final engine-based fuel consumption standards vary based on the expected weight class and usage of the truck into which the engine will be installed. Tire rolling resistance is closely related to the weight of the vehicle. Therefore, we are adopting vehicle-based standards for these trucks which vary according to one key attribute, GVWR. For this initial HD rulemaking, we are adopting standards based on the same groupings of truck weight classes used for the engine

standards—light heavy-duty, medium heavy-duty, and heavy heavy-duty. These groupings are appropriate for the final vehicle-based standards because they parallel the general divisions among key engine characteristics, as discussed in Section II.

The agencies are also finalizing an interim alternative compression ignition (diesel) engine standard for model years 2014–2016, again analogous to the alternative standards for compression ignition engines use in combination tractors. The need for this provision and our considerations in adopting it are the same for the engines used in vocational vehicles as for the engines used in combination tractors. As we proposed, these alternative standards will only be available through model year 2016. In addition, manufacturers that use the interim alternative diesel engine standards for model years 2014–2016 under the EPA program must use equivalent fuel consumption standards under the NHTSA program.

For the 2014 to 2016 model years, manufacturers may also choose to meet alternative engine standards that are phased-in over the model years to coincide with new EPA On-Board Diagnostic (OBD) requirements applicable for these same model years. See Sections II.B and II.D below.

The agencies received a significant number of comments including from the Senate authors and supporters of the Ten-in-Ten Fuel Economy Act arguing that our proposed standards for vocational vehicles did not reflect all of the technologies identified in the 2010 NAS report. The commenters encouraged the agencies to expand the program to bring in additional reductions through the use of new transmission technologies, vehicle weight reductions and hybrid drivetrains. In general, the agencies agree with the commenters’ central contention that there are additional technologies to improve the fuel efficiency of vocational vehicles. As discussed later, we are finalizing provisions to allow new technologies to be brought into the program through the innovative technology credit program. More specifically, we are including provisions to account for and credit the

use of hybrid technology as a technology that can reduce emissions and fuel consumption. Hybrid technology can currently be a cost-effective technology in certain specific vocational applications, and the agencies want to recognize and promote the use of this technology. (See Sections I.E and IV below.) However, we are not finalizing standards that are premised on the use of these additional technologies because we have not been able to develop the test procedures, regulatory mechanisms and baseline performance data necessary to adopt a more comprehensive approach to controlling fuel efficiency and GHG emissions from vocational vehicles. In concept, the agencies would need to know the baseline weight, aerodynamic performance, and transmission configuration for the wide range of vocational vehicles produced today. We do not have this information even for relatively small portions of this market (e.g. concrete mixers) nor are we well informed regarding the potential tradeoffs to changes to vehicle utility that might exist for changes to concrete mixer designs in response to a regulation. Nor did the commenters provide any such information. Absent this information and the necessary regulatory tools, we believe the standards we are finalizing for vocational vehicles represent the most appropriate standards for this segment during the model years of the first phase of the program. We intend to address fuel consumption and GHG emissions from these vehicles in a more comprehensive manner through future regulation and look forward to working with all stakeholders on this important segment in the future.

The agencies are setting standards beginning in the 2014 model year and establishing more stringent standards in the 2017 model year. Table I–4 presents EPA’s final CO<sub>2</sub> standards and NHTSA’s final fuel consumption standards for chassis manufacturers of Class 2b through Class 8 vocational vehicles for the 2017 model year. The 2017 model year standards represent a 6 to 9 percent reduction in CO<sub>2</sub> emissions and fuel consumption over a 2010 model year vehicle.

TABLE I–4—FINAL 2017 CLASS 2b–8 VOCATIONAL VEHICLE EPA CO<sub>2</sub> STANDARDS AND NHTSA FUEL CONSUMPTION STANDARDS

	Light heavy-duty Class 2b–5	Medium heavy-duty Class 6–7	Heavy heavy-duty Class 8
<b>EPA CO<sub>2</sub> (gram/ton-mile) Standard Effective 2017 Model Year</b>			
CO <sub>2</sub> Emissions .....	373	225	222

TABLE I-4—FINAL 2017 CLASS 2b-8 VOCATIONAL VEHICLE EPA CO<sub>2</sub> STANDARDS AND NHTSA FUEL CONSUMPTION STANDARDS—Continued

	Light heavy-duty Class 2b-5	Medium heavy-duty Class 6-7	Heavy heavy-duty Class 8
<b>NHTSA Fuel Consumption (gallon per 1,000 ton-mile) Standard Effective 2017 Model Year</b>			
Fuel Consumption .....	36.7	22.1	21.8

As mentioned above for Class 7 and 8 combination tractors, EPA believes that N<sub>2</sub>O and CH<sub>4</sub> emissions are technologically related solely to the engine, fuel, and emissions aftertreatment systems, and the agency is not aware of any influence of vehicle-based technologies on these emissions. Therefore, for Class 2b-8 vocational vehicles, EPA’s final N<sub>2</sub>O and CH<sub>4</sub> standards cover manufacturers of the engines to be used in vocational vehicles. EPA did not propose, nor are we adopting separate vehicle-based standards for these GHGs. As for the engines used in Class 7 and 8 tractors, we are finalizing a somewhat higher N<sub>2</sub>O and CH<sub>4</sub> emission standards reflecting new data submitted to the agencies during the public comment period. EPA expects that manufacturers of current engine technologies will be able to comply with the final “cap” standards with little or no technological improvements; the value of the standards is that they will prevent significant increases in these emissions as alternative technologies are developed and introduced in the future. Compliance with the final EPA engine-based CO<sub>2</sub> standards and the final NHTSA fuel consumption standards, as well as the final EPA N<sub>2</sub>O and CH<sub>4</sub> standards, will be determined using the appropriate EPA engine test procedure, as discussed in Section II below.

As with the other regulatory categories of heavy-duty vehicles, EPA and NHTSA are adopting standards that apply to Class 2b-8 vocational vehicles at the time of production, and EPA is adopting standards for a specified period of time in use. All of the standards for these trucks, as well as details about the final provisions for certification and implementation of these standards, are discussed in more detail later in this notice and in the RIA.

EPA did not propose, nor is it adopting A/C refrigerant leakage standards for Class 2b-8 vocational vehicles, primarily because of the number of entities involved in their manufacture and thus the potential for different entities besides the chassis manufacturer to be involved in the A/C system production and installation.

(d) What manufacturers are not covered by the final standards?

The NPRM proposed to defer temporarily greenhouse gas emissions and fuel consumption standards for any manufacturers of heavy-duty engines, manufacturers of combination tractors, and chassis manufacturers for vocational vehicles that meet the “small business” size criteria set by the Small Business Administration (SBA). 13 CFR 121.201 defines a small business by the maximum number of employees; for example, this is currently 1,000 for heavy-duty vehicle manufacturing and 750 for engine manufacturing.<sup>34</sup> The agencies stated that they would instead consider appropriate GHG and fuel consumption standards for these entities as part of a future regulatory action. This includes both U.S.-based and foreign small-volume heavy-duty manufacturers. To ensure that the agencies are aware of which companies would be exempt, the agencies proposed to require that such entities submit a declaration describing how it qualifies as a small entity under the provisions of 13 CFR 121.201 to EPA and NHTSA as prescribed in Section V below.

EPA and NHTSA were not aware of any manufacturers of HD pickups and vans that meet these criteria. For each of the other categories and for engines, the agencies identified a small number of manufacturers that would appear to qualify as small businesses under the SBA size criterion, which were estimated to comprise a negligible percentage of the U.S. market.<sup>35</sup> Therefore, the agencies believed that deferring the standards for these companies at this time would have a negligible impact on the GHG emission reductions and fuel consumption reductions that the program would otherwise achieve. The agencies proposed to consider appropriate GHG

emissions and fuel consumption standards for these entities as part of a future regulatory action.

The Institute for Policy Integrity (IPI) commented that the small business exemption proposed in the NPRM was based on the improper framework of whether the exemption would have a negligible impact, and did not adequately explain why the regulation of small businesses would face special compliance and administrative burdens. IPI argued that the only proper basis for this exemption would be if the agencies could explain how these burdens create costs that exceeded the benefits of regulation.

NHTSA believes that developing standards that are “appropriate, cost-effective, and technologically feasible” under 49 U.S.C. 32902(k)(2) includes the authority to exclude certain manufacturers if their inclusion would work against these statutory factors. Similarly, under section 202(a) of the CAA, EPA may reasonably choose to defer regulation of industry segments based on considerations of cost, cost-effectiveness and available lead time for standards. As noted above, small businesses make up a very small percentage of the market and are estimated to have a negligible impact on the emissions and fuel consumption goals of this program. The short lead time before the CO<sub>2</sub> standards take effect, the extremely small fuel savings and emissions contribution of these entities, and the potential need to develop a program that would be structured differently for them (which would require more time to determine and adopt), all led to the decision that the inclusion of small businesses would not be appropriate at this time. Therefore, the final rule exempts small businesses as proposed.

Volvo and EMA stated that by exempting small businesses based on the definition from SBA, the rules would create a competitive advantage for small businesses over larger entities. EMA commented that the exemption should not apply to market segments where a small business has a significant share of a particular HD market. Volvo argued that the exempted businesses could expand their product offerings or

<sup>34</sup> See § 1036.150 and § 1037.150

<sup>35</sup> Two heavy-duty combination tractor and ten chassis manufacturers each comprising less than 0.5 percent of the total tractor and vocational market based on Polk Registration Data from 2003 through 2007, and three engine manufacturing entities based on company information included in Hoover’s, comprising less than 0.1 percent of the total heavy-duty engine sales in the United States based on 2009 and 2010 EPA certification information.

sell vehicles on behalf of larger entities, thereby inappropriately increasing the scope of the exclusion. The agencies anticipate that the gain a manufacturer might achieve by restructuring its practices and products to circumvent the standard (which for vocational vehicles simply means installing low rolling resistance tires) in the first few years of this program will be outweighed by the costs, particularly as small businesses anticipate their potential inclusion in the next rulemaking.

Volvo also commented that the agencies should elaborate on the requirements for the exemption in greater detail. The agencies agree that this may help to clarify the process. As suggested by Volvo, the agencies will consider affiliations to other companies and evidence of spin-offs for the purpose of circumventing the standards in determining whether a business qualifies as a small entity for this exclusion. Each declaration must be submitted in writing to EPA and NHTSA as prescribed in Section V below. As the agencies gain more experience with this exemption, these clarifications may be codified in the regulatory text of a future rulemaking.

Volvo further commented that the agencies were adopting an exemption of "small businesses" in order to avoid doing a Small Business Regulatory Enforcement Fairness Act (SBREFA) and Regulatory Flexibility Act (RFA) analysis. The agencies would like to reiterate that they have decided not to include small businesses at this time due to the factors described above. The discussion on an RFA analysis is laid out in Section XII(4).

The agencies continue to believe that deferring the standards for these companies at this time will have a negligible impact on the GHG emission reductions and fuel consumption reductions that the program would otherwise achieve. Therefore, the final rules include the small business exemption as proposed. The specific deferral provisions are discussed in more detail in Section II.

The agencies will consider appropriate GHG emissions and fuel consumption standards for these entities as part of a future regulatory action.

#### (e) Light-Duty Vehicle CH<sub>4</sub> and N<sub>2</sub>O Standards Flexibility

After finalization of the N<sub>2</sub>O and CH<sub>4</sub> standards for light-duty vehicles as part of the 2012–2016 MY program, some manufacturers raised concerns that they may have difficulty meeting those standards across their light-duty vehicle fleets. In response to these concerns, as

part of the same **Federal Register** notice as the heavy-duty proposal, EPA requested comments on additional options for manufacturers to comply with light-duty vehicle N<sub>2</sub>O and CH<sub>4</sub> standards to provide additional near-term flexibility. Commenters providing comment on this issue supported additional flexibility for manufacturers. EPA is finalizing provisions allowing manufacturers to use CO<sub>2</sub> credits, on a CO<sub>2</sub>-equivalent basis, to meet the N<sub>2</sub>O and CH<sub>4</sub> standards, which is consistent with many commenters' preferred approach. Manufacturers will have the option of using CO<sub>2</sub> credits to meet N<sub>2</sub>O and CH<sub>4</sub> standards on a test group basis as needed for MYs 2012–2016.

#### (f) Alternative Fuel Engines and Vehicles

The agencies believe that it is also appropriate to take steps to recognize the benefits of flexible-fueled vehicles (FFVs) and dedicated alternative-fueled vehicles. In the NPRM, EPA proposed to determine the emissions performance of dedicated alternative fuel engines and pickup trucks and vans by measuring tailpipe CO<sub>2</sub> emissions. NHTSA proposed to determine fuel consumption performance of non-electric dedicated alternative fuel engines and pickup trucks and vans by measuring fuel consumption with the alternative fuel and then calculating a petroleum equivalent fuel consumption using a Petroleum Equivalency Factor (PEF) that is determined by the Department of Energy. NHTSA proposed to treat electric vehicles as having zero fuel consumption, comparable to the EPA proposal. Both agencies proposed to determine FFV performance in the same way as for GHG emissions for light-duty vehicles, with a 50–50 weighting of alternative and conventional fuel test results through MY 2015, and a weighting based on demonstrated fuel use in the real world after MY 2015 (defaulting to an assumption of 100 percent conventional fuel use). This approach was considered to be a reasonable and logical way to properly credit alternative fuel use in FFVs in the real world without imposing a difficult burden of proof on manufacturers. However, unlike in the light-duty rule, the agencies do not believe it is appropriate to create a provision for additional incentives similar to the 2012–2015 light-duty incentive program (See 49 U.S.C. 32904) because the HD sector does not have the incentives mandated in EISA for light-duty FFVs, and so has not relied on the existence of such credits in devising compliance strategies for the early model years of

this program. See 74 FR at 49531. In fact, manufacturers have not in the past produced FFV heavy-duty vehicles. On the other hand, the agencies sought comment on how to properly recognize the impact of the use of alternative fuels, and E85 in particular, in HD pickups and vans, including the proper accounting for alternative fuel use in FFVs in the real world.<sup>36</sup> See 75 FR at 74198.

The agencies received several comments from natural gas vehicle (NGV) interests arguing for greater crediting of NGVs than the proposed approach would have provided. Clean Energy, Hayday Farms, Border Valley, AGA, Ryder, Encana, and a group of NGV interests commented that the NPRM ignored Congress' intent to incentivize the use of NGVs by not including the conversion factor that exists in the light-duty statutory language. The commenters argued that Congress' intent to incentivize NGVs is evident in the formula contained in 49 U.S.C. 32905, which deems a gallon equivalent of gaseous fuel to have a fuel content of 0.15 gallon of fuel. The commenters also argued that Congress implicitly intended NGVs to be incentivized in this rulemaking, as evidenced by the incentives in the light-duty statutory text. AGA and Hayday suggested that the agencies were not including the NGV incentive from light-duty because Congress did not explicitly include it in 49 U.S.C. 32902(k), and argued that this would contradict the agencies' inclusion of other incentives similar to the light-duty rule.

The American Trucking Association expressed support for estimating natural gas fuel efficiency by using carbon emissions from natural gas rather than energy content to estimate fuel consumption. ATA explained that two vehicles can achieve the same fuel efficiency, yet one operated on natural gas would have a lower carbon dioxide emissions rate. A natural gas conversion factor that uses carbon content versus energy content is a more appropriate method for calculating fuel consumption, in the commenter's view. A number of other groups commented on the appropriate method to use in establishing fuel consumption from alternative fueled vehicles. A group of NGV interests, Ryder, Border Valley Trading, Waste Management, Robert Bosch and the Blue Green Alliance encouraged the agencies to adopt the 0.15 conversion factor in estimating fuel consumption for FFVs and alternative fuel vehicles finalized in the light-duty

<sup>36</sup> E85 is a blended fuel consisting of nominally 15 percent gasoline and 85 percent ethanol.

2012–2016 MY vehicle standards. The suggested incentive would effectively reduce the calculated fuel consumption for FFVs and alternative fuel vehicles by a factor of 85 percent. The commenters argued that the incentive is needed for heavy-duty vehicles to encourage the use of natural gas and to reduce the nation's dependence on petroleum.

The agencies reassessed the options for evaluating the CO<sub>2</sub> and fuel consumption performance of alternative fuel vehicles in response to comments and because the agencies recognized that the treatment of alternate fuel vehicles was one of the few provisions in the proposal where the EPA and NHTSA programs were not aligned. The agencies conducted an analysis comparing fuel consumption calculated based on CO<sub>2</sub> emissions<sup>37</sup> to fuel consumption calculated based on gasoline or diesel energy equivalency to evaluate impacts of a consistent consumption measurement for all vehicle classes covered by this program and to further understand how alternative fuels would be impacted by this measurement methodology. In particular the agencies evaluated how measuring consumption via CO<sub>2</sub> emissions would hinder or benefit the application of alternative fuels versus following similar alternative fuel incentivizing programs provided via statute for the Agency's light-duty programs. The analysis showed measuring a vehicle's CO<sub>2</sub> output converted to fuel consumption provided a fuel consumption measurement benefit to those vehicles operating on fuels other than gasoline or diesel. For CNG, LNG and LPG the benefit is approximately 19 percent to 24 percent, for biodiesel and ethanol blends the benefit is approximately 1 percent to 3 percent, and for electricity and hydrogen fuels the benefit is 100 percent benefit, as fuel consumption is zero. The agencies also considered that the EPA Renewable Fuel Standard,<sup>38</sup> a separate program, requires an increase in the volume of renewable fuels used in the U.S. transportation sector. For the fuels covered by the Renewable Fuels Standard additional incentives are not

needed in this regulation given the large volume increases required under the Renewable Fuel Standard.

The agencies continue to believe that alternative-fueled vehicles, including NGVs, provide fuel consumption benefits that should be, and are, accounted for in this program. However, the agencies do not agree with the commenters' claim that the NGV incentive contained in EISA, and reflected in the light-duty program, is an explicit Congressional directive that must also be applied to the heavy-duty program, nor that the light-duty incentive for NGVs should be interpreted as an implicit Congressional directive for NGVs to be comparably incentivized in the heavy-duty program. Further, the agencies believe that the fuel consumption benefits that alternative fuel vehicles would obtain through measuring CO<sub>2</sub> emissions for the EPA program and converting CO<sub>2</sub> emissions to fuel consumption for the NHTSA program accurately reflects their energy benefits. This accurate accounting, in conjunction with the volumetric increases required by the Renewable Fuels Standard, provides sufficient incentives for these vehicles. The agencies continue to believe that the light-duty conversion factor is not appropriate for this program. Instead, the agencies are finalizing measuring the performance of alternative fueled vehicles by measuring CO<sub>2</sub> emissions for the EPA program and converting CO<sub>2</sub> emissions to fuel consumption for the NHTSA program. The agencies are also finalizing measuring FFV performance with a 50–50 weighting of alternative and conventional fuel test results through MY 2015, and an agency- or manufacturer-determined weighting based on demonstrated fuel use in the real world after MY 2015 (defaulting to an assumption of 100 percent conventional fuel use).

The agencies believe this structure accurately reflects the fuel consumption of the vehicles while at the same time providing an incentive for the alternative fuel use. (For example, natural gas heavy duty engines perform 20 to 30 percent better than their diesel and gasoline counterparts from a CO<sub>2</sub> perspective, and so meet the standards adopted in these rules without cost, and indeed will be credit generators without cost.) We believe this is a substantial enough advantage to spur the market for these vehicles. The calculation at the same time does not overestimate the benefit from these technologies, which could reduce the effectiveness of the regulation. Therefore, the final rules do not include the light-duty 0.15 conversion factor for NGVs. The

agencies would like to clarify that the decision not to include an NGV incentive was based on this policy determination, not on a belief that incentives present in the light-duty rule could not be developed for the heavy-duty sector because they were not explicitly included in Section 32902(k).

NHTSA recognizes that EPCA/EISA promotes incentives for alternative fueled vehicles for different purposes than does the CAA, and that there may be additional energy and national security benefits that could be achieved through increasing fleet percentages of natural gas and other alternative-fueled vehicles. More alternative-fueled vehicles on road would arguably displace petroleum-fueled vehicles, and thereby increase both U.S. energy and national security by reducing the nation's dependence on foreign oil.

However, a rule that adopts identical incentive provisions reduces industry reporting burdens and NHTSA's monitoring burden. In addition, the agencies are concerned that providing greater incentives under EPCA/EISA might lead to little increased production of alternative fueled vehicles. If this were the case, then the benefits of harmonization could outweigh any potential gains from providing greater incentives. It is also consistent with Executive Order 13563.<sup>39</sup>

Adopting the same incentive provisions could also have benefits for the public, the regulated industries, and the agencies. This approach allows manufacturers to project clear benefits for the application of GHG-reduction and fuel efficiency technologies, thus spurring their adoption.

This combined rulemaking by EPA and NHTSA is designed to regulate two separate characteristics of heavy duty vehicles: Greenhouse gas emissions (GHG) and fuel consumption. In the case of diesel or gasoline powered vehicles, there is a one-to-one relationship between these two characteristics. Each gallon of gasoline combusted by a truck engine generates approximately 8,887 grams of CO<sub>2</sub>; and each gallon of diesel fuel burned generates about 10,180 grams of CO<sub>2</sub>. Because no available technologies reduce tailpipe CO<sub>2</sub> emissions per gallon of fuel combusted, any rule that limits tailpipe CO<sub>2</sub> emissions is

<sup>37</sup> Fuel consumption calculated from measured CO<sub>2</sub> using conversion factors of 8,887 g CO<sub>2</sub>/gallon for gasoline (for alternative fuel engines that are derived from gasoline engines), and 10,180 g CO<sub>2</sub>/gallon for diesel fuel (for alternative fuel engines that are derived from diesel engines).

<sup>38</sup> EPA is responsible for developing and implementing regulations to ensure that transportation fuel sold in the United States contains a minimum volume of renewable fuel. The RFS program was created under the Energy Policy Act (EPA) of 2005, and expanded under the Energy Independence and Security Act (EISA) of 2007.

<sup>39</sup> EO 13563 states that an agency shall "tailor its regulations to impose the least burden on society, consistent with obtaining regulatory objectives, taking into account, among other things, and to the extent practicable, the costs of cumulative regulations," and "promote such coordination, simplification, and harmonization" as will reduce redundancy, inconsistency, and costs of multiple regulatory requirements.

effectively identical to a rule that limits fuel consumption. Compliance by a truck manufacturer with the NHTSA fuel economy rule assures compliance with the EPA rule, and vice versa.

For alternatively fueled vehicles, which use no petroleum, the situation is different. For example, a natural gas vehicle that achieves approximately the same fuel economy as a diesel powered vehicle would emit 20 percent less CO<sub>2</sub>; and a natural gas vehicle with the same fuel economy as a gasoline vehicle would emit 30 percent less CO<sub>2</sub>. Yet natural gas vehicles consume no petroleum. To the extent that the goal of the NHTSA fuel economy portion of this rulemaking is to curb petroleum use, crediting natural gas vehicles with zero fuel consumption per mile could contribute to achieving that goal. Similar differences between oil consumption and greenhouse gas emissions would apply to electric vehicles, hybrid electric vehicles, and biofuel-powered vehicles.

NHTSA notes that the purpose of EPCA/EISA is not merely to curb petroleum use—it is more generally to secure energy independence, which can be achieved by reducing petroleum use. The value of incentivizing natural gas, electric vehicles, biofuels, hydrogen, or other alt fuel vehicles for energy independence is limited to the extent that the alternative fuels may be imported.

In the recent rulemaking for light-duty vehicles, EPA and NHTSA have followed the light duty specific statutory provision that treats one gallon of alternative fuel as equivalent to 0.15 gallons of gasoline until MY 2016, when performance on the EPA CO<sub>2</sub> standards is measured based on actual emissions. 75 FR at 25433. Following that MY 2012–2015 approach in this heavy duty program would mean that, for example, a natural gas powered truck would have attributed to it 20 percent less CO<sub>2</sub> emissions than a comparable diesel powered truck, but 85 percent less fuel consumption. Engine manufacturers with a relatively large share of alternative-fuel products would likely have an easier time complying with NHTSA’s average fuel economy standard than with EPA’s GHG standard. Similarly, engine manufacturers with a relatively small share of alternative-fuel products would have a relatively easier time complying with EPA’s CO<sub>2</sub> standard than with NHTSA’s fuel economy standard. In that way, the rule would not differ from the light duty vehicle rules.

Instead, in this program, EPA and NHTSA are establishing identical rules. Fuel consumption for alternatively-

powered vehicles will be calculated according to their tailpipe CO<sub>2</sub> emissions. In that way, there will be a one-to-one relationship between fuel economy and tailpipe CO<sub>2</sub> emissions for all vehicles. However, this might not result in a one-to-one relationship between petroleum consumption and GHG emissions for all vehicles. On the other hand, it could have the disadvantage of not doing more to encourage some cost-effective means of reducing petroleum consumption by trucks, and the accompanying energy security costs. By attributing to natural gas engines only 20 percent less fuel consumption than comparable diesel engines, because they emit 20 percent less CO<sub>2</sub>, rather than attributing to them a much larger percentage reduction in fuel consumption, because they use no petroleum, this uniform approach to rulemaking provides less of an incentive for technologies that reduce consumption of petroleum-based fuels.

In the future, the Agencies will consider the possibility of proposing standards in a way that more fully reflects differences in fuel consumption and greenhouse gas emissions. Under such standards, any given vehicle might “over-comply” with the fuel economy standard, but might “under-comply” with the greenhouse gas standard. Therefore, in meeting the fleet-wide requirements, a manufacturer would need to meet both standards using all available options, such as credit trading and technology mix. Allowing for two distinct standards might enable manufacturers to achieve the twin goals of reducing greenhouse gas emissions and decreasing consumption of petroleum-based fuels in a more cost-effective manner.

*D. Summary of Costs and Benefits of the HD National Program*

This section summarizes the projected costs and benefits of the final NHTSA fuel consumption and EPA GHG emissions standards. These projections helped to inform the agencies’ choices among the alternatives considered and provide further confirmation that the final standards are an appropriate choice within the spectrum of choices allowable under the agencies’ respective statutory criteria. NHTSA and EPA have used common projected costs and benefits as the bases for our respective standards.

The agencies have analyzed in detail the projected costs, fuel savings, and benefits of the final GHG and fuel consumption standards. Table I–5 shows estimated lifetime discounted program costs (including technological outlays), fuel savings, and benefits for

all heavy-duty vehicles projected to be sold in model years 2014–2018 over these vehicles’ lives. The benefits include impacts such as climate-related economic benefits from reducing emissions of CO<sub>2</sub> (but not other GHGs) and reductions in energy security externalities caused by U.S. petroleum consumption and imports. The analysis also includes economic impacts stemming from additional heavy-duty vehicle use attributable to fuel savings, such as the economic damages caused by accidents, congestion and noise. Note that benefits reflect on estimated values for the social cost of carbon (SCC), as described in Section VIII.G.

The costs, fuel savings, and benefits summarized here are slightly higher than at proposal, reflecting the use of 2009 (versus 2008) dollars, some minor changes to our cost estimates in response to comments, and a change to the 2011 Annual Energy Outlook (AEO) estimate of economic growth and future fuel prices. In aggregate, these changes lead to an increased estimate of the net benefits of the final action compared to the proposal.

TABLE I–5—ESTIMATED LIFETIME DISCOUNTED COSTS, FUEL SAVINGS, BENEFITS, AND NET BENEFITS FOR 2014–2018 MODEL YEAR HEAVY-DUTY VEHICLES<sup>a b</sup>

[Billions, 2009\$]

Lifetime Present Value <sup>c</sup> —3% Discount Rate	
Program Costs .....	\$8.1
Fuel Savings .....	\$50
Benefits .....	\$7.3
Net Benefits <sup>d</sup> .....	\$49
Annualized Value <sup>e</sup> —3% Discount Rate	
Annualized Costs .....	\$0.4
Fuel Savings .....	\$2.2
Annualized Benefits .....	\$0.4
Net Benefits <sup>d</sup> .....	\$2.2
Lifetime Present Value <sup>c</sup> —7% Discount Rate	
Program Costs .....	\$8.1
Fuel Savings .....	\$34
Benefits .....	\$6.7
Net Benefits <sup>d</sup> .....	\$33
Annualized Value <sup>e</sup> —7% Discount Rate	
Annualized Costs .....	\$0.6
Fuel Savings .....	\$2.6
Annualized Benefits .....	\$0.5
Net Benefits <sup>d</sup> .....	\$2.5

**Notes:**

<sup>a</sup>The agencies estimated the benefits associated with four different values of a one ton CO<sub>2</sub> reduction (model average at 2.5% discount rate, 3%, and 5%; 95th percentile at 3%), which each increase over time. For the purposes of this overview presentation of estimated costs and benefits, however, we are showing the benefits associated with the marginal value deemed to be central by the inter-agency working group on this topic: the model average at 3% discount rate, in 2009 dollars. Section VIII.F provides a complete list of values for the 4 estimates.

<sup>b</sup>Note that net present value of reduced GHG emissions is calculated differently than other benefits. The same discount rate used to discount the value of damages from future emissions (SCC at 5, 3, and 2.5 percent) is used to calculate net present value of SCC for internal consistency. Refer to Section VIII.F for more detail.

<sup>c</sup>Present value is the total, aggregated amount that a series of monetized costs or benefits that occur over time is worth now (in year 2009 dollar terms), discounting future values to the present.

<sup>d</sup>Net benefits reflect the fuel savings plus benefits minus costs.

<sup>e</sup>The annualized value is the constant annual value through a given time period (2012 through 2050 in this analysis) whose summed present value equals the present value from which it was derived.

Table I-6 shows the estimated lifetime reductions in CO<sub>2</sub> emissions (in million metric tons (MMT)) and fuel consumption for all heavy-duty vehicles sold in the model years 2014-2018. The values in Table I-6 are projected lifetime totals for each model year and are not discounted. The two agencies' standards together comprise the HD National Program, and the agencies' respective GHG emissions and fuel consumption standards, jointly, are the source of the benefits and costs of the HD National Program.

TABLE I-6—ESTIMATED LIFETIME REDUCTIONS IN FUEL CONSUMPTION AND CO<sub>2</sub> EMISSIONS FOR 2014-2018 MODEL YEAR HD VEHICLES

All heavy-duty vehicles	2014 MY	2015 MY	2016 MY	2017 MY	2018 MY	Total
Fuel (billion gallons) .....	4.0	3.6	3.6	5.1	5.8	22.1
Fuel (billion barrels) .....	0.10	0.09	0.08	0.12	0.14	0.53
CO <sub>2</sub> (MMT) <sup>a</sup> .....	50.2	44.8	44.0	62.8	71.7	273

**Note:**

<sup>a</sup> Includes upstream and downstream CO<sub>2</sub> reductions.

Table I-7 shows the estimated lifetime discounted benefits for all heavy-duty vehicles sold in model years 2014-2018. Although the agencies estimated the benefits associated with four different values of a one ton CO<sub>2</sub> reduction (\$5, \$22, \$36, \$66), for the purposes of this overview presentation of estimated benefits the agencies are showing the benefits associated with one of these marginal values, \$22 per ton of CO<sub>2</sub>, in 2009 dollars and 2010 emissions. Table I-7 presents benefits based on the \$22 per ton of CO<sub>2</sub> value.

Section VIII.F presents the four marginal values used to estimate monetized benefits of CO<sub>2</sub> reductions and Section VIII presents the program benefits using each of the four marginal values, which represent only a partial accounting of total benefits due to omitted climate change impacts and other factors that are not readily monetized. The values in the table are discounted values for each model year of vehicles throughout their projected lifetimes. The analysis includes other economic impacts such as energy security, and other

externalities such as impacts on accidents, congestion and noise. However, the model year lifetime analysis supporting the program omits other impacts such as benefits related to non-GHG emission reductions.<sup>40</sup> The lifetime discounted benefits are shown for one of four different SCC values considered by EPA and NHTSA. The values in Table I-7 do not include costs associated with new technology required to meet the GHG and fuel consumption standards.

TABLE I-7—ESTIMATED LIFETIME DISCOUNTED BENEFITS FOR 2014-2018 MODEL YEAR HD VEHICLES ASSUMING THE MODEL AVERAGE, 3% DISCOUNT RATE SCC VALUE<sup>a b c</sup>

[billions of 2009 dollars]

Discount rate (percent)	Model year					Total
	2014	2015	2016	2017	2018	
3 .....	\$10.7	\$9.4	\$9.2	\$13.2	\$14.9	\$57
7 .....	8.3	6.9	6.6	9.2	10.1	41

**Notes:**

<sup>a</sup> The analysis includes impacts such as the economic value of reduced fuel consumption and accompanying climate-related economic benefits from reducing emissions of CO<sub>2</sub> (but not other GHGs), and reductions in energy security externalities caused by U.S. petroleum consumption and imports. The analysis also includes economic impacts stemming from additional heavy-duty vehicle use, such as the economic damages caused by accidents, congestion and noise.

<sup>b</sup> Note that net present value of reduced CO<sub>2</sub> emissions is calculated differently than other benefits. The same discount rate used to discount the value of damages from future emissions (SCC at 5, 3, and 2.5 percent) is used to calculate net present value of SCC for internal consistency. Refer to Section VIII.F for more detail, including a list of all four SCC values, which increase over time.

<sup>c</sup> Benefits in this table include fuel savings.

Table I-8 shows the agencies' estimated lifetime fuel savings, lifetime CO<sub>2</sub> emission reductions, and the

monetized net present values of those fuel savings and CO<sub>2</sub> emission reductions. The gallons of fuel and CO<sub>2</sub>

emission reductions are projected lifetime values for all vehicles sold in the model years 2014-2018. The

<sup>40</sup> Non-GHG emissions and health-related impacts were estimated for the calendar year analysis. See

Section VII for more information about non-GHG

emission impacts and Section VIII for more information about non-GHG-related health impacts.

estimated fuel savings in billions of barrels and the GHG reductions in million metric tons of CO<sub>2</sub> shown in Table I-8 are totals for the five model years throughout their projected lifetime and are not discounted. The monetized values shown in Table I-8 are the summed values of the discounted monetized-fuel consumption and monetized-CO<sub>2</sub> reductions for the five model years 2014–2018 throughout their lifetimes. The monetized values in Table I-8 reflect both a 3 percent and a 7 percent discount rate as noted.

**TABLE I-8—ESTIMATED LIFETIME REDUCTIONS AND ASSOCIATED DISCOUNTED MONETIZED BENEFITS FOR 2014–2018 MODEL YEAR HD VEHICLES**  
[Monetized values in 2009 dollars]

	Amount	\$ Value (billions)
Fuel Consumption Reductions .....	0.53 billion barrels .....	\$50.1, 3% discount rate \$34.4, 7% discount rate.
CO <sub>2</sub> Emission Reductions <sup>a</sup> Valued assuming \$22/ton CO <sub>2</sub> in 2010.	273 MMT CO <sub>2</sub> .....	\$5.8 <sup>b</sup> .

**Notes:**

<sup>a</sup>Includes both upstream and downstream CO<sub>2</sub> emission reductions.

<sup>b</sup>Note that net present value of reduced CO<sub>2</sub> emissions is calculated differently than other benefits. The same discount rate used to discount the value of damages from future emissions (SCC at 5, 3, and 2.5 percent) is used to calculate net present value of SCC for internal consistency. Refer to Section VIII.F for more detail.

Table I-9 shows the estimated incremental and total technology outlays for all heavy-duty vehicles for each of the model years 2014–2018. The technology outlays shown in Table I-9 are for the industry as a whole and do not account for fuel savings associated with the program.

**TABLE I-9—ESTIMATED INCREMENTAL TECHNOLOGY OUTLAYS FOR 2014–2018 MODEL YEAR HD VEHICLES**  
[Billions of 2009 dollars]

	2014 MY	2015 MY	2016 MY	2017 MY	2018 MY	Total
All Heavy-Duty Vehicles .....	\$1.6	\$1.4	\$1.5	\$1.6	\$2.0	\$8.1

Table I-10 shows the agencies' estimated incremental cost increase of the average new heavy-duty vehicle for each model year 2014–2018. The values shown are incremental to a baseline vehicle and are not cumulative.

**TABLE I-10—ESTIMATED INCREMENTAL INCREASE IN AVERAGE COST FOR 2014–2018 MODEL YEAR HD VEHICLES**  
[2009 Dollars per unit]

	2014 MY	2015 MY	2016 MY	2017 MY	2018 MY
Combination Tractors .....	\$6,019	\$5,871	\$5,677	\$6,413	\$6,215
HD Pickups & Vans .....	165	215	422	631	1,048
Vocational Vehicles .....	329	320	397	387	378

Both costs and benefits presented in this section are in comparison to a reference case with no improvements in fuel consumption or greenhouse gas emissions in model years 2014 to 2018.

*E. Program Flexibilities*

For each of the heavy-duty vehicle and heavy-duty engine categories for which we are adopting respective standards, EPA and NHTSA are also finalizing provisions designed to give manufacturers a degree of flexibility in complying with the standards. These final provisions have enabled the agencies to consider overall standards that are more stringent and that will become effective sooner than we could consider with a more rigid program, one in which all of a manufacturer's similar

vehicles or engines would be required to achieve the same emissions or fuel consumption levels, and at the same time.<sup>41</sup> We believe that incorporating carefully structured regulatory flexibility provisions into the overall program is an important way to achieve each agency's goals for the program.

NHTSA's and EPA's flexibility provisions are essentially identical in structure and function. Within combination tractor and vocational vehicle categories and within heavy-

<sup>41</sup> NHTSA notes that it has greater flexibility in the HD program to include consideration of credits and other flexibilities in determining appropriate and feasible levels of stringency than it does in the light-duty CAFE program. Cf. 49 U.S.C. 32902(h), which applies to light-duty CAFE but not heavy-duty fuel efficiency under 49 U.S.C. 32902(k).

duty engines, we are finalizing four primary types of flexibility: Averaging, banking, and trading (ABT) provisions; early credits; advanced technology credits (including hybrid powertrains); and innovative technology credit provisions. The final ABT provisions are patterned on existing EPA and NHTSA ABT programs and will allow a vehicle manufacturer to reduce CO<sub>2</sub> emission and fuel consumption levels further than the level of the standard for one or more vehicles to generate ABT credits. The manufacturer can use those credits to offset higher emission or fuel consumption levels in the same averaging set, "bank" the credits for later use, or "trade" the credits to another manufacturer. For HD pickups and vans, we are finalizing a fleet

averaging system very similar to the light-duty GHG and CAFE fleet averaging system.

At proposal, we restricted the use of the ABT provisions of the program to vehicles or engines within the same regulatory subcategory. This meant that credit exchanges could only happen between similar vehicles meeting the same standards. We proposed this approach for two reasons. First, we were concerned about a level playing field between different manufacturers who may not participate equally in the various truck and engine markets covered in the regulation. Second, we were concerned about the uncertainties inherent in credit calculations that are based on projections of lifetime emissions for different vehicles in wholly different vehicle markets. In response to comments, we have revised our ABT provisions to provide greater flexibility while continuing to provide assurance that the projected reductions in fuel consumption and GHG emissions will be achieved. We are relaxing the restriction on averaging, banking, and trading of credits between the various regulatory subcategories, by defining three HD vehicle averaging sets: Light Heavy-Duty (Classes 2b–5); Medium Heavy-Duty (Class 6–7); and Heavy Heavy-Duty (Class 8). This allows the use of credits between vehicles within the same weight class. This means that a Class 8 day cab tractor can exchange credits with a Class 8 high roof sleeper tractor but not with a smaller Class 7 tractor. Also, a Class 8 vocational vehicle can exchange credits with a Class 8 tractor. We are adopting these revisions based on comments from the regulated industry that convinced us these changes would allow the broadest trading possible while maintaining a level playing field among the various market segments. However, we are restricting trading between engines and chassis, even within the same vehicle class.

The agencies believe that restricting trading to within the same eight classes as EPA's existing criteria pollutant program (*i.e.* Heavy-Heavy Duty, Light Heavy-Duty, Medium Heavy-Duty), but not restricting trading between vehicle or engine type (such as combination tractors), and restricting between engines and chassis for the same vehicle type, is appropriate and reasonable. We do not expect emissions from engines and vehicles—when restricted by weight class—to be dissimilar. We therefore expect that the lifetime vehicle performance and emissions levels will be very similar across these defined categories, and the estimated credit calculations will fairly ensure the

expected fuel consumption and GHG reductions.

The agencies considered even broader averaging, banking, and trading provisions but decided that in this first phase of regulation, it would be prudent to start with the program described here, which will regulate greenhouse gas emissions and fuel consumption from this sector for the first time and provide considerable early reductions as well as opportunities to learn about technical and other issues that can inform future rulemakings. In the future we intend to consider whether additional cost savings could be realized through broader trading provisions and whether such provisions could be designed so as to address any other relevant concerns.

Reducing the cost of regulation through broader use of market tools is a high priority for the Administration. See Executive Order 13563 and in particular section 1(b)(5) and section 4. Consistent with this principle, we intend to seek public comment through a Notice of Data Availability after credit trading begins in 2013, the first year we expect manufacturers to begin certifying 2014 model year vehicles, on whether broader credit trading is more appropriate in developing the next phase of heavy-duty regulations. We believe that input will be better informed by the work the agencies and the regulated industry will have put into implementing this first phase of heavy-duty regulations.

Through this public process, emphasizing the Administration's strong preference for flexible approaches and maximizing the use of market tools, the agencies intend to fully consider whether broader credit trading is more appropriate in developing the next phase of heavy-duty regulations.

This program thus does not allow credits to be exchanged between heavy-duty vehicles and light-duty vehicles, nor can credits be traded from heavy-duty vehicle fleets to light-duty vehicle fleets and vice versa.

The engine ABT provisions are also changed from the proposal and now are the same as in EPA's existing criteria pollutant emission rules. The agencies have broadened the averaging sets to include both FTP-certified and SET-certified engines in the same averaging set. For example, a SET-certified engine intended for a Class 8 tractor can exchange credits with a FTP-certified engine intended for a Class 8 vocational vehicle.

The agencies are finalizing three year deficit carry-forward provisions for heavy-duty engines and vehicles within a limited time frame. This flexibility is

expected to provide an opportunity for manufacturers to make necessary technological improvements and reduce the overall cost of the program without compromising overall environmental and fuel economy objectives. This flexibility, similar to the flexibility the agencies have offered under the light-duty vehicle program, is intended to assist the broad goal of harmonizing the two agencies' standards while preserving the flexibility of manufacturers of vehicles and engines in meeting the standards, to the extent appropriate and required by law. During the MYs 2014–2018 manufacturers are expected to go through the normal business cycle of redesigning and upgrading their heavy-duty engine and vehicle products, and in some cases introducing entirely new vehicles and engines not on the market today. As explained in the following paragraph, the carry-forward provision will allow manufacturers the time needed to incorporate technology to achieve GHG reductions and improve fuel economy during the vehicle redesign process.

We received comments from Center for Biological Diversity against the need to offer the deficit carry-forward flexibility. CBD has stated that allowing manufacturers to carry-forward deficits for up to three years would incentivize delays in investment and technological innovation and allow for the generation of additional tons of GHG emissions that may be prevented today. However, the deficit carry-forward flexibility (as well as ABT generally) has enabled the agencies to consider overall standards that are more stringent and that will become effective at an earlier period than we could consider with a more rigid program. The agencies also believe this flexibility is an important aspect of the program, as it avoids the much higher costs that would occur if manufacturers needed to add or change technology at times other than their scheduled redesigns, *i.e.* the cost of adopting a new engine or vehicle platform mid-production or mid-design. This time period would also provide manufacturers the opportunity to plan for compliance using a multi-year time frame, again consistent with normal business practice. Over these four model years, there would be an opportunity for manufacturers to evaluate practically all of their vehicle and engine model platforms and add technology in a cost effective way to control GHG emissions and improve fuel economy.

As noted above, in addition to ABT, the other primary flexibility provisions in this program involve opportunities to generate early credits, advanced technology credits (including for use of



hybrid powertrains), and innovative technology credits. For the early credits and advanced technology credits, the agencies sought comment on the appropriateness of providing a 1.5x multiplier as an incentive for their use. We received a number of comments supporting the idea of a credit multiplier, arguing it was an appropriate means to incentivize the early compliance and advanced technologies the agencies sought. We received other comments suggesting a multiplier was unnecessary. After considering the comments, the agencies have decided to finalize a 1.5x multiplier consistent with our request for comments. We believe that given the very short lead time of the program and the nascent nature of the advanced technologies identified in the proposal, that a 1.5x multiplier is an effective means to bring technology forward into the heavy-duty sector sooner than would otherwise occur. In addition, advanced technology credits could be used anywhere within the heavy duty sector (including both vehicles and engines), but early credits would be restricted to use within the same defined averaging set generating the credit.

For other technologies which can reduce CO<sub>2</sub> and fuel consumption, but for which there do not yet exist established methods for quantifying reductions, the agencies still wish to encourage the development of such innovative technologies, and are therefore adopting special “innovative technology” credits. These innovative technology credits will apply to technologies that are shown to produce emission and fuel consumption reductions that are not adequately recognized on the current test procedures and that are not yet in widespread use in the heavy-duty sector. Manufacturers will need to quantify the reductions in fuel consumption and CO<sub>2</sub> emissions that the technology is expected to achieve, above and beyond those achieved on the existing test procedures. As with ABT, the use of innovative technology credits will only be allowed for use among vehicles and engines of the same defined averaging set generating the credit, as described above. The credit multiplier will not be used for innovative technology credits.

CBD argued that including any opportunities for manufacturers to earn credits in the final rule would violate NHTSA’s statutory mandate to implement a program designed to achieve the maximum feasible improvement.

NHTSA strongly believes that creating credit flexibilities for manufacturers for

this first phase of the HD National Program is fully consistent with the agency’s obligation to develop a fuel efficiency improvement program designed to achieve the maximum feasible improvement. EISA gives NHTSA broad authority to develop “compliance and enforcement protocols” that are “appropriate, cost-effective, and technologically feasible,” and the agency believes that compliance flexibilities such as the opportunity to earn and use credits to meet the standards are a reasonable and appropriate interpretation of that authority, along with the other compliance and enforcement provisions developed for this final rule. Unlike in NHTSA’s light-duty program, where the agency is restricted from considering the availability of credits in determining the maximum feasible level of stringency for the fuel economy standards,<sup>42</sup> in this HD National Program, NHTSA and EPA have based the levels of stringency in part on our assumptions of the use of available flexibilities that have been built into the program to incentivize over-compliance in some respects, to balance out potential under-compliance in others.

By assuming the use of credits for compliance, the agencies were able to set the fuel consumption/GHG standards at more stringent levels than would otherwise have been feasible. Greater improvements in fuel efficiency will occur under more stringent standards; manufacturers will simply have greater flexibility to determine where and how to make those improvements than they would have without credit options. Further, this is consistent with EOs 12866 and 13563, which encourage agencies to design regulations that promote innovation and flexibility where possible.<sup>43</sup>

A detailed discussion of each agency’s ABT, early credit, advanced technology, and innovative technology provisions for each regulatory category of heavy-duty vehicles and engines is found in Section IV below.

#### *F. EPA and NHTSA Statutory Authorities*

##### (1) EPA Authority

Title II of the CAA provides for comprehensive regulation of mobile

sources, authorizing EPA to regulate emissions of air pollutants from all mobile source categories. When acting under Title II of the CAA, EPA considers such issues as technology effectiveness, its cost (both per vehicle, per manufacturer, and per consumer), the lead time necessary to implement the technology, and based on this the feasibility and practicability of potential standards; the impacts of potential standards on emissions reductions of both GHGs and non-GHGs; the impacts of standards on oil conservation and energy security; the impacts of standards on fuel savings by customers; the impacts of standards on the truck industry; other energy impacts; as well as other relevant factors such as impacts on safety.

This final action implements a specific provision from Title II, section 202(a).<sup>44</sup> Section 202(a)(1) of the CAA states that “the Administrator shall by regulation prescribe (and from time to time revise) \* \* \* standards applicable to the emission of any air pollutant from any class or classes of new motor vehicles \* \* \*, which in his judgment cause, or contribute to, air pollution which may reasonably be anticipated to endanger public health or welfare.” With EPA’s December 2009 final findings that certain greenhouse gases may reasonably be anticipated to endanger public health and welfare and that emissions of GHGs from section 202(a) sources cause or contribute to that endangerment, section 202(a) requires EPA to issue standards applicable to emissions of those pollutants from new motor vehicles.

Any standards under CAA section 202(a)(1) “shall be applicable to such vehicles \* \* \* for their useful life.” Emission standards set by the EPA under CAA section 202(a)(1) are technology-based, as the levels chosen must be premised on a finding of technological feasibility. Thus, standards promulgated under CAA section 202(a) are to take effect only “after providing such period as the Administrator finds necessary to permit the development and application of the requisite technology, giving appropriate consideration to the cost of compliance within such period” (section 202(a)(2);

<sup>44</sup> See 42 U.S.C. 7521 (a). A number of commenters believed that the GHG program was being adopted pursuant to section 202 (a)(3)(A) and that the lead time requirements of section 202 (a)(3)(C) therefore apply. This is mistaken. Section 202 (a)(3)(A) applies to standards for emissions of hydrocarbons, carbon monoxide, oxides of nitrogen, and particulate matter from heavy-duty vehicles and engines. This does not include the GHGs regulated under the standards in today’s action. This comment is addressed further in the Response to Comment document.

<sup>42</sup> See 49 U.S.C. 32902(h).

<sup>43</sup> EO 12866 states that an agency must “design its regulations in the most cost-effective manner to achieve the regulatory objective \* \* \* consider[ing] incentives for innovation \* \* \* [and] flexibility,” among other factors; EO 13563 directs agencies to “seek to identify, as appropriate, means to achieve regulatory goals that are designed to promote innovation,” and “identify and consider regulatory approaches that \* \* \* maintain flexibility.”

see also *NRDC v. EPA*, 655 F. 2d 318, 322 (DC Cir. 1981)). EPA is afforded considerable discretion under section 202(a) when assessing issues of technical feasibility and availability of lead time to implement new technology. Such determinations are “subject to the restraints of reasonableness”, which “does not open the door to ‘crystal ball’ inquiry.” *NRDC*, 655 F. 2d at 328, quoting *International Harvester Co. v. Ruckelshaus*, 478 F. 2d 615, 629 (DC Cir. 1973). However, “EPA is not obliged to provide detailed solutions to every engineering problem posed in the perfection of the trap-oxidizer. In the absence of theoretical objections to the technology, the agency need only identify the major steps necessary for development of the device, and give plausible reasons for its belief that the industry will be able to solve those problems in the time remaining. The EPA is not required to rebut all speculation that unspecified factors may hinder ‘real world’ emission control.” *NRDC*, 655 F. 2d at 333–34. In developing such technology-based standards, EPA has the discretion to consider different standards for appropriate groupings of vehicles (“class or classes of new motor vehicles”), or a single standard for a larger grouping of motor vehicles (*NRDC*, 655 F. 2d at 338).

Although standards under CAA section 202(a)(1) are technology-based, they are not based exclusively on technological capability. EPA has the discretion to consider and weigh various factors along with technological feasibility, such as the cost of compliance (See section 202(a)(2)), lead time necessary for compliance (section 202(a)(2)), safety (See *NRDC*, 655 F. 2d at 336 n. 31) and other impacts on consumers, and energy impacts associated with use of the technology. See *George E. Warren Corp. v. EPA*, 159 F.3d 616, 623–624 (DC Cir. 1998) (ordinarily permissible for EPA to consider factors not specifically enumerated in the CAA). See also *Entergy Corp. v. Riverkeeper, Inc.*, 129 S.Ct. 1498, 1508–09 (2009) (congressional silence did not bar EPA from employing cost-benefit analysis under Clean Water Act absent some other clear indication that such analysis was prohibited; rather, silence indicated discretion to use or not use such an approach as the agency deems appropriate).

In addition, EPA has clear authority to set standards under CAA section 202(a) that are technology forcing when EPA considers that to be appropriate, but is not required to do so (as compared to standards set under provisions such as

section 202(a)(3) and section 213(a)(3)).<sup>45</sup> EPA has interpreted a similar statutory provision, CAA section 231, as follows:

While the statutory language of section 231 is not identical to other provisions in title II of the CAA that direct EPA to establish technology-based standards for various types of engines, EPA interprets its authority under section 231 to be somewhat similar to those provisions that require us to identify a reasonable balance of specified emissions reduction, cost, safety, noise, and other factors. See, e.g., *Husqvarna AB v. EPA*, 254 F.3d 195 (DC Cir. 2001) (upholding EPA’s promulgation of technology-based standards for small non-road engines under section 213(a)(3) of the CAA). However, EPA is not compelled under section 231 to obtain the “greatest degree of emission reduction achievable” as per sections 213 and 202 of the CAA, and so EPA does not interpret the Act as requiring the agency to give subordinate status to factors such as cost, safety, and noise in determining what standards are reasonable for aircraft engines. Rather, EPA has greater flexibility under section 231 in determining what standard is most reasonable for aircraft engines, and is not required to achieve a “technology forcing” result (70 FR 69664 and 69676, November 17, 2005).

This interpretation was upheld as reasonable in *NACAA v. EPA*, 489 F.3d 1221, 1230 (DC Cir. 2007). CAA section 202(a) does not specify the degree of weight to apply to each factor, and EPA accordingly has discretion in choosing an appropriate balance among factors. See *Sierra Club v. EPA*, 325 F.3d 374, 378 (DC Cir. 2003) (even where a provision is technology-forcing, the provision “does not resolve how the Administrator should weigh all [the statutory] factors in the process of finding the ‘greatest emission reduction achievable’”). See also *Husqvarna AB v. EPA*, 254 F. 3d 195, 200 (DC Cir. 2001) (great discretion to balance statutory factors in considering level of technology-based standard, and statutory requirement “to [give appropriate] consideration to the cost of applying \* \* \* technology” does not mandate a specific method of cost analysis); see also *Hercules Inc. v. EPA*, 598 F. 2d 91, 106 (DC Cir. 1978) (“In reviewing a numerical standard the agencies must ask whether the agency’s numbers are within a zone of

<sup>45</sup> One commenter mistakenly stated that section 202 (a) standards must be technology-forcing, but the provision plainly does not require EPA to adopt technology-forcing standards. See further discussion in Section III.A below.

reasonableness, not whether its numbers are precisely right”); *Permian Basin Area Rate Cases*, 390 U.S. 747, 797 (1968) (same); *Federal Power Commission v. Conway Corp.*, 426 U.S. 271, 278 (1976) (same); *Exxon Mobil Gas Marketing Co. v. FERC*, 297 F. 3d 1071, 1084 (DC Cir. 2002) (same).

#### (a) EPA Testing Authority

Under section 203 of the CAA, sales of vehicles are prohibited unless the vehicle is covered by a certificate of conformity. EPA issues certificates of conformity pursuant to section 206 of the Act, based on (necessarily) pre-sale testing conducted either by EPA or by the manufacturer. The Heavy-duty Federal Test Procedure (Heavy-duty FTP) and the Supplemental Engine Test (SET) are used for this purpose. Compliance with standards is required not only at certification but throughout a vehicle’s useful life, so that testing requirements may continue post-certification. Useful life standards may apply an adjustment factor to account for vehicle emission control deterioration or variability in use (section 206(a)).

EPA established the Light-duty FTP for emissions measurement in the early 1970s. In 1976, in response to the Energy Policy and Conservation Act, EPA extended the use of the Light-duty FTP to fuel economy measurement (See 49 U.S.C. 32904(c)). EPA can determine fuel efficiency of a vehicle by measuring the amount of CO<sub>2</sub> and all other carbon compounds (e.g., total hydrocarbons and carbon monoxide (CO)), and then, by mass balance, calculating the amount of fuel consumed.

#### (b) EPA Enforcement Authority

Section 207 of the CAA grants EPA broad authority to require manufacturers to remedy vehicles if EPA determines there are a substantial number of noncomplying vehicles. In addition, section 205 of the CAA authorizes EPA to assess penalties of up to \$37,500 per vehicle for violations of various prohibited acts specified in the CAA. In determining the appropriate penalty, EPA must consider a variety of factors such as the gravity of the violation, the economic impact of the violation, the violator’s history of compliance, and “such other matters as justice may require.”

#### (2) NHTSA Authority

In 1975, Congress enacted the Energy Policy and Conservation Act (EPCA), mandating a regulatory program for motor vehicle fuel economy to meet the various facets of the need to conserve energy. In December 2007, Congress

enacted the Energy Independence and Securities Act (EISA), amending EPCA to require, among other things, the creation of a medium- and heavy-duty fuel efficiency program for the first time. This mandate in EISA represents a major step forward in promoting EPCA's goals of energy independence and security, and environmental and national security.

NHTSA has primary responsibility for fuel economy and consumption standards, and assures compliance with EISA through rulemaking, including standard-setting; technical reviews, audits and studies; investigations; and enforcement of implementing regulations including penalty actions. This final action implements Section 32902(k)(2) of EISA, which instructs NHTSA to create a fuel efficiency improvement program for "commercial medium- and heavy-duty on-highway vehicles and work trucks"<sup>46</sup> by rulemaking, which is to include standards, test methods, measurement metrics, and enforcement protocols. See 49 U.S.C. 32902(k)(2). Congress directed that the standards, test methods, measurement metrics, and compliance and enforcement protocols be "appropriate, cost-effective, and technologically feasible" for the vehicles to be regulated, while achieving the "maximum feasible improvement" in fuel efficiency.

NHTSA has clear authority to design and implement a fuel efficiency program for vehicles and work trucks under EISA, and was given broad discretion to balance the statutory factors in Section 32902(k)(2) in developing fuel consumption standards to achieve the maximum feasible improvement. Since this is the first rulemaking that NHTSA has conducted under 49 U.S.C. 32902(k)(2), the agency interpreted these elements and factors in the context of setting standards, choosing metrics, and determining test methods and compliance/enforcement mechanisms. Discussion of the application of these factors can be found in Section III below. Congress also gave NHTSA the authority to set separate standards for different classes of these vehicles, but required that all standards adopted provide not less than four full model years of regulatory lead-time and three full model years of regulatory stability.

In EISA, Congress required NHTSA to prescribe separate average fuel economy standards for passenger cars and light

trucks in accordance with the provisions in 49 U.S.C. Section 32902(b), and to prescribe standards for work trucks and commercial medium- and heavy-duty vehicles in accordance with the provisions in 49 U.S.C. 32902(k). See 49 U.S.C. Section 32902(b)(1). Congress also added in EISA a requirement that NHTSA shall issue regulations prescribing fuel economy standards for at least 1, but not more than 5, model years. See 49 U.S.C. 32902(b)(3)(B). For purposes of the fuel efficiency standards that the agency proposed for HD vehicles and engines, the NPRM stated an interpretation of the statute that the 5-year maximum limit did not apply to standards promulgated in accordance with 49 U.S.C. 32902(k), given the language in Section 32902(b)(1). Based on this interpretation, NHTSA proposed that the standards ultimately finalized for HD vehicles and engines would remain in effect indefinitely at their 2018 or 2019 model year levels until amended by a future rulemaking action. In any future rulemaking action to amend the standards, NHTSA would ensure not less than four full model years of regulatory lead-time and three full model years of regulatory stability. NHTSA sought comment on its interpretation of EISA.

Robert Bosch LLC (Bosch) commented that the absence of an expiration date for the standards proposed in the NPRM could violate 49 U.S.C. 32902, which it interpreted as requiring the MD/HD program to have standards that expire in five years. Section 32902(k)(3), which lays out the requirements for the MD/HD program, specifies the minimum regulatory lead and stability times, as described above, but does not specify a maximum duration period. In contrast, Section 32902(b)(3)(B) lays out the minimum and maximum durations of standards to be established in a rulemaking for the light-duty program, but prescribes no minimum lead or stability time. Bosch argued that as 49 U.S.C. Section 32902(k)(3) does not require a maximum duration period, Congress intended that NHTSA take the maximum duration period specified for the light-duty program in Section 32902(b)(3)(B), five years, and apply it to Section 32902(k)(3). Bosch also argued, however, that the minimum duration period should not be carried over from the light-duty to the heavy-duty section, as a minimum duration period for HD was specified in Section 32902(k)(3).

NHTSA has revisited this issue and continues to believe that it is reasonable to assume that if Congress intended for the HD/MD regulatory program to be

limited by the timeline prescribed in Subsection (b)(3)(B), it would have either mentioned HD/MD vehicles in that subsection or included the same timeline in Subsection (k).<sup>47</sup> In addition, in order for Subsection (b)(3)(B) to be interpreted to apply to Subsection (k), the agency would need to give less than full weight to the earlier phrase in the statute directing the Secretary to prescribe standards for "work trucks and commercial medium-duty or heavy-duty on-highway vehicles in accordance with Subsection (k)." 49 U.S.C. 32902(b)(1)(C). Instead, this direction would need to be read to mean "in accordance with Subsection (k) and the remainder of Subsection (b)." NHTSA believes this interpretation would be inappropriate. Interpreting "in accordance with Subsection (k)" to mean something indistinct from "in accordance with this Subsection" goes against the canon that statutes should not be interpreted in a way that "render[s] language superfluous." *Dobrova v. Holder*, 607 F.3d 297, 302 (2d Cir. 2010), quoting *Mendez v. Holder*, 566 F.3d 316, 321–22 (2d Cir. 2009). Based on this reasoning, NHTSA believes the more reasonable and appropriate approach is reflected in the proposal, and the final rules therefore follow this approach.

Another commenter, CBD, expressed concern that lack of an expiration date meant that the standards would remain indefinitely, thus forgoing the possibility of increased stringency in the future. CBD argued that this violated NHTSA's statutory duty to set maximum feasible standards. NHTSA disagrees that the indefinite duration of the standards in this rule would prevent the agency from setting future standards at the maximum feasible level in future rulemakings. The absence of an expiration date for these standards should not be interpreted to mean that there will be no future rulemakings to establish new MD/HD fuel efficiency standards for MYs 2019 and beyond—the agencies have already previewed the possibility of such a rulemaking in other parts of this final rule preamble. Therefore, NHTSA believes this concern is unnecessary.

<sup>47</sup> "[W]here Congress includes particular language in one section of a statute but omits it in another section of the same Act, it is generally presumed that Congress acts intentionally and purposely in the disparate inclusion or exclusion." *Russello v. United States*, 464 U.S. 16, 23 (1983), quoting *U.S. v. Wong Kim Bo*, 472 F.2d 720, 722 (5th Cir. 1972). See also *Mayo v. Questech, Inc.*, 727 F.Supp. 1007, 1014 (E.D.Va. 1989) (conspicuous absence of provision from section where inclusion would be most logical signals Congress did not intend for it to be implied).

<sup>46</sup> "Commercial medium- and heavy-duty on-highway vehicles" are defined at 49 U.S.C. 32901(a)(7), and "work trucks" are defined at (a)(19).

## (a) NHTSA Testing Authority

49 U.S.C. Section 32902(k)(2) states that NHTSA must adopt and implement appropriate, cost-effective, and technologically feasible test methods and measurement metrics as part of the fuel efficiency improvement program. For this program, manufacturers will test and conduct modeling to determine GHG emissions and fuel consumption performance, and EPA and NHTSA will perform validation testing. The results of the validation tests will be used by EPA to create a finalized reporting that confirms the manufacturer's final model year GHG emissions and fuel consumption results, which each agency will use to enforce compliance with its standards.

## (v) NHTSA Enforcement Authority

## (i) Overview

The NPRM proposed a compliance and enforcement program that included civil penalties for violations of the fuel efficiency standards. 49 U.S.C. 32902(k)(2) states that NHTSA must adopt and implement appropriate, cost-effective, and technologically feasible compliance and enforcement protocols for the fuel efficiency improvement program. Congress gave DOT broad discretion to fashion its fuel efficiency improvement program and thus necessarily did not speak directly or specifically as to the nature of the compliance and enforcement protocols that would be best suited for effectively supporting the yet-to-be-designed-and-established program. Instead, it left the matter generally to the Secretary. Congress' approach is unlike CAFE enforcement for passenger cars and light trucks, where Congress specified the precise details of a program and provided that a manufacturer either complies with standards or pays civil penalties.

The statute is silent with respect to how "protocol" should be interpreted. The term "protocol" is imprecise and thus Congress' choice of that term affords the agency substantial breadth of discretion. For example, in a case interpreting Section 301(c)(2) of the Comprehensive Environmental Response, Compensation, and Liability Act (CERCLA), the DC Circuit noted that the word "protocols" has many definitions that are not much help. *Kennecott Utah Copper Corp., Inc. v. U.S. Dept. of Interior*, 88 F.3d 1191, 1216 (DC Cir. 1996). Section 301(c)(2) of CERCLA prescribed the creation of two types of procedures for conducting natural resources damages assessments. The regulations were to specify (a) "standard procedures for simplified

assessments requiring minimal field observation" (the "Type A" rules), and (b) "alternative protocols for conducting assessments in individual cases" (the "Type B" rules).<sup>48</sup> The court upheld the challenged provisions, which were a part of a set of rules establishing a step-by-step procedure to evaluate options based on certain criteria, and to make a decision and document the results.

Taking the considerations above into account, including Congress' instructions to adopt and implement compliance and enforcement protocols, and the Secretary's authority to formulate policy and make rules to fill gaps left, implicitly or explicitly, by Congress, the agency interpreted "protocol" in the context of EISA as authorizing the agency to determine both whether manufacturers have complied with the standards, and to establish suitable and reasonable enforcement mechanisms and decision criteria for non-compliance. Therefore, NHTSA interpreted its authority to develop an enforcement program to include the authority to determine and assess civil penalties for non-compliance.

Several commenters disagreed with this interpretation. Volvo and EMA commented that the penalties proposed by NHTSA exceeded the authority granted to the agency by Congress, and Volvo commented that the fact that Congress did not adopt an entirely new statute for the HD program should be interpreted to mean that provisions adopted for the light-duty program should apply to the HD program as well. Daimler argued that it was likely that EISA did not give NHTSA the authority to assess civil penalties, and Navistar and EMA argued that NHTSA could not have the authority as Congress did not expressly grant it.

NHTSA continues to believe that it is reasonable to interpret "compliance and enforcement protocols" to include authority to impose civil penalties. Where a statute does not specify an approach, the discretion to do so is left to the agency. When Congress has "explicitly left a gap for an agency to fill, there is an express delegation of authority to the agency to elucidate a specific provision of the statute by regulation." *United States v. Mead*, 533 U.S. 218, 227 (2001), quoting *Chevron v. NRDC*, 467 U.S. 837, 843-44 (1984). The delegation of authority may be implicit rather than express. *Id.* at 229. NHTSA believes it would be unreasonable to assume that Congress intended to create a hollow regulatory program without a

mechanism for effective enforcement. Further, interpreting "enforcement protocols" to mean not more than "compliance protocols" would go against the canon noted above that statutes should not be interpreted in a way that "render[s] language superfluous." *Dobrova v. Holder*, 607 F.3d 297, 302 (2d Cir. 2010), quoting *Mendez v. Holder* 566 F. 3d 316, 321-22 (2d Cir. 2009). The interpretation urged by the commenters would render an entire program superfluous.

Further, NHTSA believes that Congress would have anticipated that compliance and enforcement protocols would include civil penalties for the HD sector, given that penalties are an integral part of a product standards program and given the long precedent of civil penalties for the light-duty sector. The agency disagrees with the argument that the HD program would have appeared in a wholly separate statute if Congress had not intended the penalty program for light-duty to apply to it. The inclusion of the MD/HD program in Title 329 does not mean that Congress intended for the boundaries and differences between the separate sections to be ignored. Rather, this argument leads to the opposite conclusion that the fact that Congress created a new section for the HD program, instead of simply amending the existing light-duty program to include "work trucks and other vehicles" in addition to automobiles, means the agency should assume that Congress acted intentionally when it created two wholly separate programs and respect their distinctions. Therefore, consistent with the statutory interpretation proposed in the NPRM, the final rule includes penalties for non-compliance with the fuel efficiency standards.

## (ii) Penalty Levels

NHTSA proposed to adopt penalty levels equal to those in EPA's existing heavy-duty program, in order to provide adequate deterrence as well as consistency with the GHG regulation. The proposed maximum penalty levels were \$37,500.00 per vehicle or engine.

Several manufacturers commented that the penalty levels should be limited to those mandated in the light-duty program. Volvo and Daimler argued that Congress intended lower penalties for the HD program than were proposed in the NPRM, because they believed that Congress had expressly or implicitly intended for the HD program to be included in the penalty calculation of Section 32912(b). That section prescribes penalty levels for violators under Section 32902 of "\$5 multiplied

<sup>48</sup> *State of Ohio v. U.S. Dept. of Interior*, 880 F.2d 432, 439 (DC Cir. 1989).

by each tenth (0.1) of a mile a gallon by which the applicable average fuel economy standard under that section exceeds the average fuel economy,”<sup>49</sup> calculated and applied to automobiles. Volvo further argued that NHTSA was relying upon the CAA as the statutory basis for the penalty levels.

NHTSA recognizes that Section 329 contains a detailed penalty scheme, for light-duty vehicle CAFE standards. However, Section 32902(k)(2) explicitly directs NHTSA to “adopt and implement appropriate test methods, measurement metrics, fuel economy standards, and compliance and enforcement protocols,” in the creation of the new HD program. NHTSA continues to believe that this broad Congressional mandate should be interpreted based on a plain text reading, which includes the authority to determine compliance and enforcement protocols that will be effective and appropriate for this new sector of regulation. NHTSA also believes that reading Section 32912 to apply to the new HD program would contradict Congress’ broad mandate for the agency to establish new measurement metrics and a compliance and enforcement program. Further, interpreting the requirement to create “enforcement protocols” for HD vehicles to mean that NHTSA should rely on the enforcement provisions for light-duty vehicles would go against the canon noted above that statutes should not be interpreted in a way that “render[s] language superfluous.” *Dobrova v. Holder*, 607 F.3d 297, 302 (2d Cir. 2010), quoting *Mendez v. Holder* 566 F. 3d 316, 321–22 (2d Cir. 2009).

NHTSA believes that Section 32912 does not apply to the new HD program for several other reasons. First, this section uses a fuel economy metric, miles/gallon, while the HD program is built around a fuel consumption metric, per the requirement to develop a “fuel efficiency improvement program” and the agencies’ conclusion, supported by NAS, that a fuel consumption metric is a much more reasonable choice than a fuel economy metric for HD vehicles given their usage as work vehicles. Second, this section specifies a calculation for automobiles, a vehicle class which is confined to the light-duty rule. In addition, the HD program

prescribes fuel consumption standards, not average fuel economy standards.

Finally, NHTSA believes that if Congress had intended for a pre-determined penalty scheme to apply to the new HD program, it would have been specific. Instead, Congress explicitly directed the agency to develop a new measurement, compliance, and enforcement scheme. Consistent with the statutory interpretation of the duration of the standards, NHTSA believes that if Congress intended for particular penalty levels to be used in Section 32902(k)(3), it would have either included a reference to those levels or included a reference in 32912 to the vehicles and metrics regulated by 32902(k)(3). See *Russello v. United States*, 464 U.S. 16, 23 (1983), quoting *United States v. Wong Kim Bo*, 472 F.2d 720, 722 (5th Cir 1972) (“[W]here Congress includes particular language in one section of a statute but omits it in another section of the same Act, it is generally presumed that Congress acts intentionally and purposely in the disparate inclusion or exclusion.”) Instead, the absence of such language could mean either that Congress did not contemplate the specific penalty levels to be used, or that Congress left the choice of specific penalty levels to the agency. See *Alliance for Community Media v. F.C.C.* 529 F. 3d 763, 779 (6th Cir. 2008) (absence of a statutory deadline in one section but not others meant that Congress authorized but did not require it in that section).

NHTSA believes that, based on EPA’s experience regulating this sector for criteria pollutants, the proposed maximum penalty is at an appropriate level to create deterrence for non-compliance, while at the same time, not so high as to create undue hardship for manufacturers. Therefore, the final rule retains the maximum penalty level proposed in the NPRM.

#### G. Future HD GHG and Fuel Consumption Rulemakings

This final action represents a first regulatory step by NHTSA and EPA to address the multi-faceted challenges of reducing fuel use and greenhouse gas emissions from these vehicles. By focusing on existing technologies and well-developed regulatory tools, the agencies are able to adopt rules that we believe will produce real and important reductions in GHG emissions and fuel consumption within only a few years. Within the context of this regulatory time frame, our program is very aggressive—with limited lead time compared to historic heavy-duty regulations—but pragmatic in the

context of technologies that are available and that can be reasonably implemented during the regulatory time frame.

While we are now only finalizing this first step, it is worthwhile to consider how the next regulatory step may be designed. Technologies such as hybrid drivetrains, advanced bottoming cycle engines, and full electric vehicles are promoted in this first step through incentive concepts as discussed in Section IV, but we believe that these advanced technologies will not be necessary to meet the final standards. Today’s standards are premised on the use of existing technologies given the short lead time, as discussed in Section III, below. When we begin work to develop a possible next set of regulatory standards, the agencies expect these advanced technologies to be an important part of the regulatory program and will consider them in setting the stringency of any standards beyond the 2018 model year.

We will not only consider the progress of technology in our future regulatory efforts, but the agencies are also committed to fully considering a range of regulatory approaches. To more completely capture the complex interactions of the total vehicle and the potential to reduce fuel consumption and GHG emissions through the optimization of those interactions may require a more sophisticated approach to vehicle testing than we are adopting today for the largest heavy-duty vehicles. In future regulations, the agencies expect to fully evaluate the potential to expand the use of vehicle compliance models to reflect engine and drivetrain performance. Similarly, we intend to consider the potential for complete vehicle testing using a chassis dynamometer, not only as a means for compliance, but also as a complementary tool for the development of more complex vehicle modeling approaches. In considering these more comprehensive regulatory approaches, the agencies will also reevaluate whether separate regulation of trucks and engines remains necessary.

In addition to technology and test procedures, vehicle and engine drive cycles are an important part of the overall approach to evaluating and improving vehicle performance. EPA, working through the WP.29 Global Technical Regulation process, has actively participated in the development of a new World Harmonized Duty Cycle for heavy-duty engines. EPA is committed to bringing forward these new procedures as part of our overall comprehensive approach for controlling

<sup>49</sup>This fine was increased by 49 CFR 578.6, which provides that “Except as provided in 49 U.S.C. 32912(c), a manufacturer that violates a standard prescribed for a model year under 49 U.S.C. 32902 is liable to the United States Government for a civil penalty of \$5.50 multiplied by each 0.1 of a mile a gallon by which the applicable average fuel economy standard under that section exceeds the average fuel economy.”

criteria pollutant and GHG emissions. However, we believe the important issues and technical work related to setting new criteria pollutant emissions standards appropriate for the World Harmonized Duty Cycle are significant and beyond the scope of this rulemaking. Therefore, the agencies are not adopting these test procedures in this action, but we are ready to work with interested stakeholders to adopt these procedures in a future action.

As noted above, the agencies also intend to further investigate possibilities of expanded credit trading across the heavy-duty sector. As part of this effort, the agencies will investigate the degree to which the issue of credit trading is connected with complete vehicle testing procedures.

As with this program, our future efforts will be based on collaborative outreach with the stakeholder community and will be focused on a program that delivers on our energy security and environmental goals without restricting the industry's ability to produce a very diverse range of vehicles serving a wide range of needs.

## II. Final GHG and Fuel Consumption Standards for Heavy-Duty Engines and Vehicles

This section describes the standards and implementation dates that the agencies are finalizing for the three categories of heavy-duty vehicles and engines. The agencies have performed a technology analysis to determine the level of standards that we believe will be cost-effective, feasible, and appropriate in the lead time provided. This analysis, described in Section III and in more detail in the RIA Chapter 2, considered for each of the regulatory categories:

- The level of technology that is incorporated in current new engines and trucks,
- Forecasts of manufacturers' product redesign schedules,
- The available data on corresponding CO<sub>2</sub> emissions and fuel consumption for these engines and vehicles,
- Technologies that would reduce CO<sub>2</sub> emissions and fuel consumption and that are judged to be feasible and appropriate for these vehicles and engines through the 2018 model year,
- The effectiveness and cost of these technologies, and
- Projections of future U.S. sales for trucks and engines.

### A. What vehicles will be affected?

EPA and NHTSA are finalizing standards for heavy-duty engines and also for what we refer to generally as

“heavy-duty vehicles.” In general, these standards will apply for the model year 2014 and later engines and vehicles, although some standards do not apply until 2016 or 2017. The EPA standards will apply throughout the useful life of the engine or vehicle, just as existing criteria emission standards apply throughout the useful life. As noted in Section I, for purposes of this preamble and rules, the term “heavy-duty or “HD” applies to all highway vehicles and engines that are not regulated by the light-duty vehicle, light-duty truck and medium-duty passenger vehicle greenhouse gas and CAFE standards issued for MYs 2012–2016. Thus, in this notice, unless specified otherwise, the heavy-duty category incorporates all vehicles rated with GVWR greater than 8,500 pounds, and the engines that power these vehicles, except for MDPVs. The CAA defines heavy-duty vehicles as trucks, buses or other motor vehicles with GVWR exceeding 6,000 pounds. See CAA section 202(b)(3). In the context of the CAA, the term HD as used in these final rules thus refers to a subset of these vehicles and engines. EISA section 103(a)(3) defines a ‘commercial medium- and heavy-duty on-highway vehicle’ as an on-highway vehicle with GVWR of 10,000 pounds or more.<sup>50</sup> EISA section 103(a)(6) defines a ‘work truck’ as a vehicle that is rated at between 8,500 and 10,000 pounds gross vehicle weight and is not a medium-duty passenger vehicle.<sup>51</sup> Therefore, the term “heavy-duty vehicles” in this rulemaking refers to both work trucks and commercial medium- and heavy-duty on-highway vehicles as defined by EISA. Heavy-duty engines affected by the standards are those that are installed in commercial medium- and heavy-duty vehicles, except for the engines installed in vehicles certified to a complete vehicle emissions standard based on a chassis test, which would be addressed as a part of those complete vehicles, and except for engines used exclusively for stationary power when the vehicle is parked. The agencies' scope is the same with the exception of recreational vehicles (or motor homes), as discussed above. The standards that EPA is

<sup>50</sup> Codified at 49 U.S.C. 32901(a)(7).

<sup>51</sup> EISA Section 103(a)(6) is codified at 49 U.S.C. 32901(a)(19). EPA defines medium-duty passenger vehicles as any complete vehicle between 8,500 and 10,000 pounds GVWR designed primarily for the transportation of persons which meet the criteria outlined in 40 CFR 86.1803–01. The definition specifically excludes any vehicle that (1) has a capacity of more than 12 persons total or, (2) is designed to accommodate more than 9 persons in seating rearward of the driver's seat or, (3) has a cargo box (e.g., pickup box or bed) of six feet or more in interior length. (See the Tier 2 final rulemaking, 65 FR 6698, February 10, 2000.)

finalizing today cover recreational on-highway vehicles, while NHTSA limited its scope in the proposal to not include these vehicles. See Section I.A above.

The NPRM did not include an export exclusion in NHTSA's fuel consumption standards. Oshkosh Corporation commented that NHTSA should add an export exclusion in order to accommodate the testing and delivery needs of manufacturers of vehicles intended for export. NHTSA agrees with this comment and Section 535.3 of the final rule specifies such an exclusion.

EPA and NHTSA are finalizing standards for each of the following categories, which together comprise all heavy-duty vehicles and all engines used in such vehicles. In order to most appropriately regulate the broad range of heavy-duty vehicles and engines, the agencies are setting separate engine and vehicle standards for the combination tractors and Class 2b through 8 vocational vehicles. The engine standards and test procedures for engines installed in the tractors and vocational vehicles are discussed within the preamble sections for combination tractors and vocational vehicles, respectively. The agencies are establishing standards for heavy-duty pickups and vans that apply to the entire vehicle;—there are no separate engine standards.

As discussed in Section IX, the agencies are not adopting GHG emission and fuel consumption standards for trailers at this time. In addition, the agencies are not adopting standards at this time for engine, chassis, and vehicle manufacturers which are small businesses (as defined by the Small Business Administration). More detailed discussion of each regulatory category is included in the subsequent sections below.

### B. Class 7 and 8 Combination Tractors

EPA is finalizing CO<sub>2</sub> standards and NHTSA is finalizing fuel consumption standards for new Class 7 and 8 combination tractors. The standards are for the tractor cab, with a separate standard for the engine that is installed in the tractor. Together these standards would achieve reductions of up to 23 percent compared to the model 2010 baseline level. As discussed below, EPA is finalizing its proposal to adopt the existing useful life definitions for Class 7 and 8 tractors and the heavy-duty engines installed in them. NHTSA and EPA are finalizing revised fuel consumption and GHG emissions standards for tractors, and finalizing as proposed engine standards for heavy-duty engines in Class 7 and 8 tractors. The agencies' analyses, as discussed

briefly below and in more detail later in this preamble and in the RIA Chapter 2, show that these standards are feasible and appropriate under each agency's respective statutory authorities.

EPA is also finalizing standards to control N<sub>2</sub>O, CH<sub>4</sub>, and HFC emissions from Class 7 and 8 combination tractors. The final heavy-duty engine standards for both N<sub>2</sub>O and CH<sub>4</sub> and details of the standard are included in the discussion in Section II.E.1.b and II.E.2.b, respectively. The final air conditioning leakage standards applying to tractor manufacturers to address HFC emissions are discussed in Section II.E.5.

The agencies are finalizing CO<sub>2</sub> emissions and fuel consumption standards for the combination tractors that reflect reductions that can be achieved through improvements in the tractor (such as aerodynamics), tires, and other vehicle systems. The agencies are also finalizing heavy-duty engine standards for CO<sub>2</sub> emissions and fuel consumption that reflect technological improvements in combustion and overall engine efficiency.

The agencies have analyzed the feasibility of achieving the CO<sub>2</sub> and fuel consumption standards, and have identified means of achieving the standards that are technically feasible in the lead time afforded, economically practicable and cost-effective. EPA and NHTSA present the estimated costs and benefits of the standards in Section III. In developing the final rules, the agencies have evaluated the kinds of technologies that could be utilized by engine and tractor manufacturers, as well as the associated costs for the industry and fuel savings for the consumer and the magnitude of the national CO<sub>2</sub> and fuel savings that may be achieved.

The agencies received comments from multiple stakeholders regarding the definition and classification of "combination tractors." The commenters raised three key issues. First, EMA/TMA, Navistar and DTNA requested that both agencies use the same definition for "tractor" or "truck tractor" in the final rules. EPA proposed a definition for "tractor" in § 1037.801 (see the proposed rule published November 30, 2010, 75 FR 74402) which stated that "tractor" means a vehicle capable of pulling trailers that is not intended to carry significant cargo other than cargo in the trailer, or any other vehicle intended for the primary purpose of pulling a trailer. For purposes of this definition, the term "cargo" includes permanently attached equipment such as fire-fighting equipment. The following vehicles are

tractors: any vehicle sold to an ultimate purchaser with a fifth wheel coupling installed; any vehicle sold to an ultimate purchaser with the rear portion of the frame exposed where the length of the exposed portion is 5.0 meters or less. See § 1037.620 for special provisions related to vehicles sold to secondary vehicle manufacturers in this condition. The following vehicles are not tractors: Any vehicle sold to an ultimate purchaser with an installed cargo carrying feature (for example, this would include dump trucks and cement trucks); any vehicle lacking a fifth wheel coupling sold to an ultimate purchaser with the rear portion of the frame exposed where the length of the exposed portion is more than 5.0 meters.

NHTSA proposed to use the 49 CFR 571.3 definition of "truck tractor" in 49 CFR 535.4 (see the proposed rule published November 30, 2010, 75 FR 74440) which stated that "truck tractor" means a truck designed primarily for drawing other motor vehicles and not so constructed as to carry a load other than a part of the weight of the vehicle and the load so drawn.

Second, EMA/TMA, NTEA and Navistar expressed concerns over, and requested the removal of, the proposed language that all vehicles with sleeper cabs would be classified as tractors. The commenters argued that because there are vocational vehicles manufactured with sleeper cabs that operate as vocational vehicles and not as tractors, those vehicles should be treated the same as all other vocational vehicles. Third, eleven different commenters requested that the agencies subdivide tractors into line-haul tractors and vocational tractors and treat each based upon their operational characteristics: vocational tractors, which operate at lower speeds offroad or in stop-and-go city driving as vocational vehicles; and line-haul tractors, which operate at highway speeds on interstate roadways over long distances, as line-haul tractors.

In response to the first comment, the agencies have decided to standardize the definition of tractor by using the long-standing NHTSA definition of "truck tractor" established in 49 CFR 571.3. 49 CFR 571.3(b) states that a "truck tractor means a truck designed primarily for drawing other motor vehicles and not so constructed as to carry a load other than a part of the weight of the vehicle and the load so drawn." EPA's proposed definition for "tractor" in the NPRM was similar to the NHTSA definition, but included some additional language to require a fifth wheel coupling and an exposed

frame in the rear of the vehicle where the length of the exposed portion is 5.0 meters or less. EMA and Navistar argued that these two different definitions could lead to confusion if the agencies applied their requirements for truck tractors differently from each other. The commenters suggested that the EPA definition was more complicated than necessary, and that the simpler NHTSA definition should be used by both agencies as the base definition of truck tractor.

The agencies agree that the definitions should be standardized and that the NHTSA definition is sufficient and includes the essential requirement that a truck tractor is a truck designed "primarily for drawing other motor vehicles and not so constructed as to carry a load other than a part of the weight of the vehicle and the load so drawn." EPA's proposed tractor definition was intended to be functionally equivalent to NHTSA's definition based on design, but to be more objective by including the criteria related to "fifth wheels" and exposed rear frame. However, EPA no longer believes that such additional criteria are needed for implementation. NHTSA established the definition for truck tractor in 49 CFR 571.3(b) years ago,<sup>52</sup> and has not encountered any notable problems with its application. Nevertheless, because the NHTSA definition relies more on design intent than EPA's proposed definition, we recognize that there may be some questions regarding how the agencies would apply the NHTSA definition being finalized to certain unique vehicles. For example, many of the common automobile and boat transport trucks may look similar to tractors, but the agencies would not consider them to meet the definition, because they have the capability to carry one or several vehicles as cargo with or without a trailer attached, and therefore are not "constructed as to carry a load other than a part of the weight of the vehicle and the load so drawn." Similarly, a "dromedary" style truck that has the capability to carry a large load of cargo with or without drawing a trailer would also not qualify as a tractor.<sup>53</sup> Even though these particular vehicles identified could potentially draw other motor vehicles like a trailer, they have also been designed to carry cargo with or without the trailer attached. NHTSA has previously interpreted its definition for "truck tractor" as excluding these specific vehicles like the dromedary and

<sup>52</sup> 33 FR 19703, December 25, 1968.

<sup>53</sup> A dromedary is a box, deck or plate mounted behind the cab to carry freight or cargo.



automobile/boat transport vehicles. Tow trucks have also been excluded from the category of truck tractor. On the other hand, it is worth clarifying that designs that allow cargo to be carried in the passenger compartment, the sleeper compartment, or external toolboxes would not exclude a vehicle from the tractor category. The agencies plan to continue with this approach for the HD fuel efficiency and GHG standards, which means that these particular vehicles will be subject to the vocational vehicle standards and not the tractor standards, but vehicles that did meet the definition above for "tractor" will be subject to the combination tractor standards.

In response to the second comment, the agencies have decided not to classify vocational vehicles with sleeper cabs as tractors. In the NPRM, the agencies proposed that vocational vehicles with sleeper cabs be classified as tractors out of concern that a vehicle could initially be manufactured as a straight truck vocational vehicle with a sleeper cab and, soon after introduction into commerce, be converted to a combination tractor as a means to circumvent the Class 8 sleeper cab regulations. Commenters who addressed this issue generally disagreed with the agencies' concern. EMA/TMA, for example, argued that it is expensive and difficult for a manufacturer to change a vehicle from a straight truck to a tractor, because of modifications required to the vehicle, such as to the vehicle's air brake system, and also because of the manufacturers ultimate responsibility for recertification to NHTSA's safety standards. EMA/TMA also argued that straight trucks are often built with sleeper cabs to perform the functions of a vocational type vehicle and not the functions of a line-haul tractor. NTEA also provided an example of a straight truck (Expediter Cab) that can be built with a sleeper cab and a cargo-carrying body, which it argued should be classified as a vocational vehicle and not a tractor.

Upon further consideration, the agencies agree that vocational vehicles with sleeper cabs are more appropriately classified as vocational vehicles than as tractors. The comments discussed above help to illustrate the reasons for building a vocational vehicle with a sleeper cab and the difficulties of converting a straight truck to a tractor. Moreover, 49 U.S.C. Chapter 301 requires any service organization making such modifications to be responsible for recertification to all applicable Federal motor vehicle safety standards, which should act as a further deterrent to anyone contemplating

making such a conversion. Together these two items address the agencies' primary reason for proposing the requirement that all vehicles with sleeper cabs be treated as tractors—the concern of circumvention of the tractor standards. However, the agencies will continue to monitor whether it appears that the definitions are creating unintended consequences, and may consider revising the definitions in a future rulemaking to address such issues should any arise. NHTSA and EPA have concluded that the engine and tire improvements required in the vocational category are appropriate for this set of vehicles based on the typical operation of these vehicles. The agencies did not intend to include vocational vehicles with sleeper cabs, such as an Expediter vehicle, into the tractor category in either the NPRM or in this final action, and the agencies' analyses at proposal reflected this intention. Therefore the agencies did not make any adjustments to the program costs and benefits due to this classification change.

In response to the third comment, the agencies have decided to allow manufacturers to exclude certain vocational-type of tractors from the combination tractor standards and instead be subject to the vocational vehicle standards. We discuss below the reasoning underlying this decision, the criteria manufacturers would use in asserting a claim that a vocational tractor should be reclassified as a vocational vehicle, and the procedures the agencies will use to accept or reject manufacturers' claims.

Multiple commenters (Allison Transmission, ATA, CALSTART, Eaton, EMA/TMA, National Solid Waste Management Association, MEMA, Navistar, NADA, RMA, and Volvo) argued that the agencies' proposed classification failed to recognize genuine differences between vocational tractors, which typically operate at lower speeds in stop-and-go city driving, and line-haul tractors, which typically operate at highway speeds on interstate roadways over long distances. Commenters argued that the proposed tractor standards and associated tractor GEM test cycles were derived based primarily upon the operational characteristics of the line-haul tractors, and that technologies that apply to these line-haul tractors, such as improved aerodynamics, vehicle speed limiters and automatic engine shutdown, as well as engine performance for improving emissions and fuel consumption, do not have the same positive impact on fuel consumption when used on tractors. In today's market, as mentioned by Volvo

and ATA, we understand that approximately 15 percent, or approximately 15,000 to 20,000, of the Class 7 and 8 tractors could be classified as vocational tractors based upon the work they perform.

The agencies agree that the overall operation of these vocational-types of tractors resembles other vocational vehicles' operation: lower average speed and more stop and go activity than line-haul tractors. Due to their operation style, a FTP certified engine is a better match for these tractors than a SET certified engine, because the FTP cycle uses a lower average speed and more stop and go activity than the SET cycle. In addition, the limited high speed operation leads to minimal opportunities for fuel consumption and CO<sub>2</sub> emissions reductions due to aerodynamic improvements. Conversely, the additional weight of the aerodynamic components could cause an unintended consequence of increasing gram per ton-mile emissions by reducing the amount of payload the vehicle can carry in those applications which are weight-limited. Similarly, the vocational tractors typically do not hotel overnight and therefore will have little to no benefit through the installation of an idle reduction technology.

The agencies received several other comments that described criteria that could be used to distinguish between vocational and non-vocational tractors. Volvo suggested that a tractor could be a vocational tractor if it meets three of five specified features:

- (1) A frame Resisting Bending Moment (RBM) greater than or equal to 2,000,000 in-lbs per rail, or rail and liner combination;
- (2) An approach angle greater than or equal to 20 degrees nominal design specification, to exclude extended front rails/bumpers for additional equipment (e.g.—pumps, winch, front engine PTO);
- (3) Ground clearance greater than or equal to 14 inches as measured unladen from the lowest point of any frame rail or body mounted components, excluding axles and suspension (for HHD and MHD vehicles this is usually considered as the lowest point of the fuel tank/mounting or chassis aerodynamic devices);
- (4) A total reduction in high gear greater than or equal to 3.00:1; and
- (5) A total reduction in low gear greater than or equal to 57:1.

The approach proposed by Volvo is somewhat similar to the approach NHTSA has for determining if a vehicle is a light truck under the light vehicle CAFE program, in which a vehicle must either have a GVWR greater than 6,000 pounds or have 4-wheel drive, and meet



four of the five specified suspension characteristics (approach angle, break-over angle, axle clearance, *etc.*) to be classified as a light truck. Although we do not believe that the criteria suggested by Volvo are workable for all manufacturers and all applications, we agree that these criteria would reflect a reasonable basis for allowing manufacturers to reclassify their vehicles as vocational tractors.

Two other commenters, EMA/TMA and Navistar, suggested simply that the manufacturer should have the burden of establishing that a tractor is a vocational tractor to the agencies' reasonable satisfaction. The commenters also suggested some factors that could be used to establish that a tractor is actually a "vocational tractor", including:

- (1) A vehicle speed limiter set at 55 mph or less;
- (2) Power take-off (PTO) controls;
- (3) Extended front frame;
- (4) Ground clearance greater than 14 in.;
- (5) An approach angle greater than 20 degrees;
- (6) Frame RBM greater than 2,000,000 in-lbs.; and
- (7) A total gear reduction in low gear greater than 57 and a total gear reduction in top gear greater than 3.

The agencies believe that both suggested approaches have some merit. A rule based on specific criteria as suggested by Volvo could help to minimize the burden on both the manufacturers and the agencies, as manufacturer-written requests for approval and agency approvals of those requests would not be required for each vocational tractor determination whereas the EMA/TMA and Navistar approach requires the opposite namely that each manufacturer would have to justify the determination of each vocational tractor based upon its related design features in a separate petition to the agencies. Neither of the two approaches, which are based on specific criteria, could be used to identify all the tractors that should be classified as vocational tractors. An urban beverage delivery tractor, for example, may not be designed with any of the features mentioned but is used in a vocational vehicle manner. Also, the agencies were concerned about the possibility of manufacturers circumventing the system by incorporating design changes to their line-haul tractors in order to classify them as vocational tractors required to meet less stringent emission and fuel consumption standards. However, at this time the agencies do not believe that circumventing the system is likely, as most of these

vocational tractors are built to order and will incorporate the design features required by the customer. Manufacturer vehicle offerings are designed or tailored to suit the particular task of the consumer. The vehicle transport mission including vehicle type, gross vehicle weight, gross combination weight, body style and load handling characteristics, must be considered in the design process. Further, how the vehicle will be utilized, including operating cycles, operating environment and road conditions, is another important consideration in designing a vehicle to accomplish a particular task. The agencies agree that these criteria could also be used as part of a basis for classification. We also note that many of these vehicles have front axle weight ratings greater than 14,600 pounds.

Although the agencies agree that these vocational tractors are operated differently than line-haul tractors and therefore fit more appropriately into the vocational vehicle category, we need to ensure that only tractors that are truly vocational tractors are classified as such. Upon further consideration of the comments received the agencies have decided to allow manufacturers to exclude certain vocational-type tractors from the combination tractor standards, and instead be subject to the standards for vocational vehicles. A vehicle determined by the manufacturer to be a HHD vocational tractor would fall into the HHD vocational vehicle subcategory and be regulated as a vocational vehicle. Similarly, MHD which the manufacturer chooses to reclassify as vocational tractors will be regulated as a MHD vocational vehicle. Specifically, under the provision being finalized at 40 CFR 1037.630 and NHTSA's regulation at 49 CFR 523.2 of today's rules only the following three types of vocational tractors are eligible for reclassification by the manufacturer:

- (1) Low-roof tractors intended for intra-city pickup and delivery, such as those that deliver bottled beverages to retail stores.
- (2) Tractors intended for off-road operation (including mixed service operation), such as those with reinforced frames and increased ground clearance.
- (3) Tractors with a GCWR over 120,000 pounds.

As adopted in 40 CFR 1037.230(a)(1)(xiii), manufacturers will be required to group vocational tractors into a unique family, separate from other combination tractors and vocational vehicles. The provision being adopted in 40 CFR 1037.630 and 49 CFR 535.8 requires the manufacturers to summarize in their applications their

basis for believing that the vehicles are eligible for manufacturer reclassification as vocational tractors. EPA and NHTSA could ask for a more detailed description of the basis and EPA would deny an application for certification where it determines the manufacturer lacks an adequate basis for reclassification. The manufacturer would then have to resubmit a modified application to certify the vehicles in question to the tractor standards. Where we determine that a manufacturer is not applying this allowance in good faith, we may require that manufacturer to obtain preliminary approval before using this allowance. This would mean that a manufacturer would need to submit its detailed records to EPA and receive formal approval before submitting its application for certification. The agencies plan to monitor how manufacturers classify their tractor fleets and would reconsider the issue of vocational tractor classification in a future rulemaking if necessary.

Because the difference between some vocational tractors and line-haul tractors is potentially somewhat subjective, we are also including an annual sales limit of 7,000 vocational tractors per manufacturer (based on a three year rolling average) consistent with past production volumes of such vehicles. It is important to note, however, that we do not expect it to be common for manufacturers to be able to justify classifying 7,000 vehicles as vocational tractors in a given model year.

Under the regulations being promulgated in 40 CFR 1037.630 and 49 CFR 523.2, manufacturers will be required to keep records of how they determined that such vehicles qualify as vocational. These records would be more detailed than the description submitted in the applications. Typically, this would be a combination of records of the design features and/or purchasers of the vehicles. The agencies have analyzed the design features that reflect the special needs of these vocational tractors in the three areas noted above—mixed service, heavy haul, and urban delivery. Mixed service applications, such as construction trucks, typically require higher ground clearance and approach angle to accommodate non-paved roads. In addition, they often require frame rails with greater resisting bending moment (RBM) because of the terrain where they operate.<sup>54</sup> The mixed service

<sup>54</sup> The agencies have found based on standard truck specifications, that vehicles designed for significant off-road applications, such as concrete

applications also sometimes require higher front axle weight ratings to accommodate extra loads and/or power take off systems for additional capability. Heavy haul tractors are typically designed with frame rails with extra strength (greater RBM) and higher front axle weight ratings to accommodate the heavy payloads. Often the heavy haul tractors will also have higher ground clearance and greater approach angle for similar reasons as the mixed service applications. Lastly, heavy haul vehicles require a total gear reduction of 57:1 or greater to provide the torque necessary to start the vehicle moving. Urban delivery tractors, such as beverage haulers, have less defined design features that reflect their operational needs. These vehicles offer options which include high RBM rails and front axle weight ratings, but not all beverage trucks are specified with these options. The primary differentiation of these urban delivery tractors is their operation. For this final rulemaking, the agencies projected the costs and benefits of the program considering this provision. As detailed in RIA Section 5.3.2.2.1, the agencies assumed that approximately 20 percent of short-haul tractors sold in 2014 model year and beyond will be vocational tractors. As such, these vehicles will experience benefits reflective of a FTP-certified engine and tire rolling resistance improvement at the technology costs projected in the rules for vocational vehicles.

(1) What is the form of the Class 7 and 8 tractor CO<sub>2</sub> emissions and fuel consumption standards?

As proposed, EPA and NHTSA are finalizing different standards for different subcategories of these tractors with the basis for subcategorization being particular tractor attributes. Attribute-based standards in general recognize the variety of functions performed by vehicles and engines, which in turn can affect the kind of technology that is available to control emissions and reduce fuel consumption, or its effectiveness. Attributes that characterize differences in the design of vehicles, as well as differences in how the vehicles will be employed in-use, can be key factors in evaluating technological improvements for

pumper and logging trucks have resisting bending moment greater than 2,100,000 lb-in. (ranging up to 3,580,000 lb-in.). The typical on highway tractors have resisting bending moment of 1,390,000 lb-in. An example line haul truck is the Mack Pinnacle which has a RBM of 1,390,000 lb-in, as shown at [http://www.macktrucks.com/assets/Mack\\_Marketing/Specifications/CXU6124x2PinAxle\\_Back.pdf](http://www.macktrucks.com/assets/Mack_Marketing/Specifications/CXU6124x2PinAxle_Back.pdf).

reducing CO<sub>2</sub> emissions and fuel consumption. Developing an appropriate attribute-based standard can also avoid interfering with the ability of the market to offer a variety of products to meet consumer demand. There are several examples of where the agencies have utilized an attribute-based standard. In addition to the example of the light-duty 2012–16 MY vehicle rule, in which the standards are based on the attribute of vehicle “footprint,” the existing heavy-duty highway engine standards for criteria pollutants have for many years been based on a vehicle weight attribute (Light Heavy, Medium Heavy, Heavy Heavy) with different useful life periods, which is a similar approach finalized for the engine GHG and fuel consumption standards discussed below.

Heavy-duty combination tractors are built to move freight. The ability of a vehicle to meet a customer’s freight transportation requirements depends on three major characteristics of the tractor: the gross vehicle weight rating (which along with gross combination weight rating (GCWR) establishes the maximum carrying capacity of the tractor and trailer), cab type (sleeper cabs provide overnight accommodations for drivers), and the tractor roof height (to mate tractors to trailers for the most fuel-efficient configuration). Each of these attributes impacts the baseline fuel consumption and GHG emissions, as well as the effectiveness of possible technologies, like aerodynamics, and is discussed in more detail below.

The first tractor characteristic to consider is payload which is determined by a tractor’s GVWR and GCWR relative to the weight of the tractor, trailer, fuel, driver, and equipment. Class 7 trucks, which have a GVWR of 26,001–33,000 pounds and a typical GCWR of 65,000 pounds, have a lesser payload capacity than Class 8 trucks. Class 8 trucks have a GVWR of greater than 33,000 pounds and a typical GCWR of greater than 80,000 pounds, the effective weight limit on the federal highway system except in states with preexisting higher weight limits. Consistent with the recommendation in the National Academy of Sciences 2010 Report to NHTSA,<sup>55</sup> the agencies are finalizing a load-specific fuel consumption metric (g/ton-mile and gal/1,000 ton-mile) where the “ton” represents the amount of payload. Generally, higher payload capacity vehicles have better specific fuel consumption and GHG emissions than lower payload capacity vehicles.

<sup>55</sup> See 2010 NAS Report, Note 21, Recommendation 2–1.

Therefore, since the amount of payload that a Class 7 vehicle can carry is less than the Class 8 vehicle’s payload capacity, the baseline fuel consumption and GHG emissions performance per ton-mile differs between the categories. It is consequently reasonable to distinguish between these two vehicle categories, so that the agencies are finalizing separate standards for Class 7 and Class 8 tractors.

The agencies are not finalizing a single standard for both Class 7 and 8 tractors based on the payload carrying capabilities and assumed typical payload levels of Class 8 tractors alone, as that would quite likely have the perverse impact of increasing fuel consumption and greenhouse gas emissions. Such a single standard would penalize Class 7 vehicles in favor of Class 8 vehicles. However, the greater capabilities of Class 8 tractors and their related greater efficiency when measured on a per ton-mile basis are only relevant in the context of operations where that greater capacity is needed. For many applications such as regional distribution, the trailer payloads dictated by the goods being carried are lower than the average Class 8 tractor payload. In those situations, Class 7 tractors are more efficient than Class 8 tractors when measured by ton-mile of actual freight carried. This is because the extra capabilities of Class 8 tractors add additional weight to vehicles that is only beneficial in the context of its higher capabilities. The existing market already selects for vehicle performance based on the projected payloads. By setting separate standards the agencies do not advantage or disadvantage Class 7 or 8 tractors relative to one another and continue to allow trucking fleets to purchase the vehicle most appropriate to their business practices.

The second characteristic that affects fuel consumption and GHG emissions is the relationship between the tractor cab roof height and the type of trailer used to carry the freight. The primary trailer types are box, flat bed, tanker, bulk carrier, chassis, and low boys. Tractor manufacturers sell tractors in three roof heights—low, mid, and high. The manufacturers do this to obtain the best aerodynamic performance of a tractor-trailer combination, resulting in reductions of GHG emissions and fuel consumption, because it allows the frontal area of the tractor to be similar in size to the frontal area of the trailer. In other words, high roof tractors are designed to be paired with a (relatively tall) box trailer while a low roof tractor is designed to pull a (relatively low) flat bed trailer. The baseline performance of

a high roof, mid roof, and low roof tractor differs due to the variation in frontal area which determines the aerodynamic drag. For example, the frontal area of a low roof tractor is approximately 6 square meters, while a high roof tractor has a frontal area of approximately 9.8 square meters. Therefore, as explained below, the agencies are using the roof height of the tractor to determine the trailer type required to be used to demonstrate compliance of a vehicle with the fuel consumption and CO<sub>2</sub> emissions standards. As with vehicle weight classes, setting separate standards for each tractor roof height helps ensure that all tractors are regulated to achieve appropriate improvements, without inadvertently leading to increased emissions and fuel consumption by shifting the mix of vehicle roof heights offered in the market away from a level determined by market forces linked to the actual trailers vehicles will haul in-use.

Tractor cabs typically can be divided into two configurations—day cabs and sleeper cabs. Line haul operations typically require overnight accommodations due to Federal Motor Carrier Safety Administration hours of operation requirements.<sup>56</sup> Therefore, some truck buyers purchase tractor cabs with sleeping accommodations, also known as sleeper cabs, because they do not return to their home base nightly. Sleeper cabs tend to have a greater empty curb weight than day cabs due to the larger cab volume and accommodations, which lead to a higher baseline fuel consumption for sleeper cabs when compared to day cabs. In addition, there are specific technologies, such as extended idle reduction technologies, which are appropriate only for tractors which hotel—such as sleeper cabs. To respect these differences, the agencies are finalizing separate standards for sleeper cabs and day cabs.<sup>57</sup>

The agencies received comments from industry stakeholders (EMA, Allison Transmission, Bosch, and the Heavy-Duty Fuel Efficiency Leadership Group) and ICCT supporting the nine tractor

regulatory subcategories proposed and did not receive any comments which supported an alternate classification. Thus, to account for the relevant combinations of these attributes, the agencies are adopting the classification scheme proposed, segmenting combination tractors into the following nine regulatory subcategories:

- Class 7 Day Cab With Low Roof
- Class 7 Day Cab With Mid Roof
- Class 7 Day Cab With High Roof
- Class 8 Day Cab With Low Roof
- Class 8 Day Cab With Mid Roof
- Class 8 Day Cab With High Roof
- Class 8 Sleeper Cab With Low Roof
- Class 8 Sleeper Cab With Mid Roof
- Class 8 Sleeper Cab With High Roof

Adjustable roof fairings are used today on what the agencies consider to be low roof tractors. The adjustable fairings allow the operator to change the fairing height to better match the type of trailer that is being pulled which can reduce fuel consumption and GHG emissions during operation. As proposed, the agencies are treating tractors with adjustable roof fairings as low roof tractors that will tested with the fairing in its lowest position.

(2) What are the Final Class 7 and 8 Tractor and Engine CO<sub>2</sub> Emissions and Fuel Consumption Standards and Their Timing?

In developing the final standards for Class 7 and 8 tractors and for the engines used in these tractors, the agencies have evaluated the current levels of emissions and fuel consumption, the kinds of technologies that could be utilized by truck and engine manufacturers to reduce emissions and fuel consumption from tractors and associated engines, the necessary lead time, the associated costs for the industry, fuel savings for the consumer, and the magnitude of the CO<sub>2</sub> and fuel savings that may be achieved. The technologies on whose performance the final tractor standards are predicated are improvements in aerodynamic design, lower rolling resistance tires, extended idle reduction technologies, and lightweighting of the tractor. The technologies on whose performance the final tractor standards are predicated are engine friction reduction, aftertreatment optimization, and turbocompounding, among others, as described in RIA Chapter 2.4. The agencies' evaluation showed that these technologies are available today, but have very low application rates on current vehicles and engines. EPA and NHTSA also present the estimated costs and benefits of the Class 7 and 8 combination tractor and engine standards in Section III and in RIA Chapter 2, explaining as well the

basis for the agencies' conclusion not to adopt standards which are less stringent or more stringent.

#### (a) Tractor Standards

The agencies are finalizing the following standards for Class 7 and 8 combination tractors in Table 0–1, using the subcategorization approach that was proposed. As explained below in Section III, EPA has determined that there is sufficient lead time to introduce various tractor and engine technologies into the fleet starting in the 2014 model year, and is finalizing standards starting for that model year predicated on performance of those technologies. EPA is finalizing more stringent tractor standards for the 2017 model year which reflect the CO<sub>2</sub> emissions reductions required for 2017 model year engines. (As explained in Section II.B(3)(h)(v) below, engine performance is one of the inputs into the compliance model, and that input will change in 2017 to reflect the 2017 MY engine standards.) The 2017 MY vehicle standards are not premised on tractor manufacturers installing additional vehicle technologies. EPA's final standards apply throughout the useful life period as described in Section V. As proposed, and as discussed further in Section IV below, manufacturers may generate and use credits from Class 7 and 8 combination tractors to show compliance with the standards.

NHTSA is finalizing Class 7 and 8 tractor fuel consumption standards that are voluntary standards in the 2014 and 2015 model years and become mandatory beginning in the 2016 model year, as required by the lead time within EISA. The 2014 and 2015 model year standards are voluntary in that manufacturers are not subject to them unless they opt-in to the standards.<sup>58</sup> Manufacturers that opt in become subject to NHTSA standards for all regulatory categories. NHTSA is also adopting new tractor standards for the 2017 model year which reflect additional improvements in only the heavy-duty engines. As proposed, NHTSA is not implementing an in-use compliance program for fuel consumption because it does not anticipate that there will be notable deterioration of fuel consumption over the useful life of the vehicle.

As explained more fully in Section III and Chapter 2 of the RIA, EPA and NHTSA are not adopting more stringent tractor standards for 2014–2017 MY. The final tractor standards are based on

<sup>56</sup> The Federal Motor Carrier Safety Administration's Hours-of-Service regulations put limits in place for when and how long commercial motor vehicle drivers may drive. They are based on an exhaustive scientific review and are designed to ensure truck drivers get the necessary rest to perform safe operations. See 49 CFR part 395, and see also <http://www.fmcsa.dot.gov/rules-regulations/topics/hos/index.htm> (last accessed August 8, 2010).

<sup>57</sup> The agencies note, as discussed in the previous section, that some day cabs and sleeper cabs will be reclassified as vocational tractors and if so will not be subject to the combination tractor standards.

<sup>58</sup> Once a manufacturer opts into the NHTSA program it must stay in the program for all the optional MYs.

the maximum application rates of available technologies considering the available lead time, and we explain in

Section III and Chapter 2 of the RIA that use of additional technologies, or further application of the technologies

already mentioned would be either infeasible in the lead time afforded, or uneconomic.

TABLE II-1—HEAVY-DUTY COMBINATION TRACTOR EMISSIONS AND FUEL CONSUMPTION STANDARDS

	Day cab		Sleeper cab
	Class 7	Class 8	Class 8
2014 Model Year CO <sub>2</sub> Grams per Ton-Mile			
Low Roof .....	107	81	68
Mid Roof .....	119	88	76
High Roof .....	124	92	75
2014–2016 Model Year Gallons of Fuel per 1,000 Ton-Mile <sup>59</sup>			
Low Roof .....	10.5	8.0	6.7
Mid Roof .....	11.7	8.7	7.4
High Roof .....	12.2	9.0	7.3
2017 Model Year CO <sub>2</sub> Grams per Ton-Mile			
Low Roof .....	104	80	66
Mid Roof .....	115	86	73
High Roof .....	120	89	72
2017 Model Year and Later Gallons of Fuel per 1,000 Ton-Mile			
Low Roof .....	10.2	7.8	6.5
Mid Roof .....	11.3	8.4	7.2
High Roof .....	11.8	8.7	7.1

The standard values shown above differ somewhat from the proposal, reflecting refinements made to the GEM in response to comments. For example, the agencies received comments from stakeholders concerned that the 2017 MY tractor standards appeared to be backsliding because the reductions were not in line with the reductions expected from the 2017 MY engine standards. The agencies reviewed the issue and found that the engine maps we created in the GEM for the 2017 model year for the proposal did not appropriately reflect the engine improvements. Therefore, the agencies developed new fuel maps for the GEM v2.0 which fully reflect the engine improvements due to the 2017 MY standards.<sup>60</sup> These changes to the GEM did not impact our estimates of the relative effectiveness of the greenhouse gas emissions and fuel consumption improving technologies modeled in this final action nor the overall cost or benefits estimated for these final vehicle standards.

Based on our analysis, the 2017 model year standards for combination tractors and engines represent up to a 23 percent reduction in CO<sub>2</sub> emissions and fuel

consumption over a 2010 model year baseline tractor (the baseline sleeper cab does not include idle shutdown technology), as detailed in Section III.A.2. In considering the feasibility of vehicles to comply with the standards, EPA also considered the potential for CO<sub>2</sub> emissions to increase during the regulatory useful life of the product. As we discuss separately in the context of deterioration factor (DF) testing, we have concluded that CO<sub>2</sub> emissions are likely to stay the same or actually decrease in-use compared to new certified configurations. In general, engine and vehicle friction decreases as products wear in leading to reduced parasitic losses and lower CO<sub>2</sub> emissions. Similarly, tire rolling resistance falls as tires wear due to the reduction in tread height. In the case of aerodynamic components, we project no change in performance through the regulatory life of the vehicle since there is essentially no change in their physical form as vehicles age. Similarly, weight reduction elements such as aluminum wheels are not projected to increase in mass through time, and hence, we can conclude will not deteriorate with regard to CO<sub>2</sub> performance in-use. Given all of these considerations, EPA is confident in projecting that the standards finalized today will be technical feasible

throughout the regulatory useful life of the program.

(b) Standards for Engines Installed in Combination Tractors

EPA is adopting GHG standards and NHTSA is adopting fuel consumption standards for new heavy-duty engines. This section discusses the standards for engines used in Class 7 and 8 combination tractors and also provides some overall background information. We also note that the agencies are adopting standards for heavy-duty engines used in vocational vehicles. However, as explained further below, compliance with the standards would be measured using different test procedures, corresponding with actual vehicle use, depending on whether the vehicle in which the engine is installed is a Class 7 and 8 combination tractor or a vocational vehicle.

The heavy-duty engine standards vary depending on the type of vehicle in which they are installed, as well as whether the engines are compression ignition or spark ignition. The agencies are adopting separate engine fuel consumption and GHG emissions standards for engines installed in combination tractors versus engines installed in vocational vehicles. Also, for the purposes of the GHG engine emissions and engine fuel consumption standards, the agencies are adopting engine subcategories that match EPA's

<sup>59</sup> As noted above, manufacturers may voluntarily opt-in to the NHTSA fuel consumption program in 2014 or 2015. Once a manufacturer opts into the NHTSA program it must stay in the program for all the optional MYs.

<sup>60</sup> See RIA Chapter 4 for the engine fuel maps used in GEM v2.0.

existing criteria pollutant emissions regulations for heavy-duty highway engines which established four regulatory service classes that represent the engine's intended and primary vehicle application.<sup>61</sup> The Light Heavy-Duty (LHD) diesel engines are intended for application in Class 2b through Class 5 trucks (8,501 through 19,500 pounds GVWR). The Medium Heavy-Duty (MHD) diesel engines are intended for Class 6 and Class 7 trucks (19,501 through 33,000 pounds GVWR). The Heavy Heavy-Duty (HDD) diesel engines are primarily used in Class 8 trucks (33,001 pounds and greater GVWR). Lastly, spark ignition engines (primarily

gasoline-powered engines) installed in incomplete vehicles less than 14,000 pounds GVWR and spark ignition engines that are installed in all vehicles (complete or incomplete) greater than 14,000 pounds GVWR are grouped into a single engine service class. The engines in these four regulatory service classes range in size between approximately five liters and sixteen liters. This subcategory structure enables the agencies to set standards that appropriately reflect the technology available for engines installed in each type of vehicle, and that are therefore technologically feasible for these engines. This is the same engine

classification scheme the agencies proposed, and there were no adverse comments in response to the proposal. Heavy heavy-duty diesel and medium heavy-duty diesel engines are used today in combination tractors. The following section refers to the engine standards for these types of engines. This section does not cover gasoline or light heavy-duty diesel engines because they are not used in combination tractors. In the NPRM, the agencies proposed CO<sub>2</sub> and fuel consumption standards for HD diesel engines to be installed in Class 7 and 8 combination tractors as shown in Table II-2.<sup>62</sup>

TABLE II-2—PROPOSED HEAVY-DUTY DIESEL ENGINE STANDARDS FOR ENGINES INSTALLED IN TRACTORS

	Effective 2014 model year		Effective 2017 Model Year	
	CO <sub>2</sub> standard (g/bhp-hr)	Voluntary fuel consumption standard (gal/100 bhp-hr)	CO <sub>2</sub> standard (g/bhp-hr)	Fuel consumption standard (gal/100 bhp-hr)
MHD diesel engine .....	502	4.93	487	4.78
HHD diesel engine .....	475	4.67	460	4.52

The agencies proposed to require diesel engine manufacturers to achieve, on average, a three percent reduction in fuel consumption and CO<sub>2</sub> emissions for the 2014 standards over the baseline MY 2010 performance for the engines.<sup>63</sup> The agencies' preliminary assessment of the findings of the 2010 NAS Report and other literature sources indicated that there are technologies available to reduce fuel consumption by this amount in the time frame in the lead time provided by the rules. These technologies include improved turbochargers, aftertreatment optimization, and low temperature exhaust gas recirculation.

The agencies also proposed to require diesel engine manufacturers to achieve, on average, a six percent reduction in fuel consumption and CO<sub>2</sub> emissions for the 2017 MY standards over the baseline MY 2010 performance for MHD and HHD diesel engines required to use the SET-based standard. The agencies stated that additional reductions could likely be achieved through the increased refinement of the technologies projected to be implemented for 2014, plus the addition of turbocompounding, which

the agencies' analysis showed would require a longer development time and would not be available in MY 2014. The agencies therefore proposed to provide additional lead time to allow for the introduction of this additional technology, and to wait until 2017 to increase stringency to levels reflecting application of this technology.

The agencies proposed that the MHD and HHD diesel engine CO<sub>2</sub> standards for Class 7 and 8 combination tractors would become effective in MY 2014 for EPA, with more stringent CO<sub>2</sub> standards becoming effective in MY 2017, while NHTSA's fuel consumption standards would become effective in MY 2017, which would be both consistent with the EISA four-year minimum lead-time requirements and harmonized with EPA's timing. The agencies explained that the three-year timing, besides being required by EISA, made sense because EPA's heavy-duty highway engine program for criteria pollutants had begun to provide new emissions standards for the industry in three year increments, which had caused the heavy-duty engine product plans to fall largely into three year cycles reflecting

this regulatory environment. To further harmonize with EPA, NHTSA proposed voluntary fuel consumption standards for MHD and HHD diesel engines that are equivalent to EPA CO<sub>2</sub> standards for MYs 2014-2016, allowing manufacturers to opt into the voluntary standards in any of those model years.<sup>64</sup> NHTSA proposed that manufacturers could opt into the program by declaring their intent to opt in to the program at the same time they submit the Pre-Certification Compliance Report, and that a manufacturer opting into the program would begin tracking credits and debits beginning in the model year in which they opt into the program. Both agencies proposed to allow manufacturers to generate and use credits to achieve compliance with the HD diesel engine standards, including averaging, banking, and trading (ABT) and deficit carry-forward. The agencies sought comment on the proposed MHD and HHD engine standards and timing.

The agencies received comments from EMA, Navistar, Cummins, ACEEE, Center for Biological Diversity, Detroit Diesel Corporation, American Lung Association, and the Union of

<sup>61</sup> See 40 CFR 86.90-2.

<sup>62</sup> The agencies note that the CO<sub>2</sub> and fuel consumption standards for Class 7 and 8 combination tractors do not cover gasoline or LHDD engines, as those are not used in Class 7 and 8 combination tractors.

<sup>63</sup> The baseline HHD diesel engine performance in MY 2010 on the SET is 490 g CO<sub>2</sub>/bhp-hr (4.81 gal/100 bhp-hr), as determined from confidential data provided by manufacturers and data submitted for the non-GHG emissions certification process. The baseline MHD diesel engine performance on the SET cycle is 518 g CO<sub>2</sub>/bhp-hr (5.09 gallon/100-bhp-hr) in MY 2010. Further discussion of the

derivation of the baseline can be found in Section III.

<sup>64</sup> Once a manufacturer opts into the NHTSA program it must stay in the program for all the optional MYs and remain standardized with the implementation approach being used to meet the EPA emission program.

Concerned Scientists. Comments were divided with respect to the proposed levels of stringency. While Cummins and DDC expressed support for the CO<sub>2</sub> and fuel consumption standards for diesel engines, and EMA and Navistar stated the standards could be met if the flexibilities outlined in the NPRM are finalized as proposed, Navistar also stated that the model year 2017 standard may not be feasible since what the agencies characterized as existing technologies are not in production for all manufacturers. In contrast, environmental groups and NGOs stated that the standards did not reflect the potential reductions outlined in the 2010 NAS study and should be more stringent. CBD argued that the standards were not set at the maximum feasible level by definition, because the agencies had said that they were based on the use of existing technologies. In addition, the Center for Neighborhood Technology encouraged the agencies to implement the rules as soon as possible, beginning in the 2012 model year.

In light of the above comments, the agencies re-evaluated the technical basis for the heavy-duty engine standards. The baseline HHD diesel engine performance in 2010 model year on the SET is estimated at 490 g CO<sub>2</sub>/bhp-hr (4.81 gal/100 bhp-hr), based on our analysis of confidential data provided by manufacturers and data submitted for

the non-GHG emissions certification process. Similarly, the baseline MHD diesel engine performance on the SET cycle is estimated to be 518 g CO<sub>2</sub>/bhp-hr (5.09 gallon/100-bhp-hr) for the 2010 model year. Further discussion of the derivation of the baseline can be found in Section III. The agencies believe that the MY 2014 standards can be achieved by most manufacturers through the use of technologies time frame such as improved aftertreatment systems, friction reduction, improved auxiliaries, turbochargers, pistons, and other components. These standards will require diesel engine manufacturers to achieve on average a three percent reduction in fuel consumption and CO<sub>2</sub> emissions over the baseline 2010 model year levels.

However, in recognizing that some manufacturers have engines that would not meet the standard even after applying technologies that improve GHG emissions and fuel consumption by three percent, the agencies are finalizing both the proposed ABT provisions for these engines and also an optional alternate engine standard for 2014 model year, described in more detail below. We believe that concerns expressed by Navistar regarding the 2014 MY standards will be addressed by this alternative standard. The agencies also continue to believe that the 2017 MY standards are achievable using the

above approaches and, in the case of SET certified engines, turbocompounding. While Navistar commented that the 2017 MY standard may be challenging because not all manufacturers are presently producing the technologies that may be required to meet the standards, the agencies believe that since manufacturers that may require turbocompounding to meet the standards will not have to do so until 2017 MY, there will be sufficient lead time for all manufacturers to introduce this technology. As noted above, by MY 2017 all MHD and HHD engines installed in combination tractors should have gone through a redesign during which all needed technology can be applied. We note that we are finalizing these standards as proposed based on the assessment that most manufacturers (not just Navistar) will need to make improvements to existing engine systems in order to meet the standards. EPA's HD diesel engine CO<sub>2</sub> emission standards and NHTSA's HD diesel engine fuel consumption standards for engines installed in tractors are presented in Table II-3. As explained above, the first set of standards take effect with MY 2014 (mandatory standards for EPA, voluntary standards for NHTSA), and the second set take effect with MY 2017 (mandatory for both agencies).

TABLE II-3—FINAL HEAVY-DUTY DIESEL ENGINE STANDARDS FOR ENGINES INSTALLED IN TRACTORS

	Effective 2014 model year		Effective 2017 model year	
	CO <sub>2</sub> standard (g/bhp-hr)	Voluntary fuel consumption standard (gal/100 bhp-hr)	CO <sub>2</sub> standard (g/bhp-hr)	Fuel consumption standard (gal/100 bhp-hr)
MHD diesel engine .....	502	4.93	487	4.78
HHD diesel engine .....	475	4.67	460	4.52

The agencies have also decided to remove NHTSA's proposed Pre-Certification Compliance Report requirement. Instead, manufacturers must submit their decision to opt into NHTSA's voluntary standards for the 2014 through 2016 model years as part of its certification process with EPA. Once a manufacturer opts into the NHTSA program it must stay in the program for all the subsequent optional model years. Manufacturers that opt in become subject to NHTSA standards for all regulatory categories. The declaration statement must be entered prior to or at the same time the manufacturer submits its first application for a certificate of conformity. NHTSA will begin tracking

credits and debits beginning in the model year in which a manufacturer opts into its program.

Compliance with the CO<sub>2</sub> emissions and fuel consumption standards will be evaluated based on the SET engine test cycle. In the NPRM, the agencies proposed standards based on the SET cycle for MHD and HHD engines used in tractors due to these engines' primary use in steady state operating conditions (typified by highway cruising). Tractors spend the majority of their operation at steady state conditions, and will obtain in-use benefit of technologies such as turbocompounding and other waste heat recovery technologies during this kind of typical engine operation. Therefore, the engines installed in tractors will be

required to meet the standard based on the SET, which is a steady state test cycle.

The agencies gave full consideration to the need for engine manufacturers to redesign and upgrade their engines during the MYs 2014–2017 to meet standards, and fully considered the cost-effectiveness of the standards and the available lead time. The final two-step CO<sub>2</sub> emission and fuel consumption standards recognize the opportunity for technology improvements over the rulemaking time frame, while reflecting the typical engine manufacturers' product plan cycles. Over these four model years there will be an opportunity for manufacturers to evaluate almost every one of their

engine models and add technology in a cost-effective way, consistent with existing redesign schedules, to control GHG emissions and reduce fuel consumption. The time-frame and levels for the standards, as well as the ability to average, bank and trade credits and carry a deficit forward for a limited time, are expected to provide manufacturers the time and flexibilities needed to incorporate technology that will achieve the final GHG and fuel consumption standards within the normal engine redesign process. This is an important aspect of the final rules, as it will avoid the much higher costs that would occur if manufacturers needed to add or change technology at times other than these scheduled redesigns.<sup>65</sup> This time period will also provide manufacturers the opportunity to plan for compliance using a multi-year time frame, again in alignment with their normal business practice. Further details on lead time, redesigns and technical feasibility can be found in Section III.

The agencies continue to believe the standards for MHD and HHD diesel engines installed in combination tractors are the most stringent technically feasible in the time frame established in this regulation. The standards will require a 3 percent reduction in engine fuel consumption and GHG emissions in 2014 MY based on improvements to engine components and aftertreatment systems. The 2017 MY standards will require a 6 percent reduction in fuel consumption and GHG emissions over a 2010 model year baseline and assumes the introduction, for some engines, of technologies such as turbocompounding. The standards, however, are not premised on the introduction of technologies that are still in development—such as Rankine

bottoming cycle—since these approaches cannot be introduced without further technical development or engine re-design.<sup>66</sup>

Additional discussion on technical feasibility is included in Section III below and in Chapter 2 of the RIA.

The agencies recognize, however, that the schedule of changes for the final standards may not be the most cost-effective one for all manufacturers. The agencies also sought comment as to whether an alternate phase-in schedule for the HD diesel engine standards for combination tractors should be considered. In developing the proposal, heavy-duty engine manufacturers stated that the phase-in of the GHG and fuel consumption standards should be aligned with the On Board Diagnostic (OBD)<sup>67</sup> phase-in schedule, which includes new requirements for heavy-duty vehicles in the 2013 and 2016 model years. The agencies did not adopt this suggestion in the proposal, explaining that the credit averaging, banking and trading provisions would provide manufacturers with considerable flexibility to manage their GHG and fuel efficiency standard compliance plans—including the phase-in of the new heavy-duty OBD requirements—but requested comment on whether EPA and NHTSA should provide an alternate phase-in schedules that would more explicitly accommodate this request in the event that manufacturers did not agree that the ABT provisions mitigated their concern about the GHG/fuel consumption standard phase-in. See 75 FR at 74178.

In response, Cummins, Engine Manufacturers Association, and DTNA commented that their first choice was a delay in the OBD effective date for one year to the 2014 model year. The

industry's second choice was to provide manufacturers with an optional GHG and fuel consumption phase-in that aligns their product development plans with their current plans to meet the OBD regulations for EPA and California in the 2013 and 2016 model years. These commenters argued that meeting the OBD regulation in the 2013 model year already poses a significant challenge, and that having to meet GHG and fuel consumption standards beginning in 2014 could require them to redesign and recertify their products just one year later. They argued that bundling design changes where possible can reduce the burden on industry for complying with regulations, so aligning the introduction of the OBD, GHG, and fuel consumption standards could help reduce manufacturers' burden for product development, validation and certification.

In order to provide additional flexibility for manufacturers looking to align their technology changes with multiple regulatory requirements, the agencies are finalizing an alternate "OBD phase-in" option for meeting the standards for MHD and HHD diesel engines installed in tractors (in addition to engines installed in vocational vehicles as noted below in Section II.D), which delivers equivalent CO<sub>2</sub> emissions and fuel consumption reductions as the primary standards for the engines built in the 2013 through 2017 model years, as shown in Table II-4. The optional OBD phase-in schedule requires that engines built in the 2013 and 2016 model years to achieve greater reductions than the engines built in those model years under the primary program, but requires fewer reductions for the engines built in the 2014 and 2015 model years.

TABLE II-4—COMPARISON OF CO<sub>2</sub> REDUCTIONS FOR THE HHD AND MHD TRACTOR STANDARDS UNDER THE ALTERNATIVE OBD PHASE-IN AND PRIMARY PHASE-IN

	HHD Tractor engines			MHD Tractor engines		
	Primary phase-in standard (g/bhp-hr)	Optional phase-in standard (g/bhp-hr)	Difference in lifetime CO <sub>2</sub> engine emissions (MMT)	Primary phase-in standard (g/bhp-hr)	Optional phase-in standard (g/bhp-hr)	Difference in lifetime CO <sub>2</sub> engine emissions (MMT)
Baseline .....	490	490	—	518	518	—
2013 MY Engine .....	490	485	14	518	512	17
2014 MY Engine .....	475	485	-28	502	512	-28
2015 MY Engine .....	475	485	-28	502	512	-28
2016 MY Engine .....	475	460	42	502	487	42
2017 MY Engine .....	460	460	0	487	487	0
Net Reductions (MMT) .....			0			3

<sup>65</sup> See 75 FR at 25467-68 for further discussion of the negative cost implications of establishing requirements outside of the redesign cycle.

<sup>66</sup> See RIA Chapter 2.4.2.7.

<sup>67</sup> On-board diagnostics (OBD) is a computer-based emissions monitoring system that was first

required in 2007 for vehicles under 14,000 pounds (65 FR 59896, Oct. 6, 2000) and in 2010 for vehicles over 14,000 pounds (74 FR 8310, Feb. 24, 2009).

The technologies for the 2013 model year optional standard include a subset of technologies that could be used to meet the primary 2014 model year standard. The agencies believe this approach is appropriate because the shorter lead time provided for manufacturers selecting this option limits the technologies which can be applied. However, in order to maintain equivalent CO<sub>2</sub> emissions and fuel consumption reduction over the 2013 through 2017 model year period, it is

necessary for the 2016 model year standard to be equal to the 2017 model year standard, using the same technology paths described for the primary engine program. If a manufacturer selects this optional phase-in, then the engines must be certified starting in the 2013 model year and continue using this phase-in through 2016 model year. That is, once electing this compliance path, manufacturers must adhere to it.<sup>68</sup> Manufacturers may opt into the optional

OBD phase-in through the voluntary NHTSA program, but must opt in in the 2013 model year and continue using this phase-in through the 2016 model year. Manufacturers that opt in to the voluntary NHTSA program in 2014 and 2015 will be required to meet the primary phase-in schedule and may not adopt the OBD phase-in option. Table II-5 below presents the final HD diesel engine CO<sub>2</sub> emission standards under the “OBD phase-in” option.

TABLE II-5—OPTIONAL HEAVY-DUTY ENGINE STANDARD PHASE-IN SCHEDULE FOR TRACTOR ENGINES

	MHD Diesel engine	HHD Diesel engine
Effective 2013 Through 2015 Model Year		
CO <sub>2</sub> Standard (g/bhp-hr) .....	512	485
Voluntary Fuel Consumption Standard (gallon/100 bhp-hr) .....	5.03	4.76
Effective 2016 Model Year and Later		
CO <sub>2</sub> Standard (g/bhp-hr) .....	487	460
Fuel Consumption (gallon/100 bhp-hr) .....	4.78	4.52

Although the agencies believe that the standards for the HD diesel engines installed in combination tractors are generally appropriate, cost-effective, and technologically feasible in the rulemaking time frame, we also recognize that when regulating a category of engines for the first time, there will be individual products that may deviate significantly from the baseline level of performance, whether because of a specific approach to criteria pollution control, or due to engine calibration for specific applications or duty cycles. In the current fleet of 2010 and 2011 model year engines used in combination tractors, NHTSA and EPA understand that there is a relatively small group of legacy engines that are up to approximately 25 percent worse than the average baseline for other engines. For this group of legacy MHD and HHD diesel engines installed in tractors, when compared to the typical performance levels of the majority of the engines in the fleet and the fuel consumption/GHG emissions reductions that the majority of engines would achieve through increased application of technology, the same reduction from the industry baseline may not be possible at reasonably comparable cost given the same amount of lead-time, because these products may require a total redesign in order to meet the standards. Manufacturers of the MHD and HHD diesel engines installed in tractors with atypically high baseline

CO<sub>2</sub> and fuel consumption levels may also, in some instances, have a limited line of engines across which to average performance to meet the generally-applicable standards.

To account for this possibility, the agencies requested comment in the NPRM on the establishment of an optional alternative MHD and HHD engine standard for those engines installed in combination tractors which would be set at 3 percent below a manufacturer’s 2011 engine baseline emissions and fuel consumption, or alternatively, at 2 percent below a manufacturer’s 2011 baseline. The agencies also requested comment on extending this optional standard one year (to the 2017 MY) for a single engine family at a 6 percent level below the 2011 baseline.<sup>69</sup> This option would not be available unless and until a manufacturer had exhausted all available credits and credit opportunities, and engines under the optional standard could not generate credits.

In comments to the NPRM, Navistar supported the alternative engine standard, but recommended that it be set at 2 percent below the manufacturer’s 2011 baseline. They also supported the extension to 2017 MY at 6 percent. Navistar provided CBI in support of its comments. Volvo, DTNA, environmental groups, NGOs, and the New York State Department of Environmental Conservation opposed the optional engine standard, arguing

that existing flexibilities are sufficient to allow compliance with the standards and that all manufacturers should be held to the same standards.

Based on the CBI submitted by Navistar, the agencies found that a large majority of the HD diesel engines used in Class 7 and 8 combination tractors were relatively close to the average baseline, with some above and some below, but also that some legacy MHD and HHD diesel engines were far enough away from the baseline that they could not meet the generally-applicable standards with application of technology that would be available for those specific engines by 2014. The agencies continue to believe that an interim alternative standard is needed for these products, and that an interim standard reflects a legitimate difference between products starting from different fuel consumption/GHG emitting baselines. As explained in the proposal, it is legally permissible to accommodate short term lead time constraints with alternative standards. Commenters did not dispute that there are legacy engine families with significantly higher CO<sub>2</sub> emissions and fuel consumption baselines, and that these engines require longer lead time to meet the principal standards in the early model years of the program. Although the agencies acknowledge the view that all manufacturers should be subject to the same burden for meeting the primary standards, the agencies believe that, in the initial years of a new program,

<sup>68</sup> See § 1036.150(e).

<sup>69</sup> See 75 FR at 74178–74179.



additional flexibilities should be provided. The GHG standards and fuel consumption standards are first-time standards for these engines, so the possibility of significantly different baselines is not unexpected.<sup>70</sup> Moreover, the agencies do not believe that the alternative standard affords a relative competitive advantage to the higher emitting legacy engines: the same level of improvement at the same cost will be required of those tractor engines, and in addition, by 2017 MY, those tractor engines will be required to make the additional improvements to meet the same standards as other engines. We believe that the concern expressed by Navistar regarding the 2014 MY standards will be addressed by this alternative. The agencies also continue to believe the 2017 MY standards are achievable using the above approaches and, in the case of MHD and HHD engines installed in tractors, turbocompounding. While Navistar commented that the 2017 MY standard may be challenging, the agencies believe that since manufacturers which may need to use turbocompounding to meet the standards will not have to do so until 2017 MY, there will be sufficient lead time for all engine manufacturers to introduce this technology. Thus, the agencies are finalizing a regulatory alternative whereby a manufacturer, for an interim period of the 2014–2016 model years, would have the option to comply with a unique standard based on a three percent reduction from an individual engine's own 2011 model year baseline level. Our assessment is that this three percent reduction is appropriate given the potential for manufacturers to apply similar technology packages with similar cost to what we have estimated for the primary program. This is similar to EPA's approach in the light-duty rule for handling a certain subset of vehicles that were deemed unable to meet the generally-applicable GHG standards during the 2012–2015 time frame due to higher initial baseline conditions, and which therefore needed alternate standards in those model years.<sup>71</sup>

The agencies stress that this is a temporary and limited option being implemented to address diverse manufacturer needs associated with complying with this first phase of the regulations. As codified in 40 CFR 1036.620 and 49 CFR 535.5(d), this optional standard will be available only for the 2014 through 2016 model years, because we believe that manufacturers will have had ample opportunity to

make appropriate changes to bring their product performance into line with the rest of the industry after that time. As proposed, the final rules require that manufacturers making use of these provisions for the optional standard would need to exhaust all credits available to this averaging set prior to using this flexibility and would not be able to generate emissions credits from other engines in the same regulatory averaging set as the engines complying using this alternate approach.

The agencies note again that manufacturers choosing to utilize this option in MYs 2014–2016 will have to make a greater relative improvement in MY 2017 than the rest of the industry, since they will be starting from a worse level—for compliance purposes, emissions from engines certified and sold at the three percent level will be averaged with emissions from engines certified and sold at more stringent levels to arrive at a weighted average emissions for all engines in the subcategory. Again, this option can only be taken if all other credit opportunities have been exhausted and the manufacturer still cannot meet the primary standards. If a manufacturer chooses this option to meet the EPA emission standards in the MY 2014–2016, and wants to opt into the NHTSA fuel consumption program in these same MYs it must follow the exact path followed under the EPA program utilizing equivalent fuel consumption standards. Since the NHTSA standards are optional in 2014, manufacturers may choose not to adopt either the alternative engine standard or the regular voluntary standard by not participating in the NHTSA program in 2014 and 2015.

Some commenters argued that manufacturers could game the standard by establishing an artificially high 2011 baseline emission level. This could be done, for example, by certifying an engine with high fuel consumption and GHG emissions that is either: (1) Not sold in significant quantities; or (2) later altered to emit fewer GHGs and consume less fuel through service changes. In order to mitigate this possibility, the agencies are requiring that the 2011 model year baseline must be developed by averaging emissions over all engines in an engine family certified and sold for that model year so as to prevent a manufacturer from developing a single high GHG output engine solely for the purpose of establishing a high baseline. As an alternative, if a manufacturer does not certify all engine families in an averaging set to the alternate standards, then the tested configuration of the

engine certified to the alternate standard must have the same engine displacement and its rated power within 5 percent of the highest rated power of the baseline tested configuration. In addition, the tested configuration of the engine certified to the alternate standard must be a configuration sold to customers. These three requirements will prevent a manufacturer from producing an engine with an artificially high power rating and therefore produce artificially low grams of CO<sub>2</sub> emissions and fuel consumption per brake horsepower. In addition, the tested configurations must have a BSFC equivalent to or better than all other configurations within the engine family which will prevent a manufacturer from creating a baseline configuration with artificially high CO<sub>2</sub> emissions and fuel consumption.

### (c) In-Use Standards

Section 202(a)(1) of the CAA specifies that EPA is to adopt emissions standards that are applicable for the useful life of the vehicle. The in-use standards that EPA is finalizing would apply to individual vehicles and engines. NHTSA is adopting an approach which does not include in-use standards.

EPA proposed that the in-use standards for heavy-duty engines installed in tractors be established by adding an adjustment factor to the full useful life emissions and fuel consumption results projected in the EPA certification process to address measurement variability inherent in comparing results among different laboratories and different engines. The agency proposed a two percent adjustment factor and requested comments and additional data during the proposal to assist in developing an appropriate factor level. The agency received additional data during the comment period which identified production variability which was not accounted for at proposal. Details on the development of the final adjustment factor are included in RIA Chapter 3. Based on the data received, EPA determined that the adjustment factor in the final rules should be higher than the proposed level of two percent. EPA is finalizing a three percent adjustment factor for the in-use standard to provide a reasonable margin for production and test-to-test variability that could result in differences between the initial emission test results and emission results obtained during subsequent in-use testing.

We are finalizing regulatory text (in § 1036.150) to allow engine manufacturers to use assigned

<sup>70</sup> See 75 FR at 74178.

<sup>71</sup> See 75 FR 25414–25419.

deterioration factors (DFs) without performing their own durability emission tests or engineering analysis. However, the engines would still be required to meet the standards in actual use without regard to whether the manufacturer used the assigned DFs. This allowance is being adopted as an interim provision applicable only for this initial phase of standards.

Manufacturers will be allowed to use an assigned additive DF of 0.0 g/bhp-hr for CO<sub>2</sub> emissions from any conventional engine (*i.e.*, an engine not including advance or innovative technologies). Upon request, we could allow the assigned DF for CO<sub>2</sub> emissions from engines including advance or innovative technologies, but only if we determine that it would be consistent with good engineering judgment. We believe that we have enough information about in-use CO<sub>2</sub> emissions from conventional engines to conclude that they will not increase as the engines age. However, we lack such information about the more advanced technologies.

EPA is also finalizing the proposed provisions requiring that the useful life for these engine and vehicles with respect to GHG emissions be set equal to the respective useful life periods for criteria pollutants. EPA is adopting provisions where the existing engine useful life periods, as included in Table II-6, be broadened to include CO<sub>2</sub> emissions for both engines (*See* 40 CFR 1036.108(d)) and tractors (*See* 40 CFR 1037.105).

TABLE II-6—TRACTOR AND ENGINE USEFUL LIFE PERIODS

	Years	Miles
Medium Heavy-Duty Diesel Engines .....	10	185,000
Heavy Heavy-Duty Diesel Engines .....	10	435,000
Class 7 Tractors .....	10	185,000
Class 8 Tractors .....	10	435,000

(3) Test Procedures and Related Issues

The agencies are finalizing a complete set of test procedures to evaluate fuel consumption and CO<sub>2</sub> emissions from Class 7 and 8 tractors and the engines installed in them. Consistent with the proposal, the test procedures related to the tractors are all new, while the engine test procedures already established were built substantially on EPA's current non-GHG emissions test procedures, except as noted. This section discusses the final simulation model developed for demonstrating compliance with the tractor standard and the final engine test procedures.

(a) Vehicle Simulation Model

We are finalizing as proposed separate engine and vehicle-based emission standards to achieve the goal of reducing emissions and fuel consumption for both combination tractors and engines. Engine manufacturers are subject to the engine standards while the Class 7 and 8 tractor manufacturers are required to install certified engines in their tractors. The tractor manufacturer is also subject to a separate vehicle-based standard which utilizes a vehicle simulation model to evaluate the impact of the tractor cab design to determine compliance with the tractor standard.

A simulation model, in general, uses various inputs to characterize a vehicle's properties (such as weight, aerodynamics, and rolling resistance) and predicts how the vehicle would behave on the road when it follows a driving cycle (vehicle speed versus time). On a second-by-second basis, the model determines how much engine power needs to be generated for the vehicle to follow the driving cycle as closely as possible. The engine power is then transmitted to the wheels through transmission, driveline, and axles to move the vehicle according to the driving cycle. The second-by-second fuel consumption of the vehicle, which corresponds to the engine power demand to move the vehicle, is then calculated according to a fuel consumption map in the model. Similar to a chassis dynamometer test, the second-by-second fuel consumption is aggregated over the complete drive cycle to determine the fuel consumption of the vehicle.

Consistent with the proposal, NHTSA and EPA are finalizing a procedure to evaluate fuel consumption and CO<sub>2</sub> emissions respectively through a simulation of whole-vehicle operation, consistent with the NAS recommendation to use a truck model to evaluate truck performance.<sup>72</sup> The EPA developed the Greenhouse gas Emissions Model (GEM) for the specific purpose of this rulemaking to evaluate truck performance. The GEM is similar in concept to a number of vehicle simulation tools developed by commercial and government entities. The model developed by the EPA and finalized here was designed for the express purpose of vehicle compliance demonstration and is therefore simpler and less configurable than similar commercial products. This approach gives a compact and quicker tool for vehicle compliance without the

overhead and costs of a more sophisticated model. Details of the model are included in Chapter 4 of the RIA. The agencies are aware of several other simulation tools developed by universities and private companies. Tools such as Argonne National Laboratory's Autonomie, Gamma Technologies' GT-Drive, AVL's CRUISE, Ricardo's VSIM, Dassault's DYMOLA, and University of Michigan's HE-VESIM codes are publicly available. In addition, manufacturers of engines, vehicles, and trucks often have their own in-house simulation tools. The agencies sought comments regarding other software packages which would better serve the compliance purposes of the rules than the GEM, but did not receive any recommendations.

The GEM is designed to focus on the inputs most closely associated with fuel consumption and CO<sub>2</sub> emissions—*i.e.*, on those which have the largest impacts such as aerodynamics, rolling resistance, weight, and others.

EPA has validated the GEM based on the chassis test results from two combination tractors tested at Southwest Research Institute. The validation work conducted on this vehicle was representative of the other Class 7 and 8 tractors. Many aspects of one tractor configuration (such as the engine, transmission, axle configuration, tire sizes, and control systems) are similar to those used on the manufacturer's sister models. For example, the powertrain configuration of a sleeper cab with any roof height is similar to the one used on a day cab with any roof height. Overall, the GEM predicted the fuel consumption and CO<sub>2</sub> emissions within 2 percent of the chassis test procedure results for three test cycles—the California ARB Transient cycle, 65 mph cruise cycle, and 55 mph cruise cycle. These cycles are the ones the agencies are utilizing in compliance testing. Since the time of the proposal, the EPA also conducted a validation of the GEM relative to a commonly used vehicle simulation software, GT-Power. The results of this validation found that the two software programs predicted the fuel efficiency of each subcategory of tractor to be within 2 percent. Test to test variation for heavy-duty vehicle chassis testing can be higher than 4 percent due to driver variation alone. The final simulation model is described in greater detail in Chapter 4 of the RIA and is available for download by at (<http://www.epa.gov/otaq/climate/regulations.htm>).

After proposal, the agencies conducted a peer review of GEM version 1.0 which was proposed. In addition, we requested comment on all aspects of

<sup>72</sup> See 2010 NAS Report, Note 21, Recommendation 8-4. Page 190.

this approach to compliance determination in general and to the use of the GEM in particular. The agencies received comments from stakeholders and made changes for the release of GEM v2.0 to address concerns raised in the comments, along with the comments received during the peer review process. The most noticeable changes to the GEM include improvements to the graphical user interface (GUI). In response to comments, the agencies have reduced the amount of information required in the Identification section; linked the inputs to the selected subcategory while graying-out the items that are not applicable to the subcategory; and added batch modeling capability to reduce the compliance burden to manufacturers. In addition, substantial work went into model validations and benchmarking against vehicle test data and other commonly used vehicle simulation models.

The model also includes a new driver model, a simplified electric system model, and revised engine fuel maps to better reflect the 2017 model year engine standards. The model in the final

rulemaking uses the targeted vehicle driving speed to estimate vehicle torque demand at any given time, and then the power required to drive the vehicle is derived to estimate the required accelerator and braking pedal positions. If the driver misses the vehicle speed target, a speed correction logic controlled by a PID controller is applied to adjust necessary accelerator and braking pedal positions in order to match targeted vehicle speed at every simulation time step. The enhanced driver model used in the final rulemaking with its feed-forward driver controls more realistically models driving behavior. The GEM v1.0, the proposed version of the model, had four individual components to model the electric system—starter, electrical energy system, alternator, and electrical accessory. For the final rulemaking, the GEM v2.0 has a single electric system model with a constant power consumption level. Based on comments received, the agencies revisited the 2017 model year proposed fuel maps, specifically the low load area, which was extrapolated during the proposal

and (incorrectly) generated negative improvements. The agencies redeveloped the fuel maps for the final rulemaking to better predict the fuel consumption of engines in this area of the fuel consumption map. Details of the changes are included in RIA Chapter 4.

To demonstrate compliance, a Class 7 and 8 tractor manufacturer will measure the performance of specified tractor systems (such as aerodynamics and tire rolling resistance), input the values into the GEM, and compare the model's output to the standard. The rules require that a tractor manufacturer provide the inputs for each of following factors for each of the tractors it wishes to certify under CO<sub>2</sub> standards and for establishing fuel consumption values: Coefficient of Drag, Tire Rolling Resistance Coefficient, Weight Reduction, Vehicle Speed Limiter, and Extended Idle Reduction Technology. These are the technologies on which the agencies' own feasibility analysis for these vehicles is predicated. An example of the GEM input screen is included in Figure II-1.

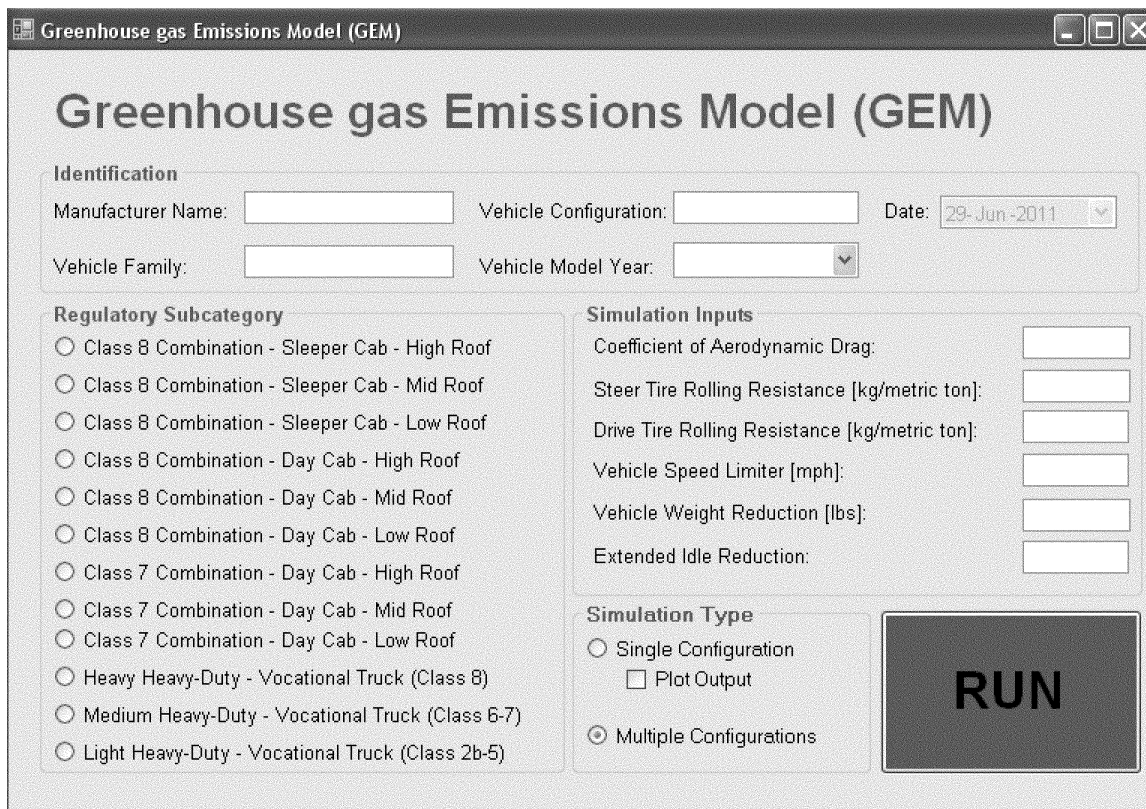

Figure 0-1: GEM Input Screen

For the aerodynamic assessment, tire rolling resistance, and tractor weight

reduction, the input values for the simulation model will be determined by

the manufacturer through conducting tests using the test procedures finalized

by the agencies in this action and described below. The agencies are allowing several testing alternatives for aerodynamic assessment referenced back to a coastdown test procedure, a single procedure for determination of the coefficient of rolling resistance (CRR) for tires, and a prescribed method to determine tractor weight reduction. The agencies have finalized defined model inputs for determining vehicle speed limiter and extended idle reduction technology benefits. The other aspects of vehicle performance are fixed within the model as defined by the agencies and are not varied for the purpose of compliance.

(b) Metric

Test metrics which are quantifiable and meaningful are critical for a regulatory program. The CO<sub>2</sub> and fuel consumption metric should reflect what we wish to control (CO<sub>2</sub> or fuel consumption) relative to the clearest value of its use: in this case, carrying freight. It should encourage efficiency improvements that will lead to reductions in emissions and fuel consumption during real world operation. The agencies are finalizing standards for Class 7 and 8 combination tractors that would be expressed in terms of moving a ton (2,000 pounds) of freight over one mile. Thus, NHTSA's final fuel consumption standards for these trucks would be represented as gallons of fuel used to move one ton of freight 1,000 miles, or gal/1,000 ton-mile. EPA's final CO<sub>2</sub> vehicle standards would be represented as grams of CO<sub>2</sub> per ton-mile. The model converts CO<sub>2</sub> emissions to fuel consumption using the CO<sub>2</sub> grams per ton mile estimated by GEM and an assumed 10,180 grams of CO<sub>2</sub> per gallon of diesel fuel.

This approach tracks the recommendations of the NAS report. The NAS panel concluded, in their report, that a load-specific fuel consumption metric is appropriate for HD trucks. The panel spent considerable time explaining the advantages of and recommending a load-specific fuel consumption approach to regulating the fuel efficiency of heavy-duty trucks. See NAS Report pages 20 through 28. The panel first points out that the nonlinear relationship between fuel economy and fuel consumption has led consumers of light-duty vehicles to have difficulty in judging the benefits of replacing the most inefficient vehicles. The panel describes an example where a light-duty vehicle can save the same 107 gallons per year (assuming 12,000 miles travelled per year) by improving one vehicle's fuel efficiency from 14 to 16 mpg or improving another vehicle's fuel

efficiency from 35 to 50.8 mpg. The use of miles per gallon leads consumers to undervalue the importance of small mpg improvements in vehicles with lower fuel economy. Therefore, the NAS panel recommends the use of a fuel consumption metric over a fuel economy metric. The panel also describes the primary purpose of most heavy-duty vehicles as moving freight or passengers (the payload). Therefore, they concluded that the most appropriate way to represent an attribute-based fuel consumption metric is to normalize the fuel consumption to the payload.

With the approach to compliance NHTSA and EPA are adopting, a default payload is specified for each of the tractor categories suggesting that a gram per mile metric with a specified payload and a gram per ton-mile metric would be effectively equivalent. The primary difference between the metrics and approaches relates to our treatment of mass reductions as a means to reduce fuel consumption and greenhouse gas emissions. In the case of a gram per mile metric, mass reductions are reflected only in the calculation of the work necessary to move the vehicle mass through the drive cycle. As such it directly reduces the gram emissions in the numerator since a vehicle with less mass will require less energy to move through the drive cycle leading to lower CO<sub>2</sub> emissions. In the case of Class 7 and 8 tractors and our gram/ton-mile metric, reductions in mass are reflected both in less mass moved through the drive cycle (the numerator) and greater payload (the denominator). We adjust the payload based on vehicle mass reductions because we estimate that approximately one third of the time the amount of freight loaded in a trailer is limited not by volume in the trailer but by the total gross vehicle weight rating of the tractor. By reducing the mass of the tractor the mass of the freight loaded in the vehicle can go up. Based on this general approach, it can be estimated that for every 1,200 pounds in mass reduction across all Class 7 and 8 tractors on the road, that total vehicle miles traveled, and therefore trucks on the road, could be reduced by one percent. Without the use of a per ton-mile metric it would not be clear or straightforward for the agencies to reflect the benefits of mass reduction from large freight carrying vehicles that are often limited in the freight they carry by the gross vehicle weight rating of the vehicle. There was strong consensus in the public comments for adopting the proposed metrics for tractors.

(c) Vehicle Aerodynamic Assessment

The aerodynamic drag of a vehicle is determined by the vehicle's coefficient of drag (Cd), frontal area, air density and speed. As noted in the NPRM, quantifying truck aerodynamics as an input to the GEM presents technical challenges because of the proliferation of vehicle configurations, the lack of a clearly preferable standardized test method, and subtle variations in measured aerodynamic values among various test procedures. Class 7 and 8 tractor aerodynamics are currently developed by manufacturers using a range of techniques, including wind tunnel testing, computational fluid dynamics, and constant speed tests.

Consistent with our discussion at proposal, we believe a broad approach allowing manufacturers to use these multiple different test procedures to demonstrate aerodynamic performance of its tractor fleet is appropriate given that no single test procedure is superior in all aspects to other approaches. Allowing manufacturers to use multiple test procedures and modeling coupled with good engineering judgment to determine aerodynamic performance is consistent with the current approach used in determining representative road load forces for light-duty vehicle testing (40 CFR 86.129-00(e)(1)). However, we also recognize the need for consistency and a level playing field in evaluating aerodynamic performance.

The agencies are retaining an aerodynamic bin structure for the final rulemaking, but are adjusting the method used to determine the bins. To address the consistency and level playing field concerns, NHTSA and EPA proposed that manufacturers use a two-part screening approach for determining the aerodynamic inputs to the GEM. The first part would have required the manufacturers to assign each vehicle aerodynamic configuration based on descriptions of vehicle characteristics to one of five aerodynamics bins created by EPA and NHTSA. The proposed assignment by bin would have fixed (by rule) the aerodynamic characteristics of the vehicle. However, the agencies, while working with industry, concluded for the final rulemaking that an approach which identified a reference aerodynamic test method and a procedure to align results from other aerodynamic test procedures with the reference method is a simpler, more accurate approach than deciphering and interpreting written descriptions of aerodynamic components.

Therefore, we are finalizing an approach, as described in Section V.B.3.d and § 1037.501, which uses an

enhanced coastdown procedure as a reference method and defines a process for manufacturers to align drag results from each of their own test methods to the reference method results.

Manufacturers will be able to use any aerodynamic evaluation method in demonstrating a vehicle's aerodynamic performance as long as the method is aligned to the reference method. The results from the aerodynamic testing will be the single determining factor for aerodynamic bin assignments.

EPA and NHTSA recognize that wind conditions, most notably wind direction, have a greater impact on real world CO<sub>2</sub> emissions and fuel consumption of heavy-duty trucks than of light-duty vehicles. As noted in the NAS report,<sup>73</sup> the wind average drag coefficient is about 15 percent higher than the zero degree coefficient of drag. In addition, the agencies received comments that supported the use of wind averaged drag results for the aerodynamic determination. The agencies considered finalizing the use of a wind averaged drag coefficient in this regulatory program, but ultimately decided to finalize drag values which represent zero yaw (*i.e.*, representing wind from directly in front of the vehicle, not from the side) instead. We are taking this approach recognizing that the reference method is coastdown testing which is not capable of determining wind averaged yaw. Wind tunnels are currently the only tool which can accurately assess the influence of wind speed and direction on a vehicle's aerodynamic performance. The agencies recognize, as NAS did, that the results of using the zero yaw approach may result in fuel consumption predictions that are offset slightly from real world performance levels, not unlike the offset we see today between fuel economy test results in the CAFE program and actual fuel economy performance observed in-use. We believe this approach will not impact overall technology effectiveness or change the kinds of technology decisions made by the tractor manufacturers in developing equipment to meet our final standards. However, the agencies are adopting provisions which allow manufacturers to generate credits reflecting performance of technologies which improve the aerodynamic performance in crosswind conditions, similar to those experienced by vehicles in use through innovative technologies, as described in Section IV.

As just noted, the agencies are adopting an approach for this final

action where the manufacturer would determine a tractor's aerodynamic drag force using their own aerodynamic assessment tools and correlating the results back to the reference aerodynamic test method of enhanced coastdown testing. The manufacturer determines the appropriate predefined aerodynamic bin based on the correlated test results and then inputs the predefined Cd value for that aerodynamic bin into the GEM. Coefficient of drag and frontal area of the tractor-trailer combination go hand-in-hand to determine the force required to overcome aerodynamic drag. The agencies proposed that the Cd value would be a GEM input derived by the manufacturer and that the agencies would specify the vehicle's frontal area for each regulatory subcategory. The agencies sought and received comment recommending an alternate approach where the aerodynamic input tables (as shown in Table 0-7 and Table 0-8) represent the drag force as defined as Cd multiplied by the frontal area. Because both approaches are essentially equivalent and the use of CdA more directly relates back to the aerodynamic testing, the agencies are finalizing the use of CdA as recommended by manufacturers.

The agencies are finalizing aerodynamic technology bins which divide the wide spectrum of tractor aerodynamics into five bins (*i.e.*, categories) for high roof tractors. The first high roof category, Bin I, is designed to represent tractor bodies which prioritize appearance or special duty capabilities over aerodynamics. These Bin I trucks incorporate few, if any, aerodynamic features and may have several features which detract from aerodynamics, such as bug deflectors, custom sunshades, B-pillar exhaust stacks, and others. The second high roof aerodynamics category is Bin II which roughly represents the aerodynamic performance of the average new tractor sold today. The agencies developed this bin to incorporate conventional tractors which capitalize on a generally aerodynamic shape and avoid classic features which increase drag. High roof tractors within Bin III build on the basic aerodynamics of Bin II tractors with added components to reduce drag in the most significant areas on the tractor, such as integral roof fairings, side extending gap reducers, fuel tank fairings, and streamlined grill/hood/mirrors/bumpers, similar to SmartWay trucks today. The Bin IV aerodynamic category for high roof tractors builds upon the Bin III tractor body with additional aerodynamic treatments such

as underbody airflow treatment, down exhaust, and lowered ride height, among other technologies. And finally, Bin V tractors incorporate advanced technologies which are currently in the prototype stage of development, such as advanced gap reduction, rearview cameras to replace mirrors, wheel system streamlining, and advanced body designs.

The agencies had proposed five aerodynamic bins for each tractor regulatory subcategory. The agencies received comments from ATA, EMA/TMA, and Volvo indicating that this approach was not consistent with the aerodynamics of low and mid roof tractors. High roof tractors are consistently paired with box trailer designs, and therefore manufacturers can design the tractor aerodynamics as a tractor-trailer unit and target specific areas like the gap between the tractor and trailer. In addition, the high roof tractors tend to spend more time at high speed operation which increases the impact of aerodynamics on fuel consumption and GHG emissions. On the other hand, low and mid roof tractors are designed to pull variable trailer loads and shapes. They may pull trailers such as flat bed, low boy, tankers, or bulk carriers. The loads on flat bed trailers can range from rectangular cartons with tarps, to a single roll of steel, to a front loader. Due to these variables, manufacturers do not design unique low and mid roof tractor aerodynamics but instead use derivatives from their high roof tractor designs. The aerodynamic improvements to the bumper, hood, windshield, mirrors, and doors are developed for the high roof tractor application and then carried over into the low and mid roof applications. As mentioned above, the types of designs that would move high roof tractors from a Bin III to Bins IV and V include features such as gap reducers and integral roof fairings which would not be appropriate on low and mid roof tractors. The agencies considered and largely agree with these comments and are therefore finalizing only two aerodynamic bins for low and mid roof tractors. The agencies are reducing the number of bins to reflect the actual range of aerodynamic technologies effective in low and mid roof tractor applications. Thus, the agencies are differentiating the aerodynamic performance for low and mid roof applications into two bins—conventional and aerodynamic.<sup>74</sup>

<sup>73</sup> See 2010 NAS Report, Note 21, Finding 2-4 on page 39.

<sup>74</sup> As explained in Section IV, there are no ABT implications to this change from proposal, since all

For high roof combination tractor compliance determination, a manufacturer would use the aerodynamic results determined through testing to establish the appropriate bin. The manufacturer would then input into GEM the Cd value specified for each bin as defined in Table II-7 and Table II-8. For

example, if a manufacturer tests a Class 8 sleeper cab high roof tractor and the test produces a CdA value between 5.8 and 6.6, the manufacturer would assign this tractor to the Class 8 Sleeper Cab High Roof Bin III. The manufacturer would then use the Cd value identified for Bin III of 0.60 as the input to GEM.

The Cd values in Table II-7 and Table II-8 differ from proposal based on a change in the reference method (enhanced coastdown procedure) and additional testing conducted by EPA. Details of the test program and results are included in RIA Chapter 2.5.1.4.

TABLE II-7—AERODYNAMIC INPUT DEFINITIONS TO GEM FOR HIGH ROOF TRACTORS

	Class 7		Class 8	
	Day cab		Day cab	Sleeper cab
	High roof	High roof	High roof	High roof≤
<b>Aerodynamic Test Results (CdA in m<sup>2</sup>)</b>				
Bin I .....	≥ 8.0	≥ 8.0	≥ 8.0	≥ 7.6
Bin II .....	7.1–7.9	7.1–7.9	7.1–7.9	6.7–7.5
Bin III .....	6.2–7.0	6.2–7.0	6.2–7.0	5.8–6.6
Bin IV .....	5.6–6.1	5.6–6.1	5.6–6.1	5.2–5.7
Bin V .....	≤ 5.5	≤ 5.5	≤ 5.5	≤ 5.1
<b>Aerodynamic Input to GEM (Cd)</b>				
Bin I .....	0.79	0.79	0.79	0.75
Bin II .....	0.72	0.72	0.72	0.68
Bin III .....	0.63	0.63	0.63	0.60
Bin IV .....	0.56	0.56	0.56	0.52
Bin V .....	0.51	0.51	0.51	0.47

The CdA values in Table II-8 are based on testing using the enhanced coastdown test procedures adopted for the final rulemaking, which includes aerodynamic assessment of the low and mid roof tractors without a trailer. The removal of the trailer significantly

reduces the CdA value of mid roof tractors with tanker trailers because of the poor aerodynamic performance of the tanker trailer. The agencies developed the Cd input for each of the low and mid roof tractor bins to represent the Cd of the tractor, its

frontal area, and the impact of the Cd value due to the trailer such that the GEM value is representative of a tractor-trailer combination, as it is for the high roof tractors.

TABLE II-8—AERODYNAMIC INPUT DEFINITIONS TO GEM FOR LOW AND MID ROOF TRACTORS

	Class 7				Class 8	
	Day Cab				Day Cab	
	Low Roof		Mid Roof		Low Roof	Mid Roof
<b>Aerodynamic Test Results (CdA in m<sup>2</sup>)</b>						
Bin I .....	≥ 5.1	≥ 5.6	≥ 5.1	≥ 5.6	≥ 5.1	≥ 5.6
Bin II .....	≤ 5.0	≤ 5.5	≤ 5.0	≤ 5.5	≤ 5.0	≤ 5.5
<b>Aerodynamic Input to GEM (Cd)</b>						
Bin I .....	0.77	0.87	0.77	0.87	0.77	0.87
Bin II .....	0.71	0.82	0.71	0.82	0.71	0.82

(d) Tire Rolling Resistance Assessment

NHTSA and EPA are finalizing as proposed that the tractor’s tire rolling resistance input to the GEM be determined by either the tire

manufacturer or tractor manufacturer using the test method adopted by the International Organization for Standardization, ISO 28580:2009.<sup>75</sup> The agencies believe the ISO test procedure

is appropriate for this program because the procedure is the same one used by NHTSA in its fuel efficiency tire labeling program<sup>76</sup> and is consistent with the testing direction being taken by

Class 8 combination tractors are considered to be a single averaging set for ABT purposes. Similarly, all Class 7 tractors are considered to be a single averaging set for ABT purposes.

<sup>75</sup> ISO, 2009, Passenger Car, Truck, and Bus Tyres—Methods of Measuring Rolling Resistance—Single Point Test and Correlation of Measurement Results: ISO 28580:2009(E), First Edition, 2009-07-01

<sup>76</sup> NHTSA, 2009. “NHTSA Tire Fuel Efficiency Consumer Information Program Development: Phase 1—Evaluation of Laboratory Test Protocols.” DOT HS 811 119. June. (<http://www.regulations.gov>, Docket ID: NHTSA-2008-0121-0019).

the tire industry both in the United States and Europe. The rolling resistance from this test would be used to specify the rolling resistance of each tire on the steer and drive axle of the tractor. The results would be expressed as a rolling resistance coefficient (CRR) and measured as kilogram per metric ton (kg/metric ton). The agencies are finalizing as proposed that three tire samples within each tire model be tested three times each to account for some of the production variability and the average of the nine tests would be the rolling resistance coefficient for the tire. The GEM will use the steer and drive tire rolling resistance inputs and distribute 15 percent of the gross weight of the tractor and trailer to the steer axle, 42.5 percent to the drive axles, and 42.5 percent to the trailer axles.<sup>77</sup> The trailer tires' rolling resistance is prescribed by the agencies as part of the standardized trailer used for demonstrating compliance at 6 kg/metric ton, which was the average trailer tire rolling resistance measured during the SmartWay tire testing.<sup>78</sup>

EPA and NHTSA conducted additional evaluation testing on HD trucks tires used for tractors, and also for vocational vehicles. The agencies also received several comments on the suitability of low rolling resistance tires for various HD vehicle applications. The summary of the agencies' findings and a response to issues raised by commenters is presented in Section II.D(1)(a).

#### (e) Weight Reduction Assessment

The agencies proposed that the tractor standards reflect improved CO<sub>2</sub> emissions and fuel consumption performance of a 400 pound weight reduction in Class 7 and 8 tractors through the substitution of single wide tires and light-weight wheels for dual tires and steel wheels. This approach was taken since there is a large variation in the baseline weight among trucks that perform roughly similar functions with roughly similar configurations. Because of this, the only effective way to quantify the exact CO<sub>2</sub> and fuel consumption benefit of mass reduction using GEM is to estimate baseline weights for specific components that can be replaced with light weight

components. If the weight reduction is specified for light weight versions of specific components, then both the baseline and weight differentials for these are readily quantifiable and well-understood. Lightweight wheels are commercially available as are single wide tires and thus data on the weight reductions attributable to these two approaches are readily available.

The agencies received comments on this approach from Volvo, ATA, MEMA, Navistar, American Chemistry Council, the Auto Policy Center, Iron and Steel Institute, Arvin Meritor, Aluminum Association, and environmental groups and NGOs. Volvo and ATA stated that not all fleets can use single wide tires and if this is the case the 400 pound weight reduction target cannot be met. Volvo stated that without the use of single wide drive tires, a 6x4 tractor will have a maximum weight reduction of 300 pounds if the customer selects all ten wheels to be outfitted with light weight aluminum wheels. A number of additional commenters—including American Chemistry Council, The Auto Policy Center, Iron and Steel Institute, Aluminum Association, Arvin Meritor, MEMA, Navistar, Volvo, and environmental and nonprofit groups—stated that manufacturers should be allowed to use additional light weight components in order to meet the tractor fuel consumption and CO<sub>2</sub> emissions standards. These groups stated that weight reductions should not be limited to wheels and tires. They asked that cab doors, cab sides and backs, cab underbodies, frame rails, cross members, clutch housings, transmission cases, axle differential carrier cases, brake drums, and other components be allowed to be replaced with light-weight versions. Materials suggested for substitution included aluminum, light-weight aluminum, high strength steel, and plastic composites. The American Iron and Steel Institute stated there are opportunities to reduce mass by replacing mild steel—which currently dominates the heavy-duty industry—with high strength steel.

In addition, The American Auto Policy Center asked that manufacturers be allowed to use materials other than aluminum and high strength steel to comply with the regulations. DTNA asked that weight reduction due to engine downsizing be allowed to receive credit. Volvo requested that weight reductions due to changes in axle configuration be credited. They used the example of a customer selecting a 4 X 2 over a 6 X 4 axle tractor. In this case, they assert there would be a 1,000 pound weight savings from removing an axle.

As proposed, many of the material substitutions could have been considered as innovative technologies for tractors and hence eligible for off cycle credits (so that the commenters overstated that these technologies were 'disallowed'). Nonetheless in response to the above summarized comments, the agencies evaluated whether additional materials and components could be used directly for compliance with the tractor weight reduction through the primary program (*i.e.* be available as direct inputs to the GEM). The agencies reviewed comments and data received in response to the NPRM and additional studies cited by commenters. A summary of this review is provided in the following paragraphs.

TIAX, in their report to the NAS, cited information from Alcoa identifying several mass reduction opportunities from material substitution in the tractor cab components which were similar to the ones identified by the Aluminum Association in their comments to this rulemaking.<sup>79</sup> TIAX included studies submitted by Alcoa showing the potential to reduce the weight of a tractor-trailer combination by 3,500 to 4,500 pounds.<sup>80</sup> In addition, the U.S. Department of Energy has several projects underway to improve the freight efficiency of Class 8 trucks which provide relevant data:<sup>81</sup> DOE reviewed prospective lightweighting alternative materials and found that aluminum has a potential to reduce mass by 40 to 60 percent, which is in line with the estimates of mass reductions of various components provided by Alcoa, and by the Aluminum Association in their comments and as cited in the TIAX report. These combined studies, comments, and additional data provided information on specific components that could be replaced with aluminum components.

With regard to high strength steel, the Iron and Steel Institute found that the use of high strength steel and redesign can reduce the weight of light-duty trucks by 25 percent.<sup>82</sup> Approximately

<sup>79</sup> TIAX, LLC. "Assessment of Fuel Economy Technologies for Medium- and Heavy-Duty Vehicles," Final Report to National Academy of Sciences, November 19, 2009. Pages 4–62 through 4–64.

<sup>80</sup> Alcoa. "Improving Sustainability of Transport: Aluminum is Part of the Solution." 2009.

<sup>81</sup> Schutte, Carol. U.S. Department of Energy, Vehicle Technologies Program. "Losing Weight—an enabler for a Systems Level Technology Development, Integration, and Demonstration for Efficient Class 8 Trucks (SuperTruck) and Advanced Technology Powertrains for Light-Duty Vehicles."

<sup>82</sup> American Iron and Steel Institute. "A Cost Benefit Analysis Report to the North American

<sup>77</sup> This distribution is equivalent to the federal over-axle weight limits for an 80,000 GVWR 5-axle tractor-trailer: 12,000 pounds over the steer axle, 34,000 pounds over the tandem drive axles (17,000 pounds per axle) and 34,000 pounds over the tandem trailer axles (17,000 pounds per axle).

<sup>78</sup> U.S. Environmental Protection Agency. *SmartWay Transport Partnership July 2010 e-update* accessed July 16, 2010, from <http://www.epa.gov/smartwaylogistics/newsroom/documents/e-update-july-10.pdf>.



10 percent of this reduction results from material substitution and 15 percent from vehicle re-design. While this study evaluated light-duty trucks, the agencies believe that a similar reduction could be achieved in heavy-duty trucks since the reductions from material substitution would likely be similar in heavy-trucks as in light-trucks. U.S. DOE, in the report noted above, identified opportunities to reduce mass by 10 percent through high strength steel.<sup>83</sup> This study was also for light-duty vehicles.

The agencies considered other materials such as plastic composites and magnesium substitutes but were not able to obtain weights for specific components made from these materials. We have therefore not included components made from these materials as possible substitutes in the primary program, but they may be considered through the innovative technology/off-cycle credits provision. We may consider including these materials as part of the primary compliance option in a subsequent regulation if data become available.

Based on this analysis, the agencies developed an expanded list of weight reduction opportunities for the final rulemaking that may be reflected in the GEM, as listed in Table II–9. The list includes additional components, but not materials, from those proposed. For high strength steel, the weight reduction value is equal to 10 percent of the presumed baseline component weight, as the agencies used a conservative value based on the DOE report. We

recognize that there may be additional potential for weight reduction in new high strength steel components which combine the reduction due to the material substitution along with improvements in redesign, as evidenced by the studies done for light-duty vehicles. In the development of the high strength steel component weights, we are only assuming a reduction from material substitution and no weight reduction from redesign, since we do not have any data specific to redesign of heavy-duty components nor do we have a regulatory mechanism to differentiate between material substitution and improved design. We are finalizing for wheels that both aluminum and light weight aluminum are eligible to be used as light-weight materials. Aluminum, but not light-weight aluminum, can be used as a light-weight material for other components. The reason for this is that data were available for light weight aluminum for wheels but were not available for other components.

The agencies received comments on the proposal from the American Chemistry Council highlighting the role of plastics and composites in heavy-duty vehicles. As they stated, composites can be low density while having high strength and are currently used in applications such as oil pans and buses. The DOE mass reduction program demonstrated for heavy vehicles proof of concept designs for hybrid composite doors with an overall mass savings of 40 percent; 30 percent mass reduction of a hood system with carbon fiber sheet molding compound;

50 percent mass reduction from composite tie rods, trailing arms, and axles; and superplastically formed aluminum body panels.<sup>84</sup> While the agencies recognize these opportunities, we do not believe the technologies have advanced far enough to quantify the benefits of these materials because they are very dependent on the actual composite material. The agencies may consider such lightweighting opportunities in future actions, but are not including them as part of this primary program. Manufacturers which opt to pursue composite and plastic material substitutions may seek credits through the innovative technology provisions.

With regard to Volvo’s request that manufacturers be allowed to receive credit for trucks with fewer axles, the agencies recognize that vehicle options exist today which have less mass than other options. However, we believe the decisions to add or subtract such components will be made based on the intended use of the vehicle and not based on a crediting for the mass difference in our compliance program. It is not our intention to create a tradeoff between the right vehicle to serve a need (e.g. one with more or fewer axles) and compliance with our final standards. Therefore, we are not including provisions to credit (or penalize) vehicle performance based on the subtraction (or addition) of specific vehicle components. Table II–9 provides weight reduction values for different components and materials.

TABLE II–9—WEIGHT REDUCTION VALUES

Weight reduction technology	Weight reduction (lb per tire/wheel)	
Single Wide Drive Tire with:		
Steel Wheel .....	84	
Aluminum Wheel .....	139	
Light Weight Aluminum Wheel .....	147	
Steer Tire or Dual Wide Drive Tire with:		
High Strength Steel Wheel .....	8	
Aluminum Wheel .....	21	
Light Weight Aluminum Wheel .....	30	
Weight reduction technologies	Aluminum weight reduction (lb.)	High strength steel weight reduction (lb.)
Door .....	20	6
Roof .....	60	18
Cab rear wall .....	49	16
Cab floor .....	56	18
Hood Support Structure .....	15	3

Steel Industry on Improved Materials and Powertrain Architectures for 21st Century Trucks.”  
<sup>83</sup> Schutte, Carol. U.S. Department of Energy, Vehicle Technologies Program. “Losing Weight—an enabler for a Systems Level Technology Development, Integration, and Demonstration for

Efficient Class 8 Trucks (SuperTruck) and Advanced Technology Powertrains for Light-Duty Vehicles”.  
<sup>84</sup> Schutte, Carol. U.S. Department of Energy, Vehicle Technologies Program. “Losing Weight—an enabler for a Systems Level Technology

Development, Integration, and Demonstration for Efficient Class 8 Trucks (SuperTruck) and Advanced Technology Powertrains for Light-Duty Vehicles”.



TABLE II-9—WEIGHT REDUCTION VALUES—Continued

Fairing Support Structure .....	35	6
Instrument Panel Support Structure .....	5	1
Brake Drums—Drive (4) .....	140	11
Brake Drums—Non Drive (2) .....	60	8
Frame Rails .....	440	87
Crossmember—Cab .....	15	5
Crossmember—Suspension .....	25	6
Crossmember—Non Suspension (3) .....	15	5
Fifth Wheel .....	100	25
Radiator Support .....	20	6
Fuel Tank Support Structure .....	40	12
Steps .....	35	6
Bumper .....	33	10
Shackles .....	10	3
Front Axle .....	60	15
Suspension Brackets, Hangers .....	100	30
Transmission Case .....	50	12
Clutch Housing .....	40	10
Drive Axle Hubs (8) .....	160	4
Non Drive Front Hubs (2) .....	40	5
Driveshaft .....	20	5
Transmission/Clutch Shift Levers .....	20	4

EPA and NHTSA are specifying the baseline vehicle weight for each regulatory vehicle subcategory (including the tires, wheels, frame, and cab components) in the GEM in aggregate based on weight of vehicles used in EPA's aerodynamic test program, but allow manufacturers to specify the use of light-weight components. The GEM then quantifies the weight reductions based on the pre-determined weight of the baseline component minus the pre-determined weight of the component made from light-weight material. Manufacturers cannot specify the weight of the light-weight component themselves, only the material used in the substitute component. The agencies assume the baseline wheel and tire configuration contains dual tires with steel wheels, along with steel frame and cab components, because these represent the vast majority of new vehicle configurations today. The weight reduction due to replacement of components with light weight versions will be reflected partially in the payload tons and partially in reducing the overall weight of the vehicle run in the GEM. The specified payload in the GEM will be set to the prescribed payload plus one third of the weight reduction amount to recognize that approximately one third of the truck miles are travelled at maximum payload, as discussed below in the payload discussion. The other two thirds of the weight reduction will be subtracted from the overall vehicle weight prescribed in the GEM.

The agencies continue to believe that the 400 pound weight target is appropriate to use as a basis for setting the final combination tractor CO<sub>2</sub>

emissions and fuel consumption standards. The agencies agree with the commenter that 400 pounds of weight reduction without the use of single wide tires may not be achievable for all tractor configurations. As noted, the agencies have extended the list of weight reduction components in order to provide the manufacturers with additional means to comply with the combination tractors and to further encourage reductions in vehicle weight. The agencies considered increasing the target value beyond 400 pounds given the additional reduction potential identified in the expanded technology list; however, lacking information on the capacity for the industry to change to these lightweight components across the board by the 2014 model year, we have decided to maintain the 400 pound target. The agencies intend to continue to study the potential for additional weight reductions in our future work considering a second phase of vehicle fuel efficiency and GHG regulations. In the context of the current rulemaking for HD fuel consumption and GHG standards, one would expect that reducing the weight of medium-duty trucks similarly would, if anything, have a positive impact on safety. However, given the large difference in weight between light-duty and medium-duty vehicles, and even larger difference between light-duty vehicles and heavy-duty vehicles with loads, the agencies believe that the impact of weight reductions of medium- and heavy-duty vehicles would not have a noticeable impact on safety for any of these classes of vehicles.<sup>85</sup>

<sup>85</sup> For more information on the estimated safety effects of this rule, see Chapter 9 of the RIA.

(f) Extended Idle Reduction Technology Assessment

Extended idling from Class 8 heavy-duty long haul combination tractors contributes to significant CO<sub>2</sub> emissions and fuel consumption in the United States. The Federal Motor Carrier Safety Administration regulations require a certain amount of driver rest for a corresponding period of driving hours.<sup>86</sup> Extended idle occurs when Class 8 long haul drivers rest in the sleeper cab compartment during rest periods as drivers find it both convenient and less expensive to rest in the tractor cab itself than to pull off the road and find accommodations.<sup>87</sup> During this rest period a driver will idle the tractor engine in order to provide heating or cooling, or to run on-board appliances. In some cases the engine can idle in excess of 10 hours. During this period, the engine will consume approximately 0.8 gallons of fuel and emit over 8,000 grams of CO<sub>2</sub> per hour. An average tractor engine can consume 8 gallons of fuel and emit over 80,000 grams of CO<sub>2</sub> during overnight idling in such a case.

Idling reduction technologies (IRT) are available to allow for driver comfort while reducing fuel consumptions and CO<sub>2</sub> emissions. Auxiliary power units, fuel operated heaters, battery supplied air conditioning, and thermal storage systems are among the technologies

<sup>86</sup> Federal Motor Carrier Safety Administration. Hours of Service Regulations. Last accessed on August 2, 2010 at <http://www.fmcsa.dot.gov/rules-regulations/topics/hos/>.

<sup>87</sup> The agencies note that some sleeper cabs may be classified as vocational tractors and therefore are expected to primarily travel locally and would not benefit from an idle reduction technology.

available today. The agencies are adopting a provision for use of extended idle reduction technology as an input to the GEM for Class 8 sleeper cabs. As discussed further in Section III, if a manufacturer wishes to receive credit for using IRT to meet the standard, then an automatic main engine shutoff must be programmed and enabled, such that engine shutdown occurs after 5 minutes of idling, to help ensure the reductions are realized in-use. A discussion of the provisions the agencies are adopting for allowing an override of this automatic shutdown can be found in RIA Chapter 2. As with all of the technology inputs discussed in this section, the agencies are not mandating the use of idle reductions or idle shutdown, but rather allowing their use as one part of a suite of technologies feasible for reducing fuel consumption and meeting the final standards and using these technologies as the inputs to the GEM. The default value (5 g CO<sub>2</sub>/ton-mile or 0.5 gal/1,000 ton-mile) for the use of automatic engine shutdown (AES) with idle reduction technologies was determined as the difference between a baseline main engine with idle fuel consumption of 0.8 gallons per hour that idles 1,800 hours and travels 125,000 miles per year, and a diesel auxiliary power unit operating in lieu of main engine during those same idling hours. The agencies received various comments from ACEEE and MEMA regarding the assumptions used to derive the idle reduction value. ACEEE argued that the agencies should use a fuel consumption rate of 0.47 gallon/hour for main engine idling based on a paper written by Kahn. MEMA argued that the agencies should use a main engine idling fuel consumption rate of 0.87 gal/hr, which is the midpoint of a DOE calculator reporting fuel consumption rates from 0.64 to 1.15 gal/hr at idling conditions, and between 800 and 1200 rpm with the air conditioning on and off, respectively. The agencies respectfully disagree with the 0.47 gal/hr recommendation because the same paper by Kahn shows that while idling fuel consumption is 0.47 gal/hr on average at 600 rpm, CO<sub>2</sub> emissions increase by 25 percent with A/C on at 600 rpm, and increase by 165 percent between 600 rpm and 1,100 rpm with A/C on.<sup>88</sup> MEMA recommended using 2,500 hours per year for APU operation. They cited the SmartWay Web site which uses 2,400 hours per year (8 hours per day and 300 days per year). Also, they cited an Argonne study

which assumed 7 hours per day and 303 days per year, which equals 2,121 hours per year. Lastly, they referred to the FMCSA 2010 driver guidelines which reduce the number of hours driven per day by one to two hours, which would lead to 2,650 to 2,900 hours per year. The agencies reviewed other studies to quantify idling operations, as discussed in greater detail in RIA Section 2.5.4.2, and believe that the entirety of the research does not support a change from the proposed calculation. Therefore, the agencies are finalizing the calculation as proposed. Additional details regarding the comments, calculations, and agency decisions are included in RIA Section 2.5.4.2.

The agencies are adopting a provision to allow manufacturers to provide an AES system which is active for only a portion of a vehicle's life. In this case, a discounted idle reduction value would be entered into GEM. A discussion of the calculation of a discounted IRT credit can be found in Section III. Additional details on the emission and fuel consumption reduction values are included in RIA Section 2.5.4.2.

#### (g) Vehicle Speed Limiters

The NPRM proposed to allow combination tractors that use vehicle speed limiters (VSL) to include the maximum governed speed value as an input to the GEM for purposes of determining compliance with the vehicle standards. The agencies also proposed not to assume the use of a mandatory vehicle speed limiter because of concerns about how to set a realistic application rate that avoids unintended consequences. See 75 FR at 74223. Governing the top speed of a vehicle can reduce fuel consumption and GHG emissions, because fuel consumption and CO<sub>2</sub> emissions increase proportionally to the square of vehicle speed.<sup>89</sup> Limiting the speed of a vehicle reduces the fuel consumed, which in turn reduces the amount of CO<sub>2</sub> emitted. The specific input to the GEM would be the maximum governed speed limit of the VSL that is programmed into the powertrain control module (PCM). The agencies stressed in the NPRM that in order to obtain a benefit in the GEM, a manufacturer must preset the limiter in such a way that the setting will not be "capable of being easily overridden by the fleet or the owner." If the top speed could be easily overridden, the fuel consumption/CO<sub>2</sub> benefits of the VSL

might not be realized, and the agencies did not want to allow the technology to be used for compliance if the technology could be disabled easily and the real world benefits not achieved.

Both the Center for Biological Diversity (CBD) and New York State Department of Transportation and Environmental Conservation commented that the application of speed limiters should be used to set the tractor standards.<sup>90</sup> CBD urged the agencies to reconsider the position and adopt a speed limitation technology. NY State commented that the technologies are cost effective, reduce emissions, and appear to be generally acceptable to the trucking industry. They continued to say that the vehicle speed limit could be set without compromising operational logistics.

Many commenters (Cummins, Daimler, EMA/TMA, ATA, AAPC, NADA) supported the use of VSLs as an input to the GEM, but requested clarification of what the specific requirements would be to ensure the VSL setting would not be capable of being easily overridden. Cummins and Daimler requested that the final rules explicitly allow vehicle manufacturers to access and adjust the VSL control feature for setting the maximum governed speed, arguing that the diverse needs of the commercial vehicle industry warrant flexibility in electronic control features, and that otherwise supply chain issues<sup>91</sup> may result from the use of VSLs. NADA and EMA/TMA also requested that VSLs have override features and be adjustable, citing various needs for flexibility by the fleets. EMA/TMA and ATA requested that VSLs be adjustable downward by fleets in order to obtain greater benefit in GEM, if company policies change or if a subsequent vehicle owner needs a different VSL setting. EMA/TMA stated that the agencies should prohibit tampering with VSLs, and both EMA and TRALA requested more information on how the agencies intended to address tampering with VSLs.

In addition to features governing the maximum vehicle speed, commenters requested adding other programmable flexibilities to mitigate potential drawbacks to VSLs. Cummins, DTNA,

<sup>89</sup> One commenter mistakenly thought that the agencies were rejecting consideration of VSLs due to perceived jurisdictional obstacles. In fact, both the CAA and EISA allow consideration of VSL technology and the agencies considered the appropriateness of basing standards on performance of the technology.

<sup>91</sup> Commenters stated that OEMs need access for setting appropriate trims for managing the VSL, otherwise significant supply chain issues could result such as parts shortages caused by the need for unique speed governed PCMs.

<sup>88</sup> See Gaines, L., A. Vyas, J. Anderson. "Estimation of Fuel Used by Idling Commercial Trucks," Page 9 (2006).

<sup>89</sup> See 2010 NAS Report, Note 21, Page 28. Road Load Force Equation defines the aerodynamic portion of the road load as  $\frac{1}{2} * \text{Coefficient of Drag} * \text{Frontal Area} * \text{air density} * \text{vehicle speed squared}$ .

and EMA/TMA requested that a programmable “soft top” speed be added to PCMs which would allow a vehicle to exceed the speed limit setting governed by a VSL for a short period of time. A “soft top” feature could be used for a limited duration in order to maneuver and pass other on-road vehicles at speeds greater than that governed by the VSL. The commenters argued this was important for vehicle passing and safety-related situations where, without a soft top feature, it could be possible for speed limited trucks to obstruct other vehicles on the road and cause severe road congestion.

ATA and EMA/TMA also requested that manufacturers be allowed to program a mileage based expiration into the VSL control feature, in order to preserve the value of vehicles for second owners who may require operation at higher speeds. ATA further commented that manufacturers should be allowed to account for additional GEM input benefits if the speed governor is reprogrammed to a lower speed within the useful life of the vehicle.

After carefully considering the comments, the agencies have decided, for these final rules, to retain most of the elements in the proposal. Manufacturers will be allowed to implement a fixed maximum governed vehicle speed through a VSL feature and to use the maximum governed vehicle speed as an input to the GEM for certification. Also consistent with the proposal, the agencies are not premising the final standards on the use of VSLs. The comments received from stakeholders did not address the agencies’ concerns discussed in the proposal, specifically the risk of requiring VSL in situations that are not appropriate from an efficiency perspective because it may lead to additional vehicle trips to deliver the same amount of freight.<sup>92</sup> The agencies continue to believe that we are not in a position to determine how many additional vehicles would benefit from the use of a VSL with a setting of less than 65 mph (a VSL with a speed set at or above 65 mph will show no CO<sub>2</sub> emissions or fuel consumption benefit on the drive cycles included in this program). The agencies further believe that manufacturers will not utilize VSLs unless it is in their interest to do so, so that these unintended consequences should not occur when manufacturers use VSLs as a compliance strategy. We will monitor the industry’s use of VSL in this program and may consider using this

technology in standard setting in the future.

The agencies have decided to adopt commenters’ suggestions to allow adjustable lower limits that can be set and governed by VSLs independent of the one governing the maximum certified speed limit to provide the desired flexibility requested by the trucking industry. We believe that this flexibility would not decrease the anticipated fuel consumption or CO<sub>2</sub> benefits of VSLs because the adjustable limits would be lower values. Issues identified by the commenters including the ability to change delivery routes requiring lower governed speeds or when a fleet’s business practices change resulting in a desire for greater fuel consumption savings are not in conflict with the purpose and benefit of VSLs. As such, the agencies have decided to allow a manufacturer to install features for its fleet customers to set their own lower adjustable limits below the maximum VSL specified by the agencies. However, the agencies have decided to not allow any additional benefit in the GEM to a manufacturer for allowing a lower governed speed in-use than the certified maximum limit for this first phase of the HD National Program because we can only be certain that the VSL will be at the maximum setting.

Both agencies also agree that manufacturers can provide a “soft top” and expiration features to be programmed into PCMs to provide additional flexibility for fleet owners and so that fleets who purchase used vehicles have the ability to have different VSL policies than the original owner of the vehicle. Although the agencies considered limiting the soft top maximum level due to safety and fuel consumption/GHG benefit concerns, we have decided to allow the soft top maximum level to be set to any level higher than the maximum speed governed by the VSL. This approach will provide drivers with the ability to better navigate through traffic. However, the agencies are requiring that manufacturers providing a soft top feature must design the system so it cannot be modified by the fleets and will not decrement the vehicle speed limit causing the vehicle to decelerate while the driver is operating a vehicle above the normal governed vehicle speed limit. For example, if a manufacturer designs a vehicle speed limiter that has a normal governed speed limiter setting of 62 mph, and a “soft top” speed limiter value of 65 mph, the algorithm shall not cause the vehicle speed to decrement causing the vehicle to decelerate while the driver is

operating the vehicle at a speed greater than 62 mph (between 62 and 65 mph). The agencies are concerned that a forced deceleration when a driver is attempting to pass or maneuver could have an adverse impact on safety.

In using a soft top feature, a manufacturer will be required to provide to the agencies a functional description of the “soft top” control strategy including calibration values, the speed setting for both the hard limit and the soft top and the maximum time per day the control strategy could allow the vehicle to operate at the “soft top” speed limit at the time of certification. This information will be used to derive a factor to discount the VSL input used in the GEM to determine the fuel consumption and GHG emissions performance of the vehicle. The agencies also agree with comments that VSLs should be adjustable so as not to potentially limit a vehicle’s resale value. However, manufacturers choosing the option to override the VSL after a specified number of miles would be required to discount the benefit of the VSL relative to the tractor’s full lifetime miles. The VSL discount benefits for using soft-top and expiration features must be calculated using Equation II-1.<sup>93</sup> Additional details regarding the derivation of the discounted equation are included in RIA Chapter 2. The agencies are also requiring that any vehicle that has a “soft top” VSL to identify the use of the “soft top” VSL on the vehicle emissions label.

#### Equation II-1: Discounted Vehicle Speed Limiter Equation

$$\text{VSL input for GEM} = \text{Expiration Factor} \times [\text{Soft Top Factor} \times \text{Soft Top VSL} + (1 - \text{Soft Top Factor}) \times \text{VSL}] + (1 - \text{Expiration Factor}) \times 65 \text{ mph}$$

The agencies will require that the VSL algorithm be designed to assure that over the useful life of the vehicle that the vehicle will not operate in the soft top mode for more miles than would be expected based on the values used in Equation 0-1, as specified by the expiration factor and the soft top factor. In addition, any time the cumulative percentage of operation in the soft top mode (based on miles) exceeds the maximum ratio that could occur at the full lifetime mileage, or at the expiration mileage if used, the algorithm must not allow the vehicle to exceed the VSL value. In this case, the soft top feature remain disabled until the vehicle mileage reaches a point where the ratio no longer meets this condition.

In response to the comments about how the agencies will evaluate

<sup>92</sup> See 75 FR at page 74223.

<sup>93</sup> See § 1037.640.

tampering, NHTSA and EPA have added a number of requirements in these final rules relating to the VSL control feature. VSL control features should be designed so they cannot be easily overridden. Manufacturers must ensure that the governed speed limit programmed into the VSL must also be verifiable through on-board diagnostic scanning tools, and must provide a description of the coding to identify the governed maximum speed limit and the expiration mileage both at the time of the initial vehicle certification and in-use. The agencies believe both manufacturers and fleets should work toward maintaining the integrity of VSLs, and the agencies may conduct new-vehicle and in-use random audits to verify that inputs into GEM are accurate.

The agencies are aware that some fleets/owners make changes to vehicles, such as installing different diameter tires, changing the axle (final drive) ratio and transmission gearing, such that a vehicle could travel at speeds higher than the speed limited by its VSL. Vehicles subject to FMCSA requirements must be in compliance with 49 CFR 393.82. The requirements apply to speedometers and states as follows:

Each bus, truck, and truck-tractor must be equipped with a speedometer indicating vehicle speed in miles per hour and/or kilometers per hour. The speedometer must be accurate to within plus or minus 8 km/hr (5 mph) at a speed of 80 km/hr (50 mph).

To facilitate adjustments for component changes affecting vehicle speed, manufacturers should provide a fleet/owner with the means to do so unless the adjustments would affect the VSL setting or operation.

DTNA and ATA additionally requested that the agencies ensure that any VSL provisions adopted under the GHG emissions and fuel efficiency rules align with existing NHTSA standards. The agencies agree and note that there are no existing standards for a VSL outside of this current rulemaking activity. However, NHTSA has announced its intent to publish a proposal in 2012 for a VSL.<sup>94</sup> While both agencies have taken steps to avoid potential conflicts between the rulemaking being finalized today for fuel consumption and GHG emissions and the anticipated safety rulemaking, different conclusions may be reached in a safety-based rulemaking on VSLs, particularly in the approach to specifying soft top parameters and VSL expiration.

#### (h) Defined Vehicle Configurations in the GEM

As discussed above, the agencies are adopting methodologies that manufacturers will use to quantify the values input into the GEM for these factors affecting vehicle efficiency: Coefficient of Drag, Tire Rolling Resistance Coefficient, Weight Reduction, Vehicle Speed Limiter, and Extended Idle Reduction Technology. The other aspects of the vehicle configuration are fixed within the model and are not varied for the purpose of compliance. The defined inputs include the tractor-trailer combination curb weight, payload, engine characteristics, and drivetrain for each vehicle type, and others.

#### (i) Vehicle Drive Cycles

The GEM simulation model uses various inputs to characterize a vehicle's configuration (such as weight, aerodynamics, and rolling resistance) and predicts how the vehicle would behave on the road when it follows a driving cycle (vehicle speed versus time). As noted by the 2010 NAS Report,<sup>95</sup> the choice of a drive cycle used in compliance testing has significant consequences on the technology that will be employed to achieve a standard as well as the ability of the technology to achieve real world reductions in emissions and improvements in fuel consumption. Manufacturers naturally will design vehicles to ensure they satisfy regulatory standards. An ill-suited drive cycle for a regulatory category could encourage GHG emissions and fuel consumption technologies which satisfy the test but do not achieve the same benefits in use. For example, requiring all trucks to use a constant speed highway drive cycle will drive significant aerodynamic improvements. However, in the real world a combination tractor used for local delivery may spend little time on the highway, reducing the benefits achieved by this technology. In addition, the extra weight of the aerodynamic fairings will actually penalize the GHG and fuel consumption performance in urban driving and may reduce the freight carrying capability. The unique nature of the kinds of CO<sub>2</sub> emissions control and fuel consumption technology means that the same technology can be of benefit during some operation but cause a reduced benefit under other

operation.<sup>96</sup> To maximize the GHG emissions and fuel consumption benefits and avoid unintended reductions in benefits, the drive cycle should focus on promoting technology that produces benefits during the primary operation modes of the application. Consequently, drive cycles used in GHG emissions and fuel consumption compliance testing should reasonably represent the primary actual use, notwithstanding that every vehicle has a different drive cycle in-use.

The agencies proposed a modified version of the California ARB Heavy Heavy-duty Truck 5 Mode Cycle<sup>97</sup>, using the basis of three of the cycles which best mirror Class 7 and 8 combination tractor driving patterns, based on information from EPA's MOVES model.<sup>98</sup> The key advantage of the California ARB 5 mode cycle is that it provides the flexibility to use several different modes and weight the modes to fit specific vehicle application usage patterns. For the proposal, EPA analyzed the five cycles and found that some modifications to the cycles were required to allow sufficient flexibility in weightings. The agencies proposed the use of the Transient mode, as defined by California ARB, because it broadly covers urban driving. The agencies also proposed altered versions of the High Speed Cruise and Low Speed Cruise modes which reflected only constant speed cycles at 65 mph and 55 mph respectively. In the NPRM, the agencies proposed to use three cycles which were the ARB transient cycle, a 55 mph steady state cruise, and a 65 mph steady state cruise.

The agencies received comment from NACAA recommending an increase in the high speed cruise cycle speed from the proposed value of 65 mph to 75 mph because trucks travel at higher speeds. The agencies analyzed the urban and rural interstate truck speed limits in each state to determine the national average truck speed limit. State interstate speed limits for trucks vary between 55 and 75 mph, depending on the state.<sup>99</sup> Based on this information, the national median truck speed limit is

<sup>96</sup> This situation does not typically occur for heavy-duty emission control technology designed to control criteria pollutants such as PM and NO<sub>x</sub>.

<sup>97</sup> California Air Resources Board. Heavy Heavy-duty Diesel Truck chassis dynamometer schedule, Transient Mode. Last accessed on August 2, 2010 at <http://www.dieselnet.com/standards/cycles/hhddt.html>.

<sup>98</sup> EPA's MOVES (Motor Vehicle Emission Simulator). See <http://www.epa.gov/otaq/models/moves/index.htm> for additional information.

<sup>99</sup> Governors Highway Safety Association. Speed Limit Laws May 2011. Last viewed on May 9, 2011 at [http://www.ghsa.org/html/stateinfo/laws/speedlimit\\_laws.html](http://www.ghsa.org/html/stateinfo/laws/speedlimit_laws.html).

<sup>94</sup> 76 FR 78.

<sup>95</sup> See 2010 NAS Report, Note 21, Chapters 4 and 8.

65 mph. The agencies also analyzed the national average truck speed limit weighted by VMT for each state based on VMT data by state from the Federal Highway Administration as described in RIA Section 3.4.2. Based on this information, the national average VMT-weighted truck speed limit is 63 mph. The agencies continue to believe that the appropriate high speed cruise speed should be set at the national average truck speed limit to appropriately balance the evaluation of technologies such as aerodynamics, but not overstate the benefits of these technologies. Therefore, the agencies are adopting as proposed a speed of 65 mph for the high speed cruise cycle.

The agencies also received comments from Allison which disagreed with proposed drive cycles for combination tractors because the cycles did not account for external factors such as grades, wind, traffic condition, etc. Allison also believes that the acceleration rates are too low. The agencies recognize that the proposed drive cycles do not incorporate the external factors described by Allison. Parallel to the approach used to evaluate light-duty vehicles, the drive cycles do not incorporate either grade or wind which can be difficult to simulate in

chassis dynamometer cells. In the final rules, the agencies are defining an approach that manufacturers may take to evaluate their aerodynamic packages in a wind-averaged condition and use a modified Cd value in GEM.<sup>100</sup> The agencies are also adopting provisions for the innovative technology demonstration that allows for the use of on-road testing which includes grades for technologies whose benefits are reflected with grade. Lastly, the agencies' final drive cycles for highway operation contain a constant speed, as proposed. The acceleration and deceleration rates are only used to bring the vehicle to the cruising speed and the CO<sub>2</sub> emissions and fuel consumption from these portions of the drive cycle are not included in the composite emissions and fuel consumption results. The agencies did not include the speed dithering, which is representative of actual driving and traffic conditions, in the proposed constant speed portion of the cycles because the dithering does not provide any additional distinction between technologies but only added complexity to the cycle. The agencies believe this approach is still appropriate for the final action.

Allison referred the agencies to the Oak Ridge National Laboratory and

SmartWay program to review the amount of time long-haul vehicles spend on the highway. They believe the steady state highway speeds are overestimated. Data provided by Allison indicates that day cabs spend only 14 percent of miles traveling at speeds greater than 60 mph. NHTSA and EPA recognize that there is a variation in the amount of miles day cabs travel under different operations. As described above, the agencies are adopting an approach where tractors which operate like vocational vehicles may be regulated as such in the HD program. Thus, these day cabs will have a drive cycle weighting representative of vocational vehicles with more weighting on the transient operation and less on the highway speed operation.

For proposal, EPA and NHTSA relied on the EPA MOVES analysis of Federal Highway Administration data to develop the mode weightings to characterize typical operations of heavy-duty trucks, per Table II-10 below.<sup>101</sup> A detailed discussion of drive cycles is included in RIA Chapter 3.<sup>102</sup> The agencies are adopting the proposed drive cycle weightings for combination tractors.

TABLE II-10—DRIVE CYCLE MODE WEIGHTINGS

	Transient	55 mph cruise	65 mph cruise
Day Cabs .....	19%	17%	64%
Sleeper Cabs .....	5%	9%	86%

(ii) Standardized Trailers

As proposed, NHTSA and EPA are adopting provisions so that the tractor performance in the GEM is judged assuming the tractor is pulling a standardized trailer. The agencies did not receive any adverse comments related to this approach. The agencies believe that an assessment of the tractor fuel consumption and CO<sub>2</sub> emissions should be conducted using a tractor-trailer combination. We believe this approach best reflects the impact of the overall weight of the tractor-trailer and the aerodynamic technologies in actual use, where tractors are designed and used with a trailer. The GEM will continue to use a predefined typical

trailer in assessing overall performance. The high roof sleeper cabs are paired with a standard box trailer; the mid roof tractors are paired with a tanker trailer; and the low roof tractors are paired with a flat bed trailer.

(iii) Empty Weight and Payload

The total weight of the tractor-trailer combination is the sum of the tractor curb weight, the trailer curb weight, and the payload. The total weight of a vehicle is important because it in part determines the impact of technologies, such as rolling resistance, on GHG emissions and fuel consumption. In this final action, the agencies are specifying

each of these aspects of the vehicle, as proposed.

In use, trucks operate at different weights at different times during their operations. The greatest freight transport efficiency (the amount of fuel required to move a ton of payload) would be achieved by operating trucks at the maximum load for which they are designed all of the time. However, logistics such as delivery demands which require that trucks travel without full loads, the density of payload, and the availability of full loads of freight limit the ability of trucks to operate at their highest efficiency all the time. M.J. Bradley analyzed the Truck Inventory and Use Survey and found that

<sup>100</sup> See Section IV.B.3.b below.

<sup>101</sup> The Environmental Protection Agency. Draft MOVES2009 Highway Vehicle Population and Activity Data. EPA-420-P-09-001, August 2009 <http://www.epa.gov/otaq/models/moves/techdocs/420p09001.pdf>.

<sup>102</sup> In the light-duty vehicle rule, EPA and NHTSA based compliance with tailpipe standards

on use of the FTP and HFET, and declined to use alternative tests. See 75 FR 25407. NHTSA is mandated to use the FTP and HFET tests for CAFE standards, and all relevant data was obtained by FTP and HFET testing in any case. Id. Neither of these constraints exists for Class 7-8 tractors. The little data which exist on current performance are principally measured by the ARB Heavy Heavy-

duty Truck 5 Mode Cycle testing, and NHTSA is not mandated to use the FTP to establish heavy-duty fuel economy standards. See 49 U.S.C. 32902(k)(2) authorizing NHTSA, among other things, to adopt and implement appropriate "test methods, measurement metrics, \* \* \* and compliance protocols".

approximately 9 percent of combination tractor miles travelled empty, 61 percent are “cubed-out” (the trailer is full before the weight limit is reached), and 30 percent are “weighed out” (operating weight equal 80,000 pounds which is the gross vehicle weight limit on the Federal Interstate Highway System or greater than 80,000 pounds for vehicles traveling on roads outside of the interstate system).<sup>103</sup>

As described above, the amount of payload that a tractor can carry depends on the category (or GVWR and GCWR) of the vehicle. For example, a typical Class 7 tractor can carry less payload than a Class 8 tractor. For proposal, the agencies used the Federal Highway Administration Truck Payload Equivalent Factors using Vehicle Inventory and Use Survey (VIUS) and Vehicle Travel Information System data to determine the proposed payloads. FHWA’s results found that the average payload of a Class 8 vehicle ranged from 36,247 to 40,089 pounds, depending on the average distance travelled per day.<sup>104</sup> The same results found that Class 7 vehicles carried between 18,674 and 34,210 pounds of payload also

depending on average distance travelled per day. Based on this data, the agencies proposed to prescribe a fixed payload of 25,000 pounds for Class 7 tractors and 38,000 pounds for Class 8 tractors for their respective test procedures. The agencies proposed a common payload for Class 8 day cabs and sleeper cabs as predefined GEM input because the data available do not distinguish based on type of Class 8 tractor. These payload values represent a heavily loaded trailer, but not maximum GVWR, since as described above the majority of tractors “cube-out” rather than “weigh-out.”

The agencies developed the proposed tractor curb weight inputs from actual tractor weights measured in two of EPA’s test programs and based on information from the manufacturers. The proposed trailer curb weight inputs were derived from actual trailer weight measurements conducted by EPA and weight data provided to ICF International by the trailer manufacturers.<sup>105</sup>

The agencies received comments from UMTRI and ATA regarding the values assumed for the combination tractor weights. UMTRI recommended using

80,000 pounds for the total weight for tractor-trailer combinations. ATA based on their analysis of the Federal Highway Administration’s Long Term Pavement Database, recommended 5,000 to 10,000 pound payload for Class 7 tractors and 25,000 to 30,000 pounds for Class 8 tractors. ATA also determined from the same database that 20 percent of tractor miles are empty, 67 percent cube-out, and 13 percent weigh-out. The agencies are adopting the proposed tractor-trailer weights because we do not have strong evidence to select other values and because changing the assumed values would not change the impact on GHG emissions or fuel consumption of the technologies included in this phase of the HD program (the relative stringency of the standards and the projected emission reductions do not change with assumed payload). NHTSA and EPA intend to continue evaluating additional sources of weight information in future phases of the program.

Details of the final individual weight inputs by regulatory category, as shown in Table II–11, are included in RIA Chapter 3.

TABLE II–11—FINAL COMBINATION TRACTOR WEIGHTS

Model type	Regulatory subcategory	Tractor tare weight (lbs)	Trailer weight (lbs)	Payload (lbs)	Total weight (lbs)
Class 8	Sleeper Cab High Roof	19,000	13,500	38,000	70,500
Class 8	Sleeper Cab Mid Roof	18,750	10,000	38,000	66,750
Class 8	Sleeper Cab Low Roof	18,500	10,500	38,000	67,000
Class 8	Day Cab High Roof	17,500	13,500	38,000	69,000
Class 8	Day Cab Mid Roof	17,100	10,000	38,000	65,100
Class 8	Day Cab Low Roof	17,000	10,500	38,000	65,500
Class 7	Day Cab High Roof	11,500	13,500	25,000	50,000
Class 7	Day Cab Mid Roof	11,100	10,000	25,000	46,100
Class 7	Day Cab Low Roof	11,000	10,500	25,000	46,500

(iv) Standardized Drivetrain

The agencies’ assessment at proposal of the current vehicle configuration process at the truck dealer’s level was that the truck companies provide tools to specify the proper drivetrain matched to the buyer’s specific circumstances. These dealer tools allow a significant amount of customization for drive cycle and payload to provide the best specification for each individual customer. The agencies are not seeking to disrupt this process. Optimal drivetrain selection is dependent on the engine, drive cycle (including vehicle speed and road grade), and payload.

Each combination of engine, drive cycle, and payload has a single optimal transmission and final drive ratio. The agencies received comments from ArvinMeritor and ICCT which suggested that the agencies incorporate the actual drivetrain configuration (axle configuration, driveline efficiency, and transmission) into the GEM. The agencies continue to believe, and therefore are adopting as proposed, that it is appropriate to specify the engine’s fuel consumption map, drive cycle, and payload; therefore, it makes sense to also specify the drivetrain that matches.

(v) Engine Input to the GEM for Tractors

As proposed, the agencies are defining the engine characteristics used in the GEM, including the fuel consumption map which provides the fuel consumption at hundreds of engine speed and torque points. If the agencies did not standardize the fuel map, then a tractor that uses an engine with emissions and fuel consumption better than the standards would require fewer vehicle reductions than those technically feasible reductions reflected in the final standards. The agencies are finalizing two distinct fuel consumption maps for use in the GEM. The first fuel

<sup>103</sup> M.J. Bradley & Associates. Setting the Stage for Regulation of Heavy-Duty Vehicle Fuel Economy and GHG Emissions: Issues and Opportunities. February 2009. Page 35. Analysis based on 1992 Truck Inventory and Use Survey data, where the survey data allowed developing the distribution of loads instead of merely the average loads.

<sup>104</sup> The U.S. Federal Highway Administration. Development of Truck Payload Equivalent Factor. Table 11. Last viewed on March 9, 2010 at [http://ops.fhwa.dot.gov/freight/freight\\_analysis/faf/faf2\\_reports/reports9/s510\\_11\\_12\\_tables.htm](http://ops.fhwa.dot.gov/freight/freight_analysis/faf/faf2_reports/reports9/s510_11_12_tables.htm).

<sup>105</sup> ICF International. Investigation of Costs for Strategies to Reduce Greenhouse Gas Emissions for Heavy-Duty On-road Vehicles. July 2010. Pages 4–15. Docket Number EPA–HQ–OAR–2010–0162–0044.

consumption map would be used in the GEM for the 2014 through 2016 model years and represents an average engine which meets EPA's final 2014 model year engine CO<sub>2</sub> emissions standards. The same fuel map would be used for NHTSA's voluntary standards in the 2014 and 2015 model years, as well as its mandatory program in the 2016 model year. A second fuel consumption map will be used beginning in the 2017 model year and represents an engine which meets the 2017 model year CO<sub>2</sub> emissions and fuel consumption standards and accounts for the increased stringency in the final MY 2017 standard. The agencies have modified the 2017 MY fuel map used in the GEM for the final rulemaking to address comments received. Details regarding this change can be found in RIA Chapter 4.4.4. Effectively there is no change in stringency of the tractor vehicle (not including the engine standards over the full rulemaking period).<sup>106</sup> These inputs are appropriate given the separate regulatory requirement that Class 7 and 8 combination tractor manufacturers use only certified engines.

(i) Heavy-Duty Engine Test Procedure for Engines Installed in Combination Tractors

The HD engine test procedure consists of two primary aspects—a duty cycle and a metric to evaluate the emissions and fuel consumption.

EPA proposed that the GHG emission standards for heavy-duty engines under the CAA would be expressed as g/bhp-hr while NHTSA's proposed fuel consumption standards under EISA, in turn, be represented as gal/100 bhp-hr. The NAS panel did not specifically discuss or recommend a metric to evaluate the fuel consumption of heavy-duty engines. However, as noted above they did recommend the use of a load-specific fuel consumption metric for the evaluation of vehicles.<sup>107</sup> An analogous metric for engines is the amount of fuel consumed per unit of work. The g/bhp-hr metric is also consistent with EPA's current standards for non-GHG emissions for these engines. The agencies did not receive any adverse comments related to the metrics for HD engines; therefore, we are adopting the metrics as proposed.

The agencies believe it is appropriate to set standards based on a single test procedure, either the Heavy-duty FTP or SET, depending on the primary

expected use of the engine. This approach differs from EPA's criteria pollutant standards for engines which currently require that manufacturers demonstrate compliance over the transient FTP cycle; over the steady-state SET procedure; and during not-to-exceed testing. EPA created this multi-layered approach to criteria emissions control in response to engine designs that optimized operation for lowest fuel consumption at the expense of very high criteria emissions when operated off the regulatory cycle. EPA's use of multiple test procedures for criteria pollutants helps to ensure that manufacturers calibrate engine systems for compliance under all operating conditions. We are not concerned if manufacturers further calibrate engines off-cycle to give better in-use fuel consumption while maintaining compliance with the criteria emissions standards as such calibration is entirely consistent with the goals of our joint program. Further, we believe that setting GHG and fuel consumption standards based on both transient and steady-state operating conditions for all engines could lead to undesirable outcomes.

It is critical to set standards based on the most representative test cycles in order for performance in-use to obtain the intended (and feasible) air quality and fuel consumption benefits. Tractors spend the majority of their operation at steady state conditions, and will obtain in-use benefit of technologies such as turbocompounding and other waste heat recovery technologies during this kind of typical engine operation. Turbocompounding is a very effective approach to lower fuel consumption under steady driving conditions typified by combination tractor trailer operation and is well reflected in testing over the SET test procedure. However, when used in driving typified by transient operation as we expect for vocational vehicles and as is represented by the Heavy-duty FTP, turbocompounding shows very little benefit. Setting an emission standard based on the Heavy-duty FTP for engines intended for use in combination tractor trailers could lead manufacturers to not apply turbocompounding even though it can be a highly cost effective means to reduce GHG emissions and lower fuel consumption. (It is for this reason that turbocompounding is not part of the technology basis for MHD or HHD engines installed in vocational vehicles.)

The agencies proposed that engines installed in tractors demonstrate compliance with the CO<sub>2</sub> emissions and fuel consumption standards over the SET cycle. Commenters such as

Cummins, Bosch, Daimler, and Honeywell supported the proposed approach. ACEEE recommended adopting a new test cycle, such as the World Harmonized Duty Cycle which was developed using newer data, to evaluate HD engines. Daimler also supported the WHDC for future phases of the program. The agencies continue to believe the important issues and technical work related to setting new criteria pollutant emissions standards appropriate for the World Harmonized Duty Cycle are significant and beyond the scope of this rulemaking. The SET cycle remains representative of typical driving cycles for combination tractors (and engines installed in them). Therefore, the agencies are adopting the SET cycle to evaluate CO<sub>2</sub> emissions and fuel consumption of HD engines installed in tractors, as proposed.

The current non-GHG emissions engine test procedures also require the development of regeneration emission rates and frequency factors to account for the emission changes during a regeneration event (40 CFR 86.004–28). EPA and NHTSA proposed not to include these emissions from the calculation of the compliance levels over the defined test procedures. Cummins and Daimler supported this approach and stated that sufficient incentives already exist for manufacturers to limit regeneration frequency. Conversely, Volvo opposed the omission of IRAF requirements for CO<sub>2</sub> emissions because emissions from regeneration can be a significant portion of the expected improvement and a significant variable between manufacturers

At proposal, we considered including regeneration in the estimate of fuel consumption and GHG emissions and decided not to do so for two reasons. See 75 FR at 74188. First, EPA's existing criteria emission regulations already provide a strong motivation to engine manufacturers to reduce the frequency and duration of infrequent regeneration events. The very stringent 2010 NO<sub>x</sub> emission standards cannot be met by engine designs that lead to frequent and extend regeneration events. Hence, we believe engine manufacturers are already reducing regeneration emissions to the greatest degree possible. In addition to believing that regenerations are already controlled to the extent technologically possible, we believe that attempting to include regeneration emissions in the standard setting could lead to an inadvertently lax emissions standard. In order to include regeneration and set appropriate standards, EPA and NHTSA would have needed to project the regeneration

<sup>106</sup> As noted earlier, use of the 2017 model year fuel consumption map as a GEM input results in numerically more stringent final vehicle standards for MY 2017.

<sup>107</sup> See NAS Report, Note 21, at page 39.



frequency and duration of future engine designs in the time frame of this program. Such a projection would be inherently difficult to make and quite likely would underestimate the progress engine manufacturers will make in reducing infrequent regenerations. If we underestimated that progress, we would effectively be setting a more lax set of standards than otherwise would be expected. Hence in setting a standard including regeneration emissions we faced the real possibility that we would achieve less effective CO<sub>2</sub> emissions control and fuel consumption reductions than we will achieve by not including regeneration emissions. Therefore, the agencies are finalizing an approach as proposed which does not include the regenerative emissions.

#### (j) Chassis-Based Test Procedure

In the proposal, the agencies considered proposing a chassis-based vehicle test to evaluate Class 7 and 8 tractors based on a laboratory test of the engine and vehicle together. A “chassis dynamometer test” for heavy-duty vehicles would be similar to the Federal Test Procedure used today for light-duty vehicles.

However, the agencies decided not to propose the use of a chassis test procedure to demonstrate compliance for tractor standards due to the significant technical hurdles to implementing such a program by the 2014 model year. The agencies recognize that such testing requires expensive, specialized equipment that is not yet widespread within the industry. The agencies have only identified approximately 11 heavy-duty chassis sites in the United States today and rapid installation of new facilities to comply with model year 2014 is not possible.<sup>108</sup>

In addition, and of equal if not greater importance, because of the enormous numbers of vehicle configurations that have an impact on fuel consumption, we do not believe that it would be reasonable to require testing of many combinations of tractor model configurations on a chassis dynamometer. The agencies evaluated the options available for one tractor model (provided as confidential business information from a truck manufacturer) and found that the company offered three cab configurations, six axle configurations, five front axles, 12 rear axles, 19 axle ratios, eight engines, 17 transmissions,

and six tire sizes—where each of these options could impact the fuel consumption and CO<sub>2</sub> emissions of the tractor. Even using representative grouping of tractors for purposes of certification, this presents the potential for many different combinations that would need to be tested if a standard were adopted based on a chassis test procedure.

The agencies received comments from ACEEE and UCS supporting a full vehicle testing approach, but these commenters recognized the difficulties in doing this in the first phase of the HD program. The agencies maintain that the full vehicle testing on chassis dynamometers is not feasible in the timeframe of this rulemaking, although we believe such an approach may be appropriate in the future, if more testing facilities become available and if the agencies are able to address the complexity of tractor configurations issue described above.

#### (4) Summary of Flexibility and Credit Provisions for Tractors and Engine Used in These Tractors

EPA and NHTSA are finalizing four flexibility provisions specifically for heavy-duty tractor and engine manufacturers, as discussed in Section IV below. These are an averaging, banking and trading program for emissions and fuel consumption credits, as well as provisions for early credits, advanced technology credits, and credits for innovative vehicle or engine technologies which are not included as inputs to the GEM or are not demonstrated on the engine SET test cycle. With the exception of the advanced technology credits, credits generated under these provisions can only be used within the same averaging set which generated the credit (for example, credits generated by HD engines installed in tractors can only be used by HD engines). EPA is also adopting a N<sub>2</sub>O emission credit program, as described in Section IV below.

#### (5) Deferral of Standards for Tractor and Engine Manufacturing Companies That Are Small Businesses

EPA and NHTSA are not adopting greenhouse gas emissions and fuel consumption standards for small tractor or engine manufacturers meeting the Small Business Administration (SBA) size criteria of a small business as described in 13 CFR 121.201.<sup>109</sup> The agencies will instead consider appropriate GHG and fuel consumption standards for these entities as part of a

future regulatory action. This includes both U.S.-based and foreign small volume heavy-duty tractor and engine manufacturers.

The agencies have identified two entities that fit the SBA size criterion of a small business.<sup>110</sup> The agencies estimate that these small entities comprise less than 0.5 percent of the total heavy-duty combination tractors in the United States based on Polk Registration Data from 2003 through 2007,<sup>111</sup> and therefore that the exemption will have a negligible impact on the GHG emissions and fuel consumption improvements from the final standards.

To ensure that the agencies are aware of which companies would be exempt, we are requiring that such entities submit a declaration to EPA and NHTSA containing a detailed written description of how that manufacturer qualifies as a small entity under the provisions of 13 CFR 121.201.

#### C. Heavy-Duty Pickup Trucks and Vans

The primary elements of the EPA and NHTSA programs for complete HD pickups and vans are presented in this section. These provisions also cover optional chassis certification of incomplete HD vehicles and of Class 4 and 5 vehicles, as discussed in detail in Section V.B(1)(e). Section II.C(1) explains the form of the CO<sub>2</sub> and fuel consumption standards, the numerical levels for those standards, and the approach to phasing in the standards over time. The measurement procedure for determining compliance is discussed in Section II.C(2), and the EPA and NHTSA compliance programs are discussed in Section II.C(3). Section II.C(4) discusses implementation flexibility provisions. Section II.E discusses additional standards and provisions for N<sub>2</sub>O and CH<sub>4</sub> emissions, for vehicle air conditioning leakage, and for ethanol-fueled and electric vehicles. HD pickup and van air conditioning efficiency is not being regulated, for reasons discussed in Section II.E.

(1) What are the levels and timing of HD pickup and van standards?

##### (a) Vehicle-Based Standards

About 90 percent of Class 2b and 3 vehicles are pickup trucks, passenger vans, and work vans that are sold by the original equipment manufacturers as complete vehicles, ready for use on the road. In addition, most of these

<sup>108</sup> For comparison, engine manufacturers typically own a large number of engine dynamometer test cells for engine development and durability (up to 100 engine dynamometers per manufacturer).

<sup>109</sup> See § 1036.150 and § 1037.150.

<sup>110</sup> The agencies have identified Ottawa Truck, Inc. and Kalmar Industries USA as two potential small tractor manufacturers.

<sup>111</sup> M.J. Bradley, Heavy-duty Vehicle Market Analysis. May 2009.



complete HD pickups and vans are covered by CAA vehicle emissions standards for criteria pollutants today (*i.e.*, they are chassis tested similar to light-duty), expressed in grams per mile. This distinguishes this category from other, larger heavy-duty vehicles that typically have only the engines covered by CAA engine emission standards, expressed in grams per brake horsepower-hour. As a result, Class 2b and 3 complete vehicles share much more in common with light-duty trucks than with other heavy-duty vehicles.

Three of these commonalities are especially significant: (1) Over 95 percent of the HD pickups and vans sold in the United States are produced by Ford, General Motors, and Chrysler—three companies with large light-duty vehicle and light-duty truck sales in the United States, (2) these companies typically base their HD pickup and van designs on higher sales volume light-duty truck platforms and technologies, often incorporating new light-duty truck design features into HD pickups and vans at their next design cycle, and (3) at this time most complete HD pickups and vans are certified to vehicle-based rather than engine-based EPA standards. There is also the potential for substantial GHG and fuel consumption reductions from vehicle design improvements beyond engine changes (such as through optimizing aerodynamics, weight, tires, and accessories), and the manufacturer is generally responsible for both engine and vehicle design. All of these factors together suggest that it is appropriate and reasonable to set standards for the vehicle as a whole, rather than to establish separate engine and vehicle GHG and fuel consumption standards, as is being done for the other heavy-duty categories. This approach for complete vehicles is consistent with Recommendation 8–1 of the NAS Report, which encourages the regulation of “the final stage vehicle manufacturers since they have the greatest control over the design of the vehicle and its major subsystems that affect fuel consumption.” There was consensus in the public comments supporting this approach.

#### (b) Work-Based Attributes

In setting heavy-duty vehicle standards it is important to take into account the great diversity of vehicle sizes, applications, and features. That diversity reflects the variety of functions performed by heavy-duty vehicles, and this in turn can affect the kind of technology that is available to control emissions and reduce fuel consumption, and its effectiveness. EPA has dealt with

this diversity in the past by making weight-based distinctions where necessary, for example in setting HD vehicle standards that are different for vehicles above and below 10,000 lb GVWR, and in defining different standards and useful life requirements for light-, medium-, and heavy-heavy-duty engines. Where appropriate, distinctions based on fuel type have also been made, though with an overall goal of remaining fuel-neutral.

The joint EPA GHG and NHTSA fuel economy rules for light-duty vehicles accounted for vehicle diversity in that segment by basing standards on vehicle footprint (the wheelbase times the average track width). Passenger cars and light trucks with larger footprints are assigned numerically higher target levels for GHGs and numerically lower target levels for fuel economy in acknowledgement of the differences in technology as footprint gets larger, such that vehicles with larger footprints have an inherent tendency to burn more fuel and emit more GHGs per mile of travel. Using a footprint-based attribute to assign targets also avoids interfering with the ability of the market to offer a variety of products to maintain consumer choice.

In developing this rulemaking, the agencies emphasized creating a program structure that would achieve reductions in fuel consumption and GHGs based on how vehicles are used and on the work they perform in the real world, consistent with the NAS report recommendations to be mindful of HD vehicles’ unique purposes. Despite the HD pickup and van similarities to light-duty vehicles, we believe that the past practice in EPA’s heavy-duty program of using weight-based distinctions in dealing with the diversity of HD pickup and van products is more appropriate than using vehicle footprint. Work-based measures such as payload and towing capability are key among the things that characterize differences in the design of vehicles, as well as differences in how the vehicles will be used. Vehicles in this category have a wide range of payload and towing capacities. These work-based differences in design and in-use operation are the key factors in evaluating technological improvements for reducing CO<sub>2</sub> emissions and fuel consumption. Payload has a particularly important impact on the test results for HD pickup and van emissions and fuel consumption, because testing under existing EPA procedures for criteria pollutants is conducted with the vehicle loaded to half of its payload capacity (rather than to a flat 300 lb as in the light-duty program), and the correlation

between test weight and fuel use is strong.<sup>112</sup>

Towing, on the other hand, does not directly factor into test weight as nothing is towed during the test. Hence only the higher curb weight caused by heavier truck components would play a role in affecting measured test results. However towing capacity can be a significant factor to consider because HD pickup truck towing capacities can be quite large, with a correspondingly large effect on design.

We note too that, from a purchaser perspective, payload and towing capability typically play a greater role than physical dimensions in influencing purchaser decisions on which heavy-duty vehicle to buy. For passenger vans, seating capacity is of course a major consideration, but this correlates closely with payload weight.

Although heavy-duty vehicles are traditionally classified by their GVWR, we do not believe that GVWR is the best weight-based attribute on which to base GHG and fuel consumption standards for this group of vehicles. GVWR is a function of not only payload capacity but of vehicle curb weight as well; in fact, it is the simple sum of the two. Allowing more GHG emissions from vehicles with higher curb weight tends to penalize lightweighted vehicles with comparable payload capabilities by making them meet more stringent standards than they would have had to meet without the weight reduction. The same would be true for another common weight-based measure, the gross vehicle combination weight, which adds the maximum combined towing and payload weight to the curb weight.

Similar concerns about using weight-based attributes that include vehicle curb weight were raised in the EPA/NHTSA proposal for light-duty GHG and fuel economy standards: “footprint-based standards provide an incentive to use advanced lightweight materials and structures that would be discouraged by weight-based standards”, and “there is less risk of ‘gaming’ (artificial manipulation of the attribute(s) to achieve a more favorable target) by increasing footprint under footprint-based standards than by increasing vehicle mass under weight-based standards—it is relatively easy for a manufacturer to add enough weight to a vehicle to decrease its applicable fuel economy target a significant amount, as compared to increasing vehicle footprint” (74 FR 49685, September 28,

<sup>112</sup> Section IIC(2) discusses our decision that GHGs and fuel consumption for HD pickups and vans be measured using the same test conditions as in the existing EPA program for criteria pollutants.

2009). The agencies believe that using payload and towing capacities as the work-based attributes avoids the above-mentioned disincentive for the use of lightweighting technology by taking vehicle curb weight out of the standards determination.

After taking these considerations into account, EPA and NHTSA proposed to set standards for HD pickups and vans based on the proposed “work factor” attribute that combines vehicle payload capacity and vehicle towing capacity, in pounds, with an additional fixed adjustment for four-wheel drive (4wd) vehicles. This adjustment accounts for the fact that 4wd, critical to enabling the many off-road heavy-duty work applications, adds roughly 500 lb to the vehicle weight. There was consensus in the public comments supporting this attribute, and the agencies are adopting it as proposed. Target GHG and fuel consumption standards will be determined for each vehicle with a unique work factor (analogous to a target for each discrete vehicle footprint in the light-duty vehicle rules). These targets will then be production weighted and summed to derive a manufacturer’s annual fleet average standard for its heavy-duty pickups and vans. Widespread support for the proposed work factor-based approach to standards and fleet average approach to compliance was expressed in the comments we received.

To ensure consistency and help preclude gaming, we are finalizing the proposed provision that payload capacity be defined as GVWR minus curb weight, and towing capacity as GCWR minus GVWR. For purposes of determining the work factor, GCWR is defined according to the Society of Automotive Engineers (SAE) Recommended Practice J2807 APR2008, GVWR is defined consistent with EPA’s criteria pollutants program, and curb weight is defined as in 40 CFR 86.1803–01. Based on analysis of how CO<sub>2</sub> emissions and fuel consumption correlate to work factor, we believe that a straight line correlation is appropriate across the spectrum of possible HD pickups and vans, and that vehicle

distinctions such as Class 2b versus Class 3 need not be made in setting standards levels for these vehicles.<sup>113</sup> This approach was supported by commenters.

We note that payload/towing-dependent gram per mile and gallon per 100 mile standards for HD pickups and vans parallel the gram per ton-mile and gallon per 1,000 ton-mile standards being finalized for Class 7 and 8 combination tractors and for vocational vehicles. Both approaches account for the fact that more work is done, more fuel is burned, and more CO<sub>2</sub> is emitted in moving heavier loads than in moving lighter loads. Both of these load-based approaches avoid penalizing vehicle designers wishing to reduce GHG emissions and fuel consumption by reducing the weight of their trucks. However, the sizeable diversity in HD work truck and van applications, which go well beyond simply transporting freight, and the fact that the curb weights of these vehicles are on the order of their payload capacities, suggest that setting simple gram/ton-mile and gallon/ton-mile standards for them is not appropriate. Even so, we believe that our setting of payload-based standards for HD pickups and vans is consistent with the NAS Report’s recommendation in favor of load-specific fuel consumption standards. Again, commenters agreed with this approach to setting HD pickup and van standards.

These attribute-based CO<sub>2</sub> and fuel consumption standards are meant to be relatively consistent from a stringency perspective. Vehicles across the entire range of the HD pickup and van segment have their respective target values for CO<sub>2</sub> emissions and fuel consumption, and therefore all HD pickups and vans will be affected by the standard. With this attribute-based standards approach, EPA and NHTSA believe there should be no significant effect on the relative distribution of vehicles with differing capabilities in the fleet, which means

<sup>114</sup> The NHTSA program provides voluntary standards for model years 2014 and 2015. Target line functions for 2016–2018 are for the second NHTSA alternative described in Section II.C(d)(ii).

that buyers should still be able to purchase the vehicle that meets their needs.

#### (c) Standards

The agencies are finalizing standards based on a technology analysis performed by EPA to determine the appropriate HD pickup and van standards. This analysis, described in detail in RIA Chapter 2, considered:

- The level of technology that is incorporated in current new HD pickups and vans,
- The available data on corresponding CO<sub>2</sub> emissions and fuel consumption for these vehicles,
- Technologies that would reduce CO<sub>2</sub> emissions and fuel consumption and that are judged to be feasible and appropriate for these vehicles through the 2018 model year,
- The effectiveness and cost of these technologies for HD pickup and vans,
- Projections of future U.S. sales for HD pickup and vans, and
- Forecasts of manufacturers’ product redesign schedules.

Based on this analysis, EPA is finalizing the proposed CO<sub>2</sub> attribute-based target standards shown in Figure 0–2 and II–3, and NHTSA is finalizing the equivalent attribute-based fuel consumption target standards, also shown in Figure 0–2 and II–3, applicable in model year 2018. These figures also shows phase-in standards for model years before 2018, and their derivation is explained below, along with alternative implementation schedules to ensure equivalency between the EPA and NHTSA programs while meeting respective statutory obligations. Also, for reasons discussed below, the agencies proposed and are establishing separate targets for gasoline-fueled (and any other Otto-cycle) vehicles and diesel-fueled (and any other Diesel-cycle) vehicles. The targets will be used to determine the production-weighted fleet average standards that apply to the combined diesel and gasoline fleet of HD pickups and vans produced by a manufacturer in each model year.

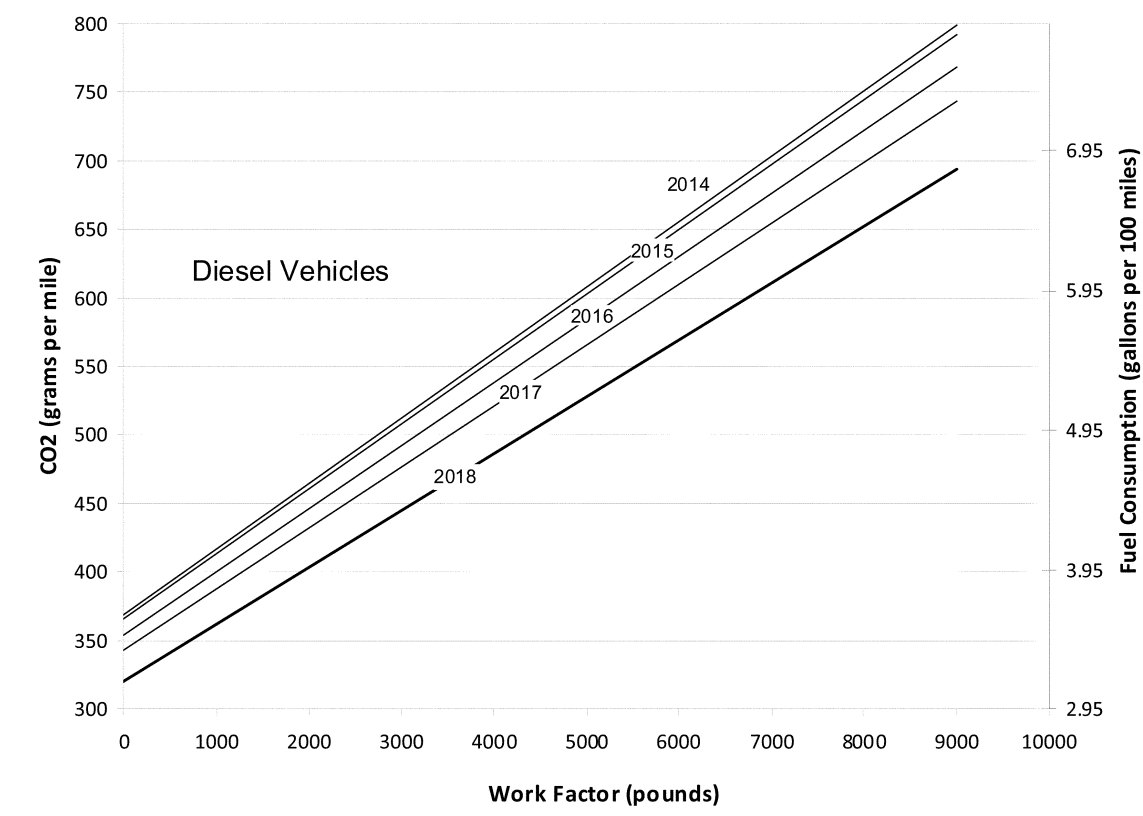

Figure II-2: EPA CO<sub>2</sub> Target Standards and NHTSA Fuel Consumption Target Standards for Diesel HD Pickups and Vans<sup>114</sup>

<sup>114</sup> The NHTSA program provides voluntary standards for model years 2014 and 2015. Target line functions for 2016–2018 are for the second NHTSA alternative described in Section II.C(d)(ii).

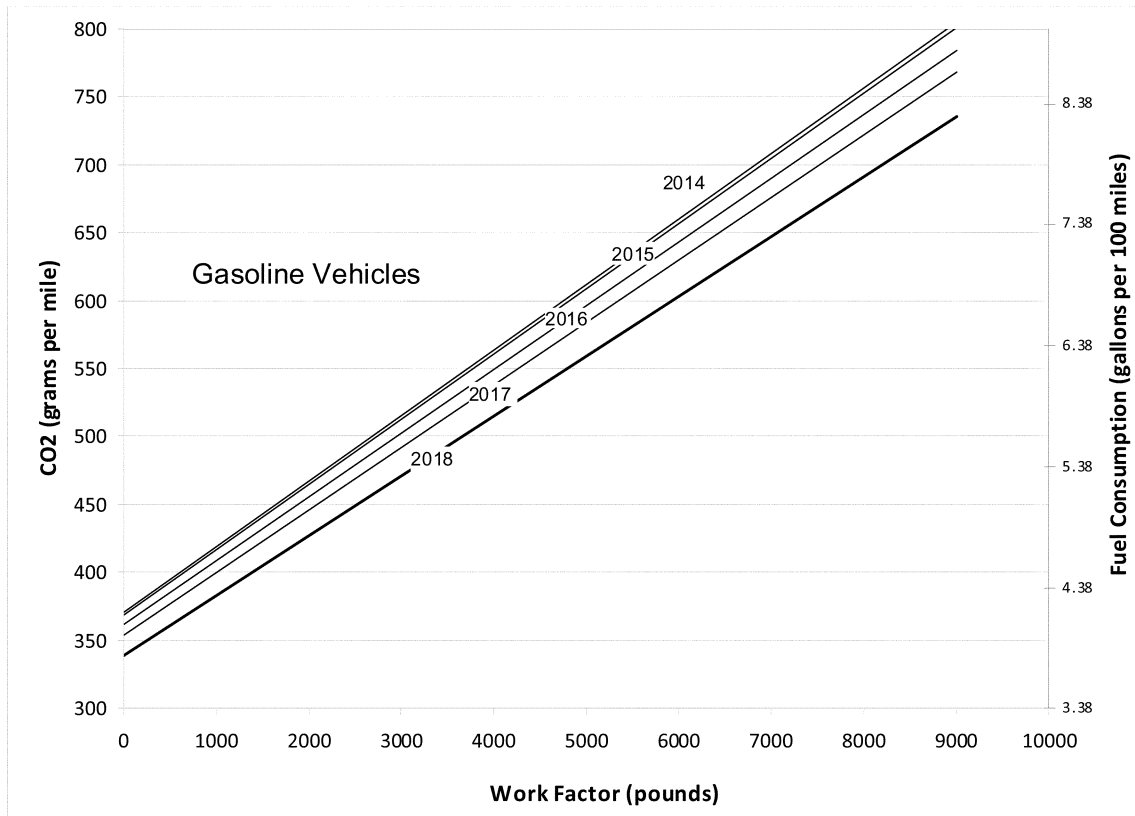

Figure II-3: EPA CO<sub>2</sub> Target Standards and NHTSA Fuel Consumption Target Standards for Gasoline HD Pickups and Vans<sup>115</sup>

Described mathematically, EPA's and NHTSA's target standards are defined by the following formulae:

$$\text{EPA CO}_2 \text{ Target (g/mile)} = \frac{a \times \text{WF}}{b} +$$

$$\text{NHTSA Fuel Consumption Target (gallons/100 miles)} = [c \times \text{WF}] + d$$

Where:

$$\text{WF} = \text{Work Factor} = [0.75 \times (\text{Payload Capacity} + \text{xwd})] + [0.25 \times \text{Towing Capacity}]$$

$$\text{Payload Capacity} = \text{GVWR (lb)} - \text{Curb Weight (lb)}$$

xwd = 500 lb if the vehicle is equipped with 4wd, otherwise equals 0 lb

$$\text{Towing Capacity} = \text{GCWR (lb)} - \text{GVWR (lb)}$$

Coefficients a, b, c, and d are taken from Table II-12 or Table II-13.

TABLE II-12—COEFFICIENTS FOR HD PICKUP AND VAN TARGET STANDARDS<sup>116</sup>

Model year	a	b	c	d
<b>Diesel Vehicles</b>				
2014 .....	0.0478	368	0.000470	3.61
2015 .....	0.0474	366	0.000466	3.60
2016 .....	0.0460	354	0.000452	3.48
2017 .....	0.0445	343	0.000437	3.37
2018 and later .....	0.0416	320	0.000409	3.14
<b>Gasoline Vehicles</b>				
2014 .....	0.0482	371	0.000542	4.17
2015 .....	0.0479	369	0.000539	4.15
2016 .....	0.0469	362	0.000528	4.07
2017 .....	0.0460	354	0.000518	3.98
2018 and later .....	0.0440	339	0.000495	3.81

<sup>115</sup> The NHTSA program provides voluntary standards for model years 2014 and 2015. Target line functions for 2016–2018 are for the second NHTSA alternative described in Section II.C(d)(ii).

<sup>116</sup> The NHTSA program provides voluntary standards for model years 2014 and 2015. Target line functions for 2016–2018 are for the second NHTSA alternative described in Section II.C(d)(ii).

TABLE II-13—COEFFICIENTS FOR NHTSA’S FIRST ALTERNATIVE AND EPA’S ALTERNATIVE HD PICKUP AND VAN TARGET STANDARDS

Model year	a	b	c	d
<b>Diesel Vehicles</b>				
2014 <sup>a</sup> .....	0.0478	368	0.000470	3.61
2015 <sup>a</sup> .....	0.0474	366	0.000466	3.60
2016–2018 .....	0.0440	339	0.000432	3.33
2019 and later .....	0.0416	320	0.000409	3.14
<b>Gasoline Vehicles</b>				
2014 <sup>a</sup> .....	0.0482	371	0.000542	4.17
2015 <sup>a</sup> .....	0.0479	369	0.000539	4.15
2016–2018 .....	0.0456	352	0.000513	3.96
2019 and later .....	0.0440	339	0.000495	3.81

**Notes:**

<sup>a</sup> NHTSA standards will be voluntary in 2014 and 2015.

These targets are based on a set of vehicle, engine, and transmission technologies assessed by the agencies and determined to be feasible and appropriate for HD pickups and vans in the 2014–2018 timeframe. See Section III.B for a detailed analysis of these vehicle, engine and transmission technologies, including their feasibility, costs, and effectiveness in HD pickups and vans.

To calculate a manufacturer’s HD pickup and van fleet average standard, the agencies are requiring that separate target curves be used for gasoline and diesel vehicles. The agencies estimate that in 2018 the target curves will achieve 15 and 10 percent reductions in CO<sub>2</sub> and fuel consumption for diesel and gasoline vehicles, respectively, relative to a common baseline for current (model year 2010) HD pickup trucks and vans. An additional two percent reduction in GHGs will be achieved by the direct air conditioning leakage standard in the EPA standards. These reductions are based on the agencies’ assessment of the feasibility of incorporating technologies (which differ significantly for gasoline and diesel powertrains) in the 2014–2018 model years, and on the differences in relative efficiency in the current gasoline and diesel vehicles. The resulting reductions represent roughly equivalent stringency levels for gasoline and diesel vehicles, which is important in ensuring our program maintains product choices available to vehicle buyers.

In written comments on the proposal, Cummins objected to setting separate diesel and gasoline vehicle standards, on the basis that it increases the burden for diesel engine manufacturers more than for gasoline engine manufacturers, and thereby could shift market share away from diesels. EMA argued for fuel-neutrality based on historical precedent

and the fact that GHGs emitted by one type of engine are no different than those emitted by another type of engine. We believe that both engine types have roughly equivalent redesign burdens as evidenced by the feasibility and cost analysis in RIA Chapter 2. Also, even though the emissions and fuel consumption reductions are expressed from a common diesel/gasoline baseline in these final rules, the actual starting base for diesels is at a lower level than for gasoline vehicles. Other industry commenters, including those with sizeable diesel sales, expressed general support for the standards. The agencies agree that standards that do not distinguish between fuel types are generally preferable where technological or market-based reasons do not strongly argue otherwise. These technological differences exist presently between gasoline and diesel engines for GHGs, as described above. The agencies emphasize, however, that they are not committed to perpetuating separate GHG standards for gasoline and diesel heavy-duty vehicles and engines, and expect to reexamine the need for separate gasoline/diesel standards in the next rulemaking.

Environmental groups and others commented that the proposed standards were not stringent enough, citing the heavy-duty vehicle NAS study finding that technologies such as hybridization are feasible. However, in the ambitious timeframe we are focusing on for these rules, targeting as it does technologies implementable in the HD pickup and van fleet starting in 2014 and phasing in with normal product redesign cycles through 2018, our assessment shows that the standards we are establishing are appropriate. More advanced technologies considered in the NAS report would be appropriate for consideration in future rulemaking

activity. Additional conventional technologies identified by commenters as promising in light-duty applications and potentially useful for HD applications are discussed in RIA chapter 2.

The NHTSA fuel consumption target curves and the EPA GHG target curves are equivalent. The agencies established the target curves using the direct relationship between fuel consumption and CO<sub>2</sub> using conversion factors of 8,887 g CO<sub>2</sub>/gallon for gasoline and 10,180 g CO<sub>2</sub>/gallon for diesel fuel.

It is expected that measured performance values for CO<sub>2</sub> will generally be equivalent to fuel consumption. However, as explained below in Section 0, EPA is finalizing a provision for manufacturers to use CO<sub>2</sub> credits to help demonstrate compliance with N<sub>2</sub>O and CH<sub>4</sub> emissions standards, by expressing any N<sub>2</sub>O and CH<sub>4</sub> undercompliance in terms of their CO<sub>2</sub>-equivalent and applying the needed CO<sub>2</sub> credits. For test families that do not use this compliance alternative, the measured performance values for CO<sub>2</sub> and fuel consumption will be equivalent because the same test runs and measurement data will be used to determine both values, and calculated fuel consumption will be based on the same conversion factors that are used to establish the relationship between the CO<sub>2</sub> and fuel consumption target curves (8,887 g CO<sub>2</sub>/gallon for gasoline and 10,180 g CO<sub>2</sub>/gallon for diesel fuel). For manufacturers that choose to use the EPA provision for CO<sub>2</sub> credit use in demonstrating N<sub>2</sub>O and CH<sub>4</sub> compliance, compliance with the CO<sub>2</sub> standard will not be directly equivalent to compliance with the NHTSA fuel consumption standard.

## (d) Implementation Plan

## (i) EPA Program Phase-In MY 2014–2018

EPA is finalizing the proposed provision that the GHG standards be phased in gradually over the 2014–2018 model years, with full implementation effective in the 2018 model year. Therefore, 100 percent of a manufacturer's vehicle fleet will need to meet a fleet-average standard that will become increasingly more stringent each year of the phase-in period. For both gasoline and diesel vehicles, this phase-in will be 15–20–40–60–100 percent of the model year 2018 stringency in model years 2014–2015–2016–2017–2018, respectively. These percentages reflect stringency increases from a baseline performance level for model year 2010, determined by the agencies based on EPA and manufacturer data. Because these vehicles are not currently regulated for GHG emissions, this phase-in takes the form of target line functions for gasoline and diesel vehicles that become increasingly stringent over the phase-in model years. These year-by-year functions have been derived in the same way as the 2018 function, by taking a percent reduction in CO<sub>2</sub> from a common unregulated baseline. For example, in 2014 the reduction for both diesel and gasoline vehicles will be 15 percent of the fully-phased-in reductions. Figures II–2 and II–3, and Table 0–12, reflect this phase-in approach.

EPA is also providing manufacturers with an optional alternative implementation schedule in model years 2016 through 2018, equivalent to NHTSA's first alternative for standards that do not change over these model years, described below. Under this option the phase-in will be 15–20–67–67–67–100 percent of the model year 2019 stringency in model years 2014–2015–2016–2017–2018–2019, respectively. Table 0–13, above, provides the coefficients "a" and "b" for this manufacturer's alternative. As explained below, this alternative will provide roughly equivalent overall CO<sub>2</sub> reductions and fuel consumption improvements as the 15–20–40–60–100 percent phase-in. In addition, as explained below, the stringency of this alternative was established by NHTSA such that a manufacturer with a stable production volume and mix over the model year 2016–2018 period could use Averaging, Banking and Trading to comply with either alternative and have a similar credit balance at the end of model year 2018.

Under the above-described alternatives, each manufacturer will need to demonstrate compliance with the applicable fleet average standard using that year's target function over all of its HD pickups and vans starting with its MY 2014 fleet of HD pickups and vans. No comments were received in support of an alternative approach that EPA requested comment on, involving phasing in an annually increasing percentage of each manufacturer's sales volume.

## (ii) NHTSA Program Phase-In 2016 and Later

NHTSA is finalizing the proposed provision to allow manufacturers to select one of two fuel consumption standard alternatives for model years 2016 and later. Each manufacturer will select an alternative in its joint pre-model year report, discussed below, that is now required to be electronically submitted to the agencies; and, once selected, the alternative will apply for model years 2016 and later, and cannot be reversed. The first alternative will define a fuel consumption target line function for gasoline vehicles and a target line function for diesel vehicles that will not change for model years 2016 to 2018. The target line function coefficients are provided in Table II–13.

The second alternative will be equivalent to the EPA target line functions in each model year starting in 2016 and continuing afterwards. Stringency of fuel consumption standards will increase gradually for the 2016 and later model years. Relative to a model year 2010 unregulated baseline for both gasoline and diesel vehicles, stringency will be 40, 60, and 100 percent of the 2018 target line function in model years 2016, 2017, and 2018, respectively. The stringency of the target line functions in the first alternative for model years 2016–2017–2018–2019 is 67–67–67–100 percent, respectively, of the 2019 stringency in the second alternative. The stringency of the first alternative was established so that a manufacturer with a stable production volume and mix over the model year 2016–2018 period could use Averaging, Banking and Trading to comply with either alternative and have a similar credit balance at the end of model year 2018 under the EPA and NHTSA programs.

## (iii) NHTSA Voluntary Standards Period

NHTSA is finalizing the proposed provision that manufacturers may voluntarily opt into the NHTSA HD pickup and van program in model years 2014 or 2015. If a manufacturer elects to opt in to the program, it must stay in the

program for all the optional model years. Manufacturers that opt in become subject to NHTSA standards for all regulatory categories. To opt into the program, a manufacturer must declare its intent to opt in to the program in its Pre-Model Year Report. The agencies have finalized new requirements for manufacturers to provide all early model declarations as a part of the pre-model year reports. See regulatory text for 49 CFR 535.8 for information related to the Pre-Model Year Report. A manufacturer would begin tracking credits and debits beginning in the model year in which they opt into the program. The handling of credits and debits would be the same as for the mandatory program.

For manufacturers that opt into NHTSA's HD pickup and van fuel consumption program in 2014 or 2015, the stringency would increase gradually each model year. Relative to a model year 2010 unregulated baseline, for both gasoline and diesel vehicles, stringency would be 15–20 percent of the model year 2019 target line function stringency (under the NHTSA first alternative) and 15–20 percent of the model year 2018 target line function stringency (under the NHTSA second alternative) in model years 2014–2015, respectively. The corresponding absolute standards target levels are provided in Figure II–2 and II–3, and the accompanying equations.

## (2) What are the HD pickup and van test cycles and procedures?

EPA and NHTSA are finalizing the proposed provision that HD pickup and van testing be conducted using the same heavy-duty chassis test procedures currently used by EPA for measuring criteria pollutant emissions from these vehicles, but with the addition of the highway fuel economy test cycle (HFET) currently required only for light-duty vehicle GHG emissions and fuel economy testing. Although the highway cycle driving pattern is identical to that of the light-duty test, other test parameters for running the HFET, such as test vehicle loaded weight, are identical to those used in running the current EPA Federal Test Procedure for complete heavy-duty vehicles.

The GHG and fuel consumption results from vehicle testing on the Light-duty FTP and the HFET will be weighted by 55 percent and 45 percent, respectively, and then averaged in calculating a combined cycle result. This result corresponds with the data used to develop the work factor-based CO<sub>2</sub> and fuel consumption standards, since the data on the baseline and technology efficiency was also

developed in the context of these test procedures. The addition of the HFET and the 55/45 cycle weightings are the same as for the light-duty CO<sub>2</sub> and CAFE programs, as we believe the real world driving patterns for HD pickups and vans are not too unlike those of light-duty trucks, and we are not aware of data specifically on these patterns that would lead to a different choice of cycles and weightings, nor did any commenters provide such data. More importantly, we believe that the 55/45 weightings will provide for effective reductions of GHG emissions and fuel consumption from these vehicles, and that other weightings, even if they were to more precisely match real world patterns, are not likely to significantly improve the program results.

Another important parameter in ensuring a robust test program is vehicle test weight. Current EPA testing for HD pickup and van criteria pollutants is conducted with the vehicle loaded to its Adjusted Loaded Vehicle Weight (ALVW), that is, its curb weight plus  $\frac{1}{2}$  of the payload capacity. This is substantially more challenging than loading to the light-duty vehicle test condition of curb weight plus 300 pounds, but we believe that this loading for HD pickups and vans to  $\frac{1}{2}$  payload better fits their usage in the real world and will help ensure that technologies meeting the standards do in fact provide real world reductions. The choice is likewise consistent with use of an attribute based in considerable part on payload for the standard. We see no reason to set test load conditions differently for GHGs and fuel consumption than for criteria pollutants, and we are not aware of any new information (such as real world load patterns) since the ALVW was originally set this way that would support a change in test loading conditions, nor did any commenters provide such information. We are therefore using ALVW for test vehicle loading in GHG and fuel consumption testing.

Additional provisions for our final testing and compliance program are provided in Section V.B.

(3) How are the HD pickup and van standards structured?

EPA and NHTSA are finalizing the proposed fleet average standards for new HD pickups and vans, based on a manufacturer's new vehicle fleet makeup. In addition, EPA is finalizing proposed in-use standards that apply to the individual vehicles in this fleet over their useful lives. The compliance provisions for these fleet average and in-use standards for HD pickups and vans

are largely based on the recently promulgated light-duty GHG and fuel economy program, as described in detail in the proposal.

(a) Fleet Average Standards

In the programs we are finalizing, each manufacturer will have a GHG standard and a fuel consumption standard unique to its new HD pickup and van fleet in each model year, depending on the load capacities of the vehicle models produced by that manufacturer, and on the U.S.-directed production volume of each of those models in that model year. Vehicle models with larger payload/towing capacities have individual targets at numerically higher CO<sub>2</sub> and fuel consumption levels than lower payload/towing vehicles, as discussed in Section II.C(1). The fleet average standard for a manufacturer is a production-weighted average of the work factor-based targets assigned to unique vehicle configurations within each model type produced by the manufacturer in a model year.

The fleet average standard with which the manufacturer must comply is based on its final production figures for the model year, and thus a final assessment of compliance will occur after production for the model year ends. Because compliance with the fleet average standards depends on actual test group production volumes, it is not possible to determine compliance at the time the manufacturer applies for and receives an EPA certificate of conformity for a test group. Instead, at certification the manufacturer will demonstrate a level of performance for vehicles in the test group, and make a good faith demonstration that its fleet, regrouped by unique vehicle configurations within each model type, is expected to comply with its fleet average standard when the model year is over. EPA will issue a certificate for the vehicles covered by the test group based on this demonstration, and will include a condition in the certificate that if the manufacturer does not comply with the fleet average, then production vehicles from that test group will be treated as not covered by the certificate to the extent needed to bring the manufacturer's fleet average into compliance. As in the light-duty program, additional "model type" testing will be conducted by the manufacturer over the course of the model year to supplement the initial test group data. The emissions and fuel consumption levels of the test vehicles will be used to calculate the production-weighted fleet averages for the manufacturer, after application of the

appropriate deterioration factor to each result to obtain a full useful life value. See generally 75 FR 25470–25472.

EPA and NHTSA do not currently anticipate notable deterioration of CO<sub>2</sub> emissions and fuel consumption performance, and are therefore requiring that an assigned deterioration factor be applied at the time of certification: an additive assigned deterioration factor of zero, or a multiplicative factor of one will be used. EPA and NHTSA anticipate that the deterioration factor may be updated from time to time, as new data regarding emissions deterioration for CO<sub>2</sub> are obtained and analyzed. Additionally, EPA and NHTSA may consider technology-specific deterioration factors, should data indicate that certain control technologies deteriorate differently than others. See also 75 FR 25474.

(b) In-Use Standards

Section 202(a)(1) of the CAA specifies that EPA set emissions standards that are applicable for the useful life of the vehicle. The in-use standards that EPA is finalizing apply to individual vehicles. NHTSA is not adopting in-use standards because they are not required under EISA, and because it is not currently anticipated that there will be any notable deterioration of fuel consumption. For the EPA program, compliance with the in-use standard for individual vehicles and vehicle models will not impact compliance with the fleet average standard, which will be based on the production-weighted average of the new vehicles.

EPA is finalizing the proposed provision that the in-use standards for HD pickups and vans be established by adding an adjustment factor to the full useful life emissions and fuel consumption results used to calculate the fleet average. EPA is also finalizing the proposed provision that the useful life for these vehicles with respect to GHG emissions be set equal to their useful life for criteria pollutants: 11 years or 120,000 miles, whichever occurs first (40 CFR 86.1805–04(a)).

As discussed above, we are finalizing the proposed provision that certification test results obtained before and during the model year be used directly to calculate the fleet average emissions for assessing compliance with the fleet average standard. Therefore, this assessment and the fleet average standard itself do not take into account test-to-test variability and production variability that can affect measured in-use levels. For this reason, EPA is finalizing the proposed adjustment factor for the in-use standard to provide some margin for production and test-to-

test variability that could result in differences between the initial emission test results used to calculate the fleet average and emission results obtained during subsequent in-use testing. EPA is finalizing the proposed provision that each model's in-use CO<sub>2</sub> standard be the model-specific level used in calculating the fleet average, plus 10 percent. This is the same as the approach taken for light-duty vehicle GHG in-use standards (See 75 FR 25473–25474). No adverse comments were received on this proposed provision.

As it does now for heavy-duty vehicle criteria pollutants, EPA will use a variety of mechanisms to conduct assessments of compliance with the in-use standards, including pre-production certification and in-use monitoring once vehicles enter customer service. The full useful life in-use standards apply to vehicles that have entered customer service. The same standards apply to vehicles used in pre-production and production line testing, except that deterioration factors are not applied.

(4) What HD pickup and van flexibility provisions are being established?

This program contains substantial flexibility in how manufacturers can choose to implement the EPA and NHTSA standards while preserving their timely benefits for the environment and energy security. Primary among these flexibilities are the gradual phase-in schedule, alternative compliance paths, and corporate fleet average approach which encompasses averaging, banking and trading described above. Additional flexibility provisions are described briefly here and in more detail in Section IV.

As explained in Section II.C(3), we are finalizing the proposed provision that, at the end of each model year, when production for the model year is complete, a manufacturer calculate its production-weighted fleet average CO<sub>2</sub> and fuel consumption. Under this approach, a manufacturer's HD pickup and van fleet that achieves a fleet average CO<sub>2</sub> or fuel consumption level better than its standard will be allowed to generate credits. Conversely, if the fleet average CO<sub>2</sub> or fuel consumption level does not meet its standard, the fleet would incur debits (also referred to as a shortfall).

A manufacturer whose fleet generates credits in a given model year will have several options for using those credits to offset emissions from other HD pickups and vans. These options include credit carry-back, credit carry-forward, and credit trading. These provisions exist in the light-duty 2012–2016 MY vehicle rule, and similar provisions are part of

EPA's Tier 2 program for light-duty vehicle criteria pollutant emissions, as well as many other mobile source standards issued by EPA under the CAA. The manufacturer will be able to carry back credits to offset a deficit that had accrued in a prior model year and was subsequently carried over to the current model year, with a limitation on the carry-back of credits to three model years, consistent with the light-duty program. We are finalizing the proposed provision that, after satisfying any need to offset pre-existing deficits, a manufacturer may bank remaining credits for use in future years, with a limitation on the carry-forward of credits to five model years. We are also finalizing the proposed provision that manufacturers may certify their HD pickup and van fleet a year early, in MY 2013, to generate credits against the MY 2014 standards. This averaging, banking, and trading program for HD pickups and vans is discussed in more detail in Section IV.A. For reasons discussed in detail in that section, we are not finalizing any credit transferability to or from other credit programs or averaging sets.

Consistent with the President's May 21, 2010, directive to promote advanced technology vehicles and with the agencies' respective statutory authorities, we are adopting flexibility provisions that parallel similar provisions adopted in the light-duty program. These include credits for advance technology vehicles such as electric vehicles, and credits for innovative technologies that are shown by the manufacturer to provide GHG and fuel consumption reductions in real world driving, but not on the test cycle. See Section IV.B.

#### *D. Class 2b–8 Vocational Vehicles*

Heavy-duty vehicles serve a vast range of functions including service for urban delivery, refuse hauling, utility service, dump, concrete mixing, transit service, shuttle service, school bus, emergency, motor homes,<sup>117</sup> and tow trucks to name only a small subset of the full range of vehicles. The vehicles designed to serve these functions are as unique as the jobs they do. They are vastly different—one from the other—in size, shape and function. The agencies were unable to develop a specific vehicle definition based on the characteristics of these vehicles. Instead at proposal, we proposed to define that Class 2b–8 vocational vehicles as all heavy-duty vehicles which are not included in the Heavy-duty Pickup

Truck and Van or the Class 7 and 8 Tractor categories. In effect, we said everything that is not a combination tractor or a pickup truck or van is a vocational vehicle. We are finalizing that definition as proposed reflecting the same challenges we faced at proposal regarding defining the full range of heavy-duty vehicles. As at proposal, recreational vehicles are included under EPA's standards but are not included under NHTSA's final standards. The agencies note that we are adding vocational tractors to the vocational vehicle category in the final rulemaking, as described above in Section II.B.

The agencies proposed that Class 4 pickup trucks although similar to Class 2b and 3 vehicles be included in the vocational vehicle category. Comments from EMA, Cummins, NTEA and Navistar supported the premise that Class 4 vehicles belong as part of the vocational vehicle program because they are specifically designed and engineered to meet vocational requirements. They stated that components such as transmissions, axles, frames, and tires differ from the similar pickup trucks and vans in the Class 2b and 3 market. We agree with commenters' arguments that there are a number of important differences between the Class 4 and Class 3 trucks it unreasonable to regulate Class 4 vehicles under the standards for heavy duty pickups and vans. As a result, we are keeping Class 4 vehicles in the vocational vehicle category, but are allowing the optional chassis certification of Class 4 and 5 vehicles. (See Section V.B(1)(e)).

As mentioned in Section I, vocational vehicles undergo a complex build process. Often an incomplete chassis is built by a chassis manufacturer with an engine purchased from an engine manufacturer and a transmission purchased from another manufacturer. A body manufacturer purchases an incomplete chassis which is then completed by attaching the appropriate features to the chassis.

The diversity in the vocational vehicle segment can be primarily attributed to the variety of vehicle bodies rather than to the chassis. For example, a body builder can build either a Class 6 bucket truck or a Class 6 delivery truck from the same Class 6 chassis. The aerodynamic difference between these two vehicles due to their bodies will lead to different baseline fuel consumption and GHG emissions. However, the baseline fuel consumption and emissions due to the components included in the common chassis (such as the engine, drivetrain, frame, and

<sup>117</sup> See above for discussion of applicability of NHTSA's standards to non-commercial vehicles.



tires) will be the same between these two types of complete vehicles.

The agencies face difficulties in establishing the baseline CO<sub>2</sub> and fuel consumption performance for the wide variety of complete vocational vehicles because of the very large number of vehicle types and the need to conduct testing on each of the vehicle types to establish the baseline. To establish standards for a complete vocational vehicle, it would be necessary to assess the potential for fuel consumption and GHG emissions improvement for each of these vehicle types and to establish standards for each vehicle type. Because of the size and complexity of this task, the agencies judged it was not practical to regulate complete vocational vehicles for this first fuel consumption and GHG emissions program. To overcome the lack of baseline information from the different vehicle types and to still achieve improvements to fuel consumption and GHG emissions, the agencies proposed to set standards for the chassis manufacturers of vocational vehicles (but not the body builders) and the engine manufacturers. Chassis manufacturers represent a limited number of companies as compared to body builders, which are made up of a diverse set of companies that are typically small businesses. These companies would need to be regulated if whole vehicle standards were established.

Similar to combination tractors, the agencies proposed to set separate vehicle and engine standards for vocational vehicles. A number of comments were received on the proposal to regulate chassis and engine manufacturers. The agencies received comments from DTNA supporting the proposal to regulate the chassis manufacturer but not body manufacturers. While organizations like Cummins and ICCT expressed support for separate engine and vehicle standards, Navistar, Pew, and Volvo, in contrast, opposed separate engine and chassis standards, stating that separate engine standards disadvantages integrated truck/engine manufacturers and full vehicle standards should be required. Volvo asked that the standards include an alternative integrated standard as well as complete vehicle modeling and testing beginning in 2017. ACEEE and Sierra Club stated that the proposed standards and test procedures should move the agencies closer to full vehicle testing.

Although the agencies understand that full vehicle standards would allow integrated truck/engine manufacturers—such as electrified accessories and weight reduction—the agencies are

finalizing separate standards for vocational vehicles that apply to chassis manufacturers and engine standards for engines installed in these vehicles that apply to engine manufacturers. The agencies continue to believe that it is not practical to regulate complete vocational vehicles for this first fuel consumption and GHG emissions program because of the size and complexity of the task associated with assessing the potential for fuel consumption and GHG emissions improvement for each of the myriad types of vocational vehicles. This issue is discussed further in comment responses found in sections 5 and 6.1.4 of the Response to Comment Document, as well as in the following section of the preamble. Thus, the agencies are finalizing a set of standards for the chassis manufacturers of vocational vehicles (but not the body builders) and for the manufacturers of HD engines used in vocational vehicles.

(1) What are the vocational vehicle and engine CO<sub>2</sub> and fuel consumption standards and their timing?

In the NPRM, the agencies proposed vehicle standards based on the agencies' assessment of the availability of low rolling resistance tires that could be applied generally to vocational vehicles across the entire category. The agencies considered the possibility of including other technologies in determining the proposed stringency of the vocational vehicle standards, such as aerodynamic improvements, but as discussed in the NPRM, tentatively concluded that such improvements would not be appropriate for basing vehicle standard stringency in this phase of the rulemaking.<sup>118</sup> For example, the aerodynamics of a recovery vehicle are impacted significantly by the equipment such as the arm located on the exterior of the truck.<sup>119</sup> The agencies found little opportunity to improve the aerodynamics of the equipment on the truck. The agencies also evaluated the aerodynamic opportunities discussed in the NAS report. The panel found that there was minimal fuel consumption reduction opportunity through aerodynamic technologies for bucket trucks, transit buses, and refuse trucks<sup>120</sup> primarily due to the low vehicle speed in normal operation. The panel did report that there are opportunities to reduce the fuel consumption of straight trucks by approximately 1 percent for trucks

which operate at the average speed typical of a pickup and delivery truck (30 mph), although the opportunity is greater for vehicles that operate at higher speeds.<sup>121</sup>

The agencies received comments from the Motor Equipment Manufacturers Association, Eaton, NRDC, NESCAUM, NACAA, ACEEE, ICCT, Navistar, Arvin Meritor, the Union of Concerned Scientists and others that technologies such as idle reduction, advanced transmissions, advanced drivetrains, weight reduction, hybrid powertrains, and improved auxiliaries provide opportunities to reduce fuel consumption from vocational vehicles. Commenters asked that the agencies establish regulations that would reflect performance of these technologies and essentially force their utilization.

The agencies assessed these technologies and have concluded that they may have the potential to reduce fuel consumption and GHG emissions from at least certain vocational vehicles, but the agencies have not been able to estimate baseline fuel consumption and GHG emissions levels for each type of vocational vehicle and for each type of technology, given the wide variety of models and uses of vocational vehicles. For example, idle reduction technologies such as APUs and cabin heaters can reduce workday idling associated with vocational vehicles. However, characterizing idling activity for the vocational segment in order to quantify the benefits of idle reduction technology is complicated by the variety of duty cycles found in the sector. Idling in school buses, fire trucks, pickup trucks, delivery trucks, and other types of vocational vehicles varies significantly. Given the great variety of duty cycles and operating conditions of vocational vehicles and the timing of these rules, it is not feasible at this time to establish an accurate baseline for quantifying the expected improvements which could result from use of idle reduction technologies. Similarly, for advanced drivetrains and advanced transmissions determining a baseline configuration, or a set of baseline configurations, is extremely difficult given the variety of trucks in this segment. The agencies do not believe that we can legitimately base standard stringency on the use of technologies for which we cannot identify baseline configurations, because absent baseline emissions and baseline fuel consumption, the emissions reductions achieved from introduction of the technology cannot be quantified. For some technologies, such as weight

<sup>118</sup> See 75 FR at 74241.

<sup>119</sup> A recovery vehicle removes or recovers vehicles that are disabled (broken down).

<sup>120</sup> See 2010 NAS Report, Note 21, page 133.

<sup>121</sup> See 2010 NAS Report, Note 21, page 110.

reduction and improved auxiliaries—such as electrically driven power steering pumps and the vehicle's air conditioning system—the need to limit technologies to those under the control of the chassis manufacturer further restricted the agencies' options for predicating standard stringency on use of these technologies. For example, lightweight components that are under the control of chassis manufacturers are limited to a very few components such as frame rails. Considering the fuel efficiency and GHG emissions reduction benefits that will be achieved by finalizing these rules in the time frame proposed, rather than delaying in order to gain enough information to include additional technologies, the agencies have decided to finalize standards that do not assume the use of these technologies and will consider incorporating them in a later action applicable to later model years. Cf. *Sierra Club v. EPA*, 325 F. 3d 374, 380 (DC Cir. 2003) (in implementing a technology-forcing provision of the CAA, EPA reasonably adopted modest initial controls on an industry sector in order to better assess rules' effects in preparation for follow-up rulemaking).

As the program progresses and the agencies gather more information, we expect to reconsider whether vocational vehicle standards for MYs 2019 and beyond should be based on the use of additional technologies besides low rolling resistance tires.

EPA is adopting CO<sub>2</sub> standards and NHTSA is finalizing fuel consumption standards for manufacturers of chassis for new vocational vehicles and for manufacturers of heavy-duty engines installed in these vehicles. The final heavy-duty engine standards for CO<sub>2</sub> emissions and fuel consumption focus on potential technological improvements in fuel combustion and overall engine efficiency and those controls would achieve most of the emission reductions. Further reductions from the Class 2b–8 vocational vehicle itself are possible within the time frame of these final regulations. Therefore, the agencies are also finalizing separate standards for vocational vehicles that will focus on additional reductions that can be achieved through improvements in vehicle tires. The agencies' analyses, as discussed briefly below and in more detail later in this preamble and in the RIA Chapter 2, show that these final standards appear appropriate under each agency's respective statutory authorities. Together these standards are estimated to achieve reductions of up to 10 percent from most vocational vehicles.

EPA is also adopting standards to control N<sub>2</sub>O and CH<sub>4</sub> emissions from Class 2b–8 vocational vehicles through controlling these GHG emissions from the HD engines. The final heavy-duty engine standards for both N<sub>2</sub>O and CH<sub>4</sub> and details of the standard are included in the discussion in Section II.E.1.b and II.E.2.b. EPA neither proposed nor is adopting air conditioning leakage standards applying to vocational vehicle chassis manufacturers.

As discussed further below, the agencies are setting CO<sub>2</sub> and fuel consumption standards for the chassis based on tire rolling resistance improvements and for the engines based on engine technologies. The fuel consumption and GHG emissions impact of tire rolling resistance is impacted by the mass of the vehicle. However, the impact of mass on rolling resistance is relatively small so the agencies proposed to aggregate several vehicle weight categories under a single category for setting the standards. The agencies proposed to divide the vocational vehicle segment into three broad regulatory subcategories—Light Heavy-Duty (Class 2b through 5), Medium Heavy-Duty (Class 6 and 7), and Heavy Heavy-Duty (Class 8) which is consistent with the nomenclature used in the diesel engine classification. The agencies received comments supporting the division of vocational vehicles into three regulatory categories from DTNA. The agencies also received comments from Bosch, Clean Air Task Force, and National Solid Waste Management Association supporting a finer resolution of vocational vehicle subcategories. Their concerns include that the agencies' vehicle configuration in GEM is not representative of a particular vocational application, such as refuse trucks. Another recommendation was to divide the category by both GVWR and by operational characteristics. Upon further consideration, the agencies are finalizing as proposed three vocational vehicle subcategories because we believe this adequately balances simplicity while still obtaining reductions in this diverse segment. (As noted in section IV.A below, these three subcategories also denominate separate averaging sets for purposes of ABT.) Finer distinctions in regulatory subcategories would not change the technology basis for the standards or the reductions expected from the vocational vehicle category. As the agencies move towards future heavy-duty fuel consumption and GHG regulations for post-2017 model years, we intend to gather GHG and fuel consumption data

for specific vocational applications which could be used to establish application-specific standards in the future.

The agencies received comments supporting the exclusion of recreational vehicles, emergency vehicles, school buses from the vocational vehicle standards. The commenters argued that these individual vehicle types were small contributors to overall GHG emissions and that tires meeting their particular performance needs might not be available by 2014. The agencies considered these comments and the agencies have met with a number of tire manufacturers to better understand their expectations for product availability for the 2014 model year. Based on our review of the information shared, we are convinced that tires with rolling resistance consistent with our final vehicle standards and meeting the full range of other performance characteristics desired in the vehicle market, including for RVs, emergency vehicles, and school buses, will be broadly available by the 2014 model year.<sup>122</sup> Absent regulations for the vast majority of vehicles in this segment, feasible cost-effective reductions available at reasonable cost in the 2014–2018 model years will be needlessly foregone. Therefore, the agencies have decided to finalize the vocational vehicle standards as proposed with recreational vehicles, emergency vehicles and school buses included in the vocational vehicle category. As RVs were not included by NHTSA for proposed regulation, they are not within the scope of the NPRM and are therefore excluded in NHTSA's portion of the final program. NHTSA will revisit this issue in the next rulemaking. In developing the final standards, the agencies have evaluated the current levels of emissions and fuel consumption, the kinds of technologies that could be utilized by manufacturers to reduce emissions and fuel consumption and the associated lead time, the associated costs for the industry, fuel savings for the consumer, and the magnitude of the CO<sub>2</sub> and fuel savings that may be achieved. After examining the possibility of vehicle improvements based on use of the technologies underlying the standards for Class 7 and 8 tractors, including improved aerodynamics, vehicle speed limiters, idle reduction technologies, tire rolling resistance, and weight reduction, as well as use of hybrid technologies, the agencies ultimately

<sup>122</sup> Bachman, Joseph. Memorandum to the Docket. Heavy-Duty Tire Evaluation. See Docket #EPA-HQ-OAR-2010-0162. Pages 2–3 and Appendix B.

determined to base the final vehicle standards on performance of tires with superior rolling resistance. For standards for diesel engines installed in vocational vehicles, the agencies examined performance of engine friction reduction, aftertreatment optimization, air handling improvements, combustion optimization, turbocompounding, and waste heat recovery, ultimately deciding to base the final standards on the performance of all of the technologies except turbocompounding and waste heat recovery systems. The standards for gasoline engine installed in vocational vehicles are based on performance of technologies such as gasoline direct injection, friction reduction, and variable valve timing. The agencies' evaluation indicates that these technologies, as described in Section III.C, are available today in the heavy-duty tractor and light-duty vehicle markets, but have very low application rates in the vocational vehicle market. The agencies have analyzed the technical feasibility of achieving the CO<sub>2</sub> and fuel consumption standards, based on projections of what actions manufacturers would be expected to take to reduce emissions and fuel consumption to achieve the standards, and believe that the standards are cost-effective and technologically feasible and appropriate within the rulemaking time frame. EPA and NHTSA also present the estimated costs and benefits of the vocational vehicle standards in Section III.

#### (a) Vocational Vehicle Chassis Standards

In the NPRM, the agencies defined tire rolling resistance as a frictional loss of energy, associated mainly with the energy dissipated in the deformation of tires under load that influences fuel efficiency and CO<sub>2</sub> emissions. Tires with higher rolling resistance lose more energy in response to this deformation, thus using more fuel and producing more CO<sub>2</sub> emissions in operation, while tires with lower rolling resistance lose less energy, and save more fuel and CO<sub>2</sub> emissions in operation. Tire design characteristics (*e.g.*, materials, construction, and tread design) influence durability, traction (both wet and dry grip), vehicle handling, ride comfort, and noise in addition to rolling resistance.

The agencies explained that a typical Low Rolling Resistance (LRR) tire's attributes, compared to a non-LRR tire, would include increased tire inflation pressure; material changes; and tire construction with less hysteresis, geometry changes (*e.g.*, reduced height

to width aspect ratios), and reduction in sidewall and tread deflection. When a manufacturer applies LRR tires to a vehicle, the manufacturer generally also makes changes to the vehicle's suspension tuning and/or suspension design in order to maintain vehicle handling and ride comfort.

The agencies also explained that while LRR tires can be applied to vehicles in all MD/HD classes, they may have special potential for improving fuel efficiency and reducing CO<sub>2</sub> emissions for vocational vehicles. According to an energy audit conducted by Argonne National Lab, tires are the second largest contributor to energy losses of vocational vehicles, after engines.<sup>123</sup> Given this finding, the agencies considered the availability of LRR tires for vocational applications by examining the population of tires available, and concluded that there appeared to be few LRR tires for vocational applications. The agencies suggested in the NPRM that this low number of LRR tires for vocational vehicles could be due in part to the fact that the competitive pressure to improve rolling resistance of vocational vehicle tires has been less than in the line haul tire market, given that line haul vehicles generally drive significantly more miles and therefore have significantly higher operating costs for fuel than vocational vehicles, and much greater incentive to improve fuel consumption. The small number of LRR tires for vocational vehicles may perhaps also be due in part to the fact that vocational vehicles generally operate more frequently on secondary roads, gravel roads and roads that have less frequent winter maintenance, which leads vocational vehicle buyers to value tire traction and durability more than rolling resistance. The agencies recognized that this provided an opportunity to improve fuel consumption and GHG emissions by creating a regulatory program that encourages improvements in tire rolling resistance for both line haul and vocational vehicles. The agencies proposed to base standards for all segments of HD vehicles on the use of LRR tires. The agencies estimated that a 10 percent reduction in average tire rolling resistance would be attainable between model years 2010 and 2014 based on the tire development achievements over the last several years

<sup>123</sup> A Class 6 pick up and delivery truck at 50% load has tires as the second largest contributor at speeds up to 35 mph, a typical average speed of urban delivery vehicles. See Argonne National Laboratory, "Evaluation of Fuel Consumption Potential of Medium and Heavy Duty Vehicles through Modeling and Simulation." October 2009. Page 91.

in the line haul truck market. This reduction in tire rolling resistance would correlate to a two percent reduction in fuel consumption as modeled by the GEM.<sup>124</sup>

#### (i) Summary of Comments

The agencies received many comments on the subject of tire rolling resistance as applied to vocational vehicles. Comments included suggestions for alternative test procedures; whether LRR tires should be applied to certain types of vocational vehicles and whether certain vehicles should be exempted from the vocational vehicle standards if the standards are based on the ability to use LRR tires; the appropriateness of the proposed standards; and compliance issues (discussed below in Section II.D.2.b).

Regarding whether LRR tires should be applied to certain types of vocational vehicles, the agencies received many comments from stakeholders, such as Daimler Trucks North America, Fire Apparatus Manufacturers Association (FAMA), International Association of Fire Chiefs, National Ready Mix, National Solid Wastes Management Association (NSWMA), Spartan Motors, National Automobile Dealers Association, among others. There were comments regarding applicability of low rolling resistance tires to vocational vehicles based on LRR tire availability, suitability of the tires for the applications, fuel consumption and GHG emissions benefits and the appropriateness of standards. Many of these commenters focused particularly on the whether LRR tires would compromise the capability of emergency vehicles.

Regarding whether LRR tires are available in the market for certain vocational vehicles and whether the vocational vehicle standards were therefore appropriate and feasible, both Ford and AAPC stated that the proposed model-based requirement for Class 2b–8 vocational chassis appeared to require tires with rolling resistance values of approximately 8.0–8.1 kg/metric ton or better, and that limited data available for smaller diameter tires, such as light-truck (LT) tires used on many light heavy-duty trucks and vans, suggested that there exist few if any choices for tires that would comply. Given this concern about the availability of compliant tires, particularly in the case of tires smaller than 22.5", during the proposed regulatory time frame, AAPC and Ford requested revisions to the requirement, or the modeling method, to establish different standards for vehicles

<sup>124</sup> See 75 FR at 74241.

that use different tire classes, with separate requirements for LT tires, 19.5" tires, and 22.5" tires. AAPC argued that standards should be set based on data collected on high volume in-use tires, and that they should be set at a level that ensures the availability of multiple compliant tires. CRR

(ii) Summary of Research Done Since the Notice of Proposed Rulemaking

Since the NPRM, the agencies have conducted additional research on tire rolling resistance for medium- and heavy-duty applications. This research involved direct discussions with tire suppliers,<sup>125</sup> assessment of the comments received, additional review of tire products available, and a more thorough review of tire use in the field. In addition, EPA has conducted tire rolling resistance testing to help inform the final rulemaking.<sup>126</sup>

The agencies discussed many aspects of low rolling resistance tire technologies and their application to vocational vehicles with tire suppliers since publication of the NPRM. Several tire suppliers indicated to the agencies that low rolling resistance tires are currently available for vocational applications that would enable compliance with the proposed vocational vehicle standards, such as delivery vehicles, refuse vehicles, and other vocations. However, these conversations also made the agencies aware that availability of low rolling resistance tires varies by supplier. Some suppliers stated they focused their company resources on areas of the medium- and heavy-duty vehicle spectrum where fleet operators would see the most fuel efficiency benefits for the application of low rolling resistance technologies; specifically the long-haul, on-highway applications that drive many miles and use large amounts of fuel. These suppliers stated that this choice was driven by the significant capital investment that would be needed to improve tire rolling resistance across the relatively large number of product offerings in the vocational vehicle segment, based on the wide range of tire sizes, load ratings, and speed ratings, compared to the much narrower range of offerings for long-haul applications.<sup>127</sup> Other suppliers stated

that they have made conscious efforts to reduce the rolling resistance of all of their medium- and heavy-duty vehicle tire offerings, including vocational applications, in an effort to become leaders in this technology.

The agencies also discussed with tire suppliers the potential tire attribute tradeoffs that may be associated with incorporating designs that improve tire rolling resistance, given the driving patterns, environmental conditions, and on-road and off-road surface conditions that vocational vehicles are subjected to. Some vehicle manufacturer commenters had suggested that changes in tire tread block design that improve rolling resistance may adversely affect tire performance characteristics such as traction, resistance to tearing, and resistance to wear and damage from scrubbing on curbs and frequent tight radius turns that are important to customers for vocational vehicle performance. The suppliers agreed that providing tires unable to withstand these conditions or meet the vehicle application needs would adversely affect customer satisfaction and warranty expenses, and would have detrimental financial effects to their businesses. One supplier indicated that theoretically, tread-wear (tire life) could be compromised if suppliers choose to reduce the initial tire tread depth without any offsetting tire compound or design enhancements as the means to achieve rolling resistance reductions. That supplier argued that taking this approach could lead to more frequent tire replacements or re-treading of existing tire carcasses, and that the agencies should therefore take a total lifecycle view when evaluating the effects of driving rolling resistance reductions. That supplier also indicated that a correlation of a 20 percent reduction in rolling resistance achieved through tread depth reduction could lead to a 30 percent decrease in tread-life and 15 percent reduction in wet traction. The agencies note that when they inquired about potential 'safety' related tradeoffs, such as traction (braking and handling) and tread wear when applying low rolling resistance technologies, tire suppliers which remain subject to safety standards regardless of this program, consistently responded that they would not produce a tire that compromises safety when fitted in its proper application.

In addition to the supplier discussions and evaluation of comments

to 17 different vocational tire designs, and for each design there may be 8–10 different tire sizes. In contrast, a line-haul application may have only 2–3 tire designs with a fewer range of sizes.

to the Notice of Proposed Rulemaking, EPA conducted a series of tire rolling resistance tests on medium- and heavy-duty vocational vehicle tires. The testing measured the CRR of tires representing 16 different vehicle applications for Class 4–8 vocational vehicles. The testing included approximately 5 samples each of both steer and drive tires for each application. The tests were conducted by two independent tire test labs, Standards Testing Lab (STL) and Smithers-Rapra (Smithers).

Overall, a total of 156 medium- and heavy-duty tires<sup>128</sup> were included in this testing, which was comprised of 88 tires covering various commercial vocational vehicle types, such as bucket trucks, school buses, city delivery vehicles, city transit buses and refuse haulers among others; 47 tires intended for application to tractors; and 21 tires classified as light-truck (LT) tires intended for Class 4 vocational vehicles such as delivery vans. In addition, approximately 20 of the tires tested were exchanged between the labs to assess inter-laboratory variability.

The test results for 88 commercial vocational vehicle tires (19.5" and 22.5" sizes) showed a test average CRR of 7.4 kg/metric ton, with results ranging from 5.1 to 9.8. To comply with the proposed vocational vehicle fuel consumption and GHG emissions standards using improved tire rolling resistance as the compliance strategy, a manufacturer would need to achieve an average tire CRR value of 8.1 kg/metric ton.<sup>129</sup> The measured average CRR of 7.4 kg/metric ton is thus better than the average value that would be needed to meet vocational vehicle standards. Of those 173 tires tested, twenty tires had CRR values exceeding 8.1 kg/metric ton, two were at 8.1 kg/metric ton, and sixty-six tires were better than 8.1 kg/metric ton. Additional data analyses examining the tire data by tire size to determine the range and distribution of CRR values within each tire size showed each tire size generally had tires ranging from approximately 6.0 to 8.5 kg/metric ton, with a small number of tires in the 5.3–5.7 kg/metric ton range and a small

<sup>128</sup> After the agencies completed their analysis of these data, the agencies received raw data on 43 additional tires. See Powell, Greg. Memorandum to the Docket. Additional Tire Testing Results. July 2011. Docket NHTSA–2010–0079. The agencies have not analyzed these additional data, nor included them in the final report, and the data therefore played no role in the agencies' determination of an appropriate standard for vocational vehicles. The agencies will analyze and consider these data, along with any future data received through continued testing, as appropriate, in the next rulemaking for the heavy duty sector.

<sup>129</sup> See 75 FR at 74244.

<sup>125</sup> Records of these communications, and additional information submitted by the supplier companies and not CBI, are available at Docket No. EPA–HQ–OAR–2010–0162.

<sup>126</sup> Bachman, Joseph. Memorandum to the Docket. Heavy-Duty Tire Evaluation. July 2011. Docket EPA–HQ–OAR–2010–0162, Pages 3–6.

<sup>127</sup> More tire types and sizes have been developed for vocational vehicle applications than for long-haul applications. In some cases, suppliers offer up

number of tires in a range as high as 9.3–9.8 kg/ton. Review of the data showed that for each tire size and vehicle type, the majority of tires tested would enable compliance with vocational vehicle fuel consumption and GHG emission standards.

The test results for the 47 tires intended for tractor application showed an overall average of 6.9 kg/ton, the lowest overall average rolling resistance of the different tire applications tested.<sup>130</sup> This is consistent with what the agencies heard through comments and meetings with tire suppliers whose efforts have focused on tractor applications, particularly for long-haul applications, which yield the highest fuel efficiency benefits from LRR tire technology.

Finally, the 21 LT tires intended for Class 4 vocational vehicles were comprised of two sizes; LT225/75R16 and LT245/75R16 with 11 and 10 samples tested, respectively. Some auto manufacturers have indicated that CRR values for tires fitted to these Class 4 vehicles typically have a higher CRR values than tires found on commercial vocational vehicles because of the smaller diameter wheel size and the ISO testing protocol.<sup>131</sup> The test data showed the average CRR for LT225/75R16 tires was 9.1 kg/metric ton and the average for LT245/75R16 tires was 8.6 kg/metric ton. The range for the LT225/75R16 tires spanned 7.4 to 11.0<sup>132</sup> and the range for the LT245/75R16 tires ranged from 6.6 to 9.8 kg/metric ton. Overall, the average for the tested LT tires was 8.9 kg/metric ton.

Analysis of the EPA test data for all vocational vehicles, including LT tires, shows the test average CRR is 7.7 kg/metric ton with a standard deviation of 1.2 kg/metric ton. Review of the data thus shows that for each tire size and vehicle type, there are many tires available that would enable compliance with the proposed standards for vocational vehicles and tractors except for LT tires for Class 4 vocational vehicles where test results show the majority of these tires have CRR worse than 8.1 kg/metric ton.

The agencies also reviewed the CRR data from the tires that were tested at both the STL and Smithers laboratories to assess inter-laboratory and test

machine variability. The agencies conducted statistical analysis of the data to gain better understanding of lab-to-lab correlation and developed an adjustment factor for data measured at each of the test labs. When applied, this correction factor showed that for 77 of the 80 tires tested, the difference between the original CRR and a value corrected CRR was 0.01 kg/metric ton. The values for the remaining three tires were 0.03 kg/metric ton, 0.05 kg/metric ton and 0.07 kg/metric ton. Based on these results, the agencies believe the lab-to-lab variation for the STL and Smithers laboratories would have very small effect on measured CRR values. Further, in analyzing the data, the agencies considered both measurement variability and the value of the measurements relative to proposed standards. The agencies concluded that although laboratory-to-laboratory and test machine-to-test machine measurement variability exists, the level observed is not excessive relative to the distribution of absolute measured CRR performance values and relative to the proposed standards. Based on this, the agencies concluded that the test protocol is reasonable for this program, but are making some revisions to the vehicle standards.

The agencies also conducted a winter traction test of 28 tires to evaluate the impact of low rolling resistance designs on winter traction. The results of the study indicate that there was no statistical relationship between rolling resistance and snow traction.<sup>133</sup>

#### (iii) Summary of Final Rules

For vocational vehicles, the agencies intend to keep rolling resistance as an input to the GEM but with modifications to the proposed targets as a result of the testing completed by EPA since the NPRM and information from tire suppliers. The agencies continue to believe that LRR tires, which are an available, cost-effective, and appropriate technology with demonstrated fuel efficiency and GHG reduction benefits, are reasonable for all on-highway vehicles.

The agencies acknowledge there can be tradeoffs when designing a tire for reduced rolling resistance. These tradeoffs can include characteristics such as wear resistance, cost and scuff resistance. However, the agencies have continued to review this issue and do not believe that LRR tires as specified in the rules present safety issues. The agencies continue to believe that LRR

tires, which are an available, cost-effective, and appropriate technology with demonstrated fuel efficiency and GHG reduction benefits, are reasonable for all on-highway vehicles. The final program also provides exemptions for vehicles meeting “low-speed” or “off-road” criteria, including application of speed restricted tires. Vocational vehicles that have speed restricted tires in order to accommodate particular applications may be exempted from the program under the off-road or low-speed exemption, described in greater detail below in Section II.D.(1)(a)(iv).

As just noted, the agencies conducted independent testing of current tires available to assist confirming the finalized rolling resistance standards. The tire test samples were selected from those currently available on the market and therefore have no known safety issues and meet all current requirements to allow availability in commerce; including wear, scuff resistance, braking, traction under wet or icy conditions, and other requirements. These tires included a wide array of sizes and designs intended for most all vocational applications, including those used for school buses, refuse haulers, emergency vehicles, concrete mixers, and recreational vehicles. As the test results revealed, there are a significant number of tires available that meet or do better than the rolling resistance targets for vocational vehicles; both light-truck (with an adjustment factor described later in this preamble section) and non-LT tire types, while meeting all applicable safety standards.

The agencies also recognize the extreme conditions fire apparatus equipment must navigate to enable firefighters to perform their duties. As described below, the final rules contain provisions to allow for exemption of specific off-road capable vocational vehicles from the fuel efficiency and greenhouse gas standards. Included in the exemption criteria are provisions for vehicles equipped with specific tire types that would be fit to a vehicle to meet extreme demands, including those vehicles designed for off-road capability.

As follow-up to the final rules and in support for development of a separate FMVSS rule, NHTSA plans to conduct additional performance-focused testing (beyond rolling resistance) for medium- and heavy-duty trucks. This testing is targeted for completion toward the end of this year. The agencies will review these performance data when available, in concert with any subsequent proposed rulemakings regarding fuel consumption and GHG emissions

<sup>130</sup> The CRR values for these applications ranged from 5.4 to 9.2 kg/metric ton.

<sup>131</sup> See comments to docket EPA–HQ–OAR–2010–0162–1761; Ford Motor Company

<sup>132</sup> The agency notes the highest CRR values recorded for LT tires, of 11.0 and 10.9, were for two tires of the same size and brand. The nearest recorded values to these two tires were 9.8; substantially beyond the differences between other tires tested.

<sup>133</sup> Bachman, Joseph. Memorandum to Docket. Heavy-Duty Tire Evaluation. Docket EPA–HQ–OAR–2010–0162. Pages 3–6.

standards for medium- and heavy-duty vehicles.

For vocational vehicles, the rolling resistance of each tire will be measured using the ISO 28850 test method for drive tires and steer tires planned for fitment to the vehicle being certified. Once the test CRR values are obtained, a manufacturer will input the CRR values for the drive and steer tires separately into the GEM where, for vocational vehicles, the vehicle load is distributed equally over the steer and drive tires. Once entered, the amount of GHG reduction attributed to tire rolling resistance will be incorporated into the overall vehicle compliance value. The following table provides the revised target CRR values for vocational vehicles for 2014 and 2017 model years that are used to determine the vehicle standards.

TABLE II-14—VOCATIONAL VEHICLE—TARGET CRR VALUES FOR GEM INPUT

	2014 MY	2017 MY
Tire Rolling Resistance (kg/metric ton).	7.7 kg/metric ton.	7.7 kg/metric ton.

These target values are being revised based on the significant availability of tires for vocational vehicles applications which have performance better than the originally proposed 8.1 kg/metric ton target. As just discussed, 63 of the 88 tires tested for vocational applications had CRR values better than the proposed target. The tires tested covered fitment to a wide range of vocational vehicle types and classes; thus agencies believe the original target value of 8.1 kg/metric ton was possibly too lenient after reviewing the testing data. Therefore, the agencies believe it is appropriate to reduce the proposed vehicle standard based on performance

of a CRR target value of 7.7 kg/metric ton for non-LT tire type. As discussed previously, this value is the test average of all vocational tires tested (including LT) which takes a conservative approach over setting a target based on the average of only the non-LT vocational tires tested. For LT tires, based on both the test data and the comments from AAPC and Ford Motor Company, the agencies recognize the need to provide an adjustment. In lieu of having two sets of Light Heavy-Duty vocational vehicle standards, the agencies are finalizing an adjustment factor which applies to the CRR test results for LT tires. The agencies developed an adjustment factor dividing the overall vocational test average CRR of 7.7 by the LT vocational average of 8.9. This yields an adjustment factor of 0.87. For LT vocational vehicle tires, the measured CRR values will be multiplied by the 0.87 adjustment factor before entering the values in the GEM for compliance.

Based on the tire rolling resistance inputs noted above, EPA is finalizing the following CO<sub>2</sub> standards for the 2014 model year for the Class 2b through Class 8 vocational vehicle chassis, as shown in Table II-15. Similarly, NHTSA is finalizing the following fuel consumption standards for the 2016 model year, with voluntary standards beginning in the 2014 model year. For the EPA GHG program, the standard applies throughout the useful life of the vehicle. The agencies note that both the baseline performance and standards derived for the final rules slightly differ from the values derived for the NPRM. The first difference is due to the change in the target rolling resistance from 8.1 to 7.7 kg/metric ton based on the agencies' test results. Second, there are minor differences in the fuel consumption and CO<sub>2</sub> emissions due to the small

modifications made to the GEM, as noted in RIA Chapter 4. Lastly, the final HHD vocational vehicle standard uses a revised payload assumption of 15,000 pounds instead of the 38,000 pounds used in the NPRM, as described in Section II.D.3.c.iii. As a result, the emission standards shown in Table II-15 for vocational vehicles have changed from the standards published in the NPRM. The changes for light heavy and medium heavy-duty vehicles are modest. The change for heavy heavy-duty vocational vehicles is larger, due to the difference in assumed payload.

As with the 2017 MY standards for Class 7 and 8 tractors, EPA and NHTSA are adopting more stringent vocational vehicle standards for the 2017 model year which reflect the CO<sub>2</sub> emissions reductions required through the 2017 model year engine standards. See also Section II.B.2 explaining the same approach for the standards for combination tractors. As explained in Section 0 below, engine performance is one of the inputs into the GEM compliance model that has a pre-defined (*i.e.* fixed) value established by the agencies, and that input will change in the 2017 MY to reflect the 2017 MY engine standards. The 2017 MY vocational vehicle standards are not premised on manufacturers installing additional vehicle technologies, and a vocational vehicle that complies with the standards in MY 2016 will also comply in MY 2017 with no vehicle (tire) changes. Thus, although chassis manufacturers will not be required to make further improvements in the 2017 MY to meet the standards, the standards will be more stringent to reflect the engine improvements required in that year. This is because in 2017 MY GEM vehicle modeling outputs (in grams per ton mile and gallons per 1,000 ton mile) will automatically decrease since engine efficiency will improve in that year.

TABLE II-15—FINAL CLASS 2b-8 VOCATIONAL VEHICLE CO<sub>2</sub> AND FUEL CONSUMPTION STANDARDS

EPA CO <sub>2</sub> (gram/ton-mile) Standard Effective 2014 Model Year			
	Light Heavy-Duty Class 2b-5 .....	Medium Heavy-Duty Class 6-7 ....	Heavy Heavy-Duty Class 8
CO <sub>2</sub> Emissions .....	388 .....	234 .....	226
NHTSA Fuel Consumption (gallon per 1,000 ton-mile) Standard Effective 2016 Model Year <sup>134</sup>			
	Light Heavy-Duty Class 2b-5 .....	Medium Heavy-Duty Class 6-7 ....	Heavy Heavy-Duty Class 8
Fuel Consumption .....	38.1 .....	23.0 .....	22.2
EPA CO <sub>2</sub> (gram/ton-mile) Standard Effective 2017 Model Year			
	Light Heavy-Duty Class 2b-5 .....	Medium Heavy-Duty Class 6-7 ....	Heavy Heavy-Duty Class 8
CO <sub>2</sub> Emissions .....	373 .....	225 .....	222

TABLE II-15—FINAL CLASS 2b-8 VOCATIONAL VEHICLE CO<sub>2</sub> AND FUEL CONSUMPTION STANDARDS—Continued

NHTSA Fuel Consumption (gallon per ton-mile) Standard Effective 2017 Model Year			
	Light Heavy-Duty Class 2b-5 .....	Medium Heavy-Duty Class 6-7 ....	Heavy Heavy-Duty Class 8
Fuel Consumption .....	36.7 .....	22.1 .....	21.8

(iv) Off-Road and Low-Speed Vocational Vehicle Standards

Some vocational vehicles, because they are primarily designed for off-road use, may not be good candidates for low rolling resistance tires. These vehicles may travel on-road for very limited periods of time, such as in traveling on an urban road, or if they are off-loaded from another vehicle onto a road and then are driven off-road. The infrequent and limited exposure to on-road environments makes these vehicles suitable candidates for providing an exemption from the CO<sub>2</sub> emissions and fuel consumption standards for vocational vehicles (although the standards for HD engines used in vocational vehicles would still apply).<sup>135</sup> The agencies are also targeting other vehicles that travel at low speeds and that are meant to be used both on- and off-road. The application of certain technologies to these vehicles may not provide the same level of benefits as it would for pure on-road vehicles, and moreover, could even reduce the functionality of the vehicle. In this case, the agencies want to ensure that vehicle functionality is maintained to the maximum extent possible, while avoiding the possibility that achievable benefits are not realized because of the structure of the regulations. The sections below explain this issue in more detail as it applies to tractors and vocational vehicles.

The agencies explained in the NPRM that certain vocational vehicles have very limited on-road usage, and that although they would be defined as “motor vehicles” per 40 CFR 85.1703, the fact that they spend the most of their operations off-road might be reason for excluding them from the vocational vehicle standards. Vocational vehicles, such as those used on oil fields and construction sites,<sup>136</sup> experience very little benefit from LRR tires or from any other technologies to reduce GHG emissions and fuel consumption. The agencies proposed to allow a narrow range of these *de facto* off-road vehicles

to be excluded from the proposed vocational vehicle standards if equipped with special off-road tires having lug type treads. The agencies stated in the NPRM that on/off road traction is the only tire performance parameter which trades off with TRR so significantly that tire manufacturers could be unable to develop tires meeting both a TRR standard while maintaining or improving the characteristic allowing them to perform off-road. See generally 75 FR at 74199–200. Therefore, the agencies proposed to exempt these vehicles from the standards while requiring them to use certified engines, which would provide fuel consumption and CO<sub>2</sub> emission reductions in all vocational applications. To ensure that these vehicles were in fact used chiefly off-road, the agencies proposed requirements that would allow exemption of a vehicle provided the vehicle and the tires were speed restricted. As mentioned, the agencies were aware that the majority of off road trucks primarily use off-road tires and are low speed vehicles as well. Based upon this understanding, the agencies specifically proposed that a vehicle must meet the following requirements to qualify for an exemption from vocational vehicle standards:

- Tires which are lug tires or contain a speed rating of less than or equal to 60 mph; and
- A vehicle speed limiter governed to 55 mph.

In response to the NPRM, EMA/TMA, Navistar and Volvo agreed with the proposal to exclude off-road vocational vehicles from the standards because these vehicles primarily operate off-road, but requested broadening the exclusion to cover other types of vocational vehicles. Several manufacturers (IAFC, FAMA, NTEA, NSWMA, AAPC, RMA, Navistar and DTNA) requested the exemption of specific vehicle types, such as on/off-road emergency vehicles, refuse vehicles, low speed transit buses or school buses, because their usage was viewed as being incompatible with LRR tires. Navistar opposed the application of the proposed regulations to school buses, arguing that LRR tires may impact the ride quality for children in school buses. However, Navistar also acknowledged that a significant portion

of the national fleet of school buses already utilizes off-road tires designed with lug type tread patterns (*e.g.*, Kentucky). IAFC, FAMA and NTEA commented that fire trucks and ambulances should also be exempted due to their part-time off-road use such as in responding to a wildland fire or hazardous materials incidents which would require operations on dirt and gravel roads, fields or other off-road environments. Commenters also contended that by requiring a 55-mph limitation, the proposed exemption would be impractical for emergency vehicles due to the need to respond quickly to life-threatening events. The refuse truck manufacturers and trade associations, NSWMA and AAPC, commented that the solid waste industry operates a variety of vocational vehicles that perform solely off-road at landfills. These comments also requested an exemption for certain refuse trucks (*i.e.*, roll-off container trucks) that frequently go off-road at construction sites. Other commenters (FAMA, IAFC and Oshkosh) opposed compliance with the LRR standard for vocational vehicles for on/off road mixed service tires with aggressive or lug treads, stating that up to this point the industry has had very little interest in improving the LRR aspects of these tires or even to conducting testing to determine values for the coefficient of rolling resistance.

For the final rules, the agencies have considered the issues raised by commenters and have decided to adopt different criteria than proposed for exempting vocational vehicles and vocational tractors that primarily travel off-road. The agencies believe that the reasons for proposing the exemption are equally applicable to a wider class of vocational vehicles operating mostly off-road so that the proposals were either unsuitable for the industry or too restrictive to capture all the vehicles intended for the exemption. For example, the NPRM proposal, by using tire tread patterns and VSLs as the basis for qualifying vehicles for the exemption, was too restrictive because other non-lug type tread patterns exist in the market as well as other technologies which are equally capable of limiting the speed of the vehicle, as mentioned by Volvo. Therefore, the

<sup>134</sup> Manufacturers may voluntarily opt-in to the NHTSA fuel consumption program in 2014 or 2015. Once a manufacturer opts into the NHTSA program it must stay in the program for all the optional MYs.

<sup>135</sup> See 75 FR at 74199.

<sup>136</sup> Vehicles such as concrete mixers, off-road dump trucks, backhoes and wheel loaders.



proposed exemption for off-road vocational vehicles will be replaced with new criteria based on the vehicle application, whether it operates at low speed and whether the vehicle has speed restricted tires. The exemption is in part based on existing industry standards established by NHTSA.<sup>137</sup> As such, any vocational vehicle including vocational tractors primarily used off-road or at low speeds must meet the following criteria to be exempt from GHG and fuel consumption vehicle standards:

- Any vehicle primarily designed to perform work off-road such as in oil fields, forests, or construction sites and having permanently or temporarily affixed components designed to work in an off-road environment (*i.e.*, hazardous material equipment or off-road drill equipment) or vehicles operating at low speeds making them unsuitable for normal highway operation; and meeting one or more of the following criteria:

- Any vehicle equipped with an axle that has a gross axle weight rating (GAWR) of 29,000 pounds; or
- Any truck or bus that has a speed attainable in 2 miles of not more than 33 mph; or
- Any truck that has a speed attainable in 2 miles of not more than 45 mph, an unloaded vehicle weight that is not less than 95 percent of its gross vehicle weight rating (GVWR), and no capacity to carry occupants other than the driver and operating crew.

The agencies are also adopting in the final rules provisions to exempt any vocational vehicle that can operate in both on and off-road environments and has speed restricted tires rated at 55 mph or below.<sup>138</sup> The agencies' reasoning in adopting a speed restricted exemption for tires is that the majority of mixed service tires used for off-road use was identified as being restricted at 55 mph or less.<sup>139</sup> Also, as identified by FMVSS No. 119, speed restricted tires at a rating of 55 mph or less are incapable

<sup>137</sup> The heavy-duty off-road exemption is based in part on requirements existing in NHTSA's Federal Motor Vehicle Safety Standards (FMVSS) Nos. 119 and 121. In FMVSS No. 119, titled "New pneumatic tires for motor vehicles with a GVWR of more than 4,538 kilograms (10,000 pounds) and motorcycles," speed restricted tires rated at a speed of 55 mph or less are subjected to lower test drum speeds in the endurance test to account for their low design speeds (*e.g.*, off-road tires). The off-road vehicle exemptions adopted for this heavy-duty program were based on the requirements used in FMVSS No. 121, "Air brake systems," to identify and exclude vocational vehicles based upon their inability to meet on-highway stopping distance requirements.

<sup>138</sup> See 40 CFR 1037.631.

<sup>139</sup> Particular tire use was identified during the FMVSS 119 rulemaking and confirmed through subsequent market research. See "2010 Year Book the Tire and RIM Association Inc."

of meeting the same on-road performance standards as conventional tires. The agencies acknowledge that using a speed restriction criteria could allow certain vehicles to be exempted inappropriately (*i.e.*, low speed city delivery tractors) but the agencies believe this is preferable to creating a situation where a segment of vehicles are precluded from performing their intended applications. Therefore, the final rules include an exemption for any mixed service (on and off-road) vocational vehicle equipped with off-road tires that are speed restricted at 55 mph or less.

Manufacturers choosing to exempt vehicles based on the above criteria will be required to provide a description of how they meet the qualifications for each vehicle family group in their end-of-the year and final year reports (see Section V).

A manufacturer having an off-road vehicle failing to meet the criteria under the agencies' off-road exemptions will be allowed to submit a petition describing how and why their vehicles should qualify for exclusion. The process of petitioning for an exemption is explained in § 1037.631 and § 535.8. For each request, the manufacturer will be required to describe why it believes an exemption is warranted and address the following factors which the agencies will consider in granting its petition:

- The agencies provide an exemption based on off-road capability of the vehicle or if the vehicle is fitted with speed restricted tires. Which exemption does your vehicle qualify under; and
- Are there any comparable tires that exist in the market to carry out the desired application both on and off road for the subject vehicle(s) of the petition which have LLR values that would enable compliance with the standard?

(b) Heavy-Duty Engine Standards for Engines Installed in Vocational Vehicles

EPA is finalizing GHG standards<sup>140</sup> and NHTSA is finalizing fuel consumption standards for new heavy-duty engines installed in vocational vehicles. The standards will vary depending on whether the engines are diesel or gasoline powered since emissions and fuel consumption profiles differ significantly depending on whether the engine is gasoline or diesel powered. The agencies' analyses, as discussed briefly below and in more detail later in this preamble and in the RIA Chapter 2, show that these

<sup>140</sup> Specifically, EPA is finalizing CO<sub>2</sub>, N<sub>2</sub>O, and CH<sub>4</sub> emissions standards for new heavy-duty engines over an EPA specified useful life period (See Section 0 for the N<sub>2</sub>O and CH<sub>4</sub> standards).

standards are appropriate and feasible under each agency's respective statutory authorities.

The agencies have analyzed the feasibility of achieving the GHG and fuel consumption standards, based on projections of what actions manufacturers are expected to take to reduce emissions and fuel consumption. EPA and NHTSA also present the estimated costs and benefits of the heavy-duty engine standards in Section III below. In developing the final rules, the agencies have evaluated the kinds of technologies that could be utilized by engine manufacturers compared to a baseline engine, as well as the associated costs for the industry and fuel savings for the consumer and the magnitude of the GHG and fuel consumption savings that may be achieved.

EPA's existing criteria pollutant emissions regulations for heavy-duty highway engines establish four service classes (three for compression-ignition or diesel engines and one for spark ignition or gasoline engines) that represent the engine's intended and primary vehicle application, as shown in Table II-16 (40 CFR 1036.140 and NHTSA's 49 CFR 535.4). The agencies proposed to use the existing service classes to define the engine subcategories in this HD GHG emissions and fuel consumption program. The agencies did not receive any adverse comments to using this approach. Thus, the agencies are adopting the four engine subcategories for this final action.

TABLE II-16—ENGINE REGULATORY SUBCATEGORIES

Engine category	Intended application
Light Heavy-duty (LHD) Diesel.	Class 2b through Class 5 trucks (8,501 through 19,500 pounds GVWR).
Medium Heavy-duty (MHD) Diesel.	Class 6 and Class 7 trucks (19,501 through 33,000 pounds GVWR).
Heavy Heavy-duty (HHD) Diesel.	Class 8 trucks (33,001 pounds and greater GVWR).
Gasoline .....	Incomplete vehicles less than 14,000 pounds GVWR and all vehicles (complete or incomplete) greater than 14,000 pounds GVWR.

(i) Diesel Engine Standards for Engines Installed in Vocational Vehicles

In the NPRM, the agencies proposed the following CO<sub>2</sub> and fuel consumption standards for HD diesel engines to be



installed in vocational vehicles, as shown in Table II–17.

TABLE II–17—VOCATIONAL DIESEL ENGINE STANDARDS OVER THE HEAVY-DUTY FTP CYCLE

Model year	Standard	Light heavy-duty diesel	Medium heavy-duty diesel	Heavy heavy-duty diesel
2014–2016	CO <sub>2</sub> Standard (g/bhp-hr)	600	600	567
	Voluntary Fuel Consumption Standard (gallon/100 bhp-hr)	5.89	5.89	5.57
2017 and Later	CO <sub>2</sub> Standard (g/bhp-hr)	576	576	555
	Fuel Consumption (gallon/100 bhp-hr)	5.66	5.66	5.45

The agencies explained in the NPRM that the standards were based on our assessment of the findings of the 2010 NAS report and other literature sources that there are technologies available to reduce fuel consumption in all these engines by this level in the final time frame in a cost-effective manner. Similar to the technology basis for HD engines used in combination tractors, these technologies include improved turbochargers, aftertreatment optimization, low temperature exhaust gas recirculation, and engine friction reductions.

The agencies proposed that the HD diesel engine CO<sub>2</sub> standards for vocational vehicles would become effective in MY 2014 for EPA, with more stringent CO<sub>2</sub> standards becoming effective in MY 2017, while NHTSA’s fuel consumption standards would become effective in MY 2017, which would be both consistent with the EISA four-year minimum lead-time requirements and harmonized with EPA’s timing for stringency increases. The agencies explained that the three-year timing, besides being required by EISA, made sense because EPA’s heavy-duty highway engine program for criteria pollutants had begun to provide new emissions standards for the industry in three year increments, which had caused the heavy-duty engine and vehicle manufacturer product plans to fall largely into three year cycles reflecting this regulatory environment.<sup>141</sup> To further harmonize with EPA, NHTSA proposed voluntary fuel consumption standards for HD diesel engines for vocational vehicles in MYs 2014–2016, allowing manufacturers to opt into the voluntary standards in any of those model years.<sup>142</sup> Manufacturers opting into the program must declare by statement their intent to comply prior to or at the same

time they submit their first application for a certificate of conformity. A manufacturer opting into the program would begin tracking credits and debits beginning in the model year in which they opt in. Both agencies proposed to allow manufacturers to generate and use credits to achieve compliance with the HD diesel engine standards for vocational vehicles, including averaging, banking, and trading (ABT), and deficit carry-forward.

The agencies proposed to require HD diesel engine manufacturers to achieve, on average, a three percent reduction in fuel consumption and CO<sub>2</sub> emissions for the 2014 standards over the baseline MY 2010 performance for the HHD diesel engines, and a five percent reduction for the LHD and MHD diesel engines. The standards for the LHD and MHD engine categories were proposed to be set at the same level because the agencies found that there is an overlap in the displacement of engines which are currently certified as LHDD or MHDD. The agencies developed the baseline 2010 model year CO<sub>2</sub> emissions from data provided to EPA by manufacturers during the non-GHG certification process. Analysis of CO<sub>2</sub> emissions from 2010 model year LHD and MHDD diesel engines showed little difference between LHD and MHD diesel engine baseline CO<sub>2</sub> performance in the 2010 model year, which overall averaged 630 g CO<sub>2</sub>/bhp-hr (6.19 gal/100 bhp-hr).<sup>143</sup> Furthermore, the technologies available to reduce fuel consumption and CO<sub>2</sub> emissions from these two categories of engines are similar. The agencies considered combining these engine categories into a single category, but decided to maintain these two separate engine categories with the same standard level to respect the different useful life periods associated with each category.

For vocational engines certified on the FTP cycle, the agencies proposed to require a five percent reduction for HHD engines and nine percent for LHD and

MHD engines. For LHD and MHD engines in 2017 MY, the nine percent reduction is based on the assumption that valvetrain friction reduction can be achieved in LHD and MHD engines in addition to turbo efficiency and accessory (water, oil, and fuel pump) improvements, improved EGR cooler, and other approaches being used for HHD engines.

Commenters who discussed the HD diesel engine standards generally did not differentiate between the standards for engines used in combination tractors and the engines used in vocational vehicles. As explained above in Section II.B.2.b, some commenters, such as EMA/TMA, Cummins, DTNA, and other manufacturers, supported the proposed standards, as long as the flexibilities proposed in the NPRM were finalized as proposed. Volvo argued that the standards are being phased in too quickly. Environmental groups and NGOs commented that the standards should be more stringent and reflect the potential for greater fuel consumption and CO<sub>2</sub> emissions reductions through the use of additional technologies outlined in the 2010 NAS study.

In response to those comments, the agencies refer back to our discussion in Section II.B.2.b. The agencies believe that the additional reductions may be achieved through the increased development of the technologies evaluated for the 2014 model year standard, but the agencies’ analysis indicates that this type of advanced engine development will require a longer development time than MY 2014. The agencies are therefore providing additional lead time to allow for the introduction of this additional technology, and waiting until 2017 to increase stringency to levels reflecting application of turbocompounding. See Chapter 2 of the RIA for more details.

While it made sense to set standards at the same level for LHD and MHD diesel engines for vocational vehicles, the agencies found that it did not make sense to set HHD standards at the same level. Based on manufacturer-submitted

<sup>141</sup> See generally 75 FR at 74200–201.

<sup>142</sup> Once a manufacturer opts into the NHTSA program it must stay in the program for all the optional MYs and remain standardized with the implementation approach being used to meet the EPA emission program.

<sup>143</sup> Calculated using the conversion 10,180 g CO<sub>2</sub>/gallon for diesel fuel.

CO<sub>2</sub> data for the non-GHG emissions certification process, the agencies found that the baseline for HHD diesel engines was much lower than for LHD/MHD diesel engines—584 g CO<sub>2</sub>/bhp-hr (5.74 gal/100 bhp-hr) on average for HHD, compared to 630 g CO<sub>2</sub>/bhp-hr (6.19 gal/100 bhp-hr) on average for LHD/MHD.<sup>144</sup> In addition to the differences in the baseline performance, the agencies believe that there may be some technologies available to reduce fuel consumption and CO<sub>2</sub> emissions that may be appropriate for the HHD diesel engines but not for the LHD/MHD diesel engines, such as turbocompounding. Therefore, the agencies are setting a different standard level for HHD diesel engines to be used in vocational vehicles. Additional discussion on technical feasibility is included in Section III below and in Chapter 2 of the RIA.

After consideration of the comments, EPA and NHTSA are adopting as proposed the CO<sub>2</sub> emission standards and fuel consumption standards for heavy-duty diesel engines installed in vocational vehicles are presented in Table II–17. Consistent with proposal, the first set of standards take effect with MY 2014 (mandatory standards for EPA, voluntary standards for NHTSA), and the second set take effect with MY 2017 (mandatory for both agencies).

Compliance with the standards for engines installed in vocational vehicles will be evaluated based on the composite HD FTP cycle. In the NPRM, the agencies proposed standards based on the Heavy-duty FTP cycle for engines used in vocational vehicles reflecting their primary use in transient operating conditions (typified by both frequent accelerations and decelerations), as well as in some steady cruise conditions as represented on the Heavy-duty FTP. The primary reason the agencies proposed two separate certification cycles for HD diesel engines—one for HD diesel engines used in combination tractors and the other for HD diesel engines used in vocational vehicles—is to encourage engine manufacturers to install technologies appropriate to the intended use of the engine with the vehicle.<sup>145</sup>

DTNA, Cummins, EMA/TMA, and Honeywell commented that certain vocational vehicle applications would achieve greater fuel consumption and CO<sub>2</sub> emissions reductions in-use by using an engine designed to meet the SET-based standard. They stated that some vocational vehicles operate at steady-state more frequently than in

transient operation, such as motor coaches, and thus should be able to have an engine certified on a steady-state cycle to better reflect the vehicle's real use.

In response, while the agencies recognize the value to manufacturers of having additional flexibility that allows them to meet the standards in a way most consistent with how their vehicles and engines will ultimately be used, we remain concerned about increasing flexibility in ways that might impair fuel consumption and CO<sub>2</sub> emissions reductions. The agencies are therefore providing the option in these final rules for some vocational vehicles, but not others, to have SET certified engines. Heavy heavy-duty vocational engines will be allowed to be SET certified for vocational vehicles, since SET certified HHD engines must meet more stringent GHG and fuel consumption standards than FTP certified engines. We believe this will provide manufacturers additional flexibility while still achieving the expected fuel consumption and CO<sub>2</sub> emissions reductions. However, medium heavy-duty vocational engines will not be allowed to be SET-certified, because medium heavy-duty engines certified on the FTP must meet a more stringent standard than engines certified on the SET, and the agencies are not confident that fuel consumption and CO<sub>2</sub> emissions reduction levels would necessarily be maintained.

As discussed above in Section II.B.2.b, the agencies place important weight in making our decisions about the cost-effectiveness of the standards and the availability of lead time on the fact that engine manufacturers are expected to redesign and upgrade their products during MYs 2014–2017. The final two-step CO<sub>2</sub> emission and fuel consumption standards recognize the opportunity for technology improvements over the rulemaking time frame, while reflecting the typical diesel truck manufacturers' and diesel engine manufacturers' product plan cycles. Over these four model years there will be an opportunity for manufacturers to evaluate almost every one of their engine models and add technology in a cost-effective way, consistent with existing redesign schedules, to control GHG emissions and reduce fuel consumption. The time-frame and levels for the standards, as well as the ability to average, bank and trade credits and carry a deficit forward for a limited time, are expected to provide

manufacturers the time needed to incorporate technology that will achieve the final GHG and fuel consumption reductions, and to do this as part of the normal engine redesign process. This is an important aspect of the final rules, as it will avoid the much higher costs that would occur if manufacturers needed to add or change technology at times other than these scheduled redesigns.<sup>146</sup> This time period will also provide manufacturers the opportunity to plan for compliance using a multi-year time frame, again in accord with their normal business practice. Further details on lead time, redesigns and technical feasibility can be found in Section III.

The agencies recognize, however, that the schedule of changes for the final standards may not be the most cost-effective one for all manufacturers. For HD diesel engines for use in tractors, the agencies discussed above in Section II.B.2.b our decision in this final program to allow an “OBD phase-in” option for meeting the standards, based on comments received from several industry organizations indicating that aligning technology changes for multiple regulatory requirements would provide them with greater flexibility. In the context of HD diesel engines for use in vocational vehicles, Volvo, EMA/TMA, and DDC specifically requested an “OBD phase-in” option in its comments to the NPRM. DDC argued that bundling design changes where possible can reduce the burden on industry for complying with regulations, so aligning the introduction of the OBD, GHG, and fuel consumption standards could help reduce the resources devoted to validation of new product designs and certification.

The agencies have the same interest in providing this flexibility for manufacturers of HD diesel engines for use in vocational vehicles as in providing it for manufacturers of HD diesel engines for use in combination tractors, as long as equivalent emissions and fuel savings are maintained. Thus, in order to provide additional flexibility for manufacturers looking to align their technology changes with multiple regulatory requirements, the agencies are finalizing an alternate “OBD phase-in” option for meeting the HD diesel engine standards which delivers equivalent CO<sub>2</sub> emissions and fuel consumption reductions as the primary standards for the engines built in the 2013 through 2017 model years, as shown in Table II–18.

<sup>144</sup> Calculated using the conversion 10,180 g CO<sub>2</sub>/gallon for diesel fuel.

<sup>145</sup> See generally 75 FR at 74201.

<sup>146</sup> See 75 FR at 25467–68.

TABLE II-18—COMPARISON OF CO<sub>2</sub> REDUCTIONS FOR THE ENGINE STANDARDS UNDER THE ALTERNATIVE OBD PHASE-IN AND PRIMARY PHASE-IN

	HHD FTP			LHD/MHD FTP		
	Primary phase-in standard (g/bhp-hr)	Optional phase-in standard (g/bhp-hr)	Difference in lifetime CO <sub>2</sub> engine emissions (MMT)	Primary phase-in standard (g/bhp-hr)	Optional phase-in standard (g/bhp-hr)	Difference in lifetime CO <sub>2</sub> engine emissions (MMT)
Baseline .....	584	584	.....	630	630	
2013 MY Engine .....	584	577	20	630	618	14
2014 MY Engine .....	567	577	-28	600	618	-22
2015 MY Engine .....	567	577	-28	600	618	-22
2016 MY Engine .....	567	555	34	600	576	29
2017 MY Engine .....	555	555	0	576	576	0
Net Reductions (MMT) .....	.....	.....	-3	.....	.....	0

Table II-19 presents the final HD diesel engine CO<sub>2</sub> emission and fuel consumption standards under the optional “OBD phase-in” option.

TABLE II-19—OPTIONAL HEAVY-DUTY ENGINE STANDARD PHASE-IN

Model year	Standard	Light heavy-duty diesel	Medium heavy-duty diesel	Heavy heavy-duty diesel
2013 .....	CO <sub>2</sub> Standard (g/bhp-hr) .....	618	618	577
	Voluntary Fuel Consumption Standard (gallon/100 bhp-hr) .....	6.07	6.07	5.67
2016 and Later .....	CO <sub>2</sub> Standard (g/bhp-hr) .....	576	576	555
	Fuel Consumption (gallon/100 bhp-hr) .....	5.66	5.66	5.45

In order to ensure equivalent CO<sub>2</sub> and fuel consumption reductions and orderly compliance, and to avoid gaming, the agencies are requiring that if a manufacturer selects the OBD phase-in option, it must certify its engines starting in the 2013 model year and continue using this phase-in through the 2016 model year. Manufacturers may opt into the OBD phase-in option through the voluntary NHTSA program, but must opt in in the 2013 model year and continue using this phase-in through the 2016 model year. Manufacturers that opt in to the voluntary NHTSA program in 2014 and 2015 will be required to meet the primary phase-in schedule and may not adopt the OBD phase-in option.

As discussed above in Section II.B.2.b, while the agencies believe that the HD diesel engine standards are appropriate, cost-effective, and technologically feasible in the rulemaking time frame, we also recognize that when regulating a category of engines for the first time, there will be individual products that may deviate significantly from the baseline level of performance, whether because of a specific approach to criteria pollution control, or due to engine calibration for specific applications or duty cycles. That earlier discussion described HD diesel engines for use in combination tractors, but the same

supporting information is relevant to the agencies’ consideration of an alternate standard for HD diesel engines installed in vocational vehicles. In the NPRM, the agencies proposed an optional engine standard for HD diesel engines installed in vocational vehicles based on a five percent reduction from the engine’s own 2011 model year baseline level, but requested comment on whether a two percent reduction would be more appropriate.<sup>147</sup> The comments received in response did not directly address engines for vocational vehicles, but the agencies believe that the information provided by Navistar and others is equally applicable to HD diesel engines for combination tractors and for vocational vehicles. Our assessment for the final standards is that a 2.5 percent reduction is appropriate for LHD and MHD engines installed in vocational vehicles and 3 percent is appropriate for HHD engines installed in vocational vehicles given the technologies available for application to legacy products by model year 2014.<sup>148</sup> Unlike the majority of engine products in this segment, engine manufacturers have devoted few resources to developing technologies for these legacy products reasoning that the investment would have little value if the engines are to be

substantially redesigned or replaced in the next five years. Hence, although the technologies we have identified to achieve the proposed five percent reduction would theoretically work for these legacy products, there is inadequate lead time for manufacturers to complete the pre-application development needed to add the technology to these engines by 2014. The mix of technologies available off the shelf for legacy engines varies between engine lines within OEMs and varies among OEMs as well. On average, based on our review of manufacturer development history and current plans, we project that for the legacy products approximately half of the defined technologies appropriate for the 2014 standard will be available and ready for application by 2014 for older legacy engine designs. Hence, we have concluded that if we limit the reductions to those improvements which reflect further enhancements of already installed systems rather than the addition or replacement of technologies with fully developed new on the shelf components, the potential improvement for the 2014 model year will be 2.5 percent for LHD and MHD engines and 3 percent HHD engines.

Just as for HD diesel engines used in combination tractors, the agencies stress that this option for HD engines used in vocational vehicles is temporary and

<sup>147</sup> See 75 FR at 74202.

<sup>148</sup> To be codified at 40 CFR 1036.620.

limited and is being adopted to address diverse manufacturer needs associated with complying with this first phase of the regulations. This optional, alternative standard will be available only for the 2014 through 2016 model years, because we believe that manufacturers will have had ample opportunity to make appropriate changes to bring their product performance into line with the rest of the industry after that time. This optional standard will not be available unless and until a manufacturer has exhausted all available credits and credit opportunities, and engines under the alternative standard could not generate credits.

The agencies note that manufacturers choosing to utilize this option in MYs 2014–2016 will have to make a greater relative improvement in MY 2017 than the rest of the industry, since they will be starting from a worse level. For compliance purposes, in MYs 2014–2016 emissions from engines certified and sold at the alternate level will be averaged with emissions from engines certified and sold at more stringent levels to arrive at a weighted average emissions level for all engines in the subcategory. Again, this option can only be taken if all other credit opportunities have been exhausted and the manufacturer still cannot meet the primary standards. If a manufacturer chooses this option to meet the EPA emission standards in MY 2014–2016, and wants to opt into the NHTSA fuel consumption program in these same MYs it must follow the exact path followed under the EPA program utilizing equivalent fuel consumption standards.

As discussed above in Section II.B.2.b, Volvo argued that manufacturers could game the standard by establishing an artificially high 2011 baseline emission level. This could be done, for example, by certifying an engine with high fuel consumption and GHG emissions that is either: (1) Not sold in significant quantities; or (2) later altered to emit fewer GHGs and consume less fuel through service changes. In order to mitigate this possibility, the agencies are requiring either that the 2011 model year baseline must be developed by averaging emissions over all engines in an engine averaging set certified and sold for that model year so as to prevent a manufacturer from developing a single high GHG output engine solely for the purpose of establishing a high baseline or meet additional criteria. The agencies are allowing manufacturers to combine light heavy-duty and medium heavy-duty diesel engines into a single

averaging set for this provision because the engines have the same GHG emissions and fuel consumption standards. If a manufacturer does not certify all engine families in an averaging set to the alternate standards, then the tested configuration of the engine certified to the alternate standard must have the same engine displacement and its rated power within 5 percent of the highest rated power as the baseline engine. In addition, the tested configurations must have a BSFC equivalent to or better than all other configurations within the engine family and represent a configuration that is sold to customers.

(ii) Gasoline Engine Standard

Heavy-duty gasoline engines are also used in vocational vehicle applications. The number of engines certified in the past for this segment of vehicles is very limited and has ranged between three and five engine models.<sup>149</sup> Unlike the heavy-duty diesel engines typical of this segment which are built for vocational vehicles, these gasoline engines are developed for heavy-duty pickup trucks and vans primarily, but are also sold as loose engines to vocational vehicle manufacturers, for use in vocational vehicles such as some delivery trucks. Some fleets still prefer gasoline engines over diesel engines. In the past, this was the case since gasoline stations were more prevalent than stations that sold diesel fuel. Because they are developed for HD pickups and vans, the agencies evaluated these engines in parallel with the heavy-duty pickup truck and van standard development. As in the pickup truck and van segment, the agencies anticipated that the manufacturers will have only one engine re-design within the 2014–2018 model years under consideration within the proposal. The agencies therefore proposed fuel consumption and CO<sub>2</sub> emissions standards for gasoline engines for use in vocational vehicles, which represent a five percent reduction in CO<sub>2</sub> emissions and fuel consumption in the 2016 model year over the 2010 MY baseline through use of technologies such as coupled cam phasing, engine friction reduction, and stoichiometric gasoline direct injection.

In our meetings with all three of the major manufacturers in the HD pickup and van segment, confidential future product plans were shared with the agencies. Reflecting those plans and our estimates for when engine changes will be made in alignment with those product plans, we had concluded for

proposal that the 2016 model year reflects the most logical model year start date for the heavy-duty gasoline engine standards. In order to meet the standards we are finalizing for heavy-duty pickups and vans, we project that all manufacturers will have redesigned their gasoline engine offerings by the start of the 2016 model year. Given the small volume of loose gasoline engine sales relative to complete heavy-duty pickup sales, we think it is appropriate to set the timing for the heavy-duty gasoline engine standard in line with our projections for engine redesigns to meet the heavy-duty pickup truck standards. Therefore, NHTSA’s final fuel consumption standard and EPA’s final CO<sub>2</sub> standard for heavy-duty gasoline engines are first effective in the 2016 model year.

The baseline 2010 model year CO<sub>2</sub> performance of these heavy-duty gasoline engines over the Heavy-duty FTP cycle is 660 g CO<sub>2</sub>/bhp-hr (7.43 gal/100 bhp-hr) in 2010 based on non-GHG certification data provided to EPA by the manufacturers. The agencies are finalizing 2016 model year standards that require manufacturers to achieve a five percent reduction in CO<sub>2</sub> compared to the 2010 MY baseline through use of technologies such as coupled cam phasing, engine friction reduction, and stoichiometric gasoline direct injection. Additional detail on technology feasibility is included in Section III and in the RIA Chapter 2. As shown in Table II–20, NHTSA is finalizing as proposed a 7.06 gallon/100 bhp-hr standard for fuel consumption while EPA is adopting as proposed a 627 g CO<sub>2</sub>/bhp-hr standard tested over the Heavy-duty FTP, effective in the 2016 model year. Similar to EPA’s non-GHG standards approach, manufacturers may generate and use credits by the same engine averaging set to show compliance with both agencies’ standards.

TABLE II–20—HEAVY-DUTY GASOLINE ENGINE STANDARDS

Model year		Gasoline engine standard
2016 and Later.	CO <sub>2</sub> Standard (g/bhp-hr).	627
	Fuel Consumption (gallon/100 bhp-hr).	7.06

(c) In-Use Standards

Section 202(a)(1) of the CAA specifies that emissions standards are to be applicable for the useful life of the vehicle. The in-use standards that EPA

<sup>149</sup>EPA’s heavy-duty engine certification database at <http://www.epa.gov/otaq/certdata.htm#largeng>.

is finalizing apply to individual vehicles and engines. NHTSA is not finalizing in-use standards that would apply to the vehicles and engines in a similar fashion.

EPA proposed that the in-use standards for heavy-duty engines installed in vocational vehicles be established by adding an adjustment factor to the full useful life emissions results projected in the EPA certification process to account for measurement variability inherent in testing done at different laboratories with different engines. The agency proposed a two percent adjustment factor and requested comments and additional data during the proposal to assist in developing an appropriate factor level. The agency received additional data during the comment period which identified production variability which was not accounted for at proposal. Details on the development of the final adjustment factor are included in RIA Chapter 3. Based on the data received, EPA determined that the adjustment factor in the final rules should be higher than the proposed level of two percent. EPA is finalizing a three percent adjustment factor for the in-use standard to provide

a reasonable margin for production and test-to-test variability that could result in differences between the initial emission test results and emission results obtained during subsequent in-use testing.

We are finalizing regulatory text (in § 1036.150) to allow engine manufacturers to use assigned deterioration factors (DFs) without performing their own durability emission tests or engineering analysis. However, the engines would still be required to meet the standards in actual use without regard to whether the manufacturer used the assigned DFs. This allowance is being adopted as an interim provision applicable only for this initial phase of standards.

Manufacturers will be allowed to use an assigned additive DF of 0.0 g/bhp-hr for CO<sub>2</sub> emissions from any conventional engine (*i.e.*, an engine not including advance or innovative technologies). Upon request, we could allow the assigned DF for CO<sub>2</sub> emissions from engines including advance or innovative technologies, but only if we determine that it would be consistent with good engineering judgment. We believe that we have enough information about in-use CO<sub>2</sub> emissions

from conventional engines to conclude that they will not increase as the engines age. However, we lack such information about the more advanced technologies.

EPA proposed that the useful life for these engines and vehicles with respect to GHG emissions be set equal to the respective useful life periods for criteria pollutants. EPA proposed that the existing engine useful life periods, as included in Table II–21, be broadened to include CO<sub>2</sub> emissions and fuel consumption for both engines and vocational vehicles. The agency did not receive any adverse comments with this approach and is finalizing the useful life periods as proposed (*see* 40 CFR 1036.108(d) and 1037.105). While NHTSA will use useful life considerations for establishing fuel consumption performance for initial compliance and for ABT, NHTSA does not intend to implement an in-use compliance program for fuel consumption, because it is not required under EISA and because it is not currently anticipated there will be notable deterioration of fuel consumption over the engines' useful life.

TABLE II–21—USEFUL LIFE PERIODS

	Years	Miles
Class 2b–5 Vocational Vehicles, Spark Ignited, and Light Heavy-Duty Diesel Engines .....	10	110,000
Class 6–7 Vocational Vehicles and Medium Heavy-Duty Diesel Engines .....	10	185,000
Class 8 Vocational Vehicles and Heavy Heavy-Duty Diesel Engines .....	10	435,000

(2) Test Procedures and Related Issues

The agencies are finalizing test procedures to evaluate fuel consumption and CO<sub>2</sub> emissions of vocational vehicles in a manner very similar to Class 7 and Class 8 combination tractors. This section describes the simulation model for demonstrating compliance, engine test procedures, and a test procedure for evaluating hybrid powertrains (a potential means of generating credits, although not part of the technology package on which the final standard for vocational vehicles is premised).

(a) Computer Simulation Model

As previously mentioned, to achieve the goal of reducing emissions and fuel consumption for both trucks and engines, we are finalizing separate engine and vehicle-based emission and fuel consumption standards for vocational vehicles and engines used in those vehicles. For the vocational vehicles, engine manufacturers are subject to the engine standards, and

chassis manufacturers are required to install certified engines in their chassis. The chassis manufacturer is subject to a separate vehicle-based standard that uses the final vehicle simulation model, the GEM, to evaluate the impact of the tire design to determine compliance with the vehicle standard.

A simulation model, in general, uses various inputs to characterize a vehicle's properties (such as weight, aerodynamics, and rolling resistance) and predicts how the vehicle would behave on the road when it follows a driving cycle (vehicle speed versus time). On a second-by-second basis, the model determines how much engine power needs to be generated for the vehicle to follow the driving cycle as closely as possible. The engine power is then transmitted to the wheels through transmission, driveline, and axles to move the vehicle according to the driving cycle. The second-by-second fuel consumption of the vehicle, which corresponds to the engine power demand to move the vehicle, is then

calculated according to the fuel consumption map embedded in the compliance model. Similar to a chassis dynamometer test, the second-by-second fuel consumption is aggregated over the complete drive cycle to determine the fuel consumption of the vehicle.

NHTSA and EPA are finalizing an approach consistent with the proposal to evaluate fuel consumption and CO<sub>2</sub> emissions respectively through a simulation of whole-vehicle operation, consistent with the NAS recommendation to use a truck model to evaluate truck performance. The EPA developed the GEM for the specific purpose of this rulemaking to evaluate vehicle performance. The GEM is similar in concept to a number of vehicle simulation tools developed by commercial and government entities. The model developed by the EPA and finalized here was designed for the express purpose of vehicle compliance demonstration and is therefore simpler and less configurable than similar

commercial products. This approach gives a compact and quicker tool for evaluating vehicle compliance without the overhead and costs of a more

complicated model. Details of the model, including changes made to the model to address concerns of the peer reviewers and commenters are included

in Chapter 4 of the RIA. An example of the GEM input screen is shown in Figure II-4.

Figure II-4: Example GEM Input Screen

EPA and NHTSA have validated the GEM simulation of vocational vehicles against a commonly used simulation tool used in industry, GT-Drive, for each vocational vehicle subcategory. Prior to using GT-Drive as a comparison tool, the agencies first benchmarked a GT-Drive simulation of the combination tractor tested at Southwest Research against the experimental test results from the chassis dynamometer in the same manner as done for GEM. Then the EPA developed three vocational vehicle models (LHD, MHD, and HHD) and simulated them using both GEM and GT-Drive. Overall, the GEM and GT-Drive predicted the fuel consumption and CO<sub>2</sub> emissions for all three vocational vehicle subcategories with differences of less than 2 percent for the three test cycles—the California ARB Transient cycle, 55 mph cruise, and 65 mph cruise cycle.<sup>150</sup> The final simulation model is described in greater detail in RIA Chapter 4 and is available

<sup>150</sup> See RIA Chapter 4, Table 4-8.

for download by interested parties at (<http://www.epa.gov/otaq/>).

The agencies are requiring that for demonstrating compliance, a chassis manufacturer would measure the performance of tires, input the values into GEM, and compare the model's output to the standard. As explained earlier, low rolling resistance tires are the only technology on which the agencies' own feasibility analysis for these vehicles is predicated. The input values for the simulation model will be derived by the manufacturer from the final tire test procedure described in this action. The remaining model inputs will be fixed values pre-defined by the agencies. These are detailed in the RIA Chapter 4, including the engine fuel consumption map to be used in the simulation.

#### (b) Tire Rolling Resistance Assessment

In terms of how tire rolling resistance would be measured, the agencies proposed to require that the tire rolling resistance input to the GEM be

determined using ISO 28580:2009(E), *Passenger car, truck and bus tyres—Methods of measuring rolling resistance—Single point test and correlation of measurement results*.<sup>151</sup> The agencies stated that they believed the ISO test method was the most appropriate for this program because the method is the same one used by the NHTSA tire fuel efficiency consumer information program,<sup>152</sup> by European regulations,<sup>153</sup> and by the EPA SmartWay program.

The NPRM also discussed the potential for tire-to-tire variability to confound rolling resistance measurement results for LRR tires—that is, different tires of the same tire model could turn out to have different rolling resistance measurements when run on

<sup>151</sup> See [http://www.iso.org/iso/iso\\_catalogue/catalogue\\_tc/catalogue\\_detail.htm?csnumber=44770](http://www.iso.org/iso/iso_catalogue/catalogue_tc/catalogue_detail.htm?csnumber=44770).

<sup>152</sup> 75 FR 15893, March 30, 2010.

<sup>153</sup> See <http://www.energy.ca.gov/2009publications/CEC-600-2009-010/CEC-600-2009-010-SD-REV.PDF> (last accessed May 9, 2011).

the same test. NHTSA's research during the development of the light-duty vehicle tire fuel efficiency consumer information program identified several sources of variability including test procedures, test equipment and the tires themselves, but found that all of the existing test methods had similar levels of and sources of variability.<sup>154</sup> The agencies proposed to address production tire-to-tire variability by specifying that three tire samples within each tire model be tested three times each, and that the average of the nine tests would be used as the Rolling Resistance Coefficient (CRR) for the tire, which would be the basis for the rolling resistance value for that tire that the manufacturer would enter into the GEM. The agencies requested comment on this proposed method.<sup>155</sup>

The agencies received many comments on the subject of tire rolling resistance, including suggestions for alternative test procedures and compliance issues. Regarding whether the agencies should base tire CRR inputs for the GEM on the use of the ISO 28580 test procedure, the American Automotive Policy Council (AAPC) argued that the agencies should instead require the SAE J2452 Coastdown test method for calculating tire rolling resistance, which the commenter stated was preferred by OEMs because it simulates the use of tires on actual vehicles rather than the ISO procedure which tests the tire by itself. The Rubber Manufacturers Association (RMA) argued, in contrast, that the agencies should use the SAE J1269 multi-point test, which is currently the basis for the EPA SmartWay™ CRR baseline values. RMA also argued that the SAE J1269 multi-point test can be used to accurately predict truck/bus tire CRR at various loads and inflations, including at the ISO 28580 load and inflation conditions, and that therefore the agencies should use the SAE test, or if the agencies want to use ISO, they should accept results from the SAE test and just correlate them. Regarding compliance obligations, RMA further argued that it was not clear how or in what format testing information would need to be provided in order to be in compliance with the proposed requirement at § 1037.125(i).

The agencies analyzed many comments on the subject of tire rolling resistance. One of the primary concerns raised in comments was that the proposed test protocol and measurement methodology would not adequately address production tire

variability and measurement variability. Commenters stated that machine-to-machine differences are a significant source of variation, and this variation would make it difficult for manufacturers to be confident that the agency would assign the same CRR to a tire was tested for compliance purposes. Commenters argued that the ISO 28580 test method is unique in that it specifies a procedure to correlate results between different test equipment (*i.e.*, different rolling resistance test machines), but not all aspects of the ISO procedure have been completely defined. Commenters stated that under ISO 28580, the lab alignment procedure depends on the specification of a reference test machine to which all other labs will align their measurement results. RMA particularly emphasized the need for establishing a tire testing reference lab for use with ISO 28580, referencing the European Tyre and Rim Technical Organization (ETRTO) estimate that CRR values could vary as much as 20 percent absent an inter-laboratory alignment procedure. RMA stated the agencies should specify a reference laboratory with the designation proposed in a supplemental notice that provides public comment. In addition, RMA commented that the extra burden proposed by the agencies for testing three tires, three times each is nine times more burdensome than what is required through the ISO procedure.

Based on the additional tire rolling resistance research conducted by the agencies, we have decided to use the ISO 28580 test procedure, as proposed, to measure tire performance for these final rules.

The agencies believe this test procedure provides two advantages over other test methods. First, the ISO 28580 test method is unique in that it specifies a procedure to correlate results between different test equipment (*i.e.*, different tire rolling resistance test machines). This is important because NHTSA's research conducted for the light-duty tire fuel efficiency program indicated that machine-to-machine differences are a source of variation.<sup>156</sup> In addition, the ISO 28580 test procedure is either used, or proposed to be used, by several groups including the European Union through Regulation (EC) No 661/2009<sup>157</sup> and the California Air Resources Board (CARB) through a staff recommendation for a California

regulation,<sup>158</sup> and the EPA SmartWay program. Using the ISO 28580 may help reduce burden on manufacturers by allowing a single test protocol to be used for multiple regulations and programs. While we recognize that commenters recommended the use of other test procedures, like SAE J1269, the agencies have determined there is no established data conversion method from the SAE J1269 vehicle condition for vocational vehicle tires to the ISO 28580 single point condition at this time, and that given our reasonable preference for the ISO procedure, it would not be practical to attempt to include the use of the SAE J1269 procedure as an optional way of determining CRR values for the GEM inputs.

The agencies received comments from the Rubber Manufacturers Association, Michelin, and Bridgestone which identified the need to develop a reference lab and alignment tires. Because the ISO has not yet specified a reference lab and machine for the ISO 28580 test procedure, NHTSA announced in its March 2010 final rule concerning the light-duty tire fuel efficiency consumer information program that NHTSA would specify this laboratory for the purposes of implementing that rule so that tire manufacturers would know the identity of the machine against which they may correlate their test results. NHTSA has not yet announced the reference test machine(s) for the tire fuel efficiency consumer information program. Therefore, for the light-duty tire fuel efficiency rule, the agencies are postponing the specification of a procedure for machine-to-machine alignment until a tire reference lab is established. The agencies anticipate establishing this lab in the future with intentions for the lab to accommodate the light-duty tire fuel efficiency program.

Under the ISO 28580 lab alignment procedure, machine alignment is conducted using batches of alignment tires of two models with defined differences in rolling resistance that are certified on a reference test machine. ISO 28580 specifies requirements for these alignment tires ("Lab Alignment Tires" or LATs), but exact tire sizes or models of LATs are not specifically identified in ISO 28580. Because the test procedure has not been finalized and heavy-duty LATs are not currently defined, the agencies are postponing the use of these elements of ISO 28580 to

<sup>154</sup> 75 FR 15893, March 30, 2010.

<sup>157</sup> See <http://eur-lex.europa.eu/LexUriServ/LexUriServ.do?uri=OJ:L:2009:200:0001:0024:EN:PDF> (last accessed May 8, 2011).

<sup>158</sup> See <http://www.energy.ca.gov/2009publications/CEC-600-2009-010/CEC-600-2009-010-SD-REV.PDF> (last accessed May 9, 2011).

<sup>154</sup> 75 FR 15893, March 30, 2010.

<sup>155</sup> See generally 75 FR at 74204.



a future rulemaking. The agencies also note the lab-to-lab comparison conducted in the most recent EPA tire test program mentioned previously. The agencies reviewed the CRR data from the tires that were tested at both the STL and Smithers laboratories to assess inter-laboratory and machine variability. The agencies conducted statistical analysis of the data to gain better understanding of lab-to-lab correlation and developed an adjustment factor for data measured at each of the test labs. Based on these results, the agencies believe the lab-to-lab variation for the STL and Smithers laboratories would have very small effect on measured CRR values. Based on the test data, the agencies judge that it is reasonable to implement the HD program with current levels of variability, and to allow the use of either Smithers or STL laboratories for determining the CRR value in the HD program, or demonstrate that the test facilities will not bias results low relative to Smithers or STL laboratories.

RMA also commented that the extra burden proposed by the agencies for testing three tires, three times each is nine times more burdensome than what is required through the ISO procedure. Since the proposal, EPA obtained replicate test data for a number of Class 8 combination tractor tires from various manufacturers. Some of these were tires submitted to SmartWay for verification, while some were tires tested by manufacturers for other purposes. Three tire model samples for 11 tire models were tested using the ISO 28580 test.<sup>159</sup> A mean and a standard deviation were calculated for each set of three replicate measurements performed on each tire of the 3-tire sample. The coefficient of variability (COV) of the CRR was calculated by dividing the standard deviation by the mean. The values of COV ranged from 0 percent (no measurable variability) to six percent. In addition, during the period September 2010 and June 2011, EPA contracted with Smithers-Rapra to select and test for rolling resistance using ISO 28580 for a representative sample of Class 4–8 vocational vehicle tires. As part of the test, 10 tires were selected for replicate testing.<sup>160</sup> Three replicate tests were conducted for each of the tires, to evaluate test variability only. The COV of the RR<sub>C</sub> results ranged from nearly 0 to 2 percent, with a mean of less than 1 percent. Based on the results of these two testing programs, the agencies

determined that the impact of production variability is greater than the impact of measurement variability. Thus, the agencies concluded that the extra burden of testing a single tire three times was not necessary to obtain accurate results, but the variability of RR<sub>C</sub> results due to manufacturing of the tires is significant to continue to require testing of three tire samples for each tire model. In summary, we are allowing manufacturers to determine the rolling resistance coefficient of the heavy-duty tires by testing three tire samples one time each.

For the final rules, the agencies are also including a warm up cycle as part of the procedure for bias ply tires to allow these tires to reach a steady temperature and volume state before ISO 28580 testing. This procedure is similar to a procedure that was developed for the light-duty tire fuel efficiency consumer information program, and was adopted from a procedure defined in Federal motor vehicle safety standard No. 109 (FMVSS No. 109).<sup>161</sup>

Finally, the agencies are including testing and reporting for ‘single-wide’ or ‘super-single’ type tires. These tires replace the traditional ‘dual’ wheel tire combination with a single wheel and tire that is nearly as wide as the dual combination with similar load capabilities. These tire types were developed as a fuel saving technology. The tires provide lower rolling resistance along with a reduction in weight when compared to a typical set of dual wheel tire combinations; and are one of the technologies included in the EPA SmartWay™ program. The agencies have learned that there is limited testing equipment available that is capable of testing single wide tires; single wide tires require a wider test machine drum than required for conventional tires. Although the number of machines available is limited, the agencies believe the equipment is adequate for the testing and reporting of CRR for this program.

As discussed above, the agencies are taking the approach of using CRR for the HD fuel efficiency and greenhouse gas program to align with the measurement methodology already employed or proposed by the EPA SmartWay program, the European Union Regulation (EC) No 661/2009<sup>162</sup> and the California Air Resources Board (CARB) through a staff recommendation for a California regulation.<sup>163</sup> In the NPRM, the agencies proposed to use CRR, but

for purposes of developing these final rules, the agencies also evaluated whether to use CRR or Rolling Resistance Force (RR<sub>F</sub>) as the measurement for tire rolling resistance for the GEM input. The agencies considered RR<sub>F</sub> largely because in the NPRM for Passenger Car Tire Fuel Efficiency (TFE) program, NHTSA had proposed to use RR<sub>F</sub>. A key distinction between these two programs, and their associated metrics, are the differences in how the measurement data are used and who uses the data. In particular, the HD fuel efficiency and GHG emissions program is a compliance program using information developed by and for technical personnel at manufacturers and agencies to determine a vehicle’s compliance with regulations. The TFE program, in contrast, is a consumer education program intended to inform consumers making purchase decisions regarding the fuel saving benefits of replacement passenger car tires. The target audiences are much different for the two programs which in turn affect how the information will be used. The agencies believe that RR<sub>F</sub> may be more intuitive for non-technical people because tires that are larger and/or that carry higher loads will generally have numerically higher RR<sub>F</sub> values than smaller tires and/or tires that carry lower loads. CRR values generally follow an opposite trend, where tires that are larger and/or carry higher loads will generally have numerically lower CRR values than smaller tires and/or tires that carry lower loads. The agencies believe this key distinction helps define the type of metrics to be used and communicated in accordance with their respective purposes.

Additionally, the CRR metric for use in the MD/HD program is not susceptible to the skew associated with tire diameter. Medium- and heavy-duty vehicle tires are available in a small fraction of the tire sizes of the passenger market and, for the most part, are larger tires than those found on passenger cars. When viewing CRR over a larger range of sizes, small diameter tires tend to appear as having a lower performance, which is not necessarily accurate, with the converse occurring as the diameter increases.

Using the CRR value for determining the rolling resistance also takes into account the load carrying capability for the tire being tested, which, intuitively, can lead to some potentially confusing results. Several vocational vehicle manufacturers argued in their comments that LRR tires were not available for, e.g., vehicles like refuse trucks, which tend to use large diameter tires to carry very heavy loads. Based on the agencies’

<sup>159</sup> Bachman, Joseph. EPA Memorandum to the Docket. Heavy-Duty Tire Evaluation. Docket EPA–HQ–OAR–2010–0162. July 2011.

<sup>160</sup> Bachman, Joseph. EPA Memorandum to the Docket. Heavy-Duty Tire Evaluation. Docket EPA–HQ–OAR–2010–0162. July 2011.

<sup>161</sup> See 49 CFR 571.109.

<sup>162</sup> See Note 157, above.

<sup>163</sup> See Note 158, above.



testing, in fact, the measured CRR (as opposed to the  $RR_F$ ) for refuse trucks were found to be among the best tested. This finding can be explained by considering that CRR is calculated by dividing the measured rolling resistance force by the tire's load capacity rating. Although the tire may have a relatively high rolling resistance force, the tire load capacity rating is also very high, resulting in an overall lower (better) CRR value than many other types of tires. The amount of load tire can carry (test load) contributes to a very low reported CRR, thus confirming low rolling resistance tires meeting the standards, as measured by CRR, are available to the industry regardless of segment or application.

Based on these considerations, the agencies have decided to use the CRR metric for the HD fuel efficiency and GHG emissions program.

#### (c) Defined Vehicle Configurations in the GEM

As discussed above, the agencies are finalizing a methodology that chassis manufacturers will use to quantify the tire rolling resistance values to be input into the GEM. Moreover, the agencies are defining the remaining GEM inputs (*i.e.*, specifying them by rule), which differ by the regulatory subcategory (for reasons described in the RIA Chapter 4). The defined inputs, among others, include the drive cycle, aerodynamics, vehicle curb weight, payload, engine characteristics, and drivetrain for each vehicle type.

##### (i) Metric

Based on NAS's recommendation and feedback from the heavy-duty truck industry, NHTSA and EPA proposed standards for vocational vehicles that would be expressed in terms of moving a ton of payload over one mile. Thus, NHTSA's proposed fuel consumption standards for these vehicles would be represented as gallons of fuel used to move one ton of payload one thousand miles, or gal/1,000 ton-mile. EPA's proposed CO<sub>2</sub> vehicle standards would be represented as grams of CO<sub>2</sub> per ton-mile. The agencies received comments that a payload-based metric is not appropriate for all types of vocational vehicles, specifically buses. The agencies recognize that a payload-based approach may not be the most representative of an individual vocational application; however, it best represents the broad vocational category. The metric which we proposed treats all vocational applications equally and requires the same technologies be applied to meet the standard. Thus, the agencies are

adopting the proposed metric, but will revisit the issue of metrics in any future action, if required, depending on the breadth of each standard.

##### (ii) Drive cycle

The drive cycles proposed for the vocational vehicles consisted of the same three modes used for the Class 7 and 8 combination tractors. The proposed cycle included the Transient mode, as defined by California ARB in the HHDDT cycle, a constant speed cycle at 65 mph and a 55 mph constant speed mode. The agencies proposed different weightings for each mode for vocational vehicles than those proposed for Class 7 and 8 combination tractors, given the known difference in driving patterns between these two categories of vehicles. The same reasoning underlies the agencies' use of the Heavy-duty FTP cycle to evaluate compliance with the standards for diesel engines used in vocational vehicles.

The variety of vocational vehicle applications makes it challenging to establish a single cycle which is representative of all such trucks. However, in aggregate, the vocational vehicles typically operate over shorter distances and spend less time cruising at highway speeds than combination tractors. The agencies evaluated for proposal two sources for mode weightings, as detailed in RIA Chapter 3. The agencies proposed the mode weightings based on the vehicle speed characteristics of single unit trucks used in EPA's MOVES model which were developed using Federal Highway Administration data to distribute vehicle miles traveled by road type.<sup>164</sup> The proposed weighted CO<sub>2</sub> and fuel consumption value consisted of 37 percent of 65 mph Cruise, 21 percent of 55 mph Cruise, and 42 percent of Transient performance.

The agencies received comments stating that the proposed drive cycles and weightings are not representative of individual vocational applications, such as buses and refuse haulers. A number of groups commented that the vocational vehicle cycle is not representative of real world driving and recommended changes to address that concern. Several organizations proposed the addition of new drive cycles to make the test more representative.

Bendix suggested using the Composite International Truck Local and Commuter Cycle (CILCC) as the general purpose mixed urban/freeway cycles

and to use four representative cycles: mixed urban, freeway, city bus, refuse, and utility. Bendix suggested using the Standardized On-Road Test (SORT) cycles for vocational vehicles operating in the urban environment in addition to SORT cycles for 3 different vocations—with separate weightings. They stated that SORT with an average speed of 11.2 mph, lines up most closely with the average of transit bus duty cycles at 9.9 mph as well as the overall U.S. National average of 12.6 mph. As alternative approaches they suggested adopting the Orange County duty cycle for the urban transit bus vocation, or creating an Urban Transit Bus cycle with several possible weighting factors—all with very high percentage transient (90% to 100%), very low 55 mph (0% to 7%), very low 65 mph (0% to 3%), and an average speed of 15 to 17 mph. Bendix supported their assertions about urban bus vehicle speed with data from the 2010 American Public Transportation Association (APTA) 'Fact Book' and other sources. In contrast, Bendix stated, the GEM cycle average speed is currently 32.6 mph. Such high speeds at steady state will penalize technologies such as hybridization.

Clean Air Task Force said the agencies have not adequately addressed the diversity of the vocational vehicle fleet since they are not distinguished by different duty cycles. They urged the agencies to sub-divide vocational vehicles by expected use, with separate test cycles for each sub-group in order to capture the full potential benefits of hybridization and other advanced technologies in a meaningful and accurate way in future rulemakings for MY2019 and later trucks.

Two groups cautioned that unintended consequences could result from the lack of diversity in duty cycles. DTNA said that the single drive cycle proposed for all vehicles by the agencies would likely lead to unintended consequences—such as customers being driven for regulatory reasons to purchase a transmission that does not suit their actual operation. Similarly, Volvo said medium- and heavy-duty vehicles are uniquely built for specific applications but it will not be feasible to develop regulatory protocols that can accurately predict efficiency in each application duty cycle. This trade-off could result in unintended or negative consequences in parts of the market.

Several commenters suggested changing the weightings of the cycle to more accurately reflect real world driving. Allison stated that the vocational vehicle cycle includes too much steady state driving time. They suggested (with supporting data from

<sup>164</sup> The Environmental Protection Agency. Draft MOVES2009 Highway Vehicle Population and Activity Data. EPA-420-P-09-001, August 2009 <http://www.epa.gov/otaq/models/moves/techdocs/420p09001.pdf>.

the Oakridge National Laboratory analysis) reducing steady state driving at 60 mph to minimal or no time on the cycle to address this problem. Allison commented that GEM contains lengthy accelerations to reach 55 and 65 miles per hour—much longer than is required in real world driving. They supported this statement with data from a testing program conducted at Oakridge National Laboratory showing medium- and heavy-duty vehicles accelerate more rapidly than in the GEM drive cycle. According to Allison, this long acceleration time in the GEM, coupled with too much steady state operation with very little variation, is not representative of vocational vehicle operation. In addition, Allison said that the GEM does not adequately account for shift time, clutch profile, turbo lag, and other impacts on both steady state and transient operation. The impact, they state, is that the cycle will hinder proper deployment of technologies to reduce fuel consumption and GHG emissions.

BAE focused their comments on urban transit bus operation. They stated the weighting factors for steady state operation are inconsistent with urban transit bus cycles.

Other commenters suggested the agencies develop chassis dynamometer tests based on the engine (FTP) test. Cummins said that chassis dynamometer testing should allow the use of average vehicle characteristics to determine road load and make use of the vehicle FTP and SET cycles. Others commented that the correlation between the FTP and the UDSS is poor.

After careful consideration of the comments, the agencies are adopting the proposed drive cycles. The final drive cycles and weightings represent the straight truck operations which dominate the vehicle miles travelled by vocational vehicles. The agencies do not believe that application-specific drive cycles are required for this final action because the program is based on the generally-applicable use of low rolling resistance tires. The drive cycles that we are adopting treat all vocational applications equally predicate standard stringency on use of the same technology (LRR tires) to meet the standard. The drive cycles in the final rule accurately reflect the performance of this technology. The agencies are also finalizing, as proposed, the mode weightings based on the vehicle speed characteristics of single unit trucks used in EPA's MOVES model which were developed using Federal Highway Administration data to distribute

vehicle miles traveled by road type.<sup>165</sup> Similar to the issue of metrics discussed above, the agencies may revisit drive cycles and weightings in any future regulatory action to develop standards specific to applications.

#### (iii) Empty Weight and Payload

The total weight of the vehicle is the sum of the tractor curb weight and the payload. The agencies are proposed to specify each of these aspects of the vehicle. The agencies developed the proposed vehicle curb weight inputs based on industry information developed by ICF.<sup>166</sup> The proposed curb weights were 10,300 pounds for the LHD trucks, 13,950 pounds for the MHD trucks, and 29,000 pounds for the HHD trucks.

NHTSA and EPA proposed payload requirements for each regulatory category developed from Federal Highway statistics based on averaging the payloads for the weight categories represented within each vehicle subcategory.<sup>167</sup> The proposed payloads were 5,700 pounds for the Light Heavy-Duty trucks, 11,200 pounds for Medium Heavy-Duty trucks, and 38,000 pounds for Heavy Heavy-Duty trucks.

The agencies received comments from several stakeholders regarding the proposed curb weights and payloads for vocational vehicles. BAE said a Class 8 transit bus has a typical curb weight of 27,000 pounds and maximum payload of 15,000 pounds. Daimler commented that Class 8 buses have a GVWR of 42,000 pounds. Autocar said that Class 8 refuse trucks typically have a curb weight of 31,000 to 33,000 pounds, typical average payload of 10,000 pounds, and typical maximum payload of 20,000 pounds.

Upon further consideration, the agencies are reducing the assigned weight of heavy heavy-duty vocational vehicles. While we still believe the proposed values are appropriate for some vocational vehicles, we reduced the total weight to bring it closer to some of the lighter vocational vehicles. The agencies are adopting final curb weights of 10,300 pounds for the LHD

trucks, 13,950 pounds for the MHD trucks, and 27,000 pounds for the HHD trucks. The agencies are also adopting payloads of 5,700 pounds for the Light Heavy-Duty trucks, 11,200 pounds for Medium Heavy-Duty trucks, and 15,000 pounds for Heavy Heavy-Duty trucks. Additional information is available in RIA Chapter 3.

#### (iv) Engine

As the agencies are finalizing separate engine and vehicle standards, the GEM will be used to assess the compliance of the chassis with the vehicle standard. To maintain the separate assessments, the agencies are adopting the proposed approach of using fixed values that are predefined by the agencies for the engine characteristics used in GEM, including the fuel consumption map which provides the fuel consumption at hundreds of engine speed and torque points. If the agencies did not standardize the fuel map, then a vehicle that uses an engine with emissions and fuel consumption better than the standards would require fewer vehicle reductions than those being finalized. As proposed, the agencies are using diesel engine characteristics in the GEM, as most representative of the largest fraction of engines in this market. The agencies did not receive any adverse comments to using this approach.

The agencies are finalizing two distinct sets of fuel consumption maps for use in GEM. The first fuel consumption map would be used in GEM for the 2014 through 2016 model years and represent a diesel engine which meets the 2014 model year engine CO<sub>2</sub> emissions standards. A second fuel consumption map would be used beginning in the 2017 model year and represents a diesel engine which meets the 2017 model year CO<sub>2</sub> emissions and fuel consumption standards and accounts for the increased stringency in the final MY 2017 standard). The agencies have modified the 2017 MY heavy heavy-duty diesel fuel map used in the GEM for the final rulemaking to address comments received. Details regarding this change can be found in RIA Chapter 4.4.4. Effectively there is no change in stringency of the vocational vehicle standard (not including the engine) between the 2014 MY and 2017 MY standards for the full rulemaking period. These inputs are reasonable (indeed, seemingly necessitated) given the separate final regulatory requirement that vocational vehicle chassis manufacturers use only certified engines.

<sup>165</sup> The Environmental Protection Agency. Draft MOVES2009 Highway Vehicle Population and Activity Data. EPA-420-P-09-001, August 2009 <http://www.epa.gov/otaq/models/moves/techdocs/420p09001.pdf>.

<sup>166</sup> ICF International. "Investigation of Costs for Strategies to Reduce Greenhouse Gas Emissions for Heavy-Duty On-Road Vehicles." July 2010. Pages 16-20. Docket ID# EPA-HQ-OAR-2010-0162-0044.

<sup>167</sup> The U.S. Federal Highway Administration. Development of Truck Payload Equivalent Factor. Table 11. Last viewed on March 9, 2010 at [http://ops.fhwa.dot.gov/freight/freight\\_analysis/faf/faf2\\_reports/reports9/s510\\_11\\_12\\_tables.htm](http://ops.fhwa.dot.gov/freight/freight_analysis/faf/faf2_reports/reports9/s510_11_12_tables.htm).

## (v) Drivetrain

The agencies' assessment of the current vehicle configuration process at the truck dealer's level is that the truck companies provide software tools to specify the proper drivetrain matched to the buyer's specific circumstances. These dealer tools allow a significant amount of customization for drive cycle and payload to provide the best specification for the customer. The agencies are not seeking to disrupt this process. Optimal drivetrain selection is dependent on the engine, drive cycle (including vehicle speed and road grade), and payload. Each combination of engine, drive cycle, and payload has a single optimal transmission and final drive ratio. The agencies are specifying the engine's fuel consumption map, drive cycle, and payload; therefore, it makes sense to specify the drivetrain that matches.

## (d) Engine Metrics and Test Procedures

EPA proposed that the GHG emission standards for heavy-duty engines under the CAA would be expressed as g/bhp-hr while NHTSA's proposed fuel consumption standards under EISA, in turn, be represented as gal/100 bhp-hr. The NAS panel did not specifically discuss or recommend a metric to evaluate the fuel consumption of heavy-duty engines. However, as noted above they did recommend the use of a load-specific fuel consumption metric for the evaluation of vehicles.<sup>168</sup> An analogous metric for engines is the amount of fuel consumed per unit of work. The g/bhp-hr metric is also consistent with EPA's current standards for non-GHG emissions for these engines. The agencies did not receive any adverse comments related to the metrics for HD engines; therefore, we are adopting the metrics as proposed.

With regard to GHG and fuel consumption control, the agencies believe it is appropriate to set standards based on a single test procedure, either the Heavy-duty FTP or SET, depending on the primary expected use of the engine. EPA's criteria pollutant standards for engines currently require that manufacturers demonstrate compliance over the transient Heavy-duty FTP cycle; over the steady-state SET procedure; and during not-to-exceed testing. EPA created this multi-layered approach to criteria emissions control in response to engine designs that optimized operation for lowest fuel consumption at the expense of very high criteria emissions when operated off the regulatory cycle. EPA's use of multiple

test procedures for criteria pollutants helps to ensure that manufacturers calibrate engine systems for compliance under all operating conditions. We are not concerned if manufacturers further calibrate these engines off cycle to give better in-use fuel consumption while maintaining compliance with the criteria emissions standards as such calibration is entirely consistent with the goals of our joint program. Further, we believe that setting standards based on both transient and steady-state operating conditions for all engines could lead to undesirable outcomes.

It is critical to set standards based on the most representative test cycles in order for performance in-use to obtain the intended (and feasible) air quality and fuel consumption benefits. We are finalizing standards based on the composite Heavy-duty FTP cycle for engines used in vocational vehicles reflecting these vehicles' primary use in transient operating conditions typified by frequent accelerations and decelerations as well as some steady cruise conditions as represented on the Heavy-duty FTP. The primary reason the agencies are finalizing two separate diesel engine standards—one for diesel engines used in tractors and the other for diesel engines used in vocational vehicles—is to encourage engine manufacturers to install engine technologies appropriate to the intended use of the engine with the vehicle. The current non-GHG emissions engine test procedures also require the development of regeneration emission rates and frequency factors to account for the emission changes during a regeneration event (40 CFR 86.004–28). EPA and NHTSA proposed not to include these emissions from the calculation of the compliance levels over the defined test procedures. Cummins and Daimler supported and stated sufficient incentives already exist for manufacturers to limit regeneration frequency. Conversely, Volvo opposed the omission of IRAF requirements for CO<sub>2</sub> emissions because emissions from regeneration can be a significant portion of the expected improvement and a significant variable between manufacturers.

For the proposal, we considered including regeneration in the estimate of fuel consumption and GHG emissions and decided not to do so for two reasons. First, EPA's existing criteria emission regulations already provide a strong motivation to engine manufacturers to reduce the frequency and duration of infrequent regeneration events. The very stringent 2010 NO<sub>x</sub> emission standards cannot be met by engine designs that lead to frequent and

extend regeneration events. Hence, we believe engine manufacturers are already reducing regeneration emissions to the greatest degree possible. In addition to believing that regenerations are already controlled to the extent technologically possible, we believe that attempting to include regeneration emissions in the standard setting could lead to an inadvertently lax emissions standard. In order to include regeneration and set appropriate standards, EPA and NHTSA would have needed to project the regeneration frequency and duration of future engine designs in the time frame of this program. Such a projection would be inherently difficult to make and quite likely would underestimate the progress engine manufacturers will make in reducing infrequent regenerations. If we underestimated that progress, we would effectively be setting a more lax set of standards than otherwise would be expected. Hence in setting a standard including regeneration emissions we faced the real possibility that we would achieve less effective CO<sub>2</sub> emissions control and fuel consumption reductions than we will achieve by not including regeneration emissions. Therefore, the agencies are finalizing an approach as proposed which does not include the regenerative emissions.

## (e) Hybrid Powertrain Technology

Although the final vocational vehicle standards are not premised on use of hybrid powertrains, certain vocational vehicle applications may be suitable candidates for use of hybrids due to the greater frequency of stop-and-go urban operation and their use of power take-off (PTO) systems. Examples are vocational vehicles used predominantly in stop-start urban driving (e.g., delivery trucks). As an incentive, the agencies are finalizing to provide credits for the use of hybrid powertrain technology as described in Section IV. Under the advanced technology credit provisions, credits generated by use of hybrid powertrains could be used to meet any of the heavy-duty standards, and are not restricted to the averaging set generating the credit, unlike the other credit provisions in the final rules. The agencies are finalizing that any credits generated using such advanced technologies could be applied to any heavy-duty vehicle or engine, and not be limited to the averaging set generating the credit. Section IV below also details the final approach to account for the use of a hybrid powertrain when evaluating compliance with the vehicle standard. In general, manufacturers can derive the fuel consumption and CO<sub>2</sub> emissions

<sup>168</sup> See NAS Report, Note 21, at page 39.

reductions based on comparative test results using the final chassis testing procedures.

### (3) Summary of Final Flexibility and Credit Provisions

EPA and NHTSA are finalizing four flexibility provisions specifically for heavy-duty vocational vehicle and engine manufacturers, as discussed in Section IV below. These are an averaging, banking and trading program for emissions and fuel consumption credits, as well as provisions for early credits, advanced technology credits, and credits for innovative vehicle or engine technologies which are not included as inputs to the GEM or are not demonstrated on the engine FTP test cycle. With the exception of the advanced technology credits, credits generated under these provisions can only be used within the same averaging set which generated the credit (for example, credits generated by HHD vocational vehicles can only be used by HHD vehicles). EPA is also adopting a temporary provision whereby N<sub>2</sub>O emission credits can be used to comply with the CO<sub>2</sub> emissions standard, as described in Section IV below.

### (3) Deferral of Standards for Small Chassis Manufacturing Business and Small Business Engine Companies

EPA and NHTSA are finalizing an approach to defer greenhouse gas emissions and fuel consumption standards from small vocational vehicle chassis manufacturers meeting the SBA size criteria of a small business as described in 13 CFR 121.201 (*see* 40 CFR 1036.150 and 1037.150). The agencies will instead consider appropriate GHG and fuel consumption standards for these entities as part of a future regulatory action. This includes both U.S.-based and foreign small volume heavy-duty truck and engine manufacturers.

The agencies have identified ten chassis entities that appear to fit the SBA size criterion of a small business.<sup>169</sup> The agencies estimate that these small entities comprise less than 0.5 percent of the total heavy-duty vocational vehicle market in the United States based on Polk Registration Data from 2003 through 2007,<sup>170</sup> and therefore that the exemption will have a negligible impact on the GHG

<sup>169</sup> The agencies have identified Lodal, Indiana Phoenix, Autocar LLC, HME, Girardin, Azure Dynamics, DesignLine International, Ebus, Krystal Koach, and Millenium Transit Services LLC as potential small business chassis manufacturers.

<sup>170</sup> M.J. Bradley, Heavy-duty Vehicle Market Analysis. May 2009.

emissions and fuel consumption improvements from the final standards.

EPA and NHTSA have also identified three engine manufacturing entities that appear to fit the SBA size criteria of a small business based on company information included in Hoover's.<sup>171</sup> Based on 2008 and 2009 model year engine certification data submitted to EPA for non-GHG emissions standards, the agencies estimate that these small entities comprise less than 0.1 percent of the total heavy-duty engine sales in the United States. The final exemption from the standards established under this rulemaking would have a negligible impact on the GHG emissions and fuel consumption reductions otherwise due to the standards.

To ensure that the agencies are aware of which companies would be exempt, we are finalizing as proposed to require that such entities submit a declaration to EPA and NHTSA containing a detailed written description of how that manufacturer qualifies as a small entity under the provisions of 13 CFR 121.201, as described in Section V below.

### E. Other Standards

In addition to finalizing CO<sub>2</sub> emission standards for heavy-duty vehicles and engines, EPA is also finalizing separate standards for N<sub>2</sub>O and CH<sub>4</sub> emissions.<sup>172</sup> NHTSA is not finalizing comparable separate standards for these GHGs because they are not directly related to fuel consumption in the same way that CO<sub>2</sub> is, and NHTSA's authority under EISA exclusively relates to fuel efficiency. N<sub>2</sub>O and CH<sub>4</sub> are important GHGs that contribute to global warming, more so than CO<sub>2</sub> for the same amount of emissions due to their high Global Warming Potential (GWP).<sup>173</sup> EPA is finalizing N<sub>2</sub>O and CH<sub>4</sub> standards which apply to HD pickup trucks and vans as well as to all heavy-duty engines. EPA is not finalizing N<sub>2</sub>O and CH<sub>4</sub> standards for the Class 7 and 8 tractor or Class 2b-8 chassis manufacturers because these

<sup>171</sup> The agencies have identified Baytech Corporation, Clean Fuels USA, and BAF Technologies, Inc. as three potential small businesses.

<sup>172</sup> NHTSA's statutory responsibilities relating to reducing fuel consumption are directly related to reducing CO<sub>2</sub> emissions, but not to the control of other GHGs.

<sup>173</sup> The global warming potentials (GWP) used in this rule are consistent with the 2007 Intergovernmental Panel on Climate Change (IPCC) Fourth Assessment Report (AR4). At this time, the 1996 IPCC Second Assessment Report (SAR) GWP values are used in the official U.S. greenhouse gas inventory submission to the United Nations Framework Convention on Climate Change (per the reporting requirements under that international convention). N<sub>2</sub>O has a GWP of 298 and CH<sub>4</sub> has a GWP of 25 according to the 2007 IPCC AR4.

emissions would be controlled through the engine program.

EPA requested comment on possible alternative CO<sub>2</sub> equivalent approaches to provide near-term flexibility for 2012–14 MY light-duty vehicles. As described below, EPA is finalizing alternative provisions allowing manufacturers to use CO<sub>2</sub> credits, on a CO<sub>2</sub>-equivalent (CO<sub>2</sub>eq) basis, to meet the N<sub>2</sub>O and CH<sub>4</sub> standards, which is consistent with many commenters' preferred approach.

Almost universally across current engine designs, both gasoline- and diesel-fueled, N<sub>2</sub>O and CH<sub>4</sub> emissions are relatively low today and EPA does not believe it would be appropriate or feasible to require reductions from the levels of current gasoline and diesel engines. This is because for the most part, the same hardware and controls used by heavy-duty engines and vehicles that have been optimized for non-methane hydrocarbon (NMHC) and NO<sub>x</sub> control indirectly result in highly effective control of N<sub>2</sub>O and CH<sub>4</sub>. Additionally, unlike criteria pollutants, specific technologies beyond those presently implemented in heavy-duty vehicles to meet existing emission requirements have not surfaced that specifically target reductions in N<sub>2</sub>O or CH<sub>4</sub>. Because of this, reductions in N<sub>2</sub>O or CH<sub>4</sub> beyond current levels in most heavy-duty applications would occur through the same mechanisms that result in NMHC and NO<sub>x</sub> reductions and would likely result in an increase in the overall stringency of the criteria pollutant emission standards. Nevertheless, it is important that future engine technologies or fuels not currently researched do not result in increases in these emissions, and this is the intent of the final "cap" standards. The final standards would primarily function to cap emissions at today's levels to ensure that manufacturers maintain effective N<sub>2</sub>O and CH<sub>4</sub> emissions controls currently used should they choose a different technology path from what is currently used to control NMHC and NO<sub>x</sub> but also largely successful methods for controlling N<sub>2</sub>O and CH<sub>4</sub>. As discussed below, some technologies that manufacturers may adopt for reasons other than reducing fuel consumption or GHG emissions could increase N<sub>2</sub>O and CH<sub>4</sub> emissions if manufacturers do not address these emissions in their overall engine and aftertreatment design and development plans. Manufacturers will be able to design and develop the engines and aftertreatment to avoid such emissions increases through appropriate emission control technology selections like those already used and available

today. Because EPA believes that these standards can be capped at the same level, regardless of type of HD engine involved, the following discussion relates to all types of HD engines regardless of the vehicles in which such engines are ultimately used. In addition, since these standards are designed to cap current emissions, EPA is finalizing the same standards for all of the model years to which the rules apply.

EPA believes that the final N<sub>2</sub>O and CH<sub>4</sub> cap standards will accomplish the primary goal of deterring increases in these emissions as engine and aftertreatment technologies evolve because manufacturers will continue to target current or lower N<sub>2</sub>O and CH<sub>4</sub> levels in order to maintain typical compliance margins. While the cap standards are set at levels that are higher than current average emission levels, the control technologies used today are highly effective and there is no reason to believe that emissions will slip to levels close to the cap, particularly considering compliance margin targets. The caps will protect against significant increases in emissions due to new or poorly implemented technologies. However, we also believe that an alternative compliance approach that allows manufacturers to convert these emissions to CO<sub>2</sub>eq emission values and combine them with CO<sub>2</sub> into a single compliance value would also be appropriate, so long as it did not undermine the stringency of the CO<sub>2</sub> standard. As described below, EPA is finalizing that such an alternative compliance approach be available to manufacturers to provide certain flexibilities for different technologies.

EPA requested comments in the NPRM on the approach to regulating N<sub>2</sub>O and CH<sub>4</sub> emissions including the appropriateness of “cap” standards, the technical bases for the levels of the final N<sub>2</sub>O and CH<sub>4</sub> standards, the final test procedures, and the final timing for the standards. In addition, EPA requested any additional emissions data on N<sub>2</sub>O and CH<sub>4</sub> from current technology engines. We solicited additional data, and especially data for in-use vehicles and engines that would help to better characterize changes in emissions of these pollutants throughout their useful lives, for both gasoline and diesel applications. As is typical for EPA emissions standards, we are finalizing that manufacturers should establish deterioration factors to ensure compliance throughout the useful life. We are not at this time aware of deterioration mechanisms for N<sub>2</sub>O and CH<sub>4</sub> that would result in large deterioration factors, but neither do we believe enough is known about these

mechanisms to justify finalizing assigned factors corresponding to no deterioration, as we are finalizing for CO<sub>2</sub>, or for that matter to any predetermined level. In addition to N<sub>2</sub>O and CH<sub>4</sub> standards, this section also discusses air conditioning-related provisions and EPA provisions to extend certification requirements to all-electric HD vehicles and vehicles and engines designed to run on ethanol fuel.

#### (1) What is EPA’s Approach to Controlling N<sub>2</sub>O?

N<sub>2</sub>O is a global warming gas with a GWP of 298. It accounts for about 0.3 percent of the current greenhouse gas emissions from heavy-duty trucks.<sup>174</sup>

N<sub>2</sub>O is emitted from gasoline and diesel vehicles mainly during specific catalyst temperature conditions conducive to N<sub>2</sub>O formation. Specifically, N<sub>2</sub>O can be generated during periods of emission hardware warm-up when rising catalyst temperatures pass through the temperature window when N<sub>2</sub>O formation potential is possible. For current heavy-duty gasoline engines with conventional three-way catalyst technology, N<sub>2</sub>O is not generally produced in significant amounts because the time the catalyst spends at the critical temperatures during warm-up is short. This is largely due to the need to quickly reach the higher temperatures necessary for high catalyst efficiency to achieve emission compliance of criteria pollutants. N<sub>2</sub>O formation is generally only a concern with diesel and potentially with future gasoline lean-burn engines with compromised NO<sub>x</sub> emissions control systems. If the risk for N<sub>2</sub>O formation is not factored into the design of the controls, these systems can but need not be designed in a way that emphasizes efficient NO<sub>x</sub> control while allowing the formation of significant quantities of N<sub>2</sub>O. However, these future advanced gasoline and diesel technologies do not inherently require N<sub>2</sub>O formation to properly control NO<sub>x</sub>. Pathways exist today that meet criteria emission standards that would not compromise N<sub>2</sub>O emissions in future systems as observed in current production engine and vehicle testing<sup>175</sup> which would also work for future diesel and gasoline technologies. Manufacturers would need to use appropriate technologies and temperature controls during future development programs with the objective to optimize for both NO<sub>x</sub> and

N<sub>2</sub>O control. Therefore, future designs and controls at reducing criteria emissions would need to take into account the balance of reducing these emissions with the different control approaches while also preventing inadvertent N<sub>2</sub>O formation, much like the path taken in current heavy-duty compliant engines and vehicles. Alternatively, manufacturers who find technologies that reduce criteria or CO<sub>2</sub> emissions but see increases N<sub>2</sub>O emissions beyond the cap could choose to offset N<sub>2</sub>O emissions with reduction in CO<sub>2</sub> as allowed in the CO<sub>2</sub>eq option discussed in Section II.E.3.

EPA is finalizing an N<sub>2</sub>O emission standard that we believe would be met by most current-technology gasoline and diesel vehicles at essentially no cost to the vehicle, though the agency is accounting for additional N<sub>2</sub>O measurement equipment costs. EPA believes that heavy-duty emission standards since 2008 model year, specifically the very stringent NO<sub>x</sub> standards for both engine and chassis certified engines, directly result in stringent N<sub>2</sub>O control. It is believed that the current emission control technologies used to meet the stringent NO<sub>x</sub> standards achieve the maximum feasible reductions and that no additional technologies are recognized that would result in additional N<sub>2</sub>O reductions. As noted, N<sub>2</sub>O formation in current catalyst systems occurs, but their emission levels are inherently low, because the time the catalyst spends at the critical temperatures during warm-up when N<sub>2</sub>O can form is short. At the same time, we believe that the standard would ensure that the design of advanced NO<sub>x</sub> control systems for future diesel and lean-burn gasoline vehicles would control N<sub>2</sub>O emission levels. While current NO<sub>x</sub> control approaches used on current heavy-duty diesel vehicles do not compromise N<sub>2</sub>O emissions and actually result in N<sub>2</sub>O control, we believe that the standards would discourage any new emission control designs for diesels or lean-burn gasoline vehicles that achieve criteria emissions compliance at the cost of increased N<sub>2</sub>O emissions. Thus, the standard would cap N<sub>2</sub>O emission levels, with the expectation that current gasoline and diesel vehicle control approaches that comply with heavy-duty vehicle emission standards for NO<sub>x</sub> would not increase their emission levels, and that the cap would ensure that future diesel and lean-burn gasoline vehicles with advanced NO<sub>x</sub> controls would appropriately control their emissions of N<sub>2</sub>O.

<sup>174</sup> Value adapted from “Inventory of U.S. Greenhouse Gas Emissions and Sinks: 1990–2007”. April 2009.

<sup>175</sup> Memorandum “N<sub>2</sub>O Data from EPA Heavy-Duty Testing”.

(a) Heavy-Duty Pickup Truck and Van N<sub>2</sub>O Exhaust Emission Standard

EPA is finalizing the proposed per-vehicle N<sub>2</sub>O emission standard of 0.05 g/mi, measured over the Light-duty FTP and HFET drive cycles. Similar to the CO<sub>2</sub> standard approach, the N<sub>2</sub>O emission level of a vehicle would be a composite of the Light-duty FTP and HFET cycles with the same 55 percent city weighting and 45 percent highway weighting. The standard would become effective in model year 2014 for all HD pickups and vans that are subject to the CO<sub>2</sub> emission requirements. Averaging between vehicles would not be allowed. The standard is designed to prevent increases in N<sub>2</sub>O emissions from current levels, *i.e.*, a no-backsliding standard.

The N<sub>2</sub>O standard level is approximately two times the average N<sub>2</sub>O level of current gasoline and diesel heavy-duty trucks that meet the NO<sub>x</sub> standards effective since 2008 model year.<sup>176</sup> Manufacturers typically use design targets for NO<sub>x</sub> emission levels at approximately 50 percent of the standard, to account for in-use emissions deterioration and normal testing and production variability, and we expect manufacturers to utilize a similar approach for N<sub>2</sub>O emission compliance. We are not adopting a more stringent standard for current gasoline and diesel vehicles because the stringent heavy-duty NO<sub>x</sub> standards already result in significant N<sub>2</sub>O control, and we do not expect current N<sub>2</sub>O levels to rise for these vehicles particularly with expected manufacturer compliance margins.

Diesel heavy-duty pickup trucks and vans with advanced emission control technology are in the early stages of development and commercialization. As this segment of the vehicle market develops, the final N<sub>2</sub>O standard would require manufacturers to incorporate control strategies that minimize N<sub>2</sub>O formation. Available approaches include using electronic controls to limit catalyst conditions that might favor N<sub>2</sub>O formation and considering different catalyst formulations. While some of these approaches may have associated costs, EPA believes that they will be small compared to the overall costs of the advanced NO<sub>x</sub> control technologies already required to meet heavy-duty standards.

<sup>176</sup> Memorandum "N<sub>2</sub>O Data from EPA Heavy-Duty Testing."

The light-duty GHG rule requires that manufacturers begin testing for N<sub>2</sub>O by 2015 model year. The manufacturers of complete pickup trucks and vans (Ford, General Motors, and Chrysler) are already impacted by the light-duty GHG rule and will therefore have this equipment and capability in place for the timing of this rulemaking.

Overall, we believe that manufacturers of HD pickups and vans (both gasoline and diesel) would meet the standard without implementing any significantly new technologies, only further refinement of their existing controls, and we do not expect there to be any significant costs associated with this standard.

(b) Heavy-Duty Engine N<sub>2</sub>O Exhaust Emission Standard

EPA proposed a per engine N<sub>2</sub>O emissions standard of 0.05 g/bhp-hr for heavy-duty engines, but is finalizing a standard of 0.10 g/bhp-hr based on additional data submitted to the agency which better represents the full range of current diesel and gasoline engine performance. The final N<sub>2</sub>O standard becomes effective in 2014 model year for diesel engines, as proposed. However, EPA is finalizing N<sub>2</sub>O standards for gasoline engines that become effective in 2016 model year to align with the first year of the CO<sub>2</sub> gasoline engine standards. Without this alignment, manufacturers would not have any flexibility, such as CO<sub>2</sub>eq credits, in meeting the N<sub>2</sub>O cap and therefore would not have any recourse to comply if an engine's N<sub>2</sub>O emissions were above the standard. The standard remains the same over the useful life of the engine. The N<sub>2</sub>O emissions would be measured over the composite Heavy-duty FTP cycle because it is believed that this cycle poses the highest risk for N<sub>2</sub>O formation versus the additional heavy-duty compliance cycles. The agencies received comments from industry suggesting that the N<sub>2</sub>O and CH<sub>4</sub> emissions be evaluated over the same test cycle required for CO<sub>2</sub> emissions compliance. In other words, the commenters wanted to have the N<sub>2</sub>O emissions measured over the SET for engines installed in tractors. The agencies are not adopting this approach for the final action because we do not have sufficient data to set the appropriate N<sub>2</sub>O level using the SET. The agencies are not requiring any additional burden by requiring the

measurement to be conducted over the Heavy-Duty FTP cycle because it is already required for criteria emissions. Averaging of N<sub>2</sub>O emissions between HD engines will not be allowed. The standard is designed to prevent increases in N<sub>2</sub>O emissions from current levels, *i.e.*, a no-backsliding standard.

The proposed N<sub>2</sub>O level was twice the average N<sub>2</sub>O level of primarily pre-2010 model year diesel engines as demonstrated in the ACES Study and in EPA's testing of two additional engines with selective catalytic reduction aftertreatment systems.<sup>177</sup> Manufacturers typically use design targets for NO<sub>x</sub> emission levels of about 50 percent of the standard, to account for in-use emissions deterioration and normal testing and production variability, and manufacturers are expected to utilize a similar approach for N<sub>2</sub>O emission compliance.

EPA sought comment about deterioration factors for N<sub>2</sub>O emissions. See 75 FR 74208. Industry stakeholders recommended that the agency define a DF of zero. While we believe it is also possible that N<sub>2</sub>O emissions will not deteriorate in use, very little data exist for aged engines and vehicles. Therefore, the value we are assigning is conservative, specifically additive DF of 0.02 g/bhp-hr. While the value is conservative, it is small enough to allow compliance for all engines except those very close to the standards. For engines too close to the standard to use the assigned DFs, the manufacturers would need to demonstrate via engineering analysis that deterioration is less than assigned DF.

EPA sought additional data on the level of the proposed N<sub>2</sub>O level of 0.05 g/bhp-hr. See 75 FR 74208. The agency received additional data of 2010 model year engines from the Engine Manufacturers Association.<sup>178</sup> The agencies reanalyzed a new data set, as shown in Table II-22, to derive the final N<sub>2</sub>O standard of 0.10 g/bhp-hr with a defined deterioration factor of 0.02 g/bhp-hr.

<sup>177</sup> Coordinating Research Council Report: ACES Phase 1 of the Advanced Collaborative Emissions Study, 2009. (This study included detailed chemical characterization of exhaust species emitted from four 2007 model year heavy heavy diesel engines).

<sup>178</sup> Engine Manufacturers Association. EMA N<sub>2</sub>O Email 03\_22\_2011. See Docket EPA-HQ-OAR-2010-0162.

TABLE II-22—N<sub>2</sub>O DATA ANALYSIS

Engine family	Rated power (HP)	Composite FTP cycle N <sub>2</sub> O result (g/bhp-hr)
EPA Data of 2007 Engine with SCR .....	.....	0.042
EPA Data of 2010 Production Intent Engine .....	.....	0.037
A .....	450	0.0181
A .....	600	0.0151
B .....	360	0.0326
C .....	380	0.0353
D .....	560	0.0433
D .....	455	0.0524
E .....	600	0.0437
F .....	500	0.0782
G .....	483	0.1127
H .....	385	0.0444
H .....	385	0.0301
H .....	385	0.0283
J .....	380	0.0317
	Mean	0.043
	2 * Mean	0.09

Engine emissions regulations do not currently require testing for N<sub>2</sub>O. The Mandatory GHG Reporting final rule requires reporting of N<sub>2</sub>O and requires that manufacturers either measure N<sub>2</sub>O or use a compliance statement based on good engineering judgment in lieu of direct N<sub>2</sub>O measurement (74 FR 56260, October 30, 2009). The light-duty GHG final rule allows manufacturers to provide a compliance statement based on good engineering judgment through the 2014 model year, but requires measurement beginning in 2015 model year (75 FR 25324, May 7, 2010). EPA is finalizing a consistent approach for heavy-duty engine manufacturers which allows them to delay direct measurement of N<sub>2</sub>O until the 2015 model year.

Manufacturers without the capability to measure N<sub>2</sub>O by the 2015 model year would need to acquire and install appropriate measurement equipment in response to this final program. EPA has established four separate N<sub>2</sub>O measurement methods, all of which are commercially available today. EPA expects that most manufacturers would use either photo-acoustic measurement equipment for stand-alone, existing FTIR instrumentation at a cost of \$50,000 per unit or upgrade existing emission measurement systems with NDIR analyzers for \$25,000 per test cell.

Overall, EPA believes that manufacturers of heavy-duty engines, both gasoline and diesel, would meet the final standard without implementing any new technologies, and beyond relatively small facilities costs for any company that still needs to acquire and install N<sub>2</sub>O measurement equipment, EPA does not project that

manufacturers would incur significant costs associated with this final N<sub>2</sub>O standard.

EPA is not adopting any vehicle-level N<sub>2</sub>O standards for heavy-duty vocational vehicles and combination tractors. The N<sub>2</sub>O emissions would be controlled through the heavy-duty engine portion of the program. The only requirement of those vehicle manufacturers to comply with the N<sub>2</sub>O requirements is to install a certified engine.

(2) What is EPA’s approach to controlling CH<sub>4</sub>?

CH<sub>4</sub> is greenhouse gas with a GWP of 25. It accounts for about 0.03 percent of the greenhouse gases from heavy-duty trucks.<sup>179</sup>

EPA is finalizing a standard that would cap CH<sub>4</sub> emission levels, with the expectation that current heavy-duty vehicles and engines meeting the heavy-duty emission standards would not increase their levels as explained earlier due to robust current controls and manufacturer compliance margin targets. It would ensure that emissions would be addressed if in the future there are increases in the use of natural gas or any other alternative fuel. EPA believes that current heavy-duty emission standards, specifically the NMHC standards for both engine and chassis certified engines directly result in stringent CH<sub>4</sub> control. It is believed that the current emission control technologies used to meet the stringent NMHC standards achieve the maximum

feasible reductions and that no additional technologies are recognized that would result in additional CH<sub>4</sub> reductions. The level of the standard would generally be achievable through normal emission control methods already required to meet heavy-duty emission standards for hydrocarbons and EPA is therefore not attributing any cost to this part of the final action. Since CH<sub>4</sub> is produced in gasoline and diesel engines similar to other hydrocarbon components, controls targeted at reducing overall NMHC levels generally also work at reducing CH<sub>4</sub> emissions. Therefore, for gasoline and diesel vehicles, the heavy-duty hydrocarbon standards will generally prevent increases in CH<sub>4</sub> emissions levels. CH<sub>4</sub> from heavy-duty vehicles is relatively low compared to other GHGs largely due to the high effectiveness of the current heavy-duty standards in controlling overall HC emissions.

EPA believes that this level for the standard would be met by current gasoline and diesel trucks and vans, and would prevent increases in future CH<sub>4</sub> emissions in the event that alternative fueled vehicles with high methane emissions, like some past dedicated compressed natural gas vehicles, become a significant part of the vehicle fleet. Currently EPA does not have separate CH<sub>4</sub> standards because, unlike other hydrocarbons, CH<sub>4</sub> does not contribute significantly to ozone formation.<sup>180</sup> However, CH<sub>4</sub> emissions levels in the gasoline and diesel heavy-duty truck fleet have nevertheless

<sup>179</sup> Value adapted from “Inventory of U.S. Greenhouse Gas Emissions and Sinks: 1990–2007. April 2009.

<sup>180</sup> But See *Ford Motor Co. v. EPA*, 604 F. 2d 685 (DC Cir. 1979) (permissible for EPA to regulate CH<sub>4</sub> under CAA section 202(b)).



generally been controlled by the heavy-duty HC emission standards. Even so, without an emission standard for CH<sub>4</sub>, future emission levels of CH<sub>4</sub> cannot be guaranteed to remain at current levels as vehicle technologies and fuels evolve.

In recent model years, a small number of heavy-duty trucks and engines were sold that were designed for dedicated use of natural gas. While emission control designs on these recent dedicated natural gas-fueled vehicles demonstrate CH<sub>4</sub> control can be as effective as on gasoline or diesel equivalent vehicles, natural gas-fueled vehicles have historically generated significantly higher CH<sub>4</sub> emissions than gasoline or diesel vehicles. This is because the fuel is predominantly methane, and most of the unburned fuel that escapes combustion without being oxidized by the catalyst is emitted as methane. However, even if these vehicles meet the heavy-duty hydrocarbon standard and appear to have effective CH<sub>4</sub> control by nature of the hydrocarbon controls, the heavy-duty standards do not require CH<sub>4</sub> control and therefore some natural gas vehicle manufacturers have invested very little effort into methane control. While the final CH<sub>4</sub> cap standard should not require any different emission control designs beyond what is already required to meet heavy-duty hydrocarbon standards on a dedicated natural gas vehicle (*i.e.*, feedback controlled 3-way catalyst), the cap will ensure that systems provide robust control of methane much like a gasoline-fueled engine. We are not finalizing more stringent CH<sub>4</sub> standards because we believe that the controls used to meet current heavy-duty hydrocarbon standards should result in effective CH<sub>4</sub> control when properly implemented. Since CH<sub>4</sub> is already measured under the current heavy-duty emissions regulations (so that it may be subtracted to calculate NMHC), the final standard will not result in additional testing costs.

#### (a) Heavy-Duty Pickup Truck and Van CH<sub>4</sub> Standard

EPA is finalizing the proposed CH<sub>4</sub> emission standard of 0.05 g/mi as measured on the Light-duty FTP and HFET drive cycles, to apply beginning with model year 2014 for HD pickups and vans subject to the CO<sub>2</sub> standards. Similar to the CO<sub>2</sub> standard approach, the CH<sub>4</sub> emission level of a vehicle will be a composite of the Light-duty FTP and HFET cycles, with the same 55 percent city weighting and 45 percent highway weighting.

The level of the standard is approximately two times the average

heavy-duty gasoline and diesel truck and van levels.<sup>181</sup> As with N<sub>2</sub>O, this standard level recognizes that manufacturers typically set emissions design targets with a compliance margin of approximately 50 percent of the standard. Thus, we believe that the standard should be met by current gasoline vehicles with no increase from today's CH<sub>4</sub> levels. Similarly, since current diesel vehicles generally have even lower CH<sub>4</sub> emissions than gasoline vehicles, we believe that diesels will also meet the standard with a larger compliance margin resulting in no change in today's CH<sub>4</sub> levels.

#### (b) Heavy-Duty Engine CH<sub>4</sub> Exhaust Emission Standard

EPA is adopting a heavy-duty engine CH<sub>4</sub> emission standard of 0.10 g/hp-hr with a defined deterioration factor of 0.02 g/bhp-hr as measured on the composite Heavy-duty FTP, to apply beginning in model year 2014 for diesel engines and in 2016 model year for gasoline engines. EPA is adopting a different CH<sub>4</sub> standard than proposed based on additional data submitted to the agency which better represents the full range of current diesel and gasoline engine performance. EPA is adopting CH<sub>4</sub> standards for gasoline engines that become effective in 2016 model year to align with the first year of the gasoline engine CO<sub>2</sub> standards. Without this alignment, manufacturers would not have any flexibility, such as CO<sub>2</sub>eq credits, in meeting the CH<sub>4</sub> cap and therefore would not be able to sell any engine with a CH<sub>4</sub> level above the standard. The final standard would cap CH<sub>4</sub> emissions at a level currently achieved by diesel and gasoline heavy-duty engines. The level of the standard would generally be achievable through normal emission control methods already required to meet 2007 emission standards for NMHC and EPA is therefore not attributing any cost to this part of this program (*see* 40 CFR 86.007–11).

The level of the final CH<sub>4</sub> standard is twice the average CH<sub>4</sub> emissions from gasoline engines from General Motors in addition to the four diesel engines in the ACES study.<sup>182</sup> As with N<sub>2</sub>O, this final level recognizes that manufacturers typically set emission design targets at about 50 percent of the standard. Thus, EPA believes the final standard would be met by current diesel and gasoline engines with little if any technological improvements. The agency believes a

<sup>181</sup> Memorandum "CH<sub>4</sub> Data from 2010 and 2011 Heavy-Duty Vehicle Certification Tests".

<sup>182</sup> Coordinating Research Council Report: ACES Phase 1 of the Advanced Collaborative Emissions Study, 2009.

more stringent CH<sub>4</sub> standard is not necessary due to effective CH<sub>4</sub> controls in current heavy-duty technologies, since, as discussed above for N<sub>2</sub>O, EPA believes that the challenge of complying with the CO<sub>2</sub> standards should be the primary focus of the manufacturers.

CH<sub>4</sub> is measured under the current 2007 regulations so that it may be subtracted to calculate NMHC. Therefore EPA expects that the final standard would not result in additional testing costs.

EPA is not adopting any vehicle-level CH<sub>4</sub> standards for heavy-duty combination tractors or vocational vehicles in this final action. The CH<sub>4</sub> emissions will be controlled through the heavy-duty engine portion of the program. The only requirement of these truck manufacturers to comply with the CH<sub>4</sub> requirements is to install a certified engine.

#### (3) Use of CO<sub>2</sub> Credits

As proposed, if a manufacturer is unable to meet the N<sub>2</sub>O or CH<sub>4</sub> cap standards, the EPA program will allow the manufacturer to comply using CO<sub>2</sub> credits. In other words, a manufacturer could offset any N<sub>2</sub>O or CH<sub>4</sub> emissions above the standard by taking steps to further reduce CO<sub>2</sub>. A manufacturer choosing this option would convert its measured N<sub>2</sub>O and CH<sub>4</sub> test results that are in excess of the applicable standards into CO<sub>2</sub>eq to determine the amount of CO<sub>2</sub> credits required. For example, a manufacturer would use 25 Mg of positive CO<sub>2</sub> credits to offset 1 Mg of negative CH<sub>4</sub> credits or use 298 Mg of positive CO<sub>2</sub> credits to offset 1 Mg of negative N<sub>2</sub>O credits.<sup>183</sup> By using the Global Warming Potential of N<sub>2</sub>O and CH<sub>4</sub>, the approach recognizes the inter-correlation of these compounds in impacting global warming and is environmentally neutral for demonstrating compliance with the individual emissions caps. Because fuel conversion manufacturers certifying under 40 CFR part 85, subpart F do not participate in ABT programs, EPA is finalizing a compliance option for fuel conversion manufacturers to comply with the N<sub>2</sub>O and CH<sub>4</sub> standards that is similar to the credit program just described above. The compliance option will allow conversion manufacturers, on an individual engine family basis, to convert CO<sub>2</sub> overcompliance into CO<sub>2</sub> equivalents of N<sub>2</sub>O and/or CH<sub>4</sub> that can be subtracted from the CH<sub>4</sub> and N<sub>2</sub>O measured values to demonstrate compliance with CH<sub>4</sub> and/or N<sub>2</sub>O standards. Other than in the limited

<sup>183</sup> N<sub>2</sub>O has a GWP of 298 and CH<sub>4</sub> has a GWP of 25 according to the IPCC AR4.



case of N<sub>2</sub>O for model years 2014–16, we have not finalized similar provisions allowing overcompliance with the N<sub>2</sub>O or CH<sub>4</sub> standards to serve as a means to generate CO<sub>2</sub> credits because the CH<sub>4</sub> and N<sub>2</sub>O standards are cap standards representing levels that all but the worst vehicles should already be well below. Allowing credit generation against such cap standard would provide a windfall credit without any true GHG reduction.

The final NHTSA fuel consumption program will not use CO<sub>2</sub>eq, as suggested above. Measured performance to the NHTSA fuel consumption standards will be based on the measurement of CO<sub>2</sub> with no adjustment for N<sub>2</sub>O and/or CH<sub>4</sub>. For manufacturers that use the EPA alternative CO<sub>2</sub>eq credit, compliance to the EPA CO<sub>2</sub> standard will not be directly equivalent to compliance with the NHTSA fuel consumption standard.

#### (4) Amendment to Light-Duty Vehicle N<sub>2</sub>O and CH<sub>4</sub> Standards

EPA also requested comment on revising a portion of the light-duty vehicle standards for N<sub>2</sub>O and CH<sub>4</sub>. 75 FR at 74211. Specifically, EPA requested comments on two additional options for manufacturers to comply with N<sub>2</sub>O and CH<sub>4</sub> standards to provide additional near-term flexibility. EPA is finalizing one of those options, as discussed below.

For light-duty vehicles, as part of the MY 2012–2016 rulemaking, EPA finalized standards for N<sub>2</sub>O and CH<sub>4</sub> which take effect with MY 2012. 75 FR at 25421–24. Similar to the heavy-duty standards discussed in Section II.E above, the light-duty vehicle standards for N<sub>2</sub>O and CH<sub>4</sub> were established to cap emissions and to prevent future emissions increases, and were generally not expected to result in the application of new technologies or significant costs for the manufacturers for current vehicle designs. EPA also finalized an alternative CO<sub>2</sub> equivalent standard option, which manufacturers may choose to use in lieu of complying with the N<sub>2</sub>O and CH<sub>4</sub> cap standards. The CO<sub>2</sub> equivalent standard option allows manufacturers to fold all N<sub>2</sub>O and CH<sub>4</sub> emissions, on a CO<sub>2</sub>eq basis, along with CO<sub>2</sub> into their otherwise applicable CO<sub>2</sub> emissions standard level. For flexible fueled vehicles, the N<sub>2</sub>O and CH<sub>4</sub> standards must be met on both fuels (e.g., both gasoline and E–85).

After the light-duty standards were finalized, manufacturers raised concerns that for a few of the vehicle models in their existing fleet they were having difficulty meeting the N<sub>2</sub>O and/or CH<sub>4</sub> standards, especially in the early years of the program for a few of the vehicle

models in their existing fleet. These standards could be problematic in the near term because there is little lead time to implement unplanned redesigns of vehicles to meet the standards. In such cases, manufacturers may need to either drop vehicle models from their fleet or to comply using the CO<sub>2</sub> equivalent alternative. On a CO<sub>2</sub>eq basis, folding in all N<sub>2</sub>O and CH<sub>4</sub> emissions would add 3–4 g/mile or more to a manufacturer's overall fleet-average CO<sub>2</sub> emissions level because the alternative standard must be used for the entire fleet, not just for the problem vehicles.<sup>184</sup> See 75 FR at 74211. This could be especially challenging in the early years of the program for manufacturers with little compliance margin because there is very limited lead time to develop strategies to address these additional emissions. As stated at proposal, EPA believed this posed a legitimate issue of sufficiency of lead time in the short term, as well as an issue of cost, since EPA assumed that the N<sub>2</sub>O and CH<sub>4</sub> standards would not result in significant costs for existing vehicles. *Id.* However, EPA expected that manufacturers would be able to make technology changes (e.g., calibration or catalyst changes) to the few vehicle models not currently meeting the N<sub>2</sub>O and/or CH<sub>4</sub> standards in the course of their planned vehicle redesign schedules in order to meet the standards.

Because EPA intended for these standards to be caps with little anticipated near-term impact on manufacturer's current product lines, EPA requested comment in the heavy-duty vehicle and engine proposal on two approaches to provide additional flexibilities in the light-duty vehicle program for meeting the N<sub>2</sub>O and CH<sub>4</sub> standards. 75 FR at 74211. EPA requested comments on the option of allowing manufacturers to use the CO<sub>2</sub> equivalent approach for one pollutant but not the other for their fleet—that is, allowing a manufacturer to fold in either CH<sub>4</sub> or N<sub>2</sub>O as part of the CO<sub>2</sub>-equivalent standard. For example, if a manufacturer is having trouble complying with the CH<sub>4</sub> standard but not the N<sub>2</sub>O standard, the manufacturer could use the CO<sub>2</sub> equivalent option including CH<sub>4</sub>, but choose to comply separately with the applicable N<sub>2</sub>O cap standard.

<sup>184</sup> 0.030 g/mile CH<sub>4</sub> multiplied by a GWP of 25 plus 0.010 g/mile N<sub>2</sub>O multiplied by a GWP of 298 results in a combined 3.7 g/mile CO<sub>2</sub>-equivalent value. Manufacturers using the default N<sub>2</sub>O value of 0.10 g/mile prior to MY 2015 in lieu of measuring N<sub>2</sub>O would fold in the entire 0.010 g/mile on a CO<sub>2</sub>-equivalent basis, or about 3 g/mile under the CO<sub>2</sub>-equivalent option.

EPA also requested comments on an alternative approach of allowing manufacturers to use CO<sub>2</sub> credits, on a CO<sub>2</sub> equivalent basis, to offset N<sub>2</sub>O and CH<sub>4</sub> emissions above the applicable standard. This is similar to the approach proposed and being finalized for heavy-duty vehicles as discussed above in Section II.E. EPA requested comments on allowing the additional flexibility in the light-duty program for MYs 2012–2014 to help manufacturers address any near-term issues that they may have with the N<sub>2</sub>O and CH<sub>4</sub> standards.

Commenters providing comment on this issue supported additional flexibility for manufacturers, and manufacturers specifically supported the heavy-duty vehicle approach of allowing CO<sub>2</sub> credits on a CO<sub>2</sub> equivalent basis to be used to meet the CH<sub>4</sub> and N<sub>2</sub>O standards. The Alliance of Automobile Manufacturers and the American Automotive Policy Council commented that the proposed heavy-duty approach represented a significant improvement over the approach adopted for light-duty vehicles. Manufacturers support de-linking N<sub>2</sub>O and CH<sub>4</sub>, and commented that the formation of the pollutants do not necessarily trend together.

Manufacturers also commented that a deficit against the N<sub>2</sub>O or CH<sub>4</sub> cap would be required to be covered with CO<sub>2</sub> credits for that model, but the approach does not “punish” manufacturers for using a specific technology (which could provide CO<sub>2</sub> benefits, e.g., diesel, CNG, etc.) by requiring manufacturers to use the CO<sub>2</sub>-equivalent approach for their entire fleet. The Natural Gas Vehicle Interests also supported allowing the use of CO<sub>2</sub> credits on a CO<sub>2</sub>-equivalent basis for compliance with CH<sub>4</sub> standards and urged providing this type of flexibility on a permanent basis. The Institute for Policy Integrity also submitted comments supportive of providing additional flexibility to manufacturers as long as it does not undermine standard stringency. This commenter was supportive of either approach discussed at proposal.<sup>185</sup>

Manufacturers supported not only adopting the aspects of the heavy-duty approach noted above, but the entire

<sup>185</sup> The Institute for Policy Integrity questioned whether EPA had provided adequate notice of the proposal, given that it appeared in the proposed GHG rules for heavy duty vehicles. EPA provided notice not only in the preamble, but in the summary of action appearing on the first page of the **Federal Register** notice (“EPA is also requesting comment on possible alternative CO<sub>2</sub>-equivalent approaches for model year 2012–14 light-duty vehicles”). 75 FR at 74152. This is ample notice (demonstrated as well by the comments received on the issue, including from the Institute).

heavy-duty vehicle approach, including two aspects of the program not contemplated in EPA's request for comments. First, manufacturers commented that EPA incorrectly characterizes the light-duty vehicle issues with CH<sub>4</sub> and N<sub>2</sub>O as short-term or early lead time issues. For the reasons discussed above, manufacturers believe the changes should be made permanent, for the entire 2012–2016 light-duty rulemaking period and, indeed, in any subsequent rules for the light-duty vehicle sector. Second, manufacturers commented that N<sub>2</sub>O and CH<sub>4</sub> should be measured on the combined 55/45 weighting of the FTP and highway cycles, respectively, as these cycles are the yardstick for fuel economy and CO<sub>2</sub> measurement. Manufacturers commented that there should not be a disconnect between the light-duty and heavy-duty vehicle programs.

EPA continues to believe that it is appropriate to provide additional flexibility to manufacturers to meet the N<sub>2</sub>O and CH<sub>4</sub> standards. EPA is thus finalizing provisions allowing manufacturers to use CO<sub>2</sub> credits, on a CO<sub>2</sub>-equivalent basis, to meet the N<sub>2</sub>O and CH<sub>4</sub> standards, which is consistent with many commenters' preferred approach. Manufacturers will have the option of using CO<sub>2</sub> credits to meet N<sub>2</sub>O and CH<sub>4</sub> standards on a test group basis as needed for MYs 2012–2016. Because fuel conversion manufacturers certifying under 40 CFR part 85, subpart F do not participate in ABT programs, EPA is finalizing a compliance option for fuel conversion manufacturers to comply with the N<sub>2</sub>O and CH<sub>4</sub> standards similar to the credit option just described above. The compliance option will allow conversion manufacturers, on an individual test group basis, to convert CO<sub>2</sub> overcompliance into CO<sub>2</sub> equivalents of N<sub>2</sub>O and/or CH<sub>4</sub> that can be subtracted from the CH<sub>4</sub> and N<sub>2</sub>O measured values to demonstrate compliance with CH<sub>4</sub> and/or N<sub>2</sub>O standards.

In EPA's request for comments, EPA discussed the new flexibility as being needed to address lead time issues for MYs 2012–2014. EPA understands that manufacturers are now making technology decisions for beyond MY 2014 and that some technologies such as FFVs may have difficulty meeting the CH<sub>4</sub> and N<sub>2</sub>O standards, presenting manufacturers with difficult decisions of absorbing the 3–4 g/mile CO<sub>2</sub>-equivalent emissions fleet wide, making significant investments in existing vehicle technologies, or curtailing the

use of certain technologies.<sup>186</sup> The CH<sub>4</sub> standard, in particular, could prove challenging for FFVs because exhaust temperatures are lower on E–85 and CH<sub>4</sub> is more difficult to convert over the catalyst. EPA's initial estimate that these issues could be resolved without disrupting product plans by MY 2015 appears to be overly optimistic, and therefore EPA is extending the flexibility through model year 2016. This change helps ensure that the CH<sub>4</sub> and N<sub>2</sub>O standards will not be an obstacle for the use of FFVs or other technologies in this timeframe, and at the same time, assure that overall fleet average GHG emissions will remain at the same level as under the main standards.

In response to comments from manufacturers and from the Natural Gas Vehicle Interests that the changes to the program make sense and should be made on a permanent basis (*i.e.* for model years after 2016), EPA is extending this flexibility through MY 2016 as discussed above, but we believe it is premature to decide here whether or not these changes should be permanent. EPA may consider this issue further in the context of new standards for MYs 2017–2025 in the planned future light-duty vehicle rulemaking. With regard to comments on changing the test procedures over which N<sub>2</sub>O and CH<sub>4</sub> emissions are measured to determine compliance with the standards, the level of the standards and the test procedures go hand-in-hand and must be considered together. Weighting the highway test result with the city test result in the emissions measurement would in most cases reduce the overall emissions levels for determining compliance with the standards, and would thereby, in effect make the standards less stringent. This appears to be inappropriate. In addition, EPA did not request comments on changing the level of the N<sub>2</sub>O and CH<sub>4</sub> standards or the test procedures and it is inappropriate to amend the standards for that reason as well.

#### (5) EPA's Final Standards for Direct Emissions From Air Conditioning

Air conditioning systems contribute to GHG emissions in two ways—direct emissions through refrigerant leakage and indirect exhaust emissions due to the extra load on the vehicle's engine to provide power to the air conditioning system. HFC refrigerants, which are powerful GHG pollutants, can leak from

the A/C system.<sup>187</sup> This includes the direct leakage of refrigerant as well as the subsequent leakage associated with maintenance and servicing, and with disposal at the end of the vehicle's life.<sup>188</sup> The most commonly used refrigerant in automotive applications—R134a, has a high GWP of 1430.<sup>189</sup> Due to the high GWP of R134a, a small leakage of the refrigerant has a much greater global warming impact than a similar amount of emissions of CO<sub>2</sub> or other mobile source GHGs.

Heavy-duty air conditioning systems today are similar to those used in light-duty applications. However, differences may exist in terms of cooling capacity (such that sleeper cabs have larger cabin volumes than day cabs), system layout (such as the number of evaporators), and the durability requirements due to longer vehicle life. However, the component technologies and costs to reduce direct HFC emissions are similar between the two types of vehicles.

The quantity of GHG refrigerant emissions from heavy-duty trucks relative to the CO<sub>2</sub> emissions from driving the vehicle and moving freight is very small. Therefore, a credit approach is not appropriate for this segment of vehicles because the value of the credit is too small to provide sufficient incentive to utilize feasible and cost-effective air conditioning leakage improvements. For the same reason, including air conditioning leakage improvements within the main standard would in many instances result in lost control opportunities. Therefore, EPA is finalizing the proposed requirement that vehicle manufacturers meet a low leakage requirement for all air conditioning systems installed in 2014 model year and later trucks, with one exception. The agency is not finalizing leakage standards for Class 2b-8 Vocational Vehicles at this time due to the complexity in the build process and the potential for different entities besides the chassis manufacturer to be involved in the air conditioning system production and installation, with

<sup>187</sup> The United States has submitted a proposal to the Montreal Protocol which, if adopted, would phasedown production and consumption of HFCs.

<sup>188</sup> The U.S. EPA has reclamation requirements for refrigerants in place under Title VI of the Clean Air Act.

<sup>189</sup> The global warming potentials used in this rule are consistent with the 2007 Intergovernmental Panel on Climate Change (IPCC) Fourth Assessment Report. At this time, the global warming potential values from the 1996 IPCC Second Assessment Report are used in the official U.S. greenhouse gas inventory submission to the United Nations Framework Convention on Climate Change (per the reporting requirements under that international convention, which were last updated in 2006).

<sup>186</sup> "Discussions with Vehicle Manufacturers Regarding the Light-duty Vehicle CH<sub>4</sub> and N<sub>2</sub>O Standards," Memorandum from Christopher Lieske to Docket EPA-HQ-OAR-2010-0162.

consequent difficulties in developing a regulatory system.

For air conditioning systems with a refrigerant capacity greater than 733 grams, EPA is finalizing a leakage standard which is a “percent refrigerant leakage per year” to assure that high-quality, low-leakage components are used in each air conditioning system design. The agency believes that a single “gram of refrigerant leakage per year” would not fairly address the variety of air conditioning system designs and layouts found in the heavy-duty truck sector. EPA is finalizing a standard of 1.50 percent leakage per year for heavy-duty pickup trucks and vans and Class 7 and 8 tractors. The final standard was derived from the vehicles with the largest system refrigerant capacity based on the Minnesota GHG Reporting database.<sup>190</sup> The average percent leakage per year of the 2010 model year vehicles is 2.7 percent. This final level of reduction is roughly comparable to that necessary to generate credits under the light-duty vehicle program. See 75 FR 25426–25427. Since refrigerant leakage past the compressor shaft seal is the dominant source of leakage in belt-driven air conditioning systems, the agency recognizes that a single “percent refrigerant leakage per year” is not feasible for systems with a refrigerant capacity of 733 grams or lower, as the minimum feasible leakage rate does not continue to drop as the capacity or size of the air conditioning system is reduced. The fixed leakage from the compressor seal and other system devices results in a minimum feasible yearly leakage rate, and further reductions in refrigerant capacity (the ‘denominator’ in the percent refrigerant leakage calculation) will result in a system which cannot meet the 1.50 percent leakage per year standard. EPA does not believe that leakage reducing technologies are available at this time which would allow lower capacity systems to meet the percent per year standard, so we are finalizing a maximum gram per year leakage standard of 11.0 grams per year for air conditioning systems with a refrigerant capacity of 733 grams or lower. EPA defined the standard, as well as the refrigerant capacity threshold, by examining the State of Minnesota GHG Reporting Database for the yearly leakage rate from 2010 and 2011 model year pickup trucks. In the Minnesota data, the average leak rate for the pickup truck category (16 unique model and refrigerant capacity combinations) was

13.3 grams per year, with an average capacity of 654 grams, resulting in an average percent refrigerant leakage per year of 2.0 percent. 4 of the 16 model/capacity combinations in the reporting data achieved a leak rate 11.0 grams per year or lower, and this was chosen as the maximum yearly leak rate, as several manufacturers have demonstrated that this level of yearly leakage is feasible. To avoid a discontinuity between the “percent leakage” and “leak rate” standards—where one approach would be more or less stringent, depending on the refrigerant capacity—a refrigerant capacity of 733 grams was chosen as a threshold capacity, below which, the leak rate approach can be used. EPA believes this approach of having a leak rate standard for lower capacity systems and a percent leakage per year standard for higher capacity systems will result in reduced refrigerant emissions from all air conditioning systems, while still allowing manufacturers the ability to produce low-leak, lower capacity systems in vehicles which require them.

Manufacturers can choose to reduce A/C leakage emissions in two ways. First, they can utilize leak-tight components. Second, manufacturers can largely eliminate the global warming impact of leakage emissions by adopting systems that use an alternative, low-Global Warming Potential (GWP) refrigerant. One alternative refrigerant, HFO–1234yf, with a GWP of 4, has been approved for use in light-duty passenger vehicles under EPA’s Significant New Alternatives Program (SNAP). While the scope of this SNAP approval does not include heavy-duty highway vehicles, we expect that those interested in using this refrigerant in other sectors will petition EPA for broader approval of its use in all mobile air conditioning systems. In addition, the EPA is currently acting on a petition to de-list R–134a as an acceptable refrigerant for new, light-duty passenger vehicles. The time frame and scale of R–134a de-listing is yet to be determined, but any phase-down of R–134a use will likely take place after this rulemaking is in effect. Given that HFO–1234yf is yet to be approved for heavy-duty vehicles, and that the time frame for the de-listing of R–134a is not known, EPA believes that a leakage standard for heavy-duty vehicles is still appropriate. If future heavy-duty vehicles adopt refrigerants other than R–134a, the calculated refrigerant leak rate can be adjusted by multiplying the leak rate by the ratio of the GWP of the new refrigerant divided by the GWP of the old refrigerant (e.g. for HFO–1234yf replacing R–134a, the

calculated leak rate would be multiplied by 0.0028, or 4 divided by 1430).

EPA believes that reducing A/C system leakage is both highly cost-effective and technologically feasible. The availability of low leakage components is being driven by the air conditioning program in the light-duty GHG rule which apply to 2012 model year and later vehicles. The cooperative industry and government Improved Mobile Air Conditioning program has demonstrated that new-vehicle leakage emissions can be reduced by 50 percent by reducing the number and improving the quality of the components, fittings, seals, and hoses of the A/C system.<sup>191</sup> All of these technologies are already in commercial use and exist on some of today’s systems, and EPA does not anticipate any significant improvements in sealing technologies for model years beyond 2014. However, EPA has recognized some manufacturers utilize an improved manufacturing process for air conditioning systems, where a helium leak test is performed on 100 percent of all o-ring fittings and connections after final assembly. By leak testing each fitting, the manufacturer or supplier is verifying the o-ring is not damaged during assembly (which is the primary source of leakage from o-ring fittings), and when calculating the yearly leak rate for a system, EPA will allow a relative emission value equivalent to a ‘seal washer’ can be used in place of the value normally used for an o-ring fitting, when 100 percent helium leak testing is performed on those fittings. While further updates to the SAE J2727 standard may be forthcoming (to address new materials and measurement methods for permeation through hoses), EPA believes it is appropriate to include the helium leak test update to the leakage calculation method at this time.

Consistent with the light-duty 2012–2016 MY vehicle rule, we are estimating costs for leakage control at \$18 (2008\$) in direct manufacturing costs. Including a low complexity indirect cost multiplier (ICM) of 1.14 results in costs of \$21 in the 2014 model year. A/C control technology is considered to be on the flat portion of the learning curve, so costs in the 2017 model year will be \$19. These costs are applied to all heavy-duty pickups and vans, and to all combination tractors. EPA views these costs as minimal and the reductions of potent GHGs to be easily feasible and reasonable in the lead times provided by the final rules.

<sup>190</sup> The Minnesota refrigerant leakage data can be found at <http://www.pca.state.mn.us/climatechange/mobileair.html#leakdata>.

<sup>191</sup> Team 1-Refrigerant Leakage Reduction: Final Report to Sponsors, SAE, 2007.

EPA is requiring that manufacturers demonstrate improvements in their A/C system designs and components through a design-based method. The method for calculating A/C leakage is based closely on an industry-consensus leakage scoring method, described below. This leakage scoring method is correlated to experimentally-measured leakage rates from a number of vehicles using the different available A/C components. Under the final approach, manufacturers will choose from a menu of A/C equipment and components used in their vehicles in order to establish leakage scores, which will characterize their A/C system leakage performance and calculate the percent leakage per year as this score divided by the system refrigerant capacity.

Consistent with the light-duty rule, EPA is finalizing a requirement that a manufacturer will compare the components of its A/C system with a set of leakage-reduction technologies and actions that is based closely on that being developed through the Improved Mobile Air Conditioning program and SAE International (as SAE Surface Vehicle Standard J2727, "HFC-134a, Mobile Air Conditioning System Refrigerant Emission Chart," August 2008 version). See generally 75 FR 25426. The SAE J2727 approach was developed from laboratory testing of a variety of A/C related components, and EPA believes that the J2727 leakage scoring system generally represents a reasonable correlation with average real-world leakage in new vehicles. Like the cooperative industry-government program, our final approach will associate each component with a specific leakage rate in grams per year that is identical to the values in J2727 and then sum together the component leakage values to develop the total A/C system leakage. However, in the heavy-duty vehicle program, the total A/C leakage score will then be divided by the value of the total refrigerant system capacity to develop a percent leakage per year. EPA believes that the design-based approach will result in estimates of likely leakage emissions reductions that will be comparable to those that would eventually result from performance-based testing.

EPA is not specifying a specific in-use standard for leakage, as neither test procedures nor facilities exist to measure refrigerant leakage from a vehicle's air conditioning system. However, consistent with the light-duty rule, where we require that manufacturers attest to the durability of components and systems used to meet the CO<sub>2</sub> standards (see 75 FR 25689), we will require that manufacturers of

heavy-duty vehicles attest to the durability of these systems, and provide an engineering analysis which demonstrates component and system durability.

#### (6) Indirect Emissions From Air Conditioning

In addition to direct emissions from refrigerant leakage, air conditioning systems also create indirect exhaust emissions due to the extra load on the vehicle's engine to provide power to the air conditioning system. These indirect emissions are in the form of the additional CO<sub>2</sub> emitted from the engine when A/C is being used due to the added loads. Unlike direct emissions which tend to be a set annual leak rate not directly tied to usage, indirect emissions are fully a function of A/C usage.

These indirect CO<sub>2</sub> emissions are associated with air conditioner efficiency, since air conditioners create load on the engine. See 74 FR 49529. However, the agencies are not setting air conditioning efficiency standards for vocational vehicles, combination tractors, or heavy-duty pickup trucks and vans. The CO<sub>2</sub> emissions due to air conditioning systems in these heavy-duty vehicles are minimal compared to their overall emissions of CO<sub>2</sub>. For example, EPA conducted modeling of a Class 8 sleeper cab using the GEM to evaluate the impact of air conditioning and found that it leads to approximately 1 gram of CO<sub>2</sub>/ton-mile. Therefore, a projected 24 percent improvement of the air conditioning system (the level projected in the light-duty GHG rulemaking), would only reduce CO<sub>2</sub> emissions by less than 0.3 g CO<sub>2</sub>/ton-mile, or approximately 0.3 percent of the baseline Class 8 sleeper cab CO<sub>2</sub> emissions.

#### (7) Ethanol-Fueled and Electric Vehicles

Current EPA emissions control regulations explicitly apply to heavy-duty engines and vehicles fueled by gasoline, methanol, natural gas and liquefied petroleum gas. For multi-fueled vehicles they call for compliance with requirements established for each consumed fuel. This contrasts with EPA's light-duty vehicle regulations that apply to all vehicles generally, regardless of fuel type. As we proposed, we are revising the heavy-duty vehicle and engine regulations to make them consistent with the light-duty vehicle approach, applying standards for all regulated criteria pollutants and GHGs regardless of fuel type, including application to all-electric vehicles (EVs). This provision will take effect in the 2014 model year, and be optional for

manufacturers in earlier model years. However, to satisfy the CAA section 202(a)(3) lead time constraints, the provision will remain optional for all criteria pollutants through the 2015 model year. Commenters did not oppose this change in EPA regulations.

This change primarily affects manufacturers of ethanol-fueled vehicles (designed to operate on fuels containing at least 50 percent ethanol) and EVs. Flex-fueled vehicles (FFVs) designed to run on both gasoline and fuel blends with high ethanol content will also be impacted, as they will need to comply with requirements for operation both on gasoline and ethanol.

The regulatory requirements we are finalizing today for certification on ethanol follow those already established for methanol, such as certification to NMHC equivalent standards and waiver of certain requirements. We expect testing to be done using the same E85 test fuel as is used today for light-duty vehicle testing, an 85/15 blend of commercially-available ethanol and gasoline vehicle test fuel. EV certification will also follow light-duty precedents, primarily calling on manufacturers to exercise good engineering judgment in applying the regulatory requirements, but will not be allowed to generate NO<sub>x</sub> or PM credits.

This provision is not expected to result in any significant added burden or cost. It is already the practice of HD FFV manufacturers to voluntarily conduct emissions testing for these vehicles on E85 and submit the results as part of their certification application, along with gasoline test fuel results. No changes in certification fees are being set in connection with this provision. We expect that there will be strong incentives for any manufacturer seeking to market these vehicles to also want them to be certified: (1) Uncertified vehicles carry a disincentive to potential purchasers who typically have the benefit to the environment as one of their reasons for considering alternative fuels, (2) uncertified vehicles are not eligible for the substantial credits they could likely otherwise generate, (3) EVs have no tailpipe or evaporative emissions and thus need no added hardware to put them in a certifiable configuration, and (4) emissions controls for gasoline vehicles and FFVs are also effective on dedicated ethanol-fueled vehicles, and thus costly development programs and specialized components will not be needed; in fact the highly integrated nature of modern automotive products make the emission control systems essential to reliable vehicle performance.

Regarding technological feasibility, as mentioned above, HD FFV manufacturers already test on E85 and the resulting data shows that they can meet emissions standards on this fuel. Furthermore, there is a substantial body of certification data on light-duty FFVs (for which testing on ethanol is already a requirement), showing existing emission control technology is capable of meeting even the more stringent Tier 2 standards in place for light-duty vehicles.

#### (8) Correction to 40 CFR 1033.625

In a 2008 final rule that set new locomotive and marine engine standards, EPA adopted a provision allowing manufacturers to use a limited number of nonroad engines to power switch locomotives provided, among other things, that “the engines were certified to standards that are numerically lower than the applicable locomotive standards of this part (1033).” (40 CFR 1033.625(a)). The goal of this provision is to encourage the replacement of aging, high-emitting switch locomotives with new switch locomotives having very low emissions of PM, NO<sub>x</sub>, and hydrocarbons. However, this provision neglected to consider the fact that preexisting nonroad engine emission standards for CO were set at levels that were slightly numerically higher than those for locomotives. The applicable switch locomotive CO standard of part 1033 is 3.2 g/kW-hr (2.4 g/hp-hr), while the applicable nonroad engine CO standard is 3.5 g/kW-hr (2.6 g/hp-hr). This is the case even for the cleanest final Tier 4 nonroad engines that will phase in starting in 2014. Thus, nonroad engines cannot be certified to CO standards that are numerically lower than the applicable locomotive standards, and the nonroad engine provision is rendered practically unusable. This matter was brought to EPA’s attention by affected engine manufacturers.<sup>192</sup>

As indicated above, EPA believes that allowing certification of new switch locomotive engines to nonroad engine standards will greatly reduce emissions from switch locomotives, and EPA does not believe the slight difference in CO standards should prevent this environmentally beneficial program. EPA is therefore adopting a corrective technical amendment in part 1033. The regulation is being amended at § 1033.625(a)(2) to add the following italicized text: “The engines were

certified to *PM*, *NO<sub>x</sub>*, and *hydrocarbon* standards that are numerically lower than the applicable locomotive standards of this part.” This change is a straightforward correction to restore the intended usability of the provision and is not expected to have adverse environmental impacts, as nonroad engines have CO emissions that are typically well below both the nonroad and locomotive emissions standards.

#### (9) Corrections to 40 CFR Part 600

EPA adopted changes to fuel economy labeling requirements on July 6, 2011 (76 FR 39478). We are making the following corrections to these regulations in 40 CFR part 600:

- We adopted a requirement to use the specifications of SAE J1711 for fuel economy testing related to hybrid-electric vehicles. In this final rule, we are extending that requirement to the calculation provisions in § 600.114–12. This change was inadvertently omitted from the earlier final rule.
- We are correcting an equation in § 600.116–12.
- We are removing text describing label content that differs from the sample labels that were published with the final rule. The sample labels properly characterize the intended label content.

#### (10) Definition of Urban Bus

EPA is adding a new section 86.012–2 to revise the definition of “urban bus.” The new definition will treat engines used in urban buses the same as engines used in any other HD vehicle application, relying on the definitions of primary intended service class for defining which standards and useful life apply for bus engines. This change is necessary to allow for installation of engines other than HHDDE for hybrid bus applications.

### III. Feasibility Assessments and Conclusions

In this section, NHTSA and EPA discuss several aspects of our joint technical analyses. These analyses are common to the development of each agency’s final standards. Specifically we discuss: the development of the baseline used by each agency for assessing costs, benefits, and other impacts of the standards, the technologies the agencies evaluated and their costs and effectiveness, and the development of the final standards based on application of technology in light of the attribute based distinctions and related compliance measurement procedures. We also discuss the agencies’ consideration of standards that are

either more or less stringent than those adopted.

This program is based on the need to obtain significant oil savings and GHG emissions reductions from the transportation sector, and the recognition that there are appropriate and cost-effective technologies to achieve such reductions feasibly in the model years of this program. The decision on what standard to set is guided by each agency’s statutory requirements, and is largely based on the need for reductions, the effectiveness of the emissions control technology, the cost and other impacts of implementing the technology, and the lead time needed for manufacturers to employ the control technology. The availability of technology to achieve reductions and the cost and other aspects of this technology are therefore a central focus of this final rulemaking.

CBD submitted several comments on whether NHTSA had met EISA’s mandate to set standards “designed to achieve the maximum feasible improvement” and, to that end, appropriately considered feasible technologies in setting the stringency level. CBD stated that the proposed rule had been improperly limited to currently available technology, and that none of the alternatives contained all of the available technology, which it argued violated EISA and the CAA. CBD also stated that the phase-in schedule violated the technology-forcing intention of EISA, and that the agencies misperceived their statutory mandates, arguing that the agencies are required to force technological innovation through aggressive standards.

As demonstrated in the standard-specific discussions later in this section of the preamble, the standards adopted in the final program are consistent with section 202(a) of the CAA and section 32902(k)(2) of EISA. With respect to the EPA rules, we note at the outset, that CBD’s premise that EPA must adopt “technology-forcing” standards for heavy-duty vehicles and engines is wrong. A technology-forcing standard is one that is to be based on standards which will be available, rather than technology which is presently available. *NRDC v. Thomas*, 805 F. 2d 410, 429 (DC Cir. 1986). Clean Air Act provisions requiring “the greatest degree of emission reduction achievable through the application of technology which the Administrator determines will be available” are technology-forcing. See e.g., CAA sections 202(a)(3)(1);<sup>193</sup>

<sup>192</sup> See e-mail correspondence from Timothy A. French, EMA, to Donald Kopinski and Charles Moulis, U.S. EPA dated 12/8/10, “Switcher Locomotive Flexibility”, docket # EPA-HQ-OAR-2010-0162.

<sup>193</sup> CBD cites the District Court’s opinion in *Cent. Valley Chrysler-Jeep Inc. v. Goldstene*, 529 F. Supp. 2d 1100 (DC Cir. 2007).  
Continued

213(a)(3). Section 202(a)(1) standards are technology-based, but not technology-forcing, requiring EPA to issue standards for a vehicle's useful life "after providing such period as the Administrator finds necessary to permit the development and application of the requisite technology, giving appropriate consideration to the cost of compliance within such period." See *NACAA v. EPA*, 489 F. 3d 1221, 1230 (DC Cir. 2007) upholding EPA's interpretation of similar language in CAA section 231(a) as providing even greater leeway to weigh the statutory factors than if the provision were technology-forcing. See generally 74 FR at 49464–465 (Sept. 28, 2009); 75 FR at 74171.

Section 202(a)(1) of course allows EPA to consider application of technologies which will be available as well as those presently available, *id.*, and EPA exercised that discretion here. For example, as shown below, the agencies carefully considered application of hybrid technologies and bottoming cycle technologies for a number of the standards. Thus, the critical issue is whether EPA's choice of technology penetration on which the standards are premised is reasonable considering the statutory factors, the key ones being technology feasibility, technology availability in the 2014–2018 model years (*i.e.*, adequacy of lead time), and technology cost and cost-effectiveness. EPA has considerable discretion to weigh these factors in a reasonable manner (even for provisions which are explicitly technology-forcing, see *Sierra Club v. EPA*, 325 F. 3d 374, 378 (DC Cir. 2003)), and has done so here.

With respect to EISA, 49 U.S.C. section 32902(k)(2) directs NHTSA to "determine in a rulemaking proceeding how to implement a commercial medium- and heavy-duty on-highway vehicle and work truck fuel efficiency improvement program designed to achieve the maximum feasible improvement," and "adopt and implement appropriate test methods, measurement metrics, fuel economy standards, and compliance and enforcement protocols that are appropriate, cost-effective, and technologically feasible for commercial medium- and heavy-duty on-highway vehicles and work trucks" NHTSA recognizes that Congress intended EPCA (and by extension, EISA, which amended it) to be technology-forcing,

2d 1151, 1178 (E.D. Cal. 2007) for the proposition that standard-setting provisions of Title II of the CAA are technology forcing, but the court was citing to the technology-forcing provision section 202(a)(3)(A)(i), which is not the applicable authority here.

See *Center for Auto Safety v. National Highway Traffic Safety Admin.*, 793 F.2d 1322, 1339 (DC Cir. 1986). However, NHTSA believes it is important to distinguish between setting "maximum feasible" standards, as EPCA/EISA requires, and "maximum technologically feasible" standards, as CBD would have NHTSA do. The agency must weigh all of the statutory factors in setting fuel efficiency standards, and therefore may not weigh one statutory factor in isolation of others.

Neither EPCA nor EISA define "maximum feasible" in the context of setting fuel efficiency or fuel economy standards. Instead, NHTSA is directed to consider and meet three factors when determining what the maximum feasible standards are—"appropriateness, cost-effectiveness, and technological feasibility." 32902(k)(2). These factors modify "feasible" in the context of the MD/HD rules beyond a plain meaning of "capable of being done." See *Center for Biological Diversity v. National Highway Traffic Safety Admin.*, 538 F.3d 1172, 1194 (9th Cir. 2008). With respect to the setting of standards for light-duty vehicles, EPCA/EISA "gives NHTSA discretion to decide how to balance the statutory factors—as long as NHTSA's balancing does not undermine the fundamental purpose of EPCA: energy conservation." *Id.* at 1195. Where Congress has not directly spoken to a potential issue related to such a balancing, NHTSA's interpretation must be a "reasonable accommodation of conflicting policies \* \* \* committed to the agency's care by the statute." *Id.* (discussing consideration of consumer demand) (internal citations omitted). In the context of the agency's light-duty vehicle authority, it was determined that Congress delegated the process for setting the maximum feasible standard to NHTSA with *broad* guidelines concerning the factors that the agency must consider. *Id.* (internal citations omitted) (emphasis in original). We believe that the same conclusion should be drawn about the statutory provisions governing the agency's setting of standards for heavy-duty vehicles. Those provisions prescribe statutory factors commensurate to, and equally broad as, those prescribed for light-duty. Thus, NHTSA believes that it is firmly within our discretion to weigh and balance the factors laid out in 32902(k) in a way that is technology-forcing, as evidenced by these standards promulgated in this final action, but not in a way that requires the application of technology which will not be available in the lead time provided by the rules,

or which is not cost-effective, or is cost-prohibitive, as CBD evidently deems mandated.

As detailed below for each regulatory category, NHTSA has considered the appropriateness, cost-effectiveness, and technological feasibility of the standards in designing a program to achieve the maximum feasible fuel efficiency improvement. It believes that each of those criteria is met.

As described in Section I. F. (2) above, the final standards will remain in effect indefinitely at their 2018 or 2019 levels, unless and until the standards are revised. CBD maintained that this is a *per se* violation of EISA, arguing that, by definition, standards which are not updated continually and regularly cannot be considered maximum feasible. NHTSA would like to clarify that the NPRM specified that the standards would remain indefinitely "until amended by a future rulemaking action." NPRM at 74172. Further, as noted above, NHTSA has broad discretion to determine the maximum feasible standards. Unlike § 32902(b)(3)(B), which applies to automobiles regulated under light-duty CAFE, § 32902(k) does not specify a maximum number of years that fuel economy standards for heavy-duty vehicles will be in place. Consistent with its broad authority to define maximum feasible standards, NHTSA interprets its authority as including the discretion to define expiration periods where Congress has not otherwise specified. This is particularly appropriate for the heavy-duty sector, where fuel efficiency regulation is unprecedented. NHTSA believes that it would be unwise to set an expiration period for this first rulemaking absent both Congressional direction and a known compelling reason for setting a specific date.

NHTSA believes that the phase-in schedules provide an appropriate balance between the technology-forcing purpose of the statute and EISA-mandated considerations of economic practicability. NHTSA recognizes, as noted in the case above, that balancing each statutory factor in order to set the maximum feasible standards means that the agency must engage in a "reasonable accommodation of conflicting policies." See 538 F.3d at 1195, *supra*. Here, the agency has determined that the phase-in schedules are one such reasonable accommodation.

Navistar commented generally that the proposed rule was not technologically feasible, stating that the proposed standards assume technologies which are not in production for all manufacturers. This is

not the test for technical feasibility. Under the Clean Air Act, EPA needs only to outline a technical path toward compliance with a standard, giving plausible reasons for its belief that technology will either be developed or applied in the requisite period. *NRDC v. EPA*, 655 F. 2d 318, 333–34 (DC Cir. 1981). EPA has done so here with respect to the alternative engine standards of particular concern to Navistar.<sup>194</sup> Similarly, NHTSA has previously interpreted “technological feasibility” to mean “whether a particular method of improving fuel economy can be available for commercial application in the model year for which a standard is being established.” 74 FR 14196, 14216. NHTSA has further clarified that the consideration of technological feasibility “does not mean that the technology must be available or in use when a standard is proposed or issued.” *Center for Auto Safety v. National Highway Traffic Safety Admin.*, 793 F.2d 1322, 1325 n12 (DC Cir. 1986), quoting 42 FR 63, 184, 63, 188 (1977).

Consistent with these previous interpretations, NHTSA believes that a technology does not necessarily need to be currently available or in use for all regulated parties to be “technologically feasible” for this program, as long as it is reasonable to expect, based on the evidence before the agency, that the technology will be available in the model year in which the relevant standard takes effect. The agencies provide multiple technology pathways for compliance with a standard, allowing each manufacturer to develop technologies which fit their current production and research, and the standards are based on fleet penetration rates of those technologies. As discussed below, it is reasonable to assume that all the technologies on whose performance the standards are premised will be available over the period the standards are in effect.

The Institute for Policy Integrity (IPI) commented that the agencies should increase the scope and stringency of the final rule to the point at which net benefits would be maximized, citing Executive Orders 12866 and 13563. EOs 12866 and 13563 instruct agencies, to the extent permitted by law, to select, among other things, the regulatory approaches which maximize net benefits. NHTSA agrees with IPI about the applicability of these EOs and has made every effort to incorporate their guidance in drafting this rule.

Though IPI agreed that the proposed rule was cost-benefit justified, IPI

further stated that the agencies must implement an alternative that provides the maximum net benefits. The agencies believe that standards that maximized net benefits would be beyond the point of technological feasibility for this first phase of the HD National Program. The standards already require the maximum feasible fuel efficiency improvements for the HD fleet in the 2014–2018 time frame. Thus, even though, the final standards are highly cost-effective, and standards that maximized net benefits would likely be more stringent than those being promulgated in this final action, NHTSA believes that standards that maximized net benefits would not be appropriate or technologically feasible in the rulemaking time frame. The Executive Orders cited by IPI cannot and do not require an agency to select a regulatory alternative that is inconsistent with its statutory obligations. Thus, the standards adopted in the final rules are consistent with the agencies’ respective statutory authorities, and are not established at levels which are infeasible or cost-ineffective.

Here, the focus of the standards is on applying fuel efficiency and emissions control technology to reduce fuel consumption, CO<sub>2</sub> and other greenhouse gases. Vehicles combust fuel to generate power that is used to perform two basic functions: (1) Transport the truck and its payload, and (2) operate various accessories during the operation of the truck such as the PTO units. Engine-based technology can reduce fuel consumption and CO<sub>2</sub> emissions by improving engine efficiency, which increases the amount of power produced per unit of fuel consumed. Vehicle-based technology can reduce fuel consumption and CO<sub>2</sub> emissions by increasing the vehicle efficiency, which reduces the amount of power demanded from the engine to perform the truck’s primary functions.

Our technical work has therefore focused on both engine efficiency improvements and vehicle efficiency improvements. In addition to fuel delivery, combustion, and aftertreatment technology, any aspect of the truck that affects the need for the engine to produce power must also be considered. For example, the drag due to aerodynamics and the resistance of the tires to rolling both have major impacts on the amount of power demanded of the engine while operating the vehicle.

The large number of possible technologies to consider and the breadth of vehicle systems that are affected mean that consideration of the manufacturer’s design and production

process plays a major role in developing the final standards. Engine and vehicle manufacturers typically develop many different models based on a limited number of platforms. The platform typically consists of a common engine or truck model architecture. For example, a common engine platform may contain the same configuration (such as inline), number of cylinders, valvetrain architecture (such as overhead valve), cylinder head design, piston design, among other attributes. An engine platform may have different calibrations, such as different power ratings, and different aftertreatment control strategies, such as exhaust gas recirculation (EGR) or selective catalytic reduction (SCR). On the other hand, a common vehicle platform has different meanings depending on the market. In the heavy-duty pickup truck market, each truck manufacturer usually has only a single pickup truck platform (for example the F series by Ford) with common chassis designs and shared body panels, but with variations on load capacity of the axles, the cab configuration, tire offerings, and powertrain options. Lastly, the combination tractor market has several different platforms and the trucks within each platform (such as LoneStar by Navistar) have less commonality. Tractor manufacturers will offer several different options for bumpers, mirrors, aerodynamic fairing, wheels, and tires, among others. However, some areas such as the overall basic aerodynamic design (such as the grill, hood, windshield, and doors) of the tractor are tied to tractor platform.

The platform approach allows for efficient use of design and manufacturing resources. Given the very large investment put into designing and producing each truck model, manufacturers of heavy-duty pickup trucks and vans typically plan on a major redesign for the models every 5 years or more (a key consideration in the choice of the five model year duration during which the vehicle standards are phased in). Recently, EPA’s non-GHG heavy-duty engine program provided new emissions standards every three model years. Heavy-duty engine and truck manufacturer product plans typically have fallen into three year cycles to reflect this regime. While the recent non-GHG emissions standards can be handled generally with redesigns of engines and trucks, a complete redesign of a new heavy-duty engine or truck typically occurs on a slower cycle and often does not align in time due to the fact that the manufacturer of engines

<sup>194</sup> See 40 CFR 1036.620.



differs from the truck manufacturer. At the redesign stage, the manufacturer will upgrade or add all of the technology and make most other changes supporting the manufacturer's plans for the next several years, including plans related to emissions, fuel efficiency, and safety regulations.

A redesign of either engine or truck platforms often involves a package of changes designed to work together to meet the various requirements and plans for the model for several model years after the redesign. This often involves significant engineering, development, manufacturing, and marketing resources to create a new product with multiple new features. In order to leverage this significant upfront investment, manufacturers plan vehicle redesigns with several model years of production in mind. Vehicle models are not completely static between redesigns as limited changes are often incorporated for each model year. This interim process is called a refresh of the vehicle and it generally does not allow for major technology changes although more minor ones can be done (*e.g.*, small aerodynamic improvements, *etc.*). More major technology upgrades that affect multiple systems of the vehicle thus occur at the vehicle redesign stage and not in the time period between redesigns.

As discussed below, there are a wide variety of CO<sub>2</sub> and fuel consumption reducing technologies involving several different systems in the engine and vehicle that are available for consideration. Many can involve major changes to the engine or vehicle, such as changes to the engine block and cylinder heads or changes in vehicle shape to improve aerodynamic efficiency. Incorporation of such technologies during the periodic engine, transmission or vehicle redesign process would allow manufacturers to develop appropriate packages of technology upgrades that combine technologies in ways that work together and fit with the overall goals of the redesign. By synchronizing with their multi-year planning process, manufacturers can avoid the large increase in resources and costs that would occur if technology had to be added outside of the redesign process. We considered redesign cycles both in our costing and in assessing needed the lead time required.

As described below, the vast majority of technology on whose performance the final standards are predicated is commercially available and already being utilized to a limited extent across the heavy-duty fleet. Therefore the majority of the emission and fuel consumption reductions which would

result from these final rules would result from the increased use of these technologies. EPA and NHTSA also believe that these final rules will encourage the development and limited use of more advanced technologies, such as advanced aerodynamics and hybrid powertrains in some vocational vehicle applications.

In evaluating truck efficiency, NHTSA and EPA have excluded consideration of standards which could result in fundamental changes in the engine or vehicle's performance. Put another way, none of the technology pathways underlying the final standards involve any alteration in vehicle utility. For example, the agencies did not consider approaches that would necessitate reductions in engine power or otherwise limit truck performance. The agencies have thus limited the assessment of technical feasibility and resultant vehicle cost to technologies which maintain freight utility. Similarly, the agencies' choice of attributes on which to base the standards, and the metrics used to measure them, are consciously adopted to preserve the utility of heavy-duty vehicles and engines.

The agencies worked together to determine component costs for each of the technologies and build up the costs accordingly. For costs, the agencies considered both the direct or "piece" costs and indirect costs of individual components of technologies. For the direct costs, the agencies followed a bill of materials approach utilized by the agencies in the light-duty 2012–16 MY vehicle rule. A bill of materials, in a general sense, is a list of components or sub-systems that make up a system—in this case, an item of technology which reduces GHG emissions and fuel consumption. In order to determine what a system costs, one of the first steps is to determine its components and what they cost. NHTSA and EPA estimated these components and their costs based on a number of sources for cost-related information. In general, the direct costs of fuel consumption-improving technologies for heavy-duty pickups and vans are consistent with those used in the light-duty 2012–2016 MY vehicle rule, except that the agencies have scaled up certain costs where appropriate to accommodate the larger size and/or loads placed on parts and systems in the heavy-duty classes relative to the light-duty classes. For loose heavy-duty engines, the agencies have consulted various studies and have exercised engineering judgment when estimating direct costs. For technologies expected to be added to vocational vehicles and combination tractors, the agencies have again consulted various

studies and have used engineering judgment to arrive at direct cost estimates. Once costs were determined, they were adjusted to ensure that they were all expressed in 2009 dollars using a ratio of gross domestic product deflators for the associated calendar years.

Indirect costs were accounted for using the ICM approach explained in Chapter 2 of the RIA, rather than using the traditional Retail Price Equivalent (RPE) multiplier approach. For the heavy-duty pickup truck and van cost projections in this final action, the agencies have used ICMs developed for light-duty vehicles (with the exception that here return on capital has been incorporated into the ICMs, where it had not been in the light-duty rule) primarily because the manufacturers involved in this segment of the heavy-duty market are the same manufacturers that build light-duty trucks. For the Class 7 and 8 tractor, vocational vehicle, and heavy-duty engine cost projections in this final rulemaking, EPA contracted with RTI International to update EPA's methodology for accounting for indirect costs associated with changes in direct manufacturing costs for heavy-duty engine and truck manufacturers.<sup>195</sup> In addition to the indirect cost multipliers varying by complexity and time frame, there is no reason to expect that the multipliers would be the same for engine manufacturers as for truck manufacturers. The report from RTI provides a description of the methodology, as well as calculations of new indirect cost multipliers. The multipliers used here include a factor of 5 percent of direct costs representing the return on capital for heavy-duty engines and truck manufacturers. These indirect cost multipliers are intended to be used, along with calculations of direct manufacturing costs, to provide improved estimates of the full additional costs associated with new technologies. The agencies did not receive any adverse comments related to this methodology.

Details of the direct and indirect costs, and all applicable ICMs, are presented in Chapter 2 of the RIA. In addition, for details on the ICMs, please refer to the RTI report (*See* Docket ID EPA–HQ–OAR–2010–0162–0283). Importantly, the agencies have revised the ICM factors and the way that indirect costs are calculated using the ICMs. As a result, the ICM factors are now higher, the indirect costs are higher and, therefore, technology costs are

<sup>195</sup> RTI International. Heavy-duty Truck Retail Price Equivalent and Indirect Cost Multipliers. July 2010.



higher. The changes made to the ICMs and the indirect cost calculations are discussed in Section VIII of this preamble and are detailed in Chapter 2 of the RIA.

EPA and NHTSA believe that the emissions reductions called for by the final standards are technologically feasible at reasonable costs within the lead time provided by the final standards, reflecting our projections of widespread use of commercially available technology. Manufacturers may also find additional means to reduce emissions and lower fuel consumption beyond the technical approaches we describe here. We encourage such innovation through provisions in our flexibility program as discussed in Section IV.

The remainder of this section describes the technical feasibility and cost analysis in greater detail. Further detail on all of these issues can be found in the joint RIA Chapter 2.

#### A. Class 7–8 Combination Tractor

Class 7 and 8 tractors are used in combination with trailers to transport freight.<sup>196</sup> The variation in the design of these tractors and their typical uses drive different technology solutions for each regulatory subcategory. The agencies are adopting provisions to treat vocational tractors as vocational vehicles instead of as combination tractors, as noted in Section II.B. The focus of this section is on the feasibility of the standards for combination tractors, not the vocational tractors.

EPA and NHTSA collected information on the cost and effectiveness of fuel consumption and CO<sub>2</sub> emission reducing technologies from several sources. The primary sources of information were the 2010 National Academy of Sciences report of Technologies and Approaches to Reducing the Fuel Consumption of Medium- and Heavy-Duty Vehicles,<sup>197</sup> TIAX's assessment of technologies to support the NAS panel report,<sup>198</sup> EPA's

Heavy-duty Lumped Parameter Model,<sup>199</sup> the analysis conducted by the Northeast States Center for a Clean Air Future, International Council on Clean Transportation, Southwest Research Institute and TIAX for reducing fuel consumption of heavy-duty long haul combination tractors (the NESCCAF/ICCT study),<sup>200</sup> and the technology cost analysis conducted by ICF for EPA.<sup>201</sup> Following on the EISA of 2007, the National Research Council appointed a NAS committee to assess technologies for improving fuel efficiency of heavy-duty vehicles to support NHTSA's rulemaking. The 2010 NAS report assessed current and future technologies for reducing fuel consumption, how the technologies could be implemented, and identified the potential cost of such technologies. The NAS panel contracted with TIAX to perform an assessment of technologies which provide potential fuel consumption reductions in heavy-duty trucks and engines and the technologies' associated capital costs. Similar to the Lumped Parameter model which EPA developed to assess the impact and interactions of GHG and fuel consumption reducing technologies for light-duty vehicles, EPA developed a new version of that model to specifically address the effectiveness and interactions of the final pickup truck and light heavy-duty engine technologies. The NESCAFF/ICCT study assessed technologies available in 2012 through 2017 to reduce CO<sub>2</sub> emissions and fuel consumption of line haul combination tractors and trailers. Lastly, the ICF report focused on the capital, maintenance, and operating costs of technologies currently available to reduce CO<sub>2</sub> emissions and fuel consumption in heavy-duty engines, combination tractors, and vocational vehicles.

(1) What technologies did the agencies consider to reduce the CO<sub>2</sub> emissions and fuel consumption of combination tractors?

Manufacturers can reduce CO<sub>2</sub> emissions and fuel consumption of combination tractors through use of, among others, engine, aerodynamic, tire, extended idle, and weight reduction technologies. The standards in the final rules are premised on use of these

technologies. The agencies note that SmartWay trucks are available today which incorporate the technologies on whose performance the final standards are based. We will also discuss other technologies that could potentially be used, such as vehicle speed limiters, although we are not basing the final standards on their use for the model years covered by this rulemaking, for various reasons discussed below.

In this section we discuss the baseline tractor and engine technologies for the 2010 model year, and then discuss the types of technologies that the agencies considered to improve performance relative to this baseline, while Section III.A.2 discusses the technology packages the agencies used to determine the final standard levels.

#### (a) Baseline Tractor & Tractor Technologies

Baseline tractor: The agencies developed the baseline tractor to represent the average 2010 model year tractor. Today there is a large spread in aerodynamics in the new tractor fleet. Trucks sold may reflect so-called classic styling (as described in Section II.B.3.c), or may be sold with aerodynamic packages. Based on our review of current truck model configurations and Polk data provided through MJ Bradley,<sup>202</sup> we believe the aerodynamic configuration of the baseline new truck fleet is approximately 25 percent Bin I, 70 percent Bin II, and 5 percent Bin III (as these bin configurations are explained above in Section II.B. (2)(c)). The baseline Class 7 and 8 day cab tractor consists of an aerodynamic package which closely resembles the Bin I package described in Section II.B. (2)(c), baseline tire rolling resistance of 7.8 kg/metric ton for the steer tire and 8.2 kg/metric ton,<sup>203</sup> dual tires with steel wheels on the drive axles, and no vehicle speed limiter. The baseline tractor for the Class 8 sleeper cabs contains the same aerodynamic and tire rolling resistance technologies as the baseline day cab, does not include vehicle speed limiters, and does not include an idle reduction technology. The agencies assume the baseline transmission is a 10 speed manual. The agencies received a comment from the ICCT stating that the 0.69 Cd baseline for high roof sleepers published in the NPRM is higher than existing studies show. ICCT cited three studies

<sup>196</sup> "Tractor" is defined in 49 CFR 571.3 to mean "a truck designed primarily for drawing other motor vehicles and not so constructed as to carry a load other than a part of the weight of the vehicle and the load so drawn."

<sup>197</sup> Committee to Assess Fuel Economy Technologies for Medium- and Heavy-Duty Vehicles; National Research Council; Transportation Research Board (2010). Technologies and Approaches to Reducing the Fuel Consumption of Medium- and Heavy-Duty Vehicles. ("The NAS Report") Washington, DC, The National Academies Press. Available electronically from the National Academy Press Web site at [http://www.nap.edu/catalog.php?record\\_id=12845](http://www.nap.edu/catalog.php?record_id=12845).

<sup>198</sup> TIAX, LLC. "Assessment of Fuel Economy Technologies for Medium- and Heavy-Duty Vehicles." Final Report to National Academy of Sciences, November 19, 2009.

<sup>199</sup> U.S. EPA. Heavy-duty Lumped Parameter Model.

<sup>200</sup> NESCCAF, ICCT, Southwest Research Institute, and TIAX. Reducing Heavy-Duty Long Haul Combination Truck Fuel Consumption and CO<sub>2</sub> Emissions. October 2009.

<sup>201</sup> ICF International. "Investigation of Costs for Strategies to Reduce Greenhouse Gas Emissions for Heavy-Duty On-Road Vehicles." July 2010. Docket Number EPA-HQ-OAR-2010-0162-0283.

<sup>202</sup> MJ Bradley. Heavy-duty Market Analysis. May 2009. Page 10.

<sup>203</sup> U.S. Environmental Protection Agency. SmartWay Transport Partnership July 2010 e-update accessed July 16, 2010, from <http://www.epa.gov/smartwaylogistics/newsroom/documents/e-update-july-10.pdf>.

including a Society of Automotive Engineering paper showing a lower Cd for tractor trailers. The agencies based the average Cd for high roof sleepers on available in use fleet composition data, combined with an assessment of drag coefficient for different truck configurations. The agencies are finalizing the 0.69 baseline Cd for high roof sleeper based on our assessment for the NPRM. However, we will continue to gather information on the composition of the in-use fleet and may alter the baseline in a future action, should more data become available that demonstrates our estimate is incorrect.

Performance from this baseline can be improved by the use of the following technologies:

**Aerodynamic technologies:** There are opportunities to reduce aerodynamic drag from the tractor, but it is difficult to assess the benefit of individual aerodynamic features. Therefore, reducing aerodynamic drag requires optimizing of the entire system. The potential areas to reduce drag include all sides of the truck—front, sides, top, rear and bottom. The grill, bumper, and hood can be designed to minimize the pressure created by the front of the truck. Technologies such as aerodynamic mirrors and fuel tank fairings can reduce the surface area perpendicular to the wind and provide a smooth surface to minimize disruptions of the air flow. Roof fairings provide a transition to move the air smoothly over the tractor and trailer. Side extenders can minimize the air entrapped in the gap between the tractor and trailer. Lastly, underbelly treatments can manage the flow of air underneath the tractor. As discussed in the TIAX report, the coefficient of drag (Cd) of a SmartWay sleeper cab high roof tractor is approximately 0.60, which is a significant improvement over a truck with no aerodynamic features which has a Cd value of approximately 0.80.<sup>204</sup> The GEM demonstrates that an aerodynamic improvement of a Class 8 high roof sleeper cab with a Cd value of 0.60 (which represents a Bin III tractor) provides a 5 percent reduction in fuel consumption and CO<sub>2</sub> emissions over a truck with a Cd of 0.68.

**Lower Rolling Resistance Tires:** A tire's rolling resistance results from the tread compound material, the architecture and materials of the casing, tread design, the tire manufacturing process, and its operating conditions (surface, inflation pressure, speed, temperature, etc.). Differences in rolling resistance of up to 50 percent have been identified for tires designed to equip the

same vehicle. The baseline rolling resistance coefficient for today's fleet is 7.8 kg/metric ton for the steer tire and 8.2 kg/metric ton for the drive tire, based on sales weighting of the top three manufacturers based on market share.<sup>205</sup> Since 2007, SmartWay trucks have had steer tires with rolling resistance coefficients of less than 6.6 kg/metric ton for the steer tire and less than 7.0 kg/metric ton for the drive tire.<sup>206</sup> Low rolling resistance (LRR) drive tires are currently offered in both dual assembly and single wide-base configurations. Single wide tires can offer rolling resistance reduction along with improved aerodynamics and weight reduction. The GEM demonstrates that replacing baseline tractor tires with tires which meet the Bin I level provides approximately a 4 percent reduction in fuel consumption and CO<sub>2</sub> emissions over the prescribed test cycle, as shown in RIA Chapter 2, Figure 2–2.

**Weight Reduction:** Reductions in vehicle mass reduce fuel consumption and GHGs by reducing the overall vehicle mass to be accelerated and also through increased vehicle payloads which can allow additional tons to be carried by fewer trucks consuming less fuel and producing lower emissions on a ton-mile basis. Initially for proposal, the agencies considered evaluating vehicle mass reductions on a total vehicle basis for combination tractors.<sup>207</sup> The agencies considered defining a baseline vehicle curb weight and the GEM would have used the vehicle's actual curb weight to calculate the increase or decrease in fuel consumption related to the overall vehicle mass relative to that baseline. After considerable evaluation of this issue, including discussions with the industry, we decided it would not be possible to define a single vehicle baseline mass for the tractors that would be appropriate and representative. Actual vehicle curb weights for these classes of vehicles vary by thousands of pounds dependent on customer features added to vehicles and critical to the function of the vehicle in the particular vocation in which it is used. This is true of vehicles such as Class 8 tractors considered in this section that may appear to be relatively homogenous but which in fact are quite heterogeneous.

This reality led us to the solution we proposed. In the proposal, we reflected mass reductions for specific technology substitutions (e.g., installing aluminum

wheels instead of steel wheels) where we could with confidence verify the mass reduction information provided by the manufacturer even though we cannot estimate the actual curb weight of the vehicle. In this way, we accounted for mass reductions where we can accurately account for its benefits.

For the final rules, based on evaluation of the comments, the agencies developed an expanded list of weight reduction opportunities, from which the sum of the weight reduction from the technologies installed on a specific tractor can be input into the GEM as listed in Table II–9 in Section II. The list includes additional components, but not materials, from those proposed in the NPRM. For high strength steel, the weight reduction value is equal to 10 percent of the presumed baseline component weight, as the agencies used a conservative value based on the DOE report. We recognize that there may be additional potential for weight reduction in new high strength steel components which combine the reduction due to the material substitution along with improvements in redesign, as evidenced by the studies done for light-duty vehicles. In the development of the high strength steel component weights, we are only assuming a reduction from material substitution and no weight reduction from redesign, since we do not have any data specific to redesign of heavy-duty components nor do we have a regulatory mechanism to differentiate between material substitution and improved design. We are finalizing for wheels that both aluminum and light weight aluminum are eligible to be used as light-weight materials. Only aluminum and not light weight aluminum can be used as a light-weight material for other components. The reason for this is data was available for light weight aluminum for wheels but was not available for other components.

As explained in Section II.B above, the agencies continue to believe that the 400 pound weight target is appropriate for setting the final combination tractor CO<sub>2</sub> emissions and fuel consumption standards. The agencies agree with the commenter that 400 pounds of weight reduction without the use of single wide tires may not be achievable for all tractor configurations. The agencies have expanded the list of weight reduction components which can be input into the GEM in order to provide the manufacturers with additional means to comply with the combination tractors and to further encourage reductions in vehicle weight. The agencies considered increasing the

<sup>205</sup> See SmartWay, Note 203, above.

<sup>206</sup> Ibid.

<sup>207</sup> The agencies are using the approach of evaluating total vehicle mass for heavy-duty pickups and vans where we have more data on the current fleet vehicle mass.

<sup>204</sup> See TIAX, Note 198, Page 4–50.

target value beyond 400 pounds given the additional reduction potential identified in the expanded technology list; however, lacking information on the capacity for the industry to change to these light weight components across the board by the 2014 model year, we have decided to maintain the 400 pound target. The agencies intend to continue to study the potential for additional weight reductions in our future work considering a second phase of truck fuel efficiency and GHG regulations.

A weight reduction of 400 pounds applied to a truck which travels at 70,000 pounds will have a minimal impact on fuel consumption. However, for trucks which operate at the maximum GVWR which occurs approximately in one third of truck miles travelled, a reduced tare weight will allow for additional payload to be carried. The GEM demonstrates that a weight reduction of 400 pounds applied to the payload tons for one third of the trips provides a 0.3 percent reduction in fuel consumption and CO<sub>2</sub> emissions over the prescribed test cycle, as shown in Figure 2–3 of RIA Chapter 2.

Extended Idle Reduction: Auxiliary power units (APU)s, fuel operated heaters, battery supplied air conditioning, and thermal storage systems are among the technologies available today to reduce main engine extended idling from sleeper cabs. Each of these technologies reduces the baseline fuel consumption during idling from a truck without this equipment (the baseline) from approximately 0.8 gallons per hour (main engine idling fuel consumption rate) to approximately 0.2 gallons per hour for an APU.<sup>208</sup> EPA and NHTSA agree with the TIAX assessment of a 6 percent reduction in overall fuel consumption reduction.<sup>209</sup>

Vehicle Speed Limiters: Fuel consumption and GHG emissions increase proportional to the square of vehicle speed. Therefore, lowering vehicle speeds can significantly reduce fuel consumption and GHG emissions. A vehicle speed limiter (VSL), which limits the vehicle's maximum speed, is a simple technology that is utilized today by some fleets (though the typical maximum speed setting is often higher than 65 mph). The GEM shows that using a vehicle speed limiter set at 62 mph on a sleeper cab tractor will provide a 4 percent reduction in fuel consumption and CO<sub>2</sub> emissions over the prescribed test cycles over a baseline

vehicle without a VSL or one set above 65 mph.<sup>210</sup>

Transmission: As discussed in the 2010 NAS report, automatic and automated manual transmissions may offer the ability to improve vehicle fuel consumption by optimizing gear selection compared to an average driver. However, as also noted in the report and in the supporting TIAX report, the improvement is very dependent on the driver of the truck, such that reductions ranged from 0 to 8 percent.<sup>211</sup> Well-trained drivers would be expected to perform as well or even better than an automatic transmission since the driver can see the road ahead and anticipate a changing stoplight or other road condition that an automatic transmission can not anticipate. However, poorly-trained drivers that shift too frequently or not frequently enough to maintain optimum engine operating conditions could be expected to realize improved in-use fuel consumption by switching from a manual transmission to an automatic or automated manual transmission. Although we believe there may be real benefits in reduced fuel consumption and GHG emissions through the application of dual clutch, automatic or automated manual transmission technology, we are not reflecting this potential improvement in our standard setting or in our compliance model. We have taken this approach because we cannot say with confidence what level of performance improvement to expect.

Low Friction Transmission, Axle, and Wheel Bearing Lubricants: The 2010 NAS report assessed low friction lubricants for the drivetrain as a 1 percent improvement in fuel consumption based on fleet testing.<sup>212</sup> The light-duty 2012–16 MY vehicle rule and the pickup truck portion of this program estimate that low friction lubricants can have an effectiveness value between 0 and 1 percent compared to traditional lubricants. However, it is not clear if in many heavy-duty applications these low friction lubricants could have competing requirements like component durability issues requiring specific lubricants with different properties than low friction.

<sup>210</sup> The Center for Biological Diversity thought that the agencies were limiting their consideration of vehicle speed limiters as a potential control technology due to perceived legal constraints. As noted above, vehicle speed limiters are a potential control technology for heavy duty vehicles and there is no statutory bar on either agency considering the performance of VSLs in developing the standards.

<sup>211</sup> See TIAX, Note 198, above at 4–70.

<sup>212</sup> See the 2010 NAS Report, Note 197, page 67.

Hybrid: Hybrid powertrain development in Class 7 and 8 tractors has been limited to a few manufacturer demonstration vehicles to date. One of the key benefit opportunities for fuel consumption reduction with hybrids is less fuel consumption when a vehicle is idling, but the standard is already premised on use of extended idle reduction so use of hybrid technology would duplicate many of the same emission reductions attributable to extended idle reduction. NAS estimated that hybrid systems would cost approximately \$25,000 per tractor in the 2015 through the 2020 time frame and provide a potential fuel consumption reduction of 10 percent, of which 6 percent is idle reduction which can be achieved (less expensively) through the use of other idle reduction technologies.<sup>213</sup> The limited reduction potential outside of idle reduction for Class 8 sleeper cab tractors is due to the mostly highway operation and limited start-stop operation. Due to the high cost and limited benefit during the model years at issue in this action (as well as issues regarding sufficiency of lead time (see Section III.2 (a) below), the agencies are not including hybrids in assessing standard stringency (or as an input to GEM). However as discussed in Section IV, the agencies are providing incentives to encourage the introduction of advanced technologies including hybrid powertrains in appropriate applications.

Management: The 2010 NAS report noted many operational opportunities to reduce fuel consumption, such as driver training and route optimization. The agencies have included discussion of several of these strategies in RIA Chapter 2, but are not using these approaches or technologies in the standard setting process. The agencies are looking to other resources, such as EPA's SmartWay Transport Partnership and regulations that could potentially be promulgated by the Federal Highway Administration and the Federal Motor Carrier Safety Administration, to continue to encourage the development and utilization of these approaches.

#### (b) Baseline Engine & Engine Technologies

The baseline engine for the Class 8 tractors is a Heavy Heavy-Duty Diesel engine with 15 liters of displacement which produces 455 horsepower. The agencies are using a smaller baseline engine for the Class 7 tractors because of the lower combined weights of this class of vehicles require less power, thus the baseline is an 11L engine with 350 horsepower. The agencies

<sup>213</sup> See the 2010 NAS Report, Note 197, page 128.

<sup>208</sup> See the RIA Chapter 2 for details.

<sup>209</sup> See the 2010 NAS Report, Note 197, above, at 128.

developed the baseline diesel engine as a 2010 model year engine with an aftertreatment system which meets EPA's 0.20 grams of NO<sub>x</sub>/bhp-hr standard with an SCR system along with EGR and meets the PM emissions standard with a diesel particulate filter with active regeneration. The baseline engine is turbocharged with a variable geometry turbocharger. The following discussion of technologies describes improvements over the 2010 model year baseline engine performance, unless otherwise noted. Further discussion of the baseline engine and its performance can be found in Section III.A.2.6 below.

With respect to stringency level, the agencies received comments from Cummins and Daimler stating that the proposed stringency levels were appropriate for the lead-times. Conversely, the agencies received comments from several environmental groups (UCS, CATF, ACEEE) supporting a greater reduction in engine CO<sub>2</sub> emissions and fuel consumption based on the NAS report. Navistar also stated that the agencies' baseline engine is inappropriate since there is not currently a 0.20 NO<sub>x</sub> compliant engine in production. A discussion of how the baseline engine configuration can be found below in Section (2)(b)(i).

Navistar also stated that the baseline engines proposed in the NPRM, MY 2010 selective catalytic reduction (SCR)-equipped, could not meet the agencies' statutory obligation to set feasible standards, and requested instead that MY 2010 engines currently in-use be used to meet the feasibility factor. The agencies thus disagree with the statement that SCR is infeasible and therefore, the agencies reaffirm that the engine used as the baseline engine in the agencies' analysis does indeed exist. In fact, several engine families have been certified by EPA using SCR technology over the past two years, all of which have met the 0.20 g/bhp-hr NO<sub>x</sub> standard.<sup>214</sup> EPA disagrees with Navistar that SCR engines currently certified do not meet this standard. Compliance with the 0.20 g/bhp-hr FTP NO<sub>x</sub> standard is measured based on an engine's performance when tested over a specific duty cycle (see 40 CFR 86.007-11(a)(2)). This is also true regarding the SET standard (see 40 CFR 86.007-11(a)(3)). Further, the FTP and SET tests are average tests, so emissions could go over 0.20 even for some portion of the test itself. Manufacturers are also required to ensure that their engines meet the NTE standard under

all conditions specified in the regulations (see 40 CFR 86.007-11(a)(4)).

Several manufacturers have been able to show compliance with these standards in applications for certification provided to EPA for several engine families. Navistar has provided no information indicating that these tests were false or improper. Indeed, Navistar does not appear to suggest, or provide any evidence, that engines with working SCR systems do not meet the NO<sub>x</sub> standard. Thus, it is demonstrably false to conclude that the NO<sub>x</sub> standard cannot be met with SCR-equipped engines.

A more detailed response to these comments appears in Section 6.2 of the Response to Comment document for this rule.

Engine performance for CO<sub>2</sub> emissions and fuel consumption can be improved by use of the following technologies:

*Improved Combustion Process:* Fuel consumption reductions in the range of 1 to 3 percent over the baseline diesel engine are identified in the 2010 NAS report through improved combustion chamber design, higher fuel injection pressure, improved injection shaping and timing, and higher peak cylinder pressures.<sup>215</sup>

*Turbochargers:* Improved efficiency of a turbocharger compressor or turbine could reduce fuel consumption by approximately 1 to 2 percent over variable geometry turbochargers in the market today.<sup>216</sup> The 2010 NAS report identified technologies such as higher pressure ratio radial compressors, axial compressors, and dual stage turbochargers as design paths to improve turbocharger efficiency.

*Higher efficiency air handling processes:* To maximize the efficiency of such processes, induction systems may be improved by manufacturing more efficiently designed flow paths (including those associated with air cleaners, chambers, conduit, mass air flow sensors and intake manifolds) and by designing such systems for improved thermal control. Improved turbocharging and air handling systems must include higher efficiency EGR systems and intercoolers that reduce frictional pressure loss while maximizing the ability to thermally control induction air and EGR. The agencies received comments from Honeywell confirming that turbochargers provide a role in reducing the CO<sub>2</sub> emissions from engines. Other components that offer opportunities for

improved flow efficiency include cylinder heads, ports and exhaust manifolds to further reduce pumping losses. Variable air breathing systems such as variable valve actuation may provide additional gains at different loads and speeds. The NESCCAF/ICCT study indicated up to 1.2 percent reduction could be achieved solely through improved EGR systems.

*Low Temperature Exhaust Gas Recirculation:* Most medium- and heavy-duty vehicle diesel engines sold in the U.S. market today use cooled EGR, in which part of the exhaust gas is routed through a cooler (rejecting energy to the engine coolant) before being returned to the engine intake manifold. EGR is a technology employed to reduce peak combustion temperatures and thus NO<sub>x</sub>. Low-temperature EGR uses a larger or secondary EGR cooler to achieve lower intake charge temperatures, which tend to further reduce NO<sub>x</sub> formation. If the NO<sub>x</sub> requirement is unchanged, low-temperature EGR can allow changes such as more advanced injection timing that will increase engine efficiency slightly more than 1 percent.<sup>217</sup> Because low-temperature EGR reduces the engine's exhaust temperature, it may not be compatible with exhaust energy recovery systems such as turbocompounding or a bottoming cycle.

*Engine Friction Reduction:* Reduced friction in bearings, valve trains, and the piston-to-liner interface will improve efficiency. Any friction reduction must be carefully developed to avoid issues with durability or performance capability. Estimates of fuel consumption improvements due to reduced friction range from 0 to 2 percent.<sup>218</sup>

*Reduced Parasitic Loads:* Accessories that are traditionally gear or belt driven by a vehicle's engine can be optimized and/or converted to electric power. Examples include the engine water pump, oil pump, fuel injection pump, air compressor, power-steering pump, cooling fans, and the vehicle's air-conditioning system. Optimization and improved pressure regulation may significantly reduce the parasitic load of the water, air and fuel pumps. Electrification may result in a reduction in power demand, because electrically powered accessories (such as the air compressor or power steering) operate only when needed if they are electrically powered, but they impose a parasitic demand all the time if they are engine driven. In other cases, such as

<sup>214</sup> See 2010 Model Year Engine Certification Data and 2011 Model Year Engine Certification Data files located in the Docket EPA-HQ-OAR-2010-0162.

<sup>215</sup> See TIAx, Note 198, Page 4-13.

<sup>216</sup> See TIAx Note 198, Page 4-2.

<sup>217</sup> See TIAx, Note 198, Page 4-13.

<sup>218</sup> TIAx, Note 198, pg 4-15

cooling fans or an engine's water pump, electric power allows the accessory to run at speeds independent of engine speed, which can reduce power consumption. The TIAX study used 2 to 4 percent fuel consumption improvement for accessory electrification, with the understanding that electrification of accessories will have more effect in short-haul/urban applications and less benefit in line-haul applications.<sup>219</sup> Bendix, in their comments to the agencies, confirmed that there are engine accessories available that can improve an engine's fuel efficiency.

*Selective catalytic reduction:* This technology is common on 2010 the medium- and heavy-duty diesel engines used in Class 7 and 8 tractors (and the agencies therefore have included it as part of the baseline engine, as noted above). Because SCR is a highly effective NO<sub>x</sub> aftertreatment approach, it enables engines to be optimized to maximize fuel efficiency, rather than minimize engine-out NO<sub>x</sub>. 2010 SCR systems are estimated to result in improved engine efficiency of approximately 3 to 5 percent compared to a 2007 in-cylinder EGR-based emissions system and by an even greater percentage compared to 2010 in-cylinder approaches.<sup>220</sup> As more effective low-temperature catalysts are developed, the NO<sub>x</sub> conversion efficiency of the SCR system will increase. Next-generation SCR systems could then enable additional efficiency improvements; alternatively, these advances could be used to maintain efficiency while down-sizing the aftertreatment. We estimate that continued optimization of the catalyst could offer 1 to 2 percent reduction in fuel use over 2010 model year systems in the 2014 model year.<sup>221</sup> The agencies estimate an additional 1 to 2 percent reduction may be feasible in the 2017 model year through additional refinement.

*Mechanical Turbocompounding:* Mechanical turbocompounding adds a low pressure power turbine to the exhaust stream in order to extract additional energy, which is then delivered to the crankshaft. Published information on the fuel consumption reduction from mechanical turbocompounding varies between 2.5

and 5 percent.<sup>222</sup> Some of these differences may depend on the operating condition or duty cycle that was considered by the different researchers. The performance of a turbocompounding system tends to be highest at full load and much less or even zero at light load.

*Electric Turbocompounding:* This approach is similar in concept to mechanical turbocompounding, except that the power turbine drives an electrical generator. The electricity produced can be used to power an electrical motor supplementing the engine output, to power electrified accessories, or to charge a hybrid system battery. None of these systems have been demonstrated commercially, but modeled results by industry and DOE have shown improvements of 3 to 5 percent.<sup>223</sup>

*Bottoming Cycle:* An engine with bottoming cycle uses exhaust or other heat energy from the engine to create power without the use of additional fuel. The sources of energy include the exhaust, EGR, charge air, and coolant. The estimates for fuel consumption reduction range up to 10 percent as documented in the 2010 NAS report.<sup>224</sup> However, none of the bottoming cycle or Rankine systems has been demonstrated commercially and are currently in only the research stage. See Section 2.4.2.7 of the RIA and Section II.B above.

## (2) Projected Technology Package Effectiveness and Cost

### (a) Class 7 and 8 Combination Tractors

EPA and NHTSA project that CO<sub>2</sub> emissions and fuel consumption reductions can be feasibly and cost-effectively achieved in these rules' time frames through the increased application of aerodynamic technologies, LRR tires, weight reduction, extended idle reduction technologies, vehicle speed limiters, and engine improvements. The agencies believe that hybrid powertrains systems for tractors will not be sufficiently developed and the necessary manufacturing capacity put in place to base a standard on any significant volume of hybrid tractors. The agencies are not aware of any full hybrid systems currently developed for long haul tractor applications. To date, hybrid systems for tractors have been primarily focused on idle shutdown technologies and not the broader energy storage and

recovery systems necessary to achieve reductions over typical vehicle drive cycles. The final standards reflect the potential for idle shutdown technologies through the GEM model. Further as highlighted by the 2010 NAS report, the agencies do believe that full hybrid powertrains have the potential in the longer term to provide significant improvements in fuel efficiency and to reduce greenhouse gas emissions. However lacking any existing systems or manufacturing base, we cannot conclude such technology will be available in the 2014–2018 timeframe. Developing a full hybrid system itself would be a three to five project followed by several more years to put in place manufacturing capacity. The agencies are including incentives for the use of hybrid technologies to help encourage their development and to reward manufacturers that can produce hybrids through prototype and low volume production methods. The agencies also are not including drivetrain technologies in the standard setting process, as discussed in Section II.B.3.h.iv.

The agencies evaluated each technology and estimated the most appropriate application rate of technology into each tractor subcategory. The next sections describe the effectiveness of the individual technologies, the costs of the technologies, the projected application rates of the technologies into the regulatory subcategories, and finally the derivation of the final standards.

### (i) Baseline Tractor Performance

The agencies developed the baseline tractor for each subcategory to represent an average 2010 model year tractor configured as noted earlier. The approach taken by the agencies was to define the individual inputs to the GEM, as shown in Table III–1. For example, the agencies evaluated the industry's tractor offerings and concluded that the average tractor contains a generally aerodynamic shape (such as roof fairings) and avoids classic features such as an exhaust stacks at the B-pillar, which increases drag. As noted earlier, our assessment of the baseline new high roof tractor fleet aerodynamics consists of approximately 25 percent Bin I, 70 percent Bin II, and 5 percent Bin III tractors. The baseline rolling resistance coefficient for today's fleet is 7.8 kg/metric ton for the steer tire and 8.2 kg/metric ton for the drive tire, based on sales weighting of the top three

<sup>219</sup> See TIAX, Note 198, Page 3–5.

<sup>220</sup> Stanton, D. "Advanced Diesel Engine Technology Development for High Efficiency, Clean Combustion." Cummins, Inc. Annual Progress Report 2008 Vehicle Technologies Program: Advanced Combustion Engine Technologies, U.S. Department of Energy. Pp 113–116. December 2008.

<sup>221</sup> See TIAX, Note 198, pg. 4–9.

<sup>222</sup> NESCCAF/ICCT study (p. 54) and TIAX (2009, pp. 3–5).

<sup>223</sup> K. G. Duleep of Energy and Environmental Analysis, R. Kruswyk, 2008, pp. 212–214, NESCCAF/ICCT, 2009, p. 54.

<sup>224</sup> See 2010 NAS Report, Note 197, page 57.

manufacturers based on market share.<sup>225</sup> The agencies assumed no application of vehicle speed limiters, weight reduction technologies, or idle reduction

technologies in the baseline tractor. The agencies use the inputs in the GEM to derive the baseline CO<sub>2</sub> emissions and fuel consumption of Class 7 and 8

tractors. The results are included in Table III-1.

TABLE III-1—BASELINE TRACTOR DEFINITIONS

	Class 7			Class 8					
	Day cab			Day cab			Sleeper cab		
	Low roof	Mid roof	High roof	Low roof	Mid roof	High roof	Low roof	Mid roof	High roof
<b>Aerodynamics (Cd)</b>									
Baseline ...	0.77	0.87	0.73	0.77	0.87	0.73	0.77	0.87	0.70
<b>Steer Tires (CRR kg/metric ton)</b>									
Baseline ...	7.8	7.8	7.8	7.8	7.8	7.8	7.8	7.8	7.8
<b>Drive Tires (CRR kg/metric ton)</b>									
Baseline ...	8.2	8.2	8.2	8.2	8.2	8.2	8.2	8.2	8.2
<b>Weight Reduction (lb)</b>									
Baseline ...	0	0	0	0	0	0	0	0	0
<b>Extended Idle Reduction (gram CO<sub>2</sub>/ton-mile reduction)</b>									
Baseline ...	N/A	N/A	N/A	N/A	N/A	N/A	0	0	0
<b>Vehicle Speed Limiter</b>									
Baseline ...	.....	.....	.....	.....	.....	.....	.....	.....	.....
<b>Engine</b>									
Baseline ...	2010 MY 11L Engine	2010 MY 11L Engine	2010 MY 11L Engine	2010 MY 15L Engine	2010 MY 15L Engine	2010 MY 15L Engine	2010 MY 15L Engine	2010 MY 15L Engine	2010 MY 15L Engine

TABLE III-2—CLASS 7 AND 8 TRACTOR BASELINE CO<sub>2</sub> EMISSIONS AND FUEL CONSUMPTION

	Class 7			Class 8					
	Day cab			Day cab			Sleeper cab		
	Low roof	Mid roof	High roof	Low roof	Mid roof	High roof	Low roof	Mid roof	High roof
CO <sub>2</sub> (grams CO <sub>2</sub> /ton- mile) .....	116	128	138	88	95	103	80	89	94
Fuel Con- sumption (gal/ 1,000 ton-mile)	11.4	12.6	13.6	8.7	9.4	10.1	7.8	8.7	9.3

(ii) Tractor Technology Package Definitions

The agencies' assessment of the final technology effectiveness was developed through the use of the GEM in coordination with chassis testing of three SmartWay certified Class 8 sleeper cabs. The agencies developed the

standards through a three-step process. First, the agencies developed technology performance characteristics for each technology, described below. Each technology is associated with an input parameter which is in turn modeled in the GEM. The performance levels for the range of Class 7 and 8 tractor

aerodynamic packages and vehicle technologies are described in Table III-3. Second, the agencies combined the technology performance levels with a projected technology application rate to determine the GEM inputs used to set the stringency of the final standards. Third, the agencies input the parameters

<sup>225</sup> U.S. Environmental Protection Agency. SmartWay Transport Partnership July 2010 e-

update accessed July 16, 2010, from <http://>

[www.epa.gov/smartwaylogistics/newsroom/documents/e-update-july-10.pdf](http://www.epa.gov/smartwaylogistics/newsroom/documents/e-update-july-10.pdf).



TABLE III-3—CLASS 7 AND 8 TRACTOR TECHNOLOGY VALUES—Continued

	Class 7		Class 8				
	Day cab		Day cab		Sleeper cab		
	Low/mid roof	High roof	Low/mid roof	High roof	Low roof	Mid roof	High roof
<b>Weight Reduction (lb)</b>							
Control .....	400	400	400	400	400	400	400
<b>Extended Idle Reduction (gram CO<sub>2</sub>/ton-mile reduction) <sup>a</sup></b>							
Control .....	N/A	N/A	N/A	N/A	5	5	5
<b>Vehicle Speed Limiter <sup>b</sup></b>							
Control .....	N/A	N/A	N/A	N/A	N/A	N/A	N/A

**Notes:**  
<sup>a</sup> While the standards are set based on this value, users would enter another value if AES is not applied or applied for less than the full useful life of the engine.  
<sup>b</sup> Vehicle speed limiters are an applicable technology for all Class 7 and 8 tractors, however the standards are not premised on the use of this technology.

(iii) Tractor Technology Application Rates

As explained above, vehicle manufacturers often introduce major product changes together, as a package. In this manner the manufacturers can optimize their available resources, including engineering, development, manufacturing and marketing activities to create a product with multiple new features. In addition, manufacturers recognize that a truck design will need to remain competitive over the intended life of the design and meet future regulatory requirements. In some limited cases, manufacturers may implement an individual technology outside of a vehicle’s redesign cycle.

With respect to the levels of technology application used to develop the final standards, NHTSA and EPA established technology application constraints. The first type of constraint was established based on the application of fuel consumption and CO<sub>2</sub> emission reduction technologies into the different types of tractors. For example, idle reduction technologies are limited to Class 8 sleeper cabs using the assumption that day cabs are not used for overnight hoteling. A second type of constraint was applied to most other technologies and limited their application based on factors reflecting the real world operating conditions that some combination tractors encounter. This second type of constraint was applied to the aerodynamic, tire, and vehicle speed limiter technologies. Table III-4 specifies the application rates that EPA and NHTSA used to develop the final standards. The agencies received a significant number of comments related to this second

basis. In particular, commenters questioned the reasons for not requiring the maximum reduction technology in every case. The agencies have not done so because we have concluded that within each of these individual vehicle categories there are particular applications where the use of the identified technologies would be either ineffective or not technically feasible. The addition of ineffective technologies provides no environmental or fuel efficiency benefit, increases costs and is not a basis upon which to set a maximum feasible improvement. For example, the agencies have not required the use of full aerodynamic vehicle treatments on 100 percent of tractors because we know that in many applications (for example gravel truck engaged in local aggregate delivery) the added weight of the aerodynamic technologies will increase fuel consumption and hence CO<sub>2</sub> emissions to a greater degree than the reduction that would be accomplished from the more aerodynamic nature of the tractor. To simply set the standard based on the largest reduction possible estimated narrowly over a single test procedure while ignoring the in-use effects of the technology would in this case result in a perverse outcome that is not in keeping with the agencies’ goals or the requirements of the CAA and EISA.

Aerodynamics Application Rate

The impact of aerodynamics on a truck’s efficiency increases with vehicle speed. Therefore, the usage pattern of the truck will determine the benefit of various aerodynamic technologies. Sleeper cabs are often used in line haul applications and drive the majority of

their miles on the highway travelling at speeds greater than 55 mph. The industry has focused aerodynamic technology development, including SmartWay tractors, on these types of trucks. Therefore the agencies are adopting the most aggressive aerodynamic technology application to this regulatory subcategory. All of the major manufacturers today offer at least one SmartWay truck model. The 2010 NAS Report on heavy-duty trucks found that manufacturers indicated that aerodynamic improvements which yield 3 to 4 percent fuel consumption reduction or 6 to 8 percent reduction in Cd values, beyond technologies used in today’s SmartWay trucks are achievable.<sup>226</sup> The aerodynamic application rate for Class 8 sleeper cab high roof cabs (*i.e.*, the degree of technology application on which the stringency of the final standard is premised) consists of 20 percent of Bin IV, 70 percent Bin III, and 10 percent Bin II reflecting our assessment of the fraction of tractors in this segment that can successfully apply these aerodynamic packages.

The 90 percent of tractors that we project can either be Bin II or Bin III equipped reflects the bulk of Class 8 high roof sleeper cab applications. We are not projecting a higher fraction of Bin III aerodynamic systems because of the limited lead time for the program and the need for these more advanced technologies to be developed and demonstrated before being applied across a wider fraction of the fleet. Aerodynamic improvements through new tractor designs and the

<sup>226</sup> See TIAx, Note 198, Page 4-40.



development of new aerodynamic components is an inherently slow and iterative process. Aerodynamic impacts are highly nonlinear and often reflect unexpected interactions between multiple components. Given the nature of aerodynamic improvements it is inherently difficult to estimate the degree to which improvements can be made beyond previously demonstrated levels. The changes required for Bins III and IV reflect the kinds of improvements projected in the Department of Energy's Supertruck program. That program assumes that such systems can be demonstrated on vehicles by 2017. In this case, the agencies are projecting that truck OEMs will be able to begin implementing these aerodynamic technologies prior to 2017 on a limited scale. Importantly, our averaging, banking and trading provisions provide manufacturers with the flexibility to implement these technologies over time even though the standard changes in a single step.

The final aerodynamic application for the other tractor regulatory categories is less aggressive than for the Class 8 sleeper cab high roof. The agencies recognize that there are truck applications which require on/off-road capability and other truck functions which restrict the type of aerodynamic equipment applicable. We also recognize that these types of trucks spend less time at highway speeds where aerodynamic technologies have the greatest benefit. The 2002 VIUS data ranks trucks by major use.<sup>227</sup> The heavy trucks usage indicates that up to 35 percent of the trucks may be used in on/off-road applications or heavier applications. The uses include construction (16 percent), agriculture (12 percent), waste management (5 percent), and mining (2 percent). Therefore, the agencies analyzed the technologies to evaluate the potential restrictions that would prevent 100 percent application of SmartWay technologies for all of the tractor regulatory subcategories.

As discussed in Section II.B.2.c, in response to comments received from manufacturers making some of these same points, the agencies are finalizing only two aerodynamic bins for low and mid roof tractors. The agencies are reducing the number of bins for these tractors from the proposal to reflect the actual range of aerodynamic technologies effective in low and mid roof tractor applications. The aerodynamic improvements to the bumper, hood, windshield, mirrors, and

doors are developed for the high roof tractor application and then carried over into the low and mid roof applications. As mentioned in Section II.B.2.c, the types of designs that would move high roof tractors from a Bin III to Bins IV and V include features such as gap reducers and integral roof fairings which would not be appropriate on low and mid roof tractors. Thus, the agencies are differentiating the aerodynamic performance for low- and mid-roof tractors into two bins—Bin I and Bin II. The application rates in the low and mid roof categories are the same as proposed, but aggregated into just two bins. Bin I for these tractors corresponds to the proposed "Classic" and "Conventional" bins and Bin II corresponds to the proposed "SmartWay," "Advanced SmartWay," and "Advanced SmartWay II" bins.

#### Low Rolling Resistance Tire Application Rate

At proposal, the agencies stated that at least one LRR tire model is available today that meets the rolling resistance requirements of the Level I and Level II tire packages so the 2014 MY should afford manufacturers sufficient lead time to install these packages. EPA and NHTSA conducted additional evaluation testing on HD tires used for tractors. The agencies also received several comments on the suitability of low rolling resistance tires for various HD truck applications. The summary of the agencies findings and a response to issues raised by commenters is presented in Section II.D(1)(a).

The agencies note that baseline rolling resistance level for tires installed on tractors is approximately equivalent to what the agencies consider to be low rolling resistance tires for vocational vehicles because of the tire manufacturer's focus on improving the rolling resistance of tractor tires. For the tire manufacturers to further reduce tire rolling resistance, the manufacturers must consider several performance criteria that affect tire selection. The characteristics of a tire also influence durability, traction control, vehicle handling, comfort, and retreadability. A single performance parameter can easily be enhanced, but an optimal balance of all the criteria will require improvements in materials and tread design at a higher cost, as estimated by the agencies. Tire design requires balancing performance, since changes in design may change different performance characteristics in opposing directions. Similar to the discussion regarding lesser aerodynamic technology application in tractor segments other than sleeper cab high

roof, the agencies believe that the final standards should not be premised on 100 percent application of Level II tires in all tractor segments given the interference with vehicle utility that would result. The agencies are basing their analyses on application rates that vary by subcategory recognizing that some subcategories require a different balancing of performance versus rolling resistance.

#### Weight Reduction Technology Application Rate

The agencies proposed setting the 2014 model year tractor standards using 100 percent application of a 400 pound weight reduction package. Volvo and ATA stated in their comments that not all fleets can use single wide tires and if this is the case the 400 pound weight reduction cannot be met. The agencies also received comments from MEMA, Navistar, American Chemistry Council, the Auto Policy Center, Iron and Steel Institute, Arvin Meritor, Aluminum Association, and environmental groups and NGOs identifying other potential weight reduction opportunities for tractors. As described in Section II.B.3.e above, the agencies are adopting an expanded list of weight reduction options which can be input into the GEM for the final rulemaking.

As also explained in that earlier discussion, the agencies, upon further analysis, continue to believe that a 400 pound weight reduction package is appropriate for tractors in the time frame. As stated in Section II.B.2.e above, for tractors where single wide tires are not appropriate, the manufacturers have additional options available to achieve weight reduction, such as body panels and chassis components as documented in the earlier discussion. The agencies have extended the list of weight reduction components in order to provide the manufacturers with additional means to comply with the combination tractors and to further encourage reductions in vehicle weight. The agencies considered increasing the target value beyond 400 pounds given the additional reduction potential components identified in the expanded list; however, lacking information on the capacity for the industry to change to these light weight components across the board by the 2014 model year, we have decided to maintain the 400 pound target. The agencies intend to continue to study the potential for additional weight reductions in our future work considering a second phase of truck fuel efficiency and GHG regulations.

<sup>227</sup> U.S. Department of Energy. *Transportation Energy Data Book*, Edition 28—2009. Table 5.7.

### Idle Reduction Technology Application Rate

Idle reduction technologies provide significant reductions in fuel consumption and CO<sub>2</sub> emissions for Class 8 sleeper cabs and are available on the market today, and therefore will be available in the 2014 model year. There are several different technologies available to reduce idling. These include APUs, diesel fired heaters, and battery powered units. Our discussions with manufacturers indicate that idle technologies are sometimes installed in the factory, but it is also a common practice to have the units installed after the sale of the truck. We would like to continue to incentivize this practice and to do so in a manner that the emission reductions associated with idle reduction technology occur in use. Therefore, as proposed, we are allowing only idle emission reduction technologies with include an automatic engine shutoff (AES). We are also adopting some override provisions in response to comments we received (as explained below). As proposed, we are adopting a 100 percent application rate for this technology for Class 8 sleeper cabs, even though the current fleet is estimated to have a 30 percent application rate. The agencies are unaware of reasons why AES with extended idle reduction technologies could not be applied to all tractors with a sleeper cab, except those deemed a vocational tractor, in the available lead time.

One commenter stated the application rate of AES should be less than 100 percent, but did not recommend an alternative application rate or provide justification for a change. The agencies re-evaluated the proposed 100 percent application rate and determined that a 100 percent application rate for this technology for Class 8 sleeper cabs remains appropriate. The agencies have also considered the many comments which raised concerns about the proposed mandatory 5 minute automatic engine shut down without override capability (in terms of safety, extreme temperatures and low battery conditions). To avoid unintended adverse impacts, we are adopting limited override provisions. Three of the five exceptions are similar to those currently in effect under a California Air Resources Board (CARB) regulation. CARB provides AES exceptions (or overrides) within its existing heavy-duty vehicle anti-idling laws, which were developed to address these same types of concerns. The exceptions we are adopting include override capability during exhaust emissions control device

regeneration, during engine servicing and maintenance, when battery state of charge is too low, in extreme ambient temperatures, when engine coolant temperature is too low, and during PTO operation. The RIA provides more detail about these final override provisions in Section 2.5.4.3.

The agencies received comment that we should extend the idle reduction benefits beyond Class 8 sleepers, including Class 7 tractors and vocational vehicles. The agencies reviewed literature to quantify the amount of idling which is conducted outside of hoteling operations. One study, conducted by Argonne National Laboratory, identified several different types of trucks which might idle for extended amounts of time during the work day.<sup>228</sup> Idling may occur during the delivery process, queuing at loading docks or border crossings, during power take off operations, or to provide comfort during the work day. However, the study provided only “rough estimates” of the idle time and energy use for these vehicles. The agencies are not able to appropriately develop a baseline of workday idling for the other types of vehicles and identify the percent of this idling which could be reduced through the use of AES. Absent such information, the agencies cannot justify adding substantial cost for AES systems with such uncertain benefits.

### Vehicle Speed Limiter Application Rate

Vehicle speed limiters may be used as a technology to meet the standard, but in setting the standard we assumed a zero percent application rate of vehicle speed limiters. Although we believe vehicle speed limiters are a simple, easy to implement, and inexpensive technology, we want to leave the use of vehicles speed limiters to the truck purchaser. Since truck fleets purchase trucks today with owner set vehicle speed limiters, we considered not including VSLs in our compliance model. However, we have concluded that we should allow the use of VSLs that cannot be overridden by the operator as a means of compliance for vehicle manufacturers that wish to offer it and truck purchasers that wish to purchase the technology. In doing so, we are providing another means of meeting that standard that can lower compliance cost and provide a more optimal vehicle solution for some truck fleets. For example, a local beverage distributor may operate trucks in a distribution network of primarily local

roads. Under those conditions, aerodynamic fairings used to reduce aerodynamic drag provide little benefit due to the low vehicle speed while adding additional mass to the vehicle. A vehicle manufacturer could choose to install a VSL set a 55 mph for this customer. The resulting truck modeled in GEM could meet our final emission standard without the use of any specialized aerodynamic fairings. The resulting truck would be optimized for its intended application and would be fully compliant with our program all at a lower cost to the ultimate truck purchaser.<sup>229</sup>

As discussed in Section II.B.2.g above, we have chosen not to base the standards on performance of VSLs because of concerns about how to set a realistic application rate that avoids unintended adverse impacts. Although we expect there will be some use of VSL, currently it is used when the fleet involved decides it is feasible and practicable and increases the overall efficiency of the freight system for that fleet operator. However, at this point the agencies are not in a position to determine in how many additional situations use of a VSL would result in similar benefits to overall efficiency. Therefore, the agencies are not premising the final standards on use of VSL, and instead will rely on the industry to select VSL when circumstances are appropriate for its use. The agencies have not included either the cost or benefit due to VSLs in analysis of the program’s costs and benefits. Implementation of this program may provide greater information for using this technology in standard setting in the future. Many stakeholders including the American Trucking Association have advocated for more widespread use of vehicle speed limits to address fuel efficiency and greenhouse gas emissions. The Center for Biological Diversity (CBD) argued the agencies should reflect the use of VSLs in setting the standard for tractors rather than assuming no VSL use in determining the appropriate standard. The agencies have chosen not to do so because, as explained, we are not able at this time to quantify to potential loss in utility due to the use of VSLs. Absent this information, we cannot make a determination regarding the reasonableness of setting a standard based on a particular VSL level. In

<sup>229</sup> Ibid.

The agencies note that because a VSL value can be input into GEM, its benefits can be directly assessed with the model and off cycle credit applications therefore are not necessary even though the standard is not based on performance of VSLs (*i.e.* VSL is an on-cycle technology).

<sup>228</sup> Gaines, L., A. Vyas, J. Anderson. Estimation of Fuel Use by Idling Commercial Trucks. January 2006.

confirmation, a number of commenters most notably the Owner Operator Independent Drivers Association (OOIDA) suggest that VSLs could significantly impact the ability of a vehicle to deliver goods against a fixed schedule and hence would significantly impact its utility. ATA commented that

limited flexibility must be built into speed limiters as not to interfere with NHTSA planned rulemaking in response to 2006 ATA petition and its 2008 Sustainability Plan. Similar comments were received from DTNA requesting that the agencies consider any NHTSA safety regulations that may

also be regulating VSLs. NHTSA plans to issue a rule in 2012 addressing the safety performance features of VSLs.

Table III-4 provides the final application rates of each technology broken down by weight class, cab configuration, and roof height.

TABLE III-4—FINAL TECHNOLOGY APPLICATION RATES FOR CLASS 7 AND 8 TRACTORS  
[In percent]

	Class 7		Class 8				
	Day cab		Day cab		Sleeper cab		
	Low/mid roof	High roof	Low/mid roof	High roof	Low roof	Mid roof	High roof
<b>Aerodynamics (Cd)</b>							
Bin I .....	40	0	40	0	30	30	0
Bin II .....	60	30	60	30	70	70	10
Bin III .....		60		60			70
Bin IV .....		10		10			20
Bin V .....		0		0			0
<b>Steer Tires (CRR kg/metric ton)</b>							
Baseline .....	40	30	40	30	30	30	10
Bin I .....	50	60	50	60	60	60	70
Bin II .....	10	10	10	10	10	10	20
<b>Drive Tires (CRR kg/metric ton)</b>							
Baseline .....	40	30	40	30	30	30	10
Bin I .....	50	60	50	60	60	60	70
Bin II .....	10	10	10	10	10	10	20
<b>Weight Reduction (lb)</b>							
400 lb. Weight Reduction .....	100	100	100	100	100	100	100
<b>Extended Idle Reduction (gram CO<sub>2</sub>/ton-mile reduction)</b>							
AES .....	N/A	N/A	N/A	N/A	100	100	100
<b>Vehicle Speed Limiter</b>							
VSL .....	0	0	0	0	0	0	0

(iv) Derivation of the Final Tractor Standards

The agencies used the technology inputs and final technology application rates in GEM to develop the final fuel consumption and CO<sub>2</sub> emissions standards for each subcategory of Class 7 and 8 combination tractors. The agencies derived a scenario tractor for each subcategory by weighting the individual GEM input parameters

included in Table III-3 with the application rates in Table III-4. For example, the Cd value for a Class 8 Sleeper Cab High Roof scenario case was derived as 10 percent times 0.68 plus 70 percent times 0.60 plus 20 percent times 0.55, which is equal to a Cd of 0.60. Similar calculations were done for tire rolling resistance, weight reduction, idle reduction, and vehicle speed limiters. To account for the two final engine standards, the agencies

assumed a compliant engine in GEM.<sup>230</sup> In other words, EPA is finalizing the use of a 2014 model year fuel consumption map in GEM to derive the 2014 model year tractor standard and a 2017 model year fuel consumption map to derive the 2017 model year tractor standard.<sup>231</sup> The agencies then ran GEM with a single set of vehicle inputs, as shown in Table III-5, to derive the final standards for each subcategory. Additional detail is provided in the RIA Chapter 2.

<sup>230</sup> See Section III.A.2.b below explaining the derivation of the engine standards.

<sup>231</sup> As explained further in Section V below, EPA would use these inputs in GEM even for engines electing to use the alternative engine standard.

TABLE III-5—GEM INPUTS FOR THE CLASS 7 AND 8 TRACTOR STANDARD SETTING

Class 7			Class 8					
Day cab			Day cab			Sleeper cab		
Low roof	Mid roof	High roof	Low roof	Mid roof	High roof	Low roof	Mid roof	High roof
<b>Aerodynamics (Cd)</b>								
0.73 .....	0.84	0.65	0.73	0.84	0.65	0.73	0.84	0.59
<b>Steer Tires (CRR kg/metric ton)</b>								
6.99 .....	6.99	6.87	6.99	6.99	6.87	6.87	6.87	6.54
<b>Drive Tires (CRR kg/metric ton)</b>								
7.38 .....	7.38	7.26	7.38	7.38	7.26	7.26	7.26	6.92
<b>Weight Reduction (lb)</b>								
400 .....	400	400	400	400	400	400	400	400
<b>Extended Idle Reduction (gram CO<sub>2</sub>/ton-mile reduction)</b>								
N/A .....	N/A	N/A	N/A	N/A	N/A	5	5	5
<b>Vehicle Speed Limiter</b>								
— .....								
<b>Engine</b>								
2014/17 MY 11L Engine ..	2014/17 MY 11L Engine	2014/17 MY 11L Engine	2014/17 MY 15L Engine	2014/17 MY 15L Engine	2014/17 MY 15L Engine	2014/17 MY 15L Engine	2014/17 MY 15L Engine	2014/17 MY 15L Engine

The level of the 2014 and 2017 model year final standards and percent reduction from the baseline for each subcategory are included in Table III-6.

TABLE III-6—FINAL 2014 AND 2017 MODEL YEAR TRACTOR REDUCTIONS

<b>2014 Model Year CO<sub>2</sub> Grams per Ton-Mile</b>			
	Day cab		Sleeper cab
	Class 7	Class 8	Class 8
Low Roof .....	107	81	68
Mid Roof .....	119	88	76
High Roof .....	124	92	75
<b>2014–2016 Model Year Gallons of Fuel per 1,000 Ton-Mile<sup>232</sup></b>			
	Day cab		Sleeper cab
	Class 7	Class 8	Class 8
Low Roof .....	10.5	8.0	6.7
Mid Roof .....	11.7	8.7	7.4
High Roof .....	12.2	9.0	7.3
<b>2017 Model Year CO<sub>2</sub> Grams per Ton-Mile</b>			
	Day cab		Sleeper cab
	Class 7	Class 8	Class 8
Low Roof .....	104	80	66
Mid Roof .....	115	86	73
High Roof .....	120	89	72
<b>2017 Model Year and Later Gallons of Fuel per 1,000 Ton-Mile</b>			

TABLE III-6—FINAL 2014 AND 2017 MODEL YEAR TRACTOR REDUCTIONS—Continued

	Day cab		Sleeper cab
	Class 7	Class 8	Class 8
	Low Roof .....	10.2	7.8
Mid Roof .....	11.3	8.4	7.2
High Roof .....	11.8	8.7	7.1

A summary of the final technology package costs is included in Table III-7 with additional details available in the RIA Chapter 2.

TABLE III-7—CLASS 7 AND 8 TRACTOR TECHNOLOGY COSTS INCLUSIVE OF INDIRECT COST MARKUPS IN THE 2014 MODEL YEAR<sup>a</sup> (2009\$)

	Class 7		Class 8				
	Day cab		Day cab		Sleeper cab		
	Low/mid roof	High roof	Low/mid roof	High roof	Low roof	Mid roof	High roof
Aerodynamics .....	\$675	\$924	\$675	\$924	\$962	\$983	\$1,627
Steer Tires .....	68	68	68	68	68	68	68
Drive Tires .....	63	63	126	126	126	126	126
Weight Reduction .....	1,536	1,536	1,980	1,980	3,275	3,275	1,980
Idle Reduction with Auxiliary Power Unit .....					3,819	3,819	3,819
Air Conditioning <sup>c</sup> .....	22	22	22	22	22	22	22
Total .....	2,364	2,612	2,871	3,119	8,271	8,291	7,641

**Notes:**

<sup>a</sup> Costs shown are for the 2014 model year so do not reflect learning impacts which would result in lower costs for later model years. For a description of the learning impacts considered in this analysis and how it impacts technology costs for other years, refer to Chapter 2 of the RIA (see RIA 2.2.2).

<sup>b</sup> Note that values in this table include penetration rates. Therefore, the technology costs shown reflect the average cost expected for each of the indicated classes. To see the actual estimated technology costs exclusive of penetration rates, refer to Chapter 2 of the RIA (see RIA 2.9 in particular).

<sup>c</sup> EPA's air conditioning standards are presented in Section II.E.5 above.

(v) Reasonableness of the Final Standards

The final standards are based on aggressive application rates for control technologies which the agencies regard as the maximum feasible for purposes of EISA section 32902 (k) and appropriate under CAA section 202 (a) for the reasons given in Section (iii) above; see also RIA Chapter 2.5.8.2. These technologies, at the estimated application rates, are available within the lead time provided, as discussed in RIA Chapter 2.5. Use of these technologies would add only a small amount to the cost of the vehicle, and the associated reductions are highly cost effective, an estimated \$20 per ton of CO<sub>2</sub>eq per vehicle in 2030 without consideration of the substantial fuel savings.<sup>233</sup> This is even more cost effective than the estimated cost effectiveness for CO<sub>2</sub>eq removal and fuel economy improvements under the light-duty vehicle rule, already considered by

the agencies to be a highly cost effective reduction.<sup>234</sup> Moreover, the cost of controls is rapidly recovered due to the associated fuel savings, as shown in the payback analysis included in Table VIII-11 located in Section VIII below. Thus, overall cost per ton of the program, considering fuel savings, is negative—fuel savings associated with the rules more than offset projected costs by a wide margin. See Table VIII-6 in Section VIII below. Given that the standards are technically feasible within the lead time afforded by the 2014 model year, are inexpensive and highly cost effective even without accounting for the fuel savings, and have no apparent adverse potential impacts (*e.g.*, there are no projected negative impacts on safety or vehicle utility), the final standards represent a reasonable choice under section 202(a) of the CAA and the maximum feasible under NHTSA's EISA authority at 49 U.S.C. 32902(k)(2).

(vi) Alternative Tractor Standards Considered

The agencies are not adopting tractor standards less stringent than the proposed standards because the agencies believe these standards are appropriate, highly cost effective, and technologically feasible within the rulemaking time frame.

The agencies considered adopting tractor standards which are more stringent than those proposed reflecting increased application rates of the technologies discussed. We also considered setting more stringent standards based on the inclusion of hybrid powertrains in tractors. We stopped short of finalizing more stringent standards based on higher application rates of improved aerodynamic controls and tire rolling resistance because we concluded that the technologies would not be compatible with the use profile of a subset of tractors which operate in off-

<sup>232</sup> Manufacturers may voluntarily opt-in to the NHTSA fuel consumption program in 2014 or 2015. If a manufacturer opts-in, the program becomes mandatory.

<sup>233</sup> See Section VIII.D below.

<sup>234</sup> The light-duty rule had an estimated cost per ton of \$50 when considering the vehicle program

costs only and a cost of –\$210 per ton considering the vehicle program costs along with fuel savings in 2030. See 75 FR 25515, Table III.H.3-1.

road conditions. We have not adopted more stringent standards for tractors based on the use of hybrid vehicle technologies, believing that additional development and therefore lead-time is needed to develop hybrid systems and battery technology for tractors that operate primarily in highway cruise operations. We know, for example, that hybrid systems are being researched to capture and return energy for tractors that operate in gently rolling hills. However, as discussed above, it is not clear to us today that these systems will be generally applicable to tractors in the time frame of this regulation. In addition, even if hybrid technologies were generally available for these tractors during the MY 2014–2017 period, their costs would be extremely high and benefits would be limited given that idle reduction controls already capture many of the same

emissions. According to the 2010 NAS Report, hybrid powertrains in tractors have the potential to improve fuel consumption by 10 percent, but it displaces the 6 percent reduction for idle reduction technologies, for a net improvement of 4 percent at a cost of \$25,000 per vehicle.<sup>235</sup>

(b) Tractor Engines

(i) Baseline Engine Performance

As noted above, EPA and NHTSA developed the baseline medium- and heavy heavy-duty diesel engine to represent a 2010 model year engine compliant with the 0.20 g/bhp-hr NO<sub>x</sub> standard for on-highway heavy-duty engines.

The agencies developed baseline SET values for medium- and heavy heavy-duty diesel engines based on 2009 model year confidential manufacturer data and from testing conducted by

EPA. The agencies adjusted the pre-2010 data to represent 2010 model year engine maps by using predefined technologies including SCR and other systems that are being used in current 2010 model year production. If an engine utilized did not meet the 0.20 g/bhp-hr NO<sub>x</sub> level, then the individual engine's CO<sub>2</sub> result was adjusted to accommodate aftertreatment strategies that would result in a 0.20 g/bhp-hr NO<sub>x</sub> emission level as described in RIA Chapter 2.4.2.1. The engine CO<sub>2</sub> results were then sales weighted within each regulatory subcategory (*i.e.*, medium heavy-duty diesel or heavy heavy-duty diesel) to develop an industry average 2010 model year reference engine. Although, most of the engines fell within a few percent of this baseline at least one engine was more than six percent above this average baseline.

TABLE III–8—2010 MODEL YEAR BASELINE DIESEL ENGINE PERFORMANCE

	CO <sub>2</sub> Emissions (g/bhp-hr)	Fuel consumption (gallon/100 bhp-hr)
Medium Heavy-Duty Diesel—SET .....	518	5.09
Heavy Heavy-Duty Diesel—SET .....	490	4.81

(ii) Engine Technology Package Effectiveness

The MHD and HHD diesel engine technology package for the 2014 model year includes engine friction reduction, improved aftertreatment effectiveness, improved combustion processes, and low temperature EGR system optimization. The agencies considered improvements in parasitic and friction losses through piston designs to reduce friction, improved lubrication, and improved water pump and oil pump designs to reduce parasitic losses. The aftertreatment improvements are available through lower backpressure of the systems and optimization of the engine-out NO<sub>x</sub> levels. Improvements to the EGR system and air flow through the intake and exhaust systems, along with turbochargers can also produce engine efficiency improvements. We note that individual technology improvements are not additive due to the interaction of technologies. The agencies assessed the impact of each technology over each of the 13 SET modes to project an overall weighted SET cycle improvement in the 2014 model year of 3 percent, as detailed in RIA Chapter 2.4.2.9 through 2.4.2.14. All of these technologies represent engine

enhancements already developed beyond the research phase and are available as “off the shelf” technologies for manufacturers to add to their engines during the engine's next design cycle. We have estimated that manufacturers will be able to implement these technologies on or before the 2014 engine model year. The agencies adopted a standard that therefore reflects a 100 percent application rate of this technology package. The agencies gave consideration to finalizing a more stringent standard based on the application of mechanical turbocompounding by model year 2014, a mechanical means of waste heat recovery, but concluded that manufacturers would have insufficient lead-time to complete the necessary product development and validation work necessary to include this technology. Implementing turbocompounding into an engine design must be done through a significant redesign of the engine architecture a process that typically takes 4 to 5 years. Hence, we believe that turbocompounding is a more appropriate technology for the agencies to consider in the 2017 timeframe.

As explained earlier, EPA's heavy-duty highway engine standards for criteria pollutants apply in three year increments. The heavy-duty engine manufacturer product plans have fallen into three year cycles to reflect these requirements. The agencies are finalizing fuel consumption and CO<sub>2</sub> emission standards recognizing the opportunity for technology improvements over this time frame (specifically, the addition of turbocompounding to the engine technology package) while reflecting the typical heavy-duty engine manufacturer product plan redesign and refresh cycles. Thus, the agencies are finalizing a more stringent standard for heavy-duty engines beginning in the 2017 model year.

The MHDD and HHDD engine technology package for the 2017 model year includes the continued development of the 2014 model year technology package including refinement of the aftertreatment system plus turbocompounding. The agencies calculated overall reductions in the same manner as for the 2014 model year package. The weighted SET cycle improvements lead to a 6 percent reduction on the SET cycle, as detailed

<sup>235</sup> See 2010 NAS Report, Note 197, Page 146.

in RIA Chapter 2.4.2.12. The agencies' final standards are premised on a 100 percent application rate of this technology package.

Commenters noted that the National Academy of Sciences (NAS) study indicates that additional technology improvements can be made to heavy-duty engines in MY 2014 and 2017. For diesel engine standards, the agencies evaluated the following technologies: Combustion system optimization, turbocharging and air handling systems, engine parasitic and friction reduction, integrated aftertreatment systems, electrification, and waste heat recovery.

The agencies carefully evaluated the research supporting the NAS report and its recommendations and incorporated them to the extent practicable in the development of the HD program. While the NAS report suggests that greater engine improvements could be achieved by the use of technologies such as improved emission control systems and turbocompounding than do the agencies in this final action, we believe the standards being finalized represent the most stringent technically feasible for diesel engines used in tractors and vocational vehicles in the 2014 to 2017 model year time frame. The NAS study concluded that tractor engine fuel consumption can be reduced by approximately 15 percent in the 2015 to 2020 time frame and vocational engine fuel consumption can be reduced by approximately 10 to 17 percent in the same time frame compared to a 2008 engine baseline.<sup>236</sup> Throughout this presentation, the agencies' projections of performance improvements are measured relative to a 2010 engine performance baseline that itself reflects a four to five percent improvement over the 2008 engine baseline used by NAS. Based on a review of existing studies, NAS study authors found a range of reduction potential exists for improvements in combustion efficiency, electrification of accessories; improved emission control systems; and turbocompounding. The study found that improvements in combustion efficiency can provide reductions of 1 percent to 4 percent; electrification of accessories can provide reductions of 2 percent to 5 percent in a hybridized vehicle; improved emission control systems can provide a 1 percent to 4 percent improvement (depending on whether the improvement is to the EGR or SCR system); and a 2.5 percent to 10 percent reduction is possible with

mechanical or electrical turbocompounding. While the reductions being finalized in this regulation are lower than those published in the NAS study, the agencies believe that the percent reductions being finalized in these rules are consistent with the findings of the NAS study. The reasons for this are as follows.

First, some technologies cannot be used by all manufacturers. For example, improved SCR conversion efficiency was projected by NAS to provide a 3 percent to 4 percent improvement in fuel consumption. Conversely, low temperature EGR was found to provide only a one percent improvement. While the majority of manufacturers do use SCR systems and will be able to realize the 3 percent to 4 percent improvement, not all manufacturers use SCR for NO<sub>x</sub> aftertreatment. Manufacturers that do not use SCR aftertreatment systems would only be able to realize the 1 percent improvement from low temperature EGR. The agencies need to take into consideration the entire market in setting the stringency of the standards and, in assessing feasibility and cost, cannot assume that all manufacturers will be able to use all technologies.

Second, significant technical advances may be needed in order to realize the upper end of estimates for some technologies. For example, studies evaluated by NAS on turbocompounding found that a 2.5 percent to 10 percent reduction is feasible. However, only one system is available commercially and this system provides reductions on the low end of this range.<sup>237</sup> Little technical information is available on the systems that achieve reductions in the upper range for turbocompounding. These systems are based on proprietary designs the improvement results for which have not yet been replicated by other companies or organizations. The agencies are assuming that all tractor engine manufacturers will use turbocompounding by 2017 model year. This will require a significant change in the design of heavy-duty tractor engines, one that represents the maximum technically feasible standard even at the low end of the assumed improvement spectrum.

Finally, different duty cycles used in the evaluation of medium- and heavy-duty engine technologies can affect reported fuel consumption improvements. For example, some technologies are dependent on high load

conditions to provide the greatest reductions. The duty cycles used to evaluate some of the technologies considered by NAS differed significantly from that used by the agencies in the modeling for this rulemaking. Maximum and average speed was higher in some of the cycles used in the studies, for example, and one result was demonstrated on a nonroad engine cycle. In another example, the effectiveness of turbocompounding when evaluated on a duty cycle with higher engine load can show a greater reduction potential than when evaluated with a lower engine load. In addition, technologies such as improvements to cooling fans, air compressors, and air conditioning systems will not be demonstrated using the engine dynamometer test procedures being adopted in this final action because those components are not installed on the engine during the testing. The agencies selected the duty cycles for analysis, and for the final standards, that we believed best suited tractor engines.

The agencies selected engine technologies and the estimated fuel reduction percentages for setting the standards. For the reasons stated above, the agencies believe the technologies and required improvements in fuel consumption represent the maximum feasible improvement, and are appropriate, cost-effective, and technologically feasible.

We gave consideration to finalizing an even more stringent standard based on the use of waste heat recovery via a Rankine cycle (also called bottoming cycle) but concluded that there is insufficient lead-time between now and 2017 for this promising technology to be developed and applied generally to all heavy-duty engines. TIAX noted in their report to the NAS committee that the engine improvements beyond 2015 model year included in their report are highly uncertain, though they include Rankine cycle type waste heat recovery as applicable sometime between 2016 and 2020.<sup>238</sup> The Department of Energy is working with industry to develop waste heat recovery systems for heavy-duty engines. At the Diesel Engine-Efficiency and Emissions Research (DEER) conference in 2010, Caterpillar presented details regarding their waste heat recovery systems development effort. In their presentation, Caterpillar clearly noted that the work is a research project and therefore does not imply

<sup>236</sup> National Research Council, "Technologies and Approaches to Reducing the Fuel Consumption of Medium- and Heavy-Duty Vehicles" Figure S-1, page 4, National Academies Press, 2011.

<sup>237</sup> NAS 2010, page 53 cites Detroit Diesel Corporation, DD15 Brochure, DDC-EMC-BRO-0003-0408, April 2008.

<sup>238</sup> See TIAX, Note 198, Page 4-29.



commercial viability.<sup>239</sup> At the same conference, Concepts NREC presented a status of exhaust energy recovery in heavy-duty engines. The scope of Concepts NREC included the design and development of prototype parts.<sup>240</sup> Cummins, also in coordination with DOE, is also active in developing exhaust energy recovery systems. Cummins made a presentation to the DEER conference in 2009 providing an update on their progress which highlighted opportunities to achieve a 10 percent engine efficiency improvement during their research, but indicated the need to focus their future development on areas with the highest recovery opportunities (such as EGR, exhaust, and charge air).<sup>241</sup> Cummins also indicated that future development

would focus on reducing the high additional costs and system complexity. Based upon the assessment of this information, the agencies did not include these technologies in determining the stringency of the final standards. However, we do believe the bottoming cycle approach represents a significant opportunity to reduce fuel consumption and GHG emissions in the future. EPA and NHTSA are therefore both finalizing provisions for advanced technology credits described in Section IV to create incentives for manufacturers to continue to invest to develop this technology.

(iii) Derivation of Engine Standards

EPA developed the final 2014 model year CO<sub>2</sub> emissions standards (based on

the SET cycle) for diesel engines by applying the three percent reduction from the technology package (just explained above) to the 2010 model year baseline values determined using the SET cycle. EPA developed the 2017 model year CO<sub>2</sub> emissions standards for diesel engines while NHTSA similarly developed the 2017 model year diesel engine fuel consumption standards by applying the 6 percent reduction from the 2017 model year technology package (reflecting performance of turbocompounding plus the 2014 MY technology package) to the 2010 model year baseline values. The final standards are included in Table III–9.

TABLE III–9—FINAL DIESEL ENGINE STANDARDS OVER THE SET CYCLE

Model year		MHD diesel engine	HHD diesel engine
2014–2016	CO <sub>2</sub> Standard (g/bhp-hr)	502	475
	Voluntary Fuel Consumption Standard (gallon/100 bhp-hr)	4.93	4.67
2017 and later	CO <sub>2</sub> Standard (g/bhp-hr)	487	460
	Fuel Consumption (gallon/100 bhp-hr)	4.78	4.52

(iv) Engine Technology Package Costs

EPA has historically used two different approaches to estimate the indirect costs (sometimes called fixed costs) of regulations including costs for product development, machine tooling, new capital investments and other general forms of overhead that do not change with incremental changes in manufacturing volumes. Where the Agency could reasonably make a specific estimate of individual components of these indirect costs, EPA has done so. Where EPA could not readily make such an estimate, EPA has instead relied on the use of markup factors referred to as indirect cost multipliers (ICMs) to estimate these indirect costs as a ratio of direct manufacturing costs. In general, EPA has used whichever approach it believed could provide the most accurate assessment of cost on a case-by-case basis. The agencies’ general approach used elsewhere in this action (for HD pickup trucks, gasoline engines, combination tractors, and vocational vehicles) estimates indirect costs based on the use of ICMs. See also 75 FR 25376. We have used this approach

generally because these standards are based on installing new parts and systems purchased from a supplier. In such a case, the supplier is conducting the bulk of the research and development on the new parts and systems and including those costs in the purchase price paid by the original equipment manufacturer. In this situation, we believe that the ICM approach provides an accurate and clear estimate of the additional indirect costs borne by the manufacturer.

For the heavy-duty diesel engine segment, however, the agencies do not consider this model to be the most appropriate because the primary cost is not expected to be the purchase of parts or systems from suppliers or even the production of the parts and systems, but rather the development of the new technology by the original equipment manufacturer itself. Most of the technologies the agencies are projecting the heavy-duty engine manufacturers will use for compliance reflect modifications to existing engine systems rather than wholesale addition of technology (e.g., improved turbochargers rather than adding a

turbocharger where it did not exist before as was done in our light-duty joint rulemaking in the case of turbo-downsizing). When the bulk of the costs come from refining an existing technology rather than a wholesale addition of technology, a specific estimate of indirect costs may be more appropriate. For example, combustion optimization may significantly reduce emissions and cost a manufacturer millions of dollars to develop but will lead to an engine that is no more expensive to produce. Using a bill of materials approach would suggest that the cost of the emissions control was zero reflecting no new hardware and ignoring the millions of dollars spent to develop the improved combustion system. Details of the cost analysis are included in the RIA Chapter 2. The agencies did not receive any comments regarding the cost approach used in the proposal.

The agencies developed the engineering costs for the research and development of diesel engines with lower fuel consumption and CO<sub>2</sub> emissions. The aggregate costs for engineering hours, technician support,

<sup>239</sup> Kruiswyk, R. “An Engine System Approach to Exhaust Waste Heat Recovery.” Presented at DOE DEER Conference on September 29, 2010. Last viewed on May 11, 2011 at [http://www1.eere.energy.gov/vehiclesandfuels/pdfs/deer\\_2010/wednesday/presentations/deer10\\_kruiswyk.pdf](http://www1.eere.energy.gov/vehiclesandfuels/pdfs/deer_2010/wednesday/presentations/deer10_kruiswyk.pdf).

<sup>240</sup> Cooper, D, N. Baines, N. Sharp. “Organic Rankine Cycle Turbine for Exhaust Energy Recovery in a Heavy Truck Engine.” Presented at the 2010 DEER Conference. Last viewed on May 11, 2011 at [http://www1.eere.energy.gov/vehiclesandfuels/pdfs/deer\\_2010/wednesday/presentations/deer10\\_baines.pdf](http://www1.eere.energy.gov/vehiclesandfuels/pdfs/deer_2010/wednesday/presentations/deer10_baines.pdf).

<sup>241</sup> Nelson, C. “Exhaust Energy Recovery.” Presented at the DOE DEER Conference on August 5, 2009. Last viewed on May 11, 2011 at [http://www1.eere.energy.gov/vehiclesandfuels/pdfs/deer\\_2009/session5/deer09\\_nelson\\_1.pdf](http://www1.eere.energy.gov/vehiclesandfuels/pdfs/deer_2009/session5/deer09_nelson_1.pdf).

dynamometer cell time, and fabrication of prototype parts are estimated at \$6.8 million (2009 dollars) per manufacturer per year over the five years covering 2012 through 2016. In aggregate, this averages out to \$284 per engine during 2012 through 2016 using an annual sales volume of 600,000 light-, medium- and heavy-HD engines. The agencies received comments from Horriba regarding the assumption the agencies used in the proposal that said manufacturers would need to purchase new equipment for measuring N<sub>2</sub>O and the associated costs. Horriba provided information regarding the cost of stand-alone FTIR instrumentation (estimated at \$50,000 per unit) and cost of

upgrading existing emission measurement systems with NDIR analyzers (estimated at \$25,000 per unit). The agencies further analyzed our assumptions along with Horriba's comments. Thus, we have revised the equipment costs estimates and assumed that 75 percent of manufacturers would update existing equipment while the other 25 percent would require new equipment. The agencies are estimating costs of \$63,087 (2009 dollars) per engine manufacturer per engine subcategory (light-, medium- and heavy-HD) to cover the cost of purchasing photo-acoustic measurement equipment for two engine test cells. This would be a one-time cost incurred in the year

prior to implementation of the standard (*i.e.*, the cost would be incurred in 2013). In aggregate, this averages out to less than \$1 per engine in 2013 using an annual sales volume of 600,000 light-, medium- and heavy-HD engines.

Where we projected that additional new hardware was needed to meet the final standards, we developed the incremental costs for those technologies and marked them up using the ICM approach. Table III-10 below summarizes those estimates of cost on a per item basis. All costs shown in Table III-18, below, include a low complexity ICM of 1.15 and flat-portion of the curve learning is considered applicable to each technology.

TABLE III-10—HEAVY-DUTY DIESEL ENGINE COMPONENT COSTS FOR COMBINATION TRACTORS<sup>a</sup> (2009\$)

Technology	2014	2017
Cylinder Head .....	\$6	\$6
Turbo efficiency .....	18	17
EGR cooler .....	4	3
Water pump .....	91	84
Oil pump .....	5	4
Fuel pump .....	5	4
Fuel rail .....	10	9
Fuel injector .....	11	10
Piston .....	3	3
Engine Friction Reduction of Valvetrain .....	82	76
Turbo-compounding (engines placed in combination tractors only) .....	0	875
MHHD and HHDD Total (combination tractors) .....	234	1,091

**Note:**

<sup>a</sup> Costs for aftertreatment improvements for MH and HH diesel engines are covered via the engineering costs (see text). For LH diesel engines, we have included the cost of aftertreatment improvements as a technology cost.

The overall diesel engine technology package cost for an engine being placed in a combination tractor is \$234 in the 2014 model year and \$1,091 in the 2017 model year.

(v) Reasonableness of the Final Standards

The final engine standards appear to be reasonable and consistent with the agencies' respective statutory authorities. With respect to the 2014 and 2017 MY standards, all of the technologies on which the standards are predicated have already been demonstrated in some capacity and their effectiveness is well documented. The final standards reflect a 100 percent application rate for these technologies. The costs of adding these technologies remain modest across the various engine classes as shown in Table III-10. Use of these technologies would add only a small amount to the cost of the vehicle,<sup>242</sup> and the associated

reductions are highly cost effective, an estimated \$20 per ton of CO<sub>2</sub>eq per vehicle.<sup>243</sup> This is even more cost effective than the estimated cost effectiveness for CO<sub>2</sub>eq removal under the light-duty vehicle rule, already considered by the agencies to be a highly cost effective reduction.<sup>244</sup> Even the more expensive 2017 MY final standard still represents only a small fraction of the vehicle's total cost and is even more cost effective than the light-duty vehicle rule. Moreover, costs are more than offset by fuel savings. Accordingly, EPA and NHTSA view these standards as reflecting an appropriate balance of the various statutory factors under section 202(a) of the CAA and under NHTSA's EISA authority at 49 U.S.C. 32902(k)(2).

(vi) Temporary Alternative Standard for Certain Engine Families

As discussed above in Section II.B(2)(b), notwithstanding the general reasonableness of the final standards, the agencies recognize that heavy-duty engines have never been subject to GHG or fuel consumption (or fuel economy) standards and that such control has not necessarily been an independent priority for manufacturers. The result is that there are a group of legacy engines with emissions higher than the industry baseline for which compliance with the final 2014 MY standards may be more challenging and for which there may simply be inadequate lead time. The issue is not whether these engines' GHG and fuel consumption performance cannot be improved by utilizing the technology packages on which the final standards are based. Those technologies can be utilized by all diesel engines installed in tractors and the same degree of reductions obtained. Rather the underlying base engine components of these engines reflect designs that are decades old and therefore have base performance levels below what is typical for the industry as a whole

<sup>242</sup> Sample 2010 MY day cabs are priced at \$89,000 while 2010 MY sleeper cabs are priced at \$113,000. See page 3 of ICF's "Investigation of Costs for Strategies to Reduce Greenhouse Gas Emissions for Heavy-Duty On-Road Vehicles." July 2010.

<sup>243</sup> See Tractor CO<sub>2</sub> savings and technology costs in Table 7-5 in RIA chapter 7.

<sup>244</sup> The light-duty rule had an estimated cost per ton of \$50 when considering the vehicle program costs only and a cost of -\$210 per ton considering the vehicle program costs along with fuel savings in 2030. See 75 FR 25515, Table III.H.3-1.

today. Manufacturers have been gradually replacing these legacy products with new engines. Engine manufacturers have indicated to the agencies they will have to align their planned replacement of these products with our final standards and at the same time add additional technologies beyond those identified by the agencies as the basis for the final standard. Because these changes will reflect a larger degree of overall engine redesign, manufacturers may not be able to complete this work for all of their legacy products prior to model year 2014. To pull ahead these already planned engine replacements would be impossible as a practical matter given the engineering structure and lead-times inherent in the companies' existing product development processes. We have also concluded that the use of fleet averaging would not address the issue of legacy engines because each manufacturer typically produces only a limited line of MHDD and HHDD engines. Because there are ample fleetwide averaging opportunities for heavy-duty pickups and vans, the agencies do not perceive similar difficulties for these vehicles.

Facing a similar issue in the light-duty vehicle rule, EPA adopted a Temporary Lead Time Allowance provision whereby a limited number of vehicles of a subset of manufacturers would meet an alternative standard in the early years of the program, affording them sufficient lead time to meet the more stringent standards applicable in later model years. See 75 FR 25414–25418. The agencies are finalizing a similar approach here. As explained above in Section II.B.(2)(b), the agencies are finalizing a regulatory alternative whereby a manufacturer, for a limited period, would have the option to comply with a unique standard requiring the same level of reduction of emissions (*i.e.*, percent removal) and fuel consumption as otherwise required, but the reduction would be measured from its own 2011 model year baseline. We are thus finalizing an optional standard whereby manufacturers would elect to have designated engine families meet a standard of 3 percent reduction from their 2011 baseline emission and fuel consumption levels for that engine family or engine subcategory. Our assessment is that this three percent reduction is appropriate based on use of similar technology packages at similar cost as we have estimated for the primary program. In the NPRM, we solicited comment on extending this alternative (See 75 FR at 74202). As explained earlier, we have decided not to allow the alternative standard to

continue past the 2016 MY. By this time, the engines should have gone through a redesign cycle which will allow manufacturers to replace those legacy engines which resulted in abnormally high baseline emission and fuel consumption levels and to achieve the MY 2017 standards which would be feasible using the technology package set out above (optimized NO<sub>x</sub> aftertreatment, improved EGR, reductions in parasitic losses, and turbocharging). Manufacturers would, of course, be free to adopt other technology paths which meet the final MY 2017 standards.

Since the alternative standard is premised on the need for additional lead time, manufacturers would first have to utilize all available flexibilities which could otherwise provide that lead time. Thus, as proposed, the alternative would not be available unless and until a manufacturer had exhausted all available credits and credit opportunities, and engines under the alternative standard could not generate credits. See also 75 FR 25417–25419 (similar approach for vehicles which are part of Temporary Lead Time Allowance under the light-duty vehicle rule). We are finalizing that manufacturers can select engine families for this alternative standard without agency approval, but are requiring that manufacturers notify the agency of their choice and also requiring manufacturers to include in that notification a demonstration that it has exhausted all available credits and credit opportunities. Manufacturers would also have to demonstrate their 2011 baseline calculations as part of the certification process for each engine family for which the manufacturer elects to use the alternative standard. See Section V.C.1(b)(i) below.

(vii) *ther Engine Standards Considered*

The agencies are not finalizing engine standards less stringent than the final standards because the agencies believe these final standards are appropriate, highly cost effective, and technologically feasible, as just described.

The agencies considered finalizing engine standards which are more stringent. Since the final standards reflect 100 percent utilization of the various technology packages, some additional technology would have to be added. The agencies are finalizing 2017 model year standards based on the use of turbocompounding. As discussed above in Section III.A.2.b.iii, the agencies considered the inclusion of more advanced heat recovery systems, such as Rankine or bottoming cycles,

which would provide further reductions. However, the agencies are not finalizing this level of stringency because our assessment is that these technologies would not be available for production by the 2017 model year.

*B. Heavy-Duty Pickup Trucks and Vans*

This section describes the process the agencies used to develop the standards the agencies are finalizing for HD pickups and vans. We started by gathering available information about the fuel consumption and CO<sub>2</sub> emissions from recent model year vehicles. The core portion of this information comes primarily from EPA's certification databases, CFEIS and Verify, which contain the publicly available data<sup>245</sup> regarding emission and fuel economy results. This information is not extensive because manufacturers have not been required to chassis test HD diesel vehicles for EPA's criteria pollutant emissions standards, nor have they been required to conduct any testing of heavy-duty vehicles on the highway cycle. Nevertheless, enough certification activity has occurred for diesels under EPA's optional chassis-based program, and, due to a California NO<sub>x</sub> requirement for the highway test cycle, enough test results have been voluntarily reported for both diesel and gasoline vehicles using the highway test cycle, to yield a reasonably robust data set. To supplement this data set, for purposes of this rulemaking EPA initiated its own testing program using in-use vehicles. This program and the results from it thus far are described in a memorandum to the docket for this rulemaking.<sup>246</sup>

Heavy-duty pickup trucks and vans are sold in a variety of configurations to meet market demands. Among the differences in these configurations that affect CO<sub>2</sub> emissions and fuel consumption are curb weight, GVWR, axle ratio, and drive wheels (two-wheel drive or four-wheel drive). Because the currently-available test data set does not capture all of these configurations, it is necessary to extend that data set across the product mix using adjustment factors. In this way a test result from, say a truck with two-wheel drive, 3.73:1 axle ratio, and 8000 lb test weight, can be used to model emissions and fuel consumption from a truck of the same basic body design, but with four-wheel drive, a 4.10:1 axle ratio, and 8,500 lb test weight. The adjustment factors are

<sup>245</sup> <http://www.epa.gov/otaq/certdata.htm>.

<sup>246</sup> Memorandum from Cleophas Jackson, U.S.EPA, to docket EPA-HQ-OAR-2010-0162, "Heavy-Duty Greenhouse Gas and Fuel Consumption Test Program Summary", September 20, 2010.

based on data from testing in which only the parameters of interest are varied. These parameterized adjustments and their basis are also described in a memorandum to the docket for this rulemaking.<sup>247</sup>

The agencies requested and received from each of the three major manufacturers confidential information for each model and configuration, indicating the values of each of these key parameters as well as the annual production (for the U.S. market). Production figures are useful because, under our final standards for HD pickups and vans, compliance is judged on the basis of production-weighted (corporate average) emissions or fuel consumption level, not individual vehicle levels. For consistency and to avoid confounding the analysis with data from unusual market conditions in 2009, the production and vehicle specification data is from the 2008 model year. We made the simplifying assumption that these sales figures reasonably approximate future sales for purposes of this analysis.

One additional assessment was needed to make the data set useful as a baseline for the standards selection. Because the appropriate standards are determined by applying efficiency-improving technologies to the baseline fleet, it is necessary to know the level of penetration of these technologies in the latest model year (2010). This information was also provided confidentially by the manufacturers. Generally, the agencies found that the HD pickup and van fleet was at a roughly consistent level of technology application, with (1) the transition from 4-speed to 5- or 6-speed automatic transmissions mostly accomplished, (2) coupled cam phasing to achieve variable valve control on gasoline engines likewise mostly in place,<sup>248</sup> and (3) substantial remaining potential for optimizing catalytic diesel NO<sub>x</sub> aftertreatment to improve fuel economy (the new heavy-duty NO<sub>x</sub> standards having taken effect in the 2010 model year).

Taking this 2010 baseline fleet, and applying the technologies determined to be feasible and appropriate by the 2018 model year, along with their effectiveness levels, the agencies could then make a determination of appropriate final standards. The assessment of feasibility, described

immediately below, takes into account the projected costs of these technologies. The derivation of these costs, largely based on analyses developed in the light-duty GHG and fuel economy rulemaking, are described in Section III.B(3).

Our assessment concluded that the technologies that the agencies considered feasible and appropriate for HD pickups and vans could be consistently applied to essentially all vehicles across this sector by the 2018 model year. Therefore we did not apply varying penetration rates across vehicle types and models in developing and evaluating the final standards.

Since the manufacturers of HD pickups and vans generally only have one basic pickup truck and van with different versions (*i.e.*, different wheel bases, cab sizes, two-wheel drive, four-wheel drive, *etc.*) and do not have the flexibility of the light-duty fleet to coordinate model improvements over several years, changes to the HD pickups and vans to meet new standards must be carefully planned with the redesign cycle taken into account. The opportunities for large-scale changes (*e.g.*, new engines, transmission, vehicle body and mass) thus occur less frequently than in the light-duty fleet, typically at spans of 8 or more years. However, opportunities for gradual improvements not necessarily linked to large scale changes can occur between the redesign cycles. Examples of such improvements are upgrades to an existing vehicle model's engine, transmission and aftertreatment systems. Given this long redesign cycle and our understanding with respect to where the different manufacturers are in that cycle, the agencies have initially determined that the full implementation of the final standards would be feasible and appropriate by the 2018 model year.

Although we did not determine a technological need for less than full implementation of any technology, we did decide that a phased implementation schedule would be appropriate to accommodate manufacturers' redesign workload and product schedules, especially in light of this sector's relatively low sales volumes and long product cycles. We did not determine a specific cost of implementing the final standards immediately in 2014 without a phase-in, but we assessed it to be much higher than the cost of the phase-in we are finalizing, due to the workload and product cycle disruptions it would cause, and also due to manufacturers' resulting need to develop some of these technologies for heavy-duty applications sooner than or

simultaneously with light-duty development efforts. See generally 75 FR 25467–25468 explaining why attempting major changes outside the redesign cycle period raises very significant issues of both feasibility and cost. On the other hand, waiting until 2018 before applying any new standards could miss the opportunity to achieve meaningful and cost-effective early reductions not requiring a major product redesign.

The final phase-in schedule, 15–20–40–60–100 percent in 2014–2015–2016–2017–2018, respectively, was chosen to strike a balance between meaningful reductions in the early years (reflecting the technologies' penetration rates of 15 and 20 percent) and providing manufacturers with needed lead time via a gradually accelerating ramp-up of technology penetration.<sup>249</sup> By expressing the final phase-in in terms of increasing fleetwide stringency for each manufacturer, while also providing for credit generation and use (including averaging, carry-forward, and carry-back), we believe our program affords manufacturers substantial flexibility to satisfy the phase-in through a variety of pathways, among them, the gradual application of technologies across the fleet (averaging a fifth of total production in each year), greater application levels on only a portion of the fleet, or a mix of the two.

We considered setting more stringent standards that would require the application of additional technologies by 2018. We expect, in fact, that some of these technologies may well prove feasible and cost-effective in this time frame, and may even become technologies of choice for individual manufacturers. This dynamic has played out in EPA programs before and highlights the value of setting performance-based standards that leave engineers the freedom to find the most cost-effective solutions.

However, the agencies do believe that at this stage there is not enough information to conclude that the additional technologies provide an appropriate basis for standard-setting. For example, we believe that 42V stop-start systems can be applied to gasoline vehicles with significant GHG and fuel consumption benefits, but we recognize that there is uncertainty at this time over the cost-effectiveness of these systems in heavy-duty applications, and legitimate concern with customer

<sup>247</sup> Memorandum from Anthony Neam and Jeff Cherry, U.S.EPA, to docket EPA-HQ-OAR-2010-0162, October 18, 2010.

<sup>248</sup> See Section III.B(2)(a) for our response to comments arguing for inclusion of this technology in the list of technologies needed to meet the standards.

<sup>249</sup> The NHTSA program provides voluntary standards for model years 2014 and 2015. NHTSA and EPA are also providing an alternative standards phase-in that meets EISA's requirement for three years of regulatory stability. See Section II.C.d.ii for a more detailed discussion.

acceptance of vehicles with high GCWR towing large loads that would routinely stop running at idle. Hybrid electric technology likewise could be applied to heavy-duty vehicles, and in fact has already been so applied on a limited basis. However, the development, design, and tooling effort needed to apply this technology to a vehicle model is quite large, and seems less likely to prove cost-effective in this time frame, due to the small sales volumes relative to the light-duty sector. Here again, potential customer acceptance would need to be better understood because the smaller engines that facilitate much of a hybrid's benefit are typically at odds with the importance pickup trucks buyers place on engine horsepower and torque, whatever the vehicle's real performance.

We also considered setting less stringent standards calling for a more limited set of applied technologies. However, our assessment concluded with a high degree of confidence that the technologies on which the final standards are premised are clearly available at reasonable cost in the 2014–2018 time frame, and that the phase-in and other flexibility provisions allow for their application in a very cost-effective manner, as discussed in this section below.

More difficult to characterize is the degree to which more or less stringent standards might be appropriate because of under- or over-estimating effectiveness of the technologies whose performance is the basis of the final standards. Our basis for these estimates is described in the following Section 0. Because for the most part these technologies have not yet been applied to HD pickups and vans, even on a limited basis, we are relying to some degree on engineering judgment in predicting their effectiveness. Even so, we believe that we have applied this judgment using the best information available, primarily from our recent rulemaking on light-duty vehicle GHGs and fuel economy, and have generated a robust set of effectiveness values.

(1) What technologies did the agencies consider?

The agencies considered over 35 vehicle technologies that manufacturers could use to improve the fuel consumption and reduce CO<sub>2</sub> emissions of their vehicles during MYs 2014–2018. The majority of the technologies described in this section is readily available, well known, and could be incorporated into vehicles once production decisions are made. Several of the technologies have already been introduced into the heavy-duty pickup

and van market (*i.e.*, variable valve timing, improved accessories, *etc.*) in a limited number of applications. Other technologies considered may not currently be in production, but are beyond the research phase and under development, and are expected to be in production in highway vehicles over the next few years. These are technologies which are capable of achieving significant improvements in fuel economy and reductions in CO<sub>2</sub> emissions, at reasonable costs. The agencies did not consider technologies in the research stage because there is insufficient time for such technologies to move from research to production during the model years covered by this final action.

The agencies received comments regarding applicability of certain advanced technologies described in the TIAX 2009 report submitted to NAS. Specifically mentioned were turbocharging and downsizing of gasoline vehicles and hydraulic hybrid systems. While turbocharging and downsizing of gasoline vehicles was a principal technology underlying the standards in the light-duty rule, the agencies determined that in the realm of heavy-duty vehicles, this approach provides much less benefit to vehicles which are required to regularly operate at high and sustained loads. In light-duty applications, downsizing of a typically oversized engine largely results in benefits mainly under partial and light load conditions. This approach is more applicable to light-duty vehicles because they infrequently require high or full power. Further, while turbo downsizing was already occurring in a portion of the light-duty fleet, it has not been demonstrated in the heavy-duty fleet, likely due to concerns with durability of this technology in the sustained high-load duty cycles frequently encountered. Similarly, other light-duty technologies (*i.e.*, cylinder deactivation, engine start stop) were also determined to not be compatible with the duty cycle of heavy-duty vehicles for similar reasons. Due to the relatively aggressive implementation of this program and the lack of commercialization in the heavy-duty market, hydraulic hybrid systems were not considered a technology that could be implemented in the time frame of this program for the HD pickup and van sector. The fact that no HD pickup or van hydraulic hybrids have been, or are the verge of being marketed makes their widespread introduction before the MY 2018 final year of the phase-in very unlikely.

The technologies considered in the agencies' analysis are briefly described

below. They fall into five broad categories: engine technologies, transmission technologies, vehicle technologies, electrification/accessory technologies, and hybrid technologies.

In this class of trucks and vans, diesel engines are installed in about half of all vehicles. The ratio between gasoline and diesel engine purchases by consumers has tended to track changes in the overall cost of oil and the relative cost of gasoline and diesel fuels. When oil prices are higher, diesel sales tend to increase. This trend has reversed when oil prices fall or when diesel fuel prices are significantly higher than gasoline. In the context of our technology discussion for heavy-duty pickups and vans, we are treating gasoline and diesel engines separately so each has a set of baseline technologies. We discuss performance improvements in terms of changes to those baseline engines. Our cost and inventory estimates contained elsewhere reflect the current fleet baseline with an appropriate mix of gasoline and diesel engines. Note that we are not basing the final standards on a targeted switch in the mix of diesel and gasoline vehicles. We believe our final standards require similar levels of technology development and cost for both diesel and gasoline vehicles. Hence the final program does not force, nor does it discourage, changes in a manufacturer's fleet mix between gasoline and diesel vehicles. Although we considered setting a single standard based on the performance level possible for diesel vehicles, we are not finalizing such an approach because the potential disruption in the HD pickup and van market from a forced shift would not be justified. Types of engine technologies that improve fuel efficiency and reduce CO<sub>2</sub> emissions include the following:

- *Low-friction lubricants*—low viscosity and advanced low friction lubricants oils are now available with improved performance and better lubrication. If manufacturers choose to make use of these lubricants, they would need to make engine changes and possibly conduct durability testing to accommodate the low-friction lubricants.

- *Reduction of engine friction losses*—can be achieved through low-tension piston rings, roller cam followers, improved material coatings, more optimal thermal management, piston surface treatments, and other improvements in the design of engine components and subsystems that improve engine operation.

- *Cylinder deactivation*—deactivates the intake and exhaust valves and prevents fuel injection into some cylinders during light-load operation.

The engine runs temporarily as though it were a smaller engine which substantially reduces pumping losses.

- *Variable valve timing*—alters the timing of the intake valve, exhaust valve, or both, primarily to reduce pumping losses, increase specific power, and control residual gases.
- *Stoichiometric gasoline direct-injection technology*—injects fuel at high pressure directly into the combustion chamber to improve cooling of the air/fuel charge within the cylinder, which allows for higher compression ratios and increased thermodynamic efficiency.
- *Diesel engine improvements and diesel aftertreatment improvements*—improved EGR systems and advanced timing can provide more efficient combustion and, hence, lower fuel consumption. Aftertreatment systems are a relatively new technology on diesel vehicles and, as such, improvements are expected in coming years that allow the effectiveness of these systems to improve while reducing the fuel and reductant demands of current systems.

Types of transmission technologies considered include:

- *Improved automatic transmission controls*—optimizes shift schedule to maximize fuel efficiency under wide ranging conditions, and minimizes losses associated with torque converter slip through lock-up or modulation.
- *Six-, seven-, and eight-speed automatic transmissions*—the gear ratio spacing and transmission ratio are optimized for a broader range of engine operating conditions specific to the mating engine.

Types of vehicle technologies considered include:

- *Low-rolling-resistance tires*—have characteristics that reduce frictional losses associated with the energy dissipated in the deformation of the tires under load, therefore improving fuel efficiency and reducing CO<sub>2</sub> emissions.
- *Aerodynamic drag reduction*—is achieved by changing vehicle shape or reducing frontal area, including skirts, air dams, underbody covers, and more aerodynamic side view mirrors.
- *Mass reduction and material substitution*—Mass reduction encompasses a variety of techniques ranging from improved design and better component integration to application of lighter and higher-strength materials. Mass reduction is further compounded by reductions in engine power and ancillary systems (transmission, steering, brakes, suspension, etc.). The agencies recognize there is a range of diversity

and complexity for mass reduction and material substitution technologies and there are many techniques that automotive suppliers and manufacturers are using to achieve the levels of this technology that the agencies have modeled in our analysis for this program.

Types of electrification/accessory and hybrid technologies considered include:

- *Electric power steering and Electro-Hydraulic power steering*—are electrically-assisted steering systems that have advantages over traditional hydraulic power steering because it replaces a continuously operated hydraulic pump, thereby reducing parasitic losses from the accessory drive.
- *Improved accessories*—may include high efficiency alternators, electrically driven (i.e., on-demand) water pumps and cooling fans. This excludes other electrical accessories such as electric oil pumps and electrically driven air conditioner compressors.
- *Air Conditioner Systems*—These technologies include improved hoses, connectors and seals for leakage control. They also include improved compressors, expansion valves, heat exchangers and the control of these components for the purposes of improving tailpipe CO<sub>2</sub> emissions as a result of A/C use.<sup>250</sup>

(2) How did the agencies determine the costs and effectiveness of each of these technologies?

Building on the technical analysis underlying the light-duty 2012–2016 MY vehicle rule, the agencies took a fresh look at technology cost and effectiveness values for purposes of this final action. For costs, the agencies reconsidered both the direct or “piece” costs and indirect costs of individual components of technologies. For the direct costs, the agencies followed a bill of materials (BOM) approach employed by NHTSA and EPA in the light-duty rule.

For two technologies, stoichiometric gasoline direct injection (SGDI) and turbocharging with engine downsizing, the agencies relied to the extent possible on the available tear-down data and scaling methodologies used in EPA’s ongoing study with FEV, Incorporated. This study consists of complete system tear-down to evaluate technologies down to the nuts and bolts to arrive at very detailed estimates of the costs associated with manufacturing them.<sup>251</sup>

<sup>250</sup> See RIA Chapter 2.3 for more detailed technology descriptions.

<sup>251</sup> U.S. Environmental Protection Agency, “Draft Report—Light-Duty Technology Cost Analysis Pilot

For the other technologies, considering all sources of information and using the BOM approach, the agencies worked together intensively to determine component costs for each of the technologies and build up the costs accordingly. Where estimates differ between sources, we have used engineering judgment to arrive at what we believe to be the best cost estimate available today, and explained the basis for that exercise of judgment.

Once costs were determined, they were adjusted to ensure that they were all expressed in 2009 dollars using a ratio of gross domestic product (GDP) values for the associated calendar years,<sup>252</sup> and indirect costs were accounted for using the new approach developed by EPA and used in the light-duty 2012–2016 MY vehicle rule. NHTSA and EPA also reconsidered how costs should be adjusted by modifying or scaling content assumptions to account for differences across the range of vehicle sizes and functional requirements, and adjusted the associated material cost impacts to account for the revised content, although some of these adjustments may be different for each agency due to the different vehicle subclasses used in their respective models.

Regarding estimates for technology effectiveness, NHTSA and EPA used the estimates from the light-duty rule as a baseline but adjusted them as appropriate, taking into account the unique requirement of the heavy-duty test cycles to test at curb weight plus half payload versus the light-duty requirement of curb plus 300 lb. The adjustments were made on an individual technology basis by assessing the specific impact of the added load on each technology when compared to the use of the technology on a light-duty vehicle. The agencies also considered other sources such as the 2010 NAS Report, recent CAFE compliance data, and confidential manufacturer estimates of technology effectiveness. NHTSA and EPA engineers reviewed effectiveness information from the multiple sources for each technology and ensured that such effectiveness estimates were based on technology hardware consistent with the BOM components used to estimate costs. Together, the agencies compared the multiple estimates and assessed their validity, taking care to ensure that common BOM definitions and other

Study,” Contract No. EP–C–07–069, Work Assignment 1–3, September 3, 2009.

<sup>252</sup> NHTSA examined the use of the CPI multiplier instead of GDP for adjusting these dollar values, but found the difference to be exceedingly small—only \$0.14 over \$100.

vehicle attributes such as performance and drivability were taken into account.

The agencies note that the effectiveness values estimated for the technologies may represent average values applied to the baseline fleet described earlier, and do not reflect the potentially-limitless spectrum of possible values that could result from adding the technology to different vehicles. For example, while the agencies have estimated an effectiveness of 0.5 percent for low friction lubricants, each vehicle could have a unique effectiveness estimate depending on the baseline vehicle's oil viscosity rating. Similarly, the reduction in rolling resistance (and thus the improvement in fuel efficiency and the reduction in CO<sub>2</sub> emissions) due to the application of LRR tires depends not only on the unique characteristics of the tires originally on the vehicle, but on the unique characteristics of the tires being applied, characteristics which must be balanced between fuel efficiency, safety, and performance. Aerodynamic drag reduction is much the same—it can improve fuel efficiency and reduce CO<sub>2</sub> emissions, but it is also highly dependent on vehicle-specific functional objectives. For purposes of this NPRM, NHTSA and EPA believe that employing average values for technology effectiveness estimates is an appropriate way of recognizing the potential variation in the specific benefits that individual manufacturers (and individual vehicles) might obtain from adding a fuel-saving technology.

The following section contains a detailed description of our assessment of vehicle technology cost and effectiveness estimates. The agencies note that the technology costs included in this NPRM take into account only those associated with the initial build of the vehicle.

#### (a) Engine Technologies

NHTSA and EPA have reviewed the engine technology estimates used in the light-duty rule. In doing so NHTSA and EPA reconsidered all available sources and updated the estimates as appropriate. The section below describes both diesel and gasoline engine technologies considered for this program.

##### (i) Low Friction Lubricants

One of the most basic methods of reducing fuel consumption in both gasoline and diesel engines is the use of lower viscosity engine lubricants. More advanced multi-viscosity engine oils are available today with improved performance in a wider temperature band and with better lubricating

properties. This can be accomplished by changes to the oil base stock (e.g., switching engine lubricants from a Group I base oils to lower-friction, lower viscosity Group III synthetic) and through changes to lubricant additive packages (e.g., friction modifiers and viscosity improvers). The use of 5W–30 motor oil is now widespread and auto manufacturers are introducing the use of even lower viscosity oils, such as 5W–20 and 0W–20, to improve cold-flow properties and reduce cold start friction. However, in some cases, changes to the crankshaft, rod and main bearings and changes to the mechanical tolerances of engine components may be required. In all cases, durability testing would be required to ensure that durability is not compromised. The shift to lower viscosity and lower friction lubricants will also improve the effectiveness of valvetrain technologies such as cylinder deactivation, which rely on a minimum oil temperature (viscosity) for operation.

Based on the light-duty 2012–2016 MY vehicle rule, and previously-received confidential manufacturer data, NHTSA and EPA estimated the effectiveness of low friction lubricants to be between 0 to 1 percent.

In the light-duty rule, the agencies estimated the cost of moving to low friction lubricants at \$3 per vehicle (2007\$). That estimate included a markup of 1.11 for a low complexity technology. For HD pickups and vans, we are using the same base estimate but have marked it up to 2009 dollars using the GDP price deflator and have used a markup of 1.24 for a low complexity technology to arrive at a value of \$4 per vehicle. As in the light-duty rule, learning effects are not applied to costs for this technology and, as such, this estimate applies to all model years.<sup>253 254</sup>

##### (ii) Engine Friction Reduction

In addition to low friction lubricants, manufacturers can also reduce friction and improve fuel consumption by improving the design of both diesel and gasoline engine components and

<sup>253</sup> Note that throughout the cost estimates for this HD analysis, the agencies have used slightly higher markups than those used in the 2012–2016 MY light-duty vehicle rule. The new, slightly higher ICMs include return on capital of roughly 6%, a factor that was not included in the light-duty analysis. The markups are also higher than those used in the proposal for this action. That change has to do with our decision to base the ICMs solely on EPA internal work rather than averaging that work with earlier work done under contract to EPA by RTI, International. That change is discussed in Section VIII.C of this preamble and is detailed in Chapter 2 of the RIA (See RIA 2.2.1)

<sup>254</sup> Note that the costs developed for low friction lubes for this analysis reflect the costs associated with any engine changes that would be required as well as any durability testing that may be required.

subsystems. Approximately 10 percent of the energy consumed by a vehicle is lost to friction, and just over half is due to frictional losses within the engine.<sup>255</sup> Examples include improvements in low-tension piston rings, piston skirt design, roller cam followers, improved crankshaft design and bearings, material coatings, material substitution, more optimal thermal management, and piston and cylinder surface treatments. Additionally, as computer-aided modeling software continues to improve, more opportunities for evolutionary friction reductions may become available.

All reciprocating and rotating components in the engine are potential candidates for friction reduction, and minute improvements in several components can add up to a measurable fuel efficiency improvement. The light-duty 2012–2106 MY vehicle rule, the 2010 NAS Report, and NESCCAF and Energy and Environmental Analysis reports, as well as confidential manufacturer data, indicate a range of effectiveness for engine friction reduction to be between 1 to 3 percent. NHTSA and EPA continue to believe that this range is accurate.

Consistent with the light-duty rule, the agencies estimate the cost of this technology at \$15 per cylinder compliance cost (2008\$), including the low complexity ICM markup value of 1.24. Learning impacts are not applied to the costs of this technology and, as such, this estimate applies to all model years. This cost is multiplied by the number of engine cylinders.

##### (iii) Coupled Cam Phasing

Valvetrains with coupled (or coordinated) cam phasing can modify the timing of both the inlet valves and the exhaust valves an equal amount by phasing the camshaft of an overhead valve engine. For overhead valve engines, which have only one camshaft to actuate both inlet and exhaust valves, couple cam phasing is the only variable valve timing implementation option available and requires only one cam phaser. Based on the light-duty rule, previously-received confidential manufacturer data, and the NESCCAF report, NHTSA and EPA estimated the effectiveness of couple cam phasing to be between 1 and 4 percent. NHTSA

<sup>255</sup> "Impact of Friction Reduction Technologies on Fuel Economy," Fenske, G. Presented at the March 2009 Chicago Chapter Meeting of the 'Society of Tribologists and Lubricated Engineers' Meeting, March 18th, 2009. Available at: <http://www.chicagostle.org/program/2008-2009/Impact%20of%20Friction%20Reduction%20Technologies%20on%20Fuel%20Economy%20-%20with%20VGs%20removed.pdf> (last accessed July 9, 2009).



and EPA reviewed this estimate for purposes of the NPRM, and continue to find it accurate.

The agencies received comments questioning the exclusion of cam phasing from the technology packages. During the rulemaking process, manufacturers introduced many new or updated gasoline engines resulting in the majority of the 2010 gasoline heavy-duty engines including cam phasing, and so we now consider this technology to be in the baseline fleet. Because of this, the baseline analysis of technology for the 2010 heavy-duty gasoline fleet already includes the benefits of cam phasing and therefore it is not appropriate for the agencies to include this as a technology that is available for most manufacturers to add to their current gasoline engines.

#### (iv) Cylinder Deactivation

In conventional spark-ignited engines throttling the airflow controls engine torque output. At partial loads, efficiency can be improved by using cylinder deactivation instead of throttling. Cylinder deactivation can improve engine efficiency by disabling or deactivating (usually) half of the cylinders when the load is less than half of the engine's total torque capability—the valves are kept closed, and no fuel is injected—as a result, the trapped air within the deactivated cylinders is simply compressed and expanded as an air spring, with reduced friction and heat losses. The active cylinders combust at almost double the load required if all of the cylinders were operating. Pumping losses are significantly reduced as long as the engine is operated in this “part-cylinder” mode.

Cylinder deactivation control strategy relies on setting maximum manifold absolute pressures or predicted torque within a range in which it can deactivate the cylinders. Noise and vibration issues reduce the operating range to which cylinder deactivation is allowed, although manufacturers are exploring vehicle changes that enable increasing the amount of time that cylinder deactivation might be suitable. Some manufacturers may choose to adopt active engine mounts and/or active noise cancellations systems to address Noise Vibration and Harshness (NVH) concerns and to allow a greater operating range of activation. Cylinder deactivation is a technology keyed to more lightly loaded operation, and so may be a less likely technology choice for manufacturers designing for effectiveness in the loaded condition required for testing, and in the real

world that involves frequent operation with heavy loads.

Cylinder deactivation has seen a recent resurgence thanks to better valvetrain designs and engine controls. General Motors and Chrysler Group have incorporated cylinder deactivation across a substantial portion of their light-duty V8-powered lineups.

Effectiveness improvements scale roughly with engine displacement-to-vehicle weight ratio: The higher displacement-to-weight vehicles, operating at lower relative loads for normal driving, have the potential to operate in part-cylinder mode more frequently. For heavy-duty vehicles tested and operated at loaded conditions, the power to weight ratio is considerably lower than the light-duty case greatly reducing the opportunity for “part-cylinder” mode and therefore was not considered in this rulemaking as an effective technology for heavy-duty pickup truck and van applications.

#### (v) Stoichiometric Gasoline Direct Injection

SGDI engines inject fuel at high pressure directly into the combustion chamber (rather than the intake port in port fuel injection). SGDI requires changes to the injector design, an additional high pressure fuel pump, new fuel rails to handle the higher fuel pressures and changes to the cylinder head and piston crown design. Direct injection of the fuel into the cylinder improves cooling of the air/fuel charge within the cylinder, which allows for higher compression ratios and increased thermodynamic efficiency without the onset of combustion knock. Recent injector design advances, improved electronic engine management systems and the introduction of multiple injection events per cylinder firing cycle promote better mixing of the air and fuel, enhance combustion rates, increase residual exhaust gas tolerance and improve cold start emissions. SGDI engines achieve higher power density and match well with other technologies, such as boosting and variable valvetrain designs.

Several manufacturers have recently introduced vehicles with SGDI engines, including GM and Ford and have announced their plans to increase dramatically the number of SGDI engines in their portfolios.

The light-duty 2012–2016 MY vehicle rule estimated the range of 1 to 2 percent for SGDI. NHTSA and EPA reviewed this estimate for purposes of the NPRM, and continue to find it accurate.

Consistent with the light-duty rule, NHTSA and EPA cost estimates for

SGDI take into account the changes required to the engine hardware, engine electronic controls, ancillary and NVH mitigation systems. Through contacts with industry NVH suppliers, and manufacturer press releases, the agencies believe that the NVH treatments will be limited to the mitigation of fuel system noise, specifically from the injectors and the fuel lines. For this analysis, the agencies have estimated the costs at \$481 (2009\$) in the 2014 model year. Flat-portion of the curve learning is applied to this technology. This technology was considered for gasoline engines only, as diesel engines already employ direct injection.

#### (b) Diesel Engine Technologies

Diesel engines have several characteristics that give them superior fuel efficiency compared to conventional gasoline, spark-ignited engines. Pumping losses are much lower due to lack of (or greatly reduced) throttling. The diesel combustion cycle operates at a higher compression ratio, with a very lean air/fuel mixture, and turbocharged light-duty diesels typically achieve much higher torque levels at lower engine speeds than equivalent-displacement naturally-aspirated gasoline engines. Additionally, diesel fuel has a higher energy content per gallon.<sup>256</sup> However, diesel fuel also has a higher carbon to hydrogen ratio, which increases the amount of CO<sub>2</sub> emitted per gallon of fuel used by approximately 15 percent over a gallon of gasoline.

Based on confidential business information and the 2010 NAS Report, two major areas of diesel engine design will be improved during the 2014–2018 time frame. These areas include aftertreatment improvements and a broad range of engine improvements.

#### (i) Aftertreatment Improvements

The HD diesel pickup and van segment has largely adopted the SCR type of aftertreatment system to comply with criteria pollutant emission standards. As the experience base for SCR expands over the next few years, many improvements in this aftertreatment system such as construction of the catalyst, thermal management, and reductant optimization will result in a significant reduction in the amount of fuel used in the process. This technology was not considered in the light-duty rule. Based on confidential business information,

<sup>256</sup> Burning one gallon of diesel fuel produces about 15 percent more carbon dioxide than gasoline due to the higher density and carbon to hydrogen ratio.

EPA and NHTSA estimate the reduction in CO<sub>2</sub> as a result of these improvements at 3 to 5 percent.

The agencies have estimated the cost of this technology at \$25 for each percentage improvement in fuel consumption. This estimate is based on the agencies' belief that this technology is, in fact, a very cost effective approach to improving fuel consumption. As such, \$25 per percent improvement is considered a reasonable cost. This cost would cover the engineering and test cell related costs necessary to develop and implement the improved control strategies that would allow for the improvements in fuel consumption. Importantly, the engineering work involved would be expected to result in cost savings to the aftertreatment and control hardware (lower platinum group metal loadings, lower reductant dosing rates, *etc.*). Those savings are considered to be included in the \$25 per percent estimate described here. Given the 4 percent average expected improvement in fuel consumption results in an estimated cost of \$119 (2009\$) for a 2014 model year truck or van. This estimate includes a low complexity ICM of 1.24 and flat-portion of the curve learning from 2012 forward.

(ii) Engine Improvements

Diesel engines in the HD pickup and van segment are expected to have several improvements in their base design in the 2014–2018 time frame. These improvements include items such as improved combustion management, optimal turbocharger design, and improved thermal management. This technology was not considered in the light-duty rule. Based on confidential business information, EPA and NHTSA estimate the reduction in CO<sub>2</sub> as a result of these improvements at 4 to 6 percent.

The cost for this technology includes costs associated with low temperature exhaust gas recirculation, improved turbochargers and improvements to other systems and components. These costs are considered collectively in our costing analysis and termed “diesel engine improvements.” The agencies have estimated the cost of diesel engine improvements at \$148 based on the cost estimates for several individual technologies. Specifically, the direct manufacturing costs we have estimated are: improved cylinder head, \$9; turbo efficiency improvements, \$16; EGR cooler improvements, \$3; higher pressure fuel rail, \$10; improved fuel injectors, \$13; improved pistons, \$2; and reduced valve train friction, \$95. All values are in 2009 dollars and are applicable in the 2014 MY. Applying a low complexity ICM of 1.24 results in a

cost of \$184 (2009\$) applicable in the 2014 MY. We consider flat-portion of the curve learning to be appropriate for these technologies.

(c) Transmission Technologies

NHTSA and EPA have also reviewed the transmission technology estimates used in the light-duty rule. In doing so, NHTSA and EPA considered or reconsidered all available sources and updated the estimates as appropriate. The section below describes each of the transmission technologies considered for the final standards.

(i) Improved Automatic Transmission Control (Aggressive Shift Logic and Early Torque Converter Lockup)

Calibrating the transmission shift schedule to upshift earlier and quicker, and to lock-up or partially lock-up the torque converter under a broader range of operating conditions can reduce fuel consumption and CO<sub>2</sub> emissions. However, this operation can result in a perceptible degradation in NVH. The degree to which NVH can be degraded before it becomes noticeable to the driver is strongly influenced by characteristics of the vehicle, and although it is somewhat subjective, it always places a limit on how much fuel consumption can be improved by transmission control changes. Given that the Aggressive Shift Logic and Early Torque Converter Lockup are best optimized simultaneously due to the fact that adding both of them primarily requires only minor modifications to the transmission or calibration software, these two technologies are combined in the modeling. We consider these technologies to be present in the baseline, since 6-speed automatic transmissions are installed in the majority of Class 2b and 3 trucks in the 2010 model year time frame.

(ii) Automatic 6- and 8-Speed Transmissions

Manufacturers can also choose to replace 4- 5- and 6-speed automatic transmissions with 8-speed automatic transmissions. Additional ratios allow for further optimization of engine operation over a wider range of conditions, but this is subject to diminishing returns as the number of speeds increases. As additional planetary gear sets are added (which may be necessary in some cases to achieve the higher number of ratios), additional weight and friction are introduced. Also, the additional shifting of such a transmission can be perceived as bothersome or busy to some consumers, so manufacturers need to develop strategies for smooth shifts.

Some manufacturers are replacing 4- and 5-speed automatics with 6-speed automatics already, and 7- and 8-speed automatics have entered production in light-duty vehicles, albeit in lower-volume applications in luxury and performance oriented cars.

As discussed in the light-duty rule, confidential manufacturer data projected that 6-speed transmissions could incrementally reduce fuel consumption by 0 to 5 percent from a 4-speed automatic transmission, while an 8-speed transmission could incrementally reduce fuel consumption by up to 6 percent from a 4-speed automatic transmission. GM has publicly claimed a fuel economy improvement of up to 4 percent for its new 6-speed automatic transmissions.<sup>257</sup>

NHTSA and EPA reviewed and revised these effectiveness estimates based on actual usage statistics and testing methods for these vehicles along with confidential business information. When combined with improved automatic transmission control, the agencies estimate the effectiveness for a conversion from a 4- to a 6-speed transmission to be 5.3 percent and a conversion from a 6- to 8-speed transmission to be 1.7 percent. While 8-speed transmissions were not considered in the light-duty 2012–2016 MY vehicle rule, they are considered as a technology of choice for this analysis in that manufacturers are expected to upgrade the 6-speed automatic transmissions being implemented today with 8-speed automatic transmissions in the 2014–2018 time frame. We are estimating the cost of an 8-speed automatic transmission at \$281 (2009\$) relative to a 6-speed automatic transmission in the 2014 model year. This estimate is based from the 2010 NAS Report and we have applied a low complexity ICM of 1.24 and flat-portion of the curve learning. This technology applies to both gasoline and diesel pickup trucks and vans.

(d) Electrification/Accessory Technologies

(i) Electrical Power Steering or Electrohydraulic Power Steering

Electric power steering (EPS) or Electrohydraulic power steering (EHPS) provides a potential reduction in CO<sub>2</sub> emissions and fuel consumption over

<sup>257</sup> General Motors, news release, “From Hybrids to Six-Speeds, Direct Injection And More, GM’s 2008 Global Powertrain Lineup Provides More Miles with Less Fuel” (released Mar. 6, 2007). Available at [http://www.gm.com/experience/fuel\\_economy/news/2007/adv\\_engines/2008-powertrain-lineup-082707.jsp](http://www.gm.com/experience/fuel_economy/news/2007/adv_engines/2008-powertrain-lineup-082707.jsp) (last accessed Sept. 18, 2008).

hydraulic power steering because of reduced overall accessory loads. This eliminates the parasitic losses associated with belt-driven power steering pumps which consistently draw load from the engine to pump hydraulic fluid through the steering actuation systems even when the wheels are not being turned. EPS is an enabler for all vehicle hybridization technologies since it provides power steering when the engine is off. EPS may be implemented on most vehicles with a standard 12V system. Some heavier vehicles may require a higher voltage system which may add cost and complexity.

The light-duty rule estimated a one to two percent effectiveness based on the 2002 NAS report for light-duty vehicle technologies, a Sierra Research report, and confidential manufacturer data. NHTSA and EPA reviewed these effectiveness estimates and found them to be accurate, thus they have been retained for purposes of this NPRM.

NHTSA and EPA adjusted the EPS cost for the current rulemaking based on a review of the specification of the system. Adjustments were made to include potentially higher voltage or heavier duty system operation for HD pickups and vans. Accordingly, higher costs were estimated for systems with higher capability. After accounting for the differences in system capability and applying the ICM markup of low complexity technology of 1.24, the estimated costs are \$115 for a MY 2014 truck or van (2009\$). As EPS systems are in widespread usage today, flat-portion of the curve learning is deemed applicable. EHPS systems are considered to be of equal cost and both are considered applicable to gasoline and diesel engines.

(ii) Improved Accessories

The accessories on an engine, including the alternator, coolant and oil pumps are traditionally mechanically-driven. A reduction in CO<sub>2</sub> emissions and fuel consumption can be realized by driving the pumping accessories electrically, and only when needed (“on-demand”). Alternator improvements include internal changes resulting in lower mechanical and electrical losses combined with control logic that charges the battery at more efficient voltage levels and during conditions of available kinetic energy from the vehicle which would normally be wasted energy such as braking during vehicle decelerations.

Electric water pumps and electric fans can provide better control of engine cooling. For example, coolant flow from an electric water pump can be reduced and the radiator fan can be shut off

during engine warm-up or cold ambient temperature conditions which will reduce warm-up time, reduce warm-up fuel enrichment, and reduce parasitic losses.

Indirect benefit may be obtained by reducing the flow from the water pump electrically during the engine warm-up period, allowing the engine to heat more rapidly and thereby reducing the fuel enrichment needed during cold starting of the engine. Further benefit may be obtained when electrification is combined with an improved, higher efficiency engine alternator. Intelligent cooling can more easily be applied to vehicles that do not typically carry heavy payloads, so larger vehicles with towing capacity present a challenge, as these vehicles have high cooling fan loads.<sup>258</sup>

The agencies considered whether to include electric oil pump technology for the rulemaking. Because it is necessary to operate the oil pump any time the engine is running, electric oil pump technology has insignificant effect on efficiency. Therefore, the agencies decided to not include electric oil pump technology.

NHTSA and EPA jointly reviewed the estimates of 1 to 2 percent effectiveness estimates used in the light-duty rule and found them to be accurate for Improved Electrical Accessories. Consistent with the light-duty rule, the agencies have estimated the cost of this technology at \$93 (2009\$) including a low complexity ICM of 1.24. This cost is applicable in the 2014 model year. Improved accessory systems are in production currently and thus flat-portion of the curve learning is applied. This technology was considered for diesel pickup trucks and vans only.

(e) Vehicle Technologies

(i) Mass Reduction

Reducing a vehicle’s mass, or down-weighting the vehicle, decreases fuel consumption by reducing the energy demand needed to overcome forces resisting motion, and rolling resistance. Manufacturers employ a systematic approach to mass reduction, where the net mass reduction is the addition of a direct component or system mass reduction plus the additional mass reduction taken from indirect ancillary systems and components, as a result of full vehicle optimization, effectively compounding or obtaining a secondary mass reduction from a primary mass

<sup>258</sup> In the CAFE model, improved accessories refer solely to improved engine cooling. However, EPA has included a high efficiency alternator in this category, as well as improvements to the cooling system.

reduction. For example, use of a smaller, lighter engine with lower torque-output subsequently allows the use of a smaller, lighter-weight transmission and drive line components. Likewise, the compounded weight reductions of the body, engine and drivetrain reduce stresses on the suspension components, steering components, wheels, tires and brakes, allowing further reductions in the mass of these subsystems. The reductions in unsprung masses such as brakes, control arms, wheels and tires further reduce stresses in the suspension mounting points. This produces a compounding effect of mass reductions.

Estimates of the synergistic effects of mass reduction and the compounding effect that occurs along with it can vary significantly from one report to another. For example, in discussing its estimate, an Auto-Steel Partnership report states that “These secondary mass changes can be considerable—estimated at an additional 0.7 to 1.8 times the initial mass change.”<sup>259</sup> This means for each one pound reduction in a primary component, up to 1.8 pounds can be reduced from other structures in the vehicle (*i.e.*, a 180 percent factor). The report also discusses that a primary variable in the realized secondary weight reduction is whether or not the powertrain components can be included in the mass reduction effort, with the lower end estimates being applicable when powertrain elements are unavailable for mass reduction. However, another report by the Aluminum Association, which primarily focuses on the use of aluminum as an alternative material for steel, estimated a factor of 64 percent for secondary mass reduction even though some powertrain elements were considered in the analysis.<sup>260</sup> That report also notes that typical values for this factor vary from 50 to 100 percent. Although there is a wide variation in stated estimates, synergistic mass reductions do exist, and the effects result in tangible mass reductions. Mass reductions in a single vehicle component, for example a door side

<sup>259</sup> “Preliminary Vehicle Mass Estimation Using Empirical Subsystem Influence Coefficients,” Malen, D.E., Reddy, K. Auto-Steel Partnership Report, May 2007, Docket EPA-HQ-OAR-2009-0472-0169. Accessed on the Internet on May 30, 2009 at: <http://www.a-sp.org/database/custom/Mass%20Compounding%20-%20Final%20Report.pdf>.

<sup>260</sup> “Benefit Analysis: Use of Aluminum Structures in Conjunction with Alternative Powertrain Technologies in Automobiles,” Bull, M. Chavali, R., Mascarin, A., Aluminum Association Research Report, May 2008, Docket EPA-HQ-OAR-2009-0472-0168. Accessed on the Internet on April 30, 2009 at: <http://www.autoaluminum.org/downloads/IBIS-Powertrain-Study.pdf>.

impact/intrusion system, may actually result in a significantly higher weight savings in the total vehicle, depending on how well the manufacturer integrates the modification into the overall vehicle design. Accordingly, care must be taken when reviewing reports on weight reduction methods and practices to ascertain if compounding effects have been considered or not.

Mass reduction is broadly applicable across all vehicle subsystems including the engine, exhaust system, transmission, chassis, suspension, brakes, body, closure panels, glazing, seats and other interior components, engine cooling systems and HVAC systems. It is estimated that up to 1.25 kilograms of secondary weight savings can be achieved for every kilogram of weight saved on a light-duty vehicle when all subsystems are redesigned to take into account the initial primary weight savings.<sup>261 262</sup>

Mass reduction can be accomplished by proven methods such as:

- **Smart Design:** Computer aided engineering (CAE) tools can be used to better optimize load paths within structures by reducing stresses and bending moments applied to structures. This allows better optimization of the sectional thicknesses of structural components to reduce mass while maintaining or improving the function of the component. Smart designs also integrate separate parts in a manner that reduces mass by combining functions or the reduced use of separate fasteners. In addition, some “body on frame” vehicles are redesigned with a lighter “unibody” construction.

- **Material Substitution:** Substitution of lower density and/or higher strength materials into a design in a manner that preserves or improves the function of the component. This includes substitution of high-strength steels, aluminum, magnesium or composite materials for components currently fabricated from mild steel.

- **Reduced Powertrain Requirements:** Reducing vehicle weight sufficiently allowing for the use of a smaller, lighter and more efficient engine while

maintaining or increasing performance. Approximately half of the reduction is due to these reduced powertrain output requirements from reduced engine power output and/or displacement, changes to transmission and final drive gear ratios. The subsequent reduced rotating mass (e.g., transmission, drivshafts/halfshafts, wheels and tires) via weight and/or size reduction of components are made possible by reduced torque output requirements.

- Automotive companies have largely used weight savings in some vehicle subsystems to offset or mitigate weight gains in other subsystems from increased feature content (sound insulation, entertainment systems, improved climate control, panoramic roof, etc.).

- Lightweight designs have also been used to improve vehicle performance parameters by increased acceleration performance or superior vehicle handling and braking.

Many manufacturers have already announced final future products plans reducing the weight of a vehicle body through the use of high strength steel body-in-white, composite body panels, magnesium alloy front and rear energy absorbing structures reducing vehicle weight sufficiently to allow a smaller, lighter and more efficient engine. Nissan will be reducing average vehicle curb weight by 15 percent by 2015.<sup>263</sup> Ford has identified weight reductions of 250 to 750 lb per vehicle as part of its implementation of known technology within its sustainability strategy between 2011 and 2020.<sup>264</sup> Mazda plans to reduce vehicle weight by 220 pounds per vehicle or more as models are redesigned.<sup>265 266</sup> Ducker International estimates that the average curb weight of light-duty vehicle fleet will decrease approximately 2.8 percent from 2009 to 2015 and approximately 6.5 percent from 2009 to 2020 via changes in automotive materials and increased change-over from previously used body-on-frame automobile and light-truck designs to newer unibody designs.<sup>263</sup> While the opportunity for mass reductions available to the light-duty

fleet may not in all cases be applied directly to the heavy-duty fleet due to the different designs for the expected duty cycles of a “work” vehicle, mass reductions are still available particularly to areas unrelated to the components and systems necessary for the work vehicle aspects.

Due to the payload and towing requirements of these heavy-duty vehicles, engine downsizing was not considered in the estimates for CO<sub>2</sub> reduction in the area of mass reduction and material substitution. NHTSA and EPA estimate that a 3 percent mass reduction with no engine downsizing results in a 1 percent reduction in fuel consumption. In addition, a 5 and 10 percent mass reduction with no engine downsizing result in an estimated CO<sub>2</sub> reduction of 1.6 and 3.2 percent respectively. These effectiveness values are 50 percent of the light-duty rule values due to the elimination of engine downsizing for this class of vehicle.

In the NPRM, EPA and NHTSA relied on three studies to estimate the cost of vehicle mass reduction. The agencies used a value of \$1.32 per pound of mass reduction that was derived from a 2002 National Academy of Sciences study, a 2008 Sierra Research report, and a 2008 MIT study. The cost was estimated to be constant, independent of the level of mass reduction.

The agencies along with the California Air Resources Board (CARB) have recently completed work on an Interim Joint Technical Assessment Report (TAR) that considers light-duty GHG and fuel economy standards for model years 2017 through 2025 and have continued this work to support the light-duty vehicle NPRM, which is expected to be issued this fall. Based on new information from various industry and literature sources, the TAR modified the mass reduction/cost relationship used in the light-duty 2012–2016 MY vehicle rule to begin at the origin (zero cost at zero percent mass reduction) and to have increasing cost with increasing mass reduction.<sup>267</sup> The resulting analysis showed costs for 5 percent mass reduction on light-duty vehicles to be near zero or cost parity.

In the proposal for heavy-duty vehicles, we estimated mass reduction costs based on the 2012–2016 light-duty analysis without accounting for the new work completed in the Interim Joint Technical Assessment and additional

<sup>261</sup> “Future Generation Passenger Compartment Validation (ASP 241)” Villano, P.J., Shaw, J.R., Polewarczyk, J., Morgans, S., Carpenter, J.A., Yocum, A.D., in “Lightweighting Materials—FY 2008 Progress Report,” U.S. Department of Energy, Office of Energy Efficiency and Renewable Energy, Vehicle Technologies Program, May 2009, Docket EPA-HQ-OAR-2009-0472-0190.

<sup>262</sup> “Preliminary Vehicle Mass Estimation Using Empirical Subsystem Influence Coefficients,” Malen, D.E., Reddy, K. Auto-Steel Partnership Report, May 2007, Docket EPA-HQ-OAR-2009-0472-0169. Accessed on the Internet on May 30, 2009 at <http://www.a-sp.org/database/custom/Mass%20Compounding%20-%20Final%20Report.pdf>.

<sup>263</sup> “Lighten Up!,” Brooke, L., Evans, H. Automotive Engineering International, Vol. 117, No. 3, March 2009.

<sup>264</sup> “2008/9 Blueprint for Sustainability,” Ford Motor Company. Available at: <http://www.ford.com/go/sustainability> (last accessed February 8, 2010).

<sup>265</sup> “Mazda to cut vehicle fuel consumption 30 percent by 2015,” Mazda press release, June 23, 2009. Available at: <http://www.mazda.com/publicity/release/2008/200806/080623.html> (last accessed February 8, 2010).

<sup>266</sup> “Mazda: Don’t believe hot air being emitted by hybrid hype,” Greimel, H. Automotive News, March 30, 2009.

<sup>267</sup> “Interim Joint Technical Assessment Report: Light-Duty Vehicle Greenhouse Gas Emission Standards and Corporate Average Fuel Economy Standards for Model Years 2017–2025,” September 2010; available at <http://epa.gov/otaq/climate/regulations/ldv-ghg-tar.pdf> and in the docket for this rule.

work the agencies have considered for the upcoming light-duty vehicle NPRM. Since the heavy-duty vehicle proposal, the agencies have been able to consider updated cost estimates in the context of both light-duty and heavy-duty vehicle bodies of work. While the agencies intend to discuss the additional work for the light-duty NPRM in much more detail in the documents for that rulemaking, we think it appropriate to explain here that after having considered a number of additional and highly-varying sources, the agencies believe that the cost estimates used in the TAR may have been lower than would be reasonable for HD pickups and vans, given their different and work-related uses and thus different construction as compared to the light-duty vehicles evaluated in the TAR. We do not believe that all of the weight reduction opportunities for light-duty vehicles can be applied to heavy-duty trucks. However, we do believe reductions in the following components and systems can be found that do not affect the payload and towing requirements of these heavy-duty vehicles: Body, closure panels, glazing, seats and other interior components, engine cooling systems and HVAC systems.

The agencies have reviewed and considered many different mass reduction studies during the technical assessment for the heavy-duty vehicle GHG and fuel efficiency rulemaking. The agencies found that many of the studies on this topic vary considerably in their rigor, transparency, and applicability to the regulatory assessment. Having considered a variety of options, the agencies for this heavy-duty analysis have been unable to come up with a way to quantitatively evaluate the available studies. Therefore, the agencies have chosen a value within the range of the available studies that the agencies believe is reasonable. The studies and manufacturers' confidential business information relied upon in determining the final mass reduction costs are summarized in Figure 2.1, Section 2.3.6 of the RIA. Each study relied upon by the agencies in this determination has also been placed in the agencies' respective dockets. See NHTSA-2010-0079; EPA-HQ-OAR-2010-0162.

The agencies note that the NAS 2010 study provided estimates of mass reduction costs, but the agencies did not consider using the NAS 2010 study as the single source of mass reduction cost estimates because the NAS 2010 estimates were not based on literature reports that focused on trucks or were necessarily appropriate for MD/HD

vehicles, and also because a variety of newer and more rigorous studies were available to the agencies than those relied upon by the NAS in developing its estimates. We note, however, that for a 5 percent reduction in mass, the NAS 2010 report estimates a per pound cost of mass reduction of \$1.65.

Thus, we are estimating the direct manufacturing costs for a 5 percent mass reduction of a 6,000 lb vehicle at a range of \$75-\$90 per vehicle. With additional margin for uncertainty, we arrive at a direct manufacturing cost of \$85-\$100, which is roughly in the upper middle of the range of values that resulted from the additional and highly-varying studies mentioned above that were considered in the agencies' review. We have broken this down for application to HD pickup trucks and vans as follows: Class 2b gasoline \$85, Class 2b diesel \$95, Class 3 gasoline \$90, and Class 3 diesel trucks \$100. Applying the low complexity ICM of 1.24 results in estimated total costs for a 5 percent mass reduction applicable in the 2016 model year as follows: Class 2b gasoline \$108, Class 2b diesel \$121, Class 3 gasoline \$115, and Class 3 diesel trucks \$127. All mass reduction costs stated here are in 2009 dollars.

#### (ii) Low Rolling Resistance Tires

Tire rolling resistance is the frictional loss associated mainly with the energy dissipated in the deformation of the tires under load and thus influences fuel efficiency and CO<sub>2</sub> emissions. Other tire design characteristics (*e.g.*, materials, construction, and tread design) influence durability, traction (both wet and dry grip), vehicle handling, and ride comfort in addition to rolling resistance. A typical LRR tire's attributes would include: increased tire inflation pressure, material changes, and tire construction with less hysteresis, geometry changes (*e.g.*, reduced aspect ratios), and reduction in sidewall and tread deflection. These changes would generally be accompanied with additional changes to suspension tuning and/or suspension design.

EPA and NHTSA estimated a 1 to 2 percent increase in effectiveness with a 10 percent reduction in rolling resistance, which was based on the 2010 NAS Report findings and consistent with the light-duty rule.

Based on the light-duty rule and the 2010 NAS Report, the agencies have estimated the cost for LRR tires to be \$7 per Class 2b truck or van, and \$10 per Class 3 truck or van (both values in 2009\$ and inclusive of a 1.24 low

complexity markup).<sup>268</sup> The higher cost for the Class 3 trucks and vans is due to the predominant use of dual rear tires and, thus, 6 tires per truck. Due to the commodity-based nature of this technology, cost reductions due to learning are not applied. This technology is considered applicable to both gasoline and diesel.

#### (iii) Aerodynamic Drag Reduction

Many factors affect a vehicle's aerodynamic drag and the resulting power required to move it through the air. While these factors change with air density and the square and cube of vehicle speed, respectively, the overall drag effect is determined by the product of its frontal area and drag coefficient, Cd. Reductions in these quantities can therefore reduce fuel consumption and CO<sub>2</sub> emissions. Although frontal areas tend to be relatively similar within a vehicle class (mostly due to market-competitive size requirements), significant variations in drag coefficient can be observed. Significant changes to a vehicle's aerodynamic performance may need to be implemented during a redesign (*e.g.*, changes in vehicle shape). However, shorter-term aerodynamic reductions, with a somewhat lower effectiveness, may be achieved through the use of revised exterior components (typically at a model refresh in mid-cycle) and add-on devices that currently are being applied. The latter list would include revised front and rear fascias, modified front air dams and rear valances, addition of rear deck lips and underbody panels, and lower aerodynamic drag exterior mirrors.

The light-duty 2012-2016 MY vehicle rule estimated that a fleet average of 10 to 20 percent total aerodynamic drag reduction is attainable which equates to incremental reductions in fuel consumption and CO<sub>2</sub> emissions of 2 to 3 percent for both cars and trucks. These numbers are generally supported by confidential manufacturer data and public technical literature. For the heavy-duty truck category, a 5 to 10 percent total aerodynamic drag reduction was considered due to the different structure and use of these vehicles equating to incremental reductions in fuel consumption and CO<sub>2</sub> emissions of 1 to 2 percent.

Consistent with the light-duty rule, the agencies have estimated the cost for this technology at \$58 (2009\$) including a low complexity ICM of 1.24. This cost is applicable in the 2014 model year to

<sup>268</sup> "Tires and Passenger Vehicle Fuel Economy," Transportation Research Board Special Report 286, National Research Council of the National Academies, 2006, Docket EPA-HQ-OAR-2009-0472-0146.

both gasoline and diesel pickup trucks and vans.

(3) What are the projected technology packages' effectiveness and cost?

The assessment of the final technology effectiveness was developed through the use of the EPA Lumped Parameter model developed for the light-duty rule. Many of the technologies were common with the light-duty assessment but the effectiveness of individual technologies was appropriately adjusted to match the expected effectiveness when implemented in a heavy-duty application. The model then uses the

individual technology effectiveness levels but then takes into account technology synergies. The model is also designed to prevent double counting from technologies that may directly or indirectly impact the same physical attribute (e.g., pumping loss reductions).

To achieve the levels of the final standards for gasoline and diesel powered heavy-duty vehicles, the technology packages were determined to generally require the technologies previously discussed respective to unique gasoline and diesel technologies. Although some of the technologies may already be implemented in a portion of heavy-duty vehicles, none of the

technologies discussed are considered ubiquitous in the heavy-duty fleet. Also, as would be expected, the available test data shows that some vehicle models will not need the full complement of available technologies to achieve the final standards. Furthermore, many technologies can be further improved (e.g., aerodynamic improvements) from today's best levels, and so allow for compliance without needing to apply a technology that a manufacturer might deem less desirable.

Technology costs for HD pickup trucks and vans are shown in Table III-11.

TABLE III-11—TECHNOLOGY COSTS FOR HD PICKUP TRUCKS & VANS INCLUSIVE OF INDIRECT COST MARKUPS FOR THE 2014MY [2009\$]

Technology	Class 2b gasoline	Class 2b diesel	Class 3 gasoline	Class 3 diesel
Low friction lubes .....	\$4	\$4	\$4	\$4
Engine friction reduction .....	116	N/A	116	N/A
Stoichiometric gasoline direct injection .....	481	N/A	481	N/A
Engine improvements .....	N/A	184	N/A	184
8s automatic transmission (increment to 6s automatic transmission) .....	281	281	281	281
Improved accessories .....	N/A	93	N/A	93
Low rolling resistance tires .....	7	7	10	10
Aerodynamic improvements .....	58	58	58	58
Electric (or electro/hydraulic) power steering .....	115	115	115	115
Aftertreatment improvements .....	N/A	119	N/A	119
Mass reduction (5%) .....	108	121	115	127
Air conditioning .....	21	21	21	21
Total .....	1,190	1,003	1,209	1,013
At 15% phase-in in 2014 .....	179	150	180	152

(4) Reasonableness of the Final Standards

The final standards are based on the application of the control technologies described in this section. These technologies are available within the lead time provided, as discussed in RIA Chapter 2.3. These controls are estimated to add costs of approximately \$1,048 for MY 2018 heavy-duty pickups and vans. Reductions associated with these costs and technologies are considerable, estimated at a 12 percent reduction of CO<sub>2</sub>eq emissions from the MY 2010 baseline for gasoline engine-equipped vehicles and 17 percent for diesel engine equipped vehicles, estimated to result in reductions of 18 MMT of CO<sub>2</sub>eq emissions over the lifetimes of 2014 through 2018 MY vehicles.<sup>269</sup> The reductions are cost effective, estimated at \$90 per ton of CO<sub>2</sub>eq removed in 2030.<sup>270</sup> This cost is consistent with the light-duty rule which was estimated at \$100 per ton of

CO<sub>2</sub>eq removed in 2020 excluding fuel savings. Moreover, taking into account the fuel savings associated with the program, the cost becomes –\$230 per ton of CO<sub>2</sub>eq (i.e. a savings of \$230 per ton) in 2030. The cost of controls is fully recovered due to the associated fuel savings, with a payback period in the second year of ownership, as shown in Table VIII-9 below in Section VIII. Given the large, cost effective emission reductions based on use of feasible technologies which are available in the lead time provided, plus the lack of adverse impacts on vehicle safety or utility, EPA and NHTSA regard these final standards as appropriate and consistent with our respective statutory authorities under CAA section 202(a) and NHTSA's EISA authority under 49 U.S.C. 32902(k)(2). Based on the discussion above, NHTSA believes these standards are the maximum feasible under EISA.

(5) Alternative HD Pickup Truck and Van Standards Considered

The agencies rejected consideration of any less stringent standards given that the standards adopted are feasible at reasonable cost and cost-effectiveness within the lead time of the program. Furthermore, as explained above, because the standards are premised on 100 percent application of available technologies during this period, the agencies rejected adoption of more stringent standards. The agencies have also explained above why the phase-in period for the standards is reasonable and that attempting more aggressive phase-ins would start to force changes outside normal redesign cycles at likely exorbitant cost.

C. Class 2b-8 Vocational Vehicles

Vocational vehicles cover a wide variety of applications which influence both the body style and usage patterns. They also are built using a complex process, which includes additional entities such as body builders. These factors create special sensitivity to

<sup>269</sup> See Table VI-4 of this preamble.

<sup>270</sup> See Table 0-3 of this preamble.

concerns of needed lead time, as well as developing standards that do not interfere with vocational vehicles' utility. The agencies are adopting a standard for vocational vehicles for the first phase of the program that relies on less extensive addition of technology than do the other regulatory categories as well as making the chassis manufacturer the manufacturer subject to the standard. We intend that future rulemakings will consider increased stringency and possibly more application-specific standards. The agencies are also finalizing standards for the diesel and gasoline engines installed in vocational vehicles, similar to those discussed above for HD engines installed in Class 7 and 8 tractors.

(1) What technologies did the agencies consider to reduce the CO<sub>2</sub> emissions and fuel consumption of vocational vehicles?

Similar to the approach taken with tractors, the agencies evaluated aerodynamic, tire, idle reduction, weight reduction, hybrid powertrain, and engine technologies and their impact on reducing fuel consumption and GHG emissions. The engines used in vocational vehicles include both gasoline and diesel engines, thus, each type is discussed separately below. As explained in Section II.D.1.b, the final regulatory structure for heavy-duty engines separates the compression ignition (or "diesel") engines into three regulatory subcategories—light heavy, medium heavy, and heavy heavy diesel engines—while spark ignition (or "gasoline") engines are a single regulatory subcategory (an approach for which there was consensus in the public comments). Therefore, the subsequent discussion will assess each type of engine separately.

#### (a) Vehicle Technologies

Vocational vehicles typically travel fewer miles than combination tractors. They also tend to be used in more urban locations (with consequent stop and start drive cycles). Therefore the average speed of vocational vehicles is significantly lower than combination tractors. This has a significant effect on the types of technologies that are appropriate to consider for reducing CO<sub>2</sub> emissions and fuel consumption.

The agencies considered the type of technologies for vocational vehicles based on the energy losses of a typical vocational vehicle. The technologies are similar to the ones considered for combination tractors. Argonne National Lab conducted an energy audit using simulation tools to evaluate the energy losses of vocational vehicles, such as a

Class 6 pickup and delivery truck. Argonne found that 74 percent of the energy losses are attributed to the engine, 13 percent to tires, 9 percent to aerodynamics, two percent to transmission losses, and the remaining four percent of losses to axles and accessories for a medium-duty truck traveling at 30 mph.<sup>271</sup>

*Low Rolling Resistance Tires:* Tires are the second largest contributor to energy losses of vocational vehicles, as found in the energy audit conducted by Argonne National Lab (as just mentioned). The range of rolling resistance of tires used on vocational vehicles today is large. This is in part due to the fact that the competitive pressure to improve rolling resistance of vocational vehicle tires has been less than that found in the line haul tire market. In addition, the drive cycles typical for these applications often lead truck buyers to value tire traction and durability more heavily than rolling resistance. Therefore, the agencies concluded that a regulatory program that seeks to optimize tire rolling resistance in addition to traction and durability can bring about fuel consumption and CO<sub>2</sub> emission reductions from this segment. The 2010 NAS report states that rolling resistance impact on fuel consumption reduces with mass of the vehicle and with drive cycles with more frequent starts and stops. The report found that the fuel consumption reduction opportunity for reduced rolling resistance ranged between one and three percent in the 2010 through 2020 time frame.<sup>272</sup> The agencies estimate that average rolling resistance from tires in 2010 model year can be reduced by 10 percent for 50 percent of the vehicles by 2014 model year based on the tire development achievements over the last several years in the line haul truck market.

*Aerodynamics:* The Argonne National Lab work shows that aerodynamics has less of an impact on vocational vehicle energy losses than do engines or tires. In addition, the aerodynamic performance of a complete vehicle is significantly influenced by the body of the vehicle. The agencies are not regulating body builders in this phase of regulations for the reasons discussed in Section II. Therefore, we are not basing any of the final standards for vocational vehicles on aerodynamic improvements. Nor would aerodynamic performance be

input into GEM to demonstrate compliance.

*Weight Reduction:* NHTSA and EPA are also not basing any of the final vocational vehicle standards on use of vehicle weight reduction. Thus, vehicle mass reductions are not an input into GEM. The agencies are taking this approach despite comments suggesting that the agencies make use of weight reductions for this segment, because we are unable to quantify the potential impact of weight reduction on vehicle utility in this broad segment. Vocational vehicles serve an incredibly diverse range of functions. Each of these unique vehicle functions is likely to have its own unique tradeoff between vehicle utility and the potential for vehicle mass reduction. The agencies have not been able at this time to determine the degree to which such tradeoffs exist nor the specific level of the tradeoff for each unique vehicle vocation. No commenter provided data to inform this question. Absent this information, the agencies cannot at this time project the potential for worthwhile weight reductions from vocational vehicles.

*Drivetrain:* Optimization of vehicle gearing to engine performance through selection of transmission gear ratios, final drive gear ratios and tire size can play a significant role in reducing fuel consumption and GHGs. Optimization of gear selection versus vehicle and engine speed accomplished through driver training or automated transmission gear selection can provide additional reductions. The 2010 NAS report found that the opportunities to reduce fuel consumption in heavy-duty vehicles due to transmission and driveline technologies in the 2015 time frame ranged between 2 and 8 percent.<sup>273</sup> Initially, the agencies considered reflecting transmission choices and technology in our standard setting process for both tractors and vocational vehicles (see previous discussion above on automated manual and automatic transmissions for tractors). We have however decided not to do so for the following reasons.

The primary factors that determine optimum gear selection are vehicle weight, vehicle aerodynamics, vehicle speed, and engine performance typically considered on a two dimensional map of engine speed and torque. For a given power demand (determined by speed, aerodynamics and vehicle mass) an optimum transmission and gearing setup will keep the engine power delivery operating at the best speed and torque points for highest engine

<sup>271</sup> Argonne National Lab. Evaluation of Fuel Consumption Potential of Medium and Heavy-duty Vehicles through Modeling and Simulation. October 2009. Page 89.

<sup>272</sup> See 2010 NAS Report, Note 197, page 146.

<sup>273</sup> See 2010 NAS Report, Note 197, pp 134 and 137.



efficiency. Since power delivery from the engine is the product of speed and torque a wide range of torque and speed points can be found that deliver adequate power, but only a smaller subset will provide power with peak efficiency. Said more generally, the design goal is for the transmission to deliver the needed power to the vehicle while maintaining engine operation within the engine's "sweet spot" for most efficient operation. Absent information about vehicle mass and aerodynamics (which determines road load at highway speeds) it is not possible to optimize the selection of gear ratios for lowest fuel consumption. Truck and chassis manufacturers today offer a wide range of tire sizes, final gear ratios and transmission choices so that final bodybuilders can select an optimal combination given the finished vehicle weight, general aerodynamic characteristics and expected average speed. In order to set fuel efficiency and GHG standards that would reflect these optimizations, the agencies would need to regulate a wide range of small entities that are final bodybuilders, would need to set a large number of uniquely different standards to reflect the specific weight and aerodynamic differences and finally would need test procedures to evaluate these differences that would not themselves be excessively burdensome. Finally, the agencies would need the underlying data regarding effectively all of the vocational trucks produced today in order to determine the appropriate standards. Because the market is already motivated to reach these optimizations themselves today, because we have insufficient data to determine appropriate standards, and finally, because we believe the testing burden would be unjustifiably high, we are not finalizing to reflect transmission and gear ratio optimization in our GEM or in our standard setting.

Some commenters suggested that the agencies predicate the vocational vehicle standard on the use of specific transmission technologies for example automated manual transmissions believing that these mechanically more efficient designs would inherently provide better fuel efficiency and lower greenhouse gas emissions than conventional torque converter automatic transmission designs. However as discussed above the agencies believe that the small mechanical efficiency differences between these transmission designs are relatively insignificant in the context of the dominant impact of proper gear ratio selection in determining a vehicle's

overall performance. In many cases, the mechanically more efficient design may prove less effective in use if other aspects of vehicle performance (such a vehicle launch under load) compromise the selection of gear ratios. This somewhat surprising outcome can be seen most readily by looking at modern passenger cars where mechanically less efficient torque converter automatic models often produce equal or better fuel economy when compared to the more mechanically efficient manual transmission versions of the same vehicles. Given this reality, we do not believe it would be appropriate to base the vocational truck standard on the use of a particular transmission technology. In the future, if we develop a complete vehicle chassis test approach to regulating this segment, we would then be able to incorporate transmission performance as we already do for the heavy-duty pickup truck and van segment.

*Idle Reduction:* Episodic idling by vocational vehicles occurs during the workday, unlike the overnight idling of combination tractors (see discussion in Section III.A.2.a). Vocational vehicle idling can be divided into two typical types. The first type is idling while waiting—such as during a pickup or delivery. This type of idling can be reduced through automatic engine shut-offs. The second type of idling is to accomplish PTO operation, such as compacting garbage or operating a bucket. The agencies have found only one study that quantifies the emissions due to idling conducted by Argonne National Lab based on 2002 VIUS data.<sup>274</sup> EPA conducted a work assignment to assist in characterizing PTO operations. The study of a utility truck used in two different environments (rural and urban) and a refuse hauler found that the PTO operated on average 28 percent of time relative to the total time spent driving and idling.<sup>275</sup> The use of hybrid powertrains to reduce idling is discussed below.

*Hybrid Powertrains:* Several types of vocational vehicles are well suited for hybrid powertrains. Vehicles such as utility or bucket trucks, delivery vehicles, refuse haulers, and buses have operational usage patterns with either a significant amount of stop-and-go activity or spend a large portion of their operating hours idling the main engine to operate a PTO unit. The industry is

currently developing many variations of hybrid powertrain systems. The hybrids developed to date have seen fuel consumption and CO<sub>2</sub> emissions reductions between 20 and 50 percent in the field. However, there are still some key issues that are restricting the penetration of hybrids, including overall system cost, battery technology, and lack of cost-effective electrified accessories. We have not predicated the standards based on the use of hybrids reflecting the still nascent level of technology development and the very small fraction of vehicle sales they would be expected to account for in this time frame—on the order of only a percent or two. Were we to overestimate the number of hybrids that could be produced, we would set a standard that is not feasible. We believe that it is more appropriate given the status of technology development and our hopes for future advancements in hybrid technologies to encourage their production through incentives. Thus, to create an incentive for early introduction of hybrid powertrains into the vocational vehicle fleet, the agencies are adopting the proposed advanced technology credits if hybrid powertrains are used as a technology to meet the vocational vehicle standard (or any other vehicle standard), as described in Section IV.

#### (b) Gasoline Engine Technologies

The gasoline (or spark ignited) engines certified and sold as loose engines into the heavy-duty truck market are typically large V8 and V10 engines produced by General Motors and Ford. The basic architecture of these engines is the same as the versions used in the heavy-duty pickup trucks and vans. Therefore, the technologies analyzed by the agencies mirror the gasoline engine technologies used in the heavy-duty pickup truck analysis in Section III.B above.

Building on the technical analysis underlying the light-duty 2012–2016 MY vehicle rule, the agencies took a fresh look at technology effectiveness values for purposes of this analysis using as a starting point the estimates from that rule. The agencies then considered the impact of test procedures (such as higher test weight of HD pickup trucks and vans) on the effectiveness estimates. The agencies also considered other sources such as the 2010 NAS Report, recent CAFE compliance data, and confidential manufacturer estimates of technology effectiveness. NHTSA and EPA engineers reviewed effectiveness information from the multiple sources for each technology and ensured that such effectiveness estimates were based

<sup>274</sup> Gaines, Linda, A. Vyas, J. Anderson (Argonne National Laboratory). *Estimation of Fuel Use by Idling Commercial Trucks*. January 2006.

<sup>275</sup> Southwest Research Institute. *Power Take Off Cycle Development and Testing*. 2010. Docket EPA–HQ–OAR–2010–0162–3335.

on technology hardware consistent with the BOM components used to estimate costs.

The agencies note that the effectiveness values estimated for the technologies may represent average values, and do not reflect the potentially-limitless spectrum of possible values that could result from adding the technology to different vehicles. For example, while the agencies have estimated an effectiveness of 0.5 percent for low friction lubricants, each vehicle could have a unique effectiveness estimate depending on the baseline vehicle's oil viscosity rating. For purposes of this final rulemaking, NHTSA and EPA believe that employing average values for technology effectiveness estimates is an appropriate way of recognizing the potential variation in the specific benefits that individual manufacturers (and individual engines) might obtain from adding a fuel-saving technology.

**Baseline Engine:** Similar to the gasoline engine used as the baseline in the light-duty rule, the agencies assumed the baseline engine in this segment to be a naturally aspirated, overhead valve V8 engine.<sup>276</sup> The agencies did not receive any comments regarding the baseline engine assumptions in the proposal. The following discussion of effectiveness is generally in comparison to 2010 baseline engine performance.

For the final rulemaking, the agencies considered the same set of technologies for loose gasoline engines at proposal. The agencies received comments which suggested that the agencies consider electrification of accessories to reduce the fuel consumption and CO<sub>2</sub> emissions from heavy-duty gasoline engines. Electrification may result in a reduction in power demand, because electrically powered accessories (such as the air compressor or power steering) operate only when needed if they are electrically powered, but they impose a parasitic demand all the time if they are engine driven. In other cases, such as cooling fans or an engine's water pump, electric power allows the accessory to run at speeds independent of engine speed, which can reduce power consumption. However, technologies such as these improvements to accessories are not demonstrated using the engine dynamometer test procedures being adopted in this final rule because those systems are not installed on the engine during the testing. Thus, the

technologies the agencies considered include the following:

**Engine Friction Reduction:** In addition to low friction lubricants, manufacturers can also reduce friction and improve fuel consumption by improving the design of engine components and subsystems. Examples include improvements in low-tension piston rings, piston skirt design, roller cam followers, improved crankshaft design and bearings, material coatings, material substitution, more optimal thermal management, and piston and cylinder surface treatments. The 2010 NAS, NESCCAF<sup>277</sup> and EEA<sup>278</sup> reports as well as confidential manufacturer data used in the light-duty vehicle rulemaking suggested a range of effectiveness for engine friction reduction to be between 1 to 3 percent. NHTSA and EPA continue to believe that this range is accurate.

**Coupled Cam Phasing:** Valvetrains with coupled (or coordinated) cam phasing can modify the timing of both the inlet valves and the exhaust valves an equal amount by phasing the camshaft of a single overhead cam engine or an overhead valve engine. Based on the light-duty 2012–2016 MY vehicle rule, previously-received confidential manufacturer data, and the NESCCAF report, NHTSA and EPA estimated the effectiveness of couple cam phasing CCP to be between 1 and 4 percent. NHTSA and EPA reviewed this estimate for purposes of the NPRM, and continue to find it accurate.

**Cylinder Deactivation:** In conventional spark-ignited engines throttling the airflow controls engine torque output. At partial loads, efficiency can be improved by using cylinder deactivation instead of throttling. Cylinder deactivation can improve engine efficiency by disabling or deactivating (usually) half of the cylinders when the load is less than half of the engine's total torque capability—the valves are kept closed, and no fuel is injected—as a result, the trapped air within the deactivated cylinders is simply compressed and expanded as an air spring, with reduced friction and heat losses. The active cylinders combust at almost double the load required if all of the cylinders were operating. Pumping losses are significantly reduced as long as the engine is operated in this “part cylinder” mode. Effectiveness improvements scale roughly with

engine displacement-to-vehicle weight ratio: The higher displacement-to-weight vehicles, operating at lower relative loads for normal driving, have the potential to operate in part-cylinder mode more frequently. Cylinder deactivation is less effective on heavily-loaded vehicles because they require more power and spend less time in areas of operation where only partial power is required. The technology also requires proper integration into the vehicles which is difficult in the vocational vehicle segment where often the engine is sold to a chassis manufacturer or body builder without knowing the type of transmission or axle used in the vehicle or the precise duty cycle of the vehicle. The cylinder deactivation requires fine tuning of the calibration as the engine moves into and out of deactivation mode to achieve acceptable NVH. Additionally, cylinder deactivation would be difficult to apply to vehicles with a manual transmission because it requires careful gear change control. NHTSA and EPA adjusted the 2012–16 MY light-duty rule estimates using updated power to weight ratings of heavy-duty trucks and confidential business information and downwardly adjusted the effectiveness to 0 to 3 percent for these vehicles to reflect the differences in drive cycle and operational opportunities compared to light-duty vehicles. Because of the complexities associated with integrating cylinder deactivation in a non-integrated vehicle assembly process and the low effectiveness of the technology, the agencies did not include cylinder deactivation in the final gasoline engine technology package.

**Stoichiometric gasoline direct injection:** SGDI (also known as spark-ignition direct injection engines) inject fuel at high pressure directly into the combustion chamber (rather than the intake port in port fuel injection). Direct injection of the fuel into the cylinder improves cooling of the air/fuel charge within the cylinder, which allows for higher compression ratios and increased thermodynamic efficiency without the onset of combustion knock. Recent injector design advances, improved electronic engine management systems and the introduction of multiple injection events per cylinder firing cycle promote better mixing of the air and fuel, enhance combustion rates, increase residual exhaust gas tolerance and improve cold start emissions. SGDI engines achieve higher power density and match well with other technologies, such as boosting and variable valvetrain designs. The light-duty 2012–2016 MY vehicle rule estimated the effectiveness

<sup>276</sup> The agencies note that baseline did not include coupled cam phasing for loose HD gasoline engines. The HD loose engines are slightly different than the ones used in the HD pickup trucks. They tend to be the older versions of the same engine.

<sup>277</sup> Northeast States Center for a Clean Air Future. “Reducing Greenhouse Gas Emissions from Light-Duty Motor Vehicles.” September 2004.

<sup>278</sup> Energy and Environmental Analysis, Inc. “Technology to Improve the Fuel Economy of Light Duty Trucks to 2015.” May 2006.

of SGDI to be between 2 and 3 percent. NHTSA and EPA revised these estimated accounting for the use and testing methods for these vehicles along with confidential business information estimates received from manufacturers while developing the program. Based on these revisions, NHTSA and EPA estimate the range of 1 to 2 percent for SGDI.

### (c) Diesel Engine Technologies

Different types of diesel engines are used in vocational vehicles, depending on the application. They fall into the categories of Light, Medium, and Heavy Heavy-duty Diesel engines. The Light Heavy-duty Diesel engines typically range between 4.7 and 6.7 liters displacement. The Medium Heavy-duty Diesel engines typically have some overlap in displacement with the Light Heavy-duty Diesel engines and range between 6.7 and 9.3 liters. The Heavy Heavy-duty Diesel engines typically are represented by engines between 10.8 and 16 liters.

**Baseline Engine:** There are three baseline diesel engines, a Light, Medium, and a Heavy Heavy-duty Diesel engine. The agencies developed the baseline diesel engine as a 2010 model year engine with an aftertreatment system which meets EPA's 0.2 grams of NO<sub>x</sub>/bhp-hr standard with an SCR system along with EGR and meets the PM emissions standard with a diesel particulate filter with active regeneration. The engine is turbocharged with a variable geometry turbocharger. As noted above in Section III.A.1.b, the agencies received comments from Navistar stating that the agencies used an artificially low baseline CO<sub>2</sub> emissions level which was tilted toward the use of SCR aftertreatment system. As discussed in Section III.A.1.b, the agencies disagree with the statement that SCR is infeasible. Additional responses from the agencies are available in the Response to Comments document, Section 6.2.<sup>279</sup> The following discussion of technologies describes improvements over the 2010 model year baseline engine performance, unless otherwise noted. Further discussion of the baseline engine and its performance can be found in Section III.C.2.(c)(i) below. The following discussion of effectiveness is generally in comparison to 2010 baseline engine performance, and is in reference to performance in

terms of the Heavy-duty FTP that would be used for compliance for these engine standards. This is in comparison to the steady state SET procedure that would be used for compliance purposes for the engines used in Class 7 and 8 tractors. See Section II.B.2.(i) above.

**Turbochargers:** Improved efficiency of a turbocharger compressor or turbine could reduce fuel consumption by approximately 1 to 2 percent over today's variable geometry turbochargers in the market today. The 2010 NAS report identified technologies such as higher pressure ratio radial compressors, axial compressors, and dual stage turbochargers as design paths to improve turbocharger efficiency.

**Low Temperature Exhaust Gas Recirculation:** Most LHDD, MHDD, and HHDD engines sold in the U.S. market today use cooled EGR, in which part of the exhaust gas is routed through a cooler (rejecting energy to the engine coolant) before being returned to the engine intake manifold. EGR is a technology employed to reduce peak combustion temperatures and thus NO<sub>x</sub>. Low-temperature EGR uses a larger or secondary EGR cooler to achieve lower intake charge temperatures, which tend to further reduce NO<sub>x</sub> formation. If the NO<sub>x</sub> requirement is unchanged, low-temperature EGR can allow changes such as more advanced injection timing that will increase engine efficiency slightly more than one percent. Because low-temperature EGR reduces the engine's exhaust temperature, it may not be compatible with exhaust energy recovery systems such as turbocompounding or a bottoming cycle.

**Engine Friction Reduction:** Reduced friction in bearings, valve trains, and the piston-to-liner interface will improve efficiency. Any friction reduction must be carefully developed to avoid issues with durability or performance capability. Estimates of fuel consumption improvements due to reduced friction range from 0.5 to 1.5 percent.<sup>280</sup>

**Selective catalytic reduction:** This technology is common on 2010 heavy-duty diesel engines. Because SCR is a highly effective NO<sub>x</sub> aftertreatment approach, it enables engines to be optimized to maximize fuel efficiency, rather than minimize engine-out NO<sub>x</sub>. 2010 SCR systems are estimated to result in improved engine efficiency of approximately 4 to 5 percent compared to a 2007 in-cylinder EGR-based emissions system and by an even greater percentage compared to 2010 in-

cylinder approaches.<sup>281</sup> As more effective low-temperature catalysts are developed, the NO<sub>x</sub> conversion efficiency of the SCR system will increase. Next-generation SCR systems could then enable still further efficiency improvements; alternatively, these advances could be used to maintain efficiency while down-sizing the aftertreatment. We estimate that continued optimization of the catalyst could offer 1 to 2 percent reduction in fuel use over 2010 model year systems in the 2014 model year.<sup>282</sup> The agencies also estimate that continued refinement and optimization of the SCR systems could provide an additional 2 percent reduction in the 2017 model year.

**Improved Combustion Process:** Fuel consumption reductions in the range of 1 to 4 percent are identified in the 2010 NAS report through improved combustion chamber design, higher fuel injection pressure, improved injection shaping and timing, and higher peak cylinder pressures.<sup>283</sup>

**Reduced Parasitic Loads:** Accessories that are traditionally gear or belt driven by a vehicle's engine can be optimized and/or converted to electric power. Examples include the engine water pump, oil pump, fuel injection pump, air compressor, power-steering pump, cooling fans, and the vehicle's air-conditioning system. Optimization and improved pressure regulation may significantly reduce the parasitic load of the water, air and fuel pumps. Electrification may result in a reduction in power demand, because electrically powered accessories (such as the air compressor or power steering) operate only when needed if they are electrically powered, but they impose a parasitic demand all the time if they are engine driven. In other cases, such as cooling fans or an engine's water pump, electric power allows the accessory to run at speeds independent of engine speed, which can reduce power consumption. The TIAX study used 2 to 4 percent fuel consumption improvement for accessory electrification, with the understanding that electrification of accessories will have more effect in short-haul/urban applications and less benefit in line-haul applications.<sup>284</sup>

<sup>279</sup> U.S. EPA. Greenhouse Gas Emissions Standards and Fuel Efficiency Standards for Medium- and Heavy-Duty Engines and Vehicles—EPA Response to Comments Document for Joint Rulemaking. EPA-420-R-11-004. Docket EPA-HQ-OAR-2010-0162.

<sup>280</sup> See TIAX, Note 198, pg. 4-15.

<sup>281</sup> Stanton, D. "Advanced Diesel Engine Technology Development for High Efficiency, Clean Combustion." Cummins, Inc. Annual Progress Report 2008 Vehicle Technologies Program: Advanced Combustion Engine Technologies, U.S. Department of Energy. Pp 113-116. December 2008.

<sup>282</sup> See TIAX, Note 198, pg. 4-9

<sup>283</sup> See 2010 NAS Report, Note 197, page 56.

<sup>284</sup> See TIAX, Note 198, Pages 3-5.

(2) What is the projected technology package's effectiveness and cost?

(a) Vocational Vehicles

(i) Baseline Vocational Vehicle Performance

The baseline vocational vehicle model is defined in the GEM, as described in RIA Chapter 4.4.6. At proposal, the agencies used a baseline rolling resistance coefficient for today's vocational vehicle fleet of 9.0 kg/metric ton.<sup>285</sup> As discussed in Section II.D.1, the agencies conducted a tire rolling resistance evaluation of tires used in vocational vehicles. The agencies found that the average rolling resistance of the tires was lower than the agencies' assessment at proposal. Based on this new information and our understanding of the potential to improve tire rolling resistance by 2014, the agencies are setting the vocational truck standard premised on the use of tires with a

rolling resistance coefficient of 7.7 kg/metric ton. This value is consistent with the average performance of the subset of tires the agencies tested. We are projecting this standard will drive a 5 percent reduction in tire rolling resistance on average across the fleet. We are projecting this 5 percent reduction based on our expectation that manufacturers will desire to bring all of their tires below the standard (not just comply on average) and knowing manufacturers will need some degree of overcompliance to ensure despite manufacturing variability and test to test variability their products are compliant with the emission standards. In order to reflect both this tighter standard (based on 7.7) and the 5 percent reduction in rolling resistance we project it will accomplish, we are modeling the baseline performance of vocational truck tires as 8.1 kg/metric ton.

Further vehicle technology is not included in this baseline, as discussed

below in the discussion of the baseline vocational vehicle. The baseline engine fuel consumption represents a 2010 model year diesel engine, as described in RIA Chapter 4. Using these values, the baseline performance of these vehicles is included in Table III-12.

The agencies note that the baseline performance derived for the final rule slightly differs from the values derived for the NPRM. The first difference is due to the change in rolling resistance from 9.0 to 8.1 kg/metric ton based on the agencies' post-proposal test results. Second, there are minor differences in the fuel consumption and CO<sub>2</sub> emissions due to the small modifications made to the GEM, as noted in RIA Chapter 4. In addition, the HHD vocational vehicle baseline performance for the final rule uses a revised payload assumption from 38,000 to 15,000 pounds, as described in Section II.D.3.c.iii.

TABLE III-12—BASELINE VOCATIONAL VEHICLE PERFORMANCE

	Vocational vehicle		
	Heavy-duty	Medium heavy-duty	Heavy heavy-duty
Fuel Consumption Baseline (gallon/1,000 ton-mile) .....	40.0	24.3	23.2
CO <sub>2</sub> Baseline (grams CO <sub>2</sub> /ton-mile) .....	408	247	236

(ii) Vocational Vehicle Technology Package

The final program for vocational vehicles for this phase of regulatory standards is based on the performance of tire and engine technologies. Aerodynamics technology, weight reduction, drive train improvement, and hybrid power trains are not included for the reasons discussed above in Section III.C (1) and Section II.D.

The assessment of the final technology effectiveness was developed through the use of the GEM. To account for the two final engine standards, EPA is finalizing the use of a 2014 model year fuel consumption map in the GEM to derive the 2014 model year truck standard and a 2017 model year fuel consumption map to derive the 2017 model year truck standard. (These fuel consumption maps reflect the main standards for HD diesel engines, not the alternative engine standards.) The

agencies estimate that the rolling resistance of 50 percent of the tires can be reduced by 10 percent in the 2014 model year, for an overall reduction in rolling resistance of 5 percent. The vocational vehicle standards for all three regulatory categories were determined using a tire rolling resistance coefficient of 7.7 kg/metric ton in the 2014 model year. The set of input parameters which are modeled in GEM are shown in Table III-13.

TABLE III-13—GEM INPUTS FOR FINAL VOCATIONAL VEHICLE STANDARDS

	2014 MY	2017 MY
Engine .....	2014 MY 7L for LHD/MHD and 15L for HHD Trucks	2017 MY 7L for LHD/MHD and 15L for HHD Trucks.
Tire Rolling Resistance (kg/metric ton) .....	7.7	7.7

The agencies developed the final standards by using the engine and tire rolling resistance inputs in the GEM, as

shown in Table III-13. The percent reductions shown in Table III-14 reflect improvements over the 2010 model year

baseline vehicle with a 2010 model year baseline engine.

<sup>285</sup> The baseline tire rolling resistance for this segment of vehicles was derived for the proposal based on the current baseline tractor and passenger car tires. The baseline tractor drive tire has a rolling resistance of 8.2 kg/metric ton based on SmartWay

testing. The average passenger car has a tire rolling resistance of 9.75 kg/metric ton based on a presentation made to CARB by the Rubber Manufacturer's Association. As noted above, further analysis has resulted in an estimate of improved

performance in the baseline fleet, which is based entirely on use of LRR tires on vocational vehicles (not cars). Additional details are available in the RIA chapter 2.

TABLE III–14—FINAL VOCATIONAL VEHICLE STANDARDS AND PERCENT REDUCTIONS

	Vocational vehicle		
	Light heavy-duty	Medium heavy-duty	Heavy heavy-duty
2016 MY Fuel Consumption Standard (gallon/1,000 ton-mile) .....	38.1	23.0	22.2
2017 MY Fuel Consumption Standard (gallon/1,000 ton-mile) .....	36.7	22.1	21.8
2014 MY CO <sub>2</sub> Standard (grams CO <sub>2</sub> /ton-mile) .....	388	234	226
2017 MY CO <sub>2</sub> Standard (grams CO <sub>2</sub> /ton-mile) .....	373	225	222
Percent Reduction from 2010 baseline in 2014 MY .....	5%	5%	4%
Percent Reduction from 2010 baseline in 2017 MY .....	8%	9%	6%

(iii) Technology Package Cost

The agencies did not receive any substantial comments on the engine costs proposed. Thus the agencies are projecting the costs of the technologies used to develop the final standards based on the costs used in the proposal, but revised to reflect 2009\$, new ICMs, and a 50 percent penetration rate of low rolling resistance tires (as explained above). EPA and NHTSA developed the costs of LRR tires based on the ICF report. The estimated cost per truck is \$81 (2009\$) for LHD and MHD trucks and \$97 (2009\$) for HHD trucks. These costs include a low complexity ICM of 1.18 and are applicable in the 2014 model year.

(iv) Reasonableness of the Final Vocational Vehicle Standards

The final standards would not only add only a small amount to the vehicle cost, but are highly cost effective, an estimated \$20 ton of CO<sub>2</sub>eq per vehicle in 2030.<sup>286</sup> This is even less than the estimated cost effectiveness for CO<sub>2</sub>eq removal under the light-duty vehicle rule, already considered by the agencies to be a highly cost effective reduction.<sup>287</sup> Moreover, the modest cost of controls is recovered almost immediately due to the associated fuel savings, as shown in the payback analysis included in Table VIII–7. Given that the standards are technically feasible within the lead time afforded by the 2014 model year, are inexpensive and highly cost effective, and do not have other adverse potential impacts (e.g., there are no projected negative impacts on safety or vehicle utility), the final standards represent a reasonable choice under section 202(a) of the CAA and NHTSA’s EISA authority under 49 U.S.C. 32902(k)(2), and the agencies believe that the standards are consistent

with their respective authorities. Based on the discussion above, NHTSA believes these standards are the maximum feasible under EISA.

(v) Alternative Vehicle Standards Considered

The agencies are not finalizing vehicle standards less stringent than the final standards because the agencies believe these standards are highly cost effective, as just explained.

The agencies considered finalizing truck standards which are more stringent reflecting the inclusion of hybrid powertrains in those vocational vehicles where use of hybrid powertrains is appropriate. The agencies estimate that a 25 percent utilization rate of hybrid powertrains in MY 2017 vocational vehicles would add, on average, \$30,000 to the cost of each vehicle and more than double the cost of the rule for this sector. See the RIA at chapter 6.1.8. The emission reductions associated with these very high costs appear to be modest. See the RIA Table 6–14. In addition, the agencies are finalizing flexibilities in the form of generally applicable credit opportunities for advanced technologies, to encourage use of hybrid powertrains. See Section IV.C. 2 below. Several commenters recommended that in addition to hybrid powertrains, the agencies consider setting more stringent standards based on the use of aerodynamic improvements, weight reduction, idle shutdown technologies, vehicle speed limiters, and specific transmission technologies. As described above, we are not finalizing standards based on these technologies for reasons that related to the unique nature of the very diverse vocational vehicle segment. At this time, the agencies have no means to determine the current baseline aerodynamic performance of all vocational vehicles (ranging from concrete mixers to school buses), nor a means to project to what degree the aerodynamic performance could be improved without compromising the utility of the vehicle. Absent this information, the agencies cannot set a

standard based on improvements in aerodynamic performance. The agencies face similar obstacles regarding our ability to project the utility tradeoffs that may exist between limitations on vehicle speed or reductions in vehicle mass and utility and safety of vocational vehicles. We are confident the answer to those questions will differ for a school bus compared to a concrete mixer compared to a fire truck compared to an ambulance. Absent an approach to set distinct standards for each of the vocational vehicle types and the information necessary to determine the appropriate level of performance for those vehicles, the agencies cannot set standards for vocational vehicles based on the use of these technologies. For these reasons, the agencies are not adopting more comprehensive standards for vocational vehicles. The agencies do agree that at least some vocational vehicles can be made more efficient through the use of technologies, including those technologies mentioned in the comments, and the agencies fully intend to take on the challenge of developing the data, test procedures and regulatory structures necessary to set more comprehensive standards for vocational trucks in the future.

(b) Gasoline Engines

(i) Baseline Gasoline Engine Performance

EPA and NHTSA developed the reference heavy-duty gasoline engines to represent a 2010 model year engine compliant with the 0.20 g/bhp-hr NO<sub>x</sub> standard for on-highway heavy-duty engines.

NHTSA and EPA developed the baseline fuel consumption and CO<sub>2</sub> emissions for the gasoline engines from manufacturer reported CO<sub>2</sub> values used in the certification of non-GHG pollutants. The baseline engine for the analysis was developed to represent a 2011 model year engine, because this is the most current information available. The average CO<sub>2</sub> performance of the heavy-duty gasoline engines was 660 g/ bhp-hour, which will be used as a

<sup>286</sup> See Section VIII.D.

<sup>287</sup> As noted above, the light-duty rule had an estimated cost per ton of \$50 when considering the vehicle program costs only and a cost of –\$210 per ton considering the vehicle program costs along with fuel savings in 2030. See 75 FR 25515, Table III.H.3–1.

baseline. The baseline gasoline engines are all stoichiometric port fuel injected V-8 engines without cam phasers or other variable valve timing technologies. While they may reflect some degree of static valve timing optimization for fuel efficiency they do not reflect the potential to adjust timing with engine speed.

(ii) Gasoline Engine Technology Package Effectiveness

The gasoline engine technology package includes engine friction reduction, coupled cam phasing, and SGDI to produce an overall five percent reduction from the reference engine based on the Heavy-duty Lumped Parameter model. The agencies are projecting a 100 percent application rate of this technology package to the heavy-duty gasoline engines, which results in a CO<sub>2</sub> standard of 627 g/bhp-hr and a fuel consumption standard of 7.05 gallon/100 bhp-hr. As discussed in Section II.D.b.ii, the agencies are adopting gasoline engine standards that begin in the 2016 model year based on the agencies' projection of the engine redesign schedules for the small number of engines in this category.

(iii) Gasoline Engine Technology Package Cost

For the proposed costs, the agencies considered both the direct or "piece" costs and indirect costs of individual components of technologies. For the direct costs, the agencies followed a BOM approach employed by NHTSA and EPA in the light-duty 2012-2016 MY vehicle rule. In this final action, the agencies are using marked up gasoline engine technology costs developed for the HD Pickup Truck and Van segment because these engines are made by the same manufacturers (primarily by Ford and GM) and are simply, sold as loose engines rather than as complete vehicles. Hence the engine cost estimates are fundamentally the same. The agencies did not receive any comments recommending adjustments to the proposed gasoline engine technology costs. The costs summarized in Table III-15 are consistent with the proposed values, but updated to reflect 2009\$ and new ICMs. The costs shown in Table III-15 include a low complexity ICM of 1.24 and are applicable in the 2016 model year. No learning effects are applied to engine friction reduction costs, while flat-portion of the curve learning is considered applicable to both coupled cam phasing and SGDI.

TABLE III-15—HEAVY-DUTY GASOLINE ENGINE TECHNOLOGY COSTS INCLUSIVE OF INDIRECT COST MARKUPS [2009\$]

	2016 MY
Engine Friction Reduction .....	\$95
Coupled Cam Phasing .....	46
Stoichiometric Gas Direct Injection .....	452
Total .....	594

(iv) Reasonableness of the Final Standard

The final engine standards are reasonable and consistent with the agencies' respective authorities. With respect to the 2016 MY standard, all of the technologies on which the standards are predicated have been demonstrated and their effectiveness is well documented. The final standards reflect a 100 percent application rate for these technologies. The costs of adding these technologies remain modest across the various engine classes as shown in Table 0-15. Use of these technologies would add only a small amount to the cost of the vehicle,<sup>288</sup> and the associated reductions are highly cost effective, an estimated \$20 per ton of CO<sub>2</sub>eq per vehicle.<sup>289</sup> This is even more cost effective than the estimated cost effectiveness for CO<sub>2</sub>eq removal and fuel economy improvement under the light-duty vehicle rule, already considered by the agencies to be a highly cost effective reduction.<sup>290</sup> Accordingly, EPA and NHTSA view these standards as reflecting an appropriate balance of the various statutory factors under section 202(a) of the CAA and under NHTSA's EISA authority at 49 U.S.C. 32902(k)(2). Based on the discussion above, NHTSA believes these standards are the maximum feasible under EISA.

Several commenters suggested that the lead time provided by the agencies for heavy-duty pickups and vans and by extension the 2016 gasoline engine standards were unnecessarily long. The agencies do not agree with this assessment. The technologies that we are considering here cannot simply be bolted on to an existing engine but can

only be effectively applied through an integrated design and development process. The four years lead time provided here is short in the context of engine redesigns and is only possible in part because the standards align with engine manufacturers' planned redesign processes that are either just starting or will be starting within the year. These standards set a clear metric of performance for those planned redesigns and we project will lead manufacturers to include a number of technologies that would not otherwise have been incorporated into those engines.

(v) Alternative Gasoline Engine Standards Considered

The agencies are not finalizing gasoline standards less stringent than the final standards because the agencies believe these standards are feasible in the lead time provided, inexpensive, and highly cost effective.

The final rule reflects 100 percent penetration of the technology package on whose performance the standard is based, so some additional technology would need to be added to obtain further improvements. The agencies considered finalizing gasoline engine standards which are more stringent reflecting the inclusion of cylinder deactivation and other advanced technologies. However, the agencies are not finalizing this level of stringency because our assessment is that these technologies cannot be adapted to the higher average engine loads of heavy-duty vehicles for production by the 2017 model year. We intend to continue to evaluate the potential for further gasoline engine improvements building on the work done for light-duty passenger cars and trucks as we begin work on the next phase of heavy-duty regulations.

(c) Diesel Engines

(i) Baseline Diesel Engine Performance

EPA and NHTSA developed the baseline heavy-duty diesel engines to represent a 2010 model year engine compliant with the 0.20 g/bhp-hr NO<sub>x</sub> standard for on-highway heavy-duty engines.

The agencies utilized 2007 through 2011 model year CO<sub>2</sub> certification levels from the Heavy-duty FTP cycle as the basis for the baseline engine CO<sub>2</sub> performance. The pre-2010 data are subsequently adjusted to represent 2010 model year engine maps by using predefined technologies including SCR and other systems that are being used in current 2010 production. The engine CO<sub>2</sub> results were then sales weighted

<sup>288</sup> Sample 2010 MY vocational vehicles range in price between \$40,000 for a Class 4 work truck to approximately \$200,000 for a Class 8 refuse hauler. See pages 16-17 of ICF's "Investigation of Costs for Strategies to Reduce Greenhouse Gas Emissions for Heavy-Duty On-Road Vehicles." July 2010.

<sup>289</sup> See Vocational Vehicle CO<sub>2</sub> savings and technology costs in Table 7-4 in RIA chapter 7.

<sup>290</sup> The light-duty rule had an estimated cost per ton of \$50 when considering the vehicle program costs only and a cost of - \$210 per ton considering the vehicle program costs along with fuel savings in 2030. See 75 FR 25515, Table III.H.3-1.

within each regulatory subcategory to develop an industry average 2010 model year reference engine, as shown in Table III-16. The level of CO<sub>2</sub> emissions and

fuel consumption of these engines varies significantly, where the engine with the highest CO<sub>2</sub> emissions is estimated to be 20 percent greater than

the sales weighted average. Details of this analysis are included in RIA Chapter 2.

TABLE III-16—2010 MODEL YEAR REFERENCE DIESEL ENGINE PERFORMANCE OVER THE HEAVY-DUTY FTP CYCLE

	CO <sub>2</sub> emissions (g/bhp-hr)	Fuel consumption (gallon/100 bhp-hr)
LHD Diesel .....	630	6.19
MHD Diesel .....	630	6.19
HHD Diesel .....	584	5.74

(ii) Diesel Engine Packages

The diesel engine technology packages for the 2014 model year include engine friction reduction, improved aftertreatment effectiveness, improved combustion processes, and low temperature EGR system optimization. The improvements in parasitic and friction losses come through piston designs to reduce friction, improved lubrication, and improved water pump and oil pump designs to reduce parasitic losses. The aftertreatment improvements are available through lower backpressure of the systems and optimization of the engine-out NO<sub>x</sub> levels. Improvements to the EGR system and air flow through the intake and exhaust systems, along with turbochargers can also produce engine efficiency improvements. It should be pointed out that individual technology improvements are not additive to each other due to the interaction of technologies. The agencies assessed the impact of each technology over the Heavy-duty FTP and project an overall cycle improvement in the 2014 model year of 3 percent for HHD diesel engines and 5 percent for LHD and MHD diesel engines, as detailed in RIA Chapter 2.4.2.9 and 2.4.2.10. EPA used a 100 percent application rate of this technology package to determine the level of the final 2014 MY standards

Recently, EPA's heavy-duty highway engine program for criteria pollutants provided new emissions standards for the industry in three year increments. The heavy-duty engine manufacturer product plans have fallen into three year cycles to reflect this environment. EPA is finalizing CO<sub>2</sub> emission standards recognizing the opportunity for technology improvements over this time frame while reflecting the typical heavy-duty engine manufacturer product plan redesign cycles. Thus, the agencies are establishing initial standards for the 2014 model year and a more stringent standard for these heavy-duty engines beginning in the 2017 model year.

The 2017 model year technology package for LHD and MHD diesel engine

includes continued development and refinement of the 2014 model year technology package, in particular the additional improvement to aftertreatment systems. This package leads to a projected 9 percent reduction for LHD and MHD diesel engines in the 2017 model year. The HHD diesel engine technology packages for the 2017 model year include the continued development of the 2014 model year technology package. A similar approach to evaluating the impact of individual technologies as taken to develop the overall reduction of the 2014 model year package was taken with the 2017 model year package. The Heavy-duty FTP cycle improvements lead to a 5 percent reduction on the cycle for HHDD, as detailed in RIA Chapter 2.4.2.13. The agencies used a 100 percent application rate of the technology package to determine the final 2017 MY standards. The agencies believe that bottom cycling technologies are still in the development phase and will not be ready for production by the 2017 model year.<sup>291</sup> Therefore, these technologies were not included in determining the stringency of the final standards. However, we do believe the bottoming cycle approach represents a significant opportunity to reduce fuel consumption and GHG emissions in the future for vehicles that operate under primarily steady-state conditions like line-haul tractors and some vocational vehicles. As discussed above, we also considered setting standards based on the use of hybrid powertrains that are a better match to many vocational vehicle duty cycles but have decided for the reasons articulated above to not base the vocational vehicle standard on the use of hybrid technologies in this first regulation. However, EPA and NHTSA are both finalizing provisions described in Section IV to create incentives for manufacturers to continue to invest to

<sup>291</sup> TIAX noted in their report to the NAS panel that the engine improvements beyond 2015 model year included in their report are highly uncertain, though they include waste heat recovery in the engine package for 2016 through 2020 (page 4-29).

develop these technologies in the believe that with further development these technologies can form the basis of future standards.

The overall projected improvements in CO<sub>2</sub> emissions and fuel consumption over the baseline are included in Table III-17.

TABLE III-17—PERCENT FUEL CONSUMPTION AND CO<sub>2</sub> EMISSION REDUCTIONS OVER THE HEAVY-DUTY FTP CYCLE

	2014	2017
LHD Diesel .....	5%	9%
MHD Diesel .....	5	9
HHD Diesel .....	3	5

(iii) Technology Package Costs

NHTSA and EPA jointly developed costs associated with the engine technologies to assess an overall package cost for each regulatory category. Our engine cost estimates for diesel engines used in vocational vehicles include a separate analysis of the incremental part costs, research and development activities, and additional equipment, such as emissions equipment to measure N<sub>2</sub>O emissions. Our general approach used elsewhere in this action (for HD pickup trucks, gasoline engines, Class 7 and 8 tractors, and Class 2b-8 vocational vehicles) estimates a direct manufacturing cost for a part and marks it up based on a factor to account for indirect costs. See also 75 FR 25376. We believe that approach is appropriate when compliance with final standards is achieved generally by installing new parts and systems purchased from a supplier. In such a case, the supplier is conducting the bulk of the research and development on the new parts and systems and including those costs in the purchase price paid by the original equipment manufacturer. The indirect costs incurred by the original equipment manufacturer need not include much cost to cover research and development since the bulk of that effort is already done. For the MHD and



HHD diesel engine segment, however, the agencies believe we can make a more accurate estimate of technology cost using this alternate approach because the primary cost is not expected to be the purchase of parts or systems from suppliers or even the production of the parts and systems, but rather the development of the new technology by the original equipment manufacturer itself. Therefore, the agencies believe it more accurate to directly estimate the indirect costs. EPA commonly uses this approach in cases where significant investments in research and development can lead to an emission control approach that requires no new hardware. For example, combustion optimization may significantly reduce emissions and cost a manufacturer millions of dollars to develop but will lead to an engine that is no more expensive to produce. Using a bill of materials approach would suggest that the cost of the emissions control was zero reflecting no new hardware and ignoring the millions of dollars spent to develop the improved combustion system. Details of the cost analysis are included in the RIA Chapter 2. To reiterate, we have used this different approach because the MHD and HHD

diesel engines are expected to comply in large part via technology changes that are not reflected in new hardware but rather knowledge gained through laboratory and real world testing that allows for improvements in control system calibrations—changes that are more difficult to reflect through direct costs with indirect cost multipliers.

The agencies developed the engineering costs for the research and development of diesel engines with lower fuel consumption and CO<sub>2</sub> emissions. The aggregate costs for engineering hours, technician support, dynamometer cell time, and fabrication of prototype parts are estimated at \$6.8 million (2009\$) per manufacturer per year over the five years covering 2012 through 2016. In aggregate, this averages out to \$284 per engine during 2012 through 2016 using an annual sales value of 600,000 light, medium, and heavy heavy-duty engines. The agencies received comments from Horriba regarding the assumption the agencies used in the proposal that said manufacturers would need to purchase new equipment for measuring N<sub>2</sub>O and the associated costs. Horriba provided information regarding the cost of stand-alone FTIR instrumentation (estimated at \$50,000 per unit) and cost of

upgrading existing emission measurement systems with NDIR analyzers (estimated at \$25,000 per unit). The agencies further analyzed our assumptions along with Horriba's comments. Thus, we have revised the equipment costs estimates and assumed that 75 percent of manufacturers would update existing equipment while the other 25 percent would require new equipment. The agencies are estimating costs of \$63,087 (2009\$) per engine manufacturer per engine subcategory (light, medium, and heavy HD) to cover the cost of purchasing photo-acoustic measurement equipment for two engine test cells. This would be a one-time cost incurred in the year prior to implementation of the standard (*i.e.*, the cost would be incurred in 2013). In aggregate, this averages out to less than \$1 per engine in 2013 using an annual sales value of 600,000 light, medium, and heavy HD engines.

EPA also developed the incremental piece cost for the components to meet each the 2014 and 2017 standards. These costs shown in Table III–18 which include a low complexity ICM of 1.15; flat-portion of the curve learning is considered applicable to each technology.

TABLE III–18—HEAVY-DUTY DIESEL ENGINE COMPONENT COSTS INCLUSIVE OF INDIRECT COST MARKUPS <sup>a</sup> [2009\$]

	2014 Model year	2017 Model year
Cylinder Head (flow optimized, increased firing pressure, improved thermal management).	\$6 (MHD & HH), \$11 (LHD) .....	\$6 (MHD & HHD), \$10 (LHD).
Exhaust Manifold (flow optimized, improved thermal management) .....	\$0 .....	\$0.
Turbocharger (improved efficiency) .....	\$18 .....	\$17.
EGR Cooler (improved efficiency) .....	\$4 .....	\$3.
Water Pump (optimized, variable vane, variable speed) .....	\$91 .....	\$84.
Oil Pump (optimized) .....	\$5 .....	\$4.
Fuel Pump (higher working pressure, increased efficiency, improved pressure regulation).	\$5 .....	\$4.
Fuel Rail (higher working pressure) .....	\$10 (MHD & HHD), \$12 (LHD) .....	\$9 (MHD & HHD), \$11 (LHD).
Fuel Injector (optimized, improved multiple event control, higher working pressure).	\$11 (MHD & HHD), \$15 (LHD) .....	\$10 (MHD & HHD), \$13 (LHD).
Piston (reduced friction skirt, ring and pin) .....	\$3 .....	\$3.
Aftertreatment system (improved effectiveness SCR, dosing, dpf) <sup>a</sup> .....	\$0 (MHD & HHD), \$111 (LHD) .....	\$0 (MHD & HHD), \$101 (LHD).
Valve Train (reduced friction, roller tappet) .....	\$82 (MHD), \$109 (LHD) .....	\$76 (MHD), \$101 (LHD).

**Note:**

<sup>a</sup> Note that costs for aftertreatment improvements for MHD and HHD diesel engines are covered via the engineering costs (see text). For LH diesel engines, we have included the cost of aftertreatment improvements as a technology cost.

The overall costs for each diesel engine regulatory subcategory are included in Table III–19.

TABLE III–19—DIESEL ENGINE TECHNOLOGY COSTS PER ENGINE [2009\$]

	2014	2017
LHD Diesel .....	\$388	\$358

TABLE III–19—DIESEL ENGINE TECHNOLOGY COSTS PER ENGINE—Continued

[2009\$]

	2014	2017
MHD Diesel .....	234	216
HHD Diesel .....	234	216

Reasonableness of the Final Standards

The final engine standards appear to be reasonable and consistent with the agencies' respective authorities. With respect to the 2014 and 2017 MY standards, all of the technologies on which the standards are based have already been demonstrated and their effectiveness is well documented. The final standards reflect a 100 percent application rate for these technologies.

The costs of adding these technologies remain modest across the various engine classes as shown in Table III–19. Use of these technologies would add only a small amount to the cost of the vehicle,<sup>292</sup> and the associated reductions are highly cost effective, an estimated \$20 per ton of CO<sub>2</sub>eq per vehicle.<sup>293</sup> This is even more cost effective than the estimated cost effectiveness for CO<sub>2</sub>eq removal and fuel economy improvement under the light-duty vehicle rule, already considered by the agencies to be a highly cost effective reduction.<sup>294</sup> Accordingly, EPA and NHTSA view these standards as reflecting an appropriate balance of the various statutory factors under section 202(a) of the CAA and under NHTSA's EISA authority at 49 U.S.C. 32902(k)(2). Based on the discussion above, NHTSA believes these standards are the maximum feasible under EISA.

#### (v) Alternative Diesel Engine Standards Considered

Other than the specific option related to legacy engine products, the agencies are not finalizing diesel engine standards less stringent than the final standards because the agencies believe these standards are highly cost effective.

The agencies have not considered finalizing diesel engine standards which are more stringent because we have exhausted the list of engine technologies that we believe are directly applicable to medium- and heavy-duty diesel engines used in vocational applications. We are continuing to evaluate the potential for bottoming cycle technologies to be used in the future, however it is not clear today that this technology, although promising for more steady-state operation will provide any significant efficiency improvement under the more transient operating cycles typical of vocational vehicles. Moreover, as stated at II.D above, the agencies do not believe that this technology will be available in the time frame of this rule in any case.

#### IV. Final Regulatory Flexibility Provisions

This section describes flexibility provisions intended to advance the goals of the overall program while providing alternate pathways to achieve

<sup>292</sup> Sample 2010 MY vocational vehicles range in price between \$40,000 for a Class 4 work truck to approximately \$200,000 for a Class 8 refuse hauler. See pages 16–17 of ICF's "Investigation of Costs for Strategies to Reduce Greenhouse Gas Emissions for Heavy-Duty On-Road Vehicles." July 2010.

<sup>293</sup> See RIA chapter 7, Table 7–4.

<sup>294</sup> The light-duty rule had a cost per ton of \$50 when considering the vehicle program costs only and a cost of –\$210 per ton considering the vehicle program costs along with fuel savings in 2030. See 75 FR 25515, Table III.H.3–1.

those goals, consistent with the agencies' statutory authority, as well as with Executive Order 13563.<sup>295</sup> The primary flexibility provisions for combination tractors and vocational vehicles and the engines installed in these vehicles are incorporated in a program of averaging, banking, and trading of credits. For HD pickups and vans, the primary flexibility provision is also an ABT program expressed in the fleet average form of the standards, along with provisions for credit and deficit carry-forward and for trading, patterned after the agencies' light-duty vehicle GHG and CAFE programs. Furthermore, EPA will allow manufacturers to comply with the N<sub>2</sub>O and CH<sub>4</sub> standards using CO<sub>2</sub> credits and is providing an opportunity for engine manufacturers to earn N<sub>2</sub>O credits that can be used to comply with the CO<sub>2</sub> standards. However, EPA is not adopting an emission credit program associated with the CH<sub>4</sub> or HFC standards. This section also describes other flexibility provisions that apply, including advanced technology credits, innovative technology credits and early compliance credits.

#### A. Averaging, Banking, and Trading Program

Averaging, Banking, and Trading (ABT) of emissions credits have been an important part of many EPA mobile source programs under CAA Title II, including engine and vehicle programs. NHTSA has also long had an averaging and banking program for light-duty CAFE under EPCA, and recently gained authority to add a trading program for light-duty CAFE through EISA. ABT programs are useful because they can help to address many issues of technological feasibility and lead-time, as well as considerations of cost. They provide manufacturers flexibilities that assist the efficient development and implementation of new technologies and therefore enable new technologies to be implemented at a more aggressive pace than without ABT. ABT programs are more than just add-on provisions included to help reduce costs, and can be, as in EPA's Title II programs an integral part of the standard setting itself. A well-designed ABT program can also provide important environmental and energy security benefits by increasing the speed at which new technologies can be

<sup>295</sup> Section 4 of EO 13563 states that "Where relevant, feasible, and consistent with regulatory objectives, and to the extent permitted by law, each agency shall identify and consider regulatory approaches that reduce burdens and maintain flexibility and freedom of choice for the public." 76 FR 3821 (Jan. 21, 2011).

implemented (which means that more benefits accrue over time than with slower-starting standards) and at the same time increase flexibility for, and reduce costs to, the regulated industry. American Council for an Energy-Efficient Economy (ACEEE) has commented that ABT and related flexibilities should not be offered for this program because the agencies are not promoting the use of new technologies but rather the use of existing technologies. However, without ABT provisions (and other related flexibilities), standards would typically have to be numerically less stringent since the numerical standard would have to be adjusted to accommodate issues of feasibility and available lead time. See 75 FR at 25412–13. By offering ABT credits and additional flexibilities the agencies can offer progressively more stringent standards that help meet our fuel consumption reduction and GHG emission goals at a faster pace.

Section II above describes EPA's GHG emission standards and NHTSA's fuel consumption standards. For each of these respective sets of standards, the agencies also offer ABT provisions, consistent with each agency's statutory authority. The agencies worked closely to design these provisions to be essentially identical to each other in form and function. Because of this fundamental similarity, the remainder of this section refers to these provisions collectively as "the ABT program" except where agency-specific distinctions are required.

As discussed in detail below, the structure of the GHG and fuel consumption ABT program for HD engines was based closely on EPA's earlier ABT programs for HD engines; the program for HD pickups and vans was built on the existing light-duty GHG program flexibility provisions; and the first-time ABT provisions for combination tractors and vocational vehicles are as consistent as possible with EPA's other HD vehicle regulations. The flexibility provisions associated with this new regulatory category were intended to build systematically upon the structure of the existing programs.

As an overview, "averaging" means the exchange of emission or fuel consumption credits between engine families or truck families within a given manufacturer's regulatory subcategories and averaging sets. For example, specific "engine families," which manufacturers create by dividing their product lines into groups expected to have similar emission characteristics throughout their useful life, would be contained within an averaging set.

Averaging allows a manufacturer to certify one or more engine families (or vehicle families, as appropriate) within the same averaging set at levels worse than the applicable emission or fuel consumption standard. The increased emissions or fuel consumption over the standard would need to be offset by one or more engine (or vehicle) families within that manufacturer's averaging set that are certified better than the same emission or fuel consumption standard, such that the average emissions or fuel consumption from all the manufacturer's engine families, weighted by engine power, regulatory useful life, and production volume, are at or below the level of the emission or fuel consumption standard.<sup>296</sup> Total credits for each averaging set within each model year are determined by summing together the credits calculated for every engine family within that specific averaging set.

"Banking" means the retention of emission credits by the manufacturer for use in future model year averaging or trading. "Trading" means the exchange of emission credits between manufacturers, which can then be used for averaging purposes, banked for future use, or traded to another manufacturer.

In EPA's current HD engine program for criteria pollutants, manufacturers are restricted to averaging, banking and trading only credits generated by the engine families within a regulatory subcategory, and EPA and NHTSA proposed to continue this restriction in the GHG and fuel consumption program for engines and vehicles. However, the agencies sought comment on potential alternative approaches in which fewer restrictions are placed on the use of credits for averaging, banking, and trading. Particularly, the agencies requested comment on removing prohibitions on averaging and trading between some or all regulatory categories in the proposal, and on removing restrictions between some or all regulatory subcategories that are within the same regulatory category (e.g., allowing trading of credits between Class 7 day cabs and Class 8 sleeper cabs).

The agencies received many comments on the restrictions proposed for the ABT program, namely on the proposal that credits could only be averaged within the specified vehicle and engine subcategories and not

averaged across subcategories or between vehicle and engine categories. Many commenters, including Union of Concerned Scientist (UCS), NY Dept of Transportation, Natural Resources Defense Council, Oshkosh, and Autocar, requested that the agencies maintain the restrictions as proposed in the NPRM. UCS argued that allowing credits to be used across categories could undermine further technology advancements, and that manufacturers that have broad portfolios would have advantages over those manufacturers that do not. The Center for Biological Diversity (CBD) argued that because of the various credit opportunities in the ABT program and the potential that manufacturers will pay penalties rather than comply with the standards, the program could actually cause an increase in emissions and a decrease in fuel efficiency. On the other hand, several commenters, including EMA/TMA, Cummins, Volvo, and ATA, requested that the agencies maintain the proposed restrictions of averaging credits between the engine and vehicle categories, but reduce the restrictions on credit averaging across vehicle subcategories or engine subcategories or averaging sets within similar vehicle and engine weight classes (LHD, MHD and HHD). Cummins requested that the agencies allow credit averaging between engine subcategories within the same weight classes (LHD, MHD and HHD). Cummins explained that tractor and vocational engines in the corresponding weight classes not only share the same useful life but also use the same emission and fuel consumption technologies and therefore should be placed into the same engine averaging set. EMA/TMA argued that the NPRM restrictions would inhibit a manufacturer's ability to use credits to address market fluctuations, which would reduce the flexibility that the ABT program was intended to provide. As an example, EMA/TMA stated that if the line-haul market were depressed for a period of time a manufacturer could make up any deficit selling more low-roof tractors with regional hauling operations. The same market shift could eliminate a manufacturer's ability to generate credits using its aerodynamic high-roof sleeper cab tractors and could create a credit deficit if there is a demand for more of the less aerodynamic low-roof tractors. EMA/TMA argued that credit exchanges across vehicle categories within the same weight classes within the tractor subcategories and across vocational vehicle and tractor subcategories would allow a manufacturer more flexibility to

deal with these types of market and customer demand situations. Finally, several commenters, including Ford, DTNA NADA, NTEA and Navistar, requested that the agencies reduce the proposed restrictions even further by allowing credit averaging between vehicle categories and engine categories. Navistar argued that more flexibility was necessary for manufacturers like itself to increase innovation at a reasonable cost, stating that more restrictions would increase costs within a shorter time frame.

After considering these comments, the agencies continue to believe that the ABT program developed by the agencies increases and accelerates the technological feasibility of the GHG and fuel consumption standards by providing manufacturers flexibility in implementing new technologies in a way that may be more consistent with their business practices and cost considerations. In response to the comments submitted by CBD, the agencies disagree with CBD's statements that the ABT program will adversely affect the fuel efficiency and GHG emission goals of this regulation. This joint final action requires vehicle and engine manufacturers to meet increasingly more stringent emission and fuel consumption standards which will result in emission reductions and fuel consumption savings. Manufacturers will not have the option of not meeting the standards. The ABT program simply provides each manufacturer the flexibility to meet these standards based upon their individual products and implementation plans.

By assuming the use of credits for compliance, the agencies were able to set the fuel consumption/GHG standards at more stringent levels than would otherwise have been feasible. One reason is that use of ABT allows each manufacturer maximum flexibility to develop compliance strategies consistent with its redesign cycles and with its product plans generally, allowing the agencies, in turn, to adopt standards which are numerically more stringent in earlier model years than would be possible with a more rigid program since those rigidities would be associated with greater costs. Greater improvements in fuel efficiency will occur under more stringent standards; manufacturers will simply have greater flexibility to determine where and how to make those improvements than they would have without credit options. Further, this is consistent with the directive in EO 13563 to "seek to identify, as appropriate, means to

<sup>296</sup> The inclusion of engine power, useful life, and production volume in the averaging calculations allows the emissions or fuel consumption credits or debits to be expressed in total emissions or consumption over the useful life of the credit-using or generating engine sales.

achieve regulatory goals that are designed to promote innovation.”

The agencies further agree that certain restrictions on use of ABT which were proposed are unnecessary. The proposed ABT program for engines was somewhat more restrictive, in its definition of averaging sets, than EPA's parallel ABT program for criteria pollutant emissions from the same engines. The final rules conform to the ABT provisions for GHG heavy-duty engine emissions to be consistent with the parallel ABT provisions for criteria pollutants with same weight engines treated as a single averaging set regardless of the vehicles in which they are installed. We have applied this same principle with respect to combination tractors and vocational vehicles: Treating like weight classes as an averaging set. The agencies have determined that these additional flexibilities will help to reduce manufacturing costs further and encourage technology implementation without creating an unfair advantage for manufacturers with vertically integrated portfolios including engines and vehicles. EPA's experience in administering the ABT program for heavy-duty diesel engine criteria pollutant emissions supports this conclusion. Therefore, the agencies have decided to allow credit averaging within and across vocational vehicle and tractor subcategories within the same weight class groups, as well as credit averaging across the same weight class vocational and tractor engine groups. This added flexibility beyond what was proposed in the NPRM will not be extended to the HD pickup truck and van category because this group of vehicles is comprised of only one subcategory and is not broken down like the other categories and corresponding subcategories into different weight classes, and the standard applies to the entire vehicle, so that there are no separate engine and vehicle standards. Put another way, the HD pickup truck and van category is one large averaging set that will remain as proposed.

However, the agencies are maintaining the restrictions against averaging vehicle credits with engine credits or between vehicle weight classes or engine subcategories for this first phase of regulation. We believe averaging or trading credits between averaging sets would be problematic because of the diversity of applications involved. This diversity creates large differences in the real world conditions that impact lifetime emissions—such as actual operating life, load cycles, and maintenance practices. In lieu of conducting extensive and burdensome

real world tracking of these parameters, along with corrective measures to provide some assurance of parity between credits earned and credits redeemed, averaging sets provide a reasonable amount of confidence that typical engines or vehicles within each set have comparable enough real world experience to make such follow-up activity unnecessary. The agencies believe this approach will ensure that CO<sub>2</sub> emissions are reduced and fuel consumption is improved in each engine subcategory without interfering with the ability of manufacturers to engage in free trade and competition. Again, EPA's experience in administering its ABT program for criteria pollutant emissions from heavy-duty diesel engines confirms these views. The agencies also note that no commenter offered an explanation of why the restrictions on this ABT program should differ from the parallel ABT program respecting criteria pollutants. As explained earlier in this preamble, the agencies intend to re-evaluate the appropriateness of the ABT averaging sets and credit use restrictions we are adopting here for the HD GHG and fuel consumption program in the future based on information we gain implementing this first phase of regulation.

Under previous ABT programs for other rulemakings, EPA and NHTSA have allowed manufacturers to carry forward credit deficits for a set period of time—if a manufacturer cannot meet an applicable standard in a given model year, it may make up its shortfall by overcomplying in a subsequent year. In the NPRM the agencies proposed to allow manufacturers of engines, tractors, HD pickups and vans, and vocational vehicles to carry forward deficits for up to three years before reconciling the shortfall—the same period allowed in numerous other EPA rules—but sought comments on alternative approaches for reconciling deficits. DTNA supported the three year period and stated that it was sufficient for reconciling deficits. CBD did not support the use of the carry forward of deficits because it would delay investments and technological innovation. The agencies respectfully disagree with CBD and believe this provision has enabled the agencies to consider overall standards that are more stringent and that will become effective sooner than we could consider with a more rigid program, one in which all of a manufacturer's similar vehicles or engines would be required to achieve the same emissions or fuel consumption levels, and at the same time. Therefore the agencies included in the final

rulemaking the proposed 3 year reconciliation period. However, the agencies' respective credit programs require manufacturers to use credits to offset a shortfall before credits may be banked or traded for additional model years. This restriction reduces the chance of manufacturers passing forward deficits before reconciling shortfalls and exhausting those credits before reconciling past deficits.

For the heavy-duty pickup and van category, the agencies proposed a 5-year credit life provision, as adopted in the light-duty vehicle GHG/CAFE program. Navistar requested that the agencies drop the 5-year credit expiration date proposed for the heavy-duty pickup and van category and not specify an expiration date for earned credits. Navistar stated that such credits are necessary to further improve the flexibilities of this program in order to meet the new stringent standards within the limited lead time provided. The agencies disagree. The 5-year credit life is substantial, and allows credits earned early in the phase-in to be held and used without discounting throughout the phase-in period.

For engines, vocational vehicles and tractors, EPA also proposed that CO<sub>2</sub> credits generated during this first phase of the HD National Program could not be used for later phases of standards, but NHTSA did not expressly specify the potential expiration of fuel consumption credits. DTNA and Cummins requested that the surplus credits from the first phase of the program not expire. DTNA suggested that the agencies drop any reference to credit expiration until the next rulemaking, at which time the agencies would have a better understanding of actual credit balances and what kind of lifespan for credits might be necessary or appropriate. DTNA argued that in some of EPA's past programs, EPA had delayed a final decision about credit expiration until development of the subsequent rule when, EPA had a better understanding of associated credit balances, along with the stringency of the standards being proposed for future model years. EPA had proposed to limit the lifespan of credits earned to the first phase of standards in the interest of ensuring a level playing field before the next phase begins. Upon further consideration, the agencies recognize that this is a new program and it is unknown whether any manufacturers will have credit surpluses by the end of the first phase of standards, much less whether some manufacturers will have significantly larger credit surpluses that might create an unlevel playing field going into the next phase. The agencies

are adopting a 5-year credit life provision for all regulatory categories, as adopted in the light-duty vehicle program and proposed for the HD pickup trucks and vans.<sup>297</sup>

The following sections provide further discussions of the flexibilities provided in this action under the ABT program and the agencies' rationale for providing them.

#### (1) Heavy-duty Engines

For the heavy-duty engine ABT program, EPA and NHTSA proposed to use six averaging sets per 40 CFR 1036.740 for EPA and 49 CFR 535.7(d) for NHTSA, which aligned with the proposed regulatory engine subcategories. As described above, the agencies have decided that these engine averaging sets should be the same as for criteria pollutants under the EPA heavy-duty diesel engine rules, and agree with commenters that increasing the size of averaging sets from within subcategories to across subcategories within the same engine weight class would provide important additional flexibilities for engine manufacturers without negatively impacting fuel savings or emissions reductions. The agencies are therefore adopting four engine averaging sets rather than the proposed six. The four engine averaging sets are light heavy-duty (LHD) diesel, medium heavy-duty (MHD) diesel, heavy heavy-duty (HHD) diesel, and gasoline or spark ignited engines without distinction for the type of vehicle in which the engine is installed. Thus, the final ABT program will allow for averaging, banking, and trading of credits between HHD diesel engines which are certified for use in vocational vehicles and HHD diesel engines which are certified for installation in tractors. Similarly, the MHD diesel engines certified for use in either vocational vehicles or tractors will be treated as a single averaging set. As noted in Section I.G above, the agencies intend to monitor this program and consider possibilities of more widespread trading based on experience in implementing the program as the first engines and vehicles certified to the new standards are introduced. Credits generated by engine manufacturers under this ABT program are restricted for use only within their engine averaging set, based on performance against the standard as defined in Section II.B and II.D. Thus, LHD diesel engine manufacturers can only use their LHD diesel engine credits for averaging,

banking and trading with LHD diesel engines, not with MHD diesel or HHD diesel engines. As noted, this limitation is consistent with ABT provisions in EPA's existing criteria pollutant program for engines and will help avoid problems created by the diversity of applications that the broad spectrum of HD engines goes into, as discussed above.

The compliance program for the final rules adopts the proposed method for generating a manufacturer's CO<sub>2</sub> emission and fuel consumption credit or deficit. The manufacturer's certification test results would serve as the basis for the generation of the manufacturer's Family Certification Level (FCL). The agencies did not receive comment on this, and continue to believe that it is the best approach. The FCL is a new term we proposed for this program to differentiate the purpose of this credit generation technique from the Family Emission Limit (FEL) previously used in a similar context in other EPA rules. A manufacturer may define its FCL at any level at or above the certification test results. Credits for the ABT program are generated when the FCL is compared to its CO<sub>2</sub> and fuel consumption standard, as discussed in Section II. Credit calculation for the Engine ABT program, either positive or negative, is based on Equation IV-1 and Equation IV-2:

#### Equation IV-1: Final HD Engine CO<sub>2</sub> credit (deficit)

$$\text{HD Engine CO}_2 \text{ credit (deficit) (metric tons)} = (\text{Std} - \text{FCL}) \times (\text{CF}) \times (\text{Volume}) \times (\text{UL}) \times (10^{-6})$$

Where:

Std = the standard associated with the specific engine regulatory subcategory (g/bhp-hr)

FCL = Family Certification Level for the engine family

CF = a transient cycle conversion factor in bhp-hr/mile which is the integrated total cycle brake horsepower-hour divided by the equivalent mileage of the Heavy-duty FTP cycle. For gasoline heavy-duty engines, the equivalent mileage is 6.3 miles. For diesel heavy-duty engines, the equivalent mileage is 6.5 miles. The CF determined by the Heavy-duty FTP cycle is used for engines certifying to the SET standard.

Volume = (projected or actual) production volume of the engine family

UL = useful life of the engine (miles)

10<sup>-6</sup> converts the grams of CO<sub>2</sub> to metric tons

#### Equation IV-2: Final HD Engine Fuel Consumption credit (deficit) in gallons

$$\text{HD Engine Fuel Consumption credit (deficit) (gallons)} = (\text{Std} - \text{FCL}) \times (\text{CF}) \times (\text{Volume}) \times (\text{UL}) \times 10^2$$

Where:

Std = the standard associated with the specific engine regulatory subcategory (gallon/100 bhp-hr)

FCL = Family Certification Level for the engine family (gallon/100 bhp-hr)

CF = a transient cycle conversion factor in bhp-hr/mile which is the integrated total cycle brake horsepower-hour divided by the equivalent mileage of the Heavy-duty FTP cycle. For gasoline heavy-duty engines, the equivalent mileage is 6.3 miles. For diesel heavy-duty engines, the equivalent mileage is 6.5 miles. The CF determined by the Heavy-duty FTP cycle is used for engines certifying to the SET standard.

Volume = (projected or actual) production volume of the engine family

UL = useful life of the engine (miles)

10<sup>2</sup> = conversion to gallons

To calculate credits or deficits, manufacturers will determine an FCL for each engine family they have designated for the ABT program. The agencies have defined engine families in 40 CFR 1036.230 and 49 CFR 535.4 and manufacturers may designate how to group their engines for certification and compliance purposes. The FCL may be above or below its respective subcategory standard and is used to establish the CO<sub>2</sub> credits earned in Equation IV-1 or the fuel consumption credits earned in Equation IV-2. The final CO<sub>2</sub> and fuel consumption standards are associated with specific regulatory subcategories as described in Sections II.B and II.D (gasoline, light heavy-duty diesel, medium heavy-duty diesel, and heavy heavy-duty diesel). In the ABT program, engines certified with an FCL below the standard generate positive credits and an FCL above the standard generates negative credits. As discussed in Section II.B and II.D, engine averaging sets that include engine families for which a manufacturer elects to use the alternative standard of a percent reduction from the engine family's 2011 MY baseline are ineligible to either generate or use credits. Credit deficits accumulated in an averaging set where engine families have used the alternate standard can carry that deficit forward for three years following the model year for which that deficit was generated at which time the deficit must be reconciled with surplus credits.

The volume used in Equations IV-1 and IV-2 refers to the total number of eligible engines sold per family participating in the ABT program during that model year. The useful life values in Equation IV-1 and IV-2 are the same as the regulatory classifications previously used for the engine subcategories. Thus, for LHD diesel engines and gasoline engines, the useful life values are 110,000 miles; for MHD

<sup>297</sup> Note, however, that manufacturers have no property right in these credits, so no issues of deprivation of property arise if later rules choose not to recognize those credits. See 69 FR at 39001-002 (June 29, 2004).

diesel engines, 185,000 miles; and for HHD diesel engines, 435,000 miles.

As described in Section II.E above, for purposes of EPA's standards, an engine manufacturer may choose to comply with the N<sub>2</sub>O or CH<sub>4</sub> cap standards using CO<sub>2</sub> credits.<sup>298</sup> A manufacturer choosing this option would convert its N<sub>2</sub>O or CH<sub>4</sub> test results into CO<sub>2</sub>eq to determine the amount of CO<sub>2</sub> credits required. This approach recognizes the correlation of these elements in impacting global climate change. To account for the different global warming potential of these GHGs, manufacturers will determine the amount of CO<sub>2</sub> credits required by multiplying the shortfall by the GWP. For example, a manufacturer would use 25 kg of positive CO<sub>2</sub> credits to offset 1 kg of negative CH<sub>4</sub> credits. Or a manufacturer would use 298 kg of positive CO<sub>2</sub> credits to offset 1 kg of negative N<sub>2</sub>O credits. In general the agencies do not expect manufacturers to use this provision, but are providing it as an alternative in the event an engine manufacturer has trouble meeting the CH<sub>4</sub> and/or N<sub>2</sub>O emission caps. There are no ABT credits for performance that falls below the CH<sub>4</sub> cap. As described below, EPA is adopting a provision applicable in MYs 2014 through 2016 to allow the creation of CO<sub>2</sub> credits by demonstrating N<sub>2</sub>O below the current average baseline performance, a value that is well below the final N<sub>2</sub>O cap standard.

Manufacturers of engines that generate a credit deficit at the end of the model year for any of its averaging sets can carry that deficit forward for three years following the model year for which that deficit was generated at which time the deficit must be reconciled with surplus credits. Manufacturers must use credits once those credits have been generated to offset a shortfall before those credits can be banked or traded for additional model years. This restriction reduces the chance of an engine manufacturer passing forward deficits before reconciling their shortfalls and exhausting those credits before reconciling past deficits. Deficits will need to be reconciled at the reporting dates for model year three. Surplus credits earned in the engine categories will expire after five model years. As noted above, the agencies may reconsider 5 year credit life during the next phase of rulemaking.

Under the EPA and NHTSA programs, engine manufacturers are provided

flexibilities in complying with compression ignition (CI) engine standards. These flexibilities are provided in order to: (1) Synchronize the implementation schedules for the upcoming EPA OBD regulatory changes with the GHG and fuel consumption regulatory requirements; (2) aid manufacturers that produce legacy engines in the early years of the HD program; and (3) provide an opportunity for manufacturers to earn early credits as mentioned in sections II.B.(2)(b), II.D.(1)(b)(i) and IV.B.(1) of this document. The flexibilities provide manufacturers of CI engines with four different and distinct paths that can be followed to meet the EPA and NHTSA emission and fuel consumption standards. Manufacturers do not have these flexibility mechanisms for gasoline engines, since the standards for gasoline engines go into effect after the flexibility mechanisms have expired. As a general guideline applicable for each of these four compliance paths, if a manufacturer chooses to opt into the NHTSA program prior to MY 2017, which is the year the NHTSA compression ignition engine standards become mandatory, the path chosen must be the same path chosen to meet the EPA emission standards. Each of the four paths is discussed below.

The first path is for a manufacturer to meet the regular or "primary" standards that become mandatory in MY 2014 under the EPA regulations. These standards are voluntary in 2014, 2015, and 2016 under the NHTSA program, and become mandatory in 2017 in the NHTSA program. The primary path standards become more stringent in model year 2017 in both the EPA and NHTSA regulations. For the NHTSA program, an engine manufacturer may choose to voluntarily opt into the program early, in any of the MYs 2014, 2015 or 2016 allowing that manufacturer to earn credits for those model years. In the NHTSA program however, once the manufacturer has made the decision to opt into the program early it must remain in the program during the subsequent model years.

Path two allows manufacturers to earn early credits as part of the "primary" MY 2014 emission standard path. Early credits can be earned in MY 2013, as discussed in section IV.B.(1). Under the NHTSA fuel consumption program, an engine manufacturer may also choose to opt into the primary standards program beginning in MY 2013 to obtain early credits, but once the decision has been made to opt into the program in MY 2013 the manufacturer must remain in the program in the subsequent model

years. If a manufacturer chooses to opt into the NHTSA program prior to the mandatory 2017 model year it must follow that same path chosen to meet the EPA emission standards.

If a manufacturer produces "legacy" engines, which typically have 2011 baseline emissions that are significantly higher than the 2010 baseline for this regulation, the manufacturer may choose path three. This path allows a manufacturer to meet alternate CI engine standards in MYs 2014 through 2016 for specific engine families. More details about this path are provided in section II.B.(2)(b) and II.D.(1)(b)(i). This path can only be taken if all other credit opportunities have been exhausted and the manufacturer still cannot meet the primary standards under the first path. Again, if a manufacturer chooses this path to meet the EPA emission standards in MY 2014–2016, and wants to opt into the NHTSA fuel consumption program in these same MYs it must follow the exact path followed under the EPA program.

The fourth path that a CI engine manufacturer can take is referred to as the alternative "OBD phase-in" path. Manufacturers that wish to "bundle" or combine design changes needed for the 2013 and 2016 heavy-duty OBD requirements with design changes needed for the GHG and fuel consumption requirements may choose this path. The EPA standards in this path become mandatory in MY 2013 instead of 2014. In addition, in this path emission and fuel consumption standards increase in stringency in 2016 rather than in 2017. While the OBD phase-in schedule requires engines built in MYs 2013 and 2016 to achieve greater reductions than those engines built in the model years under the primary program (path one above), it requires lower reductions for engines built in 2014 and 2015. Under the NHTSA program, an engine manufacturer may choose to opt into the "OBD phase-in" path only if this is the same path chosen under the EPA program and only if the manufacturer is opting into the program in MY 2013 and staying in the program through MY 2016. If a manufacturer chooses the OBD phase-in path to meet the EPA emission standards and decides to opt into the NHTSA program prior to the mandatory MY 2017 requirement, the manufacturer must follow the same path under both the EPA and NHTSA programs. Under this path the early credit MY 2013 flexibility as discussed in path two above is not available. While it does not involve credits, the agencies consider the alternative "OBD phase-in" path to be an additional flexibility.

<sup>298</sup> This option does not apply to the NHTSA fuel consumption program, since NHTSA is not regulating N<sub>2</sub>O or CH<sub>4</sub> emissions, since they are irrelevant to fuel consumption reductions.

Additional flexibilities for engines, discussed later in Section IV.B, provide manufacturers the opportunity to generate early, advanced and innovative technology credits.

(2) Heavy-Duty Vocational Vehicles and Tractors

In addition to the engine ABT program described above, the agencies also proposed a heavy-duty vehicle ABT program to facilitate reductions in GHG emissions and fuel consumption based on heavy-duty vocational vehicle and tractor design changes and improvements. EPA and NHTSA had proposed averaging sets which aligned with the proposed twelve regulatory subcategories; however in response to the comments described, which requested that averaging sets be expanded across subcategories within similar weight classes, (analogous to the principle on which ABT is structured under EPA's heavy-duty diesel engine program for criteria pollutants), the agencies are finalizing only three averaging sets—LHD, MHD, and HHD based upon the three weight classes. In other words, all HHD (Class 8) tractors, HHD vocational tractors, and HHD vocational vehicles will be treated as a single averaging set. Similarly, all MHD (Class 7) tractors, MHD vocational tractors, and MHD (Class 6–7) vocational vehicles will be treated as a single averaging set, and LHD vocational vehicles (Class 2b–5) will be treated as a single averaging set. For this category, the structure of the final ABT program should create incentives for vehicle manufacturers to advance new, clean technologies, or existing technologies earlier than they otherwise would. ABT provides manufacturers the flexibility to deal with unforeseen shifts in the marketplace that affect sales volumes. At the same time, restricting trading to within these segments gives the agencies confidence that the reductions are truly offsetting given the similarity in products engaged in trading. This structure also allows for a straightforward compliance program for each sector, with aspects that are independently quantifiable and verifiable.

Credit calculation for the final HD Vocational Vehicle and Tractor CO<sub>2</sub> and fuel consumption credits, either positive or negative, will be generated according to Equation IV–3 and Equation IV–4:

**Equation IV–3: The Final HD Vocational Vehicle and Tractor CO<sub>2</sub> credit (deficit)**

HD Vocational Vehicle and Tractor CO<sub>2</sub> credit (deficit)(metric tons) = (Std

$$- \text{FEL}) \times (\text{Payload Tons}) \times (\text{Volume}) \times (\text{UL}) \times (10^{-6})$$

Where:

Std = the standard associated with the specific regulatory subcategory (g/ton-mile)

Payload tons = the prescribed payload for each class in tons (12.5 tons for Class 7 tractors, 19 tons for Class 8 tractors, 2.85 tons for LHD vocational, 5.6 tons for MHD vocational, and 7.5 tons for HHD vocational vehicles)

FEL = Family Emission Limit for the vehicle family which is equal to the output from GEM (g/ton-mile)

Volume = (projected or actual) production volume of the vehicle family

UL = useful life of the vehicle (435,000 miles for HHD, 185,000 miles for MHD, and 110,000 miles for LHD)

10<sup>-6</sup> converts the grams of CO<sub>2</sub> to metric tons

**Equation IV–4: Final HD Vocational Vehicle and Tractor Fuel Consumption credit (deficit) in gallons**

HD Vocational Vehicle and Tractor Fuel Consumption Credit (deficit) (gallons) = (Std – FEL) × (Payload Tons) × (Volume) × (UL) × 10<sup>3</sup>

Where:

Std = the standard associated with the specific regulatory subcategory (gallons/1,000 ton-mile)

Payload tons = the prescribed payload for each class in tons (12.5 tons for Class 7 tractors, 19 tons for Class 8 tractors, 2.85 tons for LHD vocational, 5.6 tons for MHD vocational, and 7.5 tons for HHD vocational vehicles)

FEL = Family Emission Limit for the vehicle family (gallons/1,000 ton-mile)

Volume = (projected or actual) production volume of the vehicle family

UL = useful life of the vehicle (435,000 miles for HHD, 185,000 miles for MHD, and 110,000 miles for LHD)

10<sup>3</sup> = conversion to gallons

Manufacturers of vocational vehicles and tractors that generate a credit deficit at the end of the model year for any of its averaging sets can carry that deficit forward for three years following the model year for which that deficit was generated at which time the deficit must be reconciled with surplus credits. Manufacturers must use credits once those credits have been generated to offset a shortfall before those credits can be banked or traded for additional model years. This restriction reduces the chance of a vehicle manufacturer passing forward deficits before reconciling their shortfalls and exhausting those credits before reconciling past deficits. Deficits will need to be reconciled at the reporting dates for model year three. Surplus credits earned in the vehicle categories will have a five year expiration date. The agencies may reconsider the 5 year

credit life during the next phase of the rulemaking.

Additional flexibilities for HD vocational vehicles and tractors, discussed later in Section IV.B, provide manufacturers the opportunity to generate early, advanced, and innovative technology credits.

(3) Heavy-Duty Pickup Truck and Van Flexibility Provisions

The NPRM included specific flexibility provisions for manufacturers of HD pickups and vans, similar to provisions adopted in the recent rulemaking for light-duty car and truck GHGs and fuel economy. The agencies are finalizing the flexibilities as proposed. In the heavy-duty pickup and van category a manufacturer's credit or debit balance will be determined by calculating their fleet average performance and comparing it to the manufacturer's CO<sub>2</sub> and fuel consumption standards, as determined by their fleet mix, for a given model year. A target standard is determined for each vehicle. These targets, weighted by their associated production volumes, are summed at the end of the model year to derive the production volume-weighted manufacturer annual fleet average standard. A manufacturer will generate credits if its fleet average CO<sub>2</sub> or fuel consumption level is lower than its standard and will generate debits if its fleet average CO<sub>2</sub> or fuel consumption level is above that standard. To receive the benefit of the advanced technology provisions, if the manufacturer's fleet includes conventional and advanced technology vehicles, the manufacturer will divide this fleet of vehicles into two separate fleets for calculation of fleet average credits. The end-of-year reports will provide the appropriate data to reconcile pre-compliance estimates with final model year figures (see 40 CFR 1037.730 and 49 CFR 535.8).

The EPA credit calculation is expressed in metric tons and considers production volumes, the fleet standards and performance, and a factor for the vehicle useful life, as in the light-duty GHG program. The NHTSA credit calculation uses the fleet standard and performance levels in fuel consumption units (gallons per 100 miles), as opposed to fuel economy units (mpg) as done in the light-duty program, along with the vehicle useful life, in miles, allowing the expression of credits in gallons. The total model year fleet credit (debit) calculations will use the following equations:

$$\text{CO}_2 \text{ Credits (Mg)} = [(\text{CO}_2 \text{ Std} - \text{CO}_2 \text{ Act}) \times \text{Volume} \times \text{UL}] \div 1,000,000$$



Fuel Consumption Credits (gallons) =  
 $(FC\ Std - FC\ Act) \times Volume \times UL$   
 $\times 100$

Where:

CO<sub>2</sub> Std = Fleet average CO<sub>2</sub> standard (g/mi)

FC Std = Fleet average fuel consumption standard (gal/100 mile)

CO<sub>2</sub> Act = Fleet average actual CO<sub>2</sub> value (g/mi)

FC Act = Fleet average actual fuel consumption value (gal/100 mile)

Volume = the total production of vehicles in the regulatory category

UL = the useful life for the regulatory category (miles)

As described above, HD pickup and van manufacturers will be able to carry forward deficits from their fleet-wide average for three years before reconciling the shortfall. Manufacturers will be required to provide a plan in their pre-model year reports showing how they will resolve projected credit deficits. However, just as in the engine category, manufacturers will need to use credits earned once those credits have been generated to offset a shortfall before those credits can be banked or traded for additional model years. This restriction reduces the chance of vehicle manufacturers passing forward deficits before reconciling their shortfalls and exhausting those credits before reconciling past deficits. Deficits will need to be reconciled at the reporting dates for model year three. Surplus credits earned in the HD pickup and van categories (like surplus credits for all the other subcategories) will have a five year expiration date. The agencies may reconsider the 5 year credit life during the next phase of the rulemaking.

Additional flexibilities for heavy-duty pickup and van category are discussed below in Section IV.B which provides manufacturers the opportunity to generate early, advanced and innovative technology credits.

#### B. Additional Flexibility Provisions

The agencies proposed additional provisions to facilitate reductions in GHG emissions and fuel consumption beginning in the 2014 model year. While EPA and NHTSA believed the ABT and flexibility structure would be sufficient to encourage reduction efforts by heavy-duty highway engine and vehicle manufacturers, the agencies understood that other efforts could create additional opportunities for manufacturers to reduce their GHG emissions and fuel consumption. These provisions would provide additional incentives for manufacturers to innovate and to develop new strategies and cleaner technologies. The agencies requested comment on these provisions, as described below.

#### (1) Early Credit Option

The agencies proposed that manufacturers of HD engines, HD pickup trucks and vans, combination tractors, and vocational vehicles be eligible to generate early credits if they demonstrate improvements in excess of the standards prior to the model year the standards become effective. As an example, if a manufacturer's MY 2013 subcategory of tractors exceeds the EPA mandatory MY 2014 standard for those same vehicles, then that manufacturer could claim MY 2013 credits or "early credits" to utilize in its ABT program starting in the MY 2014. As noted in the NPRM, the start dates for EPA's GHG standards and NHTSA's fuel consumption standards vary by regulatory category (see Section II for the model years when the standards become effective), meaning that the early credits provision, if selected by a manufacturer, could begin during different model years. The NPRM stated that manufacturers would need to certify their engines or vehicles to the standards at least six months before the start of the first model year of the mandatory standards and that limitations on the use of credits in the ABT programs—*i.e.*, limiting averaging to within each vehicle or engine averaging set—would apply for the early credits as well. In the NPRM, NHTSA and EPA requested comment on whether a credit multiplier, specifically a multiplier of 1.5, would be appropriate to apply to early credits from HD engines, combination tractors, and vocational vehicles (but not to early credits from HD pickups and vans), as a greater incentive for early compliance. See 75 FR at 74255.

The agencies received comments from Cummins, DTNA, EMA/TMA, Navistar, Eaton, Bosch, CBD and CALSTART relating to these early credit provisions. All of these commenters supported the early credit provision for the most part, but many requested that the agencies eliminate some of the restrictions relating to this provision. EMA/TMA argued that MY 2012 should also be considered for early credits and that the requirement to certify six months before the start of the first model year would unnecessarily restrict manufacturers from earning credits for technology introduced within six months of the respective model year. In addition, EMA/TMA stated that requiring certification of the entire averaging set instead of individual vehicle configurations would not allow for early introduction of new technologies. Cummins stated that the six month lead time requirement should be removed

and that manufacturers be allowed to earn early credits for individual engine families rather than only for the entire averaging set, stating that removal of these restrictions would further benefit the environment. CBD stated that early credits should only be granted if the emission and fuel consumption benefits are in addition to or above the existing performance levels and are quantifiable and verifiable.

EPA and NHTSA have reviewed these comments and decided to clarify the proposed early credit provisions to account for the above concerns. Early credits are intended to be an incentive to manufacturers to introduce more efficient engines and vehicles earlier than they otherwise would be. However, the agencies do not want to provide a windfall of credits to manufacturers that may already have one or more products that meet the standards. Therefore, the final rules include the option for a manufacturer to obtain early credits for products if they certify their entire subcategory at GHG emissions and fuel consumption levels below the standards. See 75 FR at 74255. Thus, for example, early credits could be generated for all HHD engines installed in combination tractors. The agencies are making a clarification in this action that the manufacturers must certify their entire subcategory, not necessarily their entire averaging set, because the averaging sets are broadened under the final rulemaking from the categories proposed in the NPRM. In addition, the agencies are providing the flexibility for combination tractor manufacturers to obtain early credits for their additional sales, as compared to their 2012 model year sales, of SmartWay designated combination tractors (which includes high roof sleeper cabs only) in 2013 model year. The agencies view this subcategory of vehicles as the only segment of vehicles or engines where the true additional reductions due to the early credits can be quantified outside of certifying an entire subcategory, because the benefit is tied directly to the increase in the SmartWay vehicles manufactured in MY 2013 in excess of those manufactured in MY 2012.

A manufacturer may opt to apply for early credits from their 2013 model year SmartWay designated combination tractor sales by first calculating the difference between the number of SmartWay designated combination tractors sold in 2012 MY versus 2013 model year. The increment in sales determines the number of 2013 model year SmartWay designated tractors which can be used to certify for early credits, at the manufacturer's choice of which vehicles to consider. The

manufacturer would then determine each tractor configuration's performance by modeling in GEM, using each vehicle configuration's appropriate inputs for coefficient of drag, tire rolling resistance, idle reduction, weight reduction, and vehicle speed limiter. Next, the difference between a specific tractor configuration's performance and the 2014 MY standard for the appropriate regulatory subcategory (e.g., Class 8 sleeper cab high roof tractors) would be calculated. The CO<sub>2</sub> and fuel consumption credits are calculated using Equation IV-4 and IV-5.

As discussed above and in Section II, manufacturers may opt into the NHTSA voluntary program prior to when the program becomes mandatory. Manufacturers that opt in become subject to NHTSA standards for all regulatory categories. This provides manufacturers the option of complying with NHTSA fuel consumption standards equivalent to the EPA emission standards in order to accumulate credits in the ABT program. If a manufacturer opts into the EPA early credit program, it may also opt into an equivalent NHTSA early credit program. In this case, the manufacturer must enter the program concurrently with the EPA program and will be subject to the full MY 2014–2015/2016 NHTSA voluntary program. NHTSA would like to clarify that for the early credit provision, implementation must occur in MY 2013 exactly as implemented under the EPA emission program, and not in the model year immediately before the NHTSA standards become mandatory (since otherwise manufacturers would generate credits under the fuel consumption program as a result of complying with mandatory GHG standards—a windfall). Further, once a manufacturer opts into the NHTSA program it must stay in the program for all the optional MYs and remain standardized with the implementation approach being used to meet the EPA emission program. EPA and NHTSA intend for manufacturers' ABT credit balances to remain equivalent wherever possible.

The agencies also received comments from EMA/TMA and Cummins opposing the requirement to certify six months prior to the first model year of the mandatory standards for early credits. The commenters argued and the agencies agree that this restriction could cause some delays in technology rollout and are therefore not adopting this provision. The agencies reviewed the restriction and evaluated the light-duty 2012–2016 MY vehicle early credit program. No such restriction exists for

LD vehicles. We therefore believe that this requirement is not necessary for our implementation of the program. In addition, we are adopting a provision which allows manufacturers to generate early credits for certifying less than a full model year early.

Several commenters, including DTNA, Edison Electric Institute, Eaton, and Bosch, supported using a 1.5 multiplier for early credits, stating that it would encourage early introduction of technology. Cummins and UCS opposed the multiplier stating that the opportunity to earn credits at their normal value should be sufficient incentive for early compliance. The agencies believe that this incentive will further encourage faster implementation of emission and fuel savings technology and help to reduce the costs manufacturers will incur in efforts to comply with these rules. The agencies have therefore decided to finalize a 1.5 multiplier for early credits earned in MY 2013.<sup>299</sup> However, the agencies note that manufacturers may not apply an additional 1.5 multiplier for advanced technology credits which are also certified as early credits.

With respect to heavy-duty pickups and vans, the agencies proposed that early credits could be generated on a fleetwide basis by comparison of the manufacturer's 2013 heavy-duty pickup and van fleet with the manufacturer's fleetwide targets, using the target standards equations for the 2014 model year. 75 FR at 74255. The agencies are finalizing these provisions as proposed. Under the structure for the fleet average standards, this credit opportunity entails certifying a manufacturer's entire HD pickup and van fleet in model year 2013. Industry commenters argued that early credits should be calculated against a target curve that is less stringent than the 2014 curve. We disagree. Because it is the first year of a 5-year phase-in, the 2014 model year has quite modest emissions and fuel consumption reductions targets of only 15 percent of the 2018 model year standards stringency. Targeting even less significant improvements over the baseline would unduly increase the prospect for windfall credits by individual manufacturers who may have better than average baseline fleets. On

<sup>299</sup> There is no multiplier for the early credit provisions in the light-duty vehicle rule. However, the situation there was more complicated, since early credits needed to be correlated with credit opportunities under the California GHG program for light-duty vehicle, and also needed to be integrated with statutory credits under EPCA/EISA for flexible fuel vehicles. See 75 FR at 25440–443. Thus, the light-duty vehicle rule early credit provisions are not analogous to those adopted in this rule for the heavy duty sector.

the other hand, we are confident that the early credit program, based as it is on full fleet compliance with the MY 2014 targets, will not result in windfall credits as it represents, in effect, a complete bringing forward of the program start date by one model year for manufacturers who choose to pursue it. Again, the agencies consider the availability of early credits to be a valuable complement to the overall program to the extent that they encourage early implementation of effective technologies.

## (2) Advanced Technology Credits

The NPRM proposed targeted provisions that were expected to promote the implementation of advanced technologies. Specifically, manufacturers that incorporate these technologies would be eligible for special credits that could be applied to other heavy-duty vehicles or engines, including those in other heavy-duty categories. The credits are thus 'special' in that they can be applied across the entire heavy-duty sector, unlike the ABT and early credits discussed above and the innovative technology credits discussed in the following subsection. The eligible technologies were:

- Hybrid powertrain designs that include energy storage systems.
  - Rankine cycle engines.<sup>300</sup>
  - All-electric vehicles.
  - Fuel cell vehicles.
- NHTSA and EPA requested comment on the list of technologies identified as advanced technologies and whether additional technologies should be added to the list. In addition to the increased fungibility of advanced technology credits, NHTSA and EPA requested comment on whether a credit multiplier, specifically a multiplier of 1.5, would be appropriate to apply to advanced technology credits, as a greater incentive for the technologies' introduction. See 75 FR at 74255.

MEMA asked that the agencies expand the list of technologies that are eligible for Advanced Technology Credits to include advanced transmission and drivetrain technologies, tire and wheel accessories, and advanced engine accessories technologies (such as electronic air control systems and clutched turbocharged air compressor). Bendix requested that weight reduction approaches, improved transmission and drivetrains, driver management and coaching, and tire and wheel improvements be allowed to receive

<sup>300</sup> Although as noted in Section III above and in Chapter 2 of the RIA, this technology is still under development and so is not presently available.

credit through the Advanced Technology Credit Program.

The advanced technology credit program is intended to encourage development of technologies that are not yet commercially available. In order to provide incentives for the research and development needed to introduce these technologies, Advanced Technology Credits can be applied to any heavy-duty vehicle or engine and are not limited to the vehicle or engine categories generating the credit. Because of this flexibility in the application of these credits, it is important that the list of eligible technologies only include technologies that are not yet available in the market. In addition, the technologies must lend themselves to straight forward methodologies for quantifying emissions and fuel consumption reductions. For some of the technologies that MEMA and Bendix asked be included in the program, such as electrified accessories and improved tires, the agencies have already established a mechanism for quantifying reductions associated with these approaches. For example, the agencies assumed in the regulatory impact analysis that some electrified accessories will be used to comply with the regulations. Specifically, improved water and oil pumps are assumed to be used for 2014 LHD, MHD, and HHD FTP and SET diesel engines to comply with standards and if used, their performance would be assessed in the engine certification process. (See RIA Chapter 2.4). Any reductions in engine load and resulting emissions and fuel consumption resulting from accessory electrification thus will be accounted for in engine dynamometer testing. However, other electrified accessories, such as air conditioning do not impact engine operation over the FTP and SET cycles. As such, we are allowing credit for tailpipe AC emissions (as opposed to AC leakage) to be established through the Innovative Technology Credit Program described in section IV.B(3) below. With regard to tire rolling resistance improvements, light weight wheels, and weight reduction associated with the use of super single tires, these are already part of the technology basis for the standard for combination tractors and are accounted for in the GEM, and are also part of the technology basis for the standards for heavy-duty pickups and vans (See RIA Chapter 2.3). Some improved transmissions—such as automatic manuals—have been available commercially for ten years and as such, does not meet the criteria to be included on the list of advanced technologies. However, as described in

Section IV.B(3), advanced transmissions and drivetrains could be eligible for credits in the Innovative Technology Credit Program, and the agencies acknowledge the importance of including advanced transmissions and drivetrains in the program. With regard to weight reduction, the agencies are allowing additional weight reduction approaches to be used for tractors through modeling using GEM and through the innovative technology program. And finally, for driver management and coaching—while we recognize that there could be significant benefits to this, the difficulty in establishing a baseline condition for driver behavior limits the agencies' ability to establish a reduction for this approach at this time.

The agencies have decided not to change the proposed list of technologies evaluated as advanced technologies, but are providing additional clarity in the advanced technology list. The agencies proposed that Rankine cycle engines be included, but the agencies are adopting the wording of Rankine cycle waste heat recovery system attached to an engine.

The agencies received comments from Bendix, Bosch, MEMA, Navistar, Odyne, Green Truck Association, Eaton, ArvinMeritor and Calstart, which supported the 1.5 multiplier for advanced technology credits. MEMA argued that these added flexibilities are absolutely necessary to help advanced technologies penetrate the marketplace and are the primary impetus to integrate these technologies onto vehicles. The agencies also received comments from several stakeholders, including ACEEE and Cummins opposing the 1.5 multiplier for advanced technology credits. ACEEE argued that multipliers should be avoided because they lessen the total emission reductions by allowing a greater increase in the emissions of other vehicles than they offset. After reviewing these comments, the agencies have determined that the relatively low volumes expected in this time frame are likely to mitigate any potential dilution of environmental benefits and be outweighed by the benefits of introduction of advanced technology into the heavy-duty sector. Further, the credit multiplier will provide enough added benefit to the nascent heavy-duty hybrid community to help reduce barriers to market entry for new technologies. Therefore, the final rules include a multiplier of 1.5 for advanced technology credits. However, the agencies are also capping the amount of advanced credits that can be brought into any averaging set into any model year at 60,000 Mg to prevent market distortions.

(a) HD Pickup Truck and Van Hybrids and all Electric Vehicles

For HD pickup and van hybrids, the agencies proposed that testing would be done using adjustments to the test procedures developed for light-duty hybrids. See 75 FR at 74255. NHTSA and EPA also proposed that all-electric and other zero tailpipe emission vehicles produced in model years before 2014 be able to earn credits for use in the 2014 and later HD pickup and van compliance program, provided the vehicles are covered by an EPA certificate of conformity for criteria pollutants. These credits would be calculated based on the 2014 diesel standard targets corresponding to the vehicle's work factor, and treated as though they were earned in 2014 for purposes of credit life. Manufacturers would not have to early-certify their entire HD pickup and van fleet in a model year as for other early-complying vehicles.

NHTSA and EPA also proposed that model year 2014 and later EVs and other zero tailpipe emission vehicles be factored into the fleet average GHG and fuel consumption calculations based on the diesel standards targets for their model year and work factor. A manufacturer also has the option to subtract these vehicles out of its fleet and determine their performance as advanced technology credits that can be used for all other HD vehicle categories, but these credits would, of course, not then be reflected in the manufacturer's pickup and van category credit balance. Commenters generally supported the introduction of hybrid and zero tailpipe emission vehicles, but did not comment on the specific provisions discussed above. The agencies also proposed in determining advanced technology credits for electric and zero emission vehicles that in the credits equation the actual emissions and fuel consumption performance be set to zero (*i.e.* that emissions be considered on a tailpipe basis exclusively). We are finalizing these provisions as proposed.

The proposal also solicited comment on the accounting of upstream GHG emissions. Some commenters argued that EPA should maintain its traditional focus in mobile source rulemakings on vehicle tailpipe emissions and leave the consideration of GHG emissions from upstream fuel production and distribution-related sources such as refineries and power plants to EPA regulatory programs which could focus specifically on those sources. Others argued that, since EPA accounts for upstream GHG emissions in its benefits assessments, the agency should reflect

upstream GHG emissions impacts in vehicle compliance values as well. After considering these comments, the agencies have decided to base the credit accounting on tailpipe emissions only. The agencies believe that introduction of EV technology into the heavy-duty pickup and van sector in these model years will be limited and that incentives are important to encourage such introduction. Similarly, the agencies believe that use of EV technology for these vehicles in these model years will be infrequent so that there is no need to adopt a cap whereby upstream emissions would be counted after a certain volume of sales. See 75 FR at 25434–438 (adopting such a cap for light-duty vehicles under the 2012–2016 MY GHG standards). We also recognize that the ongoing EPA/NHTSA rulemaking to reduce GHGs and fuel consumption in MY 2017 and later light-duty vehicles is examining this issue, and may yield information and policy direction relevant to the planned follow-on rulemaking for the heavy-duty sector.

(b) Vocational Vehicle and Tractor Hybrids

For vocational vehicles or combination tractors incorporating hybrid powertrains, we proposed two methods for establishing the number of credits generated—chassis dynamometer and engine dynamometer testing—each of which is discussed next. As discussed in the NPRM the agencies are not aware of models that have been adequately peer reviewed with data that can assess this technology

without the conclusion of a comparison test of the actual physical product.

(i) Chassis Dynamometer Evaluation

For hybrid certification to generate credits we proposed to use chassis testing as an effective way to compare the CO<sub>2</sub> emissions and fuel consumption performance of conventional and hybrid vehicles. See 75 FR at 74256. We proposed that heavy-duty hybrid vehicles be certified using “A to B” vehicle chassis dynamometer testing. This concept allows a hybrid vocational vehicle manufacturer to directly quantify the benefit associated with use of its hybrid system on an application-specific basis. The concept would entail testing the conventional vehicle, identified as “A”, using the cycles as defined in Section V. The “B” vehicle would be the hybrid version of vehicle “A”. The “B” vehicle would need to be the same exact vehicle model as the “A” vehicle. As an alternative, if no specific “A” vehicle exists for the hybrid vehicle that is the exact vehicle model, the most similar vehicle model would need to be used for testing. We proposed to define the “most similar vehicle” as a vehicle with the same footprint, same payload, same testing capacity, the same engine power system, the same intended service class, and the same coefficient of drag. We did not receive any adverse comments to this approach and are therefore adopting the same criteria as proposed.

To determine the benefit associated with the hybrid system for GHG performance, the weighted CO<sub>2</sub> emissions results from the chassis test of each vehicle would define the benefit as described below:

$$1. (CO_2\_A - CO_2\_B)/(CO_2\_A) = \text{Improvement Factor}$$

$$2. \text{Improvement Factor} \times \text{GEM CO}_2 \text{ Result}_B = \text{g/ton mile benefit}$$

Similarly, the benefit associated with the hybrid system for fuel consumption would be determined from the weighted fuel consumption results from the chassis tests of each vehicle as described below:

$$3. (\text{Fuel Consumption}_A - \text{Fuel Consumption}_B)/(\text{Fuel Consumption}_A) = \text{Improvement Factor}$$

$$4. \text{Improvement Factor} \times \text{GEM Fuel Consumption Result}_B = \text{gallon/1,000 ton mile benefit}$$

The credits for the hybrid vehicle would be calculated as described in the ABT program except that the result from Equation 2 and Equation 4 above replaces the (Std-FEL) value.

The agencies proposed two sets of duty cycles to evaluate the benefit depending on the vehicle application to assess hybrid vehicle performance—without and with PTO systems. The key difference between these two sets of vehicles is that one set (e.g., delivery trucks) does not operate a PTO while the other set (e.g., bucket and refuse trucks) does.

The first set of duty cycles would apply to the hybrid powertrains used to improve the motive performance of the vehicles without a PTO system (such as pickup and delivery trucks). The typical operation of these vehicles is very similar to the overall drive cycles final in Section II. Therefore, the agencies are finalizing to use the same vehicle drive cycle weightings for testing these vehicles, as shown in Table IV–1.

TABLE IV–1—FINAL DRIVE CYCLE WEIGHTINGS FOR HYBRID VEHICLES WITHOUT PTO

	Transient (percent)	55 mph (percent)	65 mph (percent)
Vocational Vehicles .....	75%	9%	16%
Day Cab Tractors .....	19%	17%	64%
Sleeper Cab Tractors .....	5%	9%	86%

The second set of duty cycles apply to testing hybrid vehicles used in applications such as utility and refuse trucks which tend to have additional benefits associated with use of stored energy, in terms of avoiding main engine operation and related CO<sub>2</sub> emissions and fuel consumption during PTO operation. To appropriately address benefits, exercising the conventional and hybrid vehicles using their PTO would help to quantify the benefit to GHG emissions and fuel consumption reductions. The duty cycle

proposed to quantify the hybrid CO<sub>2</sub> and fuel consumption impact over this broader set of operation was the three primary drive cycles plus a PTO duty cycle. The PTO duty cycle as proposed took into account the sales impact and population of utility trucks and refuse haulers. As described in RIA Chapter 3, the agencies proposed to add an additional PTO cycle to measure the improvement achieved for this type of hybrid powertrain application. The agencies welcomed comments on the

final drive cycle weightings and the final PTO cycle.

The agencies received comments from Cummins stating that the proposed weighting of the PTO cycle used a time-based weighting instead of a VMT-based weighting. For the final rules, the agencies derived new PTO cycle weighting by calculating the average speed of a vehicle during the motive portion of its operation, as detailed in RIA Chapter 3.7.1.1. The average speed is used in a conversion factor to convert the emissions from the PTO operation

measured in grams per hour into grams per ton-mile. A number of comments were received on the proposed hybrid chassis testing approach.

The agencies received comments from engine manufacturers, hybrid manufacturers, and industry associations, as well as non-governmental organizations related to proper characterization of hybrid performance. To address concerns raised by commenters regarding hybrid testing several updates have been made to clarify a hybrid engine and/or system for pre-transmission, post-transmission, and chassis dynamometer testing. As described in 40 CFR 1036.801, a hybrid engine or hybrid power train means an engine or powertrain that includes energy storage features other than a conventional battery system or conventional flywheel. Supplemental electrical batteries and hydraulic accumulators are examples of hybrid energy storage systems. A hybrid vehicle is defined in 40 CFR 1037.801 and it means a vehicle that includes energy storage features (other than a conventional battery system or conventional flywheel) in addition to an internal combustion engine or other engine using consumable chemical fuel. The duty cycles used for testing hybrid systems as either the post-transmission or complete chassis configuration will be retained from the proposal, however the weighting factors have been adjusted so that the performance of applications expected to be hybridized in the near term is better reflected. The testing provisions for evaluating the performance including the driver model definition, vehicle model, and overall cycle performance have been enhanced as described in 40 CFR 1036.525 and 40 CFR 1037.525. Additionally, provisions for evaluating power take-off performance improvement have been addressed for charge-sustaining testing. For those hybrid systems which utilize shore power (e.g. plug-in hybrids), an innovative technology approach in which the certifier characterizes the performance associated with the operation of the system in a charge-depleting and charge-sustaining mode is most appropriate given the potential for variability in performance between applications and system designs. To address the issue of parity between methods it should be clarified that the approach taken for hybrid testing is consistent for chassis cycle based testing. This method used for both post-transmission and complete vehicle chassis testing is the development of an improvement factor which is then related to the base system performance.

The pre-transmission approach relies on work based assessment of performance as with the current engine standards.

Comments were received from EMA/TMA, ACEEE, stating that the hybrid definition and test methodology needs to be more clearly defined. Cummins and EMA/TMA asked that the control volumes for the chassis test procedure be specified. Allison stated that the baseline configuration in A to B testing needs clarification—as an example they said it is not clear if the baseline vehicle needs to be the same model year as the hybrid configuration. They added that it is unclear how to account for hotel or accessory loads.

EMA/TMA, Allison, Odyne, and American Trucking Association said that the hybrid drive cycles do not match real world hybrid applications, and as such, will result in an underestimation of benefits resulting from hybrid use. Some or all of these commenters asked that a hybrid drive cycle be developed that consists mainly of transient cycle, increased idle time, low steady state operation, and high acceleration and deceleration rates. EMA/TMA said the proposed cycle—the CARB heavy-heavy duty truck transient mode cycle, was developed as a composite cycle based on a wide range of medium- and heavy-duty vehicles but does not reflect the high acceleration and deceleration of vehicles used in urban applications and which is typical for hybrid vehicles and does not reflect the level of acceleration and deceleration typical of hybrids. Eaton asked that the agencies establish four separate test cycles for hybrids rather than two that more closely match what actual hybrids do in use. Hino said that energy recapture from regenerative braking needs to be built into the test cycle and as currently designed it is not. Hino also urged the agencies to create test cycles that capture variations in different types of hybrids. Cummins said that more representative vehicle test cycles should be developed based on the FTP and SET to ensure that the test cycles are functionally equivalent between vehicles and engines to ensure fair evaluation of the technology. ICCT articulated the same point on the need for parity between engine and vehicle test cycles.

EMA/TMA, DTNA, and Cummins asked that manufacturers not be required to conduct coastdown testing for hybrid vehicles to establish road loads for each type of vehicle. Instead, they asked that the agencies define default road load values for manufacturers to use for hybrids. EMA/TMA said that conducting coastdown tests is expensive. They also argued that

road load is irrelevant to determining hybrid performance since the chassis dynamometer method requires a comparison of a vehicle that is identical in all respects except those factors directly relating to the hybrid powertrain.

Cummins, ICCT, and Center for Clean Air Policy expressed general support for chassis dynamometer testing. Allison said that the lack of dynamometer infrastructure could limit the ability of manufacturers to certify and get hybrids into the market place. BAE said that hybrids should not have to be tested on a chassis dynamometer.

Given the options available for certification of hybrid systems, the constraints on available infrastructure for traditional chassis testing and coastdown testing has been mitigated. Should a manufacturer contemplate chassis testing or powerpack testing to assess hybrid vehicle performance, coastdown testing will still be needed for vocational applications to develop the road load values. To address concerns regarding the baseline vehicle definition, the following clarifications are provided. The baseline vehicle must be identical to the hybrid, with the exception being the presence of the hybrid vehicle. Should an identical vehicle not be available as a baseline, the baseline vehicle and hybrid vehicle must have equivalent power or the hybrid vehicle must have greater power. Additionally, the sales volume of the conventional vehicle from the previous model year (the vehicle being displaced by the hybrid), must be substantially such that there can be a reasonable basis to believe the hybrid certification and related improvement factor are authentic. Should no previous year baseline or otherwise existing baseline vehicle exist, the manufacturer shall produce or provide a prototype equivalent test vehicle. For pre-transmission hybrid certification, drivetrain components will not be included in the testing, as is the case for criteria pollutant engine certification today on a brake-specific basis. Manufacturers are expected to submit A to B test results for the hybrid vehicle certification being sought for each vehicle family. Manufacturers may choose the worst case performer as a basis for the entire family. The agencies continue to expect to use existing precedent regarding treatment of accessory loads for purposes of chassis testing. Accessory loads for A to B testing will not need to be accounted for differently for hybrid A to B chassis testing than for criteria pollutant chassis testing. Based on the description of the hybrid engines and vehicles as found in

40 CFR 1036 and 1037.801, the agencies will not restrict hybrid configuration certification. The expectation is that hybrid engines and vehicles certified under the provisions for GHG will use certified engines. As stated previously, based on data provided by commenters and industry associations, the agencies have revised the duty cycles for complete vehicle and post-transmission powerpack testing by revising the weighting factors such that the performance of the hybrid system is more appropriately characterized. The new weighting factors result in a performance assessment that more closely matches performance seen in-use by many of the applications most likely to be hybridized in the near-term. At this time the requirement to conduct coastdown testing remains in place for the vehicle to be chassis tested or for the simulated vehicle in powertrain testing. Absent appropriate coefficients that accurately reflect vehicle performance, making an assumption about vehicle performance could lead to erroneous results and/or errors in the performance assessment. The agencies have provided numerous flexibilities, so the options available to those manufacturers who choose to certify hybrid engines or vehicles are not constrained to a single test method for which limited infrastructure may exist.

#### (ii) Engine Dynamometer Evaluation

The engine test procedure proposed in the NPRM for hybrid evaluation involved exercising the conventional engine and hybrid-engine system based on an engine testing strategy. The basis for the system control volume, which serves to determine the valid test article, would need to be the most accurate representation of real world functionality. An engine test methodology would be considered valid to the extent the test is performed on a test article that does not mischaracterize criteria pollutant performance or actual system performance. Energy inputs should not be based on simulation data which is not an accurate reflection of actual real world operation. Pre-transmission test protocols will include both the engine and the hybrid system for assessing GHG performance, however EPA is not changing criteria pollutant certification at this time for engines. In effect, the engine will need to be certified for criteria pollutant performance, while the engine and hybrid system in combination may be certified for GHG performance. It is clearly important to be sure credits are generated based on known physical systems. This includes testing using the appropriate recovered vehicle kinetic

energy. Additionally, the duty cycle over which this engine-hybrid system would be exercised would need to reflect the use of the application, while not promoting a proliferation of duty cycles which prevent a standardized basis for comparing hybrid system performance. The agencies proposed the use of the Heavy-duty FTP cycle for evaluation of hybrid vehicles, which is the same test cycle final for engines installed in vocational vehicles. For powerpack testing, which includes the engine and hybrid systems in a pre-transmission format, the engine based testing is applicable for determination of brake-specific emissions benefit versus the engine standard. For post-transmission powertrain systems and vehicles, the comparison evaluation based on the Improvement Factor and the GEM result based on a vehicle drive trace in a powertrain test cell or chassis dynamometer test cell seem to accurately reflect the performance improvements associated with these test configurations. It is important that introduction of clean technology be incentivized without compromising the program intent of real world improvements in GHG and fuel consumption performance. In the NPRM the agencies asked for comments on the most appropriate test procedures to accurately reflect the performance improvement associated with hybrid systems tested using these or other protocols. 75 FR at 74257.

A number of comments were received on the proposed engine testing approaches. Comments were received from EMA/TMA, Cummins, Allison, Hino, and ICCT, stating that the hybrid test methodology needs to be more clearly defined. EMA/TMA, Cummins, and Allison stated that the agencies have not defined what they will accept as a "complete hybrid system" and a clearer definition for hybrids needs to be developed. For example, Allison stated that the DRIA says that a "complete hybrid system" can exclude the transmission. They added that a hybrid system must include a transmission. EMA/TMA stated that simulated engine dynamometer testing should include hybrid components. EMA/TMA stated that the agencies' proposal that part 1065 may be amended, but did not provide specifics on how it might be amended. They suggested the following changes to part 1065: (1) All engine and hybrid components capable of providing or recovering traction power be included in the control volume; (2) use of hybrid system torque curves rather than engine torque curves; (3) reference to J2711 for

management of energy storage devices; (4) adhere to conventional calculation of emissions with only positive work counted; and (5) provide an estimate of maximum available kinetic energy in 1065 to ensure that energy capture is consistent with real world operation of hybrids.

Hino said that energy recapture from regenerative braking needs to be built into the test cycle and as currently designed it is not. Regenerative braking provides fuel consumption and GHG reduction benefits. Eaton said that the proposed powerpack testing does not capture true performance of hybrid vehicles. As noted above, ICCT commented on the need for parity between engine and vehicle test cycles. They supported hardware-in-the-loop post-transmission testing, but only if an equivalent cycle is used as for chassis testing.

Concerns were raised by hybrid system manufacturers that the potential for a competitive advantage could exist for hybrids using different methods for certification based solely on the test method chosen. For determination of the allowable brake energy that may be used for the test cycle with hybrid engines, it is important to provide consistency between test methods. For that reason EPA is setting a brake energy fraction limit based on the engine FTP duty cycle which would apply to the pre-transmission hybrid and defining that as the limit for the post-transmission maximum available brake energy as well. The brake energy fraction will need to be determined based on the engine performance and the brake energy fraction limit will apply for all powertrain test cell (powerpack) testing. This limit on the brake energy fraction will be ratio of negative work to positive work as a function of engine rated power.

The agencies are also finalizing that the proposed duty cycles considered for the proposal will continue to be used with this final action. The agencies proposed a transient duty cycle, a 55-mile-per-hour steady state cruise and a 65-mile-per-hour steady state cruise. The transient duty cycle, which has been corrected to address a concern related to shift events, is essentially the same transient cycle proposed in the NPRM with the exception that it minimizes inappropriate shift events. Additionally, the steady state cycles proposed by the Agencies remain essentially unchanged. The modification being adopted with today's final action is to address the distribution of the emissions impact associated with each duty cycle. However, in response to the concerns detailed above and

raised by engine manufacturers, hybrid system manufacturers, environmental groups, and NGOs regarding the lack of transient operation in the hybrid cycles, the agencies are finalizing a change in the weighting of the hybrid vehicle cycles. The weighting factors will be changed such that a greater emphasis on the type of transient activity seen as more characteristic of hybrid applications will be evident. The new weighting factors between duty cycles for hybrid certification (without PTO) will be 75 percent for the transient, 9 percent for the 55 mph cruise cycle, and 16 percent for the 65 mph cruise cycle. The basis for this change may be seen in the memorandum to OAR Docket EPA-HQ-OAR-2010-0162 which describes the data set used to describe real world vehicle performance. Additionally, provisions for addressing brake energy fraction have been provided in 40 CFR 1036.525 for hybrid engine testing. The control volume for testing hybrid systems for GHG and fuel consumption assessment has included all hybrid power systems and for powertrain testing that is post-transmission, simulated components including tires and regenerative braking impacts. Additionally, provisions for accounting for the hybrid system and engine torque curve are available in the hybrid test procedures of 40 CFR 1036.525.

In addition, the final rules allow manufacturers that want to certify a hybrid on a different test cycle than the cycles described above for chassis and engine dynamometer testing instead make a demonstration using the procedures set out in the Innovative Technology Credit provisions. Likewise, a manufacturer seeking to certify a hybrid using an alternative approach, such as simulation modeling, would need to follow the procedure described in the Innovative Technology Credit section. However, manufacturers whose alternative hybrid testing procedure is approved through the Innovative Technology Credit Program would receive credits through the Advanced Technology Credit Program so such credits would be fungible across all vehicle and engine categories and would receive the 1.5 multiplier.

EMA/TMA also asked that in addition to the above-described engine, chassis, and powerpack testing, other yet-to-be-defined methods should be allowed so that a novel application of hybrids can be evaluated for credit. They included hydraulic, kinetic, electro-mechanical, and genset hybrids as examples of additional configurations that should be accommodated by additional test cycles. Allison asked how emissions and fuel

consumption changes associated with ageing of hybrid systems will be accounted for. ACEEE encouraged the agencies to finalize the three approaches outlined in the NPRM for hybrid testing in the final rules.

Cummins supported three proposed options for evaluating hybrids. ICCT supported option 1 and 3, but not 2. ICCT stated that EPA and NHTSA need to ensure that: (1) Each hybrid test method/test cycle combination requires the same amount of total energy to run the cycle (for a specific vehicle weight), (2) each test method/test cycle combination has the same amount of total energy available for capture as regeneration by a hybrid system, and (3) that this available regeneration energy appears in similar increments in each test method/test cycle combination.

In allowing for three options for certification of hybrids, two of those options require the use of a baseline vehicle. The post-transmission hybrid certification and the chassis dynamometer certification options are designed to allow for an assessment of the improvement offered by incorporating a hybrid system into the vehicle. Determination of an improvement factor for hybrid vehicle performance is significantly influenced by the selection of the baseline vehicle, test article "A". The Agencies received comments from engine and hybrid system manufacturers that the options for selection of the baseline should be carefully considered to avoid an unintended consequence of limited real world improvement due to selection of a baseline that was inappropriate. Several concerns regarding an inappropriate baseline were broached including selection of technology that is not actually available in the market, selection of baseline technology that is not representative of the application(s) either by sales volume or use, or selection of a baseline that in other ways provides an advantage to a manufacturer which creates an unfair competitive advantage. To address the concern of improvement factors that have a basis in reality and demonstrate real world improvements, as well as to continue to create incentives for the introduction of new technology the Agencies are addressing the issue of the baseline selection, as well as the determination of a "most similar" vehicle basis in the case where there may not be an existing production vehicle upon which the hybrid vehicle was based.

In making the determination of an appropriate baseline, four options were considered by the agencies. These options included a fixed baseline weight and definition by vehicle class, a non-

hybrid baseline intended for production vehicle and transmission system, a best in class conventional application, or vehicle based on highest sales volume. Each of these options has benefits and each raises potential concerns. The determination based solely on a single vehicle by class has the advantage of providing a fixed baseline the entire industry may easily target for assessing improvements. It raises concerns regarding the suitability of the vehicle selection for all applications in the weight class, as well as the appropriateness of the selection based on performance across the full range of vehicles and weights in the weight class. The "intended for production" conventional vehicle baseline ensures the baseline and hybrid vehicle pair will represent a real improvement for the specific application. The challenge exists when the conventional vehicle version of the hybrid may not exist. Another issue would exist if the conventional vehicle in the pair had performance characteristics such that the hybrid version does not represent significant improvements beyond other conventional vehicles. The best in class baseline vehicle approach provides some assurance that the improvement factor generated by the hybrid vehicle or system would in fact represent introduction of advanced technology with improvements beyond existing conventional technology. The opportunity for confusion that exists with a best in class determination includes matching all of the appropriate performance metrics with the appropriate applications in a way that is consistent with how the market values those improvements. This can become a moving target which could represent an ever evolving design target and eventually prove difficult for the Agencies to implement in a way that ensured a level playing field. The last option attempts to include the benefits of the previous options, while maintaining the clarity needed for manufacturers to design and build with a clear understanding of design targets. The highest sales volume application by weight class for the previous model year ensures benefits are measured based on how the market values performance. This has the potential to avoid ambiguity regarding which vehicle technology should serve as the baseline and it addresses a concern raised by some commenters regarding the use of a baseline vehicle that clearly is not a class leader. The presumption being that the market will value the conventional technology that provides the best value over the lifetime of the vehicle for its



intended service class and application. This approach is intended to be used in conjunction with the basic premise that the “A” vehicle will be the vehicle most similar to the hybrid “B” vehicle.

Should no apparent baseline be available, the vehicle being displaced by the hybrid may be determined based on several characteristics including but not limited to vehicle class, vehicle application, and complete power system rated power (*e.g.* engine rated power for the base vehicle versus combined rated power for the engine-hybrid system). The agencies will continue to use the primary method of highest sales volume, by application and vehicle weight class in its assessment of the manufacturers selection of a baseline, however should there be a new application introduced with no apparent existing baseline, the closest baseline vehicle may be selected by the manufacturer and will be evaluated by the agencies.

The commenters’ concerns will continue to be reviewed by the agencies as the program is implemented; however, the approach suggested may not be appropriate across every method. To the extent that the pre-transmission testing is a work based assessment consistent with today’s engine testing, we are remaining consistent with current practices in which the engine certification has applicability across applications. With that said we have defined a regenerative brake limit that will align the relative energy (regenerative to tractive) across all three methods. This can be found in 40 CFR 1036.525.

Given the use of the same duty cycles for both post-transmission and chassis dynamometer testing, we are capturing the performance of the powertrain by exercising it in the same manner for both methods, so the methods will be equivalent in all three aspects that were mentioned by the commenter.

### (3) Innovative Technology Credits

The agencies proposed a credit opportunity intended to apply to new and innovative technologies that reduce fuel consumption and CO<sub>2</sub> emissions, but for which the reduction benefits are not captured over the test procedure, including the GEM, used to determine compliance with the standards (*i.e.*, the benefits are “off-cycle”). See 75 FR at 74257–58; see also 75 FR 25438–25440 where EPA adopted a similar credit program for MY 2012–2016 light-duty vehicles.

The agencies explained in the NPRM that EPA and NHTSA are aware of some emerging and innovative technologies and concepts in various stages of

development with CO<sub>2</sub> emissions and fuel consumption reduction potential that might not be adequately captured on the final certification test cycles or are not inputs to the GEM, and that some of these technologies might merit some additional CO<sub>2</sub> and fuel consumption credit generating potential for the manufacturer. Eligible innovative technologies are those technologies that are newly introduced in one or more vehicle models or engines, but that are not yet widely implemented in the heavy-duty fleet—and more specifically, not yet widely implemented in the averaging set for which the credit is sought. Examples of such technologies mentioned in the NPRM include predictive cruise control, gear-down protection, active aerodynamic features, and adjustable ride height. Innovative technologies can include known, commercialized technologies if they are not yet widely utilized in a particular heavy-duty sector subcategory. Any credits for these technologies would need to be based on real-world fuel consumption and GHG reductions that can be measured with verifiable test methods using representative driving conditions typical of the engine or vehicle application.

In the NPRM, the agencies stated that we would not consider technologies to be eligible for these credits if the technology has a significant impact on CO<sub>2</sub> emissions and fuel consumption over the primary test cycles, or if it is one of the technologies on whose performance the various vehicle and engine standards are premised. The agencies believe it is appropriate to provide an incentive to encourage the introduction of these types of technologies and that a credit mechanism is an effective way to do so. Further, there needs to be a mechanism to account for the emission reductions and fuel efficiencies resulting when an innovative technology is used. The agencies proposed that this optional credit opportunity would be available through the 2018 model year reflecting that technologies which are now uncommon may be more widely utilized by then, but the agencies sought comment on the need to extend the ability to earn credits beyond the model year 2018. See generally 75 FR at 74257–258.

EPA and NHTSA also proposed that credits generated using innovative technologies be restricted within the subcategory averaging set where the credit was generated but requested comments on whether these innovative technology credits should be fungible across vehicle and engine categories.

The agencies also proposed that manufacturers quantify CO<sub>2</sub> and fuel consumption reductions associated with the use of the off-cycle technologies such that the credits could be applied based on the metrics (such as g/mile and gal/100 mile for pickup trucks, g/ton-mile and gal/1,000 ton-mile for tractors and vocational vehicles, and g/bhp-hr and gal/100 bhp-hr for engines). Credits would have to be based on real additional reductions of CO<sub>2</sub> emissions and fuel consumption and would need to be quantifiable and verifiable with a repeatable methodology. Such data would be submitted to EPA and NHTSA, and would be subject to a public evaluation process in which the public would have opportunity for comment. See 75 FR at 74258. We proposed that the technologies upon which the credits are based would be subject to full useful life compliance provisions, as with other emissions controls. Unless the manufacturer can demonstrate that the technology would not be subject to in-use deterioration over the useful life of the vehicle, the manufacturer would have to account for deterioration in the estimation of the credits in order to ensure that the credits are based on real in-use emissions reductions over the life of the vehicle.

In cases where the benefit of a technological approach to reducing CO<sub>2</sub> emissions and fuel consumption cannot be adequately represented using existing test cycles, it was proposed that EPA and NHTSA would review and approve as appropriate test procedures and analytical approaches to estimate the effectiveness of the technology for the purpose of generating credits. The demonstration program would have to be robust, verifiable, and capable of demonstrating the real-world emissions benefit of the technology with strong statistical significance.

Finally, the agencies explained in the NPRM that the CO<sub>2</sub> and fuel consumption benefit of some technologies may have to be demonstrated with a modeling approach. In other cases manufacturers might have to design on-road test programs that are statistically robust and based on real world driving conditions. As with the similar procedure for alternative off-cycle credits under the light-duty 2012–2016 MY vehicle program, the agencies would include an opportunity for public comment as part of any approval process.

The agencies requested comments on the proposed approach for off-cycle innovative technology emissions credits, including comments on how

best to structure the program. EPA and NHTSA particularly requested comments on how the case-by-case approach to assessing off-cycle innovative technology credits could best be designed, including ways to ensure the verification of real-world emissions benefits and to ensure transparency in the process of reviewing manufacturer's proposed test methods.

The agencies received numerous comments relating to all aspects of the innovative technology credit flexibility provision. The vast majority of the commenters supported this provision as proposed, but requested that certain aspects be further clarified, so the agencies are adopting the full provision as proposed and providing further discussion that addresses and clarifies the provision in response to comments. We also note generally that many comments asserting that the GEM or certain of the engine standards failed to account for certain types of emission reductions associated with technology improvements did not consider the availability of innovative technologies for such technologies. These comments are addressed specifically in the Response to Comment Document or elsewhere in this preamble.

A number of organizations, including DTNA, MEMA, Navistar, Green Truck Association, Eaton, ACEEE, and NESCAUM, commented that technologies such as advanced transmissions, engine cooling strategies, idle reduction, light-weight components (including light-weight engines), and advanced drivelines should be able to receive credit through the innovative technology program. The agencies agree with these commenters. The NPRM did not provide a specific list of technologies that the agencies would consider "innovative" because the agencies intended that an innovative technology could be any technology not in widespread use in the subcategory that can be proven to reduce CO<sub>2</sub> emissions and fuel consumption but for which the benefits are not captured utilizing the FTP procedures, SET procedures and GEM methodology used to determine compliance with the emission and fuel consumption standards. Any of the suggested technologies could be considered as an innovative technology if the associated emission and fuel consumption benefit has not already been considered to have widespread use in the subcategory, if the associated emission and fuel savings can be measured and validated, and if the technology and measurement methodology have been approved by the agencies. NHTSA and EPA will determine the impact of the technology

and each agency in turn will accept the credits either jointly or independently depending upon whether the technology has a direct bearing upon GHG or fuel consumption performance.

A number of commenters, including Bendix, Bosch, Cummins, EMA/TMA, Eaton, DTNA, Navistar, Volvo, ArvinMeritor and USC requested that the innovative technology process and procedures be more clearly structured and defined. Bendix requested that the agencies prescribe specific processes and procedures in the final rules by which innovative technologies can be submitted for review and approval. EMA/TMA requested that the agencies provide guidance on the certification process, and suggested that existing fuel consumption test procedures developed jointly by the Society of Automotive Engineers (SAE) and the Technology & Maintenance Council (TMC), specifically that the Type II and Type III procedures be used. Eaton requested that the agencies identify test methods that can be used for certification in order to provide transparency and certainty, and promote early technology introduction. In response to these comments, the agencies have further defined the process in the final action.

In cases where the benefit of a technological approach to reducing CO<sub>2</sub> emissions and fuel consumption cannot be adequately represented using existing test cycles, EPA and NHTSA will review and approve test procedures and analytical approaches as appropriate to estimate the effectiveness of the technology for the purpose of generating credits. The innovative technologies will be evaluated in an A-to-B comparison. The baseline engine and/or vehicle configuration must represent a configuration which is equivalent to the engine and/or vehicle with the innovative technology in terms of the other aspects of the engine and/or vehicle to prevent double counting of emissions reductions or gaming.

Since innovative credits will be available for use within the same averaging set as the engine or vehicle which employs the innovative technology (for reasons explained below), the agencies are defining innovative credit approaches by regulatory category.

#### (a) Heavy-Duty Pickup Truck and Van Innovative Technology Credits

For HD pickups and vans, EPA and NHTSA proposed that they would review and approve manufacturer-provided test procedures and analytical approaches to estimate the effectiveness of a technology for the purpose of generating credits. The proposal also

expressed the view that the 5-cycle approach currently used in EPA's fuel economy labeling program for light-duty vehicles may provide a suitable test regime, provided it can be reliably conducted on the dynamometer and can capture the impact of the off-cycle technology (*see* 71 FR 77872, December 27, 2006). EPA established the 5-cycle test methods to better represent real-world factors impacting fuel economy, including higher speeds and more aggressive driving, colder temperature operation, and the use of air conditioning. Because we have not firmly established the suitability of the 5-cycle approach for HD pickups and vans at this time, and we received no comments or data helping to establish it, we are not adopting provisions to specify its use. However, it remains a candidate approach that manufacturers may pursue in making their demonstrations for innovative technology credits, described below.

Manufacturer data submitted to the agencies in pursuit of innovative technology credits would be subject to a public evaluation process in which the public would have opportunity for comment.<sup>301</sup> Whether the approach involves on-road testing, modeling, or some other analytical approach, the manufacturer would be required to present a final methodology to EPA and NHTSA. EPA and NHTSA would approve the methodology and credits only if certain criteria were met. Baseline emissions and fuel consumption<sup>302</sup> and control emissions and fuel consumption would need to be clearly demonstrated over a wide range of real world driving conditions and over a sufficient number of vehicles to address issues of uncertainty with the data. Data would need to be on a vehicle model-specific basis unless a manufacturer demonstrated model-specific data was not necessary. The agencies would publish a notice of availability in the **Federal Register** notifying the public of a manufacturer's proposed alternative off-cycle credit calculation methodology and provide opportunity for comment. The notice will include details regarding the methodology, but not include any Confidential Business Information.

The agencies did not receive any adverse comments on using the proposed approach for HD pickup trucks and vans. Consistent with the proposal, the agencies are adopting the

<sup>301</sup> See 75 FR 25440.

<sup>302</sup> Fuel consumption is derived from measured CO<sub>2</sub> emissions using conversion factors of 8,887 g CO<sub>2</sub>/gallon for gasoline and 10,180 g CO<sub>2</sub>/gallon for diesel fuel.

proposed innovative technology credit provisions for HD pickup trucks and vans.

(b) Heavy-Duty Engine, Combination Tractor, and Vocational Vehicle Innovative Technology Credits

Innovative technology credits developed in the HD engine, combination tractor, and vocational vehicle categories will need to be applied to the subcategory in which they were generated. The agencies are adopting provisions in § 1037.610 to determine the separation of engine credits and vehicle credits based on the method which is selected by the manufacturer to determine the effectiveness of the innovative technology. For example, improvements to the engine that are demonstrated in either the engine dynamometer test or powerpack test will clearly be engine credits. Improvements that are demonstrated using chassis dynamometer or on-road test will be considered vehicle credits. However, the agencies recognize that there may be exceptions to this approach, and will allow for the manufacturer to request an alternate classification of credits. A change in credit allocation will require approval from the agencies and would be subject to a public evaluation process.

Furthermore, to address the concerns of some commenters mentioned above, the agencies are adopting an approach for HD engines and vehicles that provides two paths for approval of the test procedure to measure the CO<sub>2</sub> emissions and fuel consumption reductions of an innovative off-cycle technology used in the HD engine or vehicle. These alternative approaches are similar to those adopted in the light-duty vehicle rule. The first path will not require a public approval process of the test method. The “pre-approved” test methods for HD engines and vehicles will include the A-to-B chassis testing, powerpack testing, and on-road testing. The agencies are also adopting as proposed a second test method approval path that provides a manufacturer the ability to submit an alternative evaluation approach to EPA and NHTSA, which must be approved by the agencies prior to the demonstration program. As with HD pickup trucks and vans, such submissions of data should be submitted to the agencies and would be subject to a public evaluation process in which the public would have opportunity for comment.<sup>303</sup> Baseline emissions and control emissions would need to be clearly demonstrated over a

wide range of real world driving conditions and over a sufficient number of vehicles to address issues of uncertainty with the data. The agencies will publish a notice of availability in the **Federal Register** notifying the public of a manufacturer’s proposed alternative off-cycle credit calculation methodology and provide opportunity for comment. The notice will include details regarding the methodology, but not include any Confidential Business Information. Approval of the approach to determining a CO<sub>2</sub> and fuel consumption benefit would not imply approval of the results of the program or methodology; when the testing, modeling, or analyses are complete the results would likewise be subject to EPA and NHTSA review and approval.

The pre-approved test procedures include engine dynamometer, powerpack, chassis dynamometer, and on-road testing. Each of the test procedures require the evaluation of a baseline and control engine or vehicle (A vs. B testing) to quantify the improvement. Manufacturers may use the engine dynamometer test procedures using the HD engine FTP or SET cycle. The chassis testing and powerpack testing would be conducted the same as described above for HD vocational vehicle and tractor hybrid testing in Section IV.B.2.b using the drive cycles and weightings finalized in this action for the primary program. If a manufacturer requires the use of an alternate duty cycle, then it will require prior approval from the agencies.

The on-road testing would be tested according to SAE J1321 Joint TMC/SAE Fuel Consumption Test Procedure Type II Reaffirmed 1986–10 or SAE J1526 Joint TMC/SAE Fuel Consumption In-Service Test Procedure Type III Issues 1987–06, with additional constraints to improve the test repeatability. The first constraint requires that the minimum route distance be set at 100 miles. In addition, the route selected must be representative in terms of grade. The agencies will take into account published and relevant research in determining whether the grade is representative.<sup>304</sup> Similarly, the speed of the route must be representative of the drive cycle weighting adopted for each regulatory subcategory. For

<sup>304</sup> The agencies would consider information such as the study conducted by Oak Ridge National Lab which found that 72 percent of their data records were driven on flat terrain of less than 1 percent grade to determine the representativeness of the route. See Capps, G., O. Franzes, B. Knee, M.B. Lascourain, and P. Otaduy. Class 8 Heavy Truck Duty Cycle Project Final Report. ORNL/TM–2008/122, Oak Ridge National Laboratory. Last accessed on April 14, 2011 at page 5–14 of [http://cta.ornl.gov/data/tebd29/Edition29\\_Chapter05.pdf](http://cta.ornl.gov/data/tebd29/Edition29_Chapter05.pdf).

example, if the route selected for an evaluation of a combination tractor with a sleeper cab contains only interstate driving, then the improvement factor would only apply to 86 percent of the weighted result. Lastly, the ambient air temperature must be between 5 and 35 °C. The agencies also would allow the use of a Portable Emissions Measurement (PEMS) device for the measurement of CO<sub>2</sub> emissions during the on-road testing. The agencies are not pre-approving any routes for the on-road testing. Manufacturers will be required to submit the proposed route prior to testing for approval.

The agencies requested comments on whether credits generated using innovative technologies should be fungible across vehicle and engine categories and received comments both supporting and opposing the limited fungibility of these credits. Cummins did not support the fungibility of innovative technology credits across subcategories, arguing that it is not advisable given the large number and variability of different technology types and the uncertainty in this provision. DTNA stated that the credits should be fungible across engine and vehicle classes to be treated the same as advanced technology credits. EPA and NHTSA acknowledge that the HD program is a new program and, though the agencies continue to believe the credit provision is an important flexibility, the agencies are implementing innovative technology credits based on the ability to assign a value for future technologies and test methods that are as yet to be defined. Given the fact that the agencies cannot make a determination at this time of, what innovative technologies will be offered, and thus the impact of increased fungibility to sectors outside the original application of the innovative technology might be, it is premature to allow that credit to be traded without restriction and with additional credit. Until such uncertainty can be understood and quantified, the agencies believe the final rules should continue to include restrictions on the fungibility of innovative technology credits across service classes and categories.

The agencies proposed that this credit opportunity be available through the 2018 model year, reflecting that technologies may be common by then, but sought comment on the need to extend beyond model year 2018. The agencies received comments from DTNA, Navistar, Eaton, Cummins and Bosch supporting the extension of this provision beyond model year 2018. Eaton stated that though some

<sup>303</sup> See 75 FR 25440.

technologies will be more common in 2018, new technologies will evolve facing the same difficulties concerning implementation and would benefit from this provision. Bosch explained that extension of the provision past 2018 is important because at the time of the final rule the GEM will not incorporate any newer technology until it is updated in phase two of the program, and manufacturers will therefore continue to need the innovative technology provision for receiving credits for technologies not accounted for in GEM. The agencies have reviewed these concerns and believe that they are valid. Therefore, the final rule does not state that this provision ends in model year 2018. Any action taken on these credits in a subsequent rulemaking will be addressed by the agencies at that time in that future rulemaking.

#### (4) N<sub>2</sub>O Credit

EPA received a comment from an industry stakeholder requesting a provision to allow manufacturers of heavy-duty engines to gain credit for redesigning emission control systems to reduce N<sub>2</sub>O emissions. The commenter argued that unlike CH<sub>4</sub>, N<sub>2</sub>O emissions from some NO<sub>x</sub> control technologies can vary in inverse proportion to CO<sub>2</sub> emissions. Given such a tradeoff, it would be appropriate to allow manufacturers to exploit that tradeoff to achieve the lowest overall greenhouse gas emissions possible. Thus, EPA is adopting a provision which allows engine manufacturers to generate CO<sub>2</sub> credits for very low N<sub>2</sub>O emissions. Specifically, manufacturers that certify engines with full useful life N<sub>2</sub>O FEL emissions which are less than 0.04 g/hp-hr could generate 2.98 grams of CO<sub>2</sub> credit for 0.01 grams of N<sub>2</sub>O reduced (consistent with the relative global warming potentials of CO<sub>2</sub> and N<sub>2</sub>O). For example, where a manufacturer certifies an engine family to have low per-brake horsepower hour N<sub>2</sub>O emissions of 0.01 g/hp-hr and applies the 0.02 g/hp-hr assigned deterioration factor, it could certify the engine family to a 0.03 g/hp-hr N<sub>2</sub>O FEL and generate enough CO<sub>2</sub> credits to offset CO<sub>2</sub> emissions 2.98 g/hp-hr above the standard. The 0.04 g/hp-hr level is less than the cap standard of 0.10 g/bhp-hr (so credits generated would not be windfalls) and reflects EPA's best estimate of average N<sub>2</sub>O performance for today's engine technologies. See Table II-22 above. This value has been chosen to ensure the credit reflects improvements beyond today's baseline performance level. EPA is limiting this provision to model years 2014 through 2016, the same years that NHTSA's

program is voluntary, to maintain alignment between the CO<sub>2</sub> emissions and fuel consumption standards. EPA considered allowing the provision to continue beyond 2016 but decided given its relatively small value (we expect this credit to be worth approximately 3 g/bhp-hr on a standard of 460 g/bhp-hr) and the ultimate desirability of alignment of the EPA and NHTSA programs to limit the period of this flexibility to the period of time when the NHTSA program will be voluntary.

### V. NHTSA and EPA Compliance, Certification, and Enforcement Provisions

#### A. Overview

##### (1) Compliance Approach

This section describes EPA's and NHTSA's final program to ensure compliance with EPA's final emission standards for CO<sub>2</sub>, N<sub>2</sub>O, and CH<sub>4</sub> and NHTSA's final fuel consumption standards, as described in Section II. To achieve the goals projected in the proposal, it is important for the agencies to have an effective and coordinated compliance program for our respective standards. As is the case with the light-duty vehicle rule, the final compliance program for heavy-duty vehicles and engines has two central priorities: (1) To address the agencies' respective statutory requirements; and (2) to streamline the compliance process for both manufacturers and the agencies by building on existing practice wherever possible, and by structuring the program such that manufacturers can use a single data set to satisfy the requirements of both agencies. It is also important to consider the provisions of EPA's existing criteria pollutant program and NHTSA's existing LD program in the development of the approach used for heavy-duty certification and compliance. The existing EPA heavy-duty highway engine emissions program has an established infrastructure and methodology that will allow for an effective integration with this final GHG and fuel consumption program, without needing to create new unique processes in many instances. The HD compliance program will address the importance of the impact of new control methods for heavy-duty vehicles as well as other control systems and strategies that may extend beyond the traditional purview of the criteria pollutant program.

Section 202(b)(3)(A) of the Clean Air Act (CAA) defines "model year" to mean "the manufacturer's annual production period (as determined by the Administrator) which includes January 1 of such calendar year" or to mean

calendar year if the manufacturer has no annual production period. Section 32901(a)(16) of EISA defines "model year" with almost identical language. Section 202(b)(3)(A) of the CAA also allows the EPA Administrator to define model year differently to assure "that vehicles and engines manufactured before the beginning of a model year were not manufactured for purposes of circumventing the effective date of a standard." Consistent with this statutory language, the NPRM proposed regulatory text to define "model year," in 40 CFR 1036.801, 40 CFR 1037.801 and 49 CFR 535.4. All three codified the primary CAA and EISA definition, but differed with respect to language intended to prevent circumvention of the standards. The proposed definition for engines was in the proposed rule published November 30, 2010, 75 FR 74377, which stated that "model year" means the manufacturer's annual new model production period, except as restricted under this definition. It must include January 1 of the calendar year for which the model year is named, may not begin before January 2 of the previous calendar year, and it must end by December 31 of the named calendar year. Manufacturers may not adjust model years to circumvent or delay compliance with emission or standards or to avoid the obligation to certify annually.

The proposed definition for vehicles was in the proposed rule published November 30, 2010, 75 FR 74401, which stated that "model year" means the manufacturer's annual new model production period, except as restricted under this definition and 40 CFR part 85, subpart X. It must include January 1 of the calendar year for which the model year is named, may not begin before January 2 of the previous calendar year, and it must end by December 31 of the named calendar year. Use the date on which a vehicle is shipped from the factory in which you finish your assembly process as the date of manufacture for determining your model year. For example, where a certificate holder sells a cab-complete vehicle to a secondary vehicle manufacturer, the model year is based on the date the vehicle leaves the factory as a cab-complete vehicle.

EPA's and NHTSA's vehicle model year definitions differed slightly in wording but were essentially the same for §§ 1037.801 and 535.4. In creating the model year definition for vehicles, the agencies were mindful of the confusion chassis manufacturers may face in determining their model years in a given period of production, for example, due to manufacturing and

shipping products at different levels of completion and involving multiple manufacturers. The agencies included the term “ship date” in order to provide chassis manufacturers a clear reference date (“in which you finish your assembly process”), as well as to decrease the risk of gaming that might occur if no reference date was specified and there were therefore no parameters on the choice of model year. The engine definition was chosen based on consistency with prior EPA definitions for other mobile source programs.

The agencies received comments on the definitions from EMA/TMA and Navistar expressing concern over the potential for unintended consequences. The commenters argued that the use of “ship date” for vehicles could create difficulty and uncertainty for manufacturers for whom the ship date can be delayed for reasons outside of their control, such as late-arriving components. They also argued that the differences between the vehicle and engine definitions would increase the likelihood that a single vehicle would be subject to different fuel efficiency requirements during certain years of transition in the standards, as it would not be unlikely that a vehicle would be a later model year than an engine. For example, during the 2016–2017 period, an engine may be model year 2016 while the vehicle is model year 2017.

NHTSA and EPA have considered further whether there are benefits to maintaining separate definitions for “model year” for the engine and vehicle standards based on these comments. We continue to believe that differences in manufacturing practices for engines and vehicles support the use of separate definitions. However, for this final action, we have decided to modify the definitions to account for the above concerns, address circumstances of multiple manufacturers, and provide increased consistency and clarity. Thus, instead of “ship date,” the vehicle definition for model year will refer to the date when the certifying manufacturer’s “manufacturing operations were completed,” within the specified year. The final definition also specifies that each vehicle must be assigned a model year before introduction into U.S. commerce, but allow a manufacturer to redesignate a later model year if it does not complete its manufacturing operations for the vehicle within the initial model year.

To further standardize with EPA definitions, NHTSA will add the EPA engine model year definition to its corresponding regulation 49 CFR 535.4. We believe that this will address the concerns raised by commenters because

it will provide standardization, more specificity and account for current manufacturer practices.

The agencies are aware that the designation of a model year on a chassis for the purposes of this heavy-duty truck emission and fuel consumption program may result in a complete vehicle that has one model year associated with its chassis for emission/fuel consumption purposes and another model year designation in its vehicle identification number (VIN) for a motor vehicle’s certification to Federal motor vehicle safety standards. However, as the chassis model year designation would only be used on the certificate of conformity by the responsible manufacturer for the purpose of complying with these rules, it would not contradict other purposes for which a VIN model year may be used.

EMA/TMA also argued that the proposed dates used to specify the model year would shorten the lead time provided for manufacturers, because production for HD vehicles often begins in the early months of the year preceding the model year. We are addressing these concerns by finalizing January 1, 2014 as the date certain when manufacturers are required to comply. Prior to this date, certification of the vehicle would be optional. Thus, a manufacturer could produce uncertified model year 2014 vehicles through December 31, 2013. The heavy-duty compliance program uses a variety of mechanisms to conduct compliance assessments, including preproduction certification and postproduction testing and in-use monitoring once vehicles enter customer service. Specifically, the agencies are establishing a compliance program that utilizes existing EPA testing protocols and certification procedures. Under the provisions of this program, manufacturers will have significant opportunity to exercise implementation flexibility, based on the program schedule and design, as well as the credit provisions in the program for advanced technologies. This program includes a process to foster the use of innovative technologies, not yet contemplated in the current certification process. EPA and NHTSA will conduct compliance preview meetings which provide the agencies an opportunity to review a manufacturer’s new product plans and ABT projections. Given the nature of the final compliance program that involves both engine and vehicle compliance for some categories, it is necessary for manufacturers to begin pre-certification meetings with the agencies early enough to address issues of certification and compliance for both

integrated and non-integrated product offerings.

Based on feedback EPA and NHTSA received during the light-duty GHG comment period, both agencies are seeking to ensure transparency in the compliance process of this program. In addition to providing information in published reports annually regarding the status of credit balances and compliance on an industry basis, EPA and NHTSA sought comments in the NPRM on additional strategies for providing information useful to the public regarding industry’s progress toward reducing GHG emissions and fuel consumption from this sector while protecting sensitive business information. In response, commenters (Sierra Club and UCS) also had strong interests for the agencies to ensure that any collected data is made available to the public with an interest especially for providing details on the credit balances for each manufacturer and for data on specific vehicle configuration information data to better understand the market and help with the development of future programs. Additional requests (ALA and EDF) were also made for the agencies to expand consumer education and outreach for medium- and heavy-duty vehicles thereby empowering fleet purchasers to make better informed choices. Another commenter (ACEEE) specifically requested that the agencies publish a heavy-duty truck trend report describing vehicles and engines sold, including fuel efficiency and GHG performance and the use of advanced technology. It was further recommended (by ALA and EDF) that the agencies should create consumer education and outreach programs for medium and heavy-duty vehicles such as fuel consumption and GHG emissions information for all vehicles and engines covered by the rules, in buyers guide similar to the fuel economy guides that EPA and NHTSA provide for the light-duty CAFE program. ICCT and UCS also requested having a consumer based label for heavy-duty pickup trucks and vans providing fuel economy and emission information like in the light-duty CAFE program.

The agencies agree that there is a need for sharing heavy-duty emissions and fuel consumption information and therefore will make information publically available under this program.

(a) Heavy-Duty Pickup Trucks and Vans

The final compliance regulations (for certification, testing, reporting, and associated compliance activities) for heavy-duty pickup trucks and vans closely track both current practices and

the recently adopted greenhouse gas regulations for light-duty vehicles and trucks. Thus they are familiar to manufacturers. EPA already oversees testing, collects and processes test data, and performs calculations to determine compliance with both CAFE and CAA standards for Light-Duty. For Heavy-Duty products that closely parallel light-duty pickups and vans, under a coordinated approach, the compliance mechanisms for both programs for NHTSA and EPA would be consistent and non-duplicative for GHG pollutant standards and fuel consumption requirements. Vehicle emission standards established under the CAA apply throughout a vehicle's full useful life.

Under EPA's existing criteria pollutant emission standard program for heavy-duty pickup trucks and vans, vehicle manufacturers certify a group of vehicles called a test group. A test group typically includes multiple vehicle lines and model types that share critical emissions-related features. The manufacturer generally selects and tests a single vehicle, typically considered "worst case" for criteria pollutant emissions, which is allowed to represent the entire test group for certification purposes. The test vehicle is the one expected to be the worst case for the emission standard at issue. Emissions from the test vehicle are assigned as the value for the entire test group. However, the compliance program in the recent GHG regulations for light-duty vehicles, which is essentially the well-established CAFE compliance program, allows and may require manufacturers to perform additional testing at finer levels of vehicle models and configurations in order to get more precise model-level fuel economy and CO<sub>2</sub> emission levels. The agencies are adopting this same approach for heavy-duty pickups and vans. Additionally, like the light-duty program's use of analytically derived fuel economy (ADFE) data, we will allow manufacturers to predict CO<sub>2</sub> levels (and corresponding fuel consumption) of some vehicles in lieu of testing, using a methodology deemed appropriate by the agencies. Based on manufacturer input, a method for calculating analytically derived carbon dioxide (ADCO<sub>2</sub>) is specified in § 1037.104 of this rule.<sup>305</sup> At a manufacturer's request, EPA may approve analytical methods alternate to the method described in this rule if said alternate methods are deemed to be

more accurate than the analytical method described in this rule.

#### (b) Heavy-Duty Engines

Heavy-duty engine certification and compliance for traditional criteria pollutants has been established by EPA in its current general form since 1985. In developing a program to address GHG pollutants, it is important to build upon the infrastructure for certification and compliance that exists today. At the same time, it is necessary to develop additional tools to address compliance with GHG emissions requirements, since the final standard reflect control strategies that extend beyond those of traditional criteria pollutants. In so doing, the agencies are finalizing use of EPA's current engine test based strategy—currently used for criteria pollutant compliance—to also measure compliance for GHG emissions. The agencies are also finalizing to add new strategies to address vehicle specific designs and hardware which impact GHG emissions. The traditional engine approach would largely match the existing criteria pollutant control strategy. This would allow the basic tools for certification and compliance, which have already been developed and implemented, to be expanded for carbon dioxide, methane, and nitrous oxide. Engines with similar emissions control technology may be certified in engine families, as with criteria pollutants.

For EPA, the final approach for certification will follow the current process, which requires manufacturer submission of certification applications, approval of the application, and receipt of the certificate of conformity prior to introduction into commerce of any engines. EPA proposed the certificate of conformity be a single document that would be applicable for both criteria pollutants and greenhouse gas pollutants. For NHTSA, a manufacturer must submit certification applications with equivalent fuel consumption information. NHTSA will assess compliance with its fuel consumption standards based on the results of the EPA GHG emissions compliance process for each engine family.

#### (c) Class 7 and 8 Combination Tractors and Class 2b–8 Vocational Vehicles

Currently, except for HD pickups and vans, EPA does not directly regulate exhaust emissions from heavy-duty vehicles as a complete entity. Instead, a compliance assessment of the engine is undertaken as described above. Vehicle manufacturers installing certified engines are required to do so in a manner that maintains all functionality of the emission control system. While

no process exists for certifying these heavy-duty vehicles, the agencies believe that a process similar to the one we proposed to use for heavy-duty engines can be applied to the vehicles.

The agencies are finalizing related certification programs for heavy-duty vehicles. Manufacturers will divide their vehicles into families and submit applications to each agency for certification for each family. However, the demonstration of compliance will not require emission testing of the complete vehicle, but will instead involve a computer simulation model, GEM. This modeling tool uses a combination of manufacturer-specified and agency-defined vehicle parameters to estimate vehicle emissions and fuel consumption. This model is then exercised over certain drive cycles. EPA and NHTSA are finalizing the duty cycles over which Class 7 and 8 combination tractors would be exercised to be: 65 mile per hour steady state cruise cycle, the 55 mile per hour steady state cruise cycle, and the California ARB transient cycle. Additional details regarding these duty cycles will be addressed in Section V.D(1)(b) below. Over each duty cycle, the simulation tool will return the expected CO<sub>2</sub> emissions, in g/ton-mile, and fuel consumption, gal/1,000 ton-mile, which would then be compared to the standards.

#### B. Heavy-Duty Pickup Trucks and Vans

##### (i) Compliance Approach

EPA and NHTSA are finalizing, largely as proposed, new emission standards to control greenhouse gases (GHGs) and reduce fuel consumption from heavy-duty vehicles with gross vehicle weight rating between 8,500 and 14,000 pounds that are not already covered under the MY 2012–2016 medium-duty passenger vehicle standards. In this section "trucks" refers to heavy-duty pickup trucks and vans between 8,500 and 14,000 pounds not already covered under the light-duty rule.

First, EPA is finalizing fleet average emission standards for CO<sub>2</sub> on a gram per mile (g/mile) basis and NHTSA is finalizing fuel consumption standards on a gal/100 mile basis that would apply to a manufacturer's fleet of heavy-duty trucks and vans with a GVWR from 8,500 pounds to 14,000 pounds (Class 2b and 3). CO<sub>2</sub> is the primary pollutant resulting from the combustion of vehicular fuels, and the amount of CO<sub>2</sub> emitted is highly correlated to the amount of fuel consumed. In addition, the EPA is finalizing separate emissions standards for three other GHG

<sup>305</sup> Memorandum from Don Kopinski, U.S. EPA to docket EPA-HQ-OAR-2010-0162, July 7, 2011.

pollutants: CH<sub>4</sub>, N<sub>2</sub>O, and HFC. CH<sub>4</sub> and N<sub>2</sub>O emissions relate closely to the design and efficient use of emission control hardware (*i.e.*, catalytic converters). The standards for CH<sub>4</sub> and N<sub>2</sub>O would be set as caps that would limit emissions increases and prevent backsliding from current emission levels. In lieu of meeting the caps, EPA is allowing manufacturers the option of offsetting any N<sub>2</sub>O emissions or any CH<sub>4</sub> emissions above the cap by taking steps to further reduce CO<sub>2</sub>. Separately, EPA is finalizing to set standards to control the leakage of HFCs from air conditioning systems.

Previously, complete vehicles with a Gross Vehicle Weight Rating of 8,500–14,000 pounds could be certified according to 40 CFR part 86, subpart S. These heavy-duty chassis certified vehicles were required to pass emissions on both the Light-duty FTP and HFET (California requirement).<sup>306</sup> These rules will use the same testing procedures already required for heavy-duty chassis certification, namely the Light-duty FTP and the HFET. Using the data from these two tests, EPA and NHTSA will compare the CO<sub>2</sub> emissions and fuel consumption results against the attribute-based target. The attribute upon which the CO<sub>2</sub> standard is based is a function of vehicle payload, vehicle towing capacity and two-wheel versus four-wheel drive configuration. The attribute-based standard targets will be used to determine a manufacturer fleet standard. As discussed in section IV above, manufacturers may use the ABT program and other flexibilities in achieving and demonstrating compliance.

These rules will generally require complete HD pickups and vans to have CO<sub>2</sub>, CH<sub>4</sub> and N<sub>2</sub>O values assigned to them, either from actual chassis dynamometer testing or from the results of a representative vehicle in the test group with appropriate adjustments made for differences. Manufacturers will be allowed to exclude vehicles they sell to secondary manufacturers as incomplete vehicles, unless these vehicles are chassis-certified for criteria (non-GHG) pollutants. To the extent manufacturers are allowed to engine- or chassis-certify for criteria pollutant requirements today, they will be allowed to continue to do so under the final regulations. See subsection V.B(1)(e) for discussion of special provisions for chassis-certification to GHG and fuel consumption standards.

Because this program for heavy-duty pickup trucks and vans is so similar to the program recently adopted for light-duty trucks and codified in 40 CFR part 86, subpart S, EPA will apply most of those subpart S regulatory provisions to heavy-duty pickup trucks and vans and not recodify them in the new part 1037. Most of the new part 1037 thus would not apply for heavy-duty pickup trucks and vans. How 40 CFR part 86 applies, and which provisions of the new 40 CFR part 1037 apply for heavy-duty pickup trucks and vans is described in § 1037.104. Similarly NHTSA's requirements for these vehicles in § 535.6(a) are based on 40 CFR part 86.

#### (a) Certification Process

CAA section 203(a)(1) prohibits manufacturers from introducing a new motor vehicle into commerce unless the vehicle is covered by an EPA-issued certificate of conformity. Section 206(a)(1) of the CAA describes the requirements for EPA issuance of a certificate of conformity, based on a demonstration of compliance with the emission standards established by EPA under section 202 of the Act. The certification demonstration requires emission testing, and certification is required for each model year.<sup>307</sup>

Under existing heavy-duty chassis certification and other EPA emission standard programs, vehicle manufacturers certify a group of vehicles called a test group. A test group typically includes multiple vehicle car lines and model types that share critical emissions-related features.<sup>308</sup>

EPA requires the manufacturer to make a good faith demonstration in the certification application that vehicles in the test group will both (1) comply throughout their useful life within the emissions bin assigned, and (2) contribute to fleetwide compliance with the applicable emissions standards when the year is over. EPA issues a certificate for the vehicles included in the test group based on this demonstration, and includes a condition in the certificate that if the manufacturer does not comply with the fleet average, then production vehicles from that test group will be treated as not covered by the certificate to the extent needed to bring the manufacturer's fleet average into compliance with the applicable standards.

The certification process often occurs several months prior to production and manufacturer testing may occur months

before the certificate is issued. The certification process for the existing heavy-duty chassis program is an efficient way for manufacturers to conduct the needed testing well in advance of certification, and to receive certificates in a time frame which allows for the orderly production of vehicles. The use of conditions on the certificate has been an effective way to ensure that manufacturers comply throughout their useful life and meet fleet standards when the model year is complete and the accounting for the individual model sales is performed. EPA has also adopted this approach as part of its light-duty vehicle GHG compliance program.

These rules will similarly condition each certificate of conformity for the GHG program upon a manufacturer's good faith demonstration of compliance with the manufacturer's fleetwide average CO<sub>2</sub> standard. The following discussion explains how the agencies will integrate this new vehicle certification program into the existing certification program.

An integrated approach with NHTSA has been undertaken to allow manufacturers a single point of entry to address certification and compliance. Vehicle manufacturers will initiate the formal certification process with their submission of application for a certificate of conformity to EPA, similar to the light-duty program.

#### (b) Certification Test Groups and Test Vehicle Selection

For heavy-duty chassis certification to the criteria emission standards, manufacturers currently, as mentioned above, divide their fleet into "test groups" for certification purposes. The test group is EPA's unit of certification; one certificate is issued per test group/evaporative family combination. These groupings cover vehicles with similar emission control system designs expected to have similar emissions performance (*see* 40 CFR 86.1827–01). The factors considered for determining test groups include Gross Vehicle Weight, combustion cycle, engine type, engine displacement, number of cylinders and cylinder arrangement, fuel type, fuel metering system, catalyst construction and precious metal composition, among others. Vehicles having these features in common are generally placed in the same test group.<sup>309</sup>

This program will retain the current test group structure for heavy-duty

<sup>307</sup> CAA Section 206(a)(1).

<sup>308</sup> The specific test group criteria are described in 40 CFR 86.1827–01, car lines and model types have the meaning given in 40 CFR 86.1803–01.

<sup>309</sup> EPA provides for other groupings in certain circumstances, and can establish its own test groups in cases where the criteria do not apply. *See* 40 CFR 86.1827–01(b), (c) and (d).

<sup>306</sup> Diesel engines are engine-certified with the option to chassis certification Federally and for California.



pickups and vans in the certification requirements for CO<sub>2</sub> and fuel consumption. At the time of certification, manufacturers will use the CO<sub>2</sub> emission level from the Emission Data Vehicle as a surrogate to represent all of the models in the test group. However, following certification further testing will generally be allowed for compliance with the fleet average CO<sub>2</sub> and fuel consumption standards as described below. EPA's issuance of a certificate will be conditioned upon the manufacturer's subsequent model level testing and attainment of the actual fleet average, much like light-duty CAFE and GHG compliance requires. Under the current program, complete heavy-duty Otto-cycle vehicles under 14,000 pounds Gross Vehicle Weight Rating are required to chassis certify (see 40 CFR 86.1801–01(a)). The current program allows complete heavy-duty diesel vehicles under 14,000 pounds GVWR to optionally chassis certify (see 40 CFR 86.1863–07(a)). The new regulations we are adopting will not change these existing EPA certification options for complete (or incomplete) HD vehicles. EPA recognizes that the existing heavy-duty chassis test group criteria do not necessarily relate to CO<sub>2</sub> emission levels. See 75 FR 25472 (addressing the same issue for light-duty vehicles). For instance, while some of the criteria, such as combustion cycle, engine type and displacement, and fuel metering, may have a relationship to CO<sub>2</sub> emissions, others, such as those pertaining to the some exhaust aftertreatment features, may not. In fact, there are many vehicle design factors that impact CO<sub>2</sub> generation and emissions but are not major factors included in EPA's test group criteria.<sup>310</sup> Most important among these may be vehicle weight, horsepower, aerodynamics, vehicle size, and performance features. To remedy this, EPA will allow manufacturers provisions that are similar to the light-duty vehicle rule that would yield more accurate CO<sub>2</sub> estimates than only using the test group emission data vehicle CO<sub>2</sub> emissions.

EPA believes that the current test group concept is appropriate for N<sub>2</sub>O and CH<sub>4</sub> because the technologies that would be employed to control N<sub>2</sub>O and CH<sub>4</sub> emissions may generally be the same as those used to control the criteria pollutants. However, manufacturers will determine if this

approach is adequate method for N<sub>2</sub>O and CH<sub>4</sub> emissions compliance or if testing on additional vehicles is required to ensure their entire fleet meets applicable standards.

As just discussed, the “worst case” vehicle a manufacturer selects as the Emissions Data Vehicle to represent a test group under the existing regulations (40 CFR 86.1828–01) may not have the highest levels of CO<sub>2</sub> in that group. For instance, there may be a heavier, more powerful configuration that would have higher CO<sub>2</sub>, but may, due to the way the catalytic converter has been matched to the engine, actually have lower NO<sub>x</sub>, CO, PM or HC emissions. Therefore, EPA is allowing the use of a single Emission Data Vehicle to represent the test group for both criteria pollutant and CO<sub>2</sub> certification. The manufacturer will be allowed to initially apply the Emission Data Vehicle's CO<sub>2</sub> emissions value to all models in the test group, even if other models in the test group are expected to have higher CO<sub>2</sub> emissions. However, as a condition of the certificate, this surrogate CO<sub>2</sub> emissions value will generally be replaced with actual, model-level CO<sub>2</sub> values based on results from additional testing that occurs later in the model year much like the light-duty CAFE program, or through the use of approved methods for analytically derived fuel economy. This model level data will become the official certification test results (as per the conditioned certificate) and will be used to determine compliance with the fleet average. If the test vehicle is in fact the worst case CO<sub>2</sub> vehicle for the test group, the manufacturer may elect to apply the Emission Data Vehicle emission levels to all models in the test group for purposes of calculating fleet average emissions. Manufacturers may be unlikely to make this choice, because doing so would ignore the emissions performance of vehicle models in their fleet with lower CO<sub>2</sub> emissions and would unnecessarily inflate their CO<sub>2</sub> fleet average. Testing at the model level, in order to better represent the improved performance of vehicles within a test group other than the Emission Data Vehicle, will necessarily increase testing burden beyond the minimum EDV testing.

As explained in earlier Sections, there are two standards that the manufacturer will be subject to, the fleet average standard and the in-use standard for the useful life of the vehicle. Compliance with the fleet average standard is based on production weighted averaging of the test data that applies for each model. To address commenter concerns regarding test variability due to facility and build

variation for each model, the in-use and SEA standards are set at 10 percent higher than the level used for that model in calculating the fleet average. The certificate covers both of the fleet and in-use standards, and the manufacturer has to demonstrate compliance with both of these standards for purposes of receiving a certificate of conformity. The certification process for the in-use standard is discussed above.

### (c) Demonstrating Compliance

#### (i) CO<sub>2</sub> and Fuel Consumption Fleet Standards

As noted, attribute-based CO<sub>2</sub> and fuel consumption standards result in each manufacturer having fleet average CO<sub>2</sub> and fuel consumption standards unique to its heavy-duty truck fleet of GVWR between 8,500–14,000 pounds and that standard will be separate from the standard for passenger cars, light-trucks, and other heavy-duty trucks. The standards depend on those attributes corresponding to the relative capability, or “work factor”, of the vehicle models produced by that manufacturer. The final attributes used to determine the stringency of the CO<sub>2</sub> and fuel consumption standards are payload and towing capacity as described in Section II. Generally, fleets with a mix of vehicles with increased payloads or greater towing capacity (or utilizing four wheel drive configurations) will face numerically less stringent standards (*i.e.*, higher CO<sub>2</sub> grams/mile standards or fuel consumption gallons/100 miles standards) than fleets consisting of less powerful vehicles. (However, the standards will be expected to be equally challenging and achieve similar percent reductions.) Although a manufacturer's fleet average standard could be estimated throughout the model year based on projected production volume of its vehicle fleet, the final compliance values will be based on the final model year production figures. A manufacturer's calculation of fleet average emissions and fuel consumption at the end of the model year will be based on the production-weighted average emissions and fuel consumption of each model in its fleet. The payload and towing capacity inputs used to determine manufacturer compliance will be the advertised values.

The agencies will use the same general vehicle category definitions that are used in the current EPA HD chassis certification (See 40 CFR 86.1816–05). The new vehicle category definitions differ slightly from the EPA definitions for Heavy-duty Vehicle definitions for the existing program, as well as other EPA vehicle programs. Mainly,

<sup>310</sup> EPA noted this potential lack of connection between fuel economy testing and testing for emissions standard purposes when it first adopted fuel economy test procedures. See 41 FR 38677, Sept. 10, 1976.

manufacturers will be able to test, and possibly model, more configurations of vehicles than were historically possible. The existing criteria pollutant program requires the worst case configuration be tested for emissions certification. For HD chassis certification, this usually meant only testing the vehicle with the highest ALVW, road-load, and engine displacement within a given test group. This worst case configuration may only represent a small fraction of the test group production volume. By testing the worst case, albeit possibly small volume, vehicle configuration, the EPA had a reasonable expectation that all represented vehicles would pass the given emissions standards. Since CO<sub>2</sub> standards are a fleet standard based on a combination of sales volume and work factor (*i.e.*, payload and towing capability), it may be in a manufacturer's best interest to test multiple configurations within a given test group to more accurately estimate the fleet average CO<sub>2</sub> emission levels and not accept the worst case vehicle test results as representative of all models. Additionally, vehicle models for which a manufacturer desires to use analytically derived fuel economy (ADFE) to estimate CO<sub>2</sub> emission levels may need additional actual test data for vehicle models of similar but not identical configurations. The agencies are allowing the use of ADFE similar to that allowed for light-duty vehicles in 40 CFR 600.006–08(e). Some commenters, including the American Automotive Policy Council, were concerned that adopting the light-duty ADFE program with its current minimum test requirements would unduly increase testing burden. In addition to concerns over implementing the light-duty ADFE program for heavy-duty GHG compliance, commenters noted the need to develop a new HD ADFE methodology that addressed unique HD concerns. EPA and NHTSA have continued to work with stakeholders to address the above concerns with using a modified LD ADFE program. To address these concerns, the agencies will expand the allowed use of ADFE beyond that which is allowed in the LD program. Since ADFE equations are not final at the time of this action, updates to the HD ADFE program will be made through guidance or future rulemaking. The GHG and fuel economy rulemaking for light-duty vehicles adopted a carbon balance methodology used historically to determine fuel consumption for the light-duty labeling and CAFE programs, whereby the carbon-related combustion products HC and CO are included on an

adjusted basis in the compliance calculations, along with CO<sub>2</sub>. The resulting carbon-related exhaust emissions (CREE) of each test vehicle are calculated and it is this value, rather than simply CO<sub>2</sub> emissions, that is used in compliance determinations. The difference between the CREE and CO<sub>2</sub> is typically very small. *See generally* 75 FR at 25472.

NHTSA and EPA are not adopting the CREE methodology for HD pickups and vans, and so will not adjust CO<sub>2</sub> emissions to further account for additional HC and CO. The basis of the CREE methodology in historical labeling and CAFE programs is not relevant to HD pickups and vans, because these historical programs do not exist for HD vehicles. Furthermore, test data used in this rulemaking for standards-setting has not been adjusted for this effect, and so it would create an inconsistency, albeit a small one, to apply it for compliance with the numerical standards we are finalizing. Finally, it would add complexity to the program with little real world benefit.

#### (ii) CO<sub>2</sub> In-Use Standards and Testing

Section 202(a)(1) of the CAA requires emission standards to apply to vehicles throughout their statutory useful life. Section II discusses in-use standards.

Currently, EPA regulations require manufacturers to conduct in-use testing as a condition of certification for heavy-duty trucks between 8,500 and 14,000 gross vehicle weight that are chassis certified. The vehicles are tested to determine the in-use levels of criteria pollutants when they are in their first and third years of service. This testing is referred to as the In-Use Verification Program, which was first implemented as part of EPA's CAP 2000 certification program (*see* 64 FR 23906, May 4, 1999).

An in-use program was already set forth in the light-duty 2012–2016 MY vehicle rule similar to the heavy-duty pickups and vans. The In-Use Verification Program for heavy-duty pickups and vans will follow the same general provisions of the light-duty program in regard to testing, vehicle selection, and reporting. *See* 75 FR 25474–25476.

#### (d) Special Provisions for Chassis Certification

We proposed to include most cab-chassis Class 2b and 3 vehicles (vehicles sold as incomplete vehicles with the cab substantially in place but without the primary load-carrying enclosure) in the complete HD pickup and van program. Because their numbers are relatively small, and to reduce the testing and compliance tracking burden to

manufacturers, we proposed to treat these vehicles as equivalent to the complete van or truck product from which they are derived. The manufacturer would determine which complete vehicle configuration it produces most closely matches the cab-chassis product leaving its facility, and would include each of these cab-chassis vehicles in the fleet averaging calculations as though it were identical to the corresponding complete “sister” vehicle. *See* 75 FR at 74263.

Commenters opposed this proposed requirement for a number of reasons: (1) It would have the unintended consequence of dual certification for some of these vehicles—engine certification for criteria pollutants and vehicle certification for GHGs, and vice-versa for some other vehicles, (2) it would be of modest benefit because most of these cab-chassis vehicles would receive the desired aerodynamic and other non-engine improvements even without chassis certification, in virtue of their derivation from complete vehicles, and (3) a readily-identifiable sister vehicle may not exist in every case. Based on the comments, the agencies have re-evaluated the proposed approach for cab-chassis certification and are restructuring our compliance approach to provide significantly more flexibility while still ensuring comparable or better GHG and fuel consumption performance overall.

We are not requiring that cab-chassis vehicles be chassis-certified, but are retaining chassis-certification for them as an option using the proposed sister vehicle concept. We are instead requiring that vehicles that are chassis-certified for criteria pollutants be chassis-certified for GHGs and fuel consumption, and likewise that vehicles with engines certified for criteria pollutants (which in this case would be engines installed in vocational vehicles exclusively) be certified to the vocational vehicle standards for GHGs and fuel consumption, with minor exceptions detailed below. We believe that this approach involving consistent chassis- and engine-certification for criteria pollutants and GHGs is the most sensible way to structure a program to minimize both the testing burden and the potential for gaming.

We are allowing use of the sister vehicle concept for incomplete vehicle certification to include the selection of sister vehicles not actually produced for sale by the certifying manufacturer. For the great majority of vehicles this will not be an issue because the sister vehicle will obviously be the complete pickup truck or van from which the cab-chassis vehicle is derived. However if

the complete sister vehicle ceases production but the corresponding incomplete vehicle does not, a manufacturer may continue to use the sister vehicle emissions data through the carryover process that is already practiced today. If carryover is not appropriate because of, for example, an emissions-impacting recalibration of the engine, the manufacturer may conduct new emissions testing using the coastdown data collected on the original sister vehicle. This would still save substantial effort without sacrificing data quality because coastdowns are rather resource-intensive but are not much affected by engine changes. Another potentially inappropriate situation would exist where no sister vehicle exists because the manufacturer does not sell a related complete vehicle. In this case, the manufacturer may coastdown a mocked-up vehicle made from its incomplete vehicle and an added open or closed cargo box that simulates a complete van or pickup truck, or may coastdown one of its customers' completed vehicles.

EPA and NHTSA requested comment on whether Class 4 vehicles that are very similar to complete Class 3 pickup truck models should be chassis-certified and regulated as part of the HD pickup and van category, instead of as vocational vehicles. Commenters argued convincingly that there are a number of important differences between the Class 4 and Class 3 trucks that make such regulation inappropriate as a general matter. As a result, we are keeping Class 4 trucks in the vocational vehicle category. However, we are adding an optional provision that allows manufacturers to certify Class 4 or 5 (14,001 to 19,500 lb GVWR) complete or incomplete vehicles to GHG and fuel consumption standards, in the same way as Class 2b and 3 vehicles, and thus be included within the Class 2b/3 fleet average. The engines in these vehicles will continue to be engine-certified for criteria pollutants, but the manufacturers could include the vehicles in their fleet average standard and annual compliance calculations, using the same certification and compliance provisions as for the smaller vehicles, including the equations for determining work factors and target standards, in-use requirements, reporting requirements, credit generation and use, and sister vehicle provisions for incomplete vehicles. Such vehicles would not be required to meet the vocational vehicle standards. Because sales volumes of Class 4 and 5 trucks are relatively small, and because we expect these Class 4 and 5 and Class

2b and 3 trucks to generally use the same technologies and face roughly the same technology challenge in meeting their standards targets, we do not believe that this provision will dilute the stringency of the fleet average standards.

Any in-use testing of vehicles that are chassis-certified using the sister vehicle provisions would involve loading of the tested vehicle to a total weight equal to the ALVW of the corresponding complete vehicle configuration. If the secondary manufacturer had altered or replaced any vehicle components in a way that would substantially affect CO<sub>2</sub> emissions from the tested vehicle (*e.g.*, axle ratio has been changed for a special purpose vehicle), the vehicle manufacturer could request that EPA not test the vehicle or invalidate a test result. Secondary (finisher) manufacturers who finish incomplete vehicles certified using the sister vehicle provisions would not be subject to requirements under these regulations, other than to comply with anti-tampering regulations. However, if they modify vehicle components in such a way that GHG emissions and fuel consumption are substantially affected, they become manufacturers subject to the standards we are establishing in these rules.

Finally, we are adopting a related special provision involving chassis-certification aimed at simplifying compliance for manufacturers of complete HD pickups and vans that also sell a relatively small number of engines that are designed for other manufacturers' heavy-duty vehicles—normally referred to as 'loose' engines. Today these loose engines must be engine-certified for criteria pollutants, even though most of the vehicles that use the engines are chassis-certified. Our new provision does not change this, but it does provide manufacturers with an option to focus their energy on improving the GHG and fuel consumption performance of their complete vehicle products (including, most likely, significant engine improvements), rather than on concurrently calibrating for both vehicle and engine test compliance.

These loose engines would not be certified to engine-based GHG and fuel consumption standards, but instead would be treated as though they were additional sales of the manufacturer's complete pickup and van products, on a one-for-one basis. The pickup/van vehicle so chosen must be the vehicle with the highest ETW that uses the engine (as this vehicle is likely to have the highest GHG emissions and fuel consumption). However, if this vehicle

is a credit-generator under the HD pickup and van fleet averaging program, no credits would be generated by these engine-as-vehicle contributors to the fleet average; they would be treated as just achieving the target standard. If, on the other hand, the vehicle is a credit-user, the appropriate number of additional credits would be needed to offset the engine-as-vehicle contributors. The purchaser of the engine would treat it as any other certified engine, and would still need to meet applicable vocational vehicle standards for the vehicles in which the engine is installed.

Because it is our intent that this loose engine provision simplifies compliance for HD pickup/van manufacturers who sell a relatively small number of engines for other manufacturers' applications, we are limiting its use to 10 percent of the total engines (15,000 maximum) of the same design that a manufacturer produces in each model year for U.S.-directed heavy-duty application—including complete vehicles, incomplete vehicles, and the loose engines themselves. We are further limiting both this provision and the above-described provision for chassis certification of Class 4/5 vehicles to spark-ignition (gasoline) engines, because we believe that the HD diesel engine business is more focused on designing for and marketing into a wide variety of vehicles products, instead of into the engine manufacturer's own chassis-certified vehicle products with a small loose engine business on the side, as is common for HD gasoline engines. This dynamic is also reflected in the existing provision for criteria pollutants allowing complete HD vehicles to use certified diesel engines but not certified gasoline engines.

Together these provisions provide a robust approach to regulating these vehicles and engines. Although these certification options are not as straightforward as the certification provisions for complete Class 2b/3 pickups and vans, they are technically appropriate (for the reasons explained above) and should accomplish more improvement in GHG and fuel consumption performance than simply applying the vocational vehicle and engine standards.

## (2) Labeling Provisions

HD pickups and vans currently have vehicle emission control information labels showing compliance with criteria pollutant standards, similar to emission control information labels for engines. As with engines, we believe this label is sufficient.

### (3) Other Certification Issues

#### (a) Carryover Certification Test Data

EPA's final certification program for vehicles allows manufacturers to carry certification test data over from one model year to the next, when no significant changes to models are made. EPA will also apply this policy to CO<sub>2</sub>, N<sub>2</sub>O and CH<sub>4</sub> certification test data.

#### (b) Compliance Fees

The CAA allows EPA to collect fees to cover the costs of issuing certificates of conformity for the classes of vehicles and engines covered by this rulemaking. On May 11, 2004, EPA updated its fees regulation based on a study of the costs associated with its motor vehicle and engine compliance program (69 FR 51402). At the time that cost study was conducted the current rulemaking was not considered.

At this time the extent of any added costs to EPA as a result of this rulemaking is not known. EPA will assess its compliance testing and other activities associated with the program and may amend its fees regulations in the future to include any justifiable new costs.

### (4) Compliance Reports

#### (a) Pre-Model Year Report

In the NPRM, EPA and NHTSA proposed that manufacturers must submit early model year compliance reports demonstrating how their entire fleets of heavy-duty pickup trucks and vans would comply with GHG emissions and fuel consumption standards. The agencies understood that early model year reports would contain estimates that may change over the course of a model year and that compliance information manufacturers submit prior to the beginning of a new model year may not represent the final compliance outcome. The agencies viewed the necessity for requiring early model reports as a manufacturer's good faith projection for demonstrating compliance with emission and fuel consumption standards. The preamble language indicated that the compliance reports would be submitted prior to the beginning of the model year and prior to the certification of any test group. Preferably, a manufacturer would submit its reports during its annual certification preview meeting. Precertification preview meetings are typically held with a manufacturer before the earliest date that the model year can begin which is January 2nd of the calendar year prior to the model year. Manufacturers voluntarily choose to participate in precertification compliance meetings but meetings are

not required by EPA and NHTSA regulations. Manufacturers opt to participate in precertification meetings because of the advantage it gives to exploring with the agencies any possible compliance problems that may arise prior to seeking approval for certificates of conformity. The NPRM preamble text did not specify an exact date for manufacturers to submit early compliance reports to the agency. NHTSA attempted to adopt requirements in its regulatory text for manufactures to submit their early compliance reports no later than the end of December two years prior to the model year. NHTSA also proposed for manufacturers to provide compliance information for the current model year and to the extent possible two years into the future. NHTSA chose its submission deadline and model years for reporting based upon the same dates required by EPA in its CAFE provisions for light-duty pickups and vans beginning in model year 2012.

The NPRM included requirements for manufacturers to submit early model year compliance reports separately to each agency based upon limitations existing in the statutory authorities prescribed under EISA and CAA and the long-standing precedent set in the LD CAFE programs for receiving reports. The EPA report, called the pre-model year report, and NHTSA report, called the pre-certification compliance report, were proposed to include an estimate of the manufacturer's attribute-based standards, along with a demonstration of compliance with the standards based on projected model-level and fleet CO<sub>2</sub> emissions and fuel consumption results, and were to include an estimate of the manufacturer's production volumes. The NPRM also included a proposal for submitting a credit plan for manufacturers seeking to take advantage of credit flexibilities and a credit deficit plan for manufacturers planning to accrue deficits during the model years. Additionally, NHTSA attempted to reduce the burden on manufacturers by allowing them to submit copies of EPA's proposed pre-model year reports or applications for certifications of conformity, as a substitute to its own compliance report, so long as EPA's reports were submitted with equivalent fuel consumption information. In either case, NHTSA reserved the right to ask manufacturers to provide additional information if necessary to verify its fuel consumption requirements under this program. EPA and NHTSA also proposed to review the compliance reports for technical viability and to conduct a certification preview

discussion with the manufacturer. It was further proposed that the EPA Administrator would have to approve a manufacturer's pre-model year report before it would consider issuing any certificate of compliance for the manufacturer.

Comments were received to the NPRM from EMA and TMA strongly opposing providing separate reports to EPA and NHTSA and requested that the agencies implement a single uniform reporting template that could be submitted to both agencies simultaneously. DTNA requested that NHTSA eliminate its pre-certification compliance report, arguing that report was overly burdensome.

For the final rules, the agencies have decided to require manufacturers to submit a single report, hereafter referenced as the pre-model year report, to satisfy both agencies requirements for receiving compliance reports in advance of the model year. The agencies considered the commenters' requests and determined that the benefit gained by receiving separate or distinct compliance reports would not outweigh the burden placed on manufacturers in reporting. Therefore, the final rules establish a harmonized approach by which manufacturers will submit a single report through the EPA database system as the single point of entry for all information required for this national program and both agencies will have access to the information. If by model year 2012, the agencies are not prepared to receive information through the EPA database system, manufacturers are expected to submit written reports to the agencies. EPA and NHTSA have determined that requiring manufacturers to submit a joint pre-model year report for their combined fleet of heavy-duty pickup trucks containing both emissions and equivalent fuel consumption information falls within each agencies' statutory authority. The final rules require a manufacturer to submit the joint pre-model year report as early as the date of the manufacturer's annual certification preview meeting, or prior to the manufacturer submitting its first application for a certificate for the given model year. Consequently, a manufacturer choosing to comply in model year 2014 could submit its pre-model year report during its precertification meeting, which could occur before January 2, 2013. Alternately, the manufacturer could provide its pre-model year report any time prior to submitting its first application. In either case, a manufacturer would not be able to certify any of its test groups until the

EPA Administrator approves its pre-model year report. NHTSA will use the pre-model year report as preliminary model year data.

The agencies are adopting similar requirements for the pre-model year reports as proposed. As mentioned, the agencies proposed that reports would include an estimate of the manufacturer's attribute-based standards, expected testing results and estimated production volumes. The agencies agree that this information is essential for tracking compliance of manufacturers and is therefore adopted for the final rules. The final rules require manufacturers to identify any vehicle exclusions and other flexibilities afforded for heavy-duty pickups and vans. The summary of the required information for each pre-model year report is as follows:

- A list of each unique vehicle configuration included in the manufacturer's fleet describing the make and model designations, attribute based-values (GVWR, GCWR, Curb Weight and drive configurations) and standards.
- The emission and fuel consumption fleet average standard derived from the unique vehicle configurations;
- The estimated vehicle configuration, test group and fleet production volumes;
- The expected emissions and fuel consumption test group results and fleet average performance;
- A statement declaring whether the manufacturer chooses to comply early in MY 2013 for EPA and NHTSA. The manufacturers must acknowledge that once selected, the decision cannot be reversed and the manufacturer will continue to comply with the fuel consumption standards for subsequent model years;
- A statement declaring whether the manufacturer will use fixed or increasing standards; acknowledging that once selected, the decision cannot be reversed and the manufacturer must continue to comply with the same alternative for subsequent model years;
- A statement declaring whether the manufacturer chooses to comply voluntarily with NHTSA's fuel consumption standards for model years 2014 through 2015. The manufacturers must acknowledge that once selected, the decision cannot be reversed and the manufacturer will continue to comply with the fuel consumption standards for subsequent model years;
- The list of Class 2b–3 cab-complete vehicles and the method use to certify, as vocational vehicles and engines, or as complete pickups and vans identifying the most similar complete vehicles used

to derive the target standards and performance test results;

- The list of Class 2b–3 incomplete vehicles and the method use to certify, as vocational vehicles and engines, or as complete pickups and vans identifying the most similar complete vehicles used to derive the target standards and performance test results;
- The list of Class 4 and 5 incomplete and complete vehicles and the method use to certify, as vocational vehicles and engines, or as complete pickups and vans identifying the most similar complete vehicles used to derive the target standards and performance test results;
- List of loose engines included in the heavy-duty pickup and van category and the list of vehicles used to derive target standards.
- Copy of any notices a vehicle manufacturer sends to the engine manufacturer to notify the engine manufacturers that their engines are subject to emissions and fuel consumption standards and that it intends to use their engines in excluded vehicles; and
- A credit plan identifying the manufacturers estimated credit balances, planned credit flexibilities (*i.e.*, credit balances, planned credit trading, innovative, advanced and early credits and *etc.*) and if needed a credit deficit plan demonstrating how it plans to resolve any credit deficits that might occur for a model year within a period of up to three model years after that deficit has occurred.

#### (b) Final Reports

The NPRM proposed for manufacturers participating in the ABT program to provide two types of year end reports; end-of-the-year (EOY) reports and final reports. The EOY reports for the ABT program were required to be submitted by manufacturers no later than 90 days after the calendar year and final report no later than 270 days after the calendar year.<sup>311</sup> Manufacturers not participating in the ABT program were required to provide an EOY report within 45 days after the calendar year but no final reports were required. The submission deadline of the final ABT report was established to coincide with EPA's existing criteria pollutant report for heavy-duty engines. The EOY report is used by the agencies to review a manufacturer's preliminary final estimates and to identify manufacturers that might have a credit deficit for the given model year. Manufacturers with a credit surplus at the end of each model

year could submit a request to the agencies to receive a waiver from providing EOY reports. As proposed, the remaining manufacturers were required to submit reports to EPA and send copies of those reports to NHTSA with equivalent fuel consumption values. Manufacturers requesting to exempt vehicles in accordance with the agencies' off-road vehicle exemption were required to submit EOY reports to the agencies identifying the vehicle applicable to each report within 90 days after the model year ended.

Comments in response to the NPRM did not oppose providing EOY reports to the agencies but instead requested that they be allowed to consolidate the various EOY reports into one single submission to the agencies.

Upon consideration of commenters' requests, the agencies agree that only one consolidated EOY report should be submitted in place of the separate reports proposed in the NPRM. The consolidated EOY report should include the combination of all the required information that is applicable to a manufacturer's fleet. The agencies also agree to allow manufacturers to no longer provide separate EOY reports to each agency independently but rather to submit the single report through the EPA database system as the single point of entry for all information required for this national program. The consolidated EOY report is required to contain both GHG emissions and fuel consumption information. EPA will provide access to the information for both agencies. Likewise, manufacturers will be required to electronically provide one single final report through the EPA database system. If by model year 2012, the agencies are not prepared to receive information through the EPA database system, manufacturers are expected to submit written reports to the agencies. The required information for EOY and final reports that manufacturers must submit is as follows: A finalized list of each unique vehicle configuration included in the manufacturers fleet describing the designations, attribute based-values (GVWR, GCWR, Curb Weight and drive configurations) and standards.

- The final emission and fuel consumption fleet average standard derived from the unique vehicle configurations;
- The final vehicle configuration, test group and fleet production volumes;
- The final emissions and fuel consumption test group results and fleet average performance;
- The final list of cab-complete vehicles and the method use to certify, as vocational vehicles and engine, or as

<sup>311</sup> Corresponding to the compliance model year

complete pickups and vans identifying the most similar complete vehicles used to derive the target standards and performance test results;

- A final credit plan identifying the manufacturers estimated credit balances, planned credit flexibilities (*i.e.*, credit balances, planned credit trading, innovative, advanced and early credits, and *etc.*) and if needed a credit deficit plan demonstrating how it plans to resolve any credit deficits that might occur for a model year within a period of up to three model years after that deficit has occurred;
- A plan describing the vehicles that were exempted such as for off-road or small business purposes; and
- A plan describing any alternative fueled vehicles that were produced for the model year identifying the approaches used to determine compliance and the production volumes.

### C. Heavy-Duty Engines

#### (i) Compliance Approach

Section 203 of the CAA requires that all motor vehicles and engines sold in the United States carry a certificate of conformity issued by the U.S. EPA. For heavy-duty engines, the certificate specifies that the engine meets all requirements as set forth in the regulations (40 CFR part 86, subpart N, for criteria pollutants) including the requirement that the engine be compliant with emission standards. This demonstration is completed through emission testing as well as durability testing to determine the level of emissions deterioration throughout the useful life of the engine. In addition to comply with emission standards, manufacturers are also required to warrant their products against emission defects, and demonstrate that a service network is in place to correct any such conditions. The engine manufacturer also bears responsibility in the event that an emission-related recall is necessary. Finally, the engine manufacturer is responsible for tracking and ensuring correct installation of any emission related components installed by a second party (*i.e.*, vehicle manufacturer). EPA and NHTSA believe this compliance structure is also valid for administering the final GHG regulations for heavy-duty engines.

#### (a) Certification Process

In order to obtain a certificate of conformity, engine manufacturers must complete a compliance demonstration, normally consisting of test data from relatively new (low-hour) engines as well as supporting documentation,

showing that their product meets emission standards and other regulatory requirements. To account for aging effects, low-hour test results are coupled with testing-based deterioration factors (DFs), which provide a ratio (or offset) of end-of-life emissions to low-hour emissions for each pollutant being measured. These factors are then applied to all subsequent low-hour test data points to predict the emissions behavior at the end of the useful life.

For purposes of this compliance demonstration and certification, engines with similar engine hardware and emission characteristics throughout their useful life may be grouped together in engine families, consistent with current criteria-pollutant certification procedures. Examples of such engine characteristics that are normally used to combine emissions families include similar combustion cycle, aspiration methods, and aftertreatment systems. Under this system, the worst-case engine ("parent rating") is selected based on having the highest fuel feed per engine stroke, and all emissions testing is completed on this model. All other models within the family ("child ratings") are expected to have emissions at or below the parent model and therefore in compliance with emission standards. Any engine within the family can be subject to selective enforcement audits, in-use, confirmatory, or other compliance testing.

We are continuing the use of this approach for the selection of the worst-case engine ("parent rating") for fuel consumption and GHG emissions as well. As at proposal, we believe this is appropriate because this worst case engine configuration would be expected to have the highest in-use fuel consumption and GHG emissions within the family. See 75 FR at 72264 for further information. We note that lower engine ratings contained within this family would be expected to have a higher fuel consumption rate when measured over the Federal Test Procedures as expressed in terms of fuel consumption per brake horsepower hour. However, this higher fuel consumption rate is misleading in the context of comparing engines within a single engine family. This apparent contradiction can be most easily understood in terms of an example. For a typical engine family a top rating could be 500 horsepower with a number of lower engine ratings down to 400 horsepower or lower included within the family. When installed in identical trucks the 400 and 500 horsepower engines would be expected to operate identically when the demanded power from the engines is 400 horsepower or

less. So in the case where in-use driving never included acceleration rates leading to horsepower demand greater than 400 horsepower, the two trucks with the 400 and 500 horsepower engines would give identical fuel consumption and GHG performance. When the desired vehicle acceleration rates were high enough to require more than 400 horsepower, the 500 horsepower truck would accelerate faster than the 400 horsepower truck resulting in higher average speeds and higher fuel consumption and GHG emissions measured on a per mile or per ton-mile basis. Hence, the higher rated engine family would be expected to have the highest in-use fuel consumption and CO<sub>2</sub> emissions consistent with our current approach requiring manufacturers to certify the worst case configuration.

As explained at proposal, the reason that the lower engine ratings appear to have worse fuel consumption relates to our use of a brake specific work metric. The brake specific metric measures power produced from the engine and delivered to the vehicle ignoring the parasitic work internal to the engine to overcome friction and air pumping work within the engine. The fuel consumed and GHG emissions produced to overcome this internal work and to produce useful (brake) work are both measured in the test cycle but only the brake work is reflected in the calculation of the fuel consumption rate. This is desirable in the context of reducing fuel consumption as this approach rewards engine designs that minimize this internal work through better engine designs. The less work that is needed internal to the engine, the lower the fuel consumption will be. If we included the parasitic work in the calculation of the rate, we would provide no incentive to reduce internal friction and pumping losses. However, when comparing two engines within the very same family with identical internal work characteristics, this approach gives a misleading comparison between two engines as described above. This is the case because both engines have an identical fuel consumption rate to overcome internal work but different rates of brake work with the higher horsepower rating having more brake work because the test cycle is normalized to 100 percent of the engine's rated power. The fuel consumed for internal work can be thought of as a fixed offset identical between both engines. When this fixed offset is added to the fuel consumed for useful (brake) work over the cycle, it increases the overall fuel consumption

(the numerator in the rate) without adding any work to the denominator. This fixed offset identical between the two engines has a bigger impact on the lower engine rating. In the extreme this can be seen easily. As the engine ratings decrease and approach zero, the brake work approaches zero and the calculated brake specific fuel consumption approaches infinity. For these reasons, we are finalizing that the same selection criteria, as outlined in 40 CFR part 86, subpart N, be used to define a single engine family designation for both criteria pollutant and GHG emissions. Further, we are finalizing that for fuel consumption and CO<sub>2</sub> emissions only any selective enforcement audits, in-use, confirmatory, or other compliance testing would be limited to the parent rating for the family. Consistent with the current regulations, manufacturers may electively subdivide a grouping of engines which would otherwise meet the criteria for a single family if they have evidence that the emissions are different over the useful life. The agencies received comments from engine and truck manufacturers which indicated the useful life provisions applicable to criteria pollutants seemed appropriate for GHG emissions. For that reason, the agencies are retaining many of the same provisions for GHG certification for family useful life provisions as developed for criteria pollutants.

EPA utilizes a 12-digit naming convention for all mobile-source engine families (and test groups for light-duty vehicles). This convention is also shared by the California Air Resources Board which allows manufacturers to potentially use a single family name for both EPA and California ARB certification. Of the 12 digits, 9 are EPA-defined and provide identifying characteristics of the engine family. The first digit represents the model year, through use of a predefined code. For example, the code "A" corresponds to the 2010 model year and "B" corresponds to the 2011 model year. The 5th position corresponds to the industry sector code, which includes such examples as light-duty vehicle (V) and heavy-duty diesel engines (H). The next three digits are a unique alphanumeric code assigned to each manufacturer by EPA. The next four digits describe the displacement of the engine; the units of which are dependent on the industry segment and a decimal may be used when the displacement is in liters. For engine families with multiple displacements, the largest displacement is used for the

family name. For on-highway vehicles and engines, the tenth character is reserved for use by California ARB. The final characters (including the 10th character in absence of California ARB guidance) left to the manufacturer to determine, such that the family name forms a unique identifying characteristic of the engine family.

This convention is well understood by the regulated industries, provides sufficient detail, and is flexible enough to be used across a wide spectrum of vehicle and engine categories. In addition, the current harmonization with other regulatory bodies reduces complications for affected manufacturers. For these reasons, we are not finalizing any major changes to this naming convention for this rulemaking. There may be additional categories defined for the 5th character to address heavy-duty vehicle families, however that will be discussed later.

As with criteria pollutant standards, the heavy-duty diesel regulatory category is subdivided into three regulatory subcategories, depending on the GVW of the vehicle in which the engine will be used. These regulatory subcategories are defined as light-heavy-duty (LHD) diesel, medium heavy-duty (MHD) diesel, and heavy heavy-duty (HHD) diesel engines. All heavy-duty gasoline engines are grouped into a single subcategory. Each of these regulatory subcategories are expected to be in service for varying amounts of time, so they each carry different regulatory useful lives. For this reason, expectations for demonstrating useful life compliance differ by subcategory, particularly as related to deterioration factors.

Light heavy-duty diesel engines (and all gasoline heavy-duty engines) have the same regulatory useful life as a light-duty vehicle (110,000 miles), which is significantly shorter than the other heavy-duty regulatory subcategories. Therefore, we believe it is appropriate to maintain commonality with the light-duty vehicle rule. During the light-duty vehicle rulemaking, the conclusion was reached that no significant deterioration would occur over the useful life. Therefore, EPA is recommending that manufacturers use assigned DFs for CO<sub>2</sub>. For this final action, we believe appropriate values are zero (for additive DFs) and one (for multiplicative DFs). EPA will continue to collect data regarding deterioration of CO<sub>2</sub> emissions and may revisit these assigned values if necessary.

For the medium heavy-duty and heavy heavy-duty diesel engine segments, the regulatory useful lives are significantly longer (185,000 and

435,000 miles, respectively). For this reason, the EPA cannot rule out the possibility that engine/aftertreatment wear will have a negative impact on GHG emissions. To address useful life compliance for MHD and HHD diesel engines certified to GHG standards, EPA therefore believes that the criteria pollutant approach for developing DFs is appropriate. Using CO<sub>2</sub> as an example, many types of engine deterioration will affect CO<sub>2</sub> emissions. Reduced compression, as a result of wear, will cause higher fuel consumption and increase CO<sub>2</sub> production. In addition, as aftertreatment devices age (primarily particulate traps), regeneration events may become more frequent and take longer to complete. Since regeneration commonly requires an increase in fuel rate, CO<sub>2</sub> emissions would likely increase as well. Finally, any changes in EGR levels will affect heat release rates, peak combustion temperatures, and completeness of combustion. Since these factors could reasonably be expected to change fuel consumption, CO<sub>2</sub> emissions would be expected to change accordingly. However, we expect engine manufacturers to consider performance degradation in the design of engine and aftertreatment systems given the market incentive to reduce fuel consumption and related CO<sub>2</sub> emissions. For these reasons, EPA is not eliminating the DF from this program, but will allow for an assigned DF of zero.

HHD diesel engines may also require some degree of aftertreatment maintenance throughout their useful life. For example, one major heavy-duty engine manufacturer specifies that their diesel particulate filters be removed and cleaned at intervals between 200,000 and 400,000 miles, depending on the severity of service. Another major engine manufacturer requires servicing diesel particulate filters at 300,000 miles. This maintenance or lack thereof if service is neglected, could have serious negative implications to CO<sub>2</sub> emissions. In addition, there may be emissions-related warranty implications for manufacturers to ensure that if rebuilding or specific emissions related maintenance is necessary, it will occur at the prescribed intervals. Therefore, it is imperative that manufacturers provide detailed maintenance instructions. Lean-NO<sub>x</sub> aftertreatment devices may also facilitate GHG reductions by allowing engines to run with higher engine-out NO<sub>x</sub> levels in exchange for more efficient calibrations. In most cases, these aftertreatment devices require a consumable reductant,



such as diesel exhaust fluid, which requires periodic maintenance by the vehicle operator. Without such maintenance, the emission control system may be compromised and compliance with emission standards may be jeopardized. Such maintenance is considered to be critical emission related maintenance and manufacturers must therefore demonstrate that it is likely to be completed at the required intervals. One example of such a demonstration is an engine power derating strategy that will limit engine power or vehicle speed in absence of this required maintenance.

If the manufacturer determines that maintenance is necessary on critical emission-related components within the useful life period, it must have a reasonable basis for ensuring that this maintenance will be completed as scheduled. This includes any adjustment, cleaning, repair, or replacement of critical emission-related components. Typically, EPA has only allowed manufacturers to schedule such maintenance if the manufacturer can demonstrate that the maintenance is reasonably likely to be done at the recommended intervals. This demonstration may be in the form of survey data showing at least 80 percent of in-use engines get the prescribed maintenance at the correct intervals. Another possibility is to provide the maintenance free of charge. We see no reason to depart from this approach for GHG-related critical emission-related components. For reasons stated previously regarding the useful life provisions, EPA is retaining many of the same provisions for GHG certification for family useful life provisions as developed for criteria pollutants.

(b) Demonstrating Compliance with the Standards

(i) CO<sub>2</sub> Standards

The final test results (adjusted for deterioration, if applicable) form the basis for the Family Certification Limit (FCL), which the manufacturer must specify to be at or above the certification test results. This FCL becomes the emission standard for the family and any certification or confirmatory testing must show compliance with this limit. In addition, manufacturers may choose an FCL at any level above their certified emission level to provide a larger compliance margin. If subsequent certification or confirmatory testing reveals emissions above the FCL, the new, higher result becomes the FCL.

As proposed, the FCL is also used to determine the Family Emission Limit (FEL), which serves as the emission

limit for any subsequent field testing conducted after the time of certification. This would primarily include selective enforcement audits, but also may include in-use testing for GHGs. The FEL differs from the FCL in that it includes an EPA-defined compliance margin; which has been defined at 3 percent for the final rule. Our proposal included a two percent margin based on round-robin testing of the same engine at several laboratories. Since that time, additional confidential data provided by manufacturers has indicated that it may be more appropriate to use a three percent margin to also account for production variability between engines.<sup>312</sup> Under this final action, the FEL will always be three percent higher than the FCL.

Engine Emission Testing

Under current non-GHG engine emissions regulations, manufacturers are required to demonstrate compliance using two test methods: the heavy-duty transient cycle and the heavy-duty steady state test. Each test is an engine speed versus engine torque schedule intended to be run on an engine dynamometer. Over each test, emissions are sampled using the equipment and procedures outlined in 40 CFR part 1065, which includes provisions for measuring CO<sub>2</sub>, N<sub>2</sub>O, and CH<sub>4</sub>. Emissions may be sampled continuously or in a batch configuration (commonly known as “bag sampling”) and the total mass of emissions over each cycle are normalized by the engine power required to complete the cycle. Following each test, a validation check is made comparing actual engine speed and torque over the cycle to the commanded values. If these values do not align well, the test is deemed invalid.

The transient Heavy-duty FTP cycle is characteristic of typical urban stop-and-go driving. Also included is a period of more steady state operation that would be typical of short cruise intervals at 45 to 55 miles per hour. Each transient test consists of two 20 minute tests separated by a “soak” period of 20 minutes. The first test is run with the engine in a “cold” state, which involves letting the engine cool to ambient conditions either by sitting overnight or by forced cooling provisions outlined in § 86.1335–90 (or 40 CFR part 1036). This portion of the test is meant to assess the ability of the engine to control emissions during the period prior to reaching normal operating temperature. This is commonly a challenging area in criteria pollutant emission control, as

cold combustion chamber surfaces tend to inhibit mixing and vaporization of fuel and aftertreatment devices do not tend to function well at low temperatures.

Following the first test, the engine is shut off for a period of 20 minutes, during which emission analyzer checks are performed and preparations are made for the second test (also known as the “hot” test). After completion of the second test, the results from the cold and hot tests are weighted and a single composite result is calculated for each pollutant. Based on typical in-use duty cycles, the cold test results are given a 1/7 weighting and the hot test results are given a 6/7 weighting. Deterioration factors are applied to the final weighted results and the results are then compared to the emission standards.

Prior to 2007, compliance only needed to be demonstrated over the Heavy-duty FTP. However, a number of events brought to light the fact that this transient cycle may not be as well suited for engines which spend much of their duty cycle at steady cruise conditions, such as those used in line-haul semi-trucks. As a result, the steady-state SET procedure was added, consisting of 13 steady-state modes. During each mode, emissions were sampled for a period of five minutes. Weighting factors were then applied to each mode and the final weighted results were compared to the emission standards (including deterioration factors). In addition, emissions at each mode could not exceed the NTE emission limits. Alternatively, manufacturers could run the test as a ramped-modal cycle. In this case, the cycle still consists of the same speed/torque modes, however linear progressions between points are added and instead of weighting factors, each mode is sampled for various amounts of time. The result is a continuous cycle lasting approximately 40 minutes. With the implementation of part 1065 test procedures in 2010, manufacturers are now required to run the modal test as a ramped-modal cycle. In addition, the order of the speed/torque modes in the ramped-modal cycle have changed for 2010 and later engines.

It is well known that fuel consumption, and therefore CO<sub>2</sub> emissions, are highly dependent on the drive cycle over which they are measured. Steady cruise conditions, such as highway driving, tend to be more efficient, having lower fuel consumption and CO<sub>2</sub> emissions. In contrast, highly transient operation, such as city driving, tends to lead to lower efficiency and therefore higher fuel consumption and CO<sub>2</sub> emissions. One example of this is the difference

<sup>312</sup> See discussion in RIA 3.1.2.3.

between EPA-measured city and highway fuel economy ratings assigned to all new light-duty passenger vehicles.

For this heavy-duty engine and vehicle rule, we believe it is important to assess CO<sub>2</sub> emissions and fuel consumption over both transient and steady state test cycles, as all vehicles will operate in conditions typical of each cycle at some point in their useful life. However, due to the drive cycle dependence of CO<sub>2</sub> emissions, we do not believe it is reasonable to have a single CO<sub>2</sub> standard which must be met for both cycles. As we discussed at proposal, a single CO<sub>2</sub> standard would likely prove to be too lax for steady-state conditions while being too strict for transient conditions. Therefore, the agencies are finalizing that all heavy-duty engines be tested over both transient and steady-state tests. However, only the results from either the transient or steady-state test cycles will be used to assess compliance with GHG standards, depending on the type of vehicle in which the engine will be used. Engines that will be used in Class 7 and 8 combination tractors will use the ramped-modal cycle for GHG certification, and engines used in vocational vehicles will use the Heavy-duty FTP cycle. In both cases, results from the other test cycle will be reported but not used for a compliance decision. Engines will continue to be required to show criteria pollutant compliance over both cycles, in addition to NTE requirements.

The agencies proposed that manufacturers submit both data sets from the transient test at the time of certification. This includes providing both cold start and hot start transient heavy-duty FTP emissions results, as well as the composite emissions at the time of certification. The proposed rules also required that manufacturers submit modal data from the ramped-modal cycle test. This was proposed in an effort to improve the accuracy of the simulation model being used for assessing CO<sub>2</sub> and fuel consumption performance and overall engine emissions performance.

However several commenters were concerned that modal data was non-discernable when batch sampling was used for certification testing. Thus, an additional certification test (or tests) would need to be done using either continuous analyzers or batch sampling at each mode; each option raising the cost and complexity of certification testing. The agencies agree that (at this time) this raises practical issues for certification testing, however we also believe that manufacturers have significant data from these modal points

which could be used to satisfy our model refinement goals.

The agencies also recognize that even minor variations in test fuel properties can have an impact on measured CO<sub>2</sub> emissions. Therefore, measured CO<sub>2</sub> results are to be corrected using a reference energy content, which is defined in the regulations. This correction must be performed for each test and each batch of test fuel. However, manufacturers may develop robust testing procedures that reduce the variation in test fuel properties to within the level of measurement uncertainty of the fuel properties themselves. If this is the case, an annual review is still necessary to confirm the validity of this constant value.

As explained above in Section II, the agencies are finalizing an alternative standard whereby manufacturers may elect that certain of their engine families meet an alternative percent reduction standard, measured from the engine family's 2011 baseline, instead of the main 2014 MY standard. As part of the certification process, manufacturers electing this standard would not only have to notify the agency of the election but also demonstrate the derivation of the 2011 baseline CO<sub>2</sub> emission level for the engine family. Manufacturers would also have to demonstrate that they have exhausted all credit opportunities.

#### Durability testing

Another element of the current certification process is the requirement to complete durability testing to establish DFs. As previously mentioned, manufacturers are required to demonstrate that their engines comply with emission standards throughout the regulatory compliance period of the engine. This demonstration is commonly made through the combination of low-hour test results and testing based deterioration factors.

For engines without aftertreatment devices, deterioration factors primarily account for engine wear as service is accumulated. This commonly includes wear of valves, valve seats, and piston rings, all of which reduce in-cylinder pressure. Oil control seals and gaskets also deteriorate with age, leading to higher lubricating oil consumption. Additionally, flow properties of EGR systems may change as deposits accumulate and therefore alter the mass of EGR inducted into the combustion chamber. These factors, amongst others, may serve to reduce power, increase fuel consumption, and change combustion properties; all of which affect pollutant emissions.

For engines equipped with aftertreatment devices, DFs take into

account engine deterioration, as described above, in addition to aging effects on the aftertreatment devices. Oxidation catalysts and other catalytic devices rely on active precious metals to effectively convert and reduce harmful pollutants. These metals may become less active with age and therefore pollutant conversion efficiencies may decrease. Particulate filters may also experience reduced trapping efficiency with age due to ash accumulation and/or degradation of the filter substrate, which may lead to higher tailpipe PM measurements and/or increased regeneration frequency. If a pollutant is predominantly controlled by aftertreatment, deterioration of emission control depends on the continued operation of the aftertreatment device much more so than on consistent engine-out emissions.

At this time, we anticipate that most engine component wear will not have a significant negative impact on CO<sub>2</sub> emissions. However, wear and aging of aftertreatment devices may or may not have a significant negative impact on CO<sub>2</sub> emissions. In addition, future engine or aftertreatment technologies may experience significant deterioration in CO<sub>2</sub> emissions performance over the useful life of the engine. For these reasons, we believe that the use of DFs for CO<sub>2</sub> emissions is both appropriate and necessary. As with criteria pollutant emissions, these DFs are preferably developed through testing the engine over a representative duty cycle for an extended period of time. This is typically either half or full useful life, depending on the regulatory category. The DFs are then calculated by comparing the high-hour to low-hour emission levels, either by division or subtraction (for multiplicative & additive DFs, respectively).

This testing process may be a significant cost to an engine manufacturer, mainly due to the amount of time and resources required to run the engine out to half or full useful life. For this reason, durability testing for the determination of DFs is not commonly repeated from model year to model year. In addition, some DFs may be allowed to carry over between families sharing a common architecture and aftertreatment system. EPA prefers to have manufacturers develop testing-based DFs for their products. However, we do understand that for the reasons stated above, it may be impractical to expect manufacturers to have testing-based deterioration factors available for these final rules. Therefore, we are allowing manufacturers to use EPA-assigned DFs for CO<sub>2</sub>. However, we also understand that CO<sub>2</sub> is traditionally measured as

part of normal engine dynamometer testing. Therefore, we are requiring that manufacturers include CO<sub>2</sub> data over their criteria pollutant durability demonstrations (if available), which will aid the agency in developing more accurate assigned DFs. This action is being taken in the context of engine manufacturers' concerns regarding the impact of deterioration of emissions components relative to the GHG standards. Engine manufacturers commented that there would be no deterioration of components used to reduce GHG emissions in Phase 1. As part of the Clean Air Act responsibility to demonstrate compliance throughout the useful life, manufacturer will need to provide data already collected during traditional criteria pollutant testing for full useful life performance.

#### IRAFs/Regeneration Impacts on CO<sub>2</sub>

Heavy-duty engines may be equipped with exhaust aftertreatment devices which require periodic "regeneration" to return the device to a nominal state. A common example is a diesel particulate filter, which accumulates PM as the engine is operated. When the PM accumulation reaches a threshold such that exhaust backpressure is significantly increased, exhaust temperature is actively increased to oxidize the stored PM. The increase in exhaust temperature is commonly facilitated through late combustion phasing and/or raw fuel injection into the exhaust system upstream of the filter. Both methods impact emissions and therefore must be accounted for at the time of certification. In accordance with § 86.004–28(i), this type of event would be considered infrequent because in most cases they only occur once every 30 to 50 hours of engine operation (rather than once per transient test cycle), and therefore adjustment factors must be applied at certification to account for these effects.

Similar to DFs, these adjustment factors are based off of manufacturer testing; however this testing is far less time consuming. Emission results are measured from two test cycles: With and without regeneration occurring. The differences in emission results are used, along with the frequency at which regeneration is expected to occur, to develop upward and downward adjustment factors. Upward adjustment factors are added to all emission results derived from a test cycle in which regeneration did not occur. Similarly, downward adjustment factors are subtracted from results based on a cycle which did experience a regeneration event. Each pollutant will have a unique set of adjustment factors and

additionally, separate factors are commonly developed for transient and steady-state test cycles.

The impact of regeneration events on criteria pollutants varies by pollutant and the aftertreatment device(s) used. In general, the adjustment factor can have a very significant impact on compliance with the NO<sub>x</sub> standard. For this reason, heavy-duty vehicle and engine manufacturers are already very well motivated to extend the regeneration frequency to as long an interval as possible and to reduce the duration of the regeneration as much as possible. Both of these actions significantly reduce the impact of regeneration on CO<sub>2</sub> emissions and fuel consumption. We do not believe that adding an adjustment factor for infrequent regeneration to the CO<sub>2</sub> or fuel efficiency standards would provide a significant additional motivation for manufacturers to reduce regenerations. Moreover, doing so would add significant and unnecessary uncertainty to our projections of CO<sub>2</sub> and fuel consumption performance in 2014 and beyond. In addressing that uncertainty, the agencies would have to set less stringent fuel efficiency and CO<sub>2</sub> standards for heavy-duty trucks and engines. Therefore, we are not requiring the use of infrequent regeneration adjustment factors for CO<sub>2</sub> or fuel efficiency in this program. This is consistent with comments received from engine manufacturers.

#### Auxiliary Emission Control Devices

As part of the engine control strategy, there may be devices or algorithms which reduce the effectiveness of emission control systems under certain limited circumstances. These strategies are referred to as Auxiliary Emission Control Devices (AECs). One example would be the reduced use of EGR during cold engine operation. In this case, low coolant temperatures may cause the electronic control unit to reduce EGR flow to improve combustion stability. Once the engine warms up, normal EGR rates are resumed and full NO<sub>x</sub> control is achieved.

At the time of certification, manufacturers are required to disclose all AECs and provide a full explanation of when the AEC is active, which sensor inputs effect AEC activation, and what aspect of the emission control system is affected by the AEC. Manufacturers are further required to attest that their AECs are not "defeat-devices," which are intentionally targeted at reducing emission control effectiveness.

Several common AECs disclosed for criteria pollutant certification will have

a similarly negative influence on GHG emissions as well. One such example is cold-start enrichment, which provides additional fueling to stabilize combustion shortly after initially starting the engine. From a criteria pollutant perspective, HC emissions can reasonably be expected to increase as a result. From a GHG perspective, the extra fuel does not result in a similar increase in power output and therefore the efficiency of the engine is reduced, which has a negative impact on CO<sub>2</sub> emissions. In addition, there may be AECs that uniquely reduce GHG emission control effectiveness. Therefore, consistent with today's certification procedures, we are finalizing that a comprehensive list of AECs covering both criteria pollutant, as well as GHG emissions is required at the time of certification.

#### (ii) EPA's N<sub>2</sub>O and CH<sub>4</sub> Standards

In 2009, EPA issued rules requiring manufacturers of mobile-source engines to report the emissions of CO<sub>2</sub>, N<sub>2</sub>O, and CH<sub>4</sub> (74 FR 56260, October 30, 2009). Although CO<sub>2</sub> is commonly measured during certification testing, CH<sub>4</sub> and N<sub>2</sub>O are not. CH<sub>4</sub> has traditionally not been included in criteria pollutant regulations because it is a relatively stable molecule and does not contribute significantly to ground-level ozone formation. In addition, N<sub>2</sub>O is commonly a byproduct of lean-NO<sub>x</sub> aftertreatment systems. Until recently, these types of systems were not widely used on heavy-duty engines and therefore N<sub>2</sub>O emissions were insignificant. As noted in section II above, both species, while emitted in small quantities relative to CO<sub>2</sub>, have much higher global warming potential than CO<sub>2</sub> and therefore must be considered as part of a comprehensive GHG regulation.

EPA is requiring that CH<sub>4</sub> and N<sub>2</sub>O be reported at the time of certification, however we will allow manufacturers to submit a compliance statement based on good engineering judgment for the first year of the program in lieu of direct measurement of N<sub>2</sub>O. However, beginning in the 2015 model year, the agency is requiring the direct measurement of N<sub>2</sub>O for certification. The intent of the CH<sub>4</sub> and N<sub>2</sub>O standards are more focused on prevention of future increases in these compounds, rather than forcing technologies that reduce these pollutants. As one example, we envision manufacturers satisfying this requirement by continuing to use catalyst designs and formulations that appropriately control N<sub>2</sub>O emissions rather than pursuing a catalyst that may

increase N<sub>2</sub>O. In many ways this becomes a design-based criterion in that the decision of one catalyst over another will effectively determine compliance with N<sub>2</sub>O standards over the useful life of the engine. As discussed above, in cases where N<sub>2</sub>O emissions directly tradeoff with CO<sub>2</sub> emissions, EPA is allowing manufacturers to exploit this relationship to produce engines with the lowest overall GHG emissions. Direct measurement of N<sub>2</sub>O emissions is required in the case of engines utilizing this temporary credit program.

Since catalytic activity generally changes with age and service accumulation, it is not unreasonable to expect changes in N<sub>2</sub>O and CH<sub>4</sub> emissions over the useful life of the engine. We also believe that low-hour test results coupled with deterioration factors provides an adequate representation of end-of-life emission levels for these pollutants. However, the requirement to measure N<sub>2</sub>O and CH<sub>4</sub> during testing is relatively new and we do not expect that manufacturers have consistent durability data to formulate deterioration factors for today's action. We also do not believe it is appropriate to require all new durability testing to satisfy this requirement, as this would result in a nontrivial burden to engine manufacturers. Instead we will be assigning deterioration factors for N<sub>2</sub>O and CH<sub>4</sub> for this action. If the use of assigned deterioration factors jeopardizes compliance with the emission standards, we will also allow manufacturers to propose unique testing-based deterioration factors for these pollutants. In response to comments received from engine manufacturers regarding the timing needed to generate deterioration factors the agencies are taking this approach.

Concerns had also been raised by engine manufacturers regarding measurement techniques for quantifying N<sub>2</sub>O emissions. In an effort to expand testing options, we are adding an allowance to use laser infrared analyzers for N<sub>2</sub>O measurement in 40 CFR part 1065.275. This is to reflect the recent development of this technology for N<sub>2</sub>O measurement. We would also like to serve notice that in an upcoming rulemaking, we will be tightening the interference tolerance (both positive and negative) for engines and vehicles that are required to certify to an N<sub>2</sub>O standard. This will consist of an interference limit based on interference as a percentage of the flow weighted mean concentration of N<sub>2</sub>O expected at the standard. For example we may set the interference limit at  $\pm 10$  percent of the flow weighted mean concentration of N<sub>2</sub>O expected at the standard and

strongly recommend a lower interference that is within  $\pm 5$  percent.

### (c) Additional Compliance Provisions

#### (i) Warranty & Defect Reporting

Under section 207 of the CAA, engine manufacturers are required to warrant that their product is free from defects that would cause the engine to not comply with emission standards. This warranty must be applicable from when the engine is introduced into commerce through a period generally defined as half of the regulatory useful life (specified in hours and years, whichever comes first). The exact time of this warranty is dependent on the regulatory category of the engine. In addition, components that are considered "high cost" are required to have an extended warranty. Examples of such components would be exhaust aftertreatment devices and electronic control units.

Current warranty provisions in 40 CFR part 86 define the warranty periods and covered components for heavy-duty engines. The current list of components is comprised of any device or system whose failure would result in an increase in criteria pollutant emissions. We remain convinced that this list is adequate for addressing GHG emissions as well, based on comments received from the proposed rules. The following list identifies items commonly defined as critical emission-related components:

- Electronic control units.
- Aftertreatment devices.
- Fuel metering components.
- EGR–System components.
- Crankcase-ventilation valves.
- All components related to charge-air compression and cooling.

All sensors and actuators associated with any of these components.

When a manufacturer experiences an elevated rate of failure of an emission control device, they are required to submit defect reports to the EPA. These reports will generally have an explanation of what is failing, the rate of failure, and any possible corrections taken by the manufacturer. Based on how successful EPA believes the manufacturer to be in addressing these failures, the manufacturer may need to conduct a product recall. In such an instance, the manufacturer is responsible for contacting all customers with affected units and repairing the defect at no cost to them. We believe this structure for the reporting of criteria pollutant defects, and recalls, is appropriate for components related to complying with GHG emissions as well.

#### (ii) Maintenance

Engine manufacturers are required to outline maintenance schedules that

ensure their product will remain in compliance with emission standards throughout the useful life of the engine. This schedule is required to be submitted as part of the application for certification. Maintenance that is deemed to be critical to ensuring compliance with emission standards is classified as "critical emission-related maintenance." Generally, manufacturers are discouraged from specifying that critical emission-related maintenance is needed within the regulatory useful life of the engine. However, if such maintenance is unavoidable, manufacturers must have a reasonable basis for ensuring it is performed at the correct time. This may be demonstrated through several methods including survey data indicating that at least 80 percent of engines receive the required maintenance in-use or manufacturers may provide the maintenance at no charge to the user. During durability testing of the engine, manufacturers are required to follow their specified maintenance schedule.

Maintenance relating to components relating to reduction of GHG emissions is not expected to present unique challenges. Therefore, we are not finalizing any changes to the provisions for the specification of emission-related maintenance as outlined in 40 CFR part 86.

### (2) Enforcement Provisions

#### (a) Emission Control Information Labels

Current provisions for engine certification require manufacturers to equip their product with permanent emission control information labels. These labels list important characteristics, parameters, and specifications related to the emissions performance of the engine. These include, but are not limited to, the manufacturer, model, displacement, emission control systems, and tune-up specifications. In addition, this label also provides a means for identifying the engine family name, which can then be referenced back to certification documents. This label provides essential information for field inspectors to determine that an engine is in fact in the certified configuration.

We do not anticipate any major changes needing to be made to emission control information labels as a result of new GHG standards and a single label is appropriate for both criteria pollutant and GHG emissions purposes. Perhaps the most significant addition will be the inclusion of Family Certification Levels or Family Emission Limits for GHG pollutants, if the manufacturer is participating in averaging, banking, and

trading. In addition, the label will need to indicate whether the engine is certified for use in vocational vehicles, tractors, or both. Finally, if an engine family is uniquely certified for use in hybrid powertrain applications, a compliance statement indicating this will need to be included on the emission control label.

In response to comments from engine and truck manufacturers that tractors should be allowed to obtain engines certified for vocational use and likewise a limited number of engines certified for tractor use should be available for the appropriate vocational applications, the agencies are allowing limited use of engines certified in other categories. To address compliance needs and to discourage abuse of the provisions, proper labeling of the engines is essential.

#### (b) In-Use Standards

In-use testing of engines provides a number of benefits for ensuring useful life compliance. In addition to verifying compliance with emission standards at any given point in the useful life, it can be used along with manufacturer defect reporting, to identify components failing at a higher than normal rate. In this case, a product recall or other service campaign can be initiated and the problem can be rectified. Another key benefit of in-use testing is the discouragement of control strategies catered to the certification test cycles. In the past, engine manufacturers were found to be producing engines that performed acceptably over the certification test cycle, while changing to alternate operating strategies "off-cycle" which caused increases in criteria pollutant emissions. While these strategies are clearly considered defeat devices, in-use testing provides a meaningful way of ensuring that such strategies are not active under normal engine operation.

Currently, manufacturers of certified heavy-duty engines are required to conduct in-use testing programs. The intent of these programs is to ensure that their products are continuing to meet criteria pollutant emission standards at various points within the useful life of the engine. Since initial certification is based on engine dynamometer testing, and removing in-use engines from their respective vehicles is often impractical, a unique testing procedure was developed. This includes using portable emission measurement systems (PEMS) and testing the engine over typical in-situ drive routes rather than a prescribed test cycle. To assess compliance, emission results from a well defined area of the

speed/torque map of the engine, known as the NTE zone, are compared to the emission standards. To account for potential increases in measurement and operational variability, certain allowances are applied to the standard which results in the standard for NTE measurements (NTE limit) to be at or above the duty cycle emission standards.

In addition, EPA conducts an annual in-use testing program of heavy-duty engines. Testing procured vehicles with specific engines over well-defined drive routes using a constant trailer load allows for a consistent comparison of in-use emissions performance. If potential problems are identified in-situ, the engine may be removed from the vehicle and tested using an engine dynamometer over the certification test cycles. If deficiencies are confirmed the agency will either work with the manufacturer to take corrective action, possibly involving a product recall, or proceed with enforcement action against the manufacturer.

The GHG reporting rule requires manufacturers to submit CO<sub>2</sub> data from all engine testing (beginning in the 2011 model year), which we believe is equally applicable to in-use measurements. Methods of CO<sub>2</sub> in-situ measurement are well established and most, if not all, PEMS devices measure and record CO<sub>2</sub> along with criteria pollutants. CH<sub>4</sub> and N<sub>2</sub>O present in-situ measurement challenges that may be impractical to overcome for this testing, and therefore they are not included in in-use testing requirements at this time. While measurement of CO<sub>2</sub> may be practical and important, implementing an NTE emission standard for CO<sub>2</sub> is challenging. As previously discussed, CO<sub>2</sub> emissions are highly dependent on the drive cycle of the vehicle, which does not lend itself well to the NTE-based test procedure. Therefore, we proposed and are adopting that manufacturers be required to submit CO<sub>2</sub> data from in-situ testing, in both g/bhp-hr and g/ton-mile, but these data will be used for reference purposes only (there would be no NTE limit/standard for CO<sub>2</sub>). For the purposes of calculating the g/ton-mile metric, we prefer that manufacturers use the measured vehicle weight. However it has been brought to our attention that this may not always be available, in which case an estimated vehicle weight can be used along with a written justification for the basis of the estimation. For engine-based (dynamometer) in-use testing, compliance with CO<sub>2</sub> emission standards will be judged off of the FCL of the engine family.

#### (3) Other Certification Provisions

##### (a) Carryover/Carry Across Certification Test Data

EPA's current certification program for heavy-duty engines allows manufacturers to carry certification test data over and across certification testing from one model year to the next, when no significant changes to models are made. EPA will also apply this policy to CO<sub>2</sub>, N<sub>2</sub>O and CH<sub>4</sub> certification test data.

##### (b) Certification Fees

The CAA allows EPA to collect fees to cover the costs of issuing certificates of conformity for the classes of engines covered by this rulemaking. On May 11, 2004, EPA updated its fees regulation based on a study of the costs associated with its motor vehicle and engine compliance program (69 FR 51402). At the time that cost study was conducted, the current rulemaking was not considered. At this time the extent of any added costs to EPA as a result of this program is not known. EPA will assess its compliance testing and other activities associated with the rules and may amend its fees regulations in the future to include any justifiable new costs.

##### (c) Onboard Diagnostics

###### (a) Onboard Diagnostics

Beginning with the 2010 model year, manufacturers have been phasing in onboard diagnostic (OBD) systems on heavy-duty engines pursuant to the heavy-duty OBD rulemaking finalized by the EPA in 2009.<sup>313</sup> These systems monitor the activity of the emission control system and issue alerts when faults are detected. These diagnostic systems are currently being developed based around components and systems that influence criteria pollutant emissions. Consistent with the light-duty 2012–2016 MY vehicle rulemaking, we believe that monitoring of these components and systems for criteria pollutant emissions will have an equally beneficial effect on CO<sub>2</sub> emissions.<sup>314</sup> Therefore, we have not finalized any additional unique onboard diagnostic provisions for heavy-duty GHG emissions. In the NPRM, EPA did

<sup>313</sup> U.S. EPA, "Control of Air Pollution from New Motor Vehicles and New Motor Vehicles Engines; Final Rule Regulations Requiring Onboard Diagnostic Systems on 2010 and Later Heavy-Duty Engines Used in Highway Applications Over 14,000 Pounds; Revisions to Onboard Diagnostic Requirements for Diesel Highway Heavy-Duty Vehicles Under 14,000 Pounds," published February 24, 2009. Available here: <http://www.epa.gov/otaq/regs/im/obd/regtech/hd-obd-frm-02-24-09-notice-74-fr-8310.pdf>.

<sup>314</sup> See the Light-Duty 2012–2016 Vehicle Rule, Note 5, above.

not propose new or different diagnostic requirements from those finalized in the 2009 heavy-duty OBD rule.

The agencies received comments from engine manufacturers, hybrid system manufacturers, and related trade groups which broached concerns regarding the feasibility of applying on-board diagnostics to hybrid applications starting in 2013. The commenters stated that engine manufacturers would need several years to adapt their engine OBD systems to hybrids, and therefore requested a delay of OBD requirements for hybrid applications until 2020 with a phase-in of enforcement liability starting that same year. Details, which the agencies believe have merit, are set out below. In response, EPA is taking an approach that is consistent with certain provisions of the existing final action for heavy-duty OBD, finalized in 2009. To that end, manufacturers who certify hybrid systems will continue to have the responsibility of implementing compliant diagnostic systems, however, we are extending the OBD phase-in for engines with hybrid systems to allow time for manufacturers to be able to address communication protocol development concerns (e.g. SAE J1939, communication with diagnostic scantools), component development concerns (e.g. hardware and software), and to address the availability of heavy-duty OBD compliant engines with sufficient lead-time for additional hybrid diagnostic system development given resource constraints as engine manufacturers are focused on meeting the 2013 requirements for conventional products at this time.

Since publication of the NPRM, the EPA has undertaken extensive outreach to hybrid manufacturers, engine manufacturers, and related industry groups to further understand the technical issues involved with the implementation of full OBD on engine-hybrid systems.<sup>315</sup> Hybrid manufacturers have indicated that the interaction between hybrid systems and OBD compliant engines is not well understood at this time, for example, if the system shuts down the vehicle at idle (as is common), the OBD idle diagnostics cannot run. In addition, there are many different hybrid systems being developed which make much of this technology both immature and low volume, and engine manufacturers are concerned that this will result in high costs due to frequent design changes that could occur as this technology develops and have asked for flexibility

for unique hybrid applications. Consistent with the goal to incentivize the development of hybrid designs (systems designed to capture wasted energy and reduce fuel consumption) the EPA is allowing hybrid manufacturers time to develop their systems while simultaneously developing the capability to meet HD OBD requirements.

Communication protocol development is an integral part of developing hybrid OBD capability for the heavy-duty industry which is not vertically integrated. There are different protocols required to be used for OBD communication in a vehicle depending on the type of engine (gasoline or diesel). These protocols are developed in part to standardize the transmission of electronic signals and control information among vehicle components. The J1939 communication protocol is developed by committee through SAE and is required for use with diesel engines. J1939 defines communications messages, diagnostic messages for communications between a module and diagnostic scantool, and fault codes. Messages sent through a J1939 network contain a series of information (e.g. an identifier, message priority, data, *etc.*) and these parameters must be agreed upon through the SAE committee and tailored to work for all manufacturers. The development of this communication protocol includes developing criteria for the messages, and determining a single set of fault codes that can work for all manufacturers and all hybrid system configurations; this is expected to take a substantial amount of time and collaboration. OBD cannot exist without fault codes to report, therefore development of this protocol is critical. Hybrid manufacturers have stated that until such time as a 'plug and play scheme' is available, hybrid volumes will not be able to increase significantly. At this time, there are only a few such messages that have been developed for use in hybrid systems, and there is much additional development that needs to take place. The type of messages needed must first be identified once 2013 HD OBD compliant engines are available for use in HD hybrid OBD system development. After needed messages are identified, the content of each message must be developed and agreed upon through a ballot process. Manufacturers have stated that this will be an iterative process and will likely take at least two years to develop the protocol for use with different variations of hybrid systems and architectures, different types of energy storage

systems, and for systems used in the wide variety of applications in the heavy-duty market, and we agree with this assessment. While a level of communication exists today between engines and transmissions for this industry, the level of control and impact on engine system operation becomes much more significant once hybrid technology is introduced. The purpose of the hybrid energy system is to supplement overall vehicle power demands. As such, the methods used for integrating the energy from the hybrid system into overall vehicle operation vary from allowing additional internal combustion engine lower power operation to potentially decreasing the amount of engine "on" time. This range of performance impacts will serve to reduce GHG emissions by reducing demands on the engine. Conventional transmission systems and other powertrain components do not exercise the level of control the hybrid will need to exercise to effectively reduce GHG emissions and improve fuel consumption performance for internal combustion engines; therefore, hybrid OBD systems can reasonably be expected to be more complicated as well.

Component development concerns raised by hybrid manufacturers include both changes that may be required to software and/or hardware systems on both existing hybrid products and on hybrid systems currently under development. Software systems in existing products have been developed that provide proprietary diagnostic capability (as no standardized system such as J1939 had been developed for these systems), however, these software systems are not OBD compliant. These products will likely require entirely new software systems developed for them which may result in hardware changes as well. Manufacturers have stated that a complete software system can take up to 2 years to develop and validate. Hardware may also need to be changed to accommodate OBD on hybrid systems. In particular, hardware changes would affect current production systems which may not have controllers that can support full OBD. The low volume sales and high cost of a controller program (which can reach into the millions of dollars) means that most companies cannot justify the cost of a hardware change for hybrids alone, rather, existing hybrid systems will have to wait until such a hardware upgrade is planned for other reasons. In addition, new hardware programs, such as developing a new Electronic Control Unit, can take 3–4 years to complete.

<sup>315</sup> See EPA Docket EPA-HQ-OAR-2010-0162 for memos describing meetings held as a part of this outreach.

While it is possible for some of this work to be done concurrently, how much can be done this way is dependent on the configuration of each individual system. Finally, manufacturers may have contractual agreements with hardware and software suppliers that will have to be reconfigured to address a complete OBD program.

Hybrid manufacturers have stated that they will be unable to produce hybrid systems that will be OBD compliant in 2013. Given the concerns discussed above and the general lack of availability of OBD compliant engines until the completion of the HD OBD phase-in, to require manufacturers of systems that depend on the availability of those OBD complaint engines to then be able to immediately implement additional requirements may be impractical or infeasible in many instances. Given the phase-in of HD OBD requirements that already exists however, we do not believe a delay to 2019 or 2020 is warranted. While not all of the engines that would potentially have hybrid systems incorporated into their design are available in their final OBD configuration at the time of this action, it is clear that some engine systems will be available. Additionally, there is an expectation that engine manufacturers, their suppliers and customers will have to continue to work cooperatively to deliver products for the market. This cooperation must include a level of concurrent engineering prior to products being brought to market. At this time we believe a delay to 2016 for the phase-in of OBD for heavy-duty engines equipped with hybrid systems should provide the requisite lead time from the date of this action to the date of implementation for development of components and protocols necessary for successful integration of complete OBD systems for engines equipped with hybrid systems.

Manufacturers will be required to implement feasible controls for these hybrid systems that do not adversely impact emissions performance in 2013 and by 2016–17, all systems must be fully compliant with OBD requirements. The phase in period takes into account that current production systems are likely to be smaller in terms of sales volumes than newly developed systems, and may require more hardware and software development as some of these systems have been in production for nearly a decade and have developed a proprietary system diagnostic capability that does not meet OBD requirements. Therefore, this extended phase-in provides them an additional year of time to comply with the heavy-duty

OBD regulations. Hybrid systems put into production after January 1, 2013 will be required to meet the 2009 heavy-duty OBD requirements in 2016 consistent with the next phase-in date for heavy-duty OBD, while those hybrid systems released prior to January 1, 2013 have until 2017 to be compliant with these OBD requirements.

If a manufacturer certifies an engine-hybrid system with CARB OBD in California prior to the required phase-in date (2016 or 2017), and its diagnostics meet or exceed the requirements for full 2013 OBD, the manufacturer must either use the CARB certified package for Federal release or phase in the package and certify it with full EPA OBD.

In the interim, engine system diagnostics must show that they meet or exceed CARB's Engine Manufacturer Diagnostic Systems Requirements (EMD) including system monitoring requirements for NO<sub>x</sub> aftertreatment, fuel systems, exhaust gas recirculation, particulate matter traps, and emission-related electronic components.<sup>316</sup> Specific EMD requirements will be considered met if they are redundant due to the installed engine's fully functioning OBD content. Most manufacturers have already certified their engines with EMD for the 2011 model year, and full OBD as required in 2013 exceeds EMD requirements, therefore no new cost burden is expected as a result of this provision. In addition, new engines may be introduced in 2013 for hybrid-only use and, in lieu of meeting full OBD, meeting EMD would result in cost savings because of the flexibility in scan-tool reporting and diagnostic content.

In addition, the engine-hybrid system must maintain existing OBD capability for engines where the same or equivalent engine (e.g. displacement) has been OBD certified. An equivalent engine is one produced by the same engine manufacturer with the same fundamental design, but that may have no more than minor hardware or calibration differences, such as slightly different displacement, rated power, or fuel system. Though the OBD capability must be maintained, it does not have to meet detection thresholds and in-use performance frequency requirements; for example, a manufacturer may modify detection thresholds to prevent false detection.

As stated earlier, existing hybrid systems sold today have proprietary

diagnostic capability that is non-OBD compliant, but nonetheless will notify the driver of potential problems with the system. Hybrid manufacturers must also continue to maintain this existing diagnostic capability to ensure proper function consistent with the performance for which the hybrid system is certified as well as, safe operation of the hybrid system.

Finally, during the interim part of the phase-in, manufacturers that are not fully-OBD compliant must also submit an annual pre-compliance report to the EPA for model years 2013 and later. The engine manufacturers must submit this report with their engine certification information. Hybrid manufacturers that are not certifying the engine-hybrid systems must also submit an annual pre-compliance report to the EPA. The report must include a description of the engine-hybrid system being certified and related product plans, information as to activities undertaken and progress made by the manufacturer in achieving full OBD certification including monitoring, diagnostics, and standardization; and deviations from an originally certified full-OBD package with engineering justification.

#### (d) Applicability of Current High Altitude Provisions to Greenhouse Gases

EPA is requiring that engines covered by this program must meet CO<sub>2</sub>, N<sub>2</sub>O and CH<sub>4</sub> standards at elevated altitudes. The CAA requires emission standards under section 202 for heavy-duty engines to apply at all altitudes. EPA does not expect engine CO<sub>2</sub>, CH<sub>4</sub>, or N<sub>2</sub>O emissions to be significantly different at high altitudes based on engine calibrations commonly used at all altitudes. Therefore, EPA will retain its current high altitude regulations so manufacturers will not normally be required to submit engine CO<sub>2</sub> test data for high altitude. Instead, they will be required to submit an engineering evaluation indicating that common calibration approaches will be utilized at high altitude. Any deviation in emission control practices employed only at altitude will need to be included in the AECD descriptions submitted by manufacturers at certification. In addition, any AECD specific to high altitude will be required to include emissions data to allow EPA to evaluate and quantify any emission impact and validity of the AECD.

#### (e) Emission-Related Installation Instructions

Engine manufacturers are currently required to provide detailed installation instructions to vehicle manufacturers.

<sup>316</sup> California Air Resources Board, Final Regulation Order for EMD, Section 1971 of Title 13, California Code of Regulations, effective December 30, 2004. Available here: <http://www.arb.ca.gov/regact/emd2004/fro.pdf>.



These instructions outline how to properly install the engine, aftertreatment, and other supporting systems, such that the engine will operate in its certified configuration. At the time of certification, manufacturers may be required to submit these instructions to EPA to verify that sufficient detail has been provided to the vehicle manufacturer.

We do not anticipate any major changes to this documentation as a result of regulating GHG emissions. The most significant impact will be the addition of language prohibiting vehicle manufacturers from installing engines into vehicle categories in which they are not certified for. An example would be a tractor manufacturer installing an engine certified for only vocational vehicle use. Explicit instructions on behalf of the engine manufacturer that such acts are prohibited will serve as sufficient notice to the vehicle manufacturers and failure to follow such instructions will result in the vehicle manufacturer being in non-compliance.

#### (f) Alternate CO<sub>2</sub> Emission and Fuel Consumption Standards

Under the final rules, engine manufacturers have the option of certifying to alternate CO<sub>2</sub> emission and fuel consumption standards for model years 2014 through 2016. These alternate standards are defined as a certain percentage below a baseline value established from their corresponding 2011 model-year products. For instance, the alternate emission standard for light and medium heavy duty FTP-certified (vocational) engines is equal to 0.975 times the baseline value. If a manufacturer elects to participate in this program it must indicate this on its certification application. In addition, sufficient details must be submitted regarding the baseline engine such that the agency can verify that the correct optional CO<sub>2</sub> emission and fuel consumption standards have been calculated. These data will need to include the engine family name of the baseline engine, so references to the original certification application can be made, as well as test data showing the CO<sub>2</sub> emissions and fuel consumption of the baseline engine.

#### (4) Compliance Reports

##### (a) Early Model Year Data

NHTSA's regulatory text in the NPRM included specifications for manufacturers to submit pre-certification compliance reports for heavy-duty engines. The pre-certification reports included

requirements for manufacturers to submit information to identify the types of engines, expected test results, production volumes and credits. The reporting requirements were general in nature despite there being an existing emissions program for heavy-duty engines. The existing ABT program for NO<sub>x</sub> and PM emissions for heavy-duty engines has existed since 2001 (see 66 FR 5002 signed on January 18, 2001) but does not require reporting early model year compliance information. The agencies sought comments on the report provisions in the NPRM but commenters failed to offer recommendations on what content should be required. As a result, the agencies have decided to eliminate the pre-certification report because engine manufacturers have no experience in providing GHG information and the proposed information may not be available until subsequent model years. For the next phase of this GHG program, the agencies may adopt a pre-model year report for engines.

As an alternative to receiving early compliance model year information in the precertification reports, the agencies have decided to use manufacturer's application for certificates of conformity to obtain early model estimates. Currently, the applications for certificates are not required to include the fuel consumption information required by NHTSA. Therefore, the agencies are adopting provisions in the final rules for manufacturers to provide emission and equivalent fuel consumption estimates in the manufacturer's applications for certification. The agencies will treat information submitted in the applications as a manufacturer's demonstration of providing early compliance information, similar to the pre-model year report submitted for heavy-duty pick-up trucks and vans. The final rules establish a harmonized approach by which manufacturers will submit applications through the EPA Verify database system as the single point of entry for all information required for this national program and both agencies will have access to the information. If by model year 2012, the agencies are not prepared to receive information through the EPA Verify database system, manufacturers are expected to submit written applications to the agencies. This approach should streamline this process and reduce industry burden and provide sufficient information for the agencies to carry out their early compliance activities.

##### (b) Final Reports

For engines, the agencies proposed that manufacturers would submit EOY reports and final reports. An EOY report for manufacturers using the ABT program was required to be submitted no later than 90 days after the calendar year and final report no later than 270 days after the calendar year.<sup>317</sup> Manufacturers not participating in the ABT program were required to provide an EOY report within 45 days after the calendar year but no final reports were required. The final ABT report due date was established coinciding with EPA's existing criteria pollutant report for heavy-duty engines complying with NO<sub>x</sub> and PM standards. Similar to that program, the proposed EOY and final reports required receiving engine type designation, engine family and credit plans for engine manufacturers.

There were no comments received on the final reports for engines. For the final rules, the agencies will retain the provisions as proposed for the EOY and final reports. However, the agencies will consolidate the reporting as done for other vehicle categories and will require emissions and equivalent fuel consumption information to be submitted to EPA. The final rules establish a harmonized approach by which manufacturers will submit applications to EPA as the single point of entry for all information required for this national program and both agencies will have access to the appropriate information. If by model year 2012, the agencies are not prepared to receive information through a database system, manufacturers are expected to submit written applications to the agencies. The agencies are also combining the EOY reports for manufacturers not using ABT to provide a product volume report due 90 days after the end of the model year and the ABT report required 90 days after the model year. A summary of the required information in the final rules for EOY and final reports is as follows:

- Engine family designation and averaging set.
- Engine emissions and fuel consumption standards including any alternative standards used.
- Engine family FCLs.
- Final production volumes.
- Certified test cycles.
- Useful life values for engine families.
- A credit plan identifying the manufacturers actual credit balances, credit flexibilities, credit trades and a credit deficit plan if needed demonstrating how it plans to resolve

<sup>317</sup> Corresponding to the compliance model year.

any credit deficits that might occur for a model year within a period of up to three model years after that deficit has occurred.

(c) Additional Required Information

Throughout the model year, manufacturers may be required to

submit various reports to the agencies to comply with various aspects of the program. These reports have differing criteria for submission and approval.

Table V-1 below provides a summary of the types of submission, required submission dates and the EPA and

NHTSA regulations that apply for engines and engine manufacturers.

The agencies will review and grant any appropriate requests considering the timeliness of the submissions and the completeness of the requests.

TABLE V-1—SUMMARY OF REQUIRED INFORMATION FOR HD ENGINE COMPLIANCE

Submission	Applies to	Required submissions date	EPA regulation reference	NHTSA regulation reference
Small business exemptions	Engine manufacturers meeting the Small Business Administration (SBA) size criteria of a small business as described in 13 CFR 121.201.	Before introducing any excluded vehicle into U.S. for commerce.	§ 1036.150	§ 535.8
Incentives for early introduction.	The provisions apply with respect to tractors and vocational vehicles produced in model years before 2014.	EPA must be notified before the manufacturer submits it applications for certificates of conformity.	§ 1036.150	§ 535.8
Voluntary compliance for NHTSA standards.	Engine manufacturers seeking early compliance in model years 2014 to 2016.	NHSAT must be notified before the manufacturer submits it applications for certificates of conformity.	NA	§ 535.8
Model year 2014 N <sub>2</sub> O standards..	Manufacturers that choose to show compliance with the MY 2014 N <sub>2</sub> O standards requesting to use an engineering analysis.	EPA must be notified before the manufacturer submits it applications for certificates of conformity.	§ 1036.150	NA
Exemption from EOY reports.	Manufacturers with surplus credits at the end of the model year.	90-days after the calendar year ends ..	§ 1036.730	§ 535.8
Alternative engine standards.	Engine manufacturers not able to comply with 1036.104 and wanting to use the alternative engine standard.	EPA and NHTSA must be notified before the manufacturer submits it applications for certificates of conformity.	§ 1036.150	§ 535.8
Alternate phase-in .....	Engine manufacturers want to comply with alternate phase in standards.	EPA and NHTSA must be notified before the manufacturer submits it applications for certificates of conformity.	§ 1036.150	§ 535.8

D. Class 7 and 8 Combination Tractors

(1) Compliance Approach

In addition to requiring engine manufacturers to certify their engines, manufacturers of Class 7 and 8 combination tractors must also certify that their vehicles meet the CO<sub>2</sub> emission and fuel consumption standards. This vehicle certification will ensure that efforts beyond just engine efficiency improvements are undertaken to reduce GHG emissions and fuel consumption. Some examples include aerodynamic improvements, rolling resistance reduction, idle reduction technologies, and vehicle speed limiting systems.

Unlike engine certification however, this certification will be based on a load-specific basis (g/ton-mile or gal/1,000 ton-mile as opposed to work-based, or g/bhp-hr). This would take into account the anticipated vehicle loading that would be experienced in use and the associated effects on fuel consumption and CO<sub>2</sub> emissions. Vehicle manufacturers will also be required to warrant their products against emission control system defects,

and demonstrate that a service network is in place to correct any such conditions. The vehicle manufacturer also bears responsibility in the event that an emission-related recall is necessary.

(a) Certification Process

In order to obtain a certificate of conformity for the tractor, the tractor manufacturer will complete a compliance demonstration, showing that their product meets emission standards as well as other regulatory requirements. For purposes of this demonstration, vehicles with similar emission characteristics throughout their useful life are grouped together in vehicle families, which are defined primarily by the regulatory subclass of the vehicle. Manufacturers may further classify vehicles together into sub-families within a given vehicle family for a given regulatory subcategory. Examples of characteristics that would define a vehicle sub-family for heavy-duty vehicles are wheel and tire package, aerodynamic profile, tire rolling resistance, and vehicle speed limiting system. Compliance with the

emission standards (or FEL) will be determined at the sub-family level.

Under this system, the worst-case vehicle configuration would be selected based on having the highest fuel consumption, and all other configurations within the family or sub-family are assumed to have emissions and fuel consumption at or below the parent model and therefore in compliance with CO<sub>2</sub> emission and fuel consumption standards. Any vehicle within the family can be subject to selective enforcement auditing in addition to confirmatory or other administrator testing.

Vehicle families for Class 7 and 8 combination tractors will utilize the standardized 12-digit naming convention, as described along with the engine certification process in Section V.C.1.a, above. As with engines, each certifying vehicle manufacturer will have a unique three digit code assigned to them. Currently, there is no 5th digit (industry sector) code for this class of vehicles, for which we proposed to use the next available character, “2.” The agencies originally proposed that engine displacement be included in the vehicle

family name, however the wide range of engines available across most regulatory subcategories makes this requirement irrelevant and unnecessary at the time of this rulemaking. Therefore, we are reserving the remaining characters for California ARB and/or manufacturer use, such that the result is a unique vehicle family name.

Class 7 and 8 tractors share several common traits, such as the trailer attachment provisions, number of wheels, and general construction. However, further inspection reveals key differences related to GHG emissions. Payloads hauled by Class 7 tractors are significantly less than Class 8 tractors. In addition, Class 8 vehicles may have provisions for hoteling (“sleeper cabs”), which results in an increase in size as well as the addition of comfort features like power and climate control for use while the truck is parked. Both segments may have various degrees of roof fairing to provide better aerodynamic matching to the trailer being pulled. This is a feature which can help reduce CO<sub>2</sub> emissions significantly when properly matched to the trailer, but can also increase CO<sub>2</sub> emissions if improperly matched. Based on these differences, it is reasonable to expect differences in CO<sub>2</sub> emissions, and therefore these properties form the basis for the final combination tractor regulatory subcategories.

The various combinations of payload, cab size, and roof profile result in nine final regulatory subcategories for Class 7 and 8 tractors. Class 7 tractors are divided into three regulatory subcategories: one for low, one for mid roof height profiles, and one for high roof profiles. The Class 7 tractors are subject to a 10 year, 185,000 regulatory useful life. Class 8 tractors are split into six regulatory subcategories reflecting two cab sizes (day and sleeper) and three roof height profiles (low, mid, and high). All Class 8 tractors are subject to a 10 year, 435,000 mile regulatory useful life.

(b) Demonstrating Compliance With the Final Standards

(i) CO<sub>2</sub> and Fuel Consumption Standards

As discussed at proposal, although whole-vehicle certification may be ultimately desirable for these vehicles, it is essentially infeasible to require it now. See 75 FR at 74270–71. Most commenters agreed, as did the NAS Report. Accordingly, again consistent with the NAS Report, the agencies have developed a predictive model for demonstrating compliance with these initial standards for combination

tractors. The agencies will continue to work toward improved methods for whole vehicle performance characterization, as suggested by some commenters.

Model

Vehicle modeling will be conducted using the agencies’ simulation model, the GEM, which is described in detail in Chapter 4 of the RIA with responses to comments in the Summary and Analysis of Comments Document Section 7. Basically, this model functions by defining a vehicle configuration and then exercises the model over various drive cycles. Several initialization files are needed to define a vehicle, which include mechanical attributes, control algorithms, and driver inputs. The majority of these inputs will be predetermined by EPA and NHTSA for the purposes of vehicle certification. The net results from the GEM are weighted CO<sub>2</sub> emissions and fuel consumption values over the drive cycles. The CO<sub>2</sub> emission result will be used for demonstrating compliance with vehicle CO<sub>2</sub> standards while the fuel consumption result will be used for demonstrating compliance with the fuel consumption standards.

The vehicle manufacturer will be responsible for entering up to seven inputs relating to the GHG performance of a vehicle configuration although, depending on the regulatory category, fewer inputs may be required. These inputs include the regulatory category, coefficient of drag, steer tire rolling resistance, drive tire rolling resistance, vehicle speed limit, vehicle weight reduction, and idle reduction credit. For the GEM inputs relating to aerodynamics, the agencies have finalized lookup tables for frontal area and coefficient of drag based on typical performance levels across the industry. Manufacturers are responsible for assessing the aerodynamic performance of their vehicles through testing or a combination of testing and modeling. This test data is then used to select the most appropriate agency-defined bin for entry into the GEM.

Tire rolling resistance is simply the measured rolling resistance of the tire in kg per metric ton as described in ISO 28580:2009. This measured value is expected to be the result of three repeat measurements of three different tires of a given design, giving a total of nine data points. It is the average of these nine results that will be entered into the GEM. Tire rolling resistance may be determined by either the vehicle or tire manufacturer. In the latter case, a signed statement from the tire manufacturer

confirming testing was conducted in accordance with this part is required.

As previously described, limiting vehicle speed can have a significant effect on fuel consumption and we believe that manufacturers should be recognized for including technology that facilitates these limits. Also as described, these vehicle speed limiters are not likely to be a simple device with a fixed top speed. “Soft top” limits based on driver behavior and limit expiration dates (or mileage) are two of the most common scenarios. To properly assess the GHG and fuel consumption benefits in light of these features, we are defining the proper methodology for entering the vehicle speed limit into the GEM. This is based on an equation including terms for VSL expiration (expiration factor) and VSL soft-top (soft-top factor and soft-top VSL). The result will be an effective vehicle speed limit reflecting the expected mileage and time that the limit will be used for. Additional details regarding this equation and its derivation can be found in RIA Chapter 2.

For vehicle weight reduction, the agencies are primarily addressing the reduction of weight and perhaps number of wheels. This reduction is assessed relative to a standard combination tractor configuration with dual-wide rear tires with conventional steel wheels. Manufacturers may elect to use single-wide tires/wheels and/or aluminum (or light-weight aluminum) wheels or other components to reduce the weight of their vehicles. The agencies have defined standard weight reduction levels associated with each weight reduction technology for entry into the GEM. These reductions are listed in pounds per component, so manufacturers will need to multiply this reduction by the number of affected components for their total weight reduction entry into the GEM.

Manufacturers of sleeper cabs electing to limit idle time to 300 seconds or less can claim a GHG benefit of 5 g/ton-mile and should be entered into the GEM as such. This benefit cannot be scaled to reflect shorter or longer allowed idle times, but can be scaled based upon expiration date.

The agencies will utilize the appropriate engine map reflecting use of a certified engine in the truck (and will enter the same value even if an engine family is certified to the temporary percent reduction alternative standard, in order to evaluate vehicle performance independently of engine performance.) We believe this approach reduces the testing burden placed upon manufacturers, yet adequately assesses

improvements associated with select technologies. The model will be publicly available and will be found on EPA's Web site.

The agencies reserve the right to independently evaluate the inputs to the model by way of Administrator testing to validate those model inputs. The agencies also reserve the right to evaluate vehicle performance using the inputs to the model provided by the manufacturer to confirm the performance of the system using GEM. This could include generating emissions results using the GEM and the inputs as provided by the manufacturer based on the agency's own runs. This could also include conducting comparable testing to verify the inputs provided by the manufacturer. In the event of such testing or evaluation, the Administrator's results become the official certification results, the exception being that the manufacturer may continue to use their data as initially submitted, provided it represents a worst-case condition over the Administrator's results.

To better facilitate the entry of only the appropriate parameters, the agencies will provide a graphical user interface in the model for entering data specific to each vehicle. In addition, EPA will provide a template that facilitates batch processing of multiple vehicle configurations within a given family. It is expected that this template will be submitted to EPA as part of the certification process for each certified vehicle family or subfamily.

For certification, the model will exercise the vehicle over three test cycles; one transient and two steady-state. For the transient test, we are using the heavy heavy-duty diesel truck (HHDDT) transient test cycle, which was developed by the California Air Resources Board and West Virginia University to evaluate heavy-duty vehicles. The transient mode simulates urban, start-stop driving, featuring 1.8 stops per mile over the 2.9 mile duration. The two steady state test points are reflective of the tendency for some of these vehicles to operate for extended periods at highway speeds. Based on data from the EPA's MOVES database, and common highway speed limits, we are finalizing these two points to be 55 and 65 mph.

The model will predict the total emissions results from each configuration using the unique properties entered for each vehicle. These results are then normalized to the payload and distance covered, so as to yield a gram/ton-mile result, as well as a fuel consumption (gal/1,000 ton-mile) result for each test cycle. As with engine

and vehicle testing, certification will be based on the worst-case configuration within a vehicle family.

The results from all three tests are then combined using weighting factors, which reflect typical usage patterns. The typical usage characteristics of Class 7 and 8 tractors with day cabs differ significantly from Class 8 tractors with sleeper cabs. The trucks with day cabs tend to operate in more urban areas, have a limited travel range, and tend to return to a common depot at the end of each shift. Class 8 sleeper cabs, however, are typically used for long distance trips which consist of mostly highway driving in an effort to cover the highest mileage in the shortest time. For these reasons, we proposed that the cycles are weighted differently for these two groups of vehicles. For Class 7 and 8 trucks with day cabs, we propose weights of 64%, 17%, and 19% (65 mph, 55 mph, and transient, resp.). For Class 8 with sleeper cabs, the high speed cruise tendency results in final weights of 86%, 9%, and 5% (65 mph, 55 mph, and transient, respectively). These final, weighted emission results are compared to the emission standard to assess compliance. The agencies received comments regarding the duty cycles and the weighting factors used for assessing emissions compliance. In making final determination for the cycle weighting factors, the agencies considered those comments, as well as the agencies' own data in determining the final weighting factors and duty cycles to be used for determining emissions compliance. Demonstration of compliance is also available through the use of credits generated as part of the Averaging, Banking, and Trading Program (ABT) as described earlier in this Preamble. Additionally, compliance may be demonstrated through the use of a Vehicle Speed Limiter (VSL) and the application of the VSL is accounted for as another input to the GEM for assessing GHG and fuel consumption emissions performance.

#### Durability Testing

As with engine certification, a manufacturer must provide evidence of compliance through the regulatory useful life of the vehicle. Factors influencing vehicle-level GHG performance over the life of the vehicle fall into two basic categories: vehicle attributes and maintenance items. Each category merits different treatment from the perspective of assessing useful life compliance, as each has varying degrees of manufacturer versus owner/operator responsibility.

The category of vehicle attributes generally refers to aerodynamic features,

such as fairings, side-skirts, air dams, air foils, *etc.*, which are installed by the manufacturer to reduce aerodynamic drag on the vehicle. These features have a significant impact on GHG emissions and their emission reduction properties are assessed early in the useful life (at the time of certification). These features are expected to last the full life of the vehicle without becoming detached, cracked/broken, misaligned, or otherwise not in a state which provides the original GHG emissions reduction. In the absence of the aforementioned failure modes, the performance of these features is not expected to degrade over time and the benefit to reducing GHG emissions is expected to last for the life of the vehicle with no special maintenance requirements. To assess useful life compliance, we are following a design-based approach which will ensure that the manufacturer has robustly designed these features so they can reasonably be expected to last the useful life of the vehicle.

The category of maintenance items refers to items that are replaced, renewed, cleaned, inspected, or otherwise addressed in the preventative maintenance schedule specified by the vehicle manufacturer. Replacement items that have a direct influence on GHG emissions are primarily tires and lubricants. Synthetic engine oil may be used by vehicle manufacturers to reduce the GHG emissions of their vehicles. Manufacturers may specify that these fluids be changed throughout the useful life of the vehicle. If this is the case, the manufacturer should have a reasonable basis that the owner/operator will use fluids having the same properties. This may be accomplished by requiring (in service documentation, labeling, *etc.*) that only these fluids can be used as replacements.

If the vehicle remains in its original certified condition throughout its useful life, it is not believed that GHG emissions would increase as a result of service accumulation. This is based on the assumption that as components such as tires wear, the rolling resistance due to friction is likely to stay the same or decrease. With all other components remaining equal (tires, aerodynamics, *etc.*), the overall drag force would stay the same or decrease, thus not significantly changing GHG emissions at the end of useful life. It is important to remember however, that this vehicle assessment does not take into account any engine-related wear affects, which may in fact increase GHG emissions over time. The agencies received comments from engine and tractor manufacturers requesting an assigned deterioration factor of zero for GHG

emissions. As discussed previously, the agencies will allow the use of an assigned deterioration factor of zero where appropriate in Phase 1, however this does not negate the responsibility of the manufacturer to ensure compliance with the emissions standards throughout the useful life.

For the reasons explained above, we believe that for the first phase of this program, it is most important to ensure that the vehicle remain in its certified configuration throughout the useful life. This can most effectively be accomplished through engineering analysis and specific maintenance instructions provided by the vehicle manufacturer. The vehicle manufacturer would be primarily responsible for providing engineering analysis demonstrating that vehicle attributes will last for the full useful life of the vehicle. We anticipate this demonstration will show that components are constructed of sufficiently robust materials and design practices so as not to become dysfunctional under normal operating conditions. For instance, we expect aerodynamic fairings to be constructed of materials similar to that of the main body of the vehicle (fiberglass, steel, aluminum, *etc*) and have sufficient support and attachment mechanisms so as not to become detached or broken under normal, on-highway driving.

#### (ii) EPA's Air Conditioning Leakage Standards

Heavy-duty vehicle air conditioning systems contribute to GHG emissions in two ways. First, operation of the air conditioning unit places an accessory load on the engine, which increases fuel consumption. Second, most modern refrigerants are HFC-based, which have significant global warming potential (GWP=1430). For heavy-duty vehicles, the load added by the air conditioning system is comparatively small compared to other power requirements of the vehicle. Therefore, we are not targeting any GHG reduction due to decreased air conditioning usage or higher efficiency A/C units for this final action. However, refrigerant leakage, even in very small quantities, can have significant adverse effects on GHG emissions.

Refrigerant leakage is a concern for heavy-duty vehicles, similar to light-duty vehicles. To address this, EPA is finalizing a design-based standard for reducing refrigerant leakage from heavy-duty pickups and vans and combination tractors. This standard is based off using the best practices for material selection and interface sealing, as outlined in SAE publication J2727. Based on design criteria in this publication, a leakage

“score” can be assessed and an estimated annual leak rate can be made for the A/C system based on the refrigerant capacity. (There is no requirement for vocational vehicle AC leakage for reasons explained at 75 FR 74211.)

At the time of certification, manufacturers will be required to outline the design of their system, including the specification of materials and construction methods. They will also need to supply the leakage score developed using SAE J2727 and the refrigerant volume of their system to determine the leakage rate per year. If the certifying manufacturer does not complete installation of the air conditioning unit, detailed instructions must be provided to the final installer who ensures that the A/C system is assembled to meet the low-leakage standards. These instructions will also need to be provided at the time of certification, and manufacturers must retain all records relating to auditing of the final assembler.

#### (c) In-Use Standards

As previously addressed, the drive-cycle dependence of CO<sub>2</sub> emissions makes NTE-based in-use testing impractical. In addition, we believe the reporting of CO<sub>2</sub> data from the criteria pollutant in-use testing program will be helpful in future rulemaking efforts. For these reasons, we are not finalizing an NTE-based in-use testing program for Class 7 and 8 combination tractors for this program.

In the absence of NTE-based in-use testing, provisions are necessary for verifying that production vehicles are in the certified configuration, and remain so throughout the useful life. Perhaps the easiest method for doing this is to verify the presence of installed emission-related components. This would basically consist of a vehicle audit against what is claimed in the certification application. This includes verifying the presence of aerodynamic components, such as fairings, side-skirts, and gap-reducers. In addition, the presence of idle-reduction and speed limiting devices would be verified. The presence of LRR tires could be verified at the point of initial sale; however verification at other points throughout the useful life would be non-enforceable for the reasons mentioned previously.

The category of wear items primarily relates to tires. It is expected that vehicle manufacturers will equip their trucks with LRR tires, as they may provide a reduction in GHG emissions. The tire replacement intervals for this class of vehicle is normally in the range of 50,000 to 100,000 miles, which

means the owner/operator will be replacing the tires at several points within the useful life of the vehicle. We believe that as LRR tires become more common on new equipment, the aftermarket prices of these tires will also decrease. The primary barrier to the introduction of more fuel efficient tire designs into the truck market is the upfront costs of tire development and upfront capital costs for new production machinery (*e.g.*, new tire molds). Once manufacturers have sunk these costs into new tire designs and production facilities in order to meet our vehicle standards, there is little barrier for bringing these better products into the replacement tire market as well. Our regulations will effectively force OEMs to make these investments in tire designs and, having done so, should lead to better tires not only for new vehicles but in the replacement tire market as well. Along with decreasing tire prices, the fuel savings realized through use of LRR tires will ideally provide enough incentive for owner/operators to continue purchasing these tires. Thus, the inventory modeling in this final action reflects the continued use of LRR tires through the life of the vehicle.

#### (2) Enforcement Provisions

As identified above, a significant amount of vehicle-level GHG reduction is anticipated to come from the use of components specifically designed to reduce GHG emissions. Examples of such components include LRR tires, aerodynamic fairings, idle reduction systems, and vehicle speed limiters. At the time of certification, vehicle manufacturers will specify which components will be on their vehicle when introduced into commerce. Based on this list of installed components, GHG emissions performance of the vehicle will be assessed using the GEM, and compliance with the family (or subfamily) emissions limit will need to be shown. Given the ability of manufacturers to demonstrate compliance through the use of flexibility provisions, as previously described, that will be taken into account when assessing the performance for purposes of enforcement. Additionally, should enforcement action be necessary against systems certified using the flexibility provisions, credit balances generated through the use of the provisions may be reduced as a consequence of enforcement activity. As described in the in-use testing section, it is important to have the ability to determine if the vehicle is in the certified configuration at the time of sale.

Perhaps the most practical and basic method of verifying that a vehicle is in its certified configuration is through a vehicle emissions control information label, similar to that used for engines and light-duty vehicles. We proposed that this label list identifying features of the vehicle, including model year, vehicle model, certified engine family, vehicle manufacturer, test group, and GHG emissions category. In addition, this label would list emission-related components that an inspector could reference in the event of a field inspection. Possible examples may include LRR (for LRR tires), ARF (aerodynamic roof fairing), and ARM (aerodynamic rearview mirrors). With this information, inspectors could verify the presence and condition of attributes listed as part of the certified configuration.

Several comments were received voicing concern that the large number of vehicle permutations within a given vehicle family (and perhaps vehicle subfamily) would lead to a large number of unique labels, at significant cost and labor burden to the manufacturer. In addition, including generic emission control system (EC) identifiers for vehicles would add a significant burden while providing little usable information for inspectors. A common example given in the comments was that simply identifying "ARF" for a roof fairing would not be sufficiently detailed for an inspector to know whether the correct roof fairing is present. As a result of these concerns, commenters suggested that vehicle labels only include a minimal amount of information such as a compliance statement, vehicle family name, and date of manufacture.

The agencies generally agree with the concerns raised by the commenters and do not wish to add burdensome and arbitrary labeling requirements. Concurrently, we also remain committed to giving agency inspectors adequate tools to ensure a vehicle is in its certification at least at the time of sale. Therefore, we are finalizing a vehicle label requirement that includes:

- Compliance statement.
- Vehicle manufacturer.
- Vehicle family (and subfamily).
- Date of manufacture.
- Regulatory subcategory.
- Emission control system identifiers.

To address the concerns from vehicle manufacturers identified above, particularly related to emission control (EC) identifiers, we believe a combination of selectable information on the label as well as a set of EPA-defined EC identifiers will provide a

useful, but not overly burdensome labeling scheme. Since the intent of these identifiers is to provide inspectors with a means for simply verifying the presence of a component, we do not believe overly detailed identifiers are necessary, particularly for tires and aerodynamic components. For instance, current engine regulations require that three-way catalysts be identified on engine labels as "TWC." However, unique details such as catalyst size, loading, location, and even the number of catalysts are not on the label. In similar fashion, we believe that identifying tires and aerodynamic components in a general sense will prove similarly effective in determining if a vehicle has been built as intended or if it has been modified prior to being offered for sale.

EPA is requiring that components for which vehicle certification is dependent upon be identified on the label. This includes limited aerodynamic components (roof fairings, side skirts, & gap reducers), vehicle speed limiters, LRR tires, and idle reduction components. If vehicle certification also depends on the use of innovative or advanced technologies, this too must be included on the label. The following identifiers must be used for the emission control label:

#### Vehicle Speed Limiters

- VSL—Vehicle speed limiter.
- VSLs—"Soft-top" vehicle speed limiter.
- VSL—Expiring vehicle speed limiter.
- VSLD—Vehicle speed limiter with both "soft-top" and expiration.

#### Idle Reduction Technology

- IRT5—Engine shutoff after 5 minutes or less of idling.
- IRTE—Expiring engine shutoff.

#### Tires

- LRRD—Low rolling resistance tires—Drive (CRR of 8.2 kg/metric ton or less).
- LRRS—Low rolling resistance tires—Steer (CRR of 7.8 kg/metric ton or less).
- LRR—Low rolling resistance tires—All (meeting appropriate criteria for steer & drive).

#### Aerodynamic Components

- ATS—Aerodynamic side skirt and/or fuel tank fairing.
- ARF—Aerodynamic roof fairing.
- ARFR—Adjustable height aerodynamic roof fairing.
- TGR—Gap reducing fairing (tractor to trailer gap).

#### Other Components

- ADV—Vehicle includes advanced technology components.
- ADVH—Vehicle includes hybrid powertrain.
- INV—Vehicle includes innovative technology components.

On the vehicle label, several (if not all), available EC identifiers available in a given subfamily can be listed and the appropriate selections can be made at the time of assembly based on each unique vehicle configuration. This practice is common on engine ECI labels (normally for month/year of manufacture) and selections are made using a punch, stamp, check mark or other permanent method. This provides inspectors with the information they need while still affording flexibility to manufacturers with several unique vehicle configurations.

At the time of certification, manufacturers will be required to submit an example of their vehicle emission control label such that EPA can verify that all critical elements mentioned above are present. In addition to the label, manufacturers will also need to describe where the unique vehicle identification number and date of production can be found on the vehicle (if the date is not present on the label).

The agencies received several comments requesting the inclusion of consumer-focused labels for heavy-duty vehicles. These requests mainly involved labels similar to those found on passenger vehicles, allowing consumers to easily determine and compare fuel efficiency between vehicles. While we agree that such labels proven to be valuable to consumers in the light-duty market when shopping and comparing vehicles, the vast array of in-use drive cycles for heavy-duty vehicles and significant impact on GHG emissions reduce the intrinsic value of such fuel efficiency data to consumers. Additionally, many heavy-duty vehicles are unique and purpose-built which prevents direct comparison to other vehicles. The agencies may revisit this topic for future rulemaking activities, however there is no consumer label requirement in this final action.

#### (3) Other Certification Provisions

##### (a) Warranty

Section 207 of the CAA requires manufacturers to warrant their products to be free from defects that would otherwise cause non-compliance with emission standards. For purposes of this regulation, vehicle manufacturers must warrant all components which form the

basis of the certification to the GHG emission standards. The emission-related warranty covers vehicle speed limiters, idle shutdown systems, fairings, hybrid system components, and other components to the extent such components are included in the certified emission controls. The emission-related warranty also covers tires and all components whose failure would increase a vehicle's evaporative emissions (for vehicles subject to evaporative emission standards, which could include components which received innovative or advanced technology credits). In addition, the manufacturer must ensure these components and systems remain functional for the warranty period defined in 40 CFR part 86 for the engine used in the vehicle, generally defined as half of the regulatory useful life. As with heavy-duty engines, manufacturers may offer a more generous warranty, however the emissions related warranty may not be shorter than any other warranty offered without charge for the vehicle. If aftermarket components are installed (unrelated to emissions performance) which offer a longer warranty, this will not impact emission related warranty obligations of the vehicle manufacturer. NHTSA, for this phase of the program, is not finalizing any warranty requirements relating to its fuel consumption rule.

Several comments were received from vehicle manufacturers voicing concern that tire warranties should be the responsibility of the tire manufacturer, not the vehicle manufacturer. It has been, and remains, EPA policy to hold the certifying entities responsible for warranty obligations. In this case, tire manufacturers are not certificate holders and therefore we do not believe it is appropriate for them to independently warrant their products. The agencies see this as no different than requiring turbocharger or fuel injector manufacturers to provide warranties related to heavy-duty engines. However, we do believe that vehicle manufacturers can and should hold tire manufacturers responsible for warranty of their products as part of their sourcing and purchasing agreements. As proposed, tires are only required to be warranted for the first life of the tires (vehicle manufacturers are not expected to cover replacement tires). For heavy-duty pickups and vans and combination tractors, the vehicle manufacturer is also required to warrant the A/C system against design or manufacturing defects causing refrigerant leakage in excess of the standard. The warranty period for the A/C system is identical to the

vehicle warranty period as described above.

At the time of certification, manufacturers must supply a copy of the warranty statement that will be supplied to the end customer. This document should outline what is covered under the GHG emissions related warranty as well as the length of coverage. Customers must also have clear access to the terms of the warranty, the repair network, and the process for obtaining warranty service.

#### (b) Maintenance

Vehicle manufacturers are required to outline maintenance schedules that ensure their product will remain in compliance with emission standards throughout the useful life of the vehicle. For heavy-duty vehicles, such maintenance may include fluid/lubricant service, fairing adjustments, or service to the GHG emission control system. This schedule is required to be submitted as part of the application for certification. Maintenance that is deemed to be critical to ensuring compliance with emission standards is classified as "critical emission-related maintenance." Generally, manufacturers are discouraged from specifying that critical emission-related maintenance is needed within the regulatory useful life of the engine. However, if such maintenance is unavoidable, manufacturers must have a reasonable basis for ensuring it is performed at the correct time. This may be demonstrated through several methods including survey data indicating that at least 80 percent of engines receive the required maintenance in-use or manufacturers may provide the maintenance at no charge to the user.

Manufacturers will be required to submit the recommended emission-related maintenance schedule (and other service related documentation) at the time of certification. This documentation should provide sufficient detail to allow the owner/operator of the vehicle to maintain the emission control system in a way that will ensure functionality as intended. This would include items such as periodic inspection of aerodynamic components and maintenance unique to advanced or innovative technologies. In addition, these instructions should provide the owner/operator with adequate information to replace consumable components (such as tires) with comparable replacements.

Since low rolling resistance tires are key emission control components under this program, and will likely require replacement at multiple points within the life of a vehicle, it is logical to

clarify how this fits into the emission-related maintenance requirements. While the agencies encourage the exclusive use of LRR tires throughout the life of heavy-duty vehicles, we recognize that it is inappropriate at this time to hold vehicle manufacturers responsible for ensuring that this occurs. Additionally, we believe that owner/operators have a legitimate financial motivation for ensuring their vehicles are as fuel efficient as possible, which includes purchasing LRR replacement tires. However owner/operators may not have a sound knowledge of which replacement tires to purchase to retain the as-certified fuel efficiency of their vehicle. To address this concern and in response to comments from vehicle manufacturers, we are requiring that vehicle manufacturers supply adequate information in the owner's manual to allow the owner/operator of the vehicle to purchase tires meeting or exceeding the rolling resistance performance of the original equipment tires. We expect that these instructions will be submitted to EPA as part of the application for certification.

#### (c) Certification Fees

Similar to engine certification, the agency will assess certification fees for heavy-duty vehicles. The proceeds from these fees are used to fund the compliance and certification activities related to GHG regulation for this regulatory category. In addition to the certification process, other activities funded by certification fees include EPA-administered in-use testing, selective enforcement audits, and confirmatory testing. At this point, the exact costs associated with the heavy-duty vehicle GHG compliance are not well known. EPA will assess its compliance program cost associated with this program and assess the appropriate level of fees. We anticipate that fees will be applied based on vehicle families, following the light-duty vehicle approach.

#### (d) Requirements for Conducting Aerodynamic Assessment Using the Modified Coastdown Reference Method and Alternative Aerodynamic Methods

The requirements for conducting aerodynamic assessment using the modified coastdown reference method and alternative aerodynamic methods includes two key components: adherence to a minimum set of standardized criteria for each allowed method and submittal of aerodynamic values and supporting information on an annual basis for the purposes of certifying vehicles to a particular



aerodynamic bin as discussed in Section II.

First, we are finalizing requirements for conducting the modified coastdown reference method and each of the alternative aerodynamic assessment methods. We will cite approved and published standards and practices, where feasible, but will define criteria where none exists or where more current research indicates otherwise. A description of the requirements for each method is discussed later in this section. The manufacturer will be required to provide performance data on its vehicles and attest to the accuracy of the information provided.

Second, to ensure continued compliance, manufacturers will be required to provide a minimum set of information on an annual basis at certification time 1) to support continued use of an aerodynamic assessment method and 2) to assign an

aerodynamic value based on the applicable aerodynamic bins. The information supplied to the agencies should be based on an approved aerodynamic assessment method and adhere to the requirements for conducting aerodynamic assessment mentioned above.

The annual submission may be based on coastdown testing conducted consistent with the modified protocol detailed in this rulemaking or with an approved alternative method. The coastdown testing must be conducted using the Modified Protocol which uses SAE J1263 as a basis with some elements of SAE J2263 (e.g., post-processing and analysis techniques), in addition to the modifications developed in response to industry comments which raised concerns regarding test to test variability.

In addition to 8 valid coastdown runs in each direction, manufacturers using

in-house test methods should provide an adjustment factor for relating their drag coefficient based on their in-house method to the reference method, modified coastdown. The basis for the adjustment factor is:

$$\text{Adjustment Factor} = \frac{C_{d \text{ coastdown}}}{C_{d \text{ in-house}}}$$

For the test article used for certification that differs from the test article used for reference method testing, determine Cd to use for aerodynamics bin determination as described below.

$$C_{d \text{ certification BIN}} = \text{Adjustment Factor} \times C_{d \text{ in-house measured}}$$

The specific requirements for the test article used in reference method testing using the coastdown procedures should meet the requirements listed in Table V-2 through Table V-5, below.

TABLE V-2—REFERENCE METHOD TEST VEHICLE SPECIFICATIONS

	53' air ride dry vans
Length .....	53 feet (636 inches) +/- 1 inch.
Width .....	102 inches +/- 0.5 inches.
Height .....	102 inches (162 inches or 13 feet, 6 inches (+ 0.0 inch/ - 1 inch) from the ground).
Capacity .....	3800 cubic feet.
Assumed trailer load/capacity .....	45,000 lbs.
Suspension .....	Any (see "trailer ride height" below).
Corners .....	Rounded with a radius of 5.5 inches +/- 0.5 inches.
Bogie/Rear Axle Position .....	Tandem axle (std), 146 inches +/- 3.0 inches from rear axle centerline to rear of trailer. Set to California position.
Skin .....	Generally smooth with flush rivets.
Scuff band .....	Generally smooth, flush with sides (protruding ≤ 1/8 inch).
Wheels .....	22.5 inches. Duals. Std mudflaps.
Doors .....	Swing doors.
Undercarriage/Landing Gear .....	Std landing gear, no storage boxes, no tire storage, 105 inches +/- 4.0 inches from centerline of king pin to centerline of landing gear.
Underride Guard .....	Equipped in accordance with 49 CFR 393.86.

Tires for the Standard Trailer and the Tractor:

- a. Size: 295/75R22.5 or 275/80R22.5.
- b. CRR <5.1 kg/metric ton (In addition, the CRR for trailer tires in GEM should be updated to 5.0 kg/metric ton.).
- c. Broken in per section 8.1 of SAE J1263.
- d. Pressure per section 8.5 of SAE J1263.
- e. No uneven wear.
- f. No re-treads.
- g. Should these tires or appropriate Smart Way tires not be available, the Administrator testing may include tires used by the manufacturer for certification.

Test Conditions:

1. Tractor-trailer gap: 45 inches +/- 2.0 inches.
2. King pin setting: 36 inches +/- 0.5 inches from front of trailer to king pin center line.
3. Trailer ride height: 115 inches +/- 1.0 inches from top of trailer to fifth wheel plate, measured at the front of the trailer, and set within trailer height boundary from ground as described above.
4. Mudflaps: Positioned immediately following wheels of last axle.

TABLE V-3—REFERENCE METHOD COASTDOWN TEST TRACK CONDITION SPECIFICATIONS

Parameter	Range
Coastdown speed range .....	70 mph to 15 mph.
Average wind speed at the test site (for each run in each direction) .....	<10 mph.
Maximum wind speed (for each run in each direction) .....	<12.3 mph.
Average cross wind speed (for each run in each direction at the site) ...	<5 mph.
All valid coastdown runs in one direction .....	Within 2 standard deviations of the other valid coastdown runs in that same direction.

TABLE V-3—REFERENCE METHOD COASTDOWN TEST TRACK CONDITION SPECIFICATIONS—Continued

Parameter	Range
Grade of the test track .....	<0.02% or account for the impact of gravity as described in SAE J2263 Equation 6.

TABLE V-4—STANDARD TANKER TRAILER FOR SPECIAL TESTING

	Tanker
Length .....	42 feet ± 1 foot, overall. 40 feet ± 1 foot, tank.
Width .....	96 inches ± 2.
Height .....	140 inches (overall, from ground).
Capacity .....	7,000 gallons.
Suspension .....	Any (see “trailer ride height” below).
Tank .....	Generally cylindrical with rounded ends.
Bogie .....	Tandem axle (std). Set to furthest rear position.
Skin .....	Generally smooth.
Structures .....	(1) Centered, manhole (20 inch opening), (1) ladder generally centered on side, (1) walkway (extends lengthwise).
Wheels .....	24.5 inches. Duals.
Tanker Operation .....	Empty.

TABLE V-5—STANDARD FLATBED REFERENCE TRAILER FOR SPECIAL TESTING

	Flatbed
Length .....	53 feet.
Width .....	102 inches.
Flatbed Deck Heights .....	Front: 60 inches ± 1/2 inch. Rear: 55 inches ± 1/2 inch.
Wheels/Tires .....	22.5 inch diameter tire with steel or aluminum wheels.
Bogie .....	Tandem axles, may be in “spread” configuration up to 10 feet ± 2 inches. Air suspension.

Load Profile: 25 inches from the centerline to either side of the load;  
Mounted 4.5 inches above the deck.  
Load height 31.5 inches above the load support.

Regardless of the method, all testing using high-roof sleepers should be performed with a tractor-trailer combination to mimic real world usage. Accordingly, it is important to match the type of tractor with the correct trailer. Although, as discussed elsewhere in this rulemaking, the correct tractor-trailer combination is not always present or tractor-only operation may occur, the majority of operation in the real world involves correctly matched tractor-trailer combinations and we will attempt to reflect that here. Therefore, when performing an aerodynamic assessment for a Class 7 and 8 tractor with a high roof, a standard box trailer must be used.

The definitions of the standard trailer are further detailed in § 1037.501(g). This ensures consistency and continuity in the aerodynamic assessments, and maintains the overlap with real world operation. As mid-roof and low-roof coastdown testing will be conducted without the trailer if the aerodynamic bin is not extrapolated from a high-roof version, then testing using other

methods should also be conducted based on the tractor alone.

(e) Standardized Criteria for Aerodynamic Assessment Methods

(i) Coastdown Procedure Requirements

For coastdown testing, the test runs should be conducted in a manner consistent with SAE J1263 with additional modifications as described in the 40 CFR part 1066, subpart C, and in Chapter 3 of the RIA using the mixed model analysis method. Since the coastdown procedure is the primary aerodynamic assessment method, the manufacturer would be required to conduct the coastdown procedure according to the requirements in this final action and supply the following information to the agency for approval:

- Facility information: name and location, description and/or background/history, equipment and capability, track and facility elevation, track grade and track size/length;
- Test conditions for each test result including date and time, wind speed and direction, ambient temperature and humidity, vehicle speed, driving

distance, manufacturer name, test vehicle/model type, model year, applicable model engine family, tire type and rolling resistance, test weight and driver name(s) and/or ID(s);

- Average  $C_d$  result as calculated in 40 CFR 1037.520(b) from valid tests including, at a minimum, ten valid test results, with no maximum number, standard deviation, calculated error and error bands, and total number of tests, including number of voided or invalid tests.

(ii) Wind Tunnel Testing Requirements

Wind tunnel testing would conform to the following procedures and modifications, where applicable, including:

- SAE J1252, “SAE WIND TUNNEL TEST PROCEDURE FOR TRUCKS AND BUSES” (July 1981) shall be followed with the following exceptions: section 5.2 is modified to specify a minimum Reynold’s number ( $Re_{min}$ ) of  $1.0 \times 10^6$  and your model frontal area at zero yaw angle may exceed the recommended 5 percent of the active test section area, provided it does not exceed 25 percent;

section 6.0 is modified to add the requirement that, for reduced-scale wind tunnel testing, a one-eighth ( $\frac{1}{8}$ th) or larger scale model of a heavy-duty tractor and trailer must be used; for reduced-scale wind tunnel testing, section 6.1 is modified to add the requirement that the model be of sufficient design to simulate airflow through the radiator inlet grill and across an engine geometry representative of those commonly in your test vehicle.;

- J1594, "VEHICLE AERODYNAMICS TERMINOLOGY" (December 1994); and
- J2071, "AERODYNAMIC TESTING OF ROAD VEHICLES—OPEN THROAT WIND TUNNEL ADJUSTMENT" (June 1994).

In addition, the wind tunnel used for aerodynamic assessment would be a recognized facility by the Subsonic Aerodynamic Testing Association. If your wind tunnel is not capable of testing in accordance with these EPA modified SAE procedures, you may request EPA approval to use this wind tunnel and must demonstrate that your alternate test procedures produce data sufficiently accurate for compliance. This must be approved by EPA prior to method validation and correlation factor development. We are finalizing the provisions that manufacturers that perform wind tunnel testing do so based on the requirements detailed in this action. The wind tunnel tests should be conducted at a zero yaw angle and, if so equipped, utilizing the moving/rolling floor (*i.e.*, the moving/rolling floor should be on during the test as opposed to static) for comparison to the coastdown procedure, which corrects to a zero yaw angle for the oncoming wind. However, manufacturers may be required to test at yaw angles other than zero (*e.g.*, positive and negative six) if they voluntarily seek to improve their GHG emissions score for a given model using additional yaw sweep.

The manufacturer is required to supply the following:

- *Facility information:* Name and location, description and background/history, layout, wind tunnel type, diagram of wind tunnel layout, structural and material construction;
- *Wind tunnel design details:* Corner turning vane type and material, air settling, mesh screen specification, air straightening method, tunnel volume, surface area, average duct area, and circuit length;
- *Wind tunnel flow quality:* Temperature control and uniformity, airflow quality, minimum airflow velocity, flow uniformity, angularity and stability, static pressure variation,

turbulence intensity, airflow acceleration and deceleration times, test duration flow quality, and overall airflow quality achievement;

- *Test/Working section information:* Test section type (*e.g.*, open, closed, adaptive wall) and shape (*e.g.*, circular, square, oval), length, contraction ratio, maximum air velocity, maximum dynamic pressure, nozzle width and height, plenum dimensions and net volume, maximum allowed model scale, maximum model height above road, strut movement rate (if applicable), model support, primary boundary layer slot, boundary layer elimination method and photos and diagrams of the test section;
- *Fan section description:* Fan type, diameter, power, maximum rotational speed, maximum top speed, support type, mechanical drive, sectional total weight;
- *Data acquisition and control (where applicable):* Acquisition type, motor control, tunnel control, model balance, model pressure measurement, wheel drag balances, wing/body panel balances, and model exhaust simulation;
- *Moving ground plane or Rolling Road (if applicable):* Construction and material, yaw table and range, moving ground length and width, belt type, maximum belt speed, belt suction mechanism, platen instrumentation, temperature control, and steering; and
- Facility correction factors and purpose.

#### (iii) CFD Requirements

Currently, there is no existing standard, protocol or methodology governing the use of CFD. Therefore, we are establishing a minimum set of criteria based on today's practices and coupling the use of CFD with empirical measurements from coastdown and, for gaining innovative technology credits, wind tunnel procedures. Since there are primarily two-types of CFD software code, Navier-Stokes based and Lattice-Boltzman based, we are outlining two sets of criteria to address both types. Therefore, the agencies are requiring that manufacturers use commercially-available CFD software code with a turbulence model included or available. Further details and criteria for each type of commercially-available CFD software code follows immediately and general criteria for all CFD analysis are subsequently described.

For Navier-Stokes based CFD code, manufacturers must perform an unstructured, time-accurate analysis using a mesh grid size with total volume element count of at least fifty million cells of hexahedral and/or polyhedral

mesh cell shape, surface elements representing the geometry consisting of no less than six million elements and a near wall cell size corresponding to a  $y^+$  value of less than three hundred with the smallest cell sizes applied to local regions of the tractor and trailer in areas of high flow gradients and smaller geometry features. Navier-Stokes-based analysis should be performed with a turbulence model (*e.g.*,  $k$ -epsilon ( $k$ - $\epsilon$ ), shear stress transport  $k$ -omega (SST  $k$ - $\omega$ ) or other commercially-accepted method) and mesh deformation (if applicable) enabled with boundary layer resolution of  $\pm$  95 percent. Finally, Navier-Stokes based CFD analysis for the purposes of determining the  $C_d$  should be performed once result convergence is achieved. Manufacturers should demonstrate convergence by supplying multiple, successive convergence values.

For Lattice-Boltzman based CFD code, manufacturers must perform an unstructured, time-accurate analysis using a mesh grid size with total number of volume elements of at least fifty million with a near wall cell size of no greater than six millimeters on local regions of the tractor and trailer in areas of high flow gradients and smaller geometry features, with cell sizes in other areas of the mesh grid starting at twelve millimeters and increasing in size from this value as the distance from the tractor-trailer model increases.

In general for CFD, all analysis should be conducted using the following conditions: A tractor-trailer combination using the manufacturer's tractor and the trailer according to the trailer specifications in this regulation, an environment with a blockage ratio of less than or equal to 0.2 percent to simulate open road conditions, a zero degree yaw angle between the oncoming wind and the tractor-trailer combination, ambient conditions consistent with the modified coastdown test procedures outlined in this regulation, open grill with representative back pressures based on data from the tractor model, turbulence model and mesh deformation enabled (if applicable), and tires and ground plane in motion consistent with and simulating a vehicle moving in the forward direction of travel. For any CFD analysis, the smallest cell size should be applied to local regions on the tractor and trailer in areas of high flow gradients and smaller geometry features (*e.g.*, the  $a$ -pillar, mirror, visor, grille and accessories, trailer leading and trailing edges, rear bogey, tires, tractor-trailer gap).

Finally, with administrator approval, a manufacturer may request and

perform CFD analysis using parameters and criteria other than stated above if the manufacturer can demonstrate that the conditions above are not feasible (e.g., insufficient computing power to conduct such analysis, inordinate length of time to conduct analysis, equivalent flow characteristics with more feasible criteria/parameters) or improved criteria may yield better results (e.g., different mesh cell shape and size). A manufacturer must provide data and information that demonstrates that their parameters/criteria will provide a sufficient level of detail to yield an accurate analysis including comparison of key characteristics between the manufacturer's criteria/parameters and those stated above (e.g., pressure profiles, drag build-up, and/or turbulent/laminar flow at key points on the front of the tractor and/or over the length of the tractor-trailer combination).

#### Alternative Aerodynamic Method Comparison to the Coastdown Test Procedure Reference Method

If a manufacturer uses any alternative aerodynamic method, or any method other than the coastdown reference method, the manufacturer would have to provide a comparison to the coastdown test procedure reference method. The manufacturer would be required to perform the alternative aerodynamic method and the coastdown test procedure reference method on the same model and compare the Cd results. The alternative aerodynamic method, or any other method using good engineering judgment, and the coastdown test procedure reference method must be conducted under similar test conditions and adhere to the criteria discussed above for each aerodynamic assessment method.

This demonstration would be performed in the initial year of rule implementation and would require agency review and approval prior to use of the alternative aerodynamic method in future years and for other models.

The comparison would occur on one model of the manufacturer's highest sales volume, Class 8, high roof, sleeper cab family with a full aerodynamics package, either equipped at the factory or sold through a dealer specifically for that model as an OEM part. If the manufacturer does not have such a model, the manufacturer may select a comparable model in that family or a model from another highest sales volume family in the manufacturer's fleet.

For the comparison, the manufacturer would be required to provide information on the test conditions for

each test result including but not limited to: test date and time, wind speed (if applicable), temperature, humidity, manufacturer and model, model year, applicable model engine family, tire type and rolling resistance for actual model, model test weight, equivalent vehicle test weight, actual and simulated or equivalent vehicle speed, Reynolds number (if applicable), yaw angle (if applicable), blockage ratio, either calculated or measured (if applicable), model mounting (if applicable), model geometry, body axis force and moments (if applicable), total test duration, test vehicle and type and operator name(s) and/or ID(s). In addition, the manufacturer must provide the Cd results from valid tests.

Once the comparison is performed in the initial year, the manufacturer is required to perform this comparison every three years on the highest sales volume, Class 8, high roof, sleeper cab family equipped with a full aerodynamics package unless any or all of the following occurs: the Class 8, high roof, sleeper cab family/model used for the original comparison is no longer commercially available, and/or significantly redesigned, with the meaning of "significantly" based on good engineering judgment, a fundamental change is made to the current alternative aerodynamic method (e.g., change from facility A to facility B as a source), and/or the alternative aerodynamic method is changed to something other than the coastdown test procedure reference method (e.g., switch to wind tunnel testing from coastdown, change wind tunnel testing facilities or CFD software code). However, the agency reserves the right and has the authority under the Clean Air Act (CAA) to request and have the manufacturer perform a comparison in any year and on any model that the manufacturer has certified.

Finally, the data generated for the purpose of this comparison can be used in annual certification for that model, also called the base model, and for determining Cd for other models and/or sub-families in the base model family, or other families in the manufacturer's fleet.

#### Annual Certification Data Submittal for Aerodynamic Assessment

For each model in the manufacturer's fleet, the manufacturer is required to supply aerodynamic information on an annual basis to the agencies in their certification application. Once the manufacturer has performed the coastdown test procedure or the comparison for an alternative aerodynamic method, the aerodynamic

assessment method can be used to generate  $C_d$  values for all models the manufacturer plans to certify and introduce into commerce. For each model, the manufacturer would determine a predicted aerodynamic drag ( $C_d$  times the frontal area, A). This reduces burden on the manufacturer to perform aerodynamic assessment but provides data for all the models in a manufacturer's fleet. If a manufacturer has previously performed aerodynamic assessment on the other models, the manufacturer may submit an experimental  $C_d$  in lieu of a predicted  $C_d$ .

The aerodynamic assessment data will be used in one of two ways: the manufacturer will use the  $C_d$  (times A) values to determine the correct GEM input according to agency-defined tables, or the agencies will use the manufacturer's input data into the model and assign a GHG value/score.

Since the agencies may input the data into the model, manufacturers are required to provide the information from the coastdown test procedure, alternative aerodynamic method or the method comparison described above for annual certification. In addition, the manufacturer would supply manufacturer fleet information to the agency for annual certification purposes along with the acceptance demonstration parameters: manufacturer name, model year, model line (if different than manufacturer name), model name, engine family, engine displacement, transmission name and type, number of axles, axle ratio, vehicle dimensions, including frontal area, predicted or measured coefficient of drag, assumptions used in developing the predicted or measured  $C_d$ , justification for carry-across of aerodynamic assessment data, photos of the model line-up, if available, and model applications and usage options.

Finally, the agencies reserve the right to request that a manufacturer generate or provide additional data, prior to certification, to support and receive annual certification approval.

#### (f) Aerodynamic Validation and Compliance Audit

The agencies reserve the right to perform aerodynamic validation and compliance audit of the manufacturer's aerodynamic results. The agencies may conduct a vehicle confirmatory evaluation using a vehicle recruited from the in-use fleet and performing the reference method, coastdown test procedures, either at the manufacturer's facility or an independent facility using the agencies equipment and tools. If there is a discrepancy between the

manufacturer's data submitted for certification and the agencies' validation results, the agency may perform a full audit of the manufacturer's source data and aerodynamic assessment methods and tools used by the manufacturer to produce the data. The manufacturer would be required to make all equipment and tools available to the agencies to conduct the full audit.

Based on this audit, the agencies may require the manufacturer to make changes to their aerodynamic assessment methods ranging from minor adjustments to method criteria to switching allowed aerodynamic assessment methods. For the purposes of aerodynamic validation and compliance audit, manufacturers will be allowed an additional compliance margin of one bin from the certified bin for the model evaluated (e.g., if a manufacturer certifies a model to Bin IV, the results of the aerodynamic validation compliance audit must fall within the

next highest bin, in this case Bin III). In addition, the agencies may select any model from the manufacturer's fleet/vehicle family to perform the aerodynamic validation and compliance.

(g) Aerodynamic Bin Category Adjustment Using Yaw Sweep Information

As discussed in Section II.B.2, the agencies are finalizing aerodynamic drag values which represent zero degree yaw (i.e., representing wind from directly in front of the vehicle, not from the side). We recognize that wind conditions, most notably wind direction, have a greater impact on real world CO<sub>2</sub> emissions and fuel consumption of heavy-duty trucks than of light-duty vehicles. To provide additional incentive for manufacturers using aerodynamic techniques (i.e., techniques that use assessment at yaw angles more or less than zero degrees to

capture the influence of side winds and calculate wind average drag coefficient), the agencies are defining an approach to allow manufacturers to account for improved aerodynamic performance in crosswind conditions similar to those experienced by vehicles in use. If a manufacturer can benefit from having a model that performs in regimes or conditions other than the scope of the test parameters in this rulemaking, this creates an incentive for the entire industry. As a result, we are allowing manufacturers to use the coefficient of drag values at positive six, negative six, and zero degrees yaw to improve their GHG score.

The Yaw Sweep Adjustment would be determined using the following steps and equations:

- Step 1: Determine your aero method adjustment factor as described above in paragraph (d) of this section and using the equation;

$$\text{Adjustment Factor} = \frac{Cd_{\text{coastdown, model}}}{Cd_{\text{in-house, model}}}$$

$Cd_{\text{in-house, model}}$

- Step 2: Apply the aerodynamic method adjustment factor to the positive six, negative six and zero degrees yaw Cd values for that model using the equation;

$$Cd_{\text{Adjusted}} = \text{Adjustment Factor} \times Cd_{(+6 \text{ degrees} / -6 \text{ degrees} / 0 \text{ degrees, model})}$$

- Step 3: Calculate your Adjusted zero yaw Cd\*A

$$\text{Adjusted Zero Yaw } Cd * A_{(\text{model})} = \text{adjusted } +/- \text{ Six Yaw } Cd_{(\text{average, model})} * A_{(\text{model})} \times \text{Zero Yaw } Cd * A_{(\text{industry average})} +/- \text{ Six Yaw } Cd_{(\text{average})} * A_{(\text{industry average})}$$

- Step 4: Use the adjusted zero yaw Cd\*A for the model to determine appropriate bin and the associated Cd input for the GEM to determine your Yaw Sweep Adjusted GHG score.

Essentially, this equation becomes  $y = x * C$  where  $y$  is the adjusted zero yaw Cd,  $x$  is the corrected average of the +/- six degree yaw Cds for the manufacturer's model, and  $C$  is a constant value based on the ratio of the zero yaw Cd and WACd ratio for the industry. The current default value for this industry baseline ratio for this is rulemaking is 0.8065 based on the Cd values of current Class 8, high-roof, aero sleeper cab models in the fleet. The agencies may periodically review this industry baseline ratio and adjust it, if necessary, with notification to the industry.

The yaw sweep adjustment described above only applies to Class 7, high-roof day cab and Class 8 high-roof day or sleeper cab tractors and a manufacturer seeking yaw sweep adjustment must use an approved, alternative aerodynamic method to generate the yaw sweep data. Manufacturers may use a more yaw sweep angles (e.g., zero, +/- 1, 3, 6, 9) for their yaw sweep adjustment and, in this case, must calculate the wind-average Cd (WACd) according to SAE J1252 and use this value in lieu of the average of the +/- six degree yaw Cds in the equations above.

As stated elsewhere in this regulation, the Agencies reserve the right to review a manufacturer's proposed adjustment and discuss the proposed adjustment with the manufacturer. The Agencies will notify the manufacturer of the need for a review and the manufacturer must provide all information requested by the Agencies to support the review and subsequent discussion(s). The agencies also reserve the right to deny aerodynamic bin category adjustment independent or as a result of the review/discussions with the manufacturer. In such case, the Agencies will notify the manufacturer of denial prior to certification to ensure the proper inputs to the GEM are used.

(4) Compliance Reports

(a) Early Model Year Data

The regulatory text of the NPRM included specifications for manufacturers to submit pre-certification compliance reports for each of a manufacturer's fleet of heavy-duty tractors. Navistar and Volvo commented that the requirements specified in the NHTSA pre-certification reports are overbroad and should be eliminated. The pre-certification reports included requirements for manufactures to submit a wide variety of information on these vehicles. The variety of information was believed to be necessary given that these vehicles had no previous compliance information for meeting fuel efficiency and emission standards and the agencies wanted to ensure that enough information was obtained to ensure sufficient compliance with the program. The agencies have since reviewed the level of detail required in the precertification reports and are in agreement with commenters that the required information may be overly broad for compliance purposes and given that this is the first time these manufacturers have been regulated, the level of information required may not be available until subsequent model years. Therefore, as discussed previously for pickup trucks and vans, the agencies have removed the requirement for

manufactures to submit pre-certification compliances reports for these classes of vehicles.

As an alternative to receiving early compliance model year information in the precertification reports, the agencies have decided to use manufacturer's application for certificates of conformity to obtain early model estimates. Currently, the applications for certificates are not required to include the fuel consumption information required by NHTSA. Therefore, the agencies are adopting provisions in the final rules for manufacturers to provide emission and equivalent fuel consumption estimates in the manufacturer's applications for certification. The agencies will treat information submitted in the applications as a manufacturer's demonstration of providing early compliance information, similar to the pre-model year report submitted for heavy-duty pickup trucks and vans. The final rule establishes a harmonized approach by which manufacturers will submit applications through an EPA-administered database, such as the Verify system, as the single point of entry for all information required for this national program and both agencies will have access to the information. If by model year 2012, the agencies are not prepared to receive information through the EPA Verify database system, manufacturers are expected to submit written applications to the agencies. This approach should streamline this process and reduce industry burden and provide sufficient information for the agencies to carry out their early compliance activities.

#### (b) Final Reports

The NPRM proposed for manufacturers participating in the ABT program to provide EOY and final reports. The EOY reports for the ABT program were required to be submitted by manufacturers no later than 90 days after the calendar year and final report no later than 270 days after the calendar year.<sup>318</sup> Manufacturers not participating in the ABT program were required to provide an EOY report within 45 days after the calendar year but no final reports were required. The final ABT report due was established coinciding with EPA's existing criteria pollutant report for heavy-duty engines. The EOY report was required in order to receive preliminary final estimates and identifies manufacturers that might have a credit deficit for the given model year. Manufacturers with a credit surplus at the end of each model could receive a

waiver from providing EOY reports. As proposed, the remaining manufacturers were required to submit reports to EPA and send copies of those reports to NHTSA with equivalent fuel consumption values.

In response to the NPRM, commenters recommended collecting additional data. One commenter requested collecting information to develop and refine test cycles that more accurately reflect actual driving cycles for medium- and heavy-duty trucks. Several other commenters (ACEE, Eaton, CALSTART, NRDC and UCS) recommended collecting advanced data on in-service vehicles and that the collected data be analyzed and characterized for each vocational application, especially for hybrid vehicles, in a cooperative government and industry effort. Commenters (ACEE, DTNA, NRGDC, UCS and Volvo) also requested that the agency's data collection ensure to include information on actual vehicle configurations sold in the fleet.

Many commenters argued against the burden placed upon the industry in meeting the agencies' proposed required reporting provisions. One commenter argued against providing actual production information due to the variability that exists in building heavy-duty vehicles and in the influence of changing fleet interest each year indicating that only estimated information should have to be provided. Commenters (Volvo and Navistar) generally objected stating that the agency requirements in its reports are both unnecessary and overly burdensome. Comments in response to the NPRM requested that for manufacturers not using ABT provisions, the EOY report due 45 days after the end of the calendar year should be combined with the ABT report due 90 days after the same model year. Commenters also requested that the exempted off-road vehicle report be consolidated with the EOY report. Other concerns raised by commenters were for the agencies to remove any differences in reporting provisions and implement a single uniform reporting template that manufacturers can submit to both agencies.

One commenter (Volvo) requested that the agencies simplify the reporting requirements for vehicle configurations in both the EOY and final reports, commenting that the proposal as outlined was extremely burdensome to vehicle manufacturers. The NPRM regulation stated that the manufacturer must identify each distinguishable vehicle configuration in the vehicle family or sub-family and identification of FELs for each subfamily. The

regulation calls for reporting of results and modeling inputs for each subfamily. The commenter believed that the burden of meeting these requirements for the vast number of families/subfamilies is substantial and unjustified. For this commenter, there is a potential for almost 45 million sub-families in the vocational and tractor categories. This approach should reduce the number of vehicle families to an amount that is suitable for reporting. The BlueGreen Alliance and ACEEE also requested the agencies to implement a program as part of the final rule to collect data, actual vehicle configurations sold and their performance as estimated by simulation modeling, which will provide information required to develop a full-vehicle program in the future.

For the final rules, the agencies are requiring EOY and final reports, as proposed. However, the agencies will consolidate the reporting as requested by comments and is requiring equivalent fuel consumption information for all reports submitted to EPA. The final rules establish a harmonized approach by which manufacturers will submit reports through an EPA-administered database, such as the Verify system, as the single point of entry for all information required for this national program and both agencies will have access to the information. If by model year 2012, the agencies are not prepared to receive information through the EPA Verify database system, manufacturers are expected to submit written reports to the agencies. The agencies are also combining the EOY reports for manufacturers not using ABT provisions with other EOY reports and are requiring a submission date 90 days after the calendar year. The agencies view the adopted requirements in the final rules for EOY and final reports will provide sufficient data requests to satisfy these requests. The agencies also agree with Volvo's concerns and have adopted a new classification system for selecting vehicle families as described elsewhere in this section. A summary of the required information in the final rules for EOY and final reports is as follows:

- Vehicle family designation and averaging set.
- Vehicle emissions and fuel consumption standards including any alternative standards used.
- Vehicle family FELs.
- Final production volumes.
- Certified test cycles.
- Useful life values for vehicle families.

<sup>318</sup> Corresponding to the compliance model year.

- A credit plan identifying the manufacturers actual credit balances, credit flexibilities, credit trades and a credit deficit plan if needed demonstrating how it plans to resolve any credit deficits that might occur for a model year within a period of up to three model years after that deficit has occurred.
- A plan describing the vehicles that were exempted such as for off-road or small business purposes.

- A plan describing any alternative fueled vehicles that were produced for the model year identifying the approaches used to determinate compliance and the production volumes.

(c) Additional Required Information

Throughout the model year, manufacturers may be required to report various submissions to the agencies to comply with various aspects of the

rules. These requests have differing criteria for submission and approval. Table V-6 below provides a summary of the types of submission, required submission dates and the EPA and NHTSA regulations that apply. The agencies will review and grant requests considering the timeliness of the submissions and the completeness of the requests.

TABLE V-6—SUMMARY OF REQUIRED INFORMATION FOR COMPLIANCE

Submission	Applies to	Required submissions date	EPA regulation reference	NHTSA regulation reference
Small business exemptions	Vehicle manufacturers meeting the Small Business Administration (SBA) size criteria of a small business as described in 13 CFR 121.201.	Before introducing any excluded vehicle into U.S. commerce.	§ 1037.150	§ 535.8
Incentives for early introduction.	The provisions apply with respect to tractors and vocational vehicles produced in model years before 2014.	EPA must be notified before the manufacturer submits its applications for certificates of conformity.	§ 1037.150	§ 535.8
Voluntary compliance for NHTSA standards.	Vehicle manufacturers seeking early compliance in model years 2014 to 2016.	NHSAT must be notified before the manufacturer submits its applications for certificates of conformity.	NA	§ 535.8
Approval of alternate methods to determine drag coefficients.	Tractors meeting § 1037.106 .....	EPA must be notified before the manufacturer submits its applications for certificates of conformity.	§ 1037.150	§ 535.8
Off-road exemption .....	Manufacturers wanting to exclude tractors from vehicle standards.	EPA must be notified before the manufacturer submits its applications for certificates of conformity.	§ 1037.150	§ 535.8
Vocational Tractor .....	Manufacturers wanting to reclassify tractor as vocational tractors making them applicable to vocational vehicle standards.	EPA must be notified before the manufacturer submits it applications for certificates of conformity.	§ 1037.150	§ 535.8
Exemption from EOY reports.	Manufactures with surplus credits at the end of the model year.	90-days after the calendar year ends ..	§ 1037.730	§ 535.8

E. Class 2b-8 Vocational Vehicles

(1) Final Compliance Approach

Like Class 7 and 8 combination tractors, heavy-duty vocational vehicles will be required to have both engine and chassis certificates of conformity. As discussed in the engine certification section, engines that will be used in vocational vehicles would need to be certified using the heavy-duty FTP cycle for GHG pollutants and show compliance through the useful life of the engine. This certification is in addition to the current requirements for obtaining a certificate of conformity for criteria pollutant emissions.

For this final action, the majority of the GHG reduction for vocational vehicles is expected to come from the use of LRR tires as well as increased utilization of hybrid powertrain systems. Other technologies such as aerodynamic improvements and vehicle speed limiting systems are not as relevant for this class of vehicles, since the typical duty cycle is much more urban, consisting of lower speeds and

frequent stopping. Idle reduction strategies are expected to be encompassed by hybrid technology, which we anticipate will ultimately handle PTO operation as well. Therefore, for this final action, certification of heavy-duty vocational vehicles with conventional powertrains will focus on quantifying GHG benefits due to the use of LRR tires through the GEM.

(a) Certification Process

Vehicles will be divided into vehicle families for purposes of certification. As with Class 7 and 8 combination tractors, these are groups of vehicles within a given regulatory subcategory that are expected to share common emission characteristics. Vocational vehicle regulatory subcategories share the same structure as those used for heavy-duty engine criteria pollutant certification and are based on GVWR. This includes light-heavy (LHD) with a GVWR at or below 19,500 pounds, medium-heavy (MHD) with a GVWR above 19,500 pounds and at or below 33,000 pounds,

and heavy-heavy (HHD) with a GVWR above 33,000 pounds. We anticipate manufacturers will have one vehicle family per regulatory subcategory, however hybrid vehicles will need to be separated into additional unique vehicle families. Manufacturers may also subdivide families into sub-families if GHG emissions performance is expected to change significantly within the vehicle family. As with Class 7 and 8 combination tractors, we anticipate using the standardized 12-digit naming convention to identify vocational vehicle families. As with engines and Class 7 and 8 combination tractors, each certifying vehicle manufacturer would have a unique three digit code assigned to them. Currently, there is no 5th digit (industry sector) code for this class of vehicles and EPA will issue an update to the current guidance explaining which character(s) should be used for vocational vehicles. The agencies originally proposed that engine displacement be included in the vehicle family name, however the wide range of engines available across most regulatory



subcategories makes this requirement irrelevant and unnecessary at the time of this rulemaking. Therefore, we are reserving the remaining characters for California ARB and/or manufacturer use, such that the result is a unique vehicle family name.

Each vehicle family must demonstrate compliance with emission standards using the GEM. GEM inputs for conventional (*i.e.* non-hybrid) vocational vehicles primarily involves entering tire rolling resistance information. Additional provisions are available for certification of hybrid vehicles or vehicles using other advanced or innovative technologies, as detailed in Section IV. If the vehicle family consists of multiple configurations, only results from the worst-case configuration are necessary for certification in addition to an engineering evaluation demonstrating that the modeled configuration indeed reflects the worst-case configuration. If the vehicle family is divided into subfamilies, unique GEM results are required for at least one configuration per subfamily.

The agencies have received comments from engine manufacturers, truck manufacturers, and hybrid system manufacturers raising concerns regarding the duty cycles and the weighting factors proposed for evaluating transient applications. The agencies proposed three methods for evaluating hybrid system performance in an effort to generate credits. The proposed duty cycles considered for the proposal will continue to be used with this final action. The Agencies proposed a transient duty cycle, a 55 mile-per-hour steady state cruise and a 65 mile per hour steady state cruise. The transient duty cycle, is essentially the same transient cycle proposed in the NPRM with the exception that it minimizes inappropriate shift events. Additionally, the steady state cycles proposed by the Agencies remain essentially unchanged. In response to concerns raised by engine manufacturers and hybrid system manufacturers regarding the operation of vehicles most likely to be hybridized in the near term, we are modifying the weighting factors for each cycle to address the distribution of the emissions impact associated with each duty cycle. The weighting factors will be changed such that a greater emphasis on the type of transient activity seen as more characteristic of hybrid applications will be evident. The new weighting factors between duty cycles for hybrid certification will be 75 percent for the transient, 9 percent for the 55 mph cruise cycle, and 16 percent for the 65

mph cruise cycle. The basis for this change may be seen in the memorandum to Docket EPA-HQ-OAR-2010-0162, which describes the data set used to describe real world vehicle performance. In addition to this modification, the Power-Take-Off (PTO) operation will be characterized for vehicles utilizing a PTO system for which there is a benefit for use of the hybrid technology. The testing provisions for the comparison in the A to B testing for complete vehicle or post-transmission powerpack testing may be seen in 40 CFR 1037.525. The testing provisions for work-specific pre-transmission evaluation using an engine based approach may be seen in 40 CFR 1036.525.

(b) Demonstrating Compliance With the Final Standards

(i) CO<sub>2</sub> and Fuel Consumption Standards Model

As stated above, the technology basis for the final standards for vocational vehicles is use of LRR tires. Similar to Class 7 and 8 combination tractors, compliance with the standards will be demonstrated using the GEM predictive model. However, the input parameters entered by the vehicle manufacturer would be limited to the properties of the tires. The GEM will use the tire data, along with inputs reflecting a baseline truck and engine, to generate a complete vehicle model. The test weight used in the model will be based on the vehicle class, as identified above. Light-heavy-duty vehicles will have a test weight of 16,000 pounds; 25,150 pounds for medium heavy-duty vehicles; and heavy heavy-duty vocational vehicles will use a test weight of 67,000 pounds. The model would then be exercised over the HHDDT transient cycle as well as 55 and 65 mph steady-state cruise conditions. The results of each of the three tests would be weighted at 16%, 9%, and 75% for 65 mph, 55 mph, and transient tests, respectively. Innovative technology credits may be used to demonstrate compliance, however because the technology would not be an input into GEM, alternative procedures would be needed to determine the value of the credit as described in Preamble Section IV.

It may seem more expedient and just as accurate to require manufacturers use tires meeting certain industry standards for qualifying tires as having LRR. In addition, CO<sub>2</sub> and fuel consumption benefits could be quantified for different ranges of coefficients of rolling resistance to provide a means for comparison to the standard. However,

we believe that as technology advances, other aspects of vocational vehicles may warrant inclusion in future rulemakings. For this reason, we remain committed to having the certification framework in place to accommodate such additions. While the modeling approach may seem to be overly complicated for this phase of the rules, it also serves to create a certification pathway for future rulemakings and therefore we believe this is the best approach. Moreover, a design standard would discourage use of alternative technologies to meet the standard, and otherwise impede desirable flexibility.

In-use Standards

The category of wear items primarily relates to tires. It is expected that vehicle manufacturers will equip their trucks with LRR tires, since the final vehicle standard is predicated on LRR tire performance. The tire replacement intervals for this class of vehicle is normally in the range of 50,000 to 100,000 miles, which means the owner/operator will be replacing the tires at several points within the useful life of the vehicle. We believe that as LRR tires become more common on new equipment, the aftermarket prices of these tires will also decrease. Along with decreasing tire prices, the fuel savings realized through use of LRR tires will ideally provide enough incentive for owner/operators to continue purchasing these tires. The inventory modeling in this rulemaking package reflects the continued use of LRR tires through the life of the vehicle.

(ii) Evaporative Emission Standards

Evaporative and refueling emissions from heavy-duty highway engines and vehicles are currently regulated under 40 CFR part 86. Even though these emission standards apply to the same engines and vehicles that must meet exhaust emission standards, we require a separate certificate for complying with evaporative and refueling emission standards. An important related point to note is that the evaporative and refueling emission standards always apply to the vehicle, while the exhaust emission standards may apply to either the engine or the vehicle. For vehicles other than pickups and vans, the standards in this program to address greenhouse gas emissions apply separately to engines and to vehicles. Since we will be applying both greenhouse gas standards and evaporative/refueling emission standards to vehicle manufacturers, we believe it will be advantageous to have the regulations related to their certification requirements written

together as much as possible. EPA regards these final changes as discrete, minimal, and for the most part clarifications to the existing standards. We have not finalized any changes to the evaporative or refueling emission standards, but we have come across several provisions that warrant clarification or correction:

- When adopting the most recent evaporative emission change we did not carry through the changes to the regulatory text applying evaporative emission standards for methanol-fueled compression-ignition engine. The final regulations correct this by applying the new standards to all fuels that are subject to standards.
- We are finalizing provisions to address which standards apply when an auxiliary (nonroad) engine is installed in a motor vehicle, which is currently not directly addressed in the highway regulation. The final approach requires testing complete vehicles with any auxiliary engines (and the corresponding fuel-system components). Incomplete vehicles must be tested without the auxiliary engines, but any such engines and the corresponding fuel system components will need to meet the standards that apply under our nonroad program as specified in 40 CFR part 1060.
- We have removed the option for secondary vehicle manufacturers to use a larger fuel tank capacity than is specified by the certifying manufacturer without re-certifying the vehicle. Secondary vehicle manufacturers needing a greater fuel tank capacity will need to either work with the certifying manufacturer to include the larger tank, or go through the effort to re-certify the vehicle itself. Our understanding is that this provision has not been used and would be better handled as part of certification rather than managing a separate process. We are also finalizing corresponding changes to the emission control information label.
- Rewriting the regulations in a new part in conjunction with the greenhouse gas standards allows for some occasions of improved organization and clarity, as well as updating various provisions. For example, we have finalized a leaner description of evaporative emission families that does not reference sealing methods for carburetors or air cleaners. We have also clarified how evaporative emission standards affect engine manufacturers and are finalizing more descriptive provisions related to certifying vehicles above

26,000 pounds GVWR using engineering analysis.

- Since we adopted evaporative emission standards for gaseous-fuel vehicles, we have developed new approaches for design-based certification (see, for example, 40 CFR 1060.240). We request comment on changing the requirements related to certifying gaseous-fuel vehicles to design-based certification. This would allow for a simpler assessment for certifying these vehicles without changing the standards that apply.

#### (2) Final Labeling Provisions

It is crucial that a means exist for allowing field inspectors to identify whether a vehicle is certified, and if so, whether it is in the certified configuration. As with engines and tractors, we believe an emission control information label is a logical first step in facilitating this identification. For vocational vehicles, the engine will have a label that is permanently affixed to the engine and identify the engine as certified for use in a certain regulatory subcategory of vehicle (*i.e.*, MHD, *etc.*).

The vehicle will also have a label listing the manufacturer of the vehicle, vehicle family (and subfamily, if applicable), regulatory subcategory, date of manufacture, compliance statement, FEL, and emission control system identifiers. The required content of this label is consistent with the label description provided earlier for Class 7 and 8 tractors. Since LRR tires are expected to be the primary means for vehicles to comply, it is expected that LRR tires will be the only component identified as part of the emission control system on the label. For tires to qualify as low rolling resistance (for purposes of this vocational vehicle label), they need to have a coefficient of rolling resistance at or below 7.7 kg/metric ton. In addition, if any other emission related components are present, such as hybrid powertrains, key components will also need to be specified on the label. Like the engine label, this will need to be permanently affixed to the vehicle in an area that is clearly visible to the owner/operator. At the time of certification, manufacturers will be required to submit an example of their vehicle emission control label such that EPA can verify that all critical elements are present. In addition to the label, manufacturers will also need to describe where the unique vehicle identification number and date of production can be found on the vehicle.

#### (3) Other Certification Issues

##### Warranty

As with other heavy-duty engine and vehicle regulatory categories, vocational vehicle chassis manufacturers would be required to warrant their product to be free from defects that would result in noncompliance with emission standards. This warranty also covers the failure of emission related components for the warranty period of the vehicle. For vocational vehicles, this primarily applies to tires.

Manufacturers of chassis for vocational vehicles would be required to warrant tires to be free from defects at the time of initial sale. As with Class 7 and 8 combination tractors, we expect the chassis manufacturer to only warrant the original tires against manufacturing or design-related defects. This tire warranty would not cover replacement tires or damage from road hazards or improper inflation.

As with Class 7 and 8 combination tractors, all warranty documentation would be submitted to EPA at the time of certification. This should include the warranty statement provided to the owner/operator, description of the service repair network, list of covered components (both conventional and high-cost), and length of coverage.

##### EPA Certification Fees

Similar to engine and tractor-trailer vehicle certification, the agency will assess certification fees for vocational vehicles. The proceeds from these fees are used to fund the compliance and certification activities related to GHG regulation for this industry segment. In addition to the certification process, other activities funded by certification fees include EPA-administered in-use testing, selective enforcement audits, and confirmatory testing. At this point, the exact costs associated with the heavy-duty vehicle GHG compliance are not well known. EPA will assess its compliance program associated with this program and assess the appropriate level of fees. We anticipate that fees will be applied based on certification families, following the light-duty vehicle approach.

##### Maintenance

Vehicle manufacturers are required to outline a maintenance schedule that ensures the emission control system remains functional throughout the useful life of the vehicle. For vocational vehicles, this largely involves ensuring that customers have sufficient information to purchase replacement tires that meet or exceed original equipment specifications. As with Class

7 and 8 tractors, we believe that this information should be included in the owner's manual to the vehicle. This statement must be submitted to EPA at the time of certification to verify that the customer indeed has enough information to purchase the correct replacement tires.

#### F. General Regulatory Provisions

##### (1) Statutory Prohibited Acts

Section 203 of the CAA describes acts that are prohibited by law. This section and associated regulations apply equally to the greenhouse gas standards as to any other regulated emission. Acts that are prohibited by section 203 of the CAA include the introduction into commerce or the sale of an engine or vehicle without a certificate of conformity, removing or otherwise defeating emission control equipment, the sale or installation of devices designed to defeat emission controls, and other actions. In addition, vehicle manufacturers, or any other party, may not make changes to the certified engine that would result in it not being in the certified configuration.

EPA will apply § 86.1854–12 to heavy-duty vehicles and engines; this codifies the prohibited acts spelled out in the statute. Although it is not legally necessary to repeat what is in the CAA, EPA believes that including this language in the regulations provides clarity and improves the ease of use and completeness of the regulations. Since this change merely codifies provisions that already apply, there is no burden associated with the change.

##### (2) Regulatory Amendments Related to Heavy-Duty Engine Certification

We are adopting the new engine-based greenhouse gas emissions standards in 40 CFR part 1036 and the new vehicle-based standards in 40 CFR part 1037. We are continuing to rely on 40 CFR parts 85 and 86 for conventional certification and compliance provisions related to criteria pollutants, but the final regulations include a variety of amendments that will affect the provisions that apply with respect to criteria pollutants. We are not intending to change the stringency of, or otherwise substantively change any existing standards.

The introduction of new parts in the CFR is part of a long-term plan to migrate all the regulatory provisions related to highway and nonroad engine and vehicle emissions to a portion of the CFR called Subchapter U, which consists of 40 CFR parts 1000 through 1299. We have already adopted emission standards, test procedures, and

compliance provisions for several types of engines in 40 CFR parts 1033 through 1074. We intend eventually to capture all the regulatory requirements related to heavy-duty highway engines and vehicles in these new parts. Moving regulatory provisions to the new parts allows us to publish the regulations in a way that is better organized, reflects updates to various certification and compliance procedures, provides consistency with other engine programs, and is written in plain language. We have already taken steps in this direction for heavy-duty highway engines by adopting the engine-testing procedures in 40 CFR part 1065 and the provisions for selective enforcement audits in 40 CFR part 1068.

EPA sought comment on drafting changes and additions. This solicitation related solely to the appropriate migration, translation, and enhancement of existing provisions. EPA did not solicit comment on the substance of these existing rules, and did not amend, reconsider, or otherwise re-examine these provisions' substantive effect.

The rest of this section describes the most significant of these final redrafting changes. The proposal includes several changes to the certification and compliance procedures, including the following:

- We are requiring that engine manufacturers provide installation instructions to vehicle manufacturers (see § 1036.130). We expect this is already commonly done; however, the regulatory language spells out a complete list of information we believe is necessary to properly ensure that vehicle manufacturers install engines in a way that is consistent with the engine's certificate of conformity.

- § 1036.30, § 1036.250, and § 1036.825 spell out several detailed provisions related to keeping records and submitting information to us.

- We wrote the greenhouse gas regulations to divide heavy-duty engines into "spark-ignition" and "compression-ignition" engines, rather than "Otto-cycle" and "diesel" engines, to align with our terminology in all our nonroad programs. This will likely involve no effective change in categorizing engines except for natural gas engines. To address this concern, we are including a provision in § 1036.150 to allow manufacturers to meet standards for spark-ignition engines if they were regulated as Otto-cycle engines in 40 CFR part 86, and vice versa.

- § 1036.205 describes a new requirement for imported engines to describe the general approach to importation (such as identifying

authorized agents and ports of entry), and identifying a test lab in the United States where EPA can perform testing on certified engines. These steps are part of our ongoing effort to ensure that we have a compliance and enforcement program that is as effective for imported engines as for domestically produced engines. We have already adopted these same provisions for several types of nonroad engines.

- § 1036.210 specifies a process by which manufacturers are able to get preliminary approval for EPA decisions for questions that require lead time for preparing an application for certification. This might involve, for example, preparing a plan for durability testing, establishing engine families, identifying adjustable parameters, and creating a list of scheduled maintenance items.

- § 1036.225 describes how to amend an application for certification.

- We are revising 40 CFR 85.1701 to apply the exemption provisions described in 40 CFR part 1068 to heavy-duty highway engines starting in 2014. Manufacturers may optionally use the exemption provisions from part 1068 earlier. This involves only very minor changes in the terms and conditions associated with the various types of exemptions. This change will help us to implement a consistent compliance program for all engine and vehicle categories. We are similarly revising 40 CFR 85.1511 to reference the importation-related exemptions in part 1068 for all motor vehicles and motor vehicle engines.

- We are finalizing a provision allowing manufacturers to use the defect reporting provisions of 40 CFR part 1068 instead of those in 40 CFR part 85. This involves setting thresholds for investigating and reporting defects based on defect rates rather than absolute numbers of defects. Once we gain more experience with applying the defect-reporting provisions in 40 CFR part 1068 for motor vehicles, we will consider making those provisions mandatory, including any appropriate adjustments.

In addition, we are revising 40 CFR 1068.210 and 1068.325 to address a concern raised by engine manufacturers. The provisions for importing engines under a temporary exemption disallow selling exempted engines even though some of the situations addressed depend on engine sales (such as delegated assembly). We have added clarifying language to the individual exemptions to describe whether or how engines may be sold or leased. In the case of the testing exemption in § 1068.210, this involves a further change to specify how

a manufacturer must track the status and final disposition of exempted engines or equipment. We are also making a small change to the testing exemption to remove the administrative step of requiring an exchange of signed documents for the exemption to be effective. This will streamline the process for the testing exemption and make it more like that for other types of exemptions.

### (3) Test Procedures for Measuring Emissions From Heavy-Duty Vehicles

We are finalizing a new part 1066 that contains general chassis-based test procedures for measuring emissions from a variety of vehicles, including vehicles over 14,000 pounds GVWR. However, we are not finalizing application of these procedures broadly at this time. The test procedures in 40 CFR part 86 continue to apply for vehicles under 14,000 pounds GVWR. The final part 1066 procedures applies only for any testing that would be required for larger vehicles. This could include "A to B" hybrid vehicle testing, coastdown testing, and potentially limited innovative technology testing. Nevertheless, we will likely consider in the future applying these procedures also for other heavy-duty vehicle testing and for light-duty vehicles, highway motorcycles, and/or nonroad recreational vehicles that rely on chassis-based testing.

As noted above, engine manufacturers are already using the test procedures in 40 CFR part 1065 instead of those originally adopted in 40 CFR part 86. The new procedures are written to apply generically for any type of engine and include the current state of technology for measurement instruments, calibration procedures, and other practices. We are finalizing the chassis-based test procedures in part 1066 to have a similar structure.

The final procedures in part 1066 reference large portions of part 1065 to align test specifications that apply equally to engine-based and vehicle-based testing, such as CVS and analyzer specifications and calibrations, test fuels, calculations, and definitions of many terms. Since several highway engine manufacturers were involved in developing the full range of specified procedures in part 1065, we are confident that many of these provisions are appropriate without modification for vehicle testing.

The remaining test specifications needed in part 1066 are mostly related

to setting up, calibrating, and operating a chassis dynamometer. This also includes the coastdown procedures that are required for establishing the dynamometer load settings to ensure that the dynamometer accurately simulates in-use driving.

Current testing requirements related to dynamometer specifications rely on a combination of regulatory provisions, EPA guidance documents, and extensive know-how from industry experience that has led to a good understanding of best practices for operating a vehicle in the laboratory to measure emissions. We attempted in this rulemaking to capture this range of material, organizing these specifications and verification and calibration procedures to include a complete set of provisions to ensure that a dynamometer meeting these specifications would allow for carefully controlled vehicle operation such that emission measurements are accurate and repeatable.

The procedures are written with the understanding that heavy-duty highway manufacturers have, and need to have, single-roll electric dynamometers for testing. We are aware that this is not the case for other applications, such as all-terrain vehicles. We are not adopting specific provisions for testing with hydrokinetic dynamometers, we are already including a provision acknowledging that we may approve the use of dynamometers meeting alternative specifications if that is appropriate for the type of vehicle being tested and for the level of stringency represented by the corresponding emission standards.

Drafting a full set of test specifications highlights the mixed use of units for testing. Some chassis-based standards and procedures are written based largely on the International System of Units (SI), such as gram per kilometer (g/km) standards and kilometers per hour (kph) driving, while others are written based largely on English units (g/mile standards and miles per hour driving). The proposal includes a mix of SI and English units with instructions about converting units appropriately. However, most of the specifications and examples are written in English units. While this seems to be the prevailing practice for testing in the United States, we understand that vehicle testing outside the United States is almost universally done in SI units. In any case, dynamometers are produced with the capability of operating in either

English or SI units. We believe there would be a substantial advantage toward the goal of achieving globally harmonized test procedures if we would write the test procedures based on SI units. This would also in several cases allow for more straightforward calculations, and reduced risk of rounding errors. For comparison, part 1065 is written almost exclusively in SI units. We sought comment on the use of units throughout part 1066. At this time we are not finalizing changes from our current approach.

A fundamental obstacle toward using SI units is the fact that some duty cycles are specified based on speeds in miles per hour. To address this, it would be appropriate to convert the applicable driving schedules to meter-per-second (m/s) values. Converting speeds to the nearest 0.01 m/s would ensure that the prescribed driving cycle does not change with respect to driving schedules that are specified to the nearest 0.1 mph. The regulations would include the appropriate mph (or kph) speeds to allow for a ready understanding of speed values (see 40 CFR part 1037, Appendix I). This would, for example, allow for drivers to continue to follow a mph-based speed trace. The  $\pm 2$  mph tolerance on driving speeds could be converted to  $\pm 1.0$  m/s, which corresponds to an effective speed tolerance of  $\pm 2.2$  mph. This may involve a tightening or loosening of the existing speed tolerance, depending on whether manufacturers used the full degree of flexibility allowed for a mph tolerance value that is specified without a decimal place. Similarly, the Cruise cycles for heavy-duty vehicles could be specified as  $24.5 \pm 0.5$  m/s ( $54.8 \pm 1.1$  mph) and  $29.0 \pm 0.5$  m/s ( $64.9 \pm 1.1$  mph).

### (4) Compliance Reports

#### (a) Early Model Year Data

This information is the same as for tractors early model year data in Section V.D(4)(a).

#### (b) Final Reports

This information is the same as for tractors final reports in Section V.D(4)(b).

#### (c) Additional Required Information

Table V-7 below provides a summary of the types of requests, required application submission dates and the EPA and NHTSA regulations that apply.

TABLE V-7—SUMMARY OF REQUIRED INFORMATION FOR COMPLIANCE

Submission	Applies to	Required submissions date	EPA regulation reference	NHTSA regulation reference
Small business exemptions	Vehicle or engine manufacturers meeting the Small Business Administration (SBA) size criteria of a small business as described in 13 CFR 121.201.	Before introducing any excluded vehicle into U.S. commerce.	§ 1037.150	§ 535.8
Incentives for early introduction.	The provisions apply with respect to tractors and vocational vehicles produced in model years before 2014.	EPA must be notified before the manufacturer submits it applications for certificates of conformity.	§ 1037.150	§ 535.8
Air condition leakage exemption for vocational vehicles.	Vocational Vehicles excluded from § 1037.115.	EPA must be notified before the manufacturer submits it applications for certificates of conformity.	§ 1037.150	§ 535.8
Model year 2014 N <sub>2</sub> O standards.	Manufacturers that choose to show compliance with the MY 2014 N <sub>2</sub> O standards requesting to use an engineering analysis.	EPA must be notified before the manufacturer submits it applications for certificates of conformity.	§ 1037.150	§ 535.8
Exemption for electric vehicles.	All electric vehicles are deemed to have zero exhaust emissions of CO <sub>2</sub> , CH <sub>4</sub> , and N <sub>2</sub> O.	End of December prior to model year ..	§ 1037.150	§ 535.8
Off-road exemption .....	Manufacturers wanting to exclude vocational vehicles from vehicle standards.	EPA must be notified before the manufacturer submits it applications for certificates of conformity.	§ 1037.150	§ 535.8
Exemption from EOY reports.	Manufactures with surplus credits at the end of the model year.	90-days after the calendar year ends ..	§ 1037.730	§ 535.8

G. Penalties

(1) Overview

In the NPRM, NHTSA proposed to assess civil penalties for non-compliance with fuel consumption standards. NHTSA’s authority under EISA, as codified at 49 U.S.C. 32902(k), requires the agency to determine appropriate measurement metrics, test procedures, standards, and compliance and enforcement protocols for HD vehicles. NHTSA interprets its authority to develop an enforcement program to include the authority to determine and assess civil penalties for noncompliance that would impose penalties based on the following discussions.

In cases of noncompliance, the agency explained in the NPRM that it would establish civil penalties based on consideration of the following factors:

- Gravity of the violation.
- Size of the violator’s business.
- Violator’s history of compliance with applicable fuel consumption standards.
- Actual fuel consumption performance related to the applicable standard.
- Estimated cost to comply with the regulation and applicable standard.
- Quantity of vehicles or engines not complying.
- Civil penalties paid under CAA section 205 (42 U.S.C. 7524) for non-compliance for the same vehicles or engines.

NHTSA proposed to consider these factors in determining civil penalties in order to help ensure, given the agency’s

wide discretion, that penalties would be fair and appropriate, and not duplicative of EPA penalties. The NPRM expressly stated that neither agency intended to impose duplicative civil penalties, and that both agencies would give consideration to civil penalties imposed by the other in the case of non-compliance with its own regulations. See NPRM at 74280.

EMA, Volvo, the Truck Renting and Leasing Association (TRALA), and Navistar nevertheless commented that a dual enforcement scheme with separate NHTSA and EPA penalties could result in duplicative penalties, as manufacturers could be assessed penalties twice for the same violation.

The possibility of more than one prosecution or enforcement action arising from the same overall body of facts does not present a novel issue. It commonly arises where there is overlapping jurisdiction, such as where the federal government and a state government have jurisdiction. The issue of multiple or sequential prosecutions may be addressed as a matter of administrative policy and discretion.<sup>319</sup>

Both NHTSA and EPA are charged with regulating medium-duty and heavy-duty trucks; NHTSA regulates them under EISA and EPA regulates

them under the CAA. Both agencies also have compliance review and enforcement responsibilities for their respective regulatory requirements. The same set of underlying facts may result in a violation of EISA and a violation of the CAA. The agencies recognize the above concerns, and intend to address them through appropriate consultation. The details of the consultation and coordination between the agencies regarding enforcement will be set forth in a memorandum of understanding to be developed by EPA and NHTSA.

NHTSA believes that the above description adequately describes the process by which civil penalties may be assessed by both agencies. Therefore, for the final action, penalties for a violation of a fuel consumption standard will be based on the gravity of the violation, the size of the violator’s business, the violator’s history of compliance with applicable fuel consumption standards, the actual fuel consumption performance related to the applicable standard, the estimated cost to comply with the regulation and applicable standard, and the quantity of vehicles or engines not complying. The collaborative enforcement process will ensure that the total penalties assessed will not be duplicative or excessive.

NHTSA would also like to clarify that the “estimated cost to comply with the regulation and applicable standard,” will be used to ensure that penalties for non-compliance will not be less than the cost of compliance. It would be contrary to the purpose of the regulation

<sup>319</sup> A well-known example is the Department of Justice’s petite policy, an internal guide on whether to pursue federal prosecution after a state prosecution. The petite policy is considered “merely a housekeeping provision,” and prosecution remains entirely within the Department’s discretion. *U.S. v. Barrett*, 496 F.3d 1079, 1120 (10th Cir. 2007).

for the penalty scheme to incentivize noncompliance.

The final civil penalty amount NHTSA could impose would not exceed the limit that EPA is authorized to impose under the CAA. The potential maximum civil penalty for a manufacturer would be calculated as follows in Equation V-1:

**Equation V-1: Aggregate Maximum Civil Penalty**

Aggregate Maximum Civil Penalty for a Non-Compliant Regulatory Category = (CAA Limit) × (production volume within the regulatory category)

EPA has occasionally in the past conducted rulemakings to provide for nonconformance penalties—monetary penalties that allow a manufacturer to sell engines or vehicles that do not meet an emissions standard. Nonconformance penalties are authorized for heavy-duty engines and vehicles under section 206(g) of the CAA. Three basic criteria have been established by rulemaking for determining the eligibility of emissions standards for nonconformance penalties in any given model year: (1) The emissions standard in question must become more difficult to meet, (2) substantial work must be required in order to meet the standard, and (3) a technological laggard must be likely to develop (40 CFR 86.1103–87). A technological laggard is a manufacturer who cannot meet a particular emissions standard due to technological (not economic) difficulties and who, in the absence of nonconformance penalties, might be forced from the marketplace. The process to determine if these criteria are met and to establish penalty amounts and conditions is carried out via rulemaking, as required by the CAA. The CAA (in section 205) also lays out requirements for the assessment of civil penalties for noncompliance with emissions standards.

As discussed in detail in Section III, the agencies have determined that the final GHG and fuel consumption standards are readily feasible, and we do not believe a technological laggard will emerge in any sector covered by these final standards. In addition to the standards being premised on use of already-existing, cost-effective technologies, there are a number of flexibilities and alternative standards built into the proposal. However, in the case of potential non-conformance, civil penalties will ensure that adequate deterrence for non-conformance exists.

(2) NHTSA's Penalty Process

NHTSA proposed a detailed enforcement process in the NPRM. As

proposed, enforcement would begin with a notice of violation, after which the respondent may either pay the penalty proposed in the notice of violation or dispute it by requesting an agency hearing. For a party that did not pay the proposed penalty or request a hearing within 30 days of the notice of violation, a finding of default would be entered and the penalty set forth in the notice of violation assessed. If a hearing is timely requested, the respondent would receive written notice of the time, date and location of the hearing. The respondent would have the right to counsel and to examine, respond to and rebut evidence presented by the Chief Counsel. If civil penalties greater than \$250,000,000 were assessed in the Hearing Officer's final order, that order would contain a statement advising the party of the right to appeal to the NHTSA Administrator. In the event of a timely appeal, the decision of the Administrator would be a final agency action. This structure was intended to ensure that a party was afforded ample opportunity to be heard.

Several manufacturers commented that NHTSA's penalty procedures should be more formal than was proposed in the NPRM. EMA, Volvo and Navistar commented that the penalty procedures should be subject to the Administrative Procedure Act (APA) review requirements. EMA, Volvo and Navistar, and TRALA commented that the penalty procedures violated due process requirements. EMA argued that NHTSA must expressly grant a right to judicial review, and EMA and Navistar argued that the absence of an administrative appeals process for penalties under \$250,000,000 would violate due process. Volvo faulted NHTSA for not classifying the hearing officer's decision as a final agency action, and stated that specifications regarding who could be a hearing officer should align with those specified for the light-duty program, which was laid out in 49 CFR 511.3.

As noted in the NPRM, the APA administrative hearing requirements of Sections 554, 556, and 557 are not required where formal procedures are not required by statute (generally, the organic statute must provide that the administrative proceeding must be an adjudication, determined on the record after the opportunity for an agency hearing, sometimes referenced as an opportunity for hearing on the record). See e.g., 5 U.S.C. Section 554. Where a formal adjudication is not required by statute, in general, agencies adopt and apply informal processes. While the compliance, civil penalty and appeals provisions of 49 U.S.C. Sections 32911

and 32914 require formal adjudication in accordance with APA requirements, those sections only apply to the light-duty fuel economy program. In contrast, for the heavy-duty program of Section 32902(k), the Congress did not require formal adjudication in accordance with the APA. Therefore, informal adjudication procedures may be applied. NHTSA will not adopt the procedures of 5 U.S.C. Sections 554, 556, or 557 for the final rule.

While the APA requirements for formal hearing procedures do not apply to NHTSA's enforcement under Section 32902(k), due process requirements do apply. NHTSA believes that formal procedures are neither required by statute nor necessary for this enforcement process to meet due process requirements. NHTSA expects that the cases will not be complex. In general, there will be one or two issues: (1) Compliance with the regulations and, if not, (2) the appropriate civil penalty. Compliance likely will involve narrow technical questions under the regulations being adopted today. Non-compliance with applicable fuel consumption standards will be determined by utilizing the certified and reported CO<sub>2</sub> emissions and fuel consumption data provided by EPA as described in this part, and after considering all the flexibilities available under Section 535.7. Much of the evidence will be materials developed by the respondent. There likely will not be wide ranging issues. The parties will have ample opportunity to present their positions. A hearing officer can readily address the sorts of questions that are likely to arise. Second, if there is a noncompliance, there will be the question of the appropriate penalty. NHTSA's regulations contain factors to be considered in assessing penalties. Again, the parties will have ample opportunity to present their positions. Ultimately, the agency's final decision must be sufficiently reasoned to withstand judicial review, based on the arbitrary and capricious standard.

To address commenters' concerns about the process provided, NHTSA made several adjustments and clarifications in the final rule. The final rule provides that there will be a written decision of the Hearing Officer, and the assessment of a civil penalty by a hearing officer shall be set forth in an accompanying final order. Together, these constitute the final agency action. NHTSA has also revisited the minimum penalty level for an administrative appeal to the NHTSA Administrator and decided to lower the level significantly, to \$1,000,000. This provides a second level of review. NHTSA believes this

will promote an efficient use of administrative remedies and a further opportunity to be heard at the administrative level. Of course, if a party files an appeal with the NHTSA Administrator, the Hearing Officer's decision and order at that juncture shall no longer be final agency action.

NHTSA has considered the specifications of the Hearing Officer and determined that they are adequate for informal agency hearings of this nature. However, the agency will add a clarification to the final rule that specifies that the Hearing Officer will be appointed by the Administrator. Further, in addition to having no prior connection with the case and no responsibility, direct or supervisory, for the investigation of cases referred for the assessment of civil penalties, the Hearing Officer will have no duties related to the light-duty fuel economy or medium- and heavy-duty fuel efficiency programs.

NHTSA has also considered EMA's comment that a right to judicial review must be specified in the regulatory text. The agency does not agree with this concern. Parties, of course, cannot confer jurisdiction; only Congress can do so. *Whitman v. Department of Transportation*, 547 U.S. 512, 514 (2006); *Weinberger v. Bentex Pharmaceuticals, Inc.*, 412 U.S. 645, 652 (1973). Moreover, judicial review of a final agency action is presumed. *United States v. Fausto*, 484 U.S. 439, 452 (1998), citing *Abbot Laboratories v. Gardner*, 387 U.S. 136, 140 (1967). See generally, 28 U.S.C. Section 1331. Therefore, NHTSA has determined that the right to judicial review does not need to be specified in the regulatory text.

**VI. How will this program impact fuel consumption, GHG emissions, and climate change?**

*A. What methodologies did the agencies use to project GHG emissions and fuel consumption impacts?*

EPA and NHTSA used EPA's official mobile source emissions inventory model named Motor Vehicle Emissions Simulator (MOVES2010),<sup>320</sup> to estimate emission and fuel consumption impacts of these final rules. MOVES has the capability to take in user inputs to modify default data to better estimate emissions for different scenarios, such as different regulatory alternatives, state implementation plans (SIPs), geographic locations, vehicle activity, and microscale projects.

The agencies performed multiple MOVES runs to establish reference case and control case emission inventories and fuel consumption values. The agencies ran MOVES with user input databases that reflected characteristics of the final rules, such as emissions improvements and recent sales projections. Some post-processing of the model output was required to ensure proper results. The agencies ran MOVES for non-GHGs, CO<sub>2</sub>, CH<sub>4</sub>, and N<sub>2</sub>O for calendar years 2005, 2018, 2030, and 2050. Additional runs were performed for just the three greenhouse gases and for fuel consumption for every calendar year from 2014 to 2050, inclusive, which fed the economy-wide modeling, monetized greenhouse gas benefits estimation, and climate impacts analyses.

The agencies also used MOVES to estimate emissions and fuel consumption impacts for the other alternatives considered and described in Section IX.

*B. MOVES Analysis*

(i) Inputs and Assumptions

The analysis performed for the final action mirrors what was done for the

proposal. The methods and models are the same, with differences lying primarily in the inputs, as a result of updates in the program, standards, and baseline data.

(a) Reference Run Updates

Since MOVES2010a vehicle sales and activity data were developed from AEO2009, EPA first updated these data using sales and activity estimates from AEO2011. MOVES2010a defaults were used for all other parameters to estimate the reference case emissions inventories.

(b) Control Run Updates

EPA developed additional user input data for MOVES runs to estimate control case inventories. To account for improvements of engine and vehicle efficiency, EPA developed several user inputs to run the control case in MOVES. As explained at proposal, since MOVES does not operate based on Heavy-duty FTP cycle results, EPA used the percent reduction in engine CO<sub>2</sub> emissions expected due to the final rules to develop energy inputs for the control case runs. 75 FR at 74280. Also, EPA used the percent reduction in aerodynamic drag and tire rolling resistance coefficients and reduction in average total running weight (gross combined weight) expected from the final rules to develop road load input for the control case. The sales and activity data updates used in the reference case were used in the control case. Details of all the MOVES runs, input data tables, and post-processing steps are available in the docket (EPA-HQ-OAR-2010-0162).

Table VI-1 and Table VI-2 describe the estimated expected reductions from these final rules, which were input into MOVES for estimating control case emissions inventories.

TABLE VI-1—ESTIMATED REDUCTIONS IN ENGINE CO<sub>2</sub> EMISSION RATES<sup>321</sup>

GVWR class	Fuel	Model years	CO <sub>2</sub> reduction from 2010 MY
HHD (Class 8a-8b)	Diesel	2014-2016	3%
		2017+	6%
MHD (Class 6-7) and LHD (Class 4-5)	Diesel	2014-2016	5%
		2017+	9%
		2016+	5%
	Gasoline		

<sup>320</sup> MOVES homepage: <http://www.epa.gov/otaq/models/moves/index.htm>. Version MOVES2010 was used for emissions impacts analysis for this action. Current version as of September 14, 2010 is an updated version named MOVES2010a, available

directly from the MOVES homepage. To replicate results from this action, MOVES2010 must be used.

<sup>321</sup> Section II of this preamble discusses an alternative engine standard for the HD diesel engines in the 2014, 2015, and 2016 model years.

To the extent that engines using this alternative are expected to have baseline emissions greater than the industry average, the reduction from the industry average projected in this program would be reduced.



TABLE VI-2—ESTIMATED REDUCTIONS IN ROLLING RESISTANCE COEFFICIENT, AERODYNAMIC DRAG COEFFICIENT, AND GROSS COMBINED WEIGHT

Truck type	Reduction in tire CRR from baseline (percent)	Reduction in Cd from baseline (percent)	Weight reduction (lbs.)
Combination long-haul .....	9.6	12.1	400
Combination short-haul .....	7.0	5.9	321
Straight trucks, refuse trucks, motor homes, transit buses, and other vocational vehicles .....	5.0	0	0

Since nearly all HD pickup trucks and vans will be certified on a chassis dynamometer, the CO<sub>2</sub> reductions for these vehicles will not be represented as engine and road load reduction components, but rather as total vehicle CO<sub>2</sub> reductions. These estimated reductions are described in Table VI-3.

TABLE VI-3—ESTIMATED TOTAL VEHICLE CO<sub>2</sub> REDUCTIONS FOR HD PICKUP TRUCKS AND VANS

GVWR Class	Fuel	Model year	CO <sub>2</sub> reduction from baseline (percent)
HD Pickup Trucks and Vans .....	Gasoline .....	2014	1.5
		2015	2
		2016	4
		2017	6
		2018+	10
	Diesel .....	2014	2.3
		2015	3
		2016	6
		2017	9
		2018+	15

C. What are the projected reductions in fuel consumption and GHG emissions?

EPA and NHTSA expect significant reductions in GHG emissions and fuel consumption from these final rules—emission reductions from both downstream (tailpipe) and upstream (fuel production and distribution) sources, and fuel consumption reductions from more efficient vehicles. Increased vehicle efficiency and reduced vehicle fuel consumption will also reduce GHG emissions from upstream sources. The following subsections summarize the GHG emissions and fuel consumption reductions expected from these final rules.

(1) Downstream (Tailpipe)

Consistent with the proposal, EPA used MOVES to estimate downstream GHG inventories from these final rules. We expect reductions in CO<sub>2</sub> from all heavy-duty vehicle categories. The reductions come from engine and

vehicle improvements. EPA expects N<sub>2</sub>O emissions to increase very slightly because of a rebound in vehicle miles traveled (VMT) and because significant vehicle emissions reductions are not expected from these final rules. In the proposal, we did not account for differences in methane emissions from use of auxiliary power units (APUs) during extended idling from sleeper cab combination tractors. After accounting for these differences, EPA expects methane emissions to decrease primarily due to differences in hydrocarbon emission characteristics between on-road diesel engines and APUs. The amount of methane emitted as a fraction of total hydrocarbons is significantly less for APUs than for diesel engines equipped with diesel particulate filters. Overall, downstream GHG emissions will be reduced significantly and are described in the following subsections.

For CO<sub>2</sub> and fuel consumption, the total energy consumption “pollutant”

was run in MOVES rather than CO<sub>2</sub> itself. The energy was converted to fuel consumption based on fuel heating values assumed in the Renewable Fuels Standard and used in the development of MOVES emission and energy rates. These values are 117,250 kJ/gallon for gasoline blended with ten percent ethanol (E10)<sup>322</sup> and 138,451 kJ/gallon for diesel.<sup>323</sup> To calculate CO<sub>2</sub>, the agencies assumed a CO<sub>2</sub> content of 8,576 g/gallon for E10 and 10,180 g/gallon for diesel. Table VI-4 shows the fleet-wide GHG reductions and fuel savings from reference case to control case through the lifetime of model year 2014 through 2018 heavy-duty vehicles. Table VI-5 shows the downstream GHG emissions reductions and fuel savings in 2018, 2030, and 2050. The analysis follows what was done for the proposal. We did not receive comments indicating that this analysis was inappropriate or insufficient for estimating downstream emissions impacts of this program.

<sup>322</sup> Renewable Fuels Standards assumptions of 115,000 BTU/gallon gasoline (E0) and 76,330 BTU/

gallon ethanol (E100) weighted 90% and 10%, respectively, and converted to kJ at 1.055 kJ/BTU.

<sup>323</sup> MOVES2004 Energy and Emission Inputs. EPA420-P-05-003, March 2005. <http://www.epa.gov/otaq/models/ngm/420p05003.pdf>.

TABLE VI-4—MODEL YEAR 2014 THROUGH 2018 LIFETIME GHG REDUCTIONS AND FUEL SAVINGS BY HEAVY-DUTY TRUCK CATEGORY

	Downstream GHG reductions (MMT CO <sub>2</sub> eq)	Fuel Savings (billion gallons)
HD pickups/vans .....	18	1.9
Vocational .....	24	2.4
Combination short-haul (Day cabs) .....	50	4.9
Combination long-haul (Sleeper cabs) .....	135	12.9

TABLE VI-5—ANNUAL DOWNSTREAM GHG EMISSIONS REDUCTIONS AND FUEL SAVINGS IN 2018, 2030, AND 2050

	Downstream GHG reductions (MMT CO <sub>2</sub> eq)	Diesel Savings (million gallons)	Gasoline Savings (million gallons)
2018 .....	22	2,123	59
2030 .....	61	5,670	349
2050 .....	89	8,158	522

(2) Upstream (Fuel Production and Distribution)

Using the same approach as used in the NPRM, the upstream GHG emission reductions associated with the production and distribution of fuel were projected using emission factors from DOE's "Greenhouse Gases, Regulated Emissions, and Energy Use in Transportation" (GREET1.8) model,

with some modifications consistent with the Light-Duty 2012–2016 MY vehicle rule. More information regarding these modifications can be found in the RIA Chapter 5. These estimates include both international and domestic emission reductions, since reductions in foreign exports of finished gasoline and/or crude make up a significant share of the fuel savings

resulting from the GHG standards. Thus, significant portions of the upstream GHG emission reductions will occur outside of the United States; a breakdown and discussion of projected international versus domestic reductions is included in the RIA Chapter 5. GHG emission reductions from upstream sources can be found in Table VI-6.

TABLE VI-6—ANNUAL UPSTREAM GHG EMISSIONS REDUCTIONS IN 2018, 2030, AND 2050

	CO <sub>2</sub> (MMT)	CH <sub>4</sub> (MMT CO <sub>2</sub> eq)	N <sub>2</sub> O (MMT CO <sub>2</sub> eq)	Total GHG (MMT CO <sub>2</sub> eq)
2018 .....	5.1	0.9	0.02	6.0
2030 .....	12.2	1.9	0.06	14.2
2050 .....	16.4	2.5	0.08	19.0

(3) HFC Emissions

Based on projected HFC emission reductions due to the final AC leakage standards, EPA estimates the HFC reductions to be 120,000 metric tons of CO<sub>2</sub>eq in 2018, 440,000 metric tons of CO<sub>2</sub>eq emissions in 2030 and 600,000 metric tons CO<sub>2</sub>eq in 2050, as detailed in RIA Chapter 5.3.4.

(4) Total (Upstream + Downstream + HFC)

Table VI-7 combines downstream results from Table VI-5, upstream results Table VI-6, and HFC results to show total GHG reductions for calendar years 2018, 2030, and 2050.

TABLE VI-7—ANNUAL TOTAL GHG EMISSIONS REDUCTIONS IN 2018, 2030, AND 2050

	GHG reductions (MMT CO <sub>2</sub> eq)
2018 .....	29
2030 .....	76
2050 .....	108

D. Overview of Climate Change Impacts From GHG Emissions

Once emitted, GHGs that are the subject of this regulation can remain in the atmosphere for decades to millennia, meaning that 1) their concentrations become well-mixed throughout the global atmosphere regardless of emission origin, and 2) their effects on climate are long lasting. GHG emissions come mainly from the combustion of fossil fuels (coal, oil, and gas), with additional contributions from the clearing of forests and agricultural

activities. Transportation activities, in aggregate, are the second largest contributor to total U.S. GHG emissions (27 percent of total emissions) despite a decline in emissions from this sector during 2008.<sup>324</sup>

This section provides a summary of observed and projected changes in GHG emissions and associated climate change impacts. The source document for the section below is the Technical Support Document (TSD)<sup>325</sup> for EPA's Endangerment and Cause or Contribute Findings Under the Clean Air Act (74 FR 66496, December 15, 2009). Below is the Executive Summary of the TSD which provides technical support for the endangerment and cause or contribute analyses concerning GHG emissions under section 202(a) of the CAA. The TSD reviews observed and

<sup>324</sup> U.S. EPA (2010) Inventory of U.S. Greenhouse Gas Emissions and Sinks: 1990–2007. EPA-430-R-10-006, Washington, DC.

<sup>325</sup> See Endangerment TSD, Note 10 above.

projected changes in climate based on current and projected atmospheric GHG concentrations and emissions, as well as the related impacts and risks from climate change that are projected in the absence of GHG mitigation actions, including this program and other U.S. and global actions. The TSD was updated and revised based on expert technical review and public comment as part of EPA's rulemaking process for the final Endangerment Findings. The key findings synthesized here and the information throughout the TSD are primarily drawn from the assessment reports of the Intergovernmental Panel on Climate Change (IPCC), the U.S. Climate Change Science Program (CCSP), the U.S. Global Change Research Program (USGCRP), and NRC.<sup>326</sup>

In May 2010, the NRC published its comprehensive assessment, "Advancing the Science of Climate Change."<sup>327</sup> It concluded that "climate change is occurring, is caused largely by human activities, and poses significant risks for—and in many cases is already affecting—a broad range of human and natural systems." Furthermore, the NRC stated that this conclusion is based on findings that are "consistent with the conclusions of recent assessments by the U.S. Global Change Research Program, the Intergovernmental Panel on Climate Change's Fourth Assessment Report, and other assessments of the state of scientific knowledge on climate change." These are the same assessments that served as the primary scientific references underlying the Administrator's Endangerment Finding. Importantly, this recent NRC assessment represents another independent and critical inquiry of the state of climate change science, separate and apart from the previous IPCC and USGCRP assessments.

#### (1) Observed Trends in Greenhouse Gas Emissions and Concentrations

The primary long-lived GHGs directly emitted by human activities include CO<sub>2</sub>, CH<sub>4</sub>, N<sub>2</sub>O, HFCs, PFCs, and SF<sub>6</sub>. Greenhouse gases have a warming effect by trapping heat in the atmosphere that would otherwise escape to space. In 2007, U.S. GHG emissions were 7,150

teragrams<sup>328</sup> of CO<sub>2</sub> equivalent<sup>329</sup> (TgCO<sub>2</sub>eq). The dominant gas emitted is CO<sub>2</sub>, mostly from fossil fuel combustion. Methane is the second largest component of U.S. emissions, followed by N<sub>2</sub>O and the fluorinated gases (HFCs, PFCs, and SF<sub>6</sub>). Electricity generation is the largest emitting sector (34 percent of total U.S. GHG emissions), followed by transportation (27 percent) and industry (19 percent).

Transportation sources under section 202(a)<sup>330</sup> of the CAA (passenger cars, light-duty trucks, other trucks and buses, motorcycles, and passenger cooling) emitted 1,649 TgCO<sub>2</sub>eq in 2007, representing 23 percent of total U.S. GHG emissions. U.S. transportation sources under section 202(a) made up 4.3 percent of total global GHG emissions in 2005,<sup>331</sup> which, in addition to the United States as a whole, ranked only behind total GHG emissions from China, Russia, and India but ahead of Japan, Brazil, Germany, and the rest of the world's countries. In 2005, total U.S. GHG emissions were responsible for 18 percent of global emissions, ranking only behind China, which was responsible for 19 percent of global GHG emissions. The scope of this final action focuses on GHG emissions under section 202(a) from heavy-duty source categories (see Section II).

The global atmospheric CO<sub>2</sub> concentration has increased about 38 percent from pre-industrial levels to 2009, and almost all of the increase is due to anthropogenic emissions. The global atmospheric concentration of CH<sub>4</sub> has increased by 149 percent since pre-industrial levels (through 2007); and the N<sub>2</sub>O concentration has increased by 23 percent (through 2007). The observed concentration increase in these gases can also be attributed primarily to anthropogenic emissions. The industrial fluorinated gases, HFCs, PFCs, and SF<sub>6</sub>, have relatively low atmospheric

<sup>328</sup> One teragram (Tg) = 1 million metric tons. 1 metric ton = 1,000 kilograms = 1.102 short tons = 2,205 pounds.

<sup>329</sup> Long-lived GHGs are compared and summed together on a CO<sub>2</sub>-equivalent basis by multiplying each gas by its global warming potential (GWP), as estimated by IPCC. In accordance with United Nations Framework Convention on Climate Change (UNFCCC) reporting procedures, the U.S. quantifies GHG emissions in the official U.S. greenhouse gas inventory submission to the UNFCCC using the 100-year time frame values for GWPs established in the 1996 IPCC Second Assessment Report.

<sup>330</sup> Source categories under Section 202(a) of the CAA are a subset of source categories considered in the transportation sector and do not include emissions from non-highway sources such as boats, rail, aircraft, agricultural equipment, construction/mining equipment, and other off-road equipment.

<sup>331</sup> More recent emission data are available for the United States and other individual countries, but 2005 is the most recent year for which data for all countries and all gases are available.

concentrations but the total radiative forcing due to these gases is increasing rapidly; these gases are almost entirely anthropogenic in origin.

Historic data show that current atmospheric concentrations of the two most important directly emitted, long-lived GHGs (CO<sub>2</sub> and CH<sub>4</sub>) are well above the natural range of atmospheric concentrations compared to at least the last 650,000 years. Atmospheric GHG concentrations have been increasing because anthropogenic emissions have been outpacing the rate at which GHGs are removed from the atmosphere by natural processes over timescales of decades to centuries.

#### (2) Observed Effects Associated With Global Elevated Concentrations of GHGs

Greenhouse gases, at current (and projected) atmospheric concentrations, remain well below published exposure thresholds for any direct adverse health effects and are not expected to pose exposure risks (*i.e.*, from breathing/inhalation).

The global average net effect of the increase in atmospheric GHG concentrations, plus other human activities (*e.g.*, land-use change and aerosol emissions), on the global energy balance since 1750 has been one of warming. This total net heating effect, referred to as forcing, is estimated to be +1.6 (+0.6 to +2.4) watts per square meter (W/m<sup>2</sup>), with much of the range surrounding this estimate due to uncertainties about the cooling and warming effects of aerosols. However, as aerosol forcing has more regional variability than the well-mixed, long-lived GHGs, the global average might not capture some regional effects. The combined radiative forcing due to the cumulative (*i.e.*, 1750 to 2005) increase in atmospheric concentrations of CO<sub>2</sub>, CH<sub>4</sub>, and N<sub>2</sub>O is estimated to be +2.30 (+2.07 to +2.53) W/m<sup>2</sup>. The rate of increase in positive radiative forcing due to these three GHGs during the industrial era is very likely to have been unprecedented in more than 10,000 years.

Warming of the climate system is unequivocal, as is now evident from observations of increases in global average air and ocean temperatures, widespread melting of snow and ice, and rising global average sea level. Global mean surface temperatures have risen by 1.3 ± 0.32 °F (0.74 °C ± 0.18 °C) over the last 100 years. Nine of the 10 warmest years on record have occurred since 2001. Global mean surface temperature was higher during the last few decades of the 20th century than during any comparable period during the preceding four centuries.

<sup>326</sup> For a complete list of core references from IPCC, USGCRP/CCSP, NRC and others relied upon for development of the TSD for EPA's Endangerment and Cause or Contribute Findings See section 1(b), specifically, Table 1.1 of the TSD Docket: EPA-HQ-OAR-2009-0171-11645.

<sup>327</sup> National Research Council (NRC) (2010). *Advancing the Science of Climate Change*. National Academy Press. Washington, DC.

Most of the observed increase in global average temperatures since the mid-20th century is very likely due to the observed increase in anthropogenic GHG concentrations. Climate model simulations suggest natural forcing alone (*i.e.*, changes in solar irradiance) cannot explain the observed warming.

U.S. temperatures also warmed during the 20th and into the 21st century; temperatures are now approximately 1.3 °F (0.7 °C) warmer than at the start of the 20th century, with an increased rate of warming over the past 30 years. Both the IPCC<sup>332</sup> and the CCSP reports attributed recent North American warming to elevated GHG concentrations. In the CCSP (2008) report,<sup>333</sup> the authors find that for North America, “more than half of this warming [for the period 1951–2006] is likely the result of human-caused greenhouse gas forcing of climate change.”

Observations show that changes are occurring in the amount, intensity, frequency and type of precipitation. Over the contiguous United States, total annual precipitation increased by 6.1 percent from 1901 to 2008. It is likely that there have been increases in the number of heavy precipitation events within many land regions, even in those where there has been a reduction in total precipitation amount, consistent with a warming climate.

There is strong evidence that global sea level gradually rose in the 20th century and is currently rising at an increased rate. It is not clear whether the increasing rate of sea level rise is a reflection of short-term variability or an increase in the longer-term trend. Nearly all of the Atlantic Ocean shows sea level rise during the last 50 years with the rate of rise reaching a maximum (over 2 millimeters [mm] per year) in a band along the U.S. east coast running east-northeast.

Satellite data since 1979 show that annual average Arctic sea ice extent has shrunk by 4.1 percent per decade. The size and speed of recent Arctic summer

sea ice loss is highly anomalous relative to the previous few thousands of years.

Widespread changes in extreme temperatures have been observed in the last 50 years across all world regions, including the United States. Cold days, cold nights, and frost have become less frequent, while hot days, hot nights, and heat waves have become more frequent.

Observational evidence from all continents and most oceans shows that many natural systems are being affected by regional climate changes, particularly temperature increases. However, directly attributing specific regional changes in climate to emissions of GHGs from human activities is difficult, especially for precipitation.

Ocean CO<sub>2</sub> uptake has lowered the average ocean pH (increased acidity) level by approximately 0.1 since 1750. Consequences for marine ecosystems can include reduced calcification by shell-forming organisms, and in the longer term, the dissolution of carbonate sediments.

Observations show that climate change is currently affecting U.S. physical and biological systems in significant ways. The consistency of these observed changes in physical and biological systems and the observed significant warming likely cannot be explained entirely due to natural variability or other confounding non-climate factors.

### (3) Projections of Future Climate Change With Continued Increases in Elevated GHG Concentrations

Most future scenarios that assume no explicit GHG mitigation actions (beyond those already enacted) project increasing global GHG emissions over the century, with climbing GHG concentrations. Carbon dioxide is expected to remain the dominant anthropogenic GHG over the course of the 21st century. The radiative forcing associated with the non-CO<sub>2</sub> GHGs is still significant and increasing over time.

Future warming over the course of the 21st century, even under scenarios of low-emission growth, is very likely to be greater than observed warming over the past century. According to climate model simulations summarized by the IPCC,<sup>334</sup> through about 2030, the global warming rate is affected little by the

choice of different future emissions scenarios. By the end of the 21st century, projected average global warming (compared to average temperature around 1990) varies significantly depending on the emission scenario and climate sensitivity assumptions, ranging from 3.2 to 7.2 °F (1.8 to 4.0 °C), with an uncertainty range of 2.0 to 11.5 °F (1.1 to 6.4 °C).

All of the United States is very likely to warm during this century, and most areas of the United States are expected to warm by more than the global average. The largest warming is projected to occur in winter over northern parts of Alaska. In western, central and eastern regions of North America, the projected warming has less seasonal variation and is not as large, especially near the coast, consistent with less warming over the oceans.

It is very likely that heat waves will become more intense, more frequent, and longer lasting in a future warm climate, whereas cold episodes are projected to decrease significantly.

Increases in the amount of precipitation are very likely in higher latitudes, while decreases are likely in most subtropical latitudes and the southwestern United States, continuing observed patterns. The mid-continental area is expected to experience drying during summer, indicating a greater risk of drought.

Intensity of precipitation events is projected to increase in the United States and other regions of the world. More intense precipitation is expected to increase the risk of flooding and result in greater runoff and erosion that has the potential for adverse water quality effects.

It is likely that hurricanes will become more intense, with stronger peak winds and more heavy precipitation associated with ongoing increases of tropical sea surface temperatures. Frequency changes in hurricanes are currently too uncertain for confident projections.

By the end of the century, global average sea level is projected by IPCC<sup>335</sup> to rise between 7.1 and 23 inches (18 and 59 centimeter [cm]), relative to around 1990, in the absence of increased dynamic ice sheet loss. Recent rapid changes at the edges of the Greenland and West Antarctic ice sheets

<sup>332</sup> Hegerl, G.C. *et al.* (2007) Understanding and Attributing Climate Change. In: *Climate Change 2007: The Physical Science Basis*. Contribution of Working Group I to the Fourth Assessment Report of the Intergovernmental Panel on Climate Change [Solomon, S., D. Qin, M. Manning, Z. Chen, M. Marquis, K.B. Averyt, M. Tignor, and H.L. Miller (eds.)]. Cambridge University Press, Cambridge, United Kingdom and New York, NY, USA.

<sup>333</sup> CCSP (2008) *Reanalysis of Historical Climate Data for Key Atmospheric Features: Implications for Attribution of Causes of Observed Change*. A Report by the U.S. Climate Change Science Program and the Subcommittee on Global Change Research [Randall Dole, Martin Hoerling, and Siegfried Schubert (eds.)]. National Oceanic and Atmospheric Administration, National Climatic Data Center, Asheville, NC, 156 pp.

<sup>334</sup> Meehl, G.A. *et al.* (2007) Global Climate Projections. In: *Climate Change 2007: The Physical Science Basis*. Contribution of Working Group I to the Fourth Assessment Report of the Intergovernmental Panel on Climate Change [Solomon, S., D. Qin, M. Manning, Z. Chen, M. Marquis, K.B. Averyt, M. Tignor and H.L. Miller (eds.)]. Cambridge University Press, Cambridge, United Kingdom and New York, NY, USA.

<sup>335</sup> IPCC (2007) Summary for Policymakers. In: *Climate Change 2007: The Physical Science Basis*. Contribution of Working Group I to the Fourth Assessment Report of the Intergovernmental Panel on Climate Change [Solomon, S., D. Qin, M. Manning, Z. Chen, M. Marquis, K.B. Averyt, M. Tignor and H.L. Miller (eds.)]. Cambridge University Press, Cambridge, United Kingdom and New York, NY, USA.

show acceleration of flow and thinning. While an understanding of these ice sheet processes is incomplete, their inclusion in models would likely lead to increased sea level projections for the end of the 21st century.

Sea ice extent is projected to shrink in the Arctic under all IPCC emissions scenarios.

#### (4) Projected Risks and Impacts Associated With Future Climate Change

Risk to society, ecosystems, and many natural Earth processes increases with increases in both the rate and magnitude of climate change. Climate warming may increase the possibility of large, abrupt regional or global climatic events (e.g., disintegration of the Greenland Ice Sheet or collapse of the West Antarctic Ice Sheet). The partial deglaciation of Greenland (and possibly West Antarctica) could be triggered by a sustained temperature increase of 2 to 7 °F (1 to 4 °C) above 1990 levels. Such warming would cause a 13 to 20 feet (4 to 6 meter) rise in sea level, which would occur over a time period of centuries to millennia.

The CCSP<sup>336</sup> reports that climate change has the potential to accentuate the disparities already evident in the American health care system, as many of the expected health effects are likely to fall disproportionately on the poor, the elderly, the disabled, and the uninsured. The IPCC<sup>337</sup> states with very high confidence that climate change impacts on human health in U.S. cities will be compounded by population growth and an aging population.

Severe heat waves are projected to intensify in magnitude and duration over the portions of the United States where these events already occur, with potential increases in mortality and morbidity, especially among the elderly, young, and frail.

Some reduction in the risk of death related to extreme cold is expected. It is not clear whether reduced mortality from cold will be greater or less than

increased heat-related mortality in the United States due to climate change.

Increases in regional ozone pollution relative to ozone levels without climate change are expected due to higher temperatures and weaker circulation in the United States and other world cities relative to air quality levels without climate change. Climate change is expected to increase regional ozone pollution, with associated risks in respiratory illnesses and premature death. In addition to human health effects, tropospheric ozone has significant adverse effects on crop yields, pasture and forest growth, and species composition. The directional effect of climate change on ambient particulate matter levels remains uncertain.

Within settlements experiencing climate change, certain parts of the population may be especially vulnerable; these include the poor, the elderly, those already in poor health, the disabled, those living alone, and/or indigenous populations dependent on one or a few resources. Thus, the potential impacts of climate change raise environmental justice issues.

The CCSP<sup>338</sup> concludes that, with increased CO<sub>2</sub> and temperature, the life cycle of grain and oilseed crops will likely progress more rapidly. But, as temperature rises, these crops will increasingly begin to experience failure, especially if climate variability increases and precipitation lessens or becomes more variable. Furthermore, the marketable yield of many horticultural crops (e.g., tomatoes, onions, fruits) is very likely to be more sensitive to climate change than grain and oilseed crops.

Higher temperatures will very likely reduce livestock production during the summer season in some areas, but these losses will very likely be partially offset by warmer temperatures during the winter season.

Cold-water fisheries will likely be negatively affected; warm-water fisheries will generally benefit; and the results for cool-water fisheries will be mixed, with gains in the northern and losses in the southern portions of ranges.

Climate change has very likely increased the size and number of forest fires, insect outbreaks, and tree mortality in the interior West, the

Southwest, and Alaska, and will continue to do so. Over North America, forest growth and productivity have been observed to increase since the middle of the 20th century, in part due to observed climate change. Rising CO<sub>2</sub> will very likely increase photosynthesis for forests, but the increased photosynthesis will likely only increase wood production in young forests on fertile soils. The combined effects of expected increased temperature, CO<sub>2</sub>, nitrogen deposition, ozone, and forest disturbance on soil processes and soil carbon storage remain unclear.

Coastal communities and habitats will be increasingly stressed by climate change impacts interacting with development and pollution. Sea level is rising along much of the U.S. coast, and the rate of change will very likely increase in the future, exacerbating the impacts of progressive inundation, storm-surge flooding, and shoreline erosion. Storm impacts are likely to be more severe, especially along the Gulf and Atlantic coasts. Salt marshes, other coastal habitats, and dependent species are threatened by sea level rise, fixed structures blocking landward migration, and changes in vegetation. Population growth and rising value of infrastructure in coastal areas increases vulnerability to climate variability and future climate change.

Climate change will likely further constrain already over-allocated water resources in some regions of the United States, increasing competition among agricultural, municipal, industrial, and ecological uses. Although water management practices in the United States are generally advanced, particularly in the West, the reliance on past conditions as the basis for current and future planning may no longer be appropriate, as climate change increasingly creates conditions well outside of historical observations. Rising temperatures will diminish snowpack and increase evaporation, affecting seasonal availability of water. In the Great Lakes and major river systems, lower water levels are likely to exacerbate challenges relating to water quality, navigation, recreation, hydropower generation, water transfers, and binational relationships. Decreased water supply and lower water levels are likely to exacerbate challenges relating to aquatic navigation in the United States.

Higher water temperatures, increased precipitation intensity, and longer periods of low flows will exacerbate many forms of water pollution, potentially making attainment of water quality goals more difficult. As waters become warmer, the aquatic life they

<sup>336</sup> Ebi, K.L., J. Balbus, P.L. Kinney, E. Lipp, D. Mills, M.S. O'Neill, and M. Wilson (2008) Effects of Global Change on Human Health. In: *Analyses of the effects of global change on human health and welfare and human systems*. A Report by the U.S. Climate Change Science Program and the Subcommittee on Global Change Research. [Gamble, J.L. (ed.), K.L. Ebi, F.G. Sussman, T.J. Wilbanks, (Authors)]. U.S. Environmental Protection Agency, Washington, DC, USA, pp. 2–1 to 2–78.

<sup>337</sup> Field, C.B. et al. (2007) North America. In: *Climate Change 2007: Impacts, Adaptation and Vulnerability*. Contribution of Working Group II to the Fourth Assessment Report of the Intergovernmental Panel on Climate Change [M.L. Parry, O.F. Canziani, J.P. Palutikof, P.J. van der Linden and C.E. Hanson (eds.)]. Cambridge University Press, Cambridge, United Kingdom and New York, NY, USA.

<sup>338</sup> Backlund, P., A. Janetos, D.S. Schimel, J. Hatfield, M.G. Ryan, S.R. Archer, and D. Lettenmaier (2008) Executive Summary. In: *The Effects of Climate Change on Agriculture, Land Resources, Water Resources, and Biodiversity in the United States*. A Report by the U.S. Climate Change Science Program and the Subcommittee on Global Change Research. Washington, DC., USA, 362 pp.

now support will be replaced by other species better adapted to warmer water. In the long term, warmer water and changing flow may result in deterioration of aquatic ecosystems.

Ocean acidification is projected to continue, resulting in the reduced biological production of marine calcifiers, including corals.

Climate change is likely to affect U.S. energy use and energy production and physical and institutional infrastructures. It will also likely interact with and possibly exacerbate ongoing environmental change and environmental pressures in settlements, particularly in Alaska where indigenous communities are facing major environmental and cultural impacts. The U.S. energy sector, which relies heavily on water for hydropower and cooling capacity, may be adversely impacted by changes to water supply and quality in reservoirs and other water bodies. Water infrastructure, including drinking water and wastewater treatment plants, and sewer and stormwater management systems, will be at greater risk of flooding, sea level rise and storm surge, low flows, and other factors that could impair performance.

Disturbances such as wildfires and insect outbreaks are increasing in the United States and are likely to intensify in a warmer future with warmer winters, drier soils, and longer growing seasons. Although recent climate trends have increased vegetation growth, continuing increases in disturbances are likely to limit carbon storage, facilitate invasive species, and disrupt ecosystem services.

Over the 21st century, changes in climate will cause species to shift north and to higher elevations and fundamentally rearrange U.S. ecosystems. Differential capacities for range shifts and constraints from development, habitat fragmentation, invasive species, and broken ecological connections will alter ecosystem structure, function, and services.

#### (5) Present and Projected U.S. Regional Climate Change Impacts

Climate change impacts will vary in nature and magnitude across different regions of the United States.

Sustained high summer temperatures, heat waves, and declining air quality are projected in the Northeast,<sup>339</sup>

<sup>339</sup> Northeast includes West Virginia, Maryland, Delaware, Pennsylvania, New Jersey, New York, Connecticut, Rhode Island, Massachusetts, Vermont, New Hampshire, and Maine.

Southeast,<sup>340</sup> Southwest,<sup>341</sup> and Midwest.<sup>342</sup> Projected climate change would continue to cause loss of sea ice, glacier retreat, permafrost thawing, and coastal erosion in Alaska.

Reduced snowpack, earlier spring snowmelt, and increased likelihood of seasonal summer droughts are projected in the Northeast, Northwest,<sup>343</sup> and Alaska. More severe, sustained droughts and water scarcity are projected in the Southeast, Great Plains,<sup>344</sup> and Southwest.

The Southeast, Midwest, and Northwest in particular are expected to be impacted by an increased frequency of heavy downpours and greater flood risk.

Ecosystems of the Southeast, Midwest, Great Plains, Southwest, Northwest, and Alaska are expected to experience altered distribution of native species (including local extinctions), more frequent and intense wildfires, and an increase in insect pest outbreaks and invasive species.

Sea level rise is expected to increase storm surge height and strength, flooding, erosion, and wetland loss along the coasts, particularly in the Northeast, Southeast, and islands.

Warmer water temperatures and ocean acidification are expected to degrade important aquatic resources of islands and coasts such as coral reefs and fisheries.

A longer growing season, low levels of warming, and fertilization effects of carbon dioxide may benefit certain crop species and forests, particularly in the Northeast and Alaska. Projected summer rainfall increases in the Pacific islands may augment limited freshwater supplies. Cold-related mortality is projected to decrease, especially in the Southeast. In the Midwest in particular, heating oil demand and snow-related traffic accidents are expected to decrease.

Climate change impacts in certain regions of the world may exacerbate problems that raise humanitarian, trade, and national security issues for the

United States. The IPCC<sup>345</sup> identifies the most vulnerable world regions as the Arctic, because of the effects of high rates of projected warming on natural systems; Africa, especially the sub-Saharan region, because of current low adaptive capacity as well as climate change; small islands, due to high exposure of population and infrastructure to risk of sea level rise and increased storm surge; and Asian mega-deltas, such as the Ganges-Brahmaputra and the Zhujiang, due to large populations and high exposure to sea level rise, storm surge and river flooding. Climate change has been described as a potential threat multiplier with regard to national security issues.

#### *E. Changes in Atmospheric CO<sub>2</sub> Concentrations, Global Mean Temperature, Sea Level Rise, and Ocean pH Associated With the Program's GHG Emissions Reductions*

EPA examined<sup>346</sup> the reductions in CO<sub>2</sub> and other GHGs associated with this rulemaking and analyzed the projected effects on atmospheric CO<sub>2</sub> concentrations, global mean surface temperature, sea level rise, and ocean pH which are common variables used as indicators of climate change. The analysis projects that the preferred alternative of this program will reduce atmospheric concentrations of CO<sub>2</sub>, global climate warming and sea level rise relative to the reference case. Although the projected reductions and improvements are small in comparison to the total projected climate change, they are quantifiable, directionally consistent, and will contribute to reducing the risks associated with climate change. Climate change is a global phenomenon and EPA recognizes that this one national action alone will not prevent it: EPA notes this would be true for any given GHG mitigation action when taken alone. EPA also notes that a substantial portion of CO<sub>2</sub> emitted into the atmosphere is not removed by natural processes for millennia, and therefore each unit of CO<sub>2</sub> not emitted into the atmosphere due to this program

<sup>340</sup> Southeast includes Kentucky, Virginia, Arkansas, Tennessee, North Carolina, South Carolina, southeast Texas, Louisiana, Mississippi, Alabama, Georgia, and Florida.

<sup>341</sup> Southwest includes California, Nevada, Utah, western Colorado, Arizona, New Mexico (except the extreme eastern section), and southwest Texas.

<sup>342</sup> The Midwest includes Minnesota, Wisconsin, Michigan, Iowa, Illinois, Indiana, Ohio, and Missouri.

<sup>343</sup> The Northwest includes Washington, Idaho, western Montana, and Oregon.

<sup>344</sup> The Great Plains includes central and eastern Montana, North Dakota, South Dakota, Wyoming, Nebraska, eastern Colorado, Kansas, extreme eastern New Mexico, central Texas, and Oklahoma.

<sup>345</sup> Parry, M.L. et al. (2007) Technical Summary. In: *Climate Change 2007: Impacts, Adaptation and Vulnerability*. Contribution of Working Group II to the Fourth Assessment Report of the Intergovernmental Panel on Climate Change [M.L. Parry, O.F. Canziani, J.P. Palutikof, P.J. van der Linden, and C.E. Hanson (eds.)]. Cambridge University Press, Cambridge, United Kingdom, pp. 23S78.

<sup>346</sup> Using the Model for the Assessment of Greenhouse Gas Induced Climate Change (MAGICC) 5.3v2, <http://www.cgd.ucar.edu/cas/wigley/magicc/>, EPA estimated the effects of this rulemaking's greenhouse gas emissions reductions on global mean temperature and sea level. Please refer to Chapter 8.4 of the RIA for additional information.

avoids essentially permanent climate change on centennial time scales. The heavy-duty program makes a significant contribution towards addressing the challenge by producing substantial reductions in greenhouse gas emissions from a particularly large and important source of emissions. As the Supreme Court recognized in *State of Massachusetts v. EPA*, [A]gencies, like legislatures, do not generally resolve massive problems like climate change in one fell regulatory swoop. 549 U.S. 497, 524 (2008). They instead whittle away at them over time. *Id.*

EPA determines that the projected reductions in atmospheric CO<sub>2</sub>, global mean temperature and sea level rise are meaningful in the context of this final action. In addition, EPA has conducted an analysis to evaluate the projected changes in ocean pH in the context of the changes in emissions from this rulemaking. The results of the analysis demonstrate that relative to the reference case, projected atmospheric CO<sub>2</sub> concentrations are estimated to be reduced by 0.691 to 0.787 part per million by volume (ppmv), global mean temperature is estimated to be reduced by 0.0017 to 0.0042°C, and sea-level rise is projected to be reduced by approximately 0.017–0.040 cm by 2100, based on a range of climate sensitivities. The analysis also demonstrates that ocean pH will increase by 0.0003 pH units by 2100 relative to the reference case.

(1) Estimated Projected Reductions in Atmospheric CO<sub>2</sub> Concentration, Global Mean Surface Temperatures, Sea Level Rise, and Ocean pH

EPA estimated changes in the atmospheric CO<sub>2</sub> concentration, global mean temperature, and sea level rise out to 2100 resulting from the emissions reductions in this rulemaking using the GCAM (Global Change Assessment Model, formerly MiniCAM), integrated assessment model<sup>347</sup> coupled with the Model for the Assessment of Greenhouse Gas Induced Climate

<sup>347</sup> GCAM is a long-term, global integrated assessment model of energy, economy, agriculture and land use, that considers the sources of emissions of a suite of GHG's, emitted in 14 globally disaggregated regions, the fate of emissions to the atmosphere, and the consequences of changing concentrations of greenhouse related gases for climate change. GCAM begins with a representation of demographic and economic developments in each region and combines these with assumptions about technology development to describe an internally consistent representation of energy, agriculture, land-use, and economic developments that in turn shape global emissions.

Brenkert A. S. Smith, S. Kim, and H. Pitcher, 2003: Model Documentation for the MiniCAM. PNNL-14337, Pacific Northwest National Laboratory, Richland, Washington.

Change (MAGICC, version 5.3v2).<sup>348</sup> GCAM was used to create the globally and temporally consistent set of climate relevant variables required for running MAGICC. MAGICC was then used to estimate the projected change in these variables over time. Given the magnitude of the estimated emissions reductions associated with this action, a simple climate model such as MAGICC is reasonable for estimating the atmospheric and climate response. This widely-used, peer reviewed modeling tool was also used to project temperature and sea level rise under different emissions scenarios in the Third and Fourth Assessments of the IPCC.

The integrated impact of the following pollutant and greenhouse gas emissions changes are considered: CO<sub>2</sub>, CH<sub>4</sub>, N<sub>2</sub>O, HFC-134a, NO<sub>x</sub>, CO<sub>2</sub> and SO<sub>2</sub>, and volatile organic compounds (VOC). For CO<sub>2</sub>, CH<sub>4</sub>, HFC-134a, and N<sub>2</sub>O an annual time-series of (upstream + downstream) emissions reductions estimated from the rulemaking were input directly. The GHG emissions reductions, from Section VI.C, were applied as net reductions to a global reference case (or baseline) emissions scenario in GCAM to generate an emissions scenario specific to this rulemaking. For CO, VOCs, SO<sub>2</sub>, and NO<sub>x</sub>, emissions reductions were estimated for 2018, 2030, and 2050 (provided in Section VII.A). EPA then linearly scaled emissions reductions for these gases between a zero input value in 2013 and the value supplied for 2018 to produce the reductions for 2014–2018. A similar scaling was used for 2019–2029 and 2031–2050. The emissions reductions past 2050 for all gases were scaled with total U.S. road transportation fuel consumption from the GCAM reference scenario. Road transport fuel consumption past 2050 does not change significantly and thus emissions reductions remain relatively constant from 2050 through 2100. Specific details about the GCAM reference case scenario can be found in Chapter 8.4 of the RIA that accompanies this preamble.

MAGICC calculates the forcing response at the global scale from changes in atmospheric concentrations of CO<sub>2</sub>, CH<sub>4</sub>, N<sub>2</sub>O, HFCs, and tropospheric ozone. It also includes the effects of temperature changes on stratospheric ozone and the effects of CH<sub>4</sub> emissions on stratospheric water vapor. Changes in CH<sub>4</sub>, NO<sub>x</sub>, VOC, and

<sup>348</sup> Wigley, T.M.L. 2008. MAGICC 5.3.v2 User Manual. UCAR—Climate and Global Dynamics Division, Boulder, Colorado. <http://www.cgd.ucar.edu/cas/wigley/magicc/>.

CO emissions affect both O<sub>3</sub> concentrations and CH<sub>4</sub> concentrations. MAGICC includes the relative climate forcing effects of changes in sulfate concentrations due to changing SO<sub>2</sub> emissions, including both the direct effect of sulfate particles and the indirect effects related to cloud interactions. However, MAGICC does not calculate the effect of changes in concentrations of other aerosols such as nitrates, black carbon, or organic carbon, making the assumption that the sulfate cooling effect is a proxy for the sum of all the aerosol effects. Therefore, the climate effects of changes in PM<sub>2.5</sub> emissions and precursors (besides SO<sub>2</sub>) which are presented in the RIA Chapter 5 were not included in the calculations in this section. MAGICC also calculates all climate effects at the global scale. This global scale captures the climate effects of the long-lived, well-mixed greenhouse gases, but does not address the fact that short-lived climate forcings such as aerosols and ozone can have effects that vary with location and timing of emissions. Black carbon in particular is known to cause a positive forcing or warming effect by absorbing incoming solar radiation, but there are uncertainties about the magnitude of that warming effect and the interaction of black carbon (and other co-emitted aerosol species) with clouds. While black carbon is likely to be an important contributor to climate change, it would be premature to include quantification of black carbon climate impacts in an analysis of the final standards at this time.

Changes in atmospheric CO<sub>2</sub> concentration, global mean temperature, and sea level rise for both the reference case and the emissions scenarios associated with this action were computed using MAGICC. To calculate the reductions in the atmospheric CO<sub>2</sub> concentrations as well as in temperature and sea level resulting from this action, the output from the policy scenario associated with the preferred approach of this action was subtracted from an existing Global Change Assessment Model (GCAM, formerly MiniCAM) reference emission scenario. To capture some key uncertainties in the climate system with the MAGICC model, changes in atmospheric CO<sub>2</sub>, global mean temperature and sea level rise were projected across the most current IPCC range of climate sensitivities, from 1.5 °C to 6.0 °C.<sup>349</sup> This range reflects

<sup>349</sup> In IPCC reports, equilibrium climate sensitivity refers to the equilibrium change in the annual mean global surface temperature following a doubling of the atmospheric equivalent carbon dioxide concentration. The IPCC states that climate



the uncertainty for equilibrium climate sensitivity for how much global mean temperature would rise if the concentration of carbon dioxide in the atmosphere were to double. The information for this range come from constraints from past climate change on various time scales, and the spread of results for climate sensitivity from ensembles of models.<sup>350</sup> Details about this modeling analysis can be found in the RIA Chapter 8.4.

The results of this modeling, summarized in Table VI–8, show small,

but quantifiable, reductions in atmospheric CO<sub>2</sub> concentrations, projected global mean temperature and sea level resulting from this action, across all climate sensitivities. As a result of the emission reductions from the final standards for this action, relative to the reference case the atmospheric CO<sub>2</sub> concentration is projected to be reduced by 0.691–0.787 ppmv, the global mean temperature is projected to be reduced by approximately 0.0017–0.0042 °C by 2100, and global mean sea level rise is

projected to be reduced by approximately 0.017–0.040 cm by 2100. The range of reductions in global mean temperature and sea level rise is larger than that for CO<sub>2</sub> concentrations because CO<sub>2</sub> concentrations are only weakly coupled to climate sensitivity through the dependence on temperature of the rate of ocean absorption of CO<sub>2</sub>, whereas the magnitude of temperature change response to CO<sub>2</sub> changes (and therefore sea level rise) is more tightly coupled to climate sensitivity in the MAGICC model.

TABLE VI–8—IMPACT OF GHG EMISSIONS REDUCTIONS ON PROJECTED CHANGES IN GLOBAL CLIMATE ASSOCIATED WITH THE FINAL RULEMAKING (BASED ON A RANGE OF CLIMATE SENSITIVITIES FROM 1.5–6 °C)

Variable	Units	Year	Projected change
Atmospheric CO <sub>2</sub> Concentration .....	ppmv	2100	–0.691 to –0.787.
Global Mean Surface Temperature .....	°C	2100	–0.0017 to –0.0042.
Sea Level Rise .....	cm	2100	–0.017 to –0.040.
Ocean pH .....	pH units	2100	0.0003 <sup>a</sup> .

**Note:**

<sup>a</sup> The value for projected change in ocean pH is based on a climate sensitivity of 3.0.

The projected reductions are small relative to the change in temperature (1.8–4.8 °C), sea level rise (27–51 cm), and ocean acidity (–0.30 pH units) from 1990 to 2100 from the MAGICC simulations for the GCAM reference case. However, this is to be expected given the magnitude of emissions reductions expected from the program in the context of global emissions. This uncertainty range does not include the effects of uncertainty in future emissions. It should also be noted that the calculations in MAGICC do not include the possible effects of accelerated ice flow in Greenland and/or Antarctica: the recent NRC report estimated a likely sea level increase for the A1B SRES scenario of 0.5 to 1.0 meters.<sup>351</sup> Further discussion of EPA’s modeling analysis is found in the RIA, Chapter 8.

EPA used the Program CO2SYS,<sup>352</sup> version 1.05 to estimate projected changes in ocean pH for tropical waters based on the atmospheric CO<sub>2</sub> concentration change (reduction) resulting from this action. The program performs calculations relating parameters of the CO<sub>2</sub> system in seawater. EPA used the program to calculate ocean pH as a function of

atmospheric CO<sub>2</sub> concentrations, among other specified input conditions. Based on the projected atmospheric CO<sub>2</sub> concentration reductions resulting from this action, the program calculates an increase in ocean pH of 0.0003 pH units in 2100 relative to the reference case (compared to a decrease of 0.3 pH units from 1990 to 2100 in the reference case). Thus, this analysis indicates the projected decrease in atmospheric CO<sub>2</sub> concentrations from the program will result in an increase in ocean pH. For additional validation, results were generated using different known constants from the literature. A comprehensive discussion of the modeling analysis associated with ocean pH is provided in the RIA, Chapter 8.

(2) Program’s Effect on Climate

As a substantial portion of CO<sub>2</sub> emitted into the atmosphere is not removed by natural processes for millennia, each unit of CO<sub>2</sub> not emitted into the atmosphere avoids essentially permanent climate change on centennial time scales. Reductions in emissions in the near-term are important in determining long-term climate stabilization and associated impacts experienced not just over the next decades but in the coming centuries and

millennia.<sup>353</sup> Though the magnitude of the avoided climate change projected here is small in comparison to the total projected changes, these reductions represent a reduction in the adverse risks associated with climate change (though these risks were not formally estimated for this action) across a range of equilibrium climate sensitivities.

EPA’s analysis of the program’s impact on global climate conditions is intended to quantify these potential reductions using the best available science. EPA’s modeling results show repeatable, consistent reductions relative to the reference case in changes of CO<sub>2</sub> concentration, temperature, sea-level rise, and ocean pH over the next century.

**VII. How will this final action impact non-GHG emissions and their associated effects?**

*A. Emissions Inventory Impacts*

(1) Upstream Impacts of the Program

Increasing efficiency in heavy-duty vehicles will result in reduced fuel demand and therefore reductions in the emissions associated with all processes involved in getting petroleum to the pump. These projected upstream emission impacts on criteria pollutants

sensitivity is “likely” to be in the range of 2 °C to 4.5 °C, “very unlikely” to be less than 1.5 °C, and “values substantially higher than 4.5 °C cannot be excluded.” IPCC WGI, 2007, *Climate Change 2007—The Physical Science Basis*, Contribution of Working Group I to the Fourth Assessment Report of the IPCC, <http://www.ipcc.ch/>.

<sup>350</sup> Meehl, G.A. et al. (2007) Global Climate Projections. In: *Climate Change 2007: The Physical*

*Science Basis*. Contribution of Working Group I to the Fourth Assessment Report of the Intergovernmental Panel on Climate Change [Solomon, S., D. Qin, M. Manning, Z. Chen, M. Marquis, K.B. Averyt, M. Tignor and H.L. Miller (eds.)]. Cambridge University Press, Cambridge, United Kingdom and New York, NY, USA.

<sup>351</sup> National Research Council, 2011. *Climate Stabilization Targets: Emissions, Concentrations,*

and Impacts over Decades to Millennia. Washington, DC: National Academies Press.

<sup>352</sup> Lewis, E., and D. W. R. Wallace. 1998. Program Developed for CO<sub>2</sub> System Calculations. ORNL/CDIAC–105. Carbon Dioxide Information Analysis Center, Oak Ridge National Laboratory, U.S. Department of Energy, Oak Ridge, Tennessee.

<sup>353</sup> See NRC 2011, Note 351.

are summarized in Table VII–1. Table VII–2 shows the corresponding

projected impacts on upstream air toxic emissions in 2030.

TABLE VII–1—OVERALL ESTIMATED UPSTREAM IMPACTS ON CRITERIA POLLUTANTS FOR CALENDAR YEARS 2018, 2030, AND 2050  
[Short tons]

Calendar year	NO <sub>x</sub>	VOC	CO	PM <sub>2.5</sub>
2018 .....	–6,475	–1,765	–2,217	–971
2030 .....	–9,975	–4,367	–3,331	–1,379
2050 .....	–14,243	–6,379	–4,785	–1,998

TABLE VII–2—OVERALL ESTIMATED UPSTREAM IMPACTS ON AIR TOXICS FOR CALENDAR YEARS 2018, 2030, AND 2050  
[Short tons]

Calendar year	Benzene	1,3-butadiene	Formaldehyde	Acetaldehyde	Acrolein
2018 .....	–12	–0.6	–12	–1	–0.2
2030 .....	–19	–0.9	–26	–3	–0.5
2050 .....	–28	–1.2	–35	–5	–0.6

To project these impacts, EPA estimated the impact of reduced petroleum volumes on the extraction and transportation of crude oil as well as the production and distribution of finished gasoline and diesel. For the purpose of assessing domestic-only emission reductions it was necessary to estimate the fraction of fuel savings attributable to domestic finished gasoline and diesel, and of this fuel what fraction is produced from domestic crude. For this analysis EPA estimated that 50 percent of fuel savings is attributable to domestic finished gasoline and diesel and that 90 percent of this gasoline and diesel originated from imported crude. Emission factors for most upstream emission sources are based on the GREET1.8 model, developed by DOE’s Argonne National Laboratory but in some cases the GREET values were modified or updated by EPA to be consistent with the National Emission Inventory. These updates are

consistent with those used for the upstream analysis included in the Light-Duty GHG rulemaking. More information on the development of the emission factors used in this analysis can be found in RIA chapter 5.

(2) Downstream Impacts of the Program

While these final rules do not regulate non-GHG pollutants, EPA expects reductions in downstream emissions of most non-GHG pollutants. These pollutants include NO<sub>x</sub>, SO<sub>2</sub>, VOC, CO, and PM. The primary reasons for this are the improvements in road load (aerodynamics and tire rolling resistance) under the program and the agency’s anticipation of increased use of APUs in combination tractors for GHG reduction purposes during extended idling. APUs exhibit different non-GHG emissions characteristics compared to the on-road engines they would replace during extended idling. Another reason is that emissions from certain pollutants

(e.g., SO<sub>2</sub>) are proportional to fuel consumption. For vehicle types not affected by road load improvements, non-GHG emissions may increase very slightly due to VMT rebound. EPA used MOVES to determine non-GHG emissions inventories for baseline and control cases. Further information about the MOVES analysis is available in Section VI and RIA chapter 5. The improvements in road load, use of APUs, and VMT rebound were included in the MOVES runs and post-processing. Table VII–3 summarizes the downstream criteria pollutant impacts of this program. Most of the impacts shown are through projected increased APU use. Because APUs are required to meet much less stringent PM standards than on-road engines, the projected widespread use of APUs leads to higher PM<sub>2.5</sub>. Table VII–4 summarizes the downstream air toxics impacts of this program.

TABLE VII–3—OVERALL ESTIMATED DOWNSTREAM IMPACTS ON CRITERIA POLLUTANTS  
[Short tons]

Calendar year	Downstream NO <sub>x</sub>	Downstream VOC	Downstream SO <sub>2</sub>	Downstream CO	Downstream PM <sub>2.5</sub> <sup>a</sup>
2018 .....	–107,135	–12,951	–145	–25,614	803
2030 .....	–235,046	–25,502	–423	–52,212	1,751
2050 .....	–326,413	–35,126	–614	–72,049	2,441

Note:

<sup>a</sup> Positive number means emissions would increase from baseline to control case. PM<sub>2.5</sub> from tire wear and brake wear is included.

TABLE VII–4—OVERALL ESTIMATED DOWNSTREAM IMPACTS ON AIR TOXICS  
[Short tons]

Calendar year	Benzene	1,3-butadiene	Formaldehyde	Acetaldehyde	Acrolein
2018 .....	–158	–0.3	–2,853	–871	–120
2030 .....	–341	0.4	–6,255	–1,908	–263

TABLE VII-4—OVERALL ESTIMATED DOWNSTREAM IMPACTS ON AIR TOXICS—Continued  
[Short tons]

Calendar year	Benzene	1,3-butadiene	Formaldehyde	Acetaldehyde	Acrolein
2050 .....	-472	0.8	-8,689	-2,650	-365

(3) Total Impacts of the Program

As shown in Table VII-5 and Table VII-6, the agencies estimate that this program would result in reductions of NO<sub>x</sub>, VOC, CO, PM, and air toxics. For NO<sub>x</sub>, VOC, and CO, much of the net reductions are realized through the use of APUs, which emit these pollutants at

a lower rate than on-road engines during extended idle operation. Additional reductions are achieved in all pollutants through reduced road load (improved aerodynamics and tire rolling resistance), which reduces the amount of work required to travel a given distance. For SO<sub>x</sub>, downstream emissions are roughly proportional to

fuel consumption; therefore a decrease is seen in both upstream and downstream sources. The downstream increase in PM<sub>2.5</sub> due to APU use is mostly negated by upstream PM<sub>2.5</sub> reductions, though our calculations show a slight net increase in 2030 and 2050.<sup>354</sup>

TABLE VII-5—OVERALL ESTIMATED TOTAL IMPACTS (UPSTREAM PLUS DOWNSTREAM) ON CRITERIA POLLUTANTS  
[Results are shown in both short tons and percent change from baseline to control case.]

CY	NO <sub>x</sub>		VOC		SO <sub>2</sub>		CO		PM <sub>2.5</sub>	
	short tons	%	short tons	%	short tons	%	short tons	%	short tons	%
2018 .....	-113,610	-6.2	-14,715	-5.6	-4,566	-4.5	-27,832	-1.0	-167	-0.2
2030 .....	-245,129	-21.0	-29,932	-16.0	-6,888	-10.1	-55,579	-2.1	356	10.1
2050 .....	-340,656	-23.7	-41,506	-18.3	-9,857	-11.0	-76,834	-2.2	443	10.1

TABLE VII-6—OVERALL ESTIMATED TOTAL IMPACTS ON AIR TOXICS (UPSTREAM PLUS DOWNSTREAM)

CY	Benzene		1,3-butadiene		Formaldehyde		Acetaldehyde		Acrolein	
	short tons	%	short tons	%	short tons	%	short tons	%	short tons	%
2018 .....	-170	-4.8	-0.9	-0.1	-2,865	-18.3	-873	-13.9	-120.0	-12.4
2030 .....	-359	-15.0	-0.5	-0.1	-6,282	-46.2	-1,912	-40.2	-263.0	-40.0
2050 .....	-500	-17.4	-0.4	-0.1	-8,725	-49.5	-2,655	-44.2	-365.4	-44.5

B. Health Effects of Non-GHG Pollutants

In this section we discuss health effects associated with exposure to some of the criteria and air toxic pollutants impacted by the final heavy-duty vehicle standards.

(1) Particulate Matter

(a) Background

Particulate matter is a generic term for a broad class of chemically and physically diverse substances. It can be principally characterized as discrete particles that exist in the condensed (liquid or solid) phase spanning several orders of magnitude in size. Since 1987, EPA has delineated that subset of inhalable particles small enough to penetrate to the thoracic region (including the tracheobronchial and alveolar regions) of the respiratory tract (referred to as thoracic particles). Current National Ambient Air Quality

Standards (NAAQS) use PM<sub>2.5</sub> as the indicator for fine particles (with PM<sub>2.5</sub> referring to particles with a nominal mean aerodynamic diameter less than or equal to 2.5 μm), and use PM<sub>10</sub> as the indicator for purposes of regulating the coarse fraction of PM<sub>10</sub> (referred to as thoracic coarse particles or coarse-fraction particles; generally including particles with a nominal mean aerodynamic diameter greater than 2.5 μm and less than or equal to 10 μm, or PM<sub>10-2.5</sub>). Ultrafine particles are a subset of fine particles, generally less than 100 nanometers (0.1 μm) in aerodynamic diameter.

Fine particles are produced primarily by combustion processes and by transformations of gaseous emissions (e.g., SO<sub>x</sub>, NO<sub>x</sub>, and VOC) in the atmosphere. The chemical and physical properties of PM<sub>2.5</sub> may vary greatly with time, region, meteorology, and source category. Thus, PM<sub>2.5</sub> may

include a complex mixture of different pollutants including sulfates, nitrates, organic compounds, elemental carbon and metal compounds. These particles can remain in the atmosphere for days to weeks and travel hundreds to thousands of kilometers.

(b) Health Effects of PM

Scientific studies show ambient PM is associated with a series of adverse health effects. These health effects are discussed in detail in EPA's Integrated Science Assessment for Particulate Matter (ISA).<sup>355</sup> Further discussion of health effects associated with PM can also be found in the RIA for this final action. The ISA summarizes evidence associated with PM<sub>2.5</sub>, PM<sub>10-2.5</sub>, and ultrafine particles.

The ISA concludes that health effects associated with short-term exposures (hours to days) to ambient PM<sub>2.5</sub> include mortality, cardiovascular effects, such as

<sup>354</sup> Although the net impact is small when aggregated to the national level, it is unlikely that the geographic location of increases in downstream PM<sub>2.5</sub> emissions will coincide with the location of decreases in upstream PM<sub>2.5</sub> emissions. Impacts of

the emissions changes are included in the air quality modeling, discussed in Section VII.D of this preamble and in Chapter 8 of the RIA.

<sup>355</sup> U.S. EPA (2009) Integrated Science Assessment for Particulate Matter (Final Report).

U.S. Environmental Protection Agency, Washington, DC, EPA/600/R-08/139F, Docket EPA-HQ-OAR-2010-0162.

altered vasomotor function and hospital admissions and emergency department visits for ischemic heart disease and congestive heart failure, and respiratory effects, such as exacerbation of asthma symptoms in children and hospital admissions and emergency department visits for chronic obstructive pulmonary disease and respiratory infections.<sup>356</sup> The ISA notes that long-term exposure to PM<sub>2.5</sub> (months to years) is associated with the development/progression of cardiovascular disease, premature mortality, and respiratory effects, including reduced lung function growth, increased respiratory symptoms, and asthma development.<sup>357</sup> The ISA concludes that the currently available scientific evidence from epidemiologic, controlled human exposure, and toxicological studies supports a causal association between short- and long-term exposures to PM<sub>2.5</sub> and cardiovascular effects and mortality. Furthermore, the ISA concludes that the collective evidence supports likely causal associations between short- and long-term PM<sub>2.5</sub> exposures and respiratory effects. The ISA also concludes that the scientific evidence is suggestive of a causal association for reproductive and developmental effects and cancer, mutagenicity, and genotoxicity and long-term exposure to PM<sub>2.5</sub>.<sup>358</sup>

For PM<sub>10-2.5</sub>, the ISA concludes that the current evidence is suggestive of a causal relationship between short-term exposures and cardiovascular effects, such as hospitalization for ischemic heart disease. There is also suggestive evidence of a causal relationship between short-term PM<sub>10-2.5</sub> exposure and mortality and respiratory effects. Data are inadequate to draw conclusions regarding the health effects associated with long-term exposure to PM<sub>10-2.5</sub>.<sup>359</sup>

For ultrafine particles, the ISA concludes that there is suggestive evidence of a causal relationship between short-term exposures and cardiovascular effects, such as changes in heart rhythm and blood vessel function. It also concludes that there is suggestive evidence of association between short-term exposure to ultrafine particles and respiratory effects. Data are inadequate to draw conclusions regarding the health effects

associated with long-term exposure to ultrafine particles.<sup>360</sup>

## (2) Ozone

### (a) Background

Ground-level ozone pollution is typically formed by the reaction of VOC and NO<sub>x</sub> in the lower atmosphere in the presence of sunlight. These pollutants, often referred to as ozone precursors, are emitted by many types of pollution sources, such as highway and nonroad motor vehicles and engines, power plants, chemical plants, refineries, makers of consumer and commercial products, industrial facilities, and smaller area sources.

The science of ozone formation, transport, and accumulation is complex. Ground-level ozone is produced and destroyed in a cyclical set of chemical reactions, many of which are sensitive to temperature and sunlight. When ambient temperatures and sunlight levels remain high for several days and the air is relatively stagnant, ozone and its precursors can build up and result in more ozone than typically occurs on a single high-temperature day. Ozone can be transported hundreds of miles downwind from precursor emissions, resulting in elevated ozone levels even in areas with low local VOC or NO<sub>x</sub> emissions.

### (b) Health Effects of Ozone

The health and welfare effects of ozone are well documented and are assessed in EPA's 2006 Air Quality Criteria Document and 2007 Staff Paper.<sup>361 362</sup> People who are more susceptible to effects associated with exposure to ozone can include children, the elderly, and individuals with respiratory disease such as asthma. Those with greater exposures to ozone, for instance due to time spent outdoors (e.g., children and outdoor workers), are of particular concern. Ozone can irritate the respiratory system, causing coughing, throat irritation, and breathing discomfort. Ozone can reduce lung function and cause pulmonary inflammation in healthy individuals. Ozone can also aggravate asthma, leading to more asthma attacks that require medical attention and/or the use of additional medication. Thus, ambient

ozone may cause both healthy and asthmatic individuals to limit their outdoor activities. In addition, there is suggestive evidence of a contribution of ozone to cardiovascular-related morbidity and highly suggestive evidence that short-term ozone exposure directly or indirectly contributes to non-accidental and cardiopulmonary-related mortality, but additional research is needed to clarify the underlying mechanisms causing these effects. In a recent report on the estimation of ozone-related premature mortality published by NRC, a panel of experts and reviewers concluded that short-term exposure to ambient ozone is likely to contribute to premature deaths and that ozone-related mortality should be included in estimates of the health benefits of reducing ozone exposure.<sup>363</sup> Animal toxicological evidence indicates that with repeated exposure, ozone can inflame and damage the lining of the lungs, which may lead to permanent changes in lung tissue and irreversible reductions in lung function. The respiratory effects observed in controlled human exposure studies and animal studies are coherent with the evidence from epidemiologic studies supporting a causal relationship between acute ambient ozone exposures and increased respiratory-related emergency room visits and hospitalizations in the warm season. In addition, there is suggestive evidence of a contribution of ozone to cardiovascular-related morbidity and non-accidental and cardiopulmonary mortality.

## (3) Nitrogen Oxides and Sulfur Oxides

### (a) Background

Nitrogen dioxide (NO<sub>2</sub>) is a member of the NO<sub>x</sub> family of gases. Most NO<sub>2</sub> is formed in the air through the oxidation of nitric oxide (NO) emitted when fuel is burned at a high temperature. SO<sub>2</sub>, a member of the sulfur oxide (SO<sub>x</sub>) family of gases, is formed from burning fuels containing sulfur (e.g., coal or oil derived), extracting gasoline from oil, or extracting metals from ore.

SO<sub>2</sub> and NO<sub>2</sub> can dissolve in water droplets and further oxidize to form sulfuric and nitric acid which react with ammonia to form sulfates and nitrates, both of which are important components of ambient PM. The health effects of ambient PM are discussed in Section 0 of this preamble. NO<sub>x</sub> and NMHC are the two major precursors of

<sup>363</sup> National Research Council (NRC), 2008. *Estimating Mortality Risk Reduction and Economic Benefits from Controlling Ozone Air Pollution*. The National Academies Press: Washington, DC Docket EPA-HQ-OAR-2010-0162.

<sup>360</sup> See U.S. EPA 2009 Final PM ISA, Note 355, at Section 2.3.5, Table 2-6.

<sup>361</sup> U.S. EPA. (2006). Air Quality Criteria for Ozone and Related Photochemical Oxidants (Final). EPA/600/R-05/004aF-cF. Washington, DC: U.S. EPA. Docket EPA-HQ-OAR-2010-0162.

<sup>362</sup> U.S. EPA. (2007). Review of the National Ambient Air Quality Standards for Ozone: Policy Assessment of Scientific and Technical Information, OAQPS Staff Paper. EPA-452/R-07-003. Washington, DC, U.S. EPA. Docket EPA-HQ-OAR-2010-0162.

<sup>356</sup> See U.S. EPA, 2009 Final PM ISA, Note 355, at Section 2.3.1.1.

<sup>357</sup> See U.S. EPA 2009 Final PM ISA, Note 355, at page 2-12, Sections 7.3.1.1 and 7.3.2.1.

<sup>358</sup> See U.S. EPA 2009 Final PM ISA, Note 355, at Section 2.3.2.

<sup>359</sup> See U.S. EPA 2009 Final PM ISA, Note 355, at Section 2.3.4, Table 2-6.

ozone. The health effects of ozone are covered in Section O.

(b) Health Effects of NO<sub>2</sub>

Information on the health effects of NO<sub>2</sub> can be found in the EPA Integrated Science Assessment (ISA) for Nitrogen Oxides.<sup>364</sup> The EPA has concluded that the findings of epidemiologic, controlled human exposure, and animal toxicological studies provide evidence that is sufficient to infer a likely causal relationship between respiratory effects and short-term NO<sub>2</sub> exposure. The ISA concludes that the strongest evidence for such a relationship comes from epidemiologic studies of respiratory effects including symptoms, emergency department visits, and hospital admissions. The ISA also draws two broad conclusions regarding airway responsiveness following NO<sub>2</sub> exposure. First, the ISA concludes that NO<sub>2</sub> exposure may enhance the sensitivity to allergen-induced decrements in lung function and increase the allergen-induced airway inflammatory response following 30-minute exposures of asthmatics to NO<sub>2</sub> concentrations as low as 0.26 ppm. In addition, small but significant increases in non-specific airway hyperresponsiveness were reported following 1-hour exposures of asthmatics to 0.1 ppm NO<sub>2</sub>. Second, exposure to NO<sub>2</sub> has been found to enhance the inherent responsiveness of the airway to subsequent nonspecific challenges in controlled human exposure studies of asthmatic subjects. Enhanced airway responsiveness could have important clinical implications for asthmatics since transient increases in airway responsiveness following NO<sub>2</sub> exposure have the potential to increase symptoms and worsen asthma control. Together, the epidemiologic and experimental data sets form a plausible, consistent, and coherent description of a relationship between NO<sub>2</sub> exposures and an array of adverse health effects that range from the onset of respiratory symptoms to hospital admission.

Although the weight of evidence supporting a causal relationship is somewhat less certain than that associated with respiratory morbidity, NO<sub>2</sub> has also been linked to other health endpoints. These include all-cause (nonaccidental) mortality, hospital admissions or emergency department visits for cardiovascular disease, and decrements in lung function growth associated with chronic exposure.

<sup>364</sup> U.S. EPA (2008). *Integrated Science Assessment for Oxides of Nitrogen—Health Criteria (Final Report)*. EPA/600/R-08/071. Washington, DC: U.S. EPA. Docket EPA-HQ-OAR-2010-0162.

(c) Health Effects of SO<sub>2</sub>

Information on the health effects of SO<sub>2</sub> can be found in the EPA Integrated Science Assessment for Sulfur Oxides.<sup>365</sup> SO<sub>2</sub> has long been known to cause adverse respiratory health effects, particularly among individuals with asthma. Other potentially sensitive groups include children and the elderly. During periods of elevated ventilation, asthmatics may experience symptomatic bronchoconstriction within minutes of exposure. Following an extensive evaluation of health evidence from epidemiologic and laboratory studies, the EPA has concluded that there is a causal relationship between respiratory health effects and short-term exposure to SO<sub>2</sub>. Separately, based on an evaluation of the epidemiologic evidence of associations between short-term exposure to SO<sub>2</sub> and mortality, the EPA has concluded that the overall evidence is suggestive of a causal relationship between short-term exposure to SO<sub>2</sub> and mortality.

(4) Carbon Monoxide

Information on the health effects of CO can be found in the EPA Integrated Science Assessment (ISA) for Carbon Monoxide.<sup>366</sup> The ISA concludes that ambient concentrations of CO are associated with a number of adverse health effects.<sup>367</sup> This section provides a summary of the health effects associated with exposure to ambient concentrations of CO.<sup>368</sup>

Human clinical studies of subjects with coronary artery disease show a decrease in the time to onset of exercise-induced angina (chest pain) and electrocardiogram changes following CO exposure. In addition, epidemiologic studies show associations between

<sup>365</sup> U.S. EPA. (2008). *Integrated Science Assessment (ISA) for Sulfur Oxides—Health Criteria (Final Report)*. EPA/600/R-08/047F. Washington, DC: U.S. Environmental Protection Agency. Docket EPA-HQ-OAR-2010-0162.

<sup>366</sup> U.S. EPA. 2010. *Integrated Science Assessment for Carbon Monoxide (Final Report)*. U.S. Environmental Protection Agency, Washington, DC, EPA/600/R-09/019F, 2010. Available at <http://cfpub.epa.gov/ncea/cfm/recordisplay.cfm?deid=218686>. Docket EPA-HQ-OAR-2010-0162

<sup>367</sup> The ISA evaluates the health evidence associated with different health effects, assigning one of five “weight of evidence” determinations: causal relationship, likely to be a causal relationship, suggestive of a causal relationship, inadequate to infer a causal relationship, and not likely to be a causal relationship. For definitions of these levels of evidence, please refer to Section 1.6 of the ISA.

<sup>368</sup> Personal exposure includes contributions from many sources, and in many different environments. Total personal exposure to CO includes both ambient and nonambient components; and both components may contribute to adverse health effects.

short-term CO exposure and cardiovascular morbidity, particularly increased emergency room visits and hospital admissions for coronary heart disease (including ischemic heart disease, myocardial infarction, and angina). Some epidemiologic evidence is also available for increased hospital admissions and emergency room visits for congestive heart failure and cardiovascular disease as a whole. The ISA concludes that a causal relationship is likely to exist between short-term exposures to CO and cardiovascular morbidity. It also concludes that available data are inadequate to conclude that a causal relationship exists between long-term exposures to CO and cardiovascular morbidity.

Animal studies show various neurological effects with in-utero CO exposure. Controlled human exposure studies report inconsistent neural and behavioral effects following low-level CO exposures. The ISA concludes the evidence is suggestive of a causal relationship with both short- and long-term exposure to CO and central nervous system effects.

A number of epidemiologic and animal toxicological studies cited in the ISA have evaluated associations between CO exposure and birth outcomes such as preterm birth or cardiac birth defects. The epidemiologic studies provide limited evidence of a CO-induced effect on preterm births and birth defects, with weak evidence for a decrease in birth weight. Animal toxicological studies have found associations between perinatal CO exposure and decrements in birth weight, as well as other developmental outcomes. The ISA concludes these studies are suggestive of a causal relationship between long-term exposures to CO and developmental effects and birth outcomes.

Epidemiologic studies provide evidence of effects on respiratory morbidity such as changes in pulmonary function, respiratory symptoms, and hospital admissions associated with ambient CO concentrations. A limited number of epidemiologic studies considered copollutants such as ozone, SO<sub>2</sub>, and PM in two-pollutant models and found that CO risk estimates were generally robust, although this limited evidence makes it difficult to disentangle effects attributed to CO itself from those of the larger complex air pollution mixture. Controlled human exposure studies have not extensively evaluated the effect of CO on respiratory morbidity. Animal studies at levels of 50–100 ppm CO show preliminary evidence of altered pulmonary vascular remodeling and

oxidative injury. The ISA concludes that the evidence is suggestive of a causal relationship between short-term CO exposure and respiratory morbidity, and inadequate to conclude that a causal relationship exists between long-term exposure and respiratory morbidity.

Finally, the ISA concludes that the epidemiologic evidence is suggestive of a causal relationship between short-term exposures to CO and mortality. Epidemiologic studies provide evidence of an association between short-term exposure to CO and mortality, but limited evidence is available to evaluate cause-specific mortality outcomes associated with CO exposure. In addition, the attenuation of CO risk estimates which was often observed in copollutant models contributes to the uncertainty as to whether CO is acting alone or as an indicator for other combustion-related pollutants. The ISA also concludes that there is not likely to be a causal relationship between relevant long-term exposures to CO and mortality.

#### (5) Air Toxics

Heavy-duty vehicle emissions contribute to ambient levels of air toxics known or suspected as human or animal carcinogens, or that have noncancer health effects. The population experiences an elevated risk of cancer and other noncancer health effects from exposure to the class of pollutants known collectively as "air toxics."<sup>369</sup> These compounds include, but are not limited to, benzene, 1,3-butadiene, formaldehyde, acetaldehyde, acrolein, diesel particulate matter and exhaust organic gases, polycyclic organic matter, and naphthalene. These compounds were identified as national or regional risk drivers or contributors in the 2005 National-scale Air Toxics Assessment and have significant inventory contributions from mobile sources.<sup>370</sup>

#### (a) Diesel Exhaust

Heavy-duty diesel engines emit diesel exhaust, a complex mixture composed of carbon dioxide, oxygen, nitrogen, water vapor, carbon monoxide, nitrogen compounds, sulfur compounds and numerous low-molecular-weight hydrocarbons. A number of these gaseous hydrocarbon components are individually known to be toxic, including aldehydes, benzene and 1,3-butadiene. The diesel particulate matter

present in diesel exhaust consists mostly of fine particles (< 2.5 μm), including a significant fraction of ultrafine particles (< 0.1 μm). These particles have a large surface area which makes them an excellent medium for adsorbing organics and their small size makes them highly respirable. Many of the organic compounds present in the gases and on the particles, such as polycyclic organic matter, are individually known to have mutagenic and carcinogenic properties.

Diesel exhaust varies significantly in chemical composition and particle sizes between different engine types (heavy-duty, light-duty), engine operating conditions (idle, accelerate, decelerate), and fuel formulations (high/low sulfur fuel). Also, there are emissions differences between on-road and nonroad engines because the nonroad engines are generally of older technology. After being emitted in the engine exhaust, diesel exhaust undergoes dilution as well as chemical and physical changes in the atmosphere. The lifetime for some of the compounds present in diesel exhaust ranges from hours to days.<sup>371</sup>

#### (i) Diesel Exhaust: Potential Cancer Effects

In EPA's 2002 Diesel Health Assessment Document (Diesel HAD),<sup>372</sup> exposure to diesel exhaust was classified as likely to be carcinogenic to humans by inhalation from environmental exposures, in accordance with the revised draft 1996/1999 EPA cancer guidelines. A number of other agencies (National Institute for Occupational Safety and Health, the International Agency for Research on Cancer, the World Health Organization, California EPA, and the U.S. Department of Health and Human Services) have made similar classifications. However, EPA also concluded in the Diesel HAD that it is not possible currently to calculate a cancer unit risk for diesel exhaust due to a variety of factors that limit the current studies, such as limited quantitative exposure histories in occupational groups investigated for lung cancer.

For the Diesel HAD, EPA reviewed 22 epidemiologic studies on the subject of the carcinogenicity of workers exposed

to diesel exhaust in various occupations, finding increased lung cancer risk, although not always statistically significant, in 8 out of 10 cohort studies and 10 out of 12 case-control studies within several industries. Relative risk for lung cancer associated with exposure ranged from 1.2 to 1.5, although a few studies show relative risks as high as 2.6. Additionally, the Diesel HAD also relied on two independent meta-analyses, which examined 23 and 30 occupational studies respectively, which found statistically significant increases in smoking-adjusted relative lung cancer risk associated with exposure to diesel exhaust of 1.33 to 1.47. These meta-analyses demonstrate the effect of pooling many studies and in this case show the positive relationship between diesel exhaust exposure and lung cancer across a variety of diesel exhaust-exposed occupations.<sup>373 374</sup>

In the absence of a cancer unit risk, the Diesel HAD sought to provide additional insight into the significance of the diesel exhaust-cancer hazard by estimating possible ranges of risk that might be present in the population. An exploratory analysis was used to characterize a possible risk range by comparing a typical environmental exposure level for highway diesel sources to a selected range of occupational exposure levels. The occupationally observed risks were then proportionally scaled according to the exposure ratios to obtain an estimate of the possible environmental risk. A number of calculations are needed to accomplish this, and these can be seen in the EPA Diesel HAD. The outcome was that environmental risks from diesel exhaust exposure could range from a low of 10<sup>-4</sup> to 10<sup>-5</sup> to as high as 10<sup>3</sup>, reflecting the range of occupational exposures that could be associated with the relative and absolute risk levels observed in the occupational studies. Because of uncertainties, the analysis acknowledged that the risks could be lower than 10<sup>-4</sup> or 10<sup>-5</sup>, and a zero risk from diesel exhaust exposure was not ruled out.

#### (ii) Diesel Exhaust: Other Health Effects

Noncancer health effects of acute and chronic exposure to diesel exhaust emissions are also of concern to the EPA. EPA derived a diesel exhaust reference concentration (RfC) from

<sup>369</sup> U.S. EPA. 2002 National-Scale Air Toxics Assessment. <http://www.epa.gov/ttn/atw/nata12002/risksum.html> Docket EPA-HQ-OAR-2010-0162.

<sup>370</sup> U.S. EPA. 2009. National-Scale Air Toxics Assessment for 2002. <http://www.epa.gov/ttn/atw/nata2002/DocketEPA-HQ-OAR-2010-0162>.

<sup>371</sup> U.S. EPA (2002). *Health Assessment Document for Diesel Engine Exhaust*. EPA/600/8-90/057F Office of Research and Development, Washington DC. Retrieved on March 17, 2009, from <http://cfpub.epa.gov/ncea/cfm/recorderdisplay.cfm?deid=29060>. Docket EPA-HQ-OAR-2010-0162.

<sup>372</sup> See U.S. EPA (2002) Diesel HAD, Note 371, at pp. 1-1, 1-2.

<sup>373</sup> Bhatia, R., Lopipero, P., Smith, A. (1998). Diesel exposure and lung cancer. *Epidemiology*, 9(1), 84-91. Docket EPA-HQ-OAR-2010-0162.

<sup>374</sup> Lipsett, M. Campleman, S. (1999). Occupational exposure to diesel exhaust and lung cancer: a meta-analysis. *Am J Public Health*, 80(7), 1009-1017. Docket EPA-HQ-OAR-2010-0162.

consideration of four well-conducted chronic rat inhalation studies showing adverse pulmonary effects.<sup>375 376 377 378</sup> The RfC is 5 µg/m<sup>3</sup> for diesel exhaust as measured by diesel particulate matter. This RfC does not consider allergenic effects such as those associated with asthma or immunologic effects. There is growing evidence, discussed in the Diesel HAD, that exposure to diesel exhaust can exacerbate these effects, but the exposure-response data are presently lacking to derive an RfC. The EPA Diesel HAD states, "With [diesel particulate matter] being a ubiquitous component of ambient PM, there is an uncertainty about the adequacy of the existing [diesel exhaust] noncancer database to identify all of the pertinent [diesel exhaust]-caused noncancer health hazards." (p. 9–19). The Diesel HAD concludes "that acute exposure to [diesel exhaust] has been associated with irritation of the eye, nose, and throat, respiratory symptoms (cough and phlegm), and neurophysiological symptoms such as headache, lightheadedness, nausea, vomiting, and numbness or tingling of the extremities."<sup>379</sup>

#### (iii) Ambient PM<sub>2.5</sub> Levels and Exposure to Diesel Exhaust PM

The Diesel HAD also briefly summarizes health effects associated with ambient PM and discusses the EPA's annual PM<sub>2.5</sub> NAAQS of 15 µg/m<sup>3</sup>. There is a much more extensive body of human data showing a wide spectrum of adverse health effects associated with exposure to ambient PM, of which diesel exhaust is an important component. The PM<sub>2.5</sub> NAAQS is designed to provide protection from the noncancer and premature mortality effects of PM<sub>2.5</sub> as a whole.

<sup>375</sup> Ishinishi, N. Kuwabara, N. Takaki, Y., et al. (1988). Long-term inhalation experiments on diesel exhaust. In: *Diesel exhaust and health risks*. Results of the HERP studies. Ibaraki, Japan: Research Committee for HERP Studies; pp.11–84. Docket EPA–HQ–OAR–2010–0162.

<sup>376</sup> Heinrich, U., Fuhst, R., Rittinghausen, S., et al. (1995). Chronic inhalation exposure of Wistar rats and two different strains of mice to diesel engine exhaust, carbon black, and titanium dioxide. *Inhal Toxicol*, 7, 553–556. Docket EPA–HQ–OAR–2010–0162.

<sup>377</sup> Mauderly, J.L., Jones, R.K., Griffith, W.C., et al. (1987). Diesel exhaust is a pulmonary carcinogen in rats exposed chronically by inhalation. *Fundam. Appl. Toxicol.*, 9, 208–221. Docket EPA–HQ–OAR–2010–0162.

<sup>378</sup> Nikula, K.J., Snipes, M.B., Barr, E.B., et al. (1995). Comparative pulmonary toxicities and carcinogenicities of chronically inhaled diesel exhaust and carbon black in F344 rats. *Fundam. Appl. Toxicol.*, 25, 80–94. Docket EPA–HQ–OAR–2010–0162.

<sup>379</sup> See U.S. EPA (2002), Diesel HAD at Note 371, at p. 9–9.

#### (iv) Diesel Exhaust PM Exposures

Exposure of people to diesel exhaust depends on their various activities, the time spent in those activities, the locations where these activities occur, and the levels of diesel exhaust pollutants in those locations. The major difference between ambient levels of diesel particulate and exposure levels for diesel particulate is that exposure accounts for a person moving from location to location, proximity to the emission source, and whether the exposure occurs in an enclosed environment.

#### Occupational Exposures

Occupational exposures to diesel exhaust from mobile sources can be several orders of magnitude greater than typical exposures in the non-occupationally exposed population.

Over the years, diesel particulate exposures have been measured for a number of occupational groups. A wide range of exposures has been reported, from 2 µg/m<sup>3</sup> to 1,280 µg/m<sup>3</sup>, for a variety of occupations. As discussed in the Diesel HAD, the National Institute of Occupational Safety and Health has estimated a total of 1,400,000 workers are occupationally exposed to diesel exhaust from on-road and nonroad vehicles.

#### Elevated Concentrations and Ambient Exposures in Mobile Source-Impacted Areas

Regions immediately downwind of highways or truck stops may experience elevated ambient concentrations of directly-emitted PM<sub>2.5</sub> from diesel engines. Due to the unique nature of highways and truck stops, emissions from a large number of diesel engines are concentrated in a small area. Studies near roadways with high truck traffic indicate higher concentrations of components of diesel PM than other locations.<sup>380, 381, 382</sup> High ambient particle concentrations have also been reported near trucking terminals, truck stops, and bus garages.<sup>383, 384, 385</sup>

<sup>380</sup> Zhu, Y.; Hinds, W.C.; Kim, S.; Shen, S.; Sioutas, C. (2002) Study of ultrafine particles near a major highway with heavy-duty diesel traffic. *Atmospheric Environment* 36: 4323–4335. Docket EPA–HQ–OAR–2010–0162.

<sup>381</sup> Lena, T.S.; Ochieng, V.; Holguin-Veras, J.; Kinney, P.L. (2002) Elemental carbon and PM<sub>2.5</sub> levels in an urban community heavily impacted by truck traffic. *Environ Health Perspect* 110: 1009–1015. Docket EPA–HQ–OAR–2010–0162.

<sup>382</sup> Soliman, A.S.M.; Jacko, J.B.; Palmer, G.M. (2006) Development of an empirical model to estimate real-world fine particulate matter emission factors: the Traffic Air Quality model. *J Air & Waste Manage Assoc* 56: 1540–1549. Docket EPA–HQ–OAR–2010–0162.

<sup>383</sup> Davis, M.E.; Smith, T.J.; Laden, F.; Hart, J.E.; Ryan, L.M.; Garshick, E. (2006) Modeling particle

Additional discussion of exposure and health effects associated with traffic is included below in Section 0.

#### (b) Benzene

The EPA's Integrated Risk Information System (IRIS) database lists benzene as a known human carcinogen (causing leukemia) by all routes of exposure, and concludes that exposure is associated with additional health effects, including genetic changes in both humans and animals and increased proliferation of bone marrow cells in mice.<sup>386, 387, 388</sup> EPA states in its IRIS database that data indicate a causal relationship between benzene exposure and acute lymphocytic leukemia and suggest a relationship between benzene exposure and chronic non-lymphocytic leukemia and chronic lymphocytic leukemia. The International Agency for Research on Carcinogens (IARC) has determined that benzene is a human carcinogen and the U.S. Department of Health and Human Services (DHHS) has characterized benzene as a known human carcinogen.<sup>389, 390</sup>

A number of adverse noncancer health effects including blood disorders, such as preleukemia and aplastic anemia, have also been associated with long-term exposure to benzene.<sup>391, 392</sup>

exposure in U.S. trucking terminals. *Environ Sci Technol* 40: 4226–4232. Docket EPA–HQ–OAR–2010–0162.

<sup>384</sup> Miller, T.L.; Fu, J.S.; Hromis, B.; Storey, J.M. (2007) Diesel truck idling emissions—measurements at a PM<sub>2.5</sub> hot spot. Proceedings of the Annual Conference of the Transportation Research Board, paper no. 07–2609. Docket EPA–HQ–OAR–2010–0162.

<sup>385</sup> Ramachandran, G.; Paulsen, D.; Watts, W.; Kittelson, D. (2005) Mass, surface area, and number metrics in diesel occupational exposure assessment. *J Environ Monit* 7: 728–735. Docket EPA–HQ–OAR–2010–0162.

<sup>386</sup> U.S. EPA. 2000. Integrated Risk Information System File for Benzene. This material is available electronically at <http://www.epa.gov/iris/subst/0276.htm>. Docket EPA–HQ–OAR–2010–0162.

<sup>387</sup> International Agency for Research on Cancer. 1982. Monographs on the evaluation of carcinogenic risk of chemicals to humans, Volume 29. Some industrial chemicals and dyestuffs, World Health Organization, Lyon, France, p. 345–389. Docket EPA–HQ–OAR–2010–0162.

<sup>388</sup> Irons, R.D.; Stillman, W.S.; Colagiovanni, D.B.; Henry, V.A. 1992. Synergistic action of the benzene metabolite hydroquinone on myelopoietic stimulating activity of granulocyte/macrophage colony-stimulating factor in vitro. *Proc. Natl. Acad. Sci.* 89:3691–3695. Docket EPA–HQ–OAR–2010–0162.

<sup>389</sup> See IARC, Note 387, above.

<sup>390</sup> U.S. Department of Health and Human Services National Toxicology Program 11th Report on Carcinogens available at: <http://ntp.niehs.nih.gov/go/16183>. Docket EPA–HQ–OAR–2010–0162.

<sup>391</sup> Aksoy, M. (1989). Hematotoxicity and carcinogenicity of benzene. *Environ. Health Perspect* 82: 193–197. Docket EPA–HQ–OAR–2010–0162.



The most sensitive noncancer effect observed in humans, based on current data, is the depression of the absolute lymphocyte count in blood.<sup>393, 394</sup> In addition, recent work, including studies sponsored by the Health Effects Institute (HEI), provides evidence that biochemical responses are occurring at lower levels of benzene exposure than previously known.<sup>395, 396, 397, 398</sup> EPA's IRIS program has not yet evaluated these new data.

#### (c) 1,3-Butadiene

EPA has characterized 1,3-butadiene as carcinogenic to humans by inhalation.<sup>399, 400</sup> The IARC has determined that 1,3-butadiene is a human carcinogen and the U.S. DHHS has characterized 1,3-butadiene as a known human carcinogen.<sup>401, 402</sup> There

<sup>392</sup> Goldstein, B.D. (1988). Benzene toxicity. Occupational medicine. State of the Art Reviews. 3: 541-554. Docket EPA-HQ-OAR-2010-0162.

<sup>393</sup> Rothman, N., G.L. Li, M. Dosemeci, W.E. Bechtold, G.E. Marti, Y.Z. Wang, M. Linet, L.Q. Xi, W. Lu, M.T. Smith, N. Titenko-Holland, L.P. Zhang, W. Blot, S.N. Yin, and R.B. Hayes (1996) Hematotoxicity among Chinese workers heavily exposed to benzene. Am. J. Ind. Med. 29: 236-246. Docket EPA-HQ-OAR-2010-0162.

<sup>394</sup> U.S. EPA (2002) Toxicological Review of Benzene (Noncancer Effects). Environmental Protection Agency, Integrated Risk Information System, Research and Development, National Center for Environmental Assessment, Washington DC. This material is available electronically at <http://www.epa.gov/iris/subst/0276.htm>. Docket EPA-HQ-OAR-2010-0162.

<sup>395</sup> Qu, O.; Shore, R.; Li, G.; Jin, X.; Chen, C.L.; Cohen, B.; Melikian, A.; Eastmond, D.; Rappaport, S.; Li, H.; Rupa, D.; Suramaya, R.; Songnian, W.; Huifant, Y.; Meng, M.; Winnik, M.; Kwok, E.; Li, Y.; Mu, R.; Xu, B.; Zhang, X.; Li, K. (2003) HEI Report 115, Validation & Evaluation of Biomarkers in Workers Exposed to Benzene in China. Docket EPA-HQ-OAR-2010-0162.

<sup>396</sup> Qu, Q., R. Shore, G. Li, X. Jin, L.C. Chen, B. Cohen, et al. (2002) Hematological changes among Chinese workers with a broad range of benzene exposures. Am. J. Industr. Med. 42: 275-285. Docket EPA-HQ-OAR-2010-0162.

<sup>397</sup> Lan, Qing, Zhang, L., Li, G., Vermeulen, R., et al. (2004) Hematotoxicity in Workers Exposed to Low Levels of Benzene. Science 306: 1774-1776. Docket EPA-HQ-OAR-2010-0162.

<sup>398</sup> Turteltaub, K.W. and Mani, C. (2003) Benzene metabolism in rodents at doses relevant to human exposure from Urban Air. Research Reports Health Effect Inst. Report No.113. Docket EPA-HQ-OAR-2010-0162.

<sup>399</sup> U.S. EPA (2002) Health Assessment of 1,3-Butadiene. Office of Research and Development, National Center for Environmental Assessment, Washington Office, Washington, DC. Report No. EPA600-P-98-001F. This document is available electronically at <http://www.epa.gov/iris/supdocs/buta-sup.pdf>. Docket EPA-HQ-OAR-2010-0162.

<sup>400</sup> U.S. EPA (2002) Full IRIS Summary for 1,3-butadiene (CASRN 106-99-0). Environmental Protection Agency, Integrated Risk Information System (IRIS), Research and Development, National Center for Environmental Assessment, Washington, DC <http://www.epa.gov/iris/subst/0139.htm>. Docket EPA-HQ-OAR-2010-0162.

<sup>401</sup> International Agency for Research on Cancer (1999) Monographs on the evaluation of carcinogenic risk of chemicals to humans, Volume

are numerous studies consistently demonstrating that 1,3-butadiene is metabolized into genotoxic metabolites by experimental animals and humans. The specific mechanisms of 1,3-butadiene-induced carcinogenesis are unknown; however, the scientific evidence strongly suggests that the carcinogenic effects are mediated by genotoxic metabolites. Animal data suggest that females may be more sensitive than males for cancer effects associated with 1,3-butadiene exposure; there are insufficient data in humans from which to draw conclusions about sensitive subpopulations. 1,3-butadiene also causes a variety of reproductive and developmental effects in mice; no human data on these effects are available. The most sensitive effect was ovarian atrophy observed in a lifetime bioassay of female mice.<sup>403</sup>

#### (d) Formaldehyde

Since 1987, EPA has classified formaldehyde as a probable human carcinogen based on evidence in humans and in rats, mice, hamsters, and monkeys.<sup>404</sup> EPA is currently reviewing recently published epidemiological data. For instance, research conducted by the National Cancer Institute found an increased risk of nasopharyngeal cancer and lymphohematopoietic malignancies such as leukemia among workers exposed to formaldehyde.<sup>405, 406</sup> In an analysis of the lymphohematopoietic cancer mortality from an extended follow-up of these workers, the National Cancer Institute confirmed an association between lymphohematopoietic cancer risk and

71, Re-evaluation of some organic chemicals, hydrazine and hydrogen peroxide and Volume 97 (in preparation), World Health Organization, Lyon, France. Docket EPA-HQ-OAR-2010-0162.

<sup>402</sup> U.S. Department of Health and Human Services (2005) National Toxicology Program 11th Report on Carcinogens available at: [ntp.niehs.nih.gov/index.cfm?objectid=32BA9724-F1F6-975E-7FCE50709CB4C932](http://ntp.niehs.nih.gov/index.cfm?objectid=32BA9724-F1F6-975E-7FCE50709CB4C932). Docket EPA-HQ-OAR-2010-0162

<sup>403</sup> Bevan, C.; Stadler, J.C.; Elliot, G.S.; et al. (1996) Subchronic toxicity of 4-vinylcyclohexene in rats and mice by inhalation. Fundam. Appl. Toxicol. 32:1-10. Docket EPA-HQ-OAR-2010-0162.

<sup>404</sup> U.S. EPA (1987) Assessment of Health Risks to Garment Workers and Certain Home Residents from Exposure to Formaldehyde, Office of Pesticides and Toxic Substances, April 1987. Docket EPA-HQ-OAR-2010-0162.

<sup>405</sup> Hauptmann, M.; Lubin, J. H.; Stewart, P. A.; Hayes, R. B.; Blair, A. 2003. Mortality from lymphohematopoietic malignancies among workers in formaldehyde industries. Journal of the National Cancer Institute 95: 1615-1623. Docket EPA-HQ-OAR-2010-0162.

<sup>406</sup> Hauptmann, M.; Lubin, J. H.; Stewart, P. A.; Hayes, R. B.; Blair, A. 2004. Mortality from solid cancers among workers in formaldehyde industries. American Journal of Epidemiology 159: 1117-1130. Docket EPA-HQ-OAR-2010-0162.

peak exposures.<sup>407</sup> A recent National Institute of Occupational Safety and Health study of garment workers also found increased risk of death due to leukemia among workers exposed to formaldehyde.<sup>408</sup> Extended follow-up of a cohort of British chemical workers did not find evidence of an increase in nasopharyngeal or lymphohematopoietic cancers, but a continuing statistically significant excess in lung cancers was reported.<sup>409</sup> Recently, the IARC re-classified formaldehyde as a human carcinogen (Group 1).<sup>410</sup>

Formaldehyde exposure also causes a range of noncancer health effects, including irritation of the eyes (burning and watering of the eyes), nose and throat. Effects from repeated exposure in humans include respiratory tract irritation, chronic bronchitis and nasal epithelial lesions such as metaplasia and loss of cilia. Animal studies suggest that formaldehyde may also cause airway inflammation—including eosinophil infiltration into the airways. There are several studies that suggest that formaldehyde may increase the risk of asthma—particularly in the young.<sup>411, 412</sup>

#### (e) Acetaldehyde

Acetaldehyde is classified in EPA's IRIS database as a probable human carcinogen, based on nasal tumors in rats, and is considered toxic by the inhalation, oral, and intravenous

<sup>407</sup> Beane Freeman, L. E.; Blair, A.; Lubin, J. H.; Stewart, P. A.; Hayes, R. B.; Hoover, R. N.; Hauptmann, M. 2009. Mortality from lymphohematopoietic malignancies among workers in formaldehyde industries: The National Cancer Institute cohort. J. National Cancer Inst. 101: 751-761. Docket EPA-HQ-OAR-2010-0162.

<sup>408</sup> Pinkerton, L. E. 2004. Mortality among a cohort of garment workers exposed to formaldehyde: an update. Occup. Environ. Med. 61: 193-200. Docket EPA-HQ-OAR-2010-0162.

<sup>409</sup> Coggon, D, EC Harris, J Poole, KT Palmer. 2003. Extended follow-up of a cohort of British chemical workers exposed to formaldehyde. J National Cancer Inst. 95:1608-1615. Docket EPA-HQ-OAR-2010-0162.

<sup>410</sup> International Agency for Research on Cancer. 2006. Formaldehyde, 2-Butoxyethanol and 1-tert-Butoxypropan-2-ol. Volume 88. (in preparation), World Health Organization, Lyon, France. Docket EPA-HQ-OAR-2010-0162

<sup>411</sup> Agency for Toxic Substances and Disease Registry (ATSDR). 1999. Toxicological profile for Formaldehyde. Atlanta, GA: U.S. Department of Health and Human Services, Public Health Service. <http://www.atsdr.cdc.gov/toxprofiles/tp111.html> Docket EPA-HQ-OAR-2010-0162.

<sup>412</sup> WHO (2002) Concise International Chemical Assessment Document 40: Formaldehyde. Published under the joint sponsorship of the United Nations Environment Programme, the International Labour Organization, and the World Health Organization, and produced within the framework of the Inter-Organization Programme for the Sound Management of Chemicals. Geneva. Docket EPA-HQ-OAR-2010-0162.

routes.<sup>413</sup> Acetaldehyde is reasonably anticipated to be a human carcinogen by the U.S. DHHS in the 11th Report on Carcinogens and is classified as possibly carcinogenic to humans (Group 2B) by the IARC.<sup>414</sup> EPA is currently conducting a reassessment of cancer risk from inhalation exposure to acetaldehyde.

The primary noncancer effects of exposure to acetaldehyde vapors include irritation of the eyes, skin, and respiratory tract.<sup>416</sup> In short-term (4 week) rat studies, degeneration of olfactory epithelium was observed at various concentration levels of acetaldehyde exposure.<sup>417</sup> Data from these studies were used by EPA to develop an inhalation reference concentration. Some asthmatics have been shown to be a sensitive subpopulation to decrements in functional expiratory volume (FEV1 test) and bronchoconstriction upon acetaldehyde inhalation.<sup>419</sup> The agency is currently conducting a reassessment of the health hazards from inhalation exposure to acetaldehyde.

#### (f) Acrolein

Acrolein is extremely acrid and irritating to humans when inhaled, with acute exposure resulting in upper respiratory tract irritation, mucus hypersecretion and congestion. The intense irritancy of this carbonyl has been demonstrated during controlled tests in human subjects, who suffer intolerable eye and nasal mucosal sensory reactions within minutes of

exposure.<sup>420</sup> These data and additional studies regarding acute effects of human exposure to acrolein are summarized in EPA's 2003 IRIS Human Health Assessment for acrolein.<sup>421</sup> Evidence available from studies in humans indicate that levels as low as 0.09 ppm (0.21 mg/m<sup>3</sup>) for five minutes may elicit subjective complaints of eye irritation with increasing concentrations leading to more extensive eye, nose and respiratory symptoms.<sup>422</sup> Lesions to the lungs and upper respiratory tract of rats, rabbits, and hamsters have been observed after subchronic exposure to acrolein.<sup>423</sup> Acute exposure effects in animal studies report bronchial hyper-responsiveness.<sup>424</sup> In a recent study, the acute respiratory irritant effects of exposure to 1.1 ppm acrolein were more pronounced in mice with allergic airway disease by comparison to non-diseased mice which also showed decreases in respiratory rate.<sup>425</sup> Based on these animal data and demonstration of similar effects in humans (e.g., reduction in respiratory rate), individuals with compromised respiratory function (e.g., emphysema, asthma) are expected to be at increased risk of developing adverse responses to strong respiratory irritants such as acrolein.

EPA determined in 2003 that the human carcinogenic potential of acrolein could not be determined because the available data were inadequate. No information was available on the carcinogenic effects of acrolein in humans and the animal data provided inadequate evidence of carcinogenicity.<sup>426</sup> The IARC

determined in 1995 that acrolein was not classifiable as to its carcinogenicity in humans.<sup>427</sup>

#### (g) Polycyclic Organic Matter

The term polycyclic organic matter (POM) defines a broad class of compounds that includes the polycyclic aromatic hydrocarbon compounds (PAHs). One of these compounds, naphthalene, is discussed separately below. POM compounds are formed primarily from combustion and are present in the atmosphere in gas and particulate form. Cancer is the major concern from exposure to POM. Epidemiologic studies have reported an increase in lung cancer in humans exposed to diesel exhaust, coke oven emissions, roofing tar emissions, and cigarette smoke; all of these mixtures contain POM compounds.<sup>428,429</sup> Animal studies have reported respiratory tract tumors from inhalation exposure to benzo[a]pyrene and alimentary tract and liver tumors from oral exposure to benzo[a]pyrene. EPA has classified seven PAHs (benzo[a]pyrene, benz[a]anthracene, chrysene, benzo[b]fluoranthene, benzo[k]fluoranthene, dibenz[a,h]anthracene, and indeno[1,2,3-cd]pyrene) as Group B2, probable human carcinogens.<sup>430</sup> Recent studies have found that maternal exposures to PAHs in a population of pregnant women were associated with several adverse birth outcomes, including low birth weight and reduced length at birth, as well as impaired cognitive development in preschool children (3 years of age).<sup>431,432</sup> EPA has not yet evaluated these recent studies.

<sup>413</sup> U.S. EPA. 1991. Integrated Risk Information System File of Acetaldehyde. Research and Development, National Center for Environmental Assessment, Washington, DC. Available at <http://www.epa.gov/iris/subst/0290.htm>. Docket EPA-HQ-OAR-2010-0162.

<sup>414</sup> U.S. Department of Health and Human Services National Toxicology Program 11th Report on Carcinogens available at: [ntp.niehs.nih.gov/index.cfm?objectid=32BA9724-F1F6-975E-7FCE50709CB4C932](http://ntp.niehs.nih.gov/index.cfm?objectid=32BA9724-F1F6-975E-7FCE50709CB4C932). Docket EPA-HQ-OAR-2010-0162.

<sup>415</sup> International Agency for Research on Cancer. 1999. Re-evaluation of some organic chemicals, hydrazine, and hydrogen peroxide. IARC Monographs on the Evaluation of Carcinogenic Risk of Chemical to Humans, Vol 71. Lyon, France. Docket EPA-HQ-OAR-2010-0162.

<sup>416</sup> See Integrated Risk Information System File of Acetaldehyde, Note 413, above.

<sup>417</sup> Appleman, L. M., R. A. Woutersen, V. J. Feron, R. N. Hooffman, and W. R. F. Notten. 1986. Effects of the variable versus fixed exposure levels on the toxicity of acetaldehyde in rats. *J. Appl. Toxicol.* 6: 331-336. Docket EPA-HQ-OAR-2010-0162.

<sup>418</sup> Appleman, L.M., R.A. Woutersen, and V.J. Feron. 1982. Inhalation toxicity of acetaldehyde in rats. I. Acute and subacute studies. *Toxicology.* 23: 293-297. Docket EPA-HQ-OAR-2010-0162.

<sup>419</sup> Myou, S.; Fujimura, M.; Nishi K.; Ohka, T.; and Matsuda, T. 1993. Aerosolized acetaldehyde induces histamine-mediated bronchoconstriction in asthmatics. *Am. Rev. Respir. Dis.* 148(4 Pt 1): 940-3. Docket EPA-HQ-OAR-2010-0162.

<sup>420</sup> U.S. EPA (U.S. Environmental Protection Agency). (2003) Toxicological review of acrolein in support of summary information on Integrated Risk Information System (IRIS) National Center for Environmental Assessment, Washington, DC. EPA/635/R-03/003. p. 10. Available online at: <http://www.epa.gov/ncea/iris/toxreviews/0364tr.pdf>. Docket EPA-HQ-OAR-2010-0162.

<sup>421</sup> See U.S. EPA 2003 Toxicological review of acrolein, Note 420, above.

<sup>422</sup> See U.S. EPA 2003 Toxicological review of acrolein, Note 420, at p. 11.

<sup>423</sup> Integrated Risk Information System File of Acrolein. Office of Research and Development, National Center for Environmental Assessment, Washington, DC. This material is available at <http://www.epa.gov/iris/subst/0364.htm> Docket EPA-HQ-OAR-2010-0162.

<sup>424</sup> See U.S. EPA 2003 Toxicological review of acrolein, Note 420, at p. 15.

<sup>425</sup> Morris JB, Symanowicz PT, Olsen JE, et al. 2003. Immediate sensory nerve-mediated respiratory responses to irritants in healthy and allergic airway-diseased mice. *J Appl Physiol* 94(4):1563-1571. Docket EPA-HQ-OAR-2010-0162.

<sup>426</sup> U.S. EPA. 2003. Integrated Risk Information System File of Acrolein. Research and Development, National Center for Environmental Assessment, Washington, DC. This material is available at <http://www.epa.gov/iris/subst/0364.htm> Docket EPA-HQ-OAR-2010-0162.

<sup>427</sup> International Agency for Research on Cancer. 1995. Monographs on the evaluation of carcinogenic risk of chemicals to humans, Volume 63. Dry cleaning, some chlorinated solvents and other industrial chemicals, World Health Organization, Lyon, France. Docket EPA-HQ-OAR-2010-0162.

<sup>428</sup> Agency for Toxic Substances and Disease Registry (ATSDR). 1995. Toxicological profile for Polycyclic Aromatic Hydrocarbons (PAHs). Atlanta, GA: U.S. Department of Health and Human Services, Public Health Service. Available electronically at <http://www.atsdr.cdc.gov/ToxProfiles/TP.asp?id=122&tid=25>.

<sup>429</sup> U.S. EPA (2002). *Health Assessment Document for Diesel Engine Exhaust*. EPA/600/8-90/057F Office of Research and Development, Washington DC. <http://cfpub.epa.gov/ncea/cfm/recordisplay.cfm?deid=29060>. Docket EPA-HQ-OAR-2010-0162.

<sup>430</sup> U.S. EPA (1997). Integrated Risk Information System File of indeno(1,2,3-cd)pyrene. Research and Development, National Center for Environmental Assessment, Washington, DC. This material is available electronically at <http://www.epa.gov/ncea/iris/subst/0457.htm>.

<sup>431</sup> Perera, F.P.; Rauh, V.; Tsai, W.-Y.; et al. (2002) Effect of transplacental exposure to environmental pollutants on birth outcomes in a multiethnic population. *Environ Health Perspect.* 111: 201-205.

## (h) Naphthalene

Naphthalene is found in small quantities in gasoline and diesel fuels. Naphthalene emissions have been measured in larger quantities in both gasoline and diesel exhaust compared with evaporative emissions from mobile sources, indicating it is primarily a product of combustion. EPA released an external review draft of a reassessment of the inhalation carcinogenicity of naphthalene based on a number of recent animal carcinogenicity studies.<sup>433</sup> The draft reassessment completed external peer review.<sup>434</sup> Based on external peer review comments received, additional analyses are being undertaken. This external review draft does not represent official agency opinion and was released solely for the purposes of external peer review and public comment. The National Toxicology Program listed naphthalene as “reasonably anticipated to be a human carcinogen” in 2004 on the basis of bioassays reporting clear evidence of carcinogenicity in rats and some evidence of carcinogenicity in mice.<sup>435</sup> California EPA has released a new risk assessment for naphthalene, and the IARC has reevaluated naphthalene and re-classified it as Group 2B: possibly carcinogenic to humans.<sup>436</sup> Naphthalene also causes a number of chronic non-cancer effects in animals, including abnormal cell changes and growth in respiratory and nasal tissues.<sup>437</sup>

## (i) Other Air Toxics

In addition to the compounds described above, other compounds in

gaseous hydrocarbon and PM emissions from heavy-duty vehicles will be affected by this final action. Mobile source air toxic compounds that would potentially be impacted include ethylbenzene, propionaldehyde, toluene, and xylene. Information regarding the health effects of these compounds can be found in EPA’s IRIS database.<sup>438</sup>

## (j) Exposure and Health Effects Associated with Traffic

Populations who live, work, or attend school near major roads experience elevated exposure concentrations to a wide range of air pollutants, as well as higher risks for a number of adverse health effects. While the previous sections of this preamble have focused on the health effects associated with individual criteria pollutants or air toxics, this section discusses the mixture of different exposures near major roadways, rather than the effects of any single pollutant. As such, this section emphasizes traffic-related air pollution, in general, as the relevant indicator of exposure rather than any particular pollutant.

Concentrations of many traffic-generated air pollutants are elevated for up to 300–500 meters downwind of roads with high traffic volumes.<sup>439</sup> Numerous sources on roads contribute to elevated roadside concentrations, including exhaust and evaporative emissions, and resuspension of road dust and tire and brake wear. Concentrations of several criteria and hazardous air pollutants are elevated near major roads. Furthermore, different semi-volatile organic compounds and chemical components of particulate matter, including elemental carbon, organic material, and trace metals, have been reported at higher concentrations near major roads.

Populations near major roads experience greater risk of certain adverse health effects. The Health Effects Institute published a report on the health effects of traffic-related air pollution.<sup>440</sup> It concluded that evidence

is “sufficient to infer the presence of a causal association” between traffic exposure and exacerbation of childhood asthma symptoms. The HEI report also concludes that the evidence is either “sufficient” or “suggestive but not sufficient” for a causal association between traffic exposure and new childhood asthma cases. A review of asthma studies by Salam *et al.* (2008) reaches similar conclusions.<sup>441</sup> The HEI report also concludes that there is “suggestive” evidence for pulmonary function deficits associated with traffic exposure, but concluded that there is “inadequate and insufficient” evidence for causal associations with respiratory health care utilization, adult-onset asthma, chronic obstructive pulmonary disease symptoms, and allergy. A review by Holguin (2008) notes that the effects of traffic on asthma may be modified by nutrition status, medication use, and genetic factors.<sup>442</sup>

The HEI report also concludes that evidence is “suggestive” of a causal association between traffic exposure and all-cause and cardiovascular mortality. There is also evidence of an association between traffic-related air pollutants and cardiovascular effects such as changes in heart rhythm, heart attack, and cardiovascular disease. The HEI report characterizes this evidence as “suggestive” of a causal association, and an independent epidemiological literature review by Adar and Kaufman (2007) concludes that there is “consistent evidence” linking traffic-related pollution and adverse cardiovascular health outcomes.<sup>443</sup>

Some studies have reported associations between traffic exposure and other health effects, such as birth outcomes (*e.g.*, low birth weight) and childhood cancer. The HEI report concludes that there is currently “inadequate and insufficient” evidence for a causal association between these effects and traffic exposure. A review by Raaschou-Nielsen and Reynolds (2006) concluded that evidence of an association between childhood cancer and traffic-related air pollutants is weak,

<sup>432</sup> Perera, F.P.; Rauh, V.; Whyatt, R.M.; Tsai, W.Y.; Tang, D.; Diaz, D.; Hoepner, L.; Barr, D.; Tu, Y.H.; Camann, D.; Kinney, P. (2006) Effect of prenatal exposure to airborne polycyclic aromatic hydrocarbons on neurodevelopment in the first 3 years of life among inner-city children. *Environ Health Perspect* 114: 1287–1292.

<sup>433</sup> U. S. EPA. 2004. Toxicological Review of Naphthalene (Reassessment of the Inhalation Cancer Risk), Environmental Protection Agency, Integrated Risk Information System, Research and Development, National Center for Environmental Assessment, Washington, DC. This material is available electronically at <http://www.epa.gov/iris/subst/0436.htm>. Docket EPA–HQ–OAR–2010–0162.

<sup>434</sup> Oak Ridge Institute for Science and Education. (2004). External Peer Review for the IRIS Reassessment of the Inhalation Carcinogenicity of Naphthalene. August 2004. <http://cfpub.epa.gov/ncea/cfm/recordisplay.cfm?deid=84403> Docket EPA–HQ–OAR–2010–0162.

<sup>435</sup> National Toxicology Program (NTP). (2004). 11th Report on Carcinogens. Public Health Service, U.S. Department of Health and Human Services, Research Triangle Park, NC. Available from: <http://ntp-server.niehs.nih.gov>. Docket EPA–HQ–OAR–2010–0162.

<sup>436</sup> International Agency for Research on Cancer. (2002). Monographs on the Evaluation of the Carcinogenic Risk of Chemicals for Humans. Vol. 82. Lyon, France. Docket EPA–HQ–OAR–2010–0162.

<sup>437</sup> U. S. EPA. 1998. Toxicological Review of Naphthalene, Environmental Protection Agency, Integrated Risk Information System, Research and Development, National Center for Environmental Assessment, Washington, DC. This material is available electronically at <http://www.epa.gov/iris/subst/0436.htm> Docket EPA–HQ–OAR–2010–0162.

<sup>438</sup> U.S. EPA Integrated Risk Information System (IRIS) database is available at: <http://www.epa.gov/iris>.

<sup>439</sup> Zhou, Y.; Levy, J.I. (2007) Factors influencing the spatial extent of mobile source air pollution impacts: A meta-analysis. *BMC Public Health* 7:89. doi:10.1186/1471-2458-7-89 Docket EPA–HQ–OAR–2010–0162.

] Docket EPA–HQ–OAR–2010–0162.

<sup>441</sup> Salam, M.T.; Islam, T.; Gilliland, F.D. (2008) Recent evidence for adverse effects of residential proximity to traffic sources on asthma. *Current Opin Pulm Med* 14: 3–8. Docket EPA–HQ–OAR–2010–0162.

<sup>442</sup> Holguin, F. (2008) Traffic, outdoor air pollution, and asthma. *Immunol Allergy Clinics North Am* 28: 577–588. Docket EPA–HQ–OAR–2010–0162.

<sup>443</sup> Adar, S.D.; Kaufman, J.D. (2007) Cardiovascular disease and air pollutants: evaluating and improving epidemiological data implicating traffic exposure. *Inhal Toxicol* 19: 135–149. Docket EPA–HQ–OAR–2010–0162.

but noted the inability to draw firm conclusions based on limited evidence.<sup>444</sup>

There is a large population in the United States living in close proximity of major roads. According to the Census Bureau's American Housing Survey for 2007, approximately 20 million residences in the United States, 15.6 percent of all homes, are located within 300 feet (91 m) of a highway with 4+ lanes, a railroad, or an airport.<sup>445</sup> Therefore, at current population of approximately 309 million, assuming that population and housing are similarly distributed, there are over 48 million people in the United States living near such sources. The HEI report also notes that in two North American cities, Los Angeles and Toronto, over 40 percent of each city's population live within 500 meters of a highway or 100 meters of a major road. It also notes that about 33 percent of each city's population resides within 50 meters of major roads. Together, the evidence suggests that a large U.S. population lives in areas with elevated traffic-related air pollution.

People living near roads are often socioeconomically disadvantaged. According to the 2007 American Housing Survey, a renter-occupied property is over twice as likely as an owner-occupied property to be located near a highway with 4+ lanes, railroad or airport. In the same survey, the median household income of rental housing occupants was less than half that of owner-occupants (\$28,921/\$59,886). Numerous studies in individual urban areas report higher levels of traffic-related air pollutants in areas with high minority or poor populations.<sup>446 447 448</sup>

Students may also be exposed in situations where schools are located

near major roads. In a study of nine metropolitan areas across the United States, Appatova *et al.* (2008) found that on average greater than 33 percent of schools were located within 400 m of an Interstate, U.S., or state highway, while 12 percent were located within 100 m.<sup>449</sup> The study also found that among the metropolitan areas studied, schools in the Eastern United States were more often sited near major roadways than schools in the Western United States.

Demographic studies of students in schools near major roadways suggest that this population is more likely than the general student population to be of non-white race or Hispanic ethnicity, and more often live in low socioeconomic status locations.<sup>450 451 452</sup> There is some inconsistency in the evidence, which may be due to different local development patterns and measures of traffic and geographic scale used in the studies.<sup>449</sup>

### C. Environmental Effects of Non-GHG Pollutants

In this section we discuss some of the environmental effects of PM and its precursors such as visibility impairment, atmospheric deposition, and materials damage and soiling, as well as environmental effects associated with the presence of ozone in the ambient air, such as impacts on plants, including trees, agronomic crops and urban ornamentals, and environmental effects associated with air toxics.

#### (1) Visibility

Visibility can be defined as the degree to which the atmosphere is transparent to visible light.<sup>453</sup> Visibility impairment is caused by light scattering and absorption by suspended particles and gases. Visibility is important because it has direct significance to people's

enjoyment of daily activities in all parts of the country. Individuals value good visibility for the well-being it provides them directly, where they live and work, and in places where they enjoy recreational opportunities. Visibility is also highly valued in significant natural areas, such as national parks and wilderness areas, and special emphasis is given to protecting visibility in these areas. For more information on visibility see the final 2009 PM ISA.<sup>454</sup>

EPA is pursuing a two-part strategy to address visibility impairment. First, EPA developed the regional haze program (64 FR 35714) which was put in place in July 1999 to protect the visibility in Mandatory Class I Federal areas. There are 156 national parks, forests and wilderness areas categorized as Mandatory Class I Federal areas (62 FR 38680–38681, July 18, 1997). These areas are defined in CAA section 162 as those national parks exceeding 6,000 acres, wilderness areas and memorial parks exceeding 5,000 acres, and all international parks which were in existence on August 7, 1977. Second, EPA has concluded that PM<sub>2.5</sub> causes adverse effects on visibility in other areas that are not protected by the Regional Haze Rule, depending on PM<sub>2.5</sub> concentrations and other factors that control their visibility impact effectiveness such as dry chemical composition and relative humidity (*i.e.*, an indicator of the water composition of the particles), and has set secondary PM<sub>2.5</sub> standards to address these areas. The existing annual primary and secondary PM<sub>2.5</sub> standards have been remanded by the DC Circuit (see *American Farm Bureau v. EPA*, 559 F. 3d 512 (DC Cir. 2009) and are being addressed in the currently ongoing PM NAAQS review.

#### (2) Plant and Ecosystem Effects of Ozone

Elevated ozone levels contribute to environmental effects, with impacts to plants and ecosystems being of most concern. Ozone can produce both acute and chronic injury in sensitive species depending on the concentration level and the duration of the exposure. Ozone effects also tend to accumulate over the growing season of the plant, so that even low concentrations experienced for a longer duration have the potential to create chronic stress on vegetation. Ozone damage to plants includes visible injury to leaves and impaired photosynthesis, both of which can lead to reduced plant growth and reproduction, resulting in reduced crop yields, forestry production, and use of

<sup>444</sup> Raaschou-Nielsen, O.; Reynolds, P. (2006) Air pollution and childhood cancer: a review of the epidemiological literature. *Int J Cancer* 118: 2920–2929. Docket EPA–HQ–OAR–2010–0162.

<sup>445</sup> U.S. Census Bureau (2008) American Housing Survey for the United States in 2007. Series H–150 (National Data), Table 1A–7. [Accessed at <http://www.census.gov/hhes/www/housing/ahs/ahs07/ahs07.html> on January 22, 2009] Docket EPA–HQ–OAR–2010–0162.

<sup>446</sup> Lena, T.S.; Ochieng, V.; Carter, M.; Holguin-Veras, J.; Kinney, P.L. (2002) Elemental carbon and PM<sub>2.5</sub> levels in an urban community heavily impacted by truck traffic. *Environ Health Perspect* 110: 1009–1015. Docket EPA–HQ–OAR–2010–0162.

<sup>447</sup> Wier, M.; Sciammas, C.; Seto, E.; Bhatia, R.; Rivard, T. (2009) Health, traffic, and environmental justice: collaborative research and community action in San Francisco, California. *Am J Public Health* 99: S499–S504. Docket EPA–HQ–OAR–2010–0162.

<sup>448</sup> Forkenbrock, D.J. and L.A. Schweitzer, *Environmental Justice and Transportation Investment Policy*. Iowa City: University of Iowa, 1997. Docket EPA–HQ–OAR–2010–0162.

<sup>449</sup> Appatova, A.S.; Ryan, P.H.; LeMasters, G.K.; Grinshpun, S.A. (2008) Proximal exposure of public schools and students to major roadways: a nationwide U.S. survey. *J Environ Plan Mgmt* Docket EPA–HQ–OAR–2010–0162.

<sup>450</sup> Green, R.S.; Smorodinsky, S.; Kim, J.J.; McLaughlin, R.; Ostro, B. (2004) Proximity of California public schools to busy roads. *Environ Health Perspect* 112: 61–66. Docket EPA–HQ–OAR–2010–0162.

<sup>451</sup> Houston, D.; Ong, P.; Wu, J.; Winer, A. (2006) Proximity of licensed child care facilities to near-roadway vehicle pollution. *Am J Public Health* 96: 1611–1617. Docket EPA–HQ–OAR–2010–0162.

<sup>452</sup> Wu, Y.; Batterman, S. (2006) Proximity of schools in Detroit, Michigan to automobile and truck traffic. *J Exposure Sci Environ Epidemiol* 16: 457–470. Docket EPA–HQ–OAR–2010–0162.

<sup>453</sup> National Research Council, 1993. *Protecting Visibility in National Parks and Wilderness Areas*. National Academy of Sciences Committee on Haze in National Parks and Wilderness Areas. National Academy Press, Washington, DC. Docket EPA–HQ–OAR–2010–0162. This book can be viewed on the National Academy Press Web site at <http://www.nap.edu/books/0309048443/html/>.

<sup>454</sup> See U.S. EPA 2009 Final PM ISA, Note 355.

sensitive ornamentals in landscaping. In addition, the impairment of photosynthesis, the process by which the plant makes carbohydrates (its source of energy and food), can lead to a subsequent reduction in root growth and carbohydrate storage below ground, resulting in other, more subtle plant and ecosystems impacts.

These latter impacts include increased susceptibility of plants to insect attack, disease, harsh weather, interspecies competition and overall decreased plant vigor. The adverse effects of ozone on forest and other natural vegetation can potentially lead to species shifts and loss from the affected ecosystems, resulting in a loss or reduction in associated ecosystem goods and services. Lastly, visible ozone injury to leaves can result in a loss of aesthetic value in areas of special scenic significance like national parks and wilderness areas. The final 2006 Ozone Air Quality Criteria Document presents more detailed information on ozone effects on vegetation and ecosystems.

### (3) Atmospheric Deposition

Wet and dry deposition of ambient particulate matter delivers a complex mixture of metals (*e.g.*, mercury, zinc, lead, nickel, aluminum, cadmium), organic compounds (*e.g.*, polycyclic organic matter, dioxins, furans) and inorganic compounds (*e.g.*, nitrate, sulfate) to terrestrial and aquatic ecosystems. The chemical form of the compounds deposited depends on a variety of factors including ambient conditions (*e.g.*, temperature, humidity, oxidant levels) and the sources of the material. Chemical and physical transformations of the compounds occur in the atmosphere as well as the media onto which they deposit. These transformations in turn influence the fate, bioavailability and potential toxicity of these compounds.

Atmospheric deposition has been identified as a key component of the environmental and human health hazard posed by several pollutants including mercury, dioxin and PCBs.<sup>455</sup>

Adverse impacts on water quality can occur when atmospheric contaminants deposit to the water surface or when material deposited on the land enters a waterbody through runoff. Potential impacts of atmospheric deposition to waterbodies include those related to both nutrient and toxic inputs. Adverse effects to human health and welfare can occur from the addition of excess

nitrogen via atmospheric deposition. The nitrogen-nutrient enrichment contributes to toxic algae blooms and zones of depleted oxygen, which can lead to fish kills, frequently in coastal waters. Deposition of heavy metals or other toxics may lead to the human ingestion of contaminated fish, impairment of drinking water, damage to the marine ecology, and limits to recreational uses. Several studies have been conducted in U.S. coastal waters and in the Great Lakes Region in which the role of ambient PM deposition and runoff is investigated.<sup>456 457 458 459 460</sup>

Atmospheric deposition of nitrogen and sulfur contributes to acidification, altering biogeochemistry and affecting animal and plant life in terrestrial and aquatic ecosystems across the United States. The sensitivity of terrestrial and aquatic ecosystems to acidification from nitrogen and sulfur deposition is predominantly governed by geology. Prolonged exposure to excess nitrogen and sulfur deposition in sensitive areas acidifies lakes, rivers and soils. Increased acidity in surface waters creates inhospitable conditions for biota and affects the abundance and nutritional value of preferred prey species, threatening biodiversity and ecosystem function. Over time, acidifying deposition also removes essential nutrients from forest soils, depleting the capacity of soils to neutralize future acid loadings and negatively affecting forest sustainability. Major effects include a decline in sensitive forest tree species, such as red spruce (*Picea rubens*) and sugar maple (*Acer saccharum*), and a loss of biodiversity of fishes, zooplankton, and macro invertebrates.

In addition to the role nitrogen deposition plays in acidification, nitrogen deposition also leads to nutrient enrichment and altered

biogeochemical cycling. In aquatic systems increased nitrogen can alter species assemblages and cause eutrophication. In terrestrial systems nitrogen loading can lead to loss of nitrogen sensitive lichen species, decreased biodiversity of grasslands, meadows and other sensitive habitats, and increased potential for invasive species. For a broader explanation of the topics treated here, refer to the description in Section 7.1.2 of the RIA.

Adverse impacts on soil chemistry and plant life have been observed for areas heavily influenced by atmospheric deposition of nutrients, metals and acid species, resulting in species shifts, loss of biodiversity, forest decline and damage to forest productivity. Potential impacts also include adverse effects to human health through ingestion of contaminated vegetation or livestock (as in the case for dioxin deposition), reduction in crop yield, and limited use of land due to contamination.

Atmospheric deposition of pollutants can reduce the aesthetic appeal of buildings and culturally important articles through soiling, and can contribute directly (or in conjunction with other pollutants) to structural damage by means of corrosion or erosion. Atmospheric deposition may affect materials principally by promoting and accelerating the corrosion of metals, by degrading paints, and by deteriorating building materials such as concrete and limestone. Particles contribute to these effects because of their electrolytic, hygroscopic, and acidic properties, and their ability to adsorb corrosive gases (principally sulfur dioxide).

### (4) Environmental Effects of Air Toxics

Emissions from producing, transporting and combusting fuel contribute to ambient levels of pollutants that contribute to adverse effects on vegetation. Volatile organic compounds, some of which are considered air toxics, have long been suspected to play a role in vegetation damage.<sup>461</sup> In laboratory experiments, a wide range of tolerance to VOCs has been observed.<sup>462</sup> Decreases in harvested seed pod weight have been reported for the more sensitive plants, and some studies have reported effects on seed germination, flowering and fruit

<sup>456</sup> U.S. EPA (2004) National Coastal Condition Report II. Office of Research and Development/ Office of Water. EPA-620/R-03/002. Docket EPA-HQ-OAR-2010-0162.

<sup>457</sup> Gao, Y., E.D. Nelson, M.P. Field, et al. 2002. Characterization of atmospheric trace elements on PM<sub>2.5</sub> particulate matter over the New York-New Jersey harbor estuary. *Atmos. Environ.* 36: 1077-1086. Docket EPA-HQ-OAR-2010-0162.

<sup>458</sup> Kim, G., N. Hussain, J.R. Scudlark, and T.M. Church. 2000. Factors influencing the atmospheric depositional fluxes of stable Pb, 210Pb, and 7Be into Chesapeake Bay. *J. Atmos. Chem.* 36: 65-79. Docket EPA-HQ-OAR-2010-0162.

<sup>459</sup> Lu, R., R.P. Turco, K. Stolzenbach, et al. 2003. Dry deposition of airborne trace metals on the Los Angeles Basin and adjacent coastal waters. *J. Geophys. Res.* 108(D2, 4074): AAC 11-1 to 11-24. Docket EPA-HQ-OAR-2010-0162.

<sup>460</sup> Marvin, C.H., M.N. Charlton, E.J. Reiner, et al. 2002. Surficial sediment contamination in Lakes Erie and Ontario: A comparative analysis. *J. Great Lakes Res.* 28(3): 437-450. Docket EPA-HQ-OAR-2010-0162.

<sup>461</sup> U.S. EPA. 1991. Effects of organic chemicals in the atmosphere on terrestrial plants. EPA/600/3-91/001. Docket EPA-HQ-OAR-2010-0162.

<sup>462</sup> Cape JN, ID Leith, J Binnie, J Content, M Donkin, M Skewes, DN Price AR Brown, AD Sharpe. 2003. Effects of VOCs on herbaceous plants in an open-top chamber experiment. *Environ. Pollut.* 124:341-343. Docket EPA-HQ-OAR-2010-0162.

<sup>455</sup> U.S. EPA (2000) Deposition of Air Pollutants to the Great Waters: Third Report to Congress. Office of Air Quality Planning and Standards. EPA-453/R-00-0005. Docket EPA-HQ-OAR-2010-0162.

ripening. Effects of individual VOCs or their role in conjunction with other stressors (e.g., acidification, drought, temperature extremes) have not been well studied. In a recent study of a mixture of VOCs including ethanol and toluene on herbaceous plants, significant effects on seed production, leaf water content and photosynthetic efficiency were reported for some plant species.<sup>463</sup>

Research suggests an adverse impact of vehicle exhaust on plants, which has in some cases been attributed to aromatic compounds and in other cases to nitrogen oxides.<sup>464 465 466</sup> The impacts of VOCs on plant reproduction may have long-term implications for biodiversity and survival of native species near major roadways. Most of the studies of the impacts of VOCs on vegetation have focused on short-term exposure and few studies have focused on long-term effects of VOCs on vegetation and the potential for metabolites of these compounds to affect herbivores or insects.

*D. Air Quality Impacts of Non-GHG Pollutants*

Air quality modeling was performed to assess the impact of the heavy-duty

vehicle standards on criteria and air toxic pollutants. In this section, we present information on current modeled levels of pollution as well as projections for 2030, with respect to ambient PM<sub>2.5</sub>, ozone, selected air toxics, visibility levels and nitrogen and sulfur deposition. The results are discussed in more detail in Section 8.2 of the RIA.

We used the Community Multi-scale Air Quality (CMAQ) photochemical model, version 4.7.1, for our analysis. This version of CMAQ includes a number of improvements to previous versions of the model. These improvements are discussed in Section 8.2.2 of the RIA.

(1) Ozone

(a) Current Levels

8-hour ozone concentrations exceeding the level of the ozone NAAQS occur in many parts of the country. In 2008, the EPA amended the ozone NAAQS (73 FR 16436, March 27, 2008). The final 2008 ozone NAAQS rule set forth revisions to the previous 1997 NAAQS for ozone to provide increased protection of public health and welfare. On January 6, 2010, EPA proposed to reconsider the 2008 ozone NAAQS to ensure that they are requisite

to protect public health with an ample margin of safety, and requisite to protect public welfare (75 FR 2938, January 19, 2010). EPA intends to complete the reconsideration by July 31, 2011. If, as a result of the reconsideration, EPA promulgates different ozone standards, the new 2011 ozone standards would replace the 2008 ozone standards and the requirement to designate areas for the replaced 2008 standards would no longer apply.

As of April 21, 2011 there are 44 areas designated as nonattainment for the 1997 8-hour ozone NAAQS, comprising 242 full or partial counties with a total population of over 118 million people. These numbers do not include the people living in areas where there is a future risk of failing to maintain or attain the 1997 8-hour ozone NAAQS. The numbers above likely underestimate the number of counties that are not meeting the ozone NAAQS because the nonattainment areas associated with the more stringent 2008 8-hour ozone NAAQS have not yet been designated. Table VII-7 provides an estimate, based on 2006-08 air quality data, of the counties with design values greater than the 2008 8-hour ozone NAAQS of 0.075 ppm.

TABLE VII-7—COUNTIES WITH DESIGN VALUES GREATER THAN THE OZONE NAAQS

Standard	Number of counties	Population <sup>a</sup>
1997 Ozone Standard: counties within the 54 areas currently designated as nonattainment (as of 1/6/10) .....	266	122,343,799
2008 Ozone Standard: additional counties that would not meet the 2008 NAAQS (based on 2006-2008 air quality data) <sup>b</sup> .....	156	36,678,478
Total .....	422	159,022,277

**Notes:**

<sup>a</sup> Population numbers are from 2000 census data.

<sup>b</sup> Area designations for the 2008 ozone NAAQS have not yet been made. Nonattainment for the 2008 Ozone NAAQS would be based on three years of air quality data from later years. Also, the county numbers in this row include only the counties with monitors violating the 2008 Ozone NAAQS. The numbers in this table may be an underestimate of the number of counties and populations that will eventually be included in areas with multiple counties designated nonattainment.

(b) Projected Levels Without This Final Action

States with 8-hour ozone nonattainment areas are required to take action to bring those areas into compliance in the future. Based on the final rule designating and classifying 8-hour ozone nonattainment areas for the 1997 standard (69 FR 23951, April 30, 2004), most 8-hour ozone nonattainment areas will be required to attain the ozone NAAQS in the 2007 to 2013 time

frame and then maintain the NAAQS thereafter. As noted, EPA is reconsidering the 2008 ozone NAAQS. If EPA promulgates different ozone NAAQS in 2011 as a result of the reconsideration, these standards would replace the 2008 ozone NAAQS and there would no longer be a requirement to designate areas for the 2008 NAAQS. Attainment dates for any 2011 ozone NAAQS would range from 3 to 20 years from designation, depending on the area's classification.

EPA has already adopted many emission control programs that are expected to reduce ambient ozone levels and assist in reducing the number of areas that fail to achieve the ozone NAAQS. Even so, our air quality modeling projects that in 2030, with all current controls but excluding the impacts of the heavy-duty standards, up to 10 counties with a population of over 30 million may not attain the 2008 ozone standard of 0.075 ppm (75 ppb). These numbers do not account for those

<sup>463</sup> Cape JN, ID Leith, J Binnie, J Content, M Donkin, M Skewes, DN Price AR Brown, AD Sharpe. 2003. Effects of VOCs on herbaceous plants in an open-top chamber experiment. Environ. Pollut. 124:341-343. Docket EPA-HQ-OAR-2010-0162.

<sup>464</sup> Viskari E-L. 2000. Epicuticular wax of Norway spruce needles as indicator of traffic pollutant deposition. Water, Air, and Soil Pollut. 121:327-337. Docket EPA-HQ-OAR-2010-0162.

<sup>465</sup> Ugrekhelidze D, F Korte, G Kvesitadze. 1997. Uptake and transformation of benzene and toluene

by plant leaves. Ecotox. Environ. Safety 37:24-29. Docket EPA-HQ-OAR-2010-0162.

<sup>466</sup> Kammerbauer H, H Selinger, R Rommelt, A Ziegler-Jons, D Knoppik, B Hock. 1987. Toxic components of motor vehicle emissions for the spruce Picea abies. Environ. Pollut. 48:235-243. Docket EPA-HQ-OAR-2010-0162.

areas that are close to (e.g., within 10 percent of) the 2008 ozone standard. These areas, although not violating the standards, will also be impacted by changes in ozone as they work to ensure long-term maintenance of the ozone NAAQS.

(c) Projected Levels With This Final Action

Our modeling indicates ozone design value concentrations will decrease in many areas of the country due to this action. The decreases in ozone design values are likely due to projected tailpipe reductions in NO<sub>x</sub> and projected upstream emissions decreases in NO<sub>x</sub> and VOCs from reduced gasoline production. The majority of the ozone design value decreases are less than 1 ppb. The maximum projected decrease in an 8-hour ozone design value is 1.57 ppb in Jefferson County, Tennessee. On a population-weighted basis, the average modeled 8-hour ozone design values are projected to decrease by 0.39 ppb in 2030 and the design values for those counties that are projected to be above the 2008 ozone standard in 2030 will see population-weighted decreases of 0.16 ppb due to the heavy-duty standards.

(2) Particulate Matter

(a) Current Levels

PM<sub>2.5</sub> concentrations exceeding the level of the PM<sub>2.5</sub> NAAQS occur in many parts of the country. In 2005, EPA designated 39 nonattainment areas for the 1997 PM<sub>2.5</sub> NAAQS (70 FR 943, January 5, 2005). These areas are composed of 208 full or partial counties with a total population exceeding 88 million. The 1997 PM<sub>2.5</sub> NAAQS was revised in 2006 and the 2006 24-hour PM<sub>2.5</sub> NAAQS became effective on December 18, 2006. On October 8, 2009, the EPA issued final nonattainment area designations for the 2006 24-hour PM<sub>2.5</sub> NAAQS (74 FR 58688, November 13, 2009). These designations include 32 areas composed of 121 full or partial counties with a population of over 70 million. In total, there are 54 PM<sub>2.5</sub> nonattainment areas composed of 243 counties with a population of almost 102 million people.

(b) Projected Levels Without This Final Action

States with PM<sub>2.5</sub> nonattainment areas are required to take action to bring those areas into compliance in the future. Areas designated as not attaining the 1997 PM<sub>2.5</sub> NAAQS will need to attain the 1997 standards in the 2010 to 2015 time frame, and then maintain them thereafter. The 2006 24-hour PM<sub>2.5</sub> nonattainment areas will be required to

attain the 2006 24-hour PM<sub>2.5</sub> NAAQS in the 2014 to 2019 time frame and then be required to maintain the 2006 24-hour PM<sub>2.5</sub> NAAQS thereafter. The heavy-duty standards finalized in this action become effective in 2012 and therefore may be useful to states in attaining or maintaining the PM<sub>2.5</sub> NAAQS.

EPA has already adopted many emission control programs that are expected to reduce ambient PM<sub>2.5</sub> levels and which will assist in reducing the number of areas that fail to achieve the PM<sub>2.5</sub> NAAQS. Even so, our air quality modeling projects that in 2030, with all current controls but excluding the impacts of the heavy-duty standards adopted here, at least 4 counties with a population of almost 7 million may not attain the 1997 annual PM<sub>2.5</sub> standard of 15 µg/m<sup>3</sup> and 22 counties with a population of over 33 million may not attain the 2006 24-hour PM<sub>2.5</sub> standard of 35 µg/m<sup>3</sup>. These numbers do not account for those areas that are close to (e.g., within 10 percent of) the PM<sub>2.5</sub> standards. These areas, although not violating the standards, will also benefit from any reductions in PM<sub>2.5</sub> ensuring long-term maintenance of the PM<sub>2.5</sub> NAAQS.

(c) Projected Levels With This Final Action

Air quality modeling performed for this final action shows that in 2030 the majority of the modeled counties will see decreases of less than 0.01 µg/m<sup>3</sup> in their annual PM<sub>2.5</sub> design values. The decreases in annual PM<sub>2.5</sub> design values that we see in some counties are likely due to emission reductions related to lower fuel production at existing oil refineries and/or reductions in PM<sub>2.5</sub> precursor emissions (NO<sub>x</sub>, SO<sub>x</sub>, and VOCs) due to improvements in road load. The maximum projected decrease in an annual PM<sub>2.5</sub> design value is 0.03 µg/m<sup>3</sup> in Allen County, Indiana and Canyon County, Idaho. On a population-weighted basis, the average modeled 2030 annual PM<sub>2.5</sub> design value is projected to decrease by 0.01 µg/m<sup>3</sup> due to this final action.

In addition to looking at annual PM<sub>2.5</sub> design values, we also modeled the impact of the standards on 24-hour PM<sub>2.5</sub> design values. Air quality modeling performed for this final action shows that in 2030 the majority of the modeled counties will see changes of between -0.05 µg/m<sup>3</sup> and 0 µg/m<sup>3</sup> in their 24-hour PM<sub>2.5</sub> design values. The decreases in annual PM<sub>2.5</sub> design values that we see in some counties are likely due to emission reductions related to lower fuel production at existing oil refineries and/or reductions in PM<sub>2.5</sub>

precursor emissions (NO<sub>x</sub>, SO<sub>x</sub>, and VOCs) due to improvements in road load. The maximum projected decrease in a 24-hour PM<sub>2.5</sub> design value is 0.27 µg/m<sup>3</sup> in Canyon County, ID. There are also some counties that are projected to see increases of less than 0.1 µg/m<sup>3</sup> in their 24-hour PM<sub>2.5</sub> design values. These small increases in 24-hour PM<sub>2.5</sub> design values are likely related to downstream emission increases from APUs. On a population-weighted basis, the average modeled 2030 24-hour PM<sub>2.5</sub> design value is projected to decrease by 0.03 µg/m<sup>3</sup> due to this final action. Those counties that are projected to be above the 24-hour PM<sub>2.5</sub> standard in 2030 will see slightly smaller population-weighted decreases of 0.01 µg/m<sup>3</sup> in their design values due to this final action.

(3) Air Toxics

(a) Current Levels

The majority of Americans continue to be exposed to ambient concentrations of air toxics at levels which have the potential to cause adverse health effects.<sup>467</sup> The levels of air toxics to which people are exposed vary depending on where people live and work and the kinds of activities in which they engage, as discussed in detail in U.S. EPA's most recent Mobile Source Air Toxics Rule.<sup>468</sup> According to the National Air Toxic Assessment (NATA) for 2005,<sup>469</sup> mobile sources were responsible for 43 percent of outdoor toxic emissions and over 50 percent of the cancer risk and noncancer hazard. Benzene is the largest contributor to cancer risk of all 124 pollutants quantitatively assessed in the 2002 NATA and mobile sources were responsible for 59 percent of benzene emissions in 2002. Over the years, EPA has implemented a number of mobile source and fuel controls resulting in VOC reductions, which also reduce benzene and other air toxic emissions.

(b) Projected Levels

Our modeling indicates that the heavy-duty standards have relatively little impact on national average ambient concentrations of the modeled air toxics. Additional detail on the air toxics results can be found in Section 8.2.3.3 of the RIA.

<sup>467</sup> U.S. Environmental Protection Agency (2007). Control of Hazardous Air Pollutants from Mobile Sources; Final Rule. 72 FR 8434, February 26, 2007.

<sup>468</sup> U.S. Environmental Protection Agency (2007). Control of Hazardous Air Pollutants from Mobile Sources; Final Rule. 72 FR 8434, February 26, 2007.

<sup>469</sup> U.S. EPA. (2011) 2005 National-Scale Air Toxics Assessment. <http://www.epa.gov/ttn/atw/nata2005/>. Docket EPA-HQ-OAR-2010-0162.



## (4) Nitrogen and Sulfur Deposition

## (a) Current Levels

Over the past two decades, the EPA has undertaken numerous efforts to reduce nitrogen and sulfur deposition across the U.S. Analyses of long-term monitoring data for the U.S. show that deposition of both nitrogen and sulfur compounds has decreased over the last 17 years although many areas continue to be negatively impacted by deposition. Deposition of inorganic nitrogen and sulfur species routinely measured in the U.S. between 2005 and 2007 were as high as 9.6 kilograms of nitrogen per hectare (kg N/ha) averaged over three years and 20.8 kilograms of sulfur per hectare (kg S/ha) averaged over three years.<sup>470</sup> The data show that reductions were more substantial for sulfur compounds than for nitrogen compounds. These numbers are generated by the U.S. national monitoring network and they likely underestimate nitrogen deposition because neither ammonia nor organic nitrogen is measured. In the eastern U.S., where data are most abundant, total sulfur deposition decreased by about 44 percent between 1990 and 2007, while total nitrogen deposition decreased by 25 percent over the same timeframe.<sup>471</sup>

## (b) Projected Levels

Our air quality modeling projects decreases in nitrogen deposition, especially in the Midwest, as a result of the heavy-duty standards required by this final action. The heavy-duty standards will result in annual percent decreases of 0.5 percent to more than 2 percent in some cities in the Midwest, Phoenix, Albuquerque, and some areas in Texas. The remainder of the country will see only minimal changes in nitrogen deposition, ranging from decreases of less than 0.5 percent to increases of less than 0.5 percent. For a map of 2030 nitrogen deposition impacts and additional information on these impacts, see Section 8.2.3.4 of the RIA. The impacts of the heavy-duty standards on sulfur deposition are

minimal, ranging from decreases of up to 0.5 percent to increases of up to 0.5 percent.

## (5) Visibility

## (a) Current Levels

As mentioned in Section VII.D(1)(a), millions of people live in nonattainment areas for the PM<sub>2.5</sub> NAAQS. These populations, as well as large numbers of individuals who travel to these areas, are likely to experience visibility impairment. In addition, while visibility trends have improved in mandatory class I federal areas, the most recent data show that these areas continue to suffer from visibility impairment. In summary, visibility impairment is experienced throughout the U.S., in multi-state regions, urban areas, and remote mandatory class I federal areas.

## (b) Projected Levels

Air quality modeling conducted for this final action was used to project visibility conditions in 138 mandatory class I federal areas across the U.S. in 2030. The results show that all the modeled areas will continue to have annual average deciview levels above background in 2030.<sup>472</sup> The results also indicate that the majority of the modeled mandatory class I federal areas will see very little change in their visibility, but some mandatory class I federal areas will see improvements in visibility due to the heavy-duty standards and a few mandatory class I federal areas will see visibility decreases. The average visibility at all modeled mandatory class I federal areas on the 20 percent worst days is projected to improve by 0.01 deciviews, or 0.06 percent, in 2030. Section 8.2.3.5 of the RIA contains more detail on the visibility portion of the air quality modeling.

### VIII. What are the agencies' estimated cost, economic, and other impacts of the final program?

In this section, we present the costs and impacts of the final HD National Program. It is important to note that NHTSA's final fuel consumption standards and EPA's final GHG emissions standards will both be in effect, and each will lead to average fuel efficiency increases and GHG emission

reductions. The two agencies' final standards comprise the HD National Program.

The net benefits of the final HD National Program consist of the effects of the program on:

- The vehicle program costs (costs of complying with the vehicle CO<sub>2</sub> standards),
- Fuel savings associated with reduced fuel usage resulting from the program,
- Reductions in greenhouse gas emissions,
- The reductions in other (non-GHG) pollutants,
- Costs associated with increases in noise, congestion, and accidents resulting from increased vehicle use,
- Improvements in U.S. energy security impacts,
- Benefits associated with increased vehicle use due to the "rebound" effect.

We also present the cost-effectiveness of the standards, or the cost per ton of emissions reduced. Where possible, we identify the uncertain aspects of these economic impacts and attempt to quantify them when and if possible (e.g., sensitivity ranges associated with quantified and monetized GHG impacts; probabilistic uncertainty associated with non-GHG health benefits). For some impacts, however, there is a lack of adequate information to inform a probabilistic assessment of uncertainty. EPA continues to work toward developing a comprehensive strategy for characterizing the aggregate impact of uncertainty in key elements of its analyses and we will continue to work to refine these uncertainty analyses in the future as time and resources permit.

The program may have other effects that are not included here. The agencies sought comment on whether any costs or benefits were omitted from this analysis, so that they could be explicitly recognized in the final rules. In particular, as discussed in Section III and in Chapter 2 of the RIA, the technology cost estimates developed here take into account the costs to hold other vehicle attributes, such as size and performance, constant. In addition, the analysis assumes that the full technology costs are passed along to vehicle buyers. With these assumptions, because welfare losses are monetary estimates of how much buyers would have to be compensated to be made as well off as in the absence of the change,<sup>473</sup> the price increase measures

<sup>470</sup> U.S. EPA. U.S. EPA's Report on the Environment (Final Report). U.S. Environmental Protection Agency, Washington, DC, EPA/600/R-07/045F (NTIS PB2008-112484). Docket EPA-HQ-OAR-2010-0162. Updated data available online at: <http://cfpub.epa.gov/eroe/index.cfm?fuseaction=detail.viewInd&ch=46&subtop=341&lv=list.listByChapter&r=201744>.

<sup>471</sup> U.S. EPA. U.S. EPA's 2008 Report on the Environment (Final Report). U.S. Environmental Protection Agency, Washington, DC, EPA/600/R-07/045F (NTIS PB2008-112484). Docket EPA-HQ-OAR-2010-0162. Updated data available online at: <http://cfpub.epa.gov/eroe/index.cfm?fuseaction=detail.viewInd&ch=46&subtop=341&lv=list.listByChapter&r=201744>.

<sup>472</sup> The level of visibility impairment in an area is based on the light-extinction coefficient and a unitless visibility index, called a "deciview," which is used in the valuation of visibility. The deciview metric provides a scale for perceived visual changes over the entire range of conditions, from clear to hazy. Under many scenic conditions, the average person can generally perceive a change of one deciview. The higher the deciview value, the worse the visibility. Thus, an improvement in visibility is a decrease in deciview value.

<sup>473</sup> This approach describes the economic concept of compensating variation, a payment of money after a change that would make a consumer as well off after the change as before it. A related concept, equivalent variation, estimates the income change

the loss to the buyer.<sup>474</sup> Assuming that the full technology cost gets passed along to the buyer as an increase in price, the technology cost thus measures the welfare loss to the buyer. Increasing fuel efficiency would have to lead to other changes in the vehicles that buyers find undesirable for there to be additional losses not included in the technology costs.

The agencies sought comments, including supporting data and quantitative analyses, of any additional impacts of the final standards on vehicle attributes and performance, and other potential aspects that could positively or negatively affect the welfare implications of this final rulemaking, not addressed in this analysis.

The comments received by the agencies did not provide any clear insights into this question. Some comments noted the diversity of the trucking industry and expressed a request that the program continue the great variety of options for the industry, because of the variation in needs for different customers. Additional comments noted that the separate engine and vehicle programs support the maintenance of variety and current market structure. Though a few commenters raised concerns, no information was offered to indicate that choice will in fact be limited by the program, or that other vehicle attributes are adversely affected.

The total monetized benefits (excluding fuel savings) under the program are projected to be \$4.3 to \$11.1 billion in 2030, depending on the value used for the social cost of carbon. These benefits are summarized below in Table 0–31. The costs of the program in 2030, presented in Table 0–29 are estimated to be approximately \$2.2 billion for new engine and truck technology. The program is also estimated to provide \$20.6 billion in savings realized by trucking operations through fewer fuel expenditures (calculated using pre-tax fuel prices), as shown in Table 0–30. The present value

that would be an alternative to the change taking place. The difference between them is whether the consumer's point of reference is her welfare before the change (compensating variation) or after the change (equivalent variation). In practice, these two measures are typically very close together.

<sup>474</sup> Indeed, it is likely to be an overestimate of the loss to the buyer, because the buyer has choices other than buying the same vehicle with a higher price; she could choose a different vehicle, or decide not to buy a new vehicle. The buyer would choose one of those options only if the alternative involves less loss than paying the higher price. Thus, the increase in price that the buyer faces would be the upper bound of loss of consumer welfare, unless there are other changes to the vehicle due to the fuel economy improvements that make the vehicle less desirable to buyers.

of the total monetized benefits (excluding fuel savings) under the program is expected to range from \$48.7 billion to \$180.1 billion with a 3 percent discount rate; with a 7 percent discount rate, the total monetized benefits are expected to range from \$24.3 billion to \$155.7 billion. These values, summarized in Table 0–31, depend on the value used for the social cost of carbon. The present value of costs of the program for new engine and truck technology, in Table 0–32, are expected to be \$47.4 billion using a 3 percent discount rate, and \$24.7 billion with a 7 percent discount rate. The present value of fuel savings (calculated using pre-tax fuel prices) is estimated at \$375.3 billion with a 3 percent discount rate, and \$166.5 billion with a 7 percent discount rate, as shown in Table 0–32. Total net present benefits (in Table 0–32) are thus expected to range from \$376.6 billion to \$508 billion with a 3 percent discount rate, and \$166.1 billion to \$297.5 billion with a 7 percent discount rate.

The estimates developed here are measured against a baseline fuel efficiency associated with MY 2010 vehicles. The agencies also considered an alternate baseline associated with AEO 2011 projections, which is further discussed in Section IX. All calculations presented in Section VIII use the constant 2010 vehicle baseline. The extent to which fuel efficiency improvements may have occurred in the absence of the rules affects the net benefits associated with the program. If trucks were to install technologies to achieve the fuel savings and reduced GHG emissions in the absence of this program, then both the costs and benefits of these fuel savings could be attributed to market forces, not the rules. As a baseline for estimates of the extent of fuel-saving technologies that might have been adopted in the absence of the program, the proposal used the level of these technologies in MY 2010 vehicles. We sought comment on whether the agencies should use an alternative baseline based on data provided by commenters to estimate the degree to which the technologies discussed in the proposal would have been adopted in the absence of these rules. No comments were received on this issue. One comment cites the EPA draft RIA as noting a historic 1 percent per year improvement in fuel efficiency, and argues that the rules are therefore not needed; the actual figure in the draft RIA, however, was a 0.09 percent per year improvement.

EPA has undertaken an analysis of the economy-wide impacts of the final heavy-duty truck fuel efficiency and

GHG standards as an exploratory exercise that EPA believes could provide additional insights into the potential impacts of the program.<sup>475</sup> These results were not a factor regarding the appropriateness of the final standards. It is important to note that the results of this modeling exercise are dependent on the assumptions associated with how manufacturers would make fuel efficiency improvements and how trucking operations would respond to increases in higher vehicle costs and improved vehicle fuel efficiency as a result of the final program.

Further information on these and other aspects of the economic impacts of our rules are summarized in the following sections and are presented in more detail in the RIA for this final rulemaking.

#### *A. Conceptual Framework for Evaluating Impacts*

This regulation is motivated primarily by the goals of reducing emissions of greenhouse gases and promoting U.S. energy security by reducing consumption and imports of petroleum-based fuels. These motivations involve classic externalities, meaning that private decisions do not incorporate all of the costs associated with these problems; these costs are not borne completely by the households or businesses whose actions are responsible for them. In the absence of some mechanism to “internalize” these costs—that is, to transfer their burden to individuals or firms whose decisions impose them—individuals and firms will consume more petroleum-based fuels than is socially optimal. Externalities are a classic motivation for government intervention in markets. These externalities, as well as effects due to changes in emissions of other pollutants and other impacts, are discussed in Sections VIII.H—VIII.K.

In some cases, these classic externalities are by themselves enough to justify the costs of imposing fuel efficiency standards. For some discount rates and some projected social costs of carbon, however, the reductions in these external costs are less than the costs of new fuel saving technologies needed to meet the standards. (See Tables 9–24 and 9–25 in the RIA.) Nevertheless, this regulation reduces trucking companies' fuel costs; according to our estimates, these savings in fuel costs are by themselves sufficient to pay for the

<sup>475</sup> See Memorandum to Docket, “Economy-Wide Impacts of Heavy-Duty Truck Greenhouse Gas Emissions and Fuel Efficiency Standards”, May 20, 2011. Docket EPA–HQ–OAR–2010–0162.

technologies over periods of time considerably shorter than vehicles' expected lifetimes under the assumptions used for this analysis (e.g., AEO 2011 projected fuel prices). If these estimates are correct, then the *entire* value of the reductions in external costs represents additional net benefits of the program, beyond those resulting from the fact that the value of fuel savings exceeds the costs of technologies necessary to achieve them.

It is often asserted that there are cost-effective fuel-saving technologies that markets do not take advantage of. This is commonly known as the "energy gap" or "energy paradox." Standard economic theory suggests that in normally functioning competitive markets, interactions between vehicle buyers and producers would lead producers to incorporate all cost-effective technology into the vehicles that they offer, without government intervention. Unlike in the light-duty vehicle market, the vast majority of vehicles in the medium- and heavy-duty truck market are purchased and operated by businesses with narrow profit margins, and for which fuel costs represent a substantial operating expense.

Even in the presence of uncertainty and imperfect information—conditions that hold to some degree in every market—we generally expect firms to attempt to minimize their costs in an effort to survive in a competitive marketplace, and therefore to make decisions that are in the best interest of the company and its owners and/or shareholders. In this case, the benefits of the rules would be due exclusively to reducing the economic costs of externalities resulting from fuel production and consumption. However, as discussed below in Section VIII.E, the agencies have estimated that the application of fuel-saving technologies in response to the final standards would, on average, yield significant private returns to truck owners (see Tables VIII-9 through VIII-11, below). The agencies have also estimated that the application of these technologies would be significantly lower in the absence of the final standards (*i.e.*, under the "no action" regulatory alternative), meaning that truck buyers and operators ignore opportunities to make investments in higher fuel efficiency that appear to offer significant cost savings.

As discussed in the NPRM, there are several possible explanations in the economics literature for why trucking companies do not adopt technologies that would be expected to increase their profits: there could be a classic market

failure in the trucking industry—market power, externalities, or asymmetric or incomplete (*i.e.*, missing market) information; there could be institutional or behavioral rigidities in the industry (union rules, standard operating procedures, statutory requirements, loss aversion, *etc.*), whereby participants collectively do not minimize costs; or the engineering estimates of fuel savings and costs for these technologies might overstate their benefits or understate their costs in real-world applications. See 75 FR at 74303–307.

To try to understand why trucking companies have not adopted these seemingly cost-effective fuel-saving technologies, the agencies surveyed published literature about the energy paradox, and held discussions with numerous truck market participants. The proposal discussed five categories of possible explanations derived from these sources. Collectively, these five hypotheses may explain the apparent inconsistency between the engineering analysis, which finds a number of cost-effective methods of improving fuel efficiency, and the observation that many of these technologies are not widely adopted.

These hypotheses include imperfect information in the original and resale markets, split incentives, uncertainty about future fuel prices, and adjustment and transactions costs. As the discussion indicated, some of these explanations suggest failures in the private market for fuel-saving technology in addition to the externalities caused by producing and consuming fuel that are the primary motivation for the rules. Other explanations suggest market-based behaviors that may imply additional costs of regulating truck fuel efficiency that are not accounted for in this analysis. As noted above, an additional explanation—adverse effects on other vehicle attributes—did not elicit supporting information in the public comments. Anecdotal evidence from various segments of the trucking industry suggests that many of the hypotheses discussed here may play a role in explaining the puzzle of why truck purchasers appear to under-invest in fuel efficiency, although different explanations may apply to different segments, or even different companies. The published literature does not appear to include empirical analysis or data related to this question.

The agencies invited comment on these explanations, and on any data or information that could be used to investigate the role of any or all of these five hypotheses in explaining this energy paradox as it applies specifically

to trucks. Some comments expressed dissatisfaction about the explanations presented; they argued that these arguments were not sufficient to explain the phenomenon. These comments argued that the truck owners and operators are better judges of the appropriate amount of fuel efficiency than are government agencies; they choose not to invest because of warranted skepticism about these technologies. The agencies also requested comment and information regarding any other hypotheses that could explain the appearance that cost-effective fuel-saving technologies have not been widely incorporated into trucks. The following discussion summarizes the fuller discussion provided in the NPRM and includes discussion of the comments received.

#### (1) Information Issues in the Original Sale Markets

One potential hypothesis for why the trucking industry does not adopt what appear to be inexpensive fuel saving technologies is that there is inadequate or unreliable information available about the effectiveness of many fuel-saving technologies for new vehicles. If reliable information on the effectiveness of many new technologies is absent, truck buyers will understandably be reluctant to spend additional money to purchase vehicles equipped with unproven technologies.

This lack of information can manifest itself in multiple ways. For instance, the problem may arise purely because collecting reliable information on technologies is costly (also see Section VIII.A.5 below on transaction costs). Moreover, information has aspects of a public good, in that no single firm has the incentive to do the costly experimentation to determine whether or not particular technologies are cost-effective, while all firms benefit from the knowledge that would be gained from that experimentation. Similarly, if multiple firms must conduct the same tests to get the same information, costs could be reduced by some form of coordination of information gathering.

While its effect on information is indirect, we expect the requirement for the use of new technologies included in this program will circumvent these information issues, resulting in their adoption, thus providing more readily available information about their benefits. The agencies appreciate, however, that the diversity of truck uses, driving situations, and driver behavior will lead to variation in the fuel savings that individual trucks or fleets experience from using specific technologies.

One commenter noted that the SmartWay program targets combination tractor owners and thus should have the largest impact on that sector, rather than vocational or medium-duty trucks. However, the gap between actual investment in fuel efficiency and the agencies' estimates of optimal investment is largest for combination tractors. Some of the difference in magnitude is likely to be due to the higher vehicle miles traveled for combination tractors compared to medium-duty and vocational vehicles; more driving means more fuel savings. Additionally, not even a majority of semi-trucks are owned by participants in SmartWay; non-participants are unlikely to get all the benefits of participants. Other explanations, noted below, are also likely to play a role. This observation may also suggest some limitations of improved information provision as a means of addressing the "efficiency gap."

#### (2) Information Issues in the Resale Market

In addition to issues in the new vehicle market, a second hypothesis for why trucking companies may not adopt what appear to be cost-effective technologies to save fuel is that the resale market may not adequately reward the addition of fuel-saving technology to vehicles to ensure their original purchase by new truck buyers. This inadequate payback for users beyond the original owner may contribute to the short payback period that new purchasers appear to expect.<sup>476</sup> The agencies requested data and information on the extent to which costs of fuel saving equipment can be recovered in the resale truck market. No data were received. One reviewer disputed this theory on the basis that people are willing to pay more for better vehicles, new or used. It is not clear, however, whether buyers of used vehicles can tell which are the better vehicles.<sup>477</sup>

Some of this unwillingness to pay for fuel-saving technology may be due to the extension of the information problems in the new vehicle market into resale markets. Buyers in the resale market have no more reason to trust information on fuel-saving technologies than buyers in the original market.

Because actual fuel efficiency of trucks on the road depends on many factors, including geography and driving styles or habits, even objective sources such as logs of truck performance for used vehicles may not provide reliable information about the fuel efficiency that potential purchasers of used trucks will experience.

A related possibility is that vehicles will be used for different purposes by their second owners than those for which they were originally designed, and the fuel-saving technology is therefore of less value.

It is possible, though, that the fuel savings experienced by the secondary purchasers may not match those experienced by their original owners if the optimal secondary new use of the vehicle does not earn as many benefits from the technologies. One commenter asks whether the fuel-saving technology is undervalued because it is unproven or overrated. In that case, the premium for fuel-saving technology in the secondary market should accurately reflect its value to potential buyers participating in that market, even if it is lower than its value in the original market, and the market has not failed. Because the information necessary to optimize use in the secondary market may not be readily available or reliable, however, buyers in the resale market may have less ability than purchasers of new vehicles to identify and gain the advantages of new fuel-saving technologies, and may thus be even less likely to pay a premium for them.

For these reasons, purchasers' willingness to pay for fuel efficiency technologies may be even lower in the resale market than in the original equipment market. Even when fuel-saving technologies will provide benefits in the resale markets, purchasers of used vehicles may not be willing to compensate their original owners fully for their remaining value. As a result, the purchasers of original equipment may expect the resale market to provide inadequate appropriate compensation for the new technologies, even when those technologies would reduce costs for the new buyers. This information issue may partially explain what appears to be the very short payback periods required for new technologies in the new vehicle market.

#### (3) Split Incentives in the Medium- and Heavy-Duty Truck Industry

A third hypothesis explaining the energy paradox as applied to trucking involves split incentives. When markets work effectively, signals provided by transactions in one market are quickly transmitted to related markets and

influence the decisions of buyers and sellers in those related markets. For instance, in a well-functioning market system, changes in the expected future price of fuel should be transmitted rapidly to those who purchase trucks, who will then reevaluate the amount of fuel-saving technology to purchase for new vehicles. If for some reason a truck purchaser will not be directly responsible for future fuel costs, or the individual who will be responsible for fuel costs does not decide which truck characteristics to purchase, then those price signals may not be transmitted effectively, and incentives can be described as "split."

One place where such a split may occur is between the owners and operators of trucks. Because they are generally responsible for purchasing fuel, truck operators have strong incentives to economize on its use, and are thus likely to support the use of fuel-saving technology. However, the owners of trucks or trailers are often different from operators, and may be more concerned about their longevity or maintenance costs than about their fuel efficiency, when purchasing vehicles. As a result, capital investments by truck owners may be channeled into equipment that improves vehicles' durability or reduces their maintenance costs, rather than into fuel-saving technology. If operators can choose freely among the trucks they drive, competition among truck owners to employ operators would encourage owners to invest in fuel-saving technology. However, if truck owners have more ability to choose among operators, then market signals for improved fuel savings that would normally be transmitted to truck owners may be muted. Truck fleets that rent their vehicles may provide an example: renters may observe the cost of renting the truck, but not its fuel efficiency; if so, then the purchasers will aim for vehicles with lower costs, to lower the cost of the rental. It might be possible to test this theory by comparing the fuel efficiency of trucks by owner-operators with those that are leased by operators. The agencies have not had the data to conduct such a test.

One commenter noted that there are always tradeoffs in an investment decision: a purchaser may prefer to invest in other vehicle attributes than fuel efficiency. In an efficient market, however, a purchaser should invest in fuel-saving technology as long as the increase in fuel-saving technology costs less than the expected fuel savings. This result should hold regardless of the level of investment in other attributes, unless there are constraints on a

<sup>476</sup> See NAS 2010, Note 197, at p. 188.

<sup>477</sup> Akerlof, George A. "The Market for 'Lemons' Quality Uncertainty and the Market Mechanism," *Quarterly Journal of Economics* 84(3) (1970): 488–500 points out that asymmetric information—the seller has better information than the buyer—can potentially lead to complete failure of a market, even when both buyers and sellers would benefit from trade.

purchaser's access to investment capital. The agencies believe that truck fleets do have an incentive to make investments in fuel efficiency, and that this assumption is reflected in the regulatory analysis. The agencies also believe, however, that sufficient evidence suggests that truck fleets are not availing themselves of all the opportunities for efficiency improvements.

In addition, the NAS report notes that split incentives can arise between tractor and trailer operators.<sup>478</sup> Trailers affect the fuel efficiency of shipping, but trailer owners do not face strong incentives to coordinate with truck owners. EPA and NHTSA are not regulating trailers in this action.

By itself, information provision may be inadequate to address the potential underinvestment in fuel efficiency resulting from such split incentives. In this setting, regulation may contribute to fuel savings that otherwise may be difficult to achieve.

#### (4) Uncertainty About Future Cost Savings

Another hypothesis for the lack of adoption of seemingly fuel saving technologies may be uncertainty about future fuel prices or truck maintenance costs. When purchasers have less than perfect foresight about future operating expenses, they may implicitly discount future savings in those costs due to uncertainty about potential returns from investments that reduce future costs. In contrast, the immediate costs of the fuel-saving or maintenance-reducing technologies are certain and immediate, and thus not subject to discounting. In this situation, both the expected return on capital investments in higher fuel efficiency and potential variance about its expected rate may play a role in a firm's calculation of its payback period on such investments.

In the context of energy efficiency investments for the home, Metcalf and Rosenthal (1995) and Metcalf and Hassett (1995) observe that households weigh known, up-front costs that are essentially irreversible against an unknown stream of future fuel savings.<sup>479</sup> Notably, in this situation,

<sup>478</sup> See NAS 2010, Note 197, at p. 182.

<sup>479</sup> Metcalf, G., and D. Rosenthal (1995). "The 'New' View of Investment Decisions and Public Policy Analysis: An Application to Green Lights and Cold Refrigerators," *Journal of Policy Analysis and Management* 14: 517–531. Hassett and Metcalf (1995). "Energy Tax Credits and Residential Conservation Investment: Evidence from Panel Data" *Journal of Public Economics* 57 (1995): 201–217. Metcalf, G., and K. Hassett (1999). "Measuring the Energy Savings from Home Improvement Investments: Evidence from Monthly Billing Data." *The Review of Economics and Statistics* 81(3): 516–528.

requiring households to adopt technologies more quickly may make them worse off by imposing additional risk on them.

Greene *et al* (2009) also finds support for this explanation in the context of light-duty fuel economy decisions: a loss-averse consumer's expected net present value of increasing the fuel economy of a passenger car can be very close to zero, even if a risk-neutral expected value calculation shows that its buyer can expect significant net benefits from purchasing a more fuel-efficient car.<sup>480</sup> Supporting this hypothesis is a finding by Dasgupta *et al.* (2007) that consumers are more likely to lease than buy a vehicle with higher maintenance costs because it provides them with the option to return it before those costs become too high.<sup>481</sup> However, the agencies know of no studies that have estimated the impact of uncertainty on perceived future savings for medium- and heavy-duty vehicles.

Purchasers' uncertainty about future fuel prices implies that mandating improvements in fuel efficiency can reduce the expected utility associated with truck purchases. This is because adopting such regulation requires purchasers to assume a greater level of risk than they would in its absence, even if the future fuel savings predicted by a risk-neutral calculation actually materialize. One commenter expressed support for this argument. Thus the mere existence of uncertainty about future savings in fuel costs does not by itself assure that regulations requiring improved fuel efficiency will necessarily provide economic benefits for truck purchasers and operators. On the other hand, because risk aversion reduces expected returns for businesses, competitive pressures can reduce risk aversion: risk-neutral companies can make higher average profits over time. Thus, significant risk aversion is unlikely to survive competitive pressures.

#### (5) Adjustment and Transactions Costs

Another hypothesis is that transactions costs of changing to new technologies (how easily drivers will adapt to the changes, *e.g.*) may slow or prevent their adoption. Because of the diversity in the trucking industry, truck

<sup>480</sup> Greene, D., J. German, and M. Delucchi (2009). "Fuel Economy: The Case for Market Failure" in *Reducing Climate Impacts in the Transportation Sector*, Sperling, D., and J. Cannon, eds. Springer Science.

<sup>481</sup> Dasgupta, S., S. Siddarth, and J. Silva-Risso (2007). "To Lease or to Buy? A Structural Model of a Consumer's Vehicle and Contract Choice Decisions." *Journal of Marketing Research* 44: 490–502.

owners and fleets may like to see how a new technology works in the field, when applied to their specific operations, before they adopt it. One commenter expressed support for this argument. If a conservative approach to new technologies leads truck buyers to adopt new technologies slowly, then successful new technologies are likely to be adopted over time without market intervention, but with potentially significant delays in achieving fuel saving, environment, and energy security benefits.

In addition, there may be costs associated with training drivers to realize the potential fuel savings enabled by new technologies, or with accelerating fleet operators' scheduled fleet turnover and replacement to hasten their acquisition of vehicles equipped with new fuel-saving technologies. Here, again, there may be no market failure; requiring the widespread use of these technologies may impose adjustment and transactions costs not included in this analysis. As in the discussion of the role of risk, these adjustment and transactions costs are typically immediate and undiscounted, while their benefits are future and uncertain; risk or loss aversion may further discourage companies from adopting new technologies.

To the extent that there may be transactions costs associated with the new technologies, then regulation gives all new truck purchasers a level playing field, because it will require all of them to adjust on approximately the same time schedule. If experience with the new technologies serves to reduce uncertainty and risk, the industry as a whole may become more accepting of new technologies. This could increase demand for future new technologies and induce additional benefits in the legacy fleet through complementary efforts such as SmartWay.

#### (6) Additional Hypotheses

In the public comments, two additional ideas were raised for the lack of adoption of what appears to be cost-effective fuel-saving technology. The first suggestion is that tighter diesel emissions standards caused engine manufacturers to invest heavily (both financially and with personnel) in emissions reduction technologies, and hence, were unable to invest in fuel efficiency technologies. A second suggestion is that a truck may be a "positional good"—that is, a good whose value depends on how it compares to the goods owned by others. If trucks confer status on their owners or operators, and if that status depends on easily observable characteristics,

then owners may invest disproportionately in status-granting characteristics rather than less visible characteristics, such as fuel efficiency. Because status depends on comparisons to others, an “arms race” may develop in which all parties spend additional money on visible characteristics but may not manage to make themselves better off. In this case, regulation may improve welfare: by increasing the requirements for non-positional fuel efficiency, regulation could reduce expenditures made purely for competition rather than actual increase in welfare. In a competitive business, cost reduction provides a major opportunity cost to investing in status rather than in fuel-saving technology; thus, this argument may play less of a role in the heavy-duty market than in the consumer market for vehicles.

Both these hypotheses leave open the question, though, why additional investments were not made in fuel efficiency if they would provide rapid payback. Truck purchasers should, in principle, be willing to buy additional fuel-saving technology as long as it is cost-effective, regardless of other vehicle attributes. Limited access to capital, if it is a problem in this sector, might provide some reason for the “crowding out” of the purchase of fuel-saving technology. The agencies received no evidence indicating that constrained access to capital might explain the efficiency gap in this market.

#### (7) Summary

On the one hand, commercial vehicle operators are under competitive pressure to reduce operating costs, and thus their purchasers would be expected to pursue and rapidly adopt cost-effective fuel-saving technologies. On the other hand, the short payback period required by buyers of new trucks is a symptom that suggests some combination of uncertainty about future cost savings, transactions costs, and imperfectly functioning markets. In addition, widespread use of tractor-trailer combinations introduces the possibility that owners of trailers may have weaker incentives than truck owners or operators to adopt fuel-saving technology for their trailers. The market for medium- and heavy-duty trucks may face these problems, both in the new vehicle market and in the resale market.

Provision of information about fuel-saving technologies through voluntary programs such as SmartWay will assist in the adoption of new cost-saving technologies, but diffusion of new technologies can still be obstructed. Those who are willing to experiment with new technologies expect to find

cost savings, but those may be difficult to prove. As noted above, because individual results of new technologies vary, new truck purchasers may find it difficult to identify or verify the effects of fuel-saving technologies. Those who are risk-averse are likely to avoid new technologies out of concerns over the possibility of inadequate returns on the investment, or with other adverse impacts. Competitive pressures in the freight transport industry can provide a strong incentive to reduce fuel consumption and improve environmental performance. However, not every driver or trucking fleet operating today has the requisite ability or interest to access the technical information, some of which is already provided by SmartWay, nor the resources necessary to evaluate this information within the context of his or her own freight operation.

It is unclear, as discussed above, whether some or many of the technologies would be adopted in the absence of the program. To the extent that they would have been adopted, the costs and the benefits attributed to those technologies may not in fact be due to the program and may therefore be overstated. Both baselines used project substantially less adoption than the agencies consider to be cost-effective. The agencies will continue to explore reasons for this slow adoption of cost-effective technologies.

#### *B. Costs Associated With the Final Program*

In this section, the agencies present the estimated costs associated with the final program. The presentation here summarizes the costs associated with new technology expected to be added to meet the new GHG and fuel consumption standards. The analysis summarized here provides the estimate of incremental costs on a per truck basis and on an annual total basis.

The presentation here summarizes the best estimate by EPA and NHTSA staff as to the technology mix expected to be employed for compliance. For details behind the cost estimates associated with individual technologies, the reader is directed to Section III of this preamble and to Chapter 2 of the RIA.

With respect to the cost estimates presented here, the agencies note that, because these estimates relate to technologies which are in most cases already available, these cost estimates are technically robust.

#### (1) Costs per Truck

For the heavy-duty pickup trucks and vans, the agencies have used a methodology consistent with that used

for our recent light-duty joint rulemaking since most of the technologies expected for heavy-duty pickup trucks and vans is consistent with that expected for the larger light-duty trucks. The cost estimates presented in the recent light-duty joint rulemaking were then scaled upward to account for the larger weight, towing capacity, and work demands of the trucks in these heavier classes. For details on that scaling process and the resultant costs for individual technologies, the reader is directed to Section III of this preamble and to Chapter 2 of the RIA. Note also that all cost estimates have been updated to 2009 dollars for this analysis while the heavy-duty GHG emissions and fuel efficiency proposal was presented in 2008 dollars and the light-duty rule was presented in 2007 dollars.

For the loose heavy-duty gasoline engines, we have generally used engine-related costs from the heavy-duty pickup truck and van estimates since the loose heavy-duty gasoline engines are essentially the same engines as those sold into the heavy-duty pickup truck and van market.

For heavy-duty diesel engines, the agencies have estimated costs using a different methodology than that employed in the recent light-duty joint rulemaking. In the light-duty 2012–2016 MY vehicle rule, the fixed costs were included in the hardware costs via an indirect cost multiplier. As such, the hardware costs presented in that analysis, and in the cost estimates for Class 2b and 3 trucks, included both the actual hardware and the associated fixed costs. For this analysis, some of the fixed costs are estimated separately for HD diesel engines and are presented separately from the hardware costs. For details, the reader is directed to Chapter 2 of the RIA. Importantly, both methodologies after the figures are totaled account for all the costs associated with the program. As noted above, all costs are presented in 2009 dollars.

The estimates of vehicle compliance costs cover the years leading up to—2012 and 2013—and including implementation of the program—2014 through 2018. Also presented are costs for the years following implementation to shed light on the long term (2022 and later) cost impacts of the program. The year 2022 was chosen here consistent with the light-duty 2012–2016 MY vehicle rule. That year was considered long term in that analysis because the short-term and long-term markup factors described shortly below are applied in five year increments with the 2012 through 2016 implementation span and

the 2017 through 2021 span both representing the short-term. Since many of the costs used in this analysis are based on costs in the light-duty rule analysis, consistency with that analysis seems appropriate.

Some of the individual technology cost estimates are presented in brief in Section III, and account for both the direct and indirect costs incurred in the manufacturing and dealer industries (for a complete presentation of technology costs, please refer to Chapter 2 of the RIA). To account for the indirect costs on Class 2b and 3 pickup trucks and vans, the agencies have applied an ICM factor to all of the direct costs to arrive at the estimated technology cost. The ICM factor used was 1.24 in the short-term (2014 through 2021) to account for differences in the levels of R&D, tooling, and other indirect costs that will be incurred. Once the program has been fully implemented, some of the indirect costs will no longer be attributable to these standards and, as such, a lower ICM factor is applied to direct costs in 2022 and later. The agencies have also applied ICM factors to Class 4 through 8 trucks and to heavy-duty diesel engine technologies. Markup factors in these categories range from 1.15 to 1.30 in the short term (2014 through 2021) depending on the complexity of the given technology. We have modified the manner in which ICMs are applied in that they are no longer applied as a simple multiplicative factor on top of the direct manufacturing costs. Instead, we have broken out the warranty cost portion of the ICM and apply it in a multiplicative manner then add the non-warranty cost portion of the ICM to that. The latter portion, that for non-warranty costs, is determined for a given year and held constant rather than decreasing year-over-year. This new approach, which responds to criticisms from some that the multiplicative approach used in the past essentially double counts learning effects, is discussed in Section VIII.C and is detailed in chapter 2 of the RIA. Note that, for the HD diesel engines, the agencies have applied the ICMs to ensure that our estimates are conservative since we have estimated fixed costs separately for technologies applied to these categories—effectively making the use of markups a double

counting of indirect costs. For the details on the background and the concept behind our use of ICMs to calculate indirect costs, please refer to the report that has been placed in the docket for this final action.<sup>482</sup>

The agencies have also considered the impacts of manufacturer learning on the technology cost estimates by reflecting the phenomenon of volume-based learning curve cost reductions in our modeling using two algorithms depending on where in the learning cycle (*i.e.*, on what portion of the learning curve) we consider a technology to be—“steep” portion of the curve for newer technologies and “flat” portion of the curve for mature technologies. The observed phenomenon in the economic literature which supports manufacturer learning cost reductions are based on reductions in costs as production volumes increase, and the economic literature suggests these cost reductions occur indefinitely, though the absolute magnitude of the cost reductions decrease as production volumes increase (with the highest absolute cost reduction occurring with the first doubling of production). The agencies use the terminology “steep” and “flat” portion of the curve to distinguish among newer technologies and more mature technologies, respectively, and how learning cost reductions are applied in cost analyses. The steep learning algorithm applies for the early, steep portion of the learning curve and is estimated to result in 20 percent lower costs after two full years of implementation (*i.e.*, a 2016 MY cost would be 20 percent lower than the 2014 and 2015 model year costs for a new technology being implemented in 2014). The flat learning algorithm applies for the flatter portion of the learning curve and is estimated to result in 3 percent lower costs in each of the five years following first introduction of a mature technology added in response to this final action. Once two steep learning steps have occurred (for technologies having steep learning applied), flat learning would begin. For technologies to which flat learning is applied, learning would begin in year 2 at 3 percent per year for 5 years. Beyond 5 years of flat learning at 3 percent per year, 5 years of flat learning at 2 percent

per year, then 5 at 1 percent per year become effective.

Learning impacts have been considered on most but not all of the technologies expected to be used because some of the expected technologies are already used rather widely in the industry and, presumably, learning impacts have already occurred. The agencies have applied the steep learning algorithm for only a handful of technologies considered to be new or emerging technologies such as energy recovery systems and thermal storage units which might one day be used on big trucks. For most technologies, the agencies have considered them to be more established and, hence, the agencies have applied the lower flat learning algorithm. For more discussion of the learning approach and the technologies to which each type of learning has been applied the reader is directed to chapter 2 of the RIA.

The technology cost estimates discussed in Section III and detailed in Chapter 2 of the RIA are used to build up technology package cost estimates. For each engine and truck class, a single package for each was developed capable of complying with the final standards and the costs for each package was generated. The technology packages and package costs are discussed in more detail in Chapter 2 of the RIA. The compliance cost estimates take into account all credits and trading programs and include costs associated with air conditioning controls. Table VIII–1 presents the average incremental costs per truck for this final action. For HD pickup trucks and vans (Class 2b and 3), costs increase as the standards become more stringent in 2014 through 2018. Following 2018, costs then decrease going forward as learning effects result in decreased costs for individual technologies. By 2022, the long term ICMs take effect and costs decrease yet again. For vocational vehicles, cost trends are more difficult to discern as diesel engines begin adding technology in 2014, gasoline engines begin adding technology in 2016, and the trucks themselves begin adding technology in 2014. With learning effects the costs, in general, decrease each year except for the heavy-duty gasoline engine changes in 2016. Long term ICMs take effect in 2022 to provide more cost reductions.

<sup>482</sup> RTI International. Heavy-duty Truck Retail Price Equivalent and Indirect Cost Multipliers. July 2010.



For combination tractors, costs generally decrease each year due to learning effects with the exception of 2017 when the engines placed in sleeper cab tractors add turbo compounding. Following that, learning impacts result

in cost reductions and the long term ICMs take effect in 2022 for further cost reductions. By 2030 and later, cost-per-truck estimates remain constant for all classes. Regarding the long term ICMs taking effect in 2022, the agencies

consider this the point at which some indirect costs decrease or are no longer considered attributable to the program (e.g., warranty costs go down). Costs per truck remain essentially constant thereafter.

TABLE VIII-1—ESTIMATED COST PER TRUCK  
[2009 dollars]

	HD Pickups & vans	Vocational	Combination
2014 .....	\$165	\$329	\$6,019
2015 .....	215	320	5,871
2016 .....	422	397	5,677
2017 .....	631	387	6,413
2018 .....	1,048	378	6,215
2020 .....	985	366	6,004
2030 .....	977	311	5,075
2040 .....	977	305	5,075
2050 .....	977	304	5,075

These costs would, presumably, have some impact on new truck prices, although the agencies make no attempt at determining what the impact of increased costs would be on new truck prices. Nonetheless, on a percentage basis, the costs shown in Table VIII-1 for 2018 MY trucks (when all final requirements are fully implemented) would be roughly three percent for a typical HD pickup truck or van, less than one percent for a typical vocational vehicle, and roughly six percent for a typical combination truck/tractor using new truck prices of \$40,000, \$100,000 and \$100,000, respectively. The costs would represent lower or higher percentages of new truck prices for new trucks with higher or lower prices, respectively. Given the wide range of new truck prices in these categories—a Class 4 vocational work truck might be \$40,000 when new while a Class 8 refuse truck (i.e., a large vocational vehicle) might be as much as \$200,000 when new—it is very difficult to reflect incremental costs as percentages of new truck prices for all trucks. What is presented here is the average cost (Table VIII-1) compared with typical new truck prices.

As noted above, the fixed costs were estimated separately from the hardware costs for HD diesel engines that are placed in vocational vehicles and combination tractors. Those fixed costs are not included in Table VIII-1. The agencies have estimated the R&D costs at \$6.8 million per manufacturer per year for five years and the new test cell costs (to accommodate measurement of N<sub>2</sub>O emissions) at \$63,087 per

manufacturer. The test cell costs of N<sub>2</sub>O emissions measurement has been adjusted for the final rulemaking to reflect comments which stated approximately 75 percent of manufacturers would be required to update existing equipment while the other 25 percent would require new equipment. These costs apply individually for LHD, MHD and HHD engines. Given the 14 manufacturers impacted by the final standards, 11 of which are estimated to sell both MHD and HHD engines and 3 of which are estimated to sell LHD engines, we have estimated a five year annual R&D cost of \$170.3 million dollars (2 × 11 × \$6.8 million plus 3 × \$7.75 million for each year 2012–2016) and a one-time test cell cost of \$1.6 million dollars (2 × 11 × \$63,087 plus 3 × \$63,087 in 2013). Estimating annual sales of HD diesel engines at roughly 600,000 units results in roughly \$284 per engine per year for five years beginning in 2012 and ending in 2016. Again, these costs are not reflected in Table VIII-1, but are included in Table VIII-2 as “Other Engineering Costs.”

The certification and compliance program costs, for all engine and truck types, are estimated at \$6.5 million in the first year dropping to \$2.3 million in each year thereafter and continuing indefinitely. These costs are detailed in the “Draft Supporting Statement for Information Collection Request” which is contained in the docket for this final action.<sup>483</sup> The costs are higher in the first year due to capital expenses required to comply with new reporting burdens (facility upgrade costs are

included in engineering costs as described above). Estimating annual sales of heavy-duty trucks at roughly 1.5 million units would result in just over \$4 per engine/truck in the first year and less than \$2 per engine/truck per year thereafter. These costs are not reflected in Table VIII-1, but are included in Table VIII-2 below as “Compliance Program” costs.

(2) Annual Costs of the HD National Program

The costs presented here represent the incremental costs for newly added technology to comply with the program. Together with the projected increases in truck sales, the increases in per-truck average costs shown in Table VIII-1, above result in the total annual costs presented in Table VIII-2 below. Note that the costs presented in Table VIII-2 do not include the savings that will occur as a result of the improvements to fuel consumption. Those impacts are presented in Section 0. Note also that the costs presented here represent costs estimated to occur presuming that the final standards will continue in perpetuity. Any changes to the final standards would be considered as part of a future rulemaking. In other words, the final standards do not apply only to 2014–2018 model year trucks—they do, in fact, apply to all 2014 and later model year trucks. We present more detail regarding the 2014–2018 model year trucks in Sections VIII.L, where we summarize all monetized costs and benefits.

<sup>483</sup> “Draft Supporting Statement for Information Collection Request,” Control of Greenhouse Gas

Emissions from New Motor Vehicles: Proposed

Heavy-Duty Engine and Vehicle Standards, EPA ICR Tracking Number 2394.01.

TABLE VIII-2—ANNUAL COSTS ASSOCIATED WITH THE PROGRAM  
 [\$Millions, 2009\$]

Year	HD Pickup and vans	Vocational vehicles	Combination tractors	Other engineering costs	Compliance program costs	Annual costs
2012 <sup>a</sup>	\$0	\$0	\$0	\$170	\$0	\$170
2013	0	0	0	172	0	172
2014	130	185	1,078	170	6.5	1,569
2015	157	170	922	170	2.3	1,422
2016	300	202	820	170	2.3	1,495
2017	447	198	951	0	2.3	1,598
2018	751	201	1,000	0	2.3	1,955
2020	754	202	1,001	0	2.3	1,959
2030	918	216	1,076	0	2.3	2,212
2040	1,024	281	1,372	0	2.3	2,679
2050	1,156	354	1,777	0	2.3	3,290
NPV, 3%	17,070	4,950	24,487	793	52	47,352
NPV, 7%	8,467	2,588	12,855	724	30	24,665

**Note:**

<sup>a</sup>As explained in the text, “Other Engineering Costs” are estimated for years 2012 through 2016. These costs represent facility related costs and engineering development costs, much of which will have to begin prior to implementation of the new standards.

*C. Indirect Cost Multipliers*

(1) Markup Factors To Estimate Indirect Costs

For all segments in this analysis, indirect costs are estimated by applying indirect cost multipliers (ICM) to direct cost estimates. ICMs were calculated by EPA as a basis for estimating the impact on indirect costs of individual vehicle technology changes that would result from regulatory actions. Separate ICMs were derived for low, medium, and high complexity technologies, thus enabling estimates of indirect costs that reflect the variation in research, overhead, and other indirect costs that can occur among different technologies. ICMs were also applied in the light-duty rule.

Prior to developing the ICM methodology, EPA and NHTSA both applied a retail price equivalent (RPE) factor to estimate indirect costs. RPEs are estimated by dividing the total revenue of a manufacturer by the direct manufacturing costs. As such, it includes all forms of indirect costs for a manufacturer and assumes that the ratio applies equally for all technologies. ICMs are based on RPE estimates that are then modified to reflect only those elements of indirect costs that would be expected to change in response to a regulatory-induced technology change. For example, warranty costs would be reflected in both RPE and ICM estimates, while marketing costs might only be reflected in an RPE estimate but not an ICM estimate for a particular technology, if the new regulatory-induced technology change is not one expected to be marketed to consumers. Because ICMs calculated by EPA are for individual technologies, many of which are small in scale, they often reflect a subset of

RPE costs; as a result, the RPE is typically higher than an ICM. This is not always the case, as ICM estimates for complex technologies may reflect higher than average indirect costs, with the resulting ICM larger than the averaged RPE for the industry.

There is some level of uncertainty surrounding both the ICM and RPE markup factors. The ICM estimates used in this final action group all technologies into three broad categories and treat them as if individual technologies within each of the three categories (low, medium, and high complexity) will have the same ratio of indirect costs to direct costs. This simplification means it is likely that the direct cost for some technologies within a category will be higher and some lower than the estimate for the category in general. More importantly, the ICM estimates have not been validated through a direct accounting of actual indirect costs for individual technologies. Rather, the ICM estimates were developed using adjustment factors developed in two separate occasions: the first, a consensus process, was reported in the RTI report; the second, a modified Delphi method, was conducted separately and reported in an EPA memo.<sup>484</sup> Both these panels were composed of EPA staff members with previous background in the automobile industry; the memberships of the two panels overlapped but were not the same.<sup>485</sup> The panels evaluated each

element of the industry’s RPE estimates and estimated the degree to which those elements would be expected to change in proportion to changes in direct manufacturing costs. The method and estimates in the RTI report were peer reviewed by three industry experts and subsequently by reviewers for the International Journal of Production Economics.<sup>486</sup> RPEs themselves are inherently difficult to estimate because the accounting statements of manufacturers do not neatly categorize all cost elements as either direct or indirect costs. Hence, each researcher developing an RPE estimate must apply a certain amount of judgment to the allocation of the costs. Moreover, RPEs for heavy- and medium-duty trucks and for engine manufacturers are not as well studied as they are for the light-duty automobile industry. Since empirical estimates of ICMs are ultimately derived from the same data used to measure RPEs, this affects both measures. However, the value of RPE has not been measured for specific technologies, or for groups of specific technologies. Thus applying a single average RPE to any given technology by definition overstates costs for very simple technologies, or understates them for advanced technologies.

In the proposal, we requested comment on our ICM factors and whether it was most appropriate to use ICMs or RPEs. We received no comment on the issue specifically, other than

<sup>484</sup> Helfand, Gloria, and Sherwood, Todd. “Documentation of the Development of Indirect Cost Multipliers for Three Automotive Technologies.” Memorandum, Assessment and Standards Division, Office of Transportation and Air Quality, U.S. Environmental Protection Agency, August 2009.

<sup>485</sup> NHTSA staff participated in the development of the process for the second, modified Delphi

panel, and reviewed the results as they were developed, but did not serve on the panel.

<sup>486</sup> The results of the RTI report were published in Alex Rogozhin, Michael Gallaher, Gloria Helfand, and Walter McManus, “Using Indirect Cost Multipliers to Estimate the Total Cost of Adding New Technology in the Automobile Industry.” *International Journal of Production Economics* 124 (2010): 360–368.

basic comments that perhaps our ICM factors were low. In response, for this final action, we have adjusted our ICM factors such that they are slightly higher and, importantly, we have changed the way in which the factors are applied. The first change—increased ICM factors—has been done as a result of further thought among the EPA and NHTSA team that the ICM factors presented in the original RTI report<sup>487</sup> for low and medium complexity technologies should no longer be used and that we should rely solely on the modified-Delphi values for these complexity levels.<sup>488</sup> For that reason, we have eliminated the averaging of original RTI values with modified-Delphi values and instead are relying solely on the modified-Delphi values for low and medium complexity technologies. The second change—the way the factors are applied—results in the warranty portion of the indirect costs being applied as a multiplicative factor (thereby decreasing going forward as direct manufacturing costs decrease due to learning), and the remainder of the indirect costs being applied as an additive factor (thereby remaining constant year-over-year and not being reduced due to learning). This second change has a comparatively large impact on the resultant technology costs and,

we believe, more appropriately estimates costs over time. In addition to these changes, a secondary-level change was also made as part of this ICM recalculation to the light-duty ICMs and, therefore, to the ICMs used in this analysis for heavy-duty pickups and vans. That change was to revise upward the RPE level reported in the original RTI report from an original value of 1.46 to 1.5 to reflect the long term average RPE. The original RTI study was based on 2008 data. However, an analysis of historical RPE data indicates that, although there is year to year variation, the average RPE has remained constant at roughly 1.5. ICMs will be applied to future year's data and therefore NHTSA and EPA staff believe that it would be appropriate to base ICMs on the historical average rather than a single year's result. Therefore, ICMs were adjusted to reflect this average level since the original value excluded net income. As a result, even the High 1 and High 2 ICMs used for heavy-duty pickups and vans have also changed. These changes to our ICMs and the methodology are described in greater detail in Chapter 2 of the final RIA.

*D. Cost per Ton of Emissions Reductions*

The agencies have calculated the cost per ton of GHG reductions associated

with this program on a CO<sub>2</sub>eq basis using the above costs and the emissions reductions described in Sections VI and VII. These values are presented in Table VIII-3 through Table VIII-5 for HD pickups & vans, vocational vehicles and combination trucks/tractors, respectively. The cost per metric ton of GHG emissions reductions has been calculated in the years 2020, 2030, 2040, and 2050 using the annual vehicle compliance costs and emission reductions for each of those years. The value in 2050 represents the long-term cost per ton of the emissions reduced. The agencies have also calculated the cost per metric ton of GHG emission reductions including the savings associated with reduced fuel consumption (presented below in Section 0). This latter calculation does not include the other benefits associated with this program such as those associated with energy security benefits as discussed later in Section VIII.I. By including the fuel savings, the cost per ton is generally less than \$0 since the estimated value of fuel savings outweighs the program costs. The results for CO<sub>2</sub>eq costs per ton under the HD National Program across all regulated categories are shown in Table VIII-6.

TABLE VIII-3—ANNUAL COST PER METRIC TON OF CO<sub>2</sub>EQ REDUCED—HD PICKUP TRUCKS & VANS  
[2009 dollars]

Year	Program cost	Fuel savings (pre-tax)	CO <sub>2</sub> eq Reduced	Cost per ton (without fuel Savings)	Cost per ton (with fuel savings)
2020 .....	\$800	\$900	3	\$240	-\$30
2030 .....	900	3,000	10	90	-200
2040 .....	1,000	4,300	14	70	-240
2050 .....	1,200	5,500	16	80	-270

TABLE VIII-4—ANNUAL COST PER METRIC TON OF CO<sub>2</sub>EQ REDUCED—VOCATIONAL VEHICLES a  
[2009 dollars]

Year	Program cost	Fuel savings (pre-tax)	CO <sub>2</sub> eq reduced	Cost per ton (without fuel savings)	Cost per ton (with fuel savings)
2020 .....	\$200	\$1,100	4	\$50	-\$210
2030 .....	200	2,400	9	20	-250
2040 .....	300	3,500	12	30	-270
2050 .....	400	4,700	14	30	-310

**Note:**

<sup>a</sup> The program costs, fuel savings, and CO<sub>2</sub>eq reductions of the engines installed in vocational vehicles are embedded in the vehicle standards and analysis.

<sup>487</sup> Rogozhin, Alex, Michael Callaher, and Walter McManus. "Automobile Industry Retail Price Equivalent and Indirect Cost Multipliers." Report prepared for EPA by RTI International. EPA Report EPA-420-R-09-003, February 2009.

<sup>488</sup> Helfand, Gloria, and Sherwood, Todd. "Documentation of the Development of Indirect Cost Multipliers for Three Automotive Technologies." Memorandum, Assessment and Standards Division, Office of Transportation and

Air Quality, U.S. Environmental Protection Agency, August 2009.

TABLE VIII-5—ANNUAL COST PER METRIC TON OF CO<sub>2</sub>EQ REDUCED—COMBINATION TRACTORS <sup>a</sup>  
[2009 dollars]

Year	Program cost	Fuel savings (pre-tax)	CO <sub>2</sub> eq reduced	Cost per ton (without fuel savings)	Cost per ton (with fuel savings)
2020 .....	\$1,000	\$7,700	32	\$30	-\$210
2030 .....	1,100	15,300	57	20	-250
2040 .....	1,400	20,200	68	20	-280
2050 .....	1,800	26,400	78	20	-320

**Note:**  
<sup>a</sup> The program costs, fuel savings, and CO<sub>2</sub>eq reductions of the engines installed in tractors are embedded in the tractor standards and analysis.

TABLE VIII-6—ANNUAL COST PER METRIC TON OF CO<sub>2</sub>EQ REDUCED—FINAL  
[2009 dollars]

Year	Program cost	Fuel savings (pre-tax)	CO <sub>2</sub> eq reduced	Cost per ton (without fuel savings)	Cost per ton (with fuel savings)
2020 .....	\$2,000	\$9,600	39	\$50	-\$190
2030 .....	2,200	20,600	76	30	-240
2040 .....	2,700	28,000	94	30	-270
2050 .....	3,300	36,500	108	30	-310

*E. Impacts of Reduction in Fuel Consumption*

(1) What are the projected changes in fuel consumption?

The new CO<sub>2</sub> standards will result in significant improvements in the fuel efficiency of affected trucks. Drivers of those trucks will see corresponding savings associated with reduced fuel expenditures. The agencies have estimated the impacts on fuel consumption for the tailpipe CO<sub>2</sub> standards. To do this, fuel consumption is calculated using both current CO<sub>2</sub> emission levels and the new CO<sub>2</sub> standards. The difference between these estimates represents the net savings from the CO<sub>2</sub> standards. Note that the total number of miles that vehicles are driven each year is different under the control case scenario than in the reference case due to the “rebound effect,” which is discussed in Section 0. EPA also notes that drivers who drive more than our average estimates for vehicle miles traveled (VMT) will experience more fuel savings; drivers who drive less than our average VMT estimates will experience less fuel savings.

The expected impacts on fuel consumption are shown in Table VIII-7. The gallons shown in the tables reflect impacts from the new fuel consumption and CO<sub>2</sub> standards and include increased consumption resulting from the rebound effect.

TABLE VIII-7—FUEL CONSUMPTION REDUCTIONS OF THE PROGRAM  
[Million gallons]

Year	Gasoline	Diesel
2014 .....	1	473
2015 .....	3	846
2016 .....	14	1,171
2017 .....	31	1,643
2018 .....	58	2,123
2020 .....	114	2,986
2030 .....	348	5,670
2040 .....	453	7,046
2050 .....	522	8,158

(2) Potential Impacts on Global Fuel Use and Emissions

EPA’s quantified reductions in fuel consumption focus on the gains from reducing fuel used by heavy-duty vehicles within the United States. However, as discussed in Section VIII.I, EPA also recognizes that this regulation will lower the world price of oil (the “monopsony” effect). Lowering oil prices could lead to an uptick in oil consumption globally, leading to a corresponding increase in GHG emissions in other countries. This global increase in emissions could slightly offset some of the emission reductions achieved domestically as a result of the regulation.

(3) What are the monetized fuel savings?

Using the fuel consumption estimates presented in Table VIII-7, the agencies can calculate the monetized fuel savings associated with the final standards. To do this, reduced fuel consumption is multiplied in each year by the

corresponding estimated average fuel price in that year, using the reference case taken from the AEO 2011. These estimates do not account for the significant uncertainty in future fuel prices; the monetized fuel savings will be understated if actual fuel prices are higher (or overstated if fuel prices are lower) than estimated. AEO is a standard reference used by NHTSA and EPA and many other government agencies to estimate the projected price of fuel. This has been done using both the pre-tax and post-tax fuel prices. Since the post-tax fuel prices are the prices paid at fuel pumps, the fuel savings calculated using these prices represent the savings consumers would see. The pre-tax fuel savings are those savings that society would see. Assuming no change in fuel tax rates, the difference between these two columns represents the reduction in fuel tax revenues that will be received by state and federal governments—about \$200 million in 2014 and \$3 billion by 2050. These results are shown in Table VIII-8. Note that in Section VIII.L, the overall benefits and costs of the rules are presented and, for that reason, only the pre-tax fuel savings are presented there.

TABLE VIII-8—ESTIMATED MONETIZED FUEL SAVINGS  
[Millions, 2009\$]

Year	Fuel savings (pre-tax)	Fuel savings (post-tax)
2014 .....	\$1,200	\$1,400

TABLE VIII-8—ESTIMATED MONETIZED FUEL SAVINGS—Continued  
[Millions, 2009\$]

Year	Fuel savings (pre-tax)	Fuel savings (post-tax)
2015 .....	2,200	2,600
2016 .....	3,300	3,800
2017 .....	4,800	5,500
2018 .....	6,400	7,400
2020 .....	9,600	10,900
2030 .....	20,600	23,000
2040 .....	28,000	30,600
2050 .....	36,500	39,500
NPV, 3% .....	375,300	415,300
NPV, 7% .....	166,500	185,400

As shown in Table VIII-8, the agencies are projecting that truck consumers would realize very large fuel savings as a result of the final standards. As discussed further in the introductory paragraphs of Section VIII, it is a conundrum from an economic perspective that these large fuel savings have not been provided by manufacturers and purchased by consumers of these products. Unlike in the light-duty vehicle market, the vast majority of vehicles in the medium- and heavy-duty truck market are purchased and operated by businesses; for them, fuel costs may represent substantial operating expenses. Even in the presence of uncertainty and imperfect information—conditions that hold to some degree in every market—we generally expect firms to be cost-

minimizing to survive in a competitive marketplace and to make decisions that are therefore in the best interest of the company and its owners and/or shareholders.

A number of behavioral and market phenomena may lead to a disconnect between how businesses account for fuel savings in their decisions and the way in which we account for the full stream of fuel savings for these rules, including imperfect information in the original and resale markets, split incentives, uncertainty in future fuel prices, and adjustment or transactions costs (see Section VIII.A for a more detailed discussion). As discussed below in the context of rebound in Section VIII.E.5, the nature of the explanation for this gap may influence the actual magnitude of the fuel savings.

(4) Payback Period and Lifetime Savings on New Truck Purchases

Another factor of interest is the payback period on the purchase of a new truck that complies with the new standards. In other words, how long would it take for the expected fuel savings to outweigh the increased cost of a new vehicle? For example, a new 2018 MY HD pickup truck and van is estimated to cost \$1,048 more, a vocational vehicle \$378 more, and a combination tractor \$6,215 more (all values are on average, and relative to the reference case vehicle) due to the addition of new GHG reducing

technology. This new technology will result in lower fuel consumption and, therefore, savings in fuel expenditures. But how many months or years would pass before the fuel savings exceed the upfront costs? Table VIII-9 shows the payback period analysis for HD pickup trucks and vans. The table shows fuel consumed under the reference case and fuel consumed by a 2018 model year truck under the program, inclusive of fuel consumed due to rebound miles. The decrease in fuel consumed under the program is then monetized by multiplying by the fuel price reported by AEO (reference case) for 2018 and later. This value represents the fuel savings expected under the program for a HD pickup or van. These savings are then discounted each year since future savings are considered to be of less value than current savings. Shown next are estimated increased costs (costs do not necessarily reflect increased prices which may be higher or lower than costs) for the new truck (refer to Table VIII-1). The next columns of Table VIII-9 show the period required for the fuel savings to exceed the new truck costs. As seen in the table, in the second year of ownership, the discounted fuel savings (at both 3 and 7 percent discount rates) have begun to outweigh the increased cost of the truck. As shown in the table, the full life savings using 3 percent discounting would be \$6,138 and at 7 percent discounting would be \$4,459.

TABLE VIII-9—PAYBACK PERIOD FOR A 2018 MODEL YEAR HD PICKUP OR VAN  
[2009\$]

Year of ownership	Reduced fuel use (gallons) <sup>b</sup>		Fuel savings <sup>a</sup>		Increased cost	Cumulative savings	
	Gasoline	Diesel	3% discount	7% discount		3% discount	7% discount
1 .....	67	122	\$627	\$616	-\$1,048	-\$421	-\$433
2 .....	67	122	617	583	.....	196	151
3 .....	66	120	600	546	.....	796	696
4 .....	64	117	570	499	.....	1,366	1,196
5 .....	62	113	544	458	.....	1,910	1,654
6 .....	59	108	507	411	.....	2,417	2,065
7 .....	56	102	474	370	.....	2,890	2,435
Full Life .....	894	1,617	7,187	5,507	- 1,048	6,138	4,459

Notes:

<sup>a</sup>Fuel savings calculated using the AEO 2011 reference case fuel prices through 2035. Fuel prices beyond 2035 were extrapolated from an average growth rate for the years 2017 to 2035. Gasoline and diesel fuel prices have been weighted by gasoline and diesel fuel reductions estimated for all 2018 MY heavy-duty trucks during their lifetimes. These estimates assume no changes in fuel tax rates. If fuel taxes are increased to offset lost revenues, the post-tax savings will increase.

<sup>b</sup>Gallons under the control case include gallons consumed during rebound driving.

The story is somewhat different for vocational vehicles and combination tractors. These cases are shown in Table VIII-10 and Table VIII-11, respectively. Since these trucks travel more miles in a given year, their payback periods are

shorter and are expected to occur within the second year of ownership under both the 3 and 7 percent discounting cases. As can be seen in Table VIII-10 and Table VIII-11, the lifetime fuel savings are estimated to be considerable

with savings of \$5,494 (3%) and \$4,268 (7%) for the vocational vehicles and \$72,875 (3%) and \$58,162 (7%) for the combination tractors.

TABLE VIII-10—PAYBACK PERIOD FOR A 2018 MODEL YEAR VOCATIONAL VEHICLE  
[2009\$]

Year of ownership	Reduced fuel use (gallons) <sup>b</sup>		Fuel savings <sup>a</sup>		Increased cost	Cumulative savings	
	Gasoline	Diesel	3% discount	7% discount		3% discount	7% discount
1	51	161	\$702	\$690	-\$378	\$325	\$312
2	47	146	637	602	.....	962	914
3	44	134	576	524	.....	1,538	1,438
4	41	122	516	452	.....	2,054	1,889
5	38	110	463	390	.....	2,516	2,279
6	34	98	404	328	.....	2,921	2,607
7	31	87	359	280	.....	3,279	2,887
Full Life	550	1,458	5,872	4,646	-378	5,494	4,268

**Notes:**

<sup>a</sup>Fuel savings calculated using the AEO 2011 reference case fuel prices through 2035. Fuel prices beyond 2035 were extrapolated from an average growth rate for the years 2017 to 2035. Gasoline and diesel fuel prices have been weighted by gasoline and diesel fuel reductions estimated for all 2018 MY heavy-duty trucks during their lifetimes. These estimates assume no changes in fuel tax rates. If fuel taxes are increased to offset lost revenues, the post-tax savings will increase.

<sup>b</sup>Gallons under the control case include gallons consumed during rebound driving.

TABLE VIII-11—PAYBACK PERIOD FOR A 2018 MODEL YEAR COMBINATION TRACTOR  
[2009\$]

Year of ownership	Reduced fuel use (gallons) <sup>b</sup>		Fuel savings <sup>a</sup>		Increased cost	Cumulative savings	
	Gasoline	Diesel	3% discount	7% discount		3% discount	7% discount
1	0	3,223	\$10,736	\$10,539	-\$6,215	\$4,522	\$4,324
2	0	2,897	9,619	9,089	.....	14,141	13,413
3	0	2,619	8,564	7,790	.....	22,705	21,203
4	0	2,359	7,532	6,595	.....	30,237	27,797
5	0	2,096	6,626	5,585	.....	36,863	33,382
6	0	1,842	5,684	4,611	.....	42,546	37,993
7	0	1,617	4,951	3,867	.....	47,497	41,860
Full Life	0	26,148	79,089	64,376	-6,215	72,875	58,162

**Notes:**

<sup>a</sup>Fuel savings calculated using the AEO 2011 reference case fuel prices through 2035. Fuel prices beyond 2035 were extrapolated from an average growth rate for the years 2017 to 2035. Gasoline and diesel fuel prices have been weighted by gasoline and diesel fuel reductions estimated for all 2018 MY heavy-duty trucks during their lifetimes. These estimates assume no changes in fuel tax rates. If fuel taxes are increased to offset lost revenues, the post-tax savings will increase.

<sup>b</sup>Gallons under the control case include gallons consumed during rebound driving.

All of these payback analyses include fuel consumed during rebound VMT in the control case but not in the reference case, consistent with other parts of the analysis. Further, this analysis does not include other societal impacts such as reduced time spent refueling or noise, congestion and accidents since the focus is meant to be on those factors buyers think about most while considering a new truck purchase. Note also that operators that drive more miles per year than the average would realize greater fuel savings than estimated here, and those that drive fewer miles per year would realize lesser savings. The same holds true for operators that keep their vehicles longer (*i.e.*, more years) than average in that they would realize greater lifetime fuel savings than operators that keep their vehicles for fewer years than average. Likewise, should fuel prices be higher than the AEO 2011 reference case, operators will realize greater fuel savings than

estimated here while they would realize lesser fuel savings were fuel prices to be lower than the AEO 2011 reference case.

(5) Rebound Effect

The VMT rebound effect refers to the fraction of fuel savings expected to result from an increase in fuel efficiency that is offset by additional vehicle use. If truck shipping costs decrease as a result of lower fuel costs, an increase in truck VMT may occur. Unlike the light-duty rebound effect, the heavy-duty (HD) rebound effect has not been extensively studied. Because the factors influencing the HD rebound effect are generally different from those affecting the light-duty rebound effect, much of the research on the light-duty rebound effect is not likely to apply to the HD sectors. One of the major differences between the HD rebound effect and the light-duty rebound effect is that HD vehicles are used primarily for business purposes. Since these businesses are

profit driven, decision makers are highly likely to be aware of the costs and benefits of different shipping decisions, both in the near term and long term. Therefore, shippers are much more likely to take into account changes in the overall operating costs per mile when making shipping decisions that affect VMT.

Another difference from the light-duty case is that, as discussed in the recent NAS Report,<sup>489</sup> when calculating the percentage change in trucking costs to determine the rebound effect, all changes in the operating costs should be considered. The cost of labor and fuel generally constitute the top two shares of truck operating costs, depending on the price of petroleum,<sup>490</sup> distance traveled, type of truck, and

<sup>489</sup> See NAS Report, Note 197.

<sup>490</sup> American Transportation Research Institute, *An Analysis of the Operational Costs of Trucking*, December 2008 (Docket ID: EPA-HQ-OAR-2010-0162-0007).

commodity.<sup>491</sup> Finally, the equipment costs associated with the purchase or lease of the truck is also a significant component of total operating costs. Even though vehicle costs are lump-sum purchases, they can be considered operating costs for trucking firms, and these costs are, in many cases, expected to be passed onto the final consumers of shipping services on a variable basis. This shipping cost increase could help temper the rebound effect relative to the case of light-duty vehicles, in which vehicle costs are not considered an operating cost by vehicle owners.

When calculating the net change in operating costs, both the increase in new vehicle costs and the decrease in fuel costs per mile should be taken into consideration. The higher the net cost savings, the higher the expected rebound effect. Conversely, if the upfront vehicle costs outweighed future cost savings and total costs increased, shipping costs would rise, which would likely result in a decrease in truck VMT. In theory, other changes such as maintenance costs and insurance rates would also be taken into account, although information on these potential cost changes is extremely limited. In the proposal, we invited comments on the most appropriate methodology for factoring new vehicle purchase or leasing costs into the per-mile operating costs. We also invited comment or data on how these regulations could affect maintenance, insurance, or other operating costs. We did not receive any comments on these assumptions.

The following sections describe the factors affecting the rebound effect, different methodologies for estimating the rebound effect, and examples of different estimates of the rebound effect to date. According to the NAS study, it is “not possible to provide a confident measure of the rebound effect,” yet NAS concluded that a rebound effect likely exists and that “estimates of fuel savings from regulatory standards will be somewhat misestimated if the rebound effect is not considered.” While we believe the HD rebound effect needs to be studied in more detail, we have attempted to capture the potential impact of the rebound effect in our analysis. In the proposal, we solicited data on the rebound effect and input on the most appropriate estimates to use for the rebound effect. However, we did not receive any new data or substantive comments. Therefore, for this final action, we continue to use a rebound

effect for vocational vehicles of 15 percent, a rebound effect for HD pickup trucks and vans of 10 percent, and a rebound effect for combination tractors of 5 percent. These VMT impacts are reflected in the estimates of total GHG and other air pollution reductions presented in Chapter 5 of the RIA.

#### (a) Factors Affecting the Magnitude of the Rebound Effect

The HD vehicle rebound effect is driven by the interaction of several different factors. In the short-run, decreasing the fuel cost per mile of driving could lead to a decrease in end product prices. Lower prices could stimulate additional demand for those products, which would then result in an increase in VMT. In the long run, shippers could reorganize their logistics and distribution networks to take advantage of lower truck shipping costs. For example, shippers may shift away from other modes of shipping such as rail, barge, or air. In addition, shippers may also choose to reduce the number of warehouses, reduce load rates, and make smaller, more frequent shipments, all of which could also lead to an increase in HD VMT. Finally, the benefits of the fuel savings could ripple through the economy, which could in turn increase overall demand for goods and services shipped by trucks, and therefore increase HD VMT.

Conversely, if a fuel efficiency regulation leads to net increases in the cost of trucking because fuel savings do not fully offset the increase in upfront vehicle costs, then the price of trucking services could rise, spurring a decrease in HD VMT and a shift to alternative shipping modes. These effects would also ripple through the economy.

#### (b) Options for Quantifying the Rebound Effect

As described in the previous section, the fuel efficiency rebound effect for HD vehicles has not been studied as extensively as the rebound effect for light-duty vehicles, and virtually no research has been conducted on the HD pickup truck and van rebound effect. In the proposal, we discussed four options for quantifying the rebound effect and requested comments. We did not receive any substantive comments on the described methodologies.

#### (i) Aggregate Estimates

The aggregate approximation approach quantifies the overall change in truck VMT as a result of a percentage change in freight rates. It is important to note that most of the aggregate estimates measure the change in freight demanded (tons or ton-miles), rather than a change

in fuel consumption or VMT. The change in tons or ton-miles is more accurately characterized as a freight elasticity. Therefore, it may not be entirely appropriate to interpret these freight elasticities as measures of the rebound effect, although these terms are sometimes used interchangeably in the literature.<sup>492</sup> Given these caveats, freight elasticity estimates rely on estimates of aggregate price elasticity of demand for trucking services, given a percentage change in trucking prices, which is generally referred to as an “own-price elasticity.” Estimates of trucking own-price elasticities vary widely from positive 1.72 to negative 7.92, and there is no general consensus on the most appropriate values to use, though a 2004 literature survey found aggregate elasticity estimates generally fall in the range of  $-0.5$  to  $-1.5$ .<sup>493</sup> In other words, given an own-price elasticity of  $-1.5$ , a 10 percent decrease in trucking prices leads to a 15 percent increase in truck shipping demand.

Another challenge of estimating the rebound effect using freight elasticities is that these values appear to vary substantially based on the demand elasticity measure (e.g., ton or ton-mile), the model specification (e.g., linear functional form or log linear), the length of the trip, and the type of cargo. In general, elasticity estimates of longer trips tend to be larger than elasticity estimates for shorter trips. In addition, elasticities tend to be larger for lower-value commodities compared to higher-value commodities. Although these factors explain some of the differences in estimates, much of the observed variation cannot be explained quantitatively. For example, a recent study that controlled for these variables only accounted for about half of the observed variation.<sup>494</sup>

Another important variable influencing freight elasticity estimates is whether potential mode shifting is taken into account. Although the total demand for freight transport is generally determined by economic activity, there is often the choice of shipping freight on modes other than truck. This is because the United States has extensive rail, waterway and air transport networks in addition to an extensive highway network; these networks closely parallel

<sup>492</sup> Memo from Energy and Environmental Research Associates, LLC Regarding HDV Rebound Effect, dated June 8, 2011.

<sup>493</sup> Graham and Glaister, “Road Traffic Demand Elasticity Estimates: A Review,” *Transport Reviews* Volume 24, 3, pp. 261–274, 2004 (Docket ID: EPA-HQ-OAR-2010-0162-0005).

<sup>494</sup> Li, Z., D.A. Hensher, and J.M. Rose, *Identifying sources of systematic variation in direct price elasticities from revealed preference studies of inter-city freight demand*. Transport Policy, 2011.

<sup>491</sup> Transport Canada, Operating Cost of Trucks, 2005. See <http://www.tc.gc.ca/eng/policy/report-acg-operatingcost2005-2005-e-2-1727.htm>, accessed on July 16, 2010 (Docket ID: EPA-HQ-OAR-2010-0162-0006). See also ATRI, 2008.



each other and are often both viable choices for freight transport for long-distance routes within the continent. If rates go down for one mode, there will be an increase in demand for that mode and some demand will be shifted from other modes. This “cross-price elasticity” is a measure of the percentage change in demand for shipping by another mode (e.g., rail) given a percentage change in the price of trucking. Aggregate estimates of cross-price elasticities also vary widely, and there is no general consensus on the most appropriate value to use for analytical purposes. The NAS report cites values ranging from 0.35 to 0.59.<sup>495</sup> Other reports provide significantly different cross-price elasticities, ranging from 0.1<sup>496</sup> to 2.0.<sup>497</sup>

When considering intermodal shift, the most relevant kinds of shipments are those that are competitive between rail and truck modes. These trips generally include long-haul shipments greater than 500 miles, which weigh between 50,000 and 80,000 pounds (the legal road limit in many states). Special kinds of cargo like coal and short-haul deliveries are of less interest because they are generally not economically transferable between truck and rail modes, and they would not be expected to shift modes except under an extreme price change. However, the total amount of freight that could potentially be subject to mode shifting has also not been studied extensively.

#### (ii) Sector-Specific Estimates

Given the limited data available regarding the HD rebound effect, the aggregate approach greatly simplifies many of the assumptions associated with calculations of the rebound effect. In reality, however, responses to changes in fuel efficiency and new vehicle costs will vary significantly based on the commodities affected. A detailed, sector-specific approach would be expected to more accurately reflect changes in the trucking market in response to the standards in this program. For example, input-output

tables could be used to determine the trucking cost share of the total delivered price of a commodity. Using the change in trucking prices described in the aggregate approach, the product-specific demand elasticities could be used to calculate the change in sales and shipments for each product. The change in shipment increases could then be weighted by the share of the trucking industry total, and then summed to get the total increase in trucking output. A simplifying assumption could then be made that the increase in output results in an increase in VMT. To the best of our knowledge, this type of data has not yet been collected. We did not receive any new information in response to our request for comments in the proposal, therefore we were unable to use this methodology for estimating the rebound effect for this final action.

#### (iii) Econometric Estimates

Similar to the methodology used to estimate the light-duty rebound effect, the HD rebound effect could be modeled econometrically by estimating truck demand as a function of economic activity (e.g., GDP) and different input prices (e.g., vehicle prices, driver wages, and fuel costs per mile). This type of econometric model could be estimated for either truck VMT or ton-miles as a measure of demand. The resulting elasticity estimates could then be used to determine the change in trucking demand, given the change in fuel cost and truck prices per mile from these standards. One of the challenges associated with an econometric analysis is the potential for omitted variable bias, which could either overstate or understate the potential rebound effect if the omitted variable is correlated with the controlled variables.

#### (iv) Other Modeling Approaches

Regulation of the heavy-duty industry has been studied in more detail in Europe, as the European Commission (EC) has considered allowing longer and heavier trucks for freight transport. Part of the analysis considered by the EC relies on country-specific modeling of changes in the freight sector that would result from changes in regulations.<sup>498</sup> This approach attempts to explicitly calculate modal shift decisions and impacts on GHG emissions. Although similar types of analysis have not been conducted extensively in the United States, research is currently underway that explores the potential for

intermodal shifting in the United States. For example, Winebrake and Corbett have developed the Geospatial Intermodal Freight Transportation model, which evaluates the potential for GHG emissions reductions based on mode shifting, given existing limitations of infrastructure and other route characteristics in the United States.<sup>499</sup> This model connects multiple road, rail, and waterway transportation networks and embeds activity-based calculations in the model. Within this intermodal network, the model assigns various economic, time-of-delivery, energy, and environmental attributes to real-world goods movement routes. The model can then calculate different network optimization scenarios, based on changes in prices and policies.<sup>500</sup> However, more work is needed in this area to determine whether this type of methodology is appropriate for the purposes of capturing the rebound effect. Therefore, we have not been able to use this methodology for estimating the rebound effect for this final action.

#### (c) Estimates of the Rebound Effect

The aggregate methodology was used by Cambridge Systematics, Inc. (CSI) to show several examples of the magnitude of the rebound effect.<sup>501</sup> In their paper commissioned by the NAS in support of the recent HD report, CSI calculated an effective rebound effect for two different technology cost and fuel savings scenarios associated with an example Class 8 truck. Scenario 1 increased average fuel economy from 5.59 mpg to 6.8 mpg, with an additional cost of \$22,930. Scenario 2 increased the average fuel economy to 9.1 mpg, at an incremental cost of \$71,630 per vehicle. The CSI examples provided estimates using a range of own-price elasticities (−0.5 to −1.5) and cross-price elasticities (0.35 to 0.59) from the literature. Based on these two scenarios and a number of simplifying assumptions to aid the calculations, CSI found a rebound effect of 11–31 percent for Scenario 1 and 5–16 percent for

<sup>495</sup> See 2010 NAS Report, Note 197. See also 2009 Cambridge Systematics, Inc., Draft Final Paper commissioned by the NAS in support of the medium-duty and heavy-duty report. Assessment of Fuel Economy Technologies for Medium and Heavy-duty Vehicles: Commissioned Paper on Indirect Costs and Alternative Approaches Docket ID: EPA-HQ-OAR-2010-0162-0009.

<sup>496</sup> Friedlaender, A. and Spady, R. (1980) A derived demand function for freight transportation, *Review of Economics and Statistics*, 62, pp. 432–441 (Docket ID: EPA-HQ-OAR-2010-0162-0004).

<sup>497</sup> Christidis and Leduc, “Longer and Heavier Vehicles for freight transport,” European Commission Joint Research Center’s Institute for Prospective Technology Studies, 2009 (Docket ID: EPA-HQ-OAR-2010-0162-0010).

<sup>498</sup> Christidis and Leduc, “Longer and Heavier Vehicles for freight transport,” European Commission Joint Research Center’s Institute for Prospective Technology Studies, 2009.

<sup>499</sup> Winebrake, James and Corbett, James J. (2010). “Improving the Energy Efficiency and Environmental Performance of Goods Movement,” in Sperling, Daniel and James S. Cannon (2010) *Climate and Transportation Solutions: Findings from the 2009 Asilomar Conference on Transportation and Energy Policy*. See <http://www.its.ucdavis.edu/events/2009book/Chapter13.pdf> (Docket ID: EPA-HQ-OAR-2010-0162-0011)

<sup>500</sup> Winebrake, J. J.; Corbett, J. J.; Falzarano, A.; Hawker, J. S.; Korfmacher, K.; Ketha, S.; Zilora, S., Assessing Energy, Environmental, and Economic Tradeoffs in Intermodal Freight Transportation, *Journal of the Air & Waste Management Association*, 58(8), 2008 (Docket ID: EPA-HQ-OAR-2010-0162-0008).

<sup>501</sup> Cambridge Systematics, Inc., 2009.

Scenario 2 when the fuel savings from reduced rail usage were not taken into account (“First rebound effect”). When the fuel savings from reduced rail usage were included in the calculations, the overall rebound effect was between 9–13 percent for Scenario 1 and 3–15 percent for Scenario 2 (“Second Rebound Effect”). See Table VIII–12.

CSI included a number of caveats associated with these calculations.

Namely, the elasticity estimates derived from the literature are “heavily reliant on factors including the type of demand measures analyzed (vehicle-miles of travel, ton-miles, or tons), analysis geography, trip lengths, markets served, and commodities transported.” Furthermore, the CSI example only focused on Class 8 combination tractors and did not attempt to quantify the potential rebound effect for any other

truck classes. Finally, these scenarios were characterized as “sketches” and were not included in the final NAS report. In fact, the NAS report asserted that it is “not possible to provide a confident measure of the rebound effect,” yet concluded that a rebound effect likely exists and that “estimates of fuel savings from regulatory standards will be somewhat misestimated if the rebound effect is not considered.”

TABLE VIII–12—RANGE OF REBOUND EFFECT ESTIMATES FROM CAMBRIDGE SYSTEMATICS AGGREGATE ASSESSMENT

	Scenario 1 (6.8 mpg, \$22,930)	Scenario 2 (9.1 mpg, \$71,630)
“First Rebound Effect” (increase in truck VMT resulting from decrease in operating costs) .....	11–31%	5–16%
“Second Rebound Effect” (net fuel savings when decreases from rail are taken into account) .....	9–13%	3–15%

As an alternative, using the econometric approach, NHTSA has estimated the rebound effect in the short run and long run for single unit (Class 4–7) and (Class 8) combination tractors. As shown in Table VIII–13, the estimates for the long-run rebound effect are larger than the estimates in the short run, which is consistent with the theory that shippers have more flexibility to change their behavior (e.g., restructure

contracts or logistics) when they are given more time. In addition, the estimates derived from the national data also showed larger rebound effects compared to the state data.<sup>502</sup> One possible explanation for the difference in the estimates is that the national rebound estimates are capturing some of the impacts of changes in economic activity. Historically, large increases in fuel prices are highly correlated with

economic downturns, and there may not be enough variation in the national data to differentiate the impact of fuel price changes from changes in economic activity. In contrast, some states may see an increase in output when energy prices increase (e.g., large oil producing states such as Texas and Alaska); therefore, the state data may be more accurately isolating the individual impact of fuel price changes.

TABLE VIII–13—RANGE OF REBOUND EFFECT ESTIMATES FROM NHTSA ECONOMETRIC ANALYSIS

Truck type	National data		State data	
	Short run	Long run	Short run	Long run
Single Unit	13–22%	28–45%	3–8%	12–21%
Combination	N/A	12–14%	N/A	4–5%

As discussed throughout this section, there are multiple methodologies for quantifying the rebound effect, and these different methodologies produce a large range of potential values of the rebound effect. However, for the purposes of quantifying the rebound effect for this program, we have used a rebound effect with respect to changes in fuel costs per mile on the lower range of the long-run estimates. Given the fact that the long-run state estimates are generally more consistent with the aggregate estimates, for this program we have chosen a rebound effect for vocational vehicles (single unit trucks) of 15 percent that is within the range of estimates from both methodologies.

Similarly, we have chosen a rebound effect for combination tractors of 5 percent.

To date, no estimates of the HD pickup truck and van rebound effect have been cited in the literature. Since these vehicles are used for very different purposes than heavy-duty vehicles, it does not necessarily seem appropriate to apply one of the heavy-duty estimates to the HD pickup trucks and vans. These vehicles are more similar in use to large light-duty vehicles, so for the purposes of our analysis, we have chosen to apply the light-duty rebound effect of 10 percent to this class of vehicles.

For the purposes of this program, we have not taken into account any

potential fuel savings or GHG emission reductions from the rail sector due to mode shifting. We requested comments on this assumption in the proposal, but we did not receive any new data or input.

Furthermore, we have made a number of simplifying assumptions in our calculations, which are discussed in more detail in the RIA. Specifically, we have not attempted to capture how current market failures might impact the rebound effect. The direction and magnitude of the rebound effect in the HD market are expected to vary depending on the existence and types of market failures affecting the fuel efficiency of the trucking fleet. If firms

<sup>502</sup> NHTSA’s estimates of the rebound effect are derived from econometric analysis of national and state VMT data reported in Federal Highway Administration, *Highway Statistics*, various editions, Tables VM–1 and VM–4. Specifically, the estimates of the rebound effect reported in Table VIII–10 are ranges of the estimated short-run and long-run elasticities of annual VMT by single-unit

and combination trucks with respect to fuel cost per mile driven. (Fuel cost per mile driven during each year is equal to average fuel price per gallon during that year divided by average fuel economy of the truck fleet during that same year.) These estimates are derived from time-series regression of annual national aggregate VMT for the period 1970–2008 on measures of nationwide economic activity,

including aggregate GDP, the value of durable and nondurable goods production, and the volume of U.S. exports and imports of goods, and variables affecting the price of trucking services (driver wage rates, truck purchase prices, and fuel costs), and from regression of VMT for each individual state over the period 1994–2008 on similar variables measured at the state level.

are already accurately accounting for the costs and benefits of these technologies and fuel savings, then these regulations would increase their net costs, because trucks would already include all the cost-effective technologies. As a result, the rebound effect would actually be negative and truck VMT would decrease as a result of these final regulations. However, if firms are not optimizing their behavior today due to factors such as lack of reliable information (see Section VIII.A. for further discussion), it is more likely that truck VMT would increase. If firms recognize their lower net costs as a result of these regulations and pass those costs along to their customers, then the rebound effect would increase truck VMT. This response assumes that trucking rates include both truck purchase costs and fuel costs, and that the truck purchase costs included in the rates spread those costs over the full expected lifetime of the trucks. If those costs are spread over a shorter period, as the expected short payback period implies, then those purchase costs will inhibit reduction of freight rates, and the rebound effect will be smaller.

As discussed in more detail in Section VIII.A, if there are market failures such as split incentives, estimating the rebound effect may depend on the nature of the failures. For example, if the original purchaser cannot fully recoup the higher upfront costs through fuel savings before selling the vehicle nor pass those costs onto the resale buyer, the firm would be expected to raise shipping rates. A firm purchasing the truck second-hand might lower shipping rates if the firm recognizes the cost savings after operating the vehicle, leading to an increase in VMT. Similarly, if there are split incentives and the vehicle buyer isn't the same entity that purchases the fuel, then there would theoretically be a positive rebound effect. In this scenario, fuel savings would lower the net costs to the fuel purchaser, which would result in a larger increase in truck VMT.

If all of these scenarios occur in the marketplace, the net effect will depend on the extent and magnitude of their relative effects, which are also likely to vary across truck classes (for instance, split incentives may be a much larger problem for Class 7 and 8 tractors than they are for HD pickup trucks). Additional details on the rebound effect are included in the RIA.

#### *F. Class Shifting and Fleet Turnover Impacts*

The agencies considered two additional potential indirect costs, benefits, effects, and externalities which

may lead to unintended consequences of the program to improve the fuel efficiency and reduce GHG emissions from HD trucks. The next sections cover the agencies' qualitative discussions on potential class shifting and fleet turnover effects.

##### (1) Class Shifting

Heavy-duty vehicles are typically configured and purchased to perform a function. For example, a concrete mixer truck is purchased to transport concrete, a combination tractor is purchased to move freight with the use of a trailer, and a Class 3 pickup truck could be purchased by a landscape company to pull a trailer carrying lawnmowers. The purchaser makes decisions based on many attributes of the vehicle, including the gross vehicle weight rating of the vehicle which in part determines the amount of freight or equipment that can be carried. If the final HD National Program impacts either the performance of the vehicle or the marginal cost of the vehicle relative to the other vehicle classes, then consumers may choose to purchase a different vehicle, resulting in the unintended consequence of increased fuel consumption and GHG emissions in-use.

The agencies, along with the NAS panel, found that there is little or no literature which evaluates class shifting between trucks.<sup>503</sup> NHTSA and EPA qualitatively evaluated the final rules in light of potential class shifting. The agencies looked at four potential cases of shifting:—from light-duty pickup trucks to heavy-duty pickup trucks; from sleeper cabs to day cabs; from combination tractors to vocational vehicles; and within vocational vehicles.

Light-duty pickup trucks, those with a GVWR of less than 8,500 pounds, are currently regulated under the existing CAFE program and will meet GHG emissions standards beginning in 2012. The increased stringency of the light-duty 2012–2016 MY vehicle rule has led some to speculate that vehicle consumers may choose to purchase heavy-duty pickup trucks that are currently unregulated if the cost of the light-duty regulation is high relative to the cost to buy the larger heavy-duty pickup trucks. Since fuel consumption and GHG emissions rise significantly with vehicle mass, a shift from light-duty trucks to heavy-duty trucks would likely lead to higher fuel consumption and GHG emissions, an unintended consequence of the regulations. Given the significant price premium of a heavy-duty truck (often five to ten

thousand dollars more than a light-duty pickup), we believe that such a class shift would be unlikely even absent this program. With these final regulations, any incentive for such a class shift is significantly diminished. The final regulations for the HD pickup trucks, and similarly for vans, are based on similar technologies and therefore reflect a similar expected increase in cost when compared to the light-duty GHG regulation. Hence, the combination of the two regulations provides little incentive for a shift from light-duty trucks to HD trucks. To the extent that our final regulation of heavy-duty pickups and vans could conceivably encourage a class shift towards lighter pickups, this unintended consequence would in fact be expected to lead to lower fuel consumption and GHG emissions as the smaller light-duty pickups are significantly more efficient than heavy-duty pickup trucks.

The projected cost increases for this final action differ significantly between Class 8 day cabs and Class 8 sleeper cabs, reflecting our expectation that compliance with the final standards will lead truck consumers to specify sleeper cabs equipped with APUs while day cab consumers will not. Since Class 8 day cab and sleeper cab trucks perform essentially the same function when hauling a trailer, this raises the possibility that the higher cost for an APU equipped sleeper cab could lead to a shift from sleeper cab to day cab trucks. We do not believe that such an intended consequence will occur for the following reasons. The addition of a sleeper berth to a tractor cab is not a consumer-selectable attribute in quite the same way as other vehicle features. The sleeper cab provides a utility that long-distance trucking fleets need to conduct their operations—an on-board sleeping berth that lets a driver comply with federally-mandated rest periods, as required by the Department of Transportation Federal Motor Carrier Safety Administration's hours-of-service regulations. The cost of sleeper trucks is already higher than the cost of day cabs, yet the fleets that need this utility purchase them.<sup>504</sup> A day cab simply cannot provide this utility. The need for this utility would not be changed even if the marginal costs to reduce greenhouse gas emissions from sleeper cabs exceed the marginal costs to reduce greenhouse gas emissions from day

<sup>504</sup> A baseline tractor price of a new day cab is \$89,500 versus \$113,000 for a new sleeper cab based on information gathered by ICF in the "Investigation of Costs for Strategies to Reduce Greenhouse Gas Emissions for Heavy-Duty On-Road Vehicles", July 2010. Page 3. Docket Identification Number EPA-HQ-OAR-2010-0162-0044.

<sup>503</sup> See 2010 NAS Report, Note 197, page 152.

cabs.<sup>505</sup> A trucking fleet could decide to put its drivers in hotels in lieu of using sleeper berths, and switch to day cabs. However, this is unlikely to occur in any great number, since the added cost for the hotel stays would far overwhelm differences in the marginal cost between day and sleeper cabs. Even if some fleets do opt to buy hotel rooms and switch to day cabs, they would be highly unlikely to purchase a day cab that was aerodynamically worse than the sleeper cab they replaced, since the need for features optimized for long-distance hauling would not have changed. So in practice, there would likely be little difference to the environment for any switching that might occur. Further, while our projected costs assume the purchase of an APU for compliance, in fact our regulatory structure would allow compliance using a near zero cost software utility that eliminates tractor idling after five minutes. Using this compliance approach, the cost difference between a Class 8 sleeper cab and day cab due to our final regulations is small. We are providing this alternative compliance approach reflecting that some sleeper cabs are used in team driving situations where one driver sleeps while the other drives. In that situation, an APU is unnecessary since the tractor is continually being driven when occupied. When it is parked, it will automatically eliminate any additional idling through the shutdown software. If trucking companies choose this option, then costs based on purchase of APUs may overestimate the costs of this program to this sector.

Class shifting from combination tractors to vocational vehicles may occur if a customer deems the additional marginal cost of tractors due to the regulation to be greater than the utility provided by the tractor. The agencies initially considered this issue when deciding whether to include Class 7 tractors with the Class 8 tractors or regulate them as vocational vehicles. The agencies' evaluation of the combined vehicle weight rating of the Class 7 shows that if these vehicles were treated significantly differently from the Class 8 tractors, then they could be easily substituted for Class 8 tractors. Therefore, the agencies are finalizing to include both classes in the tractor category. The agencies believe that a shift from tractors to vocational vehicles would be limited because of the ability of tractors to pick up and drop off

trailers at locations which cannot be done by vocational vehicles.

The agencies do not envision that the final regulatory program will cause class shifting within the vocational class. The marginal cost difference due to the regulation of vocational vehicles is minimal. The cost of LRR tires on a per tire basis is the same for all vocational vehicles so the only difference in marginal cost of the vehicles is due to the number of axles. The agencies believe that the utility gained from the additional load carrying capability of the additional axle will outweigh the additional cost for heavier vehicles.<sup>506</sup>

In conclusion, NHTSA and EPA believe that the final regulatory structure for HD trucks does not significantly change the current competitive and market factors that determine purchaser preferences among truck types. Furthermore, even if a small amount of shifting does occur, any resulting GHG impacts are likely to be negligible because any vehicle class that sees an uptick in sales is also being regulated for fuel efficiency. Therefore, the agencies did not include an impact of class shifting on the vehicle populations used to assess the benefits of the program.

#### (2) Fleet Turnover Effect

A regulation that increases the cost to purchase and/or operate trucks could impact whether a consumer decides to purchase a new truck and the timing of that purchase. The term pre-buy refers to the idea that truck purchases may occur earlier than otherwise planned to avoid the additional costs associated with a new regulatory requirement. Slower fleet turnover, or low-buys, may occur when owners opt to keep their existing truck rather than purchase a new truck due to the incremental cost of the regulation.

The NAS panel discusses the topics associated with HD truck fleet turnover. NAS noted that there is some empirical evidence of pre-buy behavior in response to the 2004 and 2007 heavy-duty engine emission standards, with larger impacts occurring in response to higher costs.<sup>507</sup> However, those regulations increased upfront costs to firms without any offsetting future cost savings from reduced fuel purchases. In summary, NAS stated that

\* \* \* during periods of stable or growing demand in the freight sector, pre-buy behavior may have significant impact on purchase patterns, especially for larger fleets

with better access to capital and financing. Under these same conditions, smaller operators may simply elect to keep their current equipment on the road longer, all the more likely given continued improvements in diesel engine durability over time. On the other hand, to the extent that fuel economy improvements can offset incremental purchase costs, these impacts will be lessened. Nevertheless, when it comes to efficiency investments, most heavy-duty fleet operators require relatively quick payback periods, on the order of two to three years.<sup>508</sup>

The final regulations are projected to return fuel savings to the truck owners that offset the cost of the regulation within a few years for vocational vehicles and Class 7 and 8 tractors, the categories where the potential for prebuy and delayed fleet turnover are concerns. In the case of vocational vehicles, the added cost is small enough that it is unlikely to have a substantial effect on purchasing behavior. In the case of Class 7 and 8 trucks, the effects of the regulation on purchasing behavior will depend on the nature of the market failures and the extent to which firms consider the projected future fuel savings in their purchasing decisions.

If trucking firms account for the rapid payback, they are unlikely to strategically accelerate or delay their purchase plans at additional cost in capital to avoid a regulation that will lower their overall operating costs. As discussed in Section VIII.A, this scenario may occur if this final program reduces uncertainty about fuel-saving technologies. More reliable information about ways to reduce fuel consumption allows truck purchasers to evaluate better the benefits and costs of additional fuel savings, primarily in the original vehicle market, but possibly in the resale market as well.

Other market failures may leave open the possibility of some pre-buy or delayed purchasing behavior. Firms may not consider the full value of the future fuel savings for several reasons. For instance, truck purchasers may not want to invest in fuel efficiency because of uncertainty about fuel prices. Another explanation is that the resale market may not fully recognize the value of fuel savings, due to lack of trust of new technologies or changes in the uses of the vehicles. Lack of coordination (also called split incentives—see Section VIII.A) between truck purchasers (who emphasize the up-front costs of the trucks) and truck operators, who would like the fuel savings, can also lead to pre-buy or delayed purchasing behavior. If these market failures prevent firms from fully internalizing fuel savings when

<sup>505</sup> The average marginal cost difference between sleeper cabs and day cabs in the proposal is nearly \$6,000.

<sup>506</sup> The final rule projects the difference in costs between the HHD and MHD vocational vehicle technologies is approximately \$30.

<sup>507</sup> See NAS Report, Note 197, pp. 150–151

<sup>508</sup> See NAS Report, Note 197, page 151.

deciding on vehicle purchases, then pre-buy and delayed purchase could occur and could result in a slight decrease in the GHG benefits of the regulation.

Thus, whether pre-buy or delayed purchase is likely to play a significant role in the truck market depends on the specific behaviors of purchasers in that market. Without additional information about which scenario is more likely to be prevalent, the Agencies are not projecting a change in fleet turnover characteristics due to this regulation.

### G. Benefits of Reducing CO<sub>2</sub> Emissions

#### (1) Social Cost of Carbon

EPA has assigned a dollar value to reductions in CO<sub>2</sub> emissions using recent estimates of the social cost of carbon (SCC). The SCC is an estimate of the monetized damages associated with an incremental increase in carbon emissions in a given year. It is intended to include (but is not limited to) changes in net agricultural productivity, human health, property damages from increased flood risk, and the value of ecosystem services due to climate change. The SCC estimates used in this analysis were developed through an interagency process that included EPA, DOT/NHTSA, and other executive branch entities, and concluded in February 2010. We first used these SCC estimates in the benefits analysis for the light-duty 2012–2016 MY vehicle rule; see that rule's preamble for a discussion of application of the SCC.<sup>509</sup> The SCC Technical Support Document (SCC TSD) provides a complete discussion of the methods used to develop these SCC estimates.<sup>510</sup>

The interagency group selected four SCC values for use in regulatory analyses, which we have applied in this analysis: \$5, \$22, \$36, and \$67 per metric ton of CO<sub>2</sub> emissions in 2010, in 2009 dollars.<sup>511 512</sup> The first three values are based on the average SCC from three integrated assessment models, at discount rates of 5, 3, and 2.5 percent, respectively. SCCs at several discount rates are included because the literature shows that the SCC is quite sensitive to assumptions about the discount rate, and because no consensus exists on the

appropriate rate to use in an intergenerational context. The fourth value is the 95th percentile of the SCC from all three models at a 3 percent discount rate. It is included to represent higher-than-expected impacts from temperature change further out in the tails of the SCC distribution. Low probability, high impact events are incorporated into all of the SCC values through explicit consideration of their effects in two of the three models as well as the use of a probability density function for equilibrium climate sensitivity. Treating climate sensitivity probabilistically results in more high temperature outcomes, which in turn lead to higher projections of damages.

The SCC increases over time because future emissions are expected to produce larger incremental damages as physical and economic systems become more stressed in response to greater climatic change. Note that the interagency group estimated the growth rate of the SCC directly using the three integrated assessment models rather than assuming a constant annual growth rate. This helps to ensure that the estimates are internally consistent with other modeling assumptions. Table VIII–14 presents the SCC estimates used in this analysis.

When attempting to assess the incremental economic impacts of carbon dioxide emissions, the analyst faces a number of serious challenges. A recent report from the National Academies of Science points out that any assessment will suffer from uncertainty, speculation, and lack of information about (1) future emissions of greenhouse gases, (2) the effects of past and future emissions on the climate system, (3) the impact of changes in climate on the physical and biological environment, and (4) the translation of these environmental impacts into economic damages.<sup>513</sup> As a result, any effort to quantify and monetize the harms associated with climate change will raise serious questions of science, economics, and ethics and should be viewed as provisional.

The interagency group noted a number of limitations to the SCC

analysis, including the incomplete way in which the integrated assessment models capture catastrophic and non-catastrophic impacts, their incomplete treatment of adaptation and technological change, uncertainty in the extrapolation of damages to high temperatures, and assumptions regarding risk aversion. The limited amount of research linking climate impacts to economic damages makes the interagency modeling exercise even more difficult. The interagency group hopes that over time researchers and modelers will work to fill these gaps and that the SCC estimates used for regulatory analysis by the Federal government will continue to evolve with improvements in modeling. Additional details on these limitations are discussed in the SCC TSD.

We received several comments regarding the SCC estimates used to analyze the proposed standards. In particular, these commenters discussed the incomplete treatment of impacts as well as discount rate selection. EPA has reviewed these comments in detail and responded to them in the EPA Response to Comments Document for the Joint Rulemaking. As noted in that document, the U.S. government intends to revise these estimates, taking into account new research findings that were not included in the first round, and has set a preliminary goal of revisiting the SCC values in the next few years or at such time as substantially updated models become available, and to continue to support research in this area. The EPA Response to Comments Document for the Joint Rulemaking discusses ongoing research in greater detail.

Applying the global SCC estimates, shown in Table VIII–14, to the estimated domestic reductions in CO<sub>2</sub> emissions under this final program, we estimate the dollar value of the climate related benefits for each analysis year. For internal consistency, the annual benefits are discounted back to net present value terms using the same discount rate as each SCC estimate (*i.e.*, 5%, 3%, and 2.5%) rather than 3% and 7%.<sup>514</sup> These estimates are provided in Table VIII–15.

<sup>509</sup> See 2010 Light-Duty Final Rule, Note 5, docket ID EPA–HQ–OAR–2009–0472–11424.

<sup>510</sup> Docket ID EPA–HQ–OAR–2009–0472–114577, *Technical Support Document: Social Cost of Carbon for Regulatory Impact Analysis Under Executive Order 12866, Interagency Working Group on Social Cost of Carbon*, with participation by Council of Economic Advisers, Council on Environmental Quality, Department of Agriculture, Department of Commerce, Department of Energy, Department of Transportation, Environmental Protection Agency, National Economic Council, Office of Energy and Climate Change, Office of Management and Budget, Office of Science and

Technology Policy, and Department of Treasury (February 2010). Also available at <http://epa.gov/otaq/climate/regulations.htm>.

<sup>511</sup> The interagency group decided that these estimates apply only to CO<sub>2</sub> emissions. Given that warming profiles and impacts other than temperature change (*e.g.*, ocean acidification) vary across GHGs, the group concluded “transforming gases into CO<sub>2</sub>-equivalents using GWP, and then multiplying the carbon-equivalents by the SCC, would not result in accurate estimates of the social costs of non-CO<sub>2</sub> gases” (SCC TSD, pg 13).

<sup>512</sup> The SCC estimates were converted from 2007 dollars to 2008 dollars using a GDP price deflator

(1.021) and again to 2009 dollars using a GDP price deflator (1.009) obtained from the Bureau of Economic Analysis, National Income and Product Accounts Table 1.1.4, *Prices Indexes for Gross Domestic Product*.

<sup>513</sup> National Research Council (2009). *Hidden Costs of Energy: Unpriced Consequences of Energy Production and Use*. National Academies Press. See docket ID EPA–HQ–OAR–2009–0472–11486.

<sup>514</sup> It is possible that other benefits or costs of final regulations unrelated to CO<sub>2</sub> emissions will be discounted at rates that differ from those used to develop the SCC estimates.

TABLE VIII-14—SOCIAL COST OF CO<sub>2</sub>, 2012—2050<sup>a</sup>  
[in 2009 dollars per metric ton]

Year	Discount rate and statistic			
	5% Average	3% Average	2.5% Average	3% 95th percentile
2012	\$5.28	\$23.06	\$37.53	\$70.14
2015	5.93	24.58	39.57	75.03
2020	7.01	27.10	42.98	83.17
2025	8.53	30.43	47.28	93.11
2030	10.05	33.75	51.58	103.06
2035	11.57	37.08	55.88	113.00
2040	13.09	40.40	60.19	122.95
2045	14.63	43.34	63.59	131.66
2050	16.18	46.27	66.99	140.37

**Note:**  
<sup>a</sup> The SCC values are dollar-year and emissions-year specific.

TABLE VIII-15—MONETIZED CO<sub>2</sub> BENEFITS OF VEHICLE PROGRAM, CO<sub>2</sub> EMISSIONS<sup>a</sup>  
[Millions, 2009\$]

Year	CO <sub>2</sub> Emissions reduction (MMT)	Benefits			
		Avg SCC at 5% (\$5 – \$16) <sup>a</sup>	Avg SCC at 3% (\$23 – \$46) <sup>a</sup>	Avg SCC at 2.5% (\$38 – \$67) <sup>a</sup>	95th percentile SCC at 3% (\$70 – \$140) <sup>a</sup>
2020	37.7	\$264	\$1,021	\$1,619	\$3,133
2030	73.1	734	2,467	3,770	7,532
2040	90.3	1,182	3,650	5,437	11,108
2050	103.9	1,682	4,810	6,963	14,590
Net Present Value <sup>b</sup>		9,045	46,070	78,037	140,432

**Notes:**  
<sup>a</sup> Except for the last row (net present value), the SCC values are dollar-year and emissions-year specific.  
<sup>b</sup> Net present value of reduced CO<sub>2</sub> emissions is calculated differently from other benefits. The same discount rate used to discount the value of damages from future emissions (SCC at 5, 3, 2.5 percent) is used to calculate net present value of SCC for internal consistency. Refer to the SCC TSD for more detail.

*H. Non-GHG Health and Environmental Impacts*

This section presents EPA’s analysis of the non-GHG health and environmental impacts that can be expected to occur as a result of the HD National Program. GHG emissions are predominantly the byproduct of fossil fuel combustion processes that also produce criteria and hazardous air pollutants. The vehicles that are subject to the standards are also significant sources of mobile source air pollution such as direct PM, NO<sub>x</sub>, VOCs and air toxics. The standards will affect exhaust emissions of these pollutants from vehicles. They will also affect emissions from upstream sources related to changes in fuel consumption. Changes in ambient ozone, PM<sub>2.5</sub>, and air toxics that will result from the standards are expected to affect human health in the form of premature deaths and other serious human health effects, as well as other important public health and welfare effects.

As many commenters noted, it is important to quantify the health and environmental impacts associated with the final rules because a failure to adequately consider these ancillary co-pollutant impacts could lead to an incorrect assessment of their net costs and benefits. Moreover, co-pollutant impacts tend to accrue in the near term, while any effects from reduced climate change mostly accrue over a time frame of several decades or longer.

This section is organized as follows: the first presents the PM- and ozone-related health and environmental impacts associated with the final program in calendar year (CY) 2030; the second discusses the related co-benefits associated with the model year (MY) analysis of the program.<sup>515</sup>

<sup>515</sup> EPA typically analyzes rule impacts (emissions, air quality, costs and benefits) in the year in which they occur; for this analysis, we selected 2030 as a representative future year. We refer to this analysis as the “Calendar Year” (CY) analysis. EPA also conducted a separate analysis of the impacts over the model year lifetimes of the 2012 through 2016 model year vehicles. We refer to this analysis as the “Model Year” (MY) analysis.

(1) Quantified and Monetized Non-GHG Human Health Benefits of the 2030 Calendar Year Analysis

This analysis reflects the impact of the HD National Program in 2030 compared to a future-year reference scenario without the program in place.<sup>516</sup> Overall, we estimate that the final rules will lead to a net decrease in PM<sub>2.5</sub>-related health impacts. See Section VII.D of this preamble for more

In contrast to the CY analysis, the MY lifetime analysis shows the lifetime impacts of the program on each of these MY fleets over the course of its lifetime.

<sup>516</sup> The future-year reference scenario to which the program impacts are compared in this section assumes no future gains in mpg (a “flat” scenario). For the final rulemaking, the agencies have also conducted a sensitivity analysis relative to the baseline assumptions. The alternative baseline assumes annual mpg projections, in the absence of the program, which were developed by the U.S. Energy Information Administration (EIA) for the Annual Energy Outlook (AEO). A description of the alternative baseline can be found in RIA Chapter 6. Due to time and resource constraints, EPA was unable to conduct full-scale photochemical air quality modeling to reflect the final rule impacts relative to this alternative baseline.

information about the air quality modeling results. While the PM-related air quality impacts are relatively small, the decrease in population-weighted national average PM<sub>2.5</sub> exposure results in a net decrease in adverse PM-related human health impacts (the decrease in national population-weighted annual average PM<sub>2.5</sub> is 0.005 µg/m<sup>3</sup>).

The air quality modeling also projects decreases in ozone concentrations in many areas. While the ozone-related impacts are relatively small, the decrease in population-weighted national average ozone exposure results in a net decrease in ozone-related health impacts (population-weighted maximum 8-hour average ozone decreases by 0.164 ppb).

We base our analysis of the program's impact on human health in 2030 on peer-reviewed studies of air quality and human health effects.<sup>517 518</sup> These methods are described in more detail in

the RIA that accompanies this action. Our benefits methods are also consistent with recent rulemaking analyses such as the final Transport Rule,<sup>519</sup> the light-duty 2012–2016 MY vehicle rule,<sup>520</sup> and the final Portland Cement National Emissions Standards for Hazardous Air Pollutants (NESHAP) RIA.<sup>521</sup> To model the ozone and PM air quality impacts of this final action, we used the Community Multiscale Air Quality (CMAQ) model (see Chapter 8.2.2 of the RIA that accompanies this preamble). The modeled ambient air quality data serves as an input to the Environmental Benefits Mapping and Analysis Program version 4.0 (BenMAP).<sup>522</sup> BenMAP is a computer program developed by the U.S. EPA that integrates a number of the modeling elements used in previous analyses (e.g., interpolation functions, population projections, health impact functions, valuation functions, analysis and pooling methods) to translate

modeled air concentration estimates into health effects incidence estimates and monetized benefits estimates.

The range of total monetized ozone- and PM-related health impacts is presented in Table VIII–16. We present total benefits based on the PM- and ozone-related premature mortality function used. The benefits ranges therefore reflect the addition of each estimate of ozone-related premature mortality (each with its own row in Table VIII–16) to estimates of PM-related premature mortality. These estimates represent EPA's preferred approach to characterizing a best estimate of benefits. As is the nature of Regulatory Impact Analyses (RIAs), the assumptions and methods used to estimate air quality benefits evolve to reflect the agency's most current interpretation of the scientific and economic literature.

TABLE VIII–16—ESTIMATED 2030 MONETIZED PM- AND OZONE-RELATED HEALTH BENEFITS<sup>a</sup>

2030 Total ozone and PM benefits—PM mortality derived from American Cancer Society analysis and Six-Cities Analysis <sup>a</sup>			
Premature ozone mortality function	Reference	Total benefits (billions, 2009\$, 3% discount rate) <sup>b,c</sup>	Total Benefits (billions, 2009\$, 7% discount rate) <sup>b,c</sup>
Multi-city analyses .....	Bell <i>et al.</i> , 2004 .....	Total: \$1.3–\$2.4 .....	Total: \$1.2–\$2.2.
		PM: \$0.74–\$1.8 .....	PM: \$0.67–\$1.6.
		Ozone: \$0.55. ....	Ozone: \$0.55.
	Huang <i>et al.</i> , 2005 .....	Total: \$1.6–\$2.7 .....	Total: \$1.6–\$2.5.
		PM: \$0.74–\$1.8 .....	PM: \$0.67–\$1.6.
		Ozone: \$0.91. ....	Ozone: \$0.91.
Schwartz, 2005 .....	Total: \$1.6–\$2.6 .....	Total: \$1.5–\$2.5.	
	PM: \$0.74–\$1.8 .....	PM: \$0.67–\$1.6.	
	Ozone: \$0.83. ....	Ozone: \$0.83.	
Meta-analyses .....	Bell <i>et al.</i> , 2005 .....	Total: \$2.4–\$3.5 .....	Total: \$2.4–\$3.3.
		PM: \$0.74–\$1.8 .....	PM: \$0.67–\$1.6.
		Ozone: \$1.7. ....	Ozone: \$1.7.
	Ito <i>et al.</i> , 2005 .....	Total: \$3.1–\$4.2 .....	Total: \$3.0–\$4.0.
		PM: \$0.74–\$1.8 .....	PM: \$0.67–\$1.6.
		Ozone: \$2.4. ....	Ozone: \$2.4.
	Levy <i>et al.</i> , 2005 .....	Total: \$3.1–\$4.2 .....	Total: \$3.1–\$4.0.
		PM: \$0.74–\$1.8 .....	PM: \$0.67–\$1.6.
		Ozone: \$2.4. ....	Ozone: \$2.4.

**Notes:**

<sup>a</sup> Total includes premature mortality-related and morbidity-related ozone and PM<sub>2.5</sub> benefits. Range was developed by adding the estimate from the ozone premature mortality function to the estimate of PM<sub>2.5</sub>-related premature mortality derived from either the ACS study (Pope *et al.*, 2002) or the Six-Cities study (Laden *et al.*, 2006).

<sup>b</sup> Note that total benefits presented here do not include a number of unquantified benefits categories. A detailed listing of unquantified health and welfare effects is provided in Table VIII–17.

<sup>c</sup> Results reflect the use of both a 3 and 7 percent discount rate, as recommended by EPA's Guidelines for Preparing Economic Analyses and OMB Circular A–4. Results are rounded to two significant digits for ease of presentation and computation.

<sup>517</sup> U.S. Environmental Protection Agency. (2006). *Final Regulatory Impact Analysis (RIA) for the Proposed National Ambient Air Quality Standards for Particulate Matter*. Prepared by: Office of Air and Radiation. Retrieved March 26, 2009 at <http://www.epa.gov/ttn/ecas/ria.html>

<sup>518</sup> U.S. Environmental Protection Agency. (2008). *Final Ozone NAAQS Regulatory Impact Analysis*. Prepared by: Office of Air and Radiation, Office of Air Quality Planning and Standards. Retrieved March 26, 2009 at <http://www.epa.gov/ttn/ecas/ria.html>.

<sup>519</sup> Final Federal Implementation Plans to Reduce Interstate Transport of Fine Particulate Matter and Ozone. Signed July 6, 2011. Available at <http://epa.gov/airtransport/>.

<sup>520</sup> U.S. Environmental Protection Agency. (2010). *Regulatory Impact Analysis: Final Rulemaking to Establish Light-Duty Vehicle Greenhouse Gas Emission Standards and Corporate Average Fuel Economy Standards*, EPA–420–R–10–009, April 2010. Available on the Internet: <http://www.epa.gov/otaq/climate/regulations/420r10009.pdf>.

<sup>521</sup> U.S. Environmental Protection Agency (U.S. EPA). 2010. *Regulatory Impact Analysis: National Emission Standards for Hazardous Air Pollutants from the Portland Cement Manufacturing Industry*. Office of Air Quality Planning and Standards, Research Triangle Park, NC. Augues. Available on the Internet at <http://www.epa.gov/ttn/ecas/regdata/RIAs/portlandcementfinalria.pdf>. EPA–HQ–OAR–2009–0472–0241.

<sup>522</sup> Information on BenMAP, including downloads of the software, can be found at <http://www.epa.gov/ttn/ecas/benmodels.html>.



The benefits in Table VIII–16 include all of the human health impacts we are able to quantify and monetize at this time. However, the full complement of human health and welfare effects associated with PM and ozone remain unquantified because of current limitations in methods or available data. We have not quantified a number of

known or suspected health effects linked with ozone and PM for which appropriate health impact functions are not available or which do not provide easily interpretable outcomes (e.g., changes in heart rate variability). Additionally, we are unable to quantify a number of known welfare effects, including reduced acid and particulate

deposition damage to cultural monuments and other materials, and environmental benefits due to reductions of impacts of eutrophication in coastal areas. These are listed in Table VIII–17. As a result, the health benefits quantified in this section are likely underestimates of the total benefits attributable to this final action.

TABLE VIII–17—UNQUANTIFIED AND NON-MONETIZED POTENTIAL EFFECTS

Pollutant/effects	Effects not included in analysis—Changes in:
Ozone Health <sup>a</sup>	Chronic respiratory damage <sup>b</sup> . Premature aging of the lungs <sup>b</sup> . Non-asthma respiratory emergency room visits. Exposure to UVb (+/-) <sup>e</sup> .
Ozone Welfare	Yields for: —commercial forests. —some fruits and vegetables. —non-commercial crops. Damage to urban ornamental plants. Impacts on recreational demand from damaged forest aesthetics. Ecosystem functions. Exposure to UVb (+/-) <sup>e</sup> .
PM Health <sup>c</sup>	Premature mortality—short term exposures. <sup>d</sup> Low birth weight. Pulmonary function. Chronic respiratory diseases other than chronic bronchitis. Non-asthma respiratory emergency room visits. Exposure to UVb (+/-) <sup>e</sup> .
PM Welfare	Residential and recreational visibility in non-Class I areas. Soiling and materials damage. Damage to ecosystem functions. Exposure to UVb (+/-) <sup>e</sup> .
Nitrogen and Sulfate Deposition Welfare	Commercial forests due to acidic sulfate and nitrate deposition. Commercial freshwater fishing due to acidic deposition. Recreation in terrestrial ecosystems due to acidic deposition. Existence values for currently healthy ecosystems. Commercial fishing, agriculture, and forests due to nitrogen deposition. Recreation in estuarine ecosystems due to nitrogen deposition. Ecosystem functions. Passive fertilization.
CO Health	Behavioral effects.
HC/Toxics Health <sup>f</sup>	Cancer (benzene, 1,3-butadiene, formaldehyde, acetaldehyde). Anemia (benzene). Disruption of production of blood components (benzene). Reduction in the number of blood platelets (benzene). Excessive bone marrow formation (benzene). Depression of lymphocyte counts (benzene). Reproductive and developmental effects (1,3-butadiene). Irritation of eyes and mucus membranes (formaldehyde). Respiratory irritation (formaldehyde). Asthma attacks in asthmatics (formaldehyde). Asthma-like symptoms in non-asthmatics (formaldehyde). Irritation of the eyes, skin, and respiratory tract (acetaldehyde). Upper respiratory tract irritation and congestion (acrolein).
HC/Toxics Welfare	Direct toxic effects to animals. Bioaccumulation in the food chain. Damage to ecosystem function. Odor.

**Notes:**

<sup>a</sup> The public health impact of biological responses such as increased airway responsiveness to stimuli, inflammation in the lung, acute inflammation and respiratory cell damage, and increased susceptibility to respiratory infection are likely partially represented by our quantified endpoints.

<sup>b</sup> The public health impact of effects such as chronic respiratory damage and premature aging of the lungs may be partially represented by quantified endpoints such as hospital admissions or premature mortality, but a number of other related health impacts, such as doctor visits and decreased athletic performance, remain unquantified.

<sup>c</sup> In addition to primary economic endpoints, there are a number of biological responses that have been associated with PM health effects including morphological changes and altered host defense mechanisms. The public health impact of these biological responses may be partly represented by our quantified endpoints.

<sup>d</sup> While some of the effects of short-term exposures are likely to be captured in the estimates, there may be premature mortality due to short-term exposure to PM not captured in the cohort studies used in this analysis. However, the PM mortality results derived from the expert elicitation do take into account premature mortality effects of short term exposures.

<sup>e</sup> May result in benefits or disbenefits.

<sup>f</sup> Many of the key hydrocarbons related to this action are also hazardous air pollutants listed in the CAA.

While there will be impacts associated with air toxic pollutant emission changes that result from this final action, we do not attempt to monetize those impacts. This is primarily because currently available tools and methods to assess air toxics risk from mobile sources at the national scale are not adequate for extrapolation to incidence estimations or benefits assessment. The best suite of tools and methods currently available for assessment at the national scale are those used in the National-Scale Air Toxics Assessment (NATA). The EPA Science Advisory Board specifically commented in their review of the 1996 NATA that these tools were not yet ready for use in a national-scale benefits analysis, because they did not consider the full distribution of exposure and risk, or address sub-chronic health effects.<sup>523</sup> While EPA has since improved these tools, there remain critical limitations for estimating incidence and assessing benefits of reducing mobile source air toxics.

As part of the second prospective analysis of the benefits and costs of the Clean Air Act,<sup>524</sup> EPA conducted a case study analysis of the health effects associated with reducing exposure to benzene in Houston from implementation of the Clean Air Act. While reviewing the draft report, EPA's Advisory Council on Clean Air Compliance Analysis concluded that "the challenges for assessing progress in health improvement as a result of reductions in emissions of hazardous air pollutants (HAPs) are daunting...due to a lack of exposure-response functions, uncertainties in emissions inventories and background levels, the difficulty of extrapolating risk estimates to low doses and the challenges of tracking health progress for diseases, such as cancer, that have long latency periods."<sup>525</sup> EPA continues to work to address these limitations; however, we did not have

the methods and tools available for national-scale application in time for the analysis of the final action.<sup>526</sup>

EPA is also unaware of specific information identifying any effects on listed endangered species from the small fluctuations in pollutant concentrations associated with this program (see Section VII.D). Furthermore, our current modeling tools are not designed to trace fluctuations in ambient concentration levels to potential impacts on particular endangered species.

(a) Quantified Human Health Impacts

Table VIII-18 and Table VIII-19 present the annual PM<sub>2.5</sub> and ozone health impacts, respectively, in the 48 contiguous U.S. states associated with the HD National Program for 2030. For each endpoint presented in Table VIII-18 and Table VIII-19, we provide both the mean estimate and the 90 percent confidence interval.

Using EPA's preferred estimates, based on the American Cancer Society (ACS) and Six-Cities studies and no threshold assumption in the model of mortality, we estimate that the final rules will result in between 78 and 200 cases of avoided PM<sub>2.5</sub>-related premature mortalities annually in 2030. As a sensitivity analysis, when the range of expert opinion is used, we estimate between 26 and 260 fewer premature mortalities in 2030 (see Table 8-14 in the RIA that accompanies this action). For ozone-related premature mortality in 2030, we estimate a range of between 54 to 240 fewer premature mortalities.

TABLE VIII-18—ESTIMATED PM<sub>2.5</sub>-RELATED HEALTH IMPACTS <sup>a</sup>

Health effect	2030 Annual reduction in incidence (5th–95th percentile)
---------------	--

Premature Mortality—Derived from epidemiology literature<sup>b</sup>

<sup>526</sup> In April 2009, EPA hosted a workshop on estimating the benefits or reducing hazardous air pollutants. This workshop built upon the work accomplished in the June 2000 Science Advisory Board/EPA Workshop on the Benefits of Reductions in Exposure to Hazardous Air Pollutants, which generated thoughtful discussion on approaches to estimating human health benefits from reductions in air toxics exposure, but no consensus was reached on methods that could be implemented in the near term for a broad selection of air toxics. Please visit <http://epa.gov/air/toxicair/2009workshop.html> for more information about the workshop and its associated materials.

TABLE VIII-18—ESTIMATED PM<sub>2.5</sub>-RELATED HEALTH IMPACTS <sup>a</sup>—Continued

Health effect	2030 Annual reduction in incidence (5th–95th percentile)
Adult, age 30+, ACS Cohort Study (Pope <i>et al.</i> , 2002) .....	78 (30–130)
Adult, age 25+, Six-Cities Study (Laden <i>et al.</i> , 2006) .....	200 (110–290)
Infant, age <1 year (Woodruff <i>et al.</i> , 1997)	0 (0–1)
Chronic bronchitis (adult, age 26 and over) .....	53 (10–97)
Non-fatal myocardial infarction (adult, age 18 and over) .....	150 (54–240)
Hospital admissions—respiratory (all ages) <sup>c</sup> .....	20 (10–30)
Hospital admissions—cardiovascular (adults, age >18) <sup>d</sup> .....	45 (32–52)
Emergency room visits for asthma (age 18 years and younger) .....	81 (48–120)
Acute bronchitis, (children, age 8–12) .....	130 (0–270)
Lower respiratory symptoms (children, age 7–14) .....	1,600 (750–2,400)
Upper respiratory symptoms (asthmatic children, age 9–18) .....	1,200 (370–2,000)
Asthma exacerbation (asthmatic children, age 6–18)	1,400 (160–4,000)
Work loss days .....	9,700 (8,500–11,000)
Minor restricted activity days (adults age 18–65) .....	57,000 (48,000–66,000)

**Notes:**

<sup>a</sup> Incidence is rounded to two significant digits. Estimates represent incidence within the 48 contiguous United States.

<sup>b</sup> PM-related adult mortality based upon the American Cancer Society (ACS) Cohort Study (Pope *et al.*, 2002) and the Six-Cities Study (Laden *et al.*, 2006). Note that these are two alternative estimates of adult mortality and should not be summed. PM-related infant mortality based upon a study by Woodruff, Grillo, and Schoendorf, (1997).<sup>527</sup>

<sup>c</sup> Respiratory hospital admissions for PM include admissions for chronic obstructive pulmonary disease (COPD), pneumonia and asthma.

<sup>d</sup> Cardiovascular hospital admissions for PM include total cardiovascular and subcategories for ischemic heart disease, dysrhythmias, and heart failure.

<sup>527</sup> Woodruff, T.J., J. Grillo, and K.C. Schoendorf. 1997. "The Relationship Between Selected Causes

<sup>523</sup> Science Advisory Board. 2001. NATA—Evaluating the National-Scale Air Toxics Assessment for 1996—an SAB Advisory. <http://www.epa.gov/ttn/atw/sab/sabrev.html>.

<sup>524</sup> U.S. Environmental Protection Agency (U.S. EPA). 2011. *The Benefits and Costs of the Clean Air Act from 1990 to 2020*. Office of Air and Radiation, Washington, DC. March. Available on the Internet at <http://www.epa.gov/air/sect812/feb11/fullreport.pdf>.

<sup>525</sup> U.S. Environmental Protection Agency—Science Advisory Board (U.S. EPA—SAB). 2008. *Benefits of Reducing Benzene Emissions in Houston, 1990–2020*. EPA—COUNCIL-08-001. July. Available at [http://yosemite.epa.gov/sab/sabproduct.nsf/D4D7EC9DAEDA8A548525748600728A83/\\$File/EPA-COUNCIL-08-001-unsigned.pdf](http://yosemite.epa.gov/sab/sabproduct.nsf/D4D7EC9DAEDA8A548525748600728A83/$File/EPA-COUNCIL-08-001-unsigned.pdf).

TABLE VIII-19—ESTIMATED OZONE-RELATED HEALTH IMPACTS <sup>a</sup>

Health effect	2030 Annual reduction in incidence (5th–95th percentile)
Premature Mortality, All ages <sup>b</sup> Multi-City Analyses:	
Bell <i>et al.</i> (2004)—Non-accidental .....	54 (23–84)
Huang <i>et al.</i> (2005)—Cardiopulmonary .....	90 (43–140)
Schwartz (2005)—Non-accidental .....	82 (34–130)
Meta-analyses:	
Bell <i>et al.</i> (2005)—All cause .....	170 (96–250)
Ito <i>et al.</i> (2005)—Non-accidental .....	240 (160–320)
Levy <i>et al.</i> (2005)—All cause .....	240 (180–310)
Hospital admissions—respiratory causes (adult, 65 and older) <sup>c</sup> .....	510 (69–870)

TABLE VIII-19—ESTIMATED OZONE-RELATED HEALTH IMPACTS <sup>a</sup>—Continued

Health effect	2030 Annual reduction in incidence (5th–95th percentile)
Hospital admissions—respiratory causes (children, under 2) .....	320 (160–470)
Emergency room visit for asthma (all ages) .....	230 (0–630)
Minor restricted activity days (adults, age 18–65) .....	300,000 (150,000–450,000)
School absence days .....	120,000 (52,000–170,000)

**Notes:**  
<sup>a</sup> Incidence is rounded to two significant digits. Estimates represent incidence within the 48 contiguous U.S.

<sup>b</sup> Estimates of ozone-related premature mortality are based upon incidence estimates derived from several alternative studies: Bell *et al.* (2004); Huang *et al.* (2005); Schwartz (2005); Bell *et al.* (2005); Ito *et al.* (2005); Levy *et al.* (2005). The estimates of ozone-related premature mortality should therefore not be summed.

<sup>c</sup> Respiratory hospital admissions for ozone include admissions for all respiratory causes and subcategories for COPD and pneumonia.

(b) Monetized Benefits

Table VIII-20 presents the estimated monetary value of changes in the incidence of ozone and PM<sub>2.5</sub>-related health effects. All monetized estimates are stated in 2009\$. These estimates account for growth in real gross domestic product (GDP) per capita between the present and 2030. Our estimate of total monetized benefits in 2030 for the program, using the ACS and Six-Cities PM mortality studies and the range of ozone mortality assumptions, is between \$1.3 and \$4.2 billion, assuming a 3 percent discount rate, or between \$1.2 and \$4.0 billion, assuming a 7 percent discount rate.

TABLE VIII-20—ESTIMATED MONETARY VALUE OF CHANGES IN INCIDENCE OF HEALTH AND WELFARE EFFECTS IN 2030 [Millions, 2009\$] <sup>a b</sup>

PM <sub>2.5</sub> -Related health effect	(5th and 95th Percentile)
Premature Mortality—Derived from Epidemiology Studies: <sup>c d</sup>	
Adult, age 30+—ACS study (Pope <i>et al.</i> , 2002):	
3% discount rate .....	\$680 (\$87–\$1,800)
7% discount rate .....	\$620 (\$79–\$1,600)
Adult, age 25+—Six-Cities study (Laden <i>et al.</i> , 2006):	
3% discount rate .....	\$1,800 (\$250–\$4,300)
7% discount rate .....	\$1,600 (\$220–\$3,900)
Infant Mortality, <1 year—(Woodruff <i>et al.</i> 1997) .....	\$2.5 (\$0–\$9.4)
Chronic bronchitis (adults, 26 and over) .....	\$29 (\$2.4–\$96)
Non-fatal acute myocardial infarctions:	
3% discount rate .....	\$16 (\$3.7–\$38)
7% discount rate .....	\$16 (\$3.4–\$38)
Hospital admissions for respiratory causes .....	\$0.31 (\$0.15–\$0.45)
Hospital admissions for cardiovascular causes .....	\$1.3 (\$0.83–\$1.8)
Emergency room visits for asthma .....	\$0.03 (\$0.02–\$0.05)
Acute bronchitis (children, age 8–12) .....	\$0.01 (\$0–\$0.03)
Lower respiratory symptoms (children, 7–14) .....	\$0.03 (\$0.01–\$0.06)
Upper respiratory symptoms (asthma, 9–11) .....	\$0.04 (\$0.01–\$0.08)
Asthma exacerbations .....	\$0.08 (\$0.009–\$0.23)
Work loss days .....	\$1.6 (\$1.4–\$1.8)
Minor restricted-activity days (MRADs) .....	\$3.6 (\$2.1–\$5.2)
<b>Ozone-related Health Effect</b>	
Premature Mortality, All ages—Derived from Multi-city analyses:	
Bell <i>et al.</i> , 2004 .....	\$520 (\$69–\$1,300)
Huang <i>et al.</i> , 2005 .....	\$880 (\$120–\$2,200)
Schwartz, 2005 .....	\$800 (\$100–\$2,000)
Premature Mortality, All ages—Derived from Meta-analyses:	
Bell <i>et al.</i> , 2005 .....	\$1,700 (\$240–\$4,100)
Ito <i>et al.</i> , 2005 .....	\$2,300 (\$350–\$5,500)
Levy <i>et al.</i> , 2005 .....	\$2,400 (\$350–\$5,500)
Hospital admissions—respiratory causes (adult, 65 and older) .....	\$13 (\$1.7–\$22)
Hospital admissions—respiratory causes (children, under 2) .....	\$3.4 (\$1.8–\$5.0)
Emergency room visit for asthma (all ages) .....	\$0.09 (\$0–\$0.23)
Minor restricted activity days (adults, age 18–65) .....	\$19 (\$8.6–\$32)

TABLE VIII–20—ESTIMATED MONETARY VALUE OF CHANGES IN INCIDENCE OF HEALTH AND WELFARE EFFECTS IN 2030—  
Continued  
[Millions, 2009\$]<sup>a,b</sup>

PM <sub>2.5</sub> -Related health effect	(5th and 95th Percentile)
School absence days .....	\$11 (\$5.0–\$16)

**Notes:**

- <sup>a</sup> Monetary benefits are rounded to two significant digits for ease of presentation and computation. PM and ozone benefits are nationwide.
- <sup>b</sup> Monetary benefits adjusted to account for growth in real GDP per capita between 1990 and the analysis year (2030).
- <sup>c</sup> Valuation assumes discounting over the SAB recommended 20 year segmented lag structure. Results reflect the use of 3 percent and 7 percent discount rates consistent with EPA and OMB guidelines for preparing economic analyses.

(c) What are the limitations of the benefits analysis?

Every benefit-cost analysis examining the potential effects of a change in environmental protection requirements is limited to some extent by data gaps, limitations in model capabilities (such as geographic coverage), and uncertainties in the underlying scientific and economic studies used to configure the benefit and cost models. Limitations of the scientific literature often result in the inability to estimate quantitative changes in health and environmental effects, such as potential decreases in premature mortality associated with decreased exposure to carbon monoxide. Deficiencies in the economics literature often result in the inability to assign economic values even to those health and environmental outcomes which can be quantified. These general uncertainties in the underlying scientific and economics literature, which can lead to valuations that are higher or lower, are discussed in detail in the RIA and its supporting references. Key uncertainties that have a bearing on the results of the benefit-cost analysis of the final rules include the following:

- The exclusion of potentially significant and unquantified benefit categories (such as health, odor, and ecological benefits of reduction in air toxics, ozone, and PM);
- Errors in measurement and projection for variables such as population growth;
- Uncertainties in the estimation of future year emissions inventories and air quality;
- Uncertainty in the estimated relationships of health and welfare effects to changes in pollutant concentrations including the shape of the C–R function, the size of the effect estimates, and the relative toxicity of the many components of the PM mixture;
- Uncertainties in exposure estimation; and
- Uncertainties associated with the effect of potential future actions to limit emissions.

As Table VIII–20 indicates, total benefits are driven primarily by the reduction in premature mortalities each year. Some key assumptions underlying the premature mortality estimates include the following, which may also contribute to uncertainty:

- Inhalation of fine particles is causally associated with premature death at concentrations near those experienced by most Americans on a daily basis. Although biological mechanisms for this effect have not yet been completely established, the weight of the available epidemiological, toxicological, and experimental evidence supports an assumption of causality. The impacts of including a probabilistic representation of causality were explored in the expert elicitation-based results of the PM NAAQS RIA.
- All fine particles, regardless of their chemical composition, are equally potent in causing premature mortality. This is an important assumption, because PM produced via transported precursors emitted from heavy-duty engines may differ significantly from PM precursors released from electric generating units and other industrial sources. However, no clear scientific grounds exist for supporting differential effects estimates by particle type.
- The C–R function for fine particles is approximately linear within the range of ambient concentrations under consideration. Thus, the estimates include health benefits from reducing fine particles in areas with varied concentrations of PM, including both regions that may be in attainment with PM<sub>2.5</sub> standards and those that are at risk of not meeting the standards.
- There is uncertainty in the magnitude of the association between ozone and premature mortality. The range of ozone benefits associated with the coordinated strategy is estimated based on the risk of several sources of ozone-related mortality effect estimates. In a report on the estimation of ozone-related premature mortality published by the National Research Council, a panel of experts and reviewers concluded that short-term exposure to

ambient ozone is likely to contribute to premature deaths and that ozone-related mortality should be included in estimates of the health benefits of reducing ozone exposure.<sup>528</sup> EPA has requested advice from the National Academy of Sciences on how best to quantify uncertainty in the relationship between ozone exposure and premature mortality in the context of quantifying benefits.

Despite the uncertainties described above, we believe this analysis provides a conservative estimate of the estimated non-GHG health and environmental benefits of the standards in future years because of the exclusion of potentially significant benefit categories that are not quantifiable at this time.

Acknowledging benefits omissions and uncertainties, we present a best estimate of the total benefits based on our interpretation of the best available scientific literature and methods supported by EPA’s technical peer review panel, the Science Advisory Board’s Health Effects Subcommittee (SAB–HES). The National Academies of Science (NRC, 2002) has also reviewed EPA’s methodology for analyzing the health benefits of measures taken to reduce air pollution. EPA addressed many of these comments in the analysis of the final PM NAAQS.<sup>529, 530</sup> This analysis incorporates this work to the extent possible.

(2) Non-GHG Human Health Benefits of the Model Year (MY) Analysis

As described in Section VII, the final standards will reduce emissions of several criteria and toxic pollutants and precursors. EPA typically analyzes rule

<sup>528</sup> National Research Council (NRC), 2008. Estimating Mortality Risk Reduction and Economic Benefits from Controlling Ozone Air Pollution. The National Academies Press: Washington, DC.

<sup>529</sup> National Research Council (NRC). 2002. Estimating the Public Health Benefits of Proposed Air Pollution Regulations. The National Academies Press: Washington, DC.

<sup>530</sup> U.S. Environmental Protection Agency. October 2006. Final Regulatory Impact Analysis (RIA) for the Proposed National Ambient Air Quality Standards for Particulate Matter. Prepared by: Office of Air and Radiation. Available at <http://www.epa.gov/ttn/ecas/ria.html>.

impacts (emissions, air quality, costs and benefits) in the year in which they occur; for the analysis of non-GHG ambient air quality and health impacts, we selected 2030 as a representative future year since resource and time constraints precluded EPA from considering multiple calendar years. We refer to this analysis as the “Calendar Year” (CY) analysis because the benefits of the program reflect impacts across all regulated vehicles in a calendar year.

EPA also conducted a separate analysis of the impacts over the model year lifetimes of the 2014 through 2018 model year vehicles. We refer to this analysis as the “Model Year” (MY) analysis (See Chapter 6 of the RIA that accompanies this preamble). In contrast to the CY analysis, the MY analysis estimates the impacts of the program on each MY fleet over the course of its lifetime. Due to analytical and resource limitations, however, MY non-GHG emissions (direct PM, VOCs, NO<sub>2</sub> and SO<sub>2</sub>) were not estimated for this analysis. Because MY impacts are measured in relation to only the lifetime of a particular vehicle model year (2014, 2015, 2016, 2017, and 2018), and assumes no additional controls to model year vehicles beyond 2018, the impacts are smaller than if the impacts of all regulated vehicles were considered. We therefore expect that the non-GHG health-related benefits associated with the MY analysis will be smaller than those estimated for the CY analysis, both in a given year (such as 2030) and in present value terms across a given time period (such as 2014–2050).

*I. Energy Security Impacts*

The HD National Program is designed to reduce fuel consumption and GHG emissions in medium and heavy-duty (HD) vehicles, which will result in improved fuel efficiency and, in turn, help to reduce U.S. petroleum imports. A reduction of U.S. petroleum imports reduces both financial and strategic risks caused by potential sudden disruptions in the supply of imported petroleum to the U.S. This reduction in risk is a measure of improved U.S. energy security. This section summarizes the agencies’ estimates of U.S. oil import reductions and energy security benefits of the final HD National Program. Additional discussion of this issue can be found in Chapter 9.7 of the RIA.

(1) Implications of Reduced Petroleum Use on U.S. Imports

In 2008, U.S. petroleum import expenditures represented 21 percent of total U.S. imports of all goods and

services.<sup>531</sup> In 2008, the United States imported 66 percent of the petroleum it consumed, and the transportation sector accounted for 70 percent of total U.S. petroleum consumption. This compares to approximately 37 percent of petroleum from imports and 55 percent of consumption from petroleum in the transportation sector in 1975.<sup>532</sup> It is clear that petroleum imports have a significant impact on the U.S. economy.

Requiring lower GHG vehicle technology and fuel efficient technology in HD vehicles in the U.S. is expected to lower U.S. oil imports. EPA used the MOVES model to estimate the fuel savings due to this program. A detailed explanation of the MOVES model can be found in Chapter 5 of the RIA.

Based on a detailed analysis of differences in fuel consumption, petroleum imports, and imports of refined petroleum products and crude oil using the Reference Case presented in the Energy Information Administration’s Annual Energy Outlook (AEO) 2011 Early Release, EPA and NHTSA estimate that approximately 50 percent of the reduction in fuel consumption resulting from adopting improved GHG emissions standards and fuel efficiency standards is likely to be reflected in reduced U.S. imports of refined fuel, while the remaining 50 percent is expected to be reflected in reduced domestic fuel refining. Of this latter figure, 90 percent is anticipated to reduce U.S. imports of crude petroleum for use as a refinery feedstock, while the remaining 10 percent is expected to reduce U.S. domestic production of crude petroleum. Thus, on balance, each gallon of fuel saved as a consequence of the HD GHG and fuel efficiency standards is anticipated to reduce total U.S. imports of petroleum by 0.95 gallons.<sup>533</sup> The agencies’ estimates of the reduction in U.S. oil imports from this program for selected years, in millions of barrels per day, are presented in Table VIII–21 below. These estimates assume that the fuel efficiency of HD vehicles remains constant in the baseline.

<sup>531</sup> Source: U.S. Bureau of Economic Analysis, U.S. International Transactions Accounts Data, as shown on June 24, 2009.

<sup>532</sup> Source: U.S. Department of Energy, Annual Energy Review 2008, Report No. DOE/EIA–0384(2008), Tables 5.1 and 5.13c, June 26, 2009.

<sup>533</sup> This figure is calculated as 0.50 + 0.50\*0.9 = 0.50 + 0.45 = 0.95.

TABLE VIII–21—U.S. OIL IMPORT REDUCTIONS FROM THE HD NATIONAL PROGRAM FOR SELECTED YEARS

[Millions of barrels per day, mmbd]

Year	mmbd
2020 .....	0.202
2030 .....	0.393
2040 .....	0.489
2050 .....	0.566

(2) Energy Security Implications

In order to understand the energy security implications of reducing U.S. petroleum imports, EPA worked with Oak Ridge National Laboratory (ORNL), which has developed approaches for evaluating the economic costs and energy security implications of oil use. The energy security estimates provided below are based upon a methodology developed in a peer-reviewed study entitled “*The Energy Security Benefits of Reduced Oil Use, 2006–2015*,” completed in March 2008. This study is included as part of the docket for this final action.<sup>534 535</sup>

When conducting this analysis, ORNL considered the full economic cost of importing petroleum into the United States. The economic cost of importing petroleum into the U.S. is defined to include two components in addition to the purchase price of petroleum itself. These are: (1) The higher costs for oil imports resulting from the effect of increasing U.S. import demand on the world oil price and on the market power of the Organization of the Petroleum Exporting Countries (*i.e.*, the “demand” or “monopsony” costs); and (2) the risk of reductions in U.S. economic output and disruption of the U.S. economy caused by sudden disruptions in the supply of imported petroleum to the U.S. (*i.e.*, macroeconomic disruption/adjustment costs). Maintaining a U.S. military presence to help secure stable oil supply from potentially vulnerable regions of the world was not included in this analysis because its attribution to particular missions or activities is hard to quantify.

<sup>534</sup> Leiby, Paul N., “*Estimating the Energy Security Benefits of Reduced U.S. Oil Imports*” Oak Ridge National Laboratory, ORNL/TM–2007/028, Final Report, 2008. (Docket EPA–HQ–OAR–2010–0162).

<sup>535</sup> The ORNL study “*The Energy Security Benefits of Reduced Oil Use, 2006–2015*,” completed in March 2008, is an update version of the approach used for estimating the energy security benefits of U.S. oil import reductions developed in an ORNL 1997 Report by Leiby, Paul N., Donald W. Jones, T. Randall Curlee, and Russell Lee, entitled “*Oil Imports: An Assessment of Benefits and Costs*.” (Docket EPA–HQ–OAR–2010–0162).

For this action, ORNL estimated energy security premiums by incorporating the most recent available AEO 2011 Early Release oil price forecasts and market trends. Energy

security premiums for the years 2020, 2030, 2040, and 2050 are presented in Table VIII–22, as well as a breakdown of the components of the energy security premiums for each of these years.<sup>536</sup>

The components of the energy security premiums and their values are discussed in detail in Chapter 9.7 of the RIA.

TABLE VIII–22—ENERGY SECURITY PREMIUMS IN SELECTED YEARS  
[2009\$/Barrel]

Year (range)	Monopsony	Macroeconomic disruption/ adjustment costs	Total mid-point
2020 .....	\$11.29 (\$3.86–\$21.32)	\$7.11 (\$3.50–\$11.40)	\$18.41 (\$9.70–\$28.94)
2030 .....	\$11.17 (\$3.92–\$20.58)	\$8.32 (\$4.04–\$13.33)	\$19.49 (\$10.49–\$29.63)
2035 .....	\$10.56 (\$3.69–\$19.62)	\$8.71 (\$3.86–\$14.35)	\$19.27 (\$10.32–\$29.13)

The literature on the energy security for the last two decades has routinely combined the monopsony and the macroeconomic disruption components when calculating the total value of the energy security premium. However, in the context of using a global SCC value, the question arises: how should the energy security premium be determined when a global perspective is taken? Monopsony benefits represent avoided payments by the United States to oil producers in foreign countries that result from a decrease in the world oil price as the U.S. decreases its consumption of imported oil.

Several commenters commented on the agencies’ energy security analysis of this program. The Conservative Law Foundation, Interfaith Care for Creation, Environmental Defense Fund and American Lung Association (EDF/ALA) and R. Desjardin noted that the standards in this program will increase our national security by decreasing U.S. dependence on foreign oil imports. The Competitive Enterprise Institute (CEI) felt that there is no relationship between reduced U.S. oil imports and U.S. energy security; the commenter sees no relationship between reduced oil imports and, for example, the number of hijackings, bombings, and other terrorist-related activities that have occurred through time. CBD commented that the benefit of the reduction of military costs associated with maintaining a secure oil supply should be fully accounted for, and EDF recommended a more extensive analysis

of the external security costs of oil dependence.

The agencies recognize that potential national and energy security risks exist due to the possibility of tension over oil supplies. Much of the world’s oil and gas supplies are located in countries facing social, economic, and demographic challenges, thus making them even more vulnerable to potential local instability. For example, in 2010 just over 40 percent of world oil supply came from OPEC nations, and this share is not expected to decline in the AEO 2011 projections through 2030. Approximately 28 percent of global supply is from Persian Gulf countries alone. As another measure of concentration, of the 137 countries/ principalities that export either crude oil or refined petroleum product, the top 12 have recently accounted for over 55 percent of exports.<sup>537</sup> Eight of these countries are members of OPEC, and a 9th is Russia.<sup>538</sup> In a market where even a 1–2 percent supply loss raises prices noticeably, and where a 10 percent supply loss could lead to a significant price shock, this regional concentration is of concern. Historically, the countries of the Middle East have been the source of eight of the ten major world oil disruptions<sup>539</sup> with the 9th originating in Venezuela, an OPEC member.

Because of U.S. dependence on oil, the military could be called on to protect energy resources through such measures as securing shipping lanes from foreign oil fields. To maintain such military effectiveness and flexibility, the Department of Defense identified in the

Quadrennial Defense Review that it is “increasing its use of renewable energy supplies and reducing energy demand to improve operational effectiveness, reduce greenhouse gas emissions in support of U.S. climate change initiatives, and protect the Department from energy price fluctuations.”<sup>540</sup> The Department of the Navy has also stated that the Navy and Marine Corps rely far too much on petroleum, which “degrades the strategic position of our country and the tactical performance of our forces. The global supply of oil is finite, it is becoming increasingly difficult to find and exploit, and over time cost continues to rise.”<sup>541</sup>

In remarks given to the White House Energy Security Summit on April 26, 2011, Deputy Secretary of Defense William J. Lynn, III noted the direct impact of energy security on military readiness and flexibility. According to Deputy Security Lynn, “Today, energy technology remains a critical element of our military superiority. Addressing energy needs must be a fundamental part of our military planning.”<sup>542</sup>

Thus, to the degree to which the final rules reduce reliance upon imported energy supplies or promotes the development of technologies that can be deployed by either consumers or the nation’s defense forces, the United States could expect benefits related to national security, reduced energy costs, and increased energy supply. These benefits are why President Obama has identified this program as a key component for improving energy efficiency and putting America on a

<sup>536</sup> AEO 2011 forecasts energy market trends and values only to 2035. The energy security premium estimates post-2035 were assumed to be the 2035 estimate.

<sup>537</sup> Based on data from the CIA, combining various recent years, <https://www.cia.gov/library/publications/the-world-factbook/rankorder/2176rank.html>.

<sup>538</sup> The other three are Norway, Canada, and the EU, an exporter of product.

<sup>539</sup> IEA 2011 “IEA Response System for Oil Supply Emergencies”.

<sup>540</sup> U.S. Department of Defense. 2010. Quadrennial Defense Review Report. Secretary of Defense: Washington, DC 128 pages.

<sup>541</sup> The Department of the Navy’s Energy Goals ([http://www.navy.mil/features/Navy\\_Energy\\_Security.pdf](http://www.navy.mil/features/Navy_Energy_Security.pdf)) (Last accessed May 31, 2011).

<sup>542</sup> U.S. Department of Defense, Speech: Remarks at the White House Energy Security Summit. Tuesday, April 26, 2011. (<http://www.defense.gov/speeches/speech.aspx?speechid=1556>) (Last accessed May 31, 2011).

path to reducing oil imports in the Blueprint for a Secure Energy Future.<sup>543</sup>

Although the agencies recognize that there clearly is a benefit to the United States from reducing dependence on foreign oil, the agencies have been unable to calculate the monetary benefit that the United States will receive from the improvements in national security expected to result from this program. In contrast, the other portion of the energy security premium, the U.S.

macroeconomic disruption and adjustment cost that arises from U.S. petroleum imports, is included in the energy security benefits estimated for this program. To summarize, the agencies have included only the macroeconomic disruption portion of the energy security benefits to estimate the monetary value of the total energy security benefits of this program. The agencies have calculated energy security in very specific terms, as the reduction of both financial and strategic risks caused by potential sudden disruptions in the supply of imported petroleum to the U.S. Reducing the amount of oil imported reduces those risks, and thus increases the nation's energy security.

Another commenter, citing Administration guidelines (OMB Circular A-4) for conducting economic analyses, felt that the agency should include the monopsony benefit as part of its overall costs and benefits analysis. After reviewing the guidelines cited by the commenter, the agencies have concluded that excluding the monopsony benefit from its overall costs and benefits analysis continues to be appropriate when a global perspective is taken. However, the agencies recognize that the monopsony benefit has distributional impacts for the U.S., and continue to describe and discuss the monopsony benefit in this section of the Preamble.

The total annual energy security benefits for the final HD National Program are reported in Table VIII-23 for the years 2020, 2030, 2040 and 2050.

TABLE VIII-23—TOTAL ANNUAL ENERGY SECURITY BENEFITS FROM THE HD NATIONAL PROGRAM IN 2020, 2030, 2040 AND 2050  
[Millions, 2009\$]

Year	Benefits
2020 .....	\$499
2030 .....	1,132
2040 .....	1,477
2050 .....	1,710

J. Other Impacts

(i) Noise, Congestion and Accidents

Increased vehicle use associated with a positive rebound effect also contributes to increased traffic congestion, motor vehicle accidents, and highway noise. Depending on how the additional travel is distributed throughout the day and on where it takes place, additional vehicle use can contribute to traffic congestion and delays by increasing traffic volumes on facilities that are already heavily traveled during peak periods. These added delays impose higher costs on drivers and other vehicle occupants in the form of increased travel time and operating expenses, increased costs associated with traffic accidents, and increased traffic noise. Because drivers do not take these added costs into account in deciding when and where to travel, they must be accounted for separately as a cost of the added driving associated with the rebound effect.

EPA and NHTSA rely on estimates of congestion, accident, and noise costs caused by pickup trucks and vans, single unit trucks, buses, and combination tractors developed by the Federal Highway Administration to estimate the increased external costs caused by added driving due to the rebound effect.<sup>544</sup> The Federal Highway Administration (FHWA) estimates are intended to measure the increases in costs from added congestion, property damages and injuries in traffic accidents, and noise levels caused by various types of trucks that are borne by persons other than their drivers (or "marginal" external costs). EPA and

NHTSA employed estimates from this source previously in the analysis accompanying the light-Duty 2012-16 MY vehicle rule. The agencies continue to find them appropriate for this analysis after reviewing the procedures used by FHWA to develop them and considering other available estimates of these values.

FHWA's congestion cost estimates for trucks, which are weighted averages based on the estimated fractions of peak and off-peak freeway travel for each class of trucks, already account for the fact that trucks make up a smaller fraction of peak period traffic on congested roads because they try to avoid peak periods when possible. FHWA's congestion cost estimates focus on freeways because non-freeway effects are less serious due to lower traffic volumes and opportunities to re-route around the congestion. The agencies, however, applied the congestion cost to the overall VMT increase, though the fraction of VMT on each road type used in MOVES range from 27 to 29 percent of the vehicle miles on freeways for vocational vehicles and 53 percent for combination tractors. The results of this analysis potentially overestimate the costs and provide a conservative estimate.

The agencies are using FHWA's "Middle" estimates for marginal congestion, accident, and noise costs caused by increased travel from trucks. This approach is consistent with the current methodology used in the Light-Duty GHG rulemaking analysis. These costs are multiplied by the annual increases in vehicle miles travelled from the positive rebound effect to yield the estimated cost increases resulting from increased congestion, accidents, and noise during each future year. The values the agencies used to calculate these increased costs are included in Table VIII-24.

TABLE VIII-24—NOISE, ACCIDENT, AND CONGESTION COSTS PER MILE  
[2009\$]

External costs	Pickup trucks and vans (\$/VMT)	Vocational vehicles (\$/VMT)	Combination tractors (\$/VMT)
Congestion .....	\$0.049	\$0.111	\$0.108

<sup>543</sup> The White House, *Blueprint for a Secure Energy Future* (March 30, 2011) ([http://www.whitehouse.gov/sites/default/files/blueprint\\_secure\\_energy\\_future.pdf](http://www.whitehouse.gov/sites/default/files/blueprint_secure_energy_future.pdf)) (Last accessed May 27, 2011).

<sup>544</sup> These estimates were developed by FHWA for use in its 1997 *Federal Highway Cost Allocation Study*; See <http://www.fhwa.dot.gov/policy/hcas/final/index.htm> (last accessed July 21, 2010).



TABLE VIII-24—NOISE, ACCIDENT, AND CONGESTION COSTS PER MILE—Continued  
[2009\$]

External costs	Pickup trucks and vans (\$/VMT)	Vocational vehicles (\$/VMT)	Combination tractors (\$/VMT)
Accidents .....	0.027	0.019	0.022
Noise .....	0.001	0.009	0.020

In aggregate, the increased costs due to noise, accidents, and congestion from the additional truck driving are presented in Table VIII-25.

TABLE VIII-25: ACCIDENT, NOISE, AND CONGESTION COSTS  
[Millions, 2009\$]

Year	Pickup trucks and vans	Vocational vehicles	Combination tractors	Total costs
2012 .....	\$0	\$0	\$0	\$0
2013 .....	0	0	0	0
2014 .....	8	21	18	46
2015 .....	15	38	31	84
2016 .....	22	55	43	120
2017 .....	29	71	54	153
2018 .....	36	85	64	186
2020 .....	51	112	83	246
2030 .....	105	195	138	437
2040 .....	130	256	166	551
2050 .....	148	298	191	638
NPV, 3% .....	1,818	3,620	2,492	7,929
NPV, 7% .....	832	1,680	1,184	3,695

(2) Savings Due to Reduced Refueling Time

Reducing the fuel consumption of heavy-duty trucks may either increase their driving range before they require refueling, or motivate truck purchasers to buy, and manufacturers to offer, smaller fuel tanks. Keeping the fuel tank the same size allows truck operators to reduce the frequency with which drivers typically refuel their vehicles; it thus extends the upper limit of the range they can travel before requiring refueling. Alternatively, if purchasers and manufacturers respond to improved fuel efficiency by reducing the size of fuel tanks to maintain a constant driving range, the smaller tank will require less time in actual refueling.

Because refueling time represents a time cost of truck operation, these time savings should be incorporated into truck purchasers' decisions over how much fuel-saving technology they want in their vehicles. The savings calculated here thus raise the same questions discussed in Preamble VIII.A and RIA Section 9.1 does the apparent existence

of these savings reflect failures in the market for fuel efficiency, or does it reflect costs not addressed in this analysis? The response to these questions could vary across truck segment. See those sections for further analysis of this question.

This analysis estimates the reduction in the annual time spent filling the fuel tank; this reduced time could come either from fewer refueling events, if the fuel tank stays the same size, or less time spent during each refueling event, if the fuel tank is made proportionately smaller. The refueling savings are calculated as the savings in the amount of time that would have been necessary to pump the fuel. The calculation does not include time spent searching for a fuel station or other time spent at the station; it is assumed that the time savings occur only during refueling. The value of the time saved is estimated at the hourly rate recommended for truck operators (\$22.36 in 2009 dollars) in DOT guidance for valuing time savings.<sup>545</sup>

The refueling savings include the increased fuel consumption resulting from additional mileage associated with the rebound effect. However, the estimate of the rebound effect does not account for any reduction in net operating costs from lower refueling time. As discussed earlier, the rebound effect should be a measure of the change in VMT with respect to the net change in overall operating costs. Ideally, changes in refueling time would factor into this calculation, although the effect is expected to be minor because refueling time savings are small relative to the value of reduced fuel expenditures.

The details of this calculation are discussed in the RIA Chapter 9.3.2. The savings associated with reduced refueling time for a truck of each type throughout its lifetime are shown in Table VIII-26. The aggregate savings associated with reduced refueling time are shown in Table VIII-27 for vehicles sold in 2014 through 2050.

<sup>545</sup> U.S. Department of Transportation, "Revised Departmental Guidance for Valuation of Travel Time in Economic Analysis," February 11, 2003,

Table 4 (which shows a value of \$18.10 in 2000 dollars); available at <http://ostpxweb.dot.gov/>

[policy/Data/VOTrevision1\\_2-11-03.pdf](http://policy/Data/VOTrevision1_2-11-03.pdf) (last accessed September 9, 2010).

TABLE VIII-26—LIFETIME REFUELING SAVINGS FOR A 2018 MY TRUCK OF EACH TYPE  
[2009\$]

	Pickup trucks and vans	Vocational vehicles	Combination tractor
3% Discount Rate .....	\$31	\$34	\$341
7% Discount Rate .....	19	22	223

TABLE VIII-27—ANNUAL REFUELING SAVINGS  
[Millions, 2009\$]

Year	Pickup trucks and vans	Vocational vehicles	Combination tractor	Total
2012 .....	\$0.0	\$0.0	\$0.0	\$0.0
2013 .....	0.0	0.0	0.0	0.0
2014 .....	0.2	1.4	8.0	9.6
2015 .....	0.5	2.6	14.3	17.3
2016 .....	1.3	3.8	19.6	24.6
2017 .....	2.7	6.2	26.7	35.6
2018 .....	5.2	8.5	33.8	47.5
2020 .....	10.5	12.7	46.2	69.3
2030 .....	32.6	25.8	82.9	141
2040 .....	43.4	35.1	100.5	179
2050 .....	50.1	41.3	116.1	207
NPV, 3% .....	541	468	1,467	2,476
NPV, 7% .....	231	210	685	1,126

*K. The Effect of Safety Standards and Voluntary Safety Improvements on Vehicle Weight*

Safety standards developed by NHTSA in previous rulemakings may make compliance with the fuel efficiency and CO<sub>2</sub> emissions standards more difficult or may reduce the projected benefits of the program. The primary way that safety regulations can impact fuel efficiency and CO<sub>2</sub> emissions is through increased vehicle weight, which reduces the fuel efficiency (and thus increases the CO<sub>2</sub> emissions) of the vehicle. Using MY 2010 as a baseline, this section discusses the effects of other government regulations on MYs 2014–2016 medium and heavy-duty vehicle fuel efficiency and CO<sub>2</sub> emissions. At this time, no known safety standards will affect new models in MY 2017 or 2018. NHTSA’s estimates are based on cost and weight tear-down studies of a few vehicles and cannot possibly cover all the variations in the manufacturers’ fleets. NHTSA also requested, and various manufacturers provided, confidential estimates of increases in weight resulting from safety improvements. Those increases are shown in subsequent tables.

We have broken down our analysis of the impact of safety standards that might affect the MYs 2014–2016 fleets into three parts: (1) Those NHTSA final rules with known effective dates, (2) proposed rules or soon-to-be proposed rules by NHTSA with or without final

effective dates, and (3) currently voluntary safety improvements planned by the manufacturers.

(1) Weight Impacts of Required Safety Standards

NHTSA has undertaken several rulemakings in which several standards would become effective for medium- and heavy-duty (MD/HD) vehicles between MY 2014 and MY 2016. We will examine the potential impact on MD/HD vehicle weights for MYs 2014–2016 using MY 2010 as a baseline.

- FMVSS 119, Heavy Truck Tires Endurance and High Speed Tests.
- FMVSS 121, Air Brake Systems Stopping Distance.
- FMVSS 214, Motor Coach Lap/Shoulder Belts.
- MD/HD Vehicle Electronic Stability Control Systems.

(a) FMVSS 119, Heavy Truck Tires Endurance and High Speed Tests

NHTSA tentatively determined that the FMVSS No. 119 performance tests developed in 1973 should be updated to reflect the increased operational speeds and duration of truck tires in commercial service. A Notice of Proposed Rulemaking (NPRM) was issued December 7, 2010 (75 FR 60036). It proposed to increase significantly the stringency of the endurance test and to add a new high speed test. The data in the large truck crash causation study (LTCCS) that preceded that NPRM found that J and L load range tires were having proportionately more problems

than the other sizes and the agency’s test results indicate that H, J, and L load range tires are more likely to fail the proposed requirements among the targeted F, G, H, J and L load range tires.<sup>546</sup> To address these problems, the H and J load range tires could potentially use improved rubber compounds, which would add no weight to the tires, to reduce heat retention and improve the durability of the tires. The L load range tires, in contrast, appear to need to use high tensile strength steel chords in the tire bead, carcass and belt areas, which would enable a weight reduction with no strength penalties. Thus, if the update to FMVSS No. 119 was finalized, we anticipate no change in weight for H and J load range tires and a small reduction in weight for L load range tires. This proposal could become a final rule with an effective date of MY 2016.

(b) FMVSS No. 121, Airbrake Systems Stopping Distance

FMVSS No. 121 contains performance and equipment requirements for braking systems on vehicles with air brake systems. The most recent major final rule affecting FMVSS No. 121 was published on July 27, 2009, and became effective on November 24, 2009 (MY 2009). The final rule requires the vast

<sup>546</sup> Preliminary Regulatory Impact Analysis, FMVSS No. 119, New Pneumatic Tires for Motor Vehicles with a GVWR of More Than 4,536 kg (10,000 pounds), June 2010.

majority of new heavy truck tractors (approximately 99 percent of the fleet) to achieve a 30 percent reduction in stopping distance compared to currently required levels. Three-axle tractors with a gross vehicle weight rating (GVWR) of 59,600 pounds or less must meet the reduced stopping distance requirements by August 1, 2011 (MY 2011), while two-axle tractors and tractors with a GVWR above 59,600 pounds must meet the reduced stopping distance requirements by the later date of August 1, 2013 (MY 2013). NHTSA determined that there are several brake systems that can meet the requirements established in the final rule, including installation of larger S-cam drum brakes or disc brake systems at all positions, or hybrid disc and larger rear S-cam drum brake systems.

According to data provided by a manufacturer (Bendix) in response to the NPRM, the heaviest drum brakes weigh more than the lightest disc brakes, while the heaviest disc brakes weigh more than the lightest drum brakes. For a three-axle tractor equipped with all disc brakes, then, the total weight could increase by 212 pounds or could decrease by 134 pounds compared to an all-drum-braked tractor, depending on which disc or drum brakes are used for comparison. The improved brakes may add a small amount of weight to the affected vehicles for MYs 2014–2016, resulting in a slight increase in fuel consumption.

(c) FMVSS No. 208, Motorcoach Lap/Shoulder Belts

NHTSA is proposing lap/shoulder belts for all motorcoach seats. About

2,000 motorcoaches are sold per year in the United States. Based on preliminary results from the agency’s cost/weight teardown studies of motor coach seats,<sup>547</sup> NHTSA estimates that the weight added by 3-point lap/shoulder belts ranges from 5.96 to 9.95 pounds per 2-person seat. This is the weight only of the seat belt assembly itself, and does not include changing the design of the seat, reinforcing the floor, walls or other areas of the motor coach. Few current production motor coaches have been installed with lap/shoulder belts on their seats, and the number of vehicles with these belts already installed could be negligible. Assuming a 54 passenger motor coach, the added weight for the 3-point lap/shoulder belt assembly would be in the range of 161 to 269 pounds (27 \* (5.96 to 9.95)) per vehicle. This proposal could become a final rule with an effective date of MY 2016.

(d) Electronic Stability Control Systems (ESC) for Medium- and Heavy-Duty (MD/HD) Vehicles

The purpose of an ESC system for MD/HD vehicles is to reduce crashes caused by rollover or by directional loss-of-control. ESC monitors a vehicle’s rollover threshold and lateral stability using vehicle speed, wheel speed, steering wheel angle, lateral acceleration, side slip and yaw rate data and upon sensing an impending rollover or loss of directional control situation automatically reduces engine throttle and applies braking forces to individual wheels or sets of wheel to slow the vehicle down and regain directional

control. ESC is not currently required in MD/HD vehicles, but could be proposed to be required in these vehicles by NHTSA. FMVSS No. 105, Hydraulic and electric brake systems, requires multipurpose passenger vehicles, trucks and buses with a GVWR greater than 4,536 kg (10,000 pounds) to be equipped with an antilock brake system (ABS). All MD/HD vehicles having a GVWR of more than 10,000 pounds, are required to have ABS installed by that standard.

In addition to the existing ABS functionality, ESC requires sensors including a yaw rate sensor, lateral acceleration sensor, steering angle sensor and brake pressure sensor along with a brake solenoid valve. According to data provided by Meritor WABCO, the weight of an ESC system for the model 4S4M tractor is estimated to be around 55.5 pounds, and the weight of the ABS only is estimated to be 45.5 pounds. Thus, we estimate the added weight for the ESC for the vehicle to be 10 (55.5–45.5) pounds.

(2) Summary—Overview of Anticipated Weight Increases

Table VIII–28 summarizes estimates made by NHTSA regarding the weight added by the above discussed standards or likely rulemakings. NHTSA estimates that weight additions required by final rules and likely NHTSA regulations effective in MY 2016 compared to the MY 2010 fleet will increase motor coach vehicle weight by 171 to 279 pounds and will increase other heavy-duty truck weights by 10 pounds.

TABLE VIII–28—WEIGHT ADDITIONS DUE TO FINAL RULES OR LIKELY NHTSA REGULATIONS: COMPARING MY 2016 TO THE MY 2010 BASELINE FLEET

Standard No.	Added weight in pounds MD/HD vehicle	Added weight in kilograms MD/HD vehicle
119 .....	0	0
121 .....	<sup>a</sup> 0	<sup>a</sup> 0
208 Motor coaches only .....	161–269	73–122
MD/HD Vehicle Electronic Stability Control Systems .....	10	4.5
Total Motor coaches .....	171–279	77.5–126.5
Total All other MD/HD vehicles .....	10	4.5

**Note:**

<sup>a</sup>NHTSA’s final rule on Air Brakes, docket NHTSA–2009–0083, dated July 27, 2009, concluded that a small amount of weight would be added to the brake systems but a weight value was not provided.

<sup>547</sup> Cost and Weight Analysis of Two Motorcoach Seating Systems: One With and One Without Three-

Point Lap/Shoulder Belt Restraints, Ludtke and Associates, July 2010.

(3) Effects of Vehicle Mass Reduction on Safety

NHTSA and EPA have been considering the effect of vehicle weight on vehicle safety for the past several years in the context of our joint rulemaking for light-duty vehicle CAFE and GHG standards, consistent with NHTSA's long-standing consideration of safety effects in setting CAFE standards. Combining all modes of impact, the latest analysis by NHTSA for the light-duty 2012–2016 MY vehicle rule<sup>548</sup> found that reducing the weight of the heavier light trucks (LT > 3,870) had a positive overall effect on safety, reducing societal fatalities.

In the context of the current rulemaking for HD fuel consumption and GHG standards, one would expect that reducing the weight of medium-duty trucks similarly would, if anything, have a positive impact on safety. However, given the large difference in weight between light-duty vehicles and medium-duty trucks, and even larger difference between light-duty vehicles and heavy-duty vehicles with loads, the agencies believe that the impact of weight reductions of medium- and heavy-duty trucks would not have a noticeable impact on safety for any of these classes of vehicles.

However, the agencies recognize that it is important to conduct further study and research into the interaction of mass, size and safety to assist future rulemakings, and we expect that the collaborative interagency work currently on-going to address this issue for the light-duty vehicle context may also be able to inform our evaluation of safety effects for the final HD program. We intend to continue monitoring this issue going forward, and may take steps in a future rulemaking if it appears that the MD/HD fuel efficiency and GHG standards have unforeseen safety consequences. The American Chemistry Council stated in comments to the agencies that plastics and plastic composite materials provide a new way to lighten vehicles while maintaining passenger safety. They added that properties of plastics including strength to weight ratio, energy absorption, and flexible design make these materials well suited for the manufacture of medium- and heavy-duty vehicles. They submitted supporting analyses with their comments. The National School Transportation Association stated that added structural integrity requirements increase weight of school buses, and thus decrease fuel economy. They asked that if there are safety and fuel economy trade-offs, manufacturers should be able to receive a waiver from the regulation's

requirements. Since no weight reduction is required for school buses—or any other vocational vehicle—the agencies do not believe this is an issue with the current regulation.

L. Summary of Costs and Benefits

In this section, the agencies present a summary of costs, benefits, and net benefits of the HD National program.

Table VIII–29 shows the estimated annual monetized costs of the final program for the indicated calendar years. The table also shows the net present values of those costs for the calendar years 2012–2050 using both 3 percent and 7 percent discount rates.<sup>549</sup> Table VIII–30 shows the estimated annual monetized fuel savings of the final program. The table also shows the net present values of those fuel savings for the same calendar years using both 3 percent and 7 percent discount rates. In this table, the aggregate value of fuel savings is calculated using pre-tax fuel prices since savings in fuel taxes do not represent a reduction in the value of economic resources utilized in producing and consuming fuel. Note that fuel savings shown here result from reductions in fleet-wide fuel use. Thus, they grow over time as an increasing fraction of the fleet meets the 2018 standards.

TABLE VIII–29—ESTIMATED MONETIZED COSTS OF THE FINAL PROGRAM  
[Millions, 2009\$]<sup>a</sup>

	2020	2030	2040	2050	NPV, Years 2012–2050, 3% discount rate	NPV, Years 2012–2050, 7% discount rate
Technology Costs .....	\$2,000	\$2,200	\$2,700	\$3,300	\$47,400	\$24,700

**Note:**  
<sup>a</sup> Technology costs for separate truck segments can be found in Section VIII.B.1.

TABLE VIII–30—ESTIMATED FUEL SAVINGS OF THE FINAL PROGRAM  
[Millions, 2009\$]<sup>a</sup>

	2020	2030	2040	2050	NPV, Years 2012–2050, 3% discount rate	NPV, Years 2012–2050, 7% discount rate
Fuel Savings (pre-tax) .....	\$9,600	\$20,600	\$28,000	\$36,500	\$375,300	\$166,500

**Note:**  
<sup>a</sup> Fuel savings for separate truck segments can be found in Section VIII.B.1.

Table VIII–31 presents estimated annual monetized benefits for the indicated calendar years. The table also shows the net present values of those benefits for the calendar years 2012–2050 using both 3 percent and 7 percent

discount rates. The table shows the benefits of reduced CO<sub>2</sub> emissions—and consequently the annual quantified benefits (*i.e.*, total benefits)—for each of four SCC values estimated by the interagency working group. As

discussed in the RIA Section 9.4, there are some limitations to the SCC analysis, including the incomplete way in which the integrated assessment models capture catastrophic and non-catastrophic impacts, their incomplete

<sup>548</sup> “Final Regulatory Impact Analysis, Corporate Average Fuel Economy for MY 2012—MY 2016 Passenger Cars and Light Trucks”, NHTSA, March 2010, (Docket No. NHTSA–2009–0059–0344.1).

<sup>549</sup> For the estimation of the stream of costs and benefits, we assume that after implementation of the final MY 2014–2017 standards, the 2017 standards apply to each year out to 2050.

treatment of adaptation and technological change, uncertainty in the extrapolation of damages to high temperatures, and assumptions regarding risk aversion.

In addition, these monetized GHG benefits exclude the value of net reductions in non-CO<sub>2</sub> GHG emissions (CH<sub>4</sub>, N<sub>2</sub>O, HFC) expected under this action. Although EPA has not monetized the benefits of reductions in

non-CO<sub>2</sub> GHGs, the value of these reductions should not be interpreted as zero. Rather, the net reductions in non-CO<sub>2</sub> GHGs will contribute to this program's climate benefits, as explained in Section VI.D.

TABLE VIII-31—MONETIZED BENEFITS ASSOCIATED WITH THE FINAL PROGRAM  
[Millions, 2009\$]

	2020	2030	2040	2050	NPV, Years 2012–2050, 3% discount rate <sup>a</sup>	NPV, Years 2012–2050, 7% discount rate <sup>a</sup>
<b>Reduced CO<sub>2</sub> Emissions at each assumed SCC value<sup>b</sup></b>						
5% (avg SCC) .....	\$300	\$700	\$1,200	\$1,700	\$9,000	\$9,000
3% (avg SCC) .....	1,000	2,500	3,600	4,800	46,100	46,100
2.5% (avg SCC) .....	1,600	3,800	5,400	7,000	78,000	78,000
3% (95th percentile) .....	3,100	7,500	11,100	14,600	140,400	140,400
Energy Security Impacts (price shock) .....	500	1,100	1,500	1,700	19,800	8,800
Accidents, Congestion, Noise <sup>f</sup> .....	-200	-400	-600	-600	-7,900	-3,700
Refueling Savings .....	100	100	200	200	2,500	1,100
Non-GHG Impacts <sup>c,d</sup> .....	B	2,800	2,800	2,800	25,300	9,100
Non-CO <sub>2</sub> GHG Impacts <sup>e</sup> .....	n/a	n/a	n/a	n/a	n/a	n/a
<b>Total Annual Benefits at each assumed SCC value<sup>b</sup></b>						
5% (avg SCC) .....	700	4,300	5,100	5,800	48,700	24,300
3% (avg SCC) .....	1,400	6,100	7,500	8,900	85,800	61,400
2.5% (avg SCC) .....	2,000	7,400	9,300	11,100	117,700	93,300
3% (95th percentile) .....	3,500	11,100	15,000	18,700	180,100	155,700

**Notes:**

<sup>a</sup>Net present value of reduced CO<sub>2</sub> emissions is calculated differently than other benefits. The same discount rate used to discount the value of damages from future emissions (SCC at 5, 3, 2.5 percent) is used to calculate net present value of SCC for internal consistency. Refer to the SCC TSD for more detail.

<sup>b</sup>Section VIII.G notes that SCC increases over time. Corresponding to the years in this table, the SCC estimates range as follows: for Average SCC at 5%: \$5–\$16; for Average SCC at 3%: \$22–\$46; for Average SCC at 2.5%: \$36–\$66; and for 95th percentile SCC at 3%: \$66–\$139. See Section VIII.F.

<sup>c</sup>Note that "B" indicates unquantified criteria pollutant benefits in the year 2020. For the analysis of the final program, we only modeled the rule's PM<sub>2.5</sub>- and ozone-related impacts in the calendar year 2030. For the purposes of estimating a stream of future-year criteria pollutant benefits, we assume that the benefits out to 2050 are equal to, and no less than, those modeled in 2030 as reflected by the stream of estimated future emission reductions. The NPV of criteria pollutant-related benefits should therefore be considered a conservative estimate of the potential benefits associated with the final program.

<sup>d</sup>Non-GHG-related health and welfare impacts (related to PM<sub>2.5</sub> and ozone exposure) range between \$1,300 and \$4,200 million in 2030, 2040, and 2050. \$2,800 was chosen as the mid-point of this range for the purposes of estimating total benefits across all monetized categories.

<sup>e</sup>The monetized GHG benefits presented in this analysis exclude the value of changes in non-CO<sub>2</sub> GHG emissions expected under this program (See RIA Chapter 5). Although EPA has not monetized changes in non-CO<sub>2</sub> GHGs, the value of any increases or reductions should not be interpreted as zero.

<sup>f</sup>Negative sign represents an increase in Accidents, Congestion, and Noise.

Table VIII-32 presents estimated annual net benefits for the indicated calendar years. The table also shows the net present values of those net benefits

for the calendar years 2012–2050 using both 3 percent and 7 percent discount rates. The table includes the benefits of reduced CO<sub>2</sub> emissions (and

consequently the annual net benefits) for each of four SCC values considered by EPA.

TABLE VIII-32—MONETIZED NET BENEFITS ASSOCIATED WITH THE FINAL PROGRAM  
[Millions, 2009\$]

	2020	2030	2040	2050	NPV, 3% <sup>a</sup>	NPV, 7% <sup>a</sup>
Technology Costs .....	\$2,000	\$2,200	\$2,700	\$3,300	\$47,400	\$24,700
Fuel Savings .....	9,600	20,600	28,000	36,500	375,300	166,500
<b>Total Annual Benefits at each assumed SCC value<sup>b</sup></b>						
5% (avg SCC) .....	700	4,300	5,100	5,800	48,700	24,300
3% (avg SCC) .....	1,400	6,100	7,500	8,900	85,800	61,400
2.5% (avg SCC) .....	2,000	7,400	9,300	11,100	117,700	93,300
3% (95th percentile) .....	3,500	11,100	15,000	18,700	180,100	155,700
<b>Monetized Net Benefits at each assumed SCC value<sup>c</sup></b>						
5% (avg SCC) .....	8,300	22,700	30,400	39,000	376,600	166,100
3% (avg SCC) .....	9,000	24,500	32,800	42,100	413,700	203,200



TABLE VIII-34—MONETIZED TECHNOLOGY COSTS, FUEL SAVINGS, BENEFITS, AND NET BENEFITS ASSOCIATED WITH THE LIFETIMES OF 2014–2018 MODEL YEAR TRUCKS—Continued

[Millions, 2009\$; 7% Discount Rate]

	2014 MY	2015 MY	2016 MY	2017 MY	2018 MY	Sum
Refueling Savings .....	50	40	40	60	60	200
Non-CO <sub>2</sub> GHG Impacts and Non-GHG Impacts <sup>c d</sup> .....	n/a	n/a	n/a	n/a	n/a	n/a
<b>Reduced CO<sub>2</sub> Emissions at each assumed SCC value<sup>a b</sup></b>						
5% (avg SCC) .....	200	200	200	300	300	1,200
3% (avg SCC) .....	1,100	900	900	1,300	1,500	5,700
2.5% (avg SCC) .....	1,800	1,600	1,500	2,100	2,400	9,400
3% (95th percentile) .....	3,300	2,900	2,800	4,000	4,500	17,000
<b>Monetized Net Benefits at each assumed SCC value<sup>a b</sup></b>						
5% (avg SCC) .....	5,800	4,800	4,400	6,600	6,900	28,500
3% (avg SCC) .....	6,700	5,500	5,100	7,600	8,100	33,000
2.5% (avg SCC) .....	7,400	6,200	5,700	8,400	9,000	36,700
3% (95th percentile) .....	8,900	7,500	7,000	10,300	11,100	44,300

**Notes:**

<sup>a</sup> Net present value of reduced CO<sub>2</sub> emissions is calculated differently than other benefits. The same discount rate used to discount the value of damages from future emissions (SCC at 5, 3, 2.5 percent) is used to calculate net present value of SCC for internal consistency. Refer to the SCC TSD for more detail.

<sup>b</sup> Section VIII.G notes that SCC increases over time. Corresponding to the years in this table, the SCC estimates range as follows: for Average SCC at 5%: \$5–\$16; for Average SCC at 3%: \$22–\$46; for Average SCC at 2.5%: \$36–\$66; and for 95th percentile SCC at 3%: \$66–\$139. Section VIII.G also presents these SCC estimates.

<sup>c</sup> The monetized GHG benefits presented in this analysis exclude the value of changes in non-CO<sub>2</sub> GHG emissions expected under this action (See RIA chapter 5). Although EPA has not monetized changes in non-CO<sub>2</sub> GHGs, the value of any increases or reductions should not be interpreted as zero.

<sup>d</sup> Due to analytical and resource limitations, MY non-GHG emissions (direct PM, VOCs, NO<sub>2</sub> and SO<sub>2</sub>) were not estimated for this analysis.

<sup>e</sup> Negative sign represents an increase in Accidents, Congestion, and Noise.

Table VIII-35 and Table VIII-36 show similar model year estimates to those provided above in Table VIII-33 and Table VIII-34, but reflect specific differences in the NHTSA HD program over the 3 mandatory model years of

that program. These include no HD diesel engine impacts prior to MY 2017, assumption of the NHTSA phase-in schedule for HD pickup trucks and vans which achieves 3 year phase-in stability (67%-67%-67%-100% in MY 2016–

2019 respectively), the inclusion of combination tractors from MY 2016 forward, and the exclusion of RVs, which are not regulated by NHTSA.

TABLE VIII-35—MONETIZED TECHNOLOGY COSTS, FUEL SAVINGS, BENEFITS, AND NET BENEFITS ASSOCIATED WITH THE LIFETIMES OF 2016–2018 MODEL YEAR TRUCKS

[Millions, 2009\$; 3% Discount Rate]

	2016 MY	2017 MY	2018 MY	Sum
Technology Costs .....	\$1,500	\$1,600	\$1,700	\$5,200
Fuel Savings (pre-tax) .....	5,500	10,900	11,500	27,900
Energy Security Impacts (price shock) .....	300	600	600	1,500
Accidents, Congestion, Noise <sup>e</sup> .....	-300	-300	-300	-900
Refueling Savings .....	40	80	80	200
Non-CO <sub>2</sub> GHG Impacts and Non-GHG Impacts <sup>c d</sup> .....	n/a	n/a	n/a	n/a
<b>Reduced CO<sub>2</sub> Emissions at each assumed SCC value<sup>a b</sup></b>				
5% (avg SCC) .....	100	300	300	700
3% (avg SCC) .....	600	1,200	1,300	3,100
2.5% (avg SCC) .....	1,000	2,000	2,200	5,200
3% (95th percentile) .....	1,900	3,800	4,000	9,700
<b>Monetized Net Benefits at each assumed SCC value<sup>a b</sup></b>				
5% (avg SCC) .....	4,100	10,000	10,500	24,200
3% (avg SCC) .....	4,600	10,900	11,500	26,600
2.5% (avg SCC) .....	5,000	11,700	12,400	28,700
3% (95th percentile) .....	5,900	13,500	14,200	33,200

**Notes:**

<sup>a</sup> Net present value of reduced CO<sub>2</sub> emissions is calculated differently than other benefits. The same discount rate used to discount the value of damages from future emissions (SCC at 5, 3, 2.5 percent) is used to calculate net present value of SCC for internal consistency. Refer to the SCC TSD for more detail.



<sup>b</sup> Section VIII.G notes that SCC increases over time. Corresponding to the years in this table, the SCC estimates range as follows: for Average SCC at 5%: \$5–\$16; for Average SCC at 3%: \$22–\$46; for Average SCC at 2.5%: \$36–\$66; and for 95th percentile SCC at 3%: \$66–\$139. Section VIII.G also presents these SCC estimates.

<sup>c</sup> The monetized GHG benefits presented in this analysis exclude the value of changes in non-CO<sub>2</sub> GHG emissions expected under this program (See RIA Chapter 5). Although EPA has not monetized changes in non-CO<sub>2</sub> GHGs, the value of any increases or reductions should not be interpreted as zero.

<sup>d</sup> Due to analytical and resource limitations, MY non-GHG emissions (direct PM, VOCs, NO<sub>2</sub> and SO<sub>2</sub>) were not estimated for this analysis.

<sup>e</sup> Negative sign represents an increase in Accidents, Congestion, and Noise.

TABLE VIII–36—MONETIZED TECHNOLOGY COSTS, FUEL SAVINGS, BENEFITS, AND NET BENEFITS ASSOCIATED WITH THE LIFETIMES OF 2016–2018 MODEL YEAR TRUCKS

[Millions, 2009\$; 7% Discount Rate]

	2016 MY	2017 MY	2018 MY	Sum
Technology Costs .....	\$1,500	\$1,600	\$1,700	\$5,200
Fuel Savings (pre-tax) .....	3,800	7,200	7,300	18,300
Energy Security Impacts (price shock) .....	200	400	400	1,000
Accidents, Congestion, Noise <sup>e</sup> .....	–200	–200	–200	–600
Refueling Savings .....	30	50	50	130
Non-CO <sub>2</sub> GHG Impacts and Non-GHG Impacts <sup>c,d</sup> .....	n/a	n/a	n/a	n/a
<b>Reduced CO<sub>2</sub> Emissions at each assumed SCC value<sup>a,b</sup></b>				
5% (avg SCC) .....	100	300	300	700
3% (avg SCC) .....	600	1,200	1,300	3,100
2.5% (avg SCC) .....	1,000	2,000	2,200	5,200
3% (95th percentile) .....	1,900	3,800	4,000	9,700
<b>Monetized Net Benefits at each assumed SCC value<sup>a,b</sup></b>				
5% (avg SCC) .....	2,400	6,200	6,200	14,300
3% (avg SCC) .....	2,900	7,100	7,200	16,700
2.5% (avg SCC) .....	3,300	7,900	8,100	18,800
3% (95th percentile) .....	4,200	9,700	9,900	23,300

**Notes:**

<sup>a</sup> Net present value of reduced CO<sub>2</sub> emissions is calculated differently than other benefits. The same discount rate used to discount the value of damages from future emissions (SCC at 5, 3, 2.5 percent) is used to calculate net present value of SCC for internal consistency. Refer to the SCC TSD for more detail.

<sup>b</sup> Section VIII.G notes that SCC increases over time. Corresponding to the years in this table, the SCC estimates range as follows: for Average SCC at 5%: \$5–\$16; for Average SCC at 3%: \$22–\$46; for Average SCC at 2.5%: \$36–\$66; and for 95th percentile SCC at 3%: \$66–\$139. Section VIII.G also presents these SCC estimates.

<sup>c</sup> The monetized GHG benefits presented in this analysis exclude the value of changes in non-CO<sub>2</sub> GHG emissions expected under this program (See RIA Chapter 5). Although EPA has not monetized changes in non-CO<sub>2</sub> GHGs, the value of any increases or reductions should not be interpreted as zero.

<sup>d</sup> Due to analytical and resource limitations, MY non-GHG emissions (direct PM, VOCs, NO<sub>2</sub> and SO<sub>2</sub>) were not estimated for this analysis.

<sup>e</sup> Negative sign represents an increase in Accidents, Congestion, and Noise.

**M. Employment Impacts**

(1) Introduction

Although analysis of employment impacts is not part of a cost-benefit analysis (except to the extent that labor costs contribute to costs), employment impacts of federal rules are of particular concern in the current economic climate of sizeable unemployment. The recently issued Executive Order 13563, “Improving Regulation and Regulatory Review” (January 18, 2011), states, “Our regulatory system must protect public health, welfare, safety, and our environment while promoting economic growth, innovation, competitiveness, and job creation” (emphasis added). Although EPA and NHTSA did not undertake an employment analysis of the proposed rules, several commenters suggested that we undertake an employment analysis for the final rulemaking. Consistent with Executive order 13563, we have provided a

discussion of the potential employment impacts of the Heavy-Duty National Program.

In recent rulemakings, EPA has generally focused its employment analysis on the regulated sector and the suppliers of pollution abatement equipment. However, in this action, the agencies are offering qualitative assessment for related industries of interest. For the regulated sector, the agencies rely on Morgenstern *et al.* for guidance.<sup>550</sup> Our general conclusion is that employment impacts in the regulated sector (truck and engine manufacturing) and the parts sectors depend on a combination of factors, some of which are positive, and some of which can be positive or negative. In the related industries, the analysis

<sup>550</sup> Morgenstern, Richard D., William A. Pizer, and Jih-Shyang Shih. “Jobs Versus the Environment: An Industry-Level Perspective.” *Journal of Environmental Economics and Management* 43 (2002): 412–436.

concludes that effects on employment in the transport and shipping sectors are ambiguous; the fuel supplying sectors may face reduced employment; and there may be increased general employment due to reduction in costs that may be passed along to the transport industry and thus to the public. Because measuring employment effects depends on a variety of inputs and assumptions, some of which are known with more certainty than others, and because we did not include an employment analysis in the NPRM and provide opportunity for public comment on the methods, we here present a qualitative discussion. Because the discussion is qualitative, we do not sum the net effects on employment. We also note that the employment effects may be different in the immediate implementation phase than in the ongoing compliance phase; this analysis

focuses on the longer-term effects rather than the immediate effects.

When the economy is at full employment, an environmental regulation is unlikely to have much impact on net overall U.S. employment; instead, labor would primarily be shifted from one sector to another. These shifts in employment impose an opportunity cost on society, approximated by the wages of the employees, as regulation diverts workers from other activities in the economy.<sup>551</sup> In this situation, any effects on net employment are likely to be transitory as workers change jobs. (For example, some workers may need to be retrained or require time to search for new jobs, while shortages in some sectors or regions could bid up wages to attract workers).<sup>552</sup>

It is also true that, if a regulation comes into effect during a period of high unemployment, a change in labor demand due to regulation may affect net overall U.S. employment because the labor market is not in equilibrium. Either negative or positive effects are possible. Schmalensee and Stavins<sup>553</sup> point out that net positive employment effects are possible in the near term when the economy is at less than full employment due to the potential hiring of idle labor resources by the regulated sector to meet new requirements (e.g., to install new equipment) and new economic activity in sectors related to the regulated sector. In the longer run, the net effect on employment is more difficult to predict and will depend on the way in which the related industries respond to the regulatory requirements. As Schmalensee and Stavins note, it is possible that the magnitude of the effect on employment could vary over time, region, and sector, and positive effects on employment in some regions or sectors could be offset by negative effects in other regions or sectors. For this reason, they urge caution in reporting partial employment effects since it can “paint an inaccurate picture of net employment impacts if not placed in the broader economic context.”

This rulemaking is expected to have a relatively small effect on net employment in the United States through the regulated sector—the truck

and engine manufacturer industry—and several related sectors, specifically, industries that supply the truck and engine manufacturing industry (e.g., truck parts), the trucking industry itself, other industries involved in transporting goods (e.g., rail and shipping), the petroleum refining sector, and the retail sector. According to the U.S. Bureau of Labor Statistics, about 1.25 million people were employed in the truck transportation industry and about 675,000 people were employed in the motor vehicle parts industry between 2010 and 2011.<sup>554</sup> Although heavy-duty vehicles (HD) account for approximately 4 percent of the vehicles on the road, these vehicles consume more than 20 percent of on-road gasoline and diesel fuel use. As discussed in Chapter 5 of the RIA, this rulemaking is predicted to reduce the amount of fuel these vehicles use, and thus affect the petroleum refinery industry. The petroleum refinery industry employed about 65,000 people in the U.S. in 2009, the most recent year that employment estimates are available for this sector.<sup>555</sup> Finally, since the net reduction in cost associated with these rules is expected to lead to lower transportation and shipping costs, in a competitive market a substantial portion of those cost savings will be passed along to consumers, who then will have additional discretionary income (how much of the cost is passed along to consumers depends on market structure and the relative price elasticities).

Several commenters suggested that the HD vehicle rules would lead to an increase in employment in affected sectors by offering the potential for new employment opportunities in the design and production of new vehicle technologies. Also, these commenters suggested that since the U.S. manufacturers and suppliers are leaders in certain advanced truck technologies, this program has the potential to help them consolidate their leadership and thrive in a global market. In this context, several commenters referred to an assessment by the Union of Concerned Scientists (UCS) and CalStart of the economic and employment benefits of the improved efficiency in HD vehicles.<sup>556</sup> The study predicts an

increase in tens of thousands of jobs between 2020 and 2030, as result of higher fuel efficiency for HD vehicles.

While the commenters find unambiguous employment increases as a result of this program, we find employment impacts to involve some complexity, as the discussion that follows shows. In addition, these quantitative estimates were derived using a standard input-output model, though the estimates themselves have not yet been peer reviewed. Input-output (I/O) models do not account for opportunity costs of labor—that is, all employment needs due to the regulatory change will be met by unemployed workers. In addition, I/O models assume no changes in the average use of labor per dollar of output in the affected sectors. For these and other reasons, these may at best be considered an imprecise upper bound on actual employment impacts.<sup>557</sup>

Other commenters suggested that the rulemaking could have a negative impact on jobs if the rule was not appropriate, cost effective, and technologically feasible. These comments focused on the commenter's concern that the desirability, and therefore sales, of certain vehicles could be diminished by a poorly designed rule, or that customers of RVs in particular would not value fuel savings technologies. The preceding discussion of the conceptual framework suggests some potential reasons why consumers may not value fuel savings technologies. If vehicle sales decrease as the comments suggest such an impact could lead to job losses. Such comments were submitted by the National RV Dealers Association (RVDA) and the National Automobile Dealers Association (NADA).

Determining the direction of employment effects even in the regulated industry may be difficult due to the presence of competing effects that lead to an ambiguous adjustment in employment as a result of environmental regulation. Morgenstern, Pizer and Shih identify three separate ways that employment levels may change in the regulated industry in response to a new (or more stringent) regulation.<sup>558</sup>

- *Demand effect:* Higher production costs due to the regulation will lead to higher market prices; higher prices in turn reduce demand for the good, reducing the demand for labor to make

<sup>551</sup> Schmalensee, Richard, and Robert N. Stavins. “A Guide to Economic and Policy Analysis of EPA’s Transport Rule.” White paper commissioned by Excelon Corporation, March 2011.

<sup>552</sup> Although the employment level would not change substantially, there would be costs to the workers associated with shifting from one activity to another. Jacobson, Louis S., Robert J. LaLonde, and Daniel G. Sullivan, “Earnings Losses of Displaced Workers.” *American Economic Review* 83(4) (1993): 685–709.

<sup>553</sup> *Ibid.*

<sup>554</sup> U.S. Bureau of Labor Statistics seasonally-adjusted Current Employment Statistics Survey for the Truck Transportation Industry (NAICS 484) and the Motor Vehicle Parts Manufacturing Industry (NAICS 3363).

<sup>555</sup> U.S. Census Bureau, 2009 Annual Survey of Manufactures, Published December 3, 2010.

<sup>556</sup> Union of Concerned Scientists and CalStart, Delivering Jobs: The Economic Costs and Benefits of Improving Fuel Efficiency of Heavy Duty Vehicles, July, 2010. <http://www.ucsusa.org/deliveringjobs>.

<sup>557</sup> Berck, Peter, and Sandra Hoffman. “Assessing the Employment Impacts of Environmental and Natural Resource Policy.” *Environmental and Resource Economics* 22 (2002): 133–156.

<sup>558</sup> See Morgenstern et al (2002), Note 550, above.

that good. In the authors' words, the "extent of this effect depends on the cost increase passed on to consumers as well as the demand elasticity of industry output".

- *Cost effect:* As costs go up, plants add more capital and labor (holding other factors constant), with potentially positive effects on employment; in the authors' words, as "production costs rise, more inputs, including labor, are used to produce the same amount of output".

- *Factor-shift effect:* Post-regulation production technologies may be more or less labor-intensive (*i.e.*, more/less labor is required per dollar of output) ("factor-shift effect"). In the authors' words, "environmental activities may be more labor intensive than conventional production," meaning that "the amount of labor per dollar of output will rise," though it is also possible that "cleaner operations could involve automation and less employment, for example". The "demand effect" is expected to have a negative effect on employment, the "cost effect" to have a positive effect on employment, and the "factor-shift effect" has an ambiguous effect on employment. Without more information with respect to the magnitudes of these competing effects, it is not possible to predict the total effect environmental regulation will have on employment levels in a regulated sector.

Morgenstern *et al.* estimated the effects on employment of spending on pollution abatement for four highly polluting/regulated industries (pulp and paper, plastics, steel, and petroleum refining). They conclude that increased abatement expenditures generally have *not* caused a significant change in employment in those sectors. More specifically, their results show that, on average across the industries studied, each additional \$1 million spent on pollution abatement results in a (statistically insignificant) net increase of 1.5 jobs. While the specific sectors Morgenstern *et al.* examined are different than the sectors considered here, the methodology that Morgenstern *et al.* developed is still useful in this context.

## (2) Overview of Affected Sectors

The above discussion focuses on employment changes in the regulated sector, but the regulated sector is not the only source of changes in employment. In these rules, the regulated sectors are truck and engine manufacturers; they are responsible for meeting the standards set in these rules. The effects of these rules are also likely to have impacts beyond the directly regulated sector. Some of the related sectors

which these rules are also likely to impact include: motor vehicle parts producers, to the extent that the truck and engine industries purchase components rather than manufacture them in-house; shipping and transport, because many companies in this sector purchase trucks and their operating costs will be affected by both higher truck prices and fuel savings; oil refineries due to reduced demand for petroleum-based fuels; and the final retail market, which is where any net cost reductions due to fuel savings are ultimately expected to be experienced. We acknowledge that there may be impacts in other sectors that are not discussed here, but we have sought to include the sectors where we think the impacts are most direct. The following discussion describes the direction of impacts on employment in these industries. The effects of the HD National Program on net U.S. employment depend, not only on their relative magnitudes, but also on employment levels in the overall economy. As previously discussed, in a full-employment economy these sector-specific impacts will be mostly offset by employment changes elsewhere in the economy and would not be expected to result in a net change in jobs. However, in an economy with significant unemployment these changes may affect net employment in the U.S.

### (a) Truck and Engine Manufacturers

The regulated sector consists of truck and engine manufacturers. Employment associated with manufacturing trucks and engines may be affected by the demand, cost, and factor-shift effects.

#### Demand Effect

The demand effect depends on the effects of this rulemaking on HD vehicle sales. If vehicle sales increase, then more people will be required to assemble trucks and their components. If vehicle sales decrease, employment associated with these activities will unambiguously decrease. The effects of this rulemaking on HD vehicle sales depend on the perceived desirability of the new vehicles. Unlike in Morgenstern *et al.*'s study, where the demand effect decreased employment, there are countervailing possibilities in the HD market due to the fuel savings resulting from this program. On one hand, this rulemaking will increase vehicle costs; by itself, this effect would reduce vehicle sales. In addition, while decreases in vehicle performance would also decrease sales, this program is not expected to have any negative effect on vehicle performance. On the other hand, this rulemaking will reduce the fuel

costs of operating the vehicle; by itself, this effect would increase vehicle sales, especially if potential buyers have an expectation of higher fuel prices. The agencies have not made an estimate of the potential change in vehicle sales. However as discussed in Preamble Section VIII.E.5 the agencies have estimated an increase in vehicle miles traveled (*i.e.*, VMT rebound) due to the reduced operating costs of trucks meeting these new standards. Since increased VMT is most likely to be met with more drivers and more trucks, our projection of VMT rebound is suggestive of an increase in vehicle sales and truck driver employment (recognizing that these increases may be partially offset by a decrease in manufacturing and sales for equipment of other modes of transportation such as rail cars or barges).

As discussed above in Section VIII.A, the agencies find that the reduction in fuel costs associated with this rulemaking outweigh the increase in vehicle cost. This finding is puzzling: market forces should lead truck manufacturers and buyers to install all cost-effective fuel-saving technology, but the agencies find that they have not. Section VIII.A discusses various hypotheses that have been suggested to explain this phenomenon. Some of the explanations suggest that vehicle manufacturers and buyers will benefit from the rulemaking, and vehicle sales will increase; others suggest that the opposite might occur. The agencies do not have strong evidence supporting one specific explanation over another. However, some in the heavy-duty industry indicate the potential for an increase in jobs. As stated by Tom Linebarger (President and Chief Operating Officer of Cummins) and Fred Krupp (President of the Environmental Defense Fund), "Finally, strong environmental standards play a crucial role in getting innovations to market that will create economic opportunity for American companies and jobs for American workers. \* \* \* It helps that Cummins and other forward-thinking businesses view this as an opportunity to innovate and increase international market share."<sup>559</sup>

One commenter raised the issue of whether there could be a loss of recreation vehicle (RV) industry jobs due to a reduction in the sales of motor homes and towable RVs. As mentioned

<sup>559</sup> Tom Linebarger (President and Chief Operating Officer of Cummins) and Fred Krupp (President of the Environmental Defense Fund), "Clear rules can create better engines, clean air," Indianapolis Star, October 28, 2010, p. 19; included as part of Cummins' comments on the rule, Docket Number EPA-HQ-OAR-2010-0162-1765.1[1].

above, the effects of this rulemaking on HD vehicle sales depend on the desirability of the new vehicles.

#### Cost Effect

The truck and engine manufacturing sector has great flexibility in how to respond to the requirement for reduced greenhouse gases and increasing fuel efficiency, with a broad suite of technologies being available to achieve the standards. These technologies are described in detail in Chapter 2 of the RIA. Among these technologies, a distinction can be made between technologies that can be “added on” to conventional trucks versus those that replace features of a conventional truck. “Added on” features, such as auxiliary power units, require additional labor to install the technologies on trucks, thus clearly increasing labor demand (the “cost effect”). The pure cost effect always increases employment, though the net effect on the regulated industry depends on its effects in combination with the demand and factor-shift effects.

#### Factor-Shift Effect

For “replacement” technologies, the predicted impact on labor demand from regulation depends on the change in the amount of labor used to build and install one type of technology compared to another. In some cases, the new technologies are predicted to be more complex than the existing technologies and may therefore require additional labor installation inputs. In other cases, the opposite may be true: labor intensity may be lower for some replacement technologies.

Most of the technologies that are expected to be used to meet these standards are replacement technologies. For example, almost all of the engine improvements involve replacement technologies that are not expected to significantly change the labor requirements. Similarly, regulations of the chassis on vocational vehicles will only require the installation of a different type of tire, which is also not expected to have large labor intensity impacts. Therefore, the potential magnitude of the factor shift effect is expected to be relatively small, though slightly positive due to the additional labor needed to install more complex technologies.

#### Summary for the Truck and Engine Manufacturing Sector

For the truck and engine manufacturing sector, the demand effect may result in either increased or decreased employment; the cost effect is expected to increase employment; and the factor-shift effect is expected to have

a small, possibly slightly positive effect on employment in this sector. The net effect on employment in this sector depends on the sum of these factors.

#### (b) Motor Vehicle Parts Manufacturing Sector

Some vehicle parts are made in-house and would be included directly in the regulated sector. Others are made by independent suppliers and are not directly regulated, but they will be affected by the rules as well. The parts manufacturing sector will be involved primarily in providing “add-on” parts, or components for replacement parts built internally. If demand for these parts increases due to the increased use of these parts, employment effects in this sector are expected to be positive. If the demand effect in the regulated sectors is significantly negative enough, it is possible that demand for other parts may decrease. As noted, the agencies do not predict a direction for the demand effect.

#### (c) Transport and Shipping Sectors

Although not directly regulated by these rules, employment effects in the transport and shipping sector are likely to result from these regulations. If the overall cost of shipping a ton of freight decreases because of increased fuel efficiency (taking into account the increase in upfront purchasing costs), in a perfectly competitive industry these costs savings will be passed along to customers. With lower prices, demand for shipping would lead to an increase in demand for truck shipping services (consistent with the VMT rebound effect analysis) and therefore an increase in employment in the truck shipping sector. In addition, if the relative cost of shipping freight via trucks becomes cheaper than shipping by other modes (e.g., rail or barge), then employment in the truck transport industry is likely to increase. If the trucking industry is more labor intensive than other modes, we would expect this effect to lead to an overall increase in employment in the transport and shipping sectors.<sup>560 561</sup> Such a shift would, however, be at the expense of employment in the sectors that are losing business to trucking. The first effect—a gain due to lower shipping costs—is likely to lead to a net increase in employment. The second

<sup>560</sup> American Transportation Research Institute, “An Analysis of the Operational Costs of Trucking: 2011 Update.” See [http://www.atri-online.org/research/results/Op\\_Costs\\_2011\\_Update\\_one\\_page\\_summary.pdf](http://www.atri-online.org/research/results/Op_Costs_2011_Update_one_page_summary.pdf).

<sup>561</sup> Association of American Railroads, “All Inclusive Index and Rail Adjustment Factor.” June 3, 2011. See <http://www.aar.org/-/media/aar/RailCostIndexes/AAR-RCFA-2011-Q3.aspx>.

effect, due to mode-shifting, may increase employment in trucking, but decreases in other shipping sectors.

#### (d) Fuel Suppliers

In addition to the effects on the trucking industry and related truck parts sector, these rules will result in reductions in fuel use that lower GHG emissions. Fuel saving, principally reductions in liquid fuels such as diesel and gasoline, will affect employment in the fuel suppliers industry sectors, principally the Petroleum Refinery sector.<sup>562</sup>

Expected fuel consumption reductions by fuel type, and by heavy-duty vehicle type, can be found in Table VIII–7. These reductions reflect impacts from the new fuel efficiency and GHG standards and include increased consumption from the rebound effect. These fuel savings are monetized in Table VIII–8 by multiplying the reduced fuel consumption in each year by the corresponding estimated average fuel price in that year, using the Reference Case from the AEO 2011. In 2014, the pre-tax fuel savings is \$1.2 billion (2009\$). While these figures represent a level of fuel savings for purchasers of fuel, it also represents a loss in value of output for the petroleum refinery industry. Since 50 percent of the fuel would have been refined in the U.S., the loss in output to the U.S. Petroleum Refinery sector is \$600 million (2009\$), which will result in reduced sectoral employment.<sup>563</sup> Because this sector is very capital-intensive, the employment effect is not expected to be large.

#### (e) Fuel Savings

As a result of this rulemaking, it is anticipated that trucking firms will experience fuel savings. Fuel savings lower the costs of transportation goods and services. In a competitive market, the fuel savings that initially accrue to trucking firms are likely to be passed along as lower transportation costs that, in turn, could result in lower prices for

<sup>562</sup> North American Industry Classification System (NAICS) Code 32411.

<sup>563</sup> EPA and NHTSA estimate that approximately 50 percent of the reduction in fuel consumption resulting from adopting improved fuel GHG standards and fuel efficiency standards is likely to be reflected in reduced U.S. imports of refined fuel, while the remaining 50 percent is expected to be reflected in reduced domestic fuel refining. Of this latter figure, 90 percent is anticipated to reduce U.S. imports of crude petroleum for use as a refinery feedstock, while the remaining 10 percent is expected to reduce U.S. domestic production of crude petroleum. Because we do not expect to see a significant reduction in crude oil production in the U.S., we do not expect this rule to have a significant impact on the Oil and Gas Extraction industry sector in the U.S. (NAICS 211000). For more information, refer to Section VIII–I on the energy security impacts from the program.

final goods and services. Alternatively, the savings could be kept internally in firms for investments or for returns to firm owners. In either case, the savings will accrue to some segment of consumers: either owners of trucking firms or the general public. In both cases, the effect will be increased spending by consumers in other sectors of the economy, creating jobs in a diverse set of sectors, including retail and service industries.

As mentioned above, the value of fuel savings from this rulemaking is projected to be \$1.2 billion (2009\$) in 2014, according to Table VIII–8. If all those savings are spent, the fuel savings will stimulate increased employment in the economy through those expenditures. If the fuel savings accrue primarily to firm owners, they may either reinvest the money or take it as profit. Reinvesting the money in firm operations would increase employment directly. If they take the money as profit, to the extent that these owners are wealthier than the general public, they may spend less of the savings, and the resulting employment impacts would be smaller than if the savings went to the public. Thus, while fuel savings are expected to decrease employment in the refinery sector, they are expected to increase employment through increased consumer expenditures.

### (3) Summary of Employment Impacts

The net employment effects of this rulemaking are expected to be found throughout several key sectors: truck and engine manufacturers, the trucking industry, truck parts manufacturing, fuel production, and consumers. For the regulated sector, the demand effect may result in either increased or decreased employment, depending on the net effect on HD vehicle sales; the cost effect is expected to increase employment in the regulated sector; and the factor-shift effect is expected to have a small, possibly slightly positive effect on employment, though we cannot definitively say this is the case without quantification. The net effect depends on the combination of these effects. Increased expenditures by truck and engine parts manufacturers are expected to require increased labor to build parts, though this effect also depends on any changes in overall demand and on the labor intensity of production of new parts; increased complexity of technologies may imply increased labor inputs for some parts, though others might be less labor-intensive. It is possible, if access to capital markets is limited, that this rule might displace other HD sector investment, which would reduce employment associated

with those activities. Lower prices for shipping are expected to lead to an increase in demand for truck shipping services and, therefore, an increase in employment in that sector, though this effect may be offset somewhat by changes in employment in other shipping sectors. Reduced fuel production implies less employment in the fuel provision sectors. Finally, any net cost savings would be expected to be passed along to some segment of consumers: either the general public or the owners of trucking firms, who are expected then to increase employment through their expenditures. Given the job creation as a result of the \$1.2B (2009\$) in fuel savings in 2014 and the possible employment increases in the manufacturing and parts sectors, we find it highly unlikely that there would be significant net job losses related to this policy. Given the current level of unemployment, net positive employment effects are possible, especially in the near term, due to the potential hiring of idle labor resources by the regulated sector to plan for and meet new requirements. In the future, when full employment is expected to return, any changes in employment levels in the regulated sector due to this program are mostly expected to be offset by changes in employment in other sectors.

### IX. Analysis of the Alternatives

The heavy-duty truck segment is very complex. The sector consists of a diverse group of impacted parties, including engine manufacturers, chassis manufacturers, truck manufacturers, trailer manufacturers, truck fleet owners and the public. The final standards that the agencies have adopted today maximize the environmental and fuel savings benefits of the program while taking into consideration the unique and varied nature of the regulated industries. In developing this final rulemaking, we considered a number of alternatives that could have resulted in potentially fewer or greater GHG and fuel consumption reductions than the program we are finalizing. This section summarizes the alternatives we considered and presents assessments of technology costs, CO<sub>2</sub> reductions, and fuel savings associated with each alternative. The agencies reduced the number of alternatives analyzed in this final rulemaking compared to the proposal because we did not receive any comments supporting standard setting for a smaller subset than HD pickup trucks, combination tractors, and vocational vehicles (as well as engines installed in vocational vehicles and combination tractors). As discussed

below, the agencies have also refined some of the alternatives analyzed in response to the comments received.

#### A. What are the alternatives that the agencies considered?

In developing alternatives, NHTSA must consider EISA's requirement for the MD/HD fuel efficiency program noted above. 49 U.S.C. 32902(k)(2) and (3) contain the following three requirements specific to the MD/HD vehicle fuel efficiency improvement program: (1) The program must be "designed to achieve the maximum feasible improvement"; (2) the various required aspects of the program must be appropriate, cost-effective, and technologically feasible for MD/HD vehicles; and (3) the standards adopted under the program must provide not less than four model years of lead time and three model years of regulatory stability. In considering these various requirements, NHTSA will also account for relevant environmental and safety considerations.

The alternatives below represent a broad range of approaches for a HD vehicle fuel efficiency and GHG emissions program. Details regarding the modeling of each alternative are included in RIA Chapter 6. The alternatives in order of increasing fuel efficiency and GHG emissions reductions are:

#### (1) Alternative 1: No Action

A "no action" alternative assumes that the agencies would not issue rules regarding a MD/HD fuel efficiency improvement program. This alternative is presented in order for NHTSA to comply with the National Environmental Policy Act (NEPA) and to provide an analytical baseline against which to compare environmental impacts of the other regulatory alternatives.<sup>564</sup> The agencies refer to this as the "No Action Alternative" or as a "no increase" or "baseline" alternative. As described in RIA Chapter 5, this no-

<sup>564</sup> NEPA requires agencies to consider a "no action" alternative in their NEPA analyses and to compare the effects of not taking action with the effects of the reasonable action alternatives to demonstrate the different environmental effects of the action alternatives. See 40 CFR 1502.2(e), 1502.14(d). CEQ has explained that "[T]he regulations require the analysis of the no action alternative even if the agency is under a court order or legislative command to act. This analysis provides a benchmark, enabling decision makers to compare the magnitude of environmental effects of the action alternatives. [See 40 CFR 1502.14(c).] \* \* \* Inclusion of such an analysis in the EIS is necessary to inform Congress, the public, and the President as intended by NEPA. [See 40 CFR 1500.1(a).]" Forty Most Asked Questions Concerning CEQ's National Environmental Policy Act Regulations, 46 FR 18026 (1981) (emphasis added).

action alternative is considered the reference case.

The no action alternative first presented in this final action is based on the assumption that the new vehicle fleet continues to perform at the same level as new 2010 vehicles. In this way, it provides a comparison between today's new trucks and the increased cost and reduced fuel consumption of future compliant vehicles.

The agencies recognize that there is substantial uncertainty in determining an appropriate baseline against which to compare the effects of the proposed action. The lack of prior regulation of HD fuel efficiency means that there is a lack of historic data regarding trends in this sector. Therefore, in this final action, the agencies have also included an analysis using a baseline derived from annual projections developed by the U.S. Energy Information Administration (EIA) for the Annual Energy Outlook (AEO). For this alternative baseline, the agencies analyzed the new truck fuel economy projections for the Light Commercial Trucks, along with the Medium- and Heavy-Duty Freight Vehicles developed in AEO 2011.<sup>565</sup> The agencies converted the fuel economy improvements into CO<sub>2</sub> emissions reductions relative to a 2010 model year (See RIA Chapter 6).

The baseline derived from the AEO forecast provides a comparison between the impacts of the proposed standards and EIA's projection of future new truck performance absent regulation. This alternative baseline is informative in showing one possible projection of future vehicle performance based on other factors beyond the regulation the agencies are finalizing today. The AEO forecast makes a number of assumptions that should be noted. AEO 2011 assumes improved fuel efficiency for 8,500–10,000 lb. GVWR heavy-duty pickups due to the light-duty 2012–2016 MY regulations. We project a similar capability for fuel economy improvement as AEO does for this class of vehicles; however, the agencies recognize that absent regulation manufacturers may decline to add the necessary technologies to reach the level of our proposed standards. For medium- and heavy-duty vocational vehicles, AEO 2011 projects a small reduction in fuel efficiency over time (an increase in fuel consumption), similar to that achieved under the MY 2010 baseline. For Class 8 combination tractors, the AEO 2011 baseline projects an annual

improvement of approximately 0.3 percent.

We are not able to make an estimate of the cost of the AEO 2011 alternative baseline because we are not able to accurately determine the technology mix used in the AEO 2011 analysis to achieve the projected improvements in fuel efficiency. We do know they differ significantly from our own analysis as the EIA projections do not include the full range of technologies considered by the agencies (e.g., EIA's analysis does not consider the use of idle reduction technologies and diesel auxiliary power units to reduce fuel consumption associated with vehicle hoteling). If one were to assume that the cost of the AEO2011 baseline was proportional to projected improvement relative to our preferred alternative, the total AEO2011 baseline cost estimate would be approximately equal to the total cost of the preferred case, but would vary by category.

#### (2) Alternative 2: 12 Percent Less Stringent Than the Preferred Alternative

Alternative 2 represents an alternative stringency level to the agencies' preferred approach. Alternative 2 represents a stringency level which is approximately 12 percent less stringent than the preferred approach. The agencies calculated the Alternative 2 stringency level in order to meet two goals. First, we sought to create an alternative that regulated the same engine and vehicle categories as the preferred alternative, but at lower stringency (10–20 percent lower) than the preferred alternative. Second we wanted an alternative that reflected removal of the least cost effective technology that we believed manufacturers would add last in order to meet the preferred alternative. In other words, we wanted an alternative that as closely as possible reflected the last increment in stringency prior to reaching our preferred alternative. Please see Table 2–39 in RIA Chapter 2 for a list of all of the technologies, as well as their cost and relative effectiveness. The resulting Alternative 2 is based on the same technologies used in Alternative 3 except as follows for each of the three categories.

The combination tractor standard would be based on the removal of the Advanced SmartWay aerodynamic package and weight reduction technologies, which decreases the average combination tractor GHG emissions and fuel consumption reduction by approximately 1 percent.

The HD pickup truck and van standard would be based on removal of the 5 percent mass reduction

technology, which decreases the average truck reduction of fuel consumption and GHG emissions by approximately 1.6 percent.

The vocational vehicle standard would be based on removal of low rolling resistance tires—in essence meaning that there would be no expected improvement in performance from vocational vehicles, only from engines used to power them. This alternative would also reduce the amount of technologies applied to diesel engines used in vocational vehicles such that the engines achieve a 3 percent reduction in 2014 model year and a 5 percent reduction in 2017 model year, both compared to a 2010 model year baseline.

The agencies have decided not to finalize Alternative 2, because as shown below, Alternative 3 is more stringent, is technically feasible, highly cost effective, and results in a greater net benefit to society.

#### (3) Alternative 3: Preferred Alternative and Final Standards

Alternative 3 represents the agencies' preferred approach. This alternative consists of the finalized fuel efficiency and GHG standards for HD engines, HD pickup trucks and vans, Class 2b through Class 8 vocational vehicles, and Class 7 and 8 combination tractors. Details regarding modeling of this alternative are included in RIA Chapter 5 as the control case.

The agencies selected Alternative 3 over Alternatives 4 and 5 described below because the agencies concluded that alternatives 4 and 5 were not technically feasible to achieve given the leadtime provided in these final rules. Hence, we have concluded that Alternative 3 represents the maximum feasible improvement. Section II of this preamble provides an explanation of the consideration that agencies gave to setting more stringent standards based on the application of additional technologies and our reasons for concluding that the identified technologies for each of the vehicle and engine standards that constitute Alternative 3 represented the maximum feasible improvement based on technological feasibility. In general, for advanced technologies, we reached this conclusion for one of two reasons. For some technologies such as Rankine Waste Heat Recovery engine technologies, the agencies have concluded that the technology is still in the research phase and will not be developed fully for new engine production in the time frame of this first regulatory action. In other cases, the agencies concluded that the

<sup>565</sup> U.S. Energy Information Administration. Annual Energy Outlook 2011 Early Release. Last viewed on March 29, 2011 at <http://www.eia.doe.gov/forecasts/aeo/>. See Supplemental Tables 7, 63, and 68.

manufacturing capacity for technologies such as advanced battery systems for heavy-duty hybrid drivetrains could not be expanded quickly enough to allow for significant vehicle production volume in the time frame of this program. Section III also details the agencies' reasons for not basing standard stringencies on other technologies.

(4) Alternative 4: 20 Percent More Stringent Than the Preferred Alternative

Alternative 4 represents a modeled alternative which is 20 percent more stringent than the preferred approach. The agencies derived the stringency level based on similar goals as for Alternative 2. Specifically, we wanted an alternative that would reflect an incremental improvement over the preferred alternative based on adding the next most cost effective technology in each of the categories. We believed these were the technologies most likely to be accepted by manufacturers if a more stringent standard were established. As discussed above and in the feasibility discussion in Section III, we are not finalizing Alternative 4 because we do not believe that the technologies used in this alternative can be developed and introduced in the time frame of this rulemaking. We note that the estimated costs for this alternative are denoted as '+c.' The +c is intended to make clear that the cost estimates we are showing do not include additional costs related to pulling ahead the development and expanding manufacturing base for the additional technologies (for example, building new factories in the next few years). The resulting Alternative 4 is based on the same technologies used in Alternative 3 except as follows for each of the three categories.

The combination tractor standard would be based on the addition of Rankine waste heat recovery systems and 100 percent application of advanced aerodynamic technologies, such as underbody airflow treatment, advanced gap reduction, rearview cameras to replace mirrors, and wheel system streamlining, to high roof sleeper cab combination tractors. The agencies do not believe that either advanced aerodynamic technologies or Rankine waste heat recovery systems should be used to set the standard for HD engines in 2017 MY because this technology is still in the research phase. The agencies assumed 59 percent of all combination tractors are sleeper cabs and of those, 80 percent are high roof sleeper cabs. The agencies assumed a 12 kWh waste heat recovery system would reduce CO<sub>2</sub> emissions by 6 percent at a cost of

\$8,400 per truck.<sup>566</sup> The estimated reduction in CO<sub>2</sub> emissions from the engine for this alternative is included in RIA Chapter 6. The impact of 100 percent application of the advanced aerodynamic technology package would lead to a total 20.7 percent reduction in Cd values for high roof sleeper cabs over a 2010 MY baseline tractor. The incremental cost of this technology over the preferred case is \$1,027 per vehicle.

The HD pickup truck and van standard would be based on the addition of the turbocharged, downsized technology to gasoline engines which would bring the total reduction for gasoline HD pickup trucks and vans to 15 percent and match the level of reduction for the diesel pickup trucks. The agencies do not consider this to be a technology from which the 2017MY gasoline HD pickup truck standards should be premised on because we are not yet convinced that turbocharged downsized gasoline engines can be applied to heavy-duty truck applications in a durable manner. We are aware that manufacturers are testing such engines and that in pickup trucks with a duty cycle representing a mix of passenger vehicle and work applications the engines can be durable. However, we are unable to conclude today that such engines will be durable and hence technically feasible when applied in heavy-duty truck applications with an expected higher average load factor. The estimated incremental cost increase to HD pickup trucks and vans to replace a stoichiometric gasoline direct injected V8 engine with coupled cam phasing used in Alternative 3 with a V6 stoichiometric gasoline direct injection DOHC with dual cam phasing, discrete valve lift, and twin turbochargers is estimated to be \$1,743.<sup>567</sup>

The vocational vehicle standard would be based on the addition hybrid powertrains to 6 percent of the vehicles. The agencies assumed a 32 percent per vehicle reduction in GHG emissions and fuel consumption due to the hybrid with a cost of \$26,667 per vehicle based on the average effectiveness and costs developed in the NAS report for box trucks, bucket trucks, and refuse haulers.<sup>568</sup>

<sup>566</sup> TIA. 2009. Note 198, Page 4–20.

<sup>567</sup> See RIA chapter 2, Table 2.35.

<sup>568</sup> Committee to Assess Fuel Economy Technologies for Medium- and Heavy-Duty Vehicles; National Research Council; Transportation Research Board (2010). "Technologies and Approaches to Reducing the Fuel Consumption of Medium- and Heavy-Duty Vehicles," ("NAS Report"). Washington, DC The National Academies Press. Available electronically from the National Academies Press Web site at [http://www.nap.edu/catalog.php?record\\_id=12845](http://www.nap.edu/catalog.php?record_id=12845). Page 146.

(5) Alternative 5: Trailers Plus Accelerated Hybrid

Alternative 5 builds on Alternative 4 through additional hybrid powertrain application rates in the HD sector and by adding a performance standard for fuel efficiency and GHG emissions to commercial trailers. This alternative includes all elements of Alternative 4 (some of which we already regard as infeasible in the model years covered by the final rules), plus the application of additional hybrid powertrains to the pickup trucks, vans, vocational vehicles, and tractors. In addition, the agencies applied aerodynamic technologies to commercial box trailers, along with tire technologies for all commercial trailers.

The agencies set the hybrid penetration for each category such that it represents 50 percent of the HD pickup truck and van segment, 50 percent of vocational vehicles, and 5 percent of tractors in 2017 model year. The agencies have concluded that it is not feasible to achieve hybrid technology penetration rates at or even near these levels in the time frame of this rulemaking. As with Alternative 4, we include a +c in our cost estimates for this alternative to reflect additional costs not estimated by the agencies. The agencies assumed that a hybrid powertrain would provide a 32 percent reduction in CO<sub>2</sub> emissions and fuel consumption of a vocational vehicle at a projected cost of \$26,667 per vehicle, based on the average of the NAS report findings for box trucks, bucket trucks, and refuse vehicles.<sup>569</sup> The agencies are projecting a cost of \$9,000 per vehicle for the HD pickup trucks and vans with an effectiveness of 18 percent, again based on the NAS report.<sup>570</sup> Lastly, the effectiveness of hybrid powertrains installed in tractors was assumed to be 10 percent at a cost of \$25,000 based on the NAS report.<sup>571</sup>

The combination tractor technology package for Alternative 5 includes the preferred alternative technologies, waste heat recovery and Advanced SmartWay aerodynamic package used in Alternative 4, and application of hybrid powertrains discussed above, in addition to a regulation for commercial trailers pulled by combination tractors. The agencies assumed a box trailer program would mirror the SmartWay program and include tire and aerodynamic requirements. The agencies added low rolling resistance tires to all commercial trailers, which are assumed to have 15 percent lower rolling resistance than the baseline

<sup>569</sup> NAS Report. Page 146.

<sup>570</sup> NAS Report. Page 146.

<sup>571</sup> NAS Report. Page 146.



trailer tire which is equivalent to the target value required by SmartWay. The aerodynamics of the box trailers were assumed to improve the coefficient of drag for the combination tractor-trailer by 10 percent through the application of technologies such as trailer skirts and gap reducers.<sup>572</sup> These technologies would result in further reductions in drag coefficient and rolling resistance coefficient from the MY 2010 baseline. As stated above for hybrids, the agencies do not believe that it is possible to achieve technology penetration rates at or even near these levels in the time frame of this rulemaking.

The combination tractor costs for this alternative are equal to the costs in Alternative 4, plus \$25,000 for hybrid powertrains in ten percent of tractors, plus the costs of trailers. The costs for the trailer program of Alternative 5 were

derived based on the assumption that trailer aerodynamic improvements would cost \$2,150 per trailer. This cost assumes side fairings and gap reducers and is based on the ICF cost estimate.<sup>573</sup> The agencies applied the aerodynamic improvement to only box trailers, which represent approximately 60 percent of the trailer sales. The agencies used \$528 per trailer (2014 MY cost) for low rolling resistance based on the agencies' estimate of \$66 per tire in the tractor program. Lastly, the agencies assumed the trailer volume is equal to three times the tractor volume based on the 3:1 ratio of trailers to tractors in the market today.

*B. How Do These Alternatives Compare in Overall GHG Emissions Reductions and Fuel Efficiency and Cost?*

The agencies analyzed all five alternatives through the MOVES model

to evaluate the impact of each alternative, as shown in Table IX-1. The table contains the annual CO<sub>2</sub> and fuel savings in 2030 and 2050 for each alternative (relative to the reference scenario of Alternative 1), presenting both the total savings across all regulatory categories, and for each regulatory category.

Table IX-2 presents the annual technology costs associated with each alternative (relative to the reference scenario of Alternative 1) in 2030 and 2050 for each regulatory category. In addition, the total annual downstream impacts of NO<sub>x</sub>, CO, PM, and VOC emissions in 2030 for each of the alternatives are included in Table IX-3.

Lastly, the agencies project the monetized net benefits associated with each alternative in 2030 and 2050 as shown in Table IX-4 and Table IX-5.

TABLE IX-1—ANNUAL CO<sub>2</sub> AND OIL REDUCTIONS RELATIVE TO ALTERNATIVE 1 IN 2030 AND 2050

	Downstream CO <sub>2</sub> Reductions (MMT)		Oil reductions (billion gallons)	
	2030	2050	2030	2050
Alt. 1 Baseline .....	0	0	0	0
Alt. 1a AEO 2011 Baseline—Total .....	39	90	3.9	9.0
Tractors .....	29	73	2.9	7.1
HD Pickup Trucks .....	9	16	0.9	1.7
Vocational Vehicles .....	1	2	0.1	0.2
Alt. 2 Less Stringent—Total .....	54	78	5.4	7.7
Tractors .....	42	59	4.2	5.8
HD Pickup Trucks .....	7	11	0.8	1.2
Vocational Vehicles .....	5	7	0.4	0.7
Alt. 3 Preferred—Total .....	61	88	6.0	8.7
Tractors .....	45	63	4.4	6.2
HD Pickup Trucks .....	8	13	0.9	1.3
Vocational Vehicles .....	7	11	0.7	1.1
Alt. 4 More Stringent—Total .....	74	107	7.4	10.7
Tractors .....	53	74	5.2	7.3
HD Pickup Trucks .....	10	15	1.0	1.6
Vocational Vehicles .....	11	18	1.1	1.8
Alt. 5 Max Technology—Total .....	99	146	9.8	14.5
Tractors .....	61	85	6.0	8.3
HD Pickup Trucks .....	15	24	1.6	2.5
Vocational Vehicles .....	23	37	2.2	3.6

TABLE IX-2—TECHNOLOGY COST PROJECTIONS RELATIVE TO ALTERNATIVE 1 FOR EACH ALTERNATIVE

	Technology costs <sup>a</sup> (Millions, 2009\$)	
	2030	2050
Alt. 1 Baseline .....	\$0	\$0
Alt. 1a AEO 2011 Baseline—Total <sup>b</sup> .....	—	—
Tractors .....	—	—
HD Pickup Trucks .....	—	—
Vocational Vehicles .....	—	—
Alt. 2 Less Stringent—Total .....	\$1,676	\$2,440
Tractors .....	743	1,227
HD Pickup Trucks .....	817	1,029
Vocational Vehicles .....	117	185
Alt. 3 Preferred—Total .....	2,210	3,287

<sup>572</sup> The Cd improvement of 10 percent for trailer improvements was derived from the TIAX report, Table 4-26 on page 4-50.

<sup>573</sup> Assumed retail prices of \$1,300 for side skirts and \$850 for gap reducers based on the ICF Cost Report, page 90.



TABLE IX-2—TECHNOLOGY COST PROJECTIONS RELATIVE TO ALTERNATIVE 1 FOR EACH ALTERNATIVE—Continued

	Technology costs <sup>a</sup> (Millions, 2009\$)	
	2030	2050
Tractors .....	1,076	1,777
HD Pickup Trucks .....	918	1,156
Vocational Vehicles .....	216	354
Alt. 4 More Stringent—Total .....	5,211+c	6,996+c
Tractors .....	1,953+c	3,225+c
HD Pickup Trucks .....	1,442+c	1,816+c
Vocational Vehicles .....	1,816+c	1,954+c
Alt. 5 Max Technology—Total .....	17,909+c	27,306+c
Tractors .....	2,747+c	4,292+c
HD Pickup Trucks .....	5,669+c	7,142+c
Vocational Vehicles .....	9,493+c	15,873+c
	5,211+c	6,996+c

**Notes:**

<sup>a</sup> The +c is intended to make clear that the cost estimates we are showing do not include additional costs related to pulling ahead the development and expanding manufacturing base for these technologies.

<sup>b</sup> The agencies did not conduct a cost analysis for the AEO2011 baseline.

TABLE IX-3—DOWNSTREAM IMPACTS RELATIVE TO ALTERNATIVE 1 OF KEY NON-GHGs FOR EACH ALTERNATIVE IN 2030  
[In percent]

	NO <sub>x</sub>	CO	PM <sub>2.5</sub>	VOC
Alt. 1 Baseline .....	0	0	0	0
Alt. 1a AEO 2011 Baseline .....	8.8	1.0	-3.8	7.2
Alt. 2 Less Stringent .....	-21.9	-2.0	8.4	-19.0
Alt. 3 Preferred .....	-22.0	-2.0	8.5	-19.1
Alt. 4 More Stringent .....	-22.5	-2.0	8.7	-19.5
Alt. 5 Max Technology .....	-22.9	-2.1	8.4	-20.0

TABLE IX-4—MONETIZED NET BENEFITS ASSOCIATED WITH EACH ALTERNATIVE RELATIVE TO ALTERNATIVE 1 FOR LIFETIME OF 2014 THROUGH 2018 MODEL YEAR VEHICLES

[3% Discount rate, millions, 2009\$]

	Alt. 1 baseline	Alt. 2 less stringent	Alt. 3 preferred	Alt. 4 more stringent	Alt. 5 max technology
Truck Program Costs <sup>d</sup> .....	\$0	\$5,900	\$8,100	\$20,700+c	\$37,200+c
Fuel Savings (pre-tax) .....	0	45,000	50,100	63,900	79,100

**Reduced CO<sub>2</sub> Emissions at Each Assumed SCC Value <sup>a b</sup>**

5% (avg SCC) .....	0	1,100	1,200	1,600	1,900
3% (avg SCC) .....	0	5,100	5,700	7,200	9,000
2.5% (avg SCC) .....	0	8,400	9,400	12,000	15,000
3% (95th percentile) .....	0	16,000	17,000	22,000	27,000
Energy Security Impacts (price shock) .....	0	2,400	2,700	3,400	4,200
Accidents, Congestion, Noise <sup>e</sup> .....	0	-1,300	-1,500	-1,600	-1,600
Refueling Savings .....	0	300	400	500	600
Non-CO <sub>2</sub> GHG Impacts and Non-GHG Impacts <sup>c</sup> .....	N/A	N/A	N/A	N/A	N/A

**Monetized Net Benefits at Each Assumed SCC Value <sup>a b</sup>**

5% (avg SCC) .....	0	41,600	44,800	47,100+c	47,000+c
3% (avg SCC) .....	0	45,600	49,300	52,700+c	54,100+c
2.5% (avg SCC) .....	0	48,900	53,000	57,500+c	60,100+c
3% (95th percentile) .....	0	56,500	60,600	67,500+c	72,100+c

**Notes:**

<sup>a</sup> Net present value of reduced CO<sub>2</sub> emissions is calculated differently than other benefits. The same discount rate used to discount the value of damages from future emissions (SCC at 5, 3, and 2.5 percent) is used to calculate net present value of SCC for internal consistency. Refer to the SCC TSD for more detail.

<sup>b</sup> Section VIII.G notes that SCC increases over time. Corresponding to the years in this table, the SCC estimates range as follows: for Average SCC at 5%: 5–\$16; for Average SCC at 3%: \$22–\$46; for Average SCC at 2.5%: \$36–\$66; and for 95th percentile SCC at 3%: \$66–\$139. Section VIII.G also presents these SCC estimates.

<sup>c</sup> The monetized GHG benefits presented in this analysis exclude the value of changes in non-CO<sub>2</sub> GHG emissions expected under this rule-making (See RIA Chapter 5). Although EPA has not monetized changes in non-CO<sub>2</sub> GHGs, the value of any increases or reductions should not be interpreted as zero.

<sup>d</sup> “+c” indicates additional costs not estimated in this rulemaking.

<sup>e</sup> Negative sign represents an increase in Accidents, Congestion, and Noise.

TABLE IX-5—MONETIZED NET BENEFITS ASSOCIATED WITH EACH ALTERNATIVE RELATIVE TO ALTERNATIVE 1 FOR LIFETIME OF 2014 THROUGH 2018 MODEL YEAR VEHICLES  
[7% Discount rate, millions, 2009\$]

	Alt. 1 baseline	Alt. 2 less stringent	Alt. 3 preferred	Alt. 4 more stringent	Alt. 5 max technology
Truck Program Costs <sup>d</sup> .....	\$0	\$5,900	\$8,100	\$20,700+c	\$37,200+c
Fuel Savings (pre-tax) .....	0	30,900	34,400	43,800	53,900
<b>Reduced CO<sub>2</sub> Emissions at Each Assumed SCC Value<sup>a b</sup></b>					
5% (avg SCC) .....	0	1,100	1,200	1,600	1,900
3% (avg SCC) .....	0	5,100	5,700	7,200	9,000
2.5% (avg SCC) .....	0	8,400	9,400	12,000	15,000
3% (95th percentile) .....	0	16,000	17,000	22,000	27,000
Energy Security Impacts (price shock) .....	0	1,600	1,800	2,300	2,900
Accidents, Congestion, Noise <sup>e</sup> .....	0	-900	-1,000	-1,100	-1,100
Refueling Savings .....	0	200	200	300	400
Non-CO <sub>2</sub> GHG Impacts and Non-GHG Impacts <sup>c</sup> .....	N/A	N/A	N/A	N/A	N/A
<b>Monetized Net Benefits at Each Assumed SCC Value<sup>a b</sup></b>					
5% (avg SCC) .....	0	27,000	28,500	26,200+c	20,800+c
3% (avg SCC) .....	0	31,000	33,000	31,800+c	27,900+c
2.5% (avg SCC) .....	0	34,300	36,700	36,600+c	33,900+c
3% (95th percentile) .....	0	41,900	44,300	46,600+c	45,900+c

**Notes:**

<sup>a</sup> Net present value of reduced CO<sub>2</sub> emissions is calculated differently than other benefits. The same discount rate used to discount the value of damages from future emissions (SCC at 5, 3, and 2.5 percent) is used to calculate net present value of SCC for internal consistency. Refer to the SCC TSD for more detail.

<sup>b</sup> Section VIII.G notes that SCC increases over time. Corresponding to the years in this table, the SCC estimates range as follows: for Average SCC at 5%: \$5–\$16; for Average SCC at 3%: \$22–\$46; for Average SCC at 2.5%: \$36–\$66; and for 95th percentile SCC at 3%: \$66–\$139. Section VIII.G also presents these SCC estimates.

<sup>c</sup> The monetized GHG benefits presented in this analysis exclude the value of changes in non-CO<sub>2</sub> GHG emissions expected under this rulemaking (See RIA chapter 5). Although EPA has not monetized changes in non-CO<sub>2</sub> GHGs, the value of any increases or reductions should not be interpreted as zero.

<sup>d</sup> “+c” indicates additional costs not estimated in this rulemaking.

<sup>e</sup> Negative sign represents an increase in Accidents, Congestion, and Noise.

The agencies also project the monetized net benefits associated with each alternative by vehicle class for the 2014 through 2018 MY vehicles over their lifetimes as shown in Table IX-6

through Table IX-8 at a three percent discount rate for HD pickup trucks & vans, vocational vehicles and combination tractors, respectively, and in Table IX-9 through Table IX-11 at a

seven percent discount rate for HD pickup trucks and vans, vocational vehicles and combination tractors, respectively.

TABLE IX-6—MONETIZED NET BENEFITS ASSOCIATED WITH EACH ALTERNATIVE RELATIVE TO ALTERNATIVE 1 FOR LIFETIME OF 2014 THROUGH 2018 MODEL YEAR HD PICKUP TRUCKS & VANS  
[3% Discount rate, millions, 2009\$]

	Alt. 1 baseline	Alt. 2 less stringent	Alt. 3 preferred	Alt. 4 more stringent	Alt. 5 max technology
Truck Program Costs <sup>d</sup> .....	\$0	\$1,780	\$1,970	\$3,220+c	\$9,890+c
Fuel Savings (pre-tax) .....	0	3,480	4,060	4,910	7,700
Energy Security Impacts (price shock) .....	0	190	220	270	420
Accidents, Congestion, Noise <sup>e</sup> .....	0	-330	-350	-370	-350
Refueling Savings .....	0	40	50	60	90
Non-CO <sub>2</sub> GHG Impacts and Non-GHG Impacts <sup>c</sup> .....	N/A	N/A	N/A	N/A	N/A
<b>Reduced CO<sub>2</sub> Emissions at Each Assumed SCC Value<sup>a b</sup></b>					
5% (avg SCC) .....	0	100	100	100	200
3% (avg SCC) .....	0	500	500	600	900
2.5% (avg SCC) .....	0	800	900	1,100	1,500
3% (95th percentile) .....	0	1,400	1,600	1,900	2,800
<b>Monetized Net Benefits at Each Assumed SCC Value<sup>a b</sup></b>					
5% (avg SCC) .....	0	1,700	2,110	1,750+c	-1,830+c
3% (avg SCC) .....	0	2,100	2,510	2,250+c	-1,130+c
2.5% (avg SCC) .....	0	2,400	2,910	2,750+c	-530+c

TABLE IX-6—MONETIZED NET BENEFITS ASSOCIATED WITH EACH ALTERNATIVE RELATIVE TO ALTERNATIVE 1 FOR LIFETIME OF 2014 THROUGH 2018 MODEL YEAR HD PICKUP TRUCKS & VANS—Continued  
[3% Discount rate, millions, 2009\$]

	Alt. 1 baseline	Alt. 2 less stringent	Alt. 3 preferred	Alt. 4 more stringent	Alt. 5 max technology
3% (95th percentile) .....	0	3,000	3,610	3,550+c	770+c

**Notes:**

<sup>a</sup> Net present value of reduced CO<sub>2</sub> emissions is calculated differently than other benefits. The same discount rate used to discount the value of damages from future emissions (SCC at 5, 3, and 2.5 percent) is used to calculate net present value of SCC for internal consistency. Refer to the SCC TSD for more detail.

<sup>b</sup> Section VIII.G notes that SCC increases over time. Corresponding to the years in this table, the SCC estimates range as follows: for Average SCC at 5%: \$5–\$16; for Average SCC at 3%: \$22–\$46; for Average SCC at 2.5%: \$36–\$66; and for 95th percentile SCC at 3%: \$66–\$139. Section VIII.G also presents these SCC estimates.

<sup>c</sup> Due to analytical and resource limitations, MY non-GHG emissions (direct PM, VOCs, NO<sub>2</sub> and SO<sub>2</sub>) were not estimated for this analysis. Although EPA has not monetized changes in non-CO<sub>2</sub> GHGs, the value of any increases or reductions should not be interpreted as zero.

<sup>d</sup> “+c” indicates additional costs not estimated in this rulemaking.

<sup>e</sup> Negative sign represents an increase in Accidents, Congestion, and Noise.

TABLE IX-7 MONETIZED NET BENEFITS ASSOCIATED WITH EACH ALTERNATIVE RELATIVE TO ALTERNATIVE 1 FOR LIFETIME OF 2014 THROUGH 2018 MODEL YEAR VOCATIONAL VEHICLES  
[3% Discount rate, millions, 2009\$]

	Alt. 1 baseline	Alt. 2 less stringent	Alt. 3 preferred	Alt. 4 more stringent	Alt. 5 max technology
Truck Program Costs <sup>d</sup> .....	\$0	\$670	\$1,140	\$9,140+c	\$15,840+c
Fuel Savings (pre-tax) .....	0	3,420	5,420	8,930	14,270
Energy Security Impacts (price shock) .....	0	180	290	480	760
Accidents, Congestion, Noise <sup>e</sup> .....	0	-540	-650	-670	-500
Refueling Savings .....	0	40	60	110	170
Non-CO <sub>2</sub> GHG Impacts and Non-GHG Impacts <sup>c</sup> .....	N/A	N/A	N/A	N/A	N/A

**Reduced CO<sub>2</sub> Emissions at Each Assumed SCC Value <sup>a b</sup>**

5% (avg SCC) .....	0	100	100	200	300
3% (avg SCC) .....	0	400	600	1,000	1,500
2.5% (avg SCC) .....	0	700	1,100	1,700	2,600
3% (95th percentile) .....	0	1,300	1,900	3,100	4,700

**Monetized Net Benefits at Each Assumed SCC Value <sup>a b</sup>**

5% (avg SCC) .....	0	2,530	4,080	-90+c	-840+c
3% (avg SCC) .....	0	2,830	4,580	710+c	360+c
2.5% (avg SCC) .....	0	3,130	5,080	1,410+c	1,460+c
3% (95th percentile) .....	0	3,730	5,880	2,810+c	3,560+c

**Notes:**

<sup>a</sup> Net present value of reduced CO<sub>2</sub> emissions is calculated differently than other benefits. The same discount rate used to discount the value of damages from future emissions (SCC at 5, 3, and 2.5 percent) is used to calculate net present value of SCC for internal consistency. Refer to the SCC TSD for more detail.

<sup>b</sup> Section VIII.G notes that SCC increases over time. Corresponding to the years in this table, the SCC estimates range as follows: for Average SCC at 5%: \$5–\$16; for Average SCC at 3%: \$22–\$46; for Average SCC at 2.5%: \$36–\$66; and for 95th percentile SCC at 3%: \$66–\$139. Section VIII.G also presents these SCC estimates.

<sup>c</sup> Due to analytical and resource limitations, MY non-GHG emissions (direct PM, VOCs, NO<sub>2</sub> and SO<sub>2</sub>) were not estimated for this analysis. Although EPA has not monetized changes in non-CO<sub>2</sub> GHGs, the value of any increases or reductions should not be interpreted as zero.

<sup>d</sup> “+c” indicates additional costs not estimated in this rulemaking.

<sup>e</sup> Negative sign represents an increase in Accidents, Congestion, and Noise.

TABLE IX-8—MONETIZED NET BENEFITS ASSOCIATED WITH EACH ALTERNATIVE RELATIVE TO ALTERNATIVE 1 FOR LIFETIME OF 2014 THROUGH 2018 MODEL YEAR COMBINATION TRACTORS  
[3% Discount rate, millions, 2009\$]

	Alt. 1 baseline	Alt. 2 less stringent	Alt. 3 preferred	Alt. 4 more stringent	Alt. 5 max technology
Truck Program Costs <sup>d</sup> .....	\$0	\$3,300	\$4,950	\$8,430+c	\$11,540+c
Fuel Savings (pre-tax) .....	0	38,140	40,650	50,030	57,190
Energy Security Impacts (price shock) .....	0	2,030	2,160	2,660	3,040
Accidents, Congestion, Noise <sup>e</sup> .....	0	-450	-480	-590	-770
Refueling Savings .....	0	230	250	300	350
Non-CO <sub>2</sub> GHG Impacts and Non-GHG Impacts <sup>c</sup> .....	N/A	N/A	N/A	N/A	N/A

TABLE IX-8—MONETIZED NET BENEFITS ASSOCIATED WITH EACH ALTERNATIVE RELATIVE TO ALTERNATIVE 1 FOR LIFETIME OF 2014 THROUGH 2018 MODEL YEAR COMBINATION TRACTORS—Continued  
[3% Discount rate, millions, 2009\$]

	Alt. 1 baseline	Alt. 2 less stringent	Alt. 3 preferred	Alt. 4 more stringent	Alt. 5 max technology
<b>Reduced CO<sub>2</sub> Emissions at Each Assumed SCC Value<sup>a b</sup></b>					
5% (avg SCC) .....	0	900	1,000	1,200	1,400
3% (avg SCC) .....	0	4,200	4,500	5,600	6,500
2.5% (avg SCC) .....	0	7,000	7,500	9,300	11,000
3% (95th percentile) .....	0	13,000	14,000	17,000	20,000
<b>Monetized Net Benefits at Each Assumed SCC Value<sup>a b</sup></b>					
5% (avg SCC) .....	0	37,550	38,630	45,170+c	49,670+c
3% (avg SCC) .....	0	40,850	42,130	49,570+c	54,770+c
2.5% (avg SCC) .....	0	43,650	45,130	53,270+c	59,270+c
3% (95th percentile) .....	0	49,650	51,630	60,970+c	68,270+c

**Notes:**

<sup>a</sup> Net present value of reduced CO<sub>2</sub> emissions is calculated differently than other benefits. The same discount rate used to discount the value of damages from future emissions (SCC at 5, 3, and 2.5 percent) is used to calculate net present value of SCC for internal consistency. Refer to the SCC TSD for more detail.

<sup>b</sup> Section VIII.G notes that SCC increases over time. Corresponding to the years in this table, the SCC estimates range as follows: for Average SCC at 5%: \$5–\$16; for Average SCC at 3%: \$22–\$46; for Average SCC at 2.5%: \$36–\$66; and for 95th percentile SCC at 3%: \$66–\$139. Section VIII.G also presents these SCC estimates.

<sup>c</sup> Due to analytical and resource limitations, MY non-GHG emissions (direct PM, VOCs, NO<sub>2</sub> and SO<sub>2</sub>) were not estimated for this analysis. Although EPA has not monetized changes in non-CO<sub>2</sub> GHGs, the value of any increases or reductions should not be interpreted as zero.

<sup>d</sup> “+c” indicates additional costs not estimated in this rulemaking.

<sup>e</sup> Negative sign represents an increase in Accidents, Congestion, and Noise.

TABLE IX-9: MONETIZED NET BENEFITS ASSOCIATED WITH EACH ALTERNATIVE RELATIVE TO ALTERNATIVE 1 FOR LIFETIME OF 2014 THROUGH 2018 MODEL YEAR HD PICKUP TRUCKS & VANS  
[7% Discount rate, millions, 2009\$]

	Alt. 1 baseline	Alt. 2 less stringent	Alt. 3 preferred	Alt. 4 more stringent	Alt. 5 max technology
Truck Program Costs <sup>d</sup> .....	\$0	\$1,780	\$1,970	\$3,220+c	\$9,890+c
Fuel Savings (pre-tax) .....	0	2,180	2,550	3,090	4,830
Energy Security Impacts (price shock) .....	0	120	140	170	260
Accidents, Congestion, Noise <sup>e</sup> .....	0	-220	-230	-250	-230
Refueling Savings .....	0	30	30	40	60
Non-CO <sub>2</sub> GHG Impacts and Non-GHG Impacts <sup>c</sup> .....	N/A	N/A	N/A	N/A	N/A
<b>Reduced CO<sub>2</sub> Emissions at Each Assumed SCC Value<sup>a b</sup></b>					
5% (avg SCC) .....	0	100	100	100	200
3% (avg SCC) .....	0	500	500	600	900
2.5% (avg SCC) .....	0	800	900	1,100	1,500
3% (95th percentile) .....	0	1,400	1,600	1,900	2,800
<b>Monetized Net Benefits at Each Assumed SCC Value<sup>a b</sup></b>					
5% (avg SCC) .....	0	430	620	-70+c	-4,770+c
3% (avg SCC) .....	0	830	1,020	430+c	-4,070+c
2.5% (avg SCC) .....	0	1,130	1,420	930+c	-3,470+c
3% (95th percentile) .....	0	1,730	2,120	1,730+c	-2,170+c

**Notes:**

<sup>a</sup> Net present value of reduced CO<sub>2</sub> emissions is calculated differently than other benefits. The same discount rate used to discount the value of damages from future emissions (SCC at 5, 3, and 2.5 percent) is used to calculate net present value of SCC for internal consistency. Refer to the SCC TSD for more detail.

<sup>b</sup> Section VIII.G notes that SCC increases over time. Corresponding to the years in this table, the SCC estimates range as follows: for Average SCC at 5%: \$5–\$16; for Average SCC at 3%: \$22–\$46; for Average SCC at 2.5%: \$36–\$66; and for 95th percentile SCC at 3%: \$66–\$139. Section VIII.G also presents these SCC estimates.

<sup>c</sup> Due to analytical and resource limitations, MY non-GHG emissions (direct PM, VOCs, NO<sub>2</sub> and SO<sub>2</sub>) were not estimated for this analysis. Although EPA has not monetized changes in non-CO<sub>2</sub> GHGs, the value of any increases or reductions should not be interpreted as zero.

<sup>d</sup> “+c” indicates additional costs not estimated in this rulemaking.

<sup>e</sup> Negative sign represents an increase in Accidents, Congestion, and Noise.

TABLE 1X-10—MONETIZED NET BENEFITS ASSOCIATED WITH EACH ALTERNATIVE RELATIVE TO ALTERNATIVE 1 FOR LIFETIME OF 2014 THROUGH 2018 MODEL YEAR VOCATIONAL VEHICLES  
[7% Discount rate, millions, 2009\$]

	Alt. 1 baseline	Alt. 2 less stringent	Alt. 3 preferred	Alt. 4 more stringent	Alt. 5 max technology
Truck Program Costs <sup>d</sup> .....	\$0	\$670	\$1,140	\$9,140+c	\$15,840+c
Fuel Savings (pre-tax) .....	0	2,280	3,630	5,970	9,410
Energy Security Impacts (price shock) .....	0	120	190	320	500
Accidents, Congestion, Noise <sup>e</sup> .....	0	-380	-450	-460	-350
Refueling Savings .....	0	30	40	70	110
Non-CO <sub>2</sub> GHG Impacts and Non-GHG Impacts <sup>c</sup> .....	N/A	N/A	N/A	N/A	N/A
<b>Reduced CO<sub>2</sub> Emissions at Each Assumed SCC Value<sup>a b</sup></b>					
5% (avg SCC) .....	0	100	100	200	300
3% (avg SCC) .....	0	400	600	1,000	1,500
2.5% (avg SCC) .....	0	700	1,100	1,700	2,600
3% (95th percentile) .....	0	1,300	1,900	3,100	4,700
<b>Monetized Net Benefits at Each Assumed SCC Value<sup>a b</sup></b>					
5% (avg SCC) .....	0	1,480	2,370	-3,040+c	-5,870+c
3% (avg SCC) .....	0	1,780	2,870	-2,240+c	-4,670+c
2.5% (avg SCC) .....	0	2,080	3,370	-1,540+c	-3,570+c
3% (95th percentile) .....	0	2,680	4,170	-140+c	-1,470+c

**Notes:**

<sup>a</sup>Net present value of reduced CO<sub>2</sub> emissions is calculated differently than other benefits. The same discount rate used to discount the value of damages from future emissions (SCC at 5, 3, and 2.5 percent) is used to calculate net present value of SCC for internal consistency. Refer to the SCC TSD for more detail.

<sup>b</sup>Section VIII.G notes that SCC increases over time. Corresponding to the years in this table, the SCC estimates range as follows: for Average SCC at 5%: \$5-\$16; for Average SCC at 3%: \$22-\$46; for Average SCC at 2.5%: \$36-\$66; and for 95th percentile SCC at 3%: \$66-\$139. Section VIII.G also presents these SCC estimates.

<sup>c</sup>Due to analytical and resource limitations, MY non-GHG emissions (direct PM, VOCs, NO<sub>2</sub> and SO<sub>2</sub>) were not estimated for this analysis. Although EPA has not monetized changes in non-CO<sub>2</sub> GHGs, the value of any increases or reductions should not be interpreted as zero.

<sup>d</sup>“+c” indicates additional costs not estimated in this rulemaking.

<sup>e</sup>Negative sign represents an increase in Accidents, Congestion, and Noise.

TABLE 1X-11 MONETIZED NET BENEFITS ASSOCIATED WITH EACH ALTERNATIVE RELATIVE TO ALTERNATIVE 1 FOR LIFETIME OF 2014 THROUGH 2018 MODEL YEAR COMBINATION TRACTORS  
[7% Discount rate, millions, 2009\$]

	Alt. 1 baseline	Alt. 2 less stringent	Alt. 3 preferred	Alt. 4 more stringent	Alt. 5 max technology
Truck Program Costs <sup>d</sup> .....	0	3,300	4,950	8,430+c	11,540+c
Fuel Savings (pre-tax) .....	0	26,420	28,170	34,710	39,680
Energy Security Impacts (price shock) .....	0	1,410	1,500	1,850	2,110
Accidents, Congestion, Noise <sup>e</sup> .....	0	-320	-340	-420	-550
Refueling Savings .....	0	160	170	210	240
Non-CO <sub>2</sub> GHG Impacts and Non-GHG Impacts <sup>c</sup> .....	N/A	N/A	N/A	N/A	N/A
<b>Reduced CO<sub>2</sub> Emissions at Each Assumed SCC Value<sup>a b</sup></b>					
5% (avg SCC) .....	0	900	1,000	1,200	1,400
3% (avg SCC) .....	0	4,200	4,500	5,600	6,500
2.5% (avg SCC) .....	0	7,000	7,500	9,300	11,000
3% (95th percentile) .....	0	13,000	14,000	17,000	20,000
<b>Monetized Net Benefits at Each Assumed SCC Value<sup>a b</sup></b>					
5% (avg SCC) .....	0	25,270	25,550	29,120+c	31,340+c
3% (avg SCC) .....	0	28,570	29,050	33,520+c	36,440+c
2.5% (avg SCC) .....	0	31,370	32,050	37,220+c	40,940+c
3% (95th percentile) .....	0	37,370	38,550	44,920+c	49,940+c

**Notes:**

<sup>a</sup>Net present value of reduced CO<sub>2</sub> emissions is calculated differently than other benefits. The same discount rate used to discount the value of damages from future emissions (SCC at 5, 3, and 2.5 percent) is used to calculate net present value of SCC for internal consistency. Refer to the SCC TSD for more detail.

<sup>b</sup>Section VIII.G notes that SCC increases over time. Corresponding to the years in this table, the SCC estimates range as follows: for Average SCC at 5%: \$5-\$16; for Average SCC at 3%: \$22-\$46; for Average SCC at 2.5%: \$36-\$66; and for 95th percentile SCC at 3%: \$66-\$139. Section VIII.G also presents these SCC estimates.

<sup>c</sup>Due to analytical and resource limitations, MY non-GHG emissions (direct PM, VOCs, NO<sub>2</sub> and SO<sub>2</sub>) were not estimated for this analysis. Although EPA has not monetized changes in non-CO<sub>2</sub> GHGs, the value of any increases or reductions should not be interpreted as zero.

<sup>d</sup>“+c” indicates additional costs not estimated in this rulemaking.

<sup>e</sup>Negative sign represents an increase in Accidents, Congestion, and Noise.

### C. What is the agencies' decision regarding trailer standards?

A central theme throughout our HD Program is the recognition of the diversity and complexity of the heavy-duty vehicle segment. Trailers are an important part of this segment and are no less diverse in the range of functions and applications they serve. They are the primary vehicle for moving freight in the United States. The type of freight varies from retail products to be sold in stores, to bulk goods such as stones, to industrial liquids such as chemicals, to equipment such as bulldozers. Semi-trailers come in a large variety of styles—box, refrigerated box, flatbed, tankers, bulk, dump, grain, and many others. The most common type of trailer is the box trailer, but even box trailers come in many different lengths ranging from 28 feet to 53 feet or greater, and in different widths, heights, depths, materials (wood, composites, and/or aluminum), construction (curtain side or hard side), axle configuration (sliding tandem or fixed tandem), and multiple other distinct features. NHTSA and EPA believe trailers impact the fuel consumption and CO<sub>2</sub> emissions from combination tractors and the agencies see opportunities for reductions. Unlike our experience with trucks and engines, the agencies have very limited experience related to regulating trailers for fuel efficiency or emissions. Likewise, the trailer manufacturing industry has only the most limited experience complying with regulations related to emissions and none with regard to EPA or NHTSA certification and compliance procedures.

The agencies broadly solicited comments on controlling fuel efficiency and GHG emissions through eventual trailer regulations as we described in the notice of proposed rulemaking which could set the foundation of a future rulemaking for trailers. 75 FR at 74345–351 (although this was a solicitation for comment regarding future action outside the present rulemaking).

The general theme of the comments received was that technologies exist today that can improve trailer efficiency. We received several comments from stakeholders which encouraged the agencies to set fuel efficiency and GHG emissions standards for trailers in this rulemaking. The agencies also received comments supporting a delay in trailer regulations. Specifically, IPI commented that the agencies should regulate trailers at least to some degree, arguing that the agencies' reasoning for not doing so was

insufficient and requesting a plan and schedule in the final rule for the future regulation of trailers. One commenter recognized that there are well over 100 trailer manufacturers in the U.S., with almost all being small businesses. They stressed the need for the agencies to reach out to the trailer industry and associations prior to developing a regulatory program for this industry. In addition, they stated that time is needed to develop sufficient research into the area. None of the commenters that supported trailer regulation in this action addressed the complexities of the trailer industry, nor a method to measure trailer aerodynamic improvements.

In the NPRM, the agencies discussed relatively conceptual approaches to how a future trailer regulation could be developed; however, we did not provide a proposed test procedure or proposed standard. The agencies proposed to delay the regulation of trailers, as the inclusion would not be feasible at this time due to the lack of a test procedure and the myriad of technical and policy issues not teed up in the NPRM or addressed in comments. Additionally, since a number of trailer manufacturing entities are small businesses, EPA and NHTSA need to allow sufficient time to convene a SBREFA panel to conduct the proper outreach to the potentially impacted stakeholders. As noted earlier, the agencies do not believe it warranted to delay the combination tractor and vocational vehicle standards for the years it will take to resolve these issues. NHTSA and EPA agree that the regulation of trailers, when appropriate, is likely to provide fuel efficiency benefits. We continue to believe that both agencies must perform a more comprehensive assessment of the trailer industry, and therefore that their inclusion at this time is not feasible. Until that time, the SmartWay Transport Partnership Program will continue to encourage the development and use of technologies to reduce fuel consumption and CO<sub>2</sub> emissions from trailers.

### X. Public Participation

The agencies proposed their respective rules on November 30, 2010 (75 FR 74152). Two public hearings were held to provide interested parties the opportunity to present data, views, or arguments concerning the proposal; the first hearing was held in Chicago, IL on November 15, 2010, and the second in Cambridge, MA on November 18, 2010. The public was invited to submit

written comments on the proposal during the formal comment period, which ended on January 31, 2011. The agencies received over 41,000 comments—over 3,000 of them unique—from industry, environmental organizations, states, and individuals.

The vast majority of commenters supported the central tenets of the proposed HD National Program. That is, there was broad support for a national program which would reduce fuel consumption and GHG emissions from the three heavy-duty regulatory categories—heavy-duty pickup trucks and vans, vocational vehicles, and combination tractors. The agencies received specific comments on many aspects of the proposal.

Throughout this notice, the agencies discuss many of the key issues arising from the public comments and the agencies' responses. In addition, the agencies have addressed all of the public comments in the Response to Comments document associated with this final action and located in the docket (Docket ID EPA–HQ–OAR–2010–0162, or NHTSA–2010–0079).

### XI. NHTSA's Record of Decision

On May 21, 2010, President Obama issued a memorandum entitled “Improving Energy Security, American Competitiveness and Job Creation, and Environmental Protection through a Transformation of our Nation's Fleet of Cars and Trucks” to the Secretary of Transportation, the Administrator of NHTSA, the Administrator of EPA, and the Secretary of Energy.<sup>574</sup> The memorandum requested that the Administrators of EPA and NHTSA begin work on a Joint Rulemaking under EISA and the Clean Air Act and establish fuel efficiency and GHG emission standards for commercial medium- and heavy-duty vehicles beginning with MY 2014. The President requested that NHTSA implement fuel efficiency standards and EPA implement GHG emission standards that take into account the market structure of the trucking industry and the unique demands of heavy-duty vehicle applications; seek harmonization with applicable State standards; consider the findings and recommendations published in the National Academy of

<sup>574</sup>The White House, Office of the Press Secretary, *Presidential Memorandum Regarding Fuel Efficiency Standards* (May 21, 2010); The White House, Office of the Press Secretary, *President Obama Directs Administration to Create First-Ever National Efficiency and Emissions Standards for Medium- and Heavy-Duty Trucks* (May 21, 2010).

Sciences (NAS) report on medium- and heavy-duty truck regulation; strengthen the industry and enhance job creation in the United States; and seek input from all stakeholders, while recognizing the continued leadership role of California and other States.

In accordance with this policy, this Final Rule promulgates fuel efficiency standards for HD vehicles built in MYs 2014–2018. This Final Rule constitutes the Record of Decision (ROD) for NHTSA's HD vehicle Fuel Efficiency Improvement Program, pursuant to the National Environmental Policy Act (NEPA) and the Council on Environmental Quality's (CEQ) implementing regulations.<sup>575</sup> See 40 CFR 1505.2.

As required by CEQ regulations, this Final Rule and ROD sets forth the following: (1) the agency's decision; (2) alternatives considered by NHTSA in reaching its decision, including the environmentally preferable alternative; (3) the factors balanced by NHTSA in making its decision, including considerations of national policy; (4) how these factors and considerations entered into its decision; and (5) the agency's preferences among alternatives based on relevant factors, including economic and technical considerations and agency statutory missions. This Final Rule also briefly addresses mitigation.

#### A. The Agency's Decision

In the Draft Environmental Impact Statement (DEIS) and the Final Environmental Impact Statement (FEIS), the agency identified a Preferred Alternative which would set overall fuel consumption standards for HD vehicles and engines. The Preferred Alternative, identified as Alternative 3 in the FEIS, would include standards for engines used in Classes 2b–8 vocational vehicles (except engines in HD pickups and vans, which are regulated as complete vehicles), fuel consumption standards for HD pickups and vans by work factor, overall vehicle fuel consumption standards for Classes 2b–8 vocational vehicles (in gal/1,000 ton-miles), and overall fuel consumption standards for Classes 7 and 8 tractors.

The Preferred Alternative identified in the NPRM, DEIS, and FEIS assumed that the vocational vehicle standards would lead to a 10 percent reduction in the tire rolling resistance levels of the tires installed in vocational vehicles. After carefully reviewing and analyzing all of the information in the public

record including technical support documents, the FEIS, and public and agency comments submitted on the DEIS, the FEIS, and the NPRM, NHTSA has decided to finalize a standard that includes slightly more stringent requirements for vocational vehicles than those included in the Preferred Alternative analyzed in the FEIS. Subsequent to issuing the proposed rule, NHTSA and EPA conducted a tire testing program to evaluate the tire rolling resistance of 156 different tires across a wide range of truck applications. The results of the study indicate that the baseline tire rolling resistance of this segment of vehicles was better than the level assumed during the proposal. In the final action, therefore, the agencies made the vocational truck standards slightly more stringent than those included as part of the Preferred Alternative for the FEIS, reflecting the better overall performance of tires in this segment. In addition, the agencies have reduced the projected improvement in average tire performance from 10 percent to 5 percent, reflecting the better than expected baseline performance. NHTSA's analysis indicates that the Agency's Decision will result in slightly less fuel savings and CO<sub>2</sub> emissions reductions than those noted in the EIS.<sup>576</sup> For environmental impacts associated with the final rule, see Sections VI.C and VII of this Final Rule.<sup>577</sup>

#### B. Alternatives Considered by NHTSA in Reaching Its Decision, Including the Environmentally Preferable Alternative

When preparing an EIS, NEPA requires an agency to compare the potential environmental impacts of its proposed action and a reasonable range of alternatives. In the FEIS, NHTSA identified alternatives that represent the spectrum of potential actions the agency could take. The environmental impacts of these alternatives, in turn, represent the spectrum of potential environmental impacts that could result from NHTSA's chosen action in setting fuel efficiency standards for HD vehicles.

<sup>576</sup> The agencies' analysis indicates that the change results in a decrease in total 2014–2050 fuel savings of about 1.05 percent compared to the Preferred Alternative modeled in the EIS and a corresponding increase in CO<sub>2</sub> emissions.

<sup>577</sup> The environmental impacts of this decision fall within the spectrum of impacts analyzed in the DEIS and the FEIS. There are no "substantial changes to the proposed action" and there are no "significant new circumstances or information relevant to environmental concerns and bearing on the proposed action or its impacts." Therefore, consistent with 40 CFR 1502.9(c), no supplement to the EIS is required.

The FEIS analyzed the impacts of four "action" alternatives, each of which would separately regulate segments of the HD vehicle fleet.<sup>578</sup> Three of the action alternatives (Alternatives 2, 3 and 4) would regulate the same vehicle categories, but at increasing levels of stringency, with Alternative 2 being the least stringent alternative and Alternative 4 being the most stringent. Alternatives 2 and 4 were constructed by starting with the Preferred Alternative (Alternative 3) and either removing the least cost effective technology in each of the vehicle categories or adding the next most cost effective technology in each of the vehicle categories.<sup>579</sup>

Alternative 5 built on the Preferred Alternative by adding a performance standard for the commercial trailers pulled by tractors and by specifying more stringent standards based on accelerated adoption of hybrid powertrains for HD vehicles. The DEIS and FEIS also analyzed the impacts that would be expected if NHTSA adopted no HD vehicle standards (the No Action Alternative). For a discussion of the environmental impacts associated with each of the alternatives, see Chapters 3 and 4 of the FEIS.

Along with the FEIS, the agency conducted a national-scale photochemical air quality modeling and health risk assessment for a subset of the DEIS alternatives to support and confirm the health effects and health-related economic estimates of the EIS. The photochemical air quality study is included as Appendix F to the FEIS. The study used air quality modeling and health benefits analysis tools to quantify the air quality and health-related benefits associated with the alternative HD standards.

NHTSA's environmental analysis indicates that Alternative 5 (Trailers and Accelerated Hybrid) is the overall Environmentally Preferable Alternative because it would result in the largest reductions in fuel use and GHG emissions among the alternatives

<sup>578</sup> In the DEIS, NHTSA analyzed several alternatives that applied only to specific components and/or segments of the HD vehicle fleet. Many commenters urged the agency to consider alternatives that applied to the entire HD vehicle fleet, reasoning that such an approach would be more consistent with EISA requirements. After careful consideration, NHTSA decided that those alternatives that would set standards for the whole fleet—that is, the engine as well as the entire vehicle for pickup trucks and vans, vocational vehicles, and tractors—best met the purpose and need for this action. It also allows for the achievement of the "maximum feasible improvement" in HD fuel efficiency. Therefore, the FEIS examined impacts associated with four of the action alternatives analyzed in the DEIS.

<sup>579</sup> See Section 2.3.2 of the FEIS.

<sup>575</sup> NEPA is codified at 42 U.S.C. 4321–47. CEQ NEPA implementing regulations are codified at 40 Code of Federal Regulations (CFR) Parts 1500–08.

considered. Under each action alternative the agency considered, the reduction in fuel consumption resulting from higher fuel efficiency causes emissions that occur during fuel refining and distribution to decline. For most pollutants, this decline is more than sufficient to offset the increase in tailpipe emissions that results from increased driving due to the fuel efficiency rebound effect, leading to a net reduction in total emissions from fuel production, distribution, and use. Because it leads to the largest reductions in fuel refining, distribution, and consumption among the alternatives considered, Alternative 5 would also lead to the lowest total emissions of CO<sub>2</sub> and other GHGs, as well as most criteria air pollutants and mobile source air toxics (MSATs).<sup>580</sup>

NHTSA's environmental analysis indicates that emissions of carbon monoxide (CO), acrolein, acetaldehyde, and formaldehyde are slightly (less than one percent) higher under Alternative 5 than under some other action alternatives and analysis years. This occurs when increased tailpipe emissions are forecast to exceed the reductions in emissions due to reduced fuel refining and distribution. Thus, while Alternative 5 is the environmentally preferable alternative on the basis of CO<sub>2</sub> and other GHGs, and on the basis of most criteria air pollutants and MSATs, other alternatives are environmentally preferable from the standpoint of some criteria air pollutants and MSATs in some years. Overall, NHTSA considers Alternative 5 to be the Environmentally Preferable Alternative.

For additional discussion regarding the alternatives considered by the agency in reaching its decision, including the Environmentally Preferable Alternative, see Section IX of this Final Rule. For a discussion of the environmental impacts associated with each alternative, see Chapters 3 and 4 of the FEIS.

### C. Factors Balanced by NHTSA in Making Its Decision

For discussion of the factors balanced by NHTSA in making its decision, see Sections III, VIII and IX of this Final Rule.

### D. How the Factors and Considerations Balanced by NHTSA Entered Into Its Decision

For discussion of how the factors and considerations balanced by the agency entered into NHTSA's Decision, see Sections III, VIII and IX of this Final Rule.

### E. The Agency's Preferences among Alternatives Based on Relevant Factors, Including Economic and Technical Considerations and Agency Statutory Missions

For discussion of the agency's preferences among alternatives based on relevant factors, including economic and technical considerations, see Section VIII and IX of this Final Rule.

### F. Mitigation

The CEQ regulations specify that a ROD must "state whether all practicable means to avoid or minimize environmental harm from the alternative selected have been adopted, and if not, why they were not." 49 CFR 1505.2(c). The majority of the environmental effects of NHTSA's action are positive, *i.e.*, beneficial environmental impacts, and would not raise issues of mitigation. Emissions of criteria and toxic air pollutants are generally projected to decrease under the final standards under all analysis years as compared to their levels under the No Action Alternative. Analysis of the environmental trends reported in the FEIS indicates that the only exceptions to this decline are emissions of PM<sub>2.5</sub>, DPM, and 1,3-butadiene in some analysis years. See Chapter 5 of the FEIS. The agency forecasts these emissions increases because, under all the alternatives analyzed in the EIS, increase in vehicle use due to improved fuel efficiency is projected to result in growth in total miles traveled by HD vehicles. The growth in travel outpaces emissions reductions for some pollutants, resulting in projected increases for these pollutants. In addition, NHTSA's NEPA analysis predicted increases in emissions of air toxic and criteria pollutants to occur under certain alternatives based on assumptions about the use of Auxiliary Power Units (APUs). For example, NHTSA's NEPA analysis assumes that some manufacturers will install anti-idling technologies (including APUs) on some vehicle classes to meet the

requirements of the rule and that drivers' subsequent use of those APUs will result in an increase in emissions of some criteria and toxic air pollutants.

NHTSA's authority to promulgate new fuel efficiency standards for HD vehicles is limited and does not allow regulation of vehicle emissions or of factors affecting vehicle emissions, including driving habits and APU usage. Consequently, under the HD Fuel Efficiency Improvement Program, NHTSA must set standards but is unable to take steps to mitigate the impacts of these standards. Chapter 5 of the FEIS outlines a number of other initiatives across government that could ameliorate the environmental impacts of motor vehicle use, including the use of HD vehicles.

## XII. Statutory and Executive Order Reviews

### (1) Executive Order 12866: Regulatory Planning and Review

Under section 3(f)(1) of Executive Order 12866 (58 FR 51735, October 4, 1993), this action is an "economically significant regulatory action" because it is likely to have an annual effect on the economy of \$100 million or more. Accordingly, the agencies submitted this action to the Office of Management and Budget (OMB) for review under Executive Order 12866 and any changes made in response to OMB recommendations have been documented in the docket for this action.

The agencies are also subject to Executive Order 13563 (76 FR 3821, January 21, 2011) and NHTSA is subject to the Department of Transportation's Regulatory Policies and Procedures. These final rules are also significant within the meaning of the DOT Regulatory Policies and Procedures. Executive Order 12866 additionally requires NHTSA to submit this action to OMB for review and document any changes made in response to OMB recommendations.

In addition, the agencies prepared an analysis of the potential costs, fuel savings, and benefits associated with this action. This analysis is contained in the Regulatory Impact Analysis, which is available in the docket for these rules and at the docket Internet address listed under **ADDRESSES** above and is briefly summarized in Table XII-1.

<sup>580</sup> Emissions of fine particulate matter (PM<sub>2.5</sub>) and diesel particulate matter (DPM) for Alternative 5 are forecast to be lower than under other action alternatives under all analysis years, but slightly

higher than under the No Action Alternative in analysis years 2030 and 2050. See FEIS Tables 3.5.2-1 and 3.5.2-5. This anomaly results from the agencies' assumptions regarding the percent of all

long-haul tractors that use an APU rather than the truck's engine as a power source during extended idling (discussed further in FEIS Section 3.2.4.1).



TABLE XII-1—ESTIMATED LIFETIME DISCOUNTED COSTS, BENEFITS, AND NET BENEFITS FOR 2014–2018 MODEL YEAR HD VEHICLES<sup>a, b</sup>  
[Billion 2009\$]

Lifetime Present Value <sup>c</sup> —3% Discount Rate	
Program Costs .....	\$8.1
Fuel Savings .....	50
Benefits .....	7.3
Net Benefits <sup>d</sup> .....	49
Annualized Value <sup>e</sup> —3% Discount Rate	
Annualized Costs .....	0.4
Fuel Savings .....	2.2
Annualized Benefits .....	0.4
Net Benefits <sup>d</sup> .....	2.2
Lifetime Present Value <sup>c</sup> —7% Discount Rate	
Program Costs .....	8.1
Fuel Savings .....	34
Benefits .....	6.7
Net Benefits <sup>d</sup> .....	\$33
Annualized Value <sup>e</sup> —7% Discount Rate	
Annualized Costs .....	0.6
Fuel Savings .....	2.6
Annualized Benefits .....	0.5
Net Benefits <sup>d</sup> .....	2.5

**Notes:**

<sup>a</sup> The agencies estimated the benefits associated with four different values of a one ton CO<sub>2</sub> reduction (model average at 2.5% discount rate, 3%, and 5%; 95th percentile at 3%), which each increase over time. For the purposes of this overview presentation of estimated costs and benefits, however, we are showing the benefits associated with the marginal value deemed to be central by the interagency working group on this topic: the model average at 3% discount rate, in 2009 dollars. Section VIII.F provides a complete list of values for the 4 estimates.

<sup>b</sup> Note that net present value of reduced GHG emissions is calculated differently than other benefits. The same discount rate used to discount the value of damages from future emissions (SCC at 5, 3, and 2.5 percent) is used to calculate net present value of SCC for internal consistency. Refer to Section VIII.F for more detail.

<sup>c</sup> Present value is the total, aggregated amount that a series of monetized costs or benefits that occur over time is worth now (in year 2009 dollar terms), discounting future values to the present.

<sup>d</sup> Net benefits reflect the fuel savings plus benefits minus costs.

<sup>e</sup> The annualized value is the constant annual value through a given time period (2012 through 2050 in this analysis) whose summed present value equals the present value from which it was derived.

(2) National Environmental Policy Act

Under NEPA, a Federal agency must prepare an Environmental Impact Statement (EIS) on proposed actions that could significantly impact the quality of the human environment. The requirement is designed to serve three major functions: (1) To provide the decisionmaker(s) with a detailed description of the potential environmental impacts of a proposed action prior to its adoption, (2) to rigorously explore and evaluate all reasonable alternatives, and (3) to inform the public of, and allow comment on, such efforts.

In addition, the CEQ regulations emphasize agency cooperation early in the NEPA process and allow a lead agency (in this case, NHTSA) to request the assistance of other agencies that either have jurisdiction by law or have special expertise regarding issues considered in an EIS.<sup>581</sup> At NHTSA's request, both EPA and the Federal

Motor Carrier Safety Administration (FMCSA) agreed to act as cooperating agencies in the preparation of the EIS. EPA has special expertise in climate change and air quality, and FMCSA has special expertise regarding HD vehicles.

NHTSA, in cooperation with EPA and FMCSA, prepared a DEIS, solicited public comments in writing and in public hearings, and prepared an FEIS responding to those comments. Specifically, in June 2010, NHTSA published a Notice of Intent to prepare an EIS for proposed HD fuel efficiency standards.<sup>582</sup> See 40 CFR 1501.7. On October 29, 2010, EPA issued its Notice of Availability of the DEIS,<sup>583</sup> triggering a public comment period. See 40 CFR 1506.10. The public was invited to

submit written comments on the DEIS until January 3, 2011. NHTSA mailed (both electronically and through regular U.S. mail) copies of the DEIS to interested parties, including federal, state, and local officials and agencies; elected officials; environmental and public interest groups; Native American tribes; and other interested individuals. NHTSA and EPA held two hearings on the proposed rules and the EIS, the first on November 15, 2010 in Chicago, Illinois, and the second on November 18, 2010 in Cambridge, Massachusetts.

NHTSA received 3,048 written comments to the DEIS and the NPRM. The transcript from the public hearing and written comments submitted to NHTSA are part of the administrative record and are available on the Federal Docket, which can be found online at <http://www.regulations.gov>, Reference Docket No. NHTSA-2010-0079. NHTSA reviewed and analyzed all comments received during the public comment period and revised the FEIS in response

<sup>581</sup> 40 CFR 1501.6.

<sup>582</sup> See Notice of Intent to Prepare an Environmental Impact Statement for New Medium- and Heavy-Duty Fuel Efficiency Improvement Program, 75 FR 33565 (June 14, 2010).

<sup>583</sup> Environmental Impact Statements; Notice of Availability, 75 FR 66756 (Oct. 29, 2010); NHTSA also published a separate Notice of Availability describing the program in greater detail, 75 FR 68312 (Nov. 5, 2010).

to comments on the EIS where appropriate.<sup>584</sup>

On June 20, 2011, NHTSA submitted the FEIS to EPA. NHTSA also mailed (both electronically and through regular U.S. mail) the FEIS to interested parties and posted the FEIS on its Web site, <http://www.nhtsa.gov/fuel-economy>. On June 24, 2011, EPA published a Notice of Availability of the FEIS in the **Federal Register**.<sup>585</sup>

The FEIS analyzes and discloses the potential environmental impacts of the proposed HD fuel efficiency standards pursuant to the National Environmental Policy Act (NEPA), the CEQ regulations implementing NEPA, DOT Order 5610.1C, and NHTSA regulations.<sup>586</sup> The FEIS compares the potential environmental impacts of alternative standards considered by NHTSA for the final rule. It also analyzes direct, indirect, and cumulative impacts and analyzes impacts in proportion to their significance. See the FEIS and the FEIS Summary for a discussion of the environmental impacts analyzed. Docket No. NHTSA–2011–0079.

The standards adopted in this Final Rule have been informed by analyses contained in the *Medium- and Heavy-Duty Fuel Efficiency Improvement Program, Final Environmental Impact Statement*, Docket No. NHTSA–2010–0079 (FEIS). For purposes of this rulemaking, the agency referred to an extensive compilation of technical and policy documents available in NHTSA's EIS/Rulemaking docket and EPA's docket. NHTSA's EIS and rulemaking docket and EPA's rulemaking docket can be found online at <http://www.regulations.gov>, Reference Docket Nos.: NHTSA–2010–0079 (EIS and Rulemaking) and EPA–HQ–OAR–2010–0162 (EPA Rulemaking).

Based on the foregoing, the agency concludes that the environmental analysis and public involvement process complies with NEPA implementing regulations issued by CEQ, DOT Order 5610.1C, and NHTSA regulations.

(a) Clean Air Act (CAA)

The CAA (42 U.S.C. § 7401) is the primary Federal legislation that addresses air quality. Under the authority of the CAA and subsequent amendments, the EPA has established

National Ambient Air Quality Standards (NAAQS) for six criteria pollutants, which are relatively commonplace pollutants that can accumulate in the atmosphere as a result of normal levels of human activity. The EPA is required to review each NAAQS every five years and to change the standards if warranted by new scientific information.

The air quality of a geographic region is usually assessed by comparing the levels of criteria air pollutants found in the atmosphere to the applicable NAAQS. Concentrations of criteria pollutants within the air mass of a region are measured in parts of a pollutant per million parts of air (ppm) or in micrograms of a pollutant per cubic meter ( $\mu\text{g}/\text{m}^3$ ) of air present in repeated air samples taken at designated monitoring locations. These ambient concentrations of each criteria pollutant are compared to the permissible levels specified by the NAAQS in order to assess whether the region's air quality attains the standard.

When the measured concentrations of a criteria pollutant within a geographic region are below those permitted by the NAAQS, the region is designated by the EPA as an attainment area for that pollutant, while regions where concentrations of criteria pollutants exceed the NAAQS are called nonattainment areas (NAAs). Former NAAs that have attained the NAAQS are designated as maintenance areas. Each NAA is required to develop and implement a State Implementation Plan (SIP), which documents how the region will reach attainment levels within time periods specified in the CAA. In maintenance areas, the SIP documents how the State intends to maintain compliance with the NAAQS. When EPA changes a NAAQS, States must revise their SIPs to address how they will attain the new standard.

Section 176(c) of the CAA prohibits Federal agencies from taking actions in nonattainment or maintenance areas that do not "conform" to the State Implementation Plan (SIP). The purpose of this conformity requirement is to ensure that Federal activities do not interfere with meeting the emissions targets in the SIPs, do not cause or contribute to new violations of the NAAQS, and do not impede the ability to attain or maintain the NAAQS. The EPA has issued two sets of regulations to implement CAA Section 176(c):

- The Transportation Conformity Rules (40 CFR part 93, subpart A), which apply to transportation plans, programs, and projects funded or approved under U.S.C. Title 23 or the Federal Transit Laws (49 U.S.C. chapter

53). Projects funded by the Federal Highway Administration (FHWA) or the Federal Transit Administration (FTA) usually are subject to transportation conformity. See 40 CFR 93.102.

- The General Conformity Rules (40 CFR part 93, subpart B) apply to all other federal actions not covered under transportation conformity. The General Conformity Rule established emissions thresholds, or *de minimis* levels, for use in evaluating the conformity of a project. If the net emissions increases attributable to the project are less than these thresholds, then the project is presumed to conform and no further conformity evaluation is required. If the emissions increases exceed any of these thresholds, then a conformity determination is required. The conformity determination can entail air quality modeling studies, consultation with EPA and state air quality agencies, and commitments to revise the SIP or to implement measures to mitigate air quality impacts.

The final fuel consumption standards and associated program activities are not funded or approved under U.S.C. Title 23 or the Federal Transit Act. Further, NHTSA's HD Fuel Efficiency Improvement Program is not a highway or transit project funded or approved by FHWA or FTA. Accordingly, the standards and associated rulemakings are not subject to transportation conformity.

Under the General Conformity Rule, a conformity determination is required where a Federal action would result in total direct and indirect emissions of a criteria pollutant or precursor equaling or exceeding the rates specified in 40 CFR 93.153(b)(1) and (2) for nonattainment and maintenance areas. As explained below, NHTSA's action results in neither direct nor indirect emissions as defined in 40 CFR 93.152.

The General Conformity Rule defines direct emissions as those of "a criteria pollutant or its precursors that are caused or initiated by the Federal action and originate in a nonattainment or maintenance area and occur at the same time and place as the action and are reasonably foreseeable." 40 CFR 93.152. Because NHTSA's action only sets fuel consumption standards for HD vehicles, it causes no direct emissions within the meaning of the General Conformity Rule.

Indirect emissions under the General Conformity Rule include emissions or precursors: (1) That are caused or initiated by the Federal action and originate in the same nonattainment or maintenance area but occur at a different time or place than the action; (2) that are reasonably foreseeable; (3)

<sup>584</sup> The agency also changed the FEIS as a result of updated information that became available after issuance of the DEIS.

<sup>585</sup> 76 FR 37111 (June 24, 2011).

<sup>586</sup> NEPA is codified at 42 U.S.C. 4321–4347. CEQ NEPA implementing regulations are codified at 40 Code of Federal Regulations (CFR) Parts 1500–1508. NHTSA NEPA implementing regulations are codified at 49 CFR part 520.

that the agency can practically control; and (4) for which the agency has continuing program responsibility. 40 CFR 93.152. Each element of the definition must be met to qualify as an indirect emission. NHTSA has determined that, for the purposes of general conformity, emissions that occur as a result of the fuel consumption standards are not caused by NHTSA's action, but rather occur due to subsequent activities that the agency cannot practically control. "[E]ven if a Federal licensing, rulemaking, or other approving action is a required initial step for a subsequent activity that causes emissions, such initial steps do not mean that a Federal agency can practically control any resulting emissions" (75 FR 17254, 17260; 40 CFR 93.152). NHTSA cannot control vehicle manufacturers' production of HD vehicles and consumer purchasing and driving behavior. For the purposes of analyzing the environmental impacts of this action under NEPA, NHTSA has made assumptions regarding the technologies manufacturers will install and how companies will react to increased fuel efficiency standards. Specifically, NHTSA's NEPA analysis predicted increases in air toxic and criteria pollutants to occur in some nonattainment areas under certain alternatives based on assumptions about the use of APUs and the rebound effect. For example, NHTSA's NEPA analysis assumes that some manufacturers will install anti-idling technologies (including APUs) on some vehicle classes to meet the requirements of the program and that drivers' subsequent use of those APUs will result in an increase in some criteria pollutants. However, neither NHTSA's nor EPA's rules mandate this specific manufacturer decision or driver behavior—the program does not require that manufacturers install APUs to meet the requirements of the rule, and it does not require drivers to use anti-idling technologies instead of, for example, shutting off all power when parked. Similarly, NHTSA's NEPA analysis assumes a rebound effect, wherein the standards could create an incentive for additional vehicle use by reducing the cost of fuel consumed per mile driven. This rebound effect is an estimate of how NHTSA assumes some drivers will react to the rule and is useful for estimating the costs and benefits of the rule, but the agency does not have the statutory authority, or the program responsibility, to control, among other items discussed above, the actual vehicle miles traveled by drivers. Accordingly, changes in any emissions

that result from NHTSA's HD vehicle Fuel Efficiency Improvement Program are not changes that the agency can practically control; therefore, this action causes no indirect emissions and a general conformity determination is not required.

(b) National Historic Preservation Act (NHPA)

The NHPA (16 U.S.C. 470) sets forth government policy and procedures regarding "historic properties"—that is, districts, sites, buildings, structures, and objects included in or eligible for the National Register of Historic Places (NRHP). *See also* 36 CFR part 800. Section 106 of the NHPA requires federal agencies to "take into account" the effects of their actions on historic properties. The agency concludes that the NHPA is not applicable to NHTSA's Decision because it does not directly involve historic properties. The agency has, however, conducted a qualitative review of the related direct, indirect, and cumulative impacts, positive or negative, of the alternatives on potentially affected resources, including historic and cultural resources. *See* Section 4.5 of the FEIS.

(c) Executive Order 12898 (Environmental Justice)

Under Executive Order 12898, Federal agencies are required to identify and address any disproportionately high and adverse human health or environmental effects of its programs, policies, and activities on minority populations and low-income populations. NHTSA complied with this order by identifying and addressing the potential effects of the alternatives on minority and low-income populations in Sections 3.6 and 4.6 of the FEIS, where the agency set forth a qualitative analysis of the cumulative effects of the alternatives on these populations.

(d) Fish and Wildlife Conservation Act (FWCA)

The FWCA (16 U.S.C. § 2900) provides financial and technical assistance to States for the development, revision, and implementation of conservation plans and programs for nongame fish and wildlife. In addition, the Act encourages all Federal agencies and departments to utilize their authority to conserve and to promote conservation of nongame fish and wildlife and their habitats. The agency concludes that the FWCA is not applicable to NHTSA's Decision because it does not directly involve fish and wildlife.

(e) Coastal Zone Management Act (CZMA)

The Coastal Zone Management Act (16 U.S.C. 1450) provides for the preservation, protection, development, and (where possible) restoration and enhancement of the nation's coastal zone resources. Under the statute, States are provided with funds and technical assistance in developing coastal zone management programs. Each participating State must submit its program to the Secretary of Commerce for approval. Once the program has been approved, any activity of a Federal agency, either within or outside of the coastal zone, that affects any land or water use or natural resource of the coastal zone must be carried out in a manner that is consistent, to the maximum extent practicable, with the enforceable policies of the State's program.

The agency concludes that the CZMA is not applicable to NHTSA's Decision because it does not involve an activity within, or outside of, the nation's coastal zones. The agency has, however, conducted a qualitative review of the related direct, indirect, and cumulative impacts, positive or negative, of the alternatives on potentially affected resources, including coastal zones. *See* Section 4.5 of the FEIS.

(f) Endangered Species Act (ESA)

Under Section 7(a)(2) of the Endangered Species Act (ESA) federal agencies must ensure that actions they authorize, fund, or carry out are "not likely to jeopardize" federally listed threatened or endangered species or result in the destruction or adverse modification of the designated critical habitat of these species. 16 U.S.C. 1536(a)(2). If a federal agency determines that an agency action may affect a listed species or designated critical habitat, it must initiate consultation with the appropriate Service—the U.S. Fish and Wildlife Service (FWS) of the Department of the Interior and/or National Oceanic and Atmospheric Administration's National Marine Fisheries Service (NOAA Fisheries Service) of the Department of Commerce, depending on the species involved—in order to ensure that the action is not likely to jeopardize the species or destroy or adversely modify designated critical habitat. *See* 50 CFR 402.14. Under this standard, the federal agency taking action evaluates the possible effects of its action and determines whether to initiate consultation. *See* 51 FR 19926, 19949 (Jun. 3, 1986).

NHTSA received one comment to the Scoping notice for the HD program indicating that the agency should engage in consultation under Section 7 of the ESA when analyzing the overall impact of GHG emissions and other air pollutants. NHTSA has reviewed applicable ESA regulations, case law, guidance, and rulings in assessing the potential for impacts to threatened and endangered species from the HD fuel efficiency standards. Consistent with NHTSA's determination under the agency's most recent light-duty fuel economy rule, NHTSA believes that the agency's action, which will result in nationwide fuel savings and, consequently, emissions reductions from what would otherwise occur in the absence of the agency's action, does not require consultation with NOAA Fisheries Service or the FWS under Section 7(a)(2) of the ESA. For discussion of the agency's rationale in the context of the CAFE program, see Appendix G of the FEIS for MYs 2012–2016, available at: <http://www.nhtsa.gov/fuel-economy>. Accordingly, NHTSA has concluded its review of this action under Section 7 of the ESA.

(g) Floodplain Management (Executive Order 11988 & DOT Order 5650.2)

These Orders require Federal agencies to avoid the long- and short-term adverse impacts associated with the occupancy and modification of floodplains, and to restore and preserve the natural and beneficial values served by floodplains. Executive Order 11988 also directs agencies to minimize the impact of floods on human safety, health and welfare, and to restore and preserve the natural and beneficial values served by floodplains through evaluating the potential effects of any actions the agency may take in a floodplain and ensuring that its program planning and budget requests reflect consideration of flood hazards and floodplain management. DOT Order 5650.2 sets forth DOT policies and procedures for implementing Executive Order 11988. The DOT Order requires that the agency determine if a proposed action is within the limits of a base floodplain, meaning it is encroaching on the floodplain, and whether this encroachment is significant. If significant, the agency is required to conduct further analysis of the proposed action and any practicable alternatives. If a practicable alternative avoids floodplain encroachment, then the agency is required to implement it.

In this rulemaking, the agency is not occupying, modifying and/or encroaching on floodplains. The agency,

therefore, concludes that the Orders are not applicable to NHTSA's Decision. The agency has, however, conducted a review of the alternatives on potentially affected resources, including floodplains. See Section 4.5 of the FEIS.

(h) Preservation of the Nation's Wetlands (Executive Order 11990 & DOT Order 5660.1a)

These Orders require Federal agencies to avoid, to the extent possible, undertaking or providing assistance for new construction located in wetlands unless the agency head finds that there is no practicable alternative to such construction and that the proposed action includes all practicable measures to minimize harms to wetlands that may result from such use. Executive Order 11990 also directs agencies to take action to minimize the destruction, loss or degradation of wetlands in "conducting Federal activities and programs affecting land use, including but not limited to water and related land resources planning, regulating, and licensing activities." DOT Order 5660.1a sets forth DOT policy for interpreting Executive Order 11990 and requires that transportation projects "located in or having an impact on wetlands" should be conducted to assure protection of the Nation's wetlands. If a project does have a significant impact on wetlands, an EIS must be prepared.

The agency is not undertaking or providing assistance for new construction located in wetlands. The agency, therefore, concludes that these Orders do not apply to NHTSA's Decision. The agency has, however, conducted a review of the alternatives on potentially affected resources, including wetlands. See Section 4.5 of the FEIS.

(i) Migratory Bird Treaty Act (MBTA), Bald and Golden Eagle Protection Act (BGEPA), Executive Order 13186

The MBTA provides for the protection of migratory birds that are native to the United States by making it illegal for anyone to pursue, hunt, take, attempt to take, kill, capture, collect, possess, buy, sell, trade, ship, import, or export any migratory bird covered under the statute. The statute prohibits both intentional and unintentional acts. Therefore, the statute is violated if an agency acts in a manner that harms a migratory bird, whether it was intended or not. See, e.g., *United States v. FMC Corp.*, 572 F.2d 902 (2nd Cir. 1978).

The BGEPA (16 U.S.C. 668) prohibits any form of possession or taking of both bald and golden eagles. Under the BGEPA, violators are subject to criminal and civil sanctions as well as an

enhanced penalty provision for subsequent offenses.

Executive Order 13186, "Responsibilities of Federal Agencies to Protect Migratory Birds," helps to further the purposes of the MBTA by requiring a Federal agency to develop a Memorandum of Understanding (MOU) with the Fish and Wildlife Service when it is taking an action that has (or is likely to have) a measurable negative impact on migratory bird populations.

The agency concludes that the MBTA, BGEPA, and Executive Order 13186 do not apply to NHTSA's Decision because there is no disturbance and/or take involved in NHTSA's Decision.

(j) Department of Transportation Act (Section 4(f))

Section 4(f) of the Department of Transportation Act of 1966 (49 U.S.C. 303), as amended by Public Law 109–59, is designed to preserve publicly owned parklands, waterfowl and wildlife refuges, and significant historic sites. Specifically, Section 4(f) of the Department of Transportation Act provides that DOT agencies cannot approve a transportation program or project that requires the use of any publicly owned land from a significant public park, recreation area, or wildlife and waterfowl refuge, or any land from a significant historic site, unless a determination is made that:

- There is no feasible and prudent alternative to the use of land, and
- The program or project includes all possible planning to minimize harm to the property resulting from use, or
- A transportation use of Section 4(f) property results in a *de minimis* impact.

The agency concludes that the Section 4(f) is not applicable to NHTSA's Decision because this rulemaking does not require the use of any publicly owned land. For a more detailed discussion, please see Section 3.1 of the FEIS.

(3) Paperwork Reduction Act

The information collection requirements in these rules have been submitted for approval to OMB under the *Paperwork Reduction Act*, 44 U.S.C. 3501 *et seq.* The information collection requirements are not enforceable until OMB approves them.

The agencies propose to collect information to ensure compliance with the provisions in these rules. This includes a variety of testing, reporting and recordkeeping requirements for vehicle manufacturers. Section 208(a) of the CAA requires that vehicle manufacturers provide information the Administrator may reasonably require to determine compliance with the

regulations; submission of the information is therefore mandatory. We will consider confidential all information meeting the requirements of section 208(c) of the CAA.

It is estimated that this collection affects approximately 34 engine and vehicle manufacturers. The information that is subject to this collection is

collected whenever a manufacturer applies for a certificate of conformity. Under section 206 of the CAA (42 U.S.C. 7521), a manufacturer must have a certificate of conformity before a vehicle or engine can be introduced into commerce.

The burden to the manufacturers affected by these rules has a range based

on the number of engines and vehicles a manufacturer produces. The total estimated burden associated with these rules is 58,064 hours annually (See Table XII-2). This estimated burden for engine and vehicle manufacturers is a total estimate for new reporting requirements. Burden is defined at 5 CFR 1320.3(b).

TABLE XII-2—BURDEN FOR REPORTING AND RECORDKEEPING REQUIREMENTS

Number of Affected Manufacturers .....	34
Annual Labor Hours for Each Manufacturer to Prepare and Submit Required Information .....	Varies
Total Annual Information Collection Burden .....	58,064 Hours

An agency may not conduct or sponsor, and a person is not required to respond to a collection of information unless it displays a currently valid OMB control number. The OMB control numbers for EPA's regulations are listed in 40 CFR part 9. When this ICR is approved by OMB, the agency will publish a technical amendment to 40 CFR part 9 in the **Federal Register** to display the OMB control number for the approved information collection requirements contained in this final action.

(4) *Regulatory Flexibility Act*

(a) Overview

The Regulatory Flexibility Act generally requires an agency to prepare a regulatory flexibility analysis of any rule subject to notice and comment rulemaking requirements under the Administrative Procedure Act or any other statute unless the agency certifies that the rule will not have a significant economic impact on a substantial number of small entities. Small entities include small businesses, small organizations, and small governmental jurisdictions.

For purposes of assessing the impacts of these rules on small entities, small entity is defined as: (1) A small business as defined by SBA regulations at 13 CFR 121.201; (2) a small governmental jurisdiction that is a government of a city, county, town, school district or special district with a population of less than 50,000; and (3) a small organization that is any not-for-profit enterprise which is independently owned and operated and is not dominant in its field.

(b) Summary of Potentially Affected Small Entities

The agencies have not conducted a Regulatory Flexibility Analysis for this action because the agencies are certifying that these rules would not have a significant economic impact on

a substantial number of small entities. As proposed, the agencies are deferring standards for manufacturers meeting SBA's definition of small business as described in 13 CFR 121.201 due to the extremely small fuel savings and emissions contribution of these entities, and the short lead time to develop these rules, especially with our expectation that the program would need to be structured differently for them (which would require more time). The agencies are instead envisioning fuel consumption and GHG emissions standards for these entities as part of a future regulatory action. This includes small entities in several distinct categories of businesses for heavy-duty engines and vehicles: chassis manufacturers, combination tractor manufacturers, and alternative fuel engine converters.

Based on a preliminary assessment, the agencies have identified a total of about 17 engine manufacturers, 3 complete pickup truck and van manufacturers, 11 combination tractor manufacturers and 43 heavy-duty chassis manufacturers. Notably, several of these manufacturers produce vehicles in more than just one regulatory category (HD pickup trucks/vans, combination tractors, or vocational vehicles (i.e. heavy-duty chassis manufacturers)). Based on the types of vehicles they manufacture, these companies, however, would be subject to slightly different testing and reporting requirements. Taking this feature of the heavy-duty trucking sector into account, the agencies estimate that although there are fewer than 30 manufacturers covered by the program, there are close to 60 divisions within these companies that will be subject to the final regulations. Of these, about 15 entities fit the SBA criteria of a small business. There are approximately three engine converters, two tractor manufacturers, and ten heavy-duty chassis manufacturers in the heavy-duty engine

and vehicle market that are small businesses. (No major heavy-duty engine manufacturers, heavy-duty chassis manufacturers, or tractor manufacturers meet the small-entity criteria as defined by SBA). The agencies estimate that these small entities comprise less than 0.35 percent of the total heavy-duty vehicle sales in the United States, and therefore the deferment will have a negligible impact on the fuel consumption and GHG emissions reductions from the final standards.

To ensure that the agencies are aware of which companies are being deferred, the agencies are requiring that such entities submit a declaration to the agencies containing a detailed written description of how that manufacturer qualifies as a small entity under the provisions of 13 CFR 121.201. Some small entities, such as heavy-duty tractor and chassis manufacturers, are not currently covered under criteria pollutant motor vehicle emissions regulations. Small engine entities are currently covered by a number of EPA motor vehicle emission regulations, and they routinely submit information and data on an annual basis as part of their compliance responsibilities. Because such entities are not automatically exempted from other EPA regulations for heavy-duty engines and vehicles, absent such a declaration, EPA would assume that the entity was subject to the greenhouse gas control requirements in this program. The declaration to the agencies will need to be submitted at the time of either engine or vehicle emissions certification under the HD highway engine program for criteria pollutants. The agencies expect that the additional paperwork burden associated with completing and submitting a small entity declaration to gain deferral from the final GHG and fuel consumption standards will be negligible and easily done in the context of other routine submittals to the agencies. However, the

agencies have accounted for this cost with a nominal estimate included in the Information Collection Request completed under the Paperwork Reduction Act. Additional information can be found in the Paperwork Reduction Act discussion in Section O Paperwork Reduction Act. Based on this, the agencies are certifying that the rules will not have a significant economic impact on a substantial number of small entities.

*(5) Unfunded Mandates Reform Act*

Title II of the Unfunded Mandates Reform Act of 1995 (UMRA), Public Law 104-4, establishes requirements for Federal agencies to assess the effects of their regulatory actions on State, local, and tribal governments and the private sector. Under section 202 of the UMRA, the agencies generally must prepare a written statement, including a cost-benefit analysis, for proposed and final rules with "Federal mandates" that may result in expenditures to State, local, and tribal governments, in the aggregate, or to the private sector, of \$100 million or more in any one year. Before promulgating a rule for which a written statement is needed, section 205 of the UMRA generally requires the agencies to identify and consider a reasonable number of regulatory alternatives and adopt the least costly, most cost-effective or least burdensome alternative that achieves the objectives of the rule. The provisions of section 205 do not apply when they are inconsistent with applicable law. Moreover, section 205 allows the agencies to adopt an alternative other than the least costly, most cost-effective or least burdensome alternative if the Administrator (of either agency) publishes with the final rule an explanation why that alternative was not adopted.

Before the agencies establish any regulatory requirements that may significantly or uniquely affect small governments, including tribal governments, they must have developed under section 203 of the UMRA a small government agency plan. The plan must provide for notifying potentially affected small governments, enabling officials of affected small governments to have meaningful and timely input in the development of EPA and NHTSA regulations with significant Federal intergovernmental mandates, and informing, educating, and advising small governments on compliance with the regulatory requirements.

These rules contain no Federal mandates (under the regulatory provisions of Title II of the UMRA) for State, local, or tribal governments. The rules impose no enforceable duty on any

State, local or tribal governments. The agencies have determined that these rules contain no regulatory requirements that might significantly or uniquely affect small governments. The agencies have determined that these rules contain a Federal mandate that may result in expenditures of \$134 million or more for the private sector in any one year. The agencies believe that the program represents the least costly, most cost-effective approach to achieve the statutory requirements of the rules. Section VIII.L, above, explains why the agencies believe that the fuel savings that will result from these rules will lead to lower prices economy-wide, improving U.S. international competitiveness. The costs and benefits associated with the program are discussed in more detail above in Section VIII and in the Regulatory Impact Analysis, as required by the UMRA.

Table XII-1, above, presents the rule-related benefits, fuel savings, costs and net benefits in both present value terms and in annualized terms. In both cases, the discounted values are based on an underlying time varying stream of cost and benefit values that extend into the future (2012 through 2050). The distribution of each monetized economic impact over time can be viewed in the RIA that accompanies these rules.

Present values represent the *total* amount that a stream of monetized costs/benefits/net benefits that occur over time are worth now (in year 2009 dollar terms for this analysis), accounting for the time value of money by discounting future values using either a 3 or 7 percent discount rate, per OMB Circular A-4 guidance. An annualized value takes the present value and converts it into a *constant stream of annual values* through a given time period (2012 through 2050 in this analysis) and thus averages (in present value terms) the annual values. The present value of the constant stream of annualized values equals the present value of the underlying time varying stream of values. The ratio of benefits to costs is identical whether it is measured with present values or annualized values.

It is important to note that annualized values cannot simply be summed over time to reflect total costs/benefits/net benefits; they must be discounted and summed. Additionally, the annualized value can vary substantially from the time varying stream of cost/benefit/net benefit values that occur in any given year.

*(6) Executive Order 13132 (Federalism)*

This action does not have federalism implications. It will not have substantial direct effects on the States, on the relationship between the national government and the States, or on the distribution of power and responsibilities among the various levels of government, as specified in Executive Order 13132. These rules will apply to manufacturers of motor vehicles and not to state or local governments. Thus, Executive Order 13132 does not apply to this action. Although section 6 of Executive Order 13132 does not apply to this action, the agencies did consult with representatives of state governments in developing this action.

NHTSA notes that EPCA contains a provision (49 U.S.C. 32919(a)) that expressly preempts any State or local government from adopting or enforcing a law or regulation related to fuel economy standards or average fuel economy standards for automobiles covered by an average fuel economy standard under 49 U.S.C. Chapter 329. However, commercial medium- and heavy-duty on-highway vehicles and work trucks are not "automobiles," as defined in 49 U.S.C. 32901(a)(3). Accordingly, NHTSA has tentatively concluded that EPCA's express preemption provision would not reach the fuel efficiency standards to be established in this rulemaking.

NHTSA also considered the issue of implied or conflict preemption. The possibility of such preemption is dependent upon there being an actual conflict between a standard established by NHTSA in this rulemaking and a State or local law or regulation. *See* *Spriestma v. Mercury Marine*, 537 U.S. 51, 64-65 (2002). At present, NHTSA has no knowledge of any State or local law or regulation that would actually conflict with one of the fuel efficiency standards being established in this rulemaking.

*(7) Executive Order 13175 (Consultation and Coordination With Indian Tribal Governments)*

These final rules do not have tribal implications, as specified in Executive Order 13175 (65 FR 67249, November 9, 2000). These rules will be implemented at the Federal level and impose compliance costs only on vehicle manufacturers. Tribal governments would be affected only to the extent they purchase and use regulated vehicles. Thus, Executive Order 13175 does not apply to these rules.

*(8) Executive Order 13045: "Protection of Children From Environmental Health Risks and Safety Risks"*

This action is subject to Executive Order 13045 (62 FR 19885, April 23, 1997) because it is an economically significant regulatory action as defined by Executive Order 12866, and the agencies believe that the environmental health or safety risk addressed by this action may have a disproportionate effect on children. A synthesis of the science and research regarding how climate change may affect children and other vulnerable subpopulations is contained in the Technical Support Document for Endangerment or Cause or Contribute Findings for Greenhouse Gases under section 202(a) of the Clean Air Act, which can be found in the public docket for these rules.<sup>587</sup> A summary of the analysis is presented below.

With respect to GHG emissions, the effects of climate change observed to date and projected to occur in the future include the increased likelihood of more frequent and intense heat waves. Specifically, EPA's analysis of the scientific assessment literature has determined that severe heat waves are projected to intensify in magnitude, frequency, and duration over the portions of the United States where these events already occur, with potential increases in mortality and morbidity, especially among the young, elderly, and frail. EPA has estimated reductions in projected global mean surface temperatures as a result of reductions in GHG emissions associated with the final standards in this action (Section II). Children may receive benefits from reductions in GHG emissions because they are included in the segment of the population that is most vulnerable to extreme temperatures.

For non-GHG pollutants, EPA has determined that climate change is expected to increase regional ozone pollution, with associated risks in respiratory infection, aggravation of asthma, and premature death. The directional effect of climate change on ambient PM levels remains uncertain. However, disturbances such as wildfires are increasing in the United States and are likely to intensify in a warmer future with drier soils and longer growing seasons. PM emissions from forest fires can contribute to acute and chronic illnesses of the respiratory system, particularly in children, including pneumonia, upper respiratory diseases,

asthma and chronic obstructive pulmonary diseases.

*(9) Executive Order 13211 (Energy Effects)*

This rulemaking is not a "significant energy action" as defined in Executive Order 13211, "Actions Concerning Regulations That Significantly Affect Energy Supply, Distribution, or Use" (66 FR 28355, May 22, 2001) because it is not likely to have a significant adverse effect on the supply, distribution, or use of energy. In fact, these rules have a positive effect on energy supply and use. Because the final GHG emission and fuel consumption standards will result in significant fuel savings, these rules encourage more efficient use of fuels. Therefore, we have concluded that these rules are not likely to have any adverse energy effects. Our energy effects analysis is described above in Section VIII.I.

*(10) National Technology Transfer Advancement Act*

Section 12(d) of the National Technology Transfer and Advancement Act of 1995 ("NTTAA"), Public Law 104-113, 12(d) (15 U.S.C. 272 note) directs the agencies to use voluntary consensus standards in its regulatory activities unless to do so would be inconsistent with applicable law or otherwise impractical. Voluntary consensus standards are technical standards (e.g., materials, specifications, test methods, sampling procedures, and business practices) that are developed or adopted by voluntary consensus standards bodies. NTTAA directs the agencies to provide Congress, through OMB, explanations when the agencies decide not to use available and applicable voluntary consensus standards.

For CO<sub>2</sub>, N<sub>2</sub>O, and CH<sub>4</sub> emissions and fuel consumption from heavy-duty engines, the agencies will collect data over the same tests that are used for the heavy-duty highway engine program for criteria pollutants. This will minimize the amount of testing done by manufacturers, since manufacturers are already required to run these tests.

For CO<sub>2</sub>, N<sub>2</sub>O, and CH<sub>4</sub> emissions and fuel consumption from complete pickup trucks and vans, the agencies will collect data over the same tests that are used for EPA's heavy-duty highway engine program for criteria pollutants and for the California Air Resources Board. This will minimize the amount of testing done by manufacturers, since manufacturers are already required to run these tests.

For CO<sub>2</sub> emissions and fuel consumption from heavy-duty

combination tractors and vocational vehicles, the agencies will collect data through the use of a simulation model instead of a full-vehicle chassis dynamometer testing. This will minimize the amount of testing done by manufacturers. EPA's compliance assessment tool is based upon well-established engineering and physics principals that are the basis of general academic understanding in this area, and the foundation of any dynamic vehicle simulation model, including the models cited by ICCT in its study.<sup>588</sup> Therefore, the EPA's compliance assessment tool satisfies the description of a consensus. For the evaluation of tire rolling resistance input to the model, EPA is finalizing to use the ISO 28580 test, a voluntary consensus methodology. EPA is adopting several alternatives for the evaluation of aerodynamics which allows the industry to continue to use their own evaluation tools because EPA does not know of a single consensus standard available for heavy-duty truck aerodynamic evaluation.

For air conditioning standards, EPA is finalizing a consensus methodology developed by the Society of Automotive Engineers (SAE).

*(11) Executive Order 12898: Federal Actions To Address Environmental Justice in Minority Populations and Low-Income Populations*

Executive Order 12898 (59 FR 7629, February 16, 1994) establishes federal executive policy on environmental justice. Its main provision directs federal agencies, to the greatest extent practicable and permitted by law, to make environmental justice part of their mission by identifying and addressing, as appropriate, disproportionately high and adverse human health or environmental effects of their programs, policies, and activities on minority populations and low-income populations in the United States.

With respect to GHG emissions, EPA has determined that these final rules will not have disproportionately high and adverse human health or environmental effects on minority or low-income populations because they increase the level of environmental protection for all affected populations without having any disproportionately high and adverse human health or environmental effects on any population, including any minority or low-income population. The reductions in CO<sub>2</sub> and other GHGs associated with the standards will affect climate change

<sup>587</sup> See Endangerment TSD, Note 10, above.

<sup>588</sup> ICCT. ICCT Evaluation of Vehicle Simulation Tools. 2009.



projections, and EPA has estimated reductions in projected global mean surface temperatures (Section VI). Within communities experiencing climate change, certain parts of the population may be especially vulnerable; these include the poor, the elderly, those already in poor health, the disabled, those living alone, and/or indigenous populations dependent on one or a few resources.<sup>589</sup> In addition, the U.S. Climate Change Science Program stated as one of its conclusions: “The United States is certainly capable of adapting to the collective impacts of climate change. However, there will still be certain individuals and locations where the adaptive capacity is less and these individuals and their communities will be disproportionately impacted by climate change.”<sup>590</sup> Therefore, these specific sub-populations may receive benefits from reductions in GHGs.

For non-GHG co-pollutants such as ozone, PM<sub>2.5</sub>, and toxics, EPA has concluded that it is not practicable to determine whether there would be disproportionately high and adverse human health or environmental effects on minority and/or low income populations from these rules.

#### (12) Congressional Review Act

The Congressional Review Act, 5 U.S.C. 801 *et seq.*, as added by the Small Business Regulatory Enforcement Fairness Act of 1996, generally provides that before a rule may take effect, the agency promulgating the rule must submit a rule report, which includes a copy of the rule, to each House of the Congress and to the Comptroller General of the United States. The agencies will submit a report containing these rules and other required information to the U.S. Senate, the U.S. House of Representatives, and the Comptroller General of the United States prior to publication of the rules in the **Federal Register**. A Major rule cannot take effect until 60 days after it is published in the **Federal Register**. This action is a “major rule” as defined by 5 U.S.C. 804(2). These rules will be effective November 14, 2011, sixty days after date of publication in the **Federal Register**.

#### (13) Privacy Act

Anyone is able to search the electronic form of all comments

received into any of our dockets by the name of the individual submitting the comment (or signing the comment, if submitted on behalf of an organization, business, labor union, *etc.*). You may review DOT’s complete Privacy Act statement in the **Federal Register** (65 FR 19477–78, April 11, 2000) or you may visit <http://www.dot.gov/privacy.html>.

### XIII. Statutory Provisions and Legal Authority

#### A. EPA

Statutory authority for the vehicle controls in these rules is found in CAA section 202(a) (which requires EPA to establish standards for emissions of pollutants from new motor vehicles and engines which emissions cause or contribute to air pollution which may reasonably be anticipated to endanger public health or welfare), sections 202(d), 203–209, 216, and 301 of the CAA, 42 U.S.C. 7521 (a), 7521 (d), 7522, 7523, 7524, 7525, 7541, 7542, 7543, 7550, and 7601.

#### B. NHTSA

Statutory authority for the fuel consumption standards in these rules is found in EISA section 103 (which authorizes a fuel efficiency improvement program, designed to achieve the maximum feasible improvement to be created for commercial medium- and heavy-duty on-highway vehicles and work trucks, to include appropriate test methods, measurement metrics, standards, and compliance and enforcement protocols that are appropriate, cost-effective and technologically feasible) of the Energy Independence and Security Act of 2007, 49 U.S.C. 32902(k).

#### List of Subjects

##### 40 CFR Part 85

Confidential business information, Imports, Labeling, Motor vehicle pollution, Reporting and recordkeeping requirements, Research, Warranties.

##### 40 CFR Part 86

Administrative practice and procedure, Confidential business information, Incorporation by reference, Labeling, Motor vehicle pollution, Reporting and recordkeeping requirements.

##### 40 CFR Part 600

Administrative practice and procedure, Electric power, Fuel economy, Incorporation by reference, Labeling, Reporting and recordkeeping requirements.

##### 40 CFR Part 1033

Administrative practice and procedure, Air pollution control.

##### 40 CFR Parts 1036 and 1037

Administrative practice and procedure, Air pollution control, Confidential business information, Environmental protection, Incorporation by reference, Labeling, Motor vehicle pollution, Reporting and recordkeeping requirements, Warranties.

##### 40 CFR Part 1039

Environmental protection, Administrative practice and procedure, Air pollution control, Confidential business information, Imports, Labeling, Penalties, Reporting and recordkeeping requirements, Warranties.

##### 40 CFR Parts 1065 and 1066

Administrative practice and procedure, Air pollution control, Incorporation by reference, Reporting and recordkeeping requirements, Research.

##### 40 CFR Part 1068

Environmental protection, Administrative practice and procedure, Confidential business information, Imports, Incorporation by reference, Motor vehicle pollution, Penalties, Reporting and recordkeeping requirements, Warranties.

##### 49 CFR Parts 523, 534, and 535

Fuel economy.

### Environmental Protection Agency

#### 40 CFR Chapter I

For the reasons set forth in the preamble, the Environmental Protection Agency is amending 40 CFR chapter I of the Code of Federal Regulations as follows:

### PART 85—CONTROL OF AIR POLLUTION FROM MOBILE SOURCES

■ 1. The authority citation for part 85 continues to read as follows:

**Authority:** 42 U.S.C. 7401–7671q.

#### Subpart F—[Amended]

■ 2. Section 85.525 is revised to read as follows:

##### § 85.525 Applicable standards.

To qualify for an exemption from the tampering prohibition, vehicles/engines that have been converted to operate on a different fuel must meet emission standards and related requirements as follows:

(a) The modified vehicle/engine must meet the requirements that applied for

<sup>589</sup> See Endangerment TSD, Note 10, above.

<sup>590</sup> CCSP (2008) *Analyses of the effects of global change on human health and welfare and human systems*. A Report by the U.S. Climate Change Science Program and the Subcommittee on Global Change Research. [Gamble, J.L. (ed.), K.L. Ebi, F.G. Sussman, T.J. Wilbanks, (Authors)]. U.S. Environmental Protection Agency, Washington, DC, USA.



the OEM vehicle/engine, or the most stringent OEM vehicle/engine standards in any allowable grouping. Fleet average standards do not apply unless clean alternative fuel conversions are specifically listed as subject to the standards.

(1) If the vehicle/engine was certified with a Family Emission Limit for NO<sub>x</sub>, NO<sub>x</sub>+HC, or particulate matter, as noted on the vehicle/engine emission control information label, the modified vehicle/engine may not exceed this Family Emission Limit.

(2) Compliance with greenhouse gas emission standards is demonstrated as follows:

(i) Subject to the following exceptions and special provisions, compliance with light-duty vehicle greenhouse gas emission standards is demonstrated by complying with the N<sub>2</sub>O and CH<sub>4</sub> standards and provisions set forth in 40 CFR 86.1818–12(f)(1) and the in-use CO<sub>2</sub> exhaust emission standard set forth in 40 CFR 86.1818–12(d) as determined by the OEM for the subconfiguration that is identical to the fuel conversion emission data vehicle (EDV).

(A) If the OEM complied with the light-duty greenhouse gas standards using the fleet averaging option for N<sub>2</sub>O and CH<sub>4</sub>, as allowed under 40 CFR 86.1818–12(f)(2), the calculations of the carbon-related exhaust emissions require the input of grams/mile values for N<sub>2</sub>O and CH<sub>4</sub>, and you are not required to demonstrate compliance with the standalone CH<sub>4</sub> and N<sub>2</sub>O standards.

(B) If the OEM complied with alternate standards for N<sub>2</sub>O and/or CH<sub>4</sub>, as allowed under 40 CFR 86.1818–12(f)(3), you may demonstrate compliance with the same alternate standards.

(C) If the OEM complied with the nitrous oxide (N<sub>2</sub>O) and methane (CH<sub>4</sub>) standards and provisions set forth in 40 CFR 86.1818–12(f)(1) or 86.1818–12(f)(3), and the fuel conversion CO<sub>2</sub> measured value is lower than the in-use CO<sub>2</sub> exhaust emission standard, you also have the option to convert the difference between the in-use CO<sub>2</sub> exhaust emission standard and the fuel conversion CO<sub>2</sub> measured value into GHG equivalents of CH<sub>4</sub> and/or N<sub>2</sub>O, using 298 g CO<sub>2</sub> to represent 1 g N<sub>2</sub>O and 25 g CO<sub>2</sub> to represent 1 g CH<sub>4</sub>. You may then subtract the applicable converted values from the fuel conversion measured values of CH<sub>4</sub> and/or N<sub>2</sub>O to demonstrate compliance with the CH<sub>4</sub> and/or N<sub>2</sub>O standards.

(ii) Compliance with heavy-duty engine greenhouse gas emission standards is demonstrated by complying with the CO<sub>2</sub>, N<sub>2</sub>O, and CH<sub>4</sub> standards

(or FELs, as applicable) and provisions set forth in 40 CFR 1036.108 for the engine family that is represented by the fuel conversion emission data engine (EDE). If the fuel conversion CO<sub>2</sub> measured value is lower than the CO<sub>2</sub> standard (or FEL, as applicable), you have the option to convert the difference between the CO<sub>2</sub> standard (or FEL, as applicable) and the fuel conversion CO<sub>2</sub> measured value into GHG equivalents of CH<sub>4</sub> and/or N<sub>2</sub>O, using 298 g/hp-hr CO<sub>2</sub> to represent 1 g/hp-hr N<sub>2</sub>O and 25 g/hp-hr CO<sub>2</sub> to represent 1 g/hp-hr CH<sub>4</sub>. You may then subtract the applicable converted values from the fuel conversion measured values of CH<sub>4</sub> and/or N<sub>2</sub>O to demonstrate compliance with the CH<sub>4</sub> and/or N<sub>2</sub>O standards (or FEL, as applicable).

(3) Conversion systems for engines that would have qualified for chassis certification at the time of OEM certification may use those procedures, even if the OEM did not. Conversion manufacturers choosing this option must designate test groups using the appropriate criteria as described in this subpart and meet all vehicle chassis certification requirements set forth in 40 CFR part 86, subpart S.

(b) [Reserved]

#### Subpart P—[Amended]

■ 3. Section 85.1511 is revised to read as follows:

##### § 85.1511 Exemptions and exclusions.

(a) Individuals, as well as certificate holders, shall be eligible for importing vehicles into the United States under the provisions of this section, unless otherwise specified.

(b) Notwithstanding any other requirements of this subpart, a motor vehicle or motor vehicle engine entitled to a temporary exemption under this paragraph (b) may be conditionally admitted into the United States if prior written approval for such conditional admission is obtained from the Administrator. Conditional admission shall be under bond. A written request for approval from the Administrator shall contain the identification required in § 85.1504(a)(1) (except for § 85.1504(a)(1)(v)) and information that indicates that the importer is entitled to the exemption. Noncompliance with provisions of this section may result in the forfeiture of the total amount of the bond or exportation of the vehicle or engine. The following temporary exemptions apply:

(1) *Exemption for repairs or alterations.* Vehicles and engines may qualify for a temporary exemption under the provisions of 40 CFR

1068.325(a). Such vehicles or engines may not be registered or licensed in the United States for use on public roads and highways.

(2) *Testing exemption.* Vehicles and engines may qualify for a temporary exemption under the provisions of 40 CFR 1068.325(b). Test vehicles or engines may be operated on and registered for use on public roads or highways provided that the operation is an integral part of the test.

(3) *Precertification exemption.* Prototype vehicles for use in applying to EPA for certification may be imported by independent commercial importers subject to applicable provisions of § 85.1706 and the following requirements:

(i) No more than one prototype vehicle for each engine family for which an independent commercial importer is seeking certification shall be imported by each independent commercial importer.

(ii) Unless a certificate of conformity is issued for the prototype vehicle, the total amount of the bond shall be forfeited or the vehicle must be exported within 180 days from the date of entry.

(4) *Display exemptions.* Vehicles and engines may qualify for a temporary exemption under the provisions of 40 CFR 1068.325(c). Display vehicles or engines may not be registered or licensed for use or operated on public roads or highways in the United States, unless an applicable certificate of conformity has been received.

(c) Notwithstanding any other requirements of this subpart, a motor vehicle or motor vehicle engine may be finally admitted into the United States under this paragraph (c) if prior written approval for such final admission is obtained from the Administrator. Conditional admission of these vehicles is not permitted for the purpose of obtaining written approval from the Administrator. A request for approval shall contain the identification information required in § 85.1504(a)(1) (except for § 85.1504(a)(1)(v)) and information that indicates that the importer is entitled to the exemption or exclusion. The following exemptions or exclusions apply:

(1) *National security exemption.* Vehicles may be imported under the national security exemption found at 40 CFR 1068.315(a). Only persons who are manufacturers may import a vehicle under a national security exemption.

(2) *Hardship exemption.* The Administrator may exempt on a case-by-case basis certain motor vehicles from Federal emission requirements to accommodate unforeseen cases of extreme hardship or extraordinary

circumstances. Some examples are as follows:

(i) Handicapped individuals who need a special vehicle unavailable in a certified configuration;

(ii) Individuals who purchase a vehicle in a foreign country where resale is prohibited upon the departure of such an individual;

(iii) Individuals emigrating from a foreign country to the U.S. in circumstances of severe hardship.

(d) Foreign diplomatic and military personnel may import nonconforming vehicles without bond. At the time of admission, the importer shall submit to the Administrator the written report required in § 85.1504(a)(1) (except for information required by § 85.1504(a)(1)(v)). Such vehicles may not be sold in the United States.

(e) Racing vehicles may be imported by any person provided the vehicles meet one or more of the exclusion criteria specified in § 85.1703. Racing vehicles may not be registered or licensed for use on or operated on public roads and highways in the United States.

(f) The following exclusions and exemptions apply based on date of original manufacture:

(1) Notwithstanding any other requirements of this subpart, the following motor vehicles or motor vehicle engines are excluded from the requirements of the Act in accordance with section 216(3) of the Act and may be imported by any person:

(i) Gasoline-fueled light-duty vehicles and light-duty trucks originally manufactured prior to January 1, 1968.

(ii) Diesel-fueled light-duty vehicles originally manufactured prior to January 1, 1975.

(iii) Diesel-fueled light-duty trucks originally manufactured prior to January 1, 1976.

(iv) Motorcycles originally manufactured prior to January 1, 1978.

(v) Gasoline-fueled and diesel-fueled heavy-duty engines originally manufactured prior to January 1, 1970.

(2) Notwithstanding any other requirements of this subpart, a motor vehicle or motor vehicle engine not subject to an exclusion under paragraph (f)(1) of this section but greater than twenty OP years old is entitled to an exemption from the requirements of the Act, provided that it is imported into the United States by a certificate holder. At the time of admission, the certificate holder shall submit to the Administrator the written report required in § 85.1504(a)(1) (except for information required by § 85.1504(a)(1)(v)).

(g) Applications for exemptions and exclusions provided for in paragraphs

(b) and (c) of this section shall be mailed to the Designated Compliance Officer (see 40 CFR 1068.30).

(h) Vehicles conditionally or finally admitted under this section must still comply with all applicable requirements, if any, of the Energy Tax Act of 1978, the Energy Policy and Conservation Act and any other Federal or state requirements.

**Subpart R—[Amended]**

■ 4. Section 85.1701 is revised to read as follows:

**§ 85.1701 General applicability.**

(a) The provisions of this subpart regarding exemptions are applicable to new and in-use motor vehicles and motor vehicle engines, except as follows:

(1) Beginning January 1, 2014, the exemption provisions of 40 CFR part 1068, subpart C, apply for heavy-duty motor vehicles and engines, except that the competition exemption of 40 CFR 1068.235 and the hardship exemption provisions of 40 CFR 1068.245, 1068.250, and 1068.255 do not apply for motor vehicle engines.

(2) Prior to January 1, 2014, the provisions of §§ 85.1706 through 85.1709 apply for heavy-duty motor vehicle engines.

(b) The provisions of this subpart regarding exclusion are applicable after the effective date of these regulations.

(c) References in this subpart to engine families and emission control systems shall be deemed to apply to durability groups and test groups as applicable for manufacturers certifying new light-duty vehicles, light-duty trucks, and Otto-cycle complete heavy-duty vehicles under the provisions of 40 CFR part 86, subpart S.

(d) In a given model year, manufacturers of motor vehicles and motor vehicle engines may ask us to approve the use of administrative or compliance procedures specified in 40 CFR part 1068 instead of the comparable procedures that apply for vehicles or engines certified under this part or 40 CFR part 86.

**Subpart T—[Amended]**

■ 5. Section 85.1901 is revised to read as follows:

**§ 85.1901 Applicability.**

Except as specified in this section, the requirements of this subpart shall be applicable to all 1972 and later model year vehicles and engines. The requirement to report emission-related defects affecting a given class or

category of vehicles or engines shall remain applicable for five years from the end of the model year in which such vehicles or engines were manufactured. Manufacturers of heavy-duty motor vehicle engines may comply with the defect reporting requirements of 40 CFR 1068.501 instead of the requirements of this subpart.

**PART 86—CONTROL OF EMISSIONS FROM NEW AND IN-USE HIGHWAY VEHICLES AND ENGINES**

■ 6. The authority citation for part 86 continues to read as follows:

**Authority:** 42 U.S.C. 7401–7671q.

■ 7. Section 86.1 is amended by adding paragraphs (b)(2)(xli) and (b)(2)(xlii) and removing and reserving paragraph (b)(4)(i)(A) to read as follows:

**§ 86.1 Reference materials.**

\* \* \* \* \*

(b) \* \* \*

(2) \* \* \*

(xli) SAE J1711, Recommended Practice for Measuring the Exhaust Emissions and Fuel Economy of Hybrid-Electric Vehicles, Including Plug-In Hybrid Vehicles, June 2010, IBR approved for § 86.1811–04(n).

(xlii) SAE J1634, Electric Vehicle Energy Consumption and Range Test Procedure, Cancelled October 2002, IBR approved for § 86.1811–04(n).

\* \* \* \* \*

(4) \* \* \*

(i) \* \* \*

(A) [Reserved]

\* \* \* \* \*

**Subpart A—[Amended]**

■ 8. Section 86.010–18 is amended by adding paragraphs (j)(1)(ii)(E) and (q) to read as follows:

**§ 86.010–18 On-board Diagnostics for engines used in applications greater than 14,000 pounds GVWR.**

\* \* \* \* \*

(j) \* \* \*

(1) \* \* \*

(ii) \* \* \*

(E) For hybrid engine families with projected U.S.-directed production volume of less than 5,000 engines, the manufacturers are only required to test one engine-hybrid combination per family.

\* \* \* \* \*

(q) *Optional phase-in for hybrid vehicles.* This paragraph (q) applies for model year 2013 through 2015 engines when used with hybrid powertrain systems. It also applies for model year 2016 engines used with hybrid powertrain systems that were offered for

sale prior to January 1, 2013, as specified in paragraph (q)(4) of this section. Manufacturers choosing to use the provisions of this paragraph (q) must submit an annual pre-compliance report to EPA for model years 2013 and later, as specified in paragraph (q)(5) of this section. Note that all hybrid powertrain systems must be fully compliant with the OBD requirements of this section no later than model year 2017.

(1) If an engine-hybrid system has been certified by the California Air Resources Board with respect to its OBD requirements and it effectively meets the full OBD requirements of this section, all equivalent systems must meet those same requirements and may not be certified under this paragraph (q). For purposes of this paragraph (q)(1), an engine-hybrid system is considered to be equivalent to the certified system if it uses the same basic design (e.g. displacement) for the engine and primary hybrid components (see paragraph (q)(4) of this section). Equivalent systems may have minor hardware or calibration differences.

(2) As of 2013, if an engine-hybrid system has not been certified to meet the full OBD requirements of this section, it must comply with the following requirements:

(i) The engine in its installed configuration must meet the EMD and EMD+ requirements in 13 CCR § 1971.1(d)(7.1.4) of the California Code of Regulations. For purposes of this paragraph (q), a given EMD requirement is deemed to be met if the engine's OBD system addresses the same function. This allowance does not apply for OBD monitors or diagnostics that have been modified under paragraph (q)(2)(ii) of this section.

(ii) The engine-hybrid system must maintain existing OBD capability for engines where the same or equivalent engine has been OBD certified. An equivalent engine is one produced by the same engine manufacturer with the same fundamental design, but that may have hardware or calibration differences that do not impact OBD functionality, such as slightly different displacement, rated power, or fuel system. (Note that engines with the same fundamental design will be presumed to be equivalent unless the manufacturer demonstrates that the differences effectively preclude applying equivalent OBD systems.) Though the OBD capability must be maintained, it does not have to meet detection thresholds (as described in Tables 1 and 2 of this section) and in-use performance frequency requirements (as described in paragraph (d) of this section). A manufacturer may modify detection

thresholds to prevent false detection, and must indicate all deviations from the originally certified package with engineering justification in the certification documentation.

(iii) This paragraph (q)(2)(iii) applies for derivatives of hybrid powertrain system designs that were offered for sale prior to January 1, 2013. Until these systems achieve full OBD certification, they must at a minimum maintain all fault-detection and diagnostic capability included on similar systems offered for sale prior to 2013. Manufacturers choosing to use the provisions of this paragraph (q)(2) must keep copies of the service manuals (and similar documents) for these previous model years to show the technical description of the system's fault detection and diagnostic capabilities.

(iv) You must submit an annual pre-compliance report to EPA for model years 2013 and later, as specified in paragraph (q)(5) of this section.

(3) Engine-hybrid systems may be certified to the requirements of paragraph (q)(2) of this section by the engine manufacturer, the hybrid system manufacturer, or the vehicle manufacturer. If engine manufacturers certify the engine hybrid system, they must provide detailed installation instructions. Where the engine manufacturer does not specifically certify its engines for use in hybrid vehicles under this paragraph (q), the hybrid system manufacturer and vehicle manufacturer must install the engine to conform to the requirements of this section (i.e., full OBD) or recertify under paragraph (q)(2) of this section.

(4) The provisions of this paragraph (q) apply for model year 2016 engines where you demonstrate that the hybrid powertrain system used is a derivative of a design that was offered for sale prior to January 1, 2013. In this case, you may ask us to consider the original system and the later system to be the same model for purposes of this paragraph (q), unless the systems are fundamentally different. In determining whether such systems are derivative or fundamentally different, we will consider factors such as the similarity of the following:

(i) Transmissions.

(ii) Hybrid machines (where "hybrid machine" means any system that is the part of a hybrid vehicle system that captures energy from and returns energy to the powertrain).

(iii) Hybrid architecture (such as parallel or series).

(iv) Motor/generator size, controller/CPU (memory or inputs/outputs), control algorithm, and batteries. This

paragraph (q)(4)(iv) applies only if all of these are modified simultaneously.

(5) Manufacturers choosing to use the provisions of this paragraph (q) must submit an annual pre-compliance report to EPA for model years 2013 and later. Engine manufacturers must submit this report with their engine certification information. Hybrid manufacturers that are not certifying the engine-hybrid system must submit their report by June 1 of the model year, or at the time of certification if they choose to certify. Include the following in the report:

(i) A description of the manufacturer's product plans and of the engine-hybrid systems being certified.

(ii) A description of activities undertaken and progress made by the manufacturer towards achieving full OBD certification, including monitoring, diagnostics, and standardization.

(iii) For model year 2016 engines, a description of your basis for applying the provision of this paragraph (q) to the engines.

■ 9. A new § 86.012–2 is added to subpart A to read as follows:

**§ 86.012–2 Definitions.**

The definitions of § 86.010–2 continue to apply to model year 2010 and later model year vehicles. The definitions listed in this section apply beginning with model year 2012. *Urban bus* means a passenger-carrying vehicle with a load capacity of fifteen or more passengers and intended primarily for intracity operation, i.e., within the confines of a city or greater metropolitan area. Urban bus operation is characterized by short rides and frequent stops. To facilitate this type of operation, more than one set of quick-operating entrance and exit doors would normally be installed. Since fares are usually paid in cash or tokens, rather than purchased in advance in the form of tickets, urban buses would normally have equipment installed for collection of fares. Urban buses are also typically characterized by the absence of equipment and facilities for long distance travel, e.g., rest rooms, large luggage compartments, and facilities for stowing carry-on luggage.

■ 10. A new § 86.016–1 is added to subpart A to read as follows:

**§ 86.016–1 General applicability.**

(a) *Applicability.* The provisions of this subpart generally apply to 2005 and later model year new Otto-cycle heavy-duty engines used in incomplete vehicles and vehicles above 14,000 pounds GVWR and 2005 and later model year new diesel-cycle heavy-duty engines. In cases where a provision

applies only to a certain vehicle group based on its model year, vehicle class, motor fuel, engine type, or other distinguishing characteristics, the limited applicability is cited in the appropriate section or paragraph. The provisions of this subpart continue to generally apply to 2000 and earlier model year new Otto-cycle and diesel-cycle light-duty vehicles, 2000 and earlier model year new Otto-cycle and diesel-cycle light-duty trucks, and 2004 and earlier model year new Otto-cycle complete heavy-duty vehicles at or below 14,000 pounds GVWR. Provisions generally applicable to 2001 and later model year new Otto-cycle and diesel-cycle light-duty vehicles, 2001 and later model year new Otto-cycle and diesel-cycle light-duty trucks, and 2005 and later model year Otto-cycle complete heavy-duty vehicles at or below 14,000 pounds GVWR are located in subpart S of this part.

(b) *Optional applicability.* A manufacturer may request to certify any incomplete Otto-cycle heavy-duty vehicle of 14,000 pounds Gross Vehicle Weight Rating or less in accordance with the provisions for Otto-cycle complete heavy-duty vehicles located in subpart S of this part. Heavy-duty engine or heavy-duty vehicle provisions of this subpart A do not apply to such a vehicle.

(c) *Otto-cycle heavy-duty engines and vehicles.* The following requirements apply to Otto-cycle heavy-duty engines and vehicles:

(1) Exhaust emission standards according to the provisions of § 86.008–10 or § 86.1816, as applicable.

(2) On-board diagnostics requirements according to the provisions of § 86.007–17 or § 86.1806, as applicable.

(3) Evaporative emission standards as follows:

(i) Evaporative emission standards for complete vehicles according to the provisions of §§ 86.1810 and 86.1816.

(ii) For 2013 and earlier model years, evaporative emission standards for incomplete vehicles according to the provisions of § 86.008–10, or §§ 86.1810 and 86.1816, as applicable.

(iii) For 2014 and later model years, evaporative emission standards for incomplete vehicles according to the provisions of §§ 86.1810 and 86.1816, or 40 CFR part 1037, as applicable.

(4) Refueling emission requirements for Otto-cycle complete vehicles according to the provisions of §§ 86.1810 and 86.1816.

(d) *Non-petroleum fueled vehicles.* The standards and requirements of this part apply to model year 2016 and later non-petroleum fueled motor vehicles as follows:

(1) The standards and requirements of this part apply as specified for vehicles fueled with methanol, natural gas, and LPG.

(2) The standards and requirements of subpart S of this part apply as specified for light-duty vehicles and light-duty trucks.

(3) The standards and requirements of this part applicable to methanol-fueled heavy-duty vehicles and engines (including flexible fuel vehicles and engines) apply to heavy-duty vehicles and engines fueled with any oxygenated fuel (including flexible fuel vehicles and engines). Most significantly, this means that the hydrocarbon standards apply as NMHCE and the vehicles and engines must be tested using the applicable oxygenated fuel according to the test procedures in 40 CFR part 1065 applicable for oxygenated fuels. For purposes of this paragraph (d), oxygenated fuel means any fuel containing at least 50 volume percent oxygenated compounds. For example, a fuel mixture of 85 gallons of ethanol and 15 gallons of gasoline is an oxygenated fuel, while a fuel mixture of 15 gallons of ethanol and 85 gallons of gasoline is not an oxygenated fuel.

(4) The standards and requirements of subpart S of this part applicable to heavy-duty vehicles under 14,000 pounds GVWR apply to all heavy-duty vehicles powered solely by electricity, including plug-in electric vehicles and solar-powered vehicles. Use good engineering judgment to apply these requirements to these vehicles, including applying these provisions to vehicles over 14,000 pounds GVWR. Electric heavy-duty vehicles may not generate NO<sub>x</sub> or PM emission credits. Heavy-duty vehicles powered solely by electricity are deemed to have zero emissions of regulated pollutants.

(5) The standards and requirements of this part applicable to diesel-fueled heavy-duty vehicles and engines apply to all other heavy-duty vehicles and engines not otherwise addressed in this paragraph (d).

(6) See 40 CFR parts 1036 and 1037 for requirements related to greenhouse gas emissions.

(7) Manufacturers may voluntarily certify to the standards of paragraphs (d)(3) through (5) of this section before model year 2016. Note that other provisions in this part require compliance with the standards described in paragraphs (d)(1) and (2) of this section for model years before 2016.

(e) *Small volume manufacturers.* Special certification procedures are available for any manufacturer whose projected combined U.S. sales of light-duty vehicles, light-duty trucks, heavy-

duty vehicles, and heavy-duty engines in its product line (including all vehicles and engines imported under the provisions of 40 CFR 85.1505 and 85.1509) are fewer than 10,000 units for the model year in which the manufacturer seeks certification. To certify its product line under these optional procedures, the small-volume manufacturer must first obtain the Administrator's approval. The manufacturer must meet the eligibility criteria specified in § 86.098–14(b) before the Administrator's approval will be granted. The small-volume manufacturer's certification procedures are described in § 86.098–14.

(f) *Optional procedures for determining exhaust opacity.* (1) The provisions of subpart I of this part apply to tests which are performed by the Administrator, and optionally, by the manufacturer.

(2) Measurement procedures, other than those described in subpart I of this part, may be used by the manufacturer provided the manufacturer satisfies the requirements of § 86.007–23(f).

(3) When a manufacturer chooses to use an alternative measurement procedure, it has the responsibility to determine whether the results obtained by the procedure will correlate with the results which would be obtained from the measurement procedure in subpart I of this part. Consequently, the Administrator will not routinely approve or disapprove any alternative opacity measurement procedure or any associated correlation data which the manufacturer elects to use to satisfy the data requirements for subpart I of this part.

(4) If a confirmatory test is performed and the results indicate there is a systematic problem suggesting that the data generated under an optional alternative measurement procedure do not adequately correlate with data obtained in accordance with the procedures described in subpart I of this part, EPA may require that all certificates of conformity not already issued be based on data obtained from procedures described in subpart I of this part.

■ 11. Section 86.090–2 is amended by revising the definition of “primary intended service class” to read as follows:

**§ 86.090–2 Definitions.**

\* \* \* \* \*

*Primary intended service class* has the meaning given in 40 CFR 1036.140.

\* \* \* \* \*

**Subpart B—[Amended]**

■ 12. Section 86.144–94 is amended by adding paragraphs (b)(11) and (c)(10) to read as follows:

**§ 86.144–94 Calculations; exhaust emissions.**

\* \* \* \* \*

(b) \* \* \*

(11) Nitrous Oxide Mass:  $V_{mix} \times \text{Density}_{N_2O} \times (N_2O_{conc}/1,000,000)$

(c) \* \* \*

(10)(i)  $N_2O_{mass}$  = Nitrous oxide emissions, in grams per test phase.

(ii)  $\text{Density}_{N_2O}$  = Density of nitrous oxide is 51.81 g/ft<sup>3</sup> (1.83 kg/m<sup>3</sup>), at 68 °F (20 °C) and 760 mm Hg (101.3kPa) pressure.

(iii)(A)  $N_2O_{conc}$  = Nitrous oxide concentration of the dilute exhaust sample corrected for background, in ppm.

(B)  $N_2O_{conc} = N_2O_e - N_2O_d(1 - (1/DF))$ .

Where:

$N_2O_e$  = Nitrous oxide concentration of the dilute exhaust sample as measured, in ppm.

$N_2O_d$  = Nitrous oxide concentration of the dilution air as measured, in ppm.

\* \* \* \* \*

**Subpart F—[Amended]**

■ 13. Section 86.544–90 is amended by adding paragraphs (b)(8) and (c)(8) to read as follows:

**§ 86.544–90 Calculations; exhaust emissions.**

\* \* \* \* \*

(b) \* \* \*

(8) Nitrous Oxide Mass:  $V_{mix} \times \text{Density}_{N_2O} \times (N_2O_{conc}/1,000,000)$

(c) \* \* \*

(8)(i)  $N_2O_{mass}$  = Nitrous oxide emissions, in grams per test phase.

(ii)  $\text{Density}_{N_2O}$  = Density of nitrous oxide is 51.81 g/ft<sup>3</sup> (1.83 kg/m<sup>3</sup>), at 68 °F (20 °C) and 760 mm Hg (101.3kPa) pressure.

(iii)(A)  $N_2O_{conc}$  = Nitrous oxide concentration of the dilute exhaust sample corrected for background, in ppm.

(B)  $N_2O_{conc} = N_2O_e - N_2O_d(1 - (1/DF))$ .

Where:

$N_2O_e$  = Nitrous oxide concentration of the dilute exhaust sample as measured, in ppm.

$N_2O_d$  = Nitrous oxide concentration of the dilution air as measured, in ppm.

\* \* \* \* \*

**Subpart N—[Amended]**

■ 14. Section 86.1305–2010 is amended by revising paragraph (b) to read as follows:

**§ 86.1305–2010 Introduction; structure of subpart.**

\* \* \* \* \*

(b) Use the applicable equipment and procedures for spark-ignition or compression-ignition engines in 40 CFR part 1065 to determine whether engines meet the duty-cycle emission standards in subpart A of this part. Measure the emissions of all regulated pollutants as specified in 40 CFR part 1065. Use the duty cycles and procedures specified in §§ 86.1333–2010, 86.1360–2007, and 86.1362–2010. Adjust emission results from engines using aftertreatment technology with infrequent regeneration events as described in § 86.004–28.

\* \* \* \* \*

**Subpart S—[Amended]**

**§ 86.1806–01—[Amended]**

■ 15. Section 86.1806–01 is amended by removing and reserving paragraph (b)(8)(ii).

**§ 86.1806–05—[Amended]**

■ 16. Section 86.1806–05 is amended by removing and reserving paragraph (b)(8)(ii).

■ 17. Section 86.1811–04 is amended by revising paragraph (n) to read as follows:

**§ 86.1811–04 Emission standards for light-duty vehicles, light-duty trucks and medium-duty passenger vehicles.**

\* \* \* \* \*

(n) *Hybrid electric vehicle (HEV) and Zero Emission Vehicle (ZEV) requirements.* For FTP and SFTP exhaust emissions, manufacturers must measure emissions from all HEVs and ZEVs according to the procedures specified in SAE J1711 and SAE J1634, respectively (incorporated by reference in § 86.1).

\* \* \* \* \*

■ 18. Section 86.1818–12 is amended by revising paragraph (f) to read as follows:

**§ 86.1818–12 Greenhouse gas emission standards for light-duty vehicles, light-duty trucks, and medium-duty passenger vehicles.**

\* \* \* \* \*

(f) *Nitrous oxide (N<sub>2</sub>O) and methane (CH<sub>4</sub>) exhaust emission standards for passenger automobiles and light trucks.* Each manufacturer's fleet of combined passenger automobile and light trucks must comply with N<sub>2</sub>O and CH<sub>4</sub> standards using either the provisions of paragraph (f)(1), (f)(2), or (f)(3) of this section. Except with prior EPA approval, a manufacturer may not use the provisions of both paragraphs (f)(1) and (2) of this section in a model year. For example, a manufacturer may not

use the provisions of paragraph (f)(1) of this section for their passenger automobile fleet and the provisions of paragraph (f)(2) of this section for their light truck fleet in the same model year. The manufacturer may use the provisions of both paragraphs (f)(1) and (3) of this section in a model year. For example, a manufacturer may meet the N<sub>2</sub>O standard in paragraph (f)(1)(i) of this section and an alternative CH<sub>4</sub> standard determined under paragraph (f)(3) of this section in the same model year. Use of the provisions in paragraph (f)(3) of this section is limited to the 2012 through 2016 model years.

(1) *Standards applicable to each test group.* (i) Exhaust emissions of nitrous oxide (N<sub>2</sub>O) shall not exceed 0.010 grams per mile at full useful life, as measured according to the Federal Test Procedure (FTP) described in subpart B of this part. Manufacturers may optionally determine an alternative N<sub>2</sub>O standard under paragraph (f)(3) of this section. (ii) Exhaust emissions of methane (CH<sub>4</sub>) shall not exceed 0.030 grams per mile at full useful life, as measured according to the Federal Test Procedure (FTP) described in subpart B of this part. Manufacturers may optionally determine an alternative CH<sub>4</sub> standard under paragraph (f)(3) of this section.

(2) *Include N<sub>2</sub>O and CH<sub>4</sub> in fleet averaging program.* Manufacturers may elect to not meet the emission standards in paragraph (f)(1) of this section. Manufacturers making this election shall include N<sub>2</sub>O and CH<sub>4</sub> emissions in the determination of their fleet average carbon-related exhaust emissions, as calculated in 40 CFR part 600, subpart F. Manufacturers using this option must include both N<sub>2</sub>O and CH<sub>4</sub> full useful life values in the fleet average calculations for passenger automobiles and light trucks. Use of this option will account for N<sub>2</sub>O and CH<sub>4</sub> emissions within the carbon-related exhaust emission value determined for each model type according to the provisions of 40 CFR part 600. This option requires the determination of full useful life emission values for both the Federal Test Procedure and the Highway Fuel Economy Test. Manufacturers selecting this option are not required to demonstrate compliance with the standards in paragraph (f)(1) of this section.

(3) *Optional use of alternative N<sub>2</sub>O and/or CH<sub>4</sub> standards.* Manufacturers may select an alternative standard applicable to a test group, for either N<sub>2</sub>O, CH<sub>4</sub>, or both. For example, a manufacturer may choose to meet the N<sub>2</sub>O standard in paragraph (f)(1)(i) of this section and an alternative CH<sub>4</sub>

standard in lieu of the standard in paragraph (f)(1)(ii) of this section. The alternative standard for each pollutant must be greater than the applicable exhaust emission standard specified in paragraph (f)(1) of this section. Alternative N<sub>2</sub>O and CH<sub>4</sub> standards apply to emissions measured according to the Federal Test Procedure (FTP) described in Subpart B of this part for the full useful life, and become the applicable certification and in-use emission standard(s) for the test group. Manufacturers using an alternative standard for N<sub>2</sub>O and/or CH<sub>4</sub> must calculate emission debits according to the provisions of paragraph (f)(4) of this section for each test group/alternative standard combination. Debits must be included in the calculation of total credits or debits generated in a model year as required under § 86.1865–12(k)(5). For flexible fuel vehicles (or other vehicles certified for multiple fuels) you must meet these alternative standards when tested on any applicable test fuel type.

(4) *CO<sub>2</sub>-equivalent debits.* CO<sub>2</sub>-equivalent debits for test groups using an alternative N<sub>2</sub>O and/or CH<sub>4</sub> standard as determined under paragraph (f)(3) of this section shall be calculated according to the following equation and rounded to the nearest megagram:

$$\text{Debits} = [\text{GWP} \times (\text{Production}) \times (\text{AltStd} - \text{Std}) \times \text{VLM}] / 1,000,000$$

Where:

Debits = N<sub>2</sub>O or CH<sub>4</sub> CO<sub>2</sub>-equivalent debits for a test group using an alternative N<sub>2</sub>O or CH<sub>4</sub> standard;

GWP = 25 if calculating CH<sub>4</sub> debits and 298 if calculating N<sub>2</sub>O debits;

Production = The number of vehicles of that test group domestically produced plus those imported as defined in § 600.511 of this chapter;

AltStd = The alternative standard (N<sub>2</sub>O or CH<sub>4</sub>) selected by the manufacturer under paragraph (f)(3) of this section;

Std = The exhaust emission standard for N<sub>2</sub>O or CH<sub>4</sub> specified in paragraph (f)(1) of this section; and

VLM = 195,264 for passenger automobiles and 225,865 for light trucks.

■ 19. Section 86.1823–08 is amended by revising paragraph (m) to read as follows:

**§ 86.1823–08 Durability demonstration procedures for exhaust emissions.**

\* \* \* \* \*

(m) *Durability demonstration procedures for vehicles subject to the greenhouse gas exhaust emission standards specified in § 86.1818.* (1) CO<sub>2</sub>. (i) Unless otherwise specified under paragraph (m)(1)(ii) of this section, manufacturers may use a multiplicative CO<sub>2</sub> deterioration factor of one or an additive deterioration factor

of zero to determine full useful life emissions for the FTP and HFET tests.

(ii) Based on an analysis of industry-wide data, EPA may periodically establish and/or update the deterioration factor for CO<sub>2</sub> emissions, including air conditioning and other credit-related emissions. Deterioration factors established and/or updated under this paragraph (m)(1)(ii) will provide adequate lead time for manufacturers to plan for the change.

(iii) Alternatively, manufacturers may use the whole-vehicle mileage accumulation procedures in § 86.1823–08 (c) or (d)(1) to determine CO<sub>2</sub> deterioration factors. In this case, each FTP test performed on the durability data vehicle selected under § 86.1822 must also be accompanied by an HFET test, and combined FTP/HFET CO<sub>2</sub> results determined by averaging the city (FTP) and highway (HFET) CO<sub>2</sub> values, weighted 0.55 and 0.45 respectively. The deterioration factor will be determined for this combined CO<sub>2</sub> value. Calculated multiplicative deterioration factors that are less than one shall be set to equal one, and calculated additive deterioration factors that are less than zero shall be set to zero.

(iv) If, in the good engineering judgment of the manufacturer, the deterioration factors determined according to paragraphs (m)(1)(i), (m)(1)(ii), or (m)(1)(iii) of this section do not adequately account for the expected CO<sub>2</sub> emission deterioration over the vehicle's useful life, the manufacturer may petition EPA to request a more appropriate deterioration factor.

(2) *N<sub>2</sub>O and CH<sub>4</sub>.* (i) For manufacturers complying with the FTP emission standards for N<sub>2</sub>O and CH<sub>4</sub> specified in § 86.1818–12(f)(1) or determined under § 86.1818–12(f)(3), FTP-based deterioration factors for N<sub>2</sub>O and CH<sub>4</sub> shall be determined according to the provisions of paragraphs (a) through (l) of this section.

(ii) For manufacturers complying with the fleet averaging option for N<sub>2</sub>O and CH<sub>4</sub> as allowed under § 86.1818–12(f)(2), deterioration factors based on FTP testing shall be determined and may be used to determine full useful life emissions for the FTP and HFET tests. The manufacturer may at its option determine separate deterioration factors for the FTP and HFET test cycles, in which case each FTP test performed on the durability data vehicle selected under § 86.1822 of this part must also be accompanied by an HFET test.

(iii) For the 2012 through 2014 model years only, manufacturers may use alternative deterioration factors. For N<sub>2</sub>O, the alternative deterioration factor

to be used to adjust FTP and HFET emissions is the deterioration factor determined for NO<sub>x</sub> emissions according to the provisions of this section. For CH<sub>4</sub>, the alternative deterioration factor to be used to adjust FTP and HFET emissions is the deterioration factor determined for NMOG or NMHC emissions according to the provisions of this section.

(3) *Other carbon-related exhaust emissions.* FTP-based deterioration factors shall be determined for carbon-related exhaust emissions (CREE), hydrocarbons, and CO according to the provisions of paragraphs (a) through (l) of this section. The FTP-based deterioration factor shall be used to determine full useful life emissions for both the FTP (city) and HFET (highway) test cycles. The manufacturer may at its option determine separate deterioration factors for the FTP and HFET test cycles, in which case each FTP test performed on the durability data vehicle selected under § 86.1822 must also be accompanied by an HFET test. In lieu of determining emission-specific deterioration factors for the specific hydrocarbons of CH<sub>3</sub>OH (methanol), HCHO (formaldehyde), C<sub>2</sub>H<sub>5</sub>OH (ethanol), and C<sub>2</sub>H<sub>4</sub>O (acetaldehyde) as may be required for some alternative fuel vehicles, manufacturers may use the additive or multiplicative deterioration factor determined for (or derived from, using good engineering judgment) NMOG or NMHC emissions according to the provisions of this section.

(4) *Air Conditioning leakage and efficiency or other emission credit requirements to comply with exhaust CO<sub>2</sub> standards.* Manufacturers will attest to the durability of components and systems used to meet the CO<sub>2</sub> standards. Manufacturers may submit engineering data to provide durability demonstration. Deterioration factors do not apply to emission-related components and systems used to generate air conditioning leakage and/or efficiency credits.

■ 20. Section 86.1844–01 is amended by revising paragraph (d)(15) to read as follows:

**§ 86.1844–01 Information requirements: Application for certification and submittal of information upon request.**

\* \* \* \* \*

(d) \* \* \*

(15)(i) For HEVs and EVs, describe the recharging procedures and methods for determining battery performance, such as state of charge and charging capacity.

(ii) For vehicles with fuel-fired heaters, include the information specified in this paragraph (d)(15)(ii).

Describe the control system logic of the fuel-fired heater, including an evaluation of the conditions under which it can be operated and an evaluation of the possible operational modes and conditions under which evaporative emissions can exist. Use good engineering judgment to establish an estimated exhaust emission rate from the fuel-fired heater in grams per mile. Describe the testing used to establish the exhaust emission rate.

\* \* \* \* \*

■ 21. Section 86.1863–07 is revised to read as follows:

**§ 86.1863–07 Chassis certification for diesel vehicles.**

(a) A manufacturer may optionally certify heavy-duty diesel vehicles 14,000 pounds GVWR or less to the standards specified in § 86.1816. Such vehicles must meet all the requirements of this subpart S that are applicable to Otto-cycle vehicles, except for evaporative, refueling, and OBD requirements where the diesel-specific OBD requirements would apply.

(b) For OBD, diesel vehicles optionally certified under this section are subject to the OBD requirements of § 86.1806.

(c) Diesel vehicles certified under this section may be tested using the test fuels, sampling systems, or analytical systems specified for diesel engines in subpart N of this part or in 40 CFR part 1065.

(d) Diesel vehicles optionally certified under this section to the standards of this subpart may not be included in any averaging, banking, or trading program for criteria emissions under this part.

(e) The provisions of § 86.004–40 apply to the engines in vehicles certified under this section.

(f) Diesel vehicles may be certified under this section to the standards applicable to model year 2008 in earlier model years.

(g) Diesel vehicles optionally certified under this section in model years 2007, 2008, or 2009 shall be included in phase-in calculations specified in § 86.007–11(g).

(h) Diesel vehicles subject to the standards of 40 CFR 1037.104 are

subject to the provisions of this subpart as specified in 40 CFR 1037.104.

(i) Non-petroleum fueled complete vehicles subject to the standards and requirements of this part under § 86.016–01(d)(5) are subject to the provisions of this section applicable to diesel-fueled heavy-duty vehicles.

■ 22. Section 86.1865–12 is amended by adding paragraph (k)(5)(iv) and by revising paragraphs (l)(1)(ii)(F) and (l)(2)(i) to read as follows:

**§ 86.1865–12 How to comply with the fleet average CO<sub>2</sub> standards.**

\* \* \* \* \*

(k) \* \* \*

(5) \* \* \*

(iv) N<sub>2</sub>O and/or CH<sub>4</sub> CO<sub>2</sub>-equivalent debits accumulated according to the provisions of § 86.1818–12(f)(4).

\* \* \* \* \*

(l) \* \* \*

(1) \* \* \*

(ii) \* \* \*

(F) Carbon-related exhaust emission standard, N<sub>2</sub>O emission standard, and CH<sub>4</sub> emission standard to which the passenger car or light truck is certified.

\* \* \* \* \*

(2) \* \* \*

(i) Each manufacturer must submit an annual report. The annual report must contain for each applicable CO<sub>2</sub> standard, the calculated fleet average CO<sub>2</sub> value, all values required to calculate the CO<sub>2</sub> emissions value, the number of credits generated or debits incurred, all the values required to calculate the credits or debits, and the resulting balance of credits or debits. For each applicable alternative N<sub>2</sub>O and/or CH<sub>4</sub> standard selected under the provisions of § 86.1818–12(f)(3), the report must contain the N<sub>2</sub>O and/or CH<sub>4</sub> CO<sub>2</sub>-equivalent debits calculated according to § 86.1818–12(f)(4) for each test group and all values required to calculate the number of debits incurred.

\* \* \* \* \*

**PART 600—FUEL ECONOMY AND GREENHOUSE GAS EXHAUST EMISSIONS OF MOTOR VEHICLES**

■ 23. The authority citation for part 600 continues to read as follows:

Authority: 49 U.S.C. 32901–23919q, Pub. L. 109–58.

**Subpart A—[Amended]**

■ 24. Section 600.011 is amended by revising paragraph (c)(3) to read as follows:

**§ 600.011 Incorporation by reference.**

\* \* \* \* \*

(c) \* \* \*

(3) SAE J1711, Recommended Practice for Measuring the Exhaust Emissions and Fuel Economy of Hybrid-Electric Vehicles, Including Plug-In Hybrid Vehicles, June 2010, IBR approved for §§ 600.114–12(c) and (f), 600.116–12(b), and 600.311–12(d), (j), and (k).

\* \* \* \* \*

**Subpart B—[Amended]**

■ 25. Section 600.114–12 is amended by revising the introductory text of paragraph (c), paragraph (e)(2)(ii), and the introductory text of paragraph (f), to read as follows:

**§ 600.114–12 Vehicle-specific 5-cycle fuel economy and carbon-related exhaust emission calculations.**

\* \* \* \* \*

(c) *Fuel economy calculations for hybrid electric vehicles.* Test hybrid electric vehicles as described in SAE J1711 (incorporated by reference in § 600.011). For FTP testing, this generally involves emission sampling over four phases (bags) of the UDDS (cold-start, transient, warm-start, transient); however, these four phases may be combined into two phases (phases 1 + 2 and phases 3 + 4). Calculations for these sampling methods follow:

\* \* \* \* \*

(e) \* \* \*

(2) \* \* \*

(ii) Determine the 5-cycle highway carbon-related exhaust emissions according to the following formula:

$$\text{Highway CREE} = \frac{(\text{Start CREE} + \text{Running CREE})}{0.905}$$

Where:

$$\text{StartCREE} = 0.33 \times \frac{((0.005515 \times A) + 1.13637 \times \text{StartCREE}_{75})}{75}$$



Start CREE<sub>75</sub> = 3.6 × (Bag 1CREE<sub>75</sub> – Bag 3CREE<sub>75</sub>)  
 Running CREE = 1.007 × [(0.79 × US06 Highway CREE) + (0.21 × HFET CREE)] + [0.377 × 0.133 × ((0.00540 × A) + (0.1357 × US06 CREE))]

\* \* \* \* \*

(f) CO<sub>2</sub> and carbon-related exhaust emissions calculations for hybrid electric vehicles. Test hybrid electric vehicles as described in SAE J1711 (incorporated by reference in § 600.011). For FTP testing, this generally involves emission sampling over four phases (bags) of the UDDS (cold-start, transient, warm-start, transient); however, these four phases may be combined into two phases (phases 1 + 2 and phases 3 + 4). Calculations for these sampling methods follow:

\* \* \* \* \*

■ 26. Section 600.115–11 is amended by revising the introductory text to read as follows:

**§ 600.115–11 Criteria for determining the fuel economy label calculation method.**

This section provides the criteria to determine if the derived 5-cycle method for determining fuel economy label values, as specified in § 600.210–08(a)(2) or (b)(2) or § 600.210–12(a)(2) or (b)(2), as applicable, may be used to determine label values. Separate criteria apply to city and highway fuel economy for each test group. The provisions of this section are optional. If this option is not chosen, or if the criteria provided in this section are not met, fuel economy label values must be determined according to the vehicle-specific 5-cycle method specified in § 600.210–08(a)(1) or (b)(1) or § 600.210–12(a)(1) or (b)(1), as applicable. However, dedicated alternative-fuel vehicles, dual fuel vehicles when operating on the alternative fuel, plug-in hybrid electric vehicles while operating in charge-depleting mode, MDPVs, and vehicles imported by Independent Commercial

Importers may use the derived 5-cycle method for determining fuel economy label values whether or not the criteria provided in this section are met. Manufacturers may alternatively account for this effect by multiplying 2-cycle fuel economy values by 0.7 and dividing 2-cycle CO<sub>2</sub> emission values by 0.7.

\* \* \* \* \*

■ 27. Section 600.116–12 is amended by adding paragraph (a)(6) and revising the equation for  $UF_i$  in paragraph (b)(4) to read as follows:

**§ 600.116–12 Special procedures related to electric vehicles and plug-in hybrid electric vehicles.**

(a) \* \* \*

(6) All label values related to fuel economy, energy consumption, and range must be based on 5-cycle testing or on values adjusted to be equivalent to 5-cycle results.

(b) \* \* \*

(4) \* \* \*

$$UF_i = 1 - \left[ \exp \left( - \sum_{j=1}^k \left( \left( \frac{d_i}{ND} \right)^j \times C_j \right) \right) \right] - \sum_{i=1}^n UF_{i-1}$$

\* \* \* \* \*

**Subpart C—[Amended]**

■ 28. Section 600.210–12 is amended by revising paragraph (d)(3)(ii) to read as follows:

**§ 600.210–12 Calculation of fuel economy and CO<sub>2</sub> emission values for labeling.**

\* \* \* \* \*

(d) \* \* \*

(3) \* \* \*

(ii) Multiply 2-cycle fuel economy values by 0.7 and divide 2-cycle CO<sub>2</sub> emission values by 0.7.

\* \* \* \* \*

**Subpart D—[Amended]**

■ 29. Section 600.302–12 is amended by revising paragraph (e)(4) to read as follows:

**§ 600.302–12 Fuel economy label—general provisions.**

(e) \* \* \*

(4) Insert a slider bar in the right portion of the field to characterize the vehicle’s level of emission control for ozone-related air pollutants relative to that of all vehicles. Position a box with a downward-pointing wedge above the slider bar positioned to show where that vehicle’s emission rating falls relative to the total range. Include the vehicle’s

emission rating (as described in § 600.311) inside the box. Include the number 1 in the border at the left end of the slider bar; include the number 10 in the border at the right end of the slider bar and add the term “Best” below the slider bar, directly under the number. EPA will periodically calculate and publish updated range values as described in § 600.311. Add color to the slider bar such that it is blue at the left end of the range, white at the right end of the range, and shaded continuously across the range.

\* \* \* \* \*

■ 30. Section 600.311–12 is amended by revising paragraph (f) to read as follows:

**§ 600.311–12 Determination of values for fuel economy labels.**

\* \* \* \* \*

(f) *Fuel savings.* Calculate an estimated five-year cost increment relative to an average vehicle by multiplying the annual fuel cost from paragraph (e) of this section by 5 and subtracting this value from the average five-year fuel cost. We will calculate the average five-year fuel cost from the annual fuel cost equation in paragraph (e) of this section based on a gasoline-fueled vehicle with a mean fuel economy value, consistent with the value dividing the 5 and 6 ratings under paragraph (d) of this section. The

average five-year fuel cost for model year 2012 is \$12,600 for a 22-mpg vehicle that drives 15,000 miles per year with gasoline priced at \$3.70 per gallon. We may periodically update this five year reference fuel cost for later model years to better characterize the fuel economy for an average vehicle. Round the calculated five-year cost increment to the nearest \$50. Negative values represent a cost increase compared to the average vehicle.

**PART 1033—CONTROL OF EMISSIONS FROM LOCOMOTIVES**

■ 31. The authority citation for part 1033 continues to read as follows:

Authority: 42 U.S.C. 7401–7671q.

**Subpart G—[Amended]**

■ 32. Section 1033.625 is amended by revising paragraph (a)(2) to read as follows:

**§ 1033.625 Special certification provisions for non-locomotive-specific engines.**

\* \* \* \* \*

(a) \* \* \*

(2) The engines were certified to PM, NO<sub>x</sub>, and hydrocarbon standards that are numerically lower than the applicable locomotive standards of this part.

\* \* \* \* \*



■ 33. A new part 1036 is added to subchapter U to read as follows:

**PART 1036—CONTROL OF EMISSIONS FROM NEW AND IN-USE HEAVY-DUTY HIGHWAY ENGINES**

**Subpart A—Overview and Applicability**

- Sec.  
1036.1 Does this part apply for my engines?  
1036.2 Who is responsible for compliance?  
1036.5 Which engines are excluded from this part's requirements?  
1036.10 How is this part organized?  
1036.15 Do any other regulation parts apply to me?  
1036.30 Submission of information.

**Subpart B—Emission Standards and Related Requirements**

- 1036.100 Overview of exhaust emission standards.  
1036.108 Greenhouse gas emission standards.  
1036.115 Other requirements.  
1036.130 Installation instructions for vehicle manufacturers.  
1036.135 Labeling.  
1036.140 Primary intended service class.  
1036.150 Interim provisions.

**Subpart C—Certifying Engine Families**

- 1036.205 What must I include in my application?  
1036.210 Preliminary approval before certification.  
1036.225 Amending my application for certification.  
1036.230 Selecting engine families.  
1036.235 Testing requirements for certification.  
1036.241 Demonstrating compliance with greenhouse gas pollutant standards.  
1036.250 Reporting and recordkeeping for certification.  
1036.255 What decisions may EPA make regarding my certificate of conformity?

**Subpart D—[Reserved]**

**Subpart E—In-use Testing**

- 1036.401 In-use testing.

**Subpart F—Test Procedures**

- 1036.501 How do I run a valid emission test?  
1036.525 Hybrid engines.  
1036.530 Calculating greenhouse gas emission rates.

**Subpart G—Special Compliance Provisions**

- 1036.601 What compliance provisions apply to these engines?  
1036.610 Innovative technology credits and adjustments for reducing greenhouse gas emissions.  
1036.615 Engines with Rankine cycle waste heat recovery and hybrid powertrains.  
1036.620 Alternate CO<sub>2</sub> standards based on model year 2011 compression-ignition engines.  
1036.625 In-use compliance with family emission limits (FELs).

**Subpart H—Averaging, Banking, and Trading for Certification**

- 1036.701 General provisions.  
1036.705 Generating and calculating emission credits.  
1036.710 Averaging.  
1036.715 Banking.  
1036.720 Trading.  
1036.725 What must I include in my application for certification?  
1036.730 ABT reports.  
1036.735 Recordkeeping.  
1036.740 Restrictions for using emission credits.  
1036.745 End-of-year CO<sub>2</sub> credit deficits.  
1036.750 What can happen if I do not comply with the provisions of this subpart?  
1036.755 Information provided to the Department of Transportation.

**Subpart I—Definitions and Other Reference Information**

- 1036.801 Definitions.  
1036.805 Symbols, acronyms, and abbreviations.  
1036.810 Incorporation by reference.  
1036.815 Confidential information.  
1036.820 Requesting a hearing.  
1036.825 Reporting and recordkeeping requirements.

Authority: 42 U.S.C. 7401–7671q.

**Subpart A—Overview and Applicability**

**§ 1036.1 Does this part apply for my engines?**

(a) Except as specified in § 1036.5, the provisions of this part apply to all new 2014 model year and later heavy-duty engines. This includes engines fueled by conventional and alternative fuels.

(b) This part does not apply with respect to exhaust emission standards for HC, CO, NO<sub>x</sub>, or PM except that the provisions of § 1036.601 apply.

**§ 1036.2 Who is responsible for compliance?**

The regulations in this part 1036 contain provisions that affect both engine manufacturers and others. However, the requirements of this part are generally addressed to the engine manufacturer. The term “you” generally means the engine manufacturer, especially for issues related to certification.

**§ 1036.5 Which engines are excluded from this part's requirements?**

(a) The provisions of this part do not apply to engines used in medium-duty passenger vehicles that are subject to regulation under 40 CFR part 86, subpart S, except as specified in 40 CFR part 86, subpart S, and § 1036.108(a)(4). For example, this exclusion applies for engines used in vehicles certified to the standards of 40 CFR 1037.104.

(b) Engines installed in heavy-duty vehicles that do not provide motive

power are nonroad engines. The provisions of this part therefore do not apply to these engines. See 40 CFR parts 1039, 1048, or 1054 for other requirements that apply for these auxiliary engines. See 40 CFR part 1037 for requirements that may apply for vehicles using these engines, such as the evaporative emission requirements of 40 CFR 1037.103.

(c) The provisions of this part do not apply to aircraft or aircraft engines. Standards apply separately to certain aircraft engines, as described in 40 CFR part 87.

(d) The provisions of this part do not apply to engines that are not internal combustion engines. For example, the provisions of this part do not apply to fuel cells.

(e) The provisions of this part do not apply to engines used in heavy-duty vehicles that are subject to light-duty greenhouse gas standards under 40 CFR part 86, subpart S, except as specified in 40 CFR part 86, subpart S, and § 1036.108(a)(4).

**§ 1036.10 How is this part organized?**

This part 1036 is divided into the following subparts:

(a) Subpart A of this part defines the applicability of this part 1036 and gives an overview of regulatory requirements.

(b) Subpart B of this part describes the emission standards and other requirements that must be met to certify engines under this part. Note that § 1036.150 describes certain interim requirements and compliance provisions that apply only for a limited time.

(c) Subpart C of this part describes how to apply for a certificate of conformity.

(d) [Reserved]

(e) Subpart E of this part describes provisions for testing in-use engines.

(f) Subpart F of this part describes how to test your engines (including references to other parts of the Code of Federal Regulations).

(g) Subpart G of this part describes requirements, prohibitions, and other provisions that apply to engine manufacturers, vehicle manufacturers, owners, operators, rebuilders, and all others.

(h) Subpart H of this part describes how you may generate and use emission credits to certify your engines.

(i) Subpart I of this part contains definitions and other reference information.

**§ 1036.15 Do any other regulation parts apply to me?**

(a) Part 86 of this chapter describes additional requirements that apply to

engines that are subject to this part 1036. This part extensively references portions of 40 CFR part 86. For example, the regulations of part 86 specify emission standards and certification procedures related to criteria pollutants.

(b) Part 1037 of this chapter describes requirements for controlling evaporative emissions and greenhouse gas emissions from heavy-duty vehicles, whether or not they use engines certified under this part. It also includes standards and requirements that apply instead of the standards and requirements of this part in some cases.

(c) Part 1065 of this chapter describes procedures and equipment specifications for testing engines to measure exhaust emissions. Subpart F of this part 1036 describes how to apply the provisions of part 1065 of this chapter to determine whether engines meet the exhaust emission standards in this part.

(d) Certain provisions of part 1068 of this chapter apply as specified in § 1036.601 to everyone, including anyone who manufactures, imports, installs, owns, operates, or rebuilds any of the engines subject to this part 1036, or vehicles containing these engines. Part 1068 of this chapter describes general provisions that apply broadly, but do not necessarily apply for all engines or all persons. The issues addressed by these provisions include these seven areas:

- (1) Prohibited acts and penalties for engine manufacturers, vehicle manufacturers, and others.
- (2) Rebuilding and other aftermarket changes.
- (3) Exclusions and exemptions for certain engines.
- (4) Importing engines.
- (5) Selective enforcement audits of your production.

- (6) Recall.
- (7) Procedures for hearings.
- (e) Other parts of this chapter apply if referenced in this part.

**§ 1036.30 Submission of information.**

Send all reports and requests for approval to the Designated Compliance Officer (see § 1036.801). See § 1036.825 for additional reporting and recordkeeping provisions.

**Subpart B—Emission Standards and Related Requirements**

**§ 1036.100 Overview of exhaust emission standards.**

Engines used in vehicles certified to the applicable chassis standards for greenhouse gas pollutants described in 40 CFR 1037.104 are not subject to the standards specified in this part. All other engines subject to this part must meet the greenhouse gas standards in § 1036.108 in addition to the criteria pollutant standards of 40 CFR part 86.

**§ 1036.108 Greenhouse gas emission standards.**

This section contains standards and other regulations applicable to the emission of the air pollutant defined as the aggregate group of six greenhouse gases: carbon dioxide, nitrous oxide, methane, hydrofluorocarbons, perfluorocarbons, and sulfur hexafluoride. This section describes the applicable CO<sub>2</sub>, N<sub>2</sub>O, and CH<sub>4</sub> standards for engines. Except as specified in paragraph (a)(4) of this section, these standards do not apply for engines used in vehicles subject to (or voluntarily certified to) the CO<sub>2</sub>, N<sub>2</sub>O, and CH<sub>4</sub> standards for vehicles specified in 40 CFR 1037.104.

(a) *Emission standards.* Emission standards apply for engines measured

using the test procedures specified in subpart F of this part as follows:

(1) CO<sub>2</sub> emission standards apply as specified in this paragraph (a)(1). The applicable test cycle for measuring CO<sub>2</sub> emissions differs depending on the engine family's primary intended service class and the extent to which the engines will be (or were designed to be) used in tractors. For medium and heavy heavy-duty engines certified as tractor engines, measure CO<sub>2</sub> emissions using the steady-state duty cycle specified in 40 CFR 86.1362 (referred to as the SET cycle). This is intended for engines designed to be used primarily in tractors and other line-haul applications. Note that the use of some SET-certified tractor engines in vocational applications does not affect your certification obligation under this paragraph (a)(1); see other provisions of this part and 40 CFR part 1037 for limits on using engines certified to only one cycle. For medium and heavy heavy-duty engines certified as both tractor and vocational engines, measure CO<sub>2</sub> emissions using the steady-state duty cycle and the transient duty cycle (sometimes referred to as the FTP engine cycle), both of which are specified in 40 CFR part 86, subpart N. This is intended for engines that are designed for use in both tractor and vocational applications. For all other engines (including all spark-ignition engines), measure CO<sub>2</sub> emissions using the transient duty cycle specified in 40 CFR part 86, subpart N.

(i) The CO<sub>2</sub> standard for model year 2016 and later spark-ignition engines is 627 g/hp-hr.

(ii) The following CO<sub>2</sub> standards apply for compression-ignition engines and all other engines (in g/hp-hr):

Model years	Light heavy-duty	Medium heavy-duty—vocational	Heavy heavy-duty—vocational	Medium heavy-duty—tractor	Heavy heavy-duty—tractor
2014–2016 .....	600	600	567	502	475
2017 and later .....	576	576	555	487	460

(2) The CH<sub>4</sub> emission standard is 0.10 g/hp-hr when measured over the transient duty cycle specified in 40 CFR part 86, subpart N. This standard begins in model year 2014 for compression ignition engines and in model year 2016 for spark-ignition engines. Note that this standard applies for all fuel types just as the other standards of this section do.

(3) The N<sub>2</sub>O emission standard for all model year 2014 and later engines is 0.10 g/hp-hr when measured over the transient duty cycle specified in 40 CFR

part 86, subpart N. This standard begins in model year 2014 for compression ignition engines and in model year 2016 for spark-ignition engines.

(4) This paragraph (a)(4) describes alternate emission standards for engines certified under 40 CFR 1037.150(m). The standards of paragraphs (a)(1) through (3) of this section do not apply for these engines. The standards in this paragraph (a)(4) apply for emissions measured with the engine installed in a complete vehicle consistent with the

provisions of 40 CFR 1037.150(m)(6). The CO<sub>2</sub> standard for the engines equals the test result specified in 40 CFR 1037.150(m)(6) multiplied by 1.10 and rounded to the nearest 0.1 g/mile. The N<sub>2</sub>O and CH<sub>4</sub> standards are both 0.05 g/mile (or any alternate standards that apply to the corresponding vehicle test group). The only requirements of this part that apply to these engines are those in this paragraph (a)(4) and those in §§ 1036.115 through 1036.135.

(b) *Family certification levels.* You must specify a CO<sub>2</sub> Family Certification Level (FCL) for each engine family. The FCL may not be less than the certified emission level for the engine family. The CO<sub>2</sub> Family Emission Limit (FEL) for the engine family is equal to the FCL multiplied by 1.03.

(c) *Averaging, banking, and trading.* You may generate or use emission credits under the averaging, banking, and trading (ABT) program described in subpart H of this part for demonstrating compliance with CO<sub>2</sub> emission standards. Credits (positive and negative) are calculated from the difference between the FCL and the applicable emission standard. As described in § 1036.705, you may use CO<sub>2</sub> credits to certify your engine families to FELs for N<sub>2</sub>O and/or CH<sub>4</sub>, instead of the N<sub>2</sub>O/CH<sub>4</sub> standards of this section that otherwise apply. Except as specified in §§ 1036.150 and 1036.705, you may not generate or use credits for N<sub>2</sub>O or CH<sub>4</sub> emissions.

(d) *Useful life.* Your engines must meet the exhaust emission standards of this section throughout their full useful life, expressed in service miles or calendar years, whichever comes first. The useful life values applicable to the criteria pollutant standards of 40 CFR part 86 apply for the standards of this section.

(e) *Applicability for testing.* The emission standards in this subpart apply as specified in this paragraph (e) to all duty-cycle testing (according to the applicable test cycles) of testable configurations, including certification, selective enforcement audits, and in-use testing. The CO<sub>2</sub> FCLs serve as the CO<sub>2</sub> emission standards for the engine family with respect to certification and confirmatory testing instead of the standards specified in paragraph (a)(1) of this section. The FELs serve as the emission standards for the engine family with respect to all other testing. See §§ 1036.235 and 1036.241 to determine which engine configurations within the engine family are subject to testing.

(f) *Multi-fuel engines.* For dual-fuel, multi-fuel, and flexible-fuel engines, perform exhaust testing on each fuel type (for example, gasoline and E85).

(1) This paragraph (f)(1) applies where you demonstrate the relative amount of each fuel type that your engines consume in actual use. Based on your demonstration, we will specify a weighting factor and allow you to submit the weighted average of your emission results. For example, if you certify an E85 flexible-fuel engine and we determine the engine will produce one-half of its work from E85 and one-half of its work from gasoline, you may

average your E85 and gasoline emission results.

(2) If you certify your engine family to N<sub>2</sub>O and/or CH<sub>4</sub> FELs the FELs apply for testing on all fuel types for which your engine is designed, to the same extent as criteria emission standards apply.

#### § 1036.115 Other requirements.

(a) The warranty and maintenance requirements, adjustable parameter provisions, and defeat device prohibition of 40 CFR part 86 apply with respect to the standards of this part.

(b) [Reserved]

#### § 1036.130 Installation instructions for vehicle manufacturers.

(a) If you sell an engine for someone else to install in a vehicle, give the engine installer instructions for installing it consistent with the requirements of this part. Include all information necessary to ensure that an engine will be installed in its certified configuration.

(b) Make sure these instructions have the following information:

(1) Include the heading: "Emission-related installation instructions".

(2) State: "Failing to follow these instructions when installing a certified engine in a heavy-duty motor vehicle violates federal law, subject to fines or other penalties as described in the Clean Air Act."

(3) Provide all instructions needed to properly install the exhaust system and any other components.

(4) Describe any necessary steps for installing any diagnostic system required under 40 CFR part 86.

(5) Describe how your certification is limited for any type of application. For example, if you certify heavy heavy-duty engines to the CO<sub>2</sub> standards using only steady-state testing, you must make clear that the engine may be installed only in tractors.

(6) Describe any other instructions to make sure the installed engine will operate according to design specifications in your application for certification. This may include, for example, instructions for installing aftertreatment devices when installing the engines.

(7) State: "If you install the engine in a way that makes the engine's emission control information label hard to read during normal engine maintenance, you must place a duplicate label on the vehicle, as described in 40 CFR 1068.105."

(c) You do not need installation instructions for engines that you install in your own vehicles.

(d) Provide instructions in writing or in an equivalent format. For example,

you may post instructions on a publicly available Web site for downloading or printing. If you do not provide the instructions in writing, explain in your application for certification how you will ensure that each installer is informed of the installation requirements.

#### § 1036.135 Labeling.

Label your engines as described in 40 CFR 86.007–35(a)(3), with the following additional information:

(a) [Reserved]

(b) Identify the emission control system. Use terms and abbreviations as described in 40 CFR 1068.45 or other applicable conventions.

(c) Identify any limitations on your certification. For example, if you certify heavy heavy-duty engines to the CO<sub>2</sub> standards using only transient cycle testing, include the statement "VOCATIONAL VEHICLES ONLY".

(d) You may ask us to approve modified labeling requirements in this part 1036 if you show that it is necessary or appropriate. We will approve your request if your alternate label is consistent with the requirements of this part. We may also specify modified labeling requirement to be consistent with the intent of 40 CFR part 1037.

#### § 1036.140 Primary intended service class.

You must identify a single primary intended service class for each compression-ignition engine family. Select the class that best describes vehicles for which you design and market the engine. The three primary intended service classes are light heavy-duty, medium heavy-duty, and heavy heavy-duty. Note that provisions that apply based on primary intended service class often treat spark-ignition engines as if they were a separate service class.

(a) Light heavy-duty engines usually are not designed for rebuild and do not have cylinder liners. Vehicle body types in this group might include any heavy-duty vehicle built for a light-duty truck chassis, van trucks, multi-stop vans, motor homes and other recreational vehicles, and some straight trucks with a single rear axle. Typical applications would include personal transportation, light-load commercial delivery, passenger service, agriculture, and construction. The GVWR of these vehicles is normally below 19,500 pounds.

(b) Medium heavy-duty engines may be designed for rebuild and may have cylinder liners. Vehicle body types in this group would typically include school buses, straight trucks with dual

rear axles, city tractors, and a variety of special purpose vehicles such as small dump trucks, and refuse trucks. Typical applications would include commercial short haul and intra-city delivery and pickup. Engines in this group are normally used in vehicles whose GVWR ranges from 19,500 to 33,000 pounds.

(c) Heavy heavy-duty engines are designed for multiple rebuilds and have cylinder liners. Vehicles in this group are normally tractors, trucks, and buses used in inter-city, long-haul applications. These vehicles normally exceed 33,000 pounds GVWR.

**§ 1036.150 Interim provisions.**

The provisions in this section apply instead of other provisions in this part.

(a) *Early banking of greenhouse gas emissions.* You may generate CO<sub>2</sub> emission credits for engines you certify in model year 2013 (2015 for spark-ignition engines) to the standards of § 1036.108.

(1) Except as specified in paragraph (a)(2) of this section, to generate early credits, you must certify your entire U.S.-directed production volume within that averaging set to these standards. This means that you may not generate early credits while you produce engines in the averaging set that are certified to the criteria pollutant standards but not to the greenhouse gas standards. Calculate emission credits as described in subpart H of this part relative to the standard that would apply for model year 2014 (2016 for spark-ignition engines).

(2) You may generate early credits for an individual compression-ignition engine family where you demonstrate that you have improved a model year 2013 engine model's CO<sub>2</sub> emissions relative to its 2012 baseline level and certify it to an FCL below the applicable standard. Calculate emission credits as described in subpart H of this part relative to the lesser of the standard that would apply for model year 2014 engines or the baseline engine's CO<sub>2</sub> emission rate. Use the smaller U.S.-directed production volume of the 2013 engine family or the 2012 baseline engine family. We will not allow you to generate emission credits under this paragraph (a)(2) unless we determine that your 2013 engine is the same engine as the 2012 baseline or that it replaces it.

(3) You may bank credits equal to the surplus credits you generate under this paragraph (a) multiplied by 1.50. For example, if you have 10 Mg of surplus credits for model year 2013, you may bank 15 Mg of credits. Credit deficits for an averaging set prior to model year 2014 (2016 for spark-ignition engines)

do not carry over to model year 2014 (2016 for spark-ignition engines). We recommend that you notify us of your intent to use this provision before submitting your applications.

(b) *Model year 2014 N<sub>2</sub>O standards.* In model year 2014 and earlier, manufacturers may show compliance with the N<sub>2</sub>O standards using an engineering analysis. This allowance also applies for later families certified using carryover CO<sub>2</sub> data from model 2014 consistent with § 1036.235(d).

(c) *Engine cycle classification.* Engines meeting the definition of spark-ignition, but regulated as diesel engines under 40 CFR part 86, must be certified to the requirements applicable to compression-ignition engines under this part. Such engines are deemed to be compression-ignition engines for purposes of this part. Similarly, engines meeting the definition of compression-ignition, but regulated as Otto-cycle under 40 CFR part 86 must be certified to the requirements applicable to spark-ignition engines under this part. Such engines are deemed to be spark-ignition engines for purposes of this part.

(d) *Small manufacturers.* Manufacturers meeting the small business criteria specified for "Gasoline Engine and Engine Parts Manufacturing" or "Other Engine Equipment Manufacturers" in 13 CFR 121.201 are not subject to the greenhouse gas emission standards in § 1036.108. Qualifying manufacturers must notify the Designated Compliance Officer before importing or introducing into U.S. commerce excluded engines. This notification must include a description of the manufacturer's qualification as a small business under 13 CFR 121.201. You must label your excluded vehicles with the statement: "THIS ENGINE IS EXCLUDED UNDER 40 CFR 1037.150(c)."

(e) *Alternate phase-in standards.* Where a manufacturer certifies all of its model year 2013 compression-ignition engines within a given primary intended service class to the applicable alternate standards of this paragraph (e), its compression-ignition engines within that primary intended service class are subject to the standards of this paragraph (e) for model years 2013 through 2016. This means that once a manufacturer chooses to certify a primary intended service class to the standards of this paragraph (e), it is not allowed to opt out of these standards. Engines certified to these standards are not eligible for early credits under paragraph (a) of this section.

Tractors	LHD Engines	MHD Engines	HHD Engines
Model Years 2013–2015.	NA .....	512 g/ hp-hr.	485 g/ hp-hr.
Model Years 2016 and later <sup>a</sup> .	NA .....	487 g/ hp-hr.	460 g/ hp-hr.
Vocational	LHD Engines	MHD Engines	HHD Engines
Model Years 2013–2015.	618 g/ hp-hr.	618 g/ hp-hr.	577 g/ hp-hr.
Model Years 2016 and later <sup>a</sup> .	576 g/ hp-hr.	576 g/ hp-hr.	555 g/ hp-hr.

<sup>a</sup> **Note:** These alternate standards for 2016 and later are the same as the otherwise applicable standards for 2017 and later.

(f) *Separate OBD families.* This paragraph (f) applies where you separately certify engines for the purpose of applying OBD requirements (for engines used in vehicles under 14,000 pounds GVWR) from non-OBD engines that could be certified as a single engine family. You may treat the two engine families as a single engine family in certain respects for the purpose of this part, as follows:

(1) This paragraph applies only where the two families are identical in all respects except for the engine ratings offered and the inclusion of OBD.

(2) For purposes of this part and 40 CFR part 86, the two families remain two separate families except for the following:

(i) Specify the testable configurations of the non-OBD engine family as the testable configurations for the OBD family.

(ii) Submit the same CO<sub>2</sub>, N<sub>2</sub>O, and CH<sub>4</sub> emission data for both engine families.

(g) *Assigned deterioration factors.* You may use assigned deterioration factors (DFs) without performing your own durability emission tests or engineering analysis as follows:

(1) You may use an assigned additive DF of 0.0 g/hp-hr for CO<sub>2</sub> emissions from engines that do not use advanced or innovative technologies. If we determine it to be consistent with good engineering judgment, we may allow you to use an assigned additive DF of 0.0 g/hp-hr for CO<sub>2</sub> emissions from your engines with advanced or innovative technologies.

(2) You may use an assigned additive DF of 0.02 g/hp-hr for N<sub>2</sub>O emissions from any engine.

(3) You may use an assigned additive DF of 0.02 g/hp-hr for CH<sub>4</sub> emissions from any engine.

(h) *Advanced technology credits.* If you generate credits from engines

certified for advanced technology you may multiply these credits by 1.5, except that you may not apply this multiplier and the early-credit multiplier of paragraph (a) of this section.

(i) *CO<sub>2</sub> credits for low N<sub>2</sub>O emissions.* If you certify your model year 2014, 2015, or 2016 engines to an N<sub>2</sub>O FEL less than 0.04 g/hp-hr (provided you measure N<sub>2</sub>O emissions from your emission-data engines), you may generate additional CO<sub>2</sub> credits under this paragraph (i). Calculate the additional CO<sub>2</sub> credits from the following equation instead of the equation in § 1036.705:

$$\text{CO}_2 \text{ Credits (Mg)} = (0.04 - \text{FEL}_{\text{N}_2\text{O}}) \cdot (\text{CF}) \cdot (\text{Volume}) \cdot (\text{UL}) \cdot (10^{-6}) \cdot (298)$$

### Subpart C—Certifying Engine Families

#### § 1036.205 What must I include in my application?

Submit an application for certification as described in 40 CFR 86.007–21, with the following additional information:

(a) Describe the engine family's specifications and other basic parameters of the engine's design and emission controls with respect to compliance with the requirements of this part. Describe in detail all system components for controlling greenhouse gas emissions, including all auxiliary emission control devices (AECs) and all fuel-system components you will install on any production or test engine. Identify the part number of each component you describe. For this paragraph (a), treat as separate AECs any devices that modulate or activate differently from each other.

(b) Describe any test equipment and procedures that you used if you performed any tests that did not also involve measurement of criteria pollutants. Describe any special or alternate test procedures you used (see 40 CFR 1065.10(c)).

(c) Include the emission-related installation instructions you will provide if someone else installs your engines in their vehicles (see § 1036.130).

(d) Describe the label information specified in § 1036.135. We may require you to include a copy of the label.

(e) Identify the FCLs with which you are certifying engines in the engine family. The actual U.S.-directed production volume of configurations that have emission rates at or below the FCL must be at least one percent of your total actual (not projected) U.S.-directed production volume for the engine family. Identify configurations within the family that have emission rates at or

below the FCL and meet the one percent requirement. For example, if your total U.S.-directed production volume for the engine family is 10,583, and the U.S.-directed production volume for the tested rating is 75 engines, then you can comply with this provision by setting your FCL so that one more rating with a U.S.-directed production volume of at least 31 engines meets the FCL. Where applicable, also identify other testable configurations required under § 1036.230(b)(2).

(f) Identify the engine family's deterioration factors and describe how you developed them (see § 1036.241). Present any test data you used for this.

(g) Present emission data to show that you meet emission standards, as follows:

(1) Present exhaust emission data for CO<sub>2</sub>, CH<sub>4</sub>, and N<sub>2</sub>O on an emission-data engine to show that your engines meet the applicable emission standards we specify in § 1036.108. Show emission figures before and after applying deterioration factors for each engine. In addition to the composite results, show individual measurements for cold-start testing and hot-start testing over the transient test cycle.

(2) Note that § 1036.235 allows you to submit an application in certain cases without new emission data.

(h) State whether your certification is limited for certain engines. For example, if you certify heavy heavy-duty engines to the CO<sub>2</sub> standards using only transient testing, the engines may be installed only in vocational vehicles.

(i) Unconditionally certify that all the engines in the engine family comply with the requirements of this part, other referenced parts of the CFR, and the Clean Air Act. Note that § 1036.235 specifies which engines to test to show that engines in the entire family comply with the requirements of this part.

(j) Include the information required by other subparts of this part. For example, include the information required by § 1036.725 if you participate in the ABT program.

(k) Include the warranty statement and maintenance instructions if we request them.

(l) Include other applicable information, such as information specified in this part or 40 CFR part 1068 related to requests for exemptions.

(m) For imported engines or equipment, identify the following:

(1) Describe your normal practice for importing engines. For example, this may include identifying the names and addresses of any agents you have authorized to import your engines. Engines imported by nonauthorized

agents are not covered by your certificate.

(2) The location of a test facility in the United States where you can test your engines if we select them for testing under a selective enforcement audit, as specified in 40 CFR part 1068, subpart E.

#### § 1036.210 Preliminary approval before certification.

If you send us information before you finish the application, we may review it and make any appropriate determinations, especially for questions related to engine family definitions, auxiliary emission control devices, adjustable parameters, deterioration factors, testing for service accumulation, and maintenance. Decisions made under this section are considered to be preliminary approval, subject to final review and approval. We will generally not reverse a decision where we have given you preliminary approval, unless we find new information supporting a different decision. If you request preliminary approval related to the upcoming model year or the model year after that, we will make best-efforts to make the appropriate determinations as soon as practicable. We will generally not provide preliminary approval related to a future model year more than two years ahead of time.

#### § 1036.225 Amending my application for certification.

Before we issue you a certificate of conformity, you may amend your application to include new or modified engine configurations, subject to the provisions of this section. After we have issued your certificate of conformity, but before the end of the model year, you may send us an amended application requesting that we include new or modified engine configurations within the scope of the certificate, subject to the provisions of this section. You must amend your application if any changes occur with respect to any information that is included or should be included in your application.

(a) You must amend your application before you take any of the following actions:

(1) Add an engine configuration to an engine family. In this case, the engine configuration added must be consistent with other engine configurations in the engine family with respect to the criteria listed in § 1036.230.

(2) Change an engine configuration already included in an engine family in a way that may affect emissions, or change any of the components you described in your application for certification. This includes production

and design changes that may affect emissions any time during the engine's lifetime.

(3) Modify an FEL and FCL for an engine family as described in paragraph (f) of this section.

(b) To amend your application for certification, send the relevant information to the Designated Compliance Officer.

(1) Describe in detail the addition or change in the engine model or configuration you intend to make.

(2) Include engineering evaluations or data showing that the amended engine family complies with all applicable requirements. You may do this by showing that the original emission-data engine is still appropriate for showing that the amended family complies with all applicable requirements.

(3) If the original emission-data engine for the engine family is not appropriate to show compliance for the new or modified engine configuration, include new test data showing that the new or modified engine configuration meets the requirements of this part.

(c) We may ask for more test data or engineering evaluations. You must give us these within 30 days after we request them.

(d) For engine families already covered by a certificate of conformity, we will determine whether the existing certificate of conformity covers your newly added or modified engine. You may ask for a hearing if we deny your request (see § 1036.820).

(e) For engine families already covered by a certificate of conformity, you may start producing the new or modified engine configuration anytime after you send us your amended application and before we make a decision under paragraph (d) of this section. However, if we determine that the affected engines do not meet applicable requirements, we will notify you to cease production of the engines and may require you to recall the engines at no expense to the owner. Choosing to produce engines under this paragraph (e) is deemed to be consent to recall all engines that we determine do not meet applicable emission standards or other requirements and to remedy the nonconformity at no expense to the owner. If you do not provide information required under paragraph (c) of this section within 30 days after we request it, you must stop producing the new or modified engines.

(f) You may ask us to approve a change to your FEL in certain cases after the start of production, but before the end of the model year. If you change an FEL for CO<sub>2</sub>, your FCL for CO<sub>2</sub> is automatically set to your new FEL

divided by 1.03. The changed FEL may not apply to engines you have already introduced into U.S. commerce, except as described in this paragraph (f). If we approve a changed FEL after the start of production, you must include the new FEL on the emission control information label for all engines produced after the change. You may ask us to approve a change to your FEL in the following cases:

(1) You may ask to raise your FEL for your engine family at any time. In your request, you must show that you will still be able to meet the emission standards as specified in subparts B and H of this part. Use the appropriate FELs/FCLs with corresponding production volumes to calculate emission credits for the model year, as described in subpart H of this part.

(2) You may ask to lower the FEL for your engine family only if you have test data from production engines showing that emissions are below the proposed lower FEL (or below the proposed FCL for CO<sub>2</sub>). The lower FEL/FCL applies only to engines you produce after we approve the new FEL/FCL. Use the appropriate FELs/FCLs with corresponding production volumes to calculate emission credits for the model year, as described in subpart H of this part.

#### § 1036.230 Selecting engine families.

See 40 CFR 86.001–24 for instructions on how to divide your product line into families of engines that are expected to have similar emission characteristics throughout the useful life. You must certify your engines to the standards of § 1036.108 using the same engine families you use for criteria pollutants under 40 CFR part 86. The following provisions also apply:

(a) Engines certified as hybrid engines or power packs may not be included in an engine family with engines with conventional powertrains. Note that this does not prevent you from including engines in a conventional family if they are used in hybrid vehicles, as long as you certify them conventionally.

(b) If you certify engines in the family for use as both vocational and tractor engines, you must split your family into two separate subfamilies. Indicate in the application for certification that the engine family is to be split.

(1) Calculate emission credits relative to the vocational engine standard for the number of engines sold into vocational applications and relative to the tractor engine standard for the number of engines sold into non-vocational tractor applications. You may assign the numbers and configurations of engines within the respective subfamilies at any

time before submitting the end-of-year report required by § 1036.730. If the family participates in averaging, banking, or trading, you must identify the type of vehicle in which each engine is installed; we may alternatively allow you to use statistical methods to determine this for a fraction of your engines. Keep records to document this determination.

(2) If you restrict use of the test configuration for your split family to only tractors, or only vocational vehicles, you must identify a second testable configuration for the other type of vehicle (or an unrestricted configuration). Identify this configuration in your application for certification. The FCL for the engine family applies for this configuration as well as the primary test configuration.

(c) If you certify in separate engine families engines that could have been certified in vocational and tractor engine subfamilies in the same engine family, count the two families as one family for purposes of determining your obligations with respect to the OBD requirements and in-use testing requirements of 40 CFR part 86. Indicate in the applications for certification that the two engine families are covered by this paragraph (c).

(d) Engine configurations within an engine family must use equivalent greenhouse gas emission controls. Unless we approve it, you may not produce nontested configurations without the same emission control hardware included on the tested configuration. We will only approve it if you demonstrate that the exclusion of the hardware does not increase greenhouse gas emissions.

#### § 1036.235 Testing requirements for certification.

This section describes the emission testing you must perform to show compliance with the greenhouse gas emission standards in § 1036.108.

(a) Select a single emission-data engine from each engine family as specified in 40 CFR part 86. The standards of this part apply only with respect to emissions measured from this tested configuration and other configurations identified in § 1036.205(e). Note that configurations identified in § 1036.205(e) are considered to be “tested configurations” whether or not you actually tested them for certification. However, you must apply the same (or equivalent) emission controls to all other engine configurations in the engine family.

(b) Test your emission-data engines using the procedures and equipment specified in subpart F of this part. In the

case of dual-fuel and flexible-fuel engines, measure emissions when operating with each type of fuel for which you intend to certify the engine. Measure CO<sub>2</sub>, CH<sub>4</sub>, and N<sub>2</sub>O emissions using the specified duty cycle(s), including cold-start and hot-start testing as specified in 40 CFR part 86, subpart N. If you are certifying the engine for use in tractors, you must measure CO<sub>2</sub> emissions using the SET cycle and measure CH<sub>4</sub>, and N<sub>2</sub>O emissions using the transient cycle. If you are certifying the engine for use in vocational applications, you must measure CO<sub>2</sub>, CH<sub>4</sub>, and N<sub>2</sub>O emissions using the specified transient duty cycle, including cold-start and hot-start testing as specified in 40 CFR part 86, subpart N. Engines certified for use in tractors may also be used in vocational vehicles; however, you may not knowingly circumvent the intent of this part (to reduce in-use emissions of CO<sub>2</sub>) by certifying engines designed for vocational vehicles (and rarely used in tractors) to the SET and not the transient cycle. For example, we would generally not allow you to certify all your engines to the SET without certifying any to the transient cycle. You may certify your engine family for both tractor and vocational use by submitting CO<sub>2</sub> emission data from both SET and transient cycle testing and specifying FCLs for both.

(c) We may measure emissions from any of your emission-data engines.

(1) We may decide to do the testing at your plant or any other facility. If we do this, you must deliver the engine to a test facility we designate. The engine you provide must include appropriate manifolds, aftertreatment devices, electronic control units, and other emission-related components not normally attached directly to the engine block. If we do the testing at your plant, you must schedule it as soon as possible and make available the instruments, personnel, and equipment we need.

(2) If we measure emissions on your engine, the results of that testing become the official emission results for the engine. Unless we later invalidate these data, we may decide not to consider your data in determining if your engine family meets applicable requirements.

(3) Before we test one of your engines, we may set its adjustable parameters to any point within the physically adjustable ranges.

(4) Before we test one of your engines, we may calibrate it within normal production tolerances for anything we do not consider an adjustable parameter. For example, this would apply for an engine parameter that is subject to

production variability because it is adjustable during production, but is not considered an adjustable parameter (as defined in § 1036.801) because it is permanently sealed.

(d) You may ask to use carryover emission data from a previous model year instead of doing new tests, but only if all the following are true:

(1) The engine family from the previous model year differs from the current engine family only with respect to model year or other characteristics unrelated to emissions.

(2) The emission-data engine from the previous model year remains the appropriate emission-data engine under paragraph (b) of this section.

(3) The data show that the emission-data engine would meet all the requirements that apply to the engine family covered by the application for certification.

(e) We may require you to test a second engine of the same configuration in addition to the engine tested under paragraph (a) of this section.

(f) If you use an alternate test procedure under 40 CFR 1065.10 and later testing shows that such testing does not produce results that are equivalent to the procedures specified in subpart F of this part, we may reject data you generated using the alternate procedure.

#### **§ 1036.241 Demonstrating compliance with greenhouse gas pollutant standards.**

(a) For purposes of certification, your engine family is considered in compliance with the emission standards in § 1036.108 if all emission-data engines representing the tested configuration of that engine family have test results showing official emission results and deteriorated emission levels at or below the standards. Note that your FCLs are considered to be the applicable emission standards with which you must comply for certification.

(b) Your engine family is deemed not to comply if any emission-data engine representing the tested configuration of that engine family has test results showing an official emission result or a deteriorated emission level for any pollutant that is above an applicable emission standard (generally the FCL). Note that you may increase your FCL if any certification test results exceed your initial FCL.

(c) Apply deterioration factors to the measured emission levels for each pollutant to show compliance with the applicable emission standards. Your deterioration factors must take into account any available data from in-use

testing with similar engines. Apply deterioration factors as follows:

(1) *Additive deterioration factor for greenhouse gas emissions.* Except as specified in paragraph (c)(2) of this section, use an additive deterioration factor for exhaust emissions. An additive deterioration factor is the difference between exhaust emissions at the end of the useful life and exhaust emissions at the low-hour test point. In these cases, adjust the official emission results for each tested engine at the selected test point by adding the factor to the measured emissions. If the factor is less than zero, use zero. Additive deterioration factors must be specified to one more decimal place than the applicable standard.

(2) *Multiplicative deterioration factor for greenhouse gas emissions.* Use a multiplicative deterioration factor for a pollutant if good engineering judgment calls for the deterioration factor for that pollutant to be the ratio of exhaust emissions at the end of the useful life to exhaust emissions at the low-hour test point. Adjust the official emission results for each tested engine at the selected test point by multiplying the measured emissions by the deterioration factor. If the factor is less than one, use one. A multiplicative deterioration factor may not be appropriate in cases where testing variability is significantly greater than engine-to-engine variability. Multiplicative deterioration factors must be specified to one more significant figure than the applicable standard.

(3) *Sawtooth deterioration patterns.* The deterioration factors described in paragraphs (c)(1) and (2) of this section assume that the highest useful life emissions occur either at the end of useful life or at the low-hour test point. The provisions of this paragraph (c)(3) apply where good engineering judgment indicates that the highest useful life emissions will occur between these two points. For example, emissions may increase with service accumulation until a certain maintenance step is performed, then return to the low-hour emission levels and begin increasing again. Such a pattern may occur with battery-based electric hybrid engines. Base deterioration factors for engines with such emission patterns on the difference between (or ratio of) the point at which the highest emissions occur and the low-hour test point. Note that this applies for maintenance-related deterioration only where we allow such critical emission-related maintenance.

(d) Collect emission data using measurements to one more decimal place than the applicable standard. Apply the deterioration factor to the official emission result, as described in



paragraph (c) of this section, then round the adjusted figure to the same number of decimal places as the emission standard. Compare the rounded emission levels to the emission standard for each emission-data engine.

(e) If you identify more than one configuration in § 1036.205(e), we may test (or require you to test) any of the identified configurations. We may also require you to provide an engineering analysis that demonstrates that untested configurations listed in § 1036.205(e) comply with their FCL.

**§ 1036.250 Reporting and recordkeeping for certification.**

(a) Within 90 days after the end of the model year, send the Designated Compliance Officer a report including the total U.S.-directed production volume of engines you produced in each engine family during the model year (based on information available at the time of the report). Report the production by serial number and engine configuration. Small manufacturers may omit this requirement. You may combine this report with reports required under subpart H of this part.

(b) Organize and maintain the following records:

(1) A copy of all applications and any summary information you send us.

(2) Any of the information we specify in § 1036.205 that you were not required to include in your application.

(c) Keep routine data from emission tests required by this part (such as test cell temperatures and relative humidity readings) for one year after we issue the associated certificate of conformity. Keep all other information specified in this section for eight years after we issue your certificate.

(d) Store these records in any format and on any media, as long as you can promptly send us organized, written records in English if we ask for them. You must keep these records readily available. We may review them at any time.

**§ 1036.255 What decisions may EPA make regarding my certificate of conformity?**

(a) If we determine your application is complete and shows that the engine family meets all the requirements of this part and the Act, we will issue a certificate of conformity for your engine family for that model year. We may make the approval subject to additional conditions.

(b) We may deny your application for certification if we determine that your engine family fails to comply with emission standards or other requirements of this part or the Clean Air Act. We will base our decision on

all available information. If we deny your application, we will explain why in writing.

(c) In addition, we may deny your application or suspend or revoke your certificate if you do any of the following:

(1) Refuse to comply with any testing or reporting requirements.

(2) Submit false or incomplete information (paragraph (e) of this section applies if this is fraudulent). This includes doing anything after submission of your application to render any of the submitted information false or incomplete.

(3) Render inaccurate any test data.

(4) Deny us from completing authorized activities despite our presenting a warrant or court order (see 40 CFR 1068.20). This includes a failure to provide reasonable assistance. However, you may ask us to reconsider our decision by showing that your failure under this paragraph (c)(4) did not involve engines related to the certificate or application in question to a degree that would justify our decision.

(5) Produce engines for importation into the United States at a location where local law prohibits us from carrying out authorized activities.

(6) Fail to supply requested information or amend your application to include all engines being produced.

(7) Take any action that otherwise circumvents the intent of the Act or this part, with respect to your engine family.

(d) We may void the certificate of conformity for an engine family if you fail to keep records, send reports, or give us information as required under this part or the Act. Note that these are also violations of 40 CFR 1068.101(a)(2).

(e) We may void your certificate if we find that you intentionally submitted false or incomplete information. This includes rendering submitted information false or incomplete after submission.

(f) If we deny your application or suspend, revoke, or void your certificate, you may ask for a hearing (see § 1036.820).

**Subpart D—[Reserved]**

**Subpart E—In-use Testing**

**§ 1036.401 In-use testing.**

We may perform in-use testing of any engine family subject to the standards of this part, consistent with the provisions of § 1036.235. Note that this provision does not affect your obligation to test your in-use engines as described in 40 CFR part 86, subpart T.

**Subpart F—Test Procedures**

**§ 1036.501 How do I run a valid emission test?**

(a) Use the equipment and procedures specified in 40 CFR 86.1305 to determine whether engines meet the emission standards in § 1036.108.

(b) You may use special or alternate procedures to the extent we allow them under 40 CFR 1065.10.

(c) This subpart is addressed to you as a manufacturer, but it applies equally to anyone who does testing for you, and to us when we perform testing to determine if your engines meet emission standards.

(d) For engines that use aftertreatment technology with infrequent regeneration events, invalidate any test interval in which such a regeneration event occurs with respect to CO<sub>2</sub>, N<sub>2</sub>O, and CH<sub>4</sub> measurements.

(e) Test hybrid engines as described in 40 CFR part 1065 and § 1036.525.

(f) [Reserved]

(g) If your engine requires special components for proper testing, you must provide any such components to us if we ask for them.

**§ 1036.525 Hybrid engines.**

(a) If your engine system includes features that recover and store energy during engine motoring operation test the engine as described in paragraph (d) of this section. See § 1036.615(a)(2) for engine systems intended to include features that recover and store energy from braking unrelated to engine motoring operation. For purposes of this section, features that recover energy between the engine and transmission are considered “related to engine motoring”.

(b) If you produce a hybrid engine designed with power take-off capability and sell the engine coupled with a transmission, you may calculate a reduction in CO<sub>2</sub> emissions resulting from the power take-off operation as described in 40 CFR 1037.525. Use good engineering judgment to use the vehicle-based procedures to quantify the CO<sub>2</sub> reduction for your engines.

(c) The hardware that must be included in these tests is the engine, the hybrid electric motor, the rechargeable energy storage system (RESS) and the power electronics between the hybrid electric motor and the RESS. You may ask us to modify the provisions of this section to allow testing non-electric hybrid vehicles, consistent with good engineering judgment.

(d) Measure emissions using the same procedures that apply for testing non-hybrid engines under this part, except as specified otherwise in this part and/



or 40 CFR part 1065. If you test hybrid engines using the SET, deactivate the hybrid features unless we have specified otherwise. The five differences that apply under this section are related to engine mapping, engine shutdown during the test cycle, calculating work, limits on braking energy, and state of charge constraints.

(1) Map the engine as specified in 40 CFR 1065.510. This requires separate torque maps for the engine with and without the hybrid features active. For transient testing, denormalize the test cycle using the map generated with the hybrid feature active. For steady-state testing, denormalize the test cycle using the map generated with the hybrid feature inactive.

(2) If the engine will be configured in actual use to shut down automatically during idle operation, you may let the engine shut down during the idle portions of the test cycle.

(3) Follow 40 CFR 1065.650(d) to calculate the work done over the cycle except as specified in this paragraph (d)(3). For the positive work over the cycle set negative power from hybrid to zero. For the negative work over the cycle set the positive power to zero and set the non-hybrid power to zero.

(4)(i) Calculate brake energy fraction,  $x_b$ , as the integrated negative work over the cycle divided by the integrated positive work over the cycle according to Equation 1036.525-1. Calculate the brake energy limit for the engine,  $x_{bl}$ , according to Equation 1036.525-2. If  $x_b$  is less than  $x_{bl}$ , use the integrated positive work for your emission calculations. If the  $x_b$  is greater than  $x_{bl}$  use Equation 1036.525-3 to calculate the positive work done over the cycle. Use  $W_{cycle}$  as the integrated positive work when calculating brake-specific emissions. To avoid the need to delete extra brake work from positive work you may set an instantaneous brake target that will prevent  $x_b$  from being larger than  $x_{bl}$ .

$$x_b = \left| \frac{W_{neg}}{W_{pos}} \right|$$

Eq. 1036.525-1

$$x_{bl} = 4.158 \cdot 10^{-4} \cdot P_{max} + 0.2247$$

Eq. 1036.525-2

$$W_{cycle} = W_{pos} - \left( \left| W_{neg} \right| - x_{bl} \cdot W_{pos} \right)$$

Eq. 1036.525-3

(ii) The following definitions of terms apply for this paragraph (d)(4):

$x_b$  = the brake energy fraction.

$W_{neg}$  = the negative work over the cycle.

$W_{pos}$  = the positive work over the cycle.

$x_{bl}$  = the brake energy fraction limit.

$P_{max}$  = the maximum power of the engine with the hybrid system engaged (kW).

$W_{cycle}$  = the work over the cycle when  $x_b$  is greater than  $x_{bl}$ .

(iii) Note that these calculations are specified with SI units (such as kW), consistent with 40 CFR part 1065. Emission results are converted to g/hp-hr at the end of the calculations.

(5) Correct for the net energy change of the energy storage device as described in 40 CFR 1066.501.

**§ 1036.530 Calculating greenhouse gas emission rates.**

This section describes how to calculate official emission results for CO<sub>2</sub>, CH<sub>4</sub>, and N<sub>2</sub>O.

(a) Calculate brake-specific emission rates for each applicable duty cycle as specified in 40 CFR 1065.650. Do not apply infrequent regeneration adjustment factors to your results.

(b) Adjust CO<sub>2</sub> emission rates calculated under paragraph (a) of this section for measured test fuel properties as specified in this paragraph (b) to obtain the official emission results. You

are not required to apply this adjustment for fuels containing at least 75 percent pure alcohol, such as E85. The purpose of this adjustment is to make official emission results independent of differences in test fuels within a fuel type. Use good engineering judgment to develop and apply testing protocols to minimize the impact of variations in test fuels.

(1) For liquid fuels, determine the net energy content (Btu per pound of fuel) according to ASTM D4809 or ASTM D240 (both incorporated by reference in § 1036.810) and carbon weight fraction (dimensionless) of your test fuel according to ASTM D5291 (incorporated by reference in § 1036.810). (Note that we recommend using ASTM D4809.) For gaseous fuels, use good engineering judgment to determine the fuel's net energy content and carbon weight fraction. (Note: Net energy content is also sometimes known as lower heating value.) Calculate the test fuel's carbon-specific net energy content (Btu/lbC) by dividing the net energy content by the carbon fraction, expressed to at least five significant figures. You may perform these calculations using SI units with the following conversion factors: one Btu equals 1055.06 Joules and one Btu/lb equals 0.0023260 MJ/kg.

(2) If you control test fuel properties so that variations in the actual carbon-specific energy content are the same as or smaller than the repeatability of measuring carbon-specific energy content, you may use a constant value equal to the average carbon-specific energy content of your test fuel. Otherwise, use the measured value for the specific test fuel used for a given test. If you use a constant value, you must update or verify the value at least once per year, or after changes in test fuel suppliers or specifications.

(3) Calculate the adjustment factor for carbon-specific net energy content by dividing the carbon-specific net energy content of your test fuel by the reference level in the following table, expressed to at least five decimal places. Note that as used in this section, the unit lbC means pound of carbon and kgC means kilogram of carbon.

Fuel type	Reference carbon-specific net energy content (Btu/lbC)	Reference carbon-specific net energy content (MJ/kgC)
Diesel fuel .....	21,200	49.3112
Gasoline .....	21,700	50.4742
Natural Gas .....	28,500	66.2910
LPG .....	24,300	56.5218

(4) Your official emission result equals your calculated brake-specific emission rate multiplied by the adjustment factor specified in paragraph (b)(2) of this section. For example, if the net energy content and carbon fraction of your diesel test fuel are 18,400 Btu/lb and 0.870, the carbon-specific net energy content of the test fuel would be 21,149 Btu/lbC. The adjustment factor in the example above would be 0.99759 (21,149/21,200). If your brake-specific CO<sub>2</sub> emission rate was 630.0 g/hp-hr, your official emission result would be 628.5 g/hp-hr.

### Subpart G—Special Compliance Provisions

#### § 1036.601 What compliance provisions apply to these engines?

(a) Engine and equipment manufacturers, as well as owners, operators, and rebuilders of engines subject to the requirements of this part, and all other persons, must observe the provisions of this part, the provisions of the Clean Air Act, and the following provisions of 40 CFR part 1068:

(1) The exemption and importation provisions of 40 CFR part 1068, subparts C and D, apply for engines subject to this part 1036, except that the hardship exemption provisions of 40 CFR 1068.245, 1068.250, and 1068.255 do not apply for motor vehicle engines.

(2) Manufacturers may comply with the defect reporting requirements of 40 CFR 1068.501 instead of the defect reporting requirements of 40 CFR part 85.

(b) Engines exempted from the applicable standards of 40 CFR part 86 are exempt from the standards of this part without request.

#### § 1036.610 Innovative technology credits and adjustments for reducing greenhouse gas emissions.

(a) You may ask us to apply the provisions of this section for CO<sub>2</sub> emission reductions resulting from powertrain technologies that were not in common use with heavy-duty vehicles before model year 2010 that are not reflected in the specified test procedure. We will apply these provisions only for technologies that will result in a measurable, demonstrable, and verifiable real-world CO<sub>2</sub> reduction.

(b) The provisions of this section may be applied as either an improvement factor (used to adjust emission results) or as a separate credit, consistent with good engineering judgment. We recommend that you base your credit/adjustment on A to B testing of pairs of engines/vehicles differing only with respect to the technology in question.

(1) Calculate improvement factors as the ratio of in-use emissions with the technology divided by the in-use emissions without the technology. Adjust the emission results by multiplying by the improvement factor. Use the improvement-factor approach where good engineering judgment indicates that the actual benefit will be proportional to emissions measured over the test procedures specified in this part. For example, the benefits from technologies that reduce engine operation would generally be proportional to the engine's emission rate.

(2) Calculate separate credits based on the difference between the in-use emission rate (g/ton-mile) with the technology and the in-use emission rate without the technology. Multiply this difference by the number of engines, standard payload, and useful life. We may also allow you to calculate the credits based on g/hp-hr emission rates. Use the separate-credit approach where good engineering judgment indicates that the actual benefit will not be proportional to emissions measured over the test procedures specified in this part.

(3) We may require you to discount or otherwise adjust your improvement factor or credit to account for uncertainty or other relevant factors.

(c) Send your request to the Designated Compliance Officer. Include a detailed description of the technology and a recommended test plan. Also state whether you recommend applying these provisions using the improvement-factor method or the separate-credit method. We recommend that you do not begin collecting test data (for submission to EPA) before contacting us. For technologies for which the vehicle manufacturer could also claim credits (such as transmissions in certain circumstances), we may require you to include a letter from the vehicle manufacturer stating that it will not seek credits for the same technology.

(d) We may seek public comment on your request, consistent with the provisions of 40 CFR 86.1866–12(d)(3). However, we will generally not seek public comment on credits/adjustments based on A to B engine dynamometer testing, chassis testing, or in-use testing.

#### § 1036.615 Engines with Rankine cycle waste heat recovery and hybrid powertrains.

This section specifies how to generate advanced technology-specific emission credits for hybrid powertrains that include energy storage systems and regenerative braking (including regenerative engine braking) and for

engines that include Rankine-cycle (or other bottoming cycle) exhaust energy recovery systems.

(a) *Hybrid powertrains.* The following provisions apply for pre-transmission and post-transmission hybrid powertrains:

(1) Pre-transmission hybrid powertrains are those engine systems that include features that recover and store energy during engine motoring operation but not from the vehicle wheels. These powertrains are tested using the hybrid engine test procedures of 40 CFR part 1065 or using the post-transmission test procedures in 40 CFR 1037.550.

(2) Post-transmission hybrid powertrains are those powertrains that include features that recover and store energy from braking but that cannot function as hybrids without the transmission. These powertrains must have a single output shaft to the final drive and are tested by simulating the chassis test procedure applicable for hybrid vehicles under 40 CFR 1037.550. You need our approval before you begin testing.

(b) *Rankine engines.* Test engines that include Rankine-cycle exhaust energy recovery systems according to the test procedures specified in subpart F of this part unless we approve alternate procedures.

(c) *Calculating credits.* Calculate credits as specified in subpart H of this part. Credits generated from engines and powertrains certified under this section may be used in other averaging sets as described in § 1036.740(d). Credits may not be generated under this section and 40 CFR 1037.615 for the same technology on the same vehicle.

(d) *Innovative technologies.* You may certify using both provisions of this section and the innovative technology provisions of § 1036.610, provided you do not double count emission benefits.

#### § 1036.620 Alternate CO<sub>2</sub> standards based on model year 2011 compression-ignition engines.

For model years 2014 through 2016, you may certify your compression-ignition engines to the CO<sub>2</sub> standards of this section instead of the CO<sub>2</sub> standards in § 1036.108. However, you may not certify engines to these alternate standards if they are part of an averaging set in which you carry a balance of banked credits. You may submit applications for certifications before using up banked credits in the averaging set, but such certificates will not become effective until you have used up (or retired) your banked credits in the averaging set. For purposes of this section, you are deemed to carry credits

in an averaging set if you carry credits from advanced technology that are allowed to be used in that averaging set.

(a) The standards of this section are determined from the measured emission rate of the test engine of the applicable baseline 2011 engine family(ies) as described in paragraphs (b) and (c) of this section. Calculate the CO<sub>2</sub> emission rate of the baseline test engine using the same equations used for showing compliance with the otherwise applicable standard. The alternate CO<sub>2</sub> standard for light and medium heavy-duty vocational-certified engines (certified for CO<sub>2</sub> using the transient cycle) is equal to the baseline emission rate multiplied by 0.975. The alternate CO<sub>2</sub> standard for tractor-certified engines (certified for CO<sub>2</sub> using the SET cycle) and all other heavy heavy-duty engines is equal to the baseline emission rate multiplied by 0.970. The in-use FEL for these engines is equal to the alternate standard multiplied by 1.03.

(b) This paragraph (b) applies if you do not certify all your engine families in the averaging set to the alternate standards of this section. Identify separate baseline engine families for each engine family that you are certifying to the alternate standards of this section. For an engine family to be considered the baseline engine family, it must meet the following criteria:

(1) It must have been certified to all applicable emission standards in model year 2011. If the baseline engine was certified to a NO<sub>x</sub> FEL above the standard and incorporated the same emission control technologies as the new engine family, you may adjust the baseline CO<sub>2</sub> emission rate to be equivalent to an engine meeting the 0.20 g/hp-hr NO<sub>x</sub> standard (or your higher FEL as specified in this paragraph (b)(1)), using certification results from model years 2009 through 2011, consistent with good engineering judgment.

(i) Use the following equation to relate model year 2009–2011 NO<sub>x</sub> and CO<sub>2</sub> emission rates (g/hp-hr):  $CO_2 = a \times \log(NO_x) + b$ .

(ii) For model year 2014–2016 engines certified to NO<sub>x</sub> FELs above 0.20 g/hp-hr, correct the baseline CO<sub>2</sub> emissions to the actual NO<sub>x</sub> FELs of the 2014–2016 engines.

(iii) Calculate separate adjustments for transient and SET emissions.

(2) The baseline configuration tested for certification must have the same engine displacement as the engines in the engine family being certified to the alternate standards, and its rated power must be within five percent of the highest rated power in the engine family

being certified to the alternate standards.

(3) The model year 2011 U.S.-directed production volume of the configuration tested must be at least one percent of the total 2011 U.S.-directed production volume for the engine family.

(4) The tested configuration must have cycle-weighted BSFC equivalent to or better than all other configurations in the engine family.

(c) This paragraph (c) applies if you certify all your engine families in the primary intended service class to the alternate standards of this section. For purposes of this section, you may combine light heavy-duty and medium heavy-duty engines into a single averaging set. Determine your baseline CO<sub>2</sub> emission rate as the production-weighted emission rate of the certified engine families you produced in the 2011 model year. If you produce engines for both tractors and vocational vehicles, treat them as separate averaging sets. Adjust the CO<sub>2</sub> emission rates to be equivalent to an engine meeting the average NO<sub>x</sub> FEL of new engines (assuming engines certified to the 0.20 g/hp-hr NO<sub>x</sub> standard have a NO<sub>x</sub> FEL equal to 0.20 g/hp-hr), as described in paragraph (b)(1) of this section.

(d) Include the following statement on the emission control information label: “THIS ENGINE WAS CERTIFIED TO AN ALTERNATE CO<sub>2</sub> STANDARD UNDER § 1036.620.”

(e) You may not bank CO<sub>2</sub> emission credits for any engine family in the same averaging set and model year in which you certify engines to the standards of this section. You may not bank any advanced technology credits in any averaging set for the model year you certify under this section (since such credits would be available for use in this averaging set). Note that the provisions of § 1036.745 apply for deficits generated with respect to the standards of this section.

(f) You need our approval before you may certify engines under this section, especially with respect to the numerical value of the alternate standards. We will not approve your request if we determine that you manipulated your engine families or test engine configurations to certify to less stringent standards, or that you otherwise have not acted in good faith. You must keep and provide to us any information we need to determine that your engine families meet the requirements of this section. Keep these records for at least five years after you stop producing engines certified under this section.

#### § 1036.625 In-use compliance with family emission limits (FELs).

You may ask us to apply a higher in-use FEL for certain in-use engines, subject to the provisions of this section. Note that § 1036.225 contains provisions related to changing FELs during a model year.

(a) *Purpose.* This section is intended to address circumstances in which it is in the public interest to apply a higher in-use FEL based on forfeiting an appropriate number of emission credits.

(b) *FELs.* When applying higher in-use FELs to your engines, we would intend to accurately reflect the actual in-use performance of your engines, consistent with the specified testing provisions of this part.

(c) *Equivalent families.* We may apply the higher FELs to other families in other model years if they used equivalent emission controls.

(d) *Credit forfeiture.* Where we specify higher in-use FELs under this section, you must forfeit CO<sub>2</sub> emission credits based on the difference between the in-use FEL and the otherwise applicable FEL. Calculate the amount of credits to be forfeited using the applicable equation in § 1036.705, by substituting the otherwise applicable FEL for the standard and the in-use FEL for the otherwise applicable FEL.

(e) *Requests.* Submit your request to the Designated Compliance Officer. Include the following in your request:

- (1) The engine family name and model year of the engines affected.
- (2) A list of other engine families/model years that may be affected.
- (3) The otherwise applicable FEL for the engine families along with your recommendations for higher in-use FELs.
- (4) Your source of credits for forfeiture.

(f) *Relation to recall.* You may not request higher in-use FELs for any engine families for which we have made a determination of nonconformance and ordered a recall. You may, however, make such requests for engine families for which you are performing a voluntary emission recall.

(g) *Approval.* We may approve your request if we determine that you meet the requirements of this section and such approval is in the public interest. We may include appropriate conditions with our approval or we may approve your request with modifications.

#### Subpart H—Averaging, Banking, and Trading for Certification

##### § 1036.701 General provisions.

(a) You may average, bank, and trade (ABT) emission credits for purposes of

certification as described in this subpart and in subpart B of this part to show compliance with the standards of § 1036.108. Participation in this program is voluntary. (Note: As described in subpart B of this part, you must assign an FCL to all engine families, whether or not they participate in the ABT provisions of this subpart.)

(b) [Reserved]

(c) The definitions of subpart I of this part apply to this subpart. The following definitions also apply:

(1) *Actual emission credits* means emission credits you have generated that we have verified by reviewing your final report.

(2) *Averaging set* means a set of engines in which emission credits may be exchanged. Credits generated by one engine may only be used by other engines in the same averaging set. See § 1036.740.

(3) *Broker* means any entity that facilitates a trade of emission credits between a buyer and seller.

(4) *Buyer* means the entity that receives emission credits as a result of a trade.

(5) *Reserved emission credits* means emission credits you have generated that we have not yet verified by reviewing your final report.

(6) *Seller* means the entity that provides emission credits during a trade.

(7) *Standard* means the emission standard that applies under subpart B of this part for engines not participating in the ABT program of this subpart.

(8) *Trade* means to exchange emission credits, either as a buyer or seller.

(d) Emission credits may be exchanged only within an averaging set as specified in § 1036.740.

(e) You may not use emission credits generated under this subpart to offset any emissions that exceed an FCL or standard. This applies for all testing, including certification testing, in-use testing, selective enforcement audits, and other production-line testing. However, if emissions from an engine exceed an FCL or standard (for example, during a selective enforcement audit), you may use emission credits to recertify the engine family with a higher FCL that applies only to future production.

(f) Emission credits may be used in the model year they are generated. Surplus emission credits may be banked for future model years. Surplus emission credits may sometimes be used for past model years, as described in § 1036.745.

(g) You may increase or decrease an FCL during the model year by amending your application for certification under

§ 1036.225. The new FCL may apply only to engines you have not already introduced into commerce.

(h) You may trade emission credits generated from any number of your engines to the engine purchasers or other parties to retire the credits. Identify any such credits in the reports described in § 1036.730. Engines must comply with the applicable FELs even if you donate or sell the corresponding emission credits under this paragraph (h). Those credits may no longer be used by anyone to demonstrate compliance with any EPA emission standards.

(i) See § 1036.740 for special credit provisions that apply for credits generated under § 1036.615 or 40 CFR 1037.104(d)(7) or 1037.615.

(j) Unless the regulations explicitly allow it, you may not calculate credits more than once for any emission reduction. For example, if you generate CO<sub>2</sub> emission credits for a hybrid engine under this part for a given vehicle, no one may generate CO<sub>2</sub> emission credits for that same hybrid engine and vehicle under 40 CFR part 1037. However, credits could be generated for identical vehicles using engines that did not generate credits under this part.

#### § 1036.705 Generating and calculating emission credits.

(a) The provisions of this section apply separately for calculating emission credits for each pollutant.

(b) For each participating family, calculate positive or negative emission credits relative to the otherwise applicable emission standard based on the engine family's FCL for greenhouse gases. If your engine family is certified to both the vocational and tractor engine standards, calculate credits separately for the vocational engines and the tractor engines (as specified in paragraph (b)(3) of this section). Calculate positive emission credits for a family that has an FCL below the standard. Calculate negative emission credits for a family that has an FCL above the standard.

Sum your positive and negative credits for the model year before rounding. Round the sum of emission credits to the nearest megagram (Mg), using consistent units throughout the following equations:

(1) For vocational engines:  
Emission credits (Mg) = (Std – FCL) · (CF) · (Volume) · (UL) · (10<sup>-6</sup>)

Where:

Std = the emission standard, in g/hp-hr, that applies under subpart B of this part for engines not participating in the ABT program of this subpart (the “otherwise applicable standard”).

FCL = the Family Certification Level for the engine family, in g/hp-hr, measured over

the transient duty cycle, rounded to the same number of decimal places as the emission standard.

CF = a transient cycle conversion factor (hp-hr/mile), calculated by dividing the total (integrated) horsepower-hour over the duty cycle (average of vocational engine configurations weighted by their production volumes) by 6.3 miles for spark-ignition engines and 6.5 miles for compression-ignition engines. This represents the average work performed by vocational engines in the family over the mileage represented by operation over the duty cycle.

Volume = the number of vocational engines eligible to participate in the averaging, banking, and trading program within the given engine family during the model year, as described in paragraph (c) of this section.

UL = the useful life for the given engine family, in miles.

(2) For tractor engines:

Emission credits (Mg) = (Std – FCL) · (CF) · (Volume) · (UL) · (10<sup>-6</sup>)

Where:

Std = the emission standard, in g/hp-hr, that applies under subpart B of this part for engines not participating in the ABT program of this subpart (the “otherwise applicable standard”).

FCL = the Family Certification Level for the engine family, in g/hp-hr, measured over the SET duty cycle rounded to the same number of decimal places as the emission standard.

CF = a transient cycle conversion factor (hp-hr/mile), calculated by dividing the total (integrated) horsepower-hour over the duty cycle (average of tractor-engine configurations weighted by their production volumes) by 6.3 miles for spark-ignition engines and 6.5 miles for compression-ignition engines. This represents the average work performed by tractor engines in the family over the mileage represented by operation over the duty cycle. Note that this calculation requires you to use the transient cycle conversion factor even for engines certified to SET-based standards. Volume = the number of tractor engines eligible to participate in the averaging, banking, and trading program within the given engine family during the model year, as described in paragraph (c) of this section.

UL = the useful life for the given engine family, in miles.

(3) For engine families certified to both the vocational and tractor engine standards, we may allow you to use statistical methods to estimate the total production volumes where a small fraction of the engines cannot be tracked precisely.

(4) You may not generate emission credits for tractor engines (*i.e.*, engines not certified to the transient cycle for CO<sub>2</sub>) installed in vocational vehicles (including vocational tractors certified pursuant to 40 CFR 1037.630 or exempted pursuant to 40 CFR 1037.631). We will waive this requirement where you demonstrate

that less than five percent of the engines in your tractor family were installed in vocational vehicles. For example, if you know that 96 percent of your tractor engines were installed in non-vocational tractors, but cannot determine the vehicle type for the remaining four percent, you may generate credits for all the engines in the family.

(c) As described in § 1036.730, compliance with the requirements of this subpart is determined at the end of the model year based on actual U.S.-directed production volumes. Keep appropriate records to document these production volumes. Do not include any of the following engines to calculate emission credits:

(1) Engines that you do not certify to the CO<sub>2</sub> standards of this part because they are permanently exempted under subpart G of this part or under 40 CFR part 1068.

(2) Exported engines.

(3) Engines not subject to the requirements of this part, such as those excluded under § 1036.5. For example, do not include engines used in vehicles certified to the greenhouse gas standards of 40 CFR 1037.104.

(4) [Reserved]

(5) Any other engines if we indicate elsewhere in this part 1036 that they are not to be included in the calculations of this subpart.

(d) You may use CO<sub>2</sub> emission credits to show compliance with CH<sub>4</sub> and/or N<sub>2</sub>O FELs instead of the otherwise applicable emission standards. To do this, calculate the CH<sub>4</sub> and/or N<sub>2</sub>O emission credits needed (negative credits) using the equation in paragraph (b) of this section, using the FEL(s) you specify for your engines during certification instead of the FCL. You must use 25 Mg of positive CO<sub>2</sub> credits to offset 1 Mg of negative CH<sub>4</sub> credits. You must use 298 Mg of positive CO<sub>2</sub> credits to offset 1 Mg of negative N<sub>2</sub>O credits.

#### § 1036.710 Averaging.

(a) Averaging is the exchange of emission credits among your engine families. You may average emission credits only within the same averaging set.

(b) You may certify one or more engine families to an FCL above the applicable standard, subject to any applicable FEL caps and other the provisions in subpart B of this part, if you show in your application for certification that your projected balance of all emission-credit transactions in that model year is greater than or equal to zero, or that a negative balance is allowed under § 1036.745.

(c) If you certify an engine family to an FCL that exceeds the otherwise applicable standard, you must obtain enough emission credits to offset the engine family's deficit by the due date for the final report required in § 1036.730. The emission credits used to address the deficit may come from your other engine families that generate emission credits in the same model year (or from later model years as specified in § 1036.745), from emission credits you have banked, or from emission credits you obtain through trading.

#### § 1036.715 Banking.

(a) Banking is the retention of surplus emission credits by the manufacturer generating the emission credits for use in future model years for averaging or trading.

(b) You may designate any emission credits you plan to bank in the reports you submit under § 1036.730 as reserved credits. During the model year and before the due date for the final report, you may designate your reserved emission credits for averaging or trading.

(c) Reserved credits become actual emission credits when you submit your final report. However, we may revoke these emission credits if we are unable to verify them after reviewing your reports or auditing your records.

(d) Banked credits retain the designation of the averaging set in which they were generated.

#### § 1036.720 Trading.

(a) Trading is the exchange of emission credits between manufacturers, or the transfer of credits to another party to retire them. You may use traded emission credits for averaging, banking, or further trading transactions. Traded emission credits remain subject to the averaging-set restrictions based on the averaging set in which they were generated.

(b) You may trade actual emission credits as described in this subpart. You may also trade reserved emission credits, but we may revoke these emission credits based on our review of your records or reports or those of the company with which you traded emission credits. You may trade banked credits within an averaging set to any certifying manufacturer.

(c) If a negative emission credit balance results from a transaction, both the buyer and seller are liable, except in cases we deem to involve fraud. See § 1036.255(e) for cases involving fraud. We may void the certificates of all engine families participating in a trade that results in a manufacturer having a

negative balance of emission credits. See § 1036.745.

#### § 1036.725 What must I include in my application for certification?

(a) You must declare in your application for certification your intent to use the provisions of this subpart for each engine family that will be certified using the ABT program. You must also declare the FELs/FCL you select for the engine family for each pollutant for which you are using the ABT program. Your FELs must comply with the specifications of subpart B of this part, including the FEL caps. FELs/FCL must be expressed to the same number of decimal places as the applicable standards.

(b) Include the following in your application for certification:

(1) A statement that, to the best of your belief, you will not have a negative balance of emission credits for any averaging set when all emission credits are calculated at the end of the year; or a statement that you will have a negative balance of emission credits for one or more averaging sets, but that it is allowed under § 1036.745.

(2) Detailed calculations of projected emission credits (positive or negative) based on projected U.S.-directed production volumes. We may require you to include similar calculations from your other engine families to project your net credit balances for the model year. If you project negative emission credits for a family, state the source of positive emission credits you expect to use to offset the negative emission credits.

#### § 1036.730 ABT reports.

(a) If any of your engine families are certified using the ABT provisions of this subpart, you must send an end-of-year report within 90 days after the end of the model year and a final report within 270 days after the end of the model year.

(b) Your end-of-year and final reports must include the following information for each engine family participating in the ABT program:

(1) Engine-family designation and averaging set.

(2) The emission standards that would otherwise apply to the engine family.

(3) The FCL for each pollutant. If you change the FCL after the start of production, identify the date that you started using the new FCL and/or give the engine identification number for the first engine covered by the new FCL. In this case, identify each applicable FCL and calculate the positive or negative emission credits as specified in § 1036.225.

(4) The projected and actual U.S.-directed production volumes for the model year. If you changed an FCL during the model year, identify the actual production volume associated with each FCL.

(5) The transient cycle conversion factor for each engine configuration as described in § 1036.705.

(6) Useful life.

(7) Calculated positive or negative emission credits for the whole engine family. Identify any emission credits that you traded, as described in paragraph (d)(1) of this section.

(c) Your end-of-year and final reports must include the following additional information:

(1) Show that your net balance of emission credits from all your participating engine families in each averaging set in the applicable model year is not negative, except as allowed under § 1036.745.

(2) State whether you will reserve any emission credits for banking.

(3) State that the report's contents are accurate.

(d) If you trade emission credits, you must send us a report within 90 days after the transaction, as follows:

(1) As the seller, you must include the following information in your report:

(i) The corporate names of the buyer and any brokers.

(ii) A copy of any contracts related to the trade.

(iii) The engine families that generated emission credits for the trade, including the number of emission credits from each family.

(2) As the buyer, you must include the following information in your report:

(i) The corporate names of the seller and any brokers.

(ii) A copy of any contracts related to the trade.

(iii) How you intend to use the emission credits, including the number of emission credits you intend to apply to each engine family (if known).

(e) Send your reports electronically to the Designated Compliance Officer using an approved information format. If you want to use a different format, send us a written request with justification for a waiver.

(f) Correct errors in your end-of-year report or final report as follows:

(1) You may correct any errors in your end-of-year report when you prepare the final report, as long as you send us the final report by the time it is due.

(2) If you or we determine within 270 days after the end of the model year that errors mistakenly decreased your balance of emission credits, you may correct the errors and recalculate the balance of emission credits. You may

not make these corrections for errors that are determined more than 270 days after the end of the model year. If you report a negative balance of emission credits, we may disallow corrections under this paragraph (f)(2).

(3) If you or we determine anytime that errors mistakenly increased your balance of emission credits, you must correct the errors and recalculate the balance of emission credits.

#### § 1036.735 Recordkeeping.

(a) You must organize and maintain your records as described in this section. We may review your records at any time.

(b) Keep the records required by this section for at least eight years after the due date for the end-of-year report. You may not use emission credits for any engines if you do not keep all the records required under this section. You must therefore keep these records to continue to bank valid credits. Store these records in any format and on any media, as long as you can promptly send us organized, written records in English if we ask for them. You must keep these records readily available. We may review them at any time.

(c) Keep a copy of the reports we require in §§ 1036.725 and 1036.730.

(d) Keep records of the engine identification number (usually the serial number) for each engine you produce that generates or uses emission credits under the ABT program. You may identify these numbers as a range. If you change the FEL after the start of production, identify the date you started using each FCL and the range of engine identification numbers associated with each FCL. You must also identify the purchaser and destination for each engine you produce to the extent this information is available.

(e) We may require you to keep additional records or to send us relevant information not required by this section in accordance with the Clean Air Act.

#### § 1036.740 Restrictions for using emission credits.

The following restrictions apply for using emission credits:

(a) *Averaging sets.* Except as specified in paragraph (c) of this section, emission credits may be exchanged only within an following averaging sets. There are four principal averaging sets for engines subject to this subpart:

(1) Spark-ignition engines.

(2) Compression-ignition light heavy-duty engines.

(3) Compression-ignition medium heavy-duty engines.

(4) Compression-ignition heavy heavy-duty engines.

(b) *Applying credits to prior year deficits.* Where your credit balance for the previous year is negative, you may apply credits to that credit deficit only after meeting your credit obligations for the current year.

(c) *Credits from hybrid engines and other advanced technologies.* The averaging set restrictions of paragraph (a) of this section do not apply for credits generated under § 1036.615 or 40 CFR 1037.104(d)(7) or 1037.615 from hybrid power systems with regenerative braking, or from other advanced technologies. Such credits may also be used under 40 CFR part 1037.

(1) The maximum amount of credits you may bring into the following service class groups is 60,000 Mg per model year:

(i) Spark-ignition engines, light heavy-duty compression-ignition engines, and light heavy-duty vehicles. This group comprises the averaging sets listed in paragraphs (a)(1) and (2) of this section and the averaging set listed in 40 CFR 1037.740(a)(1).

(ii) Medium heavy-duty compression-ignition engines and medium heavy-duty vehicles. This group comprises the averaging sets listed in paragraph (a)(3) of this section and 40 CFR 1037.740(a)(2).

(iii) Heavy heavy-duty compression-ignition engines and heavy heavy-duty vehicles. This group comprises the averaging sets listed in paragraph (a)(4) of this section and 40 CFR 1037.740(a)(3).

(2) The limit specified in paragraph (c)(1) of this section does not limit the amount of advanced technology credits that can be used within a service class group if they were generated in that same service class group.

(d) *Credit life.* Credits expire after five years.

(e) *Other restrictions.* Other sections of this part specify additional restrictions for using emission credits under certain special provisions.

#### § 1036.745 End-of-year CO<sub>2</sub> credit deficits.

Except as allowed by this section, we may void the certificate of any engine family certified to an FCL above the applicable standard for which you do not have sufficient credits by the deadline for submitting the final report.

(a) Your certificate for an engine family for which you do not have sufficient CO<sub>2</sub> credits will not be void if you remedy the deficit with surplus credits within three model years. For example, if you have a credit deficit of 500 Mg for an engine family at the end of model year 2015, you must generate (or otherwise obtain) a surplus of at

least 500 Mg in that same averaging set by the end of model year 2018.

(b) You may not bank or trade away CO<sub>2</sub> credits in the averaging set in any model year in which you have a deficit.

(c) You may apply only surplus credits to your deficit. You may not apply credits to a deficit from an earlier model year if they were generated in a model year for which any of your engine families for that averaging set had an end-of-year credit deficit.

(d) If you do not remedy the deficit with surplus credits within three model years, we may void your certificate for that engine family. We may void the certificate based on your end-of-year report. Note that voiding a certificate applies *ab initio*. Where the net deficit is less than the total amount of negative credits originally generated by the family, we will void the certificate only with respect to the number of engines needed to reach the amount of the net deficit. For example, if the original engine family generated 500 Mg of negative credits, and the manufacturer's net deficit after three years was 250 Mg, we would void the certificate with respect to half of the engines in the family.

**§ 1036.750 What can happen if I do not comply with the provisions of this subpart?**

(a) For each engine family participating in the ABT program, the certificate of conformity is conditioned upon full compliance with the provisions of this subpart during and after the model year. You are responsible to establish to our satisfaction that you fully comply with applicable requirements. We may void the certificate of conformity for an engine family if you fail to comply with any provisions of this subpart.

(b) You may certify your engine family to an FCL above an applicable standard based on a projection that you will have enough emission credits to offset the deficit for the engine family. See § 1036.745 for provisions specifying what happens if you cannot show in your final report that you have enough actual emission credits to offset a deficit for any pollutant in an engine family.

(c) We may void the certificate of conformity for an engine family if you fail to keep records, send reports, or give us information we request. Note that failing to keep records, send reports, or give us information we request is also a violation of 42 U.S.C. 7522(a)(2).

(d) You may ask for a hearing if we void your certificate under this section (see § 1036.820).

**§ 1036.755 Information provided to the Department of Transportation.**

After receipt of each manufacturer's final report as specified in § 1036.730 and completion of any verification testing required to validate the manufacturer's submitted final data, we will issue a report to the Department of Transportation with CO<sub>2</sub> emission information and will verify the accuracy of each manufacturer's equivalent fuel consumption data that required by NHTSA under 49 CFR 535.8. We will send a report to DOT for each engine manufacturer based on each regulatory category and subcategory, including sufficient information for NHTSA to determine fuel consumption and associated credit values. See 49 CFR 535.8 to determine if NHTSA deems submission of this information to EPA to also be a submission to NHTSA.

**Subpart I—Definitions and Other Reference Information**

**§ 1036.801 Definitions.**

The following definitions apply to this part. The definitions apply to all subparts unless we note otherwise. All undefined terms have the meaning the Act gives to them. The definitions follow:

*Act* means the Clean Air Act, as amended, 42 U.S.C. 7401–7671q.

*Adjustable parameter* has the meaning given in 40 CFR part 86.

*Advanced technology* means technology certified under § 1036.615, 40 CFR 1037.104(d)(7) or 1037.615.

*Aftertreatment* means relating to a catalytic converter, particulate filter, or any other system, component, or technology mounted downstream of the exhaust valve (or exhaust port) whose design function is to decrease emissions in the engine exhaust before it is exhausted to the environment. Exhaust-gas recirculation (EGR) and turbochargers are not aftertreatment.

*Aircraft* means any vehicle capable of sustained air travel above treetop heights.

*Alcohol-fueled engine* mean an engine that is designed to run using an alcohol fuel. For purposes of this definition, alcohol fuels do not include fuels with a nominal alcohol content below 25 percent by volume.

*Auxiliary emission control device* means any element of design that senses temperature, motive speed, engine RPM, transmission gear, or any other parameter for the purpose of activating, modulating, delaying, or deactivating the operation of any part of the emission control system.

*Averaging set* has the meaning given in § 1036.740.

*Calibration* means the set of specifications and tolerances specific to a particular design, version, or application of a component or assembly capable of functionally describing its operation over its working range.

*Carryover* means relating to certification based on emission data generated from an earlier model year as described in § 1036.235(d).

*Certification* means relating to the process of obtaining a certificate of conformity for an engine family that complies with the emission standards and requirements in this part.

*Certified emission level* means the highest deteriorated emission level in an engine family for a given pollutant from the applicable transient and/or steady-state testing, rounded to the same number of decimal places as the applicable standard. Note that you may have two certified emission levels for CO<sub>2</sub> if you certify a family for both vocational and tractor use.

*Complete vehicle* means a vehicle meeting the definition of complete vehicle in 40 CFR 1037.801 when it is first sold as a vehicle. For example, where a vehicle manufacturer sells an incomplete vehicle to a secondary manufacturer, the vehicle is not a complete vehicle under this part, even after its final assembly.

*Compression-ignition* means relating to a type of reciprocating, internal-combustion engine that is not a spark-ignition engine.

*Crankcase emissions* means airborne substances emitted to the atmosphere from any part of the engine crankcase's ventilation or lubrication systems. The crankcase is the housing for the crankshaft and other related internal parts.

*Criteria pollutants* means emissions of NO<sub>x</sub>, HC, PM, and CO. Note that these pollutants are also sometimes described collectively as “non-greenhouse gas pollutants”, although they do not necessarily have negligible global warming potentials.

*Designated Compliance Officer* means the Manager, Heavy-Duty and Nonroad Engine Group (6405–J), U.S. Environmental Protection Agency, 1200 Pennsylvania Ave., NW., Washington, DC 20460.

*Designated Enforcement Officer* means the Director, Air Enforcement Division (2242A), U.S. Environmental Protection Agency, 1200 Pennsylvania Ave., NW., Washington, DC 20460.

*Deteriorated emission level* means the emission level that results from applying the appropriate deterioration factor to the official emission result of the emission-data engine. Note that where no deterioration factor applies,



references in this part to the *deteriorated emission level* mean the official emission result.

*Deterioration factor* means the relationship between emissions at the end of useful life (or point of highest emissions if it occurs before the end of useful life) and emissions at the low-hour/low-mileage test point, expressed in one of the following ways:

(1) For multiplicative deterioration factors, the ratio of emissions at the end of useful life (or point of highest emissions) to emissions at the low-hour test point.

(2) For additive deterioration factors, the difference between emissions at the end of useful life (or point of highest emissions) and emissions at the low-hour test point.

*Dual-fuel* means relating to an engine designed for operation on two different types of fuel but not on a continuous mixture of those fuels.

*Emission control system* means any device, system, or element of design that controls or reduces the emissions of regulated pollutants from an engine.

*Emission-data engine* means an engine that is tested for certification. This includes engines tested to establish deterioration factors.

*Emission-related maintenance* means maintenance that substantially affects emissions or is likely to substantially affect emission deterioration.

*Engine configuration* means a unique combination of engine hardware and calibration (related to the emission standards) within an engine family. Engines within a single engine configuration differ only with respect to normal production variability or factors unrelated to compliance with emission standards.

*Engine family* has the meaning given in § 1036.230.

*Excluded* means relating to engines that are not subject to some or all of the requirements of this part as follows:

(1) An engine that has been determined not to be a heavy-duty engine is excluded from this part.

(2) Certain heavy-duty engines are excluded from the requirements of this part under § 1036.5.

(3) Specific regulatory provisions of this part may exclude a heavy-duty engine generally subject to this part from one or more specific standards or requirements of this part.

*Exempted* has the meaning given in 40 CFR 1068.30.

*Exhaust-gas recirculation* means a technology that reduces emissions by routing exhaust gases that had been exhausted from the combustion chamber(s) back into the engine to be mixed with incoming air before or

during combustion. The use of valve timing to increase the amount of residual exhaust gas in the combustion chamber(s) that is mixed with incoming air before or during combustion is not considered exhaust-gas recirculation for the purposes of this part.

*Family certification level (FCL)* means a CO<sub>2</sub> emission level declared by the manufacturer that is at or above emission test results for all emission-data engines. The FCL serves as the emission standard for the engine family with respect to certification testing if it is different than the otherwise applicable standard. The FCL must be expressed to the same number of decimal places as the emission standard it replaces.

*Family emission limit (FEL)* means an emission level declared by the manufacturer to serve in place of an otherwise applicable emission standard (other than CO<sub>2</sub> standards) under the ABT program in subpart H of this part. The FEL must be expressed to the same number of decimal places as the emission standard it replaces. The FEL serves as the emission standard for the engine family with respect to all required testing except certification testing for CO<sub>2</sub>. The CO<sub>2</sub> FEL is equal to the CO<sub>2</sub> FCL multiplied by 1.03 and rounded to the same number of decimal places as the standard (e.g., the nearest whole g/hp-hr for the 2016 CO<sub>2</sub> standards).

*Flexible-fuel* means relating to an engine designed for operation on any mixture of two or more different types of fuels.

*Fuel type* means a general category of fuels such as diesel fuel, gasoline, or natural gas. There can be multiple grades within a single fuel type, such as premium gasoline, regular gasoline, or gasoline with 10 percent ethanol.

*Good engineering judgment* has the meaning given in 40 CFR 1068.30. See 40 CFR 1068.5 for the administrative process we use to evaluate good engineering judgment.

*Greenhouse gas pollutants* and *greenhouse gases* means compounds regulated under this part based primarily on their impact on the climate. This includes CO<sub>2</sub>, CH<sub>4</sub>, and N<sub>2</sub>O.

*Gross vehicle weight rating (GVWR)* means the value specified by the vehicle manufacturer as the maximum design loaded weight of a single vehicle, consistent with good engineering judgment.

*Heavy-duty engine* means any engine which the engine manufacturer could reasonably expect to be used for motive power in a heavy-duty vehicle. For purposes of this definition in this part,

the term "engine" includes internal combustion engines and other devices that convert chemical fuel into motive power. For example, a fuel cell used in a heavy-duty vehicle is a heavy-duty engine.

*Heavy-duty vehicle* means any motor vehicle above 8,500 pounds GVWR or that has a vehicle curb weight above 6,000 pounds or that has a basic vehicle frontal area greater than 45 square feet. *Curb weight* has the meaning given in 40 CFR 86.1803, consistent with the provisions of 40 CFR 1037.140. *Basic vehicle frontal area* has the meaning given in 40 CFR 86.1803.

*Hybrid engine* or *hybrid powertrain* means an engine or powertrain that includes energy storage features other than a conventional battery system or conventional flywheel. Supplemental electrical batteries and hydraulic accumulators are examples of hybrid energy storage systems. Note that certain provisions in this part treat hybrid engines and powertrains intended for vehicles that include regenerative braking differently than those intended for vehicles that do not include regenerative braking.

*Hydrocarbon (HC)* means the hydrocarbon group on which the emission standards are based for each fuel type. For alcohol-fueled engines, HC means nonmethane hydrocarbon equivalent (NMHCE). For all other engines, HC means nonmethane hydrocarbon (NMHC).

*Identification number* means a unique specification (for example, a model number/serial number combination) that allows someone to distinguish a particular engine from other similar engines.

*Incomplete vehicle* means a vehicle meeting the definition of incomplete vehicle in 40 CFR 1037.801 when it is first sold as a vehicle.

*Innovative technology* means technology certified under § 1036.610.

*Liquefied petroleum gas (LPG)* means a liquid hydrocarbon fuel that is stored under pressure and is composed primarily of nonmethane compounds that are gases at atmospheric conditions.

*Low-hour* means relating to an engine that has stabilized emissions and represents the undeteriorated emission level. This would generally involve less than 125 hours of operation.

*Manufacture* means the physical and engineering process of designing, constructing, and/or assembling a heavy-duty engine or a heavy-duty vehicle.

*Manufacturer* has the meaning given in section 216(1) of the Act. In general, this term includes any person who manufactures an engine, vehicle, or



piece of equipment for sale in the United States or otherwise introduces a new engine into commerce in the United States. This includes importers who import engines or vehicles for resale.

*Medium-duty passenger vehicle* has the meaning given in 40 CFR 86.1803.

*Model year* means the manufacturer's annual new model production period, except as restricted under this definition. It must include January 1 of the calendar year for which the model year is named, may not begin before January 2 of the previous calendar year, and it must end by December 31 of the named calendar year. Manufacturers may not adjust model years to circumvent or delay compliance with emission standards or to avoid the obligation to certify annually.

*Motor vehicle* has the meaning given in 40 CFR 85.1703.

*Natural gas* means a fuel whose primary constituent is methane.

*New motor vehicle engine* means a motor vehicle engine meeting the criteria of either paragraph (1) or (2) of this definition.

(1) A motor vehicle engine for which the ultimate purchaser has never received the equitable or legal title is a *new motor vehicle engine*. This kind of engine might commonly be thought of as "brand new" although a *new motor vehicle engine* may include previously used parts. Under this definition, the engine is new from the time it is produced until the ultimate purchaser receives the title or places it into service, whichever comes first.

(2) An imported motor vehicle engine is a *new motor vehicle engine* if it was originally built on or after January 1, 1970.

*Noncompliant engine* means an engine that was originally covered by a certificate of conformity, but is not in the certified configuration or otherwise does not comply with the conditions of the certificate.

*Nonconforming engine* means an engine not covered by a certificate of conformity that would otherwise be subject to emission standards.

*Nonmethane hydrocarbons (NMHC)* means the sum of all hydrocarbon species except methane, as measured according to 40 CFR part 1065.

*Official emission result* means the measured emission rate for an emission-data engine on a given duty cycle before the application of any deterioration factor, but after the applicability of any required regeneration adjustment factors.

*Owner's manual* means a document or collection of documents prepared by the engine or vehicle manufacturer for the

owner or operator to describe appropriate engine maintenance, applicable warranties, and any other information related to operating or keeping the engine. The owner's manual is typically provided to the ultimate purchaser at the time of sale.

*Oxides of nitrogen* has the meaning given in 40 CFR 1065.1001.

*Percent* has the meaning given in 40 CFR 1065.1001. Note that this means percentages identified in this part are assumed to be infinitely precise without regard to the number of significant figures. For example, one percent of 1,493 is 14.93.

*Petroleum* means gasoline or diesel fuel or other fuels normally derived from crude oil. This does not include methane or LPG.

*Placed into service* means put into initial use for its intended purpose.

*Primary intended service class* has the meaning given in § 1036.140.

*Rated power* has the meaning given in 40 CFR part 86.

*Rechargeable Energy Storage System (RESS)* means the component(s) of a hybrid engine or vehicle that store recovered energy for later use, such as the battery system in an electric hybrid vehicle.

*Revoke* has the meaning given in 40 CFR 1068.30.

*Round* has the meaning given in 40 CFR 1065.1001.

*Scheduled maintenance* means adjusting, repairing, removing, disassembling, cleaning, or replacing components or systems periodically to keep a part or system from failing, malfunctioning, or wearing prematurely. It also may mean actions you expect are necessary to correct an overt indication of failure or malfunction for which periodic maintenance is not appropriate.

*Small manufacturer* means a manufacturer meeting the criteria specified in 13 CFR 121.201. For manufacturers owned by a parent company, the employee and revenue limits apply to the total number of employees and total revenue of the parent company and all its subsidiaries.

*Spark-ignition* means relating to a gasoline-fueled engine or any other type of engine with a spark plug (or other sparking device) and with operating characteristics significantly similar to the theoretical Otto combustion cycle. Spark-ignition engines usually use a throttle to regulate intake air flow to control power during normal operation.

*Steady-state* has the meaning given in 40 CFR 1065.1001.

*Suspend* has the meaning given in 40 CFR 1068.30.

*Test engine* means an engine in a test sample.

*Test sample* means the collection of engines selected from the population of an engine family for emission testing. This may include testing for certification, production-line testing, or in-use testing.

*Tractor* means a vehicle meeting the definition of "tractor" in 40 CFR 1037.801, but not classified as a "vocational tractor" under 40 CFR 1037.630, or relating to such a vehicle.

*Tractor engine* means an engine certified for use in tractors. Where an engine family is certified for use in both tractors and vocational vehicles, "tractor engine" means an engine that the engine manufacturer reasonably believes will be (or has been) installed in a tractor. Note that the provisions of this part may require a manufacturer to document how it determines that an engine is a tractor engine.

*Ultimate purchaser* means, with respect to any new engine or vehicle, the first person who in good faith purchases such new engine or vehicle for purposes other than resale.

*United States* has the meaning given in 40 CFR 1068.30.

*Upcoming model year* means for an engine family the model year after the one currently in production.

*U.S.-directed production volume* means the number of engines, subject to the requirements of this part, produced by a manufacturer for which the manufacturer has a reasonable assurance that sale was or will be made to ultimate purchasers in the United States. This does not include engines certified to state emission standards that are different than the emission standards in this part.

*Vehicle* has the meaning given in 40 CFR 1037.801.

*Vocational engine* means an engine certified for use in vocational vehicles. Where an engine family is certified for use in both tractors and vocational vehicles, "vocational engine" means an engine that the engine manufacturer reasonably believes will be (or has been) installed in a vocational vehicle. Note that the provisions of this part may require a manufacturer to document how it determines that an engine is a vocational engine.

*Vocational vehicle* means a vehicle meeting the definition of "vocational" vehicle in 40 CFR 1037.801.

*Void* has the meaning given in 40 CFR 1068.30.

*We (us, our)* means the Administrator of the Environmental Protection Agency and any authorized representatives.

**§ 1036.805 Symbols, acronyms, and abbreviations.**

The following symbols, acronyms, and abbreviations apply to this part:

- ABT averaging, banking, and trading.
- AECD auxiliary emission control device.
- ASTM American Society for Testing and Materials.
- BTU British thermal units.
- CFR Code of Federal Regulations.
- CH<sub>4</sub> methane.
- CO carbon monoxide.
- CO<sub>2</sub> carbon dioxide.
- DF deterioration factor.
- DOT Department of Transportation.
- E85 gasoline blend including nominally 85 percent ethanol.
- EPA Environmental Protection Agency.
- FCL Family Certification Level.
- FEL Family Emission Limit.
- g/hp-hr grams per brake horsepower-hour.
- GVWR gross vehicle weight rating.
- HC hydrocarbon.
- kg kilogram.
- kgC kilogram carbon.
- kW kilowatts.
- lb pound.
- lbC pound carbon.
- LPG liquefied petroleum gas.
- Mg megagrams (10<sup>6</sup> grams, or one metric ton).
- MJ megajoules.
- N<sub>2</sub>O nitrous oxide.
- NARA National Archives and Records Administration.
- NHTSA National Highway Traffic Safety Administration.
- NO<sub>x</sub> oxides of nitrogen (NO and NO<sub>2</sub>).
- NTE not-to-exceed.
- PM particulate matter.
- RESS rechargeable energy storage system.
- RPM revolutions per minute.
- SET Supplemental Emission Test (see 40 CFR 86.1362).
- U.S. United States.
- U.S.C. United States Code.

**§ 1036.810 Incorporation by reference.**

(a) Certain material is incorporated by reference into this part with the approval of the Director of the Federal Register under 5 U.S.C. 552(a) and 1 CFR part 51. To enforce any edition other than that specified in this section, the Environmental Protection Agency must publish a notice of the change in the **Federal Register** and the material must be available to the public. All approved material is available for inspection at U.S. EPA, Air and Radiation Docket and Information Center, 1301 Constitution Ave., NW., Room B102, EPA West Building, Washington, DC 20460, (202) 202-1744,

and is available from the sources listed below. It is also available for inspection at the National Archives and Records Administration (NARA). For information on the availability of this material at NARA, call 202-741-6030, or go to [http://www.archives.gov/federal\\_register/code\\_of\\_federal\\_regulations/ibr\\_locations.html](http://www.archives.gov/federal_register/code_of_federal_regulations/ibr_locations.html).

(b) American Society for Testing and Materials, 100 Barr Harbor Drive, P.O. Box C700, West Conshohocken, PA, 19428-2959, (610) 832-9585, <http://www.astm.org/>.

(1) ASTM D 240-09 Standard Test Method for Heat of Combustion of Liquid Hydrocarbon Fuels by Bomb Calorimeter, approved July 1, 2009, IBR approved for § 1036.530(b).

(2) ASTM D4809-09a Standard Test Method for Heat of Combustion of Liquid Hydrocarbon Fuels by Bomb Calorimeter (Precision Method), approved September 1, 2009, IBR approved for § 1036.530(b).

(3) ASTM D5291-10 Standard Test Methods for Instrumental Determination of Carbon, Hydrogen, and Nitrogen in Petroleum Products and Lubricants, approved May 1, 2010, IBR approved for § 1036.530(b).

**§ 1036.815 Confidential information.**

The provisions of 40 CFR 1068.10 apply for information you consider confidential.

**§ 1036.820 Requesting a hearing.**

(a) You may request a hearing under certain circumstances, as described elsewhere in this part. To do this, you must file a written request, including a description of your objection and any supporting data, within 30 days after we make a decision.

(b) For a hearing you request under the provisions of this part, we will approve your request if we find that your request raises a substantial factual issue.

(c) If we agree to hold a hearing, we will use the procedures specified in 40 CFR part 1068, subpart G.

**§ 1036.825 Reporting and recordkeeping requirements.**

(a) This part includes various requirements to submit and record data or other information. Unless we specify otherwise, store required records in any format and on any media and keep them readily available for eight years after you send an associated application for certification, or eight years after you generate the data if they do not support an application for certification. You may not rely on anyone else to meet recordkeeping requirements on your

behalf unless we specifically authorize it. We may review these records at any time. You must promptly send us organized, written records in English if we ask for them. We may require you to submit written records in an electronic format.

(b) The regulations in § 1036.255 and 40 CFR 1068.25 and 1068.101 describe your obligation to report truthful and complete information. This includes information not related to certification. Failing to properly report information and keep the records we specify violates 40 CFR 1068.101(a)(2), which may involve civil or criminal penalties.

(c) Send all reports and requests for approval to the Designated Compliance Officer (see § 1036.801).

(d) Any written information we require you to send to or receive from another company is deemed to be a required record under this section. Such records are also deemed to be submissions to EPA. Keep these records for eight years unless the regulations specify a different period. We may require you to send us these records whether or not you are a certificate holder.

(e) Under the Paperwork Reduction Act (44 U.S.C. 3501 *et seq.*), the Office of Management and Budget approves the reporting and recordkeeping specified in the applicable regulations. The following items illustrate the kind of reporting and recordkeeping we require for engines and equipment regulated under this part:

(1) We specify the following requirements related to engine certification in this part 1036:

(i) In § 1036.135 we require engine manufacturers to keep certain records related to duplicate labels sent to equipment manufacturers.

(ii) In subpart C of this part we identify a wide range of information required to certify engines.

(iii) In subpart G of this part we identify several reporting and recordkeeping items for making demonstrations and getting approval related to various special compliance provisions.

(iv) In §§ 1036.725, 1036.730, and 1036.735 we specify certain records related to averaging, banking, and trading.

(2) We specify the following requirements related to testing in 40 CFR part 1066:

(i) In 40 CFR 1066.2 we give an overview of principles for reporting information.

(ii) [Reserved]

■ 34. A new part 1037 is added to subchapter U to read as follows:

## PART 1037—CONTROL OF EMISSIONS FROM NEW HEAVY-DUTY MOTOR VEHICLES

### Subpart A—Overview and Applicability

Sec.

- 1037.1 Applicability
- 1037.5 Excluded vehicles.
- 1037.10 How is this part organized?
- 1037.15 Do any other regulation parts apply to me?
- 1037.30 Submission of information.

### Subpart B—Emission Standards and Related Requirements

- 1037.101 Overview of emission standards for heavy-duty vehicles.
- 1037.102 Exhaust emission standards for NO<sub>x</sub>, HC, PM, and CO.
- 1037.104 Exhaust emission standards for CO<sub>2</sub>, CH<sub>4</sub>, and N<sub>2</sub>O for heavy-duty vehicles at or below 14,000 pounds GVWR.
- 1037.105 Exhaust emission standards for CO<sub>2</sub> for vocational vehicles.
- 1037.106 Exhaust emission standards for CO<sub>2</sub> for tractors above 26,000 pounds GVWR.
- 1037.115 Other requirements.
- 1037.120 Emission-related warranty requirements.
- 1037.125 Maintenance instructions and allowable maintenance.
- 1037.135 Labeling.
- 1037.140 Curb weight and roof height.
- 1037.150 Interim provisions.

### Subpart C—Certifying Vehicle families

- 1037.201 General requirements for obtaining a certificate of conformity.
- 1037.205 What must I include in my application?
- 1037.210 Preliminary approval before certification.
- 1037.220 Amending maintenance instructions.
- 1037.225 Amending applications for certification.
- 1037.230 Vehicle families, sub-families, and configurations.
- 1037.241 Demonstrating compliance with exhaust emission standards for greenhouse gas pollutants.
- 1037.250 Reporting and recordkeeping.
- 1037.255 What decisions may EPA make regarding my certificate of conformity?

### Subpart D—[Reserved]

### Subpart E—In-Use Testing

- 1037.401 General provisions.

### Subpart F—Test and Modeling Procedures

- 1037.501 General testing and modeling provisions.
- 1037.510 Duty-cycle exhaust testing.
- 1037.520 Modeling CO<sub>2</sub> emissions to show compliance.
- 1037.521 Aerodynamic measurements.
- 1037.525 Special procedures for testing hybrid vehicles with power take-off.
- 1037.550 Special procedures for testing post-transmission hybrid systems.

### Subpart G—Special Compliance Provisions

- 1037.601 What compliance provisions apply to these vehicles?

- 1037.610 Vehicles with innovative technologies.
- 1037.615 Hybrid vehicles and other advanced technologies.
- 1037.620 Shipment of incomplete vehicles to secondary vehicle manufacturers.
- 1037.630 Special purpose tractors.
- 1037.631 Exemption for vocational vehicles intended for off-road use.
- 1037.640 Variable vehicle speed limiters.
- 1037.645 In-use compliance with family emission limits (FELs).
- 1037.650 Tire manufacturers.
- 1037.655 Post-useful life vehicle modifications.
- 1037.660 Automatic engine shutdown systems.

### Subpart H—Averaging, Banking, and Trading for Certification

- 1037.701 General provisions.
- 1037.705 Generating and calculating emission credits.
- 1037.710 Averaging.
- 1037.715 Banking.
- 1037.720 Trading.
- 1037.725 What must I include in my application for certification?
- 1037.730 ABT reports.
- 1037.735 Recordkeeping.
- 1037.740 Restrictions for using emission credits.
- 1037.745 End-of-year CO<sub>2</sub> credit deficits.
- 1037.750 What can happen if I do not comply with the provisions of this subpart?
- 1037.755 Information provided to the Department of Transportation.

### Subpart I—Definitions and Other Reference Information

- 1037.801 Definitions.
- 1037.805 Symbols, acronyms, and abbreviations.
- 1037.810 Incorporation by reference.
- 1037.815 Confidential information.
- 1037.820 Requesting a hearing.
- 1037.825 Reporting and recordkeeping requirements.
- Appendix I to Part 1037—Heavy-duty Transient Chassis Test Cycle
- Appendix II to Part 1037—Power Take-Off Test Cycle
- Appendix III to Part 1037—Emission Control Identifiers

Authority: 42 U.S.C. 7401–7671q.

### Subpart A—Overview and Applicability

#### § 1037.1 Applicability

This part contains standards and other regulations applicable to the emission of the air pollutant defined as the aggregate group of six greenhouse gases: carbon dioxide, nitrous oxide, methane, hydrofluorocarbons, perfluorocarbons, and sulfur hexafluoride. The regulations in this part 1037 apply for all new heavy-duty vehicles, except as provided in § 1037.5. This includes electric vehicles and vehicles fueled by conventional and alternative fuels.

#### § 1037.5 Excluded vehicles.

Except for the definitions specified in § 1037.801, this part does not apply to the following vehicles:

(a) Vehicles not meeting the definition of “motor vehicle”.

(b) Vehicles excluded from the definition of “heavy-duty vehicle” in § 1037.801 because of vehicle weight, weight rating, and frontal area (such as light-duty vehicles and light-duty trucks).

(c) Medium-duty passenger vehicles.

(d) Vehicles produced in model years before 2014, unless they are certified under § 1037.150.

(e) Vehicles subject to the light-duty greenhouse gas standards of 40 CFR part 86. See 40 CFR 86.1818 for greenhouse gas standards that apply for these vehicles. An example of such a vehicle would be a vehicle meeting the definition of “heavy-duty vehicle” in § 1037.801 and 40 CFR 86.1803, but also meeting the definition of “light truck” in 40 CFR 86.1818–12(b)(2).

#### § 1037.10 How is this part organized?

This part 1037 is divided into subparts as described in this section. Note that only subparts A, B, and I of this part apply for vehicles subject to the standards of § 1037.104, as described in that section.

(a) Subpart A of this part defines the applicability of part 1037 and gives an overview of regulatory requirements.

(b) Subpart B of this part describes the emission standards and other requirements that must be met to certify vehicles under this part. Note that § 1037.150 discusses certain interim requirements and compliance provisions that apply only for a limited time.

(c) Subpart C of this part describes how to apply for a certificate of conformity for vehicles subject to the standards of § 1037.105 or § 1037.106.

(d) [Reserved]

(e) Subpart E of this part addresses testing of in-use vehicles.

(f) Subpart F of this part describes how to test your vehicles and perform emission modeling (including references to other parts of the Code of Federal Regulations) for vehicles subject to the standards of § 1037.105 or § 1037.106.

(g) Subpart G of this part and 40 CFR part 1068 describe requirements, prohibitions, and other provisions that apply to manufacturers, owners, operators, rebuilders, and all others. Section 1037.601 describes how 40 CFR part 1068 applies for heavy-duty vehicles.

(h) Subpart H of this part describes how you may generate and use emission

credits to certify vehicles that are subject to the standards of § 1037.105 or § 1037.106.

(j) Subpart I of this part contains definitions and other reference information.

**§ 1037.15 Do any other regulation parts apply to me?**

(a) Parts 1065 and 1066 of this chapter describe procedures and equipment specifications for testing engines and vehicles to measure exhaust emissions. Subpart F of this part 1037 describes how to apply the provisions of part 1065 and part 1066 of this chapter to determine whether vehicles meet the exhaust emission standards in this part.

(b) As described in § 1037.601, certain requirements and prohibitions of part 1068 of this chapter apply to everyone, including anyone who manufactures, imports, installs, owns, operates, or rebuilds any of the vehicles subject to this part 1037. Part 1068 of this chapter describes general provisions that apply broadly, but do not necessarily apply for all vehicles or all persons. The issues addressed by these provisions include these seven areas:

(1) Prohibited acts and penalties for manufacturers and others.

(2) Rebuilding and other aftermarket changes.

(3) Exclusions and exemptions for certain vehicles.

(4) Importing vehicles.

(5) Selective enforcement audits of your production.

(6) Recall.

(7) Procedures for hearings.

(c) Part 86 of this chapter applies for certain vehicles as specified in this part. For example, the test procedures and most of part 86, subpart S, applies for vehicles subject to § 1037.104.

(d) Other parts of this chapter apply if referenced in this part.

**§ 1037.30 Submission of information.**

Send all reports and requests for approval to the Designated Compliance Officer (see § 1037.801). See § 1037.825 for additional reporting and recordkeeping provisions.

**Subpart B—Emission Standards and Related Requirements**

**§ 1037.101 Overview of emission standards for heavy-duty vehicles.**

(a) This part specifies emission standards for certain vehicles and for certain pollutants. It also summarizes other standards that apply under 40 CFR part 86. This part contains standards and other regulations applicable to the

emission of the air pollutant defined as the aggregate group of six greenhouse gases: carbon dioxide, nitrous oxide, methane, hydrofluorocarbons, perfluorocarbons, and sulfur hexafluoride.

(b) The regulated emissions are addressed in four groups:

(1) Exhaust emissions of NO<sub>x</sub>, HC, PM, and CO. These pollutants are sometimes described collectively as “criteria pollutants” because they are either criteria pollutants under the Clean Air Act or precursors to the criteria pollutant ozone. These pollutants are also sometimes described collectively as “non-greenhouse gas pollutants”, although they do not necessarily have negligible global warming potential. As described in § 1037.102, standards for these pollutants are provided in 40 CFR part 86.

(2) Exhaust emissions of CO<sub>2</sub>, CH<sub>4</sub>, and N<sub>2</sub>O. These pollutants are described collectively in this part as “greenhouse gas pollutants” because they are regulated primarily based on their impact on the climate. These standards are provided in §§ 1037.104 through 1037.106.

(3) Hydrofluorocarbons. These pollutants are also “greenhouse gas pollutants” but are treated separately from exhaust greenhouse gas pollutants listed in paragraph (b)(2) of this section. These standards are provided in § 1037.115.

(4) Fuel evaporative emissions. These requirements are described in 40 CFR part 86.

(c) The regulated heavy-duty vehicles are addressed in different groups as follows:

(1) For criteria pollutants, vehicles are regulated based on gross vehicle weight rating (GVWR), whether they are considered “spark-ignition” or “compression-ignition,” and whether they are first sold as complete or incomplete vehicles. These groupings apply as described in 40 CFR part 86.

(2) For greenhouse gas pollutants, vehicles are regulated in the following groups:

(i) Complete and certain incomplete vehicles at or below 14,000 pounds GVWR (see § 1037.104 for further specification). Certain provisions of 40 CFR part 86 apply for these vehicles; see § 1037.104(h) for a list of provisions in this part 1037 that also apply for these vehicles. These provisions may also be optionally applied to certain other vehicles, as described in § 1037.104.

(ii) Tractors above 26,000 pounds GVWR.

(iii) All other vehicles subject to standards under this part. These other vehicles are referred to as “vocational” vehicles.

**§ 1037.102 Exhaust emission standards for NO<sub>x</sub>, HC, PM, and CO.**

See 40 CFR part 86 for the exhaust emission standards for NO<sub>x</sub>, HC, PM, and CO that apply for heavy-duty vehicles.

**§ 1037.104 Exhaust emission standards for CO<sub>2</sub>, CH<sub>4</sub>, and N<sub>2</sub>O for heavy-duty vehicles at or below 14,000 pounds GVWR.**

This section applies for heavy-duty vehicles at or below 14,000 pounds GVWR. See paragraph (f) of this section and § 1037.150 of this section for provisions excluding certain vehicles from this section, and allowing other vehicles to be certified under this section.

(a) *Fleet-average CO<sub>2</sub> emission standards.* Fleet-average CO<sub>2</sub> emission standards apply for each manufacturer as follows:

(1) Calculate a work factor, WF, for each vehicle subconfiguration (or group of subconfigurations allowed under paragraph (a)(4) of this section), rounded to the nearest pound, using the following equation:

$$WF = 0.75 \times (GVWR - \text{Curb Weight} + \text{xwd}) + 0.25 \times (GCWR - GVWR)$$

Where:

xwd = 500 pounds if the vehicle has four-wheel drive or all-wheel drive; xwd = 0 pounds for all other vehicles.

(2) Using the appropriate work factor, calculate a target value for each vehicle subconfiguration (or group of subconfigurations allowed under paragraph (a)(4) of this section) you produce using one of the following equations, rounding to the nearest 0.1 g/mile:

(i) For spark-ignition vehicles: CO<sub>2</sub> Target (g/mile) = 0.0440 × WF + 339

(ii) For compression-ignition vehicles and vehicles that operate without engines (such as electric vehicles and fuel cell vehicles): CO<sub>2</sub> Target (g/mile) = 0.0416 × WF + 320

(3) Calculate a production-weighted average of the target values and round it to the nearest 0.1 g/mile. This is your fleet-average standard. All vehicles subject to the standards of this section form a single averaging set. Use the following equation to calculate your fleet-average standard from the target value for each vehicle subconfiguration (Target<sub>i</sub>) and U.S.-directed production volume of each vehicle subconfiguration for the given model year (Volume<sub>i</sub>):

$$\text{Fleet-Average Standard} = \frac{\sum [\text{Target}_i \times \text{Volume}_i]}{\sum [\text{Volume}_i]}$$

(4) You may group subconfigurations within a configuration together for purposes of calculating your fleet-average standard as follows:

(i) You may group together subconfigurations that have the same equivalent test weight (ETW), GVWR, and GCWR. Calculate your work factor and target value assuming a curb weight equal to two times ETW minus GVWR.

(ii) You may group together other subconfigurations if you use the lowest target value calculated for any of the subconfigurations.

(b) *Production and in-use CO<sub>2</sub> standards.* Each vehicle you produce that is subject to the standards of this section has an “in-use” CO<sub>2</sub> standard that is calculated from your test result and that applies for selective enforcement audits and in-use testing. This in-use CO<sub>2</sub> standard for each vehicle is equal to the applicable deteriorated emission level multiplied by 1.10 and rounded to the nearest 0.1 g/mile.

(c) *N<sub>2</sub>O and CH<sub>4</sub> standards.* Except as allowed under this paragraph (c), all vehicles subject to the standards of this section must comply with an N<sub>2</sub>O standard of 0.05 g/mile and a CH<sub>4</sub> standard of 0.05 g/mile. You may specify CH<sub>4</sub> and/or N<sub>2</sub>O alternate standards using CO<sub>2</sub> emission credits instead of these otherwise applicable emission standards for one or more test groups, consistent with the provisions of 40 CFR 86.1818. To do this, calculate the CH<sub>4</sub> and/or N<sub>2</sub>O emission credits needed (negative credits) using the equation in this paragraph (c) based on the FEL(s) you specify for your vehicles during certification. You must adjust the calculated emissions by the global warming potential (GWP): GWP equals 25 for CH<sub>4</sub> and 298 for N<sub>2</sub>O. This means you must use 25 Mg of positive CO<sub>2</sub> credits to offset 1 Mg of negative CH<sub>4</sub> credits and 298 Mg of positive CO<sub>2</sub> credits to offset 1 Mg of negative N<sub>2</sub>O credits. Note that 40 CFR 86.1818–12(f) does not apply for vehicles subject to the standards of this section. Calculate credits using the following equation:

$$\text{CO}_2 \text{ Credits Needed (Mg)} = [(\text{FEL} - \text{Std}) \times (\text{U.S.-directed production volume}) \times (\text{Useful Life})] \times (\text{GWP}) \div 1,000,000$$

(d) *Compliance provisions.* Except as specified in this paragraph (d) or elsewhere in this section, the provisions of 40 CFR part 86, describing compliance with the greenhouse gas standards of 40 CFR part 86, subpart S,

apply with respect to the standards of paragraphs (a) through (c) of this section.

(1) The CO<sub>2</sub> standards of this section apply with respect to CO<sub>2</sub> emissions, not with respect to carbon-related exhaust emissions (CREE).

(2) Vehicles subject to the standards of this section are included in a single greenhouse gas averaging set separate from any averaging sets otherwise included in 40 CFR part 86.

(3) Special credit and incentive provisions related to flexible fuel vehicles and air conditioning in 40 CFR part 86 do not apply for vehicles subject to the standards of this section.

(4) The CO<sub>2</sub>, N<sub>2</sub>O, and CH<sub>4</sub> standards apply for a weighted average of the city (55%) and highway (45%) test cycle results as specified for light-duty vehicles in 40 CFR part 86, subpart S. Note that this differs from the way the criteria pollutant standards apply for heavy-duty vehicles.

(5) Apply an additive deterioration factor of zero to measured CO<sub>2</sub> emissions unless good engineering judgment indicates that emissions are likely to deteriorate in use. Use good engineering judgment to develop separate deterioration factors for N<sub>2</sub>O and CH<sub>4</sub>.

(6) Credits are calculated using the useful life value (in miles) in place of the “vehicle lifetime miles” specified in 40 CFR part 86, subpart S.

(7) Credits generated from hybrid vehicles with regenerative braking or from vehicles with other advanced technologies may be used to show compliance with any standards of this part or 40 CFR part 1036, subject to the service class restrictions in § 1037.740. Include these vehicles in a separate fleet-average calculation (and exclude them from your conventional fleet-average calculation). You must first apply these advanced technology vehicle credits to any deficits for other vehicles in the averaging set before applying them to other averaging sets.

(8) The provisions of 40 CFR 86.1818 do not apply.

(9) Calculate your fleet-average emission rate consistent with good engineering judgment and the provisions of 40 CFR 86.1865. The following additional provisions apply:

(i) Unless we approve a lower number, you must test at least ten subconfigurations. If you produce more than 100 subconfigurations in a given

model year, you must test at least ten percent of your subconfigurations. For purposes of this paragraph (d)(9)(i), count carryover tests, but do not include analytically derived CO<sub>2</sub> emission rates, data substitutions, or other untested allowances. We may approve a lower number of tests for manufacturers that have limited product offerings, or low sales volumes. Note that good engineering judgment and other provisions of this part may require you to test more subconfigurations than these minimum values.

(ii) The provisions of paragraph (g) of this section specify how you may use analytically derived CO<sub>2</sub> emission rates.

(iii) At least 90 percent of final production volume at the configuration level must be represented by test data (real, data substituted, or analytical).

(10) For dual fuel, multi-fuel, and flexible fuel vehicles, perform exhaust testing on each fuel type (for example, gasoline and E85).

(i) For your fleet-average calculations, use either the conventional-fueled CO<sub>2</sub> emission rate or a weighted average of your emission results as specified in 40 CFR 600.510–12(k) for light-duty trucks.

(ii) If you certify to an alternate standard for N<sub>2</sub>O or CH<sub>4</sub> emissions, you may not exceed the alternate standard when tested on either fuel.

(11) Test your vehicles with an equivalent test weight based on its Adjusted Loaded Vehicle Weight (ALVW). Determine equivalent test weight from the ALVW as specified in 40 CFR 86.129, except that you may round values to the nearest 500 pound increment for ALVW above 14,000 pounds).

(12) The following definitions apply for purposes of this section:

(i) Configuration means a subclassification within a test group which is based on engine code, transmission type and gear ratios, final drive ratio, and other parameters which we designate. Note that this differs from the definition in 40 CFR 86.1803 because it excludes inertia weight class as a criterion.

(ii) Subconfiguration means a unique combination within a vehicle configuration (as defined in this paragraph (d)(12)) of equivalent test weight, road-load horsepower, and any other operational characteristics or parameters that we determine may significantly affect CO<sub>2</sub> emissions within a vehicle configuration.

(iii) The terms “complete vehicle” and “incomplete vehicle” have the meanings given for “complete heavy-duty vehicle” and “incomplete heavy-duty vehicle” in 40 CFR 86.1803.

(13) This paragraph (d)(13) applies for CO<sub>2</sub> reductions resulting from technologies that were not in common use before 2010 that are not reflected in the specified test procedures. We may allow you to generate emission credits consistent with the provisions of 40 CFR 86.1866–12(d). You do not need to provide justification for not using the 5-cycle methodology option.

(14) You must submit pre-model year reports before you submit your applications for certification for a given model year. Unless we specify otherwise, include the information specified for pre-model year reports in 49 CFR 535.8.

(e) *Useful life.* Your vehicles must meet the exhaust emission standards of this section throughout their full useful life, expressed in service miles or calendar years, whichever comes first. The useful life values for the standards of this section are those that apply for criteria pollutants under 40 CFR part 86.

(f) *Exclusion of vehicles not certified as complete vehicles.* The standards of this section apply for each vehicle that is chassis-certified with respect to criteria pollutants under 40 CFR part 86, subpart S. The standards of this section do not apply for other vehicles, except as noted in § 1037.150. Note that vehicles excluded under this paragraph (f) are not considered to be “subject to the standards of this section.” The vehicle standards and requirements of § 1037.105 apply for the excluded

vehicles. The GHG standards of 40 CFR part 1036 also apply for engines used in these excluded vehicles. If you are not the engine manufacturer, you must notify the engine manufacturer that its engines are subject to 40 CFR part 1036 because you intend to use their engines in your excluded vehicles.

(g) *Analytically derived CO<sub>2</sub> emission rates (ADCs).* This paragraph (g) describes an allowance to use estimated (*i.e.*, analytically derived) CO<sub>2</sub> emission rates based on baseline test data instead of measured emission rates for calculating fleet-average emissions. Note that these ADCs are similar to ADFEs used for light-duty vehicles. Note also that F terms used in this paragraph (g) represent coefficients from the following road load equation:

$$Force - (mass)(acceleration) = F0 + F1 \cdot (velocity) + F2 \cdot (velocity)^2$$

(1) Except as specified in paragraph (g)(2) of this section, use the following equation to calculate the ADC of a new

vehicle from road load force coefficients (F0, F1, F2), axle ratio, and test weight:

$$ADC = CO_{2,base} + 2.18 \cdot \Delta F0 + 37.4 \cdot \Delta F1 + 2257 \cdot \Delta F2 + 189 \cdot \Delta AR + 0.0222 \cdot \Delta ETW$$

Where:

ADC = Analytically derived combined city/highway CO<sub>2</sub> emission rate (g/mile) for a new vehicle.

CO<sub>2,base</sub> = Combined city/highway CO<sub>2</sub> emission rate (g/mile) of a baseline vehicle.

ΔF0 = F0 of the new vehicle—F0 of the baseline vehicle.

ΔF1 = F1 of the new vehicle—F1 of the baseline vehicle.

ΔF2 = F2 of the new vehicle—F2 of the baseline vehicle.

ΔAR = Axle ratio of the new vehicle—axle ratio of the baseline vehicle.

ΔETW = ETW of the new vehicle—ETW of the baseline vehicle.

(2) The purpose of this section is to accurately estimate CO<sub>2</sub> emission rates. You must apply the provisions of this section consistent with good engineering judgment. For example, do not use the equation in paragraph (g)(1) of this section where good engineering judgment indicates that it will not accurately estimate emissions. You may ask us to approve alternate equations that allow you to estimate emissions more accurately.

(3) You may select, without our prior approval, baseline test data that meet all the following criteria:

(i) Vehicles considered for selection for the baseline test must comply with

all applicable emission standards in the model year associated with the ADC.

(ii) You must include in the pool of tests which will be considered for baseline selection all official tests of the same or equivalent basic engine, transmission class, engine code, transmission code, engine horsepower, dynamometer drive wheels, and compression ratio as the ADC subconfiguration. Do not include tests in which emissions exceed any applicable standards.

(iii) Where necessary to minimize the CO<sub>2</sub> adjustment, you may supplement the pool with tests associated with worst-case engine or transmission codes and carryover or carry-across engine families. If you do, all the data that qualify for inclusion using the elected worst-case substitution (or carryover or carry-across) must be included in the pool as supplemental data (*i.e.*, individual test vehicles may not be selected for inclusion). You must also include the supplemental data in all subsequent pools, where applicable.

(iv) Tests previously used during the subject model year as baseline tests in ten other ADC subconfigurations must be eliminated from the pool. (v) Select the tested subconfiguration with the smallest absolute difference between the ADC and the test CO<sub>2</sub> emission rate for

combined emissions. Use this as the baseline test for the target ADC subconfiguration.

(4) You may ask us to allow you use baseline test data not fully meeting the provisions of paragraph (g)(3) of this section.

(5) Calculate the ADC rounded to the nearest 0.1 g/mile. The downward adjustment of ADC from the baseline is limited to ADC values 20 percent below the baseline emission rate (*i.e.*, baseline emission rate × 0.80). The upward adjustment is not limited.

(6) You may not submit an ADC if an actual test has been run on the target subconfiguration during the certification process or on a development vehicle that is eligible to be declared as an emission-data vehicle.

(7) No more than 40 percent of the subconfigurations tested in your final CO<sub>2</sub> submission may be represented by ADCs.

(8) You must retain for five years the pool of tests, the vehicle description and tests chosen as the baseline and the basis for its selection, the target ADC subconfiguration, and the calculated emission rates. We may ask to see these records at any time.

(9) We may perform or order a confirmatory test of any subconfiguration covered by an ADC.

(10) Where we determine that you did not fully comply with the provisions of this paragraph (g), we may rescind the use of ADC data, require generation of actual test data, and require recalculation of your fleet-average emission rate.

(h) *Applicability of part 1037 provisions.* Except as specified in this section, the requirements of this part do not apply to vehicles certified to the standards of this section. The following provisions are the only provisions of this part that apply to vehicles certified under this section:

- (1) The provisions of this section.

(2) [Reserved]

(3) The air conditioning standards in § 1037.115.

(4) The interim provisions of § 1037.150(a), (b), (c), (e)–(i), (l), and (m).

(5) The definitions of § 1037.801, to the extent such terms are used relative to vehicles subject to standards under this section.

**§ 1037.105 Exhaust emission standards for CO<sub>2</sub> for vocational vehicles.**

(a) The standards of this section apply for the following vehicles:

(1) Vehicles above 14,000 pounds GVWR and at or below 26,000 pounds GVWR, but not certified to the vehicle standards § 1037.104.

(2) Vehicles above 26,000 pounds GVWR that are not tractors.

(3) Vocational tractors.

(4) Vehicles at or below 14,000 pounds GVWR that are excluded from the standards in § 1037.104 under § 1037.104 (f) or use engines certified under § 1037.150(m).

(b) The CO<sub>2</sub> standards of this section are given in Table 1 to this section. The provisions of § 1037.241 specify how to comply with these standards.

TABLE 1 TO § 1037.105—CO<sub>2</sub> STANDARDS FOR VOCATIONAL VEHICLES

GVWR (pounds)	CO <sub>2</sub> standard (g/ton-mile) for model years 2014–2016	CO <sub>2</sub> standard (g/ton-mile) for model year 2017 and later
GVWR ≤ 19,500	388	373
19,500 < GVWR ≤ 33,000	234	225
33,000 < GVWR	226	222

(c) No CH<sub>4</sub> or N<sub>2</sub>O standards apply under this section. See 40 CFR part 1036 for CH<sub>4</sub> or N<sub>2</sub>O standards that apply to engines used in these vehicles.

(d) You may generate or use emission credits under the ABT program as described in subpart H of this part. This requires that you specify a Family Emission Limit (FEL) for CO<sub>2</sub> for each vehicle subfamily. The FEL may not be less than the result of emission modeling from § 1037.520. These FELs serve as the emission standards for the vehicle subfamily instead of the standards specified in paragraph (b) of this section.

(e) Your vehicles must meet the exhaust emission standards of this section throughout their full useful life, expressed in service miles or calendar years, whichever comes first. The

following useful life values apply for the standards of this section:

(1) 110,000 miles or 10 years, whichever comes first, for vehicles at or below 19,500 pounds GVWR.

(2) 185,000 miles or 10 years, whichever comes first, for vehicles above 19,500 pounds GVWR and at or below 33,000 pounds GVWR.

(3) 435,000 miles or 10 years, whichever comes first, for vehicles above 33,000 pounds GVWR.

(f) See § 1037.631 for provisions that exempt certain vehicles used in off-road operation from the standards of this section.

(g) You may optionally certify a vocational vehicle to the standards and useful life applicable to a higher vehicle service class (such as medium heavy-duty instead of light heavy-duty),

provided you do not generate credits with the vehicle. If you include smaller vehicles in a credit-generating subfamily (with an FEL below the standard), exclude its production volume from the credit calculation.

**§ 1037.106 Exhaust emission standards for CO<sub>2</sub> for tractors above 26,000 pounds GVWR.**

(a) The CO<sub>2</sub> standards of this section apply for tractors above 26,000 pounds GVWR. Note that the standards of this section do not apply for vehicles classified as “vocational tractors” under § 1037.630.

(b) The CO<sub>2</sub> standards for tractors above 26,000 pounds GVWR are given in Table 1 to this section. The provisions of § 1037.241 specify how to comply with these standards.

TABLE 1 TO § 1037.106—CO<sub>2</sub> STANDARDS FOR TRACTORS ABOVE 26,000 POUNDS GVWR

GVWR (pounds)	Sub-category	CO <sub>2</sub> standard (g/ton-mile) for model years 2014–2016	CO <sub>2</sub> standard (g/ton-mile) for model year 2017 and later
26,000 < GVWR ≤ 33,000	Low-Roof (all cab styles)	107	104
	Mid-Roof (all cab styles)	119	115
	High-Roof (all cab styles)	124	120
GVWR > 33,000	Low-Roof Day Cab	81	80
	Low-Roof Sleeper Cab	68	66
	Mid-Roof Day Cab	88	86
	Mid-Roof Sleeper Cab	76	73
	High-Roof Day Cab	92	89
	High-Roof Sleeper Cab	75	72

(c) No CH<sub>4</sub> or N<sub>2</sub>O standards apply under this section. See 40 CFR part 1036

for CH<sub>4</sub> or N<sub>2</sub>O standards that apply to engines used in these vehicles.

(d) You may generate or use emission credits under the ABT program, as



described in subpart H of this part. This requires that you specify a Family Emission Limit (FEL) for each pollutant you include in the ABT program for each vehicle subfamily. The FEL may not be less than the result of emission modeling from § 1037.520. These FELs serve as the emission standards for the specific vehicle subfamily instead of the standards specified in paragraph (a) of this section.

(e) Your vehicles must meet the exhaust emission standards of this section throughout their full useful life, expressed in service miles or calendar years, whichever comes first. The following useful life values apply for the standards of this section:

(1) 185,000 miles or 10 years, whichever comes first, for vehicles at or below 33,000 pounds GVWR.

(2) 435,000 miles or 10 years, whichever comes first, for vehicles above 33,000 pounds GVWR.

(f) You may optionally certify a tractor to the standards and useful life applicable to a higher vehicle service class (such as heavy heavy-duty instead of medium heavy-duty), provided you do not generate credits with the vehicle. If you include smaller vehicles in a credit-generating subfamily (with an FEL below the standard), exclude its production volume from the credit calculation.

#### § 1037.115 Other requirements.

Vehicles required to meet the emission standards of this part must meet the following additional requirements, except as noted elsewhere in this part:

(a) *Adjustable parameters.* Vehicles that have adjustable parameters must meet all the requirements of this part for any adjustment in the physically adjustable range. We may require that you set adjustable parameters to any specification within the adjustable range during any testing. See 40 CFR part 86 for information related to determining whether or not an operating parameter is considered adjustable. You must ensure safe vehicle operation throughout the physically adjustable range of each adjustable parameter, including consideration of production tolerances. Note that adjustable roof fairings are deemed not to be adjustable parameters.

(b) *Prohibited controls.* You may not design your vehicles with emission control devices, systems, or elements of design that cause or contribute to an unreasonable risk to public health, welfare, or safety while operating. For example, this would apply if the vehicle emits a noxious or toxic substance it would otherwise not emit that

contributes to such an unreasonable risk.

(c) *Air conditioning leakage.* Loss of refrigerant from your air conditioning systems may not exceed 1.50 percent per year, except as allowed by paragraphs (c)(2) and (3) of this section. Calculate the total leakage rate in g/year as specified in 40 CFR 86.166. Calculate the percent leakage rate as:  $[\text{total leakage rate (g/yr)}] \div [\text{total refrigerant capacity (g)}] \times 100$ . Round your leakage rate to the nearest one-hundredth of a percent. See § 1037.150 for vocational vehicles.

(1) For purpose of this requirement, “refrigerant capacity” is the total mass of refrigerant recommended by the vehicle manufacturer as representing a full charge. Where full charge is specified as a pressure, use good engineering judgment to convert the pressure and system volume to a mass.

(2) If your system uses a refrigerant other than HFC–134a, adjust your leakage rate by multiplying it by the global warming potential of your refrigerant and dividing the product by 1430 (which is the global warming potential of HFC–134a). Apply this adjustment before comparing your leakage rate to the standard. Determine global warming potentials consistent with 40 CFR 86.1866. Note that global warming potentials represent the equivalent grams of CO<sub>2</sub> that would have the same global warming impact (over 100 years) as one gram of the refrigerant.

(3) If your total refrigerant capacity is less than 734 grams, your leakage rate may exceed 1.50 percent, as long as the total leakage rate does not exceed 11.0 g/yr. If your system uses a refrigerant other than HFC–134a, you may adjust your leakage rate as specified in paragraph (c)(2) of this section.

#### § 1037.120 Emission-related warranty requirements.

(a) *General requirements.* You must warrant to the ultimate purchaser and each subsequent purchaser that the new vehicle, including all parts of its emission control system, meets two conditions:

(1) It is designed, built, and equipped so it conforms at the time of sale to the ultimate purchaser with the requirements of this part.

(2) It is free from defects in materials and workmanship that cause the vehicle to fail to conform to the requirements of this part during the applicable warranty period.

(b) *Warranty period.* (1) Your emission-related warranty must be valid for at least:

(i) 5 years or 50,000 miles for spark-ignition vehicles and light heavy-duty vehicles.

(ii) 5 years or 100,000 miles for medium and heavy heavy-duty vehicles.

(iii) 2 years or 24,000 miles for tires.

(2) You may offer an emission-related warranty more generous than we require. The emission-related warranty for the vehicle may not be shorter than any basic mechanical warranty you provide to that owner without charge for the vehicle. Similarly, the emission-related warranty for any component may not be shorter than any warranty you provide to that owner without charge for that component. This means that your warranty for a given vehicle may not treat emission-related and non-emission-related defects differently for any component. The warranty period begins when the vehicle is placed into service.

(c) *Components covered.* The emission-related warranty covers vehicle speed limiters, idle shutdown systems, fairings, and hybrid system components, to the extent such emission-related components are included in the certified emission controls. The emission-related warranty covers all components whose failure would increase a vehicle’s emissions of air conditioning refrigerants for vehicles subject to air conditioning leakage standards. The emission-related warranty covers tires and all components whose failure would increase a vehicle’s evaporative emissions (for vehicles subject to evaporative emission standards). The emission-related warranty covers these components even if another company produces the component. Your emission-related warranty does not need to cover components whose failure would not increase a vehicle’s emissions of any regulated pollutant.

(d) *Limited applicability.* You may deny warranty claims under this section if the operator caused the problem through improper maintenance or use, as described in 40 CFR 1068.115.

(e) *Owner’s manual.* Describe in the owners manual the emission-related warranty provisions from this section that apply to the vehicle.

#### § 1037.125 Maintenance instructions and allowable maintenance.

Give the ultimate purchaser of each new vehicle written instructions for properly maintaining and using the vehicle, including the emission control system. The maintenance instructions also apply to service accumulation on any of your emission-data vehicles. See paragraph (i) of this section for



requirements related to tire replacement.

(a) *Critical emission-related maintenance.* Critical emission-related maintenance includes any adjustment, cleaning, repair, or replacement of critical emission-related components. This may also include additional emission-related maintenance that you determine is critical if we approve it in advance. You may schedule critical emission-related maintenance on these components if you demonstrate that the maintenance is reasonably likely to be done at the recommended intervals on in-use vehicles. We will accept scheduled maintenance as reasonably likely to occur if you satisfy any of the following conditions:

(1) You present data showing that, if a lack of maintenance increases emissions, it also unacceptably degrades the vehicle's performance.

(2) You present survey data showing that at least 80 percent of vehicles in the field get the maintenance you specify at the recommended intervals.

(3) You provide the maintenance free of charge and clearly say so in your maintenance instructions.

(4) You otherwise show us that the maintenance is reasonably likely to be done at the recommended intervals.

(b) *Recommended additional maintenance.* You may recommend any additional amount of maintenance on the components listed in paragraph (a) of this section, as long as you state clearly that these maintenance steps are not necessary to keep the emission-related warranty valid. If operators do the maintenance specified in paragraph (a) of this section, but not the recommended additional maintenance, this does not allow you to disqualify those vehicles from in-use testing or deny a warranty claim. Do not take these maintenance steps during service accumulation on your emission-data vehicles.

(c) *Special maintenance.* You may specify more frequent maintenance to address problems related to special situations, such as atypical vehicle operation. You must clearly state that this additional maintenance is associated with the special situation you are addressing. We may disapprove your maintenance instructions if we determine that you have specified special maintenance steps to address vehicle operation that is not atypical, or that the maintenance is unlikely to occur in use. If we determine that certain maintenance items do not qualify as special maintenance under this paragraph (c), you may identify this as recommended additional

maintenance under paragraph (b) of this section.

(d) *Noncritical emission-related maintenance.* Subject to the provisions of this paragraph (d), you may schedule any amount of emission-related inspection or maintenance that is not covered by paragraph (a) of this section (that is, maintenance that is neither explicitly identified as critical emission-related maintenance, nor that we approve as critical emission-related maintenance). Noncritical emission-related maintenance generally includes maintenance on the components we specify in 40 CFR part 1068, Appendix I, that is not covered in paragraph (a) of this section. You must state in the owners manual that these steps are not necessary to keep the emission-related warranty valid. If operators fail to do this maintenance, this does not allow you to disqualify those vehicles from in-use testing or deny a warranty claim. Do not take these inspection or maintenance steps during service accumulation on your emission-data vehicles.

(e) *Maintenance that is not emission-related.* For maintenance unrelated to emission controls, you may schedule any amount of inspection or maintenance. You may also take these inspection or maintenance steps during service accumulation on your emission-data vehicles, as long as they are reasonable and technologically necessary. You may perform this non-emission-related maintenance on emission-data vehicles at the least frequent intervals that you recommend to the ultimate purchaser (but not the intervals recommended for severe service).

(f) *Source of parts and repairs.* State clearly on the first page of your written maintenance instructions that a repair shop or person of the owner's choosing may maintain, replace, or repair emission control devices and systems. Your instructions may not require components or service identified by brand, trade, or corporate name. Also, do not directly or indirectly condition your warranty on a requirement that the vehicle be serviced by your franchised dealers or any other service establishments with which you have a commercial relationship. You may disregard the requirements in this paragraph (f) if you do one of two things:

(1) Provide a component or service without charge under the purchase agreement.

(2) Get us to waive this prohibition in the public's interest by convincing us the vehicle will work properly only

with the identified component or service.

(g) [Reserved]

(h) *Owner's manual.* Explain the owner's responsibility for proper maintenance in the owner's manual.

(i) *Tire maintenance and replacement.* Include instructions that will enable the owner to replace tires so that the vehicle conforms to the original certified vehicle configuration.

#### § 1037.135 Labeling.

(a) Assign each vehicle a unique identification number and permanently affix, engrave, or stamp it on the vehicle in a legible way. The vehicle identification number (VIN) serves this purpose.

(b) At the time of manufacture, affix a permanent and legible label identifying each vehicle. The label must be—

(1) Attached in one piece so it is not removable without being destroyed or defaced.

(2) Secured to a part of the vehicle needed for normal operation and not normally requiring replacement.

(3) Durable and readable for the vehicle's entire life.

(4) Written in English.

(c) The label must—

(1) Include the heading "VEHICLE EMISSION CONTROL INFORMATION".

(2) Include your full corporate name and trademark. You may identify another company and use its trademark instead of yours if you comply with the branding provisions of 40 CFR 1068.45.

(3) Include EPA's standardized designation for the vehicle family.

(4) State the regulatory sub-category that determines the applicable emission standards for the vehicle family (see definition in § 1037.801).

(5) State the date of manufacture [DAY (optional), MONTH, and YEAR]. You may omit this from the label if you stamp, engrave, or otherwise permanently identify it elsewhere on the engine, in which case you must also describe in your application for certification where you will identify the date on the engine.

(6) Identify the emission control system. Use terms and abbreviations as described in Appendix III to this part or other applicable conventions.

(7) Identify any requirements for fuel and lubricants that do not involve fuel-sulfur levels.

(8) State: "THIS VEHICLE COMPLIES WITH U.S. EPA REGULATIONS FOR [MODEL YEAR] HEAVY-DUTY VEHICLES."

(9) Include the following statement, if applicable: "THIS VEHICLE IS

DESIGNED TO COMPLY WITH EVAPORATIVE EMISSION STANDARDS WITH UP TO x GALLONS OF FUEL TANK CAPACITY.” Complete this statement by identifying the maximum specified fuel tank capacity associated with your certification.

(d) You may add information to the emission control information label to identify other emission standards that the vehicle meets or does not meet (such as European standards). You may also add other information to ensure that the vehicle will be properly maintained and used.

(e) You may ask us to approve modified labeling requirements in this part 1037 if you show that it is necessary or appropriate. We will approve your request if your alternate label is consistent with the requirements of this part.

**§ 1037.140 Curb weight and roof height.**

(a) Where applicable, a vehicle’s curb weight and roof height are determined from nominal design specifications, as provided in this section. Round the weight to the nearest pound and height to the nearest inch. Base roof height on fully inflated tires having a static loaded radius equal to the arithmetic mean of the largest and smallest static loaded radius of tires you offer or a standard tire we approve.

(b) The nominal design specifications must be within the range of the actual weights and roof heights of production vehicles considering normal production variability. If after production begins it is determined that your nominal design specifications do not represent production vehicles, we may require you to amend your application for certification under § 1037.225.

(c) If your vehicle is equipped with an adjustable roof fairing, measure the roof height with the fairing in its lowest setting.

**§ 1037.150 Interim provisions.**

The provisions in this section apply instead of other provisions in this part.

(a) *Incentives for early introduction.* The provisions of this paragraph (a) apply with respect to vehicles produced in model years before 2014. Manufacturers may voluntarily certify in model year 2013 (or earlier model years for electric vehicles) to the greenhouse gas standards of this part.

(1) This paragraph (a)(1) applies for regulatory sub-categories subject to the standards of § 1037.105 or § 1037.106. Except as specified in paragraph (a)(3) of this section, to generate early credits under this paragraph for any vehicles other than electric vehicles, you must certify your entire U.S.-directed production volume within the regulatory sub-category to these standards. Except as specified in paragraph (a)(4) of this section, if some vehicle families within a regulatory sub-category are certified after the start of the model year, you may generate credits only for production that occurs after all families are certified. For example, if you produce three vehicle families in an averaging set and you receive your certificates for those families on January 4, 2013, March 15, 2013, and April 24, 2013, you may not generate credits for model year 2013 production in any of the families that occurs before April 24, 2013. Calculate credits relative to the standard that would apply in model year 2014 using the equations in subpart H of this part. You may bank credits equal to the surplus credits you generate under this paragraph (a) multiplied by 1.50. For example, if you have 1.0 Mg of surplus credits for model year 2013, you may bank 1.5 Mg of credits. Credit deficits for an averaging set prior to model year 2014 do not carry over to model year 2014. These credits may be used to show compliance with the standards of this part for 2014 and later model years. We recommend that you notify EPA of your intent to use this provision before submitting your applications.

(2) This paragraph (a)(2) applies for regulatory sub-categories subject to the standards of § 1037.104. To generate early credits under this paragraph (a)(2) for any vehicles other than electric vehicles, you must certify your entire U.S.-directed production volume within the regulatory sub-category to these standards. If you calculate a separate fleet average for advanced-technology vehicles under § 1037.104(c)(7), you must certify your entire U.S.-directed production volume of both advanced and conventional vehicles within the regulatory sub-category. Except as specified in paragraph (a)(4) of this section, if some test groups are certified after the start of the model year, you may generate credits only for

production that occurs after all test groups are certified. For example, if you produce three test groups in an averaging set and you receive your certificates for those test groups on January 4, 2013, March 15, 2013, and April 24, 2013, you may not generate credits for model year 2013 production in any of the test groups that occurs before April 24, 2013. Calculate credits relative to the standard that would apply in model year 2014 using the applicable equations in 40 CFR part 86 and your model year 2013 U.S.-directed production volumes. These credits may be used to show compliance with the standards of this part for 2014 and later model years. We recommend that you notify EPA of your intent to use this provision before submitting your applications.

(3) You may generate emission credits for the number of additional SmartWay designated tractors (relative to your 2012 production), provided you do not generate credits for those vehicles under paragraph (a)(1) of this section. Calculate credits for each regulatory sub-category relative to the standard that would apply in model year 2014 using the equations in subpart H of this part. Use a production volume equal to the number of designated model year 2013 SmartWay tractors minus the number of designated model year 2012 SmartWay tractors. You may bank credits equal to the surplus credits you generate under this paragraph (a)(3) multiplied by 1.50. Your 2012 and 2013 model years must be equivalent in length.

(4) This paragraph (a)(4) applies where you do not receive your final certificate in a regulatory sub-category within 30 days of submitting your final application for that sub-category. Calculate your credits for all production that occurs 30 days or more after you submit your final application for the sub-category.

(b) *Phase-in provisions.* Each manufacturer must choose one of the following options for phasing in the standards of § 1037.104:

(1) To implement the phase-in under this paragraph (b)(1), the standards in § 1037.104 apply as specified for model year 2018, with compliance for vehicles in model years 2014 through 2017 based on the CO<sub>2</sub> target values specified in the following table:

TABLE 1 TO § 1037.150

Model year and engine cycle	Alternate CO <sub>2</sub> target (g/mile)
2014 Spark-Ignition .....	$[0.0482 \times (WF)] + 371$
2015 Spark-Ignition .....	$[0.0479 \times (WF)] + 369$

TABLE 1 TO § 1037.150—Continued

Model year and engine cycle	Alternate CO <sub>2</sub> target (g/mile)
2016 Spark-Ignition .....	$[0.0469 \times (WF)] + 362$
2017 Spark-Ignition .....	$[0.0460 \times (WF)] + 354$
2014 Compression-Ignition .....	$[0.0478 \times (WF)] + 368$
2015 Compression-Ignition .....	$[0.0474 \times (WF)] + 366$
2016 Compression-Ignition .....	$[0.0460 \times (WF)] + 354$
2017 Compression-Ignition .....	$[0.0445 \times (WF)] + 343$

(2) To implement the phase-in under this paragraph (b)(2), the standards in § 1037.104 apply as specified for model year 2019, with compliance for vehicles in model years 2014 through 2018 based on the CO<sub>2</sub> target values specified in the following table:

TABLE 2 TO § 1037.150

Model year and engine cycle	Alternate CO <sub>2</sub> target (g/mile)
2014 Spark-Ignition .....	$[0.0482 \times (WF)] + 371$
2015 Spark-Ignition .....	$[0.0479 \times (WF)] + 369$
2016–2018 Spark-Ignition .....	$[0.0456 \times (WF)] + 352$
2014 Compression-Ignition .....	$[0.0478 \times (WF)] + 368$
2015 Compression-Ignition .....	$[0.0474 \times (WF)] + 366$
2016–2018 Compression-Ignition .....	$[0.0440 \times (WF)] + 339$

(c) *Provisions for small manufacturers.* Manufacturers meeting the small business criteria specified in 13 CFR 121.201 for “Heavy Duty Truck Manufacturing” are not subject to the greenhouse gas standards of §§ 1037.104 through 1037.106, as specified in this paragraph (c). Qualifying manufacturers must notify the Designated Compliance Officer each model year before introducing these excluded vehicles into U.S. commerce. This notification must include a description of the manufacturer’s qualification as a small business under 13 CFR 121.201. You must label your excluded vehicles with the following statement: “THIS VEHICLE IS EXCLUDED UNDER 40 CFR 1037.150(c).”

(d) *Air conditioning leakage for vocational vehicles.* The air conditioning leakage standard of § 1037.115 does not apply for vocational vehicles.

(e) *Model year 2014 N<sub>2</sub>O standards.* In model year 2014 and earlier, manufacturers may show compliance with the N<sub>2</sub>O standards using an engineering analysis. This allowance also applies for later test groups families carried over from model 2014 consistent with the provisions of 40 CFR 86.1839. You may not certify to an N<sub>2</sub>O FEL different than the standard without measuring N<sub>2</sub>O emissions.

(f) *Electric vehicles.* All electric vehicles are deemed to have zero emissions of CO<sub>2</sub>, CH<sub>4</sub>, and N<sub>2</sub>O. No emission testing is required for electric vehicles.

(g) *Compliance date.* Compliance with the standards of this part is optional

prior to January 1, 2014. This means that if your 2014 model year begins before January 1, 2014, you may certify for a partial model year that begins on January 1, 2014 and ends on the day your model year would normally end. You must label model year 2014 vehicles excluded under this paragraph (g) with the following statement: “THIS VEHICLE IS EXCLUDED UNDER 40 CFR 1037.150(g).”

(h) *Off-road vehicle exemption.* In unusual circumstances, vehicle manufacturers may ask us to exempt vehicles under § 1037.631 based on other criteria that are equivalent to those specified in § 1037.631(a). For example, we would normally not grant relief in cases where the vehicle manufacturer had credits or other compliant tires were available.

(i) *Credit multiplier for advanced technology.* If you generate credits from vehicles certified with advanced technology, you may multiply these credits by 1.50, except that you may not apply this multiplier in addition to the early-credit multiplier of paragraph (a) of this section.

(j) *Limited prohibition related to early model year engines.* The prohibition in § 1037.601 against introducing into U.S. commerce a vehicle containing an engine not certified to the standards of this part does not apply for vehicles using model year 2014 or 2015 spark-ignition engines, or any model year 2013 or earlier engines.

(k) *Verifying drag areas from in-use vehicles.* We may measure the drag area of your vehicles after they have been placed into service. Your vehicle

conforms to the regulations of this part with respect to aerodynamic performance if we measure its drag area to be at or below the maximum drag area allowed for the bin to which that configuration was certified. To account for measurement variability, your vehicle is also deemed to conform to the regulations of this part with respect to aerodynamic performance if we measure its drag area to be at or below the maximum drag area allowed for the bin above the bin to which you certified (for example, Bin II if you certified the vehicle to Bin III), unless we determine that you knowingly produced the vehicle to have a higher drag area than is allowed for the bin to which it was certified.

(l) *Optional certification under § 1037.104.* You may certify certain complete or cab-complete vehicles to the standards of § 1037.104. All vehicles optionally certified under this paragraph (l) are deemed to be subject to the standards of § 1037.104. Note that certification under this paragraph (l) does not affect how you may or may not certify with respect to criteria pollutants. For example, certifying a Class 4 vehicle under this paragraph does not allow you to chassis-certify these vehicles with respect to criteria emissions.

(1) You may certify complete or cab-complete spark-ignition vehicles to the standards of § 1037.104.

(2) You may apply the provisions of § 1037.104 to cab-complete vehicles based on a complete sister vehicle. In unusual circumstances, you may ask us to apply these provisions to Class 2b or

3 incomplete vehicles that do not meet the definition of cab-complete. Except as specified in paragraph (l)(3) of this section, for purposes of § 1037.104, a complete sister vehicle is a complete vehicle of the same vehicle configuration (as defined in § 1037.104) as the cab-complete vehicle. Calculate the target value under § 1037.104(a) based on the same work factor value that applies for the complete sister vehicle. Test these cab-complete vehicles using the same equivalent test weight and other dynamometer settings that apply for the complete vehicle from which you used the work factor value. For certification, you may submit the test data from that complete sister vehicle instead of performing the test on the cab-complete vehicle. You are not required to produce the complete sister vehicle for sale to use the provisions of this paragraph (l)(2). This means the complete sister vehicle may be a carryover vehicle from a prior model year or a vehicle created solely for the purpose of testing.

(3) You may use as complete sister vehicle a complete vehicle that is not of the same vehicle configuration as the cab-complete vehicle as specified in this paragraph (l)(3). This allowance applies where the complete vehicle is not of the same vehicle configuration as the cab-complete vehicle only because of factors unrelated to coastdown performance. If your complete sister vehicle is covered by this paragraph (l)(3), you may not submit the test data from that complete sister vehicle and must perform the test on the cab-complete vehicle.

(m) *Loose engine sales.* This paragraph (m) applies for spark-ignition engines identical to engines used in vehicles certified to the standards of § 1037.104, where you sell such engines as loose engines or as engines installed in incomplete vehicles that are not cab-complete vehicles. For purposes of this paragraph (m), engines would not be considered to be identical if they used different engine hardware. You may include such engines in a test group certified to the standards of § 1037.104, subject to the following provisions:

(1) Engines certified under this paragraph (m) are deemed to be certified to the standards of 40 CFR 1036.108 as specified in 40 CFR 1036.108(a)(4).

(2) The U.S.-directed production volume of engines you sell as loose engines or installed in incomplete heavy-duty vehicles that are not cab-complete vehicles in any given model year may not exceed ten percent of the total U.S.-directed production volume of engines of that design that you produce for heavy-duty applications for that model year, including engines you

produce for complete vehicles, cab-complete vehicles, and other incomplete vehicles. The total number of engines you may certify under this paragraph (m), of all engine designs, may not exceed 15,000 in any model year. Engines produced in excess of either of these limits are not covered by your certificate. For example, if you produce 80,000 complete model year 2017 Class 2b pickup trucks with a certain engine and 10,000 incomplete model year 2017 Class 3 vehicles with that same engine, and you do not apply the provisions of this paragraph (m) to any other engine designs, you may produce up to 10,000 engines of that design for sale as loose engines under this paragraph (m). If you produced 11,000 engines of that design for sale as loose engines, the last 1,000 of them that you produced in that model year 2017 would be considered uncertified.

(3) This paragraph (m) does not apply for engines certified to the standards of 40 CFR 1036.108(a)(1).

(4) Label the engines as specified in 40 CFR 1036.135 including the following compliance statement: "THIS ENGINE WAS CERTIFIED TO THE ALTERNATE GREENHOUSE GAS EMISSION STANDARDS OF 40 CFR 1036.108(a)(4)." List the test group name instead of an engine family name.

(5) Vehicles using engines certified under this paragraph (m) are subject to the emission standards of § 1037.105.

(6) For certification purposes, your engines are deemed to have a CO<sub>2</sub> target value and test result equal to the CO<sub>2</sub> target value and test result for the complete vehicle in the applicable test group with the highest equivalent test weight, except as specified in paragraph (m)(6)(ii) of this section. Use these values to calculate your target value, fleet-average emission rate, and in-use emission standard. Where there are multiple complete vehicles with the same highest equivalent test weight, select the CO<sub>2</sub> target value and test result as specified in paragraphs (m)(6)(i) and (ii) of this section:

(i) If one or more of the CO<sub>2</sub> test results exceed the applicable target value, use the CO<sub>2</sub> target value and test result of the vehicle that exceeds its target value by the greatest amount.

(ii) If none of the CO<sub>2</sub> test results exceed the applicable target value, select the highest target value and set the test result equal to it. This means that you may not generate emission credits from vehicles certified under this paragraph (m).

(7) State in your applications for certification that your test group and engine family will include engines certified under this paragraph (m). This

applies for your greenhouse gas vehicle test group and your criteria pollutant engine family. List in each application the name of the corresponding test group/engine family.

### Subpart C—Certifying Vehicle families

#### § 1037.201 General requirements for obtaining a certificate of conformity.

(a) You must send us a separate application for a certificate of conformity for each vehicle family. A certificate of conformity is valid from the indicated effective date until the end of the model year for which it is issued, which may not extend beyond December 31 of that year. You must renew your certification annually for any vehicles you continue to produce.

(b) The application must contain all the information required by this part and must not include false or incomplete statements or information (see § 1037.255).

(c) We may ask you to include less information than we specify in this subpart, as long as you maintain all the information required by § 1037.250.

(d) You must use good engineering judgment for all decisions related to your application (see 40 CFR 1068.5).

(e) An authorized representative of your company must approve and sign the application.

(f) See § 1037.255 for provisions describing how we will process your application.

(g) We may perform confirmatory testing on your vehicles; for example, we may test vehicles to verify drag areas or other GEM inputs. We may require you to deliver your test vehicles to a facility we designate for our testing. Alternatively, you may choose to deliver another vehicle that is identical in all material respects to the test vehicle. Where certification is based on testing components such as tires, we may require you to deliver test components to a facility we designate for our testing.

#### § 1037.205 What must I include in my application?

This section specifies the information that must be in your application, unless we ask you to include less information under § 1037.201(c). We may require you to provide additional information to evaluate your application. Note that references to testing and emission-data vehicles refer to testing vehicles to measure aerodynamic drag, assess hybrid vehicle performance, and/or measure evaporative emissions.

(a) Describe the vehicle family's specifications and other basic parameters of the vehicle's design and emission controls. List the fuel type on

which your vehicles are designed to operate (for example, ultra low-sulfur diesel fuel).

(b) Explain how the emission control system operates. As applicable, describe in detail all system components for controlling greenhouse gas and evaporative emissions, including all auxiliary emission control devices (AECs) and all fuel-system components you will install on any production vehicle. Identify the part number of each component you describe. For this paragraph (b), treat as separate AECs any devices that modulate or activate differently from each other.

(c) For vehicles subject to air conditioning standards, include:

(1) The refrigerant leakage rates (leak scores).

(2) The refrigerant capacity of the air conditioning systems.

(3) The corporate name of the final installer of the air conditioning system.

(d) Describe any vehicles you selected for testing and the reasons for selecting them.

(e) Describe any test equipment and procedures that you used, including any special or alternate test procedures you used (see § 1037.501).

(f) Describe how you operated any emission-data vehicle before testing, including the duty cycle and the number of vehicle operating miles used to stabilize emission levels. Explain why you selected the method of service accumulation. Describe any scheduled maintenance you did.

(g) List the specifications of any test fuel to show that it falls within the required ranges we specify in 40 CFR part 1065.

(h) Identify the vehicle family's useful life.

(i) Include the maintenance instructions and warranty statement you will give to the ultimate purchaser of each new vehicle (see §§ 1037.120 and 1037.125).

(j) Describe your emission control information label (see § 1037.135).

(k) Identify the emission standards or FELs to which you are certifying vehicles in the vehicle family. For families containing multiple subfamilies, this means that you must identify multiple CO<sub>2</sub> FELs. For example, you may identify the highest and lowest FELs to which any of your subfamilies will be certified and also list all possible FELs in between (which will be in 1 g/ton-mile increments).

(l) Where applicable, identify the vehicle family's deterioration factors and describe how you developed them. Present any emission test data you used for this (see § 1037.241(c)).

(m) Where applicable, state that you operated your emission-data vehicles as described in the application (including the test procedures, test parameters, and test fuels) to show you meet the requirements of this part.

(n) Present evaporative test data to show your vehicles meet the evaporative emission standards we specify in subpart B of this part, if applicable. Report all valid test results from emission-data vehicles and indicate whether there are test results from invalid tests or from any other tests of the emission-data vehicle, whether or not they were conducted according to the test procedures of subpart F of this part. We may require you to report these additional test results. We may ask you to send other information to confirm that your tests were valid under the requirements of this part and 40 CFR part 86.

(o) Report modeling results for ten configurations. Include modeling inputs and detailed descriptions of how they were derived. Unless we specify otherwise, include the configuration with the highest modeling result, the lowest modeling result, and the configurations with the highest projected sales.

(p) Describe all adjustable operating parameters (see § 1037.115), including production tolerances. You do not need to include parameters that do not affect emissions covered by your application. Include the following in your description of each parameter:

(1) The nominal or recommended setting.

(2) The intended physically adjustable range.

(3) The limits or stops used to establish adjustable ranges.

(4) Information showing why the limits, stops, or other means of inhibiting adjustment are effective in preventing adjustment of parameters on in-use vehicles to settings outside your intended physically adjustable ranges.

(q) [Reserved]

(r) Unconditionally certify that all the vehicles in the vehicle family comply with the requirements of this part, other referenced parts of the CFR, and the Clean Air Act.

(s) Include good-faith estimates of U.S.-directed production volumes by subfamily. We may require you to describe the basis of your estimates.

(t) Include the information required by other subparts of this part. For example, include the information required by § 1037.725 if you participate in the ABT program.

(u) Include other applicable information, such as information

specified in this part or 40 CFR part 1068 related to requests for exemptions.

(v) Name an agent for service located in the United States. Service on this agent constitutes service on you or any of your officers or employees for any action by EPA or otherwise by the United States related to the requirements of this part.

#### § 1037.210 Preliminary approval before certification.

If you send us information before you finish the application, we may review it and make any appropriate determinations. Decisions made under this section are considered to be preliminary approval, subject to final review and approval. We will generally not reverse a decision where we have given you preliminary approval, unless we find new information supporting a different decision. If you request preliminary approval related to the upcoming model year or the model year after that, we will make best-efforts to make the appropriate determinations as soon as practicable. We will generally not provide preliminary approval related to a future model year more than two years ahead of time.

#### § 1037.220 Amending maintenance instructions.

You may amend your emission-related maintenance instructions after you submit your application for certification as long as the amended instructions remain consistent with the provisions of § 1037.125. You must send the Designated Compliance Officer a written request to amend your application for certification for a vehicle family if you want to change the emission-related maintenance instructions in a way that could affect emissions. In your request, describe the proposed changes to the maintenance instructions. If operators follow the original maintenance instructions rather than the newly specified maintenance, this does not allow you to disqualify those vehicles from in-use testing or deny a warranty claim.

(a) If you are decreasing or eliminating any specified maintenance, you may distribute the new maintenance instructions to your customers 30 days after we receive your request, unless we disapprove your request. This would generally include replacing one maintenance step with another. We may approve a shorter time or waive this requirement.

(b) If your requested change would not decrease the specified maintenance, you may distribute the new maintenance instructions anytime after you send your request. For example,

this paragraph (b) would cover adding instructions to increase the frequency of filter changes for vehicles in severe-duty applications.

(c) You need not request approval if you are making only minor corrections (such as correcting typographical mistakes), clarifying your maintenance instructions, or changing instructions for maintenance unrelated to emission control. We may ask you to send us copies of maintenance instructions revised under this paragraph (c).

**§ 1037.225 Amending applications for certification.**

Before we issue you a certificate of conformity, you may amend your application to include new or modified vehicle configurations, subject to the provisions of this section. After we have issued your certificate of conformity, you may send us an amended application requesting that we include new or modified vehicle configurations within the scope of the certificate, subject to the provisions of this section. You must amend your application if any changes occur with respect to any information that is included or should be included in your application.

(a) You must amend your application before you take any of the following actions:

(1) Add a vehicle configuration to a vehicle family. In this case, the vehicle configuration added must be consistent with other vehicle configurations in the vehicle family with respect to the criteria listed in § 1037.230.

(2) Change a vehicle configuration already included in a vehicle family in a way that may affect emissions, or change any of the components you described in your application for certification. This includes production and design changes that may affect emissions any time during the vehicle's lifetime.

(3) Modify an FEL for a vehicle family as described in paragraph (f) of this section.

(b) To amend your application for certification, send the relevant information to the Designated Compliance Officer.

(1) Describe in detail the addition or change in the vehicle model or configuration you intend to make.

(2) Include engineering evaluations or data showing that the amended vehicle family complies with all applicable requirements. You may do this by showing that the original emission-data vehicle is still appropriate for showing that the amended family complies with all applicable requirements.

(3) If the original emission-data vehicle or emission modeling for the

vehicle family is not appropriate to show compliance for the new or modified vehicle configuration, include new test data or emission modeling showing that the new or modified vehicle configuration meets the requirements of this part.

(c) We may ask for more test data or engineering evaluations. You must give us these within 30 days after we request them.

(d) For vehicle families already covered by a certificate of conformity, we will determine whether the existing certificate of conformity covers your newly added or modified vehicle. You may ask for a hearing if we deny your request (see § 1037.820).

(e) For vehicle families already covered by a certificate of conformity, you may start producing the new or modified vehicle configuration anytime after you send us your amended application and before we make a decision under paragraph (d) of this section. However, if we determine that the affected vehicles do not meet applicable requirements, we will notify you to cease production of the vehicles and may require you to recall the vehicles at no expense to the owner. Choosing to produce vehicles under this paragraph (e) is deemed to be consent to recall all vehicles that we determine do not meet applicable emission standards or other requirements and to remedy the nonconformity at no expense to the owner. If you do not provide information required under paragraph (c) of this section within 30 days after we request it, you must stop producing the new or modified vehicles.

(f) You may ask us to approve a change to your FEL in certain cases after the start of production. The changed FEL may not apply to vehicles you have already introduced into U.S. commerce, except as described in this paragraph (f). You may ask us to approve a change to your FEL in the following cases:

(1) You may ask to raise your FEL for your vehicle subfamily at any time. In your request, you must show that you will still be able to meet the emission standards as specified in subparts B and H of this part. Use the appropriate FELs with corresponding production volumes to calculate emission credits for the model year, as described in subpart H of this part.

(2) Where testing applies, you may ask to lower the FEL for your vehicle subfamily only if you have test data from production vehicles showing that emissions are below the proposed lower FEL. Otherwise, you may ask to lower your FEL for your vehicle subfamily at any time. The lower FEL applies only to vehicles you produce after we approve

the new FEL. Use the appropriate FELs with corresponding production volumes to calculate emission credits for the model year, as described in subpart H of this part.

(3) You may ask to add an FEL for your vehicle family at any time.

**§ 1037.230 Vehicle families, sub-families, and configurations.**

(a) For purposes of certifying your vehicles to greenhouse gas standards, divide your product line into families of vehicles as specified in this section. Your vehicle family is limited to a single model year. Group vehicles in the same vehicle family if they are the same in all the following aspects:

(1) The regulatory sub-category (or equivalent in the case of vocational tractors), as follows:

(i) Vocational vehicles at or below 19,500 pounds GVWR.

(ii) Vocational vehicles (other than vocational tractors) above 19,500 pounds GVWR and at or below 33,000 pounds GVWR.

(iii) Vocational vehicles (other than vocational tractors) above 33,000 pounds GVWR.

(iv) Low-roof tractors above 26,000 pounds GVWR and at or below 33,000 pounds GVWR.

(v) Mid-roof tractors above 26,000 pounds GVWR and at or below 33,000 pounds GVWR.

(vi) High-roof tractors above 26,000 pounds GVWR and at or below 33,000 pounds GVWR.

(vii) Low-roof day cab tractors above 33,000 pounds GVWR.

(viii) Low-roof sleeper cab tractors above 33,000 pounds GVWR.

(ix) Mid-roof day cab tractors above 33,000 pounds GVWR.

(x) Mid-roof sleeper cab tractors above 33,000 pounds GVWR.

(xi) High-roof day cab tractors above 33,000 pounds GVWR.

(xii) High-roof sleeper cab tractors above 33,000 pounds GVWR.

(xiii) Vocational tractors.

(2) Vehicle technology as follows:

(i) Group together vehicles that do not contain advanced or innovative technologies.

(ii) Group together vehicles that contain the same advanced/innovative technologies.

(b) If the vehicles in your family are being certified to more than one FEL, subdivide your greenhouse gas vehicle families into subfamilies that include vehicles with identical FELs. Note that you may add subfamilies at any time during the model year.

(c) Group vehicles into configurations consistent with the definition of "vehicle configuration" in § 1037.801.

Note that vehicles with hardware or software differences that are related to measured or modeled emissions are considered to be different vehicle configurations even if they have the same GEM inputs and FEL. Note also, that you are not required to separately identify all configurations for certification. See paragraph (g) of this section for provisions allowing you to group certain hardware differences into the same configuration. Note that you are not required to identify all possible configurations for certification; also, you are required to include in your end-of-year report only those configurations you produced.

(d) For a vehicle model that straddles a roof-height, cab type, or GVWR division, you may include all the vehicles in the same vehicle family if you certify the vehicle family to the more stringent standards. For roof height, this means you must certify to the taller roof standards. For cab-type and GVWR, this means you must certify to the numerically lower standards.

(e) [Reserved]

(f) You may divide your families into more families than specified in this section.

(g) You may ask us to allow you to group into the same configuration vehicles that have very small body hardware differences that do not significantly affect drag areas. Note that this allowance does not apply for substantial differences, even if the vehicles have the same measured drag areas.

**§ 1037.241 Demonstrating compliance with exhaust emission standards for greenhouse gas pollutants.**

(a) For purposes of certification, your vehicle family is considered in compliance with the emission standards in § 1037.105 or § 1037.106 if all vehicle configurations in that family have modeled CO<sub>2</sub> emission rates (as specified in subpart F of this part) at or below the applicable standards. See 40 CFR part 86, subpart S, for showing compliance with the standards of § 1037.104. Note that your FELs are considered to be the applicable emission standards with which you must comply if you participate in the ABT program in subpart H of this part.

(b) Your vehicle family is deemed not to comply if any vehicle configuration in that family has a modeled CO<sub>2</sub> emission rate that is above its FEL.

(c) We may require you to provide an engineering analysis showing that the performance of your emission controls will not deteriorate during the useful life with proper maintenance. If we determine that your emission controls

are likely to deteriorate during the useful life, we may require you to develop and apply deterioration factors consistent with good engineering judgment. For example, you may need to apply a deterioration factor to address deterioration of battery performance for an electric hybrid vehicle. Where the highest useful life emissions occur between the end of useful life and at the low-hour test point, base deterioration factors for the vehicles on the difference between (or ratio of) the point at which the highest emissions occur and the low-hour test point.

**§ 1037.250 Reporting and recordkeeping.**

(a) Within 90 days after the end of the model year, send the Designated Compliance Officer a report including the total U.S.-directed production volume of vehicles you produced in each vehicle family during the model year (based on information available at the time of the report). Report by vehicle identification number and vehicle configuration and identify the subfamily identifier. Report uncertified vehicles sold to secondary vehicle manufacturers. Small manufacturers may omit the reporting requirements of this paragraph (a).

(b) Organize and maintain the following records:

(1) A copy of all applications and any summary information you send us.

(2) Any of the information we specify in § 1037.205 that you were not required to include in your application.

(3) A detailed history of each emission-data vehicle, if applicable.

(4) Production figures for each vehicle family divided by assembly plant.

(5) Keep a list of vehicle identification numbers for all the vehicles you produce under each certificate of conformity.

(c) Keep routine data from emission tests required by this part (such as test cell temperatures and relative humidity readings) for one year after we issue the associated certificate of conformity. Keep all other information specified in this section for eight years after we issue your certificate.

(d) Store these records in any format and on any media, as long as you can promptly send us organized, written records in English if we ask for them. You must keep these records readily available. We may review them at any time.

**§ 1037.255 What decisions may EPA make regarding my certificate of conformity?**

(a) If we determine your application is complete and shows that the vehicle family meets all the requirements of this part and the Act, we will issue a

certificate of conformity for your vehicle family for that model year. We may make the approval subject to additional conditions.

(b) We may deny your application for certification if we determine that your vehicle family fails to comply with emission standards or other requirements of this part or the Clean Air Act. We will base our decision on all available information. If we deny your application, we will explain why in writing.

(c) In addition, we may deny your application or suspend or revoke your certificate if you do any of the following:

(1) Refuse to comply with any testing or reporting requirements.

(2) Submit false or incomplete information (paragraph (e) of this section applies if this is fraudulent). This includes doing anything after submission of your application to render any of the submitted information false or incomplete.

(3) Render any test data inaccurate.

(4) Deny us from completing authorized activities despite our presenting a warrant or court order (see 40 CFR 1068.20). This includes a failure to provide reasonable assistance.

(5) Produce vehicles for importation into the United States at a location where local law prohibits us from carrying out authorized activities.

(6) Fail to supply requested information or amend your application to include all vehicles being produced.

(7) Take any action that otherwise circumvents the intent of the Act or this part, with respect to your engine family.

(d) We may void the certificate of conformity for a vehicle family if you fail to keep records, send reports, or give us information as required under this part or the Act. Note that these are also violations of 40 CFR 1068.101(a)(2).

(e) We may void your certificate if we find that you intentionally submitted false or incomplete information. This includes rendering submitted information false or incomplete after submission.

(f) If we deny your application or suspend, revoke, or void your certificate, you may ask for a hearing (see § 1037.820).

**Subpart D—[Reserved]**

**Subpart E—In-Use Testing**

**§ 1037.401 General provisions.**

We may perform in-use testing of any vehicle subject to the standards of this part. For example, we may test vehicles to verify drag areas or other GEM inputs.

**Subpart F—Test and Modeling Procedures**

**§ 1037.501 General testing and modeling provisions.**

This subpart specifies how to perform emission testing and emission modeling required elsewhere in this part.

(a) [Reserved]

(b) Where exhaust emission testing is required, use the equipment and procedures in 40 CFR part 1066 to determine whether your vehicles meet the duty-cycle emission standards in subpart B of this part. Measure the emissions of all the exhaust constituents subject to emission standards as specified in 40 CFR part 1066. Use the applicable duty cycles specified in § 1037.510.

(c) [Reserved]

(d) Use the applicable fuels specified 40 CFR part 1065 to perform valid tests.

(1) For service accumulation, use the test fuel or any commercially available fuel that is representative of the fuel that in-use vehicles will use.

(2) For diesel-fueled vehicles, use the appropriate diesel fuel specified for emission testing. Unless we specify otherwise, the appropriate diesel test fuel is ultra low-sulfur diesel fuel.

(3) For gasoline-fueled vehicles, use the gasoline specified for “General Testing”.

(e) You may use special or alternate procedures as specified in 40 CFR 1065.10.

(f) This subpart is addressed to you as a manufacturer, but it applies equally to anyone who does testing for you, and to us when we perform testing to determine if your vehicles meet emission standards.

(g) Apply this paragraph (g) whenever we specify use of standard trailers. Unless otherwise specified, a tolerance of ±2 inches applies for all nominal trailer dimensions.

(1) The standard trailer for high-roof tractors must meet the following criteria:

(i) It is an unloaded two-axle dry van box trailer 53.0 feet long, 102 inches wide, and 162 inches high (measured from the ground with the trailer level).

(ii) It has a king pin located with its center 36±0.5 inches from the front of the trailer and a minimized trailer gap (no greater than 45 inches).

(iii) It has a smooth surface with nominally flush rivets and does not include any aerodynamic features such as side fairings, boat tails, or gap reducers. It may have a scuff band of no more than 0.13 inches in thickness.

(iv) It includes dual 22.5 inch wheels, standard mudflaps, and standard landing gear. The centerline of the rear-most axle must be 146 inches from the rear of the trailer.

(2) The standard trailer for mid-roof tractors is an empty two-axle tanker trailer 42±1 feet long by 140 inches high.

(i) It has a 40±1 feet long cylindrical tank with a 7000±7 gallon capacity, smooth surface, and rounded ends.

(ii) The standard tanker trailer does not include any aerodynamic features such as side fairings, but does include a centered 20 inch manhole, side-centered ladder, and lengthwise walkway. It includes dual 24.5 inch wheels.

(3) The standard trailer for low-roof tractors is an unloaded two-axle flat bed

trailer 53±1 feet long and 102 inches wide.

(i) The deck height is 60.0±0.5 inches in the front and 55.0±0.5 inches in the rear. The standard trailer does not include any aerodynamic features such as side fairings.

(ii) It includes an air suspension and dual 22.5 inch wheels on tandem axles spread up to 122 inches apart between axle centerlines, measured along the length of the trailer.

**§ 1037.510 Duty-cycle exhaust testing.**

This section applies where exhaust emission testing is required, such as when applying the provisions of § 1037.615. Note that for most vehicles, testing under this section is not required.

(a) Where applicable, measure emissions by testing the vehicle on a chassis dynamometer with the applicable test cycles. Each test cycle consists of a series of speed commands over time: variable speeds for the transient test and constant speeds for the cruise tests. None of these cycles include vehicle starting or warmup; each test cycle begins with a running, warmed-up vehicle. Start sampling emissions at the start of each cycle. The transient cycle is specified in Appendix I to this part. For the 55 mph and 65 mph cruise cycles, sample emissions for 300 second cycles with constant vehicle speeds of 55.0 mph and 65.0 mph, respectively. The tolerance around these speed setpoints is ±1.0 mph.

(b) Calculate the official emission result from the following equation:

$$Emissions \left( \frac{g}{ton - mile} \right) = \frac{1}{payload (tons)} \cdot \left( \frac{w_{transient} \cdot m_{transient}}{D_{transient}} + \frac{w_{55} \cdot m_{55}}{D_{55}} + \frac{w_{65} \cdot m_{65}}{D_{65}} \right)$$

Where:

*payload* = the standard payload, in tons, as specified in § 1037.705.

*w* = weighting factor for the appropriate test cycle, as described in paragraph (c) of this section.

*m* = grams of CO<sub>2</sub> emitted over the appropriate test cycle.

*D* = miles driven over the appropriate test cycle.

(c) Apply weighting factors specific to each type of vehicle and for each duty cycle as described in the following table:

TABLE 1 TO § 1037.510—WEIGHTING FACTORS FOR DUTY CYCLES

	Transient (%)	55 mph cruise (%)	65 mph cruise (%)
Vocational .....	42	21	37
Vocational Hybrid Vehicles .....	75	9	16
Day Cabs .....	19	17	64
Sleeper Cabs .....	5	9	86



(d) For transient testing, compare actual second-by-second vehicle speed with the speed specified in the test cycle and ensure any differences are consistent with the criteria as specified in 40 CFR part 1066. If the speeds do not conform to these criteria, the test is not valid and must be repeated.

(e) Run test cycles as specified in 40 CFR part 86. For cruise cycle testing of vehicles equipped with cruise control, use the vehicle's cruise control to control the vehicle speed. For vehicles equipped with adjustable VSLs, test the vehicle with the VSL at its highest setting.

(f) Test the vehicle using its adjusted loaded vehicle weight, unless we determine this would be unrepresentative of in-use operation as specified in 40 CFR 1065.10(c)(1).

(g) For hybrid vehicles, correct for the net energy change of the energy storage device as described in 40 CFR 1066.501.

**§ 1037.520 Modeling CO<sub>2</sub> emissions to show compliance.**

This section describes how to use the GEM simulation tool (incorporated by

reference in § 1037.810) to show compliance with the CO<sub>2</sub> standards of §§ 1037.105 and 1037.106. Use good engineering judgment when demonstrating compliance using the GEM.

(a) *General modeling provisions.* To run the GEM, enter all applicable inputs as specified by the model. All seven of the following inputs apply for sleeper cab tractors, while some do not apply for other regulatory subcategories:

(1) Regulatory subcategory (such as “Class 8 Combination—Sleeper Cab—High Roof”).

(2) Coefficient of aerodynamic drag, as described in paragraph (b) of this section. Leave this field blank for vocational vehicles.

(3) Steer tire rolling resistance, as described in paragraph (c) of this section.

(4) Drive tire rolling resistance, as described in paragraph (c) of this section.

(5) Vehicle speed limit, as described in paragraph (d) of this section. Leave this field blank for vocational vehicles.

(6) Vehicle weight reduction, as described in paragraph (e) of this section. Leave this field blank for vocational vehicles.

(7) Extended idle reduction credit, as described in paragraph (f) of this section. Leave this field blank for vehicles other than Class 8 sleeper cabs.

(b) *Coefficient of aerodynamic drag and drag area.* Determine the appropriate drag area as follows:

(1) Use the recommended method or an alternate method to establish a value for the vehicle's drag area, expressed in m<sup>2</sup> and rounded to two decimal places. Where we allow you to group multiple configurations together, measure the drag area of the worst-case configuration. Measure drag areas specified in § 1037.521.

(2) Determine the bin level for your vehicle based on the drag area from paragraph (b)(1) of this section as shown in the following tables:

TABLE 1 TO § 1037.520—HIGH-ROOF DAY AND SLEEPER CABS

Bin level	If your measured C <sub>D</sub> A (m <sup>2</sup> ) is . . .	Then your C <sub>D</sub> input is . . .
High-Roof Day Cabs		
Bin I	≥ 8.0	0.79
Bin II	7.1–7.9	0.72
Bin III	6.2–7.0	0.63
Bin IV	5.6–6.1	0.56
Bin V	≤ 5.5	0.51
High-Roof Sleeper Cabs		
Bin I	≥ 7.6	0.75
Bin II	6.7–7.5	0.68
Bin III	5.8–6.6	0.60
Bin IV	5.2–5.7	0.52
Bin V	≤ 5.1	0.47

TABLE 2 TO § 1037.520— LOW-ROOF DAY AND SLEEPER CABS

Bin level	If your measured C <sub>D</sub> A (m <sup>2</sup> ) is . . .	Then your C <sub>D</sub> input is . . .
Low-Roof Day and Sleeper Cabs		
Bin I	≥ 5.1	0.77
Bin II	≤ 5.0	0.71
Mid-Roof Day and Sleeper Cabs		
Bin I	≥ 5.6	0.87
Bin II	≤ 5.5	0.82

(3) For low- and mid-roof tractors, you may determine your drag area bin based on the drag area bin of an equivalent high-roof tractor. If the high-roof tractor

is in Bin I or Bin II, then you may assume your equivalent low- and mid-roof tractors are in Bin I. If the high-roof tractor is in Bin III, Bin IV, or Bin V,

then you may assume your equivalent low- and mid-roof tractors are in Bin II.

(c) *Steer and drive tire rolling resistance.* You must have a tire rolling resistance level (TRRL) for each tire

configuration. For purposes of this section, you may consider tires with the same SKU number to be the same configuration.

(1) Measure tire rolling resistance in kg per metric ton as specified in ISO 28580 (incorporated by reference in § 1037.810), except as specified in this paragraph (c). Use good engineering judgment to ensure that your test results are not biased low. You may ask us to identify a reference test laboratory to which you may correlate your test results. Prior to beginning the test procedure in Section 7 of ISO 28580 for a new bias-ply tire, perform a break-in procedure by running the tire at the specified test speed, load, and pressure for 60±2 minutes.

(2) For each tire design tested, measure rolling resistance of at least three different tires of that specific design and size. Perform the test at least once for each tire. Use the arithmetic mean of these results as your test result. You may use this value as your GEM input or select a higher TRRL. You must test at least one tire size for each tire model, and may use engineering analysis to determine the rolling resistance of other tire sizes of that model. Note that for tire sizes that you do not test, we will treat your analytically derived rolling resistances the same as test results, and we may

perform our own testing to verify your values. We may require you to test a small sub-sample of untested tire sizes that we select.

(3) If you obtain your test results from the tire manufacturer or another third party, you must obtain a signed statement from them verifying the tests were conducted according to the requirements of this part. Such statements are deemed to be submissions to EPA.

(4) For tires marketed as light truck tires and that have load ranges C, D, or E, use as the GEM input TRRL at or above the measured rolling resistance multiplied by 0.87.

(d) *Vehicle speed limit.* If the vehicles will be equipped with a vehicle speed limiter, input the maximum vehicle speed to which the vehicle will be limited (in miles per hour rounded to the nearest 0.1 mile per hour) as specified in § 1037.640. Otherwise leave this field blank. Use good engineering judgment to ensure the limiter is tamper resistant. We may require you to obtain preliminary approval for your designs.

(e) *Vehicle weight reduction.* For purposes of this paragraph (e), high-strength steel is steel with tensile strength at or above 350 MPa.

(1) Vehicle weight reduction inputs for wheels are specified relative to dual-wide tires with conventional steel

wheels. For purposes of this paragraph (e)(1), a light-weight aluminum wheel is one that weighs at least 21 lb less than a comparable conventional steel wheel. The inputs are listed in Table 4 to this section. For example, a tractor with aluminum steel wheels and eight (4×2) dual-wide aluminum drive wheels would have an input of 210 lb (2×21 + 8×21).

TABLE 3 TO § 1037.520—WHEEL-RELATED WEIGHT REDUCTIONS

Weight reduction technology	Weight reduction (lb per tire or wheel)
Single-Wide Drive Tire with Steel Wheel .....	84
Aluminum Wheel .....	139
Light-Weight Aluminum Wheel .....	147
Steer Tire or Dual-wide Drive Tire with . . .	
High-Strength Steel Wheel .....	8
Aluminum Wheel .....	21
Light-Weight Aluminum Wheel .....	30

(2) Vehicle weight reduction inputs for components other than wheels are specified relative to mild steel components as specified in the following table:

TABLE 4 TO § 1037.520—NONWHEEL-RELATED WEIGHT REDUCTIONS

Weight reduction technologies	Aluminum weight reduction (lb)	High-strength steel weight reduction (lb)
Door .....	20	6
Roof .....	60	18
Cab rear wall .....	49	16
Cab floor .....	56	18
Hood Support Structure System .....	15	3
Fairing Support Structure System .....	35	6
Instrument Panel Support Structure .....	5	1
Brake Drums—Drive (4) .....	140	11
Brake Drums—Non Drive (2) .....	60	8
Frame Rails .....	440	87
Crossmember—Cab .....	15	5
Crossmember—Suspension .....	25	6
Crossmember—Non Suspension (3) .....	15	5
Fifth Wheel .....	100	25
Radiator Support .....	20	6
Fuel Tank Support Structure .....	40	12
Steps .....	35	6
Bumper .....	33	10
Shackles .....	10	3
Front Axle .....	60	15
Suspension Brackets, Hangers .....	100	30
Transmission Case .....	50	12
Clutch Housing .....	40	10
Drive Axle Hubs (8) .....	160	4
Non Drive Front Hubs (2) .....	40	5
Driveshaft .....	20	5
Transmission/Clutch Shift Levers .....	20	4

(3) You may ask to apply the innovative technology provisions of § 1037.610 for weight reductions not covered by this paragraph (e).

(f) *Extended idle reduction credit.* If your tractor is equipped with idle reduction technology meeting the requirements of § 1037.660 that will automatically shut off the main engine after 300 seconds or less, use 5.0 g/ton-mile as the input (or a lesser value specified in § 1037.660). Otherwise leave this field blank.

#### § 1037.521 Aerodynamic measurements.

This section describes how to determine the aerodynamic drag area ( $C_{DA}$ ) of your vehicle using the coastdown procedure in 40 CFR part 1066 or an alternative method correlated to it.

(a) *General.* The primary method for measuring the aerodynamic drag area of vehicles is specified in paragraph (b) of this section. You may determine the drag area using an alternate method, consistent with the provisions of this section and good engineering judgment, based on wind tunnel testing, computational fluid dynamic modeling, or constant-speed road load testing. See 40 CFR 1068.5 for provisions describing how we may evaluate your engineering judgment. All drag areas measured using an alternative method ( $C_{DAalt}$ ) must be adjusted to be equivalent to the corresponding drag areas that would have been measured using the coastdown procedure as follows:

(1) Unless good engineering judgment requires otherwise, assume that coastdown drag areas are proportional to drag areas measured using alternative methods. This means you may apply a single constant adjustment factor ( $F_{alt-aero}$ ) for a given alternate drag area method using the following equation:

$$C_{DA} = C_{DAalt} \times F_{alt-aero}$$

(2) Determine  $F_{alt-aero}$  by performing coastdown testing and applying your alternate method on the same vehicle. Unless we approve another vehicle, the vehicle must be a Class 8, high-roof, sleeper cab with a full aerodynamics package, pulling a standards trailer. Where you have more than one model meeting these criteria, use the model with the highest projected sales. If you do not have such a model you may use your most comparable model with prior approval. If good engineering judgment allows the use of a single, constant value of  $F_{alt-aero}$ , calculate it from this coastdown drag area ( $C_{DAcoast}$ ) divided by alternative drag area ( $C_{DAalt}$ ):

$$F_{alt-aero} = C_{DAcoast} \div C_{DAalt}$$

(3) Calculate  $F_{alt-aero}$  to at least three decimal places. For example, if your

coastdown testing results in a drag area of 6.430, but your wind tunnel method results in a drag area of 6.200,  $F_{alt-aero}$  would be 1.037.

(b) *Recommended method.* Perform coastdown testing as described in 40 CFR part 1066, subpart D, subject to the following additional provisions:

(1) The specifications of this paragraph (b)(1) apply when measuring drag areas for tractors. Test high-roof tractors with a standard box trailer. Test low- and mid-roof tractors without a trailer (sometimes referred to as in a "bobtail configuration"). You may test low- and mid-roof tractors with a trailer to evaluate innovative technologies.

(2) The specifications of this paragraph (b)(2) apply for tractors and standard trailers. Use tires mounted on steel rims in a dual configuration (except for steer tires). The tires must—

(i) Be SmartWay-Verified tires or have a rolling resistance below 5.1 kg/ton.

(ii) Have accumulated at least 2,175 miles of prior use but have no less than 50 percent of their original tread depth (as specified for truck cabs in SAE J1263).

(iii) Not be retreads or have any apparent signs of chunking or uneven wear.

(iv) Be size 295/75R22.5 or 275/80R22.5.

(3) Calculate the drag area ( $C_{DA}$ ) in  $m^2$  from the coastdown procedure specified in 40 CFR part 1066.

(c) *Approval.* You must obtain preliminary approval before using any methods other than coastdown testing to determine drag coefficients. Send your request for approval to the Designated Compliance Officer. Keep records of the information specified in this paragraph (c). Unless we specify otherwise, include this information with your request. You must provide any information we require to evaluate whether you are applying the provisions of this section consistent with good engineering judgment.

(1) Include all of the following for your coastdown results:

(i) The name, location, and description of your test facilities, including background/history, equipment and capability, and track and facility elevation, along with the grade and size/length of the track.

(ii) Test conditions for each test result, including date and time, wind speed and direction, ambient temperature and humidity, vehicle speed, driving distance, manufacturer name, test vehicle/model type, model year, applicable model engine family, tire type and rolling resistance, weight of tractor-trailer (as tested), and driver identifier(s).

(iii) Average drag area result as calculated in 40 CFR 1066, subpart D) and all of the individual run results (including voided or invalid runs).

(2) Identify the name and location of the test facilities for your wind tunnel method (if applicable). Also include the following things to describe the test facility:

(i) Background/history.

(ii) The layout (with diagram), type, and construction (structural and material) of the wind tunnel.

(iii) Wind tunnel design details: corner turning vane type and material, air settling, mesh screen specification, air straightening method, tunnel volume, surface area, average duct area, and circuit length.

(iv) Wind tunnel flow quality: temperature control and uniformity, airflow quality, minimum airflow velocity, flow uniformity, angularity and stability, static pressure variation, turbulence intensity, airflow acceleration and deceleration times, test duration flow quality, and overall airflow quality achievement.

(v) Test/working section information: test section type (e.g., open, closed, adaptive wall) and shape (e.g., circular, square, oval), length, contraction ratio, maximum air velocity, maximum dynamic pressure, nozzle width and height, plenum dimensions and net volume, maximum allowed model scale, maximum model height above road, strut movement rate (if applicable), model support, primary boundary layer slot, boundary layer elimination method, and photos and diagrams of the test section.

(vi) Fan section description: fan type, diameter, power, maximum rotational speed, maximum top speed, support type, mechanical drive, and sectional total weight.

(vii) Data acquisition and control (where applicable): acquisition type, motor control, tunnel control, model balance, model pressure measurement, wheel drag balances, wing/body panel balances, and model exhaust simulation.

(viii) Moving ground plane or rolling road (if applicable): construction and material, yaw table and range, moving ground length and width, belt type, maximum belt speed, belt suction mechanism, platen instrumentation, temperature control, and steering.

(ix) Facility correction factors and purpose.

(3) Include all of the following for your computational fluid dynamics (CFD) method (if applicable):

(i) Official name/title of the software product.

(ii) Date and version number for the software product.

(iii) Manufacturer/company name, address, phone number and Web address for software product.

(iv) Identify if the software code is Navier-Stokes or Lattice-Boltzmann based.

(4) Include all of the following for any other method (if applicable):

(i) Official name/title of the procedure(s).

(ii) Description of the procedure.

(iii) Cited sources for any standardized procedures that the method is based on.

(iv) Modifications/deviations from the standardized procedures for the method and rational for modifications/deviations.

(v) Data comparing this requested procedure to the coastdown reference procedure.

(vi) Information above from the other methods as applicable to this method (e.g., source location/address, background/history).

(d) *Wind tunnel methods.* (1) You may measure drag areas consistent with the modified SAE procedures described in this paragraph (d) using any wind tunnel recognized by the Subsonic Aerodynamic Testing Association. If your wind tunnel is not capable of testing in accordance with these modified SAE procedures, you may ask us to approve your alternate test procedures if you demonstrate that your procedures produce equivalent data. For purposes of this paragraph (d), data are equivalent if they are the same or better with respect to repeatability and unbiased correlation with coastdown testing. Note that, for wind tunnels not capable of these modified SAE procedures, good engineering judgment may require you to base your alternate method adjustment factor on more than one vehicle. You may not develop your correction factor until we have approved your alternate method. The applicable SAE procedures are SAE J1252, SAE J1594, and SAE J2071 (incorporated by reference in § 1037.810). The following modifications apply for SAE J1252:

(i) The minimum Reynold's number ( $Re_{min}$ ) is  $1.0 \times 10^6$  instead of the value specified in section 5.2 of the SAE procedure. Your model frontal area at zero yaw angle may exceed the recommended 5 percent of the active test section area, provided it does not exceed 25 percent.

(ii) For full-scale wind tunnel testing, use good engineering judgment to select a test article (tractor and trailer) that is a reasonable representation of the test article used for the reference method

testing. For example, where your wind tunnel is not long enough to test the tractor with a standard 53 foot trailer, it may be appropriate to use shorter box trailer. In such a case, the correlation developed using the shorter trailer would only be valid for testing with the shorter trailer.

(iii) For reduced-scale wind tunnel testing, a one-eighth (1/8th) or larger scale model of a heavy-duty tractor and trailer must be used, and the model must be of sufficient design to simulate airflow through the radiator inlet grill and across an engine geometry representative of those commonly used in your test vehicle.

(2) You must perform wind tunnel testing and the coastdown procedure on the same tractor model and provide the results for both methods. Conduct the wind tunnel tests at a zero yaw angle and, if so equipped, utilizing the moving/rolling floor (i.e., the moving/rolling floor should be on during the test, as opposed to static) for comparison to the coastdown procedure, which corrects to a zero yaw angle for the oncoming wind.

(e) *Computational fluid dynamics (CFD).* You may determine drag areas using a CFD method, consistent with good engineering judgment and the requirements of this paragraph (e) using commercially available CFD software code. Conduct the analysis assuming zero yaw angle, and ambient conditions consistent with coastdown procedures. For simulating a wind tunnel test, the analysis should accurately model the particular wind tunnel and assume a wind tunnel blockage ratio consistent with SAE J1252 (incorporated by reference in § 1037.810) or one that matches the selected wind tunnel, whichever is lower. For simulation of open road conditions similar to that experienced during coastdown test procedures, the CFD analysis should assume a blockage ratio at or below 0.2 percent.

(1) Take the following steps for CFD code with a Navier-Stokes formula solver:

(i) Perform an unstructured, time-accurate, analysis using a mesh grid size with total volume element count of at least 50 million cells of hexahedral and/or polyhedral mesh cell shape, surface elements representing the geometry consisting of no less than 6 million elements, and a near-wall cell size corresponding to a  $y^+$  value of less than 300, with the smallest cell sizes applied to local regions of the tractor and trailer in areas of high flow gradients and smaller geometry features.

(ii) Perform the analysis with a turbulence model and mesh

deformation enabled (if applicable) with boundary layer resolution of  $\pm 95$  percent. Once result convergence is achieved, demonstrate the convergence by supplying multiple, successive convergence values for the analysis. The turbulence model may use k-epsilon (k- $\epsilon$ ), shear stress transport k-omega (SST k- $\omega$ ), or other commercially accepted methods.

(2) For Lattice-Boltzmann based CFD code, perform an unstructured, time-accurate analysis using a mesh grid size with total surface elements of at least 50 million cells using cubic volume elements and triangular and/or quadrilateral surface elements with a near wall cell size of no greater than 6 mm on local regions of the tractor and trailer in areas of high flow gradients and smaller geometry features, with cell sizes in other areas of the mesh grid starting at twelve millimeters and increasing in size from this value as the distance from the tractor-trailer model increases.

(3) All CFD analysis should be conducted using the following conditions:

(i) A tractor-trailer combination using the manufacturer's tractor and the standard trailer, as applicable.

(ii) An environment with a blockage ratio at or below 0.2 percent to simulate open road conditions, a zero degree yaw angle between the oncoming wind and the tractor-trailer combination.

(iii) Ambient conditions consistent with the coastdown test procedures specified in this part.

(iv) Open grill with representative back pressures based on data from the tractor model.

(v) Turbulence model and mesh deformation enabled (if applicable).

(vi) Tires and ground plane in motion consistent with and simulating a vehicle moving in the forward direction of travel.

(vii) The smallest cell size should be applied to local regions on the tractor and trailer in areas of high flow gradients and smaller geometry features (e.g., the a-pillar, mirror, visor, grille and accessories, trailer leading and trailing edges, rear bogey, tires, and tractor-trailer gap).

(viii) Simulate a speed of 55 mph.

(4) You may ask us to allow you to perform CFD analysis using parameters and criteria other than those specified in this paragraph (e), consistent with good engineering judgment, if you can demonstrate that the specified conditions are not feasible (e.g., insufficient computing power to conduct such analysis, inordinate length of time to conduct analysis, equivalent flow characteristics with more feasible

criteria/parameters) or improved criteria may yield better results (e.g., different mesh cell shape and size). To support this request, we may require that you supply data demonstrating that your selected parameters/criteria will provide a sufficient level of detail to yield an accurate analysis, including comparison of key characteristics between your criteria/parameters and the criteria specified in paragraphs (e)(1) and (2) of this section (e.g., pressure profiles, drag build-up, and/or turbulent/laminar flow

at key points on the front of the tractor and/or over the length of the tractor-trailer combination).

(f) *Yaw sweep corrections.* You may optionally apply this paragraph (f) for vehicles with aerodynamic features that are more effective at reducing wind-averaged drag than is predicted by zero-yaw drag. You may correct your zero-yaw drag area as follows if the ratio of the zero-yaw drag area divided by yaw sweep drag area for your vehicle is greater than 0.8065 (which represents

the ratio expected for a typical aerodynamic Class 8 high-roof sleeper cab tractor):

(1) Determine the zero-yaw drag area and the yaw sweep drag area for your vehicle using the same alternate method as specified in this subpart. Measure drag area for 0°, -6°, and +6°. Use the arithmetic mean of the -6° and +6° drag areas as the ±6° drag area.

(2) Calculate your yaw sweep correction factor (CF<sub>ys</sub>) using the following equation:

$$CF_{ys} = \frac{(\pm 6^\circ \text{ Drag Area}) \times 0.8065}{(\text{Zero Yaw Drag Area})}$$

(3) Calculate your corrected drag area for determining the aerodynamic bin by multiplying the measured zero-yaw drag area by CF<sub>ys</sub>. The correction factor may be applied to drag areas measured using other procedures. For example, we would apply CF<sub>ys</sub> to drag areas measured using the recommended coastdown method. If you use an alternative method, you would also need to apply an alternative correction (F<sub>alt-aero</sub>) and calculate the final drag area using the following equation:

$$C_{DA} = F_{alt-aero} \cdot CF_{ys} \cdot (C_{DA})_{zero-alt}$$

(4) You may ask us to apply CF<sub>ys</sub> to similar vehicles incorporating the same design features.

(5) As an alternative, you may choose to calculate the wind-averaged drag area according to SAE J1252 (incorporated by reference in § 1037.810) and substitute this value into the equation in paragraph (f)(2) of this section for the ±6° yaw-averaged drag area.

**§ 1037.525 Special procedures for testing hybrid vehicles with power take-off.**

This section describes the procedure for quantifying the reduction in greenhouse gas emissions as a result of running power take-off (PTO) devices with a hybrid powertrain. The procedures are written to test the PTO so that all the energy is produced with the engine. The full test for the hybrid vehicle is from a fully charged renewable energy storage system (RESS) to a depleted RESS and then back to a

fully charged RESS. These procedures may be used for whole vehicles or with a post-transmission hybrid system. When testing just the post-transmission hybrid system, you must include all hardware for the PTO system. You may ask us to modify the provisions of this section to allow testing hybrid vehicles other than electric-battery hybrids, consistent with good engineering judgment.

(a) Select two vehicles for testing as follows:

(1) Select a vehicle with a hybrid powertrain to represent the vehicle family. If your vehicle family includes more than one vehicle model, use good engineering judgment to select the vehicle type with the maximum number of PTO circuits that has the smallest potential reduction in greenhouse gas emissions.

(2) Select an equivalent conventional vehicle as specified in § 1037.615.

(b) Measure PTO emissions from the fully warmed-up conventional vehicle as follows:

(1) Without adding any additional restrictions, instrument the vehicle with pressure transducers at the outlet of the hydraulic pump for each circuit.

(2) Operate the PTO system with no load for at least 15 seconds. Measure the pressure and record the average value over the last 10 seconds (p<sub>min</sub>). Apply maximum operator demand to the PTO system until the pressure relief valve opens and pressure stabilizes; measure

the pressure and record the average value over the last 10 seconds (p<sub>max</sub>).

(3) Denormalize the PTO duty cycle in Appendix II of this part using the following equation:

$$p_{refi} = NP_i \cdot (p_{max} - p_{min}) + p_{min}$$

Where:

p<sub>refi</sub> = the reference pressure at each point i in the PTO cycle.

NP<sub>i</sub> = the normalized pressure at each point i in the PTO cycle.

p<sub>max</sub> = the maximum pressure measured in paragraph (b)(2) of this section.

p<sub>min</sub> = the minimum pressure measured in paragraph (b)(2) of this section.

(4) If the PTO system has two circuits, repeat paragraph (b)(2) and (3) of this section for the second PTO circuit.

(5) Install a system to control pressures in the PTO system during the cycle.

(6) Start the engine.

(7) Operate the vehicle over one or both of the denormalized PTO duty cycles, as applicable. Collect CO<sub>2</sub> emissions during operation over each duty cycle.

(8) Use the provisions of 40 CFR part 1066 to collect and measure emissions. Calculate emission rates in grams per test without rounding.

(9) For each test, validate the pressure in each circuit with the pressure specified from the cycle according to 40 CFR 1065.514. Measured pressures must meet the specifications in the following table for a valid test:

TABLE 1 OF § 1037.525—STATISTICAL CRITERIA FOR VALIDATING DUTY CYCLES

Parameter	Pressure
Slope,  a <sub>1</sub>   .....	0.950 ≤ a <sub>1</sub> ≤ 1.030.
Absolute value of intercept,  a <sub>0</sub>   .....	≤ 2.0% of maximum mapped pressure.
Standard error of estimate, SEE .....	≤ 10% of maximum mapped pressure.
Coefficient of determination, r <sup>2</sup> .....	≥ 0.970.

(10) Continue testing over the three vehicle drive cycles, as otherwise required by this part.

(11) Calculate combined cycle-weighted emissions of the four cycles as specified in paragraph (d) of this section.

(c) Measure PTO emissions from the fully warmed-up hybrid vehicle as follows:

(1) Perform the steps in paragraphs (b)(1) through (5) of this section.

(2) Prepare the vehicle for testing by operating it as needed to stabilize the battery at a full state of charge. For electric hybrid vehicles, we recommend running back-to-back PTO tests until engine operation is initiated to charge the battery. The battery should be fully charged once engine operation stops. The ignition should remain in the "on" position.

(3) Turn the vehicle and PTO system off while the sampling system is being prepared.

(4) Turn the vehicle and PTO system on such that the PTO system is functional, whether it draws power from the engine or a battery.

(5) Operate the vehicle over the PTO cycle(s) without turning the vehicle off, until the engine starts and then shuts down. The test cycle is completed once the engine shuts down. Measure emissions as described in paragraphs (b)(2) and (3) of this section. Use good engineering judgment to minimize the variability in testing between the two types of vehicles.

(6) Refer to paragraph (b)(9) of this section for cycle validation.

(7) Continue testing over the three vehicle drive cycles, as otherwise required by this part.

(8) Calculate combined cycle-weighted emissions of the four cycles as

specified in paragraph (d) of this section.

(d) Calculate combined cycle-weighted emissions of the four cycles for vocational vehicles as follows:

(1) Calculate the g/ton-mile emission rate for the driving portion of the test specified in § 1037.510.

(2) Calculate the g/hr emission rate for the PTO portion of the test by dividing the total mass emitted over the cycle (grams) by the time of the test (hours). For testing where fractions of a cycle were run (for example, where three cycles are completed and the halfway point of a fourth PTO cycle is reached before the engine starts and shuts down again), use the following procedures to calculate the time of the test:

(i) Add up the time run for all complete tests.

(ii) For fractions of a test, use the following equation to calculate the time:

$$t_{test} = \frac{\sum_{i=1}^N (NP_{circuit\_1,i} \cdot NP_{circuit\_2,i}) \cdot \Delta t}{\sum_{i=1}^N (NP_{circuit\_1,i} \cdot NP_{circuit\_2,i}) \cdot \Delta t} \cdot t_{cycle}$$

Where:

$t_{test}$  = time of the incomplete test.

$i$  = the number of each measurement interval.  
 $N$  = the total number of measurement intervals.

$NP_{circuit\_1}$  = Normalized pressure command from circuit 1 of the PTO cycle.

$NP_{circuit\_2}$  = Normalized pressure command from circuit 2 of the PTO cycle. Let  $NP_{circuit\_2} = 1$  if there is only one circuit.

$t_{cycle}$  = time of a complete cycle.

(iii) Sum the time from complete cycles (paragraph (d)(2)(i) of this section) and from partial cycles (paragraph (d)(2)(ii) of this section).

(3) Convert the g/hr PTO result to an equivalent g/mi value based on the assumed fraction of engine operating time during which the PTO is operating (28 percent) and an assumed average vehicle speed while driving (27.1 mph). The conversion factor is: Factor =  $(0.280)/(1.000 - 0.280)/(27.1 \text{ mph}) = 0.0144 \text{ hr/mi}$ . Multiply the g/hr emission rate by 0.0144 hr/mi.

(4) Divide the g/mi PTO emission rate by the standard payload and add this value to the g/ton-mile emission rate for the driving portion of the test.

(e) Follow the provisions of § 1037.615 to calculate improvement factors and benefits for advanced technologies.

**§ 1037.550 Special procedures for testing post-transmission hybrid systems.**

This section describes the procedure for simulating a chassis test with a post-transmission hybrid system for A to B testing. The hardware that must be included in these tests is the engine, the transmission, the hybrid electric motor, the power electronics between the hybrid electric motor and the RESS, and the RESS. You may ask us to modify the provisions of this section to allow testing non-electric hybrid vehicles, consistent with good engineering judgment.

(a) Set up the engine according to 40 CFR 1065.110 to account for work inputs and outputs and accessory work.

(b) Collect CO<sub>2</sub> emissions while operating the system over the test cycles specified in § 1037.510.

(c) Collect and measure emissions as described in 40 CFR part 1066. Calculate emission rates in grams per ton-mile without rounding. Determine values for  $A$ ,  $B$ ,  $C$ , and  $M$  for the vehicle being simulated as specified in 40 CFR part 1066. If you will apply an improvement factor or test results to multiple vehicle configurations, use values of  $A$ ,  $B$ ,  $C$ ,  $M$ ,  $k_d$ , and  $r$  that represent the vehicle configuration with the smallest potential reduction in greenhouse gas emissions as a result of the hybrid capability.

(d) Calculate the transmission output shaft's angular speed target for the driver model,  $f_{nref,driver}$ , from the linear speed associated with the vehicle cycle using the following equation:

$$f_{nref,driver} = \frac{S_{i,cycle} \cdot k_d}{2 \cdot \pi \cdot r}$$

Where:

$S_{cyclei}$  = vehicle speed of the test cycle for each point  $i$ .

$k_d$  = final drive ratio (the angular speed of the transmission output shaft divided by the angular speed of the drive axle), as declared by the manufacturer.

$r$  = radius of the loaded tires, as declared by the manufacturer.

(e) Use either speed control or torque control to program the dynamometer to follow the test cycle, as follows:

(1) *Speed control.* Program dynamometers using speed control as described in this paragraph (e)(1). We recommend speed control for automated manual transmissions or other designs where there is a power interrupt during shifts. Calculate the transmission output shaft's angular speed target for the dynamometer,  $f_{nref,dyno}$ , from the measured linear speed at the dynamometer rolls using the following equation:

$$f_{\text{nrefi,dyno}} = \frac{S_{\text{i,ref}} \cdot k_d}{2 \cdot \pi \cdot r}$$

Where:

$$S_{\text{i,ref}} = \left( FR_{\text{meas,i}} - (A + B \cdot S_i + C \cdot S_i^2) \right) \frac{t_i - t_{i-1}}{M} + S_{\text{i,ref-1}}$$

$t$  = elapsed time in the driving schedule as measured by the dynamometer, in seconds.

Let  $t_{i-1} = 0$ .

$$FR_{\text{meas,i}} = \frac{k_d \cdot T_i}{r}$$

$$S_i = \frac{2 \cdot \pi \cdot r \cdot f_{\text{n,i}}}{k_d}$$

Where:

$T_i$  = instantaneous measured torque at the transmission output shaft.

$f_{\text{n,i}}$  = instantaneous measured angular speed of the transmission output shaft.

(2) *Torque control.* Program dynamometers using torque control as described in this paragraph (e)(2).

(i) Calculate the transmission output shaft's torque target,  $T_{\text{refi}}$ , using the following equation:

$$T_{\text{refi}} = \frac{r \cdot FR_i}{k_d}$$

Where:

$FR_i$  = total road load force at the surface of the roll, calculated using the equation in 40 CFR 1066.210(d)(4), as specified in paragraph (e)(2)(ii) of this section.

(ii) Calculate the total road load force based on instantaneous speed values,  $S_i$ ,

calculated from the equation in paragraph (e)(1) of this section.

(3) For each test, validate the measured transmission output shaft's speed or torque with the corresponding reference values according to 40 CFR 1065.514(e). You may delete points when the vehicle is braking or stopped. Perform the validation based on speed and torque values at the transmission output shaft. For steady-state tests (55 mph and 65 mph cruise), apply cycle-validation criteria by treating the sampling periods from the two tests as a continuous sampling period. Perform this validation based on the following parameters for either speed-control or torque-control, as applicable:

TABLE 1 OF § 1037.550—STATISTICAL CRITERIA FOR VALIDATING DUTY CYCLES

Parameter	Speed control	Torque control
Slope, $a_1$ .....	$0.950 \leq a_1 \leq 1.030$ .....	$0.950 \leq a_1 \leq 1.030$ .
Absolute value of intercept, $a_0$ .....	$\leq 2.0\%$ of maximum test speed .....	$\leq 2.0\%$ of maximum torque.
Standard error of estimate, $SEE$ .....	$\leq 5\%$ of maximum test speed .....	$\leq 10\%$ of maximum torque.
Coefficient of determination, $r^2$ .....	$\geq 0.970$ .....	$\geq 0.850$ .

(f) Send a brake signal when throttle position is equal to zero and vehicle speed is greater than the reference vehicle speed from the test cycle. The brake signal should be turned off when the torque measured at the transmission output shaft is less than the reference torque. Set a delay before changing the brake state using good engineering judgment to prevent the brake signal from dithering.

(g) The driver model should be designed to follow the cycle as closely as possible and must meet the requirements of 40 CFR 1066.430(e) for transient testing and § 1037.510 for steady-state testing.

(h) Correct for the net energy change of the energy storage device as described in 40 CFR 1066.501.

(i) Follow the provisions of § 1037.510 to weight the cycle results and § 1037.615 to calculate improvement factors and benefits for advanced technologies.

**Subpart G—Special Compliance Provisions**

**§ 1037.601 What compliance provisions apply to these vehicles?**

(a) Engine and vehicle manufacturers, as well as owners and operators of vehicles subject to the requirements of this part, and all other persons, must observe the provisions of this part, the provisions of the Clean Air Act, and the following provisions of 40 CFR part 1068:

(1) The exemption and importation provisions of 40 CFR part 1068, subparts C and D, apply for vehicles subject to this part 1037, except that the hardship exemption provisions of 40 CFR 1068.245, 1068.250, and 1068.255 do not apply for motor vehicles.

(2) Manufacturers may comply with the defect reporting requirements of 40 CFR 1068.501 instead of the defect reporting requirements of 40 CFR part 85.

(b) Vehicles exempted from the applicable standards of 40 CFR part 86 are exempt from the standards of this part without request. Similarly, vehicles are exempt without request if the

installed engine is exempted from the applicable standards in 40 CFR part 86.

(c) The prohibitions of 40 CFR 86.1854 apply for vehicles subject to the requirements of this part. The actions prohibited under this provision include the introduction into U.S. commerce of a complete or incomplete vehicle subject to the standards of this part where the vehicle is not covered by a valid certificate of conformity or exemption.

(d) Except as specifically allowed by this part, it is a violation of section 203(a)(1) of the Clean Air Act (42 U.S.C. 7522(a)(1)) to introduce into U.S. commerce a tractor containing an engine not certified for use in tractors; or to introduce into U.S. commerce a vocational vehicle containing a light heavy-duty or medium heavy-duty engine not certified for use in vocational vehicles. This prohibition applies especially to the vehicle manufacturer.

(e) A vehicle manufacturer that completes assembly of a vehicle at two or more facilities may ask to use as the date of manufacture for that vehicle the date on which manufacturing is completed at the place of main assembly, consistent with provisions of

49 CFR 567.4. Note that such staged assembly is subject to the provisions of 40 CFR 1068.260(c). Include your request in your application for certification, along with a summary of your staged-assembly process. You may ask to apply this allowance to some or all of the vehicles in your vehicle family. Our approval is effective when we grant your certificate. We will not approve your request if we determine that you intend to use this allowance to circumvent the intent of this part.

**§ 1037.610 Vehicles with innovative technologies.**

(a) You may ask us to apply the provisions of this section for CO<sub>2</sub> emission reductions resulting from vehicle technologies that were not in common use with heavy-duty vehicles before model year 2010 that are not reflected in the GEM simulation tool. These provisions may be applied for CO<sub>2</sub> emission reductions reflected using the specified test procedures, provided they are not reflected in the GEM. We will apply these provisions only for technologies that will result in measurable, demonstrable, and verifiable real-world CO<sub>2</sub> emission reductions.

(b) The provisions of this section may be applied as either an improvement factor or as a separate credit, consistent with good engineering judgment. We recommend that you base your credit/adjustment on A to B testing of pairs of vehicles differing only with respect to the technology in question.

(1) Calculate improvement factors as the ratio of in-use emissions with the technology divided by the in-use emissions without the technology. Use the improvement-factor approach where good engineering judgment indicates that the actual benefit will be proportional to emissions measured over the test procedures specified in this part.

(2) Calculate separate credits (g/ton-mile) based on the difference between the in-use emission rate with the technology and the in-use emission rate without the technology. Multiply this difference by the number of vehicles, standard payload, and useful life. Use the separate-credit approach where good engineering judgment indicates that the actual benefit will be not be proportional to emissions measured over the test procedures specified in this part.

(3) We may require you to discount or otherwise adjust your improvement factor or credit to account for uncertainty or other relevant factors.

(c) You may perform A to B testing by measuring emissions from the vehicles

during chassis testing or from in-use on-road testing. We recommend that you perform on-road testing according to SAE J1321 Joint TMC/SAE Fuel Consumption Test Procedure Type II Reaffirmed 1986–10 or SAE J1526 Joint TMC/SAE Fuel Consumption In-Service Test Procedure Type III Issued 1987–06 (see § 1037.810 for information availability of SAE standards), subject to the following provisions:

(1) The minimum route distance is 100 miles.

(2) The route selected must be representative in terms of grade. We will take into account published and relevant research in determining whether the grade is representative.

(3) The vehicle speed over the route must be representative of the drive-cycle weighting adopted for each regulatory subcategory. For example, if the route selected for an evaluation of a combination tractor with a sleeper cab contains only interstate driving, the improvement factor would apply only to 86 percent of the weighted result.

(4) The ambient air temperature must be between 5 and 35°C, unless the technology requires other temperatures for demonstration.

(5) We may allow you to use a Portable Emissions Measurement System (PEMS) device for measuring CO<sub>2</sub> emissions during the on-road testing.

(d) Send your request to the Designated Compliance Officer. Include a detailed description of the technology and a recommended test plan. Also state whether you recommend applying these provisions using the improvement-factor method or the separate-credit method. We recommend that you do not begin collecting test data (for submission to EPA) before contacting us. For technologies for which the engine manufacturer could also claim credits (such as transmissions in certain circumstances), we may require you to include a letter from the engine manufacturer stating that it will not seek credits for the same technology.

(e) We may seek public comment on your request, consistent with the provisions of 40 CFR 86.1866. However, we will generally not seek public comment on credits or adjustments based on A to B chassis testing performed according to the duty-cycle testing requirements of this part or in-use testing performed according to paragraph (c) of this section.

**§ 1037.615 Hybrid vehicles and other advanced technologies.**

(a) This section applies for hybrid vehicles with regenerative braking, vehicles equipped with Rankine-cycle

engines, electric vehicles, and fuel cell vehicles. You may not generate credits for engine features for which the engines generate credits under 40 CFR part 1036.

(b) Generate advanced technology emission credits for hybrid vehicles that include regenerative braking (or the equivalent) and energy storage systems, fuel cell vehicles, and vehicles equipped with Rankine-cycle engines as follows:

(1) Measure the effectiveness of the advanced system by chassis testing a vehicle equipped with the advanced system and an equivalent conventional vehicle. Test the vehicles as specified in subpart F of this part. For purposes of this paragraph (b), a conventional vehicle is considered to be equivalent if it has the same footprint (as defined in 40 CFR 86.1803), vehicle service class, aerodynamic drag, and other relevant factors not directly related to the hybrid powertrain. If you use § 1037.525 to quantify the benefits of a hybrid system for PTO operation, the conventional vehicle must have same number of PTO circuits and have equivalent PTO power. If you do not produce an equivalent vehicle, you may create and test a prototype equivalent vehicle. The conventional vehicle is considered Vehicle A and the advanced vehicle is considered Vehicle B. We may specify an alternate cycle if your vehicle includes a power take-off.

(2) Calculate an improvement factor and g/ton-mile benefit using the following equations and parameters:

(i) Improvement Factor = [(Emission Rate A) – (Emission Rate B)] / (Emission Rate A)

(ii) g/ton-mile benefit = Improvement Factor × (GEM Result B)

(iii) Emission Rates A and B are the g/ton-mile CO<sub>2</sub> emission rates of the conventional and advanced vehicles, respectively, as measured under the test procedures specified in this section. GEM Result B is the g/ton-mile CO<sub>2</sub> emission rate resulting from emission modeling of the advanced vehicle as specified in § 1037.520.

(3) Use the equations of § 1037.705 to convert the g/ton-mile benefit to emission credits (in Mg). Use the g/ton-mile benefit in place of the (Std-FEL) term.

(c) See § 1037.525 for special testing provisions related to hybrid vehicles equipped with power take-off units.

(d) You may use an engineering analysis to calculate an improvement factor for fuel cell vehicles based on measured emissions from the fuel cell vehicle.

(e) For electric vehicles, calculate CO<sub>2</sub> credits using an FEL of 0 g/ton-mile.



(f) As specified in subpart H of this part, credits generated under this section may be used under this part 1037 outside of the averaging set in which they were generated or used under 40 CFR part 1036.

(g) You may certify using both provisions of this section and the innovative technology provisions of § 1037.610, provided you do not double count emission benefits.

**§ 1037.620 Shipment of incomplete vehicles to secondary vehicle manufacturers.**

This section specifies how manufacturers may introduce partially complete vehicles into U.S. commerce.

(a) The provisions of this section allow manufacturers to ship partially complete vehicles to secondary vehicle manufacturers or otherwise introduce them into U.S. commerce in the following circumstances:

(1) *Tractors.* Manufacturers may introduce partially complete tractors into U.S. commerce if they are covered by a certificate of conformity for tractors and will be in their certified tractor configuration before they reach the ultimate purchasers. For example, this would apply for sleepers initially shipped without the sleeper compartments attached. Note that delegated assembly provisions may apply (see 40 CFR 1068.261).

(2) *Vocational vehicles.* Manufacturers may introduce partially complete vocational vehicles into U.S. commerce if they are covered by a certificate of conformity for vocational vehicles and will be in their certified vocational configuration before they reach the ultimate purchasers. Note that delegated assembly provisions may apply (see 40 CFR 1068.261).

(3) *Uncertified vehicles that will be certified by secondary vehicle manufacturers.* Manufacturers may introduce into U.S. commerce partially complete vehicles for which they do not hold a certificate of conformity only as allowed by paragraph (b) of this section.

(b) The provisions of this paragraph (b) generally apply where the secondary vehicle manufacturer has substantial control over the design and assembly of emission controls. In determining whether a manufacturer has substantial control over the design and assembly of emission controls, we would consider the degree to which the secondary manufacturer would be able to ensure that the engine and vehicle will conform to the regulations in their final configurations.

(1) A secondary manufacturer may finish assembly of partially complete vehicles in the following cases:

(i) It obtains a vehicle that is not fully assembled with the intent to manufacture a complete vehicle in a certified configuration.

(ii) It obtains a vehicle with the intent to modify it to a certified configuration before it reaches the ultimate purchaser. For example, this may apply for converting a gasoline-fueled vehicle to operate on natural gas under the terms of a valid certificate.

(2) Manufacturers may introduce partially complete vehicles into U.S. commerce as described in this paragraph (b) if they have a written request for such vehicles from a secondary vehicle manufacturer that will finish the vehicle assembly and has certified the vehicle (or the vehicle has been exempted or excluded from the requirements of this part). The written request must include a statement that the secondary manufacturer has a certificate of conformity (or exemption/exclusion) for the vehicle and identify a valid vehicle family name associated with each vehicle model ordered (or the basis for an exemption/exclusion). The original vehicle manufacturer must apply a removable label meeting the requirements of 40 CFR 1068.45 that identifies the corporate name of the original manufacturer and states that the vehicle is exempt under the provisions of § 1037.620. The name of the certifying manufacturer must also be on the label or, alternatively, on the bill of lading that accompanies the vehicles during shipment. The original manufacturer may not apply a permanent emission control information label identifying the vehicle's eventual status as a certified vehicle.

(3) If you are the secondary manufacturer and you will hold the certificate, you must include the following information in your application for certification:

(i) Identify the original manufacturer of the partially complete vehicle or of the complete vehicle you will modify.

(ii) Describe briefly how and where final assembly will be completed. Specify how you have the ability to ensure that the vehicles will conform to the regulations in their final configuration. (Note: This section prohibits using the provisions of this paragraph (b) unless you have substantial control over the design and assembly of emission controls.)

(iii) State unconditionally that you will not distribute the vehicles without conforming to all applicable regulations.

(4) If you are a secondary manufacturer and you are already a certificate holder for other families, you may receive shipment of partially complete vehicles after you apply for a

certificate of conformity but before the certificate's effective date. This exemption allows the original manufacturer to ship vehicles after you have applied for a certificate of conformity. Manufacturers may introduce partially complete vehicles into U.S. commerce as described in this paragraph (b)(4) if they have a written request for such vehicles from a secondary manufacturer stating that the application for certification has been submitted (instead of the information we specify in paragraph (b)(2) of this section). We may set additional conditions under this paragraph (b)(4) to prevent circumvention of regulatory requirements.

(5) Both original and secondary manufacturers must keep the records described in this section for at least five years, including the written request for exempted vehicles and the bill of lading for each shipment (if applicable). The written request is deemed to be a submission to EPA.

(6) These provisions are intended only to allow secondary manufacturers to obtain or transport vehicles in the specific circumstances identified in this section so any exemption under this section expires when the vehicle reaches the point of final assembly identified in paragraph (b)(3)(ii) of this section.

(7) For purposes of this section, an allowance to introduce partially complete vehicles into U.S. commerce includes a conditional allowance to sell, introduce, or deliver such vehicles into commerce in the United States or import them into the United States. It does not include a general allowance to offer such vehicles for sale because this exemption is intended to apply only for cases in which the certificate holder already has an arrangement to purchase the vehicles from the original manufacturer. This exemption does not allow the original manufacturer to subsequently offer the vehicles for sale to a different manufacturer who will hold the certificate unless that second manufacturer has also complied with the requirements of this part. The exemption does not apply for any individual vehicles that are not labeled as specified in this section or which are shipped to someone who is not a certificate holder.

(8) We may suspend, revoke, or void an exemption under this section, as follows:

(i) We may suspend or revoke your exemption if you fail to meet the requirements of this section. We may suspend or revoke an exemption related to a specific secondary manufacturer if that manufacturer sells vehicles that are

in not in a certified configuration in violation of the regulations. We may disallow this exemption for future shipments to the affected secondary manufacturer or set additional conditions to ensure that vehicles will be assembled in the certified configuration.

(ii) We may void an exemption for all the affected vehicles if you intentionally submit false or incomplete information or fail to keep and provide to EPA the records required by this section.

(iii) The exemption is void for a vehicle that is shipped to a company that is not a certificate holder or for a vehicle that is shipped to a secondary manufacturer that is not in compliance with the requirements of this section.

(iv) The secondary manufacturer may be liable for penalties for causing a prohibited act where the exemption is voided due to actions on the part of the secondary manufacturer.

(c) Provide instructions along with partially complete vehicles including all information necessary to ensure that an engine will be installed in its certified configuration.

#### **§ 1037.630 Special purpose tractors.**

(a) *General provisions.* This section allows a vehicle manufacturer to reclassify certain tractors as vocational tractors. Vocational tractors are treated as vocational vehicles and are exempt from the standards of § 1037.106. Note that references to “tractors” outside of this section mean non-vocational tractors.

(1) This allowance is intended only for vehicles that do not typically operate at highway speeds, or would otherwise not benefit from efficiency improvements designed for line-haul tractors. This allowance is limited to the following vehicle and application types:

(i) Low-roof tractors intended for intra-city pickup and delivery, such as those that deliver bottled beverages to retail stores.

(ii) Tractors intended for off-road operation (including mixed service operation), such as those with reinforced frames and increased ground clearance.

(iii) Tractors with a GCWR over 120,000 pounds.

(2) Where we determine that a manufacturer is not applying this allowance in good faith, we may require the manufacturer to obtain preliminary approval before using this allowance.

(b) *Requirements.* The following requirements apply with respect to tractors reclassified under this section:

(1) The vehicle must fully conform to all requirements applicable to vocational vehicles under this part.

(2) Vehicles reclassified under this section must be certified as a separate vehicle family. However, they remain part of the vocational regulatory subcategory and averaging set that applies for their weight class.

(3) You must include the following additional statement on the vehicle’s emission control information label under § 1037.135: “THIS VEHICLE WAS CERTIFIED AS A VOCATIONAL TRACTOR UNDER 40 CFR 1037.630.”

(4) You must keep records for three years to document your basis for believing the vehicles will be used as described in paragraph (a)(1) of this section. Include in your application for certification a brief description of your basis.

(c) *Production limit.* No manufacturer may produce more than 21,000 vehicles under this section in any consecutive three model year period. This means you may not exceed 6,000 in a given model year if the combined total for the previous two years was 15,000. The production limit applies with respect to all Class 7 and Class 8 tractors certified or exempted as vocational tractors. Note that in most cases, the provisions of paragraph (a) of this section will limit the allowable number of vehicles to be a number lower than the production limit of this paragraph (c).

(d) *Off-road exemption.* All the provisions of this section apply for vocational tractors exempted under § 1037.631, except as follows:

(1) The vehicles are required to comply with the requirements of § 1037.631 instead of the requirements that would otherwise apply to vocational vehicles. Vehicles complying with the requirements of § 1037.631 and using an engine certified to the standards of 40 CFR part 1036 are deemed to fully conform to all requirements applicable to vocational vehicles under this part.

(2) The vehicles must be labeled as specified under § 1037.631 instead of as specified in paragraph (b)(3) of this section.

#### **§ 1037.631 Exemption for vocational vehicles intended for off-road use.**

This section provides an exemption from the greenhouse gas standards of this part for certain vocational vehicles intended to be used extensively in off-road environments such as forests, oil fields, and construction sites. This section does not exempt the engine used in the vehicle from the standards of 40 CFR part 86 or part 1036. Note that you may not include these exempted vehicles in any credit calculations under this part.

(a) *Qualifying criteria.* Vocational vehicles intended for off-road use meeting either the criteria of paragraph (a)(1) or (a)(2) of this section are exempt without request, subject to the provisions of this section.

(1) Vehicles are exempt if the tires installed on the vehicle have a maximum speed rating at or below 55 mph.

(2) Vehicles are exempt if they were primarily designed to perform work off-road (such as in oil fields, forests, or construction sites), and they meet at least one of the criteria of paragraph (a)(2)(i) of this section and at least one of the criteria of paragraph (a)(2)(ii) of this section.

(i) The vehicle must have affixed components designed to work in an off-road environment (*i.e.*, hazardous material equipment or off-road drill equipment) or be designed to operate at low speeds such that it is unsuitable for normal highway operation.

(ii) The vehicle must meet one of the following criteria:

(A) Have an axle that has a gross axle weight rating (GAWR) of 29,000 pounds.

(B) Have a speed attainable in 2 miles of not more than 33 mph.

(C) Have a speed attainable in 2 miles of not more than 45 mph, an unloaded vehicle weight that is not less than 95 percent of its gross vehicle weight rating (GVWR), and no capacity to carry occupants other than the driver and operating crew.

(b) *Tractors.* The provisions of this section may apply for tractors only if each tractor qualifies as a vocational tractor under § 1037.630.

(c) *Recordkeeping and reporting.* (1) You must keep records to document that your exempted vehicle configurations meet all applicable requirements of this section. Keep these records for at least eight years after you stop producing the exempted vehicle model. We may review these records at any time.

(2) You must also keep records of the individual exempted vehicles you produce, including the vehicle identification number and a description of the vehicle configuration.

(3) Within 90 days after the end of each model year, you must send to the Designated Compliance Officer a report with the following information:

(i) A description of each exempted vehicle configuration, including an explanation of why it qualifies for this exemption.

(ii) The number of vehicles exempted for each vehicle configuration.

(d) *Labeling.* You must include the following additional statement on the vehicle’s emission control information label under § 1037.135: “THIS VEHICLE

WAS EXEMPTED UNDER 40 CFR 1037.631.”.

**§ 1037.640 Variable vehicle speed limiters.**

This section specifies provisions that apply for vehicle speed limiters (VSLs) that you model under § 1037.520. This does not apply for VSLs that you do not model under § 1037.520.

(a) *General.* The regulations of this part do not constrain how you may design VSLs for your vehicles. For example, you may design your VSL to have a single fixed speed limit or a soft-top speed limit. You may also design your VSL to expire after accumulation of a predetermined number of miles. However, designs with soft tops or expiration features are subject to proration provisions under this section that do not apply to fixed VSLs that do not expire.

(b) *Definitions.* The following definitions apply for purposes of this section:

(1) Default speed limit means the speed limit that normally applies for the vehicle, except as follows:

(i) The default speed limit for adjustable VSLs must represent the speed limit that applies when the VSL is adjusted to its highest setting under paragraph (c) of this section.

(ii) For VSLs with soft tops, the default speed does not include speeds possible only during soft-top operation.

(iii) For expiring VSLs, the default does not include speeds that are possible only after expiration.

(2) Soft-top speed limit means the highest speed limit that applies during soft-top operation.

(3) Maximum soft-top duration means the maximum amount of time that a vehicle could operate above the default speed limit.

(4) Certified VSL means a VSL configuration that applies when a vehicle is new and until it expires.

(5) Expiration point means the mileage at which a vehicle's certified VSL expires (or the point at which tamper protections expire).

(6) Effective speed limit has the meaning given in paragraph (d) of this section.

(c) *Adjustments.* You may design your VSL to be adjustable; however, this may affect the value you use in the GEM.

(1) Except as specified in paragraph (c)(2) of this section, any adjustments that can be made to the engine, vehicle, or their controls that change the VSL's actual speed limit are considered to be adjustable operating parameters. Compliance is based on the vehicle being adjusted to the highest speed limit within this range.

(2) The following adjustments are not adjustable parameters:

(i) Adjustments made only to account for changing tire size or final drive ratio.

(ii) Adjustments protected by encrypted controls or passwords.

(iii) Adjustments possible only after the VSL's expiration point.

(d) *Effective speed limit.* (1) For VSLs without soft tops or expiration points that expire before 1,259,000 miles, the effective speed limit is the highest speed limit that results by adjusting the VSL or other vehicle parameters consistent with the provisions of paragraph (c) of this section.

(2) For VSLs with soft tops and/or expiration points, the effective speed limit is calculated as specified in this paragraph (d)(2), which is based on 10 hours of operation per day (394 miles per day for day cabs and 551 miles per day for sleeper cabs). Note that this calculation assumes that a fraction of this operation is speed limited (3.9 hours and 252 miles for day cabs, and 7.3 hours and 474 miles for sleeper cabs). Use the following equation to calculate the effective speed limit, rounded to the nearest 0.1 mph:

$$\text{Effective speed} = \text{ExF} * [\text{STF} * \text{STSL} + (1 - \text{STF}) * \text{DSL}] + (1 - \text{ExF}) * 65 \text{ mph}$$

Where:

ExF = expiration point miles/1,259,000 miles

STF = maximum number of allowable soft top operation hours per day/3.9 hours for day cabs (or maximum miles per day/252)

STF = maximum number of allowable soft top operation hours per day/7.3 hours for sleeper cabs (or maximum miles per day/474)

STSL = the soft top speed limit

DSL = the default speed limit

**§ 1037.645 In-use compliance with family emission limits (FELs).**

You may ask us to apply a higher in-use FEL for certain in-use vehicles, subject to the provisions of this section. Note that § 1037.225 contains provisions related to changing FELs during a model year.

(a) *Purpose.* This section is intended to address circumstances in which it is in the public interest to apply a higher in-use FEL based on forfeiting an appropriate number of emission credits.

(b) *FELs.* We may apply higher in-use FELs to your vehicles as follows:

(1) Where your vehicle family includes more than one sub-family with different FELs, we may apply a higher FEL within the family than was applied to the vehicle's configuration in your final ABT report. For example, if your vehicle family included three sub-families with FELs of 200 g/ton-mile, 210 g/ton-mile, and 220 g/ton-mile, we may apply a 220 g/ton-mile in-use FEL to vehicles that were originally

designated as part of the 200 g/ton-mile or 210 g/ton-mile sub-families.

(2) Without regard to the number of sub-families in your certified vehicle family, we may specify new sub-families with higher FELs than were included in your final ABT report. We may apply these higher FELs as in-use FELs for your vehicles. For example, if your vehicle family included three sub-families with FELs of 200 g/ton-mile, 210 g/ton-mile, and 220 g/ton-mile, we may specify a new 230 g/ton-mile sub-family.

(3) In specifying sub-families and in-use FELs, we would intend to accurately reflect the actual in-use performance of your vehicles, consistent with the specified testing and modeling provisions of this part.

(c) *Equivalent families.* We may apply the higher FELs to other families in other model years if they used equivalent emission controls.

(d) *Credit forfeiture.* Where we specify higher in-use FELs under this section, you must forfeit CO<sub>2</sub> emission credits based on the difference between the in-use FEL and the otherwise applicable FEL. Calculate the amount of credits to be forfeited using the applicable equation in § 1037.705, by substituting the otherwise applicable FEL for the standard and the in-use FEL for the otherwise applicable FEL.

(e) *Requests.* Submit your request to the Designated Compliance Officer. Include the following in your request:

(1) The vehicle family name, model year, and name/description of the configuration(s) affected.

(2) A list of other vehicle families/configurations/model years that may be affected.

(3) The otherwise applicable FEL for each configuration along with your recommendations for higher in-use FELs.

(4) Your source of credits for forfeiture.

(f) *Relation to recall.* You may not request higher in-use FELs for any vehicle families for which we have made a determination of nonconformance and ordered a recall. You may, however, make such requests for vehicle families for which you are performing a voluntary emission recall.

(g) *Approval.* We may approve your request if we determine that you meet the requirements of this section and such approval is in the public interest. We may include appropriate conditions with our approval or we may approve your request with modifications.

**§ 1037.650 Tire manufacturers.**

This section describes how the requirements of this part apply with

respect to tire manufacturers that choose to provide test data or emission warranties for purposes of this part.

(a) *Testing.* You are responsible as follows for test tires and emission test results that you provide to vehicle manufacturers for the purpose of the manufacturer submitting them to EPA for certification under this part:

(1) Such test results are deemed under § 1037.825 to be submissions to EPA. This means that you may be subject to criminal penalties under 18 U.S.C. 1001 if you knowingly submit false test results to the manufacturer.

(2) You may not cause a vehicle manufacturer to violate the regulations by rendering inaccurate emission test results you provide (or emission test results from testing of test tires you provide) to the vehicle manufacturer.

(3) Your provision of test tires and emission test results to vehicle manufacturers for the purpose of certifying under this part is deemed to be an agreement to provide tires to EPA for confirmatory testing under § 1037.201.

(b) *Warranty.* You may contractually agree to process emission warranty claims on behalf of the manufacturer certifying the vehicle with respect to tires you produce.

(1) Your fulfillment of the warranty requirements of this part is deemed to fulfill the vehicle manufacturer's warranty obligations under this part with respect to tires you warrant.

(2) You may not cause a vehicle manufacturer to violate the regulations by failing to fulfill the emission warranty requirements that you contractually agreed to fulfill.

#### **§ 1037.655 Post-useful life vehicle modifications.**

This section specifies vehicle modifications that may occur after a vehicle reaches the end of its regulatory useful life. It does not apply with respect to modifications that occur within the useful life period. It also does not apply with respect to engine modifications or recalibrations. Note that many such modifications to the vehicle during the useful life and to the engine at any time are presumed to violate 42 U.S.C. 7522(a)(3)(A).

(a) *General.* Except as allowed by this section, it is prohibited for any person to remove or render inoperative any emission control device installed to comply with the requirements of this part 1037.

(b) *Allowable modifications.* You may modify a vehicle for the purpose of reducing emissions, provided you have a reasonable technical basis for knowing that such modification will not increase

emissions of any other pollutant. Reasonable technical basis has the meaning given in 40 CFR 1068.30. This generally requires you to have information that would lead an engineer or other person familiar with engine and vehicle design and function to reasonably believe that the modifications will not increase emissions of any regulated pollutant.

(c) *Examples of allowable modifications.* The following are examples of allowable modifications:

(1) It is generally allowable to remove tractor roof fairings after the end of the vehicle's useful life if the vehicle will no longer be used primarily to pull box trailers.

(2) Other fairings may be removed after the end of the vehicle's useful life if the vehicle will no longer be used significantly on highways with vehicle speed of 55 miles per hour or higher.

(d) *Examples of prohibited modifications.* The following are examples of modifications that are not allowable:

(1) No person may disable a vehicle speed limiter prior to its expiration point.

(2) No person may remove aerodynamic fairings from tractors that are used primarily to pull box trailers on highways.

#### **§ 1037.660 Automatic engine shutdown systems.**

This section specifies requirements that apply for certified automatic engine shutdown systems (AES) that are modeled under § 1037.520. It does not apply for AES systems that you do not model under § 1037.520.

(a) *Minimum requirements.* Your AES system must meet all of the requirements of this paragraph (a) to be modeled under § 1037.520. The system must shut down the engine within 300 seconds when all the following conditions are met:

(1) The transmission is set in neutral with the parking brake engaged (or the transmission is set to park if so equipped).

(2) The operator has not reset the system timer within the 300 seconds by changing the position of the accelerator, brake, or clutch pedal; or by some other mechanism we approve.

(3) None of the override conditions of paragraph (b) of this section are met.

(b) *Override conditions.* The system may delay shutting the engine down while any of the conditions of this paragraph (b) apply. Engines equipped with auto restart may restart during override conditions. Note that these conditions allow the system to delay shutdown or restart, but do not allow it

to reset the timer. The system may delay shutdown—

(1) While an exhaust emission control device is regenerating. The period considered to be regeneration for purposes of this allowance must be consistent with good engineering judgment and may differ in length from the period considered to be regeneration for other purposes. For example, in some cases it may be appropriate to include a cool down period for this purpose but not for infrequent regeneration adjustment factors.

(2) If necessary while servicing the vehicle, provided the deactivation of the AES system is accomplished using a diagnostic scan tool. The system must be automatically reactivated when the engine is shutdown for more than 60 minutes.

(3) If the vehicle's main battery state-of-charge is not sufficient to allow the main engine to be restarted.

(4) If the external ambient temperature reaches a level below which or above which the cabin temperature cannot be maintained within reasonable heat or cold exposure threshold limit values for the health and safety of the operator (not merely comfort).

(5) If the vehicle's engine coolant temperature is too low according to the manufacturer's engine protection guidance. This may also apply for fuel or oil temperatures. This allows the engine to continue operating until it reaches a predefined temperature at which the shutdown sequence of paragraph (a) of this section would resume.

(6) The system may delay shutdown while the vehicle's main engine is operating in power take-off (PTO) mode. For purposes of this paragraph (b)(6), an engine is considered to be in PTO mode when a switch or setting designating PTO mode is enabled.

(c) *Expiration of AES systems.* The AES system may include an expiration point (in miles) after which the AES system may be disabled. If your vehicle is equipped with an expiring AES system that expires before 1,259,000 miles adjust the model input as follows:  $\text{Input} = 5 \text{ g CO}_2/\text{ton-mile} \times (\text{miles at expiration}/1,259,000 \text{ miles})$

(d) *Adjustable parameters.* Provisions that apply generally with respect to adjustable parameters also apply to the AES system operating parameters, except the following are not considered to be adjustable parameters:

(1) Accelerator, brake, and clutch pedals, with respect to resetting the idle timer. Parameters associated with other timer reset mechanisms we approve are also not adjustable parameters.

(2) Bypass parameters allowed for vehicle service under paragraph (b)(2) of this section.

(3) Parameters that are adjustable only after the expiration point.

### Subpart H—Averaging, Banking, and Trading for Certification

#### § 1037.701 General provisions.

(a) You may average, bank, and trade (ABT) emission credits for purposes of certification as described in this subpart and in subpart B of this part to show compliance with the standards of §§ 1037.105 and 1037.106. Participation in this program is voluntary.

(b) The definitions of Subpart I of this part apply to this subpart. The following definitions also apply:

(1) *Actual emission credits* means emission credits you have generated that we have verified by reviewing your final report.

(2) *Averaging set* means a set of vehicles in which emission credits may be exchanged. Credits generated by one vehicle may only be used by other vehicles in the same averaging set. Note that an averaging set may comprise more than one regulatory subcategory. See § 1037.740.

(3) *Broker* means any entity that facilitates a trade of emission credits between a buyer and seller.

(4) *Buyer* means the entity that receives emission credits as a result of a trade.

(5) *Reserved emission credits* means emission credits you have generated that we have not yet verified by reviewing your final report.

(6) *Seller* means the entity that provides emission credits during a trade.

(7) *Standard* means the emission standard that applies under subpart B of this part for vehicles not participating in the ABT program of this subpart.

(8) *Trade* means to exchange emission credits, either as a buyer or seller.

(c) Emission credits may be exchanged only within an averaging set as specified in § 1037.740.

(d) You may not use emission credits generated under this subpart to offset any emissions that exceed an FEL or standard, except as allowed by § 1037.645.

(e) You may trade emission credits generated from any number of your vehicles to the vehicle purchasers or other parties to retire the credits. Identify any such credits in the reports described in § 1037.730. Vehicles must comply with the applicable FELs even if you donate or sell the corresponding emission credits under this paragraph (e). Those credits may no longer be used

by anyone to demonstrate compliance with any EPA emission standards.

(f) Emission credits may be used in the model year they are generated. Surplus emission credits may be banked for future model years. Surplus emission credits may sometimes be used for past model years, as described in § 1037.745.

(g) You may increase or decrease an FEL during the model year by amending your application for certification under § 1037.225. The new FEL may apply only to vehicles you have not already introduced into commerce.

(h) See § 1037.740 for special credit provisions that apply for credits generated under § 1037.104(d)(7), § 1037.615 or 40 CFR 1036.615.

(i) Unless the regulations explicitly allow it, you may not calculate credits more than once for any emission reduction. For example, if you generate CO<sub>2</sub> emission credits for a given hybrid vehicle under this part, no one may generate CO<sub>2</sub> emission credits for the hybrid engine under 40 CFR part 1036. However, credits could be generated for identical engine used in vehicles that did not generate credits under this part.

#### § 1037.705 Generating and calculating emission credits.

(a) The provisions of this section apply separately for calculating emission credits for each pollutant.

(b) For each participating family or subfamily, calculate positive or negative emission credits relative to the otherwise applicable emission standard. Calculate positive emission credits for a family or subfamily that has an FEL below the standard. Calculate negative emission credits for a family or subfamily that has an FEL above the standard. Sum your positive and negative credits for the model year before rounding. Round the sum of emission credits to the nearest megagram (Mg), using consistent units throughout the following equations:

(1) For vocational vehicles:

$$\text{Emission credits (Mg)} = (\text{Std-FEL}) \times (\text{Payload Tons}) \times (\text{Volume}) \times (\text{UL}) \times (10^{-6})$$

Where:

Std = the emission standard associated with the specific tractor regulatory subcategory (g/ton-mile).

FEL = the family emission limit for the vehicle subfamily (g/ton-mile).

Payload tons = the prescribed payload for each class in tons (2.85 tons for light heavy-duty vehicles, 5.6 tons for medium heavy-duty vehicles, and 7.5 tons for heavy heavy-duty vehicles).

Volume = U.S.-directed production volume of the vehicle subfamily. For example, if you produce three configurations with the same FEL, the subfamily production

volume would be the sum of the production volumes for these three configurations.

UL = useful life of the vehicle (110,000 miles for light heavy-duty vehicles, 185,000 miles for medium heavy-duty vehicles, and 435,000 miles for heavy heavy-duty vehicles).

(2) For tractors:

$$\text{Emission credits (Mg)} = (\text{Std-FEL}) \times (\text{Payload tons}) \times (\text{Volume}) \times (\text{UL}) \times (10^{-6})$$

Where:

Std = the emission standard associated with the specific tractor regulatory subcategory (g/ton-mile).

FEL = the family emission limit for the vehicle subfamily (g/ton-mile).

Payload tons = the prescribed payload for each class in tons (12.5 tons for Class 7 and 19 tons for Class 8).

Volume = U.S.-directed production volume of the vehicle subfamily.

UL = useful life of the tractor (435,000 miles for Class 8 and 185,000 miles for Class 7).

(c) As described in § 1037.730, compliance with the requirements of this subpart is determined at the end of the model year based on actual U.S.-directed production volumes. Keep appropriate records to document these production volumes. Do not include any of the following vehicles to calculate emission credits:

(1) Vehicles that you do not certify to the CO<sub>2</sub> standards of this part because they are permanently exempted under subpart G of this part or under 40 CFR part 1068.

(2) Exported vehicles.

(3) Vehicles not subject to the requirements of this part, such as those excluded under § 1037.5.

(4) Any other vehicles, where we indicate elsewhere in this part 1037 that they are not to be included in the calculations of this subpart.

#### § 1037.710 Averaging.

(a) Averaging is the exchange of emission credits among your vehicle families. You may average emission credits only within the same averaging set.

(b) You may certify one or more vehicle families (or subfamilies) to an FEL above the applicable standard, subject to any applicable FEL caps and other provisions in subpart B of this part, if you show in your application for certification that your projected balance of all emission-credit transactions in that model year is greater than or equal to zero or that a negative balance is allowed under § 1037.745.

(c) If you certify a vehicle family to an FEL that exceeds the otherwise applicable standard, you must obtain

enough emission credits to offset the vehicle family's deficit by the due date for the final report required in § 1037.730. The emission credits used to address the deficit may come from your other vehicle families that generate emission credits in the same model year (or from later model years as specified in § 1037.745), from emission credits you have banked, or from emission credits you obtain through trading.

#### § 1037.715 Banking.

(a) Banking is the retention of surplus emission credits by the manufacturer generating the emission credits for use in future model years for averaging or trading.

(b) You may designate any emission credits you plan to bank in the reports you submit under § 1037.730 as reserved credits. During the model year and before the due date for the final report, you may designate your reserved emission credits for averaging or trading.

(c) Reserved credits become actual emission credits when you submit your final report. However, we may revoke these emission credits if we are unable to verify them after reviewing your reports or auditing your records.

(d) Banked credits retain the designation of the averaging set in which they were generated.

#### § 1037.720 Trading.

(a) Trading is the exchange of emission credits between manufacturers, or the transfer of credits to another party to retire them. You may use traded emission credits for averaging, banking, or further trading transactions. Traded emission credits remain subject to the averaging-set restrictions based on the averaging set in which they were generated.

(b) You may trade actual emission credits as described in this subpart. You may also trade reserved emission credits, but we may revoke these emission credits based on our review of your records or reports or those of the company with which you traded emission credits. You may trade banked credits within an averaging set to any certifying manufacturer.

(c) If a negative emission credit balance results from a transaction, both the buyer and seller are liable, except in cases we deem to involve fraud. See § 1037.255(e) for cases involving fraud. We may void the certificates of all vehicle families participating in a trade that results in a manufacturer having a negative balance of emission credits. See § 1037.745.

#### § 1037.725 What must I include in my application for certification?

(a) You must declare in your application for certification your intent to use the provisions of this subpart for each vehicle family that will be certified using the ABT program. You must also declare the FELs you select for the vehicle family or subfamily for each pollutant for which you are using the ABT program. Your FELs must comply with the specifications of subpart B of this part, including the FEL caps. FELs must be expressed to the same number of decimal places as the applicable standards.

(b) Include the following in your application for certification:

(1) A statement that, to the best of your belief, you will not have a negative balance of emission credits for any averaging set when all emission credits are calculated at the end of the year; or a statement that you will have a negative balance of emission credits for one or more averaging sets but that it is allowed under § 1037.745.

(2) Calculations of projected emission credits (positive or negative) based on projected U.S.-directed production volumes. We may require you to include similar calculations from your other vehicle families to project your net credit balances for the model year. If you project negative emission credits for a family or subfamily, state the source of positive emission credits you expect to use to offset the negative emission credits.

#### § 1037.730 ABT reports.

(a) If any of your vehicle families are certified using the ABT provisions of this subpart, you must send an end-of-year report within 90 days after the end of the model year and a final report within 270 days after the end of the model year.

(b) Your end-of-year and final reports must include the following information for each vehicle family participating in the ABT program:

(1) Vehicle-family and subfamily designations.

(2) The regulatory subcategory and emission standards that would otherwise apply to the vehicle family.

(3) The FEL for each pollutant. If you change the FEL after the start of production, identify the date that you started using the new FEL and/or give the vehicle identification number for the first vehicle covered by the new FEL. In this case, identify each applicable FEL and calculate the positive or negative emission credits as specified in § 1037.225.

(4) The projected and actual U.S.-directed production volumes for the

model year. If you changed an FEL during the model year, identify the actual production volume associated with each FEL.

(5) Useful life.

(6) Calculated positive or negative emission credits for the whole vehicle family. Identify any emission credits that you traded, as described in paragraph (d)(1) of this section.

(7) If you have a negative credit balance for the averaging set in the given model year, specify whether the vehicle family (or certain subfamilies with the vehicle family) have a credit deficit for the year. Consider for example, a manufacturer with three vehicle families ("A", "B", and "C") in a given averaging set. If family A generates enough credits to offset the negative credits of family B but not enough to also offset the negative credits of family C (and the manufacturer has no banked credits in the averaging set), the manufacturer may designate families A and B as having no deficit for the model year, provided it designates family C as having a deficit for the model year.

(c) Your end-of-year and final reports must include the following additional information:

(1) Show that your net balance of emission credits from all your participating vehicle families in each averaging set in the applicable model year is not negative, except as allowed under § 1037.745.

(2) State whether you will reserve any emission credits for banking.

(3) State that the report's contents are accurate.

(d) If you trade emission credits, you must send us a report within 90 days after the transaction, as follows:

(1) As the seller, you must include the following information in your report:

(i) The corporate names of the buyer and any brokers.

(ii) A copy of any contracts related to the trade.

(iii) The vehicle families that generated emission credits for the trade, including the number of emission credits from each family.

(2) As the buyer, you must include the following information in your report:

(i) The corporate names of the seller and any brokers.

(ii) A copy of any contracts related to the trade.

(iii) How you intend to use the emission credits, including the number of emission credits you intend to apply to each vehicle family (if known).

(e) Send your reports electronically to the Designated Compliance Officer using an approved information format. If you want to use a different format,

send us a written request with justification for a waiver.

(f) Correct errors in your end-of-year report or final report as follows:

(1) You may correct any errors in your end-of-year report when you prepare the final report, as long as you send us the final report by the time it is due.

(2) If you or we determine within 270 days after the end of the model year that errors mistakenly decreased your balance of emission credits, you may correct the errors and recalculate the balance of emission credits. You may not make these corrections for errors that are determined more than 270 days after the end of the model year. If you report a negative balance of emission credits, we may disallow corrections under this paragraph (f)(2).

(3) If you or we determine anytime that errors mistakenly increased your balance of emission credits, you must correct the errors and recalculate the balance of emission credits.

#### § 1037.735 Recordkeeping.

(a) You must organize and maintain your records as described in this section. We may review your records at any time.

(b) Keep the records required by this section for at least eight years after the due date for the end-of-year report. You may not use emission credits for any vehicles if you do not keep all the records required under this section. You must therefore keep these records to continue to bank valid credits. Store these records in any format and on any media, as long as you can promptly send us organized, written records in English if we ask for them. You must keep these records readily available. We may review them at any time.

(c) Keep a copy of the reports we require in §§ 1037.725 and 1037.730.

(d) Keep records of the vehicle identification number for each vehicle you produce that generates or uses emission credits under the ABT program. You may identify these numbers as a range. If you change the FEL after the start of production, identify the date you started using each FEL and the range of vehicle identification numbers associated with each FEL. You must also identify the purchaser and destination for each vehicle you produce to the extent this information is available.

(e) We may require you to keep additional records or to send us relevant information not required by this section in accordance with the Clean Air Act.

#### § 1037.740 Restrictions for using emission credits.

The following restrictions apply for using emission credits:

(a) *Averaging sets.* Except as specified in paragraph (b) of this section, emission credits may be exchanged only within an averaging set. There are three principal averaging sets for vehicles subject to this subpart.

(1) Vehicles at or below 19,500 pounds GVWR that are subject to the standards of § 1037.105.

(2) Vehicles above 19,500 pounds GVWR but at or below 33,000 pounds GVWR.

(3) Vehicles over 33,000 pounds GVWR.

(4) Note that other separate averaging sets also apply for emission credits not related to this subpart. For example, under § 1037.104, an additional averaging set comprises all vehicles subject to the standards of that section. Separate averaging sets also apply for engines under 40 CFR part 1036, including engines used in vehicles subject to this subpart.

(b) *Credits from hybrid vehicles and other advanced technologies.* The averaging set restrictions of paragraph (a) of this section do not apply for credits generated under § 1037.104(d)(7), § 1037.615 or 40 CFR 1036.615 from hybrid vehicles with regenerative braking, or from other advanced technologies.

(1) The maximum amount of credits you may bring into the following service class groups is 60,000 Mg per model year:

(i) Spark-ignition engines, light heavy-duty compression-ignition engines, and light heavy-duty vehicles. This group comprises the averaging set listed in paragraphs (a)(1) of this section and the averaging set listed in 40 CFR 1036.740(a)(1) and (2).

(ii) Medium heavy-duty compression-ignition engines and medium heavy-duty vehicles. This group comprises the averaging sets listed in paragraph (a)(2) of this section and 40 CFR 1036.740(a)(3).

(iii) Heavy heavy-duty compression-ignition engines and heavy heavy-duty vehicles. This group comprises the averaging sets listed in paragraph (a)(3) of this section and 40 CFR 1036.740(a)(4).

(2) The limit specified in paragraph (b)(1) of this section does not limit the amount of advanced technology credits that can be used within a service class group if they were generated in that same service class group.

(c) *Credit life.* Credits expire after five years.

(d) *Other restrictions.* Other sections of this part specify additional restrictions for using emission credits under certain special provisions.

#### § 1037.745 End-of-year CO<sub>2</sub> credit deficits.

Except as allowed by this section, we may void the certificate of any vehicle family certified to an FEL above the applicable standard for which you do not have sufficient credits by the deadline for submitting the final report.

(a) Your certificate for a vehicle family for which you do not have sufficient CO<sub>2</sub> credits will not be void if you remedy the deficit with surplus credits within three model years. For example, if you have a credit deficit of 500 Mg for a vehicle family at the end of model year 2015, you must generate (or otherwise obtain) a surplus of at least 500 Mg in that same averaging set by the end of model year 2018.

(b) You may apply only surplus credits to your deficit. You may not apply credits to a deficit from an earlier model year if they were generated in a model year for which any of your vehicle families for that averaging set had an end-of-year credit deficit.

(c) If you do not remedy the deficit with surplus credits within three model years, we may void your certificate for that vehicle family. Note that voiding a certificate applies *ab initio*. Where the net deficit is less than the total amount of negative credits originally generated by the family, we will void the certificate only with respect to the number of vehicles needed to reach the amount of the net deficit. For example, if the original vehicle family generated 500 Mg of negative credits, and the manufacturer's net deficit after three years was 250 Mg, we would void the certificate with respect to half of the vehicles in the family.

#### § 1037.750 What can happen if I do not comply with the provisions of this subpart?

(a) For each vehicle family participating in the ABT program, the certificate of conformity is conditioned upon full compliance with the provisions of this subpart during and after the model year. You are responsible to establish to our satisfaction that you fully comply with applicable requirements. We may void the certificate of conformity for a vehicle family if you fail to comply with any provisions of this subpart.

(b) You may certify your vehicle family or subfamily to an FEL above an applicable standard based on a projection that you will have enough emission credits to offset the deficit for the vehicle family. See § 1037.745 for provisions specifying what happens if you cannot show in your final report that you have enough actual emission credits to offset a deficit for any pollutant in a vehicle family.



(c) We may void the certificate of conformity for a vehicle family if you fail to keep records, send reports, or give us information we request. Note that failing to keep records, send reports, or give us information we request is also a violation of 42 U.S.C. 7522(a)(2).

(d) You may ask for a hearing if we void your certificate under this section (see § 1037.820).

#### **§ 1037.755 Information provided to the Department of Transportation.**

After receipt of each manufacturer's final report as specified in § 1037.730 and completion of any verification testing required to validate the manufacturer's submitted final data, we will issue a report to the Department of Transportation with CO<sub>2</sub> emission information and will verify the accuracy of each manufacturer's equivalent fuel consumption data required by NHTSA under 49 CFR 535.8. We will send a report to DOT for each vehicle manufacturer based on each regulatory category and subcategory, including sufficient information for NHTSA to determine fuel consumption and associated credit values. See 49 CFR 535.8 to determine if NHTSA deems submission of this information to EPA to also be a submission to NHTSA.

#### **Subpart I—Definitions and Other Reference Information**

##### **§ 1037.801 Definitions.**

The following definitions apply to this part. The definitions apply to all subparts unless we note otherwise. All undefined terms have the meaning the Act gives to them. The definitions follow:

*A to B testing* means testing performed in pairs to allow comparison of vehicle A to vehicle B.

*Act* means the Clean Air Act, as amended, 42 U.S.C. 7401–7671q.

*Adjustable parameter* means any device, system, or element of design that someone can adjust (including those which are difficult to access) and that, if adjusted, may affect measured or modeled emissions (as applicable). You may ask us to exclude a parameter that is difficult to access if it cannot be adjusted to affect emissions without significantly degrading vehicle performance, or if you otherwise show us that it will not be adjusted in a way that affects emissions during in-use operation.

*Adjusted Loaded Vehicle Weight* means the numerical average of vehicle curb weight and GVWR.

*Advanced technology* means vehicle technology certified under § 1037.615, § 1037.104(d)(7), or 40 CFR 1036.615.

*Aftertreatment* means relating to a catalytic converter, particulate filter, or any other system, component, or technology mounted downstream of the exhaust valve (or exhaust port) whose design function is to decrease emissions in the vehicle exhaust before it is exhausted to the environment. Exhaust-gas recirculation (EGR) and turbochargers are not aftertreatment.

*Alcohol-fueled vehicle* means a vehicle that is designed to run using an alcohol fuel. For purposes of this definition, alcohol fuels do not include fuels with a nominal alcohol content below 25 percent by volume.

*Auxiliary emission control device* means any element of design that senses temperature, motive speed, engine RPM, transmission gear, or any other parameter for the purpose of activating, modulating, delaying, or deactivating the operation of any part of the emission control system.

*Averaging set* has the meaning given in § 1037.701.

*Cab-complete vehicle* means a vehicle that is first sold as an incomplete vehicle that substantially includes its cab. Vehicles known commercially as chassis-cabs, cab-chassis, box-deletes, bed-deletes, cut-away vans are considered cab-complete vehicles. For purposes of this definition, a cab includes a steering column and passenger compartment. Note a vehicle lacking some components of the cab is a cab-complete vehicle if it substantially includes the cab.

*Calibration* means the set of specifications and tolerances specific to a particular design, version, or application of a component or assembly capable of functionally describing its operation over its working range.

*Carbon-related exhaust emissions (CREE)* has the meaning given in 40 CFR 600.002. Note that CREE represents the combined mass of carbon emitted as HC, CO, and CO<sub>2</sub>, expressed as having a molecular weight equal to that of CO<sub>2</sub>.

*Carryover* means relating to certification based on emission data generated from an earlier model year.

*Certification* means relating to the process of obtaining a certificate of conformity for a vehicle family that complies with the emission standards and requirements in this part.

*Certified emission level* means the highest deteriorated emission level in a vehicle family for a given pollutant from either transient or steady-state testing.

*Class* means relating to GVWR classes, as follows:

(1) *Class 2b* means heavy-duty motor vehicles at or below 10,000 pounds GVWR.

(2) *Class 3* means heavy-duty motor vehicles above 10,000 pounds GVWR but at or below 14,000 pounds GVWR.

(3) *Class 4* means heavy-duty motor vehicles above 14,000 pounds GVWR but at or below 16,000 pounds GVWR.

(4) *Class 5* means heavy-duty motor vehicles above 16,000 pounds GVWR but at or below 19,500 pounds GVWR.

(5) *Class 6* means heavy-duty motor vehicles above 19,500 pounds GVWR but at or below 26,000 pounds GVWR.

(6) *Class 7* means heavy-duty motor vehicles above 26,000 pounds GVWR but at or below 33,000 pounds GVWR.

(7) *Class 8* means heavy-duty motor vehicles above 33,000 pounds GVWR.

*Complete vehicle* has the meaning given in the definition of *vehicle* in this section.

*Compression-ignition* means relating to a type of reciprocating, internal-combustion engine that is not a spark-ignition engine.

*Curb weight* has the meaning given in 40 CFR 86.1803, consistent with the provisions of § 1037.140.

*Date of manufacture* means the date on which the certifying vehicle manufacturer completes its manufacturing operations, except as follows:

(1) Where the certificate holder is an engine manufacturer that does not manufacture the chassis, the date of manufacture of the vehicle is based on the date assembly of the vehicle is completed.

(2) We may approve an alternate date of manufacture based on the date on which the certifying (or primary) manufacturer completes assembly at the place of main assembly, consistent with the provisions of § 1037.601 and 49 CFR 567.4.

*Day cab* means a type of tractor cab that is not a sleeper cab.

*Designated Compliance Officer* means the Manager, Heavy-Duty and Nonroad Engine Group (6405-J), U.S. Environmental Protection Agency, 1200 Pennsylvania Ave., NW., Washington, DC 20460.

*Designated Enforcement Officer* means the Director, Air Enforcement Division (2242A), U.S. Environmental Protection Agency, 1200 Pennsylvania Ave., NW., Washington, DC 20460.

*Deteriorated emission level* means the emission level that results from applying the appropriate deterioration factor to the official emission result of the emission-data vehicle. Note that where no deterioration factor applies, references in this part to the *deteriorated emission level* mean the official emission result.

*Deterioration factor* means the relationship between emissions at the



end of useful life and emissions at the low-hour test point, expressed in one of the following ways:

(1) For multiplicative deterioration factors, the ratio of emissions at the end of useful life to emissions at the low-hour test point.

(2) For additive deterioration factors, the difference between emissions at the end of useful life and emissions at the low-hour test point.

*Driver model* means an automated controller that simulates a person driving a vehicle.

*Electric vehicle* means a vehicle that does not include an engine, and is powered solely by an external source of electricity and/or solar power. Note that this does not include electric hybrid or fuel-cell vehicles that use a chemical fuel such as gasoline, diesel fuel, or hydrogen. Electric vehicles may also be referred to as all-electric vehicles to distinguish them from hybrid vehicles.

*Emission control system* means any device, system, or element of design that controls or reduces the emissions of regulated pollutants from a vehicle.

*Emission-data vehicle* means a vehicle that is tested for certification. This includes vehicle tested to establish deterioration factors.

*Emission-related maintenance* means maintenance that substantially affects emissions or is likely to substantially affect emission deterioration.

*Excluded* means relating to vehicles that are not subject to some or all of the requirements of this part as follows:

(1) A vehicle that has been determined not to be a motor vehicle is excluded from this part.

(2) Certain vehicles are excluded from the requirements of this part under § 1037.5.

(3) Specific regulatory provisions of this part may exclude a vehicle generally subject to this part from one or more specific standards or requirements of this part.

*Exempted* has the meaning given in 40 CFR 1068.30.

*Family emission limit (FEL)* means an emission level declared by the manufacturer to serve in place of an otherwise applicable emission standard under the ABT program in subpart H of this part. The family emission limit must be expressed to the same number of decimal places as the emission standard it replaces. Note that an FEL may apply as a "subfamily" emission limit.

*Fuel system* means all components involved in transporting, metering, and mixing the fuel from the fuel tank to the combustion chamber(s), including the fuel tank, fuel pump, fuel filters, fuel lines, carburetor or fuel-injection

components, and all fuel-system vents. It also includes components for controlling evaporative emissions, such as fuel caps, purge valves, and carbon canisters.

*Fuel type* means a general category of fuels such as diesel fuel or natural gas. There can be multiple grades within a single fuel type, such as high-sulfur or low-sulfur diesel fuel.

*Good engineering judgment* has the meaning given in 40 CFR 1068.30. See 40 CFR 1068.5 for the administrative process we use to evaluate good engineering judgment.

*Gross combination weight rating (GCWR)* means the value specified by the vehicle manufacturer as the maximum weight of a loaded vehicle and trailer, consistent with good engineering judgment. For example, compliance with SAE J2807 is generally considered to be consistent with good engineering judgment, especially for Class 3 and smaller vehicles.

*Gross vehicle weight rating (GVWR)* means the value specified by the vehicle manufacturer as the maximum design loaded weight of a single vehicle, consistent with good engineering judgment.

*Heavy-duty engine* means any engine used for (or for which the engine manufacturer could reasonably expect to be used for) motive power in a heavy-duty vehicle.

*Heavy-duty vehicle* means any motor vehicle above 8,500 pounds GVWR or that has a vehicle curb weight above 6,000 pounds or that has a basic vehicle frontal area greater than 45 square feet.

*Hybrid engine or hybrid powertrain* means an engine or powertrain that includes energy storage features other than a conventional battery system or conventional flywheel. Supplemental electrical batteries and hydraulic accumulators are examples of hybrid energy storage systems. Note that certain provisions in this part treat hybrid engines and powertrains intended for vehicles that include regenerative braking different than those intended for vehicles that do not include regenerative braking.

*Hybrid vehicle* means a vehicle that includes energy storage features (other than a conventional battery system or conventional flywheel) in addition to an internal combustion engine or other engine using consumable chemical fuel. Supplemental electrical batteries and hydraulic accumulators are examples of hybrid energy storage systems. Note that certain provisions in this part treat hybrid vehicles that include regenerative braking different than those that do not include regenerative braking.

*Hydrocarbon (HC)* means the hydrocarbon group on which the emission standards are based for each fuel type. For alcohol-fueled vehicles, HC means nonmethane hydrocarbon equivalent (NMHCE) for exhaust emissions and total hydrocarbon equivalent (THCE) for evaporative emissions. For all other vehicles, HC means nonmethane hydrocarbon (NMHC) for exhaust emissions and total hydrocarbon (THC) for evaporative emissions.

*Identification number* means a unique specification (for example, a model number/serial number combination) that allows someone to distinguish a particular vehicle from other similar vehicles.

*Incomplete vehicle* has the meaning given in the definition of *vehicle* in this section.

*Innovative technology* means technology certified under § 1037.610.

*Light-duty truck* means any motor vehicle rated at or below 8,500 pounds GVWR with a curb weight at or below 6,000 pounds and basic vehicle frontal area at or below 45 square feet, which is:

(1) Designed primarily for purposes of transportation of property or is a derivation of such a vehicle; or

(2) Designed primarily for transportation of persons and has a capacity of more than 12 persons; or

(3) Available with special features enabling off-street or off-highway operation and use.

*Light-duty vehicle* means a passenger car or passenger car derivative capable of seating 12 or fewer passengers.

*Low-mileage* means relating to a vehicle with stabilized emissions and represents the undeteriorated emission level. This would generally involve approximately 4000 miles of operation.

*Low rolling resistance tire* means a tire on a vocational vehicle with a TRRL at or below of 7.7 kg/metric ton, a steer tire on a tractor with a TRRL at or below 7.7 kg/metric ton, or a drive tire on a tractor with a TRRL at or below 8.1 kg/metric ton.

*Manufacture* means the physical and engineering process of designing, constructing, and/or assembling a vehicle.

*Manufacturer* has the meaning given in section 216(1) of the Act. In general, this term includes any person who manufactures a vehicle or vehicle for sale in the United States or otherwise introduces a new motor vehicle into commerce in the United States. This includes importers who import vehicles or vehicles for resale.

*Medium-duty passenger vehicle (MDPV)* has the meaning given in 40 CFR 86.1803.

*Model year* means the manufacturer's annual new model production period, except as restricted under this definition and 40 CFR part 85, subpart X. It must include January 1 of the calendar year for which the model year is named, may not begin before January 2 of the previous calendar year, and it must end by December 31 of the named calendar year.

(1) The manufacturer who holds the certificate of conformity for the vehicle must assign the model year based on the date when its manufacturing operations are completed relative to its annual model year period. In unusual circumstances where completion of your assembly is delayed, we may allow you to assign a model year one year earlier, provided it does not affect which regulatory requirements will apply.

(2) Unless a vehicle is being shipped to a secondary manufacturer that will hold the certificate of conformity, the model year must be assigned prior to introduction of the vehicle into U.S. commerce. The certifying manufacturer must redesignate the model year if it does not complete its manufacturing operations within the originally identified model year. A vehicle introduced into U.S. commerce without a model year is deemed to have a model year equal to the calendar year of its introduction into U.S. commerce unless the certifying manufacturer assigns a later date.

*Motor vehicle* has the meaning given in 40 CFR 85.1703.

*New motor vehicle* means a motor vehicle meeting the criteria of either paragraph (1) or (2) of this definition. New motor vehicles may be complete or incomplete.

(1) A motor vehicle for which the ultimate purchaser has never received the equitable or legal title is a *new motor vehicle*. This kind of vehicle might commonly be thought of as "brand new" although a *new motor vehicle* may include previously used parts. Under this definition, the vehicle is new from the time it is produced until the ultimate purchaser receives the title or places it into service, whichever comes first.

(2) An imported heavy-duty motor vehicle originally produced after the 1969 model year is a *new motor vehicle*.

*Noncompliant vehicle* means a vehicle that was originally covered by a certificate of conformity, but is not in the certified configuration or otherwise does not comply with the conditions of the certificate.

*Nonconforming vehicle* means a vehicle not covered by a certificate of conformity that would otherwise be subject to emission standards.

*Nonmethane hydrocarbons (NMHC)* means the sum of all hydrocarbon species except methane, as measured according to 40 CFR part 1065.

*Official emission result* means the measured emission rate for an emission-data vehicle on a given duty cycle before the application of any required deterioration factor, but after the applicability of regeneration adjustment factors.

*Owners manual* means a document or collection of documents prepared by the vehicle manufacturer for the owners or operators to describe appropriate vehicle maintenance, applicable warranties, and any other information related to operating or keeping the vehicle. The owners manual is typically provided to the ultimate purchaser at the time of sale.

*Oxides of nitrogen* has the meaning given in 40 CFR 1065.1001.

*Particulate trap* means a filtering device that is designed to physically trap all particulate matter above a certain size.

*Percent* has the meaning given in 40 CFR 1065.1001. Note that this means percentages identified in this part are assumed to be infinitely precise without regard to the number of significant figures. For example, one percent of 1,493 is 14.93.

*Placed into service* means put into initial use for its intended purpose.

*Power take-off (PTO)* means a secondary engine shaft (or equivalent) that provides substantial auxiliary power for purposes unrelated to vehicle propulsion or normal vehicle accessories such as air conditioning, power steering, and basic electrical accessories. A typical PTO uses a secondary shaft on the engine to transmit power to a hydraulic pump that powers auxiliary equipment, such as a boom on a bucket truck. You may ask us to consider other equivalent auxiliary power configurations (such as those with hybrid vehicles) as power take-off systems.

*Rechargeable Energy Storage System (RESS)* means the component(s) of a hybrid engine or vehicle that store recovered energy for later use, such as the battery system in an electric hybrid vehicle.

*Regulatory sub-category* means one of following groups:

(1) Spark-ignition vehicles subject to the standards of § 1037.104. Note that this category includes most gasoline-fueled heavy-duty pickup trucks and vans.

(2) All other vehicles subject to the standards of § 1037.104. Note that this category includes most diesel-fueled heavy-duty pickup trucks and van.

(3) Vocational vehicles at or below 19,500 pounds GVWR.

(4) Vocational vehicles at or above 19,500 pounds GVWR but below 33,000 pounds GVWR.

(5) Vocational vehicles over 33,000 pounds GVWR.

(6) Low-roof tractors at or above 26,000 pounds GVWR but below 33,000 pounds GVWR.

(7) Mid-roof tractors at or above 26,000 pounds GVWR but below 33,000 pounds GVWR.

(8) High-roof tractors at or above 26,000 pounds GVWR but below 33,000 pounds GVWR.

(9) Low-roof day cab tractors at or above 33,000 pounds GVWR.

(10) Low-roof sleeper cab tractors at or above 33,000 pounds GVWR.

(11) Mid-roof day cab tractors at or above 33,000 pounds GVWR.

(12) Mid-roof sleeper cab tractors at or above 33,000 pounds GVWR.

(13) High-roof day cab tractors at or above 33,000 pounds GVWR.

(14) High-roof sleeper cab tractors at or above 33,000 pounds GVWR.

*Relating to* as used in this section means relating to something in a specific, direct manner. This expression is used in this section only to define terms as adjectives and not to broaden the meaning of the terms.

*Revoke* has the meaning given in 40 CFR 1068.30.

*Roof height* means the maximum height of a vehicle (rounded to the nearest inch), excluding narrow accessories such as exhaust pipes and antennas, but including any wide accessories such as roof fairings. Measure roof height of the vehicle configured to have its maximum height that will occur during actual use, with properly inflated tires and no driver, passengers, or cargo onboard. *Roof height* may also refer to the following categories:

(1) Low-roof means relating to a vehicle with a roof height of 120 inches or less.

(2) Mid-roof means relating to a vehicle with a roof height of 121 to 147 inches.

(3) High-roof means relating to a vehicle with a roof height of 148 inches or more.

*Round* has the meaning given in 40 CFR 1065.1001.

*Scheduled maintenance* means adjusting, repairing, removing, disassembling, cleaning, or replacing components or systems periodically to keep a part or system from failing,

malfunctioning, or wearing prematurely. It also may mean actions you expect are necessary to correct an overt indication of failure or malfunction for which periodic maintenance is not appropriate.

*Sleeper cab* means a type of tractor cab that has a compartment behind the driver's seat intended to be used by the driver for sleeping. This includes cabs accessible from the driver's compartment and those accessible from outside the vehicle.

*Small manufacturer* means a manufacturer meeting the criteria specified in 13 CFR 121.201. For manufacturers owned by a parent company, the employee and revenue limits apply to the total number employees and total revenue of the parent company and all its subsidiaries.

*Spark-ignition* means relating to a gasoline-fueled engine or any other type of engine with a spark plug (or other sparking device) and with operating characteristics significantly similar to the theoretical Otto combustion cycle. Spark-ignition engines usually use a throttle to regulate intake air flow to control power during normal operation.

*Standard payload* means the vehicle payload assumed for each class in tons for modeling and calculating emission credits. There are three standard payloads:

- (1) 2.85 tons for light heavy-duty vehicles.
- (2) 5.6 tons for medium heavy-duty vehicles.
- (3) 7.5 tons for heavy heavy-duty vehicles.

*Standard trailer* has the meaning given in § 1037.501.

*Suspect* has the meaning given in 40 CFR 1068.30.

*Test sample* means the collection of vehicles selected from the population of a vehicle family for emission testing. This may include testing for certification, production-line testing, or in-use testing.

*Test vehicle* means a vehicle in a test sample.

*Test weight* means the vehicle weight used or represented during testing.

*Tire rolling resistance level (TRRL)* means a value with units of kg/metric ton that represents that rolling resistance of a tire configuration. TRRLs are used as inputs to the GEM model under § 1037.520. Note that a manufacturer may assign a value higher than the measured rolling resistance of a tire configuration.

*Total hydrocarbon* has the meaning given in 40 CFR 1065.1001. This generally means the combined mass of organic compounds measured by the specified procedure for measuring total

hydrocarbon, expressed as a hydrocarbon with an atomic hydrogen-to-carbon ratio of 1.85:1.

*Total hydrocarbon equivalent* has the meaning given in 40 CFR 1065.1001. This generally means the sum of the carbon mass contributions of non-oxygenated hydrocarbons, alcohols and aldehydes, or other organic compounds that are measured separately as contained in a gas sample, expressed as exhaust hydrocarbon from petroleum-fueled vehicles. The atomic hydrogen-to-carbon ratio of the equivalent hydrocarbon is 1.85:1.

*Tractor* has the meaning given for "truck tractor" in 49 CFR 571.3. This includes most heavy-duty vehicles specifically designed for the primary purpose of pulling trailers, but does not include vehicles designed to carry other loads. For purposes of this definition "other loads" would not include loads carried in the cab, sleeper compartment, or toolboxes. Examples of vehicles that are similar to tractors but that are not tractors under this part include dromedary tractors, automobile haulers, straight trucks with trailers hitches, and tow trucks. Note that the provisions of this part that apply for tractors do not apply for tractors that are classified as vocational tractors under § 1037.630.

*Ultimate purchaser* means, with respect to any new vehicle, the first person who in good faith purchases such new vehicle for purposes other than resale.

*United States* has the meaning given in 40 CFR 1068.30.

*Upcoming model year* means for a vehicle family the model year after the one currently in production.

*U.S.-directed production volume* means the number of vehicle units, subject to the requirements of this part, produced by a manufacturer for which the manufacturer has a reasonable assurance that sale was or will be made to ultimate purchasers in the United States. This does not include vehicles certified to state emission standards that are different than the emission standards in this part.

*Useful life* means the period during which a vehicle is required to comply with all applicable emission standards.

*Vehicle* means equipment intended for use on highways that meets the criteria of paragraph (1)(i) or (1)(ii) of this definition, as follows:

(1) The following equipment are vehicles:

(i) A piece of equipment that is intended for self-propelled use on highways becomes a vehicle when it includes at least an engine, a transmission, and a frame. (Note: For purposes of this definition, any

electrical, mechanical, and/or hydraulic devices attached to engines for the purpose of powering wheels are considered to be transmissions.)

(ii) A piece of equipment that is intended for self-propelled use on highways becomes a vehicle when it includes a passenger compartment attached to a frame with axles.

(2) Vehicles may be complete or incomplete vehicles as follows:

(i) A *complete vehicle* is a functioning vehicle that has the primary load carrying device or container (or equivalent equipment) attached. Examples of equivalent equipment would include fifth wheel trailer hitches, firefighting equipment, and utility booms.

(ii) An *incomplete vehicle* is a vehicle that is not a complete vehicle. Incomplete vehicles may also be cab-complete vehicles. This may include vehicles sold to secondary vehicle manufacturers.

(iii) The primary use of the terms "complete vehicle" and "incomplete vehicle" are to distinguish whether a vehicle is complete when it is first sold as a vehicle.

(iv) You may ask us to allow you to certify a vehicle as incomplete if you manufacture the engines and sell the unassembled chassis components, as long as you do not produce and sell the body components necessary to complete the vehicle.

(3) Equipment such as trailers that are not self-propelled are not "vehicles" under this part 1037.

*Vehicle configuration* means a unique combination of vehicle hardware and calibration (related to measured or modeled emissions) within a vehicle family. Vehicles with hardware or software differences, but that have no hardware or software differences related to measured or modeled emissions may be included in the same vehicle configuration. Note that vehicles with hardware or software differences related to measured or modeled emissions are considered to be different configurations even if they have the same GEM inputs and FEL. Vehicles within a vehicle configuration differ only with respect to normal production variability or factors unrelated to measured or modeled emissions.

*Vehicle family* has the meaning given in § 1037.230.

*Vehicle service class* means a vehicle's weight class as specified in this definition. Note that, while *vehicle service class* is similar to primary intended service class for engines, they are not necessarily the same. For example, a medium heavy-duty vehicle may include a light heavy-duty engine.

Note also that while spark-ignition engines do not have a primary intended service class, vehicles using spark-ignition engines have a vehicle service class.

(1) Light heavy-duty vehicles are those vehicles with GVWR below 19,500 pounds.

Vehicles in this class include heavy-duty pickup trucks and vans, motor homes and other recreational vehicles, and some straight trucks with a single rear axle. Typical applications would include personal transportation, light-load commercial delivery, passenger service, agriculture, and construction.

(2) Medium heavy-duty vehicles are those vehicles with GVWR from 19,500 to 33,000 pounds. Vehicles in this class include school buses, straight trucks with a single rear axle, city tractors, and a variety of special purpose vehicles such as small dump trucks, and refuse trucks. Typical applications would include commercial short haul and intra-city delivery and pickup.

(3) Heavy heavy-duty vehicles are those vehicles with GVWR above 33,000 pounds. Vehicles in this class include tractors, urban buses, and other heavy trucks.

*Vehicle subfamily* or *subfamily* means a subset of a vehicle family including vehicles subject to the same FEL(s).

*Vocational tractor* means a vehicle classified as a vocational tractor under § 1037.630.

*Vocational vehicle* means relating to a vehicle subject to the standards of § 1037.105 (including vocational tractors).

*Void* has the meaning given in 40 CFR 1068.30.

*Volatile liquid fuel* means any fuel other than diesel or biodiesel that is a liquid at atmospheric pressure and has a Reid Vapor Pressure higher than 2.0 pounds per square inch.

*We (us, our)* means the Administrator of the Environmental Protection Agency and any authorized representatives.

#### § 1037.805 Symbols, acronyms, and abbreviations.

The following symbols, acronyms, and abbreviations apply to this part:

ABT Averaging, banking, and trading.  
 AECD auxiliary emission control device.  
 C<sub>D</sub> drag coefficient.  
 C<sub>D</sub>A drag area.  
 CFD computational fluid dynamics.  
 CFR Code of Federal Regulations.  
 CH<sub>4</sub> methane.  
 CO carbon monoxide.  
 CO<sub>2</sub> carbon dioxide.  
 CREE carbon-related exhaust emissions.  
 DOT Department of Transportation.  
 EPA Environmental Protection Agency.  
 ETW equivalent test weight.  
 FEL Family Emission Limit.

g grams.  
 GAWR gross axle weight rating.  
 GCWR gross combination weight rating.  
 GVWR gross vehicle weight rating.  
 GWP global-warming potential.  
 HC hydrocarbon.  
 ISO International Organization for Standardization.  
 kg kilograms.  
 m meter.  
 mm millimeter  
 mph miles per hour.  
 N<sub>2</sub>O nitrous oxide.  
 NARA National Archives and Records Administration.  
 NHTSA National Highway Transportation Safety Administration.  
 NO<sub>x</sub> oxides of nitrogen (NO and NO<sub>2</sub>).  
 PM particulate matter.  
 PTO power take-off.  
 RESS rechargeable energy storage system.  
 RPM revolutions per minute.  
 SAE Society of Automotive Engineers.  
 SKU Stock-keeping unit.  
 TRRL Tire rolling resistance level.  
 U.S.C. United States Code.  
 VSL vehicle speed limiter.  
 WF work factor.

#### § 1037.810 Incorporation by reference.

(a) Certain material is incorporated by reference into this part with the approval of the Director of the Federal Register under 5 U.S.C. 552(a) and 1 CFR part 51. To enforce any edition other than that specified in this section, the Environmental Protection Agency must publish a notice of the change in the **Federal Register** and the material must be available to the public. All approved material is available for inspection at U.S. EPA, Air and Radiation Docket and Information Center, 1301 Constitution Ave., NW., Room B102, EPA West Building, Washington, DC 20460, (202) 202-1744, and is available from the sources listed below. It is also available for inspection at the National Archives and Records Administration (NARA). For information on the availability of this material at NARA, call 202-741-6030, or go to [http://www.archives.gov/federal\\_register/code\\_of\\_federal\\_regulations/ibr\\_locations.html](http://www.archives.gov/federal_register/code_of_federal_regulations/ibr_locations.html).

(b) International Organization for Standardization, Case Postale 56, CH-1211 Geneva 20, Switzerland, (41) 22749 0111, <http://www.iso.org>, or [central@iso.org](mailto:central@iso.org).

(1) ISO 28580:2009(E) "Passenger car, truck and bus tyres—Methods of measuring rolling resistance—Single point test and correlation of measurement results", First Edition, July 1, 2009; IBR approved for § 1037.520(c).

(2) [Reserved]

(c) U.S. EPA, Office of Air and Radiation, 2565 Plymouth Road, Ann Arbor, MI 48105, <http://www.epa.gov>:

(1) GEM simulation tool, Version 2.0, August 2011; IBR approved for § 1037.520. The computer code for this model is available as noted in paragraph (a) of this section. A working version of this software is also available for download at <http://www.epa.gov/otaq/climate/gem.htm>.

(2) [Reserved]

(d) Society of Automotive Engineers, 400 Commonwealth Dr., Warrendale, PA 15096-0001, (877) 606-7323 (U.S. and Canada) or (724) 776-4970 (outside the U.S. and Canada), <http://www.sae.org>.

(1) SAE J1252, SAE Wind Tunnel Test Procedure for Trucks and Buses, Revised July 1981, IBR approved for § 1037.521(d), (e), and (f).

(2) SAE J1594, Vehicle Aerodynamics Terminology, Revised July 2010, IBR approved for § 1037.521(d).

(3) SAE J2071, Aerodynamic Testing of Road Vehicles—Open Throat Wind Tunnel Adjustment, Revised June 1994, IBR approved for § 1037.521(d).

#### § 1037.815 Confidential information.

The provisions of 40 CFR 1068.10 apply for information you consider confidential.

#### § 1037.820 Requesting a hearing.

(a) You may request a hearing under certain circumstances, as described elsewhere in this part. To do this, you must file a written request, including a description of your objection and any supporting data, within 30 days after we make a decision.

(b) For a hearing you request under the provisions of this part, we will approve your request if we find that your request raises a substantial factual issue.

(c) If we agree to hold a hearing, we will use the procedures specified in 40 CFR part 1068, subpart G.

#### § 1037.825 Reporting and recordkeeping requirements.

(a) This part includes various requirements to submit and record data or other information. Unless we specify otherwise, store required records in any format and on any media and keep them readily available for eight years after you send an associated application for certification, or eight years after you generate the data if they do not support an application for certification. You may not rely on anyone else to meet recordkeeping requirements on your behalf unless we specifically authorize it. We may review these records at any time. You must promptly send us organized, written records in English if we ask for them. We may require you to submit written records in an electronic format.

(b) The regulations in § 1037.255 and 40 CFR 1068.25 and 1068.101 describe your obligation to report truthful and complete information. This includes information not related to certification. Failing to properly report information and keep the records we specify violates 40 CFR 1068.101(a)(2), which may involve civil or criminal penalties.

(c) Send all reports and requests for approval to the Designated Compliance Officer (see § 1037.801).

(d) Any written information we require you to send to or receive from another company is deemed to be a required record under this section. Such records are also deemed to be submissions to EPA. Keep these records for eight years unless the regulations specify a different period. We may require you to send us these records whether or not you are a certificate holder.

(e) Under the Paperwork Reduction Act (44 U.S.C. 3501 *et seq.*), the Office of Management and Budget approves the reporting and recordkeeping specified in the applicable regulations. The following items illustrate the kind of reporting and recordkeeping we require for vehicles regulated under this part:

(1) We specify the following requirements related to vehicle certification in this part 1037:

(i) In subpart C of this part we identify a wide range of information required to certify vehicles.

(ii) In subpart G of this part we identify several reporting and recordkeeping items for making demonstrations and getting approval related to various special compliance provisions.

(iii) In § 1037.725, 1037.730, and 1037.735 we specify certain records related to averaging, banking, and trading.

(2) We specify the following requirements related to testing in 40 CFR part 1066:

(i) In 40 CFR 1065.2 we give an overview of principles for reporting information.

(ii) In 40 CFR 1065.10 and 1065.12 we specify information needs for establishing various changes to published test procedures.

(iii) In 40 CFR 1065.25 we establish basic guidelines for storing test information.

(iv) In 40 CFR 1065.695 we identify data that may be appropriate for collecting during testing of in-use vehicles using portable analyzers.

APPENDIX I TO PART 1037—HEAVY-DUTY TRANSIENT CHASSIS TEST CYCLE

APPENDIX I TO PART 1037—HEAVY-DUTY TRANSIENT CHASSIS TEST CYCLE—Continued

	Time sec.	Speed mph	Speed m/s		Time sec.	Speed mph	Speed m/s
1	0.00	0.00	0.00	70	6.65	2.97	
2	0.00	0.00	0.00	71	6.13	2.74	
3	0.00	0.00	0.00	72	5.75	2.57	
4	0.00	0.00	0.00	73	5.61	2.51	
5	0.00	0.00	0.00	74	5.65	2.53	
6	0.00	0.00	0.00	75	5.80	2.59	
7	0.41	0.18	0.18	76	5.95	2.66	
8	1.18	0.53	0.53	77	6.09	2.72	
9	2.26	1.01	1.01	78	6.21	2.78	
10	3.19	1.43	1.43	79	6.31	2.82	
11	3.97	1.77	1.77	80	6.34	2.83	
12	4.66	2.08	2.08	81	6.47	2.89	
13	5.32	2.38	2.38	82	6.65	2.97	
14	5.94	2.66	2.66	83	6.88	3.08	
15	6.48	2.90	2.90	84	7.04	3.15	
16	6.91	3.09	3.09	85	7.05	3.15	
17	7.28	3.25	3.25	86	7.01	3.13	
18	7.64	3.42	3.42	87	6.90	3.08	
19	8.02	3.59	3.59	88	6.88	3.08	
20	8.36	3.74	3.74	89	6.89	3.08	
21	8.60	3.84	3.84	90	6.96	3.11	
22	8.74	3.91	3.91	91	7.04	3.15	
23	8.82	3.94	3.94	92	7.17	3.21	
24	8.82	3.94	3.94	93	7.29	3.26	
25	8.76	3.92	3.92	94	7.39	3.30	
26	8.66	3.87	3.87	95	7.48	3.34	
27	8.58	3.84	3.84	96	7.57	3.38	
28	8.52	3.81	3.81	97	7.61	3.40	
29	8.46	3.78	3.78	98	7.59	3.39	
30	8.38	3.75	3.75	99	7.53	3.37	
31	8.31	3.71	3.71	100	7.46	3.33	
32	8.21	3.67	3.67	101	7.40	3.31	
33	8.11	3.63	3.63	102	7.39	3.30	
34	8.00	3.58	3.58	103	7.38	3.30	
35	7.94	3.55	3.55	104	7.37	3.29	
36	7.94	3.55	3.55	105	7.37	3.29	
37	7.80	3.49	3.49	106	7.39	3.30	
38	7.43	3.32	3.32	107	7.42	3.32	
39	6.79	3.04	3.04	108	7.43	3.32	
40	5.81	2.60	2.60	109	7.40	3.31	
41	4.65	2.08	2.08	110	7.39	3.30	
42	3.03	1.35	1.35	111	7.42	3.32	
43	1.88	0.84	0.84	112	7.50	3.35	
44	1.15	0.51	0.51	113	7.57	3.38	
45	1.14	0.51	0.51	114	7.60	3.40	
46	1.12	0.50	0.50	115	7.60	3.40	
47	1.11	0.50	0.50	116	7.61	3.40	
48	1.19	0.53	0.53	117	7.64	3.42	
49	1.57	0.70	0.70	118	7.68	3.43	
50	2.31	1.03	1.03	119	7.74	3.46	
51	3.37	1.51	1.51	120	7.82	3.50	
52	4.51	2.02	2.02	121	7.90	3.53	
53	5.56	2.49	2.49	122	7.96	3.56	
54	6.41	2.87	2.87	123	7.99	3.57	
55	7.09	3.17	3.17	124	8.02	3.59	
56	7.59	3.39	3.39	125	8.01	3.58	
57	7.99	3.57	3.57	126	7.87	3.52	
58	8.32	3.72	3.72	127	7.59	3.39	
59	8.64	3.86	3.86	128	7.20	3.22	
60	8.91	3.98	3.98	129	6.52	2.91	
61	9.13	4.08	4.08	130	5.53	2.47	
62	9.29	4.15	4.15	131	4.36	1.95	
63	9.40	4.20	4.20	132	3.30	1.48	
64	9.39	4.20	4.20	133	2.50	1.12	
65	9.20	4.11	4.11	134	1.94	0.87	
66	8.84	3.95	3.95	135	1.56	0.70	
67	8.35	3.73	3.73	136	0.95	0.42	
68	7.81	3.49	3.49	137	0.42	0.19	
69	7.22	3.23	3.23	138	0.00	0.00	

APPENDIX I TO PART 1037—HEAVY-DUTY TRANSIENT CHASSIS TEST CYCLE—Continued

APPENDIX I TO PART 1037—HEAVY-DUTY TRANSIENT CHASSIS TEST CYCLE—Continued

APPENDIX I TO PART 1037—HEAVY-DUTY TRANSIENT CHASSIS TEST CYCLE—Continued

Time sec.	Speed mph	Speed m/s	Time sec.	Speed mph	Speed m/s	Time sec.	Speed mph	Speed m/s
139	0.00	0.00	208	25.99	11.62	277	20.09	8.98
140	0.00	0.00	209	24.77	11.07	278	21.89	9.79
141	0.00	0.00	210	24.04	10.75	279	24.15	10.80
142	0.00	0.00	211	23.39	10.46	280	26.26	11.74
143	0.00	0.00	212	22.73	10.16	281	26.95	12.05
144	0.00	0.00	213	22.16	9.91	282	27.03	12.08
145	0.00	0.00	214	21.66	9.68	283	27.30	12.20
146	0.00	0.00	215	21.39	9.56	284	28.10	12.56
147	0.00	0.00	216	21.43	9.58	285	29.44	13.16
148	0.00	0.00	217	20.67	9.24	286	30.78	13.76
149	0.00	0.00	218	17.98	8.04	287	32.09	14.35
150	0.00	0.00	219	13.15	5.88	288	33.24	14.86
151	0.00	0.00	220	7.71	3.45	289	34.46	15.40
152	0.00	0.00	221	3.30	1.48	290	35.42	15.83
153	0.00	0.00	222	0.88	0.39	291	35.88	16.04
154	0.00	0.00	223	0.00	0.00	292	36.03	16.11
155	0.00	0.00	224	0.00	0.00	293	35.84	16.02
156	0.00	0.00	225	0.00	0.00	294	35.65	15.94
157	0.00	0.00	226	0.00	0.00	295	35.31	15.78
158	0.00	0.00	227	0.00	0.00	296	35.19	15.73
159	0.00	0.00	228	0.00	0.00	297	35.12	15.70
160	0.00	0.00	229	0.00	0.00	298	35.12	15.70
161	0.00	0.00	230	0.00	0.00	299	35.04	15.66
162	0.00	0.00	231	0.00	0.00	300	35.08	15.68
163	0.00	0.00	232	0.00	0.00	301	35.04	15.66
164	0.00	0.00	233	0.00	0.00	302	35.34	15.80
165	0.00	0.00	234	0.00	0.00	303	35.50	15.87
166	0.00	0.00	235	0.00	0.00	304	35.77	15.99
167	0.00	0.00	236	0.00	0.00	305	35.81	16.01
168	0.00	0.00	237	0.00	0.00	306	35.92	16.06
169	0.00	0.00	238	0.00	0.00	307	36.23	16.20
170	0.00	0.00	239	0.00	0.00	308	36.42	16.28
171	0.00	0.00	240	0.00	0.00	309	36.65	16.38
172	1.11	0.50	241	0.00	0.00	310	36.26	16.21
173	2.65	1.18	242	0.00	0.00	311	36.07	16.12
174	4.45	1.99	243	0.00	0.00	312	35.84	16.02
175	5.68	2.54	244	0.00	0.00	313	35.96	16.08
176	6.75	3.02	245	0.00	0.00	314	36.00	16.09
177	7.59	3.39	246	0.00	0.00	315	35.57	15.90
178	7.75	3.46	247	0.00	0.00	316	35.00	15.65
179	7.63	3.41	248	0.00	0.00	317	34.08	15.24
180	7.67	3.43	249	0.00	0.00	318	33.39	14.93
181	8.70	3.89	250	0.00	0.00	319	32.20	14.39
182	10.20	4.56	251	0.00	0.00	320	30.32	13.55
183	11.92	5.33	252	0.00	0.00	321	28.48	12.73
184	12.84	5.74	253	0.00	0.00	322	26.95	12.05
185	13.27	5.93	254	0.00	0.00	323	26.18	11.70
186	13.38	5.98	255	0.00	0.00	324	25.38	11.35
187	13.61	6.08	256	0.00	0.00	325	24.77	11.07
188	14.15	6.33	257	0.00	0.00	326	23.46	10.49
189	14.84	6.63	258	0.00	0.00	327	22.39	10.01
190	16.49	7.37	259	0.50	0.22	328	20.97	9.37
191	18.33	8.19	260	1.57	0.70	329	20.09	8.98
192	20.36	9.10	261	3.07	1.37	330	18.90	8.45
193	21.47	9.60	262	4.57	2.04	331	18.17	8.12
194	22.35	9.99	263	5.65	2.53	332	16.48	7.37
195	22.96	10.26	264	6.95	3.11	333	15.07	6.74
196	23.46	10.49	265	8.05	3.60	334	12.23	5.47
197	23.92	10.69	266	9.13	4.08	335	10.08	4.51
198	24.42	10.92	267	10.05	4.49	336	7.71	3.45
199	24.99	11.17	268	11.62	5.19	337	7.32	3.27
200	25.91	11.58	269	12.92	5.78	338	8.63	3.86
201	26.26	11.74	270	13.84	6.19	339	10.77	4.81
202	26.38	11.79	271	14.38	6.43	340	12.65	5.66
203	26.26	11.74	272	15.64	6.99	341	13.88	6.20
204	26.49	11.84	273	17.14	7.66	342	15.03	6.72
205	26.76	11.96	274	18.21	8.14	343	15.64	6.99
206	27.07	12.10	275	18.90	8.45	344	16.99	7.60
207	26.64	11.91	276	19.44	8.69	345	17.98	8.04

APPENDIX I TO PART 1037—HEAVY-DUTY TRANSIENT CHASSIS TEST CYCLE—Continued

APPENDIX I TO PART 1037—HEAVY-DUTY TRANSIENT CHASSIS TEST CYCLE—Continued

APPENDIX I TO PART 1037—HEAVY-DUTY TRANSIENT CHASSIS TEST CYCLE—Continued

Time sec.	Speed mph	Speed m/s	Time sec.	Speed mph	Speed m/s	Time sec.	Speed mph	Speed m/s
346	19.13	8.55	415	16.22	7.25	484	30.29	13.54
347	18.67	8.35	416	15.76	7.05	485	28.56	12.77
348	18.25	8.16	417	14.72	6.58	486	26.45	11.82
349	18.17	8.12	418	13.69	6.12	487	24.79	11.08
350	18.40	8.23	419	12.00	5.36	488	23.12	10.34
351	19.63	8.78	420	10.43	4.66	489	20.73	9.27
352	20.32	9.08	421	8.71	3.89	490	18.33	8.19
353	21.43	9.58	422	7.44	3.33	491	15.72	7.03
354	21.47	9.60	423	5.71	2.55	492	13.11	5.86
355	21.97	9.82	424	4.22	1.89	493	10.47	4.68
356	22.27	9.96	425	2.30	1.03	494	7.82	3.50
357	22.69	10.14	426	1.00	0.45	495	5.70	2.55
358	23.15	10.35	427	0.00	0.00	496	3.57	1.60
359	23.69	10.59	428	0.61	0.27	497	0.92	0.41
360	23.96	10.71	429	1.19	0.53	498	0.00	0.00
361	24.27	10.85	430	1.61	0.72	499	0.00	0.00
362	24.34	10.88	431	1.53	0.68	500	0.00	0.00
363	24.50	10.95	432	2.34	1.05	501	0.00	0.00
364	24.42	10.92	433	4.29	1.92	502	0.00	0.00
365	24.38	10.90	434	7.25	3.24	503	0.00	0.00
366	24.31	10.87	435	10.20	4.56	504	0.00	0.00
367	24.23	10.83	436	12.46	5.57	505	0.00	0.00
368	24.69	11.04	437	14.53	6.50	506	0.00	0.00
369	25.11	11.23	438	16.22	7.25	507	0.00	0.00
370	25.53	11.41	439	17.87	7.99	508	0.00	0.00
371	25.38	11.35	440	19.74	8.82	509	0.00	0.00
372	24.58	10.99	441	21.01	9.39	510	0.00	0.00
373	23.77	10.63	442	22.23	9.94	511	0.00	0.00
374	23.54	10.52	443	22.62	10.11	512	0.00	0.00
375	23.50	10.51	444	23.61	10.55	513	0.00	0.00
376	24.15	10.80	445	24.88	11.12	514	0.00	0.00
377	24.30	10.86	446	26.15	11.69	515	0.00	0.00
378	24.15	10.80	447	26.99	12.07	516	0.00	0.00
379	23.19	10.37	448	27.56	12.32	517	0.00	0.00
380	22.50	10.06	449	28.18	12.60	518	0.00	0.00
381	21.93	9.80	450	28.94	12.94	519	0.00	0.00
382	21.85	9.77	451	29.83	13.34	520	0.00	0.00
383	21.55	9.63	452	30.78	13.76	521	0.00	0.00
384	21.89	9.79	453	31.82	14.22	522	0.50	0.22
385	21.97	9.82	454	32.78	14.65	523	1.50	0.67
386	21.97	9.82	455	33.24	14.86	524	3.00	1.34
387	22.01	9.84	456	33.47	14.96	525	4.50	2.01
388	21.85	9.77	457	33.31	14.89	526	5.80	2.59
389	21.62	9.67	458	33.08	14.79	527	6.52	2.91
390	21.62	9.67	459	32.78	14.65	528	6.75	3.02
391	22.01	9.84	460	32.39	14.48	529	6.44	2.88
392	22.81	10.20	461	32.13	14.36	530	6.17	2.76
393	23.54	10.52	462	31.82	14.22	531	6.33	2.83
394	24.38	10.90	463	31.55	14.10	532	6.71	3.00
395	24.80	11.09	464	31.25	13.97	533	7.40	3.31
396	24.61	11.00	465	30.94	13.83	534	7.67	3.43
397	23.12	10.34	466	30.71	13.73	535	7.33	3.28
398	21.62	9.67	467	30.56	13.66	536	6.71	3.00
399	19.90	8.90	468	30.79	13.76	537	6.41	2.87
400	18.86	8.43	469	31.13	13.92	538	6.60	2.95
401	17.79	7.95	470	31.55	14.10	539	6.56	2.93
402	17.25	7.71	471	31.51	14.09	540	5.94	2.66
403	16.91	7.56	472	31.47	14.07	541	5.45	2.44
404	16.75	7.49	473	31.44	14.05	542	5.87	2.62
405	16.75	7.49	474	31.51	14.09	543	6.71	3.00
406	16.87	7.54	475	31.59	14.12	544	7.56	3.38
407	16.37	7.32	476	31.67	14.16	545	7.59	3.39
408	16.37	7.32	477	32.01	14.31	546	7.63	3.41
409	16.49	7.37	478	32.63	14.59	547	7.67	3.43
410	17.21	7.69	479	33.39	14.93	548	7.67	3.43
411	17.41	7.78	480	34.31	15.34	549	7.48	3.34
412	17.37	7.77	481	34.81	15.56	550	7.29	3.26
413	16.87	7.54	482	34.20	15.29	551	7.29	3.26
414	16.72	7.47	483	32.39	14.48	552	7.40	3.31

APPENDIX I TO PART 1037—HEAVY-DUTY TRANSIENT CHASSIS TEST CYCLE—Continued			APPENDIX I TO PART 1037—HEAVY-DUTY TRANSIENT CHASSIS TEST CYCLE—Continued			APPENDIX I TO PART 1037—HEAVY-DUTY TRANSIENT CHASSIS TEST CYCLE—Continued		
Time sec.	Speed mph	Speed m/s	Time sec.	Speed mph	Speed m/s	Time sec.	Speed mph	Speed m/s
553	7.48	3.34	592	35.92	16.06	631	46.77	20.91
554	7.52	3.36	593	37.72	16.86	632	45.54	20.36
555	7.52	3.36	594	39.26	17.55	633	43.24	19.33
556	7.48	3.34	595	39.45	17.64	634	41.52	18.56
557	7.44	3.33	596	39.83	17.81	635	39.79	17.79
558	7.28	3.25	597	40.18	17.96	636	38.07	17.02
559	7.21	3.22	598	40.48	18.10	637	36.34	16.25
560	7.09	3.17	599	40.75	18.22	638	34.04	15.22
561	7.06	3.16	600	41.02	18.34	639	32.45	14.51
562	7.29	3.26	601	41.36	18.49	640	30.86	13.80
563	7.75	3.46	602	41.79	18.68	641	28.83	12.89
564	8.55	3.82	603	42.40	18.95	642	26.45	11.82
565	9.09	4.06	604	42.82	19.14	643	24.27	10.85
566	10.04	4.49	605	43.05	19.25	644	22.04	9.85
567	11.12	4.97	606	43.09	19.26	645	19.82	8.86
568	12.46	5.57	607	43.24	19.33	646	17.04	7.62
569	13.00	5.81	608	43.59	19.49	647	14.26	6.37
570	14.26	6.37	609	44.01	19.67	648	11.52	5.15
571	15.37	6.87	610	44.35	19.83	649	8.78	3.93
572	17.02	7.61	611	44.55	19.92	650	7.17	3.21
573	18.17	8.12	612	44.82	20.04	651	5.56	2.49
574	19.21	8.59	613	45.05	20.14	652	3.72	1.66
575	20.17	9.02	614	45.31	20.26	653	3.38	1.51
576	20.66	9.24	615	45.58	20.38	654	3.11	1.39
577	21.12	9.44	616	46.00	20.56	655	2.58	1.15
578	21.43	9.58	617	46.31	20.70	656	1.66	0.74
579	22.66	10.13	618	46.54	20.81	657	0.67	0.30
580	23.92	10.69	619	46.61	20.84	658	0.00	0.00
581	25.42	11.36	620	46.92	20.98	659	0.00	0.00
582	25.53	11.41	621	47.19	21.10	660	0.00	0.00
583	26.68	11.93	622	47.46	21.22	661	0.00	0.00
584	28.14	12.58	623	47.54	21.25	662	0.00	0.00
585	30.06	13.44	624	47.54	21.25	663	0.00	0.00
586	30.94	13.83	625	47.54	21.25	664	0.00	0.00
587	31.63	14.14	626	47.50	21.23	665	0.00	0.00
588	32.36	14.47	627	47.50	21.23	666	0.00	0.00
589	33.24	14.86	628	47.50	21.23	667	0.00	0.00
590	33.66	15.05	629	47.31	21.15	668	0.00	0.00
591	34.12	15.25	630	47.04	21.03			

APPENDIX II TO PART 1037—POWER TAKE-OFF TEST CYCLE

Cycle simulation	Mode	Start time of mode	Normalized pressure, circuit 1 (%)	Normalized pressure, circuit 2 (%)
Utility	0	0	0.0	0.0
Utility	1	33	80.5	0.0
Utility	2	40	0.0	0.0
Utility	3	145	83.5	0.0
Utility	4	289	0.0	0.0
Refuse	5	361	0.0	13.0
Refuse	6	363	0.0	38.0
Refuse	7	373	0.0	53.0
Refuse	8	384	0.0	73.0
Refuse	9	388	0.0	0.0
Refuse	10	401	0.0	13.0
Refuse	11	403	0.0	38.0
Refuse	12	413	0.0	53.0
Refuse	13	424	0.0	73.0
Refuse	14	442	11.2	0.0
Refuse	15	468	29.3	0.0
Refuse	16	473	0.0	0.0
Refuse	17	486	11.2	0.0
Refuse	18	512	29.3	0.0
Refuse	19	517	0.0	0.0
Refuse	20	530	12.8	11.1
Refuse	21	532	12.8	38.2



APPENDIX II TO PART 1037—POWER TAKE-OFF TEST CYCLE—Continued

Cycle simulation	Mode	Start time of mode	Normalized pressure, circuit 1 (%)	Normalized pressure, circuit 2 (%)
Refuse .....	22	541	12.8	53.4
Refuse .....	23	550	12.8	73.5
Refuse .....	24	553	0.0	0.0
Refuse .....	25	566	12.8	11.1
Refuse .....	26	568	12.8	38.2
Refuse .....	27	577	12.8	53.4
Refuse .....	28	586	12.8	73.5
Refuse .....	29	589	0.0	0.0
Refuse .....	30	600	0.0	0.0

**Appendix III to Part 1037—Emission Control Identifiers**

This appendix identifies abbreviations for emission control information labels, as required under § 1037.135.

**Vehicle Speed Limiters**

- VSL—Vehicle speed limiter
- VSLS—“Soft-top” vehicle speed limiter
- VSLE—Expiring vehicle speed limiter
- VSLD—Vehicle speed limiter with both “soft-top” and expiration

**Idle Reduction Technology**

- IRT5—Engine shutoff after 5 minutes or less of idling
- IRTE—Expiring engine shutoff

**Tires**

- LRRR—Low rolling resistance tires (all)
- LRRD—Low rolling resistance tires (drive)
- LRRS—Low rolling resistance tires (steer)

**Aerodynamic Components**

- ATS—Aerodynamic side skirt and/or fuel tank fairing
- ARF—Aerodynamic roof fairing
- ARFR—Adjustable height aerodynamic roof fairing
- TGR—Gap reducing fairing (tractor to trailer gap)

**Other Components**

- ADVH—Vehicle includes advanced hybrid technology components

-ADVO—Vehicle includes other advanced technology components (*i.e.*, non-hybrid system)

-INV—Vehicle includes innovative technology components

**PART 1039—CONTROL OF EMISSIONS FROM NEW AND IN-USE NONROAD COMPRESSION-IGNITION ENGINES**

■ 35. The authority citation for part 1039 continues to read as follows:

Authority: 42 U.S.C. 7401–7671q.

**Subpart F—[Amended]**

■ 36. Section 1039.510 is amended by revising paragraph (b) introductory text to read as follows:

**§ 1039.510 Which duty cycles do I use for transient testing?**

\* \* \* \* \*

(b) The transient test sequence consists of an initial run through the transient duty cycle from a cold start, 20 minutes with no engine operation, then a final run through the same transient duty cycle. Calculate the official transient emission result from the following equation:

\* \* \* \* \*

**PART 1065—ENGINE-TESTING PROCEDURES**

■ 37. The authority citation for part 1065 continues to read as follows:

Authority: 42 U.S.C. 7401–7671q.

**Subpart A—[Amended]**

■ 38. Section 1065.1 is amended by adding paragraph (h) to read as follows:

**§ 1065.1 Applicability.**

\* \* \* \* \*

(h) 40 CFR part 1066 describes how to measure emissions from vehicles that are subject to standards in g/mile or g/kilometer. Those vehicle testing provisions extensively reference portions of this part 1065. See 40 CFR part 1066 and the standard-setting part for additional information.

■ 39. Section 1065.15 is amended by revising paragraph (e) to read as follows:

**§ 1065.15 Overview of procedures for laboratory and field testing.**

\* \* \* \* \*

(e) The following figure illustrates the allowed measurement configurations described in this part 1065:

BILLING CODE 4910–59–P

Figure 1 of §1065.15—Default test procedures and other specified procedures.

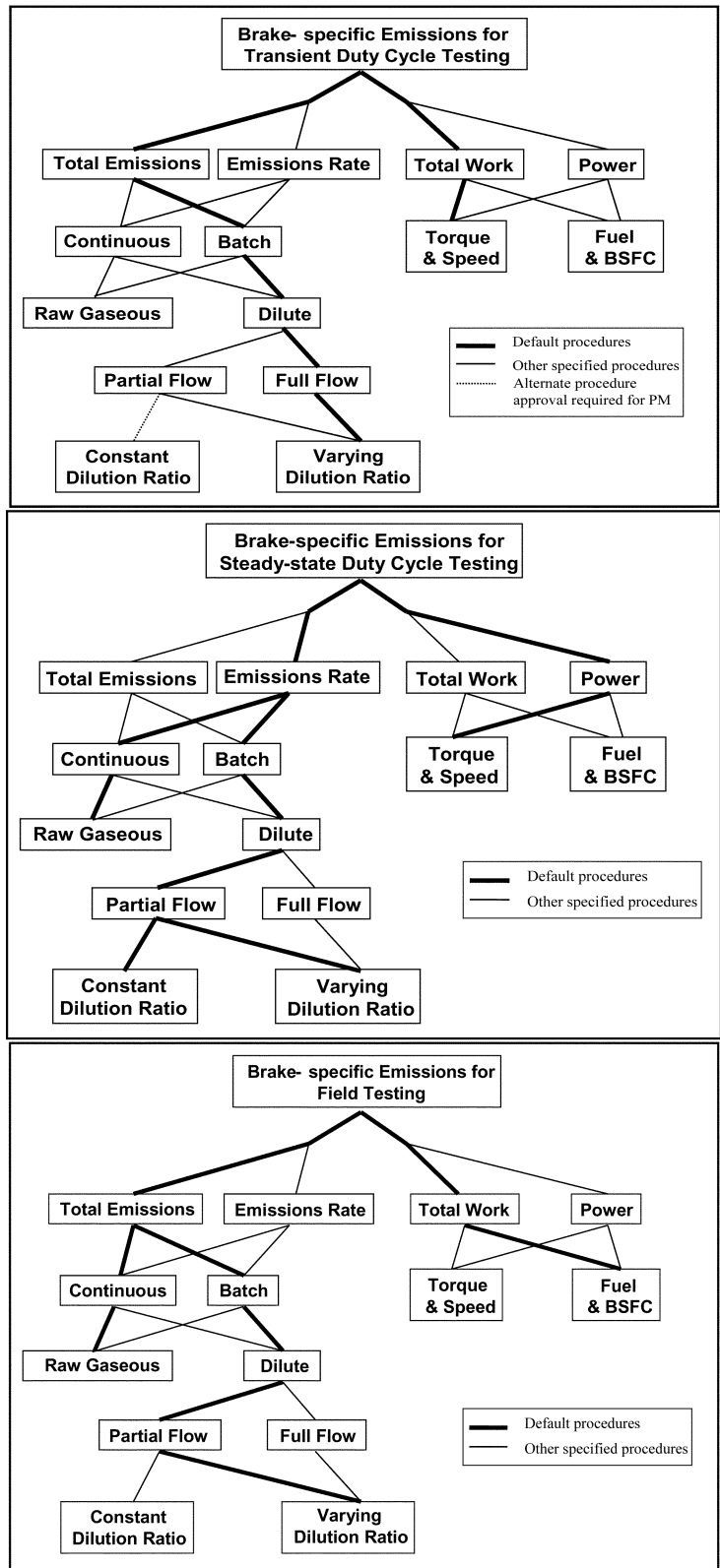

BILLING CODE 4910-59-C  
\* \* \* \* \*

■ 40. Section 1065.20 is amended by revising paragraphs (a) introductory text, (a)(1), and (e) to read as follows:

**§ 1065.20 Units of measure and overview of calculations.**  
(a) *System of units.* The procedures in this part generally follow the

International System of Units (SI), as detailed in NIST Special Publication 811, which we incorporate by reference in § 1065.1010. The following exceptions apply:

(1) We designate angular speed,  $f_n$ , of an engine's crankshaft in revolutions per minute (r/min), rather than the SI unit of radians per second (rad/s). This is based on the commonplace use of r/min in many engine dynamometer laboratories.

\* \* \* \* \*

(e) *Rounding*. You are required to round certain final values, such as final emission values. You may round intermediate values when transferring data as long as you maintain at least six significant digits (which requires more than six decimal places for values less than 0.1), or all significant digits if fewer than six digits are available. Unless the standard-setting part specifies otherwise, do not round other intermediate values. Round values to the number of significant digits necessary to match the number of decimal places of the applicable standard or specification as described in this paragraph (e). Note that

specifications expressed as percentages have infinite precision (as described in paragraph (e)(7) of this section). Use the following rounding convention, which is consistent with ASTM E29 and NIST SP 811:

(1) If the first (left-most) digit to be removed is less than five, remove all the appropriate digits without changing the digits that remain. For example, 3.141593 rounded to the second decimal place is 3.14.

(2) If the first digit to be removed is greater than five, remove all the appropriate digits and increase the lowest-value remaining digit by one. For example, 3.141593 rounded to the fourth decimal place is 3.1416.

(3) If the first digit to be removed is five with at least one additional non-zero digit following the five, remove all the appropriate digits and increase the lowest-value remaining digit by one. For example, 3.141593 rounded to the third decimal place is 3.142.

(4) If the first digit to be removed is five with no additional non-zero digits following the five, remove all the appropriate digits, increase the lowest-value remaining digit by one if it is odd

and leave it unchanged if it is even. For example, 1.75 and 1.750 rounded to the first decimal place are 1.8; while 1.85 and 1.850 rounded to the first decimal place are also 1.8. Note that this rounding procedure will always result in an even number for the lowest-value digit.

(5) This paragraph (e)(5) applies if the regulation specifies rounding to an increment other than decimal places or powers of ten (to the nearest 0.01, 0.1, 1, 10, 100, etc.). To round numbers for these special cases, divide the quantity by the specified rounding increment. Round the result to the nearest whole number as described in paragraphs (e)(1) through (4) of this section. Multiply the rounded number by the specified rounding increment. This value is the desired result. For example, to round 0.90 to the nearest 0.2, divide 0.90 by 0.2 to get a result of 4.5, which rounds to 4. Multiplying 4 by 0.2 gives 0.8, which is the result of rounding 0.90 to the nearest 0.2.

(6) The following tables further illustrate the rounding procedures specified in this paragraph (e):

Quantity	Rounding increment			
	10	1	0.1	0.01
3.141593 .....	0	3	3.1	3.14
123,456.789 .....	123,460	123,457	123,456.8	123,456.79
5.500 .....	10	6	5.5	5.50
4.500 .....	0	4	4.5	4.50

Quantity	Rounding increment			
	25	3	0.5	0.02
229.267 .....	225	228	229.5	229.26
62.500 .....	50	63	62.5	62.50
87.500 .....	100	87	87.5	87.50
7.500 .....	0	6	7.5	7.50

(7) This paragraph (e)(7) applies where we specify a limit or tolerance as some percentage of another value (such as  $\pm 2\%$  of a maximum concentration). You may show compliance with such specifications either by applying the percentage to the total value to calculate an absolute limit, or by converting the absolute value to a percentage by dividing it by the total value.

(i) Do not round either value (the absolute limit or the calculated percentage), except as specified in paragraph (e)(7)(ii) of this section. For example, assume we specify that an analyzer must have a repeatability of

$\pm 1\%$  of the maximum concentration or better, the maximum concentration is 1059 ppm, and you determine repeatability to be  $\pm 6.3$  ppm. In this example, you could calculate an absolute limit of  $\pm 10.59$  ppm ( $1059 \text{ ppm} \times 0.01$ ) or calculate that the 6.3 ppm repeatability is equivalent to a repeatability of 0.5949008498584%.

(ii) Prior to July 1, 2013, you may treat tolerances (and equivalent specifications) specified in percentages as having fixed rather than infinite precision. For example, 2% would be equivalent to 1.51% to 2.50% and 2.0% would be equivalent to 1.951% to

2.050%. Note that this allowance applies whether or not the percentage is explicitly specified as a percentage of another value.

(8) You may use measurement devices that incorporate internal rounding, consistent with the provisions of this paragraph (e)(8). You may use devices that use any rounding convention if they report six or more significant digits. You may use devices that report fewer than six digits, consistent with good engineering judgment and the accuracy, repeatability, and noise specifications of this part. Note that this provision does not necessarily require

you to perform engineering analysis or keep records.  
\* \* \* \* \*

**Subpart B—[Amended]**

■ 41. Section 1065.125 is amended by revising paragraph (e)(1) introductory text to read as follows:

**§ 1065.125 Engine intake air.**

(e) \* \* \*  
(1) Use a charge-air cooling system with a total intake-air capacity that represents production engines' in-use installation. Design any laboratory charge-air cooling system to minimize accumulation of condensate. Drain any accumulated condensate. Before starting a duty cycle (or preconditioning for a duty cycle), completely close all drains that would normally be closed during in-use operation. Keep those drains closed during the emission test. Maintain coolant conditions as follows:  
\* \* \* \* \*

■ 42. Section 1065.140 is amended by revising paragraphs (c)(6)(ii)(C) and (D) to read as follows:

**§ 1065.140 Dilution for gaseous and PM constituents.**

(c) \* \* \*

(6) \* \* \*  
(ii) \* \* \*  
(C) Identify the maximum potential mole fraction of dilute exhaust lost on a continuous basis during the entire test interval. This value must be less than or equal to 0.02. Calculate on a continuous basis the mole fraction of water that would be in equilibrium with liquid water at the measured minimum surface temperature. Subtract this mole fraction from the mole fraction of water that would be in the exhaust without condensation (either measured or from the chemical balance), and set any negative values to zero. This difference is the potential mole fraction of the dilute exhaust that would be lost due to water condensation on a continuous basis.

(D) Integrate the product of the molar flow rate of the dilute exhaust and the potential mole fraction of dilute exhaust lost, and divide by the totalized dilute exhaust molar flow over the test interval. This is the potential mole fraction of the dilute exhaust that would be lost due to water condensation over the entire test interval. Note that this assumes no re-evaporation. This value must be less than or equal to 0.005.  
\* \* \* \* \*

■ 43. Section 1065.170 is amended by revising paragraph (c)(1)(vi) to read as follows:

**§ 1065.170 Batch sampling for gaseous and PM constituents.**

(c) \* \* \*  
(1) \* \* \*  
(vi) Maintain a filter face velocity near 100 cm/s with less than 5% of the recorded flow values exceeding 100 cm/s, unless you expect the net PM mass on the filter to exceed 400 µg, assuming a 38 mm diameter filter stain area. Measure face velocity as the volumetric flow rate of the sample at the pressure upstream of the filter and temperature of the filter face as measured in § 1065.140(e), divided by the filter's exposed area. You may use the exhaust stack or CVS tunnel pressure for the upstream pressure if the pressure drop through the PM sampler up to the filter is less than 2 kPa.  
\* \* \* \* \*

■ 44. Section 1065.190 is amended by revising Table 1 in paragraph (d)(3) to read as follows:

**§ 1065.190 PM-stabilization and weighing environments for gravimetric analysis.**

(d) \* \* \*  
(3) \* \* \*

TABLE 1 OF § 1065.190—DEWPOINT TOLERANCE AS A FUNCTION OF % PM CHANGE AND % SULFURIC ACID PM

Expected sulfuric acid fraction of PM	±0.5% PM mass change	±1% PM mass change	±2% PM mass change
5% .....	±3 °C .....	±6 °C .....	±12 °C
50% .....	±0.3 °C .....	±0.6 °C .....	±1.2 °C
100% .....	±0.15 °C .....	±0.3 °C .....	±0.6 °C

\* \* \* \* \*

**Subpart C—[Amended]**

■ 45. Section 1065.205 is revised to read as follows:

**§ 1065.205 Performance specifications for measurement instruments.**

Your test system as a whole must meet all the applicable calibrations, verifications, and test-validation criteria specified in subparts D and F of this part or subpart J of this part for using PEMS and for performing field testing. We recommend that your instruments

meet the specifications in Table 1 of this section for all ranges you use for testing. We also recommend that you keep any documentation you receive from instrument manufacturers showing that your instruments meet the specifications in Table 1 of this section.

BILLING CODE 4910-59-P

Table 1 of §1065.205—Recommended performance specifications for measurement instruments

Measurement Instrument	Measured quantity symbol	Complete System Rise time ( $t_{(10-90)}$ ) and Fall time ( $t_{(90-10)}$ ) <sup>a</sup>	Recording update frequency	Accuracy <sup>b</sup>	Repeatability <sup>b</sup>	Noise <sup>b</sup>
Engine speed transducer	$f_n$	1 s	1 Hz means	2 % of pt. or 0.5 % of max.	1 % of pt. or 0.25 % of max.	0.05 % of max
Engine torque transducer	$T$	1 s	1 Hz means	2 % of pt. or 1 % of max.	1 % of pt. or 0.5 % of max.	0.05 % of max.
Electrical work (active-power meter)	$W$	1 s	1 Hz means	2 % of pt. or 0.5 % of max.	1 % of pt. or 0.25 % of max.	0.05 % of max
General pressure transducer (not a part of another instrument)	$p$	5 s	1 Hz	2 % of pt. or 1.0 % of max.	1 % of pt. or 0.5 % of max.	0.1 % of max
Atmospheric pressure meter used for PM-stabilization and balance environments	$p_{\text{atmos}}$	50 s	5 times per hour	50 Pa	25 Pa	5 Pa
General purpose atmospheric pressure meter	$p_{\text{atmos}}$	50 s	5 times per hour	250 Pa	100Pa	50 Pa
Temperature sensor for PM-stabilization and balance environments	$T$	50 s	0.1 Hz	0.25 K	0.1 K	0.1 K
Other temperature sensor (not a part of another instrument)	$T$	10 s	0.5 Hz	0.4 % of pt. K or 0.2 % of max. K	0.2 % of pt. K or 0.1 % of max. K	0.1 % of max
Dewpoint sensor for intake air, PM-stabilization and balance environments	$T_{\text{dew}}$	50 s	0.1 Hz	0.25 K	0.1 K	0.02 K
Other dewpoint sensor	$T_{\text{dew}}$	50 s	0.1 Hz	1 K	0.5 K	0.1 K
Fuel flow meter <sup>e</sup> (Fuel totalizer)	$\dot{m}$	5 s (N/A)	1 Hz (N/A)	2 % of pt. or 1.5 % of max.	1 % of pt. or 0.75 % of max.	0.5 % of max.
Total diluted exhaust meter (CVS) <sup>c</sup> (With heat exchanger before meter)	$\dot{n}$	1 s (5 s)	1 Hz means (1 Hz)	2 % of pt. or 1.5 % of max.	1 % of pt. or 0.75 % of max.	1 % of max.
Dilution air, inlet air, exhaust, and sample flow meters <sup>c</sup>	$\dot{n}$	1 s	1 Hz means of 5 Hz samples	2.5 % of pt. or 1.5 % of max.	1.25 % of pt. or 0.75 % of max.	1 % of max.
Continuous gas analyzer	$x$	5 s	1 Hz	2 % of pt. or 2 % of meas.	1 % of pt. or 1 % of meas.	1 % of max.
Batch gas analyzer	$x$	N/A	N/A	2 % of pt. or 2 % of meas.	1 % of pt. or 1 % of meas.	1 % of max.
Gravimetric PM balance	$m_{\text{PM}}$	N/A	N/A	See §1065.790	0.5 $\mu\text{g}$	N/A
Inertial PM balance	$m_{\text{PM}}$	5 s	1 Hz	2 % of pt. or 2 % of meas.	1 % of pt. or 1 % of meas.	0.2 % of max.

<sup>a</sup> The performance specifications identified in the table apply separately for rise time and fall time.

<sup>b</sup> Accuracy, repeatability, and noise are all determined with the same collected data, as described in §1065.305, and based on absolute values. "pt." refers to the overall flow-weighted mean value expected at the standard; "max." refers to the peak value expected at the standard over any test interval, not the maximum of the instrument's range; "meas" refers to the actual flow-weighted mean measured over any test interval.

<sup>c</sup> The procedure for accuracy, repeatability and noise measurement described in §1065.305 may be modified for flow meters to allow noise to be measured at the lowest calibrated value instead of zero flow rate.

**§ 1065.220 Fuel flow meter.**

(a) *Application.* You may use fuel flow in combination with a chemical balance of fuel, inlet air, and raw exhaust to calculate raw exhaust flow as described in § 1065.655(e), as follows:

(1) \* \* \*

(iii) For calculating the dilution air flow for background correction as described in § 1065.667.

\* \* \* \* \*

■ 47. Section 1065.225 is amended by revising paragraph (a) introductory text and adding paragraphs (a)(1)(iii) and (a)(1)(iv) to read as follows:

**§ 1065.225 Intake-air flow meter.**

\* \* \* \* \*

(a) *Application.* You may use an intake-air flow meter in combination with a chemical balance of fuel, inlet air, and raw exhaust to calculate raw exhaust flow as described in § 1065.655(e) and (f), as follows:

(1) \* \* \*

(iii) For validating minimum dilution ratio for PM batch sampling as described in § 1065.546.

(iv) For calculating the dilution air flow for background correction as described in § 1065.667.

\* \* \* \* \*

■ 48. Section 1065.250 is revised to read as follows:

**§ 1065.250 Nondispersive infrared analyzer.**

(a) *Application.* Use a nondispersive infrared (NDIR) analyzer to measure CO and CO<sub>2</sub> concentrations in raw or diluted exhaust for either batch or continuous sampling.

(b) *Component requirements.* We recommend that you use an NDIR analyzer that meets the specifications in Table 1 of § 1065.205. Note that your NDIR-based system must meet the calibration and verifications in §§ 1065.350 and 1065.355 and it must also meet the linearity verification in § 1065.307. You may use an NDIR analyzer that has compensation algorithms that are functions of other gaseous measurements and the engine's known or assumed fuel properties. The target value for any compensation algorithm is 0% (that is, no bias high and no bias low), regardless of the uncompensated signal's bias.

■ 49. Section 1065.260 is revised to read as follows:

**§ 1065.260 Flame-ionization detector.**

(a) *Application.* Use a flame-ionization detector (FID) analyzer to measure hydrocarbon concentrations in raw or diluted exhaust for either batch or continuous sampling. Determine

hydrocarbon concentrations on a carbon number basis of one, C<sub>1</sub>. For measuring THC or THCE you must use a FID analyzer. For measuring CH<sub>4</sub> you must meet the requirements of paragraph (f) of this section. See subpart I of this part for special provisions that apply to measuring hydrocarbons when testing with oxygenated fuels.

(b) *Component requirements.* We recommend that you use a FID analyzer that meets the specifications in Table 1 of § 1065.205. Note that your FID-based system for measuring THC, THCE, or CH<sub>4</sub> must meet all the verifications for hydrocarbon measurement in subpart D of this part, and it must also meet the linearity verification in § 1065.307. You may use a FID analyzer that has compensation algorithms that are functions of other gaseous measurements and the engine's known or assumed fuel properties. The target value for any compensation algorithm is 0% (that is, no bias high and no bias low), regardless of the uncompensated signal's bias.

(c) *Heated FID analyzers.* For measuring THC or THCE from compression-ignition engines, two-stroke spark-ignition engines, and four-stroke spark-ignition engines below 19 kW, you must use heated FID analyzers that maintain all surfaces that are exposed to emissions at a temperature of (191 ±11) °C.

(d) *FID fuel and burner air.* Use FID fuel and burner air that meet the specifications of § 1065.750. Do not allow the FID fuel and burner air to mix before entering the FID analyzer to ensure that the FID analyzer operates with a diffusion flame and not a premixed flame.

(e) *NMHC.* For demonstrating compliance with NMHC standards, you may either measure THC and CH<sub>4</sub> and determine NMHC as described in § 1065.660(b)(2) or (3), or you may measure THC and determine NMHC as described in § 1065.660(b)(1).

(f) *CH<sub>4</sub>.* For reporting CH<sub>4</sub> or for demonstrating compliance with CH<sub>4</sub> standards, you may use a FID analyzer with a nonmethane cutter as described in § 1065.265 or you may use a GC-FID as described in § 1065.267. Determine CH<sub>4</sub> as described in § 1065.660(c).

■ 50. Section 1065.265 is amended by revising paragraph (b) to read as follows:

**§ 1065.265 Nonmethane cutter.**

\* \* \* \* \*

(b) *System performance.* Determine nonmethane-cutter performance as described in § 1065.365 and use the results to calculate CH<sub>4</sub> or NMHC emissions in § 1065.660.

\* \* \* \* \*

■ 51. Section 1065.267 is revised to read as follows:

**§ 1065.267 Gas chromatograph with a flame ionization detector.**

(a) *Application.* You may use a gas chromatograph with a flame ionization detector (GC-FID) to measure CH<sub>4</sub> concentrations of diluted exhaust for batch sampling. While you may also use a nonmethane cutter to measure CH<sub>4</sub>, as described in § 1065.265, use a reference procedure based on a gas chromatograph for comparison with any proposed alternate measurement procedure under § 1065.10.

(b) *Component requirements.* We recommend that you use a GC-FID that meets the specifications in Table 1 of § 1065.205, and it must also meet the linearity verification in § 1065.307.

■ 52. Section 1065.270 is amended by revising paragraph (b) to read as follows:

**§ 1065.270 Chemiluminescent detector.**

\* \* \* \* \*

(b) *Component requirements.* We recommend that you use a CLD that meets the specifications in Table 1 of § 1065.205. Note that your CLD-based system must meet the quench verification in § 1065.370 and it must also meet the linearity verification in § 1065.307. You may use a heated or unheated CLD, and you may use a CLD that operates at atmospheric pressure or under a vacuum. You may use a CLD that has compensation algorithms that are functions of other gaseous measurements and the engine's known or assumed fuel properties. The target value for any compensation algorithm is 0% (that is, no bias high and no bias low), regardless of the uncompensated signal's bias.

\* \* \* \* \*

■ 53. Section 1065.272 is amended by revising paragraph (b) to read as follows:

**§ 1065.272 N<sub>2</sub>O measurement devices.**

\* \* \* \* \*

(b) *Component requirements.* We recommend that you use an NDUV analyzer that meets the specifications in Table 1 of § 1065.205. Note that your NDUV-based system must meet the verifications in § 1065.372 and it must also meet the linearity verification in § 1065.307. You may use a NDUV analyzer that has compensation algorithms that are functions of other gaseous measurements and the engine's known or assumed fuel properties. The target value for any compensation algorithm is 0% (that is, no bias high and no bias low), regardless of the uncompensated signal's bias.

\* \* \* \* \*

■ 54. Section 1065.275 is amended by revising paragraphs (b) and (c) to read as follows:

**§ 1065.275 N<sub>2</sub>O measurement devices.**

\* \* \* \* \*

(b) *Instrument types.* You may use any of the following analyzers to measure N<sub>2</sub>O:

(1) *Nondispersive infrared (NDIR) analyzer.* You may use an NDIR analyzer that has compensation algorithms that are functions of other gaseous measurements and the engine's known or assumed fuel properties. The target value for any compensation algorithm is 0% (that is, no bias high and no bias low), regardless of the uncompensated signal's bias.

(2) *Fourier transform infrared (FTIR) analyzer.* You may use an FTIR analyzer that has compensation algorithms that are functions of other gaseous measurements and the engine's known or assumed fuel properties. The target value for any compensation algorithm is 0% (that is, no bias high and no bias low), regardless of the uncompensated signal's bias. Use appropriate analytical procedures for interpretation of infrared spectra. For example, EPA Test Method 320 is considered a valid method for spectral interpretation (see <http://www.epa.gov/ttn/emc/methods/method320.html>).

(3) *Laser infrared analyzer.* You may use a laser infrared analyzer that has compensation algorithms that are functions of other gaseous measurements and the engine's known or assumed fuel properties. The target value for any compensation algorithm is 0% (that is, no bias high and no bias low), regardless of the uncompensated signal's bias. Examples of laser infrared analyzers are pulsed-mode high-resolution narrow band mid-infrared analyzers, and modulated continuous wave high-resolution narrow band mid-infrared analyzers.

(4) *Photoacoustic analyzer.* You may use a photoacoustic analyzer that has compensation algorithms that are functions of other gaseous measurements. The target value for any compensation algorithm is 0% (that is, no bias high and no bias low), regardless of the uncompensated signal's bias. Use an optical wheel configuration that gives analytical priority to measurement of the least stable components in the sample. Select a sample integration time of at least 5 seconds. Take into account sample chamber and sample line volumes when determining flush times for your instrument.

(5) *Gas chromatograph analyzer.* You may use a gas chromatograph with an electron-capture detector (GC-ECD) to

measure N<sub>2</sub>O concentrations of diluted exhaust for batch sampling.

(i) You may use a packed or porous layer open tubular (PLOT) column phase of suitable polarity and length to achieve adequate resolution of the N<sub>2</sub>O peak for analysis. Examples of acceptable columns are a PLOT column consisting of bonded polystyrene-divinylbenzene or a Porapack Q packed column. Take the column temperature profile and carrier gas selection into consideration when setting up your method to achieve adequate N<sub>2</sub>O peak resolution.

(ii) Use good engineering judgment to zero your instrument and correct for drift. You do not need to follow the specific procedures in §§ 1065.530 and 1065.550(b) that would otherwise apply. For example, you may perform a span gas measurement before and after sample analysis without zeroing and use the average area counts of the pre-span and post-span measurements to generate a response factor (area counts/span gas concentration), which you then multiply by the area counts from your sample to generate the sample concentration.

(c) *Interference verification.* Perform interference verification for NDIR, FTIR, laser infrared analyzers, and photoacoustic analyzers using the procedures of § 1065.375. Interference verification is not required for GC-ECD. Certain interference gases can positively interfere with NDIR, FTIR, and photoacoustic analyzers by causing a response similar to N<sub>2</sub>O. When running the interference verification for these analyzers, use interference gases as follows:

(1) The interference gases for NDIR analyzers are CO, CO<sub>2</sub>, H<sub>2</sub>O, CH<sub>4</sub>, and SO<sub>2</sub>. Note that interference species, with the exception of H<sub>2</sub>O, are dependent on the N<sub>2</sub>O infrared absorption band chosen by the instrument manufacturer. For each analyzer determine the N<sub>2</sub>O infrared absorption band. For each N<sub>2</sub>O infrared absorption band, use good engineering judgment to determine which interference gases to use in the verification.

(2) Use good engineering judgment to determine interference gases for FTIR, and laser infrared analyzers. Note that interference species, with the exception of H<sub>2</sub>O, are dependent on the N<sub>2</sub>O infrared absorption band chosen by the instrument manufacturer. For each analyzer determine the N<sub>2</sub>O infrared absorption band. For each N<sub>2</sub>O infrared absorption band, use good engineering judgment to determine interference gases to use in the verification.

(3) The interference gases for photoacoustic analyzers are CO, CO<sub>2</sub>, and H<sub>2</sub>O.

■ 55. Section 1065.280 is amended by revising paragraph (b) to read as follows:

**§ 1065.280 Paramagnetic and magnetopneumatic O<sub>2</sub> detection analyzers.**

\* \* \* \* \*

(b) *Component requirements.* We recommend that you use a PMD or MPD analyzer that meets the specifications in Table 1 of § 1065.205. Note that it must meet the linearity verification in § 1065.307. You may use a PMD or MPD that has compensation algorithms that are functions of other gaseous measurements and the engine's known or assumed fuel properties. The target value for any compensation algorithm is 0% (that is, no bias high and no bias low), regardless of the uncompensated signal's bias.

■ 56. Section 1065.284 is amended by revising paragraph (b) to read as follows:

**§ 1065.284 Zirconia (ZrO<sub>2</sub>) analyzer.**

\* \* \* \* \*

(b) *Component requirements.* We recommend that you use a ZrO<sub>2</sub> analyzer that meets the specifications in Table 1 of § 1065.205. Note that your ZrO<sub>2</sub>-based system must meet the linearity verification in § 1065.307. You may use a Zirconia analyzer that has compensation algorithms that are functions of other gaseous measurements and the engine's known or assumed fuel properties. The target value for any compensation algorithm is 0% (that is, no bias high and no bias low), regardless of the uncompensated signal's bias.

■ 57. Section 1065.295 is amended by revising paragraph (b) to read as follows:

**§ 1065.295 PM inertial balance for field-testing analysis.**

\* \* \* \* \*

(b) *Component requirements.* We recommend that you use a balance that meets the specifications in Table 1 of § 1065.205. Note that your balance-based system must meet the linearity verification in § 1065.307. If the balance uses an internal calibration process for routine spanning and linearity verifications, the process must be NIST-traceable. You may use an inertial PM balance that has compensation algorithms that are functions of other gaseous measurements and the engine's known or assumed fuel properties. The target value for any compensation algorithm is 0% (that is, no bias high and no bias low), regardless of the uncompensated signal's bias.

\* \* \* \* \*

**Subpart D—[Amended]**

**§ 1065.303 Summary of required calibration and verifications.**

and verifications described in this subpart and indicates when these have to be performed:

■ 58. Section 1065.303 is revised to read as follows:

The following table summarizes the required and recommended calibrations

**TABLE 1 OF § 1065.303—SUMMARY OF REQUIRED CALIBRATION AND VERIFICATIONS**

Type of calibration or verification	Minimum frequency <sup>a</sup>
§ 1065.305: Accuracy, repeatability and noise ...	Accuracy: Not required, but recommended for initial installation. Repeatability: Not required, but recommended for initial installation. Noise: Not required, but recommended for initial installation.
§ 1065.307: Linearity verification .....	Speed: Upon initial installation, within 370 days before testing and after major maintenance. Torque: Upon initial installation, within 370 days before testing and after major maintenance. Electrical power: Upon initial installation, within 370 days before testing and after major maintenance. Fuel flow rate: Upon initial installation, within 370 days before testing, and after major maintenance. Intake-air, dilution air, diluted exhaust, and batch sampler flow rates: Upon initial installation, within 370 days before testing and after major maintenance, unless flow is verified by propane check or by carbon or oxygen balance. Raw exhaust flow rate: Upon initial installation, within 185 days before testing and after major maintenance, unless flow is verified by propane check or by carbon or oxygen balance. Gas dividers: Upon initial installation, within 370 days before testing, and after major maintenance. Gas analyzers (unless otherwise noted): Upon initial installation, within 35 days before testing and after major maintenance. FTIR and photoacoustic analyzers: Upon initial installation, within 370 days before testing and after major maintenance. GC-ECD: Upon initial installation and after major maintenance. PM balance: Upon initial installation, within 370 days before testing and after major maintenance. Pressure, temperature, and dewpoint: Upon initial installation, within 370 days before testing and after major maintenance.
§ 1065.308: Continuous gas analyzer system response and updating-recording verification—for gas analyzers not continuously compensated for other gas species.	Upon initial installation or after system modification that would affect response.
§ 1065.309: Continuous gas analyzer system-response and updating-recording verification—for gas analyzers continuously compensated for other gas species.	Upon initial installation or after system modification that would affect response.
§ 1065.310: Torque .....	Upon initial installation and after major maintenance.
§ 1065.315: Pressure, temperature, dewpoint ....	Upon initial installation and after major maintenance.
§ 1065.320: Fuel flow .....	Upon initial installation and after major maintenance.
§ 1065.325: Intake flow .....	Upon initial installation and after major maintenance.
§ 1065.330: Exhaust flow .....	Upon initial installation and after major maintenance.
§ 1065.340: Diluted exhaust flow (CVS) .....	Upon initial installation and after major maintenance.
§ 1065.341: CVS and batch sampler verification <sup>b</sup> .	Upon initial installation, within 35 days before testing, and after major maintenance.
§ 1065.342 Sample dryer verification .....	For thermal chillers: upon installation and after major maintenance. For osmotic membranes; upon installation, within 35 days of testing, and after major maintenance.
§ 1065.345: Vacuum leak .....	For laboratory testing: upon initial installation of the sampling system, within 8 hours before the start of the first test interval of each duty-cycle sequence, and after maintenance such as pre-filter changes. For field testing: after each installation of the sampling system on the vehicle, prior to the start of the field test, and after maintenance such as pre-filter changes.
§ 1065.350: CO <sub>2</sub> NDIR H <sub>2</sub> O interference .....	Upon initial installation and after major maintenance.
§ 1065.355: CO NDIR CO <sub>2</sub> and H <sub>2</sub> O interference.	Upon initial installation and after major maintenance.
§ 1065.360: FID calibrationn .....	Calibrate all FID analyzers: upon initial installation and after major maintenance. Optimize and determine CH <sub>4</sub> response for THC FID analyzers: upon initial installation and after major maintenance. Verify CH <sub>4</sub> response for THC FID analyzers: upon initial installation, within 185 days before testing, and after major maintenance.
THC FID optimization, and THC FID verification	Optimize and determine CH <sub>4</sub> response for THC FID analyzers: upon initial installation and after major maintenance. Verify CH <sub>4</sub> response for THC FID analyzers: upon initial installation, within 185 days before testing, and after major maintenance.
§ 1065.362: Raw exhaust FID O <sub>2</sub> interference ...	For all FID analyzers: upon initial installation, and after major maintenance. For THC FID analyzers: upon initial installation, after major maintenance, and after FID optimization according to § 1065.360.
§ 1065.365: Nonmethane cutter penetration .....	Upon initial installation, within 185 days before testing, and after major maintenance.
§ 1065.370: CLD CO <sub>2</sub> and H <sub>2</sub> O quench .....	Upon initial installation and after major maintenance.
§ 1065.372: NDUV HC and H <sub>2</sub> O interference ....	Upon initial installation and after major maintenance.
§ 1065.375: N <sub>2</sub> O analyzer interference .....	Upon initial installation and after major maintenance.
§ 1065.376: Chiller NO <sub>2</sub> penetration .....	Upon initial installation and after major maintenance.
§ 1065.378: NO <sub>2</sub> -to-NO converter conversion ....	Upon initial installation, within 35 days before testing, and after major maintenance.



TABLE 1 OF § 1065.303—SUMMARY OF REQUIRED CALIBRATION AND VERIFICATIONS—Continued

Type of calibration or verification	Minimum frequency <sup>a</sup>
§ 1065.390: PM balance and weighing .....	Independent verification: upon initial installation, within 370 days before testing, and after major maintenance. Zero, span, and reference sample verifications: within 12 hours of weighing, and after major maintenance.
§ 1065.395: Inertial PM balance and weighing ..	Independent verification: upon initial installation, within 370 days before testing, and after major maintenance. Other verifications: upon initial installation and after major maintenance.

<sup>a</sup> Perform calibrations and verifications more frequently, according to measurement system manufacturer instructions and good engineering judgment.

<sup>b</sup> The CVS verification described in § 1065.341 is not required for systems that agree within ±2% based on a chemical balance of carbon or oxygen of the intake air, fuel, and diluted exhaust.

■ 59. Section 1065.307 is amended by revising paragraph (a) and Table 1 at the end of the section to read as follows:

**§ 1065.307 Linearity verification.**

(a) *Scope and frequency.* Perform a linearity verification on each measurement system listed in Table 1 of this section at least as frequently as indicated in Table 1 of § 1065.303,

consistent with measurement system manufacturer recommendations and good engineering judgment. Note that this linearity verification may replace requirements we previously referred to as “calibrations”. The intent of a linearity verification is to determine that a measurement system responds proportionally over the measurement range of interest. A linearity verification

generally consists of introducing a series of at least 10 reference values to a measurement system. The measurement system quantifies each reference value. The measured values are then collectively compared to the reference values by using a least squares linear regression and the linearity criteria specified in Table 1 of this section.

\* \* \* \* \*

TABLE 1 OF § 1065.307—MEASUREMENT SYSTEMS THAT REQUIRE LINEARITY VERIFICATIONS

Measurement system	Quantity	Linearity criteria			
		$ x_{\min}(a_1-1)+a_0 $	$a_1$	SEE	$r^2$
Speed .....	$f_n$	$\leq 0.05\% \cdot f_{n\max}$	0.98–1.02	$\leq 2\% \cdot f_{n\max}$	$\geq 0.990$
Torque .....	$T$	$\leq 1\% \cdot T_{\max}$	0.98–1.02	$\leq 2\% \cdot T_{\max}$	$\geq 0.990$
Electrical power .....	$P$	$\leq 1\% \cdot P_{\max}$	0.98–1.02	$\leq 2\% \cdot P_{\max}$	$\geq 0.990$
Fuel flow rate .....	$\dot{m}$	$\leq 1\% \cdot \dot{m}_{\max}$	0.98–1.02	$\leq 2\% \cdot \dot{m}_{\max}$	$\geq 0.990$
Intake-air flow rate .....	$\dot{n}$	$\leq 1\% \cdot \dot{n}_{\max}$	0.98–1.02	$\leq 2\% \cdot \dot{n}_{\max}$	$\geq 0.990$
Dilution air flow rate .....	$\dot{n}$	$\leq 1\% \cdot \dot{n}_{\max}$	0.98–1.02	$\leq 2\% \cdot \dot{n}_{\max}$	$\geq 0.990$
Diluted exhaust flow rate .....	$\dot{n}$	$\leq 1\% \cdot \dot{n}_{\max}$	0.98–1.02	$\leq 2\% \cdot \dot{n}_{\max}$	$\geq 0.990$
Raw exhaust flow rate .....	$\dot{n}$	$\leq 1\% \cdot \dot{n}_{\max}$	0.98–1.02	$\leq 2\% \cdot \dot{n}_{\max}$	$\geq 0.990$
Batch sampler flow rates .....	$\dot{n}$	$\leq 1\% \cdot \dot{n}_{\max}$	0.98–1.02	$\leq 2\% \cdot \dot{n}_{\max}$	$\geq 0.990$
Gas dividers .....	$X/X_{\text{span}}$	$\leq 0.5\% \cdot X_{\max/X_{\text{span}}}$	0.98–1.02	$\leq 2\% \cdot X_{\max/X_{\text{span}}}$	$\geq 0.990$
Gas analyzers for laboratory testing .....	$x$	$\leq 0.5\% \cdot \dot{x}_{\max}$	0.99–1.01	$\leq 1\% \cdot \dot{x}_{\max}$	$\geq 0.998$
Gas analyzers for field testing .....	$x$	$\leq 1\% \cdot \dot{x}_{\max}$	0.99–1.01	$\leq 1\% \cdot \dot{x}_{\max}$	$\geq 0.998$
PM balance .....	$m$	$\leq 1\% \cdot \dot{m}_{\max}$	0.99–1.01	$\leq 1\% \cdot \dot{m}_{\max}$	$\geq 0.998$
Pressures .....	$p$	$\leq 1\% \cdot \dot{p}_{\max}$	0.99–1.01	$\leq 1\% \cdot \dot{p}_{\max}$	$\geq 0.998$
Dewpoint for intake air, PM-stabilization and balance environments.	$T_{\text{dew}}$	$\leq 0.5\% \cdot T_{\text{dewmax}}$	0.99–1.01	$\leq 0.5\% \cdot T_{\text{dewmax}}$	$\geq 0.998$
Other dewpoint measurements .....	$T_{\text{dew}}$	$\leq 1\% \cdot T_{\text{dewmax}}$	0.99–1.01	$\leq 1\% \cdot T_{\text{dewmax}}$	$\geq 0.998$
Analog-to-digital conversion of temperature signals.	$T$	$\leq 1\% \cdot T_{\max}$	0.99–1.01	$\leq 1\% \cdot T_{\max}$	$\geq 0.998$

■ 60. Section 1065.340 is amended by revising paragraphs (a) through (g), adding paragraph (h), and adding and reserving paragraph (i) before Figure 1 to read as follows:

**§ 1065.340 Diluted exhaust flow (CVS) calibration.**

(a) *Overview.* This section describes how to calibrate flow meters for diluted exhaust constant-volume sampling (CVS) systems.

(b) *Scope and frequency.* Perform this calibration while the flow meter is installed in its permanent position, except as allowed in paragraph (c) of this section. Perform this calibration

after you change any part of the flow configuration upstream or downstream of the flow meter that may affect the flow-meter calibration. Perform this calibration upon initial CVS installation and whenever corrective action does not resolve a failure to meet the diluted exhaust flow verification (*i.e.*, propane check) in § 1065.341.

(c) *Ex-situ CFV and SSV calibration.* You may remove a CFV or SSV from its permanent position for calibration as long as it meets the following requirements when installed in the CVS:

(1) Upon installation of the CFV or SSV into the CVS, use good engineering judgment to verify that you have not

introduced any leaks between the CVS inlet and the venturi.

(2) After ex-situ venturi calibration, you must verify all venturi flow combinations for CFVs or at minimum of 10 flow points for an SSV using the propane check as described in § 1065.341. Your propane check result for each venturi flow point may not exceed the tolerance in § 1065.341(f)(5).

(3) To verify your ex-situ calibration for a CVS with more than a single CFV, perform the following check to verify that there are no flow meter entrance effects that can prevent you from passing this verification.

(i) Use a constant flow device like a CFO kit to deliver a constant flow of propane to the dilution tunnel.

(ii) Measure hydrocarbon concentrations at a minimum of 10 separate flow rates for an SSV flow meter, or at all possible flow combinations for a CFV flow meter, while keeping the flow of propane constant. We recommend selecting CVS flow rates in a random order.

(iii) Measure the concentration of hydrocarbon background in the dilution air at the beginning and end of this test. Subtract the average background concentration from each measurement at each flow point before performing the regression analysis in paragraph (c)(3)(iv) of this section.

(iv) Perform a power regression using all the paired values of flow rate and corrected concentration to obtain a relationship in the form of  $y = a \cdot x^b$ . Use concentration as the independent variable and flow rate as the dependent variable. For each data point, calculate the difference between the measured flow rate and the value represented by the curve fit. The difference at each point must be less than  $\pm 1\%$  of the appropriate regression value. The value of  $b$  must be between  $-1.005$  and  $-0.995$ . If your results do not meet these limits, take corrective action consistent with § 1065.341(a).

(d) *Reference flow meter.* Calibrate a CVS flow meter using a reference flow meter such as a subsonic venturi flow meter, a long-radius ASME/NIST flow nozzle, a smooth approach orifice, a laminar flow element, a set of critical flow venturis, or an ultrasonic flow meter. Use a reference flow meter that reports quantities that are NIST-traceable within  $\pm 1\%$  uncertainty. Use this reference flow meter's response to flow as the reference value for CVS flow-meter calibration.

(e) *Configuration.* Do not use an upstream screen or other restriction that could affect the flow ahead of the reference flow meter, unless the flow meter has been calibrated with such a restriction.

(f) *PDP calibration.* Calibrate a positive-displacement pump (PDP) to determine a flow-versus-PDP speed equation that accounts for flow leakage across sealing surfaces in the PDP as a function of PDP inlet pressure. Determine unique equation coefficients for each speed at which you operate the PDP. Calibrate a PDP flow meter as follows:

(1) Connect the system as shown in Figure 1 of this section.

(2) Leaks between the calibration flow meter and the PDP must be less than 0.3% of the total flow at the lowest

calibrated flow point; for example, at the highest restriction and lowest PDP-speed point.

(3) While the PDP operates, maintain a constant temperature at the PDP inlet within  $\pm 2\%$  of the mean absolute inlet temperature,  $\bar{T}_{in}$ .

(4) Set the PDP speed to the first speed point at which you intend to calibrate.

(5) Set the variable restrictor to its wide-open position.

(6) Operate the PDP for at least 3 min to stabilize the system. Continue operating the PDP and record the mean values of at least 30 seconds of sampled data of each of the following quantities:

(i) The mean flow rate of the reference flow meter,  $\bar{n}_{ref}$ . This may include several measurements of different quantities, such as reference meter pressures and temperatures, for calculating  $\bar{n}_{ref}$ .

(ii) The mean temperature at the PDP inlet,  $\bar{T}_{in}$ .

(iii) The mean static absolute pressure at the PDP inlet,  $\bar{p}_{in}$ .

(iv) The mean static absolute pressure at the PDP outlet,  $\bar{p}_{out}$ .

HERE

(v) The mean PDP speed,  $\bar{f}_{nPDP}$ .

HERE

(7) Incrementally close the restrictor valve to decrease the absolute pressure at the inlet to the PDP,  $\bar{p}_{in}$ .

(8) Repeat the steps in paragraphs (e)(6) and (7) of this section to record data at a minimum of six restrictor positions ranging from the wide open restrictor position to the minimum expected pressure at the PDP inlet.

(9) Calibrate the PDP by using the collected data and the equations in § 1065.640.

(10) Repeat the steps in paragraphs (e)(6) through (9) of this section for each speed at which you operate the PDP.

(11) Use the equations in § 1065.642 to determine the PDP flow equation for emission testing.

(12) Verify the calibration by performing a CVS verification (*i.e.*, propane check) as described in § 1065.341.

(13) Do not use the PDP below the lowest inlet pressure tested during calibration.

(g) *CFV calibration.* Calibrate a critical-flow venturi (CFV) to verify its discharge coefficient,  $C_d$ , at the lowest expected static differential pressure between the CFV inlet and outlet. Calibrate a CFV flow meter as follows:

(1) Connect the system as shown in Figure 1 of this section.

(2) Verify that any leaks between the calibration flow meter and the CFV are less than 0.3% of the total flow at the highest restriction.

(3) Start the blower downstream of the CFV.

(4) While the CFV operates, maintain a constant temperature at the CFV inlet within  $\pm 2\%$  of the mean absolute inlet temperature,  $\bar{T}_{in}$ .

(5) Set the variable restrictor to its wide-open position. Instead of a variable restrictor, you may alternately vary the pressure downstream of the CFV by varying blower speed or by introducing a controlled leak. Note that some blowers have limitations on nonloaded conditions.

(6) Operate the CFV for at least 3 min to stabilize the system. Continue operating the CFV and record the mean values of at least 30 seconds of sampled data of each of the following quantities:

(i) The mean flow rate of the reference flow meter,  $\bar{n}_{ref}$ . This may include several measurements of different quantities, such as reference meter pressures and temperatures, for calculating  $\bar{n}_{ref}$ .

(ii) The mean dewpoint of the calibration air,  $\bar{T}_{dew}$ . See § 1065.640 for permissible assumptions during emission measurements.

(iii) The mean temperature at the venturi inlet,  $\bar{T}_{in}$ .

(iv) The mean static absolute pressure at the venturi inlet,  $\bar{p}_{in}$ .

(v) The mean static differential pressure between the CFV inlet and the CFV outlet,  $\Delta\bar{p}_{CFV}$ .

(7) Incrementally close the restrictor valve or decrease the downstream pressure to decrease the differential pressure across the CFV,  $\Delta\bar{p}_{CFV}$ .

(8) Repeat the steps in paragraphs (f)(6) and (7) of this section to record mean data at a minimum of ten restrictor positions, such that you test the fullest practical range of  $\Delta\bar{p}_{CFV}$  expected during testing. We do not require that you remove calibration components or CVS components to calibrate at the lowest possible restrictions.

(9) Determine  $C_d$  and the lowest allowable pressure ratio,  $r$ , according to § 1065.640.

(10) Use  $C_d$  to determine CFV flow during an emission test. Do not use the CFV below the lowest allowed  $r$ , as determined in § 1065.640.

(11) Verify the calibration by performing a CVS verification (*i.e.*, propane check) as described in § 1065.341.

(12) If your CVS is configured to operate more than one CFV at a time in parallel, calibrate your CVS by one of the following:

(i) Calibrate every combination of CFVs according to this section and § 1065.640. Refer to § 1065.642 for

instructions on calculating flow rates for this option.

(ii) Calibrate each CFV according to this section and § 1065.640. Refer to § 1065.642 for instructions on calculating flow rates for this option.

(h) *SSV calibration.* Calibrate a subsonic venturi (SSV) to determine its calibration coefficient,  $C_d$ , for the expected range of inlet pressures. Calibrate an SSV flow meter as follows:

(1) Connect the system as shown in Figure 1 of this section.

(2) Verify that any leaks between the calibration flow meter and the SSV are less than 0.3% of the total flow at the highest restriction.

(3) Start the blower downstream of the SSV.

(4) While the SSV operates, maintain a constant temperature at the SSV inlet within  $\pm 2\%$  of the mean absolute inlet temperature,  $\bar{T}_{in}$ .

(5) Set the variable restrictor or variable-speed blower to a flow rate greater than the greatest flow rate expected during testing. You may not extrapolate flow rates beyond calibrated values, so we recommend that you make sure the Reynolds number,  $Re^\#$ , at the SSV throat at the greatest calibrated flow rate is greater than the maximum  $Re^\#$  expected during testing.

(6) Operate the SSV for at least 3 min to stabilize the system. Continue operating the SSV and record the mean of at least 30 seconds of sampled data of each of the following quantities:

(i) The mean flow rate of the reference flow meter  $\bar{n}_{ref}$ . This may include several measurements of different quantities, such as reference meter pressures and temperatures, for calculating  $\bar{n}_{ref}$ .

(ii) Optionally, the mean dewpoint of the calibration air,  $\bar{T}_{dew}$ . See § 1065.640 for permissible assumptions.

(iii) The mean temperature at the venturi inlet,  $\bar{T}_{in}$ .

(iv) The mean static absolute pressure at the venturi inlet,  $\bar{p}_{in}$ .

(v) Static differential pressure between the static pressure at the venturi inlet and the static pressure at the venturi throat,  $\Delta\bar{p}_{SSV}$ .

(7) Incrementally close the restrictor valve or decrease the blower speed to decrease the flow rate.

(8) Repeat the steps in paragraphs (g)(6) and (7) of this section to record data at a minimum of ten flow rates.

(9) Determine a functional form of  $C_d$  versus  $Re^\#$  by using the collected data and the equations in § 1065.640.

(10) Verify the calibration by performing a CVS verification (*i.e.*, propane check) as described in § 1065.341 using the new  $C_d$  versus  $Re^\#$  equation.

(11) Use the SSV only between the minimum and maximum calibrated flow rates.

(12) Use the equations in § 1065.642 to determine SSV flow during a test.

(i) *Ultrasonic flow meter calibration.* [Reserved]

\* \* \* \* \*

■ 61. Section 1065.341 is amended by revising paragraphs (a)(5), (a)(6), and (f)(5) and adding paragraph (a)(7) to read as follows:

**§ 1065.341 CVS and batch sampler verification (propane check).**

(a) \* \* \*

(5) *Change in CVS calibration.*

Perform a calibration of the CVS flow meter as described in § 1065.340.

(6) *Flow meter entrance effects.*

Inspect the CVS tunnel to determine whether the entrance effects from the piping configuration upstream of the flow meter adversely affect the flow measurement.

(7) *Other problems with the CVS or sampling verification hardware or software.* Inspect the CVS system, CVS verification hardware, and software for discrepancies.

\* \* \* \* \*

(f) \* \* \*

(5) Subtract the reference  $C_3H_8$  mass from the calculated mass. If this difference is within  $\pm 2\%$  of the reference mass, the CVS passes this verification. If not, take corrective action as described in paragraph (a) of this section.

\* \* \* \* \*

■ 62. Section 1065.350 is amended by revising paragraph (d)(7) to read as follows:

**§ 1065.350 H<sub>2</sub>O interference verification for CO<sub>2</sub> NDIR analyzers.**

\* \* \* \* \*

(d) \* \* \*

(7) While the analyzer measures the sample's concentration, record 30 seconds of sampled data. Calculate the arithmetic mean of this data. The analyzer meets the interference verification if this value is within (0.0  $\pm$  0.4) mmol/mol.

\* \* \* \* \*

■ 63. Section 1065.360 is amended by revising paragraph (e) introductory text to read as follows:

**§ 1065.360 FID optimization and verification.**

\* \* \* \* \*

(e) *THC FID methane (CH<sub>4</sub>) response verification.* This procedure is only for FID analyzers that measure THC. If the value of  $RF_{CH_4[THC-FID]}$  from paragraph (d) of this section is within  $\pm 5\%$  of its

most recent previously determined value, the THC FID passes the methane response verification. For example, if the most recent previous value for  $RF_{CH_4[THC-FID]}$  was 1.05 and it changed by  $\pm 0.05$  to become 1.10 or it changed by  $-0.05$  to become 1.00, either case would be acceptable because  $\pm 4.8\%$  is less than  $\pm 5\%$ . Verify  $RF_{CH_4[THC-FID]}$  as follows:

\* \* \* \* \*

■ 64. Section 1065.370 is amended by revising paragraph (g)(1) to read as follows:

**§ 1065.370 CLD CO<sub>2</sub> and H<sub>2</sub>O quench verification.**

\* \* \* \* \*

(g) \* \* \*

(1) You may omit this verification if you can show by engineering analysis that for your NO<sub>x</sub> sampling system and your emission calculation procedures, the combined CO<sub>2</sub> and H<sub>2</sub>O interference for your NO<sub>x</sub> CLD analyzer always affects your brake-specific NO<sub>x</sub> emission results within no more than  $\pm 1\%$  of the applicable NO<sub>x</sub> standard. If you certify to a combined emission standard (such as a NO<sub>x</sub> + NMHC standard), scale your NO<sub>x</sub> results to the combined standard based on the measured results (after incorporating deterioration factors, if applicable). For example, if your final NO<sub>x</sub> + NMHC value is half of the emission standard, double the NO<sub>x</sub> result to estimate the level of NO<sub>x</sub> emissions corresponding to the applicable standard.

\* \* \* \* \*

■ 65. Section 1065.372 is amended by revising paragraph (e)(1) to read as follows:

**§ 1065.372 NDUV analyzer HC and H<sub>2</sub>O interference verification.**

\* \* \* \* \*

(e) \* \* \*

(1) You may omit this verification if you can show by engineering analysis that for your NO<sub>x</sub> sampling system and your emission calculation procedures, the combined HC and H<sub>2</sub>O interference for your NO<sub>x</sub> NDUV analyzer always affects your brake-specific NO<sub>x</sub> emission results by less than 0.5% of the applicable NO<sub>x</sub> standard.

\* \* \* \* \*

■ 66. Section 1065.378 is amended by revising paragraph (d)(3)(iv) to read as follows:

**§ 1065.378 NO<sub>2</sub>-to-NO converter conversion verification.**

\* \* \* \* \*

(d) \* \* \*

(3) \* \* \*

(iv) Switch the ozonator on and adjust the ozone generation rate so the NO

measured by the analyzer is 20 percent of  $x_{NOref}$  or a value which would simulate the maximum concentration of  $NO_2$  expected during testing, while maintaining at least 10 percent unreacted NO. This ensures that the ozonator is generating  $NO_2$  at the maximum concentration expected during testing. Record the concentration of NO by calculating the mean of 30 seconds of sampled data from the analyzer and record this value as

$x_{NOmeas}$   
\* \* \* \* \*

**Subpart F—[Amended]**

■ 67. Section 1065.510 is amended as follows:

- a. By revising paragraphs (a) introductory text, (b)(5)(i), and (b)(6).
- b. By adding paragraph (b)(7).
- c. By revising paragraphs (c)(2), (d)(5), (f)(3), (f)(5), and (g).
- d. By adding paragraphs (c)(4) and (h) to read as follows:

**§ 1065.510 Engine mapping.**

(a) *Applicability, scope, and frequency.* An engine map is a data set that consists of a series of paired data points that represent the maximum brake torque versus engine speed, measured at the engine's primary output shaft. Map your engine if the standard-setting part requires engine mapping to generate a duty cycle for your engine configuration. Map your engine while it is connected to a dynamometer or other device that can absorb work output from the engine's primary output shaft according to § 1065.110. To establish speed and torque values for mapping, we generally recommend that you stabilize an engine for at least 15 seconds at each setpoint and record the mean feedback speed and torque of the last (4 to 6) seconds. Configure any auxiliary work inputs and outputs such as hybrid, turbo-compounding, or thermoelectric systems to represent their in-use configurations, and use the same configuration for emission testing. See Figure 1 of § 1065.210. This may involve configuring initial states of charge and rates and times of auxiliary-work inputs and outputs. We recommend that you contact the Designated Compliance Officer before testing to determine how you should configure any auxiliary-work inputs and outputs. Use the most recent engine map to transform a normalized duty cycle from the standard-setting part to a reference duty cycle specific to your engine. Normalized duty cycles are specified in the standard-setting part. You may update an engine map at any time by repeating the engine-mapping

procedure. You must map or re-map an engine before a test if any of the following apply:

- \* \* \* \* \*
- (b) \* \* \*
- (5) \* \* \*

(i) For any engine subject only to steady-state duty cycles, you may perform an engine map by using discrete speeds. Select at least 20 evenly spaced setpoints from 95% of warm idle speed to the highest speed above maximum power at which 50% of maximum power occurs. We refer to this 50% speed as the check point speed as described in paragraph (b)(5)(iii) of this section. At each setpoint, stabilize speed and allow torque to stabilize. Record the mean speed and torque at each setpoint. Use linear interpolation to determine intermediate speeds and torques. Use this series of speeds and torques to generate the power map as described in paragraph (e) of this section.

\* \* \* \* \*

(6) Use one of the following methods to determine warm high-idle speed for engines with a high-speed governor if they are subject to transient testing with a duty cycle that includes reference speed values above 100%:

(i) You may use a manufacturer-declared warm high-idle speed if the engine is electronically governed. For engines with a high-speed governor that shuts off torque output at a manufacturer-specified speed and reactivates at a lower manufacturer-specified speed (such as engines that use ignition cut-off for governing), declare the middle of the specified speed range as the warm high-idle speed.

(ii) Measure the warm high-idle speed using the following procedure:

(A) Set operator demand to maximum and use the dynamometer to target zero torque on the engine's primary output shaft. If the mean feedback torque is within  $\pm 1\%$  of  $T_{max\ mapped}$ , you may use the observed mean feedback speed at that point as the measured warm high-idle speed.

(B) If the engine is unstable as a result of in-use production components (such as engines that use ignition cut-off for governing, as opposed to unstable dynamometer operation), you must use the mean feedback speed from paragraph (b)(6)(ii)(A) of this section as the measured warm high-idle speed. The engine is considered unstable if any of the 1 Hz speed feedback values are not within  $\pm 2\%$  of the calculated mean feedback speed. We recommend that you determine the mean as the value representing the midpoint between the

observed maximum and minimum recorded feedback speed.

(C) If your dynamometer is not capable of achieving a mean feedback torque within  $\pm 1\%$  of  $T_{max\ mapped}$ , operate the engine at a second point with operator demand set to maximum with the dynamometer set to target a torque equal to the recorded mean feedback torque on the previous point plus 20% of  $T_{max\ mapped}$ . Use this data point and the data point from paragraph (b)(6)(ii)(A) of this section to extrapolate the engine speed where torque is equal to zero.

(D) You may use a manufacturer-declared  $T_{max}$  instead of the measured  $T_{max\ mapped}$ . If you do this, or if you are able to determine mean feedback speed as described in paragraphs (b)(6)(ii)(A) and (B) of this section, you may measure the warm high-idle speed before running the speed sweep specified in paragraph (b)(5) of this section.

(7) For engines with a low-speed governor, if a nonzero idle torque is representative of in-use operation, operate the engine at warm idle with the manufacturer-declared idle torque. Set the operator demand to minimum, use the dynamometer to target the declared idle torque, and allow the engine to govern the speed. Measure this speed and use it as the warm idle speed for cycle generation in § 1065.512. We recommend recording at least 30 values of speed and using the mean of those values. If you identify multiple warm idle torques under paragraph (f)(4)(i) of this section, measure the warm idle speed at each torque. You may map the idle governor at multiple load levels and use this map to determine the measured warm idle speed at the declared idle torque(s).

(c) \* \* \*

(2) Map the amount of negative torque required to motor the engine by repeating paragraph (b) of this section with minimum operator demand. You may start the negative torque map at either the minimum or maximum speed from paragraph (b) of this section.

\* \* \* \* \*

(4) For engines with an electric hybrid system, you may create a negative torque map that would include the full negative torque of the electric hybrid system, so operator demand will be at a minimum when the reference duty cycle specifies negative torque values.

(d) \* \* \*

(5) Perform one of the following:

(i) For constant-speed engines subject only to steady-state testing, you may perform an engine map by using a series of discrete torques. Select at least five evenly spaced torque setpoints from no-

load to 80% of the manufacturer-declared test torque or to a torque derived from your published maximum power level if the declared test torque is unavailable. Starting at the 80% torque point, select setpoints in 2.5% intervals, stopping at the endpoint torque. The endpoint torque is defined as the first discrete mapped torque value greater than the torque at maximum observed power where the engine outputs 90% of the maximum observed power; or the torque when engine stall has been determined using good engineering judgment (*i.e.* sudden deceleration of engine speed while adding torque). You may continue mapping at higher torque setpoints. At each setpoint, allow torque and speed to stabilize. Record the mean feedback speed and torque at each setpoint. From this series of mean feedback speed and torque values, use linear interpolation to determine intermediate values. Use this series of mean feedback speeds and torques to generate the power map as described in paragraph (e) of this section.

(ii) For any constant-speed engine, you may perform an engine map with a continuous torque sweep by continuing to record the mean feedback speed and torque at 1 Hz or more frequently. Use the dynamometer to increase torque. Increase the reference torque at a constant rate from no-load to the endpoint torque as defined in paragraph (d)(5)(i) of this section. You may continue mapping at higher torque setpoints. Unless the standard-setting part specifies otherwise, target a torque sweep rate equal to the manufacturer-declared test torque (or a torque derived from your published power level if the declared test torque is not known) divided by 180 s. Stop recording after you complete the sweep. Verify that the average torque sweep rate over the entire map is within  $\pm 7\%$  of the target torque sweep rate. Use linear interpolation to determine intermediate values from this series of mean feedback speed and torque values. Use this series of mean feedback speeds and torques to generate the power map as described in paragraph (e) of this section.

(iii) For electric power generation applications in which normal engine operation is limited to a specific speed range, map the engine with two points as described in this paragraph (d)(5)(iii). After stabilizing at the no-load governed speed in paragraph (d)(4) of this section, record the mean feedback speed and torque. Continue to operate the engine with the governor or simulated governor controlling engine speed using operator demand, and control the dynamometer to target a speed of 97.5% of the

recorded mean no-load governed speed. If the in-use performance class of the electric power generation application is known, you may use those values in place of 97.5% (*e.g.*, for ISO 8528-5 G3 Performance Class, the steady-state frequency band is less than or equal to 0.5%, so use 99.75% instead of 97.5%). Allow speed and torque to stabilize. Record the mean feedback speed and torque. Record the target speed. The absolute value of the speed error (the mean feedback speed minus the target speed) must be no greater than 20% of the difference between the recorded mean no-load governed speed and the target speed. From this series of two mean feedback speed and torque values, use linear interpolation to determine intermediate values. Use this series of two mean feedback speeds and torques to generate a power map as described in paragraph (e) of this section. Note that the measured maximum test torque determined in § 1065.610(b)(1), will be the mean feedback torque recorded on the second point.

\* \* \* \* \*  
(f) \* \* \*

(3) *Optional declared speeds.* You may use declared speeds instead of measured speeds as follows:

(i) You may use a declared value for maximum test speed for variable-speed engines if it is within (97.5 to 102.5) % of the corresponding measured value. You may use a higher declared speed if the length of the “vector” at the declared speed is within 2% of the length of the “vector” at the measured value. The term vector refers to the square root of the sum of normalized engine speed squared and the normalized full-load power (at that speed) squared, consistent with the calculations in § 1065.610.

(ii) You may use a declared value for intermediate, “A”, “B”, or “C” speeds for steady-state tests if the declared value is within (97.5 to 102.5)% of the corresponding measured value.

(iii) For electronically governed engines, you may use a declared warm high-idle speed for calculating the alternate maximum test speed as specified in § 1065.610.

\* \* \* \* \*

(5) *Optional declared torques.* (i) For variable-speed engines you may declare a maximum torque over the engine operating range. You may use the declared value for measuring warm high-idle speed as specified in this section.

(ii) For constant-speed engines you may declare a maximum test torque. You may use the declared value for

cycle generation if it is within (95 to 100) % of the measured value.

(g) *Mapping variable-speed engines with an electric hybrid system.* Map variable-speed engines that include electric hybrid systems as described in this paragraph (g). You may ask to apply these provisions to other types of hybrid engines, consistent with good engineering judgment. However, do not use this procedure for engines used in hybrid vehicles where the hybrid system is certified as part of the vehicle rather than the engine. Follow the steps for mapping a variable-speed engine as given in paragraph (b)(5) of this section except as noted in this paragraph (g). You must generate one engine map with the hybrid system inactive as described in paragraph (g)(1) of this section, and a separate map with the hybrid system active as described in paragraph (g)(2) of this section. See the standard-setting part to determine how to use these maps. The map with the system inactive is typically used to generate steady-state duty cycles, but may also be used to generate transient cycles, such as those that do not involve engine motoring. This hybrid-inactive map is also used for generating the hybrid-active map. The hybrid-active map is typically used to generate transient duty cycles that involve engine motoring.

(1) Prepare the engine for mapping by either deactivating the hybrid system or by operating the engine as specified in paragraph (b)(4) of this section and remaining at this condition until the rechargeable energy storage system (RESS) is depleted. Once the hybrid has been disabled or the RESS is depleted, perform an engine map as specified in paragraph (b)(5) of this section. If the RESS was depleted instead of deactivated, ensure that instantaneous power from the RESS remains less than 2% of the instantaneous measured power from the engine (or engine-hybrid system) at all engine speeds.

(2) The purpose of the mapping procedure in this paragraph (g) is to determine the maximum torque available at each speed, such as what might occur during transient operation with a fully charged RESS. Use one of the following methods to generate a hybrid-active map:

(i) Perform an engine map by using a series of continuous sweeps to cover the engine’s full range of operating speeds. Prepare the engine for hybrid-active mapping by ensuring that the RESS state of charge is representative of normal operation. Perform the sweep as specified in paragraph (b)(5)(ii) of this section, but stop the sweep to charge the RESS when the power measured from the RESS drops below the expected

maximum power from the RESS by more than 2% of total system power (including engine and RESS power). Unless good engineering judgment indicates otherwise, assume that the expected maximum power from the RESS is equal to the measured RESS power at the start of the sweep segment. For example, if the 3-second rolling average of total engine-RESS power is 200 kW and the power from the RESS at the beginning of the sweep segment is 50 kW, once the power from the RESS reaches 46 kW, stop the sweep to charge the RESS. Note that this assumption is not valid where the hybrid motor is torque-limited. Calculate total system power as a 3-second rolling average of instantaneous total system power. After each charging event, stabilize the engine for 15 seconds at the speed at which you ended the previous segment with operator demand set to maximum before continuing the sweep from that speed. Repeat the cycle of charging, mapping, and recharging until you have completed the engine map. You may shut down the system or include other operation between segments to be consistent with the intent of this paragraph (g)(2)(i). For example, for systems in which continuous charging and discharging can overheat batteries to an extent that affects performance, you may operate the engine at zero power from the RESS for enough time after the system is recharged to allow the batteries to cool. Use good engineering judgment to smooth the torque curve to eliminate discontinuities between map intervals.

(ii) Perform an engine map by using discrete speeds. Select map setpoints at intervals defined by the ranges of engine speed being mapped. From 95% of warm idle speed to 90% of the expected maximum test speed, select setpoints that result in a minimum of 13 equally spaced speed setpoints. From 90% to 110% of expected maximum test speed, select setpoints in equally spaced intervals that are nominally 2% of expected maximum test speed. Above 110% of expected maximum test speed, select setpoints based on the same speed intervals used for mapping from 95% warm idle speed to 90% maximum test speed. You may stop mapping at the highest speed above maximum power at which 50% of maximum power occurs. We refer to the speed at 50% power as the check point speed as described in paragraph (b)(5)(iii) of this section. Stabilize engine speed at each setpoint, targeting a torque value at 70% of peak torque at that speed without hybrid-assist. Make sure the engine is fully warmed up and the RESS state of charge is within the normal operating range. Snap the operator demand to maximum, operate the engine there for at least 10 seconds, and record the 3-second rolling average feedback speed and torque at 1 Hz or higher. Record the peak 3-second average torque and 3-second average speed at that point. Use linear interpolation to determine intermediate speeds and torques. Follow § 1065.610(a) to calculate the maximum test speed. Verify that the measured maximum test speed falls in the range from 92 to 108% of the estimated

maximum test speed. If the measured maximum test speed does not fall in this range, rerun the map using the measured value of maximum test speed.

(h) *Other mapping procedures.* You may use other mapping procedures if you believe the procedures specified in this section are unsafe or unrepresentative for your engine. Any alternate techniques you use must satisfy the intent of the specified mapping procedures, which is to determine the maximum available torque at all engine speeds that occur during a duty cycle. Identify any deviations from this section's mapping procedures when you submit data to us.

■ 68. Section 1065.514 is amended by revising paragraph (f)(3) to read as follows:

**§ 1065.514 Cycle-validation criteria for operation over specified duty cycles.**

\* \* \* \* \*

(f) \* \* \*

(3) For discrete-mode steady-state testing, apply cycle-validation criteria by treating the sampling periods from the series of test modes as a continuous sampling period, analogous to ramped-modal testing and apply statistical criteria as described in paragraph (f)(1) or (f)(2) of this section. Note that if the gaseous and particulate test intervals are different periods of time, separate validations are required for the gaseous and particulate test intervals. Table 2 follows:

TABLE 2 OF § 1065.514—DEFAULT STATISTICAL CRITERIA FOR VALIDATING DUTY CYCLES

Parameter	Speed	Torque	Power
Slope, $a_1$ .....	$0.950 \leq a_1 \leq 1.030$ .....	$0.830 \leq a_1 \leq 1.030$ .....	$0.830 \leq a_1 \leq 1.030$ .
Absolute value of intercept, $ a_0 $ .....	$\leq 10\%$ of warm idle .....	$\leq 2\%$ of maximum mapped torque .....	$\leq 2\%$ of maximum mapped power.
Standard error of estimate, <i>SEE</i> .....	$\leq 5\%$ of maximum test speed .....	$\leq 10\%$ of maximum mapped torque.	$\leq 10\%$ of maximum mapped power.
Coefficient of determination, $r^2$ .....	$\geq 0.970$ .....	$\geq 0.850$ .....	$\geq 0.910$ .

■ 69. Section 1065.520 is amended by revising paragraph (g) introductory text, (g)(5)(i), (g)(7), and (g)(8) and adding paragraph (g)(9) to read as follows:

**§ 1065.520 Pre-test verification procedures and pre-test data collection.**

\* \* \* \* \*

(g) Verify the amount of nonmethane hydrocarbon contamination in the exhaust and background HC sampling systems within 8 hours before the start of the first test interval of each duty-cycle sequence for laboratory tests. You may verify the contamination of a background HC sampling system by

reading the last bag fill and purge using zero gas. For any NMHC measurement system that involves separately measuring methane and subtracting it from a THC measurement or for any CH<sub>4</sub> measurement system that uses an NMC, verify the amount of THC contamination using only the THC analyzer response. There is no need to operate any separate methane analyzer for this verification; however, you may measure and correct for THC contamination in the CH<sub>4</sub> sample train for the cases where NMHC is determined by subtracting CH<sub>4</sub> from THC or, where CH<sub>4</sub> is determined, using an NMC as configured in § 1065.365(d),

(e), and (f); and using the calculations in § 1065.660(b)(2). Perform this verification as follows:

\* \* \* \* \*

(5) \* \* \*

(i) For continuous sampling, record the mean THC concentration as overflow zero gas flows.

\* \* \* \* \*

(7) You may correct the measured initial THC concentration for drift as follows:

(i) For batch and continuous HC analyzers, after determining the initial THC concentration, flow zero gas to the analyzer zero or sample port. When the

analyzer reading is stable, record the mean analyzer value.

(ii) Flow span gas to the analyzer span or sample port. When the analyzer reading is stable, record the mean analyzer value.

(iii) Use mean analyzer values from paragraphs (g)(2), (g)(3), (g)(7)(i), and (g)(7)(ii) of this section to correct the initial THC concentration recorded in paragraph (g)(6) of this section for drift, as described in § 1065.550.

(8) If any of the  $x_{\text{THC}|\text{THC-FID}}|_{\text{init}}$  values exceed the greatest of the following values, determine the source of the contamination and take corrective action, such as purging the system during an additional preconditioning cycle or replacing contaminated portions:

(i) 2% of the flow-weighted mean wet, net concentration expected at the HC (THC or NMHC) standard.

(ii) 2% of the flow-weighted mean wet, net concentration of HC (THC or NMHC) measured during testing.

(iii) 2  $\mu\text{mol/mol}$ .

(9) If corrective action does not resolve the deficiency, you may request to use the contaminated system as an alternate procedure under § 1065.10.

\* \* \* \* \*

■ 70. Section 1065.525 is amended by removing paragraph (c)(4) and revising paragraph (a) to read as follows:

**§ 1065.525 Engine starting, restarting, and shutdown.**

(a) For test intervals that require emission sampling during engine starting, start the engine using one of the following methods:

(1) Start the engine as recommended in the owners manual using a production starter motor or air-start system and either an adequately charged battery, a suitable power supply, or a suitable compressed air source.

(2) Use the dynamometer to start the engine. To do this, motor the engine within  $\pm 25\%$  of its typical in-use cranking speed. Stop cranking within 1 second of starting the engine.

(3) In the case of hybrid engines, activate the system such that the engine will start when its control algorithms determine that the engine should provide power instead of or in addition to power from the RESS. Unless we specify otherwise, engine starting throughout this part generally refers to this step of activating the system on hybrid engines, whether or not that causes the engine to start running.

\* \* \* \* \*

■ 71. Section 1065.530 is amended by revising paragraph (b)(13) to read as follows:

**§ 1065.530 Emission test sequence.**

\* \* \* \* \*

(b) \* \* \*

(13) Drain any accumulated condensate from the intake air system before starting a duty cycle, as described in § 1065.125(e)(1). If engine and aftertreatment preconditioning cycles are run before the duty cycle, treat the preconditioning cycles and any associated soak period as part of the duty cycle for the purpose of opening drains and draining condensate. Note that you must close any intake air condensate drains that are not representative of those normally open during in-use operation.

\* \* \* \* \*

■ 72. Section 1065.546 is amended by revising paragraph (a) to read as follows:

**§ 1065.546 Validation of minimum dilution ratio for PM batch sampling, and drift correction.**

\* \* \* \* \*

(a) Determine minimum dilution ratio based on molar flow data. This involves determination of at least two of the following three quantities: Raw exhaust flow (or previously diluted flow), dilution air flow, and dilute exhaust flow. You may determine the raw exhaust flow rate based on the measured intake air or fuel flow rate and the raw exhaust chemical balance terms as given in § 1065.655(e). You may determine the raw exhaust flow rate based on the measured intake air and dilute exhaust molar flow rates and the dilute exhaust chemical balance terms as given in § 1065.655(f). You may alternatively estimate the molar raw exhaust flow rate based on intake air, fuel rate measurements, and fuel properties, consistent with good engineering judgment.

\* \* \* \* \*

■ 73. Section 1065.550 is amended by revising the section heading and paragraph (b) to read as follows:

**§ 1065.550 Gas analyzer range validation and drift validation.**

\* \* \* \* \*

(b) *Drift validation and drift correction.* Gas analyzer drift validation is required for all gaseous exhaust constituents for which an emission standard applies. It is also required for CO<sub>2</sub> even if there is no CO<sub>2</sub> emission standard. It is not required for other gaseous exhaust constituents for which only a reporting requirement applies (such as CH<sub>4</sub> and N<sub>2</sub>O).

(1) Validate drift using one of the following methods:

(i) For regulated exhaust constituents determined from the mass of a single

component, perform drift validation based on the regulated constituent. For example, when NO<sub>x</sub> mass is determined with a dry sample measured with a CLD and the removed water is corrected based on measured CO<sub>2</sub>, CO, THC, and NO<sub>x</sub> concentrations, you must validate the calculated NO<sub>x</sub> value.

(ii) For regulated exhaust constituents determined from the masses of multiple subcomponents, perform the drift validation based on either the regulated constituent or all the mass subcomponents. For example, when NO<sub>x</sub> is measured with separate NO and NO<sub>2</sub> analyzers, you must validate either the NO<sub>x</sub> value or both the NO and NO<sub>2</sub> values.

(iii) For regulated exhaust constituents determined from the concentrations of multiple gaseous emission subcomponents prior to performing mass calculations, perform drift validation on the regulated constituent. You may not validate the concentration subcomponents (e.g., THC and CH<sub>4</sub> for NMHC) separately. For example, for NMHC measurements, perform drift validation on NMHC; do not validate THC and CH<sub>4</sub> separately.

(2) Drift validation requires two sets of emission calculations. For each set of calculations, include all the constituents in the drift validation. Calculate one set using the data before drift correction and calculate the other set after correcting all the data for drift according to § 1065.672. Note that for purposes of drift validation, you must leave unaltered any negative emission results over a given test interval (i.e., do not set them to zero). These unaltered results are used when validating either test interval results or composite brake-specific emissions over the entire duty cycle for drift. For each constituent to be validated, both sets of calculations must include the following:

(i) Calculated mass (or mass rate) emission values over each test interval.

(ii) If you are validating each test interval based on brake-specific values, calculate brake-specific emission values over each test interval.

(iii) If you are validating over the entire duty cycle, calculate composite brake-specific emission values.

(3) The duty cycle is validated for drift if you satisfy the following criteria:

(i) For each regulated gaseous exhaust constituent, you must satisfy one of the following:

(A) For each test interval of the duty cycle, the difference between the uncorrected and the corrected brake-specific emission values of the regulated constituent must be within  $\pm 4\%$  of the uncorrected value or the applicable emissions standard, whichever is

greater. Alternatively, the difference between the uncorrected and the corrected emission mass (or mass rate) values of the regulated constituent must be within ±4% of the uncorrected value or the composite work (or power) multiplied by the applicable emissions standard, whichever is greater. For purposes of validating each test interval, you may use either the reference or actual composite work (or power).

(B) For each test interval of the duty cycle and for each subcomponent of the regulated constituent, the difference between the uncorrected and the corrected brake-specific emission values must be within ±4% of the uncorrected value. Alternatively, the difference between the uncorrected and the corrected emissions mass (or mass rate) values must be within ±4% of the uncorrected value.

(C) For the entire duty cycle, the difference between the uncorrected and the corrected composite brake-specific emission values of the regulated constituent must be within ±4% of the uncorrected value or applicable emission standard, whichever is greater.

(D) For the entire duty cycle and for each subcomponent of the regulated constituent, the difference between the uncorrected and the corrected composite brake-specific emission values must be within ±4% of the uncorrected value.

(ii) Where no emission standard applies for CO<sub>2</sub>, you must satisfy one of the following:

(A) For each test interval of the duty cycle, the difference between the uncorrected and the corrected brake-specific CO<sub>2</sub> values must be within ±4% of the uncorrected value; or the difference between the uncorrected and the corrected CO<sub>2</sub> mass (or mass rate) values must be within ±4% of the uncorrected value.

(B) For the entire duty cycle, the difference between the uncorrected and the corrected composite brake-specific CO<sub>2</sub> values must be within ±4% of the uncorrected value.

(4) If the test is not validated for drift as described in paragraph (b)(1) of this section, you may consider the test results for the duty cycle to be valid only if, using good engineering judgment, the observed drift does not affect your ability to demonstrate

compliance with the applicable emission standards. For example, if the drift-corrected value is less than the standard by at least two times the absolute difference between the uncorrected and corrected values, you may consider the data to be valid for demonstrating compliance with the applicable standard.

**Subpart G—[Amended]**

■ 74. Section 1065.602 is amended by revising paragraph (f)(3) introductory text, (h), and (l)(1) to read as follows:

**§ 1065.602 Statistics.**

\* \* \* \* \*

(f) \* \* \*

(3) Use Table 1 of this section to compare *t* to the *t*<sub>crit</sub> values tabulated versus the number of degrees of freedom. If *t* is less than *t*<sub>crit</sub>, then *t* passes the *t*-test. The Microsoft Excel software has a TINV function that returns equivalent results and may be used in place of Table 1, which follows:

\* \* \* \* \*

(h) *Slope*. Calculate a least-squares regression slope, *a*<sub>1y</sub>, as follows:

$$a_{1y} = \frac{\sum_{i=1}^N (y_i - \bar{y}) \cdot (y_{refi} - \bar{y}_{ref})}{\sum_{i=1}^N (y_{refi} - \bar{y}_{ref})^2}$$

Eq. 1065.602-9

Example:  
N = 6000

*y*<sub>1</sub> = 2045.8  
*ȳ* = 1050.1

*y*<sub>ref 1</sub> = 2045.0  
*ȳ*<sub>ref</sub> = 1055.3

$$a_{1y} = \frac{(2045.8 - 1050.1) \cdot (2045.0 - 1055.3) + \dots + (y_{6000} - 1050.1) \cdot (y_{ref6000} - 1055.3)}{(2045.0 - 1055.3)^2 + \dots + (y_{ref6000} - 1055.3)^2}$$

*a*<sub>1y</sub> = 1.0110

\* \* \* \* \*

(l) \* \* \*

(1) To estimate the flow-weighted mean raw exhaust NO<sub>x</sub> concentration from a turbocharged heavy-duty compression-ignition engine at a NO<sub>x</sub> standard of 2.5 g/(kW·hr), you may do the following:

(i) Based on your engine design, approximate a map of maximum torque versus speed and use it with the applicable normalized duty cycle in the

standard-setting part to generate a reference duty cycle as described in § 1065.610. Calculate the total reference work, *W*<sub>ref</sub>, as described in § 1065.650. Divide the reference work by the duty cycle's time interval, Δ*t*<sub>dutycycle</sub>, to determine mean reference power, *P*<sub>ref</sub>.

(ii) Based on your engine design, estimate maximum power, *P*<sub>max</sub>, the design speed at maximum power, *f*<sub>imax</sub>, the design maximum intake manifold boost pressure, *p*<sub>imax</sub>, and temperature, *T*<sub>imax</sub>. Also, estimate a mean fraction of

power that is lost due to friction and pumping, *P̄*<sub>frict</sub>. Use this information along with the engine displacement volume, *V*<sub>disp</sub>, an approximate volumetric efficiency, η<sub>v</sub>, and the number of engine strokes per power stroke (2-stroke or 4-stroke), *N*<sub>stroke</sub>, to estimate the maximum raw exhaust molar flow rate, *ṅ*<sub>ehmax</sub>.

(iii) Use your estimated values as described in the following example calculation:



$$\bar{x}_{\text{exp}} = \frac{e_{\text{std}} \cdot W_{\text{ref}}}{M \cdot \dot{n}_{\text{exhmax}} \cdot \Delta t_{\text{duty cycle}} \cdot \left( \frac{\bar{P}_{\text{ref}} + (\bar{P}_{\text{frict}} \cdot P_{\text{max}})}{P_{\text{max}}} \right)}$$

Eq. 1065.602-13

$$\dot{n}_{\text{exhmax}} = \frac{P_{\text{max}} \cdot V_{\text{disp}} \cdot f_{\text{nmax}} \cdot \frac{2}{N_{\text{stroke}}} \cdot \eta_V}{R \cdot T_{\text{max}}}$$

Eq. 1065.602-14

Example:

$e_{\text{NOx}} = 2.5 \text{ g/(kW}\cdot\text{hr)}$	$\bar{P}_{\text{ref}} = 35.65 \text{ kW}$	$f_{\text{nmax}} = 2,800 \text{ r/min} = 46.67 \text{ r/s}$
$W_{\text{ref}} = 11.883 \text{ kW}\cdot\text{hr}$	$\bar{P}_{\text{frict}} = 15\%$	$N_{\text{stroke}} = 4$
$M_{\text{NOx}} = 46.0055 \text{ g/mol} = 46.0055 \cdot 10^{-6} \text{ g/}\mu\text{mol}$	$P_{\text{max}} = 125 \text{ kW}$	$\eta_V = 0.9$
$\Delta t_{\text{duty cycle}} = 20 \text{ min} = 1200 \text{ s}$	$P_{\text{max}} = 300 \text{ kPa} = 300,000 \text{ Pa}$	$R = 8.314472 \text{ J/(mol}\cdot\text{K)}$
	$V_{\text{disp}} = 3.0 \text{ l} = 0.0030 \text{ m}^3/\text{r}$	$T_{\text{max}} = 348.15 \text{ K}$

$$\dot{n}_{\text{exhmax}} = \frac{300000 \cdot 0.0030 \cdot 46.67 \cdot \frac{2}{4} \cdot 0.9}{8.314472 \cdot 348.15}$$

$\dot{n}_{\text{exhmax}} = 6.53 \text{ mol/s}$

$$\bar{x}_{\text{exp}} = \frac{2.5 \cdot 11.883}{46.0055 \cdot 10^{-6} \cdot 6.53 \cdot 1200 \cdot \left( \frac{35.65 + (0.15 \cdot 125)}{125} \right)}$$

$\bar{x}_{\text{exp}} = 189.4 \mu\text{mol/mol}$

\* \* \* \* \*

■ 75. Section 1065.610 is amended by revising paragraphs (a), (b)(1), and (c) to read as follows:

**§ 1065.610 Duty cycle generation.**

\* \* \* \* \*

(a) *Maximum test speed,  $f_{\text{n test}}$ .* This section generally applies to duty cycles for variable-speed engines. For constant-speed engines subject to duty cycles that

specify normalized speed commands, use the no-load governed speed as the measured  $f_{\text{n test}}$ . This is the highest engine speed where an engine outputs zero torque. For variable-speed engines, determine the measured  $f_{\text{n test}}$  from the power-versus-speed map, generated according to § 1065.510, as follows:

(1) Based on the map, determine maximum power,  $P_{\text{max}}$ , and the speed at which maximum power occurred,  $f_{\text{n Pmax}}$ . If maximum power occurs at multiple

speeds, take  $f_{\text{n Pmax}}$  as the lowest of these speeds. Divide every recorded power by  $P_{\text{max}}$  and divide every recorded speed by  $f_{\text{n Pmax}}$ . The result is a normalized power-versus-speed map. Your measured  $f_{\text{n test}}$  is the speed at which the sum of the squares of normalized speed and power is maximum. Note that if multiple maximum values are found,  $f_{\text{n test}}$  should be taken as the lowest speed of all points with the same maximum sum of squares. Determine  $f_{\text{n test}}$  as follows:

$$f_{\text{n test}} = f_{\text{ni}} \text{ at the maximum of } \left( f_{\text{normi}}^2 + P_{\text{normi}}^2 \right)$$

Eq. 1065.610-1

Where:

- $f_{\text{n test}}$  = maximum test speed.
- $i$  = an indexing variable that represents one recorded value of an engine map.
- $f_{\text{normi}}$  = an engine speed normalized by dividing it by  $f_{\text{n Pmax}}$ .
- $P_{\text{normi}}$  = an engine power normalized by dividing it by  $P_{\text{max}}$ .

Example:

$(f_{\text{norm1}} = 1.002, P_{\text{norm1}} = 0.978, f_{\text{n1}} = 2359.71)$	$(f_{\text{norm2}} = 1.004, P_{\text{norm2}} = 0.977, f_{\text{n2}} = 2364.42)$	$(f_{\text{norm3}} = 1.006, P_{\text{norm3}} = 0.974, f_{\text{n3}} = 2369.13)$
---	---	---

$(f_{\text{norm1}}^2 + P_{\text{norm1}}^2) = (1.002^2 + 0.978^2) = 1.960$
$(f_{\text{norm2}}^2 + P_{\text{norm2}}^2) = (1.004^2 + 0.977^2) = 1.963$
$(f_{\text{norm3}}^2 + P_{\text{norm3}}^2) = (1.006^2 + 0.974^2) = 1.961$
maximum = 1.963 at $i = 2$
$f_{\text{n test}} = 2,364.42 \text{ r/min}$

(2) For engines with a high-speed governor that will be subject to a reference duty cycle that specifies normalized speeds greater than 100%, calculate an alternate maximum test speed,  $f_{ntest,alt}$ , as specified in this paragraph (a)(2). If  $f_{ntest,alt}$  is less than the

measured maximum test speed,  $f_{ntest}$ , determined in paragraph (a)(1) of this section, replace  $f_{ntest}$  with  $f_{ntest,alt}$ . In this case,  $f_{ntest,alt}$  becomes the “maximum test speed” for that engine. Note that § 1065.510 allows you to apply an optional declared maximum test speed

to the final measured maximum test speed determined as an outcome of the comparison between  $f_{ntest}$ , and  $f_{ntest,alt}$  in this paragraph (a)(2). Determine  $f_{ntest,alt}$  as follows:

$$f_{ntest,alt} = (f_{nhi,idle} - f_{nidle}) / \% speed_{max} + f_{nidle}$$

Eq. 1065.610-2

Where:

- $f_{ntest,alt}$  = alternate maximum test speed
- $f_{nhi,idle}$  = warm high-idle speed
- $f_{nidle}$  = warm idle speed
- $\% speed_{max}$  = maximum normalized speed from duty cycle

Example:

- $f_{nhi,idle} = 2,200$  r/min
- $f_{nidle} = 800$  r/min
- $\% speed_{max} = 105\%$  (Nonroad CI Transient Cycle)
- $f_{ntest,alt} = (2,200 - 800) / 105\% + 800$
- $f_{ntest,alt} = 2,133$  r/min

(3) For variable-speed engines, transform normalized speeds to reference speeds according to paragraph

(c) of this section by using the measured maximum test speed determined according to paragraphs (a)(1) and (2) of this section—or use your declared maximum test speed, as allowed in § 1065.510.

(4) For constant-speed engines, transform normalized speeds to reference speeds according to paragraph (c) of this section by using the measured no-load governed speed—or use your declared maximum test speed, as allowed in § 1065.510.

(b) \* \* \*

(1) Based on the map, determine maximum power,  $P_{max}$ , and the speed at

which maximum power occurs,  $f_{nPmax}$ . If maximum power occurs at multiple speeds, take  $f_{nPmax}$  as the lowest of these speeds. Divide every recorded power by  $P_{max}$  and divide every recorded speed by  $f_{nPmax}$ . The result is a normalized power-versus-speed map. Your measured  $T_{test}$  is the torque at which the sum of the squares of normalized speed and power is maximum. Note that that if multiple maximum values are found,  $T_{test}$  should be taken as the highest torque of all points with the same maximum sum of squares. Determine  $T_{test}$  as follows:

$$T_{test} = T_i \text{ at the maximum of } (f_{normi}^2 + P_{normi}^2)$$

Eq. 1065.610-3

Where:

$T_{test}$  = maximum test torque.

Example:

- $(f_{norm1} = 1.002, P_{norm1} = 0.978, T_1 = 722.62 \text{ N}\cdot\text{m})$
- $(f_{norm2} = 1.004, P_{norm2} = 0.977, T_2 = 720.44 \text{ N}\cdot\text{m})$
- $(f_{norm3} = 1.006, P_{norm3} = 0.974, T_3 = 716.80 \text{ N}\cdot\text{m})$

$$(f_{norm1}^2 + P_{norm1}^2) = (1.002^2 + 0.978^2) = 1.960$$

$$(f_{norm1}^2 + P_{norm1}^2) = (1.004^2 + 0.977^2) = 1.963$$

$$(f_{norm1}^2 + P_{norm1}^2) = (1.006^2 + 0.974^2) = 1.961$$

maximum = 1.963 at  $i = 2$

$T_{test} = 720.44 \text{ N}\cdot\text{m}$   
\* \* \* \* \*

(c) *Generating reference speed values from normalized duty cycle speeds.*

Transform normalized speed values to reference values as follows:

(1) *% speed.* If your normalized duty cycle specifies % speed values, use your warm idle speed and your maximum test speed to transform the duty cycle, as follows:

$$f_{nref} = \% speed \cdot (f_{ntest} - f_{nidle}) + f_{nidle}$$

Eq. 1065.610-4

Example:

- $\% speed = 85\%$
- $f_{ntest} = 2,364$  r/min
- $f_{nidle} = 650$  r/min
- $f_{nref} = 85\% \cdot (2,364 - 650) + 650$
- $f_{nref} = 2,107$  r/min

(2) *A, B, and C speeds.* If your normalized duty cycle specifies speeds as A, B, or C values, use your power-versus-speed curve to determine the

lowest speed below maximum power at which 50% of maximum power occurs. Denote this value as  $n_{lo}$ . Take  $n_{lo}$  to be warm idle speed if all power points at speeds below the maximum power speed are higher than 50% of maximum power. Also determine the highest speed above maximum power at which 70% of maximum power occurs. Denote

this value as  $n_{hi}$ . If all power points at speeds above the maximum power speed are higher than 70% of maximum power, take  $n_{hi}$  to be the declared maximum safe engine speed or the declared maximum representative engine speed, whichever is lower. Use  $n_{hi}$  and  $n_{lo}$  to calculate reference values for A, B, or C speeds as follows:

$$f_{\text{refA}} = 0.25 \cdot (n_{\text{hi}} - n_{\text{lo}}) + n_{\text{lo}}$$

Eq. 1065.610-5

$$f_{\text{refB}} = 0.50 \cdot (n_{\text{hi}} - n_{\text{lo}}) + n_{\text{lo}}$$

Eq. 1065.610-6

$$f_{\text{refC}} = 0.75 \cdot (n_{\text{hi}} - n_{\text{lo}}) + n_{\text{lo}}$$

Eq. 1065.610-7

**Example:**

- $n_{\text{lo}} = 1005 \text{ r/min}$
- $n_{\text{hi}} = 2385 \text{ r/min}$
- $f_{\text{refA}} = 0.25 \cdot (2385 - 1005) + 1005$
- $f_{\text{refB}} = 0.50 \cdot (2385 - 1005) + 1005$
- $f_{\text{refC}} = 0.75 \cdot (2385 - 1005) + 1005$
- $f_{\text{refA}} = 1350 \text{ r/min}$
- $f_{\text{refB}} = 1695 \text{ r/min}$
- $f_{\text{refC}} = 2040 \text{ r/min}$

(3) *Intermediate speed.* If your normalized duty cycle specifies a speed as “intermediate speed,” use your torque-versus-speed curve to determine the speed at which maximum torque

occurs. This is peak torque speed. If maximum torque occurs in a flat region of the torque-versus-speed curve, your peak torque speed is the midpoint between the lowest and highest speeds at which the trace reaches the flat region. For purposes of this paragraph (c)(3), a flat region is one in which measured torque values are within 2% of the maximum recorded value. Identify your reference intermediate speed as one of the following values:

\* \* \* \* \*

■ 76. Section 1065.640 is amended by revising paragraphs (b)(1), (b)(2), (b)(5), (e)(3), (e)(4), and (e)(7) to read as follows:

**§ 1065.640 Flow meter calibration calculations.**

\* \* \* \* \*

(b) \* \* \*

(1) PDP volume pumped per revolution,  $V_{\text{rev}}$  ( $\text{m}^3/\text{r}$ ):

$$V_{\text{rev}} = \frac{\bar{n}_{\text{ref}} \cdot R \cdot \bar{T}_{\text{in}}}{\bar{P}_{\text{in}} \cdot \bar{f}_{\text{nPDP}}}$$

Eq. 1065.640-2

**Example:**

- $\bar{n}_{\text{ref}} = 25.096 \text{ mol/s}$
- $R = 8.314472 \text{ J}/(\text{mol} \cdot \text{K})$
- $\bar{T}_{\text{in}} = 299.5 \text{ K}$

- $\bar{P}_{\text{in}} = 98290 \text{ Pa}$
- $\bar{f}_{\text{nPDP}} = 1205.1 \text{ r/min} = 20.085 \text{ r/s}$

$V_{\text{rev}} = 0.03166 \text{ m}^3/\text{r}$

(2) PDP slip correction factor,  $K_s$  (s/r):

$$V_{\text{rev}} = \frac{25.096 \cdot 8.314472 \cdot 299.5}{98290 \cdot 20.085}$$

$$K_s = \frac{1}{\bar{f}_{\text{nPDP}}} \cdot \sqrt{\frac{\bar{P}_{\text{out}} - \bar{P}_{\text{in}}}{\bar{P}_{\text{out}}}}$$

Eq. 1065.640-3

**Example:**

- $\bar{f}_{\text{nPDP}} = 1205.1 \text{ r/min} = 20.085 \text{ r/s}$
- $\bar{P}_{\text{out}} = 100.103 \text{ kPa}$
- $\bar{P}_{\text{in}} = 98.290 \text{ kPa}$

$$K_s = \frac{1}{20.085} \cdot \sqrt{\frac{100.103 - 98.290}{100.103}}$$

$K_s = 0.006700 \text{ s/r}$

\* \* \* \* \*

(5) The following example illustrates these calculations:

TABLE 1 OF § 1065.640—EXAMPLE OF PDP CALIBRATION DATA

$\bar{f}_{\text{nPDP}}$ (r/min)	$a_1$ ( $\text{m}^3/\text{min}$ )	$a_0$ ( $\text{m}^3/\text{r}$ )
755.0 .....	50.43	0.056
987.6 .....	49.86	-0.013
1254.5 .....	48.54	0.028
1401.3 .....	47.30	-0.061

\* \* \* \* \*

(e) \* \* \*

(3) If the standard deviation of all the  $C_d$  values is less than or equal to 0.3% of the mean  $C_d$ , use the mean  $C_d$  in Eq 1065.642-6, and use the CFV only up to the highest  $r$  measured during calibration using the following equation:

$$r = 1 - \frac{\Delta p_{CFV}}{P_{in}}$$

Eq. 1065.640-13

Where:

$\Delta p_{CFV}$  = Differential static pressure; venturi inlet minus venturi outlet.

(4) If the standard deviation of all the  $C_d$  values exceeds 0.3% of the mean  $C_d$ , omit the  $C_d$  values corresponding to the data point collected at the highest  $r$  measured during calibration.

\* \* \* \* \*

(7) If the standard deviation of the remaining  $C_d$  values is less than or equal to 0.3% of the mean of the remaining  $C_d$ , use that mean  $C_d$  in Eq 1065.642–6, and use the CFV values only up to the highest  $r$  associated with the remaining  $C_d$ .

\* \* \* \* \*

■ 77. Section 1065.642 is amended by revising paragraph (a) to read as follows:

**§ 1065.642 SSV, CFV, and PDP molar flow rate calculations.**

\* \* \* \* \*

(a) *PDP molar flow rate.* Based upon the speed at which you operate the PDP for a test interval, select the corresponding slope,  $a_1$ , and intercept,  $a_0$ , as calculated in § 1065.640, to calculate molar flow rate,  $\dot{n}$  as follows:

$$\dot{n} = f_{nPDP} \cdot \frac{P_{in} \cdot V_{rev}}{R \cdot T_{in}}$$

Eq. 1065.642-1

Where:

$$V_{rev} = \frac{a_1}{f_{nPDP}} \cdot \sqrt{\frac{p_{out} - p_{in}}{p_{out}}} + a_0$$

Eq. 1065.642-2

*Example:*

$a_1 = 50.43 \text{ (m}^3\text{/min)} = 0.8405 \text{ (m}^3\text{/s)}$   
 $\bar{f}_{nPDP} = 755.0 \text{ r/min} = 12.58 \text{ r/s}$

$p_{out} = 99950 \text{ Pa}$   
 $p_{in} = 98575 \text{ Pa}$   
 $a_0 = 0.056 \text{ (m}^3\text{/r)}$   
 $R = 8.314472 \text{ J/(mol}\cdot\text{K)}$

$T_{in} = 323.5 \text{ K}$   
 $C_p = 1000 \text{ (J/m}^3\text{)/kPa}$   
 $C_t = 60 \text{ s/min}$

$$V_{rev} = \frac{0.8405}{12.58} \cdot \sqrt{\frac{99950 - 98575}{99950}} + 0.056$$

$V_{rev} = 0.06383 \text{ m}^3\text{/r}$

$$\dot{n} = 12.58 \cdot \frac{98575 \cdot 0.06383}{8.314472 \cdot 323.5}$$

$\bar{n} = 29.428 \text{ mol/s}$   
 \* \* \* \* \*

■ 78. Section 1065.645 is amended by revising the introductory text and paragraph (a) to read as follows:

**§ 1065.645 Amount of water in an ideal gas.**

This section describes how to determine the amount of water in an ideal gas, which you need for various performance verifications and emission calculations. Use the equation for the

vapor pressure of water in paragraph (a) of this section or another appropriate equation and, depending on whether you measure dewpoint or relative humidity, perform one of the calculations in paragraph (b) or (c) of this section. The equations for the vapor pressure of water as presented in this section are derived from equations in “Saturation Pressure of Water on the New Kelvin Temperature Scale” (Goff, J.A., Transactions American Society of Heating and Air-Conditioning Engineers, Vol. 63, No. 1607, pages 347–354). Note that the equations were originally published to derive vapor pressure in units of atmospheres and

have been modified to derive results in units of kPa by converting the last term in each equation.

(a) *Vapor pressure of water.* Calculate the vapor pressure of water for a given saturation temperature condition,  $T_{sat}$ , as follows, or use good engineering judgment to use a different relationship of the vapor pressure of water to a given saturation temperature condition:

- (1) For humidity measurements made at ambient temperatures from (0 to 100) °C, or for humidity measurements made over super-cooled water at ambient temperatures from (–50 to 0) °C, use the following equation:

$$\log_{10}(p_{H_2O}) = 10.79574 \cdot \left(1 - \frac{273.16}{T_{sat}}\right) - 5.02800 \cdot \log_{10}\left(\frac{T_{sat}}{273.16}\right) + 1.50475 \cdot 10^{-4} \cdot \left(1 - 10^{-8.2969 \cdot \left(\frac{T_{sat}}{273.16} - 1\right)}\right) + 0.42873 \cdot 10^{-3} \cdot \left(10^{4.76955 \cdot \left(1 - \frac{273.16}{T_{sat}}\right)} - 1\right) - 0.2138602$$

Eq. 1065.645-1

Where:

$p_{H_2O}$  = vapor pressure of water at saturation temperature condition, kPa.

$T_{sat}$  = saturation temperature of water at measured conditions, K.

Example:

$T_{sat} = 9.5 \text{ }^\circ\text{C}$

$T_{sat} = 9.5 + 273.15 = 282.65 \text{ K}$

$$\log_{10}(p_{H_2O}) = 10.79574 \cdot \left(1 - \frac{273.16}{282.65}\right) - 5.02800 \cdot \log_{10}\left(\frac{282.65}{273.16}\right) + 1.50475 \cdot 10^{-4} \cdot \left(1 - 10^{-8.2969 \cdot \left(\frac{282.65}{273.16} - 1\right)}\right) + 0.42873 \cdot 10^{-3} \cdot \left(10^{4.76955 \cdot \left(1 - \frac{273.16}{282.65}\right)} - 1\right) - 0.2138602$$

$\log_{10}(p_{H_2O}) = 0.074297$

$p_{H_2O} = 10^{0.074297} = 1.186581 \text{ kPa}$

(2) For humidity measurements over ice at ambient temperatures from (–100 to 0) °C, use the following equation:

$$\log_{10}(p_{H_2O}) = -9.096853 \cdot \left(\frac{273.16}{T_{sat}} - 1\right) - 3.566506 \cdot \log_{10}\left(\frac{273.16}{T_{sat}}\right) + 0.876812 \cdot \left(1 - \frac{T_{sat}}{273.16}\right) - 0.2138602$$

Eq. 1065.645-2

Example:

$T_{ice} = -15.4 \text{ }^\circ\text{C}$

$T_{ice} = -15.4 + 273.15 = 257.75 \text{ K}$

$$\log_{10}(p_{H_2O}) = -9.096853 \cdot \left(\frac{273.16}{257.75} - 1\right) - 3.566506 \cdot \log_{10}\left(\frac{273.16}{257.75}\right) + 0.876812 \cdot \left(1 - \frac{257.75}{273.16}\right) - 0.2138602$$

$\log_{10}(p_{H_2O}) = -0.798207$

$p_{H_2O} = 10^{-0.79821} = 0.159145 \text{ kPa}$

\* \* \* \* \*

■ 79. Section 1065.650 is amended as follows:

■ a. By revising paragraphs (c) introductory text, (c)(1), and (c)(4).

■ b. By adding paragraph (c)(5).

■ c. By revising paragraphs (d)(7), (e)(4), and (f)(4).

**§ 1065.650 Emission calculations.**

\* \* \* \* \*

(c) *Total mass of emissions over a test interval.* To calculate the total mass of an emission, multiply a concentration

by its respective flow. For all systems, make preliminary calculations as described in paragraph (c)(1) of this section to correct concentrations. Next, use the method in paragraphs (c)(2) through (4) of this section that is appropriate for your system. Finally, if necessary, calculate the mass of NMHC as described in paragraph (c)(5) of this section for all systems. Calculate the total mass of emissions as follows:

(1) *Concentration corrections.* Perform the following sequence of preliminary calculations on recorded concentrations:

(i) Correct all gaseous emission analyzer concentration readings,

including continuous readings, sample bag readings, and dilution air background readings, for drift as described in § 1065.672. Note that you must omit this step where brake-specific emissions are calculated without the drift correction for performing the drift validation according to § 1065.550(b). When applying the initial THC and CH<sub>4</sub> contamination readings according to § 1065.520(g), use the same values for both sets of calculations. You may also use as-measured values in the initial set of calculations and corrected values in the drift-corrected set of calculations as described in § 1065.520(g)(7).

(ii) Correct all THC and CH<sub>4</sub> concentrations, including continuous readings, sample bags readings, and dilution air background readings, for initial contamination, as described in § 1065.660(a).

(iii) Correct all concentrations measured on a “dry” basis to a “wet” basis, including dilution air background concentrations, as described in § 1065.659.

(iv) Calculate all NMHC and CH<sub>4</sub> concentrations, including dilution air background concentrations, as described in § 1065.660.

(v) For emission testing with an oxygenated fuel, calculate any HC concentrations, including dilution air background concentrations, as described in § 1065.665. See subpart I of this part for testing with oxygenated fuels.

(vi) Correct all the NO<sub>x</sub> concentrations, including dilution air background concentrations, for intake-air humidity as described in § 1065.670.

(4) *Additional provisions for diluted exhaust sampling; continuous or batch.* The following additional provisions apply for sampling emissions from diluted exhaust:

(i) For sampling with a constant dilution ratio, *DR*, of diluted exhaust versus exhaust flow (e.g., secondary dilution for PM sampling), calculate *m* using the following equation:

$$m_{PM} = m_{PMdil} \cdot DR$$

Eq. 1065.650-9

Example:

*m*<sub>PMdil</sub> = 6.853 g  
*DR* = 6:1  
*m*<sub>PM</sub> = 6.853 · 6  
*m*<sub>PM</sub> = 41.118 g

*W* = 5.09 (kW·hr)

\* \* \* \* \*

■ 80. Section 1065.655 is amended by revising paragraphs (b), (c)(5), (d), and (e)(3) and adding paragraph (f) to read as follows:

**§ 1065.655 Chemical balances of fuel, intake air, and exhaust.**

\* \* \* \* \*

(ii) For continuous or batch sampling, you may measure background emissions in the dilution air. You may then subtract the measured background emissions, as described in § 1065.667.

(5) *Mass of NMHC.* Compare the corrected mass of NMHC to corrected mass of THC. If the corrected mass of NMHC is greater than 0.98 times the corrected mass of THC, take the corrected mass of NMHC to be 0.98 times the corrected mass of THC. If you omit the NMHC calculations as described in § 1065.660(b)(1), take the corrected mass of NMHC to be 0.98 times the corrected mass of THC.

(d) \* \* \*  
 (7) Integrate the resulting values for power over the test interval. Calculate total work as follows:

$$W = \sum_{i=1}^N P_i \cdot \Delta t$$

Eq. 1065.650-10

Where:

*W* = total work from the primary output shaft.  
*P<sub>i</sub>* = instantaneous power from the primary output shaft over an interval *i*.

$$P_i = f_{ni} \cdot T_i$$

Eq. 1065.650-11

Example:

*N* = 9000  
*f*<sub>n1</sub> = 1800.2 r/min  
*f*<sub>n2</sub> = 1805.8 r/min  
*T*<sub>1</sub> = 177.23 N·m  
*T*<sub>2</sub> = 175.00 N·m  
*C*<sub>rev</sub> = 2·π rad/r  
*C*<sub>t1</sub> = 60 s/min  
*C*<sub>p</sub> = 1000 (N·m·rad/s)/kW  
*f*<sub>record</sub> = 5 Hz  
*C*<sub>t2</sub> = 3600 s/hr

$$\tilde{W} = \frac{12.0107 \left[ \frac{3.922 \cdot 0.091634}{1 + 0.02721} + \frac{\tilde{n}_2 \cdot x_{C_{combdry2}}}{1 + x_{H_2O_{exh2}}} + \dots + \frac{\tilde{n}_{3000} \cdot x_{C_{combdry3000}}}{1 + x_{H_2O_{exh3000}}} \right] \cdot 0.2}{285 \cdot 0.869}$$

(b) *Procedures that require chemical balances.* We require chemical balances when you determine the following:

(1) A value proportional to total work, *W* when you choose to determine brake-specific emissions as described in § 1065.650(f).

(2) The amount of water in a raw or diluted exhaust flow, *x*<sub>H<sub>2</sub>O<sub>exh</sub></sub>, when you do not measure the amount of water to correct for the amount of water removed

$$P_1 = \frac{1800.2 \cdot 177.23 \cdot 2 \cdot 3.14159}{60 \cdot 1000}$$

*P*<sub>1</sub> = 33.41 kW  
*P*<sub>2</sub> = 33.09 kW  
 Using Eq. 1065.650–5,  
 Δ*t* = 1/5 = 0.2 s

$$W = \frac{(33.41 + 33.09 + \dots + P_{9000}) \cdot 0.2}{3600}$$

*W* = 16.875 kW · hr

\* \* \* \* \*

(4) The following example shows how to calculate mass of emissions using mean mass rate and mean power:

*M*<sub>CO</sub> = 28.0101 g/mol  
*x*<sub>CO</sub> = 12.00 mmol/mol = 0.01200 mol/mol  
 $\bar{n}$  = 1.530 mol/s  
 $\tilde{f}_n$  = 3584.5 r/min = 375.37 rad/s  
 $\bar{T}$  = 121.50 N · m  
 $\bar{m}$  = 28.0101 · 0.01200 · 1.530  
 $\bar{m}$  = 0.514 g/s = 1850.4 g/hr  
 $\bar{P}$  = 121.5 · 375.37  
 $\bar{P}$  = 45607 W  
 $\bar{P}$  = 45.607 kW  
*e*<sub>CO</sub> = 1850.4/45.61  
*e*<sub>CO</sub> = 40.57 g/(kW·hr)

(f) \* \* \*

(4) Example. The following example shows how to calculate mass of emissions using proportional values:

*N* = 3000  
*f*<sub>record</sub> = 5 Hz  
*e*<sub>fuel</sub> = 285 g/(kW·hr)  
*W*<sub>fuel</sub> = 0.869 g/g  
*M*<sub>c</sub> = 12.0107 g/mol  
 $\tilde{n}_l$  = 3.922 mol/s = 14119.2 mol/hr  
*X*<sub>C<sub>combdry1</sub></sub> = 91.634 mmol/mol = 0.091634 mol/mol  
*X*<sub>H<sub>2</sub>O<sub>exh1</sub></sub> = 27.21 mmol/mol = 0.02721 mol/mol  
 Using Eq. 1065.650–5,  
 Δ*t* = 0.2 s

by a sampling system. Correct for removed water according to § 1065.659.

(3) The calculated dilution air flow when you do not measure dilution air flow to correct for background emissions as described in § 1065.667(c) and (d).

(c) \* \* \*

(5) The following example is a solution for *x*<sub>dil/exh,x</sub>, *x*<sub>H<sub>2</sub>O<sub>exh</sub></sub>, and *X*<sub>C<sub>combdry</sub></sub> using the equations in paragraph (c)(4) of this section:

$$x_{\text{dil/exh}} = 1 - \frac{0.184}{1 + \frac{35.37}{1000}} = 0.822 \text{ mol/mol}$$

$$x_{\text{H}_2\text{Oexh}} = \frac{35.37}{1 + \frac{35.37}{1000}} = 34.16 \text{ mmol/mol}$$

$$x_{\text{C}_{\text{comb}}\text{dry}} = 0.0252 + \frac{29.3}{1000000} + \frac{47.6}{1000000} - \frac{0.371}{1000} \cdot 0.851 - \frac{0.369}{1000} \cdot 0.172 = 0.0249 \text{ mol/mol}$$

$$x_{\text{H}_2\text{dry}} = \frac{29.3 \cdot (0.034 - 0.012 \cdot 0.851)}{3.5 \cdot \left( \frac{25.2}{1000} - \frac{0.371}{1000} \cdot 0.851 \right)} = 8.5 \text{ } \mu\text{mol/mol}$$

$$x_{\text{H}_2\text{Oexhdry}} = \frac{1.8}{2} \left( 0.0249 - \frac{47.6}{1000000} \right) + 0.012 \cdot 0.851 + 0.017 \cdot 0.172 - \frac{8.5}{1000000} = 0.0353 \text{ mol/mol}$$

$$x_{\text{dil/exhdry}} = \frac{0.822}{1 - 0.034} = 0.851 \text{ mol/mol}$$

$$x_{\text{int/exhdry}} = \frac{1}{2 \cdot 0.206} \left( \left( \frac{1.8}{2} - 0.050 + 2 + 2 \cdot 0.0003 \right) \left( 0.0249 - \frac{47.6}{1000000} \right) - \left( \frac{29.3}{1000000} - \frac{50.4}{1000000} - 2 \cdot \frac{12.1}{1000000} + \frac{8.5}{1000000} \right) \right) = 0.172 \text{ mol/mol}$$

$$x_{\text{raw/exhdry}} = \frac{1}{2} \left( \left( \frac{1.8}{2} + 0.050 + 0.0001 \right) \left( 0.0249 - \frac{47.6}{1000000} \right) + \left( 2 \cdot \frac{47.6}{1000000} + \frac{29.3}{1000000} - \frac{12.1}{1000000} + \frac{8.5}{1000000} \right) \right) + 0.172 = 0.184 \text{ mol/mol}$$

$$x_{\text{O}_2\text{int}} = \frac{0.209820 - 0.000375}{1 + \frac{17.22}{1000}} = 0.206 \text{ mol/mol}$$

$$x_{\text{CO}_2\text{int}} = \frac{0.000375 \cdot 1000}{1 + \frac{17.22}{1000}} = 0.369 \text{ mmol/mol}$$

$$x_{\text{H}_2\text{Ointdry}} = \frac{16.93}{1 - \frac{16.93}{1000}} = 17.22 \text{ mmol/mol}$$

$$x_{\text{CO}_2\text{dil}} = \frac{0.375}{1 + \frac{12.01}{1000}} = 0.371 \text{ mmol/mol}$$

$$x_{\text{H}_2\text{Odil dry}} = \frac{11.87}{1 - \frac{11.87}{1000}} = 12.01 \text{ mmol/mol}$$

$$x_{\text{COdry}} = \frac{29.0}{1 - \frac{8.601}{1000}} = 29.3 \text{ mmol/mol}$$

$$x_{\text{CO}_2\text{dry}} = \frac{24.98}{1 - \frac{8.601}{1000}} = 25.2 \text{ mmol/mol}$$

$$x_{\text{NOdry}} = \frac{50.0}{1 - \frac{8.601}{1000}} = 50.4 \text{ mmol/mol}$$

$$x_{\text{NO}_2\text{dry}} = \frac{12.0}{1 - \frac{8.601}{1000}} = 12.1 \text{ mmol/mol}$$

$$x_{\text{THCdry}} = \frac{46}{1 - \frac{34.16}{1000}} = 47.6 \text{ mmol/mol}$$

$\alpha = 1.8$   
 $\beta = 0.05$   
 $\gamma = 0.0003$   
 $\delta = 0.0001$

(d) *Carbon mass fraction.* Determine carbon mass fraction of fuel,  $w_c$ , using one of the following methods:

(1) You may calculate  $w_c$  as described in this paragraph (d)(1) based on measured fuel properties. To do so, you

must determine values for  $\alpha$  and  $\beta$  in all cases, but you may set  $\gamma$  and  $\delta$  to zero if the default value listed in Table 1 of this section is zero. Calculate  $w_c$  using the following equation:

$$w_c = \frac{1 \cdot M_C}{1 \cdot M_C + \alpha \cdot M_H + \beta \cdot M_O + \gamma \cdot M_S + \delta \cdot M_N}$$

Eq. 1065.655-19

Where:  
 $w_c$  = carbon mass fraction of fuel.  
 $M_C$  = molar mass of carbon.

$\alpha$  = atomic hydrogen-to-carbon ratio of the mixture of fuel(s) being combusted, weighted by molar consumption.

$M_H$  = molar mass of hydrogen.



$\beta$  = atomic oxygen-to-carbon ratio of the mixture of fuel(s) being combusted, weighted by molar consumption.  
 $M_O$  = molar mass of oxygen.  
 $\gamma$  = atomic sulfur-to-carbon ratio of the mixture of fuel(s) being combusted, weighted by molar consumption.  
 $M_S$  = molar mass of sulfur.

$\delta$  = atomic nitrogen-to-carbon ratio of the mixture of fuel(s) being combusted, weighted by molar consumption.  
 $M_N$  = molar mass of nitrogen.  
*Example:*  
 $\alpha = 1.8$   
 $\beta = 0.05$

$\gamma = 0.0003$   
 $\delta = 0.0001$   
 $M_C = 12.0107$   
 $M_H = 1.01$   
 $M_O = 15.9994$   
 $M_S = 32.065$   
 $M_N = 14.0067$

$$w_c = \frac{1 \cdot 12.0107}{1 \cdot 12.0107 + 1.8 \cdot 1.01 + 0.05 \cdot 15.9994 + 0.0003 \cdot 32.065 + 0.0001 \cdot 14.0067}$$

$w_c = 0.8205$

(2) You may use the default values in the following table to determine  $w_c$  for a given fuel:

TABLE 1 OF § 1065.655—DEFAULT VALUES OF  $\alpha$ ,  $\beta$ ,  $\gamma$ ,  $\delta$ , AND  $w_c$ , FOR VARIOUS FUELS

Fuel	Atomic hydrogen, oxygen, sulfur, and nitrogen-to-carbon ratios CH $\alpha$ O $\beta$ S $\gamma$ N $\delta$	Carbon mass fraction, $w_c$ g/g
Gasoline .....	CH <sub>1.85</sub> O <sub>0</sub> S <sub>0</sub> N <sub>0</sub>	0.866
E10 Gasoline .....	CH <sub>1.92</sub> O <sub>0.03</sub> S <sub>0</sub> N <sub>0</sub>	0.833
E15 Gasoline .....	CH <sub>1.95</sub> O <sub>0.05</sub> S <sub>0</sub> N <sub>0</sub>	0.817
E85 Gasoline .....	CH <sub>2.73</sub> O <sub>0.38</sub> S <sub>0</sub> N <sub>0</sub>	0.576
#1 Diesel .....	CH <sub>1.93</sub> O <sub>0</sub> S <sub>0</sub> N <sub>0</sub>	0.861
#2 Diesel .....	CH <sub>1.80</sub> O <sub>0</sub> S <sub>0</sub> N <sub>0</sub>	0.869
Liquefied Petroleum Gas .....	CH <sub>2.64</sub> O <sub>0</sub> S <sub>0</sub> N <sub>0</sub>	0.819
Natural gas .....	CH <sub>3.78</sub> O <sub>0.016</sub> S <sub>0</sub> N <sub>0</sub>	0.747
E100 Ethanol .....	CH <sub>3</sub> O <sub>0.5</sub> S <sub>0</sub> N <sub>0</sub>	0.521
M100 Methanol .....	CH <sub>4</sub> O <sub>1</sub> S <sub>0</sub> N <sub>0</sub>	0.375
Residual fuel blends .....	Must be determined by measured fuel properties as described in paragraph (d)(1) of this section.	

(e) \* \* \*

(3) *Fuel mass flow rate calculation.*  
 Based on  $\dot{m}_{fuel}$ , calculate  $\dot{n}_{exh}$  as follows:

$$\dot{n}_{exh} = \frac{\dot{m}_{fuel} \cdot w_c \cdot (1 + x_{H2Oexhdry})}{M_C \cdot x_{Ccombdry}}$$

Eq. 1065.655-21

Where:

$\dot{n}_{exh}$  = raw exhaust molar flow rate from which you measured emissions.  
 $\dot{m}_{fuel}$  = fuel flow rate including humidity in intake air.

*Example:*

$\dot{m}_{fuel} = 7.559$  g/s  
 $w_c = 0.869$  g/g  
 $M_C = 12.0107$  g/mol  
 $x_{Ccombdry} = 99.87$  mmol/mol = 0.09987 mol/mol  
 $x_{H2Oexhdry} = 107.64$  mmol/mol = 0.10764 mol/mol

$$\dot{n}_{exh} = \frac{7.559 \cdot 0.869 \cdot (1 + 0.10764)}{12.0107 \cdot 0.09987}$$

$\dot{n}_{exh} = 6.066$  mol/s

(f) *Calculated raw exhaust molar flow rate from measured intake air molar flow rate, dilute exhaust molar flow rate, and dilute chemical balance.* You may calculate the raw exhaust molar flow rate,  $\dot{n}_{exh}$ , based on the measured intake air molar flow rate,  $\dot{n}_{int}$ , the measured dilute exhaust molar flow rate,  $\dot{n}_{dexh}$ , and the values calculated using the chemical balance in paragraph (c) of this section. Note that the chemical balance must be based on dilute exhaust gas concentrations. For continuous-flow calculations, solve for the chemical balance in paragraph (c) of this section at the same frequency that

you update and record  $\dot{n}_{int}$  and  $\dot{n}_{dexh}$ . This calculated  $\dot{n}_{exh}$  may be used for the PM dilution ratio verification in § 1065.546; the calculation of dilution air molar flow rate in the background correction in § 1065.667; and the calculation of mass of emissions in § 1065.650(c) for species that are measured in the raw exhaust.

(1) *Crankcase flow rate.* If engines are not subject to crankcase controls under the standard-setting part, calculate raw exhaust flow as described in paragraph (e)(1) of this section.

(2) *Dilute exhaust and intake air molar flow rate calculation.* Calculate  $\dot{n}_{exh}$  as follows:

$$\dot{n}_{\text{exh}} = (x_{\text{raw/exhdry}} - x_{\text{int/exhdry}}) \cdot (1 - x_{\text{H}_2\text{Oexh}}) \cdot \dot{n}_{\text{dexh}} + \dot{n}_{\text{int}}$$

## Eq. 1065.655-22

**Example:**

$$\dot{n}_{\text{int}} = 7.930 \text{ mol/s}$$

$$x_{\text{raw/exhdry}} = 0.1544 \text{ mol/mol}$$

$$x_{\text{int/exhdry}} = 0.1451 \text{ mol/mol}$$

$$x_{\text{H}_2\text{Oexh}} = 32.46 \text{ mmol/mol} - 0.03246 \text{ mol/mol}$$

$$\dot{n}_{\text{dexh}} = 49.02 \text{ mol/s}$$

$$\dot{n}_{\text{exh}} = (0.1544 - 0.1451) \cdot (1 - 0.03246) \cdot 49.02 + 7.930 = 0.4411 + 7.930 = 8.371 \text{ mol/s}$$

■ 81. Section 1065.659 is amended by revising paragraphs (a), (b), and (c) to read as follows:

**§ 1065.659 Removed water correction.**

(a) If you remove water upstream of a concentration measurement,  $x$ , or upstream of a flow measurement,  $n$ , correct for the removed water. Perform this correction based on the amount of water at the concentration measurement,  $x_{\text{H}_2\text{O}[\text{emission}]_{\text{meas}}}$ , and at the flow meter,  $x_{\text{H}_2\text{Oexh}}$ , whose flow is used to determine the mass emission rate or total mass over a test interval. For continuous analyzers downstream of a sample dryer for transient and ramped-modal cycles, you must apply this correction on a continuous basis over the test interval, even if you use one of the options in § 1065.145(e)(2) that results in a constant value for  $x_{\text{H}_2\text{O}[\text{emission}]_{\text{meas}}}$  because  $x_{\text{H}_2\text{Oexh}}$  varies

over the test interval. For batch analyzers, determine the flow-weighted average based on the continuous  $x_{\text{H}_2\text{Oexh}}$  values determined as described in paragraph (c) of this section. For batch analyzers, you may determine the flow-weighted average  $x_{\text{H}_2\text{Oexh}}$  based on a single value of  $x_{\text{H}_2\text{Oexh}}$  determined as described in paragraphs (c)(2) and (3) of this section, using flow-weighted average or batch concentration inputs.

(b) Determine the amount of water remaining downstream of a sample dryer and at the concentration measurement using one of the methods described in § 1065.145(e)(2). If you use a sample dryer upstream of an analyzer and if the calculated amount of water remaining downstream of the sample dryer and at the concentration measurement,  $x_{\text{H}_2\text{O}[\text{emission}]_{\text{meas}}}$ , is higher than the amount of water at the flow meter,  $x_{\text{H}_2\text{Oexh}}$ , set  $x_{\text{H}_2\text{O}[\text{emission}]_{\text{meas}}}$  equal to  $x_{\text{H}_2\text{Oexh}}$ . If you use a sample dryer upstream of storage media, you must be able to demonstrate that the sample dryer is removing water continuously (*i.e.*,  $x_{\text{H}_2\text{Oexh}}$  is higher than  $x_{\text{H}_2\text{O}[\text{emission}]_{\text{meas}}}$  throughout the test interval).

(c) For a concentration measurement where you did not remove water, you may set  $x_{\text{H}_2\text{O}[\text{emission}]_{\text{meas}}}$  equal to  $x_{\text{H}_2\text{Oexh}}$ .

You may determine the amount of water at the flow meter,  $x_{\text{H}_2\text{Oexh}}$ , using any of the following methods:

(1) Measure the dewpoint and absolute pressure and calculate the amount of water as described in § 1065.645.

(2) If the measurement comes from raw exhaust, you may determine the amount of water based on intake-air humidity, plus a chemical balance of fuel, intake air, and exhaust as described in § 1065.655.

(3) If the measurement comes from diluted exhaust, you may determine the amount of water based on intake-air humidity, dilution air humidity, and a chemical balance of fuel, intake air, and exhaust as described in § 1065.655.

\* \* \* \* \*

■ 82. Section 1065.660 is revised to read as follows:

**§ 1065.660 THC, NMHC, and CH<sub>4</sub> determination.**

(a) *THC determination and initial THC/CH<sub>4</sub> contamination corrections.* (1) If we require you to determine THC emissions, calculate  $x_{\text{THC}[\text{THC-FID}]_{\text{cor}}}$  using the initial THC contamination concentration  $x_{\text{THC}[\text{THC-FID}]_{\text{init}}}$  from § 1065.520 as follows:

$$x_{\text{THC}[\text{THC-FID}]_{\text{cor}}} = x_{\text{THC}[\text{THC-FID}]_{\text{uncor}}} - x_{\text{THC}[\text{THC-FID}]_{\text{init}}}$$

## Eq. 1065.660-1

**Example:**

$$x_{\text{THCuncor}} = 150.3 \text{ } \mu\text{mol/mol}$$

$$x_{\text{THCinit}} = 1.1 \text{ } \mu\text{mol/mol}$$

$$x_{\text{THCcor}} = 150.3 - 1.1$$

$$x_{\text{THCcor}} = 149.2 \text{ } \mu\text{mol/mol}$$

(2) For the NMHC determination described in paragraph (b) of this section, correct  $x_{\text{THC}[\text{THC-FID}]}$  for initial THC contamination using Equation 1065.660-1. You may correct  $x_{\text{THC}[\text{NMHC-FID}]}$  for initial contamination of the CH<sub>4</sub> sample train using Equation 1065.660-1, substituting in CH<sub>4</sub> concentrations for THC.

(3) For the CH<sub>4</sub> determination described in paragraph (c) of this

section, you may correct  $x_{\text{THC}[\text{NMHC-FID}]}$  for initial THC contamination of the CH<sub>4</sub> sample train using Equation 1065.660-1, substituting in CH<sub>4</sub> concentrations for THC.

(b) *NMHC determination.* Use one of the following to determine NMHC concentration,  $x_{\text{NMHC}}$ :

(1) If you do not measure CH<sub>4</sub>, you may omit the calculation of NMHC concentrations and calculate the mass of NMHC as described in § 1065.650(c)(5).

(2) For nonmethane cutters, calculate  $x_{\text{NMHC}}$  using the nonmethane cutter's penetration fraction (*PF*) of CH<sub>4</sub> and the response factor penetration fraction

(*RFPF*) of C<sub>2</sub>H<sub>6</sub> from § 1065.365, the response factor (*RF*) of the THC FID to CH<sub>4</sub> from § 1065.360, the initial THC contamination and dry-to-wet corrected THC concentration  $x_{\text{THC}[\text{THC-FID}]_{\text{cor}}}$  as determined in paragraph (a) of this section, and the dry-to-wet corrected CH<sub>4</sub> concentration  $x_{\text{THC}[\text{NMHC-FID}]_{\text{cor}}}$  optionally corrected for initial THC contamination as determined in paragraph (a) of this section.

(i) Use the following equation for penetration fractions determined using an NMC configuration as outlined in § 1065.365(d):

$$x_{\text{NMHC}} = \frac{x_{\text{THC}[\text{THC-FID}]_{\text{cor}}} - x_{\text{THC}[\text{NMC-FID}]_{\text{cor}}} \cdot RF_{\text{CH}_4[\text{THC-FID}]}}{1 - RFPF_{\text{C}_2\text{H}_6[\text{NMC-FID}]} \cdot RF_{\text{CH}_4[\text{THC-FID}]}}$$

Eq. 1065.660-2

Where:

$x_{\text{NMHC}}$  = concentration of NMHC.

$x_{\text{THC}[\text{THC-FID}]_{\text{cor}}}$  = concentration of THC, initial THC contamination and dry-to-wet corrected, as measured by the THC FID during sampling while bypassing the NMC.

$x_{\text{THC}[\text{NMC-FID}]_{\text{cor}}}$  = concentration of THC, initial THC contamination (optional) and dry-to-wet corrected, as measured by the NMC FID during sampling through the NMC.

$RF_{\text{CH}_4[\text{THC-FID}]}$  = response factor of THC FID to CH<sub>4</sub>, according to § 1065.360(d).

$RFPF_{\text{C}_2\text{H}_6[\text{NMC-FID}]}$  = nonmethane cutter combined ethane response factor and

penetration fraction, according to § 1065.365(d).

*Example:*

$x_{\text{THC}[\text{THC-FID}]_{\text{cor}}} = 150.3 \mu\text{mol/mol}$

$x_{\text{THC}[\text{NMC-FID}]_{\text{cor}}} = 20.5 \mu\text{mol/mol}$

$RFPF_{\text{C}_2\text{H}_6[\text{NMC-FID}]} = 0.019$

$RF_{\text{CH}_4[\text{THC-FID}]} = 1.05$

$$x_{\text{NMHC}} = \frac{150.3 - 20.5 \cdot 1.05}{1 - 0.019 \cdot 1.05}$$

$x_{\text{NMHC}} = 131.4 \mu\text{mol/mol}$

(ii) For penetration fractions determined using an NMC configuration

as outlined in section § 1065.365(e), use the following equation:

$$x_{\text{NMHC}} = \frac{x_{\text{THC}[\text{THC-FID}]_{\text{cor}}} \cdot PF_{\text{CH}_4[\text{NMC-FID}]} - x_{\text{THC}[\text{NMC-FID}]_{\text{cor}}}}{PF_{\text{CH}_4[\text{NMC-FID}]} - PF_{\text{C}_2\text{H}_6[\text{NMC-FID}]}}$$

Eq. 1065.660-3

Where:

$x_{\text{NMHC}}$  = concentration of NMHC.

$x_{\text{THC}[\text{THC-FID}]_{\text{cor}}}$  = concentration of THC, initial THC contamination and dry-to-wet corrected, as measured by the THC FID during sampling while bypassing the NMC.

$PF_{\text{CH}_4[\text{NMC-FID}]}$  = nonmethane cutter CH<sub>4</sub> penetration fraction, according to § 1065.365(e).

$x_{\text{THC}[\text{NMC-FID}]_{\text{cor}}}$  = concentration of THC, initial THC contamination (optional) and

dry-to-wet corrected, as measured by the THC FID during sampling through the NMC.

$PF_{\text{C}_2\text{H}_6[\text{NMC-FID}]}$  = nonmethane cutter ethane penetration fraction, according to § 1065.365(e).

*Example:*

$x_{\text{THC}[\text{THC-FID}]_{\text{cor}}} = 150.3 \mu\text{mol/mol}$

$PF_{\text{CH}_4[\text{NMC-FID}]} = 0.990$

$x_{\text{THC}[\text{NMC-FID}]_{\text{cor}}} = 20.5 \mu\text{mol/mol}$

$PF_{\text{C}_2\text{H}_6[\text{NMC-FID}]} = 0.020$

$$x_{\text{NMHC}} = \frac{150.3 \cdot 0.990 - 20.5}{0.990 - 0.020}$$

$x_{\text{NMHC}} = 132.3 \mu\text{mol/mol}$

(iii) For penetration fractions determined using an NMC configuration as outlined in section § 1065.365(f), use the following equation:

$$x_{\text{NMHC}} = \frac{x_{\text{THC}[\text{THC-FID}]_{\text{cor}}} \cdot PF_{\text{CH}_4[\text{NMC-FID}]} - x_{\text{THC}[\text{NMC-FID}]_{\text{cor}}} \cdot RF_{\text{CH}_4[\text{THC-FID}]}}{PF_{\text{CH}_4[\text{NMC-FID}]} - RFPF_{\text{C}_2\text{H}_6[\text{NMC-FID}]} \cdot RF_{\text{CH}_4[\text{THC-FID}]}}$$

Eq. 1065.660-4

Where:

$x_{\text{NMHC}}$  = concentration of NMHC.

$x_{\text{THC}[\text{THC-FID}]_{\text{cor}}}$  = concentration of THC, initial THC contamination and dry-to-wet corrected, as measured by the THC FID during sampling while bypassing the NMC.

$PF_{\text{CH}_4[\text{NMC-FID}]}$  = nonmethane cutter CH<sub>4</sub> penetration fraction, according to § 1065.365(f).

$x_{\text{THC}[\text{NMC-FID}]_{\text{cor}}}$  = concentration of THC, initial THC contamination (optional) and dry-to-wet corrected, as measured by the

THC FID during sampling through the NMC.

$RFPF_{\text{C}_2\text{H}_6[\text{NMC-FID}]}$  = nonmethane cutter CH<sub>4</sub> combined ethane response factor and penetration fraction, according to § 1065.365(f).

$RF_{\text{CH}_4[\text{THC-FID}]}$  = response factor of THC FID to CH<sub>4</sub>, according to § 1065.360(d).

*Example:*

$x_{\text{THC}[\text{THC-FID}]_{\text{cor}}} = 150.3 \mu\text{mol/mol}$

$PF_{\text{CH}_4[\text{NMC-FID}]} = 0.990$

$x_{\text{THC}[\text{NMC-FID}]_{\text{cor}}} = 20.5 \mu\text{mol/mol}$

$RFPF_{\text{C}_2\text{H}_6[\text{NMC-FID}]} = 0.019$

$RF_{\text{CH}_4[\text{THC-FID}]} = 0.980$

$$x_{\text{NMHC}} = \frac{150.3 \cdot 0.990 - 20.5 \cdot 0.980}{0.990 - 0.019 \cdot 0.980}$$

$x_{\text{NMHC}} = 132.5 \mu\text{mol/mol}$

(3) For a GC-FID, calculate  $x_{\text{NMHC}}$  using the THC analyzer's response factor ( $RF$ ) for CH<sub>4</sub>, from § 1065.360, and the initial THC contamination and dry-to-wet corrected THC concentration  $x_{\text{THC}[\text{THC-FID}]_{\text{cor}}}$  as determined in paragraph (a) of this section as follows:

$$x_{\text{NMHC}} = x_{\text{THC}[\text{THC-FID}]_{\text{cor}}} - RF_{\text{CH}_4[\text{THC-FID}]} \cdot x_{\text{CH}_4}$$

Eq. 1065.660-5

Where:

$x_{\text{NMHC}}$  = concentration of NMHC.

$x_{\text{THC}[\text{THC-FID}]_{\text{cor}}}$  = concentration of THC, initial THC contamination and dry-to-wet corrected, as measured by the THC FID.

$x_{\text{CH}_4}$  = concentration of CH<sub>4</sub>, dry-to-wet corrected, as measured by the GC-FID.

$RF_{\text{CH}_4[\text{THC-FID}]}$  = response factor of THC-FID to CH<sub>4</sub>.

*Example:*

$x_{\text{THC}[\text{THC-FID}]_{\text{cor}}} = 145.6 \mu\text{mol/mol}$

$RF_{\text{CH}_4[\text{THC-FID}]} = 0.970$

$x_{\text{CH}_4} = 18.9 \mu\text{mol/mol}$

$x_{\text{NMHC}} = 145.6 - 0.970 \cdot 18.9$

$x_{\text{NMHC}} = 127.3 \mu\text{mol/mol}$

(c) *CH<sub>4</sub> determination.* Use one of the following methods to determine CH<sub>4</sub> concentration,  $x_{\text{CH}_4}$ :

(1) For nonmethane cutters, calculate  $x_{\text{CH}_4}$  using the nonmethane cutter's penetration fraction (*PF*) of CH<sub>4</sub> and the response factor penetration fraction (*RFPF*) of C<sub>2</sub>H<sub>6</sub> from § 1065.365, the response factor (*RF*) of the THC FID to CH<sub>4</sub> from § 1065.360, the initial THC

contamination and dry-to-wet corrected THC concentration  $x_{\text{THC}[\text{THC-FID}]_{\text{cor}}}$  as determined in paragraph (a) of this section, and the dry-to-wet corrected CH<sub>4</sub> concentration  $x_{\text{THC}[\text{NMC-FID}]_{\text{cor}}}$  optionally corrected for initial THC contamination as determined in paragraph (a) of this section.

(i) Use the following equation for penetration fractions determined using an NMC configuration as outlined in § 1065.365(d):

$$x_{\text{CH}_4} = \frac{x_{\text{THC}[\text{NMC-FID}]_{\text{cor}}} - x_{\text{THC}[\text{THC-FID}]_{\text{cor}}} \cdot RFPF_{\text{C}_2\text{H}_6[\text{NMC-FID}]}}{1 - RFPF_{\text{C}_2\text{H}_6[\text{NMC-FID}]} \cdot RF_{\text{CH}_4[\text{THC-FID}]}}$$

Eq. 1065.660-6

Where:

$x_{\text{CH}_4}$  = concentration of CH<sub>4</sub>.

$x_{\text{THC}[\text{NMC-FID}]_{\text{cor}}}$  = concentration of THC, initial THC contamination (optional) and dry-to-wet corrected, as measured by the NMC FID during sampling through the NMC.

$x_{\text{THC}[\text{THC-FID}]_{\text{cor}}}$  = concentration of THC, initial THC contamination and dry-to-wet corrected, as measured by the THC FID during sampling while bypassing the NMC.

$RFPF_{\text{C}_2\text{H}_6[\text{NMC-FID}]}$  = the combined ethane response factor and penetration fraction of the nonmethane cutter, according to § 1065.365(d).

$RF_{\text{CH}_4[\text{THC-FID}]}$  = response factor of THC FID to CH<sub>4</sub>, according to § 1065.360(d).

*Example:*

$x_{\text{THC}[\text{NMC-FID}]_{\text{cor}}} = 10.4 \mu\text{mol/mol}$

$x_{\text{THC}[\text{THC-FID}]_{\text{cor}}} = 150.3 \mu\text{mol/mol}$

$RFPF_{\text{C}_2\text{H}_6[\text{NMC-FID}]} = 0.019$

$RF_{\text{CH}_4[\text{THC-FID}]} = 1.05$

$$x_{\text{CH}_4} = \frac{10.4 - 150.3 \cdot 0.019}{1 - 0.019 \cdot 1.05}$$

$x_{\text{CH}_4} = 7.69 \mu\text{mol/mol}$

(ii) For penetration fractions determined using an NMC configuration as outlined in § 1065.365(e), use the following equation:

$$x_{\text{CH}_4} = \frac{x_{\text{THC}[\text{NMC-FID}]_{\text{cor}}} - x_{\text{THC}[\text{THC-FID}]_{\text{cor}}} \cdot PF_{\text{C}_2\text{H}_6[\text{NMC-FID}]}}{RF_{\text{CH}_4[\text{THC-FID}]} \cdot (PF_{\text{CH}_4[\text{NMC-FID}]} - PF_{\text{C}_2\text{H}_6[\text{NMC-FID}]})}$$

Eq. 1065.660-7

Where:

$x_{\text{CH}_4}$  = concentration of CH<sub>4</sub>.

$x_{\text{THC}[\text{NMC-FID}]_{\text{cor}}}$  = concentration of THC, initial THC contamination (optional) and dry-to-wet corrected, as measured by the NMC FID during sampling through the NMC.

$x_{\text{THC}[\text{THC-FID}]_{\text{cor}}}$  = concentration of THC, initial THC contamination and dry-to-wet corrected, as measured by the THC FID during sampling while bypassing the NMC.

$PF_{\text{C}_2\text{H}_6[\text{NMC-FID}]}$  = nonmethane cutter ethane penetration fraction, according to § 1065.365(e).

$RF_{\text{CH}_4[\text{THC-FID}]}$  = response factor of THC FID to CH<sub>4</sub>, according to § 1065.360(d).

$PF_{\text{CH}_4[\text{NMC-FID}]}$  = nonmethane cutter CH<sub>4</sub> penetration fraction, according to § 1065.365(e).

*Example:*

$x_{\text{THC}[\text{NMC-FID}]_{\text{cor}}} = 10.4 \mu\text{mol/mol}$

$x_{\text{THC}[\text{THC-FID}]_{\text{cor}}} = 150.3 \mu\text{mol/mol}$

$PF_{\text{C}_2\text{H}_6[\text{NMC-FID}]} = 0.020$

$RF_{\text{CH}_4[\text{THC-FID}]} = 1.05$

$PF_{\text{CH}_4[\text{NMC-FID}]} = 0.990$

$$x_{\text{CH}_4} = \frac{10.4 - 150.3 \cdot 0.020}{1.05 \cdot (0.990 - 0.020)}$$

$x_{\text{CH}_4} = 7.25 \mu\text{mol/mol}$

(iii) For penetration fractions determined using an NMC configuration as outlined in § 1065.365(f), use the following equation:

$$x_{CH4} = \frac{x_{THC[NMC-FID]cor} - x_{THC[THC-FID]cor} \cdot RFPF_{C2H6[NMC-FID]}}{PF_{CH4[NMC-FID]} - RFPF_{C2H6[NMC-FID]} \cdot RF_{CH4[THC-FID]}}$$

Eq. 1065.660-8

Where:

$x_{CH4}$  = concentration of CH<sub>4</sub>.

$x_{THC[NMC-FID]cor}$  = concentration of THC, initial THC contamination (optional) and dry-to-wet corrected, as measured by the NMC FID during sampling through the NMC.

$x_{THC[THC-FID]cor}$  = concentration of THC, initial THC contamination and dry-to-wet corrected, as measured by the THC FID during sampling while bypassing the NMC.

$RFPF_{C2H6[NMC-FID]}$  = the combined ethane response factor and penetration fraction of the nonmethane cutter, according to § 1065.365(f).

$PF_{CH4[NMC-FID]}$  = nonmethane cutter CH<sub>4</sub> penetration fraction, according to § 1065.365(f).

$RF_{CH4[THC-FID]}$  = response factor of THC FID to CH<sub>4</sub>, according to § 1065.360(d).

Example:

$x_{THC[NMC-FID]cor}$  = 10.4 μmol/mol

$x_{THC[THC-FID]cor}$  = 150.3 μmol/mol

$RFPF_{C2H6[NMC-FID]}$  = 0.019

$PF_{CH4[NMC-FID]}$  = 0.990

$RF_{CH4[THC-FID]}$  = 1.05

$$x_{CH4} = \frac{10.4 - 150.3 \cdot 0.019}{0.990 - 0.019 \cdot 1.05}$$

$x_{CH4}$  = 7.78 μmol/mol

(2) For a GC-FID,  $x_{CH4}$  is the actual dry-to-wet corrected CH<sub>4</sub> concentration as measured by the analyzer.

■ 83. Section 1065.667 is revised to read as follows:

**§ 1065.667 Dilution air background emission correction.**

(a) To determine the mass of background emissions to subtract from a diluted exhaust sample, first determine the total flow of dilution air,  $n_{dil}$ , over the test interval. This may be a measured quantity or a calculated quantity. Multiply the total flow of dilution air by the mean mole fraction (*i.e.*, concentration) of a background emission. This may be a time-weighted mean or a flow-weighted mean (*e.g.*, a proportionally sampled background). Finally, multiply by the molar mass,  $M$ , of the associated gaseous emission constituent. The product of  $n_{dil}$  and the mean molar concentration of a background emission and its molar mass,  $M$ , is the total background emission mass,  $m$ . In the case of PM, where the mean PM concentration is already in units of mass per mole of sample,  $M_{PM}$ , multiply it by the total

amount of dilution air flow, and the result is the total background mass of PM,  $m_{PM}$ . Subtract total background mass from total mass to correct for background emissions.

(b) You may determine the total flow of dilution air by a direct flow measurement.

(c) You may determine the total flow of dilution air by subtracting the calculated raw exhaust molar flow as described in § 1065.655(f) from the measured dilute exhaust flow. This may be done by totaling continuous calculations or by using batch results.

(d) You may determine the total flow of dilution air from the measured dilute exhaust flow and a chemical balance of the fuel, intake air, and dilute exhaust as described in § 1065.655. For this option, the molar flow of dilution air is calculated by multiplying the dilute exhaust flow by the mole fraction of dilution gas to dilute exhaust,  $x_{dil/exh}$ , from the dilute chemical balance. This may be done by totaling continuous calculations or by using batch results. For example, to use batch results, the total flow of dilution air is calculated by multiplying the total flow of diluted exhaust,  $n_{dexh}$ , by the flow-weighted mean mole fraction of dilution air in diluted exhaust,  $\bar{x}_{dil/exh}$ . Calculate  $\bar{x}_{dil/exh}$  using flow-weighted mean

concentrations of emissions in the chemical balance, as described in § 1065.655. The chemical balance in § 1065.655 assumes that your engine operates stoichiometrically, even if it is a lean-burn engine, such as a compression-ignition engine. Note that for lean-burn engines this assumption could result in an error in emission calculations. This error could occur because the chemical balance in § 1065.655 treats excess air passing through a lean-burn engine as if it was dilution air. If an emission concentration expected at the standard is about 100 times its dilution air background concentration, this error is negligible. However, if an emission concentration expected at the standard is similar to its background concentration, this error could be significant. If this error might affect your ability to show that your engines comply with applicable standards, we recommend that you either determine the total flow of dilution air using one of the more accurate methods in

paragraph (b) or (c) of this section, or remove background emissions from dilution air by HEPA filtration, chemical adsorption, or catalytic scrubbing. You might also consider using a partial-flow dilution technique such as a bag mini-diluter, which uses purified air as the dilution air.

(e) The following is an example of using the flow-weighted mean fraction of dilution air in diluted exhaust,  $\bar{x}_{dil/exh}$ , and the total mass of background emissions calculated using the total flow of diluted exhaust,  $n_{dexh}$ , as described in § 1065.650(c):

$$m_{bkgnd} = \bar{x}_{dil/exh} \cdot m_{bkgnddexh}$$

Eq. 1065.667-1

$$m_{bkgnddexh} = M \cdot \bar{x}_{bkgnd} \cdot n_{dexh}$$

Eq. 1065.667-2

Example:

$M_{NOx}$  = 46.0055 g/mol

$\bar{x}_{bkgnd}$  = 0.05 μmol/mol = 0.05 · 10<sup>-6</sup> mol/mol

$n_{dexh}$  = 23280.5 mol

$\bar{x}_{dil/exh}$  = 0.843 mol/mol

$m_{bkgndNOxdexh}$  = 46.0055 · 0.05 · 10<sup>-6</sup> · 23280.5

$m_{bkgndNOxdexh}$  = 0.0536 g

$m_{bkgndNOx}$  = 0.843 · 0.0536

$m_{bkgndNOx}$  = 0.0452 g

(f) The following is an example of using the fraction of dilution air in diluted exhaust,  $x_{dil/exh}$ , and the mass rate of background emissions calculated using the flow rate of diluted exhaust,  $\dot{n}_{dexh}$ , as described in § 1065.650(c):

$$\dot{m}_{bkgnd} = x_{dil/exh} \cdot \dot{m}_{bkgnddexh}$$

Eq. 1065.667-3

$$\dot{m}_{bkgnddexh} = M \cdot x_{bkgnd} \cdot \dot{n}_{dexh}$$

Eq. 1065.667-4

Example:

$M_{NOx}$  = 46.0055 g/mol

$x_{bkgnd}$  = 0.05 μmol/mol = 0.05 · 10<sup>-6</sup> mol/mol

$$\begin{aligned} \dot{n}_{d\text{exh}} &= 23280.5 \text{ mol/s} \\ x_{d\text{il/exh}} &= 0.843 \text{ mol/mol} \\ \dot{m}_{b\text{kgndNOx dexh}} &= \\ & 46.0055 \cdot 0.05 \cdot 10^{-6} \cdot 23280.5 \\ \dot{m}_{b\text{kgndNOx dexh}} &= 0.0536 \text{ g/hr} \\ \dot{m}_{b\text{kgndNOx}} &= 0.843 \cdot 0.0536 \\ \dot{m}_{b\text{kgndNOx}} &= 0.0452 \text{ g/hr} \end{aligned}$$

■ 84. Section 1065.670 is amended by revising the introductory text to read as follows:

**§ 1065.670 NO<sub>x</sub> intake-air humidity and temperature corrections.**

See the standard-setting part to determine if you may correct NO<sub>x</sub> emissions for the effects of intake-air

humidity or temperature. Use the NO<sub>x</sub> intake-air humidity and temperature corrections specified in the standard-setting part instead of the NO<sub>x</sub> intake-air humidity correction specified in this part 1065. If the standard-setting part does not prohibit correcting NO<sub>x</sub> emissions for intake-air humidity according to this part 1065, correct NO<sub>x</sub> concentrations for intake-air humidity as described in this section. See § 1065.650(c)(1) for the proper sequence for applying the NO<sub>x</sub> intake-air humidity and temperature corrections. You may use a time-weighted mean combustion air humidity to calculate

this correction if your combustion air humidity remains within a tolerance of ±0.0025 mol/mol of the mean value over the test interval. For intake-air humidity correction, use one of the following approaches:

\* \* \* \* \*

■ 85. Section 1065.675 is amended by revising paragraph (d) to read as follows:

**§ 1065.675 CLD quench verification calculations.**

\* \* \* \* \*

(d) Calculate quench as follows:

$$quench = \left( \left( \frac{x_{NOwet}}{1 - x_{H_2Omeas}} - 1 \right) \cdot \frac{x_{H_2Oexp}}{x_{H_2Omeas}} + \left( \frac{x_{NOmeas}}{x_{NOact}} - 1 \right) \cdot \frac{x_{CO2exp}}{x_{CO2act}} \right) \cdot 100 \%$$

Eq. 1065.675-1

Where:

- quench* = amount of CLD quench.
- $x_{NOdry}$  = concentration of NO upstream of a bubbler, according to § 1065.370(e)(4).
- $x_{NOwet}$  = measured concentration of NO downstream of a bubbler, according to § 1065.370(e)(9).
- $x_{H_2Oexp}$  = maximum expected mole fraction of water during emission testing, according to paragraph (b) of this section.

- $x_{H_2Omeas}$  = measured mole fraction of water during the quench verification, according to § 1065.370(e)(7).
- $x_{NOmeas}$  = measured concentration of NO when NO span gas is blended with CO<sub>2</sub> span gas, according to § 1065.370(d)(10).
- $x_{NOact}$  = actual concentration of NO when NO span gas is blended with CO<sub>2</sub> span gas, according to § 1065.370(d)(11) and

- calculated according to Equation 1065.675-2.
- $x_{CO2exp}$  = maximum expected concentration of CO<sub>2</sub> during emission testing, according to paragraph (c) of this section.
- $x_{CO2act}$  = actual concentration of CO<sub>2</sub> when NO span gas is blended with CO<sub>2</sub> span gas, according to § 1065.370(d)(9).

$$x_{NOact} = \left( 1 - \frac{x_{CO2act}}{x_{CO2span}} \right) \cdot x_{NOspan}$$

Eq. 1065.675-2

Where:

- $x_{NOspan}$  = the NO span gas concentration input to the gas divider, according to § 1065.370(d)(5).
- $x_{CO2span}$  = the CO<sub>2</sub> span gas concentration input to the gas divider, according to § 1065.370(d)(4).

*Example:*

- $x_{NOdry}$  = 1800.0 μmol/mol
- $x_{NOwet}$  = 1739.6 μmol/mol
- $x_{H_2Oexp}$  = 0.030 mol/mol
- $x_{H_2Omeas}$  = 0.030 mol/mol
- $x_{NOmeas}$  = 1515.2 μmol/mol

- $x_{NOspan}$  = 3001.6 μmol/mol
- $x_{CO2exp}$  = 3.2%
- $x_{CO2span}$  = 6.1%
- $x_{CO2act}$  = 2.98%

$$x_{NOact} = \left( 1 - \frac{2.98}{6.1} \right) \cdot 3001.6 = 1535.24459 \text{ μmol/mol}$$

$$quench = \left( \left( \frac{1739.6}{1 - 0.030} - 1 \right) \cdot \frac{0.030}{0.030} + \left( \frac{1515.2}{1535.24459} - 1 \right) \cdot \frac{3.2}{2.98} \right) \cdot 100 \%$$

quench = (-0.0036655 - 0.014020171) · 100% = -1.7685671%

**Subpart H—[Amended]**

■ 86. Section 1065.750 is amended by revising paragraphs (a)(3) introductory text and (a)(4) to read as follows:

**§ 1065.750 Analytical gases.**

\* \* \* \* \*

(a) \* \* \*

(3) Use the following gas mixtures, with gases traceable within ±1% of the NIST-accepted value or other gas standards we approve:

\* \* \* \* \*

(4) You may use gases for species other than those listed in paragraph (a)(3) of this section (such as methanol in air, which you may use to determine response factors), as long as they are traceable to within ±3% of the NIST-accepted value or other similar standards we approve, and meet the stability requirements of paragraph (b) of this section.

\* \* \* \* \*

■ 87. Section 1065.790 is amended by revising paragraph (a) to read as follows:

**§ 1065.790 Mass standards.**

(a) *PM balance calibration weights.*  
Use PM balance calibration weights that

are certified as NIST-traceable within 0.1% uncertainty. Calibration weights may be certified by any calibration lab that maintains NIST-traceability. Make sure your highest calibration weight has no greater than ten times the mass of an unused PM-sample medium.

\* \* \* \* \*

**Subpart J—[Amended]**

■ 88. Section 1065.915 is amended by revising Table 1 in paragraph (a) to read as follows:

**§ 1065.915 PEMS instruments.**

(a) \* \* \*

TABLE 1 OF § 1065.915—RECOMMENDED MINIMUM PEMS MEASUREMENT INSTRUMENT PERFORMANCE

Measurement	Measured quantity symbol	Rise time, $t_{10-90}$ , and fall time, $t_{90-10}$	Recording update frequency	Accuracy <sup>1</sup>	Repeatability <sup>1</sup>	Noise <sup>1</sup>
Engine speed transducer.	$f_n$ .....	1 s .....	1 Hz means .....	5% of pt. or 1% of max.	2% of pt. or 1% of max.	0.5% of max.
Engine torque estimator, BSFC (This is a signal from an engine's ECM)	$T$ or BSFC .....	1 s .....	1 Hz means .....	8% of pt. or 5% of max.	2% of pt. or 1% of max.	1% of max.
General pressure transducer (not a part of another instrument)	$p$ .....	5 s .....	1 Hz .....	5% of pt. or 5% of max.	2% of pt. or 0.5% of max.	1% of max.
Atmospheric pressure meter	$p_{atmos}$ .....	50 s .....	0.1 Hz .....	250 Pa .....	200 Pa .....	100 Pa.
General temperature sensor (not a part of another instrument)	$T$ .....	5 s .....	1 Hz .....	1% of pt. K or 5 K	0.5% of pt. K or 2 K.	0.5% of max 0.5 K.
General dewpoint sensor.	$T_{dew}$ .....	50 s .....	0.1 Hz .....	3 K .....	1 K .....	1 K.
Exhaust flow meter	$n$ .....	1 s .....	1 Hz means .....	5% of pt. or 3% of max.	2% of pt. ....	2% of max.
Dilution air, inlet air, exhaust, and sample flow meters	$n$ .....	1 s .....	1 Hz means .....	2.5% of pt. or 1.5% of max.	1.25% of pt. or 0.75% of max.	1% of max.
Continuous gas analyzer.	$x$ .....	5 s .....	1 Hz .....	4% of pt. or 4% of meas.	2% of pt. or 2% of meas.	1% of max.
Gravimetric PM balance.	$m_{PM}$ .....	N/A .....	N/A .....	See § 1065.790 ...	0.5 µg .....	N/A.
Inertial PM balance	$m_{PM}$ .....	N/A .....	N/A .....	4% of pt. or 4% of meas.	2% of pt. or 2% of meas.	1% of max.

<sup>1</sup> Accuracy, repeatability, and noise are all determined with the same collected data, as described in § 1065.305, and based on absolute values. "pt." refers to the overall flow-weighted mean value expected at the standard; "max." refers to the peak value expected at the standard over any test interval, not the maximum of the instrument's range; "meas" refers to the actual flow-weighted mean measured over any test interval.

\* \* \* \* \*

■ 89. Section 1065.925 is amended by revising paragraphs (h)(1), (h)(2), and (h)(3) to read as follows:

**§ 1065.925 PEMS preparation for field testing.**

\* \* \* \* \*

(h) \* \* \*

(1) Select the HC analyzer range for measuring the maximum concentration expected at the HC standard.

(2) Zero the HC analyzers using a zero gas or ambient air introduced at the analyzer port. When zeroing a FID, use the FID's burner air that would be used for in-use measurements (generally either ambient air or a portable source of burner air).

(3) Span the HC analyzer using span gas introduced at the analyzer port.

\* \* \* \* \*

**Subpart K—[Amended]**

■ 90. Section 1065.1001 is amended by revising the introductory text and the definitions for "Idle speed", "Percent (%)", and "Round" and adding definitions for "Electric power generation application", "High-idle speed", and "High-speed governor" in alphabetical order to read as follows:

**§ 1065.1001 Definitions.**

\* \* \* \* \*

*Electric power generation application* means an application whose purpose is to generate a precise frequency of electricity, which is characterized by an engine that controls engine speed very precisely. This would generally not apply to welders or portable home generators.

\* \* \* \* \*

*High-idle speed* means the engine speed at which an engine governor function controls engine speed with operator demand at maximum and with zero load applied. “Warm high-idle speed” is the high-idle speed of a warmed-up engine.

*High-speed governor* means any device, system, or element of design that modulates the engine output torque for the purpose of limiting the maximum engine speed.

\* \* \* \* \*

*Idle speed* means the engine speed at which an engine governor function

controls engine speed with operator demand at minimum and with minimum load applied (greater than or equal to zero). For engines without a governor function that controls idle speed, idle speed means the manufacturer-declared value for lowest engine speed possible with minimum load. This definition does not apply for operation designated as “high-idle speed.” “Warm idle speed” is the idle speed of a warmed-up engine.

\* \* \* \* \*

*Percent (%)* means a representation of exactly 0.01. Numbers expressed as percentages in this part (such as a tolerance of ±2%) have infinite precision, so 2% and 2.00000000% have the same meaning. This means that where we specify some percentage of a total value, the calculated value has the same number of significant digits as the total value. For example, 2% of a span value where the span value is 101.3302 is 2.026604.

\* \* \* \* \*

*Round* means to apply the rounding convention specified in § 1065.20(e), unless otherwise specified.

\* \* \* \* \*

■ 91. Section 1065.1005 is amended by revising the introductory text and paragraphs (a), (e), (f)(2), and (g) to read as follows:

**§ 1065.1005 Symbols, abbreviations, acronyms, and units of measure.**

The procedures in this part generally follow the International System of Units (SI), as detailed in NIST Special Publication 811, which we incorporate by reference in § 1065.1010. See § 1065.20 for specific provisions related to these conventions. This section summarizes the way we use symbols, units of measure, and other abbreviations.

(a) *Symbols for quantities.* This part uses the following symbols and units of measure for various quantities:

Symbol	Quantity	Unit	Unit symbol	Units in terms of SI base units
$\alpha$ .....	atomic hydrogen to carbon ratio .....	mole per mole .....	mol/mol	1
$A$ .....	area .....	square meter .....	m <sup>2</sup>	m <sup>2</sup>
$A_0$ .....	intercept of least squares regression .....	.....	.....	.....
$A_1$ .....	slope of least squares regression .....	.....	.....	.....
$\beta$ .....	ratio of diameters .....	meter per meter .....	m/m	1
$\beta$ .....	atomic oxygen to carbon ratio .....	mole per mole .....	mol/mol	1
$C^\#$ .....	number of carbon atoms in a molecule .....	.....	.....	.....
$d$ .....	Diameter .....	meter .....	m	m
$DR$ .....	dilution ratio .....	mole per mol .....	mol/mol	1
$\epsilon$ .....	error between a quantity and its reference .....	.....	.....	.....
$e$ .....	brake-specific emission or fuel consumption .....	gram per kilowatt hour .....	g/(kW-hr)	g·3.6 <sup>-1</sup> ·10 <sup>6</sup> ·m <sup>-2</sup> ·kg·s <sup>-2</sup>
$F$ .....	F-test statistic .....	.....	.....	.....
$f$ .....	frequency .....	hertz .....	Hz	s <sup>-1</sup>
$f_n$ .....	angular speed (shaft) .....	revolutions per minute .....	r/min	2· $\pi$ ·60 <sup>-1</sup> · m·m <sup>-1</sup> ·s <sup>-1</sup>
$\gamma$ .....	ratio of specific heats .....	(joule per kilogram kelvin) per (joule per kilogram kelvin) .....	(J/(kg·K))/(J/(kg·K))	1
$K$ .....	correction factor .....	.....	.....	1
$l$ .....	length .....	meter .....	m	m
$\mu$ .....	viscosity, dynamic .....	pascal second .....	Pa·s	m <sup>-1</sup> ·kg·s
$M$ .....	molar mass <sup>1</sup> .....	gram per mole .....	g/mol	10 <sup>-3</sup> ·kg·mol <sup>-1</sup>
$m$ .....	mass .....	kilogram .....	kg	kg
$\dot{m}$ .....	mass rate .....	kilogram per second .....	kg/s	kg·s <sup>-1</sup>
$\nu$ .....	viscosity, kinematic .....	meter squared per second .....	m <sup>2</sup> /s	m <sup>2</sup> ·s <sup>-1</sup>
$N$ .....	total number in series .....	.....	.....	.....
$n$ .....	amount of substance .....	mole .....	mol	mol
$\dot{n}$ .....	amount of substance rate .....	mole per second .....	mol/s	mol·s <sup>-1</sup>
$P$ .....	power .....	kilowatt .....	kW	10 <sup>3</sup> ·m <sup>2</sup> ·kg·s <sup>-3</sup>
$PF$ .....	penetration fraction .....	.....	.....	.....
$p$ .....	pressure .....	pascal .....	Pa	m <sup>-1</sup> ·kg·s <sup>-2</sup>
$\rho$ .....	mass density .....	kilogram per cubic meter .....	kg/m <sup>3</sup>	kg·m <sup>-3</sup>
$r$ .....	ratio of pressures .....	pascal per pascal .....	Pa/Pa	1
$R^2$ .....	coefficient of determination .....	.....	.....	.....
$Ra$ .....	average surface roughness .....	micrometer .....	$\mu$ m	10 <sup>-6</sup> m
$Re^\#$ .....	Reynolds number .....	.....	.....	.....
$RF$ .....	response factor .....	.....	.....	.....
$RH$ .....	relative humidity .....	.....	.....	.....
$\sigma$ .....	non-biased standard deviation .....	.....	.....	.....
$S$ .....	Sutherland constant .....	kelvin .....	K	K
$SEE$ .....	standard estimate of error .....	.....	.....	.....
$T$ .....	absolute temperature .....	kelvin .....	K	K
$T$ .....	Celsius temperature .....	degree Celsius .....	°C	K - 273.15
$T$ .....	torque (moment of force) .....	newton meter .....	N·m	m <sup>2</sup> ·kg·s <sup>-2</sup>
$t$ .....	time .....	second .....	s	s
$\Delta t$ .....	time interval, period, 1/frequency .....	second .....	s	s



Symbol	Quantity	Unit	Unit symbol	Units in terms of SI base units
V	volume	cubic meter	m <sup>3</sup>	m <sup>3</sup>
V	volume rate	cubic meter per second	m <sup>3</sup> /s	m <sup>3</sup> ·s <sup>-1</sup>
W	work	kilowatt hour	kW·hr	3.6·10 <sup>-6</sup> ·m <sup>2</sup> ·kg·s <sup>-2</sup>
w <sub>c</sub>	carbon mass fraction	gram per gram	g/g	1
x	amount of substance mole fraction	mole per mole	mol/mol	1
$\bar{x}$	flow-weighted mean concentration	mole per mole	mol/mol	1
y	generic variable			

<sup>1</sup> See paragraph (f)(2) of this section for the values to use for molar masses. Note that in the cases of NO<sub>x</sub> and HC, the regulations specify effective molar masses based on assumed speciation rather than actual speciation.

<sup>2</sup> Note that mole fractions for THC, THCE, NMHC, NMHCE, and NOTHC are expressed on a C<sub>1</sub> equivalent basis.

* * * * *		Subscript	Quantity	Subscript	Quantity
(e) <i>Subscripts.</i> This part uses the following subscripts to define a quantity:		hi, idle	condition at high – idle.	ref	reference quantity.
		i	an individual of a series.	rev	revolution.
		idle	condition at idle.	sat	saturated condition.
		in	quantity in.	slip	PDP slip.
		init	initial quantity, typically before an emission test.	span	span quantity.
		j	an individual of a series.	SSV	subsonic venturi.
		max	the maximum ( <i>i.e.</i> , peak) value expected at the standard over a test interval; not the maximum of an instrument range.	std	standard condition.
		meas	measured quantity.	test	test quantity.
		out	quantity out.	test, alt	alternate test quantity.
		part	partial quantity.	uncor	uncorrected quantity.
		PDP	positive – displacement pump.	zero	zero quantity.
				(f) * * *	
				(2) This part uses the following molar masses or effective molar masses of chemical species:	

Symbol	Quantity	g/mol (10 <sup>-3</sup> kg·mol <sup>-1</sup> )
M <sub>air</sub>	molar mass of dry air <sup>1</sup>	28.96559
M <sub>Ar</sub>	molar mass of argon	39.948
M <sub>C</sub>	molar mass of carbon	12.0107
M <sub>C<sub>3</sub>H<sub>8</sub></sub>	molar mass of propane	44.09562
M <sub>CH<sub>4</sub></sub>	molar mass of methane	16.043
M <sub>CO</sub>	molar mass of carbon monoxide	28.0101
M <sub>CO<sub>2</sub></sub>	molar mass of carbon dioxide	44.0095
M <sub>H</sub>	molar mass of atomic hydrogen	1.00794
M <sub>H<sub>2</sub></sub>	molar mass of molecular hydrogen	2.01588
M <sub>H<sub>2</sub>O</sub>	molar mass of water	18.01528
M <sub>He</sub>	molar mass of helium	4.002602
M <sub>N</sub>	molar mass of atomic nitrogen	14.0067
M <sub>N<sub>2</sub></sub>	molar mass of molecular nitrogen	28.0134
M <sub>NMHC</sub>	effective molar mass of nonmethane hydrocarbon <sup>2</sup>	13.875389
M <sub>NMHCE</sub>	effective molar mass of nonmethane equivalent hydrocarbon <sup>2</sup>	13.875389
M <sub>NO<sub>x</sub></sub>	effective molar mass of oxides of nitrogen <sup>3</sup>	46.0055
M <sub>N<sub>2</sub>O</sub>	molar mass of nitrous oxide	44.0128
M <sub>O</sub>	molar mass of atomic oxygen	15.9994
M <sub>O<sub>2</sub></sub>	molar mass of molecular oxygen	31.9988
M <sub>S</sub>	molar mass of sulfur	32.065
M <sub>THC</sub>	effective molar mass of total hydrocarbon <sup>2</sup>	13.875389
M <sub>THCE</sub>	effective molar mass of total hydrocarbon equivalent <sup>2</sup>	13.875389

<sup>1</sup> See paragraph (f)(1) of this section for the composition of dry air.

<sup>2</sup> The effective molar masses of THC, THCE, NMHC, and NMHCE are defined by an atomic hydrogen-to-carbon ratio, α, of 1.85.

<sup>3</sup> The effective molar mass of NO<sub>x</sub> is defined by the molar mass of nitrogen dioxide, NO<sub>2</sub>.

* * * * *		BSFC	brake-specific fuel consumption	DF	deterioration factor
(g) <i>Other acronyms and abbreviations.</i> This part uses the following additional abbreviations and acronyms:		CARB	California Air Resources Board	ECM	electronic control module
		CFR	Code of Federal Regulations	EFC	electronic flow control
		CFV	critical-flow venturi	EGR	exhaust gas recirculation
		CI	compression-ignition	EPA	Environmental Protection Agency
		CITT	Curb Idle Transmission Torque	FEL	Family Emission Limit
		CLD	chemiluminescent detector	FID	flame-ionization detector
		CVS	constant-volume sampler	GC	gas chromatograph
		ASTM	American Society for Testing and Materials		
		BMD	bag mini-diluter		

GC-ECD gas chromatograph with an electron-capture detector  
 GC-FID gas chromatograph with a flame ionization detector  
 IBP initial boiling point  
 ISO International Organization for Standardization  
 LPG liquefied petroleum gas  
 NDIR nondispersive infrared  
 NDUV nondispersive ultraviolet  
 NIST National Institute for Standards and Technology  
 NMC nonmethane cutter  
 PDP positive-displacement pump  
 PEMS portable emission measurement system  
 PFD partial-flow dilution  
 PMP Polymethylpentene  
 pt. a single point at the mean value expected at the standard.  
 PTFE polytetrafluoroethylene (commonly known as Teflon™)  
 RE rounding error  
 RESS rechargeable energy storage system  
 RMC ramped-modal cycle  
 RMS root-mean square  
 RTD resistive temperature detector  
 SSV subsonic venturi  
 SI spark-ignition  
 UCL upper confidence limit  
 UFM ultrasonic flow meter  
 U.S.C. United States Code

■ 92. Section 1065.1010 is amended by revising the introductory text and paragraph (c) to read as follows:

**§ 1065.1010 Reference materials.**

Certain material is incorporated by reference into this part with the approval of the Director of the Federal Register under 5 U.S.C. 552(a) and 1 CFR part 51. To enforce any edition other than that specified in this section, the Environmental Protection Agency must publish a notice of the change in the **Federal Register** and the material must be available to the public. All approved material is available for inspection at U.S. EPA, Air and Radiation Docket and Information Center, 1301 Constitution Ave., NW., Room B102, EPA West Building, Washington, DC 20460, (202) 202-1744, and is available from the sources listed below. It is also available for inspection at the National Archives and Records Administration (NARA). For information on the availability of this material at NARA, call 202-741-6030, or go to [http://www.archives.gov/federal\\_register/code\\_of\\_federal\\_regulations/ibr\\_locations.html](http://www.archives.gov/federal_register/code_of_federal_regulations/ibr_locations.html).

\* \* \* \* \*

(c) *NIST material.* Table 3 of this section lists material from the National Institute of Standards and Technology

that we have incorporated by reference. The first column lists the number and name of the material. The second column lists the section of this part where we reference it. Anyone may purchase copies of these materials from the Government Printing Office, Washington, DC 20402 or download them free from the Internet at <http://www.nist.gov>. Table 3 follows:

TABLE 3 OF § 1065.1010—NIST MATERIALS

Document number and name	Part 1065 reference
NIST Special Publication 811, 2008 Edition, Guide for the Use of the International System of Units (SI), March 2008.	1065.20(a) and (e), 1065.1005.
NIST Technical Note 1297, 1994 Edition, Guidelines for Evaluating and Expressing the Uncertainty of NIST Measurement Results, Barry N. Taylor and Chris E. Kuyatt.	1065.1001.

\* \* \* \* \*

■ 93. A new part 1066 is added to subchapter U to read as follows:

**PART 1066—VEHICLE-TESTING PROCEDURES**

**Subpart A—Applicability and General Provisions**

- Sec.
- 1066.1 Applicability.
- 1066.2 Submitting information to EPA under this part.
- 1066.5 Overview of this part 1066 and its relationship to the standard-setting part.
- 1066.10 Other procedures.
- 1066.15 Overview of test procedures.
- 1066.20 Units of measure and overview of calculations.
- 1066.25 Recordkeeping.

**Subpart B—Equipment, Fuel, and Gas Specifications**

- 1066.101 Overview.

**Subpart C—Dynamometer Specifications**

- 1066.201 Dynamometer overview.
- 1066.210 Dynamometers.
- 1066.215 Summary of verification and calibration procedures for chassis dynamometers.
- 1066.220 Linearity verification.
- 1066.225 Roll runout and diameter verification procedure.
- 1066.230 Time verification procedure.
- 1066.235 Speed verification procedure.
- 1066.240 Torque transducer verification and calibration.
- 1066.245 Response time verification.
- 1066.250 Base inertia verification.
- 1066.255 Parasitic loss verification.
- 1066.260 Parasitic friction compensation evaluation.

- 1066.265 Acceleration and deceleration verification.
- 1066.270 Unloaded coastdown verification.
- 1066.280 Driver's aid.

**Subpart D—Coastdown**

- 1066.301 Overview of coastdown procedures.
- 1066.310 Coastdown procedures for heavy-duty vehicles.

**Subpart E—Vehicle Preparation and Running a Test**

- 1066.401 Overview.
- 1066.407 Vehicle preparation and preconditioning.
- 1066.410 Dynamometer test procedure.
- 1066.420 Pre-test verification procedures and pre-test data collection.
- 1066.425 Engine starting and restarting.
- 1066.430 Performing emission tests

**Subpart F—Hybrids**

- 1066.501 Overview.

**Subpart G—Calculations**

- 1066.601 Overview.
- 1066.610 Mass-based and molar-based exhaust emission calculations.

**Subpart H—Definitions and Other Reference Material**

- 1066.701 Definitions.
- 1066.705 Symbols, abbreviations, acronyms, and units of measure.
- 1066.710 Reference materials.

Authority: 42 U.S.C. 7401-7671q.

**Subpart A—Applicability and General Provisions**

**§ 1066.1 Applicability.**

(a) This part describes the procedures that apply to testing we require for the following vehicles:

- (1) Model year 2014 and later heavy-duty highway vehicles we regulate under 40 CFR part 1037 that are not subject to chassis testing for exhaust emissions under 40 CFR part 86.
- (2) [Reserved]

(b) The procedures of this part may apply to other types of vehicles, as described in this part and in the standard-setting part.

(c) The term "you" means anyone performing testing under this part other than EPA.

(1) This part is addressed primarily to manufacturers of vehicles, but it applies equally to anyone who does testing under this part for such manufacturers.

(2) This part applies to any manufacturer or supplier of test equipment, instruments, supplies, or any other goods or services related to the procedures, requirements, recommendations, or options in this part.

(d) Paragraph (a) of this section identifies the parts of the CFR that define emission standards and other requirements for particular types of

vehicles. In this part, we refer to each of these other parts generically as the "standard-setting part." For example, 40 CFR part 1037 is the standard-setting part for heavy-duty highway vehicles.

(e) Unless we specify otherwise, the terms "procedures" and "test procedures" in this part include all aspects of vehicle testing, including the equipment specifications, calibrations, calculations, and other protocols and procedural specifications needed to measure emissions.

(f) For additional information regarding these test procedures, visit our Web site at <http://www.epa.gov>, and in particular <http://www.epa.gov/nvfel/testing/regulations.htm>.

**§ 1066.2 Submitting information to EPA under this part.**

(a) You are responsible for statements and information in your applications for certification, requests for approved procedures, selective enforcement audits, laboratory audits, production-line test reports, field test reports, or any other statements you make to us related to this part 1066. If you provide statements or information to someone for submission to EPA, you are responsible for these statements and information as if you had submitted them to EPA yourself.

(b) In the standard-setting part and in 40 CFR 1068.101, we describe your obligation to report truthful and complete information and the consequences of failing to meet this obligation. See also 18 U.S.C. 1001 and 42 U.S.C. 7413(c)(2). This obligation applies whether you submit this information directly to EPA or through someone else.

(c) We may void any certificates or approvals associated with a submission of information if we find that you intentionally submitted false, incomplete, or misleading information.

For example, if we find that you intentionally submitted incomplete information to mislead EPA when requesting approval to use alternate test procedures, we may void the certificates for all engine families certified based on emission data collected using the alternate procedures. This would also apply if you ignore data from incomplete tests or from repeat tests with higher emission results.

(d) We may require an authorized representative of your company to approve and sign the submission, and to certify that all the information submitted is accurate and complete. This includes everyone who submits information, including manufacturers and others.

(e) See 40 CFR 1068.10 for provisions related to confidential information. Note however that under 40 CFR 2.301, emission data is generally not eligible for confidential treatment.

(f) Nothing in this part should be interpreted to limit our ability under Clean Air Act section 208 (42 U.S.C. 7542) to verify that vehicles conform to the regulations.

**§ 1066.5 Overview of this part 1066 and its relationship to the standard-setting part.**

(a) This part specifies procedures that can apply generally to testing various categories of vehicles. See the standard-setting part for directions in applying specific provisions in this part for a particular type of vehicle. Before using this part's procedures, read the standard-setting part to answer at least the following questions:

- (1) What drive schedules must I use for testing?
- (2) Should I warm up the test vehicle before measuring emissions, or do I need to measure cold-start emissions during a warm-up segment of the duty cycle?
- (3) Which exhaust constituents do I need to measure? Measure all exhaust

constituents that are subject to emission standards, any other exhaust constituents needed for calculating emission rates, and any additional exhaust constituents as specified in the standard-setting part. We may approve your request to omit measurement of N<sub>2</sub>O and CH<sub>4</sub> for a vehicle, provided it is not subject to an N<sub>2</sub>O or CH<sub>4</sub> emission standard and we determine that other information is available to give us a reasonable basis for estimating or approximating the vehicle's emission rates.

(4) Do any unique specifications apply for test fuels?

(5) What maintenance steps may I take before or between tests on an emission-data vehicle?

(6) Do any unique requirements apply to stabilizing emission levels on a new vehicle?

(7) Do any unique requirements apply to test limits, such as ambient temperatures or pressures?

(8) Is field testing required or allowed, and are there different emission standards or procedures that apply to field testing?

(9) Are there any emission standards specified at particular operating conditions or ambient conditions?

(10) Do any unique requirements apply for durability testing?

(b) The testing specifications in the standard-setting part may differ from the specifications in this part. In cases where it is not possible to comply with both the standard-setting part and this part, you must comply with the specifications in the standard-setting part. The standard-setting part may also allow you to deviate from the procedures of this part for other reasons.

(c) The following table shows how this part divides testing specifications into subparts:

TABLE 1 OF § 1066.5—DESCRIPTION OF PART 1066 SUBPARTS

This subpart	Describes these specifications or procedures
Subpart A .....	Applicability and general provisions.
Subpart B .....	Equipment for testing.
Subpart C .....	Dynamometer specifications.
Subpart D .....	Coastdowns for testing.
Subpart E .....	How to prepare your vehicle and run an emission test.
Subpart F .....	How to test hybrid vehicles.
Subpart G .....	Test procedure calculations.
Subpart H .....	Definitions and reference material.

**§ 1066.10 Other procedures.**

(a) *Your testing.* The procedures in this part apply for all testing you do to show compliance with emission standards, with certain exceptions listed

in this section. In some other sections in this part, we allow you to use other procedures (such as less precise or less accurate procedures) if they do not affect your ability to show that your

vehicles comply with the applicable emission standards. This generally requires emission levels to be far enough below the applicable emission standards so that any errors caused by

greater imprecision or inaccuracy do not affect your ability to state unconditionally that the engines meet all applicable emission standards.

(b) *Our testing.* These procedures generally apply for testing that we do to determine if your vehicles comply with applicable emission standards. We may perform other testing as allowed by the Act.

(c) *Exceptions.* We may allow or require you to use procedures other than those specified in this part for laboratory testing, field testing, or both, as described in 40 CFR 1065.10(c). All the test procedures noted as exceptions to the specified procedures are considered generically as “other procedures.” Note that the terms “special procedures” and “alternate procedures” have specific meanings; “special procedures” are those allowed by 40 CFR 1065.10(c)(2) and “alternate procedures” are those allowed by 40 CFR 1065.10(c)(7). If we require you to request approval to use other procedures under this paragraph (c), you may not use them until we approve your request.

#### § 1066.15 Overview of test procedures.

This section outlines the procedures to test vehicles that are subject to emission standards.

(a) In the standard-setting part, we set emission standards in g/mile (or g/km), for the following constituents:

- (1) Total oxides of nitrogen, NO<sub>x</sub>.
- (2) Hydrocarbons (HC), which may be expressed in the following ways:
  - (i) Total hydrocarbons, THC.
  - (ii) Nonmethane hydrocarbons, NMHC, which results from subtracting methane (CH<sub>4</sub>) from THC.
  - (iii) Total hydrocarbon-equivalent, THCE, which results from adjusting THC mathematically to be equivalent on a carbon-mass basis.
  - (iv) Nonmethane hydrocarbon-equivalent, NMHCE, which results from adjusting NMHC mathematically to be equivalent on a carbon-mass basis.
- (3) Particulate mass, PM.
- (4) Carbon monoxide, CO.

(b) Note that some vehicles may not be subject to standards for all the emission constituents identified in paragraph (a) of this section.

(c) We generally set emission standards over test intervals and/or drive schedules, as follows:

(1) *Vehicle operation.* Testing may involve measuring emissions and miles travelled in a laboratory-type environment or in the field. The standard-setting part specifies how test intervals are defined for field testing. Refer to the definitions of “duty cycle” and “test interval” in § 1066.701. Note

that a single drive schedule may have multiple test intervals and require weighting of results from multiple test phases to calculate a composite distance-based emission value to compare to the standard.

(2) *Constituent determination.* Determine the total mass of each constituent over a test interval by selecting from the following methods:

(i) *Continuous sampling.* In continuous sampling, measure the constituent’s concentration continuously from raw or dilute exhaust. Multiply this concentration by the continuous (raw or dilute) flow rate at the emission sampling location to determine the constituent’s flow rate. Sum the constituent’s flow rate continuously over the test interval. This sum is the total mass of the emitted constituent.

(ii) *Batch sampling.* In batch sampling, continuously extract and store a sample of raw or dilute exhaust for later measurement. Extract a sample proportional to the raw or dilute exhaust flow rate, as applicable. You may extract and store a proportional sample of exhaust in an appropriate container, such as a bag, and then measure HC, CO, and NO<sub>x</sub> concentrations in the container after the test phase. You may deposit PM from proportionally extracted exhaust onto an appropriate substrate, such as a filter. In this case, divide the PM by the amount of filtered exhaust to calculate the PM concentration. Multiply batch sampled concentrations by the total (raw or dilute) flow from which it was extracted during the test interval. This product is the total mass of the emitted constituent.

(iii) *Combined sampling.* You may use continuous and batch sampling simultaneously during a test interval, as follows:

(A) You may use continuous sampling for some constituents and batch sampling for others.

(B) You may use continuous and batch sampling for a single constituent, with one being a redundant measurement, subject to the provisions of 40 CFR 1065.201.

(d) Refer to the standard-setting part for calculations to determine g/mile emission rates.

(e) The regulation highlights several specific cases where good engineering judgment is especially relevant. You must use good engineering judgment for all aspects of testing under this part, not only for those provisions where we specifically re-state this requirement.

#### § 1066.20 Units of measure and overview of calculations.

(a) *System of units.* The procedures in this part follows both conventional English Units and the International System of Units (SI), as detailed in NIST Special Publication 811, which we incorporate by reference in § 1066.710.

(b) *Units conversion.* Use good engineering judgment to convert units between measurement systems as needed. The following conventions are used throughout this document and should be used to convert units as applicable:

(1) 1 hp = 33,000 ft·lbf/min = 550 ft·lbf/s = 0.7457 kW.

(2) 1 lbf = 32.174 ft·lbf/s<sup>2</sup> = 4.4482 N.

(3) 1 inch = 25.4 mm.

(c) *Rounding.* The rounding provisions of 40 CFR 1065.20 apply for calculations in this part. This generally specifies that you round final values but not intermediate values. Use good engineering judgment to record the appropriate number of significant digits for all measurements.

(d) *Interpretation of ranges.* Interpret a range as a tolerance unless we explicitly identify it as an accuracy, repeatability, linearity, or noise specification. See 40 CFR 1065.1001 for the definition of tolerance. In this part, we specify two types of ranges:

(1) Whenever we specify a range by a single value and corresponding limit values above and below that value, target any associated control point to that single value. Examples of this type of range include “±10% of maximum pressure”, or “(30 ±10) kPa”.

(2) Whenever we specify a range by the interval between two values, you may target any associated control point to any value within that range. An example of this type of range is “(40 to 50) kPa”.

(e) *Scaling of specifications with respect to an applicable standard.*

Because this part 1066 applies to a wide range of vehicles and emission standards, some of the specifications in this part are scaled with respect to a vehicle’s applicable standard or weight. This ensures that the specification will be adequate to determine compliance, but not overly burdensome by requiring unnecessarily high-precision equipment. Many of these specifications are given with respect to a “flow-weighted mean” that is expected at the standard or during testing. Flow-weighted mean is the mean of a quantity after it is weighted proportional to a corresponding flow rate. For example, if a gas concentration is measured continuously from the raw exhaust of an engine, its flow-weighted mean

concentration is the sum of the products of each recorded concentration times its respective exhaust flow rate, divided by the sum of the recorded flow rates. As another example, the bag concentration from a CVS system is the same as the flow-weighted mean concentration, because the CVS system itself flow-weights the bag concentration. Refer to 40 CFR 1065.602 for information needed to estimate and calculate flow-weighted means.

**§ 1066.25 Recordkeeping.**

The procedures in this part include various requirements to record data or other information. Refer to the standard-setting part regarding recordkeeping requirements. If the standard-setting part does not specify recordkeeping requirements, store these records in any format and on any media and keep them readily available for one year after you send an associated application for certification, or one year after you generate the data if they do not support an application for certification. You must promptly send us organized, written records in English if we ask for them. We may review them at any time.

**Subpart B—Equipment, Fuel, and Gas Specifications**

**§ 1066.101 Overview.**

(a) This subpart addresses equipment related to emission testing, as well as test fuels and analytical gases. This section addresses emission sampling and analytical equipment, test fuels, and analytical gases.

(b) The provisions of 40 CFR part 1065 specify engine-based procedures for measuring emissions. Except as specified otherwise in this part, the provisions of 40 CFR part 1065 apply for testing required by this part as follows:

(1) The provisions of 40 CFR 1065.140 through 1065.195 specify equipment for exhaust dilution and sampling systems.

(2) The provisions of 40 CFR part 1065, subparts C and D, specify measurement instruments and their calibrations.

(3) The provisions of 40 CFR part 1065, subpart H, specify fuels, engine fluids, and analytical gases.

(4) The provisions of 40 CFR part 1065, subpart J, describe how to measure emissions from vehicles operating outside of a laboratory, except that provisions related to measuring engine work do not apply.

(c) The provisions of this subpart are intended to specify systems that can very accurately and precisely measure emissions from motor vehicles. We may waive or modify the specifications and requirements of this part for testing highway motorcycles or nonroad vehicles, consistent with good engineering judgment. For example, it may be appropriate to allow the use of a hydrokinetic dynamometer that is not able to meet all the performance specifications described in this subpart.

**Subpart C—Dynamometer Specifications**

**§ 1066.201 Dynamometer overview.**

This subpart addresses chassis dynamometers and related equipment.

**§ 1066.210 Dynamometers.**

(a) *General requirements.* A chassis dynamometer typically uses electrically generated load forces combined with its rotational inertia to recreate the mechanical inertia and frictional forces that a vehicle exerts on road surfaces (known as “road load”). Load forces are calculated using vehicle-specific coefficients and response characteristics. The load forces are applied to the vehicle tires by rolls connected to intermediate motor/absorbers. The dynamometer uses a load cell to measure the forces the dynamometer rolls apply to the vehicle’s tires.

(b) *Accuracy and precision.* The dynamometer’s output values for road load must be NIST-traceable. We may determine traceability to a specific international standards organization to be sufficient to demonstrate NIST-traceability. The force-measurement system must be capable of indicating force readings to a resolution of ±0.05% of the maximum forces simulated by the dynamometer or ±0.9 N (±0.2 lbf), whichever is greater, during a test.

(c) *Test cycles.* The dynamometer must be capable of fully simulating applicable test cycles for the vehicles being tested as referenced in the corresponding standard-setting part.

(1) For vehicles with a gross vehicle weight rating (GVWR) at or below 14,000 lbs, the dynamometer must be able to fully simulate a driving schedule with a maximum speed of 36 m/s (80 mph) and a maximum acceleration rate of 3.6 m/s<sup>2</sup> (8 mph/s) in two-wheel drive and four-wheel drive configurations.

(2) For vehicles with GVWR above 14,000 lbs, the dynamometer must be able to fully simulate a driving schedule with a maximum speed of 29 m/s (65 mph) and a maximum acceleration rate of 1.3 m/s<sup>2</sup> (3 mph/s) in either two-wheel drive or four-wheel drive configurations.

(d) *Component requirements.* The dynamometer must meet the following specifications:

(1) For vehicles with GVWR at or below 14,000 lbs, the nominal roll diameter must be 1.20 to 1.25 meters. The dynamometer must have an independent drive roll for each axle being driven by the vehicle during an emission test.

(2) For vehicles with GVWR above 14,000 lbs, the nominal roll diameter must be at least 1.20 meters and no greater than 3.10 meters. The dynamometer must have an independent drive roll for each axle, except that two drive axles may share a single drive roll. Use good engineering judgment to ensure that the dynamometer roll diameter is large enough to provide sufficient tire-roll contact area to avoid tire overheating and power losses from tire-roll slippage.

(3) If you measure force and speed at 10 Hz or faster, you may use good engineering judgment to convert those measurements to 1-Hz, 2-Hz, or 5-Hz values.

(4) The load applied by the dynamometer simulates forces acting on the vehicle during normal driving according to the following equation:

$$FR_i = A + B \cdot S_i + C \cdot S_i^2 + M \cdot \frac{S_i - S_{i-1}}{t_i - t_{i-1}}$$

Eq. 1066.210-1

Where:

FR = total road-load force to be applied at the surface of the roll. The total force is the

sum of the individual tractive forces applied at each roll surface.

i = a counter to indicate a point in time over the driving schedule. For a dynamometer operating at 10-Hz intervals over a 600-

second driving schedule, the maximum value of  $i$  is 6,000.  
 $A$  = constant value representing the vehicle's frictional load in lbf or newtons. See subpart C of this part.  
 $B$  = coefficient representing load from drag and rolling resistance, which are a function of vehicle speed, in lbf/mph or N-s/m. See subpart C of this part.  
 $S$  = linear speed at the roll surfaces as measured by the dynamometer, in mph or m/s. Let  $S_{i-1} = 0$ .  
 $C$  = coefficient representing aerodynamic effects, which are a function of vehicle speed squared, in lbf/mph<sup>2</sup> or N-s<sup>2</sup>/m<sup>2</sup>. See subpart C of this part.  
 $M$  = mass of vehicle in lbm or kg. Determine the vehicle's mass based on the test weight, taking into account the effect of rotating axles, as specified in § 1066.310(b)(7) and dividing the weight by the acceleration due to gravity as specified in 40 CFR 1065.630, consistent with good engineering judgment.

$t$  = elapsed time in the driving schedule as measured by the dynamometer, in seconds. Let  $t_{i-1} = 0$ .

(5) The dynamometer must be designed to generally apply an actual road-load force within  $\pm 1\%$  or  $\pm 9.8$  N ( $\pm 2.2$  lbf) of the reference value, whichever is greater. Dynamometers that do not fully meet this specification may be used consistent with good engineering judgment. For example, slightly higher errors may be permissible during highly transient operation.

(e) *Dynamometer manufacturer instructions.* This part specifies that you follow the dynamometer manufacturer's recommended procedures for things such as calibrations and general operation. If you perform testing with a dynamometer that you manufactured or

if you otherwise do not have these recommended procedures, use good engineering judgment to establish the additional procedures and specifications we specify in this part, unless we specify otherwise. Keep records to describe these recommended procedures and how they are consistent with good engineering judgment.

**§ 1066.215 Summary of verification and calibration procedures for chassis dynamometers.**

(a) *Overview.* This section describes the overall process for verifying and calibrating the performance of chassis dynamometers.

(b) *Scope and frequency.* The following table summarizes the required and recommended calibrations and verifications described in this subpart and indicates when they must occur:

TABLE 1 OF § 1066.215—SUMMARY OF REQUIRED DYNAMOMETER CALIBRATIONS AND VERIFICATIONS

Type of calibration or verification	Minimum frequency <sup>a</sup>
§ 1066.220: Linearity verification .....	Speed: Upon initial installation, within 370 days before testing, and after major maintenance. Torque (load): Upon initial installation, within 370 days before testing, and after major maintenance.
§ 1066.225: Roll runout and diameter .....	Upon initial installation and after major maintenance.
§ 1066.230: Time .....	Upon initial installation and after major maintenance.
§ 1066.235: Speed measurement .....	Upon initial installation, within 370 days before testing, and after major maintenance.
§ 1066.240: Torque (load) transducer .....	Upon initial installation and after major maintenance.
§ 1066.245: Response time .....	Upon initial installation and after major maintenance.
§ 1066.250: Base inertia .....	Upon initial installation and after major maintenance.
§ 1066.255: Parasitic loss .....	Upon initial installation, within 7 days before testing, and after major maintenance.
§ 1066.260: Parasitic friction compensation evaluation.	Upon initial installation, within 7 days before testing, and after major maintenance.
§ 1066.265: Acceleration and deceleration .....	Upon initial installation and after major maintenance.
§ 1066.270: Unloaded coastdown .....	Upon initial installation, within 7 days before testing, and after major maintenance.

<sup>a</sup> Perform calibrations and verifications more frequently, according to measurement system manufacturer instructions and good engineering judgment.

(c) *Automated dynamometer verifications and calibrations.* In some cases, dynamometers are designed with internal diagnostic and control features to accomplish the verifications and calibrations specified in this subpart. You may use these automated functions instead of following the procedures we specify in this subpart to demonstrate compliance with applicable requirements, consistent with good engineering judgment.

(d) *Sequence of verifications and calibrations.* Upon initial installation and after major maintenance, perform the verifications and calibrations in the same sequence as noted in Table 1 of this section. At other times, you may need to perform specific verifications or calibration in a certain sequence, as noted in this subpart.

(e) *Corrections.* Unless the regulation directs otherwise, if the dynamometer fails to meet any specified calibration or verification, make any necessary

adjustments or repairs such that the dynamometer meets the specification before running a test. Repairs required to meet specifications are generally considered major maintenance under this part.

**§ 1066.220 Linearity verification.**

(a) *Scope and frequency.* Perform linearity verifications upon initial installation, within 370 days before testing, and after major maintenance. Note that these linearity verifications may replace requirements previously referred to as calibrations. The intent of linearity verification is to determine that a measurement system responds accurately and proportionally over the measurement range of interest. Linearity verification generally consists of introducing a series of at least 10 reference values (or the manufacturer's recommend number of reference values) to a measurement system. The measurement system quantifies each

reference value. The measured values are then collectively compared to the reference values by using a least-squares linear regression and the linearity criteria specified in Table 1 of this section.

(b) *Performance requirements.* If a measurement system does not meet the applicable linearity criteria in Table 1 of this section, correct the deficiency by recalibrating, servicing, or replacing components as needed. Repeat the linearity verification after correcting the deficiency to ensure that the measurement system meets the linearity criteria. Before you may use a measurement system that does not meet linearity criteria, you must demonstrate to us that the deficiency does not adversely affect your ability to demonstrate compliance with the applicable standards.

(c) *Procedure.* Use the following linearity verification protocol, or use good engineering judgment to develop a

different protocol that satisfies the intent of this section, as described in paragraph (a) of this section:

(1) In this paragraph (c), the letter “y” denotes a generic measured quantity, the superscript over-bar denotes an arithmetic mean (such as  $\bar{y}$ ), and the subscript “ref” denotes the known or reference quantity being measured.

(2) Operate a dynamometer system at the specified temperatures and pressures. This may include any specified adjustment or periodic calibration of the dynamometer system.

(3) Set dynamometer speed and torque to zero and apply the dynamometer brake to ensure a zero-speed condition.

(4) Span the dynamometer speed or torque signal.

(5) After spanning, check for zero speed and torque. Use good engineering judgment to determine whether or not to rezero or re-span before continuing.

(6) For both speed and torque, use the dynamometer manufacturer’s

recommendations and good engineering judgment to select reference values,  $y_{refi}$ , that cover a range of values that you expect would prevent extrapolation beyond these values during emission testing. We recommend selecting zero speed and zero torque as reference values for the linearity verification.

(7) Use the dynamometer manufacturer’s recommendations and good engineering judgment to select the order in which you will introduce the series of reference values. For example, you may select the reference values randomly to avoid correlation with previous measurements or the influence of hysteresis; you may select reference values in ascending or descending order to avoid long settling times of reference signals; or you may select values to ascend and then descend to incorporate the effects of any instrument hysteresis into the linearity verification.

(8) Set the dynamometer to operate at a reference condition.

(9) Allow time for the dynamometer to stabilize while it measures the reference values.

(10) At a recording frequency of at least 1 Hz, measure speed and torque values for 30 seconds and record the arithmetic mean of the recorded values,  $\bar{y}_i$ . Refer to 40 CFR 1065.602 for an example of calculating an arithmetic mean.

(11) Repeat the steps in paragraphs (c)(8) through (10) of this section until you measure speeds and torques at each of the reference conditions.

(12) Use the arithmetic means,  $\bar{y}_i$ , and reference values,  $y_{refi}$ , to calculate least-squares linear regression parameters and statistical values to compare to the minimum performance criteria specified in Table 1 of this section. Use the calculations described in 40 CFR 1065.602. Using good engineering judgment, you may weight the results of individual data pairs (*i.e.*,  $(y_{refi}, \bar{y}_i)$ ), in the linear regression calculations.

TABLE 1 OF § 1066.220—DYNAMOMETER MEASUREMENT SYSTEMS THAT REQUIRE LINEARITY VERIFICATIONS

Measurement system	Quantity	Linearity criteria		$a_1$	SEE	$r^2$
		$ x_{min}(a_1-1)+a_0 $				
Speed .....	S	$\leq 0.05\% \cdot S_{max}$ .....		0.98–1.02	$\leq 2\% \cdot S_{max}$ .....	$\geq 0.990$
Torque (load) .....	T	$\leq 1\% \cdot T_{max}$ .....		0.98–1.02	$\leq 2\% \cdot T_{max}$ .....	$\geq 0.990$

**§ 1066.225 Roll runout and diameter verification procedure.**

(a) *Overview.* This section describes the verification procedure for roll runout and roll diameter. Roll runout is a measure of the variation in roll radius around the circumference of the roll.

(b) *Scope and frequency.* Perform these verifications upon initial installation and after major maintenance.

(c) *Roll runout procedure.* Verify roll runout as follows:

(1) Perform this verification with laboratory and dynamometer temperatures stable and at equilibrium. Release the roll brake and shut off power to the dynamometer. Remove any dirt, rubber, rust, and debris from the roll surface. Mark measurement locations on the roll surface using a permanent marker. Mark the roll at a minimum of four equally spaced locations across the roll width; we recommend taking measurements every 150 mm across the roll. Secure the marker to the deck plate adjacent to the roll surface and slowly rotate the roll to mark a clear line around the roll circumference. Repeat this process for all measurement locations.

(2) Measure roll runout using a dial indicator with a probe that allows for

measuring the position of the roll surface relative to the roll centerline as it turns through a complete revolution. The dial indicator must have a magnetic base assembly or other means of being securely mounted adjacent to the roll. The dial indicator must have sufficient range to measure roll runout at all points, with a minimum accuracy and precision of  $\pm 0.025$  mm. Calibrate the dial indicator according to the instrument manufacturer’s instructions.

(3) Position the dial indicator adjacent to the roll surface at the desired measurement location. Position the shaft of the dial indicator perpendicular to the roll such that the point of the dial indicator is slightly touching the surface of the roll and can move freely through a full rotation of the roll. Zero the dial indicator according to the instrument manufacturer’s instructions. Avoid distortion of the runout measurement from the weight of a person standing on or near the mounted dial indicator.

(4) Slowly turn the roll through a complete rotation and record the maximum and minimum values from the dial indicator. Calculate runout as the difference between these maximum and minimum values.

(5) Repeat the steps in paragraphs (c)(3) and (4) of this section for all measurement locations.

(6) The roll runout must be less than 0.25 mm at all measurement locations.

(d) *Diameter procedure.* Verify roll diameter based on the following procedure, or an equivalent procedure based on good engineering judgment:

(1) Prepare the laboratory and the dynamometer as specified in paragraph (c)(1) of this section.

(2) Measure roll diameter using a Pi Tape®. Orient the Pi Tape® to the marker line at the desired measurement location with the Pi Tape® hook pointed outward. Temporarily secure the Pi Tape® to the roll near the hook end with adhesive tape. Slowly turn the roll, wrapping the Pi Tape® around the roll surface. Ensure that the Pi Tape® is flat and adjacent to the marker line around the full circumference of the roll. Attach a 2.26-kg weight to the hook of the Pi Tape® and position the roll so that the weight dangles freely. Remove the adhesive tape without disturbing the orientation or alignment of the Pi Tape®.

(3) Overlap the gage member and the vernier scale ends of the Pi Tape® to read the diameter measurement to the nearest 0.01 mm. Follow the

manufacturer's recommendation to correct the measurement to 20 °C, if applicable.

(4) Repeat the steps in paragraphs (d)(2) and (3) of this section for all measurement locations.

(5) The measured roll diameter must be within  $\pm 0.25$  mm of the specified nominal value at all measurement locations. You may revise the nominal value to meet this specification, as long as you use the corrected nominal value for all calculations in this subpart.

#### § 1066.230 Time verification procedure.

(a) *Overview.* This section describes how to verify the accuracy of the dynamometer's timing device.

(b) *Scope and frequency.* Perform this verification upon initial installation and after major maintenance.

(c) *Procedure.* Perform this verification using one of the following procedures:

(1) *WWV method.* You may use the time and frequency signal broadcast by NIST from radio station WWV as the time standard if the trigger for the dynamometer timing circuit has a frequency decoder circuit, as follows:

(i) Dial station WWV at (303) 499-7111 and listen for the time announcement. Verify that the trigger started the dynamometer timer. Use good engineering judgment to minimize error in receiving the time and frequency signal.

(ii) After at least 1000 seconds, re-dial station WWV and listen for the time announcement. Verify that the trigger stopped the dynamometer timer.

(iii) Compare the measured elapsed time,  $y_{act}$ , to the corresponding time standard,  $y_{ref}$ , to determine the time error,  $y_{error}$ , using the following equation:

$$y_{error} = \frac{y_{act} - y_{ref}}{y_{ref}} \cdot 100 \%$$

#### Eq. 1066.230-1

(2) *Ramping method.* You may set up an operator-defined ramp function in the signal generator to serve as the time standard as follows:

(i) Set up the signal generator to output a marker voltage at the peak of each ramp to trigger the dynamometer timing circuit. Output the designated marker voltage to start the verification period.

(ii) After at least 1000 seconds, output the designated marker voltage to end the verification period.

(iii) Compare the measured elapsed time between marker signals,  $y_{act}$ , to the corresponding time standard,  $y_{ref}$ , to

determine the time error,  $y_{error}$ , using Equation 1066.230-1.

(3) *Dynamometer coastdown method.* You may use a signal generator to output a known speed ramp signal to the dynamometer controller to serve as the time standard as follows:

(i) Generate upper and lower speed values to trigger the start and stop functions of the coastdown timer circuit. Use the signal generator to start the verification period.

(ii) After at least 1000 seconds, use the signal generator to end the verification period.

(iii) Compare the measured elapsed time between trigger signals,  $y_{act}$ , to the corresponding time standard,  $y_{ref}$ , to determine the time error,  $y_{error}$ , using Equation 1066.230-1.

(d) *Performance evaluation.* The time error determined in paragraph (c) of this section may not exceed  $\pm 0.001\%$ .

#### § 1066.235 Speed verification procedure.

(a) *Overview.* This section describes how to verify the accuracy and resolution of the dynamometer speed determination.

(b) *Scope and frequency.* Perform this verification upon initial installation, within 370 days before testing, and after major maintenance.

(c) *Procedure.* Use one of the following procedures to verify the accuracy and resolution of the dynamometer speed simulation:

(1) *Pulse method.* Connect a universal frequency counter to the output of the dynamometer's speed-sensing device in parallel with the signal to the dynamometer controller. The universal frequency counter must be calibrated according to the instrument manufacturer's instructions and be capable of measuring with enough accuracy to perform the procedure as specified in this paragraph (c)(1). Make sure the instrumentation does not affect the signal to the dynamometer control circuits. Determine the speed error as follows:

(i) Set the dynamometer to speed-control mode. Set the dynamometer speed to a value between 4.2 m/s and the maximum speed expected during testing; record the output of the frequency counter after 10 seconds. Determine the roll speed,  $S_{act}$ , using the following equation:

$$S_{act} = \frac{f \cdot d_{roll} \cdot \pi}{n}$$

#### Eq. 1066.235-1

Where:

$f$  = frequency of the dynamometer speed sensing device, in  $s^{-1}$ , accurate to at least four significant figures.

$d_{roll}$  = nominal roll diameter, in m, accurate to the nearest 0.01 mm, consistent with § 1066.225(d).

$n$  = the number of pulses per revolution from the dynamometer roll speed sensor.

*Example:*

$$f = 2.9231 \text{ Hz} = 2.9231 \text{ s}^{-1}$$

$$d_{roll} = 904.40 \text{ mm} = 0.90440 \text{ m}$$

$$n = 1 \text{ pulse/rev}$$

$$S_{act} = \frac{2.9231 \cdot 0.90440 \cdot \pi}{1}$$

$$S_{act} = 8.3053 \text{ m/s}$$

(ii) Compare the calculated roll speed,  $S_{act}$ , to the corresponding speed set point,  $S_{ref}$ , to determine a value for speed error,  $S_{error}$ , using the following equation:

$$S_{error} = S_{act} - S_{ref}$$

#### Eq. 1066.235-2

*Example:*

$$S_{act} = 8.3053 \text{ m/s}$$

$$S_{ref} = 8.3000 \text{ m/s}$$

$$S_{error} = 8.3053 - 8.3000 = 0.0053 \text{ m/s}$$

(2) *Frequency method.* Use the method described in this paragraph (c)(2) only if the dynamometer does not have a readily available output signal for speed sensing. Install a single piece of tape in the shape of an arrowhead on the surface of the dynamometer roll near the outer edge. Put a reference mark on the deck plate in line with the arrow. Install a stroboscope or photo tachometer on the deck plate and direct the flash toward the tape on the roll. The stroboscope or photo tachometer must be calibrated according to the instrument manufacturer's instructions and be capable of measuring with enough accuracy to perform the procedure as specified in this paragraph (c)(2). Determine the speed error as follows:

(i) Set the dynamometer to speed control mode. Set the dynamometer speed to a value between 15 kph and the maximum speed expected during testing. Tune the stroboscope or photo tachometer until the signal matches the dynamometer roll speed. Record the frequency. Determine the roll speed,  $y_{act}$ , using Equation 1066.235-1, using the stroboscope or photo tachometer's frequency for  $f$ .

(ii) Compare the calculated roll speed,  $y_{act}$ , to the corresponding speed set point,  $y_{ref}$ , to determine a value for speed error,  $y_{error}$ , using Equation 1066.235-2.

(d) *Performance evaluation.* The speed error determined in paragraph (c)



of this section may not exceed  $\pm 0.02$  m/s.

**§ 1066.240 Torque transducer verification and calibration.**

Calibrate torque-measurement systems as described in 40 CFR 1065.310.

**§ 1066.245 Response time verification.**

(a) *Overview.* This section describes how to verify the dynamometer's response time.

(b) *Scope and frequency.* Perform this verification upon initial installation and after major maintenance.

(c) *Procedure.* Use the dynamometer's automated process to verify response time. Perform this test at two different inertia settings corresponding approximately to the minimum and maximum vehicle weights you expect to test. Use good engineering judgment to select road-load coefficients representing vehicles of the appropriate

weight. Determine the dynamometer's settling response time,  $t_s$ , based on the point at which there are no measured results more than 10% above or below the final equilibrium value, as illustrated in Figure 1 of this section. The observed settling response time must be less than 100 milliseconds for each inertia setting.

Figure 1 of §1066.245—Example of a settling response time diagram.

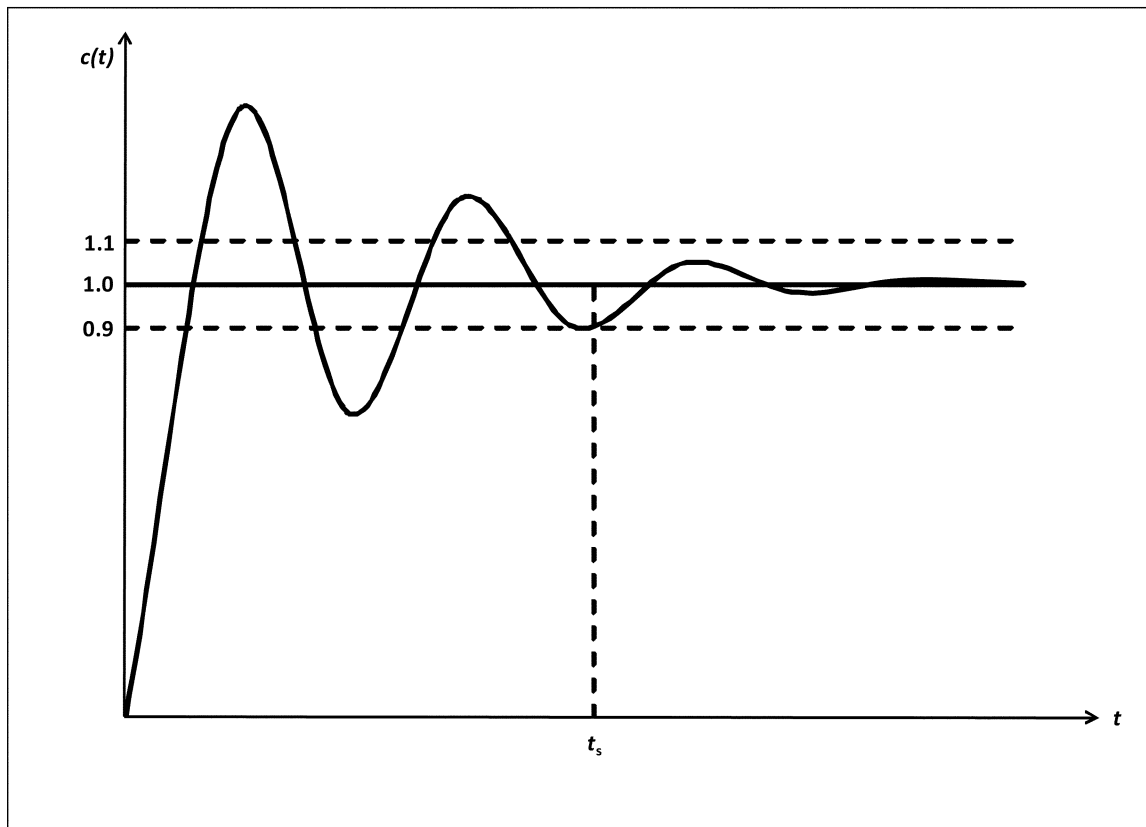

**§ 1066.250 Base inertia verification.**

(a) *Overview.* This section describes how to verify the dynamometer's base inertia.

(b) *Scope and frequency.* Perform this verification upon initial installation and after major maintenance.

(c) *Procedure.* Verify the base inertia using the following procedure:

(1) Warm up the dynamometer according to the dynamometer manufacturer's instructions. Set the dynamometer's road-load inertia to zero and motor the rolls to 5 mph. Apply a constant force to accelerate the roll at a nominal rate of 1 mph/s. Measure the elapsed time to accelerate from 10 to 40 mph, noting the corresponding speed and time points to the nearest 0.01 mph

and 0.01 s. Also determine average force over the measurement interval.

(2) Starting from a steady roll speed of 45 mph, apply a constant force to the roll to decelerate the roll at a nominal rate of 1 mph/s. Measure the elapsed time to decelerate from 40 to 10 mph, noting the corresponding speed and time points to the nearest 0.01 mph and 0.01 s. Also determine average force over the measurement interval.

(3) Repeat the steps in paragraphs (c)(1) and (2) of this section for a total of five sets of results at the nominal acceleration rate and the nominal deceleration rate.

(4) Use good engineering judgment to select two additional acceleration and deceleration rates that cover the middle

and upper rates expected during testing. Repeat the steps in paragraphs (c)(1) through (3) of this section at each of these additional acceleration and deceleration rates.

(5) Determine the base inertia,  $I_b$ , for each measurement interval using the following equation:

$$I_b = \frac{F}{\frac{S_{final} - S_{initial}}{\Delta t}}$$

Eq. 1066.250-1

Where:

$F$  = average dynamometer force over the measurement interval as measured by the dynamometer, in ft·lbm/s<sup>2</sup>.  
 $S_{\text{final}}$  = roll surface speed at the end of the measurement interval to the nearest 0.01 mph.  
 $S_{\text{initial}}$  = roll surface speed at the start of the measurement interval to the nearest 0.01 mph.  
 $\Delta t$  = elapsed time during the measurement interval to the nearest 0.01 s.

*Example:*

$F = 1.500 \text{ lbf} = 48.26 \text{ ft}\cdot\text{lbm}/\text{s}^2$   
 $S_{\text{final}} = 40.00 \text{ mph} = 58.67 \text{ ft}/\text{s}$   
 $S_{\text{initial}} = 10.00 \text{ mph} = 14.67 \text{ ft}/\text{s}$   
 $\Delta t = 30.00 \text{ s}$

$$I_b = \frac{48.26}{\frac{58.67 - 14.67}{30.00}}$$

$I_b = 32.90 \text{ lbm}$

(6) Determine the arithmetic mean value of base inertia from the five measurements at each acceleration and deceleration rate. Calculate these six mean values as described in 40 CFR 1065.602(b).

(7) Calculate the base inertia error,  $I_{\text{berror}}$ , for each measured base inertia,  $I_b$ , by comparing it to the manufacturer's stated base inertia,  $I_{\text{bref}}$ , using the following equation:

$$I_{\text{berror}} = \frac{I_{\text{bref}} - I_{\text{bact}}}{I_{\text{bref}}} \cdot 100 \%$$

Eq. 1066.250-2

*Example:*

$I_{\text{bref}} = 32.96 \text{ lbm}$   
 $I_{\text{bact}} = 33.01 \text{ lbm}$

$$I_{\text{berror}} = \frac{32.96 - 33.01}{32.96} \cdot 100 \%$$

$I_{\text{berror}} = -0.15 \%$

(8) Calculate the inertia error for each mean value of base inertia from paragraph (c)(6) of this section. Use Equation 1066.265-2, substituting the mean base inertias associated with each acceleration and deceleration rate for the individual base inertias.

(d) *Performance evaluation.* The dynamometer must meet the following specifications to be used for testing under this part:

(1) The base inertia error determined under paragraph (c)(7) of this section may not exceed  $\pm 0.50 \%$  relative to any individual value.

(2) The base inertia error determined under paragraph (c)(8) of this section may not exceed  $\pm 0.20 \%$  relative to any mean value.

**§ 1066.255 Parasitic loss verification.**

(a) *Overview.* Verify and correct the dynamometer's parasitic loss. This procedure determines the dynamometer's internal losses that it must overcome to simulate road load. These losses are characterized in a parasitic loss curve that the dynamometer uses to apply compensating forces to maintain the desired road-load force at the roll surface.

(b) *Scope and frequency.* Perform this verification upon initial installation, within 7 days of testing, and after major maintenance.

(c) *Procedure.* Perform this verification by following the dynamometer manufacturer's specifications to establish a parasitic loss curve, taking data at fixed speed intervals to cover the range of vehicle speeds that will occur during testing. You may zero the load cell at the selected speed if that improves your ability to determine the parasitic loss. Parasitic loss forces may never be negative. Note that the torque transducers must be zeroed and spanned prior to performing this procedure.

(d) *Performance evaluation.* In some cases, the dynamometer automatically updates the parasitic loss curve for further testing. If this is not the case, compare the new parasitic loss curve to the original parasitic loss curve from the dynamometer manufacturer or the most recent parasitic loss curve you programmed into the dynamometer. You may reprogram the dynamometer to accept the new curve in all cases, and you must reprogram the dynamometer if any point on the new curve departs from the earlier curve by more than  $\pm 4.5 \text{ N}$  ( $\pm 1.0 \text{ lbf}$ ).

**§ 1066.260 Parasitic friction compensation evaluation.**

(a) *Overview.* This section describes how to verify the accuracy of the dynamometer's friction compensation.

(b) *Scope and frequency.* Perform this verification upon initial installation, within 7 days before testing, and after major maintenance. Note that this procedure relies on proper verification or calibration of speed and torque, as described in §§ 1066.235 and 1066.240. You must also first verify the dynamometer's parasitic loss curve as specified in § 1066.255.

(c) *Procedure.* Use the following procedure to verify the accuracy of the dynamometer's friction compensation:

(1) Warm up the dynamometer as specified by the dynamometer manufacturer.

(2) Perform a torque verification as specified by the dynamometer manufacturer. For torque verifications relying on shunt procedures, if the results do not conform to specifications, recalibrate the dynamometer using NIST-traceable standards as appropriate until the dynamometer passes the torque verification. Do not change the dynamometer's base inertia to pass the torque verification.

(3) Set the dynamometer inertia to the base inertia with the road-load coefficients A, B, and C set to 0. Set the dynamometer to speed-control mode with a target speed of 10 mph or a higher speed recommended by the dynamometer manufacturer. Once the speed stabilizes at the target speed, switch the dynamometer from speed control to torque control and allow the roll to coast for 60 seconds. Record the initial and final speeds and the corresponding start and stop times. If friction compensation is executed perfectly, there will be no change in speed during the measurement interval.

(4) Calculate the friction compensation error,  $FC_{\text{error}}$ , using the following equation:

$$FC_{\text{error}} = \frac{I}{2 \cdot t} \cdot (S_{\text{final}}^2 - S_{\text{init}}^2)$$

Eq. 1066.260-1

Where:

$I$  = dynamometer inertia setting, in lbf·s<sup>2</sup>/ft.  
 $t$  = duration of the measurement interval, accurate to at least 0.01 s.

$S_{\text{final}}$  = the roll speed corresponding to the end of the measurement interval, accurate to at least 0.1 mph.

$S_{\text{init}}$  = the roll speed corresponding to the start of the measurement interval, accurate to at least 0.1 mph.

*Example:*

$I = 2000 \text{ lbm} = 62.16 \text{ lbf}\cdot\text{s}^2/\text{ft}$

$t = 60.0 \text{ s}$

$S_{\text{final}} = 9.2 \text{ mph} = 13.5 \text{ ft}/\text{s}$

$S_{\text{init}} = 10.0 \text{ mph} = 14.7 \text{ ft}/\text{s}$

$$FC_{\text{error}} = \frac{62.16}{2 \cdot 60.00} \cdot (13.5^2 - 14.7^2)$$

$FC_{\text{error}} = -16.5 \text{ ft}\cdot\text{lbf}/\text{s} = -0.031 \text{ hp}$

(5) The friction compensation error may not exceed  $\pm 0.1 \text{ hp}$ .

**§ 1066.265 Acceleration and deceleration verification.**

(a) *Overview.* This section describes how to verify the dynamometer's ability to achieve targeted acceleration and deceleration rates. Paragraph (c) of this section describes how this verification applies when the dynamometer is programmed directly for a specific acceleration or deceleration rate. Paragraph (d) of this section describes

how this verification applies when the dynamometer is programmed with a calculated force to achieve a targeted acceleration or deceleration rate.

(b) *Scope and frequency.* Perform this verification upon initial installation and after major maintenance.

(c) *Verification of acceleration and deceleration rates.* Activate the dynamometer's function generator for measuring roll revolution frequency. If the dynamometer has no such function generator, set up a properly calibrated external function generator consistent with the verification described in this paragraph (c). Use the function generator to determine actual acceleration and deceleration rates as the dynamometer traverses speeds between 10 and 40 mph at various nominal acceleration and deceleration rates. Verify the dynamometer's acceleration and deceleration rates as follows:

(1) Set up start and stop frequencies specific to your dynamometer by identifying the roll-revolution frequency,  $f$ , in revolutions per second (or Hz) corresponding to 10 mph and 40 mph vehicle speeds, accurate to at least four significant figures, using the following equation:

$$f = \frac{S \cdot n}{d_{\text{roll}} \cdot \pi}$$

Eq. 1066.265-1

Where:

$S$  = the target roll speed, in inches per second (corresponding to drive speeds of 10 mph or 40 mph).

$n$  = the number of pulses from the dynamometer's roll-speed sensor per roll revolution.

$d_{\text{roll}}$  = roll diameter, in inches.

(2) Program the dynamometer to accelerate the roll at a nominal rate of 1 mph/s from 10 mph to 40 mph. Measure the elapsed time to reach the target speed, to the nearest 0.01 s. Repeat this measurement for a total of five runs. Determine the actual acceleration rate for each run,  $a_{\text{act}}$ , using the following equation:

$$a_{\text{act}} = \frac{S_{\text{final}} - S_{\text{init}}}{t}$$

Eq. 1066.265-2

Where:

$a_{\text{act}}$  = acceleration rate (decelerations have negative values).

$S_{\text{final}}$  = the target value for the final roll speed.

$S_{\text{init}}$  = the setpoint value for the initial roll speed.

$t$  = time to accelerate from  $S_{\text{init}}$  to  $S_{\text{final}}$ .

*Example:*

$S_{\text{final}} = 40$  mph

$S_{\text{init}} = 10$  mph

$t = 30.003$  s

$$a_{\text{act}} = \frac{40.00 - 10.00}{30.03}$$

$a_{\text{act}} = 0.999$  mph/s

(3) Program the dynamometer to decelerate the roll at a nominal rate of 1 mph/s from 40 mph to 10 mph. Measure the elapsed time to reach the target speed, to the nearest 0.01 s. Repeat this measurement for a total of five runs. Determine the actual acceleration rate,  $a_{\text{act}}$ , using Equation 1066.265-2.

(4) Repeat the steps in paragraphs (c)(2) and (3) of this section for additional acceleration and deceleration rates in 1 mph/s increments up to and including one increment above the maximum acceleration rate expected during testing. Average the five repeat runs to calculate a mean acceleration rate,  $\bar{a}_{\text{act}}$ , at each setting.

(5) Compare each mean acceleration rate,  $\bar{a}_{\text{act}}$ , to the corresponding nominal acceleration rate,  $a_{\text{ref}}$ , to determine values for acceleration error,  $a_{\text{error}}$ , using the following equation:

$$a_{\text{error}} = \frac{\bar{a}_{\text{act}} - a_{\text{ref}}}{a_{\text{ref}}} \cdot 100 \%$$

Eq. 1066.265-3

*Example:*

$\bar{a}_{\text{act}} = 0.999$  mph/s

$a_{\text{ref}} = 1$  mph/s

$a_{\text{error}} = -0.100\%$

(d) *Verification of forces for controlling acceleration and deceleration.* Program the dynamometer with a calculated force value and determine actual acceleration and deceleration rates as the dynamometer traverses speeds between 10 and 40 mph at various nominal acceleration and deceleration rates. Verify the dynamometer's ability to achieve certain acceleration and deceleration rates with a given force as follows:

(1) Calculate the force setting,  $F$ , using the following equation:

$$F = I_b \cdot |a|$$

Eq. 1066.265-4

Where:

$I_b$  = the dynamometer manufacturer's stated base inertia, in lbf-s<sup>2</sup>/ft.

$a$  = nominal acceleration rate, in ft/s<sup>2</sup>.

*Example:*

$I_b = 2967$  lbf-s<sup>2</sup>/ft

$a = 1$  mph/s = 1.4667 ft/s<sup>2</sup>

$F = 135.25$  lbf

(2) Set the dynamometer to road-load mode and program it with a calculated force to accelerate the roll at a nominal rate of 1 mph/s from 10 mph to 40 mph. Measure the elapsed time to reach the target speed, to the nearest 0.01 s. Repeat this measurement for a total of five runs. Determine the actual acceleration rate,  $a_{\text{act}}$ , for each run using Equation 1066.265-2. Repeat this step to determine measured "negative acceleration" rates using a calculated force to decelerate the roll at a nominal rate of 1 mph/s from 40 mph to 10 mph. Average the five repeat runs to calculate a mean acceleration rate,  $\bar{a}_{\text{act}}$ , at each setting.

(3) Repeat the steps in paragraph (d)(2) of this section for additional acceleration and deceleration rates as specified in paragraph (c)(4) of this section.

(4) Compare each mean acceleration rate,  $\bar{a}_{\text{act}}$ , to the corresponding nominal acceleration rate,  $a_{\text{ref}}$ , to determine values for acceleration error,  $a_{\text{error}}$ , using Equation 1066.265-4.

(e) *Performance evaluation.* The acceleration error from paragraphs (c)(5) and (d)(4) of this section may not exceed  $\pm 1.0\%$ .

**§ 1066.270 Unloaded coastdown verification.**

(a) *Overview.* Use force measurements to verify the dynamometer's settings based on coastdown procedures.

(b) *Scope and frequency.* Perform this verification upon initial installation, within 7 days of testing, and after major maintenance.

(c) *Procedure.* This procedure verifies the dynamometer's settings derived from coastdown testing. For dynamometers that have an automated process for this procedure, perform this evaluation by setting the initial speed and final speed and the inertial and road-load coefficients as required for each test, using good engineering judgment to ensure that these values properly represent in-use operation. Use the following procedure if your dynamometer does not perform this verification with an automated process:

(1) Warm up the dynamometer as specified by the dynamometer manufacturer.

(2) With the dynamometer in coastdown mode, set the dynamometer inertia for the smallest vehicle weight that you expect to test and set A, B, and C road-load coefficients to values typical of those used during testing. Program the dynamometer to operate at 10 mph. Perform a coastdown two times at this speed setting. Repeat these

coastdown steps in 10 mph increments up to and including one increment above the maximum speed expected during testing. You may stop the verification before reaching 0 mph, with any appropriate adjustments in calculating the results.

(3) Repeat the steps in paragraph (c)(2) of this section with the dynamometer inertia set for the largest vehicle weight that you expect to test.

(4) Determine the average coastdown force,  $F$ , for each speed and inertia setting using the following equation:

$$F = \frac{I \cdot S_{si}}{t}$$

Eq. 1066.270-1

Where:

$F$  = the average force measured during the coastdown for each speed and inertia setting, expressed in lbf·s<sup>2</sup>/ft and rounded to four significant figures.

$I$  = the dynamometer's inertia setting, in lbf·s<sup>2</sup>/ft.

$S_{si}$  = the speed setting at the start of the coastdown, expressed in ft/s and rounded to four significant figures.

$t$  = coastdown time for each speed and inertia setting, accurate to at least 0.01 s.

Example:

$I = 2000 \text{ lbm} = 65.17 \text{ lbf}\cdot\text{s}^2/\text{ft}$

$S_{si} = 10 \text{ mph} = 14.66 \text{ ft/s}$

$t = 5.00 \text{ s}$

$$F = \frac{65.17 \cdot 14.66}{5.00}$$

$F = 191 \text{ lbf}$

(5) Calculate the target value of coastdown force,  $F_{ref}$ , based on the applicable dynamometer parameters for each speed and inertia setting.

(6) Compare the mean value of the coastdown force measured for each speed and inertia setting,  $\bar{F}_{act}$ , to the corresponding  $F_{ref}$  to determine values for coastdown force error,  $F_{error}$ , using the following equation:

$$F_{error} = \frac{\bar{F}_{act} - F_{ref}}{F_{ref}} \cdot 100 \%$$

Eq. 1066.270-2

Example:

$F_{ref} = 192 \text{ lbf}$

$\bar{F}_{act} = 191 \text{ lbf}$

$$F_{error} = \frac{191 - 192}{192} \cdot 100 \%$$

$F_{error} = -0.5\%$

(7) The maximum allowable error,  $F_{errormax}$ , for all speed and inertia settings

is calculated from the following formula, except that  $F_{errormax}$  for vehicles with GVWR above 14,000 lbs may be up to  $\pm 1.0\%$ :

$$F_{errormax} (\%) = (2.2 \text{ lbf}/F_{ref}) \cdot 100$$

**§ 1066.280 Driver's aid.**

Use good engineering judgment to provide a driver's aid that facilitates compliance with the requirements of § 1066.430.

**Subpart D—Coastdown**

**§ 1066.301 Overview of coastdown procedures.**

(a) The coastdown procedures described in this subpart are used to determine the load coefficients (A, B, and C) for the simulated road-load equation in § 1066.210(d)(3).

(b) The general procedure for performing coastdown tests and calculating load coefficients is described in SAE J1263 and SAE J2263 (incorporated by reference in § 1066.710). This subpart specifies certain deviations from those procedures for certain applications.

(c) Use good engineering judgment for all aspects of coastdown testing. For example, minimize the effects of grade by performing coastdown testing on reasonably level surfaces and determining coefficients based on average values from vehicle operation in opposite directions over the course.

**§ 1066.310 Coastdown procedures for heavy-duty vehicles.**

This section describes coastdown procedures that are unique to heavy-duty motor vehicles. Note as specified in the standard setting parts, this section does not apply for certain heavy-duty vehicles, such as those regulated under 40 CFR part 86, subpart S.

(a) Determine load coefficients by performing a minimum of 16 valid coastdown runs (8 in each direction).

(b) Follow the provisions of Sections 1 through 9 of SAE J1263, and SAE J2263 (incorporated by reference in § 1066.710), except as described in this paragraph (b). The terms and variables identified in this paragraph (b) have the meaning given in SAE J1263 or J2263 unless specified otherwise.

(1) The test condition specifications of SAE J1263 apply except as follows for wind and road conditions:

(i) We recommend that you do not perform coastdown testing on days for which winds are forecast to exceed 6.0 mph.

(ii) The grade of the test track or road must not be excessive (considering factors such as road safety standards and effects on the coastdown results). Road conditions should follow Section

7.4 of SAE J1263, except that road grade may exceed 0.5%. If road grade is greater than 0.02% over the length of the test surface, then the road grade as a function of distance along the length of the test surface must be incorporated in the analysis. To calculate the force due to grade use Section 11.5 of SAE J2263.

(2) You must reach a top speed of greater than 70 mph such that data collection of the coastdown can start at or above 70 mph. Data collection must occur through a minimum speed at or below 15 mph. Data analysis for valid coastdown runs must include a maximum speed of 70 mph and a minimum speed of 15 mph.

(3) Gather data regarding wind speed and direction, in coordination with time-of-day data, using at least one stationary electro-mechanical anemometer and suitable data loggers meeting the specifications of SAE J1263, as well as the following additional specifications for the anemometer placed adjacent to the test surface:

(i) Run the zero-wind and zero-angle calibration data collection.

(ii) The anemometer must have had its outputs recorded at a wind speed of 0.0 mph within 24 hours before each coastdown test in which it is used.

(iii) Record the location of the anemometer using a GPS measurement device adjacent to the test surface (approximately) at the midway distance along the test surface used for coastdowns.

(iv) Position the anemometer such that it will be at least 2.5 but not more than 3.0 vehicle widths from the test vehicle's centerline as the test vehicle passes the location of that anemometer.

(v) Mount the anemometer at a height that is within 6 inches of half the test vehicle's maximum height.

(vi) Place the anemometer at least 50 feet from the nearest tree and at least 25 feet from the nearest bush (or equivalent roadside features).

(vii) The height of the grass surrounding the stationary anemometer may not exceed 10% of the anemometer's mounted height, within a radius equal to the anemometer's mounted height.

(4) You may split runs as per Section 9.3.1 of SAE J2263, but we recommend whole runs. If you split a run, analyze each portion separately, but count the split runs as one run with respect to the minimum number of runs required.

(5) You may perform consecutive runs in a single direction, followed by consecutive runs in the opposite direction, consistent with good engineering judgment. Harmonize starting and stopping points to the

extent practicable to allow runs to be paired.

(6) All valid coastdown run times in each direction must be within 2.0 standard deviations of the mean of the valid coastdown run times (from 70 mph down to 15 mph) in that direction. Eliminate runs outside this range. After eliminating these runs you must have at least eight valid runs each direction.

(7) Determine drag area,  $C_D A$ , as follows instead of using the procedure specified in SAE J1263, Section 10:

(i) Measure vehicle speed at fixed intervals over the coastdown run (generally at 10 Hz), including speeds at or above 15 mph and at or below 70 mph. Establish the height or altitude corresponding to each interval as described in SAE J2263 if you need to incorporate the effects of road grade.

(ii) Calculate the vehicle's effective mass,  $M_e$ , in kg by adding 56.7 kg to the vehicle mass for each tire making road contact. This accounts for the rotational inertia of the wheels and tires.

(iii) Calculate the road-load force for each measurement interval,  $F_i$ , using the following equation:

$$F_i = -M_e \cdot \frac{v_i - v_{i-1}}{\Delta t}$$

Eq. 1066.310-1

Where:

$v$  = Vehicle speed at the beginning and end of the measurement interval. Let  $v_0 = 0$ .

$\Delta t$  = Elapsed time over the measurement interval.

(iv) Plot the data from all the coastdown runs on a single plot of  $F_i$  vs.  $v_i^2$  to determine the slope correlation,  $D$ , based on the following equation:

$$F_i - M_e \cdot g \cdot \frac{\Delta h}{\Delta s} = A_m + D \cdot v_i^2$$

Eq. 1066.310-2

Where:

$g$  = Gravitational acceleration = 9.81 m/s<sup>2</sup>.

$\Delta h$  = Change in height or altitude over the measurement interval, in m. Assume  $\Delta h = 0$  if you are not correcting for grade.

$\Delta s$  = Distance the vehicle travels down the road during the measurement interval, in m.

$A_m$  = the calculated value of the y-intercept based on the curve-fit.

(v) Calculate drag area,  $C_{DA}$ , in m<sup>2</sup> using the following equation:

$$C_D A = \frac{2 \cdot D_{adj}}{\rho}$$

Eq. 1066.310-3

Where:

$\rho$  = Air density at reference conditions = 1.17 kg/m<sup>3</sup>.

$$D_{adj} = D \cdot \left( \frac{\bar{T}}{293} \right) \cdot \left( \frac{98.21}{\bar{P}_B} \right)$$

Eq. 1066.310-4

$\bar{T}$  = Average ambient temperature during testing, in K.

$\bar{P}_B$  = Average ambient pressuring during the test, in kPa.

(8) Determine the A, B, and C coefficients identified in § 1066.210 as follows:

A =  $A_m$

B = 0

C =  $D_{adj}$

### Subpart E—Vehicle Preparation and Running a Test

#### § 1066.401 Overview.

(a) Use the procedures detailed in this subpart to measure vehicle emissions over a specified drive schedule. This subpart describes how to:

(1) Determine road-load power, test weight, and inertia class.

(2) Prepare the vehicle, equipment, and measurement instruments for an emission test.

(3) Perform pre-test procedures to verify proper operation of certain equipment and analyzers and to prepare them for testing.

(4) Record pre-test data.

(5) Sample emissions.

(6) Record post-test data.

(7) Perform post-test procedures to verify proper operation of certain equipment and analyzers.

(8) Weigh PM samples.

(b) An emission test generally consists of measuring emissions and other parameters while a vehicle follows the drive schedules specified in the standard-setting part. There are two general types of test cycles:

(1) *Transient cycles.* Transient test cycles are typically specified in the standard-setting part as a second-by-second sequence of vehicle speed commands. Operate a vehicle over a transient cycle such that the speed follows the target values. Proportionally sample emissions and other parameters and use the calculations in 40 CFR part 86, subpart B, or 40 CFR part 1065, subpart G, to calculate emissions. The standard-setting part may specify three

types of transient testing based on the approach to starting the measurement, as follows:

(i) A cold-start transient cycle where you start to measure emissions just before starting an engine that has not been warmed up.

(ii) A hot-start transient cycle where you start to measure emissions just before starting a warmed-up engine.

(iii) A hot running transient cycle where you start to measure emissions after an engine is started, warmed up, and running.

(2) *Cruise cycles.* Cruise test cycles are typically specified in the standard-setting part as a discrete operating point that has a single speed command.

(i) Start a cruise cycle as a hot running test, where you start to measure emissions after the engine is started and warmed up and the vehicle is running at the target test speed.

(ii) Sample emissions and other parameters for the cruise cycle in the same manner as a transient cycle, with the exception that the reference speed value is constant. Record instantaneous and mean speed values over the cycle.

#### § 1066.407 Vehicle preparation and preconditioning.

This section describes steps to take before measuring exhaust emissions for those vehicles that are subject to evaporative or refueling emission tests as specified in the standard setting part. Other preliminary procedures may apply as specified in the standard-setting part.

(a) Prepare the vehicle for testing as described in 40 CFR 86.131.

(b) If testing will include measurement of refueling emissions, perform the vehicle preconditioning steps as described in 40 CFR 86.153. Otherwise, perform the vehicle preconditioning steps as described in 40 CFR 86.132.

#### § 1066.410 Dynamometer test procedure.

(a) Dynamometer testing may consist of multiple drive cycles with both cold-start and hot-start portions, including prescribed soak times before each test phase. See the standard-setting part for test cycles and soak times for the appropriate vehicle category. A test phase consists of engine startup (with accessories operated according to the standard-setting part), operation over the drive cycle, and engine shutdown.

(b) During dynamometer operation, position a cooling fan that appropriately directs cooling air to the vehicle. This generally requires squarely positioning the fan within 30 centimeters of the front of the vehicle and directing the airflow to the vehicle's radiator.

(1) For vehicles with GVWR at or below 14,000 lbs, you may use either of the following cooling fan configurations:

(i) Use a fixed-speed fan to appropriately direct cooling air to the vehicle with the engine compartment cover open. The fan capacity may not exceed 2.50 m<sup>3</sup>/s. If you determine that additional cooling is needed to properly represent in-use operation, use good engineering judgment to increase the fan's capacity or use additional fans, subject to our approval.

(ii) Use a road-speed modulated fan system that achieves a linear speed of cooling air at the blower outlet that is within  $\pm 3.0$  mph ( $\pm 1.3$  m/s) of the corresponding roll speed when vehicle speeds are between 5 and 30 mph (2.2 to 13.4 m/s), and within  $\pm 6.5$  mph ( $\pm 2.9$  m/s) of the corresponding roll speed at higher vehicle speeds. The fan must provide no cooling air for vehicle speeds below 5 mph, unless we approve your request to provide cooling during low-speed operation based on a demonstration that this is appropriate to simulate cooling for in-use vehicles. We recommend that the cooling fan have a minimum opening of 0.2 m<sup>2</sup> and a minimum width of 0.8 m.

(2) For vehicles with GVWR above 14,000 lbs, use a road-speed modulated fan system that achieves a linear speed of cooling air at the blower outlet that is within  $\pm 3.0$  mph ( $\pm 1.3$  m/s) of the corresponding roll speed when vehicle speeds are between 5 and 30 mph (2.2 to 13.4 m/s), and within  $\pm 10$  mph ( $\pm 4.5$  m/s) of the corresponding roll speed at higher vehicle speeds. The fan must provide no cooling air for vehicle speeds below 5 mph, unless we approve your request to provide cooling during low-speed operation based on a demonstration that this is appropriate to simulate the cooling experienced by in-use vehicles. We recommend that the cooling fan have a minimum opening of 2.75 m<sup>2</sup>, a minimum flow rate of 3,600 m<sup>3</sup>/min at 50 mph, and that it maintain a minimum speed profile across the duct, in the free stream flow, of  $\pm 15\%$  of the target flow rate.

(3) If the cooling specifications in this paragraph (b) are impractical for special vehicle designs, such as vehicles with rear-mounted engines, you may arrange for an alternative fan configuration that allows for proper simulation of vehicle cooling during in-use operation, subject to our approval.

(c) Record the vehicle's speed trace based on the time and speed data from the dynamometer. Record speed to at least the nearest 0.01 m/s or 0.1 mph and time to at least the nearest 0.1 s.

(d) You may perform practice runs for operating the vehicle and the

dynamometer controls to meet the driving tolerances specified in § 1066.430 or adjust the emission sampling equipment. Verify that the accelerator pedal allows for enough control to closely follow the prescribed driving schedule. You may not measure emissions during a practice run.

(e) Inflate the drive wheel tires according to the vehicle manufacturer's specifications. The drive wheels' tire pressure must be the same for dynamometer operation and for coastdown procedures for determining road-load coefficients. Report these tire pressure values with the test results.

(f) For vehicles with GVWR above 14,000 lbs, you must use a vehicle pull down mechanism that allows simulation of the actual normal forces that the tire and dynamometer roll interface would see if a loaded vehicle were actually being tested. Use of this mechanism will ensure that wheel slip does not occur when trying to accelerate the loaded vehicle.

(g) Use good engineering judgment when testing vehicles in four-wheel drive or all-wheel drive mode. This may involve testing on a dynamometer with a separate dynamometer roll for each drive axle. This may also involve operation on a single roll, which may require disengaging the second set of drive wheels, either with a switch available to the driver or by some other means; however, operating such a vehicle on a single roll may occur only if this does not decrease emissions or energy consumption relative to normal in-use operation. Alternatively, for heavy-duty motor vehicles, up to two drive axles may use a single drive roll, as described in § 1066.210(d)(2).

(h) Warm up the dynamometer as recommended by the dynamometer manufacturer.

(i) Following the test, determine the actual driving distance by counting the number of dynamometer roll or shaft revolutions, or by integrating speed over the course of testing from a high-resolution encoder system.

#### **§ 1066.420 Pre-test verification procedures and pre-test data collection.**

(a) Follow the procedures for PM sample preconditioning and tare weighing as described in 40 CFR 1065.590 if your engine must comply with a PM standard.

(b) Unless the standard-setting part specifies different tolerances, verify at some point before the test that ambient conditions are within the tolerances specified in this paragraph (b). For purposes of this paragraph (b), "before the test" means any time from a point just prior to engine starting (excluding

engine restarts) to the point at which emission sampling begins.

(1) Ambient temperature must be (20 to 30) °C. See § 1066.430(m) for circumstances under which ambient temperatures must remain within this range during the test.

(2) Atmospheric pressure must be (80.000 to 103.325) kPa. You are not required to verify atmospheric pressure prior to a hot-start test interval for testing that also includes a cold start.

(3) Dilution air conditions must meet the specifications in 40 CFR 1065.140, except in cases where you preheat your CVS before a cold-start test. We recommend verifying dilution air conditions just before starting each test phase.

(c) You may test vehicles at any intake-air humidity.

(d) You may perform a final calibration of proportional-flow control systems, which may include performing practice runs.

(e) You may perform the following procedure to precondition sampling systems:

(1) Operate the vehicle over the test cycle.

(2) Operate any dilution systems at their expected flow rates. Prevent aqueous condensation in the dilution systems.

(3) Operate any PM sampling systems at their expected flow rates.

(4) Sample PM for at least 10 min using any sample media. You may change sample media during preconditioning. You must discard preconditioning samples without weighing them.

(5) You may purge any gaseous sampling systems during preconditioning.

(6) You may conduct calibrations or verifications on any idle equipment or analyzers during preconditioning.

(7) Proceed with the test sequence described in § 1066.430.

(f) Verify the amount of nonmethane hydrocarbon (or equivalent) contamination in the exhaust and background HC sampling systems within 8 hours before the start of the first test drive cycle for each individual vehicle tested as described in 40 CFR 1065.520(g).

#### **§ 1066.425 Engine starting and restarting.**

(a) Start the vehicle's engine as follows:

(1) At the beginning of the test cycle, start the engine according to the procedure you describe in your owners manual. In the case of hybrid vehicles, this would generally involve activating vehicle systems such that the engine will start when the vehicle's control

algorithms determine that the engine should provide power instead of or in addition to power from the rechargeable energy storage system (RESS). Unless we specify otherwise, engine starting throughout this part generally refers to this step of activating the system on hybrid vehicles, whether or not that causes the engine to start running.

(2) Place the transmission in gear as described by the test cycle in the standard-setting part. During idle operation, you may apply the brakes if necessary to keep the drive wheels from turning.

(b) If the vehicle does not start after your recommended maximum cranking time, wait and restart cranking according to your recommended practice. If you don't recommend such a cranking procedure, stop cranking after 10 seconds, wait for 10 seconds, then start cranking again for up to 10 seconds. You may repeat this for up to three start attempts. If the vehicle does not start after three attempts, you must determine and record the reason for failure to start. Shut off sampling systems and either turn the CVS off, or disconnect the exhaust tube from the tailpipe during the diagnostic period. Reschedule the vehicle for testing from a cold start.

(c) Repeat the recommended starting procedure if the engine has a "false start."

(d) Take the following steps if the engine stalls:

(1) If the engine stalls during an idle period, restart the engine immediately and continue the test. If you cannot restart the engine soon enough to allow the vehicle to follow the next acceleration, stop the driving schedule indicator and reactivate it when the vehicle restarts.

(2) If the engine stalls during operation other than idle, stop the driving schedule indicator, restart the engine, accelerate to the speed required at that point in the driving schedule, reactivate the driving schedule indicator, and continue the test.

(3) Void the test if the vehicle will not restart within one minute. If this happens, remove the vehicle from the dynamometer, take corrective action, and reschedule the vehicle for testing. Record the reason for the malfunction (if determined) and any corrective action. See the standard-setting part for instructions about reporting these malfunctions.

#### § 1066.430 Performing emission tests.

The overall test consists of prescribed sequences of fueling, parking, and driving at specified test conditions.

(a) Vehicles are tested for criteria pollutants and greenhouse gas emissions as described in the standard-setting part.

(b) Take the following steps before emission sampling begins:

(1) For batch sampling, connect clean storage media, such as evacuated bags or tare-weighted filters.

(2) Start all measurement instruments according to the instrument manufacturer's instructions and using good engineering judgment.

(3) Start dilution systems, sample pumps, and the data-collection system.

(4) Pre-heat or pre-cool heat exchangers in the sampling system to within their operating temperature tolerances for a test.

(5) Allow heated or cooled components such as sample lines, filters, chillers, and pumps to stabilize at their operating temperatures.

(6) Verify that there are no significant vacuum-side leaks according to 40 CFR 1065.345.

(7) Adjust the sample flow rates to desired levels using bypass flow, if desired.

(8) Zero or re-zero any electronic integrating devices before the start of any test interval.

(9) Select gas analyzer ranges. You may automatically or manually switch gas analyzer ranges during a test only if switching is performed by changing the span over which the digital resolution of the instrument is applied. During a test you may not switch the gains of an analyzer's analog operational amplifier(s).

(10) Zero and span all continuous gas analyzers using NIST-traceable gases that meet the specifications of 40 CFR 1065.750. Span FID analyzers on a carbon number basis of one ( $C_1$ ). For example, if you use a  $C_3H_8$  span gas of concentration 200  $\mu\text{mol/mol}$ , span the FID to respond with a value of 600  $\mu\text{mol/mol}$ . Span FID analyzers consistent with the determination of their respective response factors, *RF*, and penetration fractions, *PF*, according to 40 CFR 1065.365.

(11) We recommend that you verify gas analyzer responses after zeroing and spanning by sampling a calibration gas that has a concentration near one-half of the span gas concentration. Based on the results and good engineering judgment, you may decide whether or not to re-zero, re-span, or re-calibrate a gas analyzer before starting a test.

(12) If you correct for dilution air background concentrations of associated engine exhaust constituents, start sampling and recording background concentrations.

(13) Turn on cooling fans immediately before starting the test.

(c) Operate vehicles during testing as follows:

(1) Where we do not give specific instructions, operate the vehicle according to your recommendations in the owners manual, unless those recommendations are unrepresentative of what may reasonably be expected for in-use operation.

(2) If vehicles have features that preclude dynamometer testing, modify these features as necessary to allow testing, consistent with good engineering judgment.

(3) Operate vehicles during idle as follows:

(i) For a vehicle with an automatic transmission, operate at idle with the transmission in "Drive" with the wheels braked, except that you may shift to "Neutral" for the first idle period and for any idle period longer than one minute. If you put the vehicle in "Neutral" during an idle, you must shift the vehicle into "Drive" with the wheels braked at least 5 seconds before the end of the idle period.

(ii) For vehicles with manual transmission, operate at idle with the transmission in gear with the clutch disengaged, except that you may shift to "Neutral" with the clutch disengaged for the first idle period and for any idle period longer than one minute. If you put the vehicle in "Neutral" during idle, you must shift to first gear with the clutch disengaged at least 5 seconds before the end of the idle period.

(4) Operate the vehicle with the appropriate accelerator pedal movement necessary to achieve the speed versus time relationship prescribed by the driving schedule. Avoid smoothing speed variations and excessive accelerator pedal perturbations.

(5) Operate the vehicle smoothly, following representative shift speeds and procedures. For manual transmissions, the operator shall release the accelerator pedal during each shift and accomplish the shift with minimum time. If the vehicle cannot accelerate at the specified rate, operate it at maximum available power until the vehicle speed reaches the value prescribed for that time in the driving schedule.

(6) Decelerate without changing gears, using the brakes or accelerator pedal as necessary to maintain the desired speed. Keep the clutch engaged on manual transmission vehicles and do not change gears after the end of the acceleration event. Depress manual transmission clutches when the speed drops below 6.7 m/s (15 mph), when engine

roughness is evident, or when engine stalling is imminent.

(7) For test vehicles equipped with manual transmissions, shift gears in a way that represents reasonable shift patterns for in-use operation, considering vehicle speed, engine speed, and any other relevant variables. You may recommend a shift schedule in your owners manual that differs from your shift schedule during testing as long as you include both shift schedules in your application for certification. In this case, we may use the shift schedule you describe in your owners manual.

(d) See the standard-setting part for drive schedules. These are defined by a smooth trace drawn through the specified speed vs. time sequence.

(e) The driver must attempt to follow the target schedule as closely as possible, consistent with the

specifications in paragraph (b) of this section. Instantaneous speeds must stay within the following tolerances:

(1) The upper limit is 1.0 m/s (2 mph) higher than the highest point on the trace within 1.0 s of the given point in time.

(2) The lower limit is 1.0 m/s (2 mph) lower than the lowest point on the trace within 1.0 s of the given time.

(3) The same limits apply for vehicle preconditioning, except that the upper and lower limits for speed values are  $\pm 2.0$  m/s ( $\pm 4$  mph).

(4) Void the test if you do not maintain speed values as specified in this paragraph (e)(4). Speed variations (such as may occur during gear changes or braking spikes) may occur as follows, provided that such variations are clearly documented, including the time and

speed values and the reason for the deviation:

(i) Speed variations greater than the specified limits are acceptable for up to 2.0 seconds on any occasion.

(ii) For vehicles that are not able to maintain acceleration as specified in paragraph (c)(5) of this section, do not count the insufficient acceleration as being outside the specified limits.

(f) Figure 1 and Figure 2 of this section show the range of acceptable speed tolerances for typical points during testing. Figure 1 of this section is typical of portions of the speed curve that are increasing or decreasing throughout the 2-second time interval. Figure 2 of this section is typical of portions of the speed curve that include a maximum or minimum value.

**BILLING CODE 4910-59-P**



Figure 1 of §1066.430—Example of the allowable ranges for the driver’s trace.

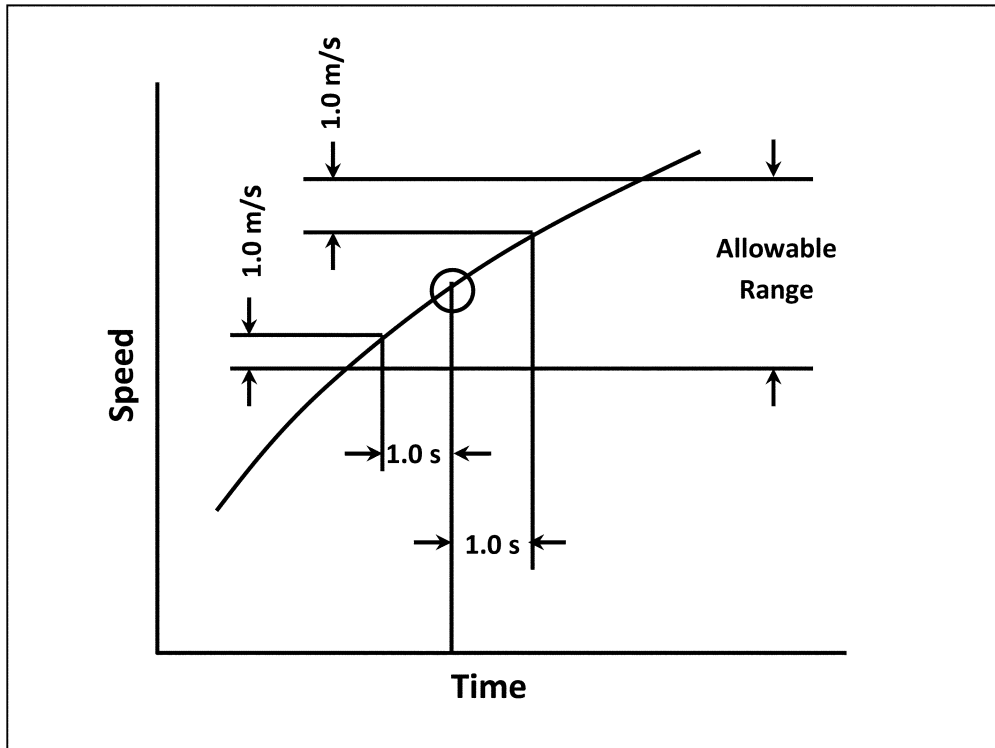
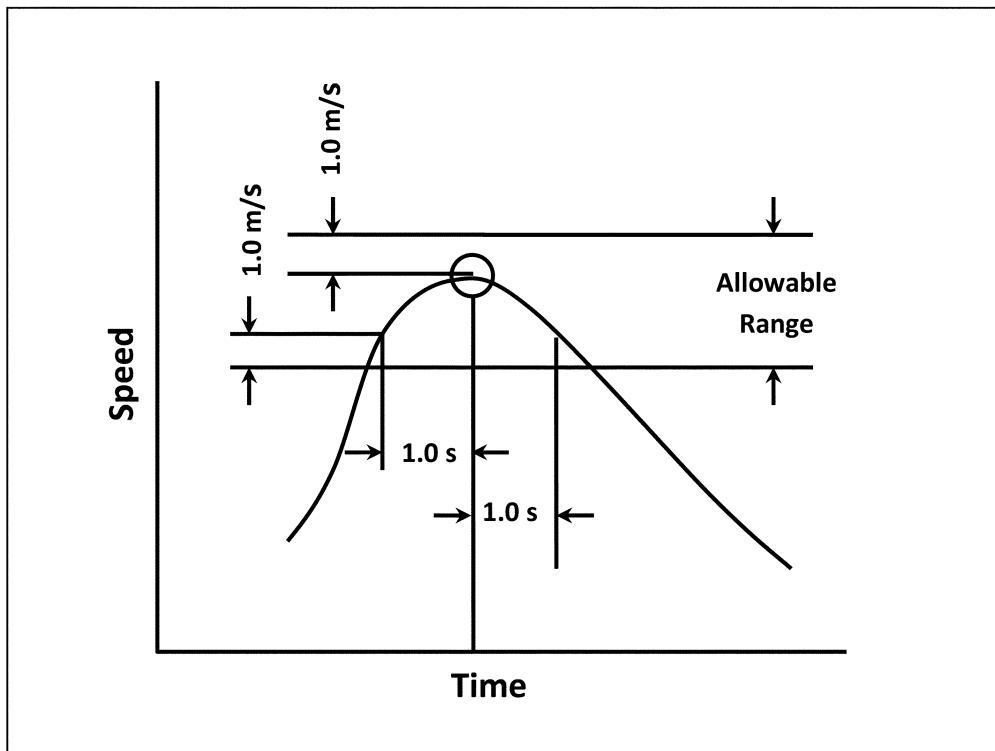

Figure 2 of §1066.430—Example of the allowable ranges for the driver’s trace.



BILLING CODE 4910-59-c

(g) Start testing as follows:

(1) If a vehicle is already running and warmed up, and starting is not part of

the test cycle, operate the vehicle as follows:

(i) For transient test cycles, control vehicle speeds to follow a drive schedule consisting of a series of idles, accelerations, cruises, and decelerations.

(ii) For cruise test cycles, control the vehicle operation to match the speed of the first phase of the test cycle. Follow the instructions in the standard-setting part to determine how long to stabilize the vehicle during each phase, how long to sample emissions at each phase, and how to transition between phases.

(2) If engine starting is part of the test cycle, initiate data logging, sampling of exhaust gases, and integrating measured values before starting the engine. Initiate the driver's trace when the engine starts.

(h) At the end of each test interval, continue to operate all sampling and dilution systems to allow the response times to elapse. Then stop all sampling and recording, including the recording of background samples. Finally, stop any integrating devices and indicate the end of the duty cycle in the recorded data.

(i) Shut down the vehicle if it is part of the test cycle or if testing is complete.

(j) If testing involves engine shutdown followed by another test phase, start a timer for the vehicle soak when the engine shuts down.

(k) Take the following steps after emission sampling is complete:

(1) For any proportional batch sample, such as a bag sample or PM sample, verify that proportional sampling was maintained according to 40 CFR 1065.545. Void any samples that did not maintain proportional sampling according to specifications.

(2) Place any used PM samples into covered or sealed containers and return them to the PM-stabilization environment. Follow the PM sample post-conditioning and total weighing procedures in 40 CFR 1065.595.

(3) As soon as practical after the test cycle is complete, or optionally during the soak period if practical, perform the following:

(i) Drift check all continuous gas analyzers and zero and span all batch gas analyzers no later than 30 minutes after the test cycle is complete, or during the soak period if practical.

(ii) Analyze any conventional gaseous batch samples no later than 30 minutes after a test phase is complete, or during the soak period if practical. Analyze nonconventional gaseous batch samples, such as NMHCE sampling with ethanol, as soon as practicable using good engineering judgment.

(iii) Analyze background samples no later than 60 minutes after the test cycle is complete.

(4) After quantifying exhaust gases, verify drift as follows:

(i) For batch and continuous gas analyzers, record the mean analyzer value after stabilizing a zero gas to the analyzer. Stabilization may include time to purge the analyzer of any sample gas, plus any additional time to account for analyzer response.

(ii) Record the mean analyzer value after stabilizing the span gas to the analyzer. Stabilization may include time to purge the analyzer of any sample gas, plus any additional time to account for analyzer response.

(iii) Use these data to validate and correct for drift as described in 40 CFR 1065.550.

(l) [Reserved]

(m) Measure and record ambient temperature and pressure. Also measure humidity, as required, such as for correcting NO<sub>x</sub> emissions. For testing vehicles with the following engines, you must record ambient temperature continuously to verify that it remains within the temperature range specified in § 1066.420(b)(1) throughout the test:

(1) Air-cooled engines.

(2) Engines equipped with emission control devices that sense and respond to ambient temperature.

(3) Any other engine for which good engineering judgment indicates that this is necessary to remain consistent with 40 CFR 1065.10(c)(1).

#### Subpart F—Hybrids

##### § 1066.501 Overview.

To correct fuel economy or emission results for Net Energy Change of the RESS, use the procedures specified for charge-sustaining operation in SAE J2711 (incorporated by reference in § 1066.710).

#### Subpart G—Calculations

##### § 1066.601 Overview.

(a) This subpart describes how to—

(1) Use the signals recorded before, during, and after an emission test to calculate distance-specific emissions of each regulated pollutant.

(2) Perform calculations for calibrations and performance checks.

(3) Determine statistical values.

(b) You may use data from multiple systems to calculate test results for a single emission test, consistent with good engineering judgment. You may also make multiple measurements from a single batch sample, such as multiple weighing of a PM filter or multiple readings from a bag sample. You may not use test results from multiple emission tests to report emissions. We allow weighted means where

appropriate. You may discard statistical outliers, but you must report all results.

##### § 1066.610 Mass-based and molar-based exhaust emission calculations.

(a) Calculate your total mass of emissions over a test cycle as specified in 40 CFR 86.144 or 40 CFR part 1065, subpart G.

(b) For composite emission calculations over multiple test phases and corresponding weighting factors, see the standard-setting part.

#### Subpart H—Definitions and Other Reference Material

##### § 1066.701 Definitions.

The definitions in this section apply to this part. The definitions apply to all subparts unless we note otherwise. Other terms have the meaning given in 40 CFR part 1065. The definitions follow:

*Base inertia* means a value expressed in mass units to represent the rotational inertia of the rotating dynamometer components between the vehicle driving tires and the dynamometer torque-measuring device, as specified in § 1066.250.

*Driving schedule* means a series of vehicle speeds that a vehicle must follow during a test. Driving schedules are specified in the standard-setting part. A driving schedule may consist of multiple test phases.

*Duty cycle* means a set of weighting factors and the corresponding test cycles, where the weighting factors are used to combine the results of multiple test phases into a composite result.

*Road-load coefficients* means sets of A, B, and C road-load force coefficients that are used in the dynamometer road-load simulation, where road-load force at speed *S* equals  $A + B \cdot S + C \cdot S^2$ .

*Test phase* means a duration over which a vehicle's emission rates are determined for comparison to an emission standard. For example, the standard-setting part may specify a complete duty cycle as a cold-start test phase and a hot-start test phase. In cases where multiple test phases occur over a duty cycle, the standard-setting part may specify additional calculations that weight and combine results to arrive at composite values for comparison against the applicable standards.

*Test weight* has the meaning given in the standard-setting part.

*Unloaded coastdown* means a dynamometer coastdown run with the vehicle wheels off the roll surface.

##### § 1066.705 Symbols, abbreviations, acronyms, and units of measure.

The procedures in this part generally follow either the International System of

Units (SI) or the United States customary units, as detailed in NIST Special Publication 811, which we incorporate by reference in § 1066.710. See 40 CFR 1065.20 for specific

provisions related to these conventions. This section summarizes the way we use symbols, units of measure, and other abbreviations.

(a) *Symbols for quantities.* This part uses the following symbols and units of measure for various quantities:

Symbol	Quantity	Unit	Unit symbol	Unit in terms of SI base units
<i>a</i> .....	acceleration .....	feet per second squared or meters per second squared.	ft/s <sup>2</sup> or m/s <sup>2</sup>	m·s <sup>-2</sup>
<i>d</i> .....	diameter .....	meters .....	m	m
<i>F</i> .....	force .....	pound force or newton .....	lbf or N	kg·s <sup>-2</sup>
<i>f</i> .....	frequency .....	hertz .....	Hz	s <sup>-1</sup>
<i>I</i> .....	inertia .....	pound mass or kilogram .....	lbm or kg	kg
<i>i</i> .....	indexing variable .....	.....	.....	.....
<i>M</i> .....	mass .....	pound mass or kilogram .....	lbm or kg	kg
<i>N</i> .....	total number in series .....	.....	.....	.....
<i>n</i> .....	total number of pulses in a series ..	.....	.....	.....
<i>R</i> .....	dynamometer roll revolutions .....	revolutions per minute .....	rpm	2·π·60 <sup>-1</sup> · m·m <sup>-1</sup> ·s <sup>-1</sup>
<i>RL</i> .....	road-load coefficient .....	horsepower or kilowatt .....	hp or kW	10 <sup>3</sup> ·m <sup>2</sup> ·kg·s <sup>-3</sup>
<i>S</i> .....	speed .....	miles per hour or meters per second.	mph or m/s	m·s <sup>-1</sup>
<i>T</i> .....	Celsius temperature .....	degree Celsius .....	°C	K-273.15
<i>T</i> .....	torque (moment of force) .....	newton meter .....	N·m	m <sup>2</sup> ·kg·s <sup>-2</sup>
<i>t</i> .....	time .....	second .....	s	s
$\Delta t$ .....	time interval, period, 1/frequency ...	second .....	s	s
<i>y</i> .....	generic variable .....	.....	.....	.....

(b) *Symbols for chemical species.* This part uses the following symbols for chemical species and exhaust constituents:

Symbol	Species
CH <sub>4</sub> .....	methane
CO .....	carbon monoxide
CO <sub>2</sub> .....	carbon dioxide
NMHC .....	nonmethane hydrocarbon
NMHCe .....	nonmethane hydrocarbon equivalent
NO .....	nitric oxide
NO <sub>2</sub> .....	nitrogen dioxide
NO <sub>x</sub> .....	oxides of nitrogen
N <sub>2</sub> O .....	nitrous oxide
O <sub>2</sub> .....	molecular oxygen
PM .....	particulate mass
THC .....	total hydrocarbon
THCE .....	total hydrocarbon equivalent

(c) *Superscripts.* This part uses the following superscripts to define a quantity:

Superscript	Quantity
overbar (such as) $\bar{y}$ .....	arithmetic mean

(d) *Subscripts.* This part uses the following subscripts to define a quantity:

Subscript	Quantity
int .....	speed interval
abs .....	absolute quantity
act .....	actual or measured condition
actint .....	actual or measured condition over the speed interval
atmos .....	atmospheric
b .....	base
c .....	coastdown

Subscript	Quantity
e .....	effective
error .....	error
exp .....	expected quantity
i .....	an individual of a series
final .....	final
init .....	initial quantity, typically before an emission test
max .....	the maximum ( <i>i.e.</i> , peak) value expected at the standard over a test interval; not the maximum of an instrument range
meas .....	measured quantity
ref .....	reference quantity
rev .....	revolution
roll .....	dynamometer roll
s .....	settling
sat .....	saturated condition
si .....	speed interval
span .....	span quantity
test .....	test quantity
uncor .....	uncorrected quantity
zero .....	zero quantity

(e) *Other acronyms and abbreviations.* This part uses the following additional abbreviations and acronyms:

CFR .....	Code of Federal Regulations
EPA .....	Environmental Protection Agency
FID .....	flame-ionization detector
GVWR ..	gross vehicle weight rating
NIST .....	National Institute for Standards and Technology
RESS ...	rechargeable energy storage system
SAE .....	Society of Automotive Engineers
U.S.C. ..	United States Code

**§ 1066.710 Reference materials.**

(a) Certain material is incorporated by reference into this part with the approval of the Director of the Federal Register under 5 U.S.C. 552(a) and 1 CFR part 51. To enforce any edition other than that specified in this section, the Environmental Protection Agency must publish a notice of the change in the **Federal Register** and the material must be available to the public. All approved material is available for inspection at U.S. EPA, Air and Radiation Docket and Information Center, 1301 Constitution Ave., NW., Room B102, EPA West Building, Washington, DC 20460, (202) 202-1744, and is available from the sources listed below. It is also available for inspection at the National Archives and Records Administration (NARA). For information on the availability of this material at NARA, call 202-741-6030, or go to [http://www.archives.gov/federal-register/code\\_of\\_federal\\_regulations/ibr\\_locations.html](http://www.archives.gov/federal-register/code_of_federal_regulations/ibr_locations.html).

(b) Society of Automotive Engineers, 400 Commonwealth Dr., Warrendale, PA 15096-0001, (877) 606-7323 (U.S. and Canada) or (724) 776-4970 (outside the U.S. and Canada), <http://www.sae.org>.

(1) SAE J1263, Road Load Measurement and Dynamometer Simulation Using Coastdown Techniques, Revised March 2010, IBR approved for §§ 1066.301(b) and 1066.310(b).

(2) SAE J2263, Road Load Measurement Using Onboard

Anemometry and Coastdown Techniques, Revised December 2008, IBR approved for §§ 1066.301(b), and 1066.310(b).

(3) SAE J2711, Recommended Practice for Measuring Fuel Economy and Emissions of Hybrid-Electric and Conventional Heavy-Duty Vehicles, Issued September 2002, IBR approved for § 1066.501.

(c) National Institute of Standards and Technology, 100 Bureau Drive, Stop 1070, Gaithersburg, MD 20899-1070, (301) 975-6478, <http://www.nist.gov>, or [inquiries@nist.gov](mailto:inquiries@nist.gov).

(1) NIST Special Publication 811, 2008 Edition, Guide for the Use of the International System of Units (SI), March 2008, IBR approved for §§ 1066.20(a) and 1066.705.

(2) [Reserved]

#### **PART 1068—GENERAL COMPLIANCE PROVISIONS FOR HIGHWAY, STATIONARY, AND NONROAD PROGRAMS**

■ 94. The authority citation for part 1068 continues to read as follows:

**Authority:** 42 U.S.C. 7401-7671q.

■ 95. The heading for part 1068 is revised to read as set forth above.

#### **Subpart A—[Amended]**

■ 96. Section 1068.1 is revised to read as follows:

##### **§ 1068.1 Does this part apply to me?**

(a) The provisions of this part apply to everyone with respect to the following engines and to equipment using the following engines (including owners, operators, parts manufacturers, and persons performing maintenance):

(1) Locomotives we regulate under 40 CFR part 1033.

(2) Heavy-duty motor vehicles and motor vehicle engines to the extent and in the manner specified in 40 CFR parts 85, 86, 1036 and 1037.

(3) Land-based nonroad compression-ignition engines we regulate under 40 CFR part 1039.

(4) Stationary compression-ignition engines certified using the provisions of 40 CFR part 1039, as indicated in 40 CFR part 60, subpart IIII.

(5) Marine compression-ignition engines we regulate under 40 CFR part 1042.

(6) Marine spark-ignition engines we regulate under 40 CFR part 1045.

(7) Large nonroad spark-ignition engines we regulate under 40 CFR part 1048.

(8) Stationary spark-ignition engines certified using the provisions of 40 CFR

part 1048 or part 1054, as indicated in 40 CFR part 60, subpart JJJJ.

(9) Recreational engines and vehicles we regulate under 40 CFR part 1051 (such as snowmobiles and off-highway motorcycles).

(10) Small nonroad spark-ignition engines we regulate under 40 CFR part 1054.

(b) This part does not apply to any of the following engine or vehicle categories, except as specified in paragraph (d) of this section or as specified in other parts:

(1) Light-duty motor vehicles (see 40 CFR part 86).

(2) Highway motorcycles (see 40 CFR part 86).

(3) Aircraft engines (see 40 CFR part 87).

(4) Land-based nonroad compression-ignition engines we regulate under 40 CFR part 89.

(5) Small nonroad spark-ignition engines we regulate under 40 CFR part 90.

(c) Paragraph (a) of this section identifies the parts of the CFR that define emission standards and other requirements for particular types of engines and equipment. This part 1068 refers to each of these other parts generically as the “standard-setting part.” For example, 40 CFR part 1051 is always the standard-setting part for snowmobiles. Follow the provisions of the standard-setting part if they are different than any of the provisions in this part.

(d) Specific provisions in this part 1068 start to apply separate from the schedule for certifying engines to new emission standards, as follows:

(1) The provisions of §§ 1068.30 and 1068.310 apply for stationary spark-ignition engines built on or after January 1, 2004, and for stationary compression-ignition engines built on or after January 1, 2006.

(2) The provisions of §§ 1068.30 and 1068.235 apply for the types of engines/equipment listed in paragraph (a) of this section beginning January 1, 2004, if they are used solely for competition.

#### **Subpart C—[Amended]**

■ 97. Section 1068.210 is revised to read as follows:

##### **§ 1068.210 What are the provisions for exempting test engines/equipment?**

(a) We may exempt engines/equipment that you will use for research, investigations, studies, demonstrations, or training. Note that you are not required to get an exemption under this section for engines that are exempted under other provisions of this

part, such as the manufacturer-owned exemption in § 1068.215.

(b) Anyone may ask for a testing exemption.

(c) If you are a certificate holder, you may request an exemption for engines/equipment you intend to include in test programs over a two-year period.

(1) In your request, tell us the maximum number of engines/equipment involved and describe how you will make sure exempted engines/equipment are used only for this testing. For example, if the exemption will involve other companies using your engines/equipment, describe your plans to track individual units so you can properly report on their final disposition.

(2) Give us the information described in paragraph (d) of this section if we ask for it.

(d) If you are not a certificate holder, do all the following things:

(1) Show that the proposed test program has a valid purpose under paragraph (a) of this section.

(2) Show you need an exemption to achieve the purpose of the test program (time constraints may be a basis for needing an exemption, but the cost of certification alone is not).

(3) Estimate the duration of the proposed test program and the number of engines/equipment involved.

(4) Allow us to monitor the testing.

(5) Describe how you will ensure that you stay within this exemption’s purposes. Address at least the following things:

(i) The technical nature of the test.

(ii) The test site.

(iii) The duration and accumulated engine/equipment operation associated with the test.

(iv) Ownership and control of the engines/equipment involved in the test.

(v) The intended final disposition of the engines/equipment.

(vi) How you will identify, record, and make available the engine/equipment identification numbers.

(vii) The means or procedure for recording test results.

(e) If we approve your request for a testing exemption, we will send you a letter or a memorandum describing the basis and scope of the exemption. It will also include any necessary terms and conditions, which normally require you to do the following:

(1) Stay within the scope of the exemption.

(2) Create and maintain adequate records that we may inspect.

(3) Add a permanent label to all engines/equipment exempted under this section, consistent with § 1068.45, with at least the following items:

(i) The label heading "EMISSION CONTROL INFORMATION".

(ii) Your corporate name and trademark.

(iii) Engine displacement, family identification, and model year of the engine/equipment (as applicable), or whom to contact for further information.

(iv) One of these statements (as applicable):

(A) "THIS ENGINE IS EXEMPT UNDER 40 CFR 1068.210 OR 1068.215 FROM EMISSION STANDARDS AND RELATED REQUIREMENTS."

(B) "THIS EQUIPMENT IS EXEMPT UNDER 40 CFR 1068.210 OR 1068.215 FROM EMISSION STANDARDS AND RELATED REQUIREMENTS."

(4) Tell us when the test program is finished.

(5) Tell us the final disposition of the engines/equipment.

(6) Send us a written confirmation that you meet the terms and conditions of this exemption.

■ 98. Section 1068.235 is revised to read as follows:

**§ 1068.235 What are the provisions for exempting engines/equipment used solely for competition?**

(a) New engines/equipment you produce that are used solely for competition are generally excluded from emission standards. See the standard-setting parts for specific provisions where applicable.

(b) If you modify any nonroad engines/equipment after they have been placed into service in the United States so they will be used solely for competition, they are exempt without request. This exemption applies only to the prohibition in § 1068.101(b)(1) and is valid only as long as the engine/equipment is used solely for competition. You may not use the provisions of this paragraph (b) to circumvent the requirements that apply to the sale of new competition engines under the standard-setting part.

(c) If you modify any nonroad engines/equipment under paragraph (b) of this section, you must destroy the original emission labels. If you loan, lease, sell, or give any of these engines/equipment to someone else, you must tell the new owner (or operator, if applicable) in writing that they may be used only for competition.

**Subpart D—[Amended]**

■ 99. Section 1068.325 is revised to read as follows:

**§ 1068.325 What are the temporary exemptions for imported engines/equipment?**

You may import engines/equipment under certain temporary exemptions, subject to the conditions in this section. We may ask U.S. Customs and Border Protection to require a specific bond amount to make sure you comply with the requirements of this subpart. You may not sell or lease one of these engines/equipment while it is in the United States except as specified in this section or § 1068.201(i). You must eventually export the engine/equipment as we describe in this section unless it conforms to a certificate of conformity or it qualifies for one of the permanent exemptions in § 1068.315.

(a) *Exemption for repairs or alterations.* You may temporarily import nonconforming engines/equipment under bond solely for repair or alteration, subject to our advance approval as described in paragraph (j) of this section. You may operate the engine/equipment in the United States only as necessary to repair it, alter it, or ship it to or from the service location. Export the engine/equipment directly after servicing is complete.

(b) *Testing exemption.* You may temporarily import nonconforming engines/equipment under bond for testing if you follow the requirements of § 1068.210, subject to our advance approval as described in paragraph (j) of this section. You may operate the engines/equipment in the United States only as needed to perform tests. This exemption expires one year after you import the engine/equipment unless we approve an extension. The engine/equipment must be exported before the exemption expires. You may sell or lease the engines/equipment consistent with the provisions of § 1068.210.

(c) *Display exemption.* You may temporarily import nonconforming engines/equipment under bond for display if you follow the requirements of § 1068.220, subject to our advance approval as described in paragraph (j) of this section. This exemption expires one year after you import the engine/equipment, unless we approve your request for an extension. We may approve an extension of up to one more year for each request, but no more than three years total. The engine/equipment must be exported by the time the exemption expires or directly after the display concludes, whichever comes first.

(d) *Export exemption.* You may temporarily import nonconforming engines/equipment to export them, as described in § 1068.230. You may operate the engine/equipment in the

United States only as needed to prepare it for export. Label the engine/equipment as described in § 1068.230. You may sell or lease the engines/equipment for operation outside the United States consistent with the provisions of § 1068.230.

(e) *Diplomatic or military exemption.* You may temporarily import nonconforming engines/equipment without bond if you represent a foreign government in a diplomatic or military capacity. In your request to the Designated Compliance Officer (see § 1068.305), include either written confirmation from the U.S. State Department that you qualify for this exemption or a copy of your orders for military duty in the United States. We will rely on the State Department or your military orders to determine when your diplomatic or military status expires, at which time you must export your exempt engines/equipment.

(f) *Delegated-assembly exemption.* You may import a nonconforming engine for final assembly under the provisions of § 1068.261. You may sell or lease the engines/equipment consistent with the provisions of § 1068.261.

(g) *Exemption for partially complete engines.* You may import an engine if another company already has a certificate of conformity and will be modifying the engine to be in its final certified configuration or a final exempt configuration under the provisions of § 1068.262. You may also import a partially complete engine by shipping it from one of your facilities to another under the provisions of § 1068.260(c). If you are importing a used engine that becomes new as a result of importation, you must meet all the requirements that apply to original engine manufacturers under § 1068.262. You may sell or lease the engines consistent with the provisions of § 1068.262.

(h) [Reserved]

(i) [Reserved]

(j) *Approvals.* For the exemptions in this section requiring our approval, you must send a request to the Designated Compliance Officer before importing the engines/equipment. We will approve your request if you meet all the applicable requirements and conditions. If another section separately requires that you request approval for the exemption, you may combine the information requirements in a single request. Include the following information in your request:

(1) Identify the importer of the engine/equipment and the applicable postal address, e-mail address, and telephone number.

(2) Identify the engine/equipment owner and the applicable postal address, e-mail address, and telephone number.

(3) Identify the engine/equipment by model number (or name), serial number, and original production year.

(4) Identify the specific regulatory provision under which you are seeking an exemption.

(5) Authorize EPA enforcement officers to conduct inspections or testing as allowed under the Clean Air Act.

(6) Include any additional information we specify for demonstrating that you qualify for the exemption.

## Department of Transportation

### National Highway Traffic Safety Administration

#### 49 CFR Chapter V

In consideration of the foregoing, under the authority of 49 U.S.C. 32901 and 32902 and delegation of authority at 49 CFR 1.50, NHTSA amends 49 CFR chapter V as follows:

#### PART 523—VEHICLE CLASSIFICATION

■ 100. The authority citation for part 523 continues to read as follows:

**Authority:** 49 U.S.C. 32901; delegation of authority at 49 CFR 1.50.

■ 101. Revise § 523.2 to read as follows:

##### § 523.2 Definitions.

As used in this part:

**Approach angle** means the smallest angle, in a plane side view of an automobile, formed by the level surface on which the automobile is standing and a line tangent to the front tire static loaded radius arc and touching the underside of the automobile forward of the front tire.

**Axle clearance** means the vertical distance from the level surface on which an automobile is standing to the lowest point on the axle differential of the automobile.

**Base tire** means the tire specified as standard equipment by a manufacturer on each subconfiguration of a model type.

**Basic vehicle frontal area** is used as defined in 40 CFR 86.1803.

**Breakover angle** means the supplement of the largest angle, in the plan side view of an automobile that can be formed by two lines tangent to the front and rear static loaded radii arcs and intersecting at a point on the underside of the automobile.

**Cab-complete vehicle** means a vehicle that is first sold as an incomplete vehicle that substantially includes the vehicle cab section as defined in 40 CFR 1037.801. For example, vehicles known

commercially as chassis-cabs, cab-chassis, box-deletes, bed-deletes, cut-away vans are considered cab-complete vehicles. A cab includes a steering column and passenger compartment. Note a vehicle lacking some components of the cab is a cab-complete vehicle if it substantially includes the cab.

**Cargo-carrying volume** means the luggage capacity or cargo volume index, as appropriate, and as those terms are defined in 40 CFR 600.315, in the case of automobiles to which either of those terms apply. With respect to automobiles to which neither of those terms apply “cargo-carrying volume” means the total volume in cubic feet rounded to the nearest 0.1 cubic feet of either an automobile’s enclosed nonseating space that is intended primarily for carrying cargo and is not accessible from the passenger compartment, or the space intended primarily for carrying cargo bounded in the front by a vertical plane that is perpendicular to the longitudinal centerline of the automobile and passes through the rearmost point on the rearmost seat and elsewhere by the automobile’s interior surfaces.

**Class 2b vehicles** are vehicles with a gross vehicle weight rating (GVWR) ranging from 8,501 to 10,000 pounds.

**Class 3 through Class 8 vehicles** are vehicles with a gross vehicle weight rating (GVWR) of 10,001 pounds or more as defined in 49 CFR 565.15.

**Commercial medium- and heavy-duty on-highway vehicle** means an on-highway vehicle with a gross vehicle weight rating of 10,000 pounds or more as defined in 49 U.S.C. 32901(a)(7).

**Complete vehicle** means a vehicle that requires no further manufacturing operations to perform its intended function and is a functioning vehicle that has the primary load carrying device or container (or equivalent equipment) attached or that is designed to pull a trailer. Examples of equivalent equipment would include fifth wheel trailer hitches, firefighting equipment, and utility booms.

**Curb weight** is defined the same as **vehicle curb weight** in 40 CFR 86.1803–01.

**Departure angle** means the smallest angle, in a plane side view of an automobile, formed by the level surface on which the automobile is standing and a line tangent to the rear tire static loaded radius arc and touching the underside of the automobile rearward of the rear tire.

**Final stage manufacturer** has the meaning given in 49 CFR 567.3.

**Footprint** is defined as the product of track width (measured in inches,

calculated as the average of front and rear track widths, and rounded to the nearest tenth of an inch) times wheelbase (measured in inches and rounded to the nearest tenth of an inch), divided by 144 and then rounded to the nearest tenth of a square foot. For purposes of this definition, track width is the lateral distance between the centerlines of the base tires at ground, including the camber angle. For purposes of this definition, wheelbase is the longitudinal distance between front and rear wheel centerlines.

**Gross combination weight rating or GCWR** means the value specified by the manufacturer as the maximum allowable loaded weight of a combination vehicle (e.g. tractor plus trailer).

**Gross vehicle weight rating or GVWR** means the value specified by the vehicle manufacturer as the maximum design loaded weight of a single vehicle (e.g. vocational vehicle).

**Heavy-duty engine** means any engine used for (or for which the engine manufacturer could reasonably expect to be used for) motive power in a heavy-duty vehicle. For purposes of this definition in this part, the term “engine” includes internal combustion engines and other devices that convert chemical fuel into motive power. For example, a fuel cell and motor used in a heavy-duty vehicle is a heavy-duty engine.

**Heavy-duty off-road vehicle** means a heavy-duty vocational vehicle or vocational tractor that is intended for off-road use meeting either of the following criteria:

(1) Vehicles with tires installed having a maximum speed rating at or below 55 mph.

(2) Vehicles primarily designed to perform work off-road (such as in oil fields, forests, or construction sites), and meeting at least one of the criteria of paragraph (2)(i) of this definition and at least one of the criteria of paragraph (2)(ii) of this definition.

(i) Vehicle must have affixed components designed to work in an off-road environment (for example, hazardous material equipment or drilling equipment) or was designed to operate at low speeds making them unsuitable for normal highway operation.

(ii) Vehicles must:

(A) Have an axle that has a gross axle weight rating (GAWR) of 29,000 pounds or more;

(B) Have a speed attainable in 2 miles of not more than 33 mph; or

(C) Have a speed attainable in 2 miles of not more than 45 mph, an unloaded vehicle weight that is not less than 95

percent of its gross vehicle weight rating (GVWR), and no capacity to carry occupants other than the driver and operating crew.

*Heavy-duty vehicle* means a vehicle as defined in § 523.6.

*Incomplete vehicle* means a vehicle which does not have the primary load carrying device or container attached when it is first sold as a vehicle or any vehicle that does not meet the definition of a complete vehicle. This may include vehicles sold to secondary vehicle manufacturers. Incomplete vehicles include cab-complete vehicles.

*Innovative technology* means technology certified under 40 CFR 1037.610.

*Light truck* means a non-passenger automobile meeting the criteria in § 523.5.

*Medium duty passenger vehicle* means a vehicle which would satisfy the criteria in § 523.5 (relating to light trucks) but for its gross vehicle weight rating or its curb weight, which is rated at more than 8,500 lbs GVWR or has a vehicle curb weight of more than 6,000 pounds or has a basic vehicle frontal area in excess of 45 square feet, and which is designed primarily to transport passengers, but does not include a vehicle that:

(1) Is an "incomplete vehicle" as defined in this subpart; or

(2) Has a seating capacity of more than 12 persons; or

(3) Is designed for more than 9 persons in seating rearward of the driver's seat; or

(4) Is equipped with an open cargo area (for example, a pick-up truck box or bed) of 72.0 inches in interior length or more. A covered box not readily accessible from the passenger compartment will be considered an open cargo area for purposes of this definition.

*Motor home* has the meaning given in 49 CFR 571.3.

*Motor vehicle* has the meaning given in 40 CFR 85.1703.

*Passenger-carrying volume* means the sum of the front seat volume and, if any, rear seat volume, as defined in 40 CFR 600.315, in the case of automobiles to which that term applies. With respect to automobiles to which that term does not apply, "passenger-carrying volume" means the sum in cubic feet, rounded to the nearest 0.1 cubic feet, of the volume of a vehicle's front seat and seats to the rear of the front seat, as applicable, calculated as follows with the head room, shoulder room, and leg room dimensions determined in accordance with the procedures outlined in Society of Automotive Engineers Recommended Practice J1100a, Motor Vehicle

Dimensions (Report of Human Factors Engineering Committee, Society of Automotive Engineers, approved September 1973 and last revised September 1975).

(1) For front seat volume, divide 1,728 into the product of the following SAE dimensions, measured in inches to the nearest 0.1 inches, and round the quotient to the nearest 0.001 cubic feet.

(i) H61—Effective head room—front.

(ii) W3—Shoulder room—front.

(iii) L34—Maximum effective leg room—accelerator.

(2) For the volume of seats to the rear of the front seat, divide 1,728 into the product of the following SAE dimensions, measured in inches to the nearest 0.1 inches, and rounded the quotient to the nearest 0.001 cubic feet.

(i) H63—Effective head room—second.

(ii) W4—Shoulder room—second.

(iii) L51—Minimum effective leg room—second.

*Pickup truck* means a non-passenger automobile which has a passenger compartment and an open cargo area (bed).

*Recreational vehicle or RV* means a motor vehicle equipped with living space and amenities found in a motor home.

*Running clearance* means the distance from the surface on which an automobile is standing to the lowest point on the automobile, excluding unsprung weight.

*Static loaded radius arc* means a portion of a circle whose center is the center of a standard tire-rim combination of an automobile and whose radius is the distance from that center to the level surface on which the automobile is standing, measured with the automobile at curb weight, the wheel parallel to the vehicle's longitudinal centerline, and the tire inflated to the manufacturer's recommended pressure.

*Temporary living quarters* means a space in the interior of an automobile in which people may temporarily live and which includes sleeping surfaces, such as beds, and household conveniences, such as a sink, stove, refrigerator, or toilet.

*Van* means a vehicle with a body that fully encloses the driver and a cargo carrying or work performing compartment. The distance from the leading edge of the windshield to the foremost body section of vans is typically shorter than that of pickup trucks and sport utility vehicles.

*Vocational tractor* means a tractor that is classified as a vocational vehicle according to 40 CFR 1037.630.

*Vocational vehicle* means a vehicle that is equipped for a particular

industry, trade or occupation such as construction, heavy hauling, mining, logging, oil fields, refuse and includes vehicles such as school buses, motorcoaches and RVs.

*Work truck* means a vehicle that is rated at more than 8,500 pounds and less than or equal to 10,000 pounds gross vehicle weight, and is not a medium-duty passenger vehicle as defined in 40 CFR 86.1803 effective as of December 20, 2007.

■ 102. Add a new § 523.6 to read as follows:

**§ 523.6 Heavy-duty vehicle.**

(a) A heavy-duty vehicle is any commercial medium- and heavy-duty on highway vehicle or a work truck, as defined in 49 U.S.C. 32901(a)(7) and (19). For the purpose of this part, heavy-duty vehicles are divided into three regulatory categories as follows:

(1) Heavy-duty pickup trucks and vans;

(2) Heavy-duty vocational vehicles; and

(3) Truck tractors with a GVWR above 26,000 pounds.

(b) The heavy-duty vehicle classification does not include:

(1) Vehicles defined as medium duty passenger vehicles.

(2) Vehicles excluded from the definition of "heavy-duty vehicle" because of vehicle weight or weight rating (such as light duty vehicles as defined in § 523.5).

(3) Vehicles excluded from the definition of motor vehicle in 40 CFR 85.1703.

■ 103. Add a new § 523.7 to read as follows:

**§ 523.7 Heavy-duty pickup trucks and vans.**

Heavy-duty pickup trucks and vans are pickup trucks and vans with a gross vehicle weight rating between 8,501 pounds and 14,000 pounds (Class 2b through 3 vehicles) manufactured as complete vehicles by a single or final stage manufacturer or manufactured as incomplete vehicles as designated by a manufacturer. A manufacturer may also optionally designate incomplete or complete Class 4 or 5 vehicles as heavy-duty pickup trucks or vans or spark-ignition (or gasoline) engines certified and sold as loose engines manufactured for use in heavy-duty pickup trucks or vans. See references in 40 CFR 1037.104 and 40 CFR 1037.150.

■ 104. Add a new § 523.8 to read as follows:

**§ 523.8 Heavy-duty vocational vehicle.**

Heavy-duty vocational vehicles are vehicles with a gross vehicle weight

rating (GVWR) above 8,500 pounds excluding:

- (a) Heavy-duty pickup trucks and vans defined in § 523.7;
- (b) Medium duty passenger vehicles; and
- (c) Truck tractors, except vocational tractors, with a GVWR above 26,000 pounds;

■ 105. Add a new § 523.9 to read as follows:

**§ 523.9 Truck tractors.**

Truck tractors for the purpose of this part are considered as any truck tractor as defined in 49 CFR part 571 having a GVWR above 26,000 pounds.

**PART 534—RIGHTS AND RESPONSIBILITIES OF MANUFACTURERS IN THE CONTEXT OF CHANGES IN CORPORATE RELATIONSHIPS**

■ 106. The authority citation for part 534 continues to read as follows:

**Authority:** 49 U.S.C. 32901; delegation of authority at 49 CFR 1.50.

■ 107. Revise § 534.1 to read as follows:

**§ 534.1 Scope.**

This part defines the rights and responsibilities of manufacturers in the context of changes in corporate relationships for purposes of the fuel economy and fuel consumption programs established by 49 U.S.C. chapter 329.

■ 108. Revise § 534.2 to read as follows:

**§ 534.2 Applicability.**

This part applies to manufacturers of passenger automobiles, light trucks, heavy-duty vehicles and the engines manufactured for use in heavy-duty vehicles as defined in 49 CFR part 523.

■ 109. Revise § 534.4 to read as follows.

**§ 534.4 Successors and predecessors.**

For purposes of the fuel economy and fuel consumption programs, “manufacturer” includes “predecessors” and “successors” to the extent specified in this section.

(a) Successors are responsible for any civil penalties that arise out of fuel economy and fuel consumption shortfalls incurred and not satisfied by predecessors.

(b) If one manufacturer has become the successor of another manufacturer during a model year, all of the vehicles or engines produced by those manufacturers during the model year are treated as though they were manufactured by the same manufacturer. A manufacturer is considered to have become the

successor of another manufacturer during a model year if it is the successor on September 30 of the corresponding calendar year and was not the successor for the preceding model year.

(c)(1) For passenger automobiles and light trucks, fuel economy credits earned by a predecessor before or during model year 2007 may be used by a successor, subject to the availability of credits and the general three-year restriction on carrying credits forward and the general three-year restriction on carrying credits backward. Fuel economy credits earned by a predecessor after model year 2007 may be used by a successor, subject to the availability of credits and the general five-year restriction on carrying credits forward and the general three-year restriction on carrying credits backward.

(2) For heavy-duty vehicles and heavy-duty vehicle engines, available fuel consumption credits earned by a predecessor after model year 2015, and in model years 2013, 2014 and 2015 if a manufacturer voluntarily complies in those model years, may be used by a successor, subject to the availability of credits and the general five-year restriction on carrying credits forward and the general three year restriction on carrying credits backward.

(d)(1) For passenger automobiles and light trucks, fuel economy credits earned by a successor before or during model year 2007 may be used to offset a predecessor’s shortfall, subject to the availability of credits and the general three-year restriction on carrying credits forward and the general three-year restriction on carrying credits backward. Credits earned by a successor after model year 2007 may be used to offset a predecessor’s shortfall, subject to the availability of credits and the general five-year restriction on carrying credits forward and the general three-year restriction on carrying credits backward.

(2) For heavy-duty vehicles and heavy-duty vehicle engines, available credits earned by a successor after model year 2015, and in model years 2013, 2014 and 2015, if a manufacturer voluntarily complies in those model years, may be used by a predecessor subject to the availability of credits and the general five-year restriction on carrying credits forward and the general three year restriction on carrying credits backward.

■ 110. Amend § 534.5 by revising paragraphs (a), (c), and (d) to read as follows:

**§ 534.5 Manufacturers within control relationships.**

(a) If a civil penalty arises out of a fuel economy or fuel consumption shortfall

incurred by a group of manufacturers within a control relationship, each manufacturer within that group is jointly and severally liable for the civil penalty.

\* \* \* \* \*

(c)(1) For passenger automobiles and light trucks, fuel economy credits of a manufacturer within a control relationship may be used by the group of manufacturers within the control relationship to offset shortfalls, subject to the agreement of the other manufacturers, the availability of the credits, and the general three year restriction on carrying credits forward or backward prior to or during model year 2007, or the general five year restriction on carrying credits forward and the general three-year restriction on carrying credits backward after model year 2007.

(2) For heavy-duty vehicles and heavy-duty engines, credits of a manufacturer within a control relationship may be used by the group of manufacturers within the control relationship to offset shortfalls, subject to the agreement of the other manufacturers, the availability of the credits, the general 5-year restriction on carrying credits forward, and the general three year restriction on offsetting past credit shortfalls as specified in the requirements of 49 CFR 535.7.

(d)(1) For passenger automobiles and light trucks, if a manufacturer within a group of manufacturers is sold or otherwise spun off so that it is no longer within that control relationship, the manufacturer may use credits that were earned by the group of manufacturers within the control relationship while the manufacturer was within that relationship, subject to the agreement of the other manufacturers, the availability of the credits, and the general three-year restriction on carrying credits forward or backward prior to or during model year 2007, or the general five-year restriction on carrying credits forward and the general three-year restriction on carrying credits backward after model year 2007.

(2) For heavy-duty vehicles and heavy-duty vehicle engines, if a manufacturer within a group of manufacturers is sold or otherwise spun off so that it is no longer within that control relationship, the manufacturer may use credits that were earned by the group of manufacturers within the control relationship while the manufacturer was within that relationship, subject to the agreement of the other manufacturers, the availability of the credits, the general 5-year restriction on carrying credits forward,



and the general three year restriction on offsetting past credit shortfalls as specified in the requirements of 49 CFR 535.7.

\* \* \* \* \*

■ 111. Revise § 534.6 to read as follows.

**§ 534.6 Reporting corporate transactions.**

Manufacturers who have entered into written contracts transferring rights and responsibilities such that a different manufacturer owns the controlling stock or exerts control over the design, production or sale of automobiles or heavy-duty vehicles to which Corporate Average Fuel Economy or Fuel Consumption standards apply shall report the contract to the agency as follows:

(a) The manufacturers must file a certified report with the agency affirmatively stating that the contract transfers rights and responsibilities between them such that one manufacturer has assumed a controlling stock ownership or control over the design, production or sale of vehicles. The report must also specify the first full model year to which the transaction will apply.

(b) Each report shall—

- (1) Identify each manufacturer;
- (2) State the full name, title, and address of the official responsible for preparing the report;
- (3) Identify the production year being reported on;
- (4) Be written in the English language; and

(5) Be submitted to: Administrator, National Highway Traffic Safety Administration, 1200 New Jersey Avenue, SE., Washington, DC 20590.

(c) The manufacturers may seek confidential treatment for information provided in the certified report in accordance with 49 CFR part 512.

■ 112. A new part 535 is added to chapter V to read as follows:

**PART 535 MEDIUM- AND HEAVY-DUTY VEHICLE FUEL EFFICIENCY PROGRAM**

Sec.

535.1 Scope.

535.2 Purpose.

535.3 Applicability.

535.4 Definitions.

535.5 Standards.

535.6 Measurement and calculation procedures.

535.7 Averaging, banking, and trading (ABT) program.

535.8 Reporting requirements.

535.9 Enforcement approach.

**Authority:** 49 U.S.C. 32902; delegation of authority at 49 CFR 1.50.

**§ 535.1 Scope.**

This part establishes fuel consumption standards pursuant to 49 U.S.C. 32902(k) for work trucks and commercial medium-duty and heavy-duty on-highway vehicles (hereafter referenced as heavy-duty vehicles) and engines manufactured for sale in the United States and establishes a credit program manufacturers may use to comply with standards and requirements for manufacturers to provide reports to the National Highway Traffic Safety Administration regarding their efforts to reduce the fuel consumption of these vehicles.

**§ 535.2 Purpose.**

The purpose of this part is to reduce the fuel consumption of new heavy-duty vehicles by establishing maximum levels for fuel consumption standards while providing a flexible credit program to assist manufacturers in complying with standards.

**§ 535.3 Applicability.**

(a) This part applies to complete vehicle and chassis manufacturers of all new heavy-duty vehicles, as defined in 49 CFR part 523, and to the manufacturers of all heavy-duty engines manufactured for use in the applicable vehicles for each given model year.

(b) Complete vehicle manufacturers, for the purpose of this part, include manufacturers that produce heavy-duty pickup trucks and vans or truck tractors as complete vehicles and that hold the EPA certificate of conformity.

(c) Chassis manufacturers, for the purpose of this part, include manufacturers that produce incomplete vehicles constructed for use as heavy-duty pickup trucks or vans or heavy-duty vocational vehicles and that hold the EPA certificate of conformity. Some vocational vehicle manufacturers are both chassis and complete vehicle manufacturers. These manufacturers will be regulated as chassis manufacturers under this program.

(d) Engine manufacturer, for the purpose of this part, means a manufacturer that manufactures engines for heavy-duty vehicles and holds the EPA certificate of conformity.

(e) The heavy-duty vehicles, chassis and engines excluded from the requirements of this part include:

(1) Recreational vehicles, including motor homes.

(2) Vehicles and engines exempted by EPA in accordance with 40 CFR parts 1036 and 1037.

(f) Vehicles and engines produced by small business manufacturers as defined by the Small Business Administration at

13 CFR 121.201 are exempted as specified in § 535.8(h).

(g) Heavy-duty off-road vehicles meeting the criteria in 49 CFR part 523 are exempt without request from vehicle standards of § 535.5(b). Manufacturers of vehicles not meeting the criteria for the heavy-duty off-road vehicle exclusion may submit a petition as specified in § 535.8(h) to EPA and NHTSA for an exclusion from the vehicle standards of § 535.5(b).

(h) A vehicle manufacturer that completes assembly of a vehicle at two or more facilities may ask to use as the date of manufacture for that vehicle the date on which manufacturing is completed at the place of main assembly, consistent with provisions of 49 CFR 567.4, as the model year. Note that such staged assembly is subject to the provisions of 40 CFR 1068.260(c). NHTSA's allowance of this provision is effective when EPA approves the manufacturer's certificates of conformity for these vehicles.

**§ 535.4 Definitions.**

The terms manufacture and manufacturer are used as defined in section 501 of the Act and the terms commercial medium-duty and heavy-duty on highway vehicle, fuel and work truck are used as defined in 49 U.S.C. 32901.

*A to B testing* means testing performed in pairs to allow comparison of vehicle A to vehicle B.

*Act* means the Motor Vehicle Information and Cost Savings Act, as amended by Pub. L. 94-163 and 96-425.

*Administrator* means the Administrator of the National Highway Traffic Safety Administration (NHTSA) or the Administrator's delegate.

*Advanced technology* means vehicle technology certified under 40 CFR 1036.615 and 1037.615.

*Averaging set* means, a set of engines or vehicles in which fuel consumption credits may be exchanged. Credits generated by one engine or vehicle family may only be used by other respective engine or vehicle families in the same averaging set. Note that an averaging set may comprise more than one regulatory subcategory. The averaging sets for this HD program are defined as follows:

(1) Heavy-duty pickup trucks and vans.

(2) Vocational light-heavy vehicles at or below 19,500 pounds GVWR.

(3) Vocational and tractor medium-heavy vehicles above 19,500 pounds GVWR but at or below 33,000 pounds GVWR.

(4) Vocational and tractor heavy-duty vehicles above 33,000 pounds GVWR.

(5) Compression-ignition light heavy-duty engines for Class 2b to 5 vehicles with a GVWR above 8,500 pounds but at or below 19,500 pounds.

(6) Compression-ignition medium heavy-duty engines for Class 6 and 7 vehicles with a GVWR above 19,500 but at or below 33,000 pounds.

(7) Compression-ignition heavy heavy-duty engines for Class 8 vehicles with a GVWR above 33,000 pounds.

(8) Spark-ignition engines in Class 2b to 8 vehicles with a GVWR above 8,500 pounds.

*Cab-complete vehicle* has the meaning given in 49 CFR part 523.

*Carryover* means relating to certification based on emission data generated from an earlier model year.

*Certificate holder* means the manufacturer who holds the certificate of conformity for the vehicle or engine and that assigns the model year based on the date when its manufacturing operations are completed relative to its annual model year period.

*Certificate of Conformity* means an approval document granted by the EPA to a manufacturer that submits an application for a vehicle or engine emissions family in 40 CFR 1036.205 and 1037.205. A certificate of conformity is valid from the indicated effective date until December 31 of the model year for which it is issued. The certificate must be renewed annually for any vehicle a manufacturer continues to produce.

*Certification* means process of obtaining a certificate of conformity for a vehicle family that complies with the emission standards and requirements in this part.

*Certified emission level* means the highest deteriorated emission level in an engine family for a given pollutant from the applicable transient and/or steady-state testing rounded to the same number of decimal places as the applicable standard. Note that you may have two certified emission levels for CO<sub>2</sub> if you certify a family for both vocational and tractor use.

*Chassis-cab* means the incomplete part of a vehicle that includes a frame, a completed occupant compartment and that requires only the addition of cargo-carrying, work-performing, or load-bearing components to perform its intended functions.

*Chief Counsel* means the NHTSA Chief Counsel, or his or her designee.

*Complete sister vehicle* is a complete vehicle of the same configuration as a cab-complete vehicle.

*Complete vehicle* has the meaning given in 49 CFR part 523.

*Compression-ignition* means relating to a type of reciprocating, internal-combustion engine, such as a diesel engine, that is not a spark-ignition engine.

*Configuration* means a subclassification within a test group which is based on engine code, transmission type and gear ratios, final drive ratio, and other parameters which the EPA designates.

*Credits (or fuel consumption credits)* in this part means an earned allowance recognizing the fuel consumption of a particular manufacturer's vehicles or engines within a particular averaging set exceeds (credit surplus or positive credits) or falls below (credit shortfall, deficit or negative credits) that manufacturer's fuel consumption standard(s) for the regulatory subcategory(s) that make-up the averaging set for a given model year, or purchased allowance. The value of an earned credit is calculated according to § 535.7.

*Curb weight* has the meaning given in 40 CFR 86.1803.

*Date of manufacture* means the date on which the certifying vehicle manufacturer completes its manufacturing operations, except as follows:

(1) Where the certificate holder is an engine manufacturer that does not manufacture the chassis, the date of manufacture of the vehicle is based on the date assembly of the vehicle is completed.

(2) EPA and NHTSA may approve an alternate date of manufacture based on the date on which the certifying (or primary) vehicle manufacturer completes assembly at the place of main assembly, consistent with the provisions of 40 CFR 1037.601 and 49 CFR 567.4.

*Day cab* means a type of truck tractor cab that is not a "sleeper cab", as defined in this section.

*Dedicated vehicle* has the same meaning as dedicated automobile as defined in 49 U.S.C. 32901(a)(8). A dedicated automobile means an automobile that operates only on alternative fuels like E85 or natural gas, etc.

*Dual fueled (multi-fuel or flexible-fuel vehicle)* has the same meaning as dual fueled automobile as defined in 49 U.S.C. 32901(a)(9). For example, a vehicle that operates on gasoline and E85 or a plug-in hybrid electric vehicle is considered a dual fueled vehicle.

*Electric vehicle* means a vehicle that does not include an engine, and is powered solely by an external source of electricity and/or solar power. Note that

this does not include electric hybrid or fuel-cell vehicles that use a chemical fuel such as gasoline, diesel fuel, or hydrogen. Electric vehicles may also be referred to as all-electric vehicles to distinguish them from hybrid vehicles.

*Engine family* has the meaning given in 40 CFR 1036.230.

*Family certification level (FCL)* means the family certification limit for an engine family as defined in 40 CFR 1036.801.

*Family emission limit (FEL)* means the family emission limit for a vehicle family as defined in 40 CFR 1037.801.

*Final-stage manufacturer* has the meaning given in 49 CFR 567.3.

*Fleet* in this part means all the heavy-duty vehicles or engines within each of the regulatory sub-categories that are manufactured by a manufacturer in a particular model year and that are subject to fuel consumption standards under § 535.5.

*Fleet average fuel consumption* is the calculated average fuel consumption performance value for a manufacturer's fleet derived from the production weighted fuel consumption values of the unique vehicle configurations within each vehicle model type that makes up that manufacturer's vehicle fleet in a given model year. In this part, the fleet average fuel consumption value is determined for each manufacturer's fleet of heavy-duty pickup trucks and vans.

*Fleet average fuel consumption standard* is the actual average fuel consumption standard for a manufacturer's fleet derived from the production weighted fuel consumption standards of each unique vehicle configuration, based on payload, tow capacity and drive configuration (2, 4 or all-wheel drive), of the model types that makes up that manufacturer's vehicle fleet in a given model year. In this part, the fleet average fuel consumption standard is determined for each manufacturer's fleet of heavy-duty pickup trucks and vans.

*Fuel cell* means an electrochemical cell that produces electricity via the non-combustion reaction of a consumable fuel, typically hydrogen.

*Fuel cell electric vehicle* means a motor vehicle propelled solely by an electric motor where energy for the motor is supplied by a fuel cell.

*Fuel efficiency* means the amount of work performed for each gallon of fuel consumed.

*Good engineering judgment* has the meaning given in 40 CFR 1068.30. See 40 CFR 1068.5 for the administrative process used to evaluate good engineering judgment.

*Gross combination weight rating (GCWR)* has the meaning given in 49 CFR part 523.

*Gross vehicle weight rating (GVWR)* has the meaning given in 49 CFR part 523.

*Heavy-duty vehicle* has the meaning given in 49 CFR part 523.

*Hybrid engine or hybrid powertrain* means an engine or powertrain that includes energy storage features other than a conventional battery system or conventional flywheel. Supplemental electrical batteries and hydraulic accumulators are examples of hybrid energy storage systems. Note that certain provisions in this part treat hybrid engines and powertrains intended for vehicles that include regenerative braking different than those intended for vehicles that do not include regenerative braking.

*Hybrid vehicle* means a vehicle that includes energy storage features (other than a conventional battery system or conventional flywheel) in addition to an internal combustion engine or other engine using consumable chemical fuel. Supplemental electrical batteries and hydraulic accumulators are examples of hybrid energy storage systems. Note that certain provisions in this part treat hybrid vehicles that include regenerative braking different than those that do not include regenerative braking.

*Incomplete vehicle* has the meaning given in 49 CFR part 523. For the purpose of this regulation, a manufacturer may request EPA and NHTSA to allow the certification of a vehicle as an incomplete vehicle if it manufactures the engine and sells the unassembled chassis components, provided it does not produce and sell the body components necessary to complete the vehicle.

*Innovative technology* means technology certified under 40 CFR 1037.610.

*Liquefied petroleum gas (LPG)* has the meaning given in 40 CFR 1036.801.

*Low rolling resistance tire* means a tire on a vocational vehicle with a tire rolling resistance level (TRRL) of 7.7 kg/metric ton or lower, a steer tire on a tractor with a TRRL of 7.7 kg/metric ton or lower, or a drive tire on a tractor with a TRRL of 8.1 kg/metric ton or lower.

*Model type* has the meaning given in 40 CFR 600.002.

*Model year* as it applies to engines means the manufacturer's annual new model production period, except as restricted under this definition. It must include January 1 of the calendar year for which the model year is named, may not begin before January 2 of the previous calendar year, and it must end by December 31 of the named calendar

year. Manufacturers may not adjust model years to circumvent or delay compliance with standards.

*Model year* as it applies to vehicles means the manufacturer's annual new model production period, except as restricted under this definition and 40 CFR part 85, subpart X. It must include January 1 of the calendar year for which the model year is named, may not begin before January 2 of the previous calendar year, and it must end by December 31 of the named calendar year.

(1) The manufacturer who holds the certificate of conformity for the vehicle must assign the model year based on the date when its manufacturing operations are completed relative to its annual model year period.

(2) Unless a vehicle is being shipped to a secondary manufacturer that will hold the certificate of conformity, the model year must be assigned prior to introduction of the vehicle into U.S. commerce. The certifying manufacturer must redesignate the model year if it does not complete its manufacturing operations within the originally identified model year. A vehicle introduced into U.S. commerce without a model year is deemed to have a model year equal to the calendar year of its introduction into U.S. commerce unless the certifying manufacturer assigns a later date.

*Natural gas* has the meaning given in 40 CFR 1036.801. Vehicles that use a pilot-ignited natural gas engine (which uses a small diesel fuel ignition system), are still considered natural gas vehicles.

*NHTSA Enforcement* means the NHTSA Associate Administrator for Enforcement, or his or her designee.

*Party* means the person alleged to have committed a violation of § 535.9, and includes manufacturers of vehicles and manufacturers of engines.

*Payload* means in this part the resultant of subtracting the curb weight from the gross vehicle weight rating.

*Petroleum* has the meaning given in 40 CFR 1036.801.

*Pickup truck* has the meaning given in 49 CFR part 523.

*Plug-in hybrid electric vehicle (PHEV)* means a hybrid electric vehicle that has the capability to charge the battery or batteries used for vehicle propulsion from an off-vehicle electric source, such that the off-vehicle source cannot be connected to the vehicle while the vehicle is in motion.

*Power take-off (PTO)* means a secondary engine shaft or other system on a vehicle that provides substantial auxiliary power for purposes unrelated to vehicle propulsion or normal vehicle accessories such as air conditioning,

power steering, and basic electrical accessories. A typical PTO uses a secondary shaft on the engine to transmit power to a hydraulic pump that powers auxiliary equipment such as a boom on a bucket truck.

*Primary intended service class* has the meaning for engines as specified in 40 CFR 1036.140.

*Rechargeable Energy Storage System (RESS)* means the component(s) of a hybrid engine or vehicle that store recovered energy for later use, such as the battery system in a electric hybrid vehicle.

*Regulatory category* means each of the three types of heavy-duty vehicles defined in 49 CFR 523.6 and the heavy-duty engines used in these heavy-duty vehicles.

*Regulatory subcategory* means the sub-groups in each regulatory category to which fuel consumption requirements apply, and are defined as follows:

- (1) Heavy-duty pick-up trucks and vans.
- (2) Vocational light-heavy vehicles at or below 19,500 pounds GVWR.
- (3) Vocational medium-heavy vehicles above 19,500 pounds GVWR but at or below 33,000 pounds GVWR.
- (4) Vocational heavy-heavy vehicles above 33,000 pounds GVWR.
- (5) Low roof day cab tractors with a GVWR above 26,000 pounds but at or below 33,000 pounds.
- (6) Mid roof day cab tractors with a GVWR above 26,000 pounds but at or below 33,000 pounds.
- (7) High roof day cab tractors with a GVWR above 26,000 pounds but at or below 33,000 pounds.
- (8) Low roof day cab tractors above 33,000 pounds GVWR.
- (9) Mid roof day cab tractors above 33,000 pounds GVWR.
- (10) High roof day cab tractors above 33,000 pounds GVWR.
- (11) Low roof sleeper cab tractors above 33,000 pounds GVWR.
- (12) Mid roof sleeper cab tractors above 33,000 pounds GVWR.
- (13) High roof sleeper cab tractors above 33,000 pounds GVWR.
- (14) Compression-ignition light heavy-duty engines in Class 2b to 5 vehicles with a GVWR above 8,500 pounds but at or below 19,500 pounds.
- (15) Compression-ignition medium heavy-duty engines in Class 6 and 7 vocational vehicles with a GVWR above 19,500 but at or below 33,000 pounds.
- (16) Compression-ignition heavy heavy-duty engines in Class 8 vocational vehicles with a GVWR above 33,000 pounds.
- (17) Compression-ignition medium heavy-duty engines in Class 7 tractors

with a GVWR above 26,000 pounds but at or below 33,000 pounds.

(18) Compression-ignition heavy heavy-duty engines in Class 8 tractors with a GVWR above 33,000 pounds.

(19) Spark-ignition engines in Class 2b to 8 vehicles with a GVWR above 8,500 pounds.

*Roof height* means the maximum height of a vehicle (rounded to the nearest inch), excluding narrow accessories such as exhaust pipes and antennas, but including any wide accessories such as roof fairings. Measure roof height of the vehicle configured to have its maximum height that will occur during actual use, with properly inflated tires and no driver, passengers, or cargo onboard. Determine the base roof height on fully inflated tires having a static loaded radius equal to the arithmetic mean of the largest and smallest static loaded radius of tires a manufacturer offers or a standard tire EPA approves. If a vehicle is equipped with an adjustable roof fairing, measure the roof height with the fairing in its lowest setting. Once the maximum height is determined, roof heights are divided into the following categories:

(1) Low-roof means a vehicle with a roof height of 120 inches or less.

(2) Mid-roof means a vehicle with a roof height between 121 and 147 inches.

(3) High-roof means a vehicle with a roof height of 148 inches or more.

*Service class group* means a group of engine and vehicle averaging sets defined as follows:

(1) Spark-ignition engines, light heavy-duty compression-ignition engines, light heavy-duty vocational vehicles and heavy-duty pickup trucks and vans.

(2) Medium heavy-duty compression-ignition engines and medium heavy-duty vocational vehicles and tractors.

(3) Heavy heavy-duty compression-ignition engines and heavy heavy-duty vocational vehicles and tractors.

*Sleeper cab* means a type of truck cab that has a compartment behind the driver's seat intended to be used by the driver for sleeping. This includes both cabs accessible from the driver's compartment and those accessible from outside the vehicle.

*Spark-ignition engines* means relating to a gasoline-fueled engine or any other type of engine with a spark plug (or other sparking device) and with operating characteristics significantly similar to the theoretical Otto combustion cycle. Spark-ignition engines usually use a throttle to regulate intake air flow to control power during normal operation.

*Subconfiguration* means a unique combination within a vehicle

configuration of equivalent test weight, road-load horsepower, and any other operational characteristics or parameters that EPA determines may significantly affect CO<sub>2</sub> emissions within a vehicle configuration.

*Test group* means the multiple vehicle lines and model types that share critical emissions and fuel consumption related features and that are certified as a group by a common certificate of conformity issued by EPA and is used collectively with other test groups within an averaging set or regulatory subcategory and is used by NHTSA for determining the fleet average fuel consumption.

*Tire rolling resistance level (TRRL)* means a value with units of kg/metric ton that represents that rolling resistance of a tire configuration. TRRLs are used as inputs to the GEM model under 40 CFR 1037.520. Note that a manufacturer may assign a value higher than a measured rolling resistance of a tire configuration.

*Towing capacity* in this part is equal to the resultant of subtracting the gross vehicle weight rating from the gross combined weight rating.

*Trade* means to exchange fuel consumption credits, either as a buyer or a seller.

*Truck tractor* has the meaning given in 49 CFR 571.3. This includes most heavy-duty vehicles specifically designed for the primary purpose of pulling trailers, but does not include vehicles designed to carry other loads. For purposes of this definition "other loads" would not include loads carried in the cab, sleeper compartment, or toolboxes. Examples of vehicles that are similar to tractors but that are not tractors under this part include dromedary tractors, automobile haulers, straight trucks with trailers hitches, and tow trucks.

*U.S.-directed production volume* means the number of vehicle units, subject to the requirements of this part, produced by a manufacturer for which the manufacturer has a reasonable assurance that sale was or will be made to ultimate purchasers in the United States.

*Useful life* has the meaning given in 40 CFR 1037.801.

*Vehicle configuration* means a unique combination of vehicle hardware and calibration (related to measured or modeled emissions) within a vehicle family. Vehicles with hardware or software differences, but that have no hardware or software differences related to measured or modeled emissions or fuel consumption can be included in the same vehicle configuration. Note that vehicles with hardware or software differences related to measured or

modeled emissions or fuel consumption are considered to be different configurations even if they have the same GEM inputs and FEL. Vehicles within a vehicle configuration differ only with respect to normal production variability or factors unrelated to measured or modeled emissions and fuel consumption for EPA and NHTSA.

*Vehicle family* has the meaning given in 40 CFR 1037.230.

*Vehicle service class* has the meaning for vehicles as specified in the 40 CFR 1037.801.

*Vocational tractor* has the meaning given in 40 CFR 1037.630.

*Zero emissions vehicle* means an electric vehicle or a fuel cell vehicle.

### § 535.5 Standards.

(a) *Heavy-duty pickup trucks and vans.* Each manufacturer of a fleet of heavy-duty pickup trucks and vans shall comply with the fuel consumption standards in this paragraph (a) expressed in gallons per 100 miles. If the manufacturer's fleet includes conventional vehicles (gasoline, diesel and alternative fueled vehicles) and advanced technology vehicles (hybrids with regenerative braking, vehicles equipped with Rankine-cycle engines, electric and fuel cell vehicles), it should divide its fleet into two separate fleets each with its own separate fleet average fuel consumption standard which a manufacturer must comply with the requirements of this paragraph (a).

(1) *Mandatory standards.* For model years 2016 and later, each manufacturer must comply with the fleet average standard derived from the unique subconfiguration target standards (or groups of subconfigurations approved by EPA in accordance with 40 CFR 1037.104) of the model types that make up the manufacturer's fleet in a given model year. Each subconfiguration has a unique attribute-based target standard, defined by each group of vehicles having the same payload, towing capacity and whether the vehicles are equipped with a 2-wheel or 4-wheel drive configuration.

(2) *Subconfiguration target standards.*

(i) Two alternatives exist for determining the subconfiguration target standards for model years 2016 and later. For each alternative, separate standards exist for compression-ignition and spark-ignition vehicles:

(A) The first alternative allows manufacturers to determine a fixed fuel consumption standard that is constant over the model years; and

(B) The second alternative allows manufacturers to determine standards that are phased-in gradually each year.

(ii) Calculate the subconfiguration target standards as specified in this paragraph (a)(2)(ii), using the appropriate coefficients from Table 1 choosing between the alternatives in paragraphs (a)(2)(i)(A) and (B) of this section. For electric or fuel cell heavy-duty vehicles, use compression-ignition vehicle coefficients “c” and “d” and for hybrid (including plug-in hybrid), dedicated and dual-fueled vehicles, use coefficients “c” and “d” appropriate for the engine type used. Round each standard to the nearest 0.01 gallons per 100 miles and specify all weights in pounds rounded to the nearest pound. Calculate the subconfiguration target standards using the following equation:  
 Subconfiguration Target Standard (gallons per 100 miles) =  $[c \times (WF)] + d$

Where:

- WF = Work Factor =  $[0.75 \times (\text{Payload Capacity} + \text{Xwd})] + [0.25 \times \text{Towing Capacity}]$
- Xwd = 4wd Adjustment = 500 lbs if the vehicle group is equipped with 4wd and all-wheel drive, otherwise equals 0 lbs for 2wd.
- Payload Capacity = GVWR (lbs) – Curb Weight (lbs) (for each vehicle group)

Towing Capacity = GCWR (lbs) – GVWR (lbs)  
 (for each vehicle group)

TABLE 1—EQUATION COEFFICIENTS FOR SUBCONFIGURATION TARGET STANDARDS

Model year	c	d
<b>Alternative 1—Fixed Target Standards</b>		
Compression-ignition Vehicle Coefficients for Model Years 2016 and later		
2016–2018 .....	0.000432	3.33
2019 and later ..	0.000409	3.14
Spark-ignition Vehicle Coefficients for Model Years 2016 and later		
2016–2018 .....	0.000513	3.96
2019 and later ..	0.000495	3.81
<b>Alternative 2—Phased-in Target Standards</b>		
Compression-ignition Vehicle Coefficients for Model Years 2016 and later		
2016 .....	0.000452	3.48
2017 .....	0.000437	3.37
2018 and later ..	0.000409	3.14

TABLE 1—EQUATION COEFFICIENTS FOR SUBCONFIGURATION TARGET STANDARDS—Continued

Model year	c	d
-Spark-ignition Vehicle Coefficients for Model Years 2016 and later		
2016 .....	0.000528	4.07
2017 .....	0.000518	3.98
2018 and later ..	0.000495	3.81

(3) *Fleet average fuel consumption standard.* (i) Calculate each manufacturer’s fleet average fuel consumption standard for conventional and advanced technology fleets separately based on the subconfiguration target standards specified in paragraph (a)(2) of this section, weighted to production volumes and averaged using the following equation combining all the applicable vehicles in a manufacturer’s U.S. directed fleet (compression-ignition, spark-ignition and advanced technology vehicles) for a given model year, rounded to the nearest 0.01 gallons per 100 miles:

$$\text{Fleet Average Standard} = \frac{\sum [\text{Subconfiguration Target Standard}_i \times \text{Volume}_i]}{\sum [\text{Volume}_i]}$$

Where:

Subconfiguration Target Standard<sub>i</sub> = fuel consumption standard for each group of vehicles with same payload, towing capacity and drive configuration (gallons per 100 miles).

Volume<sub>i</sub> = production volume of each unique subconfiguration of a model type based upon payload, towing capacity and drive configuration.

(A) A manufacturer may group together subconfigurations that have the same test weight (ETW), GVWR, and GCWR. Calculate work factor and target value assuming a curb weight equal to two times ETW minus GVWR.

(B) A manufacturer may group together other subconfigurations if it uses the lowest target value calculated for any of the subconfigurations.

(C) The fleet average shall also be derived in accordance with 40 CFR 86.1865 and 40 CFR 1037.104(d).

(ii) A manufacturer complies with the requirements of this part if it provides reports, as specified in § 535.8, by the required deadlines and meets one of the following conditions:

(A) The manufacturer’s fleet average performance, as determined in § 535.6, is less than the fleet average standard; or

(B) The manufacturer uses one or more of the credit flexibilities provided under NHTSA’s Averaging, Banking and Trading Program, as specified in § 535.7, to comply with standards.

(iii) Manufacturers must select an alternative for subconfiguration target standards at the same time they submit the model year 2016 Pre-Model year Report, specified in § 535.8. Once selected, the decision cannot be reversed and the manufacturer must continue to comply with the same alternative for subsequent model years.

(iv) A manufacturer failing to comply with the provisions specified in paragraph (a)(3)(ii) of this section is liable to pay civil penalties in accordance with § 535.9.

(4) *Voluntary standards.* (i) Manufacturers may choose voluntarily to comply early with fuel consumption standards for model years 2013 through 2015, as determined in paragraphs (a)(4)(iii) and (iv) of this section, for example, in order to begin accumulating credits through over-compliance with the applicable standard. A manufacturer choosing early compliance must comply with all the vehicles and engines it

manufactures in each regulatory category for a given model year.

(ii) A manufacturer must declare its intent to voluntarily comply with fuel consumption standards at the same time it submits a Pre-Model Report, prior to the compliance model year beginning as specified in § 535.8; and, once selected, the decision cannot be reversed and the manufacturer must continue to comply for each subsequent model year for all the vehicles and engines it manufactures in each regulatory category for a given model year.

(iii) Calculate separate subconfiguration target standards for compression-ignition and spark-ignition vehicles for model years 2013 through 2015 using the equation in paragraph (a)(2)(ii) of this section, substituting the appropriate values for the coefficients in Table 2 of this section as appropriate.

TABLE 2—VOLUNTARY COMPLIANCE EQUATION COEFFICIENTS FOR VEHICLE FUEL CONSUMPTION STANDARDS

Model Year	c	d
Compression-ignition Vehicle Coefficients for Voluntary Compliance in Model Years 2013 through 2015		
2013 and 14 .....	0.000470	3.61
2015 .....	0.000466	3.60
Spark-ignition Vehicle Coefficients for Voluntary Compliance in Model Years 2013 through 2015		
2013 and 14 .....	0.000542	4.17
2015 .....	0.000539	4.15

(iv) Calculate the fleet average fuel consumption standards for model years 2013 through 2015 using the equation in paragraph (a)(3) of this section.

(5) *Exclusion of vehicles not certified as complete vehicles.* The vehicle standards § 535.5(a) do not apply for vehicles that are chassis-certified with respect to EPA's criteria pollutant test procedure in 40 CFR part 86, subpart S. Any chassis-certified vehicles must comply with the vehicle standards and requirements of § 535.5(b) and the engine standards of § 535.5(d) for engines used in these vehicles. A vehicle manufacturer choosing to comply with this paragraph and that is not the engine manufacturer is required to notify the engine manufacturers that their engines are subject to § 535.5(d) and that it intends to use their engines in excluded vehicles.

(6) *Optional certification under this section.* Manufacturers may certify any complete or cab-complete Class 2b through 5 vehicles weighing at or below 19,500 pounds GVWR and any incomplete vehicles approved by EPA for inclusion under this paragraph to the same testing and standard that applies to a comparable complete sister vehicles as determined in accordance in 40 CFR 1037.150(l). Calculate the target standard value under paragraph (a)(2) of this section based on the same work factor value that applies for the complete sister vehicle.

(7) *Loose engines.* This paragraph applies for spark-ignition engines identical to engines used in vehicles certified to the standards of this section

§ 535.5(a), where manufacturers sell such engines as loose engines or installed in incomplete vehicles that are not cab-complete vehicles in accordance with 40 CFR 1037.150(m). A manufacturer's engines are deemed to have fuel consumption target values and test results based upon the complete vehicle in the applicable test group with the highest equivalent test weight in accordance with 40 CFR 1037.150(m). The fuel consumption subconfiguration standard for a loose engines equals the test group result of the complete vehicle as specified in 40 CFR 1037.150(m)(6) multiplied by 1.10 and rounded to the nearest 0.01 gallon per 100 miles. The U.S.-directed production volume of engines manufactured for sale as loose engines or installed in incomplete heavy-duty vehicles that are not cab-complete vehicles in any given model year may not exceed ten percent of the total U.S.-directed production volume of engines of that design that the manufacturer produces for heavy-duty applications for that model year, including engines the manufacturer produces for complete vehicles, cab-complete vehicles, and other incomplete vehicles. The total number of engines a manufacturer may certify under this paragraph (a)(7), of all engine designs, may not exceed 15,000 in any model year as specified in 40 CFR 1037.150(m). Engines produced in excess of the number cannot be certified to the standard in this paragraph (a)(7).

(b) *Heavy-duty vocational vehicles.* Each chassis manufacturer of heavy-duty vocational vehicles shall comply with the fuel consumption standards in this paragraph (b) expressed in gallons per 1,000 ton-miles. Manufacturers of engines used in heavy-duty vocational vehicles shall comply with the standards in paragraph (d) of this section.

(1) *Mandatory standards.* For model years 2016 and later, each chassis manufacturer of heavy-duty vocational vehicles must comply with the fuel consumption standards in paragraph (b)(3) of this section.

(i) The heavy-duty vocational vehicle chassis category is subdivided by GVWR into three regulatory subcategories as defined in § 535.4, each with its own assigned standard.

(ii) For purposes of certifying vehicles to fuel consumption standards,

manufacturers must divide their product lines into vehicle families that have similar emissions and fuel consumption features, as specified by EPA in 40 CFR part 1037, subpart C, and these families will be subject to the applicable standards. Each vehicle family is limited to a single model year.

(iii) A manufacturer complies with the requirements of this part, if it provides information as specified in § 535.8, by the required deadlines and meets one of the following conditions:

(A) The manufacturer's fuel consumption performance for each vehicle family, as determined in § 535.6, is lower than the applicable standard; or

(B) The manufacturer uses one or more of the credit flexibilities provided under NHTSA's Averaging, Banking and Trading Program, specified in § 535.7, to comply with standards.

(iv) A manufacturer failing to comply with the provisions specified in paragraph (b)(1)(iii) of this section is liable to pay civil penalties in accordance with § 535.9.

(2) *Voluntary compliance.* (i) For model years 2013 through 2015, a manufacturer may choose voluntarily to comply early with the fuel consumption standards provided in paragraph (b)(3) of this section. For example, a manufacturer may choose to comply early in order to begin accumulating credits through over-compliance with the applicable standards. A manufacturer choosing early compliance must comply with all the vehicles and engines it manufacturers in each regulatory category for a given model year.

(ii) A manufacturer must declare its intent to voluntarily comply with fuel consumption standards and identify its plans to comply before it submits its first application for a certificate of conformity for the respective model year as specified in § 535.8; and, once selected, the decision cannot be reversed and the manufacturer must continue to comply for each subsequent model year for all the vehicles and engines it manufacturers in each regulatory category for a given model year.

(3) *Regulatory subcategory standards.* The fuel consumption standards for heavy-duty vocational vehicles are given in the following table:

TABLE 3—HEAVY-DUTY VOCATIONAL VEHICLE FUEL CONSUMPTION STANDARDS

Regulatory subcategories	Light Heavy vehicles Class 2b–5	Medium heavy vehicles Class 6–7	Heavy heavy vehicles Class 8
Fuel Consumption Mandatory Standards (gallons per 1,000 ton-miles) Effective for Model Years 2017 and later			
Fuel Consumption Standard .....	36.7	22.1	21.8
Effective for Model Years 2016			
Fuel Consumption Standard .....	38.1	23.0	22.2
Fuel Consumption Voluntary Standards (gallons per 1,000 ton-miles) Effective for Model Years 2013 to 2015			
Fuel Consumption Standard .....	38.1	23.0	22.2

(4) *Certifying across service classes.* A manufacturer may optionally certify a vocational vehicle to the standards and useful life applicable to a higher vehicle service class (or regulatory subcategory changes such as complying with the heavy heavy-duty standard instead of medium heavy-duty standard), provided the manufacturer does not generate credits with the vehicle. If a manufacturer includes smaller vehicles in a credit-generating subfamily (with an FEL below the standard), exclude their production volume from the credit calculation.

(5) *Off-road operation.* Heavy-duty vocational vehicles including vocational tractors meeting the off-road criteria in 49 CFR 523.2 are exempted from the requirements in this paragraph (b), but the engines in these vehicles must meet the requirements of paragraph (d) of this section.

(c) *Truck tractors.* Each manufacturer of truck tractors, except vocational tractors, with a GVWR above 26,000 pounds shall comply with the fuel consumption standards in this paragraph (c) expressed in gallons per 1,000 ton-miles.

(1) *Mandatory standards.* For model years 2016 and later, each manufacturer of truck tractors must comply with the fuel consumption standards in paragraph (c)(3) of this section.

(i) The truck tractor category is subdivided by roof height and cab design into nine regulatory subcategories as shown in Table 4 of this section, each with its own assigned standard.

(ii) For purposes of certifying vehicles to fuel consumption standards, manufacturers must divide their product lines into vehicles families that have similar emissions and fuel consumption features, as specified by EPA in 40 CFR part 1037, subpart C, and these families will be subject to the applicable standards. Each vehicle family is limited to a single model year.

(iii) Standards for truck tractor engines are given in paragraph (d) of this section.

(iv) A manufacturer complies with the requirements of this part, if at the end of the model year, it provides reports, as specified in § 535.8, by the required deadlines and meets one of the following conditions:

(A) The manufacturer's fuel consumption performance for each vehicle family, as determined in § 535.6, is lower than the applicable standard; or

(B) The manufacturer uses one or more of the credit flexibilities provided under NHTSA's Averaging, Banking and Trading Program, specified in § 535.7, to comply with standards.

(v) A manufacturer failing to comply with the provisions specified in

paragraph (c)(1)(iv) of this section is liable to pay civil penalties in accordance with § 535.9.

(2) *Voluntary compliance.* (i) For model years 2013 through 2015, a manufacturer may choose voluntarily to comply early with the fuel consumption standards provided in paragraph (c)(3) of this section. For example, a manufacturer may choose to comply early in order to begin accumulating credits through over-compliance with the applicable standards. A manufacturer choosing early compliance must comply with all the vehicles and engines it manufactures in each regulatory category for a given model year.

(ii) A manufacturer must declare its intent to voluntarily comply with fuel consumption standards and identify its plans to comply before it submits its first application for a certificate of conformity for the respective model year as specified in § 535.8; and, once selected, the decision cannot be reversed and the manufacturer must continue to comply for each subsequent model year for all the vehicles and engines it manufactures in each regulatory category for a given model year.

(3) *Regulatory subcategory standards.* The fuel consumption standards for truck tractors, except for vocational tractors, are given in the following table:

TABLE 4—TRUCK TRACTOR FUEL CONSUMPTION STANDARDS

Regulatory subcategories	Day cab		Sleeper cab
	Class 7	Class 8	Class 8
Fuel Consumption Mandatory Standards (gallons per 1,000 ton-miles) Effective for Model Years 2017 and later			
Low Roof .....	10.2	7.8	6.5
Mid Roof .....	11.3	8.4	7.2
High Roof .....	11.8	8.7	7.1
Effective for Model Years 2016			
Low Roof .....	10.5	8.0	6.7
Mid Roof .....	11.7	8.7	7.4

TABLE 4—TRUCK TRACTOR FUEL CONSUMPTION STANDARDS—Continued

Regulatory subcategories	Day cab		Sleeper cab
	Class 7	Class 8	Class 8
High Roof .....	12.2	9.0	7.3
Fuel Consumption Voluntary Standards (gallons per 1,000 ton-miles) Effective for Model Years 2013 to 2015			
Low Roof .....	10.5	8.0	6.7
Mid Roof .....	11.7	8.7	7.4
High Roof .....	12.2	9.0	7.3

(4) *Certifying across service classes.* A manufacturer may optionally certify a tractor to the standards and useful life applicable to a higher vehicle service class (or regulatory subcategory changes such as complying with the Class 8 day-cab tractor standard instead of Class 7 day-cab tractor), provided the manufacturer does not generate credits with the vehicle. If a manufacturer includes smaller vehicles in a credit-generating subfamily (with an FEL below the standard), exclude their production volume from the credit calculation.

(5) *Vocational tractors.* Tractors meeting the definition of vocational tractors in 49 CFR 523.2 must comply with requirements for heavy-duty vocational vehicles specified in paragraphs (b) and (d) of this section. Class 7 and Class 8 tractors certified or exempted as vocational tractors are limited in production to no more than 21,000 vehicles in any three consecutive model years. If a manufacturer is determined as not applying this allowance in good faith by the EPA in its applications for certification in accordance with 40 CFR 1037.205 and 1037.610, a manufacturer must comply with the tractor fuel consumption standards in paragraph (c)(3) of this section.

(d) *Heavy-duty engines.* Each manufacturer of heavy-duty engines shall comply with the fuel consumption standards in this paragraph (d) expressed in gallons per 100 brake-horsepower-hours. Each engine must be certified to the primary intended service class that it is designed for in accordance with 40 CFR 1036.108;

(1) *Mandatory standards.* Each manufacturer must comply with the fuel consumption standard in paragraph (d)(3) of this section for model years 2017 and later compression-ignition engines and for model years 2016 and later spark-ignition engines.

(i) The heavy-duty engine regulatory category is divided into six regulatory subcategories, five compression-ignition subcategories and one spark-ignition subcategory, as shown in Table 5 of this section.

(ii) Separate standards exist for engines manufactured for use in heavy-duty vocational vehicles and in truck tractors.

(iii) For purposes of certifying engines to fuel consumption standards, manufacturers must divide their product lines into engine families that have similar fuel consumption features, as specified by EPA in 40 CFR part 1036, subpart C, and these families will be subject to the same standards. Each engine family is limited to a single model year.

(iv) A manufacturer complies with the requirements of this part, if at the end of the model year, it provides reports, as specified in § 535.8, by the required deadlines and meets one of the following conditions:

(A) The manufacturer's fuel consumption performance of each engine family as determined in § 535.6 is less than the applicable standard; or

(B) The manufacturer uses one or more of the flexibilities provided under NHTSA's Averaging, Banking and Trading Program, specified in § 535.7, to comply with standards.

(v) A manufacturer failing to comply with the provisions specified in

paragraph (d)(1)(iv) of this section is liable to pay civil penalties in accordance with § 535.9.

(2) *Voluntary compliance.* (i) For model years 2013 through 2016 for compression-ignition engines, and for model year 2015 for spark-ignition engines, a manufacturer may choose voluntarily to comply with the fuel consumption standards provided in paragraph (d)(3) through (5) of this section. For example, a manufacturer may choose to comply early in order to begin accumulating credits through over-compliance with the applicable standards. A manufacturer choosing early compliance must comply with all the vehicles and engines it manufacturers in each regulatory category for a given model year except in model year 2013 the manufacturer may comply with individual engine families as specified in 40 CFR 1036.150(a)(2).

(ii) A manufacturer must declare its intent to voluntarily comply with fuel consumption standards and identify its plans to comply before it submits its first application for a certificate of conformity for the respective model year as specified in § 535.8; and, once selected, the decision cannot be reversed and the manufacturer must continue to comply for each subsequent model year for all the vehicles and engines it manufacturers in each regulatory category for a given model year.

(3) *Regulatory subcategory standards.* The fuel consumption standards for heavy-duty engines are given in the following:

TABLE 5—PRIMARY HEAVY-DUTY ENGINE STANDARDS

Fuel Consumption Mandatory Standards (gallons per 100 bhp-hr)						
Regulatory Subcategory	Light Heavy-Duty Compression-Ignition Engine	Medium Heavy-Duty Compression-Ignition Engine		Heavy Heavy-Duty Compression-Ignition Engine		Spark-Ignition Engines
Truck Application .....	Vocational	Vocational	Tractor	Vocational	Tractor	All
Effective Model Years	2017 and later					2016 and later



TABLE 5—PRIMARY HEAVY-DUTY ENGINE STANDARDS—Continued

Fuel Consumption Standard.	5.66	5.66	4.78	5.45	4.52	7.06
Fuel Consumption Standards for Voluntary Compliance (gallons per100 bhp-hr)						
Regulatory Sub-category.	Light Heavy-Duty Compression-Ignition Engine	Medium Heavy-Duty Compression-Ignition Engine	Heavy Heavy-Duty Compression-Ignition Engine	Spark-ignition Engine		
Truck Application .....	Vocational	Vocational	Tractor	Vocational	Tractor	All
Effective Model Years	2013 through 2016					2015
Voluntary Fuel Consumption Standard.	5.89	5.89	4.93	5.57	4.67	7.06

(4) *Alternate subcategory standards.* The alternative fuel consumption standards for heavy-duty compression-ignition engines are as follows:

(i) Manufacturers entering the voluntary program in model years 2014 through 2016, may choose to certify compression-ignition engine families unable to meet standards provided in paragraph (d)(3) of this section to the alternative fuel consumption standards of this paragraph (d)(4).

(ii) Manufacturers may not certify engines to these alternate standards if they are part of an averaging set in which they carry a balance of banked credits. For purposes of this section,

manufacturers are deemed to carry credits in an averaging set if they carry credits from advance technology that are allowed to be used in that averaging set in accordance with § 535.7(d)(12).

(iii) The emission standards of this section are determined as specified in EPA 40 CFR 1036.620(a) through (c) and should be converted to equivalent fuel consumption values.

(5) *Alternate Phase-In Standards.* Manufacturers have the option to comply with EPA emissions standards for compression-ignition engines using an alternative phase-in schedule that correlates with the EPA OBD standards. If a manufacturer chooses to use the

alternative phase-in schedule for meeting EPA standards and optionally chooses to comply early with the NHTSA fuel consumption program, it must use the same phase-in schedule beginning in model year 2013 for fuel consumption standards and must remain in the program for each model year thereafter. The fuel consumption standard for each model year of the alternative phase-in schedule is provided in Table 6 of this section. Note that engines certified to these standards are not eligible for early credits under § 535.7.

TABLE 6—ALTERNATIVE PHASE-IN COMPRESSION IGNITION ENGINE STANDARDS

Tractors	LHD Engines	MHD Engines	HHD Engines
Model Years 2013–2015 .....	NA .....	5.03 gals/100 hp-hr .....	4.76 gals./100 hp-hr
Model Years 2016 and later† .....	NA .....	4.78 gals./100 hp-hr .....	4.52 gals/100 hp-hr
Vocational .....	LHD Engines .....	MHD Engines .....	HHD Engines
Model Years 2013–2015 .....	6.07 gals/100 hp-hr .....	6.07 gals/100 hp-hr .....	5.67 gals/100 hp-hr
Model Years 2016 and later† .....	5.66 gals/100 hp-hr .....	5.66 gals/100 hp-hr .....	5.45 gals/100 hp-hr

†Note: these alternate standards for 2016 and later are the same as the otherwise applicable standards for 2017 and later.

**§ 535.6 Measurement and calculation procedures.**

(a) *Heavy-duty pickup trucks and vans.* This section describes the testing a manufacturer must perform for each model year and the method for determining the fleet fuel consumption performance to show compliance with the fleet average fuel consumption standard for heavy-duty pickup trucks and vans in § 535.5(a).

(1) For each model year, the heavy-duty pickup trucks and vans selected by a manufacturer to comply with fuel consumption standards in § 535.5(a) must be used to determine the manufacturer's fleet average fuel consumption performance. If the manufacturer's fleet includes conventional and advanced technology heavy-duty pickup trucks and vans, the fleet should be sub-divided into two separate vehicle fleets, with all of the

conventional vehicles in one fleet and all of the advanced technology vehicles in the other fleet.

(2) Vehicles in each fleet should be divided into test groups or subconfigurations according to EPA in 40 CFR part 86, subpart S, and 40 CFR 1037.104.

(3) Test and measure the CO<sub>2</sub> emissions test results for the selected vehicles and determine the CO<sub>2</sub> emissions test group result, in grams per mile in accordance with 40 CFR part 86, subpart S.

(i) Perform exhaust testing on vehicles fueled by conventional and alternative fuels, including dedicated and dual fueled (multi-fueled and flexible fueled) vehicles and measure the CO<sub>2</sub> emissions test result.

(ii) Adjust the CO<sub>2</sub> emissions test result of dual fueled vehicles using a weighted average of your emission

results as specified in 40 CFR 600.510–12(k) for light-duty trucks.

(iii) All electric vehicles are deemed to have zero emissions of CO<sub>2</sub>, CH<sub>4</sub>, and N<sub>2</sub>O. No emission testing is required for such electric vehicles. Assign the fuel consumption test group result to a value of zero gallons per 100 miles in paragraph (a)(4) of this section.

(iv) Test cab-complete and incomplete vehicles using the applicable complete sister vehicles as determined in 40 CFR 1037.104(g).

(v) Test loose engines using applicable complete vehicles as determined in 40 CFR 1037.104(h).

(vi) Manufacturers can choose to analytically derive CO<sub>2</sub> emission rates (ADCs) for test groups or subconfigurations. Calculate the ADCs for test groups or subconfigurations in accordance with 40 CFR 1037.104(g).

(4) Calculate equivalent fuel consumption test group results, in gallons per 100 miles, from CO<sub>2</sub> emissions test group results, in grams per miles, and round to the nearest 0.01 gallon per 100 miles.

(i) Calculate the equivalent fuel consumption test group results as follows for compression-ignition vehicles and alternative fuel compression-ignition vehicles. CO<sub>2</sub>

emissions test group result (grams per mile)/10,180 grams per gallon of diesel fuel) × (10<sup>2</sup>) = Fuel consumption test group result (gallons per 100 mile).

(ii) Calculate the equivalent fuel consumption test group results as follows for spark-ignition vehicles and alternative fuel spark-ignition vehicles. CO<sub>2</sub> emissions test group result (grams per mile)/8,877 grams per gallon of gasoline fuel) × (10<sup>2</sup>) = Fuel

consumption test group result (gallons per 100 mile).

(5) Calculate the fleet average fuel consumption result, in gallons per 100 miles, from the equivalent fuel consumption test group results and round the fuel consumption result to the nearest 0.01 gallon per 100 miles. Calculate the fleet average fuel consumption result using the following equation.

$$\text{Fleet Average Fuel Consumption} = \frac{\sum [\text{Fuel Consumption Test Group Result}_i \times \text{Volume}_i]}{\sum [\text{Volume}_i]}$$

Where:

Fuel Consumption Test Group Result<sub>i</sub> = fuel consumption performance for each test group as defined in 49 CFR 523.4.

Volume<sub>i</sub> = production volume of each test group.

(6) Compare the fleet average fuel consumption standard to the fleet average fuel consumption performance. The fleet average fuel consumption performance must be less than or equal to the fleet fuel consumption standard to comply with standards in § 535.5(a).

(b) *Heavy-duty vocational vehicles and tractors.* This section describes the testing a manufacturer must perform and the method for determining fuel consumption performance to show compliance with the fuel consumption standards for vocational vehicles and tractors in § 535.5(b) and (c).

(1) Select vehicles and vehicle family configurations to test as specified in 40 CFR 1037.230 for vehicles that make up each of the manufacture’s regulatory subcategories of vocational vehicles and tractors.

(2) Determine the CO<sub>2</sub> emissions and fuel consumption results for all vehicle chassis (conventional, alternative fueled and advanced technology vehicles) using the Greenhouse Emissions Model (GEM) in accordance with 40 CFR part 1037, subpart F. Vocational vehicles and tractor chassis are modeled using the following inputs in the GEM model. All seven of the following inputs apply for sleeper cab tractors, while some do not apply for vocational vehicles and other tractor regulatory subcategories:

(i) Identification of vehicles using regulatory subcategories (such as “Class 8 Combination—Sleeper Cab—High Roof”).

(ii) Coefficient of aerodynamic drag in accordance with 40 CFR 1037.520 and 1037.521. Do not use for vocational vehicles.

(iii) Steer tire rolling resistance for low rolling resistance tires in

accordance with 40 CFR 1037.520 and 1037.650.

(iv) Drive tire rolling resistance for low rolling resistance tires in accordance with 40 CFR 1037.520 and 1037.650.

(v) Vehicle speed limit as governed by vehicles speed limiters in accordance with 40 CFR 1037.520 and 1037.640. Do not use for vocational vehicles.

(vi) Vehicle weight reduction as provided in accordance with 40 CFR 1037.520. Do not use for vocational vehicles.

(vii) Extended idle reduction credit using automatic engine shutdown systems in accordance with 40 CFR 1037.520 and 1037.660. Do not use for vehicles other than Class 8 sleeper cabs.

(3) From the GEM results, select the CO<sub>2</sub> family emissions level (FEL) and equivalent fuel consumption values for vocational vehicle and tractor families in each regulatory subcategories for each model year. Equivalent fuel consumption FELs are derived in GEM and expressed to the nearest 0.1 gallons per 1000 ton-mile. For families containing multiple subfamilies, identify the FELs for each subfamily.

(4) Paragraphs (b)(1) through (3) of this section address vocational vehicle and tractor chassis testing only. Engine performance and the advanced technologies equipped on vocational vehicles and tractors are tested separately as follows:

(i) Vocational vehicle and tractor engine test results for conventional and alternative fueled vehicles are determined in accordance with § 535.6(c).

(ii) Improvements for advanced technologies are determined as follows:

(A) Test hybrid vehicles with power take-off in accordance with 40 CFR 1037.525 and vehicles with post-transmission hybrid systems in accordance with 40 CFR 1037.550.

(B) All electric vehicles are deemed to have zero CO<sub>2</sub> emissions and fuel

consumption. No emission testing is required for such electric vehicles.

Assign the vehicle family with a fuel consumption FEL result to a value of zero gallons per 1000-ton miles in paragraph (3) of this section.

(c) *Heavy-duty engines.* This section describes the testing a manufacturer must perform and the method for determining fuel consumption performance to show compliance with the fuel consumption standards for engines in § 535.5(d). Each engine must be tested to the primary intended service class that it is designed for in accordance with 40 CFR 1036.108

(1) Select emission-data engines and engine family configurations to test as specified in 40 CFR part 86 and part 1036, subpart C for engines installed in vehicles that make up each of the manufacture’s regulatory subcategory.

(2) Test the CO<sub>2</sub> emissions for each emissions-data engine subject to the standards in § 535.5(d) using the procedures and equipment specified in 40 CFR part 1036, subpart F. Measure the CO<sub>2</sub> emissions in grams per bhp-hr as specified in 40 CFR part 86, subpart N, and part 1036, subpart C.

(i) Perform exhaust testing on each fuel type for conventional, dedicated, dual fuel (multi-fuel, and flexible fuel) vehicles and measure the CO<sub>2</sub> emissions level.

(ii) Adjust the CO<sub>2</sub> emissions result of dual fueled vehicles using a weighted average of the demonstrated emission results as specified in 40 CFR 1036.225. If EPA disapproves a manufacturer’s dual fuel vehicle demonstrated use submission, NHTSA will require the manufacturer to only use the test results with 100 percent conventional fuel to determine the fuel consumption of the engine.

(iii) All electric vehicles are deemed to have zero emissions of CO<sub>2</sub> and zero fuel consumption. No emission or fuel consumption testing is required for such electric vehicles.

(3) Determine the CO<sub>2</sub> emissions for the family certification level (FCL) from the emissions test results in paragraph (c)(2) of this section for engine families within the heavy-duty engine regulatory subcategories for each model year.

(i) If a manufacturer certifies an engine family for use both as a vocational engine and as a tractor engine, the manufacturer must split the family into two separate subfamilies in accordance with 40 CFR 1036.230. The manufacturer may assign the numbers and configurations of engines within the respective subfamilies at any time prior to the submission of the end-of-year report required by 40 CFR 1036.730 and § 535.8. The manufacturer must track into which type of vehicle each engine is installed, although EPA may allow the manufacturer to use statistical methods to determine this for a fraction of its engines.

(ii) The following engines are excluded from the engine families used to determine FCL values and the benefit for these engines is determined as an advanced technology credits under the ABT provisions provided in § 535.7(e):

(A) Engines certified as hybrid engines or power packs.

(B) Engines certified as hybrid engines designed with PTO capability and that are sold with the engine coupled to a transmission.

(C) Engines with Rankine cycle waste heat recovery.

(4) Calculate equivalent fuel consumption values for emissions FCLs and the CO<sub>2</sub> levels for certified engines, in gallons per 100 bhp-hr and round each fuel consumption value to the nearest 0.01 gallon per 100 bhp-hr.

(i) Calculate equivalent fuel consumption FCL values for compression-ignition engines and alternative fuel compression-ignition engines. CO<sub>2</sub> FCL value (grams per bhp-hr)/10,180 grams per gallon of diesel fuel) × (10<sup>-2</sup>) = Fuel consumption FCL value (gallons per 100 bhp-hr).

(ii) Calculate equivalent fuel consumption FCL values for spark-ignition engines and alternative fuel spark-ignition engines. CO<sub>2</sub> FCL value (grams per bhp-hr)/8,877 grams per gallon of gasoline fuel) × (10<sup>-2</sup>) = Fuel consumption FCL value (gallons per 100 bhp-hr).

(iii) Manufacturers may carryover fuel consumption data from a previous model year if allowed to carry over emissions data for EPA in accordance with 40 CFR 1036.235.

(iv) If a manufacturer uses an alternate test procedure under 40 CFR 1065.10 and subsequently the data is rejected by

the EPA, NHTSA will also reject the data.

#### § 535.7 Averaging, banking, and trading (ABT) program.

(a) *Fuel consumption credits (FCC)*. At the end of each model year, manufacturers may earn credits for heavy-duty vehicles and engines exceeding the fuel consumption standards in § 535.5 or by using one or more of the flexibilities in this paragraph (a) to gain credits. Manufacturers may average, bank, and trade fuel consumption credits for purposes of complying with fuel consumption standards. The following criteria and restrictions apply to averaging, banking and trading FCC (hereafter reference as the NHTSA ABT program).

(1) *Averaging*. Averaging is the exchange of FCC among a manufacturer's engines or vehicle families or test groups within an averaging set. With the exception of FCC earned for advanced technologies as further clarified below, a manufacturer may average FCC only within the same averaging set. The principle averaging sets are defined in § 535.4.

(2) *Banking*. Banking is the retention of surplus FCC by the manufacturer generating the credits for use in future model years for averaging or trading. Banked FCC retain the designation from the averaging set and model year in which they were generated and expire after five model years.

(3) *Trading*. Trading is a transaction that transfers FCC between manufacturers or other entities. A manufacturer may use traded FCC for averaging, banking, or further trading transactions. Traded FCC, other than advanced technology credits, may be used only within the averaging set in which they were generated.

(b) *ABT provisions for heavy-duty pickup trucks and vans*. (1) This regulatory category consists of one regulatory subcategory, heavy-duty pickup trucks and vans. This one regulatory subcategory makes up one averaging set.

(2) Manufacturers that manufacture vehicles within this regulatory subcategory shall calculate credits at the end of each model year based upon the final average fleet fuel consumption standard and final average fleet fuel consumption performance value within this one regulatory subcategory as identified in paragraph (b)(8) of this section. If the manufacturer's fleet includes conventional vehicles (gasoline, diesel and alternative fuel) and advanced technology vehicles (hybrids with regenerative braking,

vehicles equipped with Rankine-cycle engines, electric and fuel cell vehicles) it should be divided into two separate fleets each with its own final average fleet fuel consumption standard and final average fleet fuel consumption performance value. Credits shall be calculated for each of the two fleets.

(3) Fuel consumption levels below the standard create a "credit surplus," while fuel consumption levels above the standard create a "credit shortfall."

(4) Surplus credits, other than advanced technology credits, generated and calculated within this averaging set may only be used to offset a credit shortfall in this same averaging set.

(5) Advanced technology credits can be used to offset a credit shortfall in this same averaging set or other averaging sets. However, a manufacturer must first apply advanced technology credits to any deficits in the same averaging set before applying them to other averaging sets.

(6) Surplus credits, other than advanced technology credits, may be traded among credit holders but must stay within the same averaging set. Advanced technology credits can be traded across averaging sets.

(7) Surplus credits, if not used to offset a credit shortfall may be banked by the manufacturer for use in future model years, or traded, given the restriction that the credits have an expiration date of five model years after the year in which the credits are earned. For example, credits earned in model year 2014 may be utilized through model year 2019.

(8) Credit shortfalls must be offset by an available credit surplus within three model years after the shortfall was incurred. If the shortfall cannot be offset, the manufacturer is liable for civil penalties as discussed in § 535.9.

(9) Calculate the value of credits generated in a model year for this regulatory subcategory or averaging set using the following equation:  
Total MY Fleet FCC (gallons) = (Std – Act) × (Volume) × (UL) × (10<sup>-2</sup>)

Where:

Std = Fleet average fuel consumption standard (gal/100 mile).

Act = Fleet average actual fuel consumption value (gal/100 mile).

Volume = the total U.S.-directed production of vehicles in the regulatory subcategory.

UL = the useful life for the regulatory subcategory (120,000 miles).

(10) If a manufacturer generates credits from its fleet of advanced technology vehicles in accordance with 535.7(e)(1) a multiplier of 1.5 can be used. Advanced technology credits can be used in other averaging sets different

from the one they are generated within with the following restrictions.

(i) The maximum amount of credits a manufacturer may bring into the service class group that contains the heavy-duty pickup and van averaging set is 5.89 Mgallons (for advanced technology credits based upon compression ignition engines) or 6.76 Mgallons (for advanced technology credits based upon spark-ignition engines) per model year as specified in 40 CFR 1037.104.

(ii) The limit specified in paragraph (b)(10)(i) of this section does not limit the amount of advanced technology credits that can be used across averaging sets within the same service class group.

(11) If a manufacturer chooses to generate CO<sub>2</sub> emission credits under EPA provisions of 40 CFR 1037.150(a), it may also voluntarily generate early credits under the NHTSA fuel consumption program. Fuel consumption credits may be generated for vehicles certified in model year 2013 to the model year 2014 standards in § 535.5(a). To do so a manufacturer must certify its entire U.S. directed production volume of vehicles in its fleet. The same production volume restrictions specified in 40 CFR 1037.150(a)(2) relating to when test groups are certified apply to the NHTSA early credit provisions. Credits are calculated as specified in paragraph (b)(9) of this section relative to the fleet standard that would apply for model year 2014 using the model year 2013 production volumes. Surplus credits generated under this paragraph are available credits for banking or trading. Credit deficits for an averaging set prior to model year 2014 do not carry over to model year 2014. These credits may be used to show compliance with the standards of this part for 2014 and later model years. Once a manufacturer opts into the NHTSA program they must stay in the program for all of the optional model years and remain standardized with the same implementation approach being followed to meet the EPA CO<sub>2</sub> emission program.

(c) *ABT provisions for vocational vehicles and tractors.* (1) The two regulatory categories for vocational vehicles and tractors consist of 12 regulatory subcategory as follows:

(i) Vocational vehicles with a GVWR up to and including 19,500 pounds (Light Heavy-Duty (LHD));

(ii) Vocational vehicles with a GVWR above 19,500 pounds and no greater than 33,000 pounds (Medium Heavy-Duty (MHD));

(iii) Vocational vehicles with a GVWR over 33,000 pounds (Heavy Heavy-Duty (HHD));

(iv) Low roof day cab tractors with a GVWR above 26,000 pounds and no greater than 33,000 pounds;

(v) Mid roof day cab tractors with a GVWR above 26,000 pounds and no greater than 33,000 pounds;

(vi) High roof day cab tractors with a GVWR above 26,000 pounds and no greater than 33,000 pounds;

(vii) Low roof day cab tractors with a GVWR above 33,000 pounds;

(viii) Mid roof day cab tractors with a GVWR above 33,000 pounds;

(ix) High roof day cab tractors with a GVWR above 33,000 pounds;

(x) Low roof sleeper cab tractors with a GVWR above 33,000 pounds;

(xi) Mid roof sleeper cab tractors with a GVWR above 33,000 pounds; and

(xii) High roof sleeper cab tractors with a GVWR above 33,000 pounds.

(2) The 12 regulatory subcategories consist of three averaging sets as follows:

(i) Vocational light-heavy vehicles at or below 19,500 pounds GVWR.

(ii) Vocational and tractor medium-heavy vehicles above 19,500 pounds GVWR but at or below 33,000 pounds GVWR.

(iii) Vocational and tractor heavy-heavy vehicles above 33,000 pounds GVWR.

(3) Manufacturers that manufacture vehicles within either of these two vehicle categories, in one or more of the regulatory subcategories, shall calculate a total credit balance within each applicable averaging set at the end of each model year based upon final production volumes and the sum of the credit balances derived for each of the vehicle family groups within each averaging set.

(4) Each designated vehicle family group has a “family emissions limit” (FEL) which is compared to the associated regulatory subcategory standard. A FEL that falls below the regulatory subcategory standard creates “positive credits,” while fuel consumption level of a family group above the standard creates a “credit shortfall.”

(5) Manufacturers shall sum all shortfalls and surplus credits for each vehicle family within each applicable averaging set to obtain the total credit balance for the model year before rounding. The sum of fuel consumptions credits must be rounded to the nearest gallon.

(6) Surplus credits, other than advanced technology credits, generated and calculated within this averaging set may only be used to offset a credit shortfall in this same averaging set.

(7) Advanced technology credits can be used to offset a credit shortfall in this

same averaging set or other averaging sets. However, a manufacturer must first apply advanced technology credits to any deficits in the same averaging set before applying them to other averaging sets.

(8) Surplus credits, other than advanced technology credits, may be traded among credit holders but must stay within the same averaging set. Advanced technology credits can be traded across averaging sets.

(9) Surplus credits, if not used to offset a credit shortfall may be banked by the manufacturer for use in future model years, or traded, given the restriction that the credits have an expiration date of five model years after the year in which the credits are earned. For example, credits earned in model year 2014 may be utilized through model year 2019.

(10) Credit shortfalls must be offset by an available credit surplus within three model years after the shortfall was incurred. If the shortfall cannot be offset, the manufacturer is liable for civil penalties as discussed in § 535.9.

(11) The value of credits generated in a model year is calculated as follows:

(i) Calculate the value of credits generated in a model year for each vehicle family within an averaging set using the following equation:

$$\text{Vehicle Family FCC (gallons)} = (\text{Std} - \text{FEL}) \times (\text{Payload}) \times (\text{Volume}) \times (\text{UL}) \times (10^{-3})$$

Where:

Std = the standard for the respective vehicle family regulatory subcategory (gal/1000 ton-mile).

FEL = family emissions limit for the vehicle family (gal/1000 ton-mile).

Payload = the prescribed payload in tons for each regulatory subcategory as shown in the following table:

Regulatory subcategory	Payload (Tons)
LHD Vocational Vehicles .....	2.85
MHD Vocational Vehicles .....	5.60
HHD Vocational Vehicles .....	7.5
Class 7 Tractor .....	12.50
Class 8 Tractor .....	19.00

Volume = the number of U.S.-directed production volume of vehicles in the corresponding vehicle family.

UL = the useful life for the regulatory subcategory (miles) as shown in the following table:

Regulatory subcategory	UL (miles)
LHD Vocational Vehicles .....	110,000
MHD Vocational Vehicles .....	185,000
HHD Vocational Vehicles .....	435,000
Class 7 Tractor .....	185,000
Class 8 Tractor .....	435,000

(ii) Calculate the value of credits generated in a model year for each vehicle family for advanced technology vehicles within an averaging set using the equation above, the guidelines provided in paragraph (e)(1)(i) of this section, and the 1.5 credit multiplier.

(iii) Calculate the total credits generated in a model year for each averaging set using the following equation:

Total averaging set MY credits  
=  $\Sigma$  Vehicle family credits within each average set

(12) If a manufacturer chooses to generate CO<sub>2</sub> emission credits under EPA provisions of 40 CFR 1037.150(a), it may also voluntarily generate early credits under the NHTSA fuel consumption program as follows:

(i) Fuel consumption credits may be generated for vehicles certified in model year 2013 to the model year 2014 standards in § 535.5(b) and (c). To do so a manufacturer must certify its entire U.S. directed production volume of vehicles. The same production volume restrictions specified in 40 CFR 1037.150(a)(1) relating to when test groups are certified apply to the NHTSA early credit provisions. Credits are calculated as specified in paragraph (c)(11) of this section relative to the standards that would apply for model year 2014. Surplus credits generated under this paragraph (c)(12) may be increased by a factor of 1.5 for determining total available credits for banking or trading. For example, if you have 10 gallons of surplus credits for model year 2013, you may bank 15 gallons of credits. Credit deficits for an averaging set prior to model year 2014 do not carry over to model year 2014. These credits may be used to show compliance with the standards of this part for 2014 and later model years. Once a manufacturer opts into the NHTSA program they must stay in the program for all of the optional model years and remain standardized with the same implementation approach being followed to meet the EPA CO<sub>2</sub> emission program.

(ii) A tractor manufacturer may generate fuel consumption credits for the number of additional SmartWay designated tractors (relative to its MY 2012 production), provided that credits are not generated for those vehicles under paragraph (c)(12)(i) of this section. Calculate credits for each regulatory sub-category relative to the standard that would apply in model year 2014 using the equations in paragraph (c)(11) of this section. Use a production volume equal to the number of verified model year 2013 SmartWay

tractors minus the number of verified model year 2012 SmartWay tractors. A manufacturer may bank credits equal to the surplus credits generated under this paragraph multiplied by 1.50. A manufacturer's 2012 and 2013 model years must be equivalent in length. Once a manufacturer opts into the NHTSA program they must stay in the program for all of the optional model years and remain standardized with the same implementation approach being followed to meet the EPA CO<sub>2</sub> emission program.

(13) If a manufacturer generates credits from vehicles certified for advanced technology in accordance with § 535.7(e)(1), a multiplier of 1.5 can be used, but this multiplier cannot be used on the same credits for which the early credit multiplier is used. Advanced technology credits can be used in other averaging sets different from the one they are generated, but the maximum amount of credits a manufacturer may bring into a service class group that contains the vocational vehicle and tractor averaging sets is 5.89 Mgallons (for advanced technology credits based upon compression ignition engines) or 6.76 Mgallons (for advanced technology credits based upon spark-ignition engines) per model year as specified in 40 CFR 1037.740. However, this does not limit the amount of advanced technology credits that can be used across averaging sets within the same service class group.

(d) *ABT provisions for heavy-duty engines.* (1) Heavy-duty engines consist of six regulatory subcategories as follows:

- (i) Spark-ignition engines.
- (ii) Light heavy-duty compression-ignition engines.
- (iii) Medium heavy-duty vocational compression-ignition engines.
- (iv) Medium heavy-duty tractor compression-ignition engines.
- (v) Heavy heavy-duty vocational compression-ignition engines.
- (vi) Heavy heavy-duty tractor compression-ignition engines.

(2) The six regulatory subcategories consist of four averaging sets as follows:

- (i) Compression-ignition light heavy-duty engines.
- (ii) Compression-ignition medium heavy-duty engines.
- (iii) Compression-ignition heavy heavy-duty engines.
- (iv) Spark-ignition engines.

(3) Manufacturers that manufacture engines within one or more of the regulatory subcategories, shall calculate a total credit balance within each applicable averaging set at the end of each model year based upon final production volumes and the sum of the

credit balances derived for each of the engine families within each averaging set.

(4) Each designated engine family has a "family certification level" (FCL) which is compared to the associated regulatory subcategory standard. A FCL that falls below the regulatory subcategory standard creates "positive credits," while fuel consumption level of a family group above the standard creates a "credit shortfall."

(5) Manufacturers shall sum all surplus and shortfall credits for each engine family within the applicable averaging set to obtain the total credit balance for the model year before rounding. Round the sum of fuel consumptions credits to the nearest gallon.

(6) Surplus credits, other than advanced technology credits, generated and calculated within this averaging set may only be used to offset a credit shortfall in this same averaging set.

(7) Advanced technology credits can be used to offset a credit shortfall in this same averaging set or other averaging sets. However, a manufacturer must first apply advanced technology credits to any deficits in the same averaging set before applying them to other averaging sets.

(8) Surplus credits, other than advanced technology credits, may be traded among credit holders but must stay within the same averaging set. Advanced technology credits can be traded across averaging sets.

(9) Surplus credits, if not used to offset a credit shortfall may be banked by the manufacturer for use in future model years, or traded, given the restriction that the credits have an expiration date of five model years after the year in which the credits are earned. For example, credits earned in model year 2014 may be utilized through model year 2019.

(10) Credit shortfalls must be offset by available surplus credits within three model years after shortfall was incurred. If the shortfall cannot be offset, the manufacturer is liable for civil penalties as discussed in § 535.9.

(11) The value of credits generated in a model year is calculated as follows:

(i) The value of credits generated in a model year for each engine family within a regulatory subcategory equals Engine Family FCC (gallons) = (Std - FCL) × (CF) × (Volume) × (UL) × (10<sup>2</sup>)

Where:

Std = the standard for the respective engine regulatory subcategory (gal/100 bhp-hr).  
FCL = family certification level for the engine family (gal/100 bhp-hr).

CF = a transient cycle conversion factor in bhp-hr/mile which is the integrated total cycle brake horsepower-hour divided by the equivalent mileage of the applicable test cycle. For spark-ignition heavy-duty engines, the equivalent mileage is 6.3 miles. For compression-ignition heavy-duty engines, the equivalent mileage is 6.5 miles.

Volume = the number of engines in the corresponding engine family.

UL = the useful life of the given engine family (miles) as shown in the following table:

Regulatory subcategory	UL (miles)
Class 2b–5 Vocational Vehicles, Spark Ignited (SI), and Light Heavy-Duty Diesel Engines .....	110,000
Class 6–7 Vocational Vehicles and Medium Heavy-Duty Diesel Engines .....	185,000
Class 8 Vocational Vehicles and Heavy Heavy-Duty Diesel Engines .....	435,000
Class 7 Tractors and Medium Heavy-Duty Diesel Engines .....	185,000
Class 8 Tractors and Heavy Heavy-Duty Diesel Engines .....	435,000

(ii) Calculate the total credits generated in a model year for each averaging set using the following equation:

$$\text{Total averaging set MY credits} = \sum \text{Engine family credits within each averaging set}$$

(12) The provisions of this section apply to manufacturers utilizing the compression-ignition engine voluntary alternate standard provisions specified in § 535.5(d)(4) as follows.

(i) Manufacturers may not certify engines to the alternate standards if they are part of an averaging set in which they carry a balance of banked credits. For purposes of this section, manufacturers are deemed to carry credits in an averaging set if they carry credits from advance technology that are allowed to be used in that averaging set.

(ii) Manufacturers may not bank fuel consumption credits for any engine family in the same averaging set and model year in which it certifies engines to the alternate standards. This means a manufacturer may not bank advanced technology credits in a model year it certifies any engines to the alternate standards.

(iii) Note that the provisions of paragraph (d)(10) of this section apply with respect to credit deficits generated while utilizing alternate standards.

(13) Where a manufacturer has chosen to comply with the EPA alternative compression ignition engine phase-in standard provisions in 40 CFR 1036.150(e), and has optionally decided

to follow the same path under the NHTSA fuel consumption program, it must certify all of its model year 2013 compression-ignition engines within a given averaging set to the applicable alternative standards in § 535.5(d)(5). Engines certified to these standards are not eligible for early credits under paragraph (d)(14) of this section. Credits are calculated using the same equation provided in paragraph (d)(11) of this section.

(14) If a manufacturer chooses to generate early CO<sub>2</sub> emission credits under EPA provisions of 40 CFR 1036.150, it may also voluntarily generate early credits under the NHTSA fuel consumption program. Fuel consumption credits may be generated for engines certified in model year 2013 (2015 for spark-ignition engines) to the standards in § 535.5(d). To do so a manufacturer must certify its entire U. S.-directed production volume of engines except as specified in 40 CFR 1036.150(a)(2). Credits are calculated as specified in paragraph (d)(11) of this section relative to the standards that would apply for model year 2014 (2016 for spark-ignition engines). Surplus credits generated under this paragraph may be increased by a factor of 1.5 for determining total available credits for banking or trading. For example, if you have 10 gallons of surplus credits for model year 2013, you may bank 15 gallons of credits. Credit deficits for an averaging set prior to model year 2014 (2016 for spark-ignition engines) do not carry over to model year 2014 (2016 for spark-ignition engines). These credits may be used to show compliance with the standards of this part for 2014 and later model years. Once a manufacturer opts into the NHTSA program they must stay in the program for all of the optional model years and remain standardized with the same implementation approach being followed to meet the EPA CO<sub>2</sub> emission program.

(15) If a manufacturer generates credits from engines certified for advanced technology in accordance with § 535.7(e)(1), a multiplier of 1.5 can be used, but this multiplier cannot be used on the same credits for which the early credit multiplier is used. Advanced technology credits can be used in other averaging sets different from the one they are generated, but the maximum amount of credits a manufacturer may bring into a service class group that contains the heavy-duty engine averaging sets is 5.89 Mgallons (for advanced technology credits based upon compression ignition engines) or 6.76 Mgallons (for advanced technology credits based upon spark-ignition

engines) per model year as specified in 40 CFR 1036.740. However, this does not limit the amount of advanced technology credits that can be used across averaging sets within the same service class group.

(e) *Additional credit provisions.* (1) *Advanced technology credits.* Manufacturers of heavy-duty pickup trucks and vans, vocational vehicles, tractors and associated engines showing improvements in CO<sub>2</sub> emissions and fuel consumption using hybrid vehicles with regenerative braking, vehicles equipped with Rankine-cycle engines, electric vehicles and fuel cell vehicles are eligible for advanced technology credits. Advanced technology credits may be increased by a 1.5 multiplier and applied to any heavy-duty vehicle or engine subcategory consistent with sound engineering judgment.

(i) *Heavy-duty vehicles.* (A) For advanced technology system (hybrid vehicles with regenerative braking, vehicles equipped with Rankine-cycle engines and fuel cell vehicles), calculate the advanced technology credits as follows:

(1) Measure the effectiveness of the advanced system by chassis testing a vehicle equipped with the advanced system and an equivalent conventional system in accordance with 40 CFR 1037.615.

(2) For purposes of this paragraph (e), a conventional vehicle is considered to be equivalent if it has the same footprint, intended vehicle service class, aerodynamic drag, and other relevant factors not directly related to the advanced system powertrain. If there is no equivalent vehicle, the manufacturer may create and test a prototype equivalent vehicle. The conventional vehicle is considered Vehicle A, and the advanced technology vehicle is considered Vehicle B.

(3) The benefit associated with the advanced system for fuel consumption is determined from the weighted fuel consumption results from the chassis tests of each vehicle using the following equation:

$$\text{Benefit (gallon/1,000 ton mile)} = \text{Improvement Factor} \times \text{GEM Fuel Consumption Result}_B$$

Where:

$$\text{Improvement Factor} = \frac{(\text{Fuel Consumption}_A - \text{Fuel Consumption}_B)}{(\text{Fuel Consumption}_A)}$$

Fuel Consumption Rates A and B are the gallons per 1,000 ton-mile of the conventional and advanced vehicles, respectively, as measured under the test procedures specified by EPA.

GEM Fuel Consumption Result B is the estimated gallons per 1,000 ton-mile rate resulting from emission modeling of the

advanced vehicle as specified in 40 CFR 1037.520 and § 535.6(b).

(4) Calculate the benefit in credits using the equation in paragraph (c)(11) of this section and replacing the term (Std-FEL) with the benefit.

(B) For electric vehicles calculate the fuel consumption credits using an FEL of 0 g/1000ton-mile.

(ii) *Heavy-duty engines.* (A) This section specifies how to generate advanced technology-specific fuel consumption credits for hybrid powertrains that include energy storage systems and regenerative braking (including regenerative engine braking) and for engines that include Rankine-cycle (or other bottoming cycle) exhaust energy recovery systems.

(1) Pre-transmission hybrid powertrains are those engine systems that include features that recover and store energy during engine motoring operation but not from the vehicle wheels. These powertrains are tested using the hybrid engine test procedures of 40 CFR part 1065 or using the post-transmission test procedures.

(2) Post-transmission hybrid powertrains are those powertrains that include features that recover and store energy from braking at the vehicle wheels. These powertrains are tested by simulating the chassis test procedure applicable for hybrid vehicles under 40 CFR 1037.550.

(3) Test engines that include Rankine-cycle exhaust energy recovery systems according to the test procedures specified in 40 CFR part 1036, subpart F, unless EPA approves the manufacturer's alternate procedures.

(B) Calculate credits as specified in paragraph (c) of this section. Credits generated from engines and powertrains certified under this section may be used in other averaging sets as described in 40 CFR 1036.740(d).

(2) *Innovative technology credits.* This provision allows engine and vehicle manufacturers to generate CO<sub>2</sub> emission credits consistent with the provisions of 40 CFR 1036.610 (for engines), 40 CFR 1037.104(d)(13) (for heavy-duty pickup trucks and vans) and 40 CFR 1037.610 (for vocational vehicles and tractors) for introducing innovative technology in heavy-duty engines and vehicles for reducing greenhouse gas emissions and fuel consumption. Upon identification and approval from EPA of a manufacturer seeking to obtain innovative technology credits in a given model year, NHTSA may adopt an equivalent amount of fuel consumption credits into its program. Such credits must remain within the same regulatory subcategory in which the credits were

generated. NHTSA will adopt these fuel consumption credits depending upon whether:

(i) The technology has a direct impact upon reducing fuel consumption performance;

(ii) The manufacturer has provided sufficient information to make sound engineering judgments on the impact of the technology in reducing fuel consumption performance; and

(iii) Credits will be accepted on a one-for-one basis expressed in terms of gallons.

#### § 535.8 Reporting requirements.

(a) *General requirements.* Manufacturers producing heavy-duty vehicles and engines applicable to fuel consumption standards in § 535.5, for each given model year, must submit the required information as specified in paragraphs (b) through (h) of this section.

(1) The information required by this part must be submitted by the deadlines specified in this section and must be based upon all the information and data available to the manufacturer 30 days before submitting information.

(2) Manufacturers must submit information electronically through the EPA database system as the single point of entry for all information required for this national program and both agencies will have access to the information. The format for the required information is specified by EPA.

(3) If by model year 2012 the agencies are not prepared to receive information through the EPA database system, manufacturers are required to submit information to EPA using an approved information format. A manufacturer can use a different format, if it sends EPA a written request with justification for a waiver.

(b) *Pre-model year reports.* Manufacturers producing heavy-duty pickup trucks and vans must submit reports in advance of the model year providing early estimates demonstrating how their fleet(s) would comply with GHG emissions and fuel consumption standards. Note, the agencies understand that early model year reports contain estimates that may change over the course of a model year and that compliance information manufacturers submit prior to the beginning of a new model year may not represent the final compliance outcome. The agencies view the necessity for requiring early model reports as a manufacturer's good faith projection for demonstrating compliance with emission and fuel consumption standards.

(1) *Report deadlines.* For model years 2013 and later, manufacturer of heavy-duty pickup trucks and vans complying with voluntary and mandatory standards must submit a pre-model year report for the given model year as early as the date of the manufacturer's annual certification preview meeting with EPA and NHTSA, or prior to submitting its first application for a certificate of conformity to EPA in accordance with 40 CFR 1037.104(d). For example, a manufacturer choosing to comply in model year 2014 could submit its pre-model year report during its precertification meeting which could occur before January 2, 2013, or could provide its pre-model year report any time prior to submitting its first application for certification for the given model year.

(2) *Contents.* Each pre-model year report must be submitted including the following information for each model year.

(i) A list of each unique subconfiguration in the manufacturer's fleet describing the make and model designations, attribute based-values (*i.e.*, GVWR, GCWR, Curb Weight and drive configurations) and standards;

(ii) The emission and fuel consumption fleet average standard derived from the unique vehicle configurations;

(iii) The estimated vehicle configuration, test group and fleet production volumes;

(iv) The expected emissions and fuel consumption test group results and fleet average performance;

(v) If complying with MY 2013 fuel consumption standards, a statement must be provided declaring that the manufacturer is voluntarily choosing to comply early with the EPA and NHTSA programs. The manufacturers must also acknowledge that once selected, the decision cannot be reversed and the manufacturer will continue to comply with the fuel consumption standards for subsequent model years for all the vehicles it manufactures in each regulatory category for a given model year;

(vi) If complying with MYs 2014, 2015 or 2016 fuel consumption standards, a statement must be provided declaring whether the manufacturer will use fixed or increasing standards in accordance with § 535.5(a). The manufacturer must also acknowledge that once selected, the decision cannot be reversed and the manufacturer must continue to comply with the same alternative for subsequent model years for all the vehicles it manufactures in each regulatory category for a given model year;



(vii) If complying with MYs 2014 or 2015 fuel consumption standards, a statement must be provided declaring that the manufacturer is voluntarily choosing to comply with NHTSA's voluntary fuel consumption standards in accordance with § 535.5(a)(4). The manufacturers must also acknowledge that once selected, the decision cannot be reversed and the manufacturer will continue to comply with the fuel consumption standards for subsequent model years for all the vehicles it manufactures in each regulatory category for a given model year;

(viii) The list of Class 2b and 3 incomplete vehicles (cab-complete or chassis complete vehicles) and the method used to certify these vehicles as complete pickups and vans identifying the most similar complete sister- or other complete vehicles used to derive the target standards and performance test results;

(ix) The list of Class 4 and 5 incomplete and complete vehicles and the method use to certify these vehicles as complete pickups and vans identifying the most similar complete or sister vehicles used to derive the target standards and performance test results;

(x) List of loose engines included in the heavy-duty pickup and van category and the list of vehicles used to derive target standards and performance test results;

(xi) Copy of any notices a vehicle manufacturer sends to the engine manufacturer to notify the engine manufacturers that their engines are subject to emissions and fuel consumption standards and that it intends to use their engines in excluded vehicles;

(xii) A credit plan identifying the manufacturers estimated credit balances, planned credit flexibilities (*i.e.*, credit balances, planned credit trading, innovative, advanced and early credits and *etc.*) and if needed a credit deficit plan demonstrating how it plans to resolve any credit deficits that might occur for a model year within a period of up to three model years after that deficit has occurred; and

(xiii) The supplemental information specified in paragraph (h) of this section. [Note: NHTSA may also ask a manufacturer to provide additional information if necessary to verify compliance with the fuel consumption requirements of this regulation.]

(c) *Applications for certificate of conformity.* Manufacturers producing vocational vehicles, tractors and heavy-duty engines are required to submit applications for certificates of conformity to EPA in accordance with 40 CFR 1036.205 and 1037.205 in

advance of introducing vehicles for commercial sale. Applications contain early model year information demonstrating how manufacturers plan to comply with GHG emissions. For model years 2013 and later, manufacturers of vocational vehicles, tractors and engine complying with NHTSA's voluntary and mandatory standards must submit applications for certificates of conformity in accordance through the EPA database including both GHG emissions and fuel consumption information for each given model year.

(1) *Submission deadlines.*

Applications are primarily submitted in advance of the given model year to EPA but cannot be submitted any later than December 31 of the given model year.

(2) *Contents.* Each application for certificates of conformity submitted to EPA must include the following equivalent fuel consumption.

(i) Equivalent fuel consumption values for emissions CO<sub>2</sub> FCLs values used to certify each engine family in accordance with 40 CFR 1036.205(e). This provision applies only to manufacturers producing heavy-duty engines.

(ii) Equivalent fuel consumption values for emission CO<sub>2</sub> data engines used to comply with emission standards in 40 CFR 1036.108. This provision applies only to manufacturers producing heavy-duty engines.

(iii) Equivalent fuel consumption values for emissions CO<sub>2</sub> FELs values used to certify each vehicle families or subfamilies in accordance with 40 CFR 1037.205(k). This provision applies only to manufacturers producing vocational vehicles and tractors.

(iv) Report modeling results for ten configurations in terms of CO<sub>2</sub> emissions and equivalent fuel consumption results in accordance with 40 CFR 1037.205(o). Include modeling inputs and detailed descriptions of how they were derived. This provision applies only to manufacturers producing vocational vehicles and tractors.

(3) *Additional supplemental information.* Manufacturers are required to submit additional information as specified in paragraph (h) of this section for the NHTSA program before or at the same time it submits its first application for a certificate of conformity to EPA. Under limited conditions, NHTSA may also ask a manufacturer to provide additional information directly to the Administrator if necessary to verify the fuel consumption requirements of this regulation.

(d) *End-of-the-year-report.* Both manufacturers participating and not

participating in the ABT program are required to submit year end reports; end-of-the-year (EOY) reports in accordance with 40 CFR 1036.730 and 1037.730. The EOY reports are used to review a manufacturer's preliminary final estimates and to identify manufacturers that might have a credit deficit for the given model year. For model years 2013 and later, heavy-duty vehicle and engine manufacturers complying with NHTSA's voluntary and mandatory standards must submit EOY reports through the EPA database including both GHG emissions and fuel consumption information for each given model year.

(1) *Report deadlines.* For model year 2013 and later, heavy-duty vehicle and engine manufacturers complying with NHTSA voluntary and mandatory standards must submit EOY reports through the EPA database including both GHG emissions and fuel consumption information within 90 days after the end of the given model year and no later than April 1 of the next calendar year. For example, the EOY report for model year 2014 must be submitted no later than April 1, 2015.

(i) If a manufacturer expects differences in the information reported between the EOY and the final year report specified in 40 CFR 1036.730 and 1037.730, it must provide the most up-to-date fuel consumption projections in its EOY report and identify the information as preliminary.

(ii) If the manufacturer cannot provide any of the required fuel consumption information, it must state the specific reason for the insufficiency and identify the additional testing needed or explain what analytical methods are believed by the manufacturer will be necessary to eliminate the insufficiency and certify that the results will be available for the final report.

(2) *Contents.* Each EOY report must be submitted including the following fuel consumption information for each model year.

(i) Engine and vehicle family designations and averaging sets.

(ii) Engine and vehicle regulatory subcategory and fuel consumption standards including any alternative standards used.

(iii) Engine and vehicle family FCLs and FELs in terms of fuel consumption.

(iv) Production volumes for engines and vehicles.

(v) A credit plan (for manufacturers participating in the ABT program) identifying the manufacturers actual fuel consumption credit balances, credit flexibilities, credit trades and a credit deficit plan if needed demonstrating how it plans to resolve any credit



deficits that might occur for a model year within a period of up to three model years after that deficit has occurred

(vi) A plan describing the vocational vehicles and vocational tractors that were exempted as heavy-duty off-road vehicles.

(vii) A final plan describing any advanced technology engines or vehicles including alternative fueled vehicles that were produced for the model year identifying the approaches used to determinate compliance and the production volumes.

(viii) A final list of each unique subconfiguration included in a manufacturers fleet of heavy-duty pickup trucks and vans describing the designations, attribute based-values (GVWR, GCWR, Curb Weight and drive configurations) and standards. This provision applies only to manufacturers producing heavy-duty pickup trucks and vans.

(ix) The final fuel consumption fleet average standard derived from the unique vehicle configurations. This provision applies only to manufacturers producing heavy-duty pickup trucks and vans.

(x) The preliminary final subconfiguration and test group production volumes. This provision applies only to manufacturers producing heavy-duty pickup trucks and vans.

(xi) The preliminary final fuel consumption test group results and fleet average performance. This provision applies only to manufacturers producing heavy-duty pickup trucks and vans.

(xii) Under limited conditions, NHTSA may also ask a manufacturer to provide additional information directly to the Administrator if necessary to verify the fuel consumption requirements of this part.

(e) *Final reports.* Both manufacturers participating and not participating in the ABT program are required to submit year end final reports in accordance with 40 CFR 1036.730 and 1037.730. The final reports are used to review a manufacturer's final data and to identify manufacturers that might have a credit deficit for the given model year. For model years 2013 and later, heavy-duty vehicle and engine manufacturers complying with NHTSA's voluntary and mandatory standards must submit final reports through the EPA database including both GHG emissions and fuel consumption information for each given model year.

(1) *Report deadlines.* For model year 2013 and later, heavy-duty vehicle and engine manufacturers complying with

NHTSA voluntary and mandatory standards must submit final reports through the EPA database including both GHG emissions and fuel consumption information within 270 days after the end of the given model year and no later than October 1 of the next calendar year. For example, the final reports for model year 2014 must be submitted no later than October 1, 2015.

(2) *Contents.* Each final report must be submitted including the following fuel consumption information for each model year.

(i) Final engine and vehicle family designations and averaging sets.

(ii) Final engine and vehicle fuel consumption standards including any alternative standards used.

(iii) Final engine and vehicle family FCLs and FELs in terms of fuel consumption.

(iv) Final production volumes for engines and vehicles.

(v) A final credit plan identifying the manufacturers actual fuel consumption credit balances, credit flexibilities, credit trades and a credit deficit plan if needed demonstrating how it plans to resolve any credit deficits that might occur for a model year within a period of up to three model years after that deficit has occurred

(vi) A final plan describing the vocational vehicles and vocational tractors that were exempted as heavy-duty off-road vehicles.

(vii) A final plan describing any advanced technology engines or vehicles including alternative fueled vehicles that were produced for the model year identifying the approaches used to determinate compliance and the production volumes.

(viii) A final list of each unique subconfiguration included in a manufacturers fleet of heavy-duty pickup trucks and vans describing the designations, attribute based-values (GVWR, GCWR, Curb Weight and drive configurations) and standards. This provision applies only to manufacturers producing heavy-duty pickup trucks and vans.

(ix) The final fuel consumption fleet average standard derived from the unique vehicle configurations. This provision applies only to manufacturers producing heavy-duty pickup trucks and vans.

(x) The final subconfiguration and test group production volumes. This provision applies only to manufacturers producing heavy-duty pickup trucks and vans.

(xi) The final fuel consumption test group results and fleet average performance. This provision applies

only to manufacturers producing heavy-duty pickup trucks and vans.

(xii) Under limited conditions, NHTSA may also ask a manufacturer to provide additional information directly to the Administrator if necessary to verify the fuel consumption requirements of this regulation.

(f) *Amendments to applications for certification.* At any time, a manufacturer modifies an application for certification in accordance with 40 CFR 1036.225 and 1037.225, it must submit GHG emissions changes with equivalent fuel consumption values for the information required in paragraphs (b) through (e) and (h) of this section.

(g) *Confidential information.*

Manufacturers must submit a request for confidentiality with each electronic submission specifying any part of the for information or data in a report that it believes should be withheld from public disclosure as trade secret or other confidential business information. Information submitted to EPA should follow EPA guidelines for treatment of confidentiality. Confidential information submitted to NHTSA shall be treated according to paragraph (g)(1) of this section. For any information or data requested by the manufacturer to be withheld under 5 U.S.C. 552(b)(4) and 15 U.S.C. 2005(d)(1), the manufacturer shall provide evidence in its request for confidentiality to justify that:

(1) The item is within the scope of 5 U.S.C. 552(b)(4) and 15 U.S.C. 2005(d)(1);

(2) The disclosure of such an item would result in significant competitive damage;

(3) The period during which the item must be withheld to avoid that damage; and

(4) How earlier disclosure would result in that damage.

(h) *Additional required information.* The following additional information is required to be submitted through the EPA database. NHTSA reserves the right to ask a manufacturer to provide additional information if necessary to verify the fuel consumption requirements of this regulation.

(1) *Small business exemptions.* Vehicles and engines produced by small business manufacturers meeting the criteria in 13 CFR 121.201 are exempted from the requirements of this part. Qualifying small business manufacturers must notify the EPA and NHTSA Administrators before importing or introducing into U.S. commerce exempted vehicles or engines. This notification must include a description of the manufacturer's qualification as a small business under

13 CFR 121.201 and must be submitted to EPA. The agencies may review a manufacturer's qualification as a small business manufacturer under 13 CFR 121.201.

(2) *Early introduction.* The provision applies to manufacturers seeking to comply early with the NHTSA's fuel consumption program prior to model year 2014. The manufacturer must send the request to EPA before submitting its first application for a certificate of conformity.

(3) *NHTSA voluntary compliance model years.* Manufacturers must submit a statement declaring whether the manufacturer chooses to comply voluntarily with NHTSA's fuel consumption standards for model years 2014 through 2015. The manufacturers must acknowledge that once selected, the decision cannot be reversed and the manufacturer will continue to comply with the fuel consumption standards for subsequent model years. The manufacturer must send the statement to EPA before submitting its first application for a certificate of conformity.

(4) *Alternative engine standards.* Manufacturers choosing to comply with the alternative engine standards must notify EPA and NHTSA of their choice and include in that notification a demonstration that it has exhausted all available credits and credit opportunities. The manufacturer must send the statement to EPA before submitting its EOY report.

(5) *Alternate phase-in.* Manufacturers choosing to comply with the alternative engine phase-in must notify EPA and NHTSA of their choice. The manufacturer must send the statement to EPA before submitting its first application for a certificate of conformity.

(6) *Off-road exclusion (tractors and vocational vehicles only).* (i) Vehicles intended to be used extensively in off-road environments such as forests, oil fields, and construction sites may be exempted without request from the requirements of this regulation as specified in 49 CFR 523.2 and § 535.5(b). Within 90 days after the end of each model year, manufacturers must send EPA and NHTSA through the EPA database a report with the following information:

(A) A description of each excluded vehicle configuration, including an explanation of why it qualifies for this exclusion.

(B) The number of vehicles excluded for each vehicle configuration.

(ii) A manufacturer having an off-road vehicle failing to meet the criteria under the agencies' off-road exclusions will be

allowed to submit a petition describing how and why their vehicles should qualify for exclusion. The process of petitioning for an exclusion is explained below. For each request, the manufacturer will be required to describe why it believes an exclusion is warranted and address the following factors which the agencies will consider in granting its petition:

(A) The agencies will provide an exclusion based on off road capability of the vehicle or if the vehicle is fitted with speed restricted tires. A manufacturer should explain which exclusion does its vehicle qualify under; and

(B) A manufacturer should verify if there are any comparable tires that exist in the market to carry out the desired application both on and off road for the subject vehicle(s) of the petition which have LLR values that would enable compliance with the standard.

(7) *Vocational tractor.* Tractors intended to be used as vocational tractors may comply with vocational vehicle standards in § 535.5(b) of this regulation. Manufacturers classifying tractor as vocational tractors must provide a description of how they meet the qualifications in their applications for certificates of conformity as specified in 40 CFR 1037.205.

(8) *Approval of alternate methods to determine drag coefficients (tractors only).* Manufacturers seeking to use alternative methods to determine aerodynamic drag coefficients must provide a request and gain approval by EPA. The manufacturer must send the request to EPA before submitting its first application for a certificate of conformity.

(9) *Innovative technology credits.* Manufacturers pursuing innovative technology credits must submit information to the agencies and may be subject to a public evaluation process in which the public would have opportunity for comment if not using a test procedure in accordance with 40 CFR 1037.610(c). Whether the approach involves on-road testing, modeling, or some other analytical approach, the manufacturer would be required to present a final methodology to EPA and NHTSA. EPA and NHTSA would approve the methodology and credits only if certain criteria were met.

Baseline emissions and fuel consumption and control emissions and fuel consumption would need to be clearly demonstrated over a wide range of real world driving conditions and over a sufficient number of vehicles to address issues of uncertainty with the data. Data would need to be on a vehicle model-specific basis unless a

manufacturer demonstrated model-specific data was not necessary. The agencies may publish a notice of availability in the **Federal Register** notifying the public of a manufacturer's proposed alternative off-cycle credit calculation methodology and provide opportunity for comment. Any notice will include details regarding the methodology, but not include any Confidential Business Information.

(10) *Credit trades.* If a manufacturer trades fuel consumption credits, it must send EPA a report within 90 days after the transaction, as follows:

(i) As the seller, the manufacturer must include the following information in its report:

(A) The corporate names of the buyer and any brokers.

(B) A copy of any contracts related to the trade.

(C) The fleet, vehicle or engine families that generated fuel consumption credits for the trade, including the number of fuel consumption credits from each family.

(ii) As the buyer, the manufacturer or entity must include the following information in its report:

(A) The corporate names of the seller and any brokers.

(B) A copy of any contracts related to the trade.

(C) How the manufacturer or entity intends to use the fuel consumption credits, including the number of fuel consumption credits it intends to apply to each vehicle family (if known).

(i) *Public information.* Based upon information submitted by manufacturers and EPA, NHTSA will publish fuel consumption standards and performance results.

(j) *Information received from EPA.* NHTSA will receive information from EPA as specified in 40 CFR 1036.755 and 1037.755.

#### § 535.9 Enforcement approach.

(a) *Compliance.* (1) NHTSA will assess compliance with fuel consumption standards each year, based upon EPA final verified data submitted to NHTSA for its heavy-duty vehicle fuel efficiency program established pursuant to 49 U.S.C. 32902(k). NHTSA may conduct verification testing throughout a given model year in order to validate data received from manufacturers and will discuss any potential issues with EPA and the manufacturer.

(2) Credit values in gallons are calculated based on the final CO<sub>2</sub> emissions and fuel consumption data submitted by manufacturers and verified/validated by EPA.

(3) NHTSA will verify a manufacturer's credit balance in each

averaging set for each given model year. The average set balance is based upon the engines or vehicles performance above or below the applicable regulatory subcategory standards in each respective averaging set and any credits that are traded into or out of an averaging set during the model year.

(i) If the balance is positive, the manufacturer is designated as having a credit surplus.

(ii) If the balance is negative, the manufacturer is designated as having a credit deficit.

(4) NHTSA will provide written notification to the manufacturer that has a negative balance for any averaging set for each model year. The manufacturer will be required to confirm the negative balance and submit a plan indicating how it will allocate existing credits or earn, and/or acquire by trade credits, or else be liable for a civil penalty as determined in paragraph (b) of this section. The manufacturer must submit a plan within 60 days of receiving agency notification.

(5) Credit shortfall within an averaging set may be carried forward only three years, and if not offset by earned or traded credits, the manufacturer may be liable for a civil penalty as described in paragraph (b) of this section.

(6) Credit allocation plans received from a manufacturer will be reviewed and approved by NHTSA. NHTSA will approve a credit allocation plan unless it determines that the proposed credits are unavailable or that it is unlikely that the plan will result in the manufacturer earning sufficient credits to offset the subject credit shortfall. If a plan is approved, NHTSA will revise the respective manufacturer's credit account accordingly by identifying which existing or traded credits are being used to address the credit shortfall, or by identifying the manufacturer's plan to earn future credits for addressing the respective credit shortfall. If a plan is rejected, NHTSA will notify the respective manufacturer and request a revised plan. The manufacturer must submit a revised plan within 14 days of receiving agency notification. The agency will provide a manufacturer one opportunity to submit a revised credit allocation plan before it initiates civil penalty proceedings.

(7) For purposes of this regulation, NHTSA will treat the use of future credits for compliance, as through a credit allocation plan, as a deferral of civil penalties for non-compliance with an applicable fuel consumption standard.

(8) If NHTSA receives and approves a manufacturer's credit allocation plan to

earn future credits within the following three model years in order to comply with regulatory obligations, NHTSA will defer levying civil penalties for non-compliance until the date(s) when the manufacturer's approved plan indicates that credits will be earned or acquired to achieve compliance, and upon receiving confirmed CO<sub>2</sub> emissions and fuel consumption data from EPA. If the manufacturer fails to acquire or earn sufficient credits by the plan dates, NHTSA will initiate civil penalty proceedings.

(9) In the event that NHTSA fails to receive or is unable to approve a plan for a non-compliant manufacturer due to insufficiency or untimeliness, NHTSA may initiate civil penalty proceedings.

(10) In the event that a manufacturer fails to report accurate fuel consumption data for vehicles or engines covered under this rule, noncompliance will be assumed until corrected by submission of the required data, and NHTSA may initiate civil penalty proceedings.

(b) *Civil penalties.* (1) *Generally.* NHTSA may assess a civil penalty for any violation of this part under 49 U.S.C. 32902(k). This section states the procedures for assessing civil penalties for violations of § 535.5. The provisions of 5 U.S.C. 554, 556, and 557 do not apply to any proceedings conducted pursuant to this section.

(2) *Initial determination of noncompliance.* An action for civil penalties is commenced by the execution of a Notice of Violation. A determination by NHTSA's Office of Enforcement of noncompliance with applicable fuel consumption standards utilizing the certified and reported CO<sub>2</sub> emissions and fuel consumption data provided by the Environmental Protection Agency as described in this part, and after considering all the flexibilities available under § 535.7, underlies a Notice of Violation. If NHTSA Enforcement determines that a manufacturer's averaging set of vehicles or engines fails to comply with the applicable fuel consumption standard(s) by generating a credit shortfall, the chassis, vehicle or engine manufacturer, as relevant, shall be subject to a civil penalty.

(3) *Numbers of violations and maximum civil penalties.* Any violation shall constitute a separate violation with respect to each vehicle or engine within the applicable regulatory averaging set. The maximum civil penalty is not more than \$37,500.00 per vehicle or engine. The maximum civil penalty under this section for a related series of violations shall be determined by multiplying \$37,500.00 times the vehicle or engine

production volume for the model year in question within the regulatory averaging set. NHTSA may adjust this civil penalty amount to account for inflation.

(4) *Factors for determining penalty amount.* In determining the amount of any civil penalty proposed to be assessed or assessed under this section, NHTSA shall take into account the gravity of the violation, the size of the violator's business, the violator's history of compliance with applicable fuel consumption standards, the actual fuel consumption performance related to the applicable standards, the estimated cost to comply with the regulation and applicable standards, the quantity of vehicles or engines not complying, and the effect of the penalty on the violator's ability to continue in business. The "estimated cost to comply with the regulation and applicable standards," will be used to ensure that penalties for non-compliance will not be less than the cost of compliance.

(5) *NHTSA enforcement report of determination of non-compliance.* (i) If NHTSA Enforcement determines that a violation has occurred, NHTSA Enforcement may prepare a report and send the report to the NHTSA Chief Counsel.

(ii) The NHTSA Chief Counsel will review the report prepared by NHTSA Enforcement to determine if there is sufficient information to establish a likely violation.

(iii) If the Chief Counsel determines that a violation has likely occurred, the Chief Counsel may issue a Notice of Violation to the party.

(iv) If the Chief Counsel issues a Notice of Violation, he or she will prepare a case file with recommended actions. A record of any prior violations by the same party shall be forwarded with the case file.

(6) *Notice of violation.* (i) The Notice of Violation will contain the following information:

(A) The name and address of the party;

(B) The alleged violation(s) and the applicable fuel consumption standard(s) violated;

(C) The amount of the proposed penalty and basis for that amount;

(D) The place to which, and the manner in which, payment is to be made;

(E) A statement that the party may decline the Notice of Violation and that if the Notice of Violation is declined within 30 days of the date shown on the Notice of Violation, the party has the right to a hearing, if requested within 30 days of the date shown on the Notice of

Violation, prior to a final assessment of a penalty by a Hearing Officer; and

(F) A statement that failure to either pay the proposed penalty or to decline the Notice of Violation and request a hearing within 30 days of the date shown on the Notice of Violation will result in a finding of violation by default and that NHTSA will proceed with the civil penalty in the amount proposed on the Notice of Violation without processing the violation under the hearing procedures set forth in this subpart.

(ii) The Notice of Violation may be delivered to the party by:

(A) Mailing to the party (certified mail is not required);

(B) Use of an overnight or express courier service; or

(C) Facsimile transmission or electronic mail (with or without attachments) to the party or an employee of the party.

(iii) At any time after the Notice of Violation is issued, NHTSA and the party may agree to reach a compromise on the payment amount.

(iv) Once a penalty amount is paid in full, a finding of "resolved with payment" will be entered into the case file.

(v) If the party agrees to pay the proposed penalty, but has not made payment within 30 days of the date shown on the Notice of Violation, NHTSA will enter a finding of violation by default in the matter and NHTSA will proceed with the civil penalty in the amount proposed on the Notice of Violation without processing the violation under the hearing procedures set forth in this subpart.

(vi) If within 30 days of the date shown on the Notice of Violation a party fails to pay the proposed penalty on the Notice of Violation, and fails to request a hearing, then NHTSA will enter a finding of violation by default in the case file, and will assess the civil penalty in the amount set forth on the Notice of Violation without processing the violation under the hearing procedures set forth in this subpart.

(vii) NHTSA's order assessing the civil penalty following a party's default is a final agency action.

(7) *Hearing Officer.* (i) If a party timely requests a hearing after receiving a Notice of Violation, a Hearing Officer shall hear the case.

(ii) The Hearing Officer will be appointed by the NHTSA Administrator, and is solely responsible for the case referred to him or her. The Hearing Officer shall have no other responsibility, direct or supervisory, for the investigation of cases referred for the assessment of civil penalties. The

Hearing Officer shall have no duties related to the light-duty fuel economy or medium- and heavy-duty fuel efficiency programs.

(iii) The Hearing Officer decides each case on the basis of the information before him or her.

(8) *Initiation of action before the Hearing Officer.* (i) After the Hearing Officer receives the case file from the Chief Counsel, the Hearing Officer notifies the party in writing of:

(A) The date, time, and location of the hearing and whether the hearing will be conducted telephonically or at the DOT Headquarters building in Washington, DC;

(B) The right to be represented at all stages of the proceeding by counsel as set forth in paragraph (b)(9) of this section;

(C) The right to a free copy of all written evidence in the case file.

(ii) On the request of a party, or at the Hearing Officer's direction, multiple proceedings may be consolidated if at any time it appears that such consolidation is necessary or desirable.

(9) *Counsel.* A party has the right to be represented at all stages of the proceeding by counsel. A party electing to be represented by counsel must notify the Hearing Officer of this election in writing, after which point the Hearing Officer will direct all further communications to that counsel. A party represented by counsel bears all of its own attorneys' fees and costs.

(10) *Hearing location and costs.* (i) Unless the party requests a hearing at which the party appears before the Hearing Officer in Washington, DC, the hearing may be held telephonically. In Washington, DC, the hearing is held at the headquarters of the U.S. Department of Transportation.

(ii) The Hearing Officer may transfer a case to another Hearing Officer at a party's request or at the Hearing Officer's direction.

(iii) A party is responsible for all fees and costs (including attorneys' fees and costs, and costs that may be associated with travel or accommodations) associated with attending a hearing.

(11) *Hearing procedures.* (i) There is no right to discovery in any proceedings conducted pursuant to this subpart.

(ii) The material in the case file pertinent to the issues to be determined by the Hearing Officer is presented by the Chief Counsel or his or her designee.

(iii) The Chief Counsel may supplement the case file with information prior to the hearing. A copy of such information will be provided to the party no later than 3 business days before the hearing.

(iv) At the close of the Chief Counsel's presentation of evidence, the party has the right to examine response to and rebut material in the case file and other information presented by the Chief Counsel. In the case of witness testimony, both parties have the right of cross-examination.

(v) In receiving evidence, the Hearing Officer is not bound by strict rules of evidence. In evaluating the evidence presented, the Hearing Officer must give due consideration to the reliability and relevance of each item of evidence.

(vi) At the close of the party's presentation of evidence, the Hearing Officer may allow the introduction of rebuttal evidence that may be presented by the Chief Counsel.

(vii) The Hearing Officer may allow the party to respond to any rebuttal evidence submitted.

(viii) After the evidence in the case has been presented, the Chief Counsel and the party may present arguments on the issues in the case. The party may also request an opportunity to submit a written statement for consideration by the Hearing Officer and for further review. If granted, the Hearing Officer shall allow a reasonable time for submission of the statement and shall specify the date by which it must be received. If the statement is not received within the time prescribed, or within the limits of any extension of time granted by the Hearing Officer, it need not be considered by the Hearing Officer.

(ix) A verbatim transcript of the hearing will not normally be prepared. A party may, solely at its own expense, cause a verbatim transcript to be made. If a verbatim transcript is made, the party shall submit two copies to the Hearing Officer not later than 15 days after the hearing. The Hearing Officer shall include such transcript in the record.

(12) *Determination of violations and assessment of civil penalties.* (i) Not later than 30 days following the close of the hearing, the Hearing Officer shall issue a written decision on the Notice of Violation, based on the hearing record. This may be extended by the Hearing officer if the submissions by the Chief Counsel or the party are voluminous. The decision shall address each alleged violation, and may do so collectively. For each alleged violation, the decision shall find a violation or no violation and provide a basis for the finding. The decision shall set forth the basis for the Hearing Officer's assessment of a civil penalty, or decision not to assess a civil penalty. In determining the amount of the civil penalty, the gravity of the violation, the size of the violator's

business, the violator's history of compliance with applicable fuel consumption standards, the actual fuel consumption performance related to the applicable standard, the estimated cost to comply with the regulation and applicable standard, the quantity of vehicles or engines not complying, and the effect of the penalty on the violator's ability to continue in business. The assessment of a civil penalty by the Hearing Officer shall be set forth in an accompanying final order. The Hearing Officer's written final order is a final agency action.

(ii) If the Hearing Officer assesses civil penalties in excess of \$1,000,000, the Hearing Officer's decision shall contain a statement advising the party of the right to an administrative appeal to the Administrator within a specified period of time. The party is advised that failure to submit an appeal within the prescribed time will bar its consideration and that failure to appeal on the basis of a particular issue will constitute a waiver of that issue in its appeal before the Administrator.

(iii) The filing of a timely and complete appeal to the Administrator of a Hearing Officer's order assessing a civil penalty shall suspend the operation of the Hearing Officer's penalty, which shall no longer be a final agency action.

(iv) There shall be no administrative appeals of civil penalties assessed by a Hearing Officer of less than \$1,000,000.

(13) *Appeals of civil penalties in excess of \$1,000,000.* (i) A party may appeal the Hearing Officer's order assessing civil penalties over \$1,000,000 to the Administrator within 21 days of

the date of the issuance of the Hearing Officer's order.

(ii) The Administrator will review the decision of the Hearing Officer de novo, and may affirm the decision of the hearing officer and assess a civil penalty, or

(iii) The Administrator may:

(A) Modify a civil penalty;

(B) Rescind the Notice of Violation; or

(C) Remand the case back to the Hearing Officer for new or additional proceedings.

(iv) In the absence of a remand, the decision of the Administrator in an appeal is a final agency action.

(14) *Collection of assessed or compromised civil penalties.* (i) Payment of a civil penalty, whether assessed or compromised, shall be made by check, postal money order, or electronic transfer of funds, as provided in instructions by the agency. A payment of civil penalties shall not be considered a request for a hearing.

(ii) The party must remit payment of any assessed civil penalty to NHTSA within 30 days after receipt of the Hearing Officer's order assessing civil penalties, or, in the case of an appeal to the Administrator, within 30 days after receipt of the Administrator's decision on the appeal.

(iii) The party must remit payment of any compromised civil penalty to NHTSA on the date and under such terms and conditions as agreed to by the party and NHTSA. Failure to pay may result in NHTSA entering a finding of violation by default and assessing a civil penalty in the amount proposed in the Notice of Violation without processing

the violation under the hearing procedures set forth in this part.

(c) *Changes in corporate ownership and control.* Manufacturers must inform NHTSA of corporate relationship changes to ensure that credit accounts are identified correctly and credits are assigned and allocated properly.

(1) In general, if two manufacturers merge in any way, they must inform NHTSA how they plan to merge their credit accounts. NHTSA will subsequently assess corporate fuel consumption and compliance status of the merged fleet instead of the original separate fleets.

(2) If a manufacturer divides or divests itself of a portion of its automobile manufacturing business, it must inform NHTSA how it plans to divide the manufacturer's credit holdings into two or more accounts. NHTSA will subsequently distribute holdings as directed by the manufacturer, subject to provision for reasonably anticipated compliance obligations.

(3) If a manufacturer is a successor to another manufacturer's business, it must inform NHTSA how it plans to allocate credits and resolve liabilities per 49 CFR part 534.

Dated: August 9, 2011.

**Ray LaHood,**

*Secretary, Department of Transportation.*

Dated: August 9, 2011.

**Lisa P. Jackson,**

*Administrator, Environmental Protection Agency.*

[FR Doc. 2011-20740 Filed 9-14-11; 8:45 am]

**BILLING CODE 4910-59-P**