



From the edge of space to the bottom of the ocean...



Discover Your World with NOAA
NATIONAL OCEANIC AND ATMOSPHERIC ADMINISTRATION
An Activity Book



The Discover Your World with NOAA Activity Book was compiled and developed for NOAA's Celebration of 200 years of Science, Service, and Stewardship under the direction of the

NOAA Celebration Education Working Group

Nadia Sbeih – NOAA Ocean Service (Co-chair)

Molly Harrison – NOAA Fisheries (Co-chair)

Karrie Carnes – NOAA Ocean Service

Kim Cohen - NOAA Ocean Service

Margaret Fowke – NOAA Weather

Ron Gird – NOAA Weather

Sami Grimes – NOAA Research

Jennifer Hammond – NOAA Marine and Aviation Operations

Jorgeann Hiebert – NOAA Research

Nina Jackson – NOAA Satellites

Jamie Krauk – NOAA Research

Elizabeth McMahon - NOAA Marine and Aviation Operations

Amy Painter – NOAA Research

Krista Trono – NOAA Ocean Service

Written and Edited by Mel Goodwin, The Harmony Project, Charleston, SC

Design and Layout by Sandy Goodwin, Coastal Images Graphic Design, Mount Pleasant, SC

Cover Painting by Tate Nation, Mount Pleasant, SC, ©2007

Illustrations by Paul Rossmann, Charleston, SC

The assistance and expertise of the following reviewers is acknowledged with thanks:

Holly Bamford, Alissa Barron, George Cathcart, Ashley Chappel, Teresa Christopher, Cindy Craig, Carmella Davis Watkins, Tim Eichler, Liz Fairey, Megan Forbes, Liza Johnson, Deborah Jones, Barbara Hess, Shawna Karlson, Paula Keener-Chavis, Scott Kiser, Marina Kline, Jeanne Kouhestani, George Leigh, Julia Loy, Bruce Moravchik, Carey Morishiqe, Craig Nelson, Gregg Parent, Aria Remondi, Ann Reiser, Barry Reichenbaugh, Brent Rudman, Barbara Schroeder, George Sharman, John Simensky, Peg Steffan, and Katarina Trojnar

For more information on NOAA's history and timeline, check out the celebration Web site,

<http://celebrating200years.noaa.gov/>

For more information on NOAA's educational offerings, please visit our Web site,

www.noaa.gov



Discover Your World with NOAA
NATIONAL OCEANIC AND ATMOSPHERIC ADMINISTRATION

An Activity Book

Table of Contents

INTRODUCTION

Discover Your World with NOAA 1
 NOAA's Building Blocks 2

EXPLORE THE EARTH

Introduction 8
 Boat Building Challenge 9
 Make Your Own Astrolabe 12
 Make Your Own Compass 16
 Tied Up in Knots 18
 Who's Blue Peter? 22
 The Water Writers 25
 Nautical Chart Challenge 28
 Build an Underwater Robot 34
 Earth Origami 37
 Make Your Own Volcano! 40
 Do You Have Twisted Vision? 43
 Be A Shipwreck Detective 47
 Weird, Red and Slightly Gross! 51

SCIENCE

UNDERSTAND THE EARTH

Introduction 55
 Follow That Hurricane! 56
 Build Your Own Weather Station 61
 Build a Weather Vane 64
 Build a Barometer 66
 Build a Screened Thermometer 67
 Build a Hygrometer 67
 Build a Rain Guage 69
 Be a Citizen Weather Reporter 70
 Tornado in a Bottle 73
 Be a Tree Ring Detective 78
 Your Own El Niño 81
 Please Pass the Salt 83
 Satellite Communications 86
 Wooly Magma 89
 Survey Mark Hunting 93

SERVICE

PROTECT THE EARTH

Introduction 97
 Ocean Diversity Challenge 98
 Motion from the Ocean 108
 The Ocean Drugstore 114
 Who Trashed the Ocean? 117
 It All Runs Downhill 120
 Toxic! Or Is It? 122
 Invasive Species Super Sleuth 124
 Your Alien Dodecahedron 125
 Endangered Species Origami 132
 Is Our Climate Changing? 137
 Where Will the Polar Bears Go? 139
 Following the Ocean Unicorn 145
 Make an Edible Coral Reef 150
 Now THAT's Complex! 155
 Fixing Our Earth 158

STEWARDSHIP



Courtesy NESDIS



Courtesy OMAO

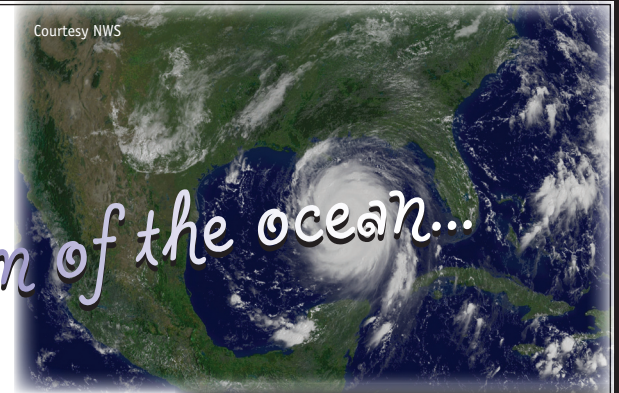

Courtesy NWS

From the edge of space to the bottom of the ocean...



Discover Your World with NOAA

NATIONAL OCEANIC AND ATMOSPHERIC ADMINISTRATION

Flying into the eye of a hurricane

Rescuing killer whales, sea lions, and dolphins

Watching the Earth from 22,000 miles above the ground

Diving into submarine canyons that could swallow Mt. Everest

Restoring marshes, wetlands, reefs, and other marine habitats

Saving lives threatened by tsunamis, tornadoes, and killer storms

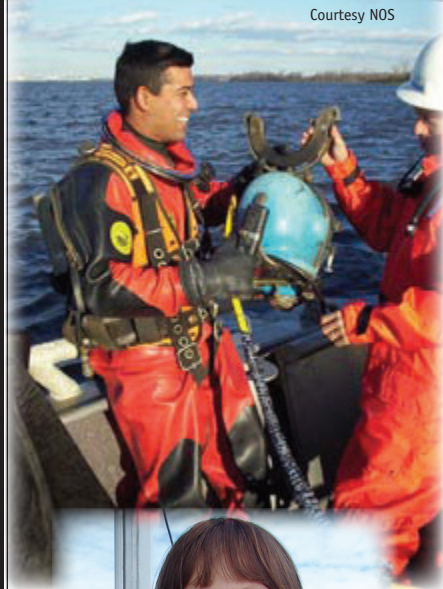

Courtesy NOS

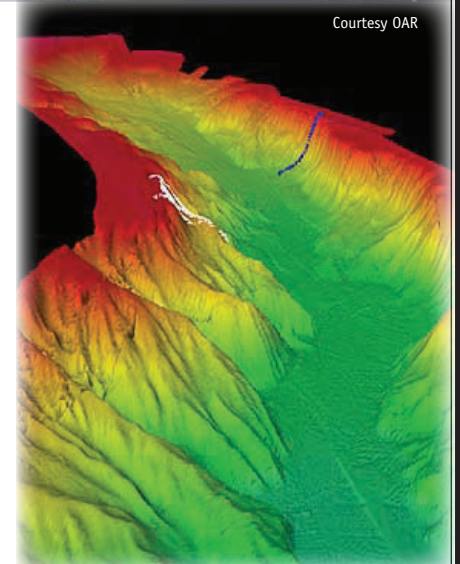

Courtesy OAR



Courtesy Todd Marsee, Michigan Sea Grant

All in a day's work for the people of NOAA as they put science, technology, and engineering to work for you. Every day, NOAA helps people with local weather forecasts, tornado warnings, oil spill cleanup, high quality seafood, navigation tools, and many other services. NOAA is also a leader in ocean exploration and environmental sciences, finding out more about the Earth and how to use and protect our planet's resources.

NOAA's motto is "Science, Service, Stewardship." Putting that motto into action leads the people of NOAA from the edge of space to the bottom of the ocean. These activities are designed to help you learn more about our world, and how NOAA helps you to explore, understand, and protect our Earth.

HAVE FUN!



Courtesy Robert Schwemmer, Channel Is. National Marine Sanctuary

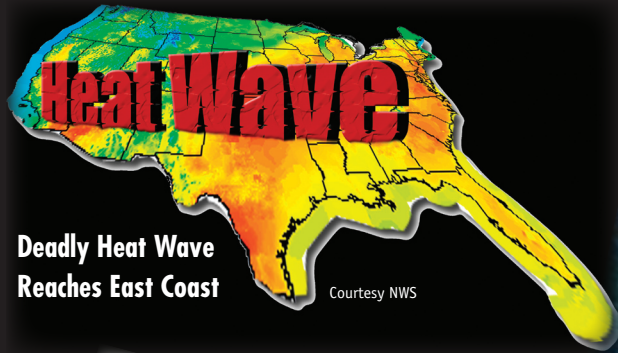

Deadly Heat Wave Reaches East Coast

Courtesy NWS

Lionfish Invade U.S. Waters



Courtesy Paula Whitfield, NOAA

New Hurricane Hunter Aircraft

Courtesy NWS



Trapped Whale Rescued

Courtesy NMFS

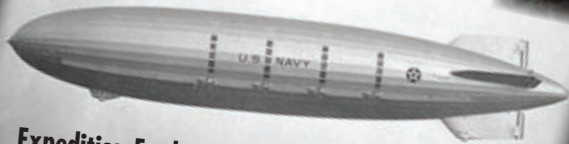

Courtesy NOAA

Expedition Explores Underwater Wreck of Historic Naval Airship

NOAA's Building Blocks

Do you know what NOAA does?
Play this game and find out!

Satellites Relay Distress Calls



Courtesy NESDIS

Astronauts Test Moon Exploration Concepts on Seafloor



Courtesy NOAA

El Nino Makes a Comeback

Courtesy NWS

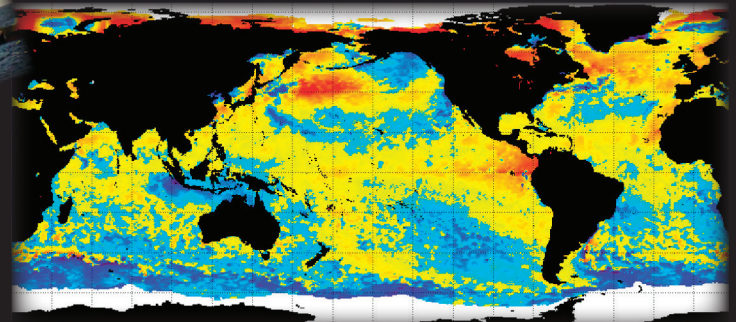

NOAA's Building BLocks

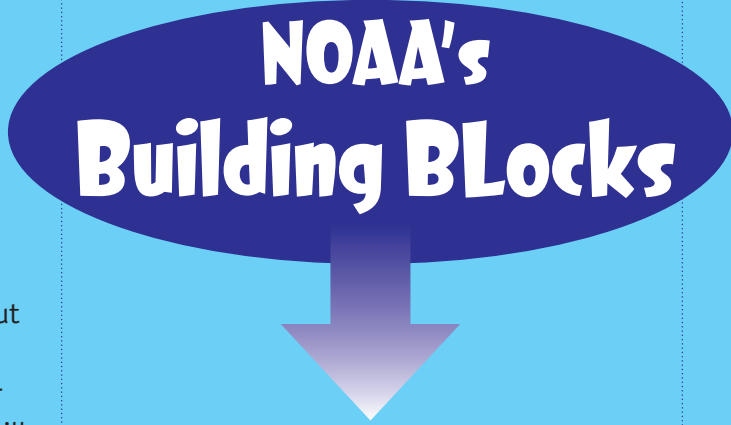

What You Will Need

- ❑ Jenga® or Uno Stacko® game
- ❑ Two sets of “NOAA’s Building Blocks Game Cards” – Make two copies of the “NOAA’s Building Blocks Game Cards” page and cut the cards out. The cards will last longer if you photocopy them onto heavy paper called “card stock” or “cover stock.” It will be easier to tell the difference between “Problems” and “Solutions” if you use one color of paper for “Problems” and another color for “Solutions.”

How to Play the Game

1. Follow the instructions that come with the game. If you are playing with one or more other people, divide into two teams. Each team gets 24 blocks, and stacks these into eight layers of three blocks per layer. Each layer should be at right angles to the layer below. Shuffle the Game Cards, and place a set of the Cards in front of each team.
2. One team at a time draws a card from the top of the Game Card pile. There are “Problem” cards and “Solution” cards. For every “Problem” there is a “Solution” somewhere in the pile of Game Cards.

What You Will Do

Play a game using blocks from Jenga® or Uno Stacko®. You can play this game by yourself, or with as many as eight players

If you draw a “Solution” card, read the card aloud and then:

- (a) Keep the card until you need it to solve a “Problem;” OR
- (b) Remove one block from the top of your team’s stack, and place the card in a discard pile separate from the Game Card pile.

If you draw a “Problem” card, read the card aloud and then:

- (a) Remove one block from any layer of the stack except the top layer, and stack it on top of the stack; OR
- (b) Solve the Problem by reading a “Solution” card that your team has drawn and saved previously.

When you have finished (a) or (b), place the card in a discard pile separate from the Game Card pile.

Players may use only ONE hand when removing and stacking blocks! Blocks that are stacked on top of the pile should be at right angles to the layer below. If more than one person is on each team, team members should take turns drawing cards and moving blocks. If you run out of Game Cards, shuffle the cards in the discard pile and use these as a new stack of Game Cards.

3. Continue playing until one team’s stack falls, or one team has removed all of their blocks from the stack. If your team is first to remove all of the blocks from your stack—you win! If your stack is the first to fall—you lose!

*Photocopy this page
and cut out the cards
along the lines.*

? **Problem 1**
You are driving from St. Louis, MO to Boise, ID, and need to know what the weather is likely to be along the way.

? **Problem 2**
You are travelling through the midwest and want to see whether severe weather is expected during the next three days.

? **Problem 3**
You just heard on the radio that an earthquake has been reported off the coast of Peru with a magnitude of 6.6 on the Richter scale. Is this likely to cause a tsunami on the U.S. Pacific coast?

? **Problem 4**
Every day, hundreds of private and commercial aircraft are in the air over the United States. How can pilots check on weather conditions that may affect the safety of their flights?

? **Problem 5**
More than 90 percent of the goods imported into the United States arrive via the oceans. How can ship captains obtain information to help them avoid dangerous sea conditions?

? **Problem 6**
Over 77 million Americans enjoy recreational boating. How can these boaters keep track of weather that may affect them?

? **Problem 7**
You just felt the earth shake! How can you find out if this is a minor tremor or a serious emergency?

? **Problem 8**
A railroad tank car is leaking chlorine gas. What system is in place to provide emergency information to the public?

? **Problem 9**
Intense bursts of electromagnetic radiation from the sun called "solar flares" can disrupt cell phones and GPS systems. Is there any way to predict when solar flares may happen?

? **Problem 10**
Lightning is the second most frequent cause of weather-related deaths in the United States (floods are number one). How can you find out about lightning safety?

? **Problem 11**
You are planning a boat trip through the Florida Keys. Where can you find out about nautical charts and other boating information for this area?

? **Problem 12**
You are planning a SCUBA diving trip to photograph coral reefs with some friends, and want to be sure everyone knows how to plan dives and what to do in case of emergencies. Who has this information?

? **Problem 13**
You live near a marina, and are concerned about what should be done in case of an oil spill. Where can you get this information?

? **Problem 14**
You live near a salt marsh that used to be used as a local dump for construction debris. Now you and your friends would like to clean it up and restore it as a wildlife habitat? Who knows how to do this?

? **Problem 15**
A ship captain entering Chesapeake Bay needs up-to-the-minute information on currents, tides, and water levels to be sure he can navigate beneath several bridges. Where can he get this information?

*Photocopy this page
and cut out the cards
along the lines.*

? Problem 16
You are looking for a poster that shows all of Earth's mountains and valleys, including those in the ocean. Where could you look?

? Problem 17
You are doing a report on coral reefs, and need some great pictures of reef animals. Where can you find them?

? Problem 18
Our nation's coasts are being developed at a rapid rate. What can be done to protect special coastal areas that contain unusual marine life and important historical resources like shipwrecks?

? Problem 19
The deep ocean contains new species that may provide solutions to problems such as energy and human disease. Yet, most oceans are still unexplored. What organization is dedicated to ocean exploration?

? Problem 20
In the days following Hurricane Katrina, rescuers desperately needed before-and-after aerial images that covered coastal areas affected by the storm. Who has these kinds of images?

? Problem 21
Man Overboard! A sailor has fallen overboard, but no one noticed when the accident happened. The Coast Guard has been called, but how can they find him in hundreds of square miles of ocean?

? Problem 22
You have just found an injured whale that seems to be stuck in shallow water. Who can you call?

? Problem 23
More people want to eat seafood, but overfishing is a serious problem and over 70% of our seafood is imported. How can we increase our domestic seafood supply and still protect our seafood resources?

? Problem 24
Many marine turtles are threatened by accidental capture and drowning in fishing gear, boat collisions, and damage to coastal beaches where they nest. What can be done to protect sea turtles?

? Problem 25
Living marine resources provide food, employment, and recreation, but are threatened by overuse, coastal development, pollution, and natural disasters. How can we protect living marine resources and still enjoy benefits they provide?

? Problem 26
You have heard that temperature changes in the Pacific Ocean called El Nino can have serious effects on your local weather. Where can you find out whether these changes are happening right now, or are expected later this year?

? Problem 27
You have heard that Earth's climate is changing. How can you find out whether temperatures in the U.S. have been above or below normal during the last few years?

? Problem 28
How can you find out how global climate change is likely to affect marine ecosystems such as coral reefs?

? Problem 29
Hurricane Hunters fly into the middle of storms to provide information for forecasts that save thousands of lives. Who has the planes and pilots to do this dangerous work?

? Problem 30
Your science teacher is fascinated by marine biology and ocean research, and wants to get first-hand experience with scientific research at sea. How can she do that?



Solution 1

NOAA's National Weather Service provides immediate access to all forecasts for the entire United States at

<http://www.nws.noaa.gov/>



Solution 2

The National Weather Service Storm Prediction Center shows active storm systems over the 48 states, and provides detailed discussions of severe weather events at

<http://www.spc.noaa.gov/>



Solution 3

NOAA's Pacific Tsunami Warning Center and West Coast / Alaska Tsunami Warning Center provide tsunami warnings and information at

<http://www.prh.noaa.gov/ptwc/>



Solution 4

NOAA's National Weather Service's Aviation Digital Data Service provides forecasts, analyses, and observations of weather conditions that may affect safe aviation.

<http://adds.aviationweather.gov/>



Solution 5

The National Weather Service's Marine and Coastal Weather Services Branch provides information on coastal waters, Great Lakes, and open oceans.

<http://nws.noaa.gov/om/marine/>



Solution 6

The National Weather Service's Marine and Coastal Weather Services Branch provides information on conditions on coastal waters, Great Lakes, and open oceans.

<http://nws.noaa.gov/om/marine/>



Solution 7

NOAA Weather Radio broadcasts weather forecasts, and emergency information about natural hazards, environmental hazards, and public safety (such as AMBER alerts).

<http://www.nws.noaa.gov/nwr/>



Solution 8

NOAA Weather Radio broadcasts weather forecasts, as well as emergency information about natural hazards, environmental hazards, and public safety (such as AMBER alerts).

<http://www.nws.noaa.gov/nwr/>



Solution 9

The National Weather Service Space Environment Center forecasts space weather caused by activity on the sun, such as solar flares.

<http://www.sec.noaa.gov>



Solution 10

NOAA's Lightning Safety Web page has handouts, safety tips, medical facts, survivor stories, photos, and much more at

<http://www.lightningsafety.noaa.gov>



Solution 11

NOAA's Office of Coast Survey provides nautical charts and other navigational products needed to safely operate marine vessels.

<http://chartmaker.ncd.noaa.gov/>



Solution 12

The NOAA Dive Manual is an encyclopedia of diving which includes information about dive planning, operations, and emergencies.

<http://www.dive.noaa.gov>



Solution 13

NOAA's Office of Response and Restoration provides information and solutions for environmental hazards from oil, chemicals, and marine debris.

<http://response.restoration.noaa.gov>



Solution 14

NOAA's Office of Response and Restoration offers case studies, planning tools, and technical assistance to projects that restore and monitor coastal and estuary habitats.

<http://response.restoration.noaa.gov>



Solution 15

NOAA's Tides and Currents Web site provides real-time and historical information on tides, water levels, currents, and weather in ports and major waterways throughout the U.S.

<http://tidesandcurrents.noaa.gov>

Photocopy this page and cut out the cards along the lines.



Solution 16

NOAA's National Geophysical Data Center provides maps, posters, data, and images of many different features on Earth's surface.

<http://www.ngdc.noaa.gov/>



Solution 17

NOAA's Photo Library has thousands of images of marine species, shorelines, weather and space; from coral reefs to the South Pole, from great whales to microscopic bacteria.

<http://www.photolib.noaa.gov/>



Solution 18

NOAA's National Marine Sanctuary Program includes 14 coastal areas where natural and cultural resources are protected while still allowing people to use and enjoy them.

<http://www.sanctuaries.nos.noaa.gov/>



Solution 19

NOAA's Office of Ocean Exploration coordinates expeditions to explore Earth's "final frontier." Expeditions take place around the world, but are concentrated in U.S. waters.

<http://oceanexplorer.noaa.gov>



Solution 20

NOAA's National Geodetic Survey has provided high-resolution aerial photography of the 95,000-mile U.S. shoreline since the 1930's.

<http://oceanservice.noaa.gov/topics/navops/mapping/>



Solution 21

NOAA operates the Search & Rescue Satellite Aided Tracking System to locate people in distress almost anywhere in the world at anytime and in most conditions.

<http://sarsat.noaa.gov/>



Solution 22

NOAA's National Marine Fisheries Service coordinates volunteer marine mammal stranding networks in all coastal states that include whale rescue teams.

<http://www.nmfs.noaa.gov/pr/health/>



Solution 23

NOAA Fisheries' Aquaculture Program develops ways to farm marine animals to provide more seafood, boost commercial and recreational fishing and restore some endangered species.

<http://www.nmfs.noaa.gov/aquaculture>



Solution 24

NOAA's National Marine Fisheries Service and the U.S. Fish and Wildlife Service have developed ways to protect and restore sea turtle populations.

<http://www.nmfs.noaa.gov/pr/recovery/>



Solution 25

NOAA Fisheries' Office of Sustainable Fisheries works to maintain healthy fishery stocks, eliminate overfishing, rebuild overfished stocks, and increase benefits from living marine resources.

<http://www.nmfs.noaa.gov/sfa/sfweb/>



Solution 26

NOAA's National Weather Service Climate Prediction Center forecasts short-term events such as El Nino, and provides information about possible risks of extreme weather events.

<http://www.cpc.ncep.noaa.gov/>



Solution 27

NOAA's Climate Program Office provides current and historical information on whether temperatures in the U.S. are above or below normal.

<http://www.ncdc.noaa.gov/oa/climate/research/cag3/cag3.html>



Solution 28

NOAA's Climate and Ecosystems Program is dedicated to understanding and predicting the effects of climate variability and change on marine ecosystems.

<http://www.climate.noaa.gov/>



Solution 29

NOAA's Office of Marine and Aviation Operations has a fleet of aircraft that operate in extreme conditions, and have the only pilots in the world qualified to fly into hurricanes at low altitudes.

<http://www.omaoo.noaa.gov/>



Solution 30

NOAA's Teacher at Sea Program provides opportunities for teachers to do scientific research aboard its ships and share that experience with students and colleagues.

<http://teacheratsea.noaa.gov/>

Photocopy this page and cut out the cards along the lines.



Taking the pulse of the planet...

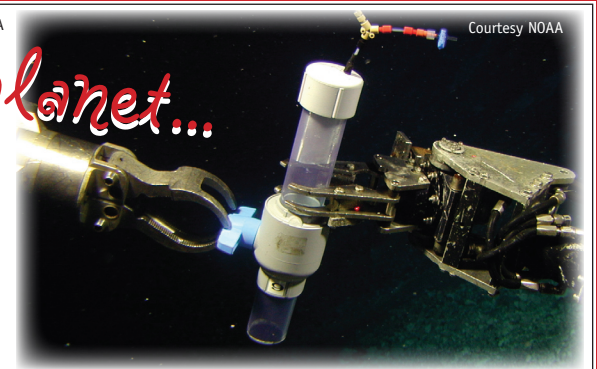
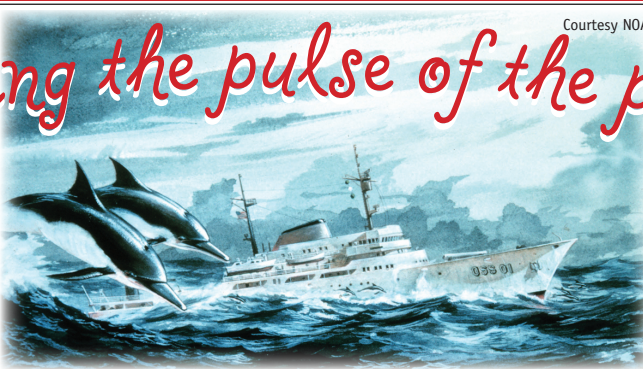

EXPLORE THE EARTH



Exploration is an important part of NOAA's focus on Earth's ecosystems. Ocean exploration in the United States began in 1807 when Thomas Jefferson authorized the Survey of the Coast. But today, after 200 years, about 95% of Earth's oceans are still unexplored—mainly because we haven't known how to handle the extreme cold and pressure of the deep ocean until very recently. Through NOAA's Ocean Explorer program, modern pioneers are investigating parts of Earth's underwater world that have been virtually unknown and unseen. Such exploration may reveal clues to the origin of life on Earth, cures for human diseases, answers on how to achieve sustainable use of resources, links to our maritime history, and information to protect endangered species.

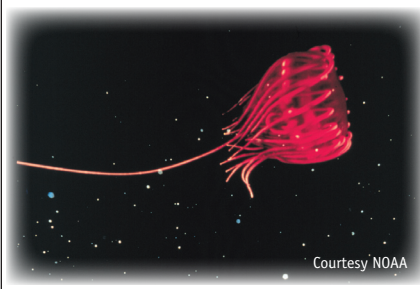

An exciting new project, the Global Earth Observation System (GOES), is about to tell us a lot more about the Earth and how it works. The basic idea is to combine information from thousands of sources that are already making observations about Earth to make people around the globe healthier, safer, and better equipped to manage basic daily needs. NOAA has partnered with more than 60 countries and the European Commission to make this idea a reality.

Learn more about NOAA's Exploration projects with these activities:

- Build an Underwater Robot
- Make Your Own Volcano
- Weird, Red, and Slightly Gross
- Do You Have Twisted Vision?
- Be A Shipwreck Detective!

and more!



Boat Building Challenge

Who were the first boat-builders?

No one really knows.

*The oldest known boats are dugout canoes constructed in China and South Korea around 6,000 B.C. But it's possible that the almost-human species Homo erectus used some type of boat **800,000 years ago!***

Since H. erectus are known to have made tools from bamboo, they may also have made rafts from the same material. But regardless of the materials and who used them, the basic principles that allowed the first boats to float are the same principles that operate on the



Egyptian tomb painting from 1450 B.C. showing officer with sounding pole. Officer is telling crew to come ahead slow. Engineers with cat-o'-nine-tails assure proper response from the "engines."
Courtesy NOAA.

What You Will Do

Design a boat hull that is able to float a specified weight.
Then, design a way to propel your vessel using wind power

What You Will Need

- Sheets of aluminum foil, 12 inches x 12 inches; one sheet for each hull
- 50 pennies for each hull
- Plastic or metal tub full of water, at least 24 inches diameter
- Foam plates
- Wooden skewers
- Poster board
- Hole punch
- Battery operated fan
- Masking tape
- Modeling clay

How to Do It

1. Fold a sheet of aluminum foil into a shape that will float in the tub of water and support the weight of ten pennies. Not sure how to do this? Read "What's Happening" for some clues.
2. Use another sheet of aluminum foil, pieces of foam plate, wooden skewers, and poster board to make a boat that will use sail power to carry ten pennies across the tub of water. The drawing below shows one way to cut and fold a piece of poster board to make a three-dimensional boat.

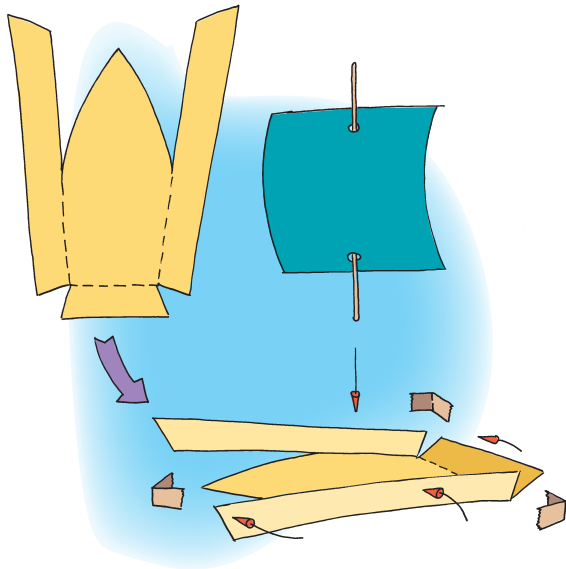

- Use masking tape at the corners of the bow (front of the boat) and stern (rear of the boat).

- Cut a sail out of poster board, and use the punch to make holes for the mast (wooden skewer).
- Use masking tape and/or modeling clay to help hold the mast onto the hull.
- To waterproof your boat, place it on top of a piece of aluminum foil, then fold the foil up and over the sides of the boat as shown below.

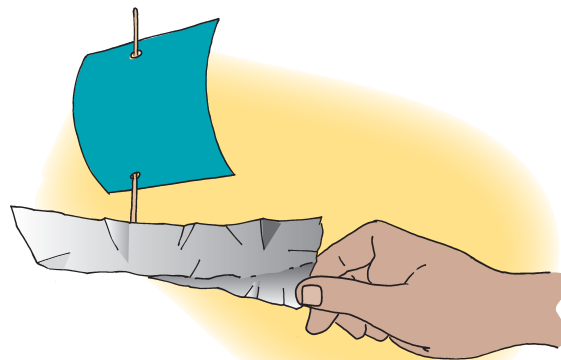
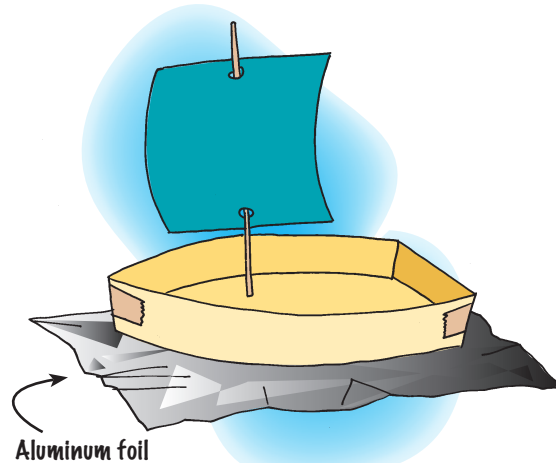

- Make a keel by pinching the aluminum foil to form a ridge that runs from front to back along the middle of the bottom of the boat. (See illustration below left.)
3. Now let's go for a sail! Place ten pennies in the boat, float the boat in a container of water, and use the fan as a source of wind to sail your vessel around the container.

Note: The pennies perform an essential function for sailing vessels: they provide weight in the hull, called "ballast," that keeps the boat from turning over when the wind presses against the sails.

Want to Do More?

Have a contest to see who can build a hull that will carry the most "cargo" (the greatest number of pennies), starting with the same materials. You can modify the contest to see whose can build the fastest sailing boat. You may want to experiment to find out whether it is better to use one large sail or several small sails to increase sailing speed, and whether triangular shaped sails or square sails give the best performance.

What's Happening?

Water tends to maintain a level surface. When you put an object into water, gravity pulls the object down and displaces some of the water,

which means some of the water is pushed aside. Now the surface of the water is no longer level. Gravity pulls the displaced water down, and causes an upward force on the object. This upward force is equal to the weight of the water that the object displaces, and is called buoyancy. Buoyancy depends upon the volume of liquid displaced as well as the density of the liquid. Density is the mass of a certain volume of liquid, usually stated as grams per milliliter. This is why it is easier to float in the ocean than in fresh water. Seawater is more dense than fresh water, so your buoyancy is greater in the ocean.

The amount of fluid that an object displaces depends upon the volume of the object: more volume means more fluid displaced, which means more buoyancy. Increasing the volume of an object also increases its surface area, which in turn increases the effect of friction as the object moves through the fluid. Boat designers have to consider buoyancy as well as friction when deciding on the shape of a boat's hull. A boat designed for speed must have enough displacement to stay afloat, but surface area has to be minimized to decrease the effects of friction. On the other hand, an object designed to carry a heavy weight, such as a cargo ship, must be designed with greater displacement, as well as greater power to overcome the effects of increased friction.

Boat hulls are designed to displace a volume of water that weighs more than the boat and its cargo. If the force of displaced water pushing on the hull is greater than the force of gravity pulling the boat down, then the boat floats! But if you could take a sea-worthy boat hull, break it down, and bundle the pieces together, the bundle will sink. Why? Because there is no longer sufficient water displacement to counteract the force of gravity on the pieces of the hull.

Visit <http://www.seidl.org/scimath/compass/v02n03/boat.html> and <http://www.thirteen.org/edonline/nttidb/lessons/jx/buoyjx.html> for more boat building challenge ideas.

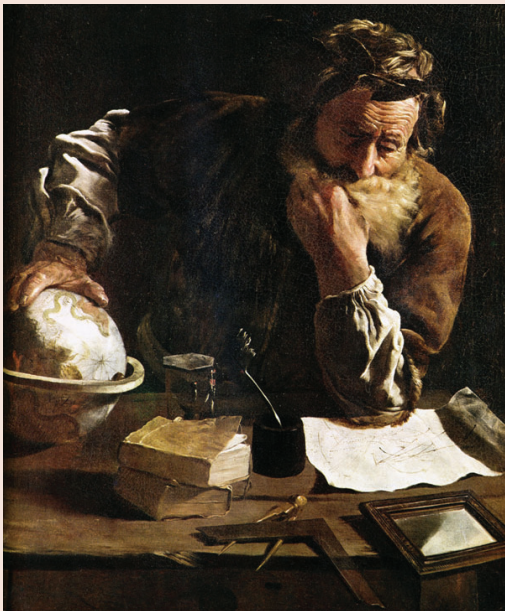

Portrait of Archimedes, by Domenico Fetti, about 1620

The Archimedes Principle

The idea of buoyancy was summed up by a Greek mathematician named Archimedes: any object, wholly or partly immersed in a fluid, is buoyed up by a force equal to the weight of the fluid displaced by the object. Today, this definition is called the Archimedes Principle.

Archimedes is considered one of the three greatest mathematicians of all time. The other two are Newton and Gauss. Archimedes was born in 287 B.C., in Syracuse, Greece. He was a master at mathematics and spent most of his time thinking about new problems to solve.

Many of these problems came from Hiero, the king of Syracuse. Archimedes came up with his famous principle while trying to solve this problem.

The king ordered a gold crown and gave the goldsmith the exact amount of metal to make it. When Hiero received it, the crown had the correct weight but the king suspected that some silver had been substituted for the gold. He did not know how to prove it, so he asked Archimedes for help.

One day while thinking this over, Archimedes went for a bath and water overflowed the tub. He recognized that there was a relationship between the amount of water that overflowed the tub and the amount of his body that was submerged. This observation gave him the means to solve the problem. He was so excited that he ran naked through the streets of Syracuse shouting "I have found it!". The goldsmith was brought to justice and Archimedes never took another bath...(just kidding!).

Make Your Own Astrolabe

The mariner's astrolabe is an ancient navigation instrument for measuring celestial altitude (celestial altitude is the "height" of a star, planet or other celestial object above the horizon). Celestial altitude is important to mariners, because it provides a way to estimate geographic latitude, which is a location's distance from the equator. Astrolabes were the most popular astronomical instrument for several centuries, but they eventually were replaced by quadrants, which today have been replaced by sextants.

What You Will Do

Make your own astrolabe, and use it to estimate the height of a tree, building, or other vertical object



A mariner using a descendant of the astrolabe called an "octant." Courtesy NOAA

What You Will Need

- Stiff cardboard, file folder, or wood, approximately 8 inches square
- Tools for cutting the cardboard or wood
- Glue
- Drill with a 3/16 inch drill bit
- #8 Round head bolt (long enough to go through both pieces of the astrolabe), #8 nut, and three #8 washers
- Rope, string, or twine, about 12 inches long (the diameter of the rope isn't very important; about 1/8 inch is ideal)

Warnings

1. Drills and cutting tools are sharp! Get help from an adult and be careful!
2. Power saw blades and drill bits can shatter or throw scraps at high speed, possibly causing serious injury. Be sure to wear eye protection and follow other recommended safety precautions before using any power tools!

How to Do It

Optional: Before you start, you may want to search the internet for images of astrolabes (there are thousands!).

Astrolabe Template

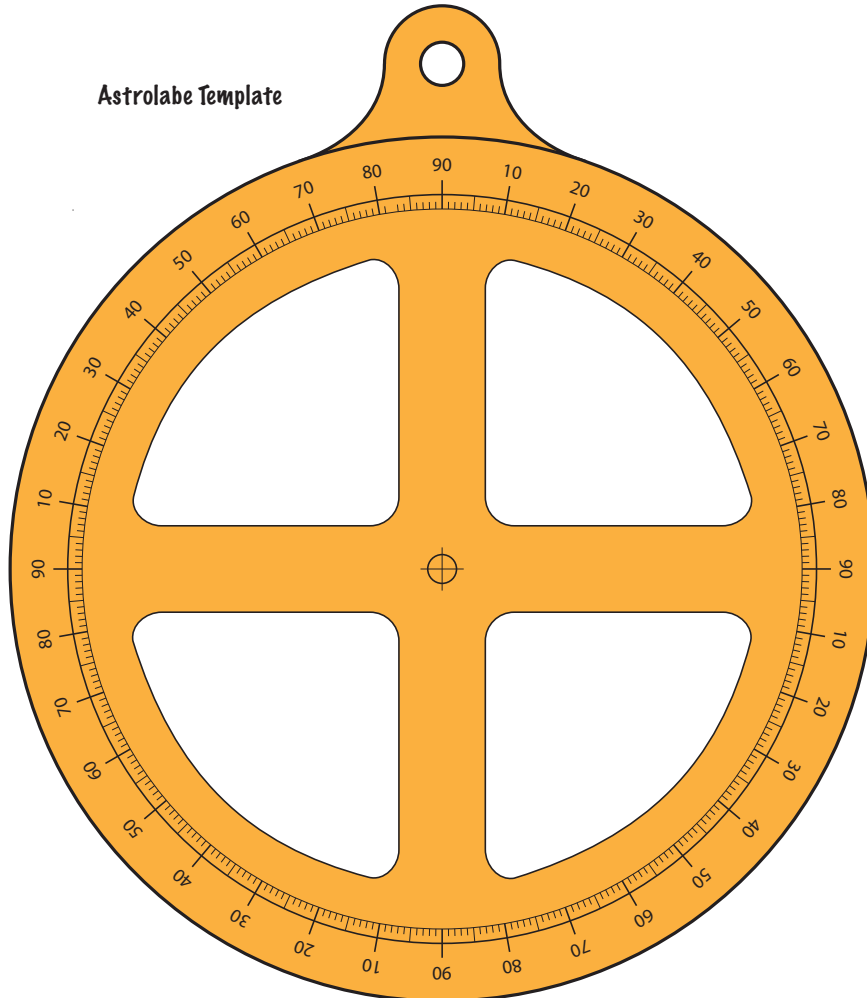

Sight Vane



1. Glue the "Astrolabe Template" onto a piece of wood or stiff cardboard. With help from an adult, cut out the two pieces of the astrolabe as closely to the lines as possible. It isn't essential to cut out the four pie-shaped pieces in the middle of the astrolabe, but it will be more authentic if you do (mariner's astrolabes had these pieces cut out to reduce wind resistance when the instrument was being used on ships).
2. Drill a $\frac{3}{16}$ inch diameter hole through the center of the astrolabe and sight vane. Assemble the two pieces with a #8 bolt, nut, and three washers (one washer under the head of the bolt, one between two astrolabe pieces, and one under the nut).

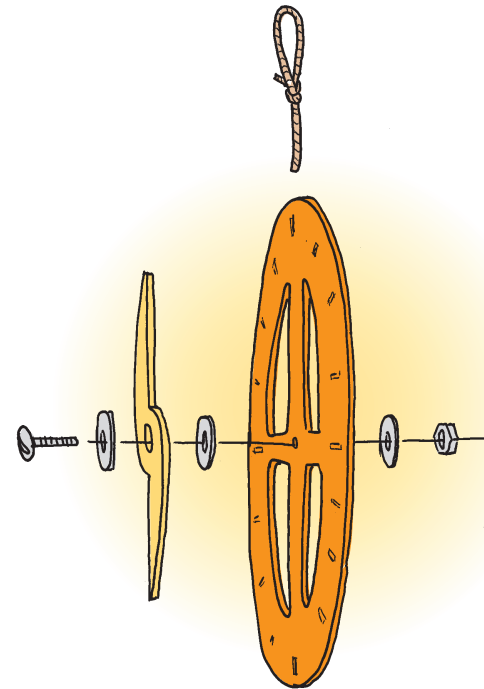

3. Tie a loop of rope, string, or twine through the hole at the top of the astrolabe.
4. To use your astrolabe, hold the instrument by the rope so that it hangs vertically. Line up the two ends of the sighting vane with the top of the object whose height you are measuring. Read the altitude of the object in degrees from the upper left or lower right scale on the astrolabe.

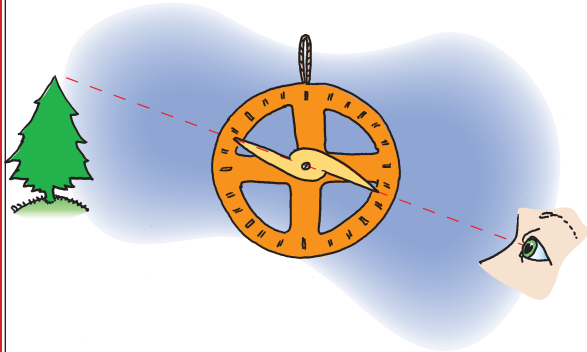

[NOTE: Notice that a horizontal object measures 90° on the upper left and lower right scales. This measurement is called “zenith distance” and is used on a mariner’s astrolabe to simplify latitude calculations.]

5. To find the height of a vertical object using your astrolabe:

- a. Set the sight vane to 45° on the upper left or lower right scale.

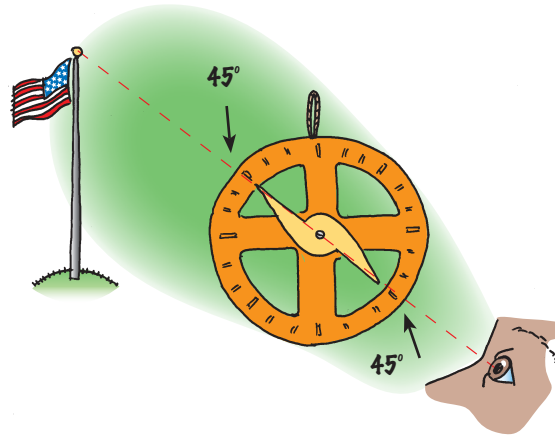

- b. Hold the astrolabe so that it hangs vertically, and walk to a position at which the top of the object you want to measure is lined up with the two ends of the sight vane. Measure the height of the astrolabe above the ground.
- c. Measure or pace the distance to the base of the object. Add this distance to the height of the astrolabe above the ground. The sum is equal to the height of the object.

Knowing the length of your pace can be useful for many things. Back in the day, a pace meant the distance traveled when you took TWO steps. For most people, this works out to be about 5.25 feet. So 1,000 paces is about equal to one mile. Find the length of your pace by walking 20 steps and measuring the distance covered. This distance divided by 10 is the length of your pace.

Want to Do More?

1. Check out <http://astrolabes.org/> for examples of astrolabes made by individuals. You may also want to watch the NOVA program, *Lost at Sea: The Search for Longitude* (available from public libraries and from <http://www.pbs.org/wgbh/nova/novastore.html>).
2. Sometimes you won’t be able to get far enough away from an object to line up the ends of the sight vane when it is set to 45° . You can still use the astrolabe to find height, but will have to use a little trigonometry (don’t worry, it isn’t really very hard). Here are the basic things you need to know:
 - a. A “right triangle” has two sides that meet at an angle of 90° .
 - b. The side of the triangle opposite the 90° angle is called the hypotenuse.

c. The tangent of one of the other angles is defined as the length of the side opposite the angle divided by the side closest to the angle (NOT the hypotenuse).

So, in the drawing below, the tangent of angle a is equal to side A divided by side B. A shorthand way to write the last sentence is:
 $\tan a = A \div B$

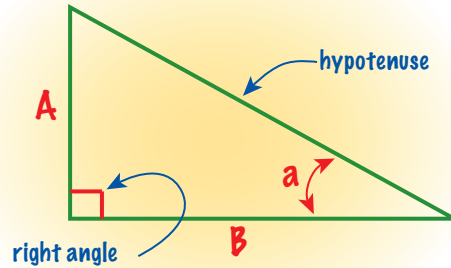

Now, we can find the height of the flagpole in the drawing to the right.

The height of the flagpole is side A plus "H" which is the height of your eyeball above the ground.

The tangent of angle a is equal to side A divided by side B. Written in the shorthand way:
 $\tan a = A \div B$

Using Trigonometry and Your Astrolabe to Find the Height of an Object

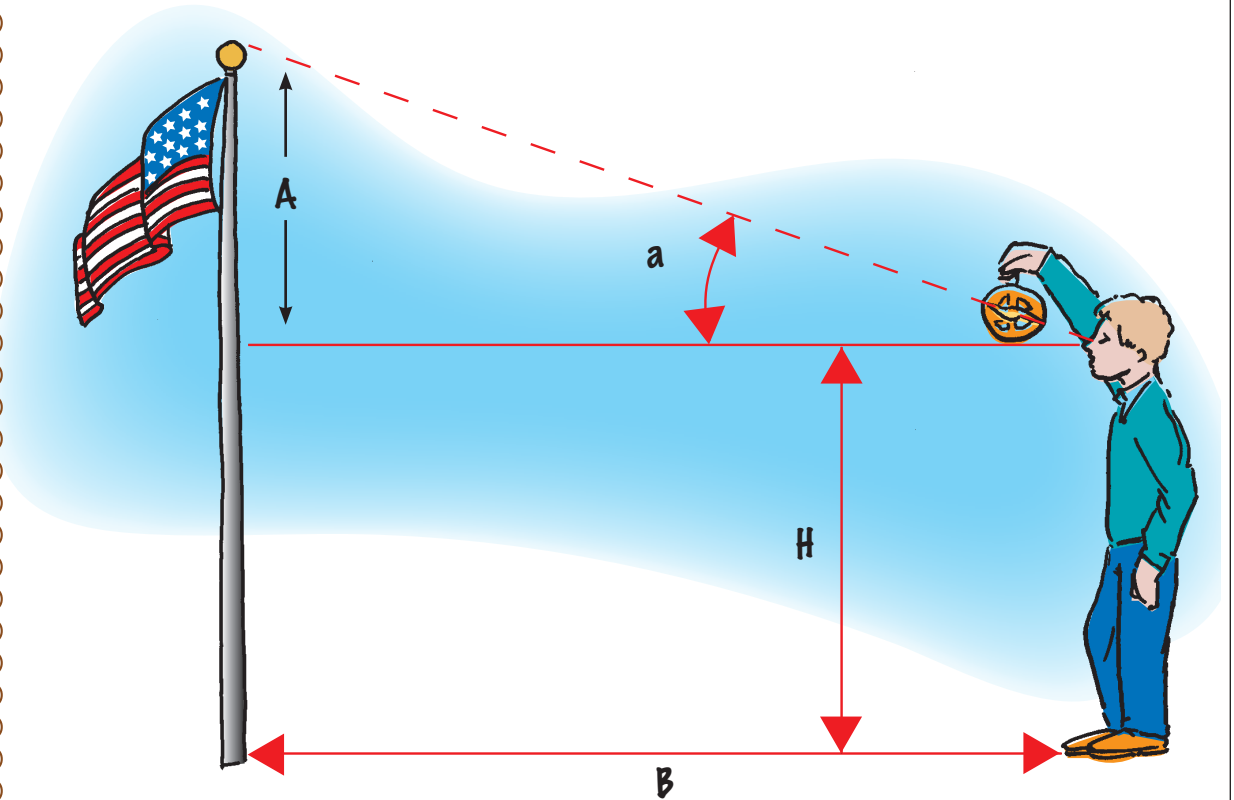

Suppose angle a is equal to 60° and side B is 50 feet. Then,

$$\tan 60^\circ = A \div 50 \text{ feet}$$

You can find tangents on many calculators, and in tables from trigonometry books and on the internet. The tangent of 60° is 1.73. So,

$$1.73 = A \div 50 \text{ feet}$$

So, A is equal to 1.73 multiplied by 50, which is 86.5 feet

The height of the flagpole is side A plus "H" which is the height of your eyeball above the ground. If H is equal to 4.5 feet, the height of the flagpole is:

$$86.5 \text{ ft} + 4.5 \text{ ft} = 91 \text{ feet}$$

Make Your Own Compass

"When neither sun nor stars appeared for many a day, they gave up hope. This was a terrible handicap to them because these ancient navigators had no compass nor any other instrument. The only way they could guide the ship was by the sun and stars. When they could not see them for many days they lost all knowledge of their whereabouts. They were drifting helplessly before a howling gale in the midst of a turbulent sea with no idea where they were headed."

~ from *God and Shipwrecks* by Ray C. Stedman
<http://www.raystedman.org/acts/0450.html>

One of the most important improvements to ocean navigation was the invention of the compass. There is some disagreement about who should get credit for this invention. It's pretty clear that the Chinese knew about magnetism as early as 2637 BC, but the first written description of a compass for navigation didn't appear in Europe until 1190. Why did it take so long? After you do this activity, you may have at least one good answer!



North Pacific storm waves as seen from the M/V NOBLE STAR, Courtesy NOAA

What You Will Need

- Sewing needle about one to two inches long
- Small bar magnet or refrigerator magnet
- A small piece of cork (corks from wine bottles work well, but not the plastic stoppers)
- A small glass or cup of water to float the cork and needle
- Pair of pliers

What You Will Do Make a simple compass to find magnetic north or south, depending on where you live

Warnings

1. Needles are sharp. Be careful!
2. Magnets can damage cards with a magnetic stripe (credit cards, library cards, school IDs, etc), floppy disks, and some electronic devices. Keep magnets away from these things.

How to Do It

1. Rub a magnet over the needle a few times, always in the same direction. This action magnetizes the needle.

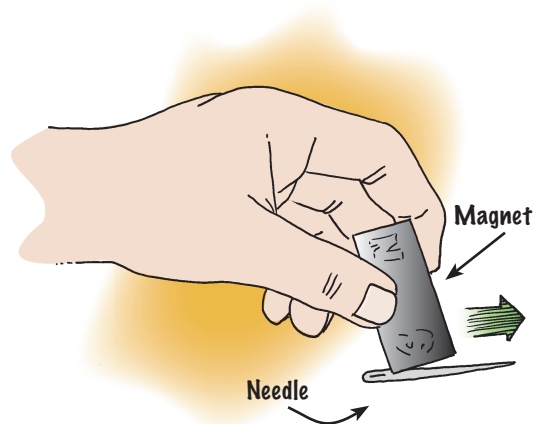

2. Cut off a small circle from one end of the cork, about 1/4-inch thick. Lay the circle on a flat surface.

3. Using a pair of pliers, carefully poke the needle into one edge of the circle and force the needle through the cork so that the end comes out the other side. Push the needle far enough through the cork so that about the same amount of needle is sticking out each side of the cork. Be careful not to stick yourself!

4. Fill the glass or cup about half full of water, and put the cork and needle assembly on the surface of the water.

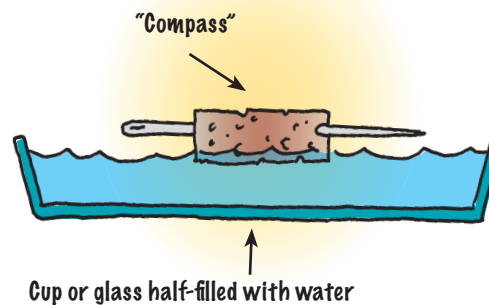

5. Place your "compass" on a flat surface and watch what happens. The needle should point towards the nearest magnetic pole—north or south, depending upon where you live.

6. Try placing a magnet near your compass and watch what happens. How close does the magnet have to be to cause any effects? Try this again with a nail or other steel object. You can see why it's important to keep metal objects away from compasses on ships!

7. Imagine you are on the deck of a ship tossing back and forth on the open ocean. How well do you think your compass would work? When the cork floats on the water it creates a sort of low-friction bearing. This kind of bearing is essential to allow the needle to rotate in response to Earth's magnetic field. But a cup of water probably wouldn't last long on the deck of a rolling ship! The need for a sturdy low-friction bearing was one of the reasons that it took a long time for mariners to use compasses at sea, even though the basic principles had been known for centuries.

What's Happening

Magnetic fields are areas that contain a force created by moving electrical charges. Earth produces a magnetic field. This field is very weak, but it is sufficient to align magnetized objects—such as your needle—that are free to rotate. By floating the needle on the cork, you allow it to rotate freely so the needle becomes lined up with Earth's magnetic field, and points toward the north or south pole of the planet.

Tied Up In Knots

“Topmen, aloft!” sang out the commodore in a piercing voice that rose above the screaming wind and roar of the sea. “Take in the topgallants and royals!”

We all raced aloft; but no sooner had these sails been furled and we returned to the deck than the commodore was at us again.

“Reef topsails!” he shouted even louder than before. “Away aloft—take in one reef!”

Mick and I scrambled up, almost out of breath, into the mizzen-top; which we hardly reached before we heard the commodore give the next order necessary to enable us to take in the reef—

“Weather topsaill braces, round in! Lower the topsails!”

~ from *Young Tom Bowling* by J.C. Hutcheson, 1896.

Do you know how to tie a reef knot? A sailor's life and the safety of the entire crew and ship can depend on the quality of knots he ties. Sailors take pride in being able to match the right knot to a specific job, and even modern sailors need to master this skill.

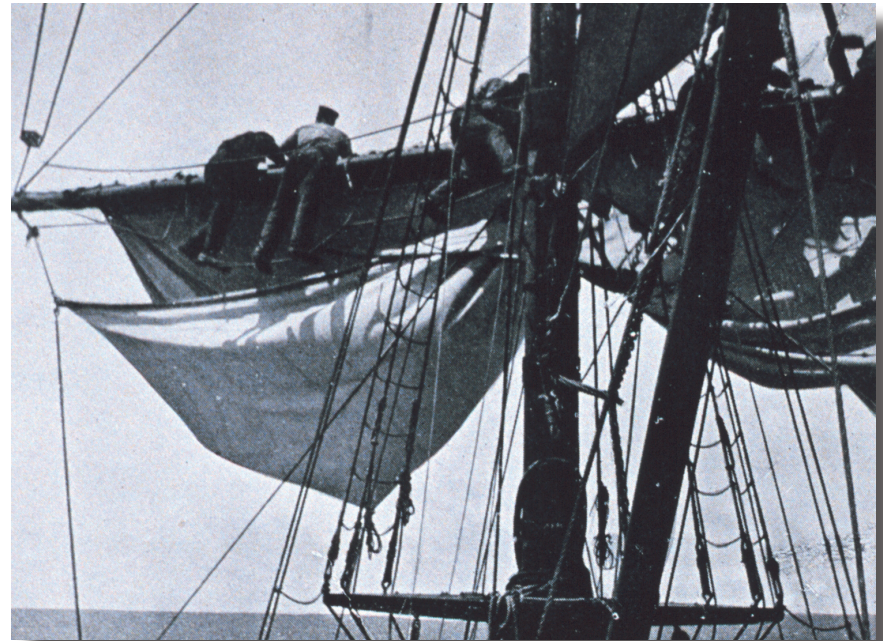

“In the rigging”. In *The South Pole*, by Roald Amundsen, 1872-1928. Archival Photograph by Mr. Steve Nicklas, NOS, NGS. Courtesy NOAA

What You Will Do

Learn to tie some basic knots that have been used by mariners for centuries and are often useful in everyday life

What You Will Need

- ❑ One or more pieces of rope, about 3 feet long; nylon, polypropylene, manila, or cotton ropes, 1/4-inch to 1/2-inch in diameter work well
- ❑ Pictures or video showing how to tie knots

How to do It

There are three different types of “knot.”

- A **Bend** is used to join two ropes (often of different diameters), or to fasten a rope to an eye, ring, or other structure. *Examples: sheet or becket bend; anchor bend*
- A **Hitch** is designed to stay in place under strain, but remain easily adjustable when the strain is removed. *Examples: clove hitch, half hitch, rolling hitch*
- A **Knot** is used to fasten ropes together, or to fasten a rope to an object, or to enlarge the end of a rope (as in a stopper knot.) A stopper knot is usually tied at the end of a rope to prevent the line from slipping through an eye, ring, or pulley. A good knot must be able to be easily untied. *Examples: bowline, reef (square) knot, overhand knot, figure eight knot*

Five Useful Knots

Bowline

Uses: Forms a loop at the end of a rope that will not slip (close up) when the rope is under tension. This knot is easy to untie, even after it has been under high strain.

How to Tie It: Be sure the free end of the rope lies inside the loop when the knot is completed.

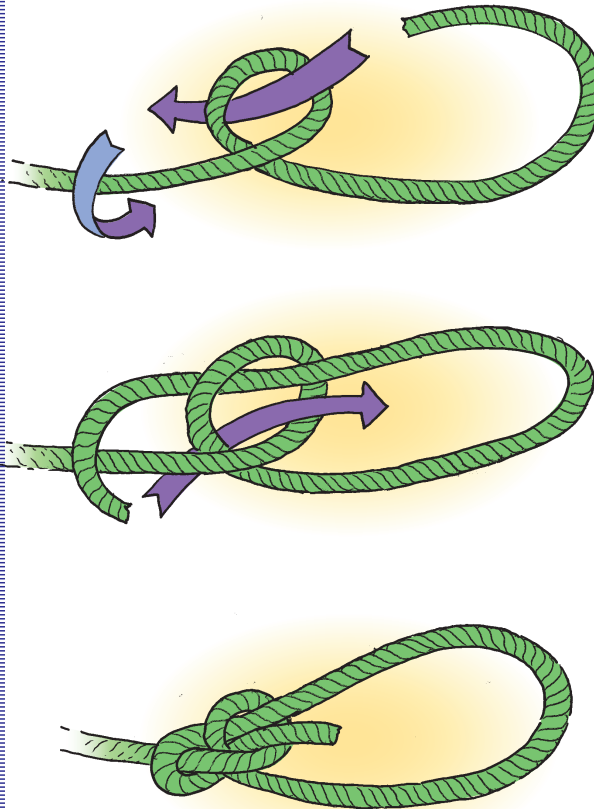
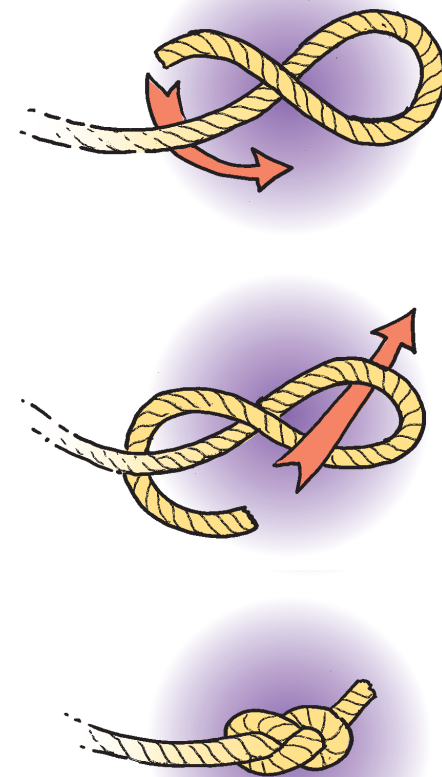

Figure Eight

Uses: A “stopper” used to prevent the end of the rope from slipping through a pulley. Also used in mountain climbing to secure a rappelling line to a climbing harness.

How to Tie It:



Clove Hitch

Uses: Used to secure a line to a round object such as a post or rail.

How to Tie It:

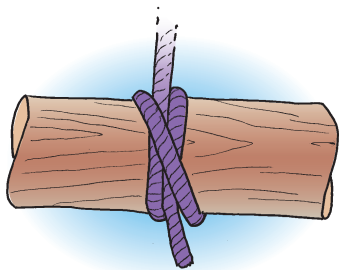
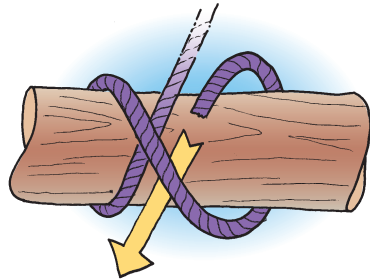
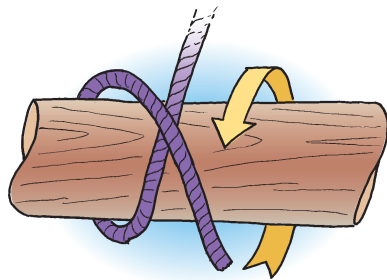

Reef Knot (Square Knot)

Uses: Used for lashings and other situations where a line must be tied around an object, but should NEVER be used as a bend to tie two ropes together. "Reefing" a sail means to make the sail smaller by partially folding or "furling" the sail. A Reef Knot is used to tie the sail in a partially folded position.

How to Tie It: If you grab one of the free ends and jerk it across the knot, the knot will "capsize" and slip apart easily.

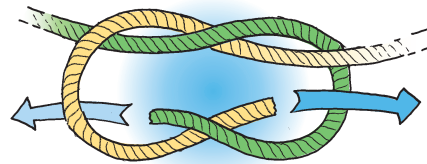
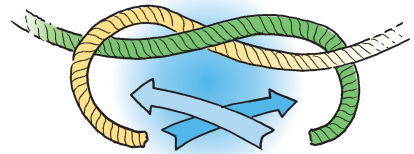

Sheet Bend

Uses: One of the best bends for joining two ropes together, especially if the ropes do not have the same diameter.

How to Tie It: The rope with the larger diameter should be used for the loop.

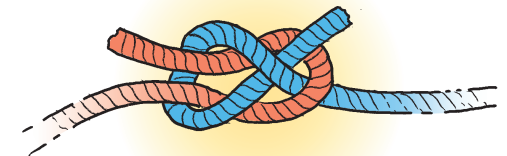
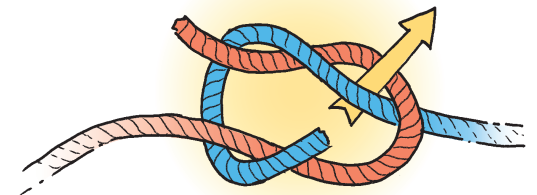
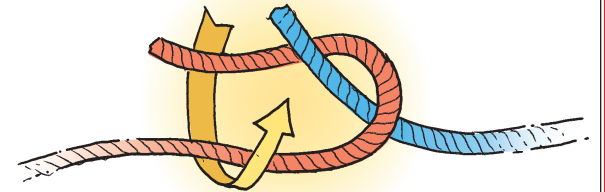

Turn Your Knot Tying Skill into a Game:

Organize a knot tying race. Give each contestant five pieces of rope, and see who will be first to correctly tie all five knots. If one knot is wrong, the contestant loses. If this seems harsh, remember that a single badly tied knot can be disaster for mariners at sea.

Want to Know More?

There are lots of books on knot tying and ropecraft. Two very good ones are:

Knotcraft: The Practical and Entertaining Art of Knot Tying by Allan and Paulette Macfarlan; Dover Craft Books, 1983

The Arts of the Sailor – Knotting, Splicing and Ropework by Hervey Garret Smith; Dover Publications, reprint edition

You can find animated knot tying instructions in the Tollesbury Sailing Club's knot gallery at

http://www.tollesburysc.co.uk/Knots/Knots_gallery.htm

Another Web site with instructions for tying many different knots is:

<http://www.2020site.org/knots/>

The dredging and sounding arrangements on board the CHALLENGER.
In *The Voyage of the CHALLENGER - The Atlantic* Vol I, by Sir C. Wyville Thomson, 1878.
Archival Photography by Steve Nicklas, NOS, NGS. Courtesy NOAA



FIG. 17.—The Dredging and Sounding Arrangements on board the 'Challenger.'

WHO'S BLUE PETER?

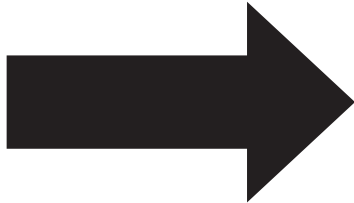

“The Gallant Frigate Amphitrite, she lay in Plymouth sound;
Blue Peter on the foremast peak for we were outward bound.
We were waiting there for orders to send us far from home;
When the orders came for Rio, and then around Cape Horn.”

~ from *The Gallant Frigate Amphitrite, a traditional sea shanty*
(This tune is available in MIDI format at
http://www.traditionalmusic.co.uk/song-midis/Rounding_the_Horn.htm)



The CHALLENGER at St. Paul's Rocks. In *The Voyage of the CHALLENGER - The Atlantic Vol I*, by Sir C. Wyville Thomson, 1878. Archival Photography by Steve Nicklas, NOS, NGS. Courtesy NOAA

Who—or what—do you think Blue Peter is?

Traditionally, Blue Peter is the nickname given to the nautical signal flag that represents the letter “P.” When communicating with signal flags, each letter of the alphabet has a specific meaning. The letter “P” means “All persons should report on board as the vessel is about to proceed to sea.” So when a ship is flying Blue Peter, everyone knows that its voyage is about to begin.

International code flags are still used to communicate between ships and between ship and shore. The colors used on nautical signal flags are chosen because red, blue, yellow, black, and white are colors that can be most easily distinguished at sea. Signals may use one or more flags to communicate a particular message. One-flag signals are used for very urgent or very common signals.

Two-flag signals are used to provide more specific information, particularly in emergency situations or when maneuvering a vessel. Three-, four-, five-, six-, and even seven-flag signals are used to convey other types of information. Sometimes, when a “standard” signal won't work, flags may be used to spell out individual words.

What You Will Do

Make a set of nautical signal flags,
and use the flags to send messages

What You Will Need

- White poster board or white cloth
- Colored markers
- Two pieces of string or light rope (1/8-inch diameter or less), long enough to loop over a tree limb or other object that will allow you to hoist your flags
- One or two copies of "Table of Single Letter Signals"
- Scissors to cut poster board or cloth
- Ruler and compass (or round object such as a bowl or can)
- Notepads and pencils

How to Do It

1. Cut out 26 rectangular pieces of poster board or cloth, about 8 inches x 10 inches. Cut one triangular pennant, shaped like this:

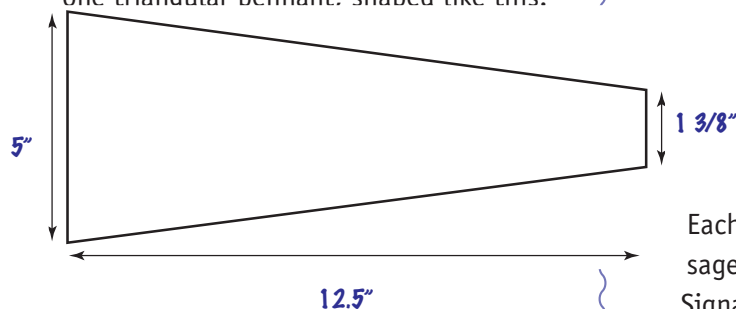

2. Use your ruler and compass (or round object) to draw the shapes needed for each flag shown in the "Nautical Signal Flags" illustration.
3. Use markers to color your flags as shown in the illustration.

4. Make holes in the left side of your flags to attach the string or rope.
5. Loop the strings or ropes over tree limbs or other objects that will allow you to raise and lower your flags.
6. If you have four or more people, you can have a competition. Each team should have a signalling crew and a receiving crew at least 20 feet away. Each crew should have a string or rope (called a "halyard") looped over a tree limb or other object that will allow the crew to hoist their signals. The signalling crew should have a complete set of alphabet flags, and the receiving crew should have an answering pennant.

Each team should make a list of ten messages using the "Table of Single Letter Signals," then give their list to the other team's signalling crew. The receiving crews are not allowed to look at the lists!

7. On the "Go" signal, each signalling crew raises the flag corresponding to the first message on their list. As soon as the receiving crew understands the message, they

should write the message on a notepad and raise their answering pennant. Then the receiving crew lowers their flag, and replaces it with the flag for the next message.

When the receiving crew understands a signal, they hoist their answering pennant as far up as the halyards will go. At this point, the pennant is said to be "close up." Then, when the signalling crew lowers their signal, the receiving crew lowers their pennant about halfway down. Now the pennant is said to be "at the dip," and is held in this position until the next signal is understood.

The first team to correctly send all ten messages wins!

Want to Do More?



























1. You can download the entire International Code of Signals (157 pgs, 2.6 MB) from the National Geospatial-Intelligence Agency Web site. Open <http://www.nga.mil/portal/site/maritime/>, and click on "Publications" on the left side of the page. Then select "International Code of Signals" from the pull-down menu at the top of the "Navigational Publications" page.
2. See <http://sartori.com/nhc/flags> for a Web page that automatically translates text into flag signals.

Single Letter Signals

- A** I have a diver down; keep well clear at slow speed.
- B** I am taking in, or discharging, or carrying dangerous goods.
- C** Yes
- D** Keep clear of me; I am maneuvering with difficulty.
- E** I am altering my course to starboard.
- F** I am disabled; communicate with me.
- G** I require a pilot. When made by fishing vessels, this signal means "I am hauling nets".
- H** I have a pilot on board.
- I** I am altering my course to port.

- J** I am on fire and have dangerous cargo on board: keep well clear of me, or I am leaking dangerous cargo.
- K** I wish to communicate with you.
- L** You should stop your vessel instantly.
- M** My vessel is stopped and making no way through the water.
- N** No
- O** Man overboard.
- P** All persons should report on board as the vessel is about to proceed to sea.
- Q** My vessel is "healthy" and I request permission to proceed into port.

- S** I am operating astern propulsion.
- T** Keep clear of me; I am engaged in pair trawling.
- U** You are running into danger.
- V** I require assistance.
- W** I require medical assistance.
- X** Stop carrying out your intentions and watch for my signals.
- Y** I am dragging my anchor.
- Z** I require a tug.

A Alfa		F Foxtrot		K Kilo		P Papa		U Uniform		Z Zulu	
B Bravo		G Golf		L Lima		Q Quebec		V Victor		 Answer	
C Charlie		H Hotel		M Mike		R Romeo		W Whiskey			
D Delta		I India		N November		S Sierra		X X-ray			
E Echo		J Juliet		O Oscar		T Tango		Y Yankee			

The Water Writers

“At about 9 p.m., I felt the vessel graze the bottom... I grabbed my cap, and rushed up the steps leading to the spar deck...and immediately afterward heard the most dreadful and agonizing sounds as the ship hurled herself on the reef...The call of the boatswain: ‘All hands prepare to abandon ship,’ I heard above all of this din. I could hardly walk the decks; the pounding and jumping of the ship swaying me from side to side.”

~ from Capt. R. O. Crisp on the loss of the revenue cutter *Tahoma* after hitting an uncharted reef on the south side of the Aleutian Islands, Alaska on September 20, 1914
(http://www.uscg.mil/history/WEB CUTTERS/Tahoma_1909.html)

If Alaska had been a U.S. state in 1914, the reef that wrecked the *Tahoma* might have been on Captain Crisp’s navigation charts. This is because more than a hundred years earlier, in 1807, President Thomas Jefferson established the Survey of the Coast to chart the U.S. coastline to make the coasts of our nation safe for navigation. A top priority of the Coast Survey was (and is) to create charts that show the shape of the coasts, currents, and the depth of coastal waters. Gathering information needed for these charts is called “hydrography,” and people who do this work are known as “hydrographers” (“hydro” means water, and “grapher” is one who writes).

Today, hydrographers working for NOAA’s Office of Coast Survey continue the work begun by the Survey of the Coast. These scientific nomads travel around the coasts collecting information needed for up-to-date charts that guide ships in and out of U.S. ports. The most basic job of hydrographers is taking measurements of water depth (called “soundings”).

What You Will Do

Make a sounding box and discover the profile of a model seafloor



Courtesy NOAA

Sounding party off USCS Brig FAUNTLEROY. 1857-Earliest picture of Coast Survey sounding operations. Watercolor by James Madison Alden, nephew of Lieutenant Commanding James Alden.

Modern hydrographers use sidescan and multibeam sonar and satellite-based global positioning systems (GPS) to produce very detailed pictures of the sea floor. For many years though, hydrographers used lead lines to make depth measurements. A lead line is a rope or line with a 10-pound lead weight attached to the end. The hydrographer lowers the line into the water until the weight reaches the bottom. Markings on the line show how much line has been let out, which is equal to the depth of the water. Depth soundings made with lead lines are accurate, but they take a lot of time and only give information about single points of the sea bottom—so many lead line measurements are needed to accurately survey a given area.

Here’s a way to get a feel for hydrographic surveying with a lead line—and you don’t even have to get your feet wet!

What You Will Need

This activity is most challenging if you have one or more friends who also make a sounding box and set up a model seafloor inside the box. Then you can trade sounding boxes and compete to see who can discover everything on an unknown seafloor.

For each sounding box you will need:

- A shoebox or other cardboard box that is about 2 inches to 4 inches high
- A replaceable air conditioner filter large enough to cover the box
- A wooden skewer about 4 inches longer than the height of the sounding box
- A ruler
- A felt tip marker
- A copy of the "Sounding Box Plotting Sheet"
- A pencil
- Small objects such as Lego® blocks, toy vehicles, rocks, modeling clay, etc.
- Masking tape
- Rubber cement

How to Do It

1. Use masking tape or rubber cement to fasten small objects to the inside bottom of the cardboard box.
2. Mark the sides of the air conditioner filter at 1/2-inch intervals as shown in the "Air Conditioner Filter Grid" drawing.

Label the horizontal lines with numbers, and vertical lines with letters as shown.

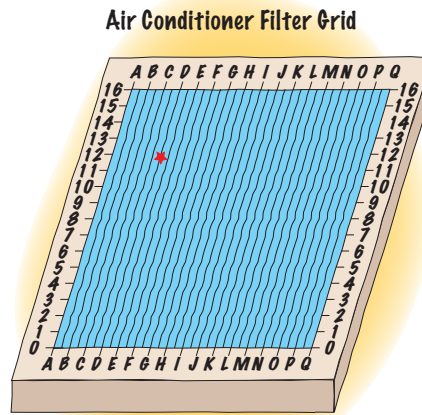

3. Mark your wooden skewer every 1/4-inch with a felt-tip marker. If you have colored markers, you can use a different color to mark one-inch and two-inch intervals as shown on the "Sounding Skewer Marking" diagram. This makes it easier to tell how deep the skewer is when you take "soundings."

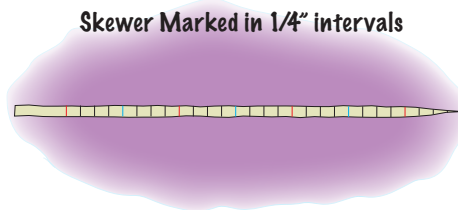

4. Fasten the air conditioner filter to the cardboard box with masking tape so no one can see inside the box.

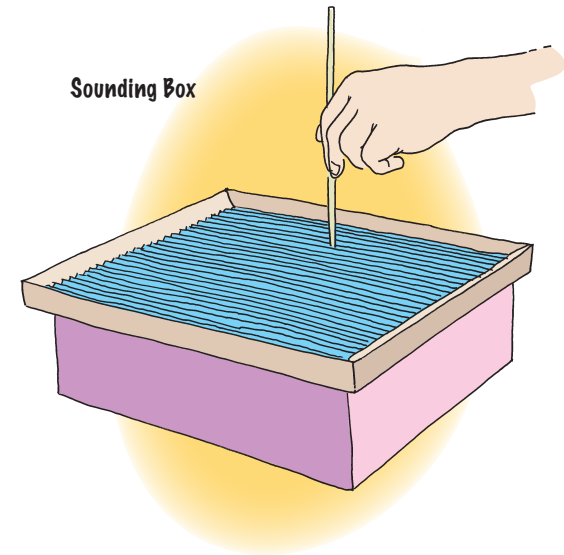

5. Now it's time to be a hydrographer! Use a ruler and the grid on the air conditioner filter to locate specific spots for "soundings." Take "soundings" by gently pushing the skewer through the air conditioner filter until the skewer hits bottom. Read the "depth" on the skewer, and record this measurement in the place on the "Sounding Box Plotting Sheet" that matches the sampling location on the air conditioner filter grid. For example, the red star on the "Sounding Box Plotting Sheet" matches the location of the red star on the "Air Conditioner Filter Grid" drawing. If your sounding box is less than 10 inches x 10 inches, you won't use all of the grid squares. If it is larger than 10 inches x 10 inches, add more horizontal and vertical lines to the Plotting Sheet.

6. Continue making soundings until you think you have a clear picture of the model seafloor. Outline the features of the model seafloor on the Plotting Sheet, then remove the filter from the top of the box and see how well your Plotting Sheet compares with the actual "seafloor."

Want to Do More?

Check out these books at the library:

- The Coast Mappers* by Taylor Morrison
- Mapping the Seas* by Walter Oleksy
- Mapping the World* by Sylvia A. Johnson
- The Story of Maps and Navigation (Signs of the Times)* by Anita Ganeri
- Small Worlds: Maps and Map Making* by Karen Romano Young

You may also want to visit these Web sites:

<http://chartmaker.ncd.noaa.gov/> – NOAA's Office of Coast Survey homepage

<http://www.secretsatsea.org/main.html> – An interactive game that includes many aspects of the ocean, including mapping

<http://nos.noaa.gov/topics/navops/hydrosurvey/welcome.html> – NOAA's hydrographic survey page

<http://historicals.ncd.noaa.gov/historical/histmap.asp> – Take a look at historical maps and charts

Sounding Box Plotting Sheet

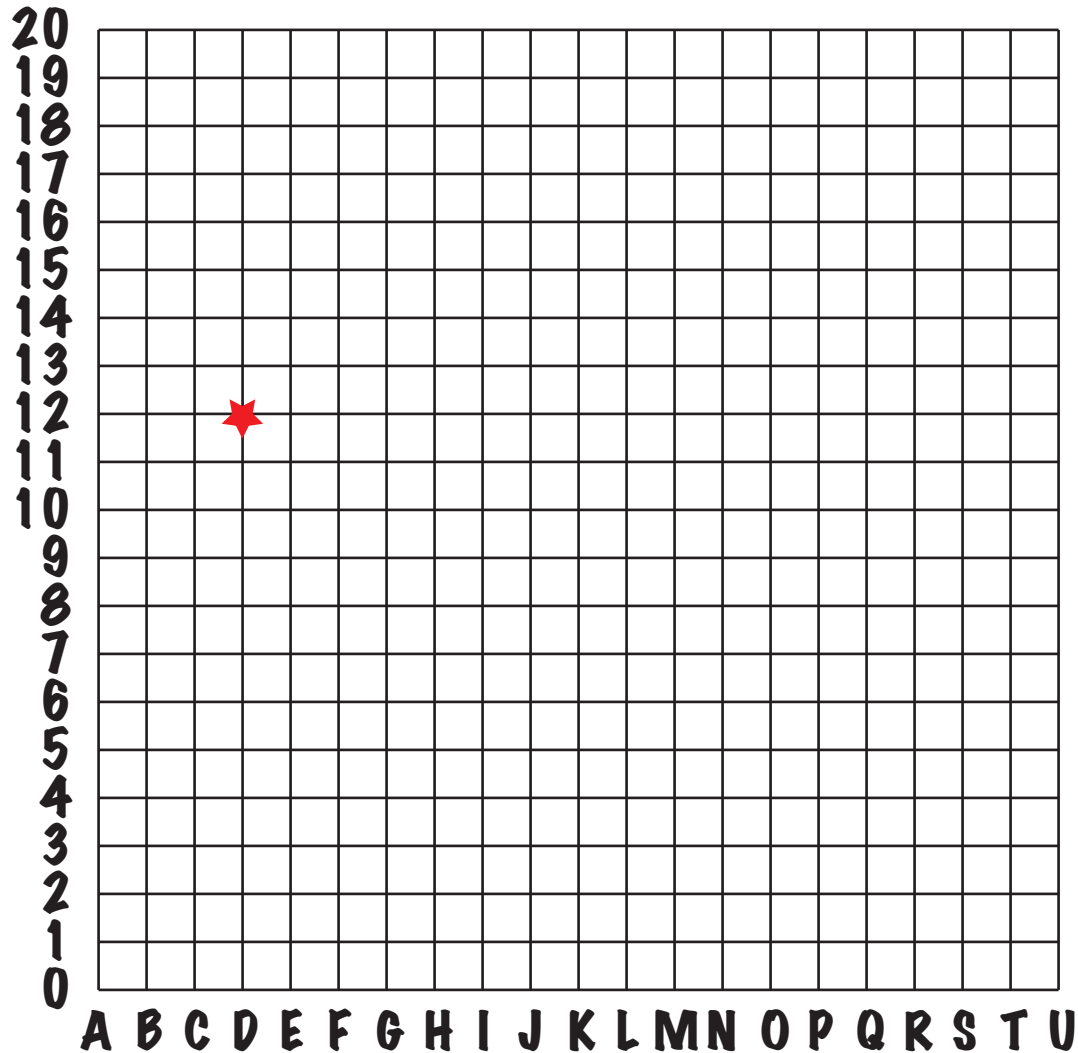

Nautical Chart Challenge

For as long as anyone in his family could remember, Francis Beaufort wanted to make scientific observations from the deck of a ship. In 1789 at the age of fourteen, he set sail as a sort of officer-in-training aboard the *Vansittart*, an East India Company tradesman bound for China and the Indies. A central goal of the *Vansittart*'s journey was to survey the Gaspar Strait, where sister ships of the East India Company had been lost on dangerous and poorly charted shoals.

The *Vansittart* found the shoals...by running hard aground, and taking on water so rapidly that the crew was forced to abandon ship on a tiny reef in the Java Sea. The waters were filled with pirates, so the crew threw thirteen treasure chests overboard, hoping to return later to reclaim them. But when they eventually made their way back aboard two British ships, Malay pirates had burned and pillaged the *Vansittart* and the crew managed to recover only three of the treasure chests.

~ based on *Defining the Wind: The Beaufort Scale, and How a 19th-Century Admiral Turned Science Into Poetry* by Scott Huler, 2004

What You Will Do

Discover some of the ways a nautical chart can help a mariner safely navigate in unfamiliar coastal waters

The sinking of the Vansittart provided dramatic evidence of the value of an accurate nautical chart, and Francis Beaufort later became one of history's premier hydrographers. Today, NOAA's Office of Coast Survey produces accurate nautical charts and many other navigational aids that help mariners navigate safely in and out of U.S. ports and along the U.S. coastline as far as 200 nautical miles from shore. How important is ocean navigation? You may be surprised to know that even in the "space age," over 98% of the nation's cargo is carried by waterborne transportation.

Here's a chance to try your hand at coastal navigation using a modern nautical chart. Watch out for shoals!

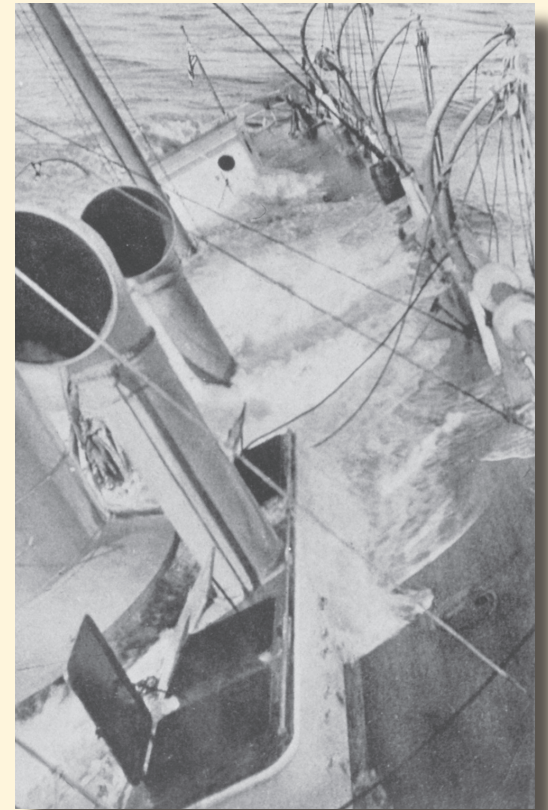

Wreck of U.S. Revenue Cutter *TAHOMA* which struck an uncharted pinnacle rock off Agattu Island, western Aleutians, September 20, 1914. Courtesy NOAA Ship Collection

What You Will Need

- “Segment of NOAA Nautical Chart 11445, Bahia Honda Key to Sugarloaf Key”

How to Do It

1. Before beginning your cruise, you need to know a few things about nautical charts. Most charts contain A LOT of information, including lights, buoys, wrecks, information about the sea bottom, shoreline features, water depth, and much more. These features are often very close together, so charts use many symbols and abbreviations. A complete list of these symbols is available in a booklet known as “Chart No. 1,” which can be downloaded from <http://nauticalcharts.noaa.gov/mcd/chart1/chart1hr.htm> (the file containing the entire publication is 85 Mb, but smaller files containing specific kinds of information are also available). Here are a few basics:
 - The compass rose is a tool provided on all nautical charts to simplify the process of measuring directions. On the sample chart, the compass rose is near the upper center of the chart. The most commonly used reference point for direction on nautical charts is Earth’s geographic north pole (“true north”).
 - Depths on nautical charts are shown as many small numbers scattered over water areas. Depths indicated by these num-

bers are expressed in feet, fathoms (one fathom is equal to six feet), or meters. Contour lines (called “depth curves”) connect points of equal depth, typically 6, 12, 18, 30, 60 and multiples of 60 feet. It’s important to remember that depths shown on charts are average depths, so the actual depth at a given location may be less than that shown on the chart.

- The general rule for coastal navigation is “red, right, returning.” This means that red markers, lights, or buoys should be on the right side of a vessel when coming into port. There are many exceptions to this general rule, though, so it is essential to have a chart that shows the arrangement of markers for a specific part of the coast.
- In shallow water, markers are often flat “signs” fastened to wood or metal stakes. Red markers are usually triangular, and green markers are square. These markers are shown on a chart by red triangles and green squares, and usually have a number that also is shown on the chart.
- Buoys are shown on nautical charts by diamond-shaped symbols and a small open circle that indicates the location of the buoy.

- Red buoys are printed in magenta and often have the letter “R” nearby.
- Green buoys are printed in green with the letter “G” nearby.
- A number in quotation marks is the number painted on the buoy’s structure.
- Lighted buoys are indicated by a magenta disk printed over the small circle that marks the buoy’s position.
- The shape of unlighted buoys is normally shown by a letter. “C” indicates a “can” buoy whose top has a cylindrical shape
- “N” indicates a “nun” buoy whose top is shaped like a cone with the pointed end cut off (this is called a “truncated” cone).
- Lights on nautical charts are all shown by a magenta symbol that looks like an exclamation point and a black dot indicating the light’s position. Notes alongside these symbols describe the color of the light and how it flashes. Some commonly used abbreviations are:
 - Q: A light flashing at a rate of not less than 60 flashes per minute
 - R: A red light.
 - G: A green light
 - If no color is indicated for a light, it is understood to be a white light.

- Numbers next to the symbol for a light show the height of the light.
- If numbers are inside quotation marks, this number is painted onto the light structure.
- Numbers followed by the letter “M” show the approximate range of visibility of the light in miles.

For example:

Q R 16ft “6” 9M

indicates a red light, 16 ft high, flashing at a rate of not less than 60 flashes per minute (“quick flashing”), with the number “6” painted on the structure, with a visibility of about 9 miles

2. Now it’s time to take the Chart Challenge! We will use part of NOAA Nautical Chart 11445, which includes the Florida Keys from Bahia Honda Key to Sugarloaf Key. Suppose you are the captain of a 24-foot fishing boat, and are taking some friends around the Keys. As the captain of a vessel, it is very important to know how much water is under your boat (underkeel clearance). This can vary depending on how much cargo you are carrying (or in this case, how many friends are aboard). Let’s say that your boat draws 2 feet, which is another way of saying that the bottom (keel) of your boat is two feet below the surface. So, you’ll need to subtract two feet from the depths

indicated on the chart to find your under-keel clearance.

- You and your friends board your boat at the dock in Doctors Arm Bay on Big Pine Key (to the right of the compass rose). What kind of markers show the location of this dock?
- After casting off from the dock, you steer southeast into Bogie Channel. What is the maximum depth shown on the chart for the Channel?
- As you pass through Spanish Harbor, you notice a low bridge ahead. The highest point on your boat is 10 feet above the water. Can you pass beneath the bridge?
- You continue heading southeast until your depth sounder shows a depth of 10 feet. What does the chart show is probably on the bottom in this area?
- Your friends are interested in snorkeling, so you decide to take them to the buoyed snorkeling area to the south of Newfound Harbor Keys, which is part of NOAA’s Florida Keys National Marine Sanctuary. Looking at the chart, you see that there are several shallow coral heads marked “Co” that are not marked with buoys. What is the water depth over these coral heads?

- Since the water over the coral heads is very shallow, you want to steer a course that will avoid them. How could you use your depth sounder to help steer clear of these dangers?
- As you travel toward the snorkeling area, one of your friends notices the vegetation on the islands to the north. According to the chart, what kind of vegetation is this?
- According to the chart, the snorkeling area is marked by buoys labeled “A,” “B,” “C,” and “D.” What is the color and shape of these buoys?
- After snorkeling, you decide to visit Ramrod Key. One of your friends says that he can see open water between Hopkins Island and Cook Island. Would this be a good way to go to Ramrod Key?
- After looking at the chart, you decide to go to the southwest of Munson Island to enter Newfound Harbor Channel. What light could you use to be sure you avoid the shallow area to the southwest of Munson Island? How tall is this light?
- After passing Munson Island, you notice four markers that showing the location of Newfound Harbor Channel. What are the color, shape, and numbers of these

markers, and how would you use them to stay in the Channel?

- l. As you enter Newfound Harbor, you notice three green markers and a red marker leading into a marina. What is the water depth near these markers?
- m. You change your mind, and decide to visit Little Torch Key instead. You want to go to a marina that is to the east of the microwave tower on Little Torch Key. Can your vessel pass beneath the bridge between Little Torch and Big Pine Key?
- n. Just before you pass beneath the bridge, one of your friends notices something sticking up out of the water. Does the chart show anything in this area?
- o. After you pass under the bridge, you notice a large marina on the west side of Big Pine Key. Are there any obstacles between your vessel and this marina?

Want to Do More?

For more about nautical charts and how to use them, see "Plot Your Course" at http://oceanservice.noaa.gov/education/classroom/lessons/18_marinenav_plotcourse.pdf; part of the NOAA's National Ocean Service Discovery Classroom.

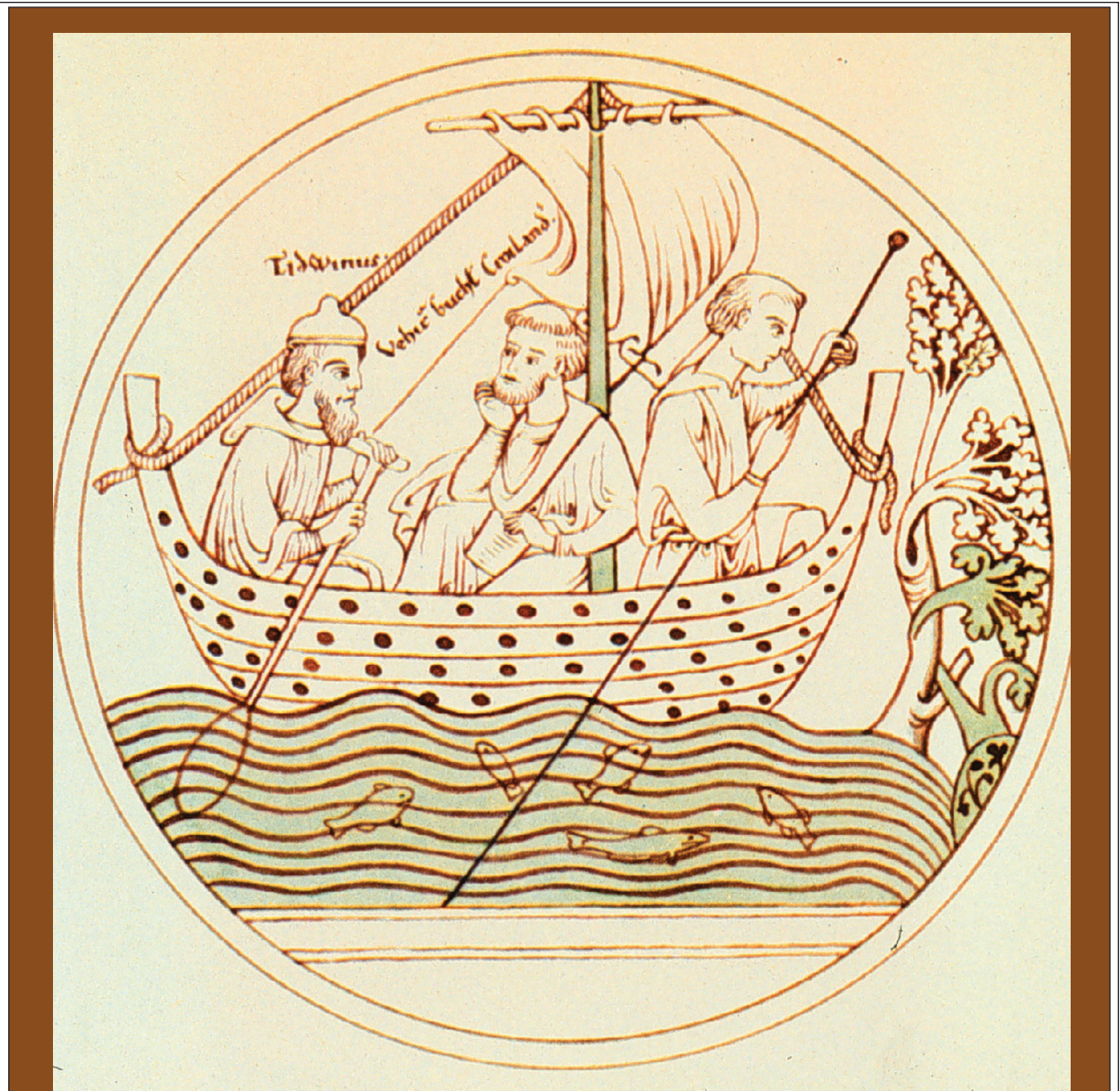

St. Brendan striking out into the Atlantic - about 6th Century A.D. St. Brendan checking depths with his sounding pole.
Courtesy NOAA.

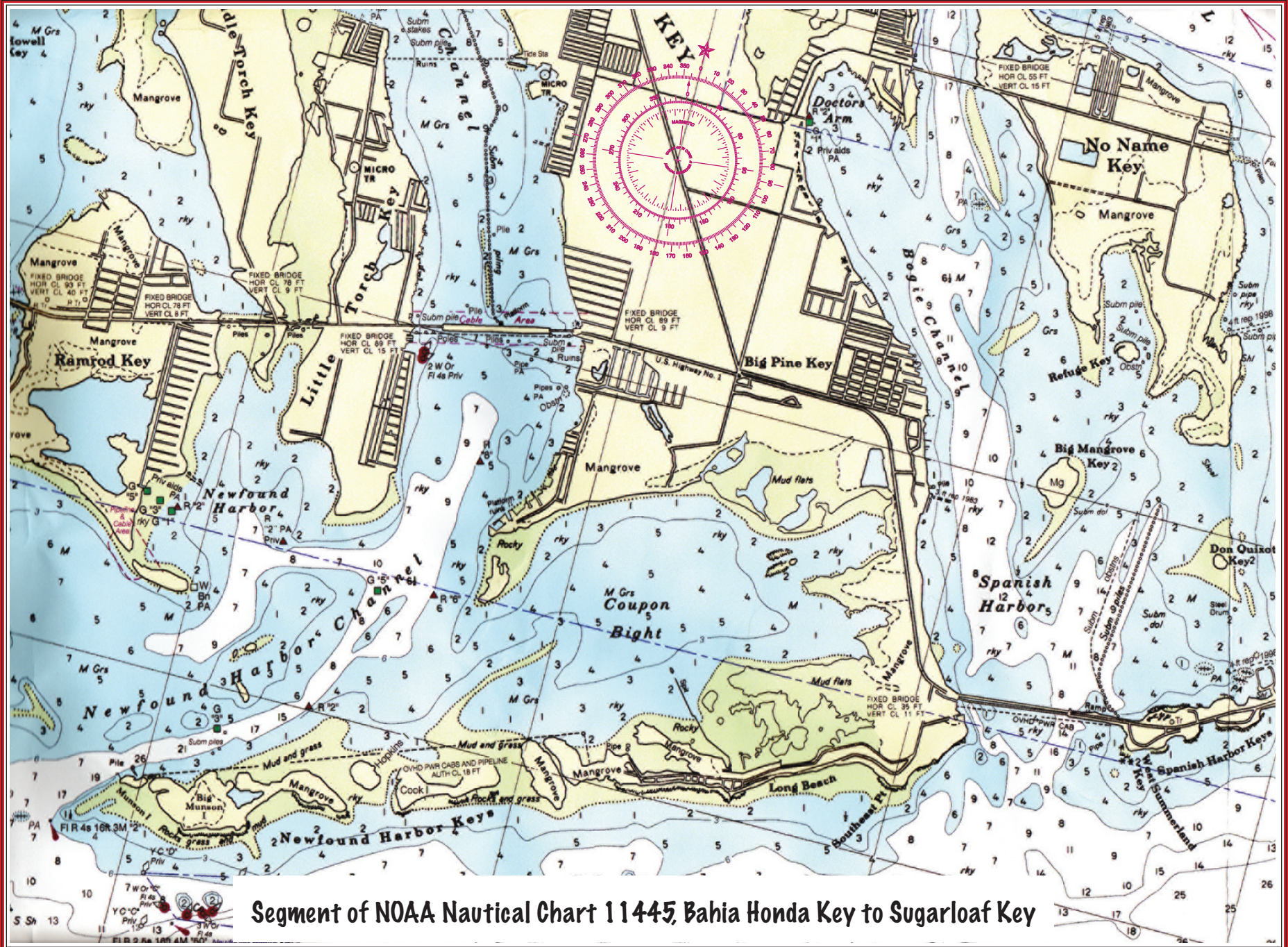

Segment of NOAA Nautical Chart 11445, Bahia Honda Key to Sugarloaf Key

Don't Peek...

Until you have answered **ALL** of the Chart Challenge questions!

Answers to the Chart Challenge

- a. A red triangle numbered "2" and a green square numbered "1"
- b. 12 feet
- c. Yes, because the vertical clearance beneath the bridge is 11 feet
- d. rocks ("rky")
- e. one to three feet
- f. You could use the depth sounder to follow the 12-foot depth contour line, which will keep you away from the coral heads.
- g. Mangroves
- h. The buoys are yellow "cans" that have a cylindrical shape.
- i. No, because the chart shows depths of less than one foot between these islands.
- j. The flashing red light which has the number "2" painted on the structure, and is 16 ft tall and visible for about three miles.
- k. There are two square green markers numbered "3" and "5" and two triangular red markers numbered "2" and "6". You would steer your vessel so that the red markers are to the right of the vessel and the green markers are to the left.
- l. one to two feet
- m. You can pass beneath the west end of the bridge because the vertical clearance is 15 feet, but the clearance is only nine feet under the east end of the bridge.
- n. The chart shows three poles on the south side of the bridge.
- o. The chart shows submerged pilings to the west of Big Pine Key.

Build an Underwater Robot

What can swim deep inside the wreck of the Titanic?

What can sit on the edge of an erupting underwater volcano?

What can dive thousands of feet below the ocean surface?

What can collect animals no one has seen before from the deep ocean?

Underwater robots can!

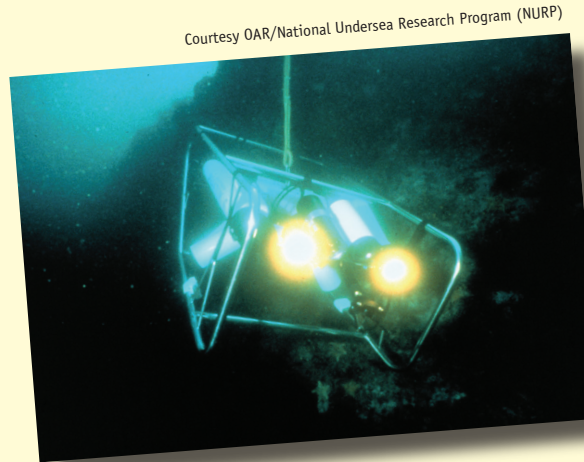

Courtesy OAR/National Undersea Research Program (NURP)

Some underwater robots are controlled by built-in computers, and can operate without any connection to the surface. These are called "Autonomous Underwater Vehicles" (AUVs). Many underwater robots are attached to a cable that allows a human operator to control the robot's movements from a ship on the ocean surface. These robots are called "Remotely Operated Vehicles" (ROVs).

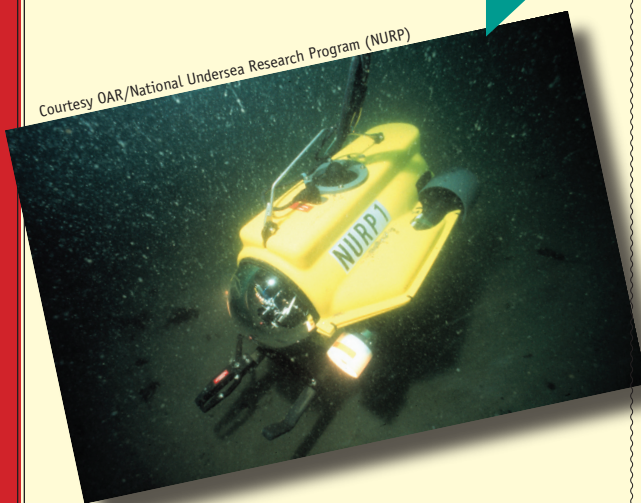

Courtesy OAR/National Undersea Research Program (NURP)

What You Will Need

- Plastic coat hanger
- 6- or 12-volt DC motor (from a hobby shop; part number LXJSS4 from www.towerhobbies.com is a 6-volt motor; part number 273-256 from Radio Shack is a 9-18-volt motor)
- Model boat propeller (from a hobby shop, or visit www.towerhobbies.com and search on "boat propeller")
- Epoxy glue
- Two pieces of #28 AWG stranded wire (telephone wire), each about five feet long
- Electrical tape
- Two film canisters with lids
- Twelve nails, about three inches long or 1/4-inch diameter bolts to use as weights
- One or two 6-volt batteries (two if you are using a 12-volt motor)
- Container of water at least 18 inches deep (bathtub, large laundry tub, etc)
- Hot glue gun
- Wire cutters or wire stripper or a sharp knife
- Optional: Hand drill and drill bit of same diameter as the motor shaft

What You Will Do

Make a simple version of an underwater remotely operated vehicle

Warnings

1. Do not connect a wire directly between the two terminals of a battery. The wire will rapidly become very hot and may start a fire or cause serious burns!
2. Do not do this activity in saltwater because everything will short out and your motor will be ruined.
3. If you use a knife to remove insulation from the wires, be careful! Put the wire onto a cutting board and roll the knife over the wire to cut the insulation, but not the wire. Keep your fingers clear of the blade!

How to Do It

1. Press the propeller onto the shaft of the motor. If the propeller is loose on the shaft, place a small drop of epoxy glue on the end of the shaft before installing the propeller. If the shaft is too large for the hole in the propeller, enlarge the hole slightly with a hand drill fitted with a small drill bit. (You may need help from an adult for this.)
2. Hold the coat hanger so that the hook is pointed down. Tape the motor onto the inside of the hook so that the propeller is facing up.
3. Tape the two film canisters, with lids on, to the upper part of the coat hanger.

4. Tape enough weights to the lower parts of the coat hanger (near the hook) so that the coat hanger floats just below the surface of the water.
5. Strip about one inch of insulation off of both ends of each wire.
6. Twist one end of each wire onto a terminal of the motor. If necessary, you can keep the wires in place with a dab of hot glue.
7. Twist the wires together to make a single cable.

8. Tape the other end of each wire to a popsicle stick or chopstick so that the bare wire end is hanging over the end of the stick.
9. If you are using a 12-volt motor, connect two 6-volt batteries in series: Strip about one inch of insulation off of both ends of a piece of #28 AWG wire about 12 inches long. Twist one end of the wire around the negative terminal of one battery, and twist the other end of the wire around the positive terminal of the other battery.

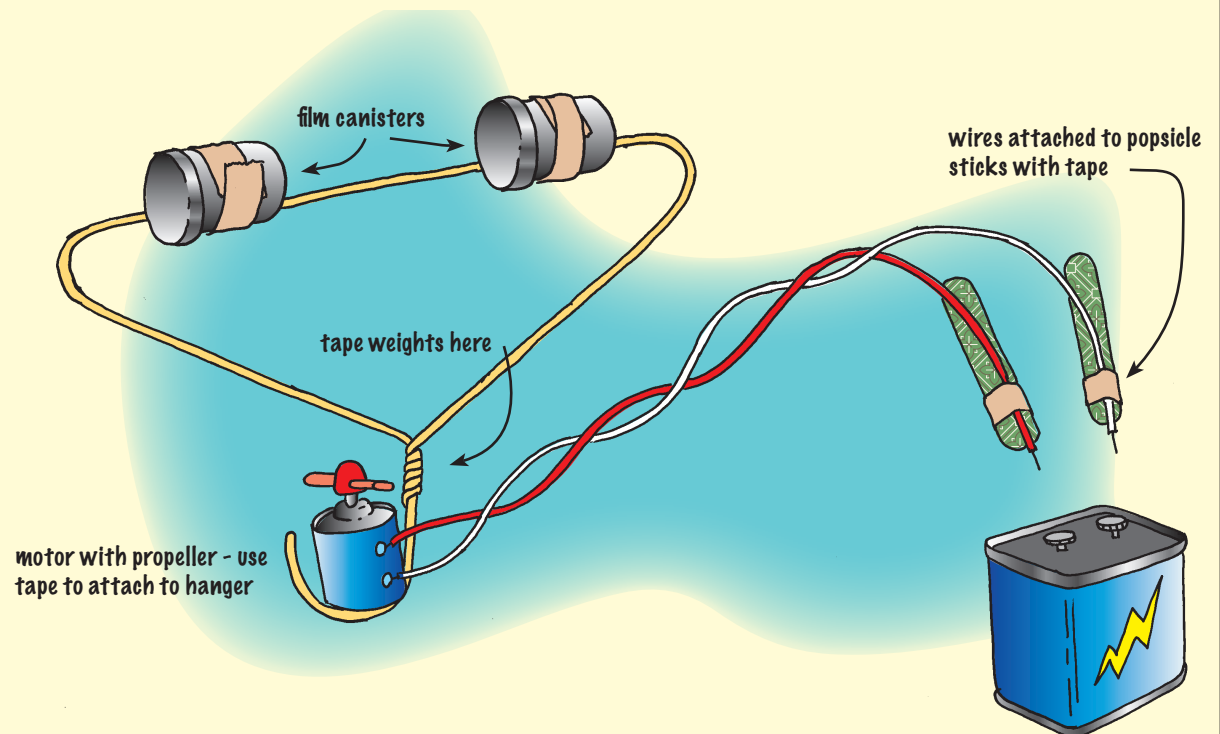

10. Test Dive Your ROV: Touch the bare end of one wire to one battery terminal, and the bare end of the other wire to the other battery terminal. If the propeller spins but does not sink, try reversing the wires on the battery terminals. If your ROV still doesn't sink, you may need to add some more weight.

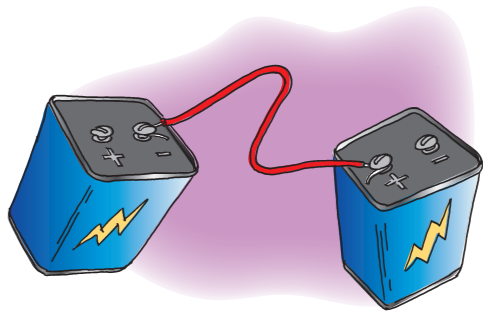

Adapted from an activity by Harry Bohm and the Marine Advanced Technology Education Center (MATE).
www.marinetech.org

Want to Do More?

1. Add two more motors to your ROV to make it move horizontally. You should be able to make your ROV spin or move in a straight line, depending upon how you connect the motors and the battery.

A Little More About Underwater Robots

Courtesy Mountains in the Sea scientific party: NOAA, URI/IAO and IFE

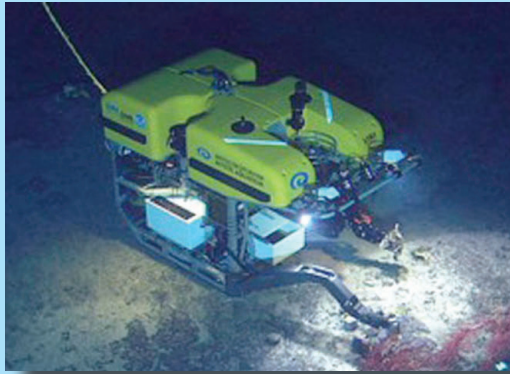

Ocean explorers use ROVs for many purposes, including monitoring underwater habitats, observing fishes and other organisms, exploring deepsea environments, investigating shipwrecks, and studying areas too dangerous for humans such as active underwater volcanoes. Underwater robots are essential tools of modern ocean explorers.

ROVs may be large or quite small, depending upon the jobs they are expected to do, but they all have some systems in common:

- Framework on which other components are mounted;

- Flotation so that the ROV is neutrally buoyant (or nearly neutral; this means it doesn't rise or sink when in the water);
- Ballast to keep the robot from rolling over;
- Power to operate motors, video cameras, and other equipment;
- Propulsion to move the robot up and down, side to side, and backward and forward;
- Control to cause the robot to perform certain tasks; and
- Navigation to keep track of the robot.

Some of these systems may not actually be on the ROV itself, but instead may be on a ship and connected to the ROV with a cable. Most ROVs carry video equipment, and many have manipulator arms that can collect samples, handle tools, etc.

For more information about underwater robots and ocean exploration, visit <http://oceanexplorer.noaa.gov/technology/subs/subs.html>. Scroll down the page for links to all kinds of submersibles!

2. For more underwater robots you can build, check out these books by Harry Bohm:
Bohm, H. 1997. *Build your own underwater robot and other wet projects*. Westcoast Words. 148 pages.

Bohm, H. and V. Jensen. 1998. *Build Your Own Programmable Lego Submersible: Project: Sea Angel AUV (Autonomous Underwater Vehicle)*. Westcoast Words. 39 pages.

Earth Origami

Carl Skalak was on a solo canoe trip in the Adirondack Mountains of upstate New York when a surprise storm brought three days of high winds and heavy rain that eventually turned to snow. When the weather cleared, the river was frozen over and he was surrounded by high drifts of heavy snow.

“I knew I couldn’t get out on my own, and didn’t know if that situation would change for the positive anytime soon.”

Skalak activated a Personal Locator Beacon (PLB), which sent a distress message to NOAA’s Search and Rescue Satellite Aid Tracking System (SARSAT). According to Lt. Daniel Karlson, SARSAT operations support officer for NOAA, “Mr. Skalak was facing a life-threatening situation because of his isolated conditions and the brutally frigid weather. In a matter of a few hours, he might have become acutely hypothermic putting his life at risk.” The SARSAT distress signal was relayed to the Air Force Rescue Coordination Center at Langley Air Force Base, Va., which in turn notified the nearest rescue unit, the U.S. Army Fort Drum Air Ambulance Detachment near Watertown, N.Y. A few hours after activating his PLB, Mr. Skalak was rescued.

~ from NOAA News Online (Story 2124) at <http://www.noaanews.noaa.gov/stories2003/s2124.htm>

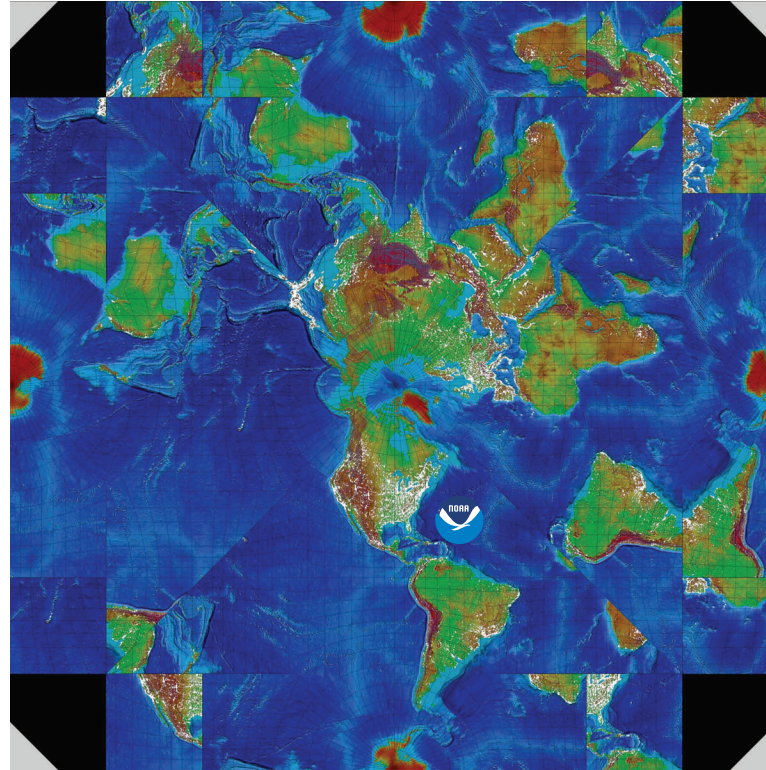

Digital Global Image by Peter W. Slos, NOAA-NGDC

What You Will Do

Make a three-dimensional model of Earth

NOAA’s National Environmental Satellite, Data, and Information Service (NESDIS) operates a search and rescue system known as COSPAS-SARSAT, in cooperation with the U.S. Coast Guard, the U.S. Air Force, and the National Aeronautics and Space Administration. This system can detect emergency signals from Personal Locator Beacons anywhere in the world. Carl Skalak’s PLB may have saved his life.

NESDIS uses satellites for many other purposes in addition to search and rescue, and gathers information about Earth’s environment that includes the location of major fishing areas, hurricanes, tsunamis, earthquakes, fires, and volcanoes, as well as information about Earth’s habitats, geology, and climate. NOAA makes this information available to many people for many different purposes. Here’s one example of a special NESDIS product: satellite images of Earth, assembled so that the combined image can be folded to produce a three-dimensional object that is almost round.

What You Will Need

- ❑ National Geophysical Data Center (NGDC) "Origami Balloon" image, copied on a color printer as large as you can make it. You can download a pdf file of this image (2.5 MB) from <http://www.ngdc.noaa.gov/mgg/image/origamiearth.pdf>
- ❑ Scissors

How to Do It

1. Cut the Origami Balloon image into a square.
2. Put the square image face-up on a flat surface so that the NOAA logo is right-side-up. Fold the bottom edge to the top edge, and make a crease that passes through the center of the square. Now unfold and refold along the same crease so the image is facing out. This will make it easier to shape the model in later steps. Unfold the image so it is a square again.

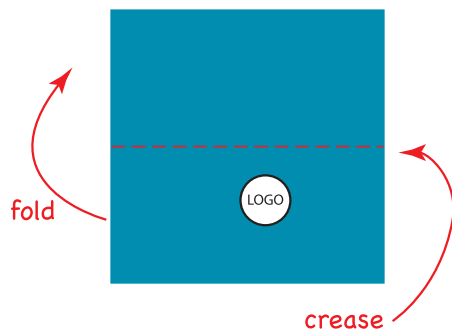

3. Bring one corner to the opposite corner and make a diagonal crease that passes through the center of the square. Unfold and re-

fold along the same crease in the opposite direction. Unfold the image so it is a square again.

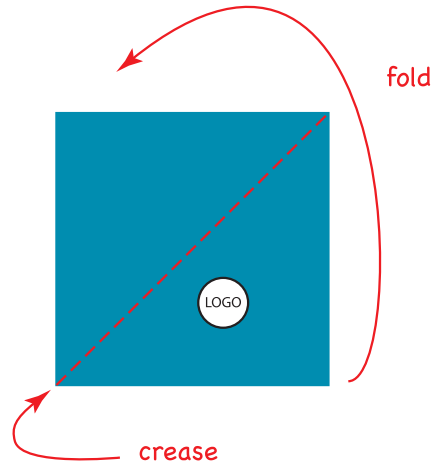

4. Fold the other corner to the opposite corner, and make another diagonal crease so that you now have three creases that cross in the center of the square. Unfold and refold along the same crease in the opposite direction. Unfold the image so it is a square again.

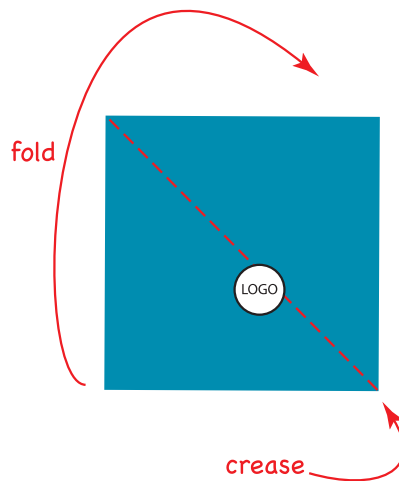

5. Put your thumbs on the ends of the horizontal crease formed in Step 2. Push the sides of the square together, and flatten into a triangle. The longest side of the triangle should be closest to you.

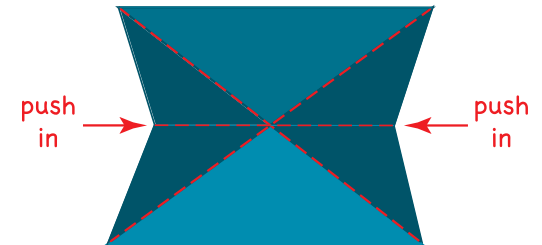

6. Notice that there are two pieces at each of the side corners of the triangle, one on top of the other. Take the upper piece at one of the side corners (a), bring it to the top of the triangle, and make a crease (b). Repeat with the upper piece of the other side corner.

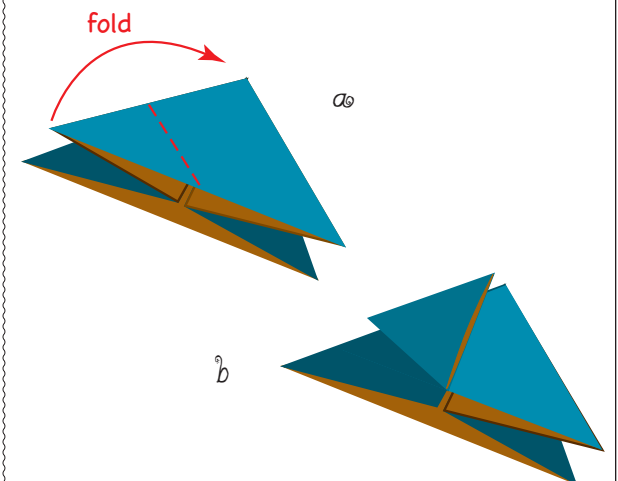

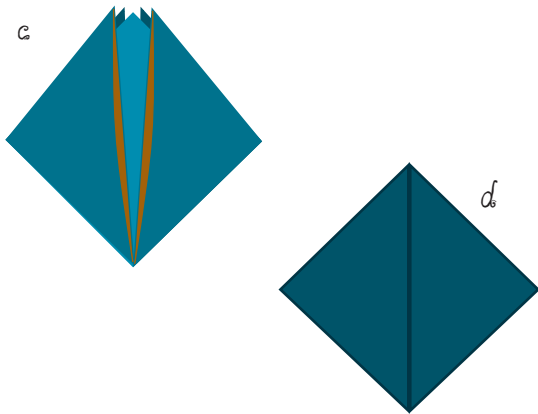

7. Turn the model over, and repeat Step 6.

8. Now there are two pieces at each of the side corners, one on top of the other. Fold the upper piece on one side to the center and make a vertical crease (a). Repeat with the upper piece of the other side (b).

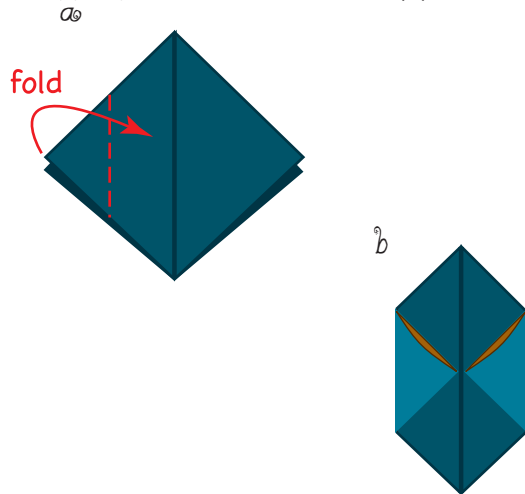

9. Turn the model over, and repeat Step 8.

10. Notice that there are two free points at the top of the model. If you turn the model over, there are two more free points at the top of the model (a). Open up the pocket on the left, and tuck the point into the pocket. Repeat with the right free point (b).

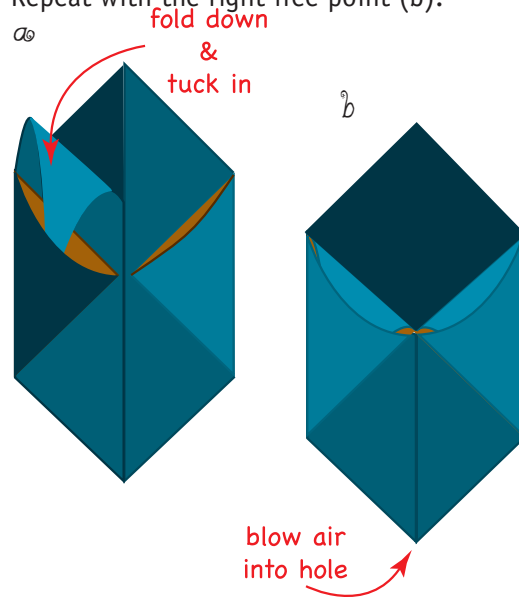

11. Turn the model over, and repeat Step 10.

12. Open up the shape and find the open end at the bottom of the model.

13. Hold the model lightly by the edges, and blow sharply into the hole. The Earth Origami Balloon will inflate!

Want to Do More?

1. See <http://www.ngdc.noaa.gov/education/education.html> for lots of other images, maps, and activities.
2. Visit <http://www.magazine.noaa.gov/stories/mag96.htm> for more information about COSPAS/SARSAT and Personal Locator Beacons.



An artist's conception of a fully integrated environmental monitoring system including satellites, balloons, ships, aircraft, buoys, and data reception and processing facilities. Courtesy NOAA.

Origami illustrations courtesy Mel Goodwin



Make Your Own Volcano!



2,000 feet below the ocean surface, we saw billowing clouds of smoke rising from the volcano's crater. Huge clouds of yellow-tinged smoke and yellow balls of molten sulfur surrounded our underwater robot...As black chunks of volcanic ash began spewing out of the pit, we decided to retreat from the site because the acidic water, sulfur, and flying rocks were endangering our robot.

— from the Ocean Explorer 2004 Ring of Fire Expedition; the first time any human actually saw an underwater volcano erupt!

What You Will Do

Make a model of a volcano, complete with eruption!

What You Will Need

- Cardboard tube from a roll of paper towels
- Sheets of newspaper
- Clear plastic tape or masking tape
- Corrugated cardboard, about 12 inches square
- Aluminum foil or homemade modeling dough (see recipe below)
- Modeling dough (store-bought or homemade)
- Baking soda (enough to fill the cardboard tube at least half full)
- Vinegar, about eight ounces
- Sharp knife to cut the cardboard tube
- Optional: spray paint; spray glue; sand; food coloring

Warnings

1. Be careful with the knife! Cut on a flat cutting board, and keep your fingers away from the blade!
2. Wear protective gloves and eye shields when handling chemicals.

Recipe for Homemade Modeling Dough

1 cup flour
1/2 cup salt
1 cup water
1 tablespoon cooking oil
2 teaspoon cream of tartar
(optional) food coloring

Mix all ingredients together and heat slowly, stirring constantly, until the mixture is thick and doughy. Let the mixture cool until it can be handled. Knead the dough ball a few times, then wrap in foil to store.

How to Do It

1. Cut the cardboard tube to a length of about eight inches. Plug the bottom of the tube with a piece of modeling dough.
2. Tape the cardboard tube to the piece of corrugated cardboard with plastic tape or masking tape.
3. Crumple sheets of newspaper into balls, and tape these onto the corrugated cardboard around the cardboard tube. Make several different size balls so the surface tapers upward from the edge of the cardboard to the top of the cardboard tube, giving your volcano its shape.
4. Cover the balls of newspaper with a sheet of aluminum foil or a rolled out sheet of homemade modeling dough. Leave a hole in the covering for the end of the cardboard tube. Fold the edges of the foil under the corrugated cardboard sheet.
5. Optional: Decorate your model. Spray with green and brown spray paint. You may also want to spray on glue and dribble sand onto the glue before it dries.
6. Fill the cardboard tube at least half full of baking soda. If desired, mix several drops of red food coloring into the vinegar to give a molten lava appearance.
7. Take your model outside before erupting!
Pour the vinegar into the tube, and stand back!

Cutaway view of the volcano model

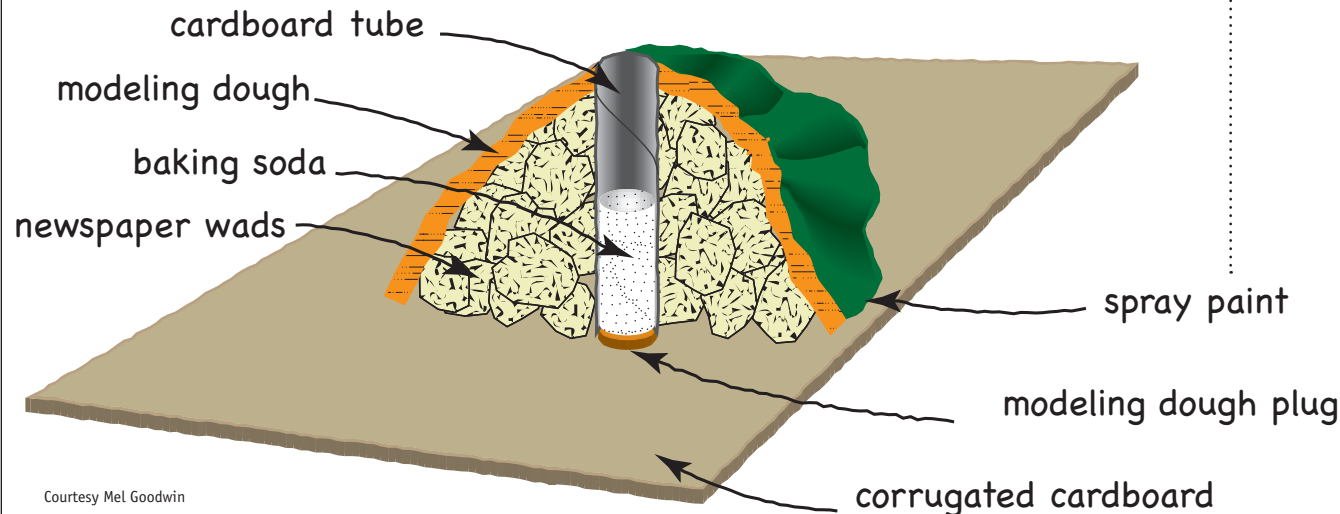

Courtesy Mel Goodwin

[Note: The volcano model made in this activity has the shape of a strato volcano. If you want to make a model of a shield volcano, cut the cardboard tube to a length of about three inches instead of eight inches (Step 1). Then follow the remaining instructions.]

What's Happening

Volcanoes erupt when rocks melt below Earth's surface. Liquid rock is called magma, and tends to rise toward the surface. Magma collects beneath the surface in magma chambers, which often contain various gases as well as magma. When the magma and gases break through the Earth's crust, an eruption happens. If pressure builds up inside the magma chamber, the eruption may be very violent. Very hot magma flows easily over the Earth's surface, and produces flattened volcanoes called shield volcanoes. If the magma is cooler, it is sticky and flows more slowly, producing the familiar cone-shaped volcanoes called strato volcanoes. If the eruption is extremely explosive and violent, the top of the volcano may be blown completely away so that only the inside of the magma chamber remains. The collapsed depression is called a caldera.

See the diagram above for a summary of the different types of submarine volcanoes.

This activity is adapted from "The Volcano Factory," a lesson from the Ocean Explorer 2004 Ring of Fire Expedition (<http://oceanexplorer.noaa.gov/explorations/04fire/background/edu/media/RoF.volcanism.pdf>); by Mel Goodwin, The Harmony Project, Charleston, SC

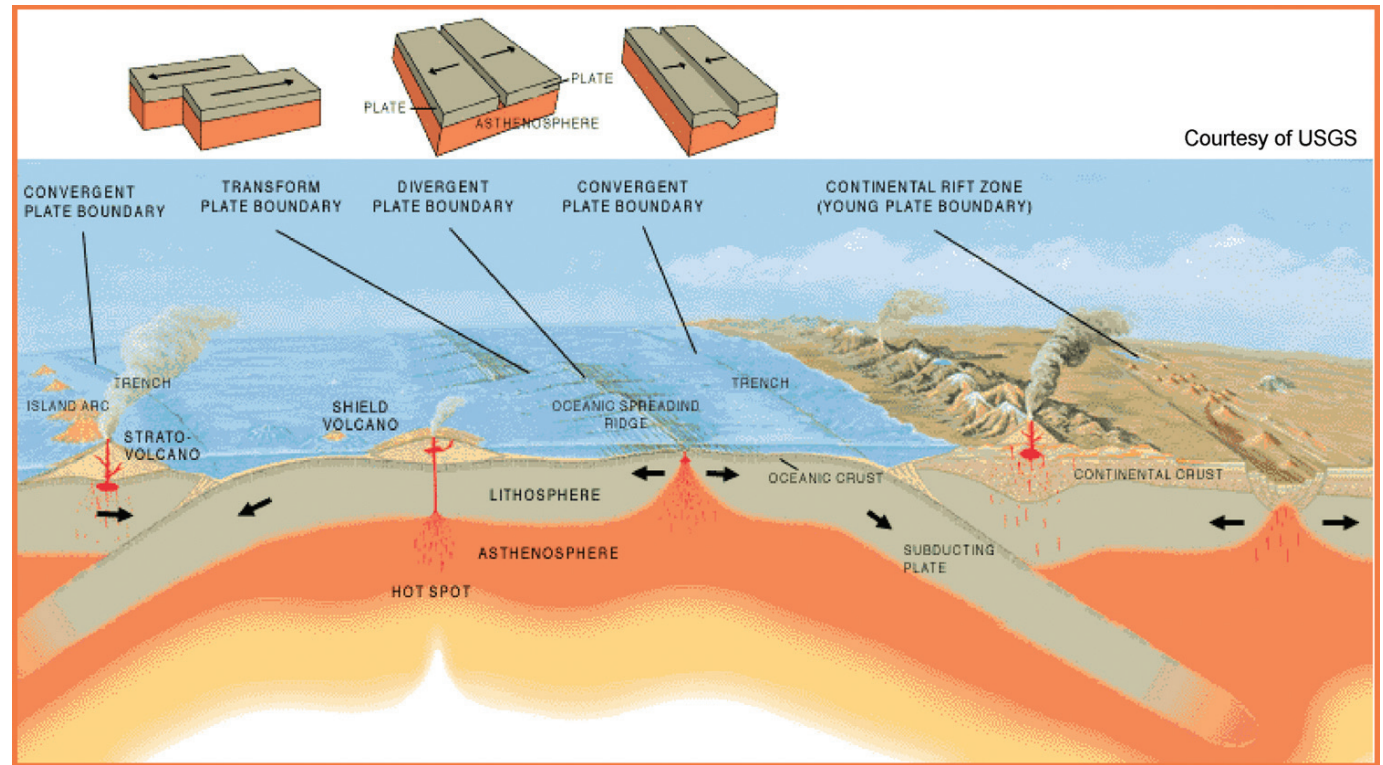

Most submarine volcanoes occur where tectonic plates are either moving apart or colliding. This image shows the many types of plate boundaries: convergent, transform, divergent, and continental rift zone. The Explorer Ridge is a divergent plate boundary at an ocean spreading ridge in the eastern Pacific, where new oceanic crust is formed. The Mariana Island Arc, on the other end of the conveyor belt in the western Pacific, was formed by the melting of the subducting Pacific Plate. (Image courtesy of USGS Web site. Cross section by Jose F. Vigil from *This Dynamic Planet*.)

Want to Do More?

1. You can see pictures from the Ocean Explorer Ring of Fire expeditions, and find out more about their discoveries at:
<http://oceanexplorer.noaa.gov/explorations/03fire/welcome.html>,
<http://oceanexplorer.noaa.gov/explorations/04fire/welcome.html>, and
<http://oceanexplorer.noaa.gov/explorations/06fire/welcome.html>.
2. Some volcanoes in the United States are also part of the Ring of Fire! Find out more at <http://vulcan.wr.usgs.gov/>.

Do You Have Twisted Vision?

Now you see them, now you don't!

Some marine animals are nearly invisible to the human eye, but become much easier to see if viewed through a polarizing filter. If you have ever put on a pair of polarized sunglasses to reduce glare, you have first-hand knowledge about how a polarized filter can make things easier to see.

Many animals, including fish, insects, birds, crabs, and shrimp have built-in polarized vision that helps them find food, avoid predators, navigate, and communicate with mates. Scientists know very little about how animals see in the deep ocean, and it's quite possible that many animals have been able to avoid being seen by deep ocean explorers. Maybe some animals can't be seen at all with ordinary human vision, even if they are right in front of us!

The Ocean Explorer Deep Scope Expeditions looked into the deep ocean with new eyes, including high-tech cameras that can see animals under extremely dim light, as well as instruments to observe animals that make their own light (bioluminescence) or use various types of polarization vision. Here are some simple experiments you can do to start exploring with polarized light.



A gallery of images of plankton viewed between two polarizers. In this particular setup, a normal transparent object would still be invisible. However, if the object, or animal, contains any birefringent (doubly refractive) substance, it will appear quite bright. Tissues such as muscle and tendon can be highly birefringent and are responsible for almost all the bright areas on these images. Photo composite: S Johnsen using images from E. Widder.

What You Will Do

Experiment with polarizing filters, and find out whether you have polarization vision

What You Will Need

- ❑ Two pieces of polarizing filter material from an old pair of polarizing sunglasses, or you can buy polarizing filters from educational supply companies or from Calumet Photo (1-800-225-8638), catalog number RC3000; about \$40 for a 19 inch x 20 inch sheet). The material will be marked with an arrow that shows the "polarization axis." If you cut the filter into pieces, use a felt tip marker to draw an arrow pointing the same way on each of the pieces.
- ❑ Plastic protractor, drafting triangle, and/or clear plastic fork

Warning

NEVER look directly at the sun, even through polarized filters!

How to Do It

1. Shine a light through a single piece of polarizing filter material. Some of the light will be absorbed by the filter, but it probably won't matter very much how the filter is rotated. Take the filter outside, and look at blue sky, away from the sun. Now, if you rotate the filter the sky will appear darker and then lighter. Most light passes through when the filter is lined up with the direction of the polarized light.

2. Put a second piece of polarizing filter material on top of the first filter and shine a light through the combined filter. When one of the filters is rotated, you will see that most light comes through when the polarization axes of the filters are pointing in the same direction (parallel). Less and less light passes through as the angle between the polarization axes increases, to a point at which almost no light is transmitted when the polarization axes are perpendicular to each other.

lines in the material. This is an example of birefringence, which is what happens when materials bend polarized light in different directions. Birefringence occurs in many living tissues, and can make food organisms much more visible to marine animals with polarized vision.

Note: Not all plastic objects show birefringence. If some of your plastic objects don't work, try some others!

The Effect of Polarizing Filters

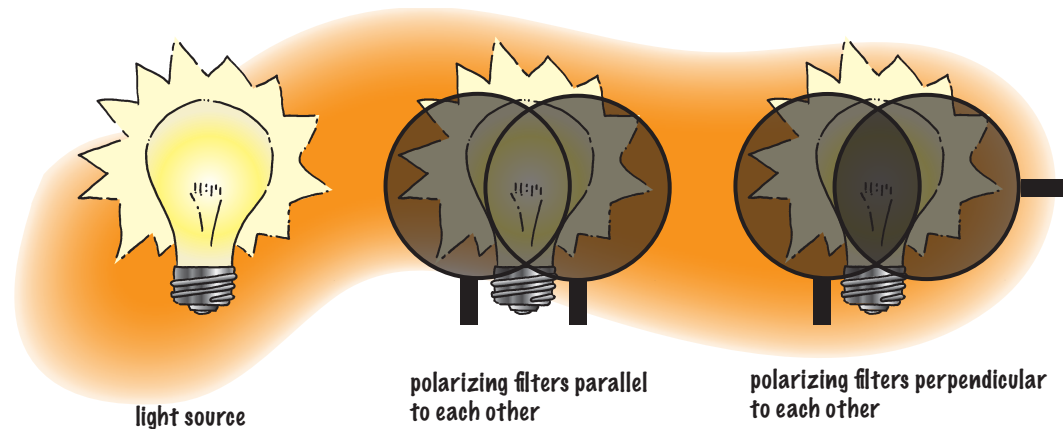

3. Place a plastic protractor, drafting triangle, or clear plastic fork between two sheets of polarizing filter material and shine a light through the stack. When one filter is rotated, bands of color will appear and move over the surface of the plastic object. Flexing the object may reveal stress

4. If human eyes could detect polarized light, you wouldn't need the second filter in these demonstrations. But some humans do seem to have very limited polarization vision. To find out if you are one of them, try this: Face blue sky, away from the sun, and concentrate on the center of your visual

field (the area of sky that you can see). If you see a fuzzy yellowish horizontal bar or bow-tie shape, you are seeing “Haidinger’s brush,” and you have a limited form of polarized vision! You can also try to see Haidinger’s brush by looking at a bright background (such as a well-lit white wall) through polarized sunglasses.

5. Why do you suppose so many invertebrates have polarized vision while humans do not? Part of the answer is that the human eye consists of a single lens that focuses an image onto light-sensitive cells in the retina that transmit nerve signal to the brain. Many invertebrates have compound eyes made of hundreds (or thousands) of “simpler” eyes called ommatidia. Each ommatidium has a lens, crystalline cone, and visual cells containing rhodopsin. In vertebrates, the visual pigment molecules are randomly oriented, but in many invertebrates these molecules are lined up in the same direction. This makes it possible for these animals to detect polarized light.

What’s Happening

We can imagine light as vibrating particles of energy moving in a series of waves, sort of like the particles of water that make ocean waves. In some light waves, the energy particles are vibrating in many different directions. These light waves produce unpolarized light. If the energy

particles are all vibrating in the same direction, the light is said to be polarized. Most light, including light from the sun, from ordinary light bulbs, and from candles is not polarized. Unpolarized light can be transformed into polarized light in several ways, including passing light through a filter that only transmits light waves that are vibrating in a single direction. Light waves vibrating in other directions are blocked.

It may be easier to understand this kind of polarization by imagining a picket fence with a rope passing between the pickets. If we raise and lower one end of the rope to make a wave, it’s easy to understand that the wave can only pass through the fence if the wave is parallel to the pickets, like this:

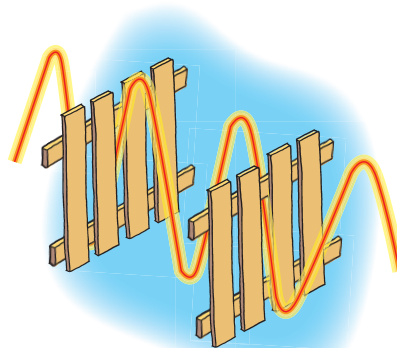

“rope” wave passing through parallel picket fences

A wave in any other direction would run into the pickets and be stopped. The same thing happens in a polarizing filter, except the molecules of the filter material are lined up instead of the pickets in the fence.

The picket fence also helps understand what happens when light is passed through two polarizing filters. If the rope passes through two picket fences, a wave in the rope will only be transmitted if the pickets in both fences are parallel. If one of the fences is rotated, the wave will be blocked, like this:

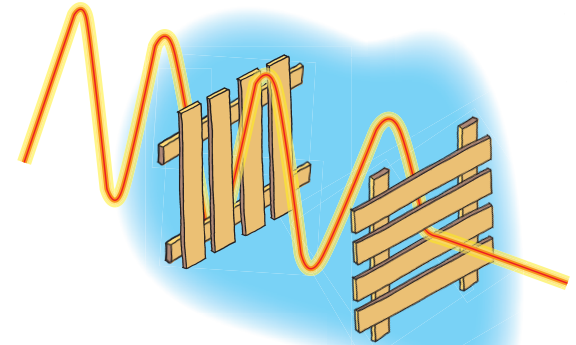

“rope” wave blocked when one fence is rotated

So, if we hold two polarizing filters in front of a light source, and then rotate one of the filters, we will see the light grow brighter as the molecular “pickets” in the two filters become parallel. Light can also be polarized by reflection from non-metallic surfaces such as roads, snow, and water. The amount of polarization depends upon the type of surface and the angle at which the light approaches the surface. Glare from these surface can be reduced or eliminated by polarizing filters (such as sunglasses) whose molecular “pickets” are not parallel to the vibration direction of the reflected light waves. Light can also be partially polarized when it is scattered off of particles in the atmosphere.

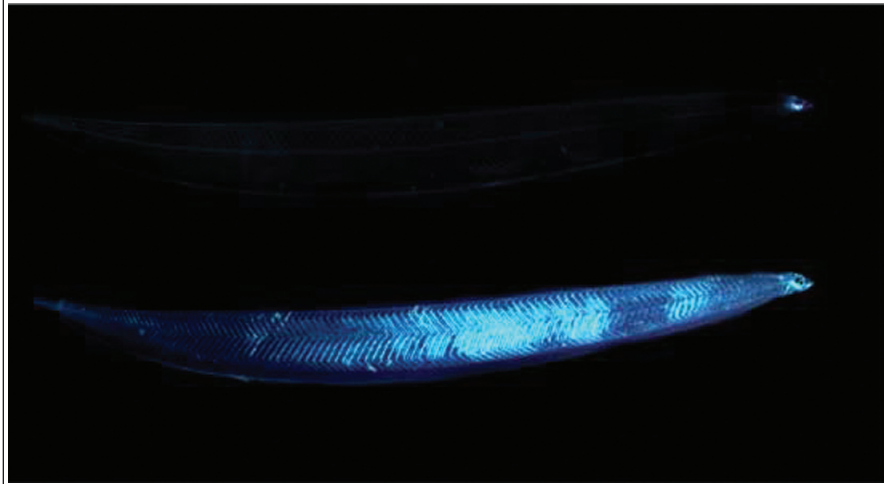

Two images of the same leptocephalus eel larva. The top image is viewed under unpolarized, transmitted light. The bottom image is viewed under polarized, transmitted light by a camera with a polarizing filter. The increased visibility of the bottom image is due to the presence of birefringent muscle and connective tissue fibers. Photo composite: S Johnsen using images from E. Widder.

Want to Do More?

One of the most famous examples of polarization vision is the discovery by Karl von Frisch that bees detect patterns of polarized light in the sky, and communicate directions to each other by dancing in a specific pattern.

- For more information about Karl von Frisch and his bees, visit <http://polarization.com/bees/bees.html>.
- For more information about Haidinger's brush and polarization vision in humans, visit <http://polarization.com/haidinger/haidinger.html>.
- For more information about the Ocean Explorer Deep Scope Expeditions, visit:
 - <http://oceanexplorer.noaa.gov/explorations/05deepscope/welcome.html>

–“Secret Communication Channels in the Ocean: Polarization Vision” <http://oceanexplorer.noaa.gov/explorations/04deepscope/background/polarization/polarization.html>

–“Hiding in Plain Sight: Birefringence” <http://oceanexplorer.noaa.gov/explorations/04deepscope/logs/aug15/aug15.html>

–“Measuring Vision in Crustaceans” <http://oceanexplorer.noaa.gov/explorations/04deepscope/background/vision/vision.html>

This activity is adapted from “Twisted Vision,” a lesson from the Ocean Explorer Operation Deep Scope 2005 Expedition (<http://oceanexplorer.noaa.gov/explorations/05deepscope/background/edu/media/twisted.pdf>); by Mel Goodwin, The Harmony Project, Charleston, SC.



This Caranichid squid, about four-inches across, uses transparency to hide from potential predators. Open-water divers can more easily observe these creatures with polarizing filters. Compare the polarized and unpolarized images to one another. Images courtesy Edie Widder.

Be A Shipwreck Detective!

*“Great acts of courage,
senseless tragedy,
the heroism of a captain,
the greed of a stingy skipowner,
the stupidity of a watchman
all find their ways into the history of shipwrecks.”*

*~ from the Channel Islands National Marine Sanctuary
Shipwreck Database Web site*

Shipwrecks are an important part of our nautical heritage. Some of our nation’s most interesting shipwrecks are found in NOAA’s National Marine Sanctuaries, including the remains of the Civil War ironclad, U.S.S. Monitor. Some shipwrecks are hazardous to other vessels. Nautical charts produced by NOAA’s Office of Coast Survey show the location of known shipwrecks and other hazards to navigation.

In September 2003, NOAA’s Ocean Exploration Program visited a newly discovered shipwreck in the Stellwagen Bank National Marine Sanctuary on the coast of Massachusetts. Underwater archaeologists studied the wreck to learn more about what happened to cause the ship to sink. Now it’s your turn to be a Wreck Detective!



Storm, shipwreck, and sea monster. Archival Photograph by Mr. Sean Linehan, NOS, NGS



What You Will Do

Examine information about items found in and around the Stellwagen Bank shipwreck, and draw conclusions about the ship, who was aboard, and why the ship sank

What You Will Need

- “Grid Reference System for Unidentified Shipwreck Q11WRK5” and “List of Artifacts Retrieved from Unidentified Shipwreck Q11WRK5”
- Imagination

How to Do It

1. Your first task is to organize information about where the artifacts were found on the shipwreck. The “List of Artifacts” gives a grid location for each item and how deeply artifacts were buried (so “22 inches from surface” means the object was buried 22 inches into the sea bottom). Archaeologists often use a grid system to precisely record the exact location of artifacts and their relationship to each other. You have already

used grids to express location if you have ever played Battleship, or even Bingo.

2. As you look at the description of each artifact, think about how deep the artifact was below the surface, and what other artifacts were found nearby. Then consider what the artifacts may suggest about
- the specific identity of the ship that sank;
 - age of the vessel;
 - the vessel’s purpose;
 - who was aboard; and
 - why the vessel sank.
3. Write your conclusions on a piece of paper. Then read “The Story of the Steamship Portland” on Page 50.

Want to Do More?

1. Visit <http://oceanexplorer.noaa.gov/explorations/03portland/welcome.html> the Web site for the Steamship Portland expedition.
2. For another shipwreck activity see “Lost at Sea: Sunken Slave Ship” activity from Newton’s Apple episode 1502. You can access this activity from <http://www.ktca.org/newtons/15/sunken.html>
3. Read “The Portland Gale” from <http://www.hazegray.org> for more information on the Portland and the monster storm of 1898.

This activity is adapted from “Wreck Detectives,” a lesson from the Ocean Explorer Steamship Portland Expedition (<http://oceanexplorer.noaa.gov/explorations/03portland/background/edu/media/portlandwreckdetec.pdf>); by Mel Godwin, The Harmony Project, Charleston, SC.

Grid Reference System for Unidentified Shipwreck Q11WRK5

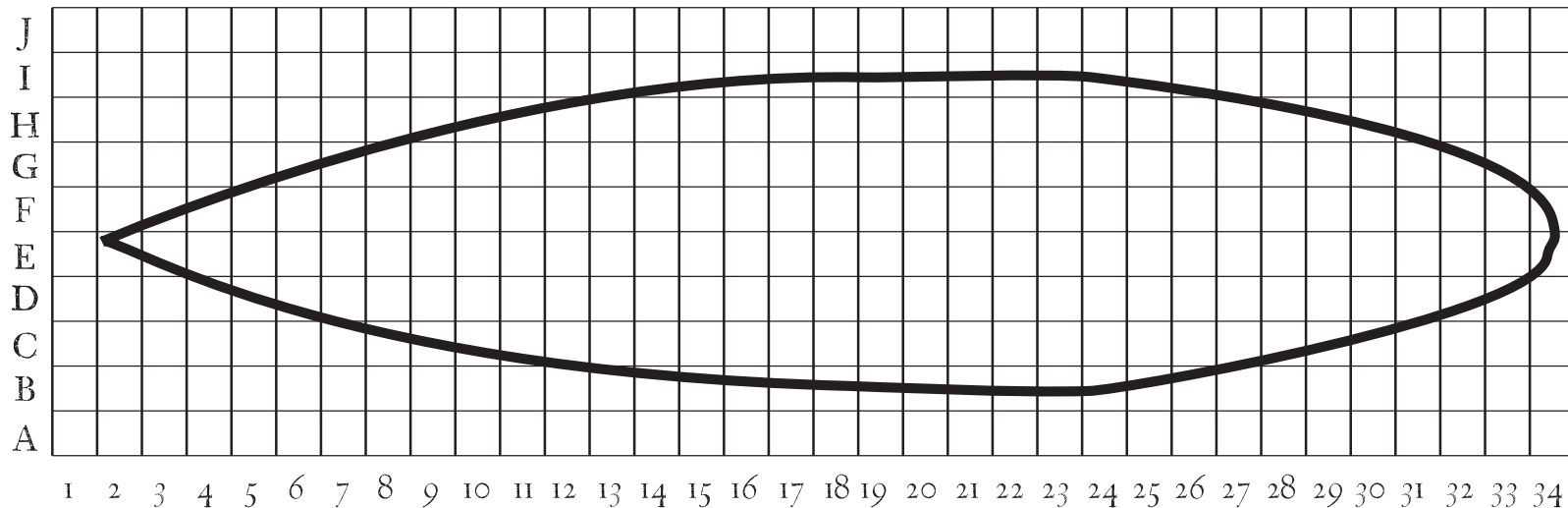
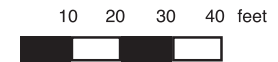

List of Artifacts Retrieved from Unidentified Shipwreck 211WRK5

Grid Reference Description

E19-E23 & F19-F23	Heavy metal structure, diamond shaped, partially buried
D10	Gentleman's gold ring, 22 inches from surface
E14	Heavy mahogany chair, velvet upholstery, 40 inches from surface
D10	China plate, 100 inches from surface
G10	China chamber pot, 20 inches from surface
D13	Silver flatware, engraved letter "P," 100 inches from surface
F14	China cup, 100 inches from surface
D10	Brandy flask, 20 inches from surface
F14	Domed skylight, 16 inches from surface
D13	Carved mahogany headboard, 28 inches from surface
F13	Ebony piano keyboard, 22 inches from surface
C19-C24	Massive paddlewheel, partially buried
G10	Child's rocking chair, mahogany, 24 inches from surface
D13	Lady's dress shoe, 26 inches from surface
G10	Shaving straight razor, 22 inches from surface
H17	Silver buckle, 28 inches from surface

Grid Reference Description

D13	China chamber pot, 24 inches from surface
E11	Carving knife, 92 inches from surface
D10	Man's leather dress shoe, 24 inches from surface
B13	Carved wooden plank, letters "RTLAND;" left side broken
E11	Silver serving platter, 92 inches from surface
E5	Rusted iron mass, possibly chain
F21	Heavily rusted iron mass, possibly tools, 100 inches from surface
E11	Ship's wheel, 12 inches from surface
D10	Small mahogany chest of drawers, 28 inches from surface
E33	Rudder, partially buried
G19-G24	Massive paddlewheel, partially buried
E17 & F17	Smokestacks

NOTE: Extensive debris around main wreck, mostly large timbers and pieces of heavy equipment; several lifeboat remnants outside main wreck. Less obvious structural debris in quadrats numbered 25 and higher; these quadrats contain mostly silt down to the apparent hull of the vessel at approximately 140 inches.

The Story of the Steamship *Portland*

On Thanksgiving Saturday, November 26, 1898, the passenger steamship *Portland* left Boston Harbor with more than 190 passengers and crew bound for Portland, Maine. The *Portland* was a state-of-the-art, luxury ship with velvet carpets, mahogany furniture, and airy staterooms. By 1898, paddlewheel steamboats had revolutionized transportation in the United States. Faster and more reliable than sailing ships, paddlewheelers could also maneuver in waters that were too shallow for sailing ships. By the 1870's, many people routinely boarded steamboats to travel between port cities. But the paddle-wheelers had a serious flaw: they were built long and narrow (the *Portland* was 281 feet long and 62 feet wide), and this shape combined with a shallow draft (the *Portland's* keel was only 11 feet below the water line) made these ships extremely unstable in high seas.

When the *Portland* steamed out of Boston Harbor, she ran straight into a monster storm moving up the Atlantic coast with northeasterly winds gusting to 90 mph, dense snow, and temperatures well below freezing. Facing a roaring northeasterly wind, the captain could not turn back; to have done so would have placed the ship broadside to wind and waves that would surely have capsized her. The only choice was to continue to head northeast into the waves, and hope to ride out the storm. Four hours after her departure, a vessel believed to have been the *Portland* was seen near Thatcher Island, about 30 miles northeast of Boston. But the *Portland* was apparently unable to make much more progress against the storm.

At 5:45 a.m. on the morning of November 27, four short blasts on a ship's steam whistle told the keeper of the Race Point Life-Saving Station on Cape Cod that a vessel was in trouble. Seventeen hours later, life jackets, debris, and human bodies washed ashore

near the Race Point station, confirming that the *Portland* and everyone aboard had been lost in one of New England's worst maritime disasters. The loss of the *Portland* underscored the inherent instability of sidewheel paddleboats. Sidewheelers were gradually replaced by propeller-driven boats, which have a lower center of gravity.

For 90 years, the location of the *Portland* wreck was unknown, despite intense and continuing public interest. In April 1989, members of the Historical Maritime Group of New England found wreckage in water more than 300 feet deep that they were certain had been the *Portland*. Because of the depth, however, the discoverers were unable to obtain photographs or other evidence that could confirm their find. Thirteen years later, on August 29, 2002, the U.S. Commerce Department's National Oceanic and Atmospheric Administration (NOAA) confirmed that the wreck of the *Portland* had been found within NOAA's Stellwagen Bank National Marine Sanctuary. Using side-scan sonar and a remotely operated vehicle (ROV), scientists obtained high-quality video and side-scan images in a joint research mission of the Stellwagen Bank National Marine Sanctuary and the National Undersea Research Center at the University of Connecticut.

Massive storms during late October and November are not particularly unusual in the New England states. At this time of the year, large cold air masses from Canada cross the midwestern states on a regular basis. At the same time, the Atlantic Ocean retains its summer heat and these warm waters sometimes spawn hurricanes. When the east-moving cold air masses encounter the warm, humid oceanic air, the result is what New Englanders call "Nor'easters:" storms that are often severe, and are often the cause of maritime disasters. ☪

Clues from the "List of Artifacts Retrieved from Unidentified Shipwreck Q11WRK5;"

The large paddlewheels near the middle of the ship clearly suggest a sidewheel paddleboat. This was a large vessel for a paddlewheel; over 280 feet. The diamond shaped metal structure is probably the remains of a walking beam engine, a common design in ships of this type. The fact that this was a large paddlewheel narrows its probable vintage to between 1890 and 1910. Artifacts in quadrats D10, D13, and G10 suggest that men, women, and children may have been aboard, and these areas may have been staterooms. The fact that artifacts in these areas were close to the surface suggests that these staterooms were on or near the deck of the vessel. Eating utensils recovered from more than 80 inches below the surface suggest a dining area, located on a lower deck. Engraved silver flatware and the carved wooden plank are valuable clues, suggesting that the name of the vessel may have begun with the letter "P" and ended with the letters "rtland." Many of the artifacts suggest wealth and luxury. This vessel almost certainly carried some wealthy passengers.

Think about the size of the debris field. Ships that sink suddenly (such as those sunk in battle) often have a rather small debris field. Ships that sink with lots of movement, on the other hand (such as ships sunk in storms) are likely to have larger debris fields. This ship has an extensive debris field, suggesting that a lot of motion, possibly due to a storm, was involved in her sinking.

Weird, Red, and Slightly Gross!

"OK, we're 8,000 feet deep now..."

Hey, there's something on the bottom that looks like twisted stone chimneys with some kind of hot fluid jetting out from the top...

Wait a minute...there's all kinds of animals down here; giant clams and huge red worms sticking out of eight-foot-long tubes...

Believe me, no one has ever seen anything like this before..."

These observations, made on February 17, 1977 aboard the deep-diving submarine Alvin, were one of the biggest scientific discoveries of the last century: a totally new ecosystem thriving at near-freezing temperatures in the total darkness of the deep Pacific Ocean, and under water pressure more than 275 times greater than the pressure at sea level.

These ecosystems, now called "hydrothermal vent communities," do not depend upon green plants and sunlight for their food. Instead, they are able to use chemicals in the hot fluids pouring out of the twisted

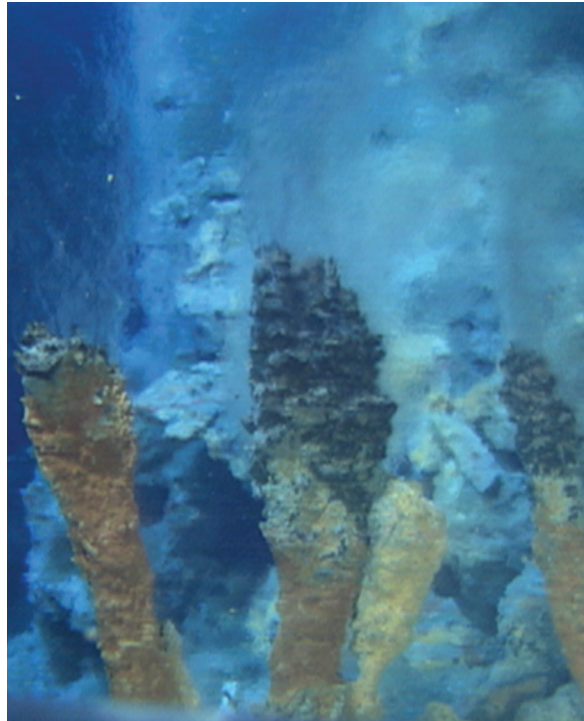

Photograph of three small (12 inches tall) actively venting spires sitting on top of one of the chimneys in the Black Forest vent field. The chimneys themselves are about 23 feet tall. The fluids here are venting at 240°C (464°F) and are expelling black (mineral-rich) smoke into the ocean.

stone "chimneys." This process is called "chemosynthesis." Most hydrothermal vent animals aren't able to use these chemicals all by themselves. Instead they have partnerships with other organisms, usually bacteria. The tubeworms, for example, have a large organ called a trophosome, that contains chemosynthetic bacteria. They do not have a mouth, stomach, or intestines. The worms have long tentacles that stick out from the end of the tube. Inside the tentacles, the worms' blood contains hemoglobin (like human blood) that can absorb chemicals from the surrounding water. The blood carries these chemicals to bacteria living in the trophosome. The bacteria produce food that provides nutrition to the tubeworm.

In May, 2002, the NOAA's Ocean Explorer Galapagos Rift Expedition revisited the site where hydrothermal vents were first seen. See <http://oceanexplorer.noaa.gov/explorations/02galapagos/logs/photolog/photolog.html> for photos and videos from the expedition.

What You Will Do

Make a three-dimensional model of a giant tubeworm

What You Will Need

1. Materials that can represent parts of the tubeworm (see the drawing below). Here are some ideas, but with a little imagination you can probably find lots of other things to use:
 - Cardboard tubes (mailing tubes or paper towel rolls) for the trunk and tube
 - Pipe cleaners for tentacles
 - Modeling clay or papier mâché (news-paper and glue made from flour and water) for the vestimentum
 - Sponge for the trophosome
 - Small corks or pieces of round cereal can represent bacteria
2. Other supplies: glue, scissors, poster board, colored markers, and/or spray paint
3. Optional: a rotten egg in a tightly-closed jar

How to Do It

Since most of a tubeworm is hidden inside the tube, you should build your model as a “cut-away” (also called a cross section) so that the major structures can be seen. Here are the parts of a tubeworm that should be included in your model:

- **Tentacles** – All the tentacles together are call the “Plume”; these should be colored red, since they contain hemoglobin.
- **Vestimentum** – This is a muscular structure that has several functions:
 - It helps to hold the worm in its tube;
 - It generates new tube material;

- It contains pores that release sperm or eggs during spawning;
- It contains the tubeworm’s version of a heart and a brain.
- **Trophosome** – This dark green-brown organ has a spongy texture, and contains bacteria

that use oxygen, carbon dioxide, and hydrogen sulfide to make food for themselves as well as the worm; be sure to include something that represents bacteria (there are billions of bacteria in the trophosome, but you don’t need to include all of them in your model!)

- **Trunk** – This is where waste is stored, since tubeworms have no mouth, stomach, intestines, or anus (nasty, maybe, but it works for the tubeworm!)
- **Tube** – This is a hard hollow cylinder, and provides protection for the worm like the shells of other animals. The tentacles can be pulled completely inside the worm to avoid predators.
- **Opisthosome** – This organ (like the vestimentum) produces new tube material and helps anchor the worm in its tube.

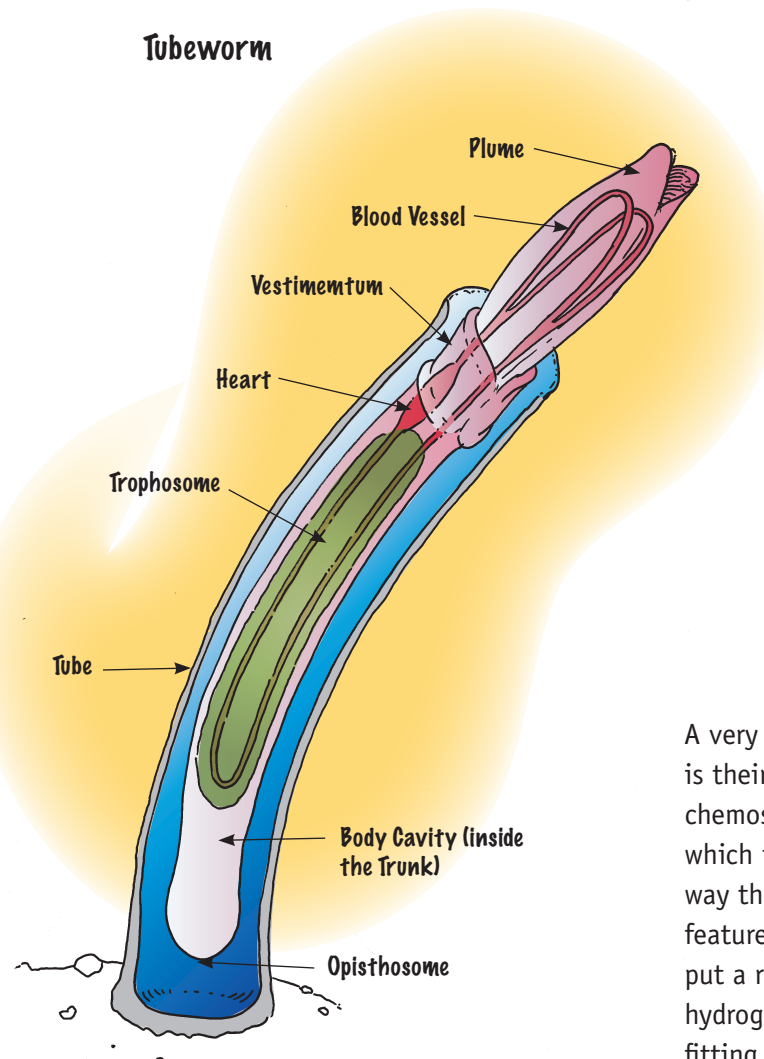

A very noticeable feature about tubeworms is their smell. One of the chemicals used by chemosynthetic bacteria is hydrogen sulfide, which is what makes rotten eggs smell the way they do. If you want to include this feature in your model, you should probably put a rotten egg (or other source of hydrogen sulfide) in a glass jar with a tight-fitting lid so you can control the smell.

Want to Do More?

1. Visit <http://www.whoi.edu/oceanus/view-Article.do?id=2400> to find out about black smokers (the "chimneys" around hydrothermal vents that emit hot fluids).
2. Visit <http://www.pmel.noaa.gov/vents/home.html> for more information and activities on hydrothermal vent communities.
3. Visit <http://www.divediscover.whoi.edu/vents/index.html> to learn more about the discovery of hydrothermal vents, including recordings of scientists aboard the submarine *Alvin*.
4. Visit <http://oceanexplorer.noaa.gov/explorations/02fire/logs/magicmountain/welcome.html> for fly-through movies of the Magic Mountain hydrothermal vent site on Explorer Ridge (in the northeastern Pacific Ocean, about 150 miles west of Vancouver Island, British Columbia, Canada).

This activity is adapted from "Let's Make a Tubeworm!", a lesson from the Ocean Explorer 2002 Gulf of Mexico Expedition (<http://oceanexplorer.noaa.gov/explorations/06mexico/background/edu/> [http://oceanexplorer.noaa.gov/explorations/02mexico/background/edu/media/gom_tube_gr56.pdf]); by Mel Goodwin, The Harmony Project, Charleston, SC.

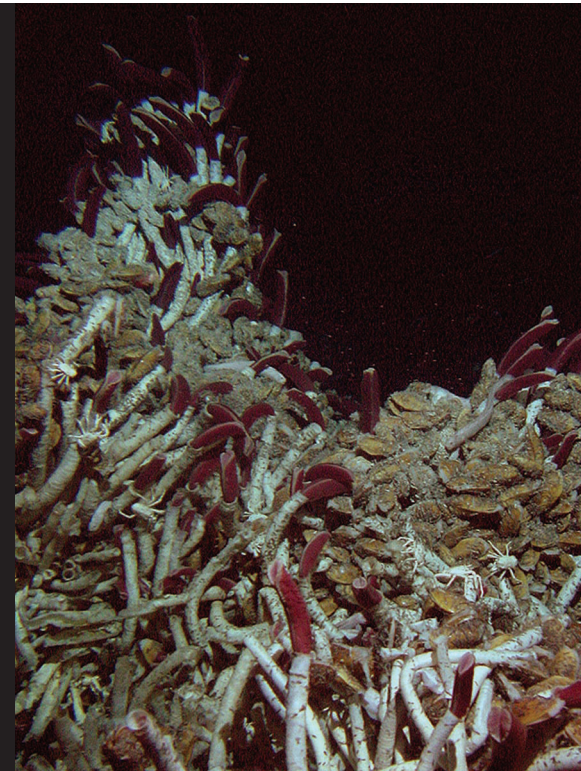

WOW!!!!
 These tube worms
 are about
 3 feet long!



Riftia tubeworms, mussels, and scavenging crabs found at the hydrothermal vent site East Wall, located at 90 North on the East Pacific Rise. Photo courtesy of C. Van Dover, NOAA.



Giant tubeworm, *Riftia pachytila*, from the hydrothermal vents at the East Pacific Rise at 2500m depth. Each individual in the photo exceeds one meter in length. Courtesy Monika Bright, University of Vienna, Austria. NOAA

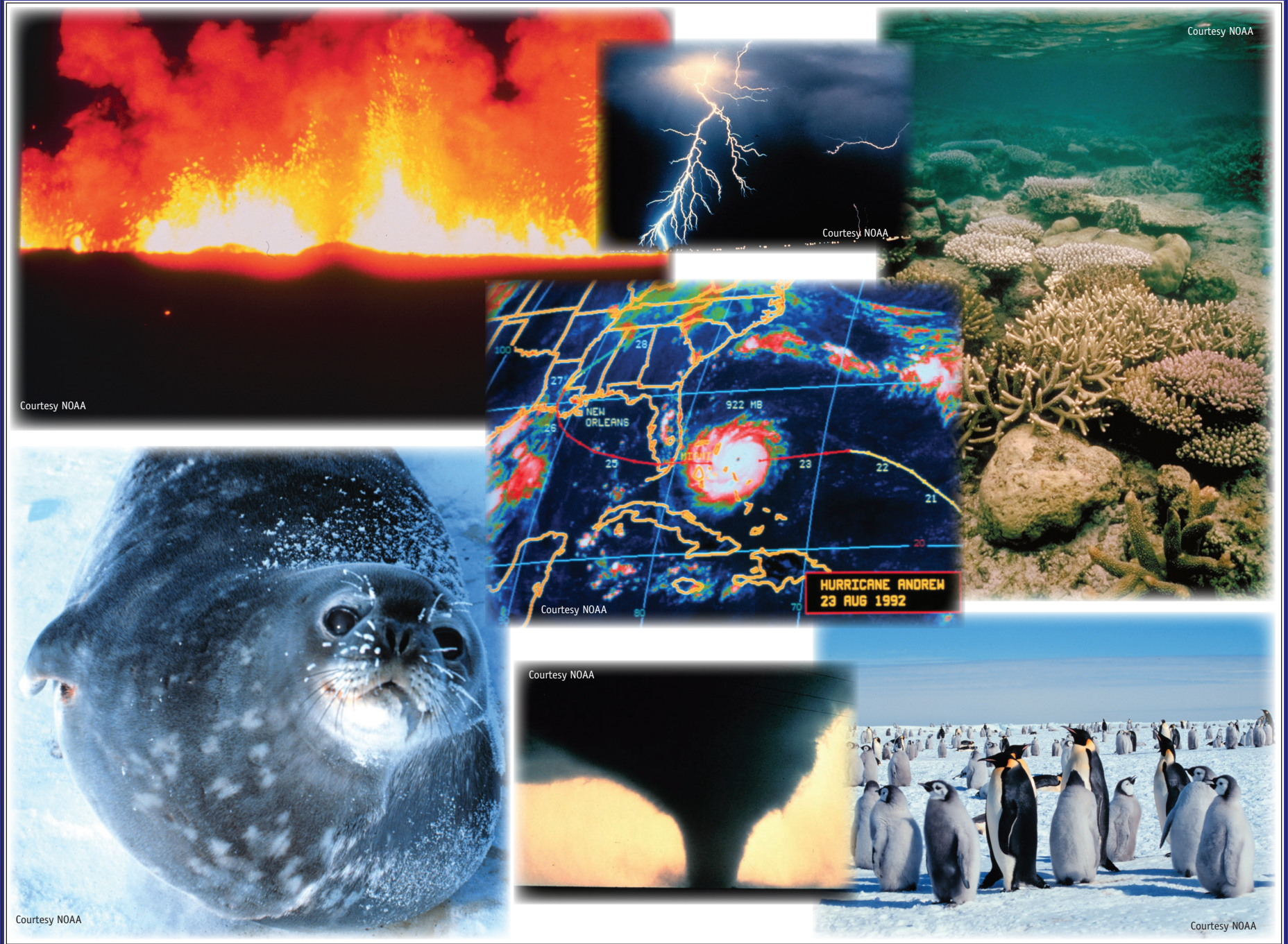

Courtesy NOAA

Courtesy NOAA

Courtesy NOAA

Courtesy NOAA

Courtesy NOAA

Courtesy NOAA

Courtesy NOAA

Courtesy NOAA



UNDERSTAND THE EARTH

NOAA programs to understand Earth's Weather, Oceans, and Climate help make our homes and communities safer, and are important for reliable commerce and transportation. Water transportation is the backbone of the U.S. economy. Almost everyone travels in aircraft and motor vehicles. But airplanes, ships, trucks, and automobiles are all affected by bad weather. Delays due to bad weather cost U.S. airlines more than \$4 billion every year. Bad weather is also involved with over 1.5 million motor vehicle accidents each year; and these accidents caused about 800,000 injuries and 7,000 deaths. NOAA contributes to safe travel and transportation in many ways, including up-to-the-minute weather information and warnings from the National Weather Service, nautical and navigational charts, satellites that gather data on weather and ocean conditions around the world, and creating accurate maps of Earth's surface.

Besides understanding Earth's weather, NOAA also works to understand climate. Earth's climate has changed many times, and those changes can have a big impact

on life in America. When some of the first people arrived in North America between 15,000 and 30,000 years ago, two great ice sheets covered much of the continent. About 1,000 years ago, a prolonged drought forced the Anasazi people of the southwestern United States to abandon large settlements in Colorado, Utah, Arizona, and New Mexico. A shorter drought caused to the "dust bowl" in the midwestern U.S. during the 1930's. NOAA's climate programs focus on detecting signs of climate change, and on helping individuals and communities decide how to cope with the effects of changing climate.

Have fun Understanding the Earth with these activities from NOAA programs:

- Satellite Communications
- Follow That Hurricane!
- Build Your Own Weather Station
- Be a Citizen Weather Reporter
- Tornado in a Bottle
- Tree Ring Detective
- Your Own El Niño
- Woolly Magma
- and more!

Courtesy NOAA



Courtesy NOAA



Courtesy NOAA



Follow That Hurricane!

What You Will Do

Track a hurricane on the same type of chart used at the National Hurricane Center

“Devastating damage expected... A most powerful hurricane with unprecedented strength... Most of the area will be uninhabitable for weeks, perhaps longer... At least one half of well constructed homes will have roof and wall failure... all wood framed low rising apartment buildings will be destroyed... High rise office and apartment buildings will sway dangerously, a few to the point of total collapse... airborne debris will be widespread... persons, pets, and livestock exposed to the winds will face certain death if struck...”

~ from Urgent Weather Statement issued by Robert Ricks, Meteorologist, National Weather Service, New Orleans/Baton Rouge Office, August 28, 2005

This weather statement, warning of Hurricane Katrina’s approach, probably saved many lives. Providing weather forecasts and warnings is one of the ways the National Weather Service carries out its mission to protect life and property and enhance the national economy. The National Hurricane Center (part of the National Weather Service) tracks tropical storms and hurricanes, and issues hurricane watches and warnings when the storms get close to the U.S. Here’s how you can track the approach of tropical storms and hurricanes.

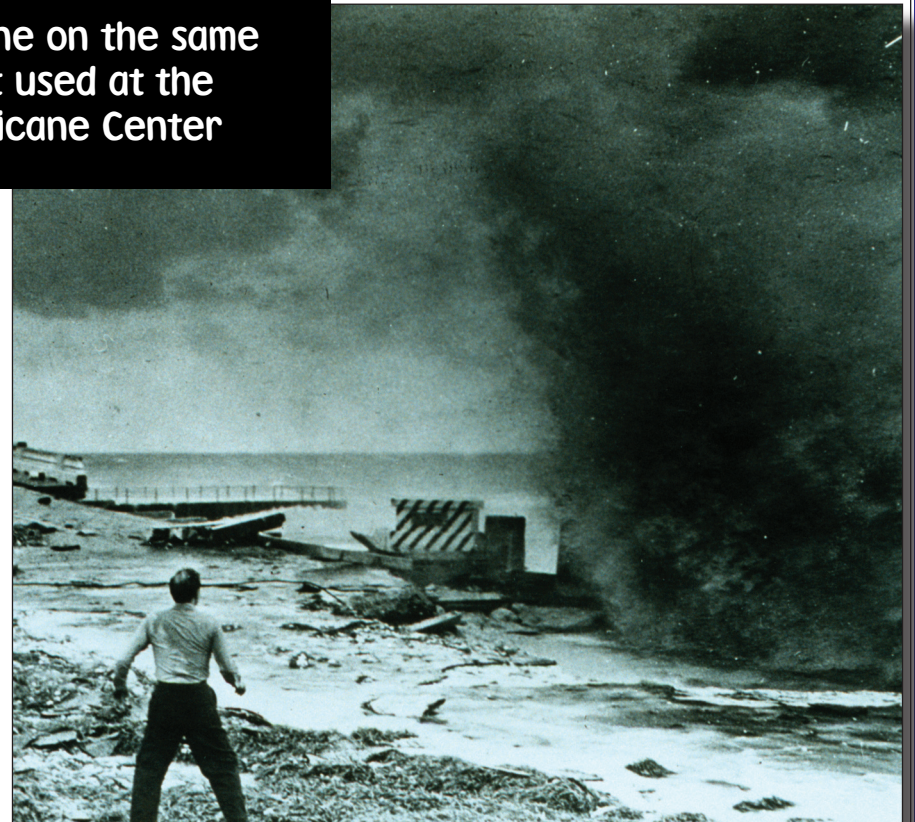

Startled man ready to run after a hurricane driven wave smashes into seawall
Historic NWS Collection. Courtesy NOAA.

What You Will Need

- Copy of the “Western Atlantic Hurricane Tracking Chart.” To download one yourself, go to <http://www.nhc.noaa.gov>, scroll down the page to the blank tracking charts and click on the Western Atlantic one.
- Pencil and eraser
- A record of hurricane locations from the National Hurricane Center, or from historical hurricane records; records from four famous hurricanes are found on the following pages.

How to Do It

1. The location of a hurricane on a particular date and time is described by the latitude and longitude of the storm’s center, called the “eye.” Latitude measures how far north or south a location is from the equator, and longitude measures how far east or west a location is from a line that goes from the North Pole to the South Pole, passing through Greenwich, England. On the “Atlantic Basin Hurricane Tracking Chart,” latitude is shown by horizontal lines and longitude is shown by vertical lines. Latitude and longitude are measured in degrees. Hurricane coordinates are given in pairs, with latitude written before longitude. So, the location of Bermuda would be written as: 32.3°N, 64.7°W. The “N” means that the location is north of the equator, and the “W” means that the location is west of Greenwich, England.

2. To plot the location of a storm:
 - (a) Find the latitude of the storm (the first coordinate in the pair), and locate the horizontal line on the map that matches this latitude.
 - (b) Find the longitude (the second coordinate in the pair, usually followed by a W or E), and locate the vertical line on the map that matches this longitude.
 - (c) Find the place on the map where the two lines intersect. This is the location of the storm eye. Draw the symbol for a hurricane or a tropical storm (depending upon the kind of storm you are tracking) at this spot, and write the date and time next to the symbol. (See above right).
3. Try plotting the track of one or more famous hurricanes. You are now ready to plot real storms during the next hurricane season! You can get coordinates from NOAA WeatherRadio-All Hazards, newspapers, or from <http://www.nhc.noaa.gov>.

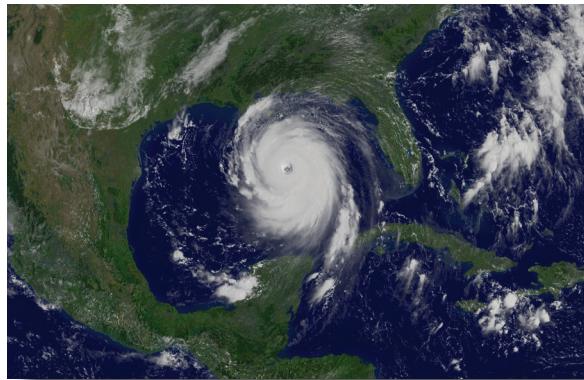

Hurricane Katrina Satellite View. Courtesy NOAA

Hurricane Symbol:



Tropical Storm Symbol:



Is It a Tropical Depression, Tropical Storm, or Hurricane?

Tropical Depressions, Tropical Storms, and Hurricanes are all cyclones, which are areas of low pressure in the atmosphere that have a spiraling inward pattern of air movement. In the Northern Hemisphere, the spiral turns counterclockwise, while cyclones in the Southern Hemisphere have spirals that turn clockwise.

A Tropical Depression is a tropical cyclone in which the maximum sustained wind speed is 38 mph or less.

A Tropical Storm is a tropical cyclone in which the maximum sustained wind speed ranges from 39 mph to 73 mph.

Hurricanes are tropical cyclones with maximum sustained wind speeds of 74 mph or greater. Hurricanes are classified into five categories:

- Category One: Winds 74-95 miles per hour
- Category Two: Winds 96-110 miles per hour
- Category Three: Winds 111-130 miles per hour
- Category Four: Winds 131-155 miles per hour
- Category Five: Winds greater than 155 miles per hour

Is Your Family Disaster-Ready?

Visit <http://www.fema.gov/kids/dizkit.htm> for information about how to make a Disaster Supply Kit.



Courtesy FEMA

Want to Do More?

Check out these Web sites:

- <http://www.nhc.noaa.gov/HAW2/english/intro.shtml> – Hurricane Awareness from the National Hurricane Center
- www.nhc.noaa.gov/aboutnames.shtml – The list of World-Wide Tropical Cyclone Names
- www.nhc.noaa.gov/aboutsshs.shtml – Information about the Saffir-Simpson Hurricane Scale
- http://www.weather.gov/os/hurricane/pdfs/Hurricane_unleashing06.pdf – “Hurricanes, Unleashing Nature’s Fury,” a booklet about hurricanes and why they happen
- <http://www.nhc.noaa.gov/pastall.shtml> – Historical Hurricane Tracks Web site, with information about dozens of hurricanes in the Atlantic and East-Central Pacific Ocean Basins

Track Coordinates of Some Famous Storms

Hurricane Hugo Location and Windspeed at 0000 GMT

Date	Latitude (North)	Longitude (West)	Wind Speed (knots)
9/11/1989	13.2	23.7	30
9/12/1989	12.5	31.0	40
9/13/1989	12.6	38.2	55
9/14/1989	12.9	44.9	70
9/15/1989	13.8	50.5	100
9/16/1989	14.8	56.1	135
9/17/1989	16.1	60.4	120
9/18/1989	17.2	64.1	130
9/19/1989	19.7	66.8	100
9/20/1989	23.5	69.3	90
9/21/1989	27.2	73.4	100
9/22/1989	31.7	78.8	120
9/23/1989	42.2	80.2	35
9/24/1989	52.0	62.0	40
9/25/1989	54.0	57.0	40



Courtesy NOAA



Three views of Hurricane Andrew on 23, 24, and 25 August 1992 as the hurricane moves East to West. Time lapse satellite image courtesy NASA.

Hurricane Andrew
Location and Windspeed at 0000 GMT

Date	Latitude (North)	Longitude (West)	Wind Speed (knots)
17/8/1992	11.2	37.4	30
18/8/1992	13.6	46.2	40
19/8/1992	16.3	53.5	45
20/8/1992	19.8	59.3	40
21/8/1992	23.2	62.4	45
22/8/1992	25.3	65.9	55
23/8/1992	25.6	71.1	110
24/8/1992	25.4	77.5	125
25/8/1992	26.2	85.0	115
26/8/1992	28.5	90.5	125
27/8/1992	31.5	91.1	35
28/8/1992	34.4	86.7	20

Hurricane Floyd
Location and Windspeed at 0000 GMT

Date	Latitude (North)	Longitude (West)	Wind Speed (knots)
8/9/1999	15.0	46.9	30
9/9/1999	16.7	52.6	45
10/9/1999	18.3	57.2	60
11/9/1999	20.8	60.4	80
12/9/1999	22.7	64.1	85
13/9/1999	23.4	68.7	125
14/9/1999	24.5	74.0	115
15/9/1999	27.1	77.7	115
16/9/1999	32.1	78.7	90
17/9/1999	40.6	73.5	50
18/9/1999	44.8	67.3	40
19/9/1999	48.0	56.3	35

Hurricane Katrina
Location and Windspeed at 0000 GMT

Date	Latitude (North)	Longitude (West)	Wind Speed (knots)
24/8/2005	23.4	75.7	30
25/8/2005	26.0	77.7	45
26/8/2005	25.9	80.3	70
27/8/2005	24.6	83.3	90
28/8/2005	24.8	85.9	100
29/8/2005	27.2	89.2	140
30/8/2005	32.6	89.1	50
31/8/2005	38.6	85.3	30

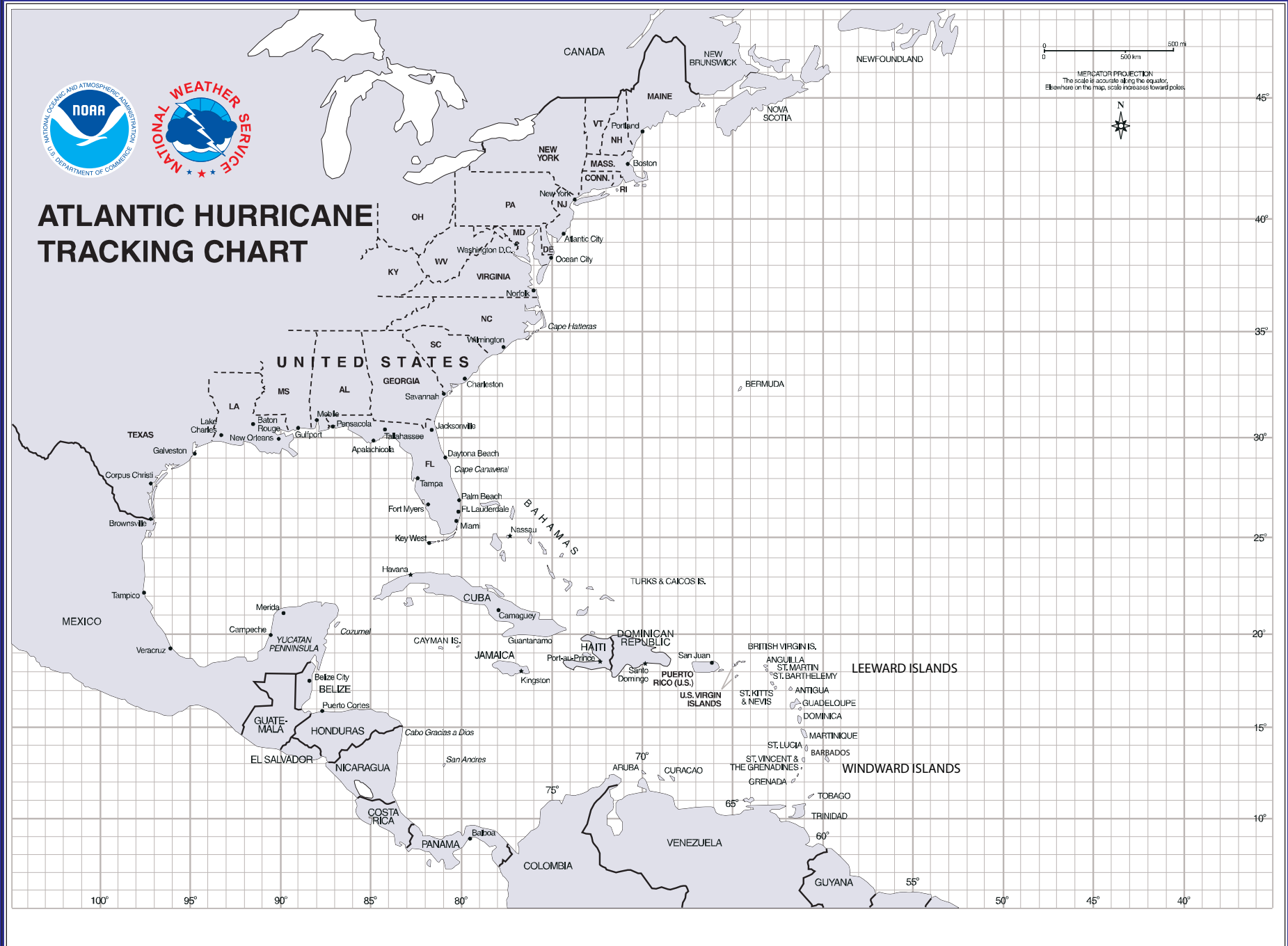

Build Your Own Weather Station



"I believe there is a train under here somewhere!"

Standing tall on North Dakota snow. A March blizzard nearly buried utility poles. Caption jokingly read "I believe there is a train under here somewhere!"
Courtesy Dr. Herbert Kroehl, NGDC

Every year, thousands of lives and millions of dollars are saved by severe weather warnings from the National Weather Service. From its earliest beginnings (on February 9th, 1870), the primary mission of the National Weather Service has been to protect life and property by providing information about dangerous weather conditions. Originally, the National Weather Service was called "The Division of Telegrams and Reports for the Benefit of Commerce" and was part of the U.S. Army. Later, its name was shortened to the Weather Bureau and it became part of the Department of Agriculture, then the Department of Commerce.

The first "weathermen" were "observing-sergeants" of the Army's Signal Service Corps. Weather forecasting in those early years was based almost entirely on the assumption that the weather observed in one location on a particular day would move to downwind locations on following days. Today, satellites, computers, and a variety of scientific instruments are added to this basic assumption to make accurate weather predictions and provide warnings about dangerous weather.

Here's how you can make your own weather observation station!

What You Will Do

Build six instruments that you can use to make scientific measurements of your local weather

Build an Anemometer to Measure Wind Speed

What You Will Need

- Five paper cups - Three ounce size
- Two straight plastic soda straws
- Straight pin
- Paper punch
- Stapler
- Sharp pencil with eraser
- Felt tip marker
- Watch or timer

Warning

Be careful with the straight pin!

How to Do It:

1. Using a paper punch, punch a hole in four paper cups about 1/2-inch below the rim of the cups.
2. Punch four equally spaced holes in a fifth paper cup about 1/4-inch below the rim, and a fifth hole in the center of the bottom of the cup (you will probably need to use the pencil to make the hole in the bottom).
3. Push a soda straw through the hole in one of the first four cups. Flatten the end of the straw and staple it to the side of the cup

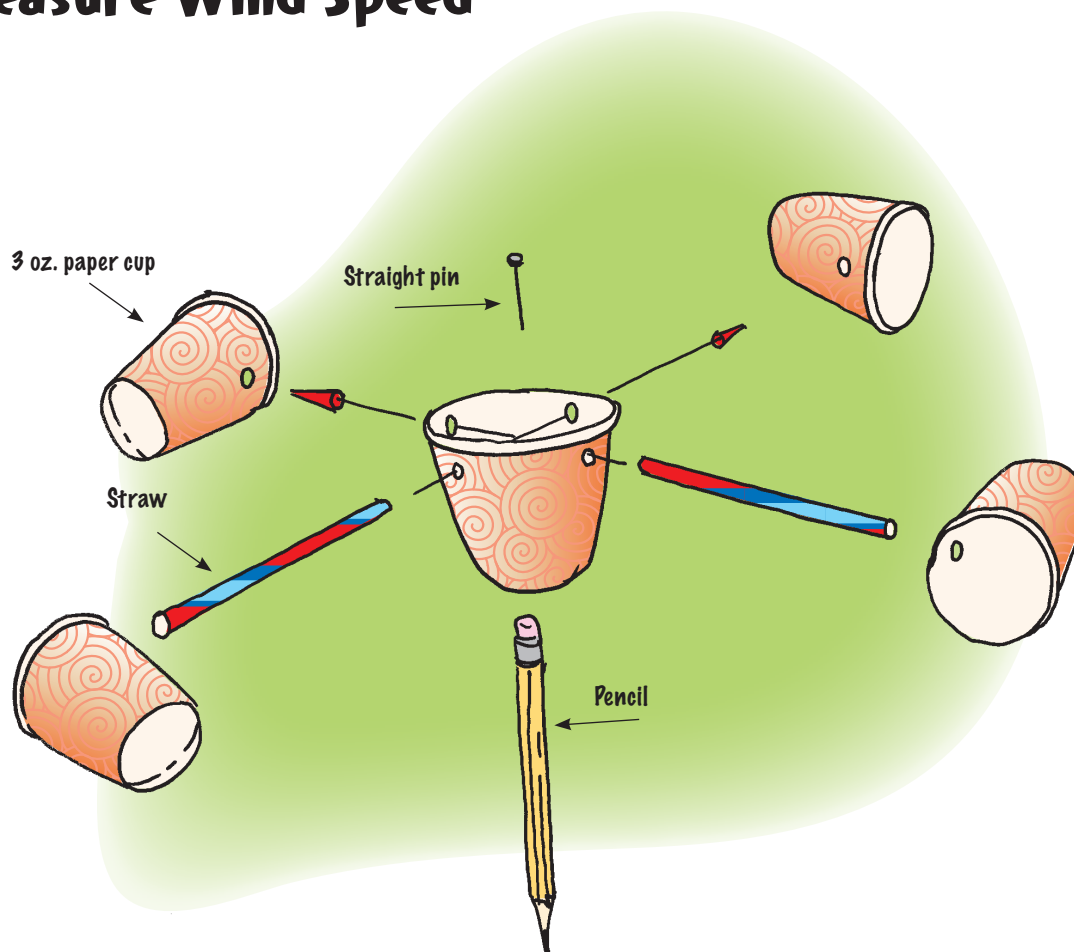

opposite the hole. Repeat this step with the other straw and another of the first four cups.

4. Slide one of the cup and straw assemblies through two opposite holes in the side of the fifth cup. Push another one-hole cup

onto the straw, and turn this cup so that the open ends of the two cups on the straw face in opposite directions. Flatten the end of the straw, and staple it to the side of the second cup. Measure the distance between the centers of the two cups. This is the diameter of your anemometer.

5. Repeat Step 4 with the remaining cup and straw assembly and the remaining one-hole cup. Before stapling the end of the straw to the last cup, turn the cups so that the open end of each cup faces the closed end of the next cup.
6. Adjust the cup and straw assemblies so that they are centered inside the fifth cup. Push the straight pin through the two straws where they intersect.
7. Push the eraser end of the pencil through the hole in the bottom of the fifth cup, and push the straight pin into the eraser as far as it will go. Now your anemometer is ready to use.
8. To use the anemometer, hold the pencil vertically in a wind, and count the number of revolutions per minute (use the felt tip marker to make a mark on one cup so that you can easily see when the cup has travelled through one complete revolution). To convert revolutions per minute (rpm) into approximate wind speed:

- a. Multiply rpm by the diameter (in inches) of your anemometer (measured in Step 4)
- b. Multiply the result by 0.003. This is the approximate wind speed in miles per hour.

Finished Anemometer

This calculation does not give exact wind speed, because drag, friction, and other forces also affect the speed at which your anemometer rotates.

Build a Weather Vane to Find Wind Direction

What You Will Need

- Broomstick or long wooden dowel, about one inch diameter
- Aluminum baking dish, about six inches x nine inches
- Wood stick, about 3/4 inch square and 12 inches long
- Nail, about one inch long
- Metal washer with a hole slightly larger than the nail
- Duct tape
- Small saw or serrated knife
- Scissors strong enough to cut the aluminum baking dish
- Ruler or tape measure
- Silicone or other glue that will stick to aluminum
- Leather gloves
- (Optional) Hand drill, and small drill bit slightly larger than the nail

Warning

Be careful of the sharp edges on the pieces of cut aluminum! Use gloves to protect your hands until the edges are taped.

How to Do It

1. Use the saw or serrated knife to cut a notch about 1/2-inch deep into each end of the wood stick. The notches should be parallel (see drawing on page 65).
2. Rotate the stick so that the two slots are vertical. Use the ruler or tape measure to find the exact center of the wood stick.

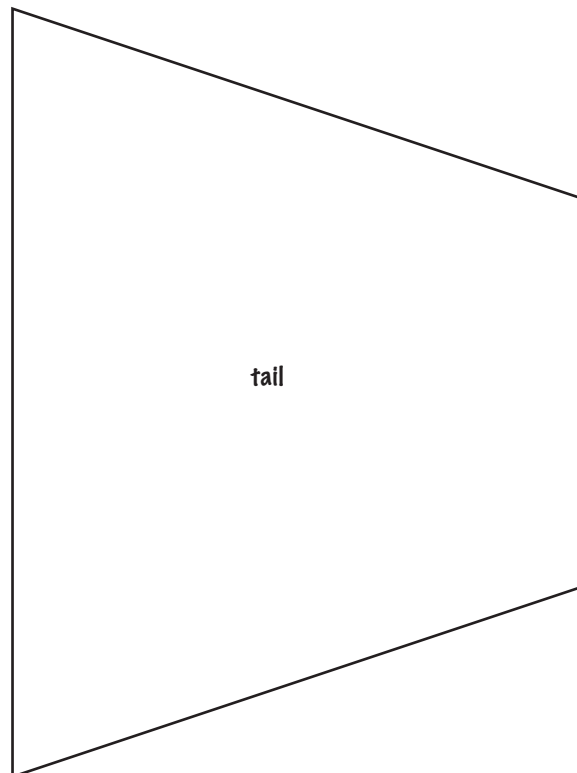

Mark this spot on the upper surface of the stick, and drive a nail through the marked spot. Be careful: if the nail is too big, the stick will probably split. To avoid this, drill a hole slightly larger than the nail through the marked spot. You may need an adult to help with the drilling.

3. Cut the head and tail pieces of the Weather Vane from the aluminum baking dish using the pattern as a guide. **Be Careful—The Edges Are Sharp!** Use duct tape to cover the sharp edges.

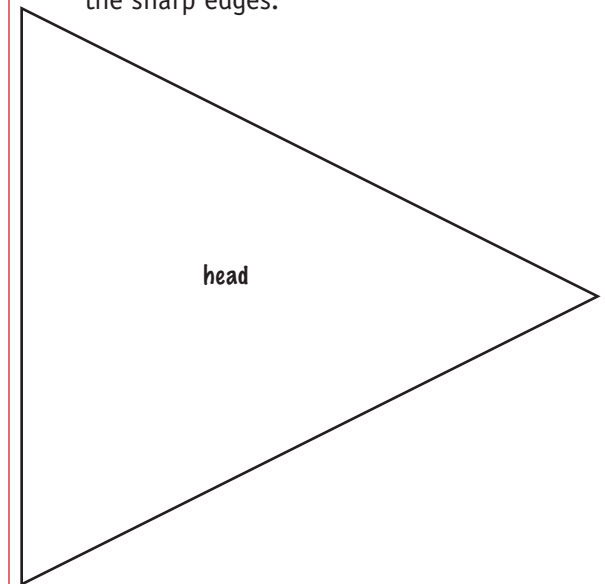

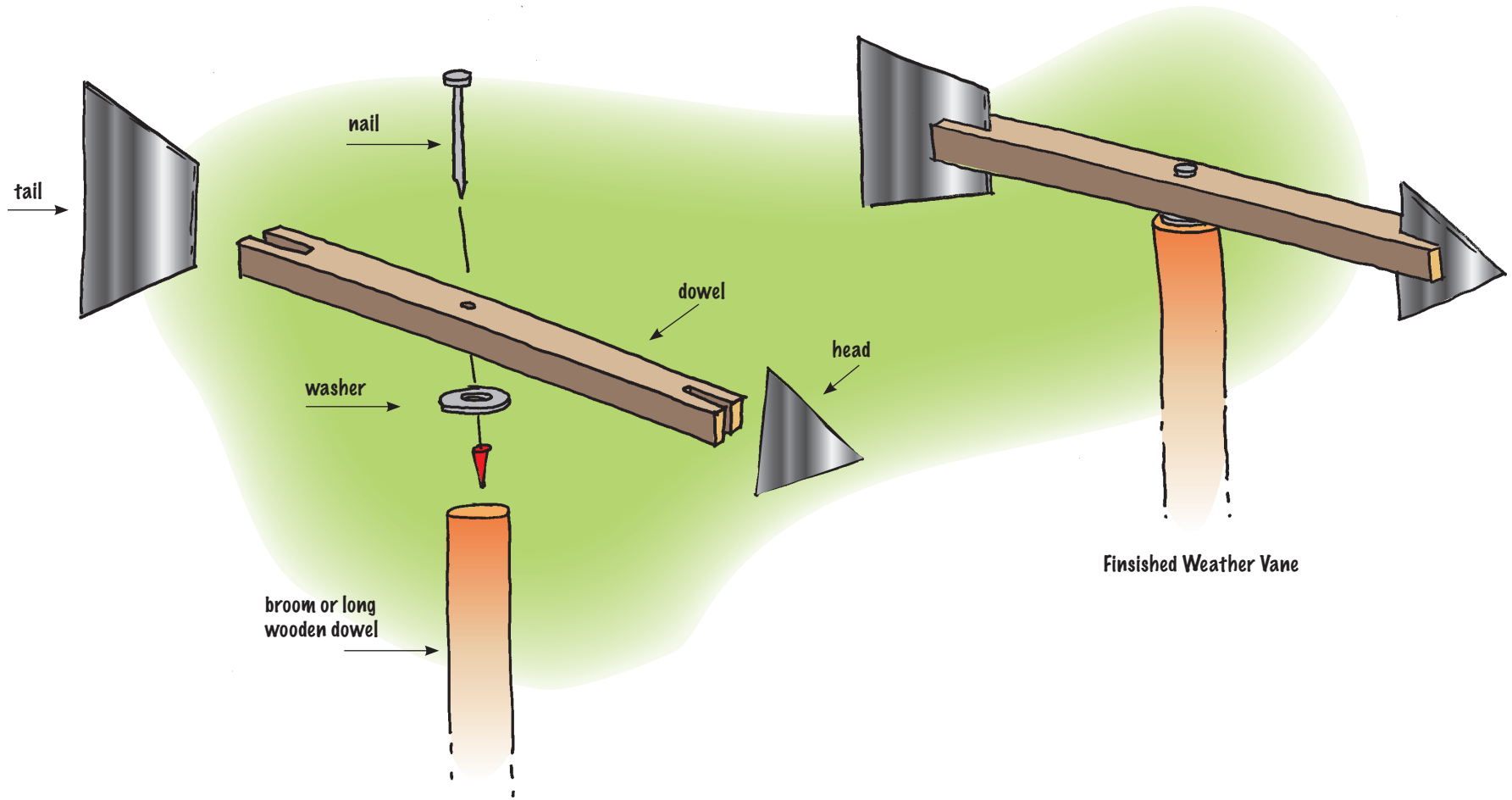

4. Fit the head piece into one of the slots in the wood stick and fit the tail piece into the other slot. Glue the head and tail pieces into place and allow the glue to dry.
5. Attach the Weather Vane to the broomstick or dowel, by placing the washer on one end of the dowel and hammering the nail through the wooden stick into the dowel.

Be sure the stick still moves freely around the nail.

6. Mount your Weather Vane outside where there are no nearby obstructions to block the wind. Try to get the dowel as high as you can while still keeping it steady and secure.

Winds are named according to the direction from which the wind is blowing, so a "north wind" is blowing from the north. The head of the Weather Vane will point to the direction from which the wind is blowing.

Build a Barometer for Measuring Atmospheric Pressure

What You Will Need

- 12-inch ruler
- Drinking glass or other container with sides tall enough to support the ruler
- Clear plastic drinking straw or piece of clear plastic tubing, about 12-inches long
- Modeling clay or chewing gum
- Clear tape
- (Optional) Food coloring

How to Do It

1. Tape the plastic straw or plastic tubing to the ruler so that one end is lined up with the "1/2-inch" mark on the ruler.
2. Stand the ruler-tubing assembly upright in the glass (or other container), and tape the assembly to the top of the container.
3. Fill the container about 3/4-full of water. If you want colored water, first mix food coloring with the water in another container.
4. Use the modeling clay or chewing gum (you'll have to chew it until it is soft enough) to plug the end of the straw or plastic tubing near the top of the ruler.

5. Carefully pour out some of the water so the container is about half full. Be sure the lower end of the straw or tubing stays beneath the water surface while you do this! When you are finished, the water in the straw or tube should be higher than the water in the container. Your barometer is now finished. Since barometers are sensitive to minor changes in weather conditions, keep your barometer indoors for greatest accuracy.

6. Keep a daily record of the height of the water in the tube, using the scale on the ruler. The water level in the tube will rise and fall as atmospheric pressure changes. When atmospheric pressure increases, air presses on the surface of the water in the container causing the height of

the water in the tube to rise. When atmospheric pressure decreases, there is less pressure on the surface of the water in the container so the height of the water in the tube falls. Decreasing atmospheric pressure usually indicates that a low pressure area is approaching, and this often brings clouds and rain. Increasing atmospheric pressure often indicates fair weather.

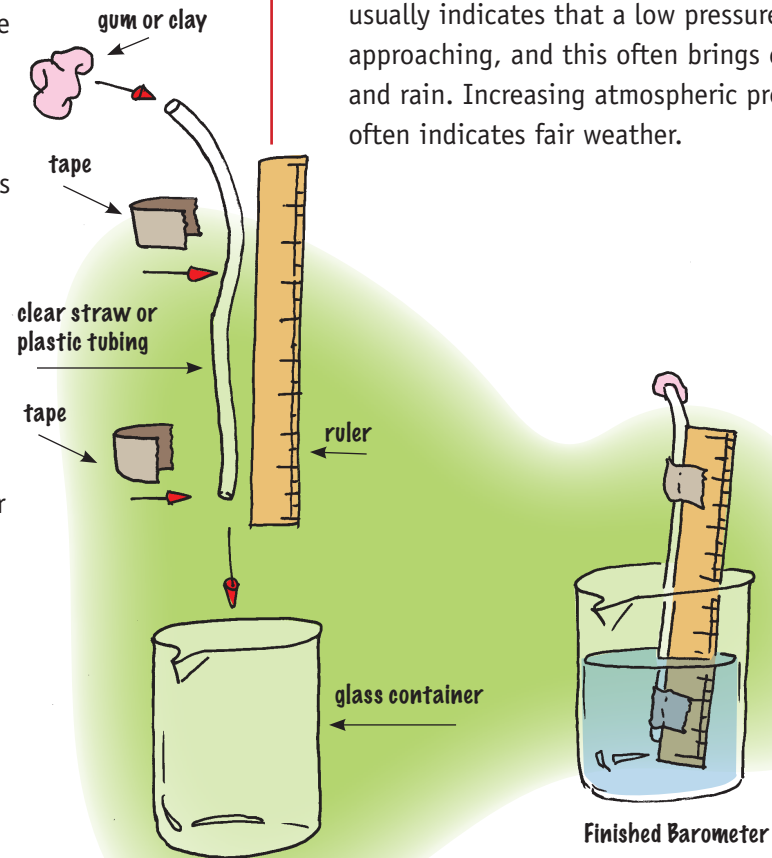

Build a Screened Thermometer to Measure Air Temperature

What You Will Need

- A wooden or plastic box, large enough to hold the thermometer and your hygrometer; see Step 1 under “How to Do It”
- Thermometer, about 0°F to 120°F
- White paint and paint brush
- Nails, screws, glue, or tape to attach the thermometer to the box

How to Do It

1. The wood or plastic box is supposed to protect your weather instruments from wind, rain, and direct sun, but still allow air to circulate so the instruments can get accurate readings. A box with a hinged lid that can be turned on its side is perfect. Turn the box on its side, and cut several slots near what is now the bottom of the box. Paint the outside of the box with white paint, and find a safe, shady outdoor location. The north side of buildings has the most shade. Try to find a location that is three to four feet above the ground.
2. Attach the thermometer to the back of the box with tape, glue, screws, or nails. The bulb of the thermometer should be about two inches above the bottom of the box.

Build a Hygrometer to Measure Humidity

What You Will Need

- Piece of wood or styrofoam about nine inches long and four inches wide
- Flat piece of plastic, thin enough to cut with scissors; about three inches long and one inch wide (an old credit card or laminated luggage tag works well)
- Two small nails
- Three strands of human hair, about eight inches long
- Dime
- Glue
- Tape
- Hammer
- Scissors

How to Do It

1. Cut the plastic into a pointer as shown on the pattern below.

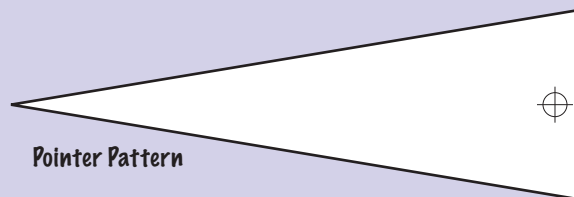

2. Poke one of the nails through the pointer near the base of the triangle. Wiggle the nail around until the pointer moves freely and loosely around the nail.
3. Tape the dime onto the pointer near the tip of the triangle.
4. Glue the hair strands onto plastic between the nail hole and the dime.
5. Use a nail to fasten the pointer to the wood or styrofoam base about 3/4 of the way down the side. Be sure the pointer can still turn freely on the nail.
6. Attach the other nail to the base about one inch from the top of the base, in line with the spot where the hair is glued to the pointer.
7. Pull the free ends of the hair tight so that the pointer is horizontal. Wrap the hair

around the upper nail and glue to hold the hair in place.

8. Make a photocopy of the scale and cut it out. Glue the scale to the base so that the pointer is pointed to the "0" mark. Your hygrometer is finished!
9. Human hair will expand and lengthen when the air is moist, causing the pointer to move down. When the air is dry, the hair will contract and shorten, causing the pointer to move up. Use the scale to record the pointer's position. Keep your hygrometer in a sheltered location. The box used for the screened thermometer is ideal.

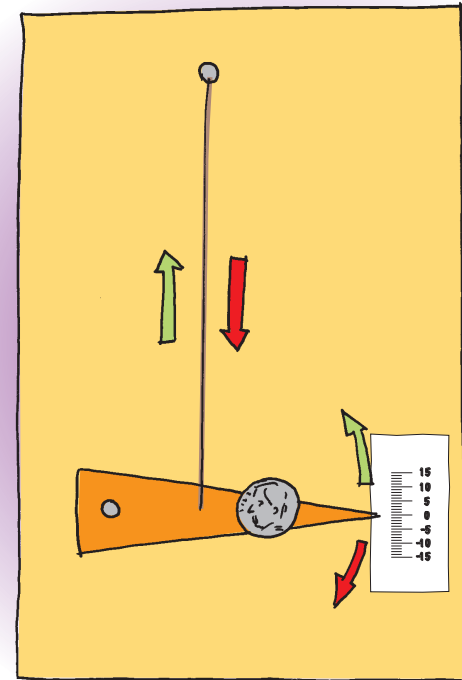
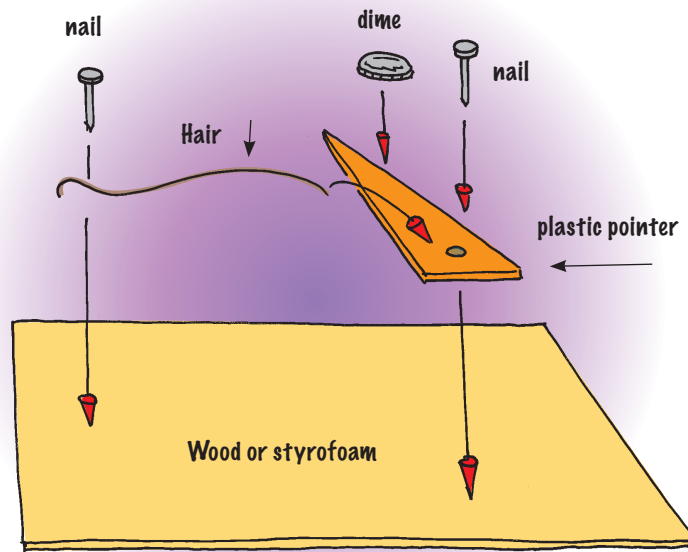

Build a Rain Gauge to Measure Rainfall

What You Need

- Straight-sided glass or plastic container, with a diameter of about two inches or less (such as an olive jar)
- Coat hanger or wire bent to make a holding rack (see picture)
- Measuring spoons: One teaspoon and 1/4 teaspoon
- Hammer and nails to secure the rack
- Felt tip marker

How to Do It

1. Rain gauges measure the amount of rainfall in cubic inches. So your first task is to make a scale for your container that shows how many cubic inches of water are in the container. One cubic inch of water is about 3 1/4 teaspoons, so you can draw the scale on your container by measuring 3 1/4 teaspoons of water to your container, then drawing a short line at the level of the water. If you look closely, the top of the water will seem to be slightly curved and thickened. Draw your line so that it matches the bottom of the curved surface (which is called a meniscus). This line corresponds to a rainfall of one inch.

2. Add another 3 1/4 teaspoons of water to the container and draw another line. The second line corresponds to a rainfall of two inches.
3. Repeat Step 2 until you have at least five marks on the container. This will be enough for most rain events; but you may want to add another line or two, just in case!
4. Find a location for your rain gauge where there is nothing overhead (such as trees or a building roof) that could direct water into or away from your gauge. The edge of a fence away from buildings is often a good spot. Another possibility is to attach your rain gauge to a broomstick driven into the ground in an open area. Be sure to record rainfall soon after a rain event to avoid false readings caused by evaporation.

Empty your gauge after each reading, and you are ready for the next event!

This activity is adapted from "Build Your Own Weather Station" by the Educational Technology Programs Team at the Franklin Institute, Philadelphia, PA (<http://www.fi.edu/weather/todo/todo.html>).

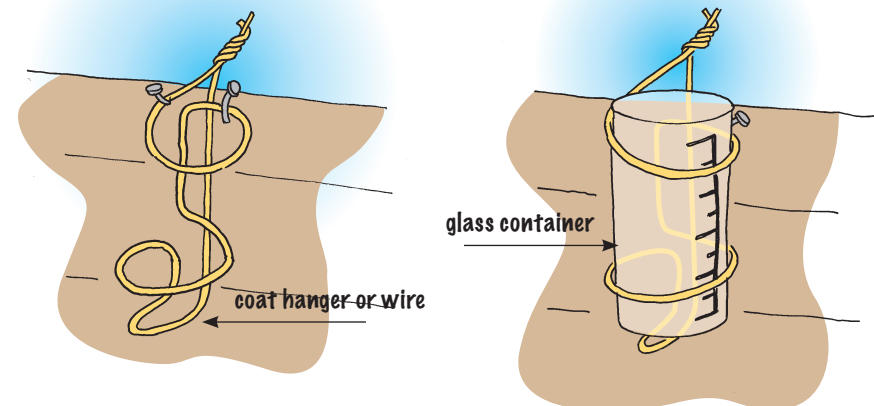

Be A Citizen Weather Reporter



A young volunteer in Granger, Utah (around 1930) operates a cooperative weather station where he observes temperature, precipitation, sky conditions, etc. Courtesy NWS.

“One of the good things is that you come away with the feeling that you have helped others and possibly saved some lives.”

Bruce Sullivan, Maryland Coordinator, Community Collaborative Rain, Hail and Snow Observing Network reported in the Bay Weekly, March 16 - 22, 2006

http://www.bayweekly.com/year06/issuexiv11/leadxiv11_3.html

Could you help save lives with your homemade weather instruments?

Maybe so!

The National Weather Service Cooperative Observer Program is a network of more than 11,000 volunteers who report weather observations from farms, urban and suburban areas, National Parks, seashores, and mountaintops. Data from volunteer weather observers are used to define the climate of the United States and to help measure long-term climate changes, as well as to provide real-time information to support forecasts, warnings, and other public service programs of the National Weather Service.

The Cooperative Observer Program was officially created in 1890, but the history of volunteer weather observers is even older. John Campanius Holm recorded the earliest known weather observations in the United States in 1644-45. George Washington, Thomas Jefferson, and Benjamin Franklin were also serious weather observers. Thomas Jefferson maintained an almost unbroken record of weather observations between 1776 and 1816, and George Washington took his last observation just a few days before he died.

An essential part of any weather observing station is a system for keeping accurate records of observations. Here's how to set up a Weather Journal, and some tips for making weather forecasts from your observations!

What You Will Do

Set up a Weather Journal and record regular measurements from the instruments in your Weather Station

What You Will Need

Copies of "Weather Journal Data Form"

How to Do It

At least once each day, record the measurements from each of the instruments in your weather station. Notice that there are two columns for "Barometric Pressure" and "Humidity." Record the readings from your instruments in the "Instrument" columns. The "NWS" column is where you can record measurements from your local weather office. Comparing the two columns gives you a way to convert your instruments readings to approximately the same scale used for official weather measurements.

Over time, you should begin to see patterns in your data. When the weather changes (it gets windy, starts raining, etc.), check your records for a day or two before. Was there a change in temperature, humidity, or barometric pressure? Did the wind direction shift? These kinds of changes can give clues about what kind of weather is coming. See "Tips for Amateur Forecasters" for more information about these clues.

Tips for Amateur Forecasters from the National Weather Service

Below is a general summary of wind and barometer indications in the United States. The amateur forecaster should modify the table as needed, based on his or her own observations. Barometric pressures in this table are in inches of mercury at sea level. If you use local weather reports to calibrate your instruments, you don't have to worry about this because official measurements are converted to sea level before they are reported to the public. A general rule of thumb is that atmospheric pressure decreases by one inch of mercury for every 1,000 feet of elevation.

If the Wind is Blowing from	and the Barometer is	the Probable Weather is
Southwest to Northwest	30.10 to 30.20 and steady	Fair with slight temperature change for one to two days
Southwest to Northwest	30.10 to 30.20 and rising rapidly	Fair, followed by rain within two days
Southwest to Northwest	30.20 and above and steady	Continued fair, with little temperature change
Southwest to Northwest	30.20 and above and falling slowly	Slowly rising temperature and fair for two days
South to Southeast	30.10 to 30.20 and falling slowly	Rain within 24 hours
South to Southeast	30.10 to 30.20 and falling rapidly	Wind increasing in force, rain within 12 to 24 hours
Southeast to Northeast	30.10 to 30.20 and falling slowly	Rain in 12 to 18 hours
Southeast to Northeast	30.10 to 30.20 and falling rapidly	Increasing wind, and rain within 12 hours
East to Northeast	30.10 and above and falling slowly	In summer: rain may not fall for several days In winter: rain within 24 hours
East to Northeast	30.10 and above and falling rapidly	In summer: rain likely within 12 to 24 hours In winter: rain or snow, with increasing winds
Southeast to Northeast	30.00 or below and falling slowly	Rain will continue one to two days
Southeast to Northeast	30.00 or below and falling rapidly	Rain, with high wind, followed by clearing within 36 hours, and by colder temperatures in winter
South to Southwest	30.00 or below and rising slowly	Clearing within a few hours, and fair for several days
South to East	29.80 or below and falling rapidly	Severe storm soon, followed by clearing within 24 hours, and by colder temperatures in winter
East to North	29.80 or below and falling rapidly	Severe northeast gale and heavy precipitation In winter: heavy snow, followed by a cold wave
Changing to West	29.80 or below and rising rapidly	Clearing and colder

Tornado in a Bottle



The Dimmitt Tornado,
South of Dimmitt, Texas
Courtesy NOAA.

“And then I was enveloped by the freight train roar...as I got to the stairs all of the front of the building blew in...like a bomb went off, just a huge explosion behind me...And then screaming wind...While I was crouched under the desk the building was breathing. You could feel the floor lift about a foot and then you could feel it drop...I thought any second this is going to drop and we are all going down to the first floor with the building on top of us. I was terrified when the building started moving, I thought I’m gonna die...”

Bill Morgan

*Journalist and retired Police Information Officer
recalling the tornado that struck Lubbock, Texas on May 11, 1970,
killing 26 people and injuring hundreds*

Did you know:

- The 1970 Lubbock tornado was classified as F-5, which is the highest a tornado can be rated
- In a typical year about 1,000 tornados will strike the United States
- The strongest tornadoes have rotating winds in excess of 250 mph
- Tornadoes can be up to one mile wide and may stay on the ground for more than 50 miles.
- Tornados can occur at any time of the year and have occurred in every state in the country
- More tornados strike the central United States than any other place in the world; which is why this area is nicknamed “tornado alley”

Tornadoes cause an average of 70 fatalities and 1,500 injuries each year. These numbers would be much higher without NOAA’s tornado warning and research programs. Nationwide tornado forecasts and urgent tornado warnings are issued by the National Weather Service and broadcast over NOAA’s All Hazards Weather Radio network, which is the nation’s one-stop source for weather and emergency information. NOAA’s National Severe Storms Laboratory is a leader in tornado-related research, and in developing technologies such as Doppler radar to improve forecasts and warnings of tornadoes and other severe weather.

When you hear the word “tornado” what picture pops into your mind? For most people it is the funnel-shaped black cloud, with spiraling winds called a “vortex.” Here’s how you can create your own “tornado in a bottle.”

What You Will Do

Create a vortex similar to the wind pattern of tornados

What You Will Need

- ❑ Two empty two-liter plastic soda bottles
- ❑ Tornado Tube plastic connector (available from science museums, science stores, novelty stores, scientific supply companies, etc.) - OR
- ❑ Metal washer, about one inch diameter with a 3/8-inch diameter hole, and plastic electrical or duct tape
- ❑ Dishwashing detergent
- ❑ (Optional) Food coloring

How to Do It

1. Fill one of the two-liter bottles about 2/3 full of water. Add three drops of dish soap and a couple of drops of food coloring to help make the vortex more visible.
2. Screw the plastic connector onto the bottle containing the water, then attach the empty bottle to the open end of the connector. Or, tape two bottles together with a flat washer between them. Use plastic electrical tape or duct tape.
3. Turn the two-bottle assembly over, and place the assembly on a table with the filled bottle on top. Watch the water slowly drip down into the lower bottle as air simultaneously bubbles up into the top bottle. The flow of water may come to a complete stop. Now, rapidly rotate the bottles in a horizontal circle a few times. Observe the

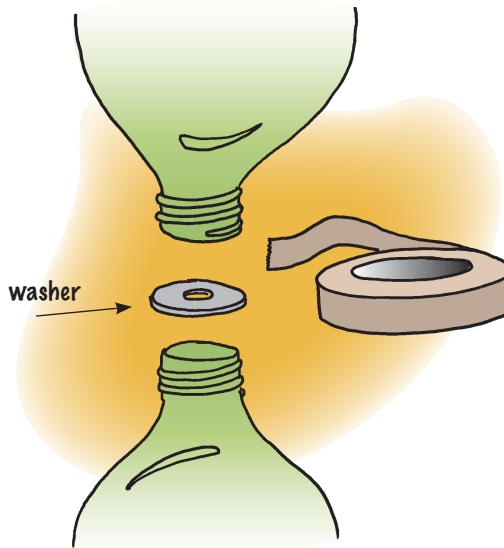

formation of a funnel shaped vortex as the top bottle drains much more quickly. You can make the vortex with a single bottle by twirling the bottle and holding it over a water basin or the ground to drain, but you lose the water and have to refill the bottle each time you use it. Now you know how to use a liquid tornado to quickly empty a large bottle!

What's Happening

When the water is not rotating, surface tension creates a skin-like layer of water across the small hole in the center of the connector or washer. If the top bottle is almost full, the weight of the water is sufficient to push out a bulge in this surface to form a large drop, which then drips into the lower bottle. As water drops

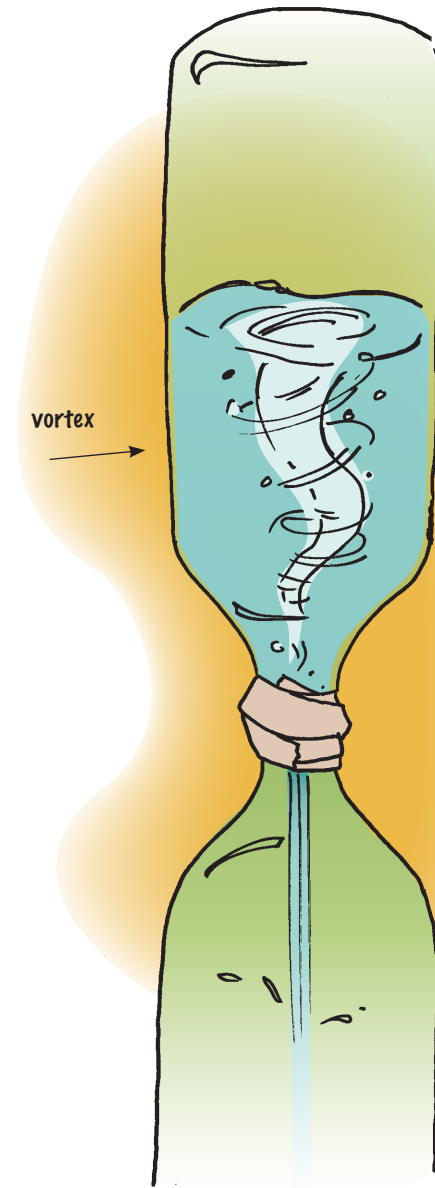

into the lower bottle, the pressure in the lower bottle increases until air bubbles are forced into the upper bottle. The pressure of the water's weight at the surface of the connector or washer decreases as the water level in the upper bottle drops. When the water level and pressure decrease enough, the water surface can hold back the water and stop the flow completely.

When you rotate the bottles in a horizontal circle, the water in the upper bottle starts rotating as well. As the water rotates, forces called *centripetal forces* pull the water toward the center of the bottle. At the same time, gravity pulls the water toward the drain hole. As the water drains into the lower bottle, a vortex forms. As water particles at the outside of the bottle move toward the hole, the speed of the particles increases and the centripetal forces increase. The slope of the water shows where centripetal forces are increasing. So at the bottom of the vortex, the slope of the water is steeper because the centripetal forces are increasing as the water moves with higher speeds and in smaller circles. The water drains smoothly and rapidly because the hole in the vortex allows air from the lower bottle to flow easily into the upper bottle.

There are many examples of vortices in nature, including whirlpools, hurricanes, the Great Red Spot on Jupiter, sunspots, and spiral galaxies (such as our own galaxy, the Milky Way). Keep in mind that while the spiralling motion makes

Tune In to NOAA Weather Radio

NOAA Weather Radio (NWR) broadcasts local weather forecasts 24 hours a day from local offices of the National Weather Service. NWR is an All-Hazards program that broadcasts warnings and information about emergencies that include:

- natural events such as tornadoes, hurricanes, floods, and earthquakes;
- technological accidents such as chemical spills, oil spills, nuclear accidents; industrial emergencies, shipping accidents, or train derailments;
- AMBER alerts; and
- terrorist attacks

NWR broadcasts cannot be heard on a simple AM/FM radio receiver, but the Weather Band is built into many automobile radios, walkie-

many vortices look similar, they occur for many different reasons. The vortex in your "bottle tornado" is caused by horizontal spin (provided by you) and gravity. But a real tornado in the atmosphere is caused by a combination of wind shear, changes in atmospheric pressure, and centrifugal force.

By the way, tornadoes in the atmosphere happen on a relatively small scale (compared to the size of the whole atmosphere). This means that tornadoes may rotate clockwise or counterclockwise, regardless of where they are on Earth; just

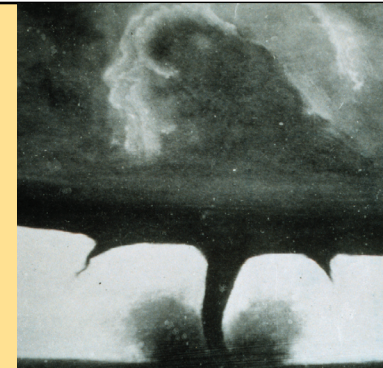

Oldest known photo of a tornado. August 28, 1884. Howard, South Dakota. Courtesy NOAA.

talkies, marine radios, and other receivers. Prices for Weather Radio receivers start at about \$20. Some receivers have a built in alarm that is turned on by a special tone sent from NWR during an emergency to signal that information is being broadcast about a life-threatening situation.

For more information about NOAA Weather Radio, visit <http://www.weather.gov/nwr/>

like your bottle tornado can be made to rotate in either direction.

Want to Do More?

Find out more about tornadoes at NOAA's Tornadoes Web page, <http://www.noaa.gov/tornadoes.html>. You may also want to visit the Tornado Project's Web site, <http://www.tornadoproject.com/>.

Portions of this activity are adapted from an Exploratorium Science Snack (<http://www.exploratorium.edu/snacks/>).

Rip Currents

"I grew up swimming in the ocean and am very comfortable in it. One of my favorite pastimes in the ocean is diving under breakers and floating over swells. [Once], I dove under a wave... but when I surfaced and looked back over my shoulder, I was way out from the shore. I knew immediately what had happened. I tried swimming parallel to the shore, but was still in a very strong current and began to tire quickly.

Then a wave broke over my head, and I felt the panic rising. I know that panic is one's worst enemy in the water, so I floated and treaded water for a few minutes to catch my breath and relax. ...When I looked out to sea to keep an eye on the swells,...I realized that just a little further out, there were surfers.

[So] instead of trying to make it back to shore on my own, I turned and swam out to where they were. I told them what had happened and asked if one of them would allow me to accompany him into shore using his board as a boogie board for both of us. Of course, one of them agreed.

It took both of us to get far enough away from the current so we could paddle back into shore. I feel very fortunate that I recognized what had happened, knew not to panic, and was able to find a solution."

by Kathryn T. Graham

from the National Weather Service Rip Current Safety Web page
http://www.ripcurrents.noaa.gov/real_life.shtml

What You Will Do

Demonstrate why swimmers caught in rip currents have to swim parallel to the shore to escape

Rip currents are powerful, channeled currents of water flowing away from shore. They can occur at any beach with breaking waves, including many Great Lakes. These currents are killers. The United States Lifesaving Association estimates that every year, rip currents on our nation's beaches kill more than 100 people.

Here are some clues that a rip current may be present:

- A channel of churning, choppy water
- A difference in water color
- A line of foam, seaweed or debris moving out to sea
- A break in the incoming wave pattern

Remember the three basic safety rules for ocean swimming:

- Know how to swim
- Never swim alone
- If in doubt, don't go out

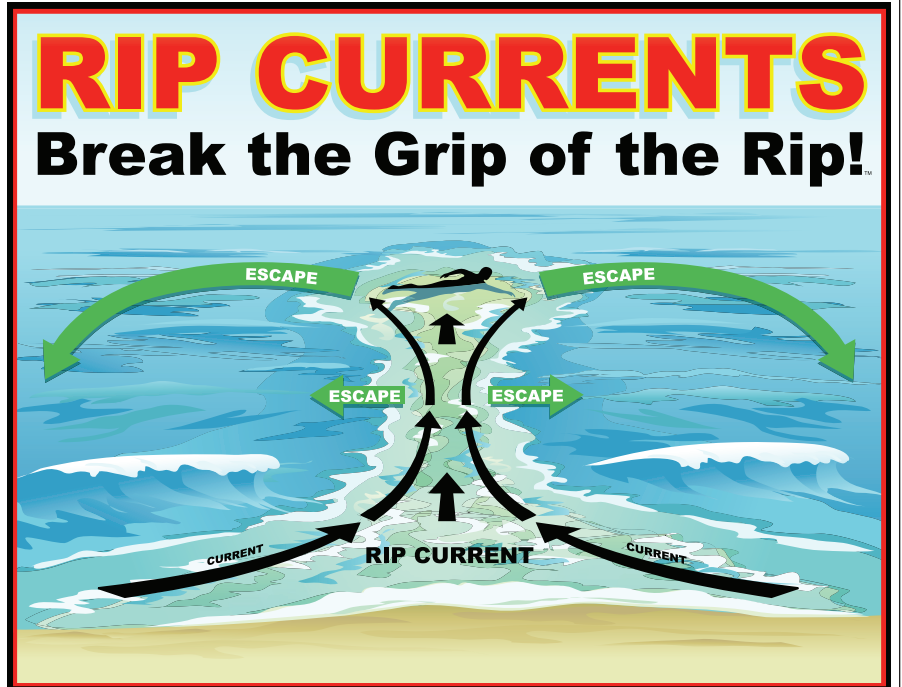

from a Rip Current Safety Poster by NOAA's National Weather Service, NOAA's National Sea Grant College Program, and the United States Lifesaving Association
(http://www.ripcurrents.noaa.gov/signs/rip_signs-r.pdf)

If you are ever caught in a rip current:

- Don't fight the current
- Stay calm
- Swim parallel to the shore to escape the current, then swim toward the beach
- If you can't escape, float or tread water
- If you need help, call or wave your arms for assistance

What You Will Need

- ❑ Two or more strips of ribbon, rope or string, each at least ten feet long; if you have a choice, a blue color is good for representing ocean waves
- ❑ At least five people, including yourself

How to Do It

1. Have pairs of participants hold opposite ends of the rope or ribbon. You will need at least two pairs of participants to do the demonstration.
2. Designate one side of a room or outdoor space as the “shore” and the opposite side as “deep water.”
3. Have pairs of participants stand so that the rope or ribbon is stretched out, and is parallel to the shore. These participants and their ropes or ribbons represent waves.
4. Place a “trapped swimmer” participant between two of the “waves.”
5. Have the “waves” walk toward the “deeper water,” staying parallel to shore as they move. The movement of the “waves” represents the flow of a rip current. The “trapped swimmer” can only escape being carried into “deeper water” by swimming parallel to the waves until she or he is out of the rip current.



Rip Current on Grand Avenue Beach
Courtesy of Chris Brewster, USLA



Beach View of Rip Current Along Jetty
Courtesy of Dr. Tom Herrington, Stevens Institute of Technology



Want to Do More?

NOAA sponsors the “Break The Grip Of The Rip®” Public Awareness Campaign, and has designated the first full week of June every year as Rip Current Awareness Week. Find out more about rip currents on NOAA’s rip current Web site at www.ripcurrents.noaa.gov, which includes a rip current brochure, rip current beach signs, photographs, and links to other resources.

In coastal areas, many of NOAA’s National Weather Service Forecast Offices issue a Rip Current Outlook as a part of their Surf Zone Forecast. NOAA identifies days with forecasts for particularly dangerous rip currents with “High Risk of rip currents.”

Visit: <http://www.ripcurrents.noaa.gov/forecasts.shtml> to learn more.

Close up of Rip Current
Courtesy of Lifeguard Captain Nick Steers,
County of Los Angeles Fire Department

Be a Tree Ring Detective



Dust storm approaching Stratford, Texas..April 18, 1935
Courtesy NOAA.

The storm took place at sundown, it lasted through the night,
When we looked out next morning, we saw a terrible sight.
We saw outside our window where wheat fields they had grown
Was now a rippling ocean of dust the wind had blown.

It covered up our fences, it covered up our barns,
It covered up our tractors in this wild and dusty storm.
We loaded our jalopies and piled our families in,
We rattled down that highway to never come back again.

~ from "The Great Dust Storm" by Woody Guthrie

Earth's climate is always changing, and these changes can have large impacts on humans. An increase in the number of droughts, floods, or hurricanes, for example, will cost U.S. citizens billions of dollars and threaten the lives of many people. Information on past climate changes can give valuable clues on how to plan and prepare for future climate change. Unfortunately, records of human weather measurements only go back about 150 years. To really understand Earth's climate change history, we need information that goes back hundreds and thousands of years.

One way to get this kind of information is to study tree rings (the analysis of tree rings is known as dendrochronology). As trees grow, their trunks increase in length and thickness. Most trees only grow during part of the year (the growing season). This starting and stopping of the growth process produces visible bands or "rings" of wood around the trunk of the tree. Each ring corresponds to one year of growth. The oldest rings are near the center of the tree, while the youngest rings are at the outside of the trunk next to the bark. The ring just inside the bark is the current year's growth. There are two kinds of wood in each ring: "earlywood" appears light in color and its cells have thin walls; "latewood" appears dark in color and its cells have thick walls. The width of the rings changes according to the environmental conditions that existed during the growing season, so ring width can tell scientists a lot about how climate changed during the years when the tree was growing. If the rings are wide, then conditions were probably favorable for tree growth. Narrow rings, on the other hand, may indicate drought, disease, or other conditions not favorable to growth.

Could you be a good Tree Ring Detective? Try solving this puzzle to find out!

What You Will Do

Cross-date tree-ring samples to find out which sample is oldest,
and then find the age of the oldest sample

What You Will Need

- Copy of "Tree Ring Sample Sheet"
- Blank piece of paper
- Scissors
- Clear tape

Warning

Be careful with scissors!

How to Do It

Most tree-ring samples are collected with a tool called an "increment borer." This is a hollow shaft of steel, about 3/16 inch diameter, with a sharp threaded bit at the tip. A handle fits into the opposite end and is used to turn the borer into the tree. When the borer is pulled out of the tree, it removes a core of wood that shows the rings. Most trees are able to seal the small bore hole with sap, so coring does not cause any serious damage to most trees that are sampled.

You might think that you could find the age of a tree simply by counting the rings, but it isn't that simple. The problem is that samples taken from trees growing in the same area (and even from the same tree) usually are not identical. There may be "extra" rings in some parts of the tree, or missing rings in other parts. To deal with this problem, dendrochronologists use a procedure called crossdating. This procedure involves comparing and matching the tree ring patterns from several trees that have grown in

the same area, and using statistical methods to find the exact year in which the rings were formed. This procedure also allows scientists to compare rings from trees that have grown at different times, so the age of very old wood samples can be accurately determined.

On Page 80, there are two sets of tree ring samples that can be matched for crossdating. Most tree-ring studies involve many more samples and some additional analytical steps (check out the resources listed under "Want to Do More?").

1. Cut out each of the tree ring samples.
2. Turn the blank piece of paper so that the longest side is horizontal, and tape the tree ring sample from the living tree onto the blank piece of paper near the upper right corner.
3. Find another tree ring sample that matches part of the tree ring pattern from the living tree. Line up the matching rings and tape the sample beneath the sample from the living tree.
4. Repeat Step 3 until you have matched all four samples.
5. Count how many rings are in the combined samples, starting with the left-hand ring of the oldest sample and ending with the ring next to the bark of the living tree sample. Be sure to count overlapping rings only once.

6. How old is the living tree? How old is the oldest tree? Which tree seems to have grown under the most stressful conditions? When you think you know the answers, check the answer box.

Want to Do More?

NOAA's Paleoclimatology Web site (<http://www.ncdc.noaa.gov/paleo/paleo.html>) has lots of information on how past climates are studied with tree-rings and other methods (called "proxies") such as ice cores, corals, and sediments. The site also has lots of information about how climate has changed during Earth's history, and how we can plan for future climate change.

<http://www.plantbio.ohiou.edu/epb/instruct/ecology/dendro.htm> – This is a do-it-yourself introduction to dendrochronology presented by Brian C. McCarthy and Darrin S. Rubino of Ohio University.

<http://www.pbs.org/wgbh/nova/vikings/treering.html> – A Web site from NOVA about how dendrochronology was used to study ships of the ancient Vikings.

Tree Ring Sample Sheet

Sample Set 1

Living Tree



bark

Dead Tree A



bark

Dead Tree B



bark

Dead Tree C



bark

Sample Set 2

Living Tree



bark

Dead Tree A



bark

Dead Tree B



bark

Dead Tree C



bark

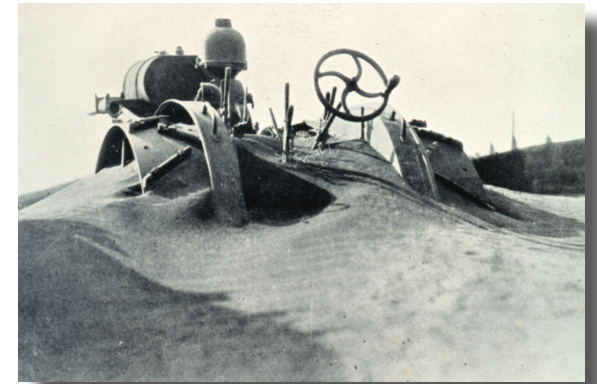

Dust buried farms and equipment, killed livestock, and caused human death and misery in the Great Plains during the height of the Dust Bowl years, 1935. Courtesy Historic NWS Collection

Answer Box DO NOT PEEK!

until you have done
your detective work....

ANSWERS
 Sample Set 1 -
 The correct sequence for this set is Living Tree - Dead Tree C - Dead Tree A - Dead Tree B. The oldest tree (Dead Tree C) is 44 years old. Tree A seems to have grown under more stressful conditions than the other trees, since most of its rings are close together, indicating slow growth during those years.
 Sample Set 2 -
 The correct sequence for this set is Living Tree - Dead Tree B - Dead Tree A - Dead Tree C. The Living Tree seems to have grown under more stressful conditions than the other trees, since more of its rings are close together than in the other samples, indicating slow growth during those years.

Your Own El Niño



Virginia National Guard helicopter rescuing an individual from the James River. Note: rescued man halfway up to helicopter. Helicopter crewman standing on debris in river. Courtesy NWS Collection

"Fifteen years ago, storms battered the West Coast of the United States...There were droughts in Australia, Indonesia, and India...Worldwide, 2,000 people died...Economic losses amounted to billions of dollars...In Indonesia and Borneo, dry conditions fed raging forest fires that consumed hundreds of thousands of acres. Smoke blanketed the area..."

~ from the PBS news program, "Bracing for El Niño"
October 7, 1997

What You Will Do

Create a working model that shows the El Niño effect, trade winds, and upwelling

What caused these disasters? Just some warm water in the Pacific Ocean!

Every two to seven years, trade-winds in the Pacific Ocean slow down or reverse their direction (no one is sure why). Normally, the Pacific trade winds blow vigorously towards the west. This causes warm surface water to pile up in the western Pacific, so that the sea surface is actually about 1/2 meter higher at Indonesia than at Ecuador. These winds also cause sea surface temperatures to be about eight degrees Celcius higher in the west, with cool temperatures off South America, due to an upwelling of cold water from deeper levels. This cold water also brings up nutrients that support the growth of marine plants, which provide food for major fisheries.

But when the trade winds slow down, everything changes. Water temperatures become warmer in the eastern Pacific and colder in the west. Nutrient upwelling slows, and fish populations become much smaller along the Pacific coast of South America. Rainfall follows the warmer water, causing flooding in Peru and drought in Indonesia and Australia. Changes in

- *the circulation of Earth's atmosphere bring unusual weather to other regions*
- *that are far away from the tropical Pacific. Fishermen in South America*
- *noticed that these changes usually happen around Christmas time, and*
- *named the event "El Niño," which means "the (Christ) Child."*
- *El Niño isn't all bad; some of the changes it causes in atmospheric*
- *circulation can reduce the chances of severe hurricanes in the North*
- *Atlantic. But many other changes are highly destructive and dangerous, so*
- *advance warning of El Niño's approach is extremely important for emergency*
- *preparation. NOAA satellites are constantly collecting information on sea*
- *surface temperatures around the globe. NOAA also operates a network of*
- *buoys that measure temperature, currents, and winds in the tropical Pacific*
- *Ocean. Every day, these buoys transmit data that are immediately available*
- *to researchers and forecasters around the world.*
- *Here's a way for you to create a miniature El Niño in your own kitchen!*

What You Will Need

- Clear plastic rectangular container, about 18 inches long, four inches high, and four inches deep (such as a food storage container)
- Water
- Mineral oil, about one cup
- Food coloring
- Hair dryer
- Funnel
- Red oil-based paint, about one ounce (two tablespoons)

Warnings

Have an adult help with the hair dryer, and be careful with any electrical appliance around water! Follow warnings on the paint container label concerning ventilation and handling.

How to Do It

1. Fill the plastic container with water to within one inch of the top.
2. Add food coloring to the water. Blue is good, since we're dealing with the ocean. Allow some of the food coloring to settle to the bottom so you can demonstrate upwelling.
3. Pour the mineral oil into a dish and mix in one to two tablespoons of the red paint.

4. Hold the funnel so that the narrow end is against the side of the container, just above the surface of the water. Gently pour mineral oil through the funnel onto the surface of the water.

5. The liquids in the plastic container represent the warm layer of surface water (the mineral oil) and the cold deep water (colored water) in the Pacific Ocean. Turn on the hair dryer and point it into one end of the container. This end represents the eastern side of the Pacific Ocean. Notice that the "warm" water piles up in the western end

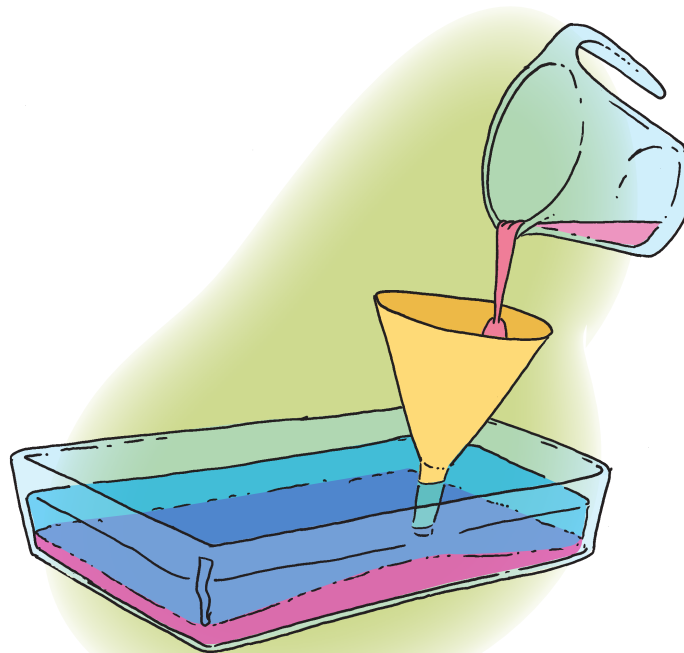

Plastic container

of the container. This is the normal condition for the Pacific Ocean near the equator. If your food coloring contained sediment particles, you may see these moving upward toward the water surface at the eastern end of the container—just like upwelling in the eastern Pacific!

6. Turn off the hairdryer, and watch what happens when the trade winds stop.

Want to Do More?

You can find out more about El Niño at:

- NOAA's Climate Prediction Center Web site http://www.cpc.ncep.noaa.gov/products/analysis_monitoring/ensocycle/enso_cycle.html
- NOAA's El Niño Web page <http://www.elnino.noaa.gov/>
- The El Niño story page <http://www.pmel.noaa.gov/tao/el-nino/el-nino-story.html>
- NASA's Jet Propulsion Laboratory Web site <http://topex-www.jpl.nasa.gov/science/el-nino.html>

This activity was adapted from "Make Your Own El Niño in the Classroom," <http://topex-www.jpl.nasa.gov/education/make-your-own-el-nino.pdf>, by Kelly Pery (Jet Propulsion Laboratory), Johan Berlin (Raytheon Corporation), James Kendall (Jet Propulsion Laboratory), and Ruby Krishnamurti (Florida State University) presented on NASA's Jet Propulsion Laboratory Education Web page (<http://topex-www.jpl.nasa.gov/education/class-activities.html>).

Please Pass the Salt



A Weddell Seal at a breathing hole. Courtesy NOAA Corps Collection
Photographer: Giuseppe Zibordi. Credit: Michael Van Woert, NOAA NESDIS, OAR

“Antarctica is the coldest, driest, windiest continent on the planet. Temperatures can plummet to -58°F , which is 90°F below freezing...Antarctica is so cold that most of the ice there never melts; the continent is permanently covered in ice. Yet, Weddell seals can live there...because some water remains unfrozen, and they can dive and re-surface through these holes in the ice. How do these holes stay open?...The answer is, it’s a joint effort between the seals and the properties of the water.”

~ from the Web site of Dr. Terrie M. Williams, Professor,
Ecology and Evolutionary Biology, University of California Santa Cruz
<http://bio.research.ucsc.edu/people/williams/teachers/intro.htm>

- What is the most obvious property of seawater? It’s salty! But if
- you mix salt from your kitchen into a glass of water, it doesn’t taste
- exactly like seawater. That’s because seawater contains many other
- chemicals in addition to sodium chloride (which is ordinary kitchen
- salt), such as magnesium sulfate, magnesium chloride, and calcium
- carbonate. Scientists call the content of all dissolved salts in seawater
- “salinity,” and measure it in parts per thousand (abbreviated ppt
- or ‰), which is equivalent to grams per kilogram. Freshwater has a
- salinity of 0‰ ; normal seawater has a salinity of about 35‰ .
-
- Salinity makes seawater very different from freshwater. Most animals
- have a specific range of salinities that they can tolerate, and cannot
- survive if the salinity is above or below their tolerance range. Changes
- in salinity can affect the circulation of the oceans, and may even
- affect climate. Because salinity influences our environment in many
- ways, NOAA keeps track of salinity in many places along the U.S.
- coasts and around the world. Here are some experiments you can do
- to discover some of the most important properties of seawater.

What You Will Do

Experiment to find some of the ways that salt changes the physical properties of water

What You Will Need:

- Salt
- Water
- Freezer
- Tablespoon measure
- Cup measure
- Spoon for stirring
- Five clear plastic cups, six ounces or larger
- One fresh egg
- Food coloring

How to Do It:

1. For your first experiment, dissolve three tablespoons of salt in one cup of water. Pour the salt solution into one of the plastic cups until the cup is about 3/4 full. Pour the same amount of fresh water into another cup. Place both cups in a freezer. Check the cups every half hour for two hours. Which solution freezes first? What has happened to the salt solution after 24 hours?

2. For the second experiment, dissolve three tablespoons of salt in one cup of water, and pour the salt solution into one of the plastic cups until the cup is about half full. Fill another cup about half full of fresh water, and add a few drops of food coloring. Now, carefully pour the colored fresh water into the cup of salt water, holding the edges of the cups together so that the fresh water flows down the inside of the cup containing the salt water. Do the two solutions mix, or

3. Finally, pour fresh water into a plastic cup until the cup is about 3/4 full. Carefully crack a fresh egg, and gently drop the contents of the egg into the cup. If your egg is fresh, the yolk will be a firm but flexible sphere that sinks to the bottom of the cup. If your egg is not-so-fresh, the yolk will break or ooze into the water and your experiment is over! Assuming the egg yolk is still intact, add two tablespoons of salt to the water, and gently stir with a spoon. Over the next few minutes, the salt will

does one float on top of the other? Which solution has the greater density?

slowly dissolve. What has happened to the egg after ten minutes?

Now, do you have an idea why holes the Antarctic ice stay open and don't immediately freeze over?

What's Going On Here?

Pure water freezes at 32°F (0°C), but adding salt lowers the freezing point of pure water. This is why salt is sometimes used to keep ice from forming on sidewalks. When water freezes, it forms crystal-like structures. When salt water freezes, only the water forms these structures; the salt is left out in unfrozen water. So as



An iceberg in Gerlache Strait, West Antarctica
Photographer: Rear Admiral Harley D. Nygren, NOAA Corps (ret.) Courtesy NOAA.

salt water freezes, the water that is not frozen becomes saltier.

After 24 hours in your freezer, the cup containing fresh water should be frozen solid (if it isn't, your freezer isn't working!). The salt solution probably contains some ice, but it is not frozen solid. It may appear slushy, and you should have no trouble sticking your finger through whatever ice is in the cup.

Salt water is more dense than freshwater, so freshwater floats on top of salt water. The greater density of salt water also means that objects float more easily in salt water than in freshwater. Remember Archimedes' Principle, which says that an object in a fluid is buoyed up by a force equal to the WEIGHT of the fluid displaced by the object (see Page 11). One cup of salt water weighs more than one cup of fresh water, so its buoyant force is greater. So your egg (if it was fresh) sank in freshwater, but was bouyed up by the salt water.

Want to Do More?

1. Check out NOAA's National Ocean Service Discovery Kits at http://www.oceanservice.noaa.gov/education/kits/estuaries/media/supp_estuar10c_salinity.html and http://www.oceanservice.noaa.gov/education/kits/estuaries/estuaries05_circulation.html to find out more about salinity and how it affects coastal ecosystems.

2. Sea nettles are stinging jellyfish that are a major menace to summer recreational activities in the Chesapeake Bay. Visit http://coastwatch.noaa.gov/seanettles/sn_salinity-model.html to see how NOAA uses salinity to give a daily "nowcast" (like a forecast except it's what's happening NOW) that tells swimmers how likely it is that they will encounter sea nettles in the Bay.
3. Other NOAA programs that provide information on salinity include:

- The Regional Ocean Forecast System (<http://polar.ncep.noaa.gov/cofs>), which provides real-time salinity measurements as well as 24-hr and 48 hr salinity forecasts
- The National Oceanographic Data Center (<http://www.nodc.noaa.gov/General/salinity.html>) with records of global ocean salinity data
- The National Estuary Research Reserve System (<http://ners.noaa.gov/Monitoring/WaterSalinity.html>) that uses automatic instruments to collect data on salinity and other physical features



NOAA wildlife biologists Mike Goebel and Birgitte McDonald get a Southern elephant seal ready for measurement and tagging, as part of the U.S. Antarctic Marine Living Resources research program that provides scientific information needed to conserve and manage marine living resources in the oceans around Antarctica. Courtesy NOAA/Scott Seganti

Satellite Communications

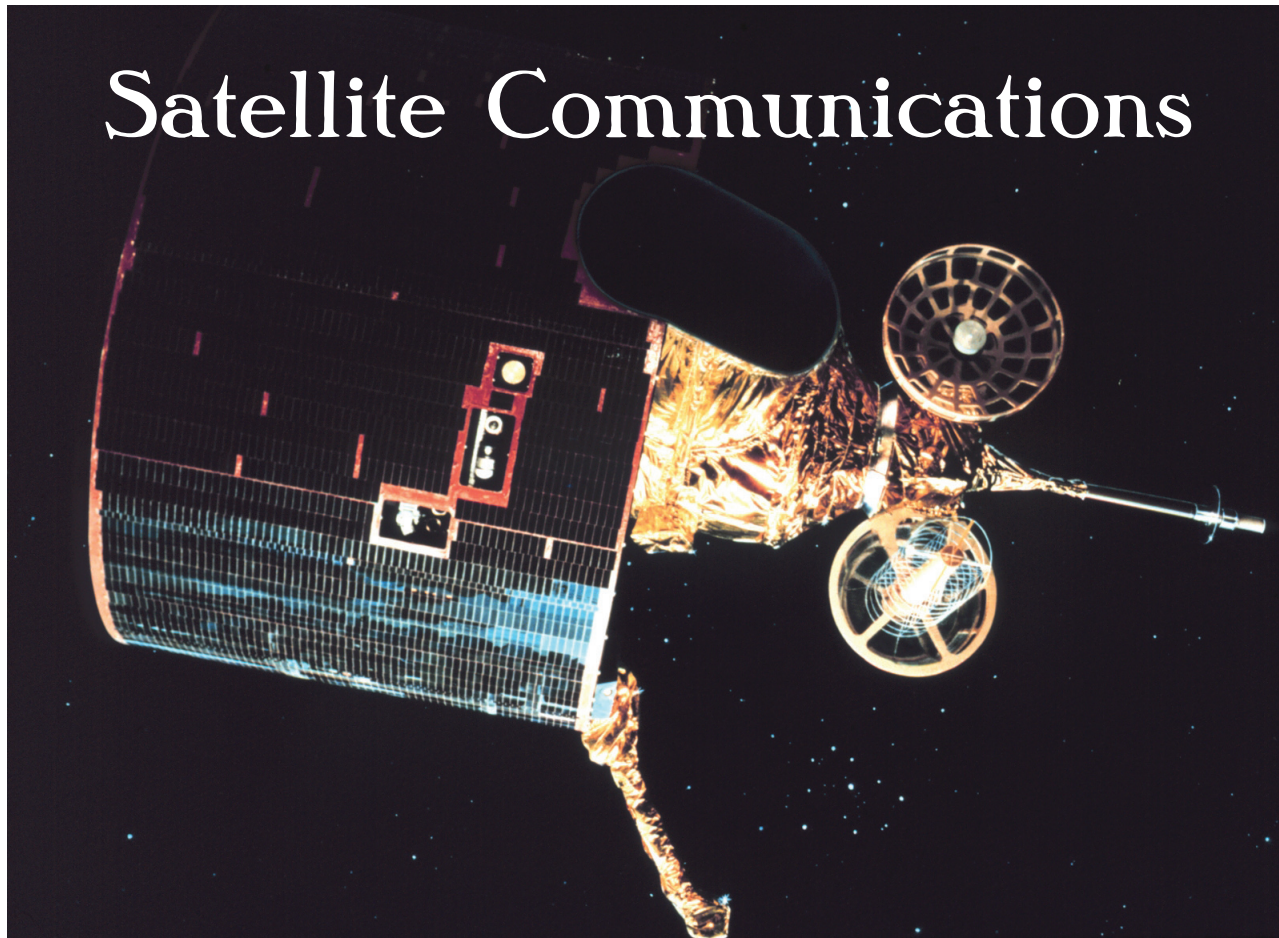

Graphic of 2nd generation GOES satellite in orbit. Courtesy NOAA.

What You Will Do

Demonstrate two of the basic principles that make satellites useful

What...

- has helped rescue more than 20,000 people since 1982;
- shows the location of fires, snow cover, thunderstorms, and erupting volcanoes everywhere on Earth;
- lets you watch the lights go on all over North America as the sun sets?

Satellites, of course! But what keeps satellites in place? And how do they help send information all over the world? Here are two simple demonstrations that answer these questions.

What You Will Need

- Empty three pound coffee can
- Poster board, at least 22-inches square
- String, about 12 inches long
- Pencil
- Scissors
- Marble
- Masking tape
- Flashlight
- Mirror
- Sheet of light-colored paper
- Two rooms connected by a doorway
- A partner

Warnings

Be careful with sharp scissors!

How to Do It

To show how satellites stay in orbit:

1. Tie one end of the string around the pencil. Hold the other end near the center of the poster board, and draw a circle about 22 inches in diameter.
2. Cut the circle out of the poster board, then cut a wedge (pie shape) that is 1/8 of the circle.
3. Overlap the two edges of the circle where the wedge was removed to form a cone, and tape the edges together so that the cone holds its shape.

4. Put the pointed end of the cone in the coffee can, and tape the cone to the sides of the can.

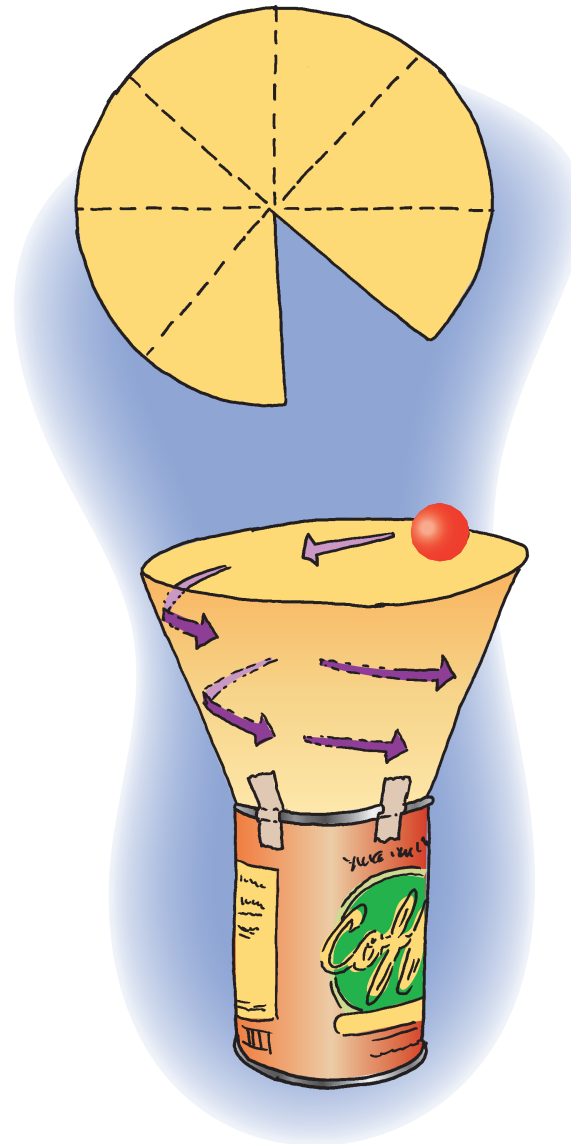

5. Roll the marble around the inside top of the cone as fast as possible, and observe the movement.

When you push the marble forward and release it, the cone applies a continuous resistance to the marble's movement and causes it to move in a circle. As the speed of the marble decreases, the gravity pulls the marble down to the bottom of the cone. If you could keep the marble moving at a constant speed, it would resist the pull from gravity and continue circling in the same place. When a satellite is launched, it moves away from Earth. Gravity causes a continuous pull on the satellite that keeps it from continuing to move out into space. Instead, the forward motion of the satellite keeps it moving in a circle around the Earth.

To show how satellites help send messages between two points on Earth:

1. Have your partner stand in one room facing the doorway and holding a piece of paper. Your demonstration will work best if your partner is about six feet away from the wall that has the doorway.
2. Set up a mirror near the doorway in the other room so that the mirror is angled toward the doorway.

3. Shine a flashlight toward the mirror. The light will reflect into the other room so that your partner can catch it on the piece of paper.

The light is like messages containing information about Earth's oceans, atmosphere, ecosystems, the location of people needing rescue, etc. These messages can be sent to satellites that relay the information to other locations on Earth that are thousands of miles away.

Before satellites were available, messages were sent by bouncing radio signals off of Earth's atmosphere. But because the atmosphere is constantly changing, radio signals don't always bounce to the place that the sender wants them to go. Satellites are above Earth's atmosphere, and are a much more reliable way to communicate.

There are two types of satellites. Geosynchronous satellites are about 22,240 miles above the equator, and travel at a speed (about 6,800 miles per hour) that matches the Earth's rotation. This allows them to hover continuously over one position on the surface. Because they stay above a fixed spot on the surface, they provide a constant lookout for the atmospheric conditions that trigger severe weather events such as tornadoes, flash floods, hail storms, and hurricanes. Polar orbiting satellites circle the Earth 14 times a day, at an altitude of about 500 miles. These satellites pass almost directly over the North and South Poles, and view all regions of the Earth in a single day.

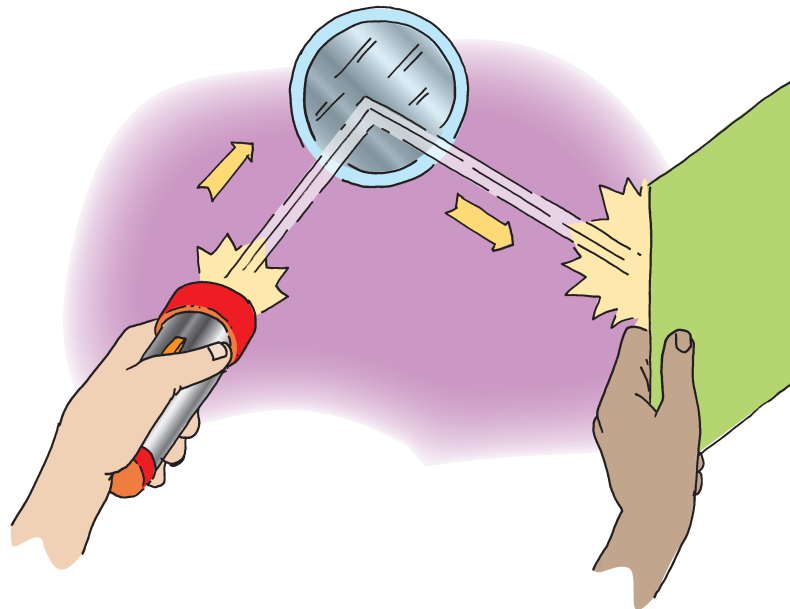

Want to Do More?

1. Visit <http://npoesslib.ipo.noaa.gov/IPOarchive/ED/k-12/IPO/unit01/satellitesAndOrbits.swf> for a Shockwave Flash presentation on artificial satellites.
2. See <http://www.nesdis.noaa.gov/About/onepagers/onepagers.html> for some one-page posters about NOAA's Satellite and Information Service.
3. See <http://www.bu.edu/satellite/classroom/model.html> for directions for making a model of an artificial satellite.
4. See <http://www.sarsat.noaa.gov/> for information about how satellites are used for search and rescue.

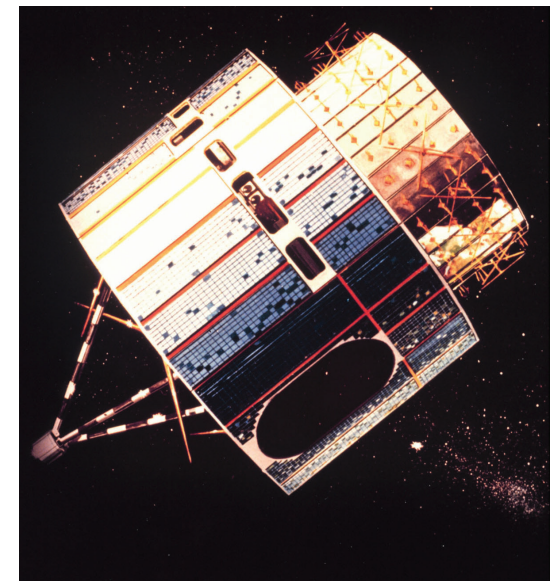

Graphic of the Synchronous Meteorological Satellite, a geosynchronous satellite that was the forerunner of the GOES (Geostationary Operational Environmental Satellite) satellites. Courtesy NOAA.

Woolly Magma

Descend into the crater of Yocul of Sneffels, which the shade of Scartaris caresses, before the kalends of July, audacious traveler, and you will reach the center of the earth. I did it.

"All scientific teaching, theoretical and practical, shows it to be impossible," I said.

"I care nothing for theories," retorted my uncle.

"But is it not well-known that heat increases one degree for every seventy feet you descend into the earth? Which gives a fine idea of the central heat. All the matters which compose the globe are in a state of incandescence; even gold, platinum, and the hardest rocks are in a state of fusion. What would become of us?"

"Don't be alarmed at the heat, my boy."

"How so?"

"Neither you nor anybody else know anything about the real state of the earth's interior. All modern experiments tend to explode the older theories."

~ from A Journey to the Center Of the Earth, by Jules Verne
http://jv.gilead.org.il/vt/c_earth/



Most of what Jules Verne wrote about the center of the Earth in 1864 is now considered to be wrong. While it is still true that no one has actually seen the Earth's interior, today's "scientific teaching, theoretical and practical" agrees more with young Harry than with his adventurous uncle. The center of the Earth is now believed to have an average temperature of 7,000°F, with maximum temperatures as high as 13,000°F. Here's a way to show what scientists think we might find if we could really take a journey to the center of the Earth.

Overflow from Mauna Ulu Crater. View east at overflow from trench into main Mauna Ulu crater on March 19, 1972. Note partially cooled skin on lake. Photo credit: R.T. Holcomb, Hawaiian Volcano Observatory, U.S. Geological Survey

What You Will Do

Make a colorful model of Earth's structure

What You Will Need

- Two containers that will each hold about eight quarts (pots or bowls are fine)
- Paper towels
- Hand towel
- Dishwashing liquid
- Sharp scissors
- Serrated knife and a cutting board
- Rubber ball, about 1-1/4 inches diameter
- Wool roving in six colors; about 2/3 ounce of each color (red, gold, pink, green, white, and blue are suggested, but any colors will work)
- Hot and cold tap water
- Ice (about seven pounds)

Warnings

1. Be careful with scissors and hot water!
2. Get help from an adult to use the serrated knife!

How to Do It

To make your model, you will use a process called "felting." You can read more about felting and how it works under "What's Happening" at the end of this section.

1. Here is a drawing that shows the layers of Earth's structure that will be included in your model. Since no one has actually seen Earth's interior, we don't know what the true colors are. So for your model, choose some colors that you like, and that are

different enough so that the layers can be easily seen.

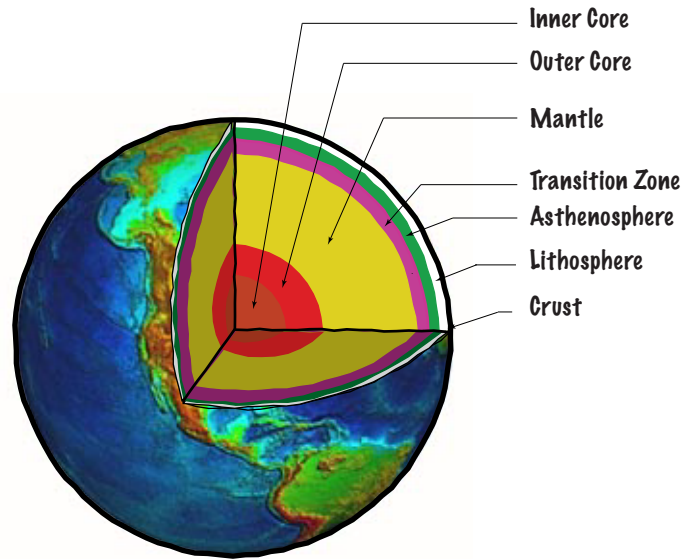

Structure of the Earth

2. Begin constructing your model with the rubber ball, which represents the INNER CORE. Wrap a piece of red wool roving around the ball. The red roving represents the OUTER CORE. Be sure to wrap the wool roving tightly, and try to switch directions as often as possible. Pull the fiber as thin as you can. When you've reached the end, pull the fibers out to be as light and transparent as cotton candy; smooth those ends over the ball by stretching and patting them into place so they neatly stick to the ball. This will make the felting process easier because the fibers can be interlocked better that way.

3. Fill one of the containers about 2/3 full with hot tap water (the water should be as hot as your hands can stand). Fill the other container about 1/2 full with ice, then add cold tap water until the container is about 2/3 full.

4. Now for the felting! Dunk your woolen ball into either the hot or ice cold water. Hold the ball under the water and squeeze it hard to make sure water penetrates all the way to the inner core ball. Lift the woolen ball out of the water and squeeze again. Put a couple of drops of dishwashing liquid on the woolen ball, and roll the ball in your hands lightly, quickly and evenly. After the fibers have joined, begin to slightly increase pressure. The harder and faster you roll, the faster the felting process takes place.

5. After about a minute, dunk the ball into the other water container (so if you dunked it in cold water first, dunk it in hot water now.) The change of temperature shocks the wool fibers and makes them cling together.
6. Repeat the rolling process, adding more dishwashing liquid only if you need to. Too much soap will make the ball slippery and hard to press against. If the ball gets too soapy, rinse or blot off the excess dishwash-

ing liquid with a paper towel. After about 5 minutes, you should have a hard, tight ball. Now you are ready to add the next layer.

7. Wrap the gold-colored roving around the ball to represent the lower Mantle layer. Remember to wrap the wool tightly, roll it in different directions, pull the end fibers out to be very thin, and smooth those ends over the ball.
8. Repeat Steps 4, 5, and 6.
Are you feeling tired? Felting is hard work – if you’re not feeling your muscles, you’re not working hard enough!
9. Wrap pink roving around the ball to represent the Transition Zone, remembering to wrap the wool tightly, roll it in different directions, pull the end fibers out to be very thin, and smooth the ends over the ball.
10. Repeat Steps 4, 5, and 6.
11. Next, add a layer of green roving to represent the Asthenosphere. You guessed it —Repeat Steps 4, 5, and 6.
12. Only two layers to go! Wrap the white roving around your ball to represent the Lithosphere, and repeat Steps 4, 5, and 6.
13. At last! It’s time to add the final layer to represent the Crust. This could be blue,

since most of Earth’s surface is covered with water, or multi-colored to represents both continental and oceanic crusts. Wrap the last piece of roving and repeat Steps 4, 5, and 6.

14. When you have finished your model, the felted wool ball should feel as firm as a tennis ball. Now, ask your adult partner to cut around the globe with a serrated knife to open the model up. **WARNING—Be sure to ask your partner not to cut all the way through! Leave a hinge area about 1/2 inch wide, or the whole thing will fall apart!** Carefully pull your model open and remove the ball. Trim any loose ends with scissors to make it uniform and smooth. Put the ball back in and ADMIRE your Wooly Magma—it’s yours and it’s unique! No two are alike.

What’s Happening More about Felting

What is felt? Do you know what it is made of? Have you ever seen someone throw a pair of woolen socks or a wool sweater in the washing machine and then the dryer? What happens to it? It shrinks! Almost anything made of 100% natural fiber can be felted. During felting, the tiny fibers that make up the wool interlock; tightening and closing the small holes that are also part of its make up. The felting process is basically a compacting of the material that makes the fibers very dense.

Three things are needed to felt wet/moist wool: ALKALINITY, HEAT, and AGITATION. In short AHA! Any two of them together will lead to a natural fiber or fabric felting. If you have a dog, cat, rabbit, or other pet with long fine hair, you’ve probably noticed mats or clumps behind its ears or on the body wherever the hair is exposed to AGITATION and moisture. That’s felt! If you’ve shampooed those spots on your animal, you’ll notice how hard and dense those clumps of fur become. That’s because you’ve added the ALKALINITY and intensified the felting process. To make your model, you use your muscles and a lot of “elbow grease” for the AGITATION. The HEAT part comes in when you shock your wool by dunking it into ice cold water and then in hot water. Dishwashing liquid provides the needed ALKALINITY for the process.

Why would people want to make felt on purpose? It can be beautiful and decorative, but more important, it is much warmer than a loosely woven garment. It can become nearly impenetrable; almost waterproof, and was especially important for the people who lived in the day when there were no synthetic fibers like nylon, polyester, or acrylic that our winter garments are made of now.

More About Earth’s Layers

Earth’s CORE is made out of iron and nickel and is about 1,550 miles in diameter. The temperature of the INNER CORE is on average about

7,000 degrees Fahrenheit, but it can go up to 13,000 degrees Fahrenheit. To give you an idea of how hot that is, you can bake a loaf of bread in your oven at 350 degrees and rock begins to melt at 1,600 degrees. Under the immense pressures in the INNER CORE, the metals do not flow as a liquid despite the high temperatures, but behave and vibrate like a solid.

The OUTER CORE is a sphere of iron and nickel, under less pressure than the inner core and nearly as hot. Here the metals are in a liquid state; between 4,000 and 9,000 degrees Fahrenheit. The Outer Core is 1,400 miles thick, located about 1,800 miles beneath the crust. Scientists believe that the circulation of an electric current in the Outer Core causes the Earth's magnetic field.

The MANTLE is Earth's largest layer, and is approximately two thirds of Earth's total mass. It is divided into several parts. The LOWER MANTLE (our gold layer) is very dense and hot (4,000 degrees Fahrenheit).

The TRANSITION ZONE divides the lower mantle from its upper portion. The Transition Zone starts at a depth of 250 miles and is roughly 190 miles thick. The temperatures here are much cooler than the lower mantle, around 1,600 degrees Fahrenheit.



Two automobiles are all that remain after this section of Royal Gardens subdivision was overrun by lava (October 7, 1987). During October the footpath from a road into the housing area was covered, cutting residents off from the few homes that remained. Photo credit: J.D. Griggs, Hawaiian Volcano Observatory, U.S. Geological Survey

The ASTHENOSPHERE is in the upper region of the mantle, and is the part that flows like asphalt. It both moves the plates of the Earth and permits their motion. This ability of a solid to flow is called "plasticity".

The LITHOSPHERE is a slab about 45 miles thick in which the continents are embedded. It gives us mountains and trenches (collisions), seafloor spreading and new oceans (separation), and long earthquake faults, like the San Andreas Fault (sliding side-by-side). This zone is composed of rigid, brittle rock.

The EARTH'S CRUST is the thinnest layer of the Earth at only 3-5 miles thick under the oceans and about 25 miles thick under the continents.

It is composed of two basic rock types: granite and basalt. The CONTINENTAL CRUST is mostly granite while the OCEANIC CRUST consists of a volcanic lava rock called basalt. Temperatures vary from air temperature to 1,600 degrees Fahrenheit. It is here that volcanoes are started and where we find rich soil, jewels, and rocks. We live on the Earth's Crust.

Please note that the layers we use in this project are not in scale to the Earth's real layers. They are too similar in size. Also, the colors have nothing to do with how the Earth looks underneath. No one really knows what the layers look like. We've used color just for fun and to

make a contrast so we can pick out each layer more easily.

Want to Do More?

For more information about Earth and its structure, visit:

<http://pubs.usgs.gov/gip/dynamic/inside.html>

http://www.windows.ucar.edu/tour/link=/earth/Interior_Structure/overview.html&edu=elem

<http://www.pbs.org/wnet/savageearth/animations/hellscrust/main.html>

This activity was created by Annie Reiser, Global Systems Division Visitor Information Specialist at NOAA's Earth System Research Laboratory

Survey Mark Hunting

National Geodetic Survey Satellite
Triangulation Program, illustrating the idea
of modeling the Earth.
Courtesy NOAA Geodesy



*Imagine bridges not meeting in the middle...
Airplanes landing next to runways instead of on them...
Ships frequently running aground...
This is just a glimpse of life without geodesy.*

What's geodesy? It's the science of measuring the size and shape of the Earth and accurately locating points on the Earth's surface (and is pronounced "gee - ODD - ess - ee").

READ ON, and find out how geodesy can be a lot of fun!

Another way to think about geodesy is to imagine a world globe with a lot of pins stuck in it. Geodesy is about giving each of those pins its own "address" written as latitude and longitude. Why is this important? Because each of those pins can serve as a starting point for describing the location of any

What You Will Do
Get information on the location and description of survey marks in your geographic area, and find out how to share your survey marking discoveries with the rest of the world!

other point on Earth; just like when you want to tell someone how to get to your house, you give them a starting point that they know, like a road or a building. In the United States, these reference points are developed and maintained by NOAA's National Geodetic Survey (NGS).

Hang on, we're almost to the fun stuff!

So where are all those pins stuck in the globe? They are everywhere—more than 1,200,000 in the United States!

Of course, they really aren't pins. Instead, NGS uses permanent marks called "survey marks" (you may hear survey marks called "benchmarks," but benchmarks are only one type of survey mark). Often, survey marks are marked with a metal disk like the photo below, set in concrete or bedrock:



Survey marks can also be stainless steel rods driven into the ground, drill holes in bedrock, bottles, pots, or landmarks visible from a long distance, such as a water tower, a radio mast, or a church steeple.

Courtesy NOAA Geodesy Collection

Now for the fun:

Although the majority of benchmarks are located in plain sight, they are usually ignored by the general public. Many benchmarks haven't actually been visited in a long time, and no one knows whether or not they still exist. So if you find one of these benchmarks, so you may actually be rediscovering long-neglected objects of American history!

Searching for survey marks is called "mark recovery" and is a lot like a treasure hunt (you may hear this activity called "benchmarking" but the correct term is "mark recovery"). Hunting for survey marks can lead to interesting places like high mountain peaks, deep woods, old buildings, bridges, and sometimes, ghost towns! You can enjoy the excitement of being the first to find and document a long-lost survey mark; write a log for your discoveries on the worldwide web; and if you find a survey mark that hasn't been recovered in a long time, you can submit a recovery note, with your name, to the NGS website. Hunting for survey marks can be even more fun if you have a global positioning system (GPS) receiver. With GPS, you can go very close to the exact latitude and longitude of survey marks installed in your area. This is a kind of treasure hunt called "geocaching" (pronounced "GEE - oh - cashing").

Here's how can you find out about survey marks in your area, and try your survey mark hunting skills!

What You Will Need

- Computer with internet access
- (Optional) Digital camera for photographing your discoveries
- (Optional) GPS receiver (this is useful for getting close to a specific survey mark, but the actual "find" is usually done by using very detailed location descriptions from the survey mark's datasheet)

Warnings

1. Mark recovery should ONLY be done with an adult partner!
2. Many survey marks are on private property, and may be in dangerous areas. Be sure to obey local laws!

How to Do It

1. The first step is to find out what survey marks are located in your area. The easiest way to do this is to use the search engine on the geocaching Web site: <http://www.geocaching.com/mark>. This site also has lots of information and "frequently asked questions" about mark recovery. Enter the zip code for the area you want to search in the box on the upper right side of the page, then click on the "GO" button. Soon you should see a page listing benchmarks in the vicinity of this zip code. You can click on the PID number (second column from the left) for a description of a survey mark's location, history, and logs from other hunters.

You can also get information for many survey marks from the NGS Web site. To recover the entire datasheets for survey marks, use the NGS Datasheet Retrieval Page at <http://www.ngs.noaa.gov/>.

- a. Click on "Datasheets" at the top of the page. This will open the "NGS Datasheet Page."
- b. Click on the "DATASHEETS" button on the left side of the page to open the "NGS DATASHEET RETRIEVAL PAGE."
- c. Click on "PID", then enter the PID number (from the geocaching.com Web site) for the survey marks, then click the "Submit" button. This will open a window titled "Station List Results for: ---"
- d. Click on the PID number in the white window, then click the "Get Datasheets" button. This opens the complete datasheet for the survey mark you selected.
- e. At the bottom of the Datasheet is a section titled "Station Description," which gives very precise instructions for finding the survey mark, starting from easy-to-find landmarks (such as a public building or the intersection of major roads). This description also includes information about things that may make it easier to find the survey mark, such as:
 "30 FEET SOUTH OF THE CENTER LINE OF THE ROAD, 23.98 FEET WEST OF

BENCH MARK 33 A (USGS), AND ABOUT 2 FEET LOWER THAN THE ROAD.”

or

“8 FEET SOUTHEAST OF A GATE IN AN EAST-AND-WEST FENCE, AND IN THE TOP OF A LAVA ROCK. A UNITED STATES GEOLOGICAL SURVEY STANDARD COPPER NAIL AND WASHER, STAMPED 5240.4.”

2. Now see whether you can locate some benchmarks. Read the location descriptions carefully, and try to start in areas that are familiar. BE SURE TO DO THIS ONLY WITH AN ADULT PARTNER!

When you find a benchmark, you can take pictures, but that's all! Never disturb or move a benchmark, even if it appears to have been damaged. Remember that benchmarks are important, they are public property, and are protected by law.

You can also log your find on the geocaching Web site. See <http://www.geocaching.com/mark> for instructions.

If the location for survey marks is described as something like a radio tower, church steeple or smokestack, the top of these structures is usually the survey point (there is not normally a separate disk or other mark). Do not climb these structures! Just log your find, and take the structure's



Members of a 1922 geodetic survey expedition. Until recent advances in satellite technology, namely the creation of the Global Positioning System (GPS), geodetic surveying was an arduous task best suited to individuals with strong constitutions, and a sense of adventure. Courtesy NOAA NOS Geodesy.

picture (from the ground!) if you have a digital camera.

<http://oceanservice.noaa.gov/education/kits/geodesy/welcome.html>

Want to Do More?

You can find out more about geodesy at NOAA's National Ocean Service Web site:

The official geocaching Web site <http://www.geocaching.com> has lots more about mark recovery and geocaching.



Courtesy Todd Marsee, Michigan Sea Grant



Courtesy Doug Helton, NOAA



Courtesy Victor Lundquist, NMFS-AFSC

Courtesy Jean Kenyon, NOAA



Courtesy Laurel Jennings, NOAA



Courtesy Laurel Jennings, NOAA



Courtesy Doug Helton, NOAA





Courtesy Caroline Rogers, USGS



Courtesy Todd Marsee, Michigan Sea Grant



Courtesy Tony Perry, NOAA

PROTECT THE EARTH

Courtesy NOAA

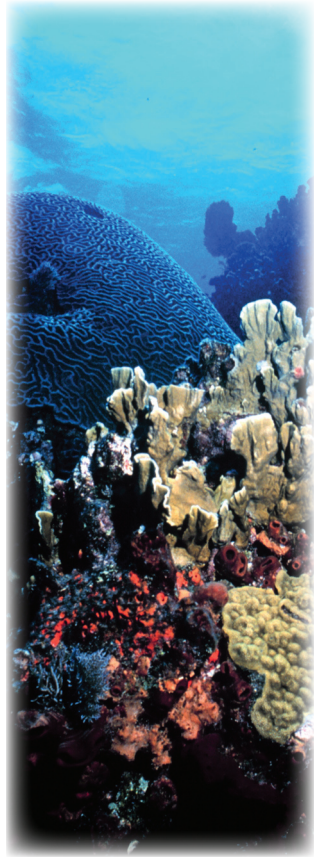

In addition to exploring and understanding the Earth, NOAA programs are also concerned with protecting Earth's Ecosystems. Here's a little challenge: How many benefits can you think of that depend on oceans and coasts? Next, how many things can you think of that might damage oceans and coasts? Your list of benefits should include food, habitat for thousands of plants and animals, marine transportation, fishing, tourism and recreation, and places for communities (more than half of the U.S. population lives and works within 50 miles of the coast). Your list of threats may include pollution (many kinds), habitat destruction for development (many types), overuse (such as over-fishing), storms, and climate change.

*NOAA's mission is to find ways to enjoy the benefits of oceans and coasts and at the same time protect and restore these resources for future generations. NOAA programs include protected areas, endangered species, fisheries, pollution control, and projects to restore damaged resources. Volunteers are an important part of many of these projects. In fact, the key to protecting Earth's Ecosystems is public understanding and action. **YOU CAN HELP PROTECT THE EARTH BY TEACHING OTHER PEOPLE ABOUT EARTH'S ECOSYSTEMS!***

*The more you know, the more you can do! The activities in this section will give you some tools for teaching other people about what **EVERYONE** can do to help protect the ecosystems that sustain life on Earth.*

Courtesy Kathy Crane, NOAA



Ocean Diversity Challenge

The Ocean is vital to life on earth. From the life-giving rain that nourishes crops, to life-saving medicines; from the fish that come from the ocean floor, to the goods that are transported on the sea's surface—in some way the ocean plays a role in your life every day.

This is a poster by artist Steve Shachter, prepared for NOAA during the International Year of the Ocean (1998). Look at the variety of living organisms!

About 275,000 marine species are known to science. But more than 95% of Earth's oceans have not been explored, so there are almost certainly many species that are still undiscovered. Some scientists think there may be as many as ten million undiscovered species living in the ocean. Other scientists think the number may be much higher. Almost all of the major animal groups are found in the ocean, and many are



Courtesy Steve Shachter, NOAA

not found anywhere else. So the sea holds most of Earth's biological heritage, which scientists call biodiversity.

Why is biodiversity important? Because we know that marine organisms already provide food, fertilizer, drugs, jewelry, clothing and many other products. With so many species undiscovered, the potential for new products is huge.

Here's a way to get acquainted with a few of the species whose home is the sea. But remember: there are millions more!

What You Will Do

Try to find all 73 ocean organisms in the Year of the Ocean poster!

What You Will Need

- ❑ Copy of the Year of the Ocean poster; you can download a pdf file of the poster from <http://www.yoto98.noaa.gov/foryou.htm>, or use the smaller version in this book
- ❑ Copy of “Species List for 1998 Year of the Ocean Poster”
- ❑ Copy of “Key to Species on the 1998 Year of the Ocean Poster”

How to Do It

1. Look at the species list and try to find these plants and animals on the poster. The list is organized according to the type of ocean habitat in which the organisms are found. This gives you a clue of where to look on the poster. When you have found as many as you can, check the “Key to Species on the 1998 Year of the Ocean Poster.”
2. If you found more than half of the species on the list, you did really well for a beginner. If you found more than 3/4 of the species, you are no longer a beginner!
3. If you like competition, try these ideas with one or two partners:
 - Take turns reading a description of an organism; your opponent has ten seconds to point to the species on the poster, or say the number that matches the description
 - If you have a third person, have one per-

son read the description while the other two compete to see who can be first to point to the species on the poster, or say the number that matches the description

- Take turns pointing to one of the organisms; the person not pointing has ten seconds to correctly name the species (it’s a good idea to have a third person hold the list to check your answers!)

Want to Do More?

Check out other Year of the Ocean activities at <http://www.yoto98.noaa.gov/>.

Species List for 1998 Year of the Ocean Poster

Tropical or Reef Habitat

1 Reef lobster - *Enoplometopus occidentalis*

- Living in crevices and caves, these nocturnal marine crustaceans that live on the sea bottom scavenge for dead animals but also eat live fish, seaweed, small mollusks and other bottom-dwelling invertebrates.

2 **Star coral** - *Montastrea cavernosa* - One of many marine invertebrates in the class Anthozoa, it has stinging cells and internal or external skeletons of a stonelike, horny, or leathery consistency. The term “coral” is also applied to the skeletons alone, particularly the stonelike ones. See 6, 7, 8, 9, 28, and 67.

3 **Tube sponge** - Phylum Porifera - A tube sponge may be 3 to 6.5 feet tall. Size within a species may vary with age, environmental conditions, and food supply. See 26, 27, and 38.

4 **Gorgonian** - *Gorgonia* species- A “soft coral” composed of polyps that grow together to form a flat structure instead of a rocky reef, it has a central internal skeleton, composed of a flexible, horny substance supporting the colony. See 21.

5 **Butterflyfish** - Family Chaetodontidae - Most often found on reefs and in warm waters, the precise number of species in this family is unknown, but exceeds 150. Their bright colors are usually patterned to provide protection from predators—frequently the tail appears to be the head. See also 12 and 17.

6 **Long-tentacled anemone** - *Heteractis magnifica* - A member of the invertebrate order Actiniaria, made up of sedentary marine animals resembling flowers but closely related to jellyfish. Anemones occur in all oceans from the intertidal zone to depths of more than 33,000 feet. See 2, 7, 8, 9, 28 and 67.

7 **Brain coral** - *Diploria strigosa* - This species of coral forms boulders that are ridged and shaped like the surface of the brain. See 2, 6, 8, 9, 28, and 67 .

8 Boulder coral - *Porites* species - Another of the many forms taken by corals. Corals are closely related to anemones. See 2, 6, 7, 9, 28, and 67.

9 Plate coral - *Agaricia tenuifolia* - Stony corals form reefs that can extend only a few feet or thousands of miles. See 2, 6, 7, 8, 28, and 67.

10 Sea grass - One of the relatively few non-algal plants living in salt water, sea grasses are most common in very shallow waters near shore. They provide food and shelter for the larvae and juveniles of many species of fishes and invertebrates.

11 Spotted moray - *Gymnothorax moringua* - Morays generally live in tropical and subtropical waters. Most have large flattened bodies and often anchor their rear half in coral and rocks, extending the head in the current, ready to grab prey that comes close. They are dangerous when provoked, with ferocious teeth producing deep wounds that usually become infected.

12 Butterflyfish - Family Chaetodontidae - Butterflyfish are most often found in reefs and in warm waters. See 5 and 17.

13 Rock beauty - *Holacanthus tricolor* - This angelfish of warm Atlantic and Caribbean waters reaches a length of 12 inches. As is

common in tropical reef fishes, juveniles have a different color pattern from adults. In most angelfish, the lips are a different color from the body, appearing to be painted on.

14 Blue spotted ray - *Taeniura lymma* - Sharks, skates, and rays are closely related; skates and rays can be thought of as flattened sharks with very large pectoral fins. Sting-rays are noted for the long, sharp spines at the base of the tail. Each spine has a venom sac at its base, and stings are extremely painful. Wounds are frequently the result of a swimmer stepping on a ray.

15 Spotted wobbegong - *Orectolobus ornatus* - Carpet sharks are bottom dwellers with the lower lobe of the tail absent. This Australian species blends into the sea bottom, where it ambushes bottom-dwelling prey at night. It has a fringe of fleshy barbels around its broad snout.

16 Common octopus - *Octopus vulgaris* - Distributed from the North Atlantic as far south as Guiana, this species reaches a length of three feet and a weight of ten pounds. The Giant Pacific Octopus span can extend 30 feet across and it can reach a maximum weight of nearly 600 pounds. Stories of octopus attacks on divers are false; octopus are generally shy and avoid confrontations with humans if possible.

17 Butterflyfish - Family Chaetodontidae - These are "picker" feeders: they use their long snout with the mouth at the end to pick small organisms and food particles from crevices and holes. See also 5 and 12.

18 Nassau grouper - *Epinephelus striatus* - A member of the sea bass family, this species lives in warm waters along rocky shores and coral reefs in the western North Atlantic. A valuable commercial species, it is in such demand that populations have been seriously damaged by overfishing.

19 Marine iguana - *Amblyrhynchus cristatus* - The only sea-going lizard in the world, the marine iguana is found throughout the Galapagos Islands in densities of 4,500 per mile of coastline. Marine iguanas eat marine algae, crustaceans, and grasshoppers. Most feed on exposed reefs close to shore. Larger males, however, are famous for their offshore swimming and diving abilities. They can dive to depths of forty feet, and usually stay down for five to ten minutes, although the longest observed dive was about sixty minutes.

20 Potato grouper - *Epinephelus tukula* - An Indo-Pacific member of a warm-water family that includes some of the largest of all reef fishes. Groupers are disruptively colored so they can blend with the coral reef or rocky bottom. Some are able to change color to match their surroundings.

21 Purple sea fan - *Gorgonia ventalina* - The living tissues form a layer over the entire surface, often in bright colors. See 4.

22 Common clownfish - *Amphiprion ocellaris* - Living among anemone tentacles, and producing a skin secretion inhibiting anemone tentacles from stinging, clownfishes can shelter amid the tentacles safe from harm, taking advantage of the anemone's own formidable defenses. They can also steal food from the anemone, which provides an easy living for them.

23 Cortez garden eel - *Taenioconger digueti* - These eels from the Gulf of California live in colonies at a depth of 12 to 132 feet; each individual has a burrow well-separated from the others. Because they feed by extending the upper half of the body up into the water to catch small animals that drift or swim by, they look like a garden that was planted.

Temperate Waters

24 Giant Kelp - *Macrocystis* spp.- Giant kelp are very large seaweeds found in colder seas and belonging to the order Laminariales (about 30 genera) of brown algae. Giant kelp is rich in minerals and produces algin, a complex carbohydrate useful in various industrial processes, including ice cream and tire manufacture.

25 Leopard shark - *Triakis semifasciata* - Living in the northeastern Pacific Ocean near the bottom, females may reach a length of about 7 feet, but males only grow to 5 feet. The markings are distinctive: black crossbars and blotches on a pale brown or gray background. This shark is frequently on display in public aquaria.

26 Velvety red sponge - *Ophlitaspongia pennata* - There are more than 5,000 species of sponges in the Phylum Porifera, occurring in many forms including tubes, balls, vases, incrustations, and shapeless masses. See 3, 27, and 68.

27 Vase sponge - Phylum Porifera - A vase sponge may be 3 to 6.5 feet tall. They live in colonies or as solitary animals attached to the sea bottom or to other solid objects. See 3, 26, and 68.

28 Northern red anemone - *Tealia crassicornis* - Occurring in the northeastern Pacific Ocean; they can be thought of as an upside-down attached jellyfish. They are largest, most numerous, and most colorful in warmer seas. See 2, 6, 7, 8, 9, and 67.

29 Ochre sea star - *Pisaster ochraceus* - Sea stars are in the Phylum Echinodermata, which is generally characterized by five-rayed symmetry, a hard, spiny covering, and tube feet. Others include sea lilies, sea

urchins, sea cucumbers, basket stars and brittle stars, and the recently discovered sea daisies. Ochre sea stars are very common in the intertidal and shallow waters of the northeastern Pacific Ocean. See 37 and 53.

30 Serpent star - Ophiuroidea - An echinoderm, serpent stars can climb and some are capable of coiling their arms vertically. They are predominantly carnivores and feed by capturing food and bringing it to the mouth by arm looping or by moving the mouth to the food. See 50.

31 Garibaldi - *Hypsypops rubicundus* - The official California state fish, Garibaldi occur in shallow warm waters. Adults are easily recognized by their uniformly reddish gold color, and reach a maximum length of about 12 inches. Young are reddish with iridescent blue spots.

32 Striped jack - *Caranx dentex* - Fast swimmers, striped jack eat smaller fishes, squids, and shrimps. Most species have rows of large heavy scales along the side near the tail fin, with small scales elsewhere, reducing drag and increasing swimming efficiency.

33 California sheephead - *Semicossyphus pulcher* - This fish can reach a length of 3 feet and weight of 36 pounds, though most

are much smaller. They range from Monterey Bay to the Gulf of California and are found most abundantly in kelp beds or along rocky shores.

34 Red sea urchin - *Strongylocentrotus franciscanus* - Urchins are echinoderms having a globular body, movable spines, radially arranged internal organs, and tube feet extending from pores arranged in bands extending from top to bottom over the skeleton. The mouth is on the underside of the body and teeth are extruded to scrape algae and other food from rocks. Sea urchins live on the ocean floor, usually on hard surfaces, and use the tube feet or spines to move about. This species lives in cool North Pacific waters near shore.

35 Sea lion - *Zalophus californianus* - Sea lions differ from seals in having external ears, a coat of short, coarse hair that lacks a distinct undercoat, and can rotate their hind flippers forward to use all four limbs in moving about on land. Sea lions eat mostly fish, squid, and octopus. Breeding in large herds, the males establish harems of 3 to 20 females. See 48 and 49.

36 Port Jackson shark - *Heterodontus portusjacksoni* - This is a relatively small Australian shark with teeth in both the upper and lower jaws; small and pointed in the front, but large and flat-surfaced in the back, al-

lowing it to eat both soft and hardshelled prey such as snails, oysters, sea urchins, and crustaceans.

37 Troschel's seastar - *Evasterias troscheli* - Seastars are in the class Asteroidea, having rays or arms surrounding an indistinct disk. The 1,800 living species of starfishes occur in all oceans, although the North Pacific has the greatest variety. This species lives in rocky, shallow subtidal areas. See 29 and 53.

Open Ocean

38 Ocean sunfish - *Mola mola* - Molas grow very large, reaching to 10 feet in depth and weighing as much as 600 pounds. They eat jellyfish. The young swim with the body in a vertical position like other fishes, but adults spend most of their time on their sides, floating as though they were dead.

39 Atlantic manta - *Manta birostris* - The few species of mantas range in size from ocean giants of over 20 feet to species of only a few feet across the pectoral fins. The two flexible head protrusions, called cephalic fins, help direct small pelagic food organisms into the wide mouth. The Atlantic manta can have a wing span at least 22 feet and weigh well over 3,000 pounds.

40 Billfish - Family Xiphiidae - Billfishes live in the open ocean and can swim almost 70

miles per hour. Their most important identifying feature is the long upper jaw forming a bill, or spear, which may be used to stun prey as they speed through schools of fish.

41 Great white shark - *Carcharodon carcharias* - The white shark, or man-eater, roams all warm and temperate seas, but appears most abundantly in waters off Australia. They average 12 feet long, but can reach over 30 feet. They are so large and powerful that it is very difficult to study them. Great whites are credited with many attacks on humans, probably mistaking them for seals or sea lions. However, as a top predator, they are an essential part of marine ecosystems and should be protected.

42 Sperm whale - *Physeter macrocephalus* - Sperm whales occur in all seas, are the largest of the toothed whales, and can dive to depths below 6,600 feet. They have the largest brains that have ever existed on earth, but it is ratio of brain to body weight that is important in intelligence, not just brain weight. They eat squid and fish; battles with giant squid often result in clear sucker marks on the skin of the whale. See 70.

43 Yellowfin tuna - *Thunnus albacares* - Tunas are fast swimmers; this species can reach speeds over 40 miles per hour. They average 15 to 25 pounds weight, but can reach

300. The long pectoral fins, pelvic fins, and finlets are bright yellow, but the brightness fades soon after death.

44 Arrow worm - *Sagitta macrocephala* - These planktonic (drifting) animals are well-adapted pelagic predators, even though they are an inch long or shorter. They are streamlined, have transparent bodies, and possess heavy grasping spines or hooks near the mouth.

45 Blue shark - *Prionace glauca* - Named for their deep metallic blue color and living in the open ocean in subtropical and cooltemperate seas., blue sharks have very large pectoral fins that help provide lift to keep them from sinking. Often seen at the surface swimming slowly with the first dorsal fin and the tip of the tail out of water, their food is mostly fish.

Polar Waters

46 Lion's mane jellyfish - *Cyanea capillata* - The largest jelly known, this species grows up to 8 feet wide and 1000 feet long, and has up to 12,000 stinging tentacles. When an animal comes in contact with these tentacles, it is stung and injected with a neurotoxin (nerve poison).

47 Icefish - Family Channichthyidae - Members of this Antarctic family have a kind of antifreeze that allows them to survive in

the coldest water, even that below freezing. They have no hemoglobin (the oxygen-carrying blood pigment) but because they live at low temperatures, their blood carries enough dissolved oxygen for life.

48 Weddell seal - *Leptonychotes weddelli* - Seals survive extremely cold temperatures by having a thick layer of blubber which insulates them. True seals lack external ears and must drag their hind flippers. This Antarctic seal weighing 900 to 1,000 pounds, searches around sea ice for prey, usually fish and squid. Its main predator is the killer whale. See 35 and 49.

49 Ringed seal - *Phoca hispida* - Ringed seals usually live in ice-covered waters. They live on both seasonal and permanent ice, where they give birth in late winter or early spring. They can be found in all seas of the Arctic ocean and in some northern Finnish and Russian lakes. The world population is estimated at 5 million, with 1 to 1.5 million in Alaskan waters. See 35 and 48.

50 Serpent star - Class Ophiuroidea - Serpent stars occur in warm, cold, deep, and shallow waters. Like most echinoderms, they cannot tolerate marked changes in salinity, temperature, or light intensity. They use their spines and tube feet in locomotion, may move forward with any part of the body and reverse direction without turning

around. See 30.

51 Antarctic cod - Family Nototheniidae - The Antarctic cods are a large, diverse family, dominating the Antarctic fish fauna. Most are bottom dwellers feeding on invertebrates and occasionally algae; some live associated with sea ice, but others live in midwater. They are a very important food for most penguins, seals and whales.

52 Arctic sea spider - Class Pycnogonida - Related to spiders but not one, the Arctic sea spider lives in very cold waters. They walk on the ocean bottom on slender legs, or crawl among plants and animals; some may tread water. They have a very small body; the internal organs extend out into the legs.

53 Bat Star - *Patiria miniata* - Starfish can digest food outside of the body by extruding their stomach around prey. They move by walking with their tube feet. See 29 and 37.

54 Long tentacle comb jelly - Phylum Ctenophora - Transparent, gelatinous planktonic animals, ctenophores have cells which, instead of stinging, have a sticky tentacle to which food particles adhere to be drawn into the mouth.

55 Antarctic octopus - Class Cephalopoda - The cephalopods are a small group of highly advanced, exclusively salt water molluscs, to which octopus, squid, cuttlefish, and chambered nautilus belong. Extinct forms outnumber the living, the class having attained great diversity in late Paleozoic and Mesozoic times. The best-known cephalopod features are the possession of arms and tentacles, eight (octopus) or ten (squid) in most forms, and the use of ink for protection.

56 Gurney's sea pen - *Ptilosarcus gurneyi* - Sea pens are colonial coelenterates that stick up from the mud like a feather, feeding by filtering water through the branches. When threatened, they pull themselves down into the mud and they may also display startling flashes of brilliant orange bioluminescence.

Deep Sea

57 Sablefish - *Anoplopoma fimbria* - Living in cold North Pacific waters at moderate to great depths near the bottom, sablefish are a valuable commercially-fished species, caught by trawling, trapping, or bottom-fishing with baited longlines. They reach a length of three feet and average 20 pounds in weight.

58 Gulper eel - *Saccopharynx harrisoni* - This truly deep-sea fish has a huge mouth and sharp teeth. It can swallow animals at least as large as itself. Despite its capacity for

food, it is very fragile, with small, weak bones. It reaches a length of at least four feet and has a whip-like tail with a light at the tip. It is collected very rarely.

59 Deep sea squid - *Heteroteuthis dispar* - This three-inch long deep sea squid is one of just a few animals (in addition to some shrimp and fish) that can expel a bioluminescent ink to confuse predators.

60 Vampire squid - *Vampyroteuthis infernalis* - Neither a squid nor an octopus, this deep-water species has ten arms like a squid. Instead of having two long prey-catching arms, two of its arms are sensory filaments that withdraw into pockets. Vampire squid have large globular eyes an inch across and, unlike octopods, many luminescent organs on the body.

61 Oarfish - *Regalecus glesne* - Possibly the world's longest fish, the oarfish has pelvic fins reduced to one ray but extremely long and often expanded to a paddle tip, thus its common name. It is huge, reaching a length of at least 35 feet. The body is silver, with a bright red dorsal fin and very small tail fin.

62 Viperfish - *Chauliodus sloani* - A remarkable fish, *Chauliodus* has teeth so long that it must open its mouth to make the jaws vertical before it can swallow prey; when the mouth is closed, the teeth overlap the

jaws. It can eat large prey by lowering the internal skeleton of the gills, allowing prey to pass into the throat without interference. Apparently it impales prey on the teeth by swimming at them, and the first vertebra (right behind the head) acts as a shock absorber! It has unusual scales that are large, thin, and hexagonal.

63 Deepsea dragonfish - *Grammatostomias flagellibarba* - A ferocious deep-sea predator, this fish is only six inches long; it has a large head and mouth armed with many sharp teeth. Dragonfishes have a long barbel, attached to the chin, with a luminous lure at the end that attracts prey.

64 Rift clam - *Calyptogena magnifica* - This deep-water clam lives around hydrothermal vents, feeding on sulphur bacteria. Its shell is white and the animal inside is a deep red. This fast-growing, large clam measures almost a foot in length. It lives in a methane-rich environment that would be poisonous to most animals.

65 Deep sea tube worms - *Riftia pachyptila* - These four to six foot "worms" have no mouth and no gut, and live around deep-sea hydrothermal vents. Blood-red feathery plumes (tentacle groups), where digestion occurs, emerge from white tubes.

66 Vent crab - *Cyanograea praedator* - Vent crabs are one of the characteristic animals associated with hydrothermal vents. They are completely white, and occur in high abundance in small areas.

67 Tube anemone - Class Anthozoa (Phylum Cnidaria) - Tube anemones are similar in basic features to other anemones but unlike them, each lives in a slime tube. They are widely distributed in tropical and subtropical waters where the ocean bottom is sand, mud, or silt. See 2, 6, 7, 8, 9, and 28.

68 Tube sponges - (Phylum Porifera) Sponges have a porous skeleton of interlocking spicules (bony, needle-like structures), glasslike rods, or horny fibers; they live in colonies or as solitary animals attached to the sea bottom or to other solid objects. Food is obtained by filtering water as it moves through the body of the sponge; organ systems are poorly developed and a nervous system is absent. Sponges can regenerate by restoration of damaged or lost parts or by complete regeneration of an adult from fragments or even single cells. See 3, 26, and 27.

69 Giant deep sea angler - *Ceratias holboelli* - Called an angler because its front dorsal fin ray is modified into a luminescent lure at the tip, this fish reaches about three feet in length. Males attach themselves to a female

fish and grow to be a permanent part of her, losing their mouths, digestive systems, and gills.

70 Giant squid - *Architeuthis princeps* - Cephalopods are the largest invertebrates. One giant squid was reported to have been almost 60 feet long, including the 20-foot tentacles. *Architeuthis* swims in the same way as other squids, whether by jet propulsion or by using the fins. This squid may inhabit depths of 300 to 600 meters, and is a favored prey of sperm whales. See 42.

71 Ratfish - *Chimaera phantasma* - Ratfishes appear to be a link between cartilaginous and bony fishes, but in reality they are not. Most chimaeras have bodies that taper toward the rear to a slender tail. The snout is rounded and conical with big eyes located on the sides of the head, and there is only a single gill opening. Ratfishes have teeth fused into large, sharp incisors at the front, giving them the appearance of rodents.

72 Japanese spider crab - *Macrocheira kaempferi* - Probably the biggest living arthropod; this crab lives in the North Pacific near Japan at depths of 150 to 1,000 feet. Reaching over 12 feet from leg tip to leg tip, and weighing as much as 40 pounds, its body is only about 15 inches in diameter.

73 Deep sea jelly - *Periphylla* sp. - The deep bell-shaped body lined by dark pigment probably masks light from the bioluminescent animals it eats. Jellyfish move by rhythmic muscular contractions of the bell, providing a slow jet propulsion. Hanging downward from the center is a stalk-like structure with the mouth at its tip, opening into the main body cavity. Unlike some other jellyfish, *Periphylla* has very short tentacles.



1998 Year of the Ocean Poster

by Steve Shachter

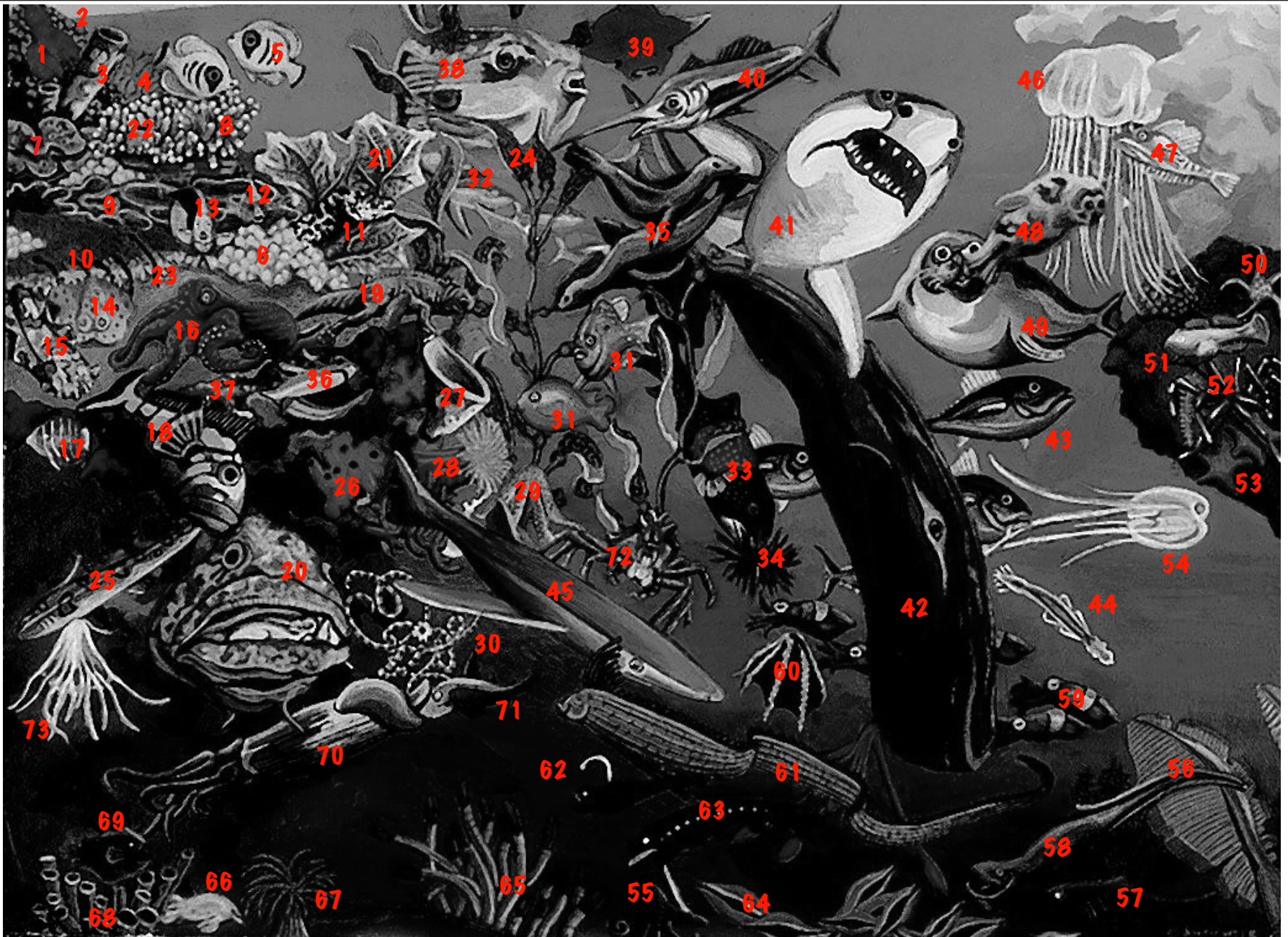

Key to the 1998 Year of the Ocean Poster

Motion from the Ocean

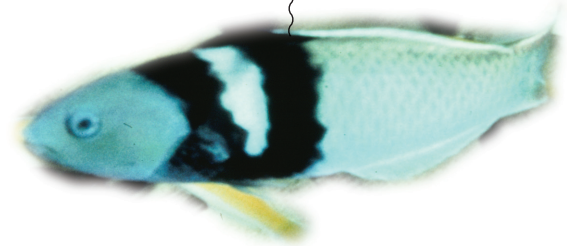
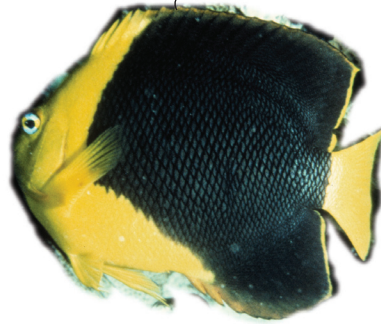
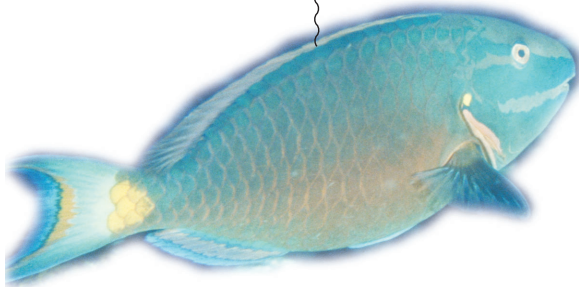

How many different kinds of fish are in the ocean? Scientists estimate that there are about 20,000 fish species. But most of the ocean is unexplored, so there may be many more!

Fish are a major source of food for many people living on Earth. In the U.S. alone, more than 9.6 billion pounds of fish were landed by commercial fishermen in 2004. Fishing is also a hobby for millions of people, and recreational fishing is an important part of coastal tourism. Fish are a major part of complex marine ecosystems, and play an important role in maintaining balance in these systems. For example, excessive fishing around coral reefs often leads to an overgrowth of seaweeds that can damage reef-building corals.

Here's a way to enjoy some of the bright colors and interesting shapes of ocean fishes.

What You Will Do

Make a mobile of ocean animals

What You Will Need

- One or more copies of fish "Patterns for Fish Mobiles"
- Crayons, colored markers, or colored pencils
- Thin cardboard (such as from a cereal box) or poster board
- Plastic lid or round piece of cardboard, at least 4 inches diameter
- Yarn, string, ribbon, or fishing line, at least 10 feet
- Scissors
- A nail, or woodworking awl

Warnings

- Be careful with the nail or awl and scissors; they are sharp!

How to Do It

1. Using page 113 as a reference, color both sides of each fish pattern and cut them out (it's easier to color them before you cut them out).
2. Glue one side of each colored fish to a piece of thin cardboard or posterboard, then cut it out again.
3. Glue the matching side of each fish to the other side of the images mounted on cardboard.
4. Punch a small hole near the top of each fish.
5. Tie different lengths of yarn, string, ribbon, or fishing line to each fish.
6. Punch holes in a plastic lid or round piece of cardboard. Try to space the holes as evenly as possible so the mobile will stay level when it is hung up. Don't worry if there is a slight tilt – it just adds interest! The "Mobile Support Marking Template" can help you punch evenly spaced holes for mobiles with 4, 8, or 12 images.
7. Tie the lines from each fish to the lid or cardboard.
8. Hang your mobile so it is free to rotate, and enjoy!

Mobile Support Marking Template

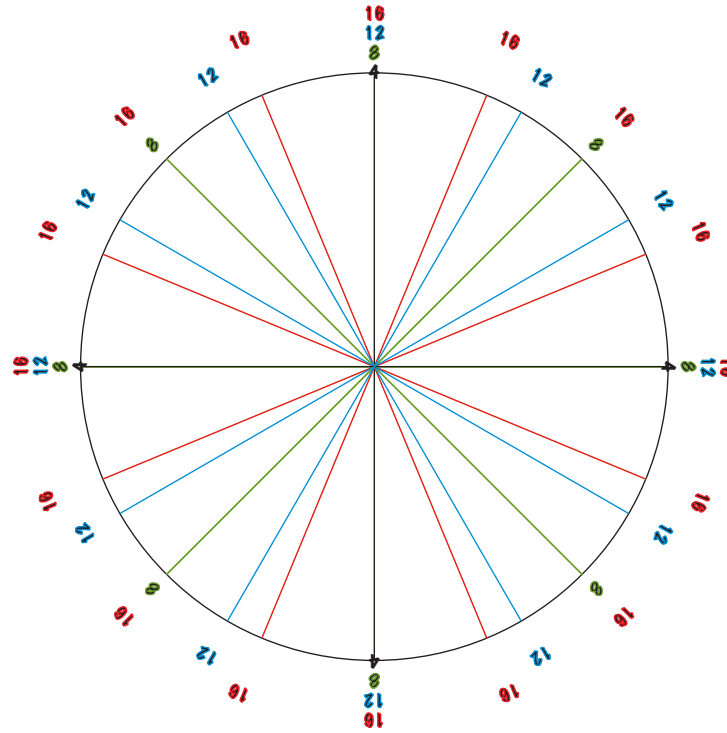

Want to Do More?

- Visit the NOAA's Ark Photo Gallery URL for many more pictures of fishes and other ocean animals.
- See NOAA's New England Fishery Science Center Fish FAQ Web page, <http://www.nefsc.noaa.gov/faq/> to find out more about fish.

- Visit NOAA's "Encyclopedia of the National Marine Sanctuaries" Web page, <http://www8.nos.noaa.gov/onms/park/> for photos, streaming video and biological information about more than 100 marine species found in the National Marine Sanctuaries

Portions of this activity were adapted from "Fish Mobile," http://pbskids.org/readingrainbow/seaya/fish_mobile.html

Patterns for Fish Mobile

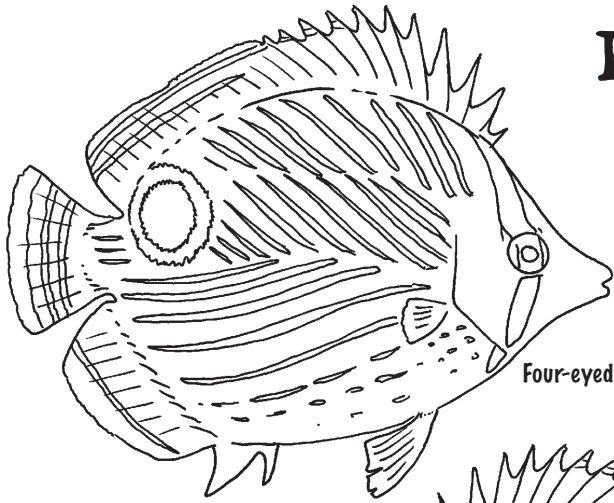

Four-eyed Butterflyfish

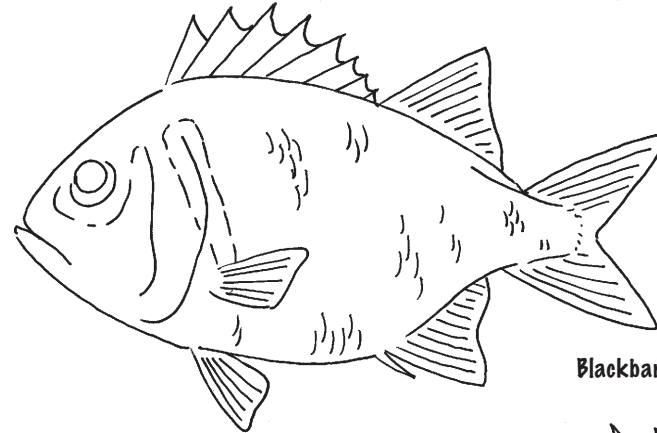

Blackbar Soldierfish

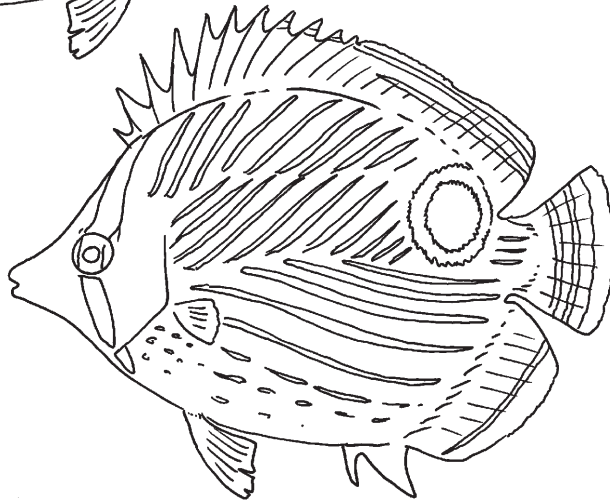

Queen Parrotfish

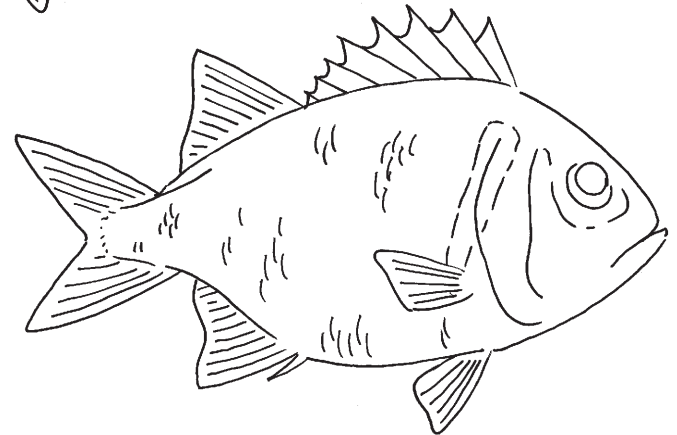

French Angel

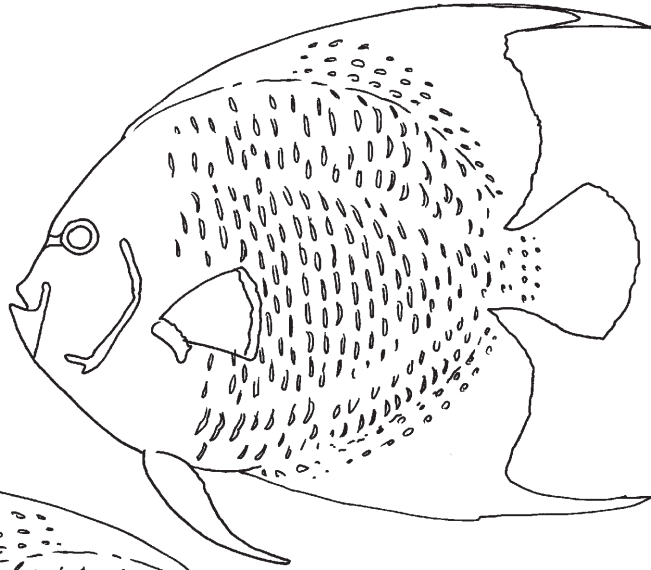

Peacock Flounder

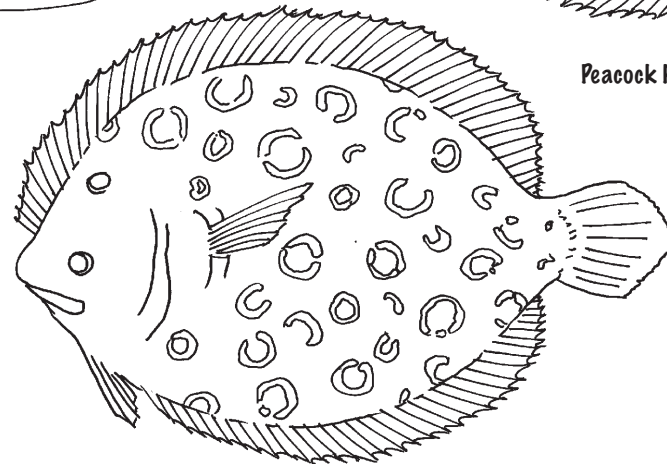
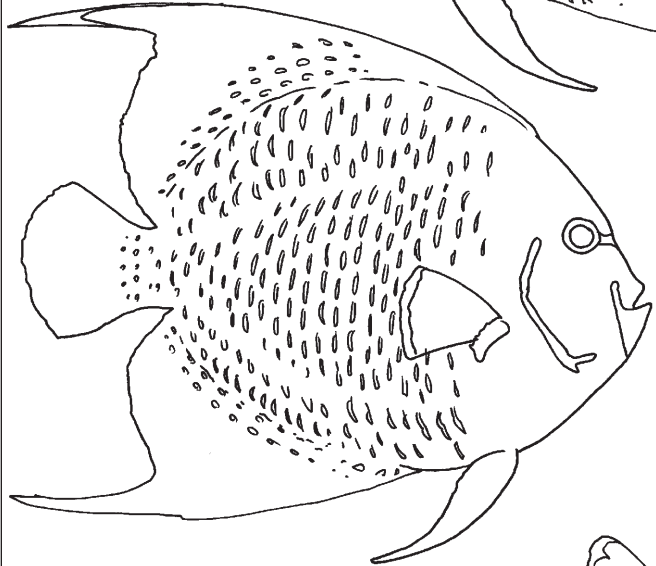
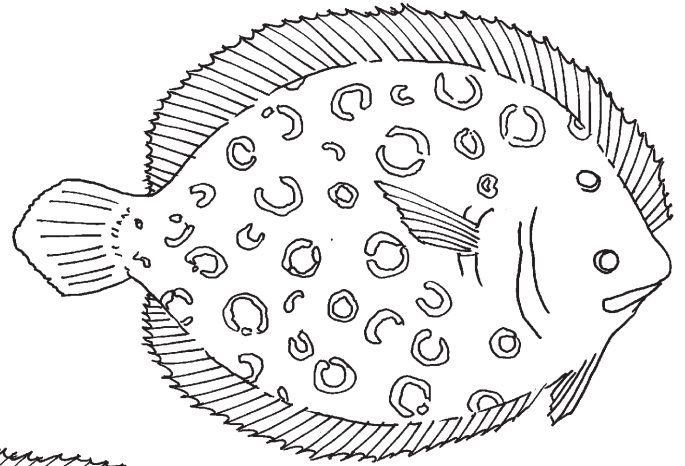

Smooth Trunkfish

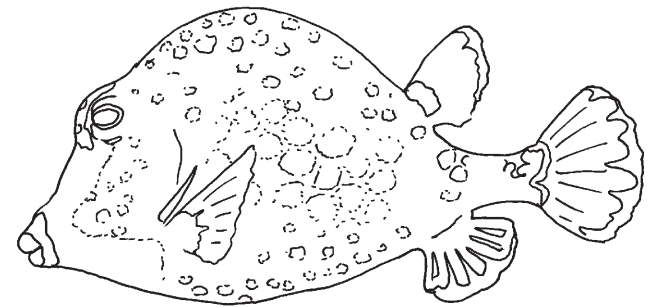
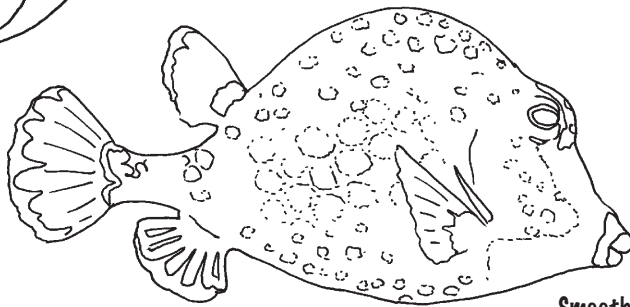

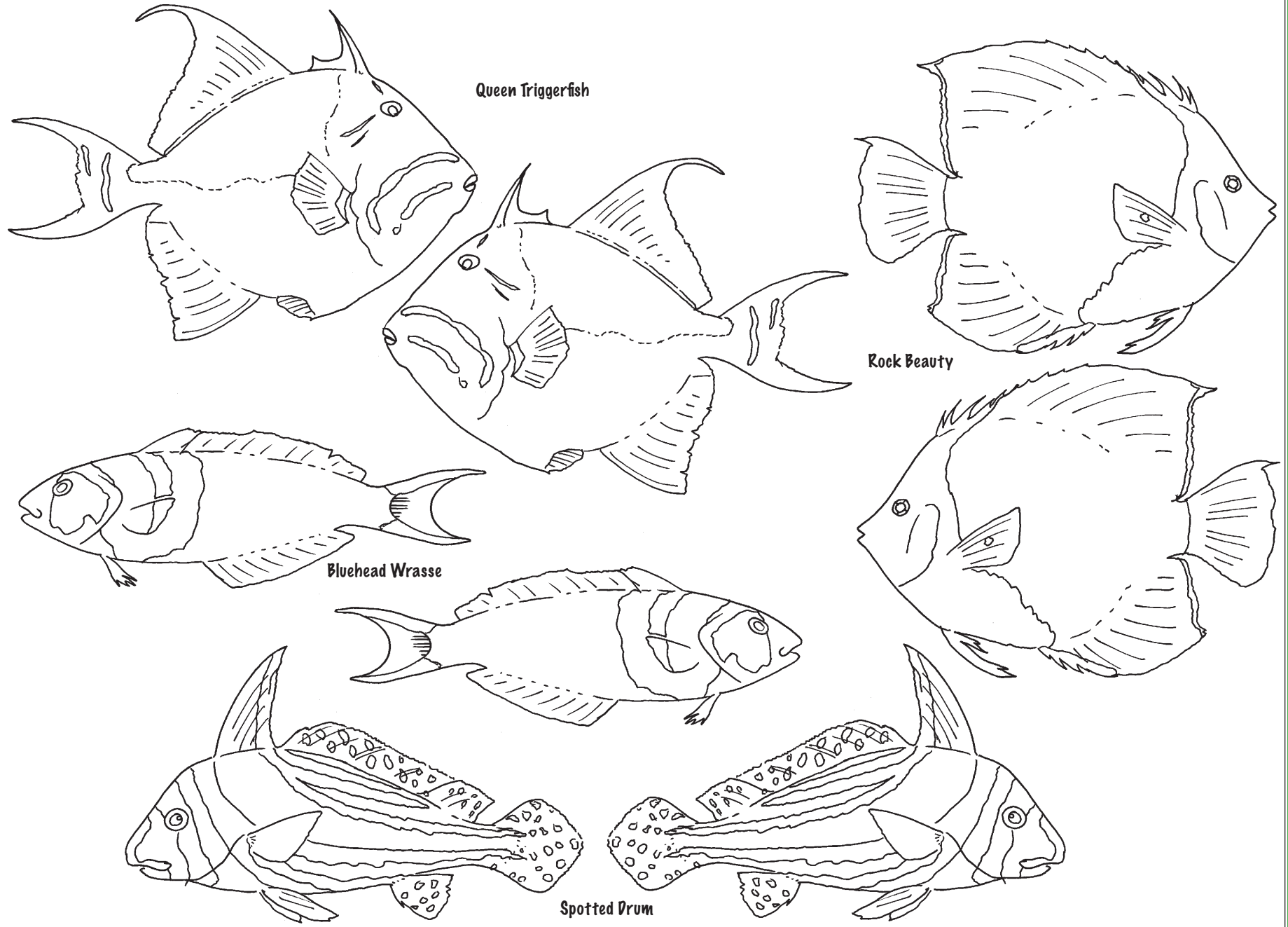

Queen Triggerfish

Rock Beauty

Bluehead Wrasse

Spotted Drum

Images for Fish Mobile



Four-eyed Butterflyfish

Courtesy Mel and Sandy Goodwin

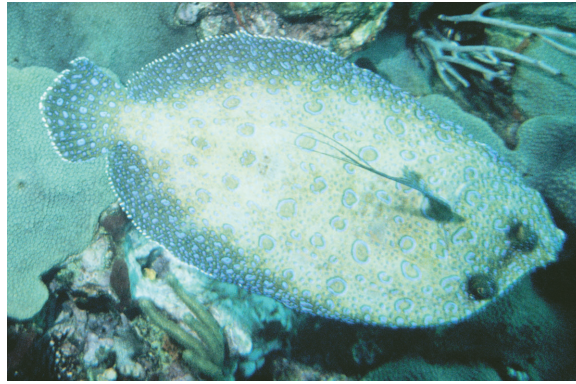

Peacock Flounder

Courtesy Mel and Sandy Goodwin

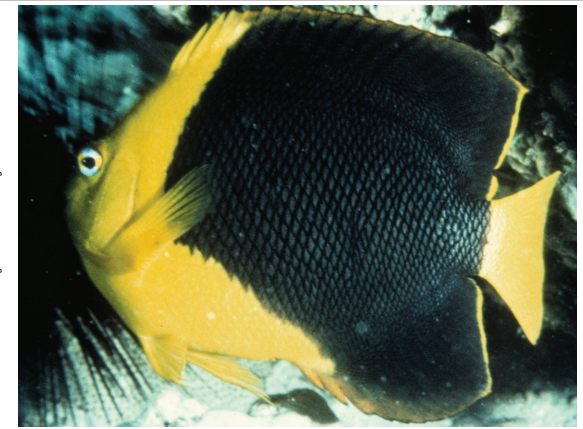

Rock Beauty

Courtesy Mel and Sandy Goodwin



Blackbar Soldierfish

Courtesy Mel and Sandy Goodwin



Queen Triggerfish

Courtesy NOAA CCMA Biogeography Team



Spotted Drum

Courtesy Mel and Sandy Goodwin

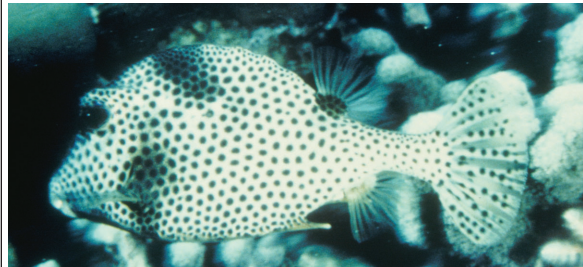

Smooth Trunkfish

Courtesy Mel and Sandy Goodwin

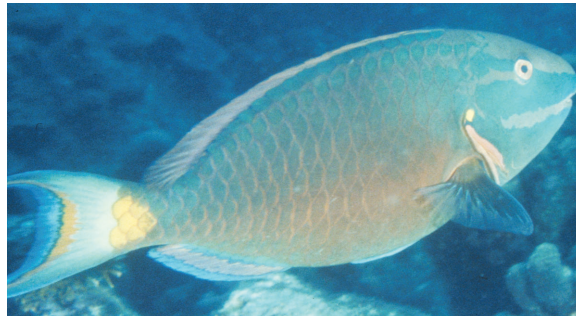

Queen Parrotfish

Courtesy Mel and Sandy Goodwin



French Angelfish

Courtesy Mel and Sandy Goodwin

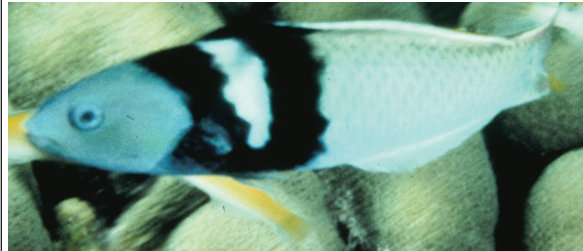

Bluehead Wrasse

Courtesy Mel and Sandy Goodwin

The Ocean Drugstore



Does this look like a drugstore?

Some of our most widely-used drugs come from nature:

- Aspirin was first extracted from the willow tree
- Morphine is extracted from the opium poppy
- Penicillin was discovered in common bread mold

Historically, almost all of our drugs from natural sources came from plants and animals that live on land. But recent searches for new drugs have discovered that marine invertebrates (animals without backbones) produce more antibiotic, anti-cancer, and anti-inflammatory substances than any group of organisms on land. Strangely, many of these substances come from animals that spend most of their lives just sitting around. If you looked at these animals in an aquarium, you would probably get bored pretty quickly because they don't move, and just look like blobs or skinny plants. And because they don't look very interesting, you might assume that they are not important.

But guess again! These unimpressive animals may hold the key to curing some of the most serious diseases that affect humans! Here's a way that you can help teach other people not to jump to conclusions about the importance of ocean animals.

NOAA's Ocean Explorer Program has supported several expeditions to search for new drugs from the sea. The 2003 Medicines from the Deep Sea Expedition was the first scientific exploration of marine organisms from deep-water habitats in the Gulf of Mexico. Samples collected during the Expedition are being studied by scientists at Harbor Branch Oceanographic Institution for chemicals that may lead to new ways to treat cancer, infectious diseases, disorders of the immune and central nervous systems, and cardiovascular disease.

What You Will Do

Make a poster to explain that we should protect animals that seem unimportant because they may provide new drugs for treating diseases such as heart disease, arthritis, and cancer

What You Will Need

- Copies of images from "Some Animals That Produce Raw Materials for New Drugs"
- Crayons, colored markers, or colored pencils
- Poster board
- Scissors (Be careful with sharp scissors!)

How to Do It

1. Use images and information from the worksheet to create a poster that explains why it is important to protect seemingly uninteresting ocean animals using the fact that these animals may be sources of important new drugs for treating human diseases.
2. Show your poster at school, to your parents, and to other groups. The more people know about the importance of ocean life, the more they will support actions to protect ocean resources.

Want to Do More?

Visit <http://oceanexplorer.noaa.gov/explorations/03bio/welcome.html> for more about the Ocean Explorer Medicines from the Deep Sea Expedition.

*This activity was adapted from *Chemists with no Backbones* (4 pages, 356k) by Mel Goodwin, *The Harmony Project*, Charleston, SC; from the *Ocean Explorer 2003 Medicines from the Deep Sea Expedition* [http://oceanexplorer.noaa.gov/explorations/03bio/background/edu/media/Meds_ChemNoBackbones.pdf]*



Competition for resources is intense in habitats such as reefs. Many of the sessile invertebrates produce natural products to help them be more competitive. Photo courtesy John Reed, NOAA.

Why Do Simple Animals Produce Powerful Drugs?

Many of ocean animals that produce powerful substances are sessile, which means that they do not move. This may give a clue about why they produce these substances: Basically, these animals are "sitting ducks," so they may use powerful chemicals to repel predators. Another possibility is that since many of these species are filter feeders, they are exposed to all sorts of parasites and disease-causing bacteria in the water; so the powerful chemicals may be a defense against parasites or antibiotics

against disease-causing organisms. Competition for space may explain why some of these animals produce anti-cancer substances: If two species are competing for the same piece of bottom space, it would be helpful to produce a substance that would attack rapidly dividing cells of the competing organism. Since cancer cells often divide more rapidly than normal cells, the same substance might have anti-cancer properties.

Some Animals That Produce Raw Materials for New Drugs

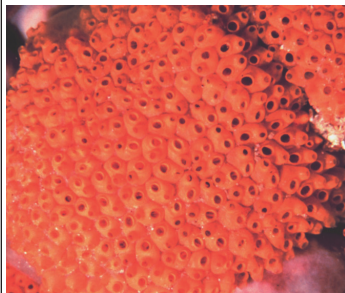

Photo courtesy NOAA.

This is a colony of tunicates. Tunicates are animals whose body is basically a sack with two openings called siphons through which water enters and exits. Small particles filtered out of the water are used for food. They are called tunicates because their body wall resembles a coat or "tunic." Some tunicates produce a chemical called Ecteinascidin, which is being tested in humans for treatment of breast and ovarian cancers and other solid tumors.

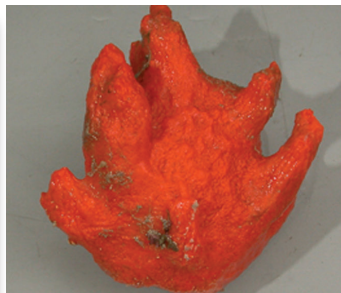

Photo courtesy NOAA.

Sponges are the most primitive invertebrate animals that are composed of more than one cell. They do not have tissues or organs, but some of their cells are specialized to perform specific functions. Sponges of the genus *Forcepia* produce substances called Lasonolides, which may provide new treatments for cancer. Other sponges belonging to the genera *Topsentia*, *Hexadella*, and *Spongisorites* produce a chemical named Topsentin, which is an anti-inflammatory that may be helpful in treating diseases like arthritis. Deep-sea sponges of the genus *Discodermia* produce a tumor-fighting substance called Discodermalide.

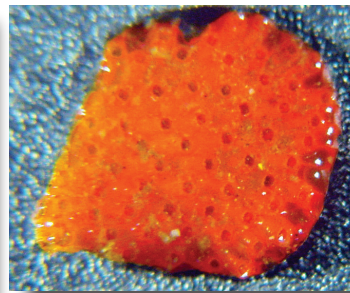

Photo courtesy NOAA.

Bryozoans are small, moss-like animals that do not move. They feed on very small floating animals called zooplankton. Some bryozoans produce a chemical called Bryostatin that may be useful in treating certain types of cancer such as leukemia and melanoma.



Courtesy Photo Collection of Dr. James P. McVey, NOAA Sea Grant Program

Gorgonians are a type of soft coral, also called "sea whips." *Pseudopterogorgia elisabethae* is a sea whip that produces substances called Pseudopterosins (soo-doh-TER-oh-sins) that reduce swelling and skin irritation and accelerate wound healing.



Photo courtesy NOAA.

Cone snails (also called cone shells) are carnivorous marine snails found in coral reefs. In this picture, the cone snail *Conus marmoreus* is eating a cowrie (another kind of snail). Cone snails produce a venom that helps capture food. The venom of some species is powerful enough to kill a human being. The cone snail *Conus magnus* also produces a chemical named ω -conotoxin MVIIA, which is a powerful pain-killer.

Who Trashed the Ocean?



Evidence of human activity extends even hundreds of miles from shore and 7,260 feet below the ocean surface. Image courtesy of Expedition to the Deep Slope.

Hundreds of miles from shore and 2,200 meters below the ocean surface, I pressed my face close to the viewport to catch my last glimpse of the seafloor... As the bottom faded away, I saw beer cans, large loops of wire fishing line, and a bright blue diving bag scattered about the bottom. These incongruous human traces served as a reminder to me of just how far human influence extends...

~ from NOAA Ocean Explorer Expedition to the Deep Slope
Log for May 15, 2006
by Stephanie Lessard-Pilon
Graduate Student, Penn State University

<http://oceanexplorer.noaa.gov/explorations/06mexico/logs/may15/may15.html>

- Marine debris is man-made trash that enters the coastal or marine environment.
- Earth's oceans are constantly polluted with a wide variety of trash ranging from soda cans and plastic bags to derelict fishing gear and abandoned vessels. Every year, marine debris injures and kills marine animals that become tangled in plastic debris or eat pieces of plastic trash. Humans are threatened too, because divers, ships, and boats can also become tangled in debris. Garbage that litters beaches and waterfronts not only looks awful; it also costs thousands of dollars to clean up.
- The NOAA Marine Debris Program is part of a national effort to protect our coastal resources from damage caused by marine debris. One of the main goals of the Program is to reduce the amount of marine debris in the environment. Another goal is to find out where marine debris comes from. One of the most important goals of the Program is to educate people about the consequences of marine debris and why we need to stop trashing the ocean.

And this is where you come in!

What You Will Do

Make a poster to inform people about why marine debris is bad and why we need to stop it.

What You Will Need

- Crayons, colored markers, or colored pencils
- Poster board
- Scissors (Be careful with sharp scissors!)
- (Optional) Copies of images from "Some Examples of Marine Debris Posters"

How to Do It

1. Use the examples and your own ideas to create a poster that explains the consequences of marine debris, and what we can do to eliminate it.
2. Show your poster at school, to your parents, and to other groups. The more people know about marine debris and what it does, the more they will take personal action to prevent it.

Want to Do More?

1. Visit the NOAA Marine Debris Program Web site at <http://marinedebris.noaa.gov/> for more about marine debris, as well as information and photographs of clean-up and prevention projects.
2. See <http://www.yoto98.noaa.gov/books/debris/debris1.htm> for more marine debris poster ideas.



Marine Refuse Disposal Project
logo © Herb Goblirsch; caption: Bill Murray

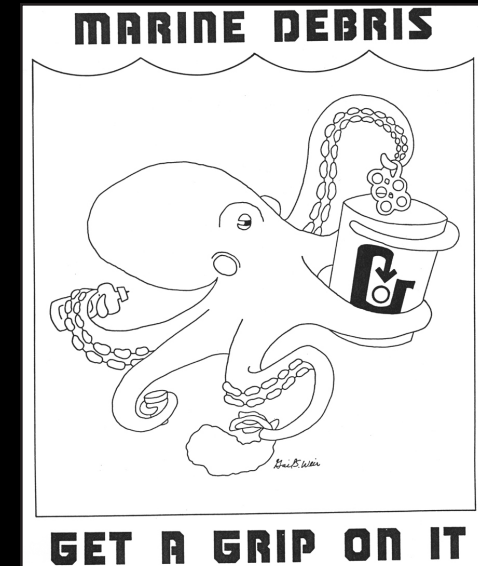
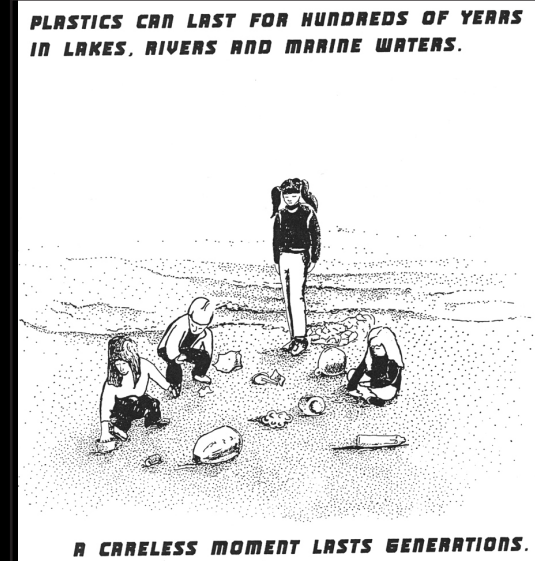

Public Involvement and Education Project, financed by proceeds from the Washington State Centennial Clean Water Fund and administered by the Puget Sound Water Quality Authority; and Washington Sea Grant, Marine Advisory Services

**DON'T SPLASH
YOUR TRASH!**

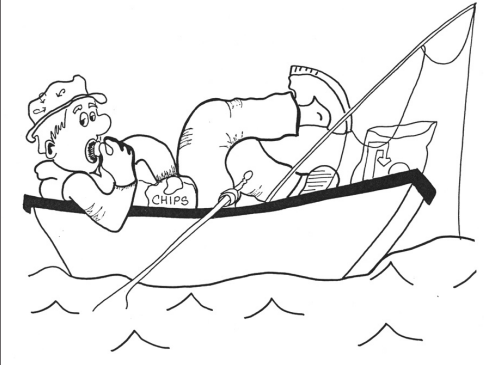

Washington State Department of Ecology

**LITTER IN THE OCEAN CAUSES
POLLUTION WHICH HURTS
THE SEALIFE**

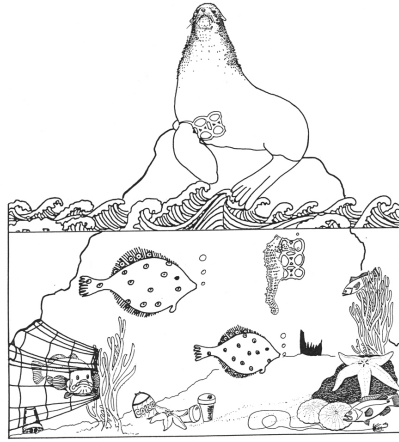

**RHOY THERE MATEY!
HAND
OVER
YOUR
TRASH!**

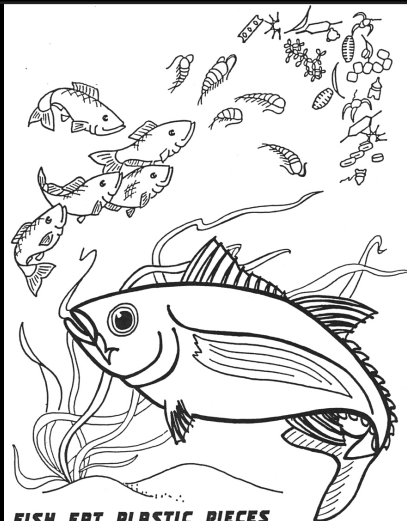

**FISH EAT PLASTIC PIECES
WITH THEIR NATURAL FOOD.**

**OSCAR THE OCTOPUS
& HIS FRIENDS
DON'T
WANT YOUR TRASH!**

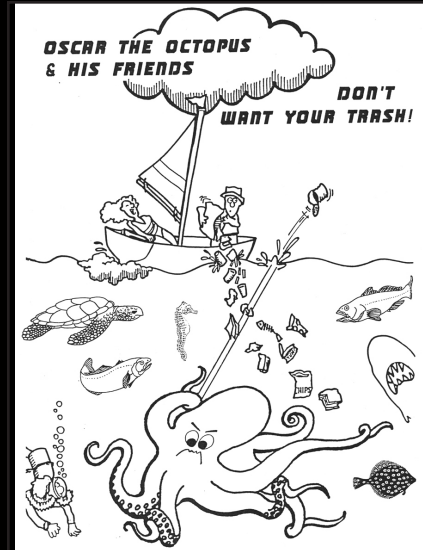

It All Runs Downhill



Iron contamination in the Idaho Blackbird Creek, Lemhi County, Idaho. Courtesy NOAA

What You Will Do

Make a model of a watershed, and show how rainfall carries pollution into the ocean and other water bodies.

What do you think of when you hear the word “pollution?” Black smoke belching out of factories? Horrible fluids pouring out of huge pipes?

Thirty years ago, these were classic symbols of pollution. But a lot of progress has been made in reducing pollution from sources such as industrial facilities and sewage treatment plants. Today, the big water pollution problem comes from rainwater and melting snow. Rain and snow are usually pretty clean when they fall from the sky. But as water flows over and through the ground it picks up chemicals, oil, animal wastes, and many other contaminants that change clean water into polluted runoff.

This kind of contamination comes from many sources, such as

- fertilizers and pest control chemicals from farms and home landscapes;
- oil, grease, and toxic fluids from roads, parking areas, and motor vehicles;
- acid drainage from abandoned mines; and
- wastes from livestock, pets, and leaking septic tanks.

Because the contaminants cannot be traced to a single source, this kind of pollution is called “nonpoint source pollution” or polluted runoff. More than half of the watersheds in the U.S. are affected by nonpoint source pollution. A “watershed” is an area of land that catches precipitation and channels this water into a marsh, stream, river, lake, or underground reservoir (groundwater). You can think of a watershed as a giant funnel. Water that falls on any land within the watershed will all be funneled to the same water body. Watersheds can be small, feeding to a single stream or pond. Several small watersheds may be part of a larger watershed that funnels into a larger stream or river, and eventually into the ocean.

The only way to stop nonpoint source pollution is through education about the problem and what people can do to prevent watershed contamination. Here’s a way that you can help!

What You Will Need

- Rectangular container, about ten inches x twelve inches x two inches; a metal baking pan or plastic storage container is perfect
- Two sheets newspaper
- Plastic wrap or a white garbage bag
- Spray bottle
- Water
- Blue food coloring, about four drops
- Baby powder, cocoa powder, colored drink powder, and/or cake sprinkles; about two tablespoons

How to Do It

1. Crumple two sheets of newspaper, and place them side by side in one end of the container, like this:

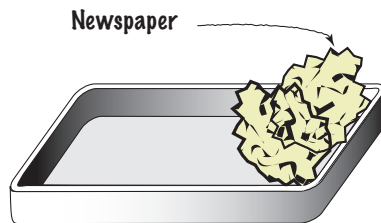

2. Stretch the plastic wrap or garbage bag over the wads of newspaper and down over the sides of the container. Press the plastic down into the container in the end without the newspaper so that it forms a shallow depression. Be sure the plastic extends all the way over both sides of the container. The wads of newspaper represent hills or high places in your model watershed, and

the shallow depression represents lakes, rivers, or the ocean.

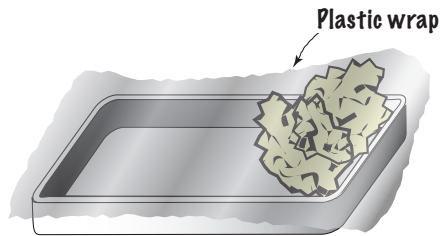

3. Sprinkle a little baby powder, drink powder, cocoa, or cake sprinkles on the hills of your model to represent pollution. You can use different materials to represent different types of pollution. For example, baby powder could represent fertilizer; cocoa powder might represent motor oil or vehicle exhaust; colored drink powder could represent chemical runoff; and chocolate cake sprinkles could represent animal waste.
4. Predict where the pollution will flow and how many watersheds you think you have. Now, rapidly spray water onto the hills to show how rainfall carries pollution into the ocean and other water bodies. Were your predictions accurate?
5. You can use your model to teach other people about nonpoint source pollution. Be sure to talk about things that everyone can do to help solve this problem! Here are some ideas:
 - Keep trash, pet waste, chemicals, etc. out of storm drains, since these often drain

directly to lakes, streams, rivers, or wetlands

- Find out about alternatives to lawn and garden chemicals such as mild detergents, planting native species, and alternating rows of herbs with rows of vegetables to attract pest predators such as damsel bugs, ladybugs, and stingless wasps
- Learn how to properly dispose of used oil and hazardous household chemicals
- Dispose of pet wastes in the garbage or toilet

You can find more ideas at <http://www.epa.gov/owow/nps/whatis.html> and <http://www.epa.gov/owow/nps/dosdont.html>

Want to Do More?

1. See NOAA's National Ocean Service Nonpoint Source Pollution Discovery Kit: <http://oceanservice.noaa.gov/education/kits/pollution/> to find out more about nonpoint source pollution with
2. See NOAA's National Ocean Service Discovery Classroom at http://oceanservice.noaa.gov/education/classroom/lessons/09_coast-manag_point.pdf for instructions on how to make a realistic model of a watershed.
3. Visit <http://www.epa.gov/win/address.html> for information on your own watershed (or any watershed in the U.S.).

Toxic! Or Is It?

One of the big questions about any type of pollution is, "Will it hurt plants, animals, or humans?"

How can we find out? We don't want to risk harming lots of living organisms to see whether a substance is toxic, especially if the organisms are humans!

Scientists investigating pollution often use a technique called "bioassay" to test for toxicity. A bioassay is a measurement of the effects of a substance on living organisms. Tests for toxic substances use certain species called "indicator species," which may be juvenile fishes, plant seeds, microscopic animals, or even bacteria! Several individuals of an indicator species are exposed to the substance being tested for a certain period of time, and then compared to another group of the same species that was not exposed to the substance (the second group is called the "control group"). If the organisms in the test group show effects such as slow growth, reduced movement, or death and these effects are not seen in the control group, this is considered to be an indication that the substance being tested is toxic.

Bioassays usually do not indicate which specific substances cause toxicity, or the amounts of toxic substances present. But they do provide a good indication of the total toxicity of samples that may contain more than one toxic substance, and they are a quick and inexpensive way to test for toxicity in many samples.

Here is a simple bioassay that you can use to test for toxicity in runoff water that you suspect may be contaminated.



Beach pollution at Bay St. Louis, MS after Hurricane Katrina. Courtesy NOAA.

What You Will Need

- 12 or more ziplock plastic bags
- One paper towel for each plastic bag
- Ten radish seeds for each plastic bag
- Permanent marker for labeling sample jars and plastic bags
- Household bleach, about 1/4-cup
- Distilled water, about one quart
- Ruler graduated in millimeters (mm)
- Tweezers or forceps
- Glass containers for collecting samples; baby food jars or similar size are perfect
- Clean glass jar for mixing bleach solution, about one pint
- Measuring cup that is not used for food
- Protective gloves and safety glasses, one set for each person participating in this activity

What You Will Do

Use a radish seed bioassay to test for toxicity

Warnings

- Do this activity with an adult partner!
- Always check with an adult before collecting samples that may be contaminated with harmful substances.
- Wear protective gloves and safety glasses when handling sample solutions!
- Do not use glasses, dishes, or any container that is used for food!
- Wash your hands after handling sample solutions, paper towels, and seeds!

How to Do It

1. Collect water samples to be tested. You may want to test water from puddles, streams, or ponds. Do this **ONLY** with an adult partner! Wear protective gloves and safety glasses! Collect each sample in a clean glass jar, and label the jar with a number.
2. Put on protective gloves and safety glasses, then mix one ounce of household bleach with nine ounces of distilled water in a clean glass jar.
3. Put the radish seeds in a clean glass container, and add about two ounces of the bleach solution from Step 2. The bleach solution kills fungi, which could interfere with seed germination.
4. Bioassays are carried out in zip-lock plastic bags containing a paper towel saturated with the test solution. Saturated means

that the towel is damp all over, but isn't dripping. Three separate tests (called "replicates") will be done for each solution. Prepare three plastic bags for each sample to be tested, plus three more bags for the control solution (distilled water). Label each bag with the sample number, plus a letter to identify the three replicates (so for sample number 1, there would be three bags labeled "1-A," "1-B," and "1-C"). Put a folded paper towel in each bag.

5. Pour enough sample solution into each bag to saturate the filter paper. Use the same amount of sample in all tests. Saturate the paper towels in the control bags with the same amount of distilled water.
6. Using tweezers or forceps, place ten seeds on the paper, evenly spaced, in each bag. Seal the top of the bag.
7. Put the bags on a tray or shallow box where they can remain for five days. The bags should be at room temperature, but do not place them in direct sunlight! Each day, record the number of seeds that germinated (split open) in each bag, and measure (to the nearest mm) the length of the root that has emerged from each germinated seed.
8. At the end of five days, calculate the average number of seeds that germinated in the three bags for each sample and for the

controls. Also, calculate the average length of the roots among the germinated seeds in the three bags. If fewer seeds germinated in bags containing test samples, or if the roots grew more slowly than in the control bags, this is an indication that the samples may contain toxic substances.

Want to Do More?

1. For more information about simple bioassays, see "A Simple Bioassay Using Lettuce Seeds," by Joe Rathbun, in *The Volunteer Monitor* volume 8, number 1 (available online at <http://www.epa.gov/owow/monitoring/volunteer/newsletter/volmon08no1.pdf>); and "Students Test for Toxics," by Mark Mitchell, in *The Volunteer Monitor* volume 5, number 1 (available online at <http://www.epa.gov/owow/monitoring/volunteer/newsletter/volmon05no1.pdf>).
2. Visit <http://www.epa.gov/owow/nps/eduinfo.html> for more information about polluted runoff.

*This activity was adapted from *The Seeds Tell the Story* (21 pages, pdf, 660 Kb) by Mel Goodwin, The Harmony Project, Charleston, SC; part of NOAA's National Ocean Service Nonpoint Source Pollution Discovery Kit [http://oceanservice.noaa.gov/education/kits/pollution/lessons/pollution_seeds.pdf].*

Invasive Species Super Sleuth

In the late 1860's, it seemed like a good idea: Let's start a silk industry in the United States! Silk is a valuable cloth, in demand all over the world. And insects do most of the work! All we need to do is import some Gypsy moths from France, then sit back and wait for the money to start rolling in!

So, the moths were imported. Unfortunately, they escaped. Today, Gypsy moths are a major threat to U.S. forests.

Gypsy moths are one example of invasive species, and there are many more. About 50,000 alien species are already in the U.S. What's the difference between "alien" and "invasive?" An alien species is not native to a particular ecosystem. If an alien species causes economic and/or environmental harm or threatens human health, then it is called invasive.

What's the big deal? Invasive species can seriously threaten native species and entire ecosystems. Plus, the costs of environmental damage, economic losses, and efforts to control invasive species average \$138 billion per year—more than the cost of all other natural disasters combined.

What can be done? NOAA's National Centers for Coastal Ocean Science are developing a group of experts that can help recognize alien species, hopefully before they become invasive. NOAA's National Sea Grant Office and state fish and wildlife agencies are partnering with the pet industry in the Habitattitude™ Campaign, which is about educating consumers about possible environmental consequences of aquarium and water garden hobbies, and how to be a responsible hobbyist. In addition, NOAA's Community-Based Restoration Program works with community groups to remove invasive plants as part of projects to repair damaged coastal habitats.

Here's how to learn a lot about aquatic invaders and have fun at the same time!

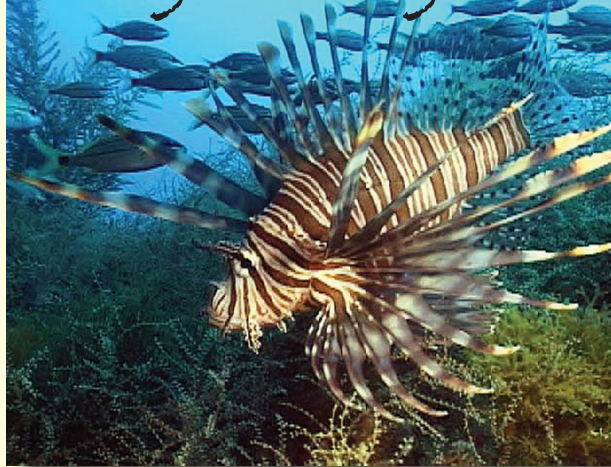

Lionfish are venomous fish from Indian and western Pacific oceans that have invaded East Coast waters Courtesy NOAA.

What You Will Need

Computer with CD-ROM drive or internet access

How to Do It

There are two ways to play Nab the Aquatic Invader! You may have received the game on a CD that came with this book. If you have the CD, load it into your computer and follow the directions. The other way to play is to use the online version of the game on the Sea Grant Nonindigenous Species Site (SGNIS) at <http://sgnis.org/kids/>.

Want to Do More?

1. Tell your teacher about the CD or the Sea Grant Nonindigenous Species Site. Maybe your whole class will get to play the game!
2. Check out the "Kids' Secret Headquarters" page (<http://www.sgnis.org/kids/kidsheadquarters.html>) for more aquatic invader activities.
3. You can find a LOT more information about invasive species on the Sea Grant Nonindigenous Species Site main page, <http://www.sgnis.org/>.

What You Will Do

Play a game called "Nab the Aquatic Invader!"

You will be a private investigator working with other detectives to catch suspected invaders including Louie "Sucker Mouth" Sea Lamprey, Zeke "The Prowler" Zebra Mussel, Purple "Lucky" Loosestrife, and Rocco "Ravenous" Ruffe.

Courtesy USGS

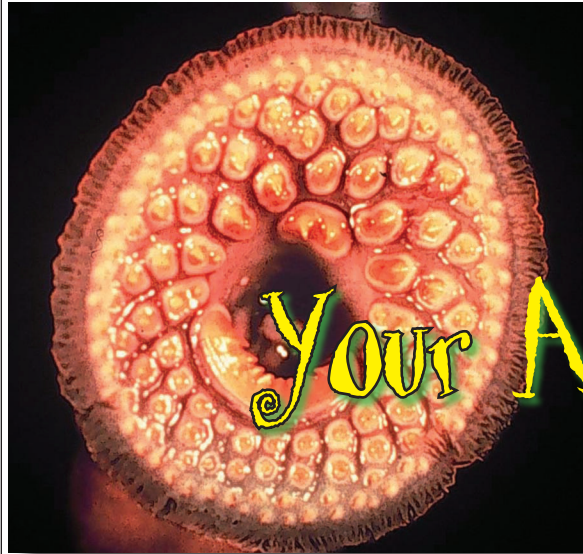

Courtesy Leo G. Nico, USGS



Courtesy Justin Secrist, Washington DFW



Your Alien Dodecahedron



Courtesy California Interagency Ecological Program

If you have played the “Invasive Species Super Sleuth” game, you already know what invasive species are and why they are a big problem (so you can skip the rest of this paragraph!). Just in case you haven’t played the game yet, invasive species are plants, animals, or other living organisms that are not native to a particular ecosystem and cause economic harm, environmental damage, or pose a threat to human health. Invasive species can seriously damage native species and entire ecosystems, and cost an about \$138 billion per year (which is more than the cost of all other natural disasters combined). NOAA’s National Centers for Coastal Ocean Science are developing a group of experts that can help recognize alien species, hopefully before they become invasive. NOAA’s National Sea Grant Office and state fish and wildlife agencies are partnering with the pet industry in the Habitattitude™ Campaign, which is about educating consumers about possible environmental consequences of aquarium and water garden hobbies, and how to be a responsible hobbyist. In addition, NOAA’s Community-Based Restoration Program works with community groups to remove invasive plants as part of projects to repair damaged coastal habitats.

You can help! Here are some pictures and more information about twelve invasive alien animals. You can use these images to make a twelve-sided object that will show these examples of invasive species. This twelve-sided object is called a dodecahedron (pronounced “doe - dek - ah - HEE - dron”). You can use your “Alien Dodecahedron” to help other people understand more about the invasive species problem. Once they start looking at the dodecahedron and the images on its twelve sides, you can tell them some of the facts about invasive species. Remember: Education and understanding are key to solving most environmental problems—including invasive species!

What You Will Do

Make a dodecahedron that shows pictures of twelve invasive animals

What You Will Need

- Color copy of images on the “Alien Dodecahedron Worksheet”
- Copy of “How to Fold a Dodecahedron” worksheet
- Scissors
- Glue for paper

Warning

Be careful with scissors; they are sharp!

How to Do It

1. Carefully cut out the pattern on the “How to Fold a Dodecahedron” worksheet. Be sure NOT to cut the dashed lines!
2. Fold all of the dashed lines away from you (backward), then unfold and flatten the pattern.
3. Cut out the twelve images on the color copy of the “Alien Dodecahedron Worksheet.”
4. Glue the images onto the dodecahedron pattern.
5. Fold the dodecahedron pattern along the dashed lines so that it makes a twelve-sided shape. Glue the tabs to keep the shape from unfolding.
6. Now you have an Alien Dodecahedron!

Look over the facts about each species on the worksheet. You will see that some alien invaders were deliberately brought to the United States for various reasons. Others arrived by accident, sometimes as part of “ballast water.” Ballast water is water that is pumped into large ships when they are not carrying cargo, so that they are more stable when sailing on the ocean. This means that water from one part of the Earth can be carried thousands of miles away before it is pumped out again. If small animals or larvae happen to be in the water when it is pumped into a ship, they get a free ride to another part of the world!

You will also see that one of the biggest problems with invasive species is that they compete with native species. Native species are the organisms that are normally found in a certain ecosystem. Often, native species do not have good defenses against invaders. Species like the

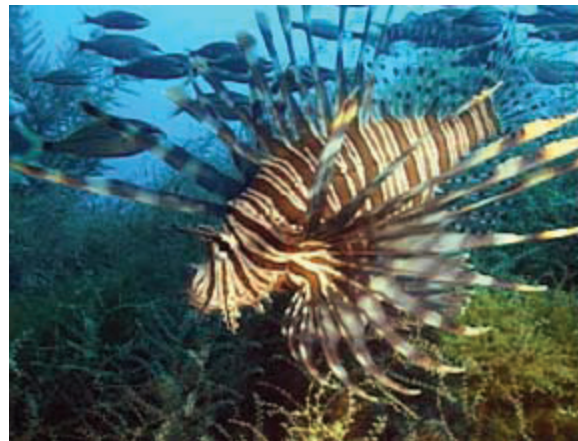

Lionfish, Courtesy Paula Whitfield, NOAA

zebra mussel cause other problems when they attach themselves inside pipes that carry water in and out of factories or power plants. Some invaders are dangerous to humans, such as the lionfish that has spines that contain a powerful venom.

Show your Dodecahedron to other people and tell them about the invasive species problem. You can also play a game with your Dodecahedron: Players take turns, and the player who is “It” gently tosses the Dodecahedron onto a flat surface, then looks at the picture that is face down. Time the player to see how long it takes to correctly name the species and what damage it causes (or whatever other facts you want to include in the game). If the face-down image has already been named by another player, the player who is “It” tosses the Dodecahedron again until a new image is face-down.

Want to Do More?

See http://www.research.noaa.gov/oceans/t_invasivespecies.html to find out more about invasive species and what is being done about them.

The National Invasive Species Information Center Web site, <http://www.invasivespeciesinfo.gov/index.shtml> has a lot of information about invasive species, including links to images.

How to Fold a Dodecahedron Worksheet

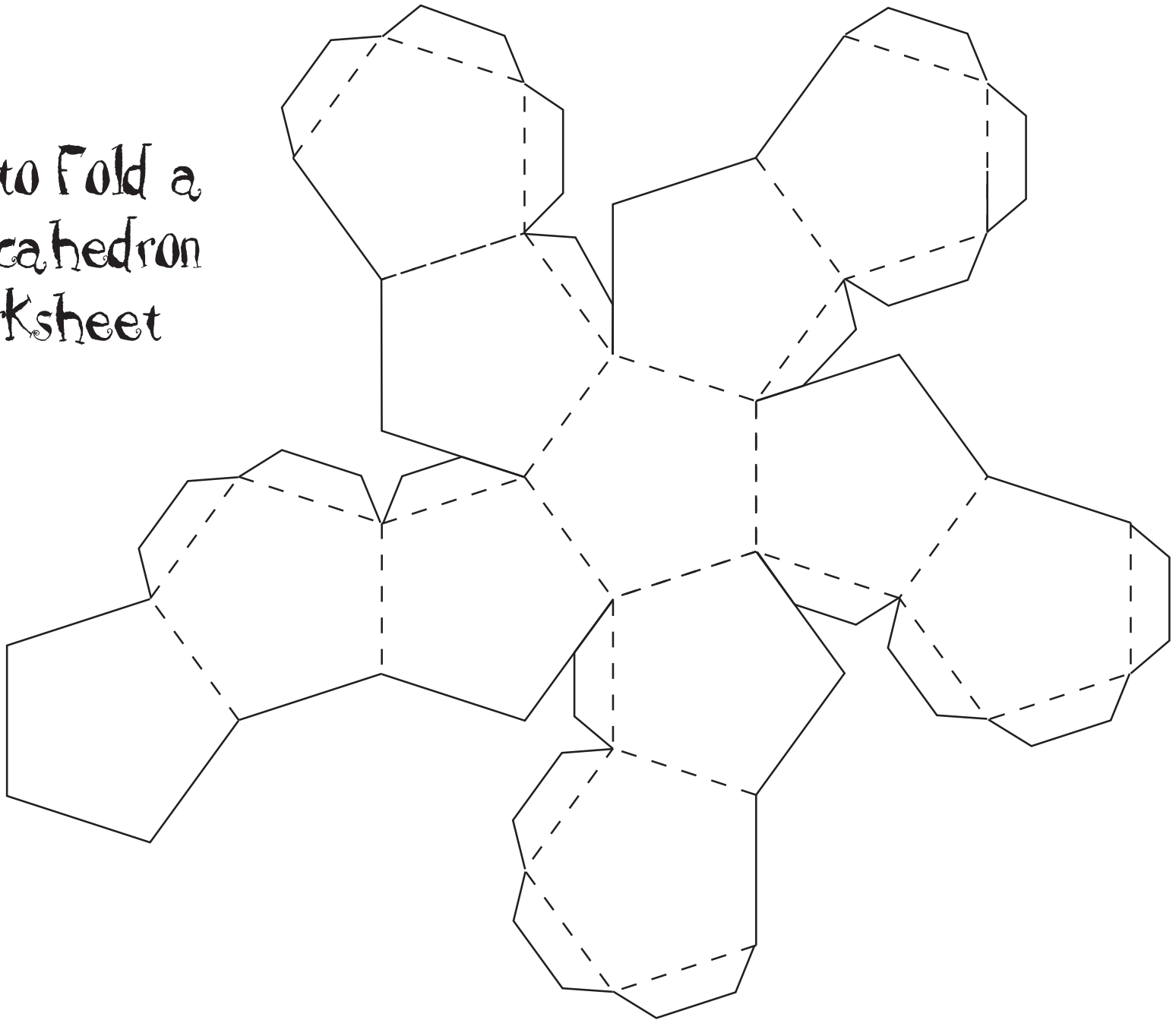

Alien Dodecahedron Worksheet

Alewife



Courtesy NOAA Restoration Center, Jim Turek

What Is It?

A fish called an Alewife (also called mulhaden, grey herring, golden shad); its scientific name is *Alosa pseudoharengus*

Where Did It Come From?

Atlantic Ocean

How Did It Get Here?

Deliberately introduced to Lake Erie

What Does It Do?

Competes with native species

Asian Swamp Eel

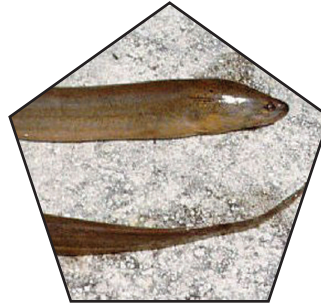

Courtesy Leo G. Nico, USGS, Gainesville, FL

What Is It?

A fish called an Asian swamp eel or rice eel; its scientific name is *Monopterus albus*

Where Did It Come From?

Asia

How Did It Get Here?

Brought to the U.S. for aquariums and fish markets, accidentally released

What Does It Do?

Competes with native species

Chinese Mitten Crab

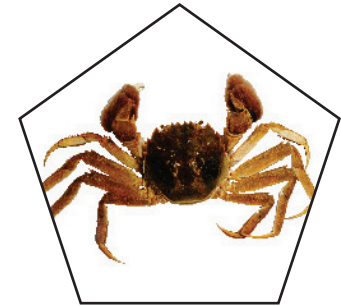

Courtesy of California Interagency Ecological Program

What Is It?

A crab called the Chinese mitten crab; its scientific name is *Eriocheir sinensis*

Where Did It Come From?

China

How Did It Get Here?

In ballast water of ships; possibly deliberately released

What Does It Do?

Competes with native species

Lionfish

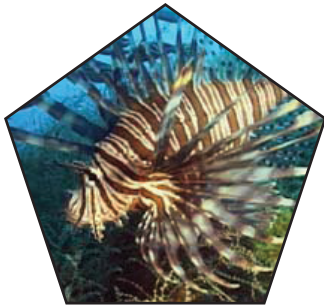

Courtesy Paula Whitfield, NOAA Center for Coastal Fisheries and Habitat Research, Beaufort, NC

What Is It?

A fish called the lionfish; its scientific name is *Pterois volitans*

Where Did It Come From?

Pacific Ocean

How Did It Get Here?

Brought to the U.S. for aquariums; accidentally or deliberately released

What Does It Do?

Eats native species and has venomous spines that are poisonous to humans

Northern Snakehead



Courtesy U.S. Geological Survey, Florida Integrated Science Center]

What Is It?

A fish called the Northern snakehead; its scientific name is *Channa argus*

Where Did It Come From?

Asia

How Did It Get Here?

Brought to the U.S. for fish markets; accidentally or deliberately released

What Does It Do?

Feeds aggressively on amphibians, fish, birds, and small mammals; can survive in waters that contain very little oxygen and can travel across land

Nutria

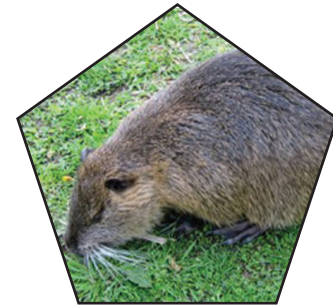

Courtesy Justin Secrist, Washington Department of Fish and Wildlife

What Is It?

A mammal called a Nutria (also called a coypu, coypu rat, nutria rat, or swamp beaver); its scientific name is *Myocastor coypus*

Where Did It Come From?

South America

How Did It Get Here?

Brought to the U.S. for fur production

What Does It Do?

Damages vegetation and destroys wetland habitats

Round Goby

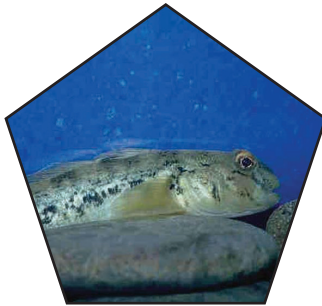

Courtesy D. Jude, University of Michigan

What Is It?

A fish called the Round Goby; its scientific name is *Neogobius melanostomus*

Where Did It Come From?

Eurasia

How Did It Get Here?

In ballast water of ships

What Does It Do?

Feeds on native species

Sea Lamprey

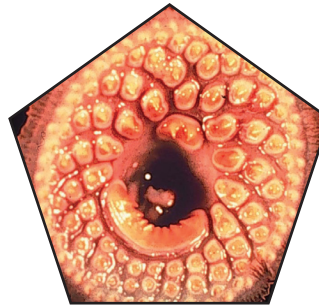

Mouth of a sea lamprey
Courtesy USGS, Great Lakes Science Center

What Is It?

A fish called a Sea Lamprey; its scientific name is *Petromyzon marinus*

Where Did It Come From?

Atlantic Ocean

How Did It Get Here?

Entered the Great Lakes through man-made canals

What Does It Do?

Feeds on native species

Sea Squirt



Courtesy Dann Blackwood, U.S. Geological Survey

What Is It?

An invertebrate called a Sea Squirt (also called an ascidian, colonial tunicate, or compound sea squirt]; its scientific name is *Didemnum lahillei*

Where Did It Come From?

Europe

How Did It Get Here?

In ballast water and attached to the hulls of ships

What Does It Do?

Forms dense mats that smother native species

Zebra Mussel



Courtesy of Ohio Sea Grant College Program

What Is It?

A mussel called the Zebra Mussel; its scientific name is *Dreissena polymorpha*

Where Did It Come From?

Eurasia

How Did It Get Here?

In ballast water of ships

What Does It Do?

Competes with native species, and clogs pipes of factories located on rivers and lakes

Veined Rapa Whelk

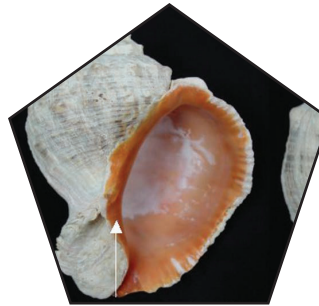

Courtesy of Julia Harding, Virginia Institute of Marine Science

What Is It?

A snail called the Veined Rapa Whelk; its scientific name is *Rapana venosa*

Where Did It Come From?

Pacific Ocean

How Did It Get Here?

In ballast water of ships

What Does It Do?

Eats commercially important bivalves, such as clams and oysters

European Green Crab



Courtesy of California Interagency Ecological Program

What Is It?

A crab named the European Green Crab; its scientific name is *Carcinus maenas*

Where Did It Come From?

Europe

How Did It Get Here?

In ballast water of ships

What Does It Do?

Eats commercially important bivalves, such as soft shell clams and scallops

Endangered Species

“When the last individual of a race of living things breathes no more, another heaven and another earth must pass before such a one can be again.”

~ William Beebe

Earth loses hundreds of species every year, and many of these losses are the result of human activity. Some of these species may have held the key to curing cancer, or feeding everyone on the planet, or improving our lives in ways we can't even imagine. But we'll never know, because they are gone.

In 1973, the U.S. Congress passed the Endangered Species Act to protect species that are in danger of extinction, as well as the ecosystems that supports these species. NOAA and the U.S. Fish and Wildlife Service are responsible for making the Endangered Species Act work. But they can't do this job alone. Protecting endangered species needs everyone's help, and the first step is getting people to think about the problem.



Humpback whales in the singing position. Courtesy Dr. Louis M. Herman, NOAA

Here's an activity that can help introduce the topic of endangered species, particularly whales and sea turtles.

What You Will Need

- 8 1/2 x 11 inches sheets of colored paper (one for each animal)
- Scissors

Warning

Be careful with sharp scissors.

What You Will Do

Make origami models of whales and turtles

How to Make an Origami Sea Turtle

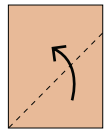
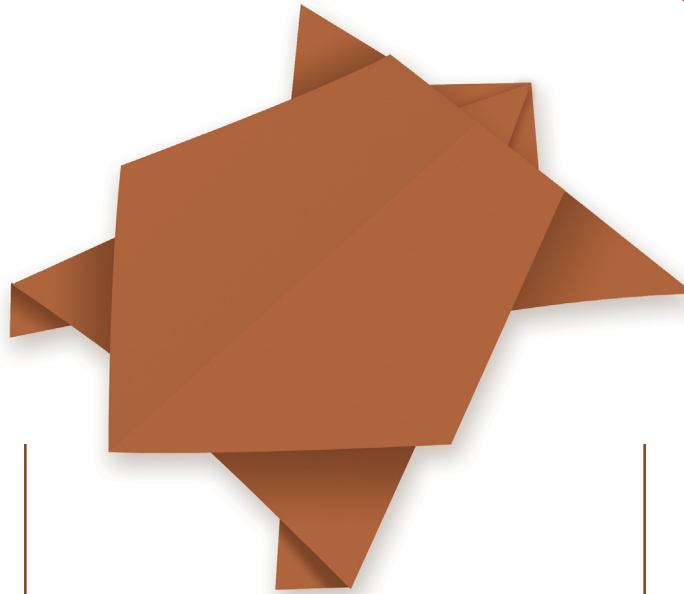

1. Begin by making a square piece of paper. Fold one corner of a piece of paper over to the adjacent side.

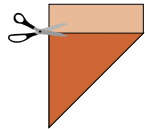

2. Like this. Finish making the square by cutting off the small rectangle.

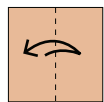

3. Fold side to side and unfold. This is the "valley fold" or "river."

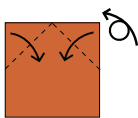

4. Turn over and fold right and left points down to form a "roof."

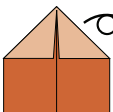

5. Like this. Then turn over.

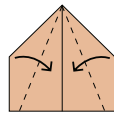

6. Bring the folded edges to meet the valley fold (the river). Crease flat.

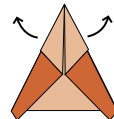

7. Unfold the top side points.

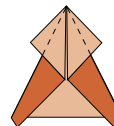

8. Like this.

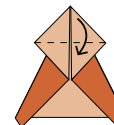

9. Fold the top point down as shown.

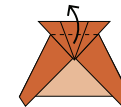

10. Fold the point upward to create a head.

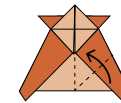

11. Lift the bottom edge to meet the vertical center line.

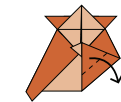

12. Like this. Press flat and fold outward as shown.

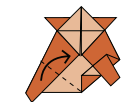

13. Repeat steps 11 and 12 with the other foot.

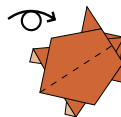

14. Turn over. You've made a turtle!

Origami illustrations courtesy Matt McIntosh, NOAA

How to Make an Origami Blue Whale

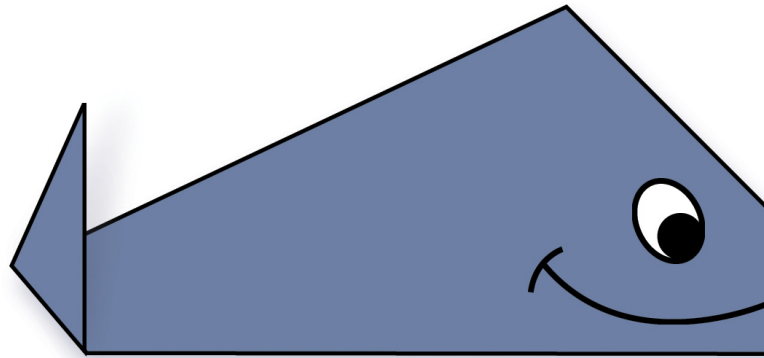

1. Begin by making a square piece of paper. Fold one corner of a piece of paper over to the adjacent side.

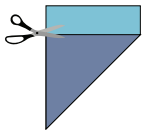

2. Like this. Finish making the square by cutting off the small rectangle.

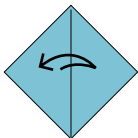

3. Put a square of paper on the table so it looks like a diamond. Fold side to side and unfold.

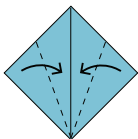

4. Fold the lower left and right sides to meet the center crease.

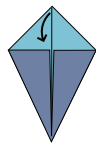

5. It looks like an ice-cream cone. Now fold the top point down, as shown.

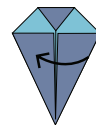

6. Fold the right side over to meet the left side.

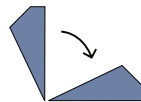

7. Put your finger on the bottom point as you turn the whale sideways.

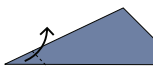

8. Fold the end point up to make a tail.

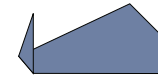

9. Like this.

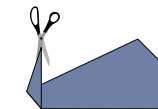

10. Make a short cut through the end of the fold in the tail. Fold the edges of the tail outwards.

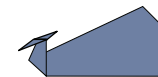

11. Like this.



12. Draw eyes, fins and any other patterns you like.

Origami illustrations courtesy Matt McIntosh, NOAA

Sea Turtle Facts

👉 Sea turtles have been on the planet since the early Mesozoic era almost 180 million years ago! They survived the great dinosaur extinction during the Cretaceous era, and flourished until recent times.

👉 There are six species of sea turtles commonly found in the United States in the Atlantic, Gulf of Mexico, and Pacific:

- * Leatherback
- * Loggerhead
- * Kemp's Ridley
- * Hawksbill
- * Green
- * Olive Ridley

👉 Sea turtles eat a variety of organisms, including algae, seagrasses, sponges, crustaceans, jellyfish and mollusks.

👉 Sea turtles have a unique life history. They are highly migratory, often swim long distances, live long lives, take a long time to reach maturity, and crawl ashore to dig nests and lay eggs.

👉 Leatherback, loggerhead, and Kemp's ridley turtles are only found in the U.S. Atlantic and Gulf of Mexico.

👉 In the Atlantic, Green and hawksbill turtles are found more commonly south of Virginia.

Caroline Rogers, USGS



Green Turtle

Caroline Rogers, USGS

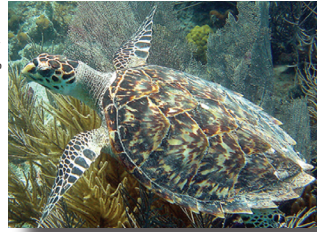

Hawksbill Turtle

👉 What's the problem? Sea turtles are threatened by:

- * Accidental capture by commercial fisheries
- * Loss of habitat and nesting areas due to coastal development
- * Being hit by ships
- * Overfishing of important food items such as mollusks, and crabs
- * Killing turtles and their eggs for food

👉 NOAA and the U.S. Fish and Wildlife Service are working together to conserve and help marine turtles recover, along with other federal agencies, state partners, coastal communities, private individuals, and other nations.

👉 Some things being done to conserve sea turtles:

- * Requiring certain types of fishing vessels to use fishing gear that prevents accidental capture of sea turtles
- * Protecting prime nesting habitat along key coastal areas

- * Requiring dredges to use equipment that protects turtles, and restricting dredge activities in certain areas where sea turtles are abundant
- * Requiring plans to reduce the chances of sea turtles being trapped in coastal power plants
- * Supporting regulations to control artificial lights near turtle nesting beaches (artificial lights can disorient sea turtle hatchlings)
- * Working with other countries to conserve sea turtles throughout their range

👉 How are sea turtles doing? None of the five species found in the Atlantic and Gulf of Mexico have met recovery plan goals. The Kemp's ridley has shown a long-term, strongly increasing trend in the number of nesting females (which is the most common way to measure population status). Sadly, thousands of dead sea turtles continue to wash ashore along the U.S Atlantic and Gulf coastline each year.

For more about sea turtle biology, status and the threats that face them: Visit NOAA's National Marine Fisheries Service Web site: <http://www.nmfs.noaa.gov/pr> and the U.S. Fish and Wildlife Service Web site: <http://northflorida.fws.gov/SeaTurtles/seaturtleinfo.htm>.



Humpback whale breaching

☞ Whales are the largest animals that ever lived on the Earth. They are even larger than the dinosaurs of prehistoric times.

☞ All whales belong to a group known as cetaceans (seh TAY shuhnzh). There are two types of whales—toothed (odontocete) and baleen (mysticete). Baleen is a special filter that whales use to sieve tiny food particles from the water.

☞ Today, there are 78 species of whales swimming in the oceans around the world; 67 species are toothed and 11 are baleen.

☞ Whales are large, intelligent, marine mammals. They breathe air through a blowhole into lungs, are warm-blooded, and give birth to their young as opposed to laying eggs.

☞ Many cetaceans, especially baleen whales, migrate over very long distances each year. They travel, sometimes in groups (pods), from coldwater feeding grounds to warm-water breeding grounds. Gray whales make the longest seasonal migration of any of the whales—about 12,500 miles each year!

Whale Facts

☞ The biggest whale is the blue whale, which grows to be about 94 feet (29 m) long—the height of a 9-story building. These enormous animals eat about 4 tons of krill (microscopic floating animals) each day, obtained by filter-feeding through baleen.

☞ The smallest whale is the dwarf sperm whale, which as an adult is only 8.5 feet (2.6 m) long.

☞ Adult blue whales have no predators except man. Almost all species of baleen whales were exploited by the commercial whaling industry from the 1700s to the mid-1900s. Several species of both toothed and baleen whales were hunted close to extinction. Most populations have not yet recovered from intense hunting and still face threats to their survival from human activities.

☞ Many baleen whales are in danger of being hit by ships, particularly the critically endangered Northern right whale.

☞ Being tangled in various types of fishing gear is a serious threat to several species of cetaceans.



Killer whale shyopping

☞ NOAA works to protect and conserve whales because all whales are pro-

ected under the Marine Mammal Protection Act, and some are also protected under the Endangered Species Act.

☞ NOAA's efforts to protect and conserve whales include legislation, National Marine Sanctuaries and other marine protected areas. NOAA also works with the U.S. Fish and Wildlife Service on issues concerning whales and other cetaceans.

Want to Do More?

- For more information, visit:
<http://www.noaa.gov/whales/> and <http://www.nmfs.noaa.gov/pr/species/mammals/> – NOAA's whale related programs
<http://sanctuaries.noaa.gov/> – NOAA's National Marine Sanctuaries
<http://mpa.gov/> – NOAA's marine protected areas
<http://www.fws.gov/> – U.S. Fish and Wildlife Service

Courtesy NOAA

Courtesy Victor Lunquist, NMFS-AFSC

Is Our Climate Changing?

We hear and read a lot about climate change. What does this mean? Is it really happening?

What's the difference between weather and climate?

Weather is what is happening in the atmosphere right now. Climate is what the weather is likely to be in a particular place over a long period of time. If you want to know the temperature in your community today, you're talking about weather. If you want to know what the temperature is likely to be a year from now, you're talking about climate. In other words, climate is what we expect, weather is what we get.

Climate usually involves the average weather conditions in a particular place or geographic region (for example, the northeastern United States) over a period of 30 – 50 years. So if your parents say that winters were colder when they were growing up, they are saying that the weather they experienced then was different from the weather they expect today, and this is what we call a change in climate.

Some Facts About Earth's climate

- Since the middle of the 1800's, Earth's average temperature has warmed about 1°F.
- 1°F doesn't sound like much, but it's important to realize that Earth's average temperature is warmer now than it has been at any time since at least 1400 AD. We say "at least" because 1400 AD is as far back as scientists have good estimates of temperatures. There is other evidence that suggests Earth's temperature is warmer now than it has been in many thousands of years, maybe nearly 100,000 years.
- On Earth today, mountain glaciers are melting, springtime snow cover is reduced, the temperature of the ground has been increasing, and sea levels have risen by several inches in the last 100 years.

Why is This Happening?

There are several possible explanations:

- The Sun may be getting brighter;
- Maybe it's just part of natural cycles in Earth's climate; or
- Human activities that release carbon dioxide, methane and other gases into Earth's atmosphere are increasing the natural "greenhouse effect" that keeps Earth's surface warm.

Scientists investigating these possibilities have found that

- If the Sun were getting brighter, this would warm Earth's surface as well as the lower and upper atmosphere. But the upper atmosphere is cooling and the Sun hasn't gotten a lot brighter.
- Natural cycles would warm some regions and cool others, back and forth at different times. But the warming has been going on for a long time, and the pattern of warming doesn't change very much.
- The amount of climate change that would be expected from human activities closely match the changes that have actually happened.

So Earth is Getting Warmer - So What?

- Sickness and deaths due to heat stress will increase during summer months;
- Tropical diseases will be able to spread farther north and south of the equator;
- Heating bills will go down, but air conditioning costs will increase;

- Earlier springtime warming will help farming in some regions, but hotter and drier summers will likely reduce agricultural production in other places;
- Changes in storm systems and snowfall will affect water supplies;
- Rising sea levels will require levees to protect cities, coastlines will move inland, and some islands will have to be abandoned;
- Changing temperatures and rainfall patterns will disrupt forest and grassland ecosystems;
- Melting polar ice caps may eliminate the habitat of arctic species and lead to the extinction of animals such as polar bears.

So, the world will not end, but it will be different from the world we know today.

What Can We Do About Climate Change?

Coal, oil, and natural gas provide more than 80% of the world's energy and produce many of the gases that contribute to climate change. Right now, there is no way to completely replace these fuels, but there is still a lot that can be done. Three important steps are:

- Use energy more efficiently;
- Choose products that reduce energy use; and
- Participate in recycling.

In addition, we need to use products that require less energy to produce, and find ways to use other sources of energy like wind and solar power.



For More Information

www.climate.noaa.gov/ — Web site for NOAA's Climate Program Office

www.climate.noaa.gov/education/ — Education Resources from NOAA's Climate Program Office

www.ngdc.noaa.gov/paleo/ctl/index.html — Web site for the Climate TimeLine with information on the causes and effects of climate change, and how they are related to our everyday lives and to human history; from NOAA's National Climatic Data Center, Paleoclimatology Branch

www.climatescience.gov — Web site for the U.S. Climate Change Science Program

www.usgcrp.gov — Web site for the U.S. Global Change Research Program

This overview is based on "Is the Climate Changing? Indeed It Is," by Michael MacCracken, Director of the Office of the U.S. Global Change Research Program, and Tom Karl, Senior Scientist, National Climatic Data Center, NOAA; <http://www.usgcrp.gov/usgcrp/documents/mbralmnac.html>



WHERE WILL THE POLAR BEARS GO?

Courtesy Kaathy Crane, NOAA Arctic Research Office

“Climate change may have its most pronounced effects in the Arctic.”

US Arctic Research Commission,
quoted by Nick Bond, Jim Overland and Nancy Soreide,
NOAA/Pacific Marine Environmental Laboratory, in
“Why is the Arctic important?” (http://www.arctic.noaa.gov/essay_bond.html)

What You Will Do

Make a poster to explain how climate change is affecting polar bears, how it may affect humans, and what we can do about it.

The Arctic is one of the least explored places on earth, and is changing fast. One of the most dramatic changes involves sea ice. Satellites have been recording Arctic perennial sea ice (sea ice that remains during the entire year) since 1979, and these records show that the amount of sea ice has been getting smaller and smaller. This image shows the perennial sea ice concentration for the year 1979:

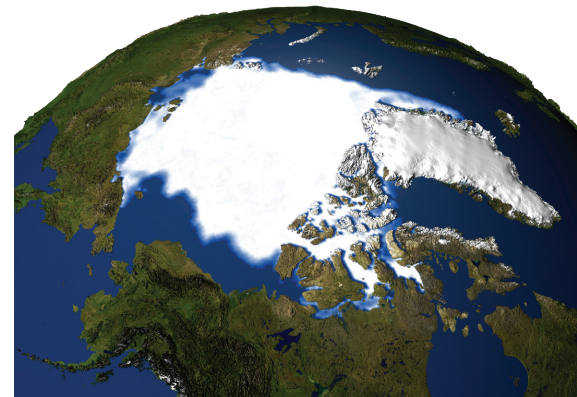

1979

Data collected by the Defense Meteorological Satellite Program Special Sensor Microwave Imager. Courtesy NASA

and this image shows the perennial sea ice concentration in 2003:

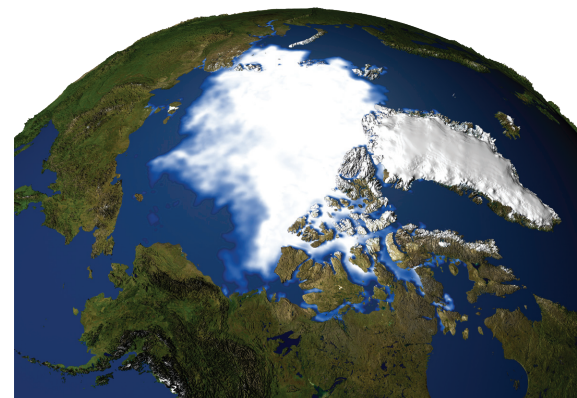

2003

Data collected by the Defense Meteorological Satellite Program Special Sensor Microwave Imager. Courtesy NASA

Since 2003, sea ice concentration has continued to decline. The lowest concentration of perennial sea ice ever measured was recorded in 2005.

These changes spell big trouble for animals that depend on sea ice for their survival. Polar bears, for example, live on sea ice all year. They rear their young on the ice, and hunt along the edges where seals make holes in the ice to breathe. An adult polar bear usually eats one seal every four or five days. When the sea ice melts during the summer, polar bears have to swim between floating chunks of ice (called "floes") to continue their hunt. Until recently, the floes were usually less than 15 miles apart. But as more and more of the perennial ice melts, the floes have become much farther apart, and the bears have had to swim over much longer distances. In September, 2005, wildlife biologists spotted polar bears swimming as much as 60 miles from shore. These long distance swims are much more dangerous for the bears. After one severe storm, the biologists found four dead bears floating in the water, and reported that they probably drowned as a result of rough seas caused by high winds.

Polar bears face other problems, too. Ocean currents can carry chemical pollution thousands of miles, and some of it reaches the Arctic. Chemicals called PCBs, for example, have been found in polar bears. These chemicals cause



Courtesy Kelly Elliott, NOAA

problems with polar bears' immune systems, so the bears are more likely to get sick.

Polar bears have been hunted by Inuits and other indigenous Arctic people (which means people who have lived in the Arctic for hundreds of years) for centuries. Today, most nations only allow indigenous people to hunt polar bears, but Canada also allows "sportsmen" to hunt polar bears for trophies. Legal hunting kills about 700 polar bears each year.

Another problem is that warmer temperatures are likely to bring more people into the Arctic region, including commercial shipping as well as drilling and mining for minerals, oil, and gas. No one is exactly sure about how this

kind of increased human activity will affect polar bears.

NOAA's Arctic Research Office works in the Arctic, Bering Sea, North Pacific and North Atlantic regions to find out how warmer temperatures will affect the climate and cultures of the Arctic, as well as how such changes will affect the climate and cultures of other regions. NOAA will also be part of the fourth International Polar Year (2007 – 2008) during which many nations coordinate Polar expeditions, observations and research.

Why should we worry about polar bears?

Some people just like the idea of having them alive on Earth, even if they never see one. But there are other reasons, too: The fact is, polar bears and every other living thing are all part of Earth's living system. If that system changes so that it is no longer friendly to polar bears, then it may not be friendly to many other species, including humans. So we need to look at the polar bears' problems as a warning for ourselves.

Here's a way to use information about polar bears to help other people understand more about global climate change.

What You Will Need

- Color copies of images from “Images for Polar Bear Posters”
- Information from the introduction for this activity and “Is Our Climate Changing?” (page 137)
- Crayons, colored markers, or colored pencils
- Poster board
- Scissors

Warning

Be careful with sharp scissors!

How to Do It

1. Use the images and information to create a poster that explains what is happening to polar bears’ habitat, how this is related to climate change, why this is important to us, and what we can do about it. You may also want to include ideas and information from “Following the Ocean Unicorn” activity (page 145) since it also deals with climate change and Arctic animals.
2. Show your poster at school, to your parents, and to other groups. The more people know about climate change and how it affects life on Earth, the more they will take action to protect Earth’s ecosystems.



Courtesy Kelley Elliott, NOAA

Want to Do More?

<http://www.arctic.noaa.gov/> – NOAA’s Arctic Theme Page with information and data about the Arctic for scientists, students, teachers and the general public.

<http://www.arctic.noaa.gov/ipy.html> – For more information about the Fourth International Polar Year

http://www.arctic.noaa.gov/gallery_polarbear.html – Polar bear photograph gallery on NOAA’s Arctic Theme Page

<http://www.polarbearsinternational.org/all-about-polar-bears/> – “All About Polar Bears” on the Polar Bears International Web site

Images for Polar Bear Posters

Courtesy Kathy Crane, NOAA

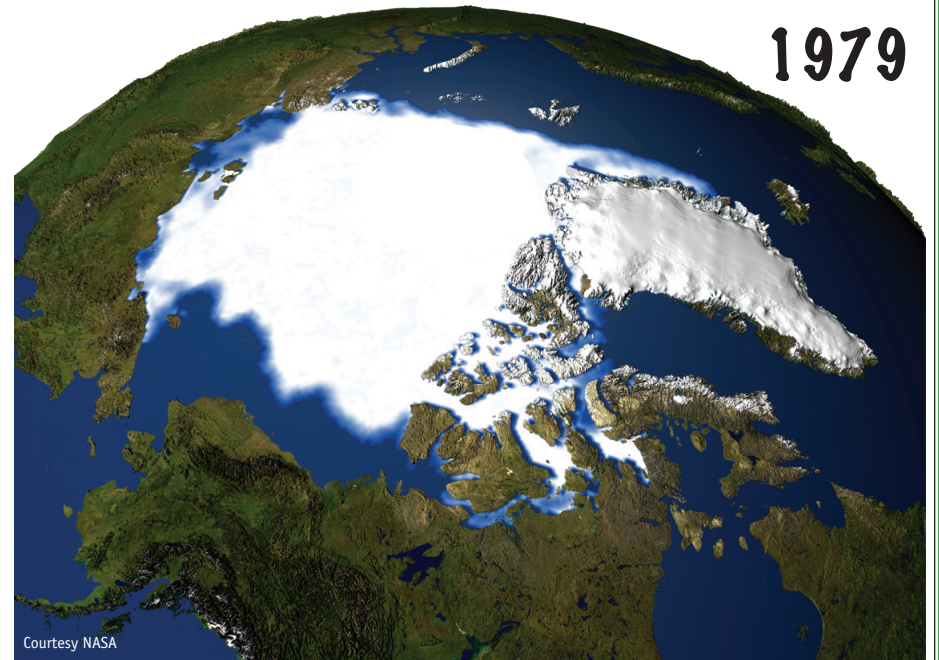

Courtesy NASA

Courtesy Kelley Elliott, NOAA

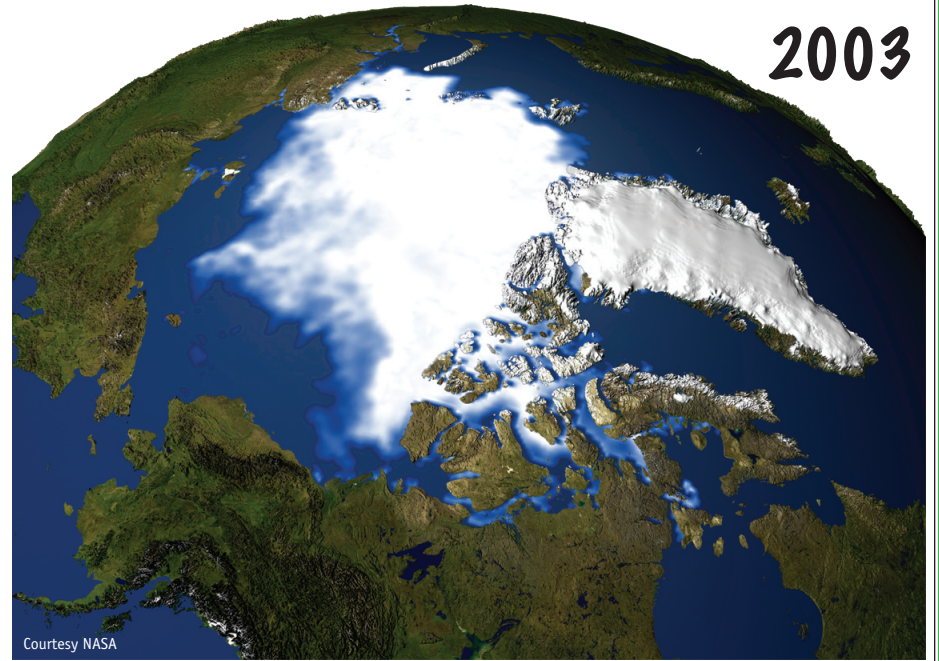

Courtesy NASA

Courtesy Kathy Crane, NOAA

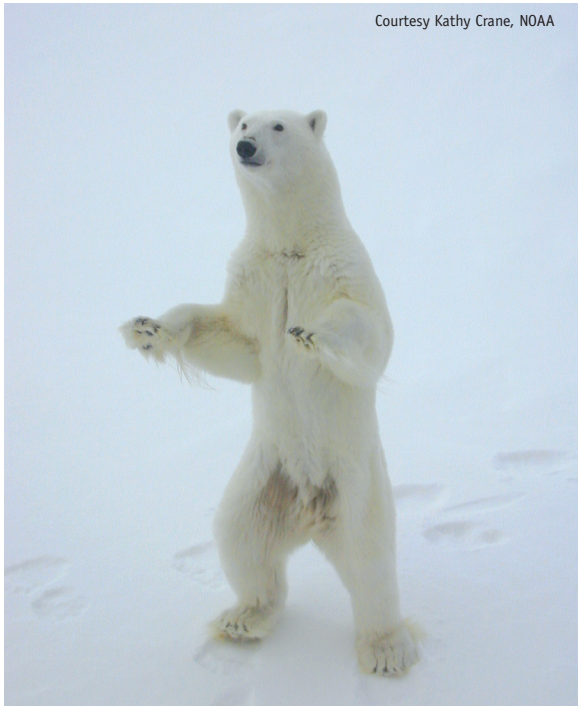

Courtesy Kelley Elliott, NOAA



Courtesy Kelley Elliott, NOAA



Courtesy Kathy Crane, NOAA





Courtesy Joel Garlich-Miller, USFWS



Courtesy Fernando Jorge, USCG



Courtesy Joel Garlich-Miller, USFWS



Courtesy Joel Garlich-Miller, USFWS

Following the Ocean Unicorn

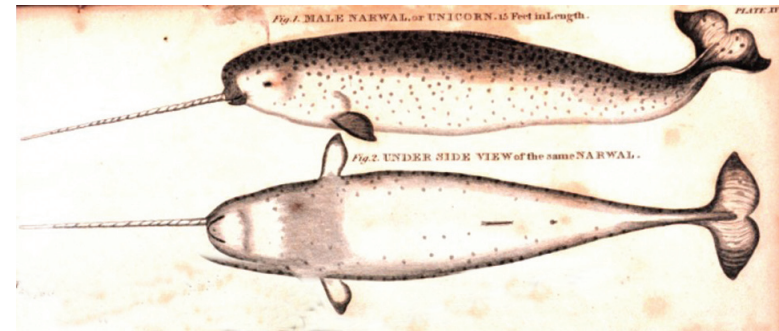

From An account of the Arctic regions with a history and description of the northern whale-fishery by W. Scoresby. 1820. Courtesy NOAA..

Is this a unicorn? Not really—it's actually a drawing of a narwhal, a whale that spends its entire life in the Arctic. Most male narwhals have a tooth in their upper jaw that forms a long tusk. For several centuries, northern traders sold narwhal tusks throughout Europe, claiming they were unicorn horns. One of the largest groups of narwhals spends most of the winter in Baffin Bay, between Canada and the western coast of Greenland. This is an unusual area, because while most of the Arctic is getting warmer, air and sea surface temperatures near western Greenland are getting cooler, and sea ice concentrations in Baffin Bay have increased significantly since 1953. But at the same time, temperatures in deep water below 1,200 feet in Baffin Bay are slowly getting warmer.

This is important, because the deep water in Baffin Bay is part of a worldwide system of deep currents that connect Earth's largest oceans. Temperature is one of the things that makes this system work, and some scientists are worried that changing temperatures in the Arctic could cause the system to slow down or even stop working entirely. Even though it's getting warmer, the Arctic is still a difficult place to do scientific work, and it has been almost impossible for scientists to gather very much information on deep ocean temperatures.

Believe it or not, narwhals may help solve this problem! Narwhals in Baffin Bay often dive more than 4,500 feet deep to find food. And they do this during the winter when it is impossible for scientists to do deep ocean research in the Arctic region. NOAA's Ocean Explorer 2006 Arctic Winter Ecosystem Exploration attached instrument pack-

What You Will Do

Make a poster about narwhals, how they are being affected by climate change, how climate change may affect humans, and what we can do about it.

ages called "satellite tags" to narwhals to record temperature and depth during deep dives for food. A transmitter in each tag sends the information to a satellite, and the satellite sends the information back to Earth to give scientists the first-ever data on deep-water winter temperatures in Baffin Bay.

Unfortunately, narwhal populations may be declining. There are several possible reasons for this:

- Hunting by indigenous Arctic peoples (which means people who have lived in the Arctic for hundreds of years);
- Increased harvest of fish by humans, reducing the amount of food available for narwhals; and/or
- Climate change.

If you have looked at "Where Will the Polar Bears Go?" you know that climate change is causing problems for polar bears, too. But the problem for polar bears is that there isn't enough sea ice. Baffin Bay is one of the few places in the Arctic where sea ice is increasing; and this causes problems for narwhals because it reduces the amount of open water needed by the whales, and increases the danger that they may become trapped in the ice.



Courtesy Kristin Laidre

Does this seem that what's bad for the narwhals might be good for the polar bears? Not really, because not enough ice where ice should be is just as bad as too much ice where ice should not be. Remember, too, that even though the average temperature in the Arctic is going up, there can still be places that are colder than the average; but these colder temperatures are balanced by temperatures in other places that are higher than the average.

Just as narwhals are helping scientists study the deep ocean, they can also help you tell other people about global climate change.

What You Will Need

- Copies of "Images for Narwhal Posters"
- Information from the introduction for this activity, the "Narwhal Fact Sheet" and "Is Our Climate Changing?" (page 137)
- Crayons, colored markers, or colored pencils
- Poster board
- Scissors

Warning

Be careful with sharp scissors!

How to Do It

1. Use the images and information to create a poster that explains about narwhals and how they are being affected by climate change. You may also want to include information about why climate change is important to us, what we can do about it, and possibly some ideas and information from the "Where Will the Polar Bears Go?" (page 139) activity, since it also deals with climate change and Arctic animals.
2. Show your poster at school, to your parents, and to other groups. The more people know about climate change and how it affects life on Earth, the more they will take action to protect Earth's ecosystems.

Want to Do More?

Visit <http://www.oceanexplorer.noaa.gov/explorations/06arctic/welcome.html> for more information about narwhals and NOAA's Ocean Explorer 2006 Arctic Winter Ecosystem Exploration.

This activity was adapted from "The Ocean Unicorn" (10 pages, 292 kb) by Mel Goodwin, The Harmony Project, Charleston, SC; from the Ocean Explorer 2006 Arctic Winter Ecosystem Exploration [<http://www.oceanexplorer.noaa.gov/explorations/06arctic/background/edu/media/unicorn.pdf>]



Several male narwhals in West Greenland. Courtesy Mads Peter Heide-Jorgensen

- Narwhals belong to the genus *Monodon* and the species *monoceros*.
- Narwhals belong to the class Mammalia and the order Cetacea.
- Male and female narwhals have two teeth, in the upper jaw. In most female narwhals, the teeth never erupt through the gum. In most males, the left tooth forms a long tusk. In rare cases, males may develop two tusks, and females may also develop one or two tusks.
- The most widely accepted explanation for the function of the narwhal's tusk is that it is possibly involved with mating behavior or as a weapon in battles over possession of females.
- Narwhals spend their entire lives in the Arctic.
- Narwhals eat fish (including polar cod, Greenland halibut, flounder, salmon, and herring), cephalopods (squids and octopuses), and shrimp.
- Narwhals can dive to depths of 4,500 feet or more.
- Narwhals need to come to the surface of the ocean periodically, because they are mammals and must surface to breathe air.
- Normally, a female narwhal produces one calf at a time.
- Narwhals seem to prefer deep water near loose pack ice. In the summer, they occupy deep bays and fjords in the Canadian High Arctic and Greenland. As winter approaches, narwhals migrate into the pack ice of Baffin Bay, the northern Davis Strait, and adjacent waters.
- Narwhals can live for 50 years or more.
- Narwhals have been traditionally hunted by indigenous Arctic peoples who value them as a staple food (the skin is rich in vitamin C), as well as for their tusks (though international efforts to control the global ivory trade may have reduced tusk sales in recent years). Narwhal sinews (tissues that attach muscles to bones) may also be used as thread.

Images for Narwhal Posters



Narwhals. Courtesy Kristin Laidre

Melville Bay is the site of many active glaciers. The area is filled with large icebergs that dwarf the *Sila*, the boat used for narwhal tagging/tracking. Courtesy Kristin Laidre.



Male narwhals. Courtesy Mads Peter Heide-Jorgensen

Narwhals. Courtesy Kristin Laidre



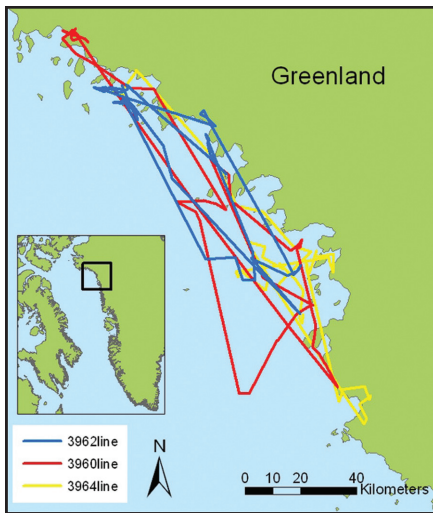

Satellite-based locations for three narwhals tagged in Melville Bay in September 2006. Whales are still in their coastal summering grounds but will migrate offshore by mid-November. Courtesy Kristin Laidre

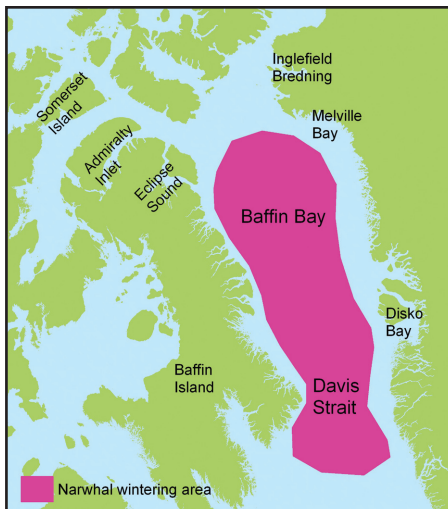

Narwhal wintering areas (pink) in Baffin Bay and Davis Strait. Courtesy Kristin Laidre

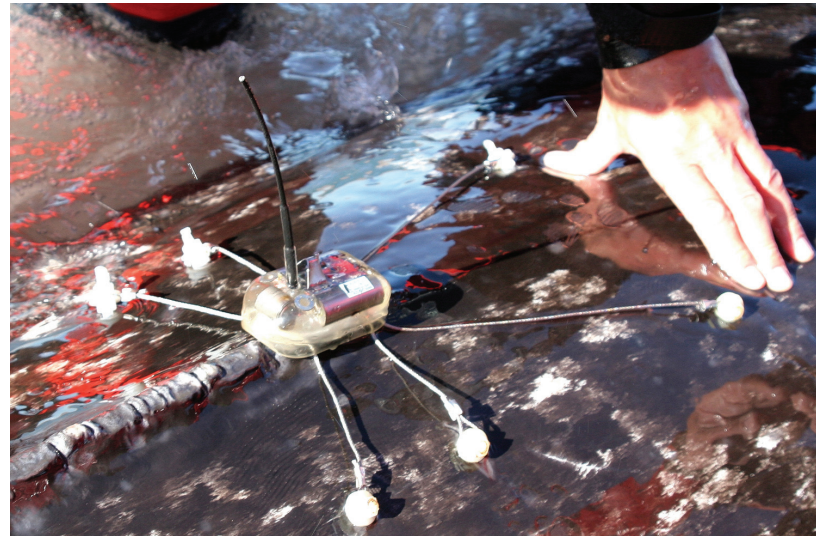

Instrument packages called “satellite tags” are attached to narwhals by plastic coated wires affixed to two nylon pins (1/4 inch diameter) inserted through the dorsal ridge on the whales’ back (the whales shed the tags after several months; 14 months is the longest time a tag has stayed on a whale). An alterna-

tive method of attaching the tags involves placing the tags into small cylinders that are implanted in the layer of blubber along the whales’ back using hand-held thrown poles similar to harpoons. Tags attached using the latter methods are only expected to provide data for four to five weeks.



Male narwhal (ID 3964) captured and satellite tagged. You can see where he went in the map to the left. Courtesy Kristin Laidre

Does Tagging Hurt Narwhals?

Researchers say “No, we have quite good evidence that tagging does not hurt them—both in the short and long term.” Satellite tags are only attached into blubber where there are few nerve endings, and the whales do not react at all when the tags are attached. As soon as the whales are released, they immediately resume normal behavior. In addition, whales that have been recaptured several years after tagging show no evidence of being harmed by the tagging process.

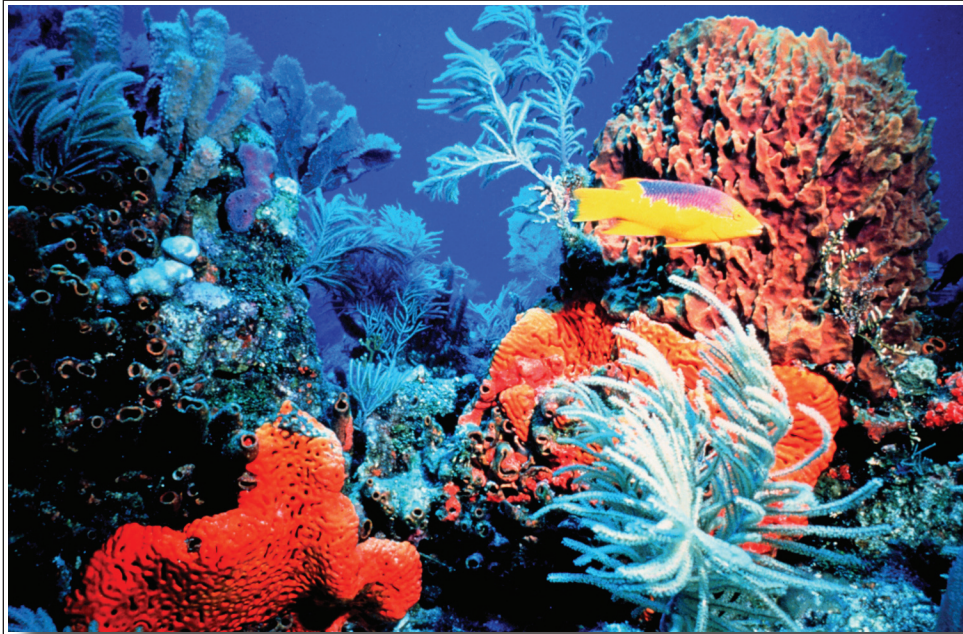

Spanish hogfish at reef.
Coutesy Florida Keys National Marine Sanctuary

Make an Edible Coral Reef

You have probably seen pictures of coral reefs before—lots of colors, fishes, and weird looking shapes! Coral reefs are not only beautiful to look at; they are also home to thousands of other species. In fact, scientists estimate that there may be another one to eight million undiscovered species living in and around reefs! Coral reefs support more species per square foot than any other marine environment. This abundance of living organisms is key to finding new medicines for the 21st century. Many drugs are now being developed from coral reef animals and plants as possible cures for cancer, arthritis, human bacterial infections, viruses, and other diseases.

Coral reefs are important for other reasons as well. Coral reefs are a breeding ground for many fish and other species, and millions of people and thousands of communities all over the world depend on coral reefs for food. In the United States, coral reef ecosystems support hundreds of commercial and recreational fisheries worth more

than 200 million dollars. Local economies receive billions of dollars from visitors to reefs through diving tours, recreational fishing trips, hotels, restaurants, and other businesses based near reef ecosystems. Coral reefs protect shorelines against waves, storms and floods, and help prevent loss of life, property damage and erosion.

Despite their importance, many of Earth's coral reefs are in trouble. Severe storms, water pollution, overfishing, disease, global climate change, and ships running aground are some of the things that have destroyed or badly damaged many reefs. Because of these threats, coral reefs and all of the creatures that call them home may be in danger of disappearing if something isn't done to protect them. NOAA

What You Will Do

Make an edible model of a coral reef!

is one of many organizations participating in the U.S. Coral Reef Task Force, which was established in 1998 to protect and conserve coral reefs. Satellites are being used to map shallow U.S. coral reefs, as well as to watch for high sea surface temperatures that can damage corals and to detect harmful algae that can smother reefs. NOAA's National Undersea Research Program does research projects to learn more about coral reefs, and restores damaged reefs in marine reserves and among deep sea coral banks.

Coral reefs need your help, too! More people need to understand why coral reefs are important and what needs to be done to protect them. Here's a tasty way to start a conversation about coral reefs.

What You Will Need:

- One half sheet cake; if you want to bake your own cake you will need a box of cake mix and other ingredients listed on the box
- Icing in various colors
- Food coloring
- Marshmallows, licorice whips, small cookies, candy sprinkles, or other edible materials for modeling coral reef animals and habitat features

Warnings:

1. Get an adult to help with baking.

2. Don't eat too much!
3. Wash your hands before handling food! If more than one person is involved with this activity, you may also want to wear disposable gloves.

How to Do It:

1. If you aren't familiar with coral reefs, read the sidebar "What is a Coral Reef?" You may also want to look at books about coral reefs or check out the Web sites listed under "Want to Do More?"



A purple soft coral. Courtesy Florida Keys National Marine Sanctuary

A healthy coral reef ecosystem contains thousands of species, so you can't really include everything in your model. Instead, plan a model that is colorful and interesting, using the images on these pages for ideas. Remember, the main idea is to create a model that will help start a conversation about coral reefs (and is also good to eat!).

Before you actually make your model, make a list of what plants or animals you want to include, and what materials will be used to show them on the model. Mounds of icing can be used for boulder-shaped corals. When icing mounds have hardened they can be sculpted to form caves and overhangs. Small cookies could represent plate-shaped corals. Coconut colored with green food coloring could be used for seagrass. Sponges could be modeled with small pieces of sponge cake (of course). Licorice whips could represent branching corals. Gummy fish or fish crackers on toothpicks can represent fish. Raisins or chocolate chips might be sea urchins. Of course, there are many more possibilities, and you probably already have a pretty good idea of things you could use in your model.

2. If you plan to bake you own cake, mix the batter according to instructions on the box, and bake the cake in an oversized flat pan like a broiler pan or turkey roasting pan. Your cake will probably take less time to bake than the time stated on the cake mix box, because your cake will be thinner than usual.
3. The flat cake is the base of your model reef. Add the features you planned in step 1 to complete the model. This is a lot of fun to do with two or three other people, but be sure you wash your hands and wear disposable gloves so you can safely eat the model later.

7. Show your model to your friends, parents, school, or other groups, and talk about why coral reefs are important, why they are in trouble, and what we can do to help save them. If you are using your model at school, your teacher may be able to arrange for you to make a presentation about coral reefs to another group of students, perhaps a younger class. When you have finished your presentation, you can say, "Now it is time for us to have a direct interaction with this model reef." Which means everyone can eat the cake!



Grey snappers at the reef.
Courtesy Florida Keys National Marine Sanctuary

Want to Do More?

<http://www.coris.noaa.gov/about/> – Information about coral reefs from NOAA's Coral Reef Information System

<http://www.coralreef.noaa.gov/outreach/things-youcando.html> – Things You Can Do to Protect Coral Reefs from NOAA's Coral Reef Conservation Program

<http://www.coralreef.noaa.gov/news/welcome.html> – NOAA's Coral Reef Newsletter

<http://www.coralreef.noaa.gov/outreach/welcome.html> – Coral Reef Conservation Program, Education and Outreach

<http://oceanservice.noaa.gov/education/kits/corals/welcome.html> – Coral Reef Discovery Kit from NOAA's National Ocean Service

<http://www.latimes.com/news/local/oceans/la-oceans-series,0,7842752.special> – A five-part series from the Los Angeles Times about what is happening to Earth's oceans

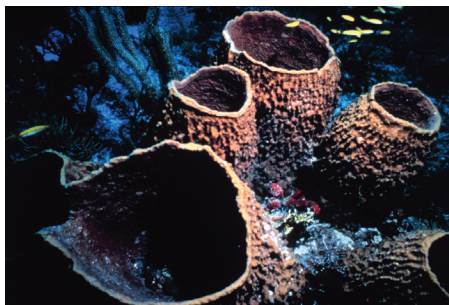

Barrel sponges.
Courtesy Florida Keys National Marine Sanctuary

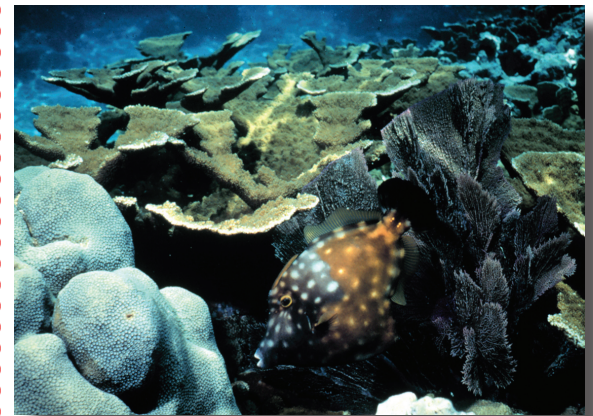

Elkhorn coral and a white spotted filefish.
Courtesy Florida Keys National Marine Sanctuary



Butter hamlet fish with soft corals.
Courtesy Florida Keys National Marine Sanctuary

Corals are animals that do not have backbones, and are related to jellyfish. The large boulders that we see in pictures of coral reefs are colonies of many individual coral animals called polyps (“PAH-lips”). Polyps are made of an outer cell layer called epidermis (“ep-ih-DERM-iss”) and an inner cell layer called gastrodermis (“gas-tro-DERM-iss”), with a jelly-like substance called mesoglea (“mez-oh-GLEE-uh”) in between. Each polyp makes its own cup-shaped skeleton called a calyx (“KAY-lix”) from limestone (calcium carbonate). The base of the calyx is called the basal plate, and the outer walls of the calyx are called the theca (“THEE-kuh”). Vertical partitions called septa extend part-way into the cup from the inner surface of the theca. The outer surface of the theca is covered by the soft tissues of the coral. Polyps have a mouth surrounded by a ring of arms called tentacles. The tentacles have stinging cells called nematocysts (“nee-MAT-oh-sists”) that polyps use to capture food. Most corals are carnivorous, and feed on small floating animals or even fish. Many corals also feed by collecting very small bits of floating material on strings of mucous, which they pull into their mouths. Food is digested by digestive filaments in the stomach. Waste is expelled through the mouth.

Most reef-building corals have very small polyps, about one to three millimeters in diameter; but all of the polyps in a whole colony can make a limestone rock that weighs several tons! Individual polyps in a coral colony are connected by a thin band of living tissue called a coenosarc (“SEE-no-sark”).

What is a Coral Reef?



A colony of star coral. Courtesy Commander William Harrigan, NOAA Corps (ret.), Florida Keys National Marine Sanctuary

As the polyps grow and multiply, the coral colony may become shaped like boulders, branches or flattened plates. Some corals form tall columns, others resemble mushrooms, and some simply grow as a thin layer on top of rocks or the skeletons of dead corals.

When corals reproduce, they release free-swimming larvae that can be carried many miles away by ocean currents. A new reef begins when these larvae attach to underwater rocks or other hard surfaces along the edges of islands or continents.

As the corals grow and expand, other animals and plants join the reef system. Sponges and soft corals (sea fans and sea rods) are particularly visible on many reefs. Various types of seaweed and algae are also important. Some of algae produce limestone structures that add to the overall reef structure. Fishes and many other types of animals take advantage of shelter provided by the reef, and feed on algae and bacteria that grow on surfaces within the reef.

Most reef-building corals also contain algae that live inside the soft tissue of the polyp. These algae are called zooxanthellae (pronounced “zoh-zan-THELL-ee”), and like other algae are able to use energy from the sun to make food. So the corals and algae have a relationship that is called “mutualistic.” This means that the coral and algae both benefit from the relationship: The coral gives the algae a protected environment and chemicals the algae need to make food. In return, the algae provide the coral with food, oxygen and help remove wastes from the coral. This relationship allows corals to grow in waters that do not have much food available.

Besides providing corals with food, zooxanthellae are also responsible for the bright colors of many corals. When corals are stressed, particularly by high temperature, the polyps lose their zooxanthellae and the coral colony becomes completely white. This is often called “coral bleaching.” Coral polyps can live for a short period of time without zooxanthellae, but if bleaching lasts too long the coral may die.

Why are Coral Reefs in Trouble?

Coral reefs face numerous hazards and threats. Scientists estimate that 20 percent of all coral reefs are practically destroyed and are not likely to recover. Twenty-four percent are in critical condition and may die soon, and another 26 percent are threatened. Most scientists believe this damage is caused by a combination of natural stresses and human activities.

(from Status of Coral Reefs of the World: 2004)

Some of the biggest problems are:

Excessive fishing – Many coral reefs have very few fishes because they have been captured for food or aquariums. In healthy reef ecosystems, fishes graze on algae. Without the fishes, algae can grow rapidly and smother coral polyps. Some algae produce poisons that make the problem even worse.

Destruction of Habitats – Some fishing methods completely destroy living reefs. Fishing with large nets that are dragged across the bottom (bottom trawling) is extremely destructive. In some countries, fishermen use dynamite to stun fish, which also kills coral animals and damages the reef structure.

Pollution – Chemical poisons from sewers, farm runoff, and many other sources kill corals and many other ocean species. Fishermen



Reef scene. Courtesy Thomas Gibson. Florida Keys National Marine Sanctuary

in some areas use cyanide which kills coral polyps as well as fishes.

Invasive Species – Plants and animals that do not naturally live on reefs can damage the reef ecosystem. Some invasive seaweeds can grow rapidly enough to smother reef-building corals.

Ocean Warming – Reef-building corals in shallow water need warm temperatures and

most are found in the tropics. But if the temperatures rise a few degrees above normal, corals can overheat. “Coral bleaching” is often the result of overheating, and is happening more often as many areas on Earth become warmer. If the temperature drops again, corals may recover. But in many cases, the corals die.

“The Rise of Slime” – Many reefs are becoming overgrown with marine algae and films of bacteria. Part of the problem is pollution. In the Gulf of Mexico, for example, fertilizer pollution causes excessive growth of algae that is responsible for a “dead zone” the size of New Jersey. Removal of fish that normally feed on algae and bacterial films is another cause. Habitat destruction, overfishing, and pollution also kill natural filters like oysters and sponges that normally help clean the water.

The big problem is that many people do not understand what is happening to Earth’s ocean, and what the ocean will be like in the future. So one of the most important things we can do is inform others, and learn more about what needs to be done. Check out the Web sites under “Want to Do More?” and <http://www.coralreef.noaa.gov/outreach/thingsyoucando.html>.



Sponge, coral, and soft coral.
Courtesy Florida Keys National Marine Sanctuary

Now THAT's Complex!

A habitat is a place where an animal or plant lives and grows. How many habitats do you see in this picture? There are thousands! This is because the branched and wrinkled shape of the sponges and corals produce many different spaces of many sizes that can provide shelter to other organisms. The variety of habitats found on coral reefs is one of the reasons that a square foot of coral reef supports more species than any other marine environment.

Here's a way to show how coral reefs create a wide variety of habitats by repeatedly dividing a space into smaller and smaller pieces.

What You Will Need:

- Colored pencils or fine-point markers
- Ruler
- Copy of "Triangle Graph Paper"

What You Will Do

Make a Sierpinski triangle that shows how repeatedly dividing a fixed space produces an infinite series of increasingly smaller spaces.

How to Do It:

1. Begin by drawing an equilateral triangle measuring 16 cm on each side. This triangle is drawn in red on the "Triangle Graph Paper."
2. Find the midpoint of each side (8 cm), and join these midpoints as shown in Step 1.

Step 1

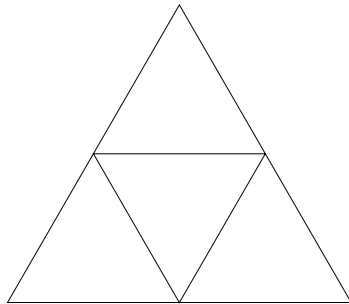

3. Shade the triangle in the middle as shown in Step 2.

Step 2

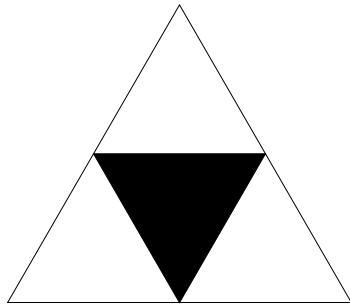

4. Find the midpoints of each side of the three outer triangles (4 cm), and join these as shown in Step 3.

Step 3

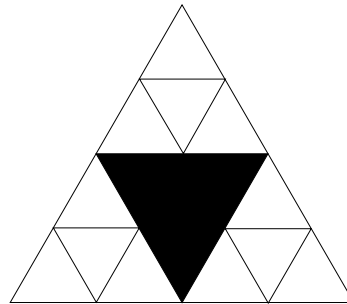

5. Shade each of the middle triangles as shown in Step 4.

Step 4

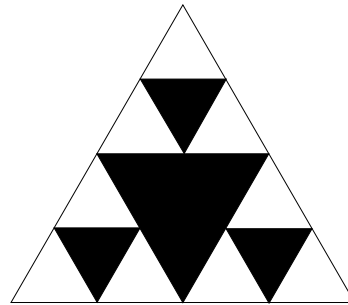

6. Continue this process three more times, until the midpoints measure 0.5 cm, shading the middle triangles each time, until the drawing appears similar to Step 5. You have made many different-size "habitats," simply by dividing the space over and over again. Theoretically, you could continue this process indefinitely to make an infinite number of habitats!

Step 5

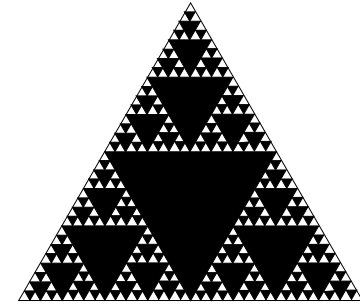

Want to Do More?

The Sierpinski Triangle is an example of fractals, which are geometric figures that have special properties and are often found in nature. For more information about fractals, visit <http://math.rice.edu/~lanius/frac/>.

This activity was adapted from "Architects of Seamount Ecosystems" (6 pages, 300k) by Mel Goodwin, The Harmony Project, Charleston, SC; from the Ocean Explorer 2004 Gulf of Alaska Seamount Expedition <http://www.oceanexplorer.noaa.gov/explorations/04alaska/background/edu/media/GOA04.Form.pdf>

Triangle Graph Paper

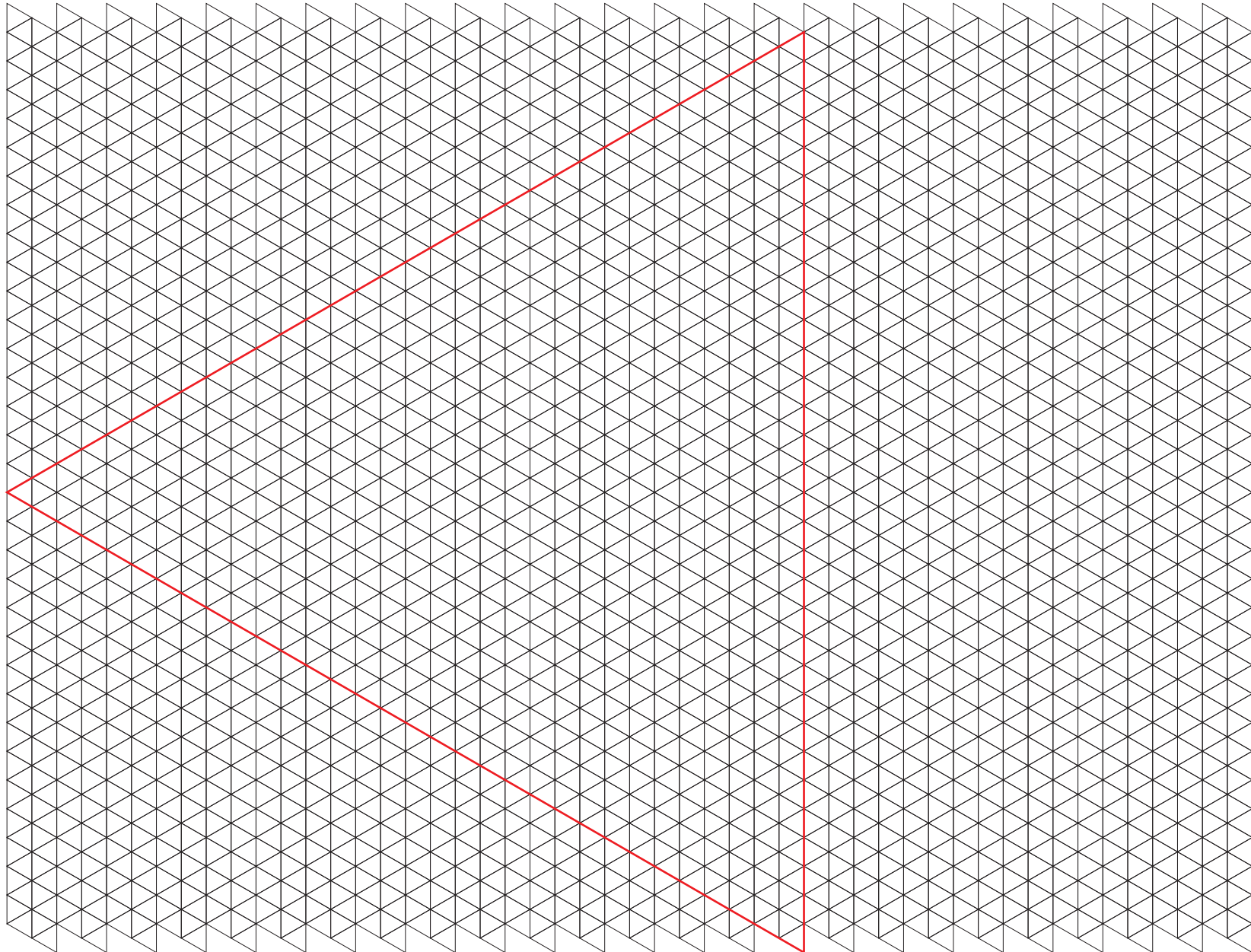

Fixing Our Earth



After four centuries as a major center of ocean commerce and naval power, the Elizabeth River is the most polluted waterway on the Chesapeake Bay for some cancer-causing chemicals. Courtesy Captain Albert E. Theberge, NOAA Corps (ret.)



Adobe Creek in Sonoma County, California was once alive with salmon and steelhead trout; but after years of pollution and neglect, state officials declared it "dead." Courtesy NOAA Restoration Center



Seagrasses provide food and habitat for different species of fish, lobster, wading birds, manatees and sea turtles. In Tampa Bay, more than 70 percent of seagrass meadows have been destroyed by pollution, coastal development, dredging, and boat propellers. Courtesy NOAA Restoration Center

What You Will Do

Get involved in a project to restore damaged natural resources

There are hundreds of stories about damage to coral reefs, rivers, fisheries and other resources caused by storms, oil spills, chemical pollution, and many other events.

So, is there anything we can do?

Yes! We can help restore habitats and save many species!

NOAA has worked with more than 2,500 groups throughout the U.S. to protect and restore marshes, wetland forests, oyster reefs, seagrass beds, beaches, and tidal streams that have been damaged by natural events and human activities. Restoration projects include:

- *Removing invasive species*
- *Repairing damaged habitats*
- *Cleaning up pollution*
- *Restoring natural ecosystem processes such as water flow*
- *Re-introducing native organisms*
- *Monitoring activities to evaluate long-term success*

Kids play a big part in many restoration projects!



Local middle and high school students grew more than 100,000 bushels of seed oysters that were used to successfully restore oyster reefs in the Elizabeth River, Portsmouth, VA. Courtesy NOAA Restoration Center



Students at Casa Grande High School built the only student run fish hatchery in the lower 48 states, removed trash from Adobe Creek, planted trees, so that Steelhead and Chinook salmon are once again spawning in the stream. Courtesy NOAA Restoration Center



Students in the Tampa Bay area grow marsh grasses and seagrasses, and assist with monitoring and planting to restore damaged habitats. Courtesy Tampa BayWatch

Here's how you can start helping to fix our Earth!

What You Will Need

- Good ideas
- Desire to make things better
- Willingness to get involved

Warning

Work on this project with an adult partner! Be sure you have permission and expert advice before starting any restoration activities.

How to Do It

1. Visit the Web sites listed on “NOAA’s Restoration Programs.” Read some of the case studies to get ideas about different kinds of restoration projects. Also, check out the “Volunteers” page at NOAA’s Restoration Portal http://www.habitat.noaa.gov/restorationtechniques/public/volunteers_about.cfm
2. Look over “Some Organizations Involved with Habitat Restoration Projects.” Check your local telephone directory to see if any of these organizations have an office nearby. If so, give them a call and ask about restoration projects in your area. If not, contact NOAA’s Fisheries Restoration Center (see the contact list at <http://www.nmfs.noaa.gov/habitat/restoration/contact.html>), and NOAA’s Office of Response and Restoration (orr.webmaster@noaa.gov) for ideas.
3. Talk to your parents, friends, teachers, and other groups about getting involved in a restoration project. Many successful restoration projects begin with one person who wants to make things better. Maybe you can be that person!

NOAA’s Restoration Programs

The Damage Assessment and Restoration Program focuses on events such as oil spills, release of toxic chemicals, or ships that run aground. http://www.nmfs.noaa.gov/habitat/restoration/projects_programs/darp/index.html

The Community-Based Restoration Program works with local partners to restore fishery habitats and encourage conservation of living marine resources. http://www.nmfs.noaa.gov/habitat/restoration/projects_programs/crp/index.html

The Office of Response and Restoration investigates natural resource damage, plans restoration projects, and helps local groups design monitoring plans to measure the success of restoration projects. <http://www.response.restoration.noaa.gov/>

Through the National Coastal Zone Management Program, NOAA partners with state coastal zone management programs to develop habitat restoration plans and carry out a variety of restoration projects. http://coastalmanagement.noaa.gov/issues/habitat_activities.html

The National Estuarine Research Reserve System works with local and state partners as well as other NOAA offices and federal agencies carry out habitat restoration projects based on scientific observations and historical analysis of

Some Organizations Involved with Habitat Restoration Projects

American Littoral Society
American Rivers
American Sportfishing Association
Chesapeake Bay Foundation
Coalition to Restore Coastal Louisiana
Connecticut River Watershed Council
Conservation Law Foundation
Ducks Unlimited
EarthCorps
Gulf of Maine Council on the Marine Environment
Gulf of Mexico Foundation
Institute for Fisheries Resources
Institute For Sustainable Forestry
National Fish and Wildlife Foundation
North Carolina Coastal Federation
Ocean Trust/National Fisheries Institute
Save the Bay (Narragansett Bay)
The Nature Conservancy
Tampa Bay Watch
Trout Unlimited

ecosystems. <http://ners.noaa.gov/Restoration/welcome.html>

The Coral Reef Conservation Program provides funding and technical assistance to NOAA offices and partner groups to support restoration, monitoring, and research on the effectiveness of coral reef restoration methods. <http://www.coralreef.noaa.gov/>



*“Knowledge of the oceans is more than a matter of curiosity.
Our very survival may hinge upon it.”*

President John F. Kennedy, Jr., March 1961 message to Congress.



U.S. Secretary of Commerce
Carlos M. Gutierrez
Undersecretary of Commerce for Oceans and Atmospheric Administration - NOAA
Conrad C. Lautenbacher, Jr.,
Vice Admiral, U.S. Navy (Retired)

www.noaa.gov

Discover.Your.World@noaa.gov