

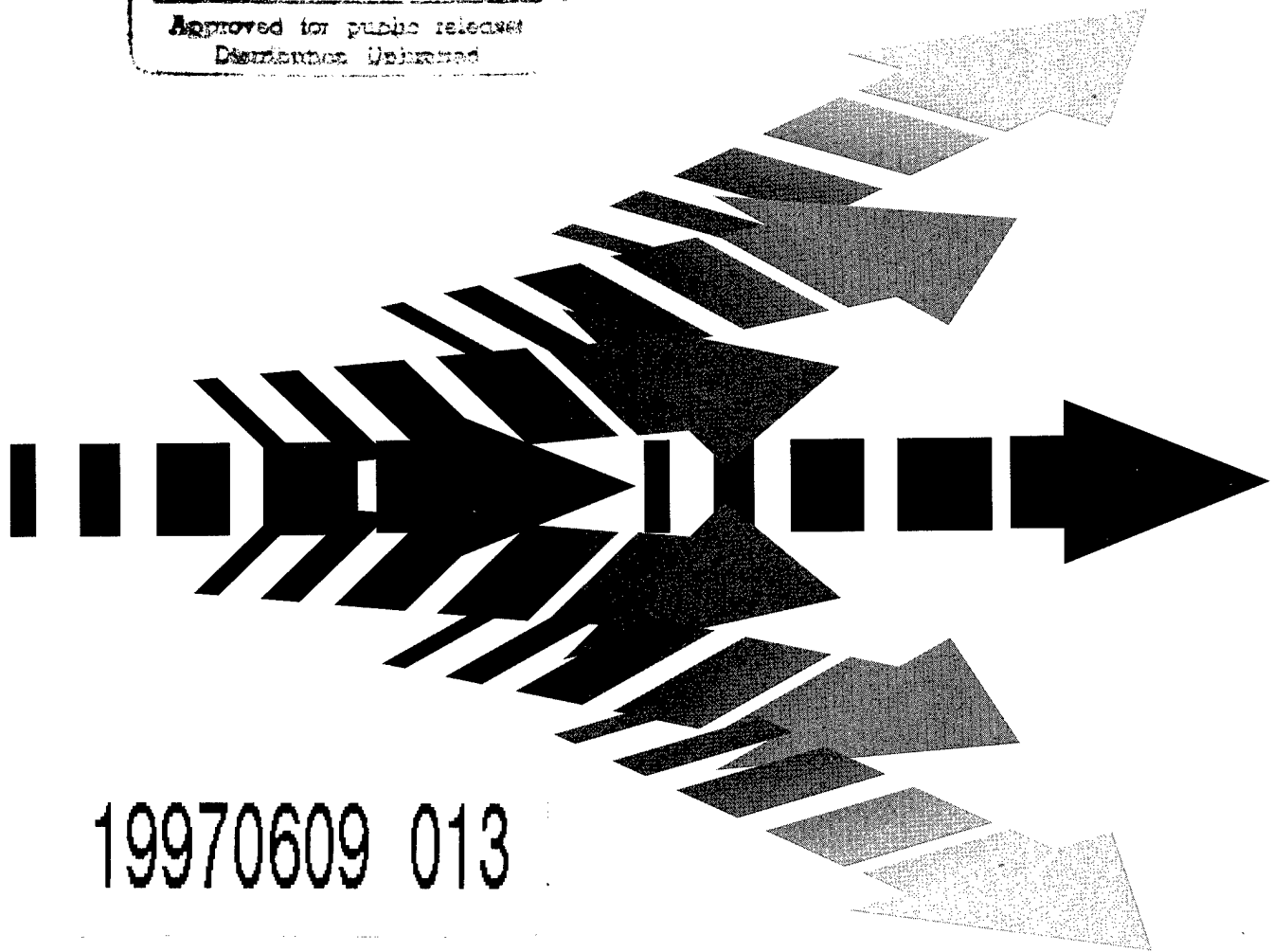


U.S. Army Corps  
of Engineers®

Water Resources Support Center  
Institute for Water Resources

# RISK-BASED EVALUATION OF FLOOD WARNING AND PREPAREDNESS SYSTEMS *Volume 2 - Technical*

Approved for public release  
Distribution Unlimited



19970609 013

FOR QUALITY IMPROVEMENT

---

# RISK-BASED EVALUATION OF FLOOD WARNING AND PREPAREDNESS SYSTEMS

*Volume 2 - Technical*

by

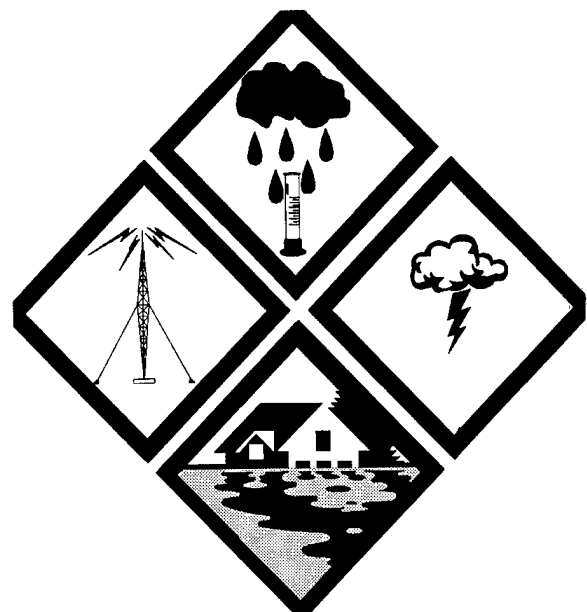
Yacov Y. Haimes, Ph.D., P.E., Project Director

Duan Li, Ph.D.

Vijay Tulsiani, M.S.

James H. Lambert, Ph.D.

Roman Krzysztofowicz, Ph.D., Consultant



---

November 1996

IWR REPORT 96-R-26

DTIC QUALITY INSPECTED 3

## Preface

This report is a product of the U.S. Army Corps of Engineers' Risk Analysis for Water Resources Investments Research Program. The program is managed by the Institute for Water Resources, which is a unit of the Water Resources Support Center. The report was prepared to fulfill part of several work units in the research program. These work units focused on developing and applying the concepts of risk preference and risk communication to water resources issues. The report conforms to the basic planning model and to the risk and uncertainty analysis recommendations presented in *Economic and Environmental Principles and Guidelines for Water Related Land Resources Implementation Studies* (P&G).

The risk analysis framework encompasses the four basic steps in dealing with any risk: characterization, qualification, evaluation, and management. The purpose of conducting these analyses is to provide additional information to both Federal and non-Federal partners on the engineering and economic performance of alternative investments that address water resources problems. The goal is to produce better informed decisions and to foster the development of the idea of rational joint consent by all parties to an investment decision.

This report, entitled *Risk-Based Evaluation of Flood Warning and Preparedness Systems*, represents a synthesis and elaboration of three earlier technical reports<sup>1</sup> to the Institute for Water Resources prepared by Environmental Systems Modeling, Inc. The results presented here have as a unifying theme that design and evaluation of structural and nonstructural measures for flood mitigation, including flood warning and preparedness systems, is an integrative, holistic process that requires an understanding of the contribution each type of measure makes to the performance of the overall system. The models rely on concepts of multiobjective decisionmaking, tradeoff analysis, and the risk of extreme events. This report is divided into OVERVIEW and TECHNICAL sections. Each of the four OVERVIEW sections summarizes in a nontechnical style a methodology developed for the integration of flood warning and preparedness systems into the design and evaluation process. The four methodologies are (1) integration of structural measures and flood warning/preparedness systems, (2) multiobjective decision-tree analysis, (3) performance characteristics of a flood warning system, and (4) selection of optimal flood warning threshold. Each OVERVIEW section describes the main features of the model, case study, or example. The four TECHNICAL sections correspond to the sections of the OVERVIEW and contain the mathematical details that would be needed in an application of the methodologies. In addition to being a consultant for this report, Prof. Roman Krzysztofowicz is the sole author of the TECHNICAL section of Part 3--Performance Characteristics of a Flood Warning System; the OVERVIEW section of Part 3 is excerpted and edited from the same TECHNICAL section. The contribution and description of case-study data in Section 4--Selection of Optimal Flood Warning Threshold--also is adopted from work of Krzysztofowicz.

---

<sup>1</sup>Performance Characteristics of a Flood Warning System and Selection of Optimal Warning Threshold (September 1990); Case Studies in Selecting Optimal Flood Warning Threshold (March 1992); and Integration of Structural Measures and Flood Warning Systems for Flood Damage Reduction (March 1992)

*Risk-Based Evaluation of  
Flood Warning and Preparedness Systems*

---

Mr. Stuart A. Davis, of the Institute for Water Resources' Technical Analysis and research Division, provided technical review for this report. Dr. Eugene Z. Stakhiv, Chief of the Policy and Special Studies Division, and Dr. David A. Moser, of the Technical Analysis and Research Division, reviewed the earlier technical reports on which this report is based. Dr. Moser is the manager of the Risk Analysis for Water Resources Investments Research Program. The Chief of the Technical Analysis and Research Division is Mr. Michael R. Krouse, and the Director of the Institute for Water Resources is Mr. Kyle E. Schilling. Mr. Robert M. Daniel, Chief of the Economics and Social Analysis Branch, Planning Division; Mr. Earl E. Eiker, Chief of the Hydrology and Hydraulics Branch; and Mr. James E. Crews, Deputy Chief, Operations, Construction, and Readiness Division at the Headquarters of the U.S. Army Corps of Engineers served as technical monitors for the research program at the time this report was prepared. Numerous field reviewers provided valuable insights and suggestions to improve early drafts.

## Table of Contents

Preface .....	i
Introduction .....	1
Multiple Objectives .....	1
Impact Analysis .....	1
The Risk of Extreme and Catastrophic Events .....	3
Flood Forecasting and Warning/Preparedness Systems .....	3
Toward Implementation of the Methodologies .....	4
Organization of the Report .....	4
Part 1 - Integration of Structural Measures and Flood Warning Systems .....	7
Introduction .....	7
Description of the Integrated Approach .....	8
Example .....	11
Local Flood Protection at South Fork and South Branch Potomac Rivers at Moorefield, West Virginia .....	11
Development of the four functional relationships for Plan 1 .....	12
Conclusions .....	37
Part 2 - Multiobjective Decision Tree Analysis .....	39
Introduction .....	39
Multiple Objectives .....	39
Impact Analysis .....	39
The Risk of Extreme and Catastrophic Events .....	40
Methodological Approach .....	41
Extension to Multiple Objectives .....	41
Impact of Experimentation .....	44
Example for the Discrete Case .....	45
Extension to Multiple-Risk Measures .....	53
Example Problem for the Continuous Case .....	58
Conclusions .....	65
Part 3 - Performance Characteristics of a Flood Warning System .....	71
Introduction .....	71
System Model .....	71
Structure .....	71
Assumptions .....	72
Monitor .....	72
Forecaster .....	73
Decider .....	74
Performance Measures .....	75

***Risk-Based Evaluation of  
Flood Warning and Preparedness Systems***

---

Performance Probabilities . . . . .	75
Relative Operating Characteristic . . . . .	75
Performance Tradeoff Characteristic . . . . .	77
Expected Lead Time . . . . .	77
Case Study . . . . .	78
General Description . . . . .	78
Input Models and Parameters . . . . .	78
Properties of the ROC and PTC . . . . .	81
Performance Differences Between Zones . . . . .	85
Operating Points . . . . .	85
Performance Tradeoffs . . . . .	86
Closure . . . . .	87
Part 4 - Selection of Optimal Flood Warning Threshold . . . . .	93
Introduction . . . . .	93
Features of the Model . . . . .	93
Description of the Methodology . . . . .	93
Case Studies . . . . .	102
Application to Milton, Pennsylvania . . . . .	102
Input Information for Eldred and Connellsville . . . . .	122
Flood Forecasts for Eldred . . . . .	122
Flood Forecasts for Connellsville . . . . .	122
Limitations of Models . . . . .	123
Flood Damages in Connellsville . . . . .	124
Application to Eldred, Pennsylvania . . . . .	126
Application to Connellsville, Pennsylvania . . . . .	128
GLOSSARY OF SYMBOLS . . . . .	153
REFERENCES . . . . .	161

**List of Figures**

Figure 1-1.	Curves for Relating Flood Frequency, Discharge, Elevation, and Damage . . . . .	9
Figure 1-2.	Discharge vs. Elevation for Plan 1 . . . . .	13
Figure 1-3.	Actual vs. Fitted Curves for Discharge vs. Elevation—Plan 1 . . . . .	14
Figure 1-4.	Frequency vs. Discharge for Plan 1 . . . . .	15
Figure 1-5.	Actual vs. Fitted Curves for Frequency vs. Discharge—Plan 1 . . . . .	16
Figure 1-6.	Frequency vs. Damage for Plan 1 . . . . .	17
Figure 1-7.	Actual vs. Fitted Curves for Frequency vs. Damage—Plan 1 . . . . .	18
Figure 1-8.	Elevation vs. Damage for Plan 1 . . . . .	18
Figure 1-9.	Discharge vs. Floodplain Elevation for Plan 4 . . . . .	20
Figure 1-10.	Comparative Discharge-vs.-Elevation Curves for Plan 1 and Plan 4 . . . . .	20

Figure 1-11.	Actual vs. Fitted Curves for Discharge vs. Elevation—Plan 4	21
Figure 1-12.	Frequency vs. Damage for Plan 4	22
Figure 1-13.	Comparative Frequency vs. Damage Curves for Plan 1 and Plan 4	22
Figure 1-14.	Actual vs. Fitted Curves for Frequency vs. Damage—Plan 4	23
Figure 1-15.	Elevation vs. Damage for Plan 1 with Flood Warning System	25
Figure 1-16.	Comparative Plots of Elevation vs. Damage for Plan 1 With and Without Flood Warning System	25
Figure 1-17.	Frequency vs. Damage for Plan 1 with Flood Warning System	27
Figure 1-18.	Actual vs. Fitted Curves for Frequency vs. Damage—Plan 1 with Flood Warning System	27
Figure 1-19.	Frequency vs. Damage for Plan 4 with Flood Warning System	28
Figure 1-20.	Actual vs. Fitted Curves for Frequency vs. Damage—Plan 4 with Flood Warning System	28
Figure 1-21.	Cost vs. Damage Tradeoff for the Expected Value ( $f_5$ )	35
Figure 1-22.	Cost vs. Conditional Expected Damage ( $f_4$ ) Tradeoff for $\alpha = 0.9$	35
Figure 1-23.	Cost vs. Conditional Expected Damage ( $f_4$ ) Tradeoff for $\alpha = 0.99$	36
Figure 1-24.	Tradeoffs Among Cost, Expected Damage ( $f_5$ ), and Conditional Expected Damage ( $f_4$ ) for the Four Alternatives	36
Figure 2-1.	Structure of Multiobjective Decision Trees	42
Figure 2-2.	Re-Shape of the Feasible Region by an Experimentation	46
Figure 2-3.	Decision Tree for the Discrete Case	47
Figure 2-4.	Averaging out at Chance Node C1 (Discrete Case)	48
Figure 2-5.	Second Stage Tree Corresponding to Chance Node C2 (Discrete Case)	50
Figure 2-6.	Decision Tree for the First Stage (Discrete Case)	54
Figure 2-7.	Pareto Optimal Frontier (Discrete Case)	55
Figure 2-8.	Variance and Region of Extreme Events	59
Figure 2-9.	Decision Tree for the Continuous Case	60
Figure 2-10.	Averaging out Chance Node C1 Using $f_5$ (Continuous Case)	62
Figure 2-11.	Second Stage Corresponding to Chance Node Cw Using $f_5$ (Continuous Case)	63
Figure 2-12.	Decision Tree for the Second Stage Using $f_5$ (Continuous Case)	68
Figure 2-13.	Pareto Optimal Frontier Using $f_5$ (Continuous Case)	69
Figure 3-1.	Functional Structure of a Flood Warning System	72
Figure 3-2.	Tree of Events Leading to One of the Four Performance States of a Flood Warning System	76
Figure 3-3.	Expected Lead Time of a Flood Warning Versus the Elevation of the Floodplain for Three Warning Systems in Milton, Pennsylvania	82
Figure 3-4.	Relative Operating Characteristics (ROC) of Warning System S1 for Four Zone Elevations, Y, in Milton, Pennsylvania.	83
Figure 3-5.	Performance Tradeoff Characteristics (PTC) of Warning System S1 for Four Zone Elevations, Y, in Milton, Pennsylvania.	84
Figure 3-6.	Relative Operating Characteristics (ROC) of Three Warning Systems, S1, S2, and S3 for Zone Elevation $y = 22$ Ft. in Milton, Pennsylvania	88
Figure 3-7.	Performance Tradeoff Characteristics (PTC) of Three Warning Systems, S1, S2, and S3, for Zone Elevation $y = 22$ Ft in Milton, Pennsylvania.	89

***Risk-Based Evaluation of  
Flood Warning and Preparedness Systems***

---

Figure 3-8.	Relative Operating Characteristics (ROC) of Three Warning Systems, S1, S2, and S3, for Zone Elevation $y = 28$ ft in Milton, Pennsylvania . . . . .	90
Figure 3-9.	Performance Tradeoff Characteristics (PTC) of Three Warning Systems, S1, S2, and S3, for Zone Elevation $y = 22$ ft in Milton, Pennsylvania . . . . .	91
Figure 4-1.	Multilevel Structure of Flood Warning System . . . . .	94
Figure 4-2.	Interaction Between Forecast and Response Subsystems . . . . .	97
Figure 4-3.	Decision Logic at Stage T . . . . .	99
Figure 4-4.	Trade-off Between Type I and Type II Errors . . . . .	104
Figure 4-5.	Relationship Between the Expected Flood-loss Reduction and the Warning Threshold for Various Response Fraction and Elevation Levels . . . . .	108
Figure 4-6.	Relationship Between the Optimal Warning Threshold and the Weighting Coefficient for $\alpha = 0.55$ at Stage 4 . . . . .	119
Figure 4-7.	Relationship Between the Optimal Warning Threshold and the Stages for $\alpha = 0.70$ and $\theta = 0.1$ . . . . .	120
Figure 4-8.	Relationship Between the Optimal Warning Threshold and the Response Fraction for $\theta = 0.02$ at Stage 3 . . . . .	121

**List of Tables**

Table 1.	Assumptions, Main Functions, and Limitations of the Four Methodologies . . . . .	2
Table 1-1.	Discharge vs. Elevation for Plan 1 . . . . .	12
Table 1-2.	Frequency vs. Discharge for Plan 1 . . . . .	14
Table 1-3.	Frequency vs. Damage for Plan 1 . . . . .	16
Table 1-4.	Discharge vs. Elevation for Plan 4 . . . . .	19
Table 1-5.	Summary of Results: Tradeoffs Among Cost, Expected Damage ( $f_3$ ), and Risk of Extreme Events ( $f_4$ ) for the Four Alternatives . . . . .	34
Table 2-1.	Expected Value of Loss Vectors for the Second-Period Decision Arcs (Discrete Case) . . . . .	52
Table 2-2.	Noninferior Decisions for the Second-Period Decision Nodes (Discrete Case) . . . . .	52
Table 2-3.	Decisions for the First-Period Decision Node (Discrete Case) . . . . .	56
Table 2-4.	Loss Vectors for the Second-period Decision Arcs (Continuous Case) . . . . .	64
Table 2-5.	Noninferior Decisions for the Second-period Decision Nodes (Continuous Case) . . . . .	64
Table 2-6.	Decisions for the First-period Node Using $f_3$ (Continuous Case) . . . . .	66
Table 2-7.	Decisions for the First-period Decision Node Using $f_4$ (Continuous Case) . . . . .	67
Table 3-1.	Parameters of Three Alternative Designs of a Flood Warning System for Milton, Pennsylvania . . . . .	80
Table 3-2.	Expected Number of Zone Floods and Expected Lead Times of Flood Warnings for Milton, Pennsylvania . . . . .	80
Table 3-3.	Coordinates of Operating Points on the ROC and PTC Curves That Give the Same Probability of False Warning $P(f)$ for Each Zone Elevation; System Design S1 for Milton, Pennsylvania . . . . .	86
Table 3-4.	Coordinates of Three Alternative Points on the ROC and PTC Curves for Zone Elevation $y = 22$ ft . . . . .	91

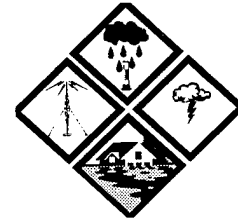


*Risk-Based Evaluation of  
Flood Warning and Preparedness Systems*

---

Table 4-1.	Probabilistic Measures of the Warning System . . . . .	103
Table 4-2.	Expected Flood-loss Reduction . . . . .	110
Table 4-3a.	Optimal Flood Warning Thresholds . . . . .	111
Table 4-4.	Discretization of the Floodplain in Connellsville, Pennsylvania . . . . .	124
Table 4-5.	Categories of Structures . . . . .	125
Table 4-6.	Distribution $\{\eta(mr)\}$ Partitioning the Maximum Possible Damage MD among Location Steps $m$ and Structural Categories $r$ in Connellsville, Pennsylvania . . . . .	125
Table 4-7.	Coefficients of the Unit Damage Functions $\delta_r(z)$ for Structural Categories $r$ Specified by a Polynomial . . . . .	127
Table 4-8.	Probabilistic Measures of the Warning System (Eldred, Pennsylvania) . . . . .	129
Table 4-9.	Expected Flood-loss Reduction . . . . .	131
Table 4-10.	Optimal Flood Warning Threshold (Eldred, Pennsylvania) . . . . .	132
Table 4-11.	Probabilistic Measures of the Warning System (Connellsville, Pennsylvania) . . . . .	142
Table 4-12.	Expected Flood-loss Reduction with Full Response (Connellsville, Pennsylvania) . . . . .	144
Table 4-13.	Optimal Flood Warning Thresholds (Connellsville, Pennsylvania, with a Dam) . . . . .	145

## Introduction



Each of the four methodologies developed in this report contributes an important dimension to risk-based evaluation of systems for flood damage reduction -- which is incomplete without accounting for both structural and nonstructural measures. The unifying theme of these results is that the design and evaluation of structural and nonstructural measures for flood mitigation, including flood warning and preparedness systems, is an integrative, holistic process that eventually must build on an understanding of the contribution of each type of measure to the performance of the overall system. Furthermore, the design of flood mitigation is tied to multiple objectives of minimizing cost and risk and maximizing performance. Consideration of the risk of extreme events is an essential element in the evaluation of design tradeoffs.

The four methodologies developed here for the modeling and evaluation of flood warning and preparedness systems are:

- (1) Integration of structural measures and flood warning/preparedness systems,
- (2) Multiobjective decision-tree analysis,
- (3) Performance characteristics of a flood warning system, and
- (4) Selection of optimal flood warning threshold.

The assumptions, main functions, and limitations of the four methodologies are summarized in Table 1.

### Multiple Objectives

The single-objective models that had been advanced in the fifties, sixties, and seventies are today considered by many to be unrealistic, too restrictive, and often inadequate for most real-world complex problems. The proliferation of books, articles, and conferences during the last decade or two on what has come to be known as multiple-criteria decisionmaking (MCDM) is a vivid indication of this somber realization and of the maturation of the field of decisionmaking [see Chankong and Haimes 1983]. In particular, an optimum derived from a single-objective mathematical model, including that which is derived from a decision tree, often may be far from representing reality -- thereby misleading the analyst(s) as well as decisionmaker(s). Fundamentally, most complex problems involve, among other things, the minimization of costs, the maximization of benefits (not necessarily in monetary values), and the minimization of risks of various kinds. For example, decision trees, which are a powerful mechanism for the analysis of complex problems, can better serve both the analysts and the decisionmakers when they are extended to deal with the above multiple objectives.

### Impact Analysis

On a long-term basis, managers and other decisionmakers are often rewarded not because they have made many optimal decisions in their tenure; rather, they are honored and thanked for avoiding adverse and

***Risk-Based Evaluation of  
Flood Warning and Preparedness Systems***

**Table 1. Assumptions, Main Functions, and Limitations of the Four Methodologies**

	<b>Assumptions</b>	<b>Main Functions</b>	<b>Limitations</b>
<b><i>Integration of structural measures and flood warning/preparedness systems</i></b>	Knowledge of flood frequency, discharge, stage, and damage relationships for various combinations of structural and flood warning/preparedness systems.	Determine the optimal design options from among alternative combinations of structural and flood warning/preparedness measures in a multiobjective framework, including cost, the expected flood loss, and risk of extreme floods .	No operational issues associated with warning/preparedness systems and structural measures are considered.
<b><i>Multiobjective decision-tree analysis</i></b>	Knowledge of the probabilities for the underlying distributions of water level. Knowledge of severity of loss with alternative decisions at various time stages.	Determine the optimal sequential decisions in an individual flood event based on the observation of water stage.	No flood forecast is taken into consideration.
<b><i>Performance characteristics of a flood warning system</i></b>	Knowledge of the joint probability description of flood forecast and actual flood crest.	Provide an evaluation model of the performance of a flood forecast system. In particular, the ROC curve characterizes the tradeoff between the probabilities of detection and false warning.	Interactions between successive flood events through the dynamics of the community response fraction are not taken into account.
<b><i>Selection of optimal flood warning threshold</i></b>	Knowledge of the joint probability description of flood forecast and actual flood crest. Knowledge of the loss to the community associated with flood stage. Knowledge of the dynamics of the community response fraction.	Find the optimal threshold level at which to issue a flood warning in order to balance the desire for high present-flood-loss reduction with the possibility of high future flood loss being inevitable.	The derived optimal threshold may not be stationary; i.e., the optimal threshold may vary in different flood events even if the community response fraction is the same.

catastrophic consequences. If one accepts this premise, then the role of impact analysis -- studying and investigating the consequences of present decisions on future policy options -- might be as important, if not actually more so, than generating an optimum for a single-objective model or identifying a Pareto-optimum set (a *Pareto-optimum*, or non-inferior, alternative cannot be improved in any one objective without seeing a corresponding loss with respect to one or more other objectives) for a multiobjective model. Certainly, when the ability to generate both is present, having an appropriate Pareto-optimum set and knowing the impact of each Pareto-optimum on future policy options should enhance the overall decisionmaking process.

### **The Risk of Extreme and Catastrophic Events**

Risk, which is a measure of the probability and severity of adverse effects, has until recently been commonly quantified via the expected-value formula. This formula essentially precommensurates events of low frequency and high damage with events of high frequency and low damage. Although learned students of risk analysis recognize the disparity between the above fallacious representation of extreme and catastrophic events and the perception of these events by individuals or the public at large, many continue to use this approach. The trend, however, is moving toward the conditional-expected-value approach, where extreme and catastrophic events are partitioned, isolated, quantified in terms of conditional expectation (e.g., using concepts from the statistics of extremes), and then evaluated along with the common expected value of risk or damage [Asbeck and Haines 1984; Haines 1988; Karlsson and Haines 1988].

The partitioned multiobjective risk method (PMRM) developed by Asbeck and Haines [1984] separates extreme events from other noncatastrophic events, and thus provides the decisionmaker(s) with additional valuable and useful information. In addition to using the traditional expected value, the PMRM generates a number of conditional expected-value functions, termed here risk functions, which represent the risk, given that the damage falls within specific probability ranges (or damage ranges).

Combining either a conditional expected risk function or the unconditional expected risk function with the cost objective function creates a set of multiobjective optimization problems in which the tradeoffs between cost and the risk arising from the various ranges of damage are analyzed. This formulation offers more information about the probabilistic behavior of the problem than the single multiobjective formulation that minimizes only the cost and the expected damage. The tradeoffs between the cost function and any risk function allow decisionmakers to consider the marginal cost of a small reduction in the risk objective, given a particular level of risk assurance for each of the partitioned risk regions, and given the unconditional risk function.

### **Flood Forecasting and Warning/Preparedness Systems**

Flood damage reduction can be provided by either structural or nonstructural measures or a combination of both. Structural flood damage reduction measures, such as an increase in dam height, affect the flood-frequency relationship. Nonstructural measures, such as a flood warning/preparedness system, do not have an impact on the flood-frequency relationship; however, they modify the flood-damage relationship.

The benefits of flood forecasts have been studied and systems approaches to flood forecasting have been pursued by many research scholars for more than twenty years [NACOA 1972; Bhavnagri and

## ***Risk-Based Evaluation of Flood Warning and Preparedness Systems***

---

Bugliarello 1965; Bock and Hendrick 1966; Day and Lee 1976; Lee et al. 1975; Sniedovich et al. 1974; Sniedovich and Davis 1977]. Curtis and Schaake [1988] evaluated flood warning benefits both on a national (or regional) scale and on a specific site problem. Prediction models for loss of life from floods were studied by Lee et al. [1986] and Shabman [1987]. Barrett et al. [1988] developed categories for flood warning systems based on types of flood forecasting systems and flood response systems.

Predicting the future behavior of a time-dependent random variable is a major research task in the theory and applications of stochastic processes. Critical events occur when the level of the random variable crosses a given high level (e.g., flooding level). An alarm is set off when the random variable exceeds a specified threshold level. An alarm system is considered optimal if it detects catastrophes with an acceptable level of probability and at the same time yields a minimum expected number of false alarms [Lindgren 1979, 1980, 1985; de Maré 1980]. The paper by de Maré [1980] indicates that when judging the performance of an alarm system, it is not very interesting to know, in the mean, how close the prediction is to the actual process; however, it is important for a system to be able to detect catastrophes without causing too many false alarms.

In a series of papers, Krzysztofowicz and his colleagues [Alexandridis and Krzysztofowicz 1985; Ferrell and Krzysztofowicz 1983; Krzysztofowicz 1983a, b; 1985; Krzysztofowicz and Davis 1983a, b, c, d; 1984] conceptualized the flood forecast-response process in the form of a total system. This system is defined as a cascade coupling of two components: (1) the forecasting system, which includes data collection, flood forecasting, and forecast dissemination; and (2) the response system, which encompasses decisionmaking and action implementation. Based on the above mathematical description of the physical flood forecast-response process, Krzysztofowicz and his colleagues establish performance measures of flood warning systems.

Paté-Cornell [1986] presents a method for assessing the performance of the forecasting system and human response, given the memory that people have kept on the quality of previous alerts. The tradeoff between the rate of false alerts and the length of the lead time is studied to account for the long-term effects of "crying wolf." An explicit formulation of benefits from warning systems is derived under the above considerations.

### **Toward Implementation of the Methodologies**

An immediate and most worthwhile challenge is the refinement of the four methodologies of this report for the operational setting. For instance, a decision support system for the risk-based evaluation of flood warning systems might be developed to integrate these methodologies in a framework consistent with Corps of Engineers planning procedures [HEC 1988].

### **Organization of the Report**

The body of this report has two major types of subdivisions: the OVERVIEW and the TECHNICAL sections. Each of the four sections subtitled OVERVIEW summarizes in a nontechnical style a methodology developed for the integration of flood warning systems into the design and evaluation process. Each OVERVIEW section describes the main features of the model, case study, or example. The four TECHNICAL sections correspond to the sections of the OVERVIEW and contain the mathematical details

*Risk-Based Evaluation of  
Flood Warning and Preparedness Systems*

---

that would be needed in an application of the methodologies. The OVERVIEW's present an excerpted group of the figures and tables used in the TECHNICAL sections.

## **Part 1**

# **Integration of Structural Measures And Flood Warning Systems: Technical**



### **Introduction**

In most cases, the maximum flood loss reduction can be only achieved through an optimal combination of both structural and nonstructural flood damage reduction measures, since the adoption of integrated measures will certainly enlarge the feasible region of flood damage reduction measures when compared with situations where only structural or nonstructural measures alone are considered. Structural measures include the construction of reservoirs, levees, and flood walls. Nonstructural measures include floodplain land use planning, flood insurance, flood warning systems, floodproofing, and permanent relocation. Various flood damage reduction measures prevent inundation of the floodplain in different ways and have different impacts on the flood damage-frequency relationship. A structural measure, such as an increase in reservoir height, affects the frequency-discharge relationship; levees and flood walls confine the discharge within certain channels, thus changing the relationship between discharge and elevation; most nonstructural measures, such as a flood warning system, modify the stage-damage relationship.

The idea of combining both structural and nonstructural measures in flood damage reduction is not new. Various research results have been reported that combine structural measures with nonstructural measures, such as zoning, floodproofing, and flood insurance. Readers can refer to Thampapillai and Musgrave [1985], which provides a comprehensive survey in reviewing integrated structural and nonstructural measures in flood damage mitigation. To date, however, no other research work on combining structural measures with flood warning systems has appeared in the literature.

Issues of both design and operation are involved in structural measures as well as nonstructural ones. Building a reservoir is a structural measure in flood damage reduction. Determination of the height of the reservoir is a design issue, while determination of the amount of the release on a monthly or daily basis is an operational issue. Installing a flood warning system is a nonstructural measure in flood damage reduction. Determination of an acceptable reliability of a warning system is a design issue with a consideration of the system cost, while determination of the flood warning threshold for various flood events is an operational issue. It is important to note that operational issues can only be addressed in a framework of dynamic optimization. For example, different levels of flood warning thresholds will cause different probabilities of missed forecast and false alarm, thus affecting the fraction of the community's future response. In this part, we consider only the design options for both structural measures and flood warning systems; thus, building on and extending the existing methodology of computing flood loss for a given structural measure developed by the Army Corps of Engineers to incorporate flood warning systems.

For the computation of flood loss for a given flood-control structural measure, a widely-used procedure developed by the Army Corps of Engineers investigates the relationships between discharge vs. frequency, discharge vs. elevation, and damage vs. elevation, such that the damage-frequency curve can be generated for an average annual flood loss. An integration approach has been developed in this report to

## ***Risk-Based Evaluation of Flood Warning and Preparedness Systems***

---

combine the calculation of flood loss reduction through flood warning systems with the calculation of flood loss for a given flood-control structure, thus facilitating the evaluation of combined structural measures and flood warning systems in reducing flood loss. This new concept is demonstrated in an example problem.

### **Description of the Integrated Approach**

In the procedure for computing flood damage that has been developed by the Army Corps of Engineers, four functional relationships (or curves -- Fig.1-1) are needed to completely quantify each alternative of structural measures:

- 1) curve of frequency vs. discharge,
- 2) curve of elevation vs. discharge,
- 3) curve of elevation vs. damage, and
- 4) curve of frequency vs. damage.

Note here that the fourth curve can be derived if the other three are known. In general, the relationships of frequency vs. discharge, elevation vs. discharge, and damage vs. elevation are constructed from real data such that the curve of frequency vs. damage can be derived in order to compare the expected flood damage for structural measures.

The approach of discrete enumeration of all possible combinations of both structural and nonstructural measures is adopted in our development. Assume that there are  $N$  feasible alternatives of structural measures and  $M$  feasible designs of flood warning systems. Therefore, there are  $(N + 1)(M + 1)$  combinations of flood damage reduction alternatives, and this includes one do-nothing option,  $N$  options involving only structural measures,  $M$  options involving only flood warning systems, and  $NM$  options involving a combination of both a structural measure and a flood warning system.

In this part we subscribe to a premise that the introduction of a flood warning system will not affect the relationships between the frequency and discharge and between the elevation and discharge. It will, however, alter the curve of elevation vs. damage, thus changing the relationship between frequency and damage.

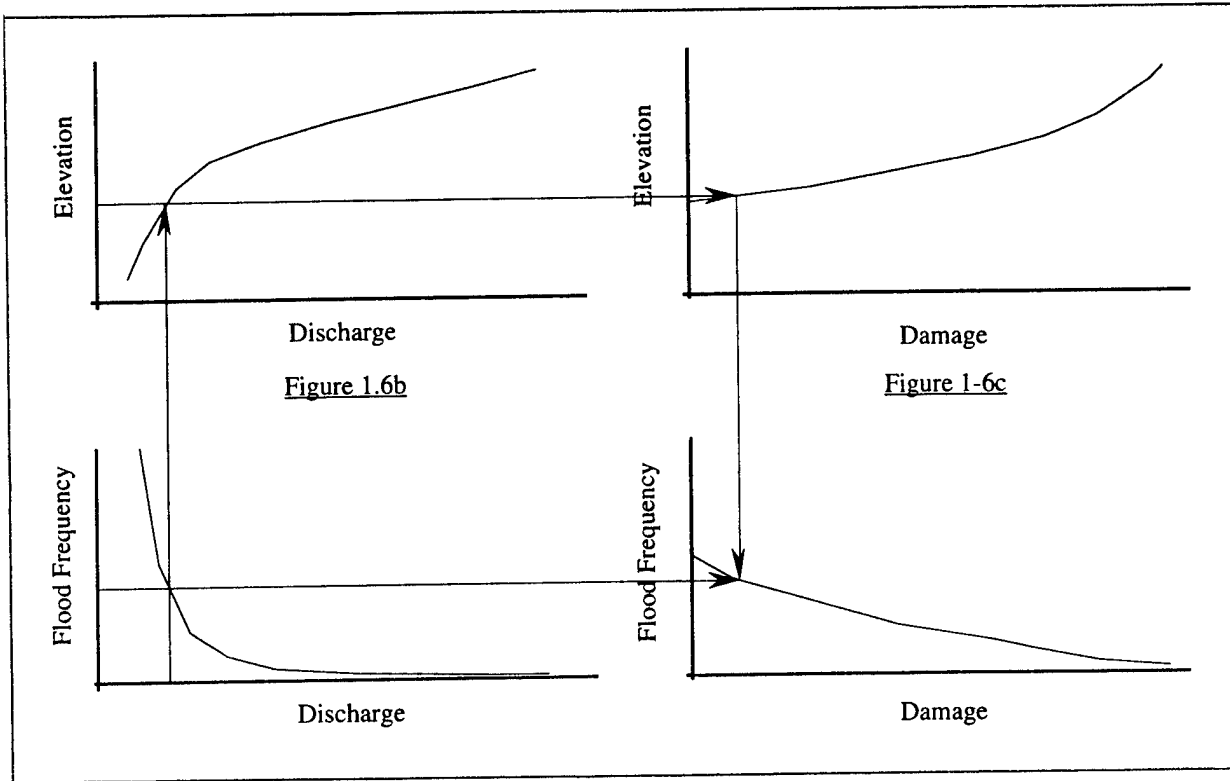
To evaluate the flood loss reduction by installing a flood warning system, the concept of category-unit loss function detailed by Krzysztofowicz and Davis [1983] is adopted. The main modification is that the notation  $\theta$ , which was originally used in Krzysztofowicz and Davis [1983] as the response degree of an individual, is used in this study to represent the fraction of people in a community who respond to flood warnings.

The cost function of evacuation,  $C_E$ , is assumed to be a linear function of the response fraction

$$C_E = MC \theta \tag{1.1}$$

where  $MC$  is the maximum evacuation cost for the community when a full response is present.





**Figure 1-1.** Curves for Relating Flood Frequency, Discharge, Elevation, and Damage

Assume that the elevation of the floodplain zone under consideration is  $y$  and the flood stage is  $h$ . The flood loss function without a warning system is essentially given by the curve of elevation vs. damage (Figure 1-1c) for each given structural measure. Alternatively, the flood loss function without a warning system  $L_{w_0}$  can be expressed by

$$L_{w_0} = MD \delta(h - y) \quad (1.2)$$

where  $MD$  is the maximum possible damage of the community due to a flood of the highest magnitude and  $\delta(h - y)$  is the unit damage function specifying the fraction of  $MD$  which occurs when the depth of flooding is  $(h - y)$ .

The flood loss with a warning system  $L_w$  is assumed to be of the following form:

$$L_w = MC \theta + MD[1 - \theta MR(h - y)]\delta(h - y) \quad (1.3)$$

where  $MR(h - y)$  is the unit reduction function specifying the reduction of the maximum flood loss  $MD$  when the depth of flooding is  $(h - y)$  and full response of the community is made, i.e.,  $\theta = 1$ .

## ***Risk-Based Evaluation of Flood Warning and Preparedness Systems***

---

In summary, the flood loss reduction,  $L_{RD}$ , can be expressed as the difference between  $L_{w0}$  and  $L_{w1}$

$$L_{RD} = \theta MD MR(h - y)\delta(h - y) - MC \theta \quad (1.4)$$

The value of the maximum flood loss for a community, MD, and the functional form of the unit damage function can be obtained from the curve of elevation vs. damage when structural measures are evaluated. The only additional information required to calculate the relationship of elevation vs. flood loss reduction through a flood warning system is the value of maximum evacuation cost, MC, the value of response fraction in the community,  $\theta$ , and the unit reduction function,  $MR(h - y)$ . The resulted curve of elevation vs. flood loss reduction can be viewed as a function parametrized by the response fraction  $\theta$ . We should note, however, that the flood loss reduction  $L_{RD}$  is a linear function of the response fraction  $\theta$ .

Reducing the value of damage in the curve of damage vs. elevation for each structural measure by  $L_{RD}(h;\theta)$  for each given value of elevation  $h$  yields a new relationship between elevation and damage when a flood warning system is introduced. Setting  $\theta$  equal to one yields a maximum achievement of flood loss reduction. Combining this new curve of elevation vs. damage with the other two curves of frequency vs. discharge and elevation vs. discharge provides us with a new relationship between frequency and damage for a combined structural measure and a flood warning system.

A recent report by Jack Faucett Associates [1990] provides procedures for calculating the cost and benefits of flood warning systems, which is useful in determining the unit reduction function  $MR(h - y)$  and in evaluating the tradeoff between the cost and the flood loss.

Although the relationship of damage vs. frequency provides the most complete evaluation for each flood damage reduction alternative, it is necessary to compress information to generate a risk measure when various flood damage reduction alternatives are compared. The most commonly used risk measure is the expected value of the flood loss. Although the expected-value approach indicates the central tendency of flood damage of each flood damage reduction alternative, it fails to separate the extreme catastrophic flood events from the rest. The partitioned multiobjective risk method (PMRM) [Asbeck and Haines 1984] adopts the concept of conditional expectation, which enables us to isolate, quantify, and evaluate the impact of each flood damage reduction alternative on extreme catastrophic flood events.

Multiobjective analysis will be performed in this study to evaluate the various flood damage reduction alternatives. There are three objective functions. In consistency with the notations used in PMRM [Asbeck and Haines 1984], for each flood damage reduction alternative we use  $f_1$  to denote the cost,  $f_2$  the expected damage, and  $f_4(\alpha)$  the conditional expectation of extreme floods whose return periods are greater than  $\frac{1}{1-\alpha}$ . Both  $f_2$  and  $f_4(\alpha)$  can be derived from the curve of damage vs. frequency for each flood damage reduction alternative:

$$f_2 = \text{mean of } \{L\} \quad (1.5)$$

and

$$f_4(\alpha) = \text{mean of } \{L \mid \text{return period of } L \geq \frac{1}{1-\alpha}\} \quad (1.6)$$

A flood damage reduction option may have different impacts on the expected flood loss and the expected

flood loss with floods whose return period exceed certain threshold level. This framework will provide more decision aids to determine the optimal flood damage reduction strategy. The added tradeoff information between the cost and the expected extreme flood loss will explicitly address public concerns about catastrophic flood loss.

## **Example**

This section develops an example to illustrate the integrated approach developed in Section II. The following four studies performed for or by the Corps of Engineers provided the basic data for this example problem:

- 1) Allegheny River and Eldred Brook, McKean County, Pennsylvania, 1977
- 2) Youghiogheny River at Connellsville, Pennsylvania—three reports, 1979, 1980, and 1985
- 3) South Branch Potomac River at Petersburg, West Virginia, 1990
- 4) South Fork and South Branch Potomac Rivers at Moorefield, West Virginia, 1990

After reviewing these four sets of documents, the study undertaken for the South Fork and South Branch Potomac Rivers at Moorefield, West Virginia, in 1990 was selected as the basis for the development of the example.

### Local Flood Protection at South Fork and South Branch Potomac Rivers at Moorefield, West Virginia

The documents provided for this study were a reconnaissance report dated September 1987 and an Integrated Feasibility Report and Environmental Impact Statement dated March 1990. The latter consists of a main report and 13 appendices [U.S. Army Corps of Engineers 1990].

The following extracts from the main report [U.S. Army Corps of Engineers 1990] provide some background for this example:

The town of Moorefield in Hardy County, West Virginia, is subject to flooding from the South Fork and South Branch Potomac River. Serious floods have occurred in March 1936, June 1949, and November 1985 .....

In response to the flooding problem, the Corps of Engineers and the Interstate Commission on the Potomac River Basin initiated a cost-shared feasibility study in February 1988 to identify and evaluate possible solutions .....

A range of possible structural and nonstructural measures was examined. These measures included levees, floodwalls, channel improvements, bridge modification, and nonstructural alternatives. The most effective measures were combined into plans for comparison to the without project condition .....

## ***Risk-Based Evaluation of Flood Warning and Preparedness Systems***

---

In the example developed in the following sections, two given structures of flood damage reduction will be investigated. Plan 1 is the zero-cost plan, that is, the without-project-condition alternative. Plan 4 is a structural plan and includes levees and floodwalls to protect residential areas, industrial plants, businesses, schools, and commercial areas in both North and South Moorefield. A detailed description of this plan is provided on page 67 of the main report [U.S. Army Corps of Engineers 1990].

### **Development of the four functional relationships for Plan 1**

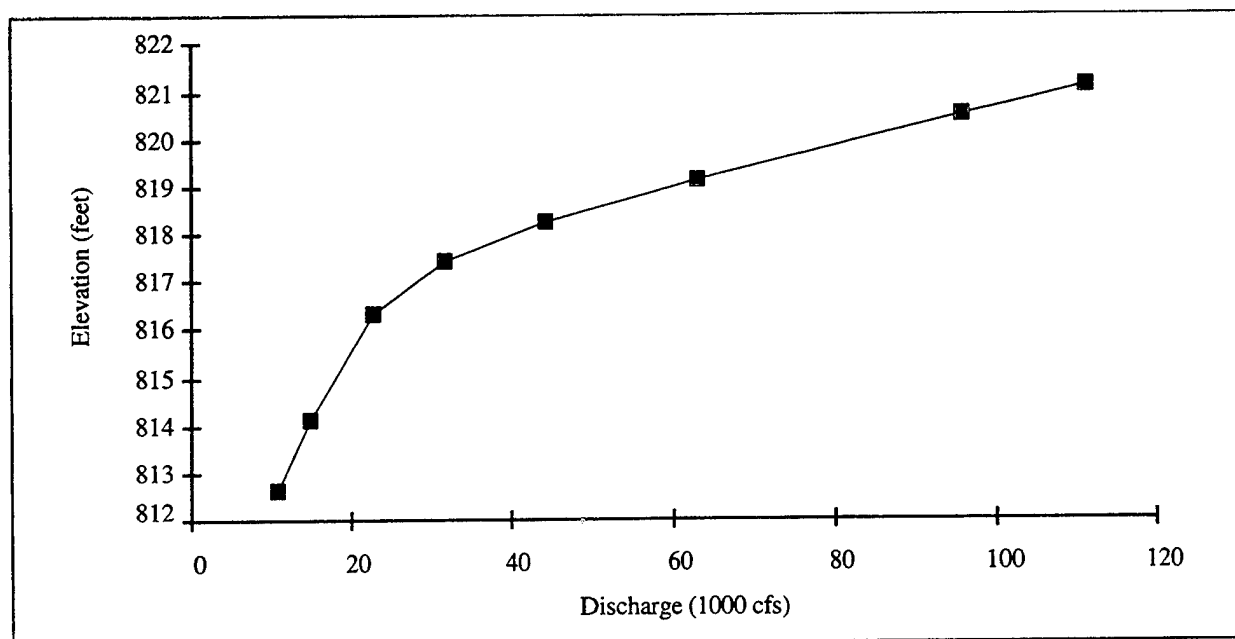
For plan 1, three of the four functional relationships were available from data provided either in the main report or in the appendices. The process for development of the functional relationship was to take the original data and perform a regression analysis in order to obtain the functional relationship. This process was carried out for all the three curves for which the data were available. The fourth relationship was obtained by use of the other three relationships.

#### *Discharge versus Elevation*

The data for this curve were extracted from Plate A17 in Appendix B [U.S. Army 1990]. The data thus obtained are shown in Table 1-1 and the corresponding plot is shown in Figure 1-2.

**Table 1-1.** Discharge vs. Elevation for Plan 1

Discharge (1000 cfs)	Elevation (feet)
10.7	812.6
15.0	814.1
23.0	816.3
31.7	817.4
44.3	818.2
63.3	819.1
96.0	820.5
111.0	821.1



**Figure 1-2** Discharge vs. Elevation for Plan 1

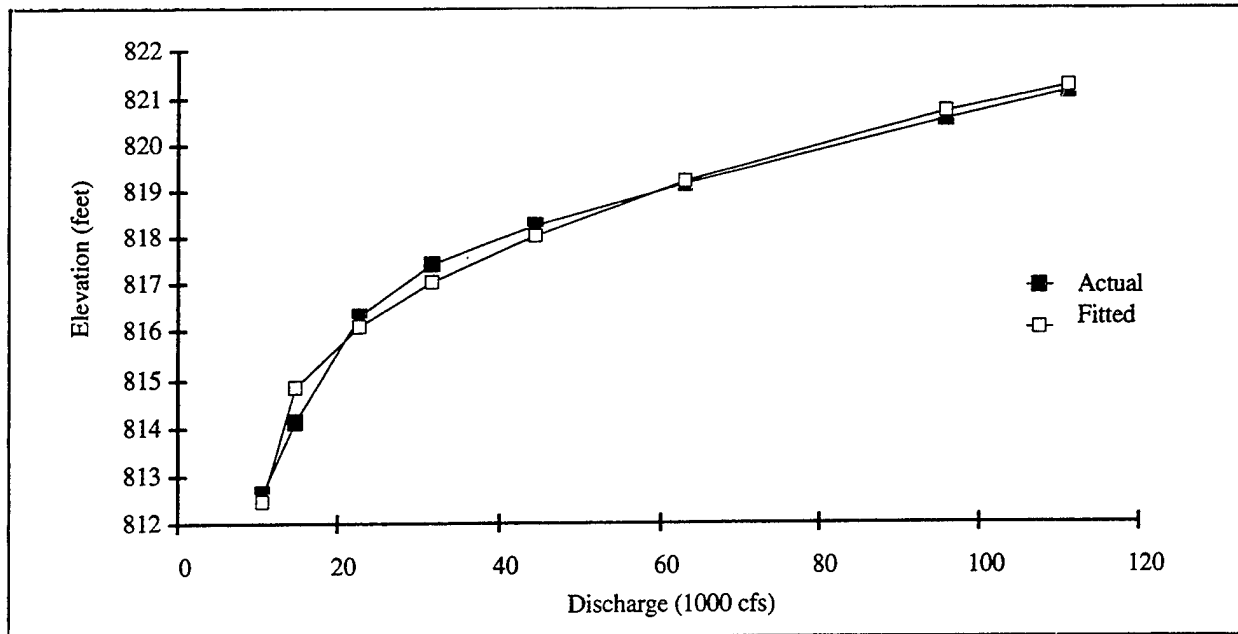
Based on this data, a regression analysis was performed and the following functional relationship was obtained:

$$E = 1.28767 \left( \frac{D}{1000} - 10.7 \right)^{0.41567} - 0.15423 + 812.6 \quad (1.7)$$

where E is the flood elevation in feet, and D is the discharge in cfs. Figure 1-3 shows the comparative plots of the actual vs. fitted curves, indicating that the derived functional relationship is an adequate model of the actual system.

#### *Frequency versus Discharge*

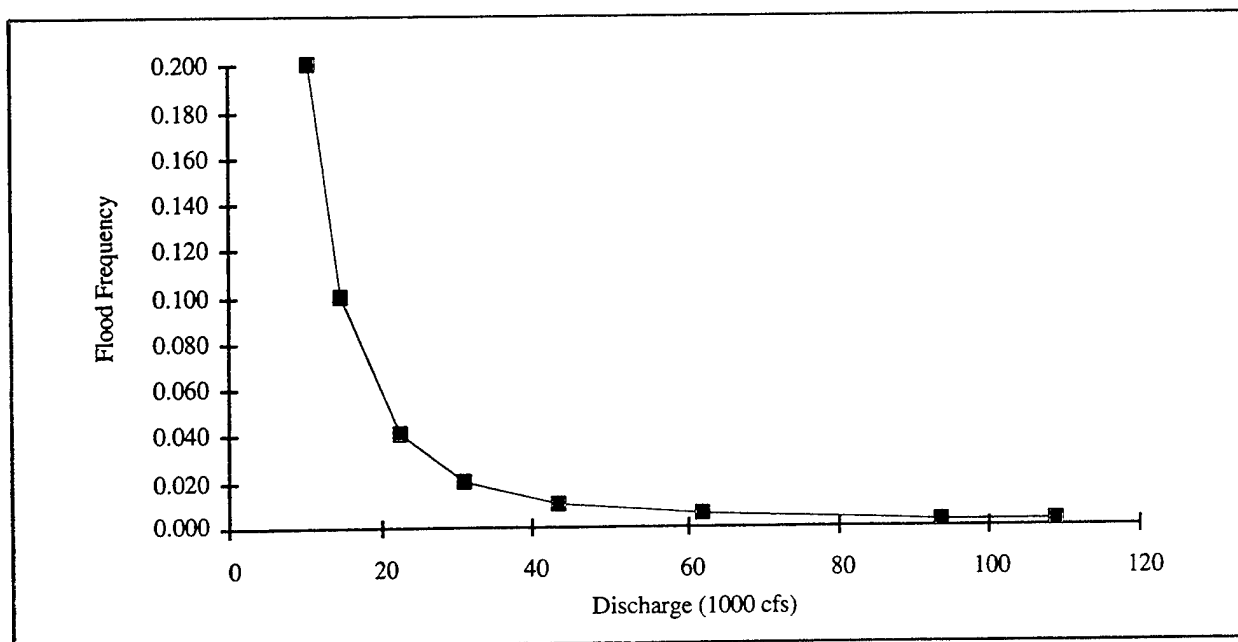
The data for this curve were obtained from Appendix B of the main report [Table 1, page 9, U.S Army 1990]. The data thus obtained are shown in Table 1-2 and the corresponding plot is shown in Figure 1-4.



**Figure 1-3.** Actual vs. Fitted Curves for Discharge vs. Elevation—Plan 1

**Table 1-2.** Frequency vs. Discharge for Plan 1

Discharge (1000 cfs)	Flood Frequency
10.5	0.200
14.6	0.100
22.6	0.040
31.2	0.020
43.5	0.010
62.0	0.005
94.0	0.003
109.0	0.002



**Figure 1-4.** Frequency vs. Discharge for Plan 1

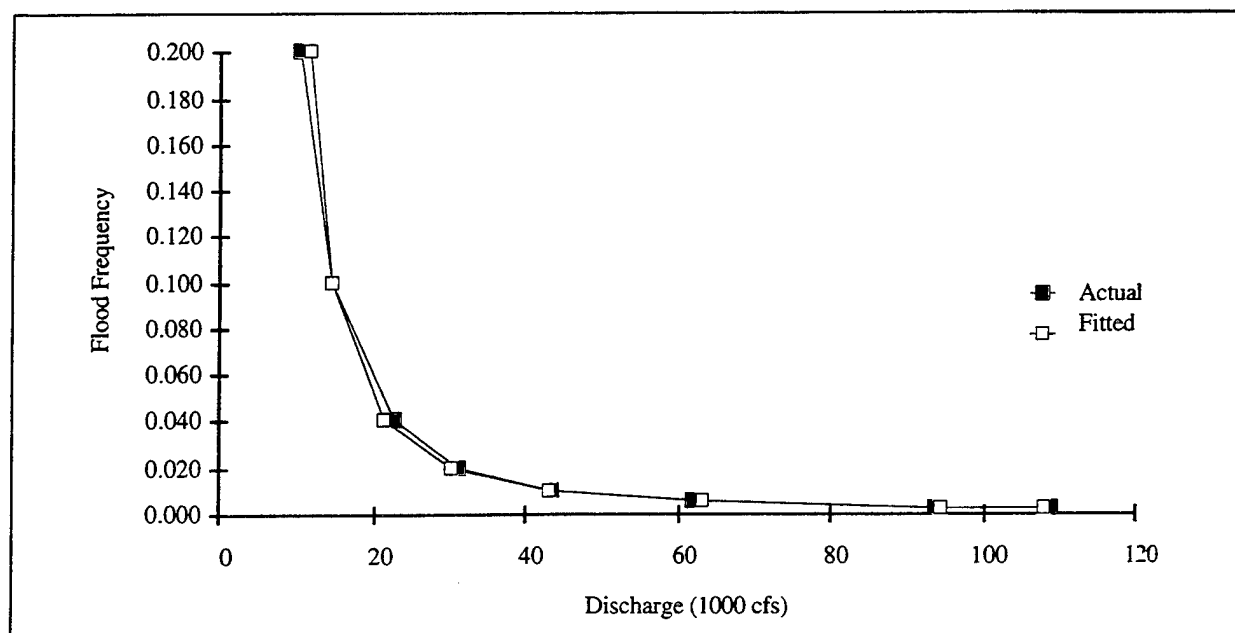
Based on this data, a regression analysis was performed and the following functional relationship was obtained:

$$D = 10^6 \left[ 0.00211 \left( \frac{1}{F} \right)^{0.62411} + 0.00582 \right] \quad (1.8)$$

where  $D$  is the discharge in cfs, and  $F$  is the flood frequency. Figure 1-5 shows the comparative plots of the actual vs. fitted curves, indicating that the derived functional relationship is an adequate model of the actual system.

#### *Frequency versus Damage*

The data for this curve were obtained from Appendix I of the main report [Table I-23, page I-35, U.S. Army Corps of Engineers 1990]. The data thus obtained are shown in Table 1-3 and the corresponding plot is shown in Figure 1-6.

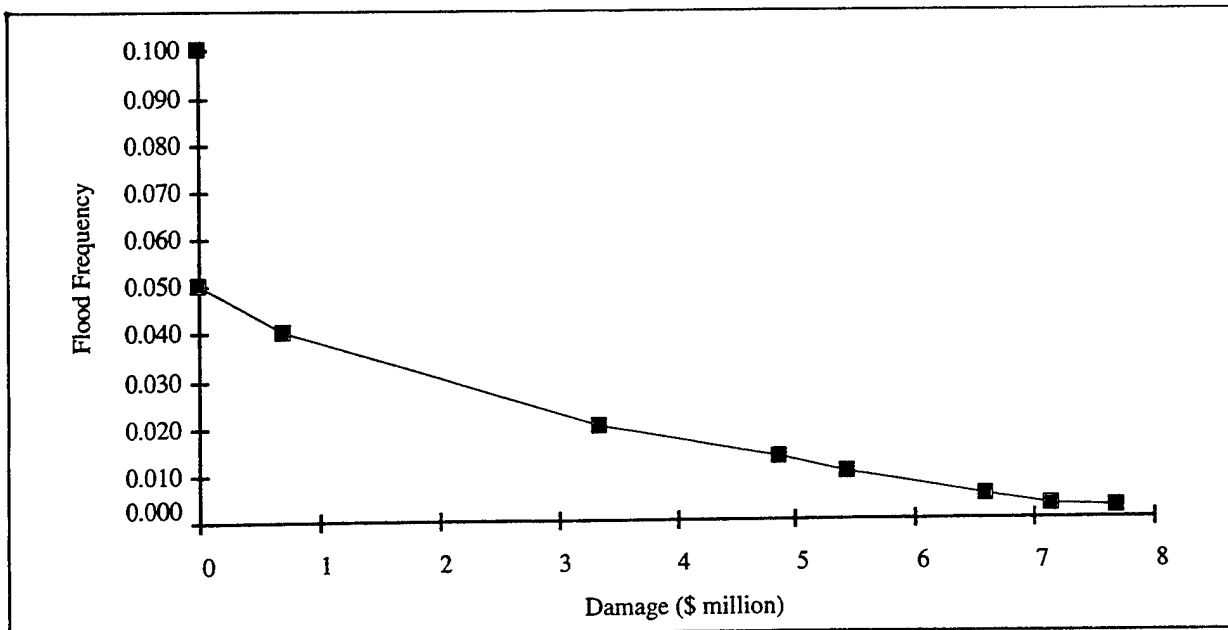


**Figure 1-5.** Actual vs. Fitted Curves for Frequency vs. Discharge—Plan 1

**Table 1-3.** Frequency vs. Damage for Plan 1

Damage (\$ million)	Flood Frequency
0.000	0.100
0.000	0.050
0.712	0.040
3.354	0.020
4.864	0.013
5.430	0.010
6.601	0.005
7.141	0.003
7.682	0.002





**Figure 1-6.** Frequency vs. Damage for Plan 1

Based on this data, a regression analysis was performed and the following functional relationship was obtained.

$$L = -56.65856 (F)^{0.59494} + 9.02988 \quad (1.9)$$

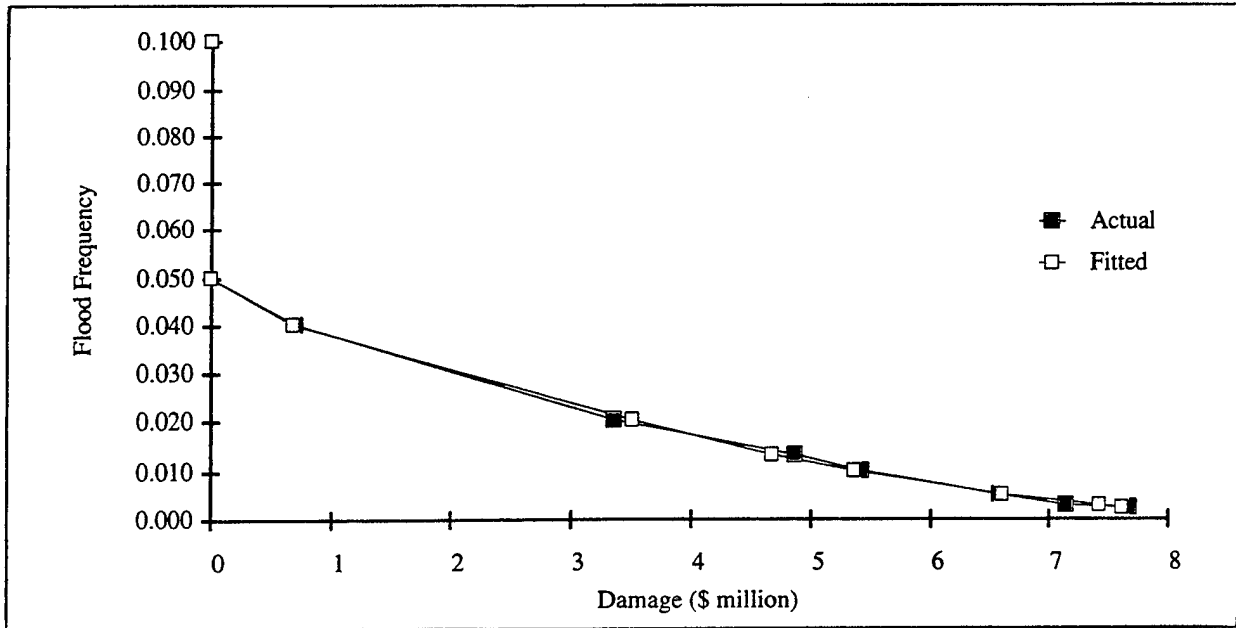
where L is the flood damage in \$ million, and F is the flood frequency. Figure 1-7 shows the comparative plots of the actual vs fitted curves, indicating that the derived functional relationship is an adequate model of the actual system.

*Elevation versus Damage*

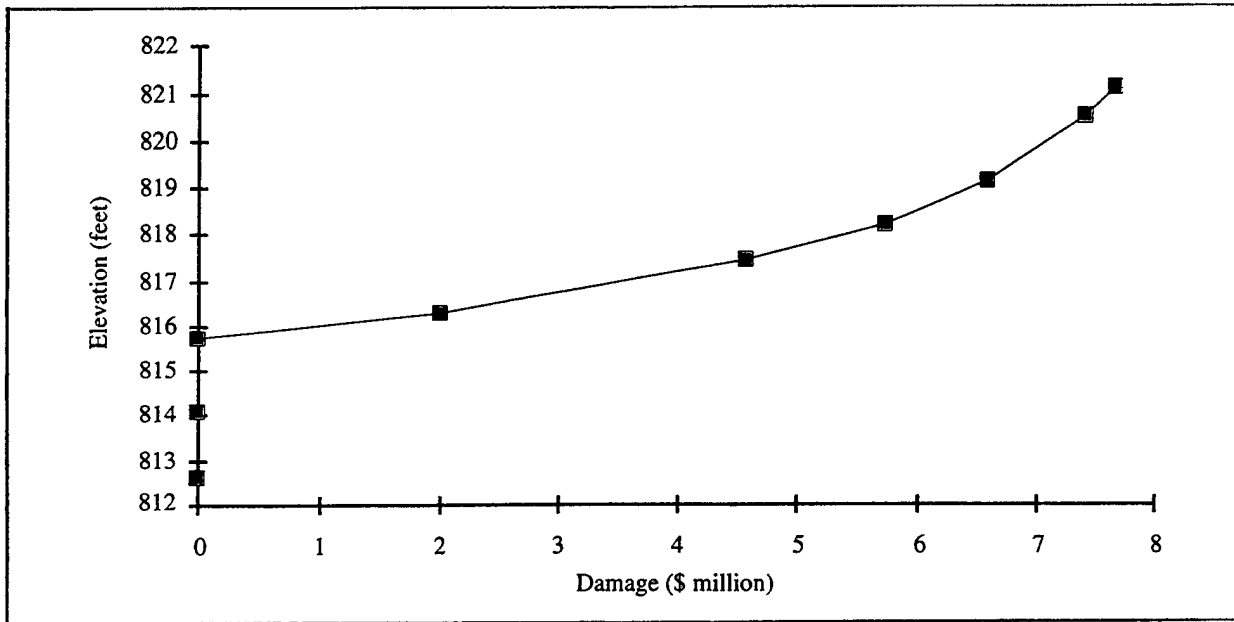
Since there were no available data relating the flood elevation to the flood damage, the three functional relationships obtained earlier, Equations (1.7)-(1.9), were used to derive the required functional relationship. The resulting equation is:

$$L = -56.65856 \left[ \frac{0.00211}{\frac{1}{1000} \left\{ \left( \frac{E+0.15423-812.6}{1.28767} \right)^{1/0.41567} + 10.7 \right\} - 0.00582} \right]^{0.59494/0.62411} + 9.02988 \quad (1.10)$$

where L is the flood damage in \$ million, and E is the flood elevation in feet. The resulting plot is shown in Figure 1-8.



**Figure 1-7. Actual vs. Fitted Curves for Frequency vs. Damage—Plan 1**



**Figure 1-8. Elevation vs. Damage for Plan 1**

Development of the Functional Relationships for Plan 4

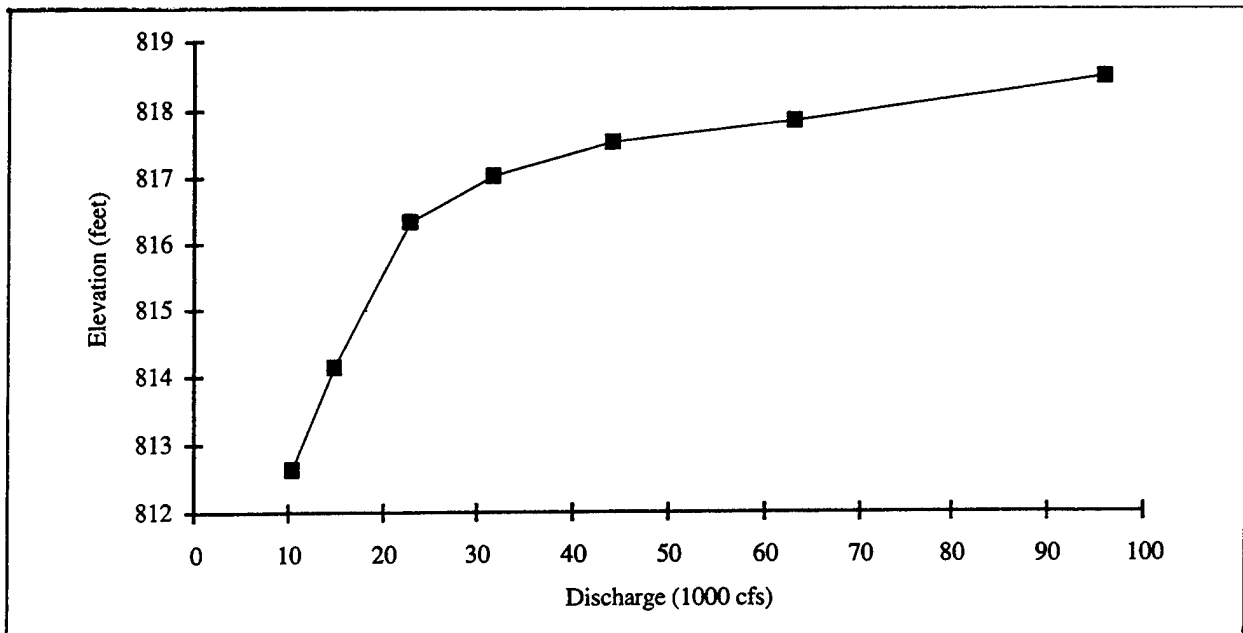
For plan 4, an alternative elevation-vs.-discharge curve was provided for the elevation in the channel [Plate A17, Appendix B, U.S. Army Corps of Engineers 1990]. However, the damage depends upon the relationship of discharge vs. elevation in the floodplain. Therefore, we assume data for this relationship. The curve obtained this way is then used to derive the other three curves. The main relationship that we are interested in is the frequency vs. the damage since this will enable us to compute the mean damage and the conditional mean damages. Therefore, for plan 4, only the development of the elevation-vs- discharge and the frequency-vs.-damage curves need to be shown.

*Discharge versus Elevation*

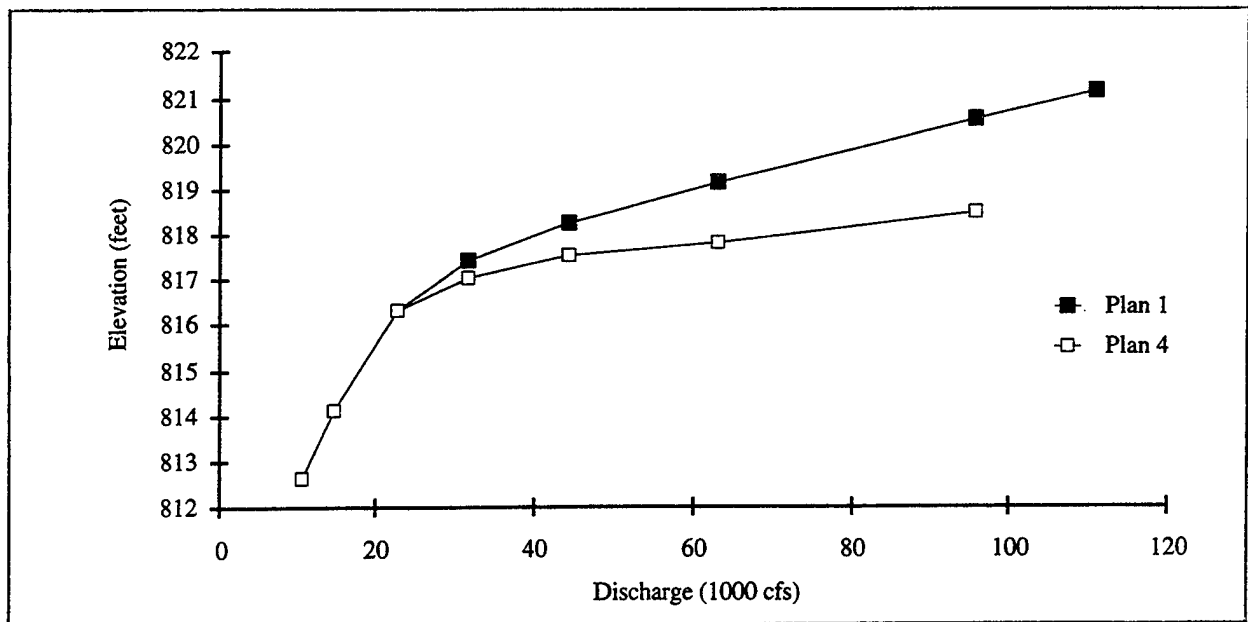
The data for the discharge-vs.-floodplain elevation were assumed from the data provided for the discharge-vs.-channel elevation. The data thus obtained are shown in Table 1-4 and the corresponding plot is shown in Figure 1-9. Figure 1-10 shows the comparative plots of floodplain elevation vs. discharge for plan 1 and plan 4.

**Table 1-4.** Discharge vs. Elevation for Plan 4

Discharge (1000 cfs)	Floodplain Elevation (feet)
10.7	812.6
15.0	814.1
23.0	816.3
31.7	817.0
44.3	817.5
63.3	817.8
96.0	818.5



**Figure 1-9.** Discharge vs. Floodplain Elevation for Plan 4

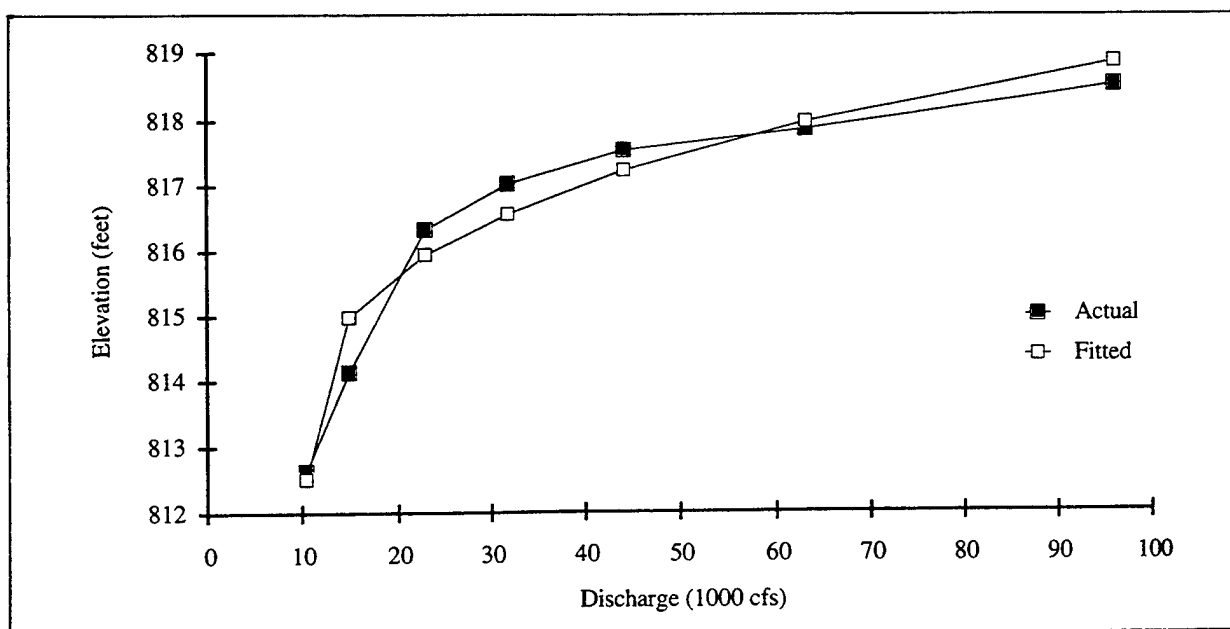


**Figure 1-10.** Comparative Discharge-vs.-Elevation Curves for Plan 1 and Plan 4

Based on this data, a regression analysis was performed and the following functional relationship between discharge and elevation was obtained for plan 4:

$$E = 1.55092 \left[ \frac{D}{1000} - 10.7 \right]^{0.31598} - 0.11404 + 812.6 \quad (1.11)$$

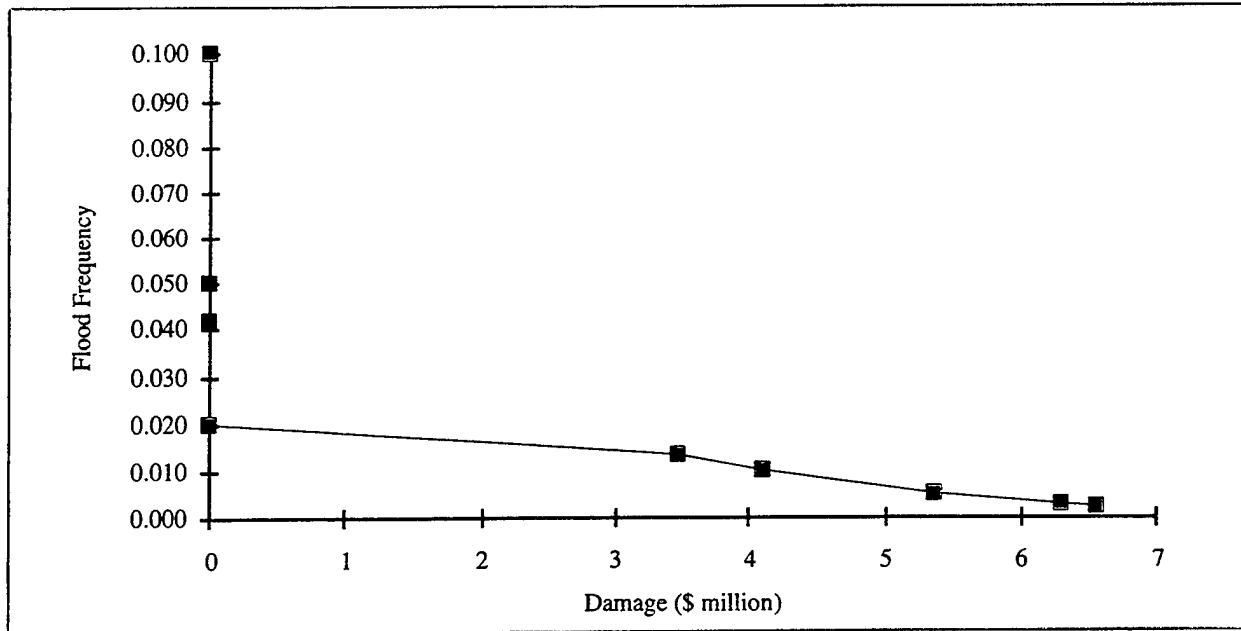
where E is the flood elevation in feet, and D is the discharge in cfs. Figure 1-11 shows the comparative plots of the actual vs fitted curves, indicating that the derived functional relationship is an adequate model of the actual system.



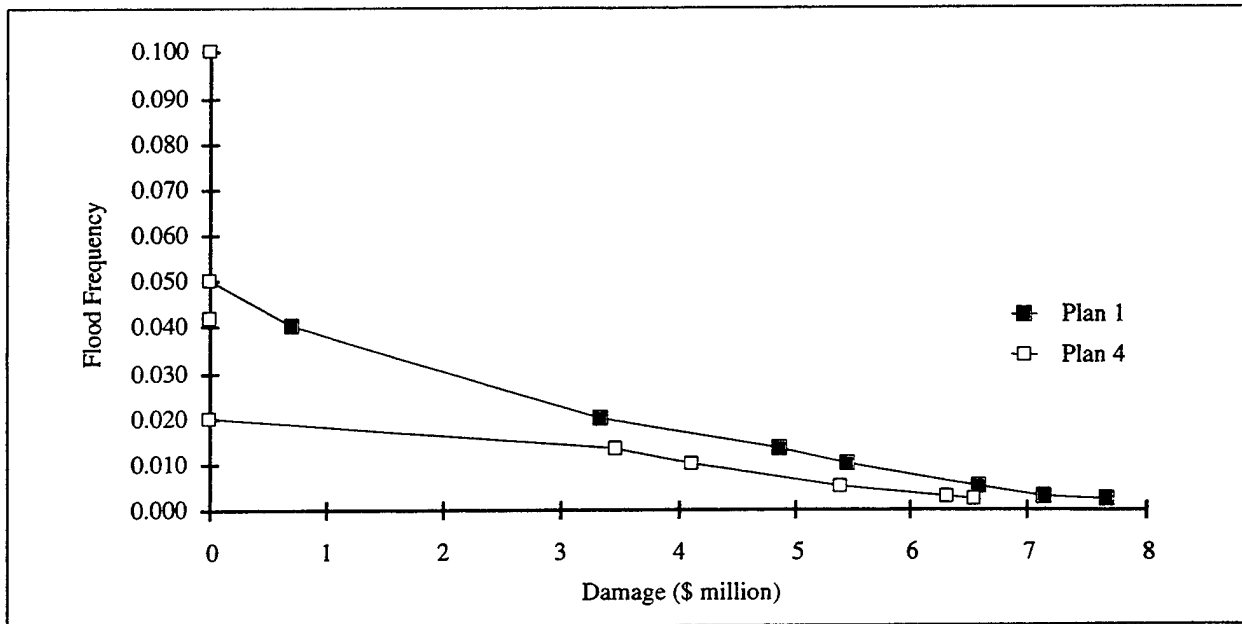
**Figure 1-11.** Actual vs. Fitted Curves for Discharge vs. Elevation—Plan 4

### *Frequency versus Damage*

Since the main curve of interest is the frequency-vs.-damage curve, this curve was developed using Equations (1.9), (1.10), and (1.11). (Note that the assumption here is that the elevation-vs.-damage and the frequency-vs.-discharge relationships do not change due to the construction of the levee, floodwalls, and other structural measures that constitute plan 4.) If the design that provides for a 50-year level of protection is selected for plan 4, then the frequency-vs.-damage curve is truncated at that level. The resulting frequency-vs.-damage curve for plan 4 is shown in Figure 1-12. Figure 1-13 shows the comparative plots of frequency vs. damage for plan 1 and plan 4.



**Figure 1-12.** Frequency vs. Damage for Plan 4



**Figure 1-13.** Comparative Frequency vs. Damage Curves for Plan 1 and Plan 4

Since the expression obtained for the frequency-vs.-damage curve is very complex, the results obtained from that expression are used as input for a regression analysis in order to obtain a simplified expression. A two-part equation was used:

(1) a straight line was used for the the return period between 50 and 75 (equivalent to frequencies between 0.02 and 0.0133) as given by Eq. (1.12a),

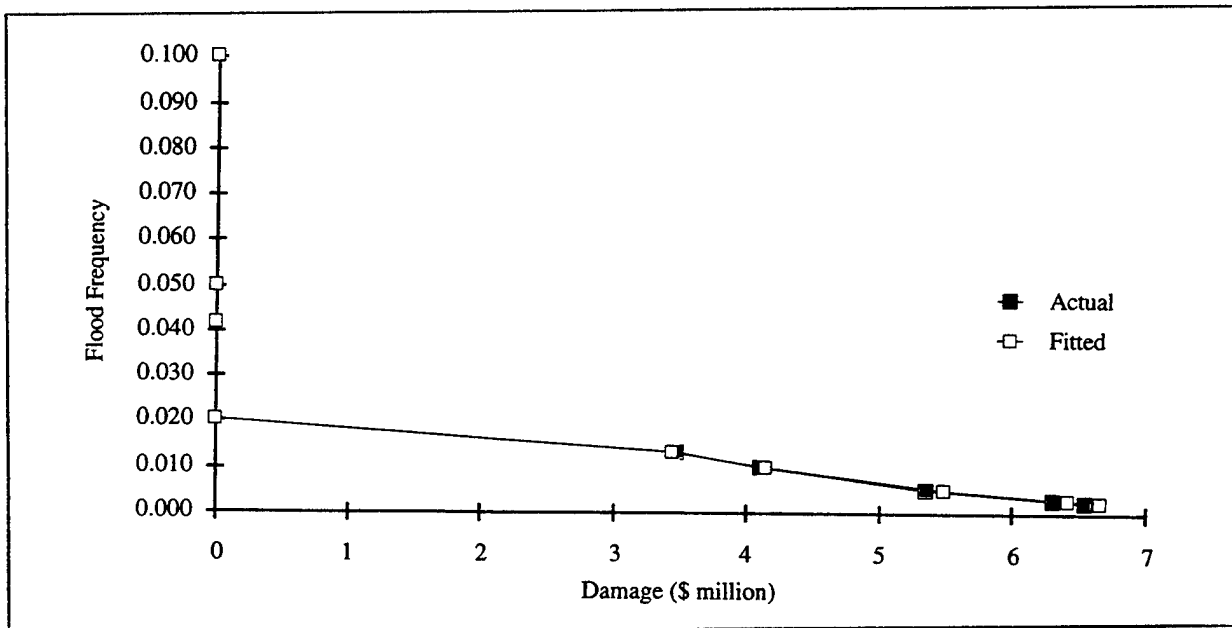
$$L = 521.70 (0.02 - F) \tag{1.12a}$$

where L is the flood damage in \$ million, and F is the flood frequency; and

(2) regression analysis was used for a return period greater than 75 years, as given in Eq. (1.12b),

$$L = -50.45478 (F)^{0.53290} + 8.49407 \tag{1.12b}$$

Figure 1-14 shows the comparative plots of the actual vs. fitted curves, indicating that the derived functional relationship is an adequate model of the actual system.



**Figure 1-14.** Actual vs. Fitted Curves for Frequency vs. Damage—Plan 4

***Risk-Based Evaluation of  
Flood Warning and Preparedness Systems***

---

**Incorporation of a Flood Warning System**

Assume that one design option for a flood warning system is available to be added to the flood damage reduction measures. This will increase two more integrated flood damage reduction measures, plan 1 + flood warning system and plan 4 + flood warning system. The alternative of adopting plan 1 + flood warning system is essentially an alternative of adopting only a nonstructural measure, since plan 1 is the zero-cost plan or the without-project-condition alternative. The alternative of plan 4 + warning system is an actual integrated measure.

Introduction of a flood warning system will change the relationship between elevation and damage. Specifically, the flood loss reduction is given by Equation (1.4) as a function of the flood elevation.

The value of the maximum flood loss for a community, MD, and the functional form of unit damage function can be obtained from Equation (1.4). In this specific example, we notice that the base elevation of the floodplain zone is 812.5 feet, the maximum flood loss for the community, MD, is equal to \$9.02988 millions, and the functional form of the unit damage function is

$$\delta(h-y) = 1 - 6.27456 \left[ \frac{0.00211}{\frac{1}{1000} \left\{ \left( \frac{h-812.44577}{1.28767} \right)^{2.40576} + 10.7 \right\} - 0.00582} \right]^{0.95326} \quad (1.13)$$

The maximum evacuation cost for the community, MC, is assumed to be equal to \$50,000 and the unit reduction function is assumed to be

$$MR(h - 812.44577) = 0.25 + 0.04(h - 812.44577) - 0.00333(h - 812.44577)^2 \quad (1.14)$$

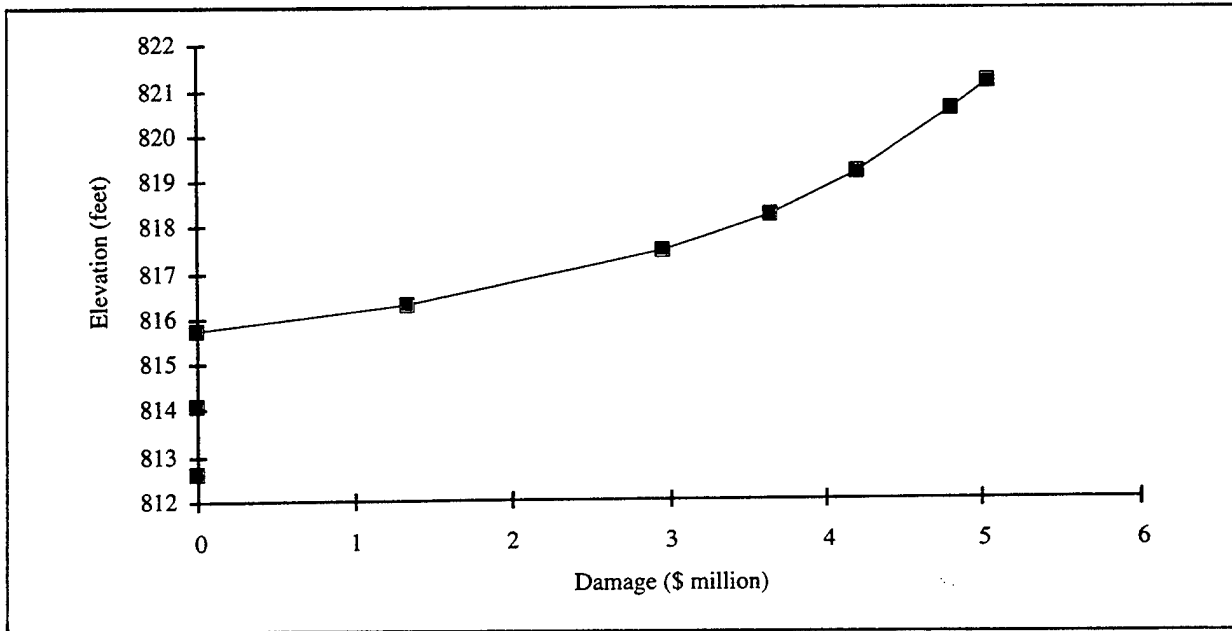
Since the flood loss reduction  $L_{RD}$  in Equation (1.4) is a linear function of the response fraction  $\theta$ , we only study the case of maximum flood loss reduction when a full response is present, i.e.,  $\theta = 1$ . The cases where a full response is not present can be easily found by interpolating the curves of elevation vs. damage with and without a flood warning system.

In summary, the loss reduction when a flood warning system is introduced can be expressed as a function of flood elevation

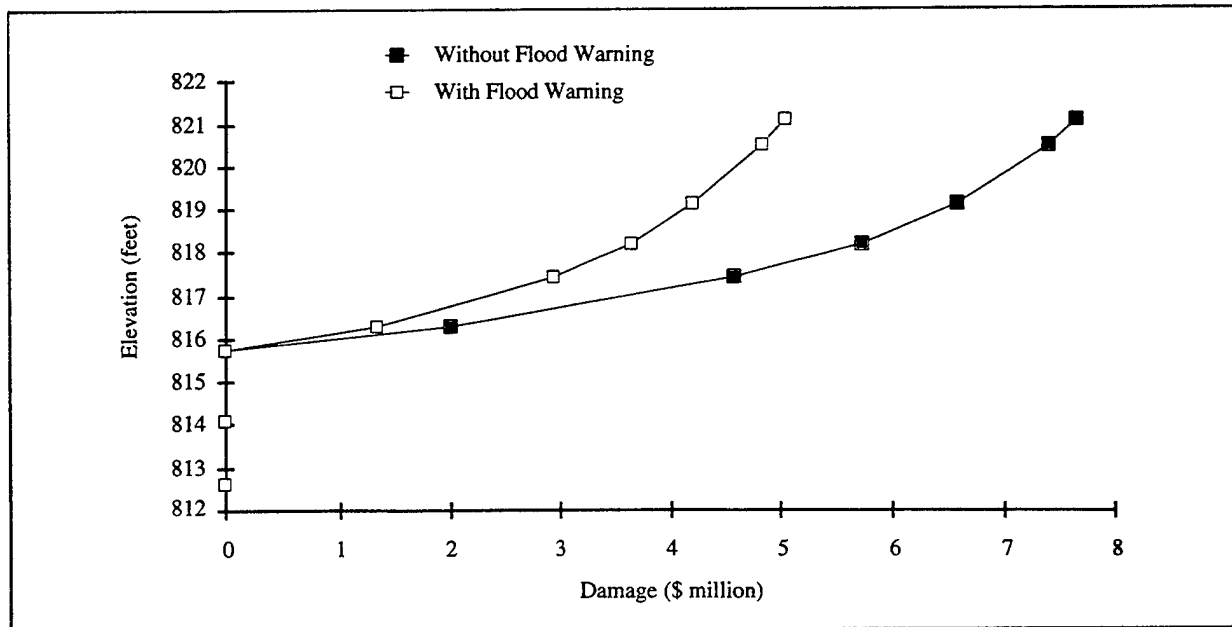
$$L_{RD} = \left\{ 9.02988 - 56.65856 \left[ \frac{0.00211}{\frac{1}{1000} \left\{ \left( \frac{h-812.44577}{1.28767} \right)^{2.40576} + 10.7 \right\} - 0.00582} \right]^{0.95326} \right\} * \{0.25 + 0.04(h - 812.44577) - 0.00333(h - 812.44577)^2\} - 0.05 \quad (1.15)$$

Subtracting  $L_{RD}$  from the damage coordinate in Figure 1-8 (Equation 1.10) for each elevation yields the curve of damage vs. elevation when a flood warning system is introduced. Figure 1-15 shows this curve. Figure 1-16 shows the comparative plots of damage vs. elevation with and without a warning system.





**Figure 1-15.** Elevation vs. Damage for Plan 1 with Flood Warning System



**Figure 1-16.** Comparative Plots of Elevation vs. Damage for Plan 1 With and Without Flood Warning System

## ***Risk-Based Evaluation of Flood Warning and Preparedness Systems***

---

Combining Figure 1-3 (Equation 3.1), Figure 1-5 (Equation 1.8) and Figure 1-15 (Equation 1.15 subtracted from Equation 1.10) gives us the curve of damage vs. frequency in Figure 1-17 for the option of plan 1 + flood warning system.

Since the expression obtained for the frequency-vs.-damage curve is very complex, the results obtained from that expression are used as input for a regression analysis in order to obtain a simplified expression. This regression analysis gives us the following functional relationship:

$$L = -32.13928 (F)^{0.54301} + 6.08851 \quad (1.16)$$

Figure 1-18 shows the comparative plots of the actual vs fitted curves, indicating that the derived functional relationship is an adequate model of the actual system.

Similarly, combining Fig. 1-9 (Eq. 1.11), Fig. 1-5 (Eq. 1.8) and Fig. 1-15 (subtracting Eq. 1.15 from Eq. 1.10) gives us the curve of damage vs. frequency in Fig. 1-19 for the option of plan 4 + flood warning system.

Since the expression obtained for the frequency-vs.-damage curve is very complex, the results obtained from that expression are used as input for a regression analysis in order to obtain a simplified expression. A two-part equation was used:

(1) a straight line was used for a return period between 50 and 75 (equivalent to frequencies between 0.02 and 0.0133) as given by Eq. (1.17a),

$$L = 340.58 (0.02 - F) \quad (1.17a)$$

where L is the flood damage in \$ million, and F is the flood frequency; and (2) regression analysis was used for a return period greater than 75 years, as given in Eq. (1.17b),

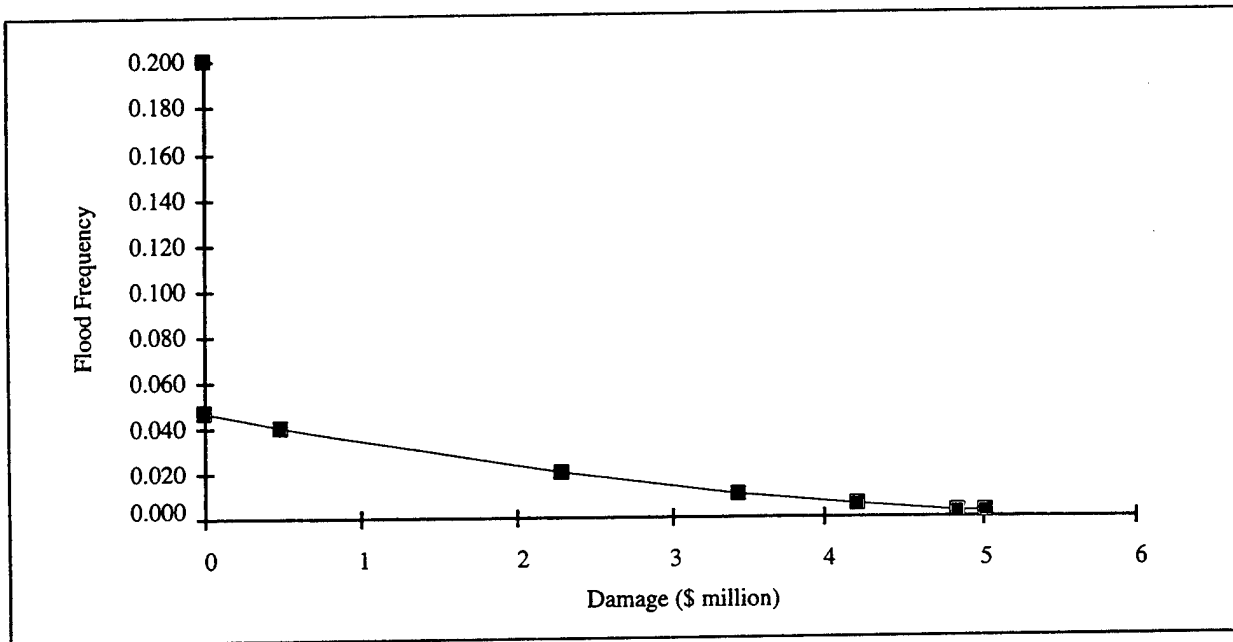
$$L = -29.39980 (F)^{0.51246} + 5.46498 \quad (1.17b)$$

Figure 1-20 shows the comparative plots of the actual vs fitted curves, indicating that the derived functional relationship is an adequate model of the actual system.

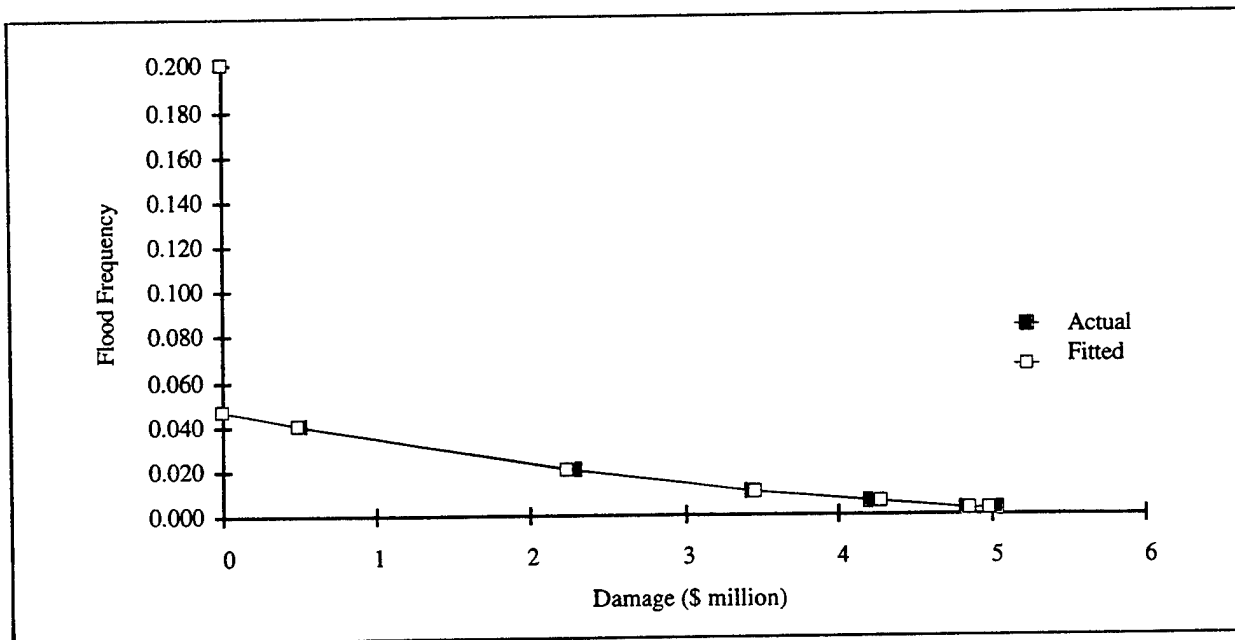
### Computation of Conditional and Unconditional Expected Damages

#### Plan 1

Recall from Equations (1.5) and (1.6) that the conditional expected damage  $f_c(L|\alpha)$  is an average of damage over the risk of extreme events given that the  $\alpha$ th percentile of damage is exceeded, and that the unconditional expected damage  $f_u(L)$  is the overall average damage. In order to compute the conditional and unconditional expected damages, we must obtain the probability density function (pdf) of damages. We can obtain this from the frequency-vs.-damage curve. This relationship is given by Eq. (1.9), which is simplified and shown in Eq. (1.18):

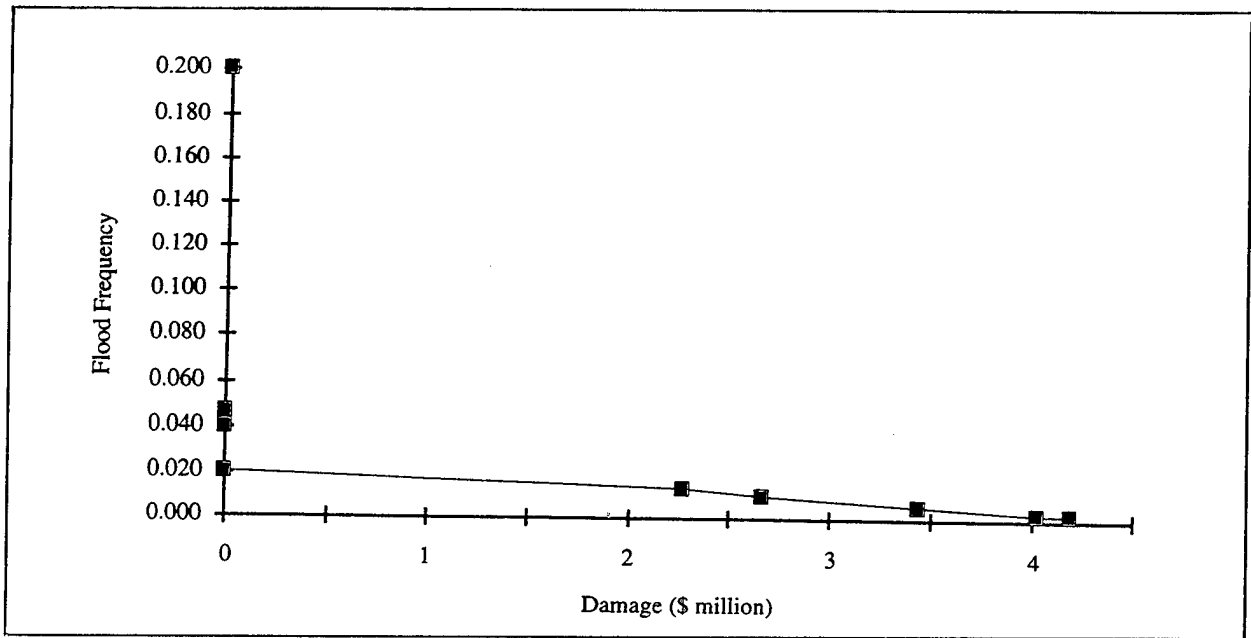


**Figure 1-17.** Frequency vs. Damage for Plan 1 with Flood Warning System

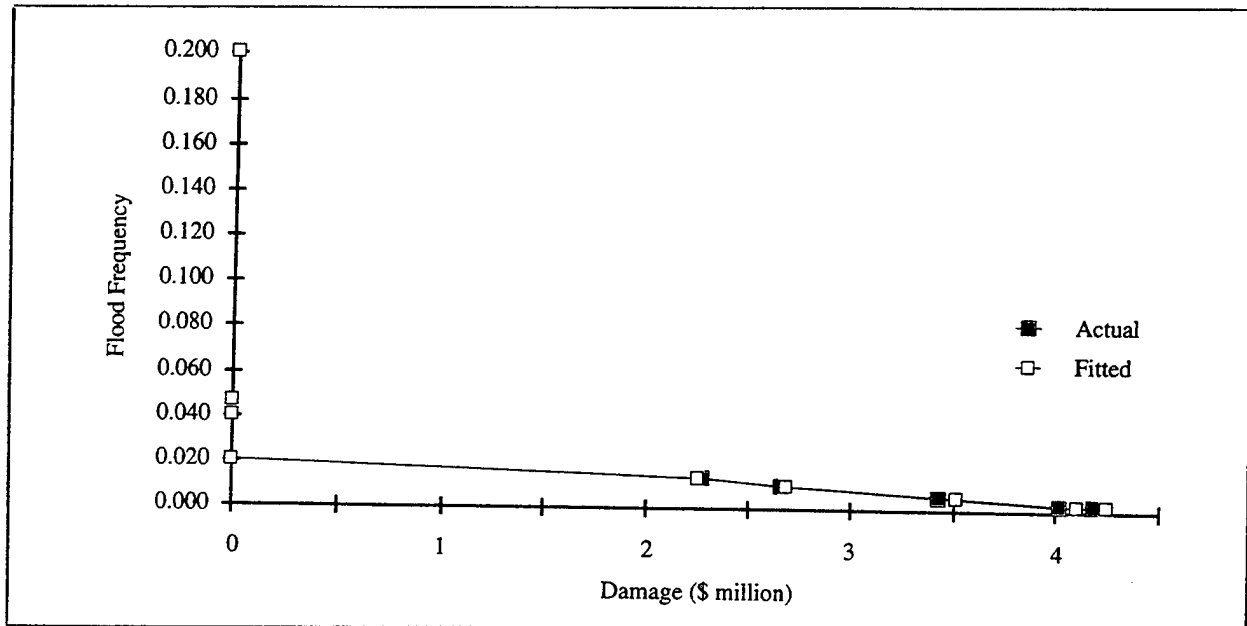


**Figure 1-18.** Actual vs. Fitted Curves for Frequency vs. Damage—Plan 1 with Flood Warning System

*Risk-Based Evaluation of  
Flood Warning and Preparedness Systems*



**Figure 1-19.** Frequency vs. Damage for Plan 4 with Flood Warning System



**Figure 1-20.** Actual vs. Fitted Curves for Frequency vs. Damage—Plan 4 with Flood Warning System

$$L = a (F)^b + c \quad (1.18)$$

where L is the flood damage in \$ million, F is the flood frequency, a equals -56.65856, b equals 0.59494, and c equals 9.02988.

Let  $f(L)$  be the pdf of L; then from Equation (1.18) we can obtain

$$f(L) = F = \left\{ \frac{L-c}{a} \right\}^{1/b} \quad (1.19)$$

The probability of flood,  $p(L)$ , is given by the area under this curve. This area is computed by integrating it from 0 to c (note that c is an upper bound for this equation since M is equal to c when F approaches 0):

$$\begin{aligned} p(L) &= \int_0^c \left\{ \frac{L-c}{a} \right\}^{1/b} dL \\ &= 0.1537 \end{aligned} \quad (1.20)$$

The mean value of the damage,  $\{f_5(L)\}$ , can be computed as follows:

$$\begin{aligned} f_5(L) &= \int_0^c L f(L) dL \\ &= \$0.3772 \text{ million} \end{aligned} \quad (1.21)$$

The conditional expected value,  $\{f_4(L|\alpha)\}$ , is given by

$$f_4(L|\alpha) = \frac{\int_{L_\alpha}^c L f(L) dL}{\int_{L_\alpha}^c f(L) dL} \quad (1.22)$$

where  $\alpha$  is the partition point on the probability axis, and

$$L_\alpha = a \left\{ \frac{[\alpha + p(L) - 1][1+b]}{a b} + \left[ \frac{-c}{a} \right]^{(1+b)/b} \right\}^{b/(1+b)} + c \quad (1.23)$$

***Risk-Based Evaluation of  
Flood Warning and Preparedness Systems***

---

is the corresponding partitioning point on the damage axis. For  $\alpha = 0.99$ , we have  $L_\alpha = 5.7716$  and

$$f_4(L|\alpha=0.99) = \$6.6568 \text{ million}$$

For  $\alpha = 0.9$ , we have  $L_\alpha = 1.3385$ , and

$$f_4(L|\alpha=0.9) = \$3.4281 \text{ million}$$

**Plan 4**

We adopt the same approach used in the previous section for plan 1 in order to compute the required measures for plan 4. The first step is to obtain the probability density function (pdf) of damages. We can obtain this from the frequency-vs.-damage curve. This relationship is a two-part equation and is given by Equations (1.12a) and (1.12b). Equation (1.12b) is simplified and shown in Equation 1.24:

$$L = a (F)^b + c \tag{1.24}$$

where  $L$  is the flood damage in \$ million,  $F$  is the flood frequency,  $a$  equals  $-50.45478$ ,  $b$  equals  $0.53290$ , and  $c$  equals  $8.49407$ .

Using Equations 1.12a and 1.12b we obtain the pdf of damage,  $f(L)$ , as

$$f(L) = \begin{cases} \left\{ 0.02 - \frac{L}{521.70} \right\} & \text{if } L < 3.4780 \\ \left\{ \frac{L-c}{a} \right\}^{1/b} & \text{if } L \geq 3.4780 \end{cases} \tag{1.25}$$

The probability of flood,  $p(L)$ , is given by the area under this curve. This area is computed by integrating it from 0 to  $c$  (note that  $c$  is an upper bound for this equation since  $M$  is equal to  $c$  when  $F$  approaches 0):

$$\begin{aligned} P(L) &= \int_0^{3.4780} \left\{ 0.02 - \frac{L}{521.70} \right\} dL + \int_{3.4780}^c \left\{ \frac{L-c}{a} \right\}^{1/b} dL \\ &= 0.0580 + 0.0229 \\ &= 0.08089 \end{aligned} \tag{1.26}$$

The mean value of the damage  $\{f_5(L)\}$  can be computed using Equation (1.21) as

$$f_5(L) = \$0.2035 \text{ million}$$

The conditional expected value  $\{f_4(L|\alpha)\}$  is given by Equation (1.22); for  $\alpha = 0.99$ , we have

$$\begin{aligned} L_\alpha &= a \left\{ \frac{[\alpha + p(L) - 1 - 0.0580][1+b]}{a b} + \left[ \frac{d-c}{a} \right]^{(1+b)/b} \right\}^{b/(1+b)} + c \\ &= 4.7345 \end{aligned} \tag{1.27}$$

and

$$f_4(L|\alpha=0.99) = \$5.7046 \text{ million}$$

and for  $\alpha = 0.9$ , we have  $L_\alpha = 0$ , and

$$\begin{aligned} f_4(L|\alpha=0.9) &= \frac{\int_0^{3.4780} \left\{ 0.02 - \frac{L}{521.70} \right\} dL + \int_{3.4780}^c L \left\{ \frac{L-c}{a} \right\}^{1/b} dL}{\int_0^{3.4780} \left\{ 0.02 - \frac{L}{521.70} \right\} dL + \int_{3.4780}^c \left\{ \frac{L-c}{a} \right\}^{1/b} dL} \\ &= \$2.5153 \text{ million} \end{aligned} \tag{1.28}$$

### Plan 1 + Flood Warning System

We adopt the same approach used in the previous section for plan 1 in order to compute the required measures for plan 1 + flood warning system. The first step is to obtain the probability density function (pdf) of damages. We can obtain this from the frequency-vs.-damage curve. This relationship is given by Equation (1.16), which is simplified and shown in Equation (1.29):

$$L = a (F)^b + c \tag{1.29}$$

where  $L$  is the flood damage in \$ million,  $F$  is the flood frequency,  $a$  equals -32.13928,  $b$  equals 0.54301, and  $c = 6.08851$ . Using Equation (1.20) we obtain

$$p(L) = 0.10008$$

***Risk-Based Evaluation of  
Flood Warning and Preparedness Systems***

---

The mean value of the damage  $\{f_5(L)\}$  can be computed using Equation (1.21) as

$$f_5(L) = \$0.1586 \text{ million}$$

The conditional expected value  $\{f_4(L|\alpha)\}$  is given by Equation (1.22) and the partition point  $\{L_\alpha\}$  is given by Equation (1.23). For  $\alpha = 0.99$ , we have  $L_\alpha = 3.3816$  and

$$f_4(L|\alpha=0.99) = \$4.0863 \text{ million}$$

For  $\alpha = 0.9$ , we have  $L_\alpha = 0.0018$ , and

$$f_4(L|\alpha=0.9) = \$1.5862 \text{ million}$$

**Plan 4 + Flood Warning System**

We adopt the same approach used in the previous section for plan 4 in order to compute the required measures for plan 4 + flood warning system. The first step is to obtain the probability density function (pdf) of damages. We can obtain this from the frequency-vs.-damage curve. This relationship is a two-part equation and is given by Eqs. (1.17a) and (1.17b). Equation (1.17b) is simplified and shown in Eq. (1.30).

$$L = a (F)^b + c \tag{1.30}$$

where  $L$  is the flood damage in \$ million,  $F$  is the flood frequency,  $a$  equals  $-29.39980$ ,  $b$  equals  $0.51246$ , and  $c$  equals  $5.46498$ .

Using Equations (1.17a) and (1.17b) we obtain the pdf of damage,  $f(L)$ , as

$$f(L) = \begin{cases} \left\{ 0.02 - \frac{L}{340.58} \right\} & \text{if } L < 2.2705 \\ \left\{ \frac{L-c}{a} \right\}^{1/b} & \text{if } L \geq 2.2705 \end{cases} \tag{1.31}$$

The probability of flood,  $p(L)$ , is given by the area under this curve. This area is computed by integrating it from 0 to  $c$  (note that  $c$  is an upper bound for this equation since  $M$  is equal to  $c$  when  $F$  approaches 0).



$$\begin{aligned}
 p(L) &= \int_0^{2.2705} \left\{ 0.02 - \frac{L}{340.58} \right\} dL + \int_{2.2705}^c \left\{ \frac{L-c}{a} \right\}^{1/b} dL \\
 &= 0.03784 + 0.01424 \\
 &= 0.05208
 \end{aligned} \tag{1.32}$$

The mean value of the damage  $\{f_3(L)\}$  can be computed using Equation (1.21) as

$$f_3(L) = \$0.0839 \text{ million}$$

The conditional expected value  $\{f_4(L|\alpha)\}$  is given by Equation (1.22). For  $\alpha = 0.99$ , we have

$$\begin{aligned}
 L_\alpha &= a \left\{ \frac{[\alpha + p(L) - 1 - 0.03784][1+b]}{a b} + \left[ \frac{d-c}{a} \right]^{(1+b)/b} \right\}^{b/(1+b)} + c \\
 &= 2.6307
 \end{aligned} \tag{1.33}$$

and

$$f_4(L|\alpha=0.99) = \$3.3478 \text{ million}$$

and for  $\alpha = 0.9$ , we have  $L_\alpha = 0$ , and

$$\begin{aligned}
 f_4(L|\alpha=0.9) &= \frac{\int_0^{2.2705} \left\{ 0.02 - \frac{L}{340.58} \right\} dL + \int_{2.2705}^c L \left\{ \frac{L-c}{a} \right\}^{1/b} dL}{\int_0^{2.2705} \left\{ 0.02 - \frac{L}{340.58} \right\} dL + \int_{2.2705}^c \left\{ \frac{L-c}{a} \right\}^{1/b} dL} \\
 &= \$1.6116 \text{ million}
 \end{aligned} \tag{1.34}$$

### Tradeoff Analysis

Once the conditional and unconditional expected values for the different plans are computed, we can perform a tradeoff analysis in terms of costs and damages. The compiled results are shown in Table 1-5.

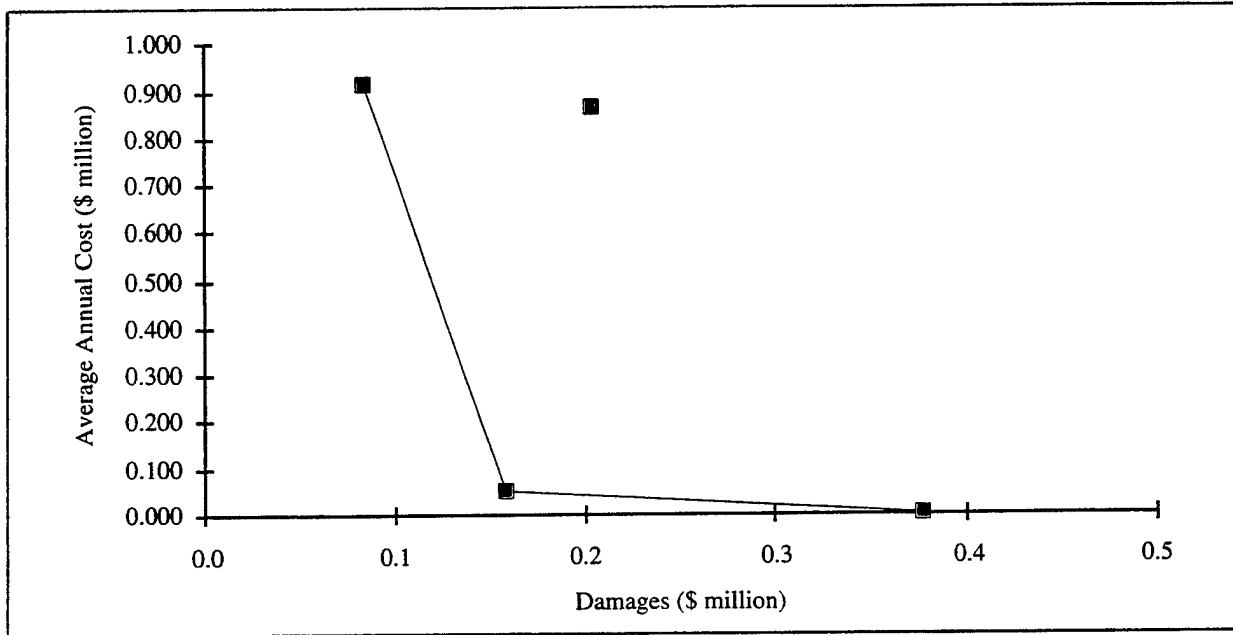
***Risk-Based Evaluation of  
Flood Warning and Preparedness Systems***

---

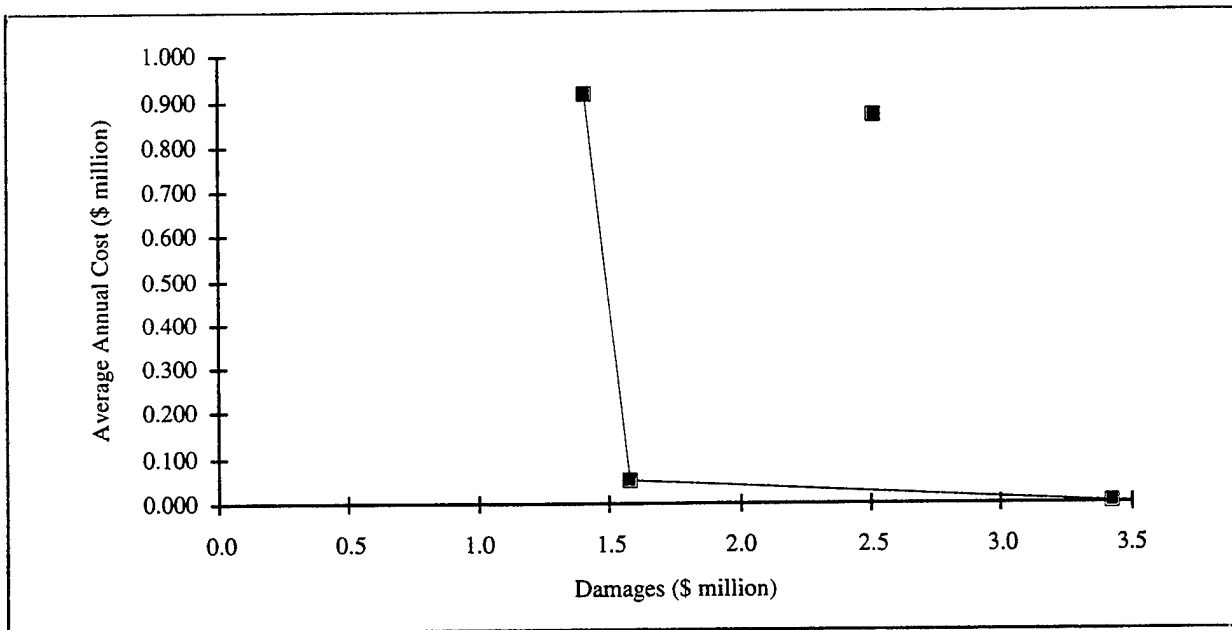
**Table 1-5.** Summary of Results: Tradeoffs Among Cost, Expected Damage ( $f_5$ ), and Risk of Extreme Events ( $f_4$ ) for the Four Alternatives

	Average Annual Cost (\$ million)	$f_5(L)$	$f_4(L \alpha=0.9)$	$f_4(L \alpha=0.99)$
Plan 1	0.000	0.377	3.428	6.657
Plan 1+W	0.050	0.159	1.586	4.086
Plan 4	0.865	0.204	2.515	5.705
Plan 4+W	0.915	0.084	1.412	3.348

Since plan 1 is the option of doing nothing, it does not have an associated cost. The average annual cost for plan 4 is given as \$0.865 million for a 50-year level of protection [Table I-18, page I-29, U.S. Army Corps of Engineers 1990]. The average annual cost of the flood warning system is assumed to be \$50,000. Figure 1-21 shows the resulting tradeoffs when using the expected value alone. The solid line shows the Pareto optimal frontier. Figures 1-22 and 1-23 show the tradeoffs for  $\alpha = 0.9$  and  $0.99$ , respectively. Figure 1-24 shows these tradeoffs together. Note that the option of plan 4 without the warning system is noninferior, or a viable option, in considering only structural measures; the same option becomes inferior when considering the warning system options. Plan 1, plan 1+W, and plan 4+W constitute the noninferior set of options in the combined structural/nonstructural analysis. The combined analysis of structural and nonstructural measures, incorporating the risk of extreme events, clearly demonstrates the relative inefficiency of plan 4 without the warning system, an important result that would not have come from a traditional approach.

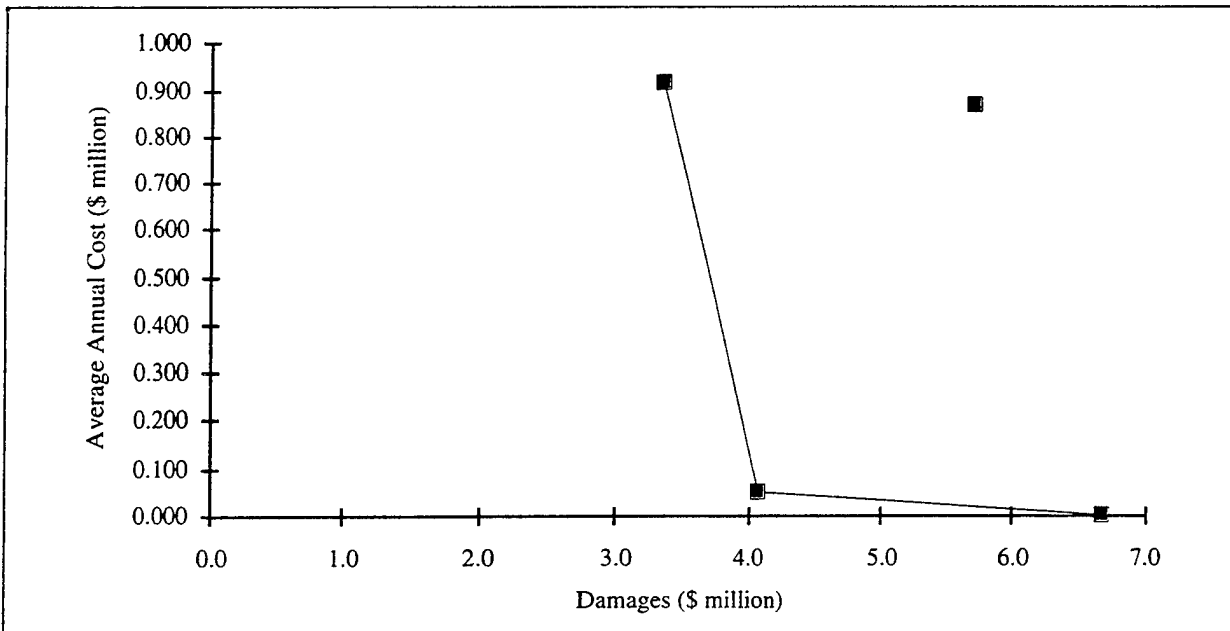


**Figure 1-21.** Cost vs. Damage Tradeoff for the Expected Value ( $f_5$ )  
(Note that there are three Pareto optimal (efficient) alternatives.)

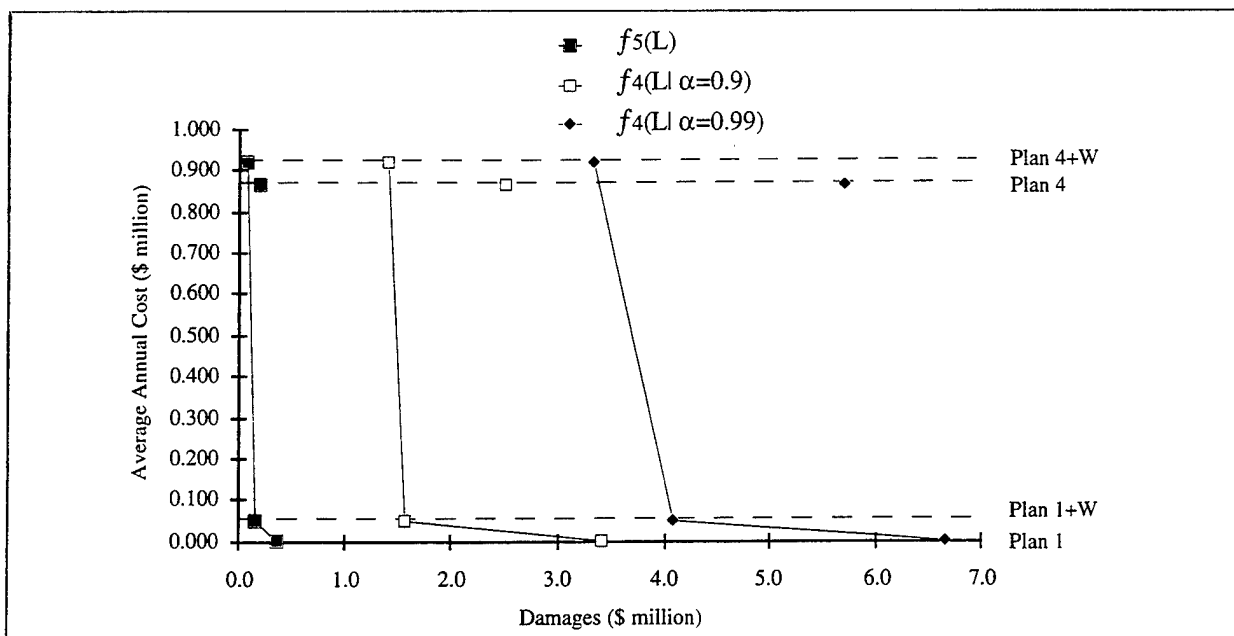


**Figure 1-22.** Cost vs. Conditional Expected Damage ( $f_4$ ) Tradeoff for  $\alpha = 0.9$   
(Note the three Pareto optimal (efficient) alternatives.)

**Risk-Based Evaluation of  
Flood Warning and Preparedness Systems**



**Figure 1-23.** Cost vs. Conditional Expected Damage ( $f_4$ ) Tradeoff for  $\alpha = 0.99$   
(Note the three Pareto optimal (efficient) alternatives.)



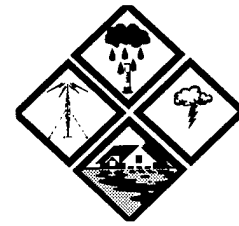
**Figure 1-24.** Tradeoffs Among Cost, Expected Damage ( $f_5$ ), and Conditional Expected Damage ( $f_4$ ) for the Four Alternatives  
(Risk of Extreme Events ( $f_4$ ) evaluated at two partitioning levels ( $\alpha = 0.9, \alpha = 0.99$ )).

## **Conclusions**

Integrated flood damage reduction alternatives using both structural measures and flood warning systems will reduce the vulnerability of a community to flood damage and add resiliency because of added redundancy, thus providing more options in decreasing expected flood loss with tradeoff consideration of the associated costs. The approach in this report builds on the previous Corps of Engineers work and is very easy to adopt and implement. Given the analysis for each structural and flood warning system, the combined analysis is simpler. The additional data requirement is minimal. The incorporation of the measure of the risk of extreme events along with the expected flood loss in a multiple-objective framework offers deeper insight in determining the best flood damage reduction strategy.

## **Part 2**

# **Multiobjective Decision Tree Analysis: Technical**



### **Introduction**

Decision-tree analysis has emerged over the years as an effective and useful tool in decisionmaking. More than two decades ago, Howard Raiffa [1968] published the first comprehensive and authoritative book on decision-tree analysis. Ever since, its applications to a variety of problems from numerous disciplines have grown by leaps and bounds [see Sage 1977 and Hamburg 1970]. Advances in science and in scientific approaches to problem solving are often made on the basis of earlier works of others. In this case, the foundation for Raiffa's contributions to decision tree analysis can be traced to the works of Bernoulli on utility theory [see von Neumann and Morgenstern 1944; Edwards 1967; Savage 1954; Adams 1960; Arrow 1963; Shubik 1964; Luce and Suppes 1965; and others]. This chapter, in an attempt to build on the above seminal works, extends and broadens the concept of decision-tree analysis to incorporate: (a) multiple, noncommensurate and conflicting objectives, (b) impact analysis, and (c) the risk of extreme and catastrophic events. Indeed, the current practice often involves one-sided use of decision trees -- optimizing a single-objective function and commensurating infrequent catastrophic events with more frequent noncatastrophic events using the common unconditional mathematical expectation.

### Multiple Objectives

The single-objective models that had been advanced in the fifties, sixties, and seventies are today considered by many to be unrealistic, too restrictive, and often inadequate for most real-world complex problems. The proliferation of books, articles, and conferences and courses during the last decade or two on what has come to be known as multiple-criteria decisionmaking (MCDM) is a vivid indication of this somber realization and of the maturation of the field of decisionmaking [see Chankong and Haimes 1983]. In particular, an optimum derived from a single-objective mathematical model, including that which is derived from a decision tree, often may be far from representing reality -- thereby misleading the analyst(s) as well as the decisionmaker(s). Fundamentally, most complex problems involve, among other things, the minimization of costs, the maximization of benefits (not necessarily in monetary values), and the minimization of risks of various kinds. Decision trees, which are a powerful mechanism for the analysis of complex problems, can better serve both the analysts and the decisionmakers when they are extended to deal with the above multiple objectives.

### Impact Analysis

On a long-term basis, managers and other decisionmakers are often rewarded not because they have made many optimal decisions in their tenure; rather, they are honored and thanked for avoiding adverse and catastrophic consequences. If one accepts this premise, then the role of impact analysis -- studying and investigating the consequences of present decisions on future policy options -- might be as important, if

not actually more so, than generating an optimum for a single-objective model or identifying a Pareto optimum set for a multiobjective model. Certainly, when the ability to generate both is present, having an appropriate Pareto optimum set and knowing the impact of each Pareto optimum on future policy options should enhance the overall decisionmaking process within the decision-tree framework.

The Risk of Extreme and Catastrophic Events

Risk, which is a measure of the probability and severity of adverse effects, has until recently been commonly quantified via the expected-value formula. This formula essentially precommensurates events of low frequency and high damage with events of high frequency and low damage. Although learned students of risk analysis recognize the disparity between the above fallacious representation of extreme and catastrophic events and the perception of these events by individuals or the public at large, many continue to use this approach. The trend, however, is moving toward the conditional-expected-value approach, where extreme and catastrophic events are partitioned, isolated, quantified in terms of the conditional expectation (e.g., using concepts from the statistics of extremes), and then evaluated along with the common expected value of risk or damage [Asbeck and Haines 1984; Haines 1985; Karlsson and Haines 1988a, 1988b].

The partitioned multiobjective risk method (PMRM) developed by Asbeck and Haines [1984] separates extreme events from other noncatastrophic events, and thus provides the decisionmaker(s) with additional valuable and useful information. In addition to using the traditional expected value, the PMRM generates a number of conditional expected-value functions, termed here risk functions, which represent the risk, given that the damage falls within specific probability ranges (or damage ranges). Assume that the risk can be represented by a continuous random variable  $X$  with a known probability density function  $p_x(x; s_j)$ , where  $s_j$  ( $j = 1, \dots, q$ ) is a control policy. The PMRM partitions the probability axis into three ranges. Denote the partitioned points on the probability axis by  $\alpha_i$  ( $i = 1, 2$ ). For each  $\alpha_i$  and each policy  $s_j$ , it is assumed that there exists a unique damage  $b_{ij}$  such that

$$P_x(\beta_{ij}; s_j) = \alpha_i \tag{2.1}$$

where  $P_x$  is the cumulative distribution function of  $X$ . These  $\beta_{ij}$  (with  $\beta_{0j}$  and  $\beta_{3j}$  representing, respectively, the lower bound and upper bound of the damage) define the conditional expectation as follows:

$$f_i(s_j) = E\{x \mid p_x(x; s_j), x \in [\beta_{i-2,j}, \beta_{i-1,j}]\} \quad (i = 2, 3, 4; j = 1, \dots, q) \tag{2.2}$$

or

$$f_i(s_j) = \frac{\int_{\beta_{i-1,j}}^{\beta_{i-1,j}} x p_x(x; s_j) dx}{\int_{\beta_{i-2,j}}^{\beta_{i-1,j}} p_x(x; s_j) dx} \quad (i = 2, 3, 4; j = 1, \dots, q) \tag{2.3}$$

where  $f_2$ ,  $f_3$ , and  $f_4$  represent the risk with high probability of exceedance and low damage, the risk with medium probability of exceedance and medium damage, and the risk with low probability of exceedance and high damage, respectively. The unconditional (conventional) expected value of  $X$  is denoted by  $f_5(s_j)$ . The relationship between the conditional expected values ( $f_2$ ,  $f_3$ ,  $f_4$ ) and the unconditional expected value ( $f_5$ ) is given by

$$f_5(s_j) = \theta_2 f_2(s_j) + \theta_3 f_3(s_j) + \theta_4 f_4(s_j) \quad (2.4)$$

where  $\theta_i$  ( $i = 2,3,4$ ) is the denominator of Eq. (3). From the definition of  $\beta_{ij}$ , it can be seen that  $\theta_i \geq 0$  is a constant, and  $\theta_2 + \theta_3 + \theta_4 = 1$ .

Combining either the generated conditional expected risk function or the unconditional expected risk function with the cost objective function,  $f_1$ , creates a set of multiobjective optimization problems:

$$\min [f_1, f_i]^t \quad (i = 2,3,4,5) \quad (2.5)$$

where the superscript  $t$  denotes the transpose operator. This formulation offers more information about the probabilistic behavior of the problem than the single multiobjective formulation  $\min [f_1, f_5]^t$ . The tradeoffs between the cost function  $f_1$  and any risk function  $f_i$  ( $i \in \{2,3,4,5\}$ ) allow decisionmakers to consider the marginal cost of a small reduction in the risk objective, given a particular level of risk assurance for each of the partitioned risk regions and given the unconditional risk function,  $f_5$ . The relationship of the tradeoffs between the cost function and the various risk functions is given by

$$1/\lambda_{15} = \theta_2/\lambda_{12} + \theta_3/\lambda_{13} + \theta_4/\lambda_{14} \quad (2.6)$$

where

$$\lambda_{ii} = -\partial f_1 / \partial f_i \quad (i = 2,3,4,5) \quad (2.7)$$

and  $\theta_2$ ,  $\theta_3$ , and  $\theta_4$  are as defined earlier. A knowledge of this relationship among the marginal costs provides the decisionmakers with insights that are useful for determining an acceptable level of risk.

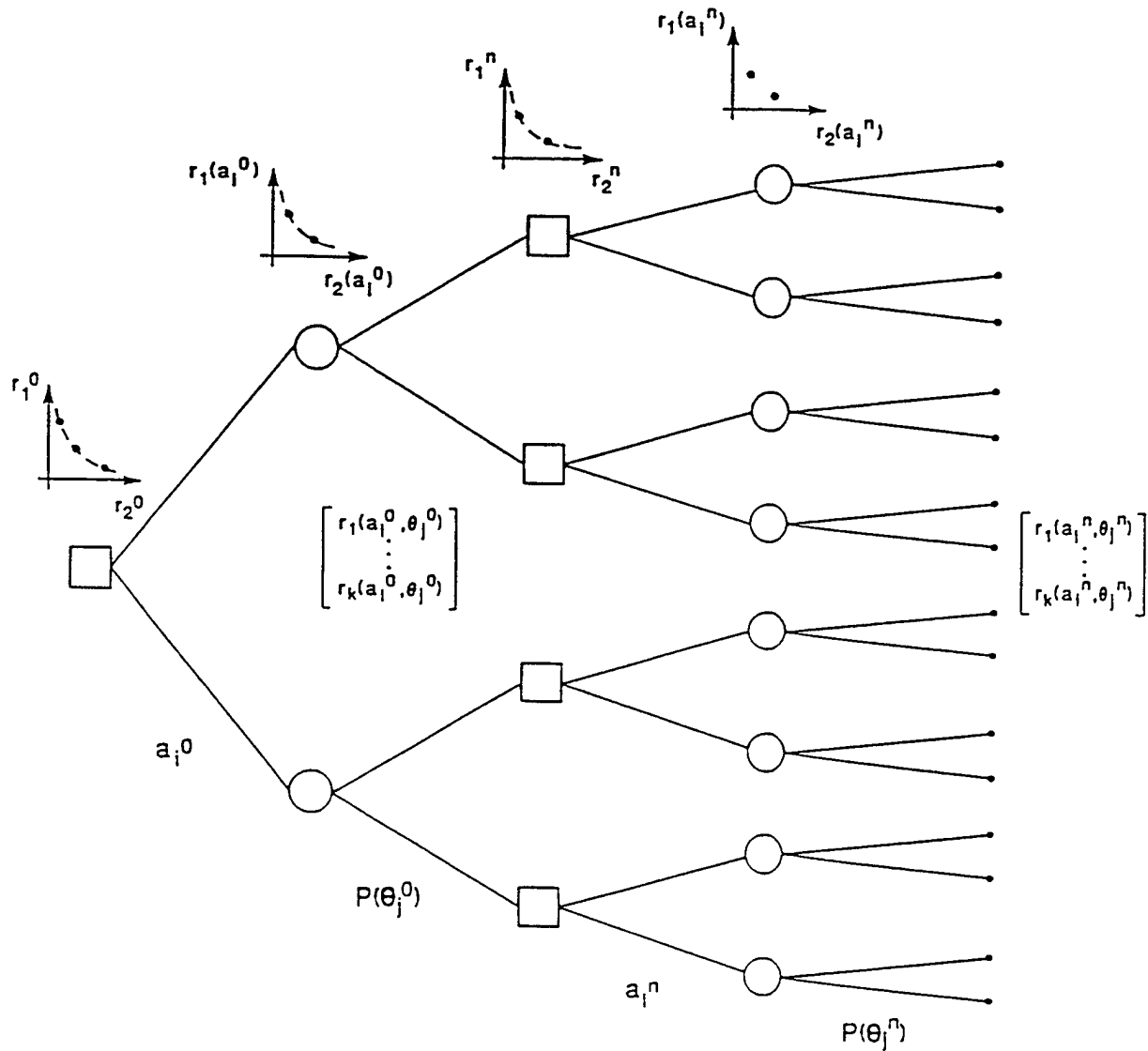
## Methodological Approach

### Extension to Multiple Objectives

Similar to the decision-tree in conventional single-objective analysis, a multiobjective decision tree (Fig. 2-1) is composed of decision nodes and chance nodes. Each pair of an alternative and a state of nature, however, is now characterized by a vector-valued performance measure.

At a decision node, usually designated by a square, the decisionmaker selects one course of action from the feasible set of alternatives. We assume that there are only a finite number of alternatives at each decision node. These alternatives are shown as branches emerging to the right side of the decision node.





**Figure 2-1.** Structure of Multiobjective Decision Trees

The performance vector associated with each alternative is written along the corresponding branch. Each alternative branch may lead to another decision node, a chance node, or a terminal point.

A chance node, designated by a circle on the tree, indicates that a chance event is expected at this point; that is, one of the states of nature may occur. We consider two cases in this study: a) a discrete case, where the number of states of nature is assumed finite; and b) a continuous case, where the possible states of nature are assumed continuous. The states of nature are shown on the tree as branches to the right of the chance nodes, and their known probabilities are written above the branches. The states of nature may be followed by another chance node, a decision node, or a terminal point.

Allowing for the evaluation of the multiple objectives at each decision node constitutes an important feature of the approach presented here. This is a significant extension of the average-out-and-folding-back strategy used in conventional single-objective decision-tree methods.

To allow for this extension, we first define a  $k$ -dimensional vector-valued performance measure associated with an action  $a_n$  and a state of nature  $\theta_n$  as follows,

$$r(a_n, \theta_n) = [r_1(a_n, \theta_n), r_2(a_n, \theta_n), \dots, r_k(a_n, \theta_n)]^t \quad (2.8)$$

A point  $r = [r_1, r_2, \dots, r_k]^t$  in the objective function space is said to be noninferior if there does not exist another feasible point  $r' = [r'_1, r'_2, \dots, r'_k]^t$  such that

$$r'_i < r_i \quad (i = 1, 2, \dots, k) \quad (2.9)$$

with at least one strict inequality holding for  $i = 1, 2, \dots, k$ .

The sequential structure of multiobjective decision trees necessitates the introduction of a vector of operators that combines the vectors of performance measures of successive decision nodes. Let  $o$  denote a  $k$ -dimensional vector of binary operators which are to be applied to elements corresponding to the same components of any two vectors of a performance measure. For example, if

$$r_1 = [2, 3]^t, r_2 = [-3, 2]^t, o = (+, \bullet)$$

then

$$r_1 o r_2 = [2-3, 3\bullet 2]^t = [-1, 6]^t$$

The solution procedure for multiobjective decision trees is stated in three steps:

*Step 1.* Chart the decision tree for the problem under study.

*Step 2.* Assign an a priori probability or calculate the posterior probability for each chance branch. Assign the vector-valued performance measure for each pair of an alternative and a state of nature. (Or map the vector-valued performance measure to each of the terminal points of the tree.)

***Risk-Based Evaluation of  
Flood Warning and Preparedness Systems***

---

*Step 3.* Start from each terminal point of the tree and fold backward on the tree.

At each decision node,  $n$ , and at each branch emerging to the right side of the decision node, find the corresponding set of vector-valued performance measures,  $r(a_i^n)$ , for each alternative,  $a_i$ , and identify the set of noninferior solutions by solving

$$r^n = \min_i U r(a_i^n) \quad (2.10)$$

Remark: In multiobjective decision-tree analysis, instead of having a single optimal value associated with a single-objective decision tree, we have  $r^n$ , a set of vector-valued objective values of noninferior decision alternatives at decision node  $n$ .

At each chance node  $m$  and at branches emerging to the right side of the chance node, find the corresponding set of vector-valued performance measures,  $r_j^m$ , for each state of nature  $\theta_j^m$ , and then calculate the vector-valued expected-performance measure, or other specified vector-valued "risk" performance measure, which is denoted by  $r^m$

$$r^m = \min_j E^s \{r_j^m\} \quad (2.11)$$

Remarks:

a) In single-objective decision-tree analysis, there is no choice process at the chance nodes, since only an averaging-out process takes place there. In multiobjective decision-tree analysis, a set of Pareto optimum alternatives,  $r_j^m$ , is associated with each branch emerging from chance node  $m$ . If each set of Pareto optimal solutions  $r_j^m$  has  $d_j^m$  elements, then there exist  $P_j\{d_j^m\}$  combinations of decision rules needing to be averaged-out, and a vector minimization must be performed to discard from further consideration the resulting inferior combinations.

b) The superscript  $s$  in  $E^s$  denotes the  $s$ th averaging-out strategy; in particular,  $E^5$  (for  $s = 5$ ) denotes the conventional expected-value operator, and  $E^4$  (for  $s = 4$ ) denotes the operator of conditional expected value in the region of extreme events (which will be discussed in detail in a later section).

Step 3 is repeated until the set of noninferior solutions at the starting point of the tree is obtained.

**Impact of Experimentation**

The impact of an added piece of information (obtained, e.g., through experimentation) on different objectives is now addressed, and the value of the information is quantified by a vector-valued measure. In conventional decision-tree analysis, whether or not an experiment should be performed depends on an assessment of the expected value of experimentation (EVE), which is the difference between the expected loss without experimentation and the expected loss with experimentation. If the EVE is negative, experimentation is deemed unwarranted; otherwise, the experiment that yields the lowest loss is selected. In multiobjective decision-tree analysis, the monetary index does not constitute the sole consideration; rather, the value of experimentation is judged in a multiobjective way where, in many cases, the noninferior

frontiers generated with and without experimentation do not dominate each other. The added experimentation in these cases reshapes the feasible region (and thus the noninferior frontier) and generates new and better options for the decisionmakers (Fig. 2-2).

### Example for the Discrete Case

#### *Problem Definition*

The example problem discussed here concerns a simplified flood warning and evacuation system. Three possible actions, (a) evacuation, (b) issuing a flood watch, and (c) doing nothing, are under consideration. There are cost factors associated with the first two options. The decision tree covers two time periods, and the cost associated with each option is a function of the period in which the action is taken. The complete decision tree for the problem is shown in Fig. 2-3. The following assumptions are made:

- a) There are three possible actions with associated costs for the first period:
  - 1) issuing an evacuation order at a cost of \$5 million [EV1],
  - 2) issuing a flood watch at a cost of \$1 million [WA1], and
  - 3) doing nothing at no cost [DN1].
- b) For the second period the actions and the corresponding costs are:
  - 1) issuing an evacuation order at a cost of \$3 million [EV2],
  - 2) issuing a flood watch at a cost of \$0.5 million [WA2], and
  - 3) doing nothing at no cost [DN2].
- c) The flood stage is reached at water flow  $(W) = 50,000$  cfs.
- d) There are three underlying probability density functions (pdfs) for the water flow:
  - 1)  $W \sim \text{lognormal}(10.4, 1)$ , represented as  $LN_1$ ,
  - 2)  $W \sim \text{lognormal}(9.1, 1)$ , represented as  $LN_2$ , and
  - 3)  $W \sim \text{lognormal}(7.8, 1)$ , represented as  $LN_3$ .

The prior probabilities that any of these pdfs is the actual pdf are equal.
- e) There are four possible events at the end of the first period:
  - 1) A flood ( $W > 50,000$  cfs) occurs.

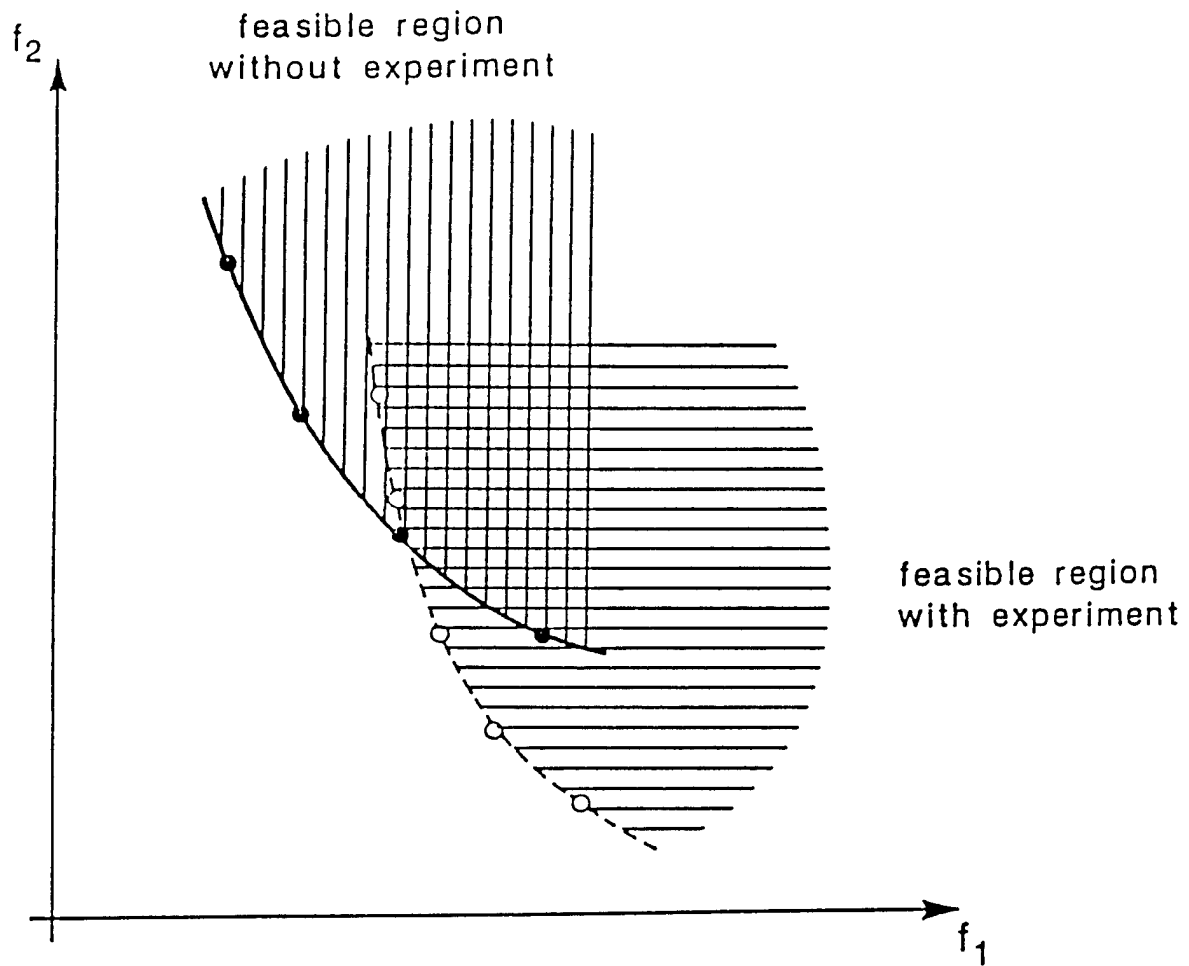
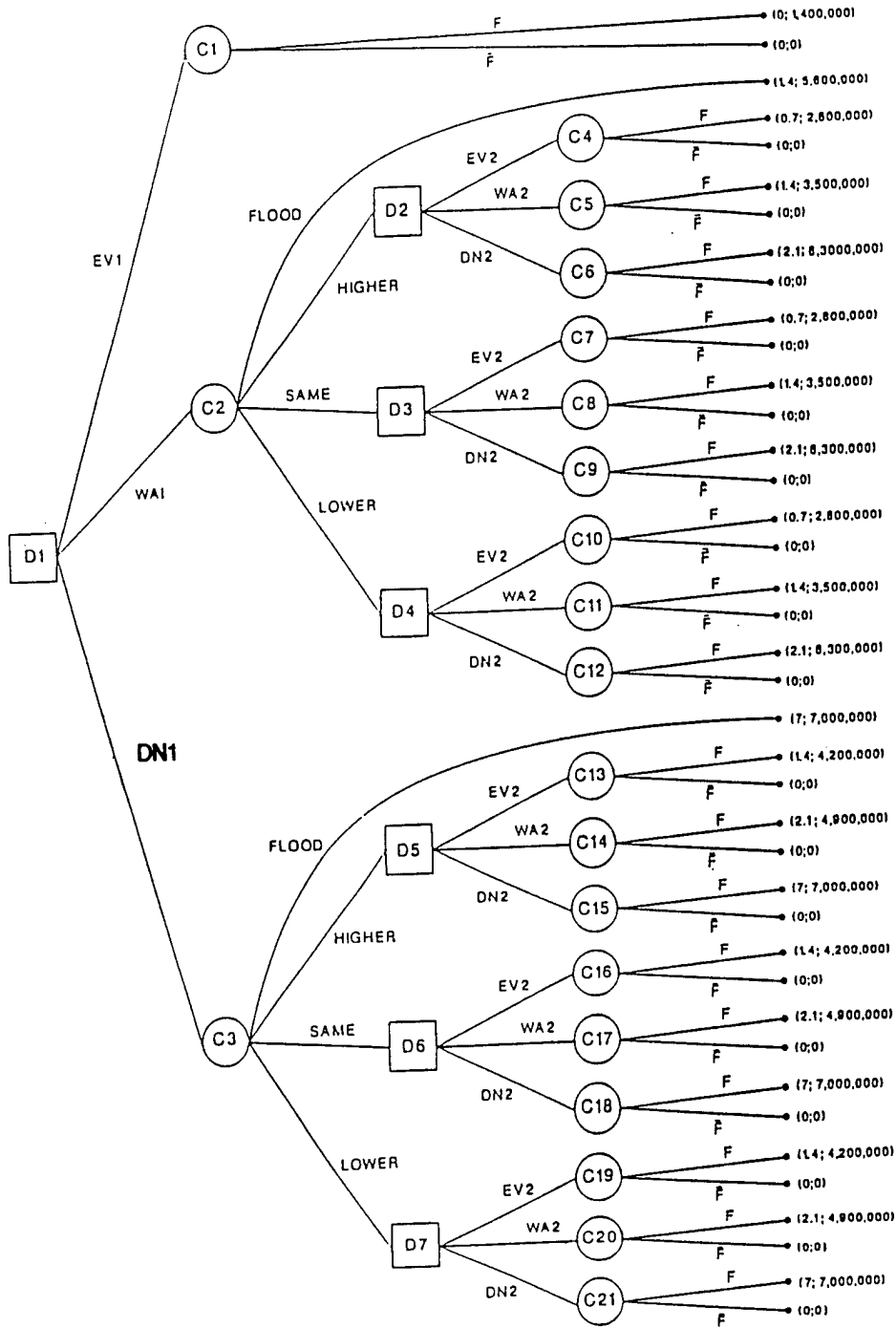


Figure 2-2. Re-Shape of the Feasible Region by an Experimentation



**Figure 2-3. Decision Tree for the Discrete Case**

***Risk-Based Evaluation of  
Flood Warning and Preparedness Systems***

2) The water flow is greater than that of the previous period ( $15,000 \text{ cfs} \leq W \leq 50,000 \text{ cfs}$ ), represented as W1.

3) The water flow is in the same range as that of the previous period ( $5000 \text{ cfs} \leq W \leq 15,000 \text{ cfs}$ ), represented as W2.

4) The water flow is lower than that of the previous period ( $W \leq 5000 \text{ cfs}$ ), represented as W3.

f)  $L = 7$  and  $C = \$7,000,000$  are respectively the maximum possible loss of lives and properties, given no flood warning. All other costs are shown in Fig. 2-3.

*Calculation of Probabilities for the First Period*

*Chance node C1*

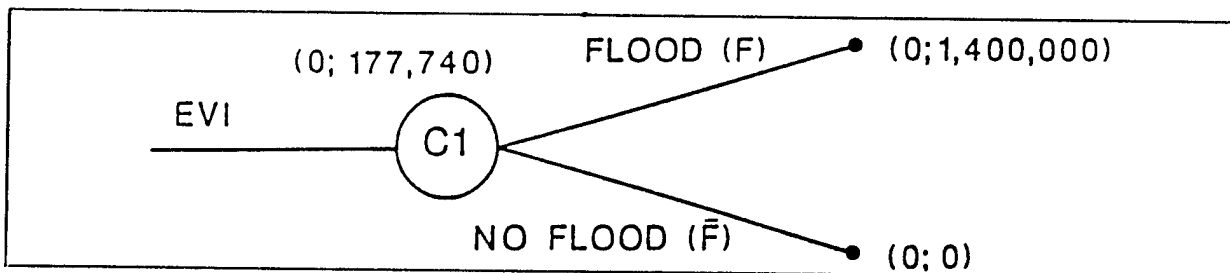
To calculate the probabilities of a flood or no flood event at the end of the second period (see Fig. 2-4), we use the facts that the possible pdf of the water flow ( $W$ ) is  $LN_i$  with probability  $1/3$ ,  $i = 1,2,3$ , and that the flood stage is at  $W = 50,000 \text{ cfs}$ . The probability of a flood event can be calculated as follows:

$$\begin{aligned} \text{prob.}(\text{flood}) &= \sum_{i=1}^3 \text{prob.}(\text{flood} \mid LN_i) \text{prob.}(LN_i) \\ &= \sum_{i=1}^3 (1/3) \text{prob.}(x \geq 50,000 \text{cfs} \mid LN_i) \end{aligned} \quad (2.12a)$$

where

Equation (12b) is converted into a standard normal distribution by using

$$\text{prob.}(x \geq 50,000 \text{cfs} \mid LN_i) = \int_{50,000}^{\infty} \frac{\exp[-\{\ln(x) - \mu_i\}^2/2\sigma_i^2] dx}{\sqrt{2\pi} x \sigma_i} \quad (2.12b)$$



**Figure 2-4.** Averaging out at Chance Node C1 (Discrete Case)

$$z = [\ln(x) - \mu_i]/\sigma_i \quad (2.13)$$

yielding

$$\text{prob.}(x \geq 50,000\text{cfs} \mid L_n) = \int_{(\ln 50000 - \mu_i/\sigma_i)}^{\infty} \frac{\exp(-z^2/2)}{\sqrt{2\pi}} dz \quad (2.14)$$

Equation (14) is evaluated using standard normal distribution tables. This yields

$$\text{prob.}(\text{flood}) = \text{prob.}(x \geq 50,000) = 0.1271$$

*Chance nodes C2 and C3*

Nodes C2 and C3 each present four possible events at the beginning of the second period: namely, a flood event, the water flow is higher, the water flow is the same, and the water flow is lower than the previous period (see Fig. 2-5). The distribution of water flow at the end of the first period is given by assumption d. The probability of each event is calculated using Eqs. (2-12), (2-13) and (2-14) with modified integral intervals:

$$\text{prob.}(\text{flood}) = \text{prob.}(50,000 \leq x \leq \infty) = 0.1271$$

$$\text{prob.}(\text{higher}) = \text{prob.}(15,000 \leq x \leq 50,000) = 0.2466$$

$$\text{prob.}(\text{same}) = \text{prob.}(5000 \leq x \leq 15,000) = 0.2686$$

$$\text{prob.}(\text{lower}) = \text{prob.}(0 \leq x \leq 5000) = 0.3577$$

*Calculation of Probabilities for the Second Period*

Regardless of whether a watch action (WA1) or do nothing (DN1) action was taken at the first period, three possible actions must be considered at the second period -- evacuate, issue another flood watch, do nothing. Depending on the actions taken in the first and the second periods and on the water flow at the second period, different values of the expected losses for each of the terminal chance nodes are calculated. Three equally probable underlying pdfs for the water flow prevail in the first period. At the end of the first period, after measuring the water flow  $W_j$ , the posterior probabilities for each of these pdfs are calculated using Bayes' formula:

$$\text{prob.}(LN_i \mid W_j) = \frac{\text{prob.}(W_j \mid LN_i) \text{prob.}(LN_i)}{\sum_{i=1}^3 \text{prob.}(W_j \mid LN_i) \text{prob.}(LN_i)} \quad (2.15)$$



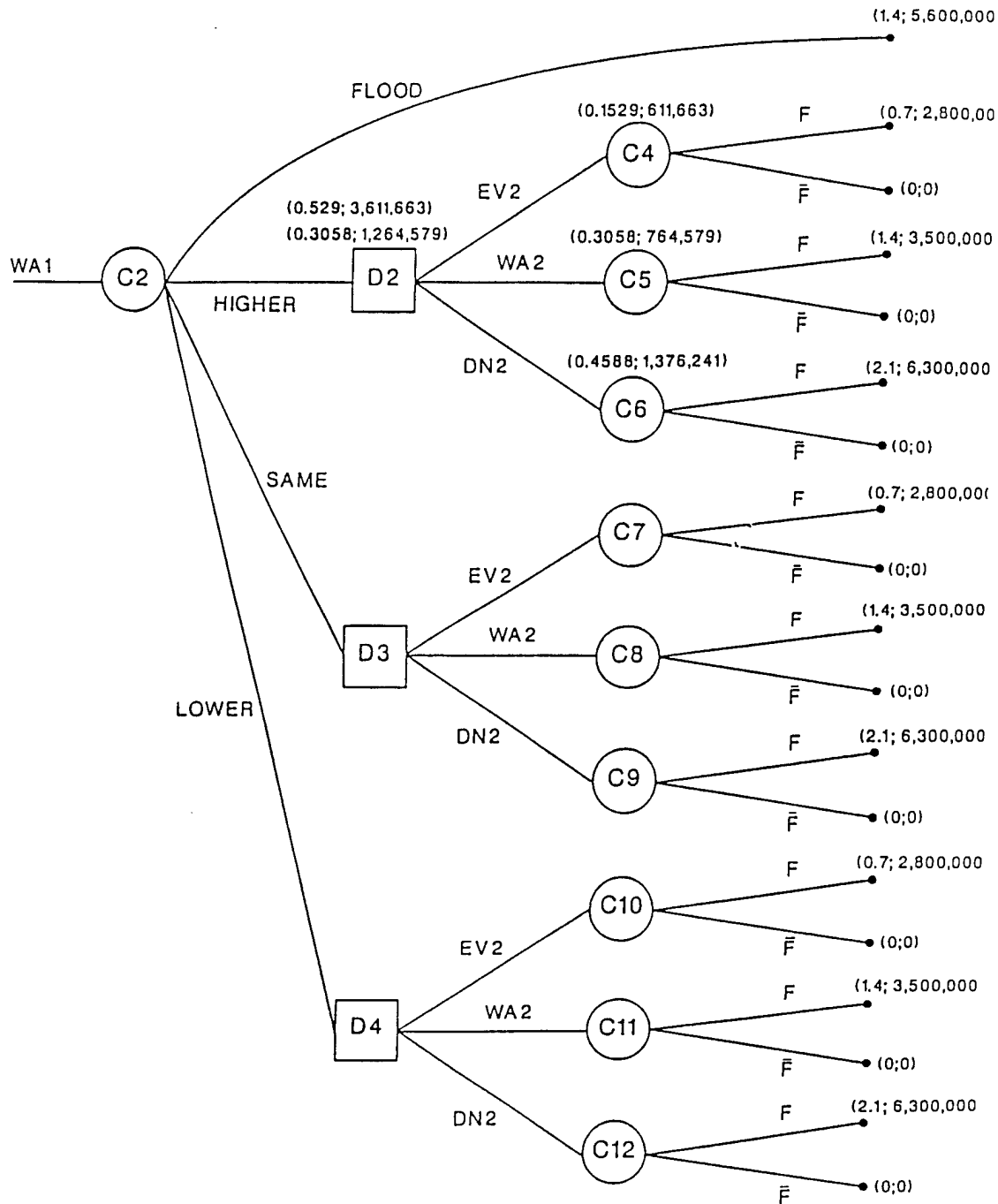


Figure 2-5. Second Stage Tree Corresponding to Chance Node C2 (Discrete Case)

where  $\text{prob.}(LN_i) = 1/3$  and  $W_j$  is given in assumption e, and  $\text{prob.}(W_j | LN_i)$  is calculated using Eqs. (2.12), (2.13), and (2.14). Then, the probability of a flood event at any chance node is calculated as

$$\text{prob. (flood} | W_j) = \sum_{i=1}^3 \text{prob. (Flood} | LN_i) \text{prob. (LN}_i | W_j) \quad 2.16$$

For example,

$$\begin{aligned} \text{prob. (flood} | \text{higher}) &= \text{prob. (flood} | LN_1) * \text{prob. (LN}_1 | \text{higher}) + \text{prob. (flood} | LN_2) * \\ &\text{prob. (LN}_2 | \text{higher}) + \text{prob. (flood} | LN_3) * \text{prob. (LN}_3 | \text{higher}) \end{aligned}$$

The values of  $\text{prob. (flood} | LN_i)$  ( $i=1, 2, 3$ ) are calculated using Eqs. (2.12), (2.13) and (2.14) and the values of  $\text{Pr}(LN_i | \text{higher})$  ( $i = 1, 2, 3$ ) are calculated using Eq. (15). Therefore, from Eq. (2.16),

$$\begin{aligned} \text{prob. (flood} | \text{higher}) \\ &= 0.3372 * 0.603129 + 0.0427 * 0.351699 + 0.0013 * 0.045172 = 0.218451 \end{aligned}$$

Similarly,

$$\begin{aligned} \text{prob. (flood} | \text{same}) &= 0.100545 \\ \text{prob. (flood} | \text{lower}) &= 0.021444 \end{aligned}$$

The required value of the loss vector-valued functions is then computed by multiplying the flood probability by the damage vector. Consider, for example, arc EV2 corresponding to decision node D2 in Fig. 2-5,

$$\begin{aligned} L_{EV2 | D2} &= 0.218451 * 0.7 = 0.1529 \\ C_{EV2 | D2} &= 0.218451 * 2,800,000 + 3,000,000 = 3,611,663 \end{aligned}$$

Table 2-1 presents the values of the loss vectors for the second-period decision arcs. Folding back at each decision node, the vector-valued functions are compared, and all dominated (inferior) solutions are eliminated. Consider, for example, decision node D2. The vector corresponding to the decision DN2 is inferior to the vector corresponding to the decision WA2.

$$\begin{bmatrix} 0.3058 \\ 1,264,579 \end{bmatrix}_{WA2} < \begin{bmatrix} 0.4588 \\ 1,376,241 \end{bmatrix}_{DN2}$$

Table 2-2 presents the noninferior decisions for the second-period decision arcs. Averaging-out at the chance nodes for the first period, each noninferior decision corresponding to each arc is multiplied by the probability for that arc, yielding a single decision rule for the first- period decision node. For example, we have 18 different combinations at WA1, one of which is (EV2 | higher, EV2 | same, EV2 | lower). The value of the loss vector for this combination is:

**Table 2-1.** Expected Value of Loss Vectors for the Second-Period Decision Arcs  
(Discrete Case)

Node	Arc	L	C
D2	EV2	0.1529	3,611,663
	WA2	0.3058	1,264,579
	DN2	0.4588	1,376,241
D3	EV2	0.0704	3,281,526
	WA2	0.1408	851,908
	DN2	0.2112	633,434
D4	EV2	0.0150	3,060,043
	WA2	0.0300	575,054
	DN2	0.0450	135,097
D5	EV2	0.3058	3,917,494
	WA2	0.4588	1,570,410
	DN2	1.5292	1,529,157
D6	EV2	0.1408	3,422,289
	WA2	0.2112	992,671
	DN2	0.7038	703,815
D7	EV2	0.0300	3,090,065
	WA2	0.0450	605,076
	DN2	0.1501	150,108
C2	F	0.1779	711,760
C3	F	0.8897	889,700

L -- loss of lives

C -- cost (\$)

**Table 2-2.** Noninferior Decisions for the Second-Period Decision Nodes (Discrete Case)

Node	Noninferior decisions
D2	EV2, WA2
D3	EV2, WA2, DN2
D4	EV2, WA2, DN2
D5	EV2, WA2, DN2
D6	EV2, WA2, DN2
D7	EV2, WA2, DN2

$$\begin{aligned} & \left[ \begin{array}{c} 0.1779 + 0.1529 * 0.2466 + 0.0704 * 0.2686 + 0.0150 * 0.3577 \\ (1,000 + 711.76 + 3,611.633 * 0.2466 + 3,281.526 * 0.2686 + 3,060.043 * 0.3577) 1,000 \end{array} \right] \\ & = \left[ \begin{array}{c} 0.2399 \\ 4,578,391 \end{array} \right] \end{aligned}$$

where the first and second elements represent a loss of lives of 0.2399 and a cost of \$4,578,391, respectively. Table 2-3 presents the values of the vector of objectives for the first-period decision node. Note from Table 2-3 that a total of nine noninferior decisions are generated for action WA1. Similarly, there are five noninferior solutions for action DN1 (by self-comparison of all vectors for that action), and fourteen noninferior solutions after comparing all decisions for all actions (see Fig. 2-6). Fig. 2-7 depicts the graph of all noninferior solutions.

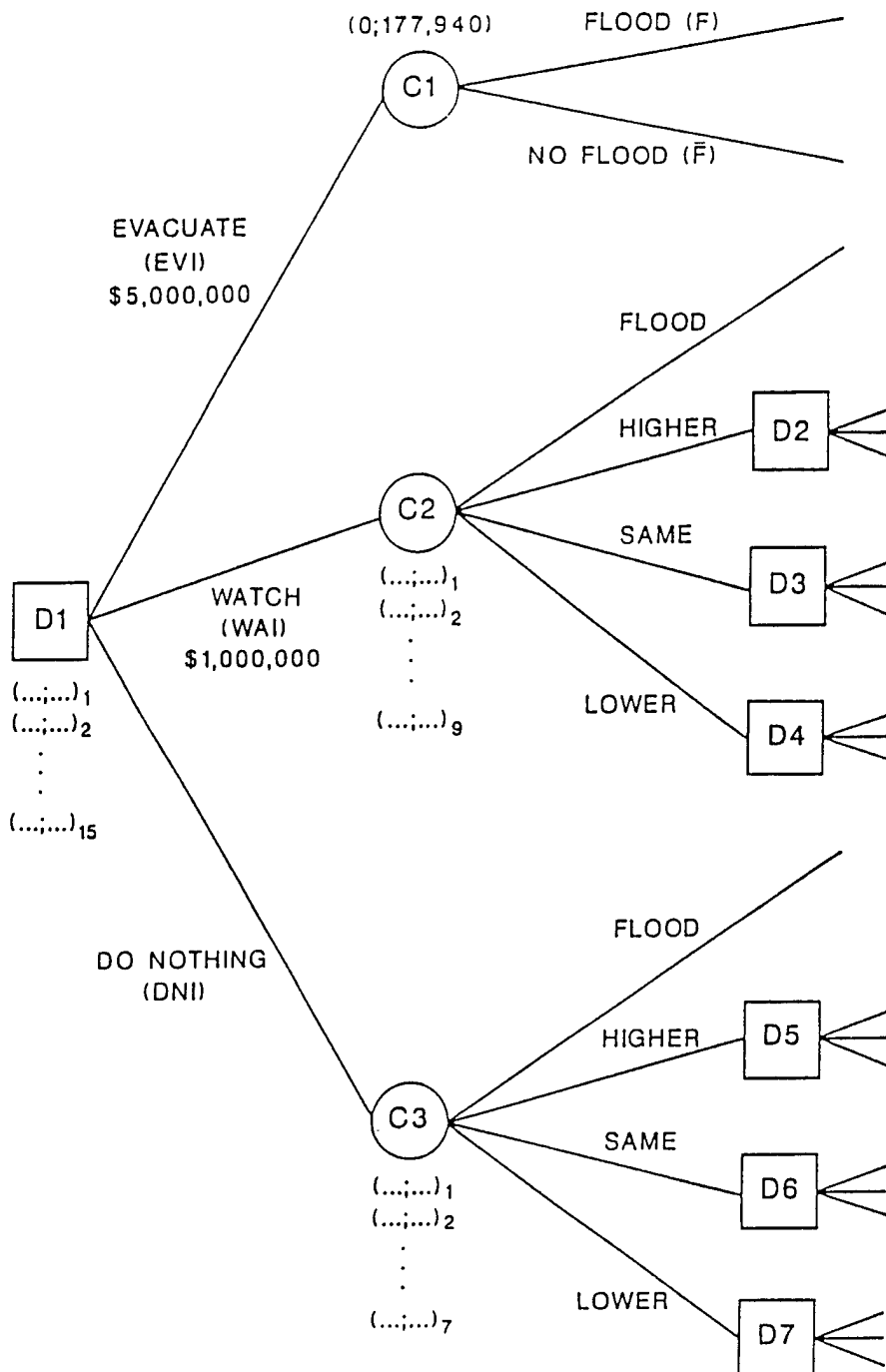
#### Extension to Multiple-Risk Measures

Multiobjective decision-tree analysis calls for the adoption of multiple-risk measures. Often, the expected value, by itself, provides insufficient information for risk management. The expected value of adverse effects, which has been most commonly used in conventional decision-tree analysis, is in many cases inadequate, since this scalar representation of risk commensurates events that correspond to all levels of losses and to their associated probabilities. The common expected-value approach is particularly deficient for addressing extreme events, since these events are concealed during the amalgamation of events of low probability and high consequence with events of high probability and low consequence. The synthesis of several approaches -- single-objective decision-tree analysis, multiobjective optimization, the partitioned multiobjective risk method (PMRM), and the statistics of extremes -- has led to the development of the multiobjective decision-tree method. This new form of decision-tree analysis can handle different risk functions, including the common expected value, the conditional expected value for extreme events, and the event with maximum probability, thus providing decisionmaker(s) with more comprehensive knowledge and a robust decision policy.

Determining the folding-back strategy associated with conditional expected values is substantially different from such an operation using the conventional expected value. Unlike the latter, which is a linear operator, the conditional expected-value operator is nonlinear. This nonlinearity represents an obstacle in decomposing the overall value of the conditional expected value and in calculating it at different decision nodes. Thus, in calculating conditional risk functions  $f_i$ , all performance measures at the different branches are mapped to the terminal points where the partitioning is performed.

In order to develop a folding-back strategy for the conditional expected value  $f_4$  (the schemes for  $f_2$  and  $f_3$  are similar and thus are omitted here), some properties in a sequential calculation of  $f_4$  will be first discussed.

Consider a two-stage decision-tree problem with a damage function  $f(a_j, \theta_j, a_{j+1}, \theta_{j+1})$ , where  $a_j$  is the action at stage  $j$  and  $\theta_j$  is the state of nature at stage  $j$  ( $j = 1$  and  $2$ ). The optimal value of  $f_4$  is given by



**Figure 2-6. Decision Tree for the First Stage (Discrete Case)**

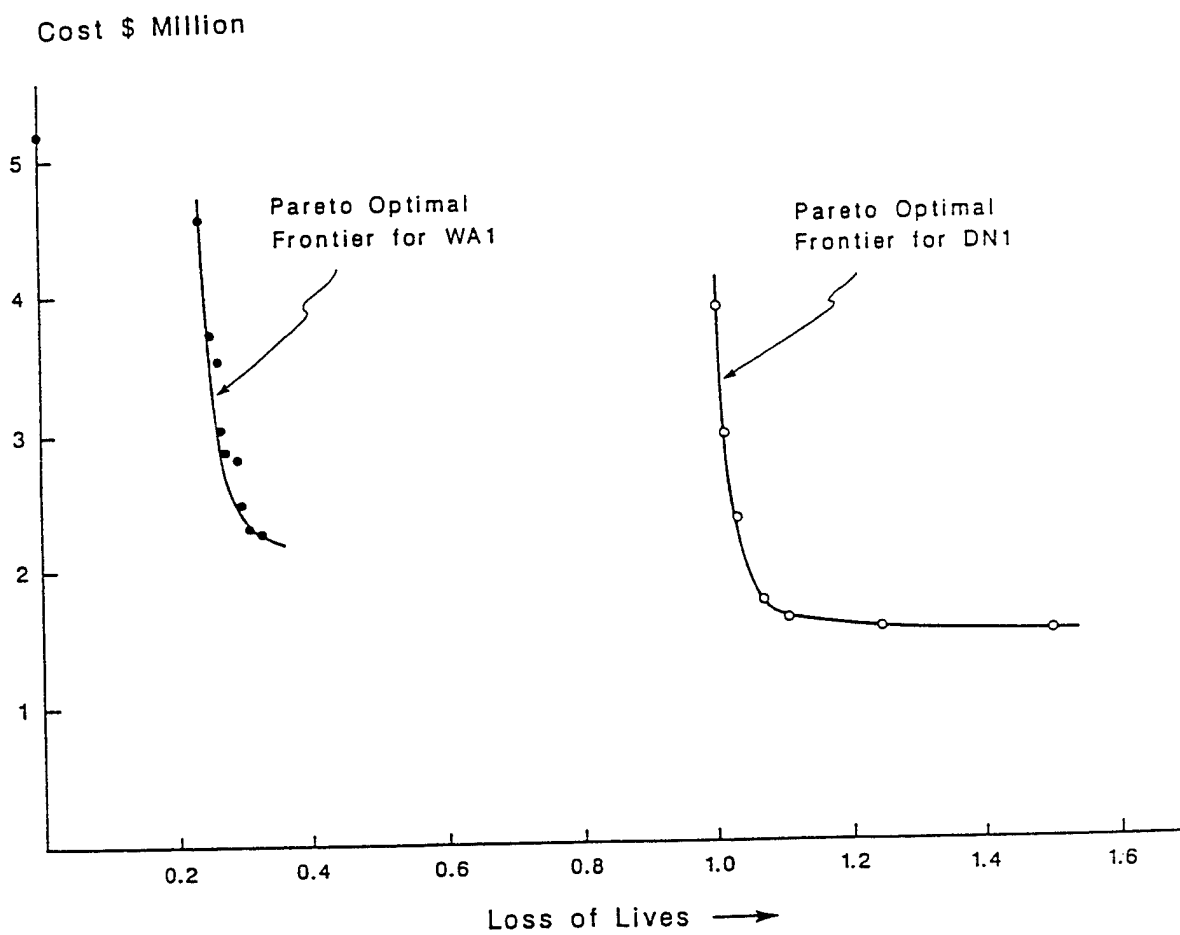


Figure 2-7. Pareto Optimal Frontier (Discrete Case)

*Risk-Based Evaluation of  
Flood Warning and Preparedness Systems*

Table 2-3. Decisions for the First-Period Decision Node (Discrete Case)

First-period decision	Second-period decision			Loss vector	
	Higher	Same	Lower	L	C
* EV1	-	-	-	0.0000	5,177,940
* WA1	EV2	EV2	EV2	0.2399	4,578,391
* WA1	EV2	EV2	WA2	0.2452	3,689,511
* WA1	EV2	EV2	DN2	0.2506	3,532,138
WA1	EV2	WA2	EV2	0.2588	3,925,796
* WA1	EV2	WA2	WA2	0.2641	3,036,916
* WA1	EV2	WA2	DN2	0.2695	2,879,543
WA1	EV2	DN2	EV2	0.2777	3,867,113
WA1	EV2	DN2	WA2	0.2830	2,978,233
* WA1	EV2	DN2	DN2	0.2884	2,820,860
WA1	WA2	EV2	EV2	0.2776	3,999,600
WA1	WA2	EV2	WA2	0.2829	3,110,720
WA1	WA2	EV2	DN2	0.2883	2,953,347
WA1	WA2	WA2	EV2	0.2965	3,347,005
* WA1	WA2	WA2	WA2	0.3018	2,458,125
* WA1	WA2	WA2	DN2	0.3072	2,300,752
WA1	WA2	DN2	EV2	0.3154	3,288,323
WA1	WA2	DN2	WA2	0.3207	2,399,442
* WA1	WA2	DN2	DN2	0.3261	2,242,070
DN1	EV2	EV2	EV2	1.0136	3,880,297
DN1	EV2	EV2	WA2	1.0190	2,991,417
DN1	EV2	EV2	DN2	1.0566	2,828,675
DN1	EV2	WA2	EV2	1.0325	3,227,701
* DN1	EV2	WA2	WA2	1.0379	2,338,821
DN1	EV2	WA2	DN2	1.0756	2,176,079
DN1	EV2	DN2	EV2	1.1648	3,150,115
DN1	EV2	DN2	WA2	1.1702	2,261,235
DN1	EV2	DN2	DN2	1.2078	2,098,493
DN1	WA2	EV2	EV2	1.0513	3,301,506
DN1	WA2	EV2	WA2	1.0567	2,412,626
DN1	WA2	EV2	DN2	1.0943	2,249,884
DN1	WA2	WA2	EV2	1.0702	2,648,910
* DN1	WA2	WA2	WA2	1.0756	1,760,030
* DN1	WA2	WA2	DN2	1.1132	1,597,288
DN1	WA2	DN2	EV2	1.2025	2,571,324
DN1	WA2	DN2	WA2	1.2079	1,682,444
* DN1	WA2	DN2	DN2	1.2455	1,519,702
DN1	DN2	EV2	EV2	1.3153	3,291,333
DN1	DN2	EV2	WA2	1.3207	2,402,453
DN1	DN2	EV2	DN2	1.3583	2,239,711
DN1	DN2	WA2	EV2	1.3342	2,638,737
DN1	DN2	WA2	WA2	1.3396	1,749,857
DN1	DN2	WA2	DN2	1.3772	1,587,115
DN1	DN2	DN2	EV2	1.4665	2,561,151
DN1	DN2	DN2	WA2	1.4719	1,672,271
* DN1	DN2	DN2	DN2	1.5095	1,509,529

\* - noninferior decisions

$$f_4^* = \min_{a_1, a_2} \frac{\int \int_{f(a_1, \theta_1, a_2, \theta_2) \geq P^{-1}(\alpha)} f(a_1, \theta_1, a_2, \theta_2) p(\theta_1, \theta_2 | a_1, a_2) d\theta_1 d\theta_2}{\int \int_{f(a_1, \theta_1, a_2, \theta_2) \geq P^{-1}(\alpha)} p(\theta_1, \theta_2 | a_1, a_2) d\theta_1 d\theta_2} \quad (2.17)$$

where  $\alpha$  is the partitioning point on the probability axis. Rewrite

$$p(\theta_1, \theta_2 | a_1, a_2) = p(\theta_2 | \theta_1, a_1, a_2) p(\theta_1 | a_1) \quad (2.18)$$

The fact that an action at a subsequent stage does not affect the state of nature at a previous stage is used in Eq. (2.18). Consequently, the optimization problem in Eq. (2.17) can be evaluated in a two-stage form.

$$f_4^* = \min_{a_1, a_2} \frac{\int \int_{f(a_1, \theta_1, a_2, \theta_2) \geq P^{-1}(\alpha)} f(a_1, \theta_1, a_2, \theta_2) p(\theta_2 | \theta_1, a_1, a_2) d\theta_2 \int p(\theta_1 | a_1) d\theta_1}{\int \int_{f(a_1, \theta_1, a_2, \theta_2) \geq P^{-1}(\alpha)} p(\theta_2 | \theta_1, a_1, a_2) d\theta_2 \int p(\theta_1 | a_1) d\theta_1} \quad (2.19)$$

The optimization problem in Eq. (2.19) is nonseparable. To separate the objective function with respect to stages, it is thus necessary to record two numbers at each stage -- the values of the numerator and the denominator for each optimal conditional expected value. A more serious problem related to the decomposition of Eq. (2.19) is its nonmonotonicity. This can be easily observed by the fact that minimization of  $a(\bullet)/b(\bullet)$  does not necessarily lead to the solution of minimization of  $[c+a(\bullet)]/[d+b(\bullet)]$  where  $c$  and  $d$  are two constants and  $b$  and  $d$  are positive. The only exception to the above claim holding is the case where  $b$  remains a constant. The following simplification will be introduced to make stagewise calculation of the value of the conditional expectation  $f_4$  possible. From the definition, we have  $P[f(\theta_1, \theta_2) \geq P^{-1}(\alpha)] = \alpha$ . When the value of  $\theta_1$  is fixed,  $P[f(\theta_1, \theta_2) \geq P^{-1}(\alpha) | \theta_1]$  is not necessarily equal to  $\alpha$ . In order to have a common denominator, we introduce a set of  $P_1^{-1}(\alpha)$  to keep  $P[f(\theta_1, \theta_2) \geq P_1^{-1}(\alpha) | \theta_1] = \alpha$ , where  $P_1$  is the conditional cumulative distribution function of  $\theta_2$ , given value of  $\theta_1$ . When we fold back, this simplification yields

$$\int_{\theta_1} P[f(\theta_1, \theta_2) \geq P_1^{-1}(\alpha) | \theta_1] p(\theta_1) d\theta_1 = \alpha \quad (2.20)$$

In summary, we should adhere to the following rules when calculating the conditional expected value in the folding-back procedure of decision trees:

- 1) Partition and calculate  $f_4$  at terminal points according to the conditional probability density function.



2) Fold back and perform at each chance node the operation of the expected value.

Note that although reducing the variance (the uncertainty) of the risk may not contribute much to reducing the expected value  $f_5$ , it often markedly reduces the conditional expected value  $f_4$  associated with extreme events (see Fig. 2-8). Two benefits that result from additional experimentation include reducing the expected loss and reducing the uncertainty associated with decisionmaking under risk. However, in most cases, these two dual aspects of experimentation conflict with each other. The general framework of multiobjective decision-tree analysis proposed here provides a medium with which these dual aspects can be captured by investigating the multiple impacts of experimentation.

### Example Problem for the Continuous Case

#### *Problem Definition*

The problem developed in the previous example for the discrete case is modified here to handle continuous loss functions and extreme random events. The main difference between the discrete and the continuous cases lies in calculating the damage vector for the terminal nodes, which can be determined using the expected value  $f_5(\bullet)$  and/or the conditional expected value  $f_4(\bullet)$ . The subsequent computations are similar to those carried out for the discrete case. Consequently, assumption f for the discrete case is modified as:

f') L and C are, respectively, the possible loss of lives and cost, given that no flood warning is issued; they are linear functions of the water flow W. All other costs (as shown in Fig. 2-4) are given in terms of the loss functions L and C, where  $L = W * L_F$ , and  $L_F = 0.0001$ ,  $C = W * C_F$ , and  $C_F = 100$

The complete decision tree for this case is shown in Fig. 2-9. The loss functions L and C are calculated using the unconditional expected-value function  $f_5(\bullet)$  and/or the conditional expected-value function  $f_4(\bullet)$ . The unconditional expected loss  $f_5(\bullet)$  is given by

$$\begin{aligned}
 f_5(\bullet) &= P_f \int_{50000}^{\infty} \frac{W}{\sqrt{2\pi}\sigma} \frac{1}{2} \exp \left[ -\frac{1}{2} \left[ \frac{\ln(W) - \mu}{\sigma} \right]^2 \right] dW \\
 &= P_f \left[ 1 - \Phi \left[ \frac{10.82 - \mu}{\sigma} \right] \right] \exp(\mu + \sigma^2/2) \left[ 1 - \Phi \left[ \frac{10.82 - \mu}{\sigma} - \sigma \right] \right]
 \end{aligned} \tag{2.21}$$

where  $P_f$  is equal to  $L_f$  or  $C_f$  when Eq. (2.21) is used to calculate  $f_5$  for loss of lives or monetary costs, respectively. The conditional expected loss  $f_4(\bullet)$  is given by

$$f_4(\bullet) = P_f \left[ 1 - \Phi \left[ \Phi^{-1}(\alpha) - \sigma \right] \right] \exp(\mu + \sigma^2/2)/(1 - \alpha) \tag{2.22}$$

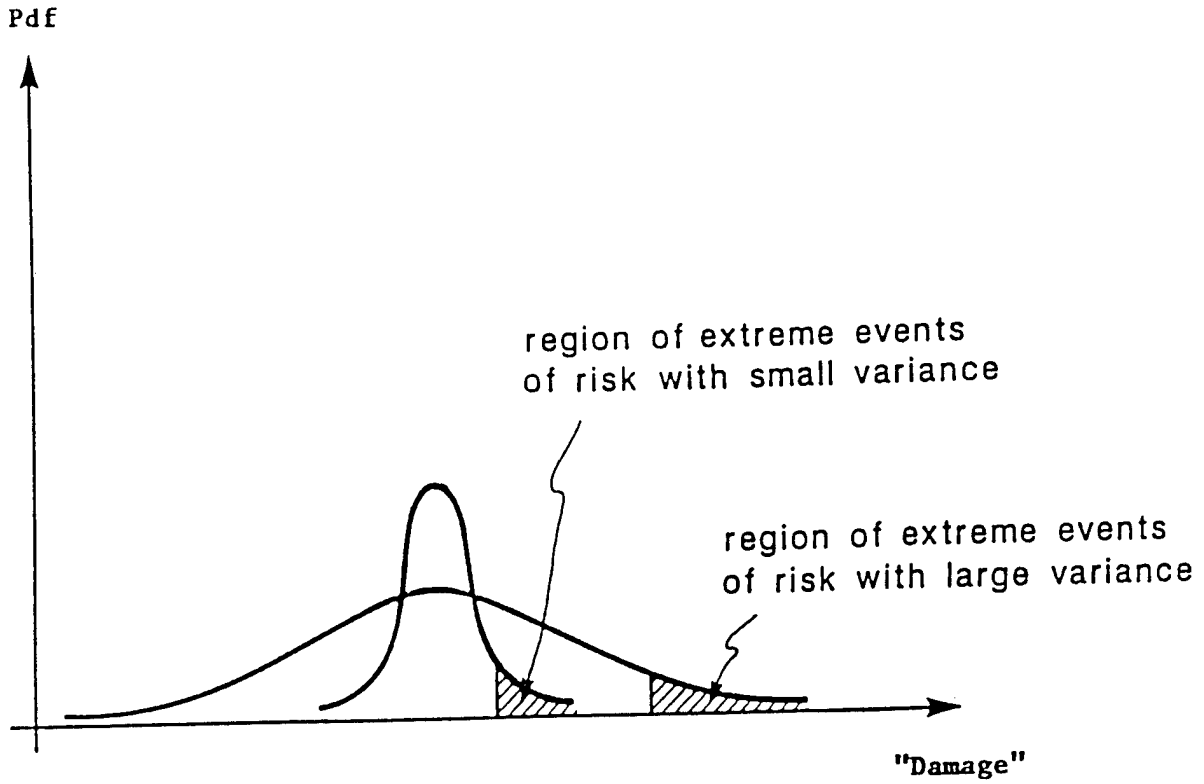
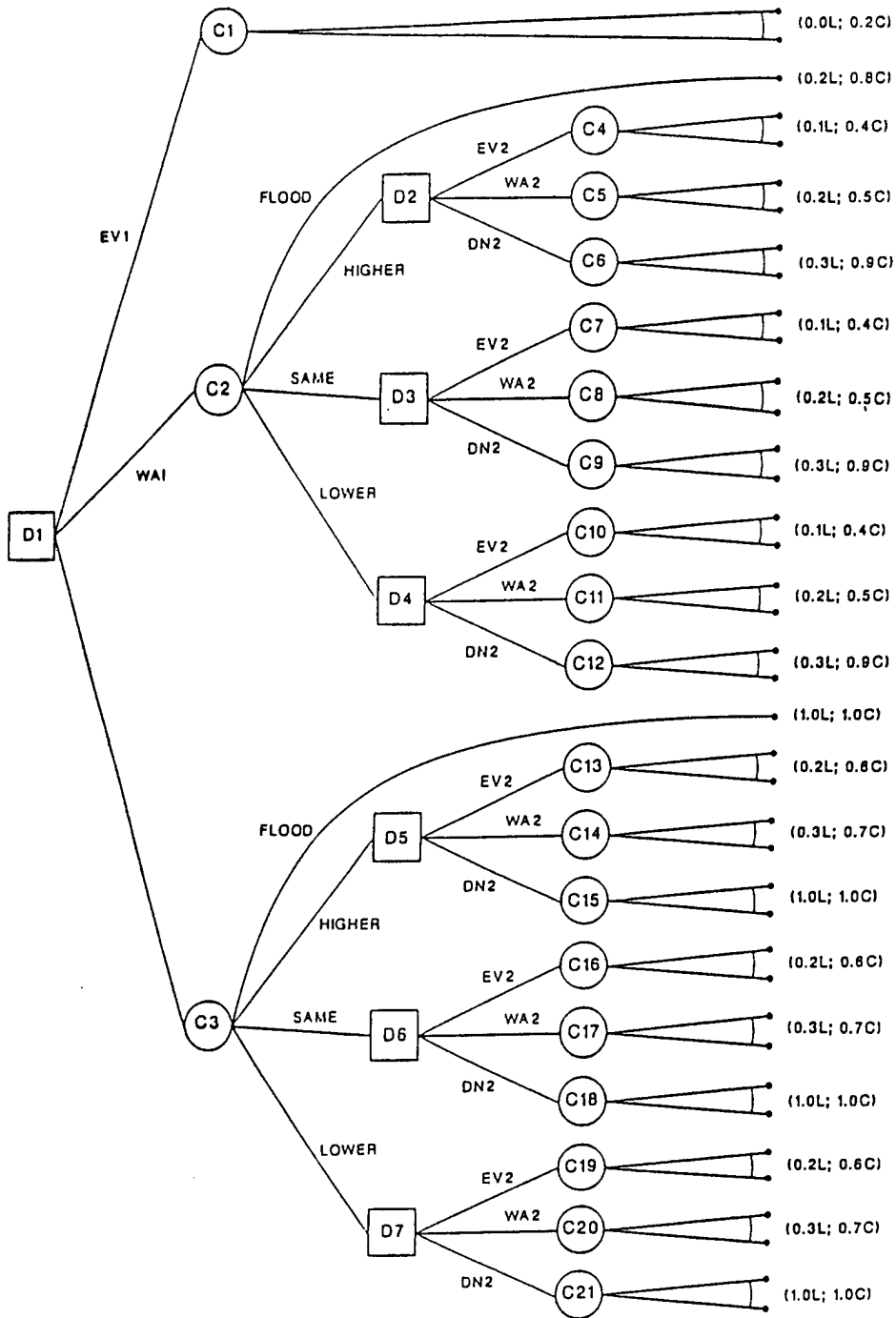


Figure 2-8. Variance and Region of Extreme Events



**Figure 2-9. Decision Tree for the Continuous Case**

where  $P_f$  is equal to  $L_f$  or  $C_f$  when Eq. (2.22) is used to calculate  $f_4$  for loss of lives or monetary costs, respectively, and  $\alpha$  is the partitioning point on the probability axis, which is 0.99 in this case. With the use of Eqs. (2.21) and (2.22), the cost (C) and the loss of lives (L) are calculated using  $f_4(\bullet)$  and  $f_5(\bullet)$  at all the terminal nodes for each of the decision arcs. Note that each of the risk functions  $f_4(\bullet)$  and  $f_5(\bullet)$  is composed of two components -- cost and loss of lives.

*Calculation of the Loss Vectors For the First Period*

*Chance node C1*

Assuming that the possible pdf of the water flow (W) is  $LN_i$  with probability  $1/3$ ,  $i = 1,2,3$  and that the flood stage is at  $W = 50,000$  cfs, two outcomes are considered at the end of the second period: a flood or no flood event (see Fig. 2-5). The values of the components of  $f_4(\bullet)$  and  $f_5(\bullet)$  for node C1 are calculated using Eqs. (2.21) and (2.22), respectively. The value of the loss vector for C1 using  $f_4(\bullet)$  is shown in Fig. 2-10.

*Chance nodes C2 and C3*

Four possible outcomes at the beginning of the second period are investigated at nodes C2 and C3: a flood event, the water flow is higher, the water flow is the same, and the water flow is lower (see Fig. 2-20). Similarly to the discrete case, the probabilities of these outcomes are calculated using Eqs. (2.12), (2.13), and (2.14).

*Calculation of Loss Vectors for Second Period*

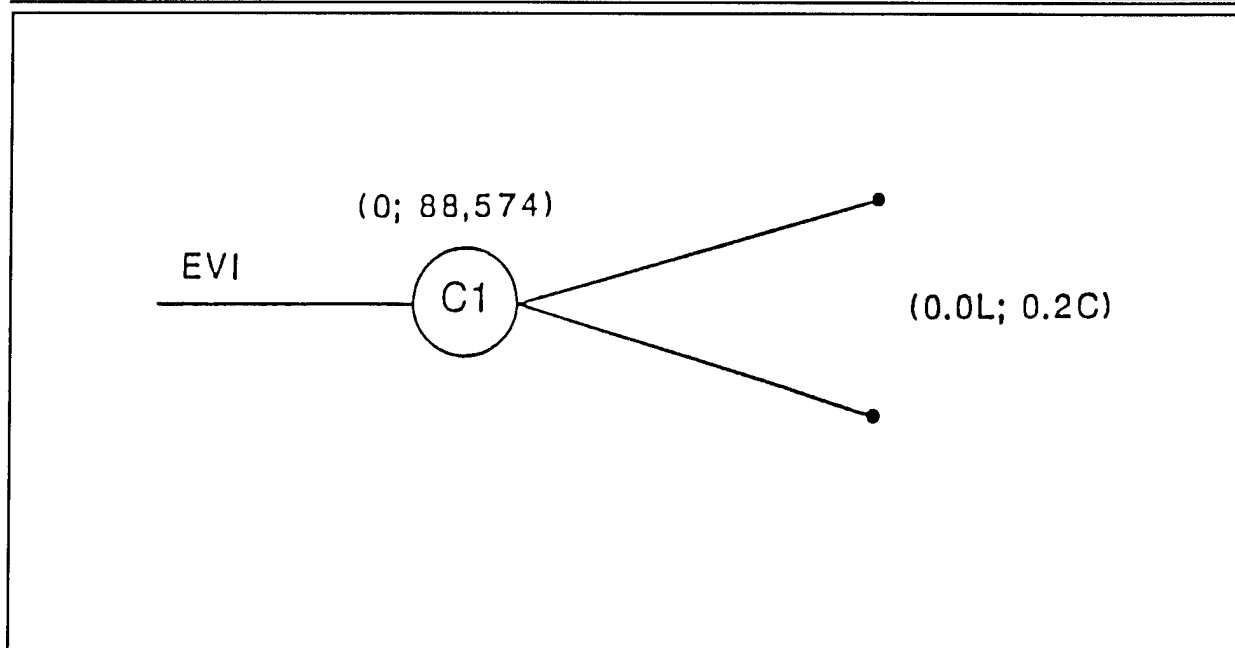
Regardless of whether a watch (WA1) was issued or a do-nothing (DN2) action was followed at the first period, the same three possible actions are evaluated at the second period: evacuate, issue another flood watch, or do nothing. Depending on the actions taken at the first and second periods and the water flow level at the second period, different values of losses are generated for each terminal chance node. There are three equally probable underlying pdfs for the water flow for the first period. After measuring the water flow  $W_j$  at the end of the first period, the posterior probabilities are calculated using Eq. (2.15). The required value of the loss vector [of  $f_4(\bullet)$  and  $f_5(\bullet)$ ] is then calculated using Eqs. (2.21) and (2.23) for  $f_5(\bullet)$  and Eqs. (2.22) and (2.24) for  $f_4(\bullet)$ :

$$f_5(\bullet | W_j) = \sum_{i=1}^3 [f_5(\bullet | LN_i) \Pr(LN_i | W_j)] \tag{2.23}$$

$$f_4(\bullet | W_j) = \sum_{i=1}^3 [f_4(\bullet | LN_i) \Pr(LN_i | W_j)] \tag{2.24}$$

For example,

$$f_4(\bullet | \text{higher}) = f_4(\bullet | LN_1) * \text{prob.}(LN_1 | \text{higher}) + f_4(\bullet | LN_2) * \\ \text{prob.}(LN_2 | \text{higher}) + f_4(\bullet | LN_3) * \text{prob.}(LN_3 | \text{higher})$$



**Figure 2-10.** Averaging out Chance Node C1 Using  $f_5$  (Continuous Case)

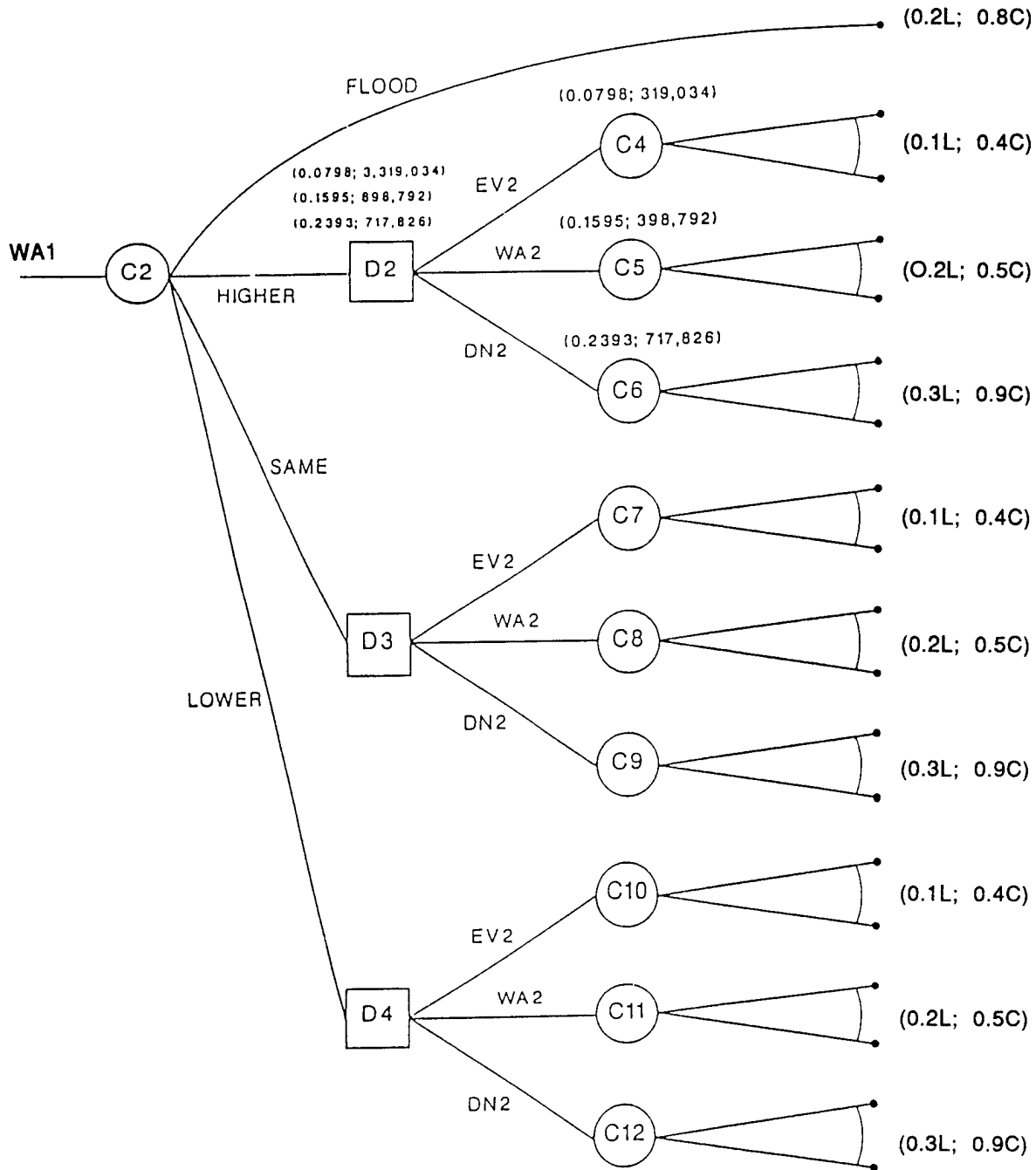
The values of  $\text{prob.}(LN_i \mid \text{higher})$  ( $i=1, 2, 3$ ) are calculated using Eq. (2.15) and the values of  $f_4(\bullet \mid \text{higher})$  are calculated using Eq. (2.22). Therefore, Eq. (2.24) yields,

$$\begin{aligned} f_4(\bullet \mid \text{higher}) & \\ &= 500,697.95 * 0.603129 + 136,456.11 * 0.351699 + 37,188.63 * 0.045172 \\ &= 351,657.32 \end{aligned} \tag{2.25}$$

The values for  $f_4(\bullet \mid \text{same})$ ,  $f_4(\bullet \mid \text{lower})$ ,  $f_5(\bullet \mid \text{higher})$ ,  $f_5(\bullet \mid \text{same})$ , and  $f_5(\bullet \mid \text{lower})$  are calculated in a similar way. The loss vector is then computed by multiplying these results by the ratio to the maximum damage and  $L_f$  or  $C_f$ , as the case may be. For example, the components of the loss vectors for arc EV2 corresponding to decision node D2 are

$$\begin{aligned} L_{EV2 \mid D2, f_4(\bullet)} &= 35.1657 * 0.1 = 3.5166 \\ C_{EV2 \mid D2, f_4(\bullet)} &= 35,165,732 * 0.4 + 3,000,000 = 17,066,293 \end{aligned} \tag{2.26}$$

Table 2-4 summarizes the values of the loss vectors  $f_5(\bullet)$  and  $f_4(\bullet)$  for the decision arcs corresponding to the second period. Once these values are calculated, the noninferior decisions for each node are calculated by folding back the same way as in the discrete case. Table 2-5 yields the noninferior decisions for the second-period decision arcs. Averaging-out at the chance nodes for the first period follows the same procedure used in the discrete case. Consider, for example, action WA1. There are 27 different combinations when using the expected value  $f_5(\bullet)$ , and four different combinations when using  $f_4(\bullet)$ . Table 2-6 yields the values of the loss



**Figure 2-11.** Second Stage Corresponding to Chance Node  $C_w$  Using  $f_5$  (Continuous Case)

**Risk-Based Evaluation of  
Flood Warning and Preparedness Systems**

**Table 2-4. Loss Vectors for the Second-period Decision Arcs (Continuous Case)**

Node	Arc	$f_5(\cdot)$		$f_4(\cdot)$	
		L	C	L	C
D2	• * EV2	0.0798	3,319,034	3.5166	17,066,293
	• WA2	0.1595	898,792	7.0332	18,082,866
	• DN2	0.2393	717,826	10.5497	31,649,159
D3	• * EV2	0.0312	3,124,816	1.9595	10,838,047
	• * WA2	0.0624	656,020	3.9190	10,297,559
	• DN2	0.0936	280,835	5.8785	17,653,606
D4	• * EV2	0.0040	3,016,172	0.7598	6,039,120
	• * WA2	0.0081	520,215	1.5196	4,298,901
	• DN2	0.0121	36,387	2.2793	6,838,021
D5	• * EV2	0.1595	3,478,550	7.0332	24,099,439
	• WA2	0.2393	1,058,309	10.5497	25,116,012
	• DN2	0.7976	797,584	35.1657	35,165,732
D6	• * EV2	0.0624	3,187,223	3.9190	14,757,071
	• * WA2	0.0936	718,427	5.8785	14,216,583
	• DN2	0.3120	312,039	19.5951	19,595,118
D7	• * EV2	0.0081	3,024,258	1.5196	7,558,681
	• * WA2	0.0121	528,301	2.2793	5,818,461
	• DN2	0.0404	40,430	7.5978	7,597,801
C2	F	0.0886	354,298	4.4956	17,982,472
C3	F	0.4429	442,872	22.4781	22,478,090

• noninferior decisions using  $f_5(\cdot)$

\* noninferior decisions using  $f_4(\cdot)$

**Table 2-5. Noninferior Decisions for the Second-period Decision Nodes (Continuous Case)**

Node	Noninferior decisions	
	$f_5(\cdot)$	$f_4(\cdot)$
D2	EV2, WA2, DN2	EV2
D3	EV2, WA2, DN2	EV2, WA2
D4	EV2, WA2, DN2	EV2, WA2
D5	EV2, WA2, DN2	EV2
D6	EV2, WA2, DN2	EV2, WA2
D7	EV2, WA2, DN2	EV2, WA2

vectors for the first-period decision node using  $f_3(\bullet)$ , and Table 2-7 yields the values of the loss vectors using  $f_4(\bullet)$ . Note from Table 2-8 that for action WA1 there are a total of 10 noninferior decisions by self-comparison. Similarly for action DN1, there are 8 noninferior solutions by self-comparison of all vectors for action DN1, and 6 noninferior solutions after comparison of all decisions for all actions using  $f_5(\bullet)$  (see Fig. 2-12). Figure 2-13 depicts the graph of all noninferior solutions using  $f_5(\bullet)$ . Note from Table 2-8 that there is only one noninferior action. The action EV1 yields the most conservative action from the point of view of extreme events. When the decisionmaker considers the possible extreme event, the potential loss of property dominates the cost of the warning system. Thus, the two objective functions do not conflict at this case.

### Conclusions

Multiobjective decision-tree analysis is an extension of the single-objective-based decision-tree analysis formally introduced more than two decades ago by Howard Raiffa [1968]. This extension is made possible by making a synthesis of the traditional method and more recently developed approaches used for multiobjective analysis and for the risk of extreme and catastrophic events. Successful applications of single-objective decision-tree analysis to numerous business, engineering, and governmental decisionmaking problems over the years have made the methodology into an important and valuable tool in systems analysis. Its extension -- incorporating multiple noncommensurate objectives, impact analysis, and the conditional expected value for extreme and catastrophic events -- might be viewed as an indicator of growth in the broader field of systems analysis and in decisionmaking under risk and uncertainty. Undoubtedly, there remain several theoretical challenges that must be addressed to fully realize the strengths and usefulness of the extended methodology. In this sense, the multiobjective decision-tree analysis proposed here constitutes the first, albeit important, step in the direction of developing improved and more representative models and decisionmaking tools.



**Risk-Based Evaluation of  
Flood Warning and Preparedness Systems**

**Table 2-6. Decisions for the First-period Node Using  $f_5$  (Continuous Case)**

First-period decision	Second-period decision			Loss vector	
	Higher	Same	Lower	L	C
* EV1	-	-	-	0.0000	5,088,574
* WA1	EV2	EV2	EV2	0.0408	3,781,716
* WA1	EV2	EV2	WA2	0.0423	2,888,912
* WA1	EV2	EV2	DN2	0.0437	2,715,847
WA1	EV2	WA2	EV2	0.0492	3,118,597
* WA1	EV2	WA2	WA2	0.0507	2,225,793
* WA1	EV2	WA2	DN2	0.0521	2,052,728
WA1	EV2	DN2	EV2	0.0575	3,017,822
WA1	EV2	DN2	WA2	0.0590	2,125,018
* WA1	EV2	DN2	DN2	0.0604	1,951,953
WA1	WA2	EV2	EV2	0.0604	3,184,884
WA1	WA2	EV2	WA2	0.0619	2,292,080
WA1	WA2	EV2	DN2	0.0633	2,119,015
WA1	WA2	WA2	EV2	0.0688	2,521,765
* WA1	WA2	WA2	WA2	0.0703	1,628,961
* WA1	WA2	WA2	DN2	0.0717	1,455,896
WA1	WA2	DN2	EV2	0.0771	2,420,990
WA1	WA2	DN2	WA2	0.0786	1,528,186
* WA1	WA2	DN2	DN2	0.0800	1,355,121
WA1	DN2	EV2	EV2	0.0801	3,140,258
WA1	DN2	EV2	WA2	0.0816	2,247,454
WA1	DN2	EV2	DN2	0.0830	2,074,389
WA1	DN2	WA2	EV2	0.0885	2,477,139
WA1	DN2	WA2	WA2	0.0900	1,584,335
WA1	DN2	WA2	DN2	0.0914	1,411,270
WA1	DN2	DN2	EV2	0.0968	2,376,364
WA1	DN2	DN2	WA2	0.0983	1,483,560
* WA1	DN2	DN2	DN2	0.0997	1,310,495
DN1	EV2	EV2	EV2	0.1153	2,851,964
DN1	EV2	EV2	WA2	0.1167	1,959,160
DN1	EV2	EV2	DN2	0.1270	1,784,649
DN1	EV2	WA2	EV2	0.1236	2,188,846
* DN1	EV2	WA2	WA2	0.1250	1,296,042
* DN1	EV2	WA2	DN2	0.1353	1,121,531
DN1	EV2	DN2	EV2	0.1823	2,079,690
DN1	EV2	DN2	WA2	0.1837	1,186,886
DN1	EV2	DN2	DN2	0.1940	1,012,375
DN1	WA2	EV2	EV2	0.1350	2,255,133
DN1	WA2	EV2	WA2	0.1364	1,362,329
DN1	WA2	EV2	DN2	0.1467	1,187,818

Table 2-6 (continued)

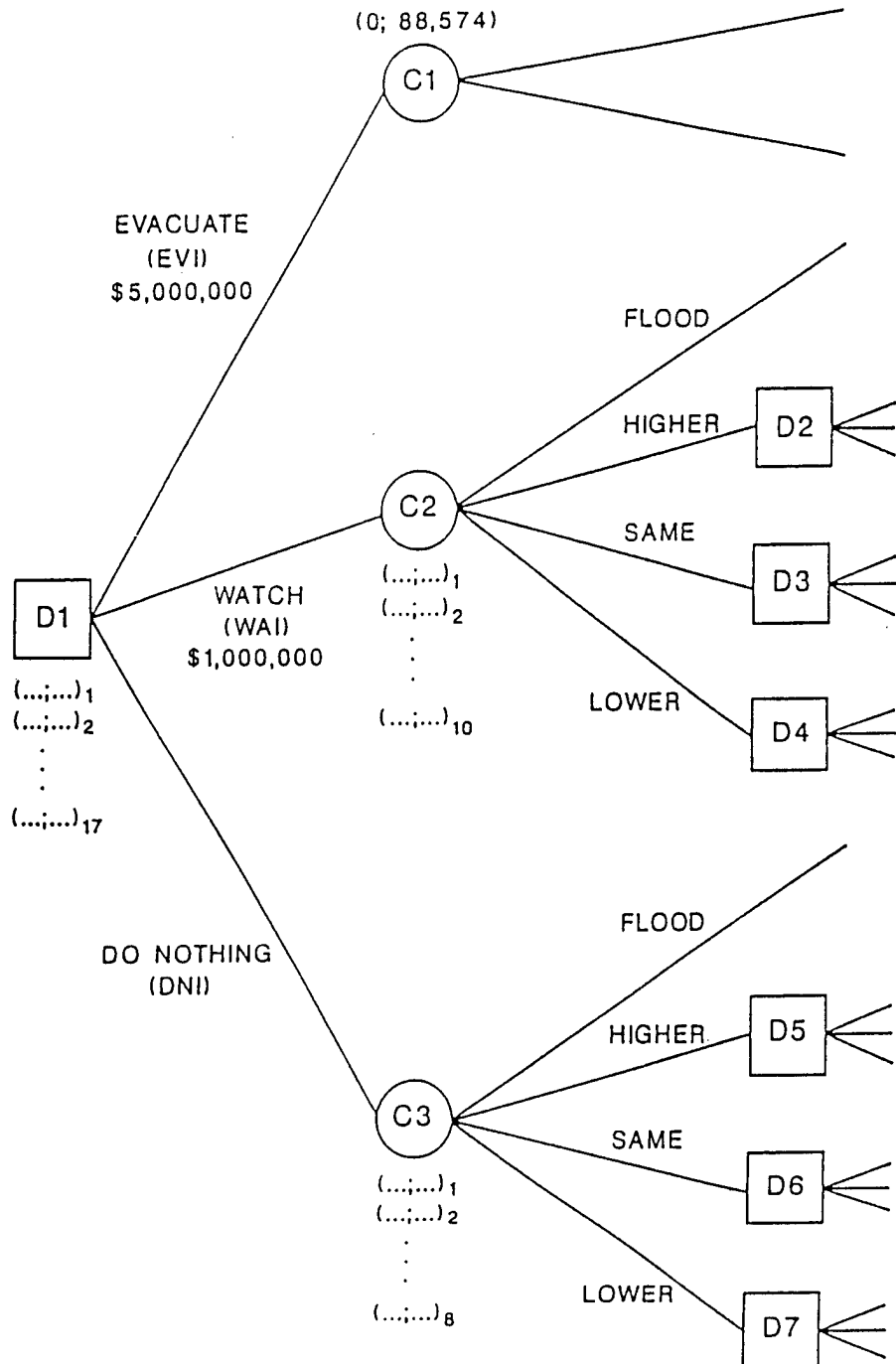
First Period Decision	Second period decision			Loss vector	
	Higher	Same	Lower	L	C
DN1	WA2	WA2	EV2	0.1433	1,592,015
* DN1	WA2	WA2	WA2	0.1447	699,211
* DN1	WA2	WA2	DN2	0.1550	524,700
DN1	WA2	DN2	EV2	0.2020	1,482,859
DN1	WA2	DN2	WA2	0.2034	590,055
* DN1	WA2	DN2	DN2	0.2137	415,544
DN1	DN2	EV2	EV2	0.2727	2,190,838
DN1	DN2	EV2	WA2	0.2741	1,298,034
DN1	DN2	EV2	DN2	0.2844	1,123,523
DN1	DN2	WA2	EV2	0.2810	1,527,720
DN1	DN2	WA2	WA2	0.2824	634,916
DN1	DN2	WA2	DN2	0.2927	460,405
DN1	DN2	DN2	EV2	0.3397	1,418,564
DN1	DN2	DN2	WA2	0.3411	525,760
* DN1	DN2	DN2	DN2	0.3514	351,249

\* noninferior decisions

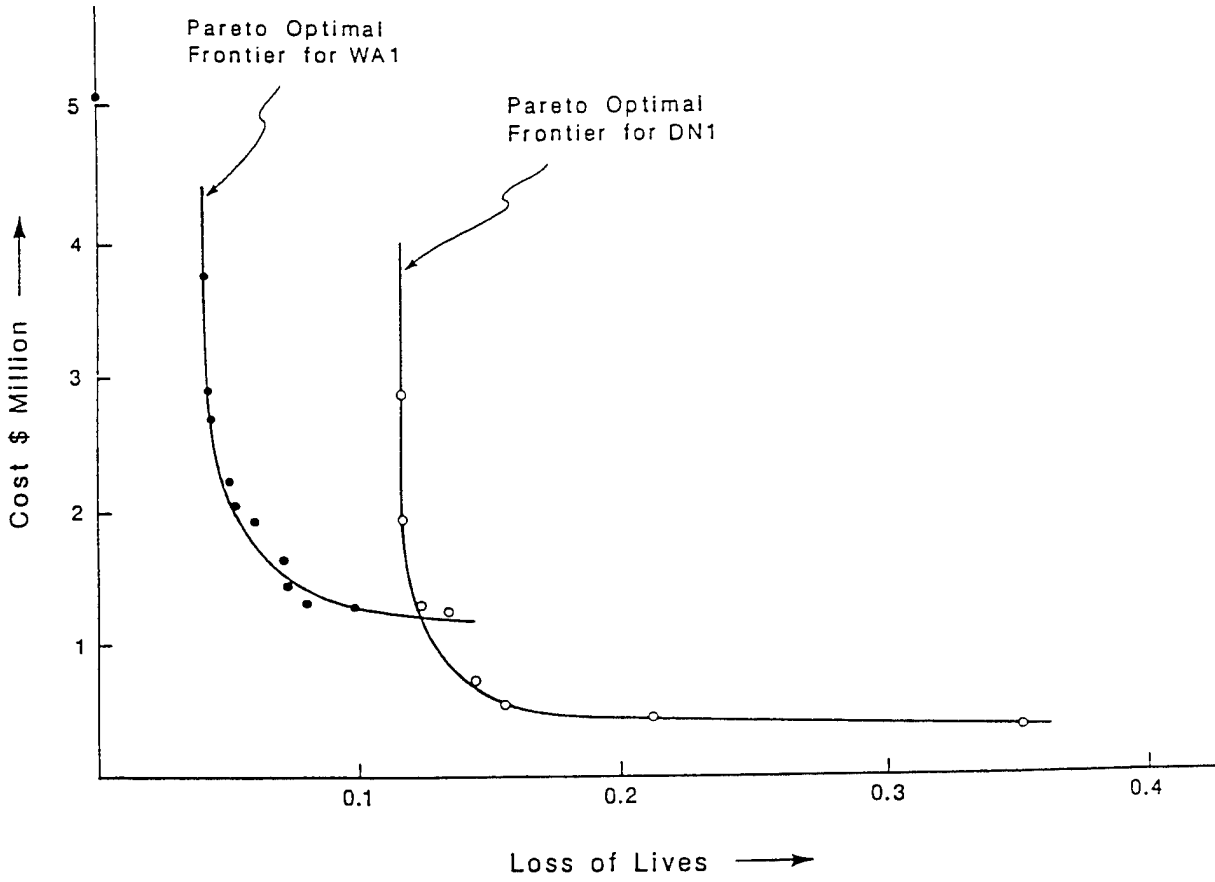
Table 2-7. Decisions for the First-period Decision Node Using  $f_4$  (Continuous Case)

First- period decision	Second-period decision			Loss vector	
	Higher	Same	Lower	L	C
* EV1	-	-	-	0.0000	9,495,618
WA1	EV2	EV2	EV2	2.2367	12,565,412
WA1	EV2	EV2	WA2	2.5085	11,942,936
WA1	EV2	WA2	EV2	2.7630	12,420,237
WA1	EV2	WA2	WA2	3.0348	11,797,761
DN1	EV2	EV2	EV2	6.1876	15,467,376
DN1	EV2	EV2	WA2	6.4593	14,844,900
DN1	EV2	WA2	EV2	6.7140	15,322,201
DN1	EV2	WA2	WA2	6.9854	14,699,725

\* - Noninferior decisions



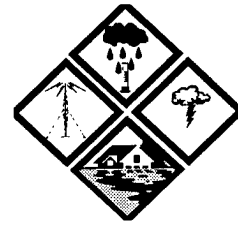
**Figure 2-12. Decision Tree for the Second Stage Using  $f_5$  (Continuous Case)**



**Figure 2-13.** Pareto Optimal Frontier Using  $f_5$  (Continuous Case)

## **Part 3**

# **Performance Characteristics of a Flood Warning System: Technical**



### **Introduction**

From the utilitarian point of view, rooted in the Bayesian principles of rationality, the ultimate measure of performance of a flood warning system is the *ex ante* economic value. From the engineering point of view, there remains the need for auxiliary measures that characterize, perhaps only partially, the performance of various components of a flood warning system. The purpose of such measures is to aid the engineer in the process of planning and design.

One aspect of the performance of a flood warning system is its reliability. The following presents an overview of a model that outputs two measures of system reliability:

- the *relative operating characteristic* (ROC), which shows a relationship among (i) the probability of detection, (ii) the probability of a false warning, and (iii) the expected lead time of a warning, and
- the *performance tradeoff characteristic* (PTC), which shows a relationship among (i) the expected number of detections per year, (ii) the expected number of false warnings per year, and (iii) the expected lead time of a warning.

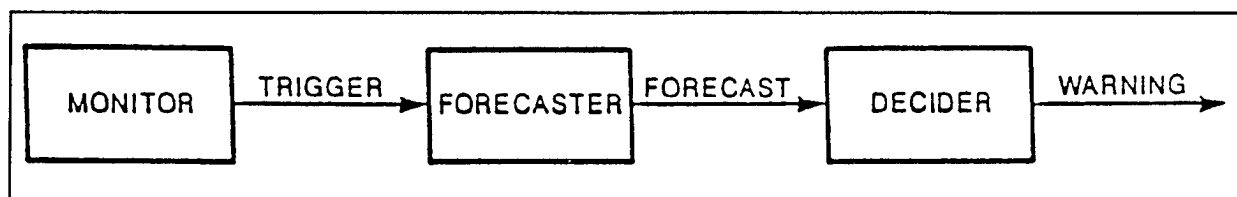
Each characteristic, the ROC and PTC, can be displayed graphically in the form of a family of curves. The displays offer an aid to engineering planning and design of flood warning systems. The concept and interpretation of these displays are illustrated with a case study of the flood warning system for Milton, Pennsylvania.

## **System Model**

### Structure

The model is tailored to a class of local warning systems which can be conceptualized as a cascade coupling of three components, shown in Figure 3-1: *monitor*, *forecaster*, and *decider*. The operation of such a system is idealized as follows.

Floods occur intermittently. For economic reasons, a flood data collection network, forecasting procedure, and emergency management do not operate continuously. Rather, their operation is triggered only when potential flood conditions are detected. To enable such detections, a system monitoring hydrometeorologic conditions operates continuously. When a set of predefined conditions is observed, the monitor triggers operation of the forecast system. The flood data collection network is activated, and a forecast of the flood hydrograph is prepared. This forecast is supplied to the decision system -- a flood



**Figure 3-1.** Functional Structure of a Flood Warning System

preparedness organization, or a floodplain manager -- who must then decide whether or not to issue a warning to the public.

### Assumptions

Principal definitions and assumptions underlying our model of a flood warning system are as follows:

1. A flood is the portion of a hydrograph above a flood stage, officially specified for a given river gauging station.
2. If a flood forecast is prepared, it is issued at a well-defined instant, consistently for every flood. The performance of a warning system is evaluated based on this one forecast.
3. The decision whether or not to issue a warning to the public is based on the forecasted flood crest.
4. The flood plain is divided into elevation zones. A flood warning is issued for a zone. Thus, depending on the forecast, it may be optimal to issue a warning for a lower zone, but not for an upper zone. Consequently, the performance characteristics are defined for a zone.

Mathematical models of the three system components are described below. Section 3 defines the performance measures. Section 4 illustrates them with numerical examples.

### Monitor

An all-important design decision is the choice of a forecast trigger -- an observable state that is likely to precede every flood and that, once observed, will trigger preparation of flood forecasts. Here are three examples of triggers:

(river stage) > (threshold)

(rainfall intensity and duration) > (threshold)

(meteorologic situation)  $\in$  {potential flood situations}

A good monitor is particularly critical to local warning systems for flash floods in headwater areas with small watersheds and short concentration times. For instance, a flood developing rapidly during nighttime may occur undetected because of an equipment failure; a trigger may be false because the oncoming storm suddenly changes its track and bypasses the watershed. Consequently, the performance of the monitor may limit the performance of the total warning system, no matter how sophisticated its flood data collection network, forecasting procedure, and emergency management.

In order to characterize the performance of a monitor, introduce the following variables:

T -- trigger indicator: trigger is not observed ( $T = 0$ ), trigger is observed ( $T = 1$ );

$\Theta$  -- flood indicator: flood does not occur ( $\Theta = 0$ ), flood occurs ( $\Theta = 1$ ).

Next, define two conditional probabilities:

$$\gamma = P(\Theta = 1 \mid T = 1) , \quad (3.1)$$

$$\rho = P(T = 1 \mid \Theta = 1) . \quad (3.2)$$

Probability  $\gamma$  characterizes the *diagnosticity* of the monitor. For example,  $\gamma = 1$  means that every trigger is followed by a flood; in other words, the monitor provides a perfect diagnosis of a flood situation. Probability  $\rho$  characterizes the *reliability* of the monitor. For example,  $\rho = 1$  means that every flood is preceded by a trigger; in other words, the monitor never fails to signal the oncoming flood. Probabilities  $\gamma$  and  $\rho$  are independent.

#### Forecaster

The objective of modeling is to obtain a stochastic characterization of floods and forecasts in the form requisite for decisionmaking and performance evaluation. Toward this end, a *Bayesian processor of forecasts* is formulated following the principles laid down in earlier works of Krzysztofowicz [1983a, 1983b, 1985, 1987]. The inputs into the processor are a prior distribution describing natural flood events and a likelihood function describing the stochastic dependence between forecasted and actual flood events. The principal output from the processor is the posterior probability of flooding a given zone elevation, conditional on the forecast. This probability provides a basis for deciding the warning. In addition, the processor outputs several other probability distributions needed for system performance evaluation. The remainder of this section outlines our approach to modeling the prior distribution and the likelihood functions.

*Model of floods: prior distribution.* A flood is described in terms of the actual flood crest,  $h$ , measured from the flood stage. Before a forecast is prepared, the uncertainty about the magnitude of the flood crest, conditional on the hypothesis that a flood will occur,  $\Theta = 1$ , is described in terms of the prior density:

$$g(h \mid \Theta = 1) . \quad (3.3)$$

***Risk-Based Evaluation of  
Flood Warning and Preparedness Systems***

---

This density should be estimated from a partial duration flood series.

*Model of forecasts: likelihood function.* When, and only when, a trigger is observed,  $T = 1$ , the forecaster is activated, hydrometeorologic observations are collected, and a flood forecast is prepared. A categorical forecast is assumed to specify a point estimate  $s$  of  $h$ .

If a flood does not occur after the forecast,  $\Theta = 0$ , then the forecasted flood crest  $s$  cannot be verified. Let

$$\kappa_0(s \mid \Theta = 0, T = 1) \tag{3.4}$$

denote the density of  $s$  on those occasions. If a flood occurs after the forecast,  $\Theta = 1$ , then the forecasted flood crest  $s$  can be verified against the actual flood crest  $h$ . Let

$$f(s \mid h, \Theta = 1, T = 1) \tag{3.5}$$

denote the density of  $s$ , conditional on  $h$ , on those occasions.

For a fixed  $s$ , functions  $\kappa_0(s \mid \bullet)$  and  $f(s \mid \bullet)$  are termed the likelihood functions of the respective events. These likelihood functions constitute a model of the forecaster. They can be estimated from a joint record of forecasted and actual floods.

Decider

When the trigger is observed,  $T = 1$ , and the forecast  $s$  of the flood crest is prepared; the manager must then decide whether or not to issue a flood warning for a zone of the floodplain:  $\{w = 0, \text{do not issue warning}; w = 1, \text{issue warning}\}$ . Thereafter the event takes place:  $\{\theta = 0, \text{zone is not flooded}; \theta = 1, \text{zone is flooded}\}$ . Each decision-event vector  $(w, \theta)$  leads to outcomes whose undesirability (as they are mostly losses rather than gains) is evaluated in terms of a disutility function. The arguments of the disutility function are the actual flood crest and the lead time of the warning (to be defined precisely later).

Let  $W$  denote a warning rule which for every forecast specifies decision  $w = W(s)$  for a given zone. The objective of decision analysis is to find the *optimal warning rule*  $W^*$ . According to the Bayesian postulates of rationality, the rule  $W^*$  should minimize the posterior expected disutility of outcomes.

For a statistical, as contrasted with the economic, evaluation of system performance, it is not necessary to find the exact form of  $W^*$ . It suffices to know its general structure. Under certain monotonicity conditions,  $W^*$  is of the threshold type:

$$W^*(s) = \begin{cases} 0 & \text{if } q(s) \leq q^* \\ 1 & \text{if } q(s) > q^* \end{cases} \tag{3.6}$$

where  $q(s) = P(\theta = 1 \mid s, T = 1)$  is the posterior probability of a flood in a given zone, and  $q^*$  is a threshold dependent upon the disutility function and the density functions (3.3) - (3.5). The optimal warning



rule states, then, that a warning should be issued for a given zone whenever the posterior probability  $q(s)$  of flooding that zone, conditional on forecast  $s$ , exceeds threshold  $q^*$ .

## Performance Measures

### Performance Probabilities

The vector  $(T, w, \Theta, \theta)$  of binary indicators of the status of the trigger  $T$ , warning  $w$ , flood  $\Theta$ , and zone flood  $\theta$  can take on nine values which define four performance states of the warning system, as shown in Figure 3-2. The states are as follows:

$$\begin{aligned}
 \text{missed flood: } M &= (w = 0 \mid \theta = 1, \Theta = 1) \\
 \text{false warning: } F &= (w = 1 \mid \theta = 0, T = 1) \\
 \text{detection: } D &= (w = 1 \mid \theta = 1, \Theta = 1) \\
 \text{quiet: } Q &= (w = 0 \mid \theta = 0, T = 1)
 \end{aligned} \tag{3.7}$$

These states are observable in the sense that one could count their occurrences over a period of time. In the limit, this count would give rise to conditional probabilities of incorrect system performance,  $P(M)$  and  $P(F)$ , and correct system performance,  $P(D)$  and  $P(Q)$ .

Since  $P(M) = 1 - P(D)$  and  $P(Q) = 1 - P(F)$ , it suffices to find the probability of detection,  $P(D)$ , and the probability of false warning,  $P(F)$ . The objective of modeling, then, is to express these probabilities in terms of parameters and functions which characterize the warning system. The main result en route to deriving such expressions is the following factorizations:

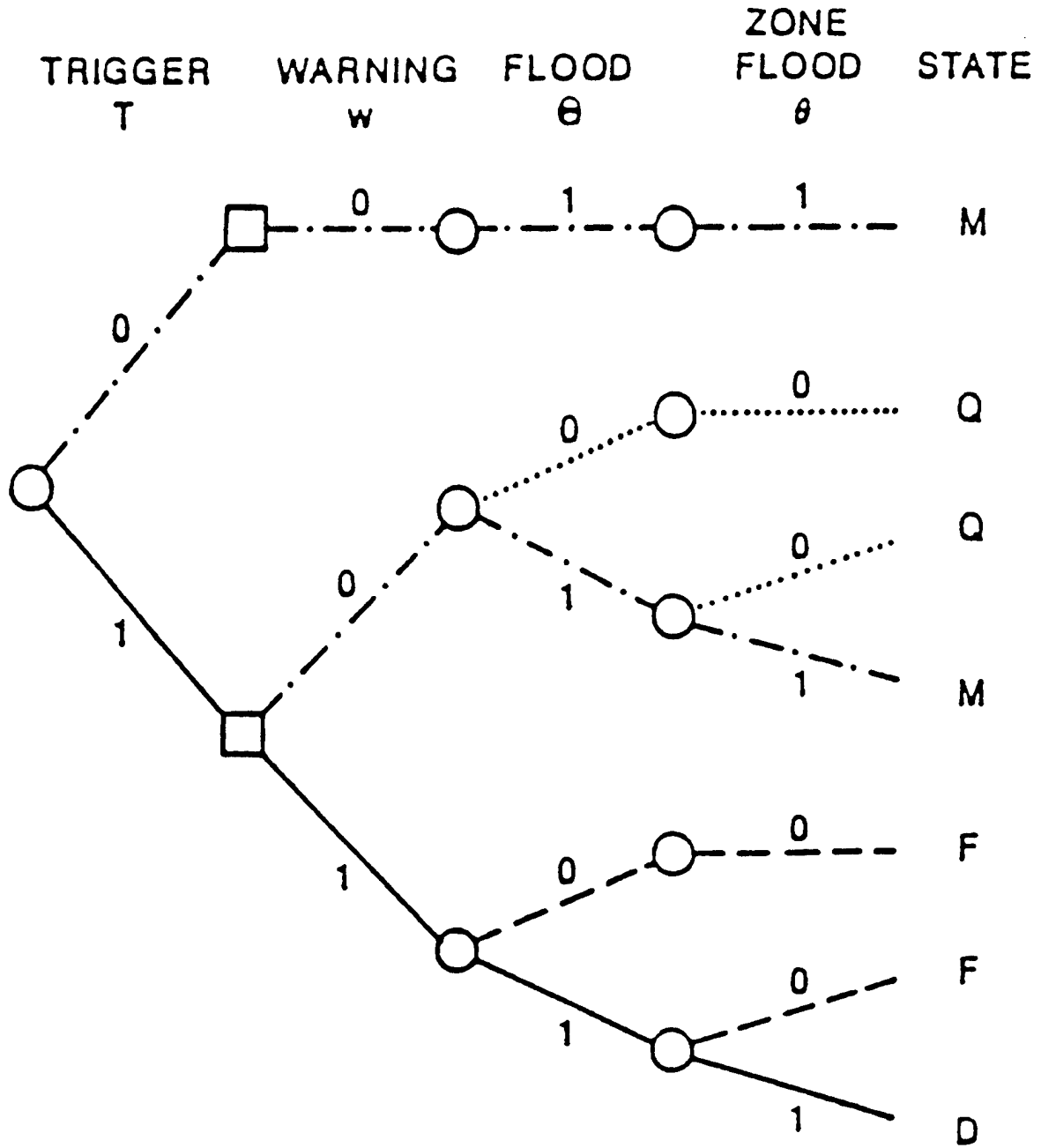
$$P(D) = \rho P(w = 1 \mid \theta = 1, \Theta = 1, T = 1) \tag{3.8}$$

$$P(F) = (1 - \gamma)P(w = 1 \mid \Theta = 0, T = 1) + \gamma P(w = 1 \mid \theta = 0, \Theta = 1, T = 1) \tag{3.9}$$

The diagnosticity  $\gamma$  and reliability  $\rho$  characterize the monitor, while the remaining conditional probabilities depend upon the prior distribution (3.3), the likelihood function (3.4)-(3.5), and the optimal warning rule (3.6).

### Relative Operating Characteristic

Different disutility functions may result in different threshold values  $q^*$  in (3.6). By varying the threshold  $q^*$  throughout its range  $(0,1)$ , one can generate all possible warning rules that could result from various disutility functions. With each threshold value, there is associated a probability of detection  $P(D)$  and a probability of false warning  $P(F)$ . A plot of  $P(D)$  versus  $P(F)$ , obtained by varying the threshold  $q^*$ , is called the *relative operating characteristic* (ROC).



**Figure 3-2.** Tree of Events Leading to One of the Four Performance States of a Flood Warning System (Missed Flood (M), False Warning (F), Detection (D), and Quiet (Q))

The ROC curve conveys the essential information about the tradeoffs that a given system offers between the probability of detection and the probability of false warning. However, the intuitive interpretation of these performance probabilities is not straightforward for they are conditional probabilities. In fact,  $P(D)$  and  $P(F)$  are the probabilities of the same event ( $w = 1$ ), but each is conditional on a different vector of two events, as shown in (3.7). Human intuition does not grasp easily such conditional events. Moreover, human cognition is generally not well trained in understanding and processing probabilities. Evidence of numerous and large biases in judgments involving probabilities is plentiful.

### Performance Tradeoff Characteristic

In order to overcome the interpretive difficulties associated with the ROC, we propose to transform the probabilities of various states into the expected number of states per year. Given the expected number of floods per year,  $N$ , the following quantities can readily be obtained:

expected number of zone floods per year:

$$n = N \cdot P(\theta = 1 \mid \Theta = 1) \quad (3.10)$$

expected number of detections per year for a zone:

$$ND = N \cdot P(D) \cdot P(\theta = 1 \mid \Theta = 1) \quad (3.11)$$

expected number of false warnings per year for a zone:

$$NF = \frac{\rho}{\gamma} \cdot N \cdot P(F) \cdot [1 - \gamma P(\theta = 1 \mid \Theta = 1)] \quad (3.12)$$

Through equations (3.11) and (3.12), the ROC curve can be rescaled into a function between the expected number of detections and the expected number of false warnings per year. This function will be called the *performance tradeoff characteristic* (PTC).

### Expected Lead Time

The forecast time is the instant up to which hydrometeorologic observations for preparing the forecast are collected. The lead time,  $\lambda$ , of a warning for a given zone, conditional on the hypothesis that the zone will be flooded,  $\theta = 1$ , is the time interval elapsed from the forecast time to the instant at which the flood waters reach the zone elevation. Let

$$g(\lambda \mid \gamma = 1) \quad (3.13)$$

denote the density of  $\lambda$ , conditional on event  $\theta = 1$ . The expected lead time is thus given by

$$LT = \int_0^{\infty} \lambda g(\lambda \mid \theta = 1) d\lambda \quad (3.14)$$

## ***Risk-Based Evaluation of Flood Warning and Preparedness Systems***

---

The designer of a warning system can affect the lead time indirectly, through the definitions of (i) the forecast trigger and (ii) the forecast time. Each of these specifications may affect all three probability densities given by (3.4), (3.5), and (3.13). Consequently, any change in the design specifications may simultaneously affect P(D), P(F), ND, NF, and LT.

### **Case Study**

#### General Description

Properties of the ROC and PTC curves, and their potential role as aids to design analysis, will be illustrated through a case study of the flood warning system for Milton, Pennsylvania. The town has a population of about 8000 and is located on the West Branch of the Susquehanna River in northeastern Pennsylvania. The data used in the study were collected by Krzysztofowicz and Davis [1983]. The source of the flood and forecast data is the U.S. National Weather Service, River Forecast Center at Harrisburg, Pennsylvania. The forecast data are from the period 1959-1975. Thus the case studies reported herein are representative of the system performance during that period.

In all specifications of the parameters, the units of time are hours and the units of elevation are feet above the zero of the river gauge. The flood stage is at 19 ft, but almost all structures are located above the elevation of 22 ft. The probability densities in the model of the forecaster are assumed to follow the Gaussian law, denoted  $N(M, S^2)$ , where  $M$  is the mean and  $S^2$  is the variance.

#### Input Models and Parameters

*Record of floods.* The record of floods from the period 1885-1975 contains 20 flood events. From this record, we estimated:

expected number of floods per year:  $N = 0.53$

prior density:  $g(h | \Theta = 1) = N(\mu_h, \sigma_h^2)$ , where  $\mu_h = 24.9$  and  $\sigma_h = 4.82$

*Models of Monitor and Forecaster.* The parameters that must be estimated from the joint record of forecasted and actual floods are as follows:

*diagnosticity* of the monitor:  $\gamma$

*reliability* of the monitor:  $\rho$

likelihood functions:  $\kappa_0(s | \Theta = 0, T = 1) = N(\mu_s, \sigma_s^2)$

$f(s | h, \Theta = 1, T = 1) = N(ah + b, \sigma^2)$

expected lead time (for each zone elevation  $y$ ):

LT

The likelihood function  $f$  arises from the linear relation:

$$s = ah + b + \varepsilon$$

where  $\varepsilon$  is a random variable, stochastically independent of  $h$ , and having density  $N(0, \sigma^2)$ , so that

$$E(s | h) = ah + b$$

and

$$\text{Var}(s | h) = \sigma^2.$$

Thus, the parameters  $a$ ,  $b$ ,  $\sigma^2$  may be estimated via a regression analysis performed on a record of the forecasted and actual flood crests.

*Record of forecasts.* The forecast verification reports for the period 1959-1975 contain a record of 9 floods and 37 forecasts. The record does not contain information sufficient for the estimation of all parameters via statistical methods. Consequently, parameters  $\gamma$  and  $\rho$  of the monitor and parameters of the likelihood function  $\kappa_0$  had to be estimated subjectively based on a plausible interpretation and interpolation of the available information. On the other hand, the parameters of the likelihood function  $f$  and the expected lead times  $LT$  were estimated statistically.

*System designs.* The monitor is assumed to trigger the forecaster when the river stage exceeds a specified threshold. Three alternative system designs are analyzed, in which the forecast trigger is defined as follows:

System S1: river stage > 11 ft

System S2: river stage > 15 ft

System S3: river stage > 19 ft

The likelihood function  $\kappa_0$  is assumed to be the same for each system; the estimates of its parameters are:

$$\mu_s = 17.8$$

$$\sigma_s = 1.17$$

The remaining parameters vary with the design. Table 3-1 lists estimates of  $\gamma$ ,  $\rho$ ,  $a$ ,  $b$ , and  $\sigma$ . Table 3-1 lists the estimated expected lead times,  $LT$ , and the calculated expected number of zone floods,  $n$ , for four zones of the floodplain extending upwards from the following elevations:

$$y = 19, 22, 25, 28$$

Since the expected numbers per year are relatively small, we rescale them in the discussion to a 100-year period.

*Risk-Based Evaluation of  
Flood Warning and Preparedness Systems*

Table 3-1. Parameters of Three Alternative Designs of a Flood Warning System for Milton, Pennsylvania

System Design	Monitor		Likelihood Function			Forecast Sufficiency Characteristic FSC
	Diagnosticity $\gamma$	Reliability $\rho$	Slope $a$	Intercept $b$	St. Dev. $\sigma$	
S1	0.80	1.00	0.44	10.65	3.06	6.95
S2	0.90	0.89	0.45	12.10	1.90	4.22
S3	1.00	0.83	0.64	8.48	2.21	3.45

Table 3-2. Expected Number of Zone Floods and Expected Lead Times of Flood Warnings for Milton, Pennsylvania

Zone Elevation $y$ [ft]	Expected Number* of Zone Floods $n$	Expected Lead Time LT [hrs]		
		System S1	System S2	System S3
19	47.1	9	5	-3
22	38.4	15	11	4
25	26.0	21	17	11
28	13.7	27	24	18

\*The expected numbers are for the period of 100 years.

*Interpretation.* Figure 3-3 shows the expected lead time LT plotted as a function of the elevation  $y$  for each of the three systems. Clearly, when the threshold stage for triggering the forecaster is raised, the expected lead time LT is reduced uniformly for all elevations. Table 3-1 reveals further implications. When the lead time decreases, the diagnosticity of the monitor  $g$  increases, since a higher threshold stage is always more diagnostic of the incoming flood. On the other hand, when the lead time LT decreases, the reliability  $r$  also decreases. This is so because the observations of the river are made in 6-hour intervals, and it is possible for a rapidly rising river to exceed both the threshold stage and the flood stage within the 6-hour interval. In such an instance, flooding occurs prior to the preparation of a forecast. The likelihood of such an event increases as the threshold stage is raised closer to the flood stage; hence the reliability  $r$  decreases.

When the expected lead time LT decreases, one also anticipates an increase in the quality of the flood crest forecasts. Table 3-1 reveals that the parameters  $a$ ,  $b$ , and  $s$  of the likelihood function change their values with LT. But do these changes imply anything about the forecast quality? The answer to this question may be obtained via the forecast sufficiency characteristic:

$$FSC = \frac{\sigma}{|a|}$$

This measure is sufficient for comparing any two forecasters who produce forecasts, say  $s_m$  and  $s_n$ , of the same variate  $h$ . A theorem of Krzysztofowicz [1987] states that  $FSC_m < FSC_n$  if, and only if, forecast  $s_m$  has the economic value at least as high as forecast  $s_n$ , for every rational decisionmaker. In other words, the FSC enables us to order forecasts in terms of their economic values. The FSCs calculated in the last column of Table 3-1 confirm our hypothesis: when LT decreases, the quality of the flood crest forecasts increases.

#### Properties of the ROC and PTC

The ROC and PTC curves for design S1 are displayed in Figures 3-4 and 3-5. We shall highlight some general properties of these curves.

1. For a fixed zone elevation, the associated ROC is a concave function specifying a unique relationship between the probability of false warning,  $P(F)$ , and the probability of detection,  $P(D)$ . Probability  $P(F)$  may vary from 0 to 1, but probability  $P(D)$  is bounded from above by the reliability of the monitor  $r$ , which for design S1 happened to be 1.0. For a fixed zone elevation and a prior distribution of the flood crest, the shape of the ROC curve depends solely upon the design specifications for the monitor (via diagnosticity  $g$  and reliability  $r$ ), and the design specifications for the forecaster (via the likelihood functions  $\kappa_0$  and  $f$ ).

2. By mapping each point from the ROC in Figure 3-4 through relations (3.11)-(3.12), we obtain the PTC shown in Figure 3-5. The PTC is also a concave function, increasing from the origin, which corresponds to  $P(F) = P(D) = 0$ , to a point which corresponds to  $P(F) = 1$  and  $P(D) = r$ . The expected number of detections per year, ND, never exceeds the expected number of zone floods  $n$ . On the other hand, the expected number of false warnings per year, NF, may exceed  $n$ . The PTC for zone elevations  $y = 25$  and  $y = 28$  do just that.

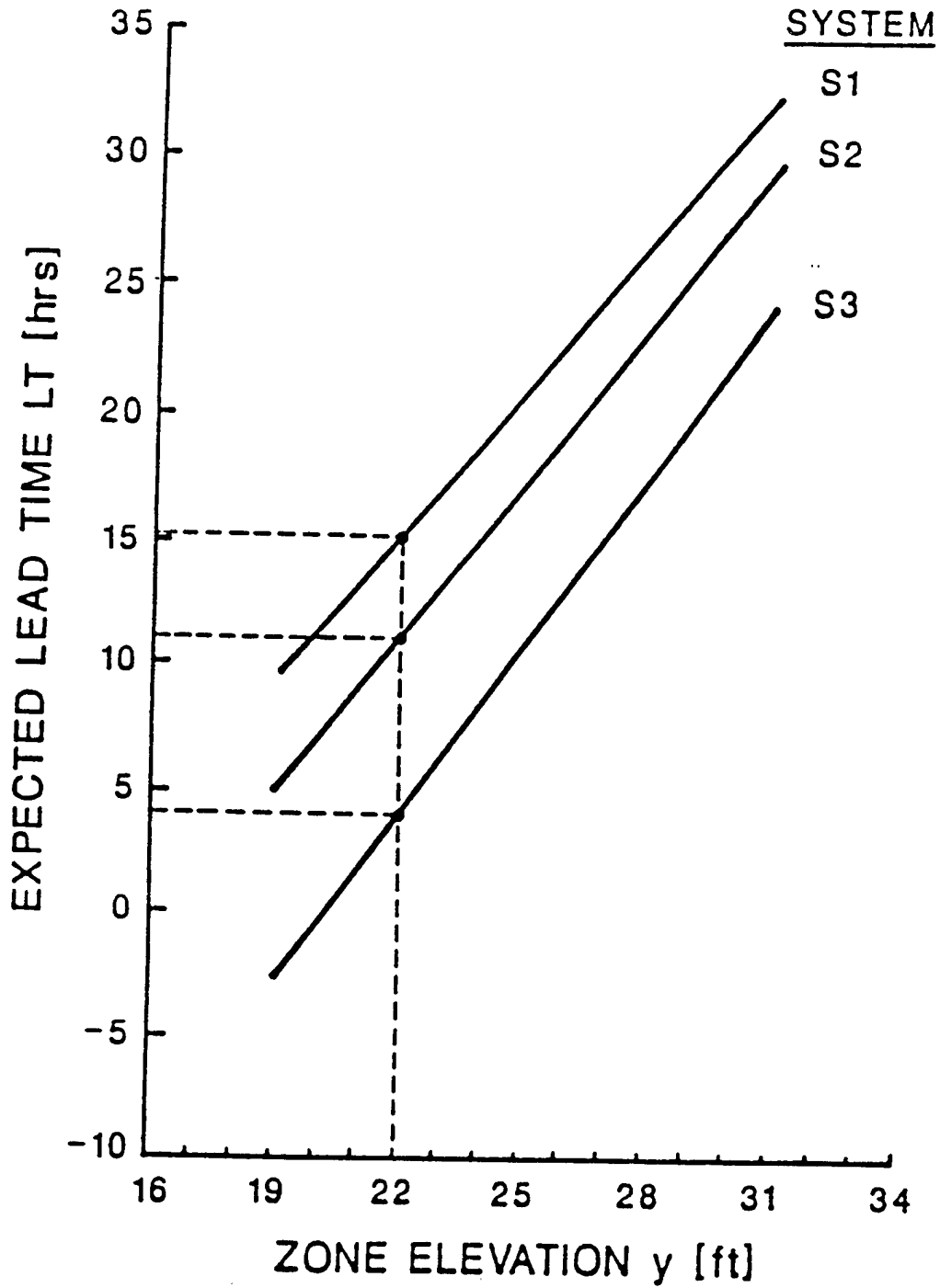
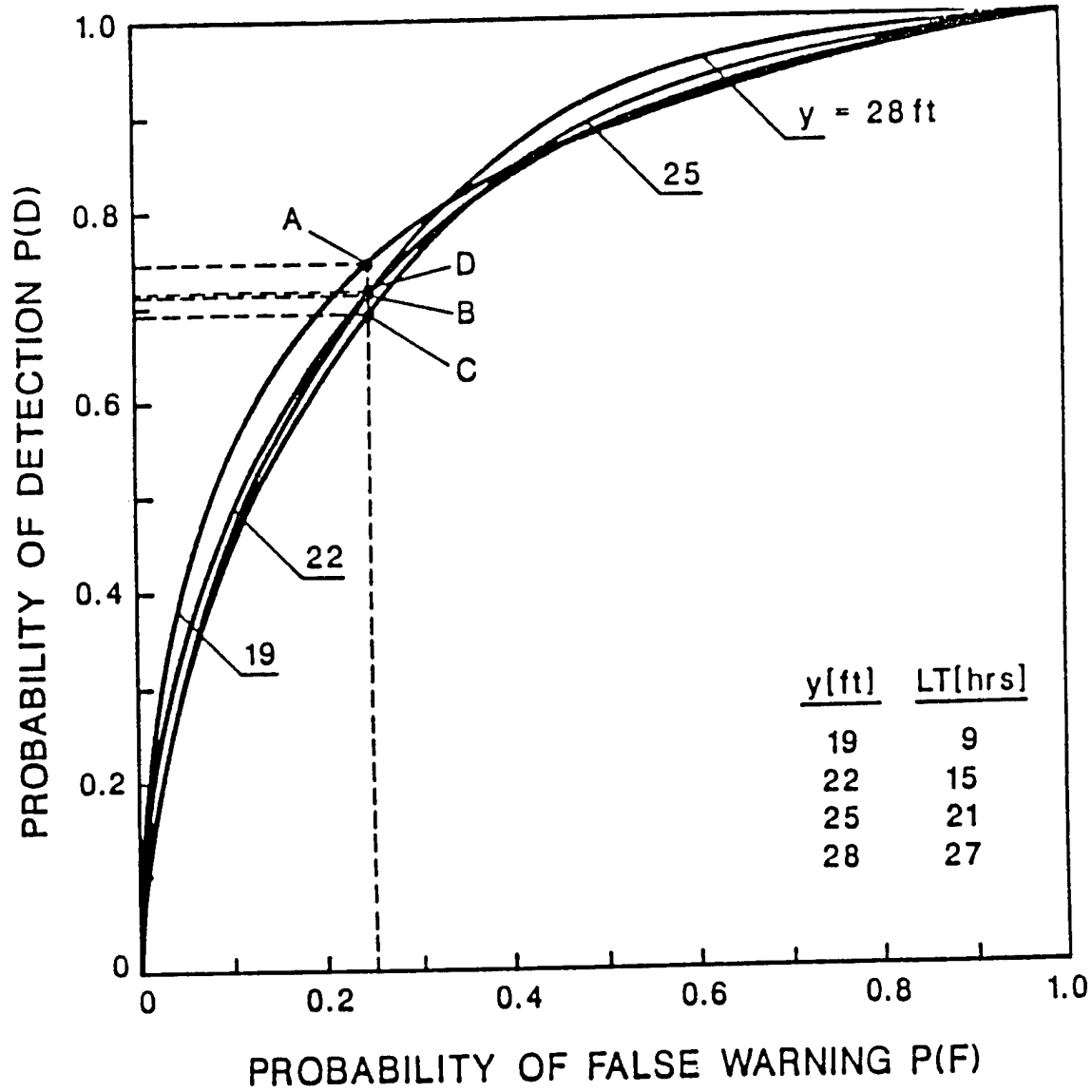
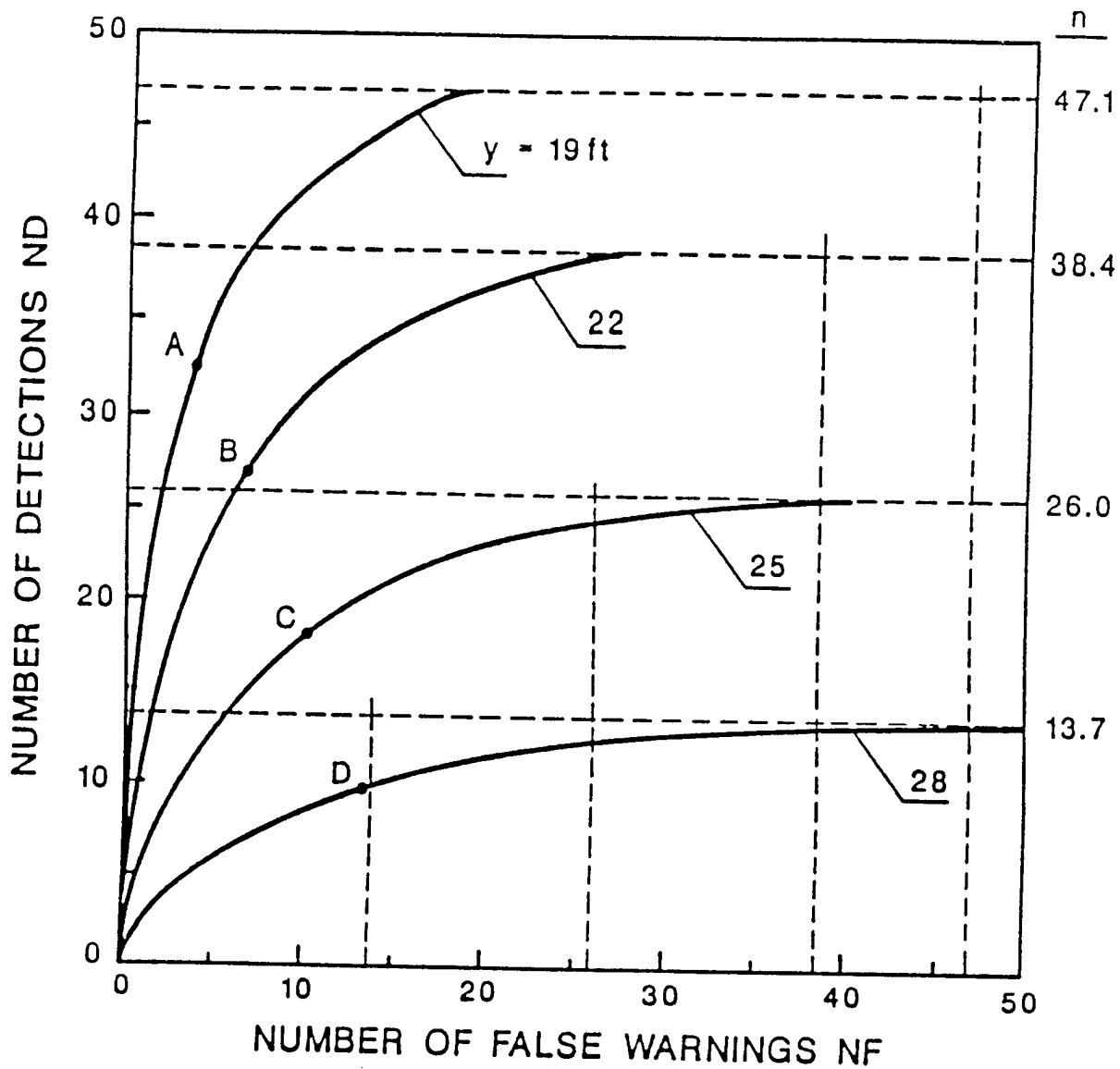


Figure 3-3. Expected Lead Time of a Flood Warning Versus the Elevation of the Floodplain for Three Warning Systems in Milton, Pennsylvania





**Figure 3-4.** Relative Operating Characteristics (ROC) of Warning System S1 for Four Zone Elevations, Y, in Milton, Pennsylvania.  
(Symbol LT Denotes the Expected Lead Time of a Flood Warning)



**Figure 3-5.** Performance Tradeoff Characteristics (PTC) of Warning System S1 for Four Zone Elevations, Y, in Milton, Pennsylvania.  
(Symbol n Denotes the Expected Number of Zone Floods. All Numbers, NF, ND, and n are for the Period of 100 Years.)

### Performance Differences Between Zones

1. The ROC curves for different elevation zones have generally similar shapes and cross each other. In other words, when the performance of a warning system is measured in terms of the probability of false warning  $P(F)$  and the probability of detection  $P(D)$ , all zones seem to be served equally well. However, the third performance measure -- the expected lead time of the warning, illuminates the differences between the low-lying zones and the high-lying zones:  $LT = 9$  hours for  $y = 19$  and  $LT = 27$  hours for  $y = 28$ , a threefold difference.

2. The PTC curves are quite dissimilar, underscoring the fact that they convey different information than the ROC curves do. There are two main distinctions between the zones. First, there is the obvious distinction resulting from the elevations difference: the expected number of floods  $n$  in 100 years is 47.1 for  $y = 19$  and only 13.7 for  $y = 28$ . Second, there is a remarkable difference in terms of the expected number of false warnings  $NF$  associated with the maximum expected number of detections  $ND = n$ . This  $NF$  is equal to 19.2 for  $y = 19$ , and it increases to 52.5 for  $y = 28$ . In other words, to reach the upper limit of expected detections for the higher zone, one must accept a rate of false warnings  $NF = 52.5$ , which is 3.8 times higher than the rate of floodings  $n = 13.7$ .

3. To place these results in proper perspective, one has only to realize that floods reaching zone  $y = 28$  are more extreme and rare than floods reaching only zone  $y = 19$ . The PTC curves in Figure 3-5 inform us that a high detection rate for rare events comes at the price of a high rate of false warnings. This appears to be an inescapable tradeoff.

### Operating Points

1. A point on the ROC, or PTC, is called an *operating point*. In Figure 3-4, we fixed an operating point for each zone such that for all zones the probability of false warning  $P(F) = 0.25$ . The probability of detection  $P(D)$  is different for each zone, but the differences are small. Table 3-3 lists the exact coordinates of these operating points on the PTC. Figure 3-5 depicts these points, each of which has distinct  $NF$  and  $ND$  coordinates.

2. In general, the mapping between the operating points of the ROC and PTC is one-to-one, with the following properties: (i) The operating points which have the same  $P(D)$  coordinate on the ROC, have also the same  $ND$  coordinate on the PTC. (ii) The operating points which have the same  $P(F)$  coordinate on the ROC, may have different  $NF$  coordinates on the PTC. We shall say that the mapping between the ROC and PTC is *nonorthogonal*.

3. The nonorthogonality of the mapping between the ROC and PTC should be taken as a caution: judgmental analysis of tradeoffs on the ROC, or PTC, is not a simple cognitive task! We recommend using the PTC as the primary aid to planning and design because the expected number  $ND$  and  $NF$  are easier to interpret and understand than the probabilities  $P(D)$  and  $P(F)$ , which, one should recall here expression (3.7), are conditional probabilities.

4. With each operating point on the PTC, or ROC, there is associated a unique threshold  $q^*$  in the warning rule (3.6). Thus, a specification of the operating point is equivalent to a specification of the rule

*Risk-Based Evaluation of  
Flood Warning and Preparedness Systems*

**Table 3-3.** Coordinates of Operating Points on the ROC and PTC Curves That Give the Same Probability of False Warning P(F) for Each Zone Elevation; System Design S1 for Milton, Pennsylvania

Operating Point	Zone Elevation y[ft]	Probability of		Expected Number* of		Expected Lead Time LT [hrs]
		Detection P(D)	False W. P(F)	Detections ND	False W. NF	
A	19	0.75	0.25	35.1	4.8	9
B	22	0.71	0.25	27.3	6.9	15
C	25	0.69	0.25	18.1	10.0	21
D	28	0.72	0.25	9.9	13.3	27

\*The expected numbers are for the period of 100 years.

for deciding warnings. To specify an operating point on the PTC for a given zone, one should consider a tradeoff between the expected number of detections ND and the expected number of false warnings NF. This tradeoff should encapsulate one's preferences for outcomes of all possible decision-event vectors for this particular zone. It follows that it would be irrational to fix the operating point based solely on a displayed PTC or ROC, without an in-depth analysis of all socioeconomic outcomes of every decision-event vector. That is why the PTC and ROC curves should be viewed only as aids to the planning and design process, rather than as a means of specifying the warning rule. The optimal warning rule should be found by minimizing the expected disutility of outcomes resulting from all possible decision-event vectors.

Performance Tradeoffs

From a purely statistical point of view, which ignores the economic and social decision criteria, the engineer could consider the design process as an optimization problem with three criteria: maximize the expected number of detections ND, minimize the expected number of false warnings NF, and maximize the expected lead time LT. The ideal solution is an operating point having the coordinates (ND, NF, LT) = (n, 0, ∞). In the absence of the ideal solution, tradeoffs must be made.

The kinds of tradeoffs that one may encounter are illustrated for the three alternative system designs, S1, S2, and S3. The ROC and PTC curves of these systems are compared in Figures 3-6 and 3-7 for zone elevation y = 22 and in Figures 3-8 and 3-9 for zone elevation y = 28. An immediate observation is that designs S1 and S2 offer distinct performance characteristics. On the other hand, designs S2 and S3 have similar ROC and PTC curves over a range of operating points, while over the remaining range S2 outperforms S3. Together with the fact that S3 offers much shorter expected lead times LT than S2 does, it is unlikely that decisionmakers would prefer S3 over S2. This example illustrates then a screening analysis that may be performed on a large set of alternative designs before a few are selected for a detailed analysis of tradeoffs.

The ensuing discussion highlights the nature of performance tradeoffs that the PTC allows one to analyze between designs S1 and S2. The discussion concentrates on three operating points, labeled A, B, C, in Figure 3-7. Their coordinates (ND, NF, LT) are listed in Table 3-4.

1. A good way to start the analysis is to fix the expected number of false warnings NF at a level that appears acceptable, at least initially, say  $NF = 5.0$ , which means that one would be willing to accept 5.0 false warnings in 100 years, on the average. At this level of NF, design S1 ensures the expected detection of  $ND = 23.8$  floods out of the expected  $n = 38.4$  floods in 100 years. The expected lead time of a warning for each detected flood is  $LT = 15$  hours. The difference,  $n - ND = 38.4 - 23.8 = 14.6$ , is the expected number of floods in 100 years that will arrive undetected, and thus will not be preceded by a warning to the public.

2. At the same level of  $NF = 5.0$ , design S2 ensures the expected detection of 28.9 floods in 100 years, with the expected lead time of a warning equal to 11 hours; the expected number of missed floods in 100 years is  $38.4 - 28.9 = 9.5$ . Thus, when comparing the operating points A and B, the following tradeoff should be considered: is it preferable or not to reduce LT from 15 to 11 hours in order to increase ND from 23.8 to 28.9 (or, equivalently to reduce the expected number of missed floods from 14.6 to 9.5)?

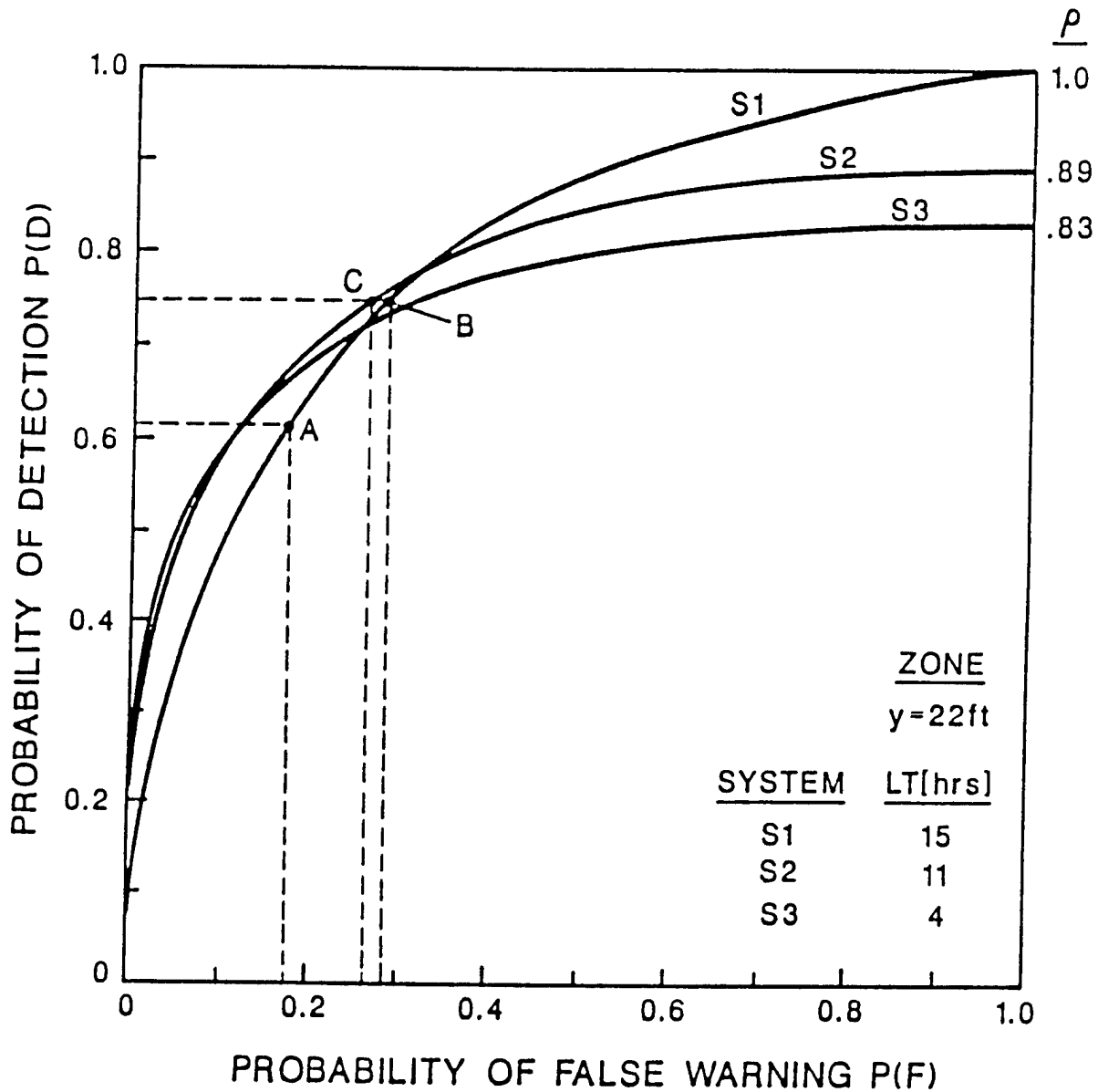
3. A similar analysis of tradeoffs may be carried out for a fixed expected number of detections ND, say 28.9 in 100 years. At this level of ND, the number of false warnings expected in 100 years is 5.0 for design S2 and 8.1 for design S1; the accompanying expected lead times of a warning are, respectively, 11 and 15 hours. Thus, when comparing the operating points B and C, the following tradeoff should be considered: is it preferable or not to reduce LT from 15 to 11 hours in order to decrease NF from 8.1 to 5.0?

4. The right endpoints of the PTC curves indicate that, given the present specifications for the monitor, design S1 can detect all  $n = 38.4$  floods expected in 100 years. However, design S2 has an upper limit of 34.2 expected detections in 100 years; thus, the minimum expected number of missed floods in 100 years is  $38.4 - 34.2 = 4.2$ . The upper limit of ND is achieved by each design at a different level of the expected number of false warnings NF, which is 27.8 for design S1, and 18.2 for design S2.

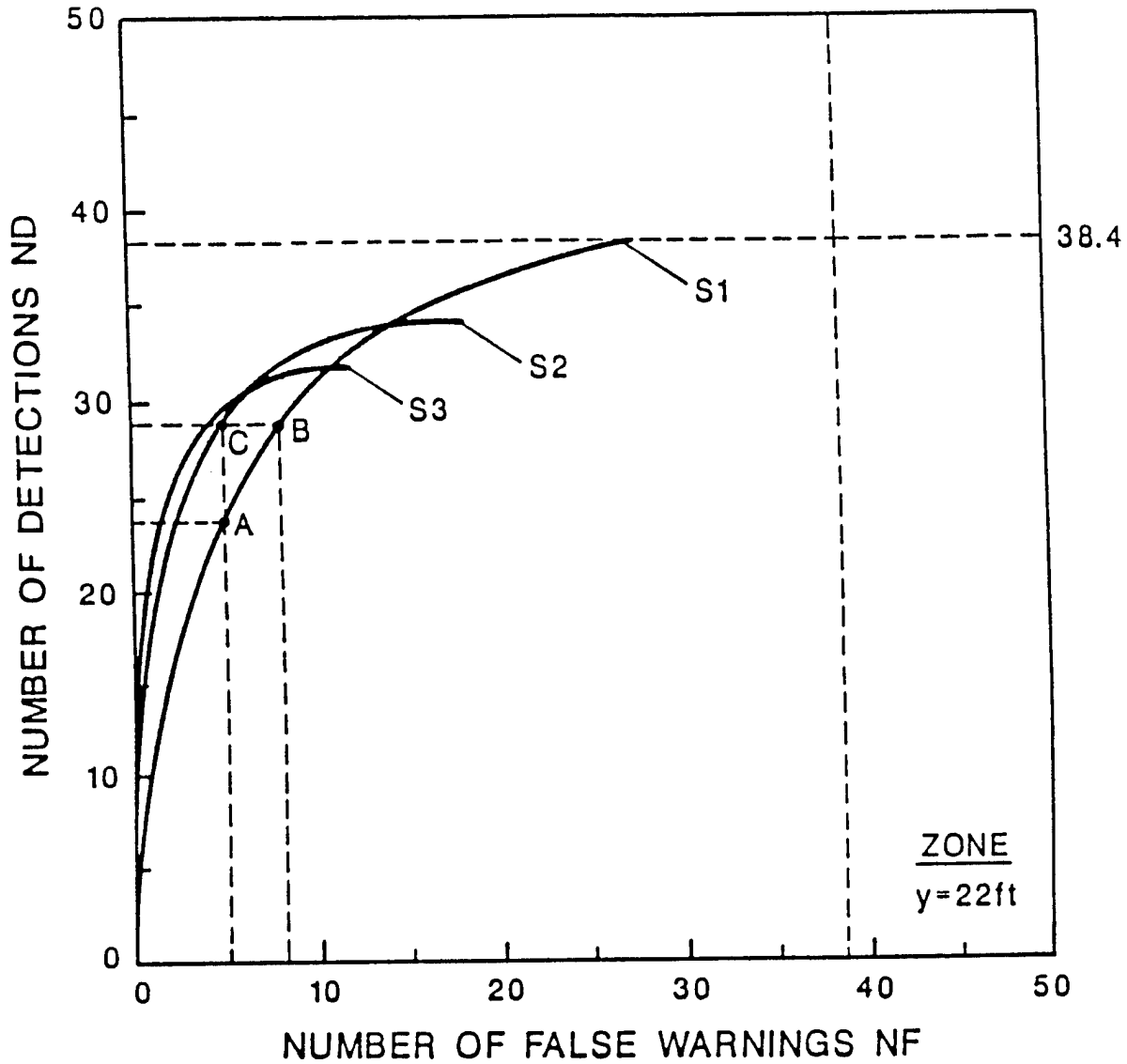
## Closure

The relative operating characteristic (ROC) and the performance tradeoff characteristic (PTC) are a part of a general theory of flood warning systems that is being developed. A number of questions are still awaiting answers. Among them is the connection between these statistical measures of performance and the *ex ante* economic value of a warning system. Such a connection is well known within the classical detection paradigm, but it remains to be investigated whether or not it extends to a much more complex paradigm of a flood warning system.

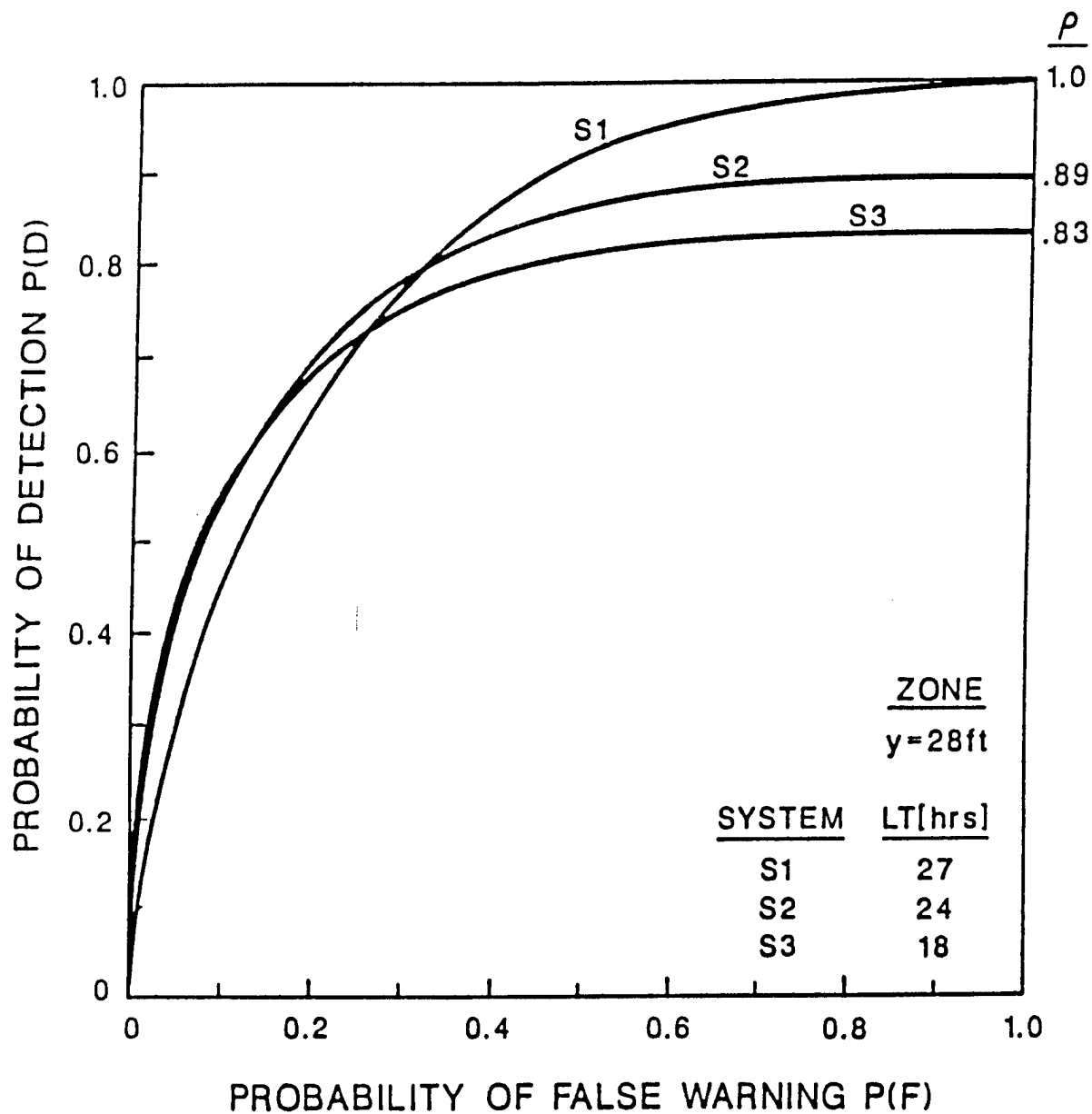
Applications of ROC and PTC concepts to other flood warning systems are also awaiting us. It would be desirable to make a number of applications to systems with distinct hydrologic regimes, such as flash-flood streams and main-stem rivers, and distinct technologies, such as found in local warning systems and the forecast offices of the National Weather Service. Collectively, results of such case studies would offer useful guidance to engineers who plan and design flood warning systems.



**Figure 3-6.** Relative Operating Characteristics (ROC) of Three Warning Systems, S1, S2, and S3 for Zone Elevation  $y = 22$  ft. in Milton, Pennsylvania.  
(Symbol  $\rho$  Denotes the Reliability of the Monitor.)

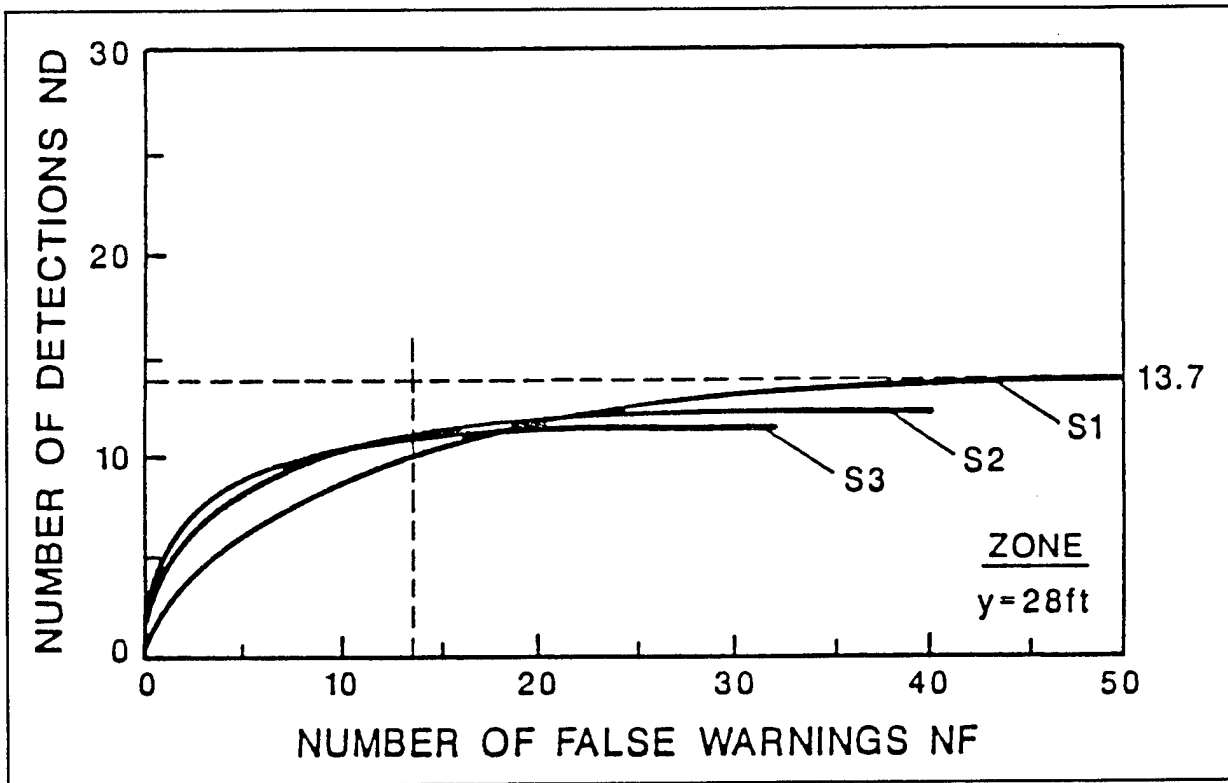


**Figure 3-7.** Performance Tradeoff Characteristics (PTC) of Three Warning Systems, S1, S2, and S3, for Zone Elevation  $y = 22$  ft. in Milton, Pennsylvania.



**Figure 3-8.** Relative Operating Characteristics (ROC) of Three Warning Systems, S1, S2, and S3, for Zone Elevation  $y = 28$  ft in Milton, Pennsylvania. (Symbol  $\rho$  Denotes the Reliability of the Monitor.)





**Figure 3-9.** Performance Tradeoff Characteristics (PTC) of Three Warning Systems, S1, S2, and S3, for Zone Elevation  $y = 22$  ft in Milton, Pennsylvania

**Table 3-4.** Coordinates of Three Alternative Points on the ROC and PTC Curves for Zone Elevation  $y = 22$  ft

System Design	Operating Point	Probability of		Expected Number* of		Expected Lead Time LT [hrs]
		Detection P(D)	False W. P(F)	Detections ND	False W. NF	
S1	A	0.62	0.18	23.8	5.0	15
S1	B	0.75	0.29	28.9	8.1	15
S2	C	0.75	0.27	28.9	5.0	11

\*The expected numbers are for the period of 100 years.

# **Part 4**

## **Selection of Optimal Flood Warning Threshold: Technical**



### **Introduction**

In this chapter flood warning systems are studied in a two-level hierarchical system framework. The interactions between the forecast subsystem and the response subsystem are investigated. Emphasis is placed on exploring the impact of the current selected flood warning threshold on the future response fraction of a flood warning. The probabilistic evaluation of a forecast system coupled with a stochastic dynamic model of the evolution of the response fraction in a community reveals that the desire for high present flood-loss reduction must be balanced with the possibility of high future flood loss. Multiobjective dynamic programming is used to select the optimal flood warning threshold. The proposed methodology is applied to the case study in Milton, Pennsylvania.

### **Features of the Model**

#### Description of the Methodology

In general, the overall flood warning system can be viewed as and modeled in a two-level hierarchical system framework (see Figure 4-1). There are two subsystems at the lower level. One is the forecasting subsystem, which issues a flood forecast based on hydrological and climatic information. The other is the response subsystem, which includes decisionmaking and action implementation of a community in response to flood warning. At the upper level, it is assumed that a regional agency exists whose functions are to set a warning threshold, disseminate a flood warning to the community, provide transportation during the evacuation process, and collect statistical data of the warning system.

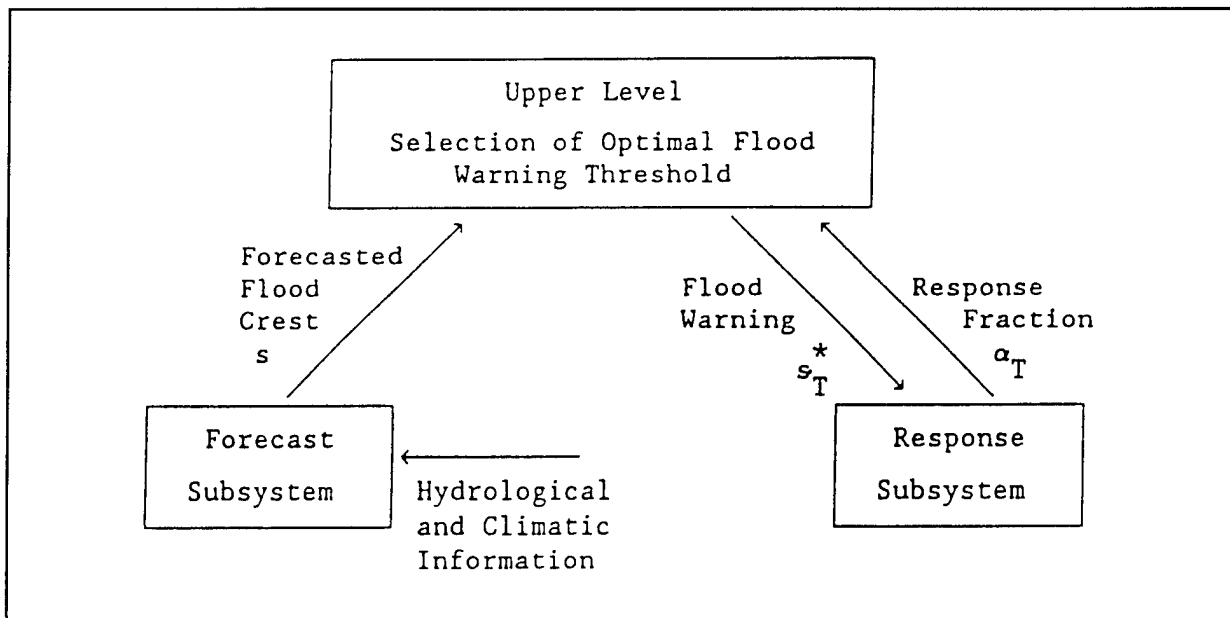
#### *Performance Measures of a Warning System*

Define  $H$  to be a random variable which represents the actual flood crest and  $S$  to be a random variable which represents the forecasted flood crest. If the prior probability density function of the flood crest is denoted by  $g(h)$  and the conditional probability density function of  $s$ , given  $h$ , is denoted by  $f(s | h)$ , then the posterior probability density function of  $h$ , given forecast  $s$ , is

$$f(h | s) = f(s | h) g(h) / k(s), \quad (4.1)$$

where  $k(s)$  is the marginal probability density function of forecast  $s$ ,

$$k(s) = \int_0^{\infty} f(s | h) g(h) dh \quad (4.2)$$



**Figure 4-1.** Multilevel Structure of Flood Warning System

In this report both prior distribution and the likelihood function are assumed to be of normal distributions with the forms [Krzysztofowicz 1987]

$$g(h) \sim N(\mu_h, \sigma_h^2) \quad (4.3)$$

and

$$f(s | h) \sim N(ah + b, \sigma^2). \quad (4.4)$$

The marginal distribution of  $s$  is then of a normal distribution [Krzysztofowicz 1987],

$$k(s) \sim N(a\mu_h + b, \sigma^2 + a^2\sigma_h^2). \quad (4.5)$$

The posterior distribution of  $h$  given a forecast,  $s$ , is also normal [Krzysztofowicz 1987],

$$f(h | s) \sim N(As + B, C^2), \quad (4.6)$$

where

$$A = a\sigma_h^2 / (\sigma^2 + a^2\sigma_h^2) \quad (4.7)$$

$$B = (\mu_h\sigma^2 - ab\sigma_h^2) / (\sigma^2 + a^2\sigma_h^2) \quad (4.8)$$

$$C^2 = \sigma^2\sigma_h^2 / (\sigma^2 + a^2\sigma_h^2). \quad (4.9)$$

The flood warning threshold,  $s^*$ , is defined by the fact that the domain for issuing a flood warning is  $\{s \geq s^*\}$ . In other words, a flood warning will be issued only when the forecasted flood crest,  $s$ , exceeds a preassigned threshold level,  $s^*$ . For a given physical forecast system, the performance of the system can be evaluated by the four probabilistic measures. Assume that the elevation of the floodplain zone under consideration is  $y$ ; the probability that this zone will be flooded, conditioned on the forecast,  $s$ , is

$$\begin{aligned} q(s,y) &= P(h \geq y \mid s) \\ &= \int_y^{\infty} f(h \mid s) dh \\ &= 1 - \Phi[(y - As - B)/C] \\ &= 0.5\{1 - \text{erf}[(y - As - B)/(\sqrt{C})]\}, \end{aligned} \quad (4.10)$$

where  $\Phi(\bullet)$  is the cumulative distribution of the standard normal and  $\text{erf}(\bullet)$  is the error function defined by

$$\text{erf}(x) = \frac{2}{\sqrt{\pi}} \int_0^x \exp(-u^2) du \quad (4.11)$$

The decision rule is to issue a flood warning if the forecasted flood crest exceeds a preassigned warning threshold,  $s^*$ , and not to issue a flood warning otherwise. There exist four possible outcomes that follow a flood warning decision: a correct warning, a false warning, a missed warning, and a correct quiet (the decision not to issue a warning). A correct warning is a warning followed by a flood. The probability of a correct warning is

$$\begin{aligned} P_{11}(s^*,y) &= \int_{s^*}^{\infty} P(h \geq y \mid s) k(s) ds \\ &= \int_{s^*}^{\infty} \frac{0.5\{1 - \text{erf}[(y - As - B)/(\sqrt{2C})]\}}{\sqrt{2\pi}\sqrt{\sigma^2 + a^2\sigma_h^2}} \exp\left[-\frac{(s - a\mu_h - b)^2}{2(\sigma^2 + a^2\sigma_h^2)}\right] ds. \end{aligned} \quad (4.12)$$

A false warning is a warning not followed by a flood. The probability of a false warning is

$$\begin{aligned} P_{10}(s^*,y) &= \int_{s^*}^{\infty} P(h < y \mid s) k(s) ds \\ &= \int_{s^*}^{\infty} k(s) ds - P_{11}(s^*,y) \\ &= 0.5\{1 - \text{erf}[s^* - a\mu_h - b)/\sqrt{2(\sigma^2 + a^2\sigma_h^2)}]\} - P_{11}(s^*,y) \end{aligned} \quad (4.13)$$

A missed forecast is a flood event which is not preceded by a warning. The probability of a missed flood warning is

$$\begin{aligned}
 P_{01}(s^*, y) &= \int_0^{s^*} P(h \geq y | s)k(s)ds \\
 &= P(h \geq y) - P_{11}(s^*, y) \\
 &= 0.5\{1 - \text{erf}[y - \mu_h]/(\sqrt{2}\sigma_h)\} - P_{11}(s^*, y)
 \end{aligned} \tag{4.14}$$

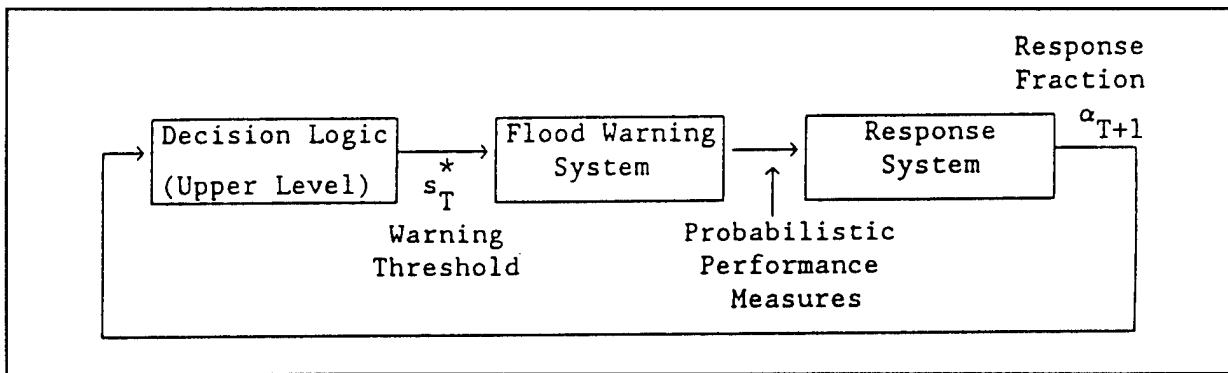
A correct quiet is the case of no warning and no flood ( $h < y$ ). The probability of acting correctly in not issuing a flood warning is

$$\begin{aligned}
 P_{00}(s^*, y) &= \int_0^{s^*} (h < y | s)k(s)ds \\
 &= \int_0^{s^*} k(s) ds - P_{01}(s^*, y) \\
 &= 0.5\{1 + \text{erf}[(s^* - a\mu_h - b)/\sqrt{2(\sigma^2 + a^2\sigma_h^2)}]\} - P_{01}(s^*, y)
 \end{aligned} \tag{4.15}$$

These four probabilistic measures are related to each other. Knowing one of them and the prior flood probability,  $P(h \geq y)$ , and the probability density function of  $k(s)$ , the other three can be calculated.

There are two types of prediction errors of a forecast system -- Type I and Type II errors. Type I errors are those of missed predictions. Type II errors are those of false alerts. It is clear from Eqs. (4.12) - (4.15) that the value of the selected threshold,  $s^*$ , plays a key role in determining the probabilities of Type I and Type II errors. If the threshold,  $s^*$ , is set lower, the forecast will have a lower probability value of a Type I error and a higher probability value of a Type II error. If the threshold,  $s^*$ , is set higher, the forecast will have a higher probability value of a Type I error and a lower probability value of a Type II error.

Type I and Type II errors have different impacts on flood-loss reduction. A Type I error will result in an immediate flood loss. Thus, it has a short-term impact. On the other hand, a Type II error will reduce the credibility of the forecast system. This cry-wolf consequence has a long-term impact. Such errors do not cause a flood loss at the present stage, but will discourage the response to flood warnings for future flood events. The present fraction of people who respond to a flood warning is certainly an indispensable factor in constructing the flood-loss function for a community. It thus affects the selection of the flood warning threshold. On the other hand, the response fraction fluctuates as time passes, based on the past performance of the warning system. The coupling between successive flood events is carried by dynamic evolvement of the fraction of people who respond to a flood warning. The past performance of a flood warning system affects the present fraction of people who respond to the warning system. Therefore, it is necessary to investigate the operation of flood warning systems in a dynamic framework. Figure 4-2 presents the interconnection between the flood warning threshold and the response fraction in the decision logic.



**Figure 4-2.** Interaction Between Forecast and Response Subsystems

*A Model of the Response System*

In general, the response of a community to a flood warning system is affected by people's experience of flooding and their subjective evaluation of the past performance of the forecasting system.

The general interaction between a forecasting system and a response system can be described from the following considerations. The effectiveness of a forecasting system can be judged from its performance measures of Type I and Type II errors. The response of a community to a flood warning can be described by a state variable, that is, the fraction of people in the community who respond to a call for evacuation when warned. This fraction is denoted by  $\alpha_T$  for the  $T$ th flood event. If a past flood event has been predicted, then confidence in the flood forecasting system will increase, and thus, future rates of response will also increase. On the other hand, a cry-wolf (Type II error) event will decrease confidence in the flood forecasting system, thereby decreasing future rates of response. People tend to have decreased confidence in a flood warning system when they have experienced a missed warning. However, the experience of flooding will increase people's alertness to the possibilities of future floods. For simplicity, it is reasonable to assume that the response fraction will remain unchanged after a missed warning has been experienced. It is also assumed that a correct quiet does not change the response fraction in the future. In view of the above discussion, the fraction  $\alpha_T$  can be assumed to evolve dynamically, being governed by the following equation:

$$\alpha_{T+1} = \begin{cases} \alpha_T + c_1(1 - \alpha_T) & \text{with prob. } P_{11}(s_T^*, y) \\ \alpha_T & \text{with prob. } P_{00}(s_T^*, y) + P_{01}(s_T^*, y) \\ c_2 \alpha_T & \text{with prob. } P_{10}(s_T^*, y) \end{cases} \quad (4.16)$$

where  $c_1$  and  $c_2$  are constants or functions of  $\alpha_T$ . Their range is in (0,1), and they can be determined using identification methods based on historic data.

***Risk-Based Evaluation of  
Flood Warning and Preparedness Systems***

---

The response fraction in the community is described here as a controlled stochastic process. Knowing the present value of the response fraction, three possible transitions exist with given probabilities. The actual transition depends on the real outcome associated with the present warning decision. This stochastic system can be controlled in the sense of the expected value.

Note here that the feedback loop that encompasses the forecast and the response subsystems is closed only when the next flood event occurs. The present performance of a forecast system does not affect the fraction  $\alpha_T$  at the present flood event, but it does affect the fraction  $\alpha_{T+1}$  at the next flood event.

*Multiobjective Multistage Optimization Model*

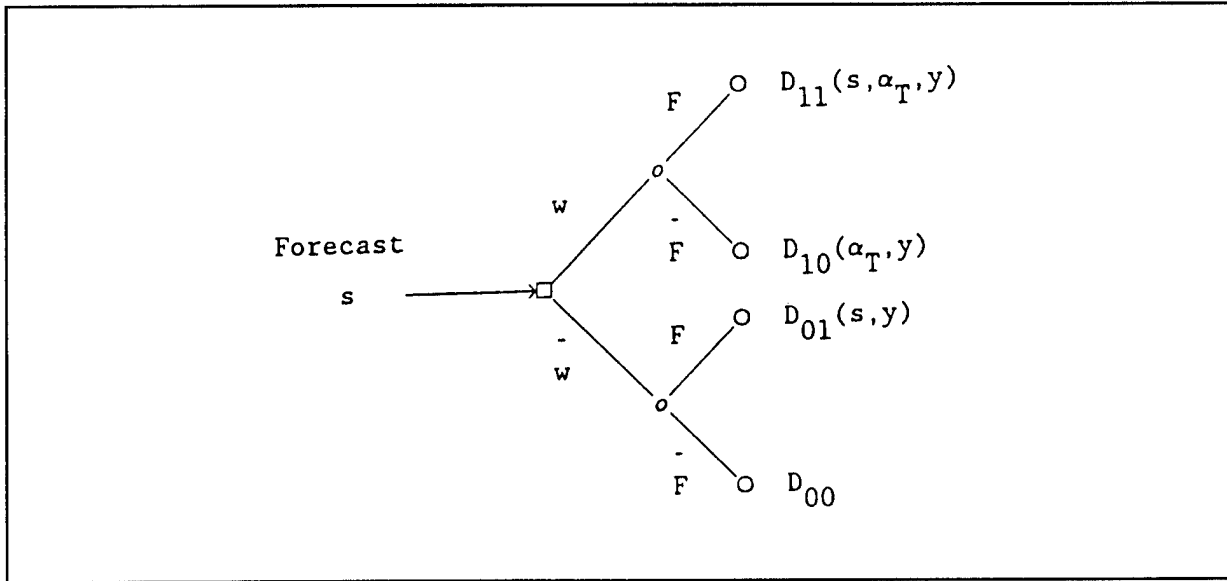
A key aspect of flood warning systems is that the selection of the flood warning threshold cannot be viewed in isolation at each single flood event since the decisionmaker must balance the desire for high present flood-loss reduction with the possibility of high future flood loss. A multiobjective multistage optimization model has been proposed by Environmental Systems Modeling, Inc. [1990] for finding the best value for the flood warning threshold of a flood warning system. Evaluating the trade-off between short- and long-term effects yields to an acceptable balance between the expected loss reduction at the current stage and the fraction of people who respond at the next flood event.

Assume that there are N successive flood events in the time horizon under consideration. At each flood event, the maximization of two noncommensurate and/or conflicting objective functions is considered. At the Tth flood event, one objective is to maximize the expected property-loss reduction; the second objective is to increase the system's credibility by reducing the cry-wolf effect (i.e., increasing the fraction of people who respond in the future).

At the Tth flood event, assume that the expected fraction of people that respond to the warning system is  $\alpha_T$ . The decision logic for property loss is described in Figure 4-3 for a given forecast s, where F is the event of flooding, w is the action of flood warning, and the notation "-" denotes the negation of an event. Denote  $D_{00}$  (which is assumed to be zero) to be the expected loss when no warning is given and no flood occurs,  $D_{01}(s,y)$  to be the expected community property loss without a warning,  $D_{10}(\alpha_T,y)$  to be the cost of the evacuation in the community, and  $D_{11}(s,\alpha_T,y)$  to be the expected community property loss with a warning. It is evident that the response fraction affects loss functions  $D_{10}$  and  $D_{11}$ . For a specific value of forecast s, the probability that a zone with elevation y is flooded is  $q(s,y) = P(h > y | s)$ . The expected property loss with no warning issued is  $q(s,y)D_{01}(s,y)$ , and the expected property loss with a warning issued is  $q(s,y)D_{11}(s,\alpha_T,y) + [1 - q(s,y)]D_{10}(\alpha_T,y)$ . Assume that the flood warning is issued when the forecast flood crest, s, exceeds a preassigned threshold level  $s_T^*$ . The expected property loss with a warning system then becomes

$$R(s_T^*, \alpha_T, y) = \int_0^{s_T^*} \{q(s,y)D_{01}(s,y) + [1 - q(s,y)]D_{00}\}k(s)ds + \int_{s_T^*}^{\infty} \{q(s,y)D_{11}(s, \alpha_T, y) + [1 - q(s,y)]D_{10}(\alpha_T, y)\}k(s)ds. \quad (4.17)$$

Recall that the expected property loss without a warning system is



**Figure 4-3.** Decision Logic at Stage T

$$R_0(\alpha_T, y) = \int_0^{\infty} q(s, y) D_{01}(s, y) k(s) ds. \quad (4.18)$$

Thus, the expected property-loss reduction,  $f_1^T$ , is

$$\begin{aligned} f_1^T &= R_0(\alpha_T, y) - R(s_T^*, \alpha_T, y) \\ &= \int_{s_T^*}^{\infty} Q(s, y) \{D_{01}(s, y) - q(s, y) D_{11}(s, \alpha_T, y) - [1 - q(s, y)] D_{10}(\alpha_T, y)\} k(s) ds \end{aligned} \quad (4.19)$$

To construct a reasonable loss function, the concept of category-unit loss functions proposed by Krzysztofowicz and Davis [1983] is adopted. The main modification is that the notation  $\alpha$ , which was originally used in Krzysztofowicz and Davis [1983] as the response degree of an individual, is used in this study to represent the fraction of people who respond to the warning. The cost function of evacuation is assumed to be a linear function of the response fraction

$$d_{10} = MC\alpha, \quad (4.20)$$

where MC is the maximum evacuation cost for the community when a full response is present.

The flood-loss function without a warning is given by

$$d_{01} = MD\delta(h - y), \quad (4.21)$$

where MD is the maximum possible damage due to flooding of the highest magnitude when no response is made, and  $\delta(h - y)$  is the unit-damage function specifying the fraction of MD which occurs when the depth of flooding is  $(h - y)$ .



**Risk-Based Evaluation of  
Flood Warning and Preparedness Systems**

---

The loss function with a warning is

$$d_{11} = MC\alpha + MD[1 - \alpha MR(h - y)]\delta(h - y), \quad (4.22)$$

where  $MR(h - y)$  is the unit reduction function specifying the reduction of  $MD$  when the depth of flooding is  $(h - y)$  and full response of the community is made,  $\alpha = 1$ .

The expected cost of the community evacuation conditioned on a given forecast,  $s$ , is

$$D_{10} = d_{10} = MC\alpha. \quad (4.23)$$

The expected property loss without a warning conditioned on a given forecast,  $s$ , is

$$D_{01} = \frac{1}{q(s,y)} \int_y^{\infty} d_{01}(h)f(h | s)dh. \quad (4.24)$$

The expected property loss with a warning conditioned on a given forecast,  $s$ , is

$$\begin{aligned} D_{11} &= \frac{1}{q(s,y)} \int_y^{\infty} d_{11}(\alpha,h)f(h | s)dh. \\ &= MC\alpha + D_{01} - \frac{\alpha MD}{q(s,y)} \int_y^{\infty} MR(h - y)\delta(h - y)f(h | s)dh. \end{aligned} \quad (4.25)$$

In this case, the expected property-loss reduction at stage  $T$  can be simplified into

$$f_1^T = \alpha \int_{s_T^*}^{\infty} [MD \int_y^{\infty} MR(h - y)\delta(h - y)f(h | s)dh - MC] k(s)ds. \quad (4.26)$$

Note here that the expected loss reduction is a linear function of the response fraction.

When  $MR(h - y)$  and  $\delta(h - y)$  are polynomial functions of  $h$ , the integration of

$$\int_y^{\infty} MR(h - y)\delta(h - y)f(h | s)dh.$$

can be solved using the following formulas:

$$\int_a^b f(h | s)dh = 0.5 \left[ \operatorname{erf}\left(\frac{b - As - B}{\sqrt{2}C}\right) - \operatorname{erf}\left(\frac{a - As - B}{\sqrt{2}C}\right) \right] \quad (4.27)$$

$$\begin{aligned} \int_a^b hf(h | s)dh &= \frac{C}{\sqrt{2\pi}} \left[ \exp\left[-\frac{(a - As - B)^2}{2C^2}\right] - \exp\left[-\frac{(b - As - B)^2}{2C^2}\right] \right] \\ &\quad + (As + B) \int_a^b f(h | s)dh \end{aligned} \quad (4.28)$$

$$\int_a^b h^n f(h | s) dh = \frac{C}{\sqrt{2\pi}} \left\{ [a^{n-1} \exp[-\frac{(a - As - B)^2}{2C^2}] - b^{n-1} \exp[-\frac{(b - As - B)^2}{2C^2}] \right\} \\ + (n - 1)C^2 \int_a^b h^{n-2} f(h | s) dh + (As + B) \int_a^b h^{n-1} f(h | s) dh \quad (4.29) \\ n \geq 2$$

The N-stage multiobjective optimization problem of flood warning systems is to maximize the sum of the expected property-loss reductions of all flood events over the time horizon under consideration, and to maximize the forecast system's credibility, which is implicitly expressed by  $E(\alpha_{N+1})$ , the expected fraction of people who respond to the warning beyond the time horizon under consideration. Mathematically, this overall multiobjective optimization problem can be posed as:

$$\max_{s^*} \left[ \begin{array}{l} f_1 = E \left\{ \sum_{T=1}^N f_1^T \right\} \\ f_2 = f_2^N = E \{ \alpha_{N+1} \} \end{array} \right] \quad (4.30a)$$

$$\text{s.t. } \alpha_{T+1} = \begin{cases} \alpha_T + c_1(1 - \alpha_T) & \text{with prob. } P_{11}(s_T^*, y) \\ \alpha_T & \text{with prob. } P_{00}(s_T^*, y) + P_{01}(s_T^*, y) \\ c_2 \alpha_T & \text{with prob. } P_{10}(s_T^*, y) \end{cases} \quad (4.30b)$$

where  $f_1^T$  is given in Eq. (4.26). It may be useful to consider also the maximization of a third objective function in Eq. (4.30a), namely, the *expected life-loss reductions* of all flood events over the time horizon under consideration. The life-loss reductions will not be discussed further in this report.

Solving the multiobjective multistage optimization problem in Eq. (4.30) yields the set of noninferior solutions. A decision sequence  $s^* = [\hat{s}_1^*, \hat{s}_2^*, \dots, \hat{s}_N^*]$  is said to be noninferior if there does not exist another decision sequence  $\hat{s}^* = [\hat{s}_1^*, \hat{s}_2^*, \dots, \hat{s}_N^*]$  such that  $f_i(\hat{s}^*) \geq f_i(s^*)$ ,  $i = 1, 2$ , with at least one strict inequality.

Equation (4.30) can be solved by the weighting method and dynamic programming. At the final stage, the following optimization problem is solved for a given weighting coefficient,  $\theta$ , and a given value of  $\alpha_N$ :

$$\Phi_N(\theta, \alpha_N) = \max_{s_N^*} \theta [f_1^N | \alpha_N] + (1 - \theta) E\{\alpha_{N+1} | \alpha_N\} \quad (4.31)$$

subject to Eq. (4.30b).

***Risk-Based Evaluation of  
Flood Warning and Preparedness Systems***

---

At stage T ( $1 \leq T \leq N - 1$ ), the following optimization problem is solved for a given value of the weighting coefficient,  $\theta$ , and a given value of  $\alpha_T$ :

$$\phi_T(\theta, \alpha_T) = \max_{s_T^*} \theta [f_T^T | \alpha_T] + E\{\phi_{T+1}(\theta, \alpha_{T+1}) | \alpha_T\} \quad (4.32)$$

where  $\alpha_T$  satisfies Eq. (4.30b).

**Case Studies**

**Application to Milton, Pennsylvania**

System design S2, described in this report, Part 3, Performance Characteristics of a Flood Warning System, developed in a study of Milton, Pennsylvania, is selected as the illustrative application of the methodology described in the above sections. In this case, the flood crest H is of a normal distribution  $N(24.88, 4.8216387^2)$  and the conditional probability density function of the forecasted flood crest S, given h, is of a normal distribution  $N(0.4503h + 12.1044, 1.8973^2)$ . It can be shown that (1) the marginal probability density function of the forecast k(s) is  $N(23.307864, 2.8833638^2)$  and (2) the posterior distribution density function of h given s,  $f(h | s)$ , is  $N(1.2591933s - 4.4691054, 3.1727162^2)$ . The probability of flooding, given forecast s, is obtained by

$$\begin{aligned} q(s,y) &= \int_y^\infty f(s | h)dh \\ &= 1 - \Phi[(y - 1.2591933s + 4.4691054)/3.1727162], \end{aligned} \quad (4.33)$$

where  $\Phi(\bullet)$  is the cumulative distribution function of the standard normal. In our computer program, the cumulative distribution function  $\Phi(\bullet)$  is calculated through its relationship with the error function,

$$\Phi(x) = 0.5[1 + \text{erf}(x/\sqrt{2})], \quad (4.34)$$

where the error function is defined by

$$\text{erf}(x) = \frac{2}{\sqrt{\pi}} \int_0^x e^{-u^2} du \quad (4.35)$$

Substituting k(s) and q(s,y) into Eqs. (4.12) - (4.15), the four probabilistic measures of a forecasting system can be calculated for given warning threshold  $s^*$  and zone elevation y. Table 4-1 shows those measures for two values of y and various values of  $s^*$ . A tradeoff between Type I and II errors can be clearly seen from Fig. 4-4. Different values of  $s^*$  associate different values of the probabilistic measures,  $P_{11}(s^*)$ ,  $P_{10}(s^*)$ ,  $P_{01}(s^*)$ , and  $P_{00}(s^*)$ . They thus yield different impacts on the response fraction at the subsequent stage.

For simplicity, we only consider property losses in this illustrative example. To construct a reasonable loss function, the concept of category-unit loss functions proposed by Krzysztofowicz and Davis [1983d] is adopted in the following. The main modification is that the notation  $\alpha$ , which was originally used in

Krzysztofowicz and Davis [1983d] as the response degree of an individual, is used here to represent the fraction of people who respond to the warning. The cost function is assumed to be of the form

$$d_{10} = MC\alpha, \tag{4.36}$$

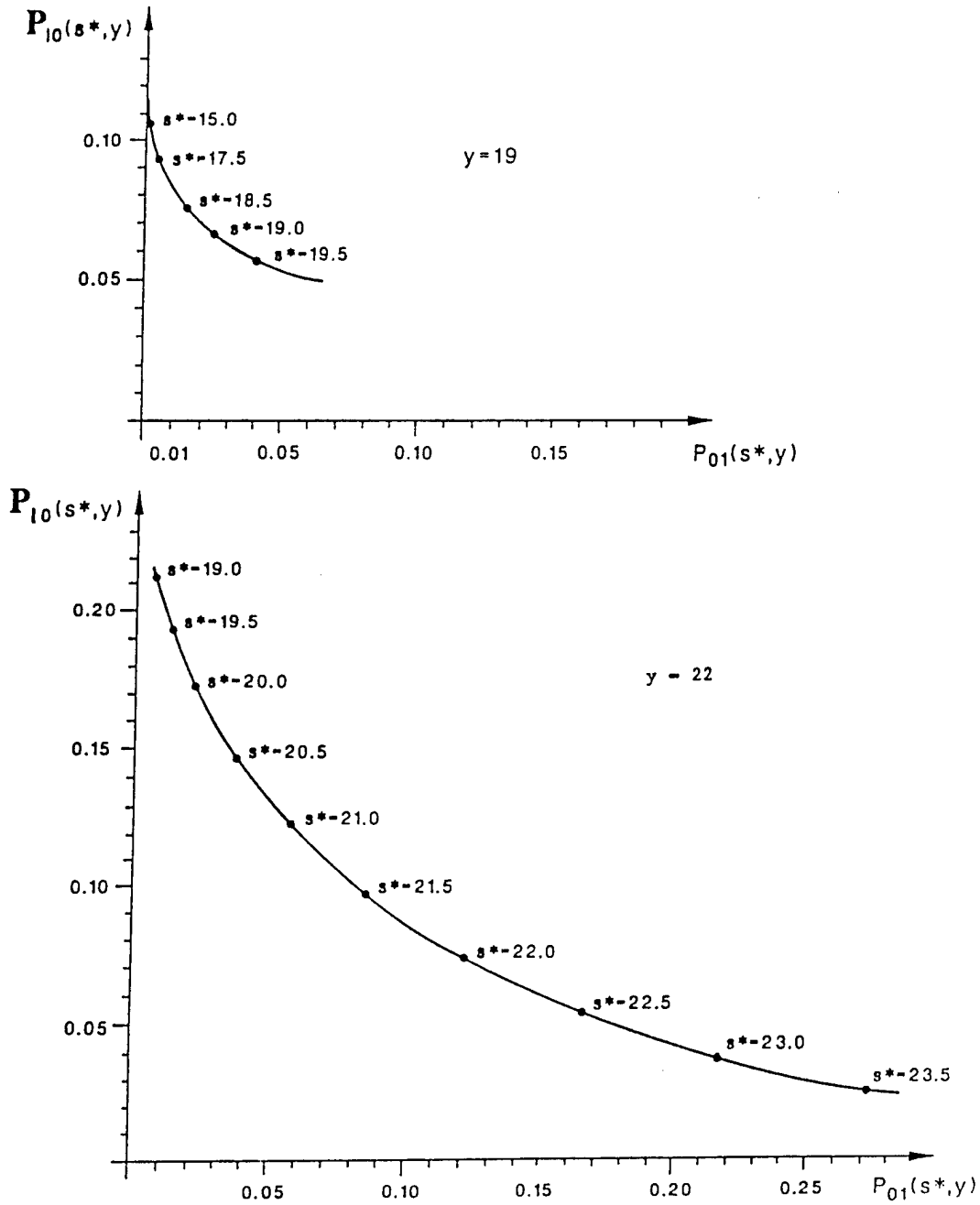
**Table 4-1.** Probabilistic Measures of the Warning System

$y = 19$

$s^*$	$P_{11}(s^*, y)$	$P_{10}(s^*, y)$	$P_{01}(s^*, y)$	$P_{00}(s^*, y)$
15.0	0.8885870	0.1094329	0.0000862	0.0018939
15.5	0.8884591	0.1081553	0.0002140	0.0031715
16.0	0.8881721	0.1061974	0.0005011	0.0051294
16.5	0.8875671	0.1033221	0.0011061	0.0080047
17.0	0.8863676	0.0992858	0.0023056	0.0120411
17.5	0.8841263	0.0938829	0.0045469	0.0174439
18.0	0.8801783	0.0870001	0.0084949	0.0243263
18.5	0.8736137	0.0786737	0.0150595	0.0326531
19.0	0.8632919	0.0691255	0.0253813	0.0422013
19.5	0.8479231	0.0587649	0.0407501	0.0525619

$y = 22$

$s^*$	$P_{11}(s^*, y)$	$P_{10}(s^*, y)$	$P_{01}(s^*, y)$	$P_{00}(s^*, y)$
19.0	0.7171233	0.2152941	0.0077255	0.0598570
19.5	0.7108782	0.1958098	0.0139707	0.0793414
20.0	0.7009019	0.1734535	0.0239469	0.1016977
20.5	0.6858719	0.1490539	0.0389770	0.1260972
21.0	0.6644858	0.1237766	0.0603631	0.1513745
21.5	0.6357059	0.0989638	0.0891429	0.1761873
22.0	0.5990129	0.0759250	0.1258360	0.1992262
22.5	0.5546101	0.0557205	0.1702388	0.2194306
23.0	0.5035065	0.0390087	0.2213424	0.2361424
23.5	0.4474492	0.0259864	0.2773997	0.2491647



**Figure 4-4.** Trade-off Between Type I and Type II Errors

where  $MC = 4$  (\$ ten thousand) is the evacuation cost for the community.

The flood-loss function without a warning is given by

$$d_{01} = MD\delta(h - y), \quad (4.37)$$

where  $MD = 100$  (\$ ten thousand) is the maximum possible damage due to flood of the highest magnitude when no response is made, and  $\delta(h - y)$  is the unit damage function specifying the fraction of  $MD$  which occurs when the depth of flooding is  $(h - y)$ . We assume  $\delta(h - y)$  to be equal to  $0.4(h - y)$  when  $h - y \leq 2.5$  and to be equal to 1 when  $h - y > 2.5$  ( $h$  and  $y$  are in the unit of 10 feet).

The loss function with a warning is

$$d_{11} = MC\alpha + MD[1 - \alpha MR(h - y)]\delta(h - y), \quad (4.38)$$

where  $MR(h - y)$  is the unit reduction function specifying the reduction of  $MD$  when the depth of flooding is  $(h - y)$  and full response of community is made,  $\alpha = 1$ . We assume  $MR(h - y)$  to be equal to  $0.25 + 0.4(h - y) - 0.333(h - y)^2$  when  $h - y \leq 1.2$  and to be equal to 0.25 when  $h - y > 1.2$ .

The expected cost of the community evacuation conditioned on a given forecast  $s$  is

$$D_{10} = d_{10} = MC\alpha. \quad (4.39)$$

The expected property loss without a warning conditioned on a given forecast  $s$  is

$$\begin{aligned} D_{01} &= \frac{1}{q(s,y)} \int_y^{\infty} d_{01}(h)f(h | s)dh \\ &= \frac{MD}{q(s,y)} \left[ \int_y^{y+2.5} 0.4(h - y)f(h | s)dh + \int_{y+2.5}^{\infty} f(h | s)dh \right]. \end{aligned} \quad (4.40)$$

The expected property-loss with a warning conditioned on a given forecast  $s$  is

$$\begin{aligned} D_{11} &= \frac{1}{q(s,y)} \int_y^{\infty} d_{11}(\alpha,h)f(h | s)dh \\ &- \frac{\alpha MD}{q(s,y)} \left[ \int_y^{y+1.2} [0.25 + 0.4(h - y) - 0.333(h - y)^2]0.4(h - y)f(h | s)dh \right. \\ &\left. + \int_{y+1.2}^{y+2.5} 0.25 \cdot 0.4(h - y)f(h | s)dh + \int_{y+2.5}^{\infty} 0.25 f(h | s)dh \right] \end{aligned} \quad (4.41)$$

**Risk-Based Evaluation of  
Flood Warning and Preparedness Systems**

---

Since  $f(h | s)$  is of normal distribution  $N(1.2591933s - 4.4691054, 3.1727162^2)$ , the above integrations can be performed using the following equations:

$$\int_a^b f(h | s)dh = \Phi\left(\frac{b - 1.2591933s + 4.4691054}{3.1727162}\right) - \Phi\left(\frac{a - 1.2591933s + 4.4691054}{3.1727162}\right) \quad (4.42)$$

$$\int_a^b f(h | s)dh = \frac{3.1727162}{\sqrt{2\pi}} \left\{ \text{Exp}\left[-\frac{(a - 1.2591933s + 4.4691054)^2}{2 \cdot 3.1727162^2}\right] - \text{Exp}\left[-\frac{(b - 1.2591933s + 4.4691054)^2}{2 \cdot 3.1727162^2}\right] \right\} + (1.2591933s + 4.4691054) \int_a^b f(h | s)dh \quad (4.43)$$

$$\int_a^b h^2 f(h | s)dh = \frac{3.1727162}{\sqrt{2\pi}} \left\{ a \text{Exp}\left[-\frac{(a - 1.2591933s + 4.4691054)^2}{2 \cdot 3.1727162^2}\right] - b \text{Exp}\left[-\frac{(b - 1.2591933s + 4.4691054)^2}{2 \cdot 3.1727162^2}\right] \right\} + 3.1727162^2 \int_a^b f(h | s)dh + (1.2591933s + 4.4691054) \int_a^b hf(h | s)dh \quad (4.44)$$

$$\int_a^b h^3 f(h | s)dh = \frac{3.1727162}{\sqrt{2\pi}} \left\{ a^2 \text{Exp}\left[-\frac{(a - 1.2591933s + 4.4691054)^2}{2 \cdot 3.1727162^2}\right] - b^2 \text{Exp}\left[-\frac{(b - 1.2591933s + 4.4691054)^2}{2 \cdot 3.1727162^2}\right] \right\} + 2 \cdot 3.1727162^2 \int_a^b hf(h | s)dh + (1.2591933s + 4.4691054) \int_a^b h^2 f(h | s)dh \quad (4.45)$$

The objective function  $f_1^T$  can now be posed as

$$f_1^T = \int_{s^*}^{\infty} \{q(s,y)D_{01}(s,y) - q(s,y)D_{11}(s,\alpha_T,y) - (1 - q(s,y))D_{10}(\alpha_T,y)\}k(s)ds \quad (4.46)$$

Table 4-2 gives the calculated values of the expected flood-loss reduction for various response fractions and preselected warning thresholds where  $y$  is equal to 19 or 22. The relationship between the expected flood-loss reduction and the warning threshold is also depicted in Fig. 4-5 for various response fractions and elevation levels. In this illustrative example, we assume that the parameters in the response fraction dynamic model, Eq. (4.16), take values of  $c_1 = 0.1$  and  $\xi = 0.9$ . We consider a five-stage problem with the initial responding fraction  $\alpha_1$  equal to 0.7. Two values of the elevation  $y$  are considered,  $y = 19$  (feet) and  $y = 22$  (feet).

The overall problem can now be posed as follows:

$$\max_{s^*} \left[ \begin{array}{l} f_1 = E \left\{ \sum_{T=1}^5 f_1^T \right\} \\ f_2 = E \{ \alpha_6 \} \end{array} \right] \quad (4.47a)$$

$$\text{s.t.} \quad \alpha_{T+1} = \begin{cases} \alpha_T + 0.1(1 - \alpha_T) & \text{with prob. } P_{11}(s_T^*,y) \\ \alpha_T & \text{with prob. } P_{00}(s_T^*,y) + P_{01}(s_T^*,y) \\ 0.9\alpha_T & \text{with prob. } P_{10}(s_T^*,y) \end{cases} \quad (4.47b)$$

$$\alpha_1 = 0.7 \quad T = 1,2,3,4,5$$

Equation (4.47) can be solved by the weighting method and dynamic programming. At the fifth stage, the following optimization problem is solved for given weighting coefficient  $\theta$  and given value of  $\alpha_5$ :

$$\Phi_5(\theta, \alpha_5) = \max_{s_5^*} \theta [f_1^5 | \alpha_5] + (1 - \theta) E \{ \alpha_6 | \alpha_5 \}, \quad (4.48)$$

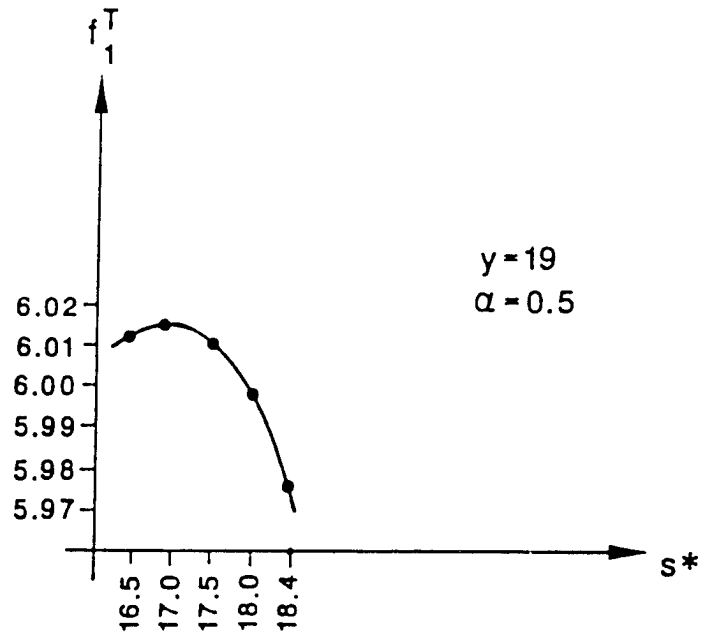
subject to Eq. (4.47b) with  $T = 5$ .

At stage  $T$ ,  $T = 4,3,2,1$ , the following optimization problem is solved for given value of the weighting coefficient  $\theta$  and given value of  $\alpha_T$ :

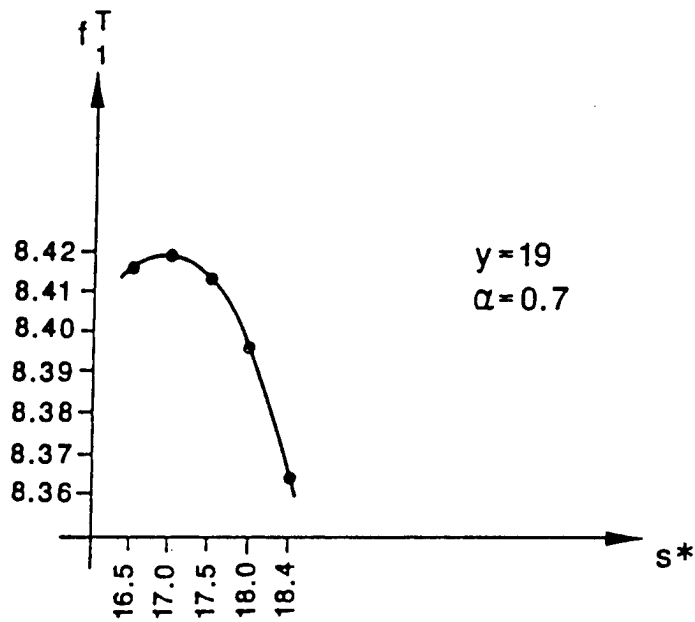
$$\Phi(\theta, \alpha_T) = \max_{s_T^*} \theta [f_1^T | \alpha_T] + E \{ \Phi_{T+1}(\theta, \alpha_{T+1}) | \alpha_T \},$$

where  $\alpha_T$  satisfies Eq. (4.47b), and  $\alpha_1 = 0.7$ .



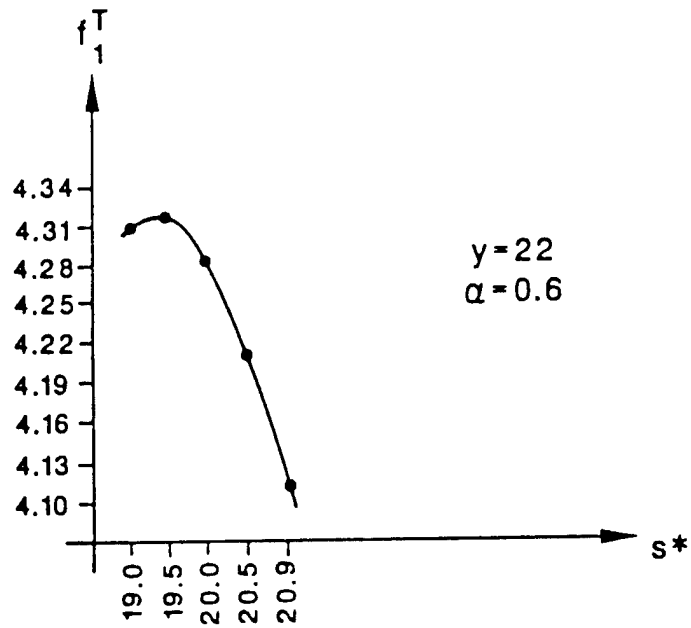


5(a)

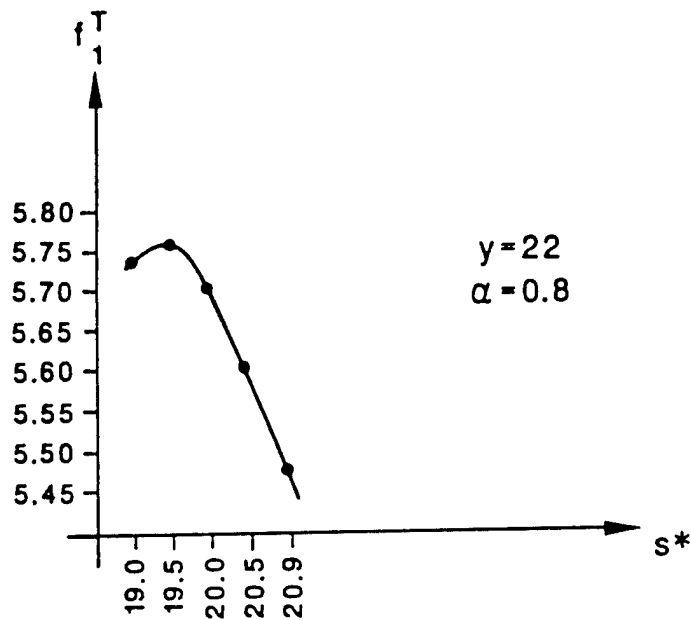


5(b)

**Figure 4-5.** Relationship Between the Expected Flood-loss Reduction and the Warning Threshold for Various Response Fraction and Elevation Levels



5(c)



5(d)

Figure 4-5. (continued)

**Table 4-2. Expected Flood-loss Reduction**

y = 19

$s^*$	$\alpha$	0.50	0.60	0.70	0.80
16.5		6.013321	7.215985	8.418648	9.621314
17.0		6.014395	7.217274	8.420152	9.623033
17.5		6.011573	7.213888	8.416201	9.618517
18.0		5.998908	7.198690	8.398471	9.598253
18.4		5.975090	7.170107	8.365125	9.560144

y = 22

$s^*$	$\alpha$	0.50	0.60	0.70	0.80
19.0		3.592137	4.310565	5.028992	5.747422
19.5		3.595634	4.314761	5.033888	5.753016
20.0		3.574387	4.289264	5.004142	5.719021
20.5		3.511868	4.214242	4.916617	5.618992
20.9		3.420732	4.104879	4.789026	5.473174

To make the computational procedure feasible, the state space of  $\alpha_T$  and the control space of  $s_T$  are quantized by the grid sizes 0.01 and 0.1, respectively. Table 4-3 (a-h) provides noninferior solutions at various stages and various  $\alpha_T$ 's for four different weighting coefficients and two different values of zone elevation. It can be seen from Table 4-3 that:

(1) the lower the weighting coefficient  $\theta$  associated with the first objective (loss reduction), the higher the value of the flood warning threshold will be set to avoid possible high Type II errors;

(2) in order to select a decision that maximizes the sum of flood-loss reductions, the flood warning threshold is set higher at the earlier stage than at the later stage (with respect to the same value of the response fraction) in order to reduce the probability of high loss at the later stages; and

(3) the higher the present response fraction, the more cautious the selection of the threshold is. That means that a higher value of threshold is set for a higher value of the present response fraction in order to avoid losing a larger number of the response population. We should note here that the third conclusion may be model-specific.

Figures 4-6, 4-7, and 4-8 show the optimal flood warning threshold as functions of the weighting coefficient, the stage, and the response fraction, respectively.

Table 4-3a. Optimal Flood Warning Thresholds

$Y = 19 \quad \theta = 0.02$

$\alpha$	Stage 1	Stage 2	Stage 3	Stage 4	Stage 5
0.45		17.6 1.084007	17.6 0.9148158	17.5 0.7508677	17.5 0.5927224
0.50		17.7 1.158004	17.6 0.9834811	17.6 0.8136330	17.6 0.6489545
0.55		17.8 1.232019	17.7 1.052161	17.7 0.8764063	17.6 0.7051916
0.60		17.8 1.306050	17.8 1.120851	17.7 0.9391865	17.7 0.7614322
0.65		17.9 1.380095	17.8 1.189550	17.8 1.001974	17.7 0.8176754
0.70	18.0 1.6522150	17.9 1.454151	17.9 1.258261	17.8 1.064767	17.8 0.8739213
0.75		18.0 1.528219	17.9 1.326976	17.9 1.127564	17.8 0.9301701
0.80		18.0 1.602293	18.0 1.395698	17.9 1.190364	17.8 0.9864190

\*)The upper number denotes the selected flood warning threshold;  
and the lower number denotes the expected loss reduction from  
the present stage to the final stage.

Table 4-3b. Optimal Flood Warning Thresholds

$$Y = 19 \quad \theta = 0.06$$

$\alpha$	Stage 1	Stage 2	Stage 3	Stage 4	Stage 5
0.45		17.5 2.045543	17.4 1.603284	17.3 1.183760	17.2 0.7894264
0.50		17.5 2.201129	17.5 1.735747	17.4 1.290610	17.2 0.8678907
0.55		17.6 2.356729	17.5 1.868221	17.4 1.397466	17.3 0.9463577
0.60		17.6 2.512346	17.6 2.000699	17.4 1.504322	17.3 1.024826
0.65		17.7 2.667974	17.6 2.133191	17.5 1.611183	17.3 1.103294
0.70	17.8 3.3908580	17.7 2.823610	17.6 2.265684	17.5 1.718046	17.3 1.181762
0.75		17.8 2.979251	17.6 2.398177	17.5 1.824910	17.3 1.260230
0.80		17.8 3.134909	17.7 2.530680	17.5 1.931774	17.4 1.338699

\*)The upper number denotes the selected flood warning threshold; and the lower number denotes the expected loss reduction from the present stage to the final stage.

**Table 4-3c. Optimal Flood Warning Thresholds**

$Y = 19 \quad \theta = 0.1$

$\alpha$	Stage 1	Stage 2	Stage 3	Stage 4	Stage 5
0.45		17.4 3.007229	17.4 2.291853	17.3 1.616717	17.1 0.9861612
0.50		17.5 3.244441	17.4 2.488155	17.3 1.767683	17.1 1.086875
0.55		17.5 3.481679	17.5 2.684460	17.3 1.918650	17.2 1.187590
0.60		17.6 3.718935	17.5 2.880785	17.4 2.069619	17.2 1.288307
0.65		17.6 3.956197	17.5 3.077110	17.4 2.220595	17.2 1.389023
0.70	17.8 5.1299780	17.7 4.193476	17.6 3.273436	17.4 2.371570	17.2 1.489740
0.75		17.7 4.430770	17.6 3.469775	17.4 2.522546	17.2 1.590457
0.80		17.7 4.668063	17.6 3.666113	17.4 2.673521	17.2 1.691174

\*)The upper number denotes the selected flood warning threshold and the lower number denotes the expected loss reduction from the present stage to the final stage.

Table 4-3d. Optimal Flood Warning Thresholds

Y = 19       $\theta = 0.5$

$\alpha$	Stage 1	Stage 2	Stage 3	Stage 4	Stage 5
0.45		17.4 12.62451	17.3 9.177906	17.2 5.946517	17.0 2.953618
0.50		17.4 13.67814	17.3 10.01264	17.2 6.538699	17.0 3.276874
0.55		17.5 14.73185	17.4 10.84742	17.2 7.130880	17.0 3.600129
0.60		17.5 15.78559	17.4 11.68223	17.2 7.723061	17.0 3.923386
0.65		17.6 16.83937	17.4 12.51704	17.3 8.315259	17.0 4.246640
0.70	17.7 22.522440	17.6 17.89324	17.5 13.35188	17.3 8.907464	17.0 4.569896
0.75		17.6 18.94711	17.5 14.18674	17.3 9.499667	17.0 4.893150
0.80		17.6 20.00097	17.5 15.02160	17.3 10.09187	17.0 5.216409

\*)The upper number denotes the selected flood warning threshold; and the lower number denotes the expected loss reduction from the present stage to the final stage.

**Table 4-3e. Optimal Flood Warning Thresholds**

$\gamma = 22 \quad \theta = 0.02$

$\alpha$	Stage 1	Stage 2	Stage 3	Stage 4	Stage 5
0.45		19.8 0.8289434	19.8 0.7296401	19.8 0.6317911	19.8 0.5355290
0.50		19.9 0.8879178	19.9 0.7864377	19.9 0.6862146	19.9 0.5873594
0.55		20.0 0.9469303	20.0 0.8432720	20.0 0.7406604	19.9 0.6392034
0.60		20.1 1.005980	20.0 0.9001282	20.0 0.7951348	20.0 0.6910616
0.65		20.1 1.065078	20.1 0.9570246	20.1 0.8496162	20.0 0.7429260
0.70	20.2 1.2348560	20.1 1.124184	20.1 1.013937	20.1 0.9041280	20.1 0.7947990
0.75		20.2 1.183335	20.2 1.070861	20.1 0.9586413	20.1 0.8466820
0.80		20.2 1.242499	20.2 1.127814	20.2 1.013166	20.1 0.8985649

\*)The upper number denotes the selected flood warning threshold;  
and the lower number denotes the expected loss reduction from  
the present stage to the final stage.



Table 4-3f. Optimal Flood Warning Thresholds

$Y = 22 \quad \theta = 0.06$

$\alpha$	Stage 1	Stage 2	Stage 3	Stage 4	Stage 5
0.45		19.7 1.373070	19.6 1.121546	19.6 0.8787987	19.5 0.6456339
0.50		19.7 1.480653	19.7 1.216034	19.6 0.9588957	19.6 0.7099622
0.55		19.8 1.588269	19.7 1.310529	19.7 1.039008	19.6 0.7742918
0.60		19.8 1.695913	19.8 1.405033	19.7 1.119128	19.6 0.8386213
0.65		19.8 1.803563	19.8 1.499559	19.7 1.199249	19.6 0.9029509
0.70	19.9 2.2306700	19.9 1.911242	19.8 1.594090	19.7 1.279371	19.6 0.9672803
0.75		19.9 2.018938	19.8 1.688627	19.7 1.359500	19.7 1.031617
0.80		19.9 2.126638	19.8 1.783173	19.8 1.439644	19.7 1.095958

\*)The upper number denotes the selected flood warning threshold;  
and the lower number denotes the expected loss reduction from  
the present stage to the final stage.

**Table 4-3g. Optimal Flood Warning Thresholds**

$\gamma = 22 \quad \theta = 0.1$

$\alpha$	Stage 1	Stage 2	Stage 3	Stage 4	Stage 5
0.45		19.6 1.917686	19.6 1.513842	19.5 1.126039	19.5 0.7558652
0.50		19.7 2.074062	19.6 1.646128	19.6 1.231924	19.5 0.8327414
0.55		19.7 2.230452	19.7 1.778437	19.6 1.337814	19.5 0.9096177
0.60		19.8 2.386854	19.7 1.910764	19.6 1.443704	19.5 0.9864939
0.65		19.8 2.543298	19.7 2.043091	19.6 1.549595	19.5 1.063370
0.70	19.9 3.2281410	19.8 2.699744	19.7 2.175418	19.6 1.655485	19.5 1.140247
0.75		19.8 2.856199	19.7 2.307755	19.7 1.761377	19.5 1.217123
0.80		19.8 3.012672	19.8 2.440112	19.7 1.867286	19.5 1.293999

\*)The upper number denotes the selected flood warning threshold;  
and the lower number denotes the expected loss reduction from  
the present stage to the final stage.

**Table 4-3h. Optimal Flood Warning Thresholds**

$$Y = 22 \quad \theta = 0.5$$

$\alpha$	Stage 1	Stage 2	Stage 3	Stage 4	Stage 5
0.45		19.6 7.365396	19.5 5.437704	19.5 3.599206	19.4 1.858485
0.50		19.6 8.009911	19.6 5.948506	19.5 3.963165	19.4 2.061026
0.55		19.7 8.654481	19.6 6.459373	19.5 4.327123	19.4 2.263566
0.60		19.7 9.299195	19.6 6.970240	19.5 4.691081	19.4 2.466107
0.65		19.7 9.943911	19.6 7.481107	19.5 5.055040	19.4 2.668648
0.70	19.8 13.207410	19.7 10.58863	19.6 7.991975	19.5 5.418999	19.4 2.871188
0.75		19.7 11.23334	19.6 8.502842	19.5 5.782957	19.4 3.073730
0.80		19.7 11.87806	19.6 9.013708	19.5 6.146915	19.4 3.276271

\*)The upper number denotes the selected flood warning threshold;  
and the lower number denotes the expected loss reduction from  
the present stage to the final stage.

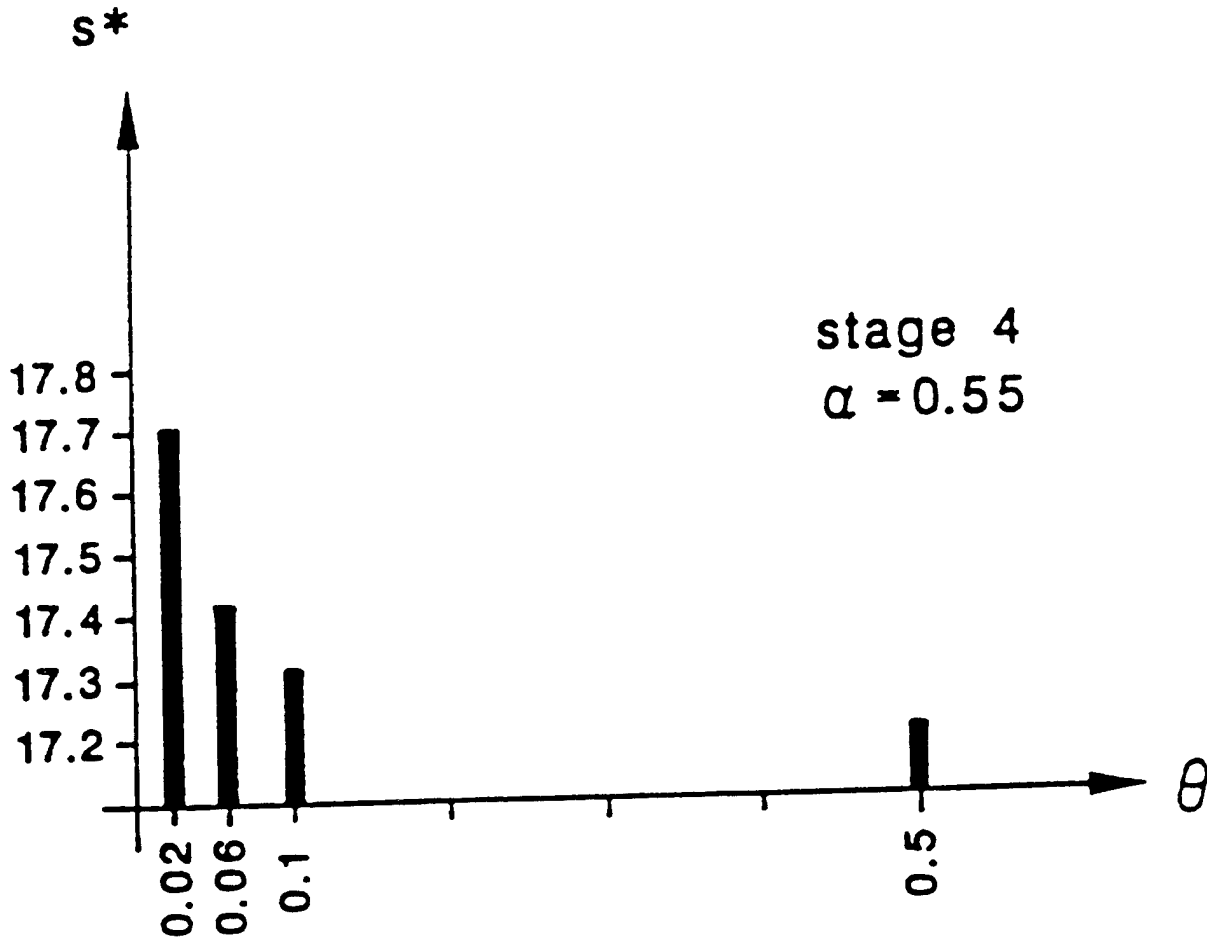


Figure 4-6. Relationship Between the Optimal Warning Threshold and the Weighting Coefficient for  $\alpha = 0.55$  at Stage 4

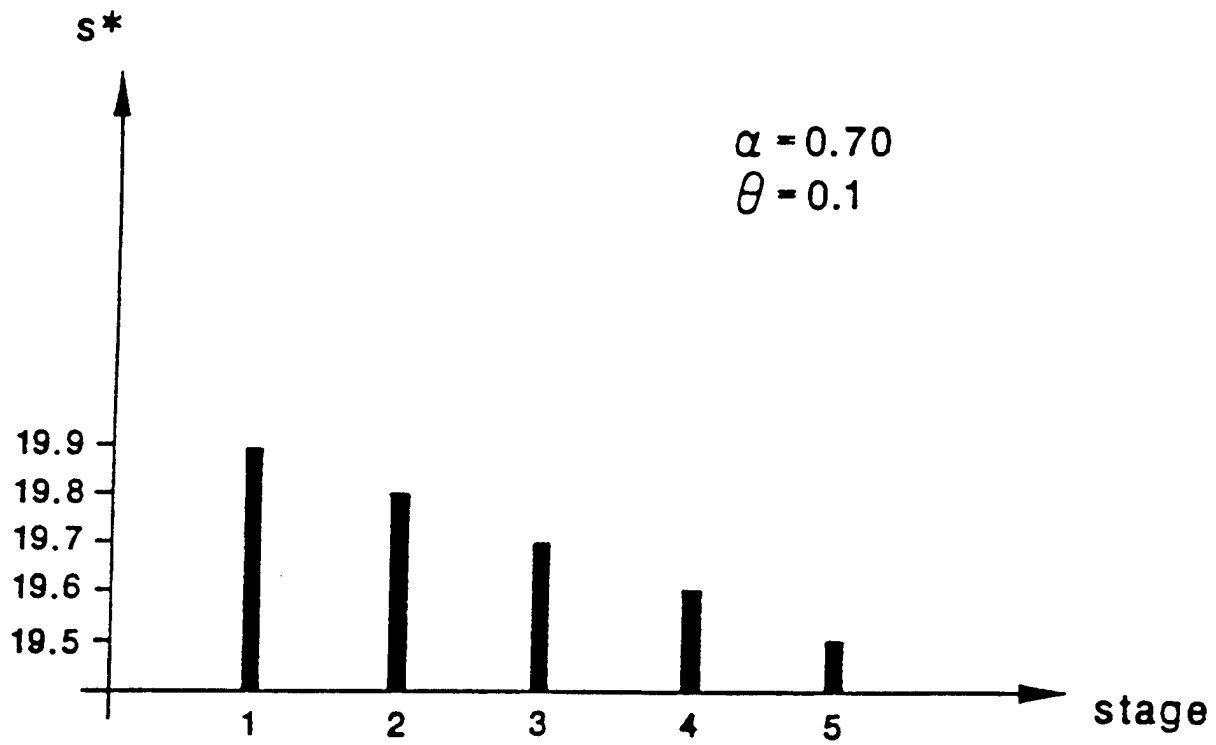
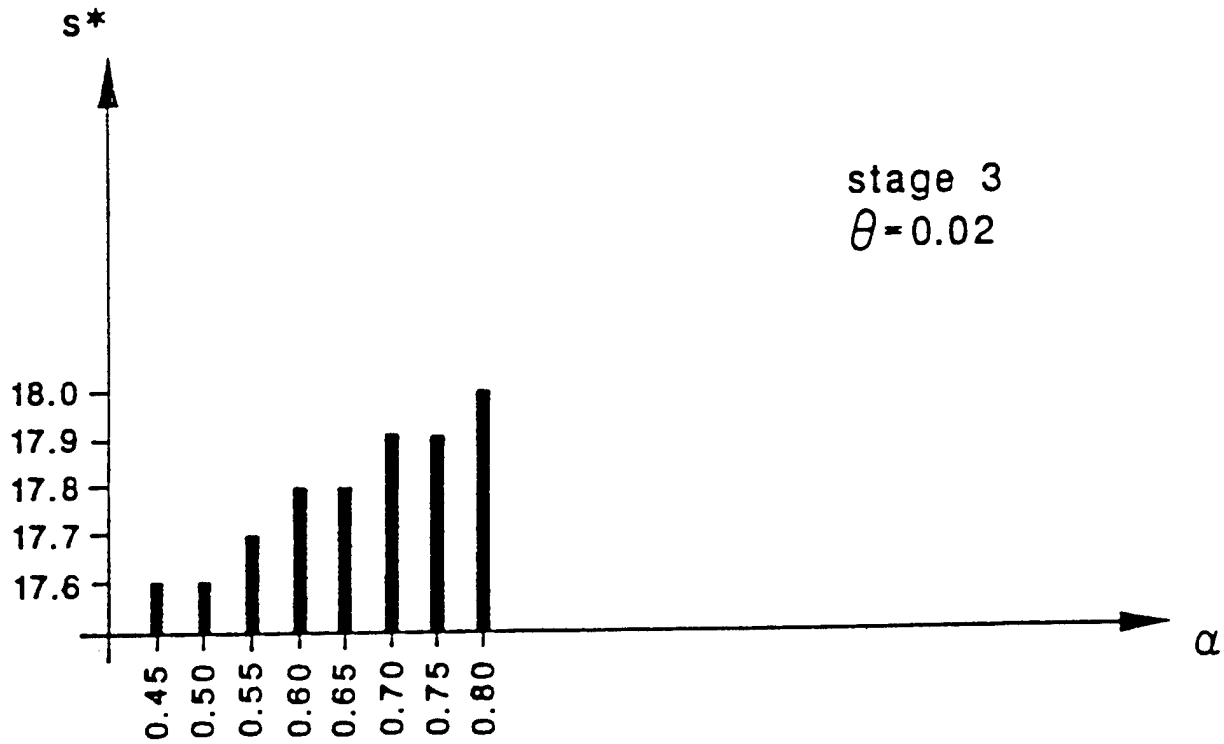


Figure 4-7. Relationship Between the Optimal Warning Threshold and the Stages for  $\alpha = 0.70$  and  $\theta = 0.1$



**Figure 4-8.** Relationship Between the Optimal Warning Threshold and the Response Fraction for  $\theta = 0.02$  at Stage 3

## **Input Information for Eldred and Connellsville**

### Flood Forecasts for Eldred

#### *Location*

Eldred is a small community situated on the upper Allegheny River in northern Pennsylvania, about three miles south of the state border with New York. The river gauge has a datum at 1417 feet and closes a drainage area of 50 square miles of mountainous terrain with highest ranges towering at 2500 feet. The river flow at Eldred is essentially unimpaired natural runoff.

#### *Data Records and Parameter Estimation*

Historical flood and forecast data were retrieved from the archives of the National Weather Service Forecast Office in Pittsburgh. The prior distribution of flood crests was estimated from a record of floods spanning 1942-1989. During these 48 years, 36 flood crests exceeded the gauge height of 11 feet (3 floods in every 4 years, on the average), and 14 had crests above the official stage of 17 feet (about one flood in every 3.5 years, on the average). The highest flood on record occurred in June 1972 and reached 29 feet.

The likelihood functions were estimated from a historical joint record of forecasted and actual flood crests. This record contained 12 floods that occurred in the period 1984-1988.

### Flood Forecasts for Connellsville

#### *Location*

Connellsville, a town in southwestern Pennsylvania, embraces the banks of the Youghiogeny River—a tributary of the Monongahela River. The river gauge has a datum at 860 feet and closes a drainage area of 1326 square miles. The terrain varies from hilly to mountainous, especially in the eastern part of the basin where Mt. Davis reaches 3213 feet—the highest point in Pennsylvania.

#### *Reservoirs*

The river flow in Connellsville is partly regulated by storage reservoirs. The Deep Creek Reservoir, completed in January 1925, is used for hydro-electric power generation. It is owned and operated by the Pennsylvania Electric Company. The reservoir has a capacity of 93,000 acre-feet and closes a drainage area of 65 square miles, or about 5% of the total basin. Thus its influence on flood flows at Connellsville is insignificant.

The Youghiogeny Reservoir, downstream of the Deep Creek Dam, was completed in October 1943. It serves multiple purposes and is operated by the U.S. Army Corps of Engineers. The reservoir has a capacity of 254,000 acre-feet, which equals 42% of the average annual runoff at the dam, and controls a drainage area of 434 square miles, which constitute 33% of the total basin. The length of the river between the dam and Connellsville is 29.4 miles. All these facts together suggest that the reservoir can only partially control floods at Connellsville.

### *Case Studies in Connellsville*

Two cases of the flood forecast system were analyzed and, accordingly, two sets of parameter estimates had to be constructed. The first case describes the present system which is composed of the Youghiogheny Dam and the National Weather Service (NWS) river forecasting technology. A flood forecast for Connellsville is prepared by routing the project regulated outflow from the dam and superimposing on it the predicted runoff from the drainage area between the dam and the forecast point. The second case describes a hypothetical system composed of the NWS river forecasting technology but without any influence of the Youghiogheny Dam on flood flows. Thus runoff from the entire basin must be predicted as flow at Connellsville is unregulated.

### *Data Records and Parameter Estimation*

Historical flood and forecast data were retrieved from the archives of the National Weather Service Forecast Office in Pittsburgh. For the present system, with the Youghiogheny Dam, the prior distribution of the flood crest was estimated from a record spanning 1943-1986. In these 44 years, 22 flood crests exceeded the official flood stage of 12 feet (thus, a flood occurred every two years, on the average). The highest flood on record occurred in October 1954 and reached 22 feet. The likelihood functions were estimated from a historical joint record of 6 forecasted and actual crests in the period 1984-1986.

For the hypothetical system, without the Youghiogheny Dam, the prior distribution of flood crests was estimated from a record spanning 1910-1942. During these 43 years, 22 flood crests were observed above the flood stage of 12 feet. The highest flood during that period occurred in March 1936 and exceeded 20 feet. Estimation of the likelihood functions presented a challenge since there is no historical joint record of forecasted and actual flood crests—a record that would correspond to the modern forecasting technology yet without any influence of the Youghiogheny Dam. The theory of sufficient comparisons of forecasts systems [Krzysztofowicz 1992] came to the rescue here. It seemed reasonable to assume that systems utilizing the same forecasting technology and operated for rivers with similar geomorphologic, hydrologic, and climatic characteristics should exhibit similar statistical characteristics of performance. In particular, their standardized sufficiency characteristics (SSC) should be similar. [For a definition and properties of the SSC see Krzysztofowicz 1992.] A flood forecast system for Milton, Pennsylvania, where river flows are unregulated, was taken as an analog. Its SSC was estimated from a historical joint record of forecasted and actual flood crests; this record contained 8 forecasts of floods that occurred in the period 1959-1975. Next, the variance estimate in the likelihood functions for Connellsville, the case with the dam, was adjusted so as to give the SSC for Connellsville the same magnitude as the SSC for Milton. In a sense, we have done a "statistical transfer" of a forecast system from Milton to Connellsville.

### Limitations of Models

Historical data records obtained from the National Weather Service were used to estimate moments of the actual and forecasted crests; these estimates were next employed as parameter values in the normal-linear model of a forecast system. It must be stressed that this mode, while convenient analytically, offers at best an approximate representation of uncertainties in flood crests and their forecasts. Moreover, the models employed in this report for computing probabilities of correct and false warnings are simplified versions which ignore several significant sources of risk. (For example, they do not account for the



*Risk-Based Evaluation of  
Flood Warning and Preparedness Systems*

---

possibility of the forecasted crest  $s$  exceeding the threshold  $s^*$ , when the actual crest  $h$  never reached the flood stage—the case of a false warning.) As a consequence of this and other simplifications, analyses based on these models cannot be taken as representative of performance of flood forecasts issued by the National Weather Service for Eldred and Connellsville. Rather, the results presented in this report should be treated as hypothetical examples having only some (but not all) realistic features.

Flood Damages in Connellsville

*Distribution of Damages*

The stage-damage function for Connellsville was estimated according to the methodology of Krzysztofowicz and Davis [1983a,b]. A crude inventory of establishments located at various elevations of the floodplain was extracted from the River Stage Data form prepared by the National Weather Service and the U.S. Geological Survey in May 1990. About 212 establishments were counted in the floodplain and the maximum possible damage for the community was estimated to be  $MD = \$10,400,000$  at the 1991 price level.

In order to construct the stage-damage function, the floodplain was discretized into five steps, whose elevations are listed in Table 4-4, and the establishments were grouped into three structural categories, which are defined in Table 4-5. The distribution  $\{\eta(mr): m = 1, \dots, 5; r = 1, 2, 3\}$ , partitioning the maximum possible damage  $MD$  among location steps  $m$  and structural categories  $r$ , is shown in Table 4-6.

Table 4-4. Discretization of the Floodplain in Connellsville, Pennsylvania

---

Location step	$m$	1	2	3	4	5
Elevation in ft	$y(m)$	12	14	16	18	20

---

Flood stage is at the elevation of 12 ft.

Table 4-5. Categories of Structures

r	Structural Category
1	Two-story house
2	Commercial, garage type
3	Commercial, store type

Table 4-6. Distribution  $\{\eta(mr)\}$  Partitioning the Maximum Possible Damage MD among Location Steps m and Structural Categories r in Connellsville, Pennsylvania

Location Step m	Structural Category r			$\eta(m)$
	1	2	3	
1	.13			.13
2	.18			.18
3	.13			.13
4	.04	.05	.05	.14
5	.40	.02		.42
$\eta(r)$	.88	.07	.05	

MD = \$10,400,000

*Stage-Damage Function*

For each structural category  $r$ , there is a unit damage function  $\delta_r(z)$  specifying the fraction of maximum possible damage to an establishment which occurs when the depth of flooding, measured from the first-floor level, is  $z$ . The general form of the unit damage function is polynomial:

$$\delta_r(z) = \sum_{i=0}^n c_{ri} z^i$$

for  $0 \leq z \leq Z_r$  and  $\delta_r(z) = 1$  for  $z > Z_r$ , where the depth of flooding  $z$  is measured in feet. Table 4-7 specifies the polynomial coefficients  $c_{ri}$  ( $i = 0, \dots, n$ ) and the domain limit  $Z_r$  for each structural category  $r = 1, 2, 3$ .

Given all this information, the stage-damage function  $D(h)$  for a community is constructed as follows. For  $h \geq y(1)$ ,

$$D(h) = MD \sum_{m=1}^{M(h)} \sum_{r=1}^3 \eta(mr) \delta_r(h - y(m)),$$

where

$$M(h) = \max \{m : h > y(m)\}.$$

For  $h < y(1)$ , we set  $D(h) = 0$ .

**Application to Eldred, Pennsylvania**

From the historical data, the flood crest,  $H$ , is fitted by a normal distribution,  $N(16.29, 17.38)$ , and the conditional probability density function of the forecasted flood crest,  $S$ , given  $h$ , is fitted by a normal distribution,  $N(0.63h + 5.57, 1.45)$ . It can be shown using Eqs. (4.5)-(4.9) that

(a) the marginal probability density function of the forecast,  $k(s)$ , is  $N(15.8327, 8.348122)$ , and

(b) the posterior distribution density function of  $h$  given  $s$ ,  $f(h | s)$ , is  $N(1.3116s - 4.476175, 3.018763)$ .

Substituting  $k(s)$  and  $f(h | s)$  into Eqs. (4.12) - (4.15), the four probabilistic measures of the forecasting system can be calculated for a given warning threshold,  $s^*$ , and zone elevation,  $y$ . Table 4-8 shows those measures for two values of  $y$  and various values of  $s^*$ . Different values of  $s^*$  associate different values of the probabilistic measures,  $P11(s^*)$ ,  $P10(s^*)$ ,  $P01(s^*)$ , and  $P00(s^*)$ . They thus yield different impacts on the response fraction at the subsequent flood stages.

The flood-loss information is not available in the case study. The following flood-loss relationship is assumed. The evacuation cost for the community,  $MC$ , is assumed to be equal to 4 (\$10 thousand). The flood-loss function without a warning is assumed to be

**Table 4-7.** Coefficients of the Unit Damage Functions  $\delta_r(z)$  for Structural Categories  $r$  Specified by a Polynomial

$$\delta_r(z) = \sum_{i=0}^n c_{ri} z^i, \quad 0 \leq z \leq Z_r .$$

$r$	Structural Category	$i$	$c_{ri}$	$Z_r$ [ft]
1	Two-story house	0	.110007	24
		1	.271166 x 10 <sup>-1</sup>	
		2	.137889 x 10 <sup>-2</sup>	
		3	-.399962 x 10 <sup>-4</sup>	
		4	-.326650 x 10 <sup>-7</sup>	
2	Commercial, garage type	0	.439931 x 10 <sup>-1</sup>	11
		1	.707324 x 10 <sup>-1</sup>	
		2	.157361 x 10 <sup>-1</sup>	
		3	-.302723 x 10 <sup>-2</sup>	
		4	-.576608 x 10 <sup>-3</sup>	
		5	.978475 x 10 <sup>-4</sup>	
		6	.887390 x 10 <sup>-5</sup>	
		7	-.143767 x 10 <sup>-5</sup>	
		8	-.476253 x 10 <sup>-7</sup>	
9	.741636 x 10 <sup>-8</sup>			
3	Commercial, store type	0	.402845	11
		1	.138426	
		2	.899010 x 10 <sup>-3</sup>	
		3	-.220052 x 10 <sup>-2</sup>	
		4	.506582 x 10 <sup>-4</sup>	
		5	.143909 x 10 <sup>-4</sup>	
6	-.648618 x 10 <sup>-6</sup>			

***Risk-Based Evaluation of  
Flood Warning and Preparedness Systems***

---

$$d_{01} = MD\delta(h - y),$$

where  $MD = 100$  (\$10 thousand) and  $\delta(h - y)$  equals  $0.4(h - y)$  when  $h - y \leq 2.5$ , and equals 1 when  $h - y > 2.5$  ( $h$  and  $y$  are in the unit of 10 feet).

The loss function with a warning is

$$d_{11} = MC\alpha + MD[1 - \alpha MR(h - y)]\delta(h - y),$$

where  $MR(h - y)$  is assumed to be equal to  $0.25 + 0.4(h - y) - 0.333(h - y)^2$  when  $h - y \leq 1.2$ , and to be equal to 0.25 when  $h - y > 1.2$ .

Table 4-9 gives the calculated values of the expected flood-loss reduction for various response fractions and preselected warning thresholds where  $y$  is equal to 16 or 19.

In this case study, it is assumed that the parameters in the response fraction dynamic model, Eq. (4.16), take values of  $c_1 = 0.1$  and  $c_2 = 0.9$ . A five-stage problem is considered with the initial response fraction  $\alpha_1$  equal to 0.7. Two values of the elevation,  $y$ , are considered,  $y = 16$  (feet) and  $y = 19$  (feet).

To make the computational procedure feasible, the state space of  $\alpha_T$  and the control space of  $s_T$  are quantized by the grid sizes 0.01 and 0.1, respectively. Table 4-10 (a-h) provides noninferior solutions at various stages and various  $\alpha_T$ 's for four different weighting coefficients and two different values of zone elevation. It can be seen from Table 4-10 that

(a) the lower the weighting coefficient  $\theta$  associated with the first objective (loss reduction), the higher the value of flood warning threshold will be set to avoid possible high Type II errors;

(b) in order to select a decision that maximizes the sum of flood-loss reductions, the flood warning threshold is set higher at the earlier stage than at the later stage (with respect to the same value of the response fraction) to reduce the probability of high loss at the later stages; and

(c) the higher the present response fraction, the more cautious is the selection of the threshold. That means that a higher threshold value is set for a higher value of the present response fraction to avoid losing a larger number of the response population. Note here that the third conclusion may be model-specific.

### **Application to Connellsville, Pennsylvania**

In the case study of Connellsville, Pennsylvania, four different situations with structural and nonstructural flood prevention measures are investigated. The expected flood losses in the following four cases are calculated:

- (1) expected flood loss in the case with neither a dam nor a flood warning system,
- (2) expected flood loss in the case with a dam and without a flood warning system,

**Table 4-8.** Probabilistic Measures of the Warning System (Eldred, Pennsylvania)

$y = 16$

$s^*$	$P_{11}(s^*, y)$	$P_{10}(s^*, y)$	$P_{01}(s^*, y)$	$P_{00}(s^*, y)$
14.7	0.5059415	0.1465411	0.0217876	0.3257299
14.8	0.5026233	0.1369883	0.0251057	0.3352826
14.9	0.4989391	0.1276417	0.0287900	0.3446293
15.0	0.4948698	0.1185335	0.0328592	0.3537375
15.1	0.4903999	0.1096941	0.0373292	0.3625769
15.2	0.4855153	0.1011519	0.0422138	0.3711191
15.3	0.4802053	0.0929329	0.0475238	0.3793381
15.4	0.4744629	0.0850599	0.0532662	0.3872111
15.5	0.4682839	0.0775526	0.0594452	0.3947184
15.6	0.4616681	0.0704275	0.0660610	0.4018435
15.7	0.4546191	0.0636972	0.0731100	0.4085738
15.8	0.4471441	0.0573709	0.0805849	0.4149001
15.9	0.4392552	0.0514533	0.0884738	0.4208177
16.0	0.4309671	0.0459459	0.0967619	0.4263251
16.1	0.4222985	0.0408466	0.1054305	0.4314244
16.2	0.4132717	0.0361495	0.1144573	0.4361214
16.3	0.4039121	0.0318458	0.1238169	0.4404252
16.4	0.3942471	0.0279234	0.1334819	0.4443476
16.5	0.3843071	0.0243680	0.1434219	0.4479030
16.6	0.3741245	0.0211626	0.1536045	0.4511083

Table 4-8. (continued)

y = 19

$s^*$	$P_{11}(s^*, y)$	$P_{10}(s^*, y)$	$P_{01}(s^*, y)$	$P_{00}(s^*, y)$
16.5	0.2443706	0.1643045	0.0134605	0.5778644
16.6	0.2423047	0.1529825	0.0155265	0.5891864
16.7	0.2400105	0.1420112	0.0178206	0.6001576
16.8	0.2374777	0.1314159	0.0203534	0.6107529
16.9	0.2346971	0.1212193	0.0231341	0.6209495
17.0	0.2316615	0.1114427	0.0261697	0.6307262
17.1	0.2283659	0.1021038	0.0294652	0.6400651
17.2	0.2248077	0.0932180	0.0330235	0.6489509
17.3	0.2209867	0.0847972	0.0368444	0.6573716
17.4	0.2169053	0.0768500	0.0409259	0.6653188
17.5	0.2125688	0.0693815	0.0452624	0.6727874
17.6	0.2079852	0.0623935	0.0498459	0.6797754
17.7	0.2031652	0.0558843	0.0546659	0.6862845
17.8	0.1981222	0.0498489	0.0597090	0.6923199
17.9	0.1928717	0.0442788	0.0649595	0.6978901
18.0	0.1874320	0.0391625	0.0703992	0.7030064
18.1	0.1818229	0.0344861	0.0760083	0.7076827
18.2	0.1760663	0.0302327	0.0817649	0.7119361
18.3	0.1701853	0.0263839	0.0876458	0.7157850
18.4	0.1642038	0.0229186	0.0936274	0.7192503

**Table 4-9.** Expected Flood-loss Reduction

$y = 16$

$s^*$	$\alpha$	0.50	0.60	0.70	0.80
14.8		2.274187	2.729024	3.183861	3.638699
15.0		2.281817	2.738181	3.194545	3.650908
15.2		2.278504	2.734205	3.189905	3.645607
15.4		2.262371	2.714845	3.167319	3.619794
15.6		2.231861	2.678233	3.124605	3.570977
15.8		2.185879	2.623055	3.060230	3.497406
16.0		2.123912	2.548693	2.973476	3.398258
16.2		2.046122	2.455346	2.864571	3.273795
16.4		1.953364	2.344036	2.734709	3.125381
16.6		1.847164	2.216596	2.586029	2.955462

$y = 19$

$s^*$	$\alpha$	0.50	0.60	0.70	0.80
16.6		0.4732468	0.5678961	0.6625457	0.7571951
16.8		0.4981555	0.5977865	0.6974179	0.7970489
17.0		0.5155946	0.6187135	0.7218326	0.8249515
17.2		0.5250767	0.6300920	0.7351076	0.8401229
17.4		0.5263813	0.6316575	0.7369340	0.8422103
17.6		0.5196016	0.6235219	0.7274424	0.8313628
17.8		0.5051445	0.6061733	0.7072024	0.8082313
18.0		0.4837199	0.5804638	0.6772079	0.7739519
18.2		0.4563089	0.5475706	0.6388326	0.7300944
18.4		0.4240967	0.5089160	0.5937355	0.6785548



*Risk-Based Evaluation of  
Flood Warning and Preparedness Systems*

Table 4-10a. Optimal Flood Warning Threshold (Eldred, Pennsylvania)

$Y = 16 \quad \theta = 0.02$

$\alpha$	Stage 1	Stage 2	Stage 3	Stage 4	Stage 5
0.45		15.2 0.6962703	15.2 0.6313940	15.2 0.5671985	15.2 0.5037215
0.50		15.4 0.7515748	15.3 0.6852435	15.3 0.6195143	15.3 0.5544193
0.55		15.4 0.8069684	15.3 0.7391637	15.3 0.6718839	15.3 0.6051552
0.60		15.5 0.8624514	15.4 0.7931497	15.4 0.7242879	15.4 0.6558943
0.65		15.5 0.9179950	15.4 0.8471968	15.4 0.7767507	15.4 0.7066774
0.70	15.5 1.0461380	15.5 0.9735616	15.4 0.9012520	15.4 0.8292162	15.4 0.7574605
0.75		15.6 1.0292320	15.5 0.9553727	15.5 0.8817053	15.4 0.8082436
0.80		15.6 1.084935	15.5 1.009541	15.5 0.9342493	15.5 0.8590660

The upper number denotes the selected flood warning threshold; the lower number denotes the expected loss reduction from the present stage to the final stage.

Table 4-10b. Optimal Flood Warning Threshold (Eldred, Pennsylvania)

$Y = 16 \quad \theta = 0.06$

$\alpha$	Stage 1	Stage 2	Stage 3	Stage 4	Stage 5
0.45		15.2 1.026391	15.1 0.8688733	15.1 0.7156359	15.1 0.5669228
0.50		15.2 1.113314	15.2 0.9466786	15.2 0.7837586	15.1 0.6247922
0.55		15.2 1.200264	15.2 1.024525	15.2 0.8519347	15.2 0.6826890
0.60		15.2 1.287223	15.2 1.102380	15.2 0.9201196	15.2 0.7406027
0.65		15.3 1.374238	15.2 1.180238	15.2 0.9883067	15.2 0.7985163
0.70	15.3 1.6659270	15.3 1.461304	15.3 1.258129	15.2 1.056494	15.2 0.8564301
0.75		15.3 1.548389	15.3 1.336045	15.2 1.124681	15.2 0.9143438
0.80		15.3 1.635497	15.3 1.413986	15.3 1.192896	15.2 0.9722574

The upper number denotes the selected flood warning threshold; the lower number denotes the expected loss reduction from the present stage to the final stage.

Table 4-10c. Optimal Flood Warning Threshold (Eldred, Pennsylvania)

Y = 16       $\theta = 0.1$

$\alpha$	Stage 1	Stage 2	Stage 3	Stage 4	Stage 5
0.45		15.1 1.356822	15.1 1.106607	15.1 0.8642271	15.1 0.6301808
0.50		15.2 1.475427	15.1 1.208406	15.1 0.9482521	15.1 0.6952969
0.55		15.2 1.594128	15.2 1.310294	15.1 1.032277	15.1 0.7604131
0.60		15.2 1.712853	15.2 1.412213	15.2 1.116337	15.1 0.8255290
0.65		15.2 1.831588	15.2 1.514143	15.2 1.200418	15.1 0.8906451
0.70	15.3 2.2871940	15.2 1.950328	15.2 1.616077	15.2 1.284499	15.1 0.9557613
0.75		15.3 2.069109	15.2 1.718019	15.2 1.368585	15.1 1.020877
0.80		15.3 2.187940	15.2 1.819972	15.2 1.452688	15.2 1.086017

The upper number denotes the selected flood warning threshold; the lower number denotes the expected loss reduction from the present stage to the final stage.

**Table 4-10d.** Optimal Flood Warning Threshold (Eldred, Pennsylvania)

$Y = 16 \quad \theta = 0.5$

$\alpha$	Stage 1	Stage 2	Stage 3	Stage 4	Stage 5
0.45		15.1 4.662013	15.1 3.484156	15.1 2.350139	15.1 1.262761
0.50		15.1 5.098404	15.1 3.827040	15.1 2.593547	15.1 1.400343
0.55		15.1 5.534795	15.1 4.169925	15.1 2.836957	15.1 1.537926
0.60		15.2 5.971472	15.1 4.512809	15.1 3.080365	15.1 1.675508
0.65		15.2 6.408165	15.1 4.855693	15.1 3.323773	15.1 1.813090
0.70	15.2 8.5052660	15.2 6.844906	15.1 5.198578	15.1 3.567182	15.1 1.950673
0.75		15.2 7.281742	15.2 5.541626	15.1 3.810591	15.1 2.088255
0.80		15.2 7.718588	15.2 5.884681	15.1 4.054000	15.1 2.225837

The upper number denotes the selected flood warning threshold; the lower number denotes the expected loss reduction from the present stage to the final stage.

*Risk-Based Evaluation of  
Flood Warning and Preparedness Systems*

Table 4-10e. Optimal Flood Warning Threshold (Eldred, Pennsylvania)

$Y = 19 \quad \theta = 0.02$

$\alpha$	Stage 1	Stage 2	Stage 3	Stage 4	Stage 5
0.45		17.5 0.5120240	17.5 0.4943402	17.5 0.4766091	17.5 0.4588294
0.50		17.6 0.5598703	17.6 0.5424591	17.6 0.5250116	17.6 0.5075260
0.55		17.6 0.6078050	17.6 0.5906430	17.6 0.5734548	17.6 0.5562404
0.60		17.7 0.6558577	17.7 0.6389248	17.7 0.6219716	17.7 0.6049971
0.65		17.7 0.7039466	17.7 0.6872281	17.7 0.6704972	17.7 0.6537544
0.70	17.8 0.7686545	17.8 0.7521415	17.8 0.7356198	17.8 0.7190891	17.8 0.7025492
0.75		17.8 0.8003519	17.8 0.7840200	17.8 0.7676843	17.8 0.7513444
0.80		17.9 0.8486295	17.9 0.8324716	17.9 0.8163140	17.9 0.8001567

The upper number denotes the selected flood warning threshold; the lower number denotes the expected loss reduction from the present stage to the final stage.

**Table 4-10f.** Optimal Flood Warning Threshold (Eldred, Pennsylvania)

$Y = 19 \quad \theta = 0.06$

$\alpha$	Stage 1	Stage 2	Stage 3	Stage 4	Stage 5
0.45		17.4 0.5703409	17.4 0.5330652	17.4 0.4960785	17.4 0.4593878
0.50		17.5 0.6242197	17.5 0.5852870	17.5 0.5466008	17.5 0.5081689
0.55		17.5 0.6781828	17.5 0.6375848	17.5 0.5971845	17.5 0.5569876
0.60		17.5 0.7321548	17.5 0.6898881	17.5 0.6477705	17.5 0.6058063
0.65		17.5 0.7861278	17.5 0.7421919	17.5 0.6983567	17.5 0.6546251
0.70	17.6 0.8857769	17.5 0.8401028	17.5 0.7944958	17.5 0.7489429	17.5 0.7034438
0.75		17.6 0.8941438	17.6 0.8468298	17.6 0.7995355	17.5 0.7522625
0.80		17.6 0.9482240	17.6 0.8992121	17.6 0.8501706	17.6 0.8108692

The upper number denotes the selected flood warning threshold; the lower number denotes the expected loss reduction from the present stage to the final stage.

*Risk-Based Evaluation of  
Flood Warning and Preparedness Systems*

Table 4-10g. Optimal Flood Warning Threshold (Eldred, Pennsylvania)

Y = 19       $\theta = 0.5$

$\alpha$	Stage 1	Stage 2	Stage 3	Stage 4	Stage 5
0.45		17.4 1.215052	17.4 0.9613236	17.3 0.7116798	17.3 0.4662075
0.50		17.4 1.337938	17.4 1.060809	17.4 0.7870544	17.3 0.5167807
0.55		17.4 1.460841	17.4 1.160317	17.4 0.8624612	17.3 0.5673540
0.60		17.4 1.583747	17.4 1.259827	17.4 0.9378675	17.3 0.6179269
0.65		17.4 1.706653	17.4 1.359338	17.4 1.013274	17.3 0.6685001
0.70	17.4 2.2007990	17.4 1.829560	17.4 1.458848	17.4 1.088681	17.3 0.7190733
0.75		17.4 1.952466	17.4 1.558359	17.4 1.164087	17.3 0.7696464
0.80		17.4 2.075372	17.4 1.657869	17.4 1.239494	17.4 0.8202195

The upper number denotes the selected flood warning threshold; the lower number denotes the expected loss reduction from the present stage to the final stage.

**Table 4-10h.** Optimal Flood Warning Threshold (Eldred, Pennsylvania)

$Y = 19 \quad \theta = 0.9$

$\alpha$	Stage 1	Stage 2	Stage 3	Stage 4	Stage 5
0.45		17.4 1.801429	17.3 1.350909	17.3 0.9078862	17.3 0.4725028
0.50		17.4 1.987141	17.4 1.493429	17.3 1.005951	17.3 0.5247576
0.55		17.4 2.172883	17.4 1.635987	17.3 1.104016	17.3 0.5770127
0.60		17.4 2.358627	17.4 1.778545	17.3 1.202080	17.3 0.6292672
0.65		17.4 2.544372	17.4 1.921103	17.3 1.300145	17.3 0.6815220
0.70	17.4 3.3975510	17.4 2.730119	17.4 2.063663	17.3 1.398209	17.3 0.7337769
0.75		17.4 2.915882	17.4 2.206238	17.4 1.496290	17.3 0.7860316
0.80		17.4 3.101650	17.4 2.348823	17.4 1.594384	17.3 0.8382865

The upper number denotes the selected flood warning threshold; the lower number denotes the expected loss reduction from the present stage to the final stage.



***Risk-Based Evaluation of  
Flood Warning and Preparedness Systems***

---

- (3) expected flood loss in the case without a dam and with a flood warning system, and
- (4) expected flood loss in the case with both a dam and a flood warning system.

When there is a dam, from the historical data the flood crest,  $H$ , is fitted by a prior normal distribution,  $N(13.72, 5.06)$ , and the conditional probability density function of the forecasted flood crest,  $S$ , given  $h$ , is fitted by a normal distribution,  $N(1.16h - 1.77, 0.45)$ . It can be shown using Eqs. (4.5)-(4.9) that (a) the marginal probability density function of the forecast,  $k(s)$ , is  $N(14.1452, 7.258735)$  and (b) the posterior distribution density function of  $h$  given  $s$ ,  $f(h | s)$ , is  $N(0.808626s - 2.281829, 0.313691)$ .

When there is no dam, from the historical data the flood crest,  $H$ , is fitted by a prior normal distribution  $N(14.53, 5.14)$  and the conditional probability density function of the forecasted flood crest,  $S$ , given  $h$ , is fitted by a normal distribution,  $N(1.16h - 1.77, 3.51)$ . It can be shown using Eqs. (4.5)-(4.9) that (a) the marginal probability density function of the forecast,  $k(s)$ , is  $N(15.0848, 10.42638)$  and (b) the posterior distribution density function of  $h$  given  $s$ ,  $f(h | s)$ , is  $N(0.571857s - 5.903653, 1.73036)$ .

Substituting  $k(s)$  and  $f(h | s)$  into Eqs. (4.12)-(4.15), the four probabilistic measures of the forecasting system can be calculated for a given warning threshold,  $s^*$ , and zone elevation,  $y$ . Table 4-11 shows those measures for two values of  $y$  and various values of  $s^*$  for both cases, with a dam and without a dam. Different values of  $s^*$  are associated with different values of the probabilistic measures,  $P_{11}(s^*)$ ,  $P_{10}(s^*)$ ,  $P_{01}(s^*)$ , and  $P_{00}(s^*)$ . They thus yield different impacts on the response fraction at the subsequent flood events.

From the historical data, the unit damage function is fitted in this case study [unit damage function for a two-story house] by

$$\delta(h - y) = 0.110007 + 0.271166(h - y) + 0.137889 (h - y)^2 - 0.0399962(h - y)^3 - 0.00032665(h - y)^4 \text{ when } h - y \leq 2.4,$$

and equals 1 when  $h - y > 2.4$  ( $h$  and  $y$  are in the unit of 10 feet). The other parameters in this model are assumed as follows.

The evacuation cost for the community,  $MC$ , is assumed to be equal to 4 (\$10 thousand).

The flood-loss function without a warning is assumed to be

$$d_{01} = MD\delta(h - y),$$

where  $MD = 100$  (\$10 thousand).

The loss function with a warning is

$$d_{11} = MC\alpha + MD[1 - \alpha MR(h - y)]\delta(h - y),$$

where  $MR(h - y)$  is assumed to be equal to  $0.25 + 0.4(h - y) - 0.333(h - y)^2$  when  $h - y \leq 1.2$ , and equal to be equal to 0.25 when  $h - y > 1.2$ .

Table 4-12 gives the calculated values of the expected flood loss without a warning system for  $y$  equal to 12 and 14 in both cases, with a dam and without a dam. Table 4-11 also gives the calculated values of the expected flood-loss reduction with full response for various preselected warning thresholds for  $y$  equal to 12 and 14 in both cases, with a dam and without a dam.

In this case study, it is assumed that the parameters in the response fraction dynamic model, Eq. (4.16), take values of  $c_1 = 0.1$  and  $c_2 = 0.9$ . A five-stage problem is considered with the initial response fraction  $\alpha_1$  equal to 0.7. Two values of the elevation,  $y$ , are considered,  $y = 12$  (feet) and  $y = 14$  (feet).

To make the computational procedure feasible, the state space of  $\alpha_T$  and the control space of  $s_T$  are quantized by the grid sizes 0.01 and 0.1, respectively. Table 4-13 (a-h) provides noninferior solutions at various stages and various  $\alpha_T$ 's for two different weighting coefficients and two different values of zone elevation for both cases, with a dam and without a dam. It can be seen from Table 4-13 that

(a) the lower the weighting coefficient,  $\theta$ , associated with the first objective (loss reduction), the higher the value of the flood warning threshold will be set to avoid possible high Type II errors;

(b) in order to select a decision that maximizes the sum of flood-loss reductions, the flood warning threshold is set higher at the earlier stage than at the later stage (with respect to the same value of the response fraction) to reduce the probability of high loss at the later stages; and

(c) the higher the present response fraction, the more cautious is the selection of the threshold. That means that a higher threshold value is set for a higher value of the present response fraction to avoid losing a larger number of the response population. Note here that the third conclusion may be model-specific.

**Table 4-11.** Probabilistic Measures of the Warning System (Connellsville, Pennsylvania)

y = 12 (with a dam)

$s^*$	$P_{11}(s^*, y)$	$P_{10}(s^*, y)$	$P_{01}(s^*, y)$	$P_{00}(s^*, y)$
11.0	0.7763117	0.1021628	0.0014434	0.1200821
11.2	0.7748482	0.0879903	0.0029068	0.1342546
11.4	0.7722843	0.0735971	0.0054707	0.1486478
11.6	0.7681055	0.0594870	0.0096495	0.1627579
11.8	0.7617464	0.0462294	0.0160087	0.1760156
12.0	0.7526836	0.0343665	0.0250714	0.1878784
12.2	0.7405316	0.0243194	0.0372235	0.1979255
12.4	0.7251226	0.0163076	0.0526324	0.2059374
12.6	0.7065377	0.0103184	0.0712173	0.2119266
12.8	0.6850762	0.0061376	0.0926788	0.2161073

y = 14 (with a dam)

$s^*$	$P_{11}(s^*, y)$	$P_{10}(s^*, y)$	$P_{01}(s^*, y)$	$P_{00}(s^*, y)$
13.6	0.4459119	0.1342705	0.0045577	0.4152599
13.8	0.4421889	0.1087867	0.0082806	0.4407437
14.0	0.4363676	0.0851224	0.0141020	0.4644080
14.2	0.4278818	0.0640043	0.0225878	0.4855261
14.4	0.4163113	0.0460156	0.0341583	0.5035149
14.6	0.4014937	0.0314805	0.0489759	0.5180500
14.8	0.3835860	0.0204010	0.0668836	0.5291294
15.0	0.3630455	0.0124725	0.0874241	0.5370579
15.2	0.3405446	0.0071667	0.1099250	0.5423638
15.4	0.3168429	0.0038577	0.1336266	0.5456727

Table 4-11. (continued)

y = 12 (without a dam)

$s^*$	$P_{11}(s^*, y)$	$P_{10}(s^*, y)$	$P_{01}(s^*, y)$	$P_{00}(s^*, y)$
9.6	0.8598625	0.0954413	0.0079126	0.0367837
9.8	0.8577797	0.0913708	0.0099954	0.0408541
10.0	0.8552552	0.0870857	0.0125198	0.0451392
10.2	0.8522224	0.0826117	0.0155527	0.0496133
10.4	0.8486115	0.0779786	0.0191636	0.0542464
10.6	0.8443505	0.0732205	0.0234246	0.0590045
10.8	0.8393664	0.0683756	0.0284086	0.0638494
11.0	0.8335869	0.0634843	0.0341881	0.0687406
11.2	0.8269404	0.0585908	0.0408347	0.0736342
11.4	0.8193607	0.0537378	0.0484143	0.0784871

y = 14 (without a dam)

$s^*$	$P_{11}(s^*, y)$	$P_{10}(s^*, y)$	$P_{01}(s^*, y)$	$P_{00}(s^*, y)$
13.0	0.5588912	0.1818558	0.0335281	0.2257249
13.2	0.5522861	0.1680066	0.0401332	0.2395740
13.4	0.5447636	0.1543220	0.0476557	0.2532586
13.6	0.5362751	0.1409070	0.0561443	0.2666736
13.8	0.5267833	0.1278629	0.0656361	0.2797178
14.0	0.5162637	0.1152843	0.0761557	0.2922964
14.2	0.5047076	0.1032567	0.0877118	0.3043239
14.4	0.4921228	0.0918543	0.1002966	0.3157264
14.6	0.4785339	0.0811387	0.1138854	0.3264419
14.8	0.4639837	0.0711576	0.1284356	0.3364230

*Risk-Based Evaluation of  
Flood Warning and Preparedness Systems*

Table 4-12. Expected Flood-loss Reduction with Full Response (Connellsville, Pennsylvania)

WITH A DAM

y - 12		y - 14	
Expected Flood Loss without a Warning System			
8.347396		4.816365	
Expected Flood Loss with a Warning System			
* s	Loss Reduction	* s	Loss Reduction
11.0	1.599759	13.5	0.8630087
11.4	1.614079	13.9	0.8862798
11.8	1.625079	14.3	0.9021807
12.2	1.627508	14.7	0.9044652
12.6	1.615778	15.1	0.8884852

WITHOUT A DAM

y - 12		y - 14	
Expected Flood Loss without a Warning System			
13.01293		9.151368	
Expected Flood Loss with a Warning System			
* s	Loss Reduction	* s	Loss Reduction
9.6	2.511642	13.2	1.688494
10.0	2.512701	13.6	1.689036
10.4	2.510649	14.0	1.684400
10.8	2.504635	14.4	1.673722
11.2	2.493745	14.8	1.656274

Table 4-13a. Optimal Flood Warning Thresholds (Connellsville, Pennsylvania, with a Dam)

$Y = 12 \quad \theta = 0.02$

$\alpha$	Stage 1	Stage 2	Stage 3	Stage 4	Stage 5
0.45		11.9 0.6457910	11.9 0.5969478	11.9 0.5466338	11.9 0.4947060
0.50		12.0 0.6870015	12.0 0.6398434	12.0 0.5913768	12.0 0.5414749
0.55		12.1 0.7283248	12.1 0.6828295	12.1 0.6361857	12.1 0.5882831
0.60		12.2 0.7697667	12.2 0.7259145	12.2 0.6810647	12.2 0.6351289
0.65		12.2 0.8113291	12.3 0.7690976	12.3 0.7260182	12.3 0.6820114
0.70	12.3 0.8930091	12.3 0.8530287	12.3 0.8123971	12.3 0.7710563	12.3 0.7289464
0.75		12.4 0.8948482	12.4 0.8557923	12.4 0.8161666	12.4 0.7759222
0.80		12.5 0.9367898	12.5 0.8992963	12.5 0.8613571	12.5 0.8229374

The upper number denotes the selected flood warning threshold; the lower number denotes the expected loss reduction from the present stage to the final stage.

*Risk-Based Evaluation of  
Flood Warning and Preparedness Systems*

Table 4-13b. Optimal Flood Warning Thresholds (Connellsville, Pennsylvania, with a Dam)

$$Y = 12 \quad \theta = 0.50$$

$\alpha$	Stage 1	Stage 2	Stage 3	Stage 4	Stage 5
0.45		12.0 1.945561	12.0 1.473788	12.0 1.028254	12.1 0.6111944
0.50		12.1 2.108311	12.1 1.606186	12.1 1.127736	12.1 0.6749548
0.55		12.1 2.271216	12.1 1.738675	12.1 1.227249	12.1 0.7387153
0.60		12.1 2.434124	12.1 1.871165	12.1 1.326761	12.1 0.8024757
0.65		12.2 2.597144	12.1 2.003655	12.1 1.426274	12.1 0.8662361
0.70	12.2 3.3968910	12.2 2.760314	12.2 2.136265	12.1 1.525787	12.1 0.9299966
0.75		12.2 2.923496	12.2 2.268907	12.2 1.625355	12.1 0.9937571
0.80		12.2 3.086682	12.2 2.401549	12.2 1.724926	12.1 1.057517

The upper number denotes the selected flood warning threshold; the lower number denotes the expected loss reduction from the present stage to the final stage.

*Risk-Based Evaluation of  
Flood Warning and Preparedness Systems*

**Table 4-13c. Optimal Flood Warning Thresholds (Connellsville, Pennsylvania, with a Dam)**

$Y = 14 \quad \theta = 0.02$

$\alpha$	Stage 1	Stage 2	Stage 3	Stage 4	Stage 5
0.45		14.4 0.5520497	14.4 0.5250422	14.4 0.4975516	14.4 0.4695483
0.50		14.5 0.5962349	14.5 0.5703243	14.5 0.5439987	14.5 0.5172327
0.55		14.6 0.6405975	14.6 0.6157462	14.6 0.5905436	14.6 0.5649695
0.60		14.6 0.6851410	14.6 0.6613101	14.7 0.6371866	14.7 0.6127548
0.65		14.7 0.7298880	14.7 0.7070405	14.7 0.6839515	14.7 0.6606089
0.70	14.8 0.7965054	14.8 0.7747915	14.8 0.7528939	14.8 0.7308034	14.8 0.7085098
0.75		14.9 0.8198694	14.9 0.7988837	14.9 0.7777481	14.9 0.7564557
0.80		14.9 0.8651059	14.9 0.8449958	15.0 0.8247769	15.0 0.8044469

The upper number denotes the selected flood warning threshold; the lower number denotes the expected loss reduction from the present stage to the final stage.



*Risk-Based Evaluation of  
Flood Warning and Preparedness Systems*

Table 4-13d. Optimal Flood Warning Thresholds (Connellsville, Pennsylvania, with a Dam)

$$Y = 14 \quad \theta = 0.5$$

$\alpha$	Stage 1	Stage 2	Stage 3	Stage 4	Stage 5
0.45		14.5 1.133536	14.5 0.8937591	14.5 0.6621569	14.5 0.4391043
0.50		14.5 1.239075	14.5 0.9805041	14.5 0.7292412	14.6 0.4856232
0.55		14.6 1.344762	14.6 1.067357	14.6 0.7963985	14.6 0.5321780
0.60		14.6 1.450539	14.6 1.154261	14.6 0.8635748	14.6 0.5787328
0.65		14.6 1.556319	14.6 1.241166	14.6 0.9307513	14.6 0.6252878
0.70	14.6 1.9998400	14.6 1.662099	14.6 1.328072	14.6 0.9979277	14.6 0.6718426
0.75		14.7 1.767897	14.6 1.414977	14.6 1.065104	14.6 0.7183975
0.80		14.7 1.873788	14.6 1.501882	14.6 1.132280	14.6 0.7649522

The upper number denotes the selected flood warning threshold; the lower number denotes the expected loss reduction from the present stage to the final stage.

**Table 4-13e.** Optimal Flood Warning Thresholds (Connellsville, Pennsylvania, without a Dam)

$Y = 12 \quad \theta = 0.06$

$\alpha$	Stage 1	Stage 2	Stage 3	Stage 4	Stage 5
0.45		10.2 0.8719684	10.2 0.7561035	10.2 0.6425062	10.2 0.5313926
0.50		10.3 0.9300157	10.3 0.8117548	10.3 0.6955323	10.3 0.5815435
0.55		10.5 0.9881452	10.5 0.8674700	10.5 0.7486029	10.4 0.6317162
0.60		10.6 1.046350	10.6 0.9232452	10.6 0.8017159	10.6 0.6819128
0.65		10.8 1.104629	10.7 0.9790777	10.7 0.8548683	10.7 0.7321298
0.70	10.9 1.2920150	10.9 1.162982	10.8 1.034964	10.8 0.9080573	10.8 0.7823657
0.75		11.0 1.221405	11.0 1.090904	10.9 0.9612833	10.9 0.8326194
0.80		11.1 1.279884	11.1 1.146892	11.0 1.014544	11.0 0.8828902

The upper number denotes the selected flood warning threshold; the lower number denotes the expected loss reduction from the present stage to the final stage.

*Risk-Based Evaluation of  
Flood Warning and Preparedness Systems*

Table 4-13f. Optimal Flood Warning Thresholds (Connellsville, Pennsylvania, without a Dam)

$$Y = 12 \quad \theta = 0.5$$

$\alpha$	Stage 1	Stage 2	Stage 3	Stage 4	Stage 5
0.45		10.1 2.866462	10.1 2.137300	10.0 1.450978	10.0 0.8119178
0.50		10.2 3.101412	10.1 2.327197	10.1 1.591223	10.0 0.8973795
0.55		10.3 3.336430	10.2 2.517138	10.1 1.731475	10.0 0.9828411
0.60		10.3 3.571528	10.3 2.707108	10.2 1.871732	10.0 1.068303
0.65		10.4 3.806681	10.3 2.897112	10.2 2.012008	10.0 1.153764
0.70	10.5 5.0148220	10.5 4.041880	10.4 3.087120	10.2 2.152283	10.0 1.239226
0.75		10.5 4.277140	10.4 3.277164	10.2 2.292558	10.0 1.324688
0.80		10.6 4.512427	10.4 3.467223	10.3 2.432843	10.0 1.410149

The upper number denotes the selected flood warning threshold; the lower number denotes the expected loss reduction from the present stage to the final stage.

Table 4-13g. Optimal Flood Warning Thresholds (Connellsville, Pennsylvania, without a Dam)

$Y = 14 \quad \theta = 0.06$

$\alpha$	Stage 1	Stage 2	Stage 3	Stage 4	Stage 5
0.45		13.7 0.6979931	13.7 0.6279304	13.7 0.5587157	13.7 0.4903911
0.50		13.9 0.7524474	13.9 0.6806543	13.9 0.6096215	13.9 0.5393894
0.55		14.1 0.8071754	14.1 0.7335954	14.1 0.6606817	14.1 0.5884703
0.60		14.3 0.8621708	14.2 0.7867416	14.2 0.7118861	14.2 0.6376284
0.65		14.4 0.9174379	14.4 0.840098	14.4 0.7632285	14.4 0.6868537
0.70	14.6 1.0525830	14.5 0.9729285	14.5 0.8936280	14.5 0.8146937	14.5 0.7361451
0.75		14.7 1.028641	14.7 0.9473197	14.6 0.8662665	14.6 0.7854905
0.80		14.8 1.084541	14.8 1.001158	14.7 0.9179361	14.7 0.8348857

The upper number denotes the selected flood warning threshold; the lower number denotes the expected loss reduction from the present stage to the final stage.

## GLOSSARY OF SYMBOLS

### Part 1. Integration of Flood Warning and Structural Measures

$C_E$	cost function of evacuation
D	flood discharge; used in the frequency-discharge-elevation curves
E	flood elevation; used in the discharge-elevation curve
F	flood frequency (exceedance probability)
$f(L)$	probability density function of damage L
$f_4$	conditional expected value of flood damage given exceedance of the flood with nonexceedance probability a; measure of the risk of extreme events in the PMRM
$f_5$	expected value of flood damage
h	flood stage
L	flood damage (millions \$)
$L_{RD}$	flood loss reduction defined as the difference between $L_{wo}$ and $L_w$
$L_w$	flood loss function with a warning system
$L_{wo}$	flood loss function without a warning system
M	number of feasible options involving only flood warning systems for flood mitigation
MC	maximum evacuation cost to community assuming full response
MD	maximum possible damage of the community due to flood of the highest magnitude
$MR(h - y)$	unit reduction function specifying the reduction of the maximum flood loss MD when the depth of flooding is (h - y) and full response of the community is made ( $q = 1$ )
N	number of feasible options involving only structural measures for flood mitigation
$p(L)$	probability of flood

***Risk-Based Evaluation of  
Flood Warning and Preparedness Systems***

---

W	denotes plans incorporating flood warning systems
y	elevation of the floodplain zone under consideration
$\alpha$	nonexceedance probability that partitions the range of extreme events; used in the definition of the conditional expected value $f_4$
$\delta(h - y)$	unit damage function specifying the fraction of MD that occurs when the depth of flooding is $(h - y)$
$\theta$	fraction of the community that responds to a flood warning; response fraction

**Part 2. Multiobjective Decision-Tree Analysis**

$a_n$	action, or alternative, or option, at a decision node n
C	maximum possible loss of property (discrete case); possible loss of lives given no flood warning -- linear function of discharge W (continuous case)
C1,C2,C3	chance nodes in the decision tree
$d_j^m$	number of elements in the the set $r_j^m$
DN1, DN2	do-nothing option in the first and second decision periods, respectively
$E[\bullet]$	expected value
$E^s[\ ]$	the sth averaging-out strategy; for example $E^4$ denotes the conditional expected value of extreme events $f_4$
EV1, EV2	evacuation order in the first and second decision periods, respectively
EVE	expected value of experimentation; difference between expected loss without experimentation and expected loss with experimentation
$\Phi$	standard normal distribution function
$f_1$	cost objective function; balanced with the risk functions $f_2$ thru $f_5$ in the PMRM
$f_2, f_3$	conditional expected values
$f_4$	conditional expected value of the (damage) risk of extreme events
$f_4^*$	optimal value of $f_4$ , see Equation (2.17)

$f_s$	overall expected value of damage
$k$	dimension of the objective function vector
$L$	maximum possible loss of lives (discrete case); possible loss of lives given no flood warning -- linear function of discharge $W$ (continuous case)
$LN$	lognormal distribution
$P_x$	cumulative distribution function of $X$
$p_x$	probability density function of $X$
$r$	the vector of objective functions in the decision tree $[r_1, \dots, r_k]$
$r_j^m$	set of Pareto optimum alternatives associated with each branch emerging from chance node $m$
$W$	actual flood level (cfs)
$WA1, WA2$	issuing a flood watch in the first and second decision periods, respectively
$X$	random variable of damage or loss
$\alpha$	partitioning nonexceedance for the conditional expected value $f_4$
$\alpha_i$	values of nonexceedance probability that partition the ranges of risk in the PMRM
$\beta_{ij}$	values of damage that partition the severity of risk in the PMRM for the $j$ th policy
$\lambda_{ii}$	tradeoffs between the cost objective function and the $i$ th risk function
$\mu$	mean of the discharge $W$
$\theta_n$	state of nature at node $n$ of the decision tree (also used in unrelated context as parameters in the PMRM defined by Equation 2.4)
$\sigma$	standard deviation of the discharge $W$

### Part 3. Performance Characteristics of a Flood Warning System

$a, b$  parameters of the normal-linear likelihood model  $f$

*Risk-Based Evaluation of  
Flood Warning and Preparedness Systems*

---

D	detection (Equation 3.7)
F	false warning (Equation 3.7)
$f(s   h, \Theta=1, T=1)$	probability density of $s$ conditional on the actual crest $h$ , $\Theta = 1$ , $T = 1$
FSC	forecast sufficiency characteristic, a measure sufficient for comparing any two forecasters who produce forecasts of the same variate
$g(h   \Theta = 1)$	prior probability density function of flood crest given flood occurs
$g(\lambda   \Theta = 1)$	probability density of $\lambda$ conditional on $\Theta = 1$
$h$	height of actual flood crest
LT	expected lead time
M	missed flood (Equation 3.7)
N	expected number of floods per year
N	normal probability distribution
$n$	expected number of zone floods per year
ND	expected number of detections per year for a zone
NF	expected number of false warnings per year for a zone
PTC	performance tradeoff characteristic, a plot of ND versus NF
$q$	quiet (Equation 3.7)
$q(s)$	$P(\theta = 1   s, T = 1)$ , posterior probability of a flood in a given zone
$q^*$	optimal threshold associated with warning rule $W^*$
ROC	relative operating characteristic, a plot of $P(D)$ versus $P(F)$
$s$	forecasted flood crest
T	trigger indicator: trigger is not observed ( $T = 0$ ), trigger is observed ( $T = 1$ )
W	warning rule, $w = W(s)$ , where $w = 0$ and $w = 1$ denote "do not issue warning" and "do issue warning," respectively



$W^*(s)$	optimal warning rule (of the threshold type) minimizes expected disutility of outcomes
$y$	zone elevation
$\gamma$	$P(\Theta = 1 \mid T = 1)$ , <i>diagnosticity</i> conditional probability
$\kappa_0(s \mid \Theta=0, T=1)$	probability density of $s$ conditional on the forecast $\Theta = 0$ and $T = 1$
$\lambda$	lead time of a warning for a given zone, conditional on hypothesis that zone will be flooded
$\mu_h, \sigma_h$	mean and standard deviation of the prior density $g(h \mid \Theta = 1)$
$\mu_s, \sigma_s$	mean and standard deviation of the likelihood function $k_0$
$\theta$	zone flood indicator: zone flood does not occur ( $\theta = 0$ ), zone flood occurs ( $\theta = 1$ )
$\rho$	$P(T = 1 \mid \theta = 1)$ , <i>reliability</i> conditional probability
$\Theta$	flood indicator: flood does not exist ( $\Theta = 0$ ), flood occurs ( $\Theta = 1$ )

#### Part 4. Selection of Optimal Flood Warning Threshold

$A, B, C$	parameters used in the normal-linear likelihood model (Equations 4.7-4.9)
$c_1, c_2$	constants governing the evolution of the response fraction $a$
$D(h)$	stage-damage function for a community
$D_{00}$	expected loss when no warning is given and no flood occurs (zero)
$D_{01}$	expected community property loss without a warning
$D_{01}$	expected property loss without a warning conditioned on forecast $s$
$D_{10}$	cost of evacuation in the community
$D_{10}$	expected cost of community evacuation conditioned on forecast $s$
$d_{10}$	cost function of evacuation, linear function of response fraction $a$
$D_{11}$	expected community property loss with a warning

***Risk-Based Evaluation of  
Flood Warning and Preparedness Systems***

---

$D_{11}$	expected property loss with a warning conditioned on forecast $s$
$d_{11}$	loss function with a warning
erf	standard error function
$f(h   s)$	posterior distribution of $h$ given a forecast $s$
$f(s   h)$	conditional density of $s$ given $h$
$f_1$	sum of the expected property loss reductions over the planning horizon
$f_1^T$	expected property loss reduction (difference made by warning system)
$f_1^T$	expected property loss reduction at stage $T$
$f_2$	objective function representing credibility of forecast system: $E\{\alpha_{N+1}\}$
$g(h)$	prior probability density of flood crest $h$
$h$	flood crest
$k(s)$	marginal probability density of forecast $s$
MC	maximum evacuation cost with a full response
MD	maximum possible damage due to highest flooding with no response
$MR(h - y)$	unit reduction function--reduction of MD when the depth of flooding is $(h - y)$ and $a = 1$
$N$	number of successive flood events on planning horizon
$N(\mu, \sigma)$	normal distribution with mean $\mu$ and variance $\sigma^2$
$P_{00}$	probability of a correct quiet
$P_{01}$	probability of a missed forecast (Type I error)
$P_{10}$	probability of a false warning (Type II error)
$P_{11}$	probability of a correct warning
$q(s, y)$	probability that zone of elevation $y$ will be flooded conditioned on forecast $s$
$r = 1, 2, 3$	structural categories in the floodplain

$s$	forecasted flood crest
$s^*$	flood warning threshold; warning issued when $s \geq s^*$
$\phi$	noninferior decision sequence consisting of the set of warning thresholds for all decision periods in the planning horizon
$y$	elevation of a zone in the floodplain
$\alpha_T$	response fraction of the community in period T
$\delta(h - y)$	unit damage function specifies the fraction of MD when flood depth is $(h - y)$
$\delta_r(z)$	fraction of maximum possible damage to an establishment that occurs when the depth of flooding measured from the first floor level is $z$
$\Phi$	standard normal distribution function
$\mu_h, \sigma_h$	mean and standard deviation of the distribution $g(h)$

## REFERENCES

- Adams, A. J. 1960. "Bernoullian Utility Theory." *Mathematical Thinking*. H. Solomon (Ed.), Free Press, New York.
- Alexandridis, M. G., and R. Krzysztofowicz. 1985. "Decision Models for Categorical and Probabilistic Weather Forecasts." *Applied Mathematics and Computation* 17: 241-66.
- Arrow, K. J. 1963. "Utility and Expectations in Economic Behavior." *Psychology: a Study of a Science*. S. Koch, Ed. McGraw-hill, New York .
- Asbeck, A. H. S., and Y. Y. Haines 1984. "The Partitioned Multiobjective Risk Method (PMRM)." *Large Scale Systems* 6:13-38.
- Barrett, C., D. M. Neal, S. Wright, R. Lee, and R. Mojib. 1988. "Primer on Flood Forecast and Response Systems." Report to U.S. Army Corps of Engineers, Ft. Belvoir, Virginia.
- Berger, J. O. 1980. *Statistical Decision Theory*. New York: Springer-verlag.
- Bhavnagri, V. S., and G. Bugliarello. 1965. "Mathematical Representat Ion of an Urban Flood Plain." *Journal of the Hydraulics Division of the American Society of Civil Engineers* 91(hy2): 149-73.
- Bock, P., and R. L. Hendrick. 1966. "Benefits of River Forecast Information." Final Rep. 7229-229, Travelers Res. Center, Inc., Hartford, Connecticut.
- Chankong, V. And Y. Y. Haines 1983. *Multiobjective Decision Making: Theory and Methodology*. Elsevier-north Holland, New York.
- Curtis, D. C., and J. C. Schaake, Jr.. 1988. "Economic Benefit Estimation for Flood Warning Systems." *Water Resources Bulletin*.
- Day, H. J., and K. K. Lee. 1976. "Flood Damage Reduction Potential of River Forecast." *J. Water Resource Planning Management Division of the American Society of Civil Engineers* 102(wr1): 77-87.
- De Mare, J. 1980. "Optimal Prediction of Catastrophes with Applications to Gaussian Processes." *The Annals of Probability* 8(4): 841-50.
- Edwards, W. 1954. "The Theory of Decision Making." *Psychology Bulletin* 51: 380-417. Also in *Decision Making: Selected Readings*. W. Edwards and A. Tversky, Eds. Penguin Books, Baltimore, Md., 1967.

***Risk-Based Evaluation of  
Flood Warning and Preparedness Systems***

---

- Environmental Systems Modeling, Inc. 1990. "Performance Characteristics of a Flood Warning System and Selection of Optimal Warning Threshold." Final Report to the Institute of Water Resources, U.S. Army Corps of Engineers, Fort Belvoir, Virginia, unpublished.
- Ferrell, W., and R. Krzysztofowicz. 1983. A "Model of Human Response to Flood Warnings for Systems Evaluation." *Water Resources Research* 19(6): 1467-75.
- Haimes, Y. Y. 1988. "Alternatives to the Precommensuration of Costs, Benefits, Risks, and Time." *The Role of the Social and Behavioral Sciences in Water Resources Planning and Management*. D. Baumann and Y. Y. Haimes, Eds., American Society of Civil Engineers, New York.
- Haimes, Y. Y., D. Li, and V. Tulsiani 1990. "Multiobjective Decision Tree Method." *Risk Analysis*. 10(1): 111-129.
- Haimes, Y. Y., R. Petrakian, P. O. Karlsson and J. Mitsiopoulos 1988. *Multiobjective Risk-partitioning: an Application to Dam Safety Risk Analysis*, Institute for Water Resources. U.S. Army Corps of Engineers. Fort Belvoir, Va. IWR Report 88-R-4.
- Hamburg, M. 1970. *Statistical Analysis for Decision Making*. Harcourt-Brace, World, New York.
- Jack Faucett Associates 1990. "Procedures for Calculating the Costs and Benefits of Flood Warning and Preparedness Systems." Final Report Submitted to U.S. Army Corps of Engineers, Water Resources Support Center, Institute for Water Resources, Fort Belvoir, Virginia 22060-5586, unpublished.
- Karlsson, P.-O., and Y. Y. Haimes 1988a. "Risk Based Analysis of Extreme Events." *Water Resources Research* 24: 9-20.
- Karlsson, P.-O., and Y. Y. Haimes 1988b. "Probability Distributions and Their Partitioning." *Water Resources Research* 24, 21-29.
- Krzysztofowicz, R. 1983a. "Why Should a Forecaster and a Decision Maker Use Bayes Theorem." *Water Resources Research* 19(2): 327-336.
- Krzysztofowicz, R. 1983b. "A Bayesian Markov Model of the Flood Forecast Process." *Water Resources Research*. 19(6): 1455-1465.
- Krzysztofowicz, R. 1985. "Bayesian Models of Forecasted Time Series." *Water Resources Bulletin* 21(5): 805-814.
- Krzysztofowicz, R. 1985. "Choice of Action Based on the Probability of a Flash Flood." Report to Office of Hydrology, National Weather Service, National Oceanic and Atmospheric Administration, and U.S. Department of Commerce, Department of Systems Engineering, University of Virginia.

- Krzysztofowicz, R. 1987. "Markovian Forecast Processes." *Journal of the American Statistical Association* 82(397): 31-37.
- Krzysztofowicz, R. 1990. "Performance Characteristics Under Forecast Uncertainty." *Risk-based Decision Making in Water Resources IV*. Y. Y. Haimes and E. Z. Stakhiv, Eds. New York: American Society of Civil Engineering.
- Krzysztofowicz, R. 1992. "Bayesian Correlation Score: A Utilitarian Measure of Forecast Skill." *Monthly Weather Review*. 120(1): 208-219.
- Krzysztofowicz, R., and D. Davis. 1983a. "A Methodology for Evaluation of Flood Forecast-Response Systems 1. Analysis and Concepts." *Water Resources Research* 19(6): 1423-29.
- Krzysztofowicz, R., and D. Davis. 1983b. "A Methodology for Evaluation of Flood Forecast-Response Systems 2. Theory." *Water Resources Research* 19(6): 1431-40.
- Krzysztofowicz, R., and D. Davis. 1983c. "A Methodology for Evaluation of Flood Forecast-Response Systems 3. Case Studies." *Water Resources Research* 19(6): 1441-54.
- Krzysztofowicz, R., and D. Davis. 1983d. "Category-unit Functions for Flood Forecast-response System Evaluation." *Water Resources Research* 19(6): 1476-80.
- Krzysztofowicz, R., and D. Davis. 1984. "Toward Improving Flood Forecast-response Systems." *Interfaces* 14(3): 1-14.
- Lee, R., P. S. Hu, D. M. Neal, M. R. Ogles, J. H. Sorensen, and D. A. Trumble. 1986. "Predicting Loss of Life from Floods." Report to the 2-19 Institute for Water Resources, U.S. Army Corps of Engineers.
- Lee, K. K., H. J. Day, and P. B. Cheney. 1975. "Progress in Simulation of Integrated Floodplain Analysis and Management." Paper Presented at Second World Congress, Int. Water Resour. Assoc.. New Delhi, India, December.
- Li, D., and Y. Y. Haimes. 1987. "The Envelope Approach for Multiobjective Optimization Problems." *IEEE Transactions on Systems, Man, and Cybernetics* 17(6): 1026-38.
- Li, D., and Y. Y. Haimes. 1988. "Decomposition Techniques in Multiobjective Discrete-time Dynamic Problems." In *Control and Dynamic Systems*. C. T. Leondes, Ed. Vol. 28, 109-80. San Diego, California: Academic Press.
- Lindgren, G. 1979. "Prediction of Level Crossing for Normal Processes Containing Deterministic Components." *Advances in Applied Probability* 11: 93-117.
- Lindgren, G. 1980. "Model Processes in Nonlinear Prediction with Application to Detection and Alarm." *The Annals of Probability* 8(4): 775-92.

***Risk-Based Evaluation of  
Flood Warning and Preparedness Systems***

---

- Lindgren, G. 1985. "Optimal Prediction of Level Crossing in Gaussian Processes and Sequences." *The Annals of Probability* 13(3): 804-24.
- Luce, R. D. And P. Suppes 1965. "Preference, Utility and Subjective Probability." R. D. Luce, R. R. Bush, and E. E. Galanter, Eds. *Handbook of Mathematical Psychology*, Vol. 3. Wiley, New York.
- National Advisory Committee on Oceans and Atmosphere (Nacoa). 1972. "The Agnes Floods." Report for the Administrator of NOAA, Washington, D.D., November.
- Paté-Cornell, M. E. 1986. "Warning Systems in Risk Management." *Risk Analysis* 6(2): 223-34.
- Press, W. H., B. P. Flannery, S. A. Teukolsky, and W. T. Vetterling. 1986. *Numerical Recipes*. Cambridge: Cambridge University Press.
- Raiffa H. 1968. *Decision Analysis, Introductory Lectures on Choice under Uncertainty*. Addison-Wesley, Reading, Massachusetts.
- Sage, A. P. 1977. *Methodology for Large Scale Systems*. McGraw-Hill, New York.
- Savage, L. J. 1954. *The Foundations of Statistics*. John Wiley and Sons, New York,.
- Shabman, L. 1987. *Measuring Non-property Residential Flood Protection Benefits: A Policy Review*. Report to the U.S. Army Corps of Engineers, Institute for Water Resources.
- Shubik, M. 1964. *Game Theory and Related Approaches to Social Behavior*. Wiley, New York.
- Sniedovich, M., and D. R. Davis. 1977. "Evaluation of Flood Forecasting- Response Systems." *Journal of the Hydraulics Division of the American Society of Civil Engineers* 103(wr1): 83-97.
- Sniedovich, M., D. R. Davis, L. Duckstein, and I. Bogardi. 1974. "A Decision Theoretic Evaluation of Hydrologic Data for Short-term Forecasts of Floods." Paper Presented at the Agu National Meeting, Washington, D.C.
- Thampapillai, D. J., and W. F. Musgrave 1985. "Flood Damage Mitigation: A Review of Structural and Nonstructural Measures and Alternative Decision Frameworks." *Water Resources Research* 21: 411-424.
- U.S. Army Corps of Engineers 1990. *Integrated Feasibility Report and Environmental Impact Statement: Local Flood Protection—Moorefield, West Virginia*.
- Von Neumann, J., and O. Morgenstern 1944. *Theory of Games and Economic Behavior*. Princeton University Press, Princeton, New Jersey.

REPORT DOCUMENTATION PAGE			Form Approved OMB No. 0704-0188
Public reporting burden for this information is estimated to average 1 hour per response, including the time for reviewing instructions, searching existing data sources, gathering and maintaining the data needed, and completing and reviewing the collection of information. Send comments regarding this burden estimate and any other aspect of this collection of information, including suggestions for reducing this burden, to Washington headquarters Service, Directorate for Information Operations and Reports, 1215 Jefferson Davis Highway, Suite 1204 Arlington, VA 22202-4302, and to the Office of Management and Budget, Paperwork Reduction Project (0704-0188), Washington, DC 20503.			
1. AGENCY USE ONLY (Leave blank)	2. REPORT DATE Nov 1996	3. REPORT TYPE AND DATES COVERED Final	
4. TITLE AND SUBTITLE Risk-Based Evaluation of Flood Warning and Preparedness Systems, Volume 2 - Technical		5. FUNDING NUMBERS	
6. AUTHOR(S) Yacov Y. Haimes, Ph.D., P.E., Project Director, Duan Li, Ph.D., Vijay Tulasiani, M.S., James H. Lambert, Ph.D., Roman Krzysztofowicz, Ph.D.			
7. PERFORMING ORGANIZATION NAME(S) AND ADDRESS(ES) USACE, Water Resources Support Center Institute for Water Resources Casey Building, 7701 Telegraph Road Alexandria, VA 22315-3868		8. PERFORMING ORGANIZATION REPORT NUMBER IWR Report 96-R-26	
9. SPONSORING/MONITORING AGENCY NAME(S) AND ADDRESS(ES) USACE, Directorate of Civil Works 20 Massachusetts Avenue, NW Washington, DC 20314-1000		10. SPONSORING/MONITORING AGENCY REPORT NUMBER	
11. SUPPLEMENTARY NOTES Available from the National Technical Information Service, 5285 Port Royal Road, Springfield, VA 22161, (703) 487-4650			
12a. DISTRIBUTION/ AVAILABILITY STATEMENT Approved for public release; distribution unlimited		12b. DISTRIBUTION CODE	
13. ABSTRACT (Maximum 200 words)  This report describes the technical aspects of four methodologies to aid in the design and evaluation of flood warning and preparedness systems. The methodologies include: 1) integration of structural measures and flood warning and preparedness, 2) multiobjective decision tree analysis; 3) performance characteristics, and 4) selection of an optimal flood warning threshold. Each methodology is intended to demonstrate how flood warning and preparedness systems need to be evaluated as part of an integrative, holistic process as part overall system with structural measures. These methodologies must build on an understanding of the contribution of each type of measure to the objectives of minimizing cost and risk and maximizing performance. Consideration of the risk of extreme events is an essential element in the evaluation of design tradeoffs.			
14. SUBJECT TERMS Flood warning, flood preparedness, nonstructural flood damage reduction, risk analysis, performance characteristics, multiobjective decision-tree analysis, flood warning threshold.		15. NUMBER OF PAGES 174	
17. SECURITY CLASSIFICATION OF REPORT Unclassified		18. SECURITY CLASSIFICATION OF THIS PAGE Unclassified	16. PRICE CODE
19. SECURITY CLASSIFICATION OF ABSTRACT Unclassified		20. LIMITATION OF ABSTRACT Unlimited	