

SHUG (SNS HFIR User Group), <http://neutrons.ornl.gov/users/shug/>
SHUG executive committee minutes.

Teleconference held May 3, 2011.

Attendees:

Executive Committee: Cora Lind, Seung-Hun Lee, Peter Khalifah, Eugenia Kharlampieva, Malcolm Guthrie and Mike Crawford, and Antonella Longo

Guests: Mike Simonson, Al Ekkebus, and Dean Myles

Minutes submitted for review May 9, 2011 by M. B. Stone.

ACTION ITEMS:

- Please note next telecon date: June 7, 2011 at 1 PM
- The SHUG executive committee suggests that information regarding limited internet resources be distributed to users prior to their arrival so that they can plan accordingly.
- Everyone on the SHUG executive committee should send a list of their un-available dates as well as potential conflicts with other meetings which may occur during November and December 2011. This should be sent to Al Ekkebus as soon as possible. Please also send suggestions for workshops for the user meeting to Al Ekkebus and the rest of the executive committee as soon as possible.

ATTACHMENTS and WEBSITES of interest from the teleconference:

- 1) User News Weekly – April 25 – May 1, 2011
- 2) User Representative Letter from the National User Facility Organization
- 3) Neutron Quarterly News – April 2011
- 4) The latest Neutron Review is available online at <http://neutrons.ornl.gov/media/pubs/pdf/2010neutronreview.pdf>

1. Update for HFIR and SNS (Mike)

The stainless steel target containing liquid mercury at SNS has been replaced and neutron production is currently taking place. Maintenance work was rescheduled to take full advantage of this outage to replace the target. The plan is to end neutron production at the end of June, and then restart in mid-August.

The recent proposal round has passed the beam allocation committee, and responses have been sent to the proposers. Future proposal rounds will very likely request information regarding what potential ancillary equipment will be brought by users to the facility. The SRC (scientific

review committees) noted that in addition to an increased number of proposals, the proposal quality is also improving.

Management would like to have a user meeting at ORNL in the late fall or early winter of the 2011 calendar year. Please see item number 4. below.

The construction of the guest house at ORNL will be completed in May 2011, and will be outfitted and commissioned in June. The current schedule is to start accepting guests in July 2011. The capacity is 47 guest rooms, with some rooms being double occupancy. Rates and policies are not available yet. There was a suggestion to also make available a roll-away bed which could double or triple a room's occupancy, without adding too much additional cost. This would allow some research groups to bring additional students.

The recent cyber-attack of ORNL has also made the IPTS and training systems unavailable from outside networks. This functionality and other online-services will very likely return within days or a few weeks. The visitor wireless network was down for 2 or 3 weeks, but is now (May 7, 2011) restored. Remote access via VPN is not yet available to ORNL staff.

The SHUG executive committee suggests that information regarding limited internet resources be distributed to users prior to their arrival so that they can plan accordingly.

2. National User Facility Organization meeting in Washington, D.C. (Cora)

The National User Facility Organization meeting was held in Washington D.C. on Thursday April 7, 2011. This was initiated by two Members of Congress, and is for the benefit of Members of Congress and their staff. There were posters representing 37 different facilities including HFIR and SNS (and 16 other facilities including astronomy, climate research, NHMFL, synchrotrons, etc.). The meeting lasted approximately 3 to 4 hours. Several representatives stopped by in person, many staffers attended. There were many people from DOE and NSF which also attended. The NUFO website <http://nufo.org> has additional information. Cora Lind, Despina Louca, and Ian Anderson attended this meeting. It is likely that there will be more of these meetings in the future.

Al Ekkebus will distribute news releases regarding this event.

3. Regional conferences.

There were no new suggestions for additional regional conferences to send a poster to from the NSSD. This information is available if you would like to post this at any meeting you are attending.

4. User meeting at ORNL. Management would like to have a user meeting at ORNL in the late fall or early winter of the 2011 calendar year. The SRC will be at ORNL to review proposals the week of October 24, 2011, and would prefer not to have the user meeting at this time. A four

day user week is being considered, with two days for the user meeting. Workshops can be arranged also, especially for perspective users.

Everyone on the SHUG executive committee should send a list of their un-available dates as well as potential conflicts with other meetings which may occur during November and December 2011. This should be sent to Al Ekkebus as soon as possible.

Please also send suggestions for workshops for the user week to Al Ekkebus and the rest of the executive committee as soon as possible.

5. User News Weekly (AI) (attached).

This publication is distributed to users and available via the web on a weekly basis. It would be very useful to list the accelerator and HFIR schedules for the week on this document. Also it is a suggestion to have the list of users at the end of the document. It would be nice to also list the JINS coffee break on this document. It would also be nice to list when the next proposals are due. Another spotlight could highlight new instruments becoming available or old instruments that are available. Another suggestion is to add a request on the newsletter asking users for their suggestions for contributions to the User Weekly. More graphics for the spotlights were also suggested.

6. Neutron Quarterly News (AI) (attached).

This publication is planned on being distributed quarterly via email to users and past users of the facilities. This has been well received by the executive committee.

7. Other business?

* Next telecon date

Tuesday June 7, 2011, at 1 PM

Contacts:

SNS Instrument Hall	241-4432
Coordinator	
ORNL LSS	574-6606
Computer Helpline	241-6765
ORNL Taxi	680-2303
	680-9800
Weather	574-9836

SNS

Control Room	576-1503
RCT Support (radiation control technician)	274-8658
User Support	241-4432
User Office	574-4600

HFIR

Control Room	574-7035
RCT Support (radiation control technician)	574-6713
User Office	574-4523

SNS Café, Bldg 8600

Breakfast hours: M–F, 7:00 am – 9:30 am

Lunch hours: M–F, 10:45 am – 1:15 pm

HFIR Canteen, Bldg 7962

Lunch hours: M–F, 10:45 am – 1:15 pm

 For questions or comments email us:
neutronscience@ornl.gov
neutrons.ornl.gov

Follow Us



Research Spotlight

SNAP elucidates competing ground states in cobalt perovskite

Divalent ion-doped cobalt perovskite is an interesting, strongly correlated electron system that involves charge, spin, lattice, and orbital degrees of freedom. This can lead to a variety of competing ground states and to such useful properties as colossal magnetoresistance and multiferroicity. Researchers are using the SNAP diffractometer at SNS this week to induce some unusual effects in Ba-doped cobalt perovskite, under extreme pressure. The pressure experiment at SNAP will benefit from large-volume pressuring cells using opposed anvils, which offer significant advances in the pressure range accessible to neutron diffraction. The team hopes to build a clearer picture of all this perovskite's coupled degrees of freedom. Cao Huibo, Vasile O. Garlea, and Bryan C. Chakoumakos, all from NSSD; Fangwei Wang and Zhaohua Cheng from Beijing; and Arsen Gukasov from France are collaborating.

This Week's Users

SNS, BASIS (BL2)

Michael Crawford (DuPont)

SNS, SNAP (BL3)

Maria Baldini (Carnegie Inst of Wash)
 Yu Lin (Stanford Univ)
 Shibing Wang (Stanford Univ)
 Bryan Chakoumakos (ORNL NScD)
 Vasile Garlea (ORNL NScD)
 Huibo Cao (ORISE)

SNS, Magnetism Reflectometer (BL4A)

Hailemariam Ambaye (ORNL)
 Valeria Lauter (ORNL NScD)
 Hwachol Lee (Univ of Alabama)
 Dieter Lott (International)
 Jochen Fenske (International)
 Valeria Lauter (ORNL NScD)
 Srikanti Kavita (UGC-DAE CSR)
 Abhijit Mardana (Univ of Neb)

SNS, Liquids Reflectometer (BL4B)

P. Shekhar (Carnegie Mellon Univ)
 Peter Yaron (Carnegie Mellon Univ)
 William Heller (ORNL)
 John Anker (ORNL NScD)
 Fred Heberle (ORNL NScD)
 Jianjun Pan (ORNL)

SNS, CNCS (BL5)

Mark Lumsden (ORNL NScD)
 Georg Ehlers (ORNL NScD)
 A. Christianson (ORNL NScD))
 Cuihuan Wang (ORNL NScD)
 Meigan Aronson (BNL)
 Liusuo Wu
 Jacob Grose (BNL)

SNS, EQ-SANS (BL6)

WS Chiang (Massachusetts Inst of Tech)
 Mingda Li (Massachusetts Inst of Tech)
 Wei-Ren Chen (ORNL NScD)
 Holly Stretz (Tenn Tech Univ)
 Jeffery Thompson (Tenn Tech Univ)
 M. Sobkowicz-Kline (NIST)

SNS, VULCAN (BL7)

Zhili Feng (ORNL MSTD)
 Eliot Specht (ORNL MSTD)
 Ke An (ORNL NScD)
 Zhenzhen Yu (ORISE)
 Wei Zhang (MSTD)
 Xun-Li Wang (ORNL NScD)
 G. Ice (ORNL PSD)
 Judy Pang (ORNL MSTD)
 Ben Larson (ORNL MSTD)
 Jonathan Tischler (ORNL MSTD)
 John Budai (ORNL MSTD)
 E. Payzant (ORNL MSTD)
 Camden Hubbard (ORNL MSTD)
 Scott Jorgensen (GM)
 Terry Johnson (SNL)
 J. Fernandez-Baca (ORNL NScD)

SNS, POWGEN (BL11A)

Jason Hodges (ORNL NScD)
 Ashfia Huq (ORNL NScD)
 Steven McIntosh (Lehigh Univ)
 Hyun ho Shin (Lehigh Univ)
 Didier Greenleaf (Lehigh Univ)

SNS, TOPAZ (BL12)

Xiaoping Wang (ORNL NScD)

SNS, NSE (BL15)

Changwoo Do (Juelich)
 Antonio Faraone (Univ of Maryland)
 Kunlun Hong (CNMS)

SNS, SEQUOIA (BL17)

Rob McQueeney (Ames Lab)
 Gregory Tucker (Ames Lab)
 Jerod Wagman (McMaster Univ)
 J. Carlo (Nat Res Council Canada)

SNS, ARCS (BL18)

Daniel Parshall (Univ of Colorado)
 Jun Zhao (Univ of California Berkeley)
 Costel Rotundu (DOE Lab)

Local Happenings

4/28/2011 – Seminar

NSSD Technical Forum: Cold Neutron
Absorption and Aledo Measurements on Neutron
Shielding Materials, Speaker Lowell Crow,
Bldg. 8600/SNS Conference Room C-156
9:30-10:30 AM

5/5/2011 – Seminar

Coated Nanoparticles In Solution and at
Interfaces, Speaker Gary Greast, Sandia National
Lab, Bldg 8600 Ian Thomas Auditorium, 11:00-
12:00 PM

April 26, 2011

Dear User Representative:

The National User Facility Organization (NUFO) would like thank you for your support of the User Science Exhibition which took place on April 7th in Washington, DC. The exhibition turned out to be a resounding success. Many house members attended in person, many others sent their staffers to obtain information about the scientific achievements of our user facilities. In addition, many families and individuals who were visiting Washington on April 7th also joined in the exhibit to learn more about the science at national user facilities.

The presenters for each facility did a wonderful job in conveying their message in a comprehensive and understandable way. The professional posters prepared by NUFO with input from the facilities were a big success and the information gathered was much appreciated not only by the attendees but also the members of DOE and NSF, both of which were well represented at the exhibition.

A NUFO folder containing copies of each poster displayed at the Exhibit and contact information for each facility was delivered to each Congressional office on April 7 and it is being mailed to each funding office at DOE and NSF.

NUFO has already received requests for a similar exhibition on the Senate side and a follow-up on the House side sometime next year. Since the responses from Washington were very positive throughout, we hope we can count on your continued support in the years to come.

Sincerely,

The NUFO Steering Committee



Rene Bellwied
University of Houston



Tony Lanzirotti
The University of Chicago



Brant Johnson
Brookhaven National Laboratory

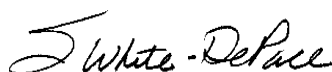

Cathy J. Knotts
*Stanford Synchrotron Radiation
Laboratory*



Al Ekkebus
Oak Ridge National Laboratory



Simon R. Bare
UOP LLC, a Honeywell Company

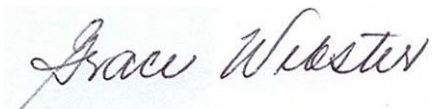

Grace Webster
Brookhaven National Laboratory

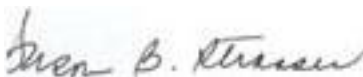

Susan Strasser
Argonne National Laboratory



Eric Gawiser
*National Optical Astronomy
Observatory*

Susan White-DePace
Brookhaven National Laboratory



Carla Vale
Brookhaven National Laboratory



Director's Note

On Sunday morning, April 3, 2011, the SNS target reached an end of life condition causing a shutdown to change the target. This target change takes about 2 weeks and during some of this time, we will do maintenance work planned for the longer summer shutdown. This means that the summer shutdown will be shorter than originally planned so that we can recover the neutron production time.

Members of Congress invited the [National User Facility Organization](#) to present posters to Congress and their staff about the science performed at our Nation's user facilities. Cora Lind (SHUG chair, Univ. Toledo), Despina Louca (Univ. Virginia), and I represented HFIR and SNS at this event.

Our budget situation for the current fiscal year appears to be stabilizing. Although we don't know the details of the budget cuts and how they will be implemented, there was a hint of good news recently in the White House Blog: *We protected funding for critical programs that invest in science programs, our kids' education, and critical health programs. Even though we will no longer double the funding of key research and development agencies, you will still see strong investments in National Institute of Standards and Technology, National Science Foundation and the Office of Science.* In several weeks, we should know the exact impact on our FY11 budget and I am hopeful that our conservatism until now will hold us in good stead to maintain our operations for the rest of the fiscal year.

We have been sending messages like this to you about every 2-3 months; I hope you like the new format. It is important that ORNL learns about your publications, honors, and awards based on research performed at SNS or HFIR as these are featured in publications and highlights sent to our sponsors.

Please [share your thoughts with us](#) about the contents and frequency of messages like this and related outreach activities.

Jan Anderson

Run Cycles and Proposal Call

At HFIR, Cycle 435 will begin May 2, 2011. The HFIR long-term schedule is [available](#). At SNS, neutron production resumed April 20, 2011, and will continue to June 30, 2011. The detailed SNS schedule is [available](#). The next call for proposals deadline will be [September 14, 2011](#) for experiments to run December 2011 – May 2012.

Science Highlights



Effects of temperature and ionic strength on chlorosome of green photosynthetic bacteria

The Bio-SANS at HFIR was used to examine chlorosome structure of a green photosynthetic bacteria under a range of thermal and ionic conditions. Results showed the structure to be stable under all tested conditions. *C. aurantiacus* chlorosomes remained intact at temperatures up to 70°C. This is in contrast to free chlorophylls, which have been found to break down at temperatures above 42 °C. The results also showed chlorosomes to be stable in a pH range of 5.5 to 11. The size, shape and organization of light-harvesting complexes such as chlorosomes are critical in electron transfer to semiconductor electrodes in solar devices. Understanding how chlorosomes function in nature could help in creating robust bio-inspired solar cells.

Tang, K.-H., et al., *Biophysical J.* **99**, 2392(2010)

Image caption: Chlorosomes (shown in green) capture and transfer light energy to the reaction center for photosynthesis in bacteria.

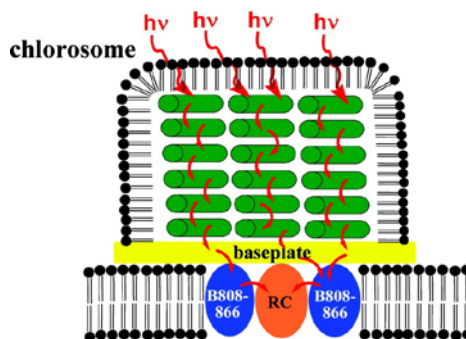

SEQUOIA measures magnetic excitation spectrum in TiOBr

Neutron scattering detected and measured the magnetic excitation spectrum of TiOBr, an oxyhalogen with a rare phase transition. Results from the time-of-flight chopper spectrometer SEQUOIA at SNS revealed two branches of magnetic excitations in the material.

This is the first direct measure of the singlet-triplet energy gap. The bandwidth of the excitations is relatively narrow compared with the size of the singlet-triplet energy gap, suggesting that the excitations are well-localized. The interactions between excited triplets appear to be small. The results will help to guide and inform future studies of these novel magnetic systems.

Clancy, J. P., et al., *Phys.Rev.Lett.* **106**, 117401(2011)

Image Caption: Maps of inelastic neutron scattering intensity, $S(Q,E)$, for TiOBr at $T = 8K$. (a) $S(Q,E)$ after empty can background subtraction to eliminate scattering from sample environment. (b) $S(Q,E)$ after high temperature (80 K) background subtraction to isolate magnetic scattering. (c) $S(Q,E)$ after high temperature background subtraction weighted by an appropriate Bose correction.

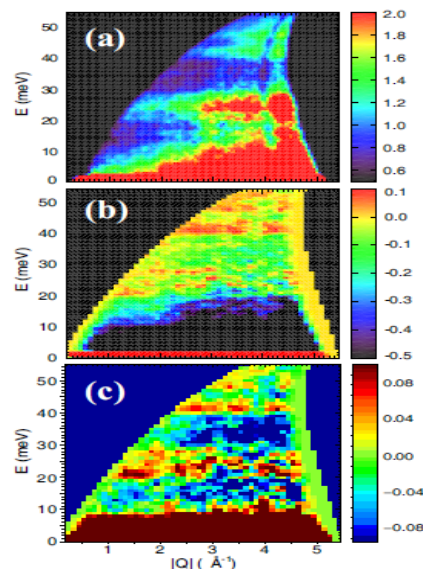

Stimuli-responsive behavior in polyelectrolyte dendrimers revealed by neutron scattering

Researchers used neutron scattering at HFIR and SNS to understand the relationship between molecular charge and properties when polyelectrolyte dendrimers are in aqueous solution. This charge-stimulated response may be used in biomedical and sustainable energy applications. The BASIS dynamics study at SNS shows that when the molecular charge increases, a significant enhancement occurs in the local dynamics. The SANS structural study at HFIR shows that a gradual increase occurs in the molecular size with a continuous redistribution of the intra-molecular density. The findings provide the microscopic picture needed to develop polyelectrolyte dendrimers for specific targeted functions.

Image caption: Normalized intra-dendrimer density profile $\rho(r)$ obtained from SANS data analysis of G3-8 PAMAM dendrimers dissolved in D_2O solutions at $\alpha = 0$ (neutral, left), 1 (primary amines charged, middle) and 1.6 (all amines charged,

right). Portion of the data with $\rho(r) < 2 \times 10^{-5} \text{ \AA}^{-3}$ is enlarged and given in the insets.

Liu, Y., et al., *J.Phys.Chem.Lett.* **1**, 2020(2011)

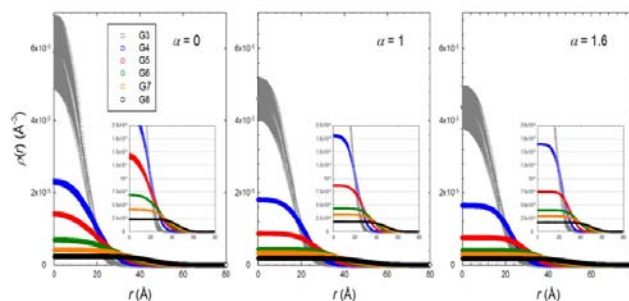

Upcoming Events [see <http://neutrons.ornl.gov/calendar/> for details]

- May 19 - 20, 2011, [What Can You Do With Neutrons?](#)
- May 21 - 24, 2011, [3rd DISCUS Workshop on Diffuse Scattering and Structure Simulation](#)
- May 23 - 27, 2011, [2nd Course on Neutron Scattering Applications in Structural Biology](#)
- June 11 - 18, 2011, [National School on Neutron and X-Ray Scattering](#) (pdfs of all lectures and videos of neutron talks will be available after the workshop).
- July 11-12, 2011, [Neutron Reflectometry Data Reduction and Analysis Workshop](#)
- October 2 - 5, 2011, [NEUtron WAVElength Dependent Imaging \(NEUWAVE-4\) Workshop](#)

• • •

Neutron Science in the News

<http://neutrons.ornl.gov/media/news/current-news.shtml>

Meetings and Events

<http://neutrons.ornl.gov/calendar/>

HFIR and SNS Contacts

User Office: 865.574.4600

Email: neutronusers@ornl.gov
<http://neutrons.ornl.gov/users/contacts.shtml>

Join our mailing list:

http://erie.ornl.gov/sns_users/AddUsers.cfm

Collaborative Research

<http://neutrons.ornl.gov/crv/>

Oak Ridge National Laboratory



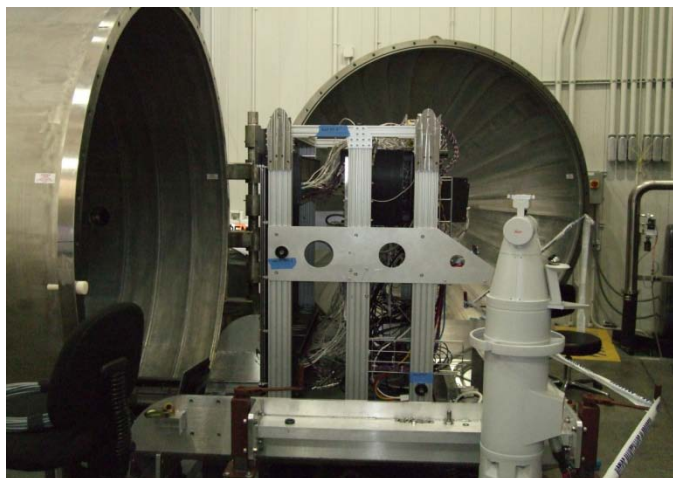

Capabilities

 **New GP-SANS detector installed.**



Instruments

 Awards and Honors—please send information on your honors, awards, and theses, that are based on research performed at HFIR or SNS to neutronscience@ornl.gov.

 Recent dissertations performed using HFIR or SNS include James Clancy (McMaster University using SEQUOIA), J. Ma (Iowa State University using ARCS), and H. Ju (University of Illinois – Urbana Champaign using ARCS).

 Recent staff additions: Robert McGreevy is joining the Neutron Sciences Directorate as Deputy Associate Laboratory Director. Paul Langan is joining the Neutron Scattering Science Division.



 Publication citations are needed for reports to our sponsor and for selection of annual report highlights. Enter the citation if your publication is not included on our [lists](#). There is a standard [acknowledgment](#) for HFIR or SNS experiments. Let us know if research here contributed to your thesis.

 The [National User Facility Organization](#) reports that participants at U.S. national user facilities—such as synchrotron and neutron, nanoscience, high-energy and nuclear physics, microscopy, and astronomy facilities—now total more than 25,000.